

# QST

DEVOTED ENTIRELY TO

# AMATEUR RADIO

*Published by the American Radio Relay League*



September  
1926

25¢

# Cunningham RADIO TUBES



IN THE ORANGE & BLUE CARTON

“Reliable”—

is the one word that best describes that type of service rendered by Cunningham Radio Tubes in millions of receivers and the type of service rendered by Cunningham dealers in thousands of communities.

These tubes are winning new friends every day and are holding old friends year after year. The enormous increase in the number of Cunningham Radio Tube users has not been brought about by magic. It has been brought about by the fact that only quality materials, quality workmanship and advanced scientific ideas are exemplified in the Cunningham product.

For new heights of efficient sensitivity, install Cunningham Radio Tubes in every socket of your receiver.

*Since 1915—Standard for All Sets*

**ALL TYPES C & CX**

*E. J. Cunningham, Inc.*

New York

Chicago

San Francisco

Manufactured and sold under rights, patents and inventions owned and or controlled by Radio Corporation of America.

CLEAR at a whisper....

CLEAR at the volume  
of a brass band....

REAL!

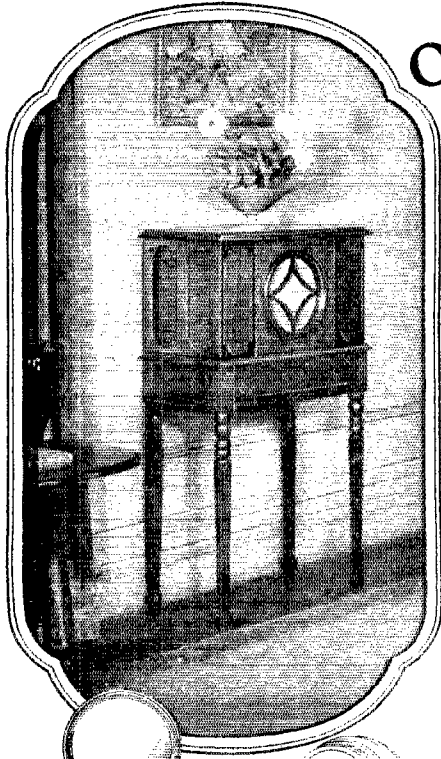

TURN it low—use the great power as a reserve to get the climax of a song without a crash. Turn it higher—let the dance music sound out clearly above the talk and the shuffling of feet. Or use it in a great hall—and get the actual volume of a great orchestra. Every instrument is real! With RCA Loudspeaker 104—get *natural* tone and *natural* volume.

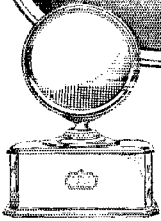

RCA Loudspeaker 102 adds a power unit to the Model 100. Plugged in on the house current, it has power to deliver almost any volume of tone—clear and undistorted. For use on 50 to 60 cycle, 110 volt A.C. lighting circuit. . . . \$140

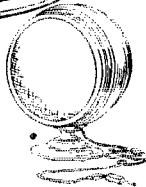

RCA Loudspeaker 100 gives clear, mellow, undistorted tone up to any volume your set can give it. It is really the only loudspeaker to buy when you use the power tubes . . . . . \$35

RCA Loudspeaker 104 is not only a power loudspeaker, but eliminates the "B" batteries of most sets. With RCA Radiola 25 or 28, it can be adapted to eliminate all batteries. It operates on the 50 to 60 cycle, 110 volt A.C. lighting circuit. \$275



# RCA Loudspeaker

MADE BY THE MAKERS OF THE RADIOLA

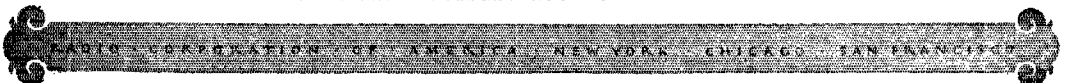

# Hammarlund's New Creation The "MIDLINE" Condenser

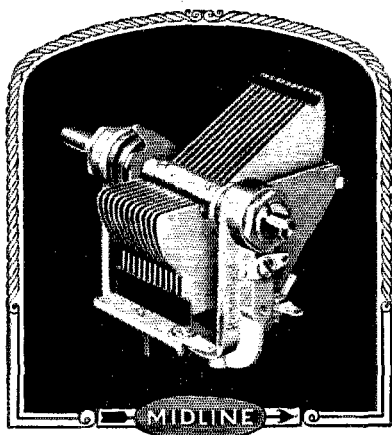

*Avoids Crowding  
at Any Part  
of the Scale*

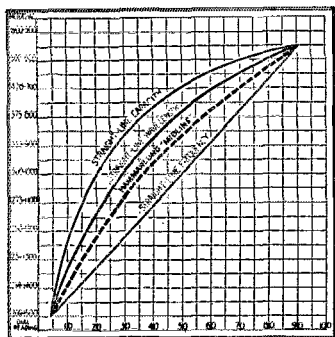

Watch for the  
handsome new  
Hammarlund  
"VERNI-TUNE" DIAL.  
A revelation in accurate,  
effortless tuning.

THE new Hammarlund "MIDLINE" condenser makes its bow with the claim of superiority over any other type ever produced.

Experience (yours and ours) is responsible for its many excellent features. "Straight-line-capacity" crowded the low waves; "Straight-line-frequency" crowded the high waves; "Straight-line-wave-length" merely compromised between the two. *But the Hammarlund "Midline" retains the important advantages of these earlier types without any of their disadvantages.*

All of the tried and true Hammarlund features are included: soldered, non-corrosive brass plates with tie bars; rib-reinforced aluminum alloy frame; minimum dielectric; one-hole mounting with anchoring screw; bronze clockspring pigtail; friction brake. In addition, there have been added ball and cone bearings, and a full-floating rotor shaft, the only function of which is to turn the rotor plates. It supports no weight; it may be entirely removed, or it may be adjusted for coupling to other condensers for tandem operation, or for mounting a variable primary coil.

The "MIDLINE" is much more compact and even stronger and more beautiful than previous Hammarlund models.

*The better dealers will  
have it soon.*

For Better Radio  
**Hammarlund**  
PRECISION  
PRODUCTS

HAMMARLUND MANUFACTURING COMPANY

424-438 W. 33d Street, New York

# THE COMMUNICATIONS DEPARTMENT, A. R. R. L.

## ATLANTIC DIVISION

S C M East. Pa. 8RQ  
 S C M Maryland-Delaware-District of Columbia \*\*3A1S  
 S C M So. N. J. 3EH  
 S C M Western N. Y. 8PJ  
 S C M West. Pa. 8XB

H. M. Walleze 597 No. James St. Hazleton  
 H. H. Layton 805 Washington St. Wilmington, Del.  
 D. J. Angus 1824 Inglewade Terrace Washington, D. C.  
 W. W. Densham 140 Washington St. Collingswood  
 G. S. Taylor 598 Masten St. Buffalo  
 G. L. Crossley State College

## CENTRAL DIVISION

S C M Illinois 9AAW  
 S C M Indiana 9C1Q  
 S C M Kentucky 9ARU  
 S C M Michigan 8ZU  
 S C M Ohio 8BYN  
 S C M Wisconsin 9VD

W. E. Schweitzer 4264 Hazel Ave. Chicago  
 D. J. Angus 319 N. Illinois St. Indianapolis  
 D. A. Downard 116 No. Longworth Ave. Louisville  
 C. E. Dart 137 Hill Ave. Highland Park, Detroit  
 H. C. Storck 694 Carpenter St. Columbus  
 C. N. Crapo 143 Newton Ave. Milwaukee

## DAKOTA DIVISION

S C M No. Dak.\* 9EFN  
 S C M So. Dak. 9EDW  
 S C M No. Minn.\* 9EGU  
 S C M So. Minn. 9ZT

G. R. Moir 820 4th St. Fargo  
 F. J. Beck Milbank  
 C. L. Barker Henning  
 D. C. Wallace 54 Penn Ave., No. Minneapolis

## DELTA DIVISION

S C M Ark.\* 5XAB  
 S C M La.\* 5UR  
 S C M Miss. 5AKP  
 S C M Tenn.\* 4DN

Dr. L. M. Hunter 207 1/2 Main St. Little Rock  
 C. A. Freitag 129 Camp St. New Orleans  
 J. W. Gullett 319 29th Ave. Meridian  
 L. K. Rush 4 Second St. Bemis

## HUDSON DIVISION

S C M East. N. Y. 2ADH  
 S C M N. Y. C. & L. I. 2UWR  
 S C M No. N. J. 2WB

Earle Peacock Box 113 Yonkers  
 F. H. Mardon 1309 W. Farms Rd. Bronx  
 A. J. Wester, Jr. 1075 Chancellor Ave. Hilton

## MIDWEST DIVISION

S C M Iowa 9DOA  
 S C M Kansas 9DNG  
 S C M Missouri 9RB  
 S C M Nebraska\* 9BYG

L. R. Huber University Heights Tipton  
 F. S. McKeever 8020 Mercier St. Lawrence  
 L. B. Laizure 3006 S. 32nd Ave. Kansas City  
 C. B. Deihl Omaha

## NEW ENGLAND DIVISION

S C M Conn. 1BM  
 S C M Maine 1B1G  
 S C M East. Mass. 1BVL  
 S C M West. Mass. 1DB  
 S C M New Hamp. 1ATJ  
 S C M R. I. 1BYB  
 S C M Vt. 1AJG

H. E. Nichols 82 Elmwood Ave. Bridgeport  
 Frederick Best 13 E. Crescent St. Augusta  
 R. S. Briggs 593 Ashmont St. Dorchester  
 A. H. Carr 30 Vassar St. Worcester  
 V. W. Hodge 227 Main St. Claremont  
 D. B. Fanher 86 Franklin St. Westerly  
 C. T. Kerr Poulney

## NORTHWESTERN DIVISION

S C M Alaska\* 7DB  
 S C M Idaho\* 7OB  
 S C M Montana\* 7NT  
 S C M Oregon\* 7IT  
 S C M Washington\* 7DD

L. H. Machin Box 452 Cordova  
 K. S. Norquest Weather Bureau Boise  
 A. R. Willson Ramsey  
 A. C. Dixon, Jr. 1350 East 36th St. Portland  
 Ott(4) Johnson 4340 30th St. W. Seattle

## PACIFIC DIVISION

S C M Hawaii 8TQ  
 S C M Nevada\* 8DO  
 S C M So. Sect. 8RUR  
 S C M Sect. 4 (No. Calif.) 8NX  
 S C M Sect. 5\* " " 8AHG  
 S C M Sect. 6\* " " 8BAF

K. A. Cantin 1593 Pilko St. Honolulu  
 C. B. Newcombe Yerington  
 L. E. Smith 340 No. Painter Ave. Whittier  
 F. J. Quement 51 Pleasant St. San Jose  
 W. J. Lorscheier 635 52nd St. Oakland  
 St. Clair Adams Eureka

## ROANOKE DIVISION

S C M N. C.\* 4JR  
 S C M Va.\* 3CA  
 S C M West. Va. 8BSU

R. S. Morris 113 Broad St. Gastonia  
 J. F. Wohlford 118 Cambridge Ave. Roanoke  
 C. S. Hoffman 126 Chantal Court Wheeling

## ROCKY MOUNTAIN DIVISION

S C M Colo.\* 9CAA  
 S C M Utah-Wyoming\* 8ZT  
 7ZO

C. R. Stedman 1841 Albin St. Denver  
 Art Johnson 247 E. 7th St. Salt Lake City, Utah  
 N. R. Hood 1022 S. Ash St. Casper, Wyo.

## SOUTHEASTERN DIVISION

S C M Ala. 5AJT  
 S C M Fla. 4GY  
 S C M Ga.-South Carolina-Cuba-Porto Rico 9KG

A. D. Trum 217 Catoma St. Montgomery  
 W. F. Grogan Box 816 Ft. Myers  
 Isle of Pines 11 Shadowlawn Ave. Atlanta

## WEST GULF DIVISION

S C M No. Tex. 5AJT  
 S C M New Mexico 5APG  
 S C M Oklahoma 5YK  
 S C M So. Texas

W. B. Forrest, Jr. 502 Royal St. Waxahatchie  
 K. M. Ehret 2904 N. Robinson St. Oklahoma City  
 E. A. Sahn Box 569 New Braunfels

## MARITIME DIVISION

S C M Newfoundland 8AR  
 S C M New Brunswick 1ET  
 S C M Nova Scotia\* 1DD  
 S C M P. E. Island 1RZ

Loyal Reid Avalon House St. Johns  
 T. B. Lacey 6 N. B. Power Co. St. John  
 W. C. Borrett 14 Sinclair St. Dartmouth  
 W. A. Hyndman Charlottetown P. E. I.

## ONTARIO DIVISION

S C M Ontario\* 9BJ

W. Y. Sloan 167 Close Ave. Toronto

## QUEBEC DIVISION

S C M Quebec\* 3RB

Alex Reid 202 Birch Ave. St. Lambert

## VAN-ALTA DIVISION

S C M Alberta\* 4GT  
 S C M B. C.\* 5GR

A. H. Asmussen 223 2nd Ave. N. E. Calgary  
 Felix E. Batt 211 8th Ave. E. Prince Rupert

## PRAIRIE DIVISION

S C M Man.\* 4DE  
 S C M Sask.\* 4CB

F. E. Rutland, Jr. 452 St. John Ave. Winnipeg  
 E. L. Maynard Morse

\*Temporary officials appointed to act until the membership of the Section concerned choose permanent SCMs by nomination and election.

\*\*Active stations in Maryland are requested to report to SCM Layton of Wilmington, Del. until an SCM is elected for the Section.

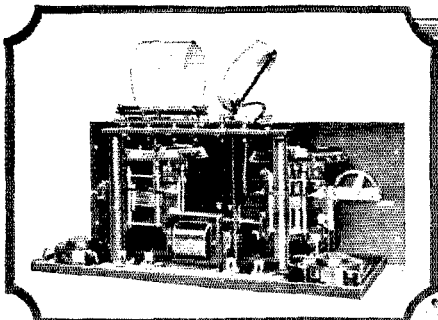

General view of interior of CR-18.

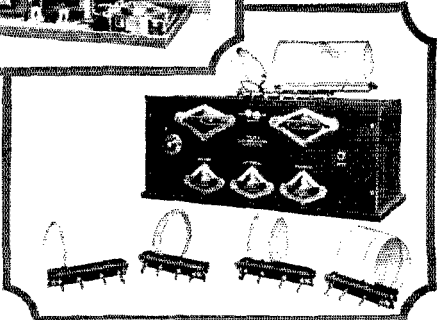

Front view of CR-18 with 200 meter coil intake and additional coils for 10, 20, 40 and 80 meter bands.

# Why the CR-18 is so Efficient

**T**HE eight outstanding features of this low-wave receiver, given below, will satisfy the most critical amateur. Grebe experience, of seventeen years standing, guarantees the quality of every detail.

An Antenna Coupling Coil provides variable electro-magnetic coupling between antenna and grid circuit. Permits of harmonic tuning to increase signal strength, gives greater selectivity and reduces interference and induction noises.

Losses are reduced to a minimum.

Plug-in Coils allow rapid-change from one frequency band to another.

Grebe S-L-F Condensers insure ease

of tuning and maximum signal strength.

Beat Frequency Control permits tuning to a fraction of a kilocycle.

Plate Circuit design gives smooth control of regeneration without affecting wave-length calibration and tuning.

Cushion Sockets eliminate microphonic noises.

The Six Self-Supporting Air Dielectric Coils are very rugged, which insures long life.

*Write for full description and charts*

A. H. Grebe & Co., Inc., 109 West 57th St., New York

Factory: Richmond Hill, N. Y.

Western Branch: 443 So. San Pedro St., Los Angeles, Cal.



Doctor Mhu

Showing coil mounting and Beat Frequency Condenser between dials.

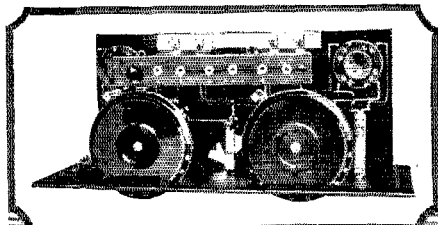

# The GREBE CR-18

This Company owns and operates stations WAHG and WBOQ; also low-wave rebroadcasting stations, mobile WGMU and Marine WRMU, and stations 22V and 2XE.



Trade Mark  
Reg. U. S. Pat. Off.

A modern coupled regenerative circuit receiving between 10 and 200 meters (1500 to 30,000 kilocycles).

All Grebe apparatus is covered by patents granted and pending.

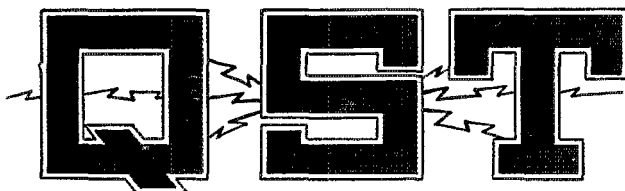

# The Official Organ of the A.R.R.L.

VOLUME X

SEPTEMBER 1926

NUMBER 9

Editorials	7
O. W. L. S.	8
Financial Statement	8
Break-In and Remote Control	<i>John M. Clayton</i> 9
Vacuum Resistances	13
Four Tuners in One	<i>Stephen I. Gilchrist</i> 14
Luminous Frequency Standards	17
Using Wave-Meters Without Indicating Devices	19
Converting the ET3619	<i>Harold P. Westman</i> 20
Election Notice	22
Examining Quartz for Oscillator Use	<i>L. H. Dawson</i> 23
A Low-Capacity Socket	25
Easy Tuner Design	26
Multi-Purpose Shielded Units	<i>Wm. M. Henderson</i> 29
A New Voltmeter	32
Radiotron Model UX210	33
New Fixed Condensers	36
A.R.R.L. Information Service Rules	36
Metallized High Resistance Units	<i>Joseph Morgan</i> 37
Spark Coil Portable Transmitters	<i>Frank Wilburn</i> 40
Shielded R. F. Stages	41
Transmitters in Kit Form	42
Experimenters' Section Report	44
Indiana State Convention	45
Amateur Radio Stations <i>3LW, 3RX, 6R1X</i>	46
Amateur Crystals Available	48
Calls Heard	49
I.A.R.U. News	52
Correspondence	56
HAM-ADS	92
QST's Directory of Advertisers	94

QST is published monthly by The American Radio Relay League, Inc., at Hartford, Conn., U. S. A.  
Official organ of the A.R.R.L. and the International Amateur Radio Union

**Kenneth B. Warner** (Secretary, A.R.R.L.),  
Editor-in-Chief and Business Manager

**F. Cheyney Beekley**  
Managing Editor and Advertising Manager

**Robert S. Kruse,**  
Technical Editor

**John M. Clayton,**  
Assistant Technical Editor

**David H. Houghton,**  
Circulation Manager

Subscription rate in United States and Possessions, Canada, and all countries in the American Postal Union, \$2.50 per year, postpaid. Single copies, 25 cents. Foreign countries not in American Postal Union, \$3.00 per year, postpaid. Remittances should be by international postal or express money order or bank draft negotiable in the U. S. and for an equivalent amount in U. S. funds.

Entered as second-class matter May 29, 1919, at the post office at Hartford, Connecticut, under the act of March 3, 1879. Acceptance for mailing at special rate of postage provided for in section 1103, Act of October 3, 1917, authorized September 8, 1922. Additional entry as second-class matter, acceptable at special rate of postage provided for above, at Springfield, Mass., authorized September 17, 1924.

Copyright 1926 by the American Radio Relay League, Inc., Title registered at United States Patent Office.  
Member of the Radio Magazine Publishers' Association.

# THE AMERICAN RADIO RELAY LEAGUE

The American Radio Relay League, Inc., is a non-commercial association of radio amateurs, bonded for the promotion of interest in amateur radio communication and experimentation, for the relaying of messages by radio, for the advancement of the radio art and of the public welfare, for the representation of the radio amateur in legislative matters, and for the maintenance of fraternalism and a high standard of conduct.

It is an incorporated association without capital stock, chartered under the laws of Connecticut. Its affairs are governed by a Board of Directors, elected every two years by the general membership. The officers are elected or appointed by the Directors. The League is non-commercial and no one commercially engaged in the manufacture, sale or rental of radio apparatus is eligible to membership on its Board.

"Of, by and for the amateur", it numbers within its ranks practically every worth-while amateur in the world and has a history of glorious achievement as the standard-bearer in amateur affairs.

Inquiries regarding membership are solicited. A bona fide interest in amateur radio is the only essential qualification; ownership of a transmitting station and knowledge of the code are not prerequisite. Correspondence should be addressed to the Secretary.

## OFFICERS

*President*  
HIRAM PERCY MAXIM  
Hartford, Conn.

*Vice-President*  
CHAS. H. STEWART  
St. David's, Pa.

*Communications Manager*  
F. E. HANDY  
Hartford, Conn.

*Treasurer*  
A. A. HEBERT  
Hartford, Conn.

*Secretary*  
K. B. WARNER  
Hartford, Conn.

## DIRECTORS

*President*  
HIRAM PERCY MAXIM  
Drawer 4,  
Hartford, Conn.

*Vice-President*  
CHAS. H. STEWART  
St. David's Pa.

*Canadian General Manager*  
A. H. K. RUSSELL  
6 Mail Bldg.,  
Toronto, Ont.

*Atlantic Division*  
DR. EUGENE C. WOODRUFF  
234 W. Fairmount Ave.,  
State College, Pa.

*Central Division*  
CLYDE E. DARR  
137 Hill Ave., Highland Park,  
Detroit, Mich.

*Dakota Division*  
C. M. JANSKY, JR.  
Dept. of Elec. Eng., U. of M.,  
Minneapolis, Minn.

*Delta Division*  
BENJ. F. PAINTER  
424 Hamilton Nat'l Bank Bldg.,  
Chattanooga, Tenn.

*Hudson Division*  
DR. LAWRENCE J. DUNN  
480 East 19th St.,  
Brooklyn, N. Y.

*Midwest Division*  
PORTER H. QUINBY  
Box 184A, Route 6,  
Omaha, Neb.

*New England Division*  
DR. ELLIOTT A. WHITE  
Dartmouth College  
Hanover, N. H.

*Northwestern Division*  
K. W. WEINGARTEN  
3219 No. 24th St.,  
Tacoma, Wash.

*Pacific Division*  
ALLEN H. BABCOCK  
65 Market St.,  
San Francisco

*Roanoke Division*  
W. TREDWAY GRAVELY  
503 Main St.,  
Danville, Va.

*Rocky Mountain Division*  
PAUL M. SEGAL  
c/o District Attorney,  
West Side Court Bldg.,  
Denver, Colo.

*Southeastern Division*  
HARRY F. DOBBS  
c/o Dobbs & Wey Co.,  
Atlanta, Ga.

*West Gulf Division*  
FRANK M. CORLETT  
2515 Catherine St.,  
Dallas, Tex.

Address General Correspondence to Executive Headquarters, Hartford, Conn



# EDITORIALS

## Loyalty

**G**OVERNMENT regulation of radio broadcasting has now broken down completely. Altho the White Bill passed the House and the Dill Bill passed the Senate, the Congress adjourned without enacting any legislation because the differences between the two bills could not be reconciled in the short time remaining before adjournment. An emergency resolution, which would give the Department of Commerce adequate authority to regulate radio until legislation can be enacted in December, was then passed by both Houses but unfortunately not in sufficient time to be signed before adjournment, which is necessary for it to become effective. Thus the adjournment of Congress left the country exactly where it has been all these years—with only the ancient 1912 law. Then Secretary Hoover sought an opinion of his powers under that act from the Attorney General. It confirmed what he must have suspected for years—that he must give a broadcasting station a license upon demand, and that that station can use practically any wavelength and power and operating hours it chooses. Thus there can be no control over broadcasting until the end of the year.

Amateur interest in this spectacle is chiefly in the opportunity it gives us to compare broadcasting and our own non-commercial amateur radio. Broadcasting is essentially a matter of commercial competition, and it will not be particularly surprising to see the "business" instinct to take advantage of every legally permissible opportunity to send broadcasting to the everlasting bowwows. Already many stations are shifting their waves, increasing powers, and changing hours, since they have no particular co-operation amongst themselves and no general loyalty to an all-embracing organization of their own. How different this selfish individualism from the splendid loyalty to organization which has always characterized our American Radio Relay League! Our A. R. R. L. stands out to-day like a lighthouse in a fog as a really co-operative association whose members are loyal to the organization and its principles, and probably the only one whose members will be sufficiently possessed of loyalty to organization to abide by the "gentlemen's agreements" of the Fourth National Radio Conference to which they are parties.

Is it necessary to emphasize again that the League still stands for the amateur wavelength allocations to which it agreed? We trust not. It is now more important than ever that we observe the wavebands specified on our existing station licenses. More than ever before we are on our honor to do the fair thing. The stuff of which radio groups are made will be clearly shown in the coming few months and we want to be able to say that amateurs played the game squarely. You fellows haven't any idea how much strength your representatives at Washington will gain if they are able to say in the future that amateurs did not take advantage of the technical breakdown of authority to run amok and become radio pirates, but that instead they were square-shooters and played the game like sportsmen! It won't be sporting—as the "G's" say, it won't be cricket—to do anything else now. One thing does need emphasizing: This is only a temporary situation. It is definitely assured that a Congress conference committee, of members from both Houses, will meet in November for the sole purpose of reconciling differences in the two bills that have been passed and perfecting a new bill that can be adopted as soon as Congress convenes in December. It is perfectly simple to see that when new regulations do come, they may come with a vengeance to those who to-day decline to play fair, and that those who show they are made of the right stuff will fare much better. In other words, behaving ourselves now is certain to pay us huge dividends in the near future.

So we know what A. R. R. L. amateurs are going to do, don't we, fellows?

## The I. A. R. U.

**A**LTHO the International Amateur Radio Union was formed in April of last year, it was just a year ago that the greatest number of American amateurs was enrolling, and hence right now is the peak in the expiration of the first-year memberships. We want to say a word to our A. R. R. L. members who belong to the Union to urge the importance of their prompt renewal of membership.

The original concept of the Union, it will be remembered, was as a federation of na-

tional amateur societies. What actually resulted at Paris was a single international association of individual memberships, those from each country grouped into a section. This radically different idea was necessarily adopted when it was found that there was no satisfactory society representing the true transmitting amateur in some of the important countries. The idea has worked out only fairly well; it has many drawbacks. It is the opinion of a considerable number of the officials of the Union that it by rights should be the originally-conceived federation of independent national societies, and that the chief service of the Union to date has been in the establishment of healthy and flourishing national sections which have developed organization spirit in the national groups where no representative amateur association existed before. It is therefore hoped that in a relatively short time the successful sections of the I. A. R. U. can be converted into autonomous societies, all of these national associations then locking hands to form a Union.

This prospect for the Union, it seems to us, is a most encouraging one. It answers any doubt that may be residing in the minds of American amateurs concerning why there should be a United States Section and a Canadian Section of the I. A. R. U. when they already have their A. R. R. L. to represent them in international relations. The day is coming, boys. Meanwhile your dollars are helping along the work of the Union to the place where genuine societies of the real article in transmitting amateurs may exist in the other countries of the globe, capable of joining with our A. R. R. L. in the international federation. This good work rates the heartiest support of every ham in the richest country on earth. Think it over, O. M., and if your I. A. R. U. membership has expired (or if you've never joined), send in that dollar's dues at once. It will pay rich dividends in better international amateur radio.

K. B. W.

O. W. L. S.

THE list which appears on page 33 of July still stands with the exception of the following corrections.

Official Wavelength Stations added:

Canadian 2BE.

U.S. 9CXU.

Crystal-control OWLS added:

\*\* 2DS

\*\* 9AUG

\*\* 6AOI

\*\* 2BRB

Cancelled:

9ECC

Those not familiar with the uses of the OWLS are reminded that these are the A.R.R.L. guideposts. They announce their wavelengths frequently while engaged in ordinary amateur communication and their accuracy is kept up so that they can be relied upon for rough calibrations of receiving sets and wavemeters. Some OWLS announce in wavelength, others in Kcs. Their operation is governed by a committee of which the chairman is D. C. Wallace of 9ZT-9XAX.

Financial Statement

BY order of the Board of Directors the following statement of the income and disbursements of the American Radio Relay League for the second quarter of 1926

is published for the information of the membership. K. B. WARNER, Secretary.

STATEMENT OF REVENUE AND EXPENSES FOR THE THREE MONTHS ENDED JUNE 30, 1926.

REVENUE	
Advertising sales .....	\$16,795.89
Newspapers sales .....	11,485.91
Newspaper syndicate sales .....	1,098.00
Dues and subscriptions .....	7,284.18
Back numbers, etc. ....	779.27
Emblems .....	139.48
Interest earned .....	150.68
Cash discounts earned .....	361.56
Bad debts recovered .....	75.45
	38,120.42
Deduct:	
Returns and allowances .....	6,757.59
Less transfer from reserve for newspaper returns .....	1,990.21
	4,767.38
Discount 2% for cash .....	239.97
Exchange and collection charges .....	23.46
	5,085.81
Net Revenue .....	33,034.61
EXPENSES	
Publication expenses .....	18,191.24
Salaries .....	12,007.40
Syndicate expenses .....	560.34
Forwarding expenses .....	618.99
Telegraph, telephone and postage .....	1,435.09
Office supplies and general expenses .....	2,492.43
Rent, light and heat .....	389.45
Traveling expenses .....	365.53
Depreciation of furniture and equipment .....	203.14
Bad debts written off .....	64.55
Communications Dept. field expenses .....	79.34
Total Expenses .....	32,403.00
Net Gain from Operations .....	\$631.61

## Break-In and Remote Control

By John M. Clayton, Assistant Technical Editor

**E**VER since the advent of good C.W. transmitters and receivers QST has been advocating the use of break-in systems and has urged the gang to put in some form of break-in arrangement in order to facilitate calling, answering and traffic handling. There is nothing like a good break-in communication with some fellow ham whose station is similarly equipped.

Suppose your station is equipped to work break-in and you want to send a CQ. You would start off something like this, "CQ CQ CQ u 3ZZZ 3ZZZ 3ZZZ bk CQ CQ CQ u 3ZZZ 3ZZZ 3ZZZ bk", etc. That little "BK" does the whole trick. It tells

tells the world that break-in communication is desired. We have worked several fellows in the laborious "you talk and I'll listen" fashion, only to learn after a twenty minute QSO that the other fellow had a break-in outfit, and wouldn't use it even when we said "pse bk me", simply because the "bk" didn't mean anything. If a fellow tells you "bk" or "bk me" by all means give him a long dash and a quick call, if you are working him. If he says this during a "CQ" he is inviting you to call him *immediately*. As soon as he hears you call, he is going to stop his CQ until you sign. So just as soon as he lays off CQ, give your call once or twice. If he does not come right back at you, you might as well give up for he is listening to someone else. Break-in operation, even when calling, will save many many minutes of useless calling and will help to establish many additional QSO's and when they are established it will speed up traffic handling greatly.

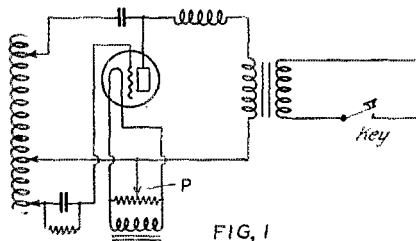

the other fellow the whole story. He knows that you are ready to receive answers to your CQ even while still calling CQ; he knows that you are wiping over the band with your receiver listening for answers. If you are equipped with break-in you start to call him as soon as you hear his "bk" and you keep on calling him until he either answers you or someone else. If he answers, almost the first dot he makes you stop calling and see who he is calling, and if it is you, you are all set for some genuine fun. If it is to be a rag-chew, you can stop him in the middle of the conversation by making a long dash and a short "bk" and he can do likewise. If it is traffic handling and you start off by dropping several words, you do not have to wait until he has finished a long message to ask him to QTA two words—no sir, you step on the key just as soon as you lose the first word and tell him to go ahead on the last word you received OK. If you have QRM and are losing him, or he is fading, you just make a dash and say "AS QRM" or "AS QSS" and he QRX's until you say "GA". And you can keep this up by the hour, handling traffic with the same rapidity, precision and accuracy as wire telegraphy would permit.

Many hams are able to work break-in but have not become acquainted with the more or less standard abbreviation which

### Simple Break-in Systems

Practically C.W. and I.C.W. commercial coastal stations are working break-in with ships at sea nowadays. Their methods are obvious when it is learned that most of the transmitters are located many miles from

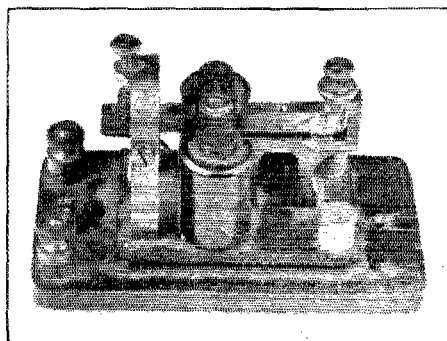

FIG. 2. A SINGLE CONTACT RELAY

the receiving station. By means of land-lines and relays the transmitter is started, stopped and keyed from the receiving station far away from the transmitter's QRM. The commercial operator can hear *any* ship who is not transmitting exactly on his wavelength even while handling traffic. He can sit on the key for an hour and at the same time hear about 95 per cent of the ships who are calling him. Fine, but impractical for amateur stations? Not by a long shot.

The simplest form of break-in consists in merely listening on the receiver with the antenna "send receive" switch on the "send" side, connected to the transmitter. If your receiver is placed close to the transmitter so that the antenna lead-in to the transfer switch is close to the receiver, or if the receiver is in inductive relation to the coils in the transmitter, on short waves you can hear many many stations when the antenna is connected to the transmitter.

Operating the receiver in this fashion you should have no trouble in working break-in with all the fellows you hear, who are prepared to do likewise. You may find, tho, that you cannot pick up stations on wavelengths very close to that to which your transmitter is tuned. You will find with some types of keying that the transmitting tubes continue to oscillate weakly (but more than enough to kill all reception on the transmitter's wavelength) even when the key is open. If you are keying in the primary circuit of your plate transformer and you get interference from the transmitter when the key is open, it may be due to the fact that the center-tap on the filament transformer is not in the electrical center of the transformer and plate voltage is secured from this unbalanced filament center-tap. Sometimes the trouble can be cured by the scheme shown in Fig. 1., which is the familiar resistance center-tap arrangement. The resistance can be a 200-ohm potentiometer. With the key open, the slider of the potentiometer is turned, while listening on the receiver, until the transmitting tubes oscillations cease. Break-in can then be accomplished on all waves. This

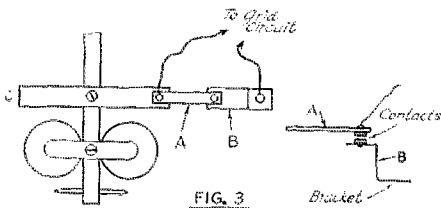

FIG. 3

arrangement will not work in all cases. A positive cure for all types of transmitters will be described later on.

### Separate Antennas

In some cases it is not possible to pick up sufficient energy from the antenna lead-in or the grounded transmitter secondary due to the fact that the receiver is not inductively associated to either, or is across the room from the transmitter. In such cases and also when extreme DX reception, on break-in, is desired, an antenna should be used with the receiver. In the old days of spark we used to use the same antenna,

having the transmitter and receiver alternately connected to it by means of a relay operated by the transmitting key. This is not a very satisfactory method since it involves high voltage insulation on the relay, and is not at all needed with C.W. when a most modest one-wire antenna can be permanently connected to the receiver. In almost all cases a piece of bell-wire string around the picture molding in the house, or run through the length of the attic, will bring in all the DX (with less static) one could possibly want. As practically all short wave receivers are equipped with primaries which are not tuned to the received signal, the only precaution to be observed with the separate antenna is to make certain that the natural period of the antenna (or its main harmonics) is not the same as the working wavelength of the transmitter. If such is the case, the receiving antenna will pick up enough of the transmitters voltage to cause rather disastrous sparking in the mesh of the detector tube when the transmitter, and grid leaks and grid condensers will be burned open. No trouble should be had in avoiding this, though. Then, barring keying troubles, the separate receiving antenna will allow even better break-in than before.

### Key Locations

The ideal method of keying a self-rectified transmitter, or one employing chemical rectifiers with not too large a filter is in the primary of the plate transformer. The inductance of the transformer allows the keying current to reach the tube gradually instead of with a terrific bang, as would be the case if keying were done in the grid circuit or in the high voltage lead. As has oft been said, the less the bang of plate voltage on the tube, the less will be the key thumps, and the smaller the strains on the tube itself. From a keying standpoint, then, it is agreed that keying in the primary of the plate transformer is as good a method as any. From the break-in standpoint, though, it is not always possible to stop the tube from oscillating even when the key is wide open and even with the balanced center-tap arrangement.

A highly satisfactory method of break-in keying is in the grid circuit of the tube. This very effectively prevents the tube's oscillating and makes the receiver absolutely quiet when the key is open. But grid circuit keying results in terrible key thumps. Why not combine the two systems by using a relay with two sets of contacts, one of which closes the grid circuit first, and a fraction of a second later closes the plate transformer circuit, reversing the process when the key is opened? This method

has been tried and has been found to be a complete success both from the key-clickless and break-in point of views. A system similar to this was described in a "Communication" by Norman R. Hood in the March 1926 issue of *QST* on page 57.

A Leach relay, or some form of relay having two sets of insulated contacts, is required. The Leach device was described in detail in *QST* several years ago. A general idea of its construction can be obtained from the illustration accompanying the above-mentioned "Communication".

A relay of this type is not absolutely essential, however. The illustration of Fig. 2 shows a very good single contact relay which was made from a standard "main line" telegraph sounder. The usual brass sub-base was removed and a piece of 3/16 inch bakelite having the same dimensions and drilled with the brass base as a template, was substituted. Two large Eby binding posts were attached to the bakelite base and the contacts were made of  $\frac{1}{4} \times \frac{1}{2}$  inch silver slugs 1/16 inch thick. These pieces of silver can be obtained from almost any jeweler. Notches were filed in the hammer and anvil of the sounder and the slugs were fitted in and soldered in place.

On the hammer, directly below the back-stop screw, a hole 3/16 inch in diameter was drilled to a depth of about 1/8 inch, and a hard rubber rod was fitted in the hole and held in place with glue. The top of the rod was cut off flush with the hammer

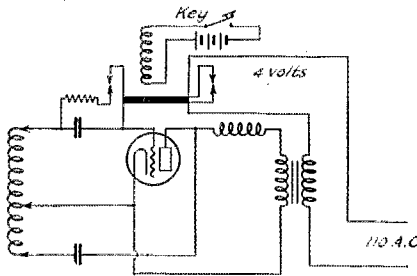

FIG. 4

and filed down smoothly. This insulation prevented the hammer from closing the contact through the stop-screw when in the "up" position. Bearing contacts were avoided by the use of a heavy piece of woven braid soldered to the end of the hammer and the "U" shaped bearing support. A piece of thin phosphor bronze spring can be substituted. With the contacts described, the relay will satisfactorily break 25 amperes without sticking or sparking excessively even though the relay is operating at Vibroplex speed. This relay com-

prises the elements of a good break-in relay in that its contacts are large enough to break the plate transformer primary circuit of almost any amateur set in use today.

An additional set of contacts should be used to open and close the grid circuit. The construction of a suitable insulating arm and contacts to fit this relay is shown in Fig. 3. By means of the screw which was used as the downward stop for the hammer, a piece of bakelite strip (C) 1/8 inch thick,  $\frac{3}{8}$  inches wide and  $2\frac{1}{2}$  inches long is attached to the hammer. At one end of the strip a phosphor bronze spring A is bolted. Through the other end of the bronze spring a Ford spark coil contact is

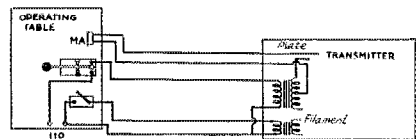

FIG. 5

riveted. Below C is a bracket B which carries another Ford contact B. The space between the contacts is so arranged (by bending the spring) that the A-B contacts close just a small fraction of a second before the main power contacts make. A flexible lead is soldered to A and another lead to the bracket B. These leads are connected to the grid circuit as shown in Fig. 4. When the key in the relay winding circuit is closed the hammer comes down, the A-B contacts close the grid circuit and immediately afterwards the main power contacts close and the plate transformer supplies voltage to the plate of the tube. When the key is opened the process is reversed.

#### Keying Synchronous Rectifiers

When keying a synchronous rectifier, in order to get a good note under operating conditions, it may be necessary to resort to the same kind of keying just described. Usually keying in the primary of the plate transformer alone results in a bad note. With the relay just described the "sinc" can be keyed in both plate and grid circuits and a good note plus break-in is assured.

#### Remote Control

It is difficult to say how far remote control is. One may justly call a transmitter remotely controlled when it is situated across the room from the receiver, or when it is a hundred feet from the operating table. For the sake of getting started, though, lets say that a transmitter is remotely controlled when you have to go down a couple of flights of stairs and out into the yard before you can start or stop it!

The further the transmitter is from the receiver, the easier the break-in job becomes. If the transmitter is situated in a dog-house out in the yard 75 or 100 feet from the receiver you are comparatively safe from tube oscillations with the key open, and your problem becomes one of merely starting the filament heating transformer and keying the plate supply, the receiver being operated on a separate antenna.

There are countless ways in which the thing can be done. First, though, let's say just a word or two of the advantages of a remotely controlled outfit. In the first place the transmitter can be placed directly under the antenna where it is out of the way of a lot of punk dielectrics and where the lead-in does not have to come through a few dozen walls and run across the inside of a perfectly conducting room. Then you are assured of quietness in the receiver and can work break-in perfection. The modern tube transmitter does not have to be petted every two seconds and nursed like a sick chicken. Once the transmitter has been adjusted and tuned properly it should keep on operating satisfactorily until a tube filament burns out or a part breaks down, which (fortunately) does not happen every evening. The only precaution to observe is that you do not try to get the very last drop of energy out of the transmitter by working it right at the spilling-over point.

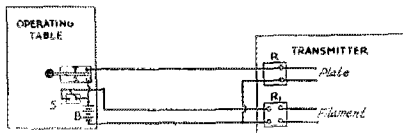

FIG. 6

If the distance between the house and the transmitter is not great a scheme such as shown in Fig 5 can be used. Three 110-volt leads are to be run from the house to the transmitter. These leads should be supported on insulators run down the side of the house, and should be run across the yard as close to the ground as possible. Use weatherproof wire, too. The filament transformer is controlled by the switch on the operating table and the plate supply by the key in the primary of the plate transformer. A further refinement consists in mounting the plate milliammeter (MA) on the operating table, and running a twisted pair of leads from the plate transformer center-tap to the MA, and back to the set. This meter will tell you *all* you need to know about the operation of the transmitter. It tells you whether or not the tube is oscillating and everything running smoothly.

If the distance between the transmitter and the operating table is great enough to cause any appreciable voltage drop in the 110-volt line the scheme shown in Fig. 6 should be used. R and R1 are relays similar to the type shown in Fig. 2. S is a single pole knife switch and K the key. The battery B is a four volt affair. Do not use the receiver's A battery as the drop in voltage when the relays are operating will be sufficient to cause the receiver to run out of oscillation if it is being operated at the verge of going out anyway. When the switch is closed the relay R1 closes and the filament transformer lights the tubes and when the key is operated the plate voltage to the tube is controlled. The 110 volt leads are kept out of the operating room entirely, and are terminated directly in the transmitter's dog-shack. The three battery leads should be run as mentioned in the preceding paragraph.

A two-wire control is shown in Fig. 7. The relays are of the construction previously suggested with the exception that R2 is a high resistance affair closing with very small currents flowing through its winding. The key and switch are wired in series. A variable resistance (a rheostat will do) is shunted across the key contacts. Keying merely short-circuits this resistance. The relays are so adjusted that when the switch is closed, sufficient current will flow through the resistance and the line to "pull" R2 and close the filament line, but the current will not be great enough to operate the keying relay. When the key is pressed (and R3 short-circuited) the added current is sufficient to throw relay R1 operating the plate transformer. This system has been used by a number of operators, and recently a special relay having a single winding and two sets of control arms has been developed by Brainerd of 8LO. We hope to be able to describe this relay in *QST* sometime soon. The system described requires careful adjustment of the relay springs and contacts, but it will operate entirely satisfactorily.

Remotely controlling the synchronous rectifier is a different problem since the rectifier will start off "butter side up" a lot of times and some form of polarized reversing relay is needed to reverse the plate leads from the rectifier.

In all of the above described systems it is urged that the constructor does not skimp on the size of main power contacts. Nothing makes a man madder than to have to run a couple of hundred feet to pry open a pair of "frozen" silver contacts. If the dimensions suggested are used this trouble will be obviated for once and for all.

A word of caution, also. In break-in systems it is absolutely necessary that the transmitting tube filament be kept lit all the time if break-in is desired. When the

tube is cold it takes an appreciable time for the filament to warm its "innards". All during this process the wave will climb to beat the band and break-in work will be

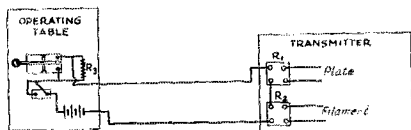

FIG. 7

impossible. So if you are going to call a man, on break-in, first light the transmitting tube filament for quite a few seconds before calling him.

Remember that even the simple system of relays and remote control is not necessary for break-in operation in practically all cases. Usually the stunt of a separate receiving antenna permanently connected to the receiver will be all that is needed. The relays and remote control ideas are refinements, nice to have, but not absolutely necessary.

Once you have tried break-in and have had the fun of working it with some of the fellows, you will never give it up, and we hope you will join us in urging the rest of the gang to work their sets this way. Break-in certainly helps better operating tremendously.

## Vacuum Resistances

FROM Germany there is being imported a new type of resistance unit which possesses several novel and new features. The units are of such construction that they should maintain their original resistance indefinitely. They are made in the following manner: the units consist of two glass members, the first being a short glass rod and the second a glass tube which contains the rod. The rods are cut to the exact length desired and are provided with terminal leads which are welded into the glass itself. It is important that good electrical contact be provided between the leads and the resistance material, so the rods are placed in a revolving drum, and a highly conductive emulsion is sprayed directly against the ends of the rod, covering the lead wires with a good conducting surface. The drum, holding about 100 of the units, is next revolved in an electrically heated circular oven, where the terminal layers are baked thoroughly. The drum then goes through another stage in which a slightly conductive spray is pro-

jected on the individual glass rods. This spray covers the whole rod so that a good contact is provided between the high resistance and the previous metallic coating around the leads. While this is being done, the resistance thus being formed is being tested on a direct reading resistance measuring meter, thereby obtaining a uniform and predetermined resistance. The rods now covered with the resistance layer proceed through a second chamber where they are dried and baked. This whole process is done automatically and the results are quite uniform. The resistance units then pass through another stage in which they are provided with the outer glass shell, sealed in and evacuated. They are finally automatically pumped and cut off and provided with silver plated end caps.

Then they pass through a maturing or ageing process being placed on a rack and subjected to a load of 0.1 watt for 24 hours and a load of .5 watt for a half an hour, after

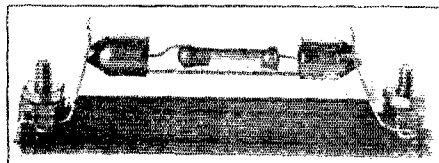

which they are tested for resistance and for quietness. The latter being done by inserting the unit in the first stage of a four stage resistance coupled amplifier. The finished units fit the standard grid leak clip. They are available in any value between 50,000 ohms and 10 megohms, and are manufactured by the Loewe Radio Company of Berlin and distributed in this country by Tobe Deutschmann.

—J. M. C.

## Strays

Hinds & Edgerton of 19 So. La Salle Street, Chicago print a little card listing the "R" system of audibility, the International abbreviations and the latest "Q" signals—just the thing to hang on the wall of your shack. The cards may be obtained free of charge by addressing the above.

GBUR sez that a Ford radiator punched full of holes and buried so that water may be poured into the spout makes a good ground. When the surrounding terra firma dries out, you can get water right to the spot in a minute.

## Four Tuners in One

By Stephen I. Gilchrist\*

**A**MONG *QST*'s rapidly growing reading family I know there are hundreds of experimenters who are never quite sure that the short wave tuner upon which they rely is the best to suit their several operating conditions. It is to them that this article is written, or dedicated, or subscribed; whichever way they may wish to regard it.

I would like to hold the support of this article back long enough to get across a lot of views on coils, but know that *QST* has not the space; so I'll get down to business in hand.

The Detroit Free Press 4-In-One Tuner—named in honor of the very human newspaper by which I am employed in non-radio moments—is a result of the "try-everything-once" itch and my inability to regard the last short-wave receiver hooked up as other than inferior to the one which had been torn down to make way for the last one hooked up—and this often, despite the fact that the last one hooked up was the one that had been up, prior to the last one which had been torn down. I know that last statement is eminently clear to all those who have been similarly afflicted.

To be a little more plain, it seemed that I was always doomed to wanting a tuner that was superior to the one that I had. My experiments had to do with four standard regenerative circuits, but I have never come to the conclusion as to which of the quartet is the superior. This situation led to the change-over arrangement. I am disposed to look on it as a means for serious study of short-wave reception.

I believe that any others who may take a fancy to constructing the 4-In-One will find one peculiar feature that solely will

correct) is a lot, to my way of thinking.

The four circuits embraced differ in their methods of regeneration and also to methods of coupling the antenna to the condenser-tuned grid circuit or secondary circuit. The combinations are:

1—3-coil arrangement used as primary, secondary and tickler.

2—3-coil arrangement used as primary, secondary and tuned-plate coil, Armstrong fashion.

3—2-coil arrangement used as secondary and tickler—the antenna being coupled to the secondary thru a small condenser after the method that you may name after Austin, Young, Schnell, Hoffman or Zurian, or by whatever name you know it best.

4—2-coil arrangement used as secondary and tuned-plate coil with antenna coupling as in circuit 3.

The four circuits included are so familiar to *QST* readers that printing will not be necessary.

The Weagant—Reinartz could have been included also, but this would involve what I believed at the time, to be the risk of greater losses than were necessary. You see that I have reasoned that the receiver would be beset by losses galore, although I had decided that none of the four phases would have the edge on any of the others. Herein comes the shock that I have not recovered from yet—that the 4-In-1, in every one of its phases is better with all of its plug-in stands and its socketed detector tubes than my previous tuner with a de-based tube, and a darned good tube, too. You figure it out.

### Carpentry Enters In

Parts necessary to the construction of the set are:

27 plug-in jacks, such as those made by General Radio.

54 spring plugs (this for a complete set of plug-in coils to cover all amateur bands). If the builder prefers to change coils on the same stands he can get along with forty connectors.

16 hardwood strips 2" long by  $\frac{3}{4}$ " wide by  $\frac{1}{8}$ " thick, and 26 hardwood strips 3" long by  $\frac{3}{4}$ " by  $\frac{1}{8}$ " thick. After they have been drilled, let them boil in a large stew pan until the paraffin ceases to bubble. I learned that from *QST* many moons ago.

Binding posts—Fahstock clips screwed to the baseboard.

C1—midget condenser of 40  $\mu\text{f}$ d. maximum capacity.

C2—2 brass angles about 1" long by  $\frac{1}{2}$ " wide.

C3—grid-coil tuning condenser of 150  $\mu\text{f}$ d.

C4—plate-circuit variable condenser, 500- $\mu\text{f}$ d. capacity. (more of this later)

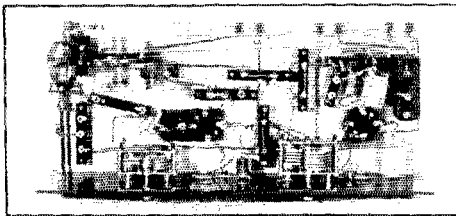

TOP VIEW OF SET

This shows equipment plugged in for 3-coil operation with tickler, i. e. circuit.

justify its existence; that in any one of its four phases, stations will be heard r-8 that do not seem to come in well on the others. This has been my experience while comparing different circuits. That feature (if

\* S.W., 1350 East Grand Boulevard, Detroit, Mich. Igan, also makeup editor, Detroit Free Press.



C5—100-, 150- or 175- $\mu$ fd. grid condenser. The writer has found the set smooth with all in the 40-meter band, but 175 works well over all the amateur bands in addition. R1, R2—rheostats to suit tubes.

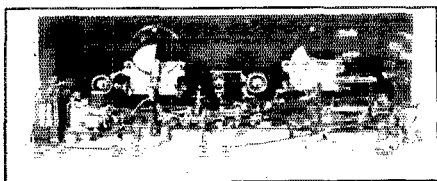

REAR VIEW OF THE SET

The three-coil arrangement operating with a tuned-plate circuit.

R3—5 megohms gridleak, but you can use any resistance from 4 to 10 megohms. Sw—filament switch. J1—phone jack. AFT—6/1 ratio audio transformer. 2 dials of any type you prefer. 1 panel 24"x7"x3/16" hard rubber preferred. Baseboard—23"x10"x3/4". 2 UX sockets. 2 rubber socket pads, or pieces of soft felt or rubber sponge. C-battery, 4.5 volts, variable if your leanings are that way.

### The Jack System

If the reader will turn to the diagram he will notice that each jackblock has been given a Roman number which should not be confused with the numbers given to the different circuit provided for. I believe the present arrangement of these blocks to be the best. Others may have entirely different ideas and are invited to hop to 'em.

At any rate—here is the arrangement.

I—A 2" block with jacks spaced 1" on centers. This block is used only when one wants a series antenna condenser for one of the three-coil circuits. Then the antenna is connected to "AN1" and a short-circuiting wire plugged into I. In other words I acts as a single-pole switch with very low capacity and leakage.

II—A block exactly like I, meant to take the antenna coil when using a three-coil circuit. The antenna goes to "AN2" for a fixed tune arrangement or to "AN1" with a shortening strip in block I if the idea is to use C1 to clear up dead spots or for antenna tuning.

III—A 3" block with jacks spaced 2". This block holds the grid circuit tuning coil—i. e. the secondary—in all of the circuits.

IV—A 2" block to receive the tickler when it is used.

V—This block is not really necessary as it is meant to receive a brass-angle con-

denser of the Schnell variety and the same thing exactly can be accomplished by the use of C1 and the block I.

I—This block may be omitted for most purposes and the post GR1 wired directly to the front jack on strip II.

VII—A three-jack block like VI. Spacing of jacks 1" on centers. A type "A" plug joins the two outer jacks when using a tickler and a type "H" jack joins the center and left jacks when the tuned plate circuits are used.

VIII—Drilled same as VI and VII. Takes type "H" plug, center and right for tuned plate, center and left for tickler.

IX—tuned plate coil, or shorting plug (type "E"), on circuit.

X—Blocking condenser for tuned plate circuit, shorting plug (type "E") for tickler circuits.

XI—Choke, type C or resistance, type D.

XII—Open when using tickler, shorted by type "H" plug when using tuned plate circuit. Before putting in shorting plug make sure that X is either open or has blocking condenser in place. X and XII must never be shorted at the same time.

### Tracing the Circuits

The reader has already decided on a number of changes he would make in the set but we may as well trace the circuits that result when using the present set. Let us begin with all jacks vacant and plug in the different devices as needed.

Circuit 3—the Austin etc. etc. arrange-

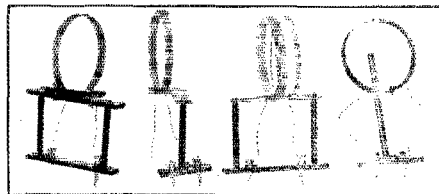

SOME OF THE PLUG-IN COILS

Left to right: Tuned-plate coil, tickler on hinged support, secondary coil which happens to be in two sections and hinged tickler. Uprights are of 3/8" bakelite tubing, tapped for 6/32" screws. No coil dimensions are given as these are a matter for personal opinion.

ment. The antenna lead is connected to the Fahstock clip AN1. The brass angle series condenser G goes into V or else this block is shorted by a type "E" plug and the condenser C1 adjusted to suit. The ground can be connected at any of the points provided—if one wants to use it at all. This completes the antenna circuit. The grid coil for the desired wavelength is plugged into III, and the tickler in IV. From the B battery the circuit is as follows; thru the A.F. transformer primary to a choke C or resistance D plugged into XI, then thru a

type "E" plug at IX and another type "E" plug at VII and a type "H" plug at VIII and so finally to the plate. The last plug is in the center and left jacks. The condenser C4 is now connected to the plate circuit by a type "E" plug at X.

Jack blocks I, II, VI and XII remain unused.

Circuit 4—the 2-coil arrangement with tuned circuit, again start with all acks vacant. The antenna circuit is made up just as before—that is to say with V either shorted or occupied by the brass-angle condenser G. The grid-circuit goes into III as before. IV remains vacant as do I and II. A type "H" plug connects the center and right jacks of VIII and another type "H" connects the center and right jacks of VII thereby extending the plate lead to IX into which the tuned plate coil is plugged. The blocking condenser B goes into X and the motor of the condenser C4 (which now tunes the plate coil) is connected to the coil by shorting XII with another type "H" plug. XI may be shorted or occupied by a choke or resistance as you see fit. The short is probably the best.

Circuit 1—the three coil arrangement with tickler. Start again with all jacks vacant. Plug primary or antenna-pick-up coil into II and a type "H" plug into the two rear jacks of VI. Then connect antenna to AN2 or else use antenna series condenser C1 by connecting antenna to AN1 and shorting I with another type "H" plug. The grid-circuit coil goes into III as usual. The rest of the tickler system is built up as for the first circuit which gives a "throttle condenser" control, or else one can set the

lar set—and with the particular antenna—used here, the primary coil operates best when set at right angles to the secondary, that is to say with the loosest coupling available.

Many ticklers have been tried and the writer finds the least tuning effect with a solenoid tickler of the same diameter as the secondary but spaced well away from the latter. I do not wish to put that forward as a final say-so—merely as my result.

My experience has been that better signal strength and sufficient selectivity are obtained by the use of a fairly large grid-circuit tuning condenser. It then becomes reasonable to use a 500- $\mu$ fd. condenser in the plate circuit.

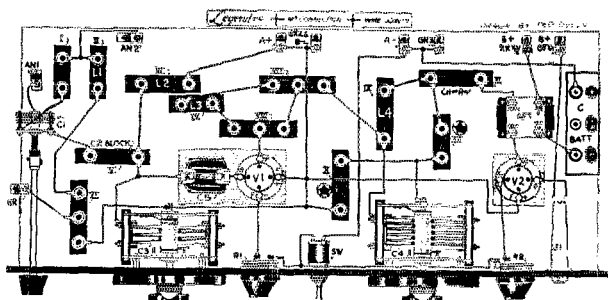
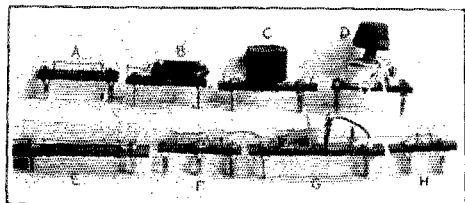

DIAGRAM OF THE CONNECTIONS TO CORRESPOND WITH THE TOP VIEW OF THE SET.

Everyone that builds another such plug-in set will certainly do all manner of things to the general layout so there's no use in going into much more detail. The causes for some of the construction will be mentioned however. The tube sockets do not rest directly on the rubber-sponge cushions but have a 1/16" sheet of insulation interposed because rubber sponge is so excellent at collecting moisture quickly, and hanging onto it for a long time.

In drilling the plug-in mounts, space the plugs 1/64" further apart on centers than you did the jacks. They go in a bit stiffer, but the contact is always good. The nice mechanical work in this regard, also in the insulating shaft-extension of the midget condenser and the drilling of the panel is that of R. C. Wender, 8DRV, my neighbor and former code instructor. He saw to it that the 4-in-1 looked like Dr. Jekyll instead of Mr. Hyde.



THE PLUG-IN DEVICES USED IN THE SET

A jumper with 2" centers, B blocking condenser for tuned-plate circuits C choke coil, D resistance for shunt-fed plate circuits, E jumper with 3" centers, F double jumper with 1" centers, G the brass-angle series condenser, H jumper with 1" centers.

throttle condenser near maximum and swing the tickler of VII.

Circuit 2—the 3-coil arrangement with a tuned plate coil. The scheme for this can be followed out readily enough by now and need not be given in detail. In the particu-



## Luminous Frequency Standards

**Q**UITE recently there has come from Germany the news of a new type of frequency standard, the luminous piezo-electric crystal resonator. Through the courtesy of Mr. David Loewe of New York City the writer has had the privilege of playing with one of the resonators as manufactured commercially by the Loewe Radio Company of Berlin. Before describing the Loewe type resonator, it is not amiss to say something about quartz resonators in general.

Much interest has been worked up in the use of the piezo-electric oscillator for transmitter frequency stabilization and wavemeter calibration but little has been said of the forerunner of the quartz oscillator—the resonator. It was with the quartz resonator that Dr. Cady did a large amount of his original piezo-electric work. In Fig. 1 a simple form of resonator is depicted. The piezo-electric quartz crystal *Q* has pieces of tinfoil *T* pasted to each of its large surfaces. To the tinfoil surfaces two connecting leads are soldered.

The piezo-electric crystal is taken from the uncut quartz as has been explained many times in *QST* and other radio journals. A crystal does not have to be tremendously piezo-electrically active to be a good resonator. A "dud" as an oscillator may be perfectly satisfactory as a resonator.

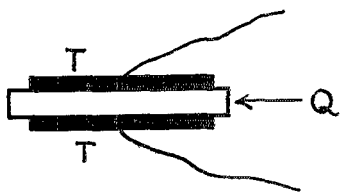

FIG. 1

There are many circuits in which the resonator may be used. Possibly the simplest is shown in Fig. 2 in which the tinfoil coatings of the crystal are connected to the tuning condenser in a 201-A tube oscillating circuit. The ordinary regenerative receiver furnishes ample power for resonator use. If the coil and condenser combination is such as to be capable of being resonated with one of the fundamental frequencies of the crystal, as the condenser *C* is varied a short musical click or "twang" will be heard in the headset when the secondary of the oscillator passes through the frequency of the crystal. As explained by Dr. Cady this note (it is really too short to be called

a note—it is a musical click at any rate) is accounted for in the following fashion: The crystal has a definite amount of inertia. Once it has been set into oscillation it tries its best to keep on oscillating even after the source of excitation has been removed. When the oscillator hits resonance with the crystal, the crystal vibrates. As the oscillator condenser is varied just a little off resonance, the crystal momentarily continues

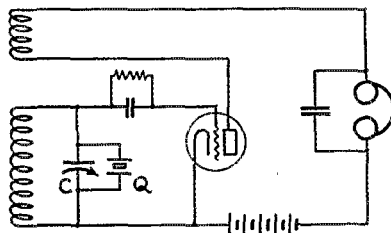

FIG. 2

to vibrate at its natural frequency. Since this frequency differs from that of the oscillator, the two frequencies combine to form the beat "twang" heard in the headset. Since the crystal maintains its vibration only for a very short time when the oscillator is off tune with it, the beat note is of very short duration. That setting of the tuning condenser at which the strongest resonance click occurs is one of the natural frequencies of the crystal. If the crystal has been previously calibrated, an extremely accurate frequency standard results.

As the crystals do not have to dissipate much power the crystal resonators can be tiny things ranging in size from a few millimeters long and a few tenths of a millimeter thick, up to a piece almost as long as a lead pencil. And since they are never worked in a circuit which impresses a comparatively high voltage of their surfaces, there is comparatively little danger of their being shattered through vibrating themselves to pieces.

In almost all cases use is made of the "lengthwise" vibration in the crystal. As a result, resonators working up in the thousands of meters are comparatively thin pieces of quartz. The lower limit of frequency of the resonator type of crystal is governed entirely by the size of uncut quartz available from which a good piece of crystal may be extracted. For very long waves, Dr. Cady cements two crystals to an iron bar and makes the iron bar vibrate at radio frequency, but this is another story.

Working on the quartz resonator, Professor Giebe and Dr. Scheibe of Germany have found that the oscillations in a quartz resonator may be made visible by a luminous effect. They found that a quartz resonator sealed in a vacuumous chamber in which a mixture of helium and neon gases are present, will glow brightly when the quartz crystal is set into vibration through an externally induced voltage. The vibration of



the quartz polarizes the "plates" forming the crystal mounting, and this polarization brings the gas to luminescence. This happens only when the exciting voltage's frequency very very closely corresponds to the natural frequency of the quartz resonator. If the frequency of the impressed E.M.F. is varied the least bit from the resonant frequency of the quartz, the resonator will cease to glow.

In practical form these resonators have been developed by the Loewe Company and are being offered for sale in this country.

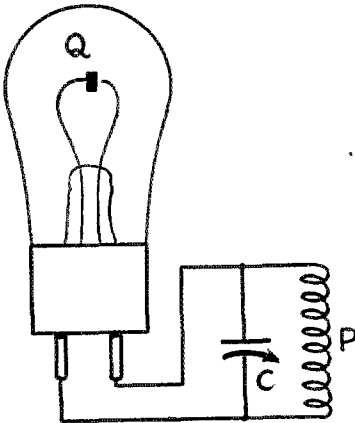

FIG. 3

The resonators are enclosed in a glass bulb and fitted with base and two pins similar to a vacuum tube. When fitted with a pick-up coil, shunted by a condenser as shown in Fig. 3 these resonators constitute a practical form of direct reading frequency

standard. The crystal being in a permanently fixed mounting inside a vacuum, will never change its frequency characteristics as long as it is not actually broken. The crystals are cut so that their temperature coefficients are essentially zero. The resonant frequency of one of these resonators can be considered as a standard, when the crystal has been calibrated from some known frequency.

The resonators will glow with a brilliant sunset colored glow when a voltage as low as 30 is induced on the plates. They will glow only when the frequency of the induced voltage does not differ from the resonator's frequency more than one part in several thousand.

For our O.W.L.S. work nothing could be simpler than one of the Loewe resonators. Set the resonator on the operating table near the transmitter, and as long as the resonator glows you know your transmitter is operating at the frequency of the resonator. If anything goes haywire, out goes the lamp!

The easiest way to get acquainted with the resonator is to connect it as shown in

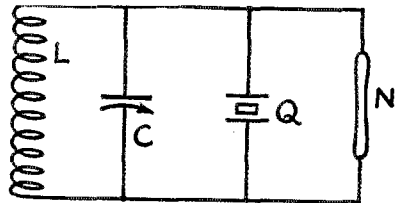

FIG. 4

Fig. 2. Do not try to find the glow, at first, but listen in on the headset and when the loudest click is heard, vary the tuning condenser very slightly and the glow will appear. The tube in the oscillator should be a 201-A and the plate voltage around ninety.

For broadcast work (or the super O.W.L.S.) a complete station frequency monitoring system is available. The broadcast type appears in Fig. 5. Five of the resonators are mounted on a bakelite strip, and are all connected in parallel and across the pick-up coil. In this case the coil is a honeycomb. The middle crystal is ground to the wavelength of the broadcasting station. The first crystal to the right is ground to 0.1 meter below the middle one, the 2nd to the right, another 0.1 meter below the crystals at the left are 0.1 and 0.2 meter above the station's wavelength. The complete assembly is set up somewhere in the operating room and as long as the station is on its correct wavelength the middle "lamp" glows. If the wave wanders south, the middle lamp goes out and one of

the others light up. The operator knows immediately whether to increase or decrease the wavelength of the transmitter!

The Loewe resonators are available in wavelengths from 35 meters to 1,200 meters. The commercial accuracy to which they can be adjusted is 1/50 of 1 per cent! If still greater accuracy is desired they can be ground even closer to the wavelength you want.

—J. M. C.

## Pacific Division Convention

October 15—16—17, San Jose, California

**T**HE Hotel Vendome has been chosen as the Headquarters for this year's Annual Convention and it will be in charge of the Santa Clara County Amateur Association.

A wonderful program has been prepared and such well known speakers as Col. Dillon, McGown, Best, Loghry of the Signal Corps, Wilkins Power Co. expert and Director Babcock will all be there. Headquarters is sending A. A. Hebert, Treasurer and Fieldman as its representative.

Special hotel rates of \$1.65 per night has been obtained and special Railroad Rates will be granted. Be sure to tell the Station Agent when buying your ticket. Registration including banquet is \$3.50. The Committee will appreciate it if you will drop a card to F. J. Quement, Chairman, 51 Pleasant St., San Jose, Calif. of your intention to be present.

## Using Wavemeters Without Indicating Devices.

**O**NLY recently we were greatly surprised to learn that a large number of the gang do not know how to use a wavemeter which has no indicating device—no thermo galvanometer, flashlamp or other device for indicating resonance between the wavemeter and the transmitter. We thought everyone knew how to use a wavemeter of this type. The old style General Radio 247W meter was not equipped with any resonance indicator, and we thought that everyone knew how to use one of these meters.

In adjusting the transmitter to a particular wavelength the wavemeter without an indicating device can be used just as easily as one with an indicator. Practically every transmitter from the lowly 201-A tube type up has either an antenna ammeter or a plate milliammeter, or both. If your transmitter has only a plate milliammeter, the wavelength to which the transmitter is tuned, can be measured by bringing the wavemeter up close to the primary of the transmitter, varying the capacity in the

wavemeter and watching the plate milliammeter. As resonance with the transmitter is approached, the plate milliammeter will either sharply rise, or fall, depending upon the type of primary circuit you are using and also upon the portion of the circuit you are coupling the wavemeter to. The point of maximum deflection (in either direction) of the plate milliammeter is the resonant point between the wavemeter and the primary.

In like manner as the wavemeter is brought into resonance with the antenna circuit, there will be a change in current in the antenna ammeter. The point of max-

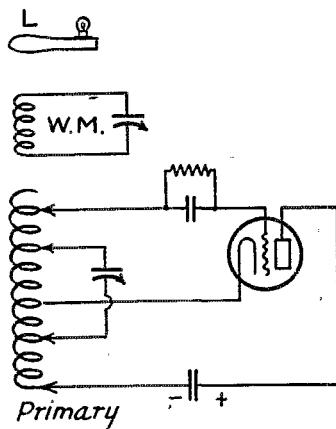

imum change in the deflection of the antenna ammeter is the resonant point of the wavemeter with the antenna, and is the wavelength to which the antenna is tuned. In both types of measurements, however, care should be taken to couple the wavemeter to the antenna or primary circuit only closely enough to get a readable deflection on the meter in the transmitter. If the coupling is too close the wavelength of the transmitter will be changed as resonance is secured, and the wavelength as measured by the wavemeter will not be the correct one.

If the transmitter has no meters of any kind in its circuit, the old scheme shown in the illustration can be used. The wavemeter is set close to the primary of the transmitter and a single turn of heavy wire is attached to the terminals of a small flashlight bulb in a miniature socket, and placed in inductive relation to the wavemeter, and fairly close to it. When in tune with the primary, the lamp will light when resonance is reached. This is due to the fact that the wavemeter, when tuned to the primary, has the effect of tightening the coupling between the lamp and the driver.

—J. M. C.

## Converting the ET3619

By Harold P. Westman, A.R.R.L. Information Service

**T**HE ET3619 is a direct-coupled transmitter designed several years ago by the General Electric Company for sale through the Radio Corporation of America. It uses four UV202 Radiotrons in a direct-coupled Hartley circuit for operation in the 150-200-meter band. Many of these sets have been sold recently and many of the purchasers are not sure how they should change the set connections to fit the present wave bands and the present regulations of the Department of Commerce.

As a matter of fact the sets may be converted quite easily to operate in the present-day, shorter wave-bands, and to use loose-coupling to the antenna circuit, as is required by the latest regulations. UX210 tubes may replace the older UV202s.

For operation in the 150-to 200-meter band, it is only necessary to loose-couple the antenna circuit as shown in Fig. 1. This may be done by disconnecting the antenna leads from the oscillator helix and inserting a coupling coil between the antenna series condenser (the side which originally went to the inductance) and the antenna ammeter (also the side which originally went to the inductance).

The antenna coupling coil may consist of three to five turns of No. 10 or No. 12 bare or enameled wire wound on a four-inch tube. The wire should be spaced equal to its diameter. This may be easily done by winding two wires parallel to each other and then removing one of them.

The tube may be mounted on a long brass

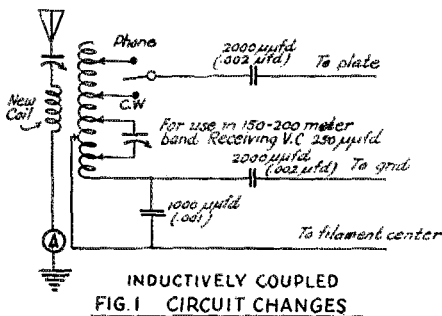

hinge and hung from the top binding strip of the helix support. About a two inch hinge will do the trick nicely. Use brass hinges as iron or steel are magnetic and will cause losses which brass averts. The coupling coil may be held at its proper position by a piece of string tied to the lower

side of the coil form and passed through the end hole in the upper half of the hinge which should extend above the top supporting bar of the helix. See Fig. 3.

The proper size of antenna to be used with this set may be found in the article on this subject appearing in the May, 1926, issue of *QST* on page 46. Make your an-

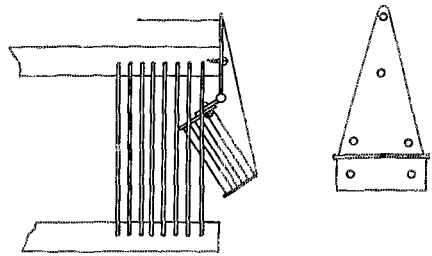

FIG. 2 EXTRA ANTENNA COIL FOR HIGHER BANDS

tenna fundamental between 5% and 15% higher than the wave you are going to work on. The series condenser will bring the wave down.

In order to allow the primary circuit to tune up to the 200-meter wave, it will be necessary to shunt part of the primary helix with a small capacity. A good make of receiving variable condenser of about 250- $\mu$ fd. capacity may be used and should be connected in as shown in the diagram. This should be mounted close to the helix and connected with heavy leads. It may be mounted on a wooden panel and fastened to the rear of the helix frame with suitable spacing brackets. By its use, the adjustment of the transmitter to a definite wavelength is simplified and it allows the circuit to tune to the higher limit of the 150-to 200-meter band without much trouble. It also helps to steady the wave by minimizing the effects of small capacity changes in the oscillating circuit.

A 1000- $\mu$ fd. (.001- $\mu$ fd.) fixed condenser is shunted across the grid portion of the oscillator helix so that when shifting from C. W. to phone the change in capacity from that of two tubes to four tubes across this part of the coil does not materially change the wavelength of the circuit. If only one type of transmission is to be used, this condenser may be cut off the circuit. The set as purchased has two plate clips with a switching arrangement so that only one is in the circuit at a time. The one nearer the filament is used on C.W. transmission

and the other for phone. Remember this when tuning up. When phone is used, the regulations of the Department of Commerce require that the circuit be tuned to the 170-to 180-meter band or the 83.3-to 85.6-meter band. These are the only two bands where amateur phone transmission is allowed.

**80-Meter Work**

If it is desirable to use the set on the 83.3-to 85.6-meter phone band, it will be

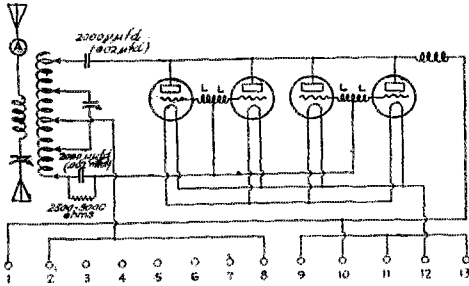

FIG 3 REVISED CIRCUIT

necessary to do a little more work than for the 170-to 180-meter band. The radio frequency choke should be replaced by a smaller one. This is the large coil of fine wire wound on a porcelain form, located in the lower left hand corner of the set (viewed from the rear). It should be replaced by a coil of 100 turns of No. 30 D.C.C. wire wound on a 1" tube. The wire from the old choke may be used. Mount the new choke on an angle bracket so that it stands vertically and put it in the position the old choke occupied. This will be at right angles to the main oscillator helix.

**40-Meter Work**

When 40-meter transmission is desired, it is advisable to remodel the set completely. Phone transmission is not allowed in this band and in any case it is essential to remove all unnecessary equipment from near the oscillating circuit. Even the iron framework should be replaced by wood. About ten turns of the inductance is all that is necessary for this band. Use a hack saw and cut through the top support strip and the base. This will give two self supporting units. Five of the fifteen turns may be cut off for the antenna coil and will save making the more complicated arrangement described above.

The circuit should be a simple one having as few accessory parts as possible. Whether or not you can get away with 4 tubes in parallel on 40 meters, is uncertain. In some cases, this is possible without taking any particular precautions, while in other cases it is necessary to insert grid chokes or resistances. If you want to be

sure, you can put them in at the start. They will do no harm and can do a considerable amount of good.

The simplest method of finding out whether all tubes are working or not is to start one operating and then plug in the others one at a time and note if the output goes up as each is inserted. If it does not go up or actually goes down, you can be sure that the tubes are not working properly and grid chokes are needed.

These chokes may consist of 20 or 25 turns of fine wire (some of the excess from the old plate choke) wound on a form the size of a lead pencil (1/4" or 3/8" dowel will do nicely) and tapped at the center turn. They should take the place of the connecting wires between the grids. Two such chokes will be required and the tubes will be connected together in pairs. Both chokes will have their ends connected to the grid of a tube and the two center taps should be connected together. The chokes are marked L in Fig. 3.

The circuit may be a simple Hartley as shown in Fig. 3 and will give excellent results if properly adjusted. For methods of adjustment see QST for June, 1925, page 23. This article, "Adjusting the Transmitter", will give you a world of information on the subject.

The condenser which is shunted across part of the coil, usually called the closed circuit, may be counted in place of the

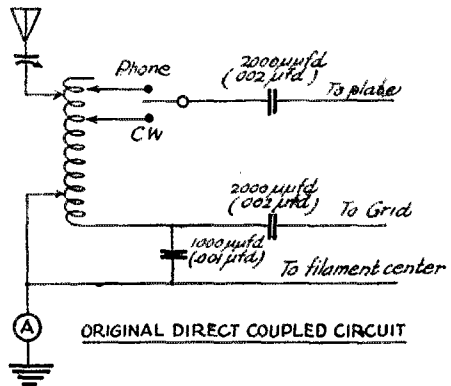

ORIGINAL DIRECT COUPLED CIRCUIT

"Signal Switch". The same antenna series condenser may be used. As the metal frame has been replaced by wood, the antenna binding post may be a small stand-off insulator similar to the General Radio type No. 260.

The sockets are mounted upon a strip of wood laid across the tops of the side pieces. The plate blocking and grid condensers can be mounted directly beneath this strip. The small flexible leads of these condensers

should be connected to 6-32 machine screws mounted in it. The leads to the helix should be run to these screws and can then be moved as much as desired without any danger of breaking the condenser lead off.

The helix is mounted on two narrow strips laid across the lower part of the end pieces. These strips may be 1" x 3/8" wood. The radio frequency choke can be placed at the left end and will have a short lead to terminal No. 1.

The numbers on the original terminal board correspond to the following circuit connections and if the ET3620 restifier unit is used its terminal connections are also as shown.

**ET 3619**

- 1. High-voltage positive
- 2. High-voltage negative
- 3. Microphone battery positive
- 4. Microphone battery negative
- 5. Microphone
- 6. Microphone
- 7. Microphone battery switch
- 8. Key
- 9. Key
- 10. Radiotron filament
- 11. Radiotron filament center tap
- 12. Radiotron filament
- 13. Microphone battery switch and ground

**ET 3620**

- 14. High-voltage positive
- 15. High-voltage negative
- 16. 110-volt A.C. line
- 17. 110-volt A.C. line
- 18. Radiotron filament
- 19. Radiotron filament center tap
- 20. Radiotron filament
- 21. Switch in microphone battery circuit
- 22. Switch in microphone battery circuit and ground

## ELECTION NOTICE

To All A.R.R.L. Members Residing in the Central, Hudson, New England, Northwestern (including Alaska), Roanoke, Rocky Mountain and West Gulf Divisions:

1. You are hereby notified that an election for an A.R.R.L. Director, for the term 1927-1928, is about to be held in each of the above Divisions, in accordance with the Constitution. Your attention is invited to Sec. 1 of Article IV of the Constitution, providing for the government of A.R.R.L. affairs by a Board of Directors; Sec. 2 of Article IV, defining their eligibility; and By-Laws 14, 15, 16, 17 and 18, providing for their nomination and election.

2. The election will take place during the month of November, 1926, on ballots which will be mailed from Headquarters in the first week of that month. The ballots for

each Division will list the names of all eligible candidates nominated for the position by A.R.R.L. members residing in that Division.

3. Nominating petitions are hereby solicited. Ten or more A.R.R.L. members living in any Division have the privilege of nominating any member of the League in their Division as a candidate for Director. The following form for nomination is suggested:

*(Place and date)*

*Executive Committee,  
A.R.R.L. Headquarters,  
Hartford, Conn.*

*Gentlemen:*

*We, the undersigned members of the  
A.R.R.L. residing in the .....*

*Division, hereby nominate .....*

*of ....., as a candidate for  
Director from this Division for 1927-1928.*

*(Signatures)*

The signers must be League members in good standing. The nominee must be a League member in good standing and must be without commercial radio connections. His complete name and address should be given. All such petitions must be filed at the headquarters office of the League in Hartford, Conn., by noon of the first day of November, 1926. There is no limit on the number of petitions that may be filed, but no member shall append his signature to more than one such petition.

4. Present Directors from these Divisions are as follows: Central, Mr. Clyde E. Darr, Detroit; Hudson, Dr. Lawrence J. Dunn, Brooklyn; New England, Dr. Elliott A. White, Hanover, N. H.; Northwestern, Mr. Karl W. Weingarten, Tacoma; Roanoke, Mr. W. Treadway, Gravelly, Danville, Va.; Rocky Mountain, Mr. Paul M. Segal, Denver; West Gulf, Mr. Frank M. Corlett, Dallas.

5. This is your opportunity to put the man of your choice in office as the representative of your Division. Members are urged to take the initiative and file nominating petitions immediately.

*For the Board of Directors:*

**K. B. WARNER, Secretary.**  
Hartford, Conn., 2 August, 1926.

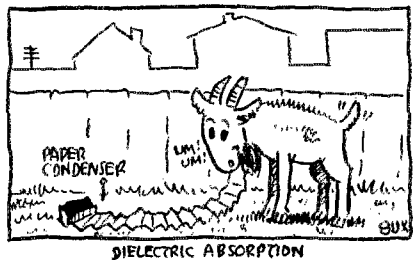



# Examining Quartz for Oscillator Use

## The Description of a Simple Instrument for Determining the Optical Properties of Quartz Plates

By L. H. Dawson\*

**T**HE quartz crystal piezo-electric oscillator had become very important in controlling the frequency of an oscillating circuit for radio and other purposes. Little has been written of the methods of testing and of cutting the crystals for oscillator purposes. These methods are optical methods, and being very simple to understand and carry out, it is thought that radio amateurs will be interested in the description of the following test-table and the directions for the use of same.

The natural quartz crystal may be pictured as a hexagonal cylinder surmounted by a hexagonal pyramid as shown in Fig. 1, a and b. It has four principal axes of symmetry, one, AB which is parallel to the sides of the hexagonal cylinder and is called the optical axis<sup>1</sup>, for along this direction the crystal has unique optical properties, and the other three CF, DG and HE, lie in a plane at right angles to the optical axis and at  $60^\circ$  to each other. These latter axes are called electric axes and have the property that a pressure exerted on the crystal in a direction parallel to any one of these produces electric charges of opposite sign at the termini of the axis, or conversely charges of opposite sign placed at the extremities of an axis will produce a slight compression in the crystal.

Piezo-electric oscillators are usually cut in such a manner that the optic axis lies in a plane of the oscillator and is perpendicular to one of the sides. Referring to Fig. 1 (a) and (b), OMN is the oscillator with the optic axis AB lying in its plane perpendicular to the side MN. One of the electric axes, HE, must lie truly perpendicular to the plane MNO, Fig. 1 b.

In order to understand the principle of the manner of determining the direction of the optic axis we must recall certain elementary facts about quartz. Crystalline quartz is a substance that is double refracting that is, when a ray of light is passed through the crystal in any direction *except* along the optic axis the ray is broken up into two plane polarized rays, polarized in planes at right angles to each other. Due to this peculiarity, when a ray of con-

vergent or divergent plane polarized light is passed through the crystal parallel to the optic axis and viewed by some means for polarizing light, a system of concentric

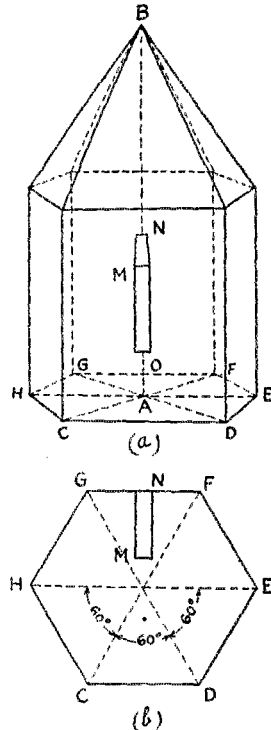

FIG. 1. A "PERFECT" QUARTZ CRYSTAL WITH THE AXES

colored rings are seen. This occurs only when the direction of the ray of light and of the optic axis of the crystal coincide. Thus a means is available for determining the direction of this important crystallographic axis.

There occurs in nature two type of quartz crystals, the so-called right handed, or right turning, and the left handed or left turning crystals. When a ray of plane polarized light is passed through the crystal parallel to the optic axis, the former rotates the plane of the light to the right and the latter rotates the plane to the left. Piezo-electrically, the effects in the right handed crystal are exactly opposite to those

1. Quartz crystals are rarely found in the perfect form shown in Fig. 1. The optic axis of the quartz is not a single line but any line through the crystal parallel to the sides, that is any line parallel to AB of Fig. 1a. In like manner the electrical axes are any lines through the crystal parallel to lines CF, HE and DG—Assist. Tech. Ed.

\*Heat and Light Division, Naval Research Laboratory, Bellevue, D. C.

in the left handed crystal; thus similar faces in the left and right handed varieties of oscillators will produce charges of opposite signs. Apparently, however, either type make equally satisfactory piezo-electric os-

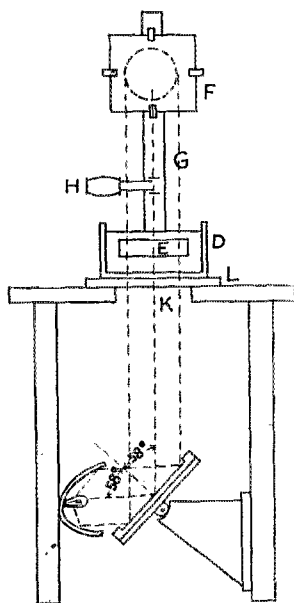

FIG. 2. FRONT VIEW OF THE SIMPLE "TEST TABLE"

cillators. It is a common phenomenon to find these two types of quartz in the same crystal, and an oscillator cut from such material will not produce satisfactory results as the left handed effects neutralize the right handed effects. This mixture of right and left handed quartz is known as "twinning" and must be carefully avoided in the selection of quartz for piezo-electric oscillators. The detection of twinning in quartz consists in passing a ray of parallel, or nearly parallel, plane polarized light through the quartz in the direction of the optic axis and observing this ray by means of some piece of apparatus that will polarize light. If the crystal happens to be twinned then beautifully colored patterns will be seen. Often these patterns will consist of pointed figures penetrating the crystal, but sometimes they may be present as parallel colored strips, or at times they may be very irregular. It must be borne in mind that this takes place only when the plane polarized ray passes through the crystal parallel to the optic axis.

An instrument for the determination of the position of the optic axis and for detect-

ing twinning is shown in the diagrams of Fig. 2 and 3 which are vertical sections at right angles to each other. There are two common methods in optics for producing plane polarized light, first by a nicol prism and second by reflection. The nicol prisms are usually very expensive, therefore in the present instrument the light is polarized by reflection, and the ray of light after passing through the quartz is examined on a reflecting surface. To produce plane polarized light by reflection the light from a source such as an incandescent lamp is allowed to fall upon a flat piece of glass at the so-called polarizing angle which is  $58^\circ$  for glass.

In the construction of the instrument, obtain or make a small table (Fig. 3) of convenient height and cut a circular hole K in the top of the table. This hole should have a diameter of about 8 inches. Cover this with a piece of ground glass L (preferably plate glass since there is less distortion of the image in plate glass than in ordinary glass). The ground glass produces a field of light which is of uniform intensity all over. Next procure two pieces of plate glass of good quality about 6 or 8 inches

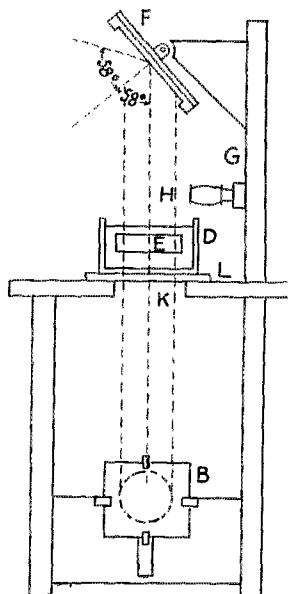

FIG. 3. SIDE VIEW OF THE TABLE

square, and paint one side of each with dull black paint. Mount one of these in position B as shown in the figure, and the other on an upright G in position F. These are the polarizing mirrors. The mirrors may be

placed upon wooden frames, with the black side next to the frame. It is convenient to mount these mirrors on some arrangement such as a ball and socket joint to facilitate the adjustment, although this is not necessary as a permanent arrangement may be used if care is taken to have the ray of light from the source strike mirror B at  $58^\circ$ , and the reflected light from B strike mirror F' at the same angle. The ray of light should be parallel, or nearly so. In order to obtain such a light source an automobile headlight A with the lens removed, may be used. The focusing may be done by the adjusting screw on the headlight. Again, care must be taken that the light

focal length (ordinary reading glass is satisfactory) and adjust it above the quartz under examination until a clear image is obtained in mirror F. Rotate the quartz in all directions until the brilliantly colored ring system is seen. At first this will require some patience, but after a little practice it can be done quite readily. When the ring system appears, the direction of the optic axis and the ray of light from B to F' coincide.

To detect the characteristic colors due to twinning in a piece of quartz bring the quartz into a position in which the optic axial ring system described above is visible, and then swing lens H around. If no twinning is present a field of uniform color will be present, while a presence of twinning will be indicated by the appearance of areas of brilliant colors extending into the quartz.

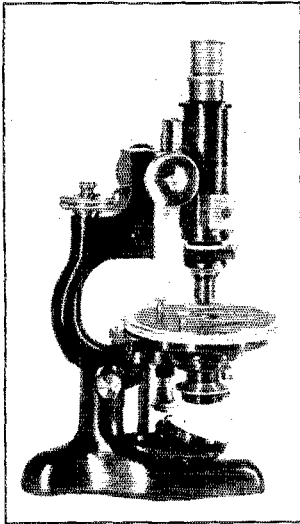

Fig. 4. (Photo courtesy of Bausch & Lomb) A petrographic microscope used for very accurately determining the optical properties of rocks and minerals. This instrument used two nicols prisms in place of the two reflecting mirrors described in the article.

is placed in such a position that the angle that the rays strike the mirror is close to  $58^\circ$ .

Having adjusted the optical system until a uniform field of light is obtained at mirror F', Fig. 2, hold the crystal in a glass vessel D filled with enough transparent machine oil of ordinary grade to cover the quartz E. The object of immersing the crystal in oil is to prevent the ray of light from being diffused by the rough surface of the quartz.

In order to observe the ring system, adjust the source A by means of the focusing screw in the lamp until a slightly convergent or divergent beam of light is obtained. Obtain a lens H of about  $1\frac{1}{4}$  to  $2\frac{1}{2}$  inches

### A Low-Capacity Socket

THE socket which appears in the illustration was designed especially to reduce the shunt capacity across the elements of any tube which is inserted in it. The ordinary socket raises the total tube capacity to some considerable extent. This new one is so cut away that the plate and grid terminals are separated by an air gap of half an inch. The base is of moulded bakelite provided with two half-moon shaped projections for steadying the tube. The contacts are of the "push-pull" type and are of heavy spring material. The socket will hold all of the standard UX-type tubes. As the path between plate and grid is broken by an air gap the resistance path between these elements of the tube are

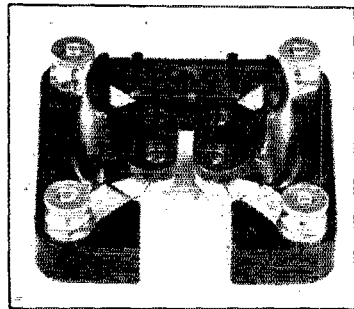

virtually governed by the internal structure of the tube, plus the resistance across the base of the tube itself. In very short wave receivers (or  $7\frac{1}{2}$ -watt transmitters, either) this type of socket should materially help things. It is made by the Airgap Products Company of Newark, N. J.

—J. M. C.

# Easy Tuner Design

**T**HROUGH the courtesy of Veech T. Baird of the Hammarlund Mfg. Co. we are able to present the following charts for the easy design of tuners and wavemeter circuits. The charts are laid out primarily for the use of the Hammar-

## Short Wave Tuners

The standard Hammarlund coil for short-wave work consists of a winding of No. 16 wire wound on a 3" tube of a substance somewhat like celluloid. The winding is spaced so that there are 10 turns per inch.

This is the kind of winding used in the Grebe CR 18 receiver, the Gross short-wave tuner etc.

Figure 1 gives almost everything one needs to know in order to build a short-wave tuner from a length of this standardized coil. Begin by deciding what the lowest wave for the coil is to be. Suppose it is 30 meters and we are fairly sure that we can keep the capacity of the tube, socket and wiring down to 10  $\mu$ fd. This means that we will have a little more than 10  $\mu$ fd. across the coil at 30 meters—for the tuning condenser never gets clear down to zero capacity. Let us suppose that the particular condenser we intend to use gets down to 5  $\mu$ fd. This means that we will have a total of 15  $\mu$ fd. across the coil at the lowest wave we want to tune to—i. e. when the dial is set at 0. Now we know the wavelength and the capacity. Turning to Fig 1 we lay a ruler across as shown by the dotted line A—crossing thru 15  $\mu$ fd. and 30 meter and striking the "Turns" scale at the place to show us the number of turns of the 10-per-inch coil which we will need. It turns out that we need almost exactly 14 turns—which makes a winding 1.4 inches long. Next question—what is the top end of the tuning range? That depends on the capacity of the variable condenser. Suppose that we used the condenser shown in the photograph, which has a maximum capacity of 100  $\mu$ fd. Adding the set capacity of 10  $\mu$ fd. this becomes 110  $\mu$ fd. Now we can find out the top end of the tuning range by running another line across the chart of Fig. 1 from 14 turns to 110  $\mu$ fd. This is line B and it can be seen to cross the wavelength line at 78. The range of the combination is from 30 to 78 meters—or if

one prefers it is from 3844 to 9994 kilocycles.

## Opening Out the Scale

Immediately someone will object that this is too much territory to cover—the stations

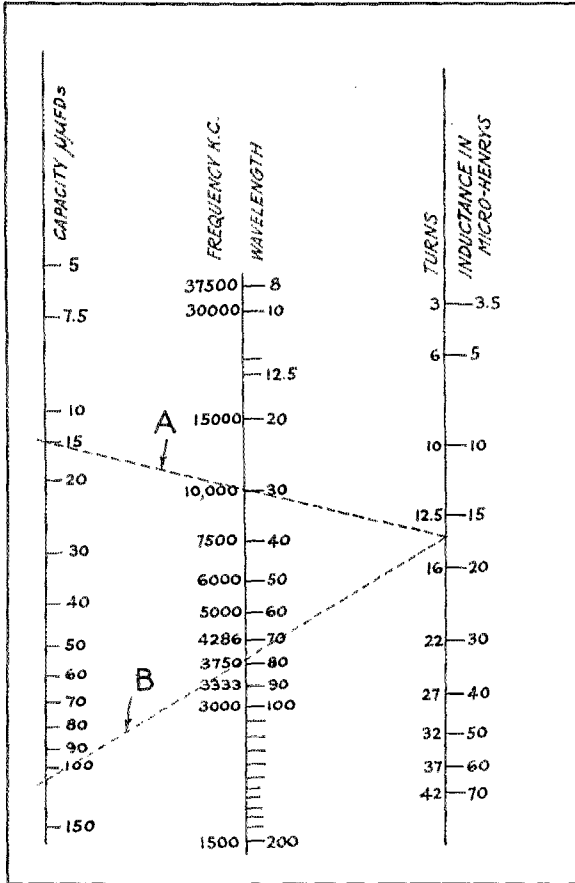

FIG. 1

### WAVELENGTH CHART, 8-200 AND 20-2000 METERS

As shown this chart goes from 8 meters to 200 meters and fits the Hammarlund short-wave coil which has 10 turns per inch on a 3-inch tube. The chart can be made to cover the range of 80-2000 meters provided the turns scale is not used. It then fits any wavelength problem as explained in the text.

lund standardized coils shown in one of our photographs but may also be used for tuners, wavemeters etc. using coils of other sorts provided they are not "trick coils" but are plain cylindrical windings—the sort of thing we call a solenoid.

will be too crowded. Very well—there are several easy ways to cure that. Suppose we use a smaller condenser instead. Since we are talking Hammarlund products anyway we can use one of their 65 or 45  $\mu$ fd.

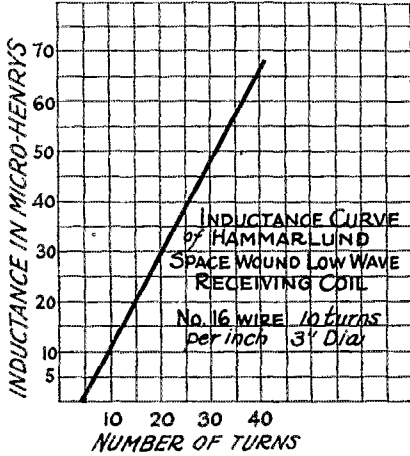

FIG. 2  
INDUCTANCE CURVE FOR THE SHORT-WAVE STANDARD HAMMARLUND COIL

The same information can be gotten from the two right-hand scales of Fig. 1.

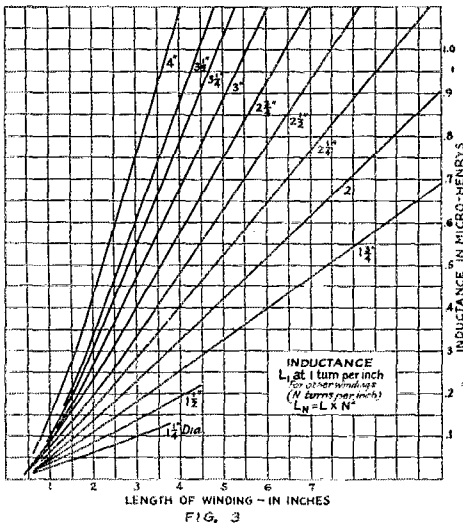

FIG. 3  
COIL-DESIGN CHART COVERING ALL BROADCAST AND AMATEUR TUNER COILS

The inductances shown are for coils having ONE TURN per inch. For any other number of turns-per-inch the inductance is made by using the simple equation shown on the chart.

vernier condensers which would give top ranges of about 65 and 55 meters respectively. The tiny 32- $\mu$ fd. condenser would give a top range of 48 meters. Incident-

ally—those of us who believe in tuners with small-capacity condensers are overlooking a good bet when we fail to use some such little condenser—not necessarily Hammarlund but some make or other which is solidly built and has a 1/4" shaft so that a freak knob isn't needed.

If you don't happen to believe in a large L/C ratio the wavelength range can be narrowed down—i.e. the scale opened out—by proceeding from the other end of the scale. First of all we cut down on the size of the coil and bring the wavelength back up by using a fixed shunting condenser. This fixed shunt can be a fixed air condenser such as those made by Cardwell or else it can be provided by the stunt suggested by Wadsworth of 3BE—also by a number of later contributors. This stunt consists of

Table A. Data for drawing curve for capacity of any condenser which is designed to give a straight line of frequency against dial setting when used to tune an inductance.

Dial setting	Percentage of Max. capacity
0	0
10	5
20	7
30	10
40	13
50	20
60	24
70	33
80	46
90	66
100	100

an operation on a condenser with semi-circular plates, such as the old-style Cardwell or National condensers. All of the fixed plates are left in place but some of the rotor plates are turned half way round on the shaft. Suppose we work the idea on a condenser with a maximum capacity of 140  $\mu$ fds. and with 3 rotor plates working between 4 stator plates. If one of the 3 rotor plates is turned around we will have a condenser that varies from one-rotor-plate-between-stator-plates to two-rotor-plates-between-stator-plates. Roughly the capacity ranges from 1/3 of 140  $\mu$ fds. to 2/3 of 140  $\mu$ fds. With corrections for the fixed capacities in the condenser it seems that the range will be about 50-100  $\mu$ fds. This is very different from the original range which was something like 3-140  $\mu$ fds. Suppose we start as before to make a tuner with a minimum wavelength of 30 meters. Allowing 10  $\mu$ fds. of fixed capacity in the set as before (tube, socket and wiring) we find from Fig. 1 that we will need just about 2 3/4 turns of coil. Practically, we can use a bit more, say 3 turns, because the tube-and-socket capacity will be less than 10  $\mu$ fds. The top range of the same tuner will be that obtained from 3 turns shunted by 110  $\mu$ fds. From Fig 1

this turns out to be 40 meters, very much the same sort of range that was gotten with the 32- $\mu$ fd. "midget" condenser. Which

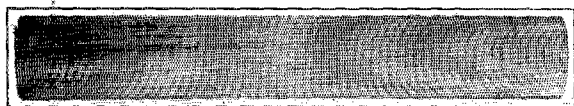

#### SOME OF THE HAMMARLUND STANDARD COILS

The upper cut shows a coil on 1-inch tubing and the lower cut one on 3-inch tubing. The tubing is of material similar to collaloid to which the wire is stuck so firmly that a 3" length of the 3 inch tubing wound with No. 26 wire can be turned inside out without destroying it.

will give the better signal strength is another question that needs some experimental work.

#### Other Uses of the 3" Coil

If one wants to know the inductance of a length of the coil this can be gotten from Figure 1 or else from Figure 2. Remember tho that these figures apply to the one type of coil only—the 3" coil with 10 turns per inch.

#### Other Coils

If some other sort of coil is to be used one must turn to Fig. 3. The use of this

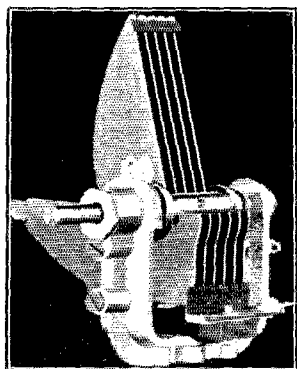

#### A SPECIAL HAMMARLUND CONDENSER FOR SHORT-WAVE TUNERS

The plate spacing is more than double to avoid dust noises and the minimum capacity is only 3  $\mu$ fd. while the maximum is 100  $\mu$ fd. The construction permits the removal of rotor plates if a lower maximum is desired.

curve is best illustrated by example. Suppose that we wish for some reason to use a coil of 4" in diameter. Curve K of Fig. 3 is drawn for such coils *but* the inductance values shown at the side of the chart are

those for coils having only ONE TURN PER INCH OF LENGTH. Suppose that the idea is to use a winding 3½ inches long and to put enough turns on this form to secure an inductance of 90 microhenries. The chart shows that a coil diameter of 4" and a length of 3½ inches will give an inductance of .915 microhenries if there is one turn per inch—i.e. 3½ turns. Now we want an inductance 100 times as great as this, which

calls for  $\sqrt{100}$ , i.e. 10 times as many turns. Therefore the coil will need to have 35 turns, or 10 turns per inch.

#### Broadcast Wave Tuners

Offhand it may not be very clear why one should wish to go through such gyrations. A little thought will show that Figure 1 may be used at broadcast waves by simply multiplying the capacity, wavelength and inductance scales by 10. The turns scale

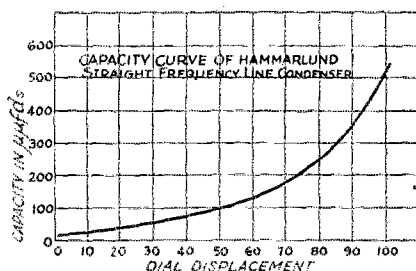

FIG. 4

#### CURVE OF CAPACITY FOR A CONDENSER WHICH GIVES A STRAIGHT LINE OF FREQUENCY AGAINST DIAL SETTING

This particular curve happens to fit the Hammarlund 550- $\mu$ fd. condenser but can readily be adapted to the special condenser shown in the photograph by use of table A.

should *not* be used (this can be gotten from Fig. 3) and of course the frequency scale will be correct if it is simply divided by 10.

When the chart has been modified in this way it becomes useful in the range of 80-2000 meters, provided the inductance of the coils is known—and that is taken care of by Fig. 3. The inductance of the standard Hammarlund coils (other than the 3", 10-per-inch kind) can be obtained from the makers and since they may change the specification now and then it is better to get the figures as needed. These values are supplied in terms of inductance of the coil for any number of inches of length up to the full 20" lengths.

#### Applying the Information

The purpose of printing this sort of information is—quite frankly—to help out  
(Concluded on Page 59)

## Multi-Purpose Shielded Units

By Wm. M. Henderson\*

**T**HE home building of a shielded R. F. amplifier, wavemeter or oscillator is quite a job. A ready-made unit to fit such needs would be of considerable convenience. Several shielded units have been constructed and while they are designed for reception, they may be used equally well for other purposes. Since the intention was in each case to devise a shielded R. F. unit, the story of one will be told from that angle.

Radio frequency amplification of the tuned amplifier type has, during the past three years, become the most popular of broadcast tuner and amplifier systems. The theoretical and ideal properties of a tuned radio frequency amplifier are so desirable that much experimentation is constantly being done with the object of more nearly approaching the ideal.

Shielding a tuned R.F. amplifier is the best and simplest method of increasing the selectivity and improving stabilization of the amplifier system. Complete shielding of an amplifier will prevent station pick-up, permit the construction of three or more

due partly to coil pick-up and partly to interstage coupling.

Station pick-up by the coils interstage and intercoil coupling have electromagnetic coupling<sup>1</sup> as the chief reason for their exist-

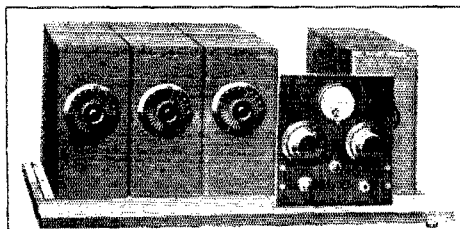

### A FIVE TUBE RECEIVER MADE OF THE UNITS

The first two units at the left are R.F. amplifiers, the next is a detector and the one at the right a two stage audio amplifier. The control panel carries an A-B voltmeter, a pilot lamp, a filament switch, a filament rheostat and a phone jack. The extra knob provides resistance control of detector regeneration. If the detector oscillates serious radiation is prevented by the amplifier stages.

ance. By placing the tuning system in a metal case, with shields between stages, magnetic coupling may be practically eliminated and consequently the faults mentioned above are prevented.

Realizing this, Samuel Cohen, began experimental work eighteen months ago on a solution to the problem of making the shielding of a radio frequency amplifier practical and within the constructional powers of the layman.

The object of this experimentation was to bring forth completely shielded, single stage, tuned radio frequency amplifiers. This unit design was chosen because the user of the shielded units would not be limited to any definite number of stages of amplification.

In starting the experiments on these units several things were set as points of perfection. First, the tuning should be sharp in a set made up of the units. Second, good amplification should be obtained, greater than in unshielded amplifiers. Third, the stabilization system should be operative over the entire frequency spectrum and simple to adjust. Fourth, the assembly of the units into complete sets, or the use of the metal cases for other than tuned radio frequency amplifiers, should be simpler than the construction of ordinary unshielded amplifiers.

1.—That is to say coupling between the coils—it is of course equally important to get rid of "IX drop" coupling by proper by-passes around those wires which would otherwise be common to the R.F. circuits of two different stages. For example, each stage must carry its own B-battery by-pass. This of course applies to any R.F. cascade amplifier. Tech. Ed.

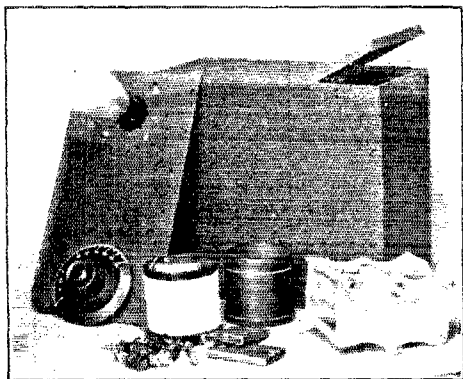

### ONE UNIT BEFORE ASSEMBLY

Two R.F. transformers are shown to indicate their appearance before and after winding.

stages of tuned radio frequency amplification, and greatly decrease interstage coupling.

The effect of metal shields on coils has been well covered in *QST* and in the Proceedings of the Institute of Radio Engineers, and will therefore not be entered into here. However, before getting to the main feature of this article a brief explanation of why shields improve the selectivity of most types of R.F. amplifiers will be given.

In an unshielded (tuned) radio frequency amplifier, poor selectivity may be

\*General Instrument Corporation, 477 Broadway, N. Y. C.

The first problem was the design of a good radio frequency transformer. In working on this part the thought was always borne in mind that the transformer had to operate perfectly in a metal case. Therefore tests were frequently made with a preliminary metal case having dimensions closely approximating those of the final one.

When the transformer gave satisfactory results comparative tests were made be-

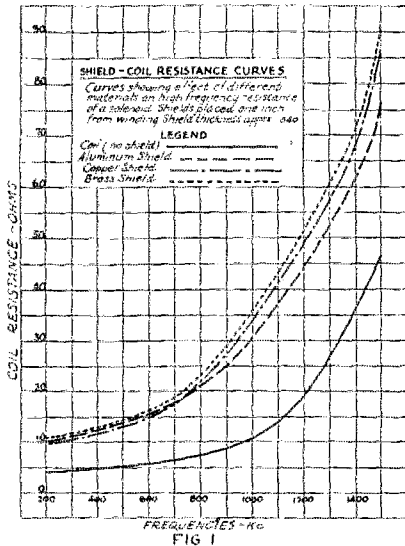

CURVES SHOWING THE VARIATION OF COIL RESISTANCE WITH FREQUENCY

tween identical shields of brass, copper and aluminum. When the proper size of the case was found for each metal and the best placement of the transformer was located the three were compared for amplification and resistance effect on the coil. The amplification of the coil was directly proportional to the effect of the case on its resistance, therefore the curve given in Fig. 1 will show the two results at once. As will be seen, aluminum proved to be best. This is but a comparative curve and not one of the transformers used in the cases.

The completed transformer construction is shown in Fig. 2. The primary coil consists of 14 turns of No. 36 enameled wire spaced with a silk thread wound in the slot. The secondary of 74 turns of No. 26 D.C.C. wire is wound directly over the primary. This transformer is tuned with a 350-micromicrofarad variable condenser for tuning a radio frequency transformer when completely shielded.

Digressing for a moment it might be interesting to some to know something about the direct reading method of measuring the coil resistance. A photograph of the set-up is given and the circuit diagram is given

in Fig. 3. This resistance measurement system was developed by the Weston Electrical Instrument Co. and operates in the following manner. The input to the measuring circuit is adjusted until the ratio of 1 to 12 is about 10 to 1, when the circuits are in resonance. The voltmeter reading and the ammeter reading of 12 are then combined in our old familiar ohm's law for the resistance of the circuit. Subtracting from this result the resistance of the ammeter and the condenser we have the high frequency resistance of the coil. In our resistance tests made in the General Instrument laboratory a moving light beam galvanometer was employed for the 12 readings.

Returning to the subject of amplification. At the present time only two stages have been measured. Two stages of tuned radio frequency amplification made up of shielded units gives an amplification of 144. A special vacuum tube voltmeter (but of the same type that was used in these tests) is being made so that three and four stages can be investigated.

The stabilizing method used in the shielded units is simple, and yet produces an amplifier that is perfectly stable over the entire broadcast band.

This method is known as the React-o-phase system and consists of an impedance element in series with a small semi-variable condenser connected between the grid and output of the tube as shown in Fig. 4. The operation of this impedance is exactly the same as those used in ordinary A.C. work.

In their simplest form these impedances

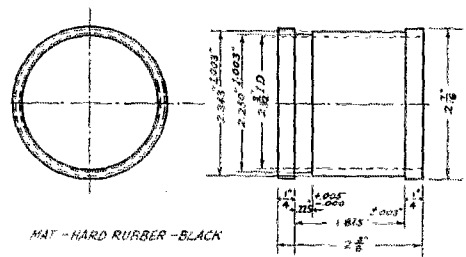

FIG. 2 THE RADIO FREQUENCY TRANSFORMER FORM

are wound on a 1/4" form with number 40 enameled wire, the number of turns being controlled by the size of the transformers used. Somewhere between eighty and two hundred is correct.

For the average tuned R.F. transformer with few primary turns as they are now made, a 100-turn coil will generally be sufficient.

The small series condenser can be any one of the mica dielectric instruments having a capacity range of 100 micromicrofarads to 500 micromicrofarads. The



system can be used for tuned or untuned R.F. amplifiers and also for stabilizing intermediate frequency amplifiers.<sup>2</sup> To stabilize an amplifier or the shielded units when using this balancing method, it is only

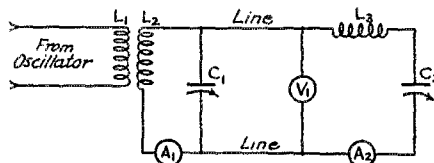

FIG. 3

#### THE WESTON METHOD OF MEASURING COIL RESISTANCE

The part labeled "line" should be about ten feet long to secure good separation between the input and measuring circuits.

C1 C2—Tuning condensers to adjust circuits to resonance.

A1, A2—R.F. ammeters.

V1—R.F. voltmeter drawing very small current. This may be a vacuum tube voltmeter or, under proper conditions, a Weston thermovoltmeter.

L3—Coil under measurements.

L1, L2—R.F. input transformer.

necessary to tune in a station and then adjust the condenser until the tubes stop oscillating. One to two minutes per tube is all that is required.

Thus with good transformer and circuit design several of the points of perfection have been reached. Good amplification and easy stabilization are so far assured. The choice of a five by eight by nine inch case for the size and binding post placement on the bakelite shelf as shown in Fig 5, take care of the constructional simplicity. There remains only the selectivity to be tested.

As an example of what can be done in selective tuning, a set made up of three shielded units as amplifiers, shielded unit amplification, one as a detector (the units as amplifiers) shielded unit amplification, one as a detector (the units are interchangeable detectors or amplifiers) and one case and shelf for an audio amplifier.

This seven tube set was operated under the antenna of WEAf with no interference from that station at any time. This extreme selectivity necessitated the use of a shielded battery cable and compartment. For ordinary work the amount of pick-up from the battery leads will not cause any trouble.

2.—Of course the choke and condenser must be changed in accordance with the frequency. Tech. Ed.

As many shielded units may be connected in cascade as is desired. More than six is not suggested however. The filament control of the radio frequency and detector tubes is not critical. One rheostat can be used to take care of them all. Once the correct setting is found for best signal strength, no further adjustment is necessary until the battery runs down.

It may occur to some readers that the use of more than one R.F. stage will result in a "three-handed set". This is of course true and some work has been done to devise a form of the set which will make it possible to concentrate the controls. It should be noted, however, that the change to such form will necessarily complicate the construction and that the inevitable result must be less flexibility in the use of the individual unit. It is worth noting at the same time that the radio public has used "three-handed sets" successfully in very large number.

Aside from straight cascade amplifiers these units lend themselves admirably for use as first detectors in super-heterodynes and as additional steps of amplification for present receivers. Readers of QST will probably be interested in the un assembled units. The aluminum case as well as any

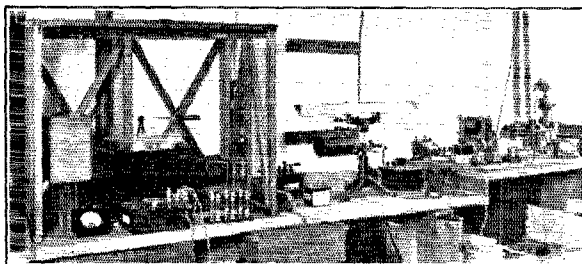

#### COIL RESISTANCE MEASUREMENT APPARATUS IN THE G. I. LABORATORY

The equipment shown is used to make measurements by the Weston method of Figure 3 or by the substitution method. At the right is the driver with its power supply. Next to that is a small pick-up coil which may be used to transfer power to the circuit under measurement. The current in this circuit may be measured by the thermo-galvanometer at the extreme left or else by the Western Electric thermo couple and the reflecting galvanometer. The thermo couple is in the square box just to the left of the three legged iron stand holding the galvanometer scale, while the galvanometer itself is mounted on the wall and fed through the shielded cable. The cage around the apparatus at the left is made of incomplete turns of wire which act as a static shield but permit r.f. energy transfer through magnetic coupling. The large object in the center of the cage is a Bureau of Standards Type precision condenser. At the right front of the cage is a mercury switch for use with the substitution method, which is described in detail in text books and in circular 74 of the Bureau of Standards.

of the other parts can be procured separately. With the case and shelf, audio frequency amplifiers can be made which will match sets made up of the assembled units, a desirable practice as then there will be

no pick-up from the audio end or intermediate frequency amplifier (if one is used).

Using the coil (condenser) case and shelf it is easy to make oscillators, wavemeters, calibrated oscillators, and other laboratory equipment. Always use the coil form if special inductances are required for use in

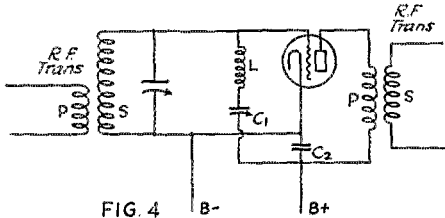

FIG. 4 THE STABILIZING SCHEME

The stabilizing action depends upon the constants of L and C1, also somewhat upon the constants of C2.

special circuits. This form is the result of much experimentation and is the correct physical size to produce a coil having the lowest resistance in the case.

Some adaptations of the unassembled units will call for additional parts mounted on the front of the case such as resistance units for controlling detector regeneration. Aluminum is easily worked and therefore no trouble should be encountered in drilling the walls for such parts.

There are one or two difficulties yet to be ironed out in the construction of short wave amplifiers built up with the Shielded Units. Fair results have been obtained down to 80 meters. When everything has been

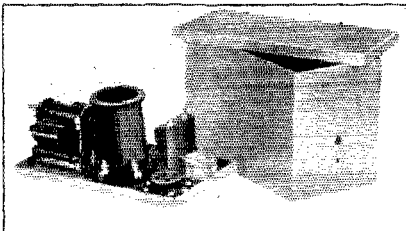

ANOTHER SHIELDED UNIT TYPICAL OF MODERN CONSTRUCTION

Holes are punched in the can for mounting of standard apparatus and plug-in coils are used adapting it to various wave bands.

smoothed over, the information will be forthcoming.

These shielded units, both assembled and unassembled, when used in the construction of super-heterodyne receivers materially decrease the trouble ordinarily encountered in the construction of shielded sets of this type.

## A New Voltmeter

**P**IN-JACK voltmeters have been available several months from a number of meter manufacturers. The latest idea in the form of a plug-in voltmeter is the type shown in the illustration. The voltmeter is equipped with pins designed to fit voltmeter terminals of several broadcast receivers. The pins are mounted on swivels so that any variation in the jack spacings on receivers of different makes can be compensated for. The meter is a high resistance type having a resistance of approximately 125 ohms per volt. This means that the instrument will draw very little current from the A battery, be it dry cell or storage cell type. A high resistance stand for this meter has just been developed. In the base of the stand a high resistance is so connected that when the meter is plugged into the jacks provided on top of the stand, the

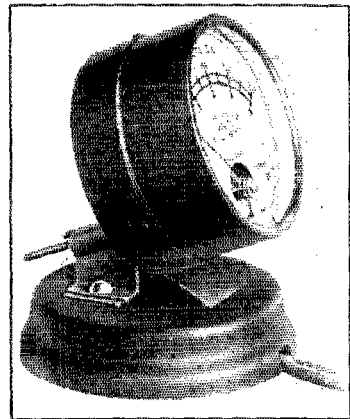

high voltage scale of the meter can be used for measuring B battery voltages and for shooting trouble in a receiver. The meters are available in two standard scales, a 160/4 volt one for dry cell tubes and a 160/8 volt one for storage cell tubes. The meters and high voltage stands are made by the Weston Electrical Instrument Corp'n. of Newark, N. J.

—J. M. C.

## Strays

The N. Y. Central Lines have recently completed some "train control" tests, the problem being to provide communication between the caboose and the engine on a mile-long freighter. Apparently the problem has been solved by the use of a radio telephone transmitter in the caboose end and a receiver up forward in the cabin.

# Radiotron Model UX210

**T**HROUGH the courtesy of Mr. J. C. Warner of the Research Laboratory of the General Electric Company, we are able to present herewith detailed information with regard to the new vacuum tube type UX-210. We believe that it will be thoroughly appreciated by our readers even at this late date. The following text, except for a change in sequence, is printed verbatim as received, the portions have been omitted for lack of space.

Radiotron model UX-210 is a vacuum tube designed for use as an oscillator, modulator or power amplifier in radio transmitting circuits. It is also intended for use as a power amplifier with loud speakers where high output is required.

The ratings of the tube are as follows:

	Amplifier	Oscillator
Filament Volts	6.0 to 7.5	7.5
Filament Amperes	1.25 (max.)	1.25
Plate Volts	425 (max.)	350
Plate Amperes	.030 (max.)	.06
Output (Watts)		7.5
Maximum Safe Plates	12 watts	15 watts
Power Dissipation		

### Installation in Transmitting Sets

In modulated CW circuits, particularly when buzzer modulation is employed, the

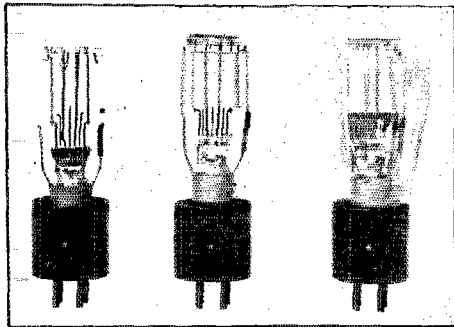

peak voltages between grid and filament may become very high and in order to protect the tube from damage from this source a 1/32" spark gap should be connected between the grid and one side of the filament.

In case of severe overload, resulting in overheating of the tube, the electron emission may decrease. Unless the overload has liberated a large amount of gas, the activity of the filament may be restored by operating at rated filament voltage for ten minutes or longer with plate voltage off. This process may be accelerated by raising the filament voltage to 9 volts but no more.

The plate power dissipation should never exceed 15 watts, and should always be kept as low as possible as the life of the tube is materially increased by conservative operation.

The UX-210 cannot be operated in parallel with the UV-202 because of the differences in amplification constant, plate impedance and mutual conductance.

When used as a modulator or a power

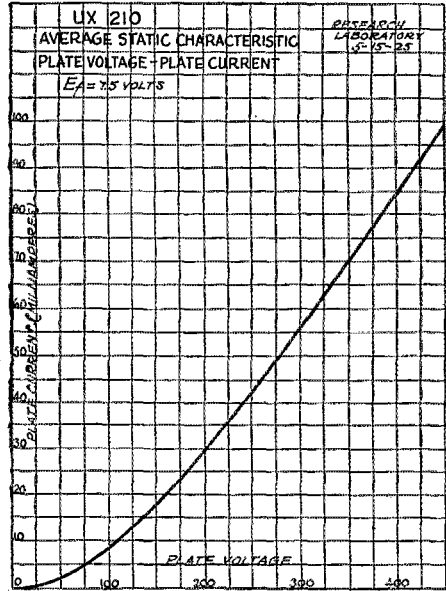

H-108878

amplifier negative grid bias should always be used and should be sufficient to limit the plate dissipation to 15 watts or less. If the plate current is greater than the normal amount when the proper grid voltage is applied, it is often an indication that the tube is oscillating or that it is picking up a radio frequency voltage from other circuits. An inductive grid leak tends to aggravate this condition.

### Use of Low Power Tubes at Short Wave Lengths

When Radiotrons, Models UX-210, UV-203A, UV-211, UV-204A and UV-851 are used at wave lengths of less than 50 meters, special precautions should be taken in order to be certain that the tube is not harmed by abnormal conditions.

Two of the most common causes of failure at short wavelengths are burnout of the grid or plate lead inside the tube or base and puncture of the glass stem or other insulation breakdown.

In general the tubes are satisfactory at wavelengths above 10 meters for the grid

and plate high frequency currents shown in the following table. A fuse blowing at the value given, placed in circuit close to the grid or plate terminal of the tube, will serve as a protection to the leads. A grid or plate lead inside of the tube should never be operated at such a temperature that it shows color.

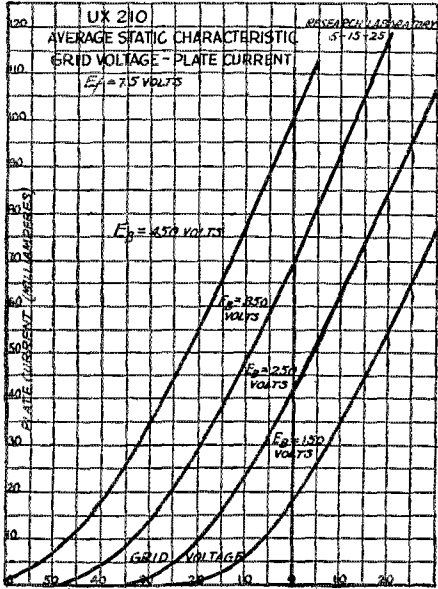

H-108879

Great care should be taken to prevent brush discharges in any part of the tube.

**Short Wave Data for Transmitting Radiotrons**

(Safe values for wavelengths above 10 meters).

Tube	Safe Plate voltage D.C. or RMS A.C.	Safe Plate Watts	Safe High Frequency Amperes Through Tube	Grid to Plate Capacity Based Microfarads
UX 210	350	10	5	8.0
UV 208-A	1000	75	7.5	22.5
UV 211	1000	75	7.5	18.5
UV 204-A	2000	200	10	19.0
UV 851	2000	600	10	57.0

For wavelengths below 10 meters even greater care should be used to obviate such a discharge and overheated interior lead wires. It may be found necessary to reduce the plate voltage and dissipation as the wavelength is reduced in order to prevent trouble.

H-108880 shows the variation in oscillating output when the filament voltage is varied. This curve indicates that the emission is ample for full output even when the filament voltage is slightly less than normal.

**Use as an Amplifier in Receiving Circuits**

The UX-210 is particularly suitable for operation of large loud speakers, since it is capable of delivering relatively large outputs without distortion.

The following table gives the correct values of grid bias for different plate voltages:

Plate Voltage	Negative Grid Bias	Filament Terminal Voltage	Approximate Plate Current Milli-Amperes
425	35	7.5	32
350	27	7.5	18
250	18	7.5	12
157.5	10.5	6.0	6
135.0	9.0	6.0	4.5
112.5	7.5	6.0	3
90.0	4.5	6.0	3

With plate voltages up to 160 volts, the filament may be operated directly from a 6 volt storage battery without rheostat control.

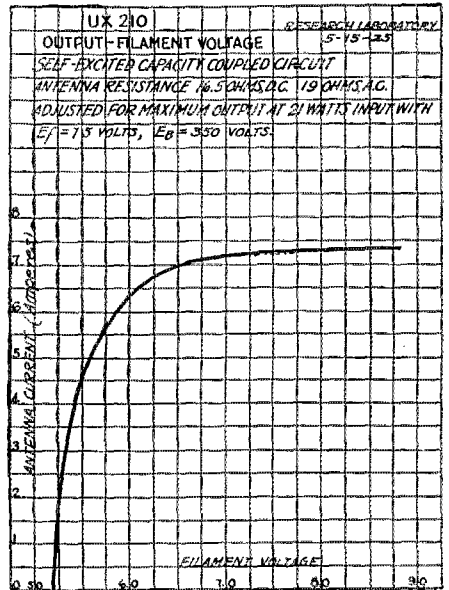

H-108880

In all cases the plate power dissipation should be limited to not more than 12 watts.

The electron emission of the X-L filament is a measure of the efficiency of the filament as a source of electrons. It is approximately 75 milliamperes per watt of filament power resulting in a total emission of nearly 700 milliamperes.

**Characteristic Curves of the UX-210 Radiotron**

The characteristic curves of the UX-210 Radiotron which follow are plotted from data obtained on a number of tubes and represent the average of these data. Individual samples of the tubes may vary somewhat from this average.

In making use of curves of plate impedance and amplification constant it must be remembered that these values are based on very small input voltages; hence are not applicable to the case of an oscillating tube. Also, in amplifier circuits where input voltages are more than a few volts some variation from these values will be found.

It is customary to make tube characteristics such as the plate voltage-plate current and plate voltage-plate impedance curves with zero grid voltage. This does not represent the usual condition of operation, since a negative grid bias is ordinarily required. However, it is not necessary to plot additional curves for each value of grid voltage, since within the limits of grid and plate voltage ordinarily used, it is possible to calculate the various quantities from the curve for zero grid voltage. This follows from the fact that applying a certain voltage to the grid has the same effect in the plate circuit as applying to the plate the same voltage multiplied by the amplification constant. It is then only necessary to find the equivalent plate voltage and make use of the curves drawn for zero grid voltage.

As an example, suppose that it is desired to find the plate impedance of a UX-210 at 350 volts on the plate and 20 volts on the grid. Print H-108883 shows that the amplification constant at 350 plate volts and zero grid voltage is 7.9. For most purposes this value of amplification constant is sufficiently accurate for use in the remainder of the calculation, but for extreme accuracy a second approximation may be made to correct for the negative bias. Thus, using 7.9 as the amplification constant, the equivalent plate voltage is found to be  $350 - (7.9 \times 20) = 192$  volts. For this value of plate voltage the amplification constant is found to be 7.7 and from this the new value of equivalent plate voltage is  $350 - (7.7 \times 20) = 196$  volts. This refinement is seldom necessary and 192 volts will be used for the remainder of the example.

Thus, with 192 volts as the plate voltage, it is found from H-108883 that the plate impedance is 4500 ohms; and from H-108879 that the plate current is 28 milliamperes.

It is obvious that the above method fails if the grid voltage times the amplification constant approaches the plate voltage.

In using the grid voltage-plate current characteristics it should be remembered that

these are *static* characteristics and must be used accordingly. For example, these curves alone cannot be used for predicting the length of the so-called "straight part of the characteristic" because the true dynamic characteristic of the tube is very different from the static characteristic and depends upon the constant of the load circuit as well as the constant of the tube. Consequently, the dynamic curves must be determined for each individual circuit condition.

A limit on distortionless amplification is encountered when the grid draws current, which occurs with the UX-210 tube at approximately zero grid potential, if the filament is lighted from D.C. source of power. When A.C. filament excitation is used the limit is at a negative grid voltage of approximately 4 volts.

The maximum output of undistorted power is obtained when the load resistance is twice the plate impedance of the tube under the conditions used.

In order to obtain the optimum operating conditions as illustrated for plate voltages of 350 and 450 volts, the plate impedance

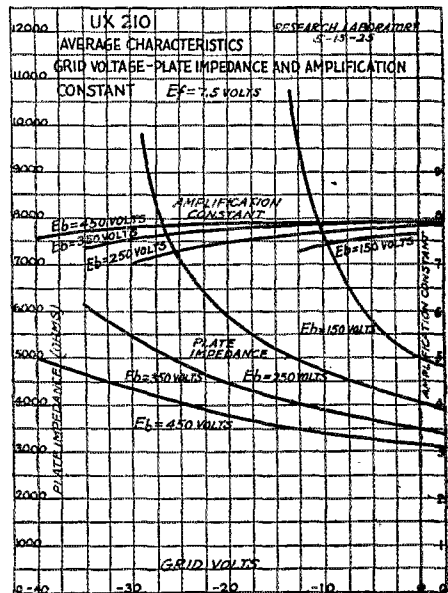

H-108883

for approximately the correct conditions should be obtained from print H-108883. A straight line with a slope equal to the reciprocal of the load resistance should be drawn across the family of plate current curves at a point where its intersection with the minimum current line is at a grid bias,

which is twice the grid bias of its intersection with the plate voltage line.

The latter intersection is the operating point. The plate impedance of the tube at the operating point should be found and the slope of the straight line shifted accordingly. This will shift the operating point slightly, but more than one correction is usually unnecessary.

The straight line finally obtained is the optimum load characteristic and its slope is the reciprocal of the load resistance. This line gives the maximum and minimum plate voltage and plate current and the output power is calculated from the following equations:

$$P = 1/8 (E_{max} - E_{min}) (I_{max} - I_{min})$$

The load resistance is, of course,

$$\frac{E_{max} - E_{min}}{I_{max} - I_{min}}$$

and knowing these two quantities the A.C. plate current can easily be determined or it can be directly calculated from the plate current swing as shown on the curves.

To clarify the use of this method an example is given below for the 350 volt case.

$$\text{Given } E_b = 350 \text{ volts}$$

$$I = 1.5 \text{ m.a.}$$

The load characteristic is then drawn and its slope and position found as described, using H-108883 to obtain tube impedance. From this the following values are obtained.

$$E_c = 30 \text{ volts}$$

$$\text{eg max} = 60 \text{ volts}$$

$$\text{eg min} = 0 \text{ volts}$$

$$I_b = 13.5 \text{ m.a.}$$

$$E_{\text{max}} = 480 \text{ volts}$$

$$E_{\text{min}} = 195 \text{ volts}$$

$$I_{\text{max}} = 27.5 \text{ m.a.}$$

$$I_{\text{min}} = 1.5 \text{ m.a.}$$

$$P = 1/8 \times 285 \times .026 = .926 \text{ watts}$$

$$R_p = 285 = 11,000 \text{ ohms}$$

$$.026$$

At a value of load resistance lower than the optimum the grid swing is limited at the negative end by the minimum current obtained and the swing does not reach the zero bias curve. At a value of load resistance higher than the optimum the zero volt curve is reached first and the swing does not reach the minimum current line. In either case, less power is obtained than at the optimum load. It should be remembered that these results are for undistorted amplification and do not hold where distortion is allowed.



## New Fixed Condensers

THE condenser shown in the photo is the latest from the Dubilier Company. It is known as their type 700, and has several very appealing features. It is enclosed in an aluminum case which makes it impervious to moisture or the most violent form of atmospheric conditions; it is tested at 1,500 volts (D.C.) which shows it to be an excellent capacity in grid and plate circuits of low power transmitters, and if several are hooked up



in series or series-parallel arrangements (as was done by Hanson in the KEGK transmitter) the type 700 can be used in even the largest of ham tube transmitters. The condensers can be "stacked" either by machine screws through the eyelets or by soldering to the "tags", the lugs being thoroughly tinned. The type 700 is available in capacities from 250- $\mu$ fd. to 20,000- $\mu$ fd., all tested at 1,500 volts.

—J. M. C.

## A.R.R.L. Information Service Rules

Please help us by observing the following rules:

1. Keep a copy of your questions and diagrams and mention that you did so.
2. Number the questions and make a paragraph of each one.
3. Make diagrams on separate sheets and fasten them to the letter.
4. Print your name and address (not merely your radio call) on your letter. Don't depend on the return address on the envelope as this is destroyed when the letter is opened.
5. Don't ask for a comparison of the various manufacturers' products.
6. Before writing, search your files of QST—the answer probably is there.
7. Address all questions to Information Service, American Radio Relay League, Inc., 1711 Park Street, Hartford, Conn.
8. It is not essential to enclose an envelope as long as you supply postage and PRINT CLEARLY your name and address on your letter.

# Metallized High Resistance Units

By Joseph Morgan\*

**U**NFORTUNATELY the development of resistance units has not kept pace with coils and condensers. This is not because the resistance unit is any less important, but chiefly because the problem is a much more difficult one.

Before tracing briefly the history of the design of high resistance units, it may be advantageous to list some of the more important applications of such units to present

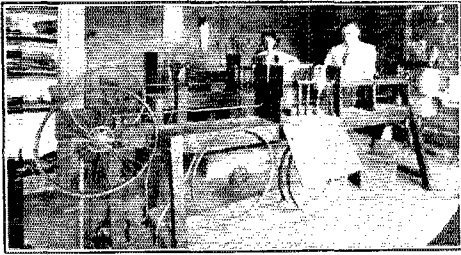

TWO OF THE GLASS-FILAMENT DRAWING MACHINES

The glass rod is fed in at the right, passes thru the flame in the center compartment and as the tip of the rod becomes heated it is drawn into glass thread which passes off to the left at great speed and is wound on the rim of the wheel at the left which is driven at high speed by the motor below. When the wheel has been wound full it is removed to the coating machine.

day radio. In radio, the chief uses for high resistance units are for gridleaks, amplifiers, coupler units, potentiometers, and for A- and B-battery eliminators. A good high resistance unit must be constant in value, noiseless, free of appreciable inductance or capacity, compact, durable, and have sufficient carrying capacity.

Naturally the first type of resistance unit was a coil of resistance wire. The limitations of this type of unit are many. In the first place, such a unit is very bulky if the resistance exceeds 100,000 ohms. Second, they are incapable of carrying much current without undue heating. Third, it is impossible to construct high resistance wire-wound units which have inductance and capacity sufficiently low for gridleaks and coupling units. Finally, these units are very expensive.

In order to overcome certain of these disadvantages, some years ago a unit was devised which consisted of two metal electrodes dipped in ink. The resistance was controlled by the distance between the two electrodes and the concentration of the ink.

This unit was in many ways very imperfect. It was not compact; it was not portable; it was not permanent; and the resistance could not be adjusted within ten per cent of the desired value.

Shortly after this, the very familiar unit consisting of a piece of paper dipped in India ink and clamped between two copper contacts was developed. There was scarcely any virtue outside of cheapness and compactness which was possessed by this type of resistor. It could not be made within 20 per cent of the desired value; it changed from day to day; was entirely unable to carry currents even of the order of a few milliamperes, without breaking down. Its chief merit was that of a humidity indicator, but unfortunately it does not seem to have been employed for this purpose.

An improvement upon the aforementioned type was made by enclosing the carbon paper and contacts in a small glass tube. Even with this protection, these units were erratic in behavior.

It was at this point in the development of high resistance units that The International Resistance Co. engineers began experimenting with a view to the development of a strictly scientific product. After many months of patient research, a method was found for coating the inside of glass tubes with a thin layer of metal. The glass tube was provided with brass caps and the caps were in metallic contact with the metal coating through the medium of low melting point alloy. While this type of resistor was



CLOSEUP OF THE COATING MACHINE  
At the extreme right is the wheel carrying the freshly-made glass thread. As this is unwound it passes thru the machine from right to left, meanwhile undergoing the processes described in the text.

an improvement over previous units, the film of metal was necessarily so thin in order to obtain the desired high resistance that it was impossible to make a perfect contact with the alloy in the brass caps.

\* Engineering Department, International Resistance Co., Perry Bldg., Philadelphia, Pennsylvania.

Further, the heat due to carrying the larger currents required for coupling units, made permanent changes in the resistance of these microscopically thin metallic films. This type of resistor frequently showed excellent characteristics immediately after manufac-

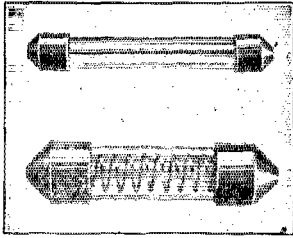

The present standard international resistor of the coated filament type and the new 15 watt resistor unit of the helical type. The resistance element in the latter is a coated glass filament, as in the smaller units.

ture. However, after several months of use these units deteriorated rapidly due to crystallization of the conducting film. Almost every conceivable type of substance was deposited on the inside of these glass tubes. Every known kind of glass and countless alloys for sealing it were tried.

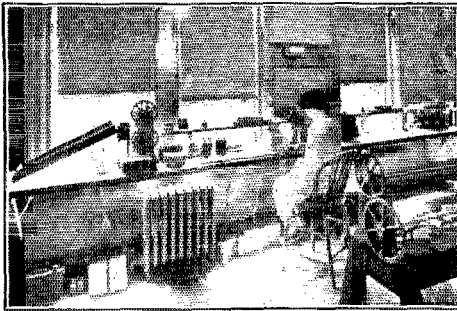

**THE COATING MACHINE IN OPERATION**

The operator is watching the meter which constantly indicates the conductivity of the coated thread. In the foreground may be seen a filament-drawing machine showing the other end, that is from the end at which the glass rod enters.

Each new specimen was subjected to the most rigorous scientific tests. Literally, thousands of specimens were constructed.

Out of all this experimentation, there was finally evolved the present type of metallized resistor with the glass core which fulfills the most exacting requirements which could be placed upon a high resistance unit. The glass tube, internally coated with a thin film, was abandoned. In its place a fine

glass filament is used. This filament is spun on a very ingenious and efficient machine in lengths of five hundred feet and is entirely uniform in diameter. The glass fibre is then passed through a conducting solution, and then into a high temperature furnace through which a steady flow of gas is maintained. This process results in the production of a perfectly homogeneous conducting surface, thoroughly hardened upon one of the finest insulators known. The coated filament has many advantages over the internally coated tube. First, due to the much smaller area of the filament it is possible to have quite a thick coating of conducting material and at the same time produce a very high resistance. Second, it is comparatively easy to put a protecting layer over the conducting filament, whereas it is difficult to coat such a layer on the interior of a tube, particularly if the bore of the

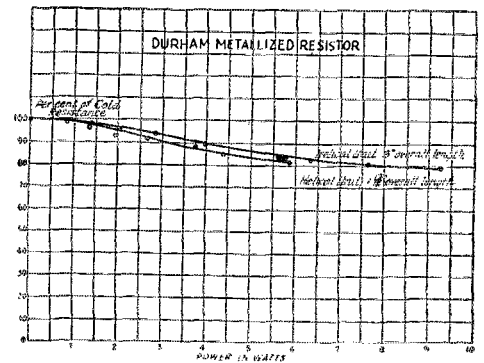

Fig. 1. Curve showing the effect of load-current in varying resistance. Note that the energies shown are far above those that will be encountered in receiving circuits, therefore this effect need not be considered in receivers. The helical units are meant for use in B battery substitutes and the like. See the table for suitable loads on the smaller straight-line units.

tube is small. Third, it is easy to make measurements of the conductivity of the coated fibre, as the fibre is fed out of the coating machine. It is difficult to make such measurements on an internally coated tube. The ease of measurement obtained in the case of the fibre insures a uniform product. Fourth, the experiences of our engineers have shown that it is possible to obtain excellent contact between the fibre and the metal cap whereas we have never been able to get satisfactory contact between an internally coated glass tube and its cap. In the case of the glass tube, comparatively short lengths of tubing must be used in the coating machine (at most eight or ten feet), whereas the coated filament can be made in lengths of five hundred feet, uniform throughout.



After the glass thread with its conducting coating has left the furnace it is next coated with durable protective film of insulating varnish which is then thoroughly dried by the application of heat. This impenetrable coating completely protects the conducting filament against atmospheric changes.

As the coated glass filament passes through the various stages of manufacture, its resistance per unit length is *continuously* tested. Literally, there is no inch of this fibre which has not been measured for resistance.

After the double-coated filament has passed through the measuring devices it is cut automatically in two foot lengths. It is then kept in sealed tubes until it is required for assembling the complete unit. Finally it is cut into lengths approximately 1 3/4" long and mounted in a glass tube with brass caps at the two ends.

A new form of power resistor has recently been developed by the engineers of the company. In this type of unit the filament is

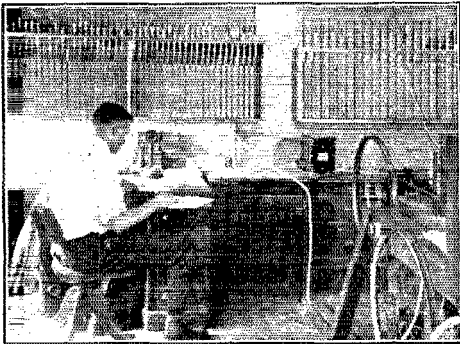

THE FINISHED FILAMENT WITH ITS DOUBLE COATING EMERGES IN TWO-FOOT LENGTHS FROM THE COATING MACHINE

Several dozens of these 2-foot lengths are stored in each of the glass tubes in the rack shown here. The filaments in one tube are of course of the same sort.

wound into the form of a helix, the diameter of this helix being exactly the inside diameter of the enclosing tube. The two ends of the helix are embedded in an alloy within the caps. The helix permits the use of a very long heavily coated fibre in a very small space. With this device it is possible to dissipate from 2 to 4 watts, depending upon the size of the unit, with less than ten per cent variation in the resistance of the unit.

The alloy in which the filament is embedded in the caps is the result of innumerable experiments. Its properties are such that it makes perfect electrical contact with the filament. The cap grips the contacting filament so tightly that it is impossible to pull the filament out without shattering it.

It is almost as if the cap, filament and alloy were made of one piece.

After the resistors are assembled they are

Standard Resistors Ohms	Milliamperes	Volts Across Resistor*
100	50	5
200	35	7
400	25	10
800	18	14
1000	16	16
2000	11	22
4000	7.9	32
8000	5.6	45
10000	5.0	50
20000	3.5	71
40000	1.8	71
80000	1.3	100
100,000	1.1	112
200,000	0.8	158
400,000	0.6	224
800,000	0.4	317
1,000,000	0.36	333
2,000,000	0.25	500
4,000,000	0.18	707
8,000,000	0.13	1000
10,000,000	0.11	1120

\* This means the voltage directly impressed across the terminals of the unit. When resistance units are used in series with the primary of transformers or in connection with the tube circuit the total voltage of the circuit does not appear across the resistor since there is a voltage drop thru the other device or devices.

FIG. 2. CURRENT CARRYING DATA ON STRAIGHT FILAMENT RESISTORS

again tested. The resistance units are normally made within a five per cent variation. On special orders it is quite possible to make them within two and one half per cent. Comprehensive tests on other makes and types have shown that on the average a resistor is seldom within ten per cent of rating and frequently exceeds fifteen per cent deviation from rating.

Current Carrying Data for Standard Straight Filament Resistors

The voltages and currents given in the table 2 are the values corresponding to the power loss which will produce

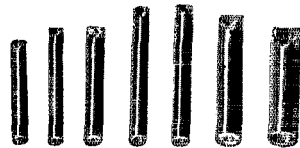

A few of the internally coated tubes which were tried. Note the varying diameters, both internally and externally. This is the first type of an internally coated tube resistor which was made in our experimental laboratories. The two curved ends were dipped into mercury cups for contact.

such a 10 per cent change in resistance. The resistors are capable of carrying, with-

(Continued on Page 55)

## Spark Coil Portable Transmitters

By Frank Wilburn\*

**W**E have a little portable transmitter that has been signing 6EL from Prescott, Arizona. It has occasionally worked as far as Massachusetts though the reliable range is of course much less. However the set has worked into California, Texas, New Mexico, Oregon, Washington, Utah, Colorado, Missouri, Illinois, Nebraska and Minnesota with signal reports to the effect that the wave was steadier than is usual for portable sets.

The power supply consists of a pair of

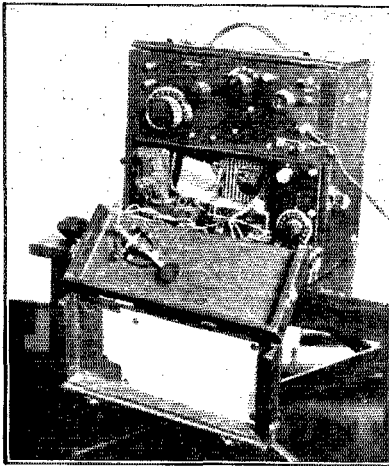

THE SET IN OPERATING CONDITION

The upper panel is the 51 receiver panel, at the left is the spark coil assembly, next the receiver B batteries and at the right is the transmitter panel.

Ford coils connected in parallel to give more output. Either vibrator may be used to operate both coils which is a convenience if one goes bad. With a little experimenting the vibrators may be adjusted to give a high steady note. The spark coils must be "poled" correctly, that is they must not buck each other and they must be connected correctly to the tube. The output from a vibrator coil is in the shape of a very "lopsided" wave amounting to interrupted D.C. If the tube or condensers spark across try reversing the Battery leads at "X"; you may have the plate negative during the strong part of the cycle.

The oscillating circuit is Hartley, series fed. The R.F. choke isn't strictly necessary but is used to make sure. The size of the coils and condensers (except C1) de-

pends on the wavelength at which the set is to be worked. This set happens to use a grid coil and a plate coil wound in the same direction on a 2 1/4" tube, using 6 turns of No. 16 D.C.C. wire in each coil.

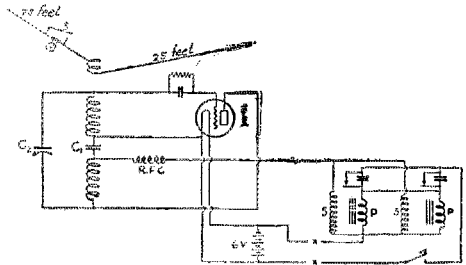

Because space was scarce it was necessary to slip the coil over the vacuum tube. The antenna coil consists of two turns of lamp cord wrapped around the other coils.

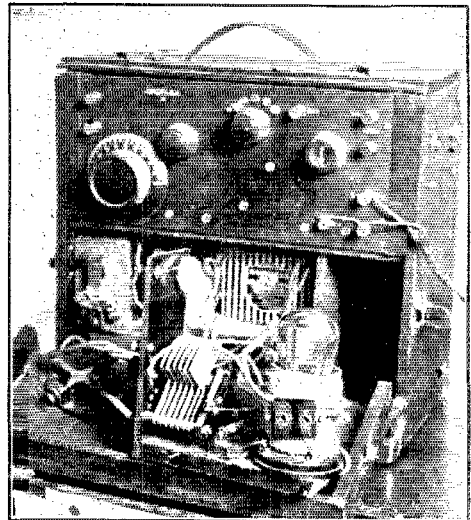

THE SENDING PANEL SWUNG OUT

The grid condenser is a 250-micromicrofarad Micadon with clips for holding the 50,000-ohm Dubilier "Metaleak". The stopping condenser C1 is a 1000-micromicrofarad Dubilier "Micadon" and need not be changed for use in different wavebands. The tuning condenser, C2, an old "23 plate"

\* 6EL, Box 730, Prescott, Arizona.

variable receiving condenser, cut down to fit the job and the space. Half the plates have been removed and the rest double-spaced after having been cut to a quarter-circle instead of a half-circle. (The capacity is probably near 60-micromicrofarads and it may be possible to use a more compact condenser such as the 65- $\mu$ fd Hammerlund vernier condenser. Tech. Ed.)

The antenna is cut to fit the wavelength (the 40-meter band in this case) and is

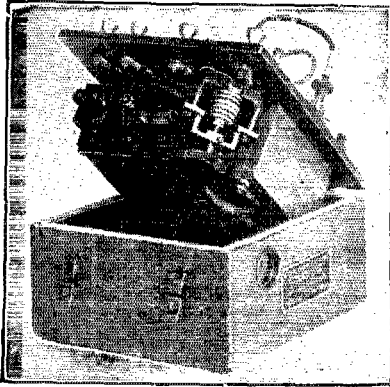

**THE LITTLE AIRPLANE SPARK COIL SET  
FORMERLY SCR 65**

This set provides everything needed for a portable transmitting set except the tube socket, key and tuning condenser. These sets have been advertised in QST.

left fixed. Slight changes in wavelength can be made by tuning the primary circuit and the antenna will accept these somewhat different wavelengths since its tuning is not extremely sharp at the fundamental. Antenna current is indicated by the flashlight lamp which is short-circuited by a switch when the set is in operation.

The UX112 tube used was chosen because of its low space resistance. Flashovers take place between the elements rather than at the stem or base where they would do harm to the tube.<sup>1</sup>

The set was built into the phone compartment of a Crosley "51" portable receiver. Incidentally, this receiver was very easily cut down to 40 meters and works quite satisfactorily.

1. The UX171 will probably be even better and just as safe. Tech. Ed.

### Shielded R. F. Stages

**M**ORE and more, the design tendency in tuned R.F. receivers leans toward the completely shielded type of construction. This does not mean that all of the apparatus is assembled in one huge tin-can. Each R. F. stage, with *all* of its elements, is

enclosed in an individual can of thick metal. The only wires running from one can to the next are A-and B-battery wires (as they can be by-passes for R.F. right in the metal container itself, this does not matter)

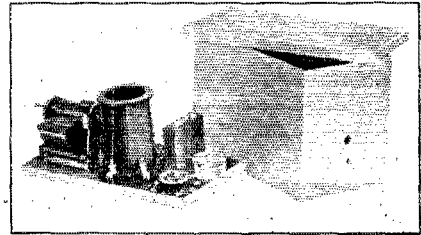

and output leads to the next can. The shielded construction shown in the illustration is about as compact a job as we have seen anywhere. For the home-constructor, these units are available, either in completely assembled form or knock-down. The containers are of heavy aluminum and can be purchased separately to accommodate your own pet hook-up. The front of the shield is drilled for a condenser and the base is drilled for condenser, coil, tube, by-pass condenser and R.F. choke mountings. These units are supplied by Silver-Marshall of Chicago. Incidentally their latest plug-in coil forms now come with the ribbing moulded with notches to hold the wire. A distinct improvement over the previous type having smooth ribbing.

—J. M. C.

### Strays

SABX uses ordinary glass test tubes as forms for R.F. chokes. A rubber stopper in the open end of the test tube serves as a mounting to hold the chokes on the panel or baseboard.



JOIN THE NAVAL RESERVE AND HEAR THE WORLD

## Transmitters in Kit Form

**W**ITH the arrival of transmitting kits in all powers from the UV199 tube size up to and including the 250 size no one should have any hesitancy or troubles in purchasing the complete parts for a short wave C. W. transmitter. Things are made particularly easy for the beginner who wants to start off with a simple, cheap and efficient set—simple and efficient from necessity, and cheap so that he can feel his way around before crawling into ham radio in quarter kilowatt style.

We have previously described one form of very fine low power kit.<sup>1</sup> The set shown assembled in Fig. 1, and known as the type A is another type of excellent "breaking-in" transmitter. When assembled it consists of a frame 12 x 12 x 12 inches with a wooden front panel 4 x 12 inches and another one 5 x 12 inches. The set is designed for use in the usual coupled Hartley circuit, the inductances being supplied for any of the amateur bands. Receiving condensers are used as primary and secondary tuning condensers, a plate milliammeter and a filament voltmeter are provided on the lower panel and the baseboard is equipped with fixed grid and plate blocking condensers, a grid leak, a Universal socket and an R. F. choke. Suitable binding posts are provided, on a long terminal strip, for antenna and counterpoise connections and for the filament and plate voltage leads.

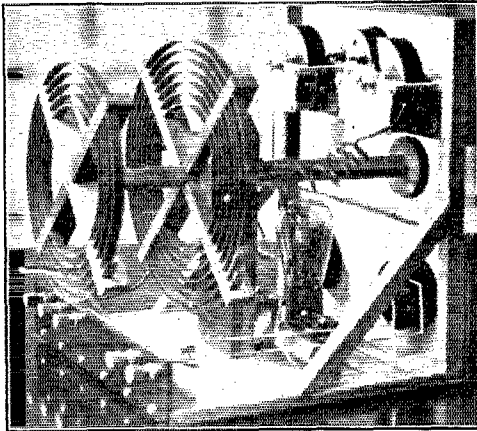

FIG. 1. TYPE A TRANSMITTER

Coupling between primary and secondary is variable by means of the knob projecting through the front of the transmitter. The type A set is intended for use with

any receiving tube or the UX210 7½-watt transmitting tube.

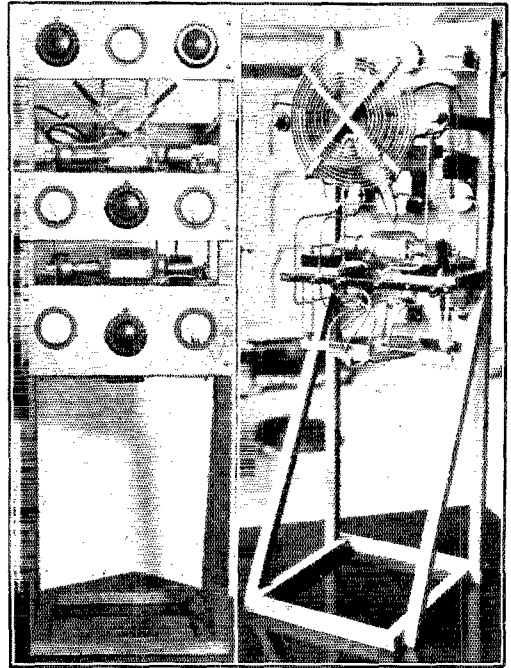

FIG. 2 AND 3. TYPE B TRANSMITTER

The type AA transmitter is practically identical with the type A, except that it is for use with a 50-watt tube. The various parts are over-size, double spaced condensers being supplied, and also a counterpoise series condenser in addition to the antenna condenser. The frame of the AA transmitter is 20 inches high, seventeen inches wide and 20 inches deep.

Still higher power can be obtained from the sets shown in Figs. 2 and 3. Fig. 2 indicates a front view of the modified type B transmitting kit. Three panels of wood support the various meters and variable condensers. The frame is 57 inches high, 19 inches wide and 27 inches deep at the base. The type B transmitter, built in and around this frame, uses a single quarter K. W. tube in a coupled Hartley circuit. Ample insulation is provided throughout, either well seasoned wood, porcelain, hard rubber or Pyrex being used at the point of contact of all R. F. conductors. Large double-spaced transmitting condensers are provided for primary circuits, and antenna-

counterpoise circuits. The inductances are interchangeable for use in all of the amateur bands. Although this set is normally intended for use with a quarter k. w. tube, it can be fitted up for use with any other type of tube at no additional cost. Appropriate filament, plate and antenna meters are provided. Heavy copper tubing is supplied for the permanent connections and large round braid for the flexible ones.

The illustrations of Figs. 2 and 3 do not show the previously described transmitter, but a modification of it, using two quarter k. w. tubes in a master-oscillator power-amplifier combination, one tube being the oscillator and the other the power amplifier. As with the regular type B this set can be supplied with parts for any type of tube. All of these kits are excellent jobs and are furnished complete from soup to nuts. They are supplied by the J. Gross & Company of New York City.

The assembled transmitter shown in Fig. 4 and 5 is supplied in kit form in three sizes, for 7½-watt 50-watt and 250-watt tubes. The illustrations show the 50-watt size. The frame is 14 inches high, 15 inches wide and 16 inches deep. The 7½-watt transmitter has a slightly smaller frame and the 250-watt set is slightly larger. Two 250-μfd. variable condensers (primary and secondary) are mounted behind the panels, which are of bakelite with engraved scales. The condensers are large affairs with double spaced plates. A 0-2 ampere thermocouple meter and a 0-15 volt A. C. meter are used to indicate antenna current and filament voltage, respectively. The

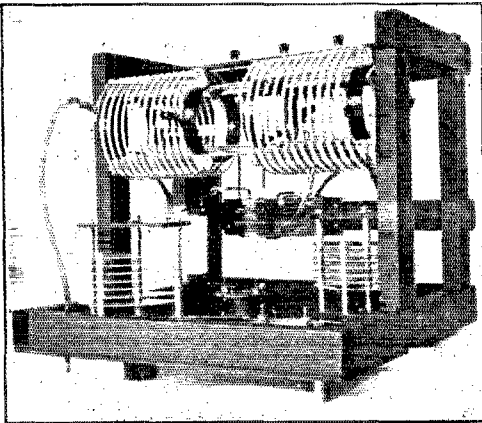

FIG. 4 REAR OF 50-WATT TYPE

inductances regularly supplied are for 20-, 40- and 80-meter operation. The 20-meter band can be hit a little easier with a smaller type of inductance which can be supplied on request. The inductances are the familiar REL type, wound with flat strip on

moulded glass insulation. The coils slide on two glass rods. The grid and plate condensers are of mica and the R. F. choke is so designed and placed that there can be no trouble with it in any of the ham bands.

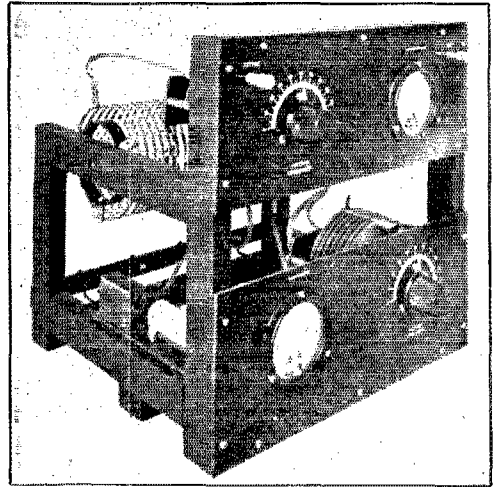

FIG. 5 FRONT OF 50-WATT TRANSMITTER FROM KIT

Modulation and speech amplifying equipment, supplied in knockdown form to match the panels of the transmitters, are available for any of these transmitters. One size uses a 7½-watt modulator and a 201-A speech amplifier. The next is a 50-watt modulator and a 7½-watt amplifier and the largest size uses a 250-watt modulator and a 50-watt speech amplifier.

Complete power supply kits are also available. The power panel is designed to match the oscillator and modulator units, and contains plate and filament voltmeters with necessary voltage regulation devices. The power units are made in two forms, a D. C. type and an A. C. type. The D. C. unit uses an Esco motor generator working off either A. C. or D. C. drive, the generator giving the appropriate voltage for the oscillator it is to be used with. The A. C. type has an Acme power transformer with plate and filament windings and the necessary aluminum, lead and all material (except the glass jars which can be purchased from any 5 and 10c store) for a chemical rectifier. In each case the transformer and rectifier material are sufficient for the type of oscillator the unit is designed for. In addition a filter comprising a brute force arrangement with choke coil and high voltage condenser can be obtained. These excellent units are supplied by the Radio Engineering Laboratories of New York City.

—J. M. C.

## Experimenters' Section Report

**T**HE details of the organization of this section were given in the July issue on page 38 and need not be repeated here.

### The 5 Meter Tests

The 5 meter tests which were announced on page 41 of the August issue were also pre-announced by a number of mimeographed letters. Since this is being written on the last day of July there is no chance to say how things are going beyond the fact that an unexpectedly large number is participating and that *signals are being heard*.

By all means take part in the test, preferably with a transmitter. If you don't happen to be enrolled in the Section start your test first and then send in your enrollment so that you will be kept informed as to progress. The details of the test were given on page 41 above referred to.

Good luck!

### 5 Meter Sets

Boyd Phelps of 2EB calls attention to a difficulty that one may easily get into when trying to build oscillators to operate over a waveband in the region of 5 meters wavelength. Referring to Fig. 1A one has the circuit most used by transmitting oscillators and sometimes in receiving oscillators at 5 meters. It is usually found that the tuning range is small because (referring to Fig. 1B) the variable capacity C1 is connected in series with a fixed L and a fixed C2, which is the grid-plate capacity of the

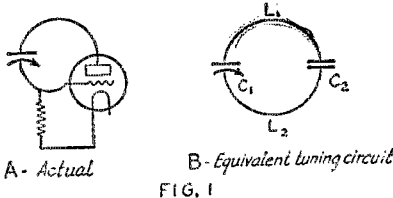
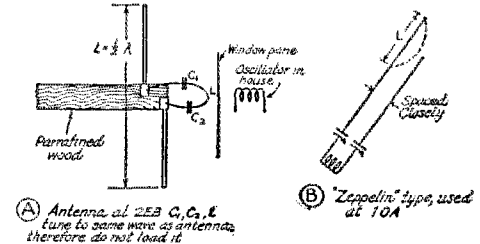

FIG. 1

tube. Since C2 is not only fixed but also very small it limits the tuning rather badly on the upper end of the range—speaking in terms of wavelengths which is the more convenient at 5 meters. There are several fairly obvious ways to cure the difficulty and one need not go into details.

Those who have begun the tests are complaining of the difficulty of building a receiver that does not have the tuning and the regeneration hopelessly interlocked. In some sets the alleged regeneration control does more tuning than the knob that is supposed to do the tuning. Several ways out of this difficulty were suggested in the July issue, p. 43. Phelps has also been trying the use of a separate heterodyne which gives one a chance to control the

note and the strength of oscillations separately, giving some relief from the interlocking situation because at least the note isn't mixed up in the argument.



ANTENNAS—NOTE: All may be used with reflectors

Fig. 2

### 5 Meter Antennas

At two stations it has been observed that 5 meter antennas seem to pick up the energy of the transmitter at surprising distances. At old 1XAQ it was possible to get some current in the antenna when it was only in the room with the 5-watt set while at 2EB with larger powers both antennas show about the same current altho only one is fed at a time. There isn't anything wrong with the feed systems and the antennas are both outside the room, widely separated and fed by different lines that do not come very close to each other, even inside the station.

This seems to indicate that one had best keep 5 meter rigs well clear of everything. It might be best to put the whole rig outside.

The antenna systems shown in Fig. 2 (originally shown in Fig. 3 in the July article) have worked out well. The "Zeppelin" scheme shown at B has worked well at 2EB even when the shorter wire is disconnected at the station. One may regard the other wire as working at a high harmonic—or perhaps as having its lower portion short-circuited out of the problem by inductive effects in the free short wire. This explanation sounds a bit thin—tho I concocted it confidently enough.

### The R.F. Choke Puzzle

Some very nice work has been done on the R.F. choke problem by Messrs. E. G. Watts of 4FM at Miami, C. H. Starr of Canadian 3KA at St. Catherines, Ontario, and F. A. Lidbury of Niagara Falls. From this work an outline will be written and there now seems to be some hope that—after 6 years—we will actually begin to find out something about the R.F. choke in the shunt-fed tube circuit. The published theories certainly do not hold up very well.

### Field-Strength Measurement

Several excellent communications of field-strength measurement sets have come in.

A short paper on the subject is being prepared for the next issue.

Using the "H" Tube

Most of the sending sets on the 5-meter test seem to be using the DeForest "H" tube, but not all appear to be having a great deal of success with them—mainly

of using a *high bias*. Note that both the output and the efficiency fall rapidly when the grid resistance is less than 15,000 ohms. Crescent non-inductive resistors seems especially suited for this duty.

The Indiana State (Central Division) Convention

FOR the third consecutive year the Indiana Amateurs have held a convention that will go down in history as one of those clean and interesting affairs considered so much a part of that A. R. L. spirit so often spoken of.

As one of the newspapers said radio artists from Orange, Tex. to Hartford, Conn.; from Madison, Wis. to Tulsa, Okla.; and from Wayland, N. Y., to St. Louis, Mo., were present. From Indianapolis, Hammond, Anderson, North Manchester and Fort Wayne there were large delegations. Under the leadership of Edward T. Neispodzainy, otherwise known as Ned, President of "The Old Timers Radio Club" who sponsored the convention and ably assisted by A. R. Kahn, there was not an idle moment. With talks by A. A. Hebert, Treasurer of the League who discussed "The Headquarters Staff in Action", Fred H. Schnell of the C. F. Burgess Laboratories; R. H. G. Mathews, formerly division manager, acting as a representative of the U. S. Naval Reserve Service and Paul Magnus, 9ho, on short wave receivers, the formal discussions were well covered, especially Schnell's talk on a "Grid Driver."

The entertainment part of the Convention consisted of a good talk by Harold E. Gray, one of the operators aboard the S/S Peary which accompanied the S/S Bowdoin to the Polar region last year and the hundreds and hundreds of feet of movie films shown were certainly appreciated. Fred Schnell's lantern slides of his trip on the NRRL kept the crowd interested for more than two hours, and the stunts pulled off at the Y. M. C. A. gymnasium capped the climax. The best one being a ball game between "Sparks" and "CW" being won by the "Sparks" with a score of 16 to 2.

With visits to the Twin Branch Power Plant, one of the largest in the country and to the plant of the Studebaker Corporation, where the assembly of complete automobiles was watched the last day was filled to overflow when the traffic meeting, under the direction of Section Manager Angus and a general hamfest was held. With a good banquet and the distribution of 16 prizes contributed by those loyal advertisers in QST, whose names are so well known, we can close this report with an expression of deep gratitude to the Committee in charge, and say:—WELL DONE!

—A. A. H.

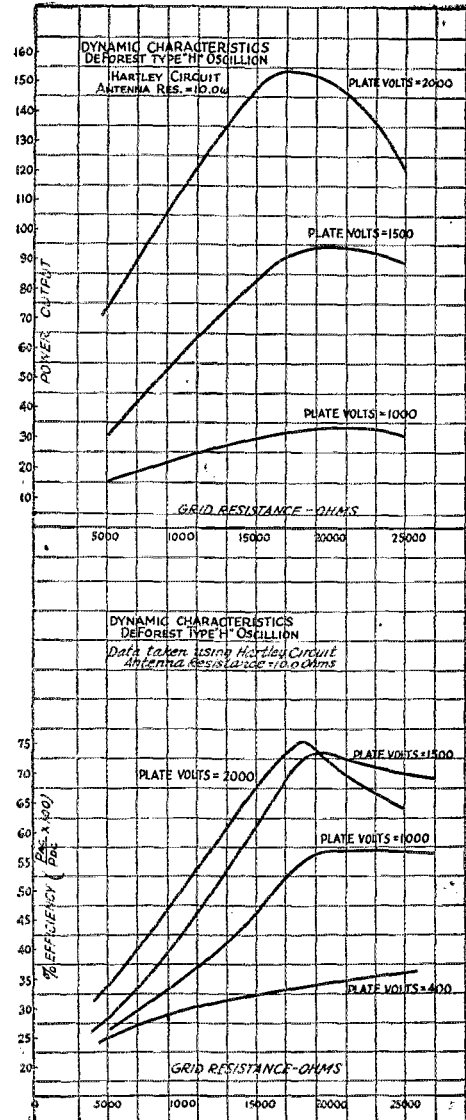
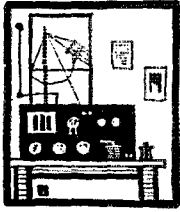
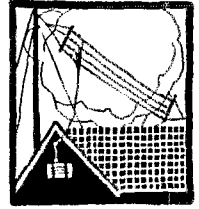

FIG. 3—DYNAMIC CHARACTERISTICS OF THE "H" TUBE.

thru not understanding the tube. Thru the courtesy of Mr. VonBrandt of the DeForest organization we herewith present a pair of dynamic curves on the tube, showing in two different ways the importance



# Amateur Radio Stations



## 3LW, Willow Grove, Penna.

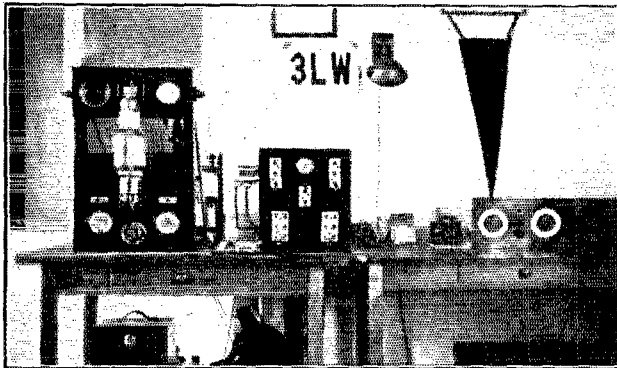

**T**HIS station is the result of the usual development from the Lizzie coil stage, to five watters and thence to a 250-watt tube. The set was constructed by H. A. Robinson and is operated by him at Silver Lake Farm.

The oscillator panel at the left is of wood painted black with a solution of Victrola records dissolved in alcohol. Possibly the Victrola records account for the semi-musical note emitted from this station. The tuning condensers, meters and other controls are mounted on the front of the panel together with the UV204-A. The conventional inductively coupled Hartley circuit is used.

The primary inductance for the 40-meter band consists of twelve turns of  $\frac{3}{8}$  inch edgewise wound copper strip, spaced  $\frac{1}{8}$  inch and supported by two hard rubber strips. When working on 80 meters an R.C.A. inductance is employed. The same secondary is used for both 40- and 80-meter operation. The secondary is a twelve turn pancake of  $\frac{3}{8}$  inch copper strip.

An Acme filament transformer with a 500-watt Bradleystat in the primary heats the filament of the tube. It was found that the same output could be obtained with the voltage on the filament as low as 8, conse-

quently the tube is operated well under normal filament rating.

To the right of the oscillator is the power panel, also of Victrola-ized wood. Mounted on this panel are the control switches for starting and stopping the synchronous rectifier, reversing the output polarity and controlling the plate voltage of the tube. Plate voltages ranging from 500 to 3,000 can be selected in steps of 500 by means of the two small single pole double throw switches. Behind the panel are the various motor starting resistances and the 500-watt Acme power transformer. The operation of the transmitter is all controlled from this panel. A 220-volt power line with 3 k.w. available is used for the transmitter, the filament transformer and synchronous motor being operated across one side of the line and the plate transformer across the other.

To the extreme right of the photo is the short wave receiver using an inductively coupled Weagant circuit, detector and two stages of audio frequency amplification. It is constructed in the usual low loss fashion using interchangeable coils space-wound with string. A box beneath the receiving table houses both storage A and B batteries with their chargers. The battery supply is



so wired that either A or B can be put on charge by means of switches.

The main antenna at 3LW consists of a single wire, inverted L type, eighty feet long. The far end is supported by a 60-foot steel mast. A two wire fan type counterpoise eight feet high is used. Both wires are eighty feet long, spread thirty feet at the far end. Number 10 copper wire and Pyrex insulation is used throughout. The antenna has a fundamental of about 105 meters. For operation in the 80-meter band a series condenser is used to bring the fundamental down. On 37.7 meters, the third harmonic

of the antenna (minus series condenser) is used.

3LW is an Official Relay Station and the operating rules are rigidly observed. Because of the fact that this is a one man station and Robinson has been very QRW at the U. of P., the station has not been on the air very much, most of the work being done over week-ends. Robinson modestly states that the DX is not very exceptional, however communication with Australia and New Zealand is maintained nearly every morning that the station is on the air. North and South poles and every continent except Asia has been worked.

## 8RX, Detroit, Michigan

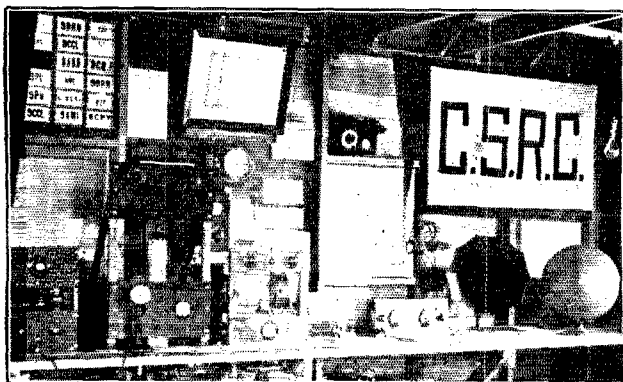

**T**HIS station is owned and operated by the members of the City of the Straits Radio Club of Detroit. The station is housed in an eighteen by eighteen foot house located at Halfway, Michigan. The station serves also as a meeting house for the Club every two weeks. Ample space and tools are on hand and the members of the club do considerable set-building and experimental work.

The receiver is of the throttle condenser regeneration control type with plug-in coils, detector and one or two stages of audio frequency amplification.

The transmitters are three in number. Number one, to the left of the receiver, is a 50-watt tube working in an inductively coupled Hartley circuit. The tuning condensers are 250- $\mu$ fd. Cardwell's. The primary inductance is 13 turns of the R.C.A. helix and the secondary 10 turns of the same. Eight inch coupling is regularly employed. The set is used for c.w. only, operating regularly in the 80-meter band. Plate supply comes from a high voltage transformer and a seventy-two jar chemical rectifier.

Transmitter number two is a 250 watter,

also in a coupled Hartley circuit using special General Instrument 250- $\mu$ fd primary and secondary condensers. A synchronous rectifier and high voltage transformer furnish plate supply to the tube, which is a W.E. This set operates both in the 40- and 80-meter bands.

Transmitter number three is a 10-watt coupled Hartley fone set using two oscillator and two modulator tubes with Heising modulation. This job is used for 185-meter fone for local use in communication with members only. The plate supply for the fone set comes from a 500-volt motor generator.

The poles for the antenna are sixty feet high and sixty-three feet apart. The antenna-counterpoise lead-ins are brought in through the house at opposite ends. The bushings are of Pyrex. A great variety of antenna-counterpoise systems have been tried at the station. The membership, besides working on individual transmitters, are co-operating on Scout portable transmitters, airplane radio and other types of experimental work. The club has been affiliated with the A.R.R.L. since 1922.

## 6BJX, Los Angeles, California

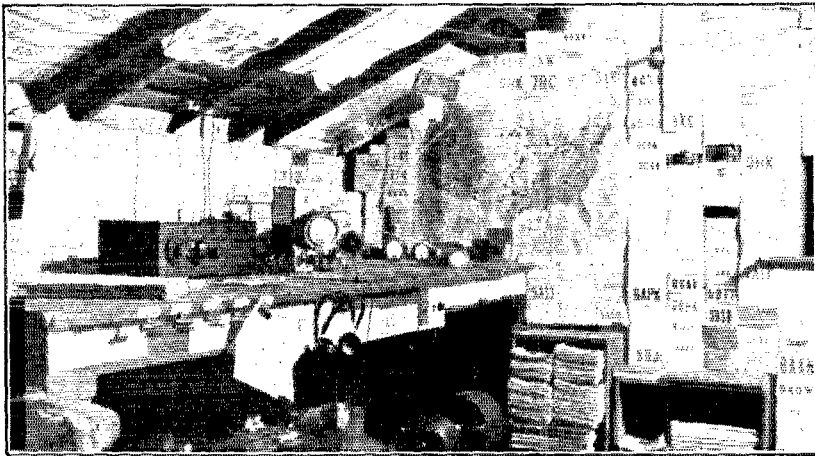

**S**TATION 6BJX is located in a corner of the attic at 2823 East Sixth Street, Los Angeles. It is owned and operated by Ernest O. Knoch. The three different "fists" heard from the station are due to the bug, the sideswiper and the straight key, but "KH" is behind them all.

The aim of the operator at 6BJX has been consistency rather than brilliant performance. No startling DX records have been made although the transmitter is heard regularly in all continents. A traffic schedule has been kept daily with piHR since September of 1925, except for a break of one month due to sickness. Schedules are kept daily with stations East and North, so the hook is always cleared promptly. An average of 250 messages per month are handled, the bulk of which are to and from the Philippines. Traffic handling is not the sole occupation, however, as the R. C. C. certificate will attest.

Referring to the photograph from left to right appear the receiver which is a Hartley type with the conventional one stage of audio frequency amplification; the transmitter which uses a coupled Hartley circuit in which a 50 wattner operates. The inductances in the transmitter are wound with copper from Mr. Ford's well-known masterpiece, on a tube formerly the property of the Quaker Oats Company. Under the table are the battery chargers, "S" tube rectifiers, R. F. and A. F. chokes, motor generator and a switch which changes from "S" tube rectified A. C. to motor generator. The M. G. is generally used. The generator supplies 790 volts to the plate of the tube at a current of 160 milliamperes.

The antenna is a single wire 120 feet

long and 38 feet high. The counterpoise is 15 feet high and 100 feet long, and consists of a five wire fan with cross wires forming a network. The counterpoise is almost directly under the antenna. The combination is tuned to 120 meters, and the transmitter is operated at the third harmonic. A particularly peculiar feature of the sigs emitted from 6BJX lies in the fact that the East Coast has been worked only twice on 40 meters, while the station is heard regularly in Europe and Africa.

Quite an array of interesting trophies from the Philippines are on display at the station. These have been sent to the operator in appreciation of messages which he had handed to and from the Philippines. Although a rather hay-wire layout, 6BJX certainly produces the goods, which after all is the main thing.

---

### Amateur Crystals Available

Oscillating quartz crystals ground to approximately 160 meters are now available from General Radio at \$15 each. The crystals are guaranteed to be good oscillators, and are supplied in wavelengths within 10 meters of 160, making them suitable for use in the 20-,40-,80- and 150-meter bands. To cheapen the cost, and allow the amateur to use his own crystal mounting, these crystals are supplied unmounted. Mountings can be obtained from G-R, however, at an additional charge. The crystals are duly licensed and are not bootleg. Something we have been waiting for for a long time. F. B.

—J. M. C.

# Calls Heard



H. C. St. John, Rockdale, N.S.W., Australia.  
40 Meter Band.

laap ladm laxa lamd laei lbdz lbzp lbqz lbjk  
 lbad lckp lcmx lga lka luw lvgf lza 2ahm 2amm  
 2azk 2agq 2bs 2cxi 2cvj 2uo 2zv 3bmn 3lw 3qp 4az  
 4dd 4ee 4iz 4jn 4nh 4ny 4oy 4rr 5aab 5aao 5aav  
 5ajk 5ame 5acy 5ael 5ado 5azu 5akt 5ada 5arn 5aqt  
 5amn 5asv 5aky 5auz 5dl 5eh 5fh 5ft 5gq 5gk 5he  
 5jf 5jd 5kk 5ls 5maj 5nw 5ql 5qr 5rp 5uk 5va  
 5vu 5ww 5zai 5aaf 5anp 5akm 5azf 6aij 6ene 6alt  
 6aon 6aps 6adw 6ava 6adt 6and 6aoy 6afs 6auf  
 6abg 6bb 6bjd 6bge 6bpc 6bis 6btm 6bev 6bva 6bjl  
 6bxd 6bxz 6bvo 6bsr 6beh 6bhi 6bhr 6bis 6bts 6bq  
 6bqt 6bwy 6bjf 6bjv 6bgv 6bvs 6bvg 6bvz 6bvy  
 6eae 6emq 6evv 6elt 6chl 6cim 6cmg 6eve 6elm  
 6euw 6ewk 6erk 6cgv 6czr 6enc 6eqa 6ekv 6dat  
 6dcl 6dec 6dbk 6ddo 6dag 6deg 6ea 6hj 6hy 6hm  
 6iy 6ky 6kb 6ke 6rb 6rp 6or 6pw 6ou 6rn 6rr  
 6rw 6sv 6tx 6ur 6ud 6vr 6zbi 7aab 7alk 7aaq 7adf  
 7afo 7aim 7av 7dd 7do 7eg 7he 7ie 7if 7lq 7no 7nh  
 7nc 7rl 7tk 7wu 7xf 7ax 7ade 7adg 7arb 7arg 7aj  
 7atz 7ajn 7bbl 7bce 7bof 7bhm 7ded 7dsg 7dqz 7dri  
 7gz 7kw 7nt 7qb 7ry 7ve 7xe 7adn 7axq 7ara 7avj  
 7bac 7bwn 7ppb 7bnf 7be 7bbw 7btr 7bvh 7bzi 7can  
 7ret 7che 7eld 7ep 7ede 7exc 7exa 7eaj 7eur 7ev  
 7eve 7epc 7epm 7eni 7dpu 7dng 7did 7er 7drd 7ens  
 7eht 7ece 7ez 7ek 7ekf 7ekt 7eli 7eji 7kb 7kd  
 7mb 7ph 7wi 7rv 7xi 7cfe 7cbr 7cgo.

as KANAK, Kvichak River, Alaska

laxa lao 2ar 2uo 6abg 6alx 6axw 6bbq 6bls 6bvz  
 6bvo 6etz 6ddo 6rd 6rh 6rn 6ro 6sb 6uo 6ur 6uv 7af  
 7aft 7aib 7aai 7dx 7it 7if 7im 7my 7nu 7oy 7vl 7vv  
 7ib 9agd 9bdw 9ppb 9caa 9clf 9clh 9dr 9dnp hu6do  
 hu6oa hufxl nkf nuw npm npl jiaa jikk au2bk  
 au7fd.

C. Contem, 24 Allee du Rocherm Clicky-s/  
Bois (S & O) France

laae laap laff lana lasu lbad lbez lbnl lbtf  
 lcaw lcib lch lckp lemf lcmx letp lmv lmy lpl  
 lrv lxy 2adm 2agc 2avy 2aie 2avp 2asa 2asq 2baa  
 2rv 2vud 2cx 2ls 2md 2mm 2uz 2uo 2wh 2xaf 3ael  
 3ahl 3ay 3bva 3fi 3mb 3pi 3hy 4hx 4hy 4iz 4yr  
 4sac 4ar 4avd 4bbw 4bf 4bsu 4bth 4bxz 4cug 4dpa  
 4eq 4rh 4xe 4bhz 4che 4eye 4zk.

bB7. Constantin Haumont, 187 Avenue Albert  
Brussels, Belgium  
40 Meter Band.

laac laaj laei lacv lafv lafo lagg lahl lain laiu  
 lams laxa lbad lbes lbhm lbke lbgc lbsu lbvi  
 lbh lecx lch lemp lcmx lckp lcxg lgb lse lij  
 lyb lxm lir lsi 2ag 2arj 2ahm 2aky 2avp 2arm  
 2ama 2ate 2axg 2bk 2brb 2bj 2cdv 2eel 2erb 2evj  
 2ev 2ds 2fo 2ff 2nf 2px 2zk 2emb 2ab 2aih 2auv  
 2bva 2bvz 2bg 2chj 2ekj 2hg 2jo 2jw 2aah 2ai 2bl  
 2bx 2dm 2er 2hx 2iz 2ok 2jv 2pk 2si 2ta 2ur 2vc  
 2vw 2xy 2aul 2ecg 2eyi 2ebi 2don 2ed 2gz 2hsf 2fk  
 2kf 2ndg 2nk 2nid 2nc 2nyh 2yvi 2ztm 2abd 2abq  
 2aef 2akb 2abg 2abq 2abn 2ahl 2aw 2bzd 2bzac  
 2bzaf 2bzai 2bzal 2bzal 2bzam 2bzlan 2bzla  
 2bzla 2bzlar 2bzlaw 2bzlay 2bzibc 2bzibd 2bzibh 2bzibi  
 2bzilb 2bzlin 2bzlip 2bzlb 2bzaf 2bzasa 2bzfab 2bzfae  
 2bzoga 2bzani 2ciar 2e2ax 2ch2id 2ch2rm 2f8sq 2f8bl 2p8aa  
 2pic8 2pr4je 2pr4ni 2pr4kt 2pr4r 2pr4x 2pr4ur 2q2bc 2rafl  
 2rbl 2rha2 2rb2 2o4z 2ydr 2yld 2z1o 2z1ax 2z2ac 2z2aq  
 2z2xa 2z2r 2z3nd 2z3af 2z4a 2z4ac 2z4ak 2z4am 2z4av.

oA3X, George N. P. Alloway, 146 Umbrillo Road,  
Durban, South Africa  
40 Meter Band.

lem lamd lazd lax laai lbhf lch lxch lxu 2ax  
 2avp 2gcb 3mbz 4ac 4cl 5ael 5aq 6amm 6axw 6bdl

6bus 6bil 6ddo 6fz 6gw 6js 6vg 6zk 7kf 7lq 8amd  
 8cur 8cau 8xe 8eq 8ark 9efi 9bvh 9ecv 9eaj 9eji 9dte  
 9dpi 9nmg 9z5bz 9z3p 9f8jn 9y2bg 9i3aa 9pic8 9eri 9xb  
 age andir ane anf psll tuk b82 ocjd.

Ch-2LD—L. M. Desmaras—Casilla 50 D—  
Santiago de Chile

laao laei lbhm lckp lcmx lkk lgw luw lxt  
 2ahm 2cgb 2cvj 2uo 3hg 3zo 4tv 4xe 5aab 5ael 5ado  
 5amn 5apo 5ajr 5aq 5asv 5auz 5eh 5he 5hy 5hz 5jf  
 5nw 5ww 6zai 6zo 6abg 6afs 6afy 6aps 6ayo 6awq  
 6bav 6bbq 6bjx 6bq 6bmw 6bam 6bei 6bh 6bjl 6cic  
 6cae 6esw 6cgm 6cpl 6ct 6ckv 6cgv 6cmg 6cdk 6dag  
 6ddf 6eb 6ec 6hm 6jn 6oi 6rn 6sb 6dm 6fx 6ati 6ark  
 6bf 6dqv 6cet 6cau 6dng 6ekf 6ee 6eas 6ii 6ry 6zlk  
 6zyi 67cw 6b2 6f2 64yz 6cgt 6ar23 6xkf 6rfj 6f8j  
 6f8jn 6f8rt 6f8rb 6f8yr 6g2cc 6zod 6g2z 6g2m 6ziam  
 6ico 6ilgw 6ra 6pry 6smuk 6smyl 6zco 6znd 6znm 6zax  
 6pic8 6pilr. China bxy. Misc: nkf nem niss kegk  
 kfuh xc5l wry pcuu fl.

ch3AN, J. Gachelin, 7 Almagro Ave., P. Valdivia,  
Santiago de Chile  
40 Meter Band.

U.S.A.: lpl lsw lra lcnf lse lrd leab lbp lbqz  
 lqd led lvy lemx lapv lapz lsi lemp lcl lbpl lafd  
 lle lbif lcrc laet lahx lamb 2cty 2xa 2ay 2cxi 2zk  
 2mw 2cyx 2ahm 2bg 2aky 2asm 2xi 2auw 2dd 2aiw  
 3pf 3hq 3csg 3oa 4rm 4cu 4we 4xo 4uf 4rz 4uj 4ain  
 4gtz 4fa 4huf 4ni 5qs 5az 5os 5he 5oq 5nj 5uk 5aab  
 5akn 5ame 5wp 5agn 5yd 5hy 5dw 5zai 5at 5av  
 5aef 5sd 5hhg 5ak 5akz 5ax 5axk 5adk 5ew 5fc  
 5jg 5za 5af 5vu 5apo 5nw 5aaz 5ap 5va 6akm 6cgv  
 6ca 6csa 6awt 6ct 6cpl 6avm 6eb 6dad 6esw 6cgo  
 6efe 6ema 6sb 6ji 6oi 6ec 6bla 6dad 6bhz 6bhm  
 6ham 6afg 6dep 6ann 6xi 6bon 6dag 6bav 6buz 6bjd  
 6att 6ckv 6bpg 6bjd 6cg 6cm 6ya 7nx 7ebi 7im 7df  
 7pl 8eg 8es 8gz 8ad 8bpl 8eq 8drs 8hto 8don 9akf  
 9ek 9bfg 9rf 9eky 9avp 9edu 9ed 9xn 9dng 9duz  
 9adk 9ado 9cip 9dhh 9ao 9bjk 9zt 9xi 9ef 9adn 9ecs  
 9av 9alk 9ek 9dpp 9aon 9bvh 9drd 9bgk 9ec 9aol  
 9dxi 9ial 9de 9ia2 9rb2 9h2 9ia3 9rh5 9ast 9rd7  
 9fg7 9a8 9eb8 9deb 9rb8 9rb9 9ria9 9z1ac 9z1nb 9z1ia  
 9z1ib 9z1aw 9z1af 9z1ap 9z1an 9z1ab 9z1af 9z1bi  
 9yep 9yoi 9yld 9yfb 9yam 9z4ac 9o4l 9z2z 9nri 9kf  
 wiz.

y1AM, A. Mantegani-Casilla No. 37,  
Montevideo-Uruguay

lch lck lcmx lxo lcf 2amj 2xi 2kao 2cxi 2ahm  
 2uo 2erb 3hg 3cu 3si 6xi 6bhz 6arw 6cto 6jr 6dan  
 6bls 6fq 6csw 6mc 6aly 6alc 8dqz 8avd 9vo 9emp  
 9zt 9dmw 9cxe 9bi 9bj 64yz ilgw mlk mlh s2co nem.

WXY, U. S. A. T. CHATEAU THIERRY Guatemala  
to Cuba

laaj lbfl lcmx lfi lfg lfi 1kl lrv 2adv 2apv 2ckf  
 2cxi 2ev 2px 2tr 2uo 2xf 3buy 3cdk 3es 3hg 3ot 3iw  
 4iv 4mv 4oq 4pr 4ry 4tn 5aky 5aip 5amn 5apo 5aq  
 5arn 5auz 5avf 5awf 5ul 5du 6ajm 6aq 6biz 6ih 6nc  
 6pr 6vc 7gz 7bf 8brc 8da 8dme 8ck 8kw 8qb 8rh  
 8sx 8adk 8aek 9ra 9asa 9ppb 9ca 9cbq 9cde 9ewg  
 9cxe 9eek 9ek 9eji 9ep 9zt 9ar hfg 9r4rx 9z4ac age  
 naw nba ngd niss nkf noh rxy.

Gordon Fagg, Western Union Telegraph Company,  
Caixa Postal 100, Bahia, Brazil

idl lbig lam lgw lbg int lbkc lahx lpi lck laff  
 2agq 2nd 2cxi 2ac 2cy 2cnz 2xi 2ai 2ak 2bw 2zk  
 2aph 2pv 2brg 2aep 2avp 2ld 2lu 2xi 2pf 2cin 2tr  
 2erp 2cev 3ai 3dw 3hg 3hj 4ua 4hu 5tt 6ga 7bm 7za  
 7dd 8enx 8eft 8cau 8bt 8dbb 8sw 8hkm 8gd 8ij 8hc  
 8afq 8cxr 8xk 8cb 9bfg 9aa 9bfi 9dsj 9clw 9drs 9bht

9dtk 9ebj 9aau 9efg 9dmj 9hd 9euz 9bus g2cc g2wj g2nm c3by c2ax c8ca c8dk c8dn bzlaq bz1ao bz1aw bz1ab bz2bl bz2ab bz1af bz2af bz5ab bz1an bz2aa bz1ae bz1ar bz1c bz1lb bz1ld bz1bi bz1ak bz1bq bz1ib bz6qa p1l pt2 pt5 fol.

2AER, John Hollywood, 33 Peters Place, Red Bank, N. J.

a2ay a2bb a2bk a2cg a2cm a2cs a2ds a2dy a2ij a2jw a2kp a2lk a2lm a2lo a2ve a2vj a2ss a2sw a2tm a2yg a2yh a2yi a2ad a2ap a2bd a2bm a2bq a2dc a2ef a3fp a3hl a3jr a3kb a3ld a3lm a3qh a3tm a3wm a3xo a3yn a3yx a4cm a4ah a4ay a4bg a4bn a4da a4kn a4lf a5ad a7bg a7es a7cw a7dx a7gt a7hl a7jb b1j b4rs b4yz b52 b52 b52 bo2 bo5 bo7 bq2 bwi by2 beber bz1a bz1aa bz1ab bz1ac bz1ae bz1af bz1an bz1ao bz1ap bz1aq bz1aw bz1la bz1ln bz2ab bz2af bz2sp bz2ab bz6qa bz7aa bz6bs bzsmi bzsal bzar c5wm ch1eg ch2ar ch2ld ch3ag ch3ij ch9te c929x d7ec eac1 ear2 ear6 ear9 ear20 f8au f8bf f8cg f8es f8kt f8dd f8dk f8dp f8es f8zi f8ip f8ix f8jj f8jn f8sk f8mb f8nn\* f8pc\* f8sm f8tok f8yb f8ynb f8yor f8zo fain fmaroc fceag focng focnm g2bz g2cc g2co g2it g2kf g2kz g2lz g2mj g2nm g2qb g2sz g2sa g2wj g2xp g2yq g2yt g3ar g5dh g5hs g5lb g5ls g5ma g5pm g5vq g5zr g5zr g6ah g6al g6gh g6iv g6kk g6lj g6ox g6rm g6td g6tm g6yd g6zk hu6axw hu6ddl hu6buc hu6est hu6dbl hu6def hu6fl ilap ilas ilay ilbw jico iter ilfg ilgw ilma ilno ilrm ilrt ilaa j1pp j1ww j3ww k5 f8h lj1w m1a m1aa m1af m1j m1k m1n m9a m1h noba nohb n2pz npb3 npb7 oa3b oa4z oa6n piae p8co p8gb petzk p1nadj p1nmb p1npo pr4ja pr4je pr4kt pr4oi pr4rl pr4sa pr4ur q2by q2jt q2lc q2mk q8kp q8kw raas raf1 raf2 rbal reb8 rdal rda5 rfb5 rfh4 rfh8 sard z2bg z5qz z1aa z1af z1ao z1ax z1fm z2ac z2aq z2ge z2xa z2ad z2af z3ai z3aj z3am z3ao z3ia z3ac z4ay z4ah z4ak z4al z4am z4ar z4as z4av z4um z4xa afo agb agc ane ank aw5 abz bhl br7 byz c85 dbr c9z ep9 ev8 f8z ftj fw ges gdvb hik ies jpx jra jsh kel kfuh kie kio kqo ln lr.

J. Alden Keyser, 25 Brunswick Rd., Montclair, New Jersey, 40-Meter Band.

6auk 6bay 6bzf 6byg 6bhz 6bjd 6bpg 6bwi 6cah 6chl 6cpl 6cut 6eto 6czm 6daz 6daj 6dec 6fa 6th 6iy 6rn 6ts 6ve 6vl 6xba 7au 7df 7ek a2bk a2lk a2lm a2mz a2ye a3bd a3ef a3kb a3ye a5kn a7cc a7cs a7cv a7dx a7hl a7hl a7pl b2 bz1ae bz1ak bz1am bz1ap bz1aq bz1at bz1aw bz2ab bz2af bz2aa bz2ab bz2qa bzmu bzsmi c4bt c9am c9bj ch2ah ch2ar ch2ld ch3ij f8ar f8fq f8ma f8yor g2az g2az g5dh g5ls ilno m1j m1k m9a nopm piae pr4ja pr4ur q8kp rari rdb2 rfb5 ubr7 ubes uvhl vev8 xip y1ed z1ao z1ax z2ac z2ld z2ua z2xa z4ac z4am z4av misc: agb agc chix (qra?) fw kfn kel kio nao nar naw nidk niss npg npo ntt nzt ocdj pell pjc pow.

2WH, Ralph Venegas, Easthampton, N. Y.

4hu pr4je pr4kt pr4rl pr4ru 4qi 5ael 5awf 5hy 5za 6auk 6aj 6ahp 6asr 6bzg 6bhs 6bhz 6cuu 6cto 6cqv 6cur 6ei 6oi 6ts 7wu 9eck 9eaj 9ek alcg a2ae a2an a2es a2lk a2yi a3kb a3ls a3te bz1ae bz1ap bz2ab c1ar clan c2ax c3ht c3il c3jw c4gt c8ar c8wm g6dh g6ls g6sa f8bx f8dx f8fr f8hn f8ix f8kf f8nx f8rb f8tb f8yor focng ky4 npb3 flbk ilor z2xa z4ac z4av piae ceaz2 c85 kfuh nez8 nidk niss ntt ntt npt pjc ur xed wvc wnp rxy kez8.

6BJX, E. O. Knoch, 2823 East 6th Street, Los Angeles, Calif.

a2ar a2bk a2cg a2gq a2gw a2jm a2so a2tm a2yi a3ad a3hq a3hl a3ir a3my a3tm a4ab a4cm a4rb a5f a5lo a5ro a7ab a7es a7cw a7dx a7la a7pl a7rk a7um a7mn ch2ar ch2ld cha8la f8aq hu6dbl hu6fl j1zq j3aa m5c m9a o1ar oa3e p1lat p1lau p1lew p1ld p1lh pr1aa p1ed8 p1pox ss2e z1ao z1ax z2ac z2bx z4aa z4ac z4ak z4am c9m d14 f70 hxx byx bdyb j1a joc kfuh najp nja npm npp npo npp npu nupm vkg wwd0.

u6CAE, 176 Prospect Ave., Long Beach, California.

usa laae laao lacl laff lafg lahb lahl lahv lahx laiu lajp lala lamd lams lapu lare lasu lbdk laur laxa laxx layl layp layy lazd lbay lbec lbdk lbqt

lbyl leca leal lekp lekw lemxx lepf ldl lga lgm lka lqb lql lrd lse luw lvc lvk lwl lxx lyy lzd 2aac 2acs 2aev 2aes 2agb 2agb 2awg 2ahk 2ahm 2apd 2apy 2atk 2auh 2avb 2ave 2bbx 2beo 2bir 2bw 2cft 2cgv 2eje 2ens 2evz 2evz 2evj 2exl 2eyw 2ff 2em 2jn 2kg 2kr 2lx 2me 2mm 2mu 2nb 2nz 2ol 2wb 2nr 2zv 2acm 2aca 2adb 2afq 2aci 2bq 2bms 2bta 2bv 2cah 2cei 2cki 2cin 2icg 2jw 2ot 2pr 2qt 2sk 2xv 2wf 2zo 2aa 2ad 2ae 2ai 2av 2bx 2ca 2ee 2el 2ey 2fz 2fw 2fx 2hl 2hu 2it 2ij 2js 2kn 2kw 2ld 2oy 2pz 2qk 2rm 2rr 2si 2tn 2ux 2vq 2wb a2bc a2cm a2es a2gw a2jm a2jp a2mz a2bb a2bk a2cg a3ad a3bd a3bh a3bm a3en a3eh a3jk a3jl a3qh a3tm a3wm a3xo a4an a4cm a4da a4kn a4ag a7bh a7cw a7gt a7hl avis avpk bz1ab bz1an bz1ap bz2ab bz2ab elar c2eg c3fe c8kp c8ml c8ni c8oh c4dq c4dw c4dy c4gt c5hf ch1gw ch2ar ch2ld ch2re ch2rm ch3ij ch9te c9mem c9aegt chngy fi8lt fi8qq hu6aff hu6aj hu6axw hu6buc hu6def hu6tg hu6tl hu6vl hu6y ilno j1fr j1oc j1rp m1aa m1b m1k m1n m9a m1b m1h p1lat p1lew p1ld p1lf p1ln p1lh pr1aa p1neqg p1nirx p1nib p1ed8 pr4kt pr4sa pr4ur q2gm q8kp q8qr \*oa3b\* oa4v oa4z oa6n raf1 rdxl ref2 rfc6 rff9 rfh4 rka9 z1aa z1ao z1ax z1fg z2ac z2ad z2bx z2ge z2xa z3ad z3ae z3af z3al z3ai z4aa z4ac z4ag z4al z4am z4fuh bam c1d fw kelh kfhw nidk nite nve pell ska xa xeg 99x.

u6CNN on ss Coalinga, Iquique, Chile

1adm 1aff 1bie 1cib 1ka 1xy 1xz 2aac 2agt 2aj 2bkr 2buy 2no 2wf 2zg 4io 4iz 4jn 4jr 4jt 4ni 4xe 5ac 5ajs 5ak1 5akn 5aq 5dg 5eh 5fz 5qj 5ql 5sq 5sw 5zl 6adv 6afs 6aj 6akm 6aj 6bk 6bg 6bv 6bh 6bj 6bl 6bm 6bq 6bd 6bt 6bu 6by 6bc 6be 6bd 6bd 6bd 6esw 6ewk 6gd 6db 6gp 6gp 6k 6ky 6nx 6rl 6tx 6zbi 7af 8adv 8br 8bz 8cg 8du 9adk 9bcg 9bht 9bj 9bh 9bt 9bt 9bw 9cay 9ck 9ej 9ed 9ed 9dmz 9dqu 9duh 9eae 9eag 9kd 9nl 9rk 9wv 9zk.

6AKM, G. D. Snell, Jr., 154 W. 6th South Street, Salt Lake City, Utah, 40 meters.

a2es a2ga a2cm a2tm a2yi a2kc a2lk a2ss a2bb a2eg a2wq a2bk a2m a2rc a2ij a3ad a3ac a3bd a3bq a3kb a3my a3tm a3ot a3wm a3lm a2xo a3yx a3ef a4rb a4cm a5ay a5da a5lf a5lo a5kn a6kx a7hl a7dx a7es a7gt a7cw a7um a7ux beber bz1ap ar1 ch3k c8eg c9ni c9xi c4gt c4af c4ax c4dq c4dy ch9te ch2ld ch3ij c929x f8f8lo f8em hu6aff hu6aje hu6aj hu6buc hu6cmh hu6cl hu6ef hu6fn hu6g hu6h hu6i hu6j hu6k hu6l hu6m hu6n hu6o hu6p hu6q hu6r hu6s hu6t hu6u hu6v hu6w hu6x hu6y hu6z j1oc j1q j1oc m1aa m1b m9a m1b m1h p1lat p1ld p1lf p1lh pr1aa p1ed8 p1nmp p1nirx p1neqg p1npo pr4sa 9zmk raf1 reb8 xref2 z1aa z1ao z1ax z2ac z2ae z2xa z3aj z3ai z3af z4aa z4ag z4ac z4ak z4am z4av z4ax. Misc.—andir fw fbio bam gdvb kfuh kfhw wiz wqo naw naj pof c8g nkf nve.

7MF, Harold D. DeVoe, 1310 West Main Street, Medford, Oregon.

a2bb a2bk a2cg a2ej a2jr a2lk a2tm a2yi a3ad a3ak a3hd a3ef a3en a3kb a3wm a4an a4an a7cw a7dd a7hl avis a7co au7kx au7mn bz6nqa c4dt c4hh c4io c5bf c5er c5ef c5go ch2ar hu6aji hu6asr hu6axw hu6dbl hu6buc hu6dbl hu6oa hu6xg hu6fl j1kk j1ts j1oc m1aa m9a oa3e p1lh y1ed z1ao z1ax z2ac z2bx z2gc z2xa z3ae z3aj z3al z3aj z4aa z4ac z4am z4av fb2 nem nkf n1mr niss noh npg npm pjc rxy ti7ap xs7g.

8ZE—8GX, Everett W. Thatcher Oberlin College, Oberlin, Ohio

a2bk a2em a2ds a2io a2tm a2yi a3bd a3bk a3ef a3lm a3ls a3yx a4do a5da a6ag a7dx \*auwvdo beber bz1ab bz1ac bz1an bz1aq bz1aw bz1ax bz2ae bz2af c4gt c4dw c4ha c1ar c5go ch2ld c929x fain f8bj, f8ip f8ix f8jn f8qg g2nm g2sz hu6aj hu6buc hu6cl hu6dbl hu6tg hu6fl lper(?) m1aa m1b m1g m1k m1n m1x m5c m9a m1h oa3b oa3e oa4z oa6n piae pr4ja pr4je pr4rl pr4sa q2rl 2qlc raas seel z1ac z1ao z1ax z2ac z2ae z2gc z2xa z3af z4aa z4ac z4ag z4ak z4am z4as z4av z1ax. misc: ane, xda nqgl nar vl fw nbp npo njo nba nar nari wyd npm npl npg n1sr n1sm n1sp n1sn n1ss n1td nidk nuzg nve wvz c8g by4 6zac kfuh kurg fbio ur voq aqe r2z (QRA QSL pse.)

8CVJ, D. F. Langham, 107 North Street,  
 Auburn, New York, U.S.A.  
 40 Meter Band.

6ahm 6adt 6afg 6ahg 6ajm 6akm 6akx 6anp 6anw  
 6aod 6aou 6api 6awt 6bam 6bbz 6bjl 6bls 6bmw 6bq  
 6bvd 6bwt 6bxr 6cae 6cecs 6cdw 6cgc 6cgv 6chl 6cix  
 6elt 6esw 6etk 6eto 6eu 6ua 6eub 6eur 6daa 6dag  
 6dai 6dam 6ddx 6fz 6hm 6hu 6ih 6is 6kb 6ky 6no  
 6nx 6or 6qi 6sb 6sz 6ts 6vr 6xao 6xaw 6xi 7aab 7ay  
 7dc 7dd 7df 7ny 7uj 7wu a3tm a7es b82 bz2ab  
 clan c1co c1ed c2be c3by c8cc c8el c8jw c8kt c8qs  
 c4dq c4dy c6qj c9am c9ay c8bu f8hb g5dh g6lj vpr4je  
 pr4rl pr4ur q2lc q8kp. Miscel: c6g(hi) df7 ex8(?)  
 fb6 fr5 fw(rs) g9y(?) hnar(?) kgbb(?) npg wla(?)

9CUC, George Johnson, 2419 South Street,  
 Lincoln, Nebr.  
 40 Meter Band.

1aap 1adm 1adt 1ah 1ahl 1amu 1ans 1asf 1auk  
 1bbj 1cdq 1ef 1elp 1emx 1fb 1hv 1pl 1qz 1si 1awq  
 1xy 1zk 2aah 2ab 2ak 2ba 2bnz 2bs 2es 2evx 2fr  
 2kg 2lx 2me 2mm 2nf 2ni 2tp 3acm 3adv 3afq 3bd  
 3bnu 3bqz 3cdy 3op 3qj 3tr 3wf 3zo 4aam 4aj 4cu  
 4gi 4gp 4hl 4hx 4ny 4if 4in 4it 4kl 4px 4pf 4ux  
 6akm 6alg 6alr 6ano 6anp 6aou 6arw 6asm 6bhc  
 6beh 6eft 6evy 6hhr 6hjf 6hle 6bol 6hqb 6hqt 6bro 6bsz  
 6bys 6cft 6cgv 6elm 6cin 6enc 6enf 6eng 6ocq 6eub  
 6evv 6ewa 6dag 6dat 6dej 6ddo 6ddw 6gw 6hv 6iy  
 6mb 6no 6ur 6rk 6rd 6uf 6ur 6xh 7afo 7aib 7aim  
 7bb 7cs 7dd 7dk 7do 7fe 7mf 7ob 7or 7ox 7tj 7tk  
 7sy 7uw 7vh 7vk 7we 7wu a2bk a2bs a2cs a2ds a2jr  
 a2zi a2ad a2bq a2dc a2kb a2hl a2la a2xo a2am a2em  
 a5bg a5lo a7es a7fw a7dx a7la avis au7kx au7mk  
 au7mn c2b c8el c4al c4dc c4dt c4fc c4io c5ef hu6ddl  
 hu6ddl hu6clj jllk joe jpc mig mtk msa mih nuu  
 pgn pje pr4rx rxf rxy vam z1ao z2ac z2bx z3ag  
 z3ai z3ek z4aa z4av.

Leo Jungem, 2349 Farnam Street, Davenport, Iowa

a2bk a2eg a2es a2em a2tm a3bd a3db a3bh a3bk  
 a4an a7mn bz1an bz1aq bz1bb bz1lb bz2ab bz2aj  
 ch2ar ch3ij ch9te g2od g2kb g5dh hu6aff hu6asr  
 hu6axw hu6buc hu6clj hu6ddl hu6oa m1j m1n m9a  
 najh pr4rx q2mc raf1 rbal rcb8 vev8 y1cd z1ao z2ac  
 z2xa z3ai z3ar z3aa z4ac z4ak z4am clad clar claw  
 c2ax c2be c2bv c3fa c3gg c3ij c8kp c8mp c3ni c8xi  
 c8zb c4al c4cl c4de c4dt c4gt c5ow agb agw agz afw  
 gdvb kel pcll pppg ssk ug ur rxy vqo xam xda nal  
 nar naw nba nidk nitc nitz nism nivr niss nkf npg  
 npc npl npm noh nrk xc5i c7y.

c5AV, J. W. Smith, New Denver, B. C., Canada

1afn 1amd 1ce 1it 1xm 1xy 2aah 2ate 3xg 3cc  
 3uy 4en 5amn 5hn 5ul 5uk 5zai 5bpl 5daq 5ex a2bb  
 a2bk a2cs a2eg a2ij a2lk a2lm a2tm a2yh a2yi a2yx  
 a3ot a3sl a3tm a3wm a4an a5kn bz9qa clar c3jw  
 c3zb c9ai ch2ld ch3ij czfr5 hu6axw hu6clj j1az mlk  
 m1j m9a mih o6gn z1ao z1ax z1fq z2ac z2ae a2bx  
 z2ce z2xa z3af z3aj z4aa z4ac z4am fbio gzw kdef  
 kdej kdek kfu h nao nar naw nidk niss npu pbn rxy  
 xj xc5lx (qra?).

g2BMM, K. E. B. Jay, 19 Elm Close,  
 Amersham, Bucks, England.

1aao 1aay 1abt 1aci 1ade 1adm 1afo 1ag 1aga 1ah  
 1ahc 1ahx 1ajh 1akq 1all 1aoh 1auf 1auk 1avf  
 1awe 1axx 1bca 1ben 1bez 1beb 1hef 1bhr 1blf 1bu  
 1buo 1eaw 1ei 1c1c 1emp 1emx 1di 1fg 1fl 1ka 1kj  
 1kl 1lj 1mv 1my 1wv 1vr 1vw 1xg 2aaw 2aco 2aes  
 2akt 2aib 2akv 2alm 2ami 2api 2arm 2atk 2ats  
 2aut 2avz 2awx 2bo 2brb 2bs 2bu j 2bv d 2bz 2bz  
 2cc 2cgb 2cns 2crb 2ctn 2ct 2in 2kg 2le 2lm 2mu  
 2dx 2ev 2gi 2gk 2gy 2ho 2to 2vj 2vm 2xg 3aj 3agc  
 2nm 2os 2pp 2sj 2si 2tr 2tb 2uo 2va 2zg 3aj 3agc  
 3aha 3any 3auv 3bmn 3bmz 3bnu 3bu v 3cdk 3cin  
 3ckl 3cqv 3fy 3hg 3ld 3py 3vx 3wf 3zo 4aj 4b  
 4by 4ce 4fx 4ha 4hx 4hy 4if 4in 4pu 4qi 4qo 4q  
 4qy 4ra 4ry 4vl 4wi 4xe 5apo 5ax 5hz 5jd 5ke 5ul 5wi  
 5abw 5ada 5agq 5ahc 5aip 5aj 5ak 5ajn 5alf 5alo  
 5avd 5avv 5ayv 5bbe 5bl 5bhm 5bni 5bns 5box  
 5bpl 5bra 5brc 5bsf 5bth 5btv 5byn 5cgr 5ocq 5oec  
 5chj 5chp 5ci 5cwt 5daq 5djf 5djj 5ndf 5dpj 5drj  
 5drs 5en 5gz 5hal 5im 5jg 5kx 5lo 5pl 5ri 5st 5wi  
 5zae 5ze 9aaw 9atv 9bft 9bht 9bpb 9bqa 9cej 9cp  
 9exc 9ecc 9eek 9ekd 9kg 9xh pr4ja pr4ur clar  
 clax c2al c2be c3jw c3kp c3xi c8wm a2bk a2lm

a2bd a3ef a3en a7cw a7hi a7la z2ac z3ak z4aa z4am  
 z4as z4av bz1ad bz1af bz1ap bz1aw bz1ax bz1b  
 bz2af bz5ab bzsqj raf1 rcb8 m9a picd8 r1rb r2nr  
 nar nba nem ngd niss nkl nrkntf pjf suc suc2 vqr  
 wgy wiz wnp u8avk (80 meters). All ris QSL'D.

d7MT, E. Poulsen, 6 Virginiavej,  
 Copenhagen, F., Denmark.  
 40 Meter Band.

1aao 1ae 1ade 1aiu 1alw 1axa 1blb 1ch 1cib 1cn  
 1nf 1pl 2amj 2bbx 2erb 2gy 2nf 3cmz 4ni 5wi a3bd  
 bz1ab bz1ac bz1ad bz1ae bz1af bz1ap bz1aw bz1ax bz1b  
 bz1ao bz1ap bz1aw bz1bi bz1lb bz2aa bz2ab bz2af  
 clam clar ch2ld fi8jw fi8qq pe6zk pi1hr pr4ic pr4je  
 raf1 ss8lbt z2af gefd kdka kegk wir wiz wuo.

g2KK, Ralph H. Parker, Radio House, Wilson Road,  
 Smethwick, Staffs, England.

1acl 1ah 1air 1aim 1amd 1an 1aof 1bgw 1bgi 1bsd  
 1bst 1by 1cak 1can 1cx 1jr 1my 1si 1sw 1xm 1xz  
 2acp 2ahm 2ago 2aim 2ain 2aky 2abs 2amj 2aul  
 2bse 2cey 2eft 2erb 2ds 2gu 2mk 2mu 2vp 2um 2wh  
 2xt 3agg 3bmz 3bwj 3de 3hg 3pb 3pf 3po 3pz 3wb  
 3xt 4aa 4aah 4ac 4aw 4cu 4dk 4eg 4er 4fr 4im 4iz  
 4je 4jk 4jn 4js 4nn 4pl 4pz 4se 4xe 5aa 5acl 5adz  
 5akl 5am 5ard 5atp 5fc 5hi 5jt 5mi 5gs 5sd 5se 5ux  
 5zai 5zl 6aak 6abl 6ael 6age 6an 6ana 6aps 6ase  
 6af 6awt 6ebb 6cbg 6cco 6chx 6cin 6cix 6cnn 6hu  
 6ih 6jc 6oa 6oi 6kg 6tg 6st 7aak 7aek 7in 7au  
 7bb 7gr 7im 7jm 7uj 7wu 8atv 8av 8av1 8avo 8bau  
 8ebr 8ecq 8eco 8adm 8eb 8ec 8kc 8nx 8ei 8ul 8zk  
 9aej 9aig 9aiv 9aif 9axx 9bht 9bhm 9bpb 9ej 9evn  
 9eyi 9det 9dp 9dpl 9udud a2bd a2bk a2em a2yi a3hd  
 a3kb a6cq bz1ab bz1ac bz1ao bz1aw bz1ar bz1au  
 bz1aw bz1lb bz2ab bz2af bz2bi bzsqj clak clar c3kq  
 c1skp ch3ij ch4tc pr6zk pr6zm prihr pr4je pr4rx  
 pr4sa z1ax z2ac z2yr z3af z4ac z4as z4wr z4xl z5al  
 ss2se ss2ase.

a3LP, L. Paul, 137 St. Georges Road,  
 Melbourne, Australia.  
 40 Meter Band.

1aao 1ajp 1ar 1awe 1axa 1blb 1bux 1bsz 1bzp 1cal  
 1emf 1emp 1emx 1er 1fg 1pl 1rd 1su 1ts 1uw 1yb  
 1yd 1za 1zu 2ahm 2aim 2akb 2blm 2bod 2cje 2ev  
 2evj 2cxa 2xl 2gk 2ry 2zk 2mu 2tp 2uo 2xbf 2zv  
 3bmz 3bnu 3bva 3cin 3jg 3wv 3te 3tr 4ab 4ag 4bl  
 4fc 4ft 4fx 4hb 4in 4iz 4jn 4ob 4rn 4sb 4ai 4in 4ux  
 4vg 5aab 5acl 5ado 5agn 5ak 5akn 5akt 5am 5aq  
 5avv 5aua 5cu 5dq 5gx 5he 5jd 5kx 5kw 5ls 5ms 5pl  
 5qs 5qw 5rk 5sd 5ul 5va 5wx 5za 5abg 6adt 6ahp  
 6ahw 6ajj 6aiv 6ajl 6ajm 6akx 6ag 6alt 6alv 6amm  
 6aps 6aro 6ary 6atm 6aqf 6aqp 6awt 6axm 6axw  
 6baf 6bav 6bby 6bej 6bge 6bhr 6bhz 6bj 6bjd 6bmw  
 6bpg 6hq 6bur 6bwi 6bws 6cae 6ccl 6ccy 6cgv 6chl  
 6ckv 6cmp 6cmh 6cmq 6cpg 6cqe 6cto 6dag 6daj  
 6dam 6dat 6dax 6dcq 6er 6eb 6fa 6fz 6hm 6hv 6jn  
 6jr 6js 6jy 6kat 6kb 6ky 6mb 6ny 6nx 6oa 6oi 6or  
 6rn 6rw 6sb 6uf 6wv 6xi 6zac 6zjb 7aaj 7adf 7alk  
 7ay 7ca 7es 7df 7do 7ek 7eo 7fq 7ha 7il 7r1 7sa 7ta  
 7tn 7vh 7vn 7wu 8adg 8aj 8ajv 8aks 8al 8aly 8atc  
 8bau 8bc 8bec 8bzn 8bth 8bj 8bt 8hy 8ki 8ces  
 8egi 8em 8dem 8dgl 8dzz 8drj 8er 8es 8gz 8hs 8iq  
 8kw 8nt 8pl 8pb 8xe 8zg 9adk 9adn 9ad 9avj 9axb  
 9bbf 9bbk 9bpy 9bv h 9cby 9cc 9ccy 9dbw 9ded  
 9doo 9epm 9cpq 9cx 9xi 9ccx 9dpz 9dzz  
 9ej 9eez 9eii 9eji 9ek 9elt 9fj 9ni 9wi  
 9xi 9xn 9za 9zd 9zt. Canada: 1ar 1aw 3kp 4ct  
 5ef 5go pilar pilau pilcw pilfn pilhr pi3sa hu6aff  
 hu6axw hu6bdl hu6buc hu6clj hu6ddl hu6def hu6fj  
 hu6tg ph4ss f8ek f8ee mij j1aa j1pp j1zq oaf6 oafz  
 fdlo fi8bt fi8aq a2nm g2od g2sz g5if g6ox ch9tc  
 iler vt2bg b4rs yfwx.





**N**UMEROUS requests have been received from the new-comer in the amateur game as to the best hour of the day to work foreign DX. The following table has been compiled. It is believed it will give the required information concerning amateur activities in the countries listed. At a later date additional countries will be added to the list, just as quickly as the data is received.

Country	Wavebands (meters) Legally Assigned	Best D.X. QSO with Band	Best Time (G.M.T.) for U. S. A.	Traffic Handling Allowed
Chile	150-230 75-85 37.5-42.5	33-36	0400 to 1000	Yes
Denmark	95-115 70-75 43-47 0-15	43-47	0100 to 0200	Experimental
England	440 90-200 44-46 32-34 (Special) 23	32-34 and 44-46	2300 to 0800	Yes, if not classed as "commercial"
Irish Free State	150-200 90 45 23 8	45 to 90	2300 to 0800	Experimental
Italy	Not Assigned	36	0300 to 0500	Experimental
Spain	20-120	33 and 45	0000-0500	Experimental
Belgium	Not Assigned	30 to 45	2300 to 0600	Experimental

The best U.S. waveband for QSO with any of the above countries at the times stated is in the so-called 40-meter band.

### South African-American Contest

The *Rand Daily Mail* of Johannesburg is instituting a new form of contest for the benefit of American hams. The award is to be a silver South African Springbok. If

you don't know what a Springbok is, consult Webster's latest. It is a prize well worth going after. The purpose of the contest is to make the award of the Springbok to the U. S., Canadian or Honolulu amateur who establishes two-way communication with the greatest number of South African amateurs during the months of September and October of this year. The competition begins at midnight (G. M. T.) on September 1st. Two-way communications held more than once in the same week between any two stations shall count only as one point in the competition. South African amateurs will send a report each week to the S.A.R.R.L. of all amateurs worked in connection with the competition. American amateurs should send QSL cards, acknowledging QSO's with the South African Stations immediately after the QSO's. These cards should be sent to A.R.R.L. Headquarters from which they will be forwarded weekly to the Headquarters of the S.A.R.R.L. for checking purposes. When the competition is completed all cards will be forwarded to the station they are addressed to. *All QSL cards must be marked "Rand Daily Mail Springbok Competition"*. No schedules may be made between American and South African amateurs. The decision of an "International Committee" consisting of the Editor of the *Rand Daily Mail*, the Editor of *QST*, the A.R.R.L. Communications Manager, the Chief Engineer of the B. C. station at Johannesburg and the Secretary of the S. A.R.R.L., will govern the awarding of the prize. A suitable award will also be made to the South African amateur whose station is worked the most times during the competition.

Remember, gang, forward your QSL cards after each South African QSO, being certain that date, time and wavelength is shown on cards, to A.R.R.L. Headquarters, and mark the cards "Rand Daily Mail Springbok Competition". Hop to it. The fellow who wins the competition is going to have a photo of the Springbok gently reposing at his feet in this section of *QST*, and he is going to be the proud possessor of a most novel trophy. Good luck.

### France

"During the month of June, American and Canadian stations were received more consistently and with better signal strength than in the two previous months especially between the hours of 2 and 5 (G.M.T.). f8YOR managed to establish 28 QSO's with

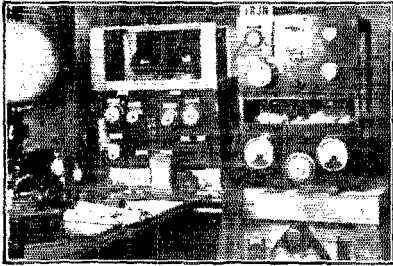

f8JN, KNOWN THE WORLD OVER

U.S.A. in three nights. The big station f8JN, had a regular schedule with z2AC and kept contact beautifully. The best QSO's for f8JN were with GEFT, KFUH, KEGK, NEDJ, TUK in Siberia, ANDIR in Java, and the Chilean stations 2LD, 3IJ and 9TC. Regular QSO between France and f8QQ in Saigon, French Indo China, has been possible since November of 1925, either through direct QSO or through relay via z2AC or LA1X. f8JN has resumed his schedule with SBLT, a ship going between Saigon and Marseille, and they are QSO throughout the entire passage. A regular schedule has also been kept with oA6N for some time. At the present writing f8JN is working in the 20-meter band and has been QSO a number of BZ stations. f8BF, known the world over, was the first station of France to QSO pi3AA. The official call f8KF has been assigned to f8CA. f8KF was the first in this country to QSO Byrd's KEGK. He has also been in contact with z2XA at a time when it was broad daylight all the way across. f8YOR with an input of 100 watts has worked TUK on 33 meters, ch2LD and has received an "r8" in New Zealand, despite the low power. All QSO's have been in the 33-meter band lately. This band is in great favor with all of the French amateurs, while the 44-meter band is gradually being abandoned. A number of the stations are cautiously migrating to the 20-meter band, since especially fine work was done on a wavelength of 20 meters by 8BF and 8CT last year. f8GI has been the first to QSO bz1AF on 20 and 17 meters"—f8YOR.

### Chile

"During the month we have had quite a few good contacts with Europe. ch2AB was in communication with i1CO. ch2AH has

worked s2CO. ch2LD has established the first QSO between Sweden and Chile when SMUK was worked by Desmaras. ch2LD also worked s2ND eight times in twelve days. ch3AT has also worked a number of Europeans, among them g2DX, f8TK and s2ND. The general conditions for QSO with the U. S. A. this month have not been very satisfactory. Communication, after winter came to this hemisphere has been very difficult because when we hear the U. S. gang QSA our signals are reported as being very weak there. On rare occasions both countries report good signals at the same instant. We hope that as soon as these poor radio weather conditions pass we will be able to QSO the U. S. more often and more satisfactorily"—ch2LD.

### Irish Free State

"Up to the beginning of this year, hardly any amateur radio men had been granted transmitting permits. Several keen enthusiasts, however, have now succeeded in obtaining the coveted permission and the following licenses have been issued to stations having these call letters; 11B, 11C, 12B, 14B, 15B, 16B, 17B, 18B and 19B. The Irish Radio Transmitters Society has been formed with a view toward stimulating interest in short wave work. The membership of this society is now twenty five. As far as actual DX work is concerned, there is very little to report. All licensed stations are allowed to use only 10 watt trans-

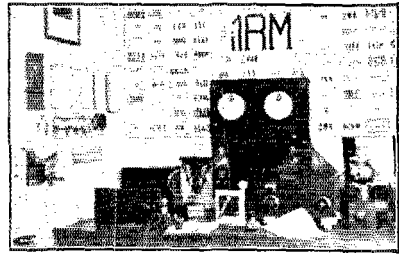

iIRM, ANOTHER PROMINENT ITALIAN STATION

mitters. 19B has worked TPA1 in Poland, whilst 18B has been QSO several European Countries. 15B has worked a number of G's when using an input of only 3 watts. He is sighing for the power available when he had the call g2KW! Colonel Dennis, gw11B, the first amateur to be licensed by the Free State Government was QSO the U. S. on several occasions. 17B will be in operation by the time this appears in print. In order that postage may be saved those who have QSL cards for "GW" stations may send their cards in a batch to *The Irish Radio Journal*, 34 Dame Street Dublin, Irish Free State. The cards will then be for-

warded promptly to their destination. It is proposed to form a Free State Section of the I. A. R. U. and in this connection 26 prospective members have signified their willingness to nominate Colonel Dennis as First National President. When the few remaining hams have signed the nomination form, it is hoped that the Free State Section will come into being.—*W. R. Burne, gw 15B, Hon. Secy. Irish Radio Transmitters Society.*

### Short Wave Commercial Stations

Through the Courtesy of Mr. L. A. Briggs of the Operating Department of the R. C. A. we are presenting below, some additions to the list of short wave commercial stations previously run in this department of QST. Also a list of changes in wavelengths previously appearing in these columns.

### New Stations

Wavelength	Approximate Frequency (Kcs)	Call Letters	Location
14.0	21420	PCRR	Kootwijk, Holland
17.7	16940	KFD	Denver, Colorado
18.3	16380	WBQ	Schenectady, N. Y.
18.62	16100	KEB	Los Angeles, Calif.
21.8	13750	KEB	Los Angeles, Calif.
21.4	14010	KDZ	Point Barrow, Alaska
23.2	12870	WBQ	Schenectady, N. Y.
24.3	12340	KFD	Denver, Colorado
25.1	11950	AGB	Nauen, Germany
25.91	11580	(call unknown)	Beam station at Dorchester, England
27.0	11100	PCPP	Kootwijk, Holland
29.3	10230	KEL	Bolinas, Calif.
30.0	9994	ANF	Malabar, Java
32.0	9369	PCLL	Kootwijk, Holland
32.0	9369	FL	Eiffel Tower, Paris
33.0	9086	QCDJ	Issy les Maulineaux
35.0	8566	WGY	Schenectady, N. Y.
37.0	8180	6XI	Bolinas, Calif.
37.43	8010	WLC	Rogers, Michigan
42.08	7120	KDZ	Point Barrow, Alaska
44.22	6783	KDA	Arcctic Expedition
50.0	5996	CA	N. Y. Times, Halifax
59.92	4997	(call unknown)	Beam station at Dorchester, England
60.82	4920	KDA	Airplane with Arctic Expedition
68.4	4380	WPV	Poinciana, Fla.
70.0	4283	KFZP	San Francisco, Calif.
74.77	4010	KDZ	Point Barrow, Alaska
74.77	4010	WLC	Rogers, Mich.

### Changes in Wavelength

- 2XAD, Schenectady N. Y. from 20 to 26.4 meters.  
 POF, 20 meters, call has been changed to AGK.  
 POW 28 meters, discontinued.  
 2XAC 40 meters, Schenectady, N. Y. Discontinued.  
 2XAF, 41.88 meters, Schenectady, N. Y. changed to 32.79 meters.  
 SFR, 75 meters, call changed to FL, Eiffel Tower, Paris.  
 2XK, 80 meters, wavelength changed to 65.5 meters.  
 KIO, Kahuku, Hawaii, wavelength changed to 90.04 meters.  
 KEL, Bolinas, California, 95 meters. D's continued.

### Siberia

Quite a number of U. S. amateurs have been QSO the station signing TUK, and contact with this station has been established from all parts of Europe and even at its Antipodes. We are indebted to S. Kalachnikoff, an amateur in Tomsk, Siberia, for the following description of this pioneer short wave station. The station is located at the University of Tomsk, the center of scientific activities in Siberia. The apparatus was installed with the help of the Nijni-Novgorod Radio Laboratory. As seen in the photograph the transmitter uses two

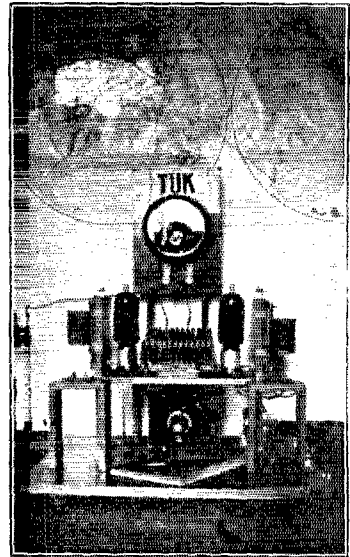

TUK, TOMSK, SIBERIA

tubes rated at 150 watts each (input). Filament supply is obtained from a storage battery, the plate power coming from two 1,000-volt, motor-generators connected in series. Most of the DX work of this station has been done on a wavelength of 34 meters. The station is in operation every day from 1700 to 2000 G. M. T. Communication has been established with 2AC, oA3B, oA6N, European, Indian, Chinese and many other stations throughout the world. The operators are particularly anxious to have more contacts with America. They are ready at any daily schedule to receive calls on wavelengths from 20 to 50 meters. All QSL's should be addressed to B. N. Putkoif, Operator, Radio Station TUK, University of Tomsk, Tomsk, Siberia, Union of the Socialistic Soviet Republics, (not addressed to Russia!)



### Spain

"The EAR Association is the Spanish Section of the I. A. R. U. The official address of the EAR Association is Mejia Lequerica 4, Madrid, Spain. Miguel Moya, EAR1 is President of the Association and EAR 10 and EAR 15 are vice-president and Secretary, respectively. The officially licensed transmitting stations have the call letters EAR followed by a number. To date the licenses include the calls EAR1 to EAR37 inclusive. Traffic handling by the Spanish hams has been particularly good during the past several months. Especially has this been so in the case of QSR's with Porto Rico, Brazil and other South American countries. QSO has been established with New Zealand, Australia and ships near these countries. The following Spanish amateurs are in more or less regular contact with Europe and America: EAR2, EAR6, EAR13, EAR15, EAR17, EAR18, EAR20, EAR22, EAR24, EAR28 and EAR31. Miguel Moya, President of the EAR negotiates with the government for the official licensing of transmitting amateurs in Spain by virtue of the authorization conceded him by the Director General of Communications.—EAR1.

### New Zealand

"Via radio from z2XA through u8GZ comes the following data from New Zealand. "The Brazilian and Argentinian stations are being picked up at noon (New Zealand Time)



11NO, THE WINNER OF THE RECENT INTERNATIONAL CONTEST HELD IN ITALY

and a little later the European stations begin to come in. The U. S. West Coast stations are heard from three P.M. and are at a maximum around seven P.M., then fading to QRZ and coming in QSA again at about ten P.M. The first, second, eighth and ninth district stations are heard from six P.M. until midnight. During any of these hours satisfactory QSO can be established. The third and fourth district stations do not come in consistently as they seem to come in at any old time. The best time for QSO is when daylight is just breaking with them. u2UO is remarkably QSA here, his audibility never being less than R6. He can be copied for hours when sending single."—Shrimpton, z2XA.

From z2AC via u9ZT the following has been received: "From August first the call of Indo-China f8QQ will be changed to IC1B, QRH 34 meters with a D.C. note. A new station is being heard regularly. It signs SK1 and is located in Sarawak, British Borneo. The QRH is 38 meters with a rectified A.C. note. The loudest Italian station heard here is i1GW who often is received with an audibility of R9."

### Ecuador

u3LD speared a new one when he was QSO a station signing gh1FG. His QRA is Mission Eitaliana, Sione Street, Aliana, Quinto, Ecuador. He was operating on a wavelength of 35 meters, with a D.C. note. At the same time u3LD was QSO this station, u1CNA reports hearing him also. Any-one any further dope?

### Metalized High Resistance Units

(Continued from Page 39)

out injury, still higher currents and voltages, but with a correspondingly larger change in resistance.

All the meters used in the manufacture and assembly tests are frequently checked against laboratory standards. Production lots of samples are also tested periodically in a 3-stage amplifier to make certain they are noiseless.

The unit thus manufactured is rugged, permanent and accurate. It has proved its utility wherever high resistance units are required.

### Strays

The brass frame around an old electric fan makes a keen inductance for that 5-meter transmitter, according to 9BLE.

"When attempting to use direct current from the house mains for a B-battery eliminator where the commutators and collector rings are indifferently true it often happens that a regular interference results. This may be cured, in most cases by using the *secondaries* of two audio frequency transformers and two 2 mfd. condensers as shown in the diagram. In my case this made

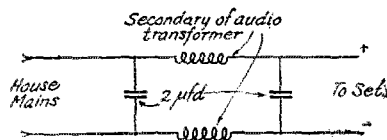

the 120-volt D.C. mains suitable for B-battery supply, while, before the filter was installed nothing but a continual roar could be heard"—c3BN.

# Correspondence

The Publishers of QST assume no responsibility for statements made herein by correspondents



## Captain Rives Leaves

The Signal School  
Fort Monmouth, N. J.

Editor, *QST*:

It is with real sorrow that I write you to tell you that I have just received orders to attend a course in Communication Engineering at Yale University for the coming session. This will of course, cause my relief as Army Liaison Agent.

While I regret very much that I will not be able to continue my work as Liaison Agent, I leave it knowing it will be capably handled. Captain A. C. Stanford, Signal Corps, U. S. A. will be appointed Army Liaison Agent in my stead. Captain Stanford is a West Point Graduate and has just completed the course at Yale. He is also a graduate of the Company Officers course at the Signal School and is a radio operator. I am sure that the Army-Amateur work will make great progress under his leadership.

The work of the Liaison Agent has reached such proportions that my successor will be allowed more personnel here and will be assigned few other duties. This will enable him to carry out many of the plans which have been made for this work, but which have not been carried out due to lack of time and the pressure of other duties of the Liaison Agent during the past year.

While I will not actively be connected with the work after August 1st, 1926, my personal interest in it is as great as ever and I intend to keep in touch with it and lend a helping hand whenever possible.

It is perhaps needless to say that the policy of the Signal Corps as laid down in the Army-Amateur plan will still remain in effect. Changes in service personnel will not affect that in any way.

I wish to thank you and the other officials of the American Radio Relay League and the thousands of amateurs of the country for the wonderful spirit of co-operation with which you all have entered into this plan. There is no other group of individuals that is so willing to give and that does actually give of its time and resources so unselfishly as do the transmitting amateurs of the country. It is a great pleasure to be associated with them.

—Tom C. Rives, Captain Signal Corps,  
Liaison Agent.

## "QSY 20"

1143 Garfield Street,  
Hammond, Indiana

Editor, *QST*:

It seems to me that the time has come to say something about our 20-meter band. Here we have a perfectly good band for our use and instead of taking advantage of it, and getting out of the 40-meter QRM, we are letting it lie idle. It seems a perfect shame that so few of the gang are down on 20 meters. For the past month I have communicated with only four stations on 20 meters. My station has been running half hour tests, daily, on 21 meters for over a month. I received astonishing reports from New Zealand, Australia, Porto Rico and Honolulu as well as every state in the U. S., but I have discontinued the tests on account of the poor co-operation the fellows have given.

We need some more good work in the 20-meter band. We need a lot of QSO's. Australia and New Zealand are QRV for 20-meter work. Let's get down to 20 for DX work and traffic handling, fellows. We are overlooking a darnd good bet.

—James Grindle, 9BSK

## Breaking-In In China

Ye Ed, Q-st:

I believe that no one could be more delighted than I to read your editorial in the January number of *Q* street, and although your promises, as far as I am concerned, are as yet to be fulfilled, I really feel as though I had been taken in out of the cold and planked down in front of a nice cheery fire with lots of coal in the scuttle.

I started as a "home-constructed B. C. L." a couple of years ago, but being a resident of China—where B. C.'ing is not all it might be (for the simple reason that all radio goods are labeled "contraband" here and are considered to be munitions of war)—I found the "home constructed" part of it more interesting than B. C. listening.

A year ago I decided to stop looking in through the window you spoke of, and walk in. I cannot help smiling now at my delightful innocence of those days—"to walk in"—Ha! Little did I know what the door was made of! So much for the decision. Yes, I would chuck up all this listening to Chinese Government spark stations on 600

meters, passing on sweet messages from passengers on President boats to folks on shore—I would stop listening to Victrola records being broadcast on 365 meters from local "broadcasting" stations. I would build a transmitter and have converse with the outer world, like I'd been reading about in *QST*. Delightful prospect.

I will briefly pass over the year that followed. It was a nightmare—the sort of nightmare I should imagine you experts have if you were sick with a fever. You find yourself in some ridiculous position—a 5 watter in one hand and a plate transformer in the other. No matter how you connect the plate transformer, it refuses to give less than 3,000 volts. A moment later you hear you are transferred to another station where lighting mains are 110 volt and all your transformers are made for 220, and you wonder whether it is 5% phase, or what. After much trouble you obtain the necessary 220 volt items, and when you get to the new station you find the Electric Light Company there, being a Chinese show and having to provide unlimited current free gratis to all officials and military posts for miles around, can at best only push out 150 volts. Moreover, you find that the voltage varies with the wind, the frequency changes every time the Chinese fitter expectorates, and anyway it isn't a bicycle, it's a tricycle.

I could quote a hundred and one problems that I have been up against since that unknowing decision. How to erect an efficient but invisible antenna—how to get DX on the receiver when the E. L. mains are arcing over at six places within a mile of you—how to get that 4 wds. per minute up to 5 when there isn't a soul near to come and buzz at you on your knobless bell—how to strip 40 feet of bell wire for your low-loss inductance (it took me six hours to do this)—how to make 3½ inch cardboard tubing out of the backs of writing pads, and when you have made it on a coffee tin, how to get it off! What is the correct method of drilling and cutting 12 inch Victrola records for your panel, and how do you resharpen the drills after the holes have been punched through? These things, and more, have I learned by bitter and sad experience.

But to revert to your original metaphor, I bumped my nose hard on the door before realizing it wasn't hard enough to swing open the pearly gates. That got my goat. I sent to England for a sledge-hammer and after three months it arrived. And I smashed in the door with much labor but much satisfaction. But alas, when I got inside the birds had flown. They'd left the 2,000 kc floor and gone higher. Unnerved, shaken, a 15 watter blown, a transformer burned out, but still a tag-along I decided

to follow to the 3,000 kc floor. But there is no staircase in this house. Not having wings myself, I sent to America for a ladder. It duly arrived and I mounted, only to be disappointed again—they'd left for the 8,000 kc floor, and higher.

I am still on the 3,000 kc level, tired, fed-up, radiating 10% of my input, struggling with fundamentals and h. f. resistances which I cannot measure, dizzy with parasitic oscillations at unknown frequencies, and never worked a soul yet!

You are right—there are lots of us, some on the first floor, some hacking at the door and crowds walking around this house of yours trying to find a door that swings. Some day we all will find the combination and the house will be overthrown!

—“Ten Per Cent”

## Good QSO

San Francisco, Calif.

Editor, *QST*:

Some weeks ago a resident of Berkeley, California came to my assistance in arranging for her, by radio, a meeting with her friends in Honolulu with whom she was about to visit.

Subsequent to her arrival at Hawaii, there came a need for what amounted finally to a conversation with a financial adviser in San Francisco, concerning some personal business that needed attention.

It was arranged that she went to the rooms of the Radio Club of Hawaii, 6BUC, with one of her friends, who is “RY” of that staff. At the same time her adviser came to my station, 6ZD, read over my shoulder the questions she asked, as transmitted to me by “RY”, wrote his replies at the same time, and I immediately transmitted them to 6BUC.

This contact amounted to a real conversation, lasting for an hour and a half, in the course of which she received all the advice necessary to enable her to reach a satisfactory conclusion of her business.

It is this sort of thing that lifts our ordinary two-way communications out of the common-place and gives us the thrill we used to get when transoceanic distances first were covered.

—A. H. Babcock, 6ZD

## Within the Law

Oberlin College,  
Oberlin, Ohio

Editor, *QST*:

I should like to make a plea for the “man within the law”. Time and time again the chance of QSO, particularly with foreign stations, is spoiled by a station above or below the band, which being free from QRM,

easily attracts the attention of the foreign operator.

Anyone can do that—be unfair to the rest of the gang—and *may* get away with it for a while, but it takes a real station and a real operator to work consistently through the QRM within the bands allotted to us.

In this connection I would like to suggest to the foreign amateurs, first, that they listen after each QSO for stations calling them, and 2nd, that they listen *within* the legal bands for U. S. stations, ignoring calls of those who insist on stretching the law.

Incidentally, that might materially improve the serious situation that exists now between 30 and 37.5 meters. Interference with Naval and commercial traffic would be minimized, and our own foreign communication conditions improved.

—Everett W. Thatcher, SZE-8GX

## Continental QRM

“The Whins”,  
Stocksfield-upon-Tyne,  
England

Editor, QST:

For some time past, complaints have appeared in the British wireless press about European amateurs who are operating their stations on a wavelength between 30 and 40 meters. All the appeals and complaints have been practically without avail, and we still have the European CQ merchant who tears the ether with his terrible raw A.C. and flat tuning. He usually calls CQ for about 10 minutes and then signs once, listens for 2 minutes and starts up again. And all of this right in our DX waveband. Apparently there is only one cure for it, and that is for all decent-minded hams to get together and absolutely boycott all stations that are operating out of their allotted bands. If this is done I think we shall soon see the end of the trouble. Surely we already have enough QRM from various commercials without having to listen to this awful stuff which is churned by the hour and which spreads over two or three meters. Lets do not encourage these fellows by working them at all.

—H. S. Nicholls, g2CC

## Super DX with Indoor Antenna

Meadowlea,  
Gerrards Cross,  
Bucks, England.

Editor, QST:

I think that perhaps some details of experiments I have been carrying out at g2OD on indoor antenna for transmission and reception may be of interest. I have lately completed a new master oscillator transmitter operating on 32.1 meters using standard circuit arrangements. I have carried out a large number of adjustment tests with this, using a large antenna out of doors. These tests have been with a2LM.

Very good and consistent signals were put into Australia by this set over a period of several weeks, a2LM being able to copy g2OD consistently. It was also found possible to maintain a morning schedule with Australia for approximately two hours, using just under 100 watts input to the master oscillator set.

The success of these tests suggested the possibility of establishing contact with a2LM when using an indoor antenna of modest proportions, for both transmission and reception. Numerous types of antennas

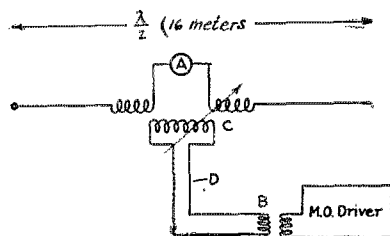

were tried but the best results were obtained by using a horizontal halfwave Hertz oscillator 16 meters long, placed immediately under the slate roof of the house, and fed from the distant transmitter by a two-wire R.F. transmission line approximately 8 yards long. The Hertz oscillator has a three turn coil at the center, magnetically coupled to a similar coil at the end of the R.F. feeder lines.

The coupling coil in the antenna is split at the point marked A and a radio frequency ammeter was inserted. The tuning of the various driving circuits is adjusted to give the maximum reading on the antenna ammeter. In this particular layout, the ammeter read two amperes when using the input previously mentioned.

In order to avoid any form of coupling likely to effect the true action of the Hertz antenna, the outside antenna was removed entirely during the tests, as it was considered that the mere presence of the outside antenna might materially assist the indoor one.

Using the arrangement outlined it was found possible to maintain consistent daily contact with a2LM, who reported the average signal strength R4. The signal was also reported as being a particularly good one to copy through QRM, etc. This latter characteristic was probably due to the fact that the signal gave a perfectly pure D.C. note of absolute steadiness. Reports were also received from New Zealand stations on these transmissions.

The reception on the indoor antenna was of excellent strength, and there was a marked reduction of the static signal-strength in favor of the desired signal.

—E. J. Simmonds, g2OD

## Easy Tuner Design

(Continued from Page 28)

a few of the many people who write to us asking how to pick a coil and condenser to tune over a certain range of wavelengths. We do this thing every once in a while and it always helps, tho the effect wears off after a while. This time it ought to last longer than usual for the curves are unusually convenient, and there's a standard coil to go with them.

—R. S. K.

### Strays

THIS RADIO INTERFERENCE BUSINESS AINT WHAT IT WUZ BEFORE THE HAMS GOT TO USING HIGH FREQUENCY !!



### Grid Condenser Correction

On page 22 of the July issue we said that it was a good idea to use receiving grid capacity at the rate of a microfarad per meter of received wavelength. That was hardly the idea—micromicrofarads were meant.—Tech. Ed.

### SHORT WAVE COILS

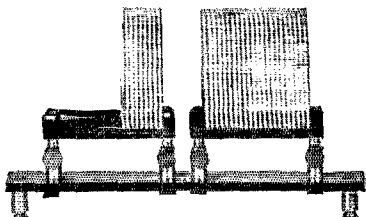

COMPLETE SET—5 Coils and 2-Coil Mount—\$5.00  
ing. 10 to 235 mtrs.

Antenna Coil and attachment \$1.00 additional

From your Ham Dealer, or direct

Other Good Short Wave Parts. Send for List

SEATTLE RADIO LABORATORY

3335 33d Avenue, South

Seattle, Wash.

Airplane flame proof Blinker Key CQ-1140, at \$4.00. SE 1012-A, S. W. Reg. Receiver, 1 tube, 50-1000 meters, \$40.00. TUBES, CQ 886, Fil. 3, 3-4, 4V; Amps. 0.91; 3 prong base Socket Pin is 4th Terminal, \$1.50 ea. 70-2500 Meter Wave-meter, Type 2500-B-2, Complete, 3 coils, graphs, meter indicator, \$40.00. Just a sample of our bargains. Get our new and latest reduced price list for a 2c stamp. We bought \$10,000.00 worth of United States Government Radio Transmitting and Receiving Sets and Parts. Mail orders sent all over the world.

WEIL'S CURIOSITY SHOP 20 South 2nd Street, Philadelphia, Pa.

## CARTER New Tip JACK



10c ea

Heavy contact spring insures positive contact. Requires minimum space. Mounts on standard panels in 1/4" hole. Carter quality. See them at your dealers.

## New Receptacle Jack

Neat appearance, eliminates wires being all over the place. For aerial and ground "A" battery, etc. Mounts flush on wall or base board.

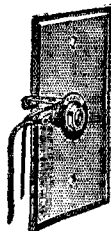

Open  
Circuit  
80c ea  
Closed  
Circuit  
85c ea

Any dealer can supply

In Canada—Carter Radio Co., Limited, Toronto



## ELECTRAD

New!

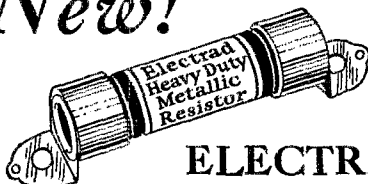

## ELECTRAD Heavy Duty Metallic Resistor

Specially developed for B eliminators and power supply units.

Special features are:

- 1—High current-carrying capacity.
- 2—Non-inductive. Accurate calibration.
- 3—Low temperature coefficient.
- 4—Resistance element fused to inside of Lavrock tube.
- 5—All standard high resistance sizes.

Ask your dealer for detailed Circular.

List price \$1.00; in Canada \$1.40

ELECTRAD, Inc.  
428 Broadway, New York City

## ELECTRAD

# And Now!

## The Ultimate Achievement A Live Rubber Socket

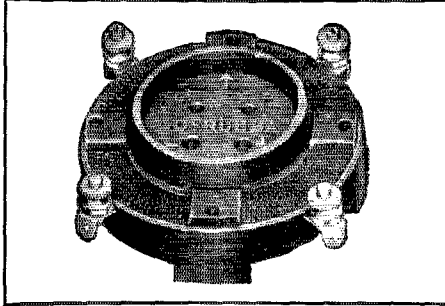

The "Sofrubba" Standard Socket 2 1/2" diameter. Lugs are equipped with N. P. binding posts and are drilled and tinned for soldering.

This new shock-absorbing socket is the last word in socket development and positively eliminates all microphonic noises. You can equip your set with this socket with economy and thereby solve V.T. socket problems.

The phase angle and the capacity test show losses almost too small to be measured.

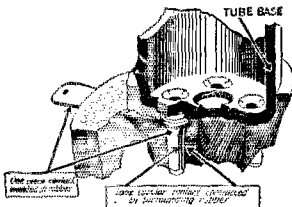

Some of the improvements embodied in this new socket are

- It is a perfect shock-absorber.
- It is made of special process soft—live—rubber.
- It is unconditionally guaranteed for 5 years, assuring that the characteristics will not change.
- It is unbreakable.
- It is adaptable to top and sub-panel mounting without change.
- It aligns itself to warped panels and imperfect panel drilling.
- It gives a perfect hugging contact.
- Each contact is one continuous piece and self-cleaning.
- It is Universal, Takes UV and UVX types of tubes.
- It is good-looking—practical—efficient.
- Its low price, alone, makes it distinctive.

This socket is a Strongson creation and is protected by patents pending.

Ask your dealer for the new Sofrubba socket and if he can not furnish you write us direct.

Attention Department D

**Moulded Products Corporation**  
549 and 551 West 52nd Street  
NEW YORK CITY

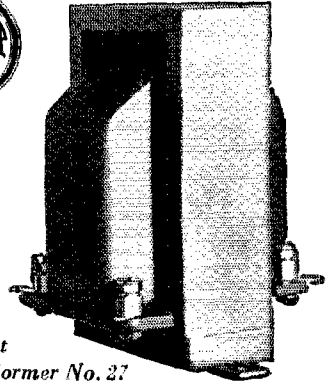

The Pacent  
Superaudiformer No. 27

## Pronounced the best transformer made

It thoroughly meets the increasing requirements for finer musical values in radio reception. It is enclosed in a handsomely finished case.

INPUT TYPE No. 27A, Ratio 3 to 1, Primary Inductance, 124 henrys, designed for use between any vacuum tubes. Shielded \$7.50. Unshielded \$6.00.

### Other Types

OUTPUT TYPE No. 27B, Ratio 1 to 1, Inductance 7 henrys. . . . Shielded \$7.50. Unshielded \$6.00.

CHOKE TYPE No. 29, Inductance 50 henrys and 36 henrys. . . . Shielded \$6.50. Unshielded \$5.00.

Ask your dealer or write us direct  
about these and other Pacent  
Radio essentials

**PACENT ELECTRIC CO., INC.**  
91 SEVENTH AVENUE NEW YORK CITY

Canadian Licensed Manufacturer :  
White Radio Limited, Hamilton, Ont.

Manufacturing Licensees for Great Britain and Ireland:  
Igranic Electric Co., Ltd., London  
and Bedford, England

# Pacent

## RADIO ESSENTIALS

# It's Here Q.M!

We give it to you after  
3 years development

Try the No. 130

**REL** Short Wave  
Receiving Kit

It's a worthy companion to the other well-known REL products. Every part has been expressly selected and the entire design made from the actual experience of hundreds of "Hams."

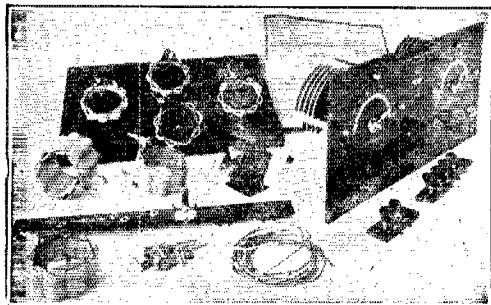

Wavelength 10 to 206 Meters

### SOME FEATURES

Seven REL small size plug-in coils.  
Coils are rugged and moistureproof.  
Special low capacity double spaced variable condensers.  
Non-metallic friction vernier controls eliminate grinding noises.

Four inch rubber extension handles on both controls positively eliminate body capacity.  
Large visible scales engraved directly on panel.  
Very easily assembled and wired.  
Front panel completely assembled with condensers and vernier controls.

It's a short wave sensation built by the pioneer short wave experts

**KIT PRICE \$36.00**

Ask your dealer or write us

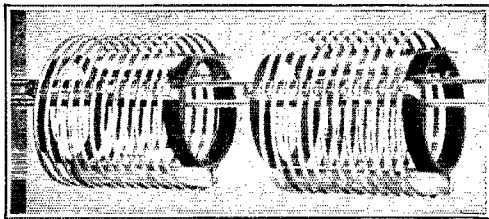

### TRANSMITTING INDUCTANCES Flatwound on Glass

Every Arctic or Tropical expedition now in action is equipped with the REL inductances. They are the inductances which every efficient short wave station will eventually use.

Type "L" — 40-80 and 150 meters

Type "S" — 20 meters and lower

Single units, with 3 clips Price \$5.50

Double units, with 2 glass rods  
(as illustrated) Price \$11.00

We manufacture a complete line of short wave equipment such as plug-in coils, RF choke coils, transmitting kits, etc.

Special three and four coil Meissner inductances built for broadcasting stations. Write us your requirements.

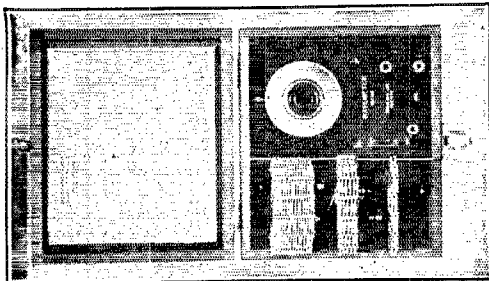

### WAVEMETER

With Neon Tube Indicator

Wavelength range 17 to 550 meters.  
Individually calibrated with 1% accuracy.  
Plain and simple reading curve chart.

Type "A" — Price \$22.00

**Radio Engineering Laboratories**  
27 Thames Street  
New York, N. Y.

## GROSS SHORT-WAVE APPARATUS PLUG-IN COILS

General Radio Jacks and Plugs used. Most efficient plug-in arrangement on the market.

Can be handled freely without fear of injuring coils, also making possible permanent calibration of set.

Minimum amount of dielectric insures lower losses resulting in stronger signals and sharper tuning.

Without question the most rugged receiving coil on the market.

Spaced winding insuring minimum distributed capacity.

Price for 80 Meter Band complete with Base (58 to 115 meters) \$5.50.

Price for 40 Meter Band (30 to 60 meters) \$5.50. Complete with Base. Separate coils for 20, 40 or 80 meters \$3.00.

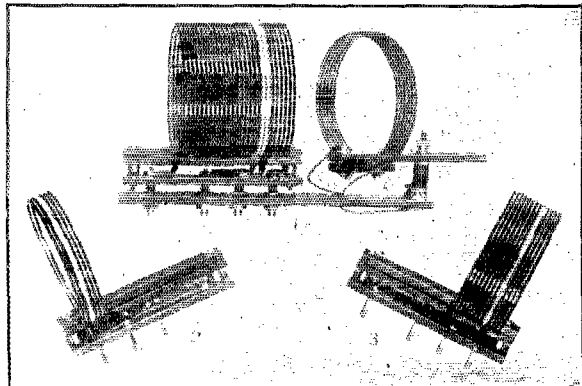

The Original Pancake Inductances for 20, 40, or 80 meters, \$5.00. Quartz Crystals, \$0.75. Transmitters of any power on hand. Send stamp for circulars describing full line of transmitting and receiving parts.

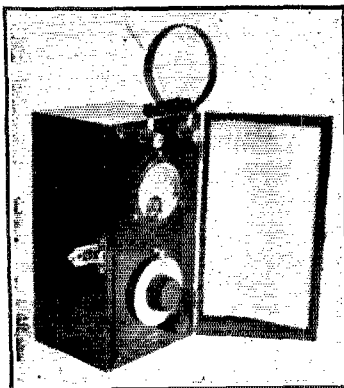

### GROSS WAVEMETER

Built into rugged and handsome cabinet, handy size, removable cover. Low-loss inductances and condenser insure a low resistance wavemeter. Separate curve for each coil checked against oscillating crystal. Accuracy better than 1% guaranteed.

Type L—with flashlamp indicator—for 20, 40, 80, meter bands, \$15.00; for 20, 40, 80, 200, meter bands, \$18.75.

Type G—with galvanometer—20, 40, 80, meter bands, \$30.00; for 20, 40, 80, 200, meter bands, \$33.75.

**J. GROSS & CO.,**

30 PARK PLACE, NEW YORK CITY

## A NEW WAY TO SELL RADIO CABINETS WHO EVER HEARD OF SUCH A THING BEFORE?

We have placed on the market two NEW STYLES on which we give you choice of stock sizes at the same price. Our "Piedmont" is made of hardwood, fancy nickeled hinges, three coats of the new lacquer varnish rubbed to a hard smooth glossy finish, mahogany finish only.

Sizes 7" x 18" x 10", 7" x 21" x 10", 7" x 24" x 10", 7" x 26" x 10"—YOUR CHOICE AT ONLY \$2.65 EACH. Cash with order, no C.O.D., f.o.b. Hickory.

We challenge anyone to show us a cabinet of this fine quality selling at such a low price. We have been making cabinets for four years—a few cents profit on each one but a big production.

SEND FOR CATALOGUE—ITS FREE

**THE SOUTHERN TOY COMPANY, INC.**

HICKORY, NORTH CAROLINA.

DEPT. Q

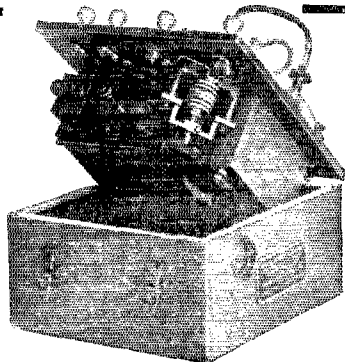

## RADIO SPARK TRANSMITTERS (75 WATT PORTABLE)

*Made for U. S. Army Aeroplanes*

This is a tuned spark coil transmitter, with a wave length of 100-300 meters. The set is made of the finest of materials and the essential parts are the spiral tuning inductance, the induction coil, sending condenser and spark gap. Average range about 25 miles more or less. Just what you want for making a Spark Coil - C.W. transmitter.

Brand new, in original cartons.

ORIGINAL GOVERNMENT COST, \$47 EACH

**OUR PRICE \$4.75 EACH**

**AMERICAN SALES COMPANY,**

21 Warren Street,

New York City



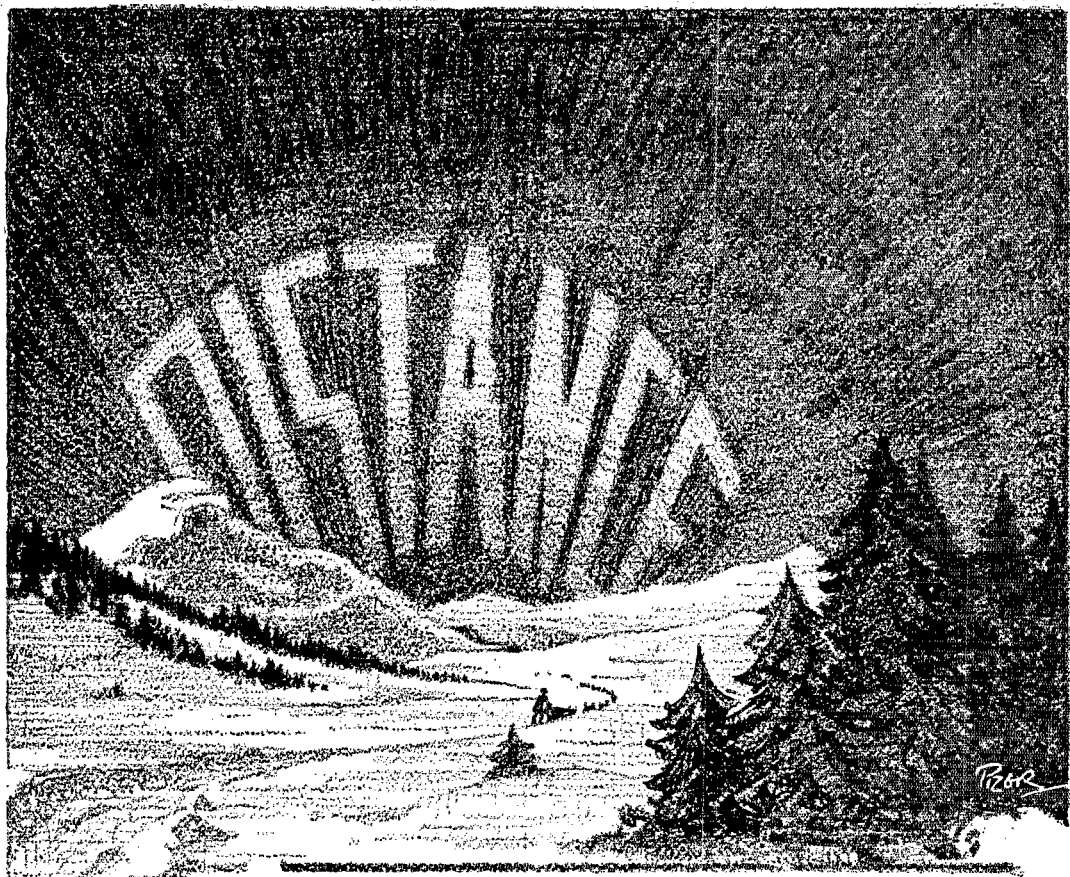

SINCE the summer of 1923, when Glenn H. Browning and Frederick H. Drake designed a radio frequency transformer which for the first time gave satisfactory amplification at the broadcast frequencies, the good will of the amateur fraternity and the voiced approval of a hundred-thousand Browning-Drake fans have placed the Browning-Drake Receiver in ever increasing demand.

This country-wide confidence in the Browning-Drake name and its stand-

ards can only be the result of Browning-Drake's consistent exceptional performance.

Browning-Drake produces only one model, fairly priced, and built complete at its Brighton laboratories. Backed by most modern research facilities, Browning-Drake is constantly improved as new instruments are proved worthy.

There are no yearly models to become obsolete. Price \$95.

Inquiries from amateurs, whether personally interested in broadcast reception or not, are always welcome and receive prompt attention.



The Browning-Drake Five

For further information address the Browning-Drake Corp., Brighton, Mass.

# BROWNING-DRAKE





# Supremacy!

Liberty and the Leviathan—supreme expressions of a Nation's greatness.

The Durham Metallized Resistor is supreme because it has improvements which lift it above most competition. Noiseless, temperature-proof and permanent in its resistance value.

10 meg. to 500 ohms, from 50c to \$1.00

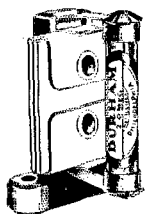

## RESISTOR MOUNTING

Made of moulded insulation of exceptionally high resistance. Best quality, tension-spring, bronze contacts. Only upright mounting made.

Single Mounting.....50c  
For Condenser.....65c

# DURHAM METALLIZED RESISTORS

INTERNATIONAL RESISTANCE CO.,  
Dept. B Perry Bldg., Philadelphia, Pa.

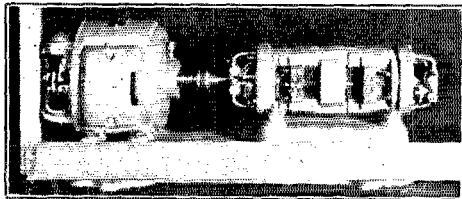

## SPECIALLY DESIGNED FOR TUBE TRANSMITTERS

Small Motor Generators manufactured by Mackie Company, London, England. Generator Low Tension: Voltage 10, Amperes 7. High Tension: Voltage 700, Amperes .1. R.P.M. 4800. D.C. or A.C. Specially built Commutators—no Commutator Ripple. Motors—D.C. or A.C. as required. While they last, \$130. D.C. and \$115. A.C.—f. o. b. New York.

### Deforest Phonoflms, Inc.

318 East 48th St. - - New York

## QST! OSCILLATING CRYSTALS

Why do you fellows want thick crystals for use in the 80 and 40 meter bands. You seem to have been misled. We can grind you a crystal guaranteed to oscillate in the 80 meter band, capable for use in transmitter circuits, giving as high as 18 watts of Crystal-controlled energy in a UX210 tube. The above described crystal can be ground for only \$30.00. If you club your orders and order 3 at a time, we can better the price to \$25.00 each.

### Broadcast Band

Crystals ground to your assigned frequency accurate to better than a tenth of 1% for \$50.00 each. Prompt deliveries.

### THE CRYSTAL SPECIALISTS

Scientific Radio Service

Box 86 Dept. D Mount Rainier, Maryland



## CORBETT'S RADIO CABINETS

Mahogany and Walnut cabinets of all designs. Prices surprisingly low. Excellent workmanship and finish. Write for circular.

CORBETT CABINET MANUFACTURING COMPANY  
ST. MARYS, PA.

# Cardwell

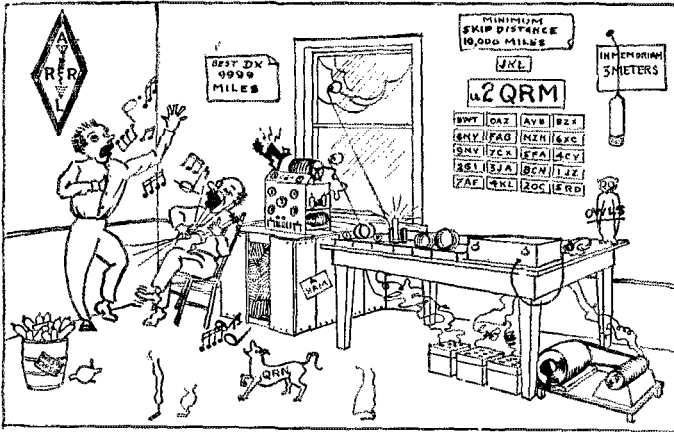

# SHARP TUNING

Sharp Tuning can only be accomplished in one way — by using the best. And every amateur knows and uses ~ ~ Cardwell Condensers

Send for booklet on the 2QA Short Wave Receiver—a better set for 40 meters. Also ask for the 36-page handbook-catalogue.

By the way—there's a rank bull in the picture—what is it?

THE new Taper Plate type E Receiving Condenser is designed to be practical rather than theoretically perfect, between straight frequency and wavelength. Full size plates, far heavier than ever used before, assure positive permanence of calibration. The type C gives a modified straight wavelength.

## Transmitting

### VARIABLE

Capacity Mmids	Type No.	Breakdown Voltage	Price
250	164-B	3000	\$ 7.00
440	147-B	3000	10.00
80*	197-B	3000	8.50
217*	157-B	3000	12.00
156	183-B	5250	15.00
297	166-B	7600	70.00
480	123-B	1400	5.00
480*	156-B	1400	7.00
980	137-B	1400	7.00

### FIXED

250	501	3000	\$ 4.50
440	502	3000	7.00
966	503	3000	10.00
250	504	5250	15.00

\*Has two insulated stators—capacity of each.

## The Allen D. Cardwell Manufacturing Corp.

81 PROSPECT STREET, BROOKLYN, N. Y.

Pacific Coast Agent, Radiowin Pacific Co.,  
Pacific Bldg., San Francisco

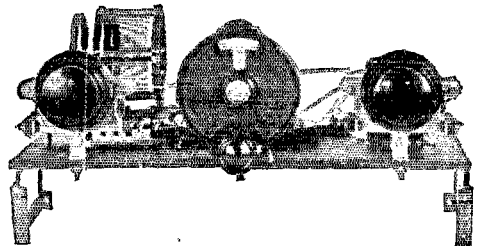

# Condensers

THE STANDARD OF COMPARISON  
SAY YOU SAW IT IN Q S T—IT IDENTIFIES YOU AND HELPS Q S T



## In The New Set Use an Instrument

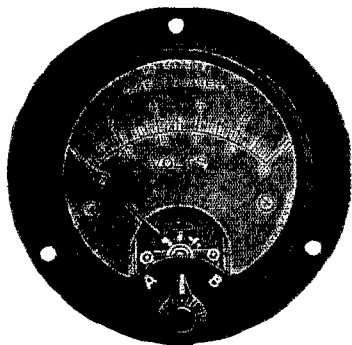

Pattern No. 55  
Combination Voltmeter  
for panel mounting

When incorporated in the panel of a set an instrument provides an accurate means of watching filament and plate voltages and instantly checking their values besides being an attractive addition to the set. There is certain to be increased pleasure in the knowledge that your set is functioning properly.

Jewell has an instrument for every radio need. Send for new radio instrument catalog No. 15-C just off the press.

### Jewell Electrical Instrument Co.

1650 Walnut St.

Chicago

26 Years Making Good Instruments

## Save 20 to 50%! ORDER NOW!

Try Us for prompt and careful attention, immediate delivery and courteous service.

**LOWEST PRICES** for DRILLED, ENGRAVED or DECORATED PANELS or SUB PANELS for the popular standard circuits, for short wave receivers or transmitters; or specially cut, drilled and engraved TO YOUR OWN SPECIFICATION.

**CORTLANDT PANEL ENGRAVING CO.**

79 CORTLANDT STREET,

NEW YORK

## TRANSMITTING

### KITS-SETS and PARTS at Reduced Prices!!

**7½ WATT TRANSMITTER -  
KIT Complete for \$24.75**

**5 - 500 WATT TRANSMITTERS**

for Dependable, Efficient DX!

**A. R. S. Co STANDARD SHORT  
WAVE RECEIVER at**



### AMATEUR RADIO SPECIALTY COMPANY

· 77 CORTLANDT ST.  
New York

## RADIO DEALERS

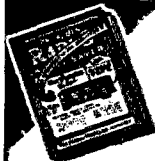

WRITE today for your free copy of Albin's LATEST Radio Money-Saver Catalog. More complete than ever! Every page crammed with latest in sets, speakers, kits, parts and accessories. Fast moving items - unbeatable values - complete stocks - unqualified guarantee - SAME DAY SERVICE. Buy from Albin and make this the BIGGEST YEAR you ever had.

**THE ALBIN RADIO CO. INC.**  
225 FOURTH AVE., NEW YORK

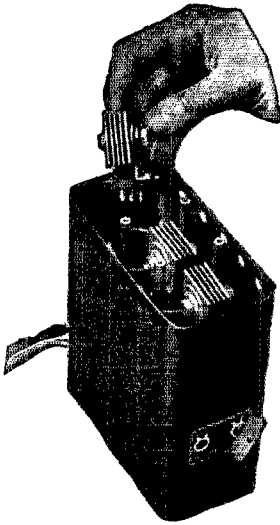

## The Elkon Rectifier

*"bone dry," silent, made of immovable solids*

Operates direct from alternating current, 105-120 v.  
50-60 cycles.

Charges radio "A" batteries.  
(25-40 cycles also available at a slightly higher price)

Charging rate 0 to 0.7 amps.

# UNILATERAL CONDUCTIVITY

THE peculiar ability of certain solids, in special arrangement in respect to each other, to cause current rectification has long been known to exist. The crystal, although useless for the purpose under discussion, is a well known example.

The Elkon Rectifier is the only successful development of this principle. This device has fully proved itself, both theoretically, and in every day use; in the hands of the technical man and in the average home, where its service is appreciated, but no attempt is made to understand it.

Its undeniable success under every service condition has brought about entirely new conceptions of the future development of radio power supply.

The Elkon Trickle Charger illustrates the radical and revolutionary change this rectifier has made in "A" battery charging. It contains *no liquids* of any kind; no tubes, no parts which oscillate or move in *any way*. It is silent, causes no interference, and does not heat up. It can be operated in any position. Neither jars, jolts, or short circuiting can harm it. It tapers automatically, and when attached to battery and house current *requires no further attention of any sort*. It is entirely *automatic*.

SET IT, INSTALL IT, \$ **15.00**  
FORGET IT

Complete  
with switch

**ELKON WORKS**  
Subsidiary of P. R. Mallory & Co. Inc.  
**ELKON WORKS**  
Weehawken, N. J. Inc.

Sole licensees under patents pending to Samuel Ruben

# Now!



**Kingston**

## B BATTERY ELIMINATOR

Do away with troublesome, expensive, bulky batteries, with acid, stained carpets, a dead radio just when you want it most. Install the KINGSTON B battery Eliminator and forget your battery troubles forever. Trim, handsomely finished in black and nickel, and guaranteed not only to remove the battery nuisance, but to deliver clearer tone and increased volume. Three different voltages obtainable at same time, each tap adjustable over a wide range, making any desired voltage from 5 to 150 possible and harmonizing perfectly with your own set. The Raytheon tube is used as a rectifier.

At Your Dealer's

Price, complete **\$37.50**  
with Raytheon tube

**KOKOMO ELECTRIC COMPANY**  
KOKOMO, INDIANA

# Kingston

## Hoyt CELLCHEK

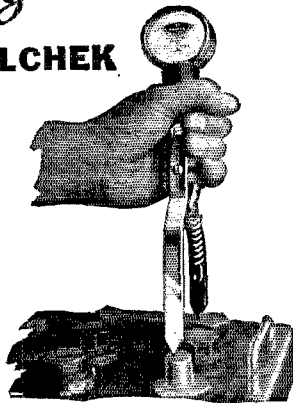

A new and more accurate instrument for testing radio and automotive storage batteries, equipped with electrical meter which indicates instantly whether the battery needs recharging, is low or in good condition.

Fits all types of batteries; tests cell by cell, showing condition of each.

Operates without withdrawal of acid—avoiding danger of damage to rugs, floors, clothing, furniture.

Tests cells under load; necessary for correct indication of condition.

THE HOYT CELLCHEK  
Price—\$2.50

**BURTON-ROGERS CO.**

BOSTON,

National Distributors

MASS.

## THREE "E" STRAIGHT LINE RHEOSTAT

Perfect Control of Filament Temperature

Gives you a fine, smooth, dependable variation of filament temperature. Turns smoothly, is absolutely NOISELESS, and once set, "stays put!" Controls volume smoothly, and without distortion, over the entire range.

Equally efficient for short and long wave sets. By all means secure this precision instrument at once. Ask your dealer or order direct. Price \$2.60 Postpaid.

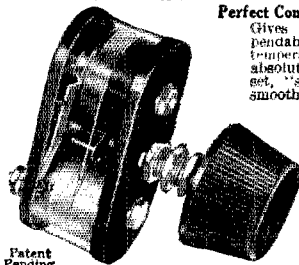

Patent Pending

Illus.  
3/4 Size  
6-15-30  
Ohms

**ELECTRICAL ENGINEERS EQUIPMENT CO.**

Radio Division

708 W. Madison St., Dept. 7 Chicago, Ill.

Information on Request



## "CAGE ANTENNA SPREADER"

DIAMETER 7 IN.  
Patented Sept. 8th, 1925

When erecting your Hertz antenna, why not feed into a 4, 6 or 8 wire cage antenna-counterpoise? By using these Spreaders, the job can be done very quickly and efficiently. Circular upon request. Price: \$5.00 per dozen \$2.75 for a half dozen. Immediate delivery, I pay the postage.

**CHARLES F. JACOBS (RADIO 2EM)**  
279 Park Place Brooklyn, N. Y.

Parts and supplies for Edison element storage "B" batteries in stock for immediate delivery. Perfect elements. Electrically welded on strip connectors. Type "A", 5c per pair. Type 3-G, 1500 M. A. 6c. Type 3-G 3000 M. A. 9c. 3x6" flat bottom jars, 3c. 1x6", 4c. No. 20 pure nickel wire, 1c per ft. No. 18, 1 1/2c. Separators, 4c per doz. Potassium Hydroxide and Lithium for making 5 lbs. Edison solution, 85c. 100 volt battery in steel case, complete in every detail, \$12.50, 140 volt, \$17.00. Send for complete list.

**J. ZIED, 904 N. 5th ST., PHILA., PA.**

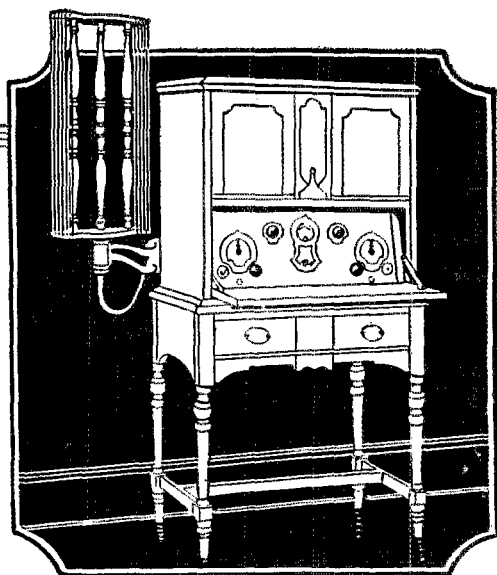

## The Totally Shielded Receiver With "Universal" Features

The new Stromberg-Carlson "Universal" 6-tube Receivers appeal to those experienced amateurs who are seeking the utmost in broadcast reception.

Features of the "Universal" models include:

Choice of operating power—either house socket power or batteries.

Choice of apparatus for audio amplification—either internal amplification with UX-112 tubes or UX-171 tubes or external amplification with super-power amplifier.

Choice of pick-up device—either loop or antenna.

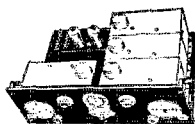

### Totally Shielded

The total enclosure of each of the three radio stages and the detector stage in separate heavy copper shields, prevents all local pick-up of signals, greatly increases selectivity and distance ability, and produces unexcelled tone quality.

No. 602 Art Console (above) American Walnut; space for all operating equipment. 6-tube totally shielded dual control; equipped with volt-meter. Furnished in both "Universal" and "Regular" models.

Receiver, Universal with external cone speaker (Loop Extra) . . . . .

Rockies  
East of  
\$365.00

Rockies  
and West  
\$385.00

Receiver, Regular (built-in speaker and without the Universal features)

340.00

360.00

No. 101-A Loop Outfit. .

22.50

25.00

*Receiver prices are less accessories*



**STROMBERG-CARLSON TELEPHONE MFG. CO.**  
ROCHESTER, NEW YORK

# Stromberg-Carlson

# ELECTRAD

Your Set is as  
Good as  
Your Parts

**N**O doubt about that. If you know radio you know how important your Grid Leaks are. Use Electrad Metallic Leaks and Resistors. New—totally different. No carbon, paper, varnish, fiber. The metallic resistance element is fused to the inside of a glass tube.

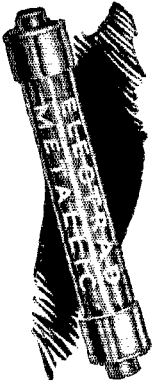

Capped with the exclusive Electrad ferrule. Paraffined under high vacuum. Six points of superiority: Noiseless, Constant, Accurate, Non-hygroscopic, Non-inductive, Unvarying under any weather or working conditions. Great current-carrying capacity without overheating or change of resistance. Make this test—try these leaks in your own set. Hear the improvement in reception. Sizes .1 to 10 megohms.

Price: U.S. 60c; Canada, 85c.

## Use ELECTRAD Certified Condensers

Without hesitancy we claim the Electrad Certified Six Point Fixed Condenser to be without equal. Here is why: Uniform pressure, insured by rigid binding at six points. Sheet copper, not tinfoil. Soldering iron can't hurt it. Certified electrically and mechanically. Guaranteed to remain within 10% of calibration. Standard capacities. All types. Prices: U. S., 30c to 75c. Canada, 45c to \$1.50. In sealed packages at all good radio stores.

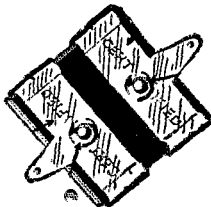

For perfect control of tone and volume use the Electrad 500,000-ohm compensator. For free hookup write 428 Broadway, New York City.



# ELECTRAD

# SM

## 635 Short Wave Kit

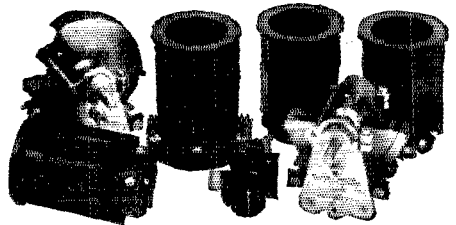

The type 635 Short Wave Receiver Kit contains the carefully designed and matched essentials for a real short wave set. Its range is 18 to 150 meters. The kit contains a set of four plug-in-coils, one coil socket, one coupling condenser and two 140 mmf. condensers. These parts are all carefully designed for operation together.

With the four coils supplied, the amateur bands fall well to the center of the tuning scale. "Dead spots" at which the receiver will not oscillate are totally eliminated. The antenna condenser allows coupling adjustment to suit individual conditions.

Price \$23.00 at Your Dealers

### Silver-Marshall, Inc.

858 West Jackson Blvd. Chicago, U. S. A

Amateurs All Over the World

# prefer

## The ADVANCE "Sync" RECTIFIER

1. The ADVANCE Sinc Rectifier actually does what any other rectifier claims to do.
2. Can be easily and quickly filtered.
3. Meets all requirements for heaviest duty.
4. Speedy starting because of Advance Bakelite wheel.
5. Requires no attention—always ready.

Its prevailing use in international transmitting is evidence that, although lower in price, the advance Sinc Rectifier is superior in quality.

Revolving disk is moulded bakelite six inches in diameter. Nickel plated brush holders with adjustable gauze copper brushes. Convenient control handle. Disk, aluminum brush arm support and brush holders perfectly insulated.

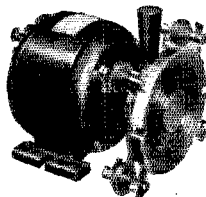

Price complete with Westinghouse 1/4 H. P. Synchronous Motor . . . \$40  
Rectifying wheel with complete brush assembly and mounting ring to fit your own motor . . . \$15

We Pay All Transportation Charges in U. S. A.  
ADVANCE ELECTRIC COMPANY  
1260-1262 West Second St., Los Angeles, Calif.



# Announcing

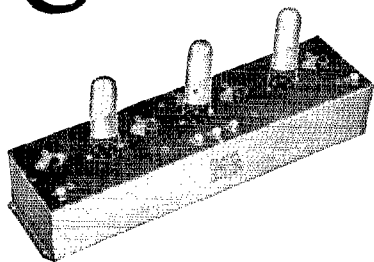

Three-stage radio frequency amplifier operating at a fixed high frequency.

# the New REMLER INFRA+DYNE AMPLIFIER

The No. 700 Infradyne Amplifier is a product worthy of the name "Remler" which, since the early days of Amateur Radio, has been recognized as symbolic of quality. Its design and manufacture are the result of careful experimentation and are in strict accord with the best engineering practice.

## New Fields Opened

The development of the Infradyne Amplifier has opened up new fields in radio broadcast reception. The "impossible" has been accomplished. Efficient amplification and perfect control of stability at short wave lengths have been realized and the use of the "sum frequency principle" has been made possible. Because of the characteristics of circuits operating at these frequencies a reduction of background noise and maximum selectivity with complete response to the full range of voice and music frequencies have been obtained. Quieter and more enjoyable reception together with improved quality of reproduction are therefore made possible.

## Exact Requirements Met

All parts used in the Remler Infradyne Amplifier have been designed and are constructed in our own laboratories and factory to meet exactly the requirements of the circuit. The Infradyne Amplifier is adapted to use with many broadcast receivers of the conventional tuned radio frequency type and when it is so employed quieter operation and improved selectivity are obtained; it has been specified by Mr. Sargent as an essential part of the Sargent Infradyne Receiver described in "Radio" for August 1926.

Reprints of this article will be furnished free upon request.

### 6 Remler Reasons Why

1. No direct pick-up in the amplifier circuit of long-wave signals or arc "rush".
2. Amplification at 86 meters does away with crowding of dials due to locally generated harmonics.
3. Quieter operation through reduction of the noise level.
4. Extraordinary selectivity.
5. Complete response to the full range of voice and music frequencies and, therefore, improved quality of reproduction.
6. Readily adapted to any standard radio-frequency circuit.

# REMLER

GRAY and DANIELSON  
Manufacturing Company

260 First Street  
San Francisco

Chicago

New York

# 20,000 CONSULTING RADIO ENGINEERS

Each one of you 20,000 members of the American Radio Relay League is looked up to in his or her community as a Radio authority.

Each one of you is called upon for opinions as to Radio performance, Radio set construction, Radio set components—coils, condensers, dials, audio amplifiers.

And we know that the opinions and advice given are invariably conscientious, unprejudiced and helpful.

Good Radio owes a never-to-be-repaid debt to you,—members of the A.R.R.L. It should be the goal of every radio manufacturer to produce material worthy of your recommendation and praise.

## NATIONAL Radio-Set Essentials

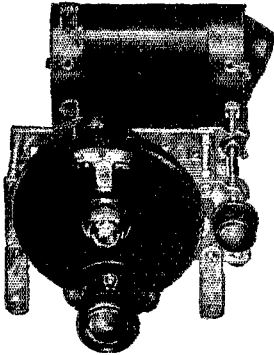

**BD-2B**  
(Patent pending)

The new NATIONAL tuning units, with their space-wound Browning-Drake Radio-frequency transformers, their light, rigid Equicycle condensers, their nationally known, NATIONAL Velvet-Vernier Dials, make a Radio set foundation, dependable, solid and true. After these, the NATIONAL Impedance-former for faithful audio amplification, and the necessary sockets, rheostats, panels and accessories; to make a broadcast receiver easily constructed, selective and sensitive, easy to operate, and oh! how easy to listen to!

Send for pamphlet 110-Q

**NATIONAL CO. Inc.**  
W. A. READY, Pres.  
**Engineers and Manufacturers**  
110 Brookline St., Cambridge, Mass.



## B-Power Units

You Can Rely  
Upon

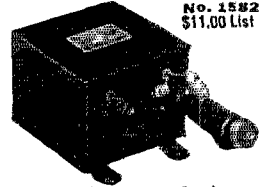

No. 1582  
\$11.00 List

Dongan has pioneered in the design and manufacture of B-Power Transformers and Chokes since Eliminators first came into practical use. Today Dongan offers several types of B-Power Units for all Full and Half-Wave Rectifying Tubes. Each type is thoroughly tested for maximum efficiency.

Perhaps the most popular type is B-Power Unit No. 1582, illustrated here. This remarkable cased unit is built especially for use with the Raytheon Tube. For smooth, uninterrupted B-Power you will find No. 1582 a pleasure to use with absolute confidence.

See your dealer or send us order direct  
*Special Transformers for Truckle Chargers*

**Dongan Electric Manufacturing Co.**  
2999-3001 Franklin St., Detroit, Mich.

TRANSFORMERS of MERIT for FIFTEEN YEARS

# AEROVOX

"Built Better"

LAVITE RESISTANCES



Guaranteed to dissipate  
4 Watts

AEROVOX products are used by over 200 of America's Radio Manufacturers. AEROVOX Fixed Condensers are approved by M. I. T. and Yale Universities. AEROVOX WIRELESS CORP. 489-491-493 Broome St., New York

Branch Offices:  
St. Louis, Mo., Vendicatore Trust Building  
Cincinnati, O., Palace Theatre Bldg.  
Chicago, Ill., 31 W. Jackson Boulevard  
Boston, Mass., 74 Portland Street  
Los Angeles, Cal., 324 N. New Pedro St.

## MERCULES AERIAL MAST

\$10 and up. We pay the freight.

All steel construction, 20 to 100 ft. high. Roof or earth type complete with guy wires, masthead pulley etc. Write for full details. S.W. Hull Co. Dept. 6 2048 E 79th St., Cleveland, Ohio



## LEARN RADIO

In New Orleans, La.,  
(2nd Port, U. S. A.)

**NOLA RADIO SCHOOL**

740 POYDRAS ST.,

Established 1918

PROSPECTUS UPON REQUEST

# Another Karas Surprise!

First there was Harmonik

—the original high-quality transformer

Then Karas presented Orthometric

—the straight frequency line condenser

Its last triumph was Micrometric

—the vernier dial without back-lash

NOW Karas announces Equamatic

—the perfect system of broadcast reception  
and oscillation control

1. The Equamatic System gives maximum and equal sensitivity and amplification of any wavelength—long, short or intermediate.
2. It develops the greatest possible selectivity without distortion or loss of harmonics.
3. It assures perfect balance on all wavelengths without employing "losser" methods of any kind.
4. It conserves the life of "A" and "B" batteries.
5. It simplifies operation of all sets by perfect synchronization of the first dial with the others.
6. It eliminates fundamental wavelength antenna absorption.
7. It provides simple adjustment to meet varying conditions, permitting perfect balance of tubes, antenna, and associated apparatus.

The essential parts for the building of an Equamatic Receiver are made by Karas. Complete instructions for assembly and wiring, including drilling layouts, will shortly be ready. Mail the coupon for the Equamatic booklet fully explaining this system for which the Radio world has so long waited.

## Karas Micrometric Dial

Tunes accurately to 1/1000th of an inch with a ratio of 63 to 1 and can never develop back-lash. Turns instantly in either direction at lightest touch on vernier knob; rough tuning is done with larger knob. Dial markings and numerals are gold inlay. Available in 180 or 360 degree rotation—clockwise or counter-clockwise. Diameter 4 1/4" and all Bakelite. Karas Micrometric Dials are stocked by good parts dealers in most cities. Orders will be filled direct if dealer cannot supply you.

Price

**\$3.50**

Each

Karas Electric Company,  
1070 Association Bldg., Chicago

Enclosed is 10c for which please send me booklet on the Equamatic System explaining what it accomplishes and how it does it.

Name.....

Address.....

**KARAS ELECTRIC CO.**

Factory N. Rockwell St.      Offices 1070 Association Building, Chicago



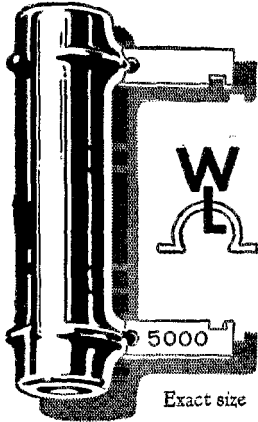

**Ward Leonard  
Adjustable Resistors**  
*for building*  
"Raytheon" and "Amertran"  
Plate Supply Circuits  
(Ask for the Vitrohm Resistor Kit)

Resistors are made in small units so you can try different combinations to find the amount of resistance that gives best results in your circuit.

Useful for other radio experimenting.

There are eight units in the Vitrohm Resistor Kit, of assorted values, totalling 21,750 ohms. They are wire wound, vitreous enamelled; no carbon or graphite. Hard to break but easy to use. Handy soldering lugs. Instructions for use and mounting included.

**\$8.90**

**Postpaid**

**Ward Leonard Electric Co.**  
Mount Vernon, New York

**"UNIVERSAL"  
Faradon  
CONDENSER BLOCK**

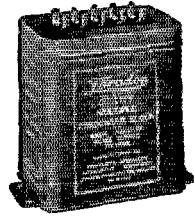

Model WS-3750

The FARADON "UNIVERSAL" Filter Condenser Block of 14.2 Mfd. in one container, is for operation in connection with the most generally used Battery Eliminator circuits. It contains important features not heretofore found in grouped filter condensers.

The total capacitance is connected to fixed terminals in convenient units, permitting ready wiring. The units to be connected in the circuit where possible high potential surges may occur are constructed to withstand a higher voltage than is usually required. Convenience, safety and continued satisfactory operation are combined in the FARADON Filter Block.

**FARADON FILTER CONDENSERS**

are also available in individual units of 1/10, 1/2, 1, 2, 3, and 4 Mfd. in two voltage classes; Class A, Flash Test 800 V.D.C., and Class B, Flash Test 1500 V.D.C. Also a complete line of Condensers in units and gangs for all by-pass and blocking applications.

**WIRELESS SPECIALTY APPARATUS COMPANY**  
Jamaica Plain Est. 1907 Boston Mass., U. S. A.

**FROST-RADIO**

**Type 880 Super Variable Resistance**

These new non-inductive, variable high resistance units are precision instruments which operate smoothly and noiselessly from zero to maximum rating. Have low temperature coefficient. Lever makes positive rolling contact with resistance element with absolutely no wear. Designed for use as tone and volume control, for resistance coupled amplification, to control regeneration, and as a stabilizer. Furnished in following resistances: 50,000, 100,000, 200,000, and 500,000 ohms. List: \$1.25.



**HERBERT H. FROST, Inc.**  
160 N. LaSalle St., Chicago New York City Los Angeles

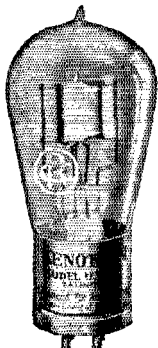

**GENUINE  
Kenotron Rectifying Tubes  
Model UV-216**



THESE Tubes are the GENUINE R.C.A. Kenotron Rectifying tubes. Filament voltage 7½ volts and will safely stand A.C. input of 750 volts. Four of these tubes will run a 50 wattier.

These Rectifying tubes will pass plenty of current and voltage for your TRANSMITTER and also are very efficient for use in "B" ELIMINATORS. STANDARD BASE. EVERY TUBE BRAND NEW AND PACKED IN ORIGINAL CARTONS.

List price \$7.50 ea.—**Extra Special \$1.85 ea.**

**AMERICAN SALES CO., 21 Warren Street, N. Y. C.**

# For Transmitting as well as Receiving

*Ray-O-Vac Radio Batteries Give a Steady, Uniform Voltage and Have Exceedingly Low Internal Resistance.*

\* \* \*

Transmitting makes rigid demands on the current supply. Any diminution or unevenness in current affects the beat of your wave and lowers your chances of having your call picked up.

That's why so many amateur transmitters use Ray-O-Vac batteries. These batteries deliver a steady, uniform voltage that makes better transmission possible. Because they have *low internal resistance*, they deliver signals free from distortion.

And Ray-O-Vacs have staying power in this work, too. It is not unusual for a Ray-O-Vac 22½ volt B battery to wear down to 17 volts without distort-

ing signals. Other sizes and types are equally long-lived.

No less a radio authority than Dr. Lee de Forest—the father of radio broadcasting—uses Ray-O-Vacs in all his experimental work.

At the 2nd Radio World's Fair at Chicago all the amateur radiograms that were sent out were by transmitters using 540 volts of Ray-O-Vac No. 9303 B batteries. After six days of practically continuous use from 2:00 to 11:00 P. M. each day, none of these 12 batteries showed a drop in voltage of over 1½ volts.

Keep your apparatus equipped with Ray-O-Vacs for all plate and grid batteries. They give you a new degree of battery longevity.

If the stores where you ordinarily buy do not have Ray-O-Vac radio batteries, write us for the name of the nearest dealer or jobber who can supply you.

**FRENCH BATTERY COMPANY, Madison, Wisconsin**

*Ray-O-Vac "B" batteries in all standard sizes, both flat and upright.*



*Ray-O-Vac "A" batteries recuperate during rest periods, lasting longer and giving excellent reception.*

*Ray-O-Vac 4½ volt "C" batteries with 3 variable terminals give voltage adjustment of 1½, 3 and 4½ volts.*

# The final condenser!

Here at last is the final condenser acclaimed by both amateurs and experts as the **ONLY** condenser embodying new and vitally important improvements over old type condensers—solving forever, the tuning evils of the past.

## METRALIGN SLT STRAIGHT LINE TUNING

METRALIGN SLT is the only condenser combining Straight Line Capacity, Straight Line Wave Length and Straight Line Frequency, eliminating the faults and retaining the advantages of each type—the result is a perfect tuning unit.

Makes any Set  
a New Set—  
in 15 Minutes

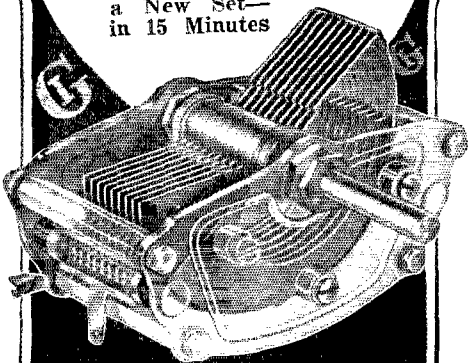

### FREE

We have prepared a most comprehensive booklet on tuning. It is written in simple language and tells all you want to know about condensers. Write for a copy today.

### GENERAL INSTRUMENT CORP.

477 Broadway  
NEW YORK CITY

## American Transformer Company

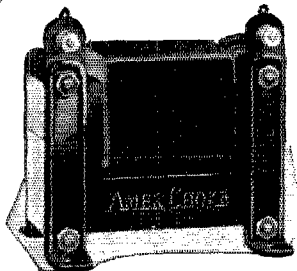

The  
AmerChoke

Most satisfactory in the long run is the set of dependable parts throughout. One of the most reliable and useful of AmerTran products is the AmerChoke Type 854—a choke coil or impedance designed primarily for use in filter circuits. As an output impedance with a fixed condenser it forms an ideal filter for the loudspeaker, insuring tone quality equal to and more economical than the average output transformer. For filter circuits in B eliminators, the AmerChoke will give excellent results due to its scientific design and generous proportions.

AmerTran Power Transformers are also of high efficiency—and are especially adapted to the use of the 7½ volt power tubes in the last audio stage. After rectification, they supply sufficient plate current for the operation of the set.

In two stages, AmerTran De Luxe Audio Transformers are famous for the natural tones developed over the entire audible range. Whatever else a set may have—if it is good, the use of these transformers will make it better. You may pay a little more but you will get a great deal more.

Write today for interesting free booklet—"Improving the Audio Amplifier"—and price list.

AmerTran Products Are Sold Only at  
Authorized AmerTran Dealers

AMERICAN TRANSFORMER CO.  
178 Emmet Street Newark, N. J.

Transformer Builders for  
Over Twenty-Five Years

# Q - R - H ?

(What is Your Wavelength?)

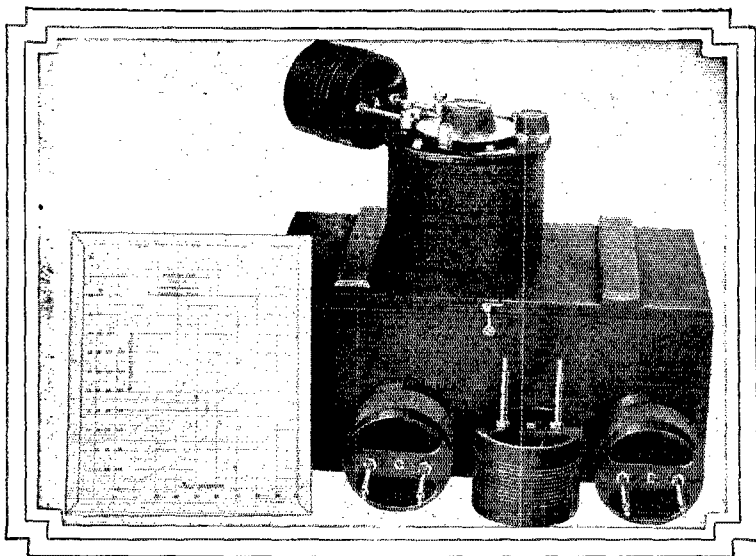

## *The General Radio Type 358 Wavemeter*

The type 358 wavemeter is designed particularly for experimental use. As it covers a wavelength range of 15 to 225 meters, it covers all the amateur bands in common use. The wavemeter consists of a set of four mechanically rugged coils of low loss construction mounting interchangeably on the binding posts of a shielded condenser of 125 MMF capacity. A resonance indicator lamp is connected in series with the condenser and coil. When the lamp is removed the socket in which the lamp is mounted becomes short circuited.

The wavemeter is equipped with the following coils calibrated with an accuracy of within 1%:

Coil A .....	15 to 30 meters
Coil B .....	25 to 60 meters
Coil C .....	50 to 115 meters
Coil D .....	100 to 225 meters

Coils A, B and C are space wound on threaded bakelite form to maintain accurate calibration.

Ask your dealer or write for our descriptive folder 358—Q.  
Price of wavemeter complete in wooden carrying case \$22.00.

**GENERAL RADIO CO.,**

**Cambridge, Mass.**

# GENERAL RADIO

**INSTRUMENTS**

*"Behind the Panels of Better Built Sets"*



# Important

little gateways of  
reception

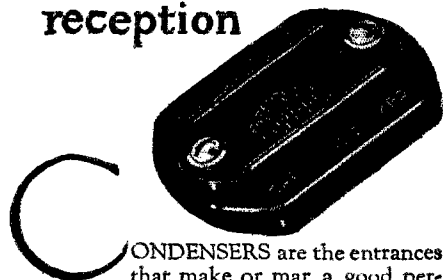

CONDENSERS are the entrances that make or mar a good performance. A good condenser stores up tone impulses, to be released at the instant they reach full-rounded perfection. An inaccurate condenser lets only a distorted part of the tone trickle through, and cuts down the receiving range of your set by putting it out of electrical balance. You'll realize the importance of accurate condensers the day you equip your set with Sangamo Mica Condensers.

## SANGAMO Mica Condensers

Being solidly molded in bakelite, Sangamo Condensers are accurate forever. All edges are sealed tight against moisture, the worst enemy of condenser accuracy. Ribs of bakelite give mechanical strength and prevent a change in pressure on the delicate mica inside, which would also change the condenser capacity. All edges are rounded to prevent chipping.

A range of 35 capacities makes it possible to get exactly the right capacity for your circuit.

Sangamo By-pass Condensers  
are now available in 1/10, 1/4,  
1/2 and 1 mfd. capacities.



Sangamo Electric Company  
6332-7 Springfield, Illinois

RADIO DIVISION, 50 Church Street, New York

SALES OFFICES—PRINCIPAL CITIES

## Tobe Transmitting Condensers

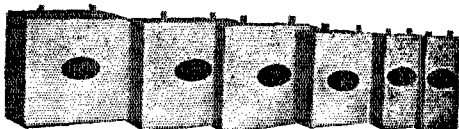

1 MFD. 1000 VOLTS \$1.75; 2000 VOLTS \$4.50  
2 MFD. 1000 VOLTS \$2.65; 2000 VOLTS \$7.50  
TESTED FOR VOLTAGE. BREAKDOWN  
AND CAPACITY. INDIVIDUALLY LA-  
BELLED WITH DATE OF TEST. CAPAC-  
ITIES GUARANTEED WITHIN 5%.

REL RADIO FREQUENCY CHOKE COILS  
FOR USE EITHER IN YOUR RECEIVER  
OR TRANSMITTER  
4" LONG 1" DIAM.—\$1.10  
— WOUND ON A BAKELITE FORM —

REL SHORT-WAVE LOW LOSS  
PLUG-IN COILS  
FIVE COILS FURNISHED WITH EACH  
UNIT AND MADE TO COVER 20, 40 AND  
80 METER WAVELENGTH BANDS.—\$3.90.

TRANSMITTING INDUCTANCES—TYPE L,  
40, 80 and 150 METERS WAVELENGTHS;  
TYPE S, 20 METERS OR LESS—\$4.60.  
DOUBLE UNIT (PRIM. AND SECOND.)  
\$8.90.

SEND CHECK OR MONEY ORDER  
M. B. S. SALES CO., DEPT. D.  
27 SCHOOL STREET, BOSTON, MASS.

## RADIO DEALERS



WRITE today for your free copy  
of Albin's LATEST Radio  
Money-Saver Catalog. More com-  
plete than ever. Every page crammed  
with latest in sets, speakers, kits,  
parts and accessories. Fast moving  
items—unbeatable values—complete  
stocks—unqualified guarantee—SAME-  
DAY SERVICE. Buy from Albin and  
make this the BIGGEST YEAR you  
ever had.

THE ALBIN RADIO CO. INC.  
225 FOURTH AVE., NEW YORK

## RADIO OPERATORS WANTED

THE EASTERN RADIO INSTITUTE can train you  
quickly and thoroughly because:

MODERN AND EFFICIENT METHODS  
THOROUGH INSTRUCTION under staff of  
LICENSED COMMERCIAL OPERATORS  
MODERN APPARATUS including SHORT WAVE  
TRANSMITTER

FOURTEEN years a RADIO SCHOOL  
THE OLDEST, LARGEST and MOST SUCCESSFUL  
school in New England. RECOMMENDED BY THE  
A. R. R. L.

Day or Evening Classes Start Every Monday.  
SPECIAL CODE CLASSES

Write for Illustrated Prospectus

EASTERN RADIO INSTITUTE  
899 BOYLSTON STREET BOSTON, MASS.



# *A Master Product!*

Designed for Reliable  
Long Distance Communication

on

1 Meter to 200 Meters



INPUT RATING 150 WATTS

Plate Voltages 500-3000

Plate Currents 40-50 MA.

Fil. Voltage 10

Fil. Current 2.35A



*Sold and Shipped Direct  
Upon Receipt of Money Order*

Price, \$18.00  
*Parcel Post Prepaid*

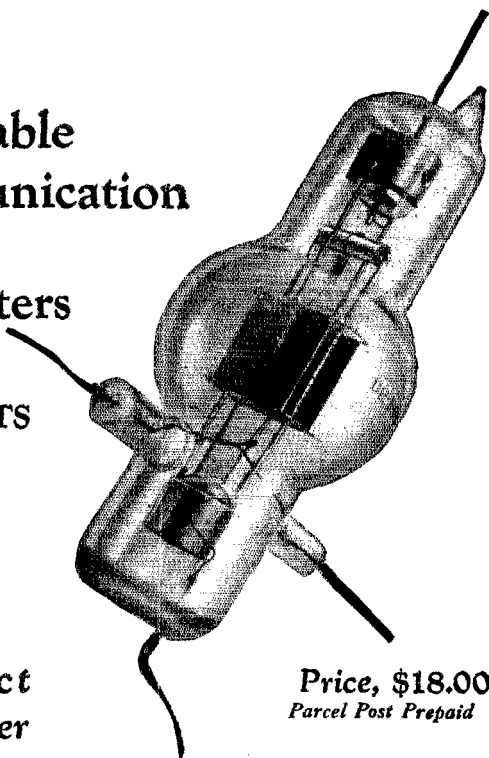

# DE FOREST

## TYPE-H

# TRANSMITTING TUBE

139 Franklin St., DE FOREST RADIO CO., Jersey City, N. J.

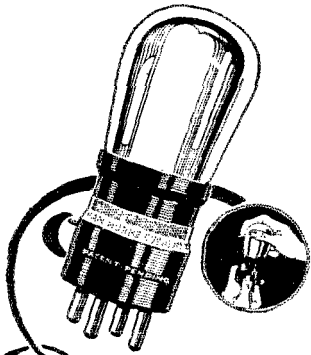

**Cushioned**  
to stop vibration—  
that's why the Cushion  
Base Tube makes such  
a wonderful improve-  
ment in reception

Equip your set with Van Horne Cushion Base tubes and note the surprising softness and fullness of tone of reception that follows the elimination of vibration. Order your set from your dealer today.

**OF SPECIAL DESIGN**  
A Popular, Short Wave  
Low Power Transmitter



The Van Horne 5 VC 5 volt 1/2 ampere tube is being used by a great number of amateurs with surprising results. Having a double filament and a lower than average plate impedance it has proven ideal for low power short wave transmitting work. Will withstand maximum plate voltage of 350 without break-down.

**ADAPTED  
MOGUL  
5 VCX  
POWER  
TUBE**

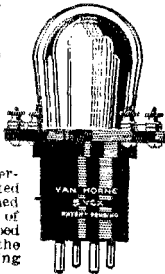

Identical to the 5VC in characteristics and construction the Adapted Mogul 5 VCX Power tube is designed for use in the last audio stage of receiving sets. This tube is equipped with a patented adapter to which the additional voltages are added making no change in set wiring necessary.

These tubes are two of a complete line of Van Horne Selected and Certified tubes of various types for all receiving purposes manufactured under patents pending to J. S. Van Horne. Amateurs are urged to acquaint themselves with the superiority of Van Horne products.

**THE VAN HORNE CO.**  
INCORPORATED  
81 Center St. Franklin, Ohio

**New!**  
**Tone and  
Volume  
Control**

Essential to thoroughly enjoy present day broadcasting. New high-priced sets feature tone control as their greatest improvement. You can have this new feature in your old set by attaching a Centralab Modulator Plug in place of the old phone plug. Takes but a moment—no tools required.

Gives any degree of tone volume from a whisper to maximum by simply turning the small knob on the plug. Static interference is reduced and programs come in clear and true with just the volume you most enjoy.

Order from your dealer, or mailed direct on receipt of the price, \$2.50

**Central Radio Laboratories**  
20 Keefe Ave. MILWAUKEE, WIS

Centralab Radi-  
ciums or Modula-  
tors are standard  
controls on any  
fine well-known  
sets.



**Centralab**

**LEARN THE CODE**

with **SIGNAL**  
a  
**High Pitch Buzzer and  
Key Set**



Built complete with key, true tone adjustable high pitch buzzer and code plate. Write us today.  
**Signal Electric Mfg. Co., Menominee, Mich.**

**SEE  
THAT  
SCREW**

A screw driver  
adjusts an -XL  
in crowded  
places.

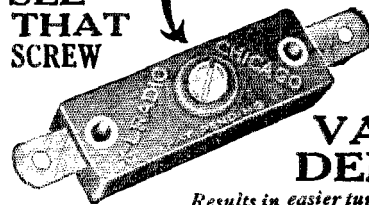

**X-L  
VARIO  
DENSER**

Results in easier tuning, more distance, volume and clarity—greater stability. Indorseed by leading radio authorities.

Model "N"  
A slight turn obtains correct tube oscillation on all tuned radio frequency circuits. Neutrodyne, Roberts two tube, Browning-Drake, McMurdo Silver's Knockout, etc., capacity range 1.8 to 20 micro-microfarads. Price **\$1.00**

Model "G"  
with grid clips obtains the proper grid capacity on Cockaday circuits, filter and intermediate frequency tuning in heterodyne and positive grid bias in all sets. Capacity range

Model G-1 .0002 to .0001 mfd.  
Model G-5 .0001 to .0005 mfd.  
Model G-10 .0003 to .001 M. f. d.  
Price \$1.50

X-L Push Post  
Push it down with your thumb, insert wire, remove pressure and wire is firmly held. Released instantly. Also furnished mounted on strips. Price 15c.



**X-L RADIO LABORATORIES**  
2428 Lincoln Avenue N. Chicago, Ill.  
80 SAY YOU SAW IT IN QST—IT IDENTIFIES YOU AND HELPS QST

# You hear *all* the tones

with an



## ALL-AMERICAN TRADE MARK Reproducer

*An All-American Quality Product*

A good speaker is the only kind worth having. A poor one will ruin otherwise good reception.

We're making a good one for you—the *Lorel* Reproducer; a cone type correctly balanced with sounding-board and sounding-chamber, to give you that purity of *all* tones, which you desire.

This remarkable unit combines the good features of both cone and sounding chamber types of speaker; and eliminates their inherent weaknesses. You can hear *all* the high and low tones with the *Lorel*; clear and full.

*Ask your dealer for a demonstration of the Lorel. You'll find it a real improvement in radio reception.*

Price \$25 Slightly higher west of the Rockies

ALL-AMERICAN RADIO CORPORATION  
4217 Belmont Avenue • Chicago

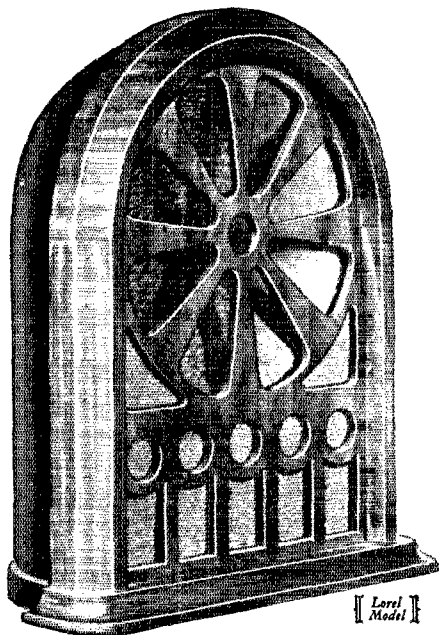

[[ Lorel Model ]]

*A Remarkable Improvement in  
Audio Amplification*

A development by All-American laboratories—the Rauland-Lyric-Trio. You know the Rauland Lyric Transformer, famous among music critics for its exceptional tone perfection. It is now combined with two Rauland Trio impedance units; retaining the advantages and eliminating the weaknesses of the two leading systems of audio amplification. The result is the last word in audio amplification. Free book, "Modern Audio Amplification," tells more about this interesting development. Write for handbook "B-go."

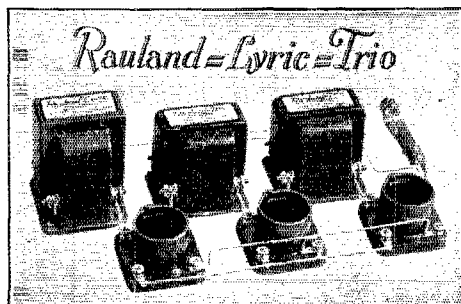

Rauland-Lyric-Trio

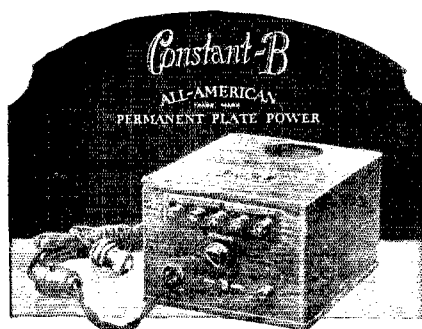

Pure full tone is possible only with unvarying "B" power. With All-American "Constant B" you get a permanent, constant plate power. There's nothing to take care of; no annoying hum, and no acid. Permanently sealed. "Constant B" has a 10 to 60 volt tap, varied in output by a "detector" control; a 67½ volt and a 90 volt tap; a variable voltage "power-tube" tap uniformly controlled by a "High-Low" switch.

Price \$37.50 Complete with Raytheon tube Slightly higher west of the Rockies

# Only the Best Radio Parts are good enough for a Good Set

All Benjamin Radio Products are of the same high standard as the far-famed Cle-Ra-Tone Sockets.

True-to-life reproduction depends upon quality radio parts. There must be no flaws—all parts must synchronize. Benjamin Radio Products increase sensitivity, selectivity and volume. Their use throughout the world—by authorities and amateurs—endorses Benjamin quality and preciseness.

## Improved Tuned Radio Frequency Transformers

Complete tests prove this the most efficient coil for modern sets. Space wound, Basket Weave, Cylindrical. Highest practical air dielectric. Gives sharper tuning, greater volume and purer tone.



2 1/4-inch Diameter Transformer—Compact. Especially desirable for easier tuning. Eliminates interfering "pick-up." Set of three, \$5.75. Single Transformer, \$2.10.

3-inch Diameter Transformer—Capacity coupling reduced to lowest degree. For use with .00035 Mfd. Condensers. Set of three, \$6.00. Single Transformer, \$2.25.

## Straight Line Frequency Condensers



No crowding of stations—broadcast range spread evenly over complete dial. Eliminates interference; gives easier tuning. Adjustable turning tension. Low loss characteristics give definite and distinct reception. Beautiful in appearance—dull silver finish. Made in three sizes: .00025 Mfd., \$5.00; .00035 Mfd., \$5.25; .0005 Mfd., \$5.50.

## Push Type Cle-Ra-Tone Sockets

Spring Supported. Shock Absorbing. Stop Tube Noises. The greatest aid to non-noisy operation. Contacts always clean. 75 cents each.

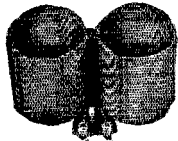
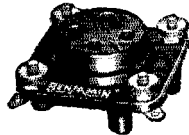

## "Lekeless" Transformers

Uniform high inductance, low distributed capacity and low resistance. Slight external field permits placing coils close together without appreciable interaction. Single Transformer, \$2.50.

## Brackets



Simplify set construction. Support sub-panel, with room underneath for accessories and wiring. Plain and adjustable. Plain, 70 cents per pair; adjustable, \$1.25 per pair.

## Battery Switch

Quick, positive, clean-cut make and break. When it's "in" it's "off"—no wasteful use of battery. 30 cents each.



If your dealer cannot furnish you with Benjamin Radio Products send amount direct to our nearest sales office with his name and we will see that you are promptly supplied.

See Benjamin Products at the Radio Shows

New York, N. Y., Sept. 13-18, Booth 9, Section CC  
Chicago, Ill., Oct. 11-17, Booth 9, Section P

## Benjamin Electric Mfg. Co.

120-128 S. Sangamon Street  
Chicago

New York  
247 W. 17th Street

San Francisco  
448 Bryant Street

Manufactured in Canada by the Benjamin Electric Mfg. Co.  
Canada, Ltd., Toronto, Ontario

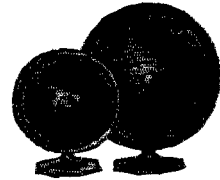

## CROSLEY Musicones

\$12.50 12 INCH CONE | 16 INCH CONE \$14.75

PRICES SLIGHTLY HIGHER ON WEST COAST

Already replacing hundreds of thousands of old-type loud speakers. Crosley patented actuating unit, not the cone shape, is the secret of unmatched tone.



MUSICONSOLE  
28 inch solid mahogany chassis with built-in Musicone. Space for all accessories.

\$32.00

Other CROSLEY RADIOS—From 1 tube Pup at \$9.75 to R.F.L. -90 Console at \$90.

Write Dept 18 for Catalog  
CROSLEY RADIO CORPORATION  
CINCINNATI

## "Outsell, Because They Excel"

## ALL TYPES



Including  
NEW DETECTOR (EX-200)  
HIGH MU and  
POWER AMPLIFIER  
Ask for Folder "Q"

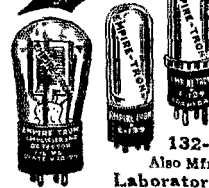

Dealers and Jobbers  
Write for Prices

## EMPIRE ELECTRICAL PRODUCTS CO.

Sales Office:

132-134 Greene St. New York  
Also Mfrs. of EMPIRE Cone and Loud Speakers  
Laboratories and Factory, Kearny, N. J.

## Become a Radio Operator

See The World. Earn a Good Income. Avoid Hard Work.

Learn in a Second Part U. S. A.

Radio Inspector located here. Positions plentiful. Splendid Climate. Other advantages to the student unequalled in any other American port. Nearly 100 per cent of operators graduating on Gulf during past four years trained by MR. CLEMMONS, Supervisor of instruction. Every graduate secures position. Day and Night Classes; enroll anytime. Write for Circular; Department TWO.

GULF RADIO SCHOOL 844 Howard Avenue, New Orleans, La.

Build Better Sets  
OF KELBRACKETS  
\$1.50 PER DOZ  
\$1.15 PER DOZ  
KELBRACKET  
HIGHEST EFFICIENT  
BRIGHT ALUMINUM  
FREE ASSEMBLY BOOKLET  
KELLERADIO, INC.  
821 Market St. San Francisco, Calif.

# DUDLO

MAGNET WIRE AND WINDINGS

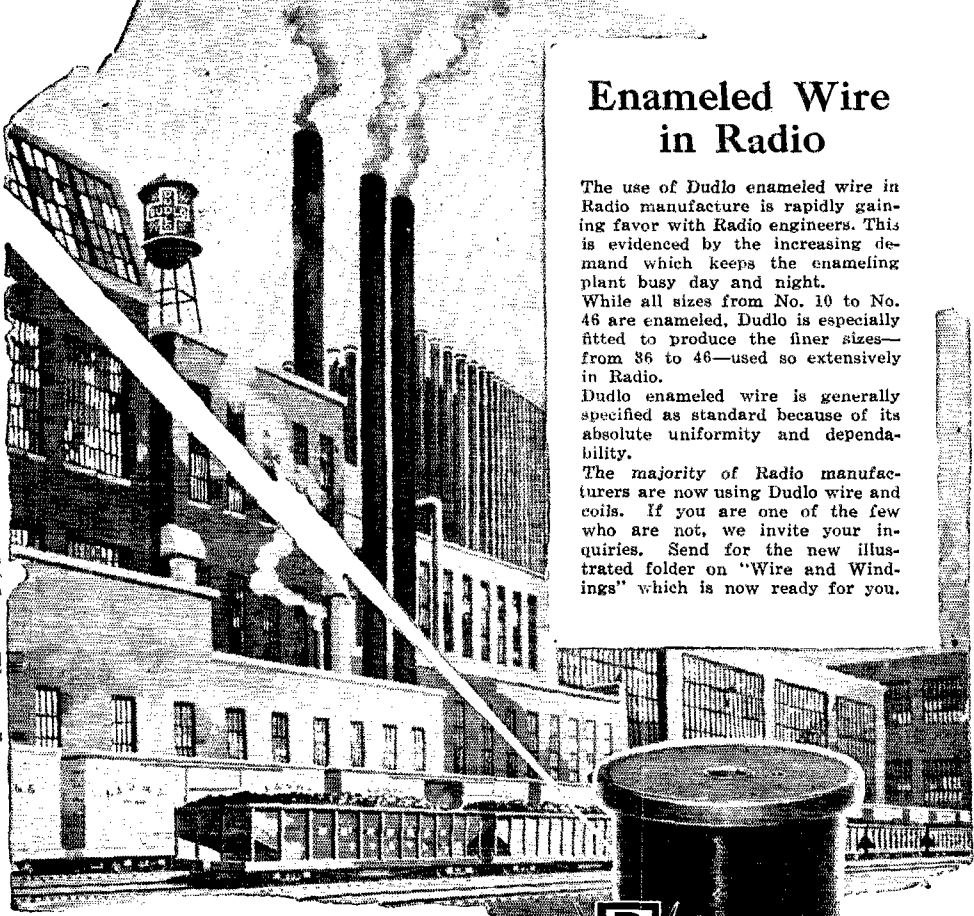

## Enameled Wire in Radio

The use of Dudlo enameled wire in Radio manufacture is rapidly gaining favor with Radio engineers. This is evidenced by the increasing demand which keeps the enameling plant busy day and night.

While all sizes from No. 10 to No. 46 are enameled, Dudlo is especially fitted to produce the finer sizes—from 36 to 46—used so extensively in Radio.

Dudlo enameled wire is generally specified as standard because of its absolute uniformity and dependability.

The majority of Radio manufacturers are now using Dudlo wire and coils. If you are one of the few who are not, we invite your inquiries. Send for the new illustrated folder on "Wire and Windings" which is now ready for you.

*Eastern Office  
and Warehouse*  
412 Chamber of  
Commerce Bldg.  
NEWARK, N. J.

*Chicago Office*  
160 N. La Salle St.  
CHICAGO, ILL.

*Western Office*  
274 Brannan St.  
SAN FRANCISCO, CAL.

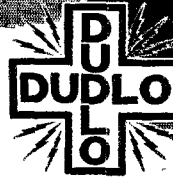

**DUDLO MANUFACTURING CORPORATION**

**FT. WAYNE, IND.**

# The "Gold" Bug for the "Gang"

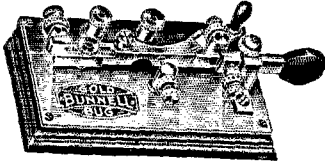

ONLY \$12.50  
with cord and plug.  
Carrying Case, \$3.50  
extra.

Here it is, the key that's being used all over the world, just the thing for the "gang." Simple in operation and easy to adjust. Made, guaranteed and sold on a money-back basis by an organization with over 40 years of experience in manufacturing transmitting apparatus.

You'll also be interested in a line of Jewell, Dubilier, Thordason, Hammerlund and other nationally known equipment.



## J. H. BUNNELL & COMPANY, INC.

Headquarters for Transmitting Apparatus Since 1878

32 Park Place, New York

Phone: Whitehall 5970

**First Offer** **SHORT WAVE RECEIVER**

**HUDSON RADIO CO.** **\$15<sup>00</sup> DOWN** WRITE FOR OUR TIME PAYMENT PLAN on ALL MATERIAL.

**1416 WYTHE PLACE - N.-Y.-C.** Balance Monthly

### A. R. R. L. Members -- What about your friends?

You must have a friend or two who ought to be members of our A.R.R.L., but aren't. Will you give us their names, so that we may write to them and tell them about the League and bring them in with the rest of us? The A.R.R.L. needs every eligible radio enthusiast within its ranks, and you will be doing your part to help bring this about by recommending some friends to us. Many thanks,

American Radio Relay League,  
Hartford, Conn.

..... 1926

I wish to propose

Mr. .... of .....

Mr. .... of .....  
Street & No. Place State

for membership in the A.R.R.L. I believe they would make good members. Please tell them the story.

.....  
.....

*"It gets that last mile"*

# The AIRGAP SOCKET

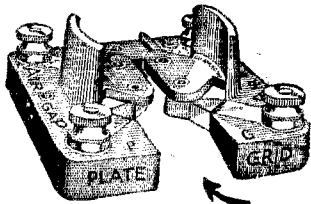

THE NEW  
Low Capacity  
U. X.  
UNIVERSAL  
Price 60c

See That Gap?

AIRGAPS will help rid any set of those squawks, howls and frying noises due to socket capacity; they keep the grids negative, stabilizing the circuit, causing tube to go into oscillations more smoothly and not "spill over" until maximum results are attained.

THEY HELP PREVENT closed circuit, absorption of current, intercoupling of circuits, feedback and undesirable capacity; they make any circuit more stable and sharpen tuning, resulting in purer and clearer tones with more volume on local and distant stations.

Sent Direct if Your Dealer Cannot Supply You. POSTPAID 60c EACH

AIRGAP PRODUCTS CO., MFR.

13 Campbell Street, Newark, New Jersey

# The AIRGAP SOCKET

*"It gets that last mile"*

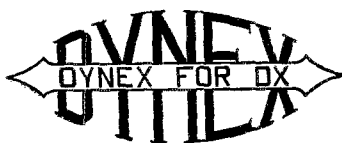

Dynex Aerial Wire is used and endorsed by the leading amateurs throughout the country. Its large conducting surface of low resistance together with its heavy coating of enamel which prevents corrosion, gives signals of maximum intensity. When putting up your new aerial insist on Dynex Solid Copper Enameled Wire.

No. 10 ..... .01-1/4c per ft.

No. 12 ..... .01c per ft.

We carry a full line of parts for the ham. If your name is not already on our mailing list drop us a card for our catalogue A-3, which will soon be ready.

## NICHOLSON ELECTRIC CO.

1407 First North St., Syracuse, N. Y.

## WARD LEONARD Transmitting Resistances NEW VITROHM RESISTOR KIT

Each kit contains the following resistances:  
1-750 ohm—3-1500 ohm—1-3000 ohm—1-3500 ohm  
2-5000 ohm.

### Special Sizes

Mailed Free Every Month! "Broadcasts", a monthly publication devoted to new things in radio. Send in your name.

### SPECIAL SERVICE

to A. R. R. L. Members.

Write for Full Particulars

**MORISON**  
Electrical Supply Co., Inc.  
15-EAST-40<sup>TH</sup> STREET.  
NEW YORK CITY



Operate your  
radio set from the  
light socket

Either with Balkite "B"  
and a Balkite Charger,  
or with the new  
Balkite Combination  
Radio Power Unit

FANSTEEL PRODUCTS CO., Inc.

North Chicago, Illinois

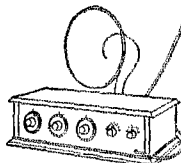

Make your fist readable at higher speed with

# THE CRICKET KEYS

Absolutely new principle. So simple they look foolish. Reports of "Fist F.B." from Chile, New Zealand, Australia, Canada, and all U. S. for months.

The only key for beginners. The best key for old Hams. **NO BUM FISTS. NO GLASS ARMS.**

How about a portable CRICKET for that portable set? We recommend desk CRICKET for beginners. Automatic. Easy learned. Easy operated. Easy read through QRN. No mental strain. Beginners teach themselves.



A "Jam Up" key for moderate price

Listen to 5EH

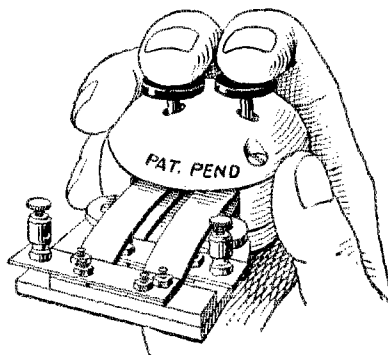

Write F. F. Mace & Son, 132 Sunset Ave., Dallas, Texas

## To Our Readers Who Are Not A. R. R. L. Members

Wouldn't you like to become a member of the American Radio Relay League? We need you in this big organization of radio amateurs, the only amateur association that does things. From your reading of *QST* you have gained a knowledge of the nature of the League and what it does, and you have read its purposes as set forth on page 6 of every issue. We would like to have you become a full-fledged member and add your strength to ours in the things we are undertaking for Amateur Radio, and incidentally you will have the membership edition of *QST* delivered at your door each month. A convenient application form is printed below—clip it out and mail it today.

.....1926

American Radio Relay League,  
Hartford, Conn., U. S. A.

Being genuinely interested in Amateur Radio, I hereby apply for membership in the American Radio Relay League, and enclose \$2.50 (\$3 in foreign countries) in payment of one year's dues. This entitles me to receive *QST* for the same period. Please begin my subscription with the .....issue. Mail my Certificate of Membership and send *QST* to the following name and address.

.....  
.....  
.....

Station call, if any .....

Grade Operator's license, if any .....

Radio Clubs of which a member .....

Do you know a friend who is also interested in Amateur Radio, whose name you might give us so we may write him about the League? .....

..... Thanks!



# WESTON "Pin-Jack Voltmeter" with HIGH RANGE STAND

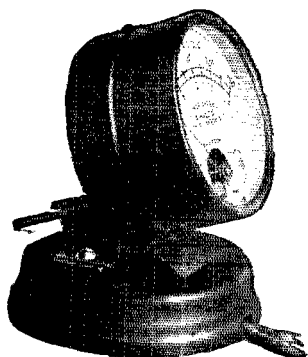

Rear showing adjustable pin terminals.



Dials showing double scale for filament and battery voltages.



Range Stand for battery Plugging Pin-Jack Voltmeter Into High testing.

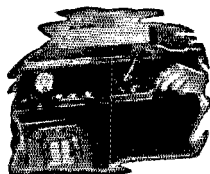

Testing "B" Battery with the Pin-Jack Voltmeter and High Range Stand.

The advantage of a Weston Voltmeter for positive set control is well known.

Here is a new combination—two instruments in one—a Pin-Jack Voltmeter and a High Range Stand. Simply plug the Pin-Jack Voltmeter into the filament Pin-Jacks on the panel and you measure tube filament voltage—remove it and plug it into the High Range Stand and you can measure battery voltages up to 160 volts!

¶ The results—tube economy, longer battery life, better all-around set operation. ¶ The new Weston Pin-Jack Voltmeter and High Range Stand is a typical Weston product designed especially for the Radio Expert and Enthusiast.

¶ For complete information write us for Bulletin "O".

WESTON ELECTRICAL INSTRUMENT CORPORATION  
158 Weston Avenue, Newark, N. J.

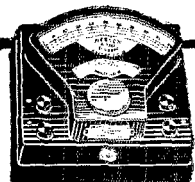

STANDARD THE WORLD OVER

# WESTON

*Pioneers since 1888*

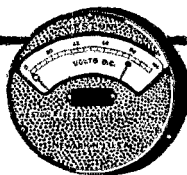

## "PYREX" insulation

Reg. U. S. Pat. Off.

THE POWER LOSS of Pyrex insulators at 500,000 cycles ( $P = K \times X^\circ$ ) is .48.

The use of Pyrex in short wave transmitters and receivers eliminates leakage and eddy losses.

Pyrex sockets for UX tubes are now available, and a receiver with these sockets, Pyrex insulated condensers and an antenna properly insulated with Pyrex, represents real short wave reception efficiency.

Fifty broadcasting stations (including several super-powers) depend on Pyrex insulation.

### CORNING GLASS WORKS

*Industrial and Equipment Division*

Corning . . . . . New York

# The World's Greatest Bug

Improved Martin

## VIBROPLEX

Reg. Trade Marks  
Vibroplex  
Bug  
Lightning Bug

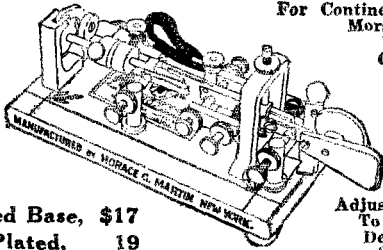

For Continental,  
Morse or  
Navy  
Codes

Adjustable  
To Any  
Desired  
Speed

Japped Base, \$17  
Nickel-Plated, 19

Over 100,000 operators use the Improved Vibroplex because it is **EASIER, QUICKER and MORE ACCURATE** than the old key.

It transmits with amazing ease. **CLEAR, CLEAN-CUT** signals at any desired speed. Saves the arm. Prevents cramp, and enables any operator to send with the skill of an expert.

### Special Radio Model

Equipped with Large Specially Constructed Contact Points. Requires no relay **\$25**

Every amateur needs this bug. Easy to learn. Sent on receipt of price. Money order or registered mail. Liberal allowance on your old (Martin) Bug. Order Now!

**THE VIBROPLEX CO., Inc.,**

825 Broadway, New York

# EAGLE



## All That's Best in Radio

Eagle Owners have the satisfaction of knowing they have the best Radio Receiver made, regardless of cost.

Ask Your Dealer



**EAGLE RADIO COMPANY**

16 Boyden Place Newark, N. J.

## GUARANTEED SAVINGS

Nationally Known Radio Equipment At 30% Discount

Write for Illustrated Catalog  
**HAMPTON-WRIGHT**  
Metropolitan Radio Prices

Dept. G

P. O. Box 181 Indianapolis, Ind.

Laboratory Product



**CRESCENT  
LAVIE  
RESISTANCES**

For Distortionless Amplification

Deal resistance for DeForest "H" tube \$3.50. Consists of two units mounted on bakelite and connected in parallel.

Please specify if your "H" tube requires 60,000 ohms or 20,000 ohms. All amateur apparatus in stock. Let us drill and engrave your panels. **CRESCENT RADIO SUPPLY CO. 1 Liberty St., Jamaica, N. Y.**

FILAMENT AND PLATE TYPES



Famous BH Transformers

**Transmitting Transformers**

Our transformers are ideal for low wave transmission. Watch for "BH" Announcements.

Write for Our Catalogue  
**Benjamin Hughes Electric Company**  
298 LaSalle Street, Montreal, Can.  
Transformer Builders Since 1910

## An Apology



We knew when we offered the TECO short wave receiver that it would be immediately recognized as the best short wave value on the amateur market. But we hardly expected the great avalanche of orders that followed the announcement. We have arranged for increased production. Delivery of your order may be delayed, but we ask that you bear with us.

The parts used in the TECO Short Wave Receiving set—Cardwell condensers, G. E. UV 712 audio transformers, TECO Plug in coils, vernier dials and a bakelite panel engraved with your call letters—would cost you more to buy than we are charging for the complete set.

We are agents for  
De Forest transmitting and receiving tubes.

TECO Type A SW Receiver \$27.50

Type B (in cabinet) \$32.50

10% deposit with order.

Write for literature

**Transmitting Equipment Co.**

19 Stuart St. Boston, Mass.

## MASS. RADIO SCHOOL

18 Boylston St., Boston, Mass.

FALL TERM SEPT. 13

Send for free Catalog

## YOU NEED THESE THESE PLUG-IN COILS

Note the many advantages of these better and different coils listed below and try to do without the m and not through a condenser. Secondary coils are specially constructed so that setting of primary coil does not need to be exchanged when secondaries are exchanged.

1. Positive contact is secured through General Radio plugs and jacks.

2. With 3 Coils, continuous, gapless range is secured from 140 to 16 meters. One of the 20-40-80 meters amateur bands is located in the middle of the tuning range of each of the 3 coils. (For this a SFL Condenser, 140 mmfd. max. cap. is essential.)

3. Operation of regeneration condenser has no effect on the tuning; the 2 controls are completely independent.

4. Antenna coupling is adjustable; by a primary coil

5. Coils are space-wound solenoids on skeleton frames.

6. Both tickler and antenna coil are at filament end of the secondary.

7. These coils cover the 3 U. S. Amateur Bands, all European Amateur Bands, Short - Wave Broadcast, U. S. Naval and Commercial Short-Wave Stations, etc.

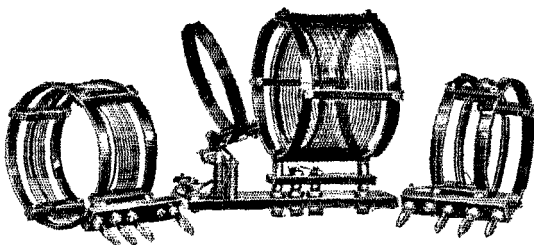

The Kit Illustrated Covering 1F. to 133 Meters Complete **\$12.50**

Coil No. 4, 125-250 M  
Price \$4.00

Coil No. 5, 235-550 M  
Price \$4.00

These coils are essential to the most efficient operation of your station. Order yours TODAY.

**AERO PRODUCTS INCORPORATED, Dept. 16, 1768-1772 Wilson Ave., Chicago, Ill.**

## THE SUPER-SYNC

The Synchronous Rectifier That Can Be Filtered

When properly filtered the Super delivers a direct current that is suitable for Broadcast transmitters. When using a Super on the transmitter you are assured of a constant voltage thus assuring a steady wave.

On installing a Super you will immediately notice the increase in Dx. reports.

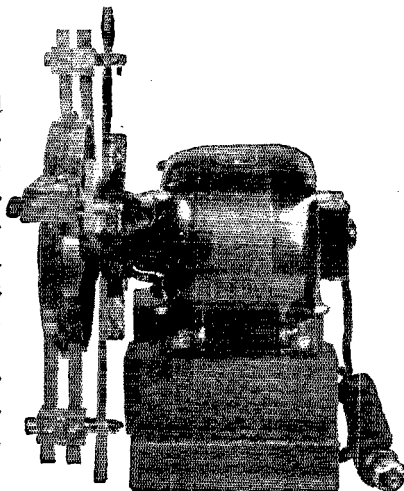

The commutator on the Super is eight inches in diameter and is turned at a synchronous speed by a 1/4 H. P. Synchronous Motor. Contact is made by eight brushes mounted ninety degrees apart in pairs. The brushes run on a smooth surface thus assuring a smooth contact and also preventing the brushes from chattering.

PAT. PENDING

PRICE \$75.00 F. O. B. ST. LOUIS

**MARLO ELECTRIC CO., 5241 Botanical Ave., St. Louis, Mo.**

# TOBE

And Now!  
"A Better  
Resistor"

## VACUUM TIPON

LOEWE-LEAK

The new Resistor in a glass tube which is pumped out to a high vacuum and sealed. Look for the sealing TIP-ON the leak—proof of the vacuum within. No moisture can reach it. No oxidation can take place. Silver plated tips can be soldered into wiring without fear of damage.

In all sizes from 10,000 to 10,000,000 ohms. Permanent and noiseless. Sold in individual sealed, silvered packages as befits a quality product.

PRICES	
10,000 ohms .....	\$1.00
50,000 ohms .....	.75
1/10 megohm .....	.75
1/4 megohm .....	.50
1/2 megohm .....	.50
1 megohm .....	1.00
2 megohms .....	.50
3 megohms .....	.50
4 megohms .....	.75
8 megohms .....	.75
10 megohms .....	1.00



Exact Size

We have tried to make it possible for you to get "TOBE" apparatus at your dealer's. Ask him first—if it happens that he is not yet stocked, we will be glad to forward your order on receipt of check or money-order.

**TOBE DEUTSCHMANN CO.**  
Engineers and Manufacturers of Technical Apparatus  
CAMBRIDGE, MASS.

## 3 GOOD BUYS



**Jewett  
VEMCO UNIT**

You don't have to buy a loud speaker. Attach the Vemco Unit to the tone arm of your phonograph and you get perfect reproduction.

Regular \$12.00  
We sell at \$2.25



**Jewett  
MICRO DIAL**

Just what you need for your short wave sets. Splits up the kilocycles and enables you to get every station on the route. Fits all sets—

List Price \$3.50  
Our Price \$1.25

"There is no substitute for the best!"

**KENNEDY  
Taper Plate**

**3 Condenser gang  
each .00035 MFD**

Plates tapered like the new Cardwell. Its efficient operation assures satisfaction.

\$

**RADIO SURPLUS CORPORATION**  
11 STEWART STREET BOSTON

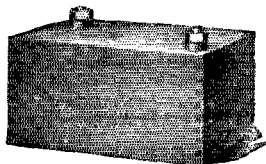

## MICA TRANSMITTING CONDENSERS

.002-6000 VOLTS

Manufactured by Connecticut Telephone & Electric Co.  
Used As Grid, Radio Frequency  
By-Pass and Plate Blocking Condenser

**EXTRA SPECIAL PRICE \$2.00 Each**

AMERICAN SALES CO.

21 Warren St.

N. Y. C.



## What Size Grid and Plate Blocking Condensers?

You have always used .002 mfd. for blocking condensers but who knows that it is the best size for short waves? The builders of KFUH believe .000036 mfd. better for their tuned grid 'n plate circuit. Our UC 1015 condenser gives eleven different capacities between .002 mfd. and .001 mfd. so you can select the best size for your set. Why not try them?

Price \$1.25 postpaid

**General Electric Gridleaks**



Brand new enameled porcelain G. E. Gridleaks in 5000 ohm and 10,000 ohm sizes for all tubes. Size 1" x 6".  
PRICES, 5000 ohm \$1.25, 10,000 ohm \$1.75. Postpaid.

Utility Radio Co., 80 Leslie St., East Orange, N. J.

## ACME CELATSITE BATTERY CABLE

— a silk-covered cable of vari-colored Flexible Celatsite wires, for connecting batteries to set. Prevents "blowing" of tubes; gives your set an orderly appearance.



The Original  
Celatsite

— a tinned, copper bus bar wire with non-inflammable "spaghetti" covering, for hook-ups. 5 colors; 30-inch lengths.

We also offer the highest grade of "spaghetti" tubing for Nos. 10 to 18 wires. 5 colors; 30-inch lengths.

Send for Complete Acme Wire  
Products Folder

ACME WIRE CO., DEPT. S, NEW HAVEN, CONN.

**ACME WIRE**  
MAKES BETTER RADIO

all "Esco" equipped.

**Byrd Took Day,  
Peary 8 Months  
To Reach Pole**  
Three-Motored Airplane  
Sped North Waste, While  
Discoverer Laid Stein  
Radio Informed World  
News of 1926 Trip Cam-  
bourn, 1908 Expedition  
Hourly, 1908 Expedition  
Was "Lost" Whole Year

**Home of Hurricanes Is Quest  
of Expedition to Greenland**

Natural History Museum's Explorers Will Study  
Weather, Birds and Beasts of Arctic

Special from *Natural History*  
NEW YORK, June 21—The school  
Mortzway bound for a summer  
in waters of Greenland, where  
ice groups, and weather con-  
ditions of the Far North will be  
studied under the auspices of the  
Museum of Natural History.  
The expedition will be led by  
Dr. W. H. Murray, and will  
include a dozen or more  
scientists, including a number  
of the party, who has been planned  
for an expedition for three years.

of the party, who has been planned  
for an expedition for three years.  
emphasized the importance of  
the purpose of the group and  
the purpose of the group and  
undertaken merely for the  
touching some new piece of  
before its explained that the  
purpose of this "competitive"  
of collectors and auto-  
recently decided to go to  
purchasing that would de-  
team visitors.  
The party includes Dr.  
of the party, who has been planned  
for an expedition for three years.

**MacMILLAN PARTY  
MOVES NORTHWARD**  
Sachsen and Bowdoin Leave  
for Rockland and Bar Harbor  
CHRISTMAS COVE, Me., June 21  
The MacMillan party, which  
left New York on June 15, is  
now in the vicinity of  
Bar Harbor, Me., where  
the party will spend the  
winter. The party will  
be led by Dr. W. H. Murray,  
and will include a dozen or  
more scientists, including  
a number of the party, who  
has been planned for an  
expedition for three years.

Where great achievements and human lives depend upon constant and effective operation—where the obligation of confidence MUST be met—"ESCO" has been chosen.

**ELECTRIC SPECIALTY COMPANY**

Manufacturers of Motors, Generators, Motor-Generator Sets, Dynamotors and Rotary Converters for all Radio Purposes. Have you got your copy of Bulletin 237B and ESCO "Filter Facts"? If not, write for them.

TRADE "ESCO" MARK

225 South Street

Stamford, Conn. U.S.A.

THE TUBE WITH THE SENSIBLE GUARANTEE

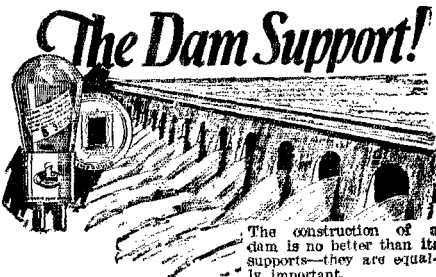

VIBRATIONLESS  
UNIFORM  
AND GOOD

All types—at public demand prices.

- SX 201 A.....\$2.00
- SX 199 ..... 2.25
- SV 199 small .... 2.25
- SV 199 large .... 2.25
- SX 112 ..... 5.00
- SX 120 ..... 2.50
- SX HIMu ..... 3.00
- Supertron Half 4.00
- Supertron Full 5.00

In Canada Slightly Higher

There are three elements in a radio tube. The slightest movement in relation to each other causes a characteristic change, invariably disqualifying the tube.

THE NEW SUPERTRONS HAVE SUPPORTS THAT TIE THE THREE ELEMENTS INTO ONE UNIT.

THE BASE AND SUPPORTS ARE ISOLANTITE

**Supertron Mfg. Co. Inc.**  
Hoboken, N. J.

Chicago Office, 30 North Dearborn St.  
Export Dept., 220 Broadway, N. Y. C.

**SUPERTRON**  
A SERIAL NUMBER GUARANTEE  
The Foremost Independent Tube in America

**A NEW SOCKET**  
with a new idea

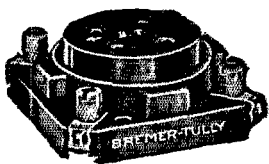

UX Absorber Socket 75c

Springs may prevent shocks but the vibrations which follow must also be prevented.

The shock absorbing material between the base and the tube holder acts like a snubber on an automobile.

The vibrations are damped out, "microphonics" disappear and your tubes last longer.

An examination will win you!  
If your dealer cannot supply you we will ship postpaid on receipt of list price.

Literature now ready on new Counterphase set models, B-Power Units and new parts.

**BREMER-TULLY MFG. CO.**  
520 SO. CANAL ST., CHICAGO, ILL.

# HAM-ADS

## NOTICE

Effective with the July issue of QST the policy of the "Ham Ad" Department was altered to conform more nearly to what it was originally intended that this department should be. It will be conducted strictly as a service to the members of the American Radio Relay League, and advertisements will be accepted under the following conditions.

- (1) "Ham Ad" advertising will be accepted only from members of the American Radio Relay League.
- (2) The signature of the advertisement must be the name of the individual member or his officially assigned call.
- (3) Only one advertisement from an individual can be accepted for any issue of QST, and the advertisement must not exceed 100 words.
- (4) Advertising shall be of a nature of interest to radio amateurs or experimenters in their pursuance of the art.
- (5) No display of any character will be accepted, nor can any typographical arrangement, such as all or part capital letters, be used which would tend to make one advertisement stand out from the others.
- (6) The "Ham Ad" rate is 7c per word. Remittance for full amount must accompany copy.
- (7) Closing date: the 25th of second month preceding publication date.

25% to 35% discount to amateurs on receiving parts. No sets. Over two pounds data, circuits catalog—25c, prepaid. Also exchange new receiving parts you want for new parts—what have you? Weekly data bulletin—\$2.50 year, trial 20 weeks—\$1.00. Fred Luther Kline, Kent, Ohio.

JEWELL meters 25% discount. We specialize on parts and carry a complete line of ham transmitting and receiving apparatus in addition to regular broadcast equipment. We carry in stock products of the best nationally known manufacturers, such as Acme, National, General Radio, Thordarson, Raytheon, Philco, Nathaniel Baldwin, Radio Engineering Laboratories, Cardwell, Allen Bradley, Tobe Deutschmann, Kellogg, Centralab, Yaxley, Acme Wire Company, Crescent Radio Company, M. M. Fleron, Aero Products, Inc. Tell us what you want. We allow discounts to A.R.R.L. members and dealers only. Give your call letters. Roy C. Stage, Wholesale Radio, Montgomery and Burt Sts., Syracuse, N. Y.

THE life-blood of your set—plate power. Powerful, permanent, infinitely superior to dry cells, lead-acid Bs, B eliminators. Trouble-free, rugged, abuse proof, that's an Edison Steel-Alkaline Storage, B-Battery. Upset electrically welded pure nickel connectors insure absolute quiet. Lithium-Potassium solution (that's no lye). Complete, knock-down kits, parts, chargers. Glass tubes, shock-proof jars, peppy elements, pure nickel, anything you need. No. 12 solid copper enameled permanently perfect aerial wire 75c 100 ft. Make easy money with 10-battery service station charger. Details, full price list, Frank Murphy, Radio 8ML, 4837 Rockwood Road, Cleveland, Ohio.

BETTER Edison Elements, welded connections 7c pair. Sample cell 10c. Paul Mills, Woodburn, Oregon.

TRANSFORMERS, chokes, built to your specifications. Write for estimate on your requirements. Oliver Kirchner, Carthage, Illinois.

CURTIS-GRIFFITH "Curgri-Co" or Roice 5-watt DX Babies \$3.15 postpaid. Mueller 150-watt input tubes \$15.00 socket free (Dealers wanted). Want used 50-watters, bugs, "S" tubes, omnigraphs. New "ham-list" with latest transmitting circuits, parts, etc., 4c. Price Griffith, 1109 Eighth Avenue, Fort Worth, Texas.

OMNIGRAPHS, vibroplexes, transmitters, tubes, receivers, chokes, coils. Bought, sold. L. J. Ryan, 9CNS, Hannibal, Missouri.

DODGE Radio Shortcut fixes Code Signals in mind to stick. Kills Hesitation; "speeds up" to 25 per quickly and easily. Hints for better key work cultivate legible transmission. 1BXA Gough reports: Speed was 15; in 10 days raised to 25; practiced 10-15 min. each evening; had tried all methods. Reports 200 licensed users showing progress made, 25 cents. Information and selected report each District on request. Shortcut and Appendix also Hints for Better Key Work \$3.50 US and Canada. Elsewhere \$4.00. Money Order only. None COD. Goods registered. C. K. Dodge, Mamaroneck, New York.

WHEN using space advertising in QST you may have to follow us around the pages. However, on the air you do not need to hold the dial to keep track of us. We use standard REL equipment and you will admit it is good. Designed for amateur use. Using the highest class equipment. For amateur equipment that will produce results drop us a line. A 100 watt master oscillator is used by Enssal Radio Laboratory, on 80 meters. Owned by Thos. Enssal of 8BDN, 1208 Grandview Ave., Warren, Ohio.

LOTS of RCA UV202 flyers, guaranteed brand new, genuine and perfect, \$2.95, postage extra. How many OM7 9CJS, Bryant, S. Dak.

PURE aluminum and lead rectifier elements, holes drilled, brass screws and nuts, pair 1/16", 1" x 4", 13c, 1 x 6, 15c, 1 1/4 x 6, 17c, 1 1/2 x 6, 19c. Sheet aluminum 1/16" \$1.00, 1/8" \$1.90. Lead \$1.00 square foot, all prepaid. Silicon transformer steel cut to order .014", 10 lbs. 25c, 5 lbs. 30c, less than 5 lbs. 35c lb. 4 cubic inches to the lb. Postage extra. 3/4 cash with order—balance C.O.D. Edgewise wound copper ribbon .350" wide; 3/4" outside diameter 10c turn, 1/4" 13c turn, 5/16" 15c turn, 3/4" 17c turn, 7/8" 20c turn, prepaid. Geo. Schulz, Calumet, Michigan.

GENERAL Electric 24/1500 volt 350 watt ball bearing Dynamotors \$45.00. Slightly used \$25.00 with extension shaft for belt or battery drive \$3.00 additional. Several hundred in use. Ask the ham who uses one. GE 12/350 volt 50 watt \$18.00. One of the Navy's best receivers released. Westinghouse manufacture range 50-1000 meters type SE1012. Excellent construction. Priced right at \$45.00. Fotos. Real Navy wavemeters 100-2500 meters, leather case, current squared meter. Fotos of any articles. Navy keys with blinker light \$2.00. Henry Kienzle, 501 East 84th Street, New York City.

SEND for your copy of the new "ham-list". New edition includes latest transmitting circuits, parts, etc. Price 4c (to cover postage, etc.). Thordarson 650-volt power-filament transformers for 5-watters \$6.90. Curtis-Griffith 250-watt power-filament transformers 550 each side \$10.50. Thordarson power transformers 350-550 each side \$9.95. 1000-1500 each side \$15.00; 80-watt filament transformers \$6.00. Edgewise wound copper strip 6-inch size per turn 12c; 4-inch size per turn 10c. Aluminum square foot 85c; Lead square foot 85c. Jewell 0-15 AC voltmeters \$7.50; 0-500 Milliammeters \$7.50. Power gridleaks \$1.60. "Ham-list", 4c. Service—That's me. James Radio Curtis, 5-A-Q-C, 1109 Eighth Avenue, Fort Worth, Texas.

BRANDES superior head phones in original cartons \$2.79 a pair. Signal variable condensers, any size, 78 cents each. Get my bargain list of fifty watters, transformers, etc. 9MV, Story City, Iowa.

PLUG-IN coils—20, 40 or 80 meter coil \$2 each, base .75, all three including base \$6. J. H. O'Connor, 729 East Tenth Ave., Denver, Colorado.

HAMS: Get our Samples and Prices on Printed Call Cards made to order as YOU want them. 9APY. HINDS, 19 S. Wells St., Chicago, Ill.

NEW 120 watt generators 275 volt, will give up to 500, \$3.00. 200 watt 500 cycle slightly used alternators \$10. Battery charging generators, charges 6 volt battery at 12 amp., speed 1700, net \$8. Hot-wire ammeters, 0 to 5 \$1. UC1831 condensers \$1.50. 1803 50c, 3 coil geared honeycomb mountings \$1.50. 1250 turn honeycombs 75c. 32 volt DC 1/4 hp motors, \$8. 750 watt RCA transformers No. 1016, \$11.50. 75 watt filament \$3.75. 150 watt filament \$4.50. No. 12 enameled, \$7.00 per thousand Postage extra. Stamp for list. R. Wood, 46/20—102nd Street, (34 Way Ave.), Corona, N. Y.

SELL quick—2 brand new G.E. thoriated filament signal watters, \$25 each. Western Electric 7-A amplifier and horn \$30.00. 75 amp. 6 volt Edison \$11.00. 75 watt G.E. filament transformer \$3. R. C. Smith, North Glenside, Pennsylvania.

## Q R A SECTION

50c straight, with copy in following address form only:  
CALL—NAME—ADDRESS.

**9ALD'S "Hamalog"**, the original ham catalog, is the only one you can't afford to be without. Thousands of amateurs, dealers, broadcasters, schools, and others have it and use it regularly. We'll be glad to send it to you free—you'll find it impossible to get as complete a line anywhere else. We stock in quantities products of the best manufacturers, for we'll never be guilty of selling what we can't highly recommend. For quick sale, we've a bargain on UC-1831 variable transmitting condensers, .0012 mfd. maximum, 4000 volt test, \$9.00 list, special only \$1.20. E. F. Johnson, 9ALD, Waseca, Minn.

**WANTED**—Several "S" tubes or Kenetrons in good condition for use with 50 watters. H. S. Weber, 313 Factory Street, Dover, Ohio.

**FOR sale**—Robins & Myers 500 volt motor generator. Write for interesting particulars. Geo. H. Smith, Charleroe, Pa., 8ANC.

**A.R.R.L. sweater emblems** should be worn by all members. They are made of the highest grade black and yellow felt, 5" x 8" diamond. \$1 postpaid. Eric Robinson, 135 Jefferson Road, Webster Groves, Mo.

**For Sale New Westinghouse double commutator 750 V.** 200 W. D. C. generators direct connected to 110 V. 60 cycle A. C. Motor \$45.00. Field rheostat \$4.50 each extra, 25% with order, balance C. O. D. Express inspection allowed. Also other voltages and capacities. James J. Smat, 1734 Grand Ave., Chicago, Ill.

**READ July QST editorial.** Get where you belong and avoid the Wouff-Hong. Here's how. Reliable wave meters \$5.00 each postpaid. Cover one band each, state which you want. Accuracy guaranteed within 1/2 of 1 percent. Edward Bromley, Whitewater, Wis.

**COMMERCIAL ammonium phosphat, factory sealed pound cartons, .50c.** Chemically pure aluminum square foot .90c. Lead .75c. Size 12 enamel antenna wire hundred feet 1.00. You pay postage. 5000 ohm grid leaks with center tap, is duplicate of the old RCA type 1718 for 50 watters, and price is 2.00. Unobtainable elsewhere. Dealers write for prices giving jobber references. Ohio brass insulators 5" .75c, 10" 1.50, Pyrex 7" 1.50, 12" 3.50. Price list of all the above and many other items is free for the asking. The only ham store in the Fifth District. Harris, 5RM, 104 East 10th St., Ft. Worth, Texas.

**9CAP**—Selling out. All parts in good condition. Write for list. Theo Githens, Jonesboro, Indiana.

**TWO new Western Electric fifty watters \$26.00 each.** UC1014 .002 mfd. 3000 volt condensers \$1.80. Rotary converter DC to AC 200 watts \$10.00. 2BYJ.

**GFT ready for fall DX.** New, guaranteed 50 watters \$20.00, sent prepaid cash or COD. Wilbur Gemmill, 434 N. Beaver St., York, Penna. 8AAO.

**FILTER chokes unmounted 20H 25 M.A. \$1.00—30 H 50 M.A. \$1.50—50H 60 M.A. \$2.00.** 275V transformer from 110 \$2.00. Use two for Raytheon tube, 420V secondary with midtap and 6V primary with midtap from 110 mounted \$4.00. All prepaid three zones. Write for list of other parts. M. Leitch, 32 Park Drive, West Orange, N. J.

**FOR sale**—Grebe CR8 excellent condition. Thomas, RCA, Catalina Terminal, Wilmington, California.

**3A CHOKES \$1.00.** Generator filters \$2.00. G.R. audio transformer \$3.50. All American Transformer \$2.75. Transmitting variable condensers \$3.00. .5 to 2 mfd. condensers .35 to .50 each. Utah loud speaker (horn type) \$12.50. Thorola loud speaker (horn type) \$15.00. Magnavox loud speaker, large size, \$20. Magnavox microphone \$4.00. Cunningham and Radiotron tubes (new C. X.) \$1.15. 1 motor generator complete with G.E. 1/4 horse motor and International Radio Generator on baseboard, output 525 volts D.C. Cheap at \$40.00. 0 to 300 milliammeter \$4.75. 0 to 2.5 Radiation ammeter \$4.50. .001 variable condensers .75. Andrew Verbance, 1932 Wager Street, Columbus, Ohio.

1ALR—W. J. L'Ecuyer, 153 Amory Street, Roxbury, Mass., U.S.A.

1BMG—Charles H. Stevens, 94 Prospect Street, Stafford Springs, Connecticut.

1IM—R. C. Martin, 1362 Kossuth Street, Bridgeport, Conn.

1JZ—Devereaux Martin, 21 Garland Ave., Malden, Mass.

1ZA—C. E. Jeffrey, Jr., 725 Commonwealth Avenue, Newton Center, Massachusetts.

2JK—Jerome F. Colligan, 1008 East 43rd St., Flatbush, Brooklyn, N. Y.

2MK—E. F. Reynolds, Central Valley, Orange County, New York.

2UM—Frank W. Edmonds, River Road, Grand View, N. Y.

4HA—Eugene L. Feagin, 226 Hyman Ave., Hendersonville, N. C.

4LK—C. Foulkes & R. Lee, 502 Spearing St., Jacksonville, Florida.

5AEA—H. N. Darst, Richmond, Texas.

5AQ—H. H. Green, 6119 Bryan Parkway, Dallas, Texas.

6BYH—Leon W. Brammer, 935—21st St., Merced, California.

6DCR—W. Schueler, 586 Anita Street, San Jose, California.

7IY—Wm. Donald McKeeth, 219 Depot Bldg., Pocatello, Idaho.

7NC—Emmet F. Brady, 727 North C St., Tacoma, Washington.

8AGI—Charley S. Blood, 40 West 4th Ave., Huntington, West Virginia.

8AZD—Edward C. Brichta, 3393 Williams Ave., Detroit, Michigan.

8RHB—John B. Trevor, Jr., McAlpin Camp, Brighton, Franklin County, New York.

8IX—Ex 6TF—Lloyd E. Furrow, 420 Lake St., Troy, Ohio.

The following stations belong to members of the A.R.R.L. Headquarters gang. Mail for them should be addressed care A.R.R.L., Hartford, Conn.

1MK Headquarters	1ES A. A. Hebert
1AL H. P. Westman	1DQ John M. Clayton
1BAO R. S. Kruse	1KP F. Cheynev Beekley
1BDI F. E. Handy	1OA R. S. Kruse
1BHW K. B. Warner	1SZ C. C. Rodimon

## S-M PARTS AT WHOLE-SALE PRICES

**DEALERS AND PROFESSIONAL SET BUILDERS!**  
We are wholesale headquarters for SILVER MARSHALL Products; also Bremer-Tully, Victoreen, Karas, Aero, Benjamin, Samson, Balkito, Jewell, Majestic, Utah, Thordarson, Thoron, K.K., Rayovac, Musasiman, Taxioly, etc. Generous discounts. New FREE catalog including all above lines and 50 others. Write today. Address Dept. C.

**SHURE RADIO CO., 19 S. Wells, Chicago**



# YAXLEY

APPROVED RADIO PRODUCTS

## Rheostat

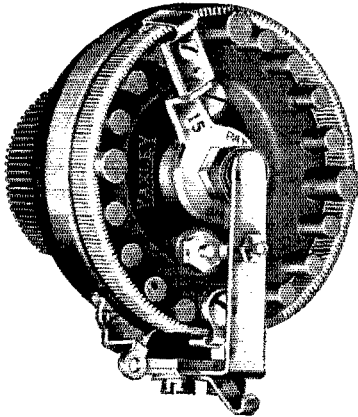

**AIR COOLED**

Designed and Constructed to meet the requirements of modern radio. You will immediately notice the accuracy and extremely fine adjustment that does away with the necessity for vernier attachments.

The coil is air-cooled on all four sides of the winding. Many turns in the coil with an unusually long contact surface, permit filament voltage to be built up slowly and held at just the right point to facilitate easy tuning and develop perfect reproduction. Bakelite base.

Made in 2, 3, 6, 10, 15, 20, 25, 30, 40 and 100 ohm sizes, each complete with a Bakelite knob ..... \$1.35

Potentiometer—Same construction as Rheostat—200 and 400 ohms. with Knob.....\$1.75—100 ohms.....\$2.00

Order from your dealer or jobber or send his name with your order to

**Yaxley Mfg. Co.**  
Dept. S, 9 So. Clinton St.  
Chicago

## FOR YOUR CONVENIENCE QST'S INDEX OF ADVERTISERS IN THIS ISSUE

Acme Wire Co. ....	90
Advance Electric Co. ....	70
Aero Products, Inc. ....	89
Aerovox Wireless Corp. ....	72
Airgap Products Co. ....	85
Albin Radio Co., Inc. ....	66, 73
All-American Radio Corp. ....	81
Amateur Radio Specialty Co. ....	86
American Sales Co. ....	62, 74, 90
American Transformer Co. ....	70
A. R. R. L. Application Blank ....	86
A. R. R. L. Recommendation Blank ....	84
Benjamin Elect. Mfg. Co. ....	82
Bremer-Fully Mfg. Co. ....	91
Browning-Drake Corporation ....	63
Burgess Battery Co. ....	4th cover
Burton-Rogers Co. ....	68
Hunnell and Co., J. H. ....	84
Cardwell Mfg. Corp., Allen D. ....	65
Carter Radio Co. ....	80
Central Radio Labs. ....	84
Corbett Cabinet Mfg. Co. ....	67
Corning Glass Works ....	84
Cortlandt Panel Engraving Co. ....	66
Crescent Radio Supply Co. ....	88
Crossley Radio Corp. ....	82
Cunningham, Inc., E. T. ....	2nd cover
DeForest Phonofilms, Inc. ....	64
DeForest Radio Co. ....	79
Deutschmann Co., Tohe ....	50
Dongan Elect. Mfg. Co. ....	72
Dudlo Mfg. Co. ....	83
Eagle Radio Co. ....	89
Eastern Radio Institute ....	78
Electrad, Inc. ....	59, 70
Electric Specialty Co. ....	91
Electrical Engineers Equip. Co. ....	68
Elkon Wire Works ....	67
Empire Elect. Products Co. ....	82
Fanstel Products Co. ....	85
French Battery Co. ....	74
Frost, Inc., Herbert H. ....	75
General Instrument Co. ....	76
General Radio Co. ....	77
Gray and Danielson ....	71
Grebe and Co., Inc., A. H. ....	4
Gross and Co., Inc., J. ....	62
Gulf Radio School ....	82
Hammarlund Mfg. Co. ....	2
Hampton-Wright ....	88
Hudson Radio Co. ....	84
Hughes Elect. Co., Bend. ....	88
Hull and Co., S. W. ....	75
International Resistance Co. ....	61
Jacobs, Chas. F. ....	68
Jewell Elect. Inst. Co. ....	66
Karas Electric Co. ....	73
Kelleradio, Inc. ....	82
Kokomo Electric Co. ....	78
M. B. S. Sales Co. ....	68
Mace and Son, F. F. ....	86
Marl Electric Co. ....	89
Mass Radio School ....	88
Morison Elect. Supply Co. ....	85
Moulded Products Corp. ....	60
National Carbon Co. ....	95
National Co. ....	72
Nicholson Elect. Co. ....	85
Nola Radio School ....	72
Pacont Electric Co. ....	60
QST Binder ....	3rd cover
Radio Corp. of America ....	1
Radio Engineering Labs. ....	61
Radio Surplus Corp. ....	90
Sanarno Elect. Co. ....	78
Scientific Radio Service ....	64
Seattle Radio Lab. ....	59
Shure Radio Co. ....	93
Signal Elect. Mfg. Co. ....	80
Silver-Marshall, Inc. ....	60
Southern Toy Co. ....	72
Stromberg-Carlson Tel. Mfg. Co. ....	69
Supertron Mfg. Co. ....	91
Thordarson Elect. Mfg. Co. ....	88
Transmitting Equipment Co. ....	90
Utility Radio Co. ....	86
VanHorne Co., Inc. ....	86
Vibronex Co. ....	89
Ward-Leonard Elect. Co. ....	74
Walt's Curiosity Shop ....	59
Weston Elect. Inst. Corp. ....	87
Wireless Specialty App. Co. ....	74
X-L Radio Labs. ....	80
Yaxley Mfg. Co. ....	94
Zied, J. ....	68



Perhaps you, too, can cut your  
 "B" battery costs in half

Just follow the chart. It gives you  
 the secret of "B" battery economy

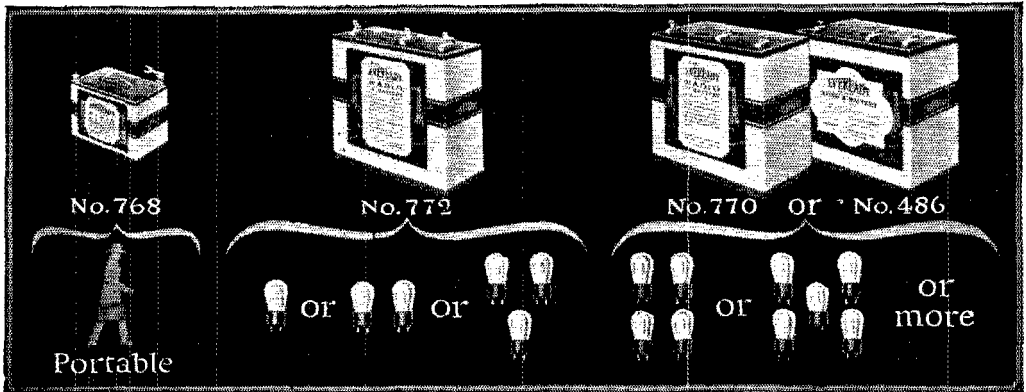

THOUSANDS of people have made the discovery that Eveready "B" Batteries, when used in the proper size, and on sets equipped with a "C" battery\*, are a most economical, reliable and satisfactory source of radio current.

Here is the secret of "B" battery economy, reliability and satisfaction:

*On all but single tube sets—Connect a "C" battery\*. The length of service given below is based on its use.*

*On 1 to 3 tubes—Use Eveready No. 772. Listening in on the average of 2 hours daily, it will last a year or more.*

*On 4 or more tubes—Use the Heavy-Duty "B" Batteries, either No. 770 or the even longer-lived Eveready Layerbilt No. 486. Used on the average of 2 hours daily, these will last 8 months or longer.*

These figures are based on the average use of receivers, which a country-wide survey has shown to be two hours daily throughout the year. If you listen longer, of course, your batteries will have a somewhat shorter life, and if you listen less, they will last longer.

Evereadys give you their remarkable service to the

full only when they are correctly matched in capacity to the demands made upon them by your receiver. It is wasteful to buy batteries that are too small. Follow the chart.

In addition to the batteries illustrated, which fit practically all the receivers in use, we also make a number of other types for special purposes. There is an Eveready Radio Battery for every radio use. To learn more about the entire Eveready line, write for the booklet, "Choosing and Using the Right Radio Batteries," which we will be glad to send you on request. There is an Eveready dealer nearby.

Manufactured and guaranteed by

NATIONAL CARBON COMPANY, INC.  
 New York San Francisco  
 Canadian National Carbon Co., Limited, Toronto, Ontario

\*NOTE: A "C" battery greatly increases the life of your "B" batteries and gives a quality of reception unobtainable without it. Radio sets may easily be changed by any competent radio service man to permit the use of a "C" battery.

**EVEREADY**  
**Radio Batteries**  
*—they last longer*

Tuesday night means Eveready Hour—8 P. M., Eastern Standard Time, through the following stations:

WEAF—New York WSAI—Cincinnati  
 WJAR—Providence WTAM—Cleveland  
 WEEI—Boston WWJ—Detroit  
 WTAG—Worcester WGN—Chicago  
 WFI—Philadelphia WOO—Davenport  
 WGB—Buffalo WOOO—St. Paul  
 WQAR—Pittsburgh WOCO—St. Paul  
 KBD—St. Louis

*from the light circuit-*

R-198  
Power Supply  
Transformer  
\$12.00

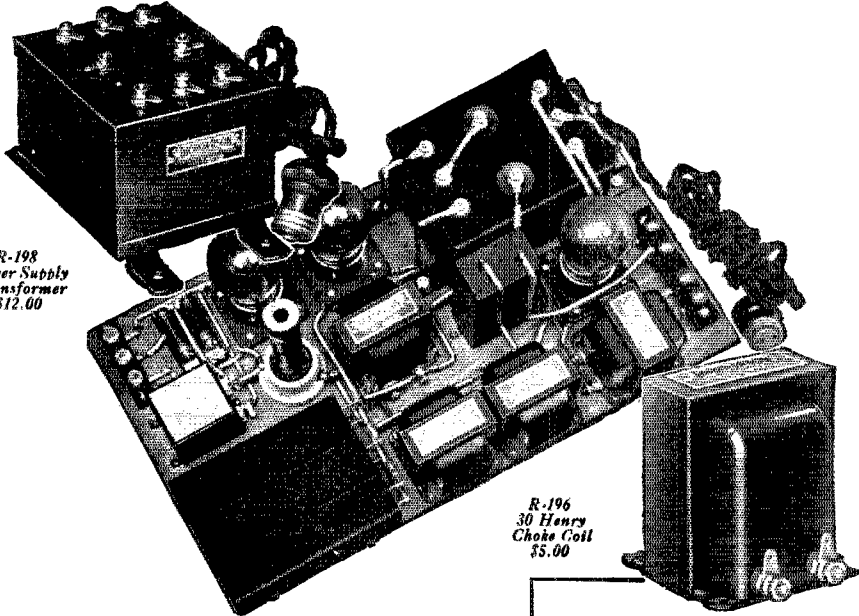

R-196  
30 Henry  
Choke Coil  
\$5.00

## THORDARSON

### POWER AMPLIFICATION and B-SUPPLY

Force a car up a steep hill and the engine knocks. Force a radio set and the quality becomes ragged and the reproduction distorted.

The Power Amplifier built with Thor Larson transformers and chokes operates from the light circuit. It uses larger capacity tubes, and reproduces the broadcast programs with an amazing richness and freedom from distortion,—at any desired volume.

In addition, this amplifier supplies the B-voltage for the entire receiver with sufficient current for any instrument.

Write for circular "Power from the light circuit."

#### Other Thor Larson Transformers

##### Standard Amplifying Transformers

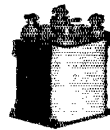

Used on the majority of quality receivers. Will meet the tonal requirements of the average ear.

R-150	3 1/2 to 1	\$4.00
R-151	6 to 1	4.50
R-152	2 to 1	5.00

##### R-200 Amplifying Transformer

A quality transformer for the musical epicure. (Unusually wide amplification range. Large core and high impedance primary winding.

\$8.00



##### R-190 Autoformer, All Frequency Amplifier.

An impedance with a step up ratio, combining the even amplification of the impedance with the amplification increase of the transformer.

\$5.00



Write for Descriptive Circulars

**THORDARSON ELECTRIC MANUFACTURING CO.**  
*Transformer specialists since 1895*  
**WORLD'S OLDEST AND LARGEST EXCLUSIVE TRANSFORMER MAKERS**  
**Chicago, U.S.A.**

(8440-10)

# NEW!

## A GOOD BINDER FOR YOUR QST's

*Never before have we had a  
satisfactory binder but here is  
one we are proud of*

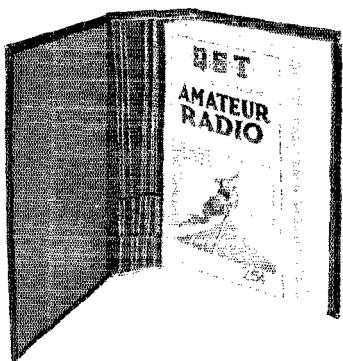

Note the wire fasteners.  
Unnecessary to mutilate  
copies. Opens and lies  
flat in any position.

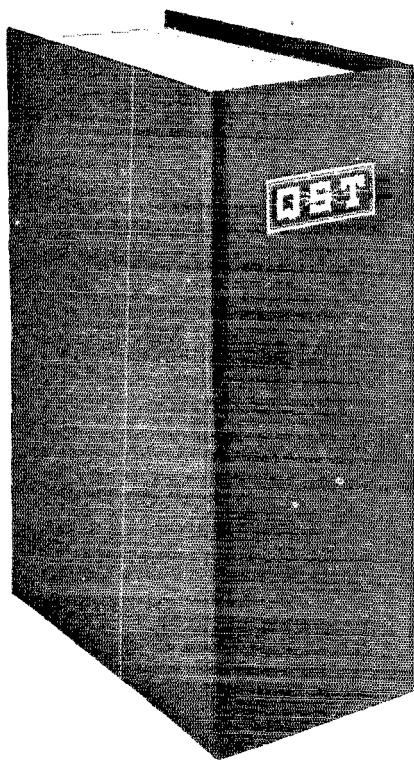

Maroon Buckram with title  
stamped in pure gold  
Just fits twelve issues of QST

SENT POSTPAID

1<sup>50</sup>—ea.

Get a set to hold all your back is-  
sues of QST—you know they de-  
serve permanent preservation

QST  
1711 PARK ST.,  
HARTFORD, CONN.

# Echoes of Byrd's Flight Over the Pole

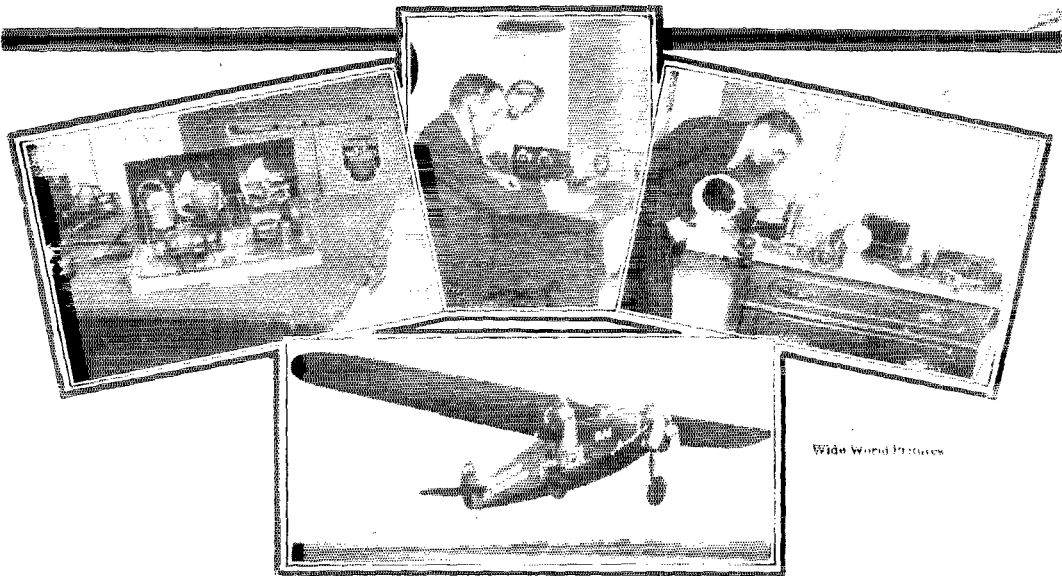

E. S. Strout, Jr., 2NZ who worked KEGK, the S. S. Chantier, before and after Byrd's successful flight over the Pole.

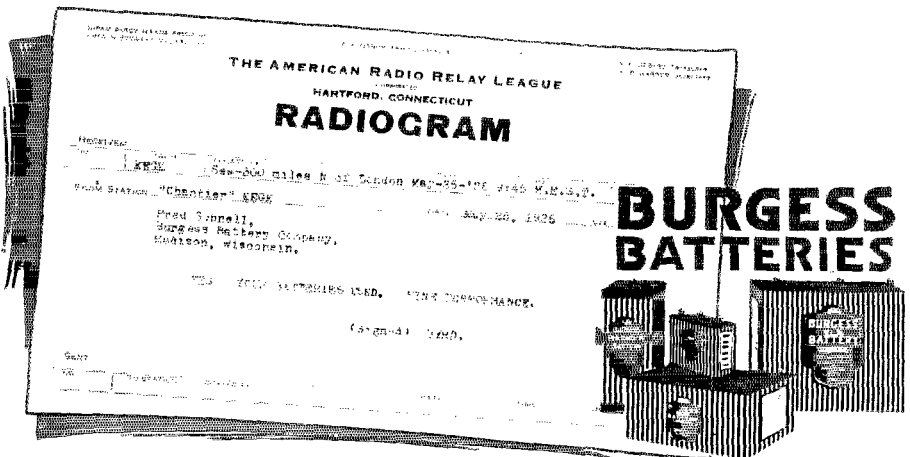

Photograph of Radiogram from Commander Byrd on board the "Chantier" to Fred Schnell of the Burgess Laboratories in reply to his question as to whether Burgess Batteries were used during the expedition.

## BURGESS BATTERY COMPANY

GENERAL SALES OFFICE: CHICAGO

CANADIAN FACTORIES AND OFFICES: NIAGARA FALLS AND WINNIPEG

*In United States: Offices and Warehouses in Principal Cities*

# The Communications Department

F. E. Handy, Communications Manager  
1711 Park St., Hartford, Conn.

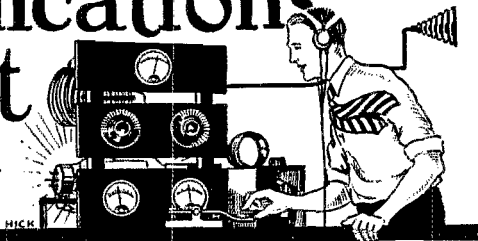

## Contact with Expeditions

### VOQ

A NUMBER of stations have reported contact with the Schooner Morrissey of the American Museum Greenland Expedition (VOQ). Probably Mr. J. R. Miller, 9CP, of Hammond, Ind. has thus far handled fully as much traffic as anyone since getting QSO on July 23. Miller is a Western Union "op" and after taking long press messages in Continental totalling thousands of words he takes them along to work and puts them over the wire in Morse. Manley on the Morrissey reports the weather fine and the sun always above the horizon at Cape York. Since this first contact 9CP has connected on schedule every night except five up to August 5 when these forms close. The nights missed were when the Morrissey was on the rocks and when 9CP went to the South Bend convention. VOQ is audible 10 to 15 feet from the phones at 9CP. Over 2500 words in about 30 messages have been handled thru 9CP.

The whole amateur world was interested and sympathetic when the story came through that the Morrissey had gone on the rocks at high tide, not getting off for two days. 24AA copied VOQ telling 1BQQ that the Morrissey was on the rocks and listed five degrees, having damaged her false keel, and sent a message to Hartford via 9CAW, 9DWN, 9ZT, 8BPL, and 1MY. Word that the Morrissey was safe at Upernivik came in about the same time this message was received.

2UO has had fairly regular contact with VOQ. 9EJI and 2AEV worked VOQ, also. 8BKM copied VOQ working 9CP and said his sigs were steady like crystal control. 8DSI handled a VOQ message going to 8DPL and relayed the answer back in 15 minutes. 1BFT and also Mr. Leo Junge of Davenport, Iowa report copying the signals at different times. 2CRB copied 600 words of press on June 28 which was used word for word in the New York Times. July 11, 9ZT hooked VOQ arranging a schedule for each Sunday noon (CST) on 19 meters. 1GA took a message the same night. July 17 9BJK (Denver) connected and Gustafson hopes to handle his share of the traffic before Manley's return. 1HJ QSOed for an hour on July 20 taking one message which was forwarded by radio. On the 25th 1CMP took a message from the Morrissey which was then at Whale Sound near Etah. 2CTF and a number of others anxious to connect have put their sets on 20 meters.

August QST carried Manley's schedules and we are glad to be able to list so many fine reports of traffic handling with the Morrissey. Miller of 9CP is on the job every night and hopes to have that polar bear skin trophy in his shack next winter. Don't forget the report for QST when you handle messages or connect with any of the expeditions.

### KGBB

KGBB, the Schooner Sachem Third, kept a regular schedule with 2GY and 2GY reports that 25 messages were originated and 46 delivered during the month—all traffic with KGBB. 1AKZ delivered 10 messages from KGBB worked when she was at Sukkertoppen Greenland. 9AEK worked the expedition the next day (24th). 1CMX took a message relayed from

WNP to KGBB when she was at Stromfjord and crossing the Arctic circle. 1CMX is putting a set on 20 meters for regular work with WNP. On the 28th 1AK took four messages. July 30th 1AAY handled 200 words and August 2nd he took one message, the expedition being then at its objective, Disko. On the 4th, five messages were handled comprising about 150 words. August 9, 150 words more were acknowledged by KGBB. Gold reports that the signals were fine except when KGBB was in motion when they were unsteady and hard to copy.

### GMD

The Roosevelt Memorial Expedition, Liner Van Dyck, sailed from New York City July 24 bound for the River of Doubt in the wilds of Brazil. The explorers, lead by Commander Dyott, will travel overland to the Amazon and follow the river to its mouth making a great many geographical observations and collecting specimens for the Museum of Natural History. Eugene Bussey (2CIL) is the senior operator and Arthur Perkins (2APQ) will handle the portable transmitter, keeping the party in touch with the United States through the base station. Both ops are members of the Yonkers Radio Club.

The base station will be located on some plateau in Brazil and will use a 500-watt 500-cycle transmitter. Opening up sometime in September for general amateur contact without prearranged schedules it will operate in the 40-meter band using the call GMD. The portable five watt set is battery supplied and uses the call 2GYA. This portable set maintained communication with the states from the Van Dyck until the expedition was a thousand miles south of Florida. Keep an ear out for GMD and do what you can to help in handling the traffic from this expedition, reporting contact for these columns as usual. Let's see if we cannot make the same kind of history of reliable daily contact for this expedition that we have made in the case of VOQ, WNP and KGBB.

### YVG and GMPV

Canadian interest centers around two expeditions just starting North. SS Beothic, YVG, and SS Bayruper, GMPV, both transmit on 35 meters and will test with amateurs. c2BE has a schedule with GMPV at 5 pm EST while c2CG has daily contact with YVG. Watch out everyone, and give all possible assistance in handling traffic. u3JW worked GMPV July 17 and the operator reported that after visiting Baffin Land and Hudson Bay Posts, the Bayruper would return to Scotland in September.

### WXF

The Army Transport Chateau Thierry, WXF, completed the 17-day trip through the Panama Canal and Lieut. Wenstrom (ex 5AKT) writes us that the amateur contact was uniformly successful. Three or four different amateurs were worked each night. One 50 watt set was used with a 750-volt plate supply from a dynamotor. The trip was sanctioned by the War Department for experimental purposes. 5AKY was worked regularly on schedule through terrific tropical

QRN. Once or twice a few schedules were broken due to official traffic and power supply troubles. 6RMV, 4RY, 2CRB, 9AEK, 3CKL and 9EJI reported contact with WXF and some of the stations worked handled a number of messages. 4MV handled a message from WXF to NAA via NAV.

### WNP

Our story of WNP contact is another story of successful and regular communication. Mr. Kenneth M. Gold, (1AAV) Holyoke Mass. and Mr. M. L. MacAdam, (1ZK) Wollaston Mass. have handled a large part of WNP's traffic. WNP is handicapped by a rotten note and the lack of a break-in but in spite of this has done good work. 1ZK has kept regular

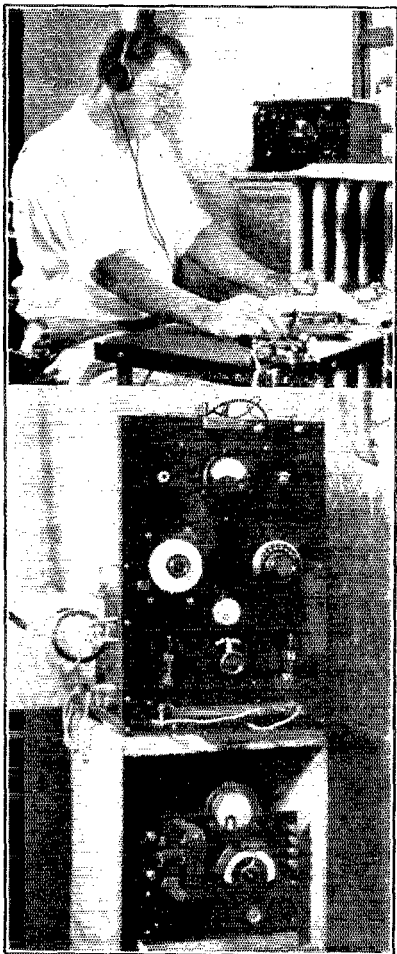

schedules on Tuesday, Thursday, Saturday and Sunday nights giving the Bowdoin an average of 250 words per night and taking about 350.

The shack at 1ZK-1BWD is a 50-watt panel type affair using the reversed feed back circuit and located right under the antenna. It is in the basement remote controlled from the third floor by three wires to relays in the transformer inputs and keying circuits. D. C. is obtained from S tubes and a brute force filter. Buzzer modulation can be used on request. MacAdam prefers reliable and worth-while two way communication to extreme DX. We are proud to have a photograph to use here showing MacAdam himself, the operating room, and the transmitter that gets thru to WNP so regularly.

1AAV took three messages from WNP on July 6 returning an answer to WNP in 20 minutes. July 11 he took four long messages from Indian Harbor.

The next night 311 words were received on schedule from 9AAW for WNP and this traffic was put through early on the 13th. 9AAW worked WNP direct consistently until July 10 when WNP lowered his wavelength. Late on the 13th the 9AAW-1AAV schedule again cleared several messages each way. WNP messages were cleared on the 14th. July 17, Gold pulled down the set at Cambridge shipping it to Holyoke. After erecting an antenna and rebuilding the receiver 1AAV was again in contact with WNP on July 29. At first the W.E. 50 water was drawing about 275 watts and overheating badly. After a considerable reduction of power WNP reported a stronger and steadier signal. Resuming contact, the hook was cleared of four messages. August 1st 1AAV took five messages totalling 200 words. On account of unusually bad radio conditions these had to be forwarded by telegrams and air mail. August 8 thirteen messages totalling 900 words were sent to WNP from 1AAV and one message was taken from the expedition. Most of the north-bound traffic came to 1AAV from 1FL and 2GY. Sixty three messages have thus far been handled thru 1AAV.

1BEZ was QSO several times. On July 3 6BQL (San Francisco) worked WNP through severe QRN. 1ADM hooked up first on July 12 making a daily schedule. One UX210 has done the same work at 1ADM that bigger tubes have carried out at other contact points. 8BUY worked WNP when he was at Fort Manors, Labrador on July 17, taking one message. 2BKR took a few hundred words for the Field Museum at Chicago on July 21st. The signals were very loud but hopping all over the dial and extremely hard to copy. 1CMP got QSO on the 22nd. 1VR tried to take a message on the 23rd. 1BFT worked WNP on Aug. 8th. July 30th 2PX worked McGee giving him the correct time. 1AAP copied the sigs reporting them somewhat wabbly. 8BKM-8BNM copied him on the 8th and 9th but the signals wavered due to the shaking of the ship from bumping ice. 2AMD-2AII connected when WNP was at Indian Harbor, Labrador. z2AC copied WNP on July 31st reporting through 9ZT that the signals were r4. 9DNG copied the signals regularly though not connecting for two-way work.

### Army-Amateur Notes.

**2ND CORPS AREA**—An "Army-Amateur Auxiliary Radio Net" for each separate state in this Corps Area is under way. Such nets consists only of those qualified amateurs selected by the A.R.R.L., who, because of geographical location, could not be assigned to a military unit, or because assignments to military organizations in their vicinity have already been made. Amateurs assigned to the auxiliary radio nets will receive their instructions from the Corps Area NCS, Station 2SC.

The New Jersey net has been almost all organized. 2WR is net control station and 2GV his alternate. The organization of the New York State Net has begun and the appointments will be announced in QST later. Members of the 78th Division Net have been meeting in the Globe Indemnity Building, Newark, N. J. once a month to discuss progress with army officials and to arrange schedules. Two or more stations are needed in the following New York State towns: Saranac Lake, Oneonta, Glens Falls, Saratoga, Hoosick Falls, Tonawanda, Walton, Mohawk, Oneida, Whithall, Olean, and Binghamton. Amateurs at these points are requested to write David Talley, 2PF, 2222 Avenue O, Brooklyn, N. Y. for application blanks and details regarding appointment in a radio net. This will complete the organization of the New York State Net after which some interesting activities are planned for everyone who has accepted appointment.

**3RD CORPS AREA**—Tests are still being conducted with A.R.R.L. operators in the Third Corps Area. Letters have been mailed to A.R.R.L. members in certain parts of the Third Corps Area where as yet no volunteers have been received. When A.R.R.L. stations have been obtained for Annapolis, Md., Richmond, Va., and Harrisburg, Pa., the Corps Area Net will be established. Some interesting tests have been held between 6SN at Fort Howard and amateurs in the area. Data collected furnishes an excellent basis for studying the character and strength of various short wavelength as they show up in different localities.

**4TH CORPS AREA**—Organization of Nets in several states of this Corps Area is now in progress. 4RM, who has been handling details of the Net for Georgia, has moved to Florida. Detailed plans for the NG and Governor's Nets for Georgia are prac-

tically complete. However, few certificates have been issued. 4TS is assisting in the organization of Nets in North Carolina. Since the last report, certificates have been issued to 4FJ, 4FM, 4IT, 4TS, 5ADA, 5AFS and 5AFL.

**5TH CORPS AREA**—The month has shown much progress in the formation of 83rd, 84th and 100th Division nets. Amateurs in the Fifth Corps Area; Ohio, Indian, Kentucky and West Virginia, who desire to hook up with the Army-Amateur project and who mean business, are invited to get in touch with A.R.R.L. representative, H. C. Storck, 8BYN, 694 Carpenter Street, Columbus, Ohio.

**6TH CORPS AREA**—Last month was a good one considering our old friend "static" who has been pretty busy around here of late. 9AZN and 9BLF handled Army business for Camp Sparta very efficiently until the Army set was installed. Six new additions to the net received appointment. Message blanks were multigraphed to various stations. More can be procured by application to the Sixth Corps Control Station. We are still unable to work anyone in Springfield, Illinois. Some applications have been received from amateurs not holding licenses and not recorded in the District Radio Supervisor's Office in Chicago. Such applications cannot be considered and the senders are only wasting their time. If you have a station and can handle this work, take out your license and then make application.

**9TH CORPS AREA**—6RW, 6KW and 6HJ, serving the Headquarters 9th Corps Area in the Army Net, are now working 2CXL at Fort Monmouth on schedule, Monday and Thursday. Appointment certificates have been mailed to about fifty amateurs in the Corps Area. It is expected that the nets in this Corps Area will be in operation in about a month. So far, no amateurs have volunteered from Salem, Oregon, or Cheyenne, Wyoming. As these cities are the state capitals, their inclusion in the state nets is essential.

## Finding a Concealed Transmitter A Suggestion for Your Club Activities in September

**D**URING the winter most clubs are obliged to limit their operations to theoretical discussions of radio principles, to station operation, and to business meetings and indoor technical sessions with occasional social activities.

In the *Wireless World* for July 21st is given an interesting account of the field day held one Sunday by the Sheffield and District Wireless Society in the hills and dales of the Peak district of Derbyshire. This club planned a fascinating and successful field day with plenty of excitement to go around, and a wealth of practical experience for everyone connected with the hunt for the carefully concealed transmitting set. As the article suggests, a field day devoted to direction finding work will open many further problems for investigation and furnish ample material for discussion during the following winter months. Besides the excitement and intense interest that prevails during such a field day, the practical experience in building and operating the apparatus, in plotting polar charts and in noting the interesting variations in the results brought about due to refraction and screening effects is most valuable.

The Sheffield Society placed a C.W. transmitter in charge of three members of the club, these members being sworn to secrecy regarding the location of the outfit to be assumed. The transmitter in this case was taken from Sheffield to its new location sometime before the "hunt" opened. A generator driven from one of the wheels of the automobile supplied the plate voltage. A battery-operated outfit would of course serve nearly as well. The transmitter was placed in operation at the unknown point at eleven o'clock in the morning, continuing in operation for forty-minute periods with suitable half-hour intervals enabling the searching parties to change location.

The members of the club were divided into three groups, each equipped with a two-tube portable receiver with a loop antenna, a compass, and a map. The loop antennas used were two feet square. The three parties working independently were given sealed instructions to be opened after proceeding to certain points specified before leaving Club Headquarters at Sheffield. All the portable receiving stations started their work of taking bearings from points within a five-mile radius drawn about the transmitting sta-

tion. After taking one bearing, the location of the portable stations were shifted about (moving three or four miles each time) in order to get a new and intersecting bearing line with which to work in making further observations. After plotting the intersecting lines on a map, the parties proceeded to other observation points closer to the point of intersection or perhaps a little *beyond* the point where the map indicated the "apparent location" of the concealed station.

All three parties closed in on the transmitting station after roughly locating the spot by the first two bearings. One party was enabled to discover the transmitter after taking four quite accurate bearings. The time elapsed in making the "find" was just a little over four hours. The transmitter was in a barn about one hundred yards from the intersection of bearings one, three and four as plotted on a map. After the day of direction finding activities members of the Sheffield Society made their way to a central point where refreshments were served and the experiences of the several parties repeated for the benefit of all.

These direction finding experiments in the open should be interesting to every amateur organization. We hope that the idea can be adapted to local conditions. The work can be carried on most effectively a few miles out in the country but this is no drawback as most of the gang belonging to any club can find plenty of cars available to carry everyone. Reports on such radio activities by any amateur organization will be welcomed for these columns. What have you been doing that is of general interest, clubs?

—F. E. H.

## Club Activities

**CALIFORNIA**—The Santa Clara County Amateur Radio Association has just concluded some interesting tests from the Mt. Hamilton observatory. The photograph shows their float which we mentioned last month which won a prize at the floral parade. The motif for the float is the famous Lick Observatory.

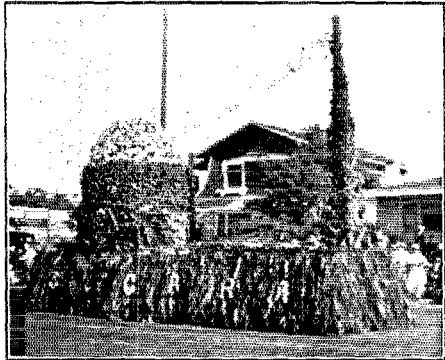

The letters SCCARA and ARRL worked in white roses and sweet peas were set off by thousands of red roses, calla lilies, daisies, and wild sweet peas. The



tower supporting the antenna of portable 6SV and the club ice cream stand is also shown. This live club has many activities worthy of adoption by other organizations who want to realize a substantial sum

for a club station or other enterprise. This Association is getting ready for the big Pacific Division A.R.R.L. Convention to be held at San Jose Oct. 15-16-17.

The Los Angeles Radio Club put on their first ham picnic Sunday August 1. The gang started from 6CMQ going in cars to the selected place. Everyone took their lunch and whistle. The stunts and a feed of hot dogs and marshmallows were enjoyed by all. 7SI and 8BXA were there!

**COLORADO**—At the first meeting of The Associated Radio Operators of Denver, 9CAA, 9BJN, and 9CAW were elected as officers. 8AX's talk was well appreciated by all. He donated two subscriptions to QST, one to go to the high traffic man during August, the other for the high man in September. We look forward to some hot competition.

**ILLINOIS**—The Chicago Radio Traffic Association had the regular meeting in July. Bill Schweitzer gave the gang a fine account of his trip around the world. The gang was out in force for the "Ham Rodeo" at Peoria August 7-8. This was the first state-wide meeting marking the beginning of a live Illinois traffic organization. July 17, the Chicago amateurs won an indoor baseball game from the suburban amateurs by a score of 29-18. Athletics certainly are the activities that keep the gang together in summer.

The Crane Radio Club, Crane Technical High School 9CL (Chicago) has just elected new officers for the coming semester.

**MAINE**—Fifield of the Queen City Radio Club reports that the fellows are all out for the Maine trophy for handling most messages through a given station during the period July 26-Oct. 26. He says the bunch have got to go some to keep up with SCM Best but that there are a few who will give him good competition.

**MANITOBA**—The Winnipeg Radio Traffic Association publishes a fine little news bulletin monthly and the paper has just recently been doubled in size. The Association has just placed a message collection box in the office of the local tourist bureau and considerable good traffic is resulting from the new source. The Association expects to put up a cup for the station in the Prairie Division having the most reliable, orderly and efficient station and turning in the best traffic reports. The editorials to stir up ham spirit, the traffic notes and live news in the WRTA Bulletin are right in keeping with A.R.R.L. policy and we recommend the paper to your attention. We look forward to having a report on the summer stunts put over by the club.

**MASSACHUSETTS**—The North High Radio Club of Worcester had its annual banquet at Hotel Warren June 17. Mr. Green, 1ASU, spoke on the history of the A.R.R.L. and amateur radio today giving advice for beginning hams. Mr. Johnson the Physics instructor discussed the relation of science in general to radio in particular. The new and retiring officers made short speeches following which the entertainment was enjoyed by all.

**MISSOURI**—Numerous technical meetings have been held by the Kansas City Radio Transmitters Association. July 10 a special meeting was held in honor of Mr. Kruse's visit to the section. Attendance was good and visitors were present from Topeka, Olathe, and St. Joseph. 9AJW came the furthest distance, 9RY won the trophy for the longest O. T. set of whiskers, 9KW (guess who) and 9RR followed suit.

**MONTANA**—The Anaconda Radio Club has been holding regular bi-weekly meetings. A number of members are interested in getting on the air. Talks on amateur and BCL subjects hold the interest of the 26 regular members and draw in between fifty and seventy-five visitors at the meetings. This club has taken the first steps toward affiliation with the A. R. R. L.

**NEW JERSEY**—All hams are invited to the Grand Banquet Saturday evening Oct. 16 at St. Francis Hotel, Newark. The Amateur Radio Association of Essex County will thus inaugurate fall and winter activities. Prominent speakers will be there. Plenty of "esis" and humorous as well as educational features are planned. The banquet committee are working hard to put over the best banquet yet. Please don't forget your two bucks. Come and have the best time ever had at a hamfest.

**NEW YORK**—The Radio Club of Rochester is going to give two exhibits, one at the Rochester Exposition Sept. 5 to 11, the other at the Rochester Radio Show Oct. 11 to 16. Two complete stations will be

operated simultaneously at the exposition. A 50 watt will be used on 40 meters and a UX210 on eighty meters. Two receivers will make it possible to use both sets at once and to clear the traffic filed more rapidly. Some special radio communication stunts are planned in addition to the traffic work mentioned. The call 8PZ has been promised for the station if available in September. Please listen for 8PZ!

**OHIO**—Detroit, Toledo, and Findlay amateurs with many visitors from surrounding cities, had a hamfest and chicken dinner July 25th. A good time was enjoyed by all.

**ONTARIO**—Stations 3GY, 3IA, 3CS, and 3CM are going to handle quantities of traffic from the Western Fair, London, Ontario during September under the auspices of the Ontario Amateur Radio Association. All amateurs are requested to be on the look out for this traffic from these stations so that it may be QSRed and delivered promptly.

**PENNSYLVANIA**—The Amateur Transmitters Association of Western Pennsylvania sponsored a ham basket lunch picnic at Camp Fineview, Sunday, July 25. The fellows drove to the camp and enjoyed a real outdoor hamfest. After the swimming and athletic contests a number of prizes was distributed to the winners. Mr. Aiken of KDKA addressed a technical meeting held August 6 on the subject "Transmitting Audible Frequencies over Metallic Circuits".

**WEST VIRGINIA**—The Delta Chapter of the Pi Alpha Tau radio fraternity was organized at Wheeling during July. 8ASE, 8BSU, 8CDV, and 8DOH were admitted as charter members of the chapter. The number of members in each chapter of this national society of hams is limited and no amateur can join without a recommendation from a member. The principles of the new organization are to foster a brotherhood among operators, to encourage expeditious traffic handling, and to act in all radio matters in accordance with A.R.R.L. standard practice and policy. Ask the candidates how they came through the initiation.

## NOTICE!

Nominating petitions for Section Communications Manager are hereby solicited from the following Sections:

Section	Petitions should be filed on or before:
Maryland-Delaware-D. of C.	Noon, Oct. 2, 1926
North Dakota	Noon, Oct. 2, 1926
Northern Minnesota	Noon, Oct. 2, 1926
Arkansas	Noon, Oct. 2, 1926
Louisiana	Noon, Oct. 2, 1926
Tennessee	Noon, Oct. 2, 1926
Alaska	Noon, Oct. 2, 1926
Idaho	Noon, Oct. 2, 1926
Montana	Noon, Oct. 2, 1926
Oregon	Noon, Oct. 2, 1926
Washington	Noon, Oct. 2, 1926
Nevada	Noon, Sept. 15, 1926
Sec. 5, No. Calif.	Noon, Dec. 15, 1926
Sonoma-Mendocino-Marin-San Francisco	Noon, June 15, 1927
Sec. 6, No. Calif.	Noon, Mar. 15, 1927
North Carolina	Noon, Oct. 2, 1926
Virginia	Noon, Oct. 2, 1926
Colorado	Noon, Oct. 2, 1926
Utah-Wyoming	Noon, Oct. 2, 1926
New Mexico	Noon, Oct. 2, 1926
Ontario	Noon, Sept. 15, 1926
Quebec	Noon, Sept. 15, 1926
Van-Alta	Noon, Oct. 2, 1926
Prairie	Noon, Oct. 2, 1926

The closing dates are given as previously announced or extended when necessary because of failure to file petitions in certain Sections. The proper form for nomination was shown on page 45 of April, 1926 QST. The candidate and five signers of a petition must be members of the League and the petition must be received before the closing date announced to be valid. Members are urged to take initiative immediately and to file nominating petitions for the officials of each Section now operating under temporary appointees. —F. E. Handy, Communication Manager.



\*\*\*\*\*  
 \* Robert E. Harris—5TW \*  
 \* 708 W. Duke St. \*  
 \* Hugo, Oklahoma \*  
 \* Orig. 90, Del. 301, Rel. 192, Total 583 \*  
 \*\*\*\*\*

traffic through the summer QRN. Lee insists that the credit should go to 1BIG's splendid operation and wonderful low power station (11.4 watts plate input to 2 UX210s). Listen on the upper edge of the 40-meter wavelength band some night. Hear for yourself how real traffic is handled between the extremities of the 1700 mile Atlantic Coast circuit. *Steady, clean-cut, well-paced signals and a thorough understanding of operating procedure count for a lot in communication work.* Let's all try to boost useful traffic work and make our own sending the kind that will make others want to work us more than once, the kind that will make our signals envied and talked about by the gang, too.

**BRASS POUNDERS' LEAGUE**

Call	Orig.	Del.	Rel.	Total
5TW	90	301	192	583
6BJX	126	137	243	506
6BQ	132	156	196	484
1BIG	27	49	354	430
2ADH	88	51	273	412
8DXH	47	250	30	327
9DWN	23	8	287	318
8DBM	82	60	160	302
6BBQ	21	19	259	299
8EU	28	37	220	285
1AUF	40	10	204	254
9DPJ	28	17	165	210
6BUC	140	51	5	196
2APT	28	—	157	185
5DL	10	47	126	183
1UE	35	53	92	180
6AXW	125	25	24	179
9DTK	87	26	64	177
6KY	29	56	81	166
1BMS	13	23	126	162
9PU	15	11	132	158
6BZJ	55	78	22	155
2CYX	45	60	40	145
8AYP	62	36	45	143
6BDL	21	19	100	140
8RY	32	20	86	138
8BLP	37	30	64	131
8AVK	25	20	82	127
8GZ	29	22	74	125
4MV	19	12	91	122
9ZT	27	70	16	113
9EK-9XH	19	8	86	113
1AOX	26	24	61	111
6CMQ	6	8	96	110
8CEO	22	34	53	109
c1AI	84	17	6	107
1BFZ	35	13	58	106
9XCX	93	8	4	105
9IX	14	26	64	104
9CEJ	53	14	36	102
6BJD	30	17	54	101

Just look at the stations that made the grade this month. 5 TW "stepped on it" and rolled up a better total than last month, making his second consecutive appearance in the starred rectangle. 6BJX kept his promise and almost unseated him. 6BQ did a lot of hard work pulling into third place with 1BIG, 2ADH and 8DEX close after.

This list of Brass Pounders speaks well for summer activity.

8DHU is the portable transmitter of 8AGQ-8CEO. It has been installed on the Steamer Princess, an excursion boat running on the Ohio river. A free message service is offered the passengers by Keister of 8AGQ who operates regularly keeping a schedule with 8CEO to deliver the traffic which is mostly for local points. FB, OM!

2AKV is on 38 meters daily for at least three hours, usually between midnight and 5 am. Schedules are kept with several stations to clear traffic promptly to western points. FX1 recently handed 2AKV eight messages in a row. Let's have more stations who can turn in a report like this. Line 'em up for Official Relay Station appointments, SCMs.

By the time this QST is in print there will be a goodly number of stations rag-chewing and handling traffic locally on 150-200 meters. 2AMQ, 2CKG and 2CXE have a bunch lined up for scheduled work on these waves in the New York City area and it's a pleasure to hear 'em after listening to some of the wabbly notes of the shorter wavelength bands. Come on up and get in the swim yourself, OM.

Just to prove that the C. R. T. A. message service is functioning nicely and that the *message delivery* in New Zealand is 100%, Mr. R. G. Black of Wellington, N. Z. sends us the acknowledgment letter from a well-satisfied recipient of an amateur radiogram. Message number 113 originated by 9GD (Chicago) travelled thru 9EAM, 7EO, and z2BX and was delivered very promptly to a very delighted young lady. Why not try to improve our local message delivery figures? There is plenty of room for improvement. It is the duty of every station-owner who accepts a message to pass it along promptly toward its destination or to deliver at once by phone, in person or by mail. A little personal responsibility on your part in giving 48 hour service to messages you handle will boost us toward that 100% mark. How about it?

c5AO is located at Ponds Inlet at the extreme northern end of Baffinland, the furthest North habitation of the Eskimos in the Canadian archipelago. This call is assigned to Constable Timbury of the Royal Canadian Mounted Police. The portable short wave

**Traffic Briefs**

7BH is the portable transmitter of the Alaskan Aerial Survey Expedition, Base No. 1, Ketchikan, Alaska. 6HJ has been consistently QSO operators Wescott and Gallagher. The wife of a member of the expedition had an hour and a half chat with her husband recently through 6BJX at Los Angeles. Good work, OM.

6BTY was the first U. S. amateur to work 7KX at Day, Alaska. 7KX is located at a cannery belonging to the Alaska-Portland Packers in the extreme northern part of Alaska. The time there is 2½ hours earlier than Pacific Standard Time.

4XE has been keeping three schedules per week with 1BIG sending strings of messages SINGLE and solid at good speed. About 1,000 words per week have been handled right along. Fred Best says that Lee's steady crystal-controlled note makes it easy to handle

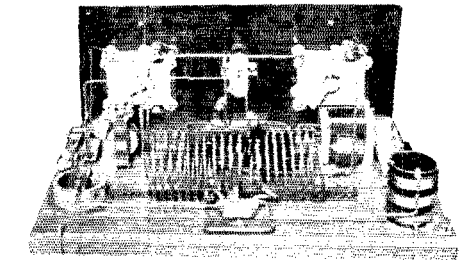

transmitter operated from dry cell batteries is shown in the photograph which we reproduce here courtesy of Mr. G. A. Wendt, Canadian Westinghouse Co., Montreal, Canada.

p11AU recently pulled off an all night chess game by amateur radio between the Filipino chess champions in Manila and Chinese chess champions in China. He says its no joke working all night at the key. Besides, the Chinese champs won the game! 1AU is now making arrangements for a game with the States. We want to hear how that comes out.

pi1CW (Sgt. C. W. DeRemer, Manila Bay, Corozidor, P. I.) was laid low with malaria just as he was hitting full stride in making a record for handling "most messages" with many different countries from one station. We are advised that he is returning to the states and can be expected to put out a mean wallop from his new address at 438 South 4th East, Salt Lake City, Utah.

Members of the Naval Reserve who own and operate amateur stations will receive a certificate similar to the one shown herewith signed by the Secretary of the Navy and sealed with the Navy Department seal.

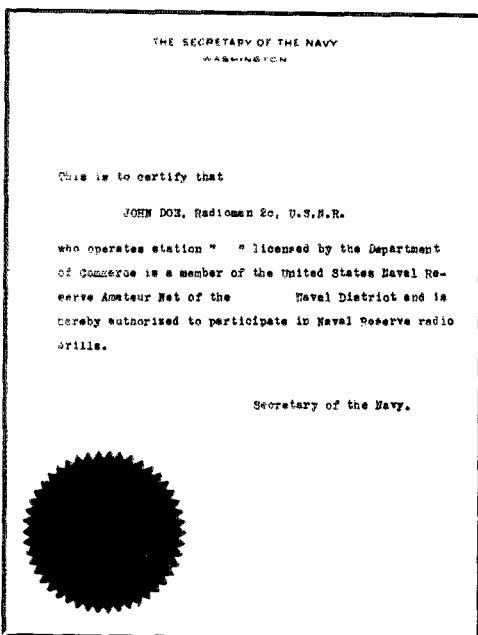

Certain stations in each Naval district are designated "Master" Naval Reserve amateur stations, selected for leadership and zeal and assigned Navy calls for official work in addition to the amateur call letters. Under certain conditions these master stations are authorized to use Navy frequencies.

The first two such master stations have been assigned to Lt-Comdr. F. H. Schnell, USNR, Madison, Wisconsin. Station 9EK-9XH, Naval Call NRRL and to Lt-Comdr. Wm. Justice Lee, USNR, Winter Park, Fla., Station 4NKF, Naval Call NRRG.

## Philippine Progress

By F. Johnson Elser, pi1ZA

UNTIL a short time ago, the name "Philippines" had little use in the radio amateur's lexicon.

Today, due to the efforts of a small but determined band of workers it is a by-word in every radio station in the world. The great distance from other amateurs and the impossibility of getting supplies opposed the efforts of workers in the Philippines from the very start. The true ham spirit, however, kept them working until actual communication with the rest of the world was a fact. There have been Philippine amateurs almost as long as there have been U. S. amateurs.

1ZA was first to copy a distant amateur when he heard 6ZW on 230 meters late in 1923. Next year 1ZA's 260-meter transmitter was copied in China and

New Zealand. In April 1925 1ZA heard several Pacific coast stations using 80 meters. In early June of the same year, Lieut. Roberts, 1HR at Ft. McKinley erected a 40-meter transmitter (the first in the Islands) and began reaching out. This station has been followed by a number of others whose calls are more or less familiar in International radio following the "pi" intermediate: 1AR, 1AT, 1AU, 1BD (ex CDS), 1CW, 1DL, 1DR, 1FB, 1HR, and 3AA. Most of these station owners are members of the Radio Club of the Philippines, a live organization of about 40 members holding meetings every other Thursday. The Club Secretary, Mr. Al DeLange, pi1DL, 333 Sulucan, Manila, P. I. will be glad to remain any cards sent him for Philippine amateurs. There are now about 125 licensed amateur stations in the Philippine Islands.

Perhaps it is the difficulty in securing parts and supplies that does it, but no Philippine amateurs operate their tubes overloaded so they become red. All apparatus at every station is put together neatly and with thought. The result is a bunch of stations that get out at all times.

You men who complain about a fifty watter arriving from New York with a broken filament should try living in the Philippines for a change. Think how a transmitting tube looks after it has come 11,000 miles.

Lieut. Roberts, pi1HR, in addition to putting up the first short-wave station, was instrumental in organizing the Radio Club of the Philippines, corraling all the interested amateurs. Reports indicate that over half the fellows attending the club meetings will have active transmitting stations this fall.

Although Lieut. Roberts is leaving the Philippines September 1st for New York (via Shanghai, China, Japan, San Francisco, California, and Panama) arriving there about Nov. 9, pi1HR will continue on the air manned by native ops. 1HR has a very complete compliment of operators and is on the job keeping traffic schedules daily from 5 pm to midnight, Manila time, including even Sundays and holidays 1HR uses two 50 watters and has a D.C. generator for plate supply. Among many schedules, the daily one with 6BJX kept to handle traffic over 7,000 miles of Pacific ocean and now in regular operation for over six months is the most noteworthy. Extra credit for this work goes to 6BJX who handles his station alone. 1HR has been operated on a wavelength of 37 meters for many months in order that every scheduled station will know where 1HR's dependable signals can be found. In emergencies some Signal Corps traffic is handled in the Philippine Islands in addition to the regular amateur work.

The volume of traffic handled by the most active traffic stations (1AN, 1AU, 1DL, 1HR, 1AT, 1CW, 3AA and 1BD) is rapidly growing and about 1,000 messages per month are handled through these stations at the present time. A large percentage of the traffic goes to the States. 1CW is also going back and his signals will be missed by many USA hams as well as by those in other parts of the world. 1AU is on a large part of the twenty-four hours of every day keeping schedules with 6BVY, 6AKM, and 6CUW. If there was a Hoover cup for the Philippines it would doubtless go to 1AU. The apparatus at this up-and-doing station is mostly homemade which in the Philippines does not mean that the station was assembled from standard parts as it does in the United States. 1AT was a little late in dropping to short waves with his 50 watter but is making up for lost time in handling his share of traffic. 1AT is an old timer who helped keep things going when amateur radio in the Philippines threatened to die of inertia. The ops at 1BD are numerous and though one of the newest stations it is 100% reliable and has made a name for itself already. Like 1HR it is at an Army post. One 250 watter is used at 1BD. 1DL is the station of the hard-working club secretary. Using one 50 watter schedules have been kept with 6BQ and 6BJD.

It will be seen from the foregoing that the Philippine states are not watter burners but they certainly are ether busters. Many American stations operated under more fortuitous conditions, can hang it's head in shame. The Philippines are the farthest point from the United States where the American flag flies and this fact alone should make you more determined than ever to hook one of the "pi" stations when they are heard at your station. They are certainly doing their part!

# Traffic Summary By Sections

The percent of all the Official Relay Stations under each officer and the percent of TOTAL messages handled by each section are included in the summary of this month's work. By comparing the two columns showing these percentage figures the standing of each section is shown on a message-handling and reporting basis. If the percentage shown opposite your name under "%ORS" is much greater than shown under "%MSGS" it means that some of the following things need to be done: (1) Dead O. R. S. need to be cancelled. (2) More live stations need to be appointed. (3) Message lanes need to be formed covering your territory. More schedules may help. Perhaps the fellows need to be urged to originate more messages. (4) Maybe the messages are being handled all right after all but the reports are not coming in as they should—which means that some letters need to be written.

The different Section Communications Managers are listed below. Are you doing your part to keep your Section and Division a leader? How will you stand next month?

If every station owner who reads these words will see that every message he handles is delivered or passed along promptly and report his good work, we will be able to show 100% delivery in the National scheme of things in a short time!

The problem of message RELAYING and DELIVERY must get some serious attention if our general service is to be one of which we are proud. The reports show that messages going over regularly scheduled routes get through with the desired speed and 100% accuracy. The figures show that there is plenty of traffic to be handled. More individual responsibility regarding prompt relaying and delivery will bring the results we want.

Messages received should always be delivered immediately (a) by telephone, (b) in person, or (c) by mail if no other means of effecting delivery is available.

Never accept messages which cannot be handled or delivered without informing the chap filing the message of the circumstances.

Keep the hook clear by handling traffic on schedule daily.

Section	ATLANTIC DIVISION				Orig.	Del.	Rel.	Tot.
	SecM	%ORS	%Msgs					
East. Pa.	H. M. Walleze	4.11	5.66	160	159	600	924	
West. Pa.	G. L. Crossley	3.63	2.55	88	80	268	468	
West. N. Y.	C. S. Taylor	4.80	7.99	161	207	482	1450	
So. N. A.	H. W. Densham	1.37	.47	19	17	50	86	
Md.-Del.	H. H. Layton	1.42	.09	2	1	14	17	
D. of C.	A. B. Goodall	—	.88	52	54	65	161	
		15.33	17.04	492	528	1479	3104	

Section	CENTRAL DIVISION				Orig.	Del.	Rel.	Tot.
	SecM	%ORS	%Msgs					
Ohio	E. C. Storck	6.17	4.94	194	141	553	896	
Wisc.	C. N. Crapo	2.68	2.88	192	75	259	526	
Ill.	W. B. Schweitzer	6.12	4.96	227	222	359	905	
Ind.	D. A. Angus	1.35	3.00	118	118	475	711	
Ky.	D. A. Dornard	.74	—	—	—	—	—	
Mich.	C. E. Darr	3.20	.50	39	25	28	92	
		20.16	17.18	870	581	1674	3130	

Section	DELTA DIVISION				Orig.	Del.	Rel.	Tot.
	SecM	%ORS	%Msgs					
Miss.	J. W. Gullett	.21	.45	35	22	25	82	
La.	C. A. Freitag	.20	—	—	—	—	—	
Tenn.	L. K. Rush	.27	—	—	—	—	—	
Ark.	Dr. L. M. Hunter	—	—	—	—	—	—	
		.68	.45	35	22	25	82	

Section	DAKOTA DIVISION				Orig.	Del.	Rel.	Tot.
	SecM	%ORS	%Msgs					
No. Minn.	G. L. Barker	1.80	1.48	58	91	133	270	
So. Minn.	D. C. Wallace	2.30	—	—	—	—	—	
So. Dak.	E. J. Beek	1.31	2.01	39	8	320	367	
No. Dak.	G. R. Moir	.93	—	—	—	—	—	
		6.34	3.49	97	99	453	637	

Section	HUDSON DIVISION				Orig.	Del.	Rel.	Tot.
	SecM	%ORS	%Msgs					
N. Y. C. & L.	H. H. Mardon	2.79	3.30	176	206	210	602	
East N. Y.	Earle Peacock	2.24	4.70	165	84	503	852	
No. N. J.	A. G. Wester, Jr.	3.53	1.32	59	27	155	241	
		8.56	9.32	400	327	958	1695	

Section	MIDWEST DIVISION				Orig.	Del.	Rel.	Tot.
	SecM	%ORS	%Msgs					
Iowa	L. R. Huber	1.07	.85	12	10	132	154	
Kansas	F. S. McKeever	1.42	—	—	—	—	—	
Missouri	L. B. Lutzire	1.92	.59	15	13	44	72	
Nebraska	C. B. Diehl	1.37	.59	33	34	27	108	
		5.78	1.83	60	57	203	334	

Section	NEW ENGLAND DIVISION				Orig.	Del.	Rel.	Tot.
	SecM	%ORS	%Msgs					
Maine	Pred. Best	.75	5.55	149	114	748	1011	
N. H.	V. W. Hojze	.75	.42	20	9	38	77	
Vt.	C. T. Kerr	.68	.19	16	6	12	34	
R. I.	D. B. Panner	.81	.53	18	7	36	61	
Conn.	H. B. Nichols	1.61	1.10	40	27	135	209	
East. Mass.	R. S. Briggs	2.66	3.69	124	130	150	304	
West. Mass.	A. H. Carr	2.10	1.15	34	46	119	209	
		9.36	12.43	411	347	1498	2266	
Section	NORTHWESTERN DIVISION				Orig.	Del.	Rel.	Tot.
	SecM	%ORS	%Msgs					
Mont.	A. R. Willson	.57	.12	13	—	9	22	
Wash.	Orto Johnson	2.04	.44	30	6	45	81	
Ore.	A. C. Dixon	1.07	.43	14	59	12	85	
Idaho	R. S. Norquest	.38	.02	—	—	3	3	
Alaska	L. H. Machin	.13	—	—	—	—	—	
		4.19	1.04	57	65	69	191	
Section	PACIFIC DIVISION				Orig.	Del.	Rel.	Tot.
	SecM	%ORS	%Msgs					
So. Sect.	J. E. Smith	3.95	15.83	683	670	1480	2883	
Sect. 4	F. J. Glement	.65	.94	32	43	97	172	
Sect. 5	F. J. Losheter	1.40	—	—	—	—	—	
Sect. 6	St. Clair Adams	.16	.02	4	—	—	4	
Nevada	C. B. Newstrom	.28	.13	—	—	—	17	
Hawaii	K. A. Cantin	1.16	4.09	509	182	148	744	
		9.60	21.01	1228	895	1725	3820	
Section	ROANOKE DIVISION				Orig.	Del.	Rel.	Tot.
	SecM	%ORS	%Msgs					
No. Car.	R. S. Morris	.84	.93	24	21	128	173	
Va.	J. P. Wolford	1.50	.36	25	7	34	66	
W. Va.	C. S. Hoffman	1.56	1.86	113	57	170	340	
		3.70	3.17	162	85	332	579	
Section	SOUTHEASTERN DIVISION				Orig.	Del.	Rel.	Tot.
	SecM	%ORS	%Msgs					
Fla.	W. F. Grogan	1.52	1.62	89	61	155	296	
Ala.	A. D. Reid	1.96	2.00	63	73	211	347	
Ga. - S. C.	H. L. Reid	1.44	1.05	31	16	145	192	
		4.92	4.67	174	150	511	855	
Section	ROCKY MOUNTAIN DIVISION				Orig.	Del.	Rel.	Tot.
	SecM	%ORS	%Msgs					
Colo.	C. R. Stedman	1.20	1.77	81	37	196	324	
Utah-Wyo.	Art. Johnson	.96	.30	11	3	41	55	
		2.16	2.07	92	40	237	379	
Section	WEST GULF DIVISION				Orig.	Del.	Rel.	Tot.
	SecM	%ORS	%Msgs					
No. Tex.	W. R. Everett	2.41	—	—	—	—	—	
So. Tex.	E. A. Sahn	1.29	.32	23	5	30	58	
Okla.	K. M. Buret	.67	3.42	96	318	216	625	
N. Mex.	—	—	—	—	—	—	—	
		4.37	3.74	119	318	216	683	
Section	MARITIME DIVISION				Orig.	Del.	Rel.	Tot.
	SecM	%ORS	%Msgs					
Nfld.	Loyal Reid	.97	—	—	—	—	—	
P. E. I.	W. A. Hyndman	.95	—	—	—	—	—	
N. B.	T. R. Lacey	.50	—	—	—	—	—	
N. S.	W. C. Barrett	.18	.37	112	38	9	159	
		.80	.87	112	38	9	159	
Section	ONTARIO DIVISION				Orig.	Del.	Rel.	Tot.
	SecM	%ORS	%Msgs					
Ontario	W. Y. Sloan	1.80	.47	—	—	—	37	
Section	QUEBEC DIVISION				Orig.	Del.	Rel.	Tot.
	SecM	%ORS	%Msgs					
Quebec	Alex. Reid	.55	.09	—	—	—	17	
Section	VAN-ALTA DIVISION				Orig.	Del.	Rel.	Tot.
	SecM	%ORS	%Msgs					
B. C.	—	—	—	—	—	—	—	
Alberta	A. H. Asmussen	.19	.46	26	26	32	84	
		1.17	.46	26	26	32	84	
Section	PRAIRIE DIVISION				Orig.	Del.	Rel.	Tot.
	SecM	%ORS	%Msgs					
Sask.	E. L. Maynard	.51	.49	22	—	10	32	
Man.	F. E. Rutland	.22	.18	52	16	30	108	
		.73	.67	74	16	50	140	
Section	TOTAL FOR COUNTRY				Orig.	Del.	Rel.	Tot.
	SecM	%ORS	%Msgs					
Delivered	1,409	3,594	9,531	18,232				

*Sa Om I just weds  
French Buz in Toulon  
Y'spose he has anything  
to do with that Prison there?*



# DIVISIONAL REPORTS

## ATLANTIC DIVISION

**EASTERN PENNSYLVANIA**—H. M. Walleze, 8BQ, SCM—A last warning is issued to non-reporting ORS of this Section. A large part have not reported as yet. A few of the old stand-by stations failed, due to the heat, we will say, while a few new ones came around. If you do not have a report here by the 25th of August, your ORS is QSKed. About 40% of the reporting stations are on 40 m. 88% are on 80 m. and the balance on both bands. The 40m. gang handled about 1/5 of the total traffic of the 80 m. gang. Not a single 80 m. man had a zero total. About half of the 40 m. gang handled traffic. An ORS is supposed to handle traffic to live up to the obligations. No mention is made of DX in these. There is one answer—get on 80. Let's go! Keep schedules! 'Can' the CQing and listen for the CQer—and watch your hook clear.

8EU says QRN is R999, which cut his total. He threatens to filter that QSB again. Hi. Has enough schedules to keep four men busy, but does it single-handed. FB. 8AVK chased him in second place. He is going to move again. (You are as bad as your SCM). 8CDB is going at half speed and rebuilding. 8BSZ has his new 50 overloaded with 550v's. Hi. 8AWT covered 2250 miles—by auto through the Middle West on his vacation. 8ADE going down to 40 as he says traffic is scarce on 80 early mornings he is on. (Hi, you better go UP, not down). 8BIR deserted 40 and is back on 80 busting out—traffic, not DX. 8BFE saw shades of a fading ORS and is going strong again. 8QY started up again. 8LK says 'other duties' kept him off. YL's? 8AHR can't find traffic on 40. Nor can 8CDS. 8ALE is building a new 100 watt set. 8CHG put to sea on the SS Howard. 8AFQ landed a few on 40. 8AIG is arranging a lot of schedules. 8CGZ thinks his junk perking half decent—after QSOing Y and G. 8BLC suffered the heat. 8CW works on both bands. 8LW handled 5 direct to NZ. 8VF wants an ORS. 8AIY bawled me out for mixing his call in June report. Sorry, OM, I may have but don't think I handled your report then. 8BLP is blasting things with his xtal. 8BWI is the only active Wilkes-Barre station. 8CMO has a pretty fist and is after an ORS. Your SCM took a 100 v. MG to raise—his traffic, of course, and has a half decent QSB again at 8BQ. Ballentine is right—Mo—PA forever! My hay-wire antenna has a "ten foot swing" but the boys say "steady as a Die"!

Traffic: 8EU 285, 8AVK 127, 8CDB 86, 8BSZ 66, 8CCQ 57, 8CMO 53, 8CGZ 39, 8ADE 36, 8AIG 28, 8BQ 23, 8VF 22, 8BFE 17, 8BIR 15, 8AVL 14, 8AIY 12, 8AWT 10, 8AVV 7, 8LW 6, 8AJR 4, 8AFQ 3, 8CW 2, 8BLC 1.

**WESTERN NEW YORK**—SCM, C. S. Taylor, 8PJ —Western New York is hitting the world in most every spot during the hot weather. 8BHM worked several 6's, Aussies, Zedders and Media. All messages received by him will be forwarded to the foreigners. His station was copied through the thunderstorm in Australia by 8TCS and New Zealand 2CS.

Official broadcasting by 8PK was copied in Finland. 8PK and 8ABX are pounding out exceptionally good. 8DSI handles messages for VOQ and relayed same in 15 minutes to 8DPL, Buffalo, N. Y. 8UL still keeps traffic going from his station. 8GB handles traffic with XCD at Vera Cruz—also hears OCD5, M5C, F8KF and handles other traffic. 8CCR works 20 meter band successfully in daylight, also handles traffic. 8CNH still handles traffic and is rebuilding his station. 8BZU blew another 50 watt and is going to increase to 100 watts. He reports 8ASP, 8BCW, 8AOZ, and 8CPE are doing good work. 8BCW is on now with 50 with ICW 500 cycle on 80 meters. 8ARG got his first card from Australia. 8DFK is off the air. 8NT handles traffic and has gone out west on a vacation trip. 8AIL is at camp. 8CTK is off the air. 8HJ handled traffic as usual. 8ADE worked Tasmania—he says his new location in wilderness is much better. 8CTI is building a new rectifier and erecting a Hertz antenna. 8AVJ handles some traffic but is off just at present. 8DRJ worked 24AC, F, G, GB, Hu, M, PR, Z and F8KF for 2 days at 10:30 pm. 8BQK is on a vacation. 8AKS works 6's and Porto Rico and just finished a new transmitter. 8CVJ handles traffic. 8RV is over in the wilds of Canada at present. 8CNX will be on after September 1st, on 20, 40, 80 and 160 meters. 8AEA has taken the rest cure at

Watkins Glen after attending the Buffalo Convention. 8DDL is handling traffic with 8AIG, 1BIV and 9DAY, a member of the RCC, says he is QSO with lots of fellows he met at the convention. 8PJ has been taken over by U. S. Army for communication purposes with Geo. McGarret of 1YB as operator. 8DPL, 8CAN, and 8PJ are on board the USS Destroyer King with the USNRF. 8BSF will be QSO again after Sept. 1. Mr. Liddbury of 8DAJ just returned from Europe and states 8KW was heard all the way over and back with his 20 meter set in daylight. 8BSF is acting SCM in the absence of 8PJ. ORS have been issued to several this month and after September, Western New York will have quite a few new ones.

8DBC is rebuilding his station for 40 and 80 meter work. 8DBQ has completed his new station. 8CZP is still trying to get going on 40. 8BLP is doing good work using a UX210. 8AHC is working good DX, including Nz, Australia and Europe. 8DHX is getting in line for the Trophy. 8CTK had his antenna blown down. 8BSF is now working FB using DC, 500 cycle and 25 cycle juice. Most of the gang at Buffalo are off the air due to the hot weather and rebuilding. 8RV is going in for DC plate supply.

8DHX heads traffic but says he has no time for DX. He has schedules with 8EU and 2ADH daily. 8CVJ, 8CZP and 8AHC are now eligible for ORS. 8AHC has handled traffic and has DX records of England, New Zealand, Australia, Azores and VIR. 8BDC is rebuilding his station for 40 and 60 meters. 8DBQ has just completed his new station.

Traffic: 8DHX 327, 8BLP 131, 8BHM 62, 8CVJ 47, 8AHC 33, 8DDL 28, 8ANX 28, 8NT 26, 8DME 24, 8DRJ 20, 8BQK 16, 8CTI 15, 8UL 13, 8BGN 12, 8DSI 12, 8ADE 5, 8QB 5, 8CZP 5, 8CCR 4, 8HJ 4, 8CTK 4, 8BSF 4, 8ARG 2.

**WESTERN PENNSYLVANIA**—SCM, G. L. Crossley, 8XE—The traffic report for this section is lighter than it should be, considering the number of ORS here. 33 ORS have not reported for two months—or as long as the SCM has been on the job. The SCM believes there are plenty of good stations not holding the ORS and some holding the certificate that need cancellation. The 33 stations mentioned have received a letter from the SCM that in accordance with the ARRL R. & R., stations not sending in their report for two consecutive months have their ORS subject to cancellation. This necessary action will follow without fear or favor with the missing of a third report to give us a 100% live Section.

8CVH and 8GK report too much heat and QRN for good work. 8BBL has taken down his Hertz and is now back to a Hartley and says that 1MI of Ecuador reports his signals coming in fine. 8GI, 8BRM and 8CES report off duty, due to too much work. 8AGO is on a trip so is not on the air. 8DNO is having antenna and tube trouble (who of us don't at some time)? 8SF, 8XE and 8CRK are rebuilding so we don't hear them on the air. 8CWQ has been trying a driver with success. 8CC is helping operate at 8CMM who has put in crystal control. 8CMM tried a 700 foot receiving antenna with good success. 8AWR, 8CEF and 8CIX are doing well on 40 meters. 8AXW is home from Florida using a 5 watt. 8HM and 8CKP are on every nite looking for traffic. Anyone hearing 8DHU will be glad to hear that it is the Steamer Princess on the Ohio River open for message traffic for the passengers. They have a schedule with 8CEO. Last but not least, the SCM reports that 8BPV is papa with a YL broadcaster in his home. And again another man tried to get rid of YL QRM. 8FM did this by getting married.

Traffic: 8CEO 109, 8BRC 91, 8CWT 69, 8DHU 51, 8EW 43, 8AGO 34, 8BBL 16, 8DNO 11, 8DKS 10, 8VE 9, 8GK 7, 8CGF 6, 8AXD 5, 8DGL 5.

**DELAWARE**—Maryland—SCM, H. H. Layton, 8AIS —8AIS was the only station in operation last month. The Calling of the great outdoors was too much for 8WJ so he packed up and went to the shore for the summer. 8SL is installing a gas engine at his station to furnish power for his set. An application for an ORS certificate was received from 8SL. 8AEB just returned from his vacation and will be on the air if the weather isn't too hot. 8BSS is moving his outfit to the cellar to be nearer the ground. Hi. 8ALQ, please get in touch with your SCM pro tem.

3AEA reports his station has been inactive due to vacation and rebuilding but promised to be on the air shortly on 80 meters. 3BUR sends his report from on board the USS Utah at Phila, Pa. ND at all at Annapolis and same luck on Utah, call NVE as had planned. Permission for operating high frequency set revoked at last minute. Only a receiver is perking. 3APV attended the Atlantic Convention at Buffalo.

Traffic: 3AIS 6, 3APV 11.

DISTRICT OF COLUMBIA—SCM, A. B. Goodall, 3AB—8BWT, who has taken a much deserved vacation during the last month, is back again on 40 meters and at this writing is tuning up the 80 meter transmitter. The fellows can look for the old traffic hound regularly now. 3AB has been battling for him during the month. Much credit must be given to the fine operating of 3NR, the new station reported last month. He is on both 40 and 80 meters alternatively and is QSO all directions. For volume of stations worked, the cake goes to 3ACM who thinks nothing of working over thirty-five stations a day. 3CAB, C. A. Briggs, is finally busting through the city wall and is reporting working into all districts.

Traffic: 3AB 76, 3BWT 63, 3ASO 15, 3ACM 17.

SOUTHERN NEW JERSEY—SCM, H. W. Densham, 3EH—3ZI is keeping regular schedules with 2SC, 2ZB, and 3SN. All of this work is on 80.5 meters. 3BMZ is handling traffic with NIDK—an ice patrol boat and has been QSO P-IAE. 3SJ has been QSO England several times recently. 3BTQ has been finding 40 meters hurts his traffic totals and will soon be back on 80 meters again. 3XAN is doing really fine work with the Army chain of stations. He is running schedules with Newark and with WVZ, Fort Hayes, Ohio on 38-76-175 meters. Wolf is to be congratulated on handling a well-designed and operated station. A new Trenton station has just opened up using a WE 250 watt on 38 and 77 meters—call is 3BLZ. 3CBX is rebuilding for the fall rush of traffic. 3AFW is feeding between 3 and 6 watts into a 201 tube and has been QSO 20 states and Canada. So far, all this work is with a Hertz antenna. 3BWJ remains the consistent DX station of the district. 3VX reports too much hot weather QRM.

Traffic: 3BWJ 15, 3SJ 15, 3BMZ 15, 3CFG 9, 3ZI 5, 3VX 8, 3BTQ 7, 3XAN 4, 3KJ 3, 3ABF 9.

### CENTRAL DIVISION

WISCONSIN—SCM, C. N. Crapo, 9VD—Dist. 1—9DTK's schedules are again beginning to work. 9BWO wants to know who report to. (9VD, of course, OM) 9CDT put up a new counterpoise. 9AFZ is on 40 meters with 8 tubes. 9EHM is doing some testing. 9HO says 9ALR has joined the benedicts. 9ECC will be on the air in about 2 weeks. (Welcome to Milwaukee, OM, we sure need that live station so let's see you go).

Dist. 2—9EK-9XH is now crystal controlled on 38.4 and 76.8 meters. 9DLD is on 80 meters. Antenna is down at 9DYR so he is off for a while. 9BPQ is off due to pressure of farm duties. 9ACM recently married and is QRT for a while. 9AFV is QRV every morning on 80 meters until 7 AM. 9TK is a new station at Waterloo. 9DZH is at Blanchardsville using pure DC on 180 meters. 9BJH is operating on 80 and 180 with 300 volts B battery. 9DLD says the second district will soon knock the first district from first place. With the help of these stations and 9FK and 9BIB, "It won't be long now". 9EAR joined the MRAC while on a visit to Milwaukee. 9COI spent his spare time experimenting with antenna's and power lines. 9ATB has a station at Lake Beulah. For schedules, write T. Mitchel, RFD 1, Lake Beulah, Wis.

Dist. 3—9AGV has a station with the call 9ABM. 9AZY finds 80 meters best for traffic handling. 9AEU says station perks OK but the only time he can be on is at noon and about 7 PM as work and YL take up the rest of his time. 9BVA hopes to have a station at St. Paul, Minn. 9ANE will have 50 watts this fall. 9CIU is commercial operator on the KDXU.

Dist. 4—9AZN worked regularly with Chicago and Milwaukee Army stations this month. 9AKY got permission to move his transmitter to Camp Sparta and an enormous message total is expected next month. 9BZA says a BCL friend got a nice burn from the antenna while the transmitter was in operation. He is coming again to burn some warts off. 9CAV blew a fifty with a 201A. He worked both coasts getting an R6 report.

9AZN handled 12 Army messages and 9DTK handled 3 army messages and 65 tourist messages. 9AZY handled 8 tourist messages and 9BWO handled 6. The call NRRL has been given to the Burgess Laboratories. Shnell is organizing a Naval Reserve unit in Wisconsin and hopes to take the lead from Florida where the Naval Reserve has 52 active stations. He is putting the Wisconsin stations on a fleet basis, designating them as Battleships, Cruisers and Destroyers. This original idea will stimulate interest, increase message totals, and take the lead from Florida.

Traffic: 9DTK 177, 9EK-9XH 113, 9AZN 66, 9AGV 54, 9DLD 31, 9AZY 27, 9BZA 19, 9BWO 15, 9CAV 6, 9EAR 6, 9CDT 4, 9AFZ 4, 9COI 3, 9AEU 1.

ILLINOIS—SCM, W. E. Schweitzer, 9AAW—9RQ is in Ohio and the station will be closed until fall, when it is to be opened with a bang. Listening in at Youngstown, he reports the gang pounding in, especially 9AAW and 9PU. 9AXB is on regularly but the heat is terrible—why not take a trip with WNP next year?

9CEC will be on the air in about a month and reports all the stations are off the air in his region until fall. 9DWH tried kenetrons but likes a chem rectifier better. 9CSL is trying to get three transmitters going, 10 and 100 watts on 170 meters and 500 watts on 40 meters. 9BVP is rebuilding the transmitter for 40 meters. 9AWI reports ND this month. 9AJM is vacationing and building a set to operate on 20 meters. 9QD has been unable to work schedules this month but promises to be going full blast by fall. 9VJ is on the air again with a 50 watt. The Chi-9s have a box posted in the Sherman Hotel and are getting quite a few messages. 9AIO was entertained by 9CYE and a gang on the eve of his departure to Europe. 9DDE is building a new transmitter and will not be active until September. 9AAE just put up a Hertz antenna for 40 meters. He also bought 9AE's equipment and is going to build a portable xmitter with it. 9APY was away most of the month. 9DYD now uses a 75 watt. After trying the 40 meter band, he has decided that 80 meters is much better for traffic. 9ELO uses a copper tubing coils and finds them FB. 9BWL uses 100 watts and keeps a schedule with Logansport, Ind., handling real traffic. 9DXZ is operating regularly. 9CNB was also vacationing but is back on the job again. 9AFF has been in charge of the Army net of the 6th corps area. 9AGQ tried a zepp antenna with poor results and now uses a single wire on a harmonic. 9PU has completely rebuilt this month with the result of QSO A, Z, Tasmania and HU. Reports traffic with A and HU. 9ELR is still active and is going to try a Hertz antenna. 9CXC is keeping schedules with 8AYV-8BQK. 9EJY is rewinding his MG so will be off the air until about Sept. 9EFF reports not much doing at this time. 9DXG uses a 50 watt now and says its FB. 9DQS is on the air once again using a UV201A on 40. 9BHM reports he had trouble working out until he put in a copper tubing inductance. The tubing must have come out of a still as his sigs have some kick in them now. 9BQA uses a UV210 with 216 watts input. 9AJJ expects to put in a 50 watt. The Danville Radio Club is going strong with 19 members. The 9AAW family are back from their trip around the world and they say there's no place like home. It is hoped to use crystal control by fall. WNP was worked consistently up to July 10th when he lowered his QRH and was heard here no more. The WNP traffic is now being sent via 1ZK, 1AAV, 2UO and 1FL.

Traffic: 9PU 158, 9CXC 105, 9IX 104, 9CEJ 102, 9RWL 72, 9AAW 59, 9CNB 56, 9DXZ 55, 9VJ 37, 9AFF 30, 9DOX 23, 9CYE 14, 9EFF 11, 9DXG 11, 9QD 8, 9ALJ 8, 9DYD 8, 9BHM 8, 9DQS 7, 9BVP 6, 9CSL 5, 9DWH 5, 9AYB 5, 9DDE 3, 9AAE 3, 9AGQ 2.

INDIANA—SCM, D. J. Angus, 9CYQ—Your reports to the SCM will be accepted by radio at SCM station 9CYQ, 82 meters, 6:00 to 7:30 PM CST or at Indianapolis stations 9CLO, 9ASJ, 9CUD or 9CJQ.

J. Robinson is heading up a new radio club at Bloomington. 9AIN and 9AYO are in on it. This represents the first real activity in Bloomington. 9BGT is on every night handling schedules. 9BNP is on regularly working all districts. 9BCM has got out of the experimental stage and is on regularly. 9DYT is trying Hertz antenna and claims Mr. Hertz didn't know his stuff as he can't make it work. 9BSK worked Japan, Holland and Ireland on 40 meters. 9DIJ works everything he hears with a 50

EX9BIQ is helping him. 9CP tried to filter his sink but it lost its kick, so uses it raw. 9ASJ is back again with a new pole. 9DSC works the west coast regularly on 40. 9CRV is beginning to be a regular traffic station now. 9AXH, who is in Canada, is having his station operated by 9ALE, 9CZL, 9ACR and 9EJL. 9CBT is on regularly and getting good reports. 9CUD has at last got the hoarseness out of his note and is getting out good. 9CLO has his outfit so he can instantly QSY from 80 to 40. 9EJI worked lots of DX. He loses more sleep and works more DX than any other Indianapolis station. 9AMI is going to put in 50 watts, although he is getting out good on a UX210. 9BDK uses a 203 on 80. 9BRG is going good on three 7.5 wattors on 80. 9AEP is rebuilding for fall. 9AEB just installed a Marlo Super Synk. 9EJI is reliable for the east coast but nil on the west. 9QR was QSO Porto Rico. 9DDZ just rebuilt and is getting out fine now. 9CXG has put in a new filter. 9BYI has raised his plate volts to 1500 and gets much better reports. 9BKJ changed from 40 to 60 jar rectifier and gets battery QSB now. 9DPJ is the best traffic station in the state. 9AMZ is a new station at Fort Wayne on 80 meters.

Traffic: 9DPJ 210, 9EJI 90, 9BGT 67, 9BKJ 64, 9BSK 43, 9BNP 34, 9CBT 29, 9RCM 20, 9CP 18, 9DYT 14, 9BYI 12, 9CXG 11, 9DIJ 11, 9BDK 13, 9QR 8, 9CAP 8, 9BRG 7, 9CRV 7, 9CLO 6, 9DHJ 6, 9AMI 6, 9DRS 5, 9EJU 5, 9AXH 5, 9DSC 5, 9ABP 4, 9CUD 3, 9DDZ 2, 9AEB 1.

MICHIGAN—SCM, C. E. Darr, 8ZZ—SAUB is having trouble on 40 meters and is going back to 80. 8ZH works practically all on schedules. 8CEP uses break-in using no antenna for receiving. He reports it FB. 8QN still operating NEU—handling amateur traffic, too. 8AMS has a new 1000 v. MG and is going up to a 50 wattor. 8MM is remodeling antenna system. 8PF has been off the air on account of a long vacation. On July 24, hams from Detroit, Toledo and adjoining cities held a hamfest at Monroe, Mich. This was the first get-together meeting we have had and it was enjoyed so much as it was proposed that they be held often. Dinner was served at Park Hotel and a good time was had by all.

The City of the Straits Radio Club of Detroit are preparing for the 1926 ARRL state Convention. It's going to be a "WOW".

Traffic: 8CEP 48, 8QN 20, 8ZH 11, 8AUB 7, 8ZZ 6.

OHIO—SCM, H. C. Storck, 8BYN—This is the SCM's first report under the new system and altho reports have been straggling in since the 15th of July, he hopes next month's reports will return to normal. He wishes to thank all the Ohio gang for their cooperation and hopes to be able to handle his office to every one's satisfaction.

8DBM leads the list of traffic handling. He's a good schedule station. Others, please take notice! 8RY is also a good schedule and DX station. He suggests the use of GMT for messages and station logs. Good idea. 8GZ mostly handles press for ARRL from Aussies and Zedders. 8BYN reports much power leak QRM which is bad for traffic. 9DIA is a great believer in DC notes and now has one. 8CQA works hard for traffic but says it's scarce. On checking up, 8AEU finds he worked 72% of all stations called. 8AZU is going to CMTC camp, but turns in a nice total for a few days work. 8BPL installed a sync rectifier with 140 watts input. 8PL has had tough luck with crystals but has one now that is holding up. 8ANB is on with a 250 wattor and looking for more traffic. 8BNA is working for the summer and has little time for radio. 8DRX is having trouble with absorption from trees. 8ADA is keeping PRR schedules thru the summer. 8BKM is 2nd cook on the H. L. Shaw. 8BXL is working station for him, pro tem. 8CBI says it's too hot for radio. 8AWX is using B batteries for plate supply. FB. 8DSY is another DC hound, and neglects traffic in order to experiment and get one. Then he says he'll go to it. 8CLR reports having trouble with his set. 8ACY is operating KFNN on the lakes and 8RN is operating KFNO. 8BBH is a proud papa now. Congratulations, OM. 8DEM is at 9CYW and handles traffic there for the summer. 8BON will soon be on with a new set and rectifier. 8AYO is now on the air with crystal control. 8BCE is mostly after DX. Worked O-ISR at Salisbury, Rhodesia. FB, OM, but more traffic will be appreciated. 8BKQ is on by this time with crystal control. Has also had tough luck with them, but OK now. The SCM wishes more stations would get the schedule habit. All the high total stations are good schedule stations. There are

less fellows on in the summer, hence we ought to be able to handle more traffic per station. DX work is all right but get to keeping schedules once, and you will find a real "thrill" you have never dreamed about so far. It beats DX work. Reports on traffic handling thru schedules are solicited.

Traffic: 8DBM 302, 8RY 138, 8GZ 125, 8BYN 90, 8DIA 38, 8CQA 37, 8AEU 36, 8AZU 22, 8BPL 20, 8CPQ 18, 8PL 18, 8ANB 16, 8BNA 11, 8DRX 7, 8ADA 3, 8BKM 3, 8CBI 3, 8ARW 3, 8AWX 2, 8DSY 2, 8CLR 2.

## DAKOTA DIVISION

SOUTH DAKOTA—SCM, F. J. Beck, 9BDW—Various summer activities, commercial operating and YLs claimed most of the gang this month. Most of the hams in the east part of the state took advantage of the opportunity of inspecting 6XBR and admiring the big bottles. 9BKB blew his H tube and had to go back to the fiver. Attendance at the CMTC shot the message total. 9BBF, using the 6HM layout, is working foreign DX in fine shape but says traffic ND. 9BBL forgot to renew his ticket and is now ex9BBL. 9AAX got the 210 working on 40 and 80 but is leaving for the coast. 9CVH's YL married the other fellow and will have more time for radio in the future. 9CJS lost his fifty and went back to the reserve fivers. 9DWN has kept a daily schedule for five weeks without a break. Has eight schedules working smoothly and says they account for at least 75% of his traffic. Also finds time for some UX. 9DBZ got his call back and is trying a Hertz antenna and complains of a stiff neck from watching the light. 9NM is in the midst of the busy season on the ranch and finds little time for work.

Traffic: 9DWN 318, 9DBZ 13, 9BKB 13, 9NM 11, 9CJS 7, 9BBF 5.

NORTH DAKOTA—SCM, G. R. Moir, 9EFN—9BJV kept schedule with 9AAX and worked Louisville, Ky. at 12:30 PM on 33 meters with 22 watts input. 9EFN has been up to Grand Forks for examination and met a few of the hams there. 9DKQ handled little traffic. Everybody seems to think it is time to take their vacation when it is so hot and have forgotten to report.

MINNESOTA—SCM, C. L. Barker, 9EGU, (pro tem) —The attention of the Minnesota gang is again called to the fact that under the new SCM system, the rules and regulations regarding the cancellation of Official Relay Station appointments will be very strictly adhered to and it behooves a great many of our stations to be careful about reporting, otherwise—they won't be, that's all!

9DYZ did not have time to be on the air much but handled some important traffic for the Warner Bros. portable station, 6XBR. 9DBW reports traffic scarce but has been working with a new circuit, like 60I and is getting ready for heavy fall work. 9CWA is on the air on 40 meters with H tube, having lost a 5 wattor. 9EGU has completed a complete rearrangement of the station with a few minor changes in the transmitter and gets out better than before. 9BMX uses a Hertz antenna, which he says is fine for USA DX, but he can't seem to get out of this country anymore. 9EIZ attended the MNG camp for two weeks and has received his Army-Amateur cipher. 9BNK is very busy at WAMD. 9SE is spending a vacation at Yellowstone, visiting all the 7's he can find and will be on the air about Sept. 15 again. 9AIR is dividing his time between operating and visiting the Southern Minnesota gang. 9GH was heard by O-DXL in South Africa. 9BNF blew his 27 month old 5 wattor, but reported DX fine with good traffic. 9ZT handled important KFUH traffic as well as important IARU press. He now uses a mercury arc rectifier and says there is nothing like it, having worked Australia and New Zealand 25 times in 4 days. 9BVH uses a Hertz antenna with less input and gets out better. 9DZA replaced his 5'er with a new 50 wattor and is turning 3BCLs into hams. FB. 9DHP has rebuilt, using a 7½ watt tube with Kenetrons. 9BCN says that DX is fair, but traffic is the bunk on 40 meters. 9DWO works out well. 9DMA is getting out very well with a new antenna and 19 watts input. 9CAJ handled some important traffic to and from Honolulu. 9EGG is finding it hard to get out now, working on 40 and 20 meters. 9DUV has lots of trouble with fluctuations in the power lines on the range—they make his signals fade and hard to read. 9EHO has started up with a Ford spark coil for plate supply and gets out fairly well. 9BYI almost lost his license but got it back by quick work. He now uses a Zeppelin antenna with fine results. 9DEQ

has Zeppelin antenna that perks fine, though not much work was done. 9DH, ex 9ABK, is putting in a 208A and has a second operator. 9EEP lost one guy wire, from his 75 foot tower by lightning. 9VH works the east coast fine with a UV 201A. 9MF is preparing for an extensive auto trip back east.

Traffic: 9ZT 113, 9BNF 38, 9DBW 20, 9CAJ 20, 9DUV 16, 9EEP 16, 9DMA 11, 9EGU 11, 9DYZ 6, 9DWO 4, 9BKX 4, 9DZA 3, 9BCN 3, 9GH 2, 9EFD 2, 9BMX 1.

### DELTA DIVISION

**M**ISSISSIPPI—SCM, J. W. Gullett, 5AKP—5QZ has a 250 watt which will go on the air soon if nothing prevents. 5ARB-5ALZ has a 250 watt Western Electric on the air now with a 50 watt for an auxiliary transmitter. 5FQ is building a 50 watt for Fall work and hopes to have it on the 40 meter band soon. 5AQU is installing two H tubes in a self-rect. circuit and hopes to work good DX. 5AGS is operating at 5AGM which is the Meridian Amateur Radio Club's portable transmitter at the Summer Boy Scout Camp. 5AKP is installing a 50 watt.

Traffic: 5AKP 24, 5QZ 23, 5AGM 15, 5AQU 13, 5ARB-5ALZ 7.

### HUDSON DIVISION

**E**ASTERN NEW YORK—SCM—Earle Peacock, 2ADH—A general clean-up has been undertaken to clear out all dead wood. Certificates will be reissued to present ORS who prove their worth. New appointments will be made with greater discrimination. C. D. rules and regs will be strictly adhered to. Stations handling over 100 msgs must send files to the SCM each month to make the BPL. These will be returned after checking. A Route Manager will be appointed as soon as some one station shows up with the goods, but he'll have to be a mean brass-pounder with lots of experience to make the grade. Who's the boy? If everyone will lend a hand, we'll show the gang how a real live Section looks under full sail.

2ADH blew two fifties and an antenna ammeter but kept several skeds and made the BPL. 2APT wkd 2ZAC on a new fifty with 3000 volts and also made the BPL. 2AVB is out for the BPL and had a sked with 1B1G on 40. 2CDH has a sked with 8HLP. 2AKH has one with 1APL using a UV201 with B bats or a "lizzie" oil. 2AWQ worked G. F. Q. Pr. and Panama. 2AJE took a tumble in traffic by trying to wk DX with his new fifty. 2AAZ blew two more tubes. 2AQG wkd O-ISR and joined the Naval Reserve. 2CNS and 2BQB are to be commended on their efforts to alleviate the QRM. They pacify the BCLs by teaching them code. 2ANV kept a sked with 3APV, but has a new gas wagon now. 2CWH wkd f8X, fOCNG, gZIT, gZOG and g5BV on 40. 2PV moved and is rebuilding. His YL opr is learning the code. 2AGM hrd a7HL in Tasmania. 2AXS is a new one to report and has lined up a new fellow already. 2NW will report regularly in the future. FB! He rivals 2CNS as the Section's youngest ham. The Roosevelt Memorial Expedition will have 2CIL and 2APQ as ops. 2AJQ has collected all the crystals in Yonkers and is experimenting. 2CTF has a 250 watt on 20 to work VOQ. 2DD finds his time limited. 2ASE spends his time chewing the rag. 2AAN tried working thru an electric storm but the lightning made his WE50 go soft. 2LA, 2BOW and about everyone has been vacationing. 2AML was home for a week and kept a sked with 5ARA and 1BMS. 9APY paid a visit to the Yonkers Radio Club and listened to the gang talk Esperanto.

Here and There in Eastern New York: 2AGQ paid visits to 2AKH, 2AMD and 2APT and was visited by 2AGZ, 2AJE and 2APT. 2AHK is spending the summer on 2AGQ's farm at Milton. That's the stuff. Local fellows ought to see more of each other. It's a real pleasure to spend a week-end at another fellow's station and pound a new key. This is definite proof that the friendship forming possibilities of Amateur Radio are not idle talk. Robert Louis Stevenson once said, "An honest friend is our most valuable possession. He is fortunate who finds many". This motto hangs on the wall at 2DD.

Traffic: 2ADH 412, 2APT 185, 2AML 43, 2AVB 43, 2CDH 37, 2AKH 31, 2AWQ 28, 2AJE 23, 2AAZ 13, 2AQG 12, 2DD 7, 2CNS 4, 2ASE 4, 2ANV 4, 2CTF 3, 2CWH 1, 2PV 1, 2AGM 1.

NEW YORK CITY AND LONG ISLAND—SCM, F. H. Mardon, 2CWR—Well, gang I offer my heartiest

thanks for your very kind support in putting my election over. I assure you I will do everything in my power to put this job over big, but without your solid co-operation, I am lost, so get on the band wagon and let's go! We will make this district something to be proud of. Wonder what happened to Staten Island—no reports from there this month! Send me your reports each month, OM, if you want to see yourself in QST. Most of the fellows report that it's too hot to work so are closed down for the summer. Some kind hearted individual pulled down 2NZ's aerial while he was on vacation—wire must be short in his neck of the woods. 2EV is now on 39.8 with a UV203A—180 watts input and on 78.6, 85 watts input on 2 UX210s. He is doing fine work. 2ALS is using crystal control on 79.8 and reports everything FB. 2BBX has his transmitter mounted on springs now and is experimenting with all kinds of antennas. He is still using the same low power input with no decrease in DX. 2CYX works all kinds of DX and handles large amounts of traffic. He is now ready for a WAC ticket. 2WH is not using a CP now—just an antenna with an antenna coil of 12 turns one end free. He reports results are much better this way. 2AKV is handling Hawaii traffic direct but having trouble with mast pulley which has come down three times. 2BO is doing fine work—has copied NISS and NTT solid right along but says he was unable to QSO WNP. 2AGW says he is disgusted with his xmitter—he hasn't worked any foreigners in two nights. HI. 2CRB has been QSO VOQ lately and recently copied 600 words of press from him. Keep it up, OM. 2AEV also QSO VOQ. 2TY is a new station in L. I. 2GP is trying out 20 meters. 2ATX is operating his portable set down at Bayside. The Radio Club of Queens has been granted affiliation with the ARRL. Brooklyn is very much on the map as usual. They have 5 crystal controlled stations working, namely: 2CLA, 2BRB, 2MU, 2WC and 2UD with several more under construction. Doc Dunn has a new 250 watt as amplifier of his xtal oscillator. He is on 80 meters but expects to be on 40 soon. 9BOK recently visited Brooklyn and was made to feel at home. 2WC has practically worked everyone possible on his crystal-controlled set and is now getting ready for a big traffic season. 2AQW recently worked with EC1FG in Spanish for 2½ hours. 2BRB is busy making three amplifiers for his crystal—one for 20, 40 and 80 meters. 2APD is closed down for the summer. He has loaned his apparatus to 2CRB. 2ARM and 2AVB who are making good use of it. 2PF can be heard punching holes in the air almost every night. He expects to put in a crystal controlled set as is 2BRB soon. 2JK has moved into Brooklyn and will soon be heard on the air again. 2UD has just returned from Canada and as soon as the effects are worn off, he will be heard on his crystal set.

Traffic:—Bronx: 2CYX 145, 2BBX 35, 2AYD 2, Brooklyn: 2AQW 30, 2PF 24, 2CRB 19, 2BO 19, 2APD 7, Long Island: 2AEV 62, 2AKV 53, 2AUE 17, 2BDI 17, 2RSL 10, 2AXI 9, 2WH 3, Manhattan: 2ALS 62, 2EV 36, 2NZ 33, 2LD 6, 2BNL 4.

**NORTHERN NEW JERSEY**—SCM, A. G. Wester, 2WR—The new SCM wishes to extend his thanks to all the traffic officials for their fine cooperation to him as ADM for the past two years. 2BBH, because of lack of time, desires his ORS cancelled. 2APA, the portable set of 2CY, is in operation until the new set is installed. 2BQQ has installed a new Hertz antenna. 2ALW, while away on a vacation, is operating at 8DLS. 2ALM is worked and a schedule with Holland and England during the summer. 2KA got married and is located now at Irvington, N. J. (Congrats, OM—SCM) 2GV has been QSO 2AM using a new 50 watt. 2EY will be going shortly with a new set and antenna on 40 meters. 2JC, the Bloomfield Radio Club, will be crystal operated this fall. 2DX is vacationing in Bermuda. 2CQZ, besides operating at WEAJ, is studying high frequencies under Morecroft at Columbia University. 2CP handled traffic with the American Legion enroute to Paris. 2BGI is still experimenting with five meters and 20 meters. 2CGK is rebuilding the whole works. 2AER and 2AQB are also very QRW experimenting on 5 meters. 2QI, a new station, maintains a daily schedule with 9B1G. 2ADV, through the help of 2BGI, is a newcomer on the air. 2AUI is a new active station in Perth Amboy.

Traffic: 2CP 68, 2ALM 54, 2AUI 22, 2AQB 15, 2CY 12, 2AHK10, 2GV 10, 2CQZ 6, 2DX 6, 2KA 6, 2JC 5, 2WR 5, 2ALW 5, 2ADV 5, 2AER 4, 2QI 3, 2CYV 3, 2BQQ 2.

## MIDWEST DIVISION

**IOWA**—SCM, L. R. Huber, 9DOA—Regular traffic routes will be established over Iowa this winter and will be in charge of 9BKV (Chief RM) and 9CZC (Asst. RM). Only bona-fide Traffic men will participate as the system will be of a high order, or not at all. More ORS are needed and your application is solicited, providing you are a Traffic man. Don't be bashful—write to your SCM—he has the reputation of being the surest-fire-letter-writer in the whole ARRL.

Every holder of an ORS ticket is expected to handle traffic and report each month. The “% msgs” of the “Summary by Sections” must be kept larger than the “% ORS” if Iowa is to get near the top of the ladder. The Bigger “% msgs” gets, the closer we will be to the top. Regular schedules is the answer. What are you doing in this line, OM?

9CGY and 9CZC keep summer schedules on 80 regularly. 9EFS hits the ball on 80 and 40. 9DSL snuffed a few on 40. 9BKV had appendicitis, but got well and was appointed Chief RM for the good work he did last winter. Give him your cooperation in every way, fellows. At present, he is simply finding out who is who for the work this winter.

Traffic: 9EFS 41, 9CGY 39, 9BWN 20, 9BKV 15, 9DSL 14, 9CZC 14, 9DMS 4, 9BOS 3, 9CS 2, 9AXQ 2.

**NEBRASKA**—SCM, C. B. Diehl, 9BYG—Traffic was light this month on account of extreme hot weather and QRN. 9CJT is on vacation. 9AWS is busy with Army-amateur work. 9NL has 1200 volts on a UX210. 9BYG is experimenting with a master-oscillator. 9DR and 9EHW report no activity there. 9EEO and 9AFR are away on business. 9BFG reports traffic very light. 9DJP says ND school QRM too bad. 9CGQ reports no activities in his camp. 9DUO is on a USNRF cruise. 9BBS is busy with his railroad. 9AGD is rebuilding. 9EEW sends in a good report as a starter. Cheerio, OMI 9BQR applied for an ORS. 9DLK says “ND” like a graveyard on 180 m. Slim at 9EBL reports fair traffic. He is rebuilding with battery power supply.

9DXY was very busy with his work and so not on as much as he would like. July 25th, 9CGS was operated on. He is OK and will be out soon. 9BNU heard a few foreigners. 9BOQ still works on 175 and is tied up until fall with QRM. 9EAK is building a new outfit for fall. 9BNU says 9CAD from Ills visited him. 9DUH swapped his MG for a pair of S tubes. 9EEW craves traffic. 9EHW is QRW with summer work.

Traffic: 9DUH 35, 9EEW 25, 9EBL 17, 9BFG 15, 9BNU 11, 9AWS 5.

**MISSOURI**—SCM, L. B. Laizure, 9RR—Dist. 2—The SCM wishes to congratulate the old reliables in this district for their quick cooperation in sending in reports according to the new system for the very first time. 9CYK and 9CKS combined for the summer using 9CKS with 200 meters, 100 watt fone and CW, 80 meters, 60 watts. 40 meters, 250 watts. 9CYK advises that his uncle has become a ham with his assistance and has a 30 watt RCA transmitter at Whitesville. 9DAE says he is getting a C & W 2 KW 500 cycle set. 9EAO is going on a trip to Europe for 2 months. 9DVF reports trying to use indoor aerial for 40 meter transmission but results were not so good. 9AOR reports QRN holding the air in Carthage. 9CZZ has moved to Carthage. 9ARA and 9CVV solicit 20 meter schedules, also QTC. 9CDF landed some traffic and DX is fine. 9BSE is sticking to 80 meters and applied for ORS. 9CRM says ND, too much QRN, but is going down on 40. 9BUE kent schedules with 5ES on 176. 9DKG reported from CMTC at Ft. Snelling. 9RSV dropped from 175 to 40 meters and is after schedule with 5DL.

Dist. 3—9DWK reports on the air occasionally but not enough to handle traffic this month. A new station, 9BLE, is reported from Charleston using a 5 watter now.

Dist. 4—Little traffic has been handled here due to QRN but club activity has been excellent.

Traffic: 9ARA 29, 9CDF 17, 9BSV 10, 9BUE 7, 9RR 4, 9DVF 3, 9AOR 2.

## NEW ENGLAND DIVISION

**WESTERN MASS.**—SCM, A. H. Carr, 1DB—We welcome three new Official Relay stations to our section—1AJM and 1BAL of Leomister and 1AZW of Pittsfield. 1AAE says he had a card from a BCL in Austria who heard him the long way around. Hi. He also worked VIS of the Australian

Air Force at Pt. Cook, Victoria, Australia. 1AMZ says a traffic total of 60 is low for him but it looks good to most of us for summer. 1APL is keeping schedule with 2AKH three times a week—that means good traffic work. 1AJK has surprised us by giving up raw AC. 1AKZ has a schedule with KGBB and delivered 10 messages from that ship, thus making his station useful. 1AAL is using harmonic transmission for all bands and can change at short notice. 1AMS says that the blankety blank 7's never send cards and, I hope that they read this. 1BVR has reduced his tube output 9/10's but has a new antenna system to make up for it. 1AQM has a broken leg as the result of a July 4th ball game and therefore CW is his best companion now. OM 1AWW is recuperating from the strenuous job of DM, at Westbrook, Conn. He is to swim, fish and study (?) until Labor Day. He caught and not originated some trout at Rangley Lakes in June. We ought to count them in his traffic total. Hi. 1AZW has a bad disease for a new Official Relay Station. It is YLitis but he has put up a new Hertz (Heart?).

We are on the road to be a lively Section and will soon be ready to compete with the best of them.

Traffic: 1AMZ 60, 1AAE 50, 1APL 21, 1ASU 19, 1AJK 11, 1AKZ 11, 1AAL 8, 1JE 7, 1AMS 5, 1BIV 5, 1BVR 2, 1AQM 3, 1AWW 3, 1AZW 2.

**MAINE**—SCM, Frederick Best, 1BIG—At last the Queen City Radio Club has started something that is going to make the fur fly. They have offered a large cup for the Maine ham who handles the greatest amount of traffic for the period July 26 to October 26, 1926. This traffic must be handled in accordance with A.R.R.L. practices and complete files must be available for inspection by the judges, who will be the officers of the Queen City Radio Club of Bangor.

1AUF is doing his stuff, and it goes without saying that he will make a strong bid for the above-mentioned cup. He maintains a system of message boxes and his total speaks for itself. 1EF has power now and is putting in a fiver. 1AFU, 1BIG and 1AYJ have been appointed Official Broadcast Stations. Two other appointments on the 80-meter band are pending. The summer slump has hit us, but the effect is not nearly as noticeable as in years past.

Traffic: 1BF 430, 1AUF 254, 1BFZ 106, 1ATV 46, 1BUB 43, 1QY 40, 1UU 31, 1AYJ 29, 1AQL 15, 1ADI 10, 1AUC 8, 1FP 5, 1BNL 2, 1BDB 1.

**RHODE ISLAND**—SCM, D. B. Fancher, 1BVB—Not much activity in this state this month due to the hot weather, rebuilding and vacations.

Dist. 1—1AID is rebuilding and installing remote control. 1DP is rebuilding. 1AEE, 1ABP, 1BIE, 1AEI and 1AWE are all plugging along as much as the hot weather will permit. 1AWV is on his vacation. 1AAU is a new ORS and promises to be a good one. He is on 80 and going strong. 1BPB has been placed on the inactive list for the present.

Dist. 2—1BVB has rebuilt the station and is getting out better than ever. 1AAP is also getting out on both 40 and 80.

Dist. 3—1BQD, our newlywed ham, has moved to a new QRA and has the set perking there now. Getting out in fine shape, he reports. Address him at 19 Charles St., Newport from now on.

Traffic: 1AAP 19, 1AEI 9, 1AWE 7, 1BVB 6, 1BQD 6, 1BIE 5, 1ABP 4, 1AAU 3, 1AWV 2.

**CONNECTICUT**, SCM, H. E. Nichols, 1BM—Enthusiasm and activity throughout the state continues despite the vacation season and hot weather and real distance work is being carried on. 1BHM has been appointed Route Manager for New Haven County and needs the support of his local stations. Watch this Section as the New Haven boys are organized and will do some good work in the near future. 1FD and 1HJ have both handled traffic with VOQ which shows all the real distance work does not have to wait until winter time to be done. 1AOX has made the BPL this month. 1ADW is constructing a radio shack where he hopes to have a real station. 1BEZ and 1BLF, new applicants for ORS, have both been doing creditable work. 1BLF being in contact with Australia and 1BEZ with WNP. Congratulations. 1VY was in communication with New Zealand 1AO which is a fine record. The Twin City Radio Club of West Haven is starting off in fine shape and the boys are working earnestly to make it a real live organization.

Traffic: 1AOX 111, 1CJX 26, 1HJ 15, 1BLF 11, 1FD 10, 1BHM 7, 1BEZ 6, 1BGC 4, 1AVX 3, 1AOS 3, 1VY 2, 1CTI 2.

**EASTERN MASS.**—SCM, R. S. Briggs, 1BVL—Don't forget, gang, that failure to report for two



consecutive months means cancellation of your ORS certificate. 1UE is the star traffic pusher and joins the Brass Pounders' League. FB, OM! 1ABA says he is breaking in a new ham. 1ALP bought a flivver and has a good time visiting hams. 1UE likes his new QRA and is very active. 1AF is closed down until fall. 1ADL reports traffic dead and DX good. 1BCN worked his first European station. 1BZQ reports QRN spoiled his schedules. 1JL is receiving reports of crystal control due to his steady DC note. 1BMS handled a bunch of traffic and also worked across the "pond" for the first time. 1BAT tried low power without luck. 1AGD sent in his first report. 1CMP, our famous DX station, is trying for an ORS. 1NV says that 1BQL, an old timer, is on the air again in

one sounds bad). 7WQ works nights but does good traffic work. Everybody reports very good DX. 7MP is in the Forestry Service and is busy putting out fires. 7NS is working out a crystal control set for the fall season. 7NH attended the CMTC at Camp Lewis. 7OO and 7EG are newcomers. 7HC and 7ACB are breaking in. 7BU is an Official Observer. 7UU will be on as soon as Bob Waskey returns from Point Barrow. 7AG works Hawaiians with ease. Traffic: 7WQ 40, 7RL 20, 7TX 8, 7VL 5, 7AF 4, 7MP 2, 7FD 2.

OREGON—SCM, A. C. Dixon, 7IT—The most active stations in the state are in Portland and Medford. 7VH-TM, 7AEK, 7IT and 7AV are the most active Portland stations. 7MF and 7ACM represent Medford. 7VH-TM uses a three coil Meissner circuit with a 208A as a driver. His station is chiefly a DX layout and not much traffic. He kept schedules with Borneo and is being reported in South Africa. 7AEK is handling lots of messages with 7KX in Alaska. He works on schedule every day. 7IT kept schedules and handled traffic with Java, Philippines, and New Zealand. He gets a DC note with a 1000 volt storage battery. 7AV has had hard luck with tubes but works consistently. 7MF is chiefly a DX station. No message report this time. 7EO at Dayton, worked Japan and did a little relay work.

Traffic: 7AEK 40, 7IT 23, 7EO 9, 7AV 4, 7VH 4. MONTANA—SCM, A. R. Willson, 7NT—7PU has been haying and hasn't had time for his new 50 watter yet. 7DD worked 1800 miles with a UV201A portable transmitter. 7PL was on regularly during August before going to the state college at Bozeman. 7AFP and 7AAT at Red Lodge are new stations, who will be running up a good message total soon. 7NT has been busy with BCL business activities and will be out of town part of August. Ham Hocks will be in print again soon. 7ACQ is a forest fire fighter in the Bitter root range. He is going to college in Oregon in September. 7BQ was on the air some. 7AGF is busy getting his radio business ready for the fall rush. The Anaconda Radio Club has a live bunch and the SCM and all the gang welcome them. Traffic: 7DD 9, 7PU 7, 7FL 4, 7NT 2.

#### PACIFIC DIVISION

Concord. 1AVF reports a case of YLitis but his traffic did not show it. 1LM and 1BBM will be off until fall. 1AWB claims to be the only active station in Attleboro. 1BVL is on with crystal control and a 50 watter. 1BUO is on again after being QRW at school. 1CIT is working on a houseboat. 1OU can only operate during week-ends. 1RF is trying to get his crystal control set to perk. 1KY is now operating at 1CPD, her summer QRA in Saunders-town, R. I. 1YC changed his location. 1GA built a crystal control transmitter. 1ADM kept schedules with WNP.

Traffic: 1UE 180, 1BMS 162, 1JL 87, 1BUO 50, 1AVF 48, 1BZQ 40, 1ADM 24, 1ABA 16, 1YC 14, 1AWB 14, 1BVL 18, 1LM 8, 1OU 6, 1RF 6, 1AIR 3, 1ALP 2, 1NV 1.

NEW HAMPSHIRE—SCM, V. W. Hodge, 1ATJ—1GKK has opened up with his crystal-controlled 208A on 38 and 77 meters and handled an important message for VOQ. 1BFT blew his new H tube but stuck in a UX210 and was reported R4 by OWC. 1AER handled a bunch of traffic and managed to do some DX, being reported by A-7BQ in Tasmania. 1AVL has finished rebuilding his set and is ready for traffic. 1AOH reports working the west coast easily with a fiveer. 1LM, 1FN and a gang from Concord were recent visitors at the SCMs.

Traffic: 1AER 48, 1AOH 10, 1ATJ 8, 1BFT 11, 1CKK 5.

VERMONT—SCM, C. T. Kerr, 1AJG—Fellows, please mail your reports to the SCM on the 26th. 1BBJ is high traffic man this month. 1BEB is on the air little now. 1AC is summering at Lake St. Catherine. 1AJG is fishing, hi. 1APU is not on. 1BDX is surveying. 1BIQ is swimming. 1CQM is not married yet. 1FN is not on. 1YD is off for the summer, also 1AVZ. We want to hand it to 1BBJ for being the only real station in the State this summer.

Traffic: 1BBJ 32, 1BEB 2.

#### NORTHWESTERN DIVISION

IDAHO—SCM, K. S. Norquest, ex7OB—The prospects for a good winter season are excellent. Several stations are waiting for licenses. 7ABB and 7GC are new this month. 7GW is experimenting with R. F. feed lines and new rectifier tubes. 7JF was away last month to the ROTC summer camp so does not report much activity. 7AT has his 500 watter running a Hertz antenna and gets better results.

Traffic: 7GW 3.

WASHINGTON—SCM, Otto Johnson-7FD—A majority of the gang are working thru the summer, and will be back with a bang in the fall. The stay at homes are having trouble with hot wx and Yls (that

NORTHERN CALIF., Sect. 4—SCM, F. J. Quemont, 6NX—Beall of 6BVY believes in thoroughness and confirms each message by mail and finds only about one third messages reaching destination via radio. All traffic from this station received via

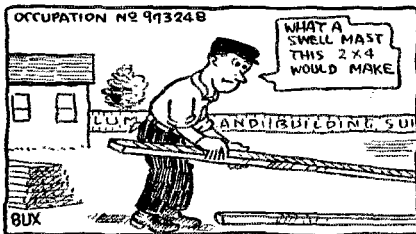

BOBK EARNS HIS BEANS IN A LUMBER YARD AND SAYS POUNDING BRASS AINT HALF SO HARD

schedules. Leon Fry of 6CLP is going to sea and the Section loses one of its best operators. L. E. Fry remains at home to keep the set perking. 6CUL visited the San Jose gang and promised a large delegation at October Convention. 6CIS keeps schedule with 6AKM while 6CJD finds it hard to get on the air. Nelson of 6APS works USA and Aussies with B Eliminator and 301 tube. 6CSX is travelling up and down the state, advertising the convention. 6AJZ uses 80 meter fone. 6NX celebrated the nineteenth monthly anniversary of his power leak and patience is just about gone. Charlie Camp of 6BW is the big noise these days—with his 250 watter he managed to hook WXF and ch2AH. 6CLI says Santa Cruz is beginning to come out of a long sleep with several new stations coming up. Ludeman is still remodeling and promised to give 6ALW a mean wallop soon. 6DEK grabbed a 400 word message from Yacht KFWH. FB!

Traffic: 6BVY 88, 6CLP 26, 6BMW 18, 6DEK 14, 6APS 12, 6CIS 9, 6CJD 6, 6AJZ 4.

NEVADA—SCM, C. B. Newcombe, 6UO—6AJP is working on a summer job at Chilcoot, Calif. He is saving his money for tubes for winter DX. 6ZO has moved to a new location where he has a new pole and a good station. 6CRV is a new station but an old time telegrapher. 6ATN is now on at Fallon but we lose him to Calif. as soon as school starts. 6ABM is struggling with the code and gaining speed daily. Swartz at Elko is having trouble getting self-rectifying circuit to perk. He has been assigned the call 6AZK.

Traffic: 6UO 17.

Section 6—SCM, St. Clair Adams. 6BAF—There are five active stations on the air here. Some of the BCLs in Eureka are practicing code and we hope they will all have stations soon. 6BAF is looking for more active brass pounders to qualify for ORS appointments.

Traffic: 6BAF 4.

SOUTHERN SECTION—SCM, L. E. Smith, 6BUR—Dist. 1—Activity is not what it should be here. Perhaps winter will bring more action. 6SB is experimenting with spool rectifiers. 6AOY now uses 500 watts—some jolt! 6BQ keeps schedules with five stations. 6SB, 6OP, 6CNK, and 6LH promise action soon—6MB promises to 1 KW in a few weeks—WOW!

Dist. 2—Activity here is sure top-notch. Great work, fellows—keep it up, you are leading them all! 6BBV has been mighty busy but still has a good traffic total. 6CT, a new Whittier ORS, is QSO So. Africa regularly. Another new ORS, 6CLK works Java, Pl. Japan etc. on 7.5 watts consistently. 6BUR spent most of the month in the mountains. 6BH is using a 203 A on 40 meters—6RN is now at 1CUE but 6BBQ and 6BRY are running his set. 6BBQ is a new Army Amateur station. 6BXD attended the CMTC. 6BLC uses a WE50 watter now. 6CMQ has a schedule with Alaskan 7NX. Our YL, 6BXA is on regularly now. 6BTM holds his schedule with piCDS. 6CQA attended CMTC. 6AKX is crazy over Hertz antenna now. A new fifty is making 6DAJ happy. 6CAE has been operating 6CGW working the Yacht Poinsettia. 6IH works schedule with KGBF. 6DDO wrote a fine article on ham radio for the Los Angeles Times. Fine work! 6BGX leads as usual—handling most of his traffic with PL. He also had charge of our So. Section ham picnic. 6RF pounds out as usual. 6BGV has a schedule with 6BAC—good dope! 6CGH reports a schedule with a YL—not radio. Hi! 6DS is doing test work for the air mail. He wants help from San Francisco. 6NP worked a new Jap. 6NW has moved to Los Angeles. 6BXC gets good results from his 50 watter. 6KY keeps schedule with portable 6XBR. KY now uses 500 watts self-rectified—500 cycle. 6AE was at CMTC. 6CDY spent his time on antennas this month. The 20 meter sigs of 6BJD reached Honduras. FB! 6RF uses a Hertz antenna now. 6CTN is building separate sets for 40 and 80. 6BHI tried 80 but goes back to 40. 6DAH has a job on KGBF going to Alaska. Everything is going smooth now says 6DAL. 6IH works schedule with KGBF. 6BGC does good DX. 6DDO does fine DX and good traffic work too. 6CTO is back in the U. S. band. Guess he was scared of the Wouff-Hong.

Dist. 3—Activity is on the increase here. Things should be strong by fall. 6ABJ is putting Santa Barbara back on the map. They handled traffic with a boy's summer camp on Santa Cruz Island. 6BVM sports a new 7.5 watter. 6ALR improves every month. 6ANZ and 6BAV spent most of the month vacationing. 6ASV is a new Army station.

Arizona—Summer is hard on activity in this hot state but winter will make up for it. 6ANQ is already rebuilding so as to do his best when good wx comes. 6BGI is also getting ready for winter. The rest of the bunch are off for the summer.

Traffic: 6BJX 506, 6BQ 484, 6BBQ 299, 6KY 166, 6ZBG 155, 6CMQ 110, 6BJD 101, 6DDO 94, 6BTM 87, 6NP 78, 6BXC 75, 6BH 67, 6CQA 66, 6BBV 61, 6BGV 55, 6ALR 53, 6CLK 51, 6BVM 45, 6DS 43, 6BXD 39, 6RN 34, 6RF 31, 6CT 27, 6IH 26, 6SB 16, 6BLS 15, 6AKX 14, 6CTN 14, 6BHI 11, 6DAJ 11, 6ANQ 7, 6AVY 7, 6CGK 6, 6BGC 5, 6MB 6, 6BAV 5, 6CAE 3, 6ASV 2, 6NW 1.

HAWAII—SCM, K. A. Cantin, 6TQ—The Honolulu Territorial Fair opens September 29 and runs for one week. 6BUC will have the station at the Fair to take traffic filed by visitors. Mainland stations should stand by so quick delivery and return answers can be arranged. Hu-6AFF is back on the air with his "traffic constructed" 250 watt set. 6AFF is out to handle traffic. 6ANW, the Luke Field Radio Club is handling traffic actively having a schedule with

6BVG. So. Africa reports sigs R4. Honolulu hopes to send a representative to the Pacific Division Convention at San Jose Oct. 15-17.

Pi-IHR and Hu-6BUC have a weekly schedule. A number of US stations have adopted the method of using the intermediate "de u" when calling other US stations. Should be discouraged and the "de" reserved for portable or boats stations in foreign parts.

A number of messages were relayed from KFWH via Hu-6BUC to U-6CGW. 6CGW and 9ZT have a kick that is more than "one half of one percent". 6BDL keeps a schedule with the Philippines, Alaska and the US. 6CFN kept schedules with 7ON. 6CQ kept traffic schedules with 6NP, 6NP and 6BMW. 6TA seldom misses a night on the air. He is installing a 250 watter. 6AJL of Kauai is making up for time lost on the mainland by a schedule with 7DO. 6CLJ has a relief while on vacation in the Orient. He won the Jewell contest for this Section. 6ASR "hits" the air long enough to keep his 250 from getting rusty. 6DCU changed to DC supply. He has schedules for handling traffic. 6CST is busy working. 6XK is a new call assigned to FX1, Fort Shafter. 6NL spent most of the time at 6BUC handling traffic with the yacht KFWH. 6ADH is a new station going in for traffic work. 6BUS and 6CMH experimented with several types of transmitters and plate supply. 6CFQ put his 40 meter set on the yacht Mariner, KGBM and is returning to San Francisco.

Traffic: 6BUC 196, 6AXW 179, 6BDL 140, 6TQ 56, 6OA 47, 6CFN 45, 6AJL 32, 6ASR 29, 6NL 9, 6DCU 6, 6CST 3, 6BUS 2.

### ROANOKE DIVISION

NORTH CAROLINA—SCM, R. S. Morris, 4JR--4RY handled messages from WXP at Balboa, C. Z. 4TS has been at Camp Glenn with the Signal Corps. 4BX has been trying his hand at a little DX.—p, z, f. 4RW and 4RF are off the air. 4QK has



3HG IS A DENTIST. HE FILLS TEETH BY DAY AND FILLS THE ETHER AT NIGHT. (BALTIMORE)

been on very little due to YL, work, and hot weather. 4JR is going to rebuild. 4MI is getting out better with a new plate transformer. 4NH gave the crystal sets at 4XE and 4RY the once over while on a business trip to Florida recently.

Traffic: 4RY 51, 4JR 42, 4MI 40, 4TS 18, 4BX 15, 4QK 7.

VIRGINIA—SCM, J. F. Wohlford, 3CA—3BMN, with an input of 70 watts, has been QSO 24AA, 24AC, 24AM and u6NL. 4MX, 8CWP and 8TC were recent visitors at this station. 3BMN is the only station at Petersburg that has been sticking out the hot weather, his shack registering 110 degrees. 3AU has quit the game and sold out to 3AOT who will open up a joint station with a lot of old timers. 3BGS sent in a report saying he finds time to work the old set several nights each week and handles some traffic. 3RL is on the air regularly with a fivev on 80 meters. 3KG blew his tubes trying out spark coil supply. The traffic for the American Legion convention at Alexandria, Va. being held the latter part of August, will be handled by 3AAI and 3BGS. 3RX has dismantled his station and gone to his home to start 8BMM up. 3BDZ gets on the air some but the heat has affected all the gang in this section. 3BZ says he has been sticking by the 20-meter band but

very little doing with practically no QSO. 3CKL seems to be able to connect with the Z stations most any time.

Traffic: 3BMM 22, 3RL 13, 3BGS 12, 3CKL 10, 3CA 9.

WEST VIRGINIA—SCM, C. S. Hoffman, 8BSU—Wheeling has a chapter of Pi Alpha Tau Ham Fraternity. Members are 8ASE, 8BSU-8QY, 8CDV and 8DOH. 8CDV worked b, bz, f, g, fm, ch. 8BSU worked Europe. He is using 10 watts and gets out good. 8AUL worked n-OWC. 8BUB and 8ARA are new hams, 8CEK does good work on low power. 8AYP again has a good message record. 8AGI is a new Huntington station. 8AMD has a 1 kw. Neuvron tube. 8BNF and 8BJG are going to Detroit for exams. 8CAY is in Charleston, temporarily. 8BJG built a MO using two UX210s and worked a5BG. 8BBM is recovering from an appendicitis operation. 8AWV and 8CYR have test schedules. 8CYR and 8ACZ built new H tube sets. A-A schedules now handled from Huntington, net control station, by 8SV during absence of 8AMD.

Traffic: 8AYP 143, 8CEK 66, 8BSU 58, 8CDV 36, 8AMD 17, 8BJG 10, 8BNF 5, 8AWV 2, 8AUL 2, 8ACZ 1.

### ROCKY MOUNTAIN DIVISION

COLORADO—SCM, C. R. Stedman, 9CAA—9BJN leads this section for traffic this month and most of them are originated. 9EAM has been too busy with his filling station to get much thru. 9DKM has a new pastime now; teaching YLs to cuss in code. 9EEA is getting out good. 9CJY has a fine wallop on 40 and is stepping right along. 9CAW cut off his antenna 30 feet and now is working all over the world. 9QL is still trying to get the crystal-controlled set to perk. 9CDW went on a trip this month and saw a number of hams. He says he is going back to the Hartley circuit. 9CAA is experimenting with aerials, but says he thinks he will have the big flat top back this winter and be on 80 meters again.

9DVL put in some good work before going to the Citizen's Military Training Camp on his vacation. 9AOI got transferred to a different office in the city by the company he works for and was so overjoyed, he went home and put 15 messages thru right off the bat.

Things are quite dull in Dist. 2 this summer. 9CFY has been too pressed with business to do much. 9CDE is with us strong.

Traffic: 9BJN 58, 9DVL 50, 9CJY 46, 9CAW 35, 9DQG 5, 9CAA 29, 9DKM 20, 9CDE 20, 9OO 17, 9AOI 15, 9EAM 2, 9EEA 12.

UTAH—SCM, Art Johnson, 6ZT—6RV appears to be the most consistent station in this Section, although his power is only five watts. This station maintains regular schedules with 6DDL in Honolulu on Monday, Wednesday and Friday nights at 10:30 pm Mountain Time. Practically all of our other station owners have been away from home on vacations and business trips and the result is very little traffic handled. On July 12th the SCM had the pleasure of visiting Rocky Mt. Director Segal in Denver and discussing the League situation in this territory. We hope that he and Mr. Hebert will be able to pay us a visit this fall.

Traffic: 6RV 30, 6FM 11, 6SI 7, 6CRS 4, 6BUV 2.

### SOUTHEASTERN DIVISION

ALABAMA—SCM, A. D. Trum, 5AJP—Now is the time for all good men to come to the aid of their country. We are getting our new methods in shape now and we want to show the rest of the sections just how Alabama stays on top. The SCM wants each and every honest-to-goodness ham in the State to come forth each month with a good illustrated report to him. Let's get some of our stations in pictures and show 'em to the others who want models to go by. Hi!

5DL is the leading man of the southern portion. 5AX is doing his bit in the Northern Section and 5ATP in the central section. 5DL is a brass pounder from the heart as well as an excellent organizer. 5AC has just returned from a trip across the ocean and tells the fellows "there's no place like home". 5QF has gone to Annapolis. 5AR reports ND but promises and promises—. 5AAD was successful in making enlistment in USNRF class V-3 as Seaman 2nd class for radioman. 5LC and 5VK just plain forgot to let us know anything about themselves. 5ADA has

been traveling around this month. 5ATP is getting the Aussies and Zedders most anytime he wants 'em. It is with regret that 5ATP will soon leave us to enter upon his college career at Georgia Tech. He has made many friends abroad. 5AJP has been absorbed in rebuilding WIBZ and has it perking fine as the Community Broadcast Station of Montgomery. Auburn has let out for the summer and 5WI and 5DI, the old reliables at Dothan and Selma, are stirring things for our state. 5WI has the old pure DC shrill that pierces most any ham's set. 5DI had hard luck when he broke one of his H tubes he was using in the self-rect. set but worked CHLE on the other with 1200 volts on the plate. 5ANE and 5IUJ are working with fivers and getting out good. 5DJ and 5AV are two new hams in Selma. 5ACX and 5AHK are touring Florida on vacation. 5AWF is getting his set into better shape for excellent DX. 5AX can be found on the air most any time and when the OW isn't around, he slips in and does his DX stuff. 5AFS has at last secured his most looked-forward-to pure DC note and was tickled pink when he got a favorable report on it. 5AHU and 5AGA are QRXing for paralyzed tubes and bum rectifiers and are working at 5YB when the opportunity arises.

Traffic: 5DL 183, 5YB 42, 5ADA 35, 5AJP 23, 5AX 21, 5DI 20, 5ATP 19, 5WI 12, 5AWF 12.

FLORIDA—SCM, W. F. Grogan, 4GY—Things are going great in Florida now. 4TK was QSO NZ and took a message for WNP. The Radio Twins, 4BL, are on vacation. 4OB is a new OBS and will be on soon. 4DD is stepping out with a new 50. 4HY handled traffic with England. FB, OM! 4VS is a hard worker and is the new RM. Let's help him get a traffic route started. Where is the old pep? Come on, gang, show some action! 4HX burned out all his receiving tubes. 4QY has hard luck with tubes.

Traffic: 4OB 80, 4XE 48, 4VS 40, 4HX 25, 4TK 23, 4TR 20, 4DD 19, 4QY 17, 4KJ 9, 4HY 7, 4TV 5.

SOUTH CAROLINA—SCM, A. M. Dupre, Jr., 4RR—in spite of the fact that QRN was this month the worst of the year, the traffic totals for the average station showed an increase. Early evening DX was all that suffered very much. 4MV found time for both traffic and DX, doing fine work in each. Among his messages was one from WXF to NAA which he handled via NAV. The current feed system appeals to 4IT, so he's experimenting with that. 4AAM QSR'd 20 messages in 12 hours. 4RR is changing antennas, rectifiers and filters about, trying to get a steady wave.

Traffic: 4MV 122, 4RR 43, 4AAM 20, 4IT 7.

### WEST GULF DIVISION

SOUTHERN TEXAS—SCM, E. A. Sahn, 5YK—Two new Official Relay Stations have been added to this section this month.—G. N. Witting, 5HE of San Antonio and E. W. Wilkins, 5ALH of Mirando City. The Wilsons, 5EW, report handling a death message from New York to Arizona. They do most of their work on 50 watts as the big 500 watt makes too much QRM. They seem to be QRK anywhere on the planet. They also report a new ham, 5PK, who has worked Australia on 80 watts. Corpus Christi is well represented by Nelson, 5MS. He says he would like schedules after 5 pm. It is rumored that c3RR is going to settle down in San Antonio. 5HY reports that he would like to see something of Dallas published. OM, get in touch with Forrest of Waxahachie who is your SCM. Report to him hereafter.

Traffic: 5HY 25, 5MS 21, 5EW 12.

OKLAHOMA—SCM, K. M. Ehret, 5APG—Ex5AGN and 5AAV report that their nine foot stripped-down transmitter has rolled up a DX record of 350 miles in 11 hours and are keeping schedules with the YLs every chance they get. 5ARD is a new station in Oklahoma City. 5SW handled one msg. from France and one for Honolulu. 5ATK operates under the call of 5AGN now and is getting out good with a rebuilt transmitter. 5APG has started construction of a master oscillator. 5QL has been knocking big hunks out of the ether and is QSO South Africa and Australia frequently. 5KD has been having a regular knock-down and drag-out trying to key his set without a regular cricket chorus. 5ANL is building a shack at Cushing in anticipation of rush business this fall. 5ADO and 5ASK have been on vacation. 5ATA reports his gang is getting together for the fall offensive. 5AFG is home on a month leave from WGY.

5AVF has his master oscillator going and in the heat of the excitement of working z2XA for an hour, almost forgot to report. Looks like 5TW has a good chance for a second leg on the BP trophy as his report consists of nothing but figures and high ones at that. It is not our policy to advertise the cancellation of ORS appointment but in the behalf of good operating and to stimulate the game and make the appointments worth while, we will say that we have cancelled eleven.

Traffic: 5TW 533, 5AGN 12, 5SW 10, 5APG 2.

### CANADA MARITIME DIVISION

NEWFOUNDLAND—SCM, Loyal Reid, 8AR—SAF worked c1ED and 1, 2, 8, 9's using 201A with 225 volts. 8AZS at Battle Harbour, Labrador, is on 41.5 meters with a 250. He has a daily schedule with WNP at 7 and 8:30 PM local time. SAR is enjoying the summer weather. 8BZ, 8BB, 8C, 8RG will soon be on the air to stay. 8WM is back again and trying a new receiver. NFDL has eight active stations and sigs are rolling in FB.

NEW BRUNSWICK—SCM, T. B. Lacey, 1ET—Most of the N. B. stations are on and active for the time of year. 1AI made the Brass Pounders. FBI Traffic has been coming this way and all stations report a good number of messages. 1AN's H tube is perking fine. 1AM is experimenting on 20 and getting good reports. 1AI is holding ten regular schedules and scooping all the traffic coming NB way. He intends to get the highest total for the Maritimes this year. FBI 1AQ says his 5 watter is working overtime daily. 1AD sent invitations by radio to the natives of his home town abroad in Canada and US to visit the town for old home week.

NOVA SCOTIA—SCM, W. C. Borrett, 1DD—Activity is at a low ebb due to rebuilding. 1DQ is back and going strong with two fifties. 1AR can be heard working the world. 1DJ and 1DD are rebuilding. 1ED is most active. 1AW is on with a low power set. New ham stations are going up at Cape Breton. Two new stations are reported from Liverpool, N. S. and one new one is in the course of construction in Yarmouth. CHNS, the Halifax County Radio Station, is still giving out our weekly QST on Wednesday nights.

PRINCE EDWARD ISLAND—SCM, W. A. Hyndman, 1BZ—1BZ says holidays completely blotted out radio this month but livelier in August.

Traffic: 1AI 107, 1AK 26, 1AM 16, 1AN 7, 1AQ 3.

### ONTARIO DIVISION

ONTARIO—SCM pro tem, W. Y. Sloan, 9BJ—The publicity gang keep things humming. Niagara Falls, Ottawa and Toronto papers carry ham news regularly. More assistance is needed. For information, see or write the Canadian News Manager, c8CK, E. C. Thompson, better known to all as c3FC, has been appointed to follow in place of 3VH. Hop to it, Ernie, and make things hu; the gang are right behind you.

Southern Ontario—3AQ has reached 205 lbs and interest in his transmitter has depreciated! 3ADY has gone to Europe with his 40 m. receiver. FB. 3ACO is waiting for Fall and a big bottle. 3AD is a druggist. Ammonium phosphate should come cheap now, OM. 3CM is still thinking about it. 3CS, an old timer, is handling traffic. 3DH says 3rd harmonic on 40 is the best yet. 3FU succumbed to the heat. How, OM? 3GY is going to the US. Good luck. OT. 3KA had poor luck with crystals and is rebuilding. 3KP, with 3BQ as second op, did his regular fine work. 3MF's ceiling fell on the junk. 3NP, 3KP and 3XI have YLitis. The latter two are FB DX stations. 3ZB is not doing much. 3ZD has a low power set at camp. 1BV will step off this fall. C'mon Maritimes—congrats!

Central Ontario—9AL was on from his new station early in the month. He took a low-power set away for the holidays to QSO his friends. 3BR is on a tour to California via Vancouver, B. C. He has with him a "river" supplied with plate juice from a 6-300 volt dynamotor, and so far, has kept QSO 9BJ. 3CK rebuilt and is on again. 3AZ, 3MV, 9AG and 3NJ break in now and then but show symptoms of Summeritis. 9BJ is once more on from summer quarters at Hanlans Point. "AJ" is using 150 volts B bat on a 201A, and a genuine 2 wire feeder Hertz on 40 and 52/5 meters. It works FBI! 3FC is heard regularly on 20 and 40. Ernie thinks it a crime

more stations do not use 20 meters in summer. 20 in summer is better than 40 in winter and he is working a number of Sunday schedules on 20, where QRN is nil. 3FC is again proud possessor of the Merit Shield, which was presented to him in recognition of his work in the Aussie Tests.

3HY is on 52/5 and 51 meters using B bat and 201A in the evenings, and a "fifty" after midnight. 3BR is responsible for 4 new licensed hams in Toronto this summer, as he taught them the code. The new fellows are 3CY, already on the air, and 3CX, 3CV and 3OA, who are getting on as fast as they can. Very FB, OM.

Traffic: 3GY 19, 9AL 16, 3ZB 14, 3BR 14, 3FC 10, 3EL 7, 3KP 3, 3DH 3, 9BJ 1.

### PRAIRIE DIVISION

MANITOBA—SCM pro tem, F. E. Rutland,—4DE —The Winnipeg gang were busy getting new members and so far, one wavemeter is assured. Nice DX, too as accomplished. c4DU was QSO Hawaiian and c4DT the same with two Zedders thrown in. Both used 50 watters. c4BT put up a new antenna. 4DY is QRW most every night with schedules and is clearing traffic in good shape. 4DW is rebuilding. 4AW is back and open for traffic. 4EK is a new station with 201A's and B batteries.

Traffic: 4DT 53, 4BT 24, 4DY 28, 4EK 3.

SASKATCHEWAN—SCM, E. L. Maynard (pro tem), 4CB—Few reports were turned in. Until further notice, send yours to 4CP. Mr. C. Banting, 1134 Clifton Ave., Moose Jaw, the acting C. D. official. 4AO is on with a 250 and open for schedules. 4HH turned in the largest traffic report. 4FA is QRW on the farm. 4AV is rebuilding. 4FC is on regularly but finds traffic scarce.

Traffic: 4HH 24, 4AO 4, 4FC 2, 4CP 2.

### QUEBEC DIVISION

QUEBEC—SCM pro tem, Alex Reid, 3BE—U2CHK and c2BE have a portable set at Ste. Jovite, 100 miles north of Montreal and find radio condition wonderful in the mountains. July 18, 8AVD was worked using only 22½ on a 201A and got a report of R4 at noon. 2DN takes 3EV's place. We will now have real live reports from the East End. 2AG is on using B supply with good DX. 2BH finished school and is on a lot. 2BV has a 50 and will push his sigs right to the Eiffel Tower.

Traffic: 2AG 7, 2DM 6, 2BE 4.

### VAN-ALTA DIVISION

BRITISH COLUMBIA AND ALBERTA—SCM, A. H. Asmussen, 4GT—6AF kept 5CR's junk sizzling while the OM was away prospecting (what for OM Galena?) and got Australian test message NR 8. 5GF put a 41 meter set on the Baymaud CKA. This station operated by 5EJ is going for a five year cruise in the Arctic. Get QSO, gang. 5GO's portable at camp working a 250 foot aerial on forty meters was QSO 44AN with an input of 20 watts. FB, OM. 5CT is getting out well. 5AR is doing good low power work. 5GT has a new antenna. 4AH is clearing station for Edmonton traffic and on steady. 4CL, an old timer, with a ticket is back in ham ranks on 40. A third ham in Edmonton has an FB S/W set awaiting call letters. 4CS is an ORS and should help swell the traffic totals from the north. 4AF handed a number of tourists, messages on 40 and 80, using B bats and is also breaking in a new ham. 4AL is awaiting a generator, after getting the Jewel prize using B bats. 4DQ is on with 201A's and was QSO 4BEF. 4GT may be off due to change in QRA. 4CC gets a great kick out of working Aussies. 4AU is touring to California and getting his US ticket renewed. 4IO grabbed a few messages and like forty meters. The date of the AREA general meeting has been postponed to December.

Traffic: 4IO 20, 4AF 15, 5GF 12, 4AH 10, 5CR 9, 4GT 6, 4CL 5, 4DQ 4, 5GO 2, 4AL 1.

### Official Broadcasting Station Changes and Additions

Call	Local Standard Time		Days of Transmission
	7.00 pm	10.30 pm	
1AUF	42.5	—	Tues. Thurs. Sat.
1AYJ*	—	—	Mon. Wed. Fri.
1RIG**	—	—	Mon. Wed. Fri.
6AMM	38	—	Mon. Wed. Fri.
* 8 pm, 38 and 80 meters			
** 6 pm, 42.5 meters			