

15 11ms. fch - Univ of Ill

QST

A MAGAZINE DEVOTED EXCLUSIVELY TO THE WIRELESS AMATEUR



COMPLETE DESCRIPTION · **8XK, PITTSBURGH** · IN THIS ISSUE

SEPTEMBER, 1920

TWENTY CENTS

MARKING THE OPENING OF FALL ACTIVITY

H-R-NICK

TWO NEW VACUUM TUBE UNITS

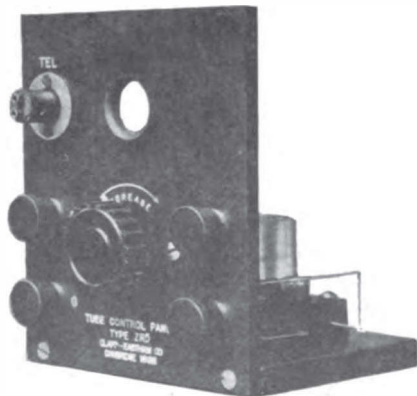

Tube Control Panel, bakelite panel, engraved in white, special telephone terminal, oak base.

Price \$12.00



1-Stage Amplifier, bakelite panel, engraved in white, oak base.

Price \$18.00

A typical letter from one of our many satisfied customers.

Rochester, N. Y., June 30, 1920.

ATLANTIC RADIO CO.

Gentlemen:—I wish to thank you for the very prompt service which you gave me on my last order and for your ability to deliver at once, just what was wanted. Such service as I received is so unusual that I cannot refrain from thanking you. The goods you sent were all perfect and the best of the kind I have yet seen,

Very truly yours,

(Name on request).

ARE YOU INTERESTED IN "C-W" TRANSMISSION?

Let us supply you with "C-W" and radio-phone equipment—filters, chokes, inductances, meters, modulation transformers, etc. Request special bulletin describing this type of apparatus.

"Bulletin 14"—108 pages—over 100 illustrations—sent upon receipt of ten cents.
A Rebate Certificate good for 10 cents on first dollar order is inclosed.

ATLANTIC RADIO CO.

MAIN OFFICE :
88 BROAD STREET
BOSTON, MASS.

INCORPORATED

PORTLAND BRANCH :
15 TEMPLE STREET
PORTLAND, ME.

THE OFFICIAL ORGAN OF THE A.R.R.L.

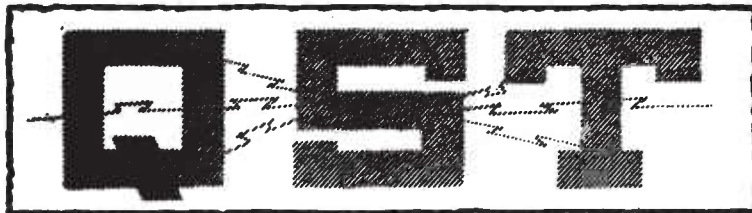

SEPTEMBER, 1920

VOLUME IV

No. 2

CONTENTS

A Few Ideas for Amateur C.W.	5
Beginning at the End	"The Old Woman" 10
Station Performance During The Bureau of Standards	
—A.R.R.L. QSS Tests of June and July, 1920	S. Kruse 11
Construction of a Two-Step Amplifier	McMurdo Silver 15
Standardizing Cabinets and Parts	16
The First Epistle from The Young Squirt to The Old Man	QRU 17
Our Less Experienced Brothers	Hiram Percy Maxim 19
How to Tune the Honeycombs	A. L. Groves 21
Editorials	23
The Operating Department	26
Amateur Radio Stations—8XK and 2NW	32
QST's Directory of Calls	37
With the Affiliated Clubs	39
The Junior Operator—The Transformer	40
Wireless vs. Women	H. A. Perrill 42
"Strays"	43
Radio Communications by the Amateurs	45
Sad But True	Cartoon by Hoffman 56
Calls Heard	57

QST is published monthly by The American Radio Relay League, Inc., at Hartford, Conn. Kenneth B. Warner (Secretary, A. R. R. L.), Manager and Editor.

Subscription price, \$2.00 per year, anywhere. Single Copies, 20 Cents.

Entered as second-class matter May 29, 1919, at the post office at Hartford, Connecticut, under the Act of March 3, 1879.

Copyright, 1920, by The American Radio Relay League, Inc.
Title registered at United States Patent Office.

THE AMERICAN RADIO RELAY LEAGUE, Inc.
HARTFORD, CONN.

THE AMERICAN RADIO RELAY LEAGUE

INCORPORATED

"A national non-commercial organization of radio amateurs, bonded for the more effective relaying of friendly messages between their stations, for legislative protection, and for scientific growth."

OFFICERS

President
HIRAM PERCY MAXIM
Hartford, Conn.

Vice President
CHAS. A. SERVICE, JR.
Bala, Pa.

Traffic Manager
J. O. SMITH
73 Hillside Ave.
Rockville Centre, L. I.

Treasurer
A. A. HEBERT
Nutley, N. J.

Secretary
K. B. WARNER
Hartford, Conn.

DIRECTORS

A. E. BESSEY
Sunnyvale, Calif.

V. F. CAMP
Brightwaters, L. I.

J. M. CLAYTON
Little Rock, Ark.

J. C. COOPER, JR.
Jacksonville, Fla.

F. M. CORLETT
Dallas, Tex.

W. T. FRASER
Buffalo, N. Y.

W. T. GRAVELY
Danville, Va.

F. H. HAMILTON
Indianapolis

A. A. HEBERT
Nutley, N. J.

HIRAM PERCY MAXIM
Hartford, Conn.

C. A. SERVICE, JR.
Bala, Pa.

J. O. SMITH
Rockville Centre, L. I.

H. L. STANLEY
Babylon, L. I.

C. H. STEWART
St. David's, Pa.

K. B. WARNER
Hartford, Conn.

M. B. WEST
Waukegan, Ill.

OPERATING DEPARTMENT

TRAFFIC MANAGER
J. O. Smith

ATLANTIC DIVISION
Manager
Chas. A. Service, Jr.
Bala, Pa.

Asst. Mgr., Central Sec.
John DiBlasi
33 Sinclair Ave.
Flushing, L. I.

Asst. Mgr., Southern Sec.
Chas. H. Stewart
St. David's, Pa.

EAST GULF DIVISION
Manager
J. C. Cooper, Jr.
Atlantic Natl. Bank Bldg.
Jacksonville, Fla.

CENTRAL DIVISION
Manager
R. H. G. Mathews
1316 Carmen Ave.
Chicago

Assistant Manager
Chas. H. Zeller
4782 N. Maplewood Ave.
Chicago

WEST GULF DIVISION
Manager
Frank M. Corlett,
1101 East Eighth St.
Dallas, Tex.

ALASKAN DIVISION
Manager
Theodore A. Stocking
Ketchikan, Alaska

ROCKY MOUNTAIN DIV.
Manager
M. S. Andelin
Richfield, Utah

PACIFIC DIVISION
Manager
A. E. Bessey,
Sunnyvale, Calif.

Assistant Manager
E. G. Arnold
181 No. 17th St.,
San Jose, Calif.

ST. LAWRENCE DIVISION
Manager
Albert J. Lorimer
248 Mackay St.
Montreal, Que.

ONTARIO DIVISION
Manager
A. H. Keith Russell
353 Markham St.
Toronto, Ont.

NEW ENGLAND DIV.
Manager
Guy R. Entwistle
137 Sutherland Road
Brookline, Mass.

ROANOKE DIVISION
Manager
W. T. Gravelly
354 Main St.
Danville, Va.

DELTA DIVISION
Manager
John M. Clayton
1301 Welch St.
Little Rock, Ark.

MIDWEST DIVISION
Manager
L. A. Benson
4942 Wiesehan Ave.
St. Louis

DAKOTA DIVISION
Manager
Russell H. Pray
Valley City, N. D.

NORTHWESTERN DIV.
Acting Manager,
Royal Mumford
518 Beech St.
Vancouver, Wash.

Address General Correspondence to Executive Headquarters, Hartford, Conn.



A Few Ideas for Amateur C.W.

THE number of C.W. sets is rapidly increasing, and because of the many advantages and the versatility of this system it is inevitable that it will be much in evidence this coming winter. Now is the time to get busy on the construction of the sets—they are worth all the effort they cost.

The main lack at present is tubes, there being at this writing only the Moorhead oscillator on the amateur market, and from this tube it is difficult to get over a few watts. QST is able to assure its readers, however, that in the very near future there positively will be supplied the amateur a complete line of high grade power bulbs, answering every need, and at reasonable prices. Let there be no hesitancy, then, about the tubes—they will be ready when they are needed—small ones, intermediate ones, and large ones. If worst comes to worst, we can send to England for our tubes, where the Edison-Swan Electric Co., Ltd., has quite a line on the open market. Their transmitting bulbs include a 50-watt tube with plate potential 200-1000 volts, filament 1 amp. at 6 volts, price £1.2.6d.; a 100-watt tube, plate 700-2000 volts, filament 3 amperes. at 6 volts, price £3; a 250-watt tube, plate voltages up to 2000, filament 11 volts, 4 amps., price £4.15. These voltages are difficult of attainment with generators, British practice being rather to use a step-up transformer and high-voltage rectifiers as the source of anode potential, and the rectifying tubes also can be bought from the same company. We will not have to send overseas for our tubes, however.

A Description of NSF

The correspondence of A.R.R.L. Headquarters shows an increasing demand for data on the construction of C.W. sets capable of working at least 500 miles. This is proper—there is not much incentive to make the change to tube transmission unless we can have a station capable of good handling of relay business, and although the little 10-watt sets have a phenomenal range, they can not regularly accomplish this distance.

Among the long distance C.W. stations of the present amateur season, 8XK and NSF stand pre-eminent. NSF is the station of the Naval Air Service Radio Labo-

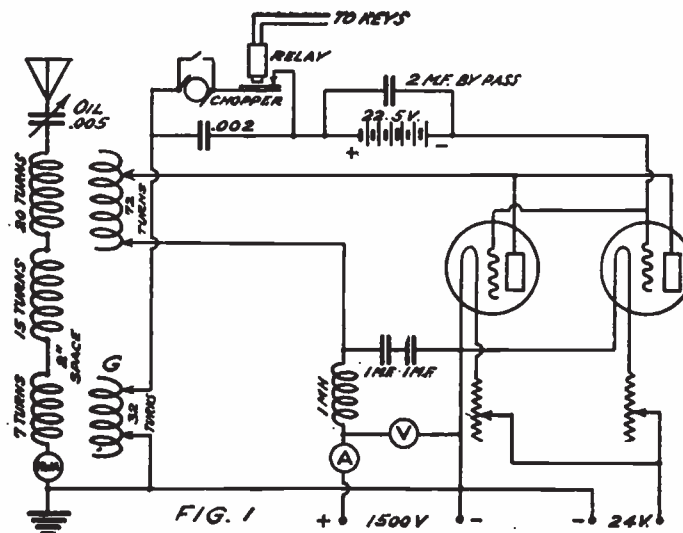

ratory at Anacostia, D. C., and has been doing pioneer work in short-wave C.W. transmission, to facilitate which development it has actively entered the amateur work of the present season. The fading tests from NSF have been sent out on

equipment comprising two 250-watt type P G.E. Plotrons, putting as much as 9.2 amperes in an Alexanderson multiple-tuned antenna 100 feet high. The circuit employed is the tuned Meissner circuit, shown in Fig. 1; and Fig. 2 will give an idea of the constructional features of the inductances. The constants of this set are such that any wave length up to 500 meters may be used, and although on the multiple-tuned antenna they have got down as low as 120 meters it is probable that better results on the shorter waves would be had by eliminating the unused turns. The aerial inductance consists of 42 turns of cable on a Bakelite form 5" diam. by 13" long. The cable is twisted up from 8 strands of standard Navy Litzendraht, spaced $\frac{1}{8}$ " by winding a cord between the turns, and the inductance should be variable in single turns by a flexible lead and clip. Note that 35 turns are wound together, and then a 2" space is left before winding the remaining 7 turns, which are for the grid coupling. The grid winding consists of 32 turns of No. 28 D.S.C. wire on a 4" form, mounted inside the 5" tube under the 7 turns just referred to, and

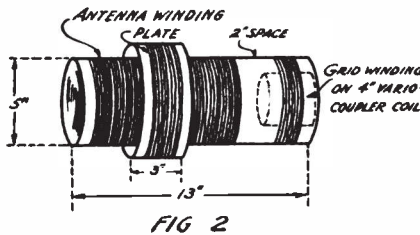

arranged to rotate, vario-coupler style. It is tapped every turn, and 12 turns are used for 250 meters when the two P-tubes in parallel are employed. The plate coil is on a Bakelite tube $6\frac{1}{2}$ " diam. by 3" long, and slides along the antenna inductance to control the coupling. It was found necessary to carefully tune this plate inductance, and so it is variable a turn at a time. It has 72 turns of No. 28 D.S.C. wire, of which 32 are used for 250 meters with the two P-tubes.

Grid modulation is used at NSF, a grid insulating condenser of .002 mfd. (without resistance leak) being shunted by a motor-driven chopper and relay key. Short-circuiting the chopper makes straight C.W. possible.

The multiple-tuned antenna is a large factor in NSF's success, and while the adaptability of this system to damped transmission is questionable, NSF has demonstrated its high value to 200-meter C.W. operation.

8XK, the station of Mr. Frank Conrad, Pittsburgh, has attracted wide attention through its excellent performance in the summer QSS tests. A full description of

it occurs elsewhere in this issue, and in itself will convey many valuable suggestions for the construction of a practical long distance C.W. station.

The Western Electric Co. stations, 2XF and 2XJ, while not operating on 200 meters, are short enough to offer us a few hints. The circuit of 2XF is shown in Fig. 3, and in principle is the same as NSF's.

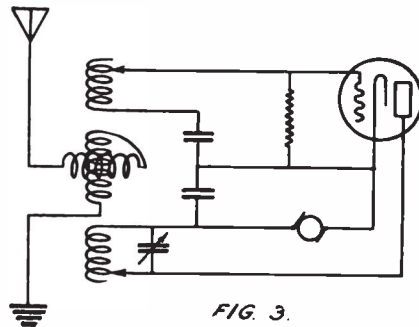
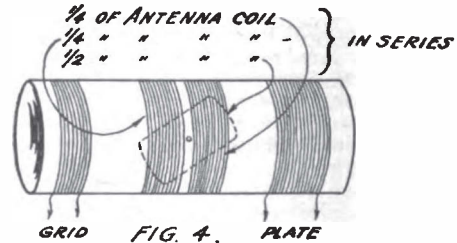

FIG. 3.

The mechanical arrangement (Fig. 4) is quite different, however. The antenna inductance is split, one-half of it being wound in two sections on a cylindrical form and the other half, variometer style, on a revolving member inside the form. The grid and plate inductance are wound on either side of the fixed portion of the antenna inductance, and although mechanically the coupling is fixed, it will automatically vary



more or less correctly in accordance with the variation of antenna circuit wave length.

A Break-In

Many amateurs have noticed that 2XJ and KQO, the S. S. "Ontario", are using a break-in system. The principle of this is shown in Fig. 5. The antenna lead from the transmitter goes to the central point of an inductance, L, forming the receptor primary, there dividing into two branches which are adjusted to the same frequency and resistance so that no e.m.f. is induced in the receptor secondary which is coupled to L. For receiving, however, this balanced condition does not obtain, and incoming signal currents induce an e.m.f.

in the receptor secondary in the regular

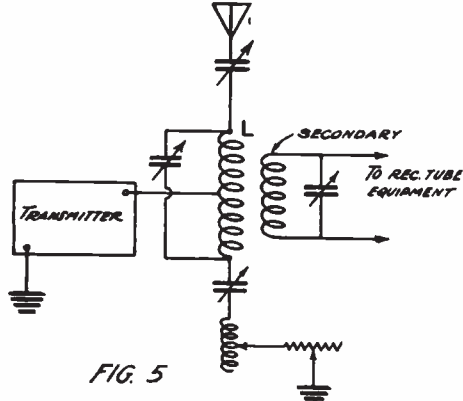

FIG. 5

manner. This is an interesting field for amateur experimentation.

Small Sets

For lower powered sets using such tubes as the Western Electric "E", the General Electric "T", and the Moorhead, we have found no other circuit the equal of the Colpitts circuit described in the May (1920) QST. At the QST Laboratory such a set is giving a very good performance and seems well adapted to the average amateur aerial. There are certain well-defined limits, however, within which the satisfactory action of this circuit seems confined. For 200 meter operation the capacity of the aerial system should not greatly exceed .0005 mfd., and the resistance should be between 10 and 25 ohms. It is difficult to secure a good performance (on 200-250 meters) on capacities of around .001, but this is true of most other circuits too, and brings up an important point in the design of amateur sets. If the aerial capacity is too large it will take energy from the tube so rapidly that the circuit will not oscillate. That is probably the reason why many amateurs have secured their best results from very low-powered sets on a single-wire aerial. It takes power to charge a large antenna. This is a new field for American amateurs, and there is interesting work to be done in determining the forms and dimensions of the aerials for best radiation and best output from the various low powers.

For best output the resistance of the aerial circuit should be as low as possible, but not at the expense of a capacity too large for the set in use. It should be remembered that, as in spark work, antenna current alone is no criterion of range, and that often a relatively low current in a high aerial of low capacity and superior form-factor will excel in actual radiation a higher current in a higher-capacity aerial of poor form-factor.

A circuit such as shown at (a) in Fig. 6 will not function satisfactorily on a large-capacity amateur aerial with a very low powered oscillator, simply because energy for radiation will be extracted from the circuit too rapidly to let it oscillate. The Colpitts circuit is somewhat better for this purpose, but Lauer & Brown, in their textbook "Radio Engineering Principles", cite the circuit of (b), Fig 6, as a satisfactory remedy. Here the plate circuit is tuned, instead of being aperiodic, and so the tube may oscillate independently of the aerial circuit, which is then tuned to the same frequency and coupled at a critical value, the same as in spark procedure.

Grid modulation, as shown in Fig. 3 in

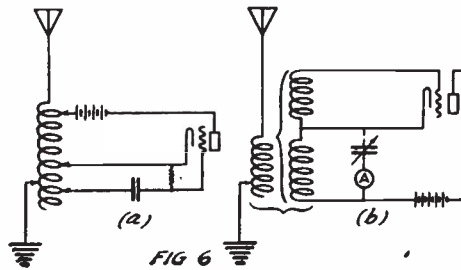

the article on C.W. in the May QST, is being used with splendid articulation in the QST Laboratory. The resistance and biasing battery have been eliminated, the secondary winding of a G.R. modulation transformer having sufficient resistance and impedance for good work with four 5-watt tubes in parallel. However, this method of modulation, while very simple, is not as efficient as the Heising d.c. modulation system.

The Master Oscillator

The master oscillator scheme is an arrangement not now used in amateur apparatus to our knowledge, but having many benefits if one has plenty of tubes. In this method, a typical case of which is illustrated in Fig. 7, the main power tubes are not coupled back so as to oscillate in themselves, but instead function only as power amplifiers, the radio-frequency currents being generated by the master oscillator (which may be any form of oscillating circuit), modulated by voice or for telegraphy in any manner desired, and the modulated radio-frequency potential then impressed upon the input circuit of the amplifiers. It is difficult to modulate large quantities of energy, and the feedback circuits of large oscillators are cumbersome to handle, all of which are avoided here, where the oscillator may be small and insulated for relatively low voltages only and employing, for example, the Eaton or Colpitts oscillator. The precautions in such a set are that the

voltage variation generated by the oscillator should be just sufficient to vary the grid potential of the power tubes through the length of the straight portion of their

very small gap—.02 mfd. was about right in the case of our coil. Now it is well known that the output of a spark coil consists of pulses much greater in one direc-

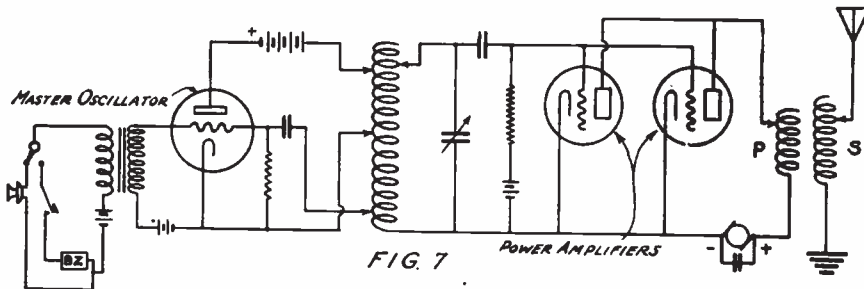

static characteristic curve; that the grid-biasing and plate potentials of the power tubes be adjusted for operation on the straight portion of the curve; and that the master oscillator, output circuit, and antenna circuit all be adjusted to the same frequency. The tuning inductances in the output circuits may be the usual amateur oscillation transformer, as at P and S in the diagram; or conductive coupling, with a 3-clip helix, may be used. Pioneer work of the Western Electric Co. in this field is described by Messrs. Craft and Colpitts in a paper entitled "Radio Telephony", presented before the A.I.E.E. in February, 1919.

tion than in the other, due to the greater speed of vibrator "break" than "make", and it is necessary to determine which terminal has a preponderance of positive polarity. This may be done easily with a milliammeter, and the positive connected to the plate and the negative to the filament. It is altogether probable that much better results could be obtained from a specially-designed induction coil with a secondary winding giving nearer the desired voltage and capable of supplying more current (since its secondary resistance could be much lessened), but we have proved to our own satisfaction that an ordinary spark coil may be used, with good results, to furnish the plate energy for a small tube set for I.C.W.

C. W. With Spark Coils

Why do we go to all the trouble of getting a motor-generator set, carefully filtering the output to get a smooth flat-topped wave to feed our tubes, and then chop it again for modulated telegraphy? 8XK solves it by using an independent set for telegraphy, with 700 cycle alternating current for the plate supply. The very same thing may be done for small tubes by using an ordinary spark coil to furnish the high potential. Thus our general nuisance seems likely to come into its own after all, and a cheap substitute evolved for expensive motor-generators, where telegraphy is the only aim. In our laboratory our small tube set, with an output of about one ampere with motor-generator supply, puts 0.4 ampere in the aerial when supplied by a 1-inch Mésco coil operated from the storage battery, and we can get any note we want by adjusting the vibrator; and because the modulation is much superior to that obtained with a buzzer in the microphone circuit, the signals from the 0.4 ampere are reported 85 per cent. as loud as from the 1 ampere with buzzer modulation. A good-sized glass condenser should be put across the secondary of the coil, to reduce its voltage to where it will just jump a

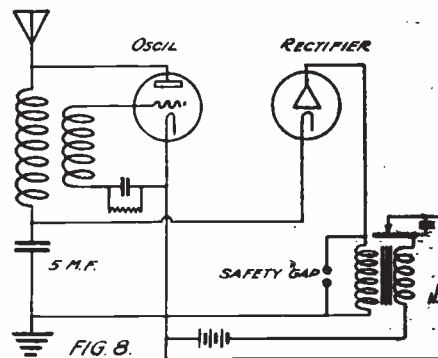

This is not new, the British having used it during the war; and the deForest company has just brought out a telephone set which gets its plate potential from two buzzers operating from the filament battery, apparently the inductive surge from making and breaking the circuit being rectified by two of the tubes, to supply current to the third as an oscillator. A typical British circuit is shown in Fig. 8, where the high potential is obtained from an induction coil, rectified by a single two-ele-

ment tube, and stored in a large condenser. With the omission of the rectifier, this illustrates very well the idea presented in the preceding paragraph, but is adapted equally well to any form of oscillator circuit, of course.

Filters

In constructing filters it is well to remember that the peak voltage of the a.c. obtained from rectifiers is 1.4 times the effective voltage which the meter shows, and allowance must be made for this in the selection of smoothing-out condensers. The

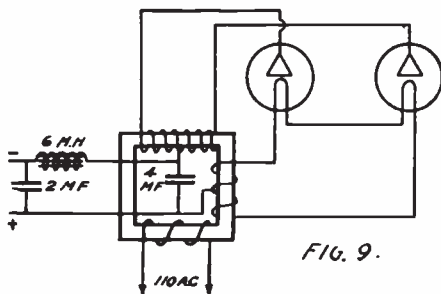

FIG. 9.

Western Electric 1 mfd. paper condenser No. 21-AA is guaranteed for 1000 volts and is very good for this purpose. Any small iron-core chokes of not too high resistance will answer for the filter inductances for a generator, although higher values are necessary for a rectifier filter. Dr. A. W. Hull has shown that for best results in a filter the capacity should be divided, with two-thirds of the total across the source of current, then the inductances (preferably in each leg), and then the other third of the capacity across the output side of the circuit. Connections for a tube rectifier circuit where the filaments are operated from a step-down winding on the same transformer are shown in Fig. 9, credited, we believe, to Mr. E. V. Amy. Note that the d.c. lead from the filaments is taken from the center of the filament winding, the same as the negative lead is tapped from the center of the high voltage winding.

A New Form of Rectifier

In the QST Laboratory we have been doing considerable experimenting with a rectifier using General Electric "Tungar" rectifier bulbs. These tubes are made for low voltage rectification and carry quite a current, the small tube for motorcycle charging handling up to 2 amperes space current. Since these tubes are "arcing" when they operate at even the lowest voltages, the idea occurred to use them for high voltage rectification, it seeming that their current-carrying capacity would be the main limiting factor. Credit for the conception of this idea is due Mr. John L.

Reinartz, of 1QP. Work was accordingly started and is very promising, although up to this writing a circuit has not been devised to rectify both halves of the cycle. Because of their low internal resistance the tubes are useless in the ordinary rectifier circuit, a short-circuit occurring through the common filament connection with brilliant ionic displays within the tubes; which, however, they seem to stand all right. The striking feature of this experimenting has been the heavy currents available. We have had no trouble in drawing .5 amperes at 700 volts d.c. (350 watts), and this can be filtered satisfactorily. The price of the small Tungars is but \$3.50 each, and we believe that experiments with their use in rectification for C.W. will be extremely profitable. Fig. 10 illustrates the circuit which has been used. The core (not shown) was built up 1 1/4" high from L-shaped pieces of stovepipe iron cut 5 1/2" x 3 1/4" and 1 1/4" wide, making a rectangle 5 1/2" x 4 1/2" outside and 3 1/4" x 3" inside. The coils were wound on cardboard forms 3" long, 1 1/4" square inside and 1 3/4" square outside, on opposite sides of the core. The primary, A, consists of 300 turns of No. 16 D.C.C. magnet wire. The secondary, B, is made up of 2250 turns of No. 26 D.C.C. magnet wire, and gives a 750-volt secondary when rectified. This winding is tapped for 500 volts at the 1500th turn, and for 350 volts at the 1050th turn. The filament winding, C, consists of 10 turns of No. 14 D.C.C. magnet wire, tapped at the 6th, 8th, and 10th turns for voltage control. This winding is wound over the primary, at the last.

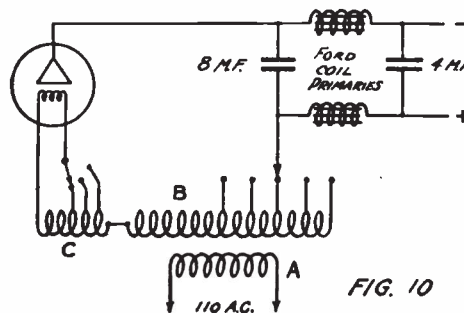

FIG. 10

The Editor will be glad to know what results other amateurs achieve with these tubes. A striking possibility for future designs of rectifier tubes developed in our work when the high voltage was once put on the tube with the filament unlighted. The typical Geissler tube display at once commenced, but during this the filament was heated to incandescence by ionic bombardment so that the tube, after a few seconds, rectified just as well as when the filament had been heated by an external (Concluded on page 35.)

Beginning at the End

By "The Old Woman"

Fellows, the State of Tennessee has recognized Woman and admitted her into participation in general activities, so we guess we will too. When first detected, this unsigned story was on the Editorial Desk, and no amount of search would develop the envelope in which it arrived. We do not know who wrote it—we swear we don't. Perhaps she will always remain an unknown contributor, like "The Old Man." At any rate, it's good stuff, and full of humor, as you'll agree. We have no means of addressing her except thru QST, but we want to say, in reply to her last paragraph, that the title "T.O.W." will be reserved for her exclusive use if she will agree to occasionally favor our gang with a story like this. Will you, T.O.W.?—Editor.

AS long as I've known QST I've resisted the temptation to write in and tell what I heard on my crystal detector. I never have done it, have I, Eddy? Well, now my firm resolution is busted, all on account of Miss Ham (f.) writing about the good old days in the July number.

I'm awfully glad there's another of us; it has mortified me to be constantly explaining that I am not Mrs. Candler; but when I contemplate that energetic and enthusiastic hameff, I feel as old as Time, world-weary, disillusioned, battle (or bottle) scarred (or scared), cynical and blase. Let her enjoy her halcyon crystal days. Say, deary, wait till you—but no, I mustn't get started on that line.

What I want to know is where's the rest of us promising three-year-olds? We all hopped off together; we all took the plunge, to save our country in its hour of need—we prepared to take our places on ships and shore stations and release the radio operators for ditch-digging and other vital operations. We were egged on by those Lovely League camps, where you put on a dashing uniform, and pranced vigorously up and down and around under the steely eye of an honest-to-God marine drill-sergeant, who seldom said what he thought, though he had the voice for it,—and where you sat in a stylish tent and listened to the strains (nothing ethereal about them, either) of a low-frequency buzzer, and nearly exploded with pride and vsinglory when you could take ten words a minute. Why, some of us felt that we could do no less than devote our lives to a career that called us so strongly and for which we were developing such an unsuspected aptitude. We stood ready for the call to foreign service at an instant's notice. But when these gifted ones had departed at the end of the session, in a burst of stars and stripes and Catherine wheels, there were still a lot of us who were interested enough to scratch around for more knowledge. Instruction in theory was scarcer than snow upon the desert's dusty face, as the Government had commandeered all the technical schools, and had an absurd

notion that it preferred the services of young men. But there was no prejudice against our getting operators' licenses, and all you needed to know for that was contained in that red question-book! Yes, deary, you're right, it's possible to learn what's in the book, but when your lack of experience costs you twenty points, and you have to make seventy-five out of a possible eighty on what you know, it requires considerable application. And we were proud, too—nothing but first-grade for us! I have left directions in my will that my monument be inscribed:

"If the circuit-breaker trips,
And the fuses blow,
Where will you look for the trouble,
And why?"

By-and-by some of the professors took pity on us, and would let us stand around the wall while they tuned up the old rotary, or listen to the oscillations of one VT-1 through the oscillations of another VT-1; and we confidently looked forward to the time when we should have a flock of VT-1's of our own—happy dreams! We hung around Government departments all the rest of the war; they always had plenty of conversation for us, but no encouragement. And at long last the ban on receiving was lifted.

I've been too busy since to follow the careers of my sisters, but I'm sure we all did the same things. I'm sure we all hung a wire out of the window or draped it around a chimney, and grounded the system to anything handy, and hooked up an audion and two stages of amplification, and proceeded to put our expert knowledge into practice. We began to plan what sort of a sending set we would have. Spark-coil? Oh heresy!! Synchronous rotary? Disagreeable. Poulsen arc? Bulky and unreliable, and we didn't like listening to the back-wash, anyway. Alexanderson alternator? Now you're talking; but after all, there's no sweeter voice in the world than that of the power tube. We would be satisfied with the little fellows, that didn't require more than seven hundred

(Concluded on page 14)

Station Performance During the Bureau of Standards — A.R.R.L. QSS Tests of June and July, 1920

By S. Kruse

Assistant Electrical Engineer, Bureau of Standards

This is a most interesting and informative paper on the performance of our stations in summer, and affords many comparisons between the work done by different stations. Mr. Kruse is in charge of the tabulation and analysis of the data gathered in the recent QSS Tests, so that these figures are authentic. All in all they show a most satisfying record, and the participating stations may know that they have helped to make radio history. We hope for similar comparisons in the future tests, which will give comparisons between conditions in summer, fall, and winter. Incidentally, in our next number we expect to have another informal paper from Mr. Kruse announcing the results of the tests. Watch for it.—Editor.

THE transmitting and recording stations of the recent fading test system were chosen by the Operating Department of the A.R.R.L. with regard to their geographical location and also their known past performance. All of the calls appearing in the system are those of well known stations. In addition to the fading data obtained, which will be discussed in a later paper, there has been obtained considerable information as to the performance of this group of stations, admittedly of our best.

A caution is in order; much of the reception here discussed is not commercial communication, nor even relay communication. Many very good curves were obtained through atmospherics which made it all but impossible to distinguish the letters which were being sent. Under such conditions the exchange of messages would have been impossible; in fact it is very likely that if the test had not been sent at a fairly exact time the station could not have been identified.

It is not well, then, to conclude that the same group of stations could have handled traffic through the very adverse weather in which the tests were run.

They did, however, obtain fading test curves consistently during a season of the year that has been regarded as making all short-wave work impossible, and did this over an average distance of 400 miles at 250 meters wave length with the existing transmitters and receivers. There was also a fairly large amount of conversation between the sending stations in the intervals between tests.

THE RECORDERS

Of the 51 recorders an average of 26 were on duty per test night, and on no occasion did less than 20 "stand watch." The figure 51 is somewhat misleading, as several pairs of recorders alternated, while others were not able to participate in the

entire 7 week test.

The performance of the individual recorders is best seen in Table I. In reading this table one must remember that the western and southern stations were not only receiving at longer ranges (as shown in the Table) but were doing this through weather of a severity totally unknown on the Atlantic coast. It is well to emphasize this.

During the winter the Mississippi Valley presents ideal transmission conditions, great ranges being covered by low-powered stations—not occasionally, late at night, but consistently, day after day from September to April. Five hundred mile communication between $\frac{1}{2}$ KW. sets is regarded as a matter of course and attracts little attention. That is about the distance from Boston to Richmond.

In the summer, conditions are violently different. Ranges decrease tremendously; often it is not possible for good one kilowatt stations 70 miles apart to communicate in daylight. And with nightfall comes QRN of a kind unknown on this coast.

It is impossible to keep a crystal in adjustment during the particularly bad evenings, while the uproar in the receivers is such that receiving becomes impossible unless signals are very loud.

I have been much surprised to find that at both Washington and New York, local lighting generally fails to produce disturbances of a violence equal to that of these regular summer evenings statics which are quite apart from storms.

Turning to Table I again, it is readily possible to see these adverse conditions appearing in the reduced number of schedules copied by the 9th district and western 8th district stations. The same effect is more prominent in the case of the two 9th district senders.

It is noteworthy that 50 of the 51 recorders used tuners employing the familiar "Paragon" Circuit.

THE SENDERS

Table I needs but little comment. It is well to reiterate that 9ZN at Chicago and 9LC at St. Louis were working through a short range season, the tremendous Mississippi valley atmospheric, and a heavy handicap of thinly spaced recorders. That both were repeatedly copied at 9ZC, Bau-

dette, Minnesota; WWV, Washington, D.C., and 5DA, Wind Rock, Tennessee, speaks well for these two stations. 9ZN was repeatedly copied in New England. All this was exceptional, however, and few records were obtained west of Pittsburgh.

Early in July 8ER at St. Mary's, Ohio, was added in a partly successful attempt to improve this condition.

TABLE I—PERFORMANCE OF RECORDING STATIONS

		Average Distance to Senders	Number Evenings on Watch	Total Tests Heard	Remarks
1AE	Young, Dorchester, Mass.	417	9	27	
1AK	Bowen, Fall River, Mass.	520	11	47	Alternate with 1HAA
1AW	Maxim-Warner, Hartford, Conn.	514	21	62	
1BG	Shorey, Melrose, Mass.	9	9	23	Stands Night Watch at NAD
1CK	Robinson, Braintree, Mass.	530	18	58	
1CM	McLane, Laconia, N. H.	554	15	54	
1DQ	Briggs, Brookline, Mass.	530	7	8	
1EK	Houston-Stoughton, Portland, Me.	615	9	23	Both left City June 22nd
1HAA	Vermilya, Marion, Mass.	548	5	6	Alternate with 1AK
1NAQ	Randall, Hartford, Conn.	440	4	3	
1SN	Dodge, Beverly, Mass.	566	1	1	
1TS	Mix, Bristol, Conn.	440	20	72	
1YB	Corbin, Hanover, N. H.		2	5	
1FB	Prout's Neck, Maine		1	2	To take over work 1EK July 3
NSF	Naval Air Station, Anacostia, D. C.	365	16	49	
2BF	Lorimer, Montreal, Quebec	567	12	39	Working evenings
2BK	Trube, Yonkers, N. Y.	396	3	3	Replaced 2JE July 1st
2FG	Myers, Albany, N. Y.	310	2	3	
2JE	Eddy, N. Rochelle, N. Y.	450	11	41	
2JU	Goette, Woodhaven, L. I.	450	17	50	Receiver out one night
2OE	Raynor, Freeport, N. Y.	410	17	10	
2TT	Rechert, New York, N. Y.	410	4	14	
2YM	Y.M.C.A., New York, N. Y.	410	16	34	No oper. 3 Nights
2ZM	Spangenberg, Clifton, N. J.	380	16	22	
WWV	Bureau Standards, Washington, D. C.	370	5	15	Saturdays only
3UU	Blair, Richard, Va.		21	0	Nil altho 2 stations on all tests
3BZ	Gravelly, Danville, Va.	430	11	46	Local spark Coil QRM 6 Tests
3EN	White, Norfolk, Va.	450	20	51	
3JR	Snow, Washington, D. C.	370	12	34	
3NB	Frye, Vineland, N. J.	380	21	69	
3UA	Duvall, Baltimore, Md.	370	15	34	
3ZA	Service, Bala, Pa.	390	15	46	
3ZS	Stewart, St. David's, Pa.	390	3	13	At Avalon N. Y. till July 1st
3SU	Chism, Washington, D. C.	370	6	26	Started July 8th
4AT	Gulledge, Ft. Pierce, Fla.	990	1	2	
5DA	Hutcheson, Wind Rock, Tenn.	490	12	38	Gone 8 tests on business trip
8AAN	Benzee, Buffalo, N. Y.	370	15	47	
8ABI	Daniels, Dayton, O.	350	6	17	Sick—Compelled to Stop
8BQ	Walleze, Milton, Pa.	340	19	88	
8CE	Ehrhardt, Dunmore, Pa.	370	5	12	
8DA	Manning, Salem, O.	330	4	14	
8EE	Candler, St. Marys, O.	330	20	47	
8IB	Higgy, Columbus, O.	330	3	12	Station Closed after June 8
8WY	Lord, Cambridge Springs, Pa.	320	20	123	
8XK	Conrad, Pittsburgh	350	21	55	
8XU	Homan, Ithaca, N. Y.	370	9	30	Station Closed after June 17
8ZW	Stroebe, Wheeling, W. Va.	310	11	37	
9DT	Patch, Dubuque, Iowa	560	18	0	Notice received 2 days late
9ET	Thompson, Galesburg, Ills.	540	0	0	Replaced by 9NQ
9JA	Stover, Marengo, Ia.		1	2	Dropped out at start tests
9LC	Woods, St. Louis, Mo.	440	4	8	
9NQ	Burke, Galesburg, Ills.	540	11	21	Replaced 9ET
9ZC	Gjelhaug, Baudette, Minn.	930	15	21	
9ZJ	Hamilton, Indianapolis, Ind.		8	27	
9ZL	Burhop, Manitowoc, Wis.	510	12	19	Station Moved—out 8 tests
9ZN	Mathews, Chicago, Ills.	500	13	17	
9ZV	Crowdus, St. Louis, Mo.			0	Dropped out at start
	Perkins, Kansas City, Mo.			0	Dropped out at start
	Radio Club, St. Paul, Minn.			0	Dropped out at start

The performance of the senders was admirable in every respect. Very few schedules were missed after June 1st, at which time only 1AW at Hartford, Conn., and 2JU at Woodhaven, L. I., had been notified. NSF at Anacostia, D. C., was compelled to miss two schedules because of power failure outside the station. The schedule of June 3rd was sent by 3ZW at Washington, D. C., which station on this occasion made a most remarkable record, 25 out of 37 operators on watch copying the complete test including the statement "3ZW sub NSF." One station breakdown occurred, at 2JU, luckily on the last test day. One schedule was missed by 9ZN. 9LC missed a number of schedules thru sickness of Mr. Woods. Before the close of the tests 9LC was dismantled and moved.

The Senders were open to one minor criticism—they did not at any time, clear to the end of the seventh week, observe the correct starting time with any exactness.

cast QRX requests. In this neighborhood 3NB's booming spark was especially helpful.

There was interference, however, mostly from shore stations (WSO, NAH and NAM), spark coils, and radiophones. The shore station interference was especially severe from NAM, seemingly because of a very broad wave.

Spark coil interference is always present, usually because of ignorance.

The radiophones cannot be so easily excused. The vicious practice of holding three-hour local conversations during the latter part of the evening cannot be too strongly condemned. It caused the loss of many records in these tests.

A few transformer-powered spark stations were guilty of deliberate interference with the tests, but all were disposed of.

TABLE II—PERFORMANCE OF TRANSMITTING STATIONS

	Number of tests scheduled	Number of tests sent	Total tests listened for: i.e. scheduled tests times observers on duty	Total tests heard	Percent of scheduled tests listened for which were heard	Average distance to recorders	Recorders within 250 miles	Equipment
1AW	21	21	555	362	65	343	22	60 cycle non-synchronous rotary gap
2JU	21	20	554	313	57	330	24	60 cycle non-synchronous rotary gap Tube set, D. C. plate—grid chopper Multiple-tuned antenna
NSF	21	17	501	305	61	330	21	60 cycle non-synchronous rotary gap Tube set, 700 cycle plate—no chopper Antenna and counterpoise
3ZW	1	1	37	25	71	330	21	60 cycle non-synchronous rotary gap
8XK	21	20	538	381	68	350	10	500 cycle quenched gap
9ZN	21	19	538	223	41	580	6	60 cycle non-synchronous rotary gap
9LC	21		538	14	3	690	1	60 cycle non-synchronous rotary gap
8ER	6	6	154	83	54	450	7	60 cycle non-synchronous rotary gap
Totals			3415	1706	50			Note—Total number of recorders, 51

Even the large time interval between schedules did not prevent overlaps on two occasions. Probably local, rather than Arlington, time was used.

CO-OPERATION BY OTHER STATIONS

At Richmond, Va., co-operative reception was attempted but no signals were heard although several operators stood watch faithfully throughout the tests.

Co-operation of another type appeared in recording. In every case where a recorder dropped out, a slight effort sufficed to find a substitute.

A surprisingly large number of operators who were purely spectators in these preliminary tests, stood by patiently during every test, and very often helped to broad-

CONCLUSIONS

Request for statement as to the relative merit of the spark and tube sets have been frequent. A very cursory examination of Table II will show that the five eastern stations (counting 3ZW) performed about alike, neither tube nor spark having a marked advantage.

The scheme of operation has proved practical and has shown convincingly the quality of operators and apparatus at the better A.R.R.L. stations.

The placement of stations was not ideal, too few recorders having been placed west of Pittsburgh, Pa. We were misled by the very great winter ranges in this region.

In the three further series of tests which will be run in October, January and April,

the general plans of procedure will be retained but the station network will be re-arranged.

The success of the recent tests was not only a proof of station quality; it was also a demonstration of the spirit of whole-hearted co-operation that the A.R.R.L. represents.

(A.R.R.L. representatives have held another conference with representatives of the Bureau of Standards and other interested bodies, at which the results of the above mentioned tests were reviewed and plans laid for future work. It is very desirable that additional data be collected, not only along special lines which past tests have shown desirable, but to get comparative data on conditions at different times of the year. Accordingly, additional tests for October, January, and April are now being planned. The new tests will be on but two nights per week instead of three, and over a period of but one month at a time, altho they will follow the former plan as regards time and wave length. It is intended also to make additional noon-day and sunset runs, probably one in each of the three months. In this conference consideration was given the many suggestions for improvement which have been made by various participants, particularly features bearing on the length of time of the tests and a more accurate time axis for the curves. It was decided that in the future tests, each letter of the alphabet will be transmitted continuously at any desired speed for a total time of five seconds, passing on to the next letter without interruption. This will prevent distortion of the time element due to the smaller length of time required to send any definite number of certain short letters such as E, I, etc. A continuous curve or series of dots is contemplated to care for changes in audibility occurring within the five-second period. Transmission will be thru the alphabet in the usual manner, then backwards to A in the reverse direction, providing a longer period of observation. The number of transmitters has not been definitely determined upon—whether a line-up much as in the first tests will be followed, with a better distribution of recorders, or whether it would be better to reduce the transmitters to not over three in number, and greatly increase the number of recorders so as to follow what seems a very desirable scheme, the securing of a larger quantity of data on a smaller number of transmissions. At any rate the recorders will be specially chosen for their reliability.

The A.R.R.L. QSS Tests will have concluded when this appears in print. It is too early to forecast the results, but they seem none to favorable as viewed at this writing. In the southern states QRN has

been so terrific as to make them practically a flat failure. They have been run at the very worst time of the year for every locality, and coupled to this is the fact that August is the great vacation month and hundreds of stations have been idle which would otherwise be on the job. All these features are combining to result in a dearth of reports, but it is still expected that information of decided value will be obtained.—Editor.)

BEGINNING AT THE END

(Concluded from page 10)

volts plate potential, and as we would have to tune the set sharply on amateur wavelengths, no one but amateurs could hear us, and none of the amateurs could, so we would never interfere with anybody. I've been a little backward in getting my set started, because I've been expecting to hear from some of the other girls about what they've done in the matter. I'm a bit rusty on the code, too; those operators at XDA and Darien think they're so smart zizzing along at seventeen words a minute, when all the biggest stations are careful not to exceed thirteen.

Well, where are we all? I sort of expected to find a corner for us in QST, with a prize for the best use of a bent hairpin, or how to keep your No. 42 copper wire combed and brushed and ready for use. There were fifty of us when I began, and there must be hundreds since. And now, Eddy, don't cut out those highbrow articles on our account! We may not understand them, but you know, we get interested in Micro Mike, and the ubiquitous Constance, and Elsie with the square foot—I mean root—and even if we don't know the difference between r.m.s. and r.p.m. we like to roll them under our tongues.

And say, if nobody else has it, can I grab this title? "The Old Woman"



9AJ's Idea of T.O.M.

Construction of a Two-Step Amplifier

By *McMurdo Silver*

SINCE the signing of the armistice and the lifting of the ban upon amateur radio activity, much has been written upon multi-stage vacuum tube amplifiers for audio and radio frequencies, but mostly in a general way, and very few articles have appeared in the current radio publications on the construction of a simple and yet efficient amplifier suitable for all around amateur use.

As stated in the May QST, audio frequency amplification is all wrong from the start, but unfortunately it is the only means of increasing signal strength at the disposal of the majority of amateurs. Radio frequency amplification, if transformer-coupled, is limited to a certain band of wave lengths, depending upon the constants of the transformers used. Major Armstrong explains why resistance coupling is unsuitable for very high frequencies, and puts forth an excellent solution of the problem in the Armstrong Amplifier, but most of us look at two or maybe three tubes with awe and veneration, let alone the number necessary to build such an amplifier.

For the above reasons it was decided to use Honeycomb Coils and a two step transformer-coupled audio frequency amplifier, as it was believed that this combination would entail the use of a minimum amount of apparatus and adjustments for the results obtained, and also because this type of amplifier will function efficiently on either long or short waves.

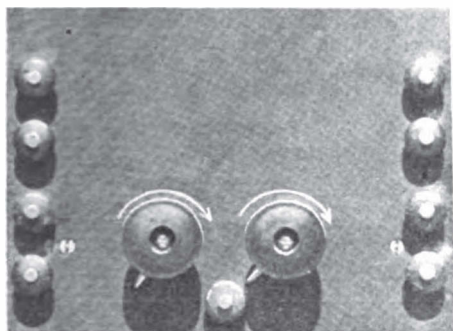

Fig. 1.

In the following paragraphs will be given the description of an amplifier constructed with an eye to extreme simplicity along the ideas outlined above.

Fig. 1 is a front view of the completed instrument. The panel is $7\frac{1}{2}$ " by $5\frac{1}{2}$ " high, of hard rubber and supports the entire unit, with the filament rheostat knobs

and all necessary binding posts conveniently located on the front. Fig. 2 gives a rear view of the same instrument, and shows the method of mounting the tube sockets, rheostats, and amplifying transformers.

The tube socket, in this case a double base, is clamped between two pieces of sponge rubber at each end, thus providing a somewhat shock-proof mounting. It will be noticed that the tubes are held horizontally, and while it might be better to mount them vertically to prevent sagging of the elements, no trouble has been ex-

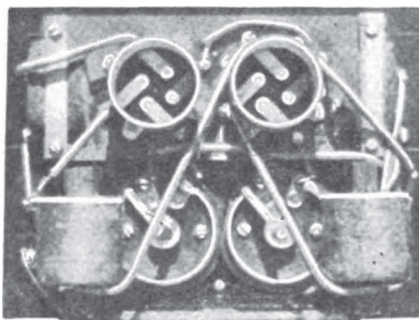

Fig. 2.

perienced from this source. The rheostats are attached to the panel by screws through holes provided in them for that purpose, and are of the Paragon type, now widely advertised. The amplifying transformers are held by small pieces of brass strip, bent into the form of a clamp, and fastened to the panel by a single machine screw. They are so placed at the side of each rheostat that there is about $4\frac{1}{2}$ " spacing between them, and while the windings are in the same plane, they run in opposite directions. Their D. C. resistance, in the two measured, was 1000 ohms for the primary and 6000 for the secondary, approximately, and they were selected after a trial of several makes, for their high transformation ratio, and for the fact that they seemed best suited to the tubes used. It should be possible to procure them from the nearest radio supply company, or they can be gotten direct from the makers*, unmounted.

It might be well to point out that transformers should be selected whose primary impedance, at the desired frequency, will conform with the output impedance of the tubes to be used. In the case of the Marconi VT, this is 60,000 ohms; of the VT-1, 20,000; the VT-11, 40,000; and for the VT-21, 60,000; approximately.

All wiring was done with No. 16 bare copper wire, covered with cambric tubing, with all connections well soldered to binding posts pinned to the panel, to prevent turning even should the fastening nuts come loose. All wires should be run as much as possible at right angles.

No provision has been made for adjusting the number of steps used, as this would only complicate the wiring and increase the possibility, and not a far distant one at that, of howling. Increasing or decreasing the filament current of either of the tubes will provide an excellent control of the amplification, although care must be taken not to burn out the filament.

Nine binding posts were used, for the input, output, filament and plate batteries. The extra post is for the insertion of a negative grid potential, which, while an amplifying tube should be operated upon the straight portion of its grid voltage-plate current curve, should never be changed to

ment rheostats, although this is not recommended as any change in I_f creates a change in E_g . The voltage drop is $E_g = R_f I_f$, in which the current flowing in the filament circuit is represented by I_f , the resistance of the drop by R_f , and the resulting grid potential by E_g . It is not always necessary to use a grid battery, and in this case the extra binding post can be connected directly to the filament.

Fig. 3 gives a circuit diagram which will operate with the same filament and plate batteries used for the detector, providing the negative terminal of the plate battery is connected to one side of the filament battery. Fig. 3 illustrates the method of holding the grid negative without the use of an extra battery, and shows only the amplifying transformer secondary, filament, filament rheostat, filament battery and grid. If the resistance of "A" is 2.0 ohms, and the filament current is 0.75 amperes, then the drop is 1.50 volts, or the resistance of

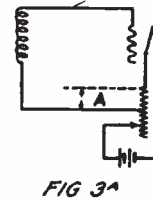
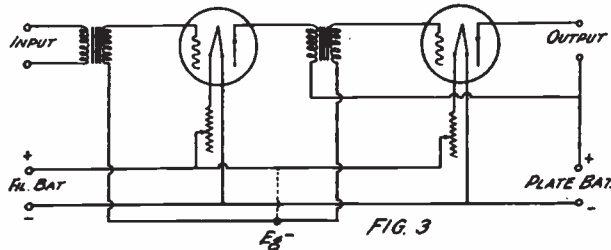

positive in order to operate the tube on this part of its curve. This potential, seldom over two volts with most tubes, should be closely adjustable so that a point of maximum amplification, at which extraneous noises and distortion will be reduced to a minimum, can easily be found. The other end of this grid battery should be connected to one of the filament leads—whichever proves best in actual use.

Another method of obtaining the desired potential is by taking a drop upon the fila-

"A" times the filament current.

The complete unit will fit into a cabinet with inside dimensions of $7\frac{1}{2}$ " by $5\frac{1}{2}$ " by 5" deep, including the tubes and two of the smaller type 22.5 volt plate batteries. The total cost, except the labor, was slightly over \$19.00, figured at list prices, compared to the \$50.00 or \$75.00 asked for the amplifiers of this type now on the market.

Name on request.—Editor.

Standardizing Cabinets and Parts

RADIO operators who build their own apparatus will be interested in the Amrad announcement, elsewhere in this issue, of a line of finished and standardized cabinets. The line includes a 10" x 10" x 10" cabinet with removable front, and can be used either as a large single unit, with 10" x 10" panel which is supplied separately, or as a carrying case to contain two or more of the smaller units. These latter are $6\frac{1}{4}$ " deep and in two sizes: 5" x 5", and 10" x 5", complete with flush-mounted Bakelite panels.

Of equal interest is the new Amrad Knob and Dial. The latter is of a non-magnetic alloy, which, in addition to its durability, acts as a shield from the capacity effects of the hand when adjusting the apparatus. The design is such that the dial is always insulated from actual electrical contact with any part of the circuits. It will be noted that the Amrad Knob and Dial is the first indicating device of its kind designed to be turned in a clockwise direction for increase of current, capacity or coupling. This will be especially appreciated by those accustomed

to the confusion which results where this detail is not standardized.



The Amrad Knob, which can be obtained separately, adapts itself to all sorts of construction with equal facility. A long, round head 8/32 screw may be secured to the knob through the threaded upper portion if desired. As in the case of the dial, the shank of the knob is drilled to pass standard 1/4" shaft, a set screw threaded through the shank securing the connection.

The Amrad Switch Arm and Knob is designed for use where space is a factor. Contact points are also listed. The high quality binding posts used on all Amrad equipment will be available everywhere soon. These have non-removable tops and like all other metal parts are furnished in dull nickel.

All the parts, panels and cabinets are identical to the stock that will be employed in the manufacture of standard Amrad Receiving Units which are now in the final stages of development. This means that an operator desiring to make one piece of apparatus and purchase another may, by using these materials, build an article that will very closely resemble the completed Amrad Unit which he may wish to add to his set of a later date. By means of simple connectors supplied at nominal cost any number of the 10" x 5" and 5" x 5" cabinets may be fastened rigidly together as a single unit. Operators may begin with two or three simple units and add others as they wish, at all times preserving the neatness and uniform appearance of the entire set without the necessity of any special construction work.

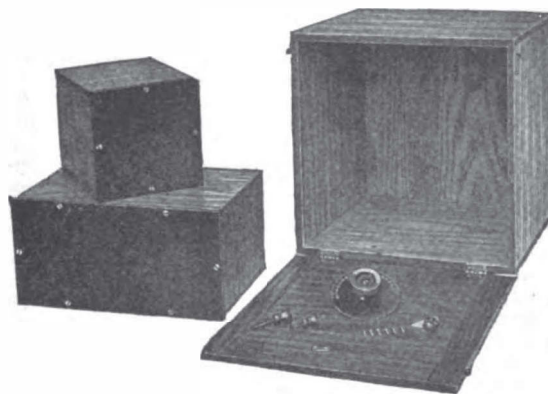

The First Epistle from The Young Squirt to The Old Man

By QRU

BY the shades of Mike Faraday and Julius-Caesar, Friend Ham, lend me your shell-like ear and let me gently inquire who in tarnashun and thunderashun is the wild galoot from the west who is always hollering "Rotten"? By heck, this bewhiskered old son-of-a-gun has got my horned animal, or to be brief, explicit, and to the point, my goat. For the last five hectic and sufferin' years all I've heard him yell is "Rotten". Tell him to go take a walk, take a bath or a shave. Perhaps he can take a drink, (if he can get it). Go and see that pretty little show called, "Open Your Eyes"; that might help some.

I want to remark with all due sang froid (which is no relation to aperiodic

oscillations) that everything about us hams ain't rotten. Just to prove my brave and bold assertion, I'll hereby request in a gentle, subdued—that is, in not too stentorian tone of voice with a chortle of discontent—that this bewhiskered gazabo take an optical slant at the antenna depicted on the July QST's cover and then peep inside at the works and the jeweled bearings of the station. Does that look rotten to you, you howling old Bullbum? Go hide your aged cranium, old Pessimistic Humbug Arratus.

Listen in on your own part of the world, Skeezeicks; hear Mrs. 8NH (as we'll always know her). Is her spark rotten, is her fist rotten, is the intensity of her signal rotten when we get her down here in New Eng-

land like seventeen regiments of Scotch Highlanders full of Gordon Rye? Answer up, you old geezer, before we dance on your old oaken coffin.

And tell me this, Methusalum, what's rotten about stations like 1HAA and 1AK? You oughter take a trip to 1AK, seat yourself in his leather upholstered operating chair, lean back in bliss and comfort and be lulled to rest by the helluvanote of YN, the whistle of POZ, or the falsetto of LCM. Then throw in his Paragon and hear the dope from Willie Smith out in Missouri who is vainly trying to date up his girl using as a means of dating his little half-inch spark coil Who said "Rotten"? Everything in the game ain't rotten, as I remarked to a fellow fan when Babe Ruth knocked his twenty-seventh homer. Of course you and I are rotten; that's why our fellerhams fall for this bunk. It's so darned rotten that they laugh out of sympathy for the authors. No matter about that, I'm all right and the world's askew and you (OM) are a loud shouting airdale, mud-slinging hashound. Release the man, he is badly lacerated!

I suspect that you have a dark, dismal and damp cellar at your domicile where you are wont to congregate down by your waterpipe and where your ground begins. On a broad and massive shelf overhead, I can now, in my mind's eye, see you reaching up and detaching a large brown bottle with a bulging belly from said shelf. This bottle, as I see it, is inscribed, "Wood Alcohol, for Adults Only". You put this horrid exhibit to your lips and take a long drag therefrom. Then you gasp for breath. Back with your shoulders, out with your chest. You feel 75 years younger. You feel fine; you're drunk y' darnphule. This is the time, I suspect, that you write those rotten, tainted and corrupted stories. I believe, you old scarecrow, you're too darned mean to speak a good cheerful word to us young hams; afraid that we'll ask you to lend us your darned old squeaking Betsy or your poor abused cat. Personally I don't believe that you've got a Betsy; I think that it's a tin Lizzie.

Did you read that stuff in our July issue written by Miss Grammerhausen—femule ham? What was rotten about that? Guess she is a regular guy. Admit it, you crab-walking, slant eyed son of Macaroni.

I sure had to laugh when I read of an old has-been like you trying out impulse excitation. Guess you know more about output indigestion!

Let's not drop the subject—while we're at it let's flay this knocking old mugwump alive. Now, I myself can sit in on my superdreadnaught set and get stuff that ain't corrupt. By suitably adjusting the deterioration of my filament due to elec-

tronic emission, (hoping that the Ham (F) gets that phrase OK and considers that my think-tank is not out of phase) and as the tiny atomic and infinitesimal electrons seek the path of Prohibition, that is to say the straight and narrow, I proceed to adjust my circuits to resonance, not neglecting the tertiary. Here am I up in New England and twitter—twitter comes NSD. I use NSD as I was wont to use a test buzzer in the Palmy Days. I hear NAM say to him, "O, NSD, O NSD, why don't you set old Ireland free?" Then I know that my antenna is still up and that there's considerable push to my main spring. So I bend my well moulded head to my work and my youthful countenance (whatever that is) lights up with a beatific and a 100KW. smile. Hope that all hands will excuse my poetic language. I gotta compete with old Jingle-Jazz. Now my gear is adjusted, so stand from under. I cut her down to 200 meters. In through the window comes 1AW—also that bird Runyon—a guy out in Oak Park, Illinois, whispers in my ear, and Mrs. 8NH flirts with me—a married man. I glow with pride because this ain't so bad for home made stuff. I try to spit on my female pussy in my zeal, for you see I'm not to be outdone by old Tom Longwhiskers. I miss pussy and spit in the baby's ear. Do you call that rotten, Old Drybones? I'll say it's gud work—it denotes perfect resonance and unerring aim.

Get some Omega Oil and douse your withered shinbones, Old Timer; then maybe you can get down on your creaking knees and thank the Lord that you're alive and that you can still hear the lusty roar of the Ham around the corner.

On the level, I'll bet that you were one of those gazaboos who, in the year 1910 or thereabouts, made the ether squirm to the tune of your decrement. I can see you now, smoking your old black pipe, a green shade pulled over your watery eyes—gazing into vacancy and pounding the devil out of one of Turnsback's keys. On the tail end of the key you have a tick tacking spark coil operated through an App's hammer. You still have the hammer, I'm sure. Down goes the key and up goes some poor old commercial station—another good old electrolytic gone wrong. You pound on in blissful ignorance and the London Constabulary arrests a man for stealing a loaf of bread.

I sure hope, though, that I can see you down in New York some time. We'll go Hellpoppin' together. We must take in a good show, guzzle a little moonshine together, accompanied by the Edison Military Band and the office force of QST.

Come out of your hop, Old Beezlebug, or I'll put Sheer-luck Holmes on your trail, and he'll have Watson with him.

Our Less Experienced Brothers

By Hiram Percy Maxim

Periodically we of the A.R.R.L. are benefited by a heart-to-heart talk by our President on some of our vital affairs, and never fail to gain thereby. The tendency of the more advanced amateurs to set themselves up as a class apart from the beginners constitutes a danger to our great organization of amateurs, and this is the topic of Mr. Maxim's article—this and how to overcome it. The careful consideration of all A.R.R.L. members is asked for this subject.—Editor.

ONE of the things which everybody must have observed for some time is the growing tendency for the experienced amateur to detach himself from the inexperienced amateur. It is not a good sign. While it may be asking considerable of the experienced amateur to limit himself to the abilities of the beginner, nevertheless, it is necessary for the common good that the new fellow should be offered not only the fraternal hand, but also the helping hand. If this had not been the practice in the early years of amateur radio, many of us who are now experienced might not have had the chance to occupy our present position. I might have been one of these. I suffered the handicap of having to start learning nearly everything, from the code up, after having passed well beyond forty years of age, and since it is quite an undertaking for an old dog to learn new tricks, it was principally because of the kindly help of those who were more experienced than I that I was enabled to take my place finally among the experienced. In those early days almost everybody was a beginner, and in consequence it was not considered a great favor to condescend to work and associate with a beginner.

Amateur radio of ten years ago was not so complicated nor so difficult to master from a standing start as it is today. Then, it was nearly a case of an aerial, a convenient water pipe, a loose coupler, a crystal detector, and a pair of telephones for receiving, while a spark coil, a fixed gap, and a photographic plate condenser made as good a transmitting set as any one had. It was simple for any one at all versed in electrical matters to quickly possess a fairly representative radio station. Amateurs rarely worked over a greater distance than five miles and signals from a few city blocks away were considered worth listening to.

It is very different now. Receiving apparatus has become a complex of very involved oscillating circuits, and not only is its cost many times that of its early equivalent, but in addition it is all but impossible for a beginner to master. When the latter is confronted by a modern amateur station such as the average experienced amateur possesses, he either abandons his hope of entering amateur

radio, or, if he is unusually persistent, he places the experienced amateur in a class by himself and makes up his mind to join hands with what he calls "the small fry". Here begins the cleavage. Two classes of amateurs having little to do with each other develop. The experienced amateur naturally joins hands with his experienced fellows and the less experienced places himself with the other less experienced. In some cities a break in cordial feeling follows and different organizations and clubs are formed. A sort of aristocracy is built up, and this is not a healthy condition. It breeds class distinction which is not American. Conflict of one form or another always follows and in this conflict both sides suffer.

The problem is how best to combat this tendency. In my own case, I try to make frequent contact with the beginner. Frequently he is difficult to cultivate. Some times he appears to misinterpret my motive, apparently thinking I am either collecting legal evidence against him, or laying plans to sell him something. It takes a long time to convince this type that I am honestly trying to help and fraternize. Many other experienced amateurs must have met this same condition.

It is the least of the trouble, however, because in time any desirable person comes to see the light and is willing to shake hands. Our chief trouble is the getting of the experienced operators as a class to act uniformly in a manner that will attract the beginner rather than repel him. It is distinctly to the interest of the experienced amateur to strive in this direction since it is the general success of amateur communication as a whole that makes it interesting to operate a fine station. If there were no worth-while traffic, for example, to handle, interest would not last very long. If instead of some form of traffic, such as our present A.R.R.L. relay traffic, everything were general conversation, indulged in by everybody generally, things would quickly become intolerable. Interference would become so great that nothing worth while could be done. General conversation by radio, as we all know, usually consumes a lot of time. We all recall instances of long waits while two stations finished some conversation, most of which was of small

point. On the other hand, message traffic is not only usually short, but it is also frequently of value. In any event, it possesses a charm and a pull which is never ending.

The beginner, no matter how crude his equipment, is invariably glad to get into this traffic game. It is even more inspiring to him to actually handle a message than it is to us experienced fellows. Once the beginner has a taste of actual traffic handling, his fate is sealed and he somehow soon finds the money to buy more and better equipment, and the time to master its theory. One cannot but feel, therefore, that there ought to be a closer bond between the experienced and the inexperienced amateur if the former would make it a practice to turn over traffic wherever possible to the latter. Judgment of course has to be used, but there are many cases where the smaller stations could have a chance.

There is a reason for this necessity for building up and maintaining cordial relations between the older amateurs and the beginners. This reason lies at the very base of amateur radio. It comes about because of the basic fact that there is only one air and we must all use it in common. We cannot go it alone from the very nature of things. It is more true of our radio than of any other activity. This makes it positively necessary that the community spirit be encouraged and prevail. The experienced amateur cannot work if the inexperienced amateur is not willing to co-operate, just as the inexperienced cannot function without the co-operation of the experienced. Even the experienced cannot function without the co-operation of their own kind, and the beginner would find it very uninteresting if he could not have the co-operation of his fellow beginners. Being so completely dependent one upon the other, the desirability of so shaping our actions that we shall not produce class distinction and conflict must be apparent to all of us.

One method of cultivating the fraternal spirit among all classes which has proved very successful is for the experienced amateur to make it a point to invite in to his station the beginner. The latter are invariably anxious to see the inside of a good station. In most cases it is their first view of a real wireless station. They acquire information at an extraordinary rate of speed and they form standards of equipment and of operation which exert powerful influences in moving them out of the

beginner class. If they can operate even passably well, they should be given the key and encouraged to actually work. If by any chance they can hear a distant station and call and receive an answer and pass a few signals, they are inoculated permanently, and tremendous good is done for all concerned. One single bit of QRM from another beginner at such a time brings down more effective criticism than volumes of printed matter could possibly accomplish.

The value of the radio club enters at this point. Nothing is so conducive to advancement of the beginner than attending meetings of a group of his fellows. But these clubs are not as effective as they should be unless the experienced amateur also joins them and attends meetings at least once in a while. His presence not only cements friendship ties, but it also educates the beginner, and frequently broadens and educates the experienced person also. The presence at club meetings of an experienced amateur also does much to bring in the beginners and make the clubs' meetings successful. It may be regarded by some old time amateurs as beneath their dignity to attend radio club meetings at which the majority of the membership are at the crystal detector stage, but this is a wrong point of view to hold. It is part of his debt to amateur radio to attend radio club meetings, and he should so regard it. Once upon a time he was a beginner and he

was very thankful for the association of those more experienced than he. The clubs themselves have a duty in this direction also, and that is to affiliate with our national organization, the A.R.R.L. Each club is like each individual member. There are beginner clubs and old timer clubs, and the latter owe to the former just that same thing which the older individual amateur owes to his younger brother. This club matter should not pass without mention of the country amateur who is located too far from a town where there is a radio club for him to attend meetings. He should be reached just the same, for he is the forerunner of a great class which are going to make use of radio. He is away from the large centers and radio communication is more important to him than it is to the city dweller. Therefore, he should lose no opportunity to avail himself of as much information and assistance as possible. The way for him

(Continued on page 31)

NEXT MONTH

Mr. Kruse's analysis of the data in the B. S.—A.R.R.L. QSS Tests. ¶ "Bulb Oscillators for Radio Transmitters", by Prof. L. A. Hazeltine. ¶ Two splendid papers.

Don't Miss Them

How to Tune the Honeycombs

By A. L. Groves

In this article Mr. Groves explains how he gets his results on the honeycomb coils—practical instructions on how to get the most out of this apparatus which will be welcomed by our readers.—Editor.

IT has come to my attention since writing the article on honeycomb coils for the March QST that the majority of bulbs require a larger plate coil than those given for the various ranges of waves, so it is best for each individual to select his own plate coil; which is an easy matter once the correct secondary value for a given wave or station is known.

I am also led to believe by the statements of many amateurs that they are not tuning the primary circuit as it should be tuned, and therefore do not get anything like the results they would get if the tuning was correctly done.

While it is impossible to describe every detail in the art of exceptionally close tuning, I believe the following will help a good many to practically double their range with the honeycombs, if a little care and patience is used until they become thoroughly familiar with the operation.

First we will suppose it is wished to tune to POZ. (I take POZ for example as most amateurs seem to hear him in some fashion.) We refer to the chart, Fig. 2 in March QST, and see the secondary condenser must be set around 46 degrees when using coil L-1500 in secondary. Then we put in a plate coil and close the coupling between the plate and secondary slowly until we hear a loud howl or bubbling sound. As soon as this sound is heard we loosen the coupling until the sound stops. If the plate coil used is too small you cannot hear the loud noise and a size larger coil should be used, and if you still can't hear it try the next size, and so on until the correct size is found. If on the other hand you put in a plate coil and hear the sound and can't make it stop by opening the coupling as far as it will go, you are using a coil too large and a smaller one should be tried. But results seem to be had when the howl starts with coupling open about half way; that is, about 45 degrees.

Now after the correct coil is found the next and a most important part is to find the correct primary coil. With the secondary and plate coils tuned carefully as above, signals from long distances can be received without the primary being tuned exactly and a good many seem to let it go at that, thinking they are getting the full value from their set, and probably the best way to actually locate a station,

if his signals are fairly strong, is in this way, as it gives broader tuning and makes stations easier to find.

We will now suppose the experimenter has L-750 in the primary circuit and hears POZ. He will then make some fine adjustments of the secondary condenser and plate coupling until he brings him in as loud as possible without actually tuning the primary. Then it would be best to loosen the plate coupling a fraction, say one-eighth of an inch, so as to avoid the possibility of the bulb being rendered insensitive when the full value of primary tuning is brought into use.

Now, with the primary coupling set at about 45 degrees, the experimenter proceeds to slowly vary his primary condenser from zero to maximum capacity, all the while listening for a sharp click in the phones. If no click is heard, try another size coil and again vary the condenser over the entire scale, and so on until a coil is found where the click is heard at some one point on the condenser scale. Until you can hear this click the circuits are not in tune and maximum results are impossible, but as soon as the click is heard signals will immediately increase and after this it is only necessary to make hairbreadth movements of the condensers and couplings to amplify the signals to an extent never heard before. It will not be well for the beginner to try to make these hairbreadth adjustments too close at first, as often one degree movement of a condenser will cause the signals to disappear entirely or the bulb to howl unmercifully, but after he learns the approximate adjustments in the manner described he will gradually learn the necessity of care and patience and come to appreciate the value of fine tuning, for fine tuning it is indeed and it can be carried up to such an extent that the faintest signal can be heard several inches or a foot or so away from the phones and then when the least bit of static that is a fraction heavier than the rest comes along it will set the bulb to howling and the signals will disappear entirely. This is of course not used for ordinary copying or measuring signal strength of stations, as it is too delicate an adjustment, but I mention it only to show the possibilities of high amplifications and the value of fine tuning, which can be learned only by the experimenter himself after he has once

learned the correct adjustment by the howling-and-click method described above.

The best thing to do is for the amateur to put the L-1500 coil in his secondary, set his condenser at zero, then find the correct plate coil that will give the howl (if no plate coil will give it, the plate leads connecting the plate coil should be reversed), then find the correct coil for primary that will give the click at some point on condenser scale. Take note of every adjustment when the correct values are once found. Then set the condenser at 2 degrees and again take note, then to 4 degrees, and so on up to about 90 degrees, of the secondary condenser scale. When this is finished you have the correct values for every wave from about 6,000 meters to about 17,000 meters. Then you should put coil L-1000 in the secondary and repeat the operation with the secondary condenser from zero to about 32 or 34 degrees. Then you will have the correct data for tuning to every wave from about 4,000 meters to about 17,000 meters.

If it is found that there are some settings of the secondary condenser where it is impossible to obtain the click on the primary condenser, it indicates the capacity of the primary condenser is not large enough and a larger condenser should be used or two of them connected in parallel. I would, however, recommend one of the large Laboratory Type Condensers manufactured by Clapp-Eastham, of either .002 or .003 mfd., for the primary condenser. With a very small aerial a .001 mfd. condenser will do; with a medium aerial .002 mfd. is necessary; and with a large one, .003 mfd. is necessary.

However this trouble can be partly overcome, though signal strength will not be as good, by using a much larger coil in the primary circuit and putting the primary condenser in series. If this method has to be resorted to to obtain the clicks at certain settings of the secondary condenser, it should be the object of the experimenter to use as much condenser capacity as possible. That is, if you have to put in, say, L-1250 for a certain setting of the secondary condenser and you get the click with the series primary condenser say near 10 or 15 degrees, you should put in Coil L-1000 (a smaller coil) and see if you can't get the click with the condenser at a higher capacity.

I have often been asked if with a small aerial the European stations can be copied, and in this connection will say that with the honeycomb coils tuned as outlined above there is absolutely no excuse for anyone with even the smallest aerial (and a good ground) not being able to hear all of the high-power stations of Europe and Hawaii. I have in my room a coil of in-

sulated copper wire one foot in diameter, 14 turns in the coil, about 40 feet of wire in all, and using this in place of the regular aerial all the high power stations including IDO, OUI, LCM, YN, NPM, etc., can be heard with the single VT. Signals are weak of course and it takes careful tuning to get them, but the mere fact that they come at all should be sufficient to put the ban on all fear that your aerial

ANOTHER CHART

of the L-1000 coil as a secondary up to 6,000 meters, which is the lowest wave of the L-1500 coil. This curve shows where to tune for the stations between 4000 and 6000 meters. It is also capable of tuning up to 15,000 meters, but at reduced signal strength, and coil L-1500 is recommended for waves above 6000 meters.

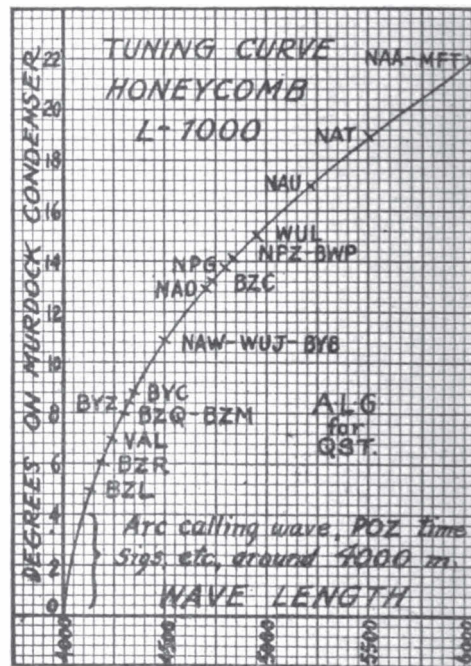

is too small. Even with no aerial at all, just tuning the primary coil to the desired station, all of the above stations have been actually copied on a single VT.

If the experimenter is in doubt as to the meaning of the howls and clicks referred to, he should put coil L-150 in the secondary, set his secondary condenser about 5 or 6 degrees, put coil L-100 in (Concluded on page 36)



In Introspect

SEPTEMBER is come. Again will the evenings begin to lengthen and the first cool breaths from the Northland warn us of what is on its way. Again will old snarling Father Static give signs of growing weary of his noisy job. Again will young men's fancy lightly turn to thoughts of something better in equipment. We welcome you, beautiful golden Autumn. You mark the opening of another new chapter in amateur radio and in this new chapter we confidently look to see the greatest accomplishments that have yet been recorded. It were well to draw apart for a moment, as we amateurs foregather here in the pages of our QST, and ponder our present and our future.

We as a body are at the high tide of our success. Through efficient organization we have built up the institution AMATEUR RADIO, until it has come to be recognized officially by our government. No less a personage than the Secretary of Commerce, one of the President's cabinet, has appointed our nominee as a member of a national committee to recommend a new radio law to meet modern conditions. We named our brother, Mr. Charles H. Stewart, of St. David's Pa., and Mr. Stewart has represented us in the conferences with all the other radio interests of the country in drawing up the terms of the proposed new law of which we shall hear presently. Who would have imagined such a thing possible a few years back!

As this number of QST is being mailed, our President and our Secretary journey to Chicago to attend a three day convention of the amateurs of the Eighth and the Ninth Districts. Never before have organized amateurs felt it possible to undertake a project of this magnitude. Philadelphia indicated what might be done last spring by getting together in convention the amateurs of the great Third District, the largest in the country. Boston paved the way for this sort of thing the previous winter by holding the first big amateur

conference in Cambridge, when the amateurs from all over New England foregathered and enjoyed the privilege of meeting each other face to face and discussing their problems. Our President has already visited our brothers on the coast of the distant Pacific. This is all part of the preliminaries to a great national convention of amateurs that is coming some day. Maybe it will come this present season, for things have a way of happening quickly with us.

Technically, our stations have improved in ability beyond anything that the most optimistic of us would have imagined possible a short time ago. All during the past summer it has been an ordinary thing to hear Pittsburgh, Washington, Chicago, New York and Hartford working each other, not to speak of many other equally distant points. And all of this has been done on wave lengths below 250 meters. Continuous wave transmission, both straight and modulated by buzzer, is in nightly use, and it is a rare evening that the human voice and the strains of music do not come in over the air. Messages by the thousands are dispatched every night, and reliable communication over long distances by the ordinary citizen without the assistance of any public equipment or organization is an accomplished fact. This is CITIZEN RADIO as some of us dreamed it years ago. We call it "amateur" radio, but it is more than that. It really is the first instance of an independent, countrywide, citizen-owned-and-operated utility. Fellows, honestly, it is going some.

Before the year rolls around we expect to see tremendous improvement in reliability, in distance covered, and in the breadth of our field. We shall see transcontinental messages as common as inter-district messages now are, we shall hear the voice used up to a thousand miles, and we shall see five radio stations where now stands one. It's a great game we are in, fellows. Let's stick and watch ourselves grow.

East Meets West

FOR the first time since we have been organized, one of our officers has visited the West Coast, and sat down face to face with the fellows of the Sixth District. Mr. Maxim attended the Democratic National Convention at San Francisco and accepted the opportunity to drop in at a meeting of the San Francisco Radio Club. It has been one of our pet hopes to meet the Pacific amateurs and that we could not present upon this interesting occasion fills us with regret. For the first time in our history the Atlantic sat down at the same table with the Pacific and each was able to see the kind of man the other was. For years we have read of each other but had never seen what the other fellow looked and acted like. We understand Mr. Maxim listened in at Brother McGown's station. We envy him the privilege of hearing a "six" call. It and the seven have never entered these ears of ours thus far.

It is evident that our Pacific brothers are possessed of that vigor which goes with things of the West. They not only seem to have radio club meetings all the year around, but they have large and commodious quarters, in which to meet. At the San Francisco Radio Club, where Mr. Maxim made an address, it might be well for the rest of the country to know that they have in addition to a large general meeting room, an operating room and a Board of Directors' room. We understand that dues are levied and collected which provide enough funds to pay rent and do things properly. This strikes us as something which clubs in the rest of the country should note. In the east, it seems to be taken for granted that a radio club is a little boy proposition and that it cannot afford to charge but a few cents a month for dues, or else no one would attend. This hampers everything, and is a little way of looking at things. Our western brothers take the ground that unless it is worth doing in a big way, it is not worth doing at all. There is something to think about in this.

From reports received from the coast since our President's visit, we gather that much good was done by the get-together. For the first time it was possible for some one who really knows the facts from the beginning to the end to tell the story of our A.R.R.L. It is a good story, and the absolute honesty and sincerity upon which our organization is built is very inspiring and promises long life. Others can talk about being "for, of and by the amateur" but after all, we ourselves are these amateurs and we are for, of and by OURSELVES. We do not have to have some one else act for us. We are fortunate in

being organized sufficiently to act for ourselves.

This visit to the Pacific by Mr. Maxim fairly well covers the country since Mr. Smith our traffic manager has already visited the south, southwest and middle west. Thus the bonds of fraternal organization are being gradually cemented more and more firmly together. It is a good thing, because some day we amateurs are going to need each other. "In union there is strength", and we welcome everything that makes toward building up a solid front to present when efforts are made to curtail our activity.

Don't Forget Our Advertisers

THIS issue of QST, in addition to marking the increase in activity incident to the nearing of Fall, makes a new high-water mark for our volume of advertising.

Of course we have to use high power to get it, but QST is QSA-very with our advertisers, and for a very splendid reason; in nearly every case QST is producing better results for them in actual business than the other places they can spend their good money. The credit for that belongs to you fellows, and we here are sincerely grateful for your help. It shows what a little co-operation will do. By buying from those manufacturers and dealers who by their support make QST possible, and never failing to mention ol' QST, we have built it up to its present status. The limit is nowhere in sight. It pays, men! Every month some new companies present their offerings to the A.R.R.L., and the reputation of QST as a result getter is fast spreading.

Help us here to keep QST the biggest and best practical amateur magazine in the world. To do your part, buy from QST's advertisers and tell them to credit it to our QST. We're getting there!

Counterpoises

WHY don't more of us use counterpoises, we wonder?

The few amateur stations we know who are using them are getting good results, and it appeals to us as one of the things we may take into consideration in our efforts to get our stations in tip-top shape for the winter's work.

Zenneck differentiates between three kinds of soil: permanently moist ground of good conductivity; poor ground but with underlying water at no great depth; and ground of very poor conductivity without water under it at any reachable depth. In the first case a good conductive ground is easily obtained, and furthermore a counterpoise would be undesirable because

of the losses in the ground by absorption. In the second case a counterpoise will be better than a ground unless a good contact with the wet strata can be secured and the same lie close to the surface. In the third case the counterpoise is the only feasible method for satisfactory work.

Between the antenna and ground, lines of force are set up, passing without loss thru the air but setting up currents when they flow thru a conductor, and so it is essential to see that the path provided for them thru the soil to the lower end of the ground-lead be of minimum resistance, to keep these ground current losses as low as possible.

Now in the case of good moist ground, there is no place for a counterpoise. We purposely bury it to save the losses of absorption—so that the currents are not induced in the ground but are actually part of the oscillating antenna current. But if we are not sure that we are getting a real good contact with an area of low resistance underlying our entire antenna, then a counterpoise will improve our operation. In the case of soil of very poor conductivity, the action of the counterpoise is to give us the old familiar "oscillator with an insulated conductor of great capacity at one end"—an arrangement having a very favorable current distribution and making excellent work possible where without it most of the energy would be dissipated in ground losses.

A little thought will show that in any case except that of soil of very good conductivity, the presence of a wire network under the antenna to conduct the currents to the ground connection will save all these losses. It is essential, however, that the network be really insulated from the ground, for if this is not done, the current will then flow to the ground under very unfavorable conditions due to crowding many lines of force into a narrow path, and the loss of energy will be relatively large.

Really, we very much doubt if any amateur ground layouts, except those whose industrious owners have buried a complex network of conductors in moist earth under their aerials, have anywhere near a good enough ground, and to these men the counterpoise offers a big increase in results.

The Bureau of Standards

ONE of the things we found out when we got into contact with the Bureau of Standards at Washington was that politics had cut the appropriation which runs the Bureau to less than one-half what was necessary to keep the establishment going on the same plane it has been running for

some years past. Most people do not know this. If they did there would be a howl, because the Bureau of Standards is the hub of our scientific wheel in this country. We are a nation of money makers, and as a general rule we do not go into research work very much unless it is dead sure to earn a dividend. When there are a lot of things about which we ought to have the facts, we have to wait until somebody in Europe finds out what we want to know and is kind enough to tell us, or we have to go to our own Bureau of Standards. Cut down the latter to where it can no longer function properly, and we are right back again where we were some years ago, before we had the Bureau.

It is a poor piece of business, it strikes us, this trying to make a political showing of economy by cutting down to less than one-half a government department which is doing for the people at large what the Bureau of Standards is doing. From establishing proper standards of purity in food all the way to establishing and verifying radio transmission formulae, the Bureau is helping every one of us. The work it has done in radio alone is an indication of what it is doing in every other field of human activity. Among the different things they are working on now are: comparison of various types of antennas, methods of measuring received radio current and signal intensity, properties of electron tubes, definition and measurement of electron tube detector co-efficients, design and construction of electron tube amplifiers, modulation of electric currents with applications to radio telephony, improvements in power tube circuit design, properties of insulating materials of the laminated Phenol-Methylene type, and study of radio wave phenomena by measurement of variations of wave intensity and direction, which is our A. R. R. L. and Bureau of Standards Fading Test. This is only a very small part of the work being done in radio. In almost every case, a pamphlet is printed giving all of the information collected and on the average pamphlets are obtainable by any American citizen from the Superintendent of Public Documents, Washington, D. C., for the munificent sum of one dime.

This is one of the places where we radio people can show our influence in attempting to cure a great wrong. We are interested in what the Bureau of Standards' radio department is doing, and we can not only help that department, but all of the other departments of this fine establishment by talking this thing around and getting as many people as possible to definitely write to their congressmen and senators and urge that at the first opportunity the Bureau of Standards appropriation be put back where it was.

THE OPERATING DEPARTMENT

J. O. SMITH
Rockville Centre, L. I.
TRAFFIC MANAGER.



IT has been the writer's great desire, for a long time, to see the traffic lines of the League perfected into a dependable, year-round means of communication, which like the great railroad systems of the country could be depended upon, regardless of weather or season. This condition has at last been realized, for during the summer just gone relay work went on as usual, as though the months had been January and February, instead of July and August where the peak of the QRN curve is reached. As an instance, on the nights of August 4 and 5 relay work was being done between stations of the First and Second Districts, between the First and Third, Second and Eighth, Third and Eighth, and possibly between others that the writer is unaware of. The amount of work as a whole which has been done this past summer has definitely established the fact that amateur relay work can be successfully carried on during the entire year—that there is no longer any such word as "season", so far as amateur radio is concerned. The word "season", in connection with amateur radio, is now only of historic value. It is a term once used in an age that is gone for good.

The QSS tests of the League have been carried on very successfully, the entire membership of the traffic department having taken an active interest in the efforts the League is making to solve the question of fading. Aside from being interesting work, all those who took part can feel that they have helped solve one of the greatest radio problems known, and the work they have done may prove of the greatest value. It must not be overlooked that aside from the tests made by the League for the Bureau of Standards, this is the first attempt ever made to collect definite data on this important question, and, certainly, the tests made are the most comprehensive and the best organized effort ever made by any radio organization to obtain definite data on abnormal and fading signal strength.

The C. W. -izing of amateur radio is progressing rapidly. From the number of inquiries received by the writer in connection with C.W. transmission, it would seem that the entire male population of the con-

tinents of North America, also a few, even, of the Superior Sex, are going to install C.W. sets very soon. The greatest drawback so far in C.W. work has been the inability to secure power tubes. The writer was recently assured by an official of one of the large radio manufacturing companies that probably by October there would be an abundant supply of power tubes available of 5, 50, 100, and 250 watts capacity, at prices within reason. Throughout the summer, when QRN was at its height, C.W. transmission and reception was easily carried on when spark sets were absolutely useless. There is, everything considered, nothing remarkable about the fact that amateur radio is turning rapidly to C.W. transmission when its many advantages over spark transmission are considered.

The reports of Division Managers, telling in detail how relay work was carried on during the summer in the various divisions, follow:

ATLANTIC DIVISION C. A. Service, Manager

The QSS tests now in progress in the ARRL Divisions may bring forth much interesting data due to their widespread character.

It is rumored the new call books will be issued some time in August or September by the Department of Commerce; we can all appreciate what a help this will be to amateurs.

Conditions in the southern section of the Atlantic Division at present are almost at a standstill, due to several causes; namely, absence of station owners on vacations, unusually warm weather, and heavy static interference. In addition to these conditions the recent removal to Norfolk of Mr. Malcolm Ferris, and his consequent resignation as District Superintendent for Eastern Pennsylvania, has temporarily left the Eastern end of Pennsylvania without a Superintendent in charge.

Mr. R. C. Devinney, Superintendent of Western Pennsylvania District, reports that traffic is light at present, though weather conditions allow work to be done in that section several nights each week. He reports that the Radio Engineering

Society of Pittsburg held their Annual Outing on the 18th of July, which was a great success and at which a number of radio men from out-of-town were in attendance; also that there were some very fine radio sets exhibited including a radio-phone set belonging to 8DR, using a motor generator set for power, operating from storage battery on an automobile. Mr. DeVinney mentions the fact that Mr. Burton P. Williams, 8EN, is absent on his honeymoon.

The report of Traffic Assistant Herbert M. Walleze, of Milton, Pa., who is acting District Superintendent of the Central Pennsylvania District in the absence of the Superintendent W. A. Cawley, states that no new stations have come to his attention that would be of service in promoting the relay work. He states that the station being erected at Danville, Pa., by Mr. Swayze will soon be in operation (Call 3ABD) and it is hoped that this station will be of assistance in handling traffic on Trunk Line B during the coming season.

Mr. E. B. Duvall, District Superintendent for Eastern Maryland, reports that station 3AN at Baltimore is out of commission due to his antenna having come down in a recent storm, and that he is now engaged in re-erecting same, and in overhauling his station for Fall work, and that Donald Primrose (3AA) has shut down his spark set, and is trying to get a C.W. set into operation, and also that 3HG is closed down during owner's absence for the summer. Mr. Duvall states that at a recent meeting of the Radio Section of the Maryland Academy of Science it was decided to hold a lawn fete in order to raise funds for the purchase of a complete station and laboratory for the Academy. He has been making frequent visits to Washington with a view to strengthening co-operation between the Baltimore and Washington stations, and has furnished considerable information of value regarding Washington amateurs available for appointment as District Superintendent in that territory.

The station of the Assistant Division Manager—3ZS—is at present out of commission, due to necessary repairs to transmitter, but it is hoped that after these repairs are completed the operation of the set will be more efficient than was the case during the past Winter. It is expected that the station will be in commission by the middle of August at the latest.

It is very important that there should be an appointment made of a District Superintendent for Eastern Pennsylvania in the very near future, and is a matter which is receiving the thoughtful consideration of the Assistant Division Manager, and any suggestions along this line or information concerning available candidates will be gratefully received.

NEW ENGLAND DIVISION Guy R. Entwistle, Manager

Have you got your pin yet?

The greatest local radio activity in the New England Division this month seems to be centered around Lynn and Salem, Mass., where F. Clifford Estey, President of the Essex County Radio Association, has called several meetings of the various chapters of the larger association for the purpose of organizing the radio men of Essex County. Law and Order is the motto of this enthusiastic club. At an executive meeting held recently the following well known radio men were elected as honorary members: Rear Admiral S. S. Robison, U. S. N., Lieut. Commander J. B. Will, U. S. N., and H. C. Gawler, U. S. Radio Inspector for the First District.

A campaign has been started against disorderly operators who operate unlicensed stations, or cause willful QRM with licensed stations and those who use profane language over the air.

Three classes of members are provided for: Honorary members, who must be men of recognized ability and have rendered a service to the radio field; members, who must have an active interest in wireless and operate stations; associate members, who may be any person with an interest in wireless or electricity whether or not they have a station. This class of membership will allow anybody with the proper interest to attend the meetings and reap the benefits of talks and discussions.

Pulley reports traffic conditions as being in good shape for this time of the year, 1CK, 1DQ, 1DY, 1DR, have been handling traffic to the Second District. 1HAA is back on the job, but does not come in so QSA. Worked 1FB, near Portland, but can't seem to raise 8th, 9th, or 3rd district men who are heard up here. Most of the traffic to New York goes through 2JU, 2OA, 2BK, 2TF. 1ES is beginning to do some work with 1HAA. We are hearing Rawson's old Telefunken 500 cycle set now in use at 9ZN, Chicago. 1AR and 1DH have C.W. sets now. Lloyd W. Green of Cambridge will open up with a C-W set soon.

1AE has been fooling around with his spark coil while waiting for a motor-generator for the C.W. set and worked 1HAA from Duxbury, some 20 miles. The Boston traffic is QRZ so haven't worked north due to the pocket that must exist.

Bates reports Old Man Staticus active in Worcester and that both QSR and QSS bad through his district lately. Hays worked 1FV, 1CM, 1TS, 1AW, 2JU, 2OA, 3HJ. Who in Boston and vicinity can work a daylight test? He reports having taken a message from Lynn via 1CN, 1TS, 1CM to 1GY, but that sure is a long distance message from home. (Better than

hanging it on the hook for a month, eh boys?) Worcester has bid for the New England A.R.R.L. convention of relay officials in September. Those wishing to attend, which means everybody who can possibly get there, can obtain the date and place of meeting from Lee A. Bates, 8 Moen Street, or the writer. Let's start off the season with a bang.

Castner writes from Portland of a continuation of the radio enthusiasm recently exhibited in his district. 1FB and 1FV can handle anything coming this way and 1UQ is about ready to be on continuously with 1KAY. Alexander, of the Bangor section, is at the B&A RR offices during the summer and will line up in that territory. 1BK recently had the decrement of his appendix measured and being over two-tenths had it removed. We wish him a speedy recovery.

3Z, of Farnham, Quebec, has left the key for a while, but will return in the early fall. Cummings, at Prouts Neck, is established for the summer and will be a valuable addition to our relay men. The present relay route is coming into Maine to 1FB, or 1FV to 1CAO, etc. L. E. Felker of Madison, Maine, an old timer, writes regarding a bewildering long wave station that sends press every noon on about 15,000 meters. Sends FFFFFFFF and stutters at the key in great style. Felker says no wonder a man misses his booze when he listens to a ham at the key of a commercial station. Can any one help him out?

Assistant Division Manager, 1TS, Donald Mix, Bristol, Conn., says activity around his section has slackened up a bit. Vacations and QRM are the apparent reason. 1FQ has not been on as much as usual, and our old stand by, 1AW, has even been heard less, as Mr. Maxim has been on the West coast listening to the 6th district stations. It will be interesting to compare the different conditions of QRM and QRN when Mr. Maxim returns.

Messages have been exchanged freely with 1BM, 1FW, 1QN, 1FAQ, 1FQ. 1GY continues to come QSA, but QSS here in Connecticut. Several Maine stations come in QSA also at 1TS, such as 1EK, 1KAY, 1LAX, 1FV, 1FB.

E. Standish Palmer, President of the Brown University Radio Club, writes of plans for the Fall at 1LAU. The university has a ½ KW rotary spark set and a two step amplifier. Providence has considerable QRM to overcome and some sort of a control station is being considered. Palmer suggests different hours for the different classes of communication and a visiting committee to go to the stations of the various amateurs who overstep and tune them up. This is a good idea. Help the young fellows out in every way possible. Make them feel as though we are

helping and not trying to dictate to them.

Division Manager Lorimer, St. Lawrence Division, writes from Montreal that there is poor outlook at present for western messages through Canada. Traffic officials please note, and divert through other channels until further notice.

Much delay in answering correspondence will be prevented if the various amateurs write direct to the relay officials in their district. The division manager would like to correspond with all personally but it is a physical impossibility.

The habit of calling on the Division Manager when in Boston is encouraged as he is always willing to drop things for a few minutes and discuss radio with the out-of-town relay men. Better make it after two P. M.

ROANOKE DIVISION W. T. Gravely, Manager

Since the last report summer static has arrived with all of its forces, and this, coupled with the extreme heat, has taken the keen edge off of all amateur operations somewhat, although many of the old guard may be heard pounding away any night. Nothing seems to stop them but I feel sure that the strong atmospherics will prove so troublesome that at least a few will turn their attentions to the question of static elimination, which may, eventually, lead to a solution of this problem.

Relaying is hard work in this division at present which is natural in a division where long jumps are necessary to get through, but the various stations may be heard every night, making efforts.

We are assured of one or two good stations in Richmond before fall, which will prove of much assistance in handling traffic. Prospects in Southwest Virginia are encouraging, while conditions in West Virginia are looking up.

Since the last report, Mr. F. L. Bunker of the Westinghouse Electric & Manufacturing Co., Charlotte, N. C., has been appointed District Superintendent of Southern, Eastern and Western North Carolina, and the A.R.R.L. is to be congratulated on having him as one of its Superintendents. (8XK PLEASE NOTE). Mr. Bunker's call is 4CE, and all stations in his territory are requested to communicate with him in future.

No definite working lines will be announced in this Division until the organization is perfected, and the personnel thoroughly informed as to conditions in their respective fields.

It is hoped, however, that well laid plans will be developed very soon, at which time announcement will be made of the various stations which will operate over the lines.

Mr. Allan S. Clarke, Pine Street, Danville, Va., will assist the Manager during

the coming season in the capacity of Traffic Assistant, and all matters pertaining to Division Traffic will have his supervision. Lines will be worked out on a practical basis, not a theoretical one, and before this can be done, a great deal of development and test work is necessary.

All District Superintendents report little of interest this month, but they say they are busy, and that a larger and stronger organization may be expected before the fall months.

District Superintendent Heck in W. Va., hasn't been heard from in days, and we are all wondering if he is trying to reach Mars on the sly, or if the potato bugs keep him busy. Will some one tell us?

Judging from the activities of 3FG, 3EN and 3GO, we may expect something unusual from them during the coming months. They are hard workers. We may expect several C.W. stations in the Division before the winter season opens.

Will the stations in North Carolina and West Virginia please get in touch with their District Superintendents as early as possible, and let them know that they are ready and willing to assist.

Summing up conditions, as a whole, I am inclined to think we have a great deal to be proud of, and should feel very much encouraged in the progress made in developing year-round lines of dependable communication.

WEST GULF DIVISION Frank M. Corlett, Manager

Who wants to loan the Division Manager the price of a vacation??? If he had it he would be tempted to take one just to be in style. By the time this is in print those that have gone will no doubt be coming back and the rest will be going.

At the time of this report four of the A.R.R.L. QSS tests have been conducted in this division and about as many reports from observing stations have been received. With the exception of 5ZU, Tilley, of Austin, all the sending stations have been right on schedule. Unfortunately Mr. Tilley could not meet the schedule on account of working nights during the summer. Some very interesting curves are being obtained between 5AO, Houston, Texas and 5ZC, Dallas, Texas. These tests are something worth while; every amateur station in the country may take part and help to make it a real success for the A.R.R.L. If sufficient data is collected by the observing stations and forwarded no doubt in years to come when the cause, and probably the overcoming of the cause of fading signals has been accomplished, you may say with pride that you helped on the first nationwide tests ever conducted.

The District Superintendents are sticking it out and making every effort to get

things lined up as near as possible, for the big times we are bound to have this fall and winter. If they can't use the radio routes they are using the U.S.M. route. You fellows who are getting your stations ready for the relay work that is-to-be, don't forget to write your District Superintendent telling him what you have, so that you can be counted in on the various routes that are being planned.

District Superintendent Louis Falconi, 5ZA, of the New Mexico District writes that he has quit wasting good hot hours trying to catch the wee noise in with the LOUD crashes. Old Man QRN is working his station on a 24-hour schedule now. 5ZA also suggests that the QSS tests be conducted when a fellow can HEAR signals.

Raymond L. White, 5AP, District Superintendent of Northern Texas, is still enjoying his vacation and the association of Mr. W. H. Smith who is operator in charge of old 9ZF, the Colorado Wireless Association's station in Denver. Being away from his district, White, of course, is not in direct touch with traffic conditions; he expects to return to Texas the first of August and it is suggested that all station owners get in touch with him immediately so that their stations may be included on the various routes to be organized.

W. H. Tilley, 5ZU, District Superintendent of Southern Texas, makes a rather meager report on account of the scarcity of news. QRN is fierce. Four of the Austin, Texas, amateurs are at sea as operators. Several attempts have been made to hold the line open to Houston but little success as yet, although 5ZW at Houston, Texas, comes in real good in Austin at 7 A. M. 5ZU will be on watch every hour on the hour from 8 A. M. to 1 P. M. for a few minutes each time so if any A.R.R.L. traffic for Austin is on your "pins" there is your chance to move it. Appointments are in order for this district but nearly everyone is out of town so it is hard to get replies to letters or make any definite arrangements.

The division headquarters station, 5ZC, sends the U. S. Weather Bureau forecasts and Highway Weather Bulletins every evening 7 P. M. 375 meters, (Sundays excepted) and immediately following this schedule broadcasts A.R.R.L. items of interest to the stations throughout the division. All stations should QRX for this schedule.

MIDWEST DIVISION L. A. Benson, Manager

The writer is very glad to report that keen interest is being shown by all stations appointed on the QSS tests. Reports are continually coming in with few exceptions where it was impossible to transmit owing

to bad electrical storms sweeping through this section.

Stations are beginning to roll in as in midwinter and traffic is starting to move in all directions. Several messages were handled direct through 5YH, Camp Pike, Ark., 4BZ, 9EL and 9HT.

Mr. J. G. O'Rourke, District Superintendent Eastern Nebraska, reports that he can freely state that his district is waking up. Not much traffic has been handled in the past month, but the interest taken by a majority of the station owners of his district in the establishment of permanent traffic routes has far exceeded his expectations. To date, two traffic routes through this section have been proposed as follows; No. 1, East and West, through southern section of district: Omaha—Wahoo, thirty miles; Wahoo—David City twenty-two miles; David City—Stromberg, twenty-four miles; Stromberg—Central City, eighteen miles.

STATIONS: Omaha:—9SC, 9HT, 9VE, Wahoo:—Wahoo Radio Club; David City, 9AEU; Stromberg, 9AFX; Central City. ??.

No. 2—North and South, through eastern section of district: Plattsmouth—Omaha, nineteen miles; Omaha—Blair, twenty miles; Blair—Oakland, twenty-two miles; Oakland—Wayne, thirty-five miles; Wayne—Niobrara, fifty miles.

STATIONS: Plattsmouth, Mr. Parmele, Omaha 9SC, 9HT, 9VE., Blair, 9AJS, Oakland, Mr. Johnson; Wayne, Wayne High School; Niobrara, ???.

Route No. 1 to connect with east and west route through southern part of Iowa.

Mr. J. A. Wanek, District Superintendent, Western Nebraska, reports an excellent station being erected at Hyattsville, Wyoming, by Dr. L. G. Van Slyke. It is admirably located and a good connecting link between the Midwest Division and the west coast.

Mr. Wanek states that he has been very busy gathering in the crops but never fails to be on the job after sundown. He is working hard to wake up some of the dead ones in his district and expects to have them on traffic routes before another moon.

Mr. H. L. Owens, District Superintendent, Eastern Kansas, is overhauling and replacing with new apparatus his entire outfit and will have things in fine condition when the heavy traffic starts. Mr. Owens refuses to be lost in the shuffle. Mr. Shultise, 9NX of Wichita, has sold his spark set and is going to install CW modulated for the coming season. He is tired of repeating messages so often and is working for that knife edge wave to break through QRM. 9AEG of Eldorado, and 9BW of Wichita, will be very good relay stations this coming season.

On Friday, July 23, 9EL reports hearing two phones, one was reading base ball news to some other station and the second station

was acting as relay for the two. Both phones were very QSA. He would like to know who were the operators of these respective stations.

Mr. G. S. Turner, District Superintendent, Western Missouri, is spending his vacation in Chicago. He is unable to make a report this month, but promises to make up for it in his August report, which he says will be a peach.

Mr. Stover, District Superintendent, Iowa, is working hard in his district and reports several good stations being erected that can be used to great advantage in his traffic routes.

The Division Manager requests all stations in Missouri, Iowa, Kansas and Nebraska to get into communication with him at once, so that relay routes can be laid out, doing away with long jumps and giving all stations a chance to prove their ability as relay stations.

NORTHWESTERN DIVISION

John Hertz, Manager

Royal Mumford, Acting Manager

The present wonder of modern times is that QRN is not in undisputed supremacy of the air. Thanks to many relayers whose ardor is undamped by poor conditions, the air has not been conquered by static, but is largely in control of the radio amateurs. We are more than proud of the fact that the usual solitary reign of QRN, instead of being in the height of its glory, is overshadowed by the unrelenting determination of the 2000 meter enthusiasts.

We find conditions so unfavorable that, at times, we cannot overcome them, but at other times the QRN slackens up a bit and conditions more nearly like mid-winter prevail for a short period. Then we break through to those on the other end of the line who have been waiting as patiently as we, and although we lack the number of stations needed for short jump relay routes, we put the business through just the same.

Most of the business south during the past month has gone via 1CR, 7CW, and 7CU. Any one of these stations works Ukiah, Calif., with ease most of the time. These stations have recently handled A.R.R.L. traffic direct with Sacramento, stations near San Francisco, and as far south as San Jose, a distance of nearly 600 miles, through static that all but made the work impossible.

In Seattle, 7BK, 7AD, and 7AN, and in Tacoma, 7BC, and 7CE, all handle messages to stations in Portland and Silverton, Ore., and 7BK has lately covered the jump to California direct. In Lacey, Wash., we have 7YS back on the job after his summer vacation and he is always dependable.

In Portland we have a number of good relayers, 7CR, 7BP, 7DS, 7DG, and 7BR,

relayers, 7CR, 7BP, 7DS, 7DG and 7BR, who can be depended on to handle traffic for Seattle. Both 7CR and 7BP work California stations direct in spite of poor radio weather.

Jack Woodworth, 7CC, District Superintendent, Moscow, Idaho, reports that very little relay work is being handled in his district because of the heavy QRN. In Moscow we have 7AL and 7CC who have done good distance work. Two new stations in Pullman, Wash., 7BQ and 7FI, have been picked up by receiving sets as far south as the sixth district. These stations can handle business to Pullman State College, of that city. He also says that many new stations are in course of construction which shows the general tendency toward increased activity in radio work with the coming of better conditions.

Currie N. Teed, 7FT, District Superintendent, Kuna, Idaho, reports that very little activity has been shown by amateurs in southern Idaho during the last month, as he has heard only two stations, 7HJ and 7GY, both of Boise, Idaho. He has been hearing radiophone conversation lately, probably from the Government forestry service sets. The speech is clear and strong; the buzzer modulation is painfully loud. No amplification other than regenerative was used.

Olfan DeGuire, 7CW, District Superintendent, Silverton, Oregon, reports that most of the amateurs of southern Oregon are doing only local work. He reports two promising relay stations, one of Mt. Angel College, at St. Benedict, Ore., the other at Silverton being put up by Alfred Adams. Both these stations are one K.W. The Mt. Angel College station has already made tests with 7YS with favorable reports.

At Astoria, Ore., we are promised a station which is being put up by Percy Dann, a pre-war DX from Portland.

Old 6KL, William Wood, now 5BR of Vancouver, B. C., reports that Canadian regulations are somewhat more stringent than those of the U. S. He is transmitting with $\frac{1}{2}$ K.W. on 100 meters and hopes to connect up with some of the "sevens" that are QSA with him.

Mr. Redeker, 7YA, 1213 N. 17 St., Boise, Idaho, has been appointed City Manager. He uses a 2 K.W. transmitter and has been heard in Phoenix, Arizona.

Mr. Teed reports that he has discovered the origin of the radiophone conversation which he mentioned. It is the Wm. Wrigley station Avalon, Catalina Island, Calif.

The fading tests have stimulated summer work to a remarkable extent. Through these tests many amateurs find that the only reason they have not been hearing many long distance stations was just because they were not on the job to take advantage of the times when the old bug-a-

boo-QRN slowed down a bit.

ONTARIO DIVISION A. H. K. Russell, Manager

The summer holidays have hit this division very hard this year and there is practically no radio work going on, with the exception of a bit of testing with C.W. sets.

The Manager had the pleasure of attending the inaugural meeting of the new radio club at Brantford, and while there arranged with Mr. W. K. Mitchell, the Secretary of the new club, to act as District Superintendent for Southern Ontario, and to try and link up with Toronto and Windsor as soon as things get going again in the fall. All the amateurs in Brantford, the "Telephone City", as it is called, are full of enthusiasm, and should give a good account of themselves in relay work in the fall.

As they used to say in the late war: from the rest of the front there is nothing to report.

OUR LESS EXPERIENCED BROTHERS (Continued from page 20)

to do this is to join a club or our national organization direct, receive his QST regularly, and keep in touch. Some day he will be an important point.

Another matter which should be dwelt upon in a discussion such as this, is the subject of taking out government licenses. The rule that is applied is that a provisional license with official call letters is granted an amateur by merely applying for it, provided he is more than forty miles from the point where there is a government radio inspector. It thus is a simple matter for any one to secure official call letters, own a government provisional license, and be identified in the radio world. His name and address is in the record and he at once secures all of the advantages which come from this fact. Moreover, it gives the government data of great value in time of public peril. It should be the aim of every amateur to install some form of transmitter, however small, so as to secure the advantages and prestige which go with an official call, and help on Amateur Radio by lending his weight to the active field.

All of the above can be seen to point directly at the necessity for organization, in all that the term implies. The time will come when we amateurs will all be so intimately in contact with each other through our appreciation of the value of efficient organization that it will be the practice of police departments to ask our aid in broadcasting such things as automobile thefts. What could be more rapid

(Concluded on page 39.)



8XK, PITTSBURGH, PA.

8XK, owned by Mr. Frank Conrad, of Pittsburgh, is one of the star A.R.R.L. stations of this summer's season and will unquestionably continue among the top-notchers this winter. The signals of 8XK during the QSS tests have been received in New England with terrific intensity, and, taken all around, its whole performance is a splendid argument in favor of C.W. transmitters. That being our favorite topic this season, it is with the greatest pleasure that we present the following description of Mr. Conrad's station, feeling that A.R.R.L. men who want constructional hints for building a C.W. set capable of long distance relay work will find a world of aid therein.—Editor.

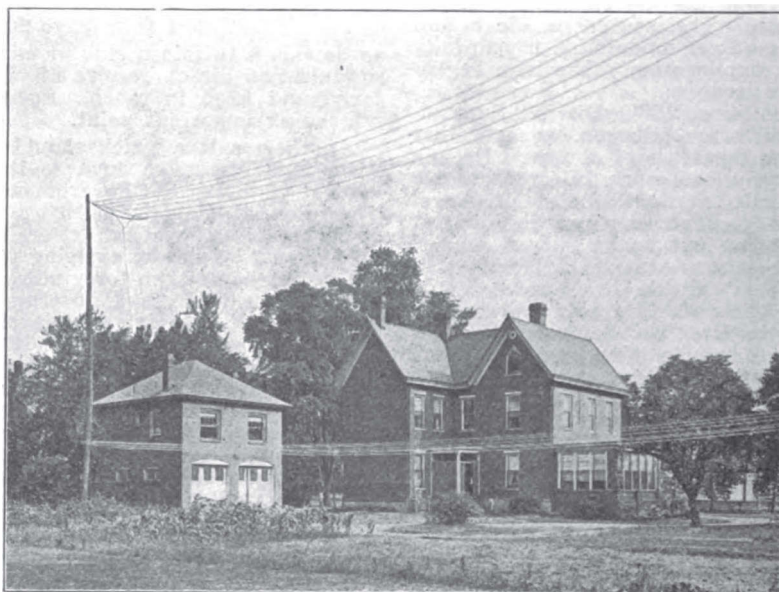

AS its call indicates, this station is primarily devoted to experimental work in connection with radio transmission and reception. The various sets are simply assembled on the table from the available stock of parts, such as condensers, inductances, etc. The antenna consists of an inverted "L", used in conjunction with a counterpoise in place of a ground. The flat-top of the antenna consists of six wires, two feet apart,

one hundred and five feet long, and fifty feet high. The counterpoise is a duplicate of the antenna, except suspended at a height of twelve (12) feet. This arrangement gives a very high ratio of radiation resistance to losses, and also permits of operation at short wave lengths without the use of a series condenser. The resistance at 250 meters is 8 ohms.

The transmitting apparatus, as shown in the illustration on our cover, comprises

a radio telephone set, a spark set, and an I.C.W. set.

The telephone set, at the right of the photograph, uses two 50 watt power tubes, the plate circuit of which is supplied by a 1000 volt D.C. generator, a 5 watt tube being used to amplify the audio-frequency

of the usual D.C. generator. The set comprises two vacuum tubes, operating in parallel, and direct coupled to the antenna inductance, the connections being as shown in diagram, Fig. 1. A condenser of .006 M.F. capacity is interposed in the plate connection to prevent short circuiting of the

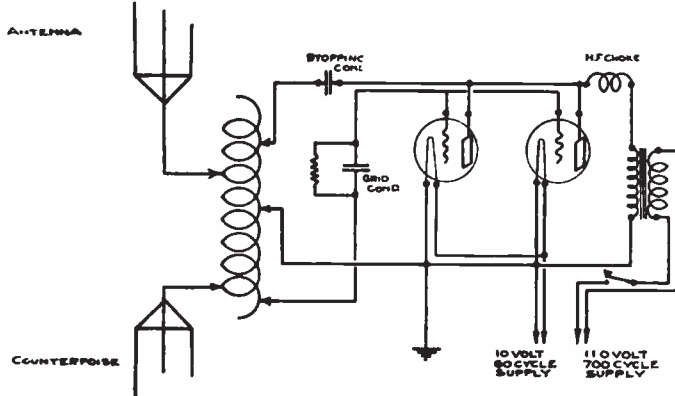

Fig. 1.

current delivered by the telephone transmitter. This set gives an antenna current of 3 1/2 amperes, when connected for telephone operation,—one of the tubes operating as oscillator and one as modulator. When connected for CW transmission, both tubes operating as oscillators, the antenna current is 5 amperes.

The spark set, in the center of the photograph, consists of the usual arrangement of power transformer, condenser, rotary spark gap, and oscillation transformer. The power transformer steps the supply voltage up to 7300 volts and is 1 K.W. capacity. The comparatively low secondary voltage is made possible by adjusting the transformer and condenser circuit to resonance at the spark frequency. The condenser is a Dubilier Mica of .01 M.F. capacity. The spark gap has eighteen stationary contacts and a rotating arm which runs at 3600 R.P.M., thus giving approximately one thousand (1000) sparks per second. As now adjusted for 250 meters, the set gives an antenna current of 7 1/2 amperes with a decrement of about .05, the power input to transformer being about 960 watts.

The I.C.W. set, shown at the left of the photograph, is the one which was used as transmitter for the Bureau of Standards—A.R.R.L. Fading Tests, during the months of June and July. This is a vacuum tube set, in which modulation of antenna current is obtained by supplying the plate circuit from a 700 cycle generator, in place

700 cycle power supply through antenna inductance, and a condenser of .0005 M.F. capacity, shunted by a 7000 ohm resistance, is used in the grid connection to give the necessary negative grid voltage. The tubes are similar to the standard Navy type 50 watt size, except that the plate connection is brought out at the end of the tube opposite the base, in order to provide adequate insulation for the plate voltage used, which is 3000 volts effective, it being supplied by the step-up transformer shown.

This type of tube is usually operated from a 1000 volt direct current supply, but by increasing the voltage as above, it is possible to so increase their efficiency as to about double their output without any reduction of life. A ground connection is shown tapped to the antenna inductance. This tap is made to a mid-potential point, between antenna and counterpoise, and no

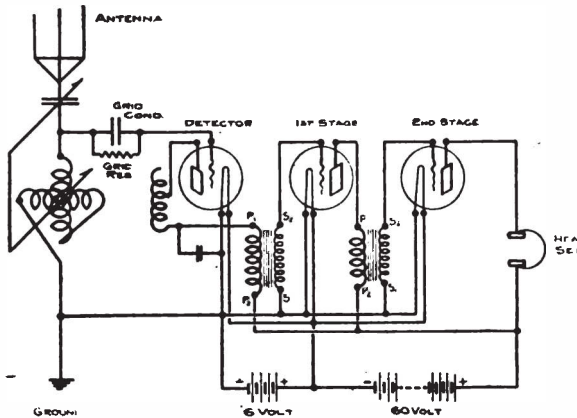
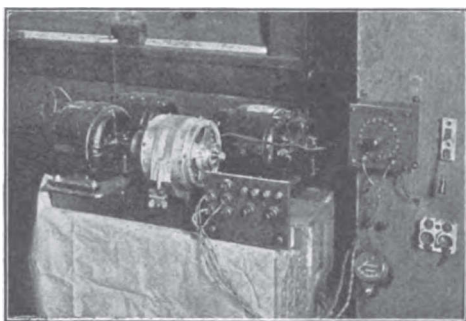

Fig. 2.

current flows through this connection. It insures that there is no radio frequency voltage between filament supply and other low voltage parts of set and ground, thus eliminating any losses from this source. This connection is not necessarily the middle of the inductance coil, as the lead-in from antenna and counterpoise form part of the total inductance, and the tap is made to the middle point of the total inductance,

which, owing to the much longer lead-in from antenna than from counterpoise, brings this tap very near the antenna end of inductance.



The 700 cycle generator, which supplies the plate circuit, is rated at 300 watts, and is driven by a $\frac{1}{2}$ H.P. induction motor. A single layer inductance is included in the secondary circuit of the step-up transformer, in order to prevent the high frequency current being by-passed through the distributed capacity of the transformer windings. This inductance and the leakage inductance of the step-up transformer, are, in connection with the .006 M.F. plate circuit coupling condenser, adjusted to 700 cycle resonance. It, of course, would be

possible to operate the plate circuit from the 60 cycle supply, in which case, however, the received note would be 120 cycles and would be of very low audibility, unless beat reception was used.

The power for filament supply is taken from the 60 cycle power circuit through a step-down transformer, which delivers 10 volts to filament terminals.

As adjusted to 250 meters for the Bureau of Standards—A.R.R.L. Fading Tests, this set delivers to the antenna a current of $6\frac{1}{2}$ amperes, with an output from the 700 cycle generator of 450 watts.

The receiving equipment is mounted on a table, which is normally in front of the transmitter, but which was removed before photographing, in order to show the transmitting apparatus. As in the case of the transmitter, it consists of a table assembly of parts to make up the particular scheme desired. The equipment generally used for ordinary short wave reception consists of a single circuit receiving tuner, used in connection with a detector and a two-stage amplifier. The scheme of this set is shown in diagram, Fig. 2. Having but one tuned circuit, the operation of finding a station of unknown wave length is reduced to the minimum, while the selectivity and response to weak signals is fully equal to that obtained by the more complicated circuits in general use.

2NW, NEW YORK CITY

Here is a very efficient station which has been installed by Mr. Ralph Brooke Austrian for the Harris Suspender Company of 694 Broadway, New York City. The company furnishes buyers who come to its showrooms with the latest news, time signals, etc., as well as accepting messages from them for transmission to their families via the A.R.R.L. The station is one of the few in the New York district which is open for business during the day. Operating hours are 12:00 noon to 1:00 P. M.—4:30 to 5:30 P. M. At present the station is closed evenings but will be ready for all night work this fall.

The antenna is of the fan type consisting of nine wires of stranded phosphor-bronze insulated cable, supported by two towers on the roof of the building, the lead being carried down one flight to the top floor, where the operating room is located. The ground connection is made to the frame work of the building which is all steel and furnishes a good ground.

The transmitter consists of a 1K.W. Type T. Thordarson Transformer, Murdock moulded condenser 5 sections, Benwood rotary gap in an extra muffling drum, Clapp-

Eastham Radio Coupler, and a new 1 K.W. Rotary Converter. The one shown in the photo is no longer in use. The converter is started and stopped by an Industrial Controller Company's automatic remote-control starting box, push button type. The volt and ammeters shown are A.C. instruments and show power input. The normal voltage is 150 and the amperage from 3 to 10. With this set six amperes have been put in the aerial at a wave length of 205 metres with decrement of .2. The small light shown in front of the muffling drum containing the gap, lights when the secondary circuit is "live." The receiving units are separate sets entirely. One is Grebe's CR6 and the other his CR7. They are equipped with the automatic plug and jack control so the two step amplifier which is built into the CR6 set may be used in connection with the CR7. The CR6 is used for all relay work and also most of the 600 metre commercial copying. Amateur stations have been copied from all parts of the country. The CR7 has done exceptionally good work and signals from all of the European stations have been copied, as well as the Pacific-Coast and Far East sta-

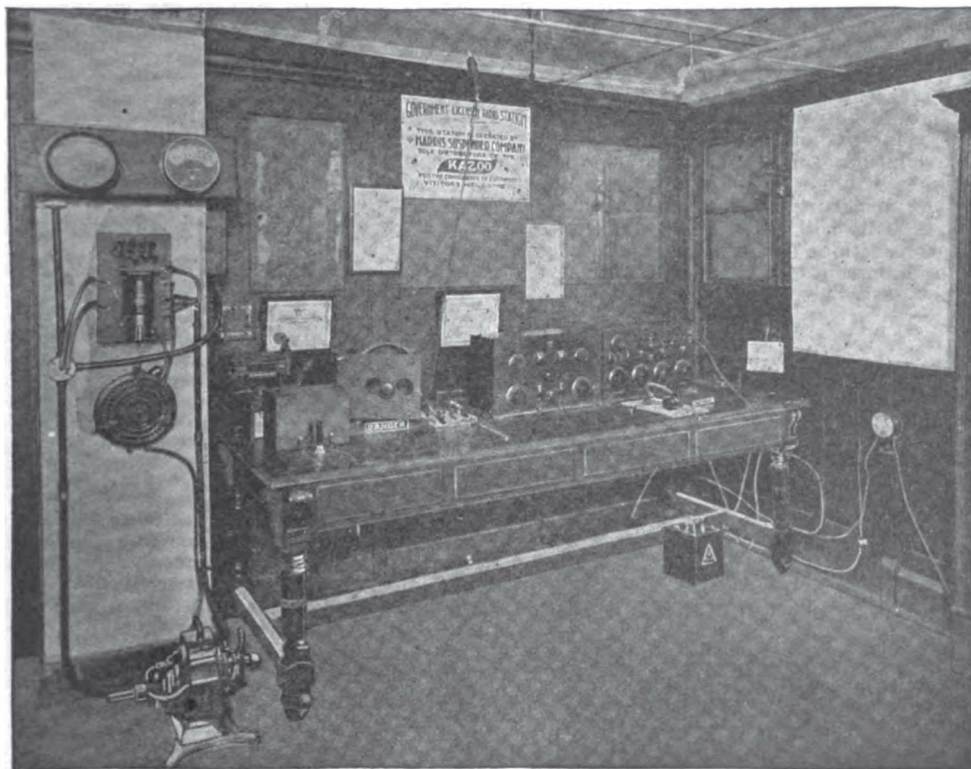

tions. Marconi bulbs are being used as detectors and amplifiers. A Magnavox loud speaker has also been added and with its use it is possible to copy some of the European stations, including POZ, with ease

from the next room.

Visitors are always welcome and are requested to drop in and make the station their headquarters when in this city.

A Few Ideas for Amateur C.W.

(Concluded from page 9.)

Heating Filaments From D. C.

The larger power tubes require a filament current which is a severe drain on a storage battery, and methods for heating the filaments with stepped-down alternating lighting current are going to be valuable. The disadvantage is the difficulty of eliminating the a.c. hum. One method of achieving this is shown in Fig. 11, where the grounded grid and plate connection is tapped from the center of the filament winding, both halves shunted by condensers, and a high-resistance impedance (an inductance wound with high resistance wire) connected across the whole. Very good results are being had in some cases we know without this arrangement, merely a connection to ground being tapped off

the center of the secondary winding. More data on this shortly.

Motor-Generators

A motor-generator set continues to be the most satisfactory method of obtaining d.c. for plate supply where any considerable amount of power is necessary. Their high cost is a big burden on the amateur, however, and we want to call attention again to the good results which may be obtained from the use of an old d.c. motor as a generator. A 500-volt one would be best suited to average work, of course, but they are rare. 220-volt motors may be rewound for higher voltages, or driven at higher speed, or both. Generally about 400 volts can be got from a 220-volt 1800 r.p.m. d.c. motor when

driving it by a 3600 r.p.m. induction motor. An external resistance should be placed in the field circuit to keep the current at the same value as obtained on the lower voltage as a motor, as it is practically at saturation and any additional current would be wasted. In the case of motors having two or three armature windings in parallel on each set of commutator bars, a higher voltage may be got by connecting the armature coils of each section in series. This will leave some unused commutator sections and will increase the generator hum, but not to an extent where it cannot easily be filtered out.

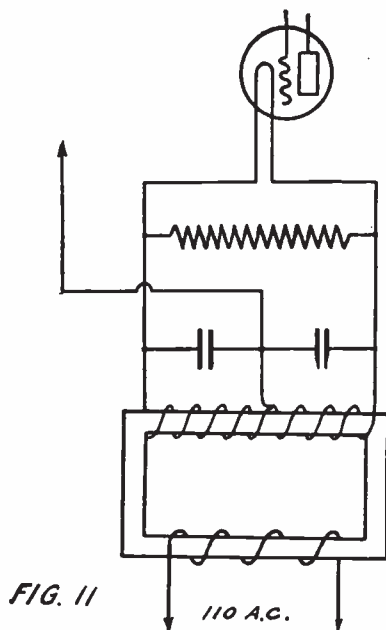

If the unit is mounted on a base, and it is set on coil springs, most of the noise and vibration will be eliminated. We know one amateur who has his set mounted on the floor of a shallow closet in his room, the closed door making its operation noiseless.

On account of the almost inevitable short-circuits occurring in experimental work, it is strongly advisable to have the generator simple shunt-wound. A short will then draw all the current from the field and the voltage will drop, whereas a series- or compound-wound generator would likely be damaged, unless protected by fuses.

Suggestions

A word about the arrangement of apparatus. An experimental set can not well be a neat job, and it is best not to try to make it so while experimenting. Arrange your pieces of apparatus in orderly array on a table or bench, much in the relative positions in which they appear in a schematic

hookup, and connect them up with flexible leads. The tube sockets can be placed in a row on a narrow base, wired up with binding posts at each end, and placed at the rear of the table where the tubes will be out of the way. Four candle-power carbon-filament lamps, with a resistance of about 3000 ohms, make good grid leaks. Meters are an absolutely vital adjunct to a C.W. set, and every station should have at least a plate voltmeter, plate milliammeter, filament ammeter, and radiation ammeter.

To minimize QRM to others, determine the constants of the aerial on which you expect to use your set, and construct a phantom or dummy antenna circuit on which all the experimental work may be done equally well. This will consist of a condenser (generally around 500 to 700 micro-mfds.) and a resistance (generally between 10 and 18 ohms) connected in series with whatever inductances and capacities are to be used in the finished set.

Keep a careful record in a notebook of all your experiments—the date, the circuit used, the readings of all the meters, and any reports on the results, such as modulation, distance, etc. Then when the final form for the finished set is determined, it may be constructed from the data and all the apparatus permanently built into a panel or cabinet set.

HOW TO TUNE THE HONEYCOMBS (Concluded from page 22)

the plate, and close the coupling until he hears the howling or bubbling very loud; then open until the sound stops. Put in L-75 in the primary and put the primary condenser in parallel with the coil. Disconnect the aerial entirely from the set and open the primary coupling about half way or a little less. Now vary the primary condenser over the entire range from zero to maximum, and at some point on the condenser scale (should be about half way) a decided click will be heard and as long as the secondary condenser stays set in this place (5 degrees) the click will be heard every time the condenser pointer passes this place. Increasing or decreasing the capacity of the secondary condenser will make the click occur at a correspondingly higher or lower point on the primary condenser scale. The couplings and condensers should then be varied minutely until the click becomes very pronounced, in fact it is possible to reach such a point of adjustment that the click fairly hurts your ears and might be likened to lightning striking a phone wire at a little distance while you are talking, especially if sensitive receivers such as the Baldwin are used.

QST'S DIRECTORY OF CALLS

In continuance of the policy recently announced, QST presents another two pages of calls, which may be cut out and kept with the January supplement if desired.

FIRST DISTRICT

Middlesex Motor Co.
J. R. Morse
Louis Snelderman
J. A. Grant
A. L. Huston
W. R. Dresser
R. B. Grant
W. N. Holden
N. T. Carr
C. A. Tribbett
A. A. Morse
A. J. Franklin
C. S. Perkins
S. A. Sweett
Ralph C. Watrous
Ralph C. Watrous
J. W. Whitmore
P. W. Dickens
A. M. Wallingford

440 Salem, St., Medford, Mass. (Correction)
234 Puritan Rd., Swampscott, Mass. (Correction)
184 Putnam St., New Haven, Conn.
15 Elm St., Everett, Mass.
8 Hazelwood St., Waterville, Me.
283 Main St., Calais, Me.
Cushman St., Monson, Mass.
84 Parrott Ave., Bridgeport, Conn.
633 Moody St., Waltham, Mass.
24 Foote St., New Haven, Conn.
563 Washington St., Bath, Me.
664 Seventh St., So. Boston, Mass.
31 Mayflower St., Plymouth, Mass.
69 Chestnut St., Cambridge, Mass.
20 Diman Pl., Providence, R. I.
Watchaug Pond, Providence, R. I.
64 Meadow St., Pawtucket, R. I.
30 Rockland St., Roxbury, Mass.
901 Broadway, West Somerville, Mass.

1JV
1RT
1VQ
1VR
1VS
1VT
1VU
1VV
1VW
1VX
1VY
1VZ
1WC
1WI
1WM
1NN
1WO
1WX
1WZ

SECOND DISTRICT

G. A. DeCortin
F. H. Giefer
A. E. Sonn
G. C. Otton
J. C. Ruckelshaus
C. P. E. Gruetske, Jr.
Henry J. McCue
E. G. Cronemeyer
J. C. Ruckelshaus
Wm. Grumhacker
Jno. H. Pettler
Thos. Martin
Chas. T. Manning
John M. High
Geo. D. Stewart
N. Y. Catholic Protectors
C. J. Ripperger
Frank X. Hayes

16 Elm St., Mt. Vernon, N. Y. (Correction)
Ravenhurst, West New Brighton, N. Y.
282 Parker St., Newark, N. J.
68 Chichester Ave., Jamaica, N. Y.
566 Ridge St., Newark, N. J.
1287 Brook Ave., New York
76 St. and Shore Rd., Brooklyn
1269 Theriot St., New York
417 Paige St., Schenectady, N. Y.
514 W. 170th St., New York
45-58d St., Corona, N. Y.
15 Troy Rd., Menando, N. Y.
81 No. Maple Ave., East Orange, N. J.
Riverdale, N. Y.
90 No. Broadway, Yonkers, N. Y.
Walker Ave., Van Nest, N. Y.
147 Wisner Ave., Middletown, N. Y.
162 E. 82d St., New York

2FE
2GB
2GC
2GE
2GF
2GG
2GI
2GJ
2GK
2GM
2GN
2GP
2GQ
2GR
2GS
2GU
2GV
2GY

FOURTH DISTRICT

Jas. T. Morehead
Carl D. Short

Greensboro, N. C.
238 Wash'n Ave., Macon, Ga.

4CC
4DA

FIFTH DISTRICT

W. C. Hutcheson
Robert Joseph Preis
C. E. Bland
Emmett H. Koehle
Fred Whitlock
Paul Bowvon
Coleman W. Gilliam
H. W. Scott
W. L. McAulliffe
Worthington Brown
Edward S. Jackson
Hurlburt Still Electric Co.
Willard Travland
Thomas Leonard Parkes
Walter L. Wellford
Jos. Henry Uhalt
Felix Boizelle
Conrad Stein
Danah Boyette

Wind Rock, Tenn.
2710 Marengo St., New Orleans, La.
Shreveport, La.
723 Fifth St., East Las Vegas, New Mexico
1203 Arizona Street, El Paso, Texas
1401 South 20th St., Birmingham, Alabama
1220 Ash St., Birmingham, Alabama
734 Yale St., Houston, Texas
3217 Washington Ave., Houston, Texas
1640 East Moreland, Memphis, Tenn.
Box 425, Silver City, New Mexico
1101 Capitol Ave., Houston, Texas
Tuleta, Texas
2411 Kensington Place, Nashville, Tenn.
205 So. Belvedere, Memphis, Tenn.
5252 Camp St., New Orleans, La.
2334 Milan St., New Orleans, La.
816 West 15th St., Little Rock, Ark.
111 North 7th St., Lawton, Okla.

5DA
5DB
5DC
5DD
5DE
5DF
5DG
5DH
5DI
5DJ
5DK
5DL
5DM
5DN
5DO
5DP
5DQ
5DR
5DS

SIXTH DISTRICT

E. H. Needham
S. H. Seeburger
F. W. Salome
H. Blasler
E. G. Underwood
Paul R. Fenner
F. L. Garrison
A. A. Kramer
C. J. Phillips
C. Steffen
J. L. McCargar

118 Fairmont Ave., Eagle Rock City, Cal.
371 60th St., Oakland, Cal.
1361 Underwood Ave., San Francisco, Cal.
3200-1/2 S. Hoover St., Los Angeles, Cal.
903 E. Commercial St., Los Angeles, Cal.
1338 Masonic Ave., San Francisco, Cal.
405 Willow St., Stockton, Cal.
1608-6th Ave., Coronado, Cal.
1016 San Antonio Ave., Alameda, Cal.
1615 Arch St., Berkeley, Cal.
1413 16th St., Oakland, Cal.

6EO
6EP
6EQ
6ER
6ES
6ET
6EU
6EV
6EW
6EX
6EY

G. R. Lee
 Edw. L. Mundt
 Bert Diamond
 A. H. Schulz
 Hallie Midkiff
 Wm. Briggs
 R. B. Dugan
 C. H. Hibbard, Jr.
 H. H. Steen
 Paul Oard
 E. D. Barrett
 DeLoss P. Trim
 D. E. Metcalf

2619 Manitau Ave., Los Angeles, Cal.
 2418 Eagle Ave., Alameda, Cal.
 408 S. Catalina St., Redondo Beach, Cal.
 1445 Cole St., San Francisco, Cal.
 Minnesota St. and Ada Sts., Glendora, Cal.
 Anderson, Chasta Co., Cal.
 3008 LaSalle St., Los Angeles, Cal.
 156 Bellsfontaine St., Pasadena, Cal.
 2007 K St., Sacramento, Cal.
 1217 N. East St., Stockton, Cal.
 960 18th St., Merced, Cal.
 4038 Louisiana St., San Diego, Cal.
 1825 So. Ardmore Ave., Los Angeles, Cal.

6EZ
 6FA
 6FB
 6FC
 6FD
 6FE
 6FF
 6FG
 6FH
 6FI
 6FJ
 6FK
 6FL

SEVENTH DISTRICT

J. Rooney
 W. McMillan
 J. C. Vogler
 W. W. Harris
 G. W. Fitzpatrick
 I. Woolf
 R. G. Stone
 E. De Nuef
 H. S. Gagnon
 H. S. Munford
 C. M. Carlquist
 O. De Guire
 L. M. Peck
 Ben Crawford
 C. E. Fraer

214 Olympic Place, Seattle
 157 Harrison St., Seattle
 122 Belmont, North, Seattle
 543 No. Broadway, Marshfield, Ore.
 3252 Ferdinand St., Seattle
 1905 Washington, Seattle
 P. O. Box 616, Boise, Ida.
 4411 Juneau St., Seattle
 409 San Rafael St., Portland, Ore.
 518 Beach St., Vancouver, Wash.
 1061 Concord St., Portland, Ore.
 Silverton, Ore.
 4916 Wallingford Ave., Seattle
 323 So. J. St., Tacoma
 88 Park Ave., Marshfield, Ore.

7CK
 7CL
 7CM
 7CN
 7CO
 7CP
 7CQ
 7CS
 7CT
 7CU
 7CV
 7CW
 7CX
 7CY
 7CZ

EIGHTH DISTRICT

Chas. Wolensky
 Chester M. Wilcox
 Cleveland Yacht Club
 Arthur M. Stellwagen
 Robt. C. Devinney
 Donald L. Wood
 Chas. R. Thompson
 L. A. Bambauser
 Albert N. Hudson
 Walter I. Partridge
 Orville D. Bower
 Norman E. Calkins
 Walter Wm. Mester
 Ernest and Albert A. Munch
 Wm. C. Babcock
 Carl E. Welsler
 Frank A. Baumgarten
 Richard J. VerKamp
 Lloyd E. Furrow
 Fred S. Travis
 Clyde W. Thorpe
 Cass Tech. High School
 Walter L. Leatherman
 Geo. W. Van Kirk

324 Lehigh Ave., Palmerton, Pa. (Correction)
 181 S. Fairview Ave., Lansing, Mich. (Correction)
 11215 Clifton Blvd., Cleveland, O. (Correction)
 312 N. Jefferson St., Ann Arbor, Mich.
 1224 Boyle St., Pittsburg, Pa.
 310 Augustine St., Rochester, N. Y.
 815 Wall St., Port Huron, Mich.
 2917 Peach St., Erie, Pa.
 406 Park Ave., Fulton, N. Y.
 3039 S. Washington Ave., Saginaw, Mich.
 834—4th St., Marietta, Ohio
 1422 W. 84th St., Cleveland, Ohio
 2170 W. 95th St., Cleveland, Ohio
 105 Excelsior St., Pittsburg, Pa.
 112 Head St., Penn Yan, N. Y.
 69 Ransom Court, Lockport, N. Y.
 325 Melwood St., Pittsburg, Pa.
 2815 Melrose Ave., Cincinnati, Ohio
 420 Lake St., Troy, N. Y.
 1090 Wilhelm St., Defiance, Ohio
 36 Grove St., Cobleskill, N. Y.
 711—2nd Ave., Detroit, Mich.
 703 W. Main St., Van Wert, Ohio
 196 S. Washington Ave., Wilkes Barre, Pa.

8AA
 8BR
 8DF
 8FA
 8FB
 8FC
 8FE
 8FF
 8FG
 8FH
 8FJ
 8FK
 8FL
 8FM
 8FN
 8FO
 8FQ
 8FS
 8FT
 8FU
 8FV
 8FX
 8FY
 8FZ

NINTH DISTRICT

William Wirick Harper
 Harold E. Mase
 Donald Anderson Kent
 Arthur Brook Heman
 Donald H. C. O'Neil
 Ralph Martin
 Leon Joseph Ostrander
 Donald Roy Graybill
 James B. Holston
 James Barnard Corum
 Ethan Mark Turley
 Charles A. Wegner
 James E. S. Hayes
 Eddie Smith
 Ross Talbot Hatton
 Richard Eugene Mathes
 John W. Smith
 Bert Frank Callender
 Ralph Eugene Dexheimer
 George D. Bauer
 Iden Monroe Kerney
 Herman Fred Fedder
 Paul Joseph Kuprion
 E. Raymond Churchill
 Bert Von Wolff
 Louis E. Hull
 Frank Eugene Phillips
 Herschel Stults
 Cyril John Otterholm

334 East Fourth St., Ottuma, Iowa
 3340 Dupont Ave., South, Minneapolis, Minn.
 DeWitt, Iowa
 5900 West Cabanne Place, St. Louis, Mo.
 5740 Bartner Ave., St. Louis, Mo.
 818 Sheridan Road, Kenosha, Wisconsin
 1202 Lincoln Highway West, Mishawaka, Indiana
 5608 So. Franklin, Polo, Illinois
 Nashville, Illinois
 Deering, North Dakota
 409 Harrison St., Lafayette, Indiana
 6208 Washington St., St. Joseph, Mo.
 220 West 4th St., Duluth, Minn.
 688 So. 39th St., Louisville, Ky.
 Box 320, Elwood, Kansas
 4325—23th Ave., So. Minneapolis, Minn.
 LeRoy, Illinois
 1844 S. Lawrence Ave., Wichita, Kansas
 2130 North 6th St., Sheboygan, Wis.
 2133 Weisser Park Ave., Fort Wayne, Indiana
 725—6th Avenue, Council Bluffs, Iowa
 1440 West High St., Davenport, Iowa
 2625 W. Chestnut St., Louisville, Ky.
 30th St., No. 609, Indianapolis, Ind.
 2056 Buchanan St., Topeka, Kansas
 1207 Organ Ave., Fort Wayne, Indiana
 728 Bluff Blvd., Clinton, Iowa
 Walnut St., Columbus Junction, Iowa
 998 Flandreau, St. Paul, Minn.

9GK
 9GL
 9GM
 9GN
 9GO
 9GP
 9GQ
 9GR
 9GS
 9GT
 9GU
 9GV
 9GW
 9GX
 9GY
 9GZ
 9HA
 9HB
 9HC
 9HD
 9HE
 9HF
 9HG
 9HH
 9HI
 9HJ
 9HK
 9HL
 9HM



RADIO CLUB OF HARTFORD

Mr. Walter B. Spencer, for several years president of the Radio Club of Hartford, is removing to New Haven to accept a position as principal of the new Commercial High School in that city, and has announced his intention of resigning the presidency of the Hartford club at its first autumn meeting. His removal will be a big loss to the Hartford society.

SEDALIA AMATEUR RADIO CLUB

The Sedalia Amateur Radio Club (Sedalia, Mo.) meets every Thursday night at 7:30 at the Y.M.C.A. The membership at present is small, but by fall we expect to have a life-size club. Even tho the membership is small, however, the bunch are live wires, and we have some very interesting talks on radio at the meetings, likewise some very heated arguments over various branches and details in wireless. Most of the club members have sets in working order, and the others contemplate having them soon. Anyone in this territory who is interested in radio is cordially invited to come in and look us over. For particulars in any detail see or write Mr. Otto S. McDaniel, President, or Mr. P. J. Handley, Secretary.

A NEW CANADIAN CLUB

Radio amateurs of Brantford, Ont., recently met at the Y.M.C.A. in that city to talk over the organization of a radio club to become affiliated with the A.R.R.L. and further relay communication. Mr. Keith Russell, manager of the Ontario Division, gave a very interesting talk on the work of the wireless telephone. Temporary officers were appointed as follows: President, Caleb Rose, 3AM; Vice-President, Chas. Colchester, 3CH; District Superintendent, W. K. Mitchell, 3BA. We wish them every success.—Canadian clubs will find interesting work in the establishment of relay routes between their stations and the U. S.

ESSEX COUNTY RADIO ASSN.

This club consists of a number of sections located in various cities within the county which gives it its name, with headquarters in Salem, and at their last meeting the Salem and Beverly members

attended a meeting of the Lynn section at the Y.M.C.A. in the latter city. Guy R. Entwistle, New England Division Manager, spoke on traffic handling, and Mr. Claude P. Cairns, chief Acme engineer, gave an interesting talk on the new devices for C.W. transmitting. The Haverhill and Lawrence radio clubs were welcomed to admittance as units of the county club. The organization is rapidly growing and has its goal a membership comprising every amateur and club in the county. Their recent membership campaign resulted in 65 new members.

At the last July meeting the A.R.R.L. emblem was accepted as the official insignia of the Club, and the traffic rules of the A.R.R.L. were adopted for its regulation. It is planned to entertain the Lowell Radio Club as guests early in September, and to hold a radiophone dance for the entire county in October.

ROCHESTER RADIO CLUB

The Rochester Radio Club (N. Y.) recently held its election of officers, and has now adjourned for the summer, but planning big things for the fall. The officers elected were: President, Ralph Hairs, 8GI; Vice-President, Maurice Nelson, 8NB; Secretary, Geo. Batterson, Asst. Secretary, Russell Deane, 8PY.

OUR LESS EXPERIENCED BROTHERS

(Concluded from page 31)

and complete than an amateur radio broadcast on automobile thefts? Instead of having to telephone one at a time to a large number of police headquarters in nearby towns and cities, well organized amateur radio could broadcast over a tremendous area in a few moments at no expense. If our country brothers were also thoroughly in with us, they would offer a tremendous help in securing the information, especially where they are located upon trunk highways. We expect to see this develop in the future. In the meantime, let us all endeavor to co-operate with each other and avoid all of those things which are bound to follow in the wake of aristocracy and class distinction.



Conducted by Guy R. Entwistle

THE TRANSFORMER

AFTER we have worn out a few sets of dry cells and lost our patience with a sticky vibrator, most of us look for relief in a transformer.

The best type, the proper size, and the amount of capacity to use with it, are problems to the beginner. The writer has heard this subject admirably analyzed by Mr. Claude F. Cairns, an expert on transformer design, and will try to give it to the readers of QST as closely to Mr. Cairns' ideas as possible.

We all know that the transformer is used to supply the high voltage necessary to charge the condenser before it can be discharged by the gap to produce wireless waves. Ordinary 110-volt A. C. forces a comparatively high current through the primary winding, creating a magnetic current or flux. This in turn cuts across the many turns of the secondary, inducing a very high voltage in it, the voltage of course being proportional to the turns ratio, which is the number of times as many turns the secondary has as the primary. If, for instance, the secondary has 100 times as many turns as the primary, then the turns-ratio is 100. Multiplying the primary voltage, 110, by 100 gives us 11,000 as the open-circuit voltage at the transformer secondary. See Fig. 14. This assumes, of

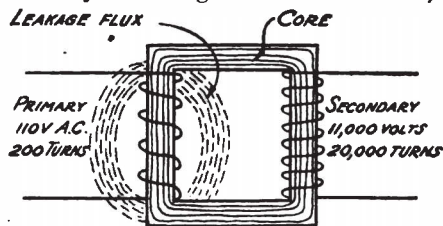

FIG. 14

course, that there has been no leakage of flux; that is, that all the flux lines created by the primary current have been conducted by the iron core over to the secondary turns. This is no place to discuss leakage flux and its effects, more than to say that it determines what the secondary voltage will be, and whether the transformer will

be best suited for a rotary gap or a quenched gap, and in a way helps us to judge the probable best spark frequency to be used at the gap if it be a rotary.

There are in general two distinct types of wireless transformers, the resonant type and the non-resonant. The former has been with us for some time and includes practically all the popular makes on the market in pre-war days, while the latter is comparatively new in amateur circles. It is important that the reader understand the main point of difference between the two types. Let us depart from electricity for a few minutes and turn to mechanics for an illustration of our term "resonant" or "resonance." We all know that we can set up a violent motion or vibration in a slender plank stretched across the banks of a narrow stream. We do this by applying a small force at the right time over a period of time. The longer we keep it up the greater becomes the vibration, up to certain limits. This phenomenon is the very heart of the existence of wireless, in fact, but the thing we are most concerned with is that it takes time to build up a strong force if we are depending on the phenomena of resonance for it. When we think of a strong vibration built up in this manner we might also think of it as a free vibration. Now there is another way to set up a vibration in our plank. If we make it smaller for convenience, then we can take it in our hands and shake it at whatever rate of vibration we wish, slow or fast. The strength or force will depend upon our strength, but the most important point is that we don't have to time our successive applications of force nor do we set up free or natural vibrations, but rather force the plank to vibrate according to our will and practically no time is taken to build up such forces or vibrations. This is an example of our non-resonant phenomena. It remains for the reader only to pass back to our electrical apparatus and apply the facts just illustrated in mechanics. Referring to Fig. 15, for the resonant type it will be seen that it takes time for the secondary voltage to attain its maximum, while with the non-resonant type practically no time is taken as the secondary

voltage reaches a maximum almost instantly. (The diagram has been exaggerated purposely.) An understanding of this feature is of great importance in selecting the proper speed for the rotary, so bear it in mind.

There is much dispute over the question of high and low gap speeds with their corresponding high and low spark frequencies. If our gap is set for 11,000 volts, from Fig. 15 it can be seen that if we have our rotary stud facing the stationary electrode at point B, for the resonant type, we will get no discharge, as the secondary has not yet had time to build up. In the case of the non-resonant type, a full discharge will occur. Not until point E does the resonant type produce a wave-train while during the same time the non-resonant type has produced several. In other words, we must be careful not to run the rotary too fast with one type of transformer, while the other type lends itself to higher spark frequencies. Now since the power put out by our entire set depends on the spark frequency, directly, if we can increase it and at the same time not destroy a balance elsewhere in our set we will increase our range. Most of us try to increase the spark frequency without a thought of what other changes we bring about. The best test is to watch the aerial ammeter when we make changes. It is a good guide in all adjustments except those affecting the coupling.

Another feature in the selection of a transformer is its power factor. We will not go into this further than saying that it is the relation between the actual watts taken by the primary and the apparent watts. The former is indicated by a wattmeter in the circuit, while the latter is computed by multiplying the voltage by the amperes drawn. The power factor is never greater than 1 (unity), and generally less. It is important for the amateur to maintain it as high as possible. The capacity used across the transformer secondary controls the power factor to a great extent. Hence the amateur should use the proper condenser as specified by the manufacturer if he would get the best out of his apparatus. A transformer is rated in kilowatts or a fraction of a thousand watts. This does not mean that we can draw 1000 watts from a 1K.W. transformer regardless of what we do with it, but it does mean that that much can be obtained under proper conditions. Progressive radio companies are sending out test tags on their apparatus telling just what values primary voltage, secondary capacity, and spark frequency to use, hence instructing the amateur how to use the apparatus properly.

Still another idea in connection with the various types of transformers. We all know that we want to get the most power in the antenna. This means we must get

a maximum amount in the condenser circuit before it is passed over. Now our power formula says that the power increases with the square of the voltage. Doubling the voltage will give us four times the power, PROVIDED THAT IN DOUBLING THE VOLTAGE WE HAVE NOT DISTURBED THE OTHER FACTORS WHICH ALSO GOVERN THE POWER. This does not mean that best results will be obtained with transformers for which the highest secondary voltage is claimed, for the reason that transformers are rated in open circuit voltages on the secondary side, and as in the case of a storage battery, the open circuit or no-load voltage means nothing. In order to know what any type will do we must obtain load voltages with the condenser on and the key

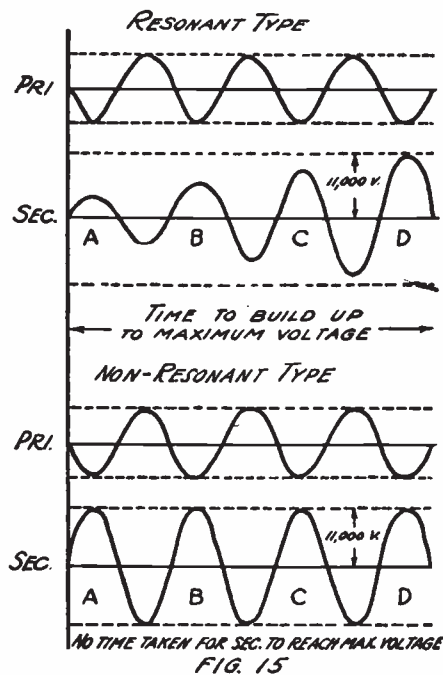

FIG. 15

pressed. Two popular makes of transformers were given this load test with results that were approximately as follows:

	No load	Load
Resonant type	13,000	7,000
Non-resonant type	11,000	9,000

These are not the exact figures, but serve to illustrate the point that under load conditions, which of course are the only ones to consider, the non-resonant type, in this particular case, was the best. Unfortunately the means for determining the secondary voltages of transformers under (Concluded on page 44)

Wireless vs. Women

Scenario by H. A. Perrill

Scenery by the same guy

(Apologues to K.C.B.)

Editor QST.
Dear Editor:—

I was over to see my girl
The other night
And I happened to think (no
pause)
How many features in common
Are possessed
By those two unfathomable
mysteries
Wireless and Women
Most women do their hair
In WAVES
Some LONG and some SHORT
And all of them
Wear SWITCHES
And when they turn
The BATTERIES of their eyes
Upon us,
The MAGNETISM in them
Draws us irresistibly
To their sides
And we often think
That we read a MESSAGE
In their depths
But when we try to COIL
Our arms about their waists
There is frequently
TOO MUCH RESISTANCE
And we find that we
Have mistaken the SIGNALS
But then again (sometimes)
They let you make
A SHORT CIRCUIT of their
waists
Which might be called
A TIGHT COUPLING

They are the RECEIVERS
Of our affections
And they hold the KEYS
To our hearts
Unless they lose CONTROL

They are the TRANSFORMERS
Of our lives and destinies
And the RECTIFIERS
Of our mistakes
And my buddie
Who has been reading this
Over my shoulder, says
That they are also ALTER-

NATORS
But he is sore
Because his sweet patootie
Has stepped out for a date
With his rival
She's quite a high fier

So I call her an AERIAL
And I think she's making
A DUMMY of him
He says that he thinks that she
Is a CONDUCTOR of his kisses
(Which must be nice for the other
fellow)
But he never can DETECTOR
Passing them along,
Because when she's alone
With the other fellow
He's never there



But to go on
With my story
Women are the GENERATORS
Of all our SPARKING
And the INTENSIFIERS
Of all our ALTERNATING
CURRENTS
Of Love and Jealousy
And most of them
Have SOLENOIDS
(or maybe it's adenoids)

But anyway, I've got a date
So I'd better stop
And make a DASH for my DOT
Or I'll be too late
To METER



Half of the QRM is unnecessarily-drawn out conversation. **BE BRIEF!**

An antenna loading inductance is almost unknown in amateur transmitters. Why? Every time the wave length of the aerial circuit is changed on a set with only an oscillation transformer, the coupling has to be carefully re-adjusted. A helix of a few turns would obviate this.

I'm Forever Losing Signals

(Tune: "I'm Forever Blowing Bubbles")

I'm forever losing signals,
Pretty signals in the air;
They're pitched so high,
Nearly reach the sky,
Then like my dreams they fade and die,
Signals always fading,
I've tuned everywhere.
I'm forever losing signals,
Pretty signals in the air.

—Written by Lose M. Ezzy.

8FN has a remedy for the decreased sigs which result when two pairs of phones are put in series in an audion circuit. He shunts them with a high resistance made from a strip of cardboard soaked in India ink, about 1½ inches long and ¼ inch wide, and says the sigs are increased about 75%.

The ordinary two-piece pull-apart plug used in lighting fixtures can be used in many places in constructing apparatus, to connect in phones, battery, etc. The plug part will firmly screw into a hole in a panel or cabinet.

How to Make Radio Fudge

Get several buckets and go out and pick all the little ohms off your antenna. With the aid of a shovel and several large wires and scoops, secure more ohms out of the ground. Dump these 5,890 ohms into a barrel with a few odd microfarads, add 30,000 volts, 20 amperes input, 7 sets of kickbacks, and stir well (for your own protection) with 1 A.R.R.L. Wouff Hong. Serve at 30 w.p.m.

The Benwood Company has reorganized and greatly enlarged its manufacturing facilities for the coming radio season. W. E. Woods, who has lately been the manager of the radio department of the

Manhattan Electric Supply Co. of St. Louis, is the president of the new concern and is the owner of station 9LC. L. A. Benson, of station 9KV, is the secretary and production manager of the company. Both of these men have many radio friends thruout the country, and will be pleased to serve them in their new capacity as officers of The Benwood Company, Inc.

Seen on the screen at the local theatre. "Coming: 'Father on the War Path'". Must be the sequel to "Willie in search of switch contacts", or "The Missing Collar Buttons."

An Ode to Eddy

(Sung to the tune of "Mother")

E just stands for "Eddy", Mr. Warner,
D is for his never-ending day,
I is for his interest in things "hammy",
T is for the tubes he lays away(!?&%\$#!)
O is for the "orful" words he uses,
R is reading letters he enjoys;

Put them all together they spell
EDDY—

The Eddies are the grand ol' boys!
6BUNK.

How do you like the cartoons by Hoffman? We'll have one every month for a while.

And what do you think about the illustrations and descriptions of interesting old obsolete stations? Are they sufficiently interesting to take up a whole page in our QST?

The owner of Canadian 3DS, Kitchener, Ontario, notes on page 41 of July QST that he was heard by 1TS, Bristol, Conn. At this time a Ford coil running from a 50-watt step-down transformer was being used. Rather a phenomenal range, he says, and wonders why they can't hear him on the same transmitter at Brantford, 30 miles away.

Just saw a sign in a hardware store in Boston: "Agents for Johnson's Underground Garbage Receiver." Howzat? Eh! Talk about underground wireless; just out, and got it beat already. How does this smell to you?

The law requires that all stations testing shall frequently sign their call letters.

The particular attention of radiophone operators, who are not in the custom of indicating their identity at all, is asked to this regulation.

Young & McCombs, Rock Island, Ills., announce that about Sept. 1st they will have a new C.W. transmitter in operation at 9BY, with a power of 550 watts, and will give radiophone concerts every Thursday evening, 7:15 to 9 o'clock, with a fifteen minute intermission at 8 p.m. for 9ZS' time signals and weather report. The latest phonograph music will be played on amateur wave lengths, and a report of their signals will be appreciated. They also operate station 9BC, using a deForest radiophone with eight bulbs, operating regularly over 200 miles.

The Navy Department is testing a new device to steer ships into New York harbor in heavy weather. It consists of a 16-mile cable laid on the harbor bottom from Fort Lafayette out to the Ambrose Channel light-ship. On foggy days a 500-cycle current will be sent thru this cable, and ships will be equipped with loops slung on either side near the bow, the loops connected thru amplifiers to a headset, to pick up the signal by induction. It is expected that vessels, guided to the Ambrose light-ship by the radio compass stations in the vicinity, will pick up the 500-cycle note, and that by the intensity of the sound the operator can guide his ship to a position directly over the cable, then by keeping the sound in each ear equalized, he can safely guide it up the channel to the end of the cable.

WOULDN'T IT BE WONDERFUL—

If after QRA-ing all evening you should find you had been working a moth! (See page 7, Radio News for July.)

If the typewriter you bought to copy MSGS with would make a few shades less noise than a boiler factory?

Wouldn't it, if you could break NAH and say, "QRT pse, half hour."?

If 7DA would throw away that side-swiper, and if 7EY should learn the code?

If Bell telephones had 2000-ohm receivers on them, instead of 75's?

If you didn't have to get out of bed when a thunder storm came up, and sit in the parlor until it passed, for fear of it coming down the aerial and jumping to your feet which stick out of the foot of the bed just far enough to reach to the lead-in where it connects to the loose-coupler?

If certain stations, mentioning no names, were detected, regenerated, and amplified?

If every second ham didn't ask you where that new station is that signs MO?

Two unfortunate mistakes have occurred in recent lists of "Calls Heard", where

portions of a list have appeared without proper heading. On page 46 of July QST, right hand column, top, the calls listed belong to 9ZL, Manitowoc. Right hand column, top, of page 55, August number, belongs to 9ZT, Minneapolis. Sorry, fellows.

MR. MAXIM DELIVERS AN ADDRESS BY RADIOPHONE

On July 3d, while on the West Coast, our President, Mr. H. P. Maxim, thru the courtesy of Lee deForest, Inc., was enabled to address the wireless world of the western United States over their 1 KW Radiophone at the California Theatre, San Francisco.

Lack of space prevents reproducing Mr. Maxim's talk in full. He called attention to the marvelous strides being made in radio development, the unlimited possibilities of the future, and the great potentialities of a national organization of citizen radio station owners—our own A.R.R.L. In closing, he extended his compliments to the amateurs of California and expressed the hope that we of the east will soon be able to communicate direct with those of the great west through the air.

On June 23d, Lieut. Ellery W. Stone, U.S.N.R.F., delivered a lecture on vacuum tube theory and practical operation, by the same means. The talk was both interesting and instructive, and altho believed to be the first occasion where a technical lecture was delivered by radiophone, its success augurs well for an extended use of this possibility of the phone.

THE JUNIOR OPERATOR

(Concluded from page 41.)

load are not available to the average amateur.

This column is not for the purpose of giving free advertising to the apparatus of any maker. The reader is asked to give his own particular apparatus a fair trial under proper conditions. Countless amateurs have come to the writer with a tale of woe about this or that, only to find that they didn't know how to use the apparatus they had properly. We are all in the game to learn, and it is no crime to make mistakes. When the quenched gap made its appearance it was condemned by many who had had no experience with quenched spark tuning, and not until much educational literature was sent out and personal attention given by the manufacturers did the amateur learn of its advantages.

Are you working YOUR APPARATUS to its full capacity?



CRITICISM OF "PROF. BUGS" LETTER

Washington, D. C.,
August 9, 1920.

Editor, QST:

I have noticed a letter on page 49 of the August QST signed "Prof. Bugs" in which several errors occur. The writer first makes use of a well known formula for the radiation resistance of an antenna. This formula is at best only a rough approximation, as few antennas approach the theoretical cases. The height H expressed in the equation is not the actual height of the horizontal part of the antenna, as "Prof. Bugs" has used it, but is the effective height of the antenna. This may be considerably less than the actual height if the antenna is not located over a good conductor, such as water, and varies slightly with the wave length. As a matter of fact the value given, 16 ohms, is much too high for the radiation resistance of the average antenna.

On reading farther I was much surprised to see that "Prof. Bugs" was about to explain an experimental method for determining radiation resistance but was disappointed to find that he had described a familiar method for measuring, not the radiation resistance, but the total effective resistance. This effective resistance is made up of several components, one of which is the radiation resistance, the others of most importance being the resistance of the conductors of the antenna and the resistance due to dielectric losses in the field of the antenna. For further discussion on this subject and also a complete description of methods of making resistance measurements, the reader is referred to Circular 74 of the Bureau of Standards.

"Prof. Bugs" scheme for using the D.C. value of resistance in the substitution is unsafe unless the resistance is absolutely non-inductive and of such large surface that the skin-effect is slight in its effect on the high-frequency value of resistance. Very few resistances approach these requirements at wave lengths as low as 200 meters.

Under good conditions the effective resistance of an antenna for amateur use may be as low as five ohms, while 8 or 10 ohms is not too high for very good work. If the lower value, 5 ohms, is taken it is readily seen that with an antenna input of

500 watts an antenna current of 10 amperes would be obtained. Of course 50 per cent. efficiency is an exceptionally high value but with a 1K.W. set and even 30 per cent. efficiency 6 amperes would be obtained if the antenna resistance were the only determining factor.

The real answer to the question of low antenna currents is in most cases not too high antenna resistance but too small condenser. This has been explained several times before in the columns of QST and need not be considered in detail here. The difficulty is met, of course, in trying to obtain a capacity large enough so that the 200 meter limit will not be exceeded.

As further proof I will cite two examples of actual transmitting stations. One used an input of 250 watts to the primary of the transformer and an antenna current of 3 amperes was obtained. The other was a 900 cycle synchronous gap set operating at 175 meters. The transformer input was 125 watts and the antenna current 2 amperes. The antenna was a T, forty-five feet long and forty feet high.

It will be noticed that both of these stations were of much lower power than 1K.W. and so could use a condenser of sufficient size to handle the power. If a 1K.W. set could be operated under conditions as favorable, antenna currents of 10 or 12 amperes would be common.

In closing I might remark that anyone who will discover a quick and accurate method of measuring the radiation resistance of an antenna will win a sure place in the "Hall of Fame" of radio telegraphy.

Very truly yours,

John C. Warner.

IRON ORE AND INDUCTION

Ishpeming, Mich.,
July 14, 1920.

Editor, QST:

Right off the bat, let me say that I am not attempting any sort of a clever letter, for publication. "I'm a Ham."

Am glad to say that I have fallen into a great big class of amateurs who wait patiently for "QST", and then absorb every word in it from cover to cover. One reason I like the blooming magazine is because it seems to have personality, sort of makes one feel as though he knew all the bunch. It has made me feel as though the

Editor is almost human and perhaps would like to hear from a part of the U. S. that most people think is as yet uncivilized, and is, as far as "Radio" is concerned.

I wish "The Old Man" would come up here with his Maltese pet, and turn loose some of his energies, in showing us birds how to get out of our difficulties. These difficulties have discouraged most of the "bugs" except two or three here, and a few in Marquette.

We are situated in the heart of the iron country. The fact that there are large deposits of magnetic ore in spots doesn't bother us as much as does the fact that the power used in most of the mines is electrical.

Here's what an amateur runs into in the erection of an aerial. Hills, all kinds of them. A nice big vertical hill about fifty feet from his lead-in, and where he wanted his greatest directional effect. This causes him to disregard directional effects, or disregard radio rules and regulations, because of the lack of radio inspectors in this part of the country, and take a thousand foot stretch to the top of the hill. When he does, he finds he is parallel to a transmission line carrying anything from 2200 V. to six wires carrying 33,000 V. If he still has some "pep" and swings his aerial some more, he is parallel with a "hay-wire street car line" whose rail binders are so poor that in the winter the snow is melted around the rail ends. In my case, the street car line turns the corner and I can't get an aerial at right angles to the line, going or coming. I can hear all the works in the Power House as well as all the cars every time they start or stop, for a mile in either direction. Perhaps "The Old Man" could devise a way of picking up some of the stray juice and using it for his C.W. set. There is enough of it for C.W. sets for all the amateurs we can educate up here.

A "Roger's Underground" is hopeless without tons of dynamite and some steam-shovels. There remains the loop. I have tried about all the loops I ever heard or read of, and a lot more. I could use most of them to tell where the street cars were or to tell how many times an hour the skips went up or down any of the mines. Sometimes after mid-night, when the cars have stopped running, and all the skips are down or up, or being repaired, by using all the audions I have, as well as a lot of imagination, I can hear NFF, NAA, or some other high power cuss, for almost five minutes at a time.

What I want to know is—are we the only ducks in the world in this fix, or is it due to our ignorance? In all the magazines, we read about no end of hook-ups, C.W. Transmitters, etc., but aerials and how to dodge induction, seem to have been forgotten. Or do the Editors take it for grant-

ed that there is no one so ignorant as not to have solved the problem?

I had the same difficulty five years ago and gave up radio as being too deep. While in the army I was again bitten by the bug. I learned everything there was to know about radio in France, absolutely. I could have talked with Mr. Marconi himself. Was put in charge of Regimental Radio Communications, and then Brigade Communications for an Artillery Unit, then sent to a F.A. School of Instruction in charge of Radio instruction. Oh, what wonders I was going to do up here when I got back. Wow! But I sure have gotten some bumps. With the same set and a similar aerial as I used in France and used to get YN, POZ, BYZ, FL, and now and then the U. S., etc., etc., I couldn't, and can't, get a blooming thing. In the discard with the cute little French audions, for something that would oscillate, plus much work; result, after waiting half an hour or so most any time by adjusting about "steen" knobs, handles, switches, etc., of half a dozen balanced unbalanced circuits, I can hear one or two of the big C.W. Stations on about 16,000 wave length.

Transmission? Fine. Given a couple 1K.W. transformers, a warehouse full of condensers, insulators, wire, etc. After giving the stuff the once-over, you decide it's good for an easy two hundred miles in hilly country. When asked to hook up two stations fifteen miles apart, with them, you think it's a pipe. You just kinda hook 'em up careless-like, to show how easy it is, get an old navy man on the other end, and listen, and sweat, and listen some more, with nary a peep except the skips going down and up. About then, you get mad, take a week off, and do the job right with no results, about then you are glad you didn't talk with Mr. Marconi. Then when you pile one station in a car and take it about fifty miles in the opposite direction and it works fine any old way, you kinda decide you don't know nothing.

Am sorry, Mr. Editor, that I raved on to such a length. If by chance you do waste your valuable time in reading all of this, I apologize for imposing upon your good will. I don't often get a spell like this, but I just gotta know if QST or anyone else can help us out. The other hams won't display their ignorance, so I must.

Again hoping that I have not imposed too greatly upon your valuable time, I am

Very truly yours,

H. C. Jarvis.

(This is not an easy problem—induction troubles and an ore-laden country to work over. But some amateurs in that territory are getting good results, and we are sure Mr. Jarvis would be grateful if they would

write him and tell how they overcame similar difficulties.—Editor).

SIMPLE, ISN'T IT?

Eddie Varner—

Static he come in my telephone receiver box very strong. Him with the signals interfere do. This worry considerable, yust like you take eraser n rub outd what transmitter man speak.

Today I fine good reliable way eliminate this static. Very simple indeed. Funny to me no one think before of it. Turn Audion Bulb outd and no more static. This is so because

$$2' x \frac{96\%}{WL} x \sim = \text{No Static.} \\ 1 \text{ CRAB.}$$

INCREASING ANTENNA CURRENT

6518 Kimbark Avenue, Chicago.

Editor, QST:

Just received July QST, and have already read it from cover to cover. Makes me sick to think I have to wait a month for the next one. On reading it over the second time I decided to "Write Something." I think that the average amateur who hopes to be a DX or LD man and is not as yet, would be interested in hearing of my efforts to increase my radiation.

To start with, I had beside the transmitting set, an ammeter to measure radiation, and an "Amrad" wave meter. Every fellow who has not these two instruments should either buy, beg, borrow, steal, or make them, for without them he is next to helpless. I had an aerial of three wires, about eighty-five feet long, and about sixty feet high. My ground was hooked on to the radiator, the water and the gas pipes, and as I live in Chicago, I thought that the city water works, gas stations, etc., ought to have enough capacity to take care of a wireless set. Of course I had heard Doc Radio and others rave about burying everything you have, even your loose change, and intended to do that sometime. As I was using a straight gap with the set, which consisted of a $\frac{1}{4}$ K.W. transformer which drew $\frac{3}{4}$, bad glass plate condenser, O.T., straight gap, and, of course key, I decided that the thing that would boost my radiation most was a good gap. Thereupon I bought me the best I could get, a Hyrad. With the plain gap I radiated two and a half amperes. With the Hyrad, my radiation increased to three. Right then and there I decided that it cost money to increase radiation. That half ampere cost me just thirty cold hard dollars. At that rate it would cost me a small fortune to put seven or eight amperes into the aerial. But the desire was strong, so I kept at it. I

have heard "Doc Radio" rave about having a mob of wires in your aerial, and having them short, not over 125 feet from ground to far end. I had also seen Mr. West's article advising a small aerial just big enough not to brush. I had noted that most of the DX stations that I knew of had plenty of wires in the aerial. Therefore, forgetting old 8AEZ's records I put up an aerial 70 feet high at one end, 60 feet high at lead-in end, having nine wires. At the high end it is supported on a 36 foot spreader, and at the lead-in end on an 18-foot spreader. The aerial proper was 30 feet long. The lead-in consists of number 4 wire and goes directly to the set, which is on the second floor. The wires to the ground were short and heavy. I expected great results, but was disappointed to find that my radiation dropped to one and a half amperes, or nearer one with proper coupling. The set was tuned OK too. I therefore traded my quarter K.W. and ten bucks for a 1K.W. Transformer. Radiation now was two amperes. I began to get disgusted. Who were these liars that radiated 7 and 8 amperes, anyway? I got some first class condenser, the kind old 9BR used, and found my radiation to be 2 $\frac{1}{4}$ amperes. Well, I had a good aerial, a fair transformer, a good condenser, a good gap, and a good O.T. I began to worry about power transformer resonance, and almost got excited enough to buy a Thordarson "thunder factory." Instead, the family got excited about my own little "thunder factory", so I sold my Hyrad, resolving to get a quenched gap. With the money in my pocket I got reckless, went to a hardware store and put \$7.50 into 50 feet of chicken netting. This I cut into two pieces and laid them down in the back yard, not taking time to bury them. I ran seven number 14 wires to the operating room, almost directly above, hooked my new ground onto my old one, pressed the key, and then did a Highland Fling. Oh boy, Ain't it a grand and glorious feeling? 7 $\frac{1}{2}$ amperes with a straight gap, and on two hundred and four meters. When I put in my Quenched Gap, put more wire in the aerial, bury that chicken wire and put some more on top of the ground, I think she ought to come up a couple more. As I am operating on a ship here on the Great Lakes and only get home for a short time, and always in the day time, I don't know how far I can work. I have been able to work everyone I can hear and have not yet been reported except as "QSA very." by all those. I use a Paragon RA6 regenerative set and a one step amplifier. Am expecting to put in another step of amplification and complete the transmitting set before next winter, and hope to get into the relay game then.

(Continued on page 52)

TUSKA "C.W."

Licensed under Armstrong U. S. Patent No. 1,114

AMATEUR "C.W." is here to stay. We have been designing and planning C.W. apparatus for several months. The results are shown below. Every piece of equipment is the result of the writer's own effort to establish a C.W. Transmitter. Each inductance is a painstaking development of laboratory measurement together with actual practical use. The same will be found true of every piece of apparatus we recommend.

You cannot go wrong in buying TUSKA "C.W."

TUSKA C.W. INDUCTANCE—Type 182. This inductance

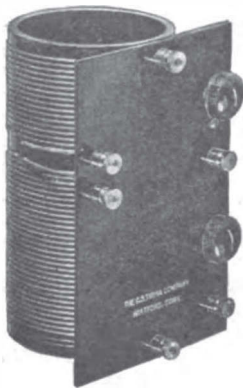

is designed for the electro-magnetic circuit shown. The aerial and filament connections are variable by means of a positive contact switch lever. The winding is threaded in Bakelite tube $3\frac{3}{4}$ " in diameter by $7\frac{1}{4}$ " high. Hard rubber panel $4\frac{1}{2}$ " x $7\frac{1}{4}$ ". Wave length range 200 to 325 meters. Shipping weight 2 lbs.

Price - - \$10.00

TUSKA C.W. INDUCTANCE--Type 181.

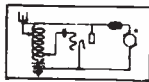

The correct coil for the capacity feed-back circuit. We recommend this circuit strongly; simple and effective.

The inductance has one winding, two switches, and four binding posts. Our design makes it easy to operate. Bakelite tube $3\frac{3}{4}$ " by 6" high. Hard rubber panel $3\frac{1}{2}$ " x 6". Wave length range 200 to 325 meters. Shipping weight 2 lbs.

Price - - \$7.50

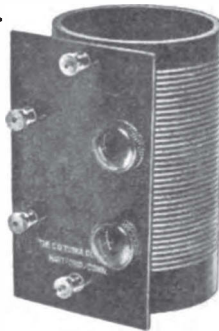

TUSKA C.W. INDUCTANCE—Type 183. Some experi-

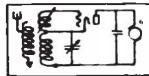
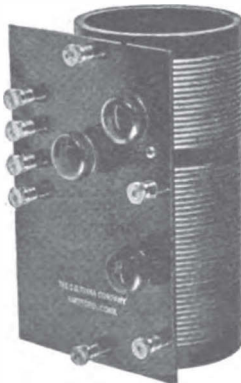

menters prefer the grid tickler type of feedback. Our inductance Type 183 is designed for this kind of circuit. The grid coil is wound on a small Bakelite form which rotates inside the plate coil. A knob on the panel controls the coupling between grid and plate. Tube size $3\frac{3}{4}$ " x $7\frac{1}{4}$ ". Panel $4\frac{1}{2}$ " x $7\frac{1}{4}$ ". Wave length range, 200 to 325 meters. Shipping weight 2 lbs.

Price - - \$12.50

EQUIPMENT. The design particular circuit for which it best and mechanical construction assure you of satisfaction.

Take for example the one wound with the correct number on a correctly proportioned filament not merely wound. The arrangement at a time. The arrangement

METERS

Without meters are essential, and correct reading be used. We recommend the ones listed below are recommended. Delivery on Weston Mod



Weston Model A plate meter type. 0 to 1 amp mounting. Price

Weston Model A plate meter type. 0 to 1 amp mounting. Price



Weston Model G. R. Hot tube trans antenna meter had in the mounting. Price

G. R. Hot tube trans antenna meter had in the mounting. Price

THE C. D. T

ATLANTIC RADIO COMPANY

A. P. MERCHANT COMPANY

GEO. S. SAUNDERS & COMPANY

PHILADELPHIA SCHOOL OF ELECTRICITY
Parkway Bldg., Broad and

EQUIPMENT

4 and U. S. Patent Application Serial No. 807,366.

uctance is based on the
With materials of the very
th and simplicity, we can

our inductances; each is
the right size copper wire,

The tube is threaded—
tive contact with a single
inding posts and knobs is

120

lements of a C.W. Trans-
f not impossible. Meters
the only sort which should
ers. They are accurate.
transmitters consisting of
apply other ranges upon
r weeks.

ter, for
to 500
l multi-
ype of

1.25

liammeter.
D'Arsonval
liamperes.



\$8.50

This
lament
Flush

.50

r. Every
nclude an
pe can be
rd mount-
ush type.
amperes.



10.00

one of planned convenience. Careful insulation takes care
of the high potentials. We are proud of the over-all
efficiency.

Your Dealer will have TUSKA "C.W." EQUIPMENT
in stock. If he hasn't, send us his name, and we will mail
you our booklet on AMATEUR C.W. TRANSMITTERS.

C. Q. Tuska President.

FILTERS

If a motor generator is used for C.W. or
telephone work, a disagreeable hum is
experienced from the commutator of the high voltage
generator. By means of condensers and inductances, this
hum may be made a minimum or entirely eliminated. The
Tuska Filter Type 170 consists of two 1 mfd. condensers
and two iron core chokes, correct-
ly made and wired. Guaranteed
for a potential of 750 volts.
Mounted in a wood case 5" x 7 1/2"
x 2 1/2" with hard rubber panel as
illustrated. Shipping weight, 3
pounds.

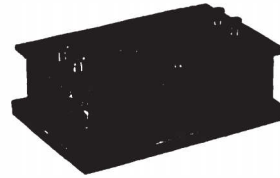

TUSKA FILTER TYPE 170
Price - - \$16.00

MISCELLANEOUS

Following our policy to
specialize in C.W. trans-
mitters, we have added a complete line of standard accesso-
ries for this work. These accessories are products well
known to the trade. Up to this time, it has been im-
possible to purchase the various units needed at one place.
We are in a position to supply all of your needs from our
stock.

Sockets	Chokes
Transformers	Rheostats
Condensers	Motor Generators

Parts of all types

COMPANY :: HARTFORD, CONN.

Carry TUSKA "C.W." ACCESSORIES In Stock.

est, Boston, Mass.	DOUBLEDAY-HILL ELECTRIC COMPANY 719 Liberty Avenue, Pittsburgh, Pa.
est, Boston, Mass.	A. H. CORWIN & COMPANY 4 West Park Street, Newark, N. J.
est, Boston, Mass.	AMERICAN ELECTRO TECHNICAL APPLIANCE CO. 235 Fulton Street, New York, N. Y.
TELEGRAPHY , Philadelphia, Pa.	CONTINENTAL RADIO AND ELECTRIC CORP. 6 Warren Street, New York, N. Y.
TTAN ELECTRICAL SUPPLY COMPANY, Inc. New York, Chicago, St. Louis.	

NG TO ADVERTISERS

41

BENWOOD

LET'S GO, FELLOWS—

ANNOUNCEMENT

We take great pleasure in announcing that the BENWOOD SPECIALTY CO. has been reorganized and will henceforth be known as THE BENWOOD CO., Inc., manufacturers and distributors of radio apparatus.

Due to our rapidly increasing business it has become necessary that we move to larger quarters where we will have greatly enlarged manufacturing facilities and where we will carry in stock at all times a comprehensive line of all standard radio apparatus and material.

It will be our policy to ship all orders the day received and in the rare cases where this cannot be done we will notify the customer of the fact and state when shipment can be made, thus assuring you that the order has received the attention it deserves.

We are well aware of the fact that when a radio man orders something he wants it and wants it quick, therefore our watch word is SERVICE and you can prove this assertion by giving us a trial for anything pertaining to radio apparatus or material. Our central location makes it possible for us to give you the utmost in promptness and owing to the fact that we are the largest distributors of wireless apparatus in the midwest we respectfully request that you favor us with your business.

The "Benwood" Rotary Quenched Spark Gap

4 AMPS. ON $\frac{1}{2}$ K.W. GOOD FOR 1000 MILES.

THE ULTIMATE SPARK GAP for the AMATEUR STATION.

Quiet and Efficient.

Cannot be heard outside of the room in which it is operated.

Absolutely airtight, practically noiseless, increases radiation, gives a beautiful clear note. Your transmitting set can now be operated anywhere in the house with none of the familiar noise. Designed for powers up to and including 1 K.W. Works equally well on any make transformer.

A NEW GAP FREE IF INSULATION BREAKS DOWN.

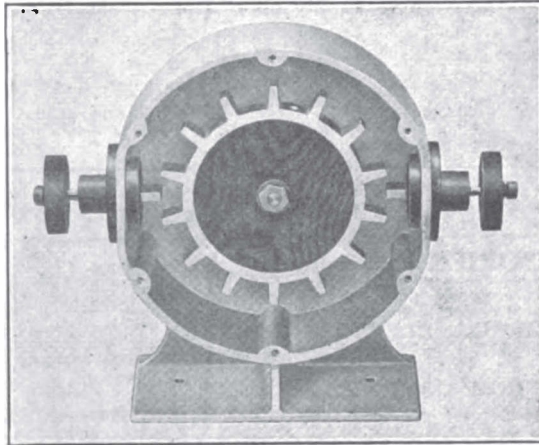

Benwood Gap—Open
OLD STYLE DISC SHOWN.

Bakelite Insulation Throughout
Absolutely Guaranteed Against Electrical Breakdown.

The disc housing is a highly polished aluminum casting. Heavy hushar copper used for static electrodes. The disc is a one piece casting and balanced.

The aluminum disc in conjunction with copper electrodes gives a beautiful quench effect with which all experienced operators are familiar.

Shaft is of best tool steel turning in a bearing 3 inches in length.

The BENWOOD gap is now being used by some of the leading amateurs of the country. Stations which you hear every evening, such as, 1GZ, 8ER, 8BZ, 6AS, 5ZA, 9ZJ, 9ZV, 9ZL, 9KV, 9HW, 9CA, 9IX, 9ET, 9JA, 9LR, 8DV, 9QJ, 9HN, 9DK, 9BG, 9HT, 9SC, 1AK, 5YH, 9AH, many others too numerous to mention.

Price equipped with 4, 8, 10 or 15 point rotor - - - \$30

THE BENWOOD CO., INC.

ALWAYS MENTION QST

APPARATUS

"DISTANCE" HAS STARTED AGAIN

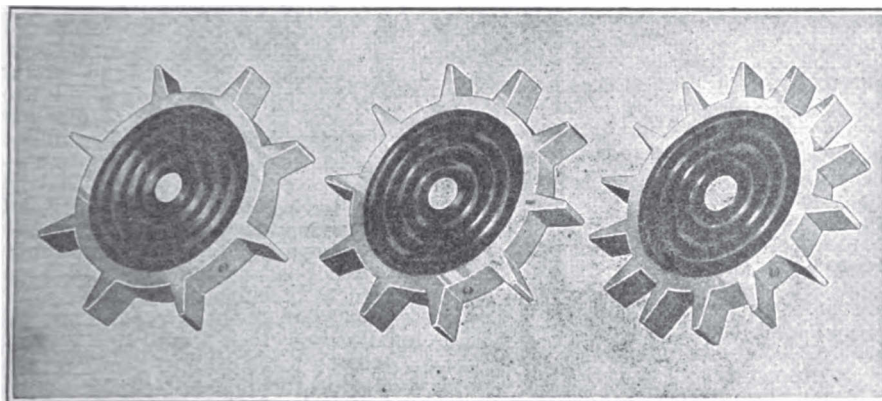

DO SOME REAL DISTANCE
The "Benwood" Rotary Discs
SOMETHING ENTIRELY NEW

A real disc suitable for any 1 K.W. installation.
 Discs are available in styles shown, with 4, 8, 10 and 14 points or complete with bushing to fit any size motor.
 Discs are of solid cast aluminum combined with the right amount of zinc to give them the red hardness. Solid black fibre center.
 Used in conjunction with the BENWOOD stationary electrodes, which are of heavy bus-bar copper, a beautiful clear soft note is obtained due to the excellent quenching qualities of the two metals combined. The disc is light enough for the smallest motor yet has sufficient sparking surface for the higher

powers. The tapered sparking points give the quick break that is so much desired and give the disc a business-like appearance.
 The discs are as beautiful as the illustration shows and they are an article of which we are justly proud.
Price complete, \$8.00
 Specify size of motor shaft.
BENWOOD STATIONARY ELECTRODES, consisting of knob, bus-bar copper sparking point, with round copper shaft but minus support,
75 cts. each, prepaid.

The "Benwood" Battery Charger
A MAGNETIC TRANSFORMER TYPE RECTIFIER.
Designed for 4 and 6 volt Storage Batteries.
CHARGES BATTERY OVERNIGHT.

Constructed to operate direct on 110 volt 60 cycle lighting circuit. No external controls are necessary. Simply screw plug that is furnished with charger into the most convenient lamp socket and connect to the battery.

A Necessity for any Wireless Station.
 The BENWOOD battery charger is already used by many radio men and is especially desirable where more than one audion bulb is used, as no battery long stand up under the strain that three or four bulbs impose upon it.

PAYS FOR ITSELF IN ONE SEASON.
 The average cost of charging the ordinary 6 volt 60 ampere hour battery is ten cents, and the results are often very disappointing. Using the BENWOOD battery charger the cost for six hours use is approximately only ten cents, therefore it is very evident that the rectifier will more than pay for itself in less than a season.
Complete with cord and plug and instruction sheet, \$23.00

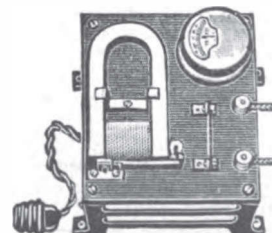

or. 13th & Olive Sts., St. Louis, Mo.
DEALERS, WRITE FOR INFORMATION.

COMMUNICATIONS
(Continued from page 47)

Yours truly,
Harold Haerle Leighton.
Senior Operator S. S. Manitou, WFW, and
9LM, Chicago.

A LETTER FROM FRANCE.

Nice, Jan. 22nd, 1920.

Oh! you, our American comrades who will read these lines, you don't know how fortunate you are!

For several years before the war I have been a radio amateur. I used to read in American magazines about your doings, how you could build and use transmitting sets, how you were organized into a number of clubs and how, through a chain of amateur stations, you sent messages all the way across the continent, and all that under official encouragement!

Here it was just the contrary. According to law licenses could be obtained from the Government to erect "experimental" stations but, in fact, they never were granted except to a half dozen companies who were building radio apparatus on a commercial scale.

As for receiving it was different. The Government and especially the administration of Posts and Telegraphs did not like us to do it but they could not prevent us, there being no law to that effect. But just before the war, towards the middle of 1914, they spoke of passing such a law, then the war broke out and all receiving stations were dismantled and the apparatus confiscated by the Government.

Now that the war is over the decree forbidding the use of receiving stations is no longer in force, our apparatus has been returned to us and we operate once more under the pre-war law.

But the aspect of the amateur question in France is very different from what it was in 1914. Then the number of people having receiving sets was comparatively very small. They were mostly clock builders who needed the time signals, a few men who had served as radio operators in the merchant marine, in the Army or in the Navy and who were still interested in the art, and a few electrical students who had taken a special interest in radio.

Now, thousands of young men have learnt and practiced radio in the Army and Navy during the war and a majority of them is anxious to continue to practice what has been their daily work and main interest during five years. So, numerous radio sets are being installed all over France and it is to be hoped and supposed that the French amateur world will be ever increasing in importance.

Is there any prospect of a new law concerning us and if so what will it be?

Such is the question on which all of us are anxiously speculating. It is hard at present to answer that question, but the author thinks it very unlikely that reception shall ever be forbidden. Everybody knows how harmless it is in time of peace and how impossible it would be to enforce such a law, a decision of that kind would only be a prejudice to the law-abiding citizen while any person willing to disobey the Government order could easily do so.

As for transmission there is unfortunately very little reason to be optimistic, the Government having the monopoly of all telegraphic communications in France no commercial company can use its influence to obtain authorisations which would be a good "precedent" for amateur to base their requests on. The author recently asked their opinions on this point to several French personalities connected with the radio world and their answers were almost in every case identical to that of a high rank army officer who said that if any kind of sending sets was allowed it would very likely be only bulb transmitters working at low power on very short waves and sharp tuning, in order to insure a minimum of chances of interferences with Government stations.

Let us hope that this at least may soon be allowed and that we too, like our American friends, can enjoy the pleasures of talking to each other through the medium of the ether waves!

H. T. S.

SPRINGFIELD HEARD FROM

Springfield, Mass.,
August 1, 1920.

Editor, QST:

We are not dead in Springfield, Mass. It seems to us that we have heard just about enuf of "there is no road thru Springfield."

Springfield is on the map. It has the best radio association in Western Mass. The Springfield Radio Association has its own home at 19 Orleans Street, Aerial 45' high and 75' long. The receiving set is under construction by members of the association, and a 1K.W. transmitter is expected this fall.

The membership is 22 and more is expected after the vacation season. The affairs of the association are conducted by a Board of Directors who have directed the installation of the aerial system. All work is done by committees with the chairman responsible.

You may expect this early fall to hear from Springfield, Mass., and also can work relay to any point within the limits of a 1K. W.

So, Relayists just keep the diaphragms

of your 2000 ohmers close to your ears, for Springfield Hertzian impulses.

We will make an official announcement of our station at a later date.

Springfield Radio Association,
19 Orleans Street,
Springfield, Mass.

A STATIC-COUPLED CIRCUIT

685 So. Greenwood,
Kankakee, Ill.,

Editor, QST:

In the last few months I have been experimenting with receiving hook-ups and at last I believe I have found the best solution for a receiver of both damped and undamped waves.

I use a statically coupled receiver and I think they are the best from an amateur's standpoint, they are the easiest to tune; tuning done almost entirely by variables.

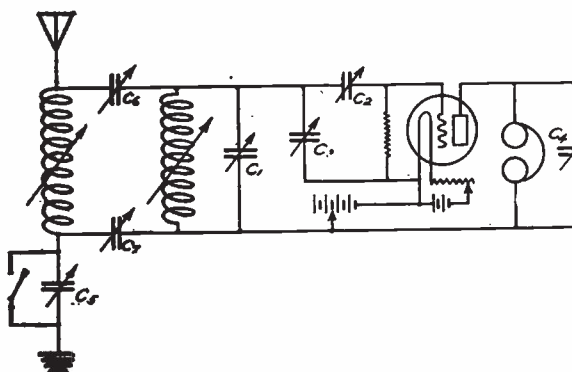

C ₁ -43	PLATE VARIABLE	.001MF.
C ₂ -43	"	.001 "
C ₃ -21	"	.0005 "
C ₄ -21	"	.0005 "
C ₅ -43	"	.001 "
C ₆ -43	"	.001 "
C ₇ -43	"	.001 "

Using this hook-up in connection with a 5000 meter loose coupler and an audiotron bulb I have heard practically all the undamped stations; some of which are: IDO, NSS, NAJ, NAA, POZ, NAR, NBA, NDD, NAW, NWW, NPG, OUI, MFT.

I have had much success in receiving damped waves from many of the U. S. stations.

For tuning undamped waves C₅ and C₈ are adjusted at 180°; the variable in series with the ground, C₆, is shorted; C₁ and C₂ set at 90°, and C₃ and C₄ are varied by experiment.

For damped work, tuning is accomplished by C₅, C₇, C₁ and C₂. C₃ and C₄ are set at zero. The series variable, C₆, is also used.

I have had very good results using this hook-up, which I think is original, as I have not seen any others similar to it.

I would be glad to help and give information to any amateur wishing to try out this hook-up.

Yours truly,
M. L. Potter, Jr.

MOO!

403 Decatur Street,
Brooklyn, New York,
June 29th, 1920.

Editor QST.,
A.R.R.L., Hartford, Conn.,
Respected Sir,

Have been feeling the impulse to write you for some time, but being a charitable soul, have put it off as long as possible, after seeing such little items as, "SOS de KBW", etc. But an item in "Strays" in QST for June, 1920, did it. You can blame yourself. You ask who the joker is that suggested MO for a QTE signal. I was present when the awful event occurred. It was a bright sunny afternoon in the summer of 1918 on the sixth floor of 44 Whitehall Street, New York City. 9PF, 2CS, 2MR, DA and many others know the place. The old control station for the various NAHs. Small loops had just been

installed at City College, New York, and at Bush Terminal, Brooklyn. The war is over now, so it's OK to disclose such highly important military information. We were instructed to try to get bearings on some ship in range. Lieutenant M. W. Arps, O-in-C of Navy Radio, New York, at the time, was there when we raised a ship that both BU and CY said they could hear, so we told the ship to send for a bearing. He asked the operator on 600 meter watch (POP Atwater—I being on 952) what to send, and Pop referred the query to Mr. Arps. After a minute's thought, Mr. Arps said, "Tell him to send MO". There you have it. We gave several other ships bearings that day, and when we eventually got five regular-guy compasses working, the MO stuck, and was apparently adopted, at least unofficially all along the coast. The canucks use the figure 2, than which nothing is prettier when MRA rattles off 2s on his 300 cycle spark. English and French use INTL. MO is kinda tuff when it busts up your traffic with NBD at 1700 miles, but it's necessarily of more importance. If the

second mate on the Princess Anne had asked his op. to get a QTE from NAH he would have been looking for Ambrose instead of trying to climb over Rockaway Point. She's an awful looking derelict now.

Another point which calls for comment is the item, (Also in Strays) on the Shipboard 2KW Arcs. A pal of mine is on the Eastern Planet, a Jap built craft, which is one of the Federal equipped ships. They get 3½ amps. on "J" with a chopper and can get fair distance if heard, but he complains it's so darn sharp he has to shift a turn at a time until he crosses their tune to raise the coast stations. Their working wave is to be 2250, and shore stations are to listen for calls on the wave during the last quarter of each hour. He ses he gets 'em once or twice a day on schedule. He worked VAL from Delaware. Breakwater on 2250, which is not so bad for daylight. VAL by the way, for general information is Barrington Passage, N. S., an undamped station of Canadian Marconi, which was recently installed to work the British ships similarly fixed. All work is on 2000. MGA, MHC, MBC, MRA and MLC all have 3 KW tube sets. Aberdeen, Scotland, is worked on the other side. I recently heard MBC (Baltic) report to WCG sailing and took a few from WCG. He then gave him a QRU. I smelled a rat, because the big Limies always have some "Good-bye" tfc when outbound, so I chased myself up to 2000 and there he was, giving New York City stuff to VAL. WCG was using crystal at the time, (now?) and couldn't hear him, though I foned the info. Think the Convention will prohibit such work, it being provided that "ships in range of station in one country, may not work beyond that station into another country unless ship is under other countries flag, and traffic is destined to second country, and work is carried on above 1600," or words to that effect. Have since heard MGA work NBD on the long wave, NBD using 1900 meter spark, and clearing traffic, what I mean, so I guess they will be good about it. All the sets installed at present are of different construction, as I understand, purpose being to find out which sets give best service, as Cunard contract with English Marconi runs out shortly, and all hands are competing for renewal. The tube sets are said to be too much in the experimental stage as yet to turn over to the average operator.

Now for a kick. The Old Man, in several of his recent ravings, has been hitting the "squeak boxes" as many raps as possible. I have always been limited to a 2 inch coil, due to impossibility of getting juice in here, but if I don't use better operating diplomacy than nine-tenths of the 1 KW QRM hounds I hear, I'll close up and

get a job on the street cars. Many others in my position will agree with me. One bird here, well-known to all N. Y. C. hams, has a practice of calling ten or twelve spark coils, (like WCG calling traffic) and telling them, in not so choice language, to shut up while HE works. I haven't had the chance of getting him right on the profane language stuff, but some time, I'm gonna have another op here so we can corroborate each other and shoot his line in to Mr. Krum. 'Stoo much of that. Please ask the Old Man where the relay tfc would get to if the spark coil hams didn't do the dirty work of running around the block to deliver the stuff. And often getting a call-down because the message was a week coming through. And another thing, one ham with 1 KW musses up more country than 472 hams with 36 watts, as I have. Consider that point of view, OM.

Having said enough for one communication, and exchanging cordial felicitations with ye ED, will say, 73,

A. R. Heydon.

WINDING VARIOMETER STATORS

1225 Hawthorne Ave., So.,
Minneapolis, Minn.

Editor, QST:

Amateurs who construct their own S.W. regenerative sets usually experience considerable difficulty in winding the field-frames of the variometers. Perhaps the following system will be found even better than the various schemes already offered.

Lay the frame in question upon a smooth surface, with the small opening down. Cut a strip of ordinary office blotting paper, and, after wetting same, line the inside of the frame taking care to fit the strip smoothly against the wood. Then mix about a pound and a half of plaster-of-paris to such consistency that it will readily run from the vessel when poured into the frame. Fill the latter until level with the top and let it stand for at least three-quarters of an hour. Remove the cast by tapping gently; the blotting-paper may be easily rubbed from same. Then proceed to wind the wire upon the cast, after which the inside of the frame is thickly shellacked and the form with the winding is inserted. Allow to stand for ten minutes only.

In again removing the cast, the upper turn of the winding is held in place (using a pair of screw-drivers or anything handy) while the cast is carefully and slowly pushed up. After the winding is set in the frame, another coating of shellac will help to keep it in place. The same cast may be used any number of times, so after the trouble of making one, the winding of frames will be comparatively easy.

Very truly yours,
W. C. Grover.

THE THINGS WORTH WHILE

1627 Seventh Ave.,
Troy, N. Y.

Editor, QST:

There is a matter I want to get off my chest while the time is ripe. I heartily agree with Mr. Hutchinson's remarks in May QST. Some of our better relay stations are commercializing amateur relay work too much. If they want commercial routine and monotony why don't they enter the Merchant Marine? I am in favor of brief sending and a snappy style of relaying, but why should our best stations give us a 73 when we tell them NIL to their QRU. As you say, not all of us can be relayers, but we can do as good work as they, and are just as interested in knowing how someone 500 miles away likes our spark. One of the A.R.R.L. traffic rules says that no more "Greetings via Radio", messages are to be accepted. And why not?? I don't encourage small talk or chewing the rag over nothing by radio, but if a friend wishes to greet another friend in some other state, and do it by radio, why shouldn't we accept his message? How many people ever order goods or send very important messages via amateur radio stations? They generally choose the lesser evil and mail it.

The Hudson Valley has as good a trunk line as can be found anywhere. Starting at Schenectady, stations are located along the river with not more than 50 miles between any two. Daylight work is always a certainty. Some of our best eastern stations are near the New York terminal of this line. However, during the past season, I have started several messages for New York City and none of them ever reached their destination. Incidentally, those stations near New York City, and upon whom delivery of the message depended are perhaps just the ones who would commercialize amateur radio. Where was their commercial-like efficiency when these messages came through? The messages weren't "Greetings via Radio" either, but were of some importance. On the other hand, haven't the transcontinental test messages always been of a congratulatory or greetings nature?

We are in this game for pleasure and scientific advancement, not money. Our trials and tribulations in improving our stations is what keeps up our interest. If everything always functioned properly, many of us would soon tire of it. Even some of our best stations don't seem satisfied with merely operating their first-class sets. They design, construct, and test new apparatus for general amateur use. And I'll wager a dollar to a doughnut that it is this part of the game that keeps alive their interest.

Well, Eddy, you are a busy man, consequently I'll take no more of your valuable time. Would like to hear more of this subject from other fellow amateurs.

Best 73's,
E. M. Williams.
(Radio 2SZ).

A LETTER TO 3HJ

Marion, Mass.,
August 3, 1920.

Dear 3HJ:

Speakin' of oscillation transformers, do you use one of them things? or is it a straight hook-up from a spark gap to antenna, or a helix?

Aintcha 'fraid you'll melt your antenna? Do they have Radio Inspectors down there? Do they have decimeters? Thought possibly you used a slip-stick to figure it out.

Now, old sock, dontcha worry about us other fellers at all, 'cause we don't mind sitting there at all till you get thru. You're not so broad but what we might go up on 2,500 meters and skin thru possibly—it's only the wave lengths between 25 and 2,490 that we get you fairly good.

Now all jokin' aside, 3HJ—get a pair of "come alongs" and yank that primary and secondary apart, else I'll just havta build a bigger tuner.

Yours, till Pitts sells Ponzi an outfit,
"Speedo".

UNUSUAL RECEPTION

181 Waverly Place,
New York City.

Editor, QST:

While sending in my list of stations received thought I would mention a few other things which will undoubtedly interest readers of "Radio Communications by the Amateurs" in QST.

On the night of June 3, I had occasion to try very loose coupling between my primary and secondary circuits of my receiver—18" clear separation—and during a period of about ten minutes copied the following stations, all QSA: 1AK, 8ER, 8DA, 8XU, 8ZW. I think this speaks quite well for the use of loose coupling, as the tuning is exceedingly sharp under such conditions.

Taking advantage of the favorable weather conditions I tried my bed spring for an aerial and heard 1AK, 8DA, 3NB, and 2TF, all loud.

Might mention that later on the same evening I heard 9YB calling 9EC.

The night of June 9th also showed fine conditions, bringing in 1HAA very loud and 8CB on silicon detector.

CUL, 73 to everybody—de

A. Rechert,
2TT.

SAD, BUT TRUE

BY HOFFMAN

FRAILTIES OF THE UNINITIATED IN THE AMATEUR RADIO FRATERNITY

TAKE THE "OLD MAN'S" ADVICE AND LAY OFF THE 30 AMP FUSES, THE BELL WIRE AND LAMP CORD POWER CONNECTIONS AND THE CALLING AND SIGNING OFF 10 TIMES PER MESSAGE

WONDER IF THAT NEEDS SOLDERING

(WE WONDER IS SHE BLONDE OR BRUNETTE? —THE ARTIST)

A LOT OF FELLOWS ARE SAVING UP FOR AMPLIFIER SETS BUT FAIL TO REALIZE THAT A FEW BERRIES INVESTED IN A SOLDERING OUTFIT WOULD IMPROVE THEIR PRESENT OUTFITS REMARKABLY

MISS GARM-HAUSEN MAY HAVE BEEN DOUBTFUL HOW TO HOOK UP A LIGHTNING SWITCH BUT THERE'S A LOT OF SMALL BOYS WITH RADIO SETS WHO NEVER EVEN HEARD OF ONE!

ER-WOTS QRS?

SOME KEEP THEIR "Q" SIGNAL CHARTS IN A DRAWER INSTEAD OF UP ON THE WALL IN PLAIN SIGHT (GET THIS 81Q?)

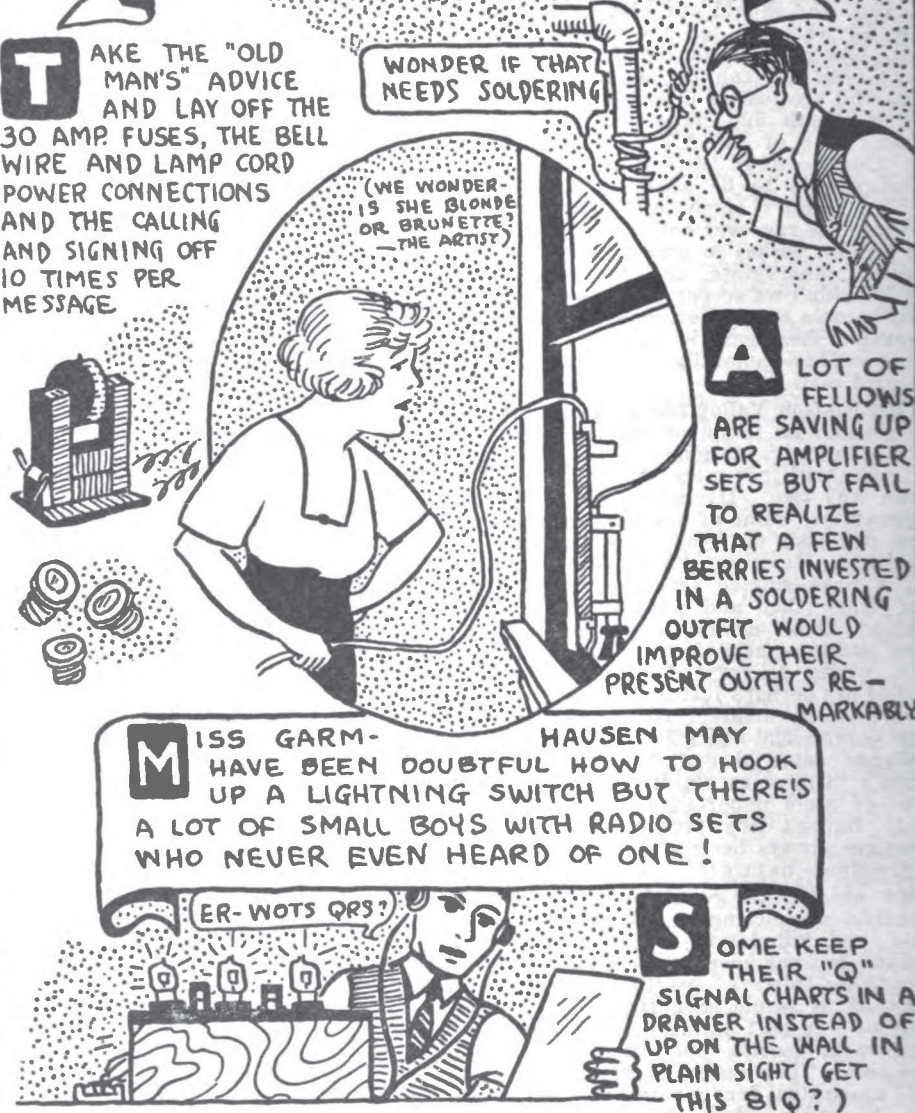

CALLS HEARD

On account of the vast quantity of calls reported we must ask your co-operation in the following.

- (1) List the calls on a separate sheet of paper—do not embody them in a letter.
- (2) Arrange by districts from 1 to 9, and alphabetically thru each district; and run them across the page, not down a column.
- (3) Put parentheses around calls of stations also worked.
- (4) Omit initial or other unauthorized calls.
- (5) State the period covered by your report.

1AW, HARTFORD, July 10—Aug. 9.
 (1CK), (1CM), (1ES), (1FV), (1QP), (1SZ), (1TS), (1AAU), (1BBL), (1HAA), (1NAQ), (1VAD), 1VAO, (2DI), (2EL), 2ER, 2GK, (2JZ), (2MK), (2RK), (2RM), (2SH), 2TF, (2ZM), 2AJW, 3BG, 3BZ, 3CS, (3EV), (3GV), (3HB), (3HJ), (3HX), (3KM), (3NB), (NSF), 3BP, (3DA), 3DC, 3DV, (3ER), (3QM), 3WY, (3XK), 3ZN.

H. POLLOCK, PAWTUCKET, R. I., June 1—Aug. 1.
 1AE, 1AK, 1AAU, 1AW, 1CK, 1EK, 1HAA, 1TS, 1YB, 2DA, 2FH, 2JU, 2NR, 2RM, 3EV, 3EY, 3GX, 3HJ, 3NB, NSF, 3CB, 3HW, 3MT, 3PG, 3RS, 3WY, 3XU, 3HA, 3ZN.

3WO, BALTIMORE, July.
 1AE, 1AK, 1AW, 1EV, 1CM, 1HAA, 1TS, 1FUL, 1FW, 1TE, 1RK, 1TF, 1YU, 2BB, 2BK, 2BY, 2DA, 2JE, 2JU, 2QR (spark and mod. CW), 2NF, 2XH, 2XJ, 2XU both (phone), 3BA, 3BE, 3BK, 3BT, 3BH, 3BZ, 3BU, 3CK, 3CQ, 3EN, 3FG, 3GO, 3HJ, 3IQ (CW), 3KM, 3NB, 3EH, 3RV, 3WF, NSF (mod. CW and phone), 4AA, 4EE, 4AO, 5AC, 5AO, 5AX, 8AW, 8BP, 8AC, 8DA, 8CS, 8EN, 8ER, 8AV, 8IB, 8HG, 8HP, 8NI, 8UA, 8WY, 8XK (mod. CW and spark), 8XU (mod. CW), 8XP, 8ZW, 9CC, 9AD, 9BT, 9ER, 9NQ, 9ZL, 9ZN.

1TS, BRISTOL, CONN., June 20—July 20.
 1AE, 1AS, (1AW), 1AY mod. C.W. and phone, 1BAY, (1BBL), 1BJ, 1BM, 1CE, 1CK, (1CM), (1CZ), 1DQ, 1DR, 1DY, 1EAV, 1EP, 1ES, 1FB, 1FV, 1FW, 1GAL, (1GY), (1HAA), 1KAZ, 1LAX, (1NAQ), 1NO mod. C.W. and phone, 1QN, 1SN, 2AJW, 2AIM, 2ANN, 2AQQ, 2ASV, 2BK, 2CI, 2DI, 2DN, 2GR, 2JE C.W., 2JU, (2OA), 2OM, 2QR spk. and C.W., 2QV, (2RB), 2RH, 2RK, 2RM, 2SH, 2TF, 2WG, 2YM, 2ZL C.W., 2ZM, 3EN, 3EV, 3FB, 3FG, 3FN, 3GB, 3GO, 3HJ, 3HX, 3LS, 3NB, 3VJ, 3ZA, 3ZW, 3BB, 3BP, 3DA, 3DI, 3DV, 3EN, 3ER, 3FO, 3GB, 3HP, 3IK, 3LE, 3NI, 3QM, 3WY, 3XK mod. C.W., 3ZW, 9ZJ, 9ZN.

5ZN, EAGLE PASS, TEX.
 (5AC), 5AG, 5AF, (5AL), (5AS), 5AO, 5AY, 5BG, 5BF, (5BJ), (5BO), 5BS, 5BT, (5BM), 5BY, 5BZ, 5CA, 5CX, (5DO), 5FH, 5GH, 5LL, (5YA), (5ZA), (5ZC), 5ZG, 5ZL, (5ZO), 6AL, 6CS, 6GE, (6GQ), 6ER, 6AB, 6AE, 6AJ, 6AP, 6BR, 6BT, 6CA, 6CN, 6CS, 6DU, 6EA, 6EF, (6EL), 6ER, 6FA, 6FB, 6FL, 6FT, 6FU, 6FZ, 6GL, 6GQ, 6GS, 6GV, 6GW, 6HN, 6HT, 6IF, 6II, 6IT, 6IX, 6JB, 6JD, 6JE, 6KJ, (6KV), (6LC), 6OT, 6OV, 6PL, 6PS, 6WE, 6YA, 6YO, 6ZJ, 6ZN.

8DA, SALEM, O., March.
 1AW, 1CM, 2BM, 2BK, 2CS, 2IR, 2JE, (2WB), 2ZC, 2RB, 3AN, 3BZ, (3DH), (3EN), (3EV),

(3FG), 3HA, (3HJ), (3NB), 3NV, (4AE), (4AG), (4AL), (4AT), 4AQ, 4CR, 4BQ, 5BS, (5DA), 5XA, 5YE, 5ZP, 5ZL, 8AGO, (8ER), 8FI, 8IV, 8IF, 8CD, 8JX, 8XP, 8NZ, (8XA), (8XU), 8ZV, 8XK, 9AJ, (9AU), 9CA, 9CE, 9DF, 9EE, 9ET, 9KO, 9LQ, 9MH, (9LC), 9YA, 9ZJ, (9ZV).

6BN, SAN FRANCISCO
 6AK, (6BQ), 6CQ, 6CS, 6CM, 6FI, (6CV), 6DP, 6DK, (6EA), 6EB, 6ED, (6EJ), 6EK, 6EM, 6EN, (6ER), 6FE, 6FS, (6GI), 6GR, (6HZ), 6IH, 6JD, 6JL, 6JJ, (6JM), (6KA), (6KP), 6MH, (6NY), 6OE, (6OH), 6PQ, (6QR), (6UM), 6XZ, 6ZA, 7AD, 7BC, 7BP, 7BY, 7CC, 7CR, 7CW, (7CU), 7YS, 7ZB.

1GY, WORCESTER, MASS., June 12—July 10.
 Worked: 1AW, 1AS, 1CM, 1FV, 1TS, 2JU, 2OA, 3HJ. Heard: 1BA, 1BM, 1BD, 1BT, 1BR, 1CE, 1CK, 1CZ, 1DY, 1DQ, 1DR, 1GM, 1JA, 1KAY, 1LAX, 1KL, 1PG, 1RZ, 2CM, 2EY, 2UD, 2AJW, 3KM, 3BB, 3DA, 3FO, 3TT, 3WY.

9GP, KENOSHA, WISC., Feb. to June
 1AK, 1AW, 2FM, 2RR, 2WB, 2ZC, 3SK, 4AE, 4BQ, 5GP, 5ZL, 5ZU, 8AA, 8AL, 8DA, 8DW, 8ER, 8CY, 8CU, 8BP, 8EZ, 8FG, 8JJ, 8FA, 8NT, 8XI, 8ZA, 9AAU, 9AFK, 9AAP, 9ADI, 9ACA, 9AES, 9AAG, 9AFR, 9ACW, 9AE, 9AT, 9AW, 9AU, 9BR, 9BT, 9CL, 9CA, 9CE, 9FG, 9ES, 9HW, 9HH, 9ST, 9KO, 9KS, 9LZ, 9LC, 9MH, 9NZ, 9OR, 9OS, 9ON, 9PR, 9SQ, 9ST, 9TE, 9UG, 9UK, 9UY, 9VD, 9VK, 9ZC, 9ZN, 9ZL, 9ZX, 9ZP.

9CS, CLINTON, IOWA.
 2SS, 4EA, 5AC, 5AL, 5BK, 5BO, 5DO, 5ZA, 5ZC, 5ZO, 8AA, 8AB, 8BP, 8DA, 8DO (8ER), 8FH, 8HG, 8IK, 8JQ, 9AK, 9AL, 9AP, 9AT, 9AU, 9AV, 9ACN, 9AAF, 9BB, (9CA), 9CW, (9DC), 9DH, 9DU, (9EE), 9ET, 9EX, (9EZ), (9GC), 9GK, 9GS, 9GX, 9HI, 9HJ, 9HT, 9HW, 9IT, 9JL, (9KV), (9LC), 9LH, 9LM, (9MQ), (9MS), 9NO, (9NV), (9OI), (9ON), 9OR, 9PI, (9MI), 9RP, 9ST, 9UU, 9ZL, (9ZN), (9ZC), 9ZX.

4DA, MACON, GA., March 17-30.
 3EN, 3ND, 3HJ, 4AT, 4BK, 4YA, 5AL, 5CP, 5ER, 5FL, 5XA, 5ZP, 8DA, 8GB, 8GT, 8JJ, 8LA, 8LH, 8NA, 8NI, 8NZ, 8ZB, 9LF, 9QP, 9ZT.

1ES, BROOKLINE, MASS., March 2 to July 31
 1AK, (1AW), 1BBL, 1BM, 1CAO, 1CBJ, 1CM, 1DT, 1EAV, 1EK, 1FB, 1FQ, 1FV, 1FW, 1GY, (1HAA), 1IAO, 1JAP, 1JY, 1KAY, 1LAX, 1NAQ, 1PAZ, 1RZ, 1SZ, 1TS, 1YB, 2AJW, 2ANN, 2AOP, 2BB, 2BG, 2BK, 2BM, 2BO, 2CD, 2CL, 2CS, 2CT, 2CY, 2DA, 2DR, 2EL, 2FS, 2GR, 2JE, 2JL, 2JN, 2JU, 2JZ, 2LO, 2ME, 2MK, 2NF, 2NP, 2OA, 2OM, 2OU, 2QR, 2QV, 2RB, 2RK, 2RL, 2SH, 2TF, 2UE, 2VA, 2WB, 2XH, 2XJ, 2XX, 2YM, 2ZC, 2ZL, 2ZM, 2ZS, 3AN, 3AW, 3BE, 3BH, 3BZ, 3DH, 3EN, 3EV, 3EW, 3EY, 3FB, 3FG, 3FR, 3GO, 3GX, 3HJ, 3HX, 3KM, 3MU, 3NB, 3NC, 3NV, 3OB, 3SJ, 3XH, 3ZA, 3ZW, 5CW, 5ABG, 8AJ, 8BP, 8BQ, 8CB, 8CE, 8DA, 8DC, 8DI, 8DV, 8DY, 8EN, 8ER, 8EV, 8FF, 8FO, 8FP, 8FW, 8GB, 8HP, 8HW, 8IK, 8JJ, 8LA, 8LI, 8MI, 8MT, 8NI, 8NQ, 8PG, 8QM, 8RQ, 8RS, 8VM, 8WY, 8XK, 8XU, 8YV, 9CE, 9MH, 9PV, 9ZJ, 9ZN, NSF.

7CU, VANCOUVER, WASH.
 (5BR) (Canadian), 6AJ, 6AN, 6AT, (6AV), (6BR), 6BJ, (6BN), (6BQ), 6BZ, 6CD, (6CI), (6CO), 6CQ, 6CV, 6DH, (6DP), 6DK, 6DT, 6DY, 6ED, (6EJ), 6EN, 6ER, (6EX), (6FE), 6FI, (6FS), 6FX, 6FY, (6GF), 6GI, (6GK), 6GN, (6GR), (6HO), (6HP), (6IC), 6JD, 6JI, 6JK, 6JM, 6JN, 6KM, 6KP, 6OC, (6OH), 6ON, 6PQ, 6QR, 6QU, 6TV, (6UM), 6ZE, 6XZ, (7AD), (7AN), (7BF), (7BK), (7BH), (7BV), (7CB), (7CE), (7CW), (7HI), (7YS).

2VA, HOBOKEN, N. J.

(1AE), (1AF), 1AK, 1AR, (1AS), (1AW), 1AZ, 1BB, 1BL, 1BM, 1CE, (1CK), 1CL, 1CM, (1DQ), 1DU, 1EAV, 1EM, 1FQ, 1FV, 1FW, 1GAL, 1HAA, 1IR, 1JAP, 1KT, 1RN, 1SN, (1TS), 1YB, (1ZA), 1ZV, 2BM, (2TF), 3AD, 3AK, 3AN, 3BB, 3BZ, 3CC, 3CH, (3CS), (3CV), (3DH), 3EM, 3EN, 3EV, (3FG), 3HG, (3JR), 3LZ, 3MU, (3NB), 3OB, 3OI, 3XE, 3ZA, 3ZS, 3ZW, 3ZY, (NSF), 4AE, 4AN, 4AT, 4CC, 5DA, 5ZA, 8AA, 8AB, 8AB, 8AL, 8ALE, 8BP, 8BQ, 8CB, 8CC, (8DA), 8DI, 8DV, 8EJ, 8EN, 8ER, 8ES, 8FD, 8FF, 8FH, 8GB, 8HG, 8HH, 8HP, 8IC, 8IF, 8IK, 8IL, 8JJ, 8JQ, 8LA, (8LH), 8LI, 8LK, 8MT, 8NI, 8OU, 8QJ, 8RS, 8TK, 8UD, 8WY, 8XA, 8XK, (8XU), 8ZY, 9AJ, 9AK, 9AU, 9BB, 9BT, 9CC, 9CJ, 9ER, 9HD, 9HJ, 9HN, 9HR, (9HW), 9IO, 9IT, 9KF, 9KV, 9LN, 9PM, 9ZJ, 9ZL, 9ZN, 9ZW.

2DX, SUMMIT, N. J., Apr. 1—June 14.

1AE, 1AW, 1DN, 1HA, 1JN, 1LW, 1QN, 1TS, 1HAA, 2QR, 2CG, 3BB, 3BE, 3CK, 3CV, 3DH, 3HJ, 3LZ, 3LY, 3MS, 3ZA, 3ZS, 3AU, 3BO, 3DA, 3DW, 3ER, 3EN, 3MT, 3NS, 3WG, 3WY, 3ZN. *Asso* following radiophones and C. W.: 2ADJ, 2EX, 2XB, 2XJ, 2XG, 2XX, 2XR, 2XL, 2ZL, 2ZM, 2QR, NSF.

1CE, BROCKTON, MASS.

(1AW), (1AW), (1CM), (1EK), (1EAV), 1FA, 1FM, 1FQ, 1FW, (1HAA), 1JH, 1JN, 1JU, 2AD, 2AK, (2BK), 2BM, 2CB, 2CM, 2DA, 2DC, 2DL, 2DM, 2DZ, 2EF, 2FE, 2FM, 2GE, (2GR), 2IE, 2ID, 2IK, 2IN, 2JE, 2JM, 2JU, 2KY, 2LO, (2ME), 2NW, (2OA), 2RJ, 2RV, 2TA, 2TF, 2TU, 2WA, 2XJ, 2ZC, 2ZL, 2ZR, 2ZS, 3AA, 3AN, 3AL, 3AR, 3BZ, 3EN, 3EV, 3FX, 3GE, (3HJ), 3HW, 3MU, 3NA, 3NB, (3NV), 3VJ, 3ZA, 3ZS, 3AB, 3AY, 3BB, 3CB, 3DA, 3DV, 3EN, 3GB, 3NS, 3XU, 3XK, Canadian 3Z.

9JE, COLORADO SPRINGS, COLO.

5AC, (5AS), 5AL, 5AV, 5AY, 5BG, 5BO, 5CP, 5DO, 5DU, 5ZA, 5ZB, 5ZC, 5ZG, 5ZL, 5ZO, (6AL), 6EY, (6IZ), 9AB, 9AJ, 9AW, 9BR, 9BT, (9CA), (9CN), 9CW, 9DV, 9CE, 9EL, 9EW, 9EY, 9FB, 9FC, 9FL, 9GS, (9HI), 9HT, (9IF), 9IX, 9JB, 9LC, 9NQ, 9OB, (9PI), 9PN, (9RV), 9YA, 9YO, 9ZC, 9ZN.

CAN. 2BF, MONTREAL, March

1AL, 1AS, 1AW, 1SZ, 1ZA, 2BK, 2BM, 2CS, 2DA, 2DS, 2GB, 2IR, 2JU, 2RS, 2ZC, 2ZM, 3OH, 3EN, 3EV, 3HJ, 3NB, 3NC, 3NV, 3NW, 3ZS, 5ZL, 8AIA, 8BB, 8CB, 8OV, 8DA, 8EN, 8ER, 8HA, 8HG, 8HH, 8HJ, 8IR, 8IL, 8MZ, 8NO, 8OU, 8XA, 8XU, 8XK, 8ZW, 9AU, 9ZJ, 9ZL, 9ZV.

CANADIAN, 3AB, TORONTO, additional.

2AN, 2JU, 3BZ, 3HJ, 3DT, 3EN, 3FR, 3GI, 3HG, 3IK, 3JF, 3LA, 3MT, (3MZ), 3NZ, 3OZ, 3XU, 9AJ, 9AX, 9HW, 9ZL.

9ZQ, OELWEIN, IOWA, Apr. 2d.

(9AAL), 9AD, 9AU, 9AX, 9CE, 9CN, 9FG, 9FI, (9FP), 9FW, 9GC, 9HI, 9HR, 9HT, 9HW, 9JN, (9JT), 9KE, 9KI, (9KV), 9LC, 9LH, 9LQ, 9LR, 9LV, 9MH, 9NQ, 9OE, 9ON, 9OV, 9PI, 9SS, 9UG, 9WI, 9ZC, 9ZL, 9ZT, 9YA, 9CB, 9LA, 9NZ, 9BT, 9BG, 9EN, 9EO, (9ZA), 9ZL, 9ZU, 9YE.

4AT, FT. PIERCE, FLA., March.

1AL, 1AW, (1FX), (2ZC), (3DH), 3IR, 1AC, 4AE, 4AG, (4AL), 4AN, (4AO), 4AR, 4ES, 4YA, 5XT, 5ZA, 8DA, (8LA).

7CR, PORTLAND, ORE., March

6AD, (6AE), 6AH, (6AK), 6AL, 6AO, 6AT, (6BQ), 6BR, 6BT, 6BU, 6CC, 6CO, 6CV, 6DK, 6DY, 6EA, 6EB, (6EJ), 6EN, 6FE, 6FH, 6FI, 6FN, 6FY, 6GI, 6, 6HO, 6HQ, 6JD, 6JR, 6JM, 6KL, 6MZ, 6NE, 6RH, 6ZA, 6ZE, 7AD, (7CC), (7CW), 7YB, (7YS).

5ZX, HOUSTON, TEX.

(4BZ), (5AD), (5AG), (5AL), (5ED), (5EJ), (5EO), 5YA (5ZA), (5ZC), (5ZG), 5ZN, (5ZU), 8ER, 8FX, 9AJ, (9AU), (9BT), (9CA), 9CS, 9CW, 9EL, 9ET, 9HI, 9HN, 9HT, 9IF, 9IT, 9JE, 9KF, 9KO, (99KV), (9LC), (9RP), 9ZL, 9ZN, 9ZT, (9ZU), (9ZV), CW.

9IO, NEWPORT, KY.

1AW, 2FG, 2XG, (Phone and modulated tel.), 2ZM, 2ZS, 3AN, 3BZ, 3EN, 3DH, 3NB, 4AE, 4AG, 4AL, 4BQ, 5AL, 5AS, 5BT, 5DA, 5DO, 5YA, 5YE, 5ZC, 5ZL, 8AA, 8CB, 8DA, 8EN, 8ER, 8FF, 8FH, 8FL, 8HA, 8HH, 8IK, 8IV, 8JJ, 8LA, 8NO, 8NI, 8WY, 8XK, 8XA, 9AB, (ex. 9AES), 9AU, 9BT, 9BR, 9AJ, 9EE, 9ER, 9HA, 9HN, 9HT, 9IT, 9KO, 9KV, 9LQ, 9LF, 9MK, 9NQ, 9ZJ, 9ZL, 9ZN, 9ZT.

6ZA, SALT LAKE CITY, to March.

6EA, 6JT, 6AK, 6BR, 6FU, 6GU, 6NQ, 6DY, 6JM, 6EI, 9RP, (6AE), (6AT), (6CQ), (6HH), (6GQ), (6BQ), (6CS), (9JE), (733), (6ZA), 6FE.

6DT, FRESNO, CAL.

5ZA, 6AE, 6AG, 6AH, 6AJ, 6AK, 6AL, 6AM, 6AN, 6AT, 6AY, 6BJ, 6BQ, 6BR, 6BS, 6CA, 6CC, 6CL, 6CL, 6CM, 6CO, 6CF, 6CQ, 6CV, 6DI, 6DP, 6EB, 6EF, 6EJ, 6EL, 6EN, 6ER, 6EX, 6FE, 6FI, 6FN, 6FS, 6FX, 6GC, 6GH, 6GK, 6GQ, 6HG, 6HH, 6HU, 6IH, 6JD, 6JE, 6JG, 6JI, 6JK, 6JM, 6JU, 6ZA, 7BP, 8BR, 7CC, 7CN, 7YS, 7ZB.

9BE, CHICAGO, March.

2ZS, 3DH, 4BZ, 4AE, 4YA, 4BH, 5ZL, 5BT, 5AL, 5YE, 5ZV, 5BO, 7BD, 8CB, 8ER, 8EN, 8DL, 8DA, 8IK, 8ZW, 8HG, 8NZ, 8ZL, FH, QAJ, 9CO, 9RP, 9LC, 9KV, 9DL, 9BT, 9PY, 9ZJ, 9ZV, 9ZP.

NOT PREVIOUSLY REPORTED, DE 3FG, PORTSMOUTH, VA.

1HAA, (2BB), (2BM), 2ME, 2RL, 2TF, 3BA, 3BO, 3GR, (3GX), 3HG, 3KM, 3MU, (3NV), 3XH, (4CC), 8DY, 8EJ, 8FD, (8NI), (8WY), 9FG.

3GX, READING, PA.

1AK, (1AW), 2DA, (2JE), (2BM), 2ZM, 3BZ, 3CN, 3EN, (3HJ), (3KM), 3NB, 3XC, 3BA, 3RP, (8DA), 8DC, 8DL, (8DJ), 8EN, 8ER, 8IK, 8LA, 8LJ, 8MT, 8NI, (8WY), 8XA, 8XU, 8ZR, 8ZT, 8ZW, 9ZN.

CANADIAN 3Z, FARNHAM, QUE., May 15-19

Canadian: 2AE, 2AM, 2AK, 2BA, 2BF, 2BN, 2WA, 2WB. American: 1CN, 1CM, 1CL, 1HAA, 1JS, 1JT, 1SN, 1TS, 2DR, 2EV, 2JK, 2QF, 2KJ, fone, 2ZM, 2ZR, 2FK, 3GO, 3HJ, 3NV, 3CB, 3FP, 3KU, 9FO.

SKM, WASHINGTON, D. C.

(1AE), 1AS, (1AW), 1BL, 1CK, 1CL, 1CM, 1DQ, 1EP, 1GX, 1KT, 1RN, 1SQ, 1SZ, 2BB, 2BK, (2BM), 2CB, 2CC, 2CS, 2CY, (2DA), 2FG, 2IR, (2JE), 2JM, (2JU), 2LO, 2LT, 2ME, 2RB, 2RR, (2TF), 2VA, 2XG, 2ZC, 2ZM, (2ZS), (2AR), (3AA), 3AK, 3AN, 3BG, (3BZ), 3CM, 3CS, 3CV, (3EE), (3EN), 3EQ, 3EV, 3FB, (3GO), (3GX), 3GZ, (3HJ), 3IB, 3IX, 3NB, 3NC, 3NP, 3NV, 3ZA, 4AA, 4AL, 4AO, 4AT, 4CC, 4CP, 5DA, 8AO, 8BP, 8BQ, 8BV, 8CB, 8CC, 8CE, 8DA, 8DE, 8DV, 8DW, 8EF, 8EN, 8ER, 8EV, 8GB, 8GI, 8GZ, 8HA, 8HD, 8HF, 8HG, 8HR, 8HY, 8IH, (8IK), 8IL, 8IN, 8IV, 8JJ, (8JQ), 8KE, 8KP, 8LA, 8LC, 8LL (8MB), 8MN, 8MT, 8NF, 8NI, 8RS, 8RW, 8SH, (8WY), 8XA, 8XK, 8XU, 8ZV, (8ZW), 8ZY, 9AJ, 9FA, 9HA, 9HD, 9HG, 9HU, 9IT, 9KF, 9LQ, 9MK, 9MN, 9ZJ, 9ZL, 9ZN.

CANADIAN 3FE, NAPANEE, ONT.

1AW, 1CE, 1FG, 1HA, 1TS, 2AP, 2JM, 2JU, 2PL, 2SH, 2TF, 2XJ (C.W.), 2XN, 2XK (C.W.), 2ZL (C.W.), 3AB (Can.), 3AC (Can.), 3HJ, 3NY, 3BO, 3XF, 3AB, 3BB, 3ER, 3FG, 3FO, 3KZ, 3MT, 3NI, 3QE, 3WY, 3XK (C.W.), 3XU, 3YA, 3CF, 9ZJ, 9ZN.

2TT, NEW YORK CITY, May 1—June 11.

1AK, 1AW, 1CK, 1CM, 1DQ, 1DY, 1HAA, 1IAV, 1JG, 1RZ, 1SE, 1SN, 1YB, 2DA, 2TF, 3AW, 3BZ, 3BE, 3DC, 3DS, 3EN, 3EV, 3FB, 3HJ, 3GX, 3NB, 3NV, 3NW, 3PB, 3SO, 3XC, 3ZA, 3ZW, NSF, 3GE, 3DA, 3ER, 3HP, 3IK, 3LI, 3MT, 3NI, 3WI, 3WY, 3XU, 3ZW, 9LQ, 9YB, 9ZN, 9ZV.

Heard by L. P. Wood, 44 Dufferin Ave., Brantford, Ont., Canada. 100 miles northwest of Buffalo, up to March 1.

1AE, 1AK, 1AW, 1DU, 1NR, 1RN, 2BB, 2CB, 2CC, 2BM, 2CG, 2FG, 2JU, 2DA, 2RB, 2JZ, 2JE.

1GR, 2SH, 2QB, 2ZC, 2ZS, 2ZL, 3BZ, 3AA, 3AF, 3BH, 3MN, 3GO, 3KM, 3EN, 3DA, 3AK, 3BR, 3CE, 3CB, 3CD, 3CL, 3DA, 3DV, 3DF, 3EN, 3ER, 3FQ, 3FP, 3HH, 3HY, 3JQ, 3IB, 3IL, 3JQ, 3FO, 3OI, 3JJ, 3GB, 3HG, 3MZ, 3XA, 3XU, 3AJ, 3CW, 3DF, 3FE, 3BJ, 3AU, 3CA, 3HT, 3HK, 3LF, 3LQ, 3IT, 3KO, 3MK, 3ZL, 3ZN, 3XA, 3ZF.

7DC, HEMPEL, PORTLAND, ORE.
3AE, 6AH, 6AJ, 6AK, 6AM, 6AT, 6BE, 6BN, 6BQ, 6BR, 6CC, 6CN, 6CO, 6CP, 6CS, 6CN, 6CV, 6DK, 6DY, 6EA, 6EB, 6EJ, 6EN, 6FI, 6FJ, 6FN, 6FS, 6FY, 6GA, 6GG, 6GQ, 6JD, 6JK, 6JM, 6JQ, 6JR, 6KL, 6KO, 6PW, 6RA, 6XZ, 6ZA, 7AD, 7BF, 7CB, 7CC, 7YS.

8CN, GENESEO, N. Y.
1AL, 1AW, 1BM, 1CK, 1CZ, 1QM, 2BM, 2KM, 2CC, 2GR, 2IR, 2XX, 3NV, 3KM, 3HJ, 3SU, 3SP, 3ABG, 3AEX, 3AP, 3BQ, 3DA, 3EK, 3EL, 3EN, 3ER, 3FC, 3GI, 3GG, 3HA, 3LN, 3LY, 3OO, 3PI, 3QK, 3SH, 3SL, 3VM, 3WY, 3XG, 3XU, 3ZK, 3GJ, 3XN.

8OJ, BIRMINGHAM, MICH.
1AW, 2CB, 2BZ, 2DH, 2XX, 2XJ, 2ZM, 3BZ, 3DH, 3BV, 4AT, 5DA, 8ACY, 8ABG, (8BP), 8CD, 8CF, 8CU, 8DA, 8DL, 8DZ, 8DI, 8DV, 8DJ, (8EN), 8ER, 8EB, 8EF, 8GI, 8GQ, 8HM, 8HA, 8IF, (8JF), 8JJ, 8LA, 8KO, 8KA, 8LQ, 8EW, 8K, (8MT), 8NI, 8RP, 8TT, 8VD, 8WS, 8WY, 8XK, 8XU, 8YV, 8ZI, 8ZW, 8ZY, 8ZY, 9AU, 9CE, 9EL, 9GX, 9HR, 9HI, 9HW, 9FU, 9GO, 9JA, 9JT, 9KV, 9KM, 9KF, 9LQ, 9MO, 9NZ, 9RJ, 9SR, 9UK, 9YB, 9ZF, 9ZL, 9ZR, 9ZT, 9ZN, 9AJ, 9ZJ.

8EA, N. S. PITTSBURGH, July 30.
1AU, 1AU, 1AD, 1NB, 1AE, 2EN, 2EC, 2FA, 3EN, 3CM, 3EW, 3KM, 3VM, 3NB, 3HJ, 3ND, 3NX, 3CB, 3CL, 3UY, 3AX, 3LA.

6EB, LOS ANGELES
(5ZA), (6AE), (6AG), (6AK), ex-6AL, 6AM, 6AT, 6BA, 6BB, 6BJ, (6BQ), 6BR, 6BZ, 6CE, 6CL, 6CL, (6CO), 6CP, 6CQ, (6CS), (6DK), 6DY, (6EJ), 6FE, 6FN, 6GL, 6GQ, 6HH, (6JQ), 6ZA, (7ZB), 7CC, 7CR, (7DK), 7BP.

9HT, OMAHA, NEBR.
(5AC), 5AL, (5AS), (5DO), 5YA, (5ZA), 8HA, (8HG), (8WQ), 9AC, 9AJ, (9AK), 9BR, 9BT, (9CA), (9CN), (9CS), 9CW, 9DR, 9DS, 9EE, (9FA), (9FL), (9FZ), 9GS, (9HB), 9HZ, 9IX, 9JE, (9KV), (9KW), 9LC, (9LN), 9OB, 9OI, 9ON, 9PQ, (9YA), 9YO, 9ZC, 9ZJ, 9ZL, 9ZN.

6JQ, NAPA, CALIF.
(6AA), (6AE), (6AH), (6AJ), (6AK), (6AM), (6AN), (6BE), (6BK), (6BN), (6BR), 6BU, (6BY), (6CA), (6CC), (6CH), (6CD), 6CP, 6CV, (6DY), (6EB), (6EJ), (6EX), 6FE, 6FN, 6FY, (6GH), 6GR, (6HP), (6IM), 6JL, 6JM, 6JN, 6JR, 6KM, 6KT, 6PH, 6PX, (6QE), 6XB, 6ZE, 7CM, 7EW, 7DK, 7CH.

5AD, NEW ORLEANS, February
4AN, 4AE, (5AB), 5AG, (5AL), 5BO, 5DO, 5BZ, 5FS, 5AU, 5DU, 5BB, 5ED, 5ZA, 5ZG, 9AJ, 9BG, 9BR, 9BT, 9CN, 9EL, 9FU, 9FZ, 9KO, (9KV), 9HT, 9HI, 9HN, 9NQ, 9PK, 9RP, 9LK, 9IW, 9KF, 9FF, 9NZ, 9ZU, 9ZL, 8DA, 8EI, 8ER, 8FH, 8LA, 8HG, 8IX, 8GB, 8IT, 8IC, 8RN, 8DC, 8BD, 8ZU.

8LF, CROFTON, PA., July
1AW, 1FB, 1HAA, 2AJW, 2AQR, 2JU, 2RK, 2TF, 2YM, 2ZL (spk. and undamp), 3CM, 3EN, 3EV, 3EW, 3FG, 3GO, 3GR, 3HJ, 3KM, 3NB, 4YA, 5YH, 8BP, 8BV, 8CF, 8DA (spk. and undamp), 8DI, 8DS, 8ER, 8FD, 8FI, 8GB, 8LA, 8JU, 9FA, 9EN, 9NV, 9ZJ, 9ZN.

Save \$2.! **ARCO AMPLIFYING TRANSFORMER** is built for tubes now on market. **Mounted \$5.10 Postpaid**
E. L. LONG
21 Magnolia Terrace, Albany, N. Y.

ALWAYS MENTION QST WHEN WRITING TO ADVERTISERS

BOUND VOLUME III



\$3.50

POST AID

Volume III of QST, just completed, handsomely bound in dark red cloth, with gilt lettering, now ready for distribution. Due to shortage of two of the numbers, the supply is limited, so send in your order at once.

The ideal way of preserving your QST's for future reference.

QST

61 Waverly Bldg., Hartford, Conn.

ATTENTION AMATEURS

45 volt "B" Batteries—6 different voltages. Guaranteed one year.....Each, \$5.50 Postpaid
Parkin RheostatsEach, \$1.00 Postpaid
Nickel-Plated Switch Points— $\frac{1}{4}$ " x $\frac{1}{4}$ " beveled heads—Complete with $\frac{3}{8}$ "—6-32 Brass machine screws30c Dozen, Postpaid

We specialize in raw materials and parts.

Write us for prices.

Pacific Radio Distributing Co.
Pomona California

RADIO APPARATUS and SUPPLIES

Send 10c in stamps for literature.

HARRISON-DUDLEY

738 W. Church St.,

Elmira, N. Y.

RADIOPHONE & "C.W." ACCESSORIES!

Our Bulletins sent for 4c. list everything you need

New variable condenser with Navy dial indicator
New rectifier VT's and transformers, filter systems
power tubes, new line of standardized parts, etc
Type J, 0-500 Milliammeter, 3" Dia. Flush Type \$6
Also 0-100 and 0-300 Milliammeters and 0-3 and 0-5 amms.

SOMERVILLE RADIO LABORATORY

102 Heath St.,

Somerville 45, Mass.

5!

Special Fall Announcement

You, Mr. Radio Amateur, re-equipping and putting your station into shape for the coming season, we are ready and waiting to serve you. Our growth has been rapid during the past year and we are pleased to announce a complete line of Transmitting as well as Receiving equipment.

Inspection of the list on the right will reveal the great number of manufacturers whom we represent and whose products we can supply.

Complete DeForest line—order direct from your catalog or send 10c for new one. Immediate shipment on Unit Panels, Vernier Condensers, etc. Honeycomb Coils now supplied in the new Duo-Lateral winding.

Bulletin No. 5, now ready, is one of the most complete lists of Radio Apparatus published. It contains a Special Section listing material for building a C.W. or Radio-Telephone Transmitter. May we send you a copy.

And don't forget—apparatus in stock—**IMMEDIATE DELIVERY** on every order. A trial will add your name to our list of regular customers. Information and description of any particular

piece of apparatus free upon request. Remember our stock is now fresh and complete. Immediate delivery may be had on any item listed below.

Electron Relay Detector Tube.....	\$6.00
Moorhead Amplifier-Oscillators.....	7.00
Moorhead Transmitting Tubes, 600 Volt..	7.50
Ace VT Socket with Grid Leak.....	1.50
DeForest Standard VT Socket.....	1.50
DeForest P-401 Audion Panels.....	14.25
Paragon Panel Rheostat.....	1.75
Esbro Grid Condensers, .0005 MF.....	.35
Corwin Dials, 3" diam.....	1.30
Corwin Dials, 3 1/8" diam.....	1.70
Federal Tel. Jack.....	1.00
Federal Tel. Plug.....	2.00
Federal Amplifying Transformers.....	7.50
New Acme Ampl. Trans., fully mounted..	5.00
Burgess "B" Batteries, 22 1/2 volts.....	2.25
Baldwin Mica Phones, Type "C".....	16.50
"Arco" Variable, with Dial, .0005 MF.....	6.00
"Arco" Variable, with Dial, .001 MF.....	7.25
Clapp-Eastham Boston Key.....	7.50
Clapp-Eastham Improved Aerial Switch..	12.50
Acme C.W. Trans. 50 W.....	15.00
Acme C.W. Trans. 200 W.....	20.00
Acme Power Transformers, fully mounted,	
1 KW.....	33.00
1/2 KW.....	22.00
1/4 KW.....	16.00
Modulation Trans.....	7.00
Modulation Trans., Semi-Mounted.....	5.00
Litz Cable, 20-38, Silk, per 100 ft.....	1.25
Grebe CR-3 Relay Receiver.....	60.00
Grebe Two Stage Amplifier.....	45.00
Murdock Loose-Coupler.....	9.00
Murdock Antenna Switch.....	4.50

CHICAGO RADIO APPARATUS CO.

3400 So. Michigan Avenue,

Chicago, Illinois

PARKIN RHEOSTAT \$1.00 POSTPAID

Why Pay More?
When this is the easiest mounted, smoothest running, best rheostat on the market.

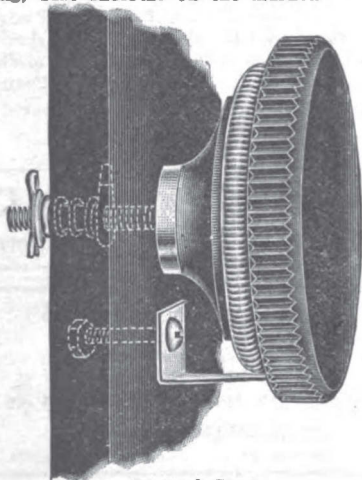

(Actual Size)

No. 35 PARKIN PANEL TYPE RHEOSTAT (Patented March 30 1920) has easily renewed resistance unit mounted on back of MOULDED BAKELITE KNOB. Shaft is moulded into knob, cannot come loose. "OFF" position provided. 360 degree rotation insures fine adjustment. Write for descriptive circular of audion panels, switches, binding posts, contacts, etc.

Dealers: Write for proposition.
PARKIN MFG. CO., San Rafael, Calif.

A Wireless Message from Detroit

If you hope to become a Licensed Radio Operator and reap your share in the opportunities of this wonderful field, it is important that you get your training in a high-grade radio school.

Our course in Radio Telegraphy, under the direction of S. W. Edwards, U. S. Radio Inspector, offers the kind of instruction that makes for success. New, complete equipment. Reasonable tuition. Day or evening classes. Opportunity to earn expenses while here.

Our day class prepares for First Class Radio Operator's License in three months, evening class in 18 weeks.

For further information, cut out this advertisement, sign your name and address, and mail to

DETROIT INSTITUTE OF TECHNOLOGY
303 Y.M.C.A. Building, Detroit, Mich.

Address

Name

(Q.S.T.)