

# QST

A MAGAZINE DEVOTED EXCLUSIVELY TO THE WIRELESS AMATEUR

APRIL

TWENTY CENTS

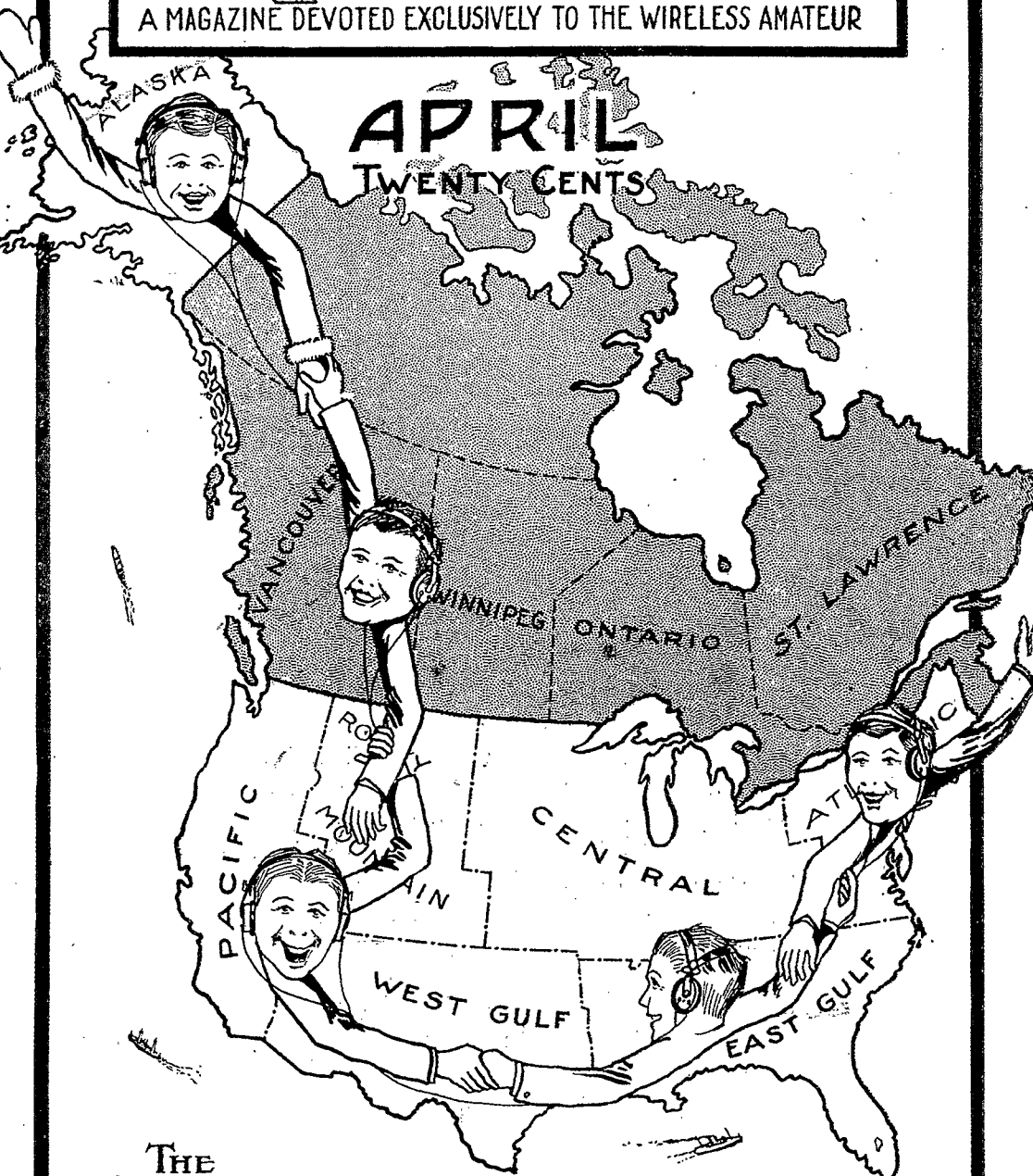

THE AMERICAN RADIO RELAY LEAGUE

Hick

# ANNOUNCEMENT

---

THE prestige gained by the simple matter of always treating a customer squarely, of striving to meet his requirements promptly and satisfactorily, constitutes an impregnable advantage.

To the enterprise fostering this spirit it means "success"—and we *have* been successful.

The increasing business with which we have been favored by our patrons necessitates our expansion.

On April 1, 1920 we move to more adequate quarters at 88 Broad Street, Boston, Mass.,—larger floor space, larger stock and an increased sales force.

To our past patrons we extend our thanks for previous favors and assure you that future orders will meet with the same prompt attention as before.

We are producing a new bulletin—"Bulletin 14" which will list a representative line of high grade Radio Equipment. A copy will be mailed you upon receipt of 10 cents—this amount may be deducted from your first dollar order.

---

Atlantic Radio Co., Inc.  
88 Broad Street                      Boston, 9, Mass.

# MAGNAVOX

## Telemegafone

*Most Efficient Telephone Receiver and Loud Speaker*

**FOR RADIO  
RECEIVING**

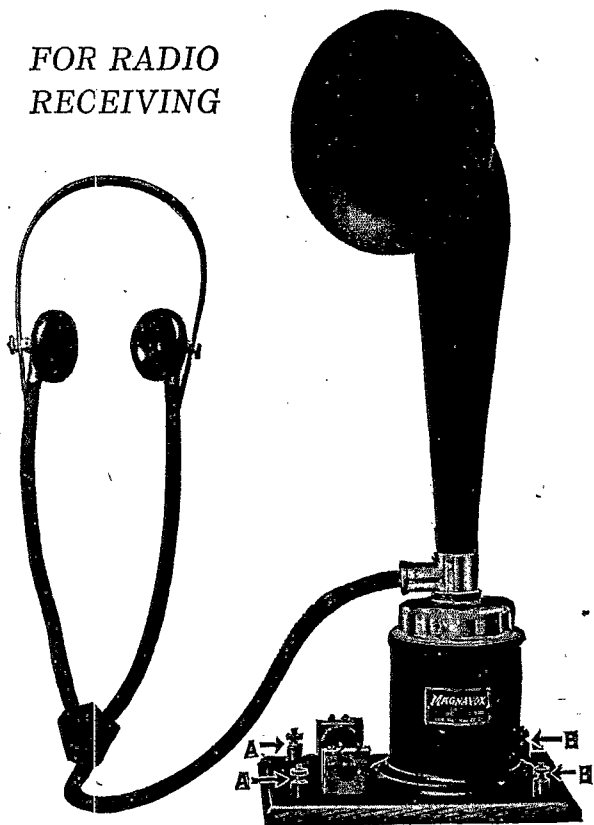

**PRICE \$75.00**

Connect AA to your receiving set where your present head-set is connected

Connect BB to a 6-volt storage battery

*Immediate Delivery—Order Early*

The most rugged, simple and reliable instrument yet produced for the reproduction of radio signals and sound.

It is not only a most sensitive receiver when used with the head-set, but is also the most powerful loud speaker.

The Magnavox Telemegafone fills the long felt need of both commercial and amateur radio stations.

By using this instrument in connection with your vacuum tube amplifier, signals will be reproduced with great volume. For weak and ordinary signals use the head-set. Strong signals can be heard a great distance from the horn.



PATENTED IN U.S.A. AND FOREIGN COUNTRIES

**2701-2759 East Fourteenth Street, Oakland, California**

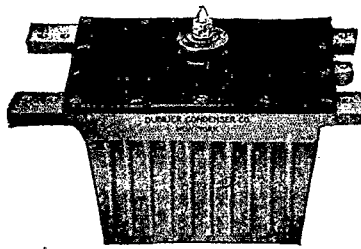

## Have You Heard These Stations ?

2ZC  
2BO  
2ZH

2ZS  
2ZY  
2YM

2ZM  
1RN  
2ZH

1AW  
2IR  
2CS

They are breaking long-distance records, even though they are so-called amateur stations. Why? Because they are getting the most out of their transmitters—getting the most despite the handicap of short wave length.

But the main question is: Are you getting the most out of YOUR transmitter? Are you covering the long ranges which you should cover with the efficient apparatus and radio knowledge now at your disposal? If not—if you are dissatisfied with your present transmitting work, here is a suggestion:

Genuine Dubilier Condensers are the most efficient condensers made. These condensers enable you to break long-distance records. They place your station in the list at the head of this announcement—among the leaders in the amateur radio field, where you have always wished to be. And don't forget it, you will eventually use a Dubilier Condenser. Why not now?

We recommend a capacity of 0.007 for transmitters working on 200 meters, and 0.01 for special stations. There is a size and capacity of Dubilier Condenser for every station.

TYPE NO.	POWER	MAX. VOLTS	CAPACITY	PRICE
D 100	¼ K.W.	10,000 V.	.007 mfd.	\$17.50
D 101	½ K.W.	14,000 V.	.007 mfd.	25.00
D 102	1 K.W.	21,000 V.	.007 mfd.	35.00
D 110	¼ K.W.	10,000 V.	.01 mfd.	19.00
D 111	½ K.W.	14,000 V.	.01 mfd.	28.00
D 112	1 K.W.	21,000 V.	.01 mfd.	40.00

The above types are recommended for use with standard makes of transformers; For special makes of transformers the following types are recommended:

D 103 Special	1 K.W.	25,000 V.	.007 mfd.	\$40.00
D 117 Special	1 K.W.	25,000 V.	.01 mfd.	45.00

Aside from transmitting condensers for spark sets, the Dubilier Condenser products also include condensers suitable for line protectors, C.W. transmission and for receiving work.

AM 888 Line protector,	tested at 2,000 volts	.....	\$4.00
CD 888 Line protector,	tested at 3,000 volts	.....	6.00

NOTE—CD 888 is used only in special cases.

D 160 Condenser of .25 mfd.	tested at 1800 volts, for protecting high-voltage generators and eliminating the hum in bulb transmitters	.....	\$5.00
D 170 Winged type condenser	for tube grid use, Five capacities from .00005 to .00025 mfd.	.....	1.50
D 171 Fixed condenser	for receiving or transmitting bulb work. Capacity of .001 mfd.	.....	2.00
D 172 Same as D 171.	Capacity of .0005 mfd.	.....	1.50

Other capacities and sizes to order.

Exclusive Agents for Dubilier Condenser Company and other prominent manufacturers of radio and electrical apparatus

## Pacent Electric Company, Inc.

Builders and Specialists of Radio, Electrical and Laboratory Equipment  
150 NASSAU STREET Telephone Beckman 5810 NEW YORK CITY

THE OFFICIAL ORGAN OF THE A.R.R.L.

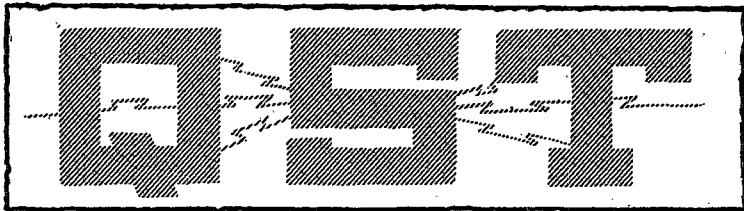

APRIL, 1920

VOLUME III

NO. 9

# CONTENTS

The Vacuum Tube as a Detector and Amplifier	L. M. Clement	5
Radio Lighthouse Keeping	S. Kruse	10
The Advent of Amateur C.W.		13
Our Rotten Hours	"A Boiled Owl"	14
Multiple Transmitters		15
Variation of Strength of Amateur Station Signals	J. O. Smith	17
A Generator for Plate Voltage	E. B. Duvall	18
Notes on Improving Transmission	M. B. West	19
Rotten Weather Relays	The Old Man	21
Schedules of High-Powered Stations		22
Addendum to Article on the Use of Honeycombs	A. L. Groves	24
Editorials		25
The Operating Department		28
The Junior Operator		34
With the Affiliated Clubs		36
Who's Who in Amateur Wireless		38
QST's Directory of Calls		39
Amateur Radio Stations		41
Strays		44
Radio Communications by the Amateurs		45
Calls Heard		50

QST is published monthly by The American Radio Relay League, Inc., at Hartford, Conn. Kenneth B. Warner (Secretary, A. R. R. L.), Manager and Editor.

Subscription price, \$2.00 per year, anywhere. Single Copies, 20 Cents.

Entered as second-class matter May 29, 1919, at the post office at Hartford, Connecticut, under the Act of March 3, 1879.

Copyright, 1920, by The American Radio Relay League, Inc.  
Title registered at United States Patent Office.

THE AMERICAN RADIO RELAY LEAGUE, Inc.  
HARTFORD, CONN.

# THE AMERICAN RADIO RELAY LEAGUE

INCORPORATED

"A national non-commercial organization of radio amateurs, bonded for the more effective relaying of friendly messages between their stations, for legislative protection, and for scientific growth."

## OFFICERS

President  
HIRAM PERCY MAXIM  
Hartford, Conn.

Vice President  
CHAS. A. SERVICE, JR.  
Bala, Pa.

Traffic Manager  
J. O. SMITH  
73 Hillside Ave.  
Rockville Centre, L. I.

Treasurer  
A. A. HEBERT  
Nutley, N. J.

Secretary  
K. B. WARNER  
Hartford, Conn.

## DIRECTORS

A. E. BESSEY  
Sunnyvale, Calif.  
V. F. CAMP  
Brightwaters, L. I.  
J. M. CLAYTON  
Little Rock, Ark.  
J. C. COOPER, JR.  
Jacksonville, Fla.  
F. M. CORLETT  
Dallas, Tex.  
W. T. FRASER  
Buffalo, N. Y.

W. T. GRAVELY  
Danville, Va.  
F. H. HAMILTON  
Indianapolis  
A. A. HEBERT  
Nutley, N. J.  
HIRAM PERCY MAXIM  
Hartford, Conn.  
C. R. RUNYON, JR.  
Yonkers, N. Y.

C. A. SERVICE, JR.  
Bala, Pa.  
J. O. SMITH  
Rockville Centre, L. I.  
H. L. STANLEY  
Babylon, L. I.  
C. H. STEWART  
St. David's, Pa.  
K. B. WARNER  
Hartford, Conn.  
M. B. WEST  
Waukegan, Ill.

## OPERATING DEPARTMENT

TRAFFIC MANAGER  
J. O. Smith

ATLANTIC DIVISION  
Manager  
Chas. A. Service, Jr.  
Bala, Pa.

Asst. Mgr., Northern Sec.  
Guy R. Entwistle  
137 Sutherland Road  
Brookline, Mass.

Asst. Mgr., Central Sec.  
John DiBlasi  
227 East 75th St.  
New York City

Asst. Mgr., Southern Sec.  
Chas. H. Stewart  
St. David's, Pa.

EAST GULF DIVISION  
Manager  
J. C. Cooper, Jr.  
Atlantic Natl. Bank Bldg.  
Jacksonville, Fla.

WEST GULF DIVISION  
Manager  
Frank M. Corlett.  
1101 East Eighth St.  
Dallas, Tex.

CENTRAL DIVISION  
Manager  
R. H. G. Mathews  
1316 Carmen Ave.  
Chicago

Assistant Manager  
Chas. H. Zeller  
4732 N. Maplewood Ave.  
Chicago

ROCKY MOUNTAIN DIV.  
Manager  
M. S. Andelin  
21 Northwest Temple St.  
Salt Lake City, Utah.

PACIFIC DIVISION  
Manager  
A. E. Bessey,  
Sunnyvale, Calif.

Asst. Mgr., Calif. Sec.  
H. L. Newnan  
Alameda, Calif.

ST. LAWRENCE DIVISION  
Manager  
Albert J. Lorimer  
243 Mackay St.  
Montreal, Que.

ONTARIO DIVISION  
Manager  
A. H. Keith Russell  
353 Markham St.  
Toronto, Ont.

---

Address General Correspondence to Executive Headquarters, Hartford, Conn.

# Q S T

A Magazine Devoted Exclusively  
to the Radio Amateur

## The Vacuum Tube as a Detector and Amplifier

By L. M. Clement

Presented at Meeting of the Radio Club of America, Columbia University,  
January 16, 1920

A large part of the practical wartime development work of the Western Electric Co. in vacuum tubes is creditable to Mr. Clement. This article therefore may be accepted as an authoritative presentation of the subject in question, and fills a need we have long felt in QST.—Editor.

The audion or vacuum tube, as it is sometimes called, due in large measure to the rapid development work during the great war and partly to the pre-war development of several of the large companies, is a necessity to all fully-equipped radio telephone and telegraph stations.

The audion, as we all know, consists of an evacuated glass tube or bulb which contains the filament, the plate, which generally surrounds it, and the control electrode or grid which is generally mounted between the filament and the plate. When this device is associated with the proper apparatus and operated under the proper conditions, it can be made to function as a detector, an amplifier, an oscillator, or a modulator.

In order to be able to design apparatus which will operate under proper conditions, we must first know something about what goes on in the tube under different conditions.

Edison, during some of his experimental work with the incandescent lamp, found that current could be made to flow from a plate inside the bulb to the filament but not in the reverse direction. This phenomenon is called "Edison Effect" and it remained unaccounted for for a number of years but was finally explained by the Electron Theory.

### Filament

The filament of the audion, generally in the form of a wire, is heated by the electric current to such a temperature that a large number of electrons attain sufficient velocity to leave the surface of the wire. The filament then is deficient in negative electricity, or, in other words, has a

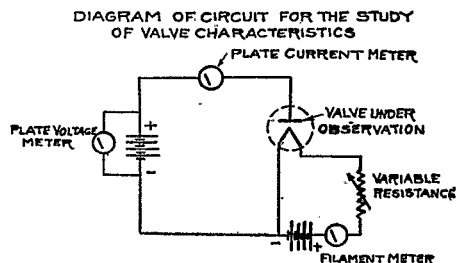

-FIG. 1-

positive charge which attracts the electrons which have left its surface. If no outside forces are active, a state of equilibrium is said to exist when the number of electrons leaving per unit of time is equal to the number falling back on the filament in that time.

Because of its very high melting point, allowing of very high operating temperature, tungsten is a very suitable substance

for vacuum tube filaments. Platinum wire filaments which have been coated with certain metallic oxides have been found to emit a copious supply of electrons at comparatively low temperatures. This accounts for the long life of the so-called "coated" type of filament.

### Plate

If the filament is placed in an evacuated bulb, it is obvious that the electrons will penetrate the space surrounding the fila-

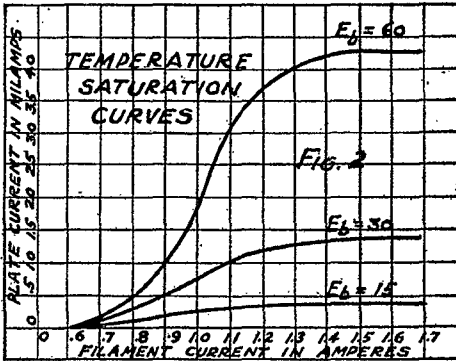

ment to a greater distance than they will in air, because of the removal of the large gas molecules. Suppose now an electrode in the form of a plate is introduced in the bulb and a potential positive with respect to the filament is applied to it. The negative electrons will flow to the plate. Instead of thinking of a flow of electrons from the filament to the plate, we generally think of a flow of current from the plate to the filament; that is, from the positive to the negatively charged body. If a negative potential were applied to the plate, no electrons would be attracted to the plate, and hence no current would flow because of the lack of these carriers of negative electricity. If an alternating potential were applied to the plate it is obvious that current would only flow through that part of the cycle when the plate was positive with respect to the filament.

The two-element tube, due to its unilateral conductivity, has found some application as a rectifier. The General Electric Company has built some commercial types of rectifiers and some tubes have been built for potentials of 180,000 volts.

Fleming recognized that this device could be used to rectify or detect radio frequency signals. He called the rectifier for this purpose a receiving valve. The device was not very generally used as it was not far superior to the ordinary crystal detectors which required no external battery.

### Ionization

In these old valves for receiving work, due to the low voltages employed, a high degree of vacuum was not necessary. In rectifiers similar to the Kenotrons of the General Electric Company, which are designed to operate at high voltage, it is necessary to remove the gas molecules to prevent ionization by collision. Ionization is generally accompanied by a pink or blue glow which fills the tube. The presence of gas in the tube causes irregularity of action at low voltages and excessive ionization or even arcing at high voltages.

In order to overcome these difficulties it is necessary to so evacuate the tube that excessive ionization does not occur at the operating voltage. This is accomplished by special vacuum pumps; and the heating of the elements, and even tubes themselves, to drive off occluded gases.

### Temperature Saturation

In order to study the action of these valves under different conditions, a circuit shown in Figure 1 is used. The data in Table I shows the effect of filament current (which is a measure of the filament temperature) on the plate current for different plate potentials. These results are shown in the curves of Figure 2. For a constant plate potential, we observe that the plate current increases with filament current until saturation point is reached, after which no rise in the plate current takes place.

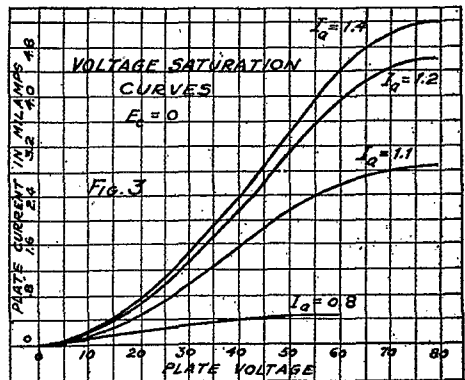

On the section of the 60 volt curve, Figure 2, AB, the plate voltage is drawing to the plate all of the electrons emitted, but beyond the saturation point the filament is supplying more electrons than the plate potential can draw to it. This is due to the resultant charge of the cloud of electrons between the filament and the plate which causes the excess of electrons to be returned to the filament. This is sometimes spoken of as the space charge effect.



CIRCUIT OF TUBE CHARACTERISTIC CURVE MEASURING SET.

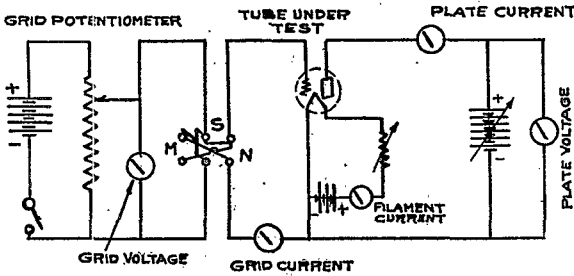

-FIG. 4-

As is to be expected the saturation points for the 30 and 15 volt currents occur at lower filament temperatures. In general, tubes should be operated beyond the temperature saturation points as then a small change in filament current produces practically no change in plate current.

**Voltage Saturation**

The voltage-current characteristics of the valve were taken at three different filament temperatures. This data is contained in Table II and plotted on curves in Figure 3. As the plate voltage is increased the plate current rises until the saturation point is reached, beyond which an increase of voltage does not produce an increase of current.

Below the saturation point the filament is emitting more electrons than can be drawn to the plate at the plate voltage applied, due to the space charge effect. Beyond the saturation point all of the electrons emitted by the filament are drawn to the plate. The saturation occurs at

CHARACTERISTIC CURVES OF A VACUUM TUBE

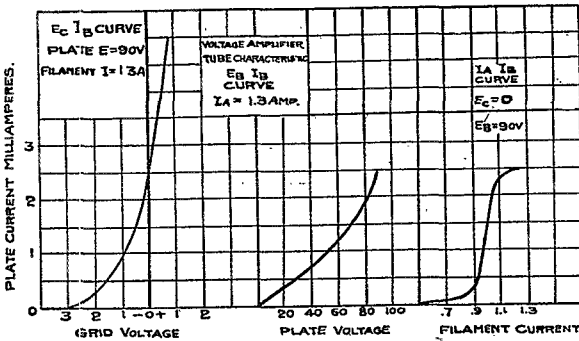

-FIG. 6-

lower plate currents when the filament current is less because fewer electrons are available.

**The Audion or Vacuum Tube**

Dr. DeForest found that the plate current or flow of electrons between the filament and the plate could be controlled by the application of potentials to a third grid-like structure placed between the filament and the plate.

The tubes (or audions as they were called by Dr. DeForest) made several years ago were not pumped very well and consequently contained a large number of gas molecules which made their action more or less unsteady. The high vacuum tubes manufactured by the British, French, General Electric Company and Western

CHARACTERISTIC CURVES OF A VACUUM TUBE

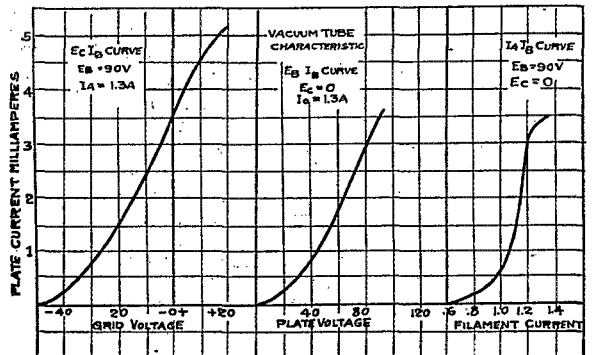

-FIG. 5-

Electric Company are pumped to a very high degree of vacuum and consequently little trouble from ionization is experienced.

Let us consider what goes on inside of the audion, and its relation to the operation of the device. The electrons, as we know, are small negatively-charged particles which are repelled by a negative charge and are attracted by a positive one. In an audion there is a flow of electrons from the filament through the grid to the plate. If there is no charge on the grid this flow will not be materially affected by its presence. If, however, the grid be negatively charged with respect to the filament, it will tend to neutralize the effect of the plate, which will result in a decrease of plate current. This can be said in another way; namely, the negative charge on the grid is in effect

a space charge which is added to the space charge of the tube and causes some of the electrons to fall back on the filament and thus reduce the plate current.

CHARACTERISTIC  $E_b I_b$  CURVES OF A VACUUM TUBE TAKEN AT DIFFERENT VALUES OF  $E_c$ .

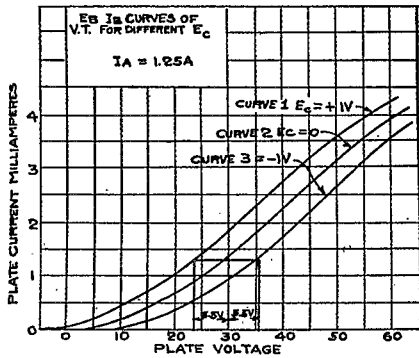

-FIG. 7-

When the grid is negative with respect to filament, no electrons are drawn to it, hence the resistance between filament and grid is infinite and practically no power loss occurs in this portion of the circuit.

A positive charge on the grid tends to neutralize the space charge effect and a greater current will flow in the plate circuit. In this condition, also, electrons will be attracted to the grid and cause current to flow between it and the filament inside the tube. This is equivalent to shunting the input circuit of the audion with a resistance. For this reason it is desirable that the grid be always maintained at a negative potential with respect to filament.

There are some losses which occur even when the grid is maintained at a negative potential but the nature of these can not be discussed in this paper.

TABLE I

Temperature Saturation—

Plate current in Milliamperes

Filament Current Amperes	Plate Voltage 15	Plate Voltage 30	Plate Voltage 60
.6	.006	.007	.008
.7	.051	.076	.098
.8	.136	.320	.510
1.1	.340	1.180	3.200
1.2	.380	1.300	3.800
1.3	.420	1.380	4.00
1.4	.440	1.440	4.30
1.7	.450	1.450	4.350

TABLE II

Voltage Saturation—

Plate Current in Milliamperes

Plate Voltage	Fil. Current .8 Amp.	Fil. Current 1.2 Amp.	Fil. Current 1.4 Amps.
10	.072	.168	.170
15	.137	.360	.400
30	.320	1.310	1.450
60	.460	3.900	4.450
80	.500	4.600	5.700

Characteristic Curves

A good deal can be found out about an audion by a study of its characteristic curves. These curves show the relation between grid voltage and plate current at constant filament current, the relation between plate voltage and plate current at a constant filament current, and the relation between filament current and plate current at a constant plate voltage. In order to be able to get this data easily, the apparatus is arranged as shown in Figure 4. The subscripts a, b and c refer to the filament, plate, and grid circuits of the tube, respectively.

- Note— $E_a$  = Filament Volts
- $E_b$  = Plate Volts
- $E_c$  = Grid Volts
- $I_a$  = Filament Current
- $I_b$  = Plate Current
- $I_c$  = Grid Current

GRID VOLTAGE ( $E_c$ ) - PLATE CURRENT ( $I_b$ ) CHARACTERISTIC

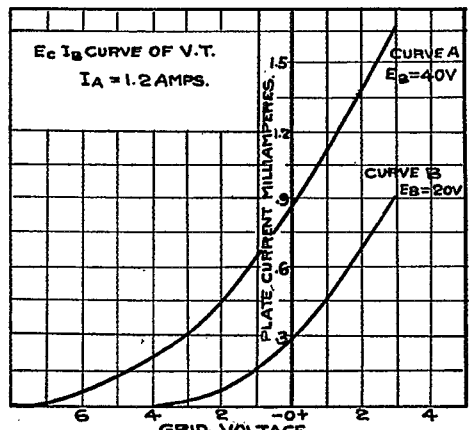

-FIG. 8-

Plate Current Filament Current Characteristic

With a grid connected to the negative leg of the filament and with a constant

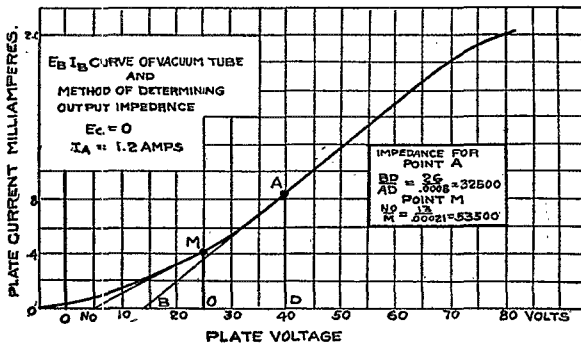

- FIG. 9.-

potential applied to the plate, note the different values of plate current for various values of filament current. Such a curve, taken on a coated filament tube, is shown in Figure 5. It should be noted that the curve shows saturation near 1.2 amperes. In all vacuum tube apparatus the tubes should be operated above this saturation point so that small changes in the filament current will not affect the operation of the tube.

**Plate Current Plate Voltage Characteristics**

The plate current plate voltage characteristics can be obtained in a similar manner by maintaining the filament current constant at the operating value, which should be greater than that necessary for saturation. The  $E_b$  and  $I_b$  curves for three types of tube are shown in Figures 5, 6, 7, and 9. The voltage saturation is shown clearly by the bending over of the curve in Figure 9.

**Grid Voltage Plate Current Characteristics**

The variation of plate current with grid voltages at constant plate potential and filament current is called a grid voltage plate current characteristic. Such characteristics for two different kinds of tube are shown in Figure 5, 6, and 8. Figure 7 shows a series of  $E_b$  and  $I_b$  curves taken at different values of  $E_c$ . This shows clearly that the plate current can be varied by changing either the plate potential or grid potential.

**The Amplification Constant**

From the curve of Figure 7 we find that the plate current for  $E_c=0$  and  $E_b=30$  volts is 1.3 milliamperes. Referring to the curve for  $E_c=+1$  volt the plate voltage which would give the same current is 24.5 volts. It is evident from this that a one volt change on the grid is equivalent to a 5.5 volt change on the plate. By inspection of the curve for  $E_c=1$  volt, we find that the one volt grid change corresponds to a 5.5 volt change in the plate, thus the grid voltage produces an effect 5.5 times as great as that produced by

the same change in plate potential. This ratio is known as the maximum amplification factor of the tube and is generally referred to as the letter  $K_a$ .

A very general but practical method of determining the amplification constant is to divide the plate potential by that value of the grid potential which produces zero plate current.

The amplification factor is dependent upon the geometry of the tube and to some extent upon the conditions under which it is to be operated.

**The Output Impedance  $R_o$**

Ohm's Law tells us that the current flowing in a circuit is dependent upon its resistance and the applied electromotive force and is expressed as follows:

$$I = \frac{E}{R}$$

$I =$  current in amperes  
 $E =$  E.M.F. in volts  
 $R =$  resistance in ohms

The current in the plate circuit of a tube does not follow Ohm's Law because it is not only dependent upon plate voltage but on grid voltage as well. It is of importance to know the output impedance of the tube in order to design some of the V.T. circuits correctly. The impedance of the tube for audio frequencies is essentially a pure resistance and its symbol is  $R_o$ . The output impedance for a small input voltage for any given set of conditions can be obtained from the  $E_b I_b$  characteristic as follows:

BRIDGE METHOD OF MEASURING AMPLIFICATION CONSTANT.

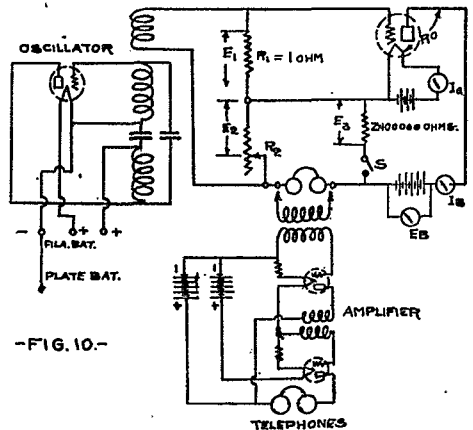

- FIG. 10.-

From the  $E_b I_b$  curve of Figure 9, which was taken under the desired conditions of grid voltage and filament current, draw a  
 (Continued on page 24)

## Radio Lighthouse Keeping

By S. Kruse

Mr. Kruse, ex old 9LQ, is really a young man of staid and sober mien, tho you can't tell it from his stories. He's an Assistant Engineer in the Bureau of Standards Radio Lab. now and writes these yarns to amuse himself. This one is great—don't miss it.—Editor.

WE sat back and let the "Southland" take her time for turning around and heading toward Norfolk. She needed time, for the Potomac is only about three steamer-lengths wide and a surprising amount of going ahead and backing is required. But let the scenery oscillate; all our radio apparatus was safe on the cargo deck and we would now forget radio for a time.

But we didn't.

You see we had spent a month in designing, building and testing those three transmitters and had managed, by overlooking details like night time and Sundays, to live with the sets pretty continuously. They had become a habit with us, a mild form of monomania. Of course the month had been varied by mail-order arguments with manufacturers who could not possibly deliver by that early date, also we had spent two frantic days in testing our power-plants but as a whole we had lived the month with our transmitters and they had "gotten under our skins." Late one night the landlady met me coming in and asked where I had been. I told her that "It ought to give 600 sparks per second"—at least she says that was the conversation. I don't know. I went on upstairs and spent several hours in adjusting the rotary gap of the number two set. At the last an irritating metallic quality crept into the spark tone and persisted till I got up and shut off the alarm clock.

Yes we had come to the point where we could look in any direction and see one of the big two kilowatt panels.

We did that now and had to start competition by resurrecting our amateur experiences. That is always supposed to be good for a long row since everyone except myself tells lies about the range of his former set.

But even that failed, so we said "Let's go eat."

Now the reasonable thing would be for me to take you on down the Potomac and thru the Chesapeake to Norfolk. But this is a radio yarn and radio is not reasonable after it get out of the laboratory. So instead let's explain what we are talking about.

Our party of three installed radio trans-

mitters at three lighthouses in Chesapeake Bay and then operated them while more Bureau of Standards men on the lighthouse tender "Arbutus" toured the bay and "shot" at us with a new sort of radio compass.

Of course you know what a lighthouse is—a slender gray stone tower on a frowning cliff against whose stern face the restless billows dash ceaselessly, only to fall back in sullen, baffled rage.

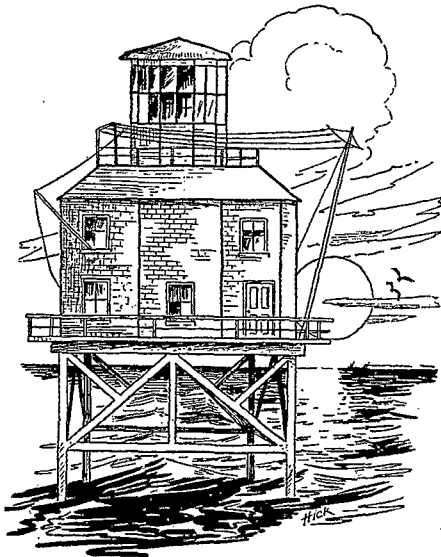

Well, that has nothing whatever to do with the light stations in Chesapeake Bay. They do not stand on cliffs, but are known as "island lights". Can't say why, for they do not stand on islands; no, they stand on their own steel legs at the sides of Chesapeake ship channel. Some of the newer ones stand on steel caissons—sort of free and independent bridge piers—instead of steel spider-legs; but they all feel perfectly competent to take care of themselves and so have camped from one to five miles offshore where the water is sometimes 10 feet deep but oftener 25. Furthermore Chesapeake Channel lights are not stone

towers but simply one-story wooden houses on the steel legs or two-story brick houses on the steel casissons. I'll admit you don't exactly expect a house to wear a square wooden cupola topped off with a great glass birdcage containing a 5,000 candle-power lantern, but you can get used to the idea with a little practice and without any pain at all. The houses are 6 or 8-sided, which complicates matters very much when your little tin hand lamp goes out while you are trying to find the corner where you think the drinking water is located. The cookstove is really in that corner and its cast iron ash-door sticks out at about mid-shin level. That is why the octagonal floor plan cannot be learned painlessly.

But the shins stop hurting and heal up, while another peculiarity of these light-houses keeps on getting more painful every day—I mean the lack of a front yard or back yard or ANY OTHER sort of yard. To a cliff-dweller—I mean an apartment-house dweller—that would not be irksome; he is accustomed to travel half a day to the nearest place where one can walk. I am not a New Yorker, nor any other sort of city dweller; I want a yard where you can set up masts and bury ground wires. When a three foot concrete walk 'round the house passes for a yard and there is nothing within five miles that one can run guy wires to, (even the house being only 30 feet across) a mast begins to seem a bit hopeless. Then too the lighthouse bureau insists that spars and spreaders which are on the seaward side of the house must stay below the focal plane of the lantern. Now what does that leave us?

It is impossible to stand a very long mast up there on the cupola deck on the shoreward side of the lantern for there is no room to guy a tall mast. It would be useless to put a very tall mast at the shore side of the house on the "Main Deck"—meaning that three foot walk—because that is only 15 feet west from the shore side of that cupola deck where your topmast MUST be. So we faked it by putting a pair of 22 foot masts on the lantern deck, standing a long mast on the east side of the "main deck," and then leaning it out at some fifteen degrees from the vertical, carefully keeping below the focal plane. The antenna lead went up this slanting mast and from its head "fanned out" to a spreader placed between the two upper masts. That made a little three cornered flat top about 25 feet long. Such a top does not have all the capacity in the world, even when the copper roof right underneath is grounded; perhaps such a small capacity might be expected to brush a little when agitated by a good husky two kilowatt set with a fine old-fashioned low pitch non-synchronous rotary gap of the gear type. Still, one would hardly expect the

thing to act as it did, even when loaded to 500 meters—three times its natural wave.

I started on full power right after getting tuned up and was rather surprised to notice what a large number of things happened when the key was touched. The gap let out the usual soul-stirring snarl but it was not as impressive as usual because you couldn't hear it. There were several reasons for that and we were all a bit mixed up as to which rated as the main one. Perhaps it was the four inch caterpillar flames that were writhing at every sharp edge of the antenna switch, perhaps also the fine purple fringe on the outer turn of the antenna loading coil, but much more probably we were being distracted by the really splendid display of brilliant white sparks pouring across a seven inch gap between the ground and antenna leads. Increasing that gap to nine inches did not interrupt this performance in the least and added so much more whoop and crash to it. The antenna was a fine blue from end to end, the lightning rod tip under it was surmounted by a big fuzzy blue ball, like the one on a Tam O' Shanter cap, and every once in a while the juice took a running start and went across the 14 inch antenna insulators with a most noble

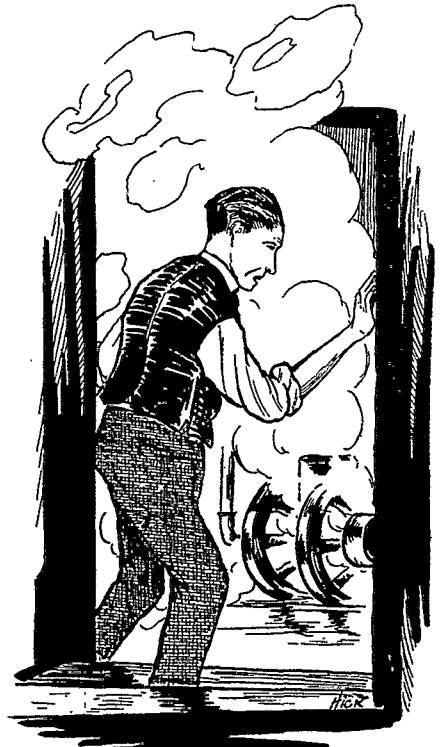

"The room was filled with steam, thru which the cylinder heads glowed an evil dull red."

ripping crash. Clearly we had achieved a success but not just of the sort we expected for we had not started to make a Tesla coil.

We changed that antenna around, took the lead out at the west side and ran it clear to the end of a spar stuck out of the second story, THEN started up the WEST side to the same old spreader between the little masts above, and from there made a flat top EASTWARD to a spreader on the long slanting mast. This gave us a much longer fan, added a real flat top, did away with all the fireworks, and caused the keeper to change his mind about resigning.

Recollect that I spoke about some plants? Each of us had one, a nice little four-cylinder gas engine driving a standard 500 cycle two kilowatt motor-generator, the d.c. motor being used as an exciter. These sets were fine save for two things, the most immediately apparent being a steel battery box designed for 1500 cycle resonance and making far more noise than the engine at that running speed. But that was easy, for any radio amateur knows that when you have trouble with part of a radio set you take it off and put it in the corner. Later we also noticed that the designer had made an error in direct-connecting a 1500 r.p.m. generator to an engine made for 900 r.p.m. operation. Those versed in advanced mechanics will see that one of the two machines had to operate at an abnormal speed. It had been the designer's idea that the engine would be that machine, but as it used up 25 gallons of gas with perfect ease in an ordinary day's transmission, we reversed the plan and ran the generator at half speed. Two gallons of gas now lasted a day, we had our old friend the 250 cycle note, the engine ran perfectly cool, the antenna ammeter stood at 6.5 amps with one kilowatt input, and everything was beautiful. I had just told the operator on the "Arbutus" how nicely the set was going when the lamp on the board went out and the rotary coasted downhill while the spark stuttered and quit. There was a gloomy silence from the engine room.

When it is very necessary one can go thru three doors and down a narrow and crooked stairway in ten seconds. It was very necessary at this time. The engine room was filled with steam thru which the cylinder heads glowed an evil dull red. I howled for the keepers and we went in to first-aid Betsy. We pretty nearly got our feet boiled in the two inches of steaming water that had run onto the concrete floor at the time that the water connection shook off. We did not speculate on that for here was a red-hot engine which might still be perfectly good. So we took turns cranking while any one of the trio who had recovered sufficiently from his last spell at

the crank poured water into the top of the jacket. The miracle happened, we got her cooled down unharmed, and after carefully inspecting and putting in new oil we hoisted in the unreasonable amount of water that the cooling system required, idled Betsy for a time, and then called the "Arbutus." I don't know who was operating on that boat but only distance prevented assault when he said—"Why don't you stay on the schedule?"

After that Betsy never balked again, but displayed a fine willingness to operate at any speed from a hundred r.p.m. to anything within reason, for any time one might request. We finally became very good friends.

I could tell you of the sort of receiving that we got there, but there is no profit in being called a liar. You can guess when you know that a perfectly good Audiotron was never set up because the crystal "got" everything within about ten times the distance one would have any reason to hope for. Some day I hope to have on shore an antenna that is half that good for receiving.

Perhaps it will be difficult to get a ground connection that will equal 200 tons of cast iron under the water of Chesapeake Bay but just the same my station will be ashore. Then when you are ready to go somewhere you can go. The keepers of the lights consider this a hammer-headed idea as there is plenty of water in all directions so one can go where one pleases. That is because they are not used to walking. I am, for I live on one of these street car lines where there is a car every ten minutes till about the time you want to go home, when they start to drop out two-thirds of the runs. That is why I must go now.

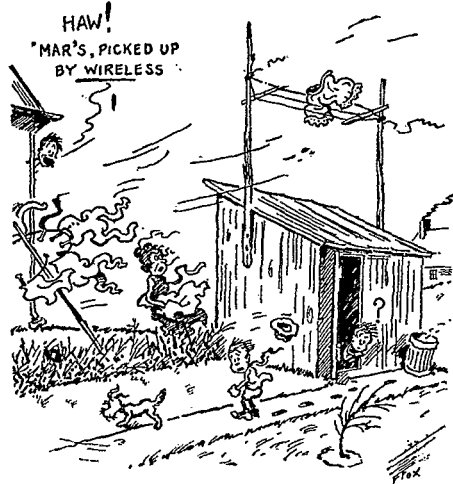

Courtesy "Providence Journal"

## The Advent of Amateur C. W.

**A**MATEUR continuous wave telegraphy for relay work has at length arrived. Not that it is by any means perfected in its details, but it is working and the benefits we expected are being experienced as well as the troubles we expected.

2ZV, Richmond Hill, L. I., is using a 340 meter wave for C.W. telegraphy, compensated wave 350 meters, with an antenna current of 6 amperes, representing 350 watts. The oscillating equipment is two Type P Pliotrons. This station should be good for 1500 miles.

UM and GMC, Air Service calls still apparently authorized at this late day, are stations of the Glenn L. Martin Co. at Cleveland. C.W. telegraphy and phone are both used. One set puts 2.5 amperes in the antenna on 180 meters with 250 watts input, and the other set 4 amperes on 370 meters with an input of 350 watts.

Others we know of are 2ZL, 2FS, 2AB, 2EX, 2ZM, 8XK, 8YO, and 2XX. 2XX, ex-2XG, the station of Mr. Robt. F. Gowen at Ossining, N. Y., has secured perhaps the best distance to date, signals being nightly QSA in Little Rock, Ark. Voice, modulated, and straight undamped are used.

NSF, the Naval Radio Laboratory at Anacostia, Washington, D. C., is testing bulb sets of various powers on 200 and 425 meters, using straight and chopped C.W.

All of these stations are desirous of receiving reports of their signals, with all data of value.

Probably the most interesting work is that done by 2ZL, the station of our Traffic Manager, Mr. J. O. Smith. That the C.W. is proving up is attested by the fact that 2ZL is junking its spark set as outgrown. The equipment consists of a few small oscillators in parallel, with an antenna current of 1.2 amperes, straight C.W. on 275 meters. Traffic has been put thru to Ohio and Massachusetts by this station when the spark signals were powerless to combat QRM and QRN. Its signals are reported from many points, among them Chicago (steady for a week); West Palm Beach, Fla.; Boston; Akron; Columbus; Youngstown; Fall River; Washington; Elmira; Chambersburg and Wayne, Pa. Comparative tests between the spark and C.W. have been made, and 8IB reported the 1.2 amperes C.W. "as loud and steadier" than 3.5 amps. spark. A similar result was obtained at 1AW when the modulated C. W. signals of 8XK, Pittsburgh, radiation 2.5 amps., were compared with his sharply-tuned spark set radiating 8.5

amps. on the same tune and found of equal audibility. The reason the smaller energy produces signals as loud as the larger energy of the spark set is of course that the former is radiated at just one frequency, whereas even in sharp-tuned spark sets the energy is distributed over a considerable band of frequencies. If we only had some form of "resonant ammeter" it would show, in such a case as this, that the energy radiated on one definite wave length was close to the same in both cases. There is still another gain in straight C.W., however—the amplification automatically obtained in heterodyning it, equal probably to about 4. Because of the totally differing characteristics, too, C.W. can often be read thru an inferno of spark QRM. 2ZL is now broadcasting traffic to certain stations by appointment at 9:30, 10:30, and 11:30 p. m., getting QSL's by mail the next day, and in nearly every case the messages go thru without trouble. That Boston stations are getting this traffic speaks more for the little 1 amp. of C.W. than volumes could.

On the other hand it has been found extremely hard to tune in these short continuous wavers. Because, too, we generally studiously avoid permitting our bulbs to oscillate, they are not often picked up accidentally. Any regenerative set will pick them up by getting the bulb oscillating at the correct amplitude and searching carefully. The very sharpness is a handicap in these early days, for one must be **right on the tune** to hear it. Oh what a world that speaks for the QRM minimizing possibilities of C.W.! The stations now operating, when not picked up thru chance and accident, have got their reports from one of two ways. One is by appointment, where by prearrangement the signals are listened for on a given tune at a given hour and so picked up. The other way is one which will be useful to use during the transition from spark to C.W. (yes, it's inevitable!)—rigging the C.W. to operate on exactly the same wave as the spark, calling on the spark, and asking stations to listen for the C.W. on the same wave.

Once such a station is tuned in the next trouble is to "hold" it, but this we are solving. A shielded set, either enclosed in metal screen or with the panel backed by a grounded metal plate, effectually prevents disturbances from the operator's hands, and vernier condensers and smaller range variometers are solving the difficulties of extremely exact tuning.

Modulating the C.W. by a buzzer, commutator, or by audio-oscillation, of course  
(Continued on next page)

## Our Rotten Hours

—A Reply to The Old Man—

By "A Boiled Owl"

**Y**ES, I'd like to know where it is going to end! Here it used to be that I could take those messages from that "poor girl over in Illinois" along about 1:00 A.M., when the wielders of the melodious rubber band vibrator had sought refuge in the arms of Morpheus, but now—Holy Smoke—I'm lucky if I can even hear the OM's spark (he don't use CW) before two or three; and hang it all, I haven't got a cat to spit on, either.

What I'm c to k, as B.L.T. says, is how do these infants manage to get up early enough to recite their A B C's the next morning, or perhaps they are so young that when they wake up to have Poppa walk the floor, they yowl for the sound of their coils instead of the gurgle of milk. It used to be that a well-behaved spark coil began to get drowsy along about 9:00 P.M. Central Time, but now at 9:00 they're just beginning to stretch for the lucky 10th, 11th, 12th and 1st. Well, gosh hang it, if they can do it and live, I guess I can manage to exist, so, sit 'em out I will! Well, that's a noble determination but where does it get me? Take last nite for instance. Here I sat, hearing thru lulls in the storm of piffle such welcome sounds as 2ZS, 5ZA, 8ER and 1AW and, thinks I, here is where I clear that old hook when these local children turn in. Well that sounds good, but when the last "How is my spark" has died away, where have 2ZS and the rest gone? I call my condenser blue in the plates and get my Hy-Rad all het up, and with what result? A squawky call from PW, whoever he may be and wherever he may be. (I know where I'd like him to be, but won't say, because I hear that Mrs. 8ER reads QST.)

It hasn't gone to my stomach yet, probably because I don't smoke, but it's beginning to go to my head and in order to keep myself out of the hoose-gow, I want to know how these other fellows in cities with precocious youngsters manage to get thru. I hear ol' 9ZJ singing along early in the evening, and can sometimes manage to get a word here and there thru the slush, but he never seems to have much trouble hearing the other fellow, and Indianapolis isn't a village, either, and I've heard they have local QRM there.

I can't enjoy "sleeping on a full stomach" as the OM says old 2AGJ used to do, because its too round and I sleep on my back anyhow, so that stuff of eating and then snoozing and relying on the Big Ben doesn't go well. I'm a pioneer member of the Boiled Owl Club, but I'll swear on a stack of QST's that I don't get any satisfaction out of my membership, and I'll donate toward a medal for the man that can tell me how to do any work before midnight. I see there's a thingmajig that Warner raves about in March QST that's supposed to cure all the ills of a receiver that's got a malignant case of QRM, and I'm going to try her out. The little girl always did say I was a fish and I guess she's right, since I'm hacking a chunk off my old OT and glomming on to some Dubiliers and hooking up a "wave-trap." I don't like the Limies much, but if this stunt of theirs is worth a gosh hang, I'm going to find a bunch of Irishmen and cheer for King George, just to celebrate.

I've made the lot look like the battle of Verdun trying to lay ground wires and have bent the end of every pick I have, since it gets kinda cold up here, but that don't do much good. I've got loops hung all over the radio shack till the neighbors think I'm in my second childhood flying kites, but loops don't seem to hanker toward the old 200 meter stuff and so I've got one more bet left and that's the hickey of Warner's. If it don't work guess there's nothing left for me to do but keep on working later and later till finally we get round to evening again.

---

### ADVENT OF AMATEUR C.W.

(Continued from page 13)

will make the signals audible on a non oscillating set, but generally the range will be cut in half and the decrement increased, altho remaining far superior to the ordinary spark. However, when we get oscillators we want to get away from "trains" and utilize all the wonderful possibilities of C. W. in its sharp tuning, high efficiency, and heterodyne amplification.

(Concluded on page 16)



# Multiple Transmitters

—Some Ideas—

**M**R. West has made it clear that by proper design and a painstaking persistency it is possible to use considerably more than 1K.W. on 200 meters. The efforts of "The Old Man" to get ten good honest amperes of radiation in a sharp 200-meter wave, however, have brought forth a number of ideas from the experimenters of our membership, mostly looking toward some multiple system whereby a set is "worked harder" or "oftener", rather than by the application of scientific knowledge to the genuinely-existent problems of a single transmitter. Nevertheless, after solving the latter a limit in distance would truly have been reached, and then the "multiple" ideas would again be desirable in the event a maximum transmitting distance on 200 meters were the goal.

Mr. L. A. Bartholomew, of Los Angeles, assisted by Mr. Arno A. Kluge, has been working along the line of double transmitters, employing a single discharger. Figure 1 shows the hookup which has been most successful. Two transformers,  $T_1$  and  $T_2$ , are used, each charging its own condenser,  $C_1$  and  $C_2$ , respectively. These condensers are each of the normal 200 meter capacity, say .007 mfd. Each circuit has its own primary in the oscillation transformer but a special gap is used to discharge both circuits, alternately.

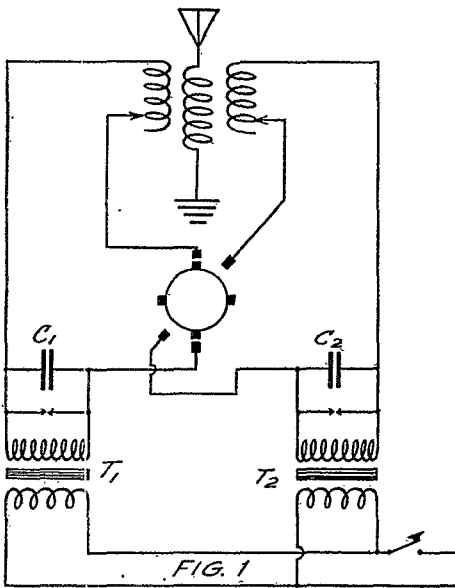

In the tests with this arrangement, using one transformer, one condenser, and one O. T. primary, a certain input, radiation, and audibility were observed. Then the second transformer was connected in and the input, radiation and signal strength were doubled. Naturally the spark frequency was also doubled, and an interesting thing is to be noticed in this connection. A high note is desirable to work thru static, but when obtained with a non-synchronous rotary very often results in decreased efficiency because of insufficient charging of the condenser between sparks,

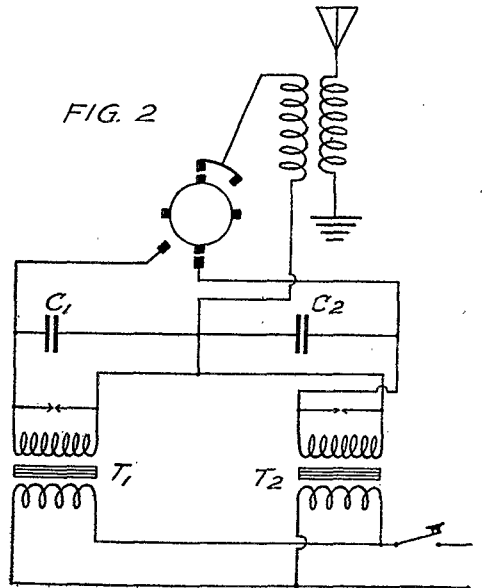

etc. In this case each set works at an efficiently low spark rate, yet the resultant tone will be double that—a goodly high note for cutting thru QRN.

In Figure 2 is a circuit similar to that of Figure 1 but having a common O. T. primary. The condensers must be of the same capacity to the same wave length. The circuit of Figure 1 would therefore seem easier to operate. The transformer secondaries must be so connected that at any instant Wire 1 will have a common polarity, either plus or minus. Thus there is no potential difference between Wires 2 and 3 when disconnected from the condensers. The action of the circuit is otherwise very similar to that of Figure 1.

Mr. K. V. Nyquist, Stromberg, Neb., proposes the arrangement of Figure 3, wherein a single transformer has two oscillating circuits arranged with the condensers in parallel for charging—whereby double load will be put on the transformer—and discharging across a rotary of the ordinary “spark-through” type arranged

directly under the aerial. In essence the action is identical with that of a high-tension power distribution system, and the total radiation is the sum of the currents flowing in the various ground connections. In a paper recently presented at a joint meeting of the A. I. E. E. and I. R. E., Dr. Alexanderson explained that such a mul-

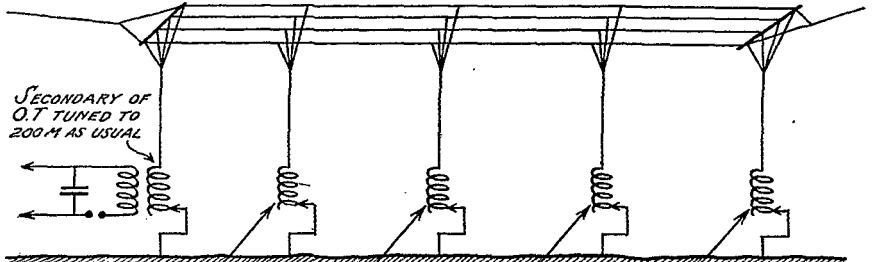

FIG. 4 COILS SITUATED OUTSIDE UNDER AERIAL. LEADS BROUGHT DOWN AND TUNED TO 200 METERS

to form two gaps in parallel, one for each condenser circuit. The circuits are tuned independently to 200 meters. Three secondaries for the O. T. are suggested, as shown.

It has also been suggested that the use of the multiple antenna by amateurs would be worth trying. This is the system originated by Dr. E. W. F. Alexanderson and installed at New Brunswick. It is shown diagrammatically in Figure 4 and will be

multiple antenna may be considered as an aggregate of several ordinary vertical antennas in parallel, each with its separate tuning coil; and, when correctly tuned radiating in phase at one frequency. Ordinarily, to increase the radiation of an antenna a given number of times, the power input must be increased by the square of that value, whereas by the multiple system, with a combined wave amplitude equal to the total of the amplitudes emitted by the units, the necessary power input increases only as the first power, plus a small correction factor due to the fact that the value of radiation resistance is common for all the units. At the New Brunswick station subdivision of the antenna in this manner (giving units of around 2000 meter minimum wave length and involving loading to regain the original wave length) resulted in increasing the radiation efficiency from 2.6 percent to 14 percent.

“The Old Man” may get his 1000 watt after all. Certainly these ideas would seem to offer an improvement under operating conditions where the utmost power must be put in a 200 meter wave.

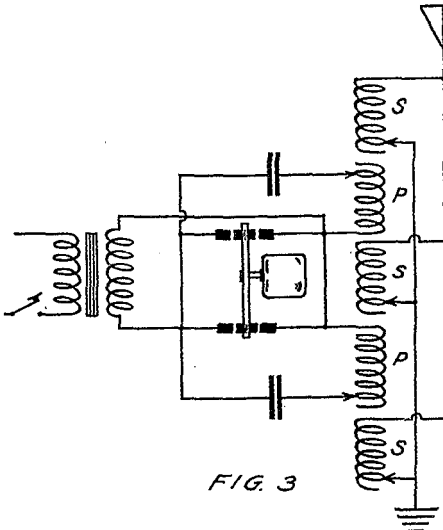

FIG. 3

seen to make use of an antenna perhaps several times the length normally necessary for the radiated wave length (tho not necessarily so), divided into sections by various vertical portions connected to earth thru outdoor tuning coils located

ADVENT OF AMATEUR C.W.

(Continued from page 14)

The Editor urges the adoption of C.W. by all serious experimenters as a field of highest interest and unlimited possibilities but with the warning that they'll have to learn transmission all over, for the old dog of spark days will not apply. QST hopes in the near future to establish a special laboratory for C.W. experiments looking toward the development of sets particularly adapted to 200 meter relay work.

# Variation of Strength of Amateur Station Signals

By J. O. Smith, Traffic Manager

**T**HE matter of variation in the strength of amateur radio station signals, particularly true of long-distance night communication, is of great interest and concerning which comparatively little has been published.

This variation of signals is frequently referred to as "fading". But is it fading? Isn't it true that it is really a rising instead of a falling characteristic? The fact that stations can be heard at night which cannot be heard in the daytime would indicate that the range of such stations had increased many times during the night as compared to the daylight range.

It has been definitely determined that daylight restricts the range of a station to a definite area. It has been definitely determined further that as a rule signals from distant stations are more likely to be stronger during a night following a cloudy day than following a day of bright sunshine.

This would seem to indicate that the daylight effect was the sole determining factor. If this were true it might be expected that with the coming of night the range of all amateur stations in all directions would increase proportionately. This, as is well known, does not happen.

What does happen is that the range of stations to the west of Long Island may greatly increase, while not a single station in New England will be heard. On another night New England stations may come through strong, and not a single station in the Middle West be heard from. On another night signals will be strong from all directions.

This shifting condition would tend to indicate that the condition of the atmosphere was a main factor, but this is disproved by the fact that it is possible to determine whether a station is located in the west or New England by the manner of the rise and fall in strength of signals.

The signals from New England stations increase and decrease very rapidly. In fact, it is a common occurrence to hear a New England station fade completely out in the middle of a four letter word, and come up strong again in the middle of the next word.

The rate of rise and fall in the case of Middle West stations is much more gradual. These stations fade out slowly, over a period of five or six words usually

and then swing back again in the same gradual way.

This would seem to indicate that the country intervening in both directions between Long Island and New England and the West was the controlling factor.

Why should signals fade rapidly in one case and gradually in the other? Can any one offer a solution? Is it a question of distance, topography, terrain, or what? The old theory of conditions at the transmitting station won't stand in the face of the foregoing facts.

There are many spots on the ocean known to commercial radio operators as dead pockets. One of these is along the New Jersey Coast, near Barnegat. Another is in the Gulf of Mexico, near the lower Mexican Coast. Why dead pockets on the ocean? The same thing is true however, on land. For instance the owner of an amateur radio station at Fall River, Mass., can work Second District stations easier than stations in New England half the distance away. He is in a pocket. New England in fact seems to be in a pocket by itself. It is easier to work New England from Ohio or Illinois than from Long Island or New York City, 75 miles away.

There are undoubtedly many localities throughout the United States and Canada where usual conditions are noticed in amateur work. The League is greatly interested in this proposition, and is endeavoring to gather all possible information from which it will endeavor to work out some theory in explanation of the rise and fade in the strength of amateur signals at night. There must be many pockets and dead spots, difficult territory, easy territory and all sorts of unusual conditions that will make very interesting reading and perhaps enable us to work out some kind of a tenable theory for these conditions.

It is accordingly requested that all amateur radio operators who have any information whatever on the subjects outlined in the preceding paragraph make such information available for study by the League and it is hoped that the response will be generous.

Such information should include location of station, inequalities noted in strength of received signals, distances in miles from transmitting station, whether distant stations in all directions fade equally, whether the rate of rise and fall is gradual or rapid, topography of the intervening country, kind of soil, etc.

# A Generator for Plate Voltage

By E. B. Duvall

**T**HE generator and filter coil described in this article are the result of a series of experiments made by the writer to produce a steady unidirectional potential for vacuum tube work, which will be found less troublesome and less expensive than the old style high voltage batteries that were used by owners of vacuum tube receivers and amplifiers before the war. Anywhere from 10 to 15 small flash-light batteries were necessary for the successful operation of a receiving tube, and due to their rapid deterioration they seldom lasted more than three months and their cost and short life made the vacuum tube receiver a luxury to many.

In nearly all the permanent stations in the U. S. Navy the 115-125 volt D.C. mains are used as plate potential, but as the average experimenter has only the 110 volt A.C. it is necessary to generate the

It must be noted that if the D. C. machine is series-wound, it must be driven in a reverse direction from that in which it will run as a motor, and it will be necessary to connect a 16 c.p. lamp across its terminals before it will generate. This serves as a load and the voltage will build up at once. The set can be placed in the cellar of the house or in some place away from the operating room and can be controlled from the operator's switchboard. When this is done the generator leads can be brought up to a lamp on the panel which will serve as a load and as an indicator or pilot lamp at the same time.

The filter coil which must be used to filter and smooth out commutator noise and induction hums, can be made very readily by the experimenter. The core is made up of a bundle of soft iron wires 1 inch in diameter and 5 inches long. Core ends  $2\frac{3}{8}$  inch square of wood or hard

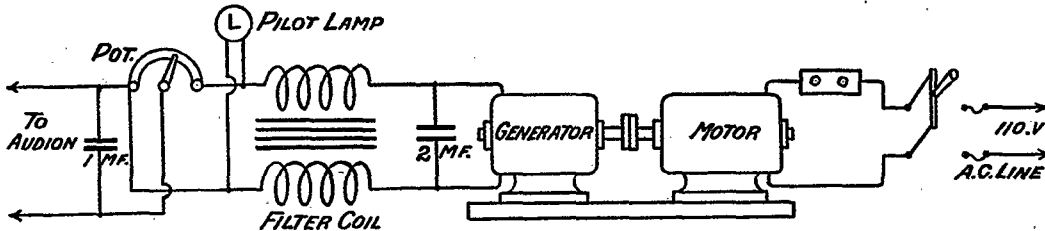

D.C. However, in case the station is supplied with D.C. the owner will find it worth while to construct the filter coil and equip his vacuum tube control panel with a graphite sector potentiometer.

For the motor-generator unit, for use when the supply is A. C., two uni-frame motors can be picked up second-hand almost anywhere and should not cost over \$10.00 each. One should be an A. C. machine, and for the best results, one of the induction type having a no-load speed of about 3000 R. P. M. and the other a 110 volt D. C. shunt-wound machine with a speed near 1800 R. P. M. If the two motors are uni-frame or practically alike in dimensions, they can be coupled shaft to shaft and will make an ideal set. In this case the two motors may be connected by a flexible coupling attached to the shafts, but they can be belt-connected and if the proper size pulleys are used they will work quite satisfactorily.

It is only necessary to say that the object is to drive the D. C. motor as a generator by the A. C. motor, and it will be found desirable to mount the unit on a heavy base.

rubber, with a 1 inch hole drilled in the center to take the core, are placed on each end. Several layers of empire cloth or waxed paper cover the core evenly and 18000 turns of No. 36 S. C. C. magnet wire are wound on evenly. This winding should be well impregnated in wax and several layers of insulating cloth evenly placed over it. On this is then wound 24000 turns of No. 36 S. C. C. magnet wire. The whole coil can now be impregnated, and an even layer of heavy twine wound over the winding to serve as a protecting cover and give it a neat appearance.

It will be found that with this coil in series with the 110-volt generator, any voltage up to 90 volts can be obtained when a graphite potentiometer sector is used on the vacuum tube control cabinet, and if a higher voltage is desired the 110 volt motor can be replaced by a 220 volt D. C. motor. This type of filter coil is used in all the control cabinets of the Navy and the writer experimented personally with this type of generator and coil to determine whether such a scheme

(Concluded on page 20)

## Notes on Improving Transmission

By M. B. West

Mr. West's ability to give sound practical advice on amateur transmission is known by all who recall his pre-war station, 8AEZ. This is just the type of article we all want: real information for perfecting our transmitters.—Editor.

**M**R. Entwistle states in his letter in QST, February, 1920:— "The power you can put in the antenna varies directly as the condenser capacity, directly as the spark frequency, and as the SQUARE of the VOLTAGE IMPRESSED ON IT." You will notice that I have not capitalized the same words that were so emphasized in the letter as printed; and "thereby hangs a tale", which, unfortunately, most amateurs ignore altogether.

The average amateur transmitter is composed of a relatively large number of pieces of apparatus, and in very few cases indeed are any two of these so designed so as to be best suited to work with each other. The big problem is to combine and adjust this apparatus to get the best possible results and to know which parts to replace if satisfactory results are not obtained.

We all know that we must have the antenna as high as possible and usually this involves all the length that the law permits; that we must have a number of wires in parallel in order to decrease the resistance and to secure better radiation,— but how many is a question; that a good ground is necessary; that there is a lot of argument about "gaps"; that condensers are always a problem; and that whenever you try to follow out all the advice you read about tuning and slowing down the gap, etc., something usually "blows up" and you have a week's work on your hands, to say nothing of being "out of business" for that week. But that it can be solved is proven by listening in any night. The successful stations present such a variety of apparatus and conditions that, to the beginner, a satisfactory solution seems well nigh impossible.

The two most important factors seem to be the height of the antenna and the voltage impressed on it.

There are two ways of increasing the voltage:— First, to increase the voltage of the transmitter, and, secondly, to add inductance in the open circuits. Also, decreasing the number of wires will result in increased potential, but as this is usually at the expense of energy actually radiated, it is not usually advisable, unless the number of wires is excessive. So if you must use a low-voltage transformer, what-

ever you do, DON'T put up an antenna with a natural period of 199 meters and expect to work across the continent.

Let us suppose that you have all the apparatus ready to set up, "gap and everything", and have decided the question as to high or low tone, etc. The first thing to do is to connect up the closed circuit and tune it to 200 meters, or the wave you have selected. Connect a hot wire ammeter to a portion of the closed circuit, as shown in the figure, start your gap and close the key and note the reading on the meter, changing the connection so as to include more or less of the closed circuit as may be necessary, in order to secure a deflection over the central portion of the scale. Then add to or subtract from the capacity of your condenser till you get the maximum current flowing in the closed

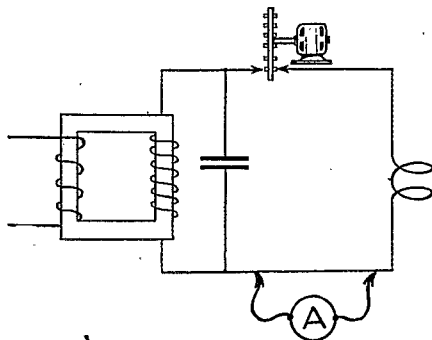

circuit, of course making the necessary changes in inductance in order to keep the wave constant. You will note, when you have secured this condition, that you have a condenser that is of just sufficient capacity to permit it to be charged by the transformer to the highest possible voltage in the time intervening between one spark and the next. When this is done, leave it alone, unless you decide to change the power transformer, or the gap frequency, in which case it will be necessary to make this adjustment all over again. In using a plate condenser of large plates, it is often advisable to provide one plate that has only a fraction of the capacity of the rest, as this adjustment is really important and should be made accurately.

The next problem is to construct the antenna, and it is best, by far, to do your

experimenting before you put up a permanent structure. If you have a high-voltage transformer (20,000 volts or more), full 1 KW, and have selected a low tone, it is safe to start with three or four wires long enough to "figure" about 180 meters; if not, start with the same number of wires but much shorter, say not exceeding 120 meters; then couple to the closed circuit and tune to resonance. This experimental antenna should be small enough to "brush" when tuned to resonance and should require some inductance, in addition to that required in the secondary of the oscillation transformer, to bring it to resonance. Now add gradually to its length till it either ceases to "brush" or you have increased its length to the greatest possible with still enough turns in the secondary to provide the necessary coupling. If the latter is the case, add additional wires until it just ceases to "brush". Each time a change is made the tuning must be carefully done, both as to resonance and to make sure that the coupling is loose enough to emit a pure wave. Then if you are satisfied with results and not until then, make up your permanent antenna of the same dimensions, and you can be certain that you will secure the best results that your apparatus and location make possible.

Having made the above experiments (and you may be sure that if they are carefully done you have secured the best possible adjustment of the apparatus you have), you will have learned a great deal of the relative importance of the various pieces of apparatus that go to make up a transmitter, and you will be able to decide just what improvement you consider worth while.

If you improve your ground connection greatly, you will probably find that it will be possible to decrease the number of wires in the antenna with good results. If you improve the gap you will find that you can use a larger condenser, which, in turn, should require more wires in the antenna, if it was accurately adjusted at first. Should you increase the voltage of the transformer, it will require a larger condenser, or one capable of standing the increased voltage, and this, in turn, a still larger antenna. Should you have done all of these and find that you still have part of your one K.W. to spare, then, and not until then, increase your spark frequency. I do not believe that you will be able to increase it very greatly, as I was able to put almost two and one-half kilowatts into a set tuned to 208 meters, and that with a spark frequency around 300 per second.

Of course, it is possible, with extremely good "quenching", to reach the point where the watts per spark increase tremendously, and when this is done, the power per spark

will be greater than any antenna of reasonable dimensions will radiate, unless the spark frequency is increased. Also, it might prove advisable to put up a higher antenna and insert a short wave condenser, in order to take advantage of the better range of the higher one and to be able to use additional inductance and thereby added voltage.

The greatest difficulty in applying the 500 cycle set to extremely short waves is that to secure sufficient voltage to radiate efficiently it is necessary to increase the voltage of the transformer greatly, thus necessitating the use of so many gap sections that the resistance of the gap consumes too great a part of the energy, or to use a small antenna and "load" it to secure the necessary voltage, and this involves cutting down something that is already small enough to say the least.

To me the most feasible plan seems to be to design a condenser that will be able to withstand the high potential that is necessary if 1 KW is to be used and 200 meters not exceeded. This should be accurately adjustable and of very low ohmic resistance, as the losses due to ohmic resistance increase enormously on the shorter waves. Some development of the oil condenser seems most promising, although it may be possible that the mica condenser may be developed so that it will operate successfully. The glass condenser is hopeless for very high voltages, as the brush from the edges soon etches the glass and it eventually punctures even if the dielectrics are of very heavy plate.

The problem of a better transmitter seems to narrow to a choice between better "quenching" and its problems of securing sufficient voltage and a satisfactory non-synchronous rotary, and the problem of a condenser that will withstand the voltage that it is possible to employ. My choice would be the latter, not only on account of the lessened expense involved, but from the standpoint of reliable operation.

## A GENERATOR FOR PLATE VOLTAGE

(Concluded from page 18)

would work out satisfactorily for amateur use. Two spark coil secondaries placed on an iron core served very nicely in place of the filter coil described, but it was found necessary to unwind a few layers to get the correct voltage. It is also necessary to place a 2 mf. condenser across the generator terminals and a 1 mf. condenser in shunt with one side of the potentiometer and the slider switch to obtain noiseless operation. The diagram shows the hookup and is self-explanatory. The progressive amateur who constructs such a set will find that with a little care of the motors he will at all times have a "B" voltage that can be depended upon.

# Rotten Weather Relays

By The Old Man

—The Old Man at his best with a yarn that we know will bring many a laugh—

IT certainly is awful, what a man will do when he is idle. This run of bad radio weather lately put us out of business here, and left us nothing to work but near-by locals. This got sort of tame after a week of it and the result was trouble. The trouble never would have happened if the good old long-distance stuff had been possible. You never take it when you can hear 9ZN booming along at his thirty a minute which he thinks easy to copy, or 8ER at her ladylike fifteen which you cannot miss, or 8AA, or 8NF or 3BZ or 5AF or 2ZS or 1AW away down East, and everybody attends to his knitting and keeps out of mischief. You always feel any one of them will give you an answer if you call him in a firm voice, and the chances of enjoying a long distance chat keep your interest up and your mind on your number. But when this is all gone, thanks to the sun spot business and the seven planets all lined up on the same side of the Sun, and there is nil but the locals, you just can't help straying off the straight and narrow. A man will stoop to things he would be ashamed of in better days. One was pulled off the other night here that would have made a horse laugh and when it all comes out in QST there will be some heavy thinking on the part of some young gentlemen not a million miles from Michigan Avenue. I don't suppose it will do any harm, however, so here she goes:—

I don't just remember how it began. Anyway, one notorious character known to certain old timers as Radical exhibited his usual finesse and supplied an evenings' entertainment for those able to take in the show. We will mention no names, but a chap we will call Mr. North who lives in a town some fifteen miles to the North asked me to ask a chap we will call Mr. South, who lives about the same distance South, something about a Burgess Battery. Each was a new one since the war, neither could work the other, and the combination was one hard to resist.

I asked the questions and handed them back and forth until somebody got mixed and both parties started sending to me at the same time. I could not get either one of them to save my life. It turned out that Radical had been listening to the affair, because at the finish of the mix-up he injected a hoarse HI which I recognized. This started me. Knowing his spark and also that he could be dragged into the thing, I called him and passed some bunk

about being called to the telephone and asked if he would kindly repeat to Mr. South that Mr. North had said that 8QXJ was waiting to know what to do about the cramjiky coupling for the Burgess battery. Don't ask me what a cramjiky coupling is, because I don't know. It was the first thing that came into my head and I thought it would serve as well to start something as anything.

Radical paused quite a pause for him while he turned it over in his mind. He sized the matter up OK, however, for he shot me back a quick and solitary R and immediately called young Mr. South and gracefully imparted the information that I had been compelled to QRT but he would be happy to undertake the repeating of the message from Mr. North. He took mine and added his to it and by the time young Mr. South had it written down it must have looked something like this: "North wants know what you said abt new cramjiky coupling audiospit hook up?" (Some cute little question to answer, eh what?)

Silence fell and darned near broke a hole in the floor. Not a buzz disturbed the serenity of the circumambient ether. Probably all the buzzing was confined to young Mr. South's noodle.

After what seemed half an hour he came back. Lame and halting, but yet he came back. He gave a deadly long call and then stopped, and you could guess he was giving his paper the final once-over to see if he couldn't possibly dig some kind of sense out of what he had taken down. ND. It was hopeless. "Please repeat did not get you sorry OM please repeat once more"

Radical went back gently and slowly with about a dozen r's and handed him this: "OK glad help understood North was it you said 7BZV using cramjiky hook up his audiospit wont fall off him get it nw om?" Sort of suggests a pair of pants, the way he puts it.

More silence. Evidently badly overstrained intellect while the poor gink tried his best to twist this hog-wash into something human. At this critical juncture young Mr. North woke up and exploded. He had been quiet but had copied Radical and had been studying things. Being of a positive temperament probably, he made up his mind that somebody was off the track. He certainly had never asked any such darned question as what he had been copying from Radical. He called feverishly, for him, and was just starting to tell

his troubles when young Mr. South began. You couldn't spit between the signals they were so thick. Both were on about the same wave if you would call a signal as broad as the Atlantic Ocean a wave and both probably had Murdock rotary gaps by the sound and both were getting heated up. The result was a grand bedlam conveying just exactly no meaning at all. When the storm passed I wondered what old Radical would say to that.

It never ruffled a hair of his serene personality. Without a sign of doubt he went back with a bank of untruthful r's and said:—"r r r r r r r r r r Yes Yes Ok OK shall I tell him that om?" It fitted both. He did not call, so each probably took the answer unto himself and the confusion became worse confounded, which was exactly what the rascally Radical was aiming for.

It was time to light up the old pipe now and see the finish. After an extra long pause, blamed if they both did not burst in again at exactly the same time. Rattlety-bang they both went at it and I could imagine Radical having the time of his life. It took them both about the same length of time to unload and then it was up to Radical again. Without a pause, and I know to a certainty he could not have read one single word of what was said, he went back:—"r r r r r r r r r r OK OK OK. Whats trouble you say they wont stay hooked up om?" No call used again, so that each thought the answer was for himself.

I don't know what happened to the North chap. Probably he was struck dumb or

was making up his mind whether the subject under discussion had been changed to pants or amplifiers or what. He kept out. Only South came back. I copied this from him:—"r r r r r sorry dont get you OM trouble with my receiver dont understand what it is he wants to know will you please repeat once again OM?" (Talk about cruelty to animals.) Radical, never phased a mite, answered:—"r r r r r r r r r r OK OK OK HR QTA OM QRX HI V V V V V HR QTA was it hooked loose or tight cramaudiojikyspit wks best loose very QSA last nite HW NW OM QRU? K" I guessed the HI was for me. The rest was for such use as poor young Mr. South could make of it. It was sent close up to eighteen with a rotten swing, and all the abbreviation simply made it a hash. There was a long awkward pause and finally the poor victim limped back with something to the effect that he would have to quit and was much obliged for the trouble and would CUL OM. Radical gave him an OK OK OK, said he was happy to have been able to straighten the matter out, told him GN and 73 and signed off as only Lord Chesterfield would have, had he been a radio bug. Then he called me at twenty-five leaving out the numeral of my call and asked if there was anything more doing to while away the time while we waited for the weather to clear. I was half afraid to answer the rascal but did and told him QRU NIL NM, for the present was enuf for one night and he'd better say double prayers when he turned in.

Can you beat it?

## Schedules of High-Powered Stations

Below we present a list of the principal high-powered stations of the world—those heard regularly in the United States—their wave lengths, character of transmission,

and operating schedules. This will tell you when to listen for the foreigners, and aid in identifying those you hear.

NAME	Call Letters	Wave Lengths	K.W.	SCHEDULES
Annapolis	NSS	17,000	500 arc	24 hours. England, France, Norway and Germany. Time signals 11:55 a. m. to noon; 9:55 p. m. to 10 p. m.; 75th meridian time.
Arlington	NAA	2,500	100 spk.	Time signals 11:55 a. m. to noon; 9:55 p. m. to 10 p. m.; 75th meridian time. Press following.
Cavite	NPO	12,000-5,000	350 arc	Time signals 10:55 a. m. to 11 a. m.; 9:55 p. m. to 10 p. m.; 120th meridian time, East.



NAME	Call Letters	Wave Lengths	K.W.	SCHEDULES
Cordova	NPA	7,600	30 arc	When called.
Darien	NBA	7,000	100 arc	Time signals 5:00 a. m. and 1:00 p. m.; 75th meridian time. NPL at 11 p. m., and 1 p. m.; 75th meridian time.
Great Lakes	NAJ	5,750	30 arc	When called. Time signals 10:55 a. m. to 11 a. m.; 90th meridian time, daily except Sunday and holidays.
Guam	NPN	5,000	30 —	Pearl Harbor, 3 a. m.; 75th meridian time.
Hanover	OUI	12,500	100 machine	— — — —
Key West	NAR	6,500	30 arc	Time signals 11:55 a. m. to noon; 75th meridian time. Guantanamo 1 a. m., 6 a. m., 9 a. m., 1 p. m., and 3 p. m.; 75th meridian time.
Lyons	YN	15,500	250 machine 200 arc	24 hours, with New Brunswick and Annapolis.
Nantes	UA	10,600	— —	— — — —
Nauen	POZ	12,600	200 machine	24 hours, with New Brunswick and Annapolis.
New Brunswick	NFF	13,600	200 machine	24 hours with England, France, Norway and Germany. 10 p. m. San Diego; 11:30 p. m. Pearl Harbor.
New Orleans	NAT	5,500	30 arc	When called. Time signals 11:55 a. m. to noon; 75th meridian time.
North Head	NPE	2,800	30 arc	Time signals 11:55 a. m. to noon, 120th meridian time, West.
Pearl Harbor	NPM	11,000-8,100	100 —	When called. Time signals mean noon; 180th meridian time. New Brunswick 11:30 p. m.; 75th meridian time.
Rome	IDO	11,000	300 arc	Annapolis 10 a. m. and 7 p. m.; 75th meridian time.
San Diego	NPL	9,800-13,000	200 arc	Time signals daily except Sundays and holidays, 11:55 a. m. to noon; 120th meridian time, West. NBA 11 p. m. Broadcast 1 a. m. NBA 4 a. m. Russian Island 9:30 a. m. Broadcast 3 p. m. NBA 1 p. m. NFF 10 p. m.
Sayville	NDD		200 —	24 hours with England, France, Norway and Germany. NBA and NAU, 11 a. m., 3 p. m., 6 p. m., and 12 midnight, Darien, 2 a. m., 8 a. m., 1:30 p. m. and 5 p. m.; 75th meridian time.
South City,				
San Francisco	NPG	8,600	300 timed spark	When called.
Stavanger	LCM	12,000	40 —	24 hours, with Annapolis.

## THE VACUUM TUBE AS A DETECTOR AND AMPLIFIER

(Concluded from page 9)

tangent AB to the curve at the point of operating voltage A and draw the line AB. The impedance is given by the quotient of the intercept BD volts divided by the current AD. For the particular tube taken, it is found to be 32,500 ohms.

In order to obtain the impedance of a tube at a grid voltage other than zero, a voltage must be added to or subtracted from the operating voltage equal to the grid potential multiplied by the amplification factor. The impedance can then be obtained from the  $E_b$  I<sub>c</sub> curve for zero  $E_c$  at the effective plate potential determined above.

Dr. Miller of the Bureau of Standards, has devised a simple bridge method of determining both the amplification constant  $K_o$  and the output impedance of the tube  $R_o$ . The operation of a similar bridge modified by H. J. Van der Bijl of the W. E. Co. is explained as follows:

Fig. 10 is a circuit diagram of the bridge showing the vacuum tube low frequency oscillator and the low frequency amplifier which is used to secure greater accuracy in the reading. It is necessary to carefully shield the bridge, oscillator, etc., by mounting the units in iron boxes, in order to be able to obtain a quiet null point for balance.

The applied alternating voltage from the oscillator should not be greater than a few volts so that the tube will not be overloaded. The resistance  $R_1$  is made 1 ohm so that the voltage across  $R_2$  will be equal numerically to  $R_2 E_1$ .

The voltage set up in the plate circuit of the tube will be equal to  $KE$ . If now  $R_2$  is adjusted until  $R_2 E_1 = KE$ , no current will flow in the telephone receivers and  $K$  will be given by the numerical value of  $R_2$ . For a measurement of  $R_o$ , close the switch  $S$ , and vary  $R_2$  until no sound is heard in the telephone receivers.

This means that the voltage across  $Z$  = the voltage across  $R_2$  or

$$\frac{KE_1 Z}{R_o + Z} = R_2 E_1$$

from which, for the case where  $Z = 100,000$ ,

$$R_o = \left\{ \frac{K}{R_2} - 1 \right\} 100,000$$

In order to obtain  $R_o$  we must measure the amplification factor under the operating conditions and determine the value of  $R_2$  as above. Knowing these, the value of  $R_o$  can be computed by the  $R_o$  equation. The question of design of detectors and amplifiers involves the proper choice of

## Addendum to Article on the Use of Honeycombs

By A. L. Groves

In undamped wave reception, using tickler coil or tuned plate circuit for producing local oscillations, there are always (on the long waves) apparently two tunes where each station comes in with practically the same audibility.

This is due to the fact that to produce a 1,000 cycle beat note in the receiver the secondary circuit must be tuned either above or below the true wave by this amount. As the long waves have a low frequency a change of 1,000 cycles make a very noticeable change in wavelength. At 18,000 meters it amounts to approximately 1,000 meters, while as the wave becomes shorter the difference is less and less until down to 200 meters it amounts to about 1 meter.

All the data given in the curve on page 12 of March QST is for the short tune. Thus MUU tunes in with the condenser reading either 60 degrees or 71 degrees LCM (12,000 meter wave) with the condenser reading either 42 degrees or 4 degrees; NPL (9,800 meter wave) with condenser reading either 24 degrees or 26½ degrees. Below this, (9,800 meters) the difference is so slight as to amount practically to a broad tune, while below about 5,500 meters the difference cannot be detected by the ordinary observer.

It will at once become apparent that the efficiency of the set on the long waves is not as great as on the short waves, owing to the losses sustained in retuning, which partly accounts for the almost invariable fact that any given station will come in slightly better on a short wave than on a long wave. Thus NPL comes better on his 9,800 meter tune than on his 13,300 meter tune, and LCM is better on 9,500 than on 12,000, etc. Still, this is the best we can do without setting up a separate oscillator circuit and employing a separate valve, batteries, coils, and variable condenser, which would hardly be worth the trouble for the slight increase in efficiency we could obtain from waves of about 9,000 meters up.

Also, the two tunes can be taken advantage of in tuning through QRM and this way is really valuable. For instance to copy NPL on his 9,800 meter wave when NDD is transmitting we have to use the  
(Concluded on page 27)

circuit and tube constants for the particular form of device in mind.

(The next section of this paper will treat of the Design of Amplifiers and Detectors)



### Our Job.

**T**HERE is something about this job of ours which breeds philosophising. Every so often it gets us and we refill the old pipe and grow retrospective. Here we are, March, 1920 A.D., the war over and we tipped back in our before-mentioned old bow-legged chair in a little coop of an office up here in staid old Connecticut, enjoying ourselves to the top notch working fourteen hours a day running QST for the rest of you fellows. When the postman brings in our mail twice a day, he grunts as he sets it down. It takes us from three to four hours to open it, and it all has to be attended to before the next load arrives or there would not be any way to get out of the coop at night. But just the same, it's a great job with many a laugh in it during the long day. Honest, we have to chuckle as we write this, because some of the stuff that comes in here daily would make a horse laugh. Why is it we radio men have such a sparkle to our humor? It seems to us that more funny things come in to our office in a day than Life or Puck or Judge receive in a week. We cannot begin to print it all because we really must have some informative matter, a few diagrams and curves and things for you high-brow chaps, the operating department stuff, the calls heard, and the general news, not to speak of an occasional ad that drifts in unbeknownst. (Hi!) There is a limit to the number of pages we can afford to print, and to cover the whole field and present a fairly well balanced magazine for you chaps once a month, we cannot print everything we would like to. Somebody told us the other day that all sorts of people not identified with wireless in any way read our QST every month just for the quality of the humor and the enjoyment they derive from getting into contact with our splendid A.R.R.L. spirit of fraternalism. Can you beat it? It certainly is great and she certainly is coming along fast. During the past month, we have had a chance to stand up on the plat-

form before some five hundred of you fellows and tell you about it, but somehow we can't just get it over to you in a speech. Just the same, it is a rare treat to meet you face to face. Won't it be great when we hold a big convention some time and a thousand or more of us all get together and shake hands and have a hearty laugh?

### The Power Companies

**W**HAT'S got into the power companies of our fair land? One would think they might have had a national conference and decided to declare war on the amateur. In a number of cities highly unjust regulations have been put in force, working a hardship on all our stations and making it impossible for the amateur of limited means to get service. The general form of this unfriendliness is a demand that a special 2 K.W. pole transformer be installed, with individual feed from the high-tension line, and it averages \$50 in cost of installation. The amateur is supposed to pay it. Generally he can't—and we're minus one more relay station. In two cities we know there are ordinances requiring wireless stations to cease transmitting at 8:30 p.m. It requires strategy to get around that, especially in one town we know where the "city lawyer" lives next door to the best DX station in town.

What are we going to do about this? We're losing stations. 8JQ, Washington, Pa., is out now because they were asked to just about buy the power company, and we can ill afford to lose him; and there are others. This seems to us a thing in which local radio clubs can be of vital aid. Get together, where this danger exists, and send a committee of good men to see your power company, and explain the injustice of their practices. They must have horrible ideas of what an amateur station is. They must be shown that their ideas are wrong—that amateurs are serious workers, knowing what they're about, advancing the art of radio communication—

quelched. We believe that tactful representations will clear the air.

### Warning!

**S**AY, we want to tell you about a certain well-known man who has just recently been appointed to a certain government board or committee where he will represent our country in radio matters.

One of our members had opportunity not long ago to interview this gentleman, and inquired his views. The gentleman got indignant at the very mention of amateur radio. He said he was in favor of Navy control and would do all in his power to further it; that if he had his way, amateurs would not be allowed to listen on any wave other than that assigned to them; that they had no business listening in on commercial or Navy messages—that people pay for messages and for secrecy in transmission. It was suggested that important messages could be coded. The ig. said it was a simple matter to decode them, and besides there was too much time wasted. Our amateur friend then asked him about the advances in the art that amateurs bring forth. We were assured by the ig. that amateurs amounted to very little, as the real work was done by engineers of the Western Electric and General Electric Companies. And so on, ad nauseam.

This is the kind of a man who is going to represent our country in an important radio conference soon. It is deplorable. Let us take this as a warning.

### "Co-operative Operating"

**O**UR fertile brain has produced another one. Get this:

Don't you know of some amateur friend, located just far enough away to be out of the QRM that breaks in on you, who'd be willing to link up with you and go it double, for mutual benefit? We've proven to our own satisfaction that points as little as twenty miles away don't have the same QRM that we do, particularly that originating locally but including the DX stuff too; and not only that, but fading may be and generally is very different there; and, most of all, very often the fellows you can't hear at all, who are "over your head", will be coming down to earth at his place. Then with low-power fast repeating, successful work can be done and traffic handled when you can't even hear the fellow you're working with!

1AW has been able to work out this scheme with beautiful results, due to splendid co-operation from 1TS and 1FQ, some twenty miles west and south respectively. Local QRM is sometimes

fierce in Hartford, but the main help has been in fading and in working stations, like Boston district stations, which normally are not heard at all in Hartford, yet come in OK at the other places. 1AW will do the transmitting, and all three stations listen together, the outside stations reporting as soon as the distant man signs off, and then only skillful piecing is necessary to get the stuff under conditions where it would otherwise be absolutely impossible.

Find you a buddy and pair off. Two can work better than one any time.

### QRN

**T**HE Demon Static can be heard tuning up down south now, for his summer transmitting schedule, and it's time we decided what we're going to do about it next fall? Let's don't. Let's try to beat him at his own game. We believe we can. There are any number of balancing-out schemes now which just about get rid of the static, and some of these methods are applicable to amateur work. We should get busy and try them out, and find something which will permit our work to go on uninterrupted. Relay traffic is running too nicely, and is too much fun to be abandoned at the first crash of QRN. Who knows which balancing-out system works best for 200-meter work?

We've got other methods of continuing our work, too. In past summers often the static and heat lightning would make reading impossible at night, yet during daylight the air would be clear and operation easy up to the daylight range of our stations. With the development of the short-relay scheme, it should be possible to get a lot of traffic thru without trouble. The H-T-L Club ought to be a busy bunch. And how about the early morning work—six or seven o'clock? Generally the air is pretty quiet then, even in summer. Try it, you chaps, as QRN starts makin' life miserable at night.

Then we have the often-cursed loop which very possibly may prove its worth to us in just this work. In ordinary work we have just about no use for a loop where an ordinary antenna may be employed. But it has a much superior signal-to-static ratio than an aerial, and we know positively that good work can be done using the regular aerial to transmit and receiving on a loop with a good amplifier to boost the signals, under conditions where static would ordinarily make operation hopeless. This not only sounds fine, but it is fine. Let's try it.

A loop will help out our QRM difficulties also, on account of its directional receiving activity to be fostered instead of

qualities. Often we think how well one should work as a relay receiving station near a large city where QRM makes it almost possible to put a message. It should be located in some town just far enough out from the city to reduce the arc which embraces the QRM area to a small angle, so it would in effect be broadside to the loop when the loop is pointed toward the transmitting relay station. And Presto! there is no QRM from the city and the traffic comes thru. (We're smoking Lucky Strikes this month, fellows. But, honestly, it has got possibilities—marvelous ones. Only try it—for goodness sake don't let's give up in the usual helpless despair. Life's too short, and relaying too good. These problems we tell you about are our common Jonahs, and even if we were never able to beat the game before the war, remember that this is our first engagement with the enemy since we reopened, and we know so very much more about how to go about it now.)

To work, then! And a brown derby to the bird that tells us how to do it first.

### New Legislation

**S**OMETHING is always happening in Washington. Absolutely, those folks down there seem never to call it a day.

Several little things are in the breeze, and we'll tell you about them. First there's the coming International Communications Convention, to be held at Washington, aspiring to "make recommendations with a view to providing the entire world with adequate facilities for international communication on a fair and equitable basis." You see, last year some time the Paris Inter-Allied Economic Commission had a communications committee draw up proposed changes to the Berne Convention, to be incorporated in the peace terms impressed upon Germany, and a protocol was signed by the military representatives of the various governments involved, including our own. Then came the idea that this would be good medicine for the whole blooming globe, and so this little meeting is coming off at Washington to consider the matter. It would make junk of the Berne Convention, completely. The thing which interests us most peculiarly is the allocation of wave lengths. Really it looks like those gentlemen didn't care very much whether we amateurs got along nicely or not.

Then there's a resolution opening Navy stations to commercial business until the Radio Corporation of America gets in shape to swing things, which doesn't interest us; and then there's S-4038 which does—immensely. This S-4038 is a Senate bill, introduced after months of hearings

before a subcommittee of the Senate Committee on Naval Affairs investigating the demerits of government ownership, and is a little local U. S. revision of the well-known and favorably-regarded law of 1912. It provides for eight classes of stations, amateurs and "specials" among them, but leaves the assignment of wave lengths and all technical regulations to be formed and announced by a National Radio Commission to consist of four men appointed, one each, by the Secretary of the Navy, Secretary of War, Secretary of Commerce, and Post Office Department. We know that in many technical respects the advances in the art have made the law of 1912 somewhat antiquated, and our A.R.R.L. does not want to adopt the position of opposing progress, but we do feel that we need more safeguard than to have our destinies in the hands of a government committee where we have no representation nor redress—we feel it would be unjust, for we amateurs can't finance a perpetual delegation at Washington to watch things, and our rights as American citizens entitle us to some assurance of operating in peace of mind. So we're agin it; and we have an idea the commercial companies will be too—some of them, anyway, but the R.C.A. seems to have fixed it up with our Uncle that if he'll give them transocean business for their own playground they'll boost Sam's aspirations to control all the rest of it. So it looks like there's fun ahead.



---

### ON HONEYCOMBS

(Concluded from page 24)

short tune of NPL, as the long tune of NPL and the short tune of NDD are nearly the same; while if we wish to copy IDO or NPM through NDD we tune to the long tune of these stations, thereby throwing them entirely away from NDD.

While according to theory the tickler coil or tuned plate circuit is not efficient on the long waves, in actual practice it is as efficient as a single valve can make it, and to date no more efficient method that is practicable for amateur use and using a single valve, has turned up.

# THE OPERATING DEPARTMENT

J. O. SMITH  
Rockville Centre, L. I.  
TRAFFIC MANAGER.

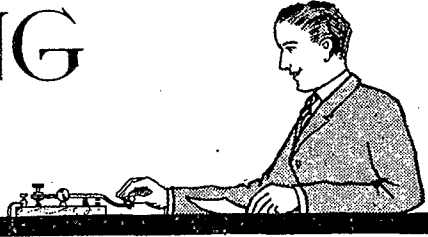

The terms\* of all Division Managers having expired with the end of the fiscal year of the League, the third Saturday in February, the following have been re-appointed for the ensuing year:

- C. A. Service, Jr., Bala, Pa.; Atlantic Division.  
F. M. Corlett, 1101 East 8th St., Dallas, Tex.; West Gulf Division.  
R. H. G. Mathews, 1316 Carmen Ave., Chicago, Ill.; Central Division.  
M. S. Andelin, 21 N. W. Temple St., Salt Lake City, Utah; Rocky Mountain Division.  
A. H. Keith Russell, 353 Markham St., Toronto, Ont., Canada; Ontario Division.  
A. J. Lorimer, 243 Mackay St., Montreal, Que., Canada; St. Lawrence Division.  
A. E. Bessey, Sunnysvale, Calif., has been appointed manager of the Pacific Division.

With the coming of spring and consequent increase in static and decrease in working range, the value of the League plan of handling traffic in short, dependable jumps becomes more and more apparent. It is to be hoped that all station operators will be able and willing to realize that as warm weather approaches long distance work will become more gradually "freaky" than during the winter, and that they will confine their efforts to short-distance, dependable, work.

The attention of all League station operators is invited to the fact that it was definitely decided that after March 1 last League stations would not work with any station using unofficial call letters. This applies to all classes of stations, both ashore and afloat.

The great question of interference has been partially solved in the Second District by means of several C. W. sets. Traffic is now being handled regularly through the division by C. W., such outfits being in operation at the following stations: 2ZM, 2FS, 2EX and 2ZL. To an operator used to the usual tooth-pulling method of extracting messages out of the evening jam, C. W. reception is a revelation. One station operator, who states that he is located within ten miles of Boston (about 200 miles from Rockville Centre) writes that "with one navy, one commercial and ten

thousand nearby amateurs, all pounding away at top speed, the signals of 2ZL came through clear and distinct. It actually seemed unreal." Straight C. W. signals from 2ZL have also been reported from Lewiston, Me., Akron and Columbus, O., and Palm Beach, Fla. The antenna current in all cases was about 1 ampere.

A lot has been said and printed as to the impossibility of maintaining steady readable undamped signals on short amateur wave lengths, with consequent high frequency. The fact, however, that traffic is being regularly handled by this means, and without any difficulty to speak of through continual heavy QRM and sometimes QRN, gives added weight to the old adage that "the man who says a thing can't be done usually gets in the way of someone else who is doing it."

Short wave C. W. transmission has done much more than was expected of it, in that it has turned out to be a very docile, tame and willing worker, instead of a fly-by-night, unreliable, unsteady means of communication. More power to it.

The reports in detail of the various division managers are as follows:

## ATLANTIC DIVISION C. A. Service, Jr., Manager Bala, Pa.

Before taking up the general relay situation in the Division, the Manager wants to get a little song of hate out of his lungs which has been increasing in size and volume for some time in the past and now demands air. It is in regard to reports. Reports from officially appointed trunk or branch line stations are due the District Superintendent on the 15th of the month; reports from the District Superintendents to the Assistant Division Managers, due on the 20th; reports from the Assistants to the Division Manager on the 25th. The whole Operating Department is based on reports and each individual station owner who takes an interest in reading its monthly offerings should realize he can make it still more interesting by contributing his bit. Normally it should take the form of a letter to his District Superintendent, who is always on the lookout for information; the

contents of the letter may range from a bald statement that you're alive and hoping the D. S. is also, to a bound volume on your relay results, equipment, distant stations heard and worked, etc. The main thing is, **WRITE!**

Now for the man higher up; the District Superintendents are the primary source of all relay wisdom for the Division and it is up to them to gather and re-transmit that wisdom to the relay stations they are representing, to the Assistant Division Managers; yes, right on up the line to the top. If they fail to produce results, no matter how much interest they take in relay work, they must make way for the man who is willing to boost his section, to be a leader in his District, not merely in transmitting range, but also in organization.

Lastly a word of final advice to the Assistant Division Managers. At the time of writing this report, that of every assistant is three days overdue, with the result the Division Manager cannot report on any particular section as heretofore. This is, in the final analysis, not only careless but selfish to the extent of depriving thousands of amateurs of a proper recognition of their activities. The Division Manager wishes to repeat that reports received late will not be published in QST.

Relay work in the Division is increasing rapidly. Long distance QRM is getting to be a very serious problem for the fellows who handle the heavy traffic. Relay message work in the early hours of the evening from 9 to 12, is getting harder and harder, simply because the fellows who should shut down at 9 P. M. commence on long distance calling, usually repeatedly calling stations at extremely long distance and utterly ignoring the League's relay regulations which lay emphasis on forwarding traffic by short, reliable jumps. If the fellows who handle a good deal of traffic between large centres in this Division would help out in the development of the short relay idea, they would find it much easier to keep their hooks clear.

Most of us here in the East have noticed the amount of ship to amateur conversation that is growing up, which is hardly to be wondered at when we consider 50% of United States vessels today are probably operated by one-time amateurs. However, let us not forget two things; effective March 1, 1920, a month ago, the League's Traffic Manager issued instructions that all relay or radio work with stations using unlicensed calls was to be discontinued; and second, ships carrying on unauthorized conversation are breaking United States and International Regulations, and stations working with them also lay themselves open to the same charge. Ship operators

will sooner or later be checked up by Department of Commerce radio inspectors and amateur stations will come in for the same thing, with possible penalties.

Appointments during the last month for this Division are as follows:

Assistant Division Manager, Middle Section, (to succeed Mr. McIntyre), Mr. John DiBlasi, % Manhattan Elec. Supply Co., New York City.

District Superintendent, Manhattan and Bronx, (to succeed Mr. DiBlasi) Y.M.C.A. Radio Club of New York, New York City.

District Superintendent, Central New York, Mr. Geo. M. Benas, 1636 Elm St., Utica, N. Y.

District Superintendent, Southern New Jersey, Mr. Marcus Frye, Vineland, N. J.

Station owners not already known to or familiar with the above should get in touch with them and do all in their power to help them in the work of organizing their districts. The Division Manager wishes them every known brand of success.

#### EAST GULF DIVISION J. C. Cooper, Manager Jacksonville, Fla.

Superintendent Wall of Tampa, Fla., has resigned on account of lack of time to devote to League interests. Mr. Elmer Rice, of Jacksonville, formerly in charge of Northern Florida, will hereafter take care of the whole state.

Supt. Rice of Jacksonville reports he at last got his set into operation on the 7th inst., and up to the date of his letter, Feb. 18th, had handled several messages in relay traffic.

Communication has been established between the writer's station, 4AG, and 5DA at Wind Rock, Tenn., which is in constant touch with 3BZ at Danville, Va. Communication has also been established with 3BZ direct, but interference is generally bad. 3BZ to 5DA, thence to 4AG, should take care of considerable traffic.

Mr. Rice (4AO) and 4AG have been in communication several times recently, and if he can find some way to get rid of some of his interference it should be possible to clear Florida business through him. He reports weather has been adverse for some time and that QRN is becoming bad. It has been found from past experience that from this time of the year on until May excellent work can be done in the early morning hours. There is usually little static disturbance or other interference at that time. Just before the war, Pinkston, at Valdosta, and the writer carried on communication one morning until one hour after sunrise, using no amplifiers. It should be possible to repeat this work in the morning hours with present improved equipment.

### WEST GULF DIVISION

Frank M. Corlett, Division Manager,  
1101 East Eighth Street, Dallas, Texas.

During the month of February the West Gulf Division was honored by a visit and tour of inspection by Mr. Arthur H. Kopper, United States Radio Inspector of the Fifth Radio District. Mr. Kopper visited Houston, Galveston and Dallas on this trip and stated that it was his intention to cover the entire district and if possible to make monthly trips. Just why Mr. Kopper should select Friday the 13th to visit Dallas I am at a loss to explain. However, the date will be remembered by quite a few whom he took it upon himself to see and politely and forcibly inform them that it required a station and operators license to operate a sending station of any description, as their signals would interfere with the reception of signals from beyond the state. Mr. Kopper also made a short talk before the local clubs and cleared up several questions that some few were not quite clear on. Examinations for the higher grade licenses were also conducted and quite a few availed themselves of the opportunity.

Mr. Kopper expressed great satisfaction at learning of the League's strong organization in this section and said he was a great believer in the A.R.R.L.

Relay conditions through the Division remain practically the same but interest seems to be running high and a number of new stations are noted. QRN is slightly on the increase and the recent warm weather and indications of spring have already been noticed in the gradual decrease in distant signal strength. One night in particular that was noticed, February 24th, signals to the North and East were almost nil until about midnight and then it was almost impossible to work, those whose call letters could be determined.

Upon the suggestion of the Division Manager in last month's report the Traffic Manager has authorized the extension of Trunk Line "F" south to Houston, Texas. This gives us a Trunk Line from Grand Forks, N. D., to Houston, Texas, and with the addition of one or two good relay stations that are promised in Oklahoma I believe this line could be worked during the day time from the northern boundary of the Division to its southern terminal.

Raymond L. White, District Superintendent of Northern Texas, reports conditions slow, but sure. Quite a let up in radio activities was noted due to so much influenza and poor weather conditions, but we are glad to hear most all of the familiar signals back in the air again.

"Zeke" Butcher, of the Greenville Texas Territory, reports some activities, appli-

cation blanks have been forwarded to prospective members and stations at Paris, Mt. Pleasant, and McKinney. Asst. Dist. Supt. Butcher, 5AL, has handled a score of messages during the month and very efficient communication with 9BT, 5ZA, 5AG and 5AC, the latter now being 5ZO. Much traffic has also been handled with 5XX at Auburn, Ala., under good conditions. However the distance is too great for dependable work.

The Waco Texas Territory, with Assistant District Superintendent Harris as its head, has experienced a slight standstill lately but promises to do better. The stations under construction at McGregor and Temple have not completed their sending sides, but both stations have good receivers and report that they can hear all stations with which they expect to work.

With the present location of stations through the heart of Texas, regular relay traffic should be handled efficiently under almost any prevailing conditions.

The Northern Texas District realizes that there are two kinds of fellows in existence now-a-days; namely, one who just believes in helping himself, and one who believes in helping others as well as himself. We desire to select the latter for the traffic department as they are the ones that will best represent the object and purpose of the League. If we can be of any assistance to you or furnish you any information in connection with your radio activities or the League we shall be very glad to have you call on us, as it is our earnest desire to render services in every possible proper way to each and every one of the League at all times.

Mr. James L. Autry, District Superintendent of Southern Texas, reports traffic going thru in fine style, the way east being thru 5ZP and 5AD in New Orleans. The west is of course thru 5ZA. For the north any number of stations are available, insuring Trunk Line "F" open every night.

Assistant District Superintendent. W. H. Tilley, of Austin, has received a special license with the call letters 5ZU and reports that he has been doing some excellent work; the same is true of 5BO.

Assistant District Superintendent C. W. Vick, in charge of the Houston Territory, has also received a special license, 5ZQ, and is also doing some excellent work recently in handling traffic successfully.

District Superintendent of New Mexico, Mr. Louis Falconi reports little interest shown in radio in New Mexico in spite of the fact that the best part of the season is at hand. Some one is heard from at great intervals but no real interest shown. Without members of the A.R.R.L. there is very small probability of an increase in relay stations; it therefore should be made the business of each member of the



A.R.R.L. to try and obtain members and to refer probable members to the Dist. Supt. or the Asst. Dist. Supt. in his district. When the slightest interest is shown, tell them of QST and once he gets QST we've got him and also a possible future station, so let's increase members with QST in their hands and the stations will soon get there. Lord knows we need the stations in New Mexico, so let's go.

The Transcontinental Relay Route, "C", seems at last to be accomplished. With 6GQ at Phoenix, Ariz., working overtime, the success has been possible. Many messages have been handled thru 5ZA and 6GQ to the Pacific.

A notable record made at 5ZA during January was the copying of 7ZB at Portland, Ore., a distance of over 1,300 miles, and WEST at that.

Mr. R. W. Goddard, Assistant District Superintendent of the Las Cruces Territory, reports considerable interest in radio in his territory. The station at the State College, which is an A.R.R.L. relay station, is in operation with the call 5CX. The station is equipped with all modern apparatus of all descriptions and manned by good operators. 5CX should be an important relay station as soon as arrangements are made for an operating schedule.

#### PACIFIC DIVISION Seefred Brothers, Managers Los Angeles, Calif.

Relay traffic on the Pacific Coast is handled from Los Angeles to Seattle with more regularity than to the East. In Los Angeles, there are five good relay stations—6AY, 6EN, 6JD, 6EB, and 6EA. In Fresno there are 6CS, 6DK, 6DH, and 6JJ. Around San Francisco there are many good relay stations some of which are 6AE, 6AT, 6CO, 6EJ and 6AK, and also 6BQ at Reno, Nevada. Next we have 6FE in Northern California. In Portland, Oregon, 7DK and 7ZB. Up at Tacoma, Lacey, and Seattle there are several good relay stations. From there communication is maintained with 7CC at Moscow, Idaho who can handle relay traffic to Lewistown, Montana, and 9EE at Valley City, N. D. On the southern route, A.R.R.L. traffic can be relayed to the east via 6GQ at Phoenix, Arizona; 5ZA at Roswell, N. M., and 5AC at Houston, Texas; or messages can be relayed to the east via 6ZA (Salt Lake City, Utah.)

Station 6EA has handled A.R.R.L. relay traffic direct with 5ZA, 7CC, 7DK, and 7ZB. It has also been heard by 6ZA, 7YS, 9CA, and 9ZN.

Our weekly test messages which are broadcasted from Stations 6EB and

6EA every Thursday night at ten o'clock have been copied by the following stations:— 6CE, 6AE, 6CO, 6AT, 6BR, 6AK, 6EJ, 6BQ, 6CU, 6FE, 6JQ, 7CR, 7DK, 7ZB, and 7YS.

Around the San Francisco district, Mr. F. E. Terman, Dist. Supt., reports that the line south is working best of all from San Francisco to Los Angeles, but to San Diego there are two stations, 6HH and 6FU, that several northern stations have heard, but due to their poor receiving outfits no traffic can be relayed to that city. He further states that the line east presents the greatest difficulties and at present the Los Angeles amateurs handle traffic eastward, as they are in a better position, geographically, than the San Francisco amateurs. At present, 6AE has exchanged calls with 6ZA, which is the extent of the eastward work from there. Quite a number of messages have gone east via Phoenix, Arizona, however, as 6AT, 6BR, and 6AE work 6GQ quite successfully.

Mr. L. E. O'Brien, Dist. Supt., (7EV) at Tacoma, Wash., states that the Tacoma Radio Club has applied for affiliation with the A.R.R.L. He is going to make a trip up to Seattle soon and try to get a club started there if possible so as to control the local QRM.

He has appointed Mr. B. W. Hagen (7AX) at Yakima, Wash., as an official A.R.R.L. relay station. The Gonzaga College at Spokane, Wash. will soon be ready to handle traffic.

The District Superintendent at Portland, Oregon, (Mr. J. D. Hertz, at 63 East 68th Street) states that they have six good stations (7DK, 7BP, 7CR, 7EC, 7DE, and 7ZB) together with 7FC and 7DS, also 7FD, who have worked or been heard by 7YS.

Of the above listed stations, 7DK, 7BP, 7CR, 7ZB, and probably 7EC by this time, have worked through to the south satisfactorily, through all except 7DK and 7ZB are using quarter and half K.W.'s. Their main difficulty working south (for any of these stations) is because the central California stations have so much QRM. They can hear each other, but owing to this cause they cannot be read with much regularity.

7ZB has been heard by 5ZA at Roswell, N. M., and by 9DR at St. Paul, Minn.

7CW, 40 miles south of Portland, Oregon, seems to have better success working 7YS than they do, even though he uses only a quarter K.W. He also works south fairly well when the QRM is not bad there.

7DK (Mr. Austin) states he has heard 9EE, 9JE, 5ZA, 5IZ. 7DP (Mr. Cameron) has heard 5ZA there.

**ONTARIO DIVISION, (Canada)**  
**A. H. Keith Russell, Manager,**  
**353 Markham St.,**  
**Toronto, Ontario, Canada.**

Fair progress only is to be reported as yet from this division, and matters are still only in the organizing stage. Practically no relay work has been attempted. However, Mr. E. Rogers, (3BP) has worked as far as 9ZN and we hope to soon have a station in Niagara Falls, Ontario, which will furnish an outlet for our Ontario south and east-bound traffic. This station should be in operation about April 1, and should have a very wide receiving and transmitting range.

Mr. W. Carter, 34 Niagara St., Windsor, Ontario, has taken over the Assistant Manager's position for the newly erected South-West Ontario District which is all that lying west of the east boundaries of the counties of Bruce, Huron, Perth, Middlesex and Elgin. Good results are looked for in this district in the near future. With one intermediate station we hope to get our west bound traffic running along well.

Nothing has been heard of any intermediate stations between Montreal and Toronto. As the distance is over three hundred miles, and of apparently bad territory for transmission, this jump for the present, seems impossible and probably we will be unable to establish a regular relay chain between these two cities until next season. It is hoped that any Ontario amateurs who might be in any way helpful in this district will write the Division Manager giving full details of receiving and transmitting sets.

**ALASKAN DIVISION**

No traffic has as yet been handled in this division, as some of the privately owned stations which form part of the League's trunk line between the Canadian border and the north will not be in operation until about April 15th.

The station at Anyox, B. C., which can communicate with Vancouver, is not well located for long distance work north, being situated several miles up a river between mountains. A new station is soon to be erected at Sulzer, Alaska. This station will be so situated that there will be no intervening mountain ranges between it and Anyox, and should enable regular communication to be carried on. Traffic can also be handled between Sulzer and Port Walter, near Wrangell. There is also a station at Washington Bay, near Sitka, and also at Tenakee. There are several other stations near Juneau which inter-communicate, these being located at Hawk Inlet, Jualin, Funter Bay, and Skagway,

the last named place being about the northern limit of present amateur radio route prospects for the present.

The distances between the foregoing points are as follows:

Anyox and Sulzer	120 miles
Sulzer and Tenakee	230 miles
Tenakee and Hawk Inlet	30 miles
Hawk Inlet and Funter	8 miles
Funter and Jualin	50 miles
Jualin and Skagway	37 miles

Other stations will probably come into operation as warm weather comes along, and before long there will undoubtedly be much League traffic going back and forth, through the Vancouver (Canadian) Division, between the Pacific Division and our far northern territory.

**ST. LAWRENCE DIVISION, (Canada)**  
**A. J. Lorimer, Manager**  
**243 Mackay St., Montreal, Que., Canada.**

So far the work of establishing relay routes has been confined to the Province of Quebec. We have yet to hear from the Maritime Provinces. If there are any live amateurs down there who are desirous of co-operating with the League in the opening of a route west, via Northern Maine, connecting up with the St. Lawrence and Atlantic routes, let us hear from them. A connecting route via Canadian territory is out of the question at present so we will call in Mr. Entwistle of the Atlantic Division on this, with a view to forming a reliable route to Boston from both districts.

Mr. Geo. H. Barnes of Stanbridge East, (2AX) has been appointed Superintendent of the Eastern Townships District which borders the states of Vermont, New Hampshire, and Maine. We hope Mr. Barnes will be instrumental in bringing in an American route from one of the states mentioned thru his district. The Eastern route via 3Z, Farnham, and 2AS, Cowansville, and 2AX on the Vermont border has been discontinued for the present.

Mr. Leo Milette of Montreal (2AI), appointed Superintendent of Mount Royal District, has, with the help of Mr. Charles Heroux (2BJ), opened a practical route for traffic to Three Rivers, with connections to Shawinigan Falls and Grande Mere.

Mr. J. D. Jarest, of Levis (2AB) has been appointed Superintendent of the Montmorency District. He reports having worked with 9AC at St. Croix a little below Three Rivers and within easy working range. This practically completes the St. Lawrence Route as originally planned.

Now for that connection with the United States. Just at present we have no route open to the States. Our hopes have been centered more or less on a possible con-

nection thru the state of Vermont, but there appears to be nothing North of Albany, N. Y.

Arrangements are now being made for a tryout test direct with Mr. F. H. Myers of 2FG, Albany. It is hoped that we get thru OK as Navigation reopening here shortly will curb our activities to some extent.

We hear many U. S. "eights", "nines", "threes", and "twos" up here but seldom if ever hear any "ones". It would seem as tho there were a few dead spots in the direction of the New England States.

#### CENTRAL DIVISION

R. H. G. Mathews, Manager,  
1316 Carmen Ave., Chicago, Ill.

During the month of February the traffic work of the Central Division has been extended considerably, especially in those parts of the division which have heretofore displayed very little interest. This is particularly true of the states of Iowa, Nebraska, Missouri and North Dakota, and the Superintendents of these Districts deserve great credit for the work they have done in creating a traffic organization.

In Iowa, Mr. Patch, District Superintendent, with his Assistants Messrs. Hammond, Stover and Nestlerode, is accomplishing some remarkable things and for the first time in the history of amateur radio, daylight communication is insured between Chicago and many cities in Iowa. At the present time Mr. Patch is planning a rather comprehensive series of tests in conjunction with the District Superintendents of North Dakota, Wisconsin, Missouri and Minnesota, with the idea in view of forming daylight routes between these various districts.

Mr. Burhop, District Superintendent of Wisconsin, has also been doing work along the lines of daylight communication, and reports that his Lakeshore route from Chicago to Neenah is in absolute working order and can handle traffic by daylight at all times to such cities as Neenah, Menasha, Plymouth, Sheboygan, Milwaukee, Racine and Kenosha. It has been the policy in this Division, so far as possible, to do district distributing work by daylight, thus reducing the interference with trunk line work, which is of necessity handled at night.

Mr. Schrage, City Manager for Madison, Wisconsin, reports that 9XM, the station of the University of Wisconsin, is ready for operation with both 4 K.W. spark set and radio telephone. It is planned to have a regular staff of operators on watch at 9XM, and the installation of a special 1 K.W. spark set to operate on 300 meters is probable, inasmuch as the use of the 4 K.W. set is possible, only on its specified 800 meter wave. The station of the

Madison High School is operating under conditions greatly similar to those of the Navy transatlantic stations, being equipped with 2 aeriels, one for transmitting and the other for receiving. The sending and receiving apparatus are in separate parts of the building, and the transmitter is operated by remote control.

Mr. Gjelhaug, District Superintendent for Northern Minnesota, reports that since last month he has been able to get into connection with a north route to the West coast. This route is now in operation and is able to handle traffic for points on the Northwest coast, and messages may be transmitted for such points via 9ZN, 9ZC or 9EE. 9EE connects with a station in Jordan, Montana, or with 7AY at Bear Creek, Montana, who in turn work 7CC of Moscow, Idaho. 7CC is able to work stations in Seattle, thus giving a West Coast connection via Trunk Line A.

Mr. Pray, District Superintendent of North Dakota, and his Assistant Mr. Wick, of Fargo, have been doing some very commendable work in reorganizing the North Dakota Radio Association. A general meeting of all North Dakota amateurs will be held in Fargo, March 12th at which time a new constitution will be drafted and new officers elected. Mr. Pray also reports the organization of local radio clubs at Fargo and at Ellendale, which we hope will be affiliated with the League in the near future. Some remarkable spark coil work is being done in Mr. Pray's territory and as a little boost for the much maligned spark coil it is hereby admitted that almost all of the North Dakota local distribution is handled through spark coil stations. One of these stations, at Fargo, using a 1½" coil, regularly works 60 miles. 9PI at Eureka, South Dakota, using a Ford coil, regularly works with 9EE over a distance of 112 miles. Another coil station at Grand Forks, North Dakota, works with 9PI at Eureka, South Dakota, quite regularly over a distance of 180 miles. We consider this remarkable work and hope to have descriptions of some of the stations which are doing it in our next report.

In addition to organization work, Mr. Pray has been covering some remarkable distance with 9EE. His best communicating record is with 3DH, at Princeton, New Jersey.

Mr. Darr, District Superintendent for Southern Michigan, reports that his District has been proceeding as usual and has been very busy with traffic work. Connections may be made with his territory via 8BO, at Toledo, or 8ER at St. Marys, Ohio.

Mr. S. L. Keller, District Superintendent for Nebraska, reports a gratifying increase  
(Concluded on page 43)

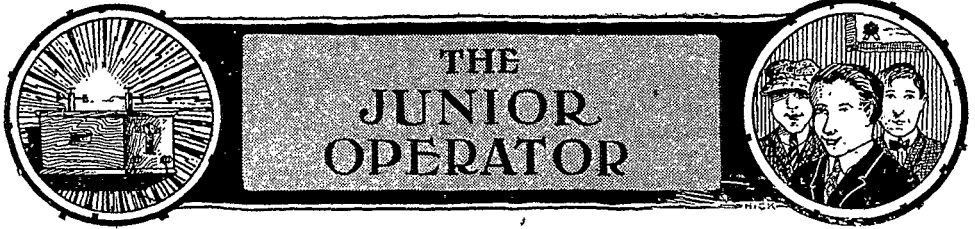

# THE JUNIOR OPERATOR

*Conducted by Guy R. Entwistle*

**A**FTER the amateur has constructed the loose coupler described in the last issue, he is ready to procure the other pieces of apparatus that go to make up the receiving set. These consist of a crystal detector, phones, and a phone condenser. Next he wants to know just what type of crystal, and how high resistance the phones should be, and the value of capacity to be used across them.

It is universally admitted among the amateur operators that galena is the most sensitive crystal for all-around use. It is important, however, to use the proper size wire for a contact. No. 28 or 30 is recommended. This is known as the cat-whisker contact. Pyrites, with a similar contact, also makes a good combination but is not so common among the amateur workers. Silicon is not as sensitive but will keep in adjustment longer. It requires a sharp point for a contact, and a heavier pressure. The combination of silicon and antimony provides a sensitive and at the same time stable combination. It will be noted that only those types of crystals that do not require a local battery have been mentioned. None of the crystals that use a small voltage across them for their most sensitive adjustment have found much favor among the amateurs. Carborundum is perhaps the most practical of this type. It is very stable and good for reliable distance work but is not as sensitive as galena or pyrites. Gragal, the new crystal, has met with favor among many amateurs. Cerusite is very sensitive also, but is scarce.

Many beginners are at loss to understand just why a detector has to be used in the receiving circuit. A study of the Figure 8 will help to clear up this point. "A" represents the alternating current flowing thru the secondary of our power transformer. It will be seen that at the point "S" when the condenser has reached

its maximum voltage it discharges producing oscillatory wave train, "B", that is transferred to the antenna circuit and radiated or sent off in all directions. The receiving antenna when properly tuned picks up or absorbs this energy and passes it on to the secondary of our loose coupler. But let us look into this wave train and see just what is going on, as it is important to properly understand the action of a detector. Assume we are receiving a 200 meter wave. This means that the current in the secondary is surging back and forth at the rate of 1,500,000 times

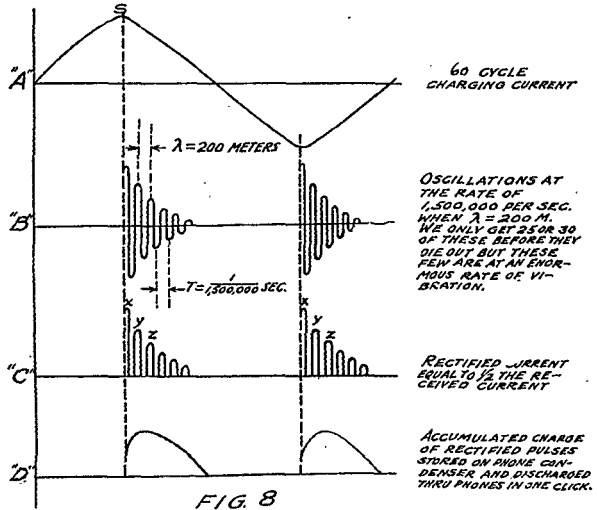

in a second. Understand, we do not get a million and a half of these oscillations in a second, but those that do exist are oscillating at that enormous rate. When it is considered that the human ear cannot respond to anything that is vibrating faster than 30,000 per second it at once becomes evident that something must be done to convert this energy into a state whereby it will be within the range of audibility. This is done by the detector in the following manner. The combination of a crystal and a point provides a

path of unilateral conductivity. That is, such a joint will allow the current to pass in one direction only. "B" also represents the current as it is oscillating in our loose coupler secondary. Since the detector circuit, consisting of the crystal, phones and phone condenser is attached to this circuit, it tends also to oscillate, but as the detector will permit the passage of the current in one direction only, only half of the energy gets thru, as is shown in "C", which is the same as the top half of "B". It might just as well have been the lower half as the upper half; the important item is that ONLY HALF of the oscillation gets thru and always in the same direction as is indicated by the fact that all the rectified current is on the same side of the line.

Now most amateurs make the mistake of supposing that since we have cut the oscillation in half, or rectified it, its frequency is now low enough to affect the phones or the ear. But is one half the frequency (750,000 cycles) any better than the whole of it (1,500,000 cycles) as far as the limit of audibility is concerned? Certainly not. Each one of these individual portions of rectified current such as "x", "y" and "z" does not discharge thru the phones but rather accumulates on the condenser, and the whole group in turn discharges as a single click in the phones, as in "D". Thus it is seen, by referring again to our figures, that at each maximum of secondary voltage at our transformer, (or what is the same thing, our condenser) we get a train of wireless waves sent out at the transmitting station. When these are passed on thru the ether and affect our receiving antenna and finally are passed on to the secondary of our loose coupler, they are too fast for the human ear to hear, and also of such a nature as not to be able to pass thru the phones even if we could hear such a rapid rate of vibration. Their state must be changed. This is where the detector comes in. This device rectifies or changes them into a current flowing in one direction only; next, this rectified energy is passed on into the small phone condenser where it is stored up and finally discharged thru the phones. Since we repeat this phenomenon for every wave train that is sent off from the transmitter, and since we get a wave train for every alternation, we will have as many clicks in the phones per second as there are alternations per second at the transmitting source of power. With a plain gap this may be, say, 120 impulses. With a rotary it varies with the speed of the gap, increasing as we speed it up. Hence the receiving instruments faithfully reproduce the note given off by the sending station.

We are now ready to select our receivers. These shall be a thousand ohms each, or a total of 2000 ohms for the set. While it is possible to obtain some results with low resistance phones they are not as sensitive as those of a high resistance. The reason for this is that a high resistance set of phones inherently means that a great many turns of fine wire have been used in their construction. Now the pull on the diaphragm on any phone and hence the strength of signals, depends on what is known as ampere-turns. The greater the ampere-turns the louder we will hear the signals from a given station. Since the current in amperes in any receiving set is very small we must make up for it by using a great many turns to get the necessary pull on the diaphragm to make the signals strong. Hence we see it is not the high resistance that we are after but the ampere turns, but in order to obtain them we must use a great many turns of fine wire which of course means a resulting high resistance. This is why phones have been marked according to their resistance.

The amount of capacity to be used across the phones is small—0.0005 mfd. For best results it should be adjustable. It is well known among some of the older amateurs that it is possible to tune out a station that has the same wave length as another but having a different pitch or spark frequency. This is called "group tuning". Without going into details, the higher the spark note the less capacity is required across the phones. Hence the reason for an adjustable capacity. Again, the lower the resistance of your phones the more the capacity that should be used across them. Since this condenser does not have to stand high voltages it can be readily made of wax paper and tinfoil of the very thin gauge. A variable condenser of small capacity can be used if desired; maximum value .0005 mfd.

Our secondary tuning condenser was mentioned last time as being of the order of .001 mfd. This is the regular standard 43 plate type.

Our set is now complete. The outstanding feature is its simplicity. A few and only the necessary instruments have been described. The beginner will do well to maintain the policy of simplicity when connecting it up, as per diagram in the March issue.

To tune an incoming wave, first adjust your detector to a sensitive spot and then move the primary switch points until the signals come in the loudest. Next, adjust the secondary until they come in still better if possible. Then vary the coupling a little by separating the primary from

(Concluded on page 43)

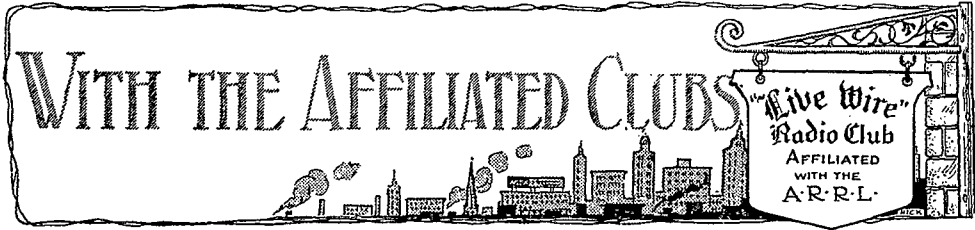

**T**HE attention of officers of local radio clubs is invited to an article on club organization appearing in the March QST. The Secretary's office will be glad to correspond with interested clubs regarding affiliation. As has been stated in this column, the A.R.R.L. regards affiliation as something more than a matter of paper record, yet it is not merely a physical connection—there is no charge, and no pennant is given away as an inducement. The future of amateur radio demands the existence of a strong federation of interests for protection and intelligent growth—which are aims of the A.R.R.L., as well as to serve as a common body for facilitating relay traffic. Neither a local club nor the League is transformed into a super-society by affiliation, but gradually we will weld ourselves into an impregnable body of amateurs, thinking as one and acting as one for our common growth and support, and in the hour of need we will be able to stand shoulder to shoulder. These are the things affiliation means—the spiritual joining of hands in the feeling that our goals are all the same.

The League takes pleasure in announcing the affiliation of the following additional societies:

Progressive Radio Assn., Chicago, Ill.  
 Central Illinois Radio Club, Bloomington, Ill.  
 Sheboygan Radio Assn., Sheboygan, Wisc.  
 Terre Haute Radio Club, Terre Haute, Ind.  
 Radio Club of Rutgers College, New Brunswick, N. J.  
 Ridge Radio League, Blue Island, Ill.  
 Colorado Springs High School Wireless Assn., Colorado Springs, Colo.

The Radio Traffic Assn., of Brooklyn, has started the publication of a most interesting semi-monthly bulletin, devoted to traffic matters and local gossip. Its present size is two mimeographed sheets, but that's no measure of the good and the fun that is in it, and from this small beginning their Secretary may find he has

wished a "regular" job onto himself. Sympathies, Brother, we feel the bond of fellowship—somebody always passes on the buck to the Sec., don't they? But congratulations too, for your little sheet is fine, fills the bill, and is an example which other clubs might do well to adopt.

The R.T.A. is a substantial organization devoted to the improvement of amateur traffic conditions and amateurs in Brooklyn and vicinity are cordially invited to join.

The San Antonio Radio Club, San Antonio, Tex., announces a reorganization and the election of new officers as follows:

President—J. C. Rodriguez  
 Vice Pres.—Earl E. Newlin  
 Secretary—J. I. Shannon  
 Asst. Secy.—Lyle B. Jones  
 Treasurer—W. G. Egerton  
 Sgt. at Arms—Jack Judson  
 Reporter—Lyle B. Jones

The club has a membership of thirty-seven at present, and is progressing rapidly.

The Radio Intelligence Post of the American Legion wishes to hear from former service men who were attached to the Radio Intelligence Division of the General Staff.

Membership in this Post should be interesting to these men for the opportunities it gives for exchange of experiences and social activity, as well as keeping abreast of radio developments.

The secretary is A. L. Bernhard, 1679 42nd Street, Brooklyn, N. Y.

Amateurs in the vicinity of Columbus, Ohio, are invited to join the Columbus Radio Club—a growing organization with forty-odd enthusiastic members. Mr. Robt. C. Higgy of 81B, 50 Eighteenth Ave., is the President; Mr. M. Fay McDowell the V. P.

The South Side Radio Assn. of Chicago (application for affiliation received) has adopted "interference rules" which contain ideas applicable in other crowded

communities. The hours between 5 a. m. and 7 p. m. are proclaimed open; 6 p. m. to 10 p. m. to be used for local communication—no testing; 10 p. m. to 5 a. m. devoted to long distance. Territory and priority rights are defined, and conversation with unlicensed stations is forbidden.

Philadelphia amateurs are invited to the meetings of the Philadelphia Radio Amateur Assn. which are held the second and fourth Mondays of every month at 1611 Columbia Ave. Live talks are made on practical amateur subjects, ideas interchanged, papers read and discussed, etc. Like other A.R.R.L. clubs, the P.R.A.A. is enjoying a healthy growth, but has room for every amateur in Philadelphia and vicinity.

**BALTIMORE AMATEURS QST.**

It has been noticed with regret by the District Superintendent of Eastern Maryland that an unusual amount of local QRM exists in Baltimore after 12 o'clock midnight, which the local radio associations have not yet been able to control; more particularly some amateurs doing local work, working on as high as 600 meters with full power. This condition has completely demoralized special relay test work with the result that we have been unable to do any work whatever in conjunction with pre-arranged tests with Washington and Philadelphia operators. It is hoped that the local associations will get behind this matter immediately with a view of reducing the interference to a minimum, as it appears there is enough time between the early hours and midnight for all local work to be transacted. Baltimore amateurs are particularly requested to read carefully the traffic rules and regulations as published in the February QST. Amateurs with short wave receiving sets and who have no transmitters for long distance work are requested to forward to the District Superintendent a log of all 3rd District amateurs that they are receiving outside of the boundary of the City of Baltimore. We are more anxious to bridge the shorter distances and in this manner get a line on the amateurs within this immediate vicinity who are heard in Baltimore.

E. B. Duvall, Dist. Supt.

A new club has been organized at Scranton, Pa.—The Electric City Radio Club—and has applied for affiliation. The officers are: President, R. C. Ehrhardt; Vice Pres., Frank Tarbox; Secretary, P. D. McFarland, 802 Woodlawn St.; and Treasurer, D. G. Shotton. Meetings are held every Tuesday evening at the Erie Railroad Apprentice School, and amateurs in the vicinity are cordially in-

vited to visit and join. The present membership is about thirty. The club has a wave meter and will tune membership stations. Operating conditions are poor in the vicinity because of the terrain, and it is hoped that by the co-operative effort the club will provide, conditions will be improved for everyone.

Amateurs residing in Worcester Co., Mass, are rapidly enrolling in a newly formed association, the Worcester County Radio Assn., and already the membership is about seventy. Mr. Lee A. Bates, the local A.R.R.L. Superintendent, is the President. The Secretary, Mr. S. A. Waite, of 49 Benefit St., Worcester, will be glad to hear from other clubs, or amateurs who would like to enroll.

The New England Amateur Wireless Assn., and the Massachusetts Institute of Technology Radio Club gave a combined banquet with affiliated clubs of the A.R.R.L. in attendance, at Walker Memorial Hall, M.I.T., on Feb. 12th, at which over three hundred and fifty amateurs from all over New England were present. The meeting was everything we promised in the announcement in the February QST—a great big hurrah meeting where everybody got together and talked things over and had a great time. First the feed:

- Radio Menu
- Condenser Oil
- Broad (well done) Vacuum Tubers
- Code Pills
- Seaweed
- Paraffin Bakelite

Very interesting talks were made by Radio Inspector H C. Gawler, Mr. Maxim, Mr. J. O. Smith, Mr. W. H. Priess, and Dr. Kennelly. The Editor of QST also tried it. The A.R.R.L. speakers were late, having traveled via

The B. & A.—  
 "The Only Way"—  
 They run a train  
 Each way each day

so missed out on the eats but got there in time for the fireworks of the evening. Mr. Entwistle presided.

The guests wore tags bearing their call letters and many new friends were made. At the conclusion of the program the Toastmaster called upon various amateurs with well-known calls to stand up so folks could see what they looked like. Then the various out-of-town clubs present stood up as a body. This was very interesting. And after the meeting came a great informal hamfest.

We know everyone had a fine time. Congratulations to the N.E.A.W.A. and M.I.T.R.C.

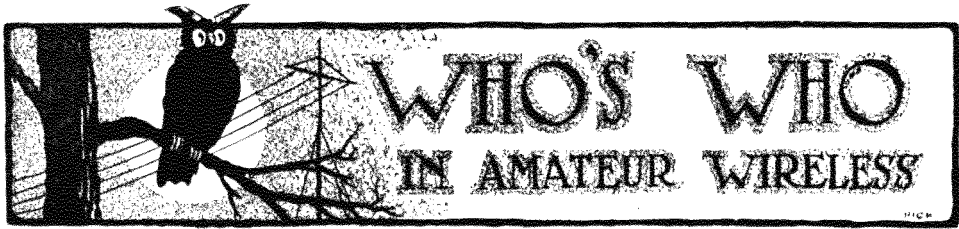

# WHO'S WHO

## IN AMATEUR WIRELESS



**Chas. A. Service, Jr.**

Introducing our new Vice President who is also Manager of the Atlantic Division and known in the air as 3ZA, ex-3QZ.

Mr. Service was born March 17, 1894, at Bala, Pa., where he has since lived most of the time. He graduated from the University of Pennsylvania with a B.S. degree in 1916. Like most good amateurs he served in Radio during the late disturbance, his record being briefly as follows: Signed up in the U. S. N. R. F. April 10, 1917, as 2nd Class Radio Electrician, serving as operator on Subchaser No. 61 and at Philadelphia Navy Yard Station (NAI); installed and had charge of a secret listening-in station "somewhere in Jersey"; radio inspector for navy in Philadelphia and vicinity; operator in charge of radio on "S. P. Nokomis" in home waters; took exam for Radio Gunner, passed and was sent to Director of Naval Communications

(Concluded on page 43)



**Frederick E. Terman**

This is Mr. Terman, A.R.R.L. Superintendent for the San Francisco Bay District, operating Station 6AE (ex-6FT) at Stanford University, Calif.

Mr. Terman was born at English, Indiana, in 1900. His first sending set was old 6FT, erected in 1916, and with the opening of the long distance season his knowledge and distance records grew rapidly so that his spark became a familiar one. Being blessed with an exceptionally good location, 6FT was heard almost every night in the 1917 season by 9ZF in Denver over 950 miles of mountainous country with an input of 220 watts.

The post-war station, 6AE, has been heard in Wyoming, 850 miles. 6AE has no connection with Stanford University, Mr. Terman's home being on the campus. He is a senior in the Engineering Department, and finds that the difference between

(Concluded on page 43)



## QST'S DIRECTORY OF CALLS

Fellows, devoting a half dozen pages per issue to calls got to where it detracted from the reading value of QST and scared us. Then we hoped to publish monthly supplements carrying advertising to finance the thing, but the Post Office Dept. has just come out best in an argument on that. So we resume in QST—two pages a month until we get them all. You can cut out this sheet and keep it with the January Supplement.

### FIRST DISTRICT

Franklin S. Huddy	204 Bowen St., Providence, R. I. (Correction)	11I
Geo. W. Nichols	3 Linwood St., Saugus, Mass. (Correction)	1IN
Geo. E. White	36 Cummings Ave., Wollaston, Mass. (Correction)	1KR
Wendell L. Wright	114 Exchange St., Rockland, Mass. (Correction)	1MF
Edmund Buckley	1605 Gorham St., East Chelmsford, Mass	1LV
Randolph G. Fairchild	95 Grant St., Lynn, Mass.	1OK
Winthrop P. Cody	1596 Center St., Newton Highlands, Mass.	1OU
Chas. A. Piltz, Jr.	Van Buren, Maine	1OY
Elmer L. White, Jr.	23 Reynolds Ave., Chelsea, Mass.	1PC
Richard Morse	907 Beacon St., Boston	1PD
T. Stanley Marshall	15 Braman St., Danvers, Mass.	1PE
Henry F. Rand	2 Gordon Terrace, Cambridge, Mass.	1PG
Roger W. Osborn	15 Olney Place, E. Lynn, Mass.	1PH
Robert P. Webb	53 Hinsdale Ave., Winsted, Conn.	1PJ
Warren Potter	15 Braemore Road, Boston	1PL
Warren Sawyer	50 Quint Ave., Allston, Mass.	1PN
Ralph R. Hayes	9 West St., Bar Harbor, Maine	1PP
Frank W. MacDonald	43 Ellsworth St., Portland, Maine	1PQ
Sylvester Ahola	13 Morgan Ave., Lanesville, Mass.	1PU
Alton H. Gould	299 Brackett, Portland, Maine	1PV

### SECOND DISTRICT

V. J. Fritch	939 College Ave., New York	2AA
C. R. Gernert	41 Bridge St., Somerville, N. J.	2AC
T. N. Whildin	Oakdale, L. I., N. Y.	2AD
Wm. H. Hoppi	365 Quincy St., Brooklyn	2AE
Benj. Berlin	1252 Flatbush Ave., Brooklyn	2AF
Howard Terry	25 Myrtle Ave., Keyport, N. J.	2AG
John G. Eber	5505 Third Ave., Brooklyn	2AI
E. T. Buttner	1376 Third Ave., New York	2AJ
Carl J. Hunkins	Johnson Ave., Newark, N. J.	2AK
W. N. Stanley	451 Hancock St., Brooklyn	2AL
C. J. Sedlak	633 Main St., No. Bergen, N. J.	2AN
R. J. Freeman	Aloah Rdo. Stn., Southampton, N. Y.	2AO
Harry Blutstein	723 Stone Ave., Brooklyn	2AQ
Harvey Kennedy	1965 Vyse Ave., New York	2AS
Herman Fischer, Jr.	146 Myrtle Ave., Irvington, N. J.	2AT
C. J. Hauff	1972 Honeywell Ave., New York	2AU
F. S. LeRoy	103 So. Maple Ave., Ridgewood, N. J.	2AV
A. A. Heberlein	768 Melrose Ave., New York	2AW
Howard Blower	664 East 18th St., Brooklyn	2AX
Burton Greenburg	332 East 67th St., New York	2AY
F. J. Rauffer	50 Shepherd Ave., Brooklyn (Correction)	2DV
L. F. Barry	20 Morningside Ave., New York (Correction)	2OH

### THIRD DISTRICT

W. J. Blome	3800 Liberty Heights Ave., Baltimore, Md.	3DW
W. D. Siddall	404 Sixth St., N. W., Washington, D. C.	3DX
A. J. Gardenhour	218 Park St., Waynesboro, Pa.	3DY
A. W. Long	143 W. Wayne Ave., Wayne Del. Co., Pa.	3DZ
C. Greenberg	7711 Botonic Ave., Philadelphia, Pa.	3EA
A. J. Bryne	5137 Columbia Ave., Philadelphia, Pa.	3EB
H. C. Gronberg	641 Massachusettes Ave., N. E., Washington, D. C.	3EC
C. S. Horn, Jr.	909 Monroe St., Wilmington, Del.	3ED
C. F. Cook	Yardley, Bucks Co., Pa.	3EE
A. Milroy, Jr.	303 Monument Ave., National Park, N. J.	3EF
R. A. J. Gallery	Edgemoor, Bethesda District, Md.	2EG
W. Phillips, H. Densham	140 Washington Ave., Collingswood, N. J.	3EH
G. C. Sprouls, Jr.	5530 N. American St., Philadelphia, Pa.	3EI
R. V. Kendall	1712 Milton Ave., Baltimore, Md.	3EJ
R. S. Fenimore	1319 Otis Place, N. W., Washington, D. C.	3EK
S. J. Gustof	104 McKean St., Philadelphia, Pa.	3EL
A. S. Morgan	314 W. Seymour St., Philadelphia	3EO
Leroy Mickey	2028 Croskey St., Philadelphia	3EP
E. C. Densten	1023 So. 46th St., Philadelphia	3ER

### FOURTH DISTRICT

P. C. Bangs	29 Albemarle Ave., Atlanta, Ga.	4AZ
P. H. Wall	253 Plant Ave., Tampa, Fla.	4BA
W. C. Rothrock	517 Ridge Ave., Winston-Salem, N. C.	4BE
W. C. Huggins	7 S. 4th St., Wilmington, N. C.	4BC
E. S. Bulluck, MD.	307 N. 4th St., Wilmington, N. C.	4BD
C. A. Roethlinger	214 Campbell St., Wilmington, N. C.	4BE
Wm. M. Sampler	No. 2 Frie Station, Macon, Ga.	4BW

### FIFTH DISTRICT

Ala. Polytec. Inst.	Auburn, Ala.	5XA
Y. M. C. A.	Jackson, Tenn. (Correction)	5YB

Nola Radio School  
Miss. A. & M. College  
Univ. of Mississippi  
Louis Falconi  
Henry M. Harris  
Paul E. Greenlaw  
Jno. M. Clayton  
C. W. Vick  
Hubert E. Deben  
I. S. Roberts, III  
W. H. Tilley

F. B. Stellson  
J. F. Brown  
Lloyd Muller  
F. H. Diemal  
C. H. Keller  
S. Hudd  
C. Vick  
L. J. Smelser  
R. McCormack  
S. Strong  
G. S. Perkins  
R. H. Cornell, Jr.  
H. J. Scharr  
O. A. Harmon  
Ira J. Kaar

A. F. Hastings  
Clifford Spike  
Geo. Mossmon  
Howard Mason  
Rupert E. Kempf  
R. T. Galyean  
Chas. L. Austin  
Jno. D. Hertz  
R. Earle Dawes

Arthur L. Kent  
Edw. J. Bennett  
Ralph Folkman  
Lloyd M. Grow  
John G. Johnston  
Edwin B. Redington  
Cyril J. Staud  
Edwin G. Boyes  
Edw. R. Wieneke  
Frank A. Henry, Jr.  
Fordyce O. Murphy  
Jack J. Baxter  
J. R. Bxtresser  
Wm. A. Nealon  
Paul Marsal  
Lee C. Evans  
Henry L. Ley  
K. A. Duerk

John Palmer Peterson  
Frank M. Bailly  
Signal Elec. Mfg. Co., J. Stanley  
William A. Liggett  
Walter Charles Koch  
Wm. Adon Van Schoyck  
Charles Beazley  
Walter A. Stenberg  
Irvin Johnson  
Herman Gisseler  
Harvey Mitchell Anthony, Muncie  
Willis L. Otto  
Albert Ruff  
Lee Burl Wilcox  
Elmer Benjamin Scribner  
John A. Gjelhaug  
Francis F. Hamilton  
H. J. Burhop & W. C. Bridges  
Geo. R. Hammond  
Minnesota Wireless Assn.

J. Picard  
LaSalle Academy  
J. Telmosse  
S. Jacobs  
P. L. Milette  
Eric W. Farmer

New Orleans  
Agriculture College, Miss.  
University, Miss.  
Roswell, N. Mex.  
Waco, Tex.  
Franklinton, La.  
1801 Welch St., Little Rock, Ark.  
1918 Smith St., Houston, Tex.  
1044 City Park Ave., New Orleans, La.  
Houston, Tex.  
Austin, Tex.

#### SIXTH DISTRICT

451 Rutliven Ave., Palo Alto, Cal.  
295 Perkins St., Oakland, Cal.  
4156 25th St., San Francisco  
1281 21st Ave., San Francisco  
5501 So. Park St., Los Angeles  
612 Anza St., San Francisco  
218 Cortland Ave., San Francisco  
2329 Carleton St., Berkeley, Cal.  
304 Delmas Ave., San Jose, Cal.  
268 Jayne St., Oakland, Cal.  
210 G. St., San Rafael, Cal.  
509 Washington Ave., Pt. Richmond, Cal.  
611 Allendale Ave., Oakland  
817 84th Ave., Oakland, Cal.  
Salt Lake City, Utah

#### SEVENTH DISTRICT

Tacoma, Wash.  
Woodstock Apt. No. 2, Tacoma, Wash.  
Tacoma, Wash.  
3335 33d Ave., S. Seattle, Wash.  
408 College Ave., Moscow, Idaho  
460 Miller Ave., Portland, Ore.  
651 E. Salmon St., Portland, Ore.  
68 East 68th St., Portland, Ore. (Correction)  
Bozeman, Mont. (Correction)

#### EIGHTH DISTRICT

199 Court St., Binghamton, N. Y.  
1923 W. 75th St., Cleveland, Ohio  
12516 Locke Ave., N. E., Cleveland, Ohio  
312 Parker Ave., Toledo, Ohio  
2240 Lawrence Ave., Toledo, Ohio  
14 Tioga St., Waverly, N. Y.  
203 Rutgers St., Rochester, N. Y.  
170 W. Willis St., Detroit, Mich.  
406 Boston Blvd. W., Detroit, Mich.  
308 Montgomery Ave., Detroit, Mich.  
150 Hogarth Ave., Detroit, Mich.  
1548 Robin wood Ave., Lakewood, Ohio  
99 Harvard Place, Buffalo, N. Y.  
1604 St. Claire St., Cleveland, Ohio  
1527 Lakeland Ave., Lakewood, Ohio (Correction)  
1032 Asbury Ave., Cleveland, Ohio  
Canton, Ohio  
1000 Wilhelm St., Defiance, O.

#### NINTH DISTRICT

636 E. 43rd St., Chicago, Ill.  
525 Kenilworth Court, Clinton, Iowa  
Brown, Menominee, Michigan  
Virden, Illinois  
226 12th St., Milwaukee, Wis.  
Gibson City, Ill.  
5703 Brexel Avenue, Chicago, Ill.  
2243 Roscoe St., Chicago, Ill.  
2505 North Spaulding Ave., Chicago, Ill.  
2826 Fletcher St., Chicago, Ill.  
Muncie Senior High School, Muncie, Indiana  
Cambridge, Illinois  
1622 Iowa Avenue, Superior, Wis.  
311 West Park Ave., Angola, Indiana  
1111 South 16th St., Sheboygan, Wis.  
Baudette, Minn.  
Indianapolis, Ind.  
Manitowoc, Wisc.  
Oelwein, Iowa  
416 Court House Bldg., Minneapolis, Minn.

#### CANADIAN

Bienville, Que.  
Three Rivers, Que.  
Shawnigan Falls, Que.  
30 Lincoln Ave., Montreal, Que.  
230 Bloomfield Ave., Montreal, Que.  
Farnham, Que.

5YC  
5YD  
5YE  
5ZA  
5ZK  
5ZL  
5ZO  
5ZP  
5ZT  
5ZU

6AW  
6AX  
6BD  
6BT  
6BV  
6BW  
6BX.  
6BY  
6BZ  
6CA  
6CB  
6CC  
6CD  
6CE  
6ZA

7AE  
7AF  
7AJ  
7BK  
7CC  
7CR  
7DK  
7ZB  
7ZD

8AC  
8AE  
8AF  
8AG  
8AI  
8AJ  
8AP  
8AQ  
8AS  
8AT  
8AU  
8AV  
8AW  
8AX  
8AY  
8AZ  
8ZV  
8ZY

9CR  
9CS  
9CT  
9CU  
9CV  
9CW  
9CX  
9CY  
9CZ  
9DA  
9DB  
9DC  
9DD  
9DF  
9DG  
9ZC  
9ZJ  
9ZL  
9ZT

2AA  
2AC  
2AD  
2AE  
2AI  
8Z



## 8ZY (Ex-8AA), DEFIANCE, OHIO

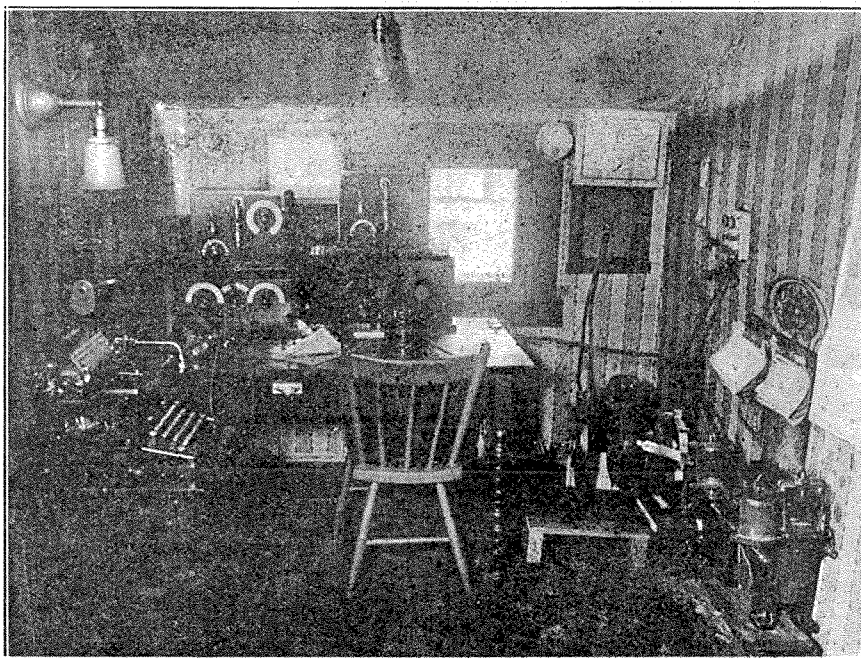

Above is a view of 8ZY, formerly 8AA, operated by Mr. K. A. Duerk, at 1000 Wilhelm Street, Defiance, Ohio. The spark of this station is familiar over three-quarters of the country.

The antenna has been a T, running east and west, 80 feet long and 60 feet high, of four stranded wires. The poles blew down in a storm on November 29th and from that date on a temporary inverted L aerial 80 feet long and less than 30 feet in average height has been used, but without much decrease in the range.

A counterpoise ground of No. 10 wires runs the entire length under the antenna, and in addition connection is made to gas pipe, cistern, buried zinc and driven pipes.

Two variometer regenerative receiving sets are used, without additional amplification. One set tunes up to 300 meters only, with maximum efficiency for the shorter waves, while the other covers up to 600.

The transmitter is seen on the floor beside the operating table, and consists of a 1 KW 20000-volt Thordarson, an oil immersed plate glass condenser, a pancake oscillation transformer with heavy ribbon wound on fibre arms, and a "Hyrad" rotary belt-driven from an induction motor. The radiation is 8 amperes on 200 meters, and 9.4 on 250 meters, with loose coupling. Note the secondary chokes, the short transmitter leads, the loose coupling, and the

direct lead to the antenna. No change-over switch is used, the break-in system being employed instead.

The station is now licensed for 200, 300, and 385 meters, and is being rebuilt accordingly, using low power on 200 meters for short distance work and high power on the longer waves for L.D. relaying.

The following actual communication records have been made:

East, Boston, 700 miles.

Northwest, Valley City, N. D., 875 miles.

South, House and Austin, Tex., 1100 miles

Southwest, Roswell, N. M., 1300 miles.

8AA has been heard from 7AY to 1BK and 1AK reports sigs 30 feet from phones.

### *They Dared Us To Print This One !*

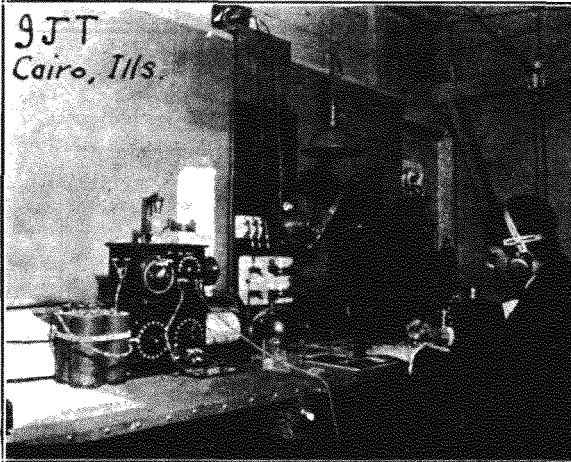

This is a photograph of the Editor's old pre-war set in Illinois. Mathews has challenged us to print it and we take him up because it contains a number of examples of How-Not-to-do-It. Get the dry-cells to run the audion, the jumbo coupler on which we once endeavored (not altogether unsuccessfully) to copy DX amateurs, the famous "resonance indicator" (divulging at last the mystery of where one of our mother's fruit jars went), the atrocious open rotary at our right elbow, the too-tight coupling, the too-long transmitter leads. The shack was all right, however. Post-war 9JT is now in Racine, Wisc., and we hope he will always press bravely onward and maintain ever the high reputation of old 9JT—and his present record shows he's already skinned us a mile.

### *5AP, ENNIS, TEXAS*



5AP is the station of Mr. Raymond L. White, A. R. R. L. District Superintendent for Northern Texas, located three miles from Ennis, Tex., at the Lake Side Country Club.

The location is ideal, being entirely in the clear in open country. A six-wire inverted L aerial is supported on two 60 ft. masts, close to one of which the station room is situated. This is a one-room boxed building, and the installation will be seen to be neat and inviting. (We just itch to sit down to the Key when we see the inside of a good radio shack. Don't you?)

The transmitter consists of a 1 K.W.

25000 volt Thor, twelve sections of Murdock moulded condenser in series-parallel (some missing in photo), Murdock rotary, pancake O.T., Radio Apparatus Co. hot wire ammeter, with all connections made of copper braid.

The receiver consists of a Navy-type Coupler, Liberty audion Cabinet using Audiotron tube, and Brandes receivers. The undamped receiver is the Radio Apparatus Co's. Type 93, with a range from 300 to 18,000 meters. Some trouble has been experienced in efficiently copying 200 meter amateurs on the coupler shown, but a short wave regenerative set has been installed since this photo was taken.

### THE OPERATING DEPARTMENT

(Concluded from page 33)

of activity in his territory. Stations are now in operation at Omaha, Wayne, Tilden, Oakland, Plattsmouth and Lincoln, and Mr. Keller, with his Assistant Mr. O'Rourke, has been busy lining these stations up and conducting tests with them. Nebraska has been very difficult territory in which to carry on traffic work, as the stations are very scattered and the interest has been at a low point. Mr. Keller deserves great credit for his efforts which have so far been very satisfactory.

Mr. Taylor, of Minonk, who has been so successfully organizing Illinois and operating 9CA until ungodly hours of the morning, evidently has still more spare time on his hands and so has proceeded to win the 1st prize in the QST Subscription Contest.

Routes are now available in daylight working order to practically all large towns in Illinois, and messages for such towns can be handled either through 9CA or 9ZN. Mr. W. L. Thomson, 1163 N. Broad Street, Galesburg, Illinois, has been appointed Assistant to Mr. Taylor, and in addition a second Assistant in the Southern part of the State will be appointed in the near future. 9CA reports the handling of 193 messages between January 10th and February 22nd.

Taken as a whole the work of the entire Division during February has been unusually satisfactory both in regard to organization and traffic handling, and it is believed that with the present daylight routes in such excellent operating condition summer work will be very probable. It has long been our aim to carry consistent work throughout the year and we believe that this summer will see the Central Division handling such work. In this connection the Division Manager wishes to extend his heartiest congratulations to his District Superintendents who have all carried out the work in their respective territories in a manner which has

been very gratifying. The organization of the present daylight routes and the efficiency of the traffic handling in general in this Division is due entirely to the unstinted efforts of these men and the Division Manager wishes to take this opportunity to express his appreciation of the good work they have done.

### THE JUNIOR OPERATOR

(Concluded from page 35)

the secondary. Finally, retune for fine adjustments by tuning the primary again, this time by the units taps. A more sensitive spot on the detector can also be attempted. However, remember adjustments of the detector do not require re-tuning of the set.

The four lessons appearing the last four months complete the receiver. A beginner should have a better understanding of the workings of the wireless and should have a simple but effective set that has been thought out before being built.

Articles on a simple transmitter will appear soon.

### WHO'S WHO

(Concluded from page 38)

**Chas. A. Service, Jr.**

Office, Washington, in early 1918, where he was assistant to Lieut. Cooper in the Transatlantic Radio Service among other duties; put on inactive duty August 10, 1919, with rank of Lieut. (j.g.);—quite a career.

He is now Radio Supervisor for the Shipping Board, at Philadelphia, and admits with all of us, that the more he fools with radio the worse the "bug" bites.

**F. E. Terman**

the work a senior and a junior is supposed to do makes him hustle to find time to "sit in". 6AE may not be heard as often as 6FT for this reason, as the old four-hour watch is no more, but no doubt it will be heard farther.



### WOULDN'T IT BE WONDERFUL

If 8ER had a sharper wave.

If 9IF got so many post-cards he could never finish reading them.

If 5ZL got a condenser that would hold up.

If a few more long distance stations started up in St. Louis.

If we had a regular opening to California.

If local QRM was always nil.

If someone invented an "unblowable" condenser.

If 2ZS got a gap that suited him.

If some of the stations whose signals are heard over a large range would get receiving sets to work as efficiently.

If the lights wouldn't flicker when drawing 10 amps off a 5-amp service line.

If it were never necessary to ask for a QTA.

If someone would present every amateur with a ½ kilowatt power tube.

If some of Chicago's amateurs would sign up their calls correctly, occasionally.

If all amateurs not interested in long distance work would QRX at 10:00 P. M.

If we could use AudioTrons without peeving Marconi.

If synchronous motors cost \$5.00 each.

If "Mars" would quit sending static.

If there was no such thing as "kick-back."

If the Navy got control of amateur radio.

If someone could induce 9ZN to pry the secondary of his O.T. off of the primary.

Wanted:—Contributions for "Wouldn't It Be Wonderful—". Out with your little hammers now, you rappers.

Errata: On page 11 of March QST, strike out the second and third lines directly under Fig. 1. On page 13 the reference to the minimum wave of coil L-1000 should read 4,000 meters instead of 4,800 meters, and the reference to coil L-750 on same page should read "and to 4,800 meters with condenser about 30 degrees" instead of about 20 degrees.

Let's get a Secretary of the Navy appointed who has a young son who is a rabid ham, and then we'll never have any trouble any more. Any of you chaps got a dad who wants the job? We ought to be able to fix it up!

### LOST

Information is wanted concerning the whereabouts of Harold C. Sever, 9DN, of Valparaiso, Ind., who left home for Chicago, Ill., Feb. 17, 1920, to test out some wireless apparatus, intending to return on a midnight train, and has not been heard from since.

He is 5 feet 6 inches tall, brown hair, blue eyes, weight 130 lbs, thumbs slightly crooked. Left in civilian clothes: mixed grey suit; dark gray overcoat; American Legion pin in coat lapel; green felt hat; navy shoes; name on all his clothes. Carried brown suitcase containing receiving set and a black bag with tools and working clothes.

His heartbroken wife and mother will appreciate any word concerning him. For this purpose address Mrs. H. C. Sever, Box 226, Pleasant Plains, Ill.



For goodness sakes, QST all owners of telephone sets! Why don't you sign once in a while? These HQ are flooded daily with fervent petitions to identify a much-hashed scrap of conversation picked up 'mid wild excitement and bearing, also, no signature. You'll get reports of your sigs all right if you'll periodically say something like this: "Station 2XX, 2XX, 2XX, calling station 5ZL, 5ZL, 5ZL." And the folks that hear you will be happy—and so will we.

Our interest in impulse excitation has gone up a few more notches. The Cutting & Washington Radio Corp. announce that they are about to bring out a 200 meter 500 cycle impact excitation transmitter. The first set is being tested out now and we hope it will be on the market before long.

# Radio Communications by the Amateurs

THE PUBLISHERS OF QST ASSUME NO RESPONSIBILITY FOR THE STATEMENTS MADE HEREIN BY CORRESPONDENTS



## GOOD OPERATING

Portland, Ore.,  
Feb. 26, 1920.

Editor, QST:

Several nights ago I witnessed a pretty piece of relay work that deserves mention in QST.

A 15 word message was handed to the operator of station 7DK at 12:01 A. M., Feb. 18th. 7DK immediately called 6CS; 6CS acknowledged; 7DK asked if 6CS could get msg. thru to Venice, Calif. yet that night; 6CS answered QRX and proceeded to connect with some Southern California Station, which he did, and then gave 7DK—QRV. 7DK gave him the msg. and got the receipt and all this only took 8 minutes. Then we listened to 6CS snap it off in the same manner.

I am of the opinion that the use of the radio abbreviations is what put this msg. thru so quickly.

Both stations used excellent methods in handling messages and they never use a lot of useless calling and signing.

7DK was using a one step amplifier and was receiving well. He has heard 9EE on a three step amplifier and 6EA two feet from the phones. The apparatus is of his own make, as is his transmitting set.

He is one of those fellows who is always on the job.

Yours truly  
C. B. Hempel.

## WE'VE ALREADY PASSED THE BUCK —TO THE PRINTER!

709 So. 10th St.,  
Tacoma, Wash.,  
Feb. 15, 1920.

Dear Editor:—

The job of A.R.R.L. Dist. Supt., with a side line as President of a Radio Club to say the least is dangerous—when the Editor makes a terrible muss of the report. Maybe the Division Manager's—I wont say—because the odds are against me.

To get down to earth and elucidate, its just this: February issue came out with plenty of pep but something was wrong with the report I sent to Seefred Bros., Division Managers covering Washington territory, especially around Tacoma; according to QST amateurs in Tacoma could

not get 7YS Lacey, Wash., altho only 20 miles away.

Our regular meeting night came on Tuesday evening and I calmly made myself present. That said evening with cold sweats going over me at the rate of 500 cycles per —. Meeting was duly opened with some 40 odd pair of eyes boring into me from all sides.

Suddenly I was confronted by the Press Agent who in as few words as possible asked me if I was responsible for the report in the February issue of QST. I didn't dare rise from my seat due to the fact my legs wouldn't function. But I did manage to stutter out my apologies to the members and pass the Buck to you. Dear Editor your shoulders are broad and you are clear across the continent, at that, so don't worry. Should you receive a Bomb, Woof Hong or some such animal of torture just pass the Buck!

Moral—To District Superintendents, especially those entertaining ambition of the president's chair: Beware of the way you make your reports for a Woof Hong would be a joke in the face of thirty or forty highly indignant and insulted Hams.

Lester E. O'Brien, 7EV,  
District Superintendent of Washington.  
P.S. We copied 9ZN QSA in Tacoma,  
Jan. 8, '20.

## THE RIGHT IDEA

Polo, Ill.,  
Feb. 5, 1919.

QST, Hartford, Conn.,

Dear Sir:

Locally, I am known as a 4 stud rotor "crank" and the reason follows: When I first started getting "junk" together, one of the instruments was a "Halcun" gap sold by a mid-west house. That was about 6 or 8 years ago. It is now sold under the name of "Sayville" and has 8 studs on rotor. I ran it with 8 studs at a terrible speed for some time, but didn't get any results. Then I cut down the speed of the motor. That helped a little. I had trouble in getting 30 miles daylight with it on ½ K.W. Next I took out every other stud. Bang! went my condensers. Then I built my condensers to hold on the four studs. Again I decided to take out

two more studs leaving two and run the gap at original speed. I did and so did the condenser again. Had to rebuild again. Everything went great and it sure did radiate, even too much, for there was a kick back to the motor. It didn't entirely burn it out, as it still runs, but have to use four studs as not enough speed for two.

The motor has sure been faithful for the abuse it has had. It barely turns over but get a fair tone on the four studs and a daylight range of at least 75-100 miles on a 40. ft aerial. Soon will have a gap going with ability to use two studs on a larger rotor than the present one and far enough from the motor to prevent damage.

There are a few good rotors on the market but they should leave out half the teeth. Personally and for my needs there is not a good gap on the market. Would like to see one built. One where the rotor studs could be taken out and put in again. There are several on the market of said type but the rotor is too small and construction too fragile. Some of the stationary supports might as well be a couple pieces of wire stuck in a board.

Why don't some one put out a good aerial switch? Don't see any yet?

Well nil and 73.

Sincerely,  
9IX.

**RE MR. CORUM'S LETTER  
IN JANUARY QST.**

Morristown, N. J.,

Editor, QST:

Referring to my letter to you last month regarding the freak transmission of radio phone last summer between the U. S. S. George Washington and the New Brunswick radio station, wherein New Brunswick radiated on 13,600 meters the conversation on the U. S. S. George Washington, I was so interested in solving the mystery that I sought and secured an interview with Mr. Alexanderson, the radio engineer in charge of these experiments. He makes a very simple explanation.

When the officials in Washington, D. C. were listening in on the ground telephone connecting Washington, D. C. and the New Brunswick radio station, a receiver receiving signals from the U. S. S. George Washington was so adjusted that a transmitter of New Brunswick received the signals from the U. S. S. George Washington and reradiated them out on the New Brunswick wave length of 13,600 meters. Thus one could hear the signals of the U. S. S. George Washington as well as the New Brunswick radio station on 13,600 and also the U. S. S. George Washington on 1,800. This was also done on 8,000 but not on 5,600 meters. It was never done with Schenectady working on

3,500 meters and thus Schenectady was always heard on 3,500 meters and not on the New Brunswick wave length of 13,600 meters.

Undoubtedly some of the amateurs were as much puzzled as we were and I think this simple explanation would be interesting to them, as it was to us.

Yours truly,  
Theo. E. Gaty, 3CV.

**YOU WIN THE ROLLER-SHADE  
CONDENSER!**

Feb. 18, 1920.

Editor, QST,  
Hartford, Conn.

I notice that it seems to be the fashion to send in a list of calls heard. I do not see the use of sending in anything except interesting call letters heard, because no one cares whether you do or do not hear ordinary call letters from stations half a mile away from you. I am sending in a few call letters from your First District, which is some distance away. These are all interesting call letters, and makes me wonder what kind of people you have down there in New England.

I heard 1NUT the other night. He was off his trolley badly. I was sorry for the poor chap. I also heard 1HAM answer him going at about three words a minute, and stuttering badly at that. 1DF came in strong and by his conversation, I judged somebody had exercised good judgment in selecting his call. I have not yet noticed for sure that I have received 1GDF, although by the messages sent, I feel quite sure he must have sent them. 1HOG fills the air up pretty full with a broad wave sometimes. 1BUG comes in fine when he can squeeze in between 1PUP and 1ASS. 1PDQ is too fast for me to copy. The poor boob he works signs 1SOL. I also hear a lot from 1BS and 1NG, and 1ND comes in now and again. The latter sometimes works 1LEG or 1ARM. They tell me that 1EYE has a glass eye to insulate him from his set. Once in a while 1SOG comes in and the less of him the better.  
The Old Man.

HI!

Rosedale, Kansas,  
Feb. 14, 1920.

Mr. K. B. Warner:

Say! O.M. Whadya mean? The Feb. copy QST just received starts out with page 54, omits approximately the first twenty pages and winds up minus some of the last pages. Dontcha think its hard enough to wait a month for QST without having to drag out the old rusty Underwood?

Wirelessly yours,  
W. J. Connolly.



## LISTENS LIKE A RECORD

3076 Central Ave.,  
Pittsburgh, Pa.,  
Jan. 30, 1920.

American Radio Relay League.

Editor, QST:

I sent you a list of calls heard at my station just a few days ago, but I picked up a station this week that I feel is something worth while.

I was listening on my station at 11 P.M. and heard, quite plainly, 7AA, H. Renfro of Seattle, Wash. He was calling someone in the 7th district, but I could not pick up the call or the fellow to whom he was talking.

This seems to me to be a wonderful distance. Almost too good to be true, but it is. I heard him sign, three times, 7AA.

I heard this on a West Penn. Electric Co. Regenerative set, audion, and no amplifier.

I shall also write to Mr. Renfro to see if he was working at that time so as to be positive. I am.

Yours very truly,  
Biddle Arthurs, Jr.

## HOW LONG DID IT LAST?

Brooklyn, N. Y.,  
Feb. 5, 1920.

Editor, QST:

The Radio Traffic Association takes pleasure in announcing that its Financial Secretary, Ernest K. Seyd, was recently assigned to placing the transmitter of the Brooklyn Navy Yard (NAH 5KW) in resonance. The work included the installation of a new inductive coupler and was completed the latter part of January. The decrement of the 600 meter wave is now .07 and the 1500 meter wave .04.

Amateurs in the neighborhood of this station report that the QRM formerly caused by this station on two hundred meters has been greatly reduced.

Sincerely yours,  
Albert L. Heydon,  
Secretary.

## OBSERVATIONS ON FADING

70 Grenville St.,  
Toronto, Canada,  
Feb. 2, 1920.

Editor, QST:

My attention was attracted recently by your brief editorial note on Freaks and Swinging signals. It is my humble hope that some of my observations of this phenomenon may prove interesting to you, and, maybe, be worth passing on to others of the Fraternity.

During 1918 I was attached to the staff of a large British Radio Station situated on the Atlantic Coast. This station is located somewhere about 43 N, 65 W, and is equipped with the rugged and thoroughly efficient British Navy apparatus. By the way don't believe all you hear about the "quaint and antiquated British stations"—The gum-chewers had their warships and stations loaded down with all the latest devices known to radio Science, but, believe me, when there was traffic to be pushed thru, the lime-juicers were "there",—every time! You American chaps must, in honesty, admit that,—what? Why I remember once—but I started to write about stray sigs. Well, this big station at V— — was built far away from the contaminating influences of power lines, street cars, and other modern evils of an electrical nature. Moreover the station is operated from a power source which is placed completely underground, and all leads and networks are also under ground. The receiving gear is installed in a sound proof, lead-encased room and this room thoroughly grounded. The aerials, rising to a great height, are not ordinarily directional. The terrain is rolling and densely covered with a species of small spruce, and matted with underbrush. In the stillness of night the ocean—dotted, near shore, with islands—can be heard dimly as its waves hurl themselves upon a rocky beach. Now, you will agree, if one searched far and wide, no more ideal conditions could be found for studying of "freaks".

My own particular duties at the above station, required that I keep a very keen W/T guard on 600 meters. And it is on wavelengths in this neighborhood that the following observations were made. I regret that I cannot quote from the official records; for very obvious reasons these are not available. But the main details I have retained in memory.

During the summer and fall of the year, we had a list of regular visitors. From about 10 a.m. until 5 p.m. there would be practically no freaks at all. About 5 p.m. stations to the northward would begin to come in very loudly—little  $\frac{1}{2}$  and 1 K.W. stations, far away, would pound in as though they were but a few miles off, but not for long. No, the northern stations never stayed long. About 8 p.m. there would be a change. I observed that this change or shift of sigs was usually accompanied by a short period of growling static lasting perhaps 15 minutes to half an hour. Then this static would settle down (on "clear" nights) to a soft rumbling and stations either east or west would begin to arrive. It is strange, to me, that, when the western stations such as WBL, WOK, NAJ, etc., were freaking

in, stations at eastern points, some of them almost including us in their normal range, were nearly inaudible or at least very weak. Only on one occasion, that I remember, were both east and west stations freaking together: One time about 2 or 3 o'clock in the a.m. Cape Race (VCE) was endeavoring to reach a Dutch or Norge ship (I forget what one). The vessel was somewhere southwest of Sable Island and apparently did not hear VCE at all. But at V—, Cape Race was unbelievably strong: I was debating with myself whether or not I dare call him up and give him QRK. The Navy regulations still prohibited such things tho the armistice had been signed a month back. I paused, my finger still on the starter button, and then Boston, WBF crashed in with "VCE de WBF, QSA, QRK? QRU?", and VCE came back loud as a thunderbolt, the weird whining note of a spark like none other in the world, and so eloquently descriptive of that bleak promontory, Cape Race, that it is a call sign in itself, proclaiming that he had an "a" for SS— and could WBF deliver. WBF could, and did. Now all thru the late hours of that night the Great Lakes stations had been working and at V— they were loud— indeed, very loud.

But the above was a rare incident. It happened only that once during my operating experience at V— and if it did repeat itself when the other ops were on the phones they did not log the occurrence. In fact, taken as a whole stations east of us were never strong on freaking; stations as far east as BWP (Azores) came in loud between the hours of 7 and 11 each night—but not so thunderingly loud as most other freaks.

The Southern States and West Indies added many freak calls to our log. On nights when sigs were swinging up from the south WST would rasp away utterly obliterating all but the loudest sigs from nearby stations. These Southern stations along the U.S. eastern seaboard, would begin to get loud about 8 p.m. I have heard them start as early as five p.m. and at which time things seemed to swing first thru Jamaica and Demerara and then to Bermuda. We did considerable work with Bermuda and conditions were for this almost invariably at their best between 2 and 4 a.m. At about 5 a.m. they would abruptly swing again and until about 8 a.m. The Gulf of St. Lawrence and Newfoundland stations with their silly 10 inch spark coils would begin to annoy me with their discussions over the price of fish, etc. The spark coil stations did not work during the early morning hours, but spark "power sets" in their neighborhood working naval stuff all night, would

be quite weak at V—. After 8 a.m. all freaks died away, and stayed out until old Sol had got well along on his way to the Pacific.

It was observed that sigs generally swung from southward to northward. As to whether the conducting strata paused in Eastern Latitudes I cannot say but never did I hear any eastern freaks during such a swing. Occasionally have I noticed a swinging tendency from west to south but never west to north, and as a rule, signals from south and west would freak simultaneously.

I endeavored to deduce some connection between these swinging signals and contemporary weather conditions. I was generally able to intercept all the Great Lakes weather reports, even those from Houghton and Duluth. When these reports varied from the NAA report, and included local barometer readings, I noted that fact and compared the Great Lakes weather with that in other places. The reason for my particular interest in Great Lakes weather, was that the Lakes stations are, at V—, the most consistent freakers. When I had almost satisfied myself that low pressure over the Lakes, brought us freaks from those stations, then one night they would come in hard as ever and report high pressure in their midst. This was baffling. And it was not the only thing that puzzled me. There were others such as these.

Once during a graveyard trick, I sat sleepily munching a piece of toast, and trying to keep awake. The Lakes stations were buzzing in now and again but things were a bit too quiet to keep one awake and alert as a war time operator should be. Suddenly I heard calling me a station with the familiar note of a "Marconi-British Navy" set. He signed what to us was an unfamiliar call group and a hasty search thru the admiralty list failed to locate it. However as it was quite obviously one of our stations—(a cruiser, I supposed), I gave the signal to "fire ahead, signals very strong". This was a few minutes after 3 a.m. I had copied about 25 groups or so when I noticed that I wasn't getting along very well; about two minutes later I wasn't getting on at all; his sigs had faded clean out! I called him several times but heard no answer. 200 miles further along the coast at K— is a small government station, one of a chain of variously equipped stations all connected thru our receiving station by land and cable wires. The operator at this station K— called me on the wire and stated that my faded-out friend was answering my calls. After some parley I found that my supposed cruiser had freaked in at K— just about the same time that he freaked out at V— and so

between us (the man at K— and myself) we pieced the message together and sent it thru to hq. Then the various direction finding stations got together and compared notes with the result that I was informed my supposed cruiser must be lying in Bermuda harbors. I later found that the signals had really proceeded from the naval radio at BZR!—It seems the lad on watch at BZR mis-read his instructions and erroneously used the private code name of a certain naval staff officer, in place of his own call sign (BZR) whereas both call groups should have been transmitted. In the above case a strange condition existed, for BZR could hear me all the time, although his signals faded at V. Moreover my receiver was certainly in good adjustment as other stations were recording quite as usual, and in further evidence of this, the D.F. station near us, lost him just when we did. BZR freaked in and out again at K—and also at several other stations along the coast. Yet bearing the above statements in mind, remember that the D.F. stations were able to agree on their bearings, and correctly located the transmitting station. Freaks are often thought to bend around mountains and forests, follow streams and so on, in their career about the earth. But BZR's sigs in this case must have followed a straight line, because the radio bearings would otherwise have been far wrong. Those sigs moved in a straight line sure, and what's more, at our latitude they switched across about 300 miles of terrain in as many seconds... Then on top of all this, you may imagine my surprise when at 5 a.m. BZR, working again, come in so loud and consistently that my 600 M aerial re-radiated into another aerial nearby on which one of the other ops was copying CW stuff on about 5000 M: it jammed him so that he threw a message pad at my offending valve and uttered many unprintable words of hate.

The above is about the queerest case of swinging signals I have heard of.

But I must tell you of another occasion when the Lakes stations were coming in strong at V—. Everyone knows of NAJ's troubles with his 600 M range. One night I heard NAJ call WOK and WBL but without any reply from either of them. Later they both called to him. He faintly heard WBL but apparently couldn't hear Detroit. They all had some little short code message that used to go thru every night. On this occasion they worked for hours (intermittently of course) trying to establish communication, and were still at it when daylight came to us and they began to fade out. I longed to call up NAJ and find if he could hear us, and though such actions were forbidden I found my fingers wandering toward the starting button

more than once. But finally I had to content myself with silence and a good damndamning of the King's perfectly good Regulations.

Now the respective latitudes of V—, WBL, and NAJ do not differ by so very much, as you will see from a map. How, I ask you, do NAJ's sigs miss Detroit, Cleveland and Buffalo and yet come in strong and clear at a station 1500 miles from him and in a straight line over their heads?

I think the amateurs should get together and try by comparing notes to see if we can't arrive at some definite law that may perhaps cause these strange swinging signals to act as they do.

I close, wishing QST the greatest success, which is its due.

Sincerely,  
Chas. A. Lowry.

#### AN ANSWER FROM T.O.M.

Dear Mr. Editor:—

You ask in February "QST" who wants to answer some rotary gap questions by E. E. House, up there in Battle Creek. I should think he would have had enough breakfast food, living up there where he does, without writing to you for more, but since he evidently is still hungry let us see if we can satisfy him. Confidentially and strictly between us friends, I never answered a query in a technical periodical before. But as I have tried everything else there is to try in this old world, I may as well take a shot at this with the rest.

First of all I don't know what he is talking about. That need not make any difference, however. He says, for example, something about charging a condenser at LOW CURRENT capacity vs. charging it at HEAVY CURRENT capacity. I only know one way to charge a condenser. That is to charge it with ENERGY. If you squeeze in an over-supply of this energy you will pack it in so tight that the pressure will be caused to rise, just like in anything. If you keep the squeezing and packing business up long enough you will build up such a pressure that the plates of the condenser will puncture. But, now, if you are a person of taste and proper discernment you will stop just short of the pressure which will puncture. And then, if you call upon Mr. Condenser to do so, he will discharge and said discharge will be of an oscillating character and of tremendously heavy current, because the whole performance is over in such a short time.

Now, OM up there among the breakfast foods, remember that it never disturbs a condenser's digestion, considering where or whence the juice came from to charge it. All juice is alike to a condenser. It

only is a matter of how far the squeezing process is going to be carried on—in other words, the pressure or potential. Once the condenser has been filled up to the point where it just will not puncture, it is full, and you cannot get any more in with a shoe horn. And when she discharges, if the resistance of the circuit, and its inductance and its impedance are the same, the discharge will always be the same. Yes, sir, every time, without fail.

Now, the trouble up there in Battle Creek is that somebody made away with the safety gaps off the power transformer. The poor unfortunate rotary gap is evidently being forced to do all the dirty work. Leastways that's my guess. If our Postum friend will put back his safety gap, and make the separation just thirteen sixteenths of an inch for a starter he will have a very effective and valuable potential regulator which will teach him many things. Not only will he protect his apparatus and force (more breakfast food, by heck) his jumping to occur where things are prepared to receive a discharge, but he will be able with smoked glass to observe the effects of varying the size of his condenser, the angular velocity of his rotor studs, the number of studs opposed per minute, etc., etc., etc., and after a couple of Sundays thus spent he will be a

wiser and a noisier boy. I know, because I have spent a month of Sundays on the little problem. While he is conducting this research work let him bear this little bit of advice in mind:— That his gap cannot give him long distance unless it gives a low decrement in the antennae circuit. That it cannot give a low decrement unless it **QUENCHES**. That it cannot quench unless it breaks the condenser spark **OFF SHORT**. That it cannot break the condenser spark off short unless it either comes up and gets away almighty spry or unless it cools almighty spry. We cannot get either one of these as spry as we would like to. To break off the condenser spark short by fast movement only would require a speed of the rotor of something like 150,000 r.p.m. To break it off by cooling only, as in the regular 500 cycle quenched gaps would require equally impossible weights of copper. So the amateurs who get the long distances do both. They do the best they can on both lines, and add what help the blast of compressed air gives which accompanies a very fast moving stud.

There's your answer, Eddy. Please suggest to 8NF a package of Post Toasties at his convenience.

The Old Man.

## CALLS HEARD

On account of the vast quantity of calls reported we must ask your co-operation in the following or calls can not be published.

(1) List the calls on a separate sheet of paper—do not embody them in a letter.

(2) Arrange by districts from 1 to 9, and alphabetically thru each district; and run them across the page, not down a column.

(3) Put parentheses around calls of stations also worked.

(4) Omit initial or other unauthorized calls.

### 1AW, HARTFORD, Feb. 4-29th

1AES, (1AE), (1AY), 1AZ, 1AK, 1CK, (1CM), (1DL), 1EK, 1EUS, (1FQ, 1GJ, (1QP), 1SE, (1TTS), 1PW, (1ZA), 2AN, (2BM), (2CB), 2CC, 2CY, (2DA), 2FG, (2II), (2IR), (2MB), 2MN, 2XY, 2ZS, (3AN), 3BZ, 3BE, 3DH, 3EA, 3EV, 3KM, (3NB), 3ZW, 4AA, 3AA, 3AM, 3AI, (3BP), 3CC, 3CB, (3DV), 3DF, (3DA), 3DG, 3ER, (3EN), 3EV, (3EX), (3FH), 3FO, 3FF, 3GB, 3HA, 3HG, 3HP, 3HH, 3IB, 3IK, (3JJ), (3JQ), 3KK, (3KP), (3KE), 3LA, 3LL, (3MB), 3NZ, 3WS, 3XA, (3XU), 3AU, 3AT, (3AW), 3CP, 3HG, 3HW, (3IT), 3KF, 3LQ, 3ZJ, (3ZL).

### 6ZA, SALT LAKE CITY, UTAH

(6AE), (6AT), 6CH, 6CC, 6AM, (6EA), (6HH), 6IZ, (6JD), 7CC, 7CH, (9JE).

### HEARD AT SZP, NEW ORLEANS,

during January: 3BZ, 3CH, 3GO (4AE), 4AG, 4AN, 4BQ, 5AC, (5AG), (5AL), 5AS, (5AU), 5BD, 5BG, 5BJ, 5BK, 5BL, 5BM, (5BO), 5BZ, 5CD, 5DA, 5DO, (5ZA), (5ZC), (5ZL), (5XA), 8AA, 8ALE, 8CB, 8DA, 8EC, 8EF, 8ER, 8EZ, 8FI, 8FP, 8HG, 8IB, 8IX, 8JG, 8JJ, 8NF, 9AA, (9AJ), 9AT, 9AU, 9BJ, (9BR), 9BT, 9CA, 9CS, 9EG, 9EM, 9EQ, 9EY, 9FB, 9FE, 9FN, 9FT, (9FU), 9GA, 9GC, 9GO, 9GV, 9GX, 9HD, 9HN, 9HT, 9HS, 9HT, 9IT, 9JB, 9JT, 9KF, 9KV, (9KO), 9LG, 9LQ, 9NQ, 9PQ, 9ZN, 9XY.

### HEARD AT 8IB, COLUMBUS, OHIO

1AE, (1AW), 1CM, 1SZ, (1RN), 1KT, 1FQ, 2BB, 2BD, (2BM), 2CS, 2CC, 2CB, (2DA), 2EH, 2FG, 2IR, (2JU), 2JE, 2JZ, 2PL, 2SH, 2VN, 2WB, 2ZM, 2ZL, (2ZS), 3AMO, (3BZ), (3CC), 3CH, 3CV, 3NB, 3ZW, 4AE, 4AG, 4BC, (5AL), 5AG, 5BM, (5DA), 5DO, 5BL, 5EX, 5ZC, 5ZL, (8AA), 8AD, (8AB), 8CB, 8CC, (8CH), 8EB, (8EN), 8FI, (8JJ), (8JQ), (8GQ), 8NF, (8XU), 8AGO, 9AD, 9AF, (9AJ), 9AK, 9AS, (9AU), 9BP, (9BR), (9BT), (9CA), 9CN, 9CE, 9CS, (9CW), 9DC, 9DV, 9DO, 9DX, 9EG, 9EQ, (9EY), 9FI, 9FC, 9FR, 9FV, 9GO, 9GX, 9GY, 9HA, 9HD, 9HI, 9HT, (9HY), 9IF, 9IL, (9IT), (9IX), 9HP, 9JA, 9JL, 9KF, 9KV, (9KO), 9LC, 9LF, 9LR, 9MK, 9NO, 9OY, 9NQ, 9PQ, 9WS, (9ZN), 9ZL, 9ZC.

### 9SV, ST. CLOUD, MINN.

8ES, 8ER, 8DA, 8EA, 9AJ, 9AK, 9BR, 9BT, 9CN, 9CS, 9DF, 9DH, 9DR, 9DU, 9DV, 9DX, 9EE, 9EO, 9ER, 9FA, 9FB, 9FL, 9FM, 9FU, 9FC, 9GC, 9HN, 9HP, 9HR, 9HT, 9HU, 9IF, 9IK, 9KM, 9LG, 9MX, 9OT, 9PI, 9PN, 9YA, 9ZC, 9ZL, 9ZN, 9ZP.

1JG, CLIFTONDALE, MASS.

1AW, 1CM, 2ACL, 2BM, 2CB, 2CZ, 2DA, 2EG, 2JE, 2JU, 2KN, 2PL, 2SH, 2ZL, 2ZM, 2ZS, 2ZV, 3AK, 3AN, 3BH, 3BZ, 3CS, 3GO, 3GX, 3NB, 3XC, 4AG, 8CC, 8CJ, 8DA, 8EN, 8ES, 8IN, 8JQ, 9CC, 9FG.

9ZN, CHICAGO

(1AW), (1RN), 2AK, (2BM), 2BK, (2CG), (2CS), (2JU), 2JE, 2WB, (2XG), (2ZM), 2ZL, (2ZS), (3NB), (3GO), 3DH, (3ZW), 4AE, (5AC), (5AL), 5AL, 5AY, (5BM), 5BT, 5YA, 5XL, (5ZC), (5ZA), (5ZL), (5ZG), (8FI), (8ER), (8DA), (8HG), (8CC), (8FD), 8GA, (8IK), (8AA), (8ALE), 8FE, (8IB), 8EK, 8EF, (8IN), 8NO, (8FI), (8VV), (8JJ), 8AE, 8GQ, (8JQ), 8AMQ, (8NF), 8GB, 8ASF, (8AH), 8AL, 8AGO, 8EN, 8DV, 8KN, (8XA), (8CB), 8BP, 8BL, (8FH), (8DU), (8XF), 8HA, 8DJ, 8GN, 8CK, (9YA), (9AJ), (9EG), (9GS), (9CS), (9II), (9FL), (9HD), (9DR), (9BR), (9GV), (9EY), (9BT), (9OY), (9FU), 9HT, (9KF), (9QR), 9IF, 9JA, (9EX), (9HS), (9CA), 9IP, (9VP), 9DX, (9JB), (9JT), 9HN, (9HY), 9UY, 9AW, (9HD), 9HG, (9KO), (9WU), (9KV), (9JT), (9HE), (9ZJ), (9ZL), (9IX), (9HT), 9LQ, 9FB, 9LC, 9DH, (9CN), (9EH), 9FQ, 9NQ, 9GC, 9EL, 9FZ, 9HT, 9EL, (9ZP), (9ZC), (9AES), (9GS), 9PC, (9OS), 9PV, (9FQ), (9DU), 9KS.

J. F. RAU AND C. A. ROETHLINGER, ABOARD U. S. S. SEMINOLE, WILMINGTON, N. C.

Report following: 1ZM, 1PF, 1CM, 1RN, 1AW, 1EN, 1AR, 1AK, 2ZS, 2ZM, 2XK, 2BB, 2PL, 2SZ, 2XG, 2BM, 2JU, 2CB, 2SH, 2KN, 2CG, 2QM, 2JA, 2IR, 2BK, 2LO, 2ZC, 2ZV, 2JE, 2XK, 2MN, 2II, 2IN, 2QF, 2FG, 3NB, 3NC, 3KH, 3XC, 3GS, 3TW, 3IY, 3EQ, 3CB, 3AN, 3CK, 3CC, 3EZ, 3KM, 3DH, 3ZS, 3FG, 3ZM, 3EM, 3CG, 3BH, 4AN, 4AE, 4BB, 4AT, 4AO, 4BQ, 4EJ, 4AK, 5ZC, 5DA, 5ZG, 5AL, 5ZP, AB, 8BD, 8DA, 8ER, 8HG, 8IK, 8KW, 8XK, 8CW, 8IB, 8CS, 8EW, 8KN, 8GN, 8LJ, 8HI, 8HA, 8DW, 8RS, 8BP, 8DJ, 8GQ, 8FP, 8CB, 8BN, 8JQ, 8BV, 8DV, 8NG, 8GB, 8LA, 8WS, 8SG, 8LK, 8FH, 8LI, 8KV, 8FN, 8CK, 8EC, 8AV, 8GK, 8CN, 8CD, 8DF, 8HU, 8XK, 8MB, 8KE, 8CH, 8EX, 8EV, 8IV, 9AJ, 9HJ, 9FN, 9IT, 9HN, 9ZN, 9GS, 9LJ, 9ZJ, 9BS, 9ER, 9ZV, 9BR, 9CA, 9CW, 9LP, 9LQ, 9NQ, 9AT, 9EY, 9ZL, 9AU, 9LC, 9UM, 9KV, 9KO, 9GC, 9HG, 9RP, 9MS, 9AX, 9LZ, 9IX, 9VK, 9FJ, 9HA, 9AK, 9FK, 9LF, 9KF.

The following heard at Cape Lookout, North Carolina; February 17th, 1920: 1AE, 1DW, 2BM, 2LO, 2IR, 2ZC, 2ZV, 3AN, 3DH, 3FG, 3NB, 3ZM, 3ZS, 3ZV, 3KM, 4BQ, 5AL, 8ER, 8DA, 8FH, 8LI, 8KV, 8FN, 8CK, 9AU, 9AMS.

The following heard at Savannah Georgia; Feb. 25th: 2ND, 2ZS, 2FG, 2JF, 2FM, 2JU, 3EN, 3EA, 4BJ, 4BY, 4AO, 8MB, 8ER, 8FH, 8DA, 9ZL, 9KO.

9CA, MINONK, ILLS.

1AW, 1ZA, 2BM, 2CB, 2CG, 2JE, 2JJ, 2KN, 2SZ, 2ZS, (3DJ), 3KM, (3NB), 3ZS, 3ZV, (5AB), (5AG), (5AL), 5AS, (5BT), 5AF, 5DO, 5ZA, (5ZC), (5ZO), 5ZU, 5YA, 6EA (heard Feb. 9th, 2:30 A.M., working 7ZB), 7CC (heard Feb. 3rd, 2:15 A.M., calling 9JE and 9EE), 8AA, 8AL, (8AL), (8CB), 8CC, 8DA, 8DP, 8ER, (8FH), 8HG, 8HH, (8HA), 8HW, (8JJ), (8JQ), (8IB), 8IK, 8IV, (9AL), 9AH, (9AU), 9BB, 9BF, 9BG, 9BK, (9EP), (9BT), 9CB, 9CE, (9CN), 9CP, (9CS), (9DH), (9DU), (9DR), (9EE), (9EL), (9FB), (9FZ), (9GC), (9GI), 9GR, 9HD, 9HI, (9HT), 9EW, 9IA, 9IR, (9IT), 9JE, (9KI), (9KF), (9KV), (9LC), 9OI, 9PG, (9RP), (9RV), 9RY, (9UG), 9YA, 9ZC, 9ZJ, (9ZN), (9ZL), (9ZT), (9ZV).

2KV, BRONXVILLE, N. Y.

2ZH, 2ZL, 2JU, 2EX, 2XI, 2AB, 2XG, 2ZC, 2SR, 2II, 2DA, 2XX, 1AW, 1CM, 1ZA, 1DL, 1CK, 3EM, 3NK, 3CV, 3NC, 3NB, 3AN, 3BE, 3CI, 3KN, 3GX, 3DH, 3ZS, 3ND, 4AG, 8HG, 8ZF, 8EN, 8ER, 8ZL, 8DA, 8ES, 8IH, 8IV, 8XU, 9AM, 9NY, 9ZY, 9ER, 9AU, 9ZJ, 9KF, 9SN.

9EL, COUNCIL GROVE, FAN.

4AG, 5AA, 5AC, 5AF, 5AL, (5AS), 5BM, 5BO, (5BT), 5DB, 5DO, (5EJ), 5ZA, 5ZC, 6GQ, 8ER, 9AF, 9AJ, (9AK), (9AU), 9BR, 9BF, 9BG, (9BW),

(9CA), 9EE, 9EQ, (9ET), 9EY, 9FA, 9FII, (9FL), 9FM, 9HN, 9HT, 9IF, 9IT, 9IX, (9JA), 9JB, (9JE), (9KM), (9KV), (9LC), 9LF, (9NQ), (9NX), 9OG, (9RP), (9RY), 9XT, 9YM, 9YV, 9WZ.

E. C. IMMEL, 90 RICHMOND AVE., DETROIT

1AE, 1AW, 1CM, 1KT, 1RN, 2BM, 2CC, 2CS, 2DA, 2EH, 2IR, 2JU, 2LO, 2WB, 2XG, 2ZH, 2ZM, 2ZS, 3AN, 3BC, 3CV, 3EZ, 3FG, 3NB, 4AA, 4AE, 4AG, 4AL, 4CB, 5AF, 5AL, 5BZ, 5ZC, 5ZL, 8AA, 8AB, 8BA, 8BO, 8CC, 8CN, 8DA, 8DG, 8EX, 8FA, 8FO, 8JZ, 8MC, 8NF, 8XA, 8XU, 8YC, 9AJ, 9AP, 9AU, 9BO, 9BR, 9BT, 9CA, 9CC, 9CN, 9CR, 9HN, 9IR, 9JW, 9MK, 9UP, 9ZC, 9ZN.

9KM, PEORIA, ILL.

(5AL), (5BM), (5ZP), (8FS), (8HG), (8NF), (8J), (8IK), (9FZ), (RP), (9KV), (9KO), (9KF). Also heard: 5AG, 5DO, 5BO, 5ZA, 5EA, 8IA, 8DA, 8LA, 2BM, 2ZS, 1AW.

7CC, MOSCOW, IDAHO

(7AD), (7AY), 7BF, (7BP), (7CH), (7CR), (7DK), (7DE), (7EC), 7FC, 7FB, 7YA, (7YS), (7ZB), (7CW), 6AJ, 6AK, 6BM, 6PQ, 6CV, 6DK, 6DP, 6DY, (6EA), (6EJ), (6FE), 6IW, 6JD, 6JK, 6KL, 6ZA, 9ZC, (6BR), 6CS, 6AE.

ITS, BRISTOL, CONN.

1AAT, 1ABM, 1ABS, 1AE, 1AES, 1AG, 1AK, 1AP, 1AR, 1AS, 1AW, 1AY, 1AZ, 1BC, 1BM, 1CK, 1CM, 1DAB, 1DH, 1DL, 1DR, 1DU, 1DY, 1EK, 1EN, 1ER, 1FE, 1FQ, 1FW, 1GAY, 1GJ, 1GZ, 1HAA, 1HAG, 1HT, 1IW, 1JD, 1KT, 1MZ, 1NO, 1OE, 1PW, 1PY, 1QP, 1QW, 1RU, 1SE, 1TUF, 1UI, 1UJ, 1VE, 1WP, 1WR, 1ZA, 1ZC, 1ZK, 2ABM, 2AN, 2AR, 2AS, 2AV, 2BB, 2BG, 2BK, 2BM, 2CB, 2CR, 2CS, 2CX, 2DA, 2DH, 2FE, 2FG, 2FS, 2GE, 2HZ, 2II, 2IR, 2JE, 2JJ, 2JU, 2KG, 2KM, 2KN, 2KR, 2MN, 2PL, 2QF, 2QR, 2QV, 2RB, 2RL, 2RV, 2SH, 2SR, 2SZ, 2WB, 2XG (phone & mod. tel.), 2XJ (phone), 2XX (phone & mod. tel.), 2YN, 2ZC, 2ZH, 2ZL (spark & mod. tel.), 2ZM, 2ZS, 2ZV (spark & mod. tel.), 3AA, 3AK, 3AN, 3BB, 3BE, 3BH, 3BP, 3BX, 3CC, 3CV, 3DH, 3EA, 3EL, 3EN, 3EM, 3GP, 3KM, 3LZ, 3NB, 3NS, 3ZS, 4CU, 8AD, 8AI, 8AKY, 8AM, 8AUX, 8AY, 8BP, 8BQ, 8BV, 8BC, 8CC, 8CH, 8CO (phone), 8CQ, 8DA, 8DI, 8DO, 8DV, 8DY, 8EN, 8ER, 8EV, 8FF, 8FO, 8FP, 8FH, 8FR, 8FV, 8FZ, 8GB, 8GL, 8GN, 8GQ, 8JS, 8HA, 8HD, 8HF, 8HG, 8HH, 8HP, 8IC, 8IK, 8IN, 8JJ, 8JQ, 8KE, 8KP, 8LA, 8LG, 8LI, 8LJ, 8MB, 8MC, 8MZ, 8QE, 8RS, 8UO, 8XA, 8XU (spark & mod. tel.), 9AC, 9AJ, 9AU, 9BR, 9CF, 9DF, 9GX, 9HD, 9HJ, 9HW, 9IT, 9KF, 9ZF, 9ZJ, 9ZL, 9ZR, 9ZB, 9HA, 9ZD.

9RP, KANSAS CITY, MO.

(3DH), 3GV, 3NB, 4AO, 5AL, (5AS), 5BB, (5DO), (5ZA), 5ZE, (5ZU), (5ZO), (5YA), 8CB, 8DA, 8DC, (8ER), 8FE, 8GQ, (8HG), 8HH, 8IK, 8LA, (9AJ), (9AU), 9BG, (9BT), (9CA), 9CI, (9CN), (9BR), (9CS), 9CT, 9EE, 9EL, 9EQ, (9FA), (9FB), (9GV), 9IT, 9IT, 9IX, 9KF, (9KM), 9KO, 9KS, 9KT, (9KV), (9LQ), (9LY), (9PS), (9RY), 9SP, (9UG), 9ZC, 9ZL, 9ZN.

9DV, NEENAH, WIS.

1AW, 1AZ, 1KT, 2CB, 2DA, 2ZL, 2ZM, 2ZR, (2ZS), 3GO, 4AE, 4AG, 5AF, 5AL, 5BM, 5DO, 5QA, 5ZA, 5ZC, 8AA, 8AL, 8BP, 8CS, 8DA, 8DV, 8DW, 8ER, 8EZ, 8FA, 8FG, 8FS, 8GL, 8NF, 9AB, 9AF, 9AH, 9AJ, 9AK, 9AT, 9AX, 9BR, 9BT, 9BY, 9CN, 9CS, 9CT, 9DK, 9DU, 9DX, (9EE), 9ER, 9EX, (9DR), 9EY, 9FA, 9FG, 9FP, 9FR, 9FS, 9FU, 9GC, 9GS, 9GV, 9HA, 9HD, 9HN, 9HR, 9HS, 9HT, 9IF, 9IJ, 9IX, (9KF), 9LN, 9LQ, 9NE, 9NQ, 9OT, 9PF, 9PQ, 9VY, 9WU, 9WV, 9YA, 9YO, 9ZC, 9ZN.

9LY, SHEBOYGAN, WIS.

1AS, 1AW, 1DP, 1IR, 2BM, 2JE, 2SN, 5BV, 6BU, 8AA, 8BA, 8CB, 8CD, 8DG, 8ER, 8FE, 8FI, 8HG, 8JJ, 8JQ, 8KB, 8KG, 8NF, 8UL, 9AJ, 9AP, 9BB, 9BG, 9BP, 9BT, 9CN, 9DN, 9HT, 9ER, 9FL, 9FW, 9IJ, 9JQ, 9KM, 9LH, 9LQ, 9NY, 9PY, 9YA, 9ZC, 9ZN.

## 9HQ, LA CROSSE, WIS.

3GB, 5BT, 5CP, 5DO, 5FS, 8AA, 8CB, 8HA, 8II, 8OD, 8XA, 9AU, 9AK, 9BP, 9CN, 9EL, 9FB, 9FL, 9FM, 9FE, 9FZ, 9GZ, 9GS, 9HI, 9HW, 9IJ, 9IX, 9JA, 9KI, 9KO, 9KV, 9LC, 9LZ, 9NQ, 9NV, 9NY, 9NZ, 9OG, 9PI, 9PY, 9UA, 9XN, 9YB, 9ZC, 9ZJ, 9ZL, 9AES, 9AOR.

## ABOARD WDN, LAKE MICHIGAN

3ZS, 8AA, 8CB, 8ER, 8FA, 8JV, 9KY, 9ER, 9IX, 9KV, 9LQ, 9MC, CD, 9ZJ.

## EX-9VK, KENOSHA, WIS.

2DA, 2XN, 2ZS, 8AA, 8DA, 8ER, 8GB, 8NB, 9AB, 9AT, 9AU, 9DP, 9ER, 9FG, 9FY, 9GP, 9IF, 9IR, 9IX, 9KE, 9KH, 9KU, 9KV, 9LH, (9PM), 9RK, 9SD, 9TZ, 9WA, 9ZE, 9ZJ, 9ZL.

## 9MH, MILTON, WIS.

2ZS, 3NB, 3NC, 5BT, 5DO, 8AJ, 8AL, 8AKY, 8BV, 8CB, 8CW, 8DO, 8ER, 8EW, 8GL, 8KV, 8NF, 8SP, 8XA, 8XF, 9AJ, 9AP, 9AW, 9BG, 9BR, 9CN, 9CT, 9DG, 9DT, 9DU, 9EA, 9EC, 9EK, 9ER, 9FZ, 9GC, 9GX, 9HG, 9HT, 9IR, 9IX, 9KF, 9KV, 9LC, 9LG, 9ND, 9PC, 9PI, 9RP, 9SJ, 9YA, 9ZC, 9ZJ, 9ZL, 9ZN, 9ZW

## 9ZL, MANITOWOC, WIS.

1AE, (1AW), (2BM), (2CB), 2DA, 2DO, 2GR, 2XG, 2ZM, (2ZS), 2ZV, (3NB), (5AL), 5BT, 5KK, 5ZG, 5ZL, 6GQ, (8AA), 8AL, 8AJ, 8AL, 8AW, (8AKY), 8AUX, 8BV, (8CB), (8DA), (8DV), (8EN), (8ER), (8FH), 8FP, 8FS, (8GB), 8GX, 8HA, 8IK, 8IT, 8JJ, 8PR, 8XA, 8ZB, 8XF, (9AJ), (9AU), 9AX, 9AH, (9BR), (9BT), (9CA), (9CN), (9CW), 9DP, 9DR, 9EE, 9EL, (9ER), 9FB, 9FM, (9FZ), (9GC), 9GH, (9GS), (9HA), 9HI, 9HT, 9HY, 9IN, 9IT, (9IX), 9JA, 9JQ, (9JT), 9KO, (9KV), (9LC), (9LH), (9LQ), 9LW, 9LV, (9ND), 9NQ, 9PI, 9RP, 9WG, 9WV, 9YA, (9ZC), 9ZJ, (9ZN).

## 6AE, STANFORD, CALIF.

6AY, (6BQ), (6CS), (6EA), (6EB), 6EF, 6EL, (6ER), (6FE), (6GQ), (6IQ), (6JD), (6JM), (6MG), (6TX), (6VS), 7CC, (DK), (7ZB).

## 6HG, REDLANDS, CALIF.

5ZA, 6AE, 6AG, 6AJ, 6AK, 6AL, 6AT, 6BQ, 6BR, 6CE, 6CF, 6CS, 6DK, 6EF, 6EJ, 6FB, 6FX, 6FY, 6GE, 6GH, 6GO, 6GQ, 6HS, 6JQ, 7ZB.

## 3CA, ROANOKE, VA.

1RN, 2AN, 2BM, 2DA, 2ZL (Damp and undamp), 2ZS, 2ZV, 3IF, 3NB, 3ZW, 4AE, 4AG, 4AT, 4BC, 4BQ, 5DA, 8AA, 8BE, 8CB, 8DA, 8DJ, 8DV, 8ER, 8HA, 8HD, 8HG, 8IF, 8IK, 8KP, 8LA, 8MN, 8NI, 8OM, 8ZJ, 8ZL, 9BR, 9CC, 9DJ, 9ER, 9GS, 9HN, 9KF, 9LF, 9PO, 9ZJ, 9ZL, 9ZN

## 1CK, BRAINTREE, MASS.

(1AW), (1CM), 1FQ, 1JH, 2BB, 2BK, (2BM), 2CB, 2CC, 2CS, 2CT, 2DA, 2DH, 2FE, 2GO, 2GR, 2JE, (2JU), 2LZ, 2PL, 2QF, 2SH, 2TO, 2VA, (2ZC), (2ZL), 2ZM, (2ZS), 2ZV, 3AA, 3AN, 3BE, 3BH, 3CC, 3EA, 3FP, 3GO, 3KM, 3NE, 3ZW, 4AO, 4AF, 5DA, 8AA, 8AKY, 8BP, 8BQ, 8BV, 8CB, 8DA, 8DU, 8DV, 8DY, 8EC, 8EN, 8ER, 8EV, 8FO, 8GB, 8HA, 8HG, 8HH, 8HP, 8IL, 8JJ, 8JQ, 8LA, 8NF, 8US, 8XU, 8AU, 8HW, 9LQ, 9ZL, 9ZJ, 9ZN.

## 6GQ, PHOENIX, ARIZ.

5AL, 5AS, 5BG, 5BZ, 5DO, (5ZA), 5ZN, 5ZC, 6AB, 6AC, (6AE), 6AK, 6AT, 6ER, (6BQ), 6CS, 6CP, 6CQ, (6DA), 6DS, 6EA, 6EB, (6EJ), (6EN), 6FE, 6FT, 6FU, 6GH, 6GK, 6HH, (6JD), 6JM, 6KZ, 6Q, 6RN, (6ST), (6VS), 9BT, 9CN, 9HT, 9IF, (9JE), (9WH), 9WE, 9ZN.

HEARD ON CARBORUNDUM OFF JUPITER, FLA.  
1AW, 2BB, 2CB, 2CS, 3BZ, 4BC, 4AC, 5AA, 8DE, 8ER, 8FP, 9EG, 9JT, 9AJ.

# 500 Miles on 1-4 K.W.

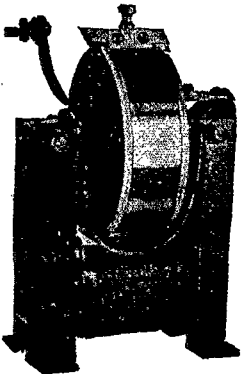

¼ K. W. Special.

Is the distance claimed by Edward B. Patterson (3BP) of 42 W. Walnut Ave., Merchantville, Camden Co., Pa. Has anyone a better record on this ¼ K.W. transformer?

Send your records to our office.

Power Factor 91%

WRITE FOR OUR NEW CATALOG "T-21"

## Thordarson Electric Manufacturing Co.

501 S. JEFFERSON STREET

CHICAGO, ILL.

# A WARNING

to Manufacturers  
Importers  
Dealers  
Jobbers

Agents  
Amateurs  
Purchasers  
Users of

## VACUUM TUBES

# The Marconi V.T. Patent is Basic

United States Letters Patent to Fleming, No. 803,684, November 7, 1905, has been held to be valid by Judge Mayer of the United States District Court for the Southern District of New York, and by the United States Circuit Court of Appeals for the Second Circuit. It is a basic patent and controls broadly all vacuum tubes used as detectors, amplifiers or oscillators in radio work.

No one is authorized to make, sell, import or use such tubes for radio purposes, other than the owners of the patent and licensees thereunder. Any others making,

selling, importing or using them alone or in combination with other devices, infringe upon the Fleming patent and are liable to a suit for injunction, damages and profits. And they will be prosecuted.

## THE AUDIOTRON AND THE LIBERTY VALVE ARE NOT LICENSED UNDER THE FLEMING PATENT

The price of the genuine Marconi V. T. delivered is \$7.00 each. The standardized socket is \$1.50 additional. The standard resistance, complete, costs \$1.00 and is made in the following sizes:  $\frac{1}{2}$  megohm, 1 megohm, 2 megohms, 4 megohms, 6 megohms.

Do not take chances by making, importing, selling, purchasing or using vacuum tubes for radio purposes not licensed under the Fleming patent. By selling, purchasing or using licensed tubes for radio purposes you secure protection under the Fleming patent and avoid the risk of litigation for infringement thereof.

This warning is given so that the trade and public may know the facts and be governed accordingly.

Send all remittances with order to **COMMERCIAL DEPARTMENT**

**RADIO CORPORATION OF AMERICA**  
**MARCONI WIRELESS TELEGRAPH CO. OF AMERICA**

227 Broadway

New York

*Sole Distributors for De Forest Radio Telephone & Telegraph Co.*

Retail Office and Exhibition Rooms, 25 Elm St., New York  
Schofield Bldg., Cleveland, Ohio  
American Bldg., Baltimore, Md.  
Insurance Exch. Bldg., San Francisco, Cal.

136 Federal St., Boston, Mass.  
301 Commercial Bank Annex, New Orleans, La.  
109 South 2nd St., Philadelphia, Pa.

# THIS QST

contains more paid radio advertising than ever appeared in a radio periodical before.

Its circulation is 10,000 copies.

It will produce more business for its advertisers than any other method of investment.

**For RESULTS**  
*Advertise in QST*

Recognized as the largest and best



Send ten cents for descriptive catalogue.  
900-902 Penn. Ave., N.W., Washington, D.C.

## ATTENTION ! Central States Amateurs

To get prompt service on the following makes of radio apparatus, order from me.—DeForest, Clapp-Eastham, Mignon, Universal, Murdock, Grebe, Amrad, Acme, Wireless Specialty, Chicago, Burgess, Modern, John Firth, Magnavox, Thordarson, Mesco, Connecticut, Wireless Improvement, etc.

Bulletins and prices on request.  
Kansas City amateurs get your apparatus from Independence Radio Laboratory, 9ZH, Indep., Mo.

**ARTHUR B. CHURCH, Wireless Specialist**

LAMONI, IOWA.

"Distributor of high grade radio equipment since 1914"

## Switch Contacts !

Com'l Type N.P. contacts.—size approx. Head  $\frac{1}{4}$ " x  $\frac{1}{8}$ ", Shank No. 6 x  $\frac{1}{4}$ " mach. screw, also one N.P. nut.

No. 5000 Contacts 35c per dozen

(Postage 1c per dozen extra)

Send five cents for sample.

Catalog ID on request

**TOLEDO RADIO SPECIALTIES COMPANY**

Box 343K Cent. P. O. Toledo, Ohio

## Tresco Tuners Deliver the Goods

### A TESTIMONIAL

Point Pleasant, N. J.

TRESCO,  
Davenport, Iowa,  
Gentlemen:—

Some time back you will remember that I bought a 20,000 meter coupler from you and now I wish to tell you of the wonderful results that I have had from it. I was very timid about buying this coupler, as I got stuck with a set of honeycombs, but now I am glad I got that coupler as I would not part with it for anything.

I could get results with it just as you show the hook-up but with a little altering I got it to working so that I have heard NPL, BZR, NAR, NFF, NDD, NSS, POZ, OUI, IDO, FL, YN, LCM, and many others that I do not call to mind just at this writing. This is no bull, either; all straight stuff. I am using one bulb—a VT, 3 variables, Baldwin phones, and your Tresco coupler.

Anybody that contemplates buying one of these couplers should not hesitate, as they are the greatest thing out, take it from me. Hoping you are selling lots of these couplers and thanking you for such a wonderful instrument, I am

Yours very truly,

R. VAN CAMP,  
Radio Station 2VC.

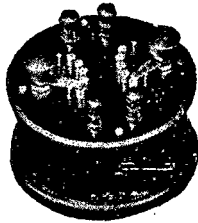

## GET OUR PRICES

Switch Points  
Rubber Knobs  
Variometers  
V.T. Tubes

Dials  
Binding Posts  
Condensers  
Sockets

B-Batteries

and Other Supplies and Instruments

**THE RADIO SPECIALTY CO.**  
OF PITTSBURGH

6243 STATION ST., PITTSBURGH, PA.

## SHORT WAVE COUPLER

—170-625 Meters—

Wound with 20/38 Litz on Bakelite Tubing, Equipped with DeForest  $1\frac{1}{2}$ " Knob, Brass Pointer and Scale. Used by U. S. Government in SCR-54 Receiver.

PRICE \$4.00 UNMOUNTED

**GOUSE & LORENSON**  
HUDSON, N. Y.

## ARNOLD Loose Couplers

Audion Detectors  
Parts and Accessories

Send 4c stamps for literature which is sure to interest you

**J. F. ARNOLD** 2082 Lexington Avenue, N.Y.  
Established 1910



## Amateurs of Minnesota and Vicinity

Will no doubt be glad to hear that they can now obtain radio apparatus at manufacturers prices in St. Paul.

We carry a COMPLETE line of DeForest Apparatus and the most used articles from these manufacturers—

Murdock  
Clapp-Eastham  
Thordarson  
Acme  
Mesco  
Audiotron Sales  
Brandes

**PIONEER ELECTRIC CO.**

St. Paul, Minn.

## VACUUM TUBE APPARATUS

Marconi VT's \$7.00 Standard Socket.....\$1.50  
Grid Leak, 2 Meg. unmounted, SPECIAL.... .45  
DeForest NEW Moulded Panel VT Socket.... 2.40  
TeCo AudioTron Adapter, just out..... 1.75  
DeForest Reversible Rheostat, 6 ohm..... 1.00  
New PARAGON Panel Rheostat, best yet... 1.75  
Burgess "B" Batts. 22V, life over 6 months.. 2.25  
Baby Burgess, 4½V. Fine for Trons..... 40  
Acme Amplifying Trans. Semi-Mounted.... 5.00  
Federal Amplifying Transformers..... 7.10  
3 inch Dial Indicator and Knob complete.... 1.30  
Telephone Jacks \$1.00, Telephone Plugs.... 1.10  
Hard Rubber Binding Posts, per dozen..... 1.75  
Mesco Radio Buzzers..... 2.05  
Bakelite Panels, 7½" Square, ¾" Thick.... 1.60

And don't forget we carry entire DeForest Line. All sizes HONEYCOMB COILS. Vernier Condensers. Unit Panels, Materials and Parts.

Six types Burgess "B" Batteries. Brandes, Baldwin, Liberty and Holtzer-Cabot Headsets. Apparatus in stock—we ship same day your order is received. Give us a trial!! Catalogs and Bulletins free upon request.

**Chicago Radio Apparatus Co.**

3400 S. Michigan Ave.,

Chicago, Ill.

## "P.W." HAS THE LATEST RADIO APPARATUS IN PHILA.

We have the "Radisco" agency for Philadelphia and vicinity; also distributors for

Clapp-Eastham, Murdock, DeForest, Acme Apparatus, International Radio, Kilbourne and Clark, Benwood Rotary Quenched, Perfection Variables and Tuners, Universal Wound Inductances, and Better "B" Batteries.

Est. 1911. Radio Call "3PW"

## PHILA. SCHOOL OF WIRELESS TELEGRAPHY

Parkway Bldg., Broad Street near Arch



SOMETHING NEW  
310 OHM RESISTANCES  
IN THE SPACE OF ONE

TRIPLE RHEOSTAT CONTROL 3 AUDIONS FROM ONE BASE GENUINE BAKELITE POSTPAID	180° CONDENSER SCALE ON 4" CIRCLE PRINTED FROM COPPER PLATE ON BRISTOL BOARD POSTPAID
\$2.50	.25¢

SEND FOR CIRCULARS  
**WORCESTER RADIO LABORATORIES**  
16 WAYNE ST., WORCESTER, MASS.

## YOU

didn't see our Ad in the last issue of QST, because we were too busy taking care of our regular customers needs, to get the copy ready, but our new and larger office, with additional help and improved facilities will enable us to handle twice as many accounts as previously, so that all can now

## BUY

ANY piece of ANY make of apparatus, parts or supplies ON THE

## INSTALLMENT PLAN

**J. DONALD VANDERCOOK**

137 SO. YORK ST

ELMHURST,

ILLINOIS

## "Radio Apparatus of Quality"

We wish to announce, that our new Catalog, illustrating and describing, the Up-to-date Amateur Radio Equipment, will be ready for distribution in the near future.

Reserve YOUR Copy—Send Ten Cents, which will be refunded on First Order.

**PITTSBURGH RADIO SUPPLY COMPANY**

SIXTEEN EUREKA STREET

PITTSBURGH, PA.



## PATENT-SENSE

*"The Book for Inventors & Mfrs."*

By Return Mail FREE. Write  
LACEY & LACEY, Dept. Washington, D.C.

## NEW ORLEANS

WIRELESS SUPPLIES AND  
MINERALS OF ALL DESCRIPTIONS

L. A. ROSE

121 CAMP STREET

NEW ORLEANS, LA.

SEND 6 CENTS FOR CATALOG



# Hook 'er to yer bulb

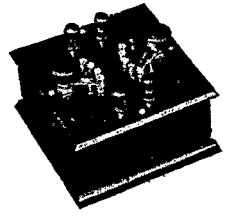

Over two hundred cities took advantage of our wonderful offer of last month for one of our tuners to each city for \$8.00.

## OFFER STILL OPEN THIS MONTH.

First tuner costs only \$8.00, second sold in your city costs \$10.00, third \$12.50, and the balance \$15.00, our regular selling price. We have a dealer in every city and Canadian Amateurs will please buy from their local dealers. Write us for nearest dealer to you.

Be a sport and send five cents for our latest catalog, brimfull of wireless dope.

## KNOCKED DOWN CONDENSERS.

43-21-11 plate. Assemble and save money.

\$2.75, \$2.25, \$1.75 respectively. Add Parcel post to all our prices. Or we ship by express. No C. O. D. orders. Fine deliveries.

## KNOCKED DOWN TRON OR V.T. PANELS

Assemble and save money.

Formica panel drilled. One 11 plate KD condenser, one panel rheostat, switches, points, binding posts, all parts fully nickeled. A wonderful looking instrument.

One to each city at \$8.00.

Regular selling price, \$10.00.

We do not sell bulbs of any kind.

VT sockets for above, extra.

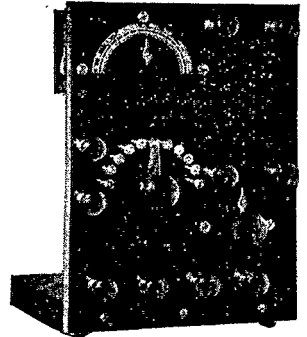

ALL PRODUCTS LICENSED BY RADIO CORP. OF AMERICA.

for sale by your dealer or

# TRESCO, Davenport, Iowa

OR THEIR DEALERS.

## Special!

—While it lasts—

We have 2500 feet of the following high tension cable which we will sell at 5c per foot, \$3.00 per C.

Just the thing for underground aerials, aerial and ground leads, transmitter connections, etc. Conductor—37 Strands No. 30 Tinned. Insulation—3 1/16" Layers, White and Black Rubber.

Braids—Two-Saturated Cotton, 7/16" Diameter.

SEND FOR SAMPLE.

PIONEER ELECTRIC CO.

137 E. 5th Street,

St. Paul Minn.

## "JUPITER" STRANDED AERIAL WIRE

nothing better made

Seven strands No. 22 solid copper. Very strong and 100% radiation. Large surface, low resistance. Price to be advanced, soon.

1 Cent per foot \$9.00 per thousand

Shipping weight, 15 lbs. per 1000 ft. Send postage. No C. O. D's.

LEE A. BATES, Sole Agt.

8 Moen St., Worcester, Mass.

# Another



# Achievement

## The Grebe Special Type CR-3 Relay Receiver

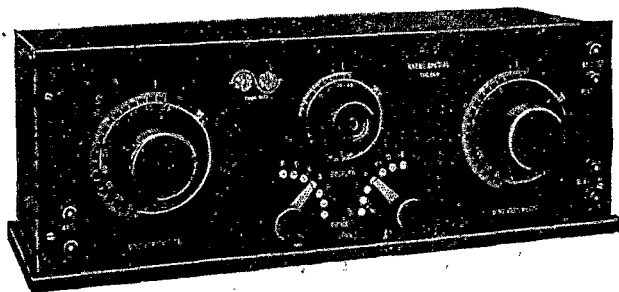

Unparalleled performance on Relay wavelengths.

Constructed according to the highest engineering and manufacturing standards.

This Instrument was fully described in Q S T for March, 1920 and may be found on display by the following concerns:

Doubleday-Hill Electric Co., Pittsburgh, Pa.

Holt Electric Utilities Co., Jacksonville, Fla.

Manhattan Electrical Supply Co., New York, Chicago, St. Louis

Pacent Electric Co., Inc., New York City

Geo. W. Parezo & Co., Washington, D.C.

F. D. Pitts Co., Inc. Boston, Mass.

---

## A. H. GREBE & CO., Inc.

74 Van Wyck Blvd.,

Richmond Hill, N. Y.

## WANTED

Copies of QST for AUGUST, 1919.  
An extension of subscription for three months, or fifteen cents in cash, for each copy returned in good condition to QST, Hartford, Conn.

## CLASSIFIED ADVERTISEMENTS

Five cents per word per insertion, in advance. Name and address must be counted. Copy must be received by the 10th of month for succeeding month's issue.

**AMATEURS:** Add refinement to your home-made apparatus. Gold lacquer for brass parts, 80 cents a bottle; also white cement for engraved panels, 30 cents a box. Radio Equipment Co., 1525 N. Fawn St., Philadelphia.

**FOR SALE:** Navy Type Receiving Transformer 200 to 4000 meters; 2 Condensers; 3 Inductances; practically new; all for \$35.00. Brandes Navy Telephones \$10.00; 2 Murdock Oscillation Transformers, new, \$8.50; 1 Pancake Helix \$1.50; 1 Panel Mounting Rheostat \$1.50; 1 VT Receptacle \$1.25; 1 Wireless Key \$1.50; 1 Murdock Telephone with plug \$4.50; Grebe Receiver Type CR-4; Detector Unit; Two Stage Amplifier. Thordarson complete transmitting set, one kilowatt, unused. All new except first three articles. M. Guyton, Cotton Plant, Miss.

**WANTED**—1 KW United Wireless transformer. Hyle, 1474 Main Street, Buffalo, N. Y.

**FOR SALE:** Arnold navy coupler, new, \$14., DeForest Audion Cabinet R. J. 4., with new "B" batteries and double filament Audiotron, \$14., Baldwin receivers (cost \$17.50) for \$12.00. E. G. Baier 253 9th St., Brooklyn, N. Y.

**FOR SALE**—One nearly new Grebe regenerative receiving set type CR-6 complete and perfect condition. Cost \$180.00 will sell for \$150.00. All letters answered. Floyd L. Vanderpoel, Litchfield, Conn.

**SELL:** 1-KW Thordarson, \$15.00; rotary gap motor, 110 V. 60 cycles, 8000 rpm, \$8.00. All letters answered. Clyde Renfroe, 203 Valley St., Valdosta, Ga.

**FOR SALE:** Type T2 1-KW 60 cycle Thordarson Transformer, \$12.00. Arthur J. Macer, Westfield, New York.

**KODAK FINISHING:** Any 6 exposure roll developed and finished, 20c. Frain, Eureka, Ill.

**FOR SALE**—P. P. \$45.00 Lionel Electric Train, \$20.00; Murdock 43 Plate-Variable Condenser, New, \$4.00; 3000 Meter Chambers Loose Coupler (Never used) \$8.50. John Tinscher, Jr., Danville, Illinois.

**TUNING**—First District Amateurs Attention—Your transmitter tuned to conform to the law and also to give best possible results, together with advice based on engineering experience, \$3.00 (plus fare outside Metropolitan Boston)... G. R. Entwistle, 18 Boylston St., Boston, 11, Mass. Phone Beach 7168.

**REAL AUDION CONTROL CABINETS.** Bakelite panel forms face for cabinet finished in black. Concealed Rheostat—switch controlled battery. Metal parts nicked. Nine left from specially constructed lot. These at nine dollars complete. Write for photo and description. Box 17, QST.

**BARGAIN:** Amateurs attention Grebe CR4 regenerative for only \$50. Wireless Specialty Triode two stage amplifier only \$50. These are new instruments, not a mark of any kind on them. They were turned in to us for credit so we can dispose of them cheap. TeCo Radio Co., P. O. Box 3362, Boston, Mass.

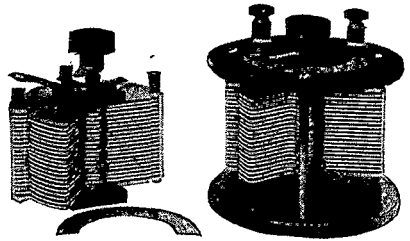

## THE "ILLINOIS" VARIABLE CONDENSER

**Hard Rolled Aluminum Plates**  
Three Styles, No. 1. Panel, No. 2. Open Type as shown, No. 3. Fully Encased, Anti Profiteer. Less than pre-war prices. Fully assembled and tested.

Sent Prepaid on Receipt of Price.

Style	No. 1	No. 2	No. 3	Money back if not	
43	Plates,	\$3.00	\$4.00	\$4.25	satisfied. Just return
23	"	2.50	3.50	3.75	condenser within 10
13	"	2.25	3.25	3.50	days by insured P. P.
In Canada 25c additional.					

These condensers are made by a watch mechanic schooled in accurate workmanship. Personally we will need no introduction to Amateurs who have "listened in" for "time" and "weather" from 9ZS.

### Postscript.

The above "Ad" certainly put "ILLINOIS" "on the map" in the Condenser industry. Not only on the map, but scattered it all over the map, from Alaska to the Gulf, and from the Penobscot to the Golden Gate. The "money back" proposition seems to have been superfluous. Instead of having any instruments returned for credit, they ask for more. And, most satisfactory of all to us, our customers write to express their appreciation. All these, we take this occasion to thank heartily.

You will notice a slight increase in our price list, on the "mounted" styles only. This will be effective from May first. The fact is we could not quite "get by" with our first prices.

The "Star Spring" feature of our design meets with great favor. We shall make this the subject of application for Patent as we think it marks a step forward in the construction of Variables. It has two important functions. It keeps the plates accurately and permanently centered; without "end-shake"; and provides sufficient friction to hold the "rotor" at any setting without liability of its dropping from its position by the unbalanced weight. It makes the Condenser in this respect as reliable as the much more expensive "balanced" type.

Kindly note: We issue no Catalog, and make no "trade discounts". We set our prices at the lowest limit, and leave the "middle man" out for the sole benefit of the "consumer".

**G. F. JOHNSON, 625 Black Ave., Springfield, Ill.**

**WANT:** 1 KW Thordarson "R", 110 volts 60 cycles, reasonable figure. Walter Leahy, Bogalusa, La.

Just out—**LATTICE COILS**—Misnamed Honeycomb. 100-500 meter, \$0.50; 500-1000 meter, \$0.75; 1000-2000 meter, \$1.00; 2000-5000 meter, \$1.25; 5000-10,000 meter, \$1.50; 10,000-20,000 meter, \$2.00. Lambert and Associates, 102 N. Wells St., Chicago, Ill.

# RADIOIST

YOUR OWN RADIO MAGAZINE

## SEND 50 CENTS

at once for special  
**Three Months' Subscription**  
Yearly subscription  
\$2.00 or 20c a copy at  
newstands.

Internat'l Society of Radioists  
Executive Headquarters. OMAHA, U.S.A.

# IT'S RESULTS THAT COUNT

Acme owners get the results. This is shown in the following extracts from correspondence from Mr. W. E. Woods, Station 9LC, St. Louis, Mo.

"Have put your  $\frac{1}{2}$  K.W. transformer in direct comparison with a 1 K.W. \_\_\_\_\_ in a test lasting a week. The results were marvelous, to say the least.

"With the little Acme I have worked both borders, Canada and Mexico, and also New Orleans, Yonkers (N. Y.), and Princeton University. I have worked all but four stations that can be heard in St. Louis, operating in direct opposition with five 1 K.W. \_\_\_\_\_ stations—we all call "CQ" together and let the best man win.

"The little Acme certainly deserves great credit."

St. Joseph, Mo.

Dear 9LC—

Just a line to let you know that your sigs are the best here from any station in St. Louis, especially thru QRM and QRN. Get you loud and sharp. Would appreciate a detailed description of your set. How do you get me there?

Yours,

9EX

Pretty good results for a half kilowatt. 1AW, who can be heard over the greater part of the east, has been using a 1 K.W. Acme. If you want long distance, high efficiency and little trouble,

## GET AN ACME !

The following are among the dealers carrying them in stock.

### BOSTON

Atlantic Radio Co.  
A. P. Merchant Co.  
F. D. Pitts Co.

### NEW YORK

Manhattan Elec. Supply  
Co., branches in St. Louis  
and Chicago.

### LOS ANGELES, CAL.

Arno A. Kluge  
The Wireless Shop

### SAN FRANCISCO, CAL.

Leo J. Meyberg Co.

### CANTON, OHIO.

Wireless Mfg. Co.

### PITTSBURGH, PA.

Doubleday-Hill Elec. Co.  
Radio Electric Co.

### ST. PAUL, MINN.

Pioneer Electric Co.

### PHILADELPHIA, PA.

Radio Sales & Mfg. Co.  
Quaker Light Supply Co.

### CINCINNATI, OHIO.

Precision Equipment Co.

### NEW CASTLE, PA.

Penn. Wireless Mfg. Co. Phil. School of Wireless

## ACME APPARATUS CO.

26 Windsor Street

Cambridge, 39, Mass.

# A Good Wavemeter AT A MODERATE PRICE

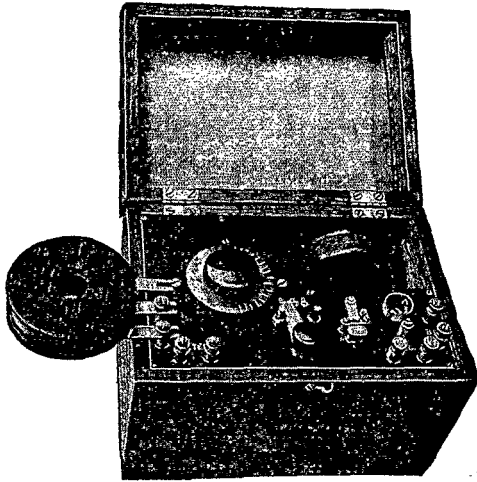

is accurate simple and rugged. Comprises a portable oak case  $5\frac{3}{4}'' \times 8\frac{1}{4}'' \times 6\frac{1}{2}''$  with hinged cover, bakelite panel, balanced condenser, buzzer, detector, switch, binding posts, and two 2 unit inductance windings, range 200 to 2000 meters.

Price \$27.50

These meters are in stock for immediate delivery and are carried in stock by most good dealers.

## TYPE B. Q. WAVEMETER

Bulletins Z and F sent for 4c Stamps list our complete line of high grade, moderately priced apparatus for the radio laboratory. Bulletin R lists the Cambridge Rectifier for Storage Battery Charging.

**CLAPP-EASTHAM CO., 114 Main St., Cambridge, Mass.**

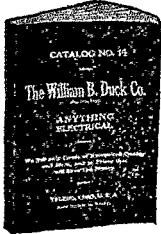

## DUCK'S New Big 200 PP. Wireless and 100 PP. Electrical Catalog

Our 200 page exclusive wireless catalog mailed for 12c and our electrical catalog mailed for 6c, in stamps or coin. The largest, most elaborate and most complete radio catalog published.

Everything in wireless worth while is listed in this catalog. The experienced amateur will tell you to see our catalog before buying. You are thereby insured against an unwise purchase. It is the Beacon Light to guide you right in the selection of your wireless apparatus. No bigger or better values are obtainable elsewhere.

**THE WILLIAM B. DUCK CO. 243-245 Superior St., Toledo, Ohio**

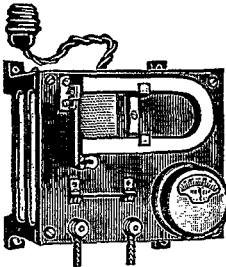

**BENWOOD DISCS** can now be supplied separate from the complete Gap as shown with 8, 10 or 14 points - - \$7.50  
(State size of motor shaft)

**BENWOOD RECTIFIERS** keep your A battery ready for use. Puts your station in the ultra modern class.

As shown - - - \$20.00

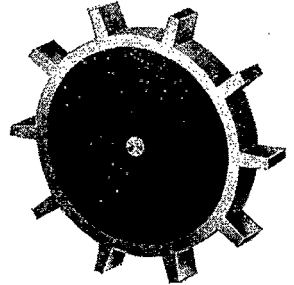

**BENWOOD SPECIALTY CO., 3424 Olive Street, St. Louis, Mo.**

# A POST-WAR OPPORTUNITY

## THIS STANDARD WAVE METER

*No other instrument anywhere near its price has the same high standard of Design---Workmanship---Material*

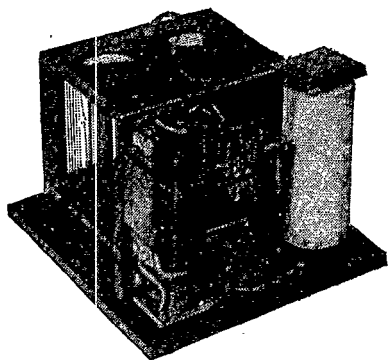

Size  
5" x 5 1/2"  
Height 4 1/2"

Weight  
2 1/4 lbs.

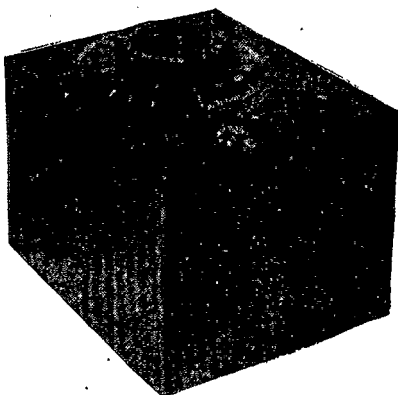

*This instrument was originally designed and manufactured to meet the exacting requirements of military use. Owing to the closing of the war a limited number is available, for amateurs, AT A PRICE BELOW THE ORIGINAL COST OF CONSTRUCTION*

Each is complete for measuring the wave length of transmitter and receiver—a real standard, guaranteed to be accurately calibrated and to hold its calibration.

**No internal sliding contacts.** Bakelite construction thruout in substantial wood case.

A self contained buzzer, battery, and current indicating lamp, which can be readily removed for replacement. The ordinary use of a lamp as a current indicating device for showing when the Wave Meter is in tune with a transmitter requires considerable power and a very close coupling to make the lamp burn

bright enough to be visible. This instrument includes a special arrangement whereby the voltage of the battery is applied to the lamp through a choke coil, and a variable rheostat that can be adjusted so that the lamp is ALMOST lighted by the battery. Then the slightest additional impulse from the coils makes the lamp burn brightly, and the sensitiveness of the instrument is therefore enormously increased.

There is no other instrument any where near this size containing all these features.

Price each, F. O. B. Washington **\$15**

*We fully guarantee every instrument, and that each cannot be duplicated except at a much higher price today. Other ranges than 150 to 300 meters furnished at slightly additional price.*

## National Electrical Supply Co.

1328-30 N. Y. Ave., N. W. WASHINGTON, D. C.

# MODERN

RADIO EQUIPMENT COMPANY  
TRADE MARK

ONE  
STEP

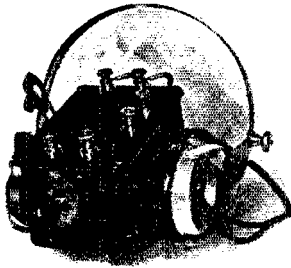

AMPLIFIER

## Amplifier

(Improved Multi-Audi-Fone)

# \$18.00

### TWO-STEP AMPLIFIER

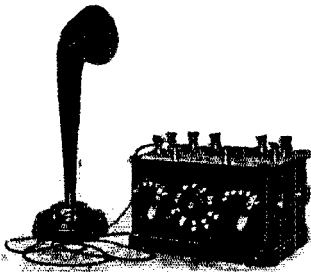

Two-Step Amplifier and Horn.

# \$75.00

Loud Speaking Horn

# \$12.50

The genuine and original instruments that really work cost less than worthless imitations. Insist on a guaranteed instrument. Note that our instruments are of moulded bakelite. "Modern" amplifiers amplify ALL signals with ANY detector and operate on ONE DRY CELL. Further information for stamp.

**Modern Radio Equipment Co.**

27 So. Broad St., Elizabeth, N. J.

# ACE

*What  
are the  
Wild  
Waves  
Saying?*

You can find out with "Ace" equipment.

We can furnish parts for audion control panels and amplifiers. The panels are 3/16" formica, grained finish, lettering in white. Control panel includes socket, grid leak, grid condenser, rheostat, binding posts and formica panel. Amplifiers include the above and transformer, etc. all ready to wire.

Audion Control Panel.....\$ 7.50  
One Step Amplifier..... 10.00  
Audion Control Panel and one step  
amplifier on large panel..... 17.50  
Two Step Amplifier on  
large panel..... 20.00

You may pay more, but you can't buy better.

**The Precision Equipment Co., Inc.**

Manufacturing Engineers.

2437 Gilbert Ave., Dept. D, Cincinnati, Ohio.

## YOUR GOOD MONEY SAVED !!

### \$10 Postpaid

Our price lists save for you—  
stamp proves it NOW

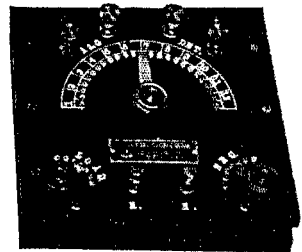

**MIGNON RECEIVING CABINET**

SPECIAL DESIGN—For amateurs, commercial and ships. Laced coil construction, Guaranteed.

DEPT. B-4

THE RADIO APPARATUS  
**SERVICE**  
UNION SAVINGS BANK BLDG., WASHINGTON, D.C.  
A SUPPLY COMPANY FOR THE RADIO AMATEUR



# TUSKA TICKLER

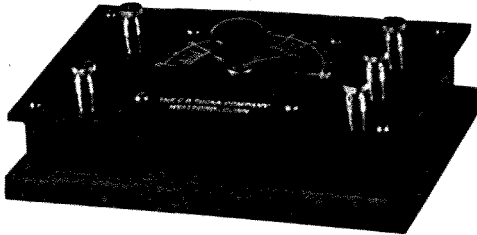

**Type 160**

That's all—not a wire in either tuner or audion has to be changed. Gives wonderful regenerative amplification of damped signals. Can also be used as an oscillator for the undamped.

Good looking—efficient, and a real performer. In two styles, panel or flat as illustrated. Post-paid for **\$10.00**. Order now and make a real set of your old tuner and audion.

A new device to make regenerative receiver out of your loose coupler. Any ordinary receiver with any type of audion can be made the equal of any regenerative set you ever saw, by the use of **THE TUSKA TICKLER**.



**Type 161**

Send six cents for catalogue R.

## The C. D. Tuska Co., Hartford, Conn.

CUT OFF HERE

Date.....

The C. D. Tuska Company,  
Hartford, Conn.

Please ship me at once one Tuska Tickler, Type 161, panel.  
Type 160, flat.

I enclose..... for \$10.00 to cover.

Name.....

Street.....

City and State.....

# Get That Clean-Cut Musical Note !

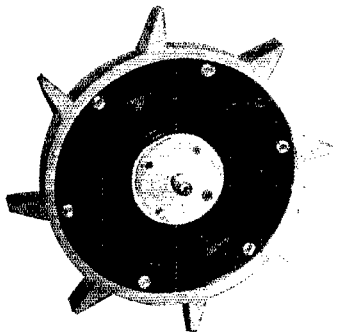

Our Hy-Rad rotary gap will give it to you. Used by 9ZN, 5ZX, 5BT, 9EE, 9ZQ, 8IK, 9HW, 9AD, 9ZL and many other prominent long distance stations.

Immediate shipment can be made of discs to fit 1/4", 5/16", and 3/8" shafts. Other sizes furnished at no increase in price, but with ten days shipping delay.

Discs are 9" in diameter, and 1" thick, of special long-wearing aluminum alloy, with Bakelite center. Teeth are our famous "saw-wheel" type, giving excellent mechanical quenching as well as constructional strength.

Every disc carefully balanced on knife edges before shipment, thus eliminating all rattling and vibration.

Hy-Rad disc, 8 point, as illustrated . . . . \$10.50

## CHICAGO RADIO LABORATORY

1316 CARMEN AVENUE  
5525 SHERIDAN ROAD

CHICAGO,

ILLINOIS

## New England Amateurs Attention !

You will be interested to know the latest figures show that ONE QUARTER OF THE TOTAL SHIP TONNAGE OF THE WORLD IS NOW UNDER THE AMERICAN FLAG. This means a GREATER DEMAND for LICENSED RADIO OPERATORS, who are paid \$100 to \$150 per month and board. Course under former U. S. GOVERNMENT RADIO INSPECTOR for NEW ENGLAND assures you of results that cannot be duplicated anywhere in New England. DAILY OMNIGRAPH PRACTICE, TWO SEPARATE LECTURES EACH SESSION, ELEMENTARY and ADVANCED. WE HAVE a place or YOU here regardless of YOUR present KNOWLEDGE of WIRELESS. WRITE for literature or CALL and let us show you the BEST EQUIPPED RADIO SCHOOL IN NEW ENGLAND.

### MASSACHUSETTS RADIO & TELEGRAPH SCHOOL.

18 Boylston Street,  
ARTHUR BATCHELLER

Telephone Beach 7168,  
(Lt.) R. F. TROP

Boston, 11, Mass.  
G. R. ENTWISTLE

## Western Electric Receivers

These are the same type as supplied to the United States Signal Corps and Navy Department. In Army circles they were known as the P-11. The Navy knew them as the CW-834.

They are without exception the best receivers on the market today. Price is \$13.00 per pair.

We carry one of the most complete stocks of high grade radio instruments in America. Send 10c for our new catalog.

"We make or sell Everything Radio"

## The Radio Electric Company

4614S Henry St.,

Pittsburgh, Penna.

DE FOREST

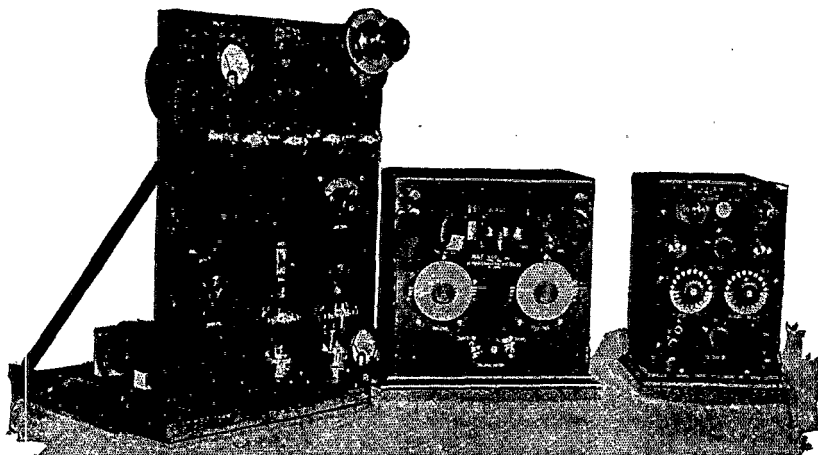

## A Wireless Telephone Now Possible For Every Radio Amateur !

Transmit your messages in words instead of dots and dashes! Install a DeForest Oscillion Radiophone Transmitter as part of your set and you can do it. Nothing complicated or impractical. The type "O" Transmitter shown above plugs into lamp socket. Just plug in, connect antennae and ground, push a button and talk! Voice quality superior to that over a wire; clear, distinct and continuous. Once adjusted it requires no further attention. No special apparatus needed to receive Radiophone messages over limited distances. Same Transmitter equally effective for both telephone and telegraph. Throw a switch and telegraph; throw it back and talk! Not an experiment or an impractical instrument. Absolutely perfect in performance and guaranteed to operate as claimed when instructions are followed.

Add the DeForest Oscillion Radiophone Transmitter to your set and you can send messages by telegraph or telephone. Its cost is not prohibitive and it is the coming development in Radio Service. Find out all about it—

### SEND FOR THE DE FOREST CATALOGUE

A 56-page book full of vital Radio information for the Amateur; including wiring diagrams and other data. Sent postpaid for 10 cents in stamps. Send for yours today.

## DeForest Radio Telephone and Telegraph Co.

*Inventors and Manufacturers of High Grade Radio Apparatus*

1407 Sedgwick Avenue

New York City

DE FOREST

# ANNOUNCEMENT

## Our New Catalog "J"

READY FOR DISTRIBUTION APRIL FIRST

Contains 24 pages of instruments, raw materials and parts you can't afford to miss. A complete line of high grade, moderate priced apparatus including switch points, knobs, switches, meters, plain and threaded brass rod, copper strip, binding posts, screws, nuts, washers, etc.

Send 5c in stamps for your copy today.

### Shotton Radio Manufacturing Company

P. O. Box 3, SCRANTON, PA.

## BURGESS "B" BATTERIES

SEVERAL  
SIZES  
FOR  
SPECIAL  
WORK



SEND FOR CATALOGUE  
**BURGESS BATTERY  
COMPANY**

HARRIS TRUST BLDG. - CHICAGO, ILL.

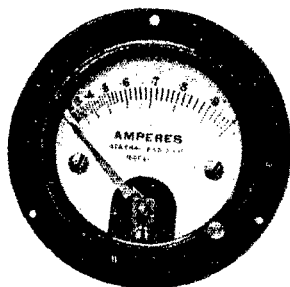

### Unusual Opportunity

to secure a

### General Radio Co. Type 127A HOT WIRE AMMETER

Special Price \$5.00—Regularly \$10.00

A portion of these meters are 0-1 ampere and a portion 0-2.5 amperes. They are mounted in flush cases, new, in good condition, and were left on our hands by termination of the war. Exactly like a large number supplied by us to the U. S. Government.

Dealers send for proposition.

Have you received our new Bulletin 9017

### General Radio Co.

WINDSOR STREET

Cambridge 39 Massachusetts

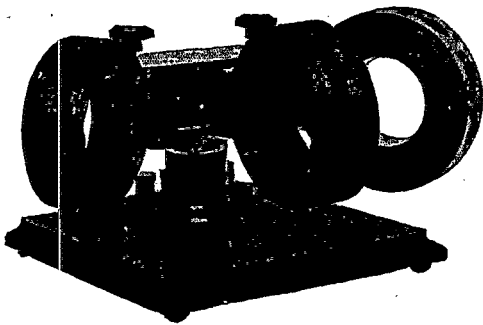

*Starting with a big  
idea, we are growing  
all the time*

---

*Washington Distributors of  
DeForest Apparatus*

---

Realizing the great and growing need of a single supply house that could furnish instantaneously all radio apparatus, the National Radio Supply Company comes to you with a message that will appeal to all that have a want in radio apparatus to supply. On April 15, 1919 our concern represented and was authorized sales agency for 40 different concerns. Today 91 of America's foremost wireless firms have placed their apparatus and sales agency with us. Think of the convenience this means to you. You get just what you want in the radio line just when you want it.

Ten cents in stamps will bring you our 74 page catalog No. 2 which shows more approved, dependable radio apparatus than any other similar book ever published by any concern outside of the National Radio Supply Company. To those who already have this wonderful catalog, the new price bulletin issued monthly will be forwarded upon request for same. Our supply of the above becomes obsolete after April 15th as this issue will be entirely exhausted.

Special notice to amateurs, radio concerns and schools: Our new catalog will be ready for distribution May 1, 1920, consisting of 125 pages of the most interesting display of radio apparatus ever published in any catalog. In addition to the display of radio apparatus, this catalog will contain 75 hook-ups, one page showing radio symbols used extensively by radio manufacturers. Prompt shipments will be made on any of the apparatus listed in this catalog; and while it is impossible to list every piece of apparatus that we handle, a postal card will bring prices on any other apparatus not listed in our catalog.

Fifteen cents in stamps will bring this catalog to your door. The hook-ups alone will be worth many times the price.

Let our radio expert answer your questions without charge. Advice given to those who contemplate putting in a wireless set; stamped, addressed envelope must be included with your inquiry.

**NATIONAL RADIO SUPPLY CO.** "The Nations' Clearing House"

**Dept. 124, 808 9th St., N. W. Washington, D. C.**

Our storeroom displays several thousand dollars in radio apparatus. When in Washington, we cordially invite you to visit our store and look over our line.

Direct outlet for the South.

References: Second National Bank, Washington, D. C.

Members of Merchants & Manufacturers Credit Association,  
Washington, D. C.

# We're Prompt !



You don't have to wait from three weeks to three months, for the apparatus you order. On everything except apparatus specially constructed to order, you'll have the benefit of

## Shipment Guaranteed Within Twenty-Four Hours

### Audions and Amplifiers

Audion Control . . . . .	\$20
Without bulb or B batteries	
1 Step Amplifier	
Without Detector . . . . .	\$25
With Detector . . . . .	\$30
2 Step Amplifier	
Without Detector . . . . .	\$35
With Detector . . . . .	\$40

The above Cabinets are built for either tubular bulb or "VT" mounting or both.

### 54 Volt "B" Battery

With a positive guarantee for six months' service, shipped in 24 hours on receipt of

**\$4.00**

If you want a bright, snappy, monthly bulletin that means something; send us 6c. in stamps.

### "Reco" Transformers

We have just produced them—they're ready for IMMEDIATE delivery—and they're wonders!

1-4 K.W. . . . .	\$14
1-2 K.W. . . . .	\$20
1 K.W. . . . .	\$30

Get one of these, and put your Station "on the map!"

Any apparatus made "your way" from your own design, and all parts furnished for Variometers and short-wave regenerative receivers.

Relay through 3-AN if you want to order by wireless

**The Radio Engineering Co.**  
Baltimore, Md.

614  
North Calvert  
Street

## Oscillation Transformers

TELEFUNKEN PANCAKE TYPE

Double "A" Quality.

Bulletin C-105 on Request.

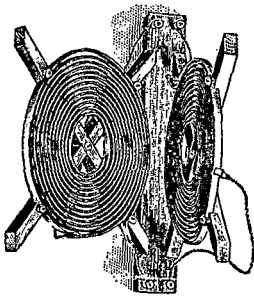

## Radio Equipment Company

1525 N. Fawn Street, PHILADELPHIA, PA.

## At Last ! Standard A. R. R. L. Letter Heads

In response to countless requests the Secretary has made the regular A.R.R.L. letter head available for general correspondence. Neatly printed in two colors on good quality paper. Arranged so that you can have your own name and station address printed or stamped in the center space with excellent appearance, if you desire. Delivered postpaid anywhere at the following prices:

100	-	-	-	\$0.75
250	-	-	-	1.70
500	-	-	-	3.25
1000	-	-	-	6.00

A convenience, not a money-making scheme; cost plus handling expense. Use this paper for your amateur correspondence and let the world know you belong to the A. R. R. L. Immediate shipment. No envelopes.

AMERICAN RADIO RELAY LEAGUE,

HARTFORD, CONN.

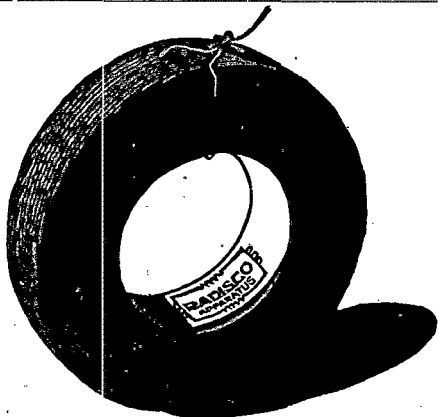

# Two Famous Radisco Specialties

## RADISCO COILS

conceded by several well known Radio Men to be far superior to any similar type of Inductances: Made in seventeen sizes, tapped and plain, Wave length range from 200 to 20,000 meters. Priced from 60c to \$4.85. Plentiful supply in stock at all Radisco Agencies.

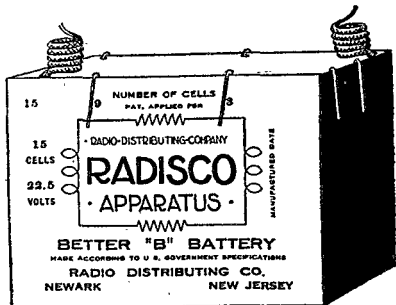

## RADISCO BETTER "B" BATTERY

is made according to Government specifications in two (2) sizes;  $3\frac{1}{4} \times 2 \times 2\frac{1}{2}$ " and  $6\frac{1}{2} \times 4 \times 3$ ". A first class 15 cell, 5 group battery. VARIABLE VOLTAGE (Pat. App. For) is a special feature of this battery which enables you to provide critical voltage regulation for your Vacuum tube by means of a switch connection with cells, taps of which have been taken off. Very economical and convenient. If one cell goes bad just test each group of 3 cells and short circuit the bad one. Price Small size \$1.40. Large size \$2.40 at any agency—or if ordered by mail include postage for 2 pounds on small size and 5 pounds on large size. RADISCO AGENTS carry only apparatus of proven merit. Look for the Radisco trade mark on all parts you buy and be sure of getting efficient apparatus. Below are listed a few of the reliable firms who carry the RADISCO COILS, Better "B" Batteries, and are our Agents for all other standard apparatus of merit.

*Communicate your wants to them*

ALBANY, N. Y.

E. L. Long,  
21 Magnolia Terrace

ATLANTIC CITY, N. J.

Independent Radio Supply Co.,  
118 So. N. J. Ave.

BALTIMORE, MD.

Radio Engineering Co.,  
827 Madison Ave.

BIENVILLE, QUEBEC, CANADA,

Canadian Radio Mfg. Co.

BOSTON, MASS.

Atlantic Radio Co.,  
34 Batterymarch St.

BROOKLYN, N. Y.

Kelly & Phillips Electric Co.,  
312 Flatbush Ave.

BRONX, NEW YORK CITY,

Amateur Wireless Equipment Co.,  
1390 Prospect Ave.

CHICAGO, ILL.

Chicago Radio Laboratories,  
1316 Carmen Ave.

EUREKA, PEORIA, ILLINOIS

Klaus Radio Co.

HAMPTON, N. H.

De Lancey Felch & Co.

LOS ANGELES, CALIF.,

The Wireless Shop,  
511 W. Washington St.

McKEESPORT, PA.

K & L Electric Co.,  
427 Olive St.

NEWARK, N. J.

A. H. Corwin & Co.,  
4 West Park St.

NEW CASTLE, PA.

Pennsylvania Wireless Mfg. Co.,  
507 Florence Ave.  
"8HA"

NEW ORLEANS, LA.

L. A. Rose,  
4323 Magnolia St.

PITTSBURGH, PA.

Radio Electric Co.,  
4521 Forbes St.

PHILADELPHIA, PA.,

Phila. School of Wireless Tel.  
Broad & Cherry Sts.

PROVIDENCE, R. I.

Rhode Island Elec. Equip. Co.,  
45 Washington St.

SPRINGFIELD, MASS.,

Electric Service Co.,  
585 Amory St.

SCRANTON, PA.

Shotton Radio Mfg. Co.  
P. O. Box 3,  
Branch at 8 Kingsbury St.,  
Jamestown, N. Y.

TORONTO, ONTARIO, CANADA,

The Vimy Supply Co.,  
585 College St.

WASHINGTON, D. C.

National Radio Supply Co.,  
1405 U St., N. W.

WICHITA, KANSAS,

The Cosradio Co.,  
1725 Fairmount Ave.

*If none of the above agencies are in your vicinity, communicate with*  
**RADIO DISTRIBUTING COMPANY,**

**Newark, N. J.**

# SH-H-H LISTEN !

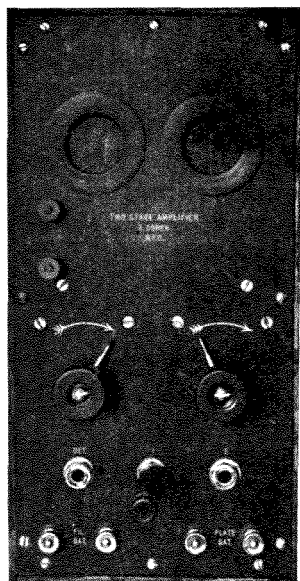

Canadian Stations are heard all over the room and you can hear all the stations now with the "Saco" Two Stage Audio Frequency Amplifier.

Guaranteed not to howl, squeal, or fry, or money refunded. Telegraph and telephone signals are amplified with maximum intensity.

Telephone plug and jack system is used. With a plug in the first jack, you can receive signals with your own detector; in the second jack one stage of amplification is added and the output is transferred to the telephones; and in the third jack two stages of amplification are added and the output is transferred to the telephones.

Modern radio engineering practice is used in the design and construction of all of our radio apparatus. We have a few new pieces of advanced amateur apparatus which are in great need by the amateur. Write and we will mail our new descriptive matter.

**"Saco" Type A-2 Two-Stage Audio Frequency Amplifier - - - \$50.00**

Exclusive Distributors of S. COHEN Products in U. S. and Canada.

**Hudson Radio Co.,**

**182 Pulaski St., Brooklyn, N.Y.**

## PARKIN RHEOSTAT now \$1.00

Why Pay More?

When this is the easiest mounted, smoothest running, best on the market.

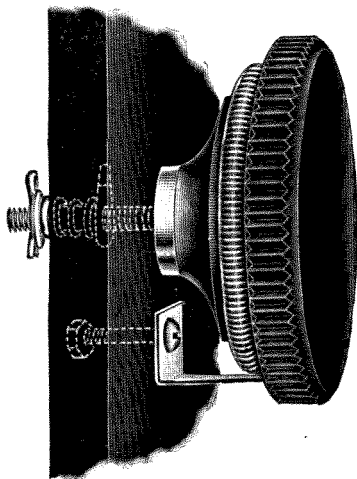

(Actual Size)

No. 35 PARKIN PANEL TYPE RHEOSTAT (Pat. pending) has easily renewed resistance unit mounted on back of MOULDED BAKELITE KNOB. Shaft is moulded into knob, cannot come loose. "OFF" position provided. 360 degree rotation insures fine adjustment.

Write for descriptive circular of audion panels, switches, binding posts, contacts, etc.

Dealers: Write for proposition.

**PARKIN MFG. CO., San Rafael, Calif.**

## Radio Amateurs

We carry in stock a complete line of the following Manufacturers:

**J. H. Bunnell & Co.**

**Acme Apparatus Co.**

**Wm. J. Murdock Co.**

**Tremaine Mfg. Co.**

**DeForest**

ADDRESS ALL MAIL

ATTENTION OF

**MR. H. DUNBAR**

## Quaker Light Supply Co.

728 Arch St.,

Phila., Pa.



## "DX" Relay Men Know Baldwin 'Phones are Best

We have just received a letter from an Ex-Sergeant of the 117th Field Signal Battalion, Rainbow Division, which shows the worth of Baldwins.

John Firth & Co.,  
New York

4022 Wayne Ave.,  
Kansas City, Mo.

Gentlemen:

Reading your advertisement of Baldwin phones in the January QST and having used several different pairs of these phones in the Signal Corps, I desire very greatly to obtain a pair.

I have tested Baldwin phones against almost every phone made, including several French, British, and even German-made receivers, and have found nothing to equal them. I used "a pair of Baldies" while on the U. S.-Mexican border, in conjunction with a Signal Corps mule-carried pack set, and can say they stood up under the severest jars and jolts a stubborn mule could give them. I also had a pair with me at the Aisne-Marne defensive, the Chateau Thierry offensive, St. Mihiel, The Argonne, and on our hike to Germany. The type phone I had I don't know and cared less—all I knew was that they had the others beat in a walk.

Awaiting your circular, I remain,

Respectfully,

B. F. Riggin

Any A R.R.L. long-distance relay will tell you there are no other phones as sensitive as Baldwins. The enormous increase in sensitivity over ordinary receivers is secured by the famous Baldwin construction—a mica diaphragm, removed from the constant pull of a permanent magnet, and a separate light iron armature. Write for interesting illustrated bulletin explaining the construction of these phones, and why they are BETTER.

**BALDWIN MEET THE EXACTING REQUIREMENTS  
OF LONG DISTANCE AMATEUR WORK**  
FOUR MODELS—FOUR PRICES

**JOHN FIRTH & COMPANY**

81 NEW STREET,

Sole Distributors

NEW YORK



### Stromberg- Carlson RADIO HEAD SET

A set that combines your ideal of extreme sensitiveness with a strong, durable construction that stands the gaff of continuous service ashore or aboard ship.

All operating parts housed in dust-proof and moisture-proof aluminum cases. The diaphragm is mounted metal-to-metal in such a way that temperature variation will not disturb the air-gap adjustments. Non-conducting spool heads and slotted pole tips eliminate 90 per cent of the eddy current losses that are found in other head sets.

Each set is wound to a resistance of 2,000 ohms with pure copper wire and furnished complete with 6-foot moisture-proof cord attached. Tested for matched diaphragm tuning and operating qualities in actual service before shipment.

Send \$12.00 for sample set for trial in your own station—satisfaction guaranteed or your money refunded upon return of set. Write for Bulletin 1106 giving full particulars.

**Stromberg-Carlson Telephone Mfg. Co.**  
Rochester, N. Y. Chicago, Ill. Kansas City, Mo. Toronto Ont.

## GET THEM--RIGHT NOW

In order to introduce the quality of "Meraco" Apparatus and Accessories to future patronizers, we are offering for a period of ONE (1) MONTH ONLY Our

### Perfect "B" Battery

at \$1.00 each postpaid to any part of the U. S. or Canada.

This offer closes at  
Twelve O'clock noon  
MAY 1, 1920.

Order a bunch today—orders filled according to rotation.

**Mercury Radio Appliance Co.**

672 Broadway, Brooklyn, New York

# Thermo-Ammeters, Milliammeters and Current-Squared Meters

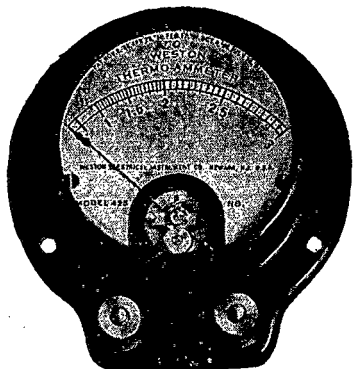

## Weston

Model 425

### Miniature Size Instruments for Radio Service

are the ideal instruments for the amateur.

They are provided as back-connected or front-connected instruments, and may be mounted on small panels or used as portable instruments.

Their characteristics of accuracy, large overload capacity, small current consumption and small size make them particularly desirable for use on amateur and other low-power outfits.

Complete information will be furnished upon request.

## WESTON ELECTRICAL INSTRUMENT COMPANY

158 Weston Avenue, Newark, N. J.

Branches in all Principal Cities.

## “COSRADIO”

Mark of Quality

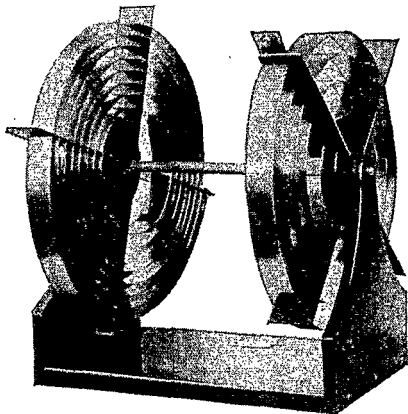

—SAVE YOUR ENERGY—

One inch ribbon—Bakelite supports—  
Mahogany finish.

Satisfaction Guaranteed—\$12.00

**THE COSRADIO CO.**  
WICHITA, KANSAS

## 3 Inch Dial Indicator

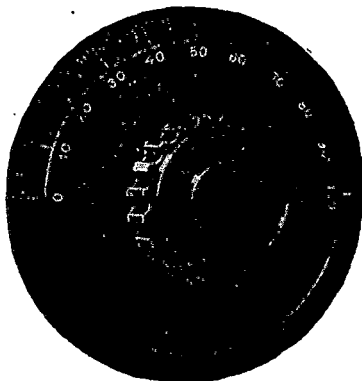

**FINE BLACK COMPOSITION DIAL**

No. 66 without Knob \$0.75 postpaid

No. 67 with Bakelite Knob \$1.30 postpaid

FOR SALE AT ALL RADISCO AGENCIES

NEW 30 page catalog just out.  
Send 10c stamps or coin.

**A. H. CORWIN & CO.**  
4 West Park Street, Newark, N. J.

# RADIO APPARATUS

*Distributors of reliable experimental and Laboratory  
Radio apparatus for High Schools,  
Colleges and individuals*

DeForest Vernier type Variable air condensers, mounted and unmounted. "A splendid condenser in any set, ideal for wave-meter work, and a good Laboratory standard."

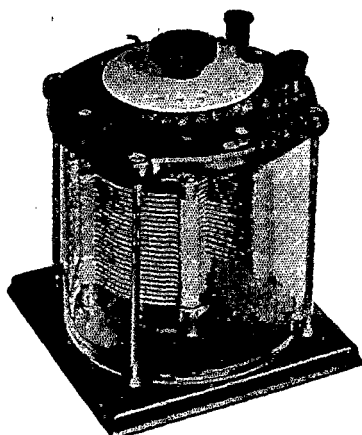
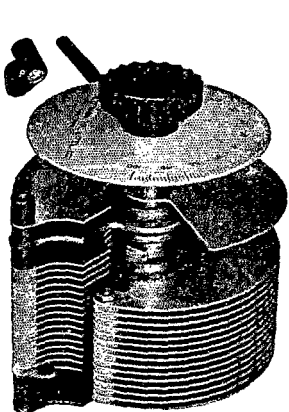

Cat. No.	Cap. MFDS.	Mounting	Price
CV-1000	.001	Unmounted without vernier.....	\$12.40
CV-1003	.001	Unmounted with vernier.....	14.25
CV-1010	.001	In standard glass case without vernier..	17.50
CV-1013	.001	In standard glass case with vernier....	19.50
CV-1500	.0015	Unmounted without vernier.....	14.00
CV-1503	.0015	Unmounted with vernier.....	15.60
CV-1510	.0015	In standard glass case without vernier..	19.00
CV-1513	.0015	In standard glass case with vernier....	20.60

## DE FOREST UNIT TYPE VERNIER AIR CONDENSERS.

UCV-1500	.0015	On unit panel without vernier.....	14.90
UCV-1503	.0015	On unit panel with vernier.....	16.75
UCV-1000	.001	On unit panel without vernier.....	13.60
UCV-1003	.001	On unit panel with vernier.....	15.50

**IMMEDIATE DELIVERY!**

Remember this material is carried right in stock and all orders filled at once!

**Give our SERVICE a trial!**

Send 6 cents for new catalog. Every amateur should have it!

## F. D. PITTS CO., INC.

12 PARK SQUARE,

Dept. A,

BOSTON, 11, MASS.

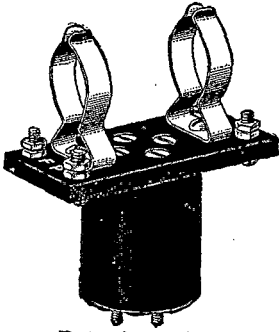

Pat. App. for.

# Attention Amateurs!

*This is the adapter which tubular bulb owners have been looking for*

**Price - - \$1.50**

## RADISCO AGENCY

*We make special instruments to order*



Eastern Agents

**INTERNATIONAL ELECTRIC CO.**

226 A Fulton St.,

Dealers write for propositions.

New York City

**Amateur Wireless Equipment Co.**

1390 Prospect Ave.,

Bronx, N. Y.

# BAKELITE-DILECTO

*the Standard Insulating Material on all Radio Work*

Water-proof, permanent, strong, used by all important Manufacturers of Wireless Apparatus and others requiring the utmost in Insulation. Furnished in Sheets, Rods and Tubes.

## THE CONTINENTAL FIBRE CO.

233 Broadway  
New York City  
525 Market St.

**NEWARK, DELAWARE**

332 So. Michigan Ave.  
Chicago, Ill.

411 S. Main St.  
Los Angeles, Cal.

San Francisco, Cal.  
119 Fairview Ave., West Toronto, Ont., Canada.

316 Fourth Ave., Pittsburgh, Pa.



## The Biggest, Busiest and Best Radio Supply Store in New England

Our expert advice is yours for the asking.

We can give you prompt and courteous attention.

Our stock is complete from the "Tower to the Key".

**A. P. MERCHANT CO.**

**9 Avery Street, Boston**

## RADIO AND ELECTRICAL EXPERIMENTERS ARE SAVING:

\$2.50 (20%) on each 6 V Storage Battery  
for which retail dealers ask \$15.00.  
\$1.00 on every Vacuum Transmitter Tube.  
\$2.50 on every Navy Type Telephone Set.

You can save substantial amounts on radio, electrical apparatus, raw material or books. This applies to almost every electrical product advertised in this magazine. We buy direct at wholesale. You receive a share of this co-operative buying. We manufacture nothing. Orders are made through the association from advertisements and manufacturers' catalogs. Hook-ups and like data are furnished free. Details by mail on request.

### SPECIAL OFFER

To members only: MARKO 4 V. 60 AMP. STORAGE BATTERIES  
for \$7.00 Net

Supply of these batteries limited.

### MANUFACTURERS:

Our radio department membership exceeds 1500, and is growing daily. We can move your stock. Submit quantity discount lists if you wish to avail yourself of this buying power. We want supply houses in several sections to deliver on telegraph order.

### MUTUAL PURCHASERS ASSOCIATION

Dept. Q, 24

2-4 Stone Street

NEW YORK CITY

21 Bridge Street

"ASK ANYONE WHO HAS USED IT"

### WHAT OUR PATRONS SAY

"I have never had to find fault with them in five years' use." (Name on request.)

## BRANDES WIRELESS HEADSET



'Superior' 2000 ohms \$7

### TRIAL OFFER

Test out Brandes Wireless Receivers against any other make. Test them for sensitiveness, clearness and distance. If within ten days you're not only satisfied but enthusiastic over them—back comes your money without a question.

Prove for yourself the fine quality, the "matched tone." The two diaphragms, toned exactly alike, strengthen the signals and prevent blurring. Used by many U. S. Government experts, and experts abroad; by colleges and technical schools; and by professionals and amateurs everywhere.

SEND 4c. FOR CATALOGUE F

C. BRANDES, Inc.

Room 521, 32 Union Square, New York  
WIRELESS RECEIVER SPECIALISTS

State  
size  
of  
Motor  
Shaft.

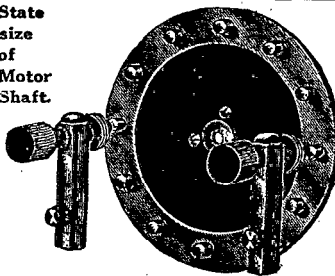

Size 5 1/2" Complete \$5.50  
Size 4 1/2" Complete \$4.80  
Size 3 1/2" Complete \$3.35

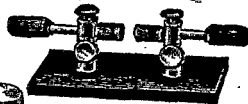

No. 1031  
Spark Gap  
75 cents.



No.	3/8	5/8	5/8	5/8	5/8	Inch
7160	7138	6647	7282	7127		
\$1.90	\$1.40	\$1.25	\$2.50	\$1.40		
Per 100.	For	polished nickel	add 1c each.			

## Continental Electric Company

117 East 129th St. N., New York, N. Y.

Get illustrated folder on Binding Posts.

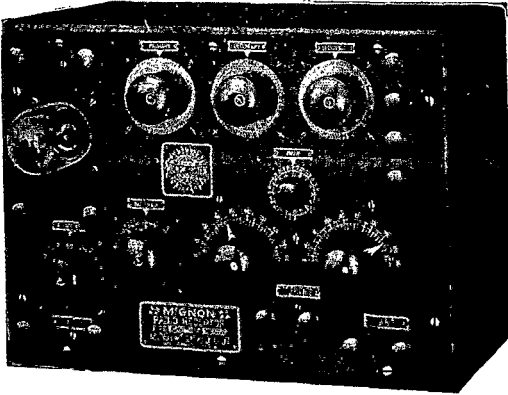

RW 4"—SIZE 12" x 9" x 6½"

# Mignon "RW4" Undamped Wave Receptors

**NO** LOOSE COUPLERS  
LOADING COILS  
VARIOMETERS  
AMPLIFIERS

**Strongest, most distinct signals**

— IMPORTANT NOTICE —

The Mignon System Apparatus, "RW1", "RW2", "RW3" and "RBD8" are no longer manufactured and are superseded by the improved "RW4", "UW1", and "BD1". These apparatus are manufactured exclusively by the MIGNON MFG. CORP., sole owners of the Mignon System Patents. (See U. S. Letters Patent No. 1329672).

**INFRINGEMENTS WILL BE PROSECUTED.**

Damped and undamped wave apparatus for all purposes  
Endorsed by Radio Dept. of D. L. & W. Ry. Co.

WRITE FOR LITERATURE (DEPT. Q)

**MIGNON MANUFACTURING CORPORATION, Newark, N. J.**



## STORAGE BATTERIES FOR WIRELESS SERVICE

Batteries especially adapted for the amateur operator are described and illustrated in our new Bulletin No. 175, copy of which will be furnished on request.

### THE ELECTRIC STORAGE BATTERY COMPANY

The largest maker of storage batteries in the world

1888 PHILADELPHIA, PA. 1920

New York Boston Chicago Washington Denver San Francisco Cleveland  
Atlanta Pittsburgh Minneapolis Kansas City Detroit Rochester  
Special Canadian Representative, Chas. E. Goad Engineering Co., Ltd., Toronto, and Montreal

## THE JONES CABINET LONG WAVE RECEIVING TRANSFORMER

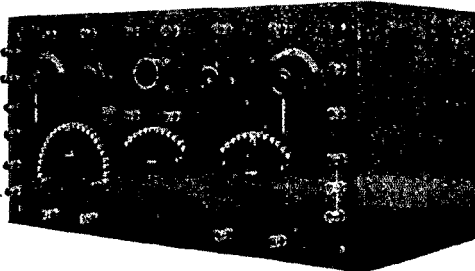

### For DAMPED or UNDAMPED Wave Reception

A carefully wound Receiving Transformer with an approximate Wave Length of from 200 to 8000 Meters Equipped with Variable and Fixed Condensers Rheostat and Grid Leak. Fitted to take the latest MARCONI Vacuum Tube. Bakelite Panel, Silver Plated Switches and Contacts, Mission Oak Cabinet. Entire Apparatus built within Metal frame to permit easy removal. Model "D", as illustrated, SIXTY DOLLARS, Net. Model "E" fitted with Modern "DEAD END" Switch and High Grade Hot Wire Ammeter, Eighty-Five Dollars net.

New Bulletin sent on request.

**THE JONES RADIO CO., 384 Monroe Street, BROOKLYN, N. Y.**



TEL.  
BACK BAY  
5 9 6 4

**EASTERN  
RADIO**

**INSTITUTE**

899 BOYLSTON ST.  
BOSTON, MASS.

**RADIO**



# LEARN WIRELESS !!

Under former U. S. Government and Marconi Experts; men who have spent YEARS in the SUCCESSFUL training of THOUSANDS of Wireless operators. OUR GRADUATES now in all parts of the world as INSTRUCTORS, RADIO INSPECTORS, ENGINEERS, OPERATORS, etc., etc.

When you realize that our Day or Evening school prepares you quickly and efficiently for positions paying from \$100 to \$150 per month, food and quarters besides, and that the entire expense of the course can be more than returned to you in one month's salary, does not this appeal to you?

THE FOLLOWING REPRESENTS A PORTION OF THE MODERN HIGH GRADE COMMERCIAL RECEIVING APPARATUS NOW IN USE AT THE EASTERN RADIO INSTITUTE.

Navy Standard I-P-500 Commercial Receiver.  
Installed by U.S. Gov't. on Shipping Board Ships.

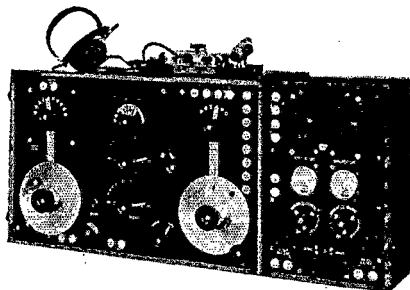

Marconi Type 106 Commercial Receiver.

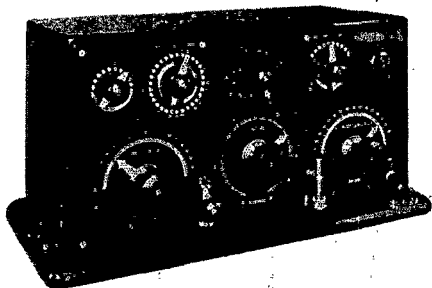

**REMEMBER:** We are the **OLDEST, LARGEST** and **BEST EQUIPPED** school of its kind in New England, have already **THOUSANDS** of satisfied graduates to our credit, have always placed **EVERY** graduate in a good position and kept them employed and can guarantee these positions. Moreover last year alone we gave instruction to more students than all other schools in New England combined! If these facts mean anything to you send in your enrollment today.

**DAY AND EVENING CLASSES. ADVANCED CLASSES IN RADIO THEORY OR CODE. SPECIAL AMATEUR CLASSES.**

**START ANY MONDAY. OUR PROSPECTUS FOR THE ASKING.**

Series No. 1

**Tubular V.T. Adapter**

Will fit any standard tubular V.T.

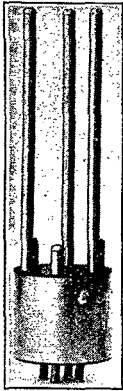

Will fit any standard 4-point socket

Removable Grid Leak



All wired for you!  
Socket and 1 Megohm  
Grid Leak Combined.

Phosphor Bronze



Price \$0.30 Dozen

Pat. applied for  
Price \$1.75 Postpaid

Solderless "B" Battery Connectors.

**TeCo Specialties**

**Honey-comb Coil Adapters.**

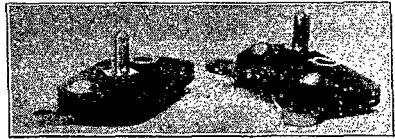

Mounted on XX Bakelite

Price \$1.50 a pair

Postpaid

**TeCo Radio Company**

P. O. Box 3362

Boston,

Mass.

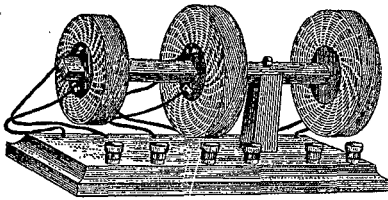

**The B & H Mounting for Radisco, DeForest and other coils**

THE single support allows easy change of coils with ample length of rod to allow very loose coupling. The square rod prevents coils from turning. Special Stands and Centers Made to Order.

THE MOST EFFICIENT STAND ON THE MARKET

	Radisco	DeForest	Special
No. 1R Complete with 6 Binding posts, flexible leads and 3 Coil centers, \$6.00		\$6.50	\$7.00
No. 2R Complete with 3 Coil centers, but without flexible leads			
or Binding posts.....	4.00	4.50	5.00
No. 3R Extra Coil Centers, (give size).....	.35	.40	.50

Pat. Applied For.  
Parcel Post Charges on 2 lbs.  
FINISHED IN WEATHERED OAK

**HIGH FREQUENCY CABLE (LITZ)**

10-38 20-38 16-2-38 16-3-38

DSC, Enameled—any other size and covering to Order.

Send stamp for further particulars.

WIRELESS

**A. T. HOVEY**

SUPPLIES

61 BELVIDERE STREET,

Dept. B,

BOSTON-17-MASS.

**PAPER TUBES**

For constructing loose couplers, loading coils, variometers, etc., smooth, round, gray, seamless, tubes.

**FOR 3500 METER COUPLER**

Primary 3 3/4" outside dia. 7" long—25c  
Secondary 3 1/4" outside dia. 6" long—20c

**FOR VARIOMETERS**

Primary 4 1/4" outside dia. 2 1/2" long—12c  
Secondary 3 3/4" outside dia. 2" long—10c

**FOR LOADING COILS**

3 3/4" Outside Dia. 14" long—40c

4 1/4" Outside Dia. 14" long—50c

Special Lengths Cut to Order

To 15" long 3 1/4" dia.—4c per in.

3 3/4" dia.—5c per in.; 4 1/4" dia.—6c per in.

All tubes have 1/8" wall.

IMMEDIATE SHIPMENTS, POSTPAID.

**THE TAYLOR COMPANY, BOX 1043C,**

**LOWELL, MASS.**

**Laboratory Signs**

Attractive 8" x 10" signs printed on high quality coated white cardboard in selected wordings for the electrical experimenter.

1. DANGER! HIGH VOLTAGE
2. EXPERIMENTAL RADIO LABORATORY  
NO ADMITTANCE
3. GOVERNMENT LICENSED RADIO  
STATION
4. DO NOT TOUCH THE INSTRUMENTS
5. PLEASE BE QUIET WHILE THE  
OPERATOR IS RECEIVING

15c EACH, ANY TWO FOR 25c

ALL 5 FOR 50c



# Standard VT Batteries

## THE VARIABLE STANDARD VT BATTERY

—Another "Standard VT" product that is without doubt the best in all respects and that is meeting with enthusiastic approval.

## THE VARIABLE STANDARD VT BATTERY gives:

Maximum service

Convenient variation— $1\frac{1}{2}$  volts to  $22\frac{1}{2}$  volts.

Negative voltages—very desirable in vacuum tube operation.

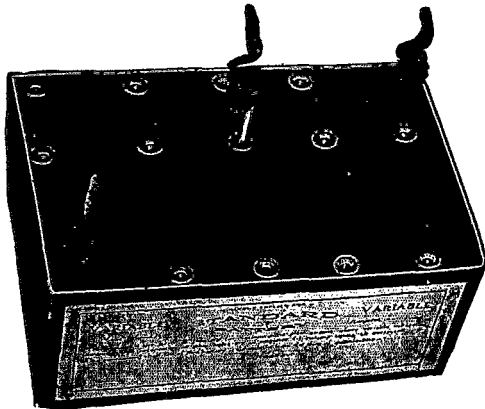

Patent Pending

**Don't Ask for a "B" Battery—Insist on a Standard VT Battery**

**DEALERS:** Handling the "Standard VT" line means quick turnover and quick profits. Write now for quotations and a quantity of descriptive literature.

**RICHTER & BYRNE, MANUFACTURERS**

1377 40th Street, Brooklyn, N. Y.

Distributed by:

PACENT ELECTRIC CO.

MANHATTAN ELECTRIC SUPPLY CO.

## NOTICE

With this issue the newsstand price of QST advances to twenty cents and the annual subscription rate to two dollars, for which we hope to give you an increasingly better and bigger magazine.

Membership in the A.R.R.L. is included in the above charge, as heretofore, so in that respect it represents no advance at all—simply the elimination of subscriptions to QST without League membership, which experience has shown undesired.

Station ownership, while desirable, is not essential to membership in the League. The real requirement is a bona-fide interest in amateur wireless. When joining the League, if you have a station in operation, consult QST and communicate with the Operating Dept. official nearest you for a place in relay affairs—he will be glad to hear from you.

For further information address

The Secretary  
AMERICAN RADIO RELAY LEAGUE  
Hartford, Conn.

## AMRAD WAVEMETER

Direct Reading

Fights  
QRM

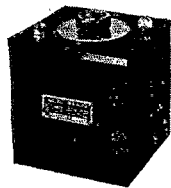

Increases  
Your Range

Over 90% of all amateur transmitters are out of resonance. How about yours? Nine chances out of ten you can increase your range by careful tuning.

Too many stations are trying to transmit on wave lengths of approximately 200 meters. You can operate much farther by tuning your transmitter to a lower wavelength. If you are troubled with QRM you can help the situation by encouraging others to do this.

Do you know the wavelength of your antenna system? You must know it in order to secure the most efficient ratios of natural wavelength to loading inductance.

Many amateur stations are transmitting on illegal wave lengths. Don't guess at your wave length. Know it.

For these important purposes use the Amrad Direct Reading Wavemeter. Range 130-230 meters. Always accurate, Bakelite top; built to last. Price \$6.50. If your dealer does not stock, order direct; enclose postage for two pounds. Immediate delivery. Description and directions in bulletin W. Send for it.

**American Radio and Research Corporation**

19A Park Row      Address all mail      Factory and shipping pt.  
New York      to New York      Medford Hillside, Mass.

# "Your Sigs. Very QSA O.M."

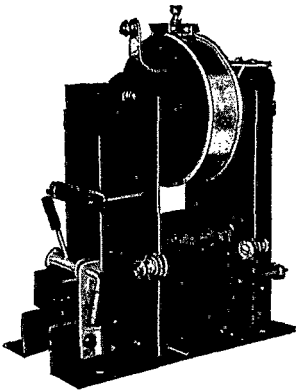

"WHAT TRANSFORMER  
ARE YOU USING?"

"A THORDARSON"

"THAT EXPLAINS IT"

Orders for Thordarson transformers filled  
from stock and shipped immediately.

1 KW Type R 25,000 Volt Secondary \$40.00

1/2 KW Type R 10,000 Volt Secondary \$22.00

We Carry a Complete Stock of High Grade Radio Apparatus.

## DOUBLEDAY-HILL ELECTRIC CO.

RADIO DEPT.—DESK A

715 12th St., WASHINGTON D.C. 719-21 Liberty Ave., PITTSBURGH, PA.

### RADISCO COILS

Cat. No. and turns.	Apx. Inductance in Millihenries	Wavelength Range with .001 Variable	Price
LRD 40	.092	225 575	\$0.60
LRD 100	.61	460 1480	0.85
LRD 175	1.6	750 2400	1.00
LRD 325	5.6	1375 4500	1.20
LRD 550	16.0	2250 7700	1.44
LRD 750	35.0	3000 11200	1.80
LRD 1200	114.0	6000 20000	2.40

Radisco Coils may be obtained with taps, which allow them to be used for a larger wavelength range.

Cat. No. and turns	Taps taken off at	Price
LRD 325-3	40 - 100 - 175	\$1.50
LRD 750-3	175 - 325 - 550	2.10
LRD 1200-3	325 - 550 - 750	2.70

Inside Diameter of all coils, 1 1/2 inches; Width, 3/4 inch.

Wooden centers for mounting coils per pair \$0.25

Murdock Variable .001 for use with above coils \$4.75

Radisco B Battery No. 1, \$1.40. No. 5, \$2.40. Postage extra.

21 Magnolia Terrace

E. L. LONG

Albany, N. Y.

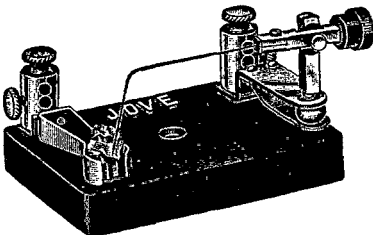

(Ghegan Patent)

Bunnell Keys, Transformers, Condensers, Spark-Gaps, Receivers, etc. are  
High Grade but Inexpensive.

Send Stamp for New Edition, 42 Q Catalog.

J. H. BUNNELL & CO.

32 Park Place, New York

## **BUNNELL** Instruments *Always Reliable*

### THE JOVE DETECTOR

HANDIEST, HANDSOMEST AND BEST

Sample by Mail, \$1.80

Tested Galena Crystal 25c.

# Licensed by De Forest AUDIOTRON

## The Original Tubular Vacuum Amplifier

The AudioTron vacuum tube is now manufactured and sold as a genuine audion licensed under DeForest Patents Nos. 841387 and 879532 to be used only for amplification in radio communication and only for experimental and amateur purposes and only in audio frequency circuits.

The Audiotron has a double filament of special thorium tungsten and the operating life is over 2000 hours. No special socket is required. The electrical and mechanical dimensions result in a heavy plate current and corresponding signal strength. Plate voltage under 40. Our guaranty insures satisfaction.

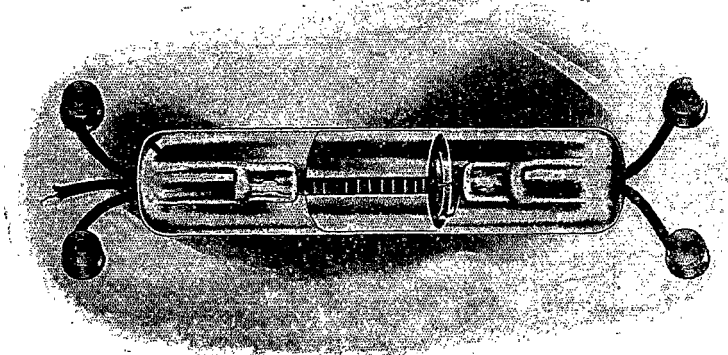

**PRICE \$6.00 EACH**

If your local dealer cannot supply you we will ship **postpaid** when cash accompanies order.

**The AudioTron Exclusive Guaranty:** Each and every Audiotron is guaranteed to arrive in good condition and to prove fully satisfactory. Replacement of unsatisfactory tubes will be made free of charge.

**AUDIOTRON AUDIO-FREQUENCY TRANSFORMER.....\$7.00**

Laminated closed core, two coil type.

**DEALERS:—Write for our attractive trade Proposition.**

# AUDIOTRON SALES CO.

Lick Bldg.,

San Francisco, Calif.

## An Announcement to All Radiomen

The INTERNATIONAL ELECTRIC COMPANY has established its distributing headquarters at 226 Fulton Street, New York, with an extensive line of Commercial and Amateur radio apparatus. The aim of the organization is to sell high class merchandise in conjunction with high class service.

Among the makes of apparatus they distribute, they are proud to list TELEFUNKEN, KILBOURNE & CLARK, DE FOREST, INTERNATIONAL RADIO, E. J. SIMON, CLAPP-EASTHAM, MURDOCK, WIRELESS EQUIPMENT, RADIO SERVICE, BALDWIN and BROWNLIE PHONES, KOLSTER DECREMETERS and many others.

Exclusive Distributors of the ENDURANCE Storage Batteries, Better Quality B-Batteries—at \$1.25 for the small 22½ volt size—Tubular Bulb Adapters at \$1.50.

The INTERNATIONAL ELECTRIC COMPANY'S catalogue is practically ready for distribution. It is sent upon receipt of 10 cents.

When in New York you are welcome to make us your headquarters. Meet your friends here, write your letters, and make yourself generally at home. Radio Clubs will be given space for holding meetings any evening, and their announcements will be placed on the bulletin board free of all costs. Our store is the meeting place of Commercial, Government and the better class Amateur operators.

### THE INTERNATIONAL ELECTRIC COMPANY

226 b Fulton Street,

DEALERS WANTED

New York, N. Y.

## The Largest Radio Supply Stock In The South

### COMMERCIAL AND AMATEUR WIRELESS APPARATUS OF ALL KINDS

Holt Electric Utilities Co. Jacksonville, Fla.

### LITTLE WONDER GAP, \$12.00 COMPLETE

ANY TONE, DOUBLE ADJUSTMENT

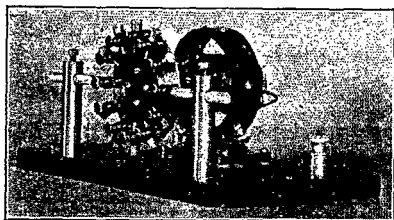

Any number of studs you wish to use. Studs can be taken out and put back in a second's time. Gives any musical note you may desire by simply changing number of studs. The finest possible adjustment in every way. Highly lacquered brass disks and posts. Highly polished base. Guaranteed to do the work of any high priced gap. Motor runs on both A.C. and D.C. Disks separate, \$3.00 each. Send us micrometer measurement of your motor shaft. Shipped upon receipt of money order. Add 15 cents for Parcel Post insured. Dealers write for proposition.

116 Bedford St.,

EDWARD E. HAYWARD, JR.,

Boston, Mass.

# HELP !

The Editor requests your aid in making QST what you wish, and will consider it a big favor if you will fill out the following form and mail it in.

Dear Eddy:

To assist you in your choice of material for our QST I am indicating below the things I like best, numbering my favorite topic "1", my second choice "2", and so on.

- Technical articles
- Non-technical informative articles
- Constructional articles—  
How-to-make-it.
- Descriptions of manufactured apparatus
- Directory of Calls
- Calls Heard
- "Communications"
- Humorous and Adventure Stories
- Practical Dope on improving operation
- Traffic reports
- Club news
- "The Junior Operator"
- Photos and descriptions of amateur stations
- Queries Answered Dept.
- .....

Sig.....

## MURDOCK

NO. 55



2000 OHM DOUBLE SET

**\$4.50**

3000 OHM DOUBLE SET

**\$5.50**

**M**ade for long and  
**U**seful service in  
**R**adio stations where their  
**D**ependable and sensitive  
**O**peration makes them the  
**C**hoice of those who  
**K**now GOOD 'phones.

**ORDER YOUR SET NOW—**  
Try it out thoroughly.  
**IF IT DOESN'T SUIT, SEND**  
**IT BACK AND GET YOUR**  
**MONEY**

Bulletin 19 shows a splendid line of the type of apparatus you want. Send for a copy.

**WM. J. MURDOCK CO.**

65 Carter St.

**CHELSEA MASS.**

221 SECOND ST.,

SAN FRANCISCO, CALIF.

# MULTI-FLEX RADIO

Our newest product, Multi-flex Radio Ribbon, is an absolute necessity for the efficiency and safety of your radio station. It is woven of pure Lake Superior Copper Wire No. 17 B. & S. gauge without sharp turns; each wire makes a very slight bend every eight inches. It is woven of continuous wires, not made of scrap or coil ends.

It is woven of wires heavy enough to withstand the weather when used as aerial, lead-in or ground. It is substantial enough to hold its shape when formed into edgewise wound coils for your oscillation transformers.

Multi-flex Radio Ribbon No. 31 is only 7-8 inch wide but has the skin carrying capacity of 4.4 inches. We also carry special connectors for this ribbon. Samples will be mailed on receipt of ten cents.

Multi-flex Radio Ribbon is sold only for use in the art of radio communication.

## JENSEN ELECTRIC CO.

1949 HURON STREET, CHICAGO, ILL.

Have You Tried OUR New AudioTron?

Sent C. O. D. \$6.00. AudioTron Guarantee. Circulars Free.

Licensed under DeForest Pats. Nos. 841387 and 87953 for use in Amateur Radio amplifying audio-frequency circuits.

# EXPERIMENTAL SCIENCE



• CHEMISTRY •

*A New Magazine of Science for the Experimenter and Practical non-Technical Man.*



• PHYSICS •

*First Issue out May 5th.  
\$1.50 per year; Canada  
\$1.75, 'New and Original.'*

WRITTEN BY AUTHORITIES

*Literature Sent on Request*

**Send In Your Subscription NOW!**

**Experimental Science Publishing Company**

710 Fourteenth Street

Washington, D. C.

# Free! Amateurs! Free!

Descriptive Circulars of

## Our "Better Quality" B-Batteries

45 Volts 30 Cells

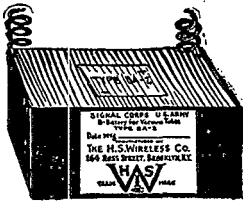

22.5 Volts 15 Cells

To enable every amateur to use our SUPER "BETTER QUALITY" B-BATTERIES they are now offered at a price within reach of all. Remember that our B-Batteries are sold to you on a MONEY-BACK BASIS. They are FULLY GUARANTEED, and your money CHEERFULLY REFUNDED if not satisfied. Our motto: "RETAILING AT WHOLESALE PRICES."

Cat. No.	Voltage	Amount of Cells	Type	Kind	Dimensions	Average Life	List Value	Our Price
B B-154	22½	15	BA-2	Signal Corps, U. S. Army	3¼"x2"x2½"	4 months	\$1.50	\$1.25
Postpaid add 10c. In Canada and foreign countries add 25c.								
B B-158	22½	15	BA-2	Signal Corps, U. S. Navy	6½"x4"x3"	8 months	2.50	2.20
Shipped by Express only in U. S. In Canada and foreign countries add 50c for postage.								
SBB-3012	45	30	BA-2	Spl. comb. Navy and Army	14"x8"x6"	1 year	6.00	4.35
Shipped by Express only in U. S. In Canada and foreign countries add \$1.00 for postage.								

AudioTron Amplifiers \$6.00 Postpaid and Insured.

ORDER through your DEALER. If he hasn't our B-Batteries order from us, but send his name and address. Send postal for B-Batteries circulars, etc.

**DEALERS:** We are now offering an attractive proposition for you. Some live territories now being allotted. Good discounts. Write now.

**THE H. S. WIRELESS CO., Dept. B, 164 Ross St., Brooklyn, N. Y.**  
Exclusive representative for the Genuine AudioTron Amplifier

### NEW ELECTRODYNE

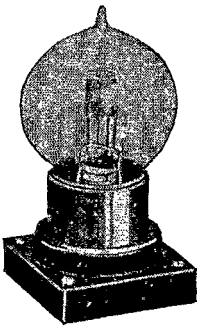

#### RECTIFIER TUBE

These tubes are used, generally in pairs, for rectifying commercial alternating current for supplying the plate circuits of Radio Telephone and C.W. Telegraph radio power tubes. They make

#### Motor Generator Unnecessary

These tubes will rectify up to 500 volts and carry 30 milliamperes each, normally, sufficient for most purposes.

Price, \$7.00 each.

Good delivery from stock.

Send at once for illustrated circular No. 14.

**WIRELESS EQUIPMENT CO., Inc.**  
19 Park Place, New York, N. Y.

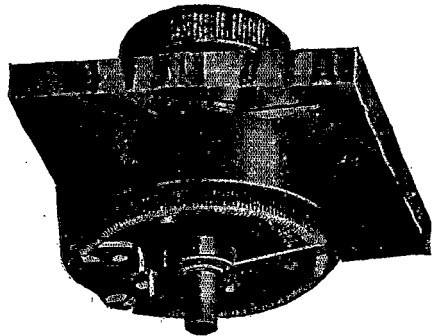

A NEW FILAMENT RHEOSTAT \$1.75 POSTPAID  
Back or Front Mounting—2½" Dia.  
6 OHM Resistance Permits Fine Variation.

#### HALF PRICE

GENERAL RADIO CO. HOT-WIRE AMMETERS

**\$5 each** Regular \$10 Flush Mounting type with Scale Reading 0-2 or 0-2½ Amps.

ORIGINAL AUDIOTRON ADAPTOR  
Fits Your VT Socket—\$1.75 Postpaid

STANDARD VT SOCKET—\$1, WHY PAY MORE?

2ND CONSOLIDATED RADIO CALL BOOK \$1.

TYPE P-11 WESTERN ELECTRIC PHONES \$12.50

### RADIO EQUIPMENT CO.

630 WASHINGTON ST., BOSTON, 11, MASS.

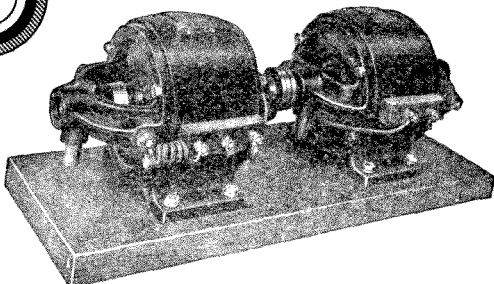

# RADIO INTERNATIONAL RADIO

## HIGH VOLTAGE—DIRECT CURRENT MOTOR GENERATORS

Price \$99.00 for 110 Volt A.C. Driving Motor, and \$110.00 for 110 Volt D.C. Driving Motor, F. O. B. Factory. Shipping Weight 80 lbs.

This unit has a normal output of 100 watts (200 milliamperes at 500 volts) with a voltage range of 200 to 500 volts. The generator is compounded to insure constant voltage under variable load. It is furnished to operate on either D.C. or A.C.; a shunt motor being supplied for D.C. and an induction motor for A.C. The generator is equipped with a commutator of 48 segments reducing the commutator hum to a minimum.

Unit is complete with insulating coupling and mounted as illustrated on a finished base 8" x 20". Shipment can be made immediately.

The motor generator illustrated above is only ONE of the many newly designed radio specialties which we have ready for you. Write us for descriptive bulletins which are being issued covering all International Radio products. Address Dept. No. 23.

International Radio Telegraph Co., 326 BROADWAY  
NEW YORK CITY

# VACUUM TUBES REPAIRED

We repair the filaments and other elements in all types of vacuum tubes and guarantee them to operate equally as well as a new tube. In most cases they operate better. We produce wonderful oscillators, detectors and amplifiers.

**MARCONI VT  
DE FOREST VT  
MOORHEAD TUBES  
WESTERN ELECTRIC  
REPAIRED AT FOUR DOLLARS AND FIFTY CENTS EACH.  
ELECTRON RELAYS  
OSCILLAUDIONS  
AND ALL OTHER TUBULAR TYPES  
REPAIRED AT FOUR DOLLARS EACH.**

All foreign made receiving tubes repaired at SIX FIFTY and power tubes depending upon size.

**WE HAVE PURCHASED A LARGE QUANTITY OF BURNED OUT  
- MARCONI VTs AND ELECTRON RELAYS WHICH  
WE OFFER FOR SALE AT FIVE DOLLARS.  
REMEMBER THESE TUBES ARE GUARANTEED GOOD AS NEW.**

DEALERS WRITE US

## THE VACUUM TUBE REPAIR COMPANY

511 Perry Building

OAKLAND, CALIFORNIA.



# G. A. STANDARDIZED SUPPLIES

## STANDARD BAKELITE PANELS.

The highest grade of insulating material obtainable. The use of standard sizes of panels makes possible the interchangeable design of equipment.

Size	1/8 in. Thick	Weight	3/16 in. Thick	Weight	1/4 in. Thick	Weight
5x5 ins.	\$0.60	1 lb.	\$0.88	1 lb.	\$1.16	1 lb.
5x10 ins.	1.18	1 lb.	1.76	1 lb.	2.30	2 lb.
10x10 ins.	2.35	1 lb.	3.50	2 lb.	4.60	2 lb.
10x15 ins.	3.50	2 lb.	5.25	2 lb.	6.85	3 lb.

Accurately cut, always kept in stock. Shipping charges extra.

## G. A. STANDARDIZED B BATTERIES, 22.5 VOLTS

Built to specifications of U. S. Signal Corps and Bureau of Steam Engineering. Made by the formula used for 90% of the B batteries by the Government. G. A. batteries last longer and are cheaper than flashlight cells. Made for V.T.'s and Audiotrons. Need no voltage adjustment tho they can be used with a potentiometer. Two Navy type batteries with one V.T. will transmit 2 to 5 miles telephone, or 4 to 10 miles telegraph. Three or four will give much greater range.

**SIGNAL CORPS TYPE, 3 1/4" long, 2" wide, 2 1/4" high, operates one V.T. 250 hours continually average life 3 months, \$1.50, weight 1 pound. Mailing extra.**

**NAVY TYPE, 6 1/2" long, 4" wide, 3" high, operates one V.T. 1,000 hours continually, average life 10 months, \$2.50, weight 5 pounds. Mailing extra.**

## G. A. STANDARD H. F. CABLE FOR RECEIVERS AND V. T. TRANSMITTERS

10 No. 38 cable, D.S. covered, for receiving coils. Good for 2-bank winding. 40 turns per inch. Price per 100 feet \$0.60.

20 No. 38 cable, D.S. covered. Gives greater signal strength and sharper tuning than solid wire, 35 turns per in., 100 feet \$0.95.

3 x 16 No. 38 cable, D.S. covered. Must be used for V.T. transmitting inductances for maximum efficiency 17 t.p.i., 100 feet \$2.00.

No. 24 S.S.C. wire, 1/4 lb.,	1/2 lb.,	\$0.50—1 lb.,	\$1.00—1 lb.,	\$2.00
No. 26 S.S.C. wire, 1/4 lb.,	1/2 lb.,	0.60—1 lb.,	1.20—1 lb.,	2.40
No. 28 S.S.C. wire, 1/4 lb.,	1/2 lb.,	0.75—1 lb.,	1.50—1 lb.,	3.00
No. 30 S.S.C. wire, 1/4 lb.,	1/2 lb.,	0.90—1 lb.,	1.80—1 lb.,	3.60

G. A. SUPPLIES ARE SOLD BY MAIL ONLY. NO GOODS SOLD AT THE NEW YORK OFFICE.

MONEY BACK  
GUARANTEE ON  
EVERY ORDER



QUICK SERVICE  
ABSOLUTE  
RELIABILITY

## The General Apparatus Company

15-T West 45th Street,

New York City

# WILCOX ROTARY GAP

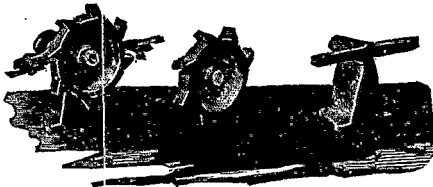

Belt-driven	Well quenched
Solid balanced rotor	Short leading spark
Large steel shaft	Clear tone
Long brass bearing	High efficiency

**COMPLETE \$10.00 POSTPAID**

Don't forget WILCOX switches, variometer parts, knobs, dials, panels, etc. 5c brings you our loose-leaf catalog, describing all our products and puts your name on our mailing list. Write now.

**WILCOX LABORATORIES, Inc., Dept. H, LANSING, MICHIGAN**

## CONSTRUCT YOUR OWN REGENERATIVE SET

By using one "variometer coupler" in your grid circuit, another in your plate circuit (and with your loose-coupler) you can duplicate the results obtained by standard regenerative sets.

One Variometer Coupler Unit, (Rotor and Stator), Wound.....	\$6.00
One Variometer Coupler Unit, (Rotor and Stator), Unwound.....	3.00
One Set Brass Assembling Parts, for above, complete.....	1.00
One "Type A" Secondary (rotor), separate, wound, range 100-300 meters.....	2.00
One "Type B" Secondary (rotor), separate, wound, range 100-600 meters.....	2.00
Either "A" or "B" type, not wound.....	1.00

These variometer couplers are ideal for use in radiophone transmitters.

LYNN RADIO MFG. CO.  
**SAWYER & STICKNEY**

26 HOWARD ST.,

Phone 7473,

LYNN, MASS.

LEARN HOW TO MAKE THE

# 90c. Vacuum Tubes and Time Tested Apparatus

VARIABLE CONDENSER  
NEW TYPE, COST \$2.00  
TO MAKE 2 AT ONCE  
CAPACITY .0005 M.F

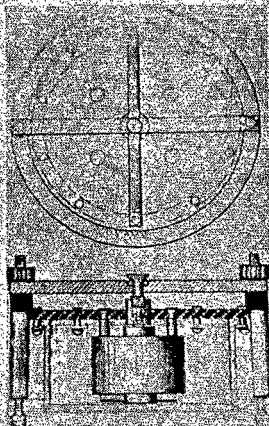
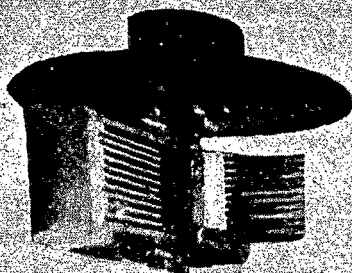

TWO FILAMENT  
EXPERIMENTAL  
VACUUM VALVE  
90% DETECTOR

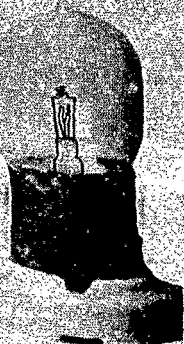

WIRELESS AGE MAGAZINE'S  
FIRST PRIZE AMATEUR GAP  
COSTS \$2. TO \$6. TO MAKE

as described in

## RADIO BUYER'S AND BUILDER'S HANDBOOK

(by an Amateur of fourteen years experience)

# NOW

The only book which  
DESCRIBES AND SIMPLIFIES  
many

# OUT

## New Radio Inventions and Improvements

(Some of which have never been made public yet)  
including

### NEW HOOKUPS to MAKE all the APPARATUS you use MORE EFFICIENT

This book will contain nearly 200 pages, many diagrams, and about 30 full page half-tones of simple efficient apparatus. Inc. 16 scale cutouts—in black and white.

THE FIRST THOUSAND WILL BE \$1.00 PER COPY.

Send now for FREE SAMPLE ILLUSTRATED pages, OR ASK YOUR DEALER TO SHOW YOU THIS BOOK. Watch the magazines for some of the writer's latest works.

### PARTIAL CONTENTS.

- A 90c EXPERIMENTAL VACUUM VALVE DETECTOR, sensitive and made in a few minutes from finished parts easily obtainable at any time.
- Radio "Tricks of the Trade"—Solid Silver Switch Points for 3 to 5 cents each.
- A NEW Combination Switching Key—Low Cost Amplifying Transformer. New!
- Variable Duplex Oil Condensers for Sending and Receiving with Switch.
- How and Where to Buy Second Hand Radio and Electrical Apparatus Cheap.
- A Rectifying Gap Motor which supplies "B" Battery current or "A" current.
- A Simple Calibrated Hot Wire Ammeter, not affected by weather. Very Fine!
- Many New and Good Ideas on "A" and "B" Batteries of Little Cost.
- Commercial Type Rotary Quenched Gaps of Low Cost, Like the Above.
- New Cheap Honey-Comb Type Receiving Coils for all Waves. Silver Contacts.
- Second-hand Electrical Motor-Generators up to 1/2 H. P. for \$6.00. Modern Type.
- Also many other methods of saving time and money on BETTER APPARATUS.

# R. U. CLARK 3rd, or YOUR DEALER

11 Barnes Rd., Newton, Mass.

# How Far Will the Crystaloi Detector Operate?

Here is the recent experience of an amateur. His letter, dated at a town in Central New York, came into our office just a few days ago. We copy it exactly as received.

Connecticut Tel. & Elec. Co.

Meriden, Conn.

Gentlemen:

Please send me at least three names and addresses of recent purchasers of your Crystaloi Detector. I have one of your type AA detectors and have done some very good work with same. On the night of Jan. 5, 1920, NAA was readable, 5 ft. from phones and audible at 15 ft. Among some of the other stations heard with receivers away from ears are: NAD, NAE, NBA, NAJ, NAW, NCQ, NAR, and dozens of others.

Please let me hear from you at once. I wish to know what others are doing.

(Name on request.)

Stations named above are:

NAD—Boston, Gloucester, Deer Island, Fourth Cliff  
(Direction finder stations)

NAE—Cape Cod, Mass

NBA—Balboa, Darien, Canal Zone

NAJ—Great Lakes, Illinois

NAW—Guantanamo Bay, Cuba

NCQ—Seattle, Ship

NAR—Key West, Florida

Would you like to do as well? You can, with a Crystaloi. Our booklet tells you all about it. Ask for a copy.

**CONNECTICUT TELEPHONE COMPANY**

Meriden,

Connecticut

## At Last! Immediate Deliveries on all

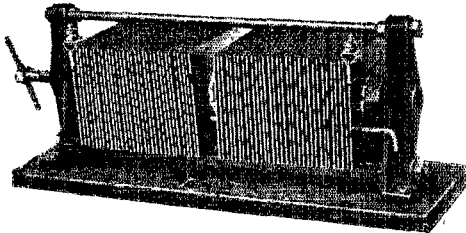

This gap is built to control the energy necessary to do real long distance work, 1,000 miles and over. It has 32 sparking chambers. Designed for use with transformers delivering 20,000 volts up. Maximum power 1,000 watts.

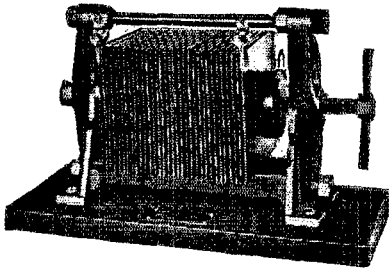

Our first gap. Out only four months, it is now in operation in every U. S. A. radio district and in Canada. No inducements offered to introduce this gap; every user a voluntary purchaser. Enthusiastic reports on file in our office. Intended for moderately long distance work, 500-900 miles. It has 16 sparking chambers and is designed for use with transformers delivering over 10,000 volts. Maximum power 500 watts.

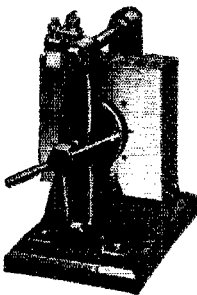

Especially designed for use with the Amrad 100 watt induction coil, but is suitable also for use with ordinary spark coils or small transformers delivering over 7,500 volts. This gap will increase the range of any induction coil set and at the same time will permit the operator to comply with the Federal law regulating decrement. It offers the only practical solution to the QRM problem in congested districts. 7 sparking chambers. Maximum capacity 250 watts.

Upon request we will enter on our monthly mailing list for one year, the names of all active radio amateurs. To these we will send our catalog, now in preparation, and all our latest bulletins as rapidly as printed, or insertion therein. An extensive line of Amrad apparatus is under development. Please include station call letters in your address. If there is no radio dealer in your town ask for our list of Amrad retailers who stock our goods.

### Why You Should Use the "Amrad" Quenched Gap

Correctly operated, it will radiate more EFFECTIVE energy on a given power input than any other type gap. This absolutely assures constant long distance work.

On the above adjustment your decrement will drop below the maximum .2 set by law. You will therefore not illegally interfere with other stations.

The Amrad Quenched Gap is silent. No longer need your radio station be a nuisance to your family or neighbors.

It puts you and your station on a high class "commercial" plane. The quenched gap is the most modern gap and its successful operation reflects no mean degree of skill and care on your part.

It is reliable. When using the Amrad Quenched Gap there is no danger of your station suddenly being put out of commission by a kick back burning out motor windings.

It is economical. It reduces electric current bills. No moving part to wear out, break or get out of balance. With careful use the quenched gap gaskets need be renewed only occasionally and then at a trifling cost.

It is efficient on 60 cycle supply circuits. Two spark frequencies may be obtained, either 120 or 240 sparks per second. When adjustments are correctly set both notes are clear, snappy and wonderfully uniform. The gap is equally efficient when used with induction coils.

It increases speed of handling traffic. No waiting for motors to come up to speed or slow down. Quick back-and-forth communication over the longest distances.

The Amrad Quenched is the STANDARD-IZED QUALITY Gap. All plates in the various types are identical and interchangeable. Each gap plate is tested to meet a high standard of accuracy. The entire instrument is essentially a "commercial" product especially designed for private use.

Full descriptions of and specific operating instructions for the Amrad Quenched Gaps, all types, together with description of adjustable resistances, contained in Bulletin Q.

Adjustable Resistances: To operate quenched gaps efficiently on 60 cycles a.c. an adjustable resistance must be used. We furnish three types of adjustable resistance. Prices and description of complete mounted units and parts contained in Bulletin Q.

Coil and Gap Combination: The Type G-3 Gap and our 100 watt Amrad Induction Coil, 6 or 32 volt type, will be sold for a limited time at the special price of \$33.50. Described in Bulletin P.

Amrad Detector Stands: For that lightweight portable set. The Amrad Stand is the nearest, ruggedest, smallest and best value built. Duplex, \$4.50. Single, \$2.50. Described in Bulletin N.

## AMERICAN RADIO AND RESEARCH CORPORATION

19A Park Row  
New York

Address all Communications  
to New York Office

Factory and Laboratory  
Medford Hillside, Mass.