

VOLUME III

NUMBER 1

QST

A MAGAZINE DEVOTED EXCLUSIVELY TO THE WIRELESS AMATEUR

AUGUST 1919.

PRICE
15c

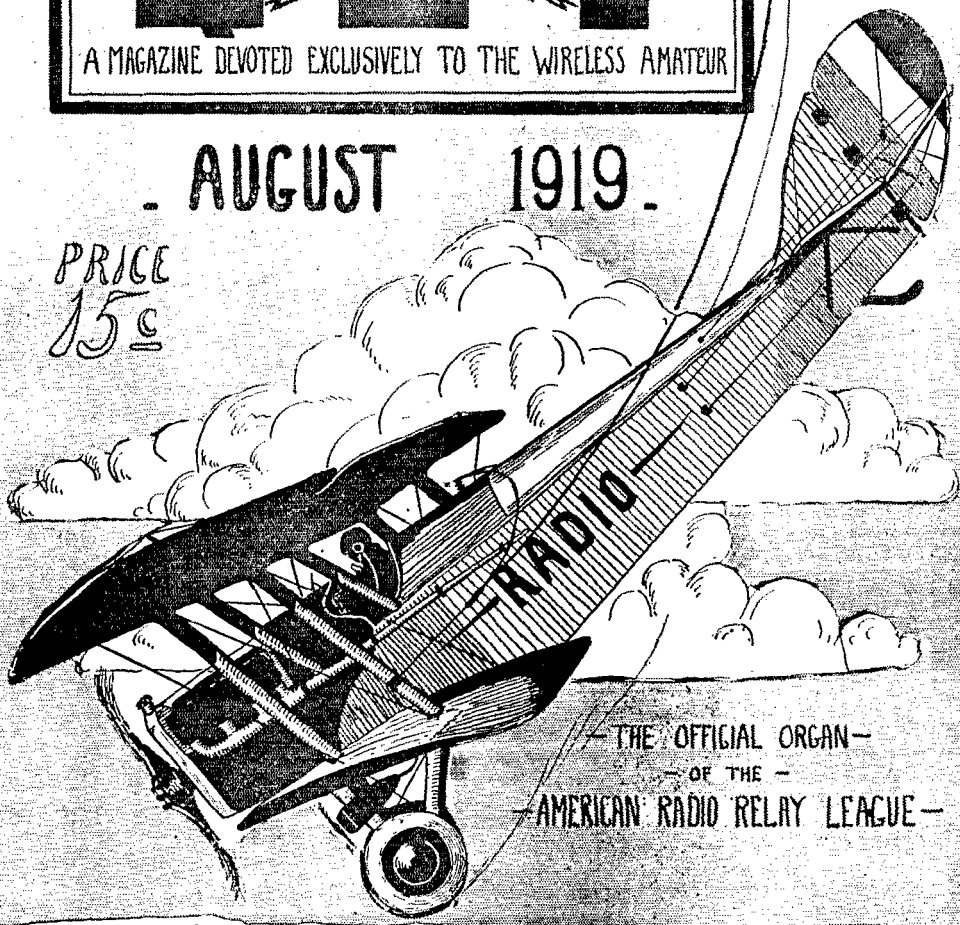

— THE OFFICIAL ORGAN —
— OF THE —
— AMERICAN RADIO RELAY LEAGUE —

In This Issue: PROSPECTS AND REGULATIONS ON RE-OPENING

INSULATORS 1,000 TO 1,000,000 VOLTS



Insulation
"MADE IN AMERICA"

Louis Steinberger's Patents

Electrose Insulators Are Standard With
UNITED STATES ARMY and NAVY

AND THE COMMERCIAL WIRELESS TELEGRAPH AND TELEPHONE COMPANIES



No. 6308



No. 4507



No. 4518



No. 6850



No. 6815

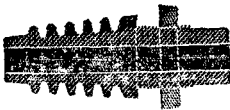

No. 6277

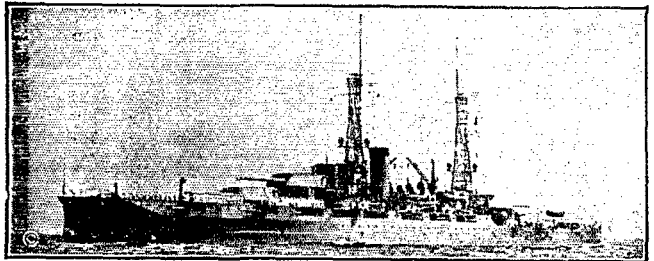

U. S. S. Arizona. ELECTROSE Equipped

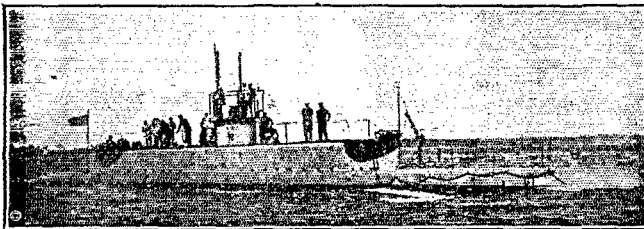

U. S. S. G-I. ELECTROSE Equipped

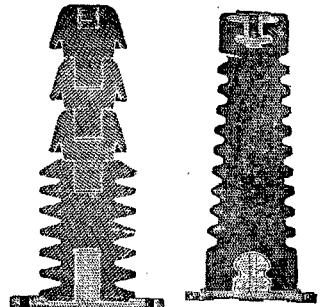

No. 7370

No. 7490

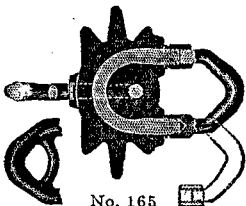

No. 165

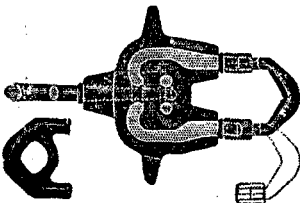

No. 160

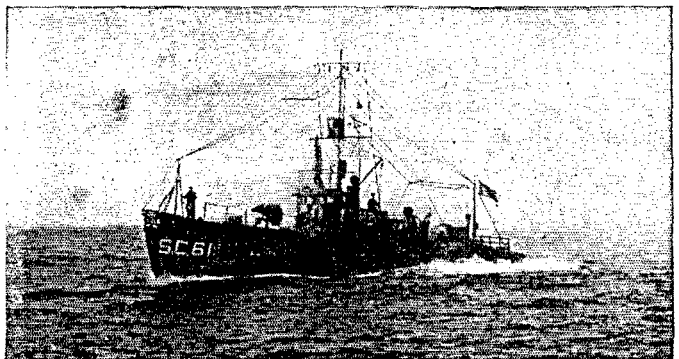

U. S. Submarine Chaser No. 61. ELECTROSE Equipped

Sole Manufacturers

60-82 WASHINGTON ST.

27-37 YORK ST.

66-76 FRONT ST. 1-23 FLINT ST.

BROOKLYN, N.Y., AMERICA

ELECTROSE MFG. CO.

QST

VOLUME III

AUGUST, 1919

NO. I

CONTENTS

3. New Apparatus for C. W.
6. Affiliating the Clubs
8. V.T. Amplifiers
11. Navy Starts Amateur Tests
13. Editorials
16. The Operating Department
21. The Thordarson Contest
23. The Measurement of Wavelength, Capacity
and Inductance by Means of the Oscillat-
ing Vacuum Tube H. E. Rawson
26. "Rotary Gaps" S. Kruse
27. Radio Communications by the Amateurs

QST is published monthly by The American Radio Relay League, Inc., at Hartford, Conn. Kenneth B. Warner (Secretary, A. R. R. L.), Manager and Editor.

Subscription price, \$1.50 per year in the United States and possessions;
Canada, \$1.75; Foreign, \$2.00. Single Copies, 15 Cents.

Entered as second-class matter May 29, 1919, at the post office at Hartford, Connecticut, under the Act of March 3, 1879.

Copyright, 1919, by The American Radio Relay League, Inc.
Title registered at United States Patent Office.

THE AMERICAN RADIO RELAY LEAGUE, Inc.
HARTFORD, CONN.

1500 MILES ON 200 METERS

IN A
CLASS
BY
ITSELF

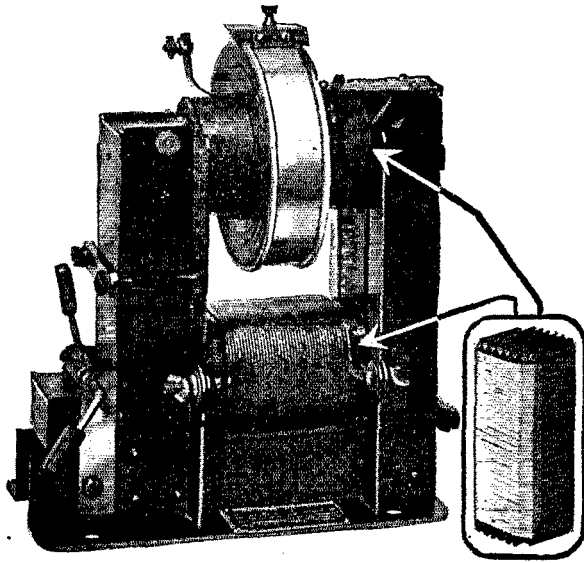

ALWAYS
ON TOP
AND
SECOND
TO
NONE

This is an illustration of the new Type "R" 25,000 volt 1 K. V. A. Wireless Transformer. At the right is shown the core construction of the primary and secondary legs. Note the toothed edge which gives absolute uniform magnetic connection.

As an award to the first A. R. R. L. amateur transmitting 1500 miles on 200 meters and complying with the conditions as outlined on another page of this magazine, we are going to give the winner one of these new transformers or \$35.00 in cash. Our 1919-1920 bulletin mailed on request.

E
F
F
I
C
I
E
N
C
Y

THORDARSON
WIRELESS
TRANSFORMERS

Write Now For Prices and Bulletin

R
E
L
I
A
B
I
L
I
T
Y

THORDARSON ELECTRIC MFG. CO.

501 S. JEFFERSON STREET

CHICAGO, ILL.

Q S T

A Magazine Devoted Exclusively
to the Radio Amateur

New Apparatus For C. W.

"Inductances that come in a box like candy"—The Old Man

IN recent editorials we made mention of the newly-developed concentrated inductances for amateur work in receiving high-powered continuous waves, and in this article some of the apparatus is described.

Fig. 1 is an illustration of an experimental set which will tune up to the highest wavelengths employed by any stations in existence today. Compare this with the

inductance in limited space. Their distributed capacity is very low, with attendant high efficiency in the circuits in which employed; and because by this new method of winding high inductance can be secured with less wire, their ohmic resistance is surprising low, being something less than 70 ohms for the larger sized inductances, as compared with several thousand ohms for the long coils we used to so laboriously wind.

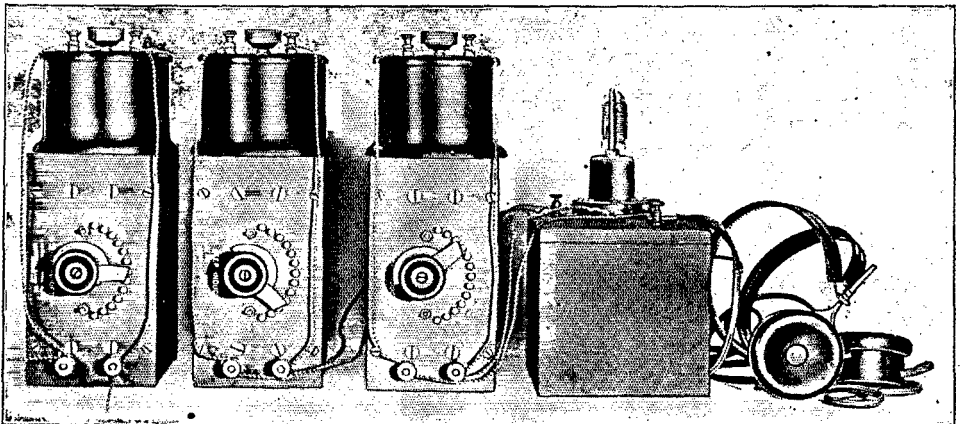

Fig. 1

mountainous coils which used to feature the amateur long-wave set of pre-war days! The inductances are the "twelve-step inductors" of the General Radio Company, of Cambridge, Mass. They employ bank windings and thus secure high in-

In Fig. 2 is shown the hookup, which is immediately recognized as the conventional tickler feedback, identical in operation with the circuit shown in Fig. 1 on page 4 of the July QST. All that is needed for a long-wave set is three such inductances, three

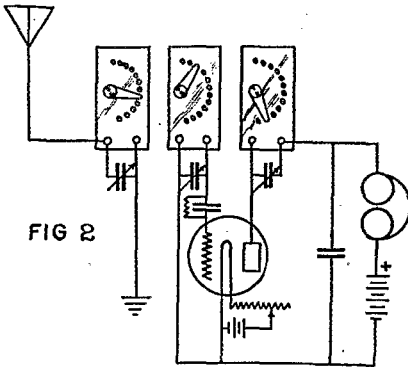

FIG 2

variables, and your regular audion circuit. The inductances are obtainable in various values, the two sizes of 75 and 150 millihenries being the ones in which we are most interested for our work. One induct-

amount of inductance in use and restoring the wavelength by compensating with the condenser.

Fig. 3 is an illustration of a 20,000 meter set constructed of these inductances and ordinary 43-plate variables by the instructors stationed at the Air Service School for Radio Officers at Columbia University, New York, during the war. The apparatus is mounted in a homemade panel of wood, stained black, and had a most excellent performance as well as pleasing appearance. The small panel inserted in the center is the Signal Corps two-stage audio-frequency amplifier.

The circuit for this set is shown in Fig. 4. Five tubes are employed, the first two being radio-frequency amplifiers, the third a detector, and the last two audio-fre-

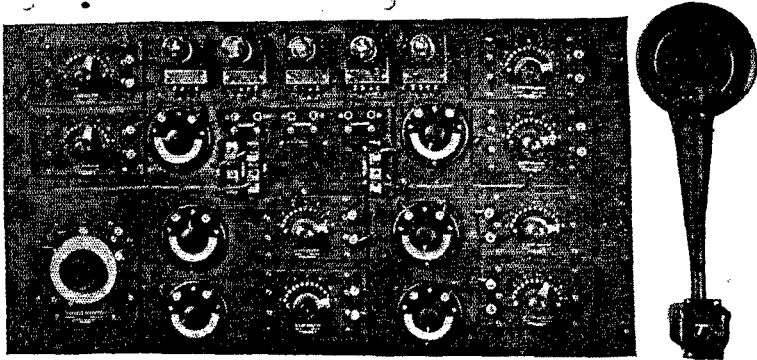

Fig. 3

ance is used for the primary, and its value for given wavelengths will of course depend on the constants of the aerial system. If desired, a variometer of large range may be substituted for the variable condenser in this circuit with some improvement in efficiency. The other two inductances form the windings for the grid (secondary) and plate circuits, and should also be shunted by condensers so that all three circuits may be tuned to the desired wavelength. The inductance cases may be placed on the table and the separation between them varied to change the coupling. About one inch is generally satisfactory, altho being variable in twelve steps it is easy to vary the mutual inductance by changing the

quency amplifiers, the iron-core repeating transformers and associated apparatus

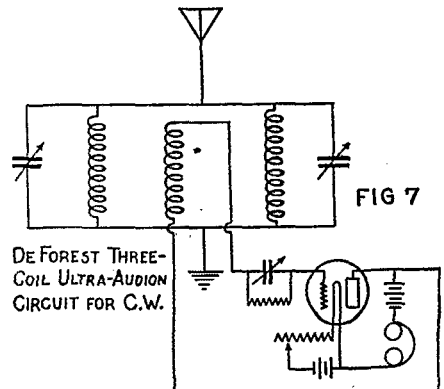

FIG 7

DE FOREST THREE-COIL ULTRA-AUDION CIRCUIT FOR C.W.

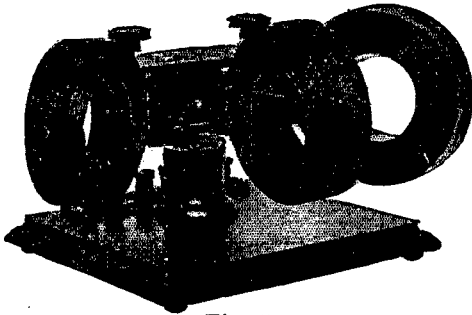

Fig. 5

being attached to the inserted amplifier panel above referred to. The circuits employed in this set will give about all the permissible amplification but it is doubtful whether the small receiving tubes employed in the last stages performed as well as small power tubes capable of handling

wound on special machinery, the turns of one layer always crossing the preceding layer at an angle, resulting in the peculiar cellular construction from which they derive their name. This method of winding greatly reduces distributed capacity, and in tests these coils have been shown to be extremely efficient. They are without taps, avoiding the losses of leads, poor contacts in switches, and the mechanical difficulties always attending a tapped inductance. Tuning is accomplished solely by variable condensers shunted across the windings, exactly in the manner shown in Fig. 2. The DeForest Company have also brot out a three-coil mounting for these inductances, shown in our Fig. 5. This very ingenious device provides for a stationary coil in the centre, and a movable coil on

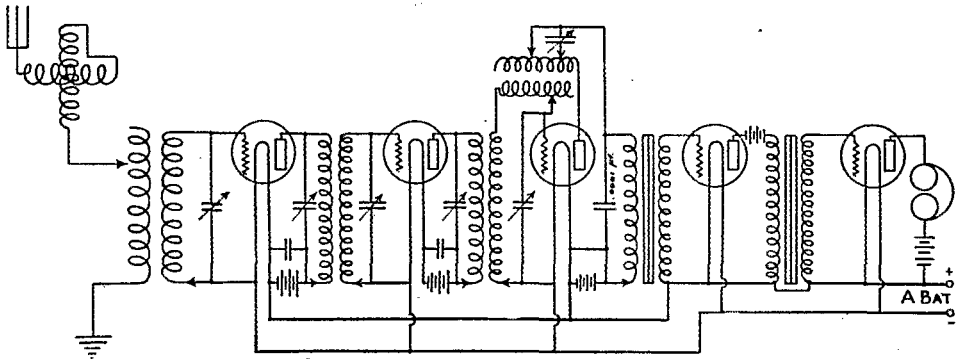

Fig. 4

more energy and operating with higher plate potential would have done. The first two stages being radio-frequency, it is of course necessary that they be tunable to the desired wavelength, and the same type of inductances, shunted by variables, were used for this purpose. The separation between the coils was mechanically fixed, as shown, but the coupling was electrically variable by varying the value of inductance employed. This set is an excellent illustration of what can be accomplished with the new concentrated inductances.

either side, the outside receptacles being mounted on bearings and geared to small pinions so that accurate adjustments of coupling between the coils can be easily secured by means of knobs at the top of the mounting. One feature of this apparatus which will greatly appeal to the amateur is that with one such mounting

Of perhaps considerably more interest to amateurs generally are the new "Honeycomb-wound" inductances of the DeForest Radio Telegraph & Telephone Company, developed by Mr. Robert F. Gowen, Radio Engineer of that concern. These coils are

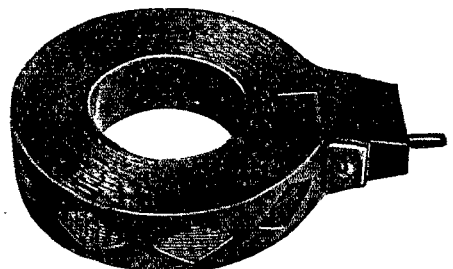

Fig. 6

and a set of interchangeable inductances he can be prepared to tune to any wavelength from 170 to 25,000 meters simply by changing inductances. Sixteen sizes of inductances are available, varying in value from .04 millihenry to 175 millihenries, which will give the wavelengths mentioned when shunted by an ordinary condenser of .001 mfd. capacity. They are remarkably cheap in price, and are also furnished wound with Litz at a slight increase in price for the amateur who wants the highest obtainable efficiency. The windings of course vary in diameter, but are all fitted with a standardized plug mounting as illustrated in Fig. 6, plugging into the inductance mounting of Fig. 5, so that it is but the work of a few seconds to change the set from short-wave work to the longest waves employed today.

In Fig. 7 is shown a three-coil Ultra-Audion circuit recommended by the DeForest Company for anti-static working. This is obtained by the use of the balanced circuit thru the other "primary", the bulb being in an oscillating state by virtue of the Ultra-Audion circuit employed rather than by tickler feedback. It is doubtful, however, if as good results will be experienced with this hookup as with the conventional feedback circuit illustrated in Fig. 2. Any number of combinations are available, however, with the three-coil mounting, and the experimenter can make his own choice of circuit.

Truly the day of the hogshead loose-coupler and eight-foot loading coils is over! We suggest that any of our readers who contemplate a long-wave set write for catalogs of this new apparatus.

Affiliating the Clubs

If all the Radio Clubs of the country were associated together in their activities in some manner, what a great thing it would be for relay work! Affiliated local clubs acting for a common purpose would be able to accomplish wonders in the perfecting of organizations to meet difficult relay problems and the control of unnecessary QRM. There is nothing which would so quickly and vastly improve the reliability of relay work undertaken by any body of traffic organizers as having at their disposal the facilities of the different Radio Clubs throughout the country. These Clubs would possess that local information essential to provide working routes thru difficult territory, and consequently their co-ordinated work toward a common end would be a tremendously helpful thing.

The A.R.R.L. has a splendid traffic organization actively at work in the perfecting of routes to handle country-wide relay traffic, and seems to be the logical

nucleus around which the different clubs should affiliate for this work. Back in 1917 relay affairs had expanded to the point where the A.R.R.L. was considering the question of inviting the different clubs to become affiliated with it in its work, but the declaration of war, coming soon after the start of the preliminary work, made it impossible to pursue it further. Now, however, amateur work has resumed all over the country and the subject has again been having much deliberation here at Headquarters.

We believe we would all benefit by such an arrangement. The A.R.R.L. is a progressive, enthusiastic, 100% amateur and wholly non-commercial organization of radio amateurs, and affiliation with it will mean association with the oldest, strongest, and cleanest amateur organization in the country—association without commercialism. In becoming affiliated, a club would be very much as an individual A.R.R.L. member except capable of much more

effective work, as its members will have any number of effective relay stations instead of one, and thru local administration will be able to effectually control that brand of QRM which has heretofore been so detrimental to relay work. And the other big benefit of the union is the mutual strength we will gain in our efforts for legislative protection. The A.R.R.L. is the only amateur organization recognized by the government, and this is because it is the only purely amateur and non-commercial association in the country. With the added strength of the affiliated clubs we will be able to better represent the vast body of amateurs contained in our country. We all know that organization is the only protection against iniquitous legislation, and the first question shot at a protester is "Whom do you represent?" The A.R.R.L. has always championed the cause of us amateurs, and we have been able to do effective work; but we all see the greatly increased strength our organization will have, and the ability afforded clubs to make their weight known in such matters, if we are all bonded together in affiliation.

Now what is affiliation—specifically, what will affiliation with the A.R.R.L. mean? We have given great thought to the matter and here is the answer: A club becoming affiliated with the A.R.R.L. gains association with the premier amateur bodies of the United States, and this interlocking of hands is wholly fraternal and having for its aims the furtherance of amateur radio and that alone. Physically it obtains a connection with the only organized body of relay men and a place in relay activities which will provide the interesting practical work which we all desire to do with our stations. In such affiliations the already-existent routes of the A.R.R.L. will be strengthened and new routes made possible, and this same union of hearts and hands will give us all added strength for protection. What we want, then, is moral support from the clubs—the joining with us spiritually in the feeling that we are all parts in a great purpose, the future of which none of us can forsee—and in return the League offers itself as

a vehicle in which is provided union free of commercialism.

Getting down to practical details, the League would expect a club desiring affiliation to declare itself willing to co-operate with the A.R.R.L. in its work, to request an active part in relay activities, and to agree to do what is possible in their territory to improve relay conditions in general in the curbing of unnecessary, wilful, and malicious interference. A resolution adopted by the club, embodying the above features, would seem the best method.

Accordingly, The American Radio Relay League announces its willingness to affiliate with it in its work, all bonafide amateur radio organizations. To this end, the following resolution should be regularly adopted by the organization, duly executed, and forwarded to The Secretary at Hartford, Conn., for action by the Board of Direction:

"Whereas this organization has been invited by The American Radio Relay League to become affiliated with it in its work and is willing to co-operate with the League in its activities in amateur radio relay operation and desires to become associated therewith, and is aware of the mutual benefits to be obtained in legislative protection thru such an alliance; be it

Resolved: that this organization hereby requests affiliation with The American Radio Relay League and agrees to actively engage in the radio relay traffic work of the A.R.R.L. thru the stations of its several members and under the jurisdiction of the recognized traffic organization of the American Radio Relay League; and further agrees to act to the best of its ability to enforce observance of the radio laws of the United States, particularly with reference to the prohibition of unnecessary interference inimical to relay traffic."

Now is the time to get busy, before the good relay weather arrives and while relay organization is still in process, so that the coming of Fall may find us a perfected association. It will be a great season. Secretaries of Radio Clubs, we invite your co-operation!

V. T. Amplifiers

WHETHER or not the development of amateur radio operation will be in the direction of much less transmitting power and the use of high amplifications at the receiving end, the amplifier is today one of the most important pieces of apparatus in our stations. In pre-war days it was a tricky thing, with an annoying tendency to howl, and necessitating the investment of considerable money in duplicate A and B batteries, and results obtained experimentally using spark-coil secondaries or other impromptu repeater coils were oftener discouraging than not. During the war the amplifier question received the same intensive investigation accorded other perplexing radio problems,

method, the radio frequency signal is first rectified, and the audio-frequency is thereafter amplified. It is the practical applications of this method which will be discussed in this article.

To begin with, we should get fixed in mind the principle of operation, and it is very simple. Reference to the characteristic grid voltage—plate current curve of typical VTs shows a comparatively straight portion, unsuited to rectification, but where changes in the grid potential will produce similar and symmetrical changes in the output current. This is the amplifying portion of the curve, and the best amplification is obtained along that portion where the curve is steepest, other things being equal. In a VT functioning as a detector and

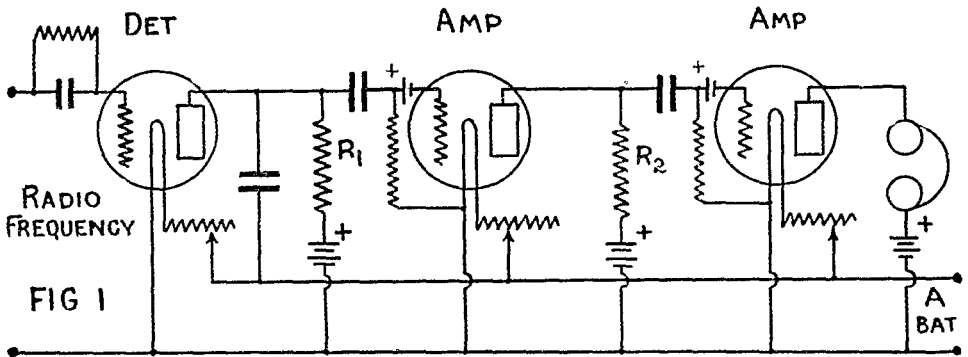

so that now multi-step amplifiers are produced that are wholly satisfactory and remarkably simple in composition, commonly operating on but one A and B battery.

Two methods of amplification by the VT are available: high and low frequency. In high-frequency amplification, the radio-frequency signal is amplified several times and then rectified so as to be heard. Such circuits of course require tuning to the proper frequency, and their complexities in comparison with audio-frequency amplification make their use desirable only in special work, and in amateur work in particular the low-frequency amplifier seems more desirable. In this latter

without grid condenser, we have to operate near a bend in the characteristic curve so that symmetrical variations in impressed grid voltage will produce asymmetrical changes in plate current, resulting in an average increase or decrease at audio frequency of the current thru the phones. But in an audio-frequency amplifier our current is already rectified and we want to impress these symmetrical audio-frequency pulsations on the grid in such a manner as to preserve their characteristics without distortion (i.e., amplify both halves of the cycle equally) and this means operation on the straight portion of the curve. The amplifying power of a VT

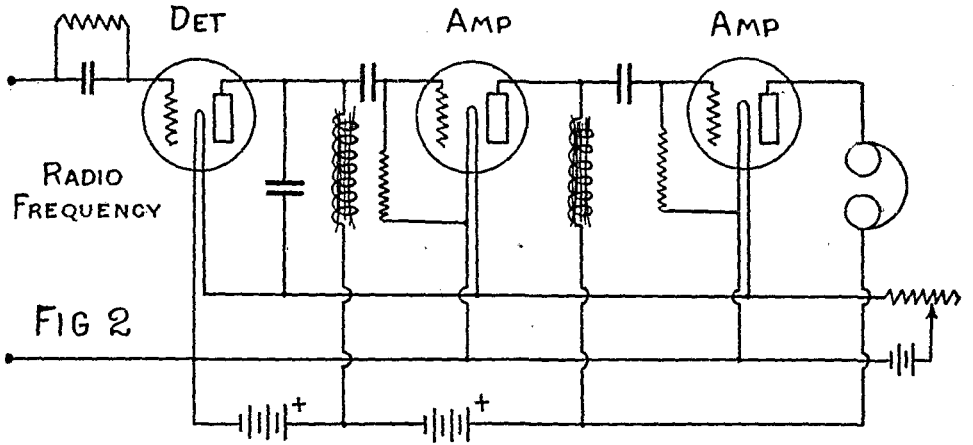

may be defined as the change in plate voltage necessary to make a certain change in plate current, divided by the change in grid voltage necessary to make the same change in plate current, and in the tubes which will be available for our use will vary between 4 and 9.

In general, three methods of audio-frequency amplification are possible with the VT :

- Resistance repeating
- Inductance repeating
- Transformer repeating

Resistance repeating has the advantage of simplicity but is wasteful of energy, and better results will be obtained by the use of inductances or transformers. Fig. 1 illustrates a hookup for amplification by resistance repeating, showing a rectifier

and two stages of amplification. R1 and R2 are the repeating resistances, and should be of about 50,000 ohms. The plate current passing thru these resistances, fluctuating potentials are established at their terminals, due to the potential drop, and these potentials are directly conveyed to the grid-filament circuit of the succeeding tube. Grid condensers are necessary to insulate the grids from the plate potential, and it is important to note that the grid leaks must be shunted direct to the filament or else they would defeat the purpose of the condenser.

In this figure a C battery is shown, this being one very desirable method of shifting the axis of grid control to a point in its curve where the variations in output current will be symmetrical with the in-

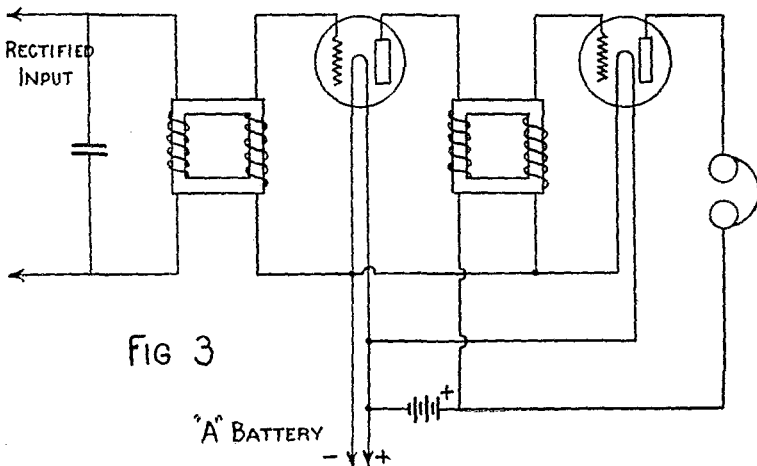

put voltages, when some such procedure is necessary with the tubes employed. The commoner method is to choose a plate voltage which will accomplish the same result, but operation by the former method is more economical.

Fig. 2 illustrates amplification by means of inductances, or "chokes" as they are commonly called. This method is considerably more efficient than by resistances, because the d. c. resistance of the inductances can be made much less for equal results, and its simplicity and compactness brot it into favor in airplane sets in particular. The chokes should be of very high impedance, having an inductance be-

Fig. 3, is by far the most satisfactory method of all, not only because the impedance of the primary and secondary can be made to fit the output and input impedance, respectively, of the tubes, but because additional voltage amplification can be obtained in the transformers themselves. A turns-ratio of about 1 to 5 is generally employed, and the transformers are of the conventional closed magnetic circuit design, laminated, about 2 inches square with a cross-section of $\frac{1}{2}$ inch by $\frac{1}{2}$ inch, and may be wound with No. 40 enameled wire. If the experimenter does not care to construct his own, very satisfactory ones of this type may be purchased

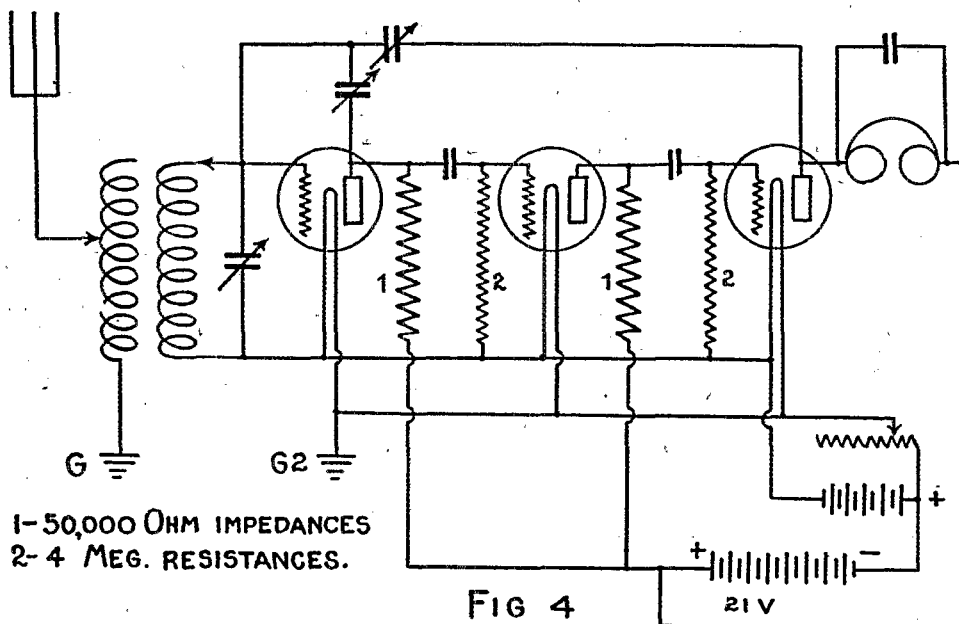

tween 10 and 20 henries. A very satisfactory one for experimental use can be constructed by winding a core of soft iron wires, $\frac{1}{2}$ inch in diameter and 3 inches long, to a diameter of 1 inch with No. 36 enameled wire. The principle is practically the same as with resistances: the passage of the fluctuating plate current produces corresponding potential fluctuations at its terminals, which are led to the input circuit of the next tube for further amplification.

Transformer amplification, as shown in

from the advertisers in Q S T. Amplifications of 10,000 are easily possible with two tubes in cascade as illustrated. Note that no grid condensers are necessary in this circuit to insulate the grids from the plate voltage, because each has its separate circuit.

In using any of these three methods it is necessary to shunt the input from the detector to the first amplifier with a condenser of about 500 micro-mfd. capacity, to by-pass the radio-frequency component

(Concluded on page 25)

Navy Starts Amateur Tests

—An Important Announcement—

IN order to maintain the interest of the radio amateurs and keep them in operating practice, the Navy Department, through the District Communication Superintendent, of the Ninth, Tenth, and Eleventh Naval Districts, has decided to send out, broadcast, nightly test messages on a wave length of 476 meters at speeds of 15 and 25 words per minute. These messages will be sent out from the Radio Station at Great Lakes, Illinois, which is the old familiar NAJ. The messages will contain the weather report for the Great Lakes, some late press news and a short code message, the form for the translation of which is contained in this article.

The test message idea was originally suggested by Mr. T. B. Lambert, a Chicago amateur, and the letters attached hereto show the manner in which the plan was developed.

The fact that the Navy Department has expressed its willingness to co-operate with the radio amateur in every particular is a distinct concession, and is greeted with satisfaction.

The details of the test message plan are contained in the attached correspondence between Lieutenant F. H. Mason, District Communication Superintendent, Ninth, Tenth and Eleventh Naval Districts and our Vice-President, Mr. R. H. G. Mathews, of Chicago.

The plan as suggested by Mr. Mathews has been adopted, and these messages will be started as soon as proper arrangements can be made. Watch QST for further announcement.

Great Lakes, Ill., June 30th, 1919.

R. H. G. Mathews, Vice Pres.,
American Radio Relay League,
Chicago, Ill.

Dear Sir:

It has been suggested that the Navy Department broadcast daily from the Great Lakes Station a drill message for the ama-

teur radio enthusiasts of the 9th, 10th and 11th Naval Districts. This matter has been taken up with the Director of Naval Communications and I am very pleased to advise you that he is in full accord and wishes me to state that the Navy Department will co-operate in every particular, so far as the regulations will permit, with the amateur radio operator.

It is the purpose now to broadcast somewhere in the neighborhood of 7:00 P. M. each day a message containing some news item and some twenty-five or thirty words of code; this code, however, depends upon whether or not the Relay Association has a code which all amateurs can copy and decode.

Before inaugurating this service we would like to have suggestions from your Association, as it is quite possible that there are some things of interest which we have neglected to take under consideration.

Awaiting your early reply, I am,

Very truly yours,

F. H. Mason.

Lieutenant F. H. Mason,
District Communication Superintendent,
Great Lakes, Ill.

Dear Sir:

I am in receipt of your letter regarding the proposed tests to be sent for the benefit of the radio amateurs, from the Great Lakes radio station, and wish to express to you my appreciation of your efforts on behalf of the amateurs.

It is very gratifying to know that the Navy Department is willing to co-operate with us in our efforts, and I am sure that the test message plan when carried out will lead to even more cordial relations between the radio amateur and the Department. The average amateur has always been a little afraid of the Navy, partly because he was not as well acquainted with it as he might have been, and partly because it was not as well acquainted with him and his uses as it could have been.

The recent war has led to better understanding on both sides, since we have all become better acquainted with the Navy and have the greatest admiration for its wonderful accomplishments during the war, and also because the Navy has found that the radio amateur has his uses in war time, especially.

attaching hereto a proposed schedule for the amateur test messages, which was drawn up with a view toward making these tests as valuable as possible to the average amateur and at the same time to stimulate his interest.

Very truly yours,
The American Radio Relay League, Inc.
R. H. G. Mathews, Vice-President.

In compliance with your request, I am

SCHEDULE

- (A.) Broadcast at 7:30 P.M. each evening the following, on a wave length of 476 meters, at a speed of 25 words per minute.
 - (1.) Weather report.
 - (2.) One late news item of about 30 words.
 - (3.) One code message of about 25 words, using code attached hereto.
 - (4.) "Suggestions and opinions regarding this amateur broadcast service should be sent to the District Communication Superintendent, Great Lakes, Ill."
- (B.) Repeated at 8:15 P.M. on wave of 476 meters, at a speed of 15 words per minute.

Code No.

1.	A B C D E F G H I J K L M N O P Q R S T U V W X Y Z
2.	B C D E F G H I J K L M N O P Q R S T U V W X Y Z A
3.	C D E F G H I J K L M N O P Q R S T U V W X Y Z A B
4.	D E F G H I J K L M N O P Q R S T U V W X Y Z A B C
5.	E F G H I J K L M N O P Q R S T U V W X Y Z A B C D
6.	F G H I J K L M N O P Q R S T U V W X Y Z A B C D E
7.	G H I J K L M N O P Q R S T U V W X Y Z A B C D E F
8.	H I J K L M N O P Q R S T U V W X Y Z A B C D E F G
9.	I J K L M N O P Q R S T U V W X Y Z A B C D E F G H
10.	J K L M N O P Q R S T U V W X Y Z A B C D E F G H I
11.	K L M N O P Q R S T U V W X Y Z A B C D E F G H I J
12.	L M N O P Q R S T U V W X Y Z A B C D E F G H I J K
13.	M N O P Q R S T U V W X Y Z A B C D E F G H I J K L
14.	N O P Q R S T U V W X Y Z A B C D E F G H I J K L M
15.	O P Q R S T U V W X Y Z A B C D E F G H I J K L M N
16.	P Q R S T U V W X Y Z A B C D E F G H I J K L M N O
17.	Q R S T U V W X Y Z A B C D E F G H I J K L M N O P
18.	R S T U V W X Y Z A B C D E F G H I J K L M N O P Q
19.	S T U V W X Y Z A B C D E F G H I J K L M N O P Q R
20.	T U V W X Y Z A B C D E F G H I J K L M N O P Q R S
21.	U V W X Y Z A B C D E F G H I J K L M N O P Q R S T
22.	V W X Y Z A B C D E F G H I J K L M N O P Q R S T U
23.	W X Y Z A B C D E F G H I J K L M N O P Q R S T U V
24.	X Y Z A B C D E F G H I J K L M N O P Q R S T U V W
25.	Y Z A B C D E F G H I J K L M N O P Q R S T U V W X
26.	Z A B C D E F G H I J K L M N O P Q R S T U V W X Y

In sending messages by these codes the words "code number", followed by the number of whichever of the 26 codes shown hereon is used in the message which follows, will be prefixed to the message. No code will be used on two consecutive nights, and neither will the codes be used in order, but an arbitrary selection will be made, thus giving the receiving operator more practice at decoding.



THE LID

All month long we have been chafing impatiently at the delay in the removal of transmitting restrictions. Then came persistent and extremely well defined rumors that the ban would be lifted effective Aug. 1st and we held QST to get the good news in his issue. Later it was unofficially announced by the Navy Department that the lid would go off August 1st and with a singing heart we wrote up the dope for this page. But today comes the sorrowful news that the Secretary of the Navy has disapproved the measure and states the restrictions will continue until the President declares a state of peace exists, when the Navy will no longer be empowered to exercise any control over us. In other words, the Navy can let us start any time now but refuses to until they can no longer prevent it. We suppose now we'll have to wait until the proper spirit moves our Honorable Senate to ratify the Peace Treaty. The news is all the more disappointing because of our earlier elation.

When we do get away from the Navy we automatically go back under our good old former bosses, the Department of Commerce. Mr. Terrell, Chief Radio Inspector, of the Department, has kindly given QST an outline of the policy under which amateurs will resume operations, and from this we present the following salient features, saved from the wreckage of our earlier editorial, and which are of much interest to us all:

(1) All amateur station and operator's licenses have expired during the war. It will therefore be necessary to take an amateur operator's examination. This consists largely of written questions much as

in the old days but the receiving test has been stiffened from 5 words per minute to 10 and will be rigidly adhered to. Second-grade licenses will be issued as in the past to operators in the remote interior who cannot reach a radio inspector for personal examination, but application for same must certify that the applicant can receive 10 words per minute. An operator's license is necessary before a station license can be secured.

(2) After receiving an operator's license, an amateur will be permitted to erect his station and should then apply to the Department for station license application blanks on which data respecting the aerial dimensions, wave length, power, etc., is to be furnished for use in issuing the station licenses. The licenses are very similar to the old ones except printed on one page only, to facilitate framing, instead of on both front and reverse as formerly. An important thing to us in view of the undoubted confusion from several thousand simultaneous applications is that the Department will permit us to operate on filing applications for station licenses and before the receipt of same. This worried us a while, as there will doubtlessly be considerable delay in handling the vast number of applications.

(3) A clean start is going to be made in issuing call letters. All former ones are cancelled and it will be practically impossible to get them back. Each call letter will have a corresponding official number in the records and no calls will be assigned out of their natural sequence. If a man wants his old call letters bad enough he can apply for them, but they may already

be assigned and if not already issued he will have to wait for his license until such time as all intermediate calls have been issued in regular sequence. We strongly advise waiving requests for old calls. It will save much precious time, cut down confusion, and it won't take long for us to learn the new calls.

(4) The outlook is rather gloomy for special licenses. The Department anticipates an immense expansion in ship traffic due to our growing Merchant Marine so that part of the work will probably be rel-

egated to 450 or 300 meters, and there is also the development of airplane radio for mail service, etc., to consider; so that we understand special licenses will be available only when no interference is probable, and with much stiffer regulation of wavelength and decrement than heretofore, with the tune probably reduced from 425 meters to 375 meters.

Our heart is heavy, friends, over this delay in getting back on the brass, but we know it will be only a short while yet, and then—The Days of Real Sport!

OUR PROGRESS

As we prepare this third post-war number of QST, we feel much elated. The old A. R. R. L. bunch is coming back strong, our Operating Department is experiencing great success in the re-establishment of its activities, and we have been able to give you a better QST each month. And the indications are that transmitting will soon be given back to us, perhaps before this QST is off the press. What more should it take to make us feel encouraged?

What do you think of our QST? If there is anything about it you don't like, write and tell us, for QST belongs to our membership and we want to make it exactly what you want.

This month we are resuming "Radio Communications from the Amateurs", and soon we shall again start "Who's Who." Do you want a Pictorial Section again? If so, don't you think we had better confine it to stations constructed since the reopening? How about calls heard? Is there any value in publishing calls heard when they are not amateur calls? We would like to hear from you on these subjects.

Now remember that QST is yours, like the rest of the A. R. R. L. The A. R. R. L. is the only national non-commercial organization of radio amateurs, and QST is the

only non-commercial amateur magazine in the country, plaster saints to the contrary notwithstanding. We are what we are because we all got together and did it. Now let us all hang close together and grow. Let every mother's son of us do his bit. Boost QST; tell the fellows who don't know it that we're back. Renew your subscription promptly when you get an expiration notice, so you will not miss anything. See that QST is obtainable on at least one news-stand in your town; if it isn't, use the coupon in this QST and give us your dealer's name. Help keep our QST growing.

Now about your A. R. R. L. dues. Do you realize that since we got going again most of you have neglected to pay your dues? It is the money derived from this source which pays the current expenses of the A. R. R. L.—keeps us going with stationary, postage, and office expenses. Two dollars dues are payable by every A. R. R. L. man who hasn't remitted since we resumed activities this year. This includes QST for a year, and will be posted as an extension of subscriptions already on the books. You who have not paid are invited by the Secretary to come across at your early convenience.

THE A. R. R. L. HONOR ROLL

We all know that thousands of A.R.R.L. men served in the Great War. Most of us are now back in mufti, happily engaged in the pursuits of peace, or expecting soon to be released and pick up the threads of life where they were so hastily dropped in

1917. But what of those of our number who went West over the Twilight Trail, whose Sparks are now forever stilled?

Fellows, we want to commemorate the deeds of these our friends and co-workers, who made the Supreme Sacrifice in the

service. We want to publish in QST an Honor Roll of their names—it is the least we should do to perpetuate their memory. Won't every reader of QST who knows of an A. R. R. L. man who "Went West" in

the service drop us a line giving his name, home, rank, outfit or branch of service, and a few words concerning the time, place, and manner of his death? We will do the rest.

EFFICIENT TRANSMITTERS

We feel just like starting something. When we think of the misdirected energy that used to be wasted in amateur stations in the construction and attempted operation of alleged apparatus that wasn't worth its binding posts, we feel the temperature rising and our typewriter (not stenographer) is generally due for a good pounding.

Last month we unburdened ourselves of a whole lot of generalities under the heading "On Resuming Transmitting". Next month we will take a little crack at the rotary gap, where there is room for a startling amount of improvement in the average amateur set. You all will remember a series of articles in QST before the war on "The Ideal Station". That's the stuff we need now. That was splendid, and by combining the ideas of many advanced experimenters on what constituted the best possible design for the various pieces of transmitting apparatus, we were able to learn a lot. But since April, 1917, haven't we been doing a whole lot of thinking on this subject? Isn't it a fact that many of us put time which hadn't theretofore been available on the studying of the

technical aspects of various perplexing questions in design, so that now we know vastly more about how to make a good amateur transmitter? We surely think so.

Another thing we must remember is that since then a couple of hundred thousand potential experimenters have been added to our ranks in the men whose interest in amateur radio has been aroused thru service in the Army and Navy, or thru the publicity being accorded radio these days. The simple little things in the question of good design, which we think are so obvious that every tyro should know them, are not always apparent to the beginner, and we should help them and make our increased knowledge available, not only because of the fellowship of the thing but because it inevitably means less QRM and better relaying.

This, then, is an invitation. All of you who have worked your way thru some knotty problem in design or construction of amateur transmitting apparatus and have something new to tell, are asked to send it in to QST, that we all may profit by it in the establishing of our new stations.

HAVE YOU BOUGHT YOUR BOND?

For the benefit of those who have not yet attended to this matter, we want to emphasize the importance of buying your Bond right away. Receiving is opened, transmitting will soon be opened, and amateur radio will have started on its way. Our A. R. R. L. and QST will quickly feel the effects and expand in a manner that most of us would not believe possible today. We have seen things happen before, and we know what is going to happen now.

In order to carry on the work of organization of us amateurs of this country for our own benefit and protection, and in

order to make QST the magazine which we can easily make it, we need a certain amount of money and we need it now. The only way to raise this money is for us all to realize the importance of amateur organization, by amateurs, and for amateurs, and to put our individual shoulders to the wheel and help.

This help is not to be considered for a moment as a gift or a donation. It is not. It is a loan, properly secured by a formal Certificate of Indebtedness. It runs for two years, unless we pay it off

(Concluded on page 22)

The Operating Department

J. O. Smith, Traffic Manager
Rockville Centre, L. I.

Reports received from the League's Division Managers indicate that the same intensive interest on the part of radio amateurs as characterized our work in the past is existent today, as vigorous as before. The remarkable enthusiasm for radio that held sway at the outbreak of war in 1917 and that had resulted in the formation of the League's traffic department, is just as evident today as then, in spite of the fact that the ban on transmitting has not been lifted.

The League's Traffic Department enjoys an enviable position in the radio situation, in that in addition to being nation-wide in scope and including practically all the best known amateur radio men of the country, it is also the only traffic organization that has an actual and active personnel, and it is the only traffic organization that actually maintains trunk relay lines for handling and distributing message traffic.

The fact that the foremost amateur radio men of the country are actively identified with the League's traffic organization is complete evidence that these men realize the value of organized effort not only as regards a traffic organization, but with particular regard to future pernicious legislation, affecting the future of the amateur.

At this writing the ban on amateur transmitting has not yet been lifted by the Navy Department in spite of the fact that the peace treaty has been duly signed, and that the country otherwise is practically on a peace basis. What good is being accomplished by this delay, it is hard to see. It is hoped, however, that these conditions will not long obtain.

The reports of the Division Managers in detail follow.

ATLANTIC DIVISION.

Chas. A. Service, Jr., Manager
Bala, Pa.

Conditions in the Atlantic Division of the American Radio Relay League have been constantly improving since the order allowing amateurs the use of their receiving apparatus again, and with the appointment of most of the District Superintendents and the formation of a tentative relay organization in practically all the States of this Division, indications are that we will be able to handle relay work with little difficulty or delay, when restrictions on transmitting are finally removed. Gaps are bound to occur, here and there, but it is hoped these can be temporarily bridged or an alternate route established until such time as new stations are found to fill the vacancies. The greatest trouble, as in the past, will be in getting messages thru to those sections of States which are weak in radio population, and the only solution in such cases will be to let these relatively unimportant districts develop themselves until the more important Trunk Lines are in reliable working order and the District Superintendents can turn their attention to the smaller Branch Lines.

The most important thing at this time, so far as individual stations are concerned, is for them to make themselves known to the District Superintendent of their section of the country and by offering to cooperate, help him, themselves, and the League as a whole. It will enable the District Superintendent to locate those stations upon whom he can rely and by means of the information furnished, to establish tentative, temporary lines which will be ready to commence work immediately upon removal of transmitting restrictions. If any station desires to take part

in the coming relay work, a letter should be addressed to the District Superintendent in charge of the district in which the station is located giving a description of receiving and transmitting apparatus, time that can be devoted to relay work each week, general relay situation in that vicinity, possibility of forming branch routes, best stations with whom reliable communication can be carried on and suggestions of value to the District Superintendent in organizing radio routes thru his section.

Reports from District Superintendents from every part of the Atlantic Division indicate a great majority of the Old Guard are already back, ready to open when the good news comes, or if still in the service have signified their intention of getting in the game again when released. Seventy five percent, at least, will return and we make the prophecy that the vacancies in the ranks will be more than filled in short order by men fresh from the service who will make the former relay stations look to their laurels.

With reference to new Trunk Lines, those in existence before the war thru the New England States to New York, Pennsylvania and the West will form a working basis for the establishment of new ones to be put in operation as soon as certain gaps, where former relay stations have dropped out, can be bridged. Assistant Division Managers should determine, if possible, where these gaps occur and with the assistance of their District Superintendents find new stations to carry traffic thru. Wherever possible, several stations in one locality should be lined up for this and a working agreement arranged between them whereby they divide the traffic, each having a certain night in the week to be on duty so there will be no delay in forwarding messages due to absence of any one of them.

ATLANTIC DIVISION (Eastern Section)

Guy R. Entwistle, Assistant Division Mgr.
137 Sutherland Rd., Brookline, Mass.

At last the first issue of QST. At last a medium thru which to reach the members of the relay chains to reorganize our stations. What a duplication of corres-

pondence without a central point to distribute the news of the various sections! This waiting for our first post-war number should teach us all the value of organization.

League workers in New England have realized the necessity of proceeding cautiously in the readjustment period as many new stations have sprung up and other older ones have been discontinued.

We regret to hear that Mr. Wm. H. Allison, formerly IZW, has decided to drop out of relay work. Allison, we wish you luck.

Mr. Lee A. Bates, formerly 1HT, of 8 Moen St., Worcester, has offered his services to the league and I am sure we are fortunate in securing such an experienced amateur as Mr. Bates. The germ caught him 15 years ago, and is apparently still with him. Mr. R. M. Peterson of Worcester Tech. will be associated with Mr. Bates, so we sure have been fortunate in Western Massachusetts. Peterson works 1YK, Worcester Polytechnic Institute.

Reports from Southern Massachusetts show that Uncle Sam is still holding many of our former members. Radio Inspector, Mr. Arthur Batcheller, at a meeting of the New England Amateur Wireless Association, said that out of about 2400 amateurs in the first district about 1100 were in some branch of the service. Now that the German fleet has victoriously sunk itself we may expect a return of our former relay men.

District Superintendent Harold C. Bowen, 168 Belmont St., Fall River, would like to hear from amateurs around Southern Massachusetts and Rhode Island who can send 15 or 20 miles and who are anxious to get into the relay game.

District Superintendent Wilbur H. Hardy of Beverly, Mass., is still on the job in Northern Massachusetts and is anxious to hear from aspirants in Maine, New Hampshire and Vermont.

I would like to suggest that there will be appointments as District Superintendents in the last three states, so it behooves wide awake amateurs in those territories to get in on the ground floor while the development is in its infancy and be one

of the lucky ones. We are believers in the merit system. Show us you have the goods and we will do the rest.

Mr. Philip Robinson of Braintree, Mass. has been delegated to look after things down the South Shore way. Robinson is an old Marconi man and has a good 500 cycle set and 3 step amplifier so he ought to cover a few miles of terra firma with ether waves.

Amateurs should, when they read of an assignment of territory in their section, immediately communicate with the station delegated to take care of traffic. In this way only can the necessary co-operation be secured.

Remember the Operating Dept. has an organization and it is the only one existing, so use it. Don't jump over the head of a subordinate official and tell your troubles to the chief, as he will only refer them back to the party they should have passed thru at first.

Now that peace is signed the happy hour is not far off.

ATLANTIC DIVISION (Middle Section.)

M. A. McIntire, Ass't Division Manager
1127 Avenue "G," Brooklyn, N. Y.

Radio work in the States of New Jersey, New York and Connecticut has started with a "bang". Reports from the different District Superintendents already appointed, a list of which is below, show that stations are springing up all over, some in places where we never had any before, and the "old-timers" are also coming back strong.

At this writing District Superintendents for Southern New Jersey and Northern Connecticut are needed, and I wish all amateurs located in those Districts, who are anxious to take active part in the traffic work of the League would communicate with me, in order that District Superintendents may be appointed.

The following is a list of the District Superintendents already appointed in this District:

Southern and Western Connecticut.

Mr. H. E. Nichols—513 Pequonnock St., Bridgeport, Conn.

Eastern New York (excepting New York City, Long Island and Staten Island)

Mr. C. R. Runyon—544 No. Broadway, Yonkers, N. Y.

Western New York

Mr. W. T. Fraser—48 Glenwood Avenue, Buffalo, N. Y.

Eastern Long Island

Mr. H. L. Stanley—Babylon, N. Y.

Northern New Jersey

Mr. Lester Spangenberg—25 South 4th St. Lake View, N. J.

New York City and Bronx

Mr. John DiBlasi—153 East 86th St. New York City. (East Side Y. M. C. A.)

Trunk Lines are being formed as quickly as we get assurance that the station will be working and it is earnestly requested that all amateurs, either new or old, large or small, communicate with either the District Superintendent in their District or with the writer in order that we may have the lines completed and ready for business as soon as the transmitting ban is lifted. Our trunk lines through western New York and through Long Island up into Connecticut are in good shape, and it is hoped that our Jersey lines into Philadelphia and along the Jersey Coast will soon shape themselves up.

ATLANTIC DIVISION (Southern Section)

Chas. H. Stewart, Assistant Division Manager.

St. David's, Penna.

The appointment of the following District Superintendents has been made.

W. T. Gravely, 503 Main St., Danville, Va.—Central Virginia District.

E. B. Duvall, Baltimore, Md.—Eastern Maryland District.

Raymond L. Schaefer, 139 B St., SE, Washington, D. C.—District of Columbia.

William A. Cawley, R. D. No. 3, Milton, Penna.—Central Pennsylvania District.

Edward R. McCaskey, 1677 North 54th St., Philadelphia—Eastern Penna. District.

It is highly desirable that the various District Superintendents hear from those who are interested in the work of the A.R.R.L., giving information as to their

receiving and transmitting equipment; stations formerly worked by them; their plans for the future, etc., to enable us to get a line on present conditions. Attached to this request should appear an up to date list of the traffic officers so far as known at the time of publication.

From the reports of E. B. Duvall and Raymond L. Schaefer it would appear that they are taking active steps to get together, and from the experience they have gained in the past two years, I feel confident that we may expect greatly improved results in their territory, although it is recognized that they have special conditions, both natural and artificial, which will have to be met and overcome. Judging from Mr. Duvall's letter there must be some very peculiar soil conditions existing between Baltimore and Washington, but doubtless there will be found some way to overcome the trouble and bridge the distance.

EAST GULF DIVISION.

J. C. Cooper, Jr., Manager.
Jacksonville, Fla.

I have appointed Mr. John W. Clayton, 5BV, 1301 Welch Street, Little Rock, Ark., as Assistant Division Manager with jurisdiction over Arkansas, Louisiana, Tennessee, and Mississippi. He has accepted the appointment and is beginning the work of organizing traffic in the part of the East Gulf Division just mentioned. All amateurs in that section are requested to communicate with him direct. Further appointments will be made in the near future.

CENTRAL DIVISION.

R. H. G. Mathews, Division Manager.
1316 Carmen Ave., Chicago, Ill.

The work of reorganizing the Central Division has been progressing favorably throughout the Division. Due to the fact that many of our more prominent relay men are still in the service, no attempts have been made to form Trunk or intra-state routes. The most important feature of our reorganization at this time is the formation of local branches of the American Radio Relay League in every town in the Division which contains any radio men, and

from our experience this means every town. To this end, secretaries of all local clubs in the Division are requested to get into touch at once with the District Superintendent in whose territory they are located, with a view toward affiliating their clubs with our National organization. A complete list of all Superintendents appointed to date will be found in the June QST, in the report for this division. Several additions will be found in this report. Clubs which are located in territory over which no Superintendent has yet been appointed should effect their affiliation through the Division Manager, at Chicago.

Especially valuable work in organizing local branches has been done by Mr. F. F. Hamilton, Supt. of Southern Indiana; Mr. W. A. Birch, former Supt. of Northern Minnesota; Mr. H. J. Burhop, Supt. of Southern Wisconsin; Mr. H. I. Crawford, Supt. of Northern Wisconsin; Mr. R. K. Trump, Supt. of Kansas; and Mr. F. H. Schnell, Chicago City Manager. The various districts under the control of these men are lining up in good order, and an effective organization is slowly taking form. Some of the other districts are not quite so far along, due largely to various local conditions, but as a whole the condition of the Division is very satisfactory.

It is regretted that Mr. W. A. Birch, Supt. of Northern Minnesota, has found it necessary to resign because of a change of location to Berkeley California, and accordingly Mr. J. A. Gjehaug, 9QK, of Baudette, Minn., has been appointed to succeed him. Mr. Birch will undoubtedly find a place in the organization of the Pacific Coast Division. The appointment has been made of Mr. John J. C. Yorn as Assistant to Mr. F. F. Hamilton, Supt. of Southern Indiana.

Mrs. Chas. Candler, of 8NH fame, will not be able to continue as Supt. of Western Ohio, due to the fact that her time is so fully occupied in teaching Young America algebra that she does not feel able to give the A.R.R.L. work the time it deserves, and therefore her territory is being handled by Mr. Alfred Ball, Supt. of Eastern Ohio. It is hoped that Mrs. Candler may be able to find time to be with us later on, in which case she will resume her former position.

The report of the Division Manager for next month will give the details of the new Divisional organization, with the names of all affiliated clubs, and accordingly it is urged that all clubs which desire to be included in our national organization get into communication with the proper Dist. Superintendent at the earliest opportunity.

ROCKY MOUNTAIN DIVISION

Cedric E. Hart, Manager
185 G. Street, Salt Lake City, Utah

Well, here I am again, fellows! Did you buy those bonds yet? None? Well, don't make excuses—there's still plenty of time.

Am pleased to state that we are coming along quite satisfactory and that several of the "old men" are figuring on getting back into the harness. Mr. Ambrose Allard of Evanston, Wyoming, has been appointed Superintendent of that state. All amateurs in his territory should get in touch with him and please do it quick; don't put it off. He's having a stiff time with you fellows and I want you all to chip right in and help him.

Would like to hear more from Colorado.

All amateurs in Montana and Idaho please communicate with Mr. S. M. Andelin, Richfield, Utah, my worthy assistant. Any other prospectives should write me direct.

WEST GULF DIVISION.

F. M. Corlett, Manager
1101 East Eighth Street, Dallas, Texas.

Shifting about from place to place looking after radio installation work for the Navy and trying to preform the duties of Division Manager is proving quite a task, due to the uncertainty of receiving mail and many other drawbacks; however, I am trying to persuade the Navy that they do not need my services any longer and I hope to be back in Dallas, Texas, early next month, where I will be better situated to take care of the reorganization work of the A.R.R.L. forces.

I want to hear from all the "old timers" as well as all the new comers in Texas,

Oklahoma, New Mexico and Arizona. My object is to locate men for the position of District Superintendent for the Districts of Northern Texas, Oklahoma, New Mexico and Arizona. Applications for District Superintendents and Assistant District Superintendents should be made direct to the Division Manager. It is necessary that these men possess strong personality, and are well thought of in their localities and are capable of forming and holding an organization. Aside from this the first consideration is that they have good long distance stations, second, that they are good operators and hold, preferably, first grade commercial license, altho consideration will be given those holding other than first grade commercial operators license. It is the intention to have an Assistant District Superintendent in every city or town of any size where a local Radio Club can be formed. File your applications at once as it is desired to get the organization on the way so that we can settle down to the real work of handling traffic. Under the new organization there is going to be plenty of work for every one as traffic is going to be handled in short relays and every station will be given a chance to do its part.

Applications for appointment of Official Relay Stations in the Southern Texas District should be made to District Supt., James L. Autry, Jr., 5 Courtlant Place, Houston, Texas. As no District Superintendents for the other West Gulf Division Districts have been made the Division Manager will receive such applications until District Superintendents are appointed.

District Superintendent of Southern Texas reports that preparations are being made in the City of Houston for the forming of a local Radio Club to affiliate with the A.R.R.L., and feelers have been sent out toward San Antonio and Beaumont. Mr. D. H. Graham, of House, Texas, thirty-five miles south of Houston, contemplates using Vacuum Tubes for Radio Telephone communication with Houston in connection with ordering supplies for his farm, which is located several miles from the nearest telegraph or telephone station. This goes to show the progressive spirit of the

amateur and no doubt vacuum tubes will be used for transmitting in a large number of amateur stations in the near future.

Lt. Charles C. Kolster, former Radio Inspector Eighth Naval District, New Orleans, La., and who has been attached to the District Communication Superintendent's Office in New Orleans during the war expects to be relieved from duty about July 1st and will take up his old duties of Radio Inspector again.

PACIFIC DIVISION

L. L. Hoyt, Manager
Seattle, Wash.

Seefred Brothers, 343 S. Fremont St., Los Angeles, Cal., and Mr. Frederick Terman, Stanford University Campus, Palo Alto, Cal. have been appointed District Superintendents for the state of California.

The A.R.R.L. is fortunate in obtaining

the services of these members as both parties are absolutely familiar with all conditions concerning the handling of traffic, having done much active work in that line previous to the war.

As to Oregon and Washington, it will not be such an easy thing to pick good men. Long distance work in the country north of the California line on amateur wave lengths has not been a success by any means and I must say that I sincerely believe geographical conditions up here are greatly against the good work that might be done otherwise.

Seefred Bros. report that they can not at present count on any good stations in the south. Up here in the Northwest I find things in about the same shape. There are a great many young ones coming into the game but to us they are simply that many more QRMers who will have to be educated.

The Thordarson Contest

At the request of the Thordarson Electric Manufacturing Company, of Chicago, the A.R.R.L. has agreed to act as the judge of their 1500-mile transmitting contest.

As announced in their advertisements in QST, the Thordarson company will give \$35.00 in cash or a new 1 k.w. transformer to the first A.R.R.L. member establishing a record of 1500-mile transmission on 200 meters, using for his transmitter one of their new Type R transformers. These Type R instruments, bearing their serial number 7861, have a secondary potential of 25,000 volts, and have been brought out in response to the demand for a higher voltage, which is so desirable in 200-meter work in utilizing power sufficient for longer distance work with the imposed limits of condenser capacity. The first of the new series of transformers have just been completed and tested at the factory, and are now ready for distribution.

This contest provides another incentive for eagerly awaiting the removal of the transmitting ban. With the distances we were working in 1917, however, we predict

this particular Gift-Thordarson won't go begging very long after we get opened up.

The test is confined to land stations, as otherwise it would provide an unfair advantage for the amateur stations on the coast because of the easier transmission over salt water. In such a test, the establishment of proof of performance is really the hardest part, and that will have to be worked out by the claimant to a considerable degree. To prevent pre-arrangement of a message, the conditions require that the transmitted matter be from a current newspaper and that the claimant file his document and furthermore have the receiving station do likewise, within twenty-four hours of the transmission. There is no other way to insure fair play and eliminate all possibility of "frame-ups".

Now get busy, you fellows, and let's see how quickly we can make Thordarson minus one transformer.

Conditions of Contest.

1. A message must be transmitted 1,500 miles, from one permanent general amateur station to another.

2. The message must be in the form of a sentence, containing at least ten words, from a newspaper published the same date the message is sent, except that where no daily paper is published in the place of transmission, a sentence from the latest issue of a weekly or semi-weekly paper will suffice. The sentence will preferably be a heading from the newspaper used.
3. The owner of the transmitting station must be a member of the American Radio Relay League, in good standing.
4. A type "R" 1-K.W. 25,000 volt Thor-darson transformer must be used for the transmission.
5. The transmitting wavelength must not exceed 200 meters, as determined with a reliable wavemeter.
6. A full record of the test, including a copy of the paper, a copy of the message transmitted with time and date, and a full statement of characteristics of the transmitting set, type of transformer, condenser, gap, antenna, etc., must be filed by the claimant. The postmark on the envelope must indicate that the letter was posted within twenty-four hours after the 1500 mile test has been successfully carried out.
7. A copy of the message as received at the receiving station must be mailed to the Contest Judge within twenty-four hours after time of the transmission. The post-office forwarding stamps will determine if this condition is fulfilled.
8. The copies of the message as transmitted and received must be identical. Both copies must show where filed, date, time, address, body, and signature.
9. The claim for the award must be made by the transmitting station within 24 hours after the 1500 miles have been successfully covered, and must be substantiated by a statement from one other station operator, also a member of the American Radio Relay League, that he has heard both the transmitted message and the acknowledgement of receipt by the receiving station. It shall be permissible, however, for the receiving station to acknowledge receipt by a relayed message, in case the transmitter's receiving station be not capable of receiving acknowledgement direct; and in this event hearing the acknowledging message while in process of being relayed shall be counted the same as having heard the distant station direct.
10. The Traffic Manager of the American Radio Relay League will be the judge of the contest. With him will rest the decision, and the right is reserved to reject the claims of any and all parties if in his opinion all the conditions have not been complied with. The award will be made to the person first satisfactorily establishing a performance as called for under these conditions.

The conditions of this contest apply only to general amateur stations in the United States, and the transmitting and receiving stations must be permanent land stations and located at least 1500 miles apart.

Claims and correspondence relative thereto should be addressed to the Traffic Manager of the League, Mr. J. O. Smith, 73 Hillside Ave., Rockville Centre, Long Island.

(Concluded from page 15)

earlier and it draws interest at five per cent per annum. The security is our American Radio Relay League, Inc.

These certificates are in all denominations from one dollar, to two hundred dollars. This makes it possible for every one of us to come in. A great many have sent five dollars, a goodly number one hundred dollars, a few two hundred dollars, and also a few five hundred dollars. But not enough have come across to make us feel that we are being backed up. It is not A. R. R. L. spirit to leave it to the

other fellow to do. According to our standards, in the A. R. R. L., when a thing is to be done and is for the common good, we all get busy and do it. This is what we want you fellows to do this time.

We will do the rest, and there is a lot to be done.

If you have not bought your bond, then figure over right now just what you can do and sit down and write us a letter and send the check or a post office money order in the letter, and thereby FINISH THE JOB.

Measurement of Wavelength, Capacity and Inductance With Oscillating Vacuum Tube

By H. E. Rawson

Ever spend a Sunday afternoon in fruitless effort to obtain the natural period of your antenna by the old method of exciting it with a buzzer or spark-coil? Then you will appreciate this. The comparison method of measuring wavelengths and capacities by means of the oscillating VT is a beautiful one, and is now employed altogether in research work. No other method will approach it, not only for accuracy, but for simplicity and ease.—Editor.

MOST of the methods for measuring the constants of oscillatory circuits involve either a rough means of putting the circuit in oscillation, or a determination of resonance by ear, or both. Very frequently the power required to generate these oscillations is so great that inaccuracies from too close coupling materially effect the accuracy of the measurements. Also the point of resonance as determined by the ear is not sharply defined. With the almost universal use of the vacuum tube of today it is a very simple and easy

is in wide use by radio engineers in this country, and because of its simplicity and accuracy should appeal to amateurs and be more generally used by them than it has been. The circuit for supplying the power is shown in figure 1. Any air core inductance on which a third tap is obtainable will do for L, provided of course that LC2 is of approximately the correct frequency for the circuit to be measured. Condenser C1 is of importance in making the tube oscillate easily, and is usually provided with a leak of a megohm or two. The tap-off point X is usually at about one

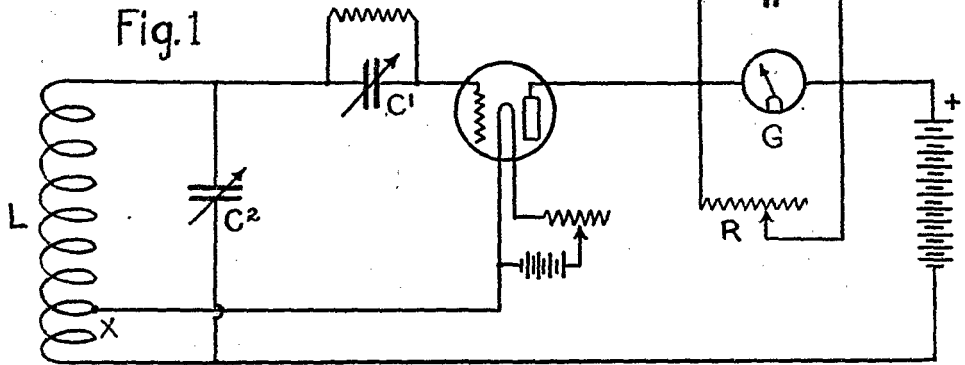

matter for anyone to make these measurements quickly and very accurately. The regular receiving tube has sufficient power for all ordinary purposes, and the apparatus in any amateur station can be used for this purpose,—the only special instrument of any kind required being a sensitive DC milliammeter.

The method briefly outlined below

fifth the total number of turns; and for best results, especially on short waves, it is advisable to have no dead ends on the coil L. In order to cover a large range of frequencies it is necessary to have a set of these inductances, as with a wavemeter, and these may cover wave lengths from a few meters to thirty thousand or higher if desired. The DC Milliammeter or Galvan-

ometer G, may conveniently be shunted with a variable resistance R so that the current-deflection may be regulated to a suitable value. The Model 301 Weston 1 milli-ampere meter is excellent for this circuit, and inexpensive as well.

When such a circuit is set up and a proper adjustment of grid condenser C1 is made, it will oscillate freely. An observation of G will show a large deflection when the tube is not oscillating, and very little when it is oscillating. When it is oscillating however, and is loosely coupled to another circuit which is nearly resonant with it, and C2 is varied, a large deflection of G will take place at exact resonance of the two circuits, showing a transfer of energy from the power circuit to the circuit being measured. This point of maximum deflection is extremely sharp, and an extension handle on C2 will usually be necessary to get and hold this point as the capacity of the hand will often effect the reading. It is an easy matter to demonstrate or test the fact that the circuits are in resonance by shorting the condenser in the measured circuit with the tips of the fingers, when G will drop back to its low position showing that the transfer of energy has been stopped.

For measuring the wave length of a receiving set or other similar circuit, the oscillator or power circuit is loosely coupled to the circuit to be measured and, with the proper coil at L, an adjustment of C2 is made to produce the kick of resonance at G. When this kick is permanently held and tested by the fingers on the second circuit, the power circuit is no longer touched or disturbed in any way. The measured circuit is removed and an accurately calibrated wavemeter, (without which no successful amateur should be) is loosely coupled to the power circuit and is now adjusted until the same sharp deflection at G is obtained. (This may not be as large a deflection as the other, depending on the looseness of coupling, but should be the maximum point of movement of the needle, and should be very sharply defined). The wavelength of the wavemeter is now exactly that of the circuit previously in resonance with the power circuit. A moment's reflection will show the ease, rapidity and

accuracy of making this measurement. In the same way the natural period of an antenna may be determined in a few seconds by grounding it with a single small turn in the ground lead, putting the power circuit in resonance loosely coupled to this single turn, and then substituting a wavemeter for the antenna circuit. After hours of tedious guess-work with buzzer, detector and phones, it is a revelation to find how simple it is with this method to get the period of an antenna.

For measuring the capacity of a condenser, an inductance is connected to it to make an oscillatory circuit, the power circuit is resonated to it, and then a calibrated variable condenser is substituted for the one being measured and is adjusted to resonance with the power circuit. As the same inductance is used in both cases it is obvious that the capacity of the calibrated condenser as set for resonance is the same as that of the one being measured. Care should be taken to use an inductance with very low distributed capacity. The same procedure is followed for getting the inductance of a coil, provided a calibrated continuously-variable inductance of low distributed capacity is available. It will be noted that no calculations of any kind whatever are required in these measurements so far. If, however, no calibrated variometer is obtainable but a fixed inductance of known value is at hand, this may be used to substitute for the one to be measured, using a variable calibrated condenser to obtain resonance in both cases.

$$\text{Then } LC = L'C'$$

Where L = unknown inductance.

L' = known inductance

C = first value of capacity

C' = second value of capacity

$$L/C'$$

$$\text{and } L = \frac{\quad}{C}$$

C

For measuring the effective capacity of an antenna, the natural period is first obtained as outlined above. Then a capacity of known value is inserted in series with the lead-in, and the resultant wavelength measured.

$$\text{Then } C = C' \frac{\lambda^2 - \lambda'^2}{\lambda'^2}$$

Where C = effective capacity of antenna
 C' = capacity inserted
 λ = natural period of antenna
 λ' = second wavelength of antenna

The same method is used for obtaining the inductance of an antenna, inserting a coil of known inductance, when

$$L = L' \frac{\lambda^2}{\lambda'^2 - \lambda^2}$$

Where L = effective coefficient of self-induction of antenna

L' = inductance inserted
 λ = natural period of antenna
 λ' = second wavelength of antenna

It is wise to use capacities and inductances of values as widely different as possible from those assumed correct for the

antenna in question, and highly important to use inductances of very low capacity. If this is not done it will be necessary to compensate for the capacities of the coils in arriving at a correct figure for the true inductance of the antenna. It is also desirable to use two or three capacities and inductances of different values, thereby getting several readings, the mean of which will be more accurate than any single reading.

The above briefly outlined method is capable of many variations to suit the needs of the experimenter and is indispensable in any laboratory or factory where frequent measurements of wavelength, capacity or inductance must be made rapidly and accurately.

V. T. AMPLIFIERS

(Concluded from page 10)

of the plate current pulsations. Such bypassing condensers are not necessary, however, in subsequent stages of amplification.

In Fig. 3 a single B battery of the proper voltage is shown supplying the plate circuits of both stages, and this may be followed for any number of additional stages up to the working load of the battery. Very often better amplification is obtained by using higher plate voltages than are required for detection, and in Fig. 2 is illustrated a method of making the detector battery also serve in the amplifier circuits, decreasing the number of necessary batteries. The functioning of amplifiers on but one A and one B battery is one of the biggest things which has been accomplished since the pre-war radio days.

The amplifier circuit shown in Fig. 4 of Dr. Radio's article on "New Developments" in the June QST was not quite correct, largely due to faulty drafting, and the corrected hookup is presented in Fig. 4 of this article. This is an impedance-repeating circuit of the same general character as Fig. 2, but more complete in detail, and arranged to supply all three tubes from a common B battery. The imped-

ances, 1, should have been drawn as chokes rather than as resistances. The impedance and capacity shunt across the phones in the original diagram results in better operation, but are not entirely necessary and so have been omitted from this diagram for clarity. For good stability in operation, it is usually necessary to ground the filament circuit at the point marked G2. A French amplifier employing this circuit is in daily use in the laboratory of a well-known Eastern experimenter, and is giving extremely good results.

Sometimes amplifiers employing any of these circuits will squeal, apparently due to audio-frequency feed-back, generally capacitative, and considerable care is necessary in arranging the circuits to obviate this difficulty. Leads should always be as direct and short as possible, and crossed at right angles when practicable. The insertion of brass plates or screening between tubes and between tubes and transformers, and the grounding of the plates, transformer cases, tube sockets, and often the filament circuit as shown in Fig. 4, generally suffices to alleviate the howling.

In another article in this issue of QST is illustrated a circuit embodying both radio and audio frequency amplification, to which the reader who is interested in extreme amplification is referred.

"Rotary Gaps"

By S. Kruse

The Old Man didn't "come across" this month, presumably still suffering from "mastitis" himself, but we are fortunate in presenting from the pen of Mr. Kruse an amusing tale of the trials and tribulations of an old-time amateur. "How dear to my heart are the scenes of my childhood!"—Editor.

BACK in 1908, one of the little yellow-backed radio magazines—yellow cover papers must have been cheap for they all used it—described a "rotary discharger invented by Signor Marconi." It appeared that "a rotary discharger when used in place of a spark gap increases the range immensely, a two kilowatt station having transmitted over a distance of 300 miles with its aid."

There were just two radiobugs in Lawrence and between us we couldn't seem to get the straight of this "rotary discharger" thing.

So we wrote the editor a letter. I am glad we did.

His reply was full—three pages of single space typewriting—it had many long words in it and some of the grammar was entirely original. Also the dissertation was written on a crimson, blue and gold letter head that it hurt your eyes to look at. It lacked only one thing—information on rotary dischargers—for the editor didn't understand them either.

So we built one for our spark coil.

You can't use a rotary gap on a spark coil, but no one had told us so, and little difference such advice would have made for every owner of a "squeak box" insists on trying it, before he will believe it can't be done.

So I built one for our Splitdorf auto coil.

I cut a four inch disc from a cardboard shirt box, boiled it in paraffine candle stubs, slapped on a one inch rim of tinfoil and put six brass machine screws thru it. Then we stuck the thing on the shaft of a "Little Hustler" motor by means of sealing wax and there was your "rotary discharger."

All the automobiles sparked on dry cells then and the garages would give you armfuls of dry cells that had "seven amperes left," whatever that means. We had about fifty that would give a good healthy "plop" when you snapped a wire across the terminals and as we wanted a good spark and also the rotary was "to be run at as high a speed as possible" we split the lot and put half of them—in series—on the coil and the other half—in series—on the motor. When I pressed the key, the vibrator emitted a rasping snarl, punctuated by small explosions with showers of red hot platinum particles from the contacts where a first rate arc light was busy melting the rubber cover off the coil box. That the tone resembled that of egg coal sliding down a tin chute did not bother us; we were not choicy as long as we got a good spark. We were *getting it. A bright yellow arc as thick as a pencil and an inch long is about all you can expect from an auto coil.

Then we turned the motor on to see if we had enuf speed. Speed? Huh! Inside of three seconds the tone was a high pitched shriek; after that the motor went on up to full speed and dragged the spark out into a flame that went clear around the wheel and burned off all the tinfoil. We were jubilant over this triumph.

The family was not so enthusiastic. They didn't care especially for the vile smells of overheated insulation and burned cardboard, and much less for the uproar the motor made when clamped to the table. So they were rather pleased when it turned out that our noble fireworks did not produce nearly as loud signals as the quiet well mannered fixt gap. As for us, we

(Concluded on page 30)

Radio Communications by the Amateurs

The Publishers of QST assume no responsibility for the statements made herein by correspondents.

A MINATURE NAA

Elza E. House, 8NF that was, Battle Creek, Mich., writes us in part as follows:

"Reading over QST, The Old Man, and Mr. J. O. Smith's articles reminds me that I might have something of interest to the rising sets. Since the notice came that I could use my receiver, my set went up in a hurry according to plans previously

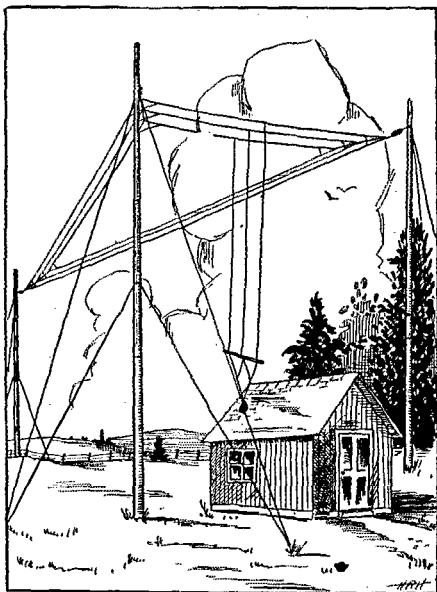

laid for it. The part I think will be interesting is the construction of my antenna and its results.

The antenna is a triangular affair, three poles 35 feet high supporting a 3-wire antenna as shown. The results are gratifying on the receiving end at least, and I expect equally as good on transmitting. I have heard numerous spark and undamped sets. Spark includes NAA readable at 50 feet from phones, NAR, XDA, and

numerous 600 meter stations. Undamped: NWW, NDD, NFF, NSS.

Have spent a very few hours listening, as my time is fully occupied otherwise and QRM has been fierce all the spring. Another thing is I can copy NAA, NWW and NFF without any antenna at all. After I tune them in, I cut off both aerial and ground, and can copy them and Old Man Static don't butt in either. Use one Audio Tron bulb. The natural period of this antenna must be about 180 meters.

Glad to see QST start and wish you every success."

ON TUNING UP

The following suggestions received from Mr. Lester A. Pulley, 33 Porter St., Melrose, Mass., contain practical tuning suggestions of much merit and interest to us all. To the new-comers in the game in particular, the Editor commends these suggestions on the determination of proper coupling.

"Well I've just been reading some of that dope of Warner's "On Resuming Transmitting and think that he has the right dope; also that some of us may be from Missouri and want to be shown. The stuff about the H. W. A. being the biggest liar in captivity is the right dope, the way that it has formerly been used. However, this may be remedied by getting a H.W.A. whose full scale deflection is not more than $\frac{1}{2}$ amp. and connect it in series with your wavemeter, and preferably have the wavemeter recalibrated. This forms a circuit which will respond to practically only one wavelength at a time if it is not too closely coupled to the circuit under measurement.

Now having approximately tuned your transmitter to 200 meters place the inductance of the wavemeter near the

ground wire but not nearer than two or three feet to the O.T. When you adjust your wavemeter with the key depressed, you should find that the needle of the H.W.A. jumps at 200 meters; if not, bring the wavemeter inductance nearer to the ground wire, but not close or you will burn out the H.W.A.

When the H.W.A. in the wavemeter circuit functions properly take readings of the H.W.A. every few meters and plot the H.W.A. readings as ordinates (vertical) and the wavelengths as abscissae (horizontal). Now this curve will show whether or not you have two waves. If you have two waves all you have to do is to loosen the coupling of your O.T. until you find that you have one; however if you only have one in the first place, be sure that it is strong enough. To do this, tighten your coupling almost to the point of obtaining a double wave.

I have had some success by making the coupling close enough to get a broad wave by the ordinary method of tuning; then, by readjusting the tuning of the open circuit slightly, bring the curve to a steeper gradient. In this manner more power would be transferred than by loosening the coupling. This has been worked very successfully on about 125-watts and I see no reason why the same would not result on larger powers.

The above method of tuning, ie., H.W.A. in series with wavemeter, may be used as a comparative method in one station provided that the coupling between the ground wire and the wavemeter inductance remains fixed, as a very slight change in this coupling makes a great difference in the H.W.A. reading.

Think this over, then try it; and remember that your wavemeter with the H.W.A. in series is nothing more than a little receiving set with a means of measuring the amount of current in it on one wave."

SHORT-WAVE RECEIVERS

W. S. Taylor, Minonk, Ill., writes the Editor as follows:

Enclosed is a diagram and description of a simple receiving set that was made and tested out while in the Naval Radio

Service and I think it gave about the best results that I ever obtained on a simple receiving set, and it proved to be very selective and easily operated.

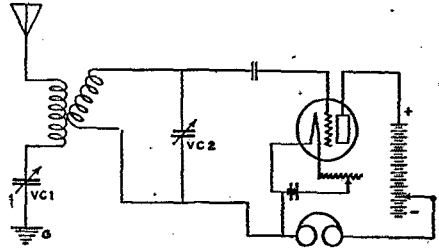

The coupler was constructed of cardboard tubing on the variometer style. The primary coil is $5\frac{1}{4}$ inches in diameter, wound with 50 turns of No. 24 D.C.C. wire. Secondary coil is $4\frac{3}{8}$ inches in diameter, wound with 68 turns of No. 28 S.S.C. wire, no taps being taken off either coil. The windings had a space of $\frac{1}{4}$ inch left in each coil and a threaded brass rod was inserted so that the inner coil could be turned thru an angle of 90 degrees.

The condensers VC1 and VC2 should have a capacity somewhere near .001 mfd. The antenna that this set was tested with had a natural period of 345 meters.

Very good results were obtained on wavelengths from 300 to 1000 meters and some excellent records were obtained on 600 meter waves with only one audion, and I see no reason why equal results cannot be obtained on 200 meter waves by winding the primary with about 20 turns and the secondary with about 25 turns of wire, and use the same hookup as shown in diagram."

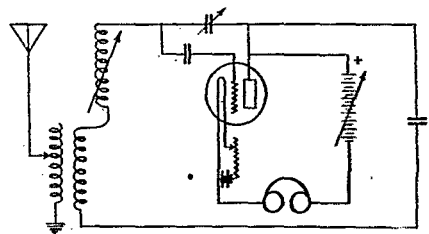

Editor's note: This circuit is the old reliable plain audion connection, and an excellent example of its efficient use in amateur work. It is entirely stable and easy to adjust, but does not compare in sensitivity or signal strength with the regenerative hookup here shown, which is taken from QST of December, 1916. A great number of sets were constructed by our readers from this description, and gave excellent results in practical relaying work.

FROM QST'S CARTOONIST, 8ADU

Pvt. 1st Cl. Donald A. Hoffman, ex-8ADU, now 7th Svc. Co., S. C., Ft. Sam Houston, Tex., writes us in part as follows:

"QST is starting out again fine. I get my copies OK thru my home address, Akron, O.

Guess I'm stuck for service down here a while longer till the "emergency" is off.

Here's a little idea—run a suggestion that the fellows with long distance ham receiving sets make themselves up a form for post cards something like this and send

To
Heard your station.....
Dates..... Hours.....
Audibilities.....
Working
Apparatus I use.....
Do you hear me?
Call.....

each time a new long distance station is heard. In this way numerous relay possibilities will be discovered where some were careless and didn't notify stations heard formerly. Fellows receiving cards would keep them on file, etc. I used to do this and got a lot of thanks for it from the ones I wrote the cards to."

A CALIFORNIA ENTHUSIAST

From Hubert Woods, Glendale, Cal., we have this interesting letter:

"Well, talk about your big surprises! If this last one isn't the biggest of all, then I don't know the difference between the new and the old audions. When I opened the mail and saw QST staring at me I thought I was "charged" for sure. It just came yesterday and I must say that I sure was tickled to think that my old love had returned once more. I forget just how much of my subscription had expired, but anyhow I enclose some dough for a renewal.

That June issue of QST sure is Jake—especially that article on new developments by Doc Radio. From my own experience I can echo his praise of the new VT-1. I wish I had about a dozen of them. I've just come back from the commercial game and it was a "Grand and Glorious Feeling" to listen in over my ham set once more. If it wasn't for the static (20 ft. fm fones at times) I should say that the air was unusually quiet (lack of amateurs). I hope to hear them soon, tho.

I think you will agree with me that the larger majority of conscientious amateurs will be using the audion as a detector from now on. Also most of them cannot afford complicated cascade connections as a means of amplifying signals. Therefore I think QST should include some good articles on single step audion circuits, mainly high wave undamped. There is a great deal still to be said about undamped circuits that won't "pop out" when anyone moves within ten feet of the set. Also about the relative merits of inductive and capacitive regenerative circuits. I hope that QST won't waste as much space over these new so-called underground antenna systems as other well-known magazines have. Experiments have shown that such antennae are impractical for amateur use for many reasons.

Say, can't the ARRL do something towards introducing a system of policing the ether so as to do away with the majority of QRM so prevalent formerly? How about having the government appoint a capable operator in each small district

to look after complaints and to see that no wilful QRM exists in this locality. I would suggest that only operators holding first class commercial licenses be appointed.

Well, Eddy, I'm going to work hard for QST. There are a lot of amateurs around Glendale who could rake up one and a half iron men if they wanted to, I'm sure. Anyway, I'll do my best, as they say in the classics. Perhaps you will hear fm me agn. My 73 to the whole bunch of amateurs, and to you too."

ONE OF OUR OLD FRIENDS.

It surely did this old "Ham" a lot of good to see the little sheet carrying the familiar title "QST", when it arrived a few days ago. I had just reached home on a short leave and you can believe that the good news of a renewed activity which it brought, added the crowning joy to the occasion.

I am enclosing a small contribution to the cause and if it will do more good as an addition to the fund which has started the good work once more, than as a loan, please consider it as such and send the Bond to the "Old Man" for a pipe-light—it will be worth more than that just to see one copy of "QST" as it used to be.

Don't hesitate to call on me in any way that I can be of use. I have lost track of a great many of the fellows who were prominent before we were closed up, but there are still a few I can locate, and the others will not be long in making their presence known after the lid is taken off transmitters. Can't say when I will be in a position to horn in on a trunk line, as the Navy still governs my movements, but you may rest assured that my application for an appointment will not be delayed long after my release from active duty.

With all good wishes for a rapid and successful return to the "Days of Real Sport" and best regards to everyone, I remain.

Most sincerely yours,

Lindley Winsor.

CE (Ro) USNRF.

"NEVER SAY DIE".

W. T. Starkweather, of Holtville, Calif., writes us as follows:

"I say 73 and I am sure glad to see you back. This has sure been a lonely hole down here since wireless went out.

We are nearly 250 miles from the coast and average 50 feet below sea-level, so you see everything is below par.

The U. S. Border Patrol took over my set about a month after the war started and still have it, at Camp John Becan, Colexico, Calif; but will try and get in the game again soon. Would like to know how I stand on the books.

Yours for better radio."

"ROTARY GAPS"

(Concluded from page 26)

concluded that the "rotary discharger" was a fraud and cast it aside.

But it didn't stay cast. When the first transformer came along the owner decided to give the rotary gap another try. Somewhere he'd gotten hold of a little series A.C. motor of about the general architecture of an orange—the California kind with a nice thick skin, but nothing much inside. I don't know who made the thing but I can name nine people who have owned it; some of them sold it to friends and in one case the friendship survived. Originally this motor ran about 3600 r.p.m., but at various times the field windings were "shot", whereupon the temporary owner simply jerked off wire till he got to the break, then connected to the remainder. When I last saw the thing, three quarters of the field winding were gone and the speed had risen to 12,000 r.p.m. with a revolution counter on, without it about 20,000.

At any rate—let's call him Tom—put a six inch disc of $\frac{1}{8}$ " fibre on the shaft of the little beast and undertook to make it run true. This amounted to a life job for that fibre warped into complex and original shapes a good deal faster than Harry—that is Tom— could adjust for them. For a while he made allowance for this by setting the fixt electrodes away out from the disc but the results in the

way of punctured condensers, kick backs and blown fuses were discouraging so he finally substituted a hard rubber wheel.

Most of the trouble quit then; but once in a while a spark would flash to the shaft, whereupon there'd be an explosion inside the motor, a burst of blue and yellow flame and a lot of evil smoke and the motor as well as the lights quit for the evening. Then the next day there was some more tinkering with the connections, pulling off burned field turns and short circuiting bum armature coils.

Finally when the motor had gotten down to one field coil and two armature coils H. S.—Tom that is—lent me the gap. I suppose I had offended him in some way. Well I rewound a field coil, closed the opens in the armature, turned down the commutator and balanced the armature

with solder. Then I re-assembled the motor and it ran like a top—and silently as one could wish. So I put on the wheel and balanced that and it ran perfectly. Then I put on the fixt electrodes, connected the "Packard" and started her once more. When she was humming away smoothly at 3,600 I reached for the key. Just at that instant a fixt electrode touched the wheel.

It rained rubber and brass bolts for ten minutes and for weeks I kept finding bits of hard rubber in unexpected places about the room. And then I disconnected the motor and Harry took it away and sold it to a friend and he sold it again until finally, like all evil things it went to a city and there it was stolen, and the thief was a hardened criminal for he did not bring the motor back. But if I hear of his repentance I shall know what caused it.

TELEGRAPHY

Both wire and wireless, and Station Agency taught thoroughly and quickly. **BIG WAGES NOW PAID**, some of our recent graduates procuring \$138.00 per month to start. Great opportunities for advancement. Our school the oldest and largest—annual enrollment 600 students. Endorsed by railway, telegraph, wireless and government officials. Expenses low—chance to earn part. Catalog free. Write. **DODGE' INSTITUTE, 27th. St. Valparaiso, Ind.**

EUGENE C. BROWN

PATENT LAWYER

Electrical Engineer, Lehigh Univ.

Former Examiner Elec. Div. U. S. Patent Office

PATENTS AND PATENT LITIGATION

734 Eighth St., N. W.

WASHINGTON, D. C.

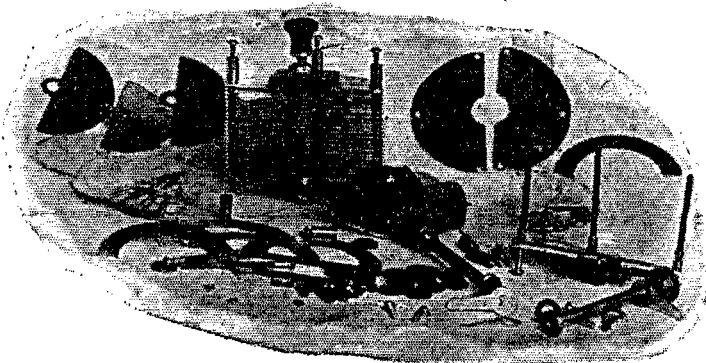

PERFECTION VARIABLE CONDENSERS

KNOCKED DOWN—YOU ASSEMBLE AND SAVE MONEY.

Full instructions in each box. Ready to mount on panels.

11 Plate	\$1.75
21 Plate	2.25
43 Plate	2.50

No outside cover, but has scale, pointer and knob.

Small hole to cut.

Guaranteed easy to mount.

TRESCO BOX 374
DAVENPORT, IOWA.

ATTENTION, UNIVERSITIES! TWO COMPLETE RADIO OUTFITS FOR SALE

DESCRIPTION.

2 K.W. Marconi 240-cycle synchronous sets. 2 KVA Motor-generator 110 volt d.c. supply, 240-cycle alternator, with enclosed synchronous rotary gap. Equipped with starting box and alternator field rheostat. Complete with high-tension condenser, oscillation transformer, aerial switch and key. DeForest Commercial Type Audion Receiver, Marconi 4000-meter couplers, Marconi 2000-ohm phones.

Two duplicate installations as above will be sold at a bargain price, either together, separately, or in part. A splendid opportunity for universities or advanced experimenters to secure the equipment for a Special License station at a remarkably low figure.

For further information, prices, etc., address

Box 31, CARE OF QST, HARTFORD, CONN.

"COS - RADIO"

Mark of Quality

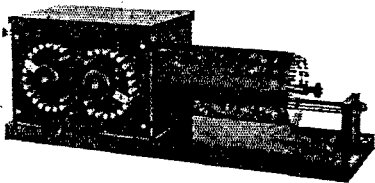

THE COUPLER THAT GETS RESULTS

Stranded silk winding throughout.

Perfect insulation, no live parts touch woodwork.

4000 meters on normal aerial.

Highest grade workmanship of any Coupler on the market.

Satisfaction Guaranteed or Money Refunded.

The Largest Factory and Supply House in Midwest.

WATKINS MFG. CO.

WICHITA,

KANSAS

The Radio Engineering Co.

MANUFACTURERS OF



RADIO APPARATUS

THE BEST KEY IN THE WORLD

\$7.75 10 Ampere size

Guaranteed Genuine AUDIOTRON BULBS \$5.00

Remler Panels, Raw Materials, Binding Posts, Contact Points, Etc.

INSTRUMENTS MADE AFTER YOUR OWN SPECIFICATIONS IF YOU SO DESIRE

22 ST. PAUL ST.

BALTIMORE, MD.

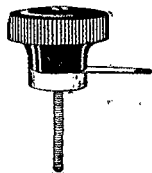

WIRELESS PARTS, SUPPLIES, Bakelite-Dilecto Panels

KNOB AND SWITCH LEVER with knob $1\frac{1}{4} \times \frac{3}{4}$, spring brass lever securely fastened to knob, large brass bearing and shaft threaded 6-32. Each 40 cents. Postage 4 cents.

CONTACT POINTS, brass, $7/32 \times 7/32$, with screw for mounting. Per dozen, postpaid, 25 cents.

KNOB, as used on switch described above, $1\frac{1}{4} \times \frac{3}{4}$, with hole in center for mounting. Each, postpaid, 20c.

Send 6 cents in stamps for our catalog and get on our mailing list for future bulletins.

Bakelite Dilecto $9\frac{1}{2} \times 19 \times \frac{1}{4}$ Black XX \$4.00
Panels in sizes $19 \times 19 \times \frac{1}{4}$ Black XX 8.00
as noted. Best $9\frac{1}{2} \times 19 \times \frac{1}{8}$ Black XX 3.00
grade $19 \times 19 \times \frac{1}{8}$ Black XX 6.00

Include postage on 3 lbs.

A. H. CORWIN & CO.

924 Kinney Building

Newark, N. J.

CLASSIFIED ADVERTISEMENTS

Five cents per word per insertion, in advance. Copy must be received by the 10th of month for succeeding month's issue.

FOR SALE—Mesco 3" spark coil with primary condensers, "Monotone" gap—\$15. E. Crylax, 219 East 71 Street, New York City.

FOR SALE—One 1KW Clapp-Eastham Hy-Tone transmitter, complete \$100.00. Excellent mechanical and electrical condition. H. E. Chapman, 296 Edgewood Street, Hartford, Conn.

FOR SALE—Receiving apparatus. Joel Young, 717 W. Gray Street, Elmira, N. Y.

FOR SALE—Steel Radio Tower, 115 ft. high. A bargain. W. Turnor Lewis, Racine, Wis.

TELEGRAPHY (both Morse and Wireless) **AND RAILWAY ACCOUNTING** taught thoroughly and quickly. Big salaries now paid. Great opportunities. Oldest and Largest School—est. 45 years. Catalog free. Dodges Institute, 28th St., Valparaiso, Ind.

Electrical and Wireless Instruments

Full line of Radio Apparatus. Our new Damp and Undamped Wave Receiver using French Circuit with Moorhead Audion Tube. All types of Vacuum Tubes.

Send 4c. for Bulletin 1.

C. & M.

P. O. BOX 317
MONTCLAIR, N. J.

Consolidated Radio Call Book

The Telephone Directory of the Sea

Now Ready for Mailing

Urgently needed by professional and amateur radio operators.

**NO RADIO STATION CAN PROPERLY OPERATE
WITHOUT AN UP-TO-DATE CALL BOOK**

This book contains:

A Brief Explanation of How Charges Are Determined on Radiograms.

Tables for Finding Charges on a Radiogram To or From a Vessel in Any Part of the World.

List of Stations Transmitting Weather Reports, Together With Data on Wave Length and Time Transmitted.

The Radio Compass—General Notes on Its Use:

American, British, Canadian and French Radio Compass Stations.

Abbreviations Used to Indicate Special Classes of Radiograms.

Variations in Form Used by Foreign Stations.

List of Special Signals Authorized by the London Convention.

High Power Undamped Wave Transmitting Stations with Wave Length Used.

Key to Abbreviations Used in the Publication.

Wireless calls of over 9000 ships and shore stations arranged alphabetically by ships and stations as well as by calls.

In fact this publication is so complete and up-to-date that large radio companies have contracted for copies for their ships. Since our advertisements in the July issue of the *Wireless Age*, *The Electrical Experimenter* and the *Everyday Engineering Magazine*, we have received and tabulated so many additional Radio Calls that it has been necessary to raise the price of the book. This book contains 3000 more calls than the April 1918 edition of the BERNE List.

PRICE, \$1.00

Orders received prior to August 1st will be accepted at the old price of
75 Cents

Published by the

Consolidated Radio Call Book Co., Inc.

41 PARK PLACE, NEW YORK CITY

Send your order to the above address if you are unable to obtain it from your local dealer in Radio Supplies. Orders have already been received from the following dealers and copies can be obtained from them:

J. H. Bunnell & Co., Park Place, N. Y. C.
Haller-Cunningham Electric Co., San Francisco, Cal.
L. Bamberger & Co., Newark, N. J.
Radio Equipment Co., Boston, Mass.

Smith Novotoy Electric, Inc., Charlotte, N. C.
National Radio Supply Co., Washington, D. C.
E. P. Noll Co., 21 N 7th St., Phila., Pa.
Electro Importing Co., New York City

CRYSTALOI DETECTOR

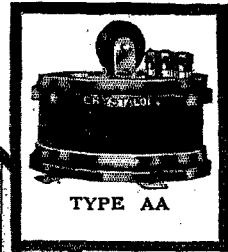
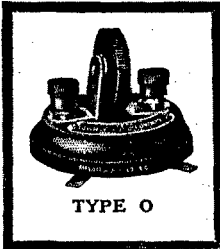

ALWAYS READY

Almost any detector will give you good results if conditions are right. But the kind you want is the one which can be depended upon at all times. Not only is the CrystalOI made in such a manner that it is next to impossible for it to get out of order but the fact that all the functional parts are enclosed in the dielectric cylinder renders them immune to moisture, oxidation and other external influences so detrimental to the proper working of the ordinary detector.

Write for Booklet.

PRICES

Type O. CrystalOI Detector \$3.50
By parcel post prepaid 3.60

Type A.A. CrystalOI Detector \$6.00
By parcel post prepaid 6.20

MANUFACTURED ONLY BY

CONNECTICUT TELEPHONE & ELECTRIC COMPANY

INCORPORATED
MERIDEN, CONNECTICUT

All rights and patents under which the CrystalOI is made were purchased from the inventor, Eugene A. Turney

Finish Your Wireless Education

EITHER BY CORRESPONDENCE OR AT OUR WASHINGTON SCHOOL

and
Let Us Train You
for a

First Grade (Government) Commercial License

□□□□□□

AMATEURS

former Signal Corps and Navy men who have had some war training in RADIO—men and boys now operating their own private SETS—should take advantage of our

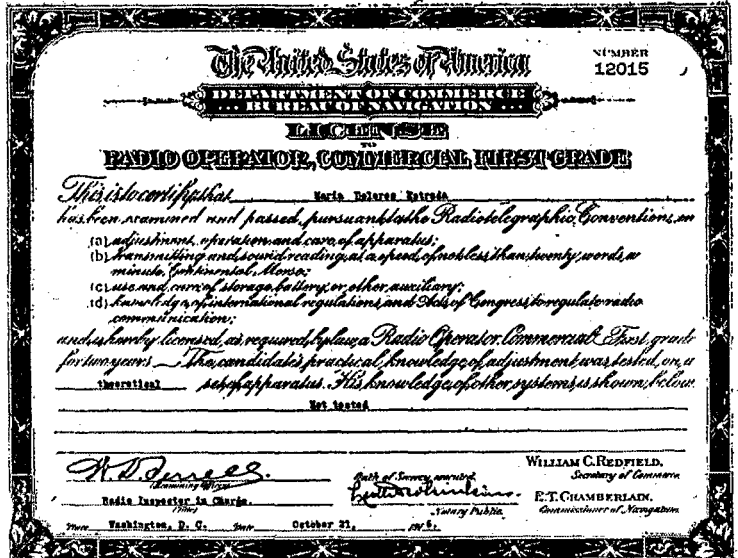

SPECIAL ADVANCED TRAINING COURSE

This course embodies all the fundamental, practical and theoretical work (including both code and theory) necessary to pass the Government tests for a First Grade Commercial License. We furnish free instruments to complete code work to students who have none of their own. This Course was planned by members of our faculty here in Washington who are especially familiar with the Government's latest requirements along this line. Men and boys holding amateur or second grade certificates CAN QUICKLY QUALIFY DURING THEIR SPARE TIME AT HOME to hold a first grade License through this intensive training Course.

OPPORTUNITIES FOR FIRST GRADE LICENSED OPERATORS NEVER SO GREAT AS NOW

A recent inquiry made by this school at the Department of Commerce, showed there are actually less than 3,000 First Grade Licensed Operators in the United States, yet the present and near future demands of the rapidly growing Merchant Marine, Aerial Mail Service, Land Stations, Railroads, Steamship Lines, etc., will call for approximately 10,000 operators.

The National Radio Institute, well known as one of the chief sources for supplying operators in the past five years, is receiving calls every week to place men WHICH IT CANNOT FILL NOW. Never before has this Institute experienced such a shortage of men to fill the demands. The salaries offered are very attractive, ranging higher than ever before. If you are a First Grade Licensed man and want a good job now, write us immediately. We can place you, as we already have a long list of positions now open waiting to be filled.

If you are not a "First Grader" get busy at once and fill out the coupon below, which will bring you full information about these special opportunities, the low cost to get the necessary training, outline of the Course, and all about our School. Representatives wanted in every district to present this Course to wireless amateurs, radio operators and experimenters.

National Radio Institute
WASHINGTON, D. C.

—FREE COUPON—FILL IN, SIGN AND MAIL TODAY—

NATIONAL RADIO INSTITUTE,
1405 U St., N. W., Washington, D. C.
Department A.
Gentlemen:—

Without obligation to myself, please send me free of charge your illustrated booklet "Wireless the Opportunity of Today." Also quote me a special reduced rate and outline of Special Course I need to qualify for a First Grade Commercial License. My past experience in wireless consists of

.....
.....
.....
Name
Address
City

THE AUDIOTRON COMPANIES NEW RADIO DEVELOPMENTS

All the radio developments with respect to amateur radio stations are based on Vacuum Tubes. The AudioTron is available and has proven its sensitiveness and reliability since 1915.

Use the AudioTron to get the best results from the latest improvements in regenerative, oscillating, beat and loop receivers.

Send for descriptive bulletin describing the AudioTron and our new Bakelite Panel for ARC & Spark reception, new smooth running rheostats, knobs, levers, contacts, etc.

DEALERS: Write for proposition. Territory now being allotted.

AUDIOTRON SALES COMPANY

311 LICK BUILDING

SAN FRANCISCO

BE PREPARED!

The standard MESSAGE BLANK FORM of the A.R.R.L., in pads of 50, is available by addressing The Secretary, A.R.R.L., Hartford, Conn. Two pads for 15 cents, postage paid. Have a supply of these message forms in your station when re-opening comes.

BOUND QST'S

VOLUME II OF QST, HANDSOMELY BOUND IN RED CLOTH WITH GOLD LETTERING, IS NOW READY FOR DISTRIBUTION. IT WILL LOOK WELL IN YOUR LIBRARY AND IS A MOST CONVENIENT WAY OF PRESERVING QST FOR REFERENCE.

POSTPAID FOR \$3.00

CLUB SUBSCRIPTIONS

Clubs of ten or more annual subscriptions to QST, sent in at one order, will be received at the special rate of \$1.25. We are able to do this because the expense of handling thru our office is lessened in such cases. Talk it over with your friends and take advantage of this opportunity to save 25 cents.

BACK COPIES OF QST

Have your QST file complete. Some numbers are already exhausted. Dec., 1915; Jan., March, April, and Sept., 1916, available at 25 cents per copy, postpaid. All issues after September, 1916, 15 cents postpaid.

Address: THE SECRETARY
AMERICAN RADIO RELAY LEAGUE,
HARTFORD, CONN.

AUDIOTRONS

—Genuine—

The original negative electron-discharge vacuum tube wireless detector. Double Filament Audiotron
\$ 5 . 0 0

Postpaid, cash with order.

PANELS, PARTS, ETC.

F. C. MYERS

Agent For Audiotron Sales Co.
45 Albany Trust Co. Bldg., Albany N. Y.

Specialists in Production :

COUPLERS DETECTORS
CONDENSERS

Regenerative and Jewelers Time Sets.
Light Machine and Turret Lathe Work

Cabinets to meet your requirements

Estimates Solicited References: Dun's

RADIO EQUIPMENT CO.

1525-27 N. Fawn St., Philadelphia, Pa.

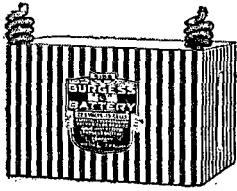

22.5 Volts—15 Cells

BURGESS "B" BATTERY

Three Sizes

BURGESS "B" BATTERIES are especially designed for Vacuum Tube Service to give maximum duty and life. Their waterproof construction and special insulation makes them noiseless. For further information write

BURGESS BATTERY COMPANY

Laboratories
Madison, Wisconsin

Sales Office
Harris Trust Bldg., Chicago

UNIVERSAL RADIO APPARATUS

THIS line of new apparatus comprises several interesting instruments. There is a regenerative receiver which covers practically the entire spark range. It has a wave length range of from about 170 to 2550 meters. The continuous wave receiver has a range up to 17,000 meters and is contained in its entirety in a cabinet measuring about 8"x12"x6". This does away with cumbersome loading coils and loose couplers which used to occupy so much space on the operating table.

We control the patent rights and are sole manufacturers of the MIGNON SYSTEM apparatus.

Send stamp for catalogue

Universal Radio Manufacturing Corporation
Dept. M
Elmira, N. Y.

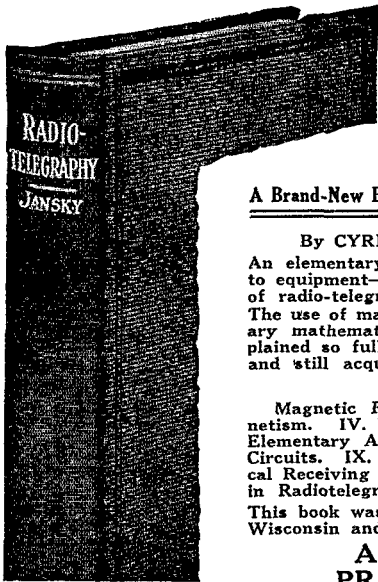

QST ANNOUNCES THE REOPENING
OF ITS
BOOK DEPARTMENT
Latest modern texts on radio and
electricity, ready for prompt shipment

A Brand-New Book: Principles of Radiotelegraphy

By CYRIL M. JANSKY, Assoc. Prof. E. E., Univ. of Wisconsin

An elementary treatment of wireless telegraphy with adequate references to equipment—a full and clear explanation of the principles and operation of radio-telegraphic apparatus.

The use of mathematical expressions is limited and only the more elementary mathematics is used. Furthermore, the principles involved are explained so fully that a reader may omit the mathematical demonstrations and still acquire a good understanding of the subject.

CHAPTER HEADINGS

Magnetic Phenomena. II. Electrostatic Phenomena. III. Electromagnetism. IV. Units of Measurement. V. Electromagnetic Waves. VI. Elementary Alternating Currents. VII. Oscillatory Circuits. VIII. Radio Circuits. IX. Practical Transmitting Appliances and Methods. X. Practical Receiving Appliances and Methods. XI. Vacuum Tubes and Their Use in Radiotelegraphy.

This book was worked out in the Extension Division of the University of Wisconsin and may therefore be accepted as

**A PRACTICAL MAN'S BOOK FOR
PRACTICAL RADIOTELEGRAPHERS**

179 ILLUSTRATIONS
242 PAGES, 6x9,

\$2.00 Postpaid

SOLD ALSO IN LOOSE-
LEAF AT SAME PRICE

SEND FOR OUR FREE BULLETIN OF TEXT-BOOKS

BOOK DEPARTMENT, QST 721 Main St., HARTFORD, CONN.

MURDOCK 55

2000 OHM
DOUBLE SET
COMPLETE
\$4.00



3000 OHM
DOUBLE SET
COMPLETE
\$5.00

AT THESE LOW PRICES

You get the biggest "money's worth" possible. Ask the fellow who owns a set. **FOURTEEN DAYS' TRIAL** allowed and money back if you are not satisfied. **ORDER YOUR SET EARLY.**

WM. J. MURDOCK & CO.
65 CARTER ST., CHELSEA, MASS.

Pacific Coast Representatives
KEELER WHITE CO.

221 Second St.
San Francisco, Cal.

THIS is a picture of a 15 panel Typical De Forest Unit Receiving Set consisting of a tuner with a wave length range of 150 to 25,000 meters, a crystal and audion detector and a one-step amplifier. Price of all the necessary units \$133.57. You can buy any of these units separately, and make just the kind of set you want for any and all wave lengths of any preferred circuit and design, at a cost ranging from \$30.00 and up. The tuning system is the most novel and efficient placed on the market. Designed and built for the De Forest audion and amplifier as only the makers of the audion can build it.

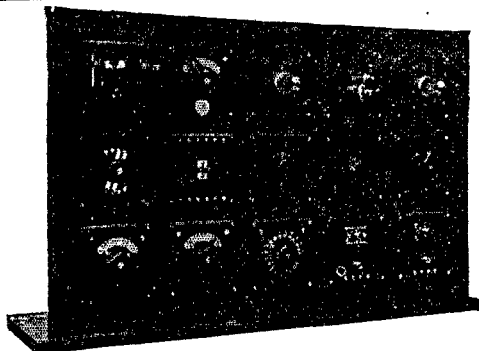

Audion Control Box
Type P-100, combining in a single compact set the Peerless de Forest audion detector, oscillator and audion amplifier. No other instrument like it has ever been built to sell for less than \$150.00. Our price without the bulb \$65.00. Descriptions of lower priced models sent on application.

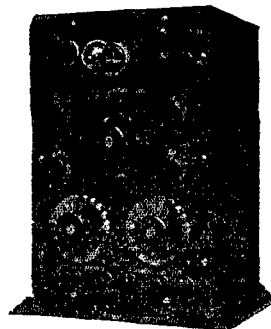

Type P-200—2-Step Amplifier—sufficient to give amplifications up to 20 times. The very latest in design,—workmanship of the highest grade. Panel quickly removable, making all parts accessible, and the replacing of the new type en block “B” batteries but a moment’s work.

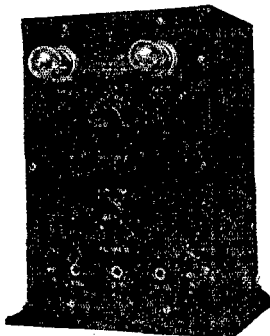

Price without the bulbs \$69.50.

DE FOREST RADIO TEL. & TEL. CO. 1415 Sedgwick Ave., N. Y. City

Important Announcement!

AUDIO - FREQUENCY TRANSFORMERS

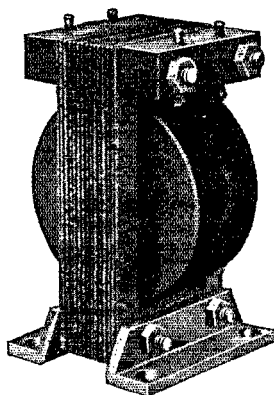

For Use with Marconi V. T. Vacuum Tubes is Now Offered to Amateurs, Laboratories Schools and Experimenters.

The Transformer is equipped with Thumb Screws and Solder Clips.

RATIO—1-3. IRON CORE.
A Highly Satisfactory Transformer.

We also offer
VACUUM TUBES AND MOUNTINGS

Makers of
Standard Air Core Audio Transformers
Liberty Head Telephones
Famous “Century” High Frequency Buzzer
Anti-Capacity Switches
Plugs, Jacks, and Accessories

The No. 226-W
Price \$7.10
Post Paid East of the
Mississippi

Federal Telephone and Telegraph Co. BUFFALO, N. Y.

BURGESS "B" BATTERIES

IDEAL FOR
V. T. USE

No. 4156	\$2.25
No. 5156	3.00
No. 2156	3.50

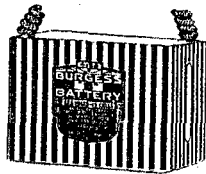

Ready for Immediate Shipment

C. D. TUSKA CO., Hartford, Conn.

MANUFACTURERS

ATTENTION!

Perhaps you wish a sketch or drawing made of that wireless catalog you are getting out. I am at your service.

Reasonable prices.

HARRY R. HICK
ILLUSTRATOR & DESIGNER
3 LEWIS STREET
HARTFORD, CONNECTICUT

Get Bigger Pay through ELECTRICITY



You will find in HAWKINS GUIDES just what you need to know about electricity. In simple everyday language—complete, concise, to the point. In questions and answers. A complete standard course in Electrical Engineering. Send for your set today to look over.

**HAWKINS
ELECTRICAL
GUIDES**

3500 PAGES
4700 PICTURES
POCKET SIZE
FLEXIBLE COVERS
\$1 A NUMBER
\$1 A MONTH

Magnetism—Induction—
Experiments—Dynamoes—
Electric Machinery—Motors
—Armatures—Armature Windings—Installing of Dynamoes—
Electrical Instrument Testing—Practical Management of Dynamoes and Motors—Distribution Systems—
Wiring—Wiring Diagrams—Sign Flashers—Storage Batteries—
Principles of Alternating Currents and Alternators—
Alternating Current Motors—Transformers—Converters—
Rectifiers—Alternating Current Systems—Circuit Breakers—
Measuring Instruments—Switch Boards—Power Stations—
Installing—Telephone—Telegraph—Wireless—Bells—
Lighting—Railways. Also many modern Practical Applications of Electricity and Ready Reference Index of the 10 numbers.

Shipped to you FREE. Not a cent to pay until you see the books. No obligation to buy unless you are satisfied. Send coupon now—today—and get this great help library and see if it is not worth \$100 to you—you pay \$1.00 a month for 10 months or return it.

**SEND
NO MONEY**

THEO. AUDEL & CO., 72
Fifth Ave., N. Y. Please
submit for examination Hawkins
Electrical Guides (Price \$1 each).
Ship at once, prepaid, the 10 numbers. If
satisfactory, I agree to send you \$1 within
seven days and to further mail you \$1 each
month until paid.

Signature _____
Occupation _____
Employed by _____
Residence _____
Reference _____

QST

FOR SALE

500 CYCLE, 1/4 KW GENERATOR:

complete with exciter and grooved pulley. Speed 3333 RPM; AC voltage 300. Will stand 50% overload continuously, is absolutely new and may be used as DC-AC motor generator set on 110 volt DC supply. Just the thing for that new transmitter. Price, \$75.00.

Also have 10 Marconi-Moorhead vacuum tubes: \$6 each, \$50 for the lot; brand new and latest type. Reason for selling—need the cash.

Box X, QST Magazine, HARTFORD, CT.

10,000 FEET

Stranded aerial cable. 7 strands number 22 pure copper. High tensile strength and highest conductivity. The need of every amateur right now.

1c. Per Foot—\$9.00 Per Thousand

L. A. BATES

8 Moen St., Worcester, Mass.

Get Our Prices

on the Wireless Apparatus
you need, before buying.

We handle new and second hand instruments on which we can save you money. All Second Hand instruments guaranteed to be in perfect working order.

WHAT DO U NEED ?

Send us your list now

Radio Equipment Co.

630A Washington Street, Boston, Mass.

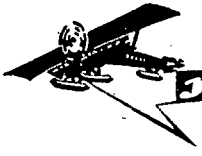

EASTERN RADIO

INSTITUTE

RADIO

899 Boylston St.
Boston - Mass.



TEL.
BACK BAY
5 9 6 4

RADIO—Splendid opportunities now in the Merchant Marine for Wireless operators. Salaries—Junior operators, \$85 per month; Chief operators, \$110; food and quarters included. Equivalent ashore from \$33 to \$40 a week. Graduates in all parts of the world as operators, instructors, inspectors, etc., etc. Recommended by Marconi and Government officials. **DAY AND EVENING CLASSES. START ANY MONDAY.**

Manufacturers of Reliable Instruments and Distributors of All Prominent Makes of **RADIO APPARATUS**

Everything Essential to the Successful
Installation of A RADIO STATION

Bunnell Apparatus is Sold by Dealers Everywhere
Catalog 40-Q on Request

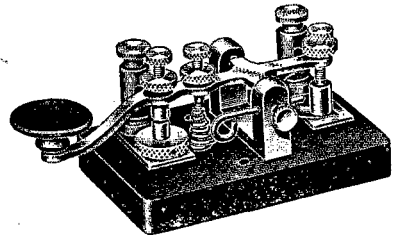

Special Feature—
The Straight Line Radio Key

J. H. Bunnell & Co. 32 Park Place, New York

EVERYTHING FOR AN IDEAL AERIAL

COMPLETE
OR PARTS

— “CQ — CQ — CQ” —

FOR LAND OR
MARINE STATIONS

OUR SPECIALITY

SPARS	TO AMATEURS	} 2, 3, 4 & 6 WIRE ANTENNAS for 200 meters LONG WAVE 2 WIRE RECEIVING ANTENNAS	Distributors of HIGH GRADE RECEIVING APPARATUS
BRIDLES	INSULATORS		
WIRE — ROPE	Construction: Specially designed, turned and perfectly tapered SPARS—fitted with galv. steel mast bands; best grade flexible galv. wire BRIDLES; galv. pulleys; ELECTROSE INSULATORS; seven strands PHOSPHOR BRONZE ANTENNA WIRE; high-grade weather-proof hoisting rope.		

Made in America

Prices quoted on application. Specify your particular requirements.

“K-K”

“AT YOUR SERVICE”

“K-K”

NORTH AMERICAN AERIAL SPAR MFG. CO.

Dubuque, Iowa

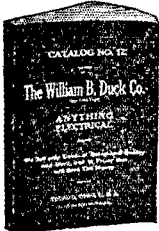

DUCK'S BIG 300 PP. Wireless and Electrical Catalog

Is now as it always has been, the largest and most complete and dependable Wireless Catalog published. Mailed for 12c. in stamps or coin which may be deducted on first order of one dollar. Catalog not sent otherwise. This catalog costs us twice the price of other catalogs.

Everything in wireless worth while is listed in this catalog. The experienced amateur will tell you to see our catalogue before buying. You are thereby insured against an unwise purchase. It is the Beacon Light to guide you right in the selection of your wireless apparatus. No bigger or better values are obtainable elsewhere. Send for revised price list. It is yours for the asking.

THE WILLIAM B. DUCK CO. 243-245 Superior St., Toledo, Ohio

WIRELESS TAUGHT BY MAIL

By the Largest Radio School in the World

Staff of high class government instructors; 16 weeks' course. Now placing our graduates in fine positions. Pay runs from \$110 per month and living expenses, up to \$3500 per year.

REDUCTION IN TUITION TO GRADUATES

and, under certain conditions, you may obtain the course for practically nothing. We need thousands of operators, inspectors and radio aids. Fascinating work; interesting study; takes only a little bit of your time daily. Write today for illustrated catalogue and details of our profit sharing plan with students.

SERVICE RADIO SCHOOL

Dept. T, 900-2 Pa. Avenue

Washington, D. C.

A New
Variometer
for the
Amateur

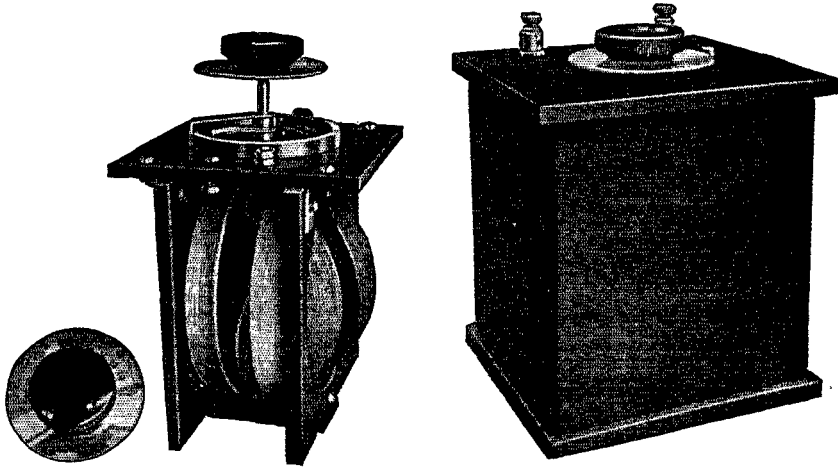

Type S.S. Variometer, in three sizes; maximum inductances, 1 millihenry, 5 millihenries, 20 millihenries. Mounted \$20.00; unmounted \$16.00.

Variometers provide an inductance as easily and gradually variable as a rotary condenser. They are the ideal inductance; efficient, no poor contacts, dead-end losses or capacity losses from multiple taps.

Clapp-Eastham Variometers are designed to give the amateur a Precision Instrument at a low price. Compact in size and beautiful in workmanship. Especially designed to minimize distributed capacity. Readily adaptable to panel mounting. Equipped with a special drum switch automatically actuated by the control knob, whereby the coils are in parallel the first half revolution providing an inductance continuously variable thru 360 degrees, giving double the range of adjustment available with other variometers.

Fully described, with other New Developments, in our interesting Bulletin Y.

NEW BULLETIN R OF RECTIFIERS FOR STORAGE BATTERY CHARGING NOW READY.

CLAPP-EASTHAM COMPANY

141 MAIN STREET

CAMBRIDGE, MASS.

REMLER RADIO MFG. CO., 62 Post St., San Francisco, Cal., Pacific Coast Representatives

ARNOLD APPARATUS

The old reliable type of instruments—the most popular low-priced apparatus obtainable. Recognized since 1910 as a standard wherever results count.

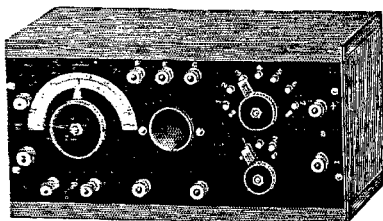
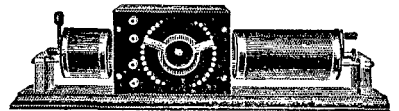

Navy Model Loose Couplers par excellence, Combination Receiving Transformers, Audion Detector Panels and Cabinets, Duplex Condensers, Accessories, etc.

Send 2c. stamp for descriptive Bulletin No. 3

J. F. ARNOLD

(Established 1910)

2082 LEXINGTON AVENUE

NEW YORK

PAUL INSTRUMENTS

Are found in well equipped laboratories
where quality comes first.

Portable Galvanometers of extreme sensi-
tivity—Measuring Instruments for all pur-
poses on direct current and alternating
current of any frequency.

Rawson Electrical Instrument Co.

CAMBRIDGE, MASS.

Sole U. S. Agents For
ROBT. W. PAUL, LONDON

TRANSMITTING VACUUM TUBE CONTROL

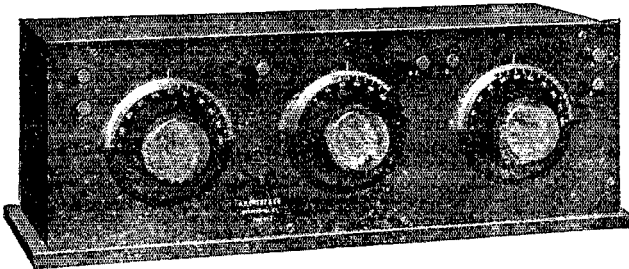

TYPE CT-1

This instrument provides the necessary controls for vacuum
tubes up to 50 watts power capacity and has a wave-
length range of 150 to 400 meters.

Send for free literature on this and many other new
GREBE developments.

A. H. GREBE & CO. **Richmond Hill, N. Y.**

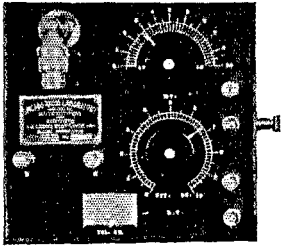

A Necessity in Using the New Underground Antennae

Static elimination by the use of the Rogers underground antennae is perhaps the most striking and far reaching discovery made during the war. By this system "Static" is absolutely eliminated, the only atmospheric interference remaining being due to ground strays. In cutting out the static, however, the signal strength on 200 meters is also reduced to about one-eighth the value of the same signal on an ordinary antenna. In order to render ordinary signals readable on the underground antenna it is therefore necessary to use one or more steps of amplification.

Our Amplifier, type AMP-1, illustrated above is especially valuable in such work owing to the high degree of amplification secured by its use. Its mechanical construction is as perfect as it can be made. The cabinet is finished in golden oak, with polished Bakelite front. All scales are engraved into the panel, and all parts are submounted, with no supporting screws on the panel front.

The amplifier coil used is the same special static-coupled type as is used in our "Amplifon" and comparative tests have shown it to be greatly superior to any other coil now on the market. We ask you to compare our price for this cabinet with the prices of others whose quality does not approach ours.

One step Amplifier, type AMP-1 (without bulb or battery)	\$33.00
Two step Amplifier, type AMP-2 (without bulb or battery)	\$60.00
Static-coupled Amplifier-coil only, mounted on base	\$10.00

Chicago Radio Laboratory

1316 CARMEN AVE.
CHICAGO, - ILL.

IT IS HERE!

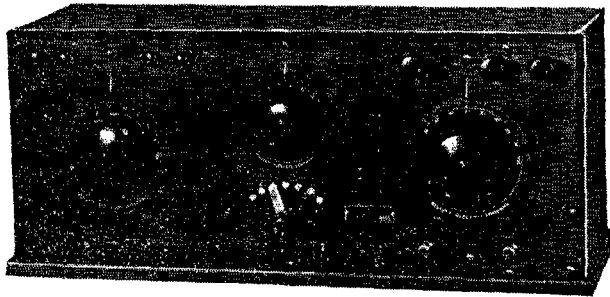

A Short Wave Regenerative Receiver at a Moderate Price

This short wave receiving set is exceedingly sensitive on wavelengths approximating 180 to 450 meters. The constants are accurately proportioned for these wavelengths, and by loading the circuit by the medium of binding posts provided for that purpose, higher wavelengths may be received.

The case is of Oak, finished in Early English. Panel is black Bakelite. The set is a beautiful piece of workmanship inside and out; and this, with the best of materials, makes all that can be desired in an instrument.

Write for our prices—they will interest you.

Manufactured by **ELLIOTT ELECTRIC CO.**, Shreveport, Louisiana

Q. S. T.

"All men having commercial licenses should report for jobs at once."

BIG SHORTAGE OF RADIO OPERATORS!

Every student completing the course secures a berth immediately, paying \$85 - \$130 per month, plus found.

Short thoro course—
Excellent laboratory.

Dormitory — Swimming Pool
Call or write for illustrated booklet

Y. M. C. A. Radio School

DEPT. R
153 East 86th St., New York City

"BEST RADIO SCHOOL IN NEW YORK"

TUSKA'S SCIENTIFIC EXPERIMENTS

	Price
No. 1. Experiments on Resistance	\$10.00
No. 2. Experiments on Inductance	10.00
No. 3. Experiments on Capacity	10.00
No. 4. Experiments on Detector	10.00
No. 5. Experiments on Wave Lengths	10.00



The most interesting and instructive thing yet produced for young men and boys.

Of especial value and help for wireless amateurs.

Makes all the phenomena plain and understandable.

Each set complete with all necessary apparatus and supplies, and also simply written and interesting Experiment Book. Theory explained, Measurements described, Data Sheets, Blank Forms, Notes and Laboratory Instructions included.

SPECIAL INTRODUCTORY OFFER:
5 EXPERIMENT BOOKS FOR \$1.00
Postpaid.

Separate Books, 25 Cents Each.

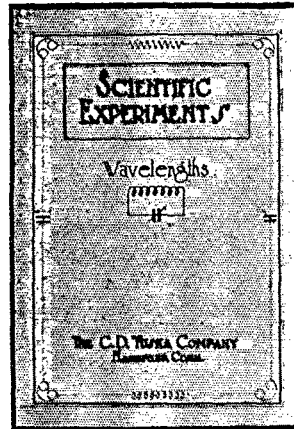

Use Return Coupon!
Send immediately 6c. in stamps for Catalog Q.

Return Coupon

The C. D. Tuska Company
Experiments Department
Hartford, Conn.

Enclosed please find \$..... Send
Experiment Books Nos.....

Name

Street

City and State

"ASK ANYONE WHO HAS USED IT"

Brandes Wireless Headsets



"Superior" Set #6

WENT THROUGH CHATEAU-THIERRY, ARGONNE AND MEUSE OFFENSIVES

A soldier who used a Brandes Headset all through the war brought it to us for slight repairs afterward. He knows that a Brandes is the best that can possibly be made. You ought to hear him talk. (Name on request.)

TRIAL OFFER Brandes Wireless Headset sent to you on trial for 10 days. Test it,—compare it with others,—for sensitiveness, clearness, distance. Prove for yourself the fine quality, the "matched tone." The two diaphragms, toned exactly alike, strengthen the signals and prevent blurring. Used by many U. S. Gov't experts, and experts abroad; by colleges and technical schools; and by professionals and amateurs everywhere. If, for any reason, you are dissatisfied, your money back without a question.

Send 4c. for Catalogue F
C. BRANDES, Inc.

Room 821, 32 Union Square, New York
WIRELESS RECEIVER SPECIALISTS

The Only Vacuum Tube which Amateurs Can Use

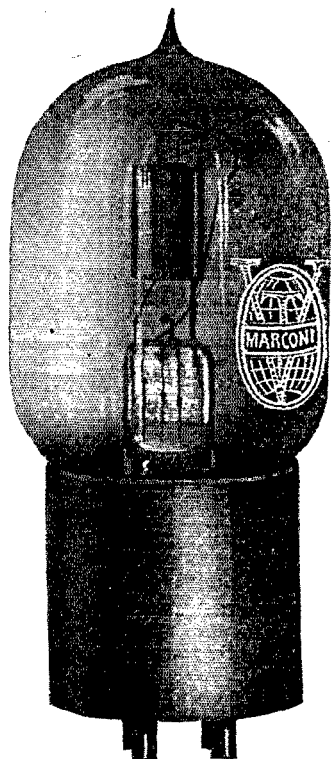

Fleming Pat. No. 803684
DeForest Pat. Nos. 841387-879532

Agreements recently effected have made vacuum tubes available for experimental use. The Marconi V. T. is the only vacuum tube, or audion, which may be sold to amateurs, laboratories, schools of instruction and experimenters.

MARCONI V.T.

\$7.⁰⁰ each

Standard base, \$1.50 additional

A highly developed, all-round tube for use as a detector and amplifier in wireless communication. It has practically the same electrical constants as the tube used by the Allied armies and navies throughout the war in continuous wave transmission and reception. The terminals of the elements of the tube are brought out to a 4-prong standardized base, fitting into the standard four-contact bayonet sockets.

Filament current 0.7 ampere. Filament potential, 4 to 6 volts.
Plate potential, 20 to 60 volts for reception.

For lighting filaments a lead storage battery is preferable because of its constancy of voltage. Ordinary dry cells or flashlight batteries may be used to provide plate voltage.

The approximate operating life of the MARCONI V. T. is 1,500 hours.

Delivered postpaid in special container insured against breakage to any address upon receipt of purchase price

COMMERCIAL DEPARTMENT

Marconi Wireless Telegraph Company of America

Sole Distributors for De Forest Radio Telephone & Telegraph Co.

WOOLWORTH BLDG. 233 Broadway NEW YORK

AMAZING AUDION DETECTOR

VALUES—\$9.50 \$11.75 \$18.85 \$22.00

Remarkably efficient and handsome audion control panels within the PRICE LIMIT of EVERY AMATEUR, BUILT AND DESIGNED FOR THE AUDION, AS ONLY THE MAKERS OF THE AUDION CAN BUILD IT. In the past, instruments of this calibre have never been offered at twice these prices.

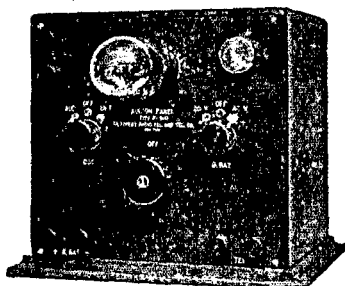

Type P-500, \$22.00

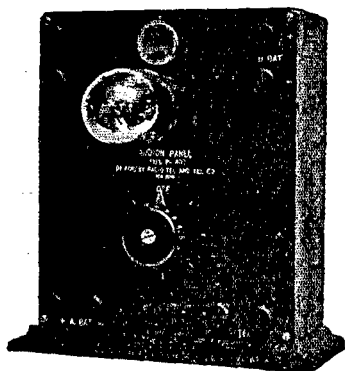

Type P-401, \$11.75

GENERAL SPECIFICATIONS ALL MODELS: Beautifully engraved and grained genuine bakelite panels; 4 prong heavy nickled tube receptacles; smooth running, positive acting, adjustable rheostats; impregnated efficient mica stopping condensers; adjustable or fixed grid leaks with polished nickel covers; bakelite covered binding posts with new slotted positive connecting feature; positive segmentally connected nickel switches; 40 volt B battery of two 20 volt type units cast enblock with operating life of 6 to 12 months—a remarkable advance in B batteries; handsome quartered oak cabinets, round corners, standard de Forest "Early English" finish; perfect workmanship and expensive design throughout.

Type P-400 Audion Panel—Consists of tube receptacle, grid leak and condenser, rheostat and binding posts for connection to tuner, A and B batteries on bakelite panel $7\frac{1}{2} \times 7\frac{1}{2}$ " without cabinet and B batteries \$9.50

Type P-401 Audion Panel—Same as above with cabinet \$11.75

Type P-402 Audion Panel—Larger panel with 40 volt B battery in cabinet \$18.85

Type P-500 Audion-Ultraudion Panel—Type P-402 Panel with two switches for audion-ultraudion connection and either 20 or 40 volt B battery in Cabinet \$22.00

Note: All de Forest audion apparatus is sold without the tubes. Audion detector oscillator or amplifier tubes, \$7.00 each additional.

Catalog sent on receipt of 10c. in stamps to cover postage.

De Forest Radio Tel. & Tel. Co.
1415 Sedgwick Ave. NEW YORK CITY

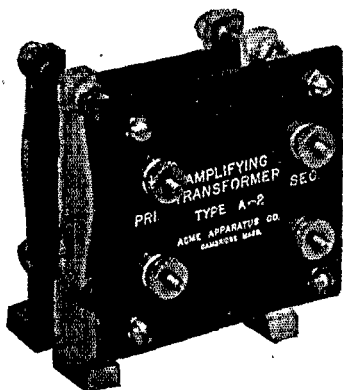

Acme Apparatus For Results

THE ACME AMPLIFYING TRANSFORMER

Type A-2

A very compact and efficient transformer especially designed for repeating between tubes in Vacuum Tube Amplifier Circuits.

Two-winding, closed magnetic type. Primary and secondary of No. 40 enamelled wire, wound on one leg, with a turns-ratio proved by exhaustive experimentation to be the best. Supported on aluminum castings, with bakelite panel and nickel-plated binding posts. Shipping weight, 2 lbs.

Type A-2 Amplifying Transformer, \$10.00

Same, unmounted 7.50

Inquiries solicited from responsible dealers.

ACME APPARATUS COMPANY
26 WINDSOR ST., CAMBRIDGE, MASS.

!! HELP

US TO PLACE QST ON ONE
NEWSTAND IN EVERY
TOWN.

Can you buy QST in your town? If not, won't you help us and yourself by filling out the blank below and mailing it to us? If you can be the first to place a standing order for six or more copies monthly with some newsdealer in your town, we will give you six months subscription free. We want only one in each town. Get us one in your town. Don't let some other fellow beat you to it. See your newsdealer today. Get him to order direct. Then mail blank.

Return blank

American Radio Relay League,
Manager, QST,
Hartford, Conn.

State..... City.....

Newsdealer

His address

My name

My address

He will take.....copies of QST monthly.

AMELCO APPARATUS

=====
CROWDED WITH
EFFICIENCY
--LOW IN COST--
=====

REQUEST CATALOG 19

AMERICAN
ELECTROMOTIVE CO.

20 EAST 42ND ST., NEW YORK, N.Y.

12 STEP INDUCTOR TYPE 111

THIS inductor is designed to permit two or more of them to be placed side by side, coupling being varied by moving them nearer to or farther away from each other. Thus every degree of coupling may easily be obtained.

Price \$12.00 to \$16.00
according to inductance.

Full data and catalogue will be sent
on request

GENERAL RADIO CO.

Windsor St., Cambridge, Mass.

“Q-S-T”

The U. S. Navy

EQUIPPED THE MAMMOTH
“NC” PLANES THAT HOPPED
THE ATLANTIC WITH

MAGNAVOX ANTI-NOISE TELEPHONES

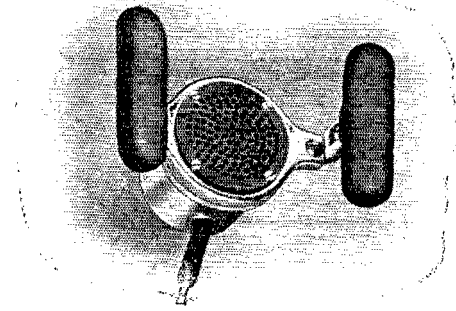

The Magnavox Anti-Noise Transmitter—U. S. Navy Standard Airplane Type, as used successfully for both radio-telephone (long range) and intercommunication on the giant “NC” planes that crossed the Atlantic Ocean.

ACTING SECRETARY ROOSEVELT SAID:

“A special feature of the telephone sets is the anti-noise microphone, which is so constructed that the engine noises are not heard. This is accomplished by having the back of the microphone open. The exterior sound waves strike the back as hard as the face of the diaphragm, and therefore the effect is neutral. The voice waves strike only the face of the diaphragm, and even though the operator cannot hear his own voice, the radio sets receive enough effect to modulate the transmitted wave.

“This single item has been the deciding factor in success or failure in long-distance transmission by telephone by airplanes. It is easy enough for short distances to get communication with an ordinary microphone, but for long ranges is impossible without the anti-noise transmitter.

“Using the same intercommunicating telephone system, the navigator can telephone to the pilots, giving them the proper direction in which to steer the plane. He may inquire of the engine room regarding the condition of the engines, or he may hold radio-telephone conversation with the navigating officer on one of the other planes.

“In other words, the intercommunicating telephone makes possible constant communication between all members of the crews in spite of the terrific noise caused by the engine and the wind rush and in spite of the fact that they are in separate parts of the seaplane. In addition to this the radio telephone makes it possible for the commanding officer and navigators to talk directly with each other, although their seaplanes may be flying at a distance of 20 miles apart.”

—Electrical World, May 24, 1919.

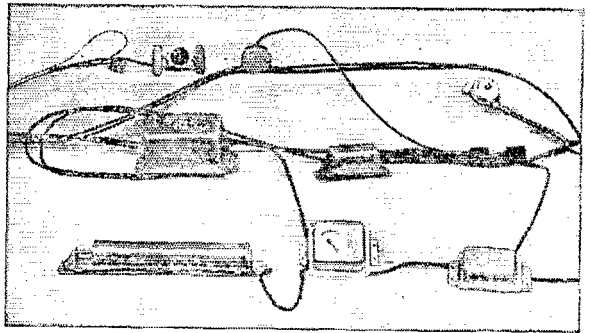

The simple “layout” of apparatus needed to equip an airplane with Magnavox Anti-Noise Telephones.

LET US TELL YOU MORE ABOUT THIS
EFFICIENT APPARATUS—A NOTABLE
“WIN-THE-WAR” INVENTION.



PATENTED IN U. S. A. AND FOREIGN COUNTRIES

2701-2759 EAST FOURTEENTH STREET
OAKLAND, CALIFORNIA

San Francisco Offices, 616 Mission Street

We Announce Our Entry Into The Field of QST

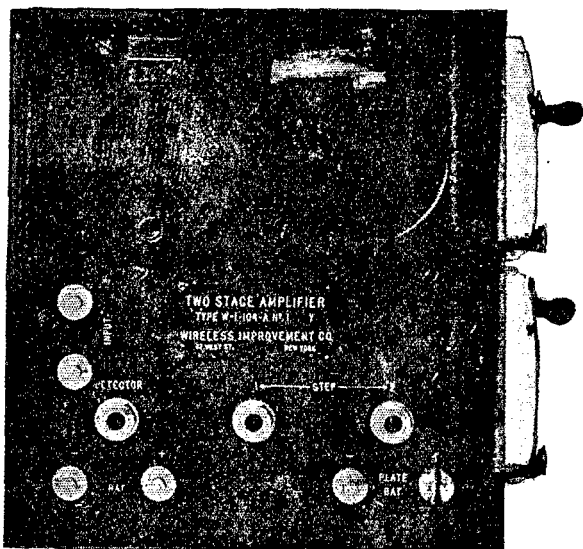

THE high grade amateur—the real experimenter or the private owner who wants real apparatus—either complete or in separate units, ready for mounting—may obtain from us a full line of equipment to meet every requirement of the private station or laboratory.

We cater only to those who want and can pay for the best.

We sell only one class of apparatus. The same to the experimenter as to the Navy, foreign government or commercial user. Modifications such as wave length, range, etc., to meet different requirements naturally are made.



A bulletin covering your particular requirements sent on request

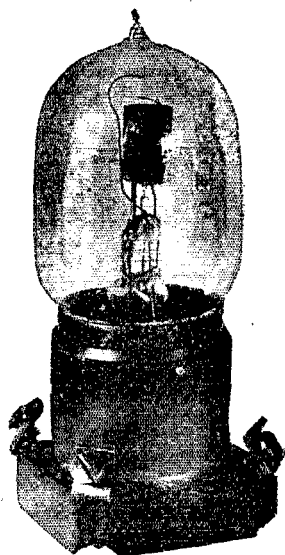

WIRELESS IMPROVEMENT COMPANY

47 WEST STREET

NEW YORK