

# QST

A MAGAZINE DEVOTED EXCLUSIVELY TO THE WIRELESS AMATEUR

September  
1917

Price  
15 cts.



H. R. HICK.

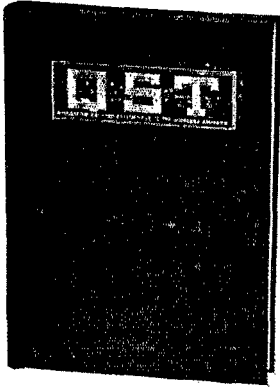

# BOUND VOLUMES

Still a Few Copies Left

## Q S T -- Volume One

*TURN IN YOUR OLD COPIES*

*Credit will be allowed for a  
complete file in good condition*

In this volume will be found the audion articles by Paul F. Godley, four of the Old Man's "Rotten Stuff", and no end of interesting material.

This is an opportunity to complete your file of QST, and at the same time possess yourself of something worth while. Covers and all are bound, making the year complete.

QST, Volume I, . . . . . \$5.00 each

QST, Volume II, 1st Half . . . 2.00 each

**The Q S T Publishing Company, Inc.**

Care of Editor

HARTFORD, CONN.

# QST

Volume II

SEPTEMBER, 1917

No. X

## CONTENTS

- |    |                                  |                    |
|----|----------------------------------|--------------------|
| 3  | Ground Telegraphy                | Roy Griffith       |
| 7  | Something Rotten Somewhere       | The Old Man        |
| 11 | A Regenerative Audion Connection | S. Kruse           |
| 13 | An Electromagnetic Switch        | T. H. Benson       |
| 14 | Air Service in War               |                    |
| 15 | Editorials                       |                    |
| 18 | Radio Communications             |                    |
| 24 | The Evolution of a Field Battery | Willis R. Prissell |
| 27 | For Sale and Exchange            |                    |

Hiram Percy Maxim, President

Clarence D. Tuska, Manager and Editor

¶ QST is published monthly by The QST Publishing Company, Incorporated at Hartford, Conn. Subscription price, \$1.50 per year. Single copies, 15 cents. ¶ Entered as second-class matter March 7, 1916, at the Post Office at Hartford, Conn., under the act of Congress of March 3, 1879. ¶ Copyright, 1917, by the QST Publishing Co., Inc. ¶ Title registered at United States Patent Office.

THE QST PUBLISHING COMPANY, INC.  
HARTFORD, CONN.

# Concerning Phantom Antennas

---

Washington, August 16, 1917

Mr. C. D. Tuska,  
Manager and Editor, QST Magazine,  
Hartford, Connecticut.

Dear Sir:

I have to acknowledge your letter of August 10th, inclosing Lieutenant Latham's letter of July 26th. Lieutenant Latham is quite right in stating that radio apparatus cannot be used for experimenting at all. But it must be borne in mind that apparatus commonly used for radio work ceases to be "radio" apparatus when entirely disconnected from the other necessary components of the radio installation.

It is not intended at all to forbid doctors using induction coils for taking X-ray pictures, or physical laboratories from performing the many conventional induction coil and transformer experiments. For such experiments no license was needed, and it would be absurd to think they were forbidden.

But all experiments involving inductance and capacity and such power and voltage as would justify the experiments being called "radio telegraphic experiments" are forbidden. No aerial must be

used, nor ground connection made. In short, all the experiments usually performed by amateurs must cease. The statement that "no experiments should be made in which radio frequency oscillations are produced" is perhaps slightly too broad, as noted above, but it is undoubtedly true that no radiotelegraphic experiments are permitted.

This would be a good time for amateurs to use their surplus energy in learning the American Morse-Code, for all good operators should know both codes; in order to secure a Commercial Extra First Grade License, for instance, one must know the American Morse. Land-line telegraphy is a particularly promising field for women or for the amateurs who cannot pass the physical examination necessary for enrollment in the Naval Reserve Force.

I think the situation is pretty clearly defined now, and can be summed up concisely as follows: No radio telegraphic experiments at all. If any point is still not clear to you, please write us to that effect.

Very respectfully,

Reed M. Fawell,

Lieut. Comdr. U. S. Navy,  
For Director Naval Communications

# Q S T

A Magazine Devoted Exclusively  
to the Radio Amateur

## Ground Telegraphy

By Roy Griffith

**T**HERE is nothing new about the fundamental principles of ground telegraphy, but my friend and I have applied modern instruments to it, and I have devised some methods of eliminating QRM from power circuits using the ground, which I believe are new.

The main idea is to use two grounds at each station, exciting the pair of grounds with a battery, key, and buzzer for transmitting, and connecting a telephone receiver across the grounds for receiving. See diagram below.

current spreads out, as shown by the broken lines in the diagram, and some small fraction of this spreads far enough to reach the receiving station, where part of it flows thru the phones connecting the receiving grounds. Now if stations AB and A'B' are separated by a given distance, obviously, to get the best response in the receiver, the distance between A and B, and between A' and B' should be as great as possible. In other words, the greater the distance between grounds at each station compared with the distance between

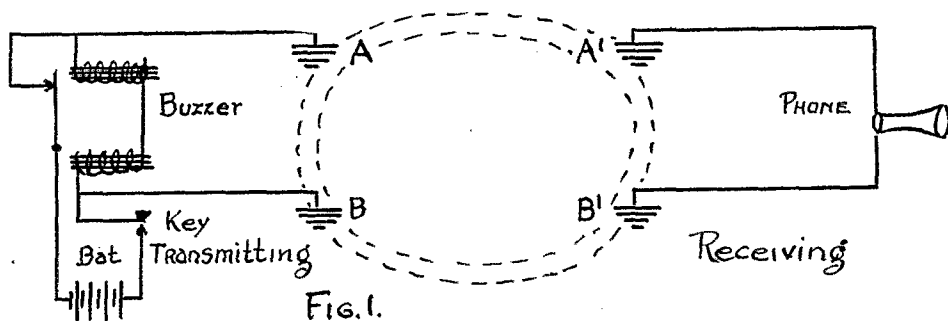

The buzzer at the transmitting station has the grounds A and B connected across its windings, thus utilizing the relative high E. M. F. of self-induction in the coils to excite the grounds. Now the greatest part of this current flows between the two grounds at the transmitting station, taking the shortest path between the two and spreading out but slightly. Some of the

stations, the greater the signal strength, or the larger the fraction of the current passing from A to B, which passes from A' to B'.

To think that such a system is practical over even short distances shows how marvellously sensitive the telephone is. Suppose the distance between stations is a half mile, spacing of the grounds 20

or 30 feet, the exciting power an ordinary buzzer and a 6 volt storage battery, and the receiver an ordinary Bell phone—how inconceivably small must be the fraction of the total current which reaches the phone! I wonder how many figures there would be in the denominator! Yet a lay-out like that just described is entirely practical.

Now for some working data. The power may be drawn from dry cells, storage battery or step-down transformer. The buzzer should be arranged to give a high-pitched note, especially if there are ground currents to read through. Most of us OM's know how to make a buzzer squeal, but the best method I have found is the following: First get an ordinary **small** watch-case buzzer. Solder the contact spring rigidly to the armature. Then remove all excess weight of solder and iron from the armature, making it as light as possible. Connect a two mfd. condenser and a telephone across the windings and adjust for a clear high tone by bending the armature supports with pliers while the buzzer is in operation. Often it will be found desirable to wedge the fixed end of the armature with a little wad of tape, or other resilient material, rather than to try to get the final adjustment by bending the supports. I have just doctored up a buzzer like this, and find, by comparison with a piano, that the tone is about 1400 cycles! This is probably too high.

The transmitting grounds may be connected either across the buzzer contacts, or across the windings. Results are the same. However, if the grounds are good ones, connecting across the contacts prevents

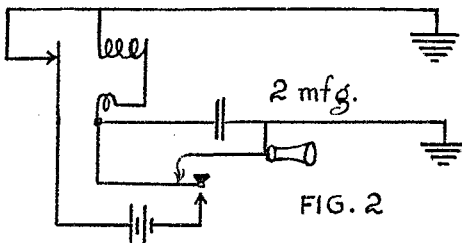

the buzzer's operation, but connecting across the windings does not do so as easily. If difficulty is experienced from this cause, connect a sufficient resistance or a 2 mfd. condenser in one of the ground leads. The 2 mfd. condenser will not cut down signal

strength in the slightest degree and will not spoil the buzzer's tone as another hook-up would. This condenser can also be used to make a "break-in" system out of the arrangement. See diagram, Figure 2.

The condenser shunts the telephone while receiving, but here again this will not cut

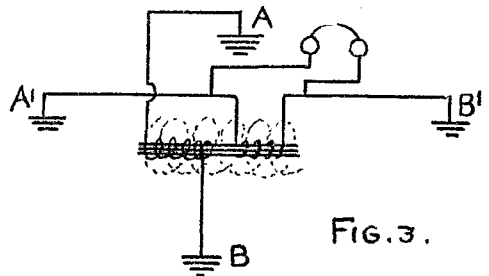

down the strength of the received signals. The back contact on the key is necessary to prevent wasted power and fractured eardrums while sending. I think this is the ideal hook-up.

The grounds need not be very good ones. I have found that an iron rod several feet long works as well as a good water pipe ground. Of course, the two grounds should be as widely separated as possible, and the line joining them should be perpendicular to the line to the other station. If the water and gas pipes come into the house well apart, they may be used as the two grounds, but I think it is always much better to use separate grounds, spacing them as much as possible and directing them properly, as explained above.

The receiving telephone should have a low resistance, the lower the better. High resistance wireless phones are excellent if connected with the secondary of a 1 inch spark coil, the primary being connected in place of the phone shown in the diagram, but they are useless without a step-up coil.

Since the buzzer's counter emf. is absorbed by the grounds, or by the grounds and condenser, there is no spark at the contacts, and so a dozen dry cells may be used, if necessary, without injuring the buzzer. A medical coil or a small spark coil may be used instead of the buzzer, but they are not as good, because the buzzer combines high emf. and low resistance.

This, I think, covers the main points.

For a further discussion, and experimental results, see the experiments of Morse, Lindsay, Trowbridge, Highton, Dering, Preese, Smith, etc., in Fahie's "History of Wireless Telegraphy." This is a wonderfully interesting book, particularly on this subject. Of course, the experiments recorded employ too long base lines for most of us, but a great deal can be done with a base line of 50-100 feet. See also Gernbach's "Wireless Telephone." For some very interesting laboratory work on lines of flow and equipotential lines, closely connected with this subject, see Ames and Bliss, "A Manual of Expts. in Physics" and Fahie, p. 96, Prof. Bell's experiments.

Now comes the great difficulty. The light companies make a practice of grounding their neutral wire on a 3-wire system or one of the outside wires on a 2 wire system. Since these grounds are located at the power house and at pole-top transformers, houses, and various places, it is practically impossible to find points on the ground which are at the same potential. A good deal of the current returns thru the ground rather than thru the wire, and as the grounds are so numerous, we can pick up some of this stray current by connecting a phone to a pair of grounds separated a few feet **anywhere** in a civilized community, and the strength of this current (in ones field, lawn, etc.) will not vary hardly at all when we change the **position** of the grounds, but only when we separate them by different distances. Thus the "ground hum," as we may call it, cannot be eliminated by locating our grounds properly, and of course if the hum is of any appreciable strength it will greatly interfere with the working of a set like the above. If a constant 60 cycle hum is encountered, and if 60 cycle current is available it can be easily balanced out of the phone circuit by means of a coil of a few turns of wire carrying the current for a small lamp (10 watts or so) arranged at the proper distance from a similar coil in the phone circuit. The coils must be arranged so that the currents oppose each other and the latter must be in phase. This is all very simple. Listen to the situation I have to cope with here at Narberth, Pa. Connecting a volt-meter between the gas and water pipes, which enter the cellar wall

about 20 feet apart, I get a current (D. C.) which varies from 0 to 10 or 12 milliamperes, + or -. This current must come from trolley lines at least two miles away! Of course, being D. C., it does not cause QRM, and if it did, a condenser would keep it out. Besides this, I get an A. C. hum, loud enough to be heard all over the room, which is a mixture of 60 cycle from the lighting lines and 25 cycle from the Penn. R. R. Main Line electrification half a mile away. The R. R. has taken every possible precaution to prevent interference with the Bell Telephone Co. from this cause, but still the juice leaks out. They have their rails carefully bonded, a heavy ground wire along their pole tops on each side of the track, a large copper ground plate below each pole, and a 3-4 inch copper cable connecting the poles on each side of the track. Yet, with all this, I get a regular roar in a telephone half a mile away with grounds only 20 feet apart. This current is of course not constant, but varies greatly in strength. Besides, whenever a car starts, a rising note can be heard in the phones. This rises in pitch and intensity as the car speeds up, until it is a perfect **screech**. It is caused by the brushes on the commutator bars, the motors used being laminated commutator type series motors. In addition to all this racket I can hear splashes of our old friend QRN! Now I know that if you have never listened in on a pair of grounds

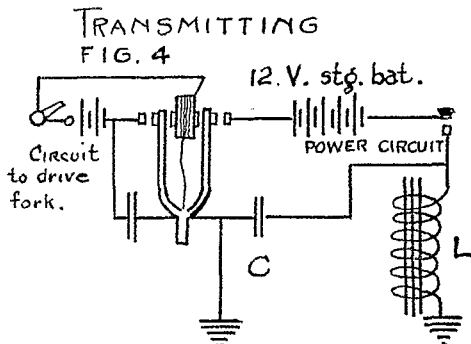

you don't believe all this. But just try it yourself or else drop in some time when you are near Philadelphia. The QRN is not as violent as on an aerial system, but it sounds like the real stuff when a thunder storm is approaching. The two can be shown to be identical by listening in on

an aerial system and a ground system simultaneously.

To eliminate all this QRM without eliminating everything else in the way of the desired signals, I devised a system of 4 grounds in connection with what I call "balancing coils." The phones are connected to the secondary of a half inch spark coil, arranged to slide easily back and forth over the primary, which is rewound in two sections, each occupying half the core and connected in opposition, each to a pair of grounds. The secondary is moved to a position where the QRM all balances out.

The two pairs of grounds, as explained above, are about equally affected by the QRM, but the signals, coming from two definite grounds only, affect one set of grounds more strongly than the other. It is even possible to set one pair of grounds on an equipotential line with respect to the transmitting grounds, and then set the other pair at right angles to these, in the position shown by the diagram. Then, while the QRM is all balanced out, the signals affect one pair of grounds not at all, and the other pair to the maximum degree. The fact that the QRM can be completely balanced out requires that the 60 cycle and 25 cycle affect the two pairs of grounds in the same relative proportions, that is, so that the ratio of 60 cycle to 25 cycle in each pair is the same. This condition is usually approximately realized. If it is not, the 60 cycle and 25 cycle balance at different points. Even then a perfect balance may be obtained by balancing the 25 cycle with the "balancing coils" and then balancing the remaining 60 cycle externally as above. Merely to secure a balance it is not necessary that the grounds be arranged symmetrically, or that the two pairs be equally spaced. The balancing coils will take care of any sort of combination in this respect. The grounds are arranged in a quadrangle to secure maximum signal strength. If we can get perfect silence to work in, attempts can then be made to secure telephonic communication. Also we can try audion amplifiers and M. A. F.'s on the received signals.

As a last caution! If you use gas and water pipes at one station don't expect that signals will be strongest with gas and water

pipes at the other station. The currents do not seem to follow the pipes.

I believe some advantage might be secured by using a transmitting current of a definite frequency, determined by a high pitch tuning fork, and having both transmitting and receiving circuits tuned to this frequency. Iron core inductances and paper and tinfoil condensers might be designed, and the final adjustment secured by means of a variable condenser.

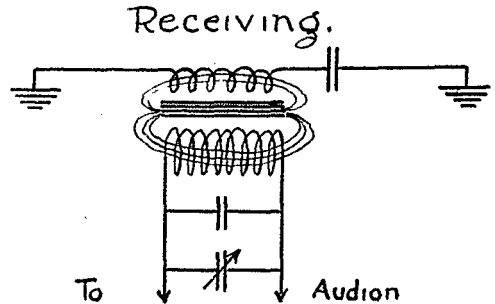

Some of these experiments ought to prove interesting, especially for those of us who are at home in these war-times. If any of our readers try these experiments and get good results, I would surely like to hear about it.

#### ERRATA

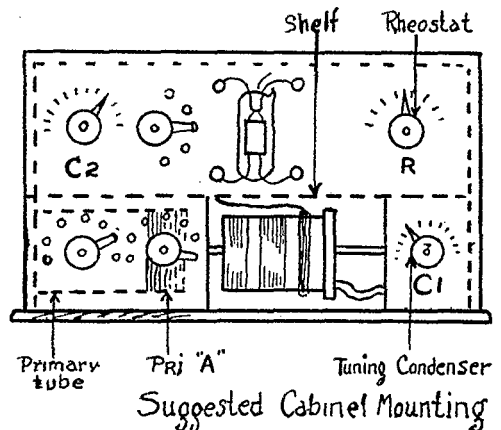

This cut should appear in place of the one shown in the second column of Page 11. The cut shown on Page 11 was placed there by mistake; it belongs with "Ground Telegraphy."



## Something Rotten Somewhere

*By The Old Man*

**W**ELL, SAY! Zenneck arrested and interned! What do you know about that!!! The gent who wrote that big book on Wireless which "Final Authority" always quotes from at Radio Club meetings and which "Radical" always flatly contradicts.

The papers say our authorities not only pinched the old boy, but interned him for the duration of the war. Well, now you know that means only one thing. There is something awful rotten going on somewhere, and it is Wireless, by heck, too, because our Department of Justice would never have selected Dr. Zenneck to occupy a front seat in the cooler for the rest of the war if the old gent had not been monkeying with the oscillatory business somewhere.

It sure does make an old wireless bug sit up and take notice. Zenneck is a wireless authority of the first class, and a German one at that. That means something more than being a Brazilian or a Patagonian wireless authority. Our erstwhile Teuton friends know a pure wave when they see one, and also which end of a wireless set you bite off and which end you light. Zenneck has been one of the world's authorities on radio. He was the big boss at WSL, Sayville, it seems to me. Sayville had a lot of trouble in the early days of the war, before we thought of taking a hand.

On several occasions they put it all over our Naval authorities when it came to monkey business. First of all they sent plain war dope to their German war ships in the Atlantic. No conscientious scruples or by-your-leave at all. They just sent it. We amateurs all noticed it. As it is not strictly according to the usages of polite war for a neutral country to permit use of its territory by one of the belligerents for conducting its attacks upon the other belligerent, our Naval authorities decided to put Naval operators in at Sayville.

These operators would send out only perfectly neutral, gentlemanly messages.

Well, did this bother old Zenneck? Not so as you would notice it. He doped out one to beat this in fifteen minutes, probably. Pretty soon our naval operators were sending out the same dope themselves, only on its face it looked different. Then it was that one of us amateurs over in Jersey got into the game and gave the biggest lift an amateur ever gave the Government. Apgar, the old sleuth, smelled something rotten just about the time some of the rest of us did. But he got busy while the rest of us only sniffed. He rigged up a phonograph and for nights and nights he sat up and recorded everything that Sayville sent out. During the days he found time from his job to repeat and study the stuff. He found very peculiar words used peculiarly often and phoney repeats and what looked like phoney messages.

He and the Secret Service got together finally and a case was brought up in court, and good old Apgar had the honor of helping the Government win it. Everybody at Sayville was bounced, including Zenneck, and the Naval authorities thereafter worded the messages themselves. That was the only way to circumvent Zenneck. Give him a piece of wire and some power and he isn't a safe person to have around these days. What he doesn't know about monkeying with oscillatory circuits, probably isn't worth bothering about until next century. No wonder, now that we ourselves are at war with his country that the Navy locked him up.

And speaking of this, have you noticed that Zenneck's arrest followed closely upon the disclosures that the Germans knew all about the sailing of our first batch of troop ships in time to have a gang of submarines out in mid-Atlantic to attack them and send several thousand of our boys to the bottom? Only our Navy convoy

saved them. Now how did this dope get to Germany?

Say! Do you suppose old Zenneck, the fellow who wrote the book we used to see advertised in QST, could answer that question? Was it another one he put over on us? Is it possible that old duck worked out a hook-up that enabled a message to be sent which finally got to Germany without being heard in this country? When we took away from him the wording of his messages did he work out a way to send them from some secret station by oscillations which cannot be heard unless you are in on the know? Like the undamped stuff, for example, only one more on top of it, just as the undamped is one on top of the ordinary spark?

The papers had just a few lines that they probably did not understand themselves, but which came down through with enough left in it to start the amateur thinking. It was something about "super-imposed oscillatory circuits." Now, what's that, for the love of Pete? It's something new on your uncle. Never heard them mentioned at any Radio Club meeting I ever attended. My, my, but it is a pity this all happened during mid-summer when our Radio Club is out of business. "Final Authority" would tell us all about it, whether he knew or not, and "Radical" would have to work up a whole new line of contradictions. No time is being wasted, however, because I took the trouble to cut the article out of the paper and send it to each. They will mull it over, each separately, and unto his own methods and liking, and I have a well defined hunch they will be about as near alike as a positive and negative charge. Come Fall I shall have something to tell you about this "super-imposed dope," most likely.

My own guess may as well be set down now as anytime. It is that our one time German friend has worked out a plurality of circuits something like multi-plex land line telegraphy and he "super-imposes" these in some manner so that you cannot hear his signals unless you have some combination which only he can furnish you. If he can do this, and I don't put it past him, then he could have put up an aerial somewhere and actually sent out signals

which we would not have been able to hear. Again, no wonder they took his tools away and locked him up. But, on the quiet, son, how about getting just one swift glance at such a hook-up? Wouldn't it come in handy when we get going again after the war? No more QRM agony. After we make up again with old Z, let's ask him into the A. R. R. L. He's probably O. K. His trouble is with his Kaiser.

Just think of this Desperate Diamond Detective wireless business going on right under our noses, and we not knowing a thing about it. Don't it make you ache? It makes you wonder how Apgar feels. Maybe he and the Secret Service are at it again copying German super-imposed stuff on some kind of a three story phonograph. Only the other day the papers came out with another one you can put in your pipe and smoke. They reported that the British Government had ordered the Marconi Company to suspend all transatlantic wireless until further notice. Now what does that mean? It reminds me of the yarn I heard the other night about digging out an enemy signal system in London. It seems it looked to the English as though something was rotten in London when the German zeppelins and flying machines found it so easy to locate the city at night. One night an order was issued to put out every one of the official sixteen aerial search lights between 1.05 and 1.10 a. m. Only five minutes notice was given. All sixteen lights were out between the times noted but there was still left one light which did not go out. There was a seventeenth, in other words.

The latest, up to this writing, is an article in the papers about a German radio station being found in an out of the way place between the hills in Campechi, Mexico. Down Yucatan way, as I remember it. It was reported as being in fine working order and doing business.

It seems kind of unneighborly of our Mexican cousins to stand for a thing like that, but they did. At least they did not stop it. And what's to prevent a station being set up at some isolated place in Mexico and collecting its information from agents in the States who could wire it to El Paso or Brownsville, carry it over the

border and re-wire it to the station? Looks easy to yours truly sitting here on the bleachers.

And if it is possible to get one station in Mexico is it not possible to get two? And if two, why can't Germany count on having at least one on the job? Mexico might remonstrate of course to this unneutral behavior, after we had told them to, but could Mexico put enough pep into her remonstrance to Germany to stop unneutral use of wireless within her borders? Probably not. Then Uncle Sam, after yawning and stretching, would wake up and allow as how if Mexico couldn't stop enemy wireless in Mexico, he would have to go in and stop it himself. Then there would start another row and some of us would have to change our clothes to light weights and go into Mexico.

We would then have one more war, and the business of killing men would go merrily on. Leastways, that is how it looms up to a wireless bug on the bleachers.

It seems to me that wireless is the big trouble for us here in America. The enemy wants to know what we are doing to lick him. He wants to know this awful bad. He will gladly sacrifice half a dozen Zennecks to find out. And he is no "ham" when it comes to wireless. He knows the game probably better than we know it. And it is a safe guess that he will go to any length to operate wireless here in America or in Mexico. Therefore, fellow amateurs, why isn't there a place for us stay-at-homes with the flat heads and square feet? All we can do as things stand is to keep our eyes skinned and our radio ears open. If enough of us do this, it is a cinch that some day somebody will see or hear something which has a rotten radio smell to it. Once we locate this smell the job is done, because we have a clew to work on. If we are in the W. U. T. Co. or the Postal Co., all the better. Even if we are in the Post Office service, we have lots of opportunities. Remember old Apgar over in Jersey. He didn't find any actual hostile messages. All he found was suspiciously frequent use of certain words. Only a little thing by itself, but it had a rotten smell to Apgar and time showed that Apgar's smell was all to the good.

We should always be on the watch for little things. The German is not naturally a good liar. He thinks he is and that is where he sets his foot on the banana peel. He gives himself away easier than most people when it comes to hiding a bang up good technical job. Therefore, his secret wireless will probably always be comparatively easy to find. It would not be going too far to expect him to show it to you in some cases if he believed you were capable of appreciating it. So, don't keep it a secret if you know wireless. Blab about it on general principles. Talk about loose couplers, detectors, regenerative receivers and "super-imposed oscillatory circuits" until your tongue gets writers cramp. Holler your head off in the street cars—and maybe some day a Dutchman will approach you and say—"You know wireless, hey? Vell, when all is doing, maybe I show you someting inderesting," which is your cue to call up the local United States District Attorney and let him do the rest.

Did it ever occur to any of you bugs that maybe we could be a big help in locating enemy wireless if we could satisfy the Government that we could be trusted? It has occurred to several of us out here in the country. Take our receiving sets and our skill in operating them. I wonder if there is a Navy station any more sensitive than any one of a hundred amateur stations we could almost call off from memory. Take those of us who were located near Chicago and have heard stations both on the Pacific and Atlantic coasts. And remember that these latter stations were using only one kw. or less. Look at the list of call letters heard and still being reported in QST. The junk used would make a Government official sick to his stomach, but it works in our hands. We know how to use a match on an audion bulb or where to locate a magnet and how to monkey a motley array of home made tuners and variables until wonders and miracles are performed. If we were allowed to listen to undamped long wave stuff it wouldn't take long with our hungry ears before we would be getting stuff that no professional station could hope to get. Remember Professor Taylor out at the University

of North Dakota rigging up a wire from his window to a tree and reading the German damped and undamped stations. And his aerial was actually below the level of the surrounding prairie, due to his house being down on the banks of the Red River of the North. He told us about it in QST last winter.

And think of the number of us there would be to listen, even counting out those who have enrolled and are now in the service. It seems from the aforesaid seat on the back row of the bleachers that a lot of help might be given, and some dope might develop which otherwise would be missed altogether. We heard of one amateur who copied German stations before the war and got stuff which neither Tuckerton nor Sayville could get and actually phoned it to Tuckerton when the latter gave it up. Strange things happen in wireless and especially in amateur wireless where the operator is hungry to do something and will work night after night getting things to their very utmost efficiency. Not one ordinary paid operator in a hundred will scratch as hard as most amateurs to read faint signals.

And another thing: With listening going on all over the country, isn't it likely that some impure or stray stuff would leak into the phones of some nearby listener, which would never reach the log of the big Navy station? If there is a way to send signals by superimposing tricks so that normally nothing would be heard a hundred miles away without knowing the trick, wouldn't a nearby amateur station be likely to get hold of some of the forced oscillations from guy wires, etc.? Again I say, from the bleachers, it seems it would.

Maybe the trouble is that the Government don't see any way to trust us. If that's the obstacle, isn't there some way we could be sworn in, or give bonds or oaths or some darned thing which would register us?

Think it over, you stay-at-homes, old and young. We want to do something even if our feet are flat.

G N - 73.

## A RADIO RAVIN'

With apologies to Edgar Allen Poe

\*\*\*\*\*

### I

Once, upon a midnight dreary,  
While I listened, drowsy, weary,  
To the faint and fading signals from a  
hundred miles and more,  
Suddenly, I heard a sputter,  
Then a spark with hiss and flutter  
Made me think of words to utter  
That I'd never said before.  
And this spark with hiss and sputter  
For some time the air did clutter  
With its wierd, unmeaning roar.  
'Twas a "ham,"—and nothing more.

### II

Stopped the sounds, once more I listened,  
And my eyes with joy then glistened  
As I heard the famous station just installed  
in district four.  
As I listened, (all elation)  
To this great, far-distant station  
Whose faint signals seemed to thrill me,  
chill me to the very core;  
Then again my phones resounded  
By a wave with breadth unbounded,  
Made me wish my ground switch grounded  
And my phones upon the floor.  
Who was this that jammed the ether with  
his awe inspiring roar?  
Just a "ham,"—and nothing more.

### III

"QRM or QRT," have your say, what e're  
it be,  
But anything you say to stop them only  
serves to make them sore.  
Evening after evening spending  
Listening to these sounds heart-rending  
Sends a man to stages pending  
Entrance to the asylum door.  
Makes him—once thought hardy, tireless,  
Feel like chucking up the wireless,  
Throwing 'phones, condensers, tuners,  
In the ash-heap, out the door;  
Give up all his old relations with his friends  
in other stations  
With a growl of "Nevermore!"

8WR

# A Regenerative Audion Connection

By S. Kruse

**D**URING the past winter it has been my good fortune to contrive an audion circuit of the regenerative type that has proven to be extremely sensitive, highly selective, and capable of giving great amplifications, without the usual tiresome tendency to go out of tune at the slightest move of the operator.

In view of the enormous number of operators now using the audion, it is highly probable that this circuit has not only been used, but also published. Nevertheless I have found that it is new to most amateur operators and this warrants its appearance here.

Reasoning from the fact that the audion has a relay action and that a small amount of applied energy will cause a very considerable change in the strength of the phone current; it seemed reasonable to suppose that if one coupled the phone circuit to the excitation circuit the process might be repeated with still further amplification. The most obvious way of accomplishing this purpose is to insert an inductance in series with the phones, and couple that in-

ductance with the tuner secondary. ...When this was tried no amplification whatever was secured, excepting on the very short wave employed by a local spark coil station. This suggested the idea that a capacity shunt across the phones was necessary and that at very high frequencies the cap-

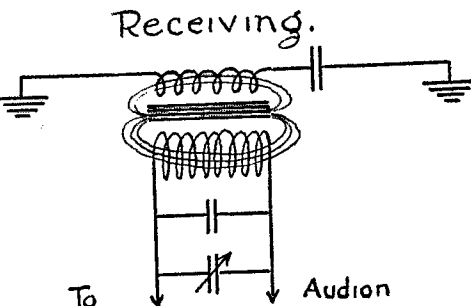

acity of the phone cord sufficed to produce the required effect. Accordingly, a variable condenser was connected across the phones. At once signals of the most amazing loudness were obtained, 8AEZ being nicely readable with the phones on the table (the distance is 600 miles) while many ships could be read all over the room. The tuning also was very sharp and only in a few cases could one hear more than one station at a time.

Trials of various tuners, condenser capacities and series coils have been made and so far the most satisfactory results have been secured with the instruments here described.

The tuner primary "A" is 3 inches in diameter and the winding consists of 49 turns of No. 26 double silk covered wire tapped to two 7 point switches, special attention being paid to making the taps short. The winding is continuous, the taps being separate lengths of wire which avoids the extra length of current-path found in loop taps. The tube is a cardboard one soaked in paraffin to prevent shrinking, but the winding is untreated. Tubes of the correct size may be cut from "Dutch Cleanser" boxes.

The tuner secondary "B" is 2 1-2 inches in diameter and carries two sections of winding. Each section is one inch long and is wound with No. 32 double silk covered wire. No taps at all are employed, all tuning being done with

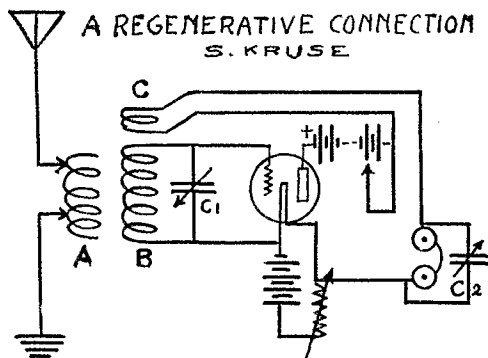

ductance with the tuner secondary. ...When this was tried no amplification whatever was secured, excepting on the very short wave employed by a local spark coil station. This suggested the idea that a capacity shunt across the phones was necessary and that at very high frequencies the cap-

the condenser. CA dead-end switch and two point secondary switch, provide a means of isolating the second section which is used only for ships. The condenser  $C_1$  is a "Blitzen" variable from which half the plates have been removed, the rest being double spaced, giving quarter the capacity, or about .0002 Mfd. maximum. This has the advantage that the scale is "spread out." It is never necessary to employ more capacity than that given.

The extra coil "C" is of No. 22 double cotton covered wire, twelve turns three inches in diameter being "bunched" together. Larger and smaller sizes of wire as well as different numbers of turns and other arrangements of the same have given inferior results.

The amplifying condenser,  $C_2$ , is a common 43 plate variable air condenser. No condenser is used in the grid lead, as the present bulb is totally inactive when such a condenser is used. Many bulbs show this characteristic but in case the bulb used requires a grid condenser it may be used without altering the action of the circuit.

### OPERATION

When the variable condenser  $C_2$  is turned to O we have a plain DeForest audion connection. The desired station is now tuned in, the coil C slipped over the secondary tube, an inch or two from the used part of the winding, and the capacity of  $C_2$  gradually increased while at the same time the coupling between the primary and secondary is loosened. In most cases signals will be received best with the secondary about 6 inches from the primary and about half of  $C_2$  in circuit. Some practice is needed to keep track of the station required while making the change to the regenerative connection as it is nearly impossible to locate a station once lost without first returning to the plain audion connection.

If the amplification is carried above a certain point the signals change to a hoarse croak which is hard to read though extremely loud. The remedy for this is to loosen the coupling of B & C, tighten that between A & B, decrease  $C_2$ , or dim down the audion filament. In general it is necessary to burn the filament at lower heat than in the DeForest connection.

500 cycle signals stand much more amplification than other spark signals. The same thing holds for a very few high pitched amateur sparks but in the case of most such sparks the signals can be amplified only a little before they turn to a hiss. Low tones, on the other hand, can be amplified to a far greater extent, 8AEZ, 9ABD, 5ED and other low pitched stations being amplified to such an extent that it is possible to lay the phones on the table and copy them with no special difficulty.

Short undamped waves have been received with this connection, best results being with rather close coupling between all three coils. There does not seem to be any special reason why this same connection cannot be used to advantage with a large tuner in receiving long undamped waves. The special advantage of the connection would be in its relative insensitivity to the approach of the hand in switching operations, since this does not have the usual effect of altering the signal pitch, though that may be changed at will by means of  $C_1$ .

---

### QUALIFICATIONS FOR OFFICERS COMMISSIONS

Men who have not been called for physical examination under the draft, and who have had a college education may make application for a commission as first lieutenant in the Aviation Section of the Signal Officers' Reserve Corps as aviators or balloon pilots, provided they are not under 19 or over 30 years of age. While college men are preferred, applications from those who have graduated from high school and have exceptionally good qualifications will be considered. If the application is approved, the applicant will be notified to appear before the Medical Board for examination. If this is satisfactory, he is assigned to schools for training.

While at the school soldiers' pay, rations, and sleeping accommodations are allowed, the officer's pay follows graduation and assignment to duty as first lieutenant.

Men having a trade who cannot fill the qualifications required for aviation or balloon pilots, can enter the aviation service by enlistment.

# An Electromagnetic Switch

By T. H. Benson

**T**HE aerial switch as employed in radio stations today differs little from those used in the infancy of the art. Beyond a few contacts for closing the primary circuit it is nothing more or less than a D. P. D. T. switch of large proportions.

A large aerial switch is the desire of every amateur; true it gives a commercial appearance to the station, but it is unwieldy, takes up valuable space and is oft-times leaky.

To remedy this, a well-known firm brought out an electromagnetically operated aerial switch that was a great improvement on the old style instruments, but being expensive, and the fact that it required quite heavy currents to throw it, prevented its general adoption in amateur stations.

The switch described herewith is of a very simple construction, efficient, quick in action and above all, easy on the 'juice.' It consists of a special switch operated by the magnets from a polarized ringer.

As to the switch proper, referring to Fig. 1, it is made from a block of fibre 1-2 inch thick and measuring 2 x 3 inches. The mercury cups are made by drilling holes with a quarter inch drill three quarter way through the fibre as shown, and in the center of each of these holes drilling a one-eighth inch hole to pass the 8-32 screws that are used to make connection to the mercury in the cups. The exact location of these holes is not important, the details being left to the constructor.

The moving part of the switch consists of a piece of 1-4 inch fibre wide enough to reach to the center of the holes, and a little shorter than the middle block.

Along the edges of this strip fasten a strip of brass which has three projecting prongs as illustrated, the center prong being 1-2 inch longer than the others. A one-eighth or three-sixteenth hole is

drilled in the center of the block to pass the tapper arm of the ringer.

A baseboard of convenient size is cut and beveled, the ringer being mounted on the upper end with the tapper arm extending downward. The heavy block of

FIG. 1  
An Electromagnetic Aerial Switch

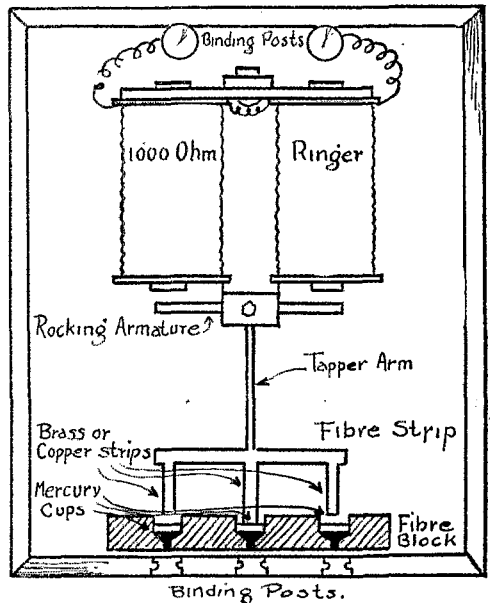

fibre is screwed to the board below the ringer. Now hold the base upright and lay the small block with the prongs in place, the longer prongs resting in the holes midway the length of the larger block. Tilt it back and forth so that the outer prongs will drop into the holes in the ends of the bottom block. The prongs should be bent so they enter easily and do not touch the sides of the holes as they go in. An extension may now be soldered to the tapper arm so that it will fit into the hole in the center of the upper block.

A few minor adjustments now remain to be made. Still supporting the base

vertical, connect a few dry cells to the coils of the ringer. This will throw the switch one way, make sure that the prongs on that end touch the bottom of the cup, if not, cut a small length off the center prongs.

Now reverse the battery leads, throwing the switch the other way and again make

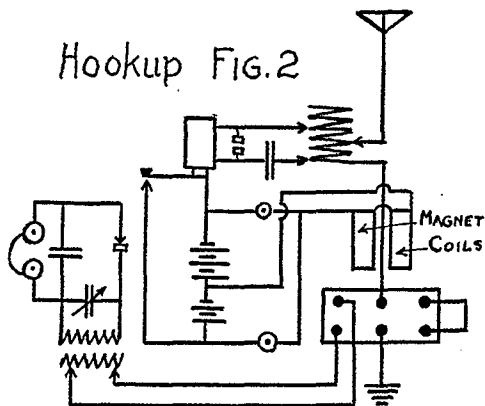

sure that the prongs touch the bottom of the cups on that side also. This condition may be arrived at in some cases by slightly enlarging the holes in the center of the moving element. This should be done carefully, for the switch will be sluggish in action if the holes are made too large.

With a little care, this device may be so adjusted that with every reversal of the current, the switch will be thrown. This can be helped to a certain extent by balancing the moving parts.

After making sure that the screws in the mercury cups are tight, the cups may be filled with mercury to a depth of one-eighth inch. When the switch is thrown to one side, the prongs on the opposite side should clear the surface of the mercury by at least three-eighths of an inch. The switch may be mounted in a box.

The connections are clearly shown in Fig. 2, a tap being brought from the center of the regular battery used for sending and push buttons being connected in the leads from the ends of the battery. The wiring to the switch proper should be carefully studied, since it differs from the usual hookup employed with aerial switches. The helix is in the circuit at all times.

The pushbuttons may be mounted close to the key, and the combination will prove very handy, and a mere pressure of the finger being required to throw from sending to receiving. Energy losses due to a leaky switch will be unknown, since it is in series with the aerial circuit, and no high tension stress will ever be created across the contacts.

## Air Service In War

**T**IME has fully demonstrated the value of the air service in war, and experts say that many of the great decisive and effective battles of the future will be fought in the air.

This appears to be confirmed by the great activity of the Signal Corps and the passing unanimously by the House and Senate and the signing by the President without delay of the bill appropriating six hundred and forty million dollars for aeronautics.

### 25,000 MEN REQUIRED

It has been said that the United States would require, to do its bit in the war, 25,000 masters of aeronautical apparatus,—that is, men capable of flying the air-

plane and hydroplane, and directing the movements of the "kite" or observation balloon, known as aviators or balloon pilots.

### AVIATORS AND BALLOON PILOTS

The work of the aviator is well known, and the marvellous results of these air-speeders; the work accomplished by them as the eyes of the army is published from time to time in the dispatches from abroad. The fastest machines attain a speed of 140 miles per hour.

The observers in them locate the position of the enemy's armies and guns, and protect cities and towns from attack, although at times the enemy's flyers get by

Concluded On Page 26





## NOW THE ARMY

If any amateur wireless operator wants to get into military service other than the Naval, he now has a good chance in the Army. The latter is looking for radio operators in the Signal Corps, for both regular field service and for air service. We have not as much first handed personal knowledge of what the Army offers in the way of training and instruction in electrical engineering, as we have in the case of the Navy, but from what we hear, it is pretty good. There seem to be two branches. One is said to be a short course of training for service in the regular field companies, where the sets used are the portable ones mounted in a cart and operated by a small gasoline engine, and all a part of the regular hand forces. The other is a very much more elaborate training at one of the big aviation camps. Two months is the duration of the course and plenty of actual signalling from flying machines, as well as photographing, machine gun shooting and bomb dropping, is

said to figure also. We have no doubt that the opportunities for a liberal education and a fine training are excellent and that a fellow who takes it will profit all the rest of his life.

A feature of it which sounds attractive is that in ninety days time, one would probably be in France, and seeing the real game. To those who are looking for this and who may be in doubt about their abilities to hold their dinners down in bad weather on the "salt sea ocean," this land service may be just what they have been looking for. If so they should immediately drop a line to Aero Personnel Division, Army Chief Signal Office, Washington, D. C. We were told that there are a lot of good jobs waiting for fellows who know radio. All those not already enrolled in the Navy, better think this over and get busy before the best places are filled. If we can help anybody, let them write in and we will do our best.

## MORE STRINGENT THAN SUPPOSED

The lid is on tighter than we supposed. Not only is it no antenna and no radiation, but it is no ground connection, no capacity and no inductance. Think this over a minute. We happened upon all this accidentally the other day. We had supposed that one could build a rotary gap and run it

and even hook it to a condenser and phantom antennae through a hot wire meter. Our attention was officially directed to the fact that this is not the case, however, and that any work of this kind would be contrary to the terms of the President's proclamation and therefore unlawful. We

believe this will be as much of a surprise to the majority of the amateurs of the country as it was to us.

The facts are that we must not touch any radio apparatus. All we can do is to read radio books and think radio thoughts. Until we become Germanized, we at least have these liberties. This does not proscribe a key or a head phone, because both may be used for other purposes. But it does proscribe a condenser, or a rotary gap, or an oscillation transformer, or a loose coupler or detector, because these have no other use than for radio purposes. It prohibits all experimental and research work in which radio frequency oscillations are involved for communicating anything.

It does not prohibit the doctor's X-ray machine or his electrical massage gear, but it does prohibit all research work on submarine detectors employing radio. Of course, all radio inventing and development work must stop if anything more than a lead pencil and a piece of paper are involved.

How long this undemocratic condition is to continue, no one knows. Probably we amateurs better strictly observe the law for a while longer and give our authorities all the head they ask to enable them to conduct the war to a successful conclusion. We hope they will not hold us in our present uncomfortable position any longer than is actually necessary.

## ***ANOTHER SEASON OPENS, BUT---***

Good old September has come around once more with its promise to cut down on the static, but——. In happier days the coming of September would start us thinking about the cells in the "B" battery, and wondering how many of them had thrown up the sponge during the summer, but——. Probably many of us would already have gone so far as to take another look over that article on how to build a regenerative receiving tuner, and have made a few sketches of what would best suit a certain particular stock of miscellaneous pieces of wood and general junk, but——. Not a few would be writing in asking what was doing on audion bulbs about now and what the chances were going to be to get inside on something especially sensitive, but——. No doubt several would be measuring off the back yard and giving serious thought to Kruse's illuminating treatise, recently printed in QST, on "Tin Masts," but——. Anyway, the various manufacturers would be noting a big increase in their mail and they would be rolling up their sleeves getting ready to handle the coming business, but——.

This time, old September is different than he has ever been before. None of these little things dear to the heart of the Amateur Wireless Bug are happening. Not since "Amateur Number One," first

strung a wire in the air, has there been a September like this fateful one of 1917. Not a single amateur aerial is in the air, from the Atlantic to the Pacific. The little buzzing spark is gone and dust covers the once shining apparatus. How long this condition will last is a guess. It probably will be many months, and we expect to see at least another September come and go which will be not much different.

'Tis a sad, sad tale. But, like most sad tales, it is not without a big ray of hope. This hope is that the present conditions cannot go on forever, and that the spirit of *amateur wireless* is just as much alive in these dead days as it ever was. Whether the law closes up our stations or even takes away our apparatus, whether we ourselves are scattered to the four winds of heaven, whether we are in the army in France, or in the Navy on the tossing sea, we are still Amateur Wireless Bugs, and nothing will ever change us. Dead Septembers may come and go and the years may change us from springy youth to sober age, but the call of the "spark" will still be in our hearts and the desire to have and use the little old set up in the attic or down in the cellar will still be the one great yearning. We will always be Amateur Wireless Bugs, come what may. That's right, isn't it, fellows?

## ROTTEN, ALL RIGHT

Our dear old grouchy pal, "The Old Mah" touches a very timely topic in this issue. That is, enemy wireless in this country. We who know something about wireless only too well appreciate what is possible when it comes to making a business of secret operating. The number of different ways in which the secret operator has the advantage over the one attempting to locate him is legion. In an extremely interesting article in a recent issue of the New York World, our old friend, ZRE, Mr. L. G. Pacent, points out the use that the enemy spy can easily make of steel frame buildings, lightning rods, and very short and very long wave lengths. He makes an eloquent plea for the amateur showing in arguments which must be pretty hard to refute, how the great body of amateurs would probably be of immense value rather than the reverse if they were set to work in some systematic listening organization. Our "OLD MAN," oddly enough, emphasizes the same point.

The peculiar conditions surrounding ourselves, Germany and Mexico in the present war, make wireless specially important. We are four thousand miles away, all cables are cut and Mexico is neutral, or supposed to be, and our next door neighbor. What would be more nat-

ural than short wave or some entirely new form of wave, for short distance communication between spies right here in our midst, and possibly for relay to Mexico. From Mexico to Spain or even Germany direct is easy.

How are we going to stop it? That is what is especially interesting to the amateurs who are kept at home. Most of us are true blue when it comes to loyalty and patriotism, and if we take Mr. Pacent's estimate, which we are certainly entitled to do, since he is identified with no less a house than our old friends, The Manhattan Electrical Supply Company, we have some \$10,000,000 worth of apparatus with which to work. Is it not more than likely that we could do something with this? The argument is sometimes heard that we would hear the Navy wireless if we were permitted to listen. Suppose we did. It is in code if it is important, and does not the German spy listen to it anyway? If the latter has it what harm would it do for us loyal Americans to have it also? We would like to make a little bet that if we amateurs were permitted to listen, we would between all of us, dig some astonishing things and make it extremely interesting for those who are putting over the "rotten" stuff evidently now going on.

## IF WE EVER GET LOOSE AGAIN

If an all wise Providence ever signs the papers letting us amateur wireless enthusiasts loose again, and if the benevolent authority sends back to us in sound body and mind the army of trained radio operators now in the Naval service, there will truly be something doing in radio in these good old United States of America after the war. We have many times thought of this during the past months as we contemptuously regarded the two flat feet we call our own. A few of us were pretty snappy when it came to operating and handling traffic, last winter before we were closed up. What will it be like when a thousand or more trained naval operators take the place of these few? With their military experience and training and

their familiarity with the finest kind of wireless apparatus, it looks to us as though amateur wireless might come pretty near being a new kind of a game when we get loose again. And it is not going to be boy's junk in the way of apparatus, either, nor boy's methods of handling traffic. These will go into the discard accompanied by a blush of shame that they ever existed. The A. R. R. L. and the traffic it will handle, when the happy days arrive, will be something that even the craziest of us has no idea of today. Think it over, you good fellow-in-the-service now. It is a sweet morsel to roll over in the mind. You will be big guns when you come home after the war. You will be the ones who will run things.

# Radio Communications by the Amateurs

The Publishers of QST assume no responsibility for the statements made herein by correspondents.

## Enemy Wireless ?

Editor QST:

Just a few days after I received the June issue of QST, and read the O. M's excellent article on "Rotten" closing-up of stations, we figured in a little incident that might be called a fit companion to his "stuff."

As soon as our station was closed, we set up a buzzer, with loud, clear tone, and used it both for ourselves and also to give instruction or practice to some friends. Some of these have already gone, and others will go, as soon as they can "brush up" into Gov't service. We thought we were doing something very practical, being as we could not go into the service ourselves—right away, anyhow.

Well, it ran this way for almost two months, when some well-meaning but ignorant folks in the neighborhood thought we were working our wireless, and deemed it a patriotic duty to report the matter to the authorities.

At 9 o'clock one evening, we received a call from a special officer whom I took upstairs and showed the buzzer, and explained it to him. He admitted he never saw a wireless before. At 11:30, the same evening, he came back, accompanied by another "special" and two secret service men. All hands upstairs to see the buzzer! They might have known something about shadowing criminals, but (oh, my!) they surely never learnt a line about wireless, practical or theoretical. One of them asked me how far it would send (imagine that, with no aerial or ground!). Another asked me if we could receive with this buzzer! I sat up there on the old table, (all the instruments were packed away on one end of it) and gave a lecture on the

buzzer, explaining that it was nothing but a doorbell, and if it was a receiving set, then there was a receiving set on the front door of every house equipped with an electric door-bell. They took our word for it, but I'll bet an audion to a snap switch that they didn't understand it.

Not satisfied with this, we directed a letter to the Supt. of Police, and explained the whole case, told what it was we were using, and why; also told him about the farce investigation. His reply showed some more ignorance on the part of the men who followed up the clue. The letter stated that they called at the house because previous to that we had been seen "using a wireless key" and "with a code book in our hands." Whadyemean, "code book?" Will someone please tell me if a book containing the Continental code looks any different at a distance than any other kind of book and, secondly, if you push a "wireless key," do you necessarily send out wireless signals?

The O. M. was right. It certainly is a joke when they send men out to look for illegal wireless plants when they don't know a wireless set from a front door bell. Why don't they see to it that they send a man who understands wireless, or why not commission some amateur in the city, who is not capable for military service? Then I think you would see some practical results and at the same time, the standard of the service would not be lessened, or be a subject for jokes.

Sincerely yours,

James A. Nassau,

1510 N. 18th Street  
Phila., Pa.

3CT.

## High Note--Low Note Again

S. S. Rush, Herendeen Bay, Alaska  
Editor QST:

Dear Mr. Tuska,

Have noticed considerable controversy in your worthy little publication on the question of "High Note vs. Low." My experience in that line may be of interest.

In my own home station at Portland, Oregon, I have heard many kinds of spark among the amateurs, but have seldom heard what we would term "high note" in the commercial game. In Portland 7ZN and KDP handled practically all of the long distance communication, notably 7ZN, as KDP is unable to receive short waves efficiently for some unknown reason. Now while 7ZN has a heavy spk with good carrying qualities, yet the note—about 120-150 cycles—does not strike me as easy to copy. Of course, he being located in Vancouver, Wn and I in Portland, we're only separated by a few miles, so cannot say how his note sounds at a distance. Probably 6AV or 6EA cud enlighten us on this point. As for KDP, his note is slightly higher than 7ZN and reads a little better. As for carrying qualities, cannot say, as he is unable to work with any real distant stations. Whether they hear him, although he cannot hear them, is a question the distant stations will have to volunteer information on.

One night, a new note pierced the air. It was a 500 cycle spark and belongs to 7JH. Since that time, he has done very fine work, seeming to be the only one able to work direct with 7YS at Lacey. Wn. Seems that 7ZN can handle southern biz as far south as Los Angeles but can only occasionally manage a signal thru to 7YS. Seems to be a hole in the air north of Portland. Since 7JH's advent with his 500 cycle spk, his set has been the envy of many of the Portland fellows. Speaking with several of them who have made exclamation as to the superiority of his outfit, they all seem to agree that their enthusiasm in this respect is due to the fact that he is "easy to read." Personally, when idly listening in to various stations, if 7JH should start up, I wud tune out

others for the pleasure of reading his spark. Others hv told me that they do the same. Seems that this unconscious habit of tuning in the high tones speaks well for them.

Now as to the commercial side. I have here on the Rush, a 2KW. 500 cycle quenched set. Owing to lack of sufficient capacity at the ships dynamo, I am unable to use more than 1KW. or half power. Now WAR has a 1KW., 120 cycle quenched set, and came up inside Kodiak Island, Alaska, some distance astern of us. When we got within working range of each other, he told me cud hr me 3 days before cud work me and he using his full power and I using my half power.

That, it seems to me, speaks well for the carrying capacity of the higher note. He had the additional advantage in aerials. My antenna is but 65 feet long and 40 high—his abt 175 feet long and 60 feet high.

Now as to QRM and the note question. We are laying in Herendeen Bay about 15 miles from KWR, who has same set I have—2 KW. 500 cycle quenched. Couple days ago WAM was anchored right off KWR. WRJ was days run from here (abt 200 miles), WNE 30 miles and WSG abt 75 mi., I should judge from her strength. I worked WNE a short time, then wkcd WRJ. While copying WRJ, 200 miles away, WNE and WAM started working—one 15 miles away and using 1 KW. Couldn't tune 'em out without losing WRJ, but on acct his higher spk fnd it unnecessary to even bk them. WNE and WAM hv 1KW 120 cycle quenched sets and WRJ and WSG same as mine. Now as for QRM between like notes. Was copying WSG when KWR, 15 miles distant, started up. QRM? Never a bit. Just chgnd adjustment of receiver and WSG drowned KWR in 50 fathoms.

This is the "note" situation as I see it, so you will see I am a firm advocate of the 500 cycle stuff.

H. Sherman Pyle,  
Chf. Opr. S. S. Rush

Mite add that 7JH uses only 100 watts while 7ZN uses 1-2 KW. and KDP from 2 to 4 KW!

## Here's a Nice One From 9EP

I do not know if you are still hankering after these letters from the members of the League, but I have mooned around wondering how it was all going to end for so long that I feel like saying something to some congenial soul. I heartily endorse all that the Old Man says about our closing.

At this time we are depending on QST to keep us informed about things and we will still continue to back up the League and QST with whatever they need. In fact, I am writing to 9AMT (he shared relay honors in Denver with 9ZF last winter) who recently wrote me that when the war was over he was going to join the League, that he had better join now. We have no way of knowing what is going on except through QST, so it must be kept going, and Mr. Editor, I have recently heard several say that they would be willing to pay more if we could put QST where it stood several months ago, and of course providing the rest would do the same.

Regarding the contents of QST. I see that you have cut out the reports and call letters. Of course, there could not have been many more reports, but surely there were final reports for the season. And you stated that you had calls to last well into the summer.

The consensus of opinion around here is that you might have left out the article on Lightning Phenomena and substituted call letters for it. You see, the thing we feel the need of most is the thing that will keep us reminded of actual operating conditions, and if we could still be learning of new stations that have heard us for the next several months, we wouldn't feel the closing as badly as if we have nothing to remind us of those happy days when we thought it was a hardship to have all the QRM that we had. But we would give anything to be back there now. So please, Mr. Editor, let us still have the call letters providing you still have them left. And keep up the pictures and the amateur communications, even if you have room for nothing else. I am sure that we will be more interested in these things than the article of which I spoke, as we all, or nearly all of us, know the wherefor of

lightning, and that it causes lots of QRN but beyond that we care little about it, except we would like to know of some way to relieve us of QRN. I have been reading about semi-annually that Prof. Pupin has been inventing a QRN preventer for the last six years, but nothing has ever come of it, so I guess that it is more or less of a false alarm.

I read Mr. Warner's letter with a lot of interest as I heard him often last winter, and worked with him quite a bit, but never had any luck with him. I could have but little better luck with 9ABD, who is only a little over a hundred miles away. He used to come in like a house afire for a few seconds, and then in a few seconds he would be inaudible. The same thing applied to a lot of others, also. Even 9JW only 60 miles away could scarcely ever be heard at night, though strange to say, he came a-roaring during the day. 9GY is another who faded badly. The easiest station to work seemed to be 9ZF in Denver, 560 miles away, with whom I have talked for hours with scarcely ever a repeat. He almost never faded and was sometimes audible 100 ft. from the phones. It seemed that stations over 600 miles faded less than those closer. I do not believe that I ever heard 2AGJ in Albany fade and he was nearly 1200 miles from here. 6ZQ, in Phoenix, 1100 miles from here said that I never faded there and that it was very seldom that he ever heard a station east of Denver fade. I have noticed that it was nearly always the closer stations, say under 400 miles that faded the worst. So possibly distance is a factor in fading. It would seem so from my observation.

I was extremely interested in Mr. Warner's question about location. I believe that location has a lot to do with results and that radiation is no indication of what ones results should be. I know that radiating 3 amps prior to January 1st, I was consistently heard 1100 miles away. And I know of fellows who used to write me that they had heard me, who were radiating two to three times as much as I was, and yet were never heard anywhere. Af-

ter January 1st, I got a new transformer and increased my radiation to nearly 8 amps. But somehow or other I was heard but little farther than before, though I was reported much more QSA by everyone. I am generally given credit by the bugs here as having the best location in the city, so you will see that we are firm believers in location, and I think that location is 50 per cent. of a fellows set.

About receiving, I believe that location has nearly, if not as much to do with range as in sending. I did not have a Paragon last winter, but tested out one against the set that I used, and it was 500 per cent. better, and was using a hookup that was better than the one given in December QST, and which was a dandy. I never heard a First District station here all winter, 2AGJ was the only consistent 2nd and the only 3rd heard was 3PC and he only

once. I heard 4 4's, but none consistently. I heard some 6's and 7's, but they were not consistent, either. I do not believe I had as good a location for receiving as for sending, so it might seem that the same location would not act the same for both sending and receiving. I have gotten a Paragon since we have closed and I am going after some real long distance receiving in a few years when the war is over.

These may help Mr. Warner out and if you don't print this, let me know and I will have it forwarded to him as it might interest him. In closing, let me repeat my first suggestion that you continue the call letters, pictures, and communications to the last, cutting the other things out first, as I think that is what most of us desire. I thank you for your patience in reading this and remain, as ever, an ardent follower of QST and the A. R. R. L.

Guy E. Wilson

## Why Not Reform the "Squeek-Box?"

*By ICO*

I have read what the "Old Man" has to say about QRM with a great deal of interest and amusement, but when I look back on my "Ham" days, I wonder how it was that I behaved myself as well as I did. There was nobody to tell me what to do and what not to do; I passed the Amateur exam—but what of that? It simply taught me to leave the air free for commercial business and proved my ability to receive ten words a minute. As far as teaching me not to test my spark any time I felt like it, and all those other "Ham" tricks, it might as well have been on Sandscrit. We fellows with the spark coils felt that we were being bullied by the fellows with the high powered sets; they had the best of us—they drowned us out every time we sent, and then they tried to tell us to shut up when we were in the midst of a conversation with a brother "Ham" a mile away, so that they could receive some darn long-distance station that we couldn't hear. We had just learned how to "talk," and we wanted to improve. We thought it wasn't fair; we told them so, and a lot of other things.

I have a First Grade Commercial License now, but I still operate a one inch coil transmitter. By a great deal of hard work, I have made it a model of efficiency, and can now "work" stations 15 miles distant, (although not in all directions). Every now and then (although I am not home much) I have delivered relay messages, and helped some on their way. This suggested a plan. Why not reform the "squeek-box?" Teach him manners, and give him some responsibility. Why not establish trunk line routes of spark coil stations extending throughout our larger cities, and run test messages along them just like larger relay lines? Let them try to do a little relay work themselves, and then they will realize the difficulties under which the larger stations have been working. Above all, teach them how to tune their stations. Very little has been written on this subject, and the result is that newcomers try all sorts of fantastic arrangements, which they finally discard in disgust and become outlaws as far as tuning is concerned.

Sumner B. Young

## First Class Advice

The June copy of QST read, and it does stimulate, to say the least, the interest that seems to lag, for it is true that a majority of Hams had their sets up just for the pleasure derived and not for the purpose of advancing themselves or the art. But thank the real fellows for the chance to keep at it and experiment and study for now is the time to doll up the dope on why that loose coupler didn't work, or why the little boy makes more noise with the spark coil than you do with a Big One.

There is no doubt but what this is the time that is going to prove whether or not a fellow has Blue Blood running neck and neck with the oscillations, for it takes lots to down the ardor of a radio "henginear," and the fact that the law says nothing about testing our sets with dummy antenna and improving them in regards to heat losses, radiation, brush discharge, mechanical and electrical design, so why not get busy? The same applies to the receptor, and a buzzer and coil will do all the sending for you, so that it is merely a question of how far your set can pick up the signals. Then again, why should simple mathematics stick a number of our fellow workers? Understand the principle behind the problem and go to it, and it won't be long before an aerial in the form of an inductance, condenser and coil of resistance wire looks the same as something stuck up in the air. If the close down is looked at in this way, it may be the making of a foundation for good long distance work in the future when the order is given, "Up Aerials."

In regards to Mr. K. B. Warner's article about the disadvantage of being a low lander and having his friend on the hill beat him in certain directions, I would like to call attention to the fact that Mr. Warner doesn't need anyone to tell him what the trouble is, for believe me, that story about what happened was just what I was looking for, for a long time, namely the ability to analyze what the answer might be and stating same when the article is written. He seems to have covered all the theory that is at hand to day, and I guess that the real trouble will be found out only under actual conditions of test-

ing. His idea of the trolley wire being an antenna and re-radiating waves is the right answer as far as I can see, but there might be something done in the line of testing, such as 5 100 volt lamps in series and connected to trolley line and ground. This suggestion could be followed out if taken up in the proper manner with the Trolley Company, at least it would prove of great interest to many amateurs, for they no doubt have noticed the same thing.

The Old Man was rotten, to say the most, and I hope that he continues to go to movies, for what he had to say hit the mark, and he writes better stuff when he does go than when he stays home and spits on the cat. It is said that a man that is not connected with a business generally sees the weak spot and helps to build up with good suggestions. But, as the soldier said about the cannon ball, "We'll let that pass," and find out what has become of DR. RADIO. His mental gyrations were worth reading; besides, they helped lots. Why, it gave people a chance to argue, and that is a whole lot toward efficiency in a radio set.

The ideal station sounds good, and I want to get in on it, for there is a way to do everything better and get more time for other work. Go to it, and let's see what ideas are forthcoming, but take my suggestion and go down to the bare essentials needed for good sending and reception for the pendulum is swinging back toward the simple outfit and a lot of junk that causes the visiting friend to marvel and say, "How wonderful, I just knew Willie was another Marconi," is out of date and the sooner Willie gets it into his nut that a lot of switches and stuff pasted all over the room only causes loss of good energy, why the better. Some stations that you see remind one that the owner is trying to put himself through a course of training for piano moving. What with a coil up in this corner, a switch across the room and the sending junk on the floor, table and wall, it just naturally keeps one busy pulling and hauling on one thing and another in order to hear the kid in the next block. Introduce



your apparatus to itself and marry them for the juice gets all het up paying carfare to visit its friends the conny, sparks and iceclate.

What makes most fellows sore is the fact that they are unable to build apparatus that looks like the catalog; forget it, electrical efficiency first, then mechanical detail and finish are the order of the day. Why not use your spare time and get a thorough understanding as to the proper way that tools should be used, because you can't build a set unless you are able to handle material. Don't let a little thing like sawing a straight line or soldering brass phase you, just get some old material and practice with it. The satisfaction of saying that YOU made the set goes a long ways towards success and the ability to handle tools cuts the cost of instruments practically in half.

My mental storage battery is running low and the specific gravity is down around 1000, but as a last and beautiful short I want to say that QST returned with all its vigor since the war started, and the Editor ought not be called, for he certainly is doing a lot for his country by sticking to his job and giving the real fellows a chance to co-operate and forget that we can't send or receive. Work of the right kind properly directed aids all parties concerned, so you that have had the nerve to read this, get busy on that new set and make it something worth while.

W. J. Howell

\*\*\*\*\*

### REOPEN CITY COLLEGE RADIO

(New York Times, 5-30-17)

Work on the reconstruction of the wireless antennae began yesterday at the College of the City of New York upon the rescinding of the Government order which caused the dismantling of the apparatus two weeks ago. When the order to dismantle all wireless apparatus except that under Government supervision was issued the powerful station at City College was not exempted.

The apparatus will be used in conjunction with the courses in telegraphy and telephony offered at the war summer session of the college.

### S. U. I. WILL TRAIN ARMY TELEGRAPHERS

**Course for preparing Iowa young men for  
Signal Service announced—  
No entrance requirements**

In response to a request from the central department signal officer of the United States Army, the State University at Iowa City Iowa, will give during the next school year a course of training for telegraphers and wireless telegraphers. The work will be in charge of the head of the electrical engineering department and will be open to young men of the state, without regard to entrance requirements usually made or students by the University. The course for the individual will last only until he has mastered the art of telegraphy enough to pass the Government's examination in the subject.

"The need of telegraphers in the signal corps is serious," declared Lieut. Col. Wildman in a letter to President Jessup. "The available supply has been exhausted and new men must be trained to complete the present organization and prepare for the future increase."

The decision of the University to open the course to all, without demanding a certain preparatory training, is based on the belief that there are a large number of young men throughout the country who recognize the opportunity that the signal corps offers in the way of valuable experience, quick promotion, and variety of service, who lack the training ordinarily required by the University. No University credit is given for the work. It is offered simply as an aid to the Government in meeting the present emergency.

All of the University's present electrical equipment will be available for the course, and it is possible that more will be obtained. The major portion of the time of instruction will be consumed in actual instruction in sending and receiving in the Morse code, although some time will be spent in studying the elements of electricity and the technique of the apparatus.

## The Evolution of a Field Battery

*By Willis R. Prissell, 6VI Radio Co. A, 4th Field Batt'n*

The New Field Radio Company "A"  
 Arrived on the Zone on the fourth of May.  
 They were brought by rail to the Corozal  
 station,  
 Which, of course, was their destination.  
 Happily to bed they went,  
 Most restfully the night was spent.  
 The morning dawned most clear and bright,  
 As the boys rose up from a peaceful night.  
 The Transport trip had been a fright,  
 And all were glad she was out of sight.  
 The next day passed without a sign,  
 To disturb their restful peace of mind;  
 For there was naught for them to do  
 But lie on their bunks the whole day  
 through.

\*\*\*\*\*

Thus did a week slide smoothly by  
 Nor none had cause to breathe a sigh  
 Some Johns were heard to contemplate  
 That to them the life was great.  
 They looked ahead with joyful eyes  
 To the day they'd have horse exercise.  
 Old timers knew it would be a sight  
 To see these rookies take a hike.  
 With silent mirth the old boys waited  
 For the dawning of the day just stated.  
 Then early one Sunday 'ere the day had  
 begun,

A horse was given each bloomin' one,  
 To nourish and cherish and take good care  
 And see that he always got his share.

\*\*\*\*\*

So days had passed without a hitch,  
 Though some of the Johns got the "Dobie  
 Itch;"  
 But that was a "skemption" if they but  
 knew  
 Their troubles had only begun to brew.  
 The first day at horse exercise,  
 Their talk of joys brought mournful sighs.  
 The old boys laughed, but the rookies  
 swore  
 When they found that riding made them  
 sore.

All they heard was "Trot, Trot, Trot,"  
 It seemed their saddles had grown red hot;  
 And as they trotted around and around,  
 Many wished they were homeward bound.  
 Already their joys had gone to wreck;  
 Some had dreams of a broken neck.  
 T'was great relief to seek their bunk  
 After such a day of useless junk.  
 But in their bunks not long they waited,  
 Because a school was instigated  
 To teach the boys Electricity  
 Was good for their efficiency;  
 So every day to school they went;  
 And thus the afternoons were spent.

\*\*\*\*\*

The teacher taught the volt and Mho  
 And lots of things they did not know.  
 He said he'd prove Electricity  
 Was nothing but Simplicity;  
 But 'ere he'd proved his words were true  
 The teacher to a Captain grew,  
 And though they wished that he might stay,  
 He took a ship and sailed away.  
 And thus all good things must cease;  
 So did the school to the great relief  
 Of all concerned: For "Now" says they  
 "In the afternoons we shall hit the hay."

\*\*\*\*\*

But the kindly Skipper looked about  
 And had the students all turned out.  
 Says he "Tis now in time of war,  
 This is no time to sleep and snore;  
 Fence off a little grassy plot,  
 'Twill make a dandy garden spot.  
 Dig out the stones, hew down the shrubs  
 And plant therein some beans and spuds."  
 Some fell out with spades and tools  
 While some fell out and got the mules.  
 And now the students drill and toil;  
 From day to day they till the soil;  
 They drill and work the whole day through  
 And smile while eating beans and stew.  
 They've learned to ride: They've learned  
 to plow;  
 The rookies that were are soldiers now.

**9CF IS IN THE SERVICE**

Dear Editor:

I hope you will excuse the personal letter but I would like to have a few words with you in regard to the U. S. Naval Reserve. I fail to see why any REAL amateur operator should not enlist in the service. To anyone who has the great desire to keep in the business and do a good turn for UNCLE SAM I would say "Enlist and do it now." While as I understand it, they are not taking any more amateurs for duty on land but for active service in "Class 2" which is sea duty, there is the chance to do some real work and get the best training and experience that is to be had anywhere. Personally, I would not give up the experience that I have gained since enlisting for anything. I am stationed at present at the Marconi station at Duluth, Minn., but hope to be transferred to sea soon. While the work here is not very exciting, it helps in a way to take the place of my station at home. I am a constant reader of QST and with great regret notice the decrease in size, but can readily see the reason for it.

Wishing you every possible bit of success for the future of QST and the A. R. R. L.,

Sincerely yours,

H. R. Hall 9CF

\*\*\*\*\*

**RADIO CLUB OF TACOMA**

The Radio Club of Tacoma elected officers as follows to hold office for the next six months: A. Stenso, President; H. G. Reichert, Vice-President; Norman J. Arndt, Secretary; Nevelle Benoit, Treasurer; and H. D. Longmire, Associate Secretary.

Altho the Government has closed up our stations, we still hold regular meetings, which are marked by good attendance, and are delving into the deeper side of the radio art. Some of the amateurs, including myself, are constructing Tesla coils, thereby using some of our spare time to good advantage, which might otherwise be spent in sad reminiscence of the nights when we strived to hear that distant amateur's call or inwardly cursed that latest addition to the QRM ranks in the next block.

We are contemplating having code pract-

ice at speeds of five, ten, fifteen and twenty words a minute at our meetings, giving those who are slow receivers a chance to work up speed and preventing the others from becoming stale.

We shall be glad to hear from other amateurs and clubs, which communications should be addressed to Norman J. Arndt, Secretary, address 110 1-2 South 14th St., Tacoma, Wash.

\*\*\*\*\*

**THE DECEMBER REGENERATIVE SET**

Being a brand new subscriber to QST (thro Mr. Carl Linxweiler of Dayton, O.) I thought it only fair to show my appreciation of your publication by giving my experience with the small regenerative set described in the November or December issue. Mr. Stanley Copp, (8LT) of Dayton, Ohio, suggested that I build one of these sets, and I did so.

The results were positively wonderful, and, in fact, I never thought such amplification possible.

On the night of March 14th (using "T" audion and 2,000 Brandes phones) I heard the following stations 9XM two feet away):

3PC, 4BY, 5DU, 5ZC, 8AIR, 8AMN, 8LT, 8LE, 8NH, 8OH, 9LH, 9LR, 9JI, 9PC, 9WG, 9XM, 9ZF, 8ALE and about ten or twelve others, all very loud.

I heard Mrs. Candler (8NH) of St. Mary's, Ohio, ten feet from the phones, so you can get an idea of how loud the others were. My suggestion to all the other amateurs would be, "build one yourself, and see" because, if you follow the "blue print" exactly, you are bound to have success.

Cincinnati has usually been somewhat closed to the outside world, judging by what some of the other fellows say, but not for me any more.

John E. Fox

I forgot to mention my own call, which is 8IV.

\*\*\*\*\*

**WIRELESS OPERATORS**

Operators in North Florida, Georgia, and South Carolina who desire to enroll are requested to communicate with the "Communication Office," Navy Yard, Charleston, S. C.

### EUREKA COLLEGE HAS COMPLETE WIRELESS STATION

A complete wireless station has been installed at Eureka College, Eureka, Illinois. The station is to be used for experimental and training work. A special license has been obtained and the call letters are 9YQ. (420 metres.)

The sending equipment consists of a one kilowatt Thordarson transformer, 250 cycle rotary, oil immersed condenser and other standard apparatus. For receiving, audions and tron tubes are used in connection with short and long wave couplers. A special long-wave undamped receiver is being installed at present.

Anyone hearing the call letters 9YQ will do us a favor by writing Alvin C. Spencer, Eureka, Illinois. The station has been installed and is operated by the above operator, formerly of 9LJ.

\*\*\*\*\*

### PACIFIC COAST WORK

I take great pleasure in reading your magazine each month, and I think it surely gives us the facts. I want to congratulate you.

I am located in Burlingame, California, 20 miles south of San Francisco. My call is 6WZ. Last night at 11 o'clock I clearly heard a station signing 9AMT. The tone of the spark was wonderful, and the signals did not fade. I can't find this fellow's name in the call book, and I would like to let him know. He was talking to 5AB.

I have been heard by the following stations: 6DM, 6UP, 6EA, 6AAG, 6ZW, 6AV, 7SL, and 7ZN. I hear all these boys OK.

Hall Berringer

\*\*\*\*\*

### UNUSUAL RELAYING

Wish to call your attention to a condition in handling relay work that happened on March 30th, about 2 a. m., which I think you and your readers of QST—those that were not on watch at that hour—will be interested to know.

Conditions were such that 8NH had messages from the second district for 8JZ. The latter could not hear 8NH, so he asked for help from the second district through 2 PM.

There another condition prevailed. 8NH

could not hear 2PM. So the business was handled this way: 2PM told 8JZ to tell 8NH to GA, which when done enabled 2PM, after a few checks from 8NH through 8JZ to QSL message.

You will note that the said message is now back in the second district where it started from.

From 2PM, it was given to 8JZ and QSL received, after which all of the three stations said GM.

L. Spangenberg  
73. 2ZM

## Air Service In War

Concluded From Page 14

the watchfulness of the allied air fleet with disastrous results to humanity and property.

All aviators and balloon pilots become officers in the aviation section of the Signal Officers Reserve Corps of the Army immediately upon graduating, being commissioned as first lieutenants with a base salary of \$2,000 annually and additional compensation when in active service at home and abroad.

### THE "KITE" OR STATIONARY BALLOON

The usefulness of the "kite" or stationary balloon is not generally known. One familiar with its employment says that at the balloon schools, an applicant for officer's commission must first qualify as a pilot of spherical balloons. Then they are taught to become pilots and observers in the "kite" balloons.

This balloon is allowed to ascend to a height of about 3000 feet with a wire cable attached to it by which it is drawn down when desired by motor power.

In war, these balloons are located from three to five miles from the first line of trenches, and from the basket two men, a pilot and an observer, give the range and result of firing by telephone to the artillery.

On the western front they are placed from one-half to a mile apart, according to conditions, and are provided with parachutes attached to the men in the basket; in event of accident to the balloon the men parachute safely back to the earth.

# FOR SALE & EXCHANGE



**FOR SALE**—Complete 1½ inch Spark Coil Sending Set, and 3000 Meter Receiving Set; also two Storage Batteries. Walter J. Schneider, R. R. No. 2, Mason Road, Hamilton, Ohio.

**FOR SALE**—One EXPO watch camera complete as new, value \$3.00; and one printing press, value \$2.00. First reasonable offer takes them. G. Holmes, Hastings, N. Y.

**FOR SALE OR EXCHANGE**—Good motorcycle, running order, for Thordarson transformer, 1 kw. I have one combination long and short wave regenerative set without audion, \$25., couplers, switches, coils, condensers, wire—all sizes—1-40,000 meter loading coil, \$5. All answered. H. F. Dildine, 526 So. Race St., Van Wert, Ohio.

**FOR SALE**—One daylight loading premo junior camera, size 2¼ x 3¼. First \$1.50 takes it. All letters answered. E. V. Edwards, 1425 N. 31 St., Richmond, Va.

**FOR SALE**—Audio-Tron double filament bulb, never been used, tuning coil, 3000 meters, detector, fixed condenser, switch, slide condenser, Murdock phones, 1-2 kw. transformer, helix, gap, electric whistle, 3 pounds of copper, No. 14, 7 copies of QST, also four cameras and complete printing and developing outfit. Cash or exchange. Al. R. Leavitt, 18 Grant St., Natick, Mass.

**WHAT AM I OFFERED** in cash for a hand operating Omnigraph with dials, valued at \$2.50. Albert V. Abelin, 249 Elder St., Brooklyn, N. Y.

**FOR SALE OR EXCHANGE**—1 brand new, never used, double filament, improved type Electron Relay; one 1-2 H. P. light weight gasoline engine, one type SS dynamo motor; 1 General Electric type 110 volt DC fan motor; 1 pair of 2000 ohm "Red Head" phones; 1 1-2 H. P. water motor; 1 home made step down transformer, 4 volt steps from 4 to 40, can take 27 amps from secondary at 4 volts 15 at 3 volts, size of core 10 inches x 8 inches; wire; belts; buzzers; electric lights, etc. What am I offered for same? Write for other bargains. R. R. Grimshaw, 6 Port St., Pulaski, N. Y.

**FOR SALE OR EXCHANGE**—Have a "Willard" storage battery, 8 volt, 42 amps capacity. Will exchange for 4 sections Murdock copper sheet moulder condenser with rack for same. Will sell for \$10.00. Will consider good Tesla coil or other high frequency apparatus (nothing home made wanted). Atlee Gullledge, Fort Pierce, Fla.

**FOR SALE**—1 3 horse power motorcycle engine, very good condition, \$12.00; 1 4 horse power engine, has fan attached for cooling, good condition, starts with crank, \$18.00; 1 3A folding brownie camera with tripod, good as new, only \$9.50; 1 good Superior receiver, \$1.00; about 50 copies "Popular Mechanics," \$3.50. Write me. Glen Decker, Ligouier, Indiana.

**AM SELLING OUT** and have the following for sale cheap: \$2.95 antenna switch, \$2.25; \$1.75 telegraph sounder, 200 ohm, \$1.00; \$3.00 telephone magneto, \$1.50; \$2.25 galena catwisker detector, \$2.00; 3 55 cent induction coils, 30 cents each; \$1.95 bell ringer, \$1.25; 2 wet battery jars with carbons, 75 cents; 3 inside carbons, extra, 50 cents or 20 cents each. Everything is in perfect condition, guaranteed working order and some are even brand new. Adrian Kishpaugh, R. D. No. 2, Newton, N. J.

**WANTED**—Two sections of Murdock transmitting condenser. Will pay cash. Address to A. Hautmann, 21 Vine St., Pittsburg, Pa.

**FOR SALE**—A complete receiving set, consisting of a loose coupler, detector, variable condenser, fixed condenser, loading coil, \$6.50. A reactance coil, \$1.00. A 25-35 calibre Winchester repeating rifle, \$12.00. A 1 inch spark coil, \$2.00. A Murdock loose coupler, \$4.50. Viplax double speed key, \$4.50. A 500 foot, No. 14 wire 2 wire aerial, \$4.75. A Eugene Dietzen drawing set, cheap. These articles in good condition. All letters answered. Ted Hopkins, 2228 Oakes Ave., Everett, Wash.

**FOR SALE**—Cabinet set consisting of Blitzen tuner, variable, oscillation coil, audion and amplifier. No transformer, broken round bulbs. Switch points, coils, cabinets and wire. Any reasonable offer considered. McMurdo Silver, 264 West 57th St., New York City.

**WANTED**—Will trade the above set for either of the following Colt powder and ball pistols: Walker model, 44 calibre; Texas model, 34 calibre, concealed trigger; Old Model Army, 44 calibre or any three different pistols of any make stamped "C. S. A.," usually with brass frame. Will give full particulars of set, also of pistols, if wanted, for stamp. McMurdo Silver, 264 West 57th St., New York City.

**UNUSUAL VALUES** for prompt disposal. Large drill press, 2 speed hand drive, 3 speed automatic and hand wheel feed, \$7.50; 6 inch Red Devil water motor, new, \$3.00; Cyclopeda of Engineering, 6 vol., \$6.00; 9 Eveready No. 703 electric flashlight batteries at 10c., \$0.90. All inquiries cheerfully answered. J. A. Wever, 238 S. Patterson Park Ave., Baltimore, Md.

**FOR SALE**—\$9.00 Radiopticon, good as new, complete with 175 postcard views, and a 5x7 foot screen, \$7.50; or will exchange for Godell amateur bench lathe. A \$10.00 Millers Falls companion foot power lathe with equipment, \$6.00. Also a \$3.00 scroll saw attachment for same, hardly ever used, with equipment, \$2.50 delivered. About 15 boys' books, cheap. Write for list and prices. **WANTED**—1-16—1-5 H. P. 110 volt, AC motors, and raw materials, switch points, wire, etc. All letters answered immediately. Address Harry Wilcox, Jr., 147 Oakland Terrace, Hartford, Conn.

**WANTED**—A 1 KW. Marconi or United Wireless open core transformer, 110 v., 60 cycle. Harry Weber, 1113 N. Walnut St., Canal Dover, Ohio.

**FOR SALE OR EXCHANGE**—\$1.80 Amco. galena detector (new) for \$1.10; E. I. 2 slide tuner, \$1.00; Turney resonator (new) \$.65; marble base detector, \$.75; loading 200 meter coil, (12 taps) \$1.50; small helix, \$.35; rotary spark gap, \$2.50 and 34 inch loading coil (5 inch diameter wound with silk covered wire, cost \$8.50, has never been used, \$5.50. All in fine condition. Want section of Murdock sending condenser or GOOD crystalol—or what have you? Write Robert M. Curts, 581 East 25th St., Paterson, N. J.

**FIRST CHECK OR MONEY ORDER**—I will send express prepaid a new type Thordarson Transformer, 1KW. never used, only bought last month from dealer in Chicago direct. Paid \$30., will sell for \$25. Also a first-class O. T. Transformer, Adams-Morgan Pan Cake Type for \$3.50. **WANTED**—A Paragon RA6 Regenerative Receiver with seals unbroken. Will pay cash. Please write. All letters answered. Chas. Fucci, 606 Henderson St., Jersey City, N. J.

**WANTED**—10 to 30 ampere commercial sending key. State condition and manufacture. B. W. Nestlerode, care of Y. M. C. A., Sioux City, Ia.

**FOR SALE**—9HN 1KW. transmitting set minus transformer. Set includes rotary gap, variable oil immersed condenser, oscillation transformer, all mounted in oak cabinet. Set has transmitted 900 miles. Complete description and photo furnished on request. Also have panel regenerative receiving set, Navy type coupler, Blitzen loading coils, and mounted Packard transformer. Further information and photos on request. J. A. Crowds, 5047 Washington Ave., St. Louis, Mo.

**FOR SALE OR EXCHANGE**—R. L. Co's special Mignon Cabinet, adapted for undamped waves, 10,000 meters, \$18., or exchange for 1KW. flexible transformer, 1-2 H. P. air-cooled gasolene engine for Brandes navy phones, or what will you offer? Arthur Brown, 1218 East Erie Ave., Lorain, Ohio.

**FOR SALE**—Duck Audion Potentiometer, complete with switch and drilled for posts. Cost \$1.50. Practically unused. First \$1.00 money order takes it. Benjamin Baur, 1116 W. Indiana St., Evansville, Ind.

**FOR SALE OR EXCHANGE**—Marconi NAA 3500 Loose Coupler. \$2.50 detector, a \$1.00 .003mfd. tubular fixed condenser, \$2.00 radiator zinc spark gap, and \$1.00 glass plate condenser. All articles are of the Marconi make. All brand new and in perfect condition. I want any of the following: Tubular audion, audion tron, R39 audion, or 2 sections of Murdock condenser. Will exchange or sell separately. Write for prices to Myrl Patterson, Frost, Texas.

**FOR SALE**—Cyclopedia of Applied Electricity, 7 volumes, good as new; 1 Weston Duplex Meter Amperes and Volts 0-150 charge and discharge has external shunt and D'Arsonval type movements, is in fine condition. 1 Telephone Desk Set in good working order, 1 Bunnell 3 slide tuner, Murdock 1500 ohm No. 55 Head-set. Best cash or exchange offer will be accepted. Write immediately. Also have good silicon and galena at 1 cent per pound. R. G. Devaney, 4624 Winthrop St., Pittsburg, Pa.

**WILL EXCHANGE** Wintson's Cumulative Encyclopedia, 10 volumes, for wireless apparatus or panoramic camera, or—what have you? Lee Henry, Bennington, Kansas.

**FOR SALE**—One kilowatt open core United Wireless transformer, \$35.00; high capacity oil immersed glass plate condenser with tank, case and oil, variable, \$25.00; heavy and well-made Vernier type oscillation transformer of heavy copper wire and Bakelite, \$5.00. Complete, \$75. Covered 1800 miles with this set. Details if requested. Woodcock, 279 Highland Avenue, Buffalo, N. Y.

**EXCHANGE**—Have a number of fine moving picture reels 900 to 1200 feet in length, have been very little used, and are in perfect condition. Want good rotary gap, transformer and condensers. All letters answered. Francis Joannini, 3326 17th St., Washington, D. C.

**WANTED**—June and July, 1916 issues of QST, in good condition. State price. Guy E. Wilson, 9EP, 3822 Flora Ave., Kansas City, Mo.

**FOR SALE**—A snap. 7 dozen switch contact points brass, as manufactured by Maguire & Shotton, Albany, N. Y. 1-4 inch diam., 3-9 inch high, tapped 6-32. Regular price, 35c dozen. While they last 20c a dozen or \$1.25 for 7 dozen. Theodore Olson, 528 Market St., Portland, Ore.

**FOR SALE OR EXCHANGE**—1 guitar and instruction book, value \$10. Also have 1 Bristol Recording Thermograph. Will exchange for a Packard 1-2 KW. Transformer, Hawkins' Electrical Guides or for a good receiving transformer. R. G. Devaney, 4624 Winthrop St., Pittsburg, Pa.

**FOR SALE**—Receiving panel of hard rubber, size 12 x 16 inches with audion, two variable condensers, coupler, etc., new, worth \$100., will sacrifice for \$35. Also have couplers, motors and a bench lathe. Want typewriter. Louis E. Schwab 3708 Brooklyn Ave., Cleveland, Ohio.

**FOR SALE**—Have complete wireless set sending 1 to 3 miles, receiving 1 to 500 miles, price \$8. pp. 75 ohm double pole receiver, with head band and cord, price \$1.00, pp. I have a new key (used once for about one minute) for .75 or will exchange key for rotary potentiometer to control audion. Will pay cash for 25 feet helix wire. Geo. Vaughan, Box 89, Hurst, Ill.

**SELL OR EXCHANGE**—Type "O" Crystalol in good condition, for small dynamo or motor, or will buy dynamo separately. Name your lowest price. Must be a bargain for cash. Answer now. Roy Linville, 646 18th St., Winston-Salem, N. C.

**FOR SALE**—Type "O" Crystalol, Type "BB" Crystalol, 800 ft. 7 strand copper antenna wire, 4-4 inch electrose insulators, 4 ball electrose insulators, 100 ampere 600 volt ampere switch, 1 No. 10 Roome Navy Tuner, .001 M. F. Turney Condenser, No. 12 Manhattan Audion Transformer, Clapp-Eastham carbon resistance switch, Stromberg-Carlson, Murdock, Turney phones, phone condensers, sending keys, Bunnell switch points, switches, posts. V. C. DeChesne, Issequah, Wash.

**FOR SALE**—Solenoid antenna switch, nothing like it on the market, change all connections from receiving to sending and reverse at pressure of button, permits transmitter and switch to be placed any distance from receiver and eliminated high tension wires in receiving room; enclosed in iron casting and absolutely dependable, powers up to 2 KW., first check for \$12.00 takes it, satisfaction guaranteed or return. Woodcock, 279 Highland Avenue, Buffalo, N. Y.

**FOR SALE**—Amateurs, good bargains! 1 Brandes' 1000 ohm receiver, \$1.15; \$1.75 ohm receiver, .30; 400 meter coupler, \$1.85; 1-4 in. coil, \$1.40; 3 hrs. 18 D. C. wire, .55. Write early if you want to buy. This is a sacrifice. Paul Jeffries, 2005 Arctic Ave., Atlantic City, N. J.

**WANTED**—A complete high grade 1-2 or 3-4 KW. sending set. Will pay cash. In replying state maker, age, etc. C. B. Weed, 224 St. Ronan St., New Haven, Conn.

**FOR EXCHANGE**—One Type SS dynamo, and five bar telephone generator. Will exchange for three filament bulb in good condition, or 500 watt transformer coil with vibrator, also want December, 1916 issue of QST. Claude Romjue, La Plata, Mo.

# "Oh! Lookey!"

## WIRELESS BOOKS



Experimental Wireless Stations .....	\$1.50
Experiments, Edelman .....	1.50
Zenneck's Wireless Telegraphy .....	4.00
Text Book on Wireless Telegraphy .....	2.25
An Elementary Manual, Fleming .....	2.00
The Wave Meter .....	1.00
Experimental Wireless Construction .....	.25
Lessons in Wireless Telegraphy .....	.25
Wireless Telegraphy and Telephony Fully Explained. Massie and Underhill.....	1.00
Wireless Telegraph Construction for Amateurs, Morgan .....	1.50
Radio Telegraphy, Monckton .....	2.00

**Postage  
Free!!**

THE QST PUBLISHING COMPANY, INC.  
Book Department  
HARTFORD, CONNECTICUT

### COUPON

*The Q S T Publishing Company  
Book Department  
Hartford, Conn.*

Gentlemen :

Enclosed please find \$.....for.....

Names of Books

Name.....

Address.....

**EVERYDAY**  
**ENGINEERING**  
*Formerly* EVERYDAY MECHANICS

**FOR THE FINEST OF  
CONSTRUCTIVE AND INSTRUCTIVE RADIO ARTICLES**

TEN CENTS A COPY  
ONE DOLLAR A YEAR

34 WEST 42nd STREET  
NEW YORK CITY



# AMATEURS, ATTENTION!

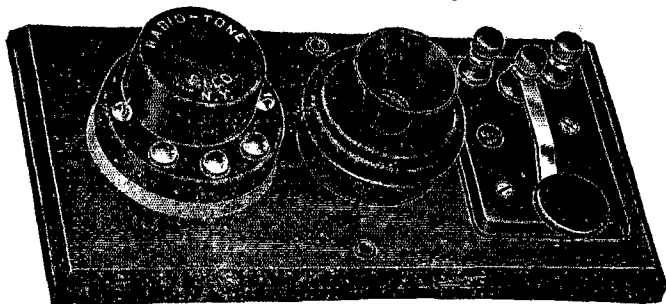

**Radiotone Codegraph**

Now that we are for the time being, deprived of using our Radio outfits, it behooves us to become proficient in learning the Wireless Codes. Operators who know the Code are, and will be, in ever rising demand. The army and navy need thousands of operators right now. Can you qualify? Can you send and receive

at the required speed, when your country calls you?

The **Radiotone Codegraph** is positively the only instrument made that will send such an unbelievably close imitation of a high pitch Radio Station, that it has baffled experts. The outfit replaces the old-fashioned learner's outfit, consisting of key and sounder. The **Radiotone Codegraph** comprises our famous Radiotone High Frequency Silent Buzzer, a special loud talking receiver with horn, and a key all mounted on a base. Operated on one or two dry cells, the phone will emit the characteristic high pitch sound, which while not harsh, is heard all over the room. With little trouble you can learn the code correctly in 30 days—

## AND THAT IS NOT ALL:

Connect two of these outfits together for intercommunication work and you and your friend five or fifteen blocks distant can converse over a NO. 36 WIRE, so fine that no one will see it. Or you can use instead of the wire, a metallic fence and the ground. Or you can communicate over your 110 lighting line, using no extra wire, only the ground. Full directions how to do this are furnished with the instrument. **DEALERS:** This is the 20th Century instrument that sells like WILDFIRE. 600 sold in New York in 10 days. Get our proposition today.

**Radiotone Codegraph** complete as described, each **\$1.95**  
Shipping weight, 3 pounds. Enclose sufficient postage for mailing  
**IMMEDIATE SHIPMENTS**

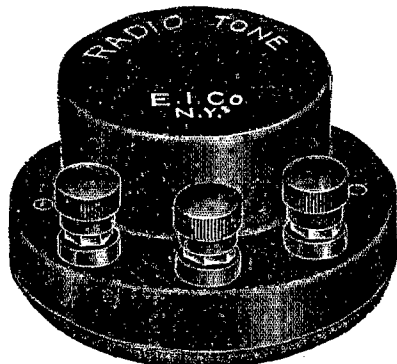

No 1800

## The "Electro" Radiotone HIGH FREQUENCY SILENT TEST BUZZER

of pleasure for intercommunication work. Particularly now that we cannot use our Wireless sets, the **RADIOTONE** is already in wonderful demand. All the interesting things as described with our Radiotone Codegraph, elsewhere on this page, can be performed with the Radiotone, a key, a dry cell and a phone. Shipping weight, one pound. Enclose sufficient postage for mailing  
Radiotone as described.....each **\$0.90** **IMMEDIATE SHIPMENTS**

The **RADIOTONE** is NOT a mere test buzzer, it is infinitely more. Mr. H. Gernsback who designed this instrument labored incessantly to produce an instrument which would imitate the sound of a high power wireless station as heard in a set of phones. This actually has been achieved in the **RADIOTONE**. This instrument gives a wonderful high-pitched MUSICAL NOTE in the receivers, impossible to obtain with the ordinary test buzzer. The **RADIOTONE** is built along entirely new lines; it is NOT an ordinary buzzer, reconstructed in some manner. The **RADIOTONE** has a single fine steel reed vibrating at a remarkably high speed, adjusted to its most efficient frequency at the factory. Hard silver contacts are used to make the instrument last practically forever.

Yes, the **RADIOTONE** is SILENT. In fact, it is so silent that you must place your ear on top of it to hear its beautiful musical note.

You will be astounded at the wonderfully clear, 500 cycle note, sounding sharply in your receivers, when operated on one dry cell. To learn the codes, there is absolutely nothing like it. With the **RADIOTONE**, a key and one dry cell and ANY telephone, a fine learner's set is had. Two or more such sets in series will afford no end

## THE LIVEST CATALOG IN AMERICA

Our big, new electrical cyclopedia No. 18 is waiting for you. Positively the most complete Wireless and electrical catalog in print today. 200 Big Pages, 600 illustrations, 500 instruments and apparatus, etc. Big "Treatise on Wireless Telegraphy." 20 FREE coupons for your 160-page FREE Wireless Course in 20 lessons. FREE cyclopedia No. 18 measures 7x5 1-4 inches. Weight, 1-2 lb.

Now before you turn this page write your name and address on margin below, cut or tear out, enclose 6 cts. in stamps to cover mail charges, and the Cyclopedia is yours by return mail.

**THE ELECTRO IMPORTING COMPANY**

**246 Fulton Street, New York City**

# Have You a Wireless Library?



Look over the  
list on page 29.

Sent Post Free  
by return mail.

# RADIO

Learn under a United States Gov-  
ernment Inspector.

A thorough and complete course pre-  
paring for a U. S. Govt. Commercial First  
Grade Certificate is offered.

Our graduates are now with the Marconi  
Wireless Telegraph Companies, United  
Fruit Co., National Electric Signalling Co.,  
Kilbourne and Clark, De Forest Co., Tele-  
funken, Private Yachts and many others.

The enormous demand for competent  
Radio Men makes this a field of limitless  
opportunity.

Expert instruction—Modernly equipped  
Laboratory, lowest tuition—Dormitories—  
Employment Bureau.

**Y. M. C. A. RADIO SCHOOL**  
(Founded 1910)

153 East 86th St. New York, N. Y.

## WIRELESS

BOOKS— —RAW MATERIALS

While your station is dismantled you can study  
and build apparatus. Buy from our stocks which  
we still maintain complete.

The Electro-Set Company, now known as  
**THE NEWMAN-STERN COMPANY**  
Dept. Q-15 Cleveland, Ohio



You May Learn Theory, Code and  
Laws of Radio Communication  
In Our School or at Your Home,  
fitting you for positions paying good sala-  
ries with wonderful chance to travel the  
world over. It's the most interesting pro-  
fession known and the demand for skilled  
operators is increasing. Send stamp for  
catalog, which gives full information.  
**NATIONAL RADIO SCHOOL, 1405 U St.**  
Washington, D. C.

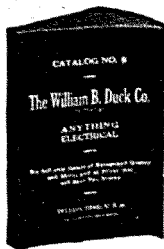

## DUCK'S BIG 300 pp. ELECTRICAL AND WIRELESS CATALOG

Mailed on receipt of 8c in stamps or coin which may be deducted on  
first dollar purchase. Catalog contains 160 pages of wireless instru-  
ments and 140 pages of electrical supplies. No bigger or better values  
are obtainable elsewhere. We have a complete stock of everything  
listed in this catalog.

**THE WILLIAM B. DUCK CO., 236-238 Superior St., Toledo, Ohio**

See Page 29 if You Are  
Interested in Wireless Books

# Two Books

for

# Your Wireless Library

A  
M  
A  
T  
E  
U  
R  
S

No wireless library is complete without these two books.

An Elementary Manual of Radio

Telegraphy and Radio Telephony,

Fleming

Principles of Wireless Telegraphy,

Pierce

These are reference books of the highest character, and are recommended by many authorities.

Prices \$2.00 and \$3.00 respectively.

Send \$5.00 today. Books will be sent postpaid by return mail.

The Q S T Publishing Co., Inc.

(Book Department)

HARTFORD, CONNECTICUT

# Wireless Books

## At Popular

## Prices

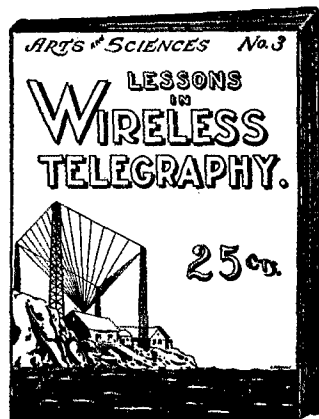
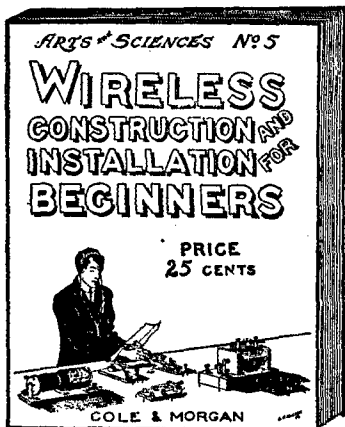

# 25 cents postpaid

It isn't necessary to buy high priced books to learn the fundamental principles. If you are a **BEGINNER**, these are the books you want.

During the temporary closing up, you can go in for construction and study up to help Uncle Sam.

*Order Today!*

## The QST Publishing Co., Inc.

(Book Department)

HARTFORD, CONN.

*Large Stock — Shipped By Return Mail — Order Today!*