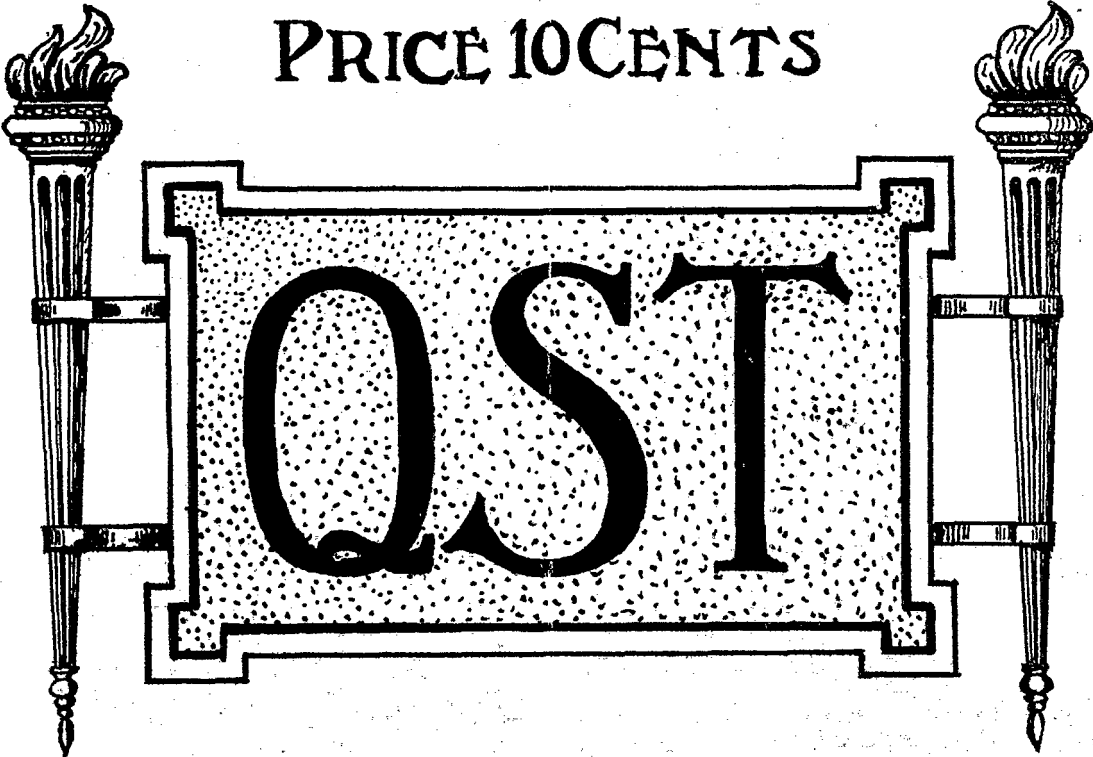

*An Amateur Wireless Magazine*

PRICE 10 CENTS

A decorative rectangular frame with a stippled interior, flanked by two torches with flames. The letters 'QST' are prominently displayed in the center of the frame.

**QST**

DE

**The American Radio  
Relay League**



**FOR THE MONTH OF JANUARY  
NINETEEN HUNDRED AND SIXTEEN**

# Two New Bunnell Specialties

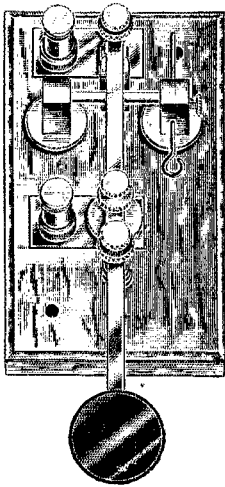

## The Straight Line Renewable Contact Radio Key

By far the **BEST** and **HANDSOMEST** transmitter yet produced. Not only are the contacts renewable, but they are kept in a straight line with perfect surface contact until completely work out, and the lever remains in its original horizontal position.

Fading signals caused by varying resistance of contact points are entirely eliminated.

Its binding posts automatically clamp the wires, making loose connections impossible.

**Net Price, \$7.50**

Send for descriptive circular.

## The Jove Detector Holder

The most perfect of crystal holders.

Holds one or two different crystals of any form at once without the use of a clamp-screw.

A sensitive point of either crystal quickly found, the correct pressure held constantly without moving a single screw or nut.

Beautifully finished and mounted on dark glazed porcelain.

**Net Price, \$1.00**

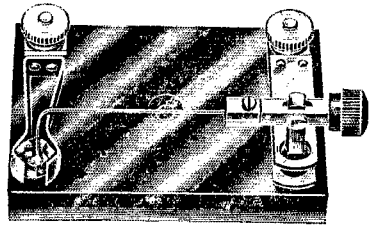

---

SEND FOR OUR NO. 36 WIRELESS CATALOG

---

**J. H. Bunnell & Co., Incorporated**

**32 Park Place—Broadway Block**

**New York**

## CONTENTS.

The Oscillating Audion	By Clarence D. Tuska.....	3
Q S T Department	.....	5
In an American Radio Relay League Station	By ..—.....	6
Amateur Radio Stations	Illustrated.....	7
Running Tests between Amateur Stations	By "The Old Man" .....	8
Q S T Press News	.....	10
Latest List of Additions to League List of Stations	.....	11
Radio Communications by the Amateurs	.....	14
Kansas City, Kansas, High School Radio Club	.....	15
A Volunteer Radio Corps	.....	16
Items of Interest	.....	17
Exchange, For Sale and Wanted Department	.....	18

Issued by Hiram Percy Maxim and Clarence D. Tuska  
 Hartford, Conn

# ANNOUNCEMENT

¶ Q S T is published by and at the expense of Hiram Percy Maxim and Clarence D. Tuska.

¶ Its object is to help maintain the organization of the American Radio Relay League and to keep the Amateur Wireless Operators of the country in constant touch with each other.

¶ Every Amateur will help himself and help his fellows by sending in 25 cents for a three months' trial subscription.

---

THE PUBLISHERS OF Q S T

# January Radio Relay Bulletin

## The Oscillating Audion

By Clarence D. Tuska.

During the past few months, amateur and professional experimenters have been doing rather remarkable work with the oscillating audion. These amateurs say it is not unusual to receive strong signals with this instrument over a distance of three, and even four thousand miles. The apparatus used with the oscillating audion is by no means complex, but data has not been available for the construction of the instrument. It is the purpose of this article to place before the amateur experimenters a brief description of the apparatus used.

### THEORY.

It is beyond the scope of "QST" to go into the theory of this wonderful piece of radio apparatus. Amateurs who are interested in the technical of the oscillating valve will find a complete article on the theory by Armstrong. The title of Armstrong's paper is "Some Recent Developments in the Audion Receiver" and will be found in Volume 3, Number 3, of the "Proceedings of the Institute of Radio Engineers."

In order that the reader may understand the operation, it is well to say that the Audion is used simultaneously as a receiver and generator of undamped waves. The incoming oscillations are received at a definite frequency and are super-imposed upon a slightly higher or lower frequency of the Audion oscillations. For example, the incoming wave has a frequency of 100,000 per second and at the same time the Audion is generating waves at the rate of 101,000 per second; the result of these two series of oscillations is a musical note of 1,000 vibrations per second. This is known as the "beat" effect.

### CONSTRUCTION OF LOOSE COUPLER.

One of the important instruments used in the oscillating audion hook-up is a loose coupler; especially designed for the reception of long waves. This tuner is not radically different from the ordinary loose coupler. It is constructed along the same

lines as a receiving transformer of large size. The best results have been obtained using coils of a larger diameter. The primary should be ten inches in diameter and wound with eight or nine hundred turns of No. 28 double silk covered wire. The secondary is nine inches in diameter and also wound with No. 28 D. S. C. copper wire. About 1,100 turns will be found sufficient for the secondary winding. The first tap on the primary should include 400 turns, as one never needs less than this amount. The rest of the primary is divided into sections containing 50 turns and a tap is brought out from each section. The secondary is tapped off into sections of 100 turns. A sliding coupling is used, the same as on an ordinary loose coupler.

Fibre tubes are the ideal thing to wind these inductances on. Tubes of nine and ten-inch diameters, with 3-16-inch walls can be obtained from any large paper supply house. One difficulty to be contended with is the shrinking of the tubes. This may be counteracted by boiling the tubes in a solution of paraffine and rosin. This drives out the moisture in the fibre. After the forms have been treated in this manner the wire may be shellaced on, but for best results do not use shellac. The writer has not gone into a detailed account of loose coupler construction. The average amateur understands the manufacture of a receiving transformer and should have no difficulty in constructing one with the above dimensions.

### VARIABLES.

The most important instruments in the working of an oscillating valve are the variable condensers. An essential property of a variable, to be used in the system shown, is good insulation. In experimenting with this apparatus, the amateur will find the whole set is thrown out of resonance, when he brings his hand near the apparatus. The remedy for this troublesome effect is to construct long handles for the condensers. An insulated handle

from 18 to 20 inches in length will be found satisfactory. This little effect shows the remarkable sensitiveness of the Audion when used as an oscillator.

In the sketch, "A" is a tuning condenser of very small capacity. Too much capacity in this place will prevent the system from oscillating properly. A small Murdock variable can be used at "B" and "D," provided they are well insulated. "C" is another small variable about the same size as "A." The operator will find "A" and "C" never need a large capacity. The whole secret of getting effective results from this connection is to tune the condenser combination properly. That is, to vary the capacity of the various condensers

operating the oscillating valve, but the majority of amateurs will have no trouble with it. In five or ten minutes they will stumble on the proper combination and get far better results than the writer could suggest. **IMPORTANT**—If the Audion is oscillating properly, a sharp click can be heard in the telephone when the point marked "X" in the diagram, is touched.

#### RECEIVING.

One of the writer's friends used the instruments described. His station was located on the Atlantic Seaboard. The antenna used was two wires, 200 feet long, and not over 50 feet high at any point. In a

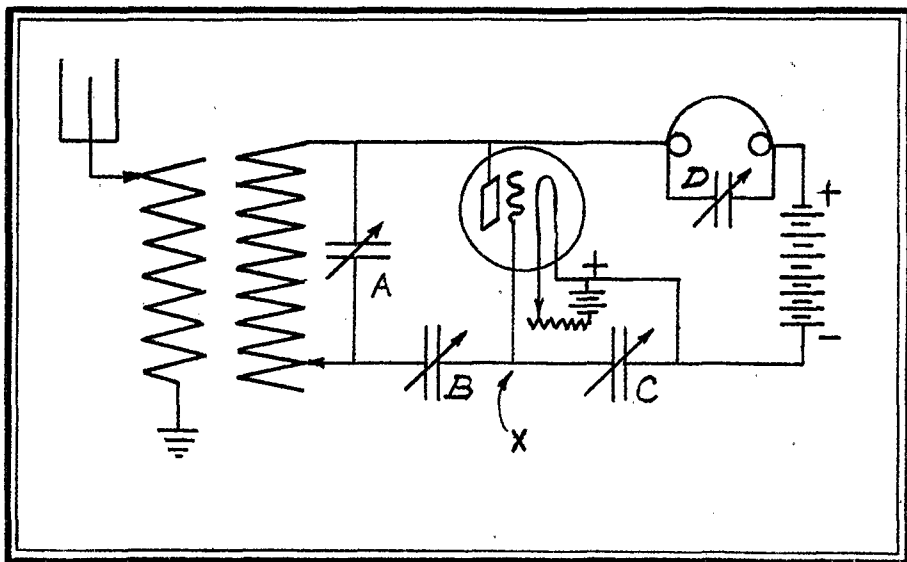

so that the Audion will oscillate. Once the Audion is generating undamped waves, the set is tuned with the loose coupler and the signals heterodyned. This merely means "beats" are produced. The operator can vary the frequency of the signals at will, as the "beat" frequency depends upon the capacity of the condensers.

#### OPERATION.

The most sensitive Audion bulbs for this work are those which "turn blue" at a telephone voltage of about 30. Bulbs which have this property of using a low telephone voltage, will work well without burning the filament brighter than a cherry red. It is difficult to give precise directions for

series of experiments, no difficulty was found in copying arc stations located at Nauen, Hanover, and Elvsee, Germany. Signals sent with the Goldschmidt alternator from Tuckerton, N. J. were also heard. The longest receiving was done when the signals of the Federal Telephone Company's station at Honolulu, were copied.

Any amateur who carefully reads the suggestion given, should have no trouble operating an oscillating Audion with an aerial of fair length. Amateurs throughout the country are now in a position to receive signals from distances of several thousand miles. The writer hopes the amateurs will write of their experiences as he knows their fellow amateurs will be glad to hear about the results obtained.

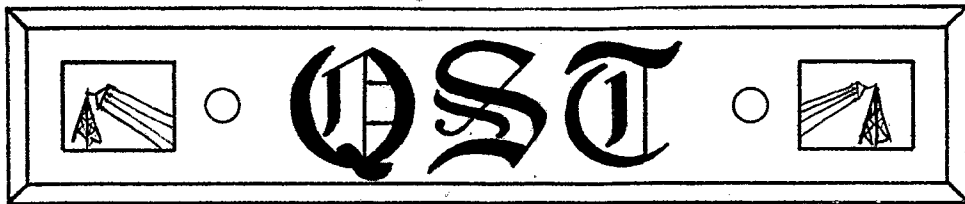

### A NEW WIRELESS ASSOCIATION WHILE YOU WAIT.

It seems to be the fashion to announce a new Amateur Wireless Association every few days. It reminds one of the automobile association boom. It was the style a short time ago to get up a new automobile association every time somebody thought of a new thing to sell. It became so acute that the American Automobile Association, the original organization of automobile users of America, were compelled to come to the rescue, and take steps to protect the users of automobiles. The uninformed man who had a car was unable to tell what he should join and what he should avoid. Some of them offered very superior buttons to wear in the coat while others beat this all out by offering a highly colored pennant. Some promised to protect him if he got into trouble for running his car contrary to good taste and the interests of his fellow countrymen. All of them required some cash payment for something or other.

The wireless world is apparently to be invaded in the same manner. Amateurs should consider carefully what these different associations offer. If it is a subscription to some magazine, and he wants the magazine it is all right if he wants to pay the price asked, which is usually much in excess of the straight subscription price. But, do not confuse this with our own Relay League, which is the property of all of us together, not intended in any way as a money making scheme, but entirely for our mutual assistance in telegraphing to each other, whether we are separated by a distance of ten miles or by the entire continent.

### THE VOLUNTEER RADIO CORPS.

Last month we detailed at length the efforts made by the Directors to place the League at the disposal of the Federal authorities for national defense purposes. This seems to have stirred the blood of many of our good American members, for we

now have the formation of a Volunteer Radio Corps being actively agitated.

The idea seems to be to have the owners of the best Relay Stations offer their stations to the Government in time of need, and bind themselves to comply with certain regulations regarding secrecy, permanence, drills and regular listening hours, and log records, just as owners of automobiles and trucks in England and France join in a Corps and offer their cars and services to the Government on demand. In Europe these Volunteer Motor Corps and other similar organizations have done incalculable good, and there is no reason why in our great country with its enormous area and its extended sea front, a large number of privately owned radio stations would not be of equal value. What is said upon this subject on another page should be carefully considered by those of us who look upon our country as something to serve to the best of our individual abilities, whether there is anything in it or not, in the way of personal gain.

### THE OSCILLATING AUDION.

Things are happening in the wireless world with a frequency in proportion to their radio origin. The amateur, as usual, is found following closely behind the leaders. This latest development, by which an amateur with an aerial fifty feet high and two hundred feet long is able to hear Nauen and Hanover, Germany, is very pointedly covered in the article in this number of QST, which every good relay station owner should read. The audion has come to be very common in our stations all over the country, and this latest use of it will sure to be taken advantage of by the more prominent amateurs at first and then the smaller ones. The only point is to find a way to get the results with inexpensively contrived apparatus. We can depend upon our membership to look out for this. We hope that any one with any good results to point to will send them in for publication, for the assistance of all.

**TESTING.**

How many times have you tried to work a distant amateur and failed? And you felt that if something only had been done right you would have been able to reach him easily. Read what "THE OLD MAN" has to say about this matter. He seems to have given this practical operating question a lot of thought and every amateur should read his words.

**APPLICATION BLANKS.**

Every man, woman or child who reads these lines and is interested in Amateur Wireless, and owns a station, should not put this magazine down until he or she has cut out the page which forms an application blank, and filled it in and mailed it.

The whole success of our Relay League depends upon having a wireless station at the point where there is a message to be sent or received. You may not have but one message a year, but it might well be that this one little MSG would mean a tremendous lot to somebody.

We at headquarters are working hard and enthusiastically and spending good money. You will help more than you think by sending in your application blank, and if you can show a working station, to secure the LIST OF STATIONS BOOK, and the APPOINTMENT CERTIFICATE. It costs you nothing but a two-cent stamp to send in your blank. The List of Stations Book costs you thirty-five cents, which is what it cost us. The appointment certificate, if you are appointed, costs you fifty cents, which pays for the certificate and the printing of this magazine.

## In An American Radio Relay League Station

By ..—..

Scene: Relay League station, Almost—anywhere.

Characters: Operator, a willing amateur explaining his set.

Another amateur, Mr. I am It—I know it all.

College student, somewhat scientific.

Opr.—"This is the sending set. I use about 1 kilowatt."

I am It—"Kill-oh-what?"

Student—"A.C. or D.C.?"

Mr. Opr.—"A.C. of course. This Clapp-ham transformer is very efficient it steps the juice up to 20,000 and (opening shunt switch on hot-wire ammeter) I push 5 amps into the aerial."

Other Am.—"Well that's fair but if you had a good transformer like my Hardpack you'd get 6 amps. Then, of course, your wave is broad, and over 200."

College student, trying to get a word in to interrupt the coming war—"Now I don't quite understand that. You put in about 1,000 watts and get out 5 times 20,000 or 100,000 watts. Apparently 100 times as much; of course that couldn't be true by the Law of the Conservation of Energy. I wish you would explain that."

I am It—(In I-know-it-all-tone) Oh, that conservation of energy stuff is all wrong. The big stiffs in college guess too much. Why look here I'll prove it's all wrong.

Suppose I take a watch spring and wind it up. I've done work haven't I? Now I will drop it in to a jar of very strong acid. The acid will eat the spring up. Where has the energy in the spring gone? Well?"

Mr. Student—Now my good friend, your course of reasoning is all wrong. The evident disappearance of the energy can easily be explained by the First Law of Thermodynamics. You see—(Here his condenser broke down!)



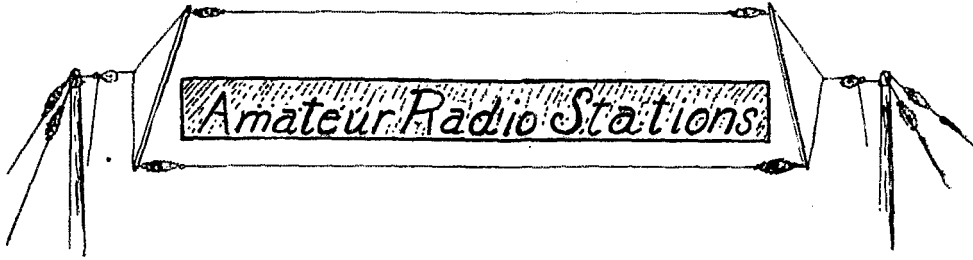

**THE TRANSMITTING SET OF AN AMERICAN RADIO RELAY LEAGUE STATION OWNED BY MR. J. WEISS, PORT WASHINGTON, L. I.**

This is not a picture of an infernal machine, but a picture of a very efficient station of the American Radio Relay League.

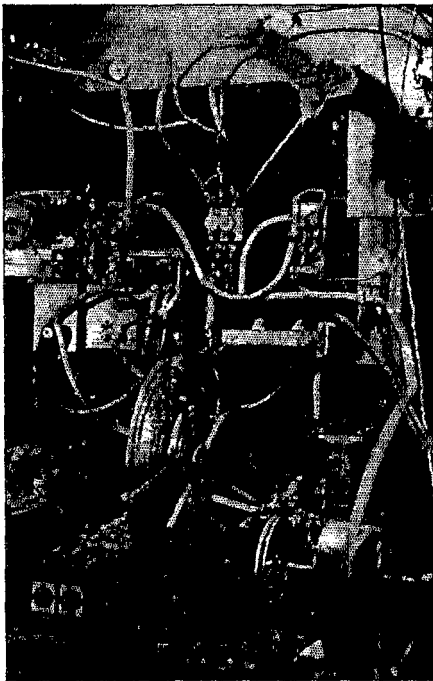

The sending set is located at a distance from the operating room and controlled by a number of relays shown in the photograph. The oscillation transformer, rotary gap, and condenser are well arranged with short, direct, conductors. This is one of the secrets of the success of Mr. Weiss in long distance transmission. Last winter he repeatedly worked 400 and 500 miles on one kilowatt. On one occasion Mr. Weiss sent

a relay message to Waynesfield, Ohio; from there it was sent to Superior, Wisc. While we have no direct evidence, the officers of the League believe the message reached San Francisco and in one evening. The League needs more stations like this. Come Mr. Amateur, get your stations working efficiently. If one man can do this, why can't the rest?

**RADIO STATION OF STUART W. PIERSON CARROLLTON, ILL.**

Power 550 watts                      Call letters 9PY

This picture shows the neat, novel aerial pole erected by Mr. Pierson. We can all have a strong, well-made aerial support, if we copy this type of pole. 9PY said in one of his letters: "Have written to all amateurs having a fair sending range to join the League. All within 40 miles of here." Copy his good example. Help



yourself and the other fellow by helping the Relay League.

### OPERATING ROOM AND POWER SUPPLY OF MR. ROSS GUNN, OBERLIN, OHIO.

Another of the well kept League stations is shown in the accompanying pictures. Mr. Gunn gets his power from the A. C. generator and its exciter and by means of the meters he knows just what power he is

using. On the left hand side of the picture under the operation table is a rather novel form of oscillation transformer. The editor has no details as to its size but it certainly should be very efficient. Mr. Gunn has arranged his apparatus neatly; perhaps you can get some suggestions from his arrangement.

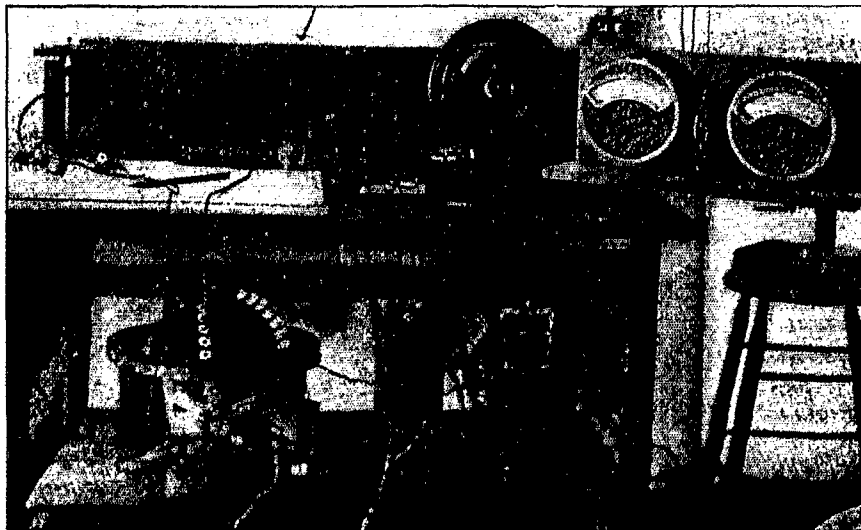

## Running Tests Between Amateur Stations

By "THE OLD MAN."

From an operating standpoint, the chief difficulty which confronts the amateur wireless telegrapher, is the lack of uniformity in the methods of test. Numerous examples of this have come to the writer's attention during the past three years in which he has spent much time on amateur radio communication.

The program which usually happens when two amateurs want to reach each other, is the following:— A hears from X that the latter gets B loud every night. A never has heard B and wonders how it is that X gets him when they are approximately the same distance away. A tunes up and tests and calls B, and makes a nuisance of himself all over his state, but fails utterly to communicate with B. He then sits down and writes B a letter. B answers in a few days to the effect that he was not at his instruments on the evening in question. Then he tells about some

wonderful record he has made with a station anywhere from two to ten times as far away as A.

Then A decides he will do it right this time, so he writes back to B and says how pleased he was to hear from him, and suggests that they make a definite test the following Wednesday night at 9:15 sharp, Western Union time.

Wednesday night and 9:15 comes around on time, and A opens up exactly on the second. He has arranged to send the first 2½ minutes and then listen the next 2½ minutes for B. They were to alternate back and forth in this fashion until they got each other. A begins and sends carefully until exactly 9:17:30, and then he throws his aerial switch and begins to tune. He hears very distinctly a little boy on the next block with a spark coil, and a few dry cells stumbling through "HOW DO I SOUND." A waits for this young

man to finish, hoping he will get through before B's 2½ minutes is up. The little boy is just finishing when two other little boys on the next street break in together each one calling the other simultaneously, sending HS and OT or something similar some fifty-six times in straight succession before they begin their own sign in, which they send exactly thirty-seven times.

By this time, 9:20 has come around, and A must begin calling B again. He starts and everything goes all right, apparently from his end. At 9:22½, he throws in his aerial switch again for receiving, and begins tuning. There are only two or three stations which bother much and he has high hopes. At this juncture a door slams, somewhere down stairs, and loud voices ascend, and the next moment some one shouts, that he is wanted on the telephone. By this time 9:25 has slipped around, and he has not had the faintest idea of whether B was coming in or not.

This sort of thing goes on until B or A or both puncture a condenser, blow a fuse or burn out an audion bulb, or something similar. The test is a howling failure, and both A and B secretly harbor a suspicion that this relay business is not all that it is cracked up to be, and that if Mother were to be taken sick, it might be a good scheme to depend upon the phone or else get back to good old reliable Western

at school, they would have had a "clear line." This is an absolute necessity, and it is a waste of time to attempt to run a long distance test if there is any danger of interference. It is not always necessary to wait until night. The rush hours for interference seem to be between seven-thirty and ten. At noon and at six o'clock, and late at night, the writer has found a clear line very frequently. Therefore, if tests are to be run without attempting control of interference, we should limit ourselves to hours which are liable to be free from interference.

While on this point, it is desirable to bring up this question of control of interference. The writer has noticed that a general understanding that things should be quiet at a certain time, is fairly generally respected. For example, there is a sort of general feeling that around ten p. m., one should keep quiet so that others might read Arlington without trouble, and get time. In some places, press news or weather reports coming at known times have respect. Therefore, it does not seem altogether unreasonable to expect that if a certain time were set aside for Relay League testing or even transmission, that in time it would come to be respected, especially if properly advertised.

In last month's issue, the League Di-

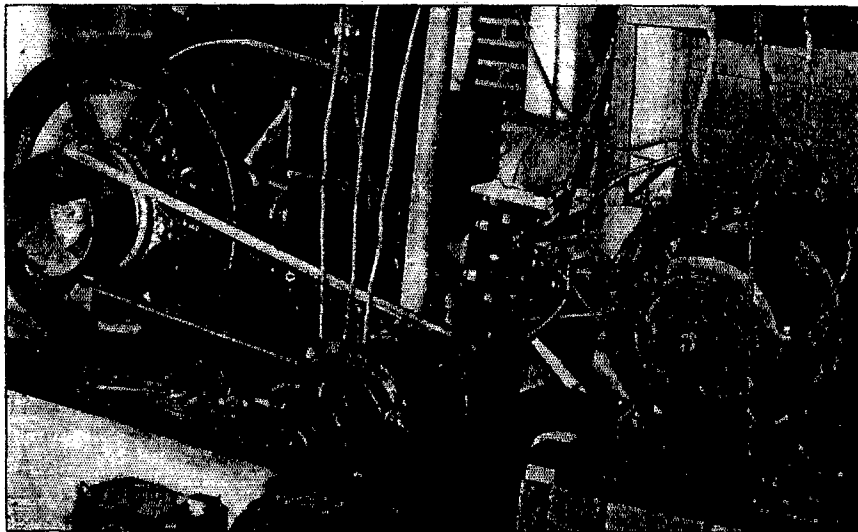

Union.

But all of this is the result of lack of systematic preparation. If A and B, first of all would select an hour during the day or during the night, when the little boys had been tucked away for the night, or were

rectors suggested that every night between 8:45 and 9:15, League relay stations make a point of listening for calls, or sending out QST inquiry calls. This is the beginning of a very good idea, according to the writer's notions. If we were all to talk about this

and be very impressive and emphatic on the point, when any of the small boys happen to be around, it would not take very long for the general impression to go abroad that between 8:45 and 9:15 P. M. it would be bad form to do any butting in.

It seems to the writer that this is a very important matter, and he wishes to suggest that it be considered by the League Membership, and made the subject of general discussion. If it could be arranged that between the hours stated, or any others more suitable, it were understood that all Relay League testing and transmitting were to be done, and that unimportant amateur work were to QRT, there would be less of the sort of thing described earlier in this article. It is even conceivable that the League could induce some form of Federal co-operation in the matter, and in view of the possibility that an efficient working chain of relay stations throughout the country is to the public good, it might not be so hard to show that the unimportant amateur sending ought to be prohibited by law during these few minutes each evening.

The alternative is of course the rigid enforcement of the existing law regarding wave length and decrement and sharpness of wave. If this were strictly observed by those amateurs who have not the equipment, skill or knowledge to do any relay work it would help to a great extent, except for those cases where the little boy with the spark coil and the dry cells and the untuned aerial circuit is next door. The writer does not feel that it is expedient to force a strict observance of the letter of the law at this time, in view of the war conditions prevailing. He is of the opinion that it would be better to attempt to control interference by working among ourselves and showing that it is for the general good of the public at large for us to have a little assistance, and co-operation. After all, it is not such a terrible hardship for the little boys of the wireless world to keep quiet for a few minutes a day. They should be encouraged to practice radio signaling, without doubt, and the writer is one of their strongest advocates, but they should not have the entire 24 hours of the

day. One-half of one hour ought to be reserved for the American Radio Relay League.

Another matter in this plan of testing which experience has shown the writer is important, is exact and unmistakable preliminary arrangements. It should be understood by Mr. A just what wave length Mr. B is using, and what the tone of the spark is. It should be known exactly to the second when Mr. B. is to begin and stop sending. Western Union time is a good standard because it is easily got by phone any minute of the day or night. No attempts should be made to cover a long stretch unless each station is in perfect adjustment, and will not fail at the critical moment. If possible a third station should be called in which can easily read both A. and B. And finally, the long distance telephone should be made use of if it can be afforded. It serves to explain failures which otherwise are the cause of disappointment, and often make a test a success which without it would have been put down as an impossibility.

In conclusion, the writer wishes to touch upon the question of directional aerials. Several things have happened recently which lead him to wonder if amateurs are not in greater need of umbrella aerials than are ships or coast stations. He proposes to try one in the near future in place of an inverted L running East and West, and hopes to be able to report results some day.

---

#### QST Press News.

Press news is transmitted at 10:15 p. m. Eastern time, from the New York Herald (WHB). The news is brief, but always interesting.

The Government station at Key West, Florida, (NAR) transmits Associated Press news beginning between 9:15 p. m. to 9:30 p. m. Eastern time. This news is very complete and stations desiring to receive it should stand by on a long wave length.

---

Are you a member of the League? Write to the Secretary, American Radio Relay League, Hartford, Conn. for application blank.

## Latest List of Additions to American Radio Relay League Stations

**ARKANSAS**

Fort Smith	Paul E. Nelson	1012 S. 18th St.	5 CB
------------	----------------	------------------	------

**CALIFORNIA**

Sawtelle	George E. Chamberlain	121 N. 6th St.	6 OJ
----------	-----------------------	----------------	------

**CONNECTICUT**

New Britain	Francis A. Mulvihill	369 Main St.	1 TB
New Britain	Harold Bacon	70 Monroe St.	1 DA
Middletown	Philip A. Bailey	64 Washington St.	1 WW
West Hartford	L. D. Fisk	Bloomfield Ave.	1 DV

**FLORIDA**

St. Petersburg	A. L. Conn	75 4th Ave.	4 CE
----------------	------------	-------------	------

**ILLINOIS**

Carrollton	Stuart W. Pierson	214 Maple Ave.	9 PY
Chicago	John F. Born	6649 Champlain Ave.	9 OP
Chicago	George W. Debus	1910 Sunnyside Ave.	9 RH
Chicago	Hardin Masters	4853 Kenwood Ave.	9 OC
Chicago	D. V. Johnson	5514 Kenmore Ave.	9 RD
Maywood	R. J. Iversen	422 So. 16th Ave.	9 SQ
Polo	Clarence H. Fahrney		9 DC

**IOWA**

Burlington	Norman B. Hood	Burlington High School	9 XZ
------------	----------------	------------------------	------

**KANSAS**

Kansas City	Wilbur Witcraft	1941 Thompson St.	9 TP
Topeka	Robert K. Trump	1254 Van Buren St.	9 JW

**KENTUCKY**

Bellevue	Thomas Tallenture	458 Foote Ave.	9 PZ
----------	-------------------	----------------	------

**MAINE**

Lewiston	John H. Weber, Jr.	12 Russell St.	1 FZ
----------	--------------------	----------------	------

## MASSACHUSETTS

Beverly Farms	Archibald A. Carswell	78 Hart St.	LF
Fall River	Raymond S. Sutcliffe	29 Foster St.	1 NF
Holyoke	Philip H. Bloom	9 Adams St.	1 EH
Medford	Howard Baumann	24 Hale Ave.	1 GU
New Bedford	Franklin Allen	125 Sycamore St.	1 KG
Townsend	Francis Struthers	Main St.	1 OQ

## MICHIGAN

Battle Creek	Elra E. House	38 Taft St.	8 NF
Detroit	Norton Richardson	70 Davenport St.	8 IK

## MISSOURI

Columbia	Lawrence W. Stewart	211 Hicks Ave.	LWS
Kansas City	Cecil E. Cassaday	3038 Brooklyn Ave.	9 PD

## NEW JERSEY

Fair Haven	Fred F. Dennis	Main St.	2 JT
Keyport	Joseph E. Judson	89 3rd St.	2 AAQ
Keyport	Edward W. Maurer	65 Osborn St.	2 AAG
Laurel Springs	C. Chester Stephen	Beach Ave.	3 BC

## NEW YORK

Bronx	Irving Ralph Flisser	1930 Webster Ave.	AF
Brooklyn	W. S. Browne	1565 E. 12th St.	2 KD
Buffalo	Walter H. Bernactt	65 Good Ave.	8 RZ
Buffalo	Ray Swanecamp	207 Lemon St.	8 LL
Buffalo	H. W. Woodmansee	214 Morris Ave.	8 AGO
Cazenovia	Ronald Marshall		8 UU
Clyde	Murray Rob't Cookman	118 Glasgow St.	8 KU
Cornwall	Frank M. Ham	Cornwall-on-Hudson	2 CW
Ithaca	Norman G. Snyder	214 University Ave.	8 FO
New York City	Arthur F. Loub	445 E. 88th St.	2 VI
Rochester	Elliott Ford	129 Dartmouth St.	8 ADK
Southampton	R. J. Freeman	Aloah Radio Station	2 IX

## OHIO

Akron	Donald A. Hoffman	50 South Balch St.	8 ADU
Akron	Roland F. Palmer	470 E. Buchtel Ave.	8 LB
Akron	Herman E. Werner	41 Fay St.	8 ADF
East Cleveland	A. G. Spiller	211 Strathmore Ave.	8 HK
Hamilton	Miles Bruning	2842 Mt. Pleasant	8 AHE
Oberlin	Donald W. Balson	243 College St.	8 AEH
Ravenna	R. N. Kingsbury	504 E. Main St.	8 AMY
Toledo	Frederick Gamble	2412 Putnam St.	8 PK
Wapakoneta	Frayne L. Combs	601 W. Anglaize St.	8 KO
Warren	S. Eugene Dyke	211 Porter Ave.	8 AKY
Wellington	Loyd Brothers	North Main St.	8 AIM

## PENNSYLVANIA

Allentown	Arthur C. Jacoby	517 Linden St.	3 OV
Arlington	Charles Wm. Weber	Huntington Road	3 AFA
Harrisburg	Albert C. Michael	550 Camp St.	3 AGS
Media	S. Delbert, Jr.		3 HZ
Philadelphia	James I. Toner	1432 Christian St.	JIT
Pittsburg	Raymond C. Bender	2642 Norwood St., N. S.	8 AKA
Scranton	Marix Vanderveken	2210 Washington Ave.	8 SX
York	C. Brown Hyatt	310 Carlisle Ave.	3 SE

## TEXAS

Dallas	M. L. Hunt	R'm 39, Tep. Gen. Office	HN
New Braunfels	Arthur E. Mollenhauer		5 ZB

## WISCONSIN

Milwaukee	Jack W. Lobas	635 31st St.	9 GK
Sheboygan	Harold Burhop	1945 N. 7th St.	9 RW
Sheboygan	Walter Meyer	1832 N. 13th St.	9 RS

## VIRGINIA

Portsmouth	L. C. Herndon	409 Middle St.	3 SZ
------------	---------------	----------------	------

## HOW ABOUT YOU?

The rapid growth of the League is shown by the large number of stations added this month. The list is swelling day by day and next month it will be a record breaker. YOU can get your name in this list by using the application blank. It is a big honor to belong to the

### AMERICAN RADIO RELAY LEAGUE

the only active wireless association in the U. S.

Nearly one-quarter of the licensed amateurs of the country are in the league.

HOW ABOUT YOU?

## Radio Communications by the Amateurs

Port Washington, L. I., Dec. 2, 1915.  
Mr. C. D. Tuska,  
Dear Sir:

I am in receipt of the first QST, and I want to say it is a "peach." The idea is great. I am very much interested in it. Any thing which promises to further the interests of the Amateur, like the QST does, ought to, and no doubt, will succeed. I have already the List of Stations last issued, but I enclose \$1.00 for year's subscription to QST. May it succeed.

In reference to time of working, and relaying msgs., I would like to make a suggestion. After taking a msg. for forwarding, would it not be a good idea for the Relay Station to call back to the sending station, and confirm its forwarding. I do not know whether this is being done. I have not observed this custom in general use, though I do it myself when possible. As to the time of working of the different stations, we might have special days, and hours allotted to us by previous arrangement. I am always on the job, at from 11:45 A. M. to 1:00 P. M., and from 10:30 P. M. till 12:00 M. or later, as may be necessary.

I enclose in separate cover, photos which are the best I have on hand just now, but if you think you can use them, I will make others, and better ones, and send them immediately. In the case of your being able to use them, please drop me a line, and I will print others, and send them.

I heard through 2PC that 1CM had heard my signals, up in N. H. I also had a letter from E. Erikson, Winnetka, Ill., this week as having heard my signals, and we are arranging for tests.

Wishing you every success in your new venture, I am

Sincerely,  
(Signed) JACOB WEISS.  
922 North St., Portsmouth, Va.,

November 28, 1915.

The American Radio Relay League,  
Hartford, Conn.

My Dear Mr. Tuska,

I wish to state that I heard the following stations on the night of the 26th between the hours of eleven P. M. and two A. M., 8 WP/8ZM/8NH/2JD/ and 8YL all of these stations were on about two hundred fifty meters with the exception of 8YL who was on about four hundred twenty-five meters. I

could read all of them with ease except 8NH, who, I only heard once.

On the following night about the same time I heard 8AEZ communicating with 2JD but could not get the latter.

I heard 8WP forward a message to 2JD which was addressed to a Mr. Tuska, I thought perhaps that was you.

I have been hearing 8AEZ all the winter and have heard 9DM and 2KK. I have written to all of these stations telling them about my hearing them.

I was not using my Audion on any of them. My aerial is 60 feet high and 85 feet long; am using Radio Loose-coupler model 15A Navy type; Galena detector, Brandes Phones, and Murdock fixed Condenser.

Hoping that this will be of some interest to you, I remain,

Yours very respectfully,  
(Signed) IRVING I. BLANFORD,  
"3TV"

1432 Christian St., Philadelphia, Pa.  
American Radio Relay League, Inc.,  
Hartford, Conn.

Sir:—

I beg to acknowledge your interesting magazine, and wish to subscribe for the same for January, February, March.

Enclosed you will find the amount specified in your valuable magazine, and hope to become a member, so you will please send me an application blank to my home address.

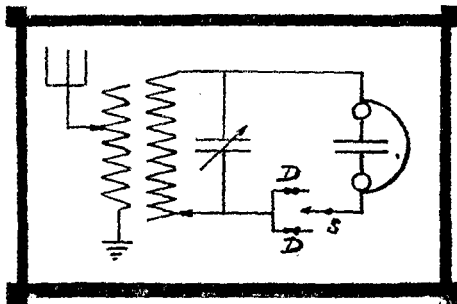

I also thank the LEAGUE for thinking of me in regard to such a good magazine.

Hoping the LEAGUE the best of success, of which it has already received.

I am,  
Yours truly,  
(Signed) JAMES I. TONER.



I am enclosing what I should say is a freak, as you say in your magazine to work for the success of the magazine.

(Mr. Toner uses a loose coupler, phones, variable, and two mineral detectors for receiving. The two detectors are connected with a two point switch. He found strong signals could be heard faintly when the two point switch was as is shown in diagram. That is, the lever arm of the switch was not on a contact point. This apparent freak may be explained either by leakage through the base of the switch or by inductive effects between connecting wires. This effect is often noticed with strong signals.—Editor.)

117 Marshall St., Elizabeth, N. J.,  
Dec. 2, 1915.

American Radio Relay League,  
Hartford, Conn.

Gentlemen:

Your (QST) received and I think it is all to the mustard. Enclosed find money order for \$.75 for three months subscription to the (QST) and \$.50 for an Official League License, and believe me I am going to make this winter a good one for relaying messages. I remain,

Sincerely yours,  
(Signed) ROBERT CAMPBELL, Jr.

515 McLean Ave., Yonkers, New York,  
November 18, 1915.

Mr. C. D. Tuska, Secy.,  
American Radio Relay League,

Hartford, Conn.

Dear Sir:

The List of Stations and Blanks received for which I thank you. If you look at my previous letter you will see that I said that I think I can easily get 100 miles. I now give you some of the results I got since my last letter to you.

On Sunday night, November 14th, between 11:30 P. M. and 2:30 A. M. I heard 8AAE, 8NH, 8WP, 8AEZ, 3ZL, 8JA, 9IK, 9PC and 1CM. All of them came in fine. I called 8WP, and 8AEZ in Lima, Ohio (a distance approx. 750 miles) answered me and said signals (QSA). Then 8NH in St. Marys, Ohio called me. But when I was through with 8AEZ and called 8NH, I didn't get an answer but 8NH must have surely heard me. So I think that my distance in miles could be boosted a bit, as 8AEZ is 750 miles away. 1CM in Laconia, N. H. came in fine, and am going to try to work him some night.

I will try for 9PC later and will let you know, I would also like your opinion on the above.

Yours very truly,  
(Signed) WALTER T. FEENEY,  
(2IB)

W. A. Meyer of Sheboygan, Wis., remarks:—

"I think it would be a great help to the U. S. Government if every licensed amateur belonged to this RELAY LEAGUE because it keeps him in contact with more outside affairs. Also by this excellent "QST" magazine every page of which I have read with great enthusiasm."

## Kansas City,<sup>1</sup> Kansas,<sup>2</sup> High School Radio Club

Kansas City, Kans: A radio club has been formed in this city under the name of "The Kansas City, Kansas, High School Radio Club." The club has not been organized very long, but it is progressing rapidly. The members are being trained so that they may become competent operators. Mr. Lyons has given several talks about the theory of electricity and wireless telegraphy. Under the instruction of Mr. Lyons, the members are rapidly becoming efficient operators. For sending the club has installed a one kilowatt transformer made by the

members. The members have also made a loose coupler, variable condenser, and several other instruments. They use a pair of Brandes Navy Receivers and obtain excellent results. The members hope to increase the present set. The following is a partial list of the members:—

Parker E. Wiggins, Pres., Ralph Mueller, Secy., William Ritter, Treas., Fred White, Press Agt., Edw. Foulks, Frank Reichen-ecker, William Mauzy, Erland Curtis, Paul Jefferds, Bert Kellar.

## A Volunteer Radio Corps

In the last issue of "QST" there was considerable said about the American Radio Relay League offering its assistance to the Federal Government for purposes of communication. The idea is of course a good one and one which every patriotic American who is a member of the League will commend. But the question arises, whether the offering of the League organization to the Government gives the latter just the form of help which it could best take advantage of. This matter would seem to be one worth further consideration.

The League has its own organization and its own methods of handling this organization. Without appearing to criticise these methods, it is possible that they might not suit the Government, or be the best for meeting the conditions which may arise in case of war or other trouble. It is like a private military organization, which might be very satisfactory to its own membership, but when it came to co-operating with the regular forces it might be very much at fault for the want of the right kind of experience, training or equipment. This is a very old story to those who have been connected with matters of this kind.

Rather than limit the value of a large group of amateur wireless stations to what it can do as at present handled, it would seem very much better if those amateurs who were best equipped would offer their individual services to the Government and leave it to the Government to work out the method of control.

This is not written with any idea of diverting any of the glory from the Relay League. The latter deserves much and will get it. It is offered only as a practical plan for carrying out the idea of offering amateur services to the Government. As a matter of fact it is more than likely the League could do more in the matter of starting the thing along than in any other way. As a means by which the Government could get into touch with the better class of amateurs there probably is nothing better.

The banding together of a group of people having certain equipment and training for Federal use is not a new thing. In Europe the automobile owners have had a Volunteer Motor Corps for a long time. They agree to conform to certain regulations, attend meetings at certain stated times and hold themselves in readiness at any moment to turn their motor car over to the Government, either with or without driver.

They have drills and manoeuvres with the idea of being able to serve as a quick dispatch bearing service, a quick mobilizing force or a hospital corps. In the present war they have been of inestimable value. The owners of fast motor boats, it is understood have a similar corps. Of course there are a great many doctors corps for hospital service.

In none of these Corps is it intended to adhere to any rigid discipline, and thereby possibly work inconvenience and hardship to the membership. The principle point is to have a certain number of men available with their equipment at call. In the case of amateur wireless stations and their owners, it probably would not be considered necessary to call upon a volunteer corps for foreign or distant operating service. Such would render the amateur station unavailable. Rather, it is supposed that a Corps would be expected to offer their own stations and their own operating services if such were necessary. The station is the important element, as it is not mobile and its parts cannot always be assembled instantly. The ability to call into instant life a chain of good operating radio stations in various parts of the country, would be a very valuable thing under some conditions.

If the Government were to consider favorably taking charge of a Volunteer Radio Corps it would mean that only those amateurs who had first class tuned stations and who kept them in good working order would be considered eligible, in all probability. The Government has a way of choosing only the best and it is very likely that this rule would be more than ever adhered to in selecting a radio corps. That it would be a big honor to be selected by the Government, goes without saying, and it seems likely also that stations selected would be given special licenses to use the longer wave lengths, which would be a very agreeable concession.

It behooves the amateur, therefore, to look to his station equipment these days, and if it will not stand inspection to fix it so it will. If there is any thing to come of offering the amateur service to the Government, it will come suddenly, and some day we will find a Radio Inspector at the front door announcing that he would like to look your station over. If it is in good order, you will stand among the good ones. If it is not he will listen politely to your fine line of excuses and reasons why, but you will probably go down in the book as one of the no accounts.

### Items of Interest

#### FEBRUARY QST.

The next issue of "QST" will surpass everybody's expectations. Don't fail to read the article on "Arrangement." You can get efficiency and send a long distance if your apparatus is arranged properly. There is more in this subject than the majority realize. "Arrangement" will be another clear and interesting article by a competent writer.

February "QST" will be a wonder in many respects. Some remarkable photographs of amateur stations have been received. You will wish to look them over. Subscribe to "QST" and you will have the opportunity. One amateur will tell how he receives distant amateurs and transmits 600 miles with a half kilowatt. That is something everybody wants to do. Read the article. Some answers to the Japanese letter will be published. They are great.

#### MISCELLANEOUS.

The Editorial on "A New Wireless Association While You Wait" puts it mildly. Don't join the wrong association. In many ways the AMERICAN RADIO RELAY LEAGUE has been a great success. Other associations have sprung up like grass. Will they die? One in particular seems to like OUR name. We have incorporated the LEAGUE to protect our name, but we can't enter into a legal battle. We are trusting you to fight for us.

Read "Radio Communications." You can see what the amateurs are doing. Some of them talk about "QST." See what they have to say. Do you agree with them? If you do, you should subscribe. If you want to keep abreast of wireless development read "QST." It's the ONLY REAL WIRELESS MAGAZINE OF THE AMATEUR, FOR THE AMATEUR, AND BY THE AMATEUR.

### To Those Who Are Not Subscribers

We have sent you the December issue of "QST;" here is the January. You have now gotten an idea as to it's value. Subscribe now. Read it every month. Don't miss anything. If you have not the quarter, write to us; send us the name and address of your newsdealer. We shall see that you can purchase your "QST" from him.

Tell your friends where "QST" may be purchased.

CUT OFF ON THIS LINE

### SUBSCRIPTION BLANK

American Radio Relay League  
Hartford, Conn.

Gentlemen:

Enclosed find 25c (stamps, currency, check or money order); kindly send me February, March and April numbers of Q S T.

Name .....

Street and No.....

Town and State .....

## Exchange, For Sale and Wanted

### "Second Hand Apparatus"

**In order to facilitate the exchange and sale of second hand apparatus, "QST" will print, free of charge, want and for sale ads. up to a reasonable number of words. The publishers reserve the right to withhold any ad. which is against the policy of this department**

**HAVE A FEW** 6-60 and 6-80 storage batteries, also a few (automobile) spark coils. Want a large and a medium sized rotary variable condenser (unmounted). S. Touroff, 1828 Topping Ave., Bronx, N. Y.

**AUDION CABINET** receiving set for sale, also  $\frac{1}{2}$  KW transformer, rotary and other wireless apparatus. Write Chas. A Service, Jr., Bala, Pa.

**FOR SALE:** Mahogany cabinet loose coupler. Tapped on primary and secondary. Tunes to 2,500 meters. Price \$10.00 or part payment on audion. Write for list of instruments. J. Wallace Peckham, Melville, Newport, R. I.

**WANTED:** Subscription agents for "QST." Help yourself, help the LEAGUE, help everybody. Address, AMERICAN RADIO RELAY LEAGUE, Circulation Agent, Hartford, Conn.

**FOR SALE:** A brand new RJ4 audion Detector, \$15.00. Has never been used. Another audion practically new but bulb burnt out, \$12.00. Walter A. Meyer, 1832 N. 13th St., Sheboygan, Wisconsin.

**WANTED:** Clapp-Eastham Blitzen receiving transformer. Must be reasonable. Frederick Gamble, 2412 Putnam St., Toledo, Ohio.

**FOR SALE:** A complete receiving set. Consisting of 2 audions, loose coupler and 2 variables. All mounted in a mahogany cabinet. Instruments nickel plated. Will send photograph on request. A reasonable price asked. A. H. Morris, 704 W. 23rd St., Wilmington, Del.

**WANTED:** Articles, photographs, anything that interests the amateurs. For "QST." The Editors, AMERICAN RADIO RELAY LEAGUE, Hartford, Conn.

**FOR SALE:** 2 KW 110 primary 30,000 secondary 60 cycle, open core, DeForest transformer. First \$30.00 takes it. Never been used; in fine condition. W. E. Donelson, 1215 West Ave., Eureka, Cal.

**AMATEURS WRITE ME** your needs. Have slightly used apparatus for sale. Address, George Holmes, 164 W. 146th St., New York City.

**I HAVE FOR SALE** or for trade: 3 sections of sending condenser, medium size. 1 small closed core step-up transformer of about 100 watts. 1 step-down transformer 4 voltages (to be run on 110 volts). All in first-class condition, guaranteed. Will dispose of all together or separately. First good offer takes them. Earl Dawes, Bozeman, Mont.

**FOR EXCHANGE:** Each month, a brand new number, of a brand new wireless magazine, filled with brand new articles, on brand new subjects. Will exchange twelve numbers of this brand new wireless magazine, "QST," for one dollar. Address, Secretary, AMERICAN RADIO RELAY LEAGUE, Hartford, Conn.

**FOR SALE OR EXCHANGE:** 10 "V." dynamo, spark gap, sending and receiving condenser, loading coil, large, double slide tuner, 2 A. Browne camera, wire, books, geisler tubes, sockets, and other electrical goods. Want wireless or electrical goods. Norman Himes, 17 Asylum St., Norwich, Conn.

**FOR SALE:** "Martin" vibroplex key, 5.00; one telephone transmitter, .75; Western Elect. whetstone bridge; 20.00;  $\frac{1}{4}$  K.W. closed core transformer core .50; Blitzen var. cond. 1.50; one  $\frac{1}{4}$  K.W. (C-E Co.) condenser, 4.00; one 30 amp. com. key, 5.00; one 1/10 H. P. 6000 R. P. M. Barnes var. speed motor, 8.00; one 3 K.W. type "E" transformer, 65.00; one Western Elec. portable volt-meter, 0-140 and 0-3 volts, 5.00; one  $\frac{1}{2}$  K. W. fixed spark gap, .75; one Murdock series cond., 1.25; one "Radio Apparatus Co. receiving transformer, 7.50; one 40 inch glazed porcelain petty-coat deck insulator, 6.00; one pair "Brandes" 3200 ohm navy type phones, 6.00; H. E. Chapman, 320 Wethersfield Ave., Hartford, Conn.

# APPLICATION BLANK

## American Radio Relay League

Incorporated

HARTFORD, CONNECTICUT

Your Name ..... Address .....  
(Street, City and State.)

Your Age ..... Your Station Call Letters .....

Are you a member of any Radio or Wireless Club, and if so give its name and address:

.....

Length of your Aerial ..... Height above ground .....

Number of wires in Aerial and space between .....

### SENDING EQUIPMENT

Do you obtain your power from Batteries or City Current? .....

Do you use a Spark Coil or a Transformer? .....

What is your Power Input? .....

Is your Spark Gap Rotary, Fixed or Quenched? .....

What Tone has your Spark? ..... Approximate Wave Length .....

Give names and addresses of the FIVE most distant stations you communicate with:

State distance in miles .....

.....

.....

.....

.....

(OVER)

# RECEIVING EQUIPMENT

Describe your Receiving Set .....

Do you use an Audion Detector? .....

What is your approximate receiving range in miles? .....

Are you troubled by interference? .....

What are your usual listening hours and how many evenings a week do you average at your instrument? .....

Have you telephone connection in your house, or convenient? .....

Do you keep your station practically constantly in running order? .....

Can you copy Press News? .....

About how many words per minute can you receive with certainty? .....

What is the nearest Commercial or Government Station to you? .....

Have you a Government license, and if so what Grade and No. ....

Please make any remarks or comments which you think will be of help in perfecting a chain of Amateur Radio Relay Stations throughout the country. The object of the League is strictly confined to facilitating the relaying of radio messages among amateurs.

I HEREBY OFFER TO RELAY OR DELIVER ANY AMATEUR RADIO MESSAGES THAT ARE SENT TO ME

Signature ..... Date .....

# GENERAL NOTICE

## to the Licensed Amateurs of the U. S.

Headquarters, Hartford, Conn., Dec. 24, 1915

At a meeting of the Directors of the AMERICAN RADIO RELAY LEAGUE, held in Hartford on the above date; the Secretary was authorized to publish the following statement:

"First, the Secretary shall supply until further notice 'The List of Stations' book and a three months' trial subscription to 'QST', at a reduced price of fifty cents to any licensed amateur.

Second, the object of this action is to give the amateurs an opportunity to obtain the 'List of Stations' book at a reduced rate, and at the same time to introduce 'QST.'

CLARENCE D. TUSKA, Secretary

The Book is one which every amateur must have, as it contains detailed data about six hundred of the best stations in the U. S.

The hard-working publishers want "QST" to be read by EVERY amateur. Through it the officers of the LEAGUE will keep the amateurs informed: of all important steps in wireless, long distance records, construction of new apparatus, work of the various clubs throughout the country, and everything which interests the amateur operators and experimenters. Take advantage of this offer and USE THE COUPON.

---

**AMERICAN RADIO RELAY LEAGUE**  
Hartford, Conn.

Gentlemen:—

With regard to the action taken by the Directors on Dec. 24th, I am enclosing \$.50 for three months' trial subscription to "QST" and the List of Stations Book.

Name \_\_\_\_\_

Address \_\_\_\_\_

City \_\_\_\_\_

State \_\_\_\_\_

**IN AN AGE OF PROGRESS  
STANDING STILL IS DRIFTING  
BACKWARD**

The **MOST RECENT** inventions in radio telegraphy and telephony are accurately described in the

**Proceedings of  
The Institute of Radio Engineers**  
by the engineers who discovered them

There is no better way of following the trend of radio work than thru its pages. Full information as to membership and subscription to the "Proceedings" will be furnished on request by

**THE SECRETARY, INSTITUTE OF RADIO ENGINEERS  
111 Broadway, New York**

**Concentration  
on the  
Amateur  
Field  
will bring  
Success!**

The few publications containing wireless news are read by thousands of people, but "QST" is the only wireless publication devoted entirely to the amateurs. You can concentrate your advertisements on the five thousand amateurs who read "QST."

The Secretary of the American Radio Relay League, Hartford, Conn., will be pleased to give you information concerning "QST."



# Brandes' Radio Headsets



Superior Type, \$5.00

The Great Favorite with both Professionals and Amateurs

Send Stamp for Our Catalogue F

## C. BRANDES, INC.

Room 821, 32 Union Square

### NEW YORK

# "Mignon - System"

The Last Word in Radio Signal Receiving Apparatus for Commercial and Amateur Use

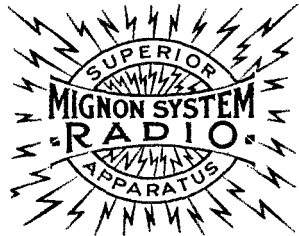

Unapproached Selectivity Sensitiveness and Durability

WRITE FOR CATALOG

Dept. A

## Mignon Wireless Corp.

Specialists in

Radio Receiving Apparatus

Elmira - N. Y.

The publishers of "QST" wish the amateurs a most prosperous New Year. Start the New Year right by mentioning "QST" when writing to the advertisers.

# Our Standard Loose Coupler

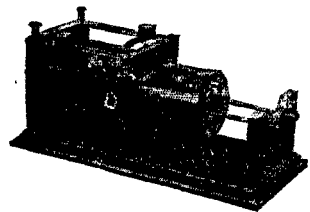

The greatest thing out. 7 in. high, 7 in. wide, 15 in. over all. Wound with Enameled wire (secondary with silk, if desired), has double slide and eight taps, with heavy rheostat handle. Woodward mahogany finished. Price, \$7.00. Also have a new one, 6 in. high, 6 in. wide, 14 in. over all, wound with same wire, but with single slide. Only \$4.50.

## F. B. CHAMBERS & CO.

2046 Arch Street

### Philadelphia, Pa.

# No. 5 Model Loose Coupler

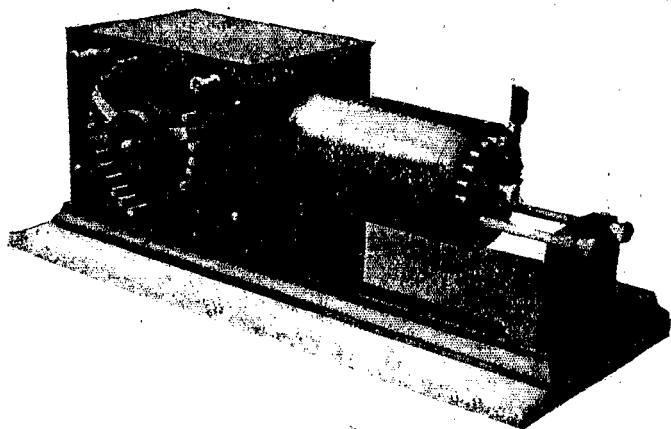

This instrument is made of the best material obtainable, is very handsome and accurately made. Will tune up to 3,500 meters on a fair size antenna. PRICE, \$15.00

Send two cent stamp for complete literature

**J. F. ARNOLD,** 135 East 119th Street **New York City**

# YOU WILL FIND

the audion detector in the best amateur wireless stations.

A combination audion detector and amplifier set will assure you of results which are impossible with any other detector. It's superiority over anything else to be had is easily proven to your own satisfaction, and it's extreme sensitiveness will delight you. There is great satisfaction in knowing that each time you are through transmitting you will hear the distant station with the same intensity — by merely moving a switch.

We have a booklet which explains the audion amplifiers which we would like to send you. If you will send us your name and address we will forward a copy to you at once.

We carry in stock at all times a complete line of audion detectors; renewal bulbs, etc., and can usually make shipments the same day your order is received.

We manufacture many other good instruments, and full information and literature will be sent anyone upon request.

**The Wireless Mfg. Co. - Canton, Ohio**

# **The List of Stations Book**

**COMPLETE LIST OF RELAY STATIONS  
OF  
THE AMERICAN RADIO  
RELAY LEAGUE  
INC.**

**Shows what Relay Stations are within  
your Range**

**Gives name of owner. Complete address. Call  
letters. Sending power. Kind of gap used.  
Number of words can receive per minute. Lis-  
tening in hours. What license is held. Tele-  
phone connection or not.**

**Best list of Amateur Radio Stations  
in existence**

**Indispensable to every amateur whether in  
Relay League or not**

**Sent postpaid to anyone upon receipt of 35 cents  
in stamps, currency, check or post  
office money order**

---

**THE AMERICAN RADIO RELAY LEAGUE  
Incorporated  
HARTFORD, CONN.**

# New Mesco Radio Apparatus

## ROTARY SPARK GAP

A Rotary Spark Gap is required in every transmitting station by the Federal authorities, for the reason that this type of gap produces a pure wave of low damping decrement. It also increases the efficiency of any transmitting station from 20 to 30 per cent.

This Rotary Spark Gap emits a high musical note, more audible to the human ear, can be heard at greater distances than the note from the stationary type, and cannot be mistaken for static or other atmospheric disturbances, a fault common with the stationary gap due to its low frequency note.

The rotating member has twelve sparking points mounted on a hard rubber disk and is carried on the motor shaft.

Also fitted with two stationary electrodes with special adjusting devices.

The Gap can be successfully used on any of our spark coils or transformers up to and including 1 K. W. capacity.

Our standard Globe Motor is used, which will operate on 110 A. C. or D. C. circuits and attains a speed of 4,500 R.P.M. Also made with our

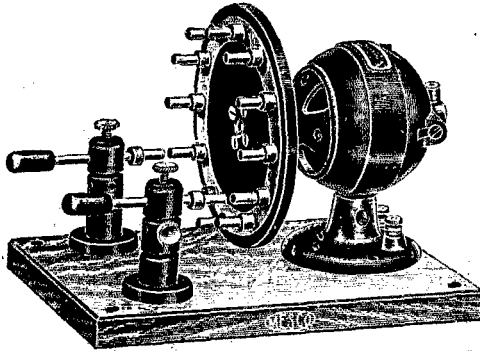

Globe Battery Motor, which can be operated on a six-volt circuit.

List. No.		Price
222	Mesco Rotary Spark Gap, 6 volt .....	\$12.00
223	Mesco Rotary Spark Gap, 110 v., A. C. or D. C. ....	13.00
216	Rotary Unit only, with two Stationary Electrodes, 1 3/16 in. shaft .....	5.00

## UNIVERSAL DETECTOR STAND

This Stand has a heavy brass cup, with four binding screws, capable of holding crystals up to and including 3/4 in. diameter.

A hollow standard encloses a brass ball. Through an opening in the wall, a brass arm with hard rubber handle is secured fast to the ball, making a ball and socket joint, allowing it to be adjusted at any angle or used in any position.

A hole for the introduction of different size wires extends through the arm. A set screw in the side of the arm binds the wire.

Supplied with two binding posts. All mounted on a heavy genuine hard rubber base 2 1/4 x 4 1/4 x 3/8 in. All metal parts nickel plated. A spring rests on the ball in the hollow standard and sets into a cup under the adjusting screw, so that varying pressures can be had as circumstances require. Remains permanently in adjustment under jars and vibrations of every description.

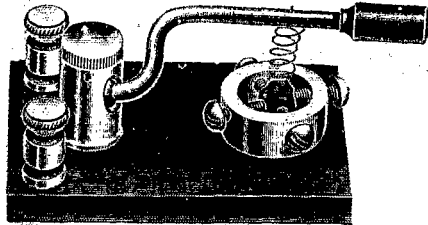

List. No.	248 Universal Detector Stand .....	Price
		\$3.00

### SEND FOR OUR NEW CATALOG H28

It is pocket size, 8x4 1/2 inches, contains 248 pages, with over 1,100 illustrations, and describes in plain, clear language all about Bells, Push Buttons, Batteries, Telephone and Telegraph Material, Electric Toys, Burglar and Fire Alarm Contrivances, Electric Call Bells, Electric Alarm Clocks, Medical Batteries, Motor Boat Horns, Electrically Heated Apparatus, Battery Connectors, Switches, Battery Gauges, Wireless Telegraph Instruments, Ignition Supplies, Etc.

There exist a thousand and one ways where electrical devices may be used, and to know what is best for your purpose you need this catalog. It costs you nothing.

### SEND FOR OUR NO. 17 MANUAL WIRELESS TELEGRAPHY

You should have it even if only superficially interested. Around about you every day you read of some marvelous occurrence in which wireless played a distinguished part. It may not be entirely clear to you. The Manual will explain it. To the student of Wireless Telegraphy, the Manual contains much that is indispensable to a proper understanding of the art. A good portion of this is now published for the first time.

We ask ten cents (\$.10) for it—give you a coupon receipt which can be applied on any order amounting to One Dollar (\$1) or more.

Send your name and address now, and get one of the most complete, comprehensive and reliable wireless pamphlets published.

# Manhattan Electrical Supply Co.

NEW YORK  
17 Park Place

CHICAGO  
114 S. 5th Ave.  
SAN FRANCISCO 604 Mission Street

ST. LOUIS  
1105 Pine St.