

DX News

•Serving DX'ers since 1933•

Volume 59, No. 28 - August 3, 1992 (ISSN 0737-1659)



Inside...

- 2 .. Concerning Dajja Enterprises
- 8 .. AM Switch
- 11 .. DDXD
- 14 .. New DDXD Editors
- 20 .. FM DXD
- 24 .. Antenna Switcher
- 25 .. Answerman
- 27 .. Collins R390A

- 32 .. In the Beginning
- 33 .. Loop Amp
- 37 .. Noise-Reducing Antennas
- 38 .. Cuban AM/FM List
- 40 .. Radio Waves
- 41 .. Radio Roundup
- 44 .. Musings
- 47 .. Convention Page
- 48 .. Your Page!

From the publisher ...

By the time you read this, the *NRC Domestic Log* is being printed and will be available by September 1. Ken Chatterton is taking advance orders, and you may plan to pick up your copy of the log at Omaha, if you wish.

Without trying to sound crabby, I need to make clear that NRC'ers who renew late run the risk of not automatically receiving some of their DXN's, as we do not keep a record of the last issue mailed. However, if you find that you are missing an issue, you may write and ask for a replacement copy. You'll find renewal reminders several months ahead of your final issue on your mail label.

Also, when you renew, if you would be sure to send your correct address (check with your post office) and nine-digit ZIP to Ron Musco, you can help us keep mailing costs as low as possible. For example, in Topeka, "2840 Illinois" is no longer a correct address; "2840 SE Illinois Ave." is complete.

They joined ... Steve Alexsy, Brighton, MI; Thomas "Skip" Arey (rejoins), Cinnaaminson, NJ; Michael Baranich, Warren, OH; Eugene M. Cronin, West Roxbury, MA; and Joe Kureth (rejoins), Uniontown, MA.

DXChange ... For sale: Complete set of *PopCom*, in official binders; make offer to Skip Dabelstein - 3131 Sumter Ave. N - Crystal, MN 55427 ... Sony ICF-2010, in excellent condition, postpaid for \$240.00, by Chris Vito - 8241 SW 15 St, #1122 - Plantation, FL 33324, (305) 424-2170. Also, Richard Steck writes to let us know that the GE Superadio II (7-2885D) has been discontinued by GE and will be replaced by model #7-2887 in September; watch for closeouts on the old model. Finally, Skip received a convention donation from Man From Mars Publications - 159 Orange St -

Manchester, NH 03104, who offer a catalog of airchecks which might be of interest to members. Be sure to mention the NRC if you request the catalog.

Remaining DXN Schedule, Volume 59:

#	Deadline	Pub. Date	#	Deadline	Pub. Date
29.	Aug. 21	Aug. 31	30.	Sept. 18	Sept. 28

DXN Schedule, Volume 60

1.	Oct. 2	Oct. 12	16.	Jan. 29	Feb. 8
2.	Oct. 9	Oct. 19	17.	Feb. 5	Feb. 15
3.	Oct. 16	Oct. 26	18.	Feb. 12	Feb. 22
4.	Oct. 23	Nov. 2	19.	Feb. 19	Mar. 1
5.	Oct. 30	Nov. 9	20.	Feb. 26	Mar. 8
6.	Nov. 6	Nov. 16	21.	Mar. 5	Mar. 15
7.	Nov. 13	Nov. 23	22.	Mar. 12	Mar. 22
8.	Nov. 20	Nov. 30	23.	Mar. 19	Mar. 29
9.	Nov. 27	Dec. 7	24.	April 9	April 19
10.	Dec. 4	Dec. 14	25.	April 23	May 3
11.	Dec. 11	Dec. 21	26.	May 21	May 31
12.	Dec. 18	Dec. 28	27.	June 18	June 28
13.	Jan. 8	Jan. 18	28.	July 16	July 26
14.	Jan. 15	Jan. 25	29.	Aug. 13	Aug. 23
15.	Jan. 22	Feb. 1	30.	Sept. 10	Sept. 20

DX Time Machine

Receptions from the DX log of Max Watkins, Tecumseh, NE: 1923: Oct. 4: WDAO, Dallas, TX; CHBC, Calgary, Canada; CKCK, Regina, Canada; KJJK, Bristow, OK; Oct. 5: WMAY, St. Louis, MO.

From the pages of *DX News*:

50 years ago ... (no *DX News* in July because Editor Ray edge was moving into a new home) from the August 8, 1942 *DXN*: *DX News* carried a 1 1/2 page report on the NRC Convention at Buffalo, NY, on July 4 and 5, where a great time was had by all.

25 years ago ... from the August 19, 1967 *DXN*: The membership was getting ready for the NRC Convention in Eugene, OR.

10 years ago ... from the August 23, 1982 *DXN*: The Louisville Convention was approaching.

2 Concerning Dajja Enterprises ...

Since January of this year, your club's Board of Directors has been attempting to obtain the computer database for the NRC AM Log from former general manager Mike Knitter. Mr. Knitter not only refused to release this database but also claimed it to be his won and announced his own soon-to-be-published AM log by Dajja Enterprises.

Your Board then decided to retain an attorney to protect the club's interests. What follows will be two letters written to date to Mr. Knitter and/or his attorney, and their responses.

Once other point needs to be mentioned. With the refusal of Mr. Knitter, dba Dajja Enterprises, to forward the original Log computer database, your club has been forced to completely reconstruct and totally correct the information from the 1992 NRC AM Log into a new computer database. The end result will be published and available Sept. 1, 1992 - the most accurate Log of its type available today, thanks to many members who volunteered their time and efforts.

What follows will take up several pages of valuable bulletin space, but we believe the membership should be totally informed concerning these matters. Any additional correspondence will likewise be published in subsequent issues.

-NRC Board of Directors

CONNELLY, KAERCHER & STAMPER
ATTORNEYS AT LAW
1410 KENTUCKY HOME LIFE BUILDING
LOUISVILLE, KENTUCKY 40202-3208
(502) 589-2100

MICHAEL T. CONNELLY
ROBERT M. KAERCHER
JEFFREY D. STAMPER
DAVID D. FULLER

March 12, 1992

FAX (502) 589-2881
FAIRDALE OFFICE
(502) 361-5656
MIDDLETOWN OFFICE
(502) 245-9677
VALLEY STATION OFFICE
(502) 935-3140

Mr. Mike Knitter, Editor
Ms. Sue Knitter, Owner
d/b/a DAJJA Enterprises
P.O. Box 24
Cambridge, Wisconsin 53523-0024

via CERTIFIED MAIL

Dear Mr. and Ms. Knitter:

This firm has been retained by the National Radio Club, Inc. ("NRC"), the non-profit corporation of which Mr. Knitter was General Manager until his resignation letter dated January 6, 1992.

It has come to NRC's attention that you are attempting to exploit for personal gain certain assets of NRC, which assets include, but are not limited to, its membership list, its radio log book databases, its name and the P.O. box number made familiar to its members at its expense.

Please be advised that Mr. Knitter's fiduciary duties owed to NRC did not terminate with his resignation.

As General Manager, Mr. Knitter was fully aware of NRC's policy of non-dissemination of its membership mailing list. Use of that mailing list to solicit orders for books directly competing with publications of NRC is a gross and willful violation of the fiduciary duty and position of trust enjoyed by Mr. Knitter while he was NRC's General Manager.

Please be advised further that the NRC mailing list/roster of members belongs exclusively to NRC irrespective of whether Mr. Knitter may have caused it to be typed into a computer during his term as NRC's General Manager.

Please be advised further that the NRC AM Radio Log book, as well as other publications of NRC, belongs to NRC irrespective of whether Mr. Knitter may have caused it to be typed into a computer during his term as NRC's General Manager.

Please be advised further that your Cambridge, Wisconsin P.O. Box number "24" was made familiar to the NRC membership at NRC expense during Mr. Knitter's term as NRC's General Manager.

Demand is hereby made that you immediately cease and desist your wrongful use of NRC's assets and that you immediately cease and desist your attempts to profit personally from matters developed for NRC during Mr. Knitter's term as General Manager.

Furthermore, demand is hereby made that you immediately cease and desist usage of our client's name, initials and/or any variation thereof to indicate falsely and misleadingly any authorization by, association with or approval of NRC with your private endeavors.

Please take further notice that the log books that you are attempting to sell to NRC's membership will be carefully reviewed to determine whether any false and misleading likeness or similarity exists between them and the publications of NRC.

It is unfortunate that these matters have arisen, particularly since NRC is a non-profit organization maintained for the exclusive enjoyment and benefit of its members. You of all people should know of NRC's steadfast policy against exploiting its membership, and you of all people should have been the last ones to try to exploit them for your personal gain.

Such abuses will not be condoned.

Such formal legal action as is necessary to enforce NRC's rights will be taken against you if you fail to comply voluntarily with the demands set forth herein.

Very truly yours,

CONNELLY, KAERCHER & STAMPER

JEFFREY D. STAMPER

JDS/sw
35.s5u

LOUDERMAN, HAYES, VAN CAMP,
PRIESTER, STROTHER & SCHWARTZ, S.C.



ATTORNEYS AT LAW

April 7, 1992

Mr. Jeffrey D. Stamper
Attorney at Law
CONNELLY, KAERCHER & STAMPER
1410 Kentucky Home Life Building
Louisville, KY 40202-3208

Dear Mr. Stamper:

We represent Michael and Susan Knitter and Dajja Enterprises.

Your letter of March 12, 1992, to Mr. and Mrs. Knitter has been referred to us for response.

Mr. and Mrs. Knitter emphatically deny that they are attempting to exploit any assets of the National Radio Club, Inc.

As members of the NRC, Mr. and Mrs. Knitter have access to its membership list. The membership list is not a confidential document or trade secret. Rather, it is a document accessible without qualification to all members of the NRC.

The Federal Communications Commission publishes updated data bases on a monthly basis. The most current, published data base makes prior data bases obsolete. Mr. and Mrs. Knitter have purchased the most current data bases in their possession. Data bases which were purchased by the NRC were returned to the NRC.

Mr. and Mrs. Knitter have never used NRC's name. Further, the post office box in Cambridge, Wisconsin, is leased by Mr. and Mrs. Knitter. As lessees of the P.O. Box, they have a right to use it in their business enterprises.

On behalf of Mr. and Mrs. Knitter and Dajja Enterprises, we hereby demand that the NRC and its board of directors cease and desist from all defamatory actions it has initiated against Mr. Knitter and Dajja Enterprises. Of particular concern are statements made in the March 16, 1992 DX News and in the Volume 1, No. 3 - March, 1992, NRC News.

In the March 16, 1992 DX News, there is a statement entitled "Concerning a solicitation from Dajja Enterprises". The introductory paragraph states that neither Dajja Enterprises nor Mike Knitter have been authorized by the NRC to publish or offer TV, FM and AM listings. Neither Mr. Knitter nor Dajja Enterprises needs permission from the NRC to engage in business. The NRC does not have the exclusive right to publish TV, FM and AM listings. In paragraph 1 of the statement, there is a reference to "any possible irregularity in a mail-order firm's practices." This infers there is something improper or irregular about Mr. Knitter or Dajja's soliciting payment by credit card. This improper inference must be corrected by the DX News. Paragraph 2 states that use of the NRC membership list for solicitation is a prohibited activity. As noted above, as members of the NRC, Mr. and Mrs. Knitter, like all members, have access to the membership list. It is not a condition of membership that the members not use the membership list for solicitation. Paragraph 3 states that Dajja is using FCC listing purchased by the NRC. As stated above, the FCC data bases are published on a monthly basis. The data bases used by Dajja were purchased by Mr. and Mrs. Knitter and not the NRC.

Volume 1, No. 3 - March, 1992, NRC News, is equally defamatory. It states that Mr. Knitter is attempting to "rip the NRC off". As noted twice previously in this letter, the FCC data bases used by Mr. and Mrs. Knitter were purchased by them and not the NRC. All information which will appear in the Dajja logbooks is in the public domain and not a trade secret or confidential information of the NRC. The commentary in the NRC News states "We are uncovering a number of irregularities unrelated to the quality of his management of the club". What are the alleged irregularities? The inference left by this unsubstantiated, defamatory statement in the NRC News must be corrected.

On behalf of Mr. and Mrs. Knitter and Dajja Enterprises, we hereby demand that public apologies for the untruthful, defamatory statements referred to above be published in both DX News and NRC News. In the absence of appropriate, published apologies, we will counsel Mr. and Mrs. Knitter to take all steps necessary to protect their legal interests.

If you have any questions, please contact me.

Very truly yours,

LOUDERMAN, HAYES, VAN CAMP,
PRIESTER, STROTHER & SCHWARTZ, S.C.

Hugh J. Hayes
Hugh J. Hayes

HJH:kak
cc: Michael Knitter and Susan Knitter

ATTORNEYS AT LAW
1410 KENTUCKY HOME LIFE BUILDING
LOUISVILLE, KENTUCKY 40202-3208

(502) 589-2100

MICHAEL T. CONNELLY
ROBERT M. KAERCHER
JEFFREY D. STAMPER
DAVID D. FULLER

FAX (502) 589-2881
FAIRDALE OFFICE
(502) 361-5656
MIDDLETOWN OFFICE
(502) 245-8677
VALLEY STATION OFFICE
(502) 933-3140

July 17, 1992

Mr. Hugh J. Hayes
Attorney at Law
222 South Bedford Street
Madison, Wisconsin 53703

Dear Mr. Hayes:

I am in receipt of your letter of April 7, 1992, and apologize for the delay in responding. The National Radio Club, Inc. ("NRC") board of directors has authorized the following response.

This letter is also prompted, in part, by Mr. Knitter's more recent mail solicitation using the confidential NRC membership list, which use again violated the NRC policy against the commercial use of its membership list. The solicitation this time appears to have been made to all NRC members except members of its board of directors, apparently in an effort to delay the board's discovery of such solicitation beyond certain publication dates.

In reading your letter it is obvious that your clients have been less than candid with you in relating their version of the facts.

For example, your letter states that Mr. and Mrs. Knitter have "unqualified" access to NRC's membership list because they are members. Obviously, your clients misinformed you. The NRC membership list is not, in fact, available to the members on an unrestricted basis. One of the reasons for such policy of protecting the privacy of its members is to prevent the same abuses of contact and misrepresentation as is being practiced by your clients in the instant matters.

But, please, don't take my word for it. Enclosed is a copy of a page of an NRC membership list prepared August 29, 1990. (Please note that I have marked out the members' last names and addresses to protect their privacy). Please note the reference at the top of each and every page, quote:

+++FOR OFFICIAL USE ONLY --- NOT FOR PUBLIC RELEASE+++

The above notification reflects the longstanding official NRC policy. A policy which is certainly not one of "accessible without qualification to all members of NRC," as your clients would have you believe, and as you state in your letter. The copy referred to above came from the membership list prepared by and printed out by Mr. Knitter during his term as NRC General Manager. Surely he would not be so crass as to assert that the membership list is "For Official Use Only" and "Not For Public Release" when he has it as a club official, but such list magically transforms into an unrestricted public document for him to use for his own profit when he ceases to be a club official.

Next, your client has apparently told you that the FCC data base is what will be published in their log. NRC has no problem with that, and never did. However, your clients' solicitation materials promise to print more than the publicly available data. Your clients apparently failed to tell you that the NRC AM Log publication contains so much more than the FCC data, such as station slogans, verification signers, station operating schedules, broadcast programming format specialties, silent periods, exclusive NRC created antenna designators, station address and telephone updates.

These and many more features represent countless thousands of hours of contributions by thousands of NRC members over the past 24 years that NRC has produced its Log. Some members have individually contributed hundreds of hours to verify and update information that was not available elsewhere.

This is the information that NRC owns. This is the information that was entrusted to Mr. Knitter when he was General Manager, and it is this information that it is feared will be stolen from NRC's copyrighted Log. It doesn't matter how your clients may reformat, rearrange or regurgitate the material - if they plagiarize the information it is copyright infringement regardless of the format. Please advise your clients to be very careful to publish only what they own and not what they acquired from the innocent efforts of others.

Next, your clients claim never to have used NRC's name. This is a particularly interesting comment when viewed in the light of some of your clients' solicitations to "Fellow NRC Members" claiming "10 years of Log experience" and so on ad nauseam (Note the capital "L" in Log, and how did he get 10 years experience if not publishing NRC's Log?). These are not uses of the name?

Further, each of these solicitations should be read in the context of asking NRC members to send money to the very same P.O. Box number from which they have purchased official the NRC Log in the past. It doesn't matter whose name is on the P.O. Box lease. What matters is that NRC paid for that box for years, and NRC paid all of the expenses associated with making that box number familiar to its members, and then your clients waltz in and start using it for their private, personal profit. If not violative of laws against misrepresentation, it surely is inappropriate to try to take advantage of the club's members in such a manner.

And while we are on the subject of misrepresentation, what is meant by your client's order blank for the "Completely Revised for 1992 AM Radio Log"? "Revised" from what? Out of one side of his mouth Mr. Knitter professes to be selling original data that he did not steal from the NRC Log, and out of the other side of his mouth he is selling a "Revised" publication. This is your clients' first alleged AM publication. There was nothing to "Revise" it from, unless, of course, it is revised from the NRC AM Log publication.

Or how about this published statement of Mr. Knitter, also taken verbatim from your clients' solicitation cards to NRC members:

"Speaking of log books, I am still editing the world famous log books that you have grown to love over the past 10 years"

Now how could NRC members have fallen in "love" with Mr. Knitter's log book over the last 10 years, when this year is the first of its existence? And how can Mr. Knitter be "still editing" since he has not edited the NRC Log book since he quit in a tiff when the NRC Board tried to limit his abuse of position as General Manager. And how did Mr. Knitter's personal, for-profit log book become "world famous" when it hasn't even been published yet?

The whole mess smells. Your clients' campaign to profit from Mr. Knitter's past association with NRC is designed to mislead the NRC membership into believing things which aren't true. Call it misrepresentation; call it rip-off; call it theft - it doesn't matter what it's called - it's wrong, pure and simple.

I hate even to dignify with a response your clients' claims that they have been somehow defamed in NRC publications. But I will note that truth is an absolute defense to actions for slander and libel. If there is even the slightest doubt about whether NRC can prove the absolute truth of each and every thing NRC has or will publish regarding them, then your clients should file a lawsuit. But before doing so, please make sure that they understand the consequences of filing false and frivolous claims.

Your clients' demand for a public apology, although ludicrous, is respectfully declined. However, I will recommend to my client that it publish in full the correspondence that you and I have had, as well as my original letter to your clients, so that the entire membership of NRC can be informed fully of the extent to which their Board has gone in an effort to protect the integrity of the club and its assets, and to the extent their former General Manager has gone to try to profit off of them.

I have recommended against filing formal legal proceedings against your clients - not because they don't deserve it but because of the prohibitive legal costs that would be associated with such action. Any way you look at it, NRC is still a small, non-profit hobby club that exists solely for the mutual benefit of its members. It does not have the budget to litigate at will (or even to pay me my normal hourly rates). But as limited as its resources are, the club can only take so much.

Again, demand is made that Michael Knitter, Susan Knitter and DAJJA Enterprises immediately cease, desist and refrain from all use of the NRC membership list, from use of "P.O. Box 24" in connection with the members of NRC, from all false, fraudulent and misleading usage of NRC's name and initials, and from publication in any form the fruits of many years' worth of labors of love unselfishly performed by the membership of the National Radio Club.

Very truly yours,

CONNELLY, KAERCHER & STAMPER

[Handwritten Signature]

JEFFREY D. STAMPER

FOR OFFICIAL NRC USE ONLY --- NOT FOR PUBLIC RELEASE ---

File:	Active Domestic					
Report:	List w/Duplicate					
Last Name:	First Name:	Address:	City:	St:	Zip Code:	Due Date:

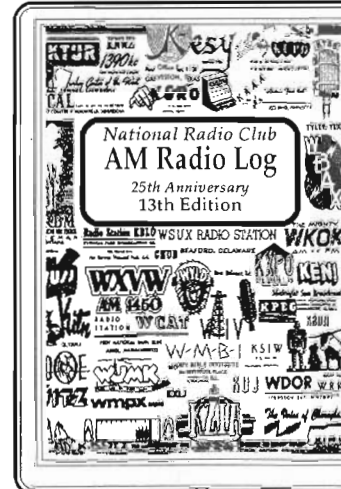

The NRC AM Radio Logbook, 13th Edition, is the most accurate AM radio listing of stations in the U. S. and Canada. Only \$16.95; Canada \$17.95 to U. S./Canadian NRC Subscribers ONLY. \$19.95 to U. S., Non-NRC Subscriber; \$20.95 Canadian Non-NRC Subscriber. Others - please write. Remember - your purchase benefits the NRC.

Mail to: NRC Publications - Box 164 - Mannsville, NY 13661 (NY residents add sales tax). Or pick up your copy at Omaha!

Problems, problems?

We can't solve all your woes, but we can solve your DX News problems. Torn, soiled, partially-printed, MIA, or worst of all, delivered in a USPS plastic baggie? No need to return the copy - just end a postcard to NRC - 2840 SE Illinois Ave. - Topeka, KS 66605, and a replacement copy will be mailed free. Missing back issue? Replacement copies from Vol. 56 on, to current NRC members only, are sent for the cost of first-class postage (29¢ for a 24-pager, 52¢ for a 48-pager). Quantities of 24 may be sent book rate for \$1.48.

See? No problem!

AM Switch

Jerry Starr
c/o WHOT Radio
4040 Simon Road
Youngstown, OH 44512-1320

Status changes in AM stations, supplied by the FCC and listeners

CALL LETTER CHANGES

Old call	New call	Old call	New call
730 WVIC MI East Lansing	WVFN	1330 WYWR OH Campbell	WZKC
850 KTAC WA Tacoma	KMTT	1360 WBKN NY Binghamton	WKOP
900 WKAJ NY Saratoga Spg.	WBGJ	1400 WIKY IN Evansville	WJPS
1110 KXSA AR Dermott	KGPL	WAMQ PA Loretto	WJRV
1260 WVLC SC Lake City	WRIP	1460 WFVY FL Jacksonville	WZZN
1290 KLVS OR Lake Oswego	KPHP	1480 KMMZ TX San Antonio	KCHL
WOOV WI Sparta	WKLJ	1530 WEHN PA North East	WFLP
1300 WFXN NC Goldsboro	WSSG	1560 WCDN OH Chardon	WATJ
WKAZ WV Saint Albans	WOOZ	1570 WOBS IN New Albany	WZOC

APPLICATIONS/GRANTS FOR NEW STATIONS

None

APPLICATIONS FROM EXISTING FACILITIES

550 WASG AL Atmore: day power to 25000 watts (see Mike Collins' excellent article in the last DX News for an outline of the recent NARBA reclassifications which may let a few stations on "regional" frequencies operate with more than the traditional 5000 watts. So far the FCC has not initiated any rule making to give the green light to any of these applications. With the congestion that already exists on these Class B frequencies it is doubtful that more than a handful of stations would be able to meet the interference minimums and still achieve a meaningful increase in power. Time will tell.)

640 WROR MI Zeeland: reduce night power to 230 watts

1160 WMVI NY Mechanicville: day power to 50000 watts, city of license to Clifton Knolls, NY (reapplication)

KSL UT Salt Lake City: install DRRR antenna as auxiliary (Wow! For those of us who are antenna freaks this is stunning news. The Directional Discontinuity Ring Radiator is a radical antenna design used primarily on high and VHF frequencies. It consists of a circular horizontal radiating element very near the earth over a ground screen. We have never heard of it being proposed for use in CB frequencies. By our figures for 1160 the antenna would consist of a 67-foot diameter circle of 6 to 12 inch pipe about 5 or 6 feet above the ground. VERY interesting!)

1460 KENO NV Las Vegas: day power to 30000 watts (see 550 above)

1500 KUMU HI Honolulu: powers to 50000/50000

GRANTS TO EXISTING FACILITIES

670 KMVP CO Commerce City: relocate transmitter site (new station not on the air yet)

1060 KFIT TX Lockhart: city of license to Sunset Valley, TX

1120 WUST DC Washington: powers to 20000 day (3000 CH)

1200 KTCD CA Eureka: night power to 2500 watts, city of license to Cottonwood, CA

1230 KWIX MO Moberly: changes in antenna system

1350 WCRM FL Fort Myers: day power to 5000 watts

1400 KTUC AZ Tucson: reduce powers to 757/757 (change necessary to facilitate diplexing into the tower of KJYK-1490)

1500 KRCK CA Burbank: changes in antenna system

OTHERNESS

590 WWLX TB Lawrenceburg: silent station is ON THE AIR

650 KUUY WY Orchard Valley: application to change city of license to Cheyenne is DISMISSED

800 WOOM MA Lawrence: although there is no night power shown for this station in any listing we can find or even in the FCC's own database, they ARE licensed for 250 watts at night and, in fact, operate until midnight every night. This info directly from WOOM

880 KWIP OR Dallas: silent station is ON THE AIR

890 KPTO CA Citrus Heights: application to change city of license to Sloughhouse, CA is DISMISSED

910 CKLY ON Lindsey: station is SILENT

1260 WBBK GA Blakely: station is SILENT

1270 WVKY KY Louisa: silent station is ON THE AIR relaying WPKE

1290 KPHP OR Lake Oswego: application to raise day power to 25000 watts is DISMISSED

1320 WAGF AL Dothan: the FCC recently issued a show cause order looking toward revoking the license of this long silent station. Now a new owner has come forward so this one may have been saved in the final round.

WFRK FL Coleman: license for this long silent station has been CANCELLED and call letters DELETED

1410 KCOL CO Fort Collins: application to increase day power to 5000 watts has been DISMISSED

1420 KSES CA Yucca Valley: station is SILENT

KBIL TX San Angelo: license renewal of this silent station has been DISMISSED

1440 KPUR TX Amarillo: station is SILENT (as is their FM)

1450 CHCL AB Medley: station is SILENT (40 watter at a Canadian military base called Cold Lake. This should really help clear up that nasty interference on 1450)

1460 WBPA KY Elkhorn City: silent station is ON THE AIR relaying WPKE-1240 as is WVKY (see 1270 above)

1500 WSMX NC Winston-Salem: station seems to be SILENT, not heard on the air and phone number now gets answering machine at an advertising agency

1510 WPSC SC Pageland: after repeated attempts to contact the licensee of this station, silent since 9/89, the FCC has REVOKED its license and the call is DELETED

1520 WHRF MD Bel Air: silent station is ON THE AIR

1550 WOR1 TN Oak Ridge: at the request of the owner the license of this long silent station is CANCELLED and the call letters DELETED

WVAB VA Virginia Beach: silent station is ON THE AIR

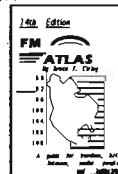

Bruce Elving's FM Atlas...14th Edition

The world-famous guide which has served FM DX'ers for over 20 years is now available from NRC Publications at the special price of \$12.00. NY orders, please add sales tax.

CONSTRUCTION PERMITS CANCELLED

The FCC recently went through a major housecleaning effort and has CANCELLED the Construction Permits of these new but never built AM stations. In addition, the call letters of each station has been DELETED. Some of these CPs have been laying around for years and others are fairly recent but all of them are now history. Your new NRC AM Log will, of course, reflect all these changes but to keep you up to date until then here is the list of cancellations.

600	WICI	IN	Ellettsville	1120	KCHN	MN	Jeffers
	WXIK	NY	Brownville		WLJH	MS	Denham Springs
650	WRUB	MD	Pittsville		WKMP	NC	Rocky Mount
670	WAQX	NY	Syracuse	1160	WTFW	FL	Woodville
710	KKMT	MT	Ennis	1170	WMPP	DE	Laurel
720	KVGR	CA	Templeton		WARN	VA	Falmouth
	WNOC	NC	Wake Forest	1180	WBOQ	PA	Quakertown
	KSWX	WA	Long Beach		WLRG	SC	Timmonsville
760	WAFK	AL	Saraland		KCLP	TX	Amarillo Township
810	KXDS	HI	Princeville		WNDR	VA	Danville
870	WSAG	CT	Poquonock	1200	WJHP	MS	Columbia
880	WARH	VA	Dayton		WBYY	NC	Atlantic Beach
890	KCBB	CO	Stratmoor		WWRJ	SC	James Island
	WREE	GA	College Park	1230	KZNE	NE	Chadron
	WJFG	NY	Solvay	1250	WARP	ME	Bangor
	WPGP	SC	Pendleton	1290	WRFS	VA	Garrisonville
	WLJD	VA	Falmouth	1330	WMII	TN	Hendersonville
950	KAJD	AK	Juneau	1340	WDXW	MI	L'Anse
980	WJIW	NY	Cazenovia	1360	KOBG	AK	Wasilla
1000	WMDE	GA	Remerton	1570	WBND	FL	Pensacola Beach
1010	KOUS	MN	Sartell		WLVZ	OH	Athens
1020	WBSH	AL	Heflin		WMPS	WV	Elk Hills
1030	KGZA	NV	Boulder	1600	WTKS	ME	Brewer
1040	WANQ	NY	Delmar		WLMO	NY	Geneseo
1060	KWQA	TX	Hawley		KCDV	WA	Dungeness
1100	KDHB	NV	Las Vegas				

With the FCC getting tough on their promise to not let unbuilt CPs languish in their files through endless extension requests, you can probably expect to see other stations being added to this list soon.

WOW! What a huge AM Switch. I'll need the next month to recover from this one.

THANKS: Dave Schmidt, Jack Parks, Al Merriman, Ron Musco, John Bowker, Eric Bueneman, Dick Burns and M Street Journal

73 and Good DX, *Jerry & BKF* Jerry Starr & Buffalo K. Fooman

Music Grade audio cassettes

C-90 tapes: retail value ... \$4.00 each; just \$9.00 per 10, \$22.00 per 25, or \$42.00 per 50.

C-12 tapes, perfect for airchecks: 10 for \$7.50.

Order from NRC Publications - Box 164 - Mannsville, NY 13661. NY orders, please add sales tax.

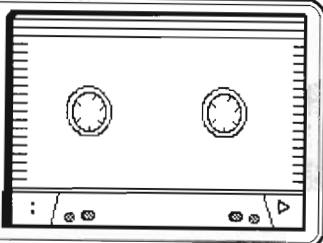

Domestic DX Digest

William Hale

15366 La Paz Avenue, #110
Victorville, CA 92392

DX Catches in the Eastern U. S. and Canada, with 24-hr. ELT

MEDIUM WAVE RAMBLINGS

- Please observe the deadlines for this column, which are always one week prior to the deadlines published in DX News. This is necessary because it takes a week from final preparation (usually a Sunday) to arrival at HQ. Again, here are the DDXD deadlines for the rest of this Volume Year. **Issue 29 August 15 . . . Issue 30 Sept 12.**
- Word from **Charles Reh** of Leamington, Ontario is that the **Star Country** network is "belly-up" and that **CHYR-7 Leamington** (and it is assumed all other former **Star** affiliates) is/are now carrying **Country Coast-To-Coast** from SRN. This item should have ran last issue, but I misplaced the paper on which it was written, and just found it. Excuses, excuses, excuses!
- Welcome Back, **Joe Kureth**, who recently rejoined the NRC. Joe checked in with his updated **Graveyard Totals . . .** maybe some good Uniontown DX next time?
- I received an unsolicited catalog from an outfit called **Broadcast Pro-file** in Hollywood, CA. Seems this outfit has station history profiles on thousands of stations throughout the nation. I can imagine these would be pretty interesting to anyone interested in those things. I would be, but not at \$10 a pop. If you'd like their address, send me an SASE with your request.
- A new station signs on, two return, and another is off again. Details, and other stuffings, below . . . And thanks to **Bill Hardy** and the vacationing **Todd Brandenburg**, you left coasters have something to read this issue.
- See you next issue from Idaho (along with a new address)!!

THE EAST

SPECIAL

- 640 WWJZ NJ Mount Holly** - 7/4 1016-1103 Good signal with transmitter tests. Brand new station!! On much of the day. (HH-MD)
- 910 WLAS NC Jacksonville** - 6/30 0550 Noted carrier on. 0559 Into brief instrumental music to brief **sign-on announcement and mention that station was now HOT NEWS TALK RADIO and → CBS News**. Checked frequency several times prior, first noting woman announcer on 6/24 with continuous, repeating voice IDs as **AM 910, WLAS Jacksonville**. This testing continued until 6/29 when noted off at 0525 (noted with ID at 0425 ✓). At 0550, a new repeating announcement by a man was noted **Regular programming resumes Tuesday morning at 6 O'Clock, on 910 AM WLAS Jacksonville**. Tape was heard throughout the day until 6/30 0530 when carrier was noted off. Additional announcements included: promos for **North Carolina Wolfpack** football; **Hot Talk** with **Charles Adler** is on at both 0645 and 1700 with phone number of 1-800-878-TALK; News on the hour from USA Radio Network; Frequent mentions of Sun Radio Network; promos for . . . **upcoming sports from ESPN**; feeds from Sun Radio Network meant for off-air taping frequently heard (someone asleep at the switch, hl); poor (or non-existent) signal noted while driving to Wilmington, NC (50 miles SW of Jacksonville). Still 5kw as listed and announced?? New studio address is: 535 Bell Fork Road, Jacksonville, NC 28540. (MH-NC)
- 1250 WXOX MI Bay City** - on again/off again station first noticed **silent again 6/12**. (TS-MI)
- 1340 WLAV MI Grand Rapids** - as of 6/22, is running **Juke Box Oldies**, (the old SMN **Kool Gold** format). Ex: AOR | FM. (PLB-MI)
- 1480 CKAN ON Newmarket** - station which had been silent since March **went back on the air in mid-May** with help from local advertisers. Format is Adult Contemporary and slogan is **Energy 1480**. (MS-ON)



UNIDS AND UNID HELP

- 690 CBU BC Vancouver - most likely SA-MB's unID in 6/8/92 issue. They've been running 24 hours, using *CBC Stereo* (FM) format of offbeat music during their former silent period of 0400-0830. (BH-WA)
- 1090 CKKW ON Kitchener - could be Gary Mitchell's unID (Issue 26), as they do use slogan *AM-109*. (MS-ON)
- 1300 WOOD MI Grand Rapids - is likely Doug Smith's unID of 5-15. No such town, but Plainfield Avenue is a major street in northeast Grand Rapids. (TS-MI) [This, along with the data in last issue pretty well socks it - Ed.]

TIS & OTHER STUFF

- 521 INE MT Missoula - 7/5 0617 NDB repeating *INE* in code. Good signal. (VALDX)
- 530 GA Chickamauga NMP - 6/8 1100-1230 No CLs, but info included historic significance of the park and visitor center programs. (TS-GA)
- KY Williamsburg - 6/10 1230-1300 No CLs. Visitor info for Southeast Kentucky and the Cumberland Gap region. (TS-KY)
- OH Lima - 6/10 2330-2345 No CLs. What to see and where to eat out in Lima. Who else would be listening at this late hour? [Fred Vobbe? hi - Ed.] (TS-OH)
- VA Quantico - 6/4 1100-1115 No CLs, but good signal with long message including info on points of interest within Quantico Marine Base. (TS-VA)

MIDNIGHT TO 0800 HOURS ELT

- 640 WOI IA Ames - 7/5 0103 Poor with BBC News. Under CFOB. (VALDX)
- CFOB ON Fort Francis - 7/5 0429 Good with CFOB and 64-CFOB Hits & ROK music. (VALDX)
- 700 CKRD AB Red Deer - 7/5 0432 Good with CKRD and Radio 7 IDs → AC and oldies music. (VALDX)
- 710 KIRO WA Seattle - 6/20 0230 Good with call-in show in regard to Father's Day. (TB-WA)
- 740 KCBS CA San Francisco - 6/23 0305 With CBS News, KCBS ID and local weather. (TB-WA)
- 810 KGO CA San Francisco - 6/20 0236 Good with call-in program. (TB-WA)
- 840 KVEG NV Las Vegas - 6/22 0400 Legal ID after sports program. (TB-WA)
- 1130 CKWX BC Vancouver - 6/22 0248 Ads for Countrywide Lakeview Realty and Stacy's Furniture. C&W program | CFAC-960 Calgary. (TB-WA)
- CKWX BC Vancouver - 7/5 0550 Strong with CKWX ID, local ads, C&W music. (VALDX)
- 1160 KSL UT Salt Lake City - 6/22 0306 *Coast To Coast with Bob Costas on KSL*. (TB-WA)
- 1240 WVO NY Liberty - 5/20 0051-0105 Poor with oldies and BBD. News at 0100. *WVO5---1240*. QRM from unID. (DT-ON)
- 1320 CHQM BC Vancouver - 7/5 0600 Good with time check and ID → news. (VALDX)

0800 TO 1600 HOURS ELT

- 870 WQRX AL Valley Head - 6/8 1000-1300 With CH/classic rock and many promos for upcoming *June Jam* in Fort Payne, Alabama. Great to hear this music on AM! WQRX slogan is *Just what the doctor ordered*. Serves Chattanooga, but is on Central Time. (TS-GA)
- 1450 WOL DC Washington - 6/4 1000-1100 With *Black Music Month* tributes. Blues, Hendrix, Motown all in one hour. Lost them in Fredericksburg, VA. (TS-VA)

Are you expiring?

We hope not! To avoid expiration, mail your remittance to the *DX News* Membership Center early. Allow at least three weeks after mailing your check or money order for new renewal data to appear on your *DXN* mail label.

1600 TO 2400 HOURS ELT

- 950 WRUL MA Boston - 5/26 2050-2130 Man talking in SS (REL?). At 2100 man singing in SS and more SS talk. No interference, but poor with deep fades. (DT-ON)
- 1240 WHVN NC Charlotte - 6/14 2045-2121 With REL, ad for Billy Graham. promo for program . . . *weekdays on WHVN*. Poor, over/under WJTN. (DT-ON)
- 1340 WVNR VT Poultney - 6/16 2222-2340 With *Yankees vs Red Sox* pbp on *Yankees* network. Sign-off at 2350 with CLs. Poor, under unID. (DT-ON)
- 1370 WWCB PA Corry - 6/13 2115-2126 With rock oldies, sports scores, weather, ID as *CB 1370* with sounds of rockets going off. (DT-ON)
- 1450 WMGP MS Meridian - 6/3 2158-2205 With talk show, sports news, weather, *WMGP forecast*. Poor under unID. Verie in for this already. MS #1. (DT-ON)
- 1450 WGNS TN Murfreesboro - 6/3 2211-2230 With talk show, Call letter ID at 2230. Poor, over/under unID. Verie in for this already! (DT-ON)
- 1480 WSDS MI Ypsilanti - 5/4 2115-2120 With C&W mx, request phone numbers, *AM 1480 WSDS*. Under WHBC. (DT-ON)
- 1550 WBSC SC Bennettsville - 6/5 2128-2157 Poor, over/under CBE with *Oldies 155 WBSC*. (DT-ON)

THE WEST

SPECIAL

- 840 KDBS OR Eugene - 6/20 0520 With adcon music. Expected CKBX 'til an ID sounded like *KBBS Eugene, the station that wants to make you a star*. Had to look back to 12/28/91 AM Switch to find correct calls, which were listed on 860 kHz! Good, over/under KVEG. (BH-WA)

TIS

- 1610 UT - 7/6 1200 TIS noted with standard *what to see and what to do* info for Bryce Canyon National Park. Antenna (which looked like a CB base station) noted on Visitor Info Center on Northbound side of I-15 at about mile marker 40. Signal seemed strongest there, so assumed it was XR site. No call letters noted over 20 minutes or so of monitoring until signal faded out. BOY! When they say *Canyons*, then really mean it!! [Ed-UT]

MIDNIGHT TO 0800 HOURS ELT

- 540 CBK SK Watrous - 6/20 0203 With CBC News and local weather. (TB-WA)
- 570 KVI WA Seattle - 6/20 0208 KVI mentions between oldies records. (TB-WA)
- 610 KYJC OR Medford - 6/17 0241 With *country format*, ex:SMN adcon, *K-97 FM, Hot Country Hits*. Call letters KYJC-AM-FM given in hourly legal ID only; 96.9 had been KFMI. Appears to be 24 hours on weekends and off 0400-0800 weekdays. Good, atop KFRC, in KONA null. (BH-WA)
- 650 CKOM SK Saskatoon - 6/20 0215 Fair with Top 40 music. (TB-WA)
- 660 CFFR AB Calgary - 6/20 0224 With oldies and singing *CFR* jingle. (TB-WA)
- 670 KBOI ID Boise - 6/20 0222 Very strong with a C&W tune. (TB-WA)
- 680 KNBR CA San Francisco - 6/20 0225 Very strong with sports talk show. (TB-WA)
- 690 CBU BC Vancouver - 6/20 0226 Good with CLA music. (TB-WA)
- 700 CKRD AB Red Deer - 6/20 0229 Red Deer promo & list of songs played. (TB-WA)
- 790 CFCW AB Camrose - 6/15 0613 *Country Coast-to-Coast, Time Zone Roundup* (gives time checks Pacific thru Newfoundland zones), country music. Good atop KGMJ's Talknet. (BH-WA)
- 860 CFPR, BC Prince Rupert - 6/15 0528 Presumed them | CBU-690 with CBC-FM all-night show. Strong signal, some 40-watt relay transmitters carry this too, but CFPR most likely with 10,000 watts. Not needed here, but rarely this strong. (BH-WA)

- 14
930 **KROE** **WY Sheridan** - 7/12 0700 Satellite C&W ending. Expected an ID from KBFW, fell out of my chair at *KROE* ID! Stayed with it 'til 0706 to record a nice, legal ID. Map says they shouldn't be 5,000 watts until 0730 (unless they were testing). Quite good in KSEI null. (BH-WA)
- 940 **CJIB** **BC Vernon** - 6/15 0622 *Oldies Coast-to-Coast*, local ad. Good thru hard-to-permeate KFRE. (BH-WA)
- 1340 **KWWW** **WA Wenatchee** - 6/15 0644 Up thru the mess with end of NBA basketball report, *K-W-3* jingle, oldie *Good Golly, Miss Molly* | unID on 1360. Noted in 1991 with BRN biznews. (BH-WA)
- 1360 **KPOP** **CA San Diego** - 6/15 0700 Caught legal ID between *Talknet* and NBC News. Last logged years ago as KGB! Poor with KKMO off, and also an unID satellite oldies station (KRKK?). (BH-WA)

0800 TO 1600 HOURS ELT

- 920 **KSHO** **OR Lebanon** - 7/12 0835 Ending ads/PSAs, *Albany likes the show* . . . *KSHO* → SMN Stardust nostalgia music. Good in KQEU null. Ex:K GAL. (BH-WA)
- 1050 **KEYF**, **WA Dishman** - 6/16 0805-0817 With rock oldies, lots of *Oldies 101.1* slogans and a jingle at 0811 for *Oldies 101.1, Spokane*. This matches KEYF-FM format noted in Spokane last summer. KEYF-AM format last year was nostalgia music, so 1050 joins the *Format of the Month Club*, hi. Good over CICF and one or more religious stations. (BH-WA)
- 1340 **KLOO** **Corvallis** - 6/14 0851 Adcon or oldies, PSA for *Corvallis Art Center*, two mentions of KLOO. Good atop channel. Fairly rare here compared to KFLY-1240. (BH-WA)

- PLB-MI Philip L. Boersma Spring Lake, MI;
TS-xx Tom Sanders Davison, MI; ICF-2010 or I-95 in Northern VA or Chattanooga, TN or Chickamauga NMP, GA or other towns listed in TIS section; all with JVC Caradio
- DT-ON Don Treford Scarborough, ON;
TB-WA Todd Brandenburg, KA/KAN/7 Topeka, KS visiting Spokane, WA; DX-440
MH-NC Mike Hardester Jacksonville, NC
VALDX Shawn Axelrod & Wayne McRae, Valhalla Beach, MBDX Site; Icom R-70 w/PLAM Board & 4 kHz filter attached to west and south Beverage antennas
- BH-WA Bill Hardy Aberdeen, WA; Yaesu FRG-7, Radio West Loop
MS-ON Morris Sorensen Scarborough, ON;
Ed-UT Editor, N5SZC/6 I-15 near Bryce Canyon NP, UT; Deloo AMS/FMS ETR

REPORTERS

WCHY AM/FM
P.O. Box 1247
SAVANNAH, GEORGIA 31402

73, Bill



Starting now, for issue #29, deadline about August 14 ... depending upon the reporting zone in which you live, you should send your DDXD reports to the DDXD section editor in your zone: North (including Canada): Bill Hale, Boise, ID (use 15366 La Paz Avenue, #110 - Victorville, CA 92392 until he is able to announce his new address); East: Dave Braun - 11 Mill Bend Acres - Wyoming, DE 19934-9523; and South - Duncan Shaw - 15 Mooring Road - San Rafael, CA 94901-3514 until September 1 and then to 3131 S. McClintock B111 - Los Angeles, CA 90007 after September 1.

The partition is to divide the work load more or less evenly among the three editors, and if for some reason it doesn't work out, we'll come up with another one. Also, if you live close to a borderline and feel that a report would be of more

use sent to another editor, use your common sense and good judgment in directing it.

Meanwhile, our thanks to Bill Hale for taking on an extra workload for several months while we've been waiting for his next destination to become final. And to those of you who volunteered to edit DDXD, thanks - and don't be afraid to volunteer again if you weren't chosen this time. - The Publisher

International DX Digest

Jim Renfrew

61 Wilcox Street
Rochester, NY 14607-3832

Foreign DX Catches. Times are UTC; for ELT, subtract 5 hrs.

Just when I thought we'd seen the last of the spring loggings, we get yet another demonstration of amazing DX in Newfoundland. By the way, Jean uses SIO (an abbreviated SINPO code), with Signal strength, Interference, Overall rated on a 0-5 scale.

I had just decided to pick up and move to Newfoundland, when the Trans-Pacific loggings from coastal Washington and British Columbia came in. Maybe I'll move there instead!

Shawn Axelrod tells the sad story of up to 4000 feet of beverage wire inadvertently plowed under the mud by a zealous farmer up at Valhalla Beach. It gives a new meaning to "terminated beverage".

In recent columns I have dispensed with most abbreviations to make your reading of IDXD less tedious. I hope you find it more digestible.

at 0041. [JB-NF] 1431 ENGLAND Breeze AM, Southend 6/18 0032-0043 - Gaining strength with old pops, weather at 0033, 3 IDs copied, SIO 222 up to 333. [JB-NF]

1449 CIS unknown site 6/18 0026-0031 - Light classical music // 1431, 0029 Moscow Interval Signal, news in Russian at 0030. Terrible hets, SIO 222. [JB-NF]

1544 CLANDESTINE R. Nacional de la Republica Saharani Democratica 6/17 2326-0007 (first noted on this frequency (ex-1355) on 6/14) - News and views in Arabic till 0000 when into Spanish with full ID announcing 1544 and 576 kHz. The latter was not heard; then news and anti-Moroccan commentaries. Heard them s/off with an anthem at 0105 on 6/14. SIO 344. [JB-NF]

TRANS-ATLANTIC

- 612 IRELAND RTE, Athlone 6/14 0152-0156 - Pop music, DJ had list of "world's most resistable women (top of the list were Sinead O'Connor and Madonna), then hip-hop music. SIO 333. [JB-NF]
- 1188 BELGIUM BRTV, Kuurne 6/18 0109-0149 - C&W songs and rock music, Flemish talk including a long report from Copenhagen 0133-0143, then song in German, SIO 232. [JB-NF]
- 1278 IRELAND RTE (2 sites) 6/18 0100-0102 - News of English football hooligans in Sweden, splatter from CJCB-1270, SIO 333. [JB-NF]
- 1359 SPANISH MOROCCO RNE, Melilla 6/18 0011-0015 - Huge signal, man talking about events on that day in history: Treaty of Alce and the Battle of Waterloo, SIO 443. [JB-NF]
- 1367 ANGOLA Luanda 6/18 0009 - Noted in passing with pop music, male announcer in Portuguese but the audio was muffled. SIO 243. [JB-NF]
- 1386t GREECE, probably Athens 6/14 0208-0236 - Unusual slow emotional music with mid-eastern flavor; I think the female DJ was speaking Greek, but I'm not sure (not Arabic!). SIO 232. [JB-NF]
- 1431 CIS unknown site 6/18 0028-0043 - Light classical music // 1431, news, something with telephone numbers at 0037, seemed end of news at 0041, song by the Beatles, SIO 343 at 0028, but 322



PAN-AMERICAN

- 655 EL SALVADOR YSS/S 7/4 0312-0330 - Up to very good with what sounds like Spanish elevator music, ID'd as "R. Nacional de Salvador" [CV-FL]
- 660 ST LUCIA R. St. Lucia 7/4 0250-0310 - Light pop music into brief inspirational program, then full ID with mention of FM frequencies and sign-off. Very good signal. [CV-FL]
- 780 VENEZUELA R. Coro 7/16 0445 - Fair under WBBM, with music, time checks, and R. Coro singing ID. [JR-NY]
- 970 MEXICO XEMBB, Mérida 7/4 0345 - Up out of nowhere with spots and call mention into Spanish ballad. [CV-FL]
- 1020 VENEZUELA Mundial Margarita 7/15 0746 - Fair in KDKA null, music, "Mundial" slogan. [JR-NY]
- 1110 BRAZIL unid station 6/14 0002-0016 - Pips at 0002, ID (garbled!) then program from Ministry of Education, "Radio MEC" about Environment Conference and educational matters. Disappointed not to ID! SIO 343. [JB-NF]

- 1120 BRAZIL Radio Paulista 6/14 0028-0033 - Possible ads in rapid Portuguese, many IDs (simply as "R. Paulista", not R. Mundial Paulista as in WRTH) and time checks. SIO 232. [JB-NF]
- 1190 BRAZIL Radio Tropical 6/14 0020-0027 - Telephone conversation, music program, promo, ads, clear jingle ID just before 0027, SIO 243-2. [JB-NF]
- 1290 VENEZUELA R. Puerto Cabello 6/15 0053-0113 - Program for Portuguese in Spanish and Portuguese with news reports in Portuguese regarding elections and parliament in Portugal; long ad string 0100-0111:30, SIO 233. [JB-NF]
- 1330 HAITI Port-au-Prince 6/7 0203-0235, 0659-0701 - Initially mixing with Quebec station, in Haitian-accented French with news, ad with telephone numbers at 0232, lively music and hyper DJ. At 0659 in Creole with talk about a masquerade, slogan, lively music. At 0215 SIO 322, at 0659 SIO 343. [JB-NF]
- 1550 BOLIVIA R. Em. Canaravi 6/14 0106-0112 - Heard again! with news, two definite IDs, Andean flute music, SIO 343. [JB-NF]
- 1555 CAYMAN ISLANDS R. Cayman 6/18 0645-0730 - Presumed, het only, noted for about an hour. [DX*WA] 7/5 0330 - Solid signal with music and talk. This is heard every time we go up to Valhalla Beach. [DX*MB]
- 1600 PUERTO RICO WLUZ Radio Luz 6/15 0030-0034 - Old time LA music promo for program "La Montaña Canta", ID at 0032: "Desde Bayamon, Puerto Rico, transmite WLUZ Radio Luz, 1600 kHz ... el mundo de sus recuerdos." Boston is inaudible these days, frequency dominated by WLUZ, SIO 243. [JB-NF]
- 1610 ANGUILLA Caribbean Beacon 6/18 0630-0730 - Monitored for more than an hour over-rising several TIS signals, sometimes reaching S-7 levels. Much modern pops, plus much talk and telephone numbers by Dr. Gene Scott. He was very insistent that "at least 10,000 of you out there must call me" presumably to pledge support. Also talked about a "super 4th of July"; sometimes excellent levels. [DX*WA] 7/5 0400 - Religious program in English. Alone on frequency, no TIS heard. [DX*MB]

TRANS-PACIFIC

- 531 AUSTRALIA UNID 6/25 1229 - English audio, this is usually 2MC, West Kempsey. Very poor and dropping (15 minutes after local sunrise). [DX*BC]
- 576 UNID 6/25 1230 - English audio, very poor level. [DX*BC]
- 585 UNID 6/25 1231 - English audio at 1231, very poor level. [DX*BC]
- 612 AUSTRALIA UNID 6/25 1227 - English audio, poor level, 4QR Brisbane is probable here. [DX*BC]
- 702 AUSTRALIA 2BL, Sydney 6/19 1204 - Excellent level with ABC news. [DX*WA] 6/25 1202 - With ABC news read by a male announcer, poor level. [DX*BC]
- 738t TAHITI RFO 6/18 0630-0730 - Presumed, het noted, nothing after 0730. 6/19 0810 - Good levels with island music and talk // 6135.3 and 15170.2. [DX*WA]
- 747 JAPAN JOIB, Sapporo 6/18 1110 - Low-level talk by male in definite Japanese at 1110. [DX*WA]
- 738 AUSTRALIA 2NR, Grafton 6/18 1200 - Presumed, ABC news not // to 9580 at 1200. There also seemed to be a Chinese or Korean station beneath. Fair to good signal. [DX*WA]
- 765 UNID 6/19 0842 - English programming, presume Australia, fair to poor. [DX*WA]
- 774 JAPAN JOUB, Akita 6/18 1117 - Low-level talk by male in definite Japanese at 1117. [DX*WA]
- 774 AUSTRALIA 3LO, Melbourne 6/18 1215 - With news until 1215, good signal. 6/19 0817, 1015 - Presumed, with *English-speaking male announcer at 0817, very low level, poor at 1015 also. [DX*WA]
- 783 NEW ZEALAND 2YB, Wellington 6/19 0920 - Presumed, English programming, poor level. 6/19 1200 - With Maori language talk and music show (is ethnic access channel part-time now), Maori programming noted at various times from 1000 until 1200 or so (later than WRTH schedule). Many mentions of New Zealand towns in news segments. [DX*WA] (I'll mention here that transmission schedules have been curtailed in New Zealand due to scarcity of hydro power during drought, which probably affects program schedules also- Jim)
- 828 JAPAN JOBB, Osaka 6/18 1118 - Mostly he with some Japanese talk breaking through at 1118. [DX*WA]
- 828 AUSTRALIA 3GI, Sale 6/25 1150 - Presumed with light English rock/ballads, very poor. [DX*BC]

- 830 HAWAII KIKI, 6/18 0800-1000 - Was given QRM throughout the night by a Spanish station (presumably KPLS). The Spanish station was a call-in/talk format. [DX*WA] 6/25 1155 - "83 Rock" plus mentions of Honolulu, running S-7. [DX*BC]
- 837 JAPAN JOQK, Niigata 6/18 1119 - Presumed, het plus some Japanese audio at 1119. [WA*DX]
- 837 AUSTRALIA 4RK, Rockhampton 6/18 1217 - Presumed, with Aussie talk at 1217. 6/19 0925 - Fair to very poor with English ballads. [DX*WA] 6/25 1159 - Presumed with threshold level talk at 1159, ID was impossible. [DX*BC]
- 873t AUSTRALIA 6/19 - English talk show, unid Aussie, 2GB, Sydney, most probable. [DX*WA]
- 891 FIJI R. Fiji 2, Lautoka 6/19 0819 - Excellent signal with female in Hindi at 0819. [DX*WA] 891 AUSTRALIA 4RR, Townsville 6/19 1221 - Fair to good with an ad string, ballads - believe 5AN, Adelaide, was audible beneath. [DX*WA]
- 945 UNID 6/19 0930 - English programming. [DX*WA]
- 963 UNID 6/19 1221-1232 - English programming, poor level, Australia or New Zealand both possible. [DX*WA]
- 1008 NEW ZEALAND 1ZD, Tauranga 6/18 1220 - Presumed, with English programming. 6/19 0822, 0930, 1020 - With light English rock music, poor at 0822, poor at 0930, very good with talk of Kiwi politics at 1020. [DX*WA] 6/25 1214 - ID as "Zed D", fair on New Zealand beverage. [DX*BC]
- 1008 UNID 7/5 0930 - Good solid het for about 40 minutes with bits of audio in possible Japanese. Third time we heard bits of audio but no ID, so far suspect JONR. [DX*MB] (Shawn also reports hets on 756, 747, 1017, and 1035 during this same time period - Jim)
- 1017 TONGA - 6/18 0800-1000 - Presumed, with het noted after 0800, seemed to leave the air after 1000. 6/19 0815 - Noted with island talk (Tongan?), very strong carrier but barely any audio, transmitter or mike trouble. [DX*WA]
- 1026 NEW ZEALAND 1ZK/1ZN, Whanagarei 6/18 1221 - Presumed with New Zealand talk show. 6/19 1025 - English talk show, fair at 1025. [DX*WA]
- 1026 AUSTRALIA UNID 6/25 1214 - English programming on Aussie wire. 4MK, MacKay is the usual aussie here. [DX*BC]

- 1035 NEW ZEALAND 2ZB, Wellington 6/18 1223 - Presumed with English programming, mentions of New Zealand, fair level. [DX*WA]
- 1098 AUSTRALIA UNID 6/25 1218 - Unid very weak English audio. [DX*BC]
- 1107 AUSTRALIA 2UV, Sydney 6/25 1220 - Probably this one on Aussie wire with very weak English light rock. [DX*BC]
- 1161 UNID 6/18 1225 - Two English-speaking programs of equal levels, no clue to separate IDs. [DX*WA]
- 1206 FIJI R. Fiji 2, Sigatoka 6/19 0827 - With threshold audio, seemed // to 891, very difficult copy. [DX*WA]
- 1215 NEW ZEALAND 1ZE, Kaikohe 6/19 1027 - Carrying 1ZN talk show. [DX*WA]
- 1287 JAPAN JOHR, Sapporo 6/18 1124-1128 - Male speaking Japanese. [DX*WA]



- 1296 NEW ZEALAND 1ZH, Hamilton 6/19 1232-1237 - With "The All Nighter Show", rose from a mess for five crucial minutes. Male announcer with "oldies" (golden?) music format, TC from New Zealand, ID as "ZH-FM, 98.6, Hamilton and ___ FM, Christchurch" at 1234. WRTH indicates this is FM only now. Ears say different. This into an oldie ballad, down in the muck by 1237. [DX*WA] (Many AM stations in Australia and New Zealand are shifting to FM, with temporary simulcasting - Jim)
- 1314 JAPAN JOUF, Osaka 6/18 1129 - Some Japanese audio, very poor. [DX*WA]
- 1332 UNID 6/19 1240 - English program, possible Aussie or New Zealand, very poor. [DX*WA] 6/25 1222 - Unid English programming, New Zealand/Australia equally probable from the antennas. [DX*BC]
- 1386 JAPAN NHK 6/18 1135 - NHK programming in Japanese, three possible sites. [DX*WA]
- 1413 UNID 6/18 1235 - English programming. [DX*WA]
- 1475 MALAYSIA Kota Kinabalu 6/18 1239 - Probable as het here. [DX*WA]

- 1548 AUSTRALIA 4QD, Emerald 6/19 1243 - Good to excellent levels at 1243, TC from Queensland, easy light rock. [DX*WA] 6/25 1224 - Het only on west wire, presume 4QD, later some English audio at threshold levels. [DX*BC]
- 1566 SOUTH KOREA HLAZ, Cheju Island 6/18 1140-1145 - Fair to poor with Christian programming in standard Chinese - does not argue with schedule in WRTH. [DX*WA] 6/25 1133 - Strong het on Asia wire, presumed South Korea. [DX*BC]
- 1575 AUSTRALIA 200, Wollongong 6/18 1250 - Presumed with continuous light English pops, no interruption, lasted until after 1250, fair to good to gone. [DX*WA] 6/25 1225 - Presumed with light rock/ballads at fair to good levels. [DX*BC]
- 1620 AUSTRALIA 1PPP, Canberra 6/19 1035 - Presumed, excellent modulation, but weak English talk. [DX*WA] 6/25 1141 - Male and female in aussie English, seemed to be a "radio play". There was a second English program under the dominant. The dominant IDed as "One Triple P" at 1200. The other station almost certainly 5RPH, Hobart, Tasmania. [DX*BC]

JOHN BRYANT'S TRANS-PACIFIC COMMENTS

The morning of June 18 was quite unsatisfactory/unusual for DX at the well-known Grayland coastal site. During most of the night, little or nothing was heard from the Pacific basin until quite late, almost local dawn, when there was a short Japanese/Korean opening, followed by a short Australia/New Zealand opening. Signal levels were generally disappointing. The most unusual loggings were the two Caribbean signals off the back side of the west-pointing terminated beverage.

The morning of June 19 was completely different propagationally from June 18, although there were still very few stations from the central Pacific logged. What was very different was the presence of masses of low-level audio and hets from Australia and New Zealand. These stations were present for most of the night with either hets or frustratingly low level audio often present on every split frequency for 200 kHz or so at a time. The lack of strong level loggings so normal in the past may very well be due to our position in the turbulent solar period just after a solar cycle peak. The loggings not identified as "presumed" were IDed either with calls or by inference from frequency and programming.



Like the other mornings, June 25 conditions seemed quite poor. Although many signals were present, at least as hets, few produced audio at listenable levels. The Pacific island nations were noticeable by being almost totally absent, even as hets. No real MW loggings were made during the heart of the night and signals first appeared about 1130 UTC, 45 minutes before local dawn at Sombrio Beach. Luckily, Tropical Band DXing was considerably better!

STATION NEWS

- AUSTRALIA: 4VL has closed down for good, due to financial problems [Rob Williams DXA in NZDXT 44-9]. 200 and 2WL are expected to move to FM during the latter half of this year. 2NX and 2KO Newcastle will also make the change soon. [Ian Baxter DXA in NZDXT 44-9]
- CROATIA: Croatian Radio First Program from Zagreb is now heard 24 hrs daily on 774 kHz. Daytime on 1125 and 1134 kHz, Nighttime on 1143. [BDXC in Medium Wave News 38-3]
- GREENLAND: KNR had to reduce its schedule considerably due to lack of funds, the new schedule is: Mon-Fri 1000-1240, 1500-1700, 2000-0210, Sat 1000-0305, Sun 1100-0215. [BT in ARC #20]
- ICELAND: The bad luck with the MW transmitter in Reyjavik (Vatsendi) on 206 kHz continues, its 150 meter mast from 1930 collapsed 2/3/90. A temporary antenna was installed last autumn and the transmitter was back on the air 10/31/91. On 3/9/92 a fire in the power supply building totally destroyed it. It is uncertain when the transmitter will be back on the air again. It should be noted that the WRTH 92 gives a wrong power for this transmitter. For at least 10 years this transmitter was run with only to kW ERP instead of 100 kW due to the bad

condition of the old antenna facilities. [MV-EKO in Medium Wave News 38-3]

MOLDOVA: R. Pridnestrovye (R. Dnestr region) is a radio station that has been set up by Russian speaking separatists in the so called Dnestr Moldavian Republic, using 999 kHz with a power of 300 kW. The transmitter is listed in WRTH as Grigoriopol. [BDXC in Medium Wave News 38-3]

MONTSERRAT: R. Antilles, 930 kHz, has begun testing with 100 kW and expects to resume regular broadcasting in late July or early August. It has been off the air for three years since its original 135 kw xmtr was destroyed by Hurricane Hugo. The BBC has helped install a 100 kW Harris xmtr and two phased quarter-wave vertical antennas. Reuben Mead, Montserrat's Chief Minister, says that seven hours a day will be local or regional programming. The rest will be sold to the likes of the BBC, VOA (which provided the new equipment) and Deutsche Welle. No manager had been named in early June. The address is: R. Antilles, PO Box 35, Montserrat, W.I. [R. Nederland Media Network 6/4 in NASWA 7/92]

NETHERLANDS: Most of the 186 meter pirates are now using 1603-1611 in view of the Morse signal stations that have popped up. The transmitters are operated by R. Scheveingen (Government-owned) and are thought to have been set up to remove the pirates. [Derek Taylor in Medium Wave News 38-3]

NEW ZEALAND: Several reporters mention that New Zealand stations may reduce hours because of power cuts this winter (our summer). [NZDXT 44-9]

NICARAGUA: R. RICA Managua is on 1100 till 0500 s/off. Also on 4920 SW. Transmission times may vary due to power failures and important events. [ARC via IRCA in NZDXT 44-9]

SURINAM: RANI R. Nickerie has moved from 914 to 910 kHz. Sign-on scheduled 0800-0400. [ARC via IRCA in NZDXT 44-9]

UNITED KINGDOM: The new independent national radio service due to take over the MW channels of 1215 & 1197 kHz from BBC Radio 3 now seems unlikely to be on the air till next spring. This should make 1200, 1210 and 1220 kHz excellent channels this autumn and winter. [Medium Wave News (UK) 38-3] Additional information in the same newsletter gives details concerning

independent and BBC Stations that are leaving AM for FM, too extensive to list here.



ODDS AND ENDS

Interesting statistics from other clubs: From New Zealand, Laurie Boyer has 3789 Medium Wave QSLs from 136 countries, Arthur Cushen has 2925 QSLs from 166 countries, Keith Robinson has 2731 QSLs from 151 countries. [NZDXT 44-9] From Sweden, SW has heard 410 US, 215 Canadian Medium Wave Stations from every state and province except Delaware. HAT has heard 707 total US and Canadian stations. [Distance #7] Derek Taylor in the UK has heard 920 MW stations from 90 countries and 47 states/provinces. [Medium Wave News 38-3]

CONTRIBUTORS

- [JB-NF] Jean Burnell, St. John's NF; Icom IC-R71A, various antennas with phasing and regeneration.
- [DX*WA] John H. Bryant (6/18 & 19), David M. Clark (6/18 & 19), Guy Atkins (6/19), Grayland WA; NRD-525 + MAP, two Drake R-8's, 450' terminated beverage at 270 degrees (Pacific and PNG), 1000' terminated beverage at 320 degrees (Asian Coast). Logs are from John Bryant, but similar to those of Clark and Atkins. Note: local dawn in Grayland was 1215 UTC.
- [DX*BC] John H. Bryant; David M. Clark, Sombrio Bay BC; NRD-525 + MAP, Drake R-8; 1000' terminated beverage at 270 degrees (PNG/Aust./Pacific), 800' terminated beverage at 230 degrees (NZ and eastern Pacific), 1000' terminated beverage at 320 degrees (Asian Coast).
- [DX*MB] Wayne McRae and Shawn Axelrod, Valhalla Beach MB DX site; ICOM R-70 with PLAM Board and 4kHz filter, beverages west and south.
- [CV-FL] Chris Vito, Plantation FL; Radio West ICOM R-70 with PLAM board and Balun Loop.
- [JR-NY] Jim Renfrew, Rochester NY; HQ-180, Radio West loop.

Jim

Todd Brandenburg, KA0KAN

9720 NW 31st

Silver Lake, KS 66539-9403

It looks like the E-skip is not as good as it was a couple months ago, so I don't feel so bad about not spending the time at the dials as I should.

By the time you get this the Omaha convention will be 5 weeks off, and yes I have every intention of being there. Hope to see you as well. See you in 4 weeks. 73 for now.

Robert S. Ross VE3JFC, Box 1003, Stn. B, London, ON N6A 5K1 Sherwood S-2660 + FM Beam, Delco car stereo + whip

5.30.92 tropo
1425 107.7 WRKR MI Portage- male DJ talk between songs. ID's ad 'WRKR' and '107.7 WRKR'. Mixing with WHSB.

6.8.92 Tropo
0035 88.9 WFRJ PA Johnstown- GOS & choir music. ID's as 'Family Radio' // WEFR-88.1 Erie, PA. 900 watts.

1858 104.7 WORD PA Pittsburgh - weather, ID as 'The new FM-104.7 WORD', Family news, religion.

1930 97.7 WLER PA Butler- Larry King- Sports in Focus, soft rock, ads. ID as 'WLER 97.7 FM'.

6.8.92 E-skip
2100 91.1 KLSU LA Baton Rouge- ad for 'southeast Louisiana's best night club', local weather.

2132 98.9 KKMGM CO Pueblo- ad for local business, dance music. 'Continuous music 98.9-Magic FM'.

2135 97.3 KKJQ KS Garden City- local Garden City ads, 'Q-97 FM' IDs, promo. 2148107.7 KMAJ

KS Topeka- ads, 'Topeka's got KMAJ- Super Gold' oldies music.

2155 95.5 KDCK KS Dodge City- Kansas local ads for Garden City and Dodge City, K-95 weather, severe thunderstorms. (FYI- 95.5 KWEN Tulsa, OK also uses K-95- trb)

2156 98.5 KSAJ KS Abilene- "You're listening to KSAJ Abilene, Salina, Junction City- The Oldies Channel', oldies music.

6.14.92 E-skip
1538 98.5 KYGO CO Denver- 'FM98.5 KYGO' sung out, into American Country Countdown.

6.14.92 Tropo
1702 89.9 WTLR PA State College- news, IDs as 'WTLR-89.9 FM' Gospel music, community calendar.

6.17.92 E-skip
0812 89.5 KLUX TX Robstown- ID as 'KLUX 89.5 FM', local weather, into MOR music after CDT time check.

1745 88.5 KEOM TX Mesquite- 'Fact File' community service message for Mesquite, rock music.

6.18.92 E-skip
2348 99.9 WACO TX Waco- Sears ad, weather, ID as 'Texas' #1 country, WACO 100', C&W music.

2358 107.5 KXTN TX San Antonio- SS pop music, male DJ talk in SS, ID as 'KXTN Tejano 107', SS news.

6.19.92 E-skip
0000 107.5 KSJT TX San Angelo- ID by female in SS 'KSJT FM-107.5', SS female talk- mix with KXTN/KCDU.

0000 107.5 KCDU TX Fort Worth- 'KCDU- Fort Worth, Dallas- The new CD-107.5'. Rock music, mix with KXTH & KSJT. 0018

106.1 KTTX TX Brenham- C&W music, 'K-Tex 100' and 'KTTX' IDs, lady DJ.

0042 104.3 KPLE TX Temple- C&W music, ID and station promo, 'Super Station- KPLE gives away the cash'.

Hank Holbrook, 407 Arundel Rd, Fair Haven Cliffs, Dunkirk, MD 20754 Scott 310E tuner (from the 60's) with an Archer amp, Winegard CS-6065 10 element yagi with Channel Master HD-9515 rotor.

6.13.92 Tropo
0855 96.1 WTTT NJ Margate- good- Nil to some QRM from WGCB, ID as '96.1 WTTT The Touch'. Rock plus commercials.

1314 95.3 WDNO DE Laurel- Good, Nil QRM, ID as 'Maverick 95' Rock, community notes, commercials.

6.15.92 Tropo
0932 91.1 WWNJ NJ Dover Township- Good, fading after 0950 EDT. CLA music // WWFM-89.1 Trenton NJ, plus weather.

6.18.92 Tropo
0455 88.9 WJMJ CT Hartford- Good prior to 0514 then fading. Pop music from 40s and 50s etc. News and weather.

6.26.92 Tropo
0509 88.9 WCVF VA Richmond- Good and in clear till WEAAs on at

0552 then covered by the Baltimore station. News, weather, CLA music.
0827 102.7 WSKR NJ Petersburg- In and out w/ moderate to heavy QRM from WXYV MD. Relay WIP Sports 610. Station expressed shock when I called them- they could be heard 'so far?' 100 miles. (Hank, I have several 200 mile regulars - trb).

6.27.92 Tropo
0734 105.9 WXJN DE Lewes- to 0750 and gone- little to very heavy QRM from WCXR VA. Surprised they were so poor as reception here favors NE. Slogan is the 'All New Kicks 106'. Country music, weather and commercials.

6.29.92 Tropo
0859 99.3 WVES VA Accomac- STRONG- country music and commercials, weather- 'WVES All The Time 99'.

7.3.92 Tropo 0002 91.7 WLFR NJ Pomona- strong on excellent opening. Hardcore rock, PSA and long s/off message. Off at 0016 EDT. 1028 98.3 WKTU NJ Ocean City- good much of period to 1102- Nil to heavy QRM (after 1048 from WECY DE). Oldies, weather, commercials. Good report.

7.6.92 Tropo
0954 92.3 WXRK NY New York- Good prior to 1015 hen eventually faded under WEQR MD. News (Their view of the news!), commercials. K-Rock ID.

AM note----
rx- Hammarlund SP-600 w/ 50 foot long wire. 640 WWJZ Mt. Holly NJ, 7.4.92 1016-1103 good on Transmitter tests. Brand new station! On much of day.

Eric Bueneman, 631 Coachway Lane, Hazelwood, MO 63042 Realistic STA-90 AM/FM/FM\$ receiver with amplified rabbit ears except June 19 in which Yorx AM/FM/FM\$/4.5" b&w TV and whip was used.

6.19.92 E-skip from Marietta, GA, time ELT
0020 107.9 KLTE MO Kirksville- skipped over WENN splash with no sign of WPEZ/WJRX with light CCM, "Light 107.9's Evening Reflections" slogan.

7.4.92 Trop from Hazelwood, MO, times CLT
2300 107.1 WEAL IL Lynnville- good with 'This is WEAL Lynnville/Jacksonville' legal ID into St. Louis Cardinals baseball.

7.7.92 Tropo
???? 103.7 WBLN KY Murray- good over KIRK/WDBR with '103.7 WBLN' ID and SMN AC. ????. 9 2 . 9
WZEZ TN Nashville- good/fair over WSEI/KGRC with concert promo mentioning the Starwood Amphitheatre,

into light AC. 2333
WWTN TN Manchester- fair over unID CHR (WMC-FM or WAPW?) with Larry King, splash from semi-local KFAV 99.9.

2346 105.1 WVRV TN Waverly- fair with 'V-105 WVRV' slogan and OLD, splash from WCBW-104.9.
2347 107.9 WCVC TN Clarksville/Ft. Campbell, KY- fair with AC, some KMJM-107.7 splash.

2348 97.9 WSIX TN Nashville- fair with CWM, splash from KYKY-98.1.
7.9.92 Tropo

2135 103.7 KIRK MO Lebanon/ Lake of the Ozarks- good over WDBR with KC Royals baseball and local ads.

2136 103.7 WDBR IL Springfield- popped up over KIRK with local ad 2141 95.9 WRVI

IL city??- good with Springfield Cardinals Class A BB, ex-96.7 Virden, IL. (Eric, my books still show WRVI on 96.7 in Virden. A spur perhaps?- trb)

2152 95.5 KJEZ MO Poplar Bluff- good with ad for the REO Speedwagon concert at the Missouri Racepark in Poplar Bluff, some imaging from KSHE-94.7

2157 104.5 KSLQ-F MO Washington- good over WFMB with old-time radio program, IRS PSA, old-time radio record offer, seat belt PSA, 'This is KSLQ-FM Washington, MO' legal ID into USA Radio News, so maybe no longer // KSLQ-1350?

2237 106.9 WWYN TN McKenzie- good with local ads, 'Win 107' slogan into CWM, over KTTY.

2245 100.7 KGMO MO Cape Girardeau- good with oldies (change from AC and move from KAPE-1550), 'Oldies 100.7' slogan.

2251 97.5 WBBA-FM/IL Pittsfield- good with KHTK-97.1 splash with St. Louis Cardinals BB, ex-97.7.

7.10.92 Tropo
2240 106.9 KTTY MO Jefferson City- good with contest promo, 'Best Music Mix, Y- 107' slogan into AC/CHR.

2243 98.7 WNNIS IL Springfield- good with KTJJ-98.5 splash with 'Light Rock 99' slogan into light AC.

2247 104.7 KRES MO Moberly- fair to poor between KSLQ-FM 104.5 and WCBW-104.9 with St. Louis Cardinals BB.

CKQT 94.9 FM

AM 1350

DIVISIONS OF POWER BROADCASTING INC.
360 King Street West, Oshawa, Ontario L1J 2K2

DX in Metro Atlanta went out with a bang with an E-skip opening to the NNW on June 19, also was able to null out local TV stations on channels 2 and 5 for good signals on Cedar Rapids IA on 2 and Bismarck ND on 5. Also had both KELO- land TV stations on 3 and 6 and Sioux City IA on 4. At this writing I haven't dug up my logs for final totals from Marietta.

Returning to Hazelwood (two blocks from the old QTH), I have only gained two semi-locals (KFAV-99.9 and KSLQ-FM 104.5) since last gracing metro St. Louis on a permanent basis in 1988. In the mornings I can still get WOOZ under KFAV and WFMB is an occasional visitor under KSLQ-FM. Hopefully by the next FMDXD, I may announce my hours at KCFV-89.5, which is still off as of this writing, as studio renovations continue (which is covered by a tuition increase, hi! (sounds normal- trb)). I will also be going for a no-code ham license. 73, KDX0STL.

Morris Sorensen, 29 Janet Blvd, Scarborough, ON M1R 1H7 Panasonic RF B65 with whip antenna.

Not much DX on FM this summer, and most of it was done away from the home QTH.

From Scarborough, Ontario

5.7.92 Tropo

1952/101.7 CKNX-FM

ON Wingham- fair, local ads, concert promo

5.12.92 groundwave

1052 88.9 CIRV ON Toronto- testing on this channel with regular Oriental (Chinese?) program. Back to 88.7 in EE at 1100. Testing off and on all week.

5.20.92 Tropo

2309 92.5 WBEE NY Rochester- country music, IDs, excellent signal.

2312 98.9 WKLY NY Rochester- oldies, ID, good signal.

5.21.92 Tropo

2058 91.5 WXXI-FM

NY Rochester- 'Evening concert' ID, good signal

From Kemptville, Ontario

6.23.92

2235 92.7 WPAC NY Ogdensburg- 'Pac-93', weather, local ad, good sig, groundwave.

2242 96.5 WVVV NY Malone- country music, 'V-96' slogans, weather, legal ID and s/off at 2300, good sig, tropo

2303 96.3 CFMK ON Kingston- sports, ID, fair sig, groundwave.

2304 96.5 WVNC NY Canton- good, 'Mix 96', groundwave.

6.24.92

1004 99.5 CIME PQ Ste. Adele- ID in FF as 'cime' (pronounced like seem), mention of Laval and other area communities, FF adult contemporary music. tropo

2257 99.3 WSNN NY Potsdam- rock music, legal ID, ABC news, good sig. tropo

2301 98.1 CBOF-6 ON Cornwall- CBC 'Radio Canada' news in FF, good-groundwave

6.25.92 groundwave

???? 97.5 WCIZ NY Watertown- PSA's, 'CIZ-FM', rock music, good. groundwave

6.26.92 groundwave

1635 95.5 CBOC ON Cornwall- CBC network, good

1640 98.3 CFLY ON Kingston- 'Fly FM', good

2300 89.5 WSLU NY Canton- excellent with ID

From Bancroft, Ontario

7.14.92 2035-2115 EDT

89.3 CBOB ON Maynooth- CBC English, good, groundwave, 110 watts.

90.7 CBOF ON Ottawa- CBC French, poor, tropo

93.1 CHAY ON Barrie- easy-listening, poor, groundwave

93.5 CBCP ON Peterborough- CBC English, good, groundwave

94.5 WNED-FM NY Buffalo- classical, fair, tropo

95.5 CJBC-1 ON Belleville- CBC French, good, groundwave

96.7 CBCD ON Pembroke- CBC English, good- groundwave

97.1 CIGL ON Belleville- fair, groundwave

100.5 WVOR NY Rochester- ID, tropo

101.5 CKWF ON Peterborough- rock, The Wolf, groundwave

101.9 CKAT-FM ON North Bay- Blue Jays baseball, fair, tropo

102.5 WMJQ NY Buffalo- rock, fair, tropo

103.1 CFMX ON Cobourg- classical, groundwave

103.9 CBCP-FM ON Peterborough- CBC Stereo Network, good, groundwave

105.1 CKQM ON Peterborough- country music, good, groundwave

106.3 CJBC-5 ON Peterborough- CBC French, good, groundwave



Mike Hawk NOOSY, 10212 P St., Omaha, NE 68127 Kenwood KT-815 IF modified, FM-10 up 30', rabbit ears for phasing (rarely used)

Well, DX took a terrible turn for the worse this month. Although tropo was pretty good, E-skip was terrible, even on TV. Let's hope that we get some late season skip in August. 73

7.6.92 Tropo

88.7WSIE IL Edwardsville- 0805 jazz

107.7 KMJM MO St. Louis- 0809 Magic 108

96.3 KRJY MO St. Louis- 0818 oldies, Juke Box 96

89.1 KCLC MO St. Charles- 0822 jazz, Lindenwood College stn.

94.7 KSHE MO Crestwood- 0827 K-She

96.7 WRVI IL Virden- 0829 oldies

100.5 WYMG IL Jacksonville- 0836 oldies

107.5 KRXV CO Lakewood- 0844 Mix 107.5

103.5 KRFX CO Denver- 0847 The Fox

97.5KQSK NE Chadron- 0853 Q-Country

91.9KCNE NE Chadron- NE Public Radio

99.5KVOD CO Denver- 0859 Classical Voice of Denver

99.1KUAD CO Windsor- 0923 K-99

104.3 KQKS CO Longmont- 0927 KS-104

104.7 KNNG CO Sterling- 0939 NE Colorado weather, #600 on FM

7.7.92 Tropo

99.5KSJN MN Minneapolis- 1102 classical music

95.3 KRGR MN Albert Lea- 1118 oldies and rock, ID, thought they were 94.9? (according to my books they are moving to 94.9 but not there yet -trb)

101.7 KRCH MN Rochester- 1122 local ads

7.7.92 E-skip

88.9 WSHA NC Raleigh- 1312 ID

88.7 WJFR FL Jacksonville- 1316 Family Radio

94.7 WRDR NC Raleigh- 1322 country music

92.1 WFEZ FL Williston- 1323 local ads

96.7 WKRXt NC Roxboro- 1330 country, Kirks 97

98.1 WGNE FL Titusville- 1335 98-Frog

89.1 WTUC SC Ailen- 1925 ID

96.7 WAKB GA Wrens- 1930 ID mentioning // 1480 AM

95.5 WIXV GA Savannah- 1943 very strong

88.3 WLPT GA Jessup- 2000 ID mentioning several stns in network

102.9 WIVY FL Jacksonville- 2006 Y-103

7.9.92 Tropo

103.7 KEYN KS Wichita- 0053 local KXKT off air

97.5WHMS IL Champaign- 0112 Lite Rock 97.5

107.5 WGCI IL Chicago- 0125 GCI

96.7WIHN IL Normal- 0137 Oldies 96

95.1WDZQ IL Decatur- 0141 95-Q, country, KLDZ off air

92.1WCAZ IL Carthage- 0154 Z-92

97.7WBFgt IL Effingham- 0159 USA news, religious, didn't ID!!

91.9WJCH IL Joliet 0207 religion

99.5WQCY IL Quincy 0210 rock, ads

107.5 WZZQ IN Terre Haute- 0216 rock, ZZQ

7.16.92 Tropo

88.9 WLSU WI LaCrosse- 0817 ID

101.9 KNWS IA Waterloo- 0830 religion and ID, over KFMQ!

7.18.92 E-skip

88.1 WHOV VA Hampton- 2016 in and out until 2100 with unID's 88.7, 89.1 and 94.9.

Yours Truly, Silver Lake, KS 66539

Marantz ST-300 IF modified, Heath AR-1650, FM-10 up 35 feet I caught local

KLZR-105.9 on low power (maybe 2kw?) which let me on the adjacents with less splatter.

7.22.92 groundwave

105.7 KXXK MO Knob Noster- 1730 'Kix 105.7', USAF ad, C&W music, ex-105.5

105.5 KESM MO El Dorado Springs- 1738 'Keeping you going throughout your day, were KESM', one of my closer unheards

105.5 KZZT MO Moberly- 1745 '105.5 KZZT' into a Fleetwood Mac record

105.7 KSUX NE Winnebago- 1756 'KSUX Winnebago/Sioux City' legal ID, ads

105.7 KMCK AR Siloam Springs- 1810 'Hot new Power 105.7', promos, into B-52's song. Not new, but very rare in this part of KS.



NORTHAMPTON HOLDINGS, INC.
P.O. BOX 268
15 HAMPTON AVENUE
NORTHAMPTON, MA 01061-0268

A simple antenna switching box ... by Shawn Axelrod

As my antenna farm began to grow, I decided to put together a box that would allow me to go from one antenna to another without having to disconnect the antenna from the back of my ICOM R-70. It had to be cheap, easy to build, and effective. I came up with the idea of a box using banana jacks because they were easy to work with. Now, what to mount them on to? I settled on a PVC plastic box used by electricians because they were cheap and easy to drill into. This setup would allow me to put six jacks into a box and bolt it down via the bolt holes already molded to the box. All I needed was ...

One PVC box about 4 to 5 inches square and 2 inches deep

One 20-foot length of wire

Six banana jacks (or substitute of your choice)

One banana plug (or substitute of your choice)

Two screws to mount the box

Step one:

Map out where you want to put your jacks, ensuring that you leave enough room to mount them. Then drill the six holes in the faceplate you have marked. Then drill a hole on the top of the box to be able to draw out six wires from inside the box for leads from the jacks.

Step two:

Mount the jacks onto the box. Make sure they are on tight. Now, cut six 2'- to 2.5"-long pieces of wire and strip off about one inch of coating from each end. Solder one piece of wire onto one separate jack. Repeat until you have all six wires soldered on to separate jacks. This will ensure no crossover from one antenna to another. You may wish to label each wire from "1" through "6" so when you are finished you know who belongs to whom.

Step three:

Feed the six wires through the large hole on the top of the box. Seal it back up (mine came with four screws that were removed to open the box up). All you have to do now is to mount the box and attach your antennas, one to each lead. Take the banana plug and attach it to the leftover wire and fit the other end to your receiver. You are all set to go.

To switch from one antenna to another, all you have to do is to move the plug from one jack to another. This also allows you to keep a good match on your antennas, as using a 50-Ohm coax switch with a longwire of several hundred Ohms can cause a mismatch. This gets more of the signal to your radio for less money. Like I said, cheap, easy, and effective.

I hope some of you find this of use. And, by the way, going from one antenna to another

on this is easier than going around and around on a switch that will wear out from such repeated motion. If a jack or plug wears out on this model you replace one cheap part instead of a switch in its entirety.

Drill holes spaced evenly around the face of the box for the jacks to go into.

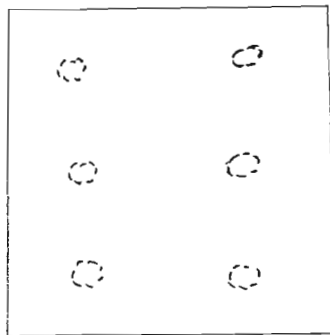

Drill a large hole on the top of the box to feed the wires out.

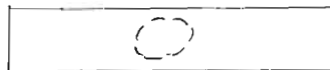

Lead out wires to attach to antennas

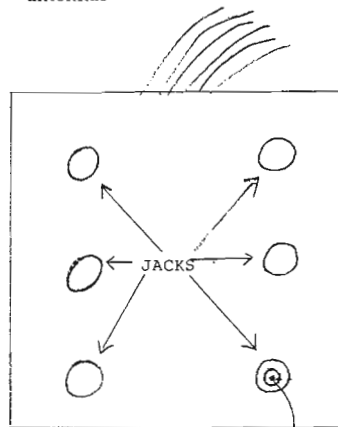

Wire to receiver using the plug.

The Box is completed with the six jacks installed and a wire into the plug for the receiver

The Answer Man

"No Question Is A Dumb Question"

Answers to members' questions, from the basic to the technical

Hello, again. With this edition of the Answerman, we will be up to date with all contributions received here as of 7/10/92.

QUESTION: What would work best for AM DX, (antenna 1) or (antenna 2) with the following receivers: X or Y ?

ANSWER: Once again, I am not equipped to answer specific questions about specific equipment or combinations. Whenever a DX'er is contemplating such a question, it is useful to assess individual needs and characteristics. If a receiver has no terminals to connect an antenna, any antenna which cannot operate by being placed in close proximity to the receiver, whether by size or configuration, would be incompatible. In a similar manner, an antenna with a balanced output (3 leads) would be at least somewhat incompatible with a receiver having only one or two antenna/ground terminals. There are, of course, many other considerations, which would be in the areas of your intended use, available space, location and budget. Also, while a given antenna/receiver combination may work well for one person under one set of conditions, it may not do so for everyone.

QUESTION: Can you tell me anything about the device pictured in a recent Brookstone catalog (an "energized" AM/FM antenna). It is priced at \$89.

ANSWER: It seems that almost every year there's another one or two of these. Remember the old maxim that says that anything which sounds too good to be true, probably is. To that, I would add, regardless of price. Any device which proposes to amplify signals on both AM and FM is simply some kind of a broadband amplifier, which will also amplify noise (both man-made and atmospheric). Such devices also frequently generate both their own noise and also spurious signals, due to the inherent compromises in constructing a circuit which will have some effect over a wide range of frequencies. In this particular ad, it states a 400% improvement over a standard dipole. I have no idea what their idea of a standard dipole is, even if there really were such a thing, but since a dipole isn't a particularly efficient antenna for AM in the first place, a 400% improvement (including noise) probably isn't worth the \$89 price.

QUESTION: My MacIntosh PC and my loop antenna, both located in my shack, about 6 feet apart, don't seem to like

R. J. Edmunds

753 Valley Road

Blue Bell, PA 19422-2052

that arrangement. I get too much interference from the Mac. A friend says that the PC "leaks" too much, and that I should create a "housing" of a cardboard box covered with aluminum foil. Will this help? Do you have any other suggestions?

ANSWER: Your friend is right as to the cause of the problem, and his cure may help some, and it might help even more if you grounded the housing, but that might introduce some problems for the PC, as well as a potential shock hazard. If you cannot separate the loop and the PC by more distance, I would suggest contacting the dealer or the manufacturer for some assistance. In the meantime, perhaps one of our readers will have a suggestion, which I'll forward directly to you to avoid publication delay.

QUESTION: Do you have any information on the Interceptor LA1200 series antenna from the latest EEB catalogue?

ANSWER: I haven't seen nor heard of this one before. The models listed (at \$150) are all broadband, and therefore the same conditions apply as in the answer to the question about the AM/FM energized antenna above, but, at a higher price, coupled with battery-only use with relatively limited life expectancy for batteries, it doesn't seem particularly well-suited to BCB use. My initial reaction is that this unit might be seriously overpriced.

QUESTION: I am concerned about lightning protection for my DX shack. What should I do about this?

ANSWER: I believe that there is an article in "Getting Started in MW DX'ing" which talks some on this, unless it's been removed in a later edition. In any event, a start would be a grounded surge-protected outlet strip for AC-operated equipment. Another easy one is protecting the FET's in any loop amplifier by keeping clip leads from the outer connections to the center (ground) connection of the amp input (on a balanced loop) or from one input connection to the other on an unbalanced loop. This will prevent unwanted static charges from killing the FET's. Outdoor antennas should be equipped with properly-connected lightning arrestors, and all longwires should be insulated from trees by mounting with an insulation

loop and ceramic insulators. [The insulation loop of wire goes around the tree, looping through the ceramic insulator, while the end of the antenna also goes through the insulator. The feedline goes through the lightning arrester.] These precautions (in addition to not operating the equipment during electrical storms) ought to do it except in severe lightning areas. I'd appreciate any additional suggestions from those who have experience or information with those types of locales.

FURTHER ANSWER: Last time, a question was raised about station applications to lower power. We are informed that an increasing number of these are also due to antenna height increases, most of those due to a desire to maximize the sister-FM coverage. Since in both cases an increase in tower height results in increased signal in at least some directions, and since FCC requirements stipulate specific levels of signal strength, a reduction in AM power becomes necessary to meet those strength requirements.

Still others result from the cost of or unavailability of land suitable to house a multi-tower directional AM array. Land prices in some areas being what they are, at least in some cases as a result of congestion, it may be financially impossible to use a higher-powered directional array, and

therefore either a lower-powered, less complex array or a non-directional may be the result.

QUESTION: What's the deal with the proliferation of FM translators?

ANSWER: In a word, profit. Radio stations aren't inexpensive to operate, and, for many noncommercial broadcasters for whom advertising revenues are nonexistent, the addition of a translator or a network of them can be a cost-efficient means of increasing potential audience. In the noncommercial arena, increased coverage equals increased audience, which equals increased revenue from donations, subscription, dues, or whatever. Although primarily used by religious broadcasters at first, many other public and/or educational stations are adopting this route. Local WRTI, Temple University's all-jazz outlet not only has two satellite stations (not translators) to go with its two translators, but they plan at least four more (either stations or translators) and are promoting some kind of an add-on device for car radios which would automatically "home in" on whichever one of the group happened to provide the strongest signal wherever the car was, and regardless of the fact that all are on separate frequencies! [They'll probably make a profit selling that, too, hi.]

Well, that's it - outta space *Me* 73's

Collins R39A - The Original 'World's Best'

by Graham Maynard - Newtownabbey, N. Ireland

Question: Why do I still use a heavy old Collins R390A for broadcast reception when there are so many other compact and easy to use desk top receivers to choose from?

Answer: Frankly I have not yet come across a better package.

Tracked RF tuning protects the 390A from most of the strong signal internal modulation problems that so often beset modern receivers when connected to effective low and medium frequency antenna systems. And yet, while fully functional and properly aligned R390As with selected tubes and good components remain competent and versatile, they cannot be described as audibly friendly or ideal broadcast receivers.

Changes are necessary to achieve full potential on both AM and SSB, so here I group together some that transform their listening and DXing capability. By modifying non-intrusively, that is without chassis removal or any component changes, I avoid the enthusiasm trap that leads to circuit re-working and the IFT damper snipping mentioned by some authors.

Remember, mods that compromise unmanufactured originality also compromise resale value.

* * * * *

My receivers are US Service updated, supplied with isolated 110 volts a.c. and incorporate the following:-

- (A) to bring unadjusted V503 gain within the controlled domain, turn the GAIN ADJUST pre-set fully clockwise and clip a wire link between it's unused tag and terminal 1 on the rear block;
- (B) for reduced IF amplifier noise and hiss, plus improved a.g.c. characteristic, fit 6BJ6 tubes in sockets V501 and V502;
- (C) for improved a.g.c. range and dynamic linearity use a 6AH6 as V508;
- (D) remove V203 and select a quiet 5749/6BA6 in the VFO socket, V701 underneath; watch some can drift with temperature;
- (E) also remove V202 and check V202/3/4 for moise in socket V204; use only quiet 6C4s, the best as V202;
- (F) select a 6DC6 with good gain for V201; poor examples degrade overall performance;
- (G) fully re-align the receiver as per the maintenance manual, though use your main antenna(s) as the signal source(s) for RF coil trimming;
- (H) optional; for improved local audio V603 may be a 6AQ5 with pin 7 carefully cut off, right back to the glass.

Further improvements are possible using the following, easily revertable, "clip on" modifications; a voltmeter and RF generator are required:-

- (1) passive synchronous AM demodulation using only three additional components;
- (2) a dedicated, passive, low impedance, low frequency input, via the (unused) whip antenna socket; three components;
- (3) fast audio a.g.c. plus accurate five decade logarithmic carrier meter drive, 0 to 100 - 0.32uV to 32mV input on bands 0 and 1MHz, including SSB, receiver powered; twenty components plus three optional and easily accessible wire changes behind the front panel - two at the carrier meter and one at the RF gain potentiometer;
- (4) optional, a quality, receiver powered, remote audio/ notch/ filter stage; twenty-one components.

Together, modifications (A) and (3) above, provide an accurate positive carrier meter indication of receiver desensitisation as the RF Gain control is manually backed.



New from NRC's DX Audio Service:
"After Dark #2"
 Four C-90 tapes in a holder now available for only \$9.50 postpaid. Listen to accounts about the VOA ... news about radio today ... 45 minutes from WNRC, and more airchecks from special stations ... and many special features. Order from NRC Publications - Box 164 - Mannsville, NY 13661. NY orders, please add sales tax.

Logsheets - By Frequency

110 sheets, 25 entries possible per sheet with space available to add your own columns. Punched for three-ring binders, full-size 8.5 x 11 inches, on heavy paper. US\$5.00 (25 sheets for US\$1.25). From NRC Publications (NY residents, add sales tax).



Promote the NRC and DX News and help us grow!

Planning to attend a DX'ers or hobbyist gathering? Include *DX News* in your plans. Upon request, we'll send you a packet of up to 50 recent DXN's to be given free to attendees. Just send a postcard to NRC - P. O. Box 5711 - Topeka, KS 66605. Packets are sent by Book Rate, so please allow 10 days for delivery. Thanks - and tell your friends that the NRC is on the grow!

Sets thus treated should be good for:-

- * AM listening, with 8kHz passband, down to 1uV input signal;
- ** clear CW and SSB reception with fully automatic audio a.g.c.;
- *** MW DXing, at 2 or 4kHz bandwidth, to sub uV/m field strengths with a matched 10m passive whip antenna; QRM and QRN permitting of course.

* * * * *

(1) Synchronous Demodulation.

The most irritating R390A characteristic arises in demodulation, it's simple envelope detector cannot cope with the mechanical IF filters, and thus generates audible products that are higher in frequency than the passband-width selected. 390As were tested at 30% carrier modulation, but today's broadcast transmitters peak at 90% plus; the resulting distortion under crowded band or weak signal conditions is both strange and tiresome.

Carrier synchronous demodulation overcomes this problem and is simply achieved within a 390 series receiver by coherently locking the diode reciprocating beat frequency oscillator in phase with wanted carrier IF signal. This method introduces an internal synchrodyne ability, which, without retuning the receiver, and without fear of pulling or strong signal capture, is capable of tuning, locking and demodulating an individual carrier, when other signals and carriers simultaneously occupy the passband; this feature is not yet available on other sets and is similar in effect to passband shifting with conventional demodulation.

Synchronisation thus favours wanted signals against others, adjacent sidebands and also to a lesser extent, against splatter and impulse noise. Simply tune the receiver for minimum interference then turn on the BFO and zero beat; very useful for resolving US/European MW splits.

C1 is 10 turns of 22swg wire coiled around V508 - 6AH6.

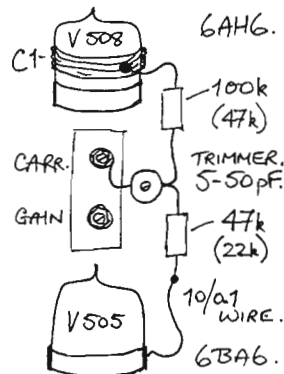
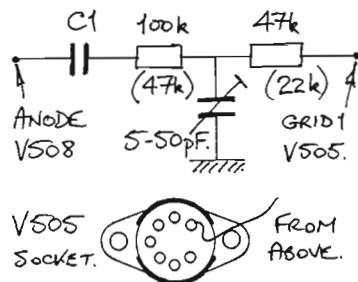

C1 is home made and formed by a simple ten turn wrapping of 22swg finned copper wire knotted around tube V508, over the anode.

C2 is a 5-50pF sub-miniature trimmer mounted on stiff wire and grounded by the carrier meter adjust potentiometer nut.

The electrical connection to V505 is made by pushing fine strands of a short piece of p.v.c. insulated wire into pin socket 1 and then re-inserting the tube. From above pin socket 1 is the last clockwise.

Set up is simple, though first make sure that the IF deck is unaltered and correctly stagger tune aligned. Connect a voltmeter to rear terminals (14) black and (16) red. Tune a steady carrier, switch on and zero beat the BFO, then trim C2 for maximum voltage. Repeat the procedure to counter interaction then re-zero the BFO knob. Some BFOs lock more readily than others, those that have limited range will benefit from lower resistor values; try 47k/22k. Re-trim C525 if an external converter is connected to the IF Output Socket.

To speed zero beat tuning when the audio a.v.c. modification is fitted;- turn line gain to maximum, switch the BFO on, zero beat, return line gain to normal level. This method is quick and accurate; it also obviates off-tune howling.

* * * * *

(2) Low Frequency Input.

Though outwardly a general coverage receiver the R390A cannot tune low frequencies - it's RF stage does not function below 480kHz. However, the first oscillator, mixer and tuned IF do run and present opening for an input that may be left permanently in place without upsetting normal operation above 480kHz, i.e. a simple low pass RF filter connected between the antenna relay and the first mixer cathode.

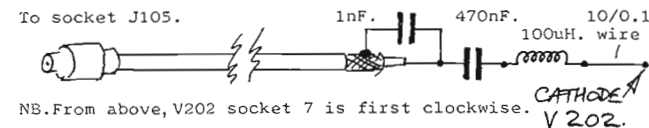

Fine strands of a short piece of p.v.c. insulated wire are pushed into pin socket 7 of V202 and then the tube re-inserted. Insulate C2 and L1, and position close to V202. The whip antenna socket J103 now becomes a dedicated, rear panel, low impedance, low frequency input.

With this connection long and medium wave audio quality is excellent. Reception is quiet with full passband treble and none of the upper bass plumminess that is caused by cascaded medium frequency tuned RF circuits. Higher megahertz bands are not similarly affected and already sound good. I use P103 for quality local broadcast listening with a high fidelity amplification system, and P104 for MW DX, Tropical, SW etc. Unfortunately a half frequency IF birdie remains at 227.5 kHz, though it is not troublesome.

If you have the real estate then an old fashioned, matched long wire is fine, if not an active whip, tuned ferrite or frame alternative must be considered.

* * * * *

(3) Audio AGC and Meter Drive.

The 390 series receivers employ true carrier averaging a.g.c. with selectable time constants. This acts well on AM signals but cannot cope with deep carrier fades, intense noise bursts or SSB transmissions; also the logarithmic carrier meter is inaccurate on SSB and at both scale ends. My add-on audio a.g.c./meter drive circuit corrects these inadequacies and updates the receiver by producing a positive meter reading as the manual RF Gain control is manually backed. It connects to and takes power from the rear panel terminal block, yet is fully automatic with operating level simply set by adjusting the Line Level output control.

Power is derived from the 6.3Vac "Break In" relay supply (9), turn Break In "On".

R1,2+3, TR1, D1+2 are the meter drive circuit, disconnect and insulate the original meter wires; omit these components if you are happy with tube driven linearity;

line audio output is full wave rectified and smoothed - (10) (11) (12) (13), D5+6, R4, C3;

R4 allows leading edge desensitisation, R4-C3 controls average level, R5-C3 the release rate;

R5 current turns on TR2+3 so that the receiver cathode line (1) is held low, i.e. at maximum set gain;

audio peaks that overcome LED junction potential reduce TR3 current, cutting RF/IF gain as the cathodes go high;

the circuit works well with terminal (1)(2) metal link in place and the manual RF Gain pre-set or at zero;

works much better with the link removed and an extra wire screwed to terminal (1), run through to the RF Gain potentiometer and soldered in place of the two white-yellow wires; these wires should be removed from the pot., connected together and sleeve insulated;

pre-set R2 to mid track; adjust on your favourite band using a calibrated signal generator - say 10mV rms pd for a 90dB carrier meter reading.

Receiver a.g.c. is now versatile and works normally until the Line Gain control is advanced. Only audio peaks are cut with a level 4-5 setting; above 5-6 audio a.g.c. takes progressively more control and ultimately defeats all receiver a.g.c. circuitry, time constants and even the MGC setting. The response is fast and accurate, assuring fully automatic control for synchronous exalted carrier AM reception and SSB listening; both with the ease that comes with the name Collins.

* * * * *

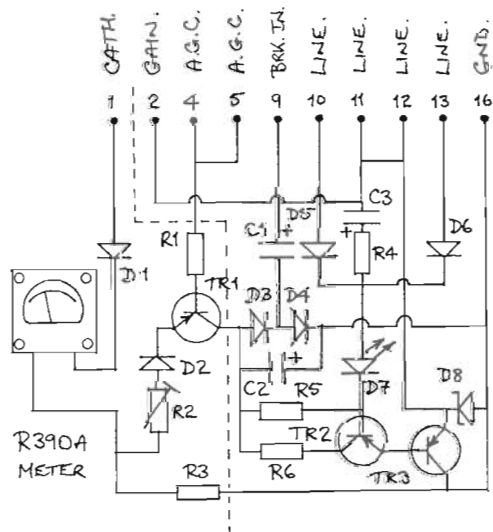

COMPONENTS.

R1, 6 22kR
R2 22kR pre-set
R3 220kR
R4 680R
R5 1MR

D1, 2, 3, 4,
1N4001.
D5, 6 0A91.
D7 RED LED.
D8 20V ZENER

TR1, 2, 3, BC327
or 2N4126

C1, 2 100µF 25V.
C3 1000µF 6.3V.

AUDIO AGC + METER DRIVE.

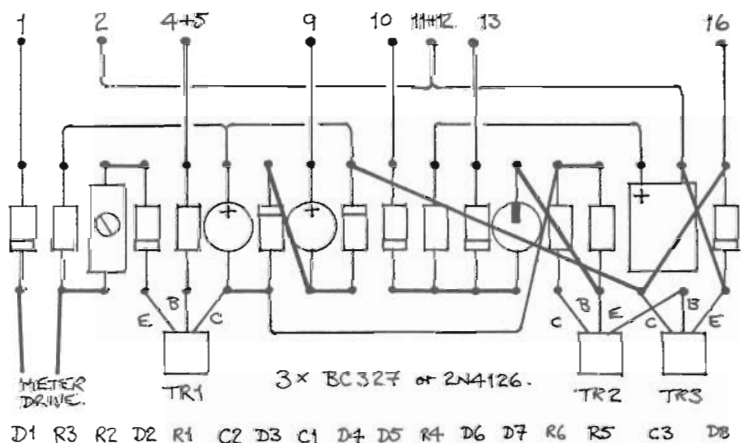

(4) Audio Adapter.

The audio stage is built around an external single transistor circuit that connects directly to the set's rear terminals. It is inserted in place of the rear diode link (14)(15) and provides tone and notch filtering plus a high quality amplifier/tape feed. Constructional layout is not critical, mine are built within a component/control box that is connected by cable and sits in front of the receiver.

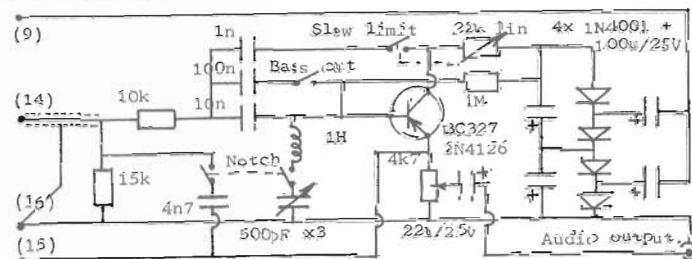

Power is derived from the 6.3Vac "Break In" relay supply (9), turn Break In "On";

the new diode load, 15k, is purely resistive and provides useful extra V504/T503 damping;

the switched 4n7 capacitor reduces output above notch frequency; to extend notch range down to 2kHz switch is extra parallel capacity across the variable;

on AM listen with the notch set to the lower of; - heterodynes or mechanical filter disc resonance effects induced by adjacent channel beating.

NOTES:

When correctly matched to an antenna system or signal source the R390A is amazingly trustworthy; hence I avoid directly connecting their 125 ohm input to the single ended 50 or 75 ohm cables and generators that have become our modern norm. When faced with this situation I insert a suitable 1:1.6 balanced and centre tapped RF isolating transformer.

Though large, the kilocycle and megacycle knobs do not turn freely and must be gripped by the whole hand to prevent fingertip slip. I fit a wide band of black bicycle inner tube rubber over mine to add feel, grip and speed. Fingertips do not now go near to or scratch the front panel.

Four series connected 1N4001 diodes will maintain operation in the event of RT510 failure; - push the free end wires into pin sockets 2 and 7. This method is as effective as other alternatives, but only 3TF7s can maintain good stability with winter line voltage variations.

Keep powerful loudspeakers and magnets away from the top left of the receiver - mechanical filter disc resonance can be disturbed and they will sound as if faulty.

For interest try connecting the IF output J116 to an oscilloscope Y input via 100pF, and the diode/buffer AF output to the X input. You'll observe trapezoidal displays of transmitter modulation that tie in with the sounds you hear. A pointed triangle indicates 100% carrier mod., a horizontal line 0% mod.; a bobbing pattern either fading or a transmitter with dynamic carrier control. See how synchronous demodulation maintains audio during carrier fades and how audio a.g.c. limits IF amplitude.

* * * * *

And finally.

My aim was to develop a top class broadcast listening and DXing R390A with the minimum of alteration. This in itself became an education, and provided ample proof of the fundamental knowledge and competence already encapsulated within original design.

I determined success by living with each change and comparing long term off-air observations, not by using dummy antenna/laboratory instrument techniques; for workbench methods, while representative, can neither foresee nor mimic real life receiving conditions, and most certainly they cannot measure merit.

At long, long, last, those hours consumed in study and empiricism reap pleasure and on going satisfaction; this could be yours also.

Good listening,

Graham

In the Beginning

John D. Bowker

The complete list of U. S. broadcast stations on the indicated frequency as published by the Federal Radio Commission in 1934. "S" = shared; "SH" = Specified hours; "T" = Transmitter location; "D" = Daytime operation only; "U" = Unlimited time

Frequency (kc)	Call letters	Main studio and transmitter location	Power	Time designation
1420, local...	WILM	Wilmington, Del.	100 w.	S-WAZL.
	WAGM	Presque Isle, Maine... 100 w.	100 w.	S.H.
	WTBO	Cumberland, Md. 100 w.	250 w LS.	U.
	WMAS	Springfield, Mass. 100 w.	100 w.	U.
	WHDL	Tupper Lake, N.Y. 100 w.	100 w.	D.
	WPAD	Paducah, Ky. 100 w.	100 w.	U.
	WELL	Battle Creek, Mich. 50 w.	50 w.	U.
	WMBC	Detroit, Mich. 100 w.	250 w LS.	U.
	WJMS	Ironwood, Mich. 100 w.	100 w.	U.
	WAZL	Hazleton, Pa. 100 w.	100 w.	S-WILM.
	WAMC	Anniston, Ala. 100 w.	100 w.	U (C.P. only).
	WNRA	Muscle Shoals City, Ala. 100 w.	100 w.	D (C.P. only).
	KCMC	Texarkana, Ark. 100 w.	100 w.	U.
	WENC	Americus, Ga. 100 w.	100 w.	D.
	WJBO	Baton Rouge, La. 100 w.	100 w.	D (C.P. only).
	WEED	Greenville, N.C. 100 w.	100 w.	D.
	KGFF	Shawnee, Okla. 100 w.	100 w.	U.
	WSPA	Spartanburg, S.C. 100 w.	250 w LS.	U.
	KABC	San Antonio, Tex. 100 w.	100 w.	U.
	WACO	Waco, Tex. 100 w.	100 w.	S.H.
	WEHS	Cicero, Ill. 100 w.	100 w.	S.H.
	WHFC	do. 100 w.	100 w.	S.H.
	WBFI	do. 100 w.	100 w.	S.H.
	KICK	Carter Lake, Iowa. 100 w.	100 w.	U.
	KWCR	Cedar Rapids, Iowa. 100 w.	250 w LS.	U.
	WLBF	Kansas City, Kans. 100 w.	100 w.	U.
	WMBH	Joplin, Mo. 100 w.	250 w LS.	S.H.
	KFIZ	Fond du Lac, Wis. 100 w.	100 w.	S.H.
	KUMA	Yuma, Ariz. 100 w.	100 w.	S.H.
	KGCC	San Francisco, Calif. 100 w.	100 w.	S.H.
	KGIW	Alamosa, Colo. 100 w.	100 w.	S-KIDW.
	KIDW	Lamar, Colo. 100 w.	100 w.	S-KGIW.
	KGIX	Las Vegas, Nev. 100 w.	100 w.	S.H.
	KORE	Eugene, Oreg. 100 w.	100 w.	U.
	KBPS	Portland, Oreg. 100 w.	100 w.	S-KXL.
	KXL	do. 100 w.	100 w.	S-KBPS.

High Performance General Purpose Loop Amp

by Dallas Lankford

This amp is a further improved variant of the Kolb-Sanserino amp which has been widely used for many years, such as in Radio West's loops, in the RTL-1 remotely tuned loop and other circuits developed by Mark Connelly, and, I have been told, in Palomar Engineers' loops. In my article "What's wrong with present-day loop antennas" in *DX News* 58, 23 (April 1, 1991) I described some minor improvements to the Kolb-Sanserino amp. However, it took almost another year of development and testing to obtain the major improvements described here.

One of the main differences between my amp below and all previous variants of the Kolb-Sanserino amp is that the output of my amp is completely balanced. Balancing the output reduced amp noise (a minor but annoying problem with previous versions), and improved 2nd order IMD performance. It was also found that 2nd order performance was further improved by using FET's for Q3 and Q4 instead of BJT's (which were used in previous versions). My output transformer is homemade, 11 trifilar turns of #26 enameled copper wire on an Amidon FT-50-43 ferrite toroid core. Mark Connelly has reported equivalent performance with a T4-6T-X65 transformer (Mini-Circuits, P.O. Box 350166, Brooklyn, NY 11235-0003).

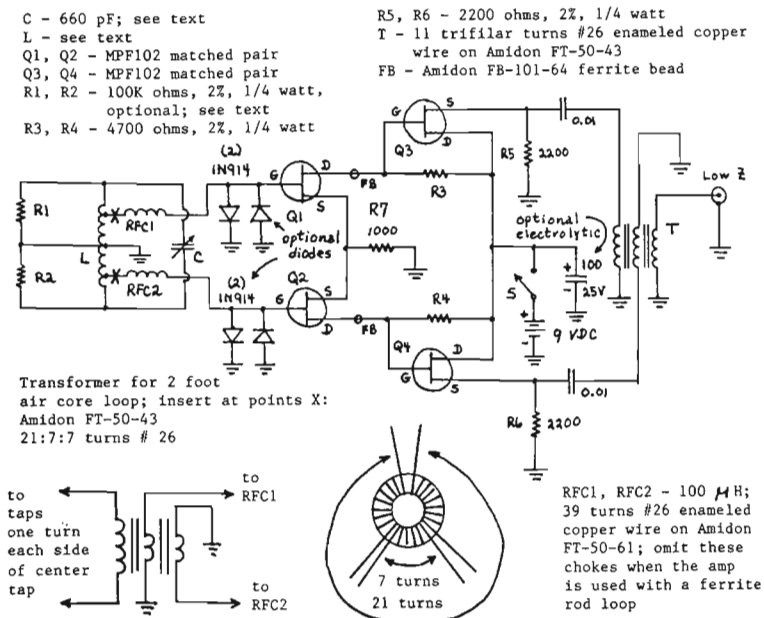

Another major difference between my amp and all previous variants of the Kolb-Sanserino amp are the 100 micro-Henry chokes RFC1 and RFC2. The chokes are not necessary or desirable when the amp is used with a ferrite rod loop; they should be omitted in that case. The chokes are necessary to eliminate 2nd order IMD products due to SW signals when the amp is used with 1 foot or 2 foot air core loops as described below.

The pair of back-to-back diode pairs (4 1N914 diodes) are static protection. I added these to my design recently when Ralph Sanserino told me he occasionally "kills" FET's, especially during dry periods when the Santa Ana winds blow dry desert air across Southern California. Mark Connelly expressed concern that these diodes might cause spurious mixing products, and he has a good point. However, signal levels at the gates of Q1 and Q2 should not be high enough to cause spurious mixing products provided the amp is used correctly. I have observed no spurious mixing products due to the diodes during extensive testing. If any spurious mixing products are observed, you may remove the diodes and replace FET's when you "kill" them.

Amp gain is determined by the 4700 ohm load resistors R3 and R4. For lower gain you may reduce the values of R3 and R4. However, I have found (not surprisingly) that for best strong signal handling performance the amp should be operated at or near maximum gain, and signal levels should be reduced (if necessary) to an appropriate level before the gates of Q1 and Q2.

Resistors R1 and R2 are Q-spilling resistors for the loop coil. The original Kolb-Sanserino schematic (IRCA reprint A8) included these resistors as optional, but did not discuss their function, or the pros and cons for using them. In my experience, these Q-spilling resistors are only necessary for previous variants of the Kolb-Sanserino amp which do not have a balanced output, and then only when the amp is used with a ferrite rod loop coil. In that case, without R1 and R2, the loop tuning is asymmetric, which adds some distortion to received audio when the loop is not precisely tuned. This is especially evident on weaker signals as hiss, and is more apparent when the loop is de-tuned to one side of the signal than to the other. With my completely balanced output, the distortion for ferrite rod loops due to this asymmetry is much less apparent, and so the Q-spilling resistors are not necessary unless you want the best possible audio quality from a received signal. When the Q-spilling resistors are used, signal levels will be reduced about 6 dB. The Q-spilling resistors are not necessary or desirable for a 1 foot or 2 foot air core loop.

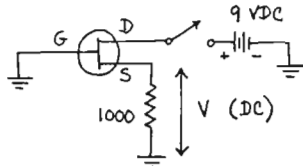

Q1 and Q2 should be matched pairs of MPF102's, and Q3 and Q4 should be matched pairs of MPF102's. It is not necessary or desirable that all 4 FET's be matched. The best way I know to match FET's is due to Kolb and Sanserino, and is shown at left. Measure the DC voltage across a 1000 ohm source resistor as shown, and select pairs of FET's with measured V's within 2%. You'll probably need at least 10 MPF102's to get two matched pairs. I use a Radio Shack or similar proto board to breadboard the circuit. FET's can be plugged into and removed from the proto board quickly.

The 660 pF air variable capacitor is available from Antique Electronic Supply, 6221 S. Maple Ave., Tempe, AZ 85263, (602) 820-5411, catalog no. CV-240, \$4.65 each. It is two sections, 320 pF and 345 pF, which are wired in parallel. As I pointed out previously, you will have to degrease and regrease the bearings because the original grease has dried out, causing stiff bumpy rotation of the shaft.

The main reason this amp was developed was for use with a 1 foot air core MW loop. My 1 foot square loop coil is 22 turns of #18 bare stranded (7x22) copper wire, center tapped, about 1/4 inch spacing between turns, 2 inch spacing between 11 turn halves, with taps 1 turn each side of center tap. The tuning range is about 485 KHz to 2150 KHz. Ralph told me he has constructed a similar 15 inch square air core MW loop with the amp connected across the entire loop coil, but I have recommended that he not do that because the resulting signal levels will be higher than needed and the strong signal handling performance will be degraded.

This amp can be used with many ferrite rod loops, especially those built by Ralph Sanserino and sold by Radio West. For most ferrite rod loops the amp is connected across the entire loop coil, and, as I said above, RFC1 and RFC2 are omitted. For ferrite rod loops, R1 and R2 are optional; see my previous remarks. I have used a homemade version of Ralph's ferrite rod loop which consists of 4 rods, bundled and overlapped, 3/8 inch diameter by 8 inches long rods, initial permeability 125, 26 turns of #22 enameled copper wire, center tapped. It is an excellent amplified MW loop.

This amp can also be used with a 2 foot air core MW loop. In that case a matching transformer should be inserted at the points marked X as shown on the schematic above. For details of the 2 foot air core loop coil you should consult my previous article, "High dynamic range balun loops," which appeared in DX News 58, 23 (April 1, 1991). The IMD performance of this amp and matching transformer seems to be about as good as the high dynamic range balun loop amp which was originally used with my 2 foot air core MW loop. Unlike the balun loop amp, the gain of this amp does not depend on the load it sees. Thus it would appear to be an improvement over the balun loop amp.

As I have said many times before, the most frequent defect of many previous amplified loop antennas is excessively high signal levels. When excessively high signal levels are applied to the input of an amp, spurious responses are often generated in the amp. And when excessively high signal levels are output from an amplified loop, the receiver dynamic range is degraded. In both cases the weak DX you want to hear may be covered up by spurious responses. Yet many DXers continue to degrade the performance of their receiving systems with amplified loop antennas which have excessive signal levels.

Tapping down on the 1 foot loop coil, as described above, illustrates the preferred solution to the excessive signal level problem for amplified loops with high input impedance amps. The signal levels input to the amp are reduced before the signals arrive at the amp. Sometimes a loop coil does not have enough turns to permit the signal levels to be reduced to a suitably low level. For example, a balanced 2 foot air core loop for the MW band typically has 14 turns, center tapped. Thus the minimum signal levels which can be obtained directly from a 2 foot air core MW loop are obtained by taps one turn each side of center tap. However, if my amp is connected directly to those two taps, signal levels are about 10 dB higher than needed. (In the past, high gain, high input impedance amps were connected across the entire loop coil, which resulted in signal levels 20 dB or more higher than needed!) This problem could be solved by reducing amp gain by 10 dB. However, signal levels at the input to the amp would still be 10 dB higher than needed. For best strong signal handling performance I have found that many of these kinds of amps should be operated at or near maximum gain, and the input signal levels to the amp should be reduced by an appropriate amount, in this case 10 dB. The matching transformer for the 2 foot air core MW loop reduces the output voltage from the coil by a factor of 3, which is equivalent to a 10 dB reduction in signal levels input to the amp. In theory this improves the effective 2nd order intercept of the system by 10 dB, and improves the effective 3rd order intercept of the system by 20 dB.

Spurious responses observed from an amplified, balanced, air core, MW loop antenna are seldom the result of inadequate 3rd order IMD performance. As a matter of fact, I have never observed any 3rd order IMD products from an amplified MW loop during on-the-air use. Of course, 3rd order products can be generated and observed using signal generators in a laboratory setting. The same cannot be said for 2nd order IMD products. If you observe any IMD products from an amplified MW loop during on-the-air use, you can be virtually certain they are 2nd order products. Moreover, the 2nd order products you hear, if your amplified loop has any, are usually due to a frequency difference $f_1 - f_2$ of two SW signals of frequencies f_1 and f_2 . For example, if you connect my amp directly to a 2 foot air core MW loop (without the 3:1 turns ratio matching transformer), and do not use the 100 micro-Henry chokes RFC1 and RFC2, or if you use any similar high gain, high input impedance amp, then almost every evening for the first several hours after local sunset you may observe some (and occasionally numerous) SW 2nd order IMD products as you tune your receiver between 1.6 and 2.0 MHz, especially with the receiver BFO turned on, and with the loop detuned (say, to around 500 KHz). Even with the loop tuned to the received frequency (in the 1.6 to 2.0 MHz range) you may still observe SW 2nd order IMD products near the ambient noise floor on a quiet night.

Balanced, amplified, MW air core loops are susceptible to SW 2nd order IMD products because they are actually quite good antennas for the SW frequencies above about 5 MHz. If you have a 2 foot or larger balanced, amplified, MW air core loop, turn the amp on and tune your receiver between 6 and 16 MHz during the early evening hours. Unless your amp is my balun amp, or my amp above with chokes RFC1 and RFC2, you will find that signal levels above about 9 MHz are almost as high as with a full size outdoor LW antenna. In effect, your loop is a broadband SW antenna, and you amp is a broadband amp for SW signals above about 5 MHz. Even the best amplifiers do not have high enough 2nd order intercepts to prevent 2nd order IMD products from being observed at medium frequencies (on quiet afternoons and evenings) when the amp is used with a balanced, air core MW loop. Fortunately, I discovered a simple solution for this problem some time ago when I developed the balun amp. A 100 micro-Henry choke added at the appropriate point in the balun amp, or a pair of 100 micro-Henry chokes added at the appropriate points in my variant of the Kolb-Sanserino amp pass MW signals without loss, but reduce SW signal levels, especially those above 9 MHz, up to 20 dB or more. Thus SW 2nd order IMD products are reduced up to 20 dB or more, and well below the threshold of detectability.

Perhaps I should add that if you live in an urban area with high levels of ambient man-made noise, then you may seldom hear the SW 2nd order IMD products discussed above. For example, in Riverside, CA Ralph Sanserino normally has about 20 dB of ambient man-made noise when using one of the loops described above with an R-390A, while I normally have 0 dB or less ambient man-made noise. With previous versions of the Kolb-Sanserino amp (sans chokes, and not tapped down on the loop coil), SW 2nd order IMD products are seldom as strong as 10 dB and so Ralph has never observed them. Similarly, many DXers in noisy urban areas may never hear these SW 2nd order IMD products. However, it appears that the problem of SW 2nd order IMD products is not entirely unheard of. In a recent issue of DX News the IDXD editor discussed several SW "images" which had been reported to IDXD and another SW "image" which he had observed recently. It appears they observed SW 2nd order IMD products which originated in their amplified MW loop antennas.

Some variation in components for my amp is permissible. For example, Mark Connelly suggested using a Mini-Circuits T4-6T-X65 transformer instead of my

homemade transformer T. While I was typing this article I received one of these MC transformers from Mark. I checked it out and found no differences in signal levels or IMD performance. So the MC transformer would appear to be a winner because it saves time making a transformer. The chokes RFC1 and RFC2 were homemade because the chokes I had been using ("high reliability" Mouser 43HH104) proved unreliable. Ordinary handling can cause them to develop an internal open circuit. Perhaps some other commercial choke (maybe Mouser 434-1120-101L) would be satisfactory. In a similar amp, Alan Merriman reported that a Radio Shack 100 micro-Henry choke caused bad spurious responses. Using different FET's is not a good idea unless you are willing and able to do extensive testing, and you have extremely low levels of ambient man-made noise. For example, I tried U310's in place of the MPF102's after someone suggested them. The U310's gave greater gain, as I was told, but they also generated considerably more amp noise. The additional amp noise was about equal to the additional gain. When the load resistors were adjusted to equalize amp noise, there was no difference in amp gain. So there is no advantage to using U310's in place of MPF102's. These experiences illustrate the importance of testing if you make any component changes.

I would like to express my appreciation to Mark Connelly and Ralph Sanserino for comments and suggestions relating to this article and the amp design. For example, Ralph recently asked me to clarify how ambient man-made noise could give a carrier meter reading of less than 0 dB on an R-390A. Of course, Ralph is right. The R-390A carrier meter (when properly adjusted) does not read below 0 dB. What I meant was that because an R-390A has delayed AGC, there is 20 dB or more "headroom" above the R-390A noise floor and below the point at which the carrier meter begins to move. On extremely quiet days at my location the ambient man-made noise floor in the MW band is (I estimate) about 5 to 10 dB below 0 dB on the R-390A meter using any of my standardized antennas. That is what I meant when I said I have less than 0 dB of man-made noise on some occasions. Although I can't find the letter or article where Mark mentioned it, I recall Mark writing that he has experienced SW second order intermodulation distortion when using this amp with a ferrite rod loop. So my suggestion above to omit the 100 microHenry chokes when using the amp with a ferrite rod loop should be ignored, and you should use the 100 microHenry chokes with all MW loops. It never occurred to me that DXers closer to Europe, like Mark, would experience SW second order intermodulation products with loops which would be free of spurious responses at my location where SW signal levels are lower. But apparently that is indeed the case.

Finally, a few words are in order regarding which kind of loop you should build or buy - ferrite rod(s) or air core. Recently while testing the AGC mod I performed on Russell Scotka's NRD-525, I discovered, much to my surprise, that my two foot air core loop was much less susceptible to the NRD-525 display noise than my ferrite rod loop. I do not know whether this is also true for a one foot air core loop because I did not have one prototyped at the time. I have no explanation for this strange discovery, but it should be studied further. For an NRD-525, display noise was reduced below ambient man-made noise at my location (which is considerably lower than ambient man-made noise in typical urban locations) when the two foot air core loop was moved three feet or more away from the NRD-525. With the two foot air core loop three or four feet away from the NRD-525 it was not awkward or difficult to operate the loop and receiver simultaneously. In fact, it would be inconvenient to have the loop much closer to the receiver. If a one foot air core loop is equally less susceptible to NRD-525 display noise than a ferrite rod loop, and if air core loops are equally less susceptible to display noise of other solid state receivers than a ferrite rod loop, then air core loops would clearly be the MW band loops of choice. Increased prices of ferrite rods, and inherently limited sensitivity of ferrite rod loops are other reasons which make air core loops more attractive than ferrite rod loops.

AM Radio Station Maps

by Bill Hale

Complements the *NRC AM Radio Log*. Large type ... maps show location of stations ... easy to keep up-to-date. Now priced at \$8.00. Order from NRC Publications - Box 164 - Mannsville, NY 13661. NY orders, please add sales tax.



Another Look at Noise-Reducing Antenna Systems

by Mark Connelly - WA1ION

Dallas Lankford and Denzil Wraight, in their 1991 articles, introduced the DX community to the noise-reducing inverted-L antenna. These articles are, or will soon be, NRC / IRCA reprints. The authors based their work on ideas put forth by F. R. W. Strafford in *Wireless World*, 25 NOV 1937.

I have experimented with some of these designs. Also, I have come across similar noise-reduction properties when using Beverage-matching transformers, as described by Nick Hall-Patch / John Bryant ("Impedance Matching a Beverage Antenna to a Receiver", *Proceedings* 1988) and me ("Bevmatcher", 15 JAN 1991).

My experiments indicate that isolating the various grounds is the major factor in reducing local electrical noise from TV's, light dimmers, digital circuits, fluorescent lights, motors, and the like. Isolation transformers and a "field site" earth ground not tied directly to the station (e. g. mains) ground are key elements in the noise-reduction scheme. Improvements have been noted with even a modest separation (such as 30 ft./ 9 m.) between station ground and field site ground. If the field site is removed by a greater distance (e. g. 66 ft./ 20 m., or more) from the immediate vicinity of house wiring, all the better. A suitable feedline must be used between the two isolation transformers. Wraight and Lankford have used balanced lines (such as twinlead and "zip cord"). I have had good success using 50-ohm coaxial cable of the RG-58 and RG-8 varieties. The shield of the coaxial cable is not tied directly to either the station ground or the field site ground. My set-up for a single noise-reducing antenna is shown in Figure 1.

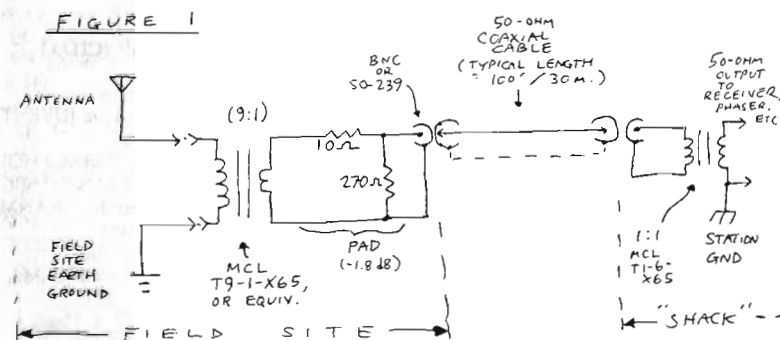

Note that the field site transformer provides broadband impedance matching (9:1 step down from approximately 450 ohms antenna to 50 ohms transmission line) as well as ground isolation. One could use either the Mini-Circuits T9-1-X65 or an equivalent homebrew model - for instance, Nick's FT50-43 Amidon core with 35 turns primary, 11 turns secondary. Other ratio transformers (e. g. 1:1, 4:1, 16:1) may be tried; in some circumstances, a different ratio might provide more signal transfer.

A low-loss matching pad (-1.8 dB) is used to reduce mismatch which could compromise antenna directivity and noise suppression. Refer to my "Bevmatcher" article (cited above). The 9:1 field site transformer and the matching pad should be enclosed in a weatherproof box.

NRC Coffee Mug

Nine-ounce size ... white glass ... with NRC emblem printed in black on both sides. It's oven-proof and microwavable. Makes a great gift. \$6 to U. S. addresses \$6.75 Canadian. Order from NRC Publications (NY residents, add sales tax).



The transformer on the "shack" end of the cable should be a 1:1 type such as Mini-Circuits T1-6-X65. The antenna length or orientation isn't critical. Any length from 33 ft. / 10 m. on up to Beverage length should work. Short lengths (less than 164 ft. / 50 m.) will probably require in-shack tuned amplification. For a small to medium sized lot, consider a sloper. A 62 ft. / 19 m. sloper suspended from a tree or mast can give better directivity and pick-up than any other orientation of that wire length. Additionally, with a decent ground system, it can be used for transmitting on the 75-m (3.8 MHz) ham band if the transformers and pad resistors are switched out of the line.

The field site earth ground system should consist of at least one buried 6.6 ft. / 2 m. copper rod and, preferably, more of these plus several radial wires of length comparable to that of the sloper.

I have two such low-noise antenna set-ups which I route to the inputs of an MWDX-5 phasing unit and/or MWT-2 regenerative tuner. Amplification in the MWDX-5 (or MWT-2) compensates for the relatively low signal levels from the short slopers. The lack of TV hash, etc. on the two antennas allows me to use phasing to null out "pest" stations to hear DX rather than using phasing to null out local electrical noise to hear routine "pest" stations. Weak DX is besieged by TV-related QRM when loops and whips are used, even when they're located out in the yard, 50 ft. away from any houses or power lines. A system with two phased noise-reducing slopers, followed by high-Q regenerative amplification, is the best set-up I can fit on my fairly compact (0.3 acres) suburban lot. The slopers are arranged to favor different directions. Obviously, Beverages would do much better, but few DXers have that kind of space at their home QTH's.

Cuban AM and FM Stations List

Compiled by Alain Pepin, Canadian International DX Club (CIDX)

MEDIUM WAVE STATIONS

540 CMHV1 (R) Sancti Spiritus
 550 CMDC1 (R) Manzanillo GRANMA
 550 CMAN (R) Pinar del Rio
 570 CMDC2 (R) Pilon GRANMA
 580 CMKF (R) Baracoa Guantánamo
 580 CMAN1 (R) Mantua PINAR DEL RIO
 590 CMDN (R) Guantánamo
 590 CMW (R) La Julia HABANA
 590 CMHI (RR) Santa Clara VILLA CLARA
 600 CMKV (R) Urbano Noris HOLGUIN
 610 CMAN2 (R) Bahia Honda PINAR DEL RIO
 610 CMH2 (RR) Trinidad SANCTI SPIRITUS
 620 CMDQ (R) Moa HOLGUIN
 620 CMGN (R) Colón MATANZAS
 640 CMDC (R) La Mercedes GRANMA
 640 CMBC (P) La Habana
 650 CMDC3 (R) Media Luna GRANMA
 650 CMKU (R) Santiago de Cuba
 660 CMHG (P) Santa Clara VILLA CLARA
 670 CMQ (R) La Habana
 680 CMJV (R) Ciego de Avila
 680 CMHN (P) Cienfuegos
 680 CMDB (P) Santiago de Cuba
 690 CM (P) Jovellanos MATANZAS
 700 CMDU (E) Guantánamo
 710 CMJN (R) Camagüey
 710 CMKJ (R) Holguin
 710 CMHQ (R) Santa Clara VILLA CLARA
 720 CMHQ1 (R) Cienfuegos
 730 CMQ1 (P) La Fe ISLA DE JUVENTUD
 740 CMJL (P) Camagüey
 740 CMKP1 (P) Sagua de Tanamo HOLGUIN
 750 CMHV (R) Trinidad SANCTI SPIRITUS
 760 CMDE1 (RR) La Mercedes GRANMA
 760 CMCD (RR) La Habana
 790 CMAQ (RR) Pinar del Rio
 800 CMDT (P) Manzanillo GRANMA
 810 CMDW (P) Guantánamo
 810 CMCA La Habana (*) R. Ciudad del La Habana
 820 CMJT (P) Moron CIEGO DE AVILA
 820 CMCA Santa Catalina CIUDAD DE HABANA
 820 CMDE2 (RR) Contramaestre GRANMA
 830 CM (T) La Julia HABANA
 840 CMBQ1 (E) La Fe ISLA DE JUVENTUD
 840 CMDQ (P) Las Tunas
 840 CMKC Santiago de Cuba
 840 CMHW Santa Clara VILLA CLARA
 850 CMKB (P) Baracoa Guantánamo
 850 CMHL1 (P) Trinidad SANCTI SPIRITUS
 860 CMBL La Habana
 870 CMDT1 (P) Pilon GRANMA
 870 CMHL (P) Sancti Spíritus
 880 CMAF (P) Pinar del Rio
 890 CMDZ (M) Santiago de Cuba
 890 CMHD Santa Clara VILLA CURA
 900 CMKP (P) Holguin
 910 CMFA Camagüey R. Cadena Agramonte

910 CMGL (RR) Matanzas
 920 CMGL1 (RR) Union de Reyes MATANZAS
 930 CMDP (RR) Las Tunas
 930 CMGB (RR) Cardenas MATANZAS
 930 CMKN (RR) Santiago de Cuba
 930 CMJS (RR) Ciego de Avila
 940 CMKD (RR) Holguin
 940 CMGU (RR) Colón MATANZAS
 950 CMBF (M) La Habana
 950 CMH1 (RR) Sancti Spíritus
 960 CMHJ (RR) Cienfuegos
 960 CMDJ (RR) Guantánamo
 960 CMGF (E) Matanzas
 960 CMJD (M) Ciego de Avila
 980 CMDE (RR) Bayamo GRANMA
 980 CMCK La Habana
 980 CMKR Moa HOLGUIN
 990 CMAS Pinar del Rio
 1000 CMJB (M) Camagüey
 1000 CMAC Los Palacios PINAR DEL RIO
 1000 CMHB (M) Sancti Spíritus
 1010 CMKM (M) Holguin
 1010 CMAP Guane PINAR DEL RIO
 1030 CMAX La Palma PINAR DEL RIO
 1040 CMKT1 Puerto Padre LAS TUNAS R. Victoria
 1050 CMKT Las Tunas R. Victoria
 1060 CMDX Baracoa Guantánamo
 1060 CMKT2 Amancio Rodriguez LAS TUNAS R. Victoria
 1070 CMKS Guantánamo
 1080 CMCH1 Guines HABANA R. Cadena Habana
 1080 CMAB Bahia Honda PINAR DEL RIO
 1090 CMK01 Moa HOLGUIN
 1090 CMAP1 Minas de Matahambre PINAR DEL RIO
 1100 CMCH Jaruco HABANA
 1100 CMK02 Banes HOLGUIN
 1110 CMKO Holguin
 1120 CMCH2 Artemisa HABANA
 1120 CMK03 Mayarí HOLGUIN
 1130 CMK04 Sagua de Tanamo HOLGUIN
 1130 CMHA (E) Santa Clara VILLA CLARA
 1140 CMKX1 Media Luna GRANMA
 1140 CMCG Loma de la Cruz HABANA
 1150 CMKX Bayamo GRANMA R. Bayamo
 1160 CMKX2 Pilon GRANMA
 1170 CMKS1 Maisi Guantánamo
 1180 CM (T) Villa Maria CIUDAD HABANA
 1180 CMBM (RR) Nueva Gerona ISLA DE JUVENTUD
 1180 CMDDB1 (P) Mayarí Arriba SANTIAGO DE CUBA
 1190 CMGW1 (26) La Caridad MATANZAS
 1190 CMHT1 Yaguajay SANCTI SPIRITUS R. Sancti Spíritus
 1200 CMBS San Antonio de los Banos HABANA
 1200 CMHT2 Trinidad SANCTI SPIRITUS R. Sancti Spíritus
 1200 CMK1 Palma Soriano SANTIAGO DE CUBA
 1210 CMHT Sancti Spíritus R. Sancti Spíritus
 1210 CMKC1 Chivirico SANTIAGO DE CUBA
 1210 CMKC2 Mayarí Arriba SANTIAGO DE CUBA
 1220 CMGY (26) Colón MATANZAS
 1230 CMGJ (26) Union de Reyes MATANZAS
 1240 CMGW (26) Matanzas
 1250 CMKS2 Imias Guantánamo
 1250 CMHW1 Caibarien VILLA CLARA
 1260 CMGH Torriente MATANZAS
 1270 CMJG (RR) Camagüey
 1270 CMBN Nuevo Gerona ISLA DE JUVENTUD R. Caribe
 1280 CMJC Guaimaro MATANZAS
 1280 CMGF1 (E) Varadero MATANZAS
 1280 CMKW Santiago de Cuba
 1290 CMHW2 Rancho Veloz VILLA CLARA
 1300 CMDA1 (E) Las Tunas
 1310 CMBF1 (M) Nueva Gerona ISLA DE JUVENTUD
 1310 CMHR Sagua la Grande VILLA CLARA
 1320 CMHA1 (E) Sancti Spíritus
 1320 CMDA (E) Santiago de Cuba
 1330 CMDO Banes HOLGUIN
 1340 CMHU Cienfuegos R. Ciudad del Mar
 1350 CMHU2 Agua de Pasajeros CIENFUEGOS R. Ciudad del Mar
 1350 CMKY Puerto Padre LAS TUNAS
 1360 CMFA1 Rodolfo Ramirez Camagüey R. Cadena Agramonte
 1370 CMFA2 Nuevitas Camagüey R. Cadena Agramonte
 1370 CMDV Santiago SANTIAGO DE CUBA
 1380 CMFA3 Centro Brasil Camagüey R. Cadena Agramonte
 1390 CMBT Jaruco HABANA
 1400 CMFA4 Guaimaro Camagüey R. Cadena Agramonte
 1400 CMGX (M) Matanzas
 1410 CMJW Santa Cruz del Sur Camagüey R. Santa Cruz
 1410 CMAL Pinar del Rio
 1420 CM Colón MATANZAS
 1420 CMHS Caibarien VILLA CLARA R. Surco
 1430 CMJY Moron CIEGO DE AVILA
 1440 CMBU Guines HABANA
 1440 CMJP Ciego de Avila R. Surco
 1450 CMJF Amancio Rodriguez LAS TUNAS
 1460 CMHZ Sola Camagüey
 1470 CMGE Cardenas MATANZAS
 1480 CMJI Florida Camagüey
 1490 CMBW San Jose de las Lajas HABANA
 1490 CMDH Mayarí HOLGUIN
 1500 CMDA2 (E) Holguin
 1500 CMKQ San Luis SANTIAGO DE CUBA
 1510 CMDA3 (E) Moa HOLGUIN
 1520 CMKZ Palma Soriano SANTIAGO DE CUBA

1530 CMJX Morón CIEGO DE AVILA
 1530 CM Sagua la Grande VILLA CLARA
 1550 CMJQ Nuevitas Camagüey
 1560 CM (E) Ciego de Avila
 1580 CMFA5 Santa Cruz del Sur Camagüey
 R. Cadena Agramonte
 1590 CDMF Manzanillo GRANMA R.
 Granma

FM STATIONS

88.3 CMJP-FM Ciego de Avila
 90.3 CMBC-FM La Habana
 90.5 CMDZ-FM Santiago de Cuba
 90.5 CMBQ-FM Trinidad relay?
 90.9 CMHT-FM Sancti Spiritus
 92.1 CMQ-FM La Habana
 93.7 CMBQ-FM La Habana
 93.7 CMHW-FM Santa Clara VILLA
 CLARA W-FM Stereo 93
 93.9 CMKC-FM Santiago de Cuba
 95.1 CMBF-FM La Habana
 95.1 CMDV-FM Santiago de Cuba
 95.9 CMKX-FM Bayamo GRANMA
 95.9 CMCD-FM La Habana
 97.7 CMCK-FM La Habana
 99.3 CMDB-FM Santiago de Cuba
 101.0 CMCA-FM La Habana (*) R. Ciudad
 de La Habana
 101.9 CMHW-FM The Escambrays VILLA
 CLARA (19 hours)
 102.1 CMBL-FM La Habana

104.0 CMCH-FM La Habana (*) R. Cadena
 Habana

If no province name is indicated, province
 name is same as city shown.

(*) Added from info published in the WRTH
 Latin American Newsletter.

NETWORK AFFILIATION

(R) Radio Rebelde (RR) Radio Reloj
 (P) Radio Progreso (T) Radio Taino
 (M) CMBF Radio Musical (E) Radio
 Enciclopedia
 (26) Radio Veinte-seis

COMMENTS

Alain used the 1992 WRTH and personal
 observations while visiting Cuba in 1991 and
 1992 in compiling this list.

Networks air only the callsign of the
 flagship station, and callsigns shown above
 are as heard over the air, disregarding the list
 registered with the IFRB in Geneva. The
 added digit to some callsigns is Alain's own
 invention to distinguish between relays from
 the originating station.

Most stations, except Radio Rebelde,
 Progreso and Reloj operate 0600-0100 ELT
 (0100-2000 UTC Winters, 0200-2100 UTC
 Summers).

Thank you, Alain, for permission to reprint
 information originally presented in the CIDX
 Messenger (May, 1992).

Radio Waves

News of the industry, of interest to DX'ers

Greetings to all summertime static lovers!
 Some interesting and semi-interesting
 industry notes of late ... Clear Channel
 Communications recently added to its stable
 of winter acquisitions with the purchase of
 AM/FM combo WRVA-WRVQ in Richmond
 and WRBQ AM and FM in Tampa Bay. Clear
 Channel paid \$18.5 million cash to Edens
 Broadcasting for the two combos. In February,
 Clear Channel bought UHF-TV station WPTY
 in Memphis for \$21 million; in March it
 bought the Kentucky State network (radio) and
 the radio rights to the NFL New Orleans
 Saints. A week later it bought WKCI-FM in
 New Haven CT for \$14 million to complement
 its AM there, WELI ... The FCC's three-year
 freeze on changes to AM technical facilities
 ended at midnight on April 19. The
 commission stopped taking applications for
 changes while it worked up new AM rules.

The freeze is being lifted even though there are
 still several pending petitions asking it to
 reconsider certain aspects of the package.
 According to insiders, don't look for big
 changes in the new text, as any changes to the
 new rules will be minor. The new rules, say
 FCC engineers, will reduce "interference" over
 a 10- to 15-year period ... If new ownership
 rules, scheduled for implementation August 1,
 were in effect today, at least five markets
 would change tiers - Chicago, Nassau-Suffolk
 NY, St. Louis, Pittsburgh, and Monterey-
 Salinas. Chicago now has 42 signals, up from
 36 in flal '91, representing a shift into the
 FCC's 40-plus-signal ownership tier from the
 previous tier of 39-29 signals. At 40-plus
 signals, according to the new rules, one owner
 will be allowed to own 3 AM's and 3 FM's,
 provided the owner doesn't control more than
 25% of the 12+ audience shares at the time of

Laura McCusker

Oakbrook Manor #23E
 Ravena, NY 12143-1017

acquisition. The FCC's 30-39 signal tier will
 allow ownership of 1 less FM, for a possible
 total of 2 FM's and 3 AM's ... Small market
 station owners, already facing more
 competition than ever, told the FCC they
 support an NAB plan to freeze FM petitions
 and allocations while the agency reviews its
 rules for granting new stations. In addition,
 supporters of the freeze also urged the FCC to
 tighten its grip on the FM band by taking such
 NAB-recommended steps as requiring
 petitioners to prove a proposed station's
 "economic viability"; acting quickly to delete
 silent or unbuild stations; and toughening the
 criteria for determining whether a new
 allotment should be made ... And to bring up
 the rear, some ratings news!! -Howard Rules
 L. A.!!! Well, not quite yet, but getting there.
 According to Arbitron, Howard Stern's
 morning simulcast on KLSC-FM pulled a 3.8
 share, upping the station to 7th in morning
 drive. Howie fell a bit in NY, dropping from a

7.7 to a 7.3, which also dropped him to
 second-highest rated AM-drive show in the
 Big Apple, after WINS (which also dropped,
 from a 7.6 to a 7.4). Elsewhere in the ratings
 game, country music continues to post big
 numbers nationwide. In Phoenix, KNIX is on
 top with an 11.7 share. Down in Dallas,
 "Young Country" KRSR posted a 3.1 share
 and appears to be luring some listeners away
 from the three other major C&W stations. In
 Houston, KILT was on top with an 8.9, with
 runner-up KKIK pulling a 7.1. In Seattle,
 KPMS unseated long-time market leader
 KIRO in the 12+ numbers. In Indianapolis,
 WFMS was on top with a 10.8. In Baltimore,
 WPOC led the pack with an 8.9. And finally,
 it's not C&W, but worth noting that new 3 kW
 drop-in UC WROU in Dayton posted a 7.2
 share in its first full book, coming in second ...

Source of Original Instance for Gleaned
 Material Contained Herein: *Radio Business
 Report and Radio and Records.*

Radio Roundup

News of radio personalities, of interest to DX'ers

Pete Kemp (KZ1Z)

P. O. Box 73
 Bethel, CT 06801-0073

Greetings all ... Sharp-eared NRCer
 Bill Hale reports that KMEN-1290 has gone
 the all-sports route carrying a wide variety of
 events and ESPN radio feeds. All sports
 programming is gaining in CA. XETRA, just
 over the border from San Diego, and even
 KMPC, to a lesser degree, are jumping on the
 band wagon ... Fellow NRCer Jeff Multer
 checks in with some additional information
 on the José Feliciano, WMMM article which
 ran in the *DX News* a few issues back. José
 received a lot of criticism for his version of the
 Star Spangled Banner back in 1968 during the
 World Series. He has since recorded another
 stylized version which WMMM uses at sign-
 off ... Jeff also reports that Desert Island Discs,
 a BBC program on Radio 4 has just celebrated
 its 50th anniversary. This show's premise is a
 simple one. You are a castaway, alone on a
 desert island. You may take 8 musical
 selections with you. Which ones would you
 take? Weekly guests engage in small talk,
 play their selections and discuss their
 rationale for inclusion. The special guest for
 the 50th anniversary show was Prime
 Minister John Major ... Please share your
 thoughts with other NRCers.

Digital Audio Broadcasting
 was expected to get a lot of attention at the
 World Administrative Radio Council
 meetings in Torremolinos, Spain but, in the

end, universal standards were not adopted,
 leaving this mode in limbo. The lack of
 standards will not affect domestic
 development with the United States ... Looking
 for specialized radio show? Try this one, The
 Sports Collector's Radio Show, to be aired on
 WGBB-AM Sunday evenings. It will be
 hosted by sportscaster Jay Bustman and
 Baseball Autograph News publisher John L.
 Raybin ... The F.C.C. has moved to pull the
 licenses of 10 AMers that had been off the air:
 KBRS, WKIJ, KOKY, WFRK, WSPC, KMHT,
 WAGF, WAPR, WDAT, and WOR1 ...
 Evergreen Media, owners of WLUP-1000 are
 being taken to court for failure to pay their
 F.C.C. fine, despite two formal requests.
 Evergreen still maintains their innocence in
 broadcasting obscene material ... Veteran
 radio actor John Dahner has died, at the age
 of 73. He played the title role of Paladin on
 radio's *Have Gun Will Travel*. He also
 appeared on many radio drama's in addition
 to his other famous radio role as Frontier
 Gentleman ... While on this sad subject,
 radio/tv actor Dick York has passed away.
 He played the part of Billy Fairfield on the
 radio series *Jack Armstrong*, but is mostly
 known to his fans as Darren of TV's
Bewitched ... NRCers who are on Prodigy
 should note that they have added a Radio
 section to their Arts board. Many discussions

on a variety of commercial radio related subjects. GENIE also has an area for such discussion in the Radio and Electronics sub area (M8009;2) and the Fido Net on both the Shortwave and Broadcasting echos. You would be surprised how many NRcErs maintain an ongoing correspondence via the telephone modem networks ... Station programming consultant J. R. Russ is pushing his new Amplitude format, containing equal amounts of news, weather, traffic and music. He is testing the format on WBUX-1570, in Bucks County, PA. The station is now using the slogan "The All-New 'BUX-1570'" ... In a surprising move, WCBS has resigned its CPCS-1 (Common Program Control Station) status in the Emergency Broadcast System (EBS). WCBS-AM/FM will now monitor WFAN-660 for EBS Alerts. The station is still smarting from a reprimand they received from last summers failure to respond for EBS warnings for Hurricane Bob, which affected the area ... The Voice of America recently celebrated its 50th Anniversary ... The Washington Redskins are moving their radio outlet in our nation's capitol from WMAL to WTEM after a 44 year run. WTEM is a new all-sports station in Washington, DC ... The FCC has increased the authority of its various bureaus, including the Private Radio Bureau, to levy fines for rules infractions. The bureaus now may levy such fines in amounts up to 20,000 dollars on their own authority. On August 1, 1991, the Commission issued new policy guidelines authorizing greatly increased amounts for fines, but the bureaus were limited by much lower ceilings of authority. Large fines had to be authorized by the commissioners themselves. The average FCC monetary fine is about 8,000 dollars ... Pete "Banned from Baseball" Rose has signed on to WABC-770 for a sports-talk show on weekday evenings from 7 to 9 p.m. when the Yankees are not playing. He will be with the station on through the baseball season ... Bob Fitzsimmons has left the morning spot on WNEW. The station couldn't come to a new contract agreement. He was told to seek other employment when his contract expires. The Management then turned around took him off the air immediately. Nice guys! WNEW sure has dropped a lot in the past few years and the ratings show it. Big names of the past like William B. Williams, Klavan & Finch, shows like the Make Believe Ballroom and the Milkman's Matinee are just history. Sad, really sad to which a once powerful 50,000 watter fall into such a state ... Curtis Sliwa, the founder of the famed Guardian Angels, who together with his wife Lisa, host the morning show on WABC is back on the air following a little altercation. It seems that Curtis was beaten up by a gang of thugs on the lower Eats

Side. After six stitches, numerous bruises, a broken wrist he says he is OK. In the future he says he'll travel more often with a small entourage and be more careful ... listeners in the Raleigh, NC area sure were happy to listen to the DJ Reunion on WTRG-FM reuniting the KIX Men of Music, of WKIX Channel 85 back in the sixties. Attendees included: Russ Spooner, Pat Patterson, Rick Dees, Charlie Brown, Jack Kane, Tommy Walker, Bob Jones, Bob Kelly and Gary Edens. Another alumus from the station is Entertainment Tonight's newlywed John Tesh ... Veteran Dodger sportscaster Vin Scully has been selected to receive the 1992 Los Angeles Area Governor's Emmy Award. He started on radio with the grand old man of sportscasters, Red Barber, 42 years ago ... Legendary Rock and Roll programmer Rick Sklar has passed way. He will long be remembered as the man behind WABC at its powerful best in the 60s ... Does anybody know why Los Angeles radio stations are using the phrase "...the Southland". LA certainly isn't near Georgia! ... Sportscaster Pete Franklin has surfaced on KNBR on the west coast. He will probably be remembered for his Cleveland days and the brief time he spent on WFAN when they went All-Sports in New York City ... Travelers passing through San Francisco International Airport during the month of July, were treated to a display of old radios, in the North terminal. The display was a Hollow-State listener's delight, names like Adler Royal, Hallicrafters, Colonial, Remler and more. The collection belongs to Dan Healy, who is also a sound engineer for the Grateful Dead ... Chicago's WGN recently spent over \$250,000 to overhaul its newsroom. It is great news to hear of such an investment in light of today's economy. Many major city stations are cutting back, and in some cases, eliminating their news departments ... In a speech delivered to media specialists and the Massachusetts Institute of Technology, Kazuhiko Nishi of ASCII Corporation of Tokyo, says that in the future of a new form of digital audio broadcasting will allow viewers/listeners to WYWIWYS, What You Want, Is What You See, for television. This systematic consumer driven approach, could be applied to a wide variety of integrated media. Just think for a second, you could call up specific programming at anytime, music, news, weather reports and more. With many stations moving from local to syndicated/satellite distribution, could it be that radio listening the way he have always appreciated it will come to an end in the next century? Something to think about ... WLAD-800 has recently redone its studios. What made this transition unique was that many of the on-air staff contributed their hands-on

talent during they off-air times ... One of Howard Stern's most loyal listeners probably won't be in the future. Kevin Renzulli has received a cease and desist order from Stern's lawyer to stop publishing a Howard Stern Newsletter. Seems that the newsletter is getting too big and has some commercial appeal. Renzulli's operation only has 600 subscribers at \$1.50 a month. He claims that it costs him between 8 to 10 thousand dollars a year to publish his newsletter, making it a money looser, but a labor of love for Kevin ... Both Brad Sherman and Brad Phillips have decided to accept WINS's early retirement offer. Both have been with the station for many years ... Charles Osgood recently celebrated his Osgood File's 25th anniversary on the CBS Radio Network. Osgood will be leaving his daily morning CBS tv anchor network spot to concentrate on feature pieces ... Tom Bodet, who worked with the Dallas-base Richards Group creating the famous Motel 6, We'll Leave a Light on For You, ads recently won a Mercury Award for Radio Advertising; the top prize is worth \$100,000 ... NRcEr Eric Bueneman reports that WCNN-680 is now carrying CBS's Major League Baseball .. Eddie Schwartz has moved from WGN to WLUP in the Windy City ... Freddy Mertz is out at WGST by ex-WSB staffer Kim Peterson ... Little Dalton, GA has TWO full-time Oldies stations, WBLJ-1230 and WLSQ-1430 ... WYNX-1550, in Smyrna, Georgia has stopped broadcasting in AM- Stereo ... WSM, in Nashville, is now using the Hot Country slogan ... If you are ever visiting Chattanooga, CNN Headline News may be heard on WLMX- 980 ... 10-10 in Toronto, CFRB, is now replaying its talk shows during the overnight weekday hours ... Singer Perry Como recently his 80th birthday. Many MOR stations have offered an extra dose of the crooner. WNEW's Program Director Russ Knight put together a 2-hour special to air on station around the country. I still remember Russ Knight from his Weird Beard times on KLIF in Dallas during its Rock and Roll days ... Neal Busch recently celebrated his 25th anniversary has a Traffic Helicopter Reporter for WCBS-News Radio 88. He estimates that he has put in over 20,000 hours behind the stick. His only mishap was when a wayward Canadian goose came in on an unscheduled visit through the windshield ... Gene Burns', WOR afternoon Talkshow host, is going "national", having been syndicated on 24 stations. He will be moving from Boston to New York permanently. WRKO will not be carrying the show, in Beantown, as it would be in competition with Jerry Williams ...

The rumor mill in Boston says that the syndicated Gene Burns show may find a home on WHDH, replacing Ted

O'Brien's afternoon talk show ... Covering the LA Riots was certainly deserving of battle pay for those media participating. Reports from the area depict a wide range of negative happenings: bullet holes in vehicles/helicopters, reporters being assaulted "live", crews being issued body armor by their stations, and many dollars worth of equipment being stolen/damaged. A sad commentary on this entire event ... WNEW's continued decline in every way has media types speculating in the Big Apple. Salem Communications, owner of WMCA, was rumored to have put in an offer for the Westwood One station. The speculation put WNEW at the 570 dial position with WMCA moving its religious/syndicated talkers to the 1130, 50,000 watt spot. A few days after the rumors, everybody was denying everything. WNEW is still unofficially on the selling block and in sad shape. The ghosts of the station's glorious past, William B. Williams, Al Jazzbo Collins, Rayburn, Klavan and Finch must be sighing ... Jim Donnelly, newsman and "voice" of WCBS-880 has taken early retirement after 20 years with the station. WCBS is also reeling from the news that Tom Franklin, its afternoon news anchor committed suicide. A very well-liked professional, his untimely death was a blow to the entire staff. Psychologists have been brought in to assist station personnel ... Jay Diamond, ex-WABC is returning to New York, this time on WNCN, 104.3. The station is a classical music station, so this is quite a switch. The station management says they wanted to try something new in the morning. Boy, did they do that! Diamond is a Bob Grant-type host, with a degree from Yale ... Curtis Sliwa, WABC-770's morning host, with his wife Lisa, was ambushed on his way to the station. He came outside his apartment building, hailed a cab and was shot three times before he could escape via the window. Initial reports indicated that the cab was stolen and that Sliwa was set-up for the hit. He has had a number of attacks upon himself during the past few months. He is nationally known as being the founder of the Guardian Angels. He is expected to make a full recovery ... If you would like to contribute to this column, I may be reached at the address above, via GENIE (P.KEMP3), CompuServe 72376,2557, Prodigy SMHB11A, the FIDO system in the Shortwave, Ham or Broadcasting echo areas, or amateur radio packet, KZ1Z @ K1UOL.CT So much for now.

WVNE
 760 AM

Thoughts from NRC members ... the opinions expressed in this column are those of the individual writer and do not necessarily reflect those of the editors, publishers, or the National Radio Club, Inc.

Dave Schmidt

P. O. Box 11502

Wilmington, DE 19850-1502

*Times are local per Muse; submit double-spaced only.***BOB HARRISON - 166 RENNER AVENUE - UNION, NJ 07083-8839**

It's been quite a while since I checked in, so on the occasion of my 10th anniversary with the NRC, it seemed like a good idea to say hello. DXing is a crazy game. In the last decade, I've managed to log 927 stations (not including call letter changes) and collect 601 veries. But in spite of having verified stations in Utah & Alberta, I still haven't heard WTTM-920, just 42 miles down the road. And in spite of my East Coast location, I haven't heard a peep out of Europe but I've heard & verified Saudi Arabia! This past year has been without question my slowest of all, with very little time at the dials due to other contingencies. But thanks to an outstanding schedule of CPC tests, the verie totals have surpassed the 600 mark. Hats off to those who put together that great series of tests! The second decade of DXing has already netted a couple of surprises. On the afternoon of 7/2, a new TIS station was booming in here on 1610 khz with a brief tape loop announcing a test for the NJ Turnpike Authority with 10 watts of power. The next day, the test announcement was replaced by regular TIS Fere, with mentions of the callign KPD673 and another TIS station "27 miles S, at exit 8A", which puts this one in nearby Elizabeth. What's a new TIS doing on 1610 khz, when that part of the dial is being cleared out for regular AM broadcasters? (So the people who made the transmitter can sell hundreds of 1710 crystals?-DWS). The next surprise was down at 640 khz, where the new WWJZ was noted testing in the early evening of 7/2 with NOS music and frequent test announcements mentioning Mt Holly & Pemberton Township. Per a call to the station, they were using 1000 watts and they have a "way to go" before commencing a regular schedule. That's it for now. Good DX! (ET's on WWJZ were noted 6/24 and hasn't been back since 7/10. Operated by the same people that run WMVI-DWS)

JOHN H. ROSE II - 26015 THOMAS - WARREN, MI 48091

Perhaps I have acquired the ultimate perishable ephemeral collectible here at Radio Free Warren. My previous 'prize' was a beer can sponsored by WFBC. The can contents had been removed long ago, as expected. While perusing one of my usual flea market haunts, I spotted some cigarette packs having advertising for local businesses from various parts of the country. All were still unopened, had their Federal & State revenue stamps intact and most were still sealed in cellophane wrappers. This collecting 'junkie' bankrupt himself (\$4) to acquire this 'ultimate' collectible from station "KBOA the Voice of Southeast Mo. AM 830 KCS FM 90.9 MGS" (sic). "Twenty Reminders! Your Advertising Will Pay on KBOA" says the other side. Today, any station distributing such an item might open themselves up to litigation at most and a great deal of criticism at least. Can any members help me to date this item? I searched Scott's stamp catalog but did not find this item in the revenue section. Are there collectors of cigarettes out there? How unique is this find? With the details available, I date this from the late 50's. What do you think?

STEPHEN H. PONDER - P O BOX 58941 - HOUSTON, TX 77258

Hello again from the HOT-HOT-HOT SE TX. IF it were any hotter, I think the keys on my computers keyboard would melt! The humidity, combined with the heat is enough to may you want to stay inside and DX...alas, then comes WORK and there goes all my free time! Some interesting tidbits: First, some station address changes: (1) KELG-1440 is now listed as 7524 N Lamar Blvd., Manor, TX 78653 (telephone 512-453-1491). My reception report was returned by the USPS as being "Undeliverable as addressed - forwarding order expired", so I phoned Ma Bell to get the new address & phone number. (2) The box number for KBRN-1500 has changed to P O Box 1766, Boerne, TX 78006 (telephone 512-249-9336). Followed the same Ma Bell procedure as I did with KELG. Not much DX to report, unless you count the 2-meter traffic between the Johnson Space Centers ham station (WSRRR) and the STS-50 crew (using Commander Dick Richard's call, KB551W). I am working in the Flight Activities Officer's support room during the flight. I help prepare all the neat modem and teleprinter messages to & from the crew that you hear about on CNN. I work the lead shift (Orbit 2) and will be on console until 7/8. My 2nd time to wok a shuttle flight! I can hardly wait for the space station to become operational! Anyway, it's been too many words & lines for this Muse, so I'll close for now. Enjoy the summer - Good DX!

SHAWN AXELROD - 30 BECONTREE WAY - WINNIPEG, MB R2N 2X9

It never fails, you finally get your radio into tip-top shape and the band goes to pieces. I have gotten the PLAM (Phase Locked Amplitude Modulation) board installed to the ICOM R70. It is well worth the price (\$150 Canadian Funds). The board comes with a great manual that guides you through the step by step installation. It comes with detailed pictures that shows you where to solder right down to which side of the diode. Even an inexperienced operator could do this if he were half decent with a soldering gun. All you need is a screw driver, small wire cutters and a soldering gun to put the board in and align the receiver. All is

spelled out clearly and simply with no big technical words or schematic drawings. Once you have it in, you WILL like this unit. It is used in either USB or SSB and gives you use of not only your AM filter but your SSB on AM as a bonus. I now have use of a 4 & a 2.4 filter on the AM and the 2.4 for the Plam board. The board works something like the synchronous tuner found on the Sony 2010 and Drake R8. The Plam board however goes a step further and helps boost the signal after it locks on to it, plus improves the audio. On the 1st trial, the board came through with flying colours. 1375 has yielded hats on several occasions here but tuning the Plam board, the het turned in audio for a new one, St. Pierre. The same has proven true for Cuba-640, which is only 10 khz away from CKRC which runs all of 10000 watts, about 2 1/2 miles from my place. The Plam and a 4 foot loop make a great combination. As for the technical aspect of how it works, I'm not to sure, all I know is that it DOES work and work well. Anyone interested in more info can write to me. As far as I know, the PLAM works on the Icom R70 & 71's as well as the NRD 525 & 535's. Hope you have a great summer, 73.

BRUCE REYNOLDS - 1617 CORTE DE MEDEA - SAN JOSE, CA 95124

Greetings. A couple of items from a weekend trip to San Luis Obispo during the weekend of 6/20-21. The Carmel Valley station on 540 has changed calls & format again, abandoning satellite CW & KHKN (Kickin' Country) for a satellite easy listening format and KIEZ (E-z 54 AM). KKAL-1280, Arroyo Grande was silent. I called their FM sister station and was told it was off due to technical problems. They had been off a week and expected to be off approx. a month. I was not surprised as when I passed through teh area in April, they had perhaps the worst audio signal quality I ever had heard. Also, as I have advised TONY FITZHERBERT, local KEEN-1370 did not change format as reported earlier in DX NEWS. An impending change was reported in the press in Jan., but KEEN announced shortly before the schedud switch at the end of this month that they would stick with CW. They sited listener and advertiser reponse, but another probably factore was that KEEN was reported to be considering an Asian format and KSJX-1500 beat them to it. Also, on the local scene, sports talker Pete Franklin, late of Cleveland and New York just joined KNBR-680 and is on 1-4 PM weekday afternoons. 73

ERIC BUENEMAN - 631 COACHWAY LANE - HAZELWOOD, MO 63042-1347

For those who like to call, my new phone number is 314-839-8751 and if I'm not here, leave a message on the answering machine. I am back in St. Louis now, and with that, MORE LOCALS! The only Atlanta stations I could get on a regular basis 24 hours a day from either Woodstock or Marietta were WKHX-590, WGST-640, WSB-750 & WAFS-920, with WAOX-1380 heard 24 hours a day only in Marietta. The new locale is less than a half mile from the old Lamplight Lane QTH and one of my new neighbors is an ELEMENTARY SCHOOL! The only new nighttime local here is KSIV-1320 which is 24 hours and much stronger with 270 watts. KWRE-730 is also heard regularly here on their 120 watts night power, hours are 0630-2400 daily. WB6Z-1570 has converted to an all talk format with new primary for the Alton/Godfrey/Wood River area. KEZK-590 has gone Stereo, C-Quam. WINU has moved from 1510 to 880 but they are 2500 D3 until their night pattern is finished. WLS-890 can still be heard here in stereo during the day. KXOK-630 is also promoting their format as 'Classic Soul' el la WIG0-1340. WRYT-1080 is NOT on the BRN net, as previously reported. They are News/NOS and affiliated with UPI. WGNU-920 has affiliated with the USA Radio Network replacing AP/UPI and also carries Tom Snyder from ABC Talkradio via phone lines! KJCF-1400 in Festus has returned to CW dropping OLD, KASP-1380 has affiliated with the Unistar and SEN networks. If ground conductivity has a value of 15 around here in contrast to 1 or 2 in Atlanta, I should have good luck with airchecking locals. 73 & good DX

BRUCE WINKELMAN (AA5CO) - 3014 W 68th PLACE - TULSA, OK 74132-1762

Greetings from Tulsa! Summer is in full swing here with thunder storms, heat, swimming pools and Boy Scout summer camp. Not much BCB DX going on but have been monitoring the 3200-3400 khz range at sunrise for Indonesia & Papua New Guinea stations. Have heard numerous stations but only 3 solid ID's, oh well, it gives me something to work on. Speaking of work, I'm in the process of entering all my BCB logbooks into a database on the PC. Just finished the Kansas logbook from 1971 & 1972 and am currently working on the WV logbooks from 1973-75. The NC & OK logs are next. Hope to have the project complete by the end of summer (8/13 is the official date here, school starts for my sons that day, can you believe it?) Some Tulsa radio news, KQLL-1430 has gone all talk with local personality Ann Williams hosting a mid-day show, second hour features only women as guests. Ann Williams recently left KRMG-740 when the station decided to add an hour of Rush Limbaugh and reducing her show to 1 hour. KQLL is also broadcasting all the Cardinal games for the rest of 1992. Tulsa has never had a regular major league network station in the 13 years I've lived here. All the stations said in the past that they could sell the ad time, KQLL had ALL the local time sold in 10 DAYS! Glad to see major league baseball on radio back in Tulsa. 73 & enjoy your summer!

AL QUAGLIERI - P O BOX 888 - ALBANY, NY 12201-0888

I haven't MUSED in something like 11 YEARS so pardon if I'm a bit rusty at it. Having lived the better part of the past decade in an incredibly noisy neighborhood (RF wise), my AM DXing skills have eroded back to novice level. However, the

impending completion of my SP600JX rebuild and new QTH will, hopefully, change all that. Plus, I can't wait to try out some of the circuits detailed by MARK CONNELLY in these pages. Some observations: surprised no one has logged WMVV205-1610 khz, a powerful TIS station located at Exit 23 of the NYS Thruway. It's been on around the clock for over a year and covers the entire city of Albany quite well (the groundwave spreads out to about a 15 mile radius). Listen for the familiar "I Love NY" music which precedes a recurring announcement. In Utica, WTLB-1310 is now NSP and is relayed by WZLB-1450 in Rome. All log details remain and phone # is 315-797-1330. Format is bizarre, really deep doo-wop/oldies, nothing post 1962, as if the Beatles never happened. Speaking of formats, 640 in Toronto may be CHOG but you'd never know from listening, they never ID as anything but "AM 640, the new beat of Toronto". Only FM announced is a relay on local cable system, 107.1. All new music, anything with a beat. To these aging ears, recalls the melting pot that was Top 40 radio in the 60's. I'd be glad to copy their Top 30 chart for the asking. 73 (And welcome back to the fold, Al, glad to receive your report. Keep us posted on your SP600JX rebuild project, that is a monster but good receiver!-DWS)

MIKE BROOKER - 99 WYCHCREST AVENUE - TORONTO, ON M6G 3X8

Now that we're in the midst of the DX 'off season', here's a retrospective on my 1991-92 DX season highlights: CPC TESTS heard from WARV-1590, WKVA-920, WJTC-1510, WVNE-760 & WZAO-1370, all new stations except WZAO which I heard in 1977 as WEIF. SRS/SSS highlights; WQIZ-810, WBAA-920, WBRV-900, WCPA-900 & WPHM-1380. Also noted WRPQ-740 after CBL s/off. After going silent for 3 months, CKAN-1480 returned to the air as 'Energy 1480'. I don't think they changed calls, but like Ottawa's Energy 1200 (CF60), they're another Canadian non-IDer. The CRTC still hasn't decided what to do with the 99.1 frequency formerly occupied by CKO in Toronto, unused since CKO went kaput in 1989. There are 3 potential applicants for this much-wanted spot, CJEZ-97.3 (MOR/EZL), CFMX-96.3 (Classical) or a CW station that was granted 92.5 in 1990 but has yet to sign on. Why do FM frequencies at the middle of the dial continue to be more sought after than those at either end of the band? 73

DAVE SCHMIDT - P O BOX 11502 - WILMINGTON, DE 19850-1502

There must be a TIS transmitter salesman going around the eastern US as I am now cheerfully greeted by WXP-450 on 1610 khz 24 hours a day, welcoming me to Delaware ('no sales tax here'...). Naturally, it's about 3/4 miles from this den, very good day and fair at night. Interesting to note that as you get closer to Wilmington, it gets eaten up pretty nicely by the mixing products to WILM-1450/WJBR-1290. Location is at the intersections of I495 & I-95, operated by the DE Turnpike Authority. 2 silent stations have recently returned, WVAB-1550 noted back in Mid-July featuring big band music and WRRF-1520 has returned with talk from the Sun Radio Network. Regretfully, a couple of MUSINGS which arrived were not typed up for this issue, they did not contain ANY DX related material. I must again request that reports submitted are radio/DX related and double spaced (it really helps speed up the process). We, also, have gone through a pile of pages for the new log project and my hat is off to WAYNE HEINEN for his efforts. As noted by BOB HARRISON, WWJZ-640 was on at various periods late June/early July with standards/big band music and, naturally, a nice signal into here with just 1000 watts. Looks like this will scatter those carrier current systems used for years in the east, all over the dial, 640 was pretty much a standard frequency for that. Our next deadline: August 14th. Let's hear from you?

The International Radio Club of America is offering a number of updaters to its 1991 *IRCA AM-FM Almanac*.

- Updater 5.1: 6-page *Almanac* index, 11-page AM slogan updater, silent station update, network updates
- Updater 5.2: revised AM listings for SMN, UNI/TRA, talk shows, nets, 1991 baseball, including minors.
- Updater 5.3: Rush Limbaugh list, TIS stations on 530, 1610 kHz, 1991 NFL/college football, 1991-'92 NHL hockey.
- Updater 5.4: ABC, AP, UPI, USA net updates; ESPN, SEN nets, Canadian nighttime music nets, 1991-'92 NBA, college basketball net updates.
- Updater 5.5: 1992 baseball nets, Spanish nets, IRN, AM slogans.
- Updater 5.6 (available in September): talk networks.

Each updater is 20 pages at \$2.00 each to U. S. or Canadian addresses, \$3.00 elsewhere. Send check or money order to Bill Hardy - 2301 Pacific Ave. - Aberdeen, WA 98520.

NRC DXCon - '92 in Omaha

Less than four weeks away!

That's the word from the '92 Convention HQ in Omaha, NE. Two of the three tours have been confirmed: Friday at 3:30 pm and Saturday at 1 pm. **Important: Friday's tour is limited to the first 20 that register; Saturday's tour, the first 35. No cameras or bags allowed (may be left on the bus.)**

The registration fee of \$40 includes these tours, two meals, and all the fun. Make your check payable to "National Radio Club". **Deadline is August 11!** Send registrations to Ernie Wesolowski - 13312 Westwood Lane - Omaha, NE 68144-3543.

Hotel reservations go to Days Inn - 3001 Chicago St. - Omaha, NE 68131, phone (402) 345-2222. You must mention the "NRC Convention" to receive the special rate of \$46.00 plus \$7.52 tax per night.

Send for a free convention Packet now. Late registration is acceptable but you are not guaranteed a room or on the special tours where limits apply. We must have your complete address and home phone number! Lots of prizes. Ship auction items postpaid to Ernie. All of the hosts will be wearing bright red Nebraska Cornhuskers T-Shirts. An optional Omaha Royals vs. Denver baseball game is planned at 7:05 pm Thursday, September 3. The convention ends at noon on Monday, September 7. Sorry, Laurie Boyer can't make it across the equator this year; we'll miss you!

1992 IRCA Convention

The 1992 IRCA Convention will be held in Huntsville, AL August 21, 22, and 23 at the Holiday Inn Research Park - 5903 University Drive - Huntsville, AL 35816. Room rates: \$45.00 + 10% lodging tax for either (1) a room with two double beds or (2) a room with one king-size bed. Reservations can be made by calling 1-800-845-7275, M-F, 8:30 am - 4:30 pm CDT. Please mention IRCA when making the reservations. There will also be a \$25.00 reservation fee made payable upon arrival to the IRCA. This reservation fee includes the cost of the Saturday night banquet, as well as refreshments during the convention. Check-in time at the hotel is 2:00 pm, and checkout time is 12:00 noon. Convention committee co-chairpersons are J. D. Stephens - 3715 Conger Road, SW - Huntsville AL 35805; home (205) 650-0642; work (205) 961-4353 / Lynn Hollerman - 514 Carrsbrook Road - Huntsville, AL 35803; home (205) 883-1668. Items to be donated for the auction may be sent to Lynn Hollerman. For a convention kit, including a map to the hotel, please contact J. D. Stephens.

Not sure about renewing?

Consider these benefits of a membership in the National Radio Club: 720+ pages per year of easy-to-read, comprehensive DX and radio information ... reduced prices for publications ... responsive editors ... and the friendliest bunch of DX'ers in the world! Why not send that renewal check to Ron today!