



DX NEWS

*the magazine of the
National Radio Club*

SINCE 1933

Volume 49, Number 27 Monday, June 14, 1982

NO MORE ISSUES!!!

Yes this is the last issue from Louisville, but don't panic and run to the pawnshop with your NRC Log!! Contrary to rumors printed in at least two different club bulletins that we are aware of, the NRC is ALIVE & WELL. Since last issue we have received no less than 4 bids to takeover publishing duties and today are most pleased to announce that Mike Knitter will be the new publisher effective with the next bulletin dated July 19th!! Mike and wife Sue have volunteered their services until.... and have located a printer with a price very close to what we are now paying here in Louisville. So we foresee no need for an immediate increase in dues to cover the change in publishers. The new address for ALL columns, feature articles, clips and filler material for the bulletin is: National Radio Club, P.O. Box 24, Cambridge, WI 53523. Treasury and Secretarial functions will stay in Louisville.

Mike will finish out volume 49 and will publish a volume 50 schedule in the July Issue. ALL EDITORS PLEASE NOTE: The deadline in Wisconsin for the 7/19 issue will be 7/10. The August issue is being changed to a masthead date of 8/23 with a deadline in Wis. of 8/15, and the September issue will be dated 9/27 with a deadline in Wis. of 9/18. The August and September issues have been pushed back one week from the dates originally announced to accommodate those editors and contributors who will be going to any of the three known conventions scheduled in August and early September.

More good news-the advance registration form for the 1982 NRC Convention is on page 39. Also a special offer for T-Shirt fans who plan on attending this year's affair. A unique souvenir awaits you IF you come to Louisville in 1982!

More good news- Per a notice in the latest ANARC bulletin, Radio West is back in business. Any questions/orders can be mailed direct to Radio West, 3417 Purer Road, Escondido, CA 92025. Phone is (714) 741 2891.

Still more good news. The NRC 6th edition Domestic Log is selling like we never anticipated. Over 1150 have been sold and shipped to-date. Ken advises that he has received 18 complaints concerning missing pages and has sent missing pages out. Apparently the main problem is pages 27/28 and 181/182. One member (it had to be ERC) received a log with ALL pages out of order- this also has been corrected. If you find one or two pages out of order, it is very easy to correct by simply removing the spiral comb, placing the pages in order and rethreading the comb onto about 30 pages at a time. An updater from Ron Musco is inside to update the Log since Feb. 1st. Ron advises that few updaters will be forthcoming as ALL information for updating the Log can be obtained from the regular AM Switch columns and the irregular Canadian Kerner column. Future updaters will be mainly correcting any errors brought to our attention in the current log.

With all the good news, we are sorry to relay that the Newark News Radio Club has indeed gone out of business due to a negative cash flow problem. We are sorry to see a club with so many years of history pass from the DX scene.

George Greene advises that the Golden West DX Association (GWDXA) will hold its annual convention in Brimfield, Ohio (near Akron) June 24th-27th. The site will be the Knight's Inn Motel at I-76 and State Route 46. Registration fee of \$15 should be sent to George Greene, 1527 Sunset Ave., Akron, OH 44301.

LOOK INSIDE

More on page 3 bottom.....

AM Switch.....	2	NRC Log Updater.....	13
Domestic DX Digest.....	4	The Super HQ-180.....	18
International DX Digest.....	8	Digital TRF Readout.....	22
Unreported Stations Update.....	10	Contests.....	24
Contents On The Condada.....	11	Musings of the Members.....	25
		1982 Convention Registration.....	39

On hand for this LAST LFC pub session are former LFCer's Pat Hartlage and Bob Walker. We collectively wish Mike and Sue the best of luck as publishers!

THE WORLD'S OLDEST AND LARGEST ALL MEDIUM-WAVE DX CLUB

Do we have any NRC member who will attend the ANARC Convention July 23, 24 & 25 in Montreal? If so, advise us here at HQ. We need a NRC representative.

AM SWITCH

JERRY STARR
c/o WSRD RADIO
401 N. BLAINE AVE.
YOUNGSTOWN, OH 44505

Greetings fellow fun seekers. Once again it's AMS time... 'nother long one so lets dive right in.

CALL LETTER APPLICATIONS

Present call:

WABT Montgomery, AL 1000
 KCNL Homer, AK 620
 KIFN Phoenix, AZ 860
 KWBZ Englewood, CO 1150
 KPUB Pueblo, CO 1480
 WRNG North Atlanta, GA 680
 KIVM Lihue, HI 1350
 WLTV Fort Wayne, IN 1450
 KWNT Davenport, IA 1580
 WQTK St. Johns, MI 1580
 WXMN Lexington, MS 1000
 *New Sardis, MS 1500
 WBMS Black Mountain, NC 1350
 WQIO Canton, OH 1060
 KCGG Henryetta, OK 1590
 WFBA San Sebastian, PR 1460
 WWSW Pittsburgh, PA 970
 WDIQ Orangeburg, SC 1150
 KDBQ Aberdeen, SD 1420
 WZZI Madisonville, TN 1250
 WMAK Nashville, TN 1300
 *New Huntsville, TX 1400
 KSXX Sandy, UT 630

CALL LETTER GRANTS

Seeks:	Old call:	New call:
WZTN	610 WHPL	Winchester, VA
KGTL	840 WMOB	Mobile, AL
KVVA	850 *New	Fairview, TN
KRZN	860 WAZE	Clearwater, FL
KGMQ	910 *New	Burnside, KY
WCNN	1030 *New	White Bluff, TN
KIPO	1060 WXLX	Milledgeville, GA
WAFX	1080 *New	Oliver Springs, TN
KXRX	1090 WIUA	Albertville, AL
WKZY	KLDR	Denver, CO
WLTD	1150 *New	Clinton, MS
WRDS	1230 KSUN	Bisbee, AZ
WONO	KKRC	Sioux Falls, SD
WRCW	1300 KMDD	Tulsa, OK
KHEN	WYLV	West Hazelton, PA
WLRP	1320 KADI	Clayton, MO
WTKN	1330 *New	Wishak, ND
WIZX	1340 WMKE	Milwaukee, WI
KGIM	1420 *New	California, MO
WRKQ	1430 *New	Staples, MN
WLUX	1450 WHIT	New Bern, NC
KKNX	1470 WYYY	Kalamazoo, MI
KZJO	KTWN	Anoka, MN
	1500 KBGG	Merkel, TX

Note: Address for new Oliver Springs, TN is Box "T", Oliver Springs 37840

APPLICATIONS FOR NEW FACILITIES:

680 Wellington, CO seeks 1000 D1
 870 Depere, WI resubmits application for 1000/1000 U2
 940 Pembroke, NC requests 100000
 1180 Council Bluffs, IA seeks 2500/1000
 Bellevue, WA wants 5000/1000
 Lincoln, NE has 2 more applications for this freq: 1000/1000 and 5000/1000
 1200 Stevens Point, WI wants 1000/500
 1360 Madison, AL asks for 500 D
 1490 Ruidoso Downs, NM requests 1000/250 U1

GRANTS FOR NEW FACILITIES:

900 Nashua, NH granted 1000 D1 (old WOTW deleted facilities)
 960 La Follette, TN granted 1000 D3
 1040 Moca, PR granted 350 D1
 1400 Huntsville, TX gets 1000/250 U1
 1420 California, MO granted 500 D1

APPLICATIONS FROM EXISTING FACILITIES:

790 WYNR Brunswick, GA seeks to make permanent it's temporary authority to operate on 990 to avoid Cuban interference, wants 5000/2500
 850 WKBZ Muskegon, MI seeks day power increase to 10000 watts
 990 WPIK Flomaton, AL seeks to change it's new CP for 2500 D3 to 2500 D1
 WNYR Rochester, NY seeks to remain on 990 permanently with 5000/2500
 1060 WKKQ Hibbing, MN seeks 1080 10000/5000
 1180 KOFI Kalspell, MT asks to increase night power to 10000
 1270 KCVL Colville, WA wants to move to 1240 with 1000/250 U1
 1330 WADJ Somerset, PA wants power increase to 5000 D3
 1470 KCMY San Marcos, TX seeks fulltime by adding 250 watts night
 1500 KUMU Honolulu, HI seeks 10000/10000 U1
 1510 KKNW Mountainlake Terrace, WA asks for 500 day, 250 critical hours, move XR
 1540 WYNC Yanceyville, NC seeks 2500 day, 1000 critical hours
 1550 WMLB West Hartford, CT asks to move XR, change city of license to Bloomfield

To fill a little white space, the latest information on the FLASH ALERT now being handled by Ken Chatterton can be obtained by reading Ken's muse on the top of page 32 this issue. This service will prove invaluable this Fall when late breaking Tests once again become reality. Why not get a supply of cards off to Ken now, while you're thinking about it. It will pay-off in the longrun. -HQ

GRANTS TO EXISTING FACILITIES:

740 WGSN Huntington, NY granted changes in antenna system
 1190 WSGI Springfield, TN granted change from DA to non-DA, same power
 1240 WTPF Charleston, WV granted move of transmitter
 1270 WAIN Columbia, KY gets change of XR location
 1300 WTYM Tampa, FL becomes Temple Terrace's 2nd station with 5000/1000 U3
 1400 WPRY Perry, FL granted increase in tower height
 1450 KNET Palestine, TX granted changes in antenna system
 1530 KAWS Hemphill, TX gets fulltime by moving to 1240 with 1000/250 U1
 1550 WPTN Cookeville, TN granted tower height increase to 93 feet !

OTHERNESS:

1240 Coeur d'Alene, ID application for new station dismissed
 1250 KUUK Wickenburg, AZ application for 1000 watts returned by FCC
 1420 WTGE Kalkaska, MI CP here has just been sold, station NOT on air yet
 And finally a note from faithful contributor Stan Morss concerning one of our "mystery call applications" from the last AMS. Stan sez the Four Bears, ND calls may go with the recent application for Waterford City, ND 1020 since that town is very close to the Four Bear Recreation area. Could be, but since the Waterford City application was accepted for filing only a month or so ago it's difficult to imagine that the FCC could process and grant a license so quickly. Hell, they don't even answer their phone that fast. Anybody in this area that can let us know what's happening?

73 and Good DX,
Jerry & B.K.F.
 Jerry Starr &

Buffalo K. Foonman

NOTE: ELSEWHERE IN THIS DX NEWS IS AN AD FOR OFFICIAL NRC CONVENTION T-SHIRTS THAT MY WIFE'S SILK-SCREENING BUSINESS IS MAKING UP. EXCLUSIVE FOR CONVENTION GOERS, WILL HAVE SPECIAL CONVENTION DESIGN ALONG WITH NRC LOGO. ORDERS BY MAIL ONLY. THESE SHIRTS WILL NOT BE MAILED, THEY MUST BE PICKED UP IN L-VILLE. PROFITS FROM THE SALE GO TO THE NRC TREASURY. See bottom page 39 for ordering.

More from front page.....

Armando Di Filippo advises that there is an organization publishing a quarterly journal of radio history. North American Archives (NARA) offers membership for \$14.00 annual dues. Sample copies are available for \$2.00. Make checks payable to "NARA". ALL requests should be sent to NARA Membership, c/o Steve K. Ham, 4418 Irvington, Fremont, CA 94538.

Don Erickson has sent a multipage listing of publications available from his Century Print Shop. If interested, see bottom of page 21 for additional info.

For a clip sent from Bruce Winkelman, it appears that WLS-890 may soon follow the path of sister station WABC. Look for a change in format to news/talk in July or August.

Ernie Cooper advises that WRVL-FM Lynchburg, VA had its tower cut down by vandals on 5/31. This was Jerry Falwell's station, maybe someone is trying to tell the Reverend Jerry something??

THEY JOINED

Welcome to the following new members. Muse soon and introduce yourselves!

Allen E. Clingman, 3235 Quessnel Drive, Vancouver, B.C. V6S 1Z7 (Rejoins)
 Rae Elsu, V.J. Hospital, Lyons, NJ 07939
 Carey M. Jones, P.O. Box 832, Waynesboro, GA 30830
 Robert E. Lamb, P.O. Box 454, Leander, TX 78641
 William P. O'Brien, 315 Bonnie Brae, Hinsdale, IL 60521
 Bill Prather Jr., P.O. Box 62, Tryon, NC 28782
 David L. Raudenbush, R.D. #4, Box 404, Pine Grove, PA 17963
 Bill P. Shaffer, 2307 Murray Drive, Toledo, OH 43613
 David Shapiro, P.O. Box 135, Griffin, GA 30224 (Rejoins)
 Mel Sulzburgh, 38 York, Nob Hill Apts., Blackwood, NJ 08012
 John W. Tribbey Jr., R.R.3 Box 437-H, 1199 Dafler Rd., West Alexandria, OH
 Frank E. Werner, KA4EPG, P.O. Box 7, Inverness, FL 32650

DOMESTIC DX DIGEST

DAVE SCHMIDT
42 CHELWYNNE RD.
CASTLE HILLS
NEW CASTLE, DE 19720

Here is the official NRC column which is about as exciting as listening to Wayne Newton sing the official song of the Swan Islands! When sending your items in, please type or neatly write, skip a line between items and we will stick with ELT thru the summer months. Here we go:

SPECIAL:

- 820 WAIT IL CHICAGO - Now on AN7 w/MYL type programming, sometimes o/WBAP but usually the other way around. (ERC-MA)
- 910 WKXZ SC N. CHARLESTON - Noted w/new calls on 4/1, ex-WNCG. (RUGG)
- WRDQ CT NEW BRITAIN - AN-7 and is suddenly loud & clear every AM w/their BPL format, pattern change? (ERC-MA)
- 930 WITN NC WASHINGTON - Is now AN-7 w/BFL/EZL format, on a landline network feed, noted MM 4/5 0103-0110 fadeout, ID's often as "Something Special Radio." (ERC-MA)
- 940 WECO TN WARTBURG - 5/3 0530 began rog. sked. w/5000 watts, CP is now on. Will continue w/234 watt PSA. (TC-TN)
- 960 WSBY MD SALISBURY - Noted w/new call on 3/24, ex-WBOC. Local Billboards were promoting the change, WBOC letters still on their building. (RUGG on vacation) TV kept WBOC. (DS)
- 970 WWSW PA PITTSBURGH - Announced on 4/28 that they would be dropping their music format and become all talk, joining the ABC Talkradio network. Call change to WTKN is suppose to be in the works. (JM-PA) Noted w/new talk format 4/31, still on the WWSW calls. (DS-DE)
- 1000 WCMX MA LEOMINSTER - Ex-WLMS, semi-local here w/new CW music format, ID's as "Country Music Ten." (X for Roman Numeral 10.) (ERC-MA) About as slick as tooth paste! (DS)
- 1240 WOCB MA WEST YARMOUTH - Back in AN sked for summer, now AN-6 w/Talknet/female advice giver. (ERC-MA)
- 1300 WKXC PA WEST HAZELTON - 4/30 1340-1430+ first time noted w/field measurement tests, OC and frequent announcements. Strong signal at 25 miles from a two tower array, way o/WING/WFBR. (KG-PA)
- 1340 WAAV NC WILMINGTON - 3/29 noted w/MYL format, ex WGNI. (RUGG)
- WRAN PA READING - Has dropped their Top 40 format and switched to a MYL format. (VIC-PA)
- 1450 WCCA SC CHARLESTON - Noted w/new call on 4/1, ex-WQSN. (RUGG)
- 1540 WMYP NH EXETER - In all day w/MYL format, o/u WADK, ex-WXYR. Seems to be a reluctant verifier. (ERC-MA)
- 1550 WORI TN OAK RIDGE - 5/24 1245-1400 noted running ABC Dimension (Ad) network at :45, TN net. at :55, Ta also noted. No sign of Mutual network. (TC-TN)

DX TESTS:

1000 WSUM Not heard: TB-VA, JM-PA, DS-DE, JF-ON.

FREQ. CHECKS:

- 1st THURS. . . WMCT-1390 w/TT 0015-0038 on 5/6. Still no verie. (KG-PA)
- 4th MON. . . WCBG-1590 w/TT. (DS-DE, JF-ON)
- WMBT-1530 w/pop music. (JF-ON)
- WCDN-1450 TT noted 0008-0013 w/breaks every min., tant. (DS)
- WOND-1400 w/TT 0017-0019. (DS-DE)

MIDDAY - MIDNIGHT:

- 540 WLIX NY ISLIP - 5/18 1425-1430 audible w/9M2 in noise, standard religious music programs. (RH-MA)
- 860 CBH NS HALLFAX - 5/16 2055 simulcast of classical music w/CBL-740, audible u/CJBC french talk. (RH-MA)
- 940 WPNC NC FAYETTEVILLE - 4/5 1845 jingle/ID, CW music. (NAP-AL)
- WNRO VA GRUNDY - 4/5 1845 in briefly w/ID in mix w/WFNC/WMAZ/WCPG while looking for Tom Connatser (WECO). (NAP-AL)
- 1090 WILD MA BOSTON - 5/19 1415 w/jazz type program, ID. (RH-MA)
- 1100 WHLI NY HEMPSTEAD - 5/19 1420 w/MYL program, weak but improved w/SM-2. (RH-MA) Day regular w/WGPA here. (DS)
- 1110 WHIM RI PROVIDENCE - 5/16 1957 CW music right after s/off of local WUPE, mixing w/another MYL type. (RH-MA)

WALK FM 97.5
AM 1370

- 1170 WCCR NY CORNWALL - 5/19 1425 CW music, surprisingly good signal, ex-WWLE. (RH-MA)
- 1240 KFBC WY CHEYENNE - 5/24 1200 like a local w/public affairs program, noted w/KRDO weakly under. (RH-CO)
- KRDO CO COLORADO SPRINGS - 5/24 1310 took o/XFBC w/rock music, many ID's, weather. (RH-CO) Your reports are about as exciting as Brian Cartwright's! (DS)
- 1270 WHYD GA COLUMBUS - 4/5 1912 local ads, several ID's, promo for Dare to Discover program on Sunday. (NAP-AL)
- 1370 WVMR WV FROST - 5/6 2032 fair at s/off w/mention of Pocahontas Broadcasting Corp. (WPT-DC)
- 1400 WFEC PA HARRISBURG - 5/6 2125-2135 on top w/rock music, clustered ads, jingle/ID. (KG-PA)
- 1440 WGVL SC GREENVILLE - 4/22 1820-1825 good w/sports, ads. (TC-TN)
- 1460 WBET MA BROCKTON - 5/17 1950-1959 sports talk on Boston Celtics, Chassett High School and invite to call 587-2400. Lost at pattern change. (TF-PA) Did a train detail near the power lines that feed WCHB in Wornleysburg? (DS)
- 1480 WHBC OH CANTON - 4/22 1814-1818 fair w/pop music. (TC-TN)
- 1520 WCHE PA WEST CHESTER - fair in WKBW null w/s/off 5/10 at 2014, female anc'r w/mention of West Chester. (WPT-DC) I'd worry if they said Kankakee! (DS)
- 1550 WNTN MA NEWTON - 5/8 1930-1945 Irish Hour Show w/Irish Humor, then a very audible s/off. (TF-PA)
- 1570 WKXS KY VANCEBURG - 5/6 2045 fair w/s/off w/mention of Ohio Valley B'casting Corp., 1000 watt day power. (WPT-DC)
- 1580 WCRV NJ WASHINGTON - 5/16 1950-1955 good w/pop music. (RH-MA)
- WLIM NY PATCHOGUE - 5/18 1825-1830 MYL type format, much fading w/some WCRV under. (RH-MA)
- 1600 UNID 4/25 2200-2202 s/off w/mention of 1000 watts after news, ID sounded like WKXQ Reidsville but nothing in log. (TB-VA). That was they...and go order a new NRC log! (DS)
- WYYY MA EAST LONGMEADOW - 5/16 1955 end of baseball game, mixing w/WWRL/WLNC. (RH-MA)

MIDNIGHT - MIDDAY: (A trip thru Staticville!)

- 540 CEK SK WATROUS - 5/9 0200 strong w/promo and CBC ID then news. (JF)
- 550 KEYR ND BISMARCK - 5/9 0105 weak u/WGR w/"K-Fire" jingle/ID then Top 40 music. (JF-ON)
- 590 WEEI MA BOSTON - 5/4 0322 in mess w/time check, weather, talk program, first positive ID on this one. (JF-ON)
- 670 WMAQ IL CHICAGO - 4/12 noted off this AM, channel was clear! (ERC)
- 680 WCBM MD BALTIMORE - 4/26 0034 this post noted off this AM, conducting a PoP w/various TT. (DS-DE)
- 920 CJCH NS HALLFAX - 5/9 0258 on top w/weather, ID, Top 40 music. (JF)
- 950 WTBX NY UTICA - 5/5 0120 noted w/extra inning METS game from LA, a Wednesday morning. (ERC-MA)
- 960 UNID 5/6 0151 TT noted here this AM, wonder if this could have been WPCN retuning their DA? (ERC-MA)
- WHYL PA CARLISLE - 5/12 0136 noted on ET w/music, ID. (ERC-MA)
- 1130 WRRJ WV RAINELLE - 4/23 0602 s/on w/SSB and full data. (KG-PA)
- 1170 WCOV AL MONTGOMERY - 5/17 0016 noted u/WVVA w/MoR, ID's. (DS-DE)
- 1190 WSCN NY COBLESKILL - 5/8 0558-0606 instr. SSB, detailed s/on, news w/Mutual fillers, promo for Mutual Sunday programs. (TF-PA)
- 1230 WCMC NJ WILDWOOD - 5/13 0612 SSB then s/on, good in WSEX's null while looking for WCMD. (KG-PA)
- 1250 WPRZ VA WARRENTON - 5/6 0603-0623 on top w/news, religious messages, hymns and PSA's, ID's as "Praise Radio." They do answer every letter rec'd. (KG-PA) Well...praise that! (DS)
- WLEM PA EMPORIUM - 5/18 0600 SSB then s/on into news and ads, all by female anc'r. (KG-PA)
- CHWO ON OAKVILLE - 4/12 noted AN w/EZL/BPL format, "Your Memory Music Station". (ERC-MA) Usually w/WTAE here. (DS)
- 1260 WNRK DE NEWARK - 4/27 0624 on top w/movie ticket giveaway, weather, Pop music then local news at 0630. (KG-PA)
- UNID 5/15 0030-0110 TT, looping NE/SW along w/WZZE, no ID's. (KG)
- 1290 WQIN PA LYXENS - 4/29 0548 way atop w/rock music, ID w/mention of Cable FM 107.5. (TF-PA)
- 1310 WSSJ NJ CAMDEN - 4/19 0215 good briefly w/Ron Allen show, ID, 1st time since WCAM days. (JF-ON)
- 1340 WOYL PA OIL CITY - 5/4 0500 only caught ID then Mutual news. (JF-ON)
- 1360 WCHL NC CHAPEL HILL - 4/26 0029 very strong on ET w/rock music, ID's between records, then OC. Rare bird here. (DS-DE) (KG-PA)
- 1380 WNVN CT NAUGATUCK - 5/13 0520 w/s/on into pop music, sports, weather.

WIS
Newstalk1510am

WPRN AM 1460

WJYI 1030 AM
THE "MUSIC OF YOUR LIFE"

WVAM

6 1390 WRIV NY RIVERHEAD - 5/10 0542 ad for Watermill Inn, Polka Music, honest! (TF-PA) You taken PC Greens again? (DS)
 1400 EMHL MN MARSHALL - 5/7 0200-0205 fair o/u mess w/weather then s/off w/plug for FM, vocal SSB. (JF-ON)
 WPAY OH PORTSMOUTH - 5/3 0126 fair w/weather, ID for AM and FM 104 then CW music. (JF-ON)
 WWIN MD BALTIMORE - 4/26, 4/27 0540 B/sol music, news, way atop both AM's. (TF-PA)
 WALE MA FALL RIVER - 4/21 in WEST's null 0550 w/run down of areas in WALE service area, along w/names of listeners. (KG-PA)
 WILI CT WILLIMANTIC - 4/28 0625 in WEST's null w/world/local news. (KG)
 1430 WTTT MA AMHERST - 4/28 0700-0715 way o/all w/local news program, into "Scoreboard" sports program. (KG-PA)
 1450 WOL DC WASHINGTON - 5/20 0001-0105 noted off this AM. (WPT-DC)
 1490 WEMJ NH LACONIA - 5/1 0107-0152 tentative w/TT, one ID noted which sounded like their call. (KG-PA)
 WITA TN KNOXVILLE - 5/10 0406 caught w/ID and into the mess w/pop music. (JF-ON)
 WOMI KY OWENSBORO - 5/3 0300 ID only on hour. (JF-ON)
 1530 WJDM NJ ELIZABETH - 5/6 0056-0141 on w/Pop o/u WCKY, ID at and then s/off. (ERC-MA)
 1570 WGHC GA CLAYTON - 4/26 0558 s/on w/SSB, full data then CBS news. (KG)
 WTLK NC TAYLORSVILLE - 4/26 0623-0633 on top w/CW music, weather and local ads. (KG-PA)
 WKOL NY AMSTERDAM - 5/2 0559 detailed s/on, welcoming listener comments and suggestions (must have liked mine, verie back in 4 days!). (TF-PA)
 1580 WANB PA WAYNESBURG - 4/27 0558 s/on then SSB, NBC news on hour then local news and sports, 45 minutes before legal s/on time, evidently a DST screw up! (KG-PA)
 WCLS GA COLUMBUS - 4/22 0308 strong w/religious music, ID, not heard up here for a while. (JF-ON) That'll change! (DS)
 1590 WGGO NY SALAMANCA - 5/9 0559-0608 detailed s/on, ABC Info news, weather and their verie was #400! (TF-PA) The next 600 will be a little tougher! (DS)
 WGOE VA RICHMOND - 5/23 0019 xlt w/ET, ID. (WPT-DC)
 WETT MD OCEAN CITY - 5/12 0102-0130+ noted w/Baltimore baseball from Seattle, extra inning game w/WAKR either off or it was they in background w/TT. (ERC-MA)
 1600 WIYY MA EAST LONGMEADOW - 4/22 0250 strong w/CW music, mention of "Wixie-land weather." (JF-ON)

Now a DDYD special....at no extra charge!
 THE RUGG REPORT....or notes that I wrote down on my shirt while travelling thru the eastern US that may be of value! Donated by Andy Rugg, PQ:

MIDNIGHT-MIDDAY:
 710 WQEX VA CHRISTIANSBURG - 4/7 1056-1123 noted w/Top 40 format, "Music Radio 7-Q" slogan, dual ID for Blacksburg/Christiansburg, also items for Radford, also used slogan "News Radio 7-Q." Evidently has dropped CW.
 1260 WJJJ VA CHRISTIANSBURG - 4/7 1046-1054 w/Top 40 format, "Triple J Radio", mention of ABC.
 1270 WELF AL PRICHARD - 4/5 1141 w/MYL format, ABC Direction news on the hour.
 1340 WFLV VA PULASKI - 4/7 1030-1045 w/slogan "24 hours a day country music," ID.
 1450 UNID 4/4 1055-1130 someone here w/Silver Gospel Jubilee and many local ads, ID's sounded like "2 WNT" which may be WNT in Dothan, Alabama, correct call not in log.
 1480 WUEZ VA SALEM - 4/7 1127-1145 w/CW music, "Music Radio" slogan and slight over-mod. (You noticed, huh? A pest here! DS)
 1560 WAGC AL CENTRE - 4/6 1105-1115 w/CW music and #1 Country ID's.
MIDDAY-MIDNIGHT:
 590 WDLF FL PANAMA CITY - 4/4 1212 noted w/"American Top 40".
 610 WHPE VA WINCHESTER - 4/7 1855-1915 w/pop music and "61 R-P-L" ID's. (So this guy DOES exist! DS)
 790 WSIG VA MT. JACKSON - 4/7 1529-1544 noted w/CW format.

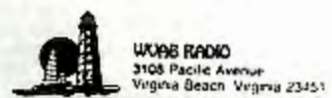

7 840 WMOB AL MOBILE - 4/4 1915 noted w/"Solid Gold 84" ID then s/off w/mention of 0630 s/on and writing to FCC about going 24 hours.
 950 UNID 4/5 1520-1610 someone here ID'ing as "95 Rock", which was the only ID on the hour, in the Montgomery, AL area, is this WMSG or WKKJ?
 WWWI NY HYDE PARK - 4/9 1300 w/"95 I" slogan, NBC news, mention of Mets Baseball.
 970 WXOK TN SPRING CITY - 4/6 1600-1609 w/TN Network news, pop music.
 990 WEIS AL CENTRE - 4/6 1204-1210 w/news, local ads, CW request program, slogan is "Weiss Country Music." Call is pronounced as one word as in nearby Weiss Lake.
 1010 WCST WV BERKELEY SPRINGS - 4/7 1830-1845 w/CW/Bluegrass music, s/off w/plug for FM, no SSB. Left WGUN.
 1070 WANM FL TALLAHASSEE - 4/3 noted w/B/Sol format.
 1230 WICF VA CLIFTON FORGE - 4/7 1200 w/Mutual news, slogan is "Highlands Country Radio" and "Mutual in the Highlands", then into religious program after my pit stop.
 1410 WKQE FL TALLAHASSEE - 4/3 1700 w/oldies, ID's as "KQE".
 1450 WBSR FL PENSACOLA - 4/4 1455-1505 w/oldies format, "Rock, Roll and Remember", ABC news.
 1480 WABB AL MOBILE - 4/5 1250 w/"Cavalcade of Big Bands and Artists."
 WLPH AL IRONDALE - 4/5 1650-1701 w/UPI news, Gospel music.
 WKCC FL PANAMA CITY - 4/4 1200 noted o/WABB w/BBC Concert Hall then into The Vocal Scene (relayed from WQXR). Both programs apparently sponsored by local citizens. Ex-WGNE.

Thanks Andy, I listed the ones which haven't been listed in the column with the hope it will help others in trying to hear certain ones. Anyone else who may want to send in this type of information is welcome to do so, we'll take the ones which may help and put them in the column.

RANDUMBS:
 This is everything rec'd as of 6/1. Our next deadline will be 7/3.
 Former NRC'er ED PHILLIPS (Phoenixville, PA) reports that WBIA-1230 was due to close down at the beginning of May. ED is stationed at Fort Gordon, GA and is operations manager of the base carrier current station, WFG. If anyone ever hears WFG, I'm sure Ed would appreciate a report.

MEMBERS OF THE STATIC CLUB:
 TB-VA Tim Braun, Falls Church, VA
 JM-PA John Malicky, Pittsburgh, PA
 MAP-AL Neal Perdue, Falkville, AL
 RUGG-Vac. Andy Rugg, Vacation trip
 RH-CO Rob Harrington, Littleton, CO
 TC-TN Tom Connatser, Seiverville, TN
 WPT-DC Bill Townsend, Washington, DC
 VIC-PA Vic Melis, Spring City, PA
 KG-PA Kermit Geary, Walnutport, PA
 TP-PA Tony Fitzherbert, Chalfont, PA
 JF-ON Jeff Falconer, Clinton, ON
 ERC-MA Ernest Cooper, Provincetown, MA
 RH-MA Rich Harrison (NYC), Stockbridge, MA
 DS-DE Who'd you expect? M T Pette?
 DX100, LW
 Aiwa AR154
 SX110, Wedge
 Delco Car Radio
 R1000
 Superadio
 ICF55W
 Superadio
 HQ180, SM2, LW
 Superadio
 NeRD 515, SM2
 HQ180, TRF, LW, Loop
 Grundig 3400, SM2
 Superadio, HQ180, SM2

73's - Good DX!

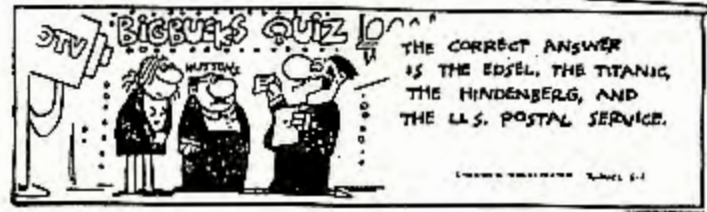

INTERNATIONAL DX DIGEST

Times are GMT. For ELT subtract 4 hours. Deadlines are usually Monday.

CHUCK HUTTON
1035 LATHAM ROAD
DECATUR, GA 30033
(404) 633 1198
BEFORE 2300 ELT

- 155 USSR Khebarovsk 3/28 1149 male w/RR talk //191. (Vernon)
- 182 USSR Petropavlovsk 3/28 1154+ MoR or ballad type mx w/female anncr. (Vernon)
- 191 USSR Blagoveshchensk 3/28 1153 male w/talk, xint sig. (Vernon)
- 570 VENEZUELA Villa de Cura YVLX 0410 5/16 poor behind WMCA post: SS talk, festive mx //YVLL-67D. (Connelly)
- 612 AUSTRALIA 4QR Brisbane 3/26 1316 1/2 women w/TC then ballad type mx. (Vernon)
- 620 UNID (Jamaica or Antigua) reggae mx, Veribbean EE talk jumbled w/SS LA and domestics 0351 5/16. (Connelly)
- 640 VENEZUELA Puerto la Cruz YVQO 0358 5/16 dominant w/sign-off and Venezuelan National Anthem. 0300+ 5/17 s/off with anthem, good. (Connelly)
- 640 GUADELUPE Arnouville rising atop mess at 0402 5/16: s/off w/ La Marseillaise then topical style instrumental-good. After Guadelupe went off, CBN popped in with s/off: three clear s/off's heard (YVQO, Guadelupe and CBN) within 5 minutes of each other. (Connelly)
- 670 VENEZUELA Caracas YVLL 0410 5/16 SS talk, festive mx, xint, way o/WHAQ. (Connelly)
- 675 NEW ZEALAND 3YA Christchurch 3/26 1219 instrumental mx // 819. (Vernon)
- 700 COLOMBIA Cali HJXC 0256 5/17 good w/ID "Radio Sutatenza-la emisora de las noticias". (Connelly)
- 720 JAMAICA Kingston 0415 5/16 good w/disco-influenced reggae similar to recent hit "Genius of Love" by the Tom Tom Club. Caribbean EE anncr using reverb talked over the segued-together songs. (Connelly)
- 720 NEW ZEALAND 4YZ Invercargill noted 3/26 at 1320 //B19, 675. (BV)
- 725 SURINAM Paramaribo SRS 0108 5/16 booming in w/disco then DD talk followed by calypso and reggae. (Connelly)
- 750 VENEZUELA Caracas YVKS 0330 5/16 atop other LA's and WSB: Stylistics/Delphonics type mellow soul then Radio Caracas mention. (Connelly)
- 760 CUBA R. Roloj o/u WJR w/usual stuff (clock ticks, droned mx in SS, etc.) 0338 5/16. (Connelly)
- 765 SENEGAL Dakar fair w/AA talk; single musical note heard on the hour 0059-0101 5/16. (Connelly)
- 770 JAMAICA Spur Tree 0420 5/16 soul mx, shouting w/WABC, o/SS LA's. (Connelly)
- 774 AUSTRALIA 3LO Melbourne 3/26 1320 big band mx, 40's style, xint sig. (Vernon)
- 792t AUSTRALIA 4QG Brisbane 3/26 probably the stn w/classical piano mx 1321. (Vernon)
- 810 NEW ZEALAND 4YA Dunedin 3/26 vocal version of The Entertainer, no QRH at 1247, fair sig //B19. (Vernon)
- 814 NEW ZEALAND 1YZ Rotorua 3/28 1310 woman anncr w/intro to mx by Judy Collins, xint sig, //B10 fair. (Vernon)
- 825 ST. KITTS Basseterre 0056 5/16 EE preaching, like a local. (Con) Battling HIJB-830 0050-0103 4/8 on car radio near Chambersburg, Pa. Until 0100 had "Back to the Bible" broadcast, then ID, mention of eastern Caribbean and AST TC followed by more religion. (Rugg)
- 830 VENEZUELA San Antonio de los Altos YVLT 0449 5/16 good o/other LA's: female SS vocal then R. Sensacion ID. (Connelly)
- 834 BELIZE Belize City 0447 5/16 Hall and Oates mx then EE talk followed by disco. (Connelly) Bleating in on car radio 0029-0115 5/5 between Mobile and Biloxi. Had SS 0029, into EE 0030 with ID and mention of 834 plus relays on 910, 930 and 940. "Sunday Request" religious pgs to 0100 when IS, ID and news hrd. At 0002 had jingoistic ad "building the new nation of Belize". Occasional lapses into pidgin Spanish. Guatemala covets Belize and may try to Falklandize it. (Rugg)
- 830 DOMINICAN REPUBLIC HIJB Santo Domingo, blasting into Pa on car radio 0025-0032 4/8. Had vocal mx and frequent "HIJB" ID's. Slogan was "la estacion de la musica el colot de la noche". (Rugg)

- 846 KIRIBATI T3K1 Tarawa 3/26 1333 noted w/female native singing, don't remember hearing this on so late. (Vernon)
- 870 HAWAII KAH Honolulu 4/9 ballad mx, 1327 male mentioned was on air for equipment test, audio off 1328, carrier remained, local-like sig, best of the Hawaiians this AM. (Vernon)
- 890 COLOMBIA HJCE 0044 5/16 to good peak o/rumble of other LA's (no WLS): LV de Bogota ID, o&w uptempo SS ballad. (Connelly)
- 891 AUSTRALIA 5AN Adelaide 3/27 1256 rr mx, 1259 1/2 male anncr, 1300 pips, women w/nx, faded on hour but TC by man noted 1307. (BV)
- 950t ALASKA KRKA Seward 4/13 1223 some one testing w/OC ans mostly 1 KHz TT, signal strength would suggest KRKA, no ID through 1227. (BV)
- 954 JAPAN JOQR Tokyo 3/28 1408 man and woman w/JJ talk. (Vernon)
- 954t NEW ZEALAND 1XN Hamilton 3/27 1403 man w/wx then rr mx, was in and out w/rr and man anncr, "Hamilton" clearly mentioned at 1414 and report sent. (Vernon)
- 972 SOUTH KOREA HJCA Dangiin 3/28 1407 male w/very deep voice, KK lingo then woman anncr. (Vernon)
- 995 ECUADOR Guayaquil HCEW2 poor w/pop mx 0445 5/16. (Connelly)
- 999a CHINA Xinjiang 3/28 1350-1355 w/CC talk, had to tune-out of a very bad hot from KOMO so not sure of exact freq. (Vernon)
- 1017 JAPAN JOLB Fukuoka 3/28 1220 familiar flute and harp mx then man and woman w/JJ talk. (Vernon)
- 1026 UNID 4/7 1238 man and woman w/EE play, DU accents. (Vernon)
- 1035 NEW ZEALAND 2ZB Wellington 4/13 1248 Rod Stewart record //1008 and 1044 who wore both fair, 1296 was poor. (Vernon)
- 1044 CHINA Changzhou 3/28 1313 woman w/Oriental talk, xint sig. (BV)
- 1044t NEW ZEALAND 4ZB Dunedin 4/18 1239 ballad, fair sig, //1008 and 1035 but both poor. (Vernon)
- 1134 AUSTRALIA 2AD Armidale 4/7 1320 man w/ID and TC between rr mx, poor signal. (Vernon)
- 1134 JAPAN JOQR Tokyo 4/18 1238 male and female w/JJ talk. (Vernon)
- 1152t AUSTRALIA 2WG Wagga Wagga 4/7 1254 noted w/Kasey Kason and intro to mx by the Go-Go's, likely this. (Vernon)
- 1152 NEW ZEALAND 3Z0 Timaru 4/9 poor sig, //1008 poor, 1035 xint, 1044 and 1095 good. (Vernon)
- 1165 ANTIQUA St. John's CRL 0123 5/16 fair w/sermon. Cx mediocre (short-skip dominated) at the time. (Connelly)
- 1170 AUSTRALIA 2CH Sydney 4/7 1308+ EZL mx, 1313 man w/talk, poor sig, 1314 TC noted then 60 second religious spot, 1315 more EZL mx. (Vernon)
- 1179t AUSTRALIA 3K2 Melbourne 4/7 1300 man w/nx, 1301 brief weather then rr mx, poor sig, no ID noted but audio very muddy. (Vernon)
- 1197 AUSTRALIA 400 Southport 4/9 1256 spot for a jewellers, "Four Double-G" ID, safety hint, 1257 rr mx. (Vernon)
- 1206 CHINA Jiangsu 3/28 1402 woman w/CC talk, xint sig. (Vernon)
- 1206 NEW ZEALAND 4XO Tuendin 3/27 1326 male w/spots, 1327 ID "Otago Radio 4XO with Tim O'Day", TC then rr mx, xint topping 2GF briefly. (Vernon)
- 1242 JAPAN JOLP Tokyo 4/13 1256 male w/JJ talk. (Vernon)
- 1296 NEW ZEALAND 1ZM Hamilton 3/28 1313 rr mx //1035. (Vernon)
- 1314t AUSTRALIA 2WL Woolongong 4/15 rr mx 1220 anncr "this is a more music weekend with ??? on 2WL". (Vernon)
- 1332 NEW ZEALAND 1XI Auckland 4/13 1250 male w/TC and rundown of previous records on "Radio I", Whistling Jack Smith record followed, xint sig. (Vernon)
- 1350 NEW ZEALAND 1ZC Rotorua 3/26 1236 male w/talk about moles, poor sig but clear audio //1035. (Vernon)
- 1316t UNID 3/26 1254+ woman anncr, audio too muddy to pick up lingo, 1300 6 pips. (Vernon)
- 1395 NEW ZEALAND 4ZW Oamaru 3/26 1244 male w/talk //1035. (Vernon)
- 1449 JAPAN JOQM Abashiri 3/28 1321 woman w/JJ talk then band mx //1287. (Vernon)
- 1459 NEW ZEALAND 3YW Westport 3/27 1316 BeeGees record //1035 etc. (Vernon)
- 1476 NEW ZEALAND 1XA Auckland 4/13 rr mx 1219 30 second jingle for "Music on Hauraki". (Vernon)
- 1512 AUSTRALIA 2MA Newcastle 3/28 classical guitar mx, 1200 pips and ABC news sounder, man with nx. (Vernon)
- 1548 AUSTRALIA 4QD Emeralds 4/7 Julie Andrews mx, man with intro to mx by Boston Pops, xint sig; 4/13 1207 rundown of Easter Rd. deaths in NSW, other mx, 1210 tone, TC and Queensland mx. (Vernon)
- 1566 SOUTH KOREA HLAZ Jeju 3/28 1156 noted w/classical mx. (Vernon)
- 1575 UNID 1301 man w/Oriental talk, fair sig, very clear audio, sounded a little like KK, Thailand listed w/Lao, could have been this but sig usually has more background noise. (Vernon)

1593 New ZEALAND 12P Auckland 4/13 1254 male w/tele-talk show, xint sig. (Vernon)

and the contributors from last time.....

Marc DeLorenzo-Sudbury, Ma. HQ100, SM2, LW
Paul Kowalski-Milwaukee, Wis. OPR90, 15' hpmbrew ferrite loop
Gene Martin-Denver, Colo. HQ180, box loop
Brian Vernon-Elsa, Yukon Terr. FRG7000, DX300, DX160, 5 Beverages

And this time....

Mark Connelly-W. Yarmouth, Ma. TRP, PCIM-177 counter
Andy Rugg-mobile in Pa, Al amd Miss. car radio
Brian Vernon-Elsa, Yukon Terr. same stuff
(did you ever get a reply from Indie-1134 Brian?)

***** TURKS AND CAICOS*****
If you weren't one of the few lucky ones who heard them off frequency about 5 or 6 years ago, or one of the couple who have heard them on 1550 since, GET READY! There is a new station due on the air 6/1 with 50 kw (yep that's right) on 1570. The clever and original name for this religious station is "The Caicos Beacon". The plan is "to cover all of the East Coast of the US". Obviously no DX'er is in charge of this station.

***** THE MEGAWATT TRANSMITTER*****
Remember the great Radio Millon affair? Did you want to forget it? Well you can't because it is alleged that the transmitter (which was sold a few years back to La Voz de Venezuela) will be back on the air by the time you read this, 2 102 meter antennas having been installed. This implies a directional pattern. No word on which way.

A German DX listing from Littek is on hand, along with a truckload of news items, QSL lists, etc. By the time you read this I hope to have the whole thing computerized. That will make things much easier on me. Now if the turkeys who do the log will get smart and put it on a computer....

If you are wondering what the PCIM177 counter listed with Mark Connelly's TRP is, it's a \$25 LCD frequency counter/display assembly all ready to be mounted in a radio. Accuracy is to the nearest 100 Hertz. It is a neat little package and is easier to install than a counter and discrete LED's. Unfortunately it doesn't fit perfectly anywhere in the TRP faceplate. I mounted mine along the bottom of the faceplate where it looks a bit out of place but neat. Try one is my advice.

UNREPORTED STATIONS UPDATE

by Don Kenkey

The following chart lists the total number of stations in the USA and Canada and the volume they were last reported as being heard, as reported in DXN through V49 #25...

Table with columns: COUNTRY, V49, V48, V47, V46, V45, V44, V43, V42, Prior, Total. Rows for CANADA, U.S.A., and TOTAL.

New stations reported as having taken to the air during the period between V49 #14 through #25:

- AZ--1080--KGVY
CA--1180--KWSO (x-1050)
LA--770--KJCB
MN--1070--KMCM
MN--1270--KPRM (x-1240)
MS--1180--WKCE (x-1190)
NV--1410--KVEG (x-1400)
NM--1090--KRZY (x-1450) EF only
NY--850--WO20
NY--1170--WWEVI
TN--1150--WDEM (x-1130)
TX--1000--KJJT (NRC-Log)
UT--1470--KBNH
VA--1140--WSPC
WA--1330--XENU
WV--1250--WYKM
WI--1190--WERU
AB--1340--C1OK1
NP--970--CFIQ (NRC Log)

Deletions I:
Please scratch WCTA-810-TN recently reported as on the air in error. WCTA definitely is NOT on the air. Also the NRC Log shows deletions of stations WLLB-570-NC & WTHO-1530-GA. Continued bottom page 12....

CONTENTO ON THE CONDADO

or - "A TRIP DOWN THE DIAL AT OCEAN PARK" (E.R.COOPER) (SAN JUAN)

Table with columns: MHz, Call, Location, Volume (1-9). Lists various radio stations and their details.

1210	WNOY	Salinas, P.R. "R. Hoy", features SS MoR, with NX @ .55. UnID PP or SS underneath, couldn't be IDed.	4
1230	WNIK	Arecibo, P.R. Fair signal in the clear, pop SS mx.	2
1240	WALO	Humacao, P.R. "R. Oriental", also in the clear, pop SS mx, with IDs after every record as "Wallow".	7
1260		Very weak SS here, unID, likely WISO in Ponce.	2
1280	WCMN	Arecibo, P.R., popular P.R. music, not too good a signal.	5
1290	WERA	Frederickstad, V.I., a rocker, but with Caribbean-EE, rather weak and slaughtered by severe WUNO-1320 sloop on the TRP.	5
1320	WUNO	San Juan, another one IDing as "R. Uno" - the XR must have been close by but I never did see its tower or any other, for that matter, anywhere in the Condado/Ocean Park area. This one slops something awful; loud SS music.	9
1340	WSTA	Charlotte Amalie, St. Thomas, V.I. in and alone, but slooped out by WUNO-1320; Caribbean-style EE & programming.	5
1350	WEGA	Vega Baja, P.R. This one has a fadey signal even in the daytime; unusual. Lots of cries of "Mas Musicos!"	0-3
1370	WIVV	Vieques, P.R., is all-EE and all-REL.	6
1400	WIDA	Carolina, P.R. (Car-o-LEEN-a), solid signal, a brand new station, but probably using WVOZ's old XR, seems to be all REL/SS.	9
1430	WNEL	Caguas, P.R., SS & EE rock songs & pop SS mx.	8
1450		Two ooo-so-weak signals equal to one another, neither one intelligible - I wonder if one is my unID VOA job?	1
1460	WPAB	Juncos, P.R. (Hoonk'-us) "La Fabulosa" IDs frequently, SS pop	7
1470	WCKK	Orocovia, P.R., brand newie, SS pop mx, a nice station to listen to!	6
1480	WKDD	Fajardo, P.R. Pop SS station, good signal.	8
1520	WRAI	San Juan, P.R. IDs often as "Radio Aeropuerto", but I saw no sign of them in the airport. Solid local.	9
1560	WRJS	Bayamon, P.R. "Radio San Juan", solid local w/EZL in SS	9
1580	WGPE	Korovin, P.R., but calls sounded to me like WPAP or WEPF, a weak signal at Arocas Blancos, but nice EZL vocals in SS.	5
1590	WXRF	Guayama, P.R., tentative, weak and muffled.	3
1600	WLUZ	Santurce, P.R., many IDs as "Radio Luz" & SS pops.	8

Ponce and Mayaguez stations were either very weak or completely absent, apparently due to the high mountains in the central part of Puerto Rico.

Flash Alert: CHUCK HUTTON telephoned with the hot tip that a new 1,000,000 watt station will be going on the air June One (6/1) on, of all frequencies, 1240 kHz, in Venezuela on the Coast, exact town unknown as yet - it is the old one million watt XR from Costa Rica-625!

Continued from bottom page 10.....

DELETIONS II:

Previously unreported stations noted by NRC Reporters in DXN since the last update (V49 #18).

- AL-3--WRMG-1430 (Marshall-TN)
- AZ-16--KAZM-780 (Toshe-GA) x-1470
- AR-7--EVEE-1330 (Kramer-IL)
- FL-14--WNER-1250 (Bowling-OH)
- GA-17--WAGL-570 (Ledbetter-MS)
- KS-4--KIND-1010 (Nine-MO)
- KY-4--WPTM-1240 (Bowling-OH)
- LA-12--WPCG-1060 (Ledbetter-MS) & KJCB-770 (Bigley-TX)
- MS-8--WXIX-1310, WAML-1340, WOJU-1450, WLOX-1490 (all-Ledbetter-MS); WAZP-1230 (Marshall-TN); WMYQ-1410 (Pardue-AL); WKKE-1180 (Bigley-TX) x-1190
- MO-3--KBCC-1410 (Dablestein-KS); KRMO-990, KOTE-1140, KNEM-1240, KBTN-1420 (all Nina-MO)
- NY-3--WVVI-1170 (Musco-GT); WOZO-850 (Bond-NY)
- NC-10--WDLV-550 (Geary-PA)
- OK-6--KBEL-1240 (George-TX); KCCO-1050 (Pardue-AL)
- OR-5--KIVR-1400 (H. Hardy-WA)
- SD-3--KOBH-580 (Hauser-vac SD)
- TN-7--WSVT-710 (Truax-KY); WDTM-1150 (forgot) x-1130
- TX-48--KJBC-1150 (Sherman-MN); KEAN-1280 (Bowling-OH)
- VA-3--WSPC-1140 (Romstadt-OR)
- WA-7--KJUN-1450 & KSCR-1420 (Nolan from WA)
- WV-9--WYKM-1250 (DeLaurere-WV)
- WI-3--WERO-1190 (Knitter-WI)
- WF-12--CBDQ-1490 (Hanninen-Finland)

That's all for this time. Keep reporting...dkk...

VOLUME 6 NRC LOG UPDATER NUMBER 1

510	*CJSB-ON	Ottawa, CP: U 50000/10000	910	WFLA-FL	SCH: 0500-0000
	#CKEY-OH	Sault Ste. Marie CP: U 15000/2500 PO: 970 KHZ		*WKEQ-KY	Call for Burnside CP ex WOKX
550	*WATB-FL	CP: D1 2500	920	WVLA-SD	PWR: U3 500/1000
560	WMDU-MI	Addr: Box 306		KKSN-WA	Net: Ap
570	CJEM-WB	SCH: 0500(0600 sat, 0700 Sun)-0000		KVBC-CA	San Luis Obispo 93101 PWR: U1 1000/500 Box 787 SCH: 24h. Net: Ac Add to log.
610	WIOD-FL	Delete KING		KYST-TX	Net: M
	WVAI-VA	ex WHPL		KQRU-WA	ex KITH. City of license is "Olympia." Delete "Lacey" altogether.
	KONA-WA	SCH: 24h HSP			
630	KIDD-CA	Addr: 2555 Garden Rd	930	KPIS-AZ	ex KAFP
	KHGW-DO	Addr: Box 17630 FA Zip: 80217		*WKCY-KY	CP: U1 5000/500
	KSHE-OR	ex KWRO		WKFX-AL	CP is on, delete Gadsden city of license and power r KCRB-1360
	WMSD-TN	Collierville, D1 500 Box 447. Net: Tn Sch is G: Zip: 38017		CKNS-ON	
670	#KPUA-MI	Insert # before call Still on 970	940	WIDQ-MI	Net: Ap
680	WWLF-FL	Delete Net		WKXK-NC	PWR: U2 5000/250
	WRMG-GA	CP is on, delete + PWR: U1 50000/10000		WAMH-VA	CP is on, delete * Addr: 228 N. Main St.
	EFAM-UT	CP is on, delete *	950	*KAHY-CA	CP: U1 5000/5000
710	*KFIA-CA	CP: U1 10000/2500	960	KLAD-OR	SCH: 0900-0300
	WGBS-FL	Net: M/K an TLK		WBEU-SC	Addr: 3040 Boundary Street
	WEEK-KI	CP is on, delete *	970	WFLA-FL	SCH: 24h HSP
	WQZM-MS	Ditto		*KPUA-MI	Kilo 96720 PWR: U1 5000/5000 Addr: 58 Mainolana Plaza N: 24h (+1) Net: Cv CP: 670 Add to log.
	WSTV-TX	Ditto		WAVG-KY	Addr: Box 37970 Zip: 40233
	WLTJ-PR	PWR: U 10000/500		KSAX-TX	ex KNOX
750	*EPCM-UT	Park City 81060 CP: U2 5000/1000 Box 1372 Sch: M		KITP-MI	ex WALK
770	KXA-WA	Net: Ac	980	WBSS-FL	ex WPJP
	KJCB-LA	PWR: U2 1000/500		KESB-NH	ex WAIL
		SCH: 24 h HSP	990	*WPIX-AL	CP: D3 2500
780	#WWS-FL	Insert # before call PO: 790 KHZ	1000	WTAX-AL	ZIP: 35804
790	*WJJK-TN	ANT is D1		WABT-AL	PWR: D1 5000
	KULF-TX	NET: Add Tx		WEMX-FL	PWR: D1 1000
800	WSST-FL	SCH: 0600-1SS p250		WCGE-MA	ex WIMS
810	#ITRQ-WA	PO: 730		WSUM-OH	Location is Ohio
850	*WLRC-MS	Call for Walnut CP	1010	WPKY-AL	CP is on, delete *
	WJAC-PA	SCH: 24h		WCFB-FL	SCH: 0600-1SS
	*WBLP-TN	Call for Fairview CP			PSA: 500
860	WAMA-FL	ex WAZE	1030	CFYQ-NF	CP is on, delete *
890	KBYE-OK	Addr: 2333 East Britton Road St. George. Add # before listing		*WDBX-TN	White Bluff 37187 CP: U1 1000/250
	*___-UT		1040	*___-PR	Moca 00716 CP: D1 250
910	KNEW-CA	Network is Ac	1050	KNSO-CA	Delete listing, on 1180 kHz
	WRCQ-GT	ANT: U2		WNIC-AL	ex WCRI
	WFLA-FL	ANT: U2			

1050 WROB-FL Correct call is WREB
PSA: 250 SCH: 0600-
LSS
WYEO-NY Nets: Ap
KOTO-OK ex KRAV
1060 WMAN-GA ex WLLX
+WNCR-NC CP: 1080 kHz
1070 WSCM-NC CP is on, delete *
1080 KGVY-AZ CP is on, delete *
#WNCR-NC ST. Pauls 28384 CP:
D1 5000 ch; 2500
Box 169 Net: Ap
PD: 1060 kHz
*WBTZ-TX Oliver Springs, Zip:
37840 CP: D3 2500
KRFX-UT PSA: 500
KRLD-TX Zip: 75225
1090 *WJBE-AL ex WJBA (listed as
WJVA)
KYBB-CO ex KIDR
WAQE-WI CP is on: D3 5000
CHRS-PQ Addr: 25, Rue St-
Jacques; St. Jean'
J3B 2J6
1100 #KDRY-TX Alamo Heights 78204
CP: U2 2500/1000
Box 6628 PO: 1110
1110 * ___-AZ Marana 85238 CP:
D1 2500
+KEND-OR CP: U2 25000/5000
+WSLV-TN CP: D1 2500 ch; 1000
+KDRY-TX CP: 1100
+KTRX-TX Zip: 77531 PWR: D1
500 Addr: 1100
County Road 833
North Bay. CP: U2
10000/10000
1130 WWSA-IN Correct call is WWSM
+WSJP-KY CP: U2 1000/250
KWNH-LA Delete CP at end of
listing
+KENC-ND CP: D3 50000
WCOO-SC ex WFUB
1140 WQBA-FL CP is on: U4 50000/
10000
#WSAO-MS Insert # before call
PD: 1550 kHz
1150 WTHP-FL SCH: 24h MSP
KBAI-CA SCH: 0900-0305
*WTVZ-MS Call for Clinton CP
KDFZ-WH ex KDRM
+EVIL-TX CP: U4 1000/1000
KATO-WA CP is on: U2 5000/
5000
+CHGM-PQ Call for Gasps CP
1170 KSGR-CO ex KUAD
+XFWW-ND CP: 1200 kHz
1180 KWSO-CA CP is on, delete #
PWR: U2 10000/1000
WLDL-IL Net: APR/A1
1180 WKEK-MS CP is on, delete #
PWR: U2 10000/5000
Addr: 2741 Old Bra-
ndon Rd; Jackson
Miss 39208
+KOFI-MT SCH: 24h SP;M
0206-0758
1190 WHII-AL CP is on: D1 2500
+WKEK-MS Delete listing
+WSML-NC ex WWOE
WERU-WI CP is on, delete *
Addr: 3392 Brooks
Dr. Net: APR
1200 #KPNW-ND West Fargo. CP: U2
10000/1000 PO: 1170
WOAY-TX Addr: 6222 W I.H.
10 Zip: 78201
1210 *KCLD-UT Call for Washington
CP
1220 WQSA-FL SCH: 0600-1800 (ex-
cept s/off earlier
Late Dec, early Jan)
WHSO-TN Delete listing, on
630 kHz
+XVLL-TX CP: 1490
1230 KBZB-AZ ex KSON
KTRC-SD ex KXRC
1240 KAKZ-ES Net: Add UPI
WMPG-MI Delete listing, on
1230
1250 KOKY-AR Addr: 1501 N. Uni-
versity Zip: 72207
PWR: U4 2500/1000
#KONO-CA Addr: 504 Isaac St.
WDAE-FL Tampa 33609
Addr: Box 647
WIRL-TN ex WEEB
WPRZ-VA In addr: Marrow
KNSU-WA CP is on, delete *
WYIM-WY
1260 *WCRT-AL CP is for Vestavia
Hills, Alabama
KIPR-TX ex KSPF
* ___-BC Delete Richwood CP
CP: D1 5000
+WJJC-GA Correct call is
WJSH-ND
WTJZ-VA CP is on: U2 1000/
1000
Net: APR
KBAM-WA SCH: 0530-
1280 WKST-PA Delete listing, on
810 kHz
*WCTA-TN ex CJJD
CHAM-ON Addr: Box 3335
1290 WIRL-IL West Glen Station
1300 *WTIM-FL To Temple Terrace
CP: U4 5000/1000
Net: UPI
WQBX-NY SCH: 24h

1300 WSSO-NC ex WDMO
KBBJ-OK ex KMDD Net: NBC
*WVIC-PA ex WYLV
WFSM-SC ex WXXI
1310 *XIAK-JN Insert # before call
1320 *WAMR-FL CP: U2 5000/1000
SCH: 24h MSP
KSTV-ND ex KADI
*WDER-WH Call for Derry CP
WJAS-PA Net: Ad
KITZ-TX Delete Net
CFGM-OK SCH: 24h SP;M
0100-0500
1330 #KSKI-ID Insert # before call
WJDO-MS ex WDAL
*KWSK-ND Call for Wishek CP
KENS-WA Delete #, CP is on
Addr: 2541 Griffin
Avenue
1340 WYAN-FL Net: Ap/Ad
KREB-ES ex KCBN
KMTI-UT Delete listing, on
1590 kHz
+WYBR-VT CP: U1 1000/250
1350 WDFP-FL Delete CP, PWR: D1
1000
+WLOD-KY CP: U2 5000/5000
+WLLX-NC CP: D3 5000
CFIQ-KF Delete listing, on
1010 kHz
GKAR-ON r GQY-FM 0000-
0500
1360 WZMQ-FL Delete Winter Haven
listing, CP is on.
Net: Ac SCH: 0500-
0100
KCHS-CA ex KGB Net: CNN
1370 KAMA-AR Correct call is KAWW
KTPA-AR CP is on: D1 1000
WCCN-WI Net is only APR
1380 WAOK-GA Addr: 401 Peachtree
Street N.E.
Zip: 46816
WQHK-IN ex KJET
KTEL-TX Calls for Moncton
CP
1390 *KJJZ-CO ex KFHL. City is
Westminster
KXCM-OK Addr: Box 1663, St.
Cloud 56302
WYOO-ON ex WTCY
KJAN-SO Addr: Box 2
+ ___-AB Medicine Hat, CP:
U2 10000/10000
1400 *KRVZ-AZ Call for Springer-
ville-Eager. Note
correct town.
KLSB-MH ex KEEI
KVEO-NV Delete listing, on
1410 kHz
1400 WENY-MY PWR: U1 1000/250
WENW-NC Addr: 200 W. Wand-
over Ave. 27401
KIVE-OR CP is on, delete #
KBCB-OR SCH: 0900(1000)-
0300(0000)
* ___-TX Huntville 77340
PWR: U1 1000/250
1410 WFTZ-IN ex WAZI
KVEO-NV Henderson 89105
PWR: U4 5000/5000
Addr: Box 15223,
Las Vegas 89114
P: 24h MSP PO: U1
1000/250
+WSCM-WV CP: D1 5000
WIZW-WI SCH: 24h SP: irreg K
1420 *WMOO-AZ Call for Payson CP
PWR: U2 5000/2500
+WFLT-MI To Burton, MI CP:
U4 5000/5000
*KTAH-MO Call for California
CP
KBBQ-SD Silent
KSCR-WA CP is on, delete #
1430 *KNSP-NH Staples 56479 CP:
D1 1000
*WDEI-NC Call for Monroe CP
CJCL-ON SCH: 24h MSP
1440 KOPA-AZ ex KLAH
WQVL-SC ex WQK
1450 KDRN-CO CP is on, delete *
WJQT-NC ex WHIT
1460 EZEP-FL Correct call to WZEP
WPCN-MI Addr: 1011 West Har-
on Ave. 48053
ex KLLL
KNAZ-TX
1470 WYQT-FL PSA: 500
WXLZ-MI ex WYYY
KXKC-MH ex KTVH
WGBU-PA SCH: 24h SP;Sun AM,
MH
KREN-UT CP is on, delete *
Addr: Box 115
*WBEV-WI To West Bend Town-
ship. CP: U2 1000/
2500
1480 KPHX-AZ CP is on: U2 1000/500
1490 WABK-ND SCH: -0000
WETA-NY PWR: U1 1000/250
WGBB-SC Addr: Box 597, 29602
#XVLL-TX Woodville 75979. CP:
U1 1000/250 Addr: Box
458 Net: Tx, PO: 1220
KXCM-WA Net: Ac (drop CBS)
CROO1-BC City is "Deyoons"
r CROO-1240
1500 * ___-MS Sardis: 38666. CP: D1
500
CP: *KXCI-TX Boerne 78006 D1 250

- 1500 KXIO-TX ex KBGG
 1510 KIRV-CA CP is out D3 10000
 WDJR-MI Silent
 WTRD-NC Delete listing, on 1520 kHz
 1520 WAAB-GA Note call for Dahl-
 onaga CP which is on
 delete *
 *WCSP-MS CP: D1 1000 ch:250
 KRSS-SD Addr: Box 1783 Zip:
 57101
 WTRD-NC Delete # before call
 1530 *WGBH-MA Call for Middleboro
 CP which is D3 1000
 *WMBE-WI Call for Chilton CP
 1540 WMYT-NH ex WKCR. Time zone is
 E:
 *WBJA-PE CP: D1 1000
 1550 WRNC-FL City is Coral Gables-
 Miami
 WYOU-FL SCH: 0600-LSS
 WLUJ-LA Baton Rouge
 WRZB-NC ex WINA
 1560 *WKDO-KY CP: D1 1000
 1570 WYOX-AL Call is WTQX
 WLIB-MA City is Westfield
 *WYLR-NY CP: D1 5000
 CHLO-OH ex DLIS (call was
 never used).
 WPPC-PR Pennellias D1 1000



It's been a long time since I've done a Log Updater so bear with me. I've left off time zones but the reader is capable of adding them where necessary. This Updater will bring your Log current as of 8-1-82.

I do have some call changes sent in by Don Kusky which I'm having Buffalo K. Foonman check out. Your Log can be kept current by using Dave Schmidt's "SPECIALS" section of DDD and "AM SWITCH."

I haven't bothered to update the Call/Letter Index section as that is easy for the reader to do. In that section please add; KOKK-1370 and WHPF-1500 and Delete WLB-1100.

THE WIZARD will be in Louisville for the Convention and I understand Alphonso Bedoya will accompany him.

**NATIONAL
 RADIO CLUB
 CONVENTION**

Louisville

Cuba May 'Wreck' Radio Stations in U.S.

MIAMI (AP) — Cuba's plans to double its number of AM radio stations will disrupt the signals of more than 100 U.S. stations in 32 states and the District of Columbia, according to an industry report.

And the new stations will probably wipe out the long-range, nighttime programming of 19 "clear-channel" stations as far away as Detroit, New York and Salt Lake City, says the report by the National Association of Broadcasters.

Only six clear-channel stations in the United States will be unaffected if Cuba goes through with plans to build 10 more stations, said the computer-based report, released earlier this month in Washington.

Small AM stations will be affected from New York to Colorado, according to the broadcasting group that represents some 4,600 stations nationwide.

"Who would have thought Castro was going to be involved in my little neck of the woods," marveled a frustrated Freda Carter, station manager of KAMD in Camden, Ark., where Cuban interference would cut coverage from 160 square miles to 70 square miles.

At least 38 Florida radio stations — eight in Dade County, two in Broward County, one in West Palm Beach — will be affected, the report said, and some will lose as much as 80-99 percent of their coverage areas.

Cuba has renounced international broadcast treaties and refused to take part in negotiations for a new treaty, which would limit the power of broadcasts in the direction of another country, where other stations use the same frequencies.

The NAB's computer study, supervised by staff engineer Michael C. Rau, was based on a list of planned stations Cuban representatives submitted last year before they walked out of an international radio conference. The communist island nation, 30 miles south of Key West, plans 99 new stations — two of them 10 times as powerful as the strongest U.S. station — by December.

Cuban officials have not explained why they want the additional high-power radio stations or why they won't go along with broadcasting treaties. But many South Florida stations, including the Spanish-language stations that broadcast anti-Castro sentiments, are easily picked up in Cuba.

South Florida stations have been plagued by Cuban interference for nearly two years. Because of it, six Dade County stations have received Federal Communication Commission permission to increase their power.

But spokesmen at the stations say power increases are expensive and only partially recoup the loss.

Matthew Leibowitz, a former FCC attorney representing the South Florida Radio Broadcasters Association, said WQBA of Miami spent more than \$1 million to strengthen its signal.

"These are temporary increases," Leibowitz said. He said if Cuban interference stopped, U.S. stations would be forced to cut back power to original levels, making their new equipment useless.

"Stepped up power won't remove interference," Rau told the Miami Herald. "You can only regain a small amount of your lost coverage. You can only stop interference at the source."

That's nearly impossible. "Castro will do what he wants, when he wants," said Leibowitz.

"If they do this, it's going to play havoc with our station," said Ed Holliday, manager of Meridian, Miss. station WOKK, which stands to lose 88.4 percent of its coverage area. "This is going to take away our bread and butter. But I can't think of a thing we can do about it."

The Reagan administration wants to set up a government-financed "information" station called Radio Marti to broadcast back into Cuba. The bill, pending approval by the U.S. House Foreign Affairs Committee, would also allow domestic stations suffering from interference to be reimbursed by the U.S. government.

Some U.S. broadcasters fear Radio Marti will only make matters worse and start a "jamming" war with Cuba.

"Let the CIA finance it out of El Salvador or on some ship floating in the ocean," said Joe Martello, manager of WJTL in Detroit, which could suffer a 98.3 percent loss of its 1.3-million square mile night coverage area.

"If they do it out of this country and Cuba reacts, it's only the broadcasters who suffer."

Both the FCC and NAB have expressed concern about Radio Marti but neither has opposed it.

Rau said Cuba's new stations may cause as many problems among themselves as they will for U.S. broadcasters.

"There's already a lot of interference among Cuban stations," Rau said. "And there isn't a lot that the Cuban engineers down there can do about it. But down there, engineers don't have much say about where a radio station goes."

Besides WJTL, other clear-channel stations that will suffer great losses include WLN in Chicago, New York's WNBC and KSL in Salt Lake City.

At least 38 Florida radio stations — eight in Dade County, two in Broward, one in West Palm Beach — will be affected, some losing as much as 80-99 percent of their coverage areas. The identity of the West Palm Beach station was unknown.

via
 Mike Cooper

House panel OKs Radio Marti funds

WASHINGTON (AP) — Despite possible Cuban retaliation, the House Foreign Affairs Committee voted 24-5 yesterday to authorize \$10 million for the start-up of a new U.S. radio station broadcasting to Cuba.

Rep. Jim Leach, R-Iowa, said he supported the station, Radio Marti, but he voiced concern that plans for the operation could result in political embarrassment for President Reagan.

Cuba may decide to retaliate against Radio Marti, he said, by putting into operation a massive 500-kilowatt transmitter broadcasting on the same AM frequency of 1940 kHz. Leach noted that this frequency also is used by WFLW, a clear channel station in Des Moines.

During 1932-37, Reagan worked at a sports announcer for WFLW.

Leach concluded that the prospect of embarrassing Reagan would tend to increase the chances of Cuban electronic retaliation. He urged that Radio Marti instead broadcast on another frequency, 1100 kHz, by sharing an AM transmitter in Narahan, Va., now used by the Voice of America.

The legislative language finally adopted by the committee puts Radio Marti under the control of the U.S. Board for International Broadcasting.

It authorizes the board to make payments to U.S. radio stations to compensate them for measures such as higher-power transmitters needed to cope with Cuban radio interference.

via
 Mike Cooper
 &
 Thomas Taylor



SEE PAGE 39 BOTTOM.....

THE SUPER HQ-180

'180 + COLLINS P455FA40 MECHANICAL FILTER = SUPER-'180

Dallas Lankford
(c) 1982

The symmetrical bandpass, 455 khz center, Collins P455FA and PB series of mechanical filters provide a wide range of bandwidths from which to choose. The PA series of filters are identical in performance to the PB series, but do not have measured 20 db points marked on the filters. The PA (PB) series parameters are listed below.

TYPE NUMBER	COLLINS PART NO.	6/60 DB BW
P455FA-05	526-9765-020	0.5/3.0 khz
P455FA-15	526-9495-000	1.5/3.5 khz
P455FA-21	526-9427-000	2.1/5.3 khz
P455FA-27	526-9500-000	2.9/6.2 khz
P455FA-31	526-9496-000	3.1/6.5 khz
P455FA-40	526-9497-000	4.0/8.5 khz
P455FA-60	526-9498-000	6/12.6 khz

We wonder why the 27 filter should have a 2.9 khz 6 db BW, so perhaps there is a typo in the Collins catalog from which we obtained our information. The 500 cycle filter is surely too narrow to be of much use in AM DXing, but all of the others are potentially suitable for more or less narrow AM DXing. I chose the 4 khz BW filter for installation in the '180 because I wanted to retain as many of the '180's BW options as possible. In this case, all but the 6 khz

and 3 khz upper and lower sideband selectivity options remain available (the 3 khz upper and lower sideband selectivities can still be had by adjusting the vernier fine tuning ± 1 khz). The 2.1 khz BW filter would, perhaps, give slightly better performance under extreme listening conditions (say, between two 50 KW locals), but then you lose a great deal of the '180's selectivity options on bands 1 - 4.

It is generally agreed that for best performance a mechanical filter should be placed immediately after the first mixer. Unfortunately, because of space and circuitry problems, installing a mechanical filter in a '180

FIGURE 1

Mixer, gate, 455 khz IF amplifier schematic for 1970 model HQ-180A.

In earlier model '180's C158 may not be present, and R99 may be 1000 ohms. In addition, R18 is realized by two parallel 100 K resistors.

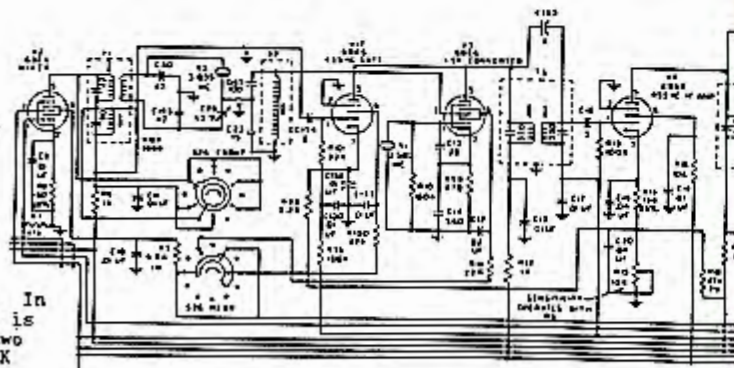

is non-trivial. A schematic of the '180 mixer and immediately following stages is given in Fig. 1. A Collins data sheet for the PA series filters contains a suggested installation circuit which would remove the first 455 khz IF transformer, but that circuit seems difficult to use because the first 455 khz IF in the '180 is an essential part of the '180 bandswitching scheme. The suggested Collins output circuit also seems undesirable because additional AVC line would be required, thereby creating additional stray signal paths and reducing ultimate rejection of the mechanical filter. However, on the plus side there is plenty of reserve gain available by modifying the 455 khz GATE to more than overcome the insertion loss of the mechanical filter. (The GATE is a reduced gain, AVC controlled, 455 khz IF amplifier, with further signal loss due to the very low 2 pf grid coupling capacitor shunted by the 22 K resistor.)

The circuit I used was arrived at by consultations with Dr. Tom Williams, formerly a professor of electrical engineering at Louisiana Tech University who, coincidentally, had previously worked for Collins for about 10 years. Basically, we looked at schematics of Collins receivers which used mechanical

filters until we found something that looked feasible. For the input circuit, we used a standard B+ feed via a single tuned IF transformer (so that we could use the existing '180 circuitry) capacitor-coupled by C1n to the tuned filter input. In my installation, I removed the 100K R107 so that I could determine the effect of different values for R107, but observed no noticeable differences for values in the 50K - 500K range and so I would leave R107 alone in future such installations (R107 is rather difficult to replace because of its position between the pins of T1). We have denoted the capacitance of the shielded cable input CCin to remind us that its capacitance adds with the 90 pf capacitor in T1, requiring that the 455 khz section of T1 be realigned for maximum signal. (In practice, the signal loss due to a misaligned T1 is generally negligible.) The output circuit allows easy filter termination and AVC feed at the GATE tube socket. A simplified schematic of the installation is shown in Fig. 2 below. The input and output coupling capacitors are shown with nominal values. Any values between .001 and .01 should do, and values as low as 100 pf do not significantly lower signal levels (though you might lose a few microvolts of sensitivity, longwire performance is unaffected, and strong signal handling performance is probably slightly improved). The filter is tuned to resonance at input and output by 130 pf capacitors Ct. The 130 pf of capacity includes stray capacity, e.g. CCout in the output Ct. For Ct I used a 100 pf silver mica parallel with a 50 pf air variable trimmer. I found that tuning of the filter is so broad that I could have just as well used 130 fixed for Ct input and 110 fixed for Ct output (I estimated about 20 pf for CCout). The output termination resistor can be anything from as high as 500K to as low as 20 K (Collins recommends against values below 50 K, but I noticed no problems). The lower values reduce the signal level somewhat, and so are useful for increasing the dynamic range of the '180. To restore the lost signal (insertion loss of these filters is not given in the Collins data sheets, but it is more than the '180 circuitry it replaces), the GATE cathode circuit was changed as shown. We originally used $\frac{1}{2}$ watt power ratings for RA and RB because Hammarlund used a $\frac{1}{2}$ watt power rating for R99 (which our circuit replaces). However, we measured voltage drops across RA and RB for various operating conditions, and discovered to our surprise that RB generally dissipates about 1.1 watt. A "finger test" revealed that RB was warm, but not hot, but we will still replace it with a 2 watt variable. The ground return point of C130 was changed to the same GATE tube socket ground lug as C158. In

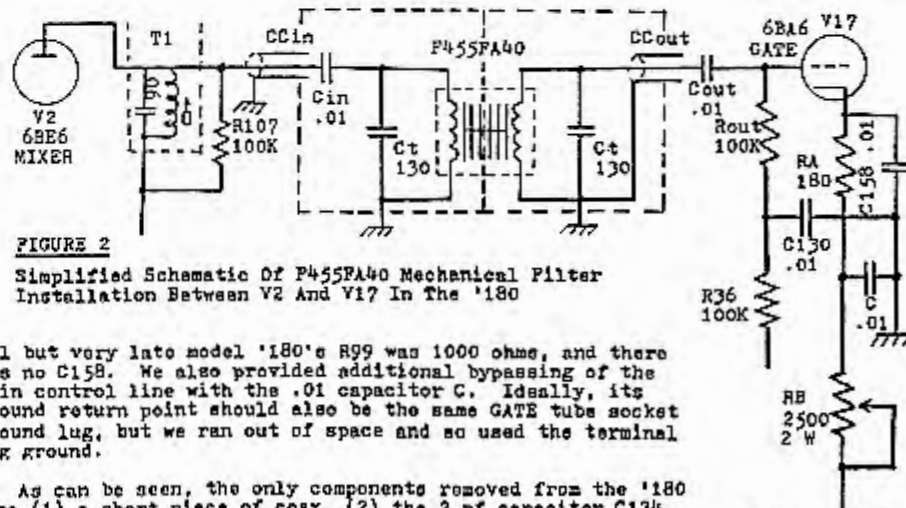

FIGURE 2
Simplified Schematic of P455FA40 Mechanical Filter Installation Between V2 And V17 In The '180

all but very late model '180's R99 was 1000 ohms, and there was no C158. We also provided additional bypassing of the gain control line with the .01 capacitor C. Ideally, its ground return point should also be the same GATE tube socket ground lug, but we ran out of space and so used the terminal lug ground.

As can be seen, the only components removed from the '180 are (1) a short piece of coax, (2) the 2 pf capacitor C134, (3) the 22K resistor R101, and (4) the 2.2K resistor R99. The new coax shields are grounded at one end only, CCin to a ground lug near T1, and CCout to the filter output ground. CCout replaces C134, and Rout replaces R101 (I used the same tube socket pins and terminal lugs, and positioned the new components similar to the originals).

I originally intended to use a 2000 ohm variable for RB, but 2500 was the closest $\frac{1}{2}$ watt variable I could find at nearby parts houses. When I replace it with a 2 watt variable, I'll try a higher value, say 5000 ohms, because a larger value will give greater gain control. In my opinion, reduction of the IF gain before the 455 - 60 khz conversion could prove useful in some extreme listening situations. In addition, there seems to be a small range of frequencies around 1200 khz where additional gain would be useful in some

situations. So operator control of the sensitivity and dynamic range of the modified '180 would seem to be a useful addition. Before I start drilling holes in the front panel of my '180 I will mount the variable on a bracket bolted to the bandspread tuning capacitor so that it can be adjusted by opening the lid. And if I open the lid a lot, then I may drill a hole in the front panel. I should add that the gain of my '180 is more uniform on bands 1 and 2 than stock because I have installed a 50 pf dual variable capacitor in place of the original single section antenna trimmer which gives me dual ANT/RF & RE/MIXER tuning on band 1 (and single section tuning as before on bands 2 - 6). Spurious front end products resulting from the '180's unusual first conversion on band 6 prevented me from having dual front end fine tuning on all bands. Nevertheless, I am very pleased with my present arrangement because my stations on 1050 KHz now give the same S-meter reading on both bands 1 and 2.

A good approximation of the combined selectivity of the Super-'180 can be had by subtracting the mechanical filter attenuation curve from the selectivity curves in the '180 manual, which we have done in Fig. 3 below. As can be seen the main effect of the 4 kHz mechanical filter is to steepen and deepen the skirt selectivity (the 6 kHz BOTH and 3 kHz U and L bandwidths are also narrowed). When considering the performance of the Super-'180, one must remember that the 455 - 60 kHz conversion occurs between the mechanical filter and the 60 kHz IF selectivity, so that the combined selectivity curves are not as effective as they would otherwise be. Still, by judicious use of the main tuning, vernier fine tuning, and bandwidth options, the Super-'180 possesses very steep skirted, continuously variable 0 - 4 kHz bandwidth, 120 + db ultimate rejection selectivity. In side-by-side listening tests with the same 100 foot long wire antenna, the Super-'180 beats the R-390A in some extreme listening conditions. For example, the Super-'180 extracts better signals on 1480 and 1500 kHz beside my super-local KRUS 1490. Before the modification, the '180 never produced readable signals on 1480 or 1500 because of severe overloading. Also, the Super-'180 sometimes beats the R-390A on Once Viento 1124.8(v) kHz when KMOX is strong. Moreover, the Super-'180 generally beats the R-390A in routine listening (both domestic and foreign splits) because the continuously variable selectivity can be used to minimize interference while maximizing the bandwidth for better audio quality. In severe listening conditions, the Super-'180 can present its 4 kHz skirt to the QRM before its second conversion, whereas the R-390A is triple conversion (on the ECB) before any significant selectivity. The Super-'180 has significantly better dynamic range as a consequence, and you can really hear the difference in extreme listening situations. The very deep skirt selectivity of the Super-'180 is also vastly superior to either the R-390A or the stock '180, and may be responsible for a large part of the dazzling Super-'180 selectivity. Whatever the cause, such of the "slop" that used to cover and hide weak DX is now gone in many cases, so that on nights of low atmospheric noise I can follow many splits down into the background (man-made) noise, a feat seldom previously possible (either on the stock '180 or the R-390A). And strong splits, like R. Belize S34, are now received with much improved clarity.

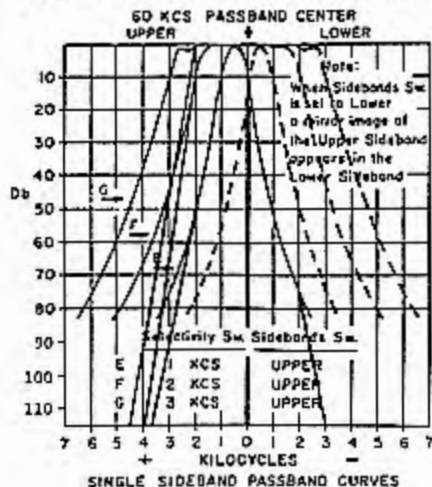

FIGURE 3A

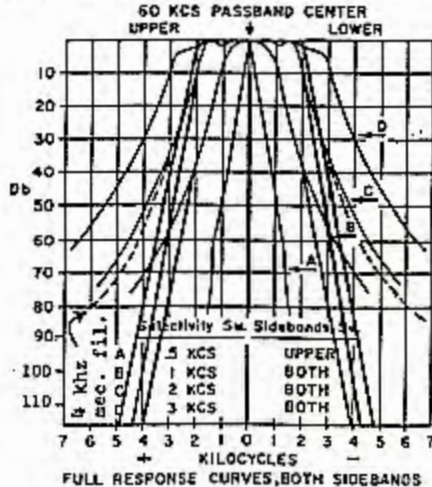

FIGURE 3B

As we have said, the curves of Figs. 3A and 3B were obtained by subtracting the mechanical filter attenuation curve from the stock '180 curves. The dashed lines in Fig. 3B denote the 4 kHz BW mechanical filter, while the more or less straight lines branching off the '180 selectivity curves represent the combined selectivity. In Fig. 3A, the lower '180 sideband curves are denoted by dashed lines, and the combined upper sideband selectivity by the straight line branchings. The Db scale in both cases has been extended to 110 db, near the limit of the original Hammarlund graphs. The deep skirt structure of the 0.5 kHz bandwidth is not shown in Fig. 3B because of insufficient information. It is interesting to observe that when centered on a 5 kHz split, offending domestic carriers are down at least 120 db (though at the 455 - 60 kHz conversion domestic carriers are down much less, say about 70 db). The graphs also show that the U and L sideband selectivity positions of the Super-'180 have better skirt selectivity than the BOTH positions. This difference can actually be heard in a few extreme listening situations. Because of their shapes, the combined U selectivity is ideal for DXing the 5 kHz spectrum below a domestic carrier, while the combined L selectivity is ideal for the 5 kHz above. And by setting the vernier fine tuning ± 1 kHz, you have 3 kHz selectivity with a very steep skirt on one side and a merely steep skirt on the other. In practice, none of the standard selectivity settings is usually optimal, but it is easy to find optimal settings by piddling around with the main and vernier fine tuning.

This article is not intended as a construction guide. If there is enough interest, I'll write a sequel which discusses the actual construction and debugging of the filter circuitry and enclosure. With regard to debugging the filter, let me warn the unwary that to eliminate all stray signal paths around the filter required, among other things, rebuilding the GATE grid and cathode circuitry, and fabricating about 8 inches of double shielded cable from RG-58/U and copper braid from RG-8/U.

Permission is given to the National Radio Club to copy and/or otherwise use all or parts of this article.

ACKNOWLEDGEMENT: I would like to express my appreciation to Dr. Tom Williams for his invaluable assistance in the preliminary theoretical studies of feasible mechanical filter input circuits, and especially for doing the power transfer analysis of the final circuit. His experience was also crucial in arriving at the final design, particularly with regard to elimination of stray signal paths around the filter.

CENTURY PRINT SHOP CPS shipped 500+ copies of the 1982 World Radio TV Handbook during the first 10 days of Feb. 1982; all who ordered should have their copy. If you failed to receive yours in good condition, please advise promptly. Eff. June 1, 1982, the remainder of the copies of the 1979, 1981, and 1982 WRTBs in stock will be summer-special priced at \$15 each, postpaid, USA; \$16 elsewhere, U.S. funds only, payable to: CENTURY PRINT SHOP. All orders must contain a SASE for eventual confirmation of shipment. CPS specializes in discount, mail-order sales of books of interest to the radio and computer hobbyist; the minimum discount on most books is 25%. CPS stocks, for immediate shipment, the complete line of publications by RFI, Sams, TAB, Vintage, 75/Green, and the ARRL. Most publications from the following are also available: Addison-Wesley, Cologne, CoB, Creative Computing, Davis, Gllithium, Dover, Dustbooks, FM Atlas, Grove, Ham Radio, Hayden, IL/Austin, McGraw-Hill (Byte), Miesek, Penguin, Police Call, Prentice-Hall, Radio Amateur Callbook, SYBEX, Universal, Van Nostrand Reinhold, Viking, Watson-Guptill (Billboard), Wiley, Ziff-Davis, IRCA, NRC, IMCA, RSOB, SDDXC, and WTPBA. Century Print Shop will release Catalog 82-12 with 16 pages of listings approx. July 1, 1982; requests should include a legal-size SASE with 37¢ postage or, outside the USA, equivalent mint stamps or LDCs. Orders and catalog requests should be mailed to: CENTURY PRINT SHOP, Donald Erickson, 6059 Essex St., Riverside, CA 92504-1599. Telephone inquiries welcome anytime, 714-667-5910.

OH! KENTUCKY
You'll come to love it.

CONVENTIONS ARE
GREAT
IN LOUISVILLE

Digital TRF Readout; The Easy Way!

By Bill Block and Frank Aden, Jr.

The PCIM 177 is a LGD readout module with 26 different IF offsets built in. The unit will work with LW, AM, FM, and SW but needs a prescaler unit to operate above 3999.9 kHz. A 5 volt incandescent light is also included.

The PCIM 177 is available from Printed Circuits International, 1145 Bonora Court, Sunnyvale CA 94086. Cost is \$25 postpaid.

For Broadcast Band only all you have to do is connect the unit to a 3-7 voltage source and the input to your receiver's local oscillator.

We decided to install the unit in the Radio Shack TRF. Before you read on please note the unit does generate interference on the Broadcast Band. To solve this problem we decided to use a SPST switch to turn the display on/off. The TRF's power source of 6 volts is used to power the PCIM 177.

No noticeable shift in the TRF's tuning was noted so a buffer circuit is probably not required. The unit has very low power consumption so little drain will be put on the TRF's batteries.

Another SPST switch is used to allow momentary operation of the unit's light but since the TRF's 6 volts is too high a voltage drop resistor must be used. We found that 33 ohms to be acceptable, dropping the voltage to 4.8 volts.

We installed the module in the front of the TRF just left of the speaker. Cutting the hole took several hours (you have to be very careful) and a coping saw was found to be the best way to go.

The IRCA TECHNICAL GUIDE is the best reference on how to get into the TRF. We recommend the use of shielded audio cable for all hookups and advise to keep all leads as short as possible. Note only the inner conductor is used.

Solder the wires to the module as flat as possible (do not let up stick upward) otherwise the AC power cord compartment will be in the way once the receiver is put back together. Also use a pencil type soldering gun only as a regular type gun will be too hot for both the PCIM 177 and the TRF's components.

For those who want to avoid the interference problem it is suggested to install the module in a mini-box using audio cable to connect with the TRF. Install a jack on the rear of the TRF with connections to ground and the local oscillator. A battery holder can be used to power the unit instead of the TRF's power.

Step by step instructions follow:

1. Run wire from module IMP to terminal 1 of switch 2.
2. From other terminal of switch 2 run a 33 ohm resistor to the top right hand red wire of the TRF's PC board.
3. Run a wire from this position to switch 1 terminal 1.
4. From switch 1 terminal 2 run a wire to VDD on the module.
5. Run jumper cable on module from VDD to AM/FM.
6. From other IMP position on module run a wire to the bottom right hand inside red wire on the TRF's PC board.
7. Run another wire from this position to VSS on the module.
8. Run wire from input on module to bottom lead of the transistor (below tuning capacitor) on the TRF's PC board, solder this very carefully, use a heat sink if possible. It is suggested to put a little solder on the wire then soldering it to transistor. Do not touch the transistor lead with the soldering pencil directly.

Switch 1 turns on the display, switch 2 turns on the lamp. Now align the TRF as per instruction in the IRCA TECHNICAL GUIDE. Happy tuning!

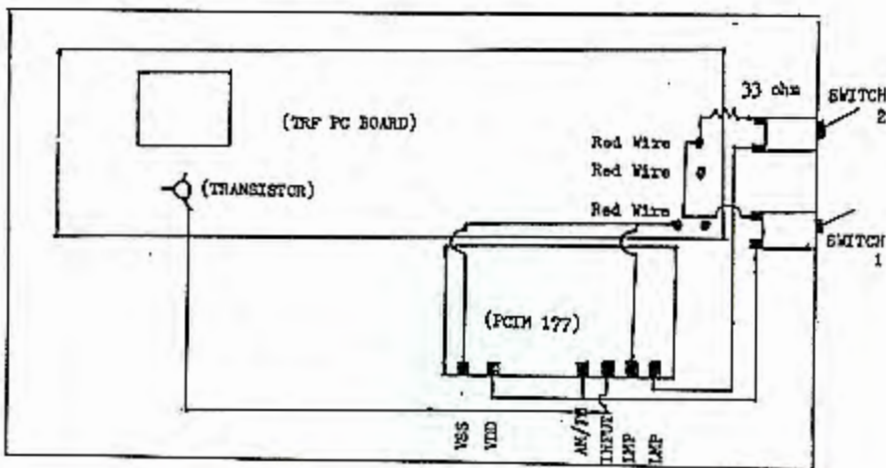

RADIO SALES CO.

Majestic Radio

Blytheville, Arkansas

March 19th, 1929.

Mr. Myron Fullerton,
#109 East Daggly St.,
Tuscola, Illinois.

Dear Radio Friend:-

Thanks for your letter of Feb. 3rd.,
advising as to your reception of our test program.

In lieu of an Ekko Stamp, we enclose
you a Photo. of KLCN, the little 7 1/2 Watt Station,
that has a record of reaching out more than 1750
miles, as we have been heard in New York and Canadian
points, also one California point.

Regret to advise that the Radio Commission
has seen fit to put a stop to our tests; so, if you miss
us, you will know the reason why.

Glad to have heard from you.

Sincerely,

Via
Raymond Nemeo

RADIO SALES CO.

By *M. H. P. [Signature]*

Cuba's Radio Broadcasts To Disrupt U.S. Stations

FCC silences anti-Castro voice in Miami

MIAMI (AP) — Cuba's plans to double its number of AM radio stations will disrupt the signals of more than 200 U.S. stations in 12 states and could "play havoc" with some parts of the U.S. industry, broadcasters say.

The new Cuban stations also probably will wipe out the magazine, nighttime programming of 10 "clear channel" stations as far away as Detroit, New York and Salt Lake City, according to a report by the National Association of Broadcasters, which represents some 4,600 stations nationwide.

Only six clear channel stations in the United States will be unaffected if Cuba goes through with plans to build 93 more stations, said the report, released earlier this month.

"Who would have thought Castro was going to be involved in my little neck of the woods," said Freda Carter, station manager of KANM in Camden, Ark., whose Cuban interference would cut coverage from 180 square miles to 70 square miles.

Cuba has renounced international broadcast treaties and refused to take part in negotiations for a new treaty, which would limit the power of broadcasts in the direction of another country, where other stations use the same frequencies.

The NAB's study, supervised by staff engineer Michael C. Ilea, was based on a list of planned stations Cuban representatives submitted last year before they walked out of an international radio conference. The Communist island nation, located 51 miles south of Key West, plans 93 new stations.

MIAMI (AP) — For two years, "Radio Alpha" broadcast a half-hour program nightly to Cuba, mingling anti-Castro propaganda with ads urging counter-revolutionary attacks. Then the U.S. government pulled the plug.

Alpha 66, a militant organization of exiles using the oversight of Cuban President Fidel Castro, used a bulky Army surplus transmitter of World War II vintage in three secret Miami locations.

But two weeks ago the Federal Communications Commission stepped in to silence the Voice of Alpha 66.

Laying fines of \$2,210 and issuing stern warnings of jail, the FCC said the transmitter was not licensed.

Radio Alpha transmitted from the three Miami sites to keep interference with neighbors' TVs and radio to a minimum, Diego Medina, a physician who serves as Alpha's spokesman, told the Miami Herald.

The anti-Castro messages were broadcast each evening from 9 to 9:30. Medina, 49, wrote the broadcasts and recorded them at Alpha headquarters in the Latin section of Miami.

The ads asked listeners to act to sabotage the Castro regime.

Listeners were told to set fires in sugar cane fields, tobacco-curing houses and anywhere else to hurt the Castro regime.

One commercial said, "The most beautiful sight is a curing house full of tobacco and burning away like a torch . . . If the Russians want cigars, let them grow (tobacco) themselves."

The broadcasts ended when U.S. amateur radio operators and the Cuban government complained and the FCC sent engineers to the broadcast sites.

Each of the three residents of homes where the broadcasts had taken place were fined \$750, and told not to transmit again.

via
Mike Cooper

via
Bill Hale
&
Conrad Durocher

CONTESTS

RICH LEVIN
7311 CROSS CREEK BLVD.
LOUISVILLE, KY 40228

ERNEST R. COOPER
5 ANTHONY STREET
PROVINCETOWN, MA 02657

MUSINGS

The opinions expressed in this column are those of the individual members, and do not necessarily reflect those of the editors, publishers or NRC.

CONTEST #5 - RESULTS: STATIONS ON A CLEAR CHANNEL OPERATING WITH 50KW

TOTAL STATIONS - 187

NAME, LOC.	#	%	ICH	PTS.
1. FRANK WHEELER Erie, PA	50	26.7	WBAP-820	10
2. RAY BARNO Portage, PA	39	20.9	WOAI-1200	?
3. NANCY HARDY Aberdeen, WA	29	15.5	WOAI-1200	5

That's all! Frank Wheeler is the lucky winner of the KBUF-1050 coverage map with Gary Atkins', Bob Walker's, Dick Truax's, and my autographs. Since we have no newcomers for this contest, no one will be awarded the three dollars worth of reprints. Hail NRC! WOAI was Ray's and Nancy's longest heard clear. I wonder how long that will last. The last contest...

CONTEST #6: LOG AS MANY STATIONS AS YOU CAN

This is the final showdown between Frank Wheeler and Ray Barno. Any station in the NRC Log or its updaters will count.

TIME: Use it as you desire, as long as it doesn't exceed four (4) hours.

DEADLINE: July 3, 1982.

PRIZE: The winner between Ray and Frank receives the free NRC membership. The winner between anyone else will receive three dollars of goodies from the NRC Reprints Store.

This contest was deliberately made easy because it will mainly be between Ray and Frank, and that it's really not the DX season anymore. This late contest is my fault, I played my dates wrong last month, and got an issue behind.

THE STANDINGS

	1	2	3	4	5	T
1. FRANK WHEELER	10	10	7	10	10	37
2. RAY BARNO	10	7	5	7	7	36
3. NANCY HARDY	7	1	3	5	5	21
4. BOB CURTIS	-	-	10	-	-	10
5. GEORGE WALTON	-	5	-	-	-	5
6. DOUG McABEE	-	3	-	-	-	3

USELESS STATISTICS DEPT.

Seven people have participated in Contests this season. Only one entry sent in this season has not received points. 73's...

Rich

Music dies on former top rock station, WABC

By RICK HAMMOND
Of The Associated Press

NEW YORK — WABC, once the nation's most powerful and popular AM music radio station, shifted from rock to talk yesterday, and to some of the millions who grew up with disc jockeys Cousin Bruce and Big Dan Ingram, it was the day the music died.

"There won't ever be a radio station that will come close to being what we were," said disc jockey Ron Lundy, who acted as co-host for the station's last music show.

In the mid-1960s the 50,000-watt, clear-channel station reached more people than any other station in America, with 6 million listeners a week.

But earlier this year ABC announced that because of sagging ratings, the station would end "Top 40" music and switch to talk shows.

During their final three-hour show, Lundy and Ingram played oldies and talked about what made WABC special to millions from Nova Scotia to Louisiana back when rock promised to change the world.

Meanwhile, Cousin Bruce Morrow, who had been WABC's most famous disc jockey, was listening to WABC in his office at WRAX, his radio station in northern New Jersey.

"It's the end of a lifestyle," said Morrow. "It's like an old relative dying."

Ingram and Lundy, who will be joining ABC's new "Superadio" satellite

program service, talked about the focus that hurt Top 40 AM rock: FM radio, disco, and the end of the post-World War II baby boom that provided WABC with legions of listeners.

"There's hard rock, adult rock, chicken rock" now, Ingram said.

"There's no room for a mass appeal local station."

Ingram recalled the day he learned his afternoon show had a 28 percent share of the area radio audience.

"I never was too impressed by that, though. I always figured 72 percent of the people weren't listening," he said.

His most exciting moment? "That's easy... seven years ago I proposed to my wife on the air in front of 2 million people."

The station also was known for its promotions, including a competition for the best imitation of the Moon Lisa judged by Salvador Dali. The winner featured a face much like Queen Elizabeth's.

During a Beatles tour, Ringo Starr asked the station to help recover a St. Christopher's medal that a fan had swiped from him. WABC began broadcasting appeals, and the guilty girl came forward.

As the end of his last WABC show neared, Ingram announced, "This is WABC, New York" and left his listeners with a last song "to nail it down": John Lennon's "Imagine."

The song was followed by four seconds of silence and, for the last time, the WABC time-telling chime. It was noon, and the music had died.

BACK IN THE SADDLE AGAIN!

YE EDITOR'S FINGER IS NOW ALL HEALED, AND HIS VACATION IS ALL OVER, AND SO IT IS BACK TO THE TYPESLIDER ONCE AGAIN. IT TOO HAS BEEN OVERHAULED AND IS AS GOOD AS NEW. OL' ERC DOES NOT WANT TO GIVE UP THE MUSINGS EDITORSHIP AFTER FOUR MORE ISSUES, GANG - SO - SOMEBODY OUT THERE - PLEASE COME TO THE RESCUE OF THE N.R.C. AND E.R.C. - AND BECOME OUR NEW PUBLISHER!

OUR HEARFELT THANKS TO RAY ARRUDA FOR DOING SUCH A SPLENDID JOB IN THE APRIL 5th AND MAY 11 ISSUES OF "DX NEWS" STANDING IN AS MUSINGS EDITOR!

APRIL IN WALNUTPORT

KERMIT GEARY - R.D. 4 - Box 321 - Walnutport, PA - 18088 April 24, 1982
***** The DX season is evidently not over yet, as evidenced by eight new catches entered in the log and 41 new varies received since my last report. The new WJMK-1070 (ex-WCIR) was logged on 3/27 6:20-6:30pm s/off w/BFL mx, and also on 3/28 by W5IV-1540 "Inspirational Radio 6:05-6:15pm s/off w/REL mx, and on 3/29 by a PoP TT from WFSR-1470 1:25-1:55am thru local W5AN. WDEX-1530 was relogged on 4/1 7-7:15pm s/off w/MoR songs. On 4/3 WCKG-1550 signed on w/top mx. On 4/4 reloggings were made of WUTQ-1550 5:15 s/on to 5:45am w/C&W, and WTAJ-1000 7-7:15pm s/off w/pop mx. WGVJ-1470 (ex-WGOK) was relogged on 4/5 5 s/on to 5:30am w/MX, WX, & BBD. After a lull, CX heated up on 4/14 w/a logging of WJWJ-1260 6 s/on-6:29am w/MX & C&W, and on 4/26 a logging of WPNH-1300 6 s/on to 6:12 w/MX, WX, & bulletin board. On 4/19 WRCQ-910 was relogged w/a tremendous signal 5:18-6am playing BBD, and on 4/20 WSBV-1560 5:45-5:58am w/C&W. Last but not least, WCHX-1130 was logged on 4/22 6:08-6:15am w/pop mx. During the same period, the following v/l's were received: WCVC-1330 (+CM, business card, brochure), WJWZ-970 (+v/q, sports sked), WTAJ-1000 (+promos), WAVG-970 (+v/q & CM), WEND-560-BEST (+v/q, CM, BS, promos), WPRZ-1250 (+CM), WJWJ-1260 (+CM), WFSR-1470, W5AC-1500, WPNH-1300, & WGVJ-1440. Per varies: WFSR-1470 is now 5,000w; WJWJ-1260 is using a new 2500w XR w/state-of-the-art pulse-width modulation, and mentioned a recent reception report from Bronitz, West Germany! Anyone for logging a 2500w West German? The CE of WAVG-970 says that he enjoys getting DX reports, so go to it, DXers! Many thanks to KEN ROWSTADT for looking into the WCMA-1230 veris situation, but with Moon's past performance on promises, I'm not holding my breath, hi! Good DX to all!

NEAL HAS A NEW KENWOOD R-1000

NEAL A. PERDUE - Route 1 - Box 159 - Falkville, AL - 35622 4/29/82
***** We've been covered up in rain and static here lately, I've been playing with the new Kenwood R-1000 for three weeks or so and am trying to give more or less equal time to SW & CBX so that hopefully I won't get burned out on either one as has happened in the past. The only antenna terminal on the R-1000 that works on the CBX is the high impedance single wire input, and hooking up a GND connection when this is in use seems to mute the EX, so I don't see how a loop could be used on this RX. A shame. At \$359 or so, from ham discount dealers, the Kenwood is probably the best general coverage RX bargain around. You'd need to spend a couple hundred dollars more to get significant improvement, unless you're willing to take your chances with one of the "gray market" dealers in NYC. The very sharp 2.7 kHz filter with a skirt selectivity (shape-factor) if less than 2:1 can be used in the AM mode as well as selectable USB or LSB. With selectivity this sharp, you can often just "tune away" from a hot or QRM. However, the audio is less than perfect, and often the best audio response will be found by "climbing the skirt" a few hundred hertz. The 6 kHz filter is virtually useless. Sensitivity is hotter than a firecracker. There are no images, but some cross-mod problems might occur in urban areas. Stability is solid as a rock. The 20db steps of attenuation introduce noise, & I prefer to just slightly detune the tuner to take care of occasional overload problems. I feel that I got my money's worth in a GC SW EX, but the venerable Hallcrafters SX-100 with the Wedge loop is still the CBX DX-getter here. The new stations that have made my logbook are all considered DX, and have gone to DAVE. One format change to report, since the otherwise fine new Domestic Log has omitted this column: WMSL-1400 Deatur, AL is now playing OLD, circa 50's, with just a tad of pop. This station doesn't even get out well locally, so I doubt there will be many DX reports on it. I'm still verifying for WHT, Hartselle, but reports should come to my house if you want the nice montage-letter I worked up. Otherwise, you might get a scribbled note on a piece of scratch paper from Gene Newman. 73.

OUR NEXT MUSINGS DEADLINE IS SATURDAY, JULY 3, as MONDAY JULY 5 is a HOLIDAY.

DX SEASON SALVAGED

GENE MARTIN - 3303 East Evans Avenue - Denver, CO - 80210.
 ***** Just when I had written off the 81-82 DX season as the worst in 20 years, then here comes Thailand-1575 on April 4 taking its place as my most distant station heard from Denver. That reception goes a long way toward redeeming the whole season. I haven't figured the mileage from Denver to Ban Pachi (which is spelled Pacha in my huge British atlas) but it's apparent the station managed to squeeze in between the Colorado sunrise and the Thailand sunset. There was not much time to spare in this particular sunrise-sunset equation. Ban Pachi is located 100° E of Greenwich while Denver is 105° W. The two points are 10 1/2 hours apart, and the period of darkness on April 4 is 11 hours, 52 minutes at Denver's latitude. The length of night would be not much different in Thailand on that date. The pattern of reception that morning goes far toward bearing out this sunrise-sunset situation. When I first found the 1575 carrier at 1134 GMT, that was 6:34pm in Thailand, and the carrier was too weak to deliver any audio. By 6:46pm in Thailand the signal had built up to the point where I could make out a male voice in talk, not readable but it seemed to have an English flavor. Talk was continuous and in the five minutes before the hour, the tape picked up strains of martial-sounding music here and there. That hour was 7pm in Thailand, 7am EST, 1200 GMT. (And 8:30am in Newfoundland, hi-ERC) On the hour, a solitary pip, not sharp, but low-pitched. In two more minutes, the signal had weakened to the point I stopped taping. And by 15 more minutes, it took the BFO to find any kind of signal on 1575. By that time the impending Denver sunrise seemed to be affecting the signal, taking it away. Denver sunrise was 1244 that morning. Summing up, between SSS in Thailand and SRS in Denver, audio could be detected only about 15-17 minutes that morning. I have eight minutes on tape, nothing positively IDable there, but I have no doubt as to what it was. There is just nothing else on 1575. I wonder too if this is not the farthest East that station has been heard?

APRIL IN PORTUGAL

ARNIE LITTEK - Bianroderweg 54/2618, 3300 - Braunschweig, West Germany 18/4/82
 ***** I did miss the BEER Musings, too bad, but I've just got back from a tour of Spain and Portugal, including a little (not much) bit of DX directly on the Atlantic coast, so.... Original plans were to find a deserted beach in Portugal close to an orange grove, to camp for a week of sun, swimming & DX. Things seemed to get in the way, but I did spend one night in a little hotel in Lagos, Portugal actually with the headphones on. It's all the rage these days to go backpacking along the Algarve Coast in Portugal (the S coast) where the sun always shines and the scenery is spectacular, but seriously, the people don't go any further than Sayres, the SW tip of Portugal. The Atlantic Coast N from Sayres is every bit as beautiful, and deserted. Access is a little difficult, since the railway runs quite a piece inland, and the nearest highway is also 4-6km inland, but for those willing to hike a bit, it's beautiful. The coast is alternately cliffs and little beaches (200-400 metres long) and the land immediately along the coast is a semi-desert region. There were no orange groves along the coast, but the dry desert vegetation would make a great place to set up a couple of beverages. In the corner of Portugal one has seawater paths from N by NW all the way around to somewhat E of S. Fantastic! The only hitch is 1) electricity, and 2) a good ground, assuming one uses a unidirectional Beverage pointing out to sea. One of these days, though.... On 3/4/82 I spent a few hours in the wee hours tuning around but didn't really hear anything you wouldn't expect at almost any time from such a location. The Arabs, the Spaniards, and the Portuguese put in rock-solid signals, and the other big Europeans were in pretty stable too. I can't hear the difference between the Arabs in Morocco, Algeria or Libya, but all the rest was fairly easy to isolate. The most noticeable thing was the absolute lack of noise on the band. Both in Lagos and on the beach, I've never been in a location so free of man-made noise. I just wish it was like that here in the residence in Braunschweig. I never managed to keep my eyes open long enough to try for any TA DX, which from this side of the Atlantic is best done after local sunrise. Who takes an alarm clock on vacation? Winter is long gone here, and so too the better DX. Plans to keep active though, DX-wise, include a tour of Radio Free Europe in Munchen, next time I'm there (and an article, of course), and some technical questions which have piqued my interest of late. I'm still trying to talk myself into getting an amateur call sign here, which is something I still haven't got around to back home in Canada, and Jurgen Trochimczyk wants me to fix his R-390A one of these days. H'mm. Till the next time, this little tidbit will have to do. And if somebody comes to Europe on tour this Summer and doesn't drop by to chew the fat for a couple of days, well then, may the fleas of a thousand camels infest his armpits. 73's from the other side of the pond.

ANECDOTE - Lady to boy, "Does your dog have a family tree?" Boy, "No, lady, with him any old tree will do!"

CUSTOMER POEM - "The lightning bug is brilliant, He hasn't any mind. He meanders through the darkness, With his headlights on behind."

WELCOME BACK, BRIAN!

BRIAN PITMAN - 835 Milford Drive - Apt. 102 - Kingeton, ON - K7P 1A7 4/10/82
 ***** As an ex-member of the NRC let me say it's good to be back in the #1 DX club in the world. I haven't DXed much since the mid-70's, & I can't believe the changes that have occurred since then. I practically had to learn the radio dial all over again. I ordered & finally received the new VJ station guide, & I am also ordering the Domestic Log as well as some reprint articles. I would have joined the NRC back in December, but having thrown out all my DX NEWSes years ago I didn't think I had their address. I finally stumbled upon my old Domestic Log and found a Bounton NJ address. Thanks for forwarding my letter, RUSS EDMUNDS. I guess a re-intro is in order. I am 25, single, & a taxi cab owner here in K town. I DX with a Philco P-914 which was purchased for under \$50 in 1971. My fascination with DXing began at the age of 14 when a friend & I had a contest to see who could hear the most distant radio station. After discovering the Vane Jones Guide in the library, there was no looking back. I DXed for five or six years before a job and other interests took care of my spare time. This year I started DXing after work which concludes anywhere from midnight to 4am, & caught DX fever once again. I've had pretty good luck this season, hearing a total of 57 stations since December plus a number of UNIDs. I attribute some of this year's success to the fact that 95% of my DXing has been done in the early and mid-morning hours, which were relatively UNDXed before. My more noteworthy catches since December are KROC-1340, up w/a quick ID & fadeout, & also on 1340, WROD which was heard twice within two weeks w/a good steady signal both times, mentioned WROD free movie, mx by Sinatra. Also noteworthy, CKDM-730 heard at approximately 7am, must have been on their day power. They mentioned "You're in CKDM Country"; it really took me by surprise. Speaking of surprises, did anyone else hear Pirate Joe-1616 kHz on 4/1? This was the first pirate I ever heard. Call sounded like KEPRC & programming consisted of talk and mx by the Beatles, Platters, etc. He signed off with Good Night Irene @ 4:19am & gave his mailing address as PRC, Box 747, Exeter, NH 03833 saying he goes on the air from time to time but he couldn't say when. Without further ado, here's what I've heard this year: WIS-560, Jams 10a-580, CHIR/WPMC/CKDM/WDOS-730, WNW-790, CJEN-900, WAVL-910, CKNS-930, CKJD-1110, CJNH/CKLS-1240, WECW/WITB-1230, WIFB-1250, WPHB/WBEO-1260, CJTN-1270, WOOD-1300, WTLB/WVIP-1310, WKAN/WAGY-1320, KROC/WROD/CKMG/WLOK-1340, WINY-1350, CJVL-1360, CKCB/CKOB/WPEG-1400, WASH-1420, WCTC/WYFZ/WHTC/WKLA-1450, WVOX-1460, WLEA/CKAN & much-wanted WGIN-1480, WGM/WJNL/WKVT/WKLA-1490, WLAN/WRSC-1390, WKMC-1370, WDJZ-1530, WNYF-1540, WLDM-1570, WRDI-1580, WAYC/WBVL-1600, & on 1610, the Caribbean Beacon. And still they come: WQCH-1490 w/6am s/on. Some help on these UNIDs would be appreciated: R. Coro-1210, R. Compelito-550 mentions "musica nacional por cubical dial". R. Vision-720 I think in Margarita, & R. Prechl-540. What are calls of Barrenquillas-1100? Anyone heard an PP on 1080, Haiti perhaps? Does WANQ-1400 use the slogan "All new 14-Q"? When do you count a station as new? I've never counted call changes as new, what's the ruling on this? (Up to YOU! -ERC)

APRIL IN NEW ZEALAND

DAVID RICQUISH - Chief Editor - New Zealand DX Times - Box 2956 - Wellington
 ***** 6000, New Zealand 26 April 1982
 Our Winter is fast approaching, which means DX gets even better. Latin signals are dominating most early evenings, w/Colombians, Venezuelans & Peruvians extra good so far this season. R. Mar-760 thundered through 0550-0605 GMT 4/13 with perfect ID on the hour including recording of crashing surf & seagulls. Freak reception of ZK1ZC Cook Islands-630 when semi-local 2YZ suffered an audio break, & F DJ heard in Cook Islands Maori, then local mx at 0722 GMT 4/16 for just 20 seconds. Also on 4/16 WUVU American Samoa heard w/ clear signal on new frequency 648, announcing "Great at 648" 1126-1155 GMT, local ads, mx in English/Samoan. I just finished editing a sixpage BC Trail for our April Edition - the longest ever, with 60 countries heard over the last month from every continent except Europe including St. Pierre, Seyohelles & St. Vincent. Our DX cup overfloweth! If GREG MYERS wants a QSL from KNVI-550 Welluku, try a report to Alan Roycroft, Broadcast Services Inc., 2877 Kalakaua Avenue, Honolulu 96815. Otherwise, KNVI is a very slow verifier - it took me three reports and four years. Amongst other Pacific DX noted, Radio Tuvalu on Funafuti Atoll is now closing down at 0830 GMT on 580 with full ID in EE/Tuvalu and puts in a fantastic signal. We are all wondering why we can't hear Jamaica down here, as we can get Ceymans even on 1205; Cuba (of course!) and are slowly picking off the Caribbean islands but Jamaica just eludes our best efforts even on clear channels. Are they all beamed due N or something? Any suggestions on how to track down this elusive island welcomed! I had to ask my bank manager for a loan to mail this, so a DXpedition to Jamaica is some way off! I hope the finger is now working, ERNIE! 73's from the South Pacific - where all good radio signals visit for their vacation!

THE DEADLINES FOR THE REMAINDER OF VOLUME #49 IN PROVINCETOWN FOR MUSINGS ARE A BIT INDEFINITE - BUT THE NEXT ISSUE'S DEADLINE DATE HAS BEEN CONFIRMED AS SATURDAY, JULY 3rd. OUR NORMAL MONDAY DEADLINE HAS TO BE MOVED UP BECAUSE JULY 5th IS A NATIONAL HOLIDAY, WITH NO MAIL DELIVERIES. SEE THIS NEXT ISSUE FOR DATES FOR THE AUGUST AND SEPTEMBER DEADLINES! LET'S HAVE A MUSING FROM YOU!

TONY FITS HIS VERIES IN!

TONY FITZGERBERT - 116 Devon Road - Chalfont, PA - 18914 5/2/82
 ***** Well, the DX season is about over, and this Kuse will thank lots of people who contribute to our hobby. First, to GARY & DICK who have prepared a most interesting DX NEWS, on time, consistently (and the rail-road is not on time consistently!). That represents a lot of work and sacrifice. Then plaudits to ERC, DAVE SCHMIDT (author of the Dave Schmidt Show) & others who input features and the regular columns. And, thanks to all of the radio stations who do verify, indulging us, with our hobby - & I have found that about 75% of the AM stations do verify - finally, thanks to CHOO for NOT verifying, setting itself up for a few CHOO jokes occasionally! Spring DX was great; every morning before the New York Migration, through April. All of the catches went to the DAVE SCHMIDT Dog, Pony, & Medicine Show. The veries: V/1 & CM from WAMS-1380, v/1 & BS from WEIM-1280, v/1 from CHOK-1070, CM, BS, v/1 from a very friendly WPWC-1530; friendly v/1 from WMER-1440 for six-minute report, v/q from WNAV-1430, WKBA-1550 noted and returned my report; nice v/1 from WVAB, who noted they were back on the air as of 3/22. V/1 & CM from WGBK-1300, v/1 from WCPA, WHIM-1110 my report noted & returned by the CE w/BS. WDAS-1480, a marketing brochure (got them before we leave the area), v/1 from WAGL-1560, v/1 for 12/28/81 report from most-wanted WLAM-1470, v/1 from WUNI-1410 for 11/1/81 report, my report noted by the GM from WITN-930, w/BS. A friendly v/1 from WCNX-1150, v/1, BS, CM, v/q all from WFSB-1450, noting they got an accurate report from Great Britain, v/1 from WRCQ-910, my report photographed by the CE, plus BS from WKJJ-920; v/1 from WGER-1150, friendly v/1 from WMLR-1150, noting that the furthest report he had ever got was from Walnutport, PA (now, who do we know in Walnutport?) (Buffalo K. Foonman?? -ERC) And a friendly v/1 from WASP-1130. We are in the process of looking in Milford, CT, for our new home, but NOT Devon, where WFIP-1500 locates its XR. All for now!

GARY HAS LOTS OF RADIOS

GARY MITCHELL - 1234 Formosa North - Los Angeles, CA - 90046 May 7, 1982
 ***** Five more issues of NRC Bulletins? I hope somebody picks up the tab because I would hate to be stuck with just IRCA. (Please do not mention GMDXA). Most of all NRCers seem to have a little I.Q. and operate in an adult professional fashion. In short, membership, I have now obtained virtually everything needed to ECB listen: ICOM 720s receiver (the best I have found), Yaesu FRG-7700, Kenwood R-300 Superadio, reel recorder, two good cassette decks, multiple portable recorders, radios, car radios, what else? I just scored Hammarlund HQ-160. I forgot AM/FM stereos-speakers-mics. Should we involve amateur radio? I'm bankrupt. I wish a Kusing could be devoted to NRCers who have autos with chronic age and cancer. I still owe a couple members cassettes of local bandscans - upcoming. I've been too busy. ERC notes he is lacking QSL from WACZ-620 Bangor, ME. I do not know what happened - I got one on 9/14/82 signed by Howie Soule who seemed to run things up there; nice reply! He even offered to set up a CPC TEST. (We have talked via amateur radio). An article came out in Playboy Magazine on WACZ and it seems Howie Soule turned silent. Maybe his ego is in outer space awaiting touchdown. He gave a member a novice test (amateur) and told him I am a potential big problem because my FCC license is now in Samoa (KHSAC) awaiting FCC modification. I hope he understands if FCC seems kind of slow. I gave fair warning! QSLs have ground to a halt here in '82. I hate to have to store records on tape. It costs nothing. I expect to be going back to California this year so at least I have logged all East USA & Canada (states/provinces). In amateur radio I worked 200 countries from East on 3500 kHz and almost 100 to East on 1800 kHz. So I expect to be busy with many things in future and all ECB listening in spare time and become part of Silent Majority. My tape recorders will work graveyard shift. Local as still the same except WFIP-1500 country part time. TV-20 Waterbury CT, a never-seen here at sea level. They just added 1,000 feet to antenna and 2 million watts. Amazing!

MIKE'S HEADING FOR THE TARHEEL STATE

MIKE HARDESTER - Box 1565 - San Marcos, CA - 92069-0560 15 April 1982
 ***** Greetings! As I type this, I'm still awaiting written orders transferring me to North Carolina (Cherry Point) for a three year tour (see) to include deployments with NATO forces. Best of all will be a shot at my final nine states & D.C. needed to complete 50/50 on the ECB...not to mention who knows how many foreign countries! Transfer will be in the latter part of this year. Locally, (San Diego area), we have a pirate on 1610 + or - IDing as "16-K". The station does have fair/good technical quality at times, and we'll be trying to DF the station this weekend (16-18 April), if they're on. The 1982 Broadcasting Yearbook has arrived. This year's price tag was an uncomfortable \$60, but the contents are well worth the price tag. Anyone needing current AM/FM/TV station addresses and info common to past BYB's, an SASE will bring the needed info, but please: no requests to copy the whole book! Hi! I had a surprise SSS log on KUBA-1600 a couple of weeks ago - KWOW/KGST were completely absent! Seems as of late, my only real "DX" has been while driving on the freeways! All for now. Very 73 and best of DX de Mike.

HANK MARCHES IN WITH GOOD MARCH DX

HANK HOLBROOK - 7211 Chestnut Street - Chevy Chase, MD - 20815 5/8/82
 ***** Since I started using the Colgrove air loop in January, I have come across a number of stations for the first time. I would imagine that over 95% of the stations listed below were added because of the loop. We've got DX to report from three listening locations - (1) Chevy Chase with the SP-600 and 24" air loop, (2) Fair Haven Cliffs, MD, cottage 15 miles below Annapolis w/SQ-129X and the air loop and (3) one station logged on Super Toyote auto radio while on an FM DXpedition to nearby mountains (mobile FM DX-ing within a 50 mile radius of D.C. area at Sugar Loaf Mountain, ten miles SE of Frederick MD. The following were logged & reported from Chevy Chase since my last report. We'll pick up at Marsh 7th. WNLB-1150 Churchville, VA 5:17-5:30pm, v/1 back, 1kw. On the 14th, WAO-540 Canonsburg, PA 6:30 s/on to 6:56 a good. On the 17th CFLS-920 Lewis, QU 6:47-7:07pm often stop the channel for a good report, all PP. On the 24th WCXI-1130 Detroit with nice signal but messed up at times by WUST splash, copied 7:03-7:25am. Nice letter back - I could never QSL them with the old WCAR call! Then on the 27th I got the s/on of WNCR St. Pauls, NC sneaking on @ 6:29am & nice log till others came on at 6:30 EDT. Nice hand-written v/1 on 5kw. Last stop in March was on the 28th with the addition of CKJD-1110 Sarnia ON atop WBT for about three minutes and then crushed. WNNI-1060 Mebane, NC started April off, on the 4th, from 6:14-7:15am, w/some KYW QRM & splash from WGAY-1050, v/1. On the 7th WUJI-1080 Marietta GA from 7:03 to s/off @ 7:15pm, little to moderate QRM from Cuban, v/1. The next day I added WADR-1080 Surfsideboro NC @ 5:32am s/on until 5:46. On the 11th I was surprised to find WBT off & finally got a log on much-wanted 50KW WZAM-1110 Norfolk from 5:30-6am w/some QRM from KFAB. V/1 says in part, "WZAM is the bastard step-child of WMYK(PH)-K-94 93.7 & we simulcast a good portion of the day." On the 12th WNIS-1350 Portsmouth VA stop from 5:28-5:51 am. April 20 - WVAI-610 Winchester, VA with new calls (ex-WHPL) & new format - good to see another BBD station on the dial! Letter says "We are a Big Band/MOR format which has received tremendous response in this area." On the 21st WIGT-1000 Horseheads, NY from 6:01 to 6:24am and has been noted many mornings since stop the channel; very professional-sounding station. (Con'd next time).

DREW'S LOOKING FOR CORRIES

DREW TECHNER - 3719 Belleire Road - Philadelphia, PA - 19154 5/11/82
 ***** It's only been five months since I wrote, so here is my first Muse since the dead of Winter. Right now I am attending the Community College of Philadelphia (thrilling, isn't it?) and have been quite busy. So far, 1982 has netted me a new state, Arkansas (KLRA-1010), & also the pirates on 1616 & 1620. I know the one on 1620 is in NYC, & is 'WFUN', but where is Pirate Radio Central-1616 located? 1982 veries are: CHOK, WIBG, WCNC, WOYK, & WHUM. I've given up on tapeswapping because my recorder is dying. I can't find the time for it anyhow. No real good AM CX to speak of, but FM has been great! On 4/20 & 5/7 I logged stations all over New England. WXKS-107.9 in Medford, MA was 265 air miles DX & WAAF-107.3 in Worcester was 228 air miles DX. WAAF & WXKS were received excellent. WAAF was my DX dream come true. It came in way better than their AM station, WFTQ-1650! Does anyone wish to exchange letters? This is a lot cheaper & less time consuming than tapeswapping. I'm especially interested in corresponding with DXers in New England, NJ, NY, MD, DC, VA, NC, SC, or ON. A new friend of mine & a local DJ in my area loves to hear from DXers on the phone. He is Steve Bessler and is on most weekday AMs till noon at WBCB-1490 (215-464-1490). He also is on WRCP-1540 (215-263-6750) on weekends from 4pm till 833 s/off. 73's.

SUMMER DXING: SOME ER' NOT!

JEPF FALCONER - Box 63 - Clinton, ON - N0M 1L0 VE3LSK
 ***** Not too much to say this time. I just received the new NRC Domestic Log & must say it was worth waiting for. Much thanks to JOHN CALLERMAN & RON MUSCO & everyone else who worked on the Log. We are indeed fortunate to have such dedicated members in the NRC! No veries in lately, still stuck at 978. I will reach 1,000 by 1983 with a lot of luck, hi. Some DX here recently: 5/3 - I took log on WPAX-1400 on top @ 1:26am. At 3am WOH1-1490 1lded o/mess. 5/4 - I finally got a positive ID on WBEI-590 @ 3:22am. WOTL-1340 surfaced at 3am w/ID, Mutual news. 5/7 - I caught nice s/off of KMLL-1400 @ 2:05am w/vocal SSB. 5/10 - 4:06am, I got an ID from WITA-1490. All the above are new logs. Many DXers consider Summer the off-season for DX on the ECB and pack away their earphones until Autumn returns. I recommend you try some DXing over the Summer months, and you will be pleasantly surprised. I've DXed every Summer since I began listening on the ECB and have received many of my prize catches that way. By the way, today (May 10) marks my 13th year of DXing the ECB & I still am not bored with it, hi. (No neither, hi!) -ERC. ?? till next time.

Gene Aubry, grandson of Baptist minister: "There's more money to be made in religion than General Motors. Chrysler is broke, but is General Roberts broke?"

JOKE FROM SAMOA, CALIFORNIA - Father to his daughter in a bikini, "I'm ashamed of you. You should wear a one-piece bathing suit." Daughter, "O.K. Dad, which piece should I take off?"

SIDNEY LOVES OUR NEW NRC LOG!

SIDNEY E. MARSHALL - 7224 Pam Drive - Millington, TN - 38053 May 16, 1982
***** With the arrival of the new edition of the NRC Domestic Log, a few weeks ago, I've had the time to update it from the AM Switch columns and to give it a general review. To all who had a part in putting this edition together I wish to say Thanks for a job well done! I did note that WMSD, Collierville, TN (ex-1590) is listed in the log on 1220 kHz. This should be on 630 kHz with 500w daytime power. They have been on this frequency for some time now. I noted in the most recent AM Switch that semi-local WVEZ-1430 has been granted a CP to go fulltime with a power increase. I called the station to get info on when they will go to full time operation but no target date has been set yet. I've only had a few brief periods of time at the dials, since my last Muse, but have managed to log six new ones to push my station total up to 1,051 heard. These "newies" are as follows: On 4/29 @ 3am WIKC-1490, LA, was in strong with top-of-hour ID and time check. It was also back in at 3:15 a.m. w/ax & station promo. This is GYer #90. Then on 5/1 @ 9:30pm I caught the s/off announcement of KLKC-1540, KS. KCEL was very weak this evening. On morning of 5/2 WACQ-1130 AL, was in u/WKWH @ 7:20am with station promo and WX. Also on 5/2 @ 9:21pm EGRI-1000, TX, was in very clear with a few minutes late s/off with mention of their FM outlet. On 5/11 @ 8:44pm I heard the s/off of WWLX-520 AL, folo with vocal SSB. Evening of 5/12 resped me much-wanted WTSP-1550, TN, with s/off heard @ 8:45pm. For a not-too-distant station, this has been a tough one to log! Due to work sked and the usual Summer CX at the dials, I may shut the shack down until the new season starts, so it may be the Fall of the year before you hear from me again. Good Summer DXing to those who stay at the dials!

STEPHEN PONDERS TEXAS; DECIDES AGAINST IT

STEPHEN H. PONDER - 4105 Glen Street - Bossier City, LA - 71112 May 15, 1982
***** Greetings again! I have once more found the time to write to ERC to be included in this fine fellowship of fellow friends! Lots of things have happened since my last Muse (way back in February, I think). First, I have settled into my new quarters, with my folks here in Louisiana. I have my old room, although I have considerably more junk now than when I left almost ten years ago, hi! Second, I still am working at the church as Music and Education Director. I had contemplated moving to another church just out of San Antonio, TX, but decided to remain here. Third, I am now teaching (have been since the end of March) at Trinity Heights Christian Academy in Shreveport. I am at present the Chemistry and General Science instructor in the high school, but this Fall will be teaching in both the high school and the junior high school areas with Physics, Physical Science, General Science, and maybe a Bible class. I enjoy all of this, and so far could not wish for anything better! Mom & Dad & I are getting along extremely well, and that makes it just that much better. Now to the DX department. I really have not had the time to DX much, but the veries have been filtering in slowly. Latest veries include: WGNL-1340, WGEN-1440, KMYZ-1570, KARV-610, KTYJ-1350, WMTS-810, WEUP-1600, KUZN-1310, WCPC-940, KXLA-990, KJIM-870, WDBO-580 & EGLC-910. Latest heards (which really date from some time around March) include KAPE-1370, KTLN-1360, & KWCL-1280. All of my better radios are still pecked away, so I am using (or will be using, when I find a chance to get to the dials) my two TRP's and my GR7B. Now that I am home, I plan to set up my Mosely SWV-7 antenna once more and see how it works. It has been in boxes since I have been away. Take care and stay away from as many storms as you can, hi! (And garage doors! -ERC) Good DX!

WE HAVE A VOLUNTEER!

TERRY A. KLASEK - 9720 Vickie Place - St. Louis, MO - 63136 314-868-7274 FPD
***** Greetings and salutations fellow DXers! Here I am once again with yet another Muse. Not much DX lately, but hear plenty news! I sent a letter to DICK THUAX from me and RICH EDDIE. We are the St. Louis Publishing Committee! Yes, we are crazy, and we have volunteered to take over publishing DX NEWS from the Great LOUISVILLE Publishing Committee! We will be all set up to take over any time after July 1, 1982. The Bulletin will be published on Fridays (if St. Louis becomes publisher) as I am off on Fridays as is RICH EDDIE. I get off work at 1:30 p.m. local time, and can devote most of the afternoons to NRC business. I am 36 years old, married with two daughters. I am purchasing a home, and I do not plan to move from here until I die or ROGER GIANNINI moves in, hi! If we get publishing, then we can guarantee at least five years! I will be at the LOUISVILLE Convention with RICH EDDIE so if we get the publishing, then YOU can meet the publishers on Labor Day weekend! I don't know if RON MUSCO and the Connecticut Crazies, or anybody else will be volunteering for the job. Chances are that nobody else will come forward, and we have been preparing since last Summer when we first bid for the Publishing Committee. More news as it develops, and we'll see you in LOUISVILLE Labor Day.

WE HOPE TO SEE LOTS OF YOU OVER THE LABOR DAY WEEKEND! MAKE THOSE PLANS NOW! THE DATES ARE SEPTEMBER 3-4-5-6, AND LOUISVILLE'S THE PLACE! FUN!

AUSTRALIA ON A CRYSTAL SET - ON SW. WATCH

MIKE TUGGLE - 909 Moores Mill Road - Bel Air, MD - 21014 5/16/82
***** For all intents and purposes the season here is dead - and has been since about the last week of April. The first part of April, however, was uncommonly decent, yielding the first SRS catches I've had in ages. But the switch to daylight time made CX worse, not better, as might be expected. Most of the interesting stuff has been reported to DAVE SCHMIDT's DDXD column. One near-miss not reported was an unID 4/21 on 930 around 7:15pm talking about hockey and mentions of Rochester Mall, Rochester-this and Rochester-that. It did seem a little strange that WBEH (who owns 930 about 95% of the time here) should be doing business in Rochester, which is not all that close to Buffalo. Never did hear an ID, and it was a couple of hours later while checking the log that I discovered that there is a Rochester, NH with a station on 930. (And they carry Bruins' hockey -ERC) Oh well, something to look for next year. So the season rounds out at a total of 517 heard on the crystal set. My one veris attempt - for #500 - WOKY - appears to have gone for naught. Them's the breaks, I suppose. The kind comments of JEFF FALCONER in #26 are much appreciated. I might note that numerous fine catches appeared in DDXD this season under the label (JP-ON). Fine work! During the Spring NW lull I have been able to finally catch B. Australia on the GEORGE MULDINGER-inspired SW crystal set - several times on both 19 & 31 meters. Melbourne is 10,200 miles from here, which may seem impressive on the surface, but actually it was little more difficult than say, a 50kw BCB clear some 1,000 miles distant. Just a matter of being at the right place at the right time, under the right conditions. Here's hoping everyone has a really fine summer! 73's.

GREG'S PLANNING ON THE WTPDA CONVENTION

GREG MONTI - 1110 Fidler Lane #1424 - Silver Spring, MD - 20910 5/16/82
***** A few loose ends here. For JERRY STARR: I show an FM application for 102.5 MHz at Rome, NY so that explains one mystery call. I don't show anything for Four Bears, ND, but I'll bet the story is the same, our favorite regulatory body listing FM's under "AM". I guess you already know that ENCI-1500 is in Boerne, TX with 250w-D. We now have another one of those unusual shared-AM-antenna situations here in the nation's capital. WQAY-1050 & WMDO-1540 now use the same tower in Silver Spring. The tower behind the WMDO studios in Wheaton MD is now used only for two-way communications and to support a microwave antenna to feed the WMDO program to the new, shared site. This results in a slightly better signal in WMDO's community of license. Wheaton. WTOP-1500 is right down the street and gives 1540 a run for its money even at the WMDO studios. The DX word here in urban America is: NOISE! I've been getting in some FM & UHF-TV DX as time is available, though, and may attend the WTPDA Convention on Staten Island this Summer. It's the only convention on the East Coast this Summer, as it turns out. Satellite Music Network's traditional MoR service has been named "Stardust", so I guess that warrants a change in its unofficial abbreviation from SKM/TM to SKM/SD. Teft Broadcasting's new Primitime Radio (TAP/PT?) big-band network is starting up. It'll compete with the on-tape MYL stations. 73 to all.

TWO INTERESTING TESTS LOOM!

ROBERT J. BINAU - 408 Fensborn Boulevard - Hagerstown, MD - 21740 May 16, 1982
***** Hi all. Not much new for DX, mostly due to the fact I don't have the radio on very much. One format change in the area; WHPL-610 is now MXL format using automation. I have been talking to the CE of WJBJ-WBEO; it looks good for TESTS next season from both stations. More on this in the Fall of '82. To RON MUSCO, thanks for a job well done. I love the new NRC Log - it's very nice. While I'm thanking people, I would like to thank everyone who wrote to me this past season. It's fun to get mail other than bills, hi. Also thanks to ERC, JERRY STARR, BFP, DAVE SCHMIDT, CHUCK HUTTON, & to everyone who reported to DX NEWS. With your help I had a very good season after a ten year layoff. Again thanks to all. I will be going to Lakeland, FL, for two weeks in late June. I will try to report on Radio in the area. I have not been down there for two years, so there should be many changes. By the way, my parents live in Lakeland. If anyone would like to trade airshucks, I would be glad to help out. Also I still have stickers from WNGS, WJEJ, WKMD, WQCH, & new WPGO, all for trade. That's about it from here. Have a good Summer. O yes, if any of you come through the area, I work 4pm-midnight; I'm home most days. 301-797-0859 - no collect, please.

THE LATEST CHANCES ALONG FLORIDA'S WEST COAST

ED MITKUS - 8001 Landmark Circle - Tampa, FL - 33615
***** Time for an update from West-Central Florida. Tampa Bay's first fulltime SS format station is now on, call'd are WAMA (ex-WAZE), city of license is Dunedin, but the address is: 1,000 Harbor Street - Safety Harbor, FL 33572, U.S. 1kw, 860 kHz. XR & studio are at the above address. Sked is 6am-midnight, seven days. They call themselves "Radio Progresso". Very nice! A visit to the station is in order, as I was invited per phone call, the night addition was made, May 10th. Other news: Rumour has it that WNSI wants to

(Ed Mitkus, con'd.) drop CBS, & go to ABC-II Plus, the Sports Call Show will be dropped 6-9pm. Also add the new Cuban on 1380 that hurts WNSI in Tampa, R. Cadena Azromonte, 10kw! They book in here at night & can be heard almost as well as WNSI. DX: WQIZ-810 St. George, SC 4/29 7:45pm w/s/off, GOS format. WHTT-1260 Miami finally heard 4/17 @ 7:18pm w/Black Motown format. "That Girl" and a promo for new format heard. Not much DX lately, but I still do a lot of bandscanning and aircheckins. Total heard: 565. Thanks to all who have talked or took the trouble to write to me, I enjoy all letters and cards, as well as tapes! 73's to all. I recently slammed my car door on my left thumb, and since I'm a lefty, it really bothered me, but I'm OK.

FLASH ALERT SERVICE IS RE-ACTIVATED!

KEN CHATTERTON - RFD #2 - Box 44 - Mannville, NY - 13661 315-387-3583
 ***** DX has recently had to take a back seat. No employment here over the Winter and no prospects this Spring has forced the decision to go into business on my own (odd jobs from remodeling homes to mowing lawns). By keeping my prices competitive I've landed all the work I can handle. Only recent DX NEWS came last Sunday (5/2) when I received a phone call from recently reported new station WOZO-850 in Penn Yan, NY. DJ saw my reception report and wanted an on-the-air interview. To the 41 members with cards on file for Flash Alert Service, your cards have been received here from DAN MYERS. All are 10¢ cards and need another 3¢ to update them. If you are unsure of how many cards you have in just send postage to update two or three and the first time the cards are used I'll note how many cards are left. Remember, any test tips not just arranged specials are worth noting. Best time to call in info is any time after 7pm. If I'm not home the phone isn't answered. I will need info by Wednesday for a MM TEST. If writing use my home address above, NOT the Publications Center address. If you have compliments regarding the new Domestic Log, how about including them in a Musing so the hero of this log, RON MUSCO, can see them, he doesn't get to see the many compliments that come to the Publications Center! 73.

VAZ YOU EFFER IN ZINZINATI?

HAROLD HINGENBERG - 404 Sugar Maple Lane - Cincinnati, OH - 45246 5/17/82
 ***** The Greater Cincinnati International Airport is located of all things, across the Ohio River in Kentucky. It is approximately 30 miles, as a sober crow flies, from our residence located in Springdale, OH, a Cincinnati suburb. When a traveler approaches the airport and switches on his radio to 1610 kHz he can listen for information telling him how to get to the airport, each terminal, plus other information. Local radio personalities give these taped messages 24 hours a day. The call letters are WXT-613. Now as to my latest DXing. While reclining in a Lazy-Boy chair, usually in the wee hours of the morning, I tuned in the following stations: WOKJ-1550 Jackson MS, WQXR-1560 NYC, WEUP-1600 Huntsville, AL, & XERL (?) REL program, unld. I cannot find this last station in my log book. Do any of you MRCers know about its location? (Frequency?? -ERC) In a little over three years I have logged 214 AM radio stations using the ICP-6700-W Sony radio and a 50' inside hookup wire antenna. We had sold our home where I had an 80' long outside antenna. Here I listened to radio stations but I did not keep a list of them. When we moved into an apartment N of Montgomery, OH, I joined several radio clubs and kept a record of the stations received. From here my wife & I moved into the Maple Knoll Retirement Village where I am now DXing.

MORE KANADIAN KAPERS

STAN MORSS - Route 3 - Bradford, MA - 01830
 ***** I sure hope someone can take up publication of DX NEWS - would be a sad day to see it follow all the other clubs into oblivion. The new Log is fine - except for no list of applications on file at FCC. No time for DX - I'm up at 4:45am & finish the day with an hour's bookkeeping to about 9:30pm. I have car radio set at 1320 but no sign of WDER. List of proposed assignments by CRTG on U.S. clears will clutter up all the "clear channels" in the N.E. with proposed assignments like 50kw's in Montreal on 1200, & Ottawa, ditto, & 10kw in Halifax on same channel. Peros QU on 1180, Sherbrooke & Bale Comeau on 1160, Halifax & Sherbrooke on 1120, Sackville & Montreal on 1040, New Glasgow on 1020 as a few examples. Some weird power proposals also with Campbellton NB proposal for 10kw D & 600w at night, and Edson AB, 10kw day and 300w at night - a total of 160-odd proposed assignments on clear channels, and the U.S. has frozen applications that might conflict with these!

ADD TO LARRY KING NETWORK

- 760 K C U Honolulu, HI 1240-WHUM ReadingPA/1310 W N I C Deerborn, MI
- 770 K O B Albuquerque, NM
- 1000 K T O K Oklahoma City, OK
- 1530 W C K Y Cincinnati, OH

DELETE FROM LARRY KING NETWORK

- 1310 W N I C Deerborn, MI
- 1350 W N I S Portsmouth, VA
- 1360 W S A I Cincinnati, OH
- 1430 W E N E Endicott, NY

There may be other additions/deletions - I missed out on Larry King changes during my sojourn in Puerto Rico - did anybody hear Larry's announcements of new stations added to his network during the last half of April, per chance? If you did, please send them in to your editor at his Provincetown address.

WRAPPING UP GLEN'S TRIP LAST SUMMER

GLEN HAUSER - Box 6287 - Knoxville, TN - 37914-0287
 ***** (con'd from Vol. 49 - #25 -ERC) To my surprise, there was a worthwhile AM station in Boise, ID, KYME-740 which runs jazz (and classical at 12-1pm & 6-7pm EDT per announcements) - and adsl (By the way, I hope some readers find these times converted into EDT as absurd as I do). KSL-1160 had CBS RMT @ 10:06pm, after the CBS NX on seven-second delay. Salt Lake City is also blessed with a 'cultural' AM station though it also has PMs of that nature, unlike Boise - KWHO-860, playing movements on "Daybreak" morning program with a British-accented woman announcer, & @ 2:15pm daily, "State of the Arts". After dark approaching Grand Junction, Ciudad Juarez was in well on 800, now SS-only, as "R. Cañon". Saturdays at 8pm, per a promo, KOB-770 has "The Swingin' Years", which I suppose lasts for hours. Another Cl. Jz. station, XEJ-970, called itself "La Jota Mejicana". KREX-1100 had amazingly poor groundwave coverage, for a 50/10kw directional West. I discovered a brand-new TIS at the Elk Creek Visitor Center, Curacanti NHA, CO, 7/16. They said it was installed the previous week; the entire unit including solar panels, is on a pole, & succeeded in hitting 1610.0. This is on U.S. 50 West of Gunnison, a lakeless area the last time I was there! The box had the legend "Travelers Information Services, Inc., Raleigh NC 27607." I wish someone in Raleigh would try to get a list of TIS XR customers out of them for our DXing benefit; they ignored my letter. (BILL COLEMAN; ARE YOU LISTENING?? -ERC) Around Garden City, KS, 740 daytime exhibited an SAR of about 5 Hz, between KSSS CO and KRMG, OK. On a farm road S of Windhorst KS (E of Dodge City) I indulged in some ad-hoc de-facto daytime barwire Beverage DX bandscanning; at a right angle clipped on the ICP-5900W first to the E/W branch, where KLMX dominated 540 from NM, & then to the N/S where it was KWMT IA. KOAM-860 was strong on the E/W, inaudible on N/S. Being NW, KHOW-630 & KOA-850 were audible on both, & for that matter without the Bev. So help me, KARY-610, Russellville, AR has a "poultry forecast" at 107 each hour, advice on fogging & other techniques to compensate for variations in temperature and humidity, which was expressed to 0.1%. CBSRMT was on WOAI-1200 @ 10:06pm, one minute behind WSB-750. So much for last July. I saw next found spinning (oops, punching) the MW dial in Carababella, Venezuela, on the Caribbean coast E of La Guaira, 12/30 @ 10pm EST when Voice of Barbados-790 was relaying VOA NX in EE. Montserrat was well heard on 930 there; the best trans-Caribbean signal in the daytime was WIVV-1370 Vieques, PR, seemingly GOS format in EE. RON SCHATZ made more extensive notes on the MW band there & presumably will have reported on it.

ELY MAY GET A NEW FM & TV

PAUL ZEHR - Box 573 - Ely, NV - 89301-0573 April 15, 1982
 ***** How's DX? Well, mine is very slow with no new catches. The WX here has been very cold with snow! For those TV & FM DXers out there, there are two applications before the FCC for an FM & a TV station building permits here in Ely. The TV station will be used for local programs only. Who knows if they will pass - we need them here, anyway. Soon I may go to Salt Lake City where I'll try to visit several stations & even maybe to Rock Springs WY. There are two programs here in Ely on radio that I've been wondering if they're on nationwide, or what. They are the Earl Nightingale program and the Man and Molecules, made by National Aeronautics Space Administration. (sic-ERC) Does anyone have any ideas on this? Well, I feel I'd best begoing, good DX, 73's.

BEN'S BACK FROM A VISIT TO THE SOUTH PACIFIC

BENJAMIN DANCERFIELD - 202 Governor's Drive - Wallingford, PA - 19086 4/27/82
 ***** Well, this time we went Down Under, to New Zealand, (three weeks), & Fiji (four days), plus a few days in California. I had with me, as usual, my trusty Panasonic (1970 \$20 radio) until Fiji, but left it there as a tip to a taxi driver, when I had bought a new Sanyo radio (AM-SW) for only \$25 at a duty-free shop. I bought it after I tested it & could pick up all ten Fiji stations better than on the Panasonic. I had to tip the taxi driver because he went to untold hardships in retrieving a piece of luggage we had left on the dock at Lautoka. What a thrill it was to hear the Zedders first-hand in New Zealand! (still on the Panasonic). This is a country from which I have two varies here in Wallingford: 4YA-Dunedin, in 1961, & again in 1964, & 2YC-Wellington, also in '64. (Ah, those were the days!) First stop this March was Auckland. Nearly at the end of Summer, they had just gone off Summer time. Seven locals, I think: four national & three private. 1YC-882 is all concert music; 1YA-756 all types of programming. No call letters are given on either. 1ZB-1080 & 1ZM-1251 are DJ stations, & use calls frequently. The "X" stations use calls, but mainly slogans such as "Radio I" & "R. Pacific" & feature mostly pop mx. Best bet for U.S. reception are 1YA-756 & 1XP-1593, both 24 hours. After dark the rest of New Zealand comes in, plus Fiji-774 (Hindi) & Tonga-1017, & after about 10pm, the Australians, with 2BL-702, Sydney, by far the best. The Aussies are also heard before 8 a.m. Moving to the N end of North Island, the reception wasn't much different except that the Auckland stations were much weaker & the Northland stations much stronger. We then flew to Christchurch, a bit of England on the South Island, where there are six locals. 3YA-675 & 2ZB-1098 would be best for the U.S. (Con'd next week).

PROTECT YOUR DX EQUIPMENT!

MIKE KNITTER - 2159 Circle Drive - Cambridge, WI - 53523 608-423-4159 5/21/82
 ***** Time for another one of these Musas. Not too much DX, mostly
 static! I did a little FM; got Provo, UT - but that's another subject. I've
 been busy around here re-doing my electrical wiring in my radio room. I added
 a few more outlets and re-ran the ground. It now goes directly to the power
 company ground stake. I also put static/lightning arrestors on all the an-
 tenna lead-in wires coming into the house. And also placed a smoke/heat de-
 tector about the radio equipment. So now I'm all set for that lightning
 strike! We've had quite a few close calls around here the past few weeks.
 The neighbors' house across the street got hit by lightning and so did a tree
 across from my house! So - one never knows. Just thinking... Instead of you
 just reading this, why not do the same, just call your local Fire Department &
 have them come down and inspect your radio room. I've got a brother who works
 for the Fire Department so he came over and gave me the safety inspection, so
 now I'm all set for the lightning! Now back to DX. I've been going over my
 tapes that I had made during the season while I slept. KE1X-1310, WXOL-
 1450, & WDUZ-1400 so far heard, new, off the tapes. Also I've been doing some
 other things with this Club but I'll save it till next issue, maybe. So far
 it looks like me and the wife will be coming down to LOUISVILLE for the Con-
 vention. It'll be nice to watch names with bodies, plus maybe even see a bev-
 crage! If I don't get hit by a meteor or something on that level we should be
 there. I'm not one for planning anything, 'cause every time I do, something
 always goes wrong. (Murphy's Law #43, I believe!) Oh yes, I'll be bringing my
 video so as to put that Convention into my video collection of weird things!

FORMER NRC LOG MAN COMPLIMENTS THE NEW ONE!

JOHN A. CALLAHAN - 1122 Maple Street - Mount Vernon, IL - 62864
 ***** I would like to express, through Musings, my personal
 gratitude to RON MUSCO and his wife for coming through when I was unable to
 complete the NRC Log project. I am happy to see the finished product, and
 touched at the dedication, though I felt the latter was undeserved. A word
 of explanation about what has happened in my professional life may be of inter-
 est, at least to some. After 26 1/2 years in the broadcasting field, I have
 changed careers, and become City Editor of the Mt. Vernon Register-News. I was
 offered the job in November and accepted it, effectively in mid-December. My
 wife's teaching job and our 1970 mortgage at under 8% were keeping me in Mount
 Vernon and at WMIX, in spite of a failure to keep up with the cost of living.
 The cost of the night facility for WMIX-AM, new studios for the station, 24-
 hour operation, the purchase of a new station in Ksokuk, IA and other opera-
 tional costs managed to keep my salary at the same level for three years.
 Ironically, the job I was offered in 1972 at \$1,000 under my WMIX salary was
 re-offered at \$4,000 more than my 1981 WMIX salary, & I have already had a
 raise since moving to the newspaper. I have no hard feelings toward the radio
 station, though, as I understand the industry and it was my choice to seek and
 remain in a relatively small market. I am happy in the new job, and my boss
 is happy, too, because he now has a news department that's closer to entry
 level cost. It is unusual for a radio newsman to want to put down roots in a
 single community, so I was bucking against the norm. DX here has been confined
 to FM. A storm last Summer resulted in extensive roof damage, including the
 toppling of an old TV antenna. The insurance company funded all but the deduc-
 tible's worth of repairs, including replacement of the TV antenna by a
 stacked, top-of-the-line Winegard rotatable FM array. My divorce from the
 broadcasting industry was finalized, I guess, in February when I let my sub-
 scription to Broadcasting Magazine expire. Except for two years in the Service
 between 1956 & 1958, I had been a subscriber since I was 15 years old in 1950!

CHARLES MAY SOON BE WORKING FOR KJIM-870

CHARLES GEORGE - 6407 Howard - Dallas, TX - 75227
 ***** I have been doing more listening than usual this month, since
 I caught a viral infection that was causing me breathing problems. I did not
 manage to come up with any new catches; however, I feel I got better faster
 than otherwise due to this special interest of DXing. There have been several
 T-storms recently around here. Since I have a fear of these T-storms most of
 my DXing has been done with the built-in ferrite rod on my RF-2600. I received
 a v/l from R. Ceyman in 11 days for a report on reception of their 1555 kHz
 frequency. This makes my tenth country verified. If things work out for me I
 soon will be working part time as a salesman for KJIM-870, Fort Worth. The
 sales manager is a friend of mine. He is the person who sold me the broad-
 casting board I own. We used to co-host a program on SW DXing over KCEU (FM).
 He said he would try to get me work with the station. I have been enjoying
 trading airchecks with several other NRCers. I would like to hear from others
 interested in trading air checks of their area stations for those here in the
 Dallas/Fort Worth area. If any NRCers are visiting in the Dallas area I would
 enjoy your coming over for a DX exchange of information. My number is 381-
 5931. In case you want to make sure I will be available. 73's.

LET'S HAVE FUN IN LOUISVILLE! THE MORE THERE, THE MORE FUN! BE SURE TO COME!
 IT'S THE LABOR DAY WEEKEND, OF COURSE - MAKE THOSE PLANS NOW!

BILL WALKS AND ROCKS

BILL TOWNSHEND - 4500 Connecticut Avenue #901 - Washington DC - 20008 5/4/82
 ***** It's time for another re-intro Musas. 202-966-8046
 I'm 52, happily single, & living with my 79-year-young stepmother on the top
 floor of a nine-story flat in upper NW DC, a place that is the pits as far as
 FM DXing goes due to the proximity of several FM/TV masts. I am 5.7 miles or
 9.1 km NW of the Capitol & I work on the third floor of an eight-story DX-
 buster (FM is not affected; my exotic FM catches are logged there) in Marlow
 Heights, MD in the heart of Tobacco (cancer-stick) country, hi, just inside
 the Capital Beltway, seven miles, 11.2 km SE of the Capitol. Thank goodness
 the long bitter Winter is over! Good riddance! But DXing is on the downturn
 with warmer weather. I'm keeping tabs on WLS-890 Chicago for high noon recep-
 tion now that we're in the high sun season. I'm hoping to catch WLS @ 1:30pm
 EDT (high noon between DC & IL) on Mon. 6/21 (Summer Solstice with sun less
 than 17° from Zenith) by nulling out enough WLMD-900 slop right after midday
 DJ Pat O'Leary finishes up his Oldies sub-show on that station; I saw him to-
 night at a local hotel restaurant (Holiday Inn at College Park, MD) hosting an
 Oldies show as he spun the platters from 8:30-11:30pm. I eat lunch late on
 purpose so that I may catch the Oldies. Last Sunday, 5/2, I walked from home
 in NW DC to Frederick in Western MD, 39 miles/63 km to the NW, along the route
 travelled by Gen. Braddock and his boys in the Spring of 1755 on route to Fort
 Duquesne PA (now Fort Pitt) during the French & Indian War. I covered a total
 distance of 42 1/2 miles/68 km on foot that day. On the way out (I came back by
 the Big Blue, Grayhound Bus) I listened to BBD & rr (mostly rock oldies) on
 WMAL-630 & WINX-1600 respectively, occasionally switching to WDCD-FM-101.1 and
 WPPW-89.3 for H&B & Aor respectively. The night before my walk & the previous
 Sat. night (4/24) I went to two oldies stage shows downtown with several of
 the street-corner "doo-wop" groups singing on stage like back in the 1954-62
 era. In fact a total of 10 artists or groups were featured, five on each show.
 Last Sat. night Dan Robinson, who works for VOA, hosted a WADXA GYG at his
 Chevy Chase DC pad in my neighborhood which is very poor for FM/TV DX. Among
 the 23 who attended were NRCers TOM WHITE & me. Tom came from Charlottesville
 VA for the day. WADXA is planning to bid in Montreal in late July for next
 year's convention here in DC, probably in June. Although ANARC is SW-oriented
 the BCB DXers will have their day. I'll be in Atlanta Memorial Day weekend
 for a CAC (Catholic Alumni Clubs) convention with the partying & sightseeing.
 I might get in a midday bandscan & some high noon DXing with the trusty Sony.
 Two weeks ago we broke 90° for the first time & I have had my first outdoor
 swim of the season a few days later. 1001001 (binary for 73) & good DX.

KARL HAS A SPRING FLOOD OF DX

KARL V. JETER - 3590-C Clubhouse Circle East - Decatur, GA - 30032 5/25/82
 ***** Seems hard to believe the last Muse I wrote was dated 3/29!
 Time really increases between DX NEWSes during the off-season, hi. So, onward
 with two month's of DXing highlights. Veris count stands at 1,115, with April
 additions: WUNI-1410, WLTM-1480, WTML-1260 (all v/l); v/f from KSAL-1150; veris
 on my report letter from WLS-640, & the following "replacements" for former
 PP'ers (all v/l): WRAX-1250, WETU-1250 & WZOO-710. May's additions so far:
 v/q from Guadeloupe (PR-3-640) in one month, v/PP/c from WROX-1450 (two f/ups
 & one call); & v/l's from WAAO-1530 (one f/up, but I got a felt-tip pen, book
 matches, & B/S); WENY-1250, WZLP-1360 & WSLG-1090. Way back on 4/4, new WQMS-
 1500 heard @ 7:18pm w/canned format & late s/off. 4/6-WSYD-1300 a newie in
 mess w/local MX 7:33pm. 4/9, another newie, WLTM-1480 blasting in @ s/on, 6am,
 w/female voice, & SSB after announcement. Later same morn, an ID on 1520 from
 the new WAAH Dalonega, GA, apparently ETing around Bam? One very pleasant
 surprise on the eve of 4/12 on a seemingly "washed-up" channel for me - 1270.
 I was half-listening while reading & suddenly a nice "WCBC-Cumberland MD" ID
 was heard, along with an in/out signal from 8:48-9pm, when CBS MX was noted.
 4/22 AM brought me WNTT-1250 at s/on 6:01am, mentioned "Cooper Broadcasting"
 and 500w. (GREAT station! -ERC) April finished with a 4/27 catch of WNUF-
 1000, 8:30pm s/off, good signal, & on 1250, ex-KTRM, now "TX-1250" (KTXC) with
 "Brenda Lee's Country Clubhouse" program 8:30pm on 4/28. May started nicely
 with the s/on 5/1 of WFRB-560, 6am, w/a choral SSB, weak signal. Then on 5/2
 feeling really ambitious, an attempted "whammy" (i.e., null) on WLAC-1510 netted
 me a tentative on KROB-1510 s/off @ 9:15pm w/LAC's religious talk show.
 5/4- WZLP-1360 netted with local ads u/semi-local WLAW @ 6:20am. All's quiet
 until 5/9 when, sitting on 1090 produced a duo of newies: WMYL briefly at 8:29
 PM w/s/off, and a strong signal after that until 8:45 proved to be another new
 station, WXBK-1090, w/c/w. 1090 continued to be fruitful on eve of 5/13, when
 WSLG-1090 was bagged at s/off, 8:44pm. The rest of May? Zip! I have a re-
 strung loop with all-new #12 gauge wire and improved frame... but it still
 won't tune the band below about 1050! Help? I hope there'll be some Summer
 DX to report here, if things get better than they've been the last week. 73's.

The disgruntled member sued the
 nudist club to get his clothes back,
 but found the rules offered him no
 redress.

A useful hint:
 "May your footprints in the sands
 of time be such that you need not
 worry about where you left your
 fingerprints."

Medical Note: People who have
 hobbles seldom go crazy. However
 those who have to live with them do.

DAN'S LIVING IN NEBRASKA NOW

DANIEL BARTEK - 308 East 2nd Street - Wahoo, NE - 68066
***** Please note new address! Heard: XEL Mexico, EE before mid-
night, I think (5/11-12). Heard GBW-990, Winnipeg, MB (5/18-19), tentative.
Thanks very much to the following: Mr. MARK CONNELLY, Mr. GENE MARTIN, Mr. KEN
CHATTERTON and his Beverages. What catches, drool, slobber, slobber! Thanks
to all for answering my many questions! The next four months will be spent
putting together MARK CONNELLY's "Co-Phased AM Antenna" project; then learning
how to use it. I have the SM-2 & Radio Shack TRF etc. here. The new NRC Dom-
estic Log is very good! Thanks to all who made it possible! The NRC '81
Convention was GREAT! There was this cute blond, --- and MARK CONNELLY gave a
special demonstration of his "Co-Phase Two-Wire AM DX antenna". Only one word
for it - fantastic! He then courteously answered many many questions about it.
He also gave a demo of a small "Car Radio Antenna Tuner". Though small in size
it gave quite a lot of dB gain to the radio signals when hooked up! For the
above reasons, I just had to renew for four more reasons! NRC has the best to
offer the AM DXer! Sorry to hear about your finger, ERNIE - glad it wasn't
your hand or leg! Time to go, so the best. See you in LOUISVILLE '82???

A NEW IRCA ALMANAC IS COMING

BILL HARDY - 2301 Pacific Avenue - Aberdeen, WA - 98529 May 21, 1982
***** In April, Nancy & I received our first verie in years. Nice v/l
from the Chief Naturalist at Mt. Rainier National Park. We had sent a trans-
cript of the message we heard on 1610 kHz 3/19 & 3/28. He confirmed it's their
TIS near park HQ in the Tahjoma Woods, between Elbe and Ashford. Call sign per
IRCA's Almanac is KOD762. Format change: KKFV-1250 Seattle has expanded its
nighttime format to 24 hours, dropping the daytime oldies. Mostly upbeat soul-
disco with a dancing beat, "contemporary". A big THANK YOU! to RON MUSCO for
all the work he put into the new NRC Log. Ours arrived in fine shape in late
April. We're disappointed at the omission of formats, and hope they'll be re-
instated some day. But in all other respects, the Log is a fine one. We hope
it can be published each two years in the future. Perhaps if it can be comput-
erized or put on a word processor, updating would be simpler, allowing a print-
out at the push of a button. Quite a few of us would probably buy a new NRC
Log each year, if it were published yearly! Regarding a different publication,
which I supervise, IRCA plans a third edition of the "IRCA Almanac" this Octo-
ber. I had a number of good suggestions from NRC members, especially THOMAS
CONNATSER. He suggested a loose-leaf format for easier updating. IRCA plans
to publish Vol. 3 of the Almanac in your choice of comb-binding or loose leaf;
how many of you would be interested in looseleaf? This is also a good time to
suggest listings for the new edition. We plan to include as many of the new
satellite networks, plus interconnected shows like Larry King, "America Over
Night", "Talknet", "Music Country Network", "Dick Clark National Music Survey",
etc. as we can obtain. If you have a favorite and would like it included,
please drop me a line this Summer. The Almanac is a good companion to the NRC
Log, and we hope to improve it. 73 and good DX.

JOHN'S GOT SOME NICE NEW VERIES

JOHN B. MALICKY - 995 Shadycrest Road - Pittsburgh, PA - 15216 5/25/82
***** Hello all. What's new? Well, since May 10 v/l's & cards in
from WIFE, WAGE, WILS, WFIN, WNLB, WCPM, CKOY, CKSL, & WDLB. The first five
are from the WJAS firm, CKSL from 12/8, and note CKOY-1310's new address: Suite
1900, Place de Ville, Tower B, 112 Kent Street, K1P 6J1. Only one new station
heard on 5/22, WNIS-1350 at 2:30-3:14am w/talk show, ads, local & NBC NX, WX, &
IDing as "Talkradio" & "News-Talk" 1350, WNIS, Tidewater. Also, WSSJ-1310 heard
well o/u WNIC @ 3:30-4 w/ads, SX, WX, & RAB-SOL mx. Reports sent to both.
Otherwise, DXing has been zilch. About five weeks ago local WWSW-970 announced
they would go all-talk, dropping their MoR, hook up w/ABC's Direction Net, and
try to change to WEKN "Talkin'", keeping the PH side WW, effective June 1. Two
slogans I recently heard: WAKO-860 is "We Are Moving On" & WPLW "We're Praising the
Lords Word". Thank you very much RON MUSCO, for the outstanding job on the
Log & to creditors. Also, I especially like the enlarged ring binder for easier
page turning. Some radio facts from the SM of WWSW-FM that I heard. Every
family has on the average of six radios, a person listens to radio three hours
& 19 minutes a day, 93% of the people (U.S.) have a radio, & 96% 12 years and
over listens to radio. Now, some NRC facts from Redi Kilowatt and Welland Dowd.
Every NRC family has on the average of 66 radios, members listen to radio 13
hours & 19 minutes a day (And 23 hours, 19 minutes in the Winter) and 100% have
and listen to, a radio - at least that's right. And, with Spring almost into
Summer comes the bugs. On a few mornings were 2 3/4 inch size ants on the
floor (at different times) and a locust buzzing outside the window sorens. I
think they wanted to DX. So you have any bugs, ERC? (No, I shower every day,
hi! -ERC) This morning on TV (no bugs), Pirates in Los Angeles finally play
sound fundamental baseball and pound Dodgers, 9-3, with Don Robinson pitching a
complete game for the first time for the team in 45 games. That's it, so 73's.
I think this may be my shortest written column and under 30 lines!

THE NEXT MUSINGS DEADLINE IS SATURDAY, JULY 3. LET'S HAVE ONE FROM Y.O.U.????

HOW TO AVOID DXER'S BURN OUT

HARRY J. HAYES - 9 Henry Street - Wilkes-Barre, PA - 18702 EDT 5/16/82
***** I hope ERC's finger is all set to go! (It's back in service.
Harry! -ERC) The "For Sale" sign is out in front of 9 Henry Street as of May
3rd so the number of future Musings from this address should be limited. The
house here has been in the family since 1917 so it seems kind of funny to let
go of it. My active season has ended and it has been a very good season domes-
tically. I'm now into my TV & FM DXing and that season is starting out really
well. Some of the nicest catches this season were WSON-860, KWMT-1580, WPIX-
1450 from AL, WKZN-1500 & WROM-710. In other radio news, I received a verie
from WKCR-FM from NYC. Siger mentioned that my report was the second one in
recent times. The other came from Cape Cod, he said. Could it be from a fella
named ERNIE? (Great guess, Harry! You are correct! -ERC) WABC-770 went to
their new format on Monday May 10 at 12 noon. Last song was Lennon's "Imagine".
I happened to be at the parents' house during the evening NRCast that day from
a New York station, WCBS-2. They gave quite a feature story on the event. New
York is, I guess, somewhat behind the times, they still have a T-40 station on
AM, WNBC-660. (And 650 & 670 -ERC) The Wilkes-Barre/Scranton area is also be-
hind the times. We have a T-40 station in WILK-980 and WEJL-630 & WARM-590
still play lots of T-40 with some oldies and o/w loaded in. Also we have not one
religious station in the area. I don't consider Montrose or Danville PA the
local area; both towns have REL stations but their signals are not dominant ones
in the area. The best signal is from Montrose, WPEL-96.5, TAMARA TAYLOR men-
tioned she had DXer's burnout a while back. This can come about by the DXing
method of starting at one end of the band and going to the other. The best way
to get over this and the only way you are going to get new catches later on in
your DXing career is to DX by strategy. Before you start DXing, scan the band
quickly and see which direction is most enhanced, then go after stations in that
direction that you need. There is nothing more satisfying than getting a sta-
tion that you've "hunted". That frequency by frequency method works fine for
the beginner but ultimately you reach a point where that no longer works, you
end up spending too little time on the very frequencies you should be sitting
on. Well, that's it, I will be DXing AM if the VHF season turns into a dud.

A REGIONAL GEOGRAPHY LESSON

MORRIS SORENSEN - General Delivery - Huntville, ON - POA 1K0 May 21st 1982
***** It looks as if I'll be spending my Summer in Huntville, 40
miles N of Toronto. I have a Summer job here as a historic interpreter at
Muskoka Pioneer Village. This site depicts life in a typical central Ontario
crossroads community circa 1890. There are 14 buildings plus a museum. If any
of you are up this way during the Summer I hope you will stop in for a visit.
I lived (and DXed) in this general area (actually about 17 miles N of here) a-
round 1967-71 so it is not completely new to me. I have my TRF with me and have
been doing some random tuning - it is a pleasure to be further away from all the
Toronto locals. Some interesting catches include 5/19: WCHB-1440 @ 10:07pm &
WLRK-1260 @ 10:22. 5/20: WNYR-990 @ 9:47pm; CFTJ-960 @ 11:32. Yesterday I
heard CHWO ID as "CHWO in Halton". I recall that a few months ago someone asked
why they do this as their city of license is Oakville. Well, back around 1970
the Ontario government embarked on a policy known as "regional government". A
two tier system of municipal government was set up based mainly on former county
or district boundaries. Oakville is in the Regional Municipality of Halton
(formerly Halton County). They would have their own mayor but would also have
one or more representatives at the district level (Halton council). When CHWO
IDs as Halton they are indicating they serve the entire Regional Municipality of
Halton and not just Oakville. Clear as mud, isn't it? Other stations which
often mention the district or regional municipality include CKAR-1350 (Durham),
CHOO-1390 (Durham), CKAN-1480 (York & South Simcoe) and CPBK-630 (Muskoka). In
closing I should mention that TIM KERRFOOT came up to Richmond Hill for a visit
just a week before I left. We walked past CFCM's studios and noted a for-rent
sign on the building but it turned out to be another tenant, not the station.73.

MORE DETAIL ON WING-1300

KERMIT GEARY - R.D. 4 - Box 321 - Walnutport, PA - 18088 May 25, 1982
***** With all due respect to TONY FITZGERBERT for his fine series of
station profiles, the story of WING-1300 in the May10 issue of DM NEWS con-
tained some historical inaccuracies and omissions, and the record should be set
straight. Actually, the history of this station is considerably more involved
and colorful than was presented, and goes as follows: The station began in 1923
as WOAX, operating on 1250 kHz w/s power of 500w and licensed to Franklin J.
Wolff (Monument Pottery Co.) In 1927, WOAX entered into a time-sharing arrange-
ment with WCAP, a new 500 watt in Asbury Park, NJ. With the first general
station reallocation in 1928 by the old Federal Radio Commission, WOAX & WCAP
were re-assigned to 1280 kHz, along with WCAP, Camden, NJ, a 500-watt from
1340 kHz in a three-way time-sharing arrangement. In 1933, the call was
changed to WTNJ; the station was licensed to the Trenton Broadcasting Co. & was
located in the Stacy Trent Hotel. The old call letters were revived in 1937
when the licensee became WOAX, Inc., but the station call continued to be WTNJ.
With the general frequency reallocation of 3/29/41, all three stations were
moved to 1310 kHz, still sharing time. In 1949, in order to get out of the

Kermit Geary, con'd.) time-sharing arrangement, WTNJ moved to 1300 kHz w/a daytime-only license & a reduced power of 250w non-directional. WCAM & WCAP, (by then WJLK) remained on 1310, but also reduced power to 250w and ended their time sharing. After WAAT-970, Newark NJ, relinquished its historic call letters to become WNTA, WTNJ picked them up in 1959; the license was now the Delaware Valley Broadcasting Co. and studios were still located in the Stacy Trent Hotel. In 1964, the station was granted a daytime power of 5,000w from a directional array at Washington Crossing, PA. After 12 years as WAAT, the call reverted to WTNJ in 1971; in the meantime, the studios had been moved to 1 South Montgomery Street. The station became WING "Imagination Radio" in 1979. I'll have an update on my DX in the next issue. Until then, a pleasant Summer and Happy Vacations to all!

PAUL'S TURNED TO FM

PAUL MOUNT - 471 Emerson Avenue - Teaneck, NJ - 07666 201-836-1137 8203.24 ***** Since my last Muse I had a surprise visit from FRANK MERRILL. He showed up at 11pm May 4, & we stayed up till almost 5 playing records and watching MTV. Making it through in-plant class at work May 5 was rough, to say the least. Frank also called around 5/18 to tell me of a TEST the next morning from WGLX-1570. I called a few people - RAY ARRUDA, ROBERT KRAMER, & MIKE KNITTER & hope they notified people too. I did hear tones around 12:40 & 12:47, but CPOR was too strong. Gladly no CKLM interferences. I didn't have anything strong, & I don't like to call stations to ask if they're the weak tone coming thru, putting the phono to the radio. It could be them, but it could be someone else. And usually luck has it that I can't even pick up the tone once I call them. There has been some trop up and down the NE coast (that's North-Eastern U.S. I mean) on TV & FM in May but no other AM DX has been attempted. BILL HALE mentioned some of the top hits in England. While they are not Billboard Hot 100 Hits yet, some artists like A Flock of Seagulls, Haircut 100, Duran Duran, Soft Cell, the Human League, & Bananarama have been established hitmakers on the "Wavebreaker" chart, a syndicated program aired mostly on college stations that play the Top 20 new wave hits in America. I'm an avid listener of this type of music & would like to trade cassette tapes of stations that play a lot of new wave and British mx. I'm also interested in trading bumper stickers in case there are any new collectors out there. The new NRC Log is a welcome addition to the shack & I've got a lot of envelopes addressed now to send out to many AM stations for various purposes. Now to find a source of FM addresses in a cheaper form than Broadcasting Yearbook! It's nice out, so play friebes, you may need to know how in the LOUISVILLE motel parking lot, hi! Have a nice Summer & good DX - if it's FM I'm still taking phone numbers for a tip line - only one response so far. 73.

BACK IN THE SADDLE AGAIN

ERNEST COOPER - 5 Anthony St. - Provincetown, MA - 02657 617-487-9337 5/31/82 ***** I'd like to acknowledge phone calls from JOE PELA, PAUL MOUNT, RAY ARRUDA, STAN MORRIS, FRANK MERRILL & CHUCK HUTTON. Verles are in from Cuba - a v/q for a 12/81 report - card specifies 550 kHz; my report specified 1160! I will count it as 1160 as 550 was NOT in EE at that time, as was my report for the 1160 outlet. Also, v/1 from WITN-930 from Gregg Allinson, thanks, Gregg! And, v/1-SS with several SS travel folders from HIFA-980. My finger is a-OK now, and our vacation in Puerto Rico was super! Even though we didn't do the night club bit. What weather! It made me want to sell this barn and buy something in the Condado area! Incidentally, you CAN buy a condo on the Condado or in Ocean Park, Santurce in collaboration with 51 other people, and you own it for ONE WEEK a year! There's plenty of EE radio available all day, only two Puerto Ricans are EE though - WOSO-1030 and WIVV-1370, the latter, all REL/GOS. See my report from the Condado elsewhere in this edition, I believe. SanJuan is on the North Shore of the Island; stations in Mayaguez on the South Shore were not audible, nor were any Cuban or U.S.A. stations by day. WKVN-810 is silent; ZBVI-780 was silent 4/6-4/29 but are back on as of 4/30, our last say there. It's a great place for a vacation, even though a can of beer (only 10 ounces, too!) costs you \$1.75 at a bar! DX since returning has been glum. A few comments on the last issue: BOB MIELCAREK; WALK is not on 1580, but rather, 1370, 500 D-1. GARY MITCHELL: It couldn't have been me in Atlantic City - I can't ride a bicycle! I haven't been there in a decade-and-a-half! My "Night Talk" station reported last time is on 1550, not 1530, heard since, and still unID. BON MUSCO, GREAT Log! Muchas Gracias! DX: Fri. 3/16- WENE-1430 noted on an AN o/w satellite net & off Larry King. Sweep tones on 1450, 1.52, still going @ 2:37, no ID caught. Sat. 4/17- TTers on 860 1:44-1:56, & 1600, 1:59-2:02, no IDs. NM 5/3- A very noisy AM; the VOA "past" again on 1450 @ 2, using GMT. WABC-770 was on OC, but a zilch morn. Tue. 5/4- METS heard on WINF-1230 @ 2am. Venezuelan NA heard on 840 in WLAS' null @ 1:01. WOGB-1240 has begun its Summer AN sked, but this year are on the NBC F talk show; extremely dull. Wed. 5/5- WIBX-950 had the METS also, noted @ 1:20. Thu. 5/6- WABC-770 still rocking; WYNZ-970 on Red Sox BB, replacing WGAN-560. UnID TT on 960 @ 1:51, would this have been one of WPCN's tests? 5/7,8, nothing doing. SM 5/9- Paradise-825 AMing, as on the next morn too, as usual for Mother's Day. Unn testers heard today were WHHO-1320 @ 12:54, & WBYL-960 @ 1:36, and an unID TT on WITS-1510 @ 2:18. Yankees BB on 1240 & post-game shows still going on @ 1:30, but not IDed, WWC0 or WWND? Paradise-825 was AN again. Sat. 5/15- Unn WMM-1260 ETing w/MoR mx & ID @ 2:55, o/WEZE. NM 5/17- Baltimore BB on WTOP-1500, WFER-1300, WETT-1590 & WOYK-1350. 1am. CUN-35.

1982 NRC CONVENTION

SEPTEMBER 3, 4 and 5, 1982

NAME _____ PHONE () _____
 ADDRESS _____
 CITY _____ STATE/PROVINCE _____
 DATE & TIME OF ARRIVAL _____ DEPARTURE _____
 TYPE OF ROOM DESIRED: SINGLE (\$28.00) _____ DOUBLE (\$33.00) _____
 TRIPLE (\$38.00) _____ QUAD (\$43.00) _____
 NONE-I WILL NOT BE STAYING AT MOTEL _____

NRC LOUISVILLE CONVENTION REGISTRATION FEE is \$22.00, which will include costs of refreshments, meeting room, hospitality room and the banquet. We urge you to register early to insure the above special NRC rates above - also to enable us to locate you with or near others you may wish to list below.

Convention site is the Sheraton Inn-Louisville East at the Hurstbourne Lane exit of Interstate 64 on the East side of Louisville. In addition to being readily accessible via the three Interstates serving Louisville, the motel has limosine service from the Louisville airport, which is served primarily by Piedmont, U.S. Air and Delta airlines. Also bus service via Greyhound & Trailways is available to Louisville from virtually all points.

Present plans call for the Business Meeting and the Auction to be held on Saturday night, Sept. 4. The banquet is scheduled for Sunday evening, Sept. 5th followed by a Beverage DXpedition if all details can be finalized. And of course, the customary station tours as well as possibly a ride on the Belle of Louisville on the Ohio River is in the planning stages.

All reservations must be made through the NRC, P.O. Box 32125, Louisville, KY 40232. DO NOT RESERVE DIRECTLY WITH THE MOTEL!!! Registration deadline is August 16, 1982 to enable us to insure enough rooms, headcount for the banquet, etc.

BASEBALL SHIRTS

**NATIONAL
RADIO CLUB
CONVENTION**

T-SHIRTS

WHITE BODY, RED SLEEVES
BLUE SILK-SCREENED LOGO

DEADLINE: JULY 31, 1982
DELIVERY: LOUISVILLE CONVENTION
Will NOT be mailed



\$8.00

<input type="checkbox"/> S (34-36)	Name _____	Check off MO to:
<input type="checkbox"/> M (38-40)	Address _____	JERRY STARR
<input type="checkbox"/> L (42-44)		161 FOX STREET
<input type="checkbox"/> XL (46-48)	Total shirts ordered _____	HUBBARD, OHIO
<input type="checkbox"/> XXL (50-52)	Total money enclosed _____	44425