

RADIO TODAY

JOIN THE PROFESSIONALS!

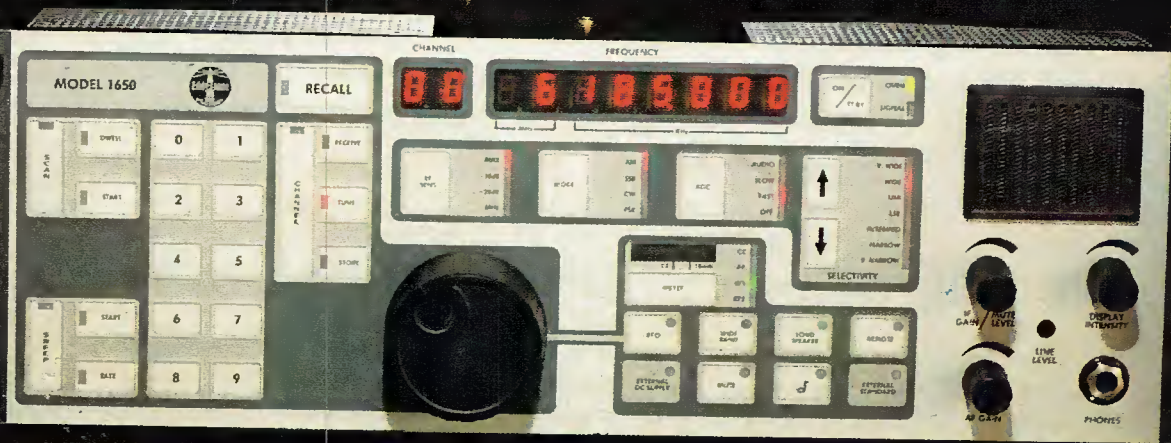

HOW GOOD ARE HIGH GRADE RECEIVERS?

■ KENPRO BUDGET HANDY REVIEWED ■ YAESU'S NEW FT211RH ■ HOW TO WORK TOP BAND FROM PINT-SIZED SITES ■ SHORT WAVE LISTENER GUIDES — FINDING THE BEST BUY ■ HOME BREW LINEAR FOR 70cms ■

R. WITHERS COMMUNICATIONS LTD

Manufacturers, importers and suppliers of world famous communications products
 584 HAGLEY ROAD WEST OLDBURY, WARLEY, BIRMINGHAM B68 0BS
 021-421 8201/2/3. CELLNET 0860 323056. PRESTEL MBX 214218216 FAX 0215614074
 Amateur Radio. Business Radio. Radio Telephones. Sales. Service Accessories and antenna systems.



YAESU



**THE TECHNICALLY ORIENTATED
 RADIO COMMUNICATIONS
 SPECIALISTS.**

RWC STOCKTAKING SALE

We've been told we have too much stock! So for **ONE MONTH ONLY** we are offering Hi-Tech Radios at the UK's lowest prices! **CALL IF THE RADIO YOU WANT IS NOT ON THIS LIST!**

SPECIAL THIS MONTH. FREE SO239 moulded lead Guttermount assy, with 6mtrs. of quality UR43 coaxial cable, with every 2mtr. transceiver purchased. (Normally £8.50).

• **HANDHELD TRANSCEIVERS** • we offer more to choose from...

• KENPRO	KT220EE	2MTR 5W LCD H/H	£199.00	P/P £10.00
• KENPRO	KT400EE	70CM 2W H/H	£199.00	" "
• CTE	1600 2MTR	3W (SAME AS IC2E)	£165.00	" "
• ICOM	MICRO 2E	2MTR 2.5W EXT RX	£229.00	" "
• ICOM	IC28E 25W	MOBILE EXTND RX	£349.00	
• YAESU	FT209R	2MTR FNB3 NICAD	£229.00	P/P £10.00
• YAESU	FT290R	MK1 2MTR M/MODE	£319.00	" "
• YAESU	FT290R	MK1 C/W NICADS	£339.00	" "
• YAESU	FT290R	MK2 2MTR M/MODE	£399.00	" "
• YAESU	FT690R	MK1 6MTR M/MODE	£279.00	" "
• YAESU	FT690R	MK1 c/W NICADS	£299.00	" "

NEW YAESU ★FT211E, FT757GX MK2, ★FT23R/FT73R/FT27R subject to availability, price depending on version/nicad/charger. Several extended and special versions available. Please telephone and discuss your requirements.

★ = Extended RX available, TX for export only. Full range of matching accessories in stock.

• **SCANNING RECEIVERS** • we offer the largest Range and options.

YAESU	FRG9600	MK1 60-905 MHz	£459.00	P/P £10.00
YAESU	FRG9600	MK2 60-950 MHz	£499.00	" "
YAESU	FRG9600	MK3 100KHz-950 MHz	£625.00	" "
YAESU	FRG9600	MK3 PACKAGE: MK3 Receiver, ICOM AH7000 Super		

Discone Antenna, PA4C AC Adapter, 1/2 size G5RV. Complete H/F-UHF Broadcast/Amateur/PMR Receiving Station **£725.00** inc carriage. Options: PAL Video Unit **£27.50**, BBC CONTROLLER PROG, **£49.50** inc post. SAE or phone for more details.

ICOM ICR7000E 25-1300MHZ SPECIAL PRICE **£862.50** CARR £10.00

• **BEARCAT** • The world's best known scanners, direct from the distributors. Bearcat Scanners are value for money and the most popular.

UBC100XL	LB/AIR BAND VHF/UHF handheld	£229.00	POST FREE
UBC175XL	as above, desk-top FREE DISCONE	£209.00	POST FREE
DX1000	SHORT WAVE RECEIVER. sorry SOLD OUT		
FDK	AIR BAND SYNTHESIZED H/H 118-136 MHZ	£139.00	Post £3.00
FDK	VHF-FM SYNTH. H/H 139-174 MHZ	£145.00	Post £3.00
REGENCY HX850	AM/FM VHF/UHF H/H SCANNER	£235.00	

WE STOCK ALL CURRENTLY AVAILABLE MAKES OF SCANNING RECEIVERS.

★ **SPECIAL MOBILE ANTENNA OFFER** ★ Sun KG309SE2 5/8 Ant c/w Moulded SO239 Lead and guttermount assy. **£20.00 INC POST.**

IMPORTANT. Please confirm your order before sending payment as we do not wish you to be disappointed if the model you require is sold out or the price has gone up! Special offers are subject to availability, we DO NOT advertise products or models that are NOT normal stock items. The above offers will be sold on a first come first served basis. Please DO NOT DELAY, as with previous offers we always get hundreds of enquiries when the offers are SOLD OUT! Instant credit available Subject to Status.

Mail order welcome, you may order by Access, Visa, Diners Club, Amex. or CWO for immediate despatch. Please call further details or brochures. Prices variable and are subject to change without prior notice.

ALL PRICES CORRECT AT TIME OF GOING TO PRESS. E OE.

Tel: 021 421 8201 (24hr answerphone)

Telex: 334303 G TXAGWM

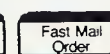

HAM RADIO CONTENTS

TODAY

VOLUME 5 NO 8 AUGUST 1987

Editor
Dave Bradshaw, G1HRT

Deputy Editor
Dave Bobbett, G4IRQ

Technical Illustrator
Jerry Fowler

Advertisement Manager
Christopher Harris

Classified Sales Executive
Sue Curtis

Published by:
Argus Specialist Publications Ltd

Distributed by:
SM Distribution Ltd

Printed by:
Adlard & Son Ltd, The Garden City Press, Letchworth, Herts SG6 1JS

Design by:
ASP Design Studio

Editorial and Advertising address:
(please mark your letter for the appropriate department)
Ham Radio Today
ASP Ltd
1 Golden Square
London W1R 3AB
Tel: 01 437 0626

Subscriptions and back-issues:
Ham Radio Today Subscription Dept, Infonet Ltd, Times House, 179 The Marlowes, Hemel Hempstead, Herts HP1 1BB.
Tel: (0442) 48432

Subscription rates:
UK £17.30, o/seas surface £21, USA surface \$28, o/seas air £39.
Back issues: £1.70 inc p&p

Member of the Audit Bureau of Circulation



Ham Radio Today is normally published on the first Friday in the month preceding cover date. The contents of this publication including all articles, designs, plans, drawings and programs and all copyright and other intellectual property rights therein belong to Argus Specialist Publications Limited. All rights conferred by the Law of Copyright and other intellectual property rights and by virtue of international copyright conventions are specifically reserved to Argus Specialist Publications Limited and any reproduction requires the prior written consent of the Company. © 1987 Argus Specialist Publications Ltd.

All reasonable care is taken in the preparation of the magazine contents, but the publishers cannot be held legally responsible for errors. Where mistakes do occur, a correction will normally be published as soon as possible afterwards. All prices and data contained in advertisements are accepted by us in good faith as correct at the time of going to press. Neither the advertisers nor the publishers can be held responsible, however, for any variations affecting price or availability which may occur after the publication has closed for press.

REGULAR COLUMNS

LETTERS	9
Is the RSGB morse test really all that great?	
RADIO TODAY	23
New products, news and a bit of tittle-tattle	
METREWAVE	53
RADIO TOMORROW	55
Get the wellies out, the summer rally season is here	

CONSTRUCTION

70CMS 40 WATT RF AMPLIFIER PROJECT	36
Homebrew yourself a larger SSB signal for 430MHz	
TOP BAND IN A POSTAGE STAMP	47
You can be QRV on MF if you really try	

FEATURES

MORSE FORUM	11
An introduction to a brand new CW series	
MACHRIHANISH — END OF A DREAM	19
How a gale changed the course of radio history	
GUIDE TO SHORT WAVE GUIDES	30
We take an in depth look at the top three	
CLUB NIGHT	58
How to run a rotten club!	

REVIEWS

EDDYSTONE 1650 REVIEW	14
A look at the professional approach to radio	
YAESU FT211 REVIEW	26
Another mini-mobile gets the run around	
KENPRO KT220	42
The ultimate clock radio, this one transmits too!	
KIT REVIEW — THE PAC-COMM TNC 220	49
Packet radio for the cost conscious constructor	

NEXT MONTH IN HAM RADIO TODAY	46
FREE READERS ADS	59
CLASSIFIED ADS	63
EMPORIUM GUIDE	65
HAM RADIO TODAY SUBSCRIPTION FORM	66
ADS INDEX	66

2 NEW MOBILE MASTERPIECES

IC-900 Super Multiband FM System.

This new addition to ICOM's Ham radio equipment is a multiband FM transceiver system that allows the mobile operator to customize a communications system for his favourite bands. Up to 5 optional band-units can be installed with the IC-900 for instant access to a wide range of frequencies from the 28MHz HF band to the 1240MHz UHF band. Only a small remote controller is necessary for control of all these bands. A flexible optical fibre is used between the Remote Controller and the Interface Unit. The IC-900 has independent, full duplex capability on all bands, providing simultaneous receive and transmit operation.

The function display on the Remote Controller shows two separate operating frequencies simultaneously. The IC-900 system transceiver is equipped with 10 fully programmable memory channels in each Band Unit. The system can therefore store up to 50 different memory channels.

This revolutionary new concept in Multiband operation is available from your ICOM dealer. Also feel free to contact ICOM (UK) LTD for assistance or information. The IC-900 Multi-band system consists of a Remote Controller, Interface Unit A, Interface Unit B and a series of specially designed Band Units.

UX19	28—30MHz	10 watts
*UX59	50—54MHz	10 watts
*(No mobile operation allowed in UK)		
UX29	144—146MHz	25 watts
UX29H	144—146MHz	45 watts
UX49	430—440MHz	25 watts
UX129	1240—1300MHz	10 watts



IC-1200, 23cms FM Mobile.

To complete the range of VHF/UHF FM Mobiles this new model is now available for the 23cm Ham band, it is based on similar features to the already existing IC-28E 2m and IC-48E 70 cms mobile units. This Mini-mobile transceiver will fit easily anywhere in your vehicle or shack. Power output is 10 watts or 1 watt low. The IC-1200 is so new we do not even have a picture of it, however, the large front panel LCD readout is designed for wide angle viewing and front panel controls are straightforward to make mobile operation safe and easy. The IC-1200 is a superb example of ICOM's dedication to exploring new communication equipment.

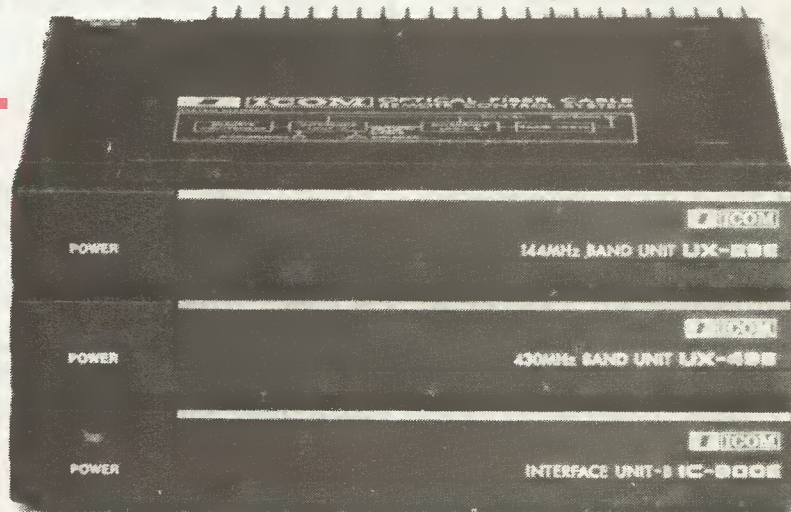

Telephone us free-of-charge on:

HELPLINE 0800-521145.

Mon-Fri 09.00-13.00 and 14.00-17.30

This is strictly a helpline for obtaining information about or ordering ICOM equipment. We regret this service cannot be used by dealers or for repair enquiries and parts orders. Thank you



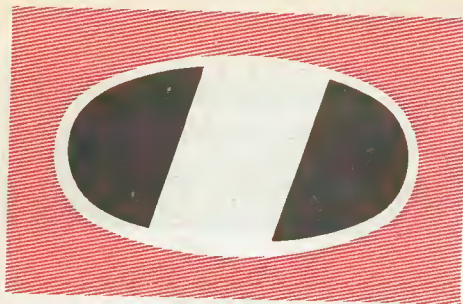

ICOM

Communications

VHF/UHF FM Handportables

If you want a handheld with exceptional features quality built to last and a wide variety of interchangeable accessories, take a look at the ICOM range of FM transceivers, all ICOM handportables come with a nicad battery pack, AC wall charger, flexible antenna and wrist strap.

Micro 2E/4E

These new micro-sized 2 metre and 70 centimetre handportables give the performance and reliability you've come to expect from ICOM.

Measuring only 148 x 50 x 30 the Micro fits in your pocket as easily as a cassette tape. The Micro 2E/4E features an up/down tuning system for quick frequency adjustments, 10 programmable memories, a top panel LCD readout, up to 2.5 watts of output (optional).

IC-2E 2 metre Thumbwheel Handportable

This popular handheld from ICOM is still available. For those amateurs who require a straightforward and effective FM transceiver the IC-2E takes some beating. Frequency selection is by means of thumbwheel switches (with 5Khz up switch) simplex or duplex facility. Power output is 1.5 watts or low 150 milliwatts (2.5 watts possible with BP5A battery pack).

IC-02E/04E 2 metre and 70cm Keypad Handportable

These direct entry CPU controlled handhelds utilise a 16 button keypad allowing easy access to frequencies, memories and scan functions. Ten memories store frequency and offset, these handhelds have an LCD readout and power output is 2.5 watts or low 0.5 watt. 5 watts is possible with the IC-BP7 battery pack or external 13.8v DC.

IC-12E 23cm Handportable

Similar in design and style to the 02E/04E this 1296Mhz handheld utilises ICOM's experience in GHz technology, gained by the excellent IC-1271E base station. Power output is 1 watt from the standard BP3 nicad pack, external 13.8v DC powering is available to the top panel jack. With the growing number of repeaters on 23cm. The IC-12E makes it an ideal band for rag chew contacts.

ALSO AVAILABLE FOR ICOM HANDPORTABLES ARE A LARGE RANGE OF OPTIONAL EXTRAS INCLUDING A VARIETY OF RECHARGEABLE NICAD POWER PACKS, DRY CELL BATTERY PACKS, DESK CHARGERS, HEADSET AND BOOM MIC, LEATHERETTE CASES AND MOBILE MOUNTING BRACKETS.

You can get what you want just by picking up the telephone. Our mail order department offers you free same day despatch whenever possible, instant credit, interest free H.P., Barclaycard and Access facility, 24 hour answerphone service.

Datapost



ICOM (UK) LIMITED
Dept HRT, Sea Street,
Herne Bay, Kent CT6 8LD.
Tel: 0227 363859.

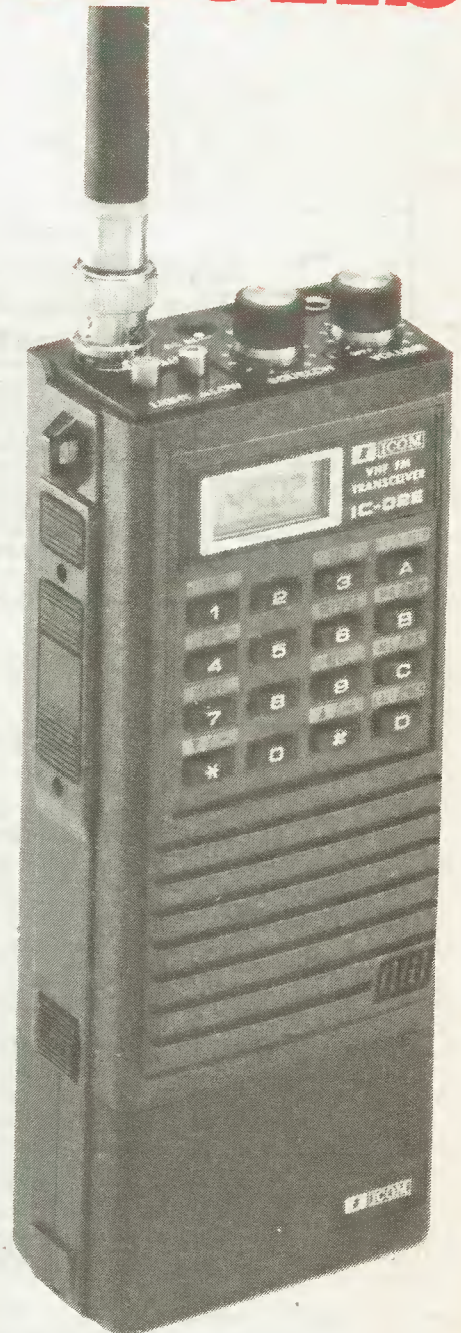

YOUR ONE SOURCE FOR RADIO

THE NAME YOU CAN TRUST FOR PRICE & AFTER SALES SERVICE

ARROW

ELECTRONICS LIMITED
5, The Street,
Hatfield Peverel,
Chelmsford, Essex

FOR IMMEDIATE DESPATCH
phone with your Access, Eurocard,
Mastercharge or Visa number to
0245 (Chelmsford) 381673 or 381626.
Telex 995801 (ref: A5)

THIS MONTH'S SPECIAL OFFERS!

**FT23R YAESU'S
SUPER MINI
2M FM HANDY**
£229.00

**FRG8800 YAESU
GEN. COV.
RECEIVER**
£575.00

**FT290R MK II
NEW YAESU
25W VERSION
INCL. MMB**
£479.00

**IC-R7000 ICOM
UNIQUE
SCANNER**
£865.00

**TM 201A 25W
2mFm** £269.00

The Cost Cutters

SOME OF OUR PRICES ARE SO LOW WE DARE NOT QUOTE THEM - CALL IN NOW!



**I C 3200E
DUAL BANDER
BARGAIN**
£499.00

**FT767GX NEW!
YAESU HF.
SPECIAL MODEL
2M & 70CM
SPECIAL
UNBEATABLE
PRICE- PLEASE
PHONE**

All mail orders to
ARROW ELECTRONICS LTD
5 The Street, Hatfield Peverel,
Chelmsford, Essex



Hatfield Peverel showrooms which are just off the A12 trunk road, are open 9-5pm Mon, Tues, Weds, Fri, Sat. Closed all day Thursdays. Approach by road via M25 & A12. By rail to BR Hatfield Peverel (3 mins from shop). We will taxi you back to rail station with heavy equipment. Buses from Chelmsford and Colchester pass the door. Free parking in our own car park. Local repeater GB3DA R5.

Scottish customers welcome at **ARROW ELECTRONICS (SCOTLAND)** Glasgow. Tel:041-339 6445 ask for Jim. Parking free outside the shop, which is near the Clyde Tunnel and Kelvin Museum. Open six days (closed Sunday) 9-5.30

In Leicester area Tel:0858 62827 you will find Alan G4TZY who will be pleased to assist you. Alan lives at 32 Fairway, Market Harborough, Leics. but please telephone first.

In Manchester Jim Cook, 106, Wirral Drive, Winstanley Wigan. WW3 6LD. Tel: 0942 214969

In N. Wales area John Lewis GW8UZL waits to talk to you in English or Welsh! John is an expert on Satellite work. Tel:0248 714657. 14 Carr-y-gad Anglesey Llanfair-p-g N Wales.

SMJ ELECTRONICS

Specialists in Semiconductors

Transistors

2N3065	£0.47	2SC945	£0.08	2SC2028	£1.30	2SK30	£0.37	BD235	£0.28
2N3773	£1.85	2SC1080	£0.59	2SC2029	£1.15	2SK33	£0.40	BD241	£0.34
2N3886	£1.10	2SC1081	£0.49	2SC2078	£0.74	3N201	£1.11	BD243	£0.30
2SA473	£0.42	2SC1098	£0.71	2SC2086	£0.43	3SK40	£1.27	BD244C	£0.33
2SA564	£0.10	2SC1213	£0.12	2SC2092	£1.41	3SK48	£2.26	BD245	£0.84
2SA608	£0.11	2SC1306	£0.74	2SC2097	£21.09	3SK88	£0.59	BD246	£0.75
2SA873	£0.13	2SC1312	£0.09	2SC2099	£19.25	3SK97	£2.08	BD246C	£0.51
2SA878	£0.38	2SC1318	£0.22	2SC2168	£0.95	40673	£1.50	BF244	£0.39
2SA883	£0.20	2SC1359	£0.13	2SC2205	£0.22	5C107	£0.13	BF245	£0.29
2SA884	£0.31	2SC1384	£0.27	2SC2290	£24.55	BC106	£0.07	BFY50	£0.25
2SA899	£0.86	2SC1398	£0.60	2SC2312	£3.15	BC109	£0.14	BFY51	£0.25
2SA733	£0.13	2SC1674	£0.15	2SC2314	£0.30	BC141	£0.26	MRF237	£3.39
2SA966	£0.26	2SC1675	£0.14	2SC2320	£0.10	BC142	£0.19	MRF238	£13.64
2SA989	£0.10	2SC1678	£0.80	2SC2395	£16.20	BC182	£0.06	MRF450	£13.50
2SA1012	£0.88	2SC1815	£0.10	2SC2398	£10.82	BC184	£0.10	MRF450A	£13.80
2SA1015	£0.11	2SC1908	£0.92	2SC3020	£12.90	BC212	£0.06	MRF451	£22.94
2SB525	£0.25	2SC1945	£3.41	2SD234	£0.46	BC214L	£0.08	MRF455	£23.65
2SC380	£0.09	2SC1946	£12.37	2SD235	£0.41	BC238	£0.06	TIP29C	£0.26
2SC495	£0.35	2SC1947	£4.29	2SD313	£0.56	BC639	£0.12	TIP30C	£0.29
2SC536	£0.10	2SC1957	£0.66	2SD325	£0.43	BC640	£0.13	TIP31C	£0.27
2SC710	£0.11	2SC1969	£1.58	2SD330	£0.48	BD131	£0.42	TIP32C	£0.33
2SC711	£0.09	2SC1970	£1.52	2SD380	£4.26	BD132	£0.32	TIP41C	£0.35
2SC730	£3.63	2SC1971	£2.95	2SD471	£0.29	BD135	£0.22	TIP42C	£0.36
2SC828	£0.09	2SC1972	£8.25	2SD837	£0.71	BD139	£0.22	TIP120	£0.38
2SC900	£0.27	2SC1973	£0.51	2SD880	£0.41	BD140	£0.25		
2SC930	£0.17	2SC2002	£0.25	2SK192	£0.23	BD201	£0.33		

FCC Conversion Boards

We stock a range of modification boards to convert the most popular UK FM rigs to work on the new FCC band in addition to the existing UK band. Please quote make and model of CB when ordering. Price £9.99

Active Filter Boards

A 10.695MHz active filter specifically designed for the HAM international and NATO 2000 type CBs. This board significantly reduces image reception and cross modulation without affecting sensitivity. Price £5.50

Crystal Filter

This is a 10.695MHz 1khm 10KHz bandwidth xtal filter suitable for most FM CBs. The filter greatly reduces cross modulation (bleedover) and is extremely easy to fit. Price £2.39

Integrated Circuits

7805	£0.40	HA1377	£1.90	LC7120	£2.75	RC4558	£0.55	TD1010	£1.15
7806	£0.38	HA1388	£3.81	LC7130	£3.26	S042	£2.50	TD1011	£1.37
7812	£0.39	HA1392	£2.54	LC7131	£3.21	TA7061	£0.76	TD1020	£2.28
7815	£0.37	HA1394	£2.72	LC7132	£2.89	TA7120	£0.48	TD1510	£3.89
7818	£0.59	HA1397	£2.55	LC7137	£2.77	TA7130	£0.53	TD1512	£3.12
AN240	£1.28	HA1399	£2.68	LM324	£0.45	TA7204	£0.98	TD2002	£0.74
AN6551	£0.73	LA1230	£1.19	LM386	£1.15	TA7205	£0.91	TD2004	£1.85
AN7131	£1.37	LA4102	£0.84	M51102	£1.85	TA7217	£1.22	TD2005	£1.65
AN7140	£1.05	LA4112	£0.94	M51513	£1.86	TA7222	£1.22	TD2020	£1.81
AN7178	£2.95	LA4150	£0.58	M51515	£1.94	TA7227	£2.06	TD2030	£1.30
BA402	£1.28	LA4201	£1.19	M51517	£1.84	TA7240	£2.06	TD2031	£1.81
BA521	£1.55	LA4220	£1.41	MB3712	£0.99	TA7241	£1.96	UPC1029	£0.71
BA656	£1.19	LA4250	£2.23	MB3730	£2.06	TA7270	£1.93	UPC1032	£0.75
CD4001	£0.28	LA4400	£2.59	MB3756	£1.94	TA7271	£1.93	UPC1156	£2.05
CD4008	£0.89	LA4420	£1.32	MB8719	£4.12	TA7274	£1.96	UPC1181	£0.91
CD4011	£0.11	LA4422	£1.13	MC1723	£0.48	TA7310	£0.66	UPC1182	£1.04
CD4049	£0.25	LA4440	£1.89	MC3357	£2.11	TA7502	£0.99	UPC1185	£1.81
CD4066	£0.34	LA4445	£1.90	MC3359	£2.33	TBA800	£0.99	UPC1186	£0.71
CD4069	£0.19	LA4460	£1.71	MM5510	£3.00	TBA810T	£0.49	UPC1230	£1.80
HA13001	£2.18	LA4481	£1.71	NE567	£0.52	TC9106	£6.60	UPD858	£1.65
HA136W	£1.33	LB1405	£0.97	PLL02	£7.59	TC9109	£4.38	UPD216	£5.34

We have listed only a small proportion of our stock. Please feel free to contact us with your requirements. All prices are quoted at the one off prices, discounts being available for quantities of ten or more of any one device. Same day despatch on all items in stock. Cheque/Postal order with order. Please add 7.5p postage and packaging on all orders under £10.00. All prices are exclusive of VAT. All mail order to: 55 Slatford Road, EDINBURGH, EH11 1PB. Callers Welcome. TEL: 031 337 6950/031 337 2446.

AX.25 PACKET RADIO

Your gateway to the network

New MFJ-1274 lets you work VHF and HF packet with built-in tuning indicator for £179. . .

... you get MFJ's latest clone of TAPR's TNC-2, TAPR's VHF/HF modem and built-in tuning indicator that features 20 LEDs for easy precise tuning

Pac-Comm TNC-220 £139 KIT £159 ASSEMBLED

The TNC-220 is a newly designed successor to the TNC-200 and other TNC-2 "clones", giving more features at lower cost. It uses a single-chip modem that is software switchable between two radio ports, conveniently supporting both VHF and HF packet operation. Each of the TNC-220 radio ports may be configured with jumpers for 300 or 1200 bauds. Switching between ports is entirely done in software and no cable changing, disconnect header is provided to allow the use of accessory high-speed or satellite modems. provision for an active bandpass filter to optimise HF operation, one filter is standard. An optional tuning indicator will mount inside the cabinet. A standard modem disconnect header is provided to allow the use of accessory high-speed or satellite modems.

HAVING PROBLEMS TUNING HF PACKET?

NEW MFJ 1273 Tuning indicator £4 .00 Built Fits all TNC 2 clones

TNC-2 VI.1.4 UPGRADE KITS NOW AVAILABLE

32K EPROM + 32K RAM + INSTRUCTIONS £25

WHY NOT USE YOUR SPECTRUM WITH A TNC?

Spectrum Interface-1 £29.00 inc Spectrum Microdrive £29.00 inc
Spectrum Terminal Program on Microdrive Cartridge £5.00 inc
Blank Cartridge-Pack of 2 £4.00 inc

G WHIPS HF + VHF AERIALS

AMDA1 now stocks the full range of G Whip aerials which includes
NEW Compact 8 band HF Base Station antenna £97.50 + pp
NEW Lightweight 2 metre Base Station antenna £44.75 + pp

Come and see us at **WOBBURN**

AMDAT

Crofters, Harry Stoke Road
Stoke Gifford, Bristol BS12 6HQ
(0272) 699352/559398



RADIO AMATEURS EXAM? PASS FIRST TIME!

Before you enrol check the benefits of
RRC'S unique Home Tuition Service

RRC has helped thousands of students to success in their examinations with this unique system of postal tuition, one which guides you, step-by-step, to qualify in the shortest possible time. Only The Rapid Results College offers you all these advantages:

- | | |
|--|---|
| <input checked="" type="checkbox"/> A qualified personal tutor | <input checked="" type="checkbox"/> Free advice before you enrol |
| <input checked="" type="checkbox"/> Study material prepared by specialists | <input checked="" type="checkbox"/> Telephone Helpline |
| <input checked="" type="checkbox"/> Completely self-contained courses | <input checked="" type="checkbox"/> Free 'How to Study' Guide |
| <input checked="" type="checkbox"/> Handy pocket-sized booklets | <input checked="" type="checkbox"/> Instalment Plan |
| <input checked="" type="checkbox"/> Personal study programme | <input checked="" type="checkbox"/> Free Postage on course material |
| <input checked="" type="checkbox"/> Regular marked tests | <input checked="" type="checkbox"/> Worldwide Airmail Service |
| <input checked="" type="checkbox"/> Courses regularly updated | <input checked="" type="checkbox"/> Extra tuition free if you don't pass first time |
| <input checked="" type="checkbox"/> 48 hour despatch | |

POST COUPON TODAY FOR FREE RADIO AMATEURS PROSPECTUS
Please send me my prospectus as quickly as possible.

Mr/Mrs/Miss/Ms _____

Address _____

Postcode _____

RRC The Rapid Results College
Dept. JN7, Tuition House, London SW19 4DS. FREE ADVICE: 01-947 7272 (9am-5pm) 
PROSPECTUS: 01-946 1102 (24 hour Recordcall Service quoting Dept. No. JN7.)

SPECTRUM TRANSCIVE

The **TX-3 RTTY/CW/ASCII TRANSCIVE** program is now available for the Spectrum. It has all the facilities of the BBC and CBM64 versions and will operate with an interface or T.U.

Forget what you thought you knew about Spectrum direct decode systems. This one will transceive 300 baud RTTY or ASCII at 170Hz shift with only a simple interface. Its performance and facilities outclass other software by a large margin yet it is very easy to use. Some of the features are: Split-screen type-ahead operation, receive screen unwrap, 24 large memories, clock, review store, callsign capture, RTTY auto CR/LF, CW software filtering and much, much more.

The program comes with an adapter board which plugs into the Spectrum expansion port and accepts the interface or T.U. It will work with any 48/128k Spectrum, including the +2. Tape + adapter £35. Users of the CW QSO program can upgrade for £25. **BBC** and **CBM64** program £20 tape, £22 disc.

TIF1 INTERFACE has computer noise reduction, RX filters, TX outputs for MIC, PTT and KEY. Perfect for our TX-3 and RX-4 programs. Kit £15 (assembled PCB + cables & connectors), ready-made boxed with all connections £25 (state rig).

SPECTRUM RX-4 RECEIVE

We now have a version of this amazing program using the adapter board mentioned above. This enables even better reception of RTTY/CW/SSTV and AMTOR with any 48/128k Spectrum, including the +2. Uses TIF1 (see above) for all modes or a T.U. for RTTY and CW. Tape + adapter £40. Existing RX-4 users can upgrade for £21. RX-4 is also available for **BBC**, **CBM64** and **VIC20** £25 tape, £27 disc (not VIC20). The BBC RX-4 is now completely compatible with the Master Series. Master users may exchange their programs free of charge.

We also have superb BBC, CBM64, Spectrum, VIC20, Electron programs for Morse Tutor £6, Locator £7, Logbook £8 and RAE Maths £9 as well as a great UK/Europe and World Map and Locator for BBC/Electron £10. Any BBC or CBM64 program also on disc at £2 extra.

Prices include VAT and 1st Class p&p Inland, airmail overseas, normally by return. Eire, C.I. BFPO deduct 13%.



technical software (HRT)



Fron, Upper Llandwrog, Caernarfon LL54 7RF
Tel: 0286 881886

SPECTRUM COMMUNICATIONS MANUFACTURERS OF RADIO EQUIPMENT AND KITS

NEW PRODUCT

FOUNDATION TRANSMITTER, ideal for the newly licensed amateur. 2 meter FM, crystal controlled unit with 6 crystal positions, nominal output 750mW. Complete system comprises RF generator FTX201 with S20 crystal, £31, Frequency modulator board FM1000T £4.00, and Transmit Switching board TS25, £3.75.

CB TO 10 FM CONVERSION BOARDS, The first commercially available, suits all UK FM CB rigs to give 29.31 to 29.70MHz. Size only 63*40*13mm. Built and aligned board SC29 £15. Or send your rig and we'll fit it. £28. inc. return P&P for mobiles. £31 inc. for base rigs.

MULTIMODE CB CONVERSIONS, send your 120 channel rig and we'll convert it to give 28.01 to 29.70MHz in straight sequences without gaps. Colt 1200DX, Cobra 148, Hy Gain 5, Multimode 2, Major M360, Tristar 747 & 777, Super Star 360, Concorde, etc., £62 inc. return P&P. Jumbo or Colt Excalibur 1200, £65. 80 Channel rigs such as Stalker 9 or Major M588 are modified to give 28.31 to 29.70MHz in straight sequence without gaps. £45.00 inc. return P&P. 200 Channel in 4 bands of 50 are converted to give 28.00 to 30.00MHz or 28.00 to 29.70MHz as required. Super Hy Gain 5, Lafayette 1800, Super Star 2000. £45.50 inc. return P&P. Nato 2000 £52.50, Super Star 2000-5x40CH £70. Colt 1600, 4x40CH. £65.50.

FREQUENCY MODEM adds FM to synthesised rigs with 455KHz IF. Type FM 455, PCB Kit £6.50, PCB built £9.50.

FREQUENCY MODULATOR adds FM to receivers with 455KHz IF, suits R600, R1000, FRG7000. Type FD455, PCB kit £5.50, PCB built £7.50.

FREQUENCY MODULATOR adds FM to synthesised rigs or rigs with clarifier. Type FM1000, PCB kit £3.00, PCB built £4.00.

RECEIVE CONVERTERS 2, 4 or 6 Metre aerial input with 10 metre IF or 4, 6, 10 or 20 metre aerial input with 2 metre IF, 26dB gain, low noise with OSC output. Types RC2-10, RC4-10, RC6-10, RC4-2, RC6-2, RC10-2, RC20-2. pcb KIT £17.25, PCB built and tested £24.50, Boxed kit £29.25. Boxed built and tested £41.

TRANSCIVE CONVERTER, single board version of receive & transmit converters, 500mW output, with repeater shift facility. Types TRC2-10, TRC4-10, TRC6-10, PCB kit £39, PCB built and tested £54, Boxed kit £54, Boxed built and tested £83.25.

TRANSMIT AMPLIFIER unswitched, suitable for Transmit Converters, Transceive Converters and MEON, 500mW in, 20W min output. Types TA2U2, TA4U2, TA6U2 PCB kit £40.50, PCB built & tested £48.75. Boxed kit £45.00, boxed, built and tested £53.00.

RECEIVE PREAMPS 2, 4, 6 or 10 metre, RF & DC switched, 0-2dB variable gain, low noise, 100W handling. Types RP2S, RP4S, RP6S, RP10S. Also masthead version DC coax fed, types RP2SM, RP4SM, RP6SM, PCB kit £12, PCB built and tested £16.75, Boxed kit £20.25, Boxed built and tested £27.00.

NOISE SQUELCH squelches rig when noise is high. Allows reception between noise bursts. Type NS1000, PCB kit £7.25, PCB built £10.25.

VAT & P&P PRICES

Delivery within 14 days subject to availability. 24 hr answering.

 UNIT B6, MARABOUT INDUSTRIAL ESTATE,
DORCHESTER, DORSET. TEL: 0305 62250 

NEW! from Cirkit

SUMMER 1987 ELECTRONIC CONSTRUCTORS CATALOGUE



**6
MULTIMETERS
TO BE WON**

PRICE ONLY
£1.20

• Many new lines
• Extended range
of test equipment

- £11 worth of discount vouchers
- 6 Multimeters to be won in easy to enter competition.
- Available at your local newsagent or direct from address below.

Cirkit

Access 

(0992) 444111

Cirkit Distribution Ltd Park Lane, Broxbourne, Herts EN10 7NQ
Telephone: (0992) 444111 Telex: 22478

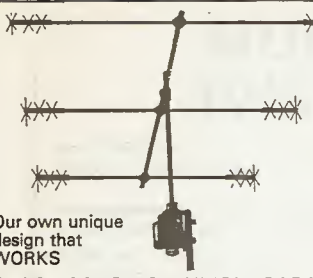

ALTRON
COMPACT Spacesaver ANTENNAS
AQ6 20, 2 Ele and 3 Ele
 4 BAND, 6, 10, 15, 20 M
AQ40, 2 Ele, 40M! NEW

Our own unique design that WORKS

CLOSE COUPLED—HI 'Q'—CAPACITY HAT LOADED YAGI
Special features:

- Unique Altron fully sealed coils for max stability
- Resonant length elements for improved VSWR (1-1)
- Selectively detuned for optimum performance and gain (no gimmick quad needed)
- Easy trim spokes with lock nuts and spares
- Minimized wind load and weight
- Double insulated elements



Typical performance

Antenna model	AQ-20/2E	AQ6-20/3E	AQ40/2E
Forward Gain Dbd	3.8 to 4.8	5.5 to 7.5	3.8
Front to Back Db	13 to 15	16 to 18	12
Side Null Db	25	25	20
VSWR (typical)	1.1:1	1.1:1	1.1:1
Weight	7.5lb	12lb	12lb
Wind load	2ft ² 0.18M ²	3ft ² 0.27M ²	3ft ² 0.27M ²
Turning radius	76"/1930mm	96"/2438mm	114"/2895mm

PRICE + p&p £114.50 (4.50) £169.00 (7.00) £149.50 (7.00)
 PRICES ARE INCLUSIVE OF VAT. TERMS. CWO. ACCESS. VISA
WE DESIGN—WE MAKE—WE SELL DIRECT. You get best value

Callers welcome.
 Open Mon-Fri 9am-5
 Sat 9am-12.15pm

ALLWELD ENGINEERING
 Unit 6, 232 Selsdon Road
 S Croydon CP2 6PL
 Telephone: 01-680 2995 (24 hr) 01-681 6734

STOCK ITEMS NORMALLY DESPATCHED WITHIN 7 DAYS

AMATEUR ELECTRONICS UK

**G6XBH
G1RAS
G8UUS**

**R.A.S. (Nottingham)
Radio Amateur Supplies
Tel: 0602 290267**



Visit your Local Emporium
 Large selection of New/Used Equipment on Show

AGENTS FOR: F.D.K., AZDEN, ICOM, YAESU, ALINCO, KENPRO

ACCESSORIES: Welz Range Microwave Modules, Adonis Mics, Mutek Pre-Amps, Barenco Mast Supports

DRAE products
 BNOS Linears and PSUs

Agents for VODAPHONE & CELLNET

AERIALS: Tonna, Halbar, Jaybeam, New Diamond Range of Mobile Whips
 Bring in your secondhand equipment for sale
JUST GIVE US A RING

Monday: CLOSED Tuesday-Saturday: 10am to 5pm

3 Fardon Green, Wollaton Park, Nottingham NG8 1DU
 Off Ring Rd. between A52 (Derby Road) & A609 (Ilkeston Road)

FARNBOROUGH COMMUNICATIONS

97 OSBORNE ROAD, NORTH CAMP,
 FARNBOROUGH, HANTS

Read the reviews in this issue and then decide. Phone us for a quotation, and that little extra service now, on 0252 518009.

Stockist of Drae psu's, Jaybeam and Cue Dee Antennas, Microwave Modules, Oskerblock SWR, CDE, RSGB publications, quality cables, our own TVI filters, Welz, Bencher, Mirage amps.

Open Monday to Saturday 10am-6pm

ACCESS + H.P. Available + BARCLAYCARD

Telephone: Farnborough (0252) 518009

GAREX THE SCANNER SPECIALIST

Just a small advertisement this month to let you know that we are still very much in business. See our previous ad for product details.

Ask for our secondhand scanner bargain list.

MEET US AT THE FOLLOWING MOBILE RALLIES FOR STORES CLEARANCE BARGAINS AND REGULAR LINES AT POST-FREE PRICES: Brighton 12th July; Woburn 2nd Aug; Derby 9th Aug; Torbay 30th Aug; Lincoln 13th Sept; Harlow 27th Sept.

MAIN DISTRIBUTOR OF REVCO PRODUCTS
 PRICES INCLUDE UK P&P and 15% VAT
 Goods normally despatched by return.

GAREX ELECTRONICS

HARROW HOUSE, AKEMAN STREET, TRING, HP23 6AA
phone Tring (044 282) Callers by appointment only.

It's easy to complain about advertisements. But which ones?

Every week millions of advertisements appear in print, on posters or in the cinema. Most of them comply with the rules contained in the British Code of Advertising Practice.

But some of them break the rules and warrant your complaints. If you're not sure about which ones they are, however, drop us a line and we'll send you an abridged copy of the Advertising Code. Then, if an advertisement bothers you, you'll be justified in bothering us.

The Advertising Standards Authority. 

If an advertisement is wrong, we're here to put it right.

ASA Ltd, Dept 2 Brook House, Torrington Place, London WC1E 7HN



This space is donated in the interests of high standards of advertising.

REG WARD & CO LTD The Southwest's largest Amateur Radio Dealer

1 Western Parade, Axminster, Devon EX13 5NY

appointed agent for

★ Yaesu, Trio, Icom, FDS ★
 ★ Complete range stocked ★
 ★ Full demonstration facilities ★
 ★ Mail/Phone orders on all items ★
 ★ Barclaycard, Instant Credit, Access ★

Ancillary equipment by Adonis, AKD, AOR, Bencher, BNOS, Cap. Co., Datong, Diawa, Drae, Hansen, Himound, JIL, Kenpro, Microwave Modules, Mutek, SEM, Shure, Tokyo Hypower, Tono, Toyo, Welz, Wood & Douglas.

Aerials by: G. Whip, Hygain, Jaybeam, Mini Products, MET, Revco, Tonna

full range of Wood & Douglas kits:

Opening hours: Tues-Sat 9.00-5.30 (lunch 1-2) Closed Mondays

Tel. Axminster (0297) 34918

BINDERS

FOR YOUR VALUABLE COLLECTION OF HAM RADIO TODAY MAGAZINES

• SMART • EASY TO USE • TOP QUALITY

To ASP Readers Services, PO Box 35, Wolsey House, Wolsey Road, Hemel Hempstead, Herts HP2 4SS (0442-41221)

£5.20 inc P&P

Please supplyHam Radio Today Binders @ £5.20 inc. P&P

Total £ (Please make cheques payable to ASP Ltd.)

Years Required — 198.....198.....198.....198.....

Name

Address

Please allow 21 days for delivery



LETTERS

Packet Working Group should 'pack it in'

Dear HRT, I am writing to you because it has come to my notice that the RSGB Packet Working Group are considering to transfer the packet network from 144MHz to 50MHz with effect from 1.1.88. The ideal criteria for the chosen band have been stated to be as follows:—

- (a) The network should be on a band which is a *primary* allocation.
- (b) The band should have sufficient space to allow 35kHz for *exclusive* packet operation.
- (c) The band should be available to all licence holders.
- (d) The band should have good propagation characteristics over short distances but should not support long distance propagation except in exceptional circumstances.

The band which meets all these requirements except (a) is of course 432MHz. However it has been stated that to establish a network on 432MHz would take a long time due to clearance being required from the MOD.

At the present time the packet network exists within 50kHz on the 144MHz and there seems no valid reason why this should not continue until a network can be established on 432MHz. Although this might mean some short term overcrowding, this could be tolerated for a while. The main reason which has been quoted for moving off 2 metres is that the IARU are against packet repeater operation on 144MHz and that we must comply with their dictat. However this argument does not stand up to close scrutiny because our existing 432MHz repeater network has not complied with IARU standards for many years. The possibility of mutual interference from UK packet repeaters on 144MHz would only be during enhanced propagation which only occurs infrequently (More is the pity!). Furthermore the use of 144MHz for packet is widespread in Europe and there seems little likelihood that there will be a mass QSY off the band. Indeed there is every reason to believe that additional packet channels can be found on 144MHz if 12.5kHz spacing is exploited fully.

I am sure you will agree that the

use of 50MHz for packet repeaters would be an unmitigated disaster which must be stopped at any cost. The RSGB Packet Working Group may take such a decision without consulting interested parties such as yourselves. I therefore urge you to write to the Repeater Working Group Chairman Mike Dennison G3XDV with a copy to David Evans G30UF asking for this proposal to be dropped. If you need any further information please do not hesitate to contact me.
P L Crosland G6JNS

Well events have overtaken you somewhat with this one Peter, as of 1st June both criterion (a) and (c) are accommodated by the new 50MHz allocation and the opening of the band to all licence holders. As for the idea of an exclusive 350kHz packet allocation we would imagine that the majority of non packeteers would find this rather excessive — true, packet is catching on fast but not that fast surely? As always, we would be most interested to hear other readers comments concerning allocations for this new mode. — G4IRO

QRO Bandhogs

Dear HRT, I just had to write in reply to the letter from Stephen Wilson, G3VMW, as to me it typifies the arrogance and intolerance so often displayed by DX operators towards those of us with lesser ambitions.

Although not a QRP operator, I only have a limited amount of time for operating and my aerial system is of necessity modest in size and hence performance, and so countries which may not be DX to G3VMW may well be DX to me. On a number of occasions I have heard a station calling CQ DX for some minutes without a reply. Eventually, I have replied to the station, expecting that he might at least be pleased to know he is putting a good signal into the UK. However, more often than not, I have been told in one way or another to go away, in one case so rudely that I switched off the rig and did not operate again for several weeks.

Of course I, like any amateur, have experienced the thrill of making a contact with a station in a far corner of the world, but I fail to see

why having a rubber-stamp contact with some weak and distant station is so important that it is considered justification for being downright rude to someone who merely happens to be not so far away.

I fail to see what satisfaction people can gain from DXing to the exclusion of all else. This obsession with collecting things — countries, locator squares — has all but ruined 2 metre SSB, which during an opening is filled with splatter of badly-adjusted FT290's overdriving 100W 'linears' (which are anything but!) making it completely impossible for someone running a modest 10 or 25W to work anything. It has been argued that DXing encourages the amateur to strive to improve his station, and to learn in the process, but my observation is that in most cases it is only the would-be DXer's credit cards which get exercised, not his technical knowledge.

I just wish that all the CQ DX callers would take up stamp collecting, and the contesters and the locator square collectors would take up bingo, which is just as much fun, with the added possibility of winning a prize, and leave the amateur bands to those of us who actually wish to practise the art of communication.
Julian V Moss G4ILO

Certainly our technical reviewers comments regarding the inability of modern receivers to handle strong signals must have some relevance here, it may even explain why so many people yearn for kilowatt linears to 'punch through the QRM' as some people put it. Perhaps we should run an international 50 watt week to persuade people that it is possible to have perfectly satisfactory QSOs without linears and large electricity bills? — G4IRO

Two pleas for 2m

Dear HRT, May I, as a fairly new G1, make two pleas through your pages?

1. To the many operators who must whistle up their transceiver or linear on the 2m SSB calling frequency, please find a *vacant* frequency as it certainly is a bit off putting if you are listening either with the volume turned up, or with ear phones to suddenly have possibly an S9+ signal



blasting through.

2. Please all operators, study the bandplan for 2m SSB and you will find that F3E isn't advised in this part of the band.

Finally, please pass my thanks and best wishes to all operators, especially those that have helped me to operate my station more effectively, with hints and tips on calling CQ and replying. PS Many thanks for a great mag!

Alan Palmer G1UIY

More on morse tests

Dear HRT, You ask how people have fared since the RSGB took over morse testing.

Shortly before the previous arrangements were discontinued I phoned my nearest Coast Station, well spoken of by other amateurs, about their procedure for testing. I was advised, in a manner that was once courteous and friendly, to phone again when I felt ready to go and arrangements would be promptly made. I could not then proceed, but now I could make a sporting shot under these conditions.

Today however I must write to the RSGB for arbitrary dates at assorted locations; obtain, fill in and return an application which may or may not be accepted; attend under possibly quite unsettling circumstances at some rally or convention, by that time in no nervous state to face two inquisitors and then wait a few more weeks to be told the result — possibly that it is all to do again. I find the proposed quite intimidating.

I was never convinced by the excuses for removing testing from

British Telecom International; certainly the fee was an inconsiderable part of the expenses of going HF. While some people are prepared to be satisfied by RSGB arrangements, it is wrong that an option was not left for those who wished to go to BTI: I urge that this option be made available, if necessary on the basis of individual negotiation with BTI. Or does someone not hold with competition?

A L Dick GM6KKP

I must confess that I do sympathise with your comments, yet some sort of 'farming out' was inevitable given the automation programme for coastal radio which has closed a number of these stations, including Oban Radio in the NW Highlands where where I sat my morse test. Even so, I can't say that the hustle and bustle of rallies and conventions constitute the ideal environment to sit any sort of exam — and it is assumed that anybody wishing to take the morse test is willing and able to travel sometimes considerable distances. My personal experience of the old system was just

like yours — a friendly, courteous and sympathetic reception. — G4IRQ.

Obscure bandplan?

Dear HRT, I was interested in Jack G5UM comments on 70cm activity, the RSGB don't help much when their band plan for 70 & 23cm doesn't state that 432.200 and 1296.200MHz are calling freqs. These freqs have been used as calling for as long as I can remember.

The change of a QSO with the receiver left on 200 is remote, so without a calling freq it's nil. Thank goodness 70cm amateurs are a sane lot and make their own rules.

John Tye G4BYV

In fairness to the RSGB their bandplan does nominate 432.200MHz and 1296.200MHz as 'narrowband centres of activity', likewise S20, SU20 and SM20 for FM calling. However, in view of the fact that most QSOs are going start out from these frequencies, perhaps they should be made a bit clearer — it took quite a bit of hunting to find the detail in our 1986 Callbook. — G4IRQ

£10 FOR THE LETTER OF THE MONTH

You've got a gripe about the bandplans, or you're sick of being wiped out by next doors microwave. Or maybe you've been bowled over by the excellent service from your local radio shop.

Whatever you've got to say about amateur radio say it here in the letters column and you could win yourself £10 for writing the letter of the month.

Send your epistles to: Letters Column, Ham Radio Today, ASP Ltd, 1 Golden Square, London W1R 3AB.

MORSE FORUM

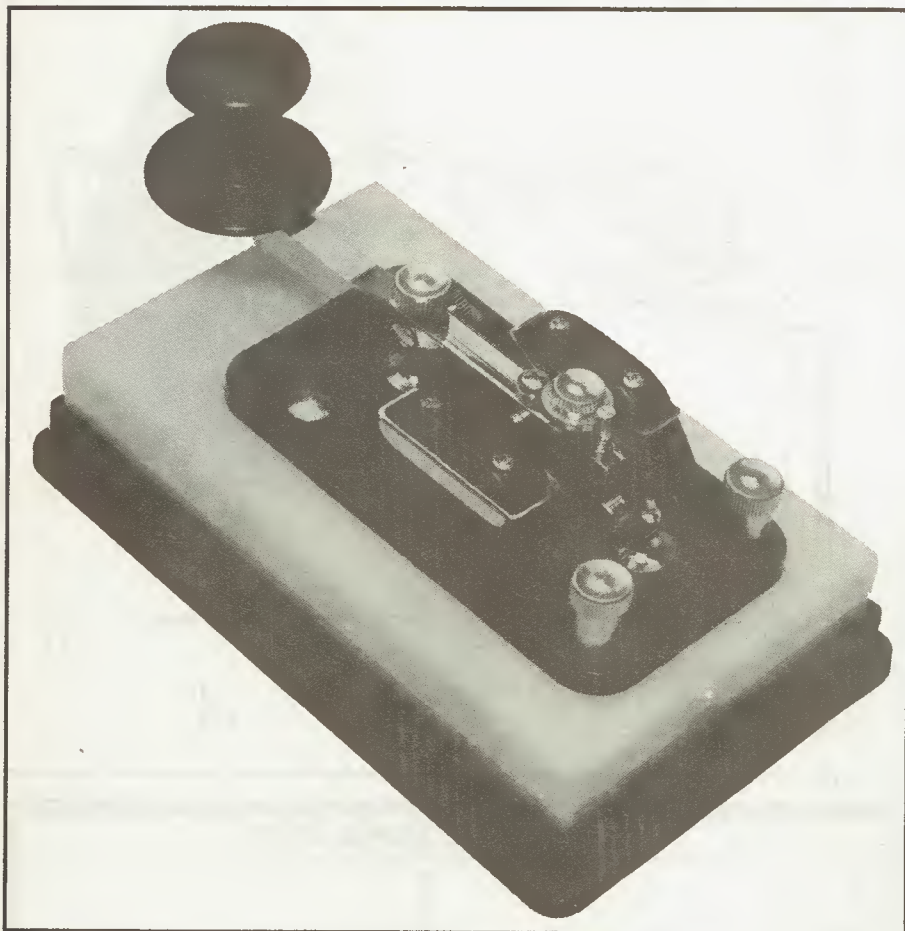

Morse code is currently enjoying something of a revival, being a cheap and easy mode to get going on. Ian Poole, G3YWX, introduces CW and the first of a series devoted to code enthusiasts.

CW is far from dead. In fact there seems to be a growing interest in its use. This can be seen by listening down in the CW segments of the bands. Here there seems to be more life than ever before. Linked to this revival in some degree is the growing interest in QRP operation. More people want to have the challenge and excitement of contacting the world on low power equipment which they have built themselves.

Of course not all this interest is due to QRP operation alone. There seems to be a general growth in interest. Manufacturers have been

quick to capitalise on this with the result that there is a large variety of equipment for sale. Automatic keyers; random morse generators for learning the code; computer software to transmit and receive morse; filters and a whole range of equipment are all freely available. In addition to this many of today's transceivers have built in electronic keyers.

Whilst all of these pieces of equipment are very useful and have their place, it is sometimes good to put them aside for an ordinary, no frills straight key.

Background to the Code

The Morse Code dates back a long way to the first code developed by Morse himself in 1835. Even before this there were other codes used with signalling fires, such as those used in the Ancient World.

However the first major milestone was the invention of the telegraph system. This resulted in a vast network of telegraphs being set up, first in the USA and slightly later in Europe. The new telegraphs enabled information to be transmitted over great distances, much faster than it had been thought possible before. The next major milestone came with the invention of wireless. Initially morse was the only mode which could be used as a spark gap transmitter could not be modulated in other ways. Even after radio transmissions could be audio modulated, morse was still very widely used. Today with the many highly sophisticated forms of modulation, morse still finds a place because of its simplicity and efficiency.

To the radio amateur 'the code' is more than just another form of modulation, it is almost another language because the abbreviations and codes which are widely used enable people from all over the world to talk to one another with little knowledge of each others languages. These abbreviations and codes are so widely accepted that they are used on 'fone' transmissions as well.

Some of these abbreviations date back to the very early days of the telegraph systems well before wireless was discovered. It has been suggested that 73 was a greeting sent from one telegraph operator onto the next. Originally it consisted of two dashes six dots and two dashes, but as the years went by it was split up into the two numbers we know today.

Other abbreviations are more obvious, such as 'agn' for again, 'wud' for would and so on. Then there are the Q codes which are an internationally agreed set of codes defined in the form of questions and answers, but which have assumed

less specific meanings in the amateur radio scene.

All of these codes and abbreviations are used and enable people to communicate quickly and easily on CW, making it a more efficient mode than many would believe.

Key Requirements

It is possible to use almost any old key to send morse, but obviously if it is well adjusted it will make life a lot easier. Not only will it make the CW a lot easier to send, but it will also make it a lot easier to read at the other end because it is much more likely to be properly spaced. In spite of this one does not have to pay too much for a reasonable key. For example it is possible to use one of the many ex-service keys quite happily. Yet if one wants to buy a new key there is a large variety to choose from. These range from the very cheap, at about five pounds or less, to the better — yet still quite economical ones at around the £20 mark. If one still wants a better key it is possible to spend up to £100 or more for an individually made key with a marble base.

Whatever key one settles for it still has to be adjusted and set up properly. The first requirement for any key is that it should not move around on the operating table. It can be very off-putting if the key starts to move or wobble in any way. Most of the cheap keys and ex-service keys need to be screwed down onto the operating table or possibly onto another base to prevent them tipping. Obviously the disadvantage with screwing them onto the table is that they are more difficult to remove when a clear surface is required for construction or for some other reason. On top of this they leave unsightly holes in the surface. For these reasons, when I had an ex-service key I mounted it onto a wooden base which had rubber feet to stop it moving.

Another important requirement is that the arm of the key should move freely. As some keys have pivot and centering adjustments these should be checked to ensure that the arm can move freely, but the adjustments should not be loose enough to cause free play in the pivot. They should also be checked to ensure that the arm is centred and the



INTERNATIONAL MORSE CODE

A . _ .	N _ _ .
B _	O _ _ _ _
C _ . _ . .	P _
D _ _ . .	Q _ _ . . .
E .	R _ . . .
F _ . . .	S . . .
G _ _ . .	T _
H	U _ . .
I . .	V
J _ . _ . .	W _ . . .
K _ . . .	X _
L _	Y _
M _ _ . .	Z _
1 _	6 _
2 _	7 _
3	8 _
4	9 _
5	0 _

Full stop	Comma _
?	= _
Wait	Mistake
Stroke (/) _	

Start of Work (CT) _	End of Message (AR)
Invitation to Transmit (K) _	Invitation for a particular station to transmit (KN) _
End of Work (VA)	

contacts align.

Finally the spring tension and the contact gaps need to be adjusted. There is no hard and fast rule for setting these except to say that it is best to use whatever suits you most. However, as a starting point it is worth setting the gap to about a sixteenth of an inch and the tension so that it returns the key positively to the 'rest' position but not so tight that it causes fatigue.

Having set up the key it is now ready to use.

Sending Good Morse

It is very much easier to send morse than to receive it, and the temptation when learning the code

is to start it as soon as possible. Very quickly this leads to bad habits developing. So in order to develop a good sending technique, or good 'fist' it is essential to leave a key alone until a reasonable proficiency has been developed in receiving.

When one is ready to start sending it is necessary to start developing a good sending technique right from the word go. Unfortunately once bad habits have developed they are very difficult to break.

The first step to good sending is to have the setting and positioning of the key right. A poorly set key or a bad sending position will adversely affect the morse which is sent. For example, if the tension in the return

spring is too low, or the contact gap is too small the characters may become indistinct and slurred as the key will stay down too long. Whereas if the tension is too high or the gap too large the sending becomes hard and choppy as there is a tendency not to hold the key down for long enough.

The positioning of the key is also very important. All too often there is insufficient space left for comfortable operation. There should be sufficient room left to allow the elbow to rest on the table. This will not only be a more relaxing position for operating, but it will also encourage a wrist movement which will improve ones sending.

The grasp of the key should also be relaxed with the forefinger at the front of the knob on the key, and the thumb and middle finger either side. Again, this is not a hard and fast rule, but it is a good starting point.

QRV CW?

Having set the key and organised the operating position the rest is up to the operator himself. In order to develop a good 'fist' it is best to start sending slowly to get used to sending with the correct ratios of dots and dashes and the correct spacing. Only when this has been done should the speed be increased. It is also worth recording some of your morse from time to time and listening to it critically afterwards. In this way it will be possible to detect any bad sending habits before they become established and become too difficult to change.

Having properly mastered a straight key it can be surprisingly easy and enjoyable to use. This is probably why many people who can use high speed keyers very proficiently still like to blow the dust off their straight keys for a session of brass pounding. So why not join the ever increasing number of CW buffs and discover how rewarding it can be.

Contributions to 'Morse Forum' in the shape of news, hints, tips, Morse classes and contest details will be most welcome - please send your information to either Ian Poole, QTHR or direct to the 'Ham Radio Today' editorial offices at the address shown on the 'Contents' page.

Q Code	Meaning
QRG	Will you tell me my exact frequency in kilohertz? Your exact frequency is
QRH	Does my frequency vary? Your frequency varies.
QRI	How is the tone of my transmission? The tone of your transmission is (1—good, 2—variable, 3—bad).
QRK	What is the intelligibility of my signals? The intelligibility of your signals is (1—unintelligible to 5—perfectly intelligible).
QRL	Are you busy? I am busy. Please do not interfere.
QRM	Is my transmission being interfered with? Your transmission is being interfered with.
QRN	Are you troubled by static? I am troubled by static.
QRO	Shall I increase power? Increase power.
QRP	Shall I decrease power? Decrease power.
QRQ	Shall I send faster? Send faster, _____ words per minute.
QRS	Shall I send slower? Send slower, _____ words per minute.
QRT	Must I stop sending? Stop sending.
QRU	Have you anything for me? I have nothing for you.
QRV	Are you ready? I am ready.
QRX	When will you call again (on _____ kHz)? I will call you again at (hours) on _____ kHz.
QRZ	Who is calling me? You are being called by _____ on _____ kHz.
QSA	What is the strength of my signals? The strength of your signals is (from 1—barely audible to 5—extremely strong).
QSB	Are my signals fading? Your signals are fading.
QSL	Can you acknowledge receipt? I acknowledge receipt.
QSO	Can you communicate with _____ direct or by relay? I can communicate with _____ direct or by relay through _____.
QSP	Will you relay to _____? I will relay to _____.
QSY	Shall I change to another frequency? Change to another frequency or to _____ kHz.
QTC	How many messages have you to send? I have _____ messages to send.
QTH	What is your location? My location is _____.
QTR	What is the correct time? The correct time is _____.

EDDYSTONE 1650 REVIEW

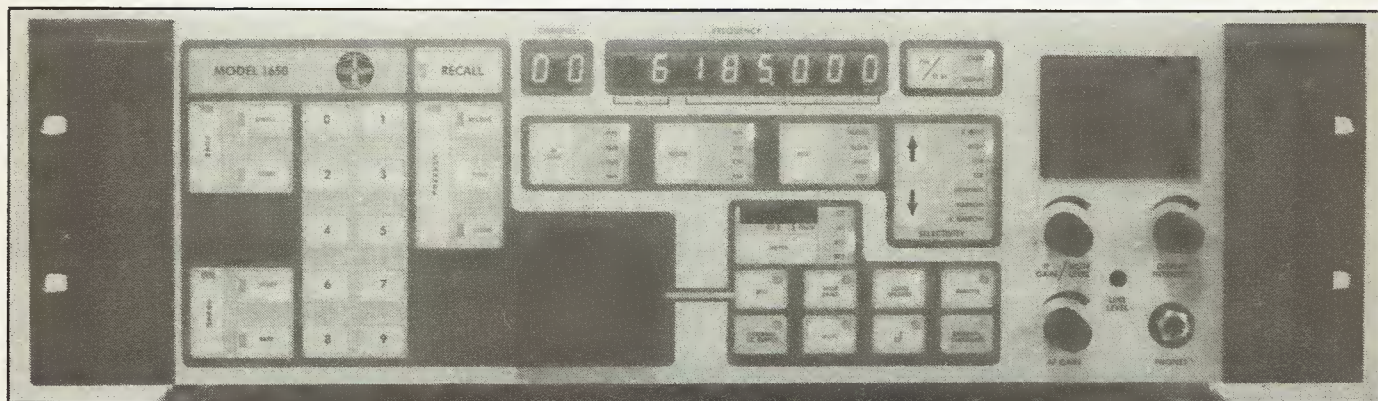

The Eddystone 1650 receiver.

Super rig and super price, but just what do professional users get for their money in the 'ultimate rig' market? Chris Lorek, G4HCL, casts an envious eye over the new Eddystone 1650 receiver

OK, you've now had your HF station set up for a while, complete with the 'ultimate' in amateur gear and the associated 'ultimate' aerial array. Certificates are starting to adorn your shack wall. Either as a transmitting amateur or primarily as a listening station, you feel that you could go just that bit better, a larger aerial will put a better radiated signal out but unless you go to the extent of something like a huge rotatable log periodic array you'll probably just end up putting more attenuation in your receiver to counteract the never ending 'power struggle' on the HF bands. I sometimes sympathize with amateur QRP devotees in this ongoing power rat-race, as communications efficiency is often dependant upon extracting weak signals from the high power QRM, rather than the signal itself not getting there in the first place.

What's The Solution?

Rather than campaign for all the propaganda and other stations to reduce their power, the remedy can only lie in improving your receiver's

immunity to strong adjacent frequency signal reception. Advances in HF receiver technology have brought us transistors and IC's, the digital synthesiser, reliability, and an overall deterioration in strong signal handling, when compared to receivers of the 'good old days'! I recently visited the shack of a very experienced HF listener, equipped with all mod cons such as Data, TOR, Fax, and weather satellite reception facilities. His £900 latest all-singing Japanese receiver was placed to one side in favour of his veteran Eddystone valve receiver, simply because it pulled the signals out of the never ending QRM when the other failed.

CQ DX, CQ DX

If you're an LF/HF DXer, take a look at ON4UN's excellent book on 80m DXing, or W9KNI's 'The Complete DXer', and see what the leading DX stations use. You won't find the latest transceivers, in fact you won't find *any* transceivers, as they use separate receivers, of the 'classic' makes not originating from the land of the rising sun.

Eddystone's latest offering, that may be of interest to the amateur wanting the best of everything, is the Model 1650 receiver covering 10kHz to 30MHz. As would be expected, the price tag of just over £3000 plus VAT reflects it's performance. Do you get what you pay for, or would you be better sticking with your trusty transceiver? It depends what you're after. If you're a casual listener, not too worried about reliable communication then it may be *too* good, if however you wish to be able to receive signals where all others fail then read on to see what it can offer. Alternatively you might, like me, just like to see what you can't afford!

Features

The receiver offers complete coverage of 10kHz to 30MHz in 5Hz increments, the frequency control being commanded by direct key entry, tuning knob, or remotely from a computer. AM, USB, LSB CW modes are selectable, together with bandwidth, AGC, RF sensitivity and BFO injection frequency. FSK or NBFM operation is available as an option if required. 99 memories are available each storing any combination of the above together with the reception frequency. Memories may be independantly selected or may be scanned with a user selected scanning rate of 1 to 99 seconds reception time per channel. A sweep mode is also available, where the receiver automatically tunes bet-

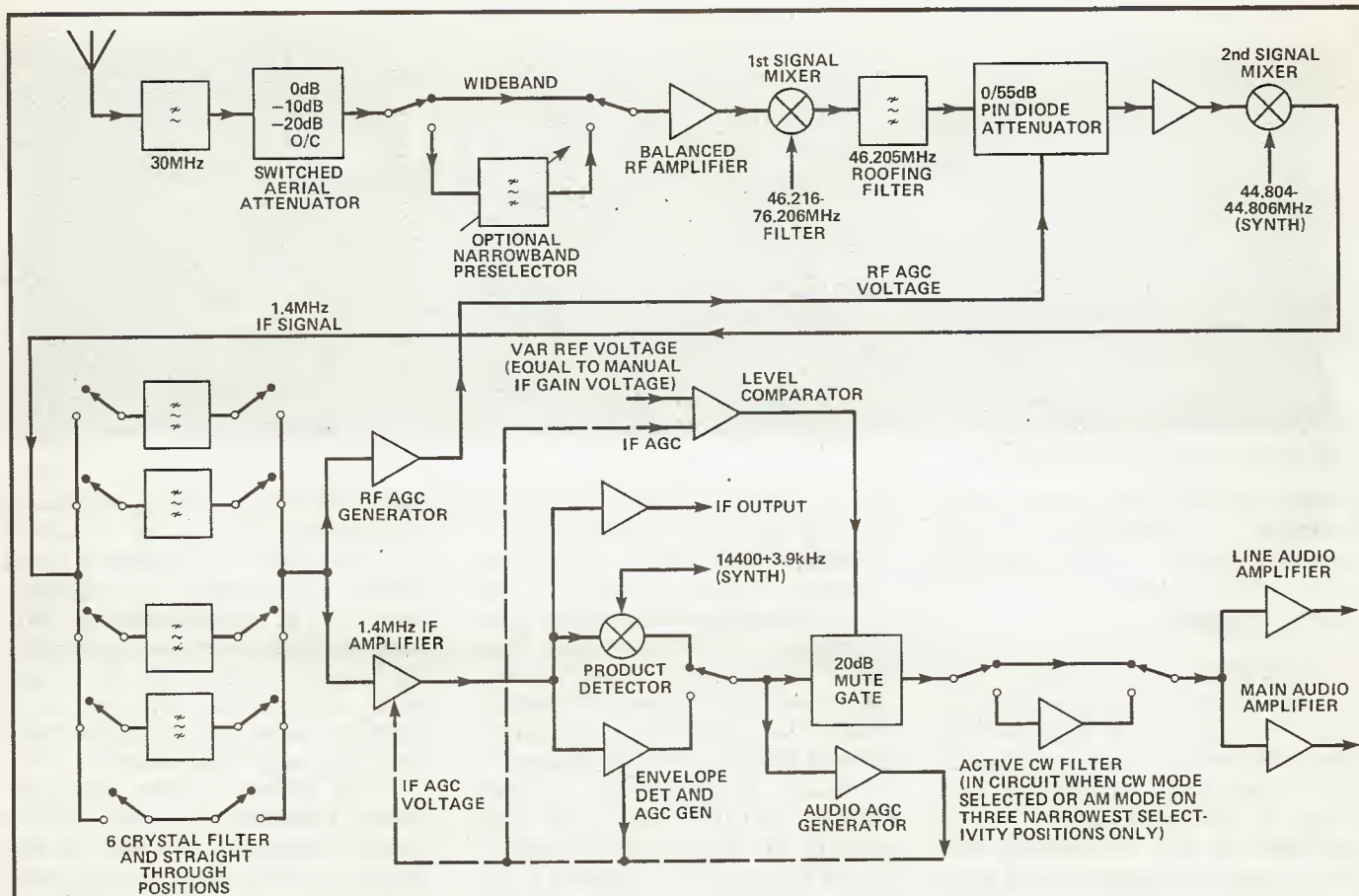

Fig.1 Block diagram of the Eddystone 1650.

ween the frequencies stored in two sequential memories, the sweep rate being adjustable from 1kHz to 29kHz per second. All front panel controls are fitted on a sealed membrane panel, with a switchable tone bleep signifying each correct control entry.

Six receive bandwidths are available, these being Very Narrow (400Hz), Narrow (1kHz), Intermediate (3kHz), SSB (2.4kHz), Wide (8kHz), and Very Wide (14kHz), using individual crystal filters for the narrow modes together with a roofing filter used in the Very Wide position. The AGC may be switched to operate on audio level, on RF level (with fast or slow decay) or may be switched off altogether and the overall gain manually controlled with the IF gain control. When AGC is used, the IF gain control functions as an audio mute, similar to a carrier-operated variable squelch, giving a 20dB reduction in audio output when muted, this control being enabled by a front panel mounted push button. An RF attenuator of 10dB and 20dB may be switched in if required, and a 'MIN' sensitivity position disconnects the aerial input

via an internal relay. A 10-segment LED bargraph indicator provides a meter function of signal strength, audio output line level, or signal centre zero.

The optional front end pre-selector (more of this later) may be switched in or out as required by a further push button, other controls allow CW/FSK BFO injection frequency variation between ± 3.9 kHz, loudspeaker on/off, display dimming down to zero, meter function, remote control, and keyboard tone on/off. A preset line level control allows adjustment of the 600ohm audio output level from zero to 30mW. Besides this output, a small front panel mounted loudspeaker may be used, or mono headphones via the adjacent jack socket.

The receiver can be mounted in a standard 19 inch rack, or may be supplied in a case suitable for desk or benchtop use. The dimensions of the rackmount version (as supplied for review) are 133mm(H) \times 500mm(D) \times 483mm(W), the set weighs approximately 19kg. The benchtop version is 164mm(H) \times 560mm(D) \times 502mm(W) and

weighing in at around 23kg. A very comprehensive manual is supplied with the receiver, giving full operation and servicing information. Power requirements are standard mains AC or 24V DC, the latter being automatically enabled if the mains supply fails.

Remote Control

A rear panel mounted 9 pin D connector allows full remote control using serial asynchronous data at 1200 baud, which allows operation and interrogation of all functions apart from loudspeaker monitoring, display intensity, line output level and 'standby' switching. Manual IF gain/mute level and meter outputs are available as analogue levels. A 25 way D connector on the rear gives loudspeaker and 600 ohm audio outputs, and inputs for sidetone, RF and AF mute, IF desense, and ground connections. A large earth tag is used for RF earthing, and BNC sockets are used for aerial input and 1.4MHz receiver IF output.

The entire receiver could be remotely mounted and possibly a control unit built and linked to a

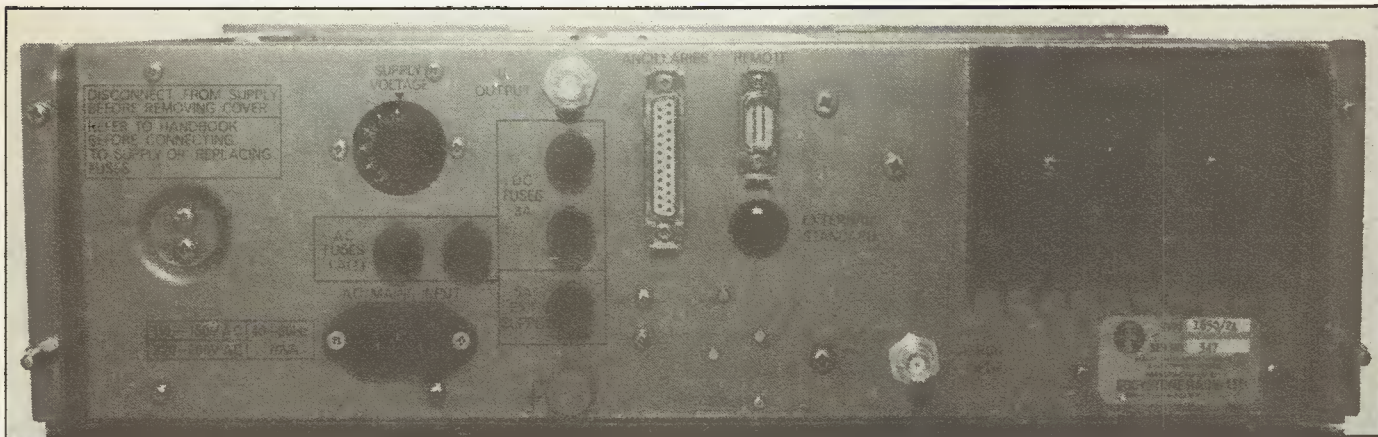

Rear panel connections on the 1650.

home computer, to provide greater flexibility if required. A complete matching remote control panel for the receiver is available from Eddystone if required.

Circuitry

The accompanying block diagram shows that a conventional approach has been used in the lineup, however it's the details that count of course and one can be confident in the knowledge that good design techniques have been used.

The aerial signal is passed via a 30MHz Low Pass Filter and switched attenuator to an optional narrow-band preselector, which was fitted to the review model. The preselector consists of eight bandpass tuned circuits used between 150kHz-30MHz, together with a fixed low pass filter below 150kHz. A novel feature is that the relevant circuit is automatically tuned, under synthesiser control, to precise resonance by using a motor driven airspaced variable capacitor gang! The output from the preselector (or attenuator if bypassed) is passed to a balanced RF amplifier using a pair of 'beefy' BFW30 transistors having a flat response from 100kHz to 30MHz, with negative feedback giving a gradual gain reduction below 100kHz. Differential outputs from this stage drive an SL6440C high level double-balanced mixer, where the resultant 46.205MHz IF signal is passed through a 16kHz roofing filter.

Up to 55dB of RF AGC is achieved from a double bridged 'T' pin diode attenuator, following which a BFX89 first IF Amp stage feeds a further SL6640C mixer to provide the second IF of 1.4MHz.

Here one of six crystals filters are used to provide narrow selectivity, however in the 'very wide' position the signal is diverted straight through and the resultant selectivity is determined by the 46MHz roofing filter. The IF signal is then amplified by a pair of MC1350P's and a BFR54, followed by an SL1625 envelope detector and SL1641 product detector.

Audio amplification follows, together with an audio CW filter peaking at 800-1000Hz placed in circuit whenever CW mode is selected, or when AM together with the three narrowest selectivity positions are used. 1W of loudspeaker audio is generated by a TBA810S IC, together with an SL1621 which controls audio AGC when selected.

Local oscillator injection is generated by a dual 40673 FET oscillator with reed relay switched tuned circuits, feeding an SP8690B prescaler and HEF4751 programmable divider. The HEF4750 phase comparator employs both analogue and digital phase comparators to give the best possible noise performance; an oven controlled crystal standard provides an accurate frequency reference for the synthesiser. A 6802P microprocessor and peripheral components perform all the 'housekeeping' functions and a lithium battery provides memory backup in the absence of power.

Impressions

A common complaint of several modern receivers is the use of switched input tuned circuits with each one covering an octave or so of frequency rather than a continually tuned preselector control. Using varicap diodes in a receiver front end to perform a tuning function can

often introduce mixing problems between strong signals; in the 'old days' one had a mechanically tuned preselector control which overcame this — but at the expense of control flexibility. Eddystone have performed this function with a motor driven unit inside the receiver, all done automatically when you type the frequency in, very nice indeed!

The ability to store every required parameter in memory for manual selection, as well as the ability to control virtually everything remotely from a computer offers a great deal for those who want everything at their fingertips. However for manual use I took a great dislike to the membrane keypad which despite their advantages, I find difficult to use. In speaking with other amateurs and computer users I find that I'm certainly not alone in my thinking. The set was of course designed with professional users in mind and built to withstand tough treatment, so at least it should carry on working if I spill my coffee on it!

On the air

I coupled the receiver up to my LF/HF trap dipole and rotary HF beam system, using a multiway coax switch which also served my FRG7700M receiver and FT107M transceiver for comparison purposes. My thoughts about the membrane panel were confirmed when I started to use the receiver and I found it annoying when entering commands. This, aside, I loaded the memories with my favourite frequencies and started listening. The result, pure bliss! Gone were the 'burbling' noises in the background of weak signals caused by internal mixing products. Tuning across strong broadcast stations in

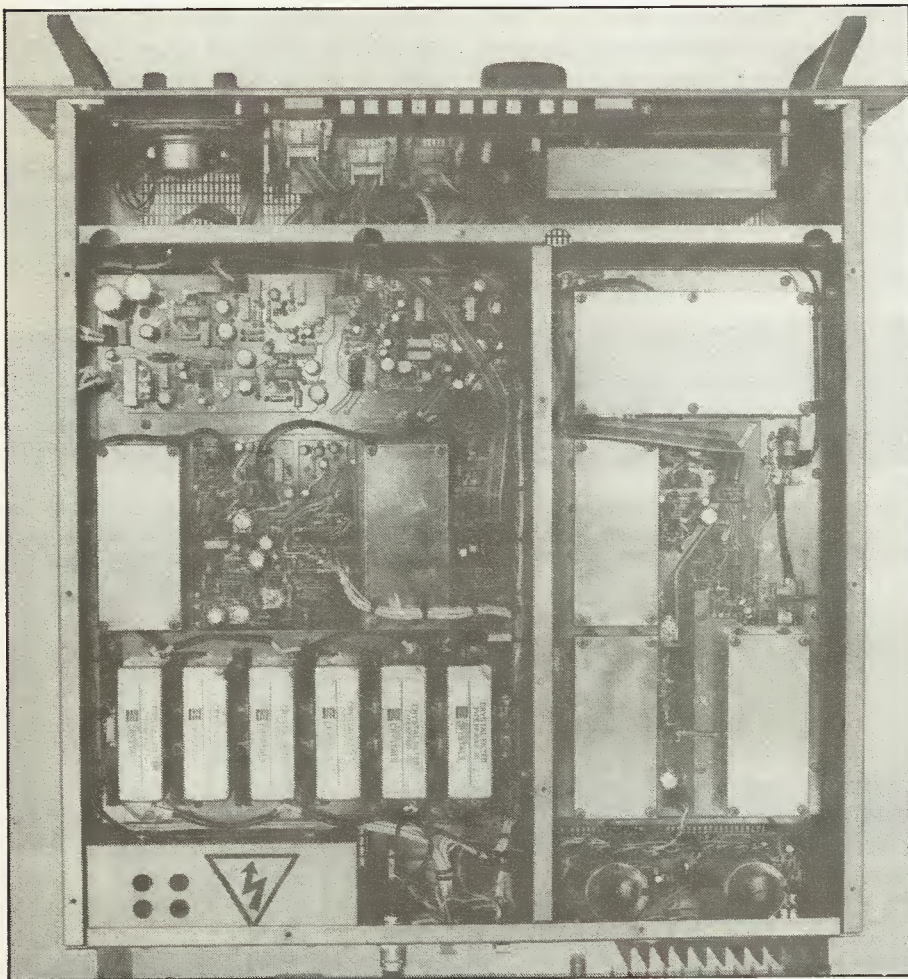

Internal view from above.

particular showed a remarkable degree of rejection of unwanted adjacent signals and the stations literally came and went as I tuned, rather than sensing there was a strong signal coming up through limitations in receiver selectivity. Very nice indeed. Listening to 80m and 40m DX at night was limited only by splatter from other stations rather than blocking problems whilst switching between my general coverage RX and the Eddystone showed that there was no contest whatsoever. I could find no hint of reciprocal mixing caused by synthesiser phase noise, which is often the limiting factor in selectivity in modern receivers no matter how good their crystal filters are.

Operationally, I found the mute facility useful in monitoring a frequency, but I was rather annoyed at the scanning mode not being able to be quickly stopped on reception of a wanted signal even though it lifted the mute (see later). In the end, I set the scanning rate to 99 seconds and manually altered the scanned chan-

nel 'start' frequency with the main tuning knob, hence providing a more convenient memory search. I did notice that on scanning, there was sometimes a pause of a couple of seconds before full sensitivity occurred, no matter what delay time the AGC was set to. Full sensitivity then appeared following a quiet electrical 'crackle' from the speaker. At first I thought a fault was present, but upon further investigation I found this to be due to the pre-selector motor doing its job in tuning the variable capacitor bank! Searching for signals with the receiver switched to 'Wideband' mode allowed rapid operation of course. Using the main tuning knob provided a smooth tuning rate whilst spinning the knob quickly increased the tune rate, allowing a fast QSX as an alternative to the membrane keypad.

The small internal speaker was simply not man enough for main station use, being very inefficient and limited in frequency range, an external speaker is available of course and would normally be used.

I found the RF AGC sometimes showed a limited attack time, giving a slight burst of distortion at the beginning of SSB speech syllables or bursts of CW and I tended to prefer the audio derived AGC which did not suffer from this. The latter has a fixed 'hang' time of a few seconds, after which the sensitivity increases very quickly. Some operators prefer this while others detest it, but at least in this receiver you do have a choice between the two.

Laboratory Tests

In a single sentence, the lab results were excellent. Where the dynamic range exceeded 110dB (as it often did). I considered absolute measurements totally hypercritical, one must stop somewhere! In measuring the excellent selectivity, the receiver totally outperformed most modern signal generators. Transistor oscillators were useless for measurement sources so I eventually had to use a valve oscillator in a high-Q resonant cavity at 10.7MHz with a cavity attenuator and in-line matched crystal filter. Using this setup, I managed to measure a better skirt selectivity than Eddystone claims as typical in each case, due to the low level of generator induced noise apparently widening the real selectivity performance. Of note is the very good shape factor of 1.3 in the 'Wide' position, as would be used for AM reception, and 1.4 in the SSB positions. The crystal filter bank comprises a large part of the final cost of this receiver and it is good to see that sensible synthesiser design has been used to get the best out of it.

Forthcoming Facelift

In communication with Eddystone regarding the scanning limitations, it appears that a slightly improved version of this receiver in terms of operational flexibility will shortly be available. Apart from a built-in self-check facility, the scan will be automatically halted on occupied channels with variable 'hold' and 'dwell' times. The sweep tuning step rate, together with the manual rotary tuning step rate, will also be variable between 10Hz and 99.99kHz. Four independently selectable aerial connections are catered for and the memory channels also offer a storage facility for these. I'm

told there is little difference in price as well!

Conclusions

If all the above has left you drooling, then make sure you've got a sympathetic bank manager! It is not a cheap receiver for the average amateur. However, if you take a

typical Eddystone receiver from years gone by and translate its price into real terms today, you'll not find much difference. HF amateur transceivers can now cost over £2,000 so it makes you think doesn't it? For me, I'll stick to my inferior transceiver, not being such an HF devotee as many others, but it's nice to see what we're missing. For the enthus-

iasts who can afford it, it'll mean those few extra DX contacts in their logs, and the realization that 'this is the best.'

My thanks go to Lowe Electronics, UK Eddystone Distributors, for the loan of the receiver and to Chris Pettitt and Roger Sutton of Eddystone Radio Ltd.

Laboratory Results

Overall Bandwidth: Measured at 10.7MHz.

Filter b/w	-3dB	-6dB	-60dB
V. Wide	15.99kHz	16.53kHz	29.21
Wide	8.14	8.62	11.24
USB	2.25	2.50	3.47
LSB	2.19	2.41	3.28
Intermed	3.22	3.49	5.08
Narrow	1.19	1.23	2.13
V. Narrow	0.54	0.60	2.05

Sensitivity: Input level in μV p.d. at 50 ohm SO239 connection giving 12dB SINAD.

FREQ (MHz)	SSB 'USB' b/w	AM (30% mod) 'Wide' b/w
0.500	0.48	2.9
1.0	0.53	2.7
2.0	0.57	3.5
4.0	0.97	5.3
6.0	0.68	4.3
8.0	0.67	4.2
10.0	0.58	3.1
12.0	0.49	3.0
14.0	0.52	2.9
16.0	0.57	3.2
18.0	0.65	4.1
20.0	0.65	3.9
22.0	0.71	3.6
24.0	0.66	4.1
26.0	0.65	4.7
28.0	0.72	4.8
30.0	0.88	4.9

S-Meter Readout: 'RF2' Measured at 14.25 MHz.

LED Segments	Signal Level
1	0.92 μV pd 0dB ref
2	0.98 +0.5dB
3	1.05 +1.1
4	1.29 +2.9
5	1.60 +4.8
6	2.28 +7.9
7	27.0 and above +29.3

Intermodulation Rejection: Level of two signals, separated by +100kHz and +200kHz, required to cause 12dB SINAD on-channel signal, measured using SSB and USB RX bandwidth.

RX Freq (MHz)	Interfering Signal Level
2.0	20.2mV pd 91.0dB
7.0	27.1 92.3
15.0	18.8 90.5
28.0	19.2 88.5

NB: 'RF1', when selected, commences strong-signal display at signal levels above 500 μV pd.

Image Rejection: Level of signal separated by (2 x 46.205MHz) to cause 12 dB SINAD on-channel signal, measured using SSB and USB RX bandwidth.

RX Freq (MHz)	Interfering Signal Level
2.0 MHz	>0.3V pd >110dB
7.0	>0.3V >110
15.0	>0.3V >110
28.0	160mV >107

Blocking Rejection: Level of unmodulated interfering carrier required to cause degradation of 12dB SINAD on-channel signal to 6dB SINAD, measured using SSB and USB RX bandwidth.

RX Freq (MHz)	Interfering signal separation		
	+100kHz	+1MHz	+10MHz
2.0	>0.3V pd >110dB	>0.3V pd >110dB	>0.3V pd >110dB
7.0	>0.3V pd >110dB	>0.3V pd >110dB	>0.3V pd >110dB
15.0	71mV pd 102dB	0.18V pd 110dB	>0.3V >110dB
28.0	0.16V pd 107dB	>0.3V pd >110dB	>0.3V pd >110dB

Attenuator Performance: Measured at 14.25MHz.

Setting	Measured
10dB	10.5dB
20dB	20.5dB
Min	51.0dB

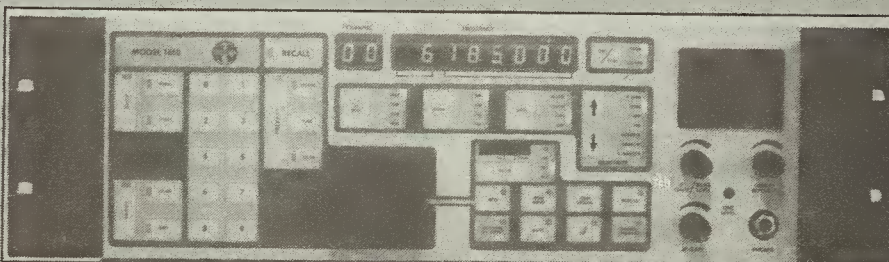

MACHRIHANISH

end of a dream

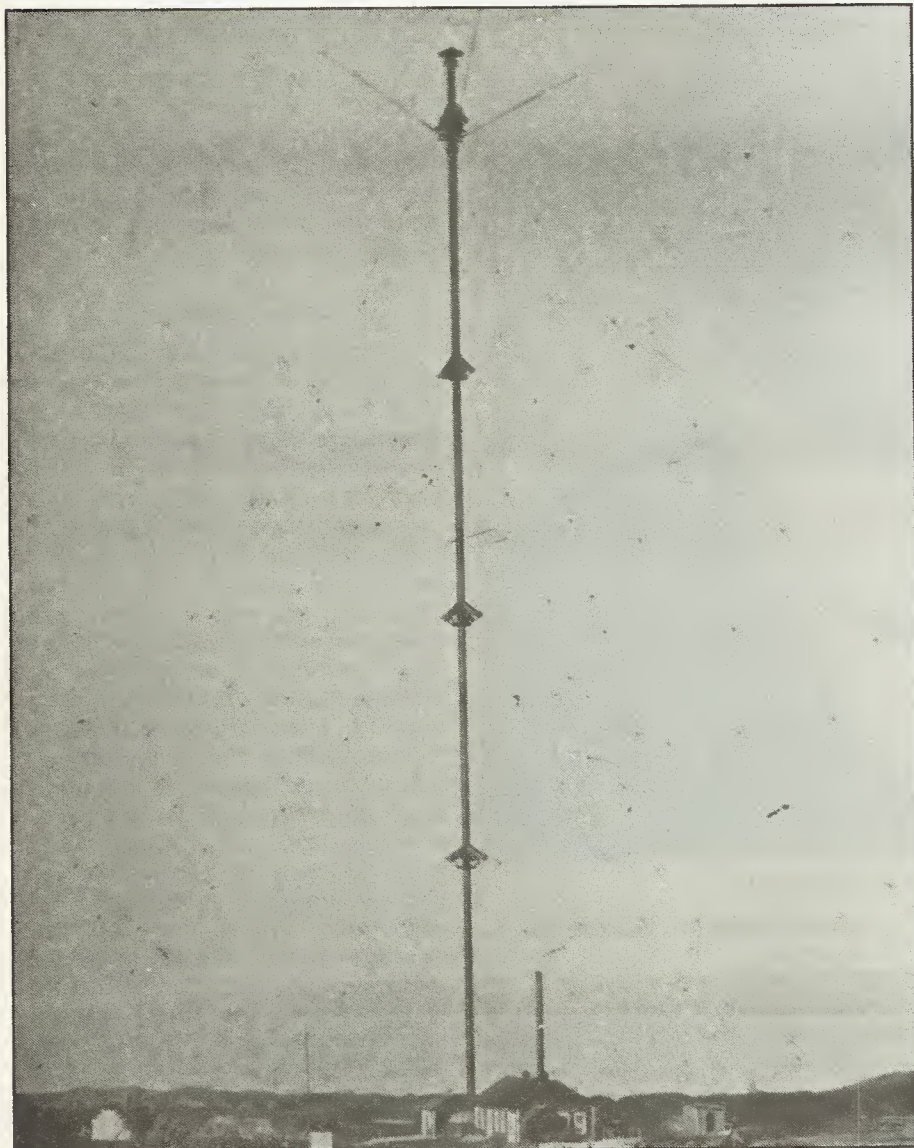

Machrihanish Wireless station eighty - one years ago — not even the massive 420ft tower could survive the highland weather.

Where? If it hadn't been for the Scottish weather Marconi, and Poldhu might have been replaced in radio history by Fessenden and the name of a small highland village. Tim Wander, G6GUX, tells this fascinating tale.

Saturday the 8th of December 1987 will mark the Eighty First anniversary of the collapse of the huge Machrihanish wireless station that very nearly gave that small Scottish village a place in wireless history.

The turn of this century saw many inventors and scientists chasing the new art of 'wire-less' communication. A young Italian called Guglielmo Marconi fresh from the success of his first permanent

wireless stations on the Isle of Wight was rapidly pushing toward his great triumph of transmitting the morse letter 'S' some 2,170 miles across the Atlantic ocean. In America a Canadian inventor called Professor Reginald Aubrey Fessenden (1868-1932), had by the November of 1900 actually achieved the transmission of highly distorted, but recognisable speech. His quest for greater quality led to rapid development of his equipment and by late 1905 the transmission of speech using Fessenden's systems was much improved. However morse code was still used due to the simplicity of transmission and on the 3rd of January 1906 Fessenden was the first to repeatedly exchange a wireless signal across the Atlantic ocean. The morse letter D was used, and the wireless stations involved were located at Brant Rock in Massachusetts and at Machrihanish on the far western coast of Scotland.

Fessenden and telephony

Fessenden was ecstatic even though he had always despised morse code as a means of communication. His career was dominated by the thought of sending voices through the air, and more importantly a dream to surpass the achievements of Marconi and actually send voices across the Atlantic using a wireless. In the middle of November 1906 his chance came when a letter, marked personal and private, arrived from the operator at the Machrihanish wireless station, a certain Mr Armor. The letter contained the following paragraph.

"At four o'clock in the morning I was listening for telegraph signals from Brant Rock when to my astonishment I heard instead of dots and dashes the voice of Mr Stein (the Brant Rock operator) telling Plymouth how to run their dynamo."

The Plymouth (USA) site was in



Professor R. A. Fessenden. Photo courtesy of Marconi Ltd.

fact another of Fessenden's wireless stations some eleven miles up the coast from Brant Rock, and it was usual for the two operators to use speech over this short distance. However for the Machrihanish operator to overhear this conversation was almost unbelievable, but the log-books and operators accounts were all checked and re-checked and they tallied completely. Fessenden was overjoyed for there could be no doubt that speech *had* crossed the Atlantic ocean, albeit by accident. His equipment had been working exceptionally well of late in the early hours of the morning the echo of morse signals from the Scotland station could clearly be heard one fifth of a second later, having travelled the long way around the earth. History had been made, but if your name is Fessenden you refuse to announce your success to the world until you are certain of reproducible results.

Machrihanish Wireless Station

The station at Machrihanish is first mentioned in the now defunct Argyllshire Herald on Saturday 6th May 1905 when negotiations for a six acre site at Uisaed point in Machrihanish Bay were rapidly nearing completion. Fessenden's National Electric Signalling Company leased the land from the local landowner Captain MacNeal for a period of six years with an option on termination after two years.

Construction of the wireless station started on the 1st of August 1905 by the Brown Hoisting Machinery Company of Cleveland, Ohio. The tower was built in tubular sections some five feet in diameter, and when completed the mast was 420 feet high with an internal continuous ladder to the top. To support the mast it was guyed at 100 foot

intervals using four platforms and its base was mounted on a large concrete block via a ball and joint arrangement. The radiating aerial was provided by a mushroom-shaped arrangement of wires strung between three 50 foot cross-spars at the top of the mast. To provide a ground-plane for the aerial system the entire station perimeter was fenced off, and the whole area was covered with a grid of wires laid in shallow earth-filled trenches. These were 'earthed' by joining all the ends of the wires and burying them in a deep trench that ran along the shoreline at sea level.

Disaster Strikes

The planned public demonstration of speech crossing the Atlantic ocean was six days off when, as the Argyllshire Herald reported on Saturday 8th December, disaster struck. From early Wednesday morning, a storm had raged that pounded the transmitter building with squalls of exceptional velocity, until by mid-day when the gale was at its height the mast was visibly swaying backwards and forwards. Shortly before one o'clock in the afternoon, without warning, one of the stays parted on the west side of the mast. People for miles around were startled by the loud double report as the tower snapped, and then crashed to the ground. The mast narrowly missed the transmitter building and machinery house, but did little damage beside breaking a few windows. The direction of collapse is marked on the map, with the bottom 100ft section falling to the north, and the remaining 320ft falling backwards (south) as the tower buckled. The top section hit the ground so hard that it was completely flattened and deeply embedded, but even the bottom section was smashed and twisted beyond repair. The 70 tons of metalwork that had taken months to painstakingly erect was in a few moments rendered to a wrecked mass of shapeless metal.

There, like Fessenden's dream of transatlantic communication by voice, it lay in pieces amongst the jagged rocks and foaming seas of a Scottish headland. The site manager Mr H J Glaubitz gave the local press a statement where he deplored the loss of the mast, but bravely

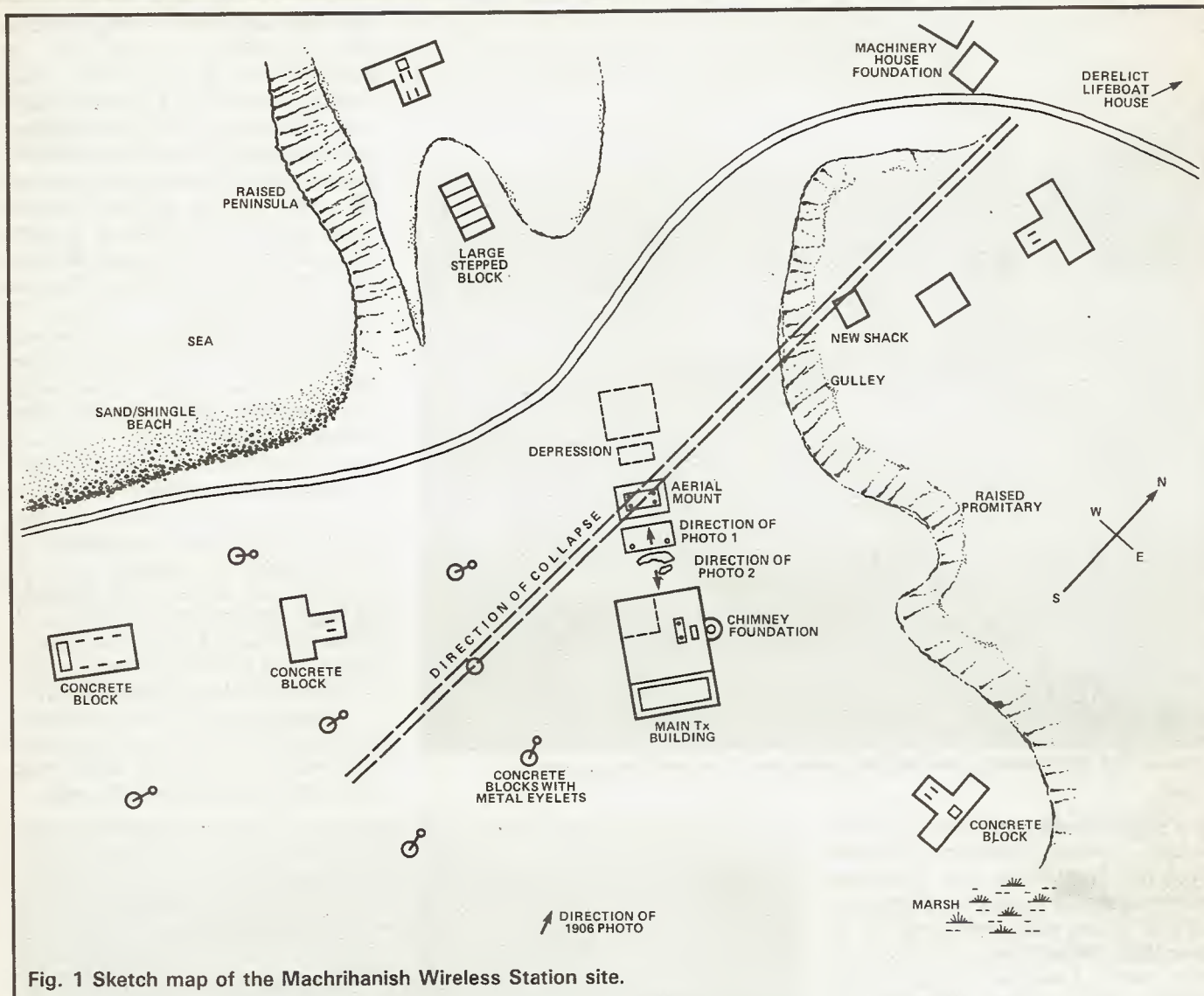

Fig. 1 Sketch map of the Machrihanish Wireless Station site.

announced that it would soon be rebuilt. However it was not to be, as the financial loss caused by the collapse was equal to the structural damage. Within weeks the staff had left, the station was soon dismantled and Machrihanish became another monument to the pioneering days of radio.

Christmas broadcast

To bolster his sagging spirits after the collapse of the Machrihanish radio station and the end of his transatlantic speech experiments, Fessenden decided to organise a Christmas wireless concert. His initial speech tests went out on the 11th December, just six days after the collapse at Machrihanish. The modulation of the spark transmitter was achieved by connecting the water cooled microphone directly into the aerial circuit. The transmitter used a high frequency

AC alternator to finally radiate a signal of around 1kW at 80kHz. Fessenden then set about presenting the world's first advertised broadcast of speech and music using the remaining radio mast at Brant Rock in Massachusetts.

At exactly nine o'clock, a general CQ call to all stations was sent out in morse code, whereupon Fessenden stepped to the microphone and gave a short speech about the programme to follow. The Edison phonograph squeaked out a solo voice singing Handel's Largo, and Fessenden quickly fiddled through his own version of Gounod's 'O, Holy Night', even managing to sing the last verse as he played. As his helpers voices froze from microphone shyness, Fessenden read a passage from the Bible and closed the festive broadcast by wishing his listeners a Merry Christmas and advising that the program would be

repeated on New Year's Eve. The words and music were picked up by a number of US Navy radio operators, on some banana boats from the United Fruit Company and by a few amateurs who lived within a five mile range of the radio station. The second broadcast on New Year's Eve gave the world a brief glimpse of the future, when with far more favourable atmospheric conditions, reliable reception was reported from as far away as the West Indies.

The loss of the Machrihanish station had been a great setback, but with Fessenden's other successes the NESCO (National Electric Signalling Co.) was launched as an inventors laboratory with the backers pouring millions into the enterprise. However further research into the transmission of speech led to no practical system, the Company was mismanaged, and by 1910 it had collapsed in dispute and acrimony. At



View to the NW showing the original aerial mount in the foreground.

one stage armed detectives actually forcibly evicted Fessenden's team from the Brant Rock site. The loyal staff eventually retook the transmitter hut armed with shotguns, but it was obvious that the grand scheme was over. Lawyers fought over patent and contract infringement (Fessenden had over 500 to his name), but the Company soon went bankrupt and disappeared from the history of radio. On the 31st of March 1928, Fessenden finally won the court battles and recouped something of the thousands owed to him. However by then history had passed Reginald Fessenden by, for broadcasting was well established on both sides of the Atlantic and no wireless company bore Fessenden's name.

Machrihanish Today

Machrihanish is a magnificent bay with a curving broad belt of fine white sand that stretches for nearly six miles on the Western Scottish coast of the Kintyre peninsula. It is noted for its golf course, but few now remember the wireless station that once stood on the headland even though the site is quite easy to

find. The A83 from Campbeltown joins the B843 into the town of Machrihanish although this road quickly peters out to a single carriage road just through the village. Before this road rises onto the headland there is a white cottage set back on the right, with a derelict lifeboat house in the near distance. A right turn just after this cottage down a gated track takes you past the old lifeboat house and a further 100 yards brings you to the foundations of the station. The ground is littered with numerous anchor blocks with metal eyelets and several huge concrete aerial mounts complete with rusted nuts and bolts. There is nothing on the remote headland to tell the story of the Machrihanish wireless station, indeed passers by refer vaguely to 'something to do with the war'. Sheep now graze by the large concrete blocks and foundations that mark where Fessenden's station rose and fell, perhaps a site for future 'Wireless Archaeologists'?

I would like to thank Campbeltown Public Library and the Tourist Information Office for their help during my visit to Machrihanish.

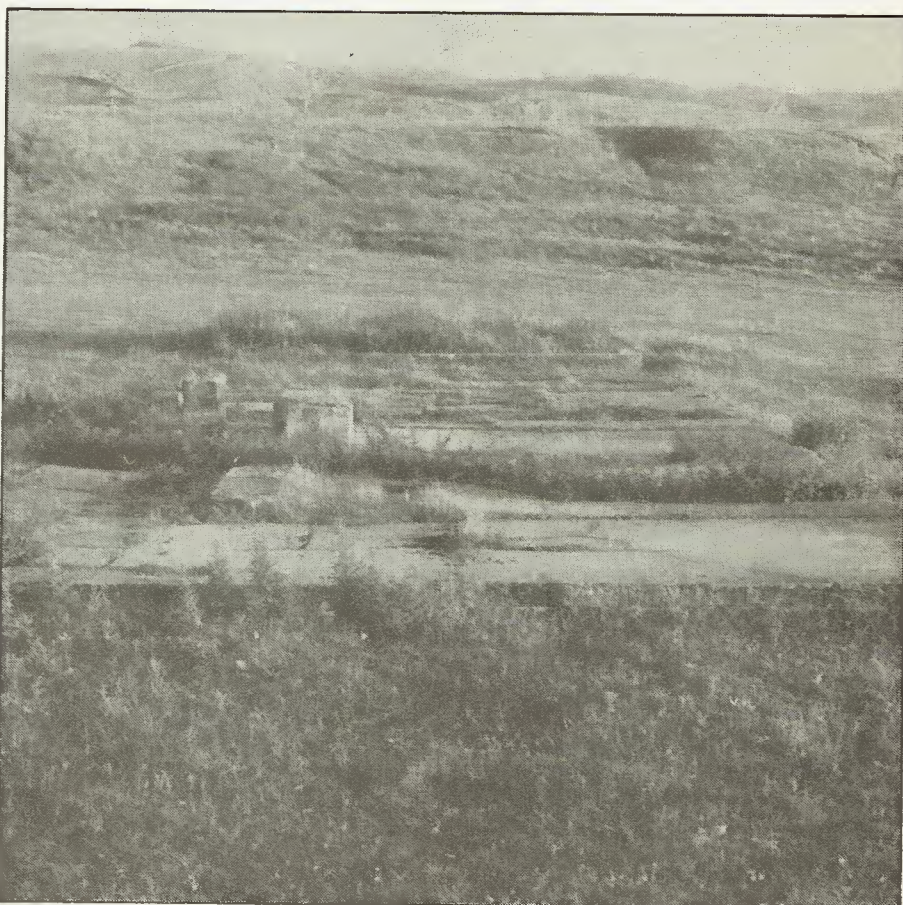

The view to the SE shows what little remains of the transmitter building.

RADIO TODAY

IARU Conference

The IARU is probably best described as the United Nations of amateur radio societies. Most national societies are members, so anyone who is a member of a national society such as the RSGB — is automatically also a member of the IARU.

For administration purposes, the IARU is split into three regional divisions. The UK, along with the rest of Europe, Africa and part of the Middle East, belongs to region 1. The American continent forms region 2, while region 3 is made up of the rest of the world, ie, Australia, New Zealand and most of Asia. Most IARU business is conducted by post or in meetings of small sub-groups and committees, but once every three years a conference is organised for each region.

A conference of region 1 member societies was held in April of this year in the Dutch town of Noordwijkerhout and was attended by over 150 delegates from 41 countries, including places as far afield as Iceland, the Societ Union, Kenya and the Sultanate of Oman.

170 papers had been submitted, on a wide variety of subjects including band planning, the co-ordination of con-

tests, amateur band intruders, packet radio and procedures for meteor scatter and EME. The delegates met in plenary sessions during the day, with working group meetings being held in the evenings (and occasionally during the lunch hour!) to discuss more specialised subjects such as EMC, direction finding, the CEPT Licence and the promotion of amateur radio in developing countries.

In addition, a special working group was set up to draft a new constitution for IARU region 1, based on suggestions received from the various member societies.

About 40 proposals were adopted at the final plenary and declared official IARU recommendations. Most of them were about organisational things (such as contest rules or the setting up of working groups), but several of the motions passed were on matters which are of direct concern to active operators. Some minor changes were made to the bandplans for 2m and 70cm as well as some of the microwave bands, and new procedures were agreed for meteor scatter operation. On 14MHz, the RTTY segment has been extended downwards



Malcolm Appleby G3ZNU (Chairman of the RSGB VHF Committee) in conversation with Masayoshi Fujioka JM1UXU (Secretary of IARU Region 3)



Relaxing after a hard day's work: Mirko Mandrino YT7MM (member of Region 1 Executive Committee), John Allaway G3FKM (Secretary of IARU Region 1), David Evans G3OUF (Secretary of the RSGB) and Hans Berg DJ6TJ (Chairman of Region 1 HF Committee)

by 5kHz to 14.070MHz, and a reminder was issued that packet radio stations should operate in the RTTY sections of the HF band and not elsewhere.

Although IARU recommendations are not legally binding, most national societies expect their members to abide by them, for obvious reasons — just imagine the chaos that would prevail if we did not have a band plan, or if everyone organised contests on the same week-end...

Besides dealing with such things as band planning and operating standards, the IARU fulfills an important task in representing the amateur radio service to international organisations such as the ITU and the CEPT — without the efforts of the IARU, we would still be without the 10, 18 and 24 MHz bands, nor would there be such a thing as a common licence (even if UK amateurs are *still* waiting to benefit from it...)

Derby Contest Winners

The winners of the Derby and District ARS 144-145 MHz contest, held on Sunday 15th March, are as follows: for the

full legal power limit section G4CRA (working /P) was the winner and G6HKM the runner-up; in the 'Low' power (25W maximum output) the winner was G4RLF and second was GW6TGX (both working /P); there was no award for

the SWL section as the only entry was disqualified, unfortunately. All the winners and the runners-up get certificates.

One point that we were very interested to note was that the number of contacts and the number of points scored by the

'low' power entrants was higher than the equivalent for the full legal power limit. In fact, the third placed 'low' power entrant could have won the full legal power section. So put away the linear and go tweak your antenna!



Radio Amateur Information Sheet No 2:

Amateur Service Allocation in the 50 MHz Band (6 metre)

The Department of Trade and Industry has allocated the band 50-50.50 MHz to radio amateurs. Mr Geoffrey Pattie, Minister for State of Industry and Information Technology, gave the news on 28 June 1985. He said he was accepting the recommendation of the Merriman Report on the future use of TV Bands I and II that the radio amateur service should be given space in Band I.

The initial conditions for the release of the band are:

- The allocation shall be primary within the United Kingdom.
- Initially, only Class A licensees will be permitted access to the band.
- The maximum power at all times shall be

Carrier	PEP
14 dBW	20 dBW
erp	erp

- maximum transmitting antenna height to be 20 metres above ground level.
- Antennas shall be horizontally polarised.
- No mobile or portable or 'temporary premises' operation will be allowed.
- There will be no restriction on modes or times of operation.
- No repeaters will be allowed in the band.
- Existing permits will be withdrawn.

Here we try to answer some of the questions you may have.

There is no Region 1 allocation to the Amateur Service so how has this new Amateur allocation been possible?

For the purposes of the International Radio Regulations, the world is divided into three Regions. The UK, the rest of Europe, Africa and USSR are all in Region 1. Within Regions 2 and 3 (but not Region 1 except for certain African countries) the band 50-54 MHz is allocated to the Amateur service on a primary basis. However, within Region 1 the whole of the band 47-68 MHz is allocated to the Broadcasting Service on a primary basis. There are thus no international rights for UK radio amateurs to have access to 50 MHz. However, with the closure of 405-line TV broadcasting the UK frequencies at 47-68 MHz have become available for re-allocation. Ministers have decided that, in the main, the frequencies should be used for land mobile services. However the Merriman Report on the future use of the frequencies said that radio amateurs should be given a suitable allocation.

BR42

More Info Sheets

The DTI have just published two more Radio Amateur Information Sheets, numbers 4 and 5, and they both are very helpful.

Sheet 4 deals with the allocation of call signs and covers, amongst many other things, how call-signs are made up, how they're allocated and under what circumstances a call sign can be passed from one person to another (and the answer is, not very often).

Sheet 5 is on radio clubs and societies, and deals mainly with the issuing of club call signs. Did you realise that you only have to have five members including three licensed amateurs to apply for a club licence?

These two information sheets, along with information sheets 1 (a general sheet), 2 (on the 50MHz allocation — but since this has yet to be reissued since the recent change it's now out of date) and 3 (on Morse code), and the introductory booklet 'How

to become a radio amateur' are all available from the Department of Trade and Industry, Amateur Radio Section, Radiocommunications Division, Waterloo Bridge House, Waterloo Road, London SE1 8AU, telephone 01-275-3316 (By the way, don't bother sending a stamped addressed envelope, they can't use them and have to return them).

The first three information sheets are now available in special format (large type on a lurid yellow background) for partially sighted amateurs; perhaps clubs would be doing a service to some of their members if they were to request these, as anyone with partial sight is unlikely to be able to read this news item.

A full list of results is available from Derby and District ARS, 119 Green Lane, Derby DE1 1RZ (please send them a stamped addressed envelope). The club would like to thank all those who took part, and also say that the comments and suggestions received were much appreciated.

New Super Rotators

South Midlands Communications have started selling two new rotators for the amateur and commercial markets. SMC say that the KR800SDX and KR1000SDX are full specification rotators to a standard never achieved before in the amateur radio world.

The following unique features are incorporated: 450 degree rotation, so you can reach those awkward beam settings very quickly; speed decrease before braking for longer brake life and higher accuracy; variable speed rotation, settable between 43 seconds for the smaller antennas or light wind loading to 93 seconds for larger antennas with greater inertia; and switch positioning with a preset direc-

tion control with single push button operation.

Vertical loading on both units is 200 Kgs and the brake torque is 4000 Kg.cm on the KR800SDX and 6000 Kg.cm on the KR1000SDX. The motor voltage is 20V DC and the position graticule is fully adjustable providing null setting to the operators choice. Full auto stop is provided (limit switch) and a safety mechanical stop is fitted as back up.

Prices for the KR800SDX and KR1000SDX are £325.00 and £386.00 inc VAT respectively, and they are available immediately from South Midlands Communications Ltd, SM House, School Close, Chandlers Ford Industrial Estate, Eastleigh, Hampshire SO5 3BY, telephone 0703 255111 (note this is the new number for SMC).

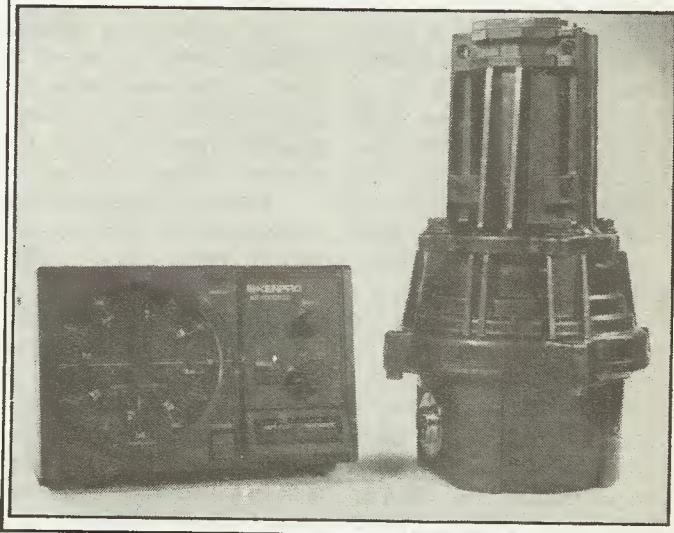

50MHz Broadens — As Predicted Here!

A certain deputy editor had difficulty getting his head through the door when the official announcement of the changes to 50 and 70 MHz came through.

As predicted, the band now runs from 50 to 52 MHz, although we have the upper 1MHz on a secondary basis only. Antennas are limited to 20 metres above ground level,

and they must be horizontally polarized (the idea here is not to interfere with continental TV stations which use vertical polarisation — but who knows what polarisation the signal will have by the time it crosses the Channel?). No mobile operation is allowed either, presumably because the DTI doesn't believe mobile operators will be able to stick to horizontal polarisation. All types of transmission, except FSTV, are permitted with a maximum carrier power of

14 dBW ERP (20 dBW ERP PEP). There is no amateur satellite allocation.

Also, 70MHz is now widened, and the frequency allocation runs from 70 to 70.5 MHz, this is all on a secondary basis, ie subject to not interfering with other services. Again all modes are permitted except FSTV, and the powers are 16dBW for the carrier or 22 dBW PEP, and again there is no amateur satellite allocation.

But the good news for Class-B licensees is that both

bands are open to them, as reported in Ham Radio Today, March 1987. So we'll be seeing all the new GIs on six and four, won't we? Not everyone thinks this is a good thing, mind, so we'll just have to wait and see.

Oh, a certain other person associated with the mag is equally swelled with pride at having got it right over what the DTI were going to do. We won't say anything more, except that he had a few problems getting his Vodaphone strap round his neck on the day of the announcement!

Demand Outstrips Supply!

It seems that some of you are so keen to spend your money that the poor suppliers can't keep pace! In particular we hear that Lowe Electronics can't make HF125 receivers fast enough and have had to introduce a waiting list, and that Garex Electronics can't test Sentinel pagers (HRT June 2m mini-monitor project) fast enough!

Garex do have ample supplies of pagers, though, which they are testing as quickly as they can, and they expect to be able to meet all

but the largest orders (what do you need 200 pagers for?) within two weeks of receipt. However, they have run out of nicads for the pagers, and they're offering an alternative of a spare case so that you can hack one case to accommodate a standard PP3 battery, and keep the other until you manage to pick up the right nicads at a rally.

So all advertisers please take note: get your product on the front of HRT and you'll have to run hard to keep up with demand. Bribes accepted by negotiation, used notes only or straight into the Editor's numbered Swiss bank account...

Welsh Island Expedition

The Newport Amateur Radio Society will be taking to the water in early August to activate, for the first time, three islands off the Dyfed coast, from the 1st to the 8th August.

The islands involved will be Skokholm (WAB SM70; callsign to be used GB4WIE), Skomer (SM70/71; GB2WIE) and Grassholm (SM50/60, GB0WIE). The base for the week will be Skokholm, and the other islands will only be activated on specific dates.

On Monday 3rd, it will be

Grassholm's turn, and only about 1½ hours' work will be possible here. The main purpose is to concentrate on HF and VHF nets of WAB, with GB4WIE acting as net controller, and speeding up contact by a list (please allow list working first, then the contact will be open to all).

The trip to Skomer is planned late in the week, but no specific date has yet been set. There is an award for working all three islands and you can also arrange a sked by contacting the club at PO Box 33, Newport, Gwent (which is also the address for QSLs direct).

A GUIDE TO
AMATEUR
RADIO
EQUIPMENT

Summer 1987
£1.20

Circuit
electronic constructor's
catalogue

Bigger stock.
Better service.

6
MULTIMETERS
TO BE WON

Guide To Gear

If you're looking to buy some second-hand (or even new) equipment, you may well find the new publication, *A Guide To Amateur Radio*, from Geefor Enterprises (now I'm sure that name has some significance...), of use.

The guide consists of one hundred A5 pages or so crammed with the basic details of hundreds of rigs (we're afraid that the editor ran out of fingers and toes after the first six pages, so we don't know how many...), plus photographs of many of them, and details of

where to find reviews and mods for them.

The one criticism we'd have is that the quality of production of the booklet isn't great, it looks as though it's just been photocopied, but then neither is the price great either, at £2.50 inc P&P.

Geefor says that they are also producing a companion guide to second-hand prices for £2 inclusive, but we haven't seen that yet. Geefor Enterprises, 112 Leeds Road, Mirfield, West Yorkshire WF14 0JE; send a stamped addressed envelope if you'd like to enquire of further details.

YAESU FT211

REVIEW

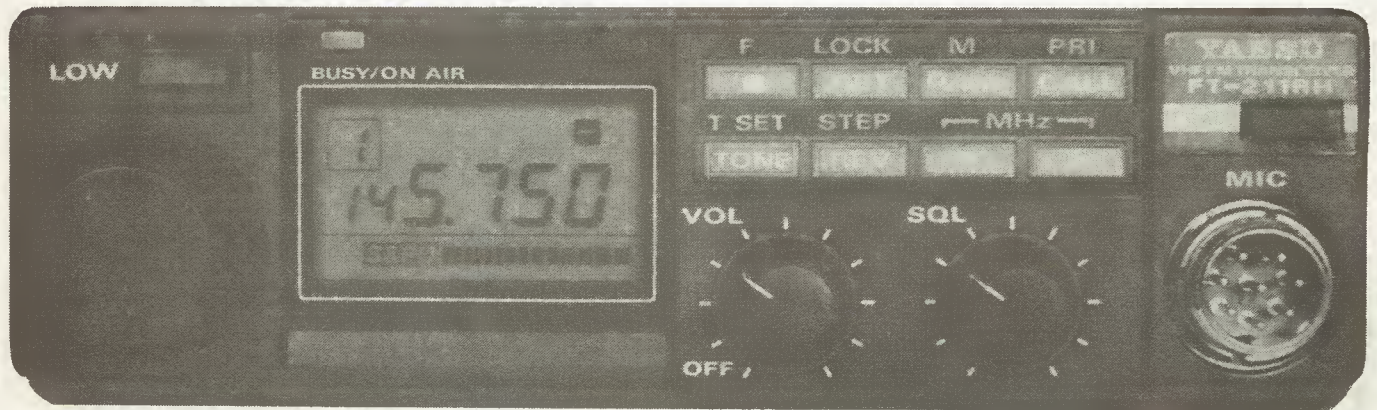

The Yaesu FT-211RH

In the beginning there was the Kenwood TM-221, and now there is the Yaesu FT-211RH. Chris Lorek, G4HCL, investigates a new addition to the 45W 2m mobile market.

The amateur looking for a 2m mobile now has a bewildering selection of sets to choose from, with each manufacturer hotly competing to gain a share of the market. A standing joke in Japan is that all one needs to do is to start a rumour that a design team has a project under way and a competing product will appear from another manufacturer! The current trend seems to be very small, easy to use 45W 2m FM mobiles, the latest FT211RH from Yaesu being no exception.

Features

The set offers coverage of 144-146MHz in user-selectable 12.5kHz or 25kHz steps, with a switchable 45W or 5W transmitter output power. Ten memory channels are available, each storing frequency and programmed TX offset, memory channels 0-6 may be used for splits other than the standard 600kHz if required. Positive or negative TX shifts may be programmed and one-touch reverse operation is possible by a press of the 'Rev' button.

Frequency or memory channel control is accomplished by a large rotary knob, supplemented by up/down buttons fitted to both the set's fascia and the fist microphone. Also on the microphone is a 1750Hz tone button for repeater access, again duplicated on the front panel by a 'T Call' button.

Scanning of the entire frequency range when in 'VFO' mode is initiated by keeping one of the up or down buttons depressed for more than half a second, likewise in memory mode the memory channels are sampled for activity. In each case, the scan resumes after the channel has been quiet for two seconds and the scan may be halted at any time by pressing the PTT, Up, Down, or D/MR buttons. Any memory channel may be inhibited from scanning if required, to avoid having to listen to constantly occupied frequencies such as busy repeaters. Alternatively, a 'Priority' channel 1 is sampled briefly every five seconds with the set locking onto the signal if the channel becomes occupied. A

quick press of the PTT will inhibit further sampling. The controls may be locked to prevent accidental operation by depression of the function button followed by 'Lock', and a slide switch mounted on the rear of the microphone case locks the Up/Down mic buttons. Standard rotary controls are used for on/off/volume and squelch and these, together with the frequency control buttons, are illuminated in use.

A green backlit LCD panel displays the operational frequency, memory channel number, \pm offset direction if selected, keyboard lockout, and gives a bargraph indication of transmit mode and relative signal strength on receive. An optional extra is an internal sub-audible tone encoder/decoder unit, when this is fitted the display also acts as a tone frequency readout during programming, giving an indication of encode and/or decode mode in normal use. A dual-colour LED adjacent to the display turns green when the squelch raises on receive and red to indicate transmit mode. Users familiar with the FT23R portable will notice that this set is virtually identical in its operation apart from the extra microphone facilities.

With a slight internal re-wiring modification, Yaesu state the set may be used with a packet radio

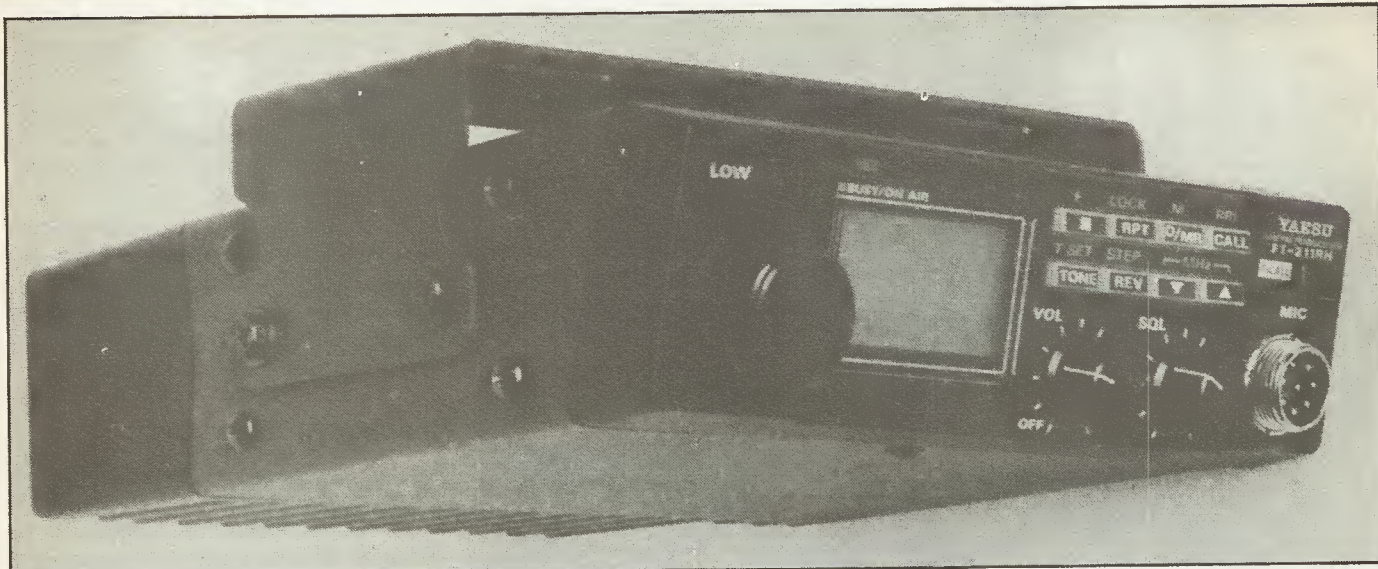

The FT-211 features a unique tiltable front panel, ideal for lorry drivers or Range Rover posers!

TNC (Terminal Node Controller) by connection only to the microphone plug, this having PTT, RX audio, TX audio, and squelch state lines. But note that this modification inhibits the mic-fitted tone button.

A small internal speaker is fitted to the lower case lid, the rear panel having a 3.5mm jack socket allowing an external speaker to be connected. Also on the rear is the SO239 aerial socket, and short flying DC power leads with shrouded bullet type connectors. Supplied accessories are a fixed mobile mounting bracket and fixing screws, a 2.8m long mating DC power cable fitted with 10A fuses in each leg, two spare fuses, an external speaker jack connector, four stick-on sponge rubber feet for base use, a fist microphone and a well written user manual giving both block and circuit diagrams. The set measures 160mm(W) x 50mm(H) x 175mm(D) and weighs approximately 1.5kg. Finally, a novel feature for the goods vehicle driver is the facility to reverse the tilt of the facia, allowing the set to be mounted *above* the normal angle of vision rather than below the dashboard.

Impressions

Readers of 'Mobile Safety' in the May 1987 issue of HRT will realize the importance of simplicity of operation in a set designed for mobile use, coupled with good visibility of it's display and controls. Yaesu, I feel, have certainly scored in this respect. However looking inside the set there's plenty of fresh air and

I'm surprised they didn't make it a little smaller to allow greater versatility in it's mounting position. A smaller facia though could of course make the controls fiddly to use, so I mustn't complain too much. The reversible front panel tilt could be a useful feature for 'professional' drivers, as some mobile sets give very poor visibility, especially of the LCD, when viewed from below.

When looking at the modular interior circuitry, I initially thought that I was looking at an FT23R in a larger case. However, closer examination showed there are circuit differences, the only similarity being in the control module. This demonstrates that the design team really had come up with a new set, but based I feel on the basic design principles used in the FT23R.

In Use

As with the FT23R, I found the set extremely easy to use, especially whilst mobile by using the microphone mounted Up/Down buttons. The ability to initiate scan mode by keeping one of the Up/Down buttons pressed for half a second was also very useful and for most of the time I rarely needed to take my eyes of the road. The toneburst button fitted to the microphone is also a welcome feature, being the most sensible place for it in my opinion especially as all European Region 1 specification repeaters only require an initial access tone to 'open the box.'

Under high speed motoring conditions, the audio from the internal speaker was a little muffled and only

just about sufficient with the set mounted under my dash, due to the speaker's downward facing position. When used in base station mode, with the set on a table top using the stick-on feet the speaker was right next to the surface, and in either case I would recommend the use of an external speaker. On transmit, poor audio reports were obtained whilst mobile, due to high mic gain. Backing off the microphone cured this and I was surprised to find very little evidence of background road noise. I found the mic to be fairly directional, and speaking directly into it at a slight distance, rather than across it at close quarters, gave the best results. I found the main tuning knob to be too lightly detented for normal use and I sometimes found it would increment to the next channel before a slight click was felt. When mobile this sometimes caused the odd problem in QSYing by counting the number of clicks, but using the mic mounted up/down buttons overcame this limitation.

Even when used at high power for long periods the large rear heatsink kept the set reasonably cool. Oddly, I noticed no change in the LCD bargraph reading between low and high power also the case with the FT23R readout, although the manual states this to be a relative power indication. The receive sensitivity appeared fairly well matched to the transmit power for most purposes, but I did find the odd station who could hear me a lot better than I could hear them. Quickly fitting a Microwave Modules

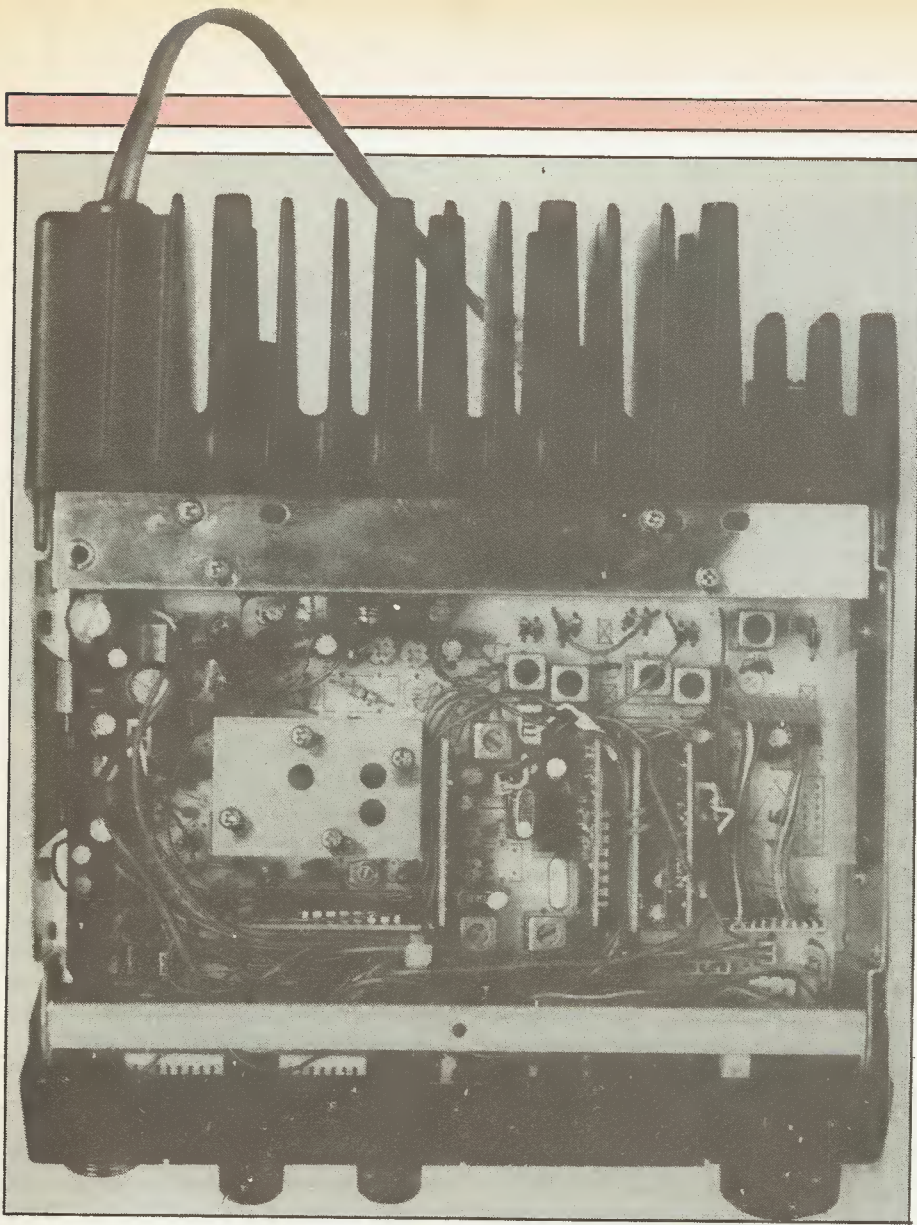

Plenty of space inside and hefty cooling fins result in an absence of overheating problems.

in-line pre-amp gave an improvement in this respect.

Internals

The set employs a main 'mother-board' construction with several 'daughter' boards soldered in, again very similar to the FT23R. A screened final transmitter amplifier section is mounted directly to the rear heatsink, and a front mounted control board houses the digital circuitry, user controls, and LCD display. A 'cloning' facility is available, where the memory contents of one FT211RH may be linked via the microphone connector to another FT211RH and the data transferred to the second rig — very useful for special purposes such as RAYNET.

On receive, a 3SK122 is used in a varicap-tuned front end bandpass circuit. It is interesting to note that this enables operation to above

174MHz when the control board is suitably linked. A 3SK81 mixer produces the 10.7MHz first IF, a pair of monolithic dual crystal filters giving a degree of adjacent channel selectivity. A TK10420 IF subsystem IC provides mixing down to 455kHz, where further selectivity is achieved via a CFW455E ceramic filter. Noise squelch operation, discrimination, and audio amplification to loud-speaker level follows.

Two separate final frequency VCOs are present, used independently for transmit and receive. A common synthesiser is employed, using an M54475P prescaler and MC145158P programmable divider under serial control from the HD613901 microprocessor. The receive VCO provides the first local oscillator injection, whilst the transmit VCO is directly modulated with processed mic audio and amplified to drive the M57726 block PA

module. An ALC loop here controls the preset high and low power levels, but there is no evidence of the detected power level being fed to the display control circuits to give an indication, confirming the observations found in use.

The general circuitry construction was of a very high quality, together with good mechanical rigidity. This should present few reliability problems from vibration effects found in mobile use.

Laboratory Tests

On receive, a reasonable if not exceptional sensitivity was noted, however the adjacent channel selectivity at 25kHz was quite good. At ± 12.5 kHz the selectivity was rather lopsided, good on one side but a little indifferent on the other. The intermodulation rejection, where off-channel signals combine to cause a further on-channel product was fairly good, yet the in-band strong signal blocking performance was disappointing. Here signals 100kHz away were being rejected only by a similar amount to those on adjacent channels — probably being caused by reciprocal mixing from synthesiser limitations which may possibly cause the odd problem in RF-congested areas such as large cities. The image rejection however was fairly good, especially considering the low first IF of 10.7MHz and few problems should be found from aircraft communication breakthrough.

On transmit the harmonics and spurs were well down in level and the frequency accuracy was good. The peak deviation was a little over the maximum recommended 5kHz but within a reasonable tolerance. The maximum power was well controlled by the ALC loop to a little below 45W but no doubt this, together with the deviation, could be easily reset with a quick turn of the trimming tool.

Summing up

Yaesu's latest mobile is extremely easy to operate whilst on the move, allowing the user to pay attention to the road rather than trying to operate their set, the superb backlighting of the main controls also helping to aid night-time operation. I must commend the designers on this as all too often a multiplicity of functions are found on mobile sets

which are very nice for base station and portable use but are very difficult for a driver to control safely.

The RF performance was perfectly satisfactory for average mobile usage, but possibly not spectacular for successful primary use as a base station in heavily RF congested areas. However, the current price of just under £300 shows that for around £50 more than the FT23R, you get a similarly featured 45W mobile which, in my opinion, represents good value for money.

My thanks go to Ray Withers Communications Ltd, for the loan of the review set.



Laboratory Results — FT211RH

Receiver

Sensitivity: Signal level in μV pd required to give 12dB SINAD.

Freq (MHz)	Sensitivity
144	0.164 μV pd
145	0.161
146	0.178

S-Meter Linearity

Segments	Signal Level
2	0.508 μV pd (19.3dB)
4	0.824 μV pd (-15.1dB)
6	1.24 μV pd (-11.5dB)
8	1.74 μV pd (-8.6dB)
10	2.21 μV pd (-6.5dB)
12	2.69 μV pd (-4.8dB)
14	4.67 μV pd (0dB ref)

Image Rejection: Increase in level of signal at -21.4MHz to give identical 12dB SINAD signals; 93.0dB.

Intermodulation Rejection: Increase in level over 12dB SINAD level of two interfering signals giving identical 12dB SINAD on-channel 3rd order intermodulation product.

Spacing kHz	Rejection dB
12.5/25	65.5
25/50	69.5
50/100	69.5

Maximum Audio Output: Measured at 1kHz on the onset of clipping.

Load	Power
3 ohm	3.30W
8 ohm	1.89W
15 ohm	0.96W

The Yaesu rig shown with its up/down button microphone — very handy for scanning or simple channel changes.

Adjacent Channel Selectivity: Measured as increase in level of interfering signal, modulated with 400Hz at 30% system deviation, above 12dB SINAD ref. level to cause 6dB degradation of 12dB SINAD on-channel signal.

Spacing	Selectivity
+12.5kHz	58.0dB
-12.5	23.5
+25	72.0
-25	71.5

Blocking: Increase over 12dB SINAD level of signal 1MHz away to cause 6dB degradation in 12dB SINAD on-channel signal.

Spacing	Level
+100kHz	72.5dB
-100kHz	71.0
+1MHz	85.0
-1MHz	84.0
+10MHz	96.0
-10MHz	96.0

Squelch Sensitivity

Threshold	0.062 μV pd (2.0dB SINAD)
Maximum	0.257 μV pd (24dB SINAD)

Transmitter

TX Power and Current Consumption

Freq (MHz)	10.8V Supply	13.8V Supply	15.6V Supply
144MHz	24.6W/5.48A	41.4W/7.19A	41.9W/7.19A
145MHz	25.1W/5.48A	41.8W/7.18A	42.6W/7.20A
146MHz	25.1W/5.42A	41.9W/7.10A	43.2W/7.15A

Low power in all cases well regulated at 4.75W/2.58A

Frequency Accuracy: -90Hz at switch-on

Harmonics/Spuril

2nd Harmonic	-89dBc
3rd Harmonic	-94dBc
4th Harmonic	-97dBc
All other products less than -100dBc	

Peak Deviation: 5.12kHz

Toneburst Deviation: 4.78kHz

GUIDE TO SHORT

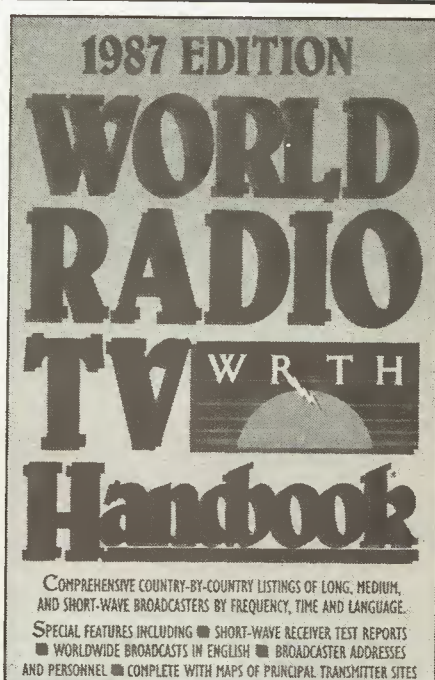
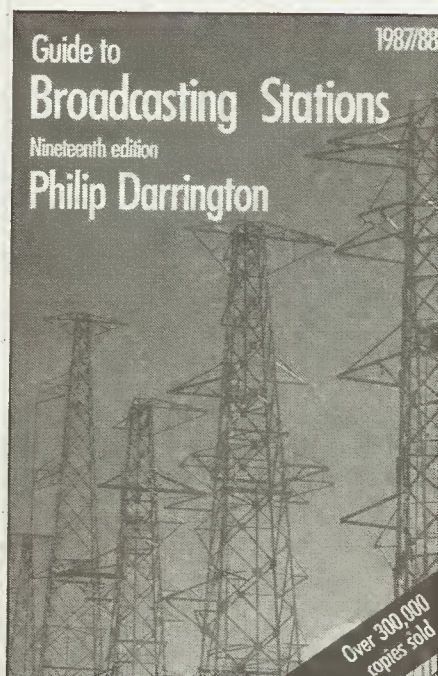
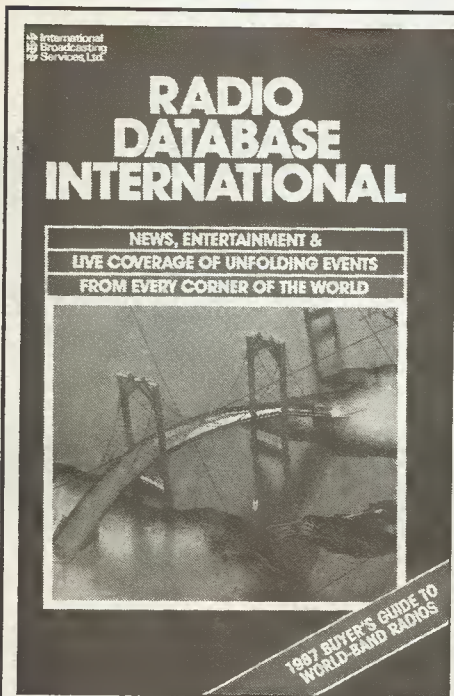

The three contenders for the Best Guide award: 'Guide to Broadcasting Stations' at £6.95, 'World Radio & TV Handbook' at £17.95 and 'Radio Database International' costing £12.

With the variety of books available to the shortwave listener/DXer it is often difficult to decide which one to opt for since it would be duplicative, not to mention expensive, to buy several. From the three looked at

ification. By listing the power which station run on the particular frequency it is also an aid to finding out the likeliest station one is listening to bearing in mind propagation conditions.

heard, and the incidences of jamming.

Surfacing from yet another hard night at the dial, K Berkeley Henderson casts a bleary eye over the three leading short wave guides and asks — which one?

here it is evident that they all have different points in their favour, for different uses and applications, many of them being dependent upon how expert or inexpert one considers oneself to be.

Guide to Broadcasting Stations

The seemingly very basic *Guide to Broadcasting Stations*, now in its nineteenth edition, sets itself up as a 'standard guide' which it undoubtedly is insofar as station listings go. The handy format of stations in order of frequency is quite invaluable when one hand is on the dial and both ears are straining for some form of ident-

Radio Database International

The same information is contained in *Radio Database International*, a publication which claims to have 'everything you need to know' about world radio but in fact, falls rather short of this statement on several counts. In its defence however, it also claims to be a 'quick-access guide,' which, with its novel graphics and charts, supports this claim well. It also does contain a little extra information in the form of the language being spoken by different stations at certain times, seasonal variations, when the stations were

World Radio and TV Handbook

Both guides also give a country listing but neither backs this up with the sort of facts offered in *The World Radio and Television Handbook*, now in its forty-first year. Where 'World Radio & TV Handbook' really comes into its own is with the cheer volume of information, some of which could be regarded as essential, and some of which is simply of interest to shortwave listeners wanting to gain a little more knowledge of each country. Addresses are very important in QSLing but it is only 'World Radio & TV Handbook' which provides comprehensive information on this; interval signals, announcement identifications and advice on verification procedure for individual countries are further helpful additions.

The book is categorized by continent but, like the other two guides there is a similar listing of shortwave stations by frequency, and where possible, power ratings

HRT WAVE GUIDES

Short wave					Short wave				
Frequency (kHz)	Wave-length (m)	Station	Country	Power (kW)	Frequency (kHz)	Wave-length (m)	Station	Country	Power (kW)
5965	50.29	BBC	Cyprus	250	5995	50.04	Lyndhurst	Australia	10
		WS	UK	250			Allouis	France	100
		RCI	UK	100			Radio Loyola	Poland	8
		VOA	UK	250			Warsaw	Tibet	50
		VOA	Greece	50			Lhasa	Tibet	50
			Japan	100			RCI	UK	100
		Kajang	Malaysia	100			Bamako	Malawi	20/50
		Jos	Nigeria	10			VOA	Mali	50
5970	50.25	RFE/RL	West Germany	100			Arequipa	Peru	250
		Gauhati	India	10	6000	50.00	Vienna	Austria	10/500
		NHK	Japan	100			DW	West Germany	100/500
		Lima	Peru 2	—			DW	Malta	250
		Gauhati	India	10			DW	People's Republic of China	50
		Alma Ata	USSR	100			WS	Singapore	50
		Yemen	Yemen	100			La Paz	Ascension Island	125/250
			Indonesia	1			Zanzibar	Bolivia	10
5975	50.21	Benjarasin	UK	100/250			Lanzhou	Tanzania	10
		Beijing	People's Republic of China	120			WS	Yemen	100
							WS	People's Republic of China	10
		Radio Garuja	Brazil	10			Montreal	Sri Lanka	20
		Suwon	Korea	10			V of Hope	Canada	1
		Gweu	Zimbabwe	100			San Jose	USA	250
		Cochabamba	Bolivia	1			Radio Berlin	Costa Rica	3
		Radio Macarena	Colombia	5			Aparecida	East Germany	50/100
5980	50.17	Kota Kinabalu	Malaysia	10	6010	49.92	WS	UK	100/250
		Sierra Leone	Sierra Leone	250			Radio RSA	Brazil	250
		Quetta	Pakistan	10			WS	South Africa	250
		Radio RSA	South Africa	500			WS	India	10
5985	50.13	Rangoon	Burma	50			WS	Singapore	100
		RE/RL	West Germany	100			WS	Peru	2.5
		Rabaul	Papua New Guinea	10			WS	Venezuela	100/500
		VOA	Greece	250			DW	Antarctica	1
		V of Free China	USA	100			McMardo Base	Greece	250
		Mexico City	Mexico	10	6012	49.90	VOA	Korea	250
5990	50.08	Allouis	France	500	6015	49.88	Suwon	Portugal	500
		Rome	Italy	100			RCI	UK	250
		Bucharest	Romania	250			VOA	Philippines	250
		WS	UK	500			WS	Vatican City	100
			Ethiopia	100			Beijing	People's Republic of China	50
		Bhopal	India	10			DW	West Germany	100/500
		DW	West Germany	100/500					
		FBC	Philippines	50					
		DW	West Germany	100/500					
5995	50.04				6020	49.83	DW		

'Guide to Broadcasting Stations' presents data in a neat and concise fashion.

between beginners and seasoned listeners are apparent. To start with, 'Guide to Broadcasting Stations' has an excellent introductory chapter on 'Choosing a shortwave receiver' by Richard Lambley, the Projects Officer of 'Electronic and Wireless World.' This not only sets out the advantages and disadvantages of different tuning mechanisms as compared to synthesized receivers but also explains in simple easy to use tables, tuning ranges and the different categories of broadcast service. Another table lists a range of shortwave receivers available, with style, coverage, price and other valuable information. In addition, addresses of UK manufacturers and distributors are given, which by necessity, give this particular guide a very British base.

'World Radio & TV Handbook' however, also offers a similar section on buying receivers, and lists manufacturers addresses worldwide, but the format of the chapter is very different to 'Guide to Broadcasting Stations', 'Radio Database International' being closer to 'World Radio & TV Handbook' in this respect. More space has been given than in the latter two with regard to specific receivers, and no comparative tables are offered. The facts in 'World Radio & TV Handbook' are concise, to the

are given. Other facts such as SSB outlets, and seasonal variations are accommodated within this section, together with extras such as local times, maps and coverage of DXTV all of which contribute to one's inclination to go for 'World Radio and TV Handbook' when comparing it

with 'Radio Database International' and 'Guide to Broadcasting Stations.'

Other features

After comparing similar information it is then necessary to look at what else is on offer from the books and it is here that the real divisions

SHORTWAVE STATIONS OF THE WORLD

1000000
100000
10000
1000
100
10
1

1000000
100000
10000
1000
100
10
1

1000000
100000
10000
1000
100
10
1

1000000
100000
10000
1000
100
10
1

SHORTWAVE STATIONS OF THE WORLD

1000000
100000
10000
1000
100
10
1

1000000
100000
10000
1000
100
10
1

1000000
100000
10000
1000
100
10
1

1000000
100000
10000
1000
100
10
1

SHORTWAVE STATIONS OF THE WORLD

1000000
100000
10000
1000
100
10
1

1000000
100000
10000
1000
100
10
1

1000000
100000
10000
1000
100
10
1

1000000
100000
10000
1000
100
10
1

'World Radio & TV Handbook' also offers a simple listing section whilst 'Radio Database International' has used a much more visual approach which some people find easier to follow.



SOUTH AMERICA

SOUTH AMERICA

ARGENTINA

LT: UTC-3h — Pr.L: Spanish — E.C: avc 50, 220V (yes).
ITU: ARG — IOD: 54.

MINISTERIO DE OBRAS Y SERVICIOS PUBLICOS
SECRETARIA DE COMUNICACIONES

Dirección Nacional de Telecomunicaciones
Departamento de Operaciones
ADDR: Secretaría de Comunicaciones, Sarmiento 151, 1000 Buenos Aires. Te: Sector Radiodifusión: (01) 30-5031.
L.P: Ing. Roberto Hugo Zubeta.
Departamento de Operaciones: Ayacucho 1556, 1112 Buenos Aires. Te: 84-0504.

Dirección Nat. de Telecomunicaciones:
L.P: Subsecr. Ing. Di Benedetto.

COMITE FEDERAL DE RADIODIFUSION

ADDR: Supacha 765, 1008 Buenos Aires.
L.P: Pres: Pedro Sánchez. Programación y Desarrollo: Dr. Reynaldo Pizarro.

CONFER controls certain technical aspects of broadcasting along with Secretaría de Comunicaciones, and also controls the progr. transmitted over all kinds of broadcasting stations.

STATIONS: All privately owned commercial st's exc. a) National State owned non-comm. st's (exc. st. 9 which is comm) — b) National State owned comm st's — c) Provincial and Municipal owned non-comm st's.

NB: Days of the week refer to local time.

Milestones

Call	kHz	kW	Name, location and h. of tr.
1) LRA14 a	540	25/1	R. Nac. Santa Fé: 1100-0300
2) LRA25 a	540	5	R. Nac. Tartagal: 1100-0400
3) LRA9 a	540	25/5	R. Nac. Esquel: 1000-0400 (n.560)
4) LRA13 a	560	25/5	R. Nac. Bahía Blanca: 1000-0500
5) LT15	560	10/3	R. del Litoral, Concordia: 0900-0300
6) LV1	560	25/5	R. Colón, San Juan: 0900-0400
7) LRA16 a	580	25/1	R. Nac. La Quiaca: 1000-0400
8) LU20	580	20/5	R. Chubut, Trelew: 0930-0330
9) LW1 a	580	25/5	R. Universidad Nacional de Córdoba, Córdoba: 0900-0400
10) LS4	590	25/5	R. Continental, Buenos Aires: 24h
11) LRA30 a	590	25/1	R. Nac. San Carlos de Bariloche: 0900-0400
12) LV12	590	25/5	R. Independencia, San Miguel de Tucumán: 24h
13) LRA18 a	620	25/5	R. Nac. Río Turbio: 1000-0400
14) LT17 c	620	25/5	R. Provincia de Misiones, Posadas: 0900-0300 (n.150)
15) LRA28 a	620	25/5	R. Nac. la Rioja: 0900-0400
16) LS5	630	25/5	R. Rivadavia, Buenos Aires: 24h
17) LRA24 b	640	25/5	R. Nac. Río Grande: 24h
18) LU18	640	10/1	R. El Valle, General Roca: 0900-0400
19) LV15	640	5/1	R. Villa Mercedes: 0900-0300
20) LRA11 a	670	25/5	R. Nac. Comodoro Rivadavia: 24h
21) LRA52 a	670	1	R. Nac. Chos Malai: 1100-1800, 1900-0200
22) LT4	670	25/5	R. Del. Misiones, Posadas: 0900-0300
23) LRA209	670	25/5	R. Mar del Plata, Mar del Plata: 24h
24) LU12	680	25/5	R. Río Gallegos: 1000-0400
25) LU17	680	5/1	R. Golfo Nuevo, Pto. Madryn: 0900-0300
26) LV6	680	25/5	R. Nihul, Mendoza: 0900-0600*
27) LRA4 a	680	25/5	R. Nac. Salta: 24h
28) LU19	680	10/5	La Voz de Comahue, Cipolletti: 1000-0400
29) LRA17 a	710	25/1	R. Nac. Zapala: 1000-0500
29b) LRA19 a	710	25/5	R. Nac. Pto. Iguaçu: 0900-0400
30) LS1 c	710	25/5	R. Municipal de la Ciudad de Buenos Aires: 24h

Argentina

31) LRA59 a	720	1	R. Nac. Gobernador Gregores: 1100-2300
32) LV10	720	25/5	R. de Cuyo, Mendoza: 0900-0700
33) LRA3 a	730	20/5	R. Nac. Santa Rosa: 0930-0330
34) LU23 b	730	10/1	R. Lago Argentino, El Calafate: 1000-0400
35) LRA27 a	730	25/5	R. Nac. Catamarca: 0900-0400
36) LRA55 a	740	1	R. Nac. Alto Río Senguer: 1100-1700, 2000-0200
36b) LRA200	740	1	R. Pto. Deseado: 1900-0100
37) LRA7 a	750	100-10	R. Nac. Córdoba: 1000-0400
38) LRA10 a	780	5/1	R. Nac. Ushuaia e Islas Malvinas, Ushuaia: 24h
39) LRA12 a	780	5	R. Nac. Sotio Tomá: 0900-0300
40) LV8 b	780	25/5	R. Libertador, Mendoza: 0900-0400 (n.960)
41) LR6 b	790	25/5	R. Mtro. Buenos Aires: 24h
42) LRA22 a	790	25/5	R. Nac. San Salvador de Jujuy: 1000-0400
43) LRA53 a	800	1/5	R. Nac. San Martín de los Andes: 1000-0400
44) LU15	800	1	R. Nac. Soria Tomá: 0900-0300
45) LV23	800	1/5	R. Río Abul, General Aghar: 1000-0400
46) LRA8 a	820	25/5	R. Nac. Formosa: 0900-0300
47) LU21	820	25/5	R. Pto. Deseado, Jorge, Caleta Olivia: 1000-0300
48) LU24	820	3	R. Tres Arroyos: 0900-0400
49) LT8 b	830	10/1.5	R. Rosario: 24h
50) LT43	830	1/0.5	R. Viedma: 0900-0300
51) LU14 c	830	5	R. Provincia de Santa Cruz, Río Gallegos: 1000-0600
52) LW8	830	25/5	R. San Salvador de Jujuy: 0900-0400
53) LR200	840	25	R. Pto. Deseado, Concepción: 0900-0400
54) LT12 b	840	10/5	R. General Madariaga, Paso de los Lobos: 0900-0300
55) LT3	840	10/5	R. Nac. Santa Fé: 1100-0300
56) LU2	840	25/5	R. Bahía Blanca: 24h
57) LRA56 a	860	1	R. Nac. Perito Moreno: 1100-1700, 2000-0200
58) LRA1 a	870	100	R. Nac. Buenos Aires: 24h
51) LU14 c	870	5	R. Provincia de Santa Cruz, Las Heras: 1000-0600
59) LU33 b	890	25	Em. Pampaesina, Santa Rosa: 0900-0400
60) LV11	890	25/5	Em. Santiago del Estero: 0900-0300
61) LT77	900	25/2.5	R. Provincia de Corrientes: 0900-0400
62) LRA23 a	910	50/5	R. Nac. San Juan: 0915-0400
63) LR5 b	910	25/5	R. Excoyator, Buenos Aires: 24h
64) LR3	950	100	R. Belgrano, Buenos Aires: 24h
65) LU4 b	950	25/5	R. Del. Patagonia Argentina, Comodoro Rivadavia: 0900-0500
66) LRA6 a	960	25/1	R. Nac. Mendoza: 24h
67) LT44	960	25/0.25	R. Nac. Formosa: 0900-0400
68) LU13	960	10/5	R. Neocochis: 0900-0400
69) LU5	970	20/5	R. Neuquén: 0900-0500
70) LV2	970	25/5	R. General Paz, Córdoba: 24h
63) LR4	990	25/5	R. Splendid, Buenos Aires: 24h
71) LU18	1000	1	R. Río Negro, Villa Regina: 0900-0300
72) LV16	1010	20/5	R. Río Cuarto: 0900-0300
73) LT10 a	1020	10/5	R. Universidad Nacional del Litoral, Santa Fé: 0900-0500
15) LRA28	1020	1	R. Nac. La Rioja, Chilecito
74) LRA58 a	1020	1	R. General Paz, Córdoba: 24h
78) LS10	1030	25/5	R. Del Plata, Buenos Aires: 24h
77) LR1	1070	25	R. El Mundo, Buenos Aires: 24h
78) LU3	1080	25/5	R. Del Sur, Bahía Blanca: 0900-0400
79) —	r1080	0.25	R. Departamento Minas, Andacollo
64) LR2	b 1110	20/5	R. Argentina, Buenos Aires: 24h
80) LV7	b 1110	10/5	R. Tucumán, San Miguel de Tucumán: 0900-0400
81) LU6	b 1120	25/5	Em. Atlántica, Mar del Plata: 24h

An example of the region by region section of 'World Radio & TV Handbook', one of its strong points being the accompanying maps.

point and a personal note is added on each receiver in the comments section, however, 'Radio Database International' appears to give more information in this area, with a star-rating system in operation, but they do fall down on lack of detail on such essentials as frequency coverage, size and power requirements.

'Guide to Broadcasting Stations' follows this chapter with an excellent 'Guide to Listening' section, written in a clear, methodical but interesting manner by Pat Hawker, the IBA's Engineering Information Officer — a name which should ring a bell with most short wave listeners. The range of the topic is good because it deals with the simplest of information which the new DXer requires, to the more complex matters which follow on logically as one's hobby continues; for example, how the earth's atmosphere and structure can influence propagation. Some

figures and information seem a little daunting at first, but on re-reading they become far more 'user-friendly', to use an oft-repeated computer term — in the same chapter, a small section does detail how home computers are now being used in conjunction with both receivers and transmitters. Advice and diagrams on aerials are also featured, as they are in 'Radio Database International', but again, clarity, and easy to understand instructions pull in favour of 'Guide to Broadcasting Stations.'

ID and announcements

As mentioned earlier, WRTH is the only guide which specifically details announcements and international identification signals, in some cases with musical notation — for those lucky enough to be able to read their scales! 'The Guide to Broadcasting Stations' does have a

little information on signal identification which includes details of the belonging to tunes a small selection of stations. Hints on the best ways to successfully identify stations, and on building up a library of tape recordings are also given. The only book which gives a comprehensive guide to QSL writing is the 'Guide to Broadcasting Stations', again, illustrating the books suitability for a newcomer to shortwave listening. The final chapter on Latin American DXing would be useful to all DXers, giving as it does, twenty-five well-used phrases for use on reception reports, a short letter, and their equivalent translations in both Spanish and Portuguese — indispensable for QSLing a part of the world where English is rarely spoken.

An additional item in 'World Radio & TV Handbook' concerns the activities of the BBC Monitoring Service, an interesting choice since

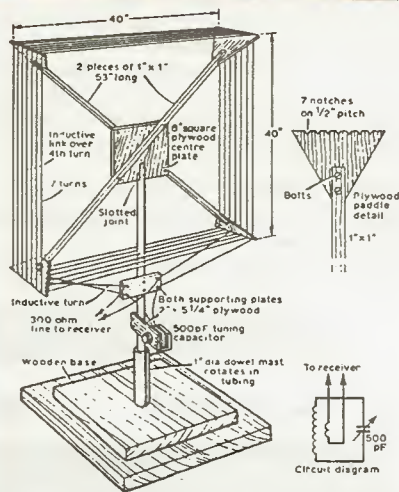

Figure 12 Constructional details of loop aerial for operation on medium waves and/or 1.8 MHz and capable of providing deep null on interfering signals

Only if you are fortunate enough to live in an interference-free area can you expect an indoor active aerial to equal the performance of an outdoor aerial.

For reception on medium waves and on short waves below about 4 MHz (above 75 metres) a home made frame aerial can provide an effective directional aerial. This form of aerial was the fore-runner to the widely-used ferrite-rod aerial and can be made more efficient than the short ferrite rods positioned close to other components. Both the large frame-aerial and the smaller ferrite rod aerial have the useful property of providing sharp nulls (very sharp in the case of the frame aerial) to reject unwanted signals coming from a different direction to the wanted signal. This form of aerial is also less susceptible to local electrical interference than other indoor aerials that are not in the form of a closed loop.

An inverted-L aerial, Figure 13(a), is quite suitable for long and medium wave reception. Results improve as the length of the horizontal section and the height above the ground are increased. The horizontal

[26]

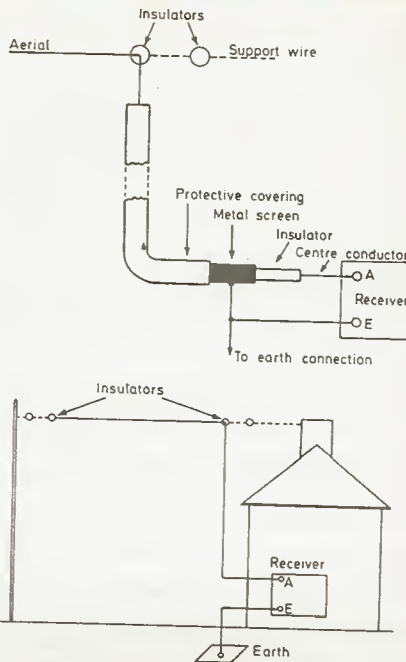

Figure 13 (a) Inverted L aerial. (b) Screened down-lead

section should be insulated from the supporting wires or ropes by several small porcelain insulators at each end. The downlead should be a continuous length of wire with the aerial and not joined separately because soldered and other kinds of joints are likely to deteriorate with weathering and eventually cause crackles and other effects in the receiver. The lead-in should be arranged to drop from the aerial well away from the building to avoid contact with gutters and to minimize

[27]

One of 'Guide to Broadcasting Stations' strong points, a section which answers many of the questions which everybody asks in the early stages of the hobby.

one of 'Radio Database International's articles looks at the other side of the BBC — the 100 million listeners who tune in! Another unusual and informative article is on clandestine stations, including a short list

of them, pointing out the difference between pirates and clandestines, and the development of the sub-sect of shortwave listeners who regularly listen out for them and the difficulties involved in QSLing. Where possible, addresses are printed in a listing by country section, and it was of interest to see a reproduction of a letter from The Voice of Fedaii, one of Iran's many clandestine stations.

In conclusion

To sum up, 'World Radio & TV Handbook' has a small but helpful guide to DX programmes offered by different countries, a section on religious broadcasting and general information which can be found in the other two books which we have looked at, such as Time Signal Stations, and time differences.

'Radio Database International' does not include Medium Wave and VHF FM broadcasting in its contents but it is a simply arranged, accessible guide to shortwave stations worldwide. One has to bear in mind that the DXer would not be able to use this alone but would need the 'World Radio & TV Handbook' for addresses. The same can also be

said of 'Guide to Broadcasting Stations', although some have been provided towards the end of the book together with an assortment of other 'Useful Information for DXers'.

For the absolute beginner, 'Guide to Broadcasting Stations' clearly stands out as the best choice, and a combination of this and 'World Radio & TV Handbook' would seem the ideal. 'Radio Database International', despite its novel graphics, may be trying to plug a gap, but unfortunately that gap may just be covered by slotting together the other two guides on the radio reference section of one's bookshelves.

If cost is a factor then either go for the 'Guide to Broadcasting Stations', which at £6.95 is good value or save up and buy the 'World Radio & TV Handbook', and keep for a couple of years — you don't have to replace it every year and it gives exhaustive coverage for £17.95. 'Radio Database International' at £12.50 is worth considering if you are averse to page after page of listings and prefer a more visual approach, very much a question of personal preference really. Good DX'ing!

EXTERNAL ANTENNAS: DO THEY HELP?

There is a WW II movie, *Voice of Tokyo*, in which British airmen struggle to overcome the effects of a German clandestine radio station. A hero of the film is none other than an interference set. And what we think of today as a world-band set. No, this was by a long way a truck with coils.

That's what "real" interference receivers used to be like. They were fed by lengthy outdoor antennas spanning acres from another tower — The Wind of the Giant Spider. One of its legs was the "leg" — a 100-foot-long Ziegler dipole — that had them a good 25 metres or yards across the sky. In fact, mile-wide antennas were once so big, in fact, that they were what you'd expect to find when old-timers talk of shorepots.

Unfortunately, the same people who today become curious about shorepots when they see today's handy, compact work-radio sets are still put off by the mistaken idea that they need to fit their back yard with enormous lengths of antenna wire.

Outdoor Antennas Usually Unnecessary

The truth is that the majority of world radio listeners need no antennas at all other than their radio's own built-in telescopic "whip". This sort of antenna works fine, so long as your set is reasonably sensitive and you are not into listening to low-powered stations.

But if you are trying to snare faint stations — or if you live in a concrete-jungle building — you should consider something fancier. Too, if you're using a first-rate communications receiver, you'll want an equally first-rate antenna so your receiver can reach its full potential.

Antennas for Simple Portables

What's your radio like? If you have one of those \$20-\$35 communications all-bandwork-radio-then-soup models that can't even handle the signals coming in through its built-in antenna, all a fancy external antenna is going to do is provide you with a greener result called "overloading" — a mish-mash of stations all heard at once because of your radio's dimensions intruding. Either buy a better set or take up another pastime, such as collecting belly button lint.

But even costlier portables (some field portables included) often don't take kindly to high-gain external antennas. These radios were designed to work at their peak with built-in antennas, so a minimalist approach usually works best.

If you live in a house and have a portable that you'd like to coax a bit more out of, there's an easy solution. Run several metres or yards of just about any kind of insulated wire — doorbell wire is fine — through your listening room's window. Connect one end high up on a nearby structure or tree, the other end and enter to the set's external antenna input (if it has one) or directly to the built-in antenna, using a

garden-variety "ragged" dip such as is found at electronics parts stores.

Assuming the wire is plastic-coated, you can get away with tying it around a tree limb or whatnot. But a much better solution is to isolate your antenna fully from the signal-absorbing tree or structure by using an insulator, inexpensive ceramic or plastic insulators for this purpose can also be found at electronics parts stores. If your antenna is short and lightweight, an ordinary plastic hair curler will do.

Wrap the far end of your antenna wire through one of the holes in an insulator. Tie a piece of cord through the insulator's other hole, then wrap that cord around a high tree or structure.

Do the same thing at the antenna's near end, then run the antenna's lead-in wire to your set (or better — its gas-type lightning arrestor), and you're ready to unweave the hair-to-hair secrets of world radio.

In any event, use common sense. Don't drape the thing under or over a 30,000-volt power line unless you're planning to do a circuitous detour for the role of Christy Ben Franklin. And forget trying to tie a modern-day Ben Franklin. When there's lightning nearby, disconnect your antenna. And, if you have overhead power lines, unplug your radio, TV, computer and anything else you value.

But why buy an antenna that's just like the one already built into your radio? The reason is simple. The concrete-and-steel walls of a high-rise building act as a "shield", keeping out radio signals. An outdoor accessory antenna is needed to catch signals before they are made faint by trying to pass through the building's outer walls.

Secure an automobile "whip" antenna firmly to your window frame or balcony railing so that it's a flagpole, then run it a metre from the antenna to your radio. This allows your set to be fed healthy outdoor signals unimpeded by your building's metal-and-concrete shielding. If neighbors cast suspicious glances, hang a small flag from the antenna.

Worried Receivers Need Worthy Antennas

Many high-quality receivers don't even come with built-in antennas, so radio engineers know that such elementary devices are inadequate for sophisticated receivers. So, even if you suspect this is your own antenna, you should contemplate something better.

Why? While simple portables can do only so much because of the cost of the components

'Radio Database International' offers a somewhat less practical guide to aerial problems.

HOKUSHIN aerials.

BASE STATION AERIALS

HF5...80 to 10 metre vertical, no radials required when ground mounted £83.39 inc vat, carriage £7.00.
HF5R...Radial kit for use with HF5 when mounted on chimney or gable end..... £54.81 inc vat, carriage £7.00
GFV5...Two metre base station colinear, 6.5 dB gain, 3.1 metres high £54.92 inc vat, carriage £7.00.
GFV23...as above but 3 section colinear, 7.8 dB gain, 4.45 metres high £51.97 inc vat, carriage £7.00.
GFV7...Seventy centimetre triple 5/8 base station colinear, 6.8 dB gain £45.59 inc vat, carriage £7.00.
GFV720...Dual band (144/430 MHz) base station aerial. £45.68 inc vat, carriage £7.00.

MOBILE AERIALS

2E...Two metres 5/8 whip, 3.4 dB gain, foldover base £14.55 inc vat, carriage £2.00.
2NE...Two metres 7/8 whip, 4.5 dB gain, foldover base £24.23 inc vat, carriage £2.00.
OSCAR430...Seventy centimetre triple 5/8 whip, 6.3 dB gain £27.72 inc vat, carriage £2.00.
OSCAR720...Dual band (144/430 MHz) whip ... £24.59 inc vat, carriage £2.00.
HS770...144/430 MHz diplexer for use with OSCAR720 . £18.02 inc vat, carriage £1.50.
GSS...Gutter mount (requires RG4M cable assembly) . £6.26 inc vat, carriage £1.25.
RG4M...Cable assembly for GSS base, complete with SO239 and PL259 plug £6.26 inc vat, carriage £1.00.
12B...Car wing mount with SO239 top and bottom £5.73 inc vat, carriage £1.00.
HSTMB...Car boot mount including cable and PL259 £15.42 inc vat, carriage £1.50.
MA2008...High quality mag mount with cable and strong protective cover to prevent paintwork damage.. £22.90 inc vat, carriage £2.00.

data equipment

CD600 ... RTTY, CW, ASCII, TOR, AMTOR decoder, output for UHF television, monitor and printer, can also be used as morse tutor.

CD600 ... £215.14 inc VAT, carriage £7.00.

CD670 ... A higher specification RTTY, CW, ASCII, TOR and AMTOR decoder complete with liquid crystal dot matrix display, variable RTTY shift, normal/reverse mode switch, outputs for TV, monitor and printer and can also be used as morse tutor.

CD670 ... £327.77 inc VAT, carriage £7.00.

CD660 ... Similar in specification to the CD670 but without the built-in dot matrix display.

CD660 ... £264.97 inc VAT, carriage £7.00.



LOWE ELECTRONICS OPEN DAY,

Saturday, 15th August from 10.00 am.

On the 15th of August, Lowe Electronics are holding an OPEN DAY at their head office in Matlock.

This is your opportunity to see not only the latest in equipment from KENWOOD but also visit the workshop facilities that have made LOWE ELECTRONICS the leading amateur radio company in Europe.

To make the event even more special, other well-known names in amateur radio are joining us for the day: MICROWAVE MODULES, J BEAM AERIALS, JOHN BIRKETT from Lincoln, STRUMECH, and M & B from Leeds.

Personalities in Matlock on the 15th for you to meet will be Geoff Arnold, editor of PRACTICAL WIRELESS (also representing the new SHORT WAVE MAGAZINE), Andrew Steele, English programme director from the short wave station HCJB, and Simon Spanswick and Michael Murray from EDXC (European DX council for short wave listeners).

The RSGB in the shape of Martin and Jenny Shardlow (Martin is our regional

representative) will be in the entrance hall, extending a warm welcome and answering any queries you may have on the society.

Talk-in on the day is in the capable hands of our local club, the TOR AMATEUR RADIO ASSOCIATION and a two metre station will be found on S22 from around 9.30 using the call sign G8LOW. There will also be an HF station on the air, its call sign being G4LOW. Even if you can't make it to Matlock, look out for both these stations as a special QSL card will be issued on the day.

The club are also organising a BRING and BUY section in the parking area behind the offices. This will be your opportunity to rent table space for an hour or so and get rid of your surplus radio bits and pieces (note, this is not a car boot sale). Further details from David, G8GIY on 0629 2817.

Finally for the children there will be FREE rides behind a scaled-down steam traction engine.

It promises to be a great day, we look forward to seeing you on Saturday, 15th August.

LOWE ELECTRONICS LTD.

Chesterfield Road, Matlock, Derbyshire DE4 5LE

Telephone 0629 2817, 2430, 4057, 4995.

Send £1 for complete mail order catalogue.



45 watts on 2 metres, the TM221E. 35 watts on 70 centimetres, the TM421E.



The new KENWOOD and TM421E two metre and seventy centimetre FM mobile transceivers have been specifically designed to condense maximum performance and operating convenience into a compact package. Output power is 45 watts on two metres (TM221E) and 35 watts on 70 centimetres (TM421E). Receiver sensitivity matches the output power of the set and measures an amazing 0.14µV for 12dB SINAD (across 144-146). The figures are those given by Chris Lorek in his recent TM221E review published in the July edition of HAM RADIO TODAY.

Much discussion has taken place recently regarding 12.5 and 25 kHz spaced frequency channels on the two metre band. With the new mobiles channel spacing is not a problem. KENWOOD with their usual attention to detail have made the frequency step user selectable. The steps available are 5, 10, 12.5, 15, 20 and 25 kHz. Once programmed either microphone up/down button or the transceivers front panel knob can be used to step the transceiver across the band. Of course should it be necessary the selected step can easily be changed.

A new orange backlit liquid crystal display gives the transceiver an amazingly clear frequency readout that can be read in the brightest of sunlight.

The transceiver has all essential operating aids. There are 14 memory channels, each of which holds frequency, whether simplex or repeater operation is required and whether or not the toneburst is on or off. Scanning can either be memory with the ability to lock out unwanted channels or band with the scan limits set by the operator. The usual priority channel facility is also included to make sure that

no call is missed. As well as showing the operating frequency the display also indicates which of the facilities are being used.

Occasionally a piece of equipment comes along which catches the imagination; the RC10 remote controller/handset for the TM221E and TM421E does just that. Designed to operate with either transceivers or link both together, the RC10 looks more like a cellular radio car phone than a piece of amateur radio equipment.

In fact the RC10 not only looks like a car phone, but as a speaker and microphone are built-in, operates as would a telephone handset. Easily mounted in any car, dashboard or transmission tunnel, the RC10 controls all transceiver front panel functions with the exception of on/off and high/low power selection. The functions controlled by the RC10 are volume, squelch on/off, frequency readout, keypad frequency entry, memory selection and frequency or memory scanning. Full duplex operation is possible when both transceivers are fitted.

From a security point of view it may even possible to mount the transceivers out of sight and only have the controller on view. Since most thieves now know that a cellular phone is not a saleable item, owning an RC10 may be a wise investment!

Although I have not seen the RC10, I am of the opinion that it will do much more than I have already described. I suspect that it will be possible for the RC10, when used in conjunction with both 2 metre and 70 centimetre transceivers, to operate as a personal repeater. Parked at the top of a multi-storey car park and left unattended, I would not be surprised if you could not talk-in to the installation from another small handheld on 70 centimetres (say a TH41E) and have your transmission re-broadcast at a higher power from the good location on 2 metres. Any reply would be re-transmitted to you on 70 centimetres. Useful and ideal for staying in contact when wandering around town. Helpful also for RAYNET use.

Of course I may be wrong!

TM221E £334.60 inc VAT Carriage £7.00
TM421E £372.08 inc VAT Carriage £7.00

the TS711E and TS811E PERFECT BASE STATIONS!



The KENWOOD TS711E two metre base station is perfection epitomised; receiver sensitivity and the ability to reject unwanted adjacent signals is outstanding. For the serious operator, any other transceiver is unacceptable.

Similar in specification and appearance to the TS711E but operating on seventy centimetres is the KENWOOD TS811E. When used along side the TS711E, the TS811E completes the ideal equipment line-up and provides the best possible access to the satellites for the VHF/UHF enthusiast.

The TS711E (TS811E) covers the two metre (seventy centimetre) band from 144 to 146 MHz (430 to 440 MHz). Operating modes are USB, LSB, CW and FM. When switched to the "auto" position the transceiver correctly selects mode according to frequency, a great advantage for the blind operator. Simple up/down frequency shift is provided on the front panels and also on the microphones.

Power output on all modes is 25 watts. For QRP operation the output can be reduced using a front panel control.

The TS711E (TS811E) has IF shift, an essential feature when the band is crowded during a contest. To help work DX, speech processing is also available.

The transceiver has two separate VFO's and forty memory channels. Each memory stores frequency, operating mode, whether simplex or repeater shift and if the 1750 Hz tone burst is on or off. The VFO can be either free running as for SSB or CW operation or electrically switched to a "click" stop for FM where it changes frequency in 12.5 or 5 kHz steps. Frequencies stored in memory can be readily transferred to either VFO A or B. Depending on how VFO was set when the information was put into memory ie. click stop or free running VFO, the rig is set the same when memory information is transferred. It is therefore possible to have SSB frequencies transferred with a free running VFO and FM channels with click stop. A great aid to operating! The second VFO can also be quickly put on the same frequency as the one currently being used, ideal when checking the position of a strong adjacent signal whilst remaining on your operating frequency.

Frequency scan on VFO can either be between or outside user set limits. On memory the transceiver can either scan the entire memory content or be instructed to look at those frequencies of a particular mode. The TS711E (TS811E) has a timed hold on an occupied channel.

Both priority channel and immediate recall of your local net frequency are possible with the TS711E (TS811E).

For those with failing sight or a blind operator the TS711E (TS811E) is a dream come true; not only is the operating mode identified by the appropriate CW letter sent in tone (F for FM, U for USB etc.) but when fitted with the VSI optional board, a digitally encoded girl's voice will announce both frequency and, where applicable, whether the rig is switched to repeater shift.

DCS (digital code squelch) is also fitted to the TS711E (TS811E).

TS711E £991.00 inc VAT Carriage £7.00
TS811E £1095.00 inc VAT Carriage £7.00
VSI £34.00 inc VAT Carriage £7.00

LOWE ELECTRONICS LTD.

Chesterfield Road, Matlock, Derbyshire DE4 5LE

Telephone 0629 2817, 2430, 4057, 4995.

Send £1 for complete mail order catalogue.



70cms 40watt AMPLIFIER

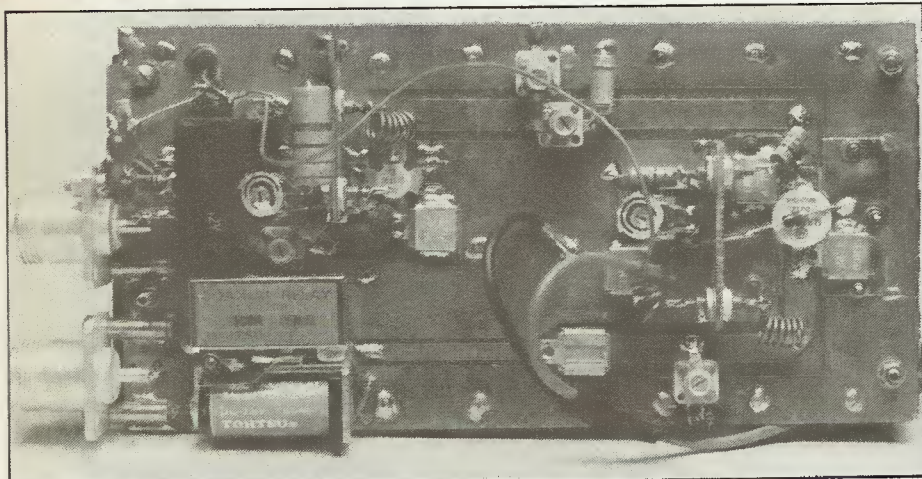

Photograph of the prototype unit, here a coaxial relay was used for RF output switching.

70cm may be UHF but you can still homebrew for this band. Geoffrey Pike, G10GDP, offers a simple 40 watt SSB amplifier for 1 watt handies.

Probably many people like myself have been introduced to the 70cm band by way of the FT790 or similar integrated transceiver, but with an output of only 1 watt or so and even in conjunction with a 19 or 21 element beam, and coupled with the increase in path losses (up to 10dB greater than 2 metres), effective reliable communication is likely to be over a very small distance, say 100km with luck. However with good tropo conditions such as we had in October 1985, 500km could be worked with as little as 200mW, unfortunately this is not very common and these problems have probably contributed to the relatively low activity on the band.

Although it is always possible to increase station coverage by upping the ERP with say 4 x 19 element or 4 x 21 element antennas, such low initial power is probably only going to give good results during tropo openings. With this in mind my design requirements were for a linear amplifier of about 40-50 watts, for 1 watt input on SSB — constant

duty was not considered. It is possible that the amplifier could be used for ATV, here linearity is a prime consideration, but this has not been tried.

Although valves are usually the first choice for high power linear operation, and semiconductors for UHF are very expensive, it was decided that transistors were worth trying, especially as I already had available a suitable 13.8V power supply like many QRO operators.

The UHF semiconductor costs of this amplifier are about 60-70% or so of the overall cost, but the overall cost will be between £1.50-£1.75 per watt, depending on the relays used. This compares favourably with any commercially available unit.

Circuit description

This is essentially in two parts, a driver stage consisting of SD1136 and using an output stage with a MRF646, in fact the amplifier could be built so as to give a 1 in 8 watt out or 10 in 40+ watts out amplifier,

so it will therefore be described in this way.

The driver stage consists of a single hole, stud mounted SD1136 in a MT90 package. This is rated at 10 watts with more than 6dB gain at 470MHz, although about 9dB has been measured at the 432MHz/8 watt level. This stage brings up the level of a FT790 to about 8 watts for driving the output stage device. The input from the antenna switching relay RL1 to the SD1136 is impedance matched via C1, C2, Z1 and C3. The input impedance of the SD1136 at 450MHz is $1.4 + j.44\Omega$ and this is transformed to 50Ω resistive input by C3 and then via the transmission line Z1 and C1, C2. The transmission line Z1 has Z_0 of about 30Ω . Measured input SWR on the prototypes have been less than 1.5:1 and no problems should be encountered here with high SWRs; as the SD1136 is required to be linear, a small standing current is required. This is set by VR1 to about 10mA in Q1 collector. The bias network is RF decoupled from Q1 base via a 22uH moulded choke, L2 and C4. Further decoupling at audio is provided by C5. L1/C7 decouples any RF from reaching the supply rails. The output network Z2, again with a Z_0 of about 30Ω , C8 and C9 transforms the output impedance of $6.4 - j.3.4\Omega$ to 50Ω before driving the input of Q2. C8 and C9 provide adjustment for maximum power delivery, and while air space types are to be recommended for lowest losses, acceptable results will be achieved from the teftor, ceramic or film type trimmers.

Total current draw for this stage is about 1A+ at the 8 watt level. Large deviations from this should be investigated.

Output stage

This consists of a single SOE flange mounted 'controlled Q' device type MRF646 from Motorola. This has a minimum gain of 4.8dB at

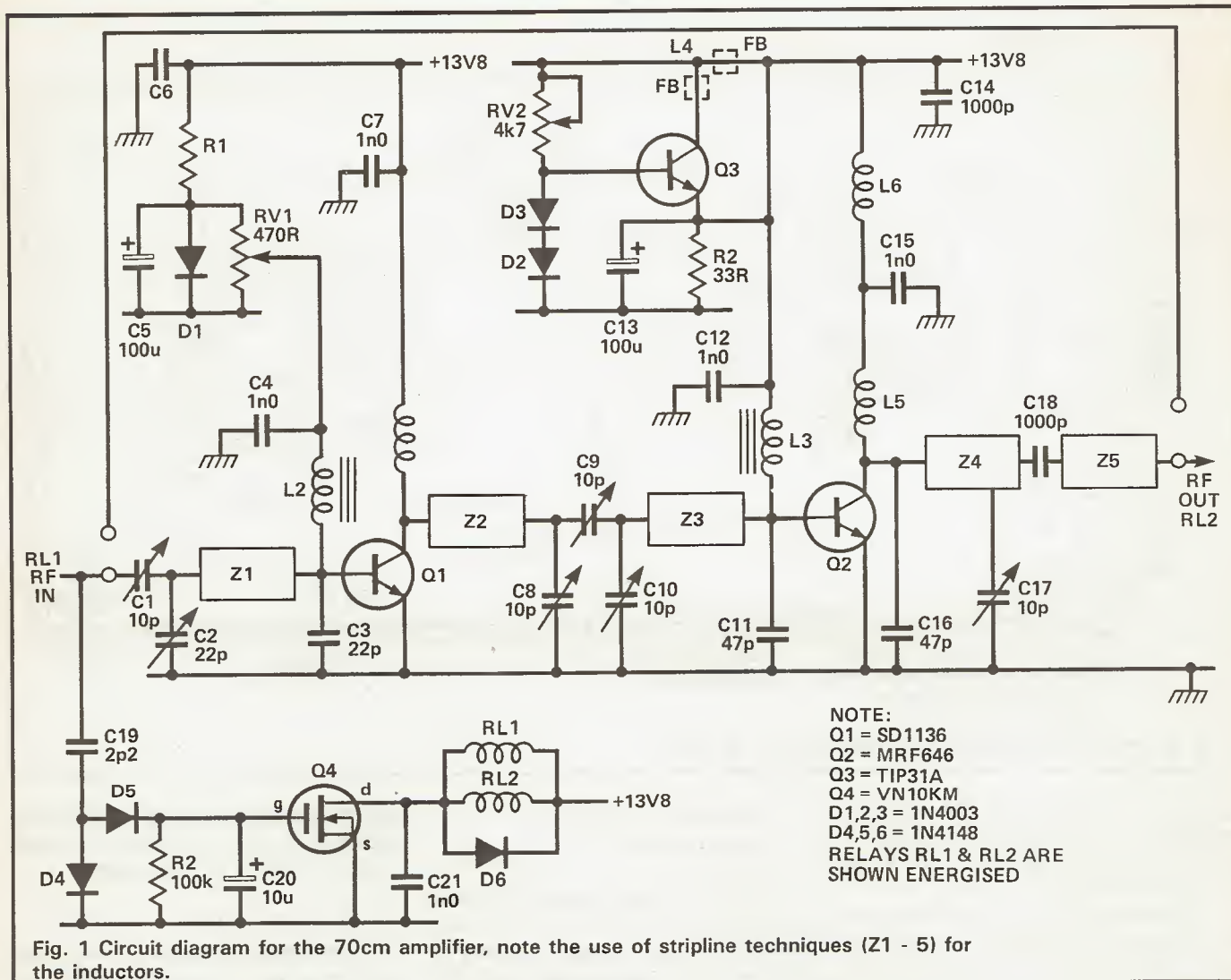

Fig. 1 Circuit diagram for the 70cm amplifier, note the use of stripline techniques (Z1 - 5) for the inductors.

470MHz, 45 watt level, and when driven from the driver stage Q1 should produce about 40 watts output. Although these devices are not specifically designed for SSB service their performance is quite good. Impedance matching from 50Ω to the low input impedance of 1.4 + j 3.9Ω is accomplished by the transmission line Z3 (Zo about 30Ω) C10 and C11. C10 is made variable to facilitate adjustment while C11 is a mica wrapped fixed capacitor mounted very close to the MRF646 body. These types must be used and mounted correctly with plenty of solder flowed around them.

To facilitate proximity to Q2 these capacitors are mounted upside down (value down) and if needed the centre lead or tab trimmed at 45° get close into the transistor. Under no circumstances use any other type of capacitor here as they will overheat and may explode and impair power delivery into the load.

The output network C16, Z4, C17 and C18 matches the output impedance of 1.2 + j 2.8Ω to 50Ω. C16 is a mica wrapped type and needs to be mounted closely to Q2 collector. C17 is a variable to allow adjustment on tune up for maximum power output. The output from Z4 is coupled via a 1000pF mica capacitor for DC isolation into a 50Ω transmission line to the output relay RL2, which for the lowest losses, should be a coaxial type.

However if losses can be tolerated, with decreased collector efficiency another OM1 type relay can be used (as RL1). This can be mounted on a piggy back board onto the main PCB with short interconnecting leads. About .75-1.0dB loss can be expected on transmit with this type of relay, and a commensurate increase in noise figure.

RF is decoupled from the supply lines with L5, C15 and L6. The bias network for the output stage is Q3,

a medium power audio transistor used as an emitter follower with a very low output impedance. Bias is thermally tracked with D2, and this is in contact with the output transistor top cap.

Q2 bias current is set to about 30-40mA by VR2. L3/C12 decouple RF from the bias network. L4/C14 removes any RF on the supply lines from reaching the bias network with C13 providing decoupling at audio frequencies. Q3 is bolted to the main PCB to act as a heatsink, and must be insulated with a mica washer and nylon bush.

Transmit/receive switching

Ideally this should be hard wired with the prime mover. My own FT790 has a relay fitted inside for this purpose. RF sensed changeover is convenient, however preventing relay chatter under all conditions of use with a reasonable hang time is not always easy in a simple circuit.

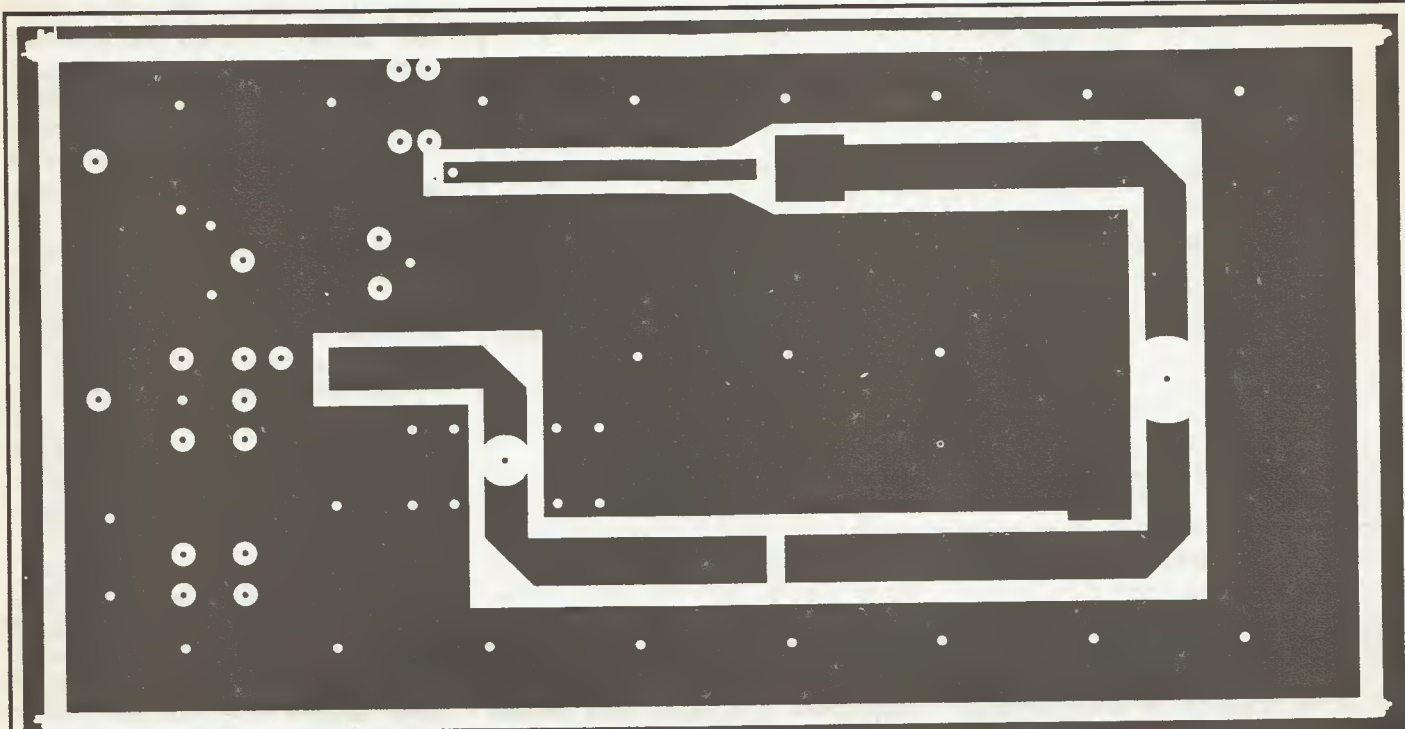

Fig. 3 Top foil pattern, etched areas are shown in white.

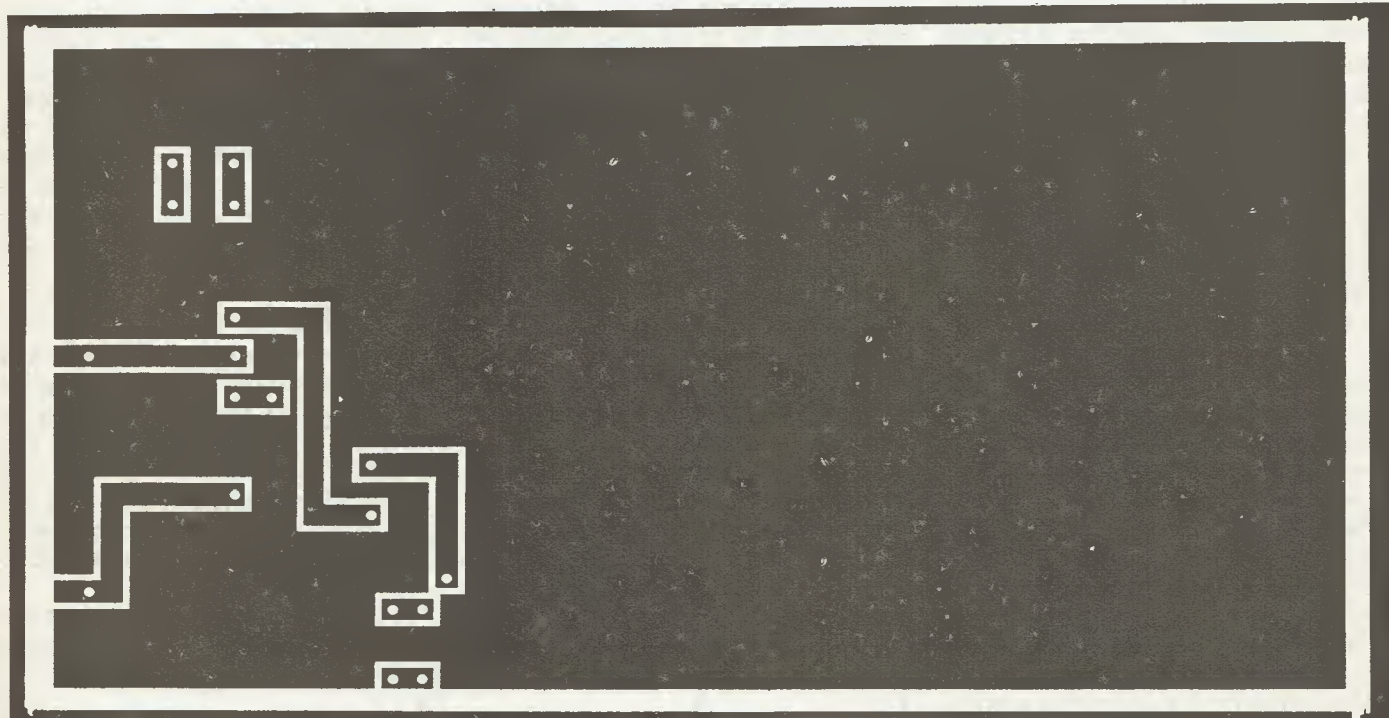

Fig. 4 Bottom foil pattern, etched areas are shown in white.

where copper is needed. Then when finished spray the whole board in cellulose car primer paint (top and bottom). Before removing the remaining plastic sheet ensure that all holes are marked. This can be done with a centre punch or the sharp end of a 4mm tap. The holes can be drilled later after etching and any adhesive left behind from the plas-

tic must be removed by burnishing with some kitchen roll.

To aid simplicity in layout the bottom side of the board only carries a few 50Ω lines for antenna switching, these lines can be drawn directly onto the previously painted bottom surface of the board. Using a sharpened nail or tap, the areas of copper to be etched between the

50Ω lines and the main ground plane can be scraped away and thus exposed to the etchant.

Although this procedure may seem complicated, in practice it is very easy to do. The results are a good clean board with straight and parallel transmission lines on both the top and bottom surfaces. When the board is etched and cleaned up,

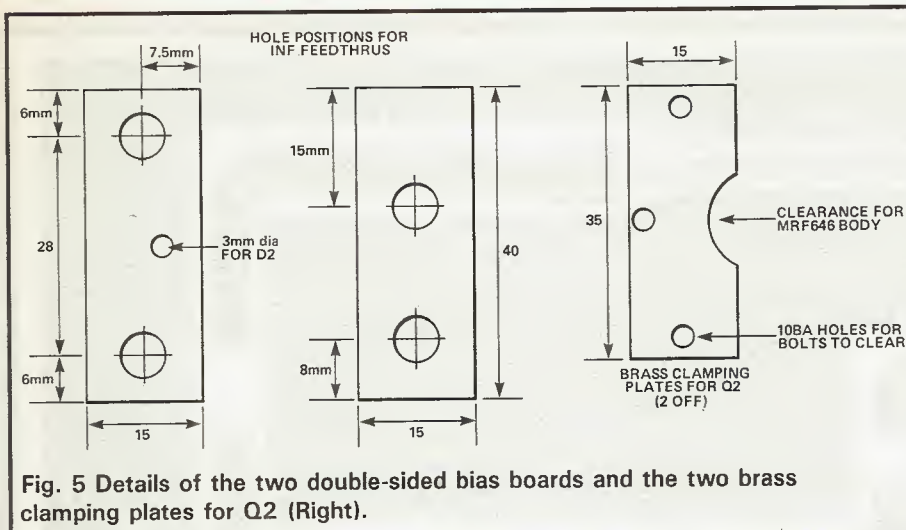

can if desired by soldered into position, similarly ensure that thermal compound is on the flange. However it is suggested that the brass mounting plates in Fig. 5 are made, these clamp Q2 emitters to the board and ensure an earth link to the lower ground plane, and also help removal of the transistor if needed. C11, C16 and D2 can be fitted and soldered to the brass clamping plates. These plates are held in position with 10BA bolts, the nuts being soldered onto the bottom ground plane. It may be necessary to file the tops of the mounting bolts on Q2 flange to prevent the brass plates from bending over them and thus making a poor earth connection.

remove the cellulose paint with thinners and drill all the holes and open up those needing veropins which bond the upper ground plane to the lower ground plane. Ensure that the relays fit the board without undue pressure on the pins, also check that any pins which connect only to the underside of the board have sufficient clearance of copper on the top surface. This can be achieved by removing the copper with a 2½mm drill turned by hand.

Fitting the components. The mounting holes for Q1 and Q2 need to be opened up, Q1 needs a hole 7mm in diameter and Q2 a hole 13mm in diameter. Q2 needs slots for its flange to pass through the board.

Do not make the clearance for the flange excessive. When all the holes have been drilled, pins fitted and soldered, the PCB should be set on the heatsink and a 5/32" hole (4mm) drilled for Q1 stud and two holes for Q2 flange. These devices are soldered in later. Also mark and drill four 6BA clearance holes to support the PCB on the heatsink. Please note that it will be necessary to make a small shim plate of 22g aluminium for Q1 so that its mounting surface comes into contact with the main heatsink body. It will also be necessary to mill out a hole on the underside of the heatsink to recess the nut for tightening up the stud. With this done the leads of Q1 sit comfortably on the top surface of the PCB. Failure to do this will put undue vertical pressure onto the package and may lead to failure when the stud nut is tightened.

At this stage the other components can be fitted to the

board, however some cannot be fitted easily into position, these include L2, C3, L1 and C11, C16, D2. Begin by fitting RL1 and RL2 and proceed to fit all the tuning capacitors. The piggy back boards can be fitted after first drilling holes for the 1nF feedthrough, then the rest of the circuitry for the bias control can be fitted when these are soldered to the main upper ground plane. See the sketches which should make this easy to follow. At this stage the 'N' type connectors can be fitted onto the upper ground plane using 6BA bolts and ½" spacers to solder onto. The board can be placed over the heatsink and lightly bolted up. Then Q1 and Q2 can be fitted into place, ensuring that the grounding links around Q1 have been fitted. Do not solder the transistors yet, check for a good fit onto the board and cut out the leads of Q1 as shown. Lightly tighten Q1 stud nut and check that the 22g spacer plate is fitted and has thermal compound on it.

If all is OK then solder Q1 into place and tighten up the bolts. Q2

The bias transistor Q4 is mounted on a mica washer/nylon bush and smeared with thermal compound also. Finally when fitting the mica capacitors ensure a good flow of solder around them. Also ensure that any variables have their earthy (ie. adjuster) side to earth. Check for correct polarity of all diodes, electrolytics and the correct orientation of all semiconductors. Also make sure that all relevant veropins clear the top foil and do not ground out. Solder up two power leads, placing the ground lead as near as possible to Q2 emitters and the positive temporarily to the junction of C14/L6.

Tuning up procedure

To do this a power indicator and dummy 50Ω load is needed, rated at 30W, and an ammeter to measure collector current (10 amps max). The quiescent current in Q1 and Q2 needs to be set before applying any RF. Preset VR1 to minimum resistance (wiper to ground) and VR2 to maximum resistance.

Before applying 13.8V, limit the

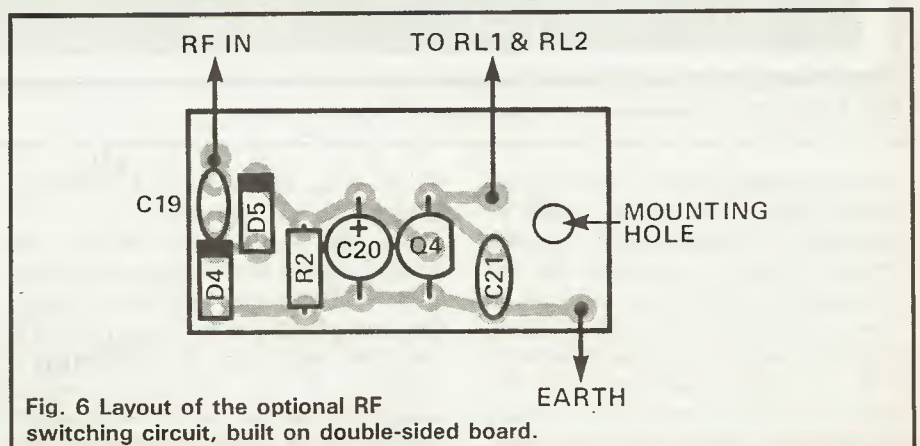

Fig. 6 Layout of the optional RF switching circuit, built on double-sided board.

current by a series 2R or 4R 10W resistor. This will prevent any disasters if a fault should occur. Temporarily disconnect the positive supply from C14/L6 junction. Arrange a supply to the SD1136 driver stage only, and insert a meter capable of reading up to 100mA in series with the supply lead. Switch on and only about 60mA should flow, adjust VR1 until the current rises by 10mA. This will reflect the bias current in Q1, check that this is stable over 5-10 minutes. When satisfied with this the bias in Q2 can be set. Disconnect the supply from Q1 stage and reconnect to C14/L6 junction, but via the milliammeter. The preset VR2 should be adjusted to about halfway along its track. Apply power again, and about 60-90mA should flow. Set this by means of VR2 to 60mA, approximately 35mA of this is Q2 bias current. Check that this does not drift over a ten minute period. Also check that when a finger is placed on D2 to warm it up that the bias current falls, and when the finger is removed this should return to about 60mA.

If everything is satisfactory, reconnect the supply to Q1. Leave the limit resistor in place, preset the variable capacitors thus, C1 50% meshed, C2 30% meshed, C8 & 9 about 50% meshed, C10 almost at max capacitance and finally C17 about 80% meshed. These positions will give a very approximate starting point. Connect up a UHF power meter/dummy load and transceiver.

If desired you can temporarily hard wire the relays to the on position (thus preventing relay chatter if the RF sensed circuit is used during the initial tuning up period). Apply about .5-1.0W of drive, preferably in 30 second bursts, rather than constantly on. Adjust all trimmers for maximum power output, do this a few times until maximum power is achieved. If desired the predriver can be tuned separately, and then reconnected to the output stage and it tuned. However no problems exist in doing it all in one attempt. With the limit resistor still in circuit (4R) it is unlikely that more than about 4 watts maximum will be achieved. If all is OK, remove the limit resistor and retune all of the trimmers, but mainly C10 and C17 until maximum power is attained, this may need to be done a few

times again. Again this should be done in 30 second bursts to prevent excessive dissipation whilst establishing correct tune.

Check that the total current is in the region of 7-8 amps for a constant carrier, and that no instability exists. Check that the delay for SSB is suitable, if not adjust C20 until it is correct. However about 10uF seems about right, in parallel with R2. Using my FT790 and a Weltz power meter, and using a coaxial relay in the output, approximately 15-17 watts on the low power position was achieved and about 40-45 watts on the high power position.

The linear was tuned at 432.2MHz, for about 45 watts, this falling to 25 watts at 439.9MHz. If tuned at mid-band the power profile is likely to improve. The results with an OM1 relay in the output are about .75dB inferior.

During use it is desirable to have a PEP meter in line so as to avoid excessive drive levels. From the above results it is clear that already quite a lot of gain compression exists, so overdriving is not recommended. However if correctly driven, reasonable audio quality and spreading reports are likely to be given from others on the band.

Components list

RESISTORS

R1	220R	1 watt
R2	33R	1 watt
R3	100K	¼ watt
VR1	470R	vertical preset
VR2	4K7	vertical preset

CAPACITORS

C1,8,9,10,17	10p	tefter trimmer
C2	22p	film trimmer
C3	22p	mica wrapped
C4,7,12,15	1n	feedthru (solder or bolted)
C5,13	100u	10V radial electrolytic
C6	470n	100V polyester
C11,16	47p	mica wrapped
C14,18	1000p	mica wrapped
C19	2p2	50V ceramic
C20	10u	6.3V tantalum
C21	1000p	50V ceramic

Mica wrapped types available from Cirkit

INDUCTORS

L1	6T	5mm ID 10mm long 22swg
L2, L3	22uH	moulded choke
L4	two	ferrite beads over wire
L5	6T	5mm ID 10mm long 22swg
L6	4T	5mm ID 8mm long 22swg

RELAYS

RL1	OM1
RL2	CX-120P coaxial relay or OM1 (reduced output)

Relays available from Cirkit

SEMICONDUCTORS

Q1	SD1136
Q2	MRF646
Q3	TIP31A
Q4	VN10KM
D1, D2, D3, D4	IN4001
D5, D6	IN4148

Q1 and Q2 both available from: Raedek Electronics, 102 Priory Road, Scribers Lane, Scribers Lane, Hall Green, Birmingham, B28 0TB.

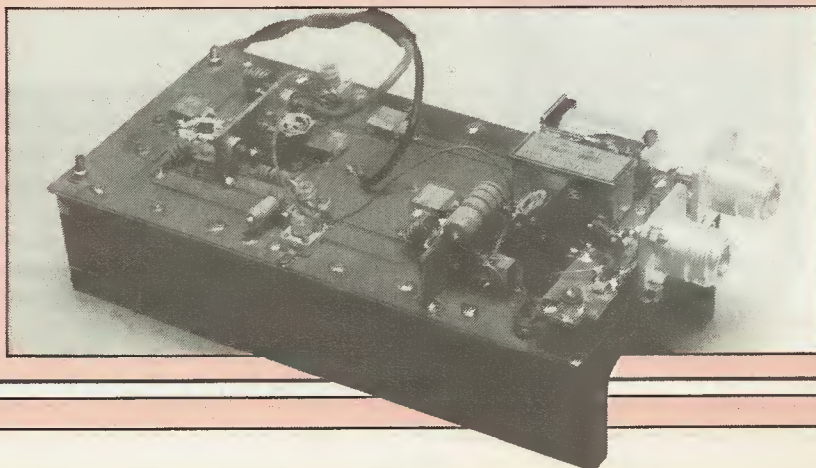

KENPRO

KT220EE



The Kenpro KT-220EE.

Amateurs starting up on 2m want an all-rounder for their first set, one that can be used in the shack, out portable and for the occasional burst of mobile operation en route for club meetings or whatever, just to keep in touch with the locals. But they

med transmit offset. The offset has a positive or negative 600kHz shift in normal use, but may be set to any 10kHz multiple up to 9.990MHz for operation or memory programming. A multi-function rubberised keypad is used to enter most required oper-

“Why don’t you review more cheap gear?” is a frequent question from our readers. “Because there isn’t much around,” is our perennial reply. Well, this Kenpro 2m handie breaks the price barrier — but is it a bargain? Chris Lorek finds out.

want all this versatility for the minimum of outlay . . .

Tokyo-based Toyomura Electronics have been making 2m and 70cm thumbwheel-controlled sets for some time under the brand name Kenpro; the KT400EE 70cm rig was reviewed in our March '86 issue. The KT220EE represents a shift to push-button control, and a tremendous increase in the operating features — it even includes a digital clock (well you’ve got the crystal-controlled oscillator and you’ve got the display, so why not — doesn’t it make log-keeping easier?). This rig is obviously the makers play for the all-rounder market; and it undercuts the ‘big three’ manufacturers’ equivalent rigs by a wide margin.

Features

The set covers 144-145.995MHz in user programmable steps of 5kHz multiples, ie. steps of 5kHz, 25kHz, 100kHz, etc. Various market options are available, and the set is capable of operating over 140-155.995MHz with appropriate internal modification. Operating frequencies may be keyed in directly, and ten memory channels are available, each storing receive frequency and any program-

ating functions, this may be locked if required by a side-mounted slide switch.

Memory channels may be scanned for activity, alternatively a programmed section of the band may be scanned in user-defined steps. Any number of memory channels may be locked out of scan mode, apart from memory 0 which sets the upper limit of the programmed band scan. No less than four modes of scanning are possible, namely manual, scan, search and open. In manual mode on each depression of the relevant keys the set increments by one frequency step or memory channel. In scan mode the scan halts on detecting a signal; even if the carrier is still there after 15 seconds the scan carries on to the next channel. Search mode looks for a signal and stops there when it finds one, not resuming, while open mode does the same except it continues its scan when the squelch drops.

The operating frequency and selected offset direction, memory channel, scan mode, Tx/Rx state, and a low battery warning are shown on a large LCD panel. This doubles as a programming display for Tx offset,

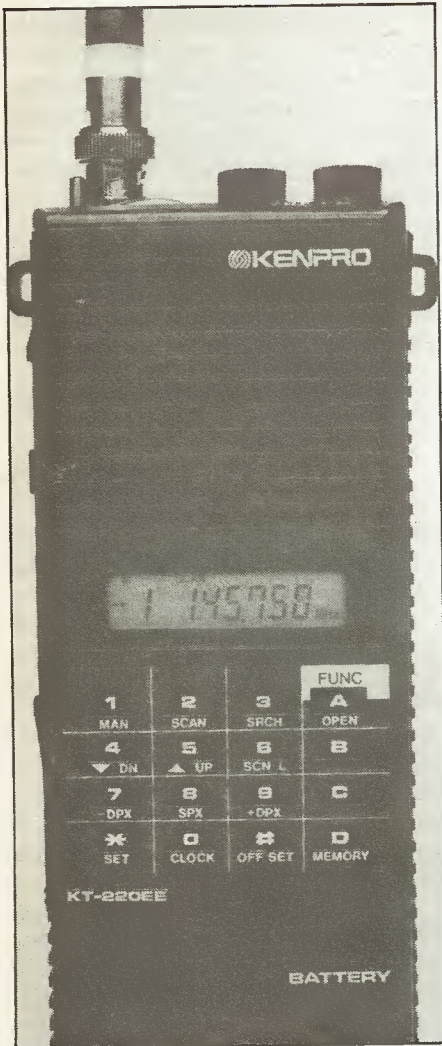

General view of the transceiver.

sub-audible tone and auto-send touch-tone number storage (when fitted), and of course the digital clock display giving the time to the nearest second, this staying on if required when the radio is switched off. (No, it doesn't have a clock radio alarm facility to wake you up!)

The usual rotary top-mounted controls for volume and squelch are fitted, these are accompanied by a low/high transmit power switch, a BNC connector for the supplied helical or your own aerials, and further sockets for external DC power, speaker and microphone. An analogue meter shows relative signal strength on receive, and an indication of battery voltage on transmit; this may be backlit together with the LCD by pressing a side-mounted switch panel. Pushing the squelch knob transmits a 1750Hz tone for repeater access.

The set may operate on any battery voltage from 7.5V to 16V, the

maximum transmit power varying accordingly. Using a 9.6V nicad (250mAh) as supplied gives a claimed transmit power of 3.5W with a switch-selectable low-power mode of 500mW. Optional battery packs are available giving 10.8V at 450mAh and 13.2V at 450mAh. An empty battery case is also available, either as an option or as standard if required as an initial economy measure.

The accessories supplied are: a large belt clip; helical aerial; flexible carrying strap; earphone; plugs for external DC power, microphone and speaker; and a very comprehensive instruction manual giving full circuit diagrams and component layouts. Optional accessories available include a protective soft case, wall and desk top chargers, mobile charging cable, the various battery packs previously described, and a speaker microphone. With the 9.6V nicad fitted, the set measures 182mm(H) x 63mm(W) x 43mm(D) and weighs 535g.

Inner Thoughts

Well, it took me a good two hours to fully read the manual and understand how to operate the set correctly. The incorporation of so many operating functions is certainly very useful but requires the use of techniques almost akin to simple computer programming. Once learned though, it's no problem, but don't expect a friend to be able to use it first time!

The case appears to be built to withstand rough usage; the rear is cast metal whilst the remainder is constructed from tough moulded plastic. There is no provision for protecting the top-mounted socket holes from rain entering, apart from this set looks reasonably weather-resistant. The slide-on battery mechanics, right down to the last detail, appear remarkably similar to those employed by Icom, as do the internal construction techniques; somebody somewhere has obviously been doing a bit of homework!

On The Air

The first thing that struck me was the excellent sensitivity of the receiver. I live in a fringe area between four repeaters, my 'local' one is around 35 miles away, and

although this gives a rock-crushing signal from my tower-mounted aerial system, it normally offers marginal copy on a portable inside the house. With the Kenpro, I could find very few spots where I could not receive it, which I greatly appreciated when listening for calls. Walking around rallies with the set, amongst many other strong 2m signals, showed it to be a little susceptible to off-frequency signals though. This is a common problem of course with sensitive sets built with low current drain in mind: bomb-proof front ends tend to flatten batteries quickly with present technology.

Despite the very comprehensive operating features, I found the set extremely fiddly to use, QSYing was rather a pain if attempted whilst mobile. To increment by one channel, two button pushes were required, but I had most problems when trying to revert back to where I was after accidentally pressing the wrong button.

In the set's favour, however, once in memory mode, only one key press was needed to access each memory, which I found very useful. Storing normally used channels together with programmed reverse repeaters, in the memories provided simple control as long as I kept my fingers off the other buttons!

When scanning in small steps, I noticed that the scan stopped only when a correctly frequency centered carrier was located, rather than when the squelch raised. This is most useful, and overcomes the annoying effect I've found on some other portables of giving badly distorted audio when searching using 5kHz steps. 12.5kHz offset stations caused the set to stop 2.5kHz below the centre frequency rather than be completely ignored, again a nice touch, but what a pity that true 12.5kHz steps are not accommodated. I found I missed having a 'priority' channel scan (where a preset channel is briefly sampled for activity every few seconds) but now I'm getting pedantic.

The received audio was very clear, with ample volume available from the internal speaker. I did sometimes find the set 'hooted' at me with the volume cranked up to maximum, due to microphone feedback between the internal speaker and the VCO, but no problems were experienced with an external speaker

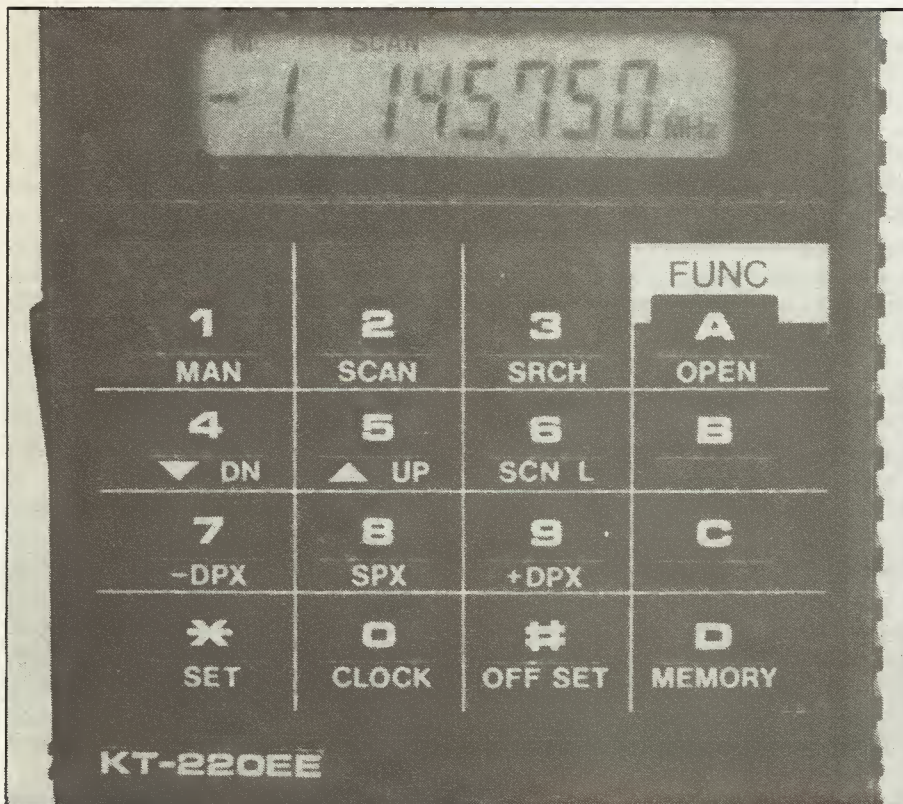

Close-up detail of the LCD and keypad area.

though. I could I could happily monitor all day without flattening the 250mAH nicad. The set could be placed in 'top-up' mode whilst in use by plugging the wall charger into the battery charging socket, a built-in LED indicating that charging was taking place.

On transmit excellent reports were received, with very few of the breath noises that can make amateurs sound like a long distance runner as they walk along!

Inner Circuitry

Conventional discrete components are used for the analogue circuit functions, mounted on two boards housed in a sandwich-form metal chassis, with hinges to allow easy servicing. The control board, fitted to the front panel, uses a surface-mounted NEC uPD7503G microprocessor and peripheral chip components, the crystal-controlled 1750Hz tone generator being mounted on a small sub-board.

Dual conversion is used on receive, with IFs of 16.9MHz and 455kHz. 2SK241 FETs are used for the front end and first mixer stages. Adjacent channel selectivity is achieved by a pair of monolithic dual crystal filters at the first IF, and a CFU455E ceramic filter at the

second, discrimination being performed by a 455kHz ceramic resonator used with a TK10420 IF subsystem IC. An NEC uPD2834C synthesiser in conjunction with a uPB571C dual-modulus prescaler controls the final-frequency voltage controlled oscillator, the varicap tuning voltage to this also being fed to the receive front end bandpass circuits to actively tune these to resonance.

On transmit, the VCO is directly modulated with processed microphone audio and internally generated tones to achieve true FM generation. The VCO output is amplified in three bipolar stages before final amplification by a 2SC2237 transistor, the set's rear metal case acting as a heatsink for this. Two elliptical low pass filter stages follow the PIN diode Tx/Rx switch before connection to the BNC aerial socket.

Laboratory Results

The sensitivity figures confirm the excellent results achieved on-air, whilst the blocking results show the varicap-tuned front end was performing well. Intermodulation rejection was reasonable if not exceptionally good, here is the trade-off for good sensitivity. Adjacent channel selectivity at 25kHz was reasonable also, but strong signals one channel away when used, say, as a base station could cause the odd problem or two. The manual in fact warns of using high gain aerials for this reason.

A useful range of squelch threshold variation can be seen, allowing you to squelch out distant signals if required. The S-meter gave a slightly better-than-average dynamic range than found with other FM sets.

The current consumption, both on receive and transmit, was very good showing the set to be capable of operating for long periods without



Top panel view.

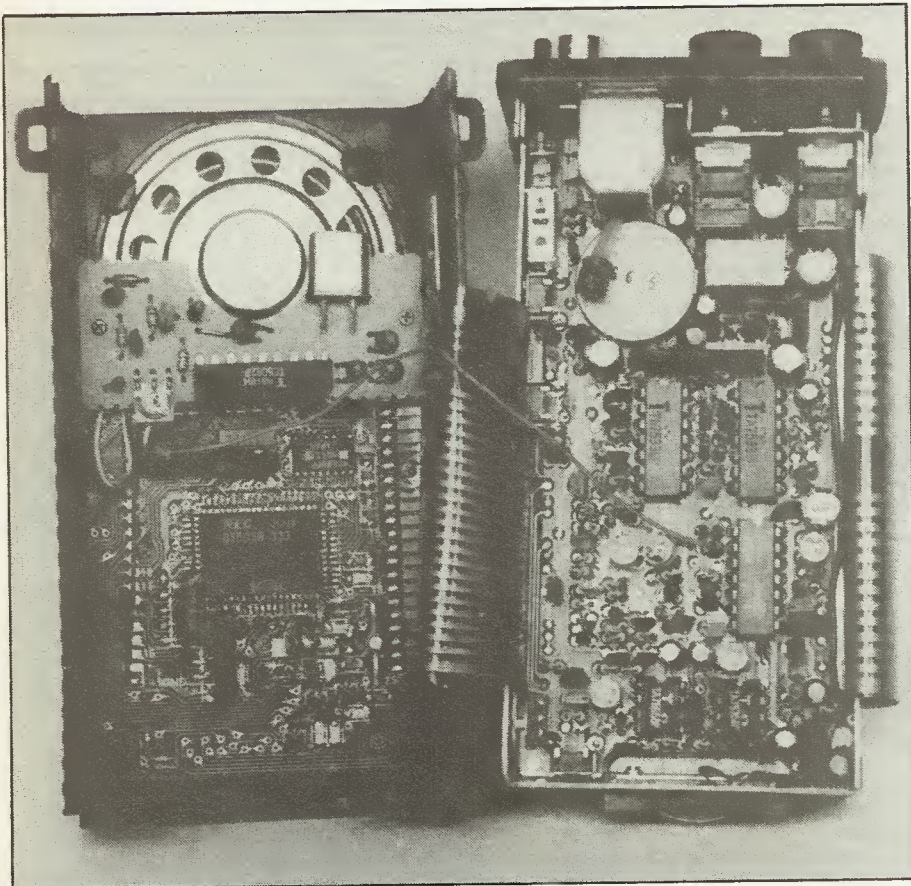

A good standard of internal construction is evident.

transmitted spurs were detected, showing the final-frequency VCO to be clean of extraneous mixing signals.

Conclusions

The set is very versatile, and allows a high degree of operating flexibility but in my opinion it becomes a little difficult to control when not in memory mode and 12.5kHz steps are not accommodated. Otherwise for portable use it is very good indeed, having a low current drain coupled with a very sensitive receiver. It should also survive the odd knock or two, but if you contemplate using it in the rain remember to cover up the top holes with a piece of sticky tape to stop water getting in. For base use with an external aerial, you may find problems if you use an external preamp fitted, say, to an add-on power amplifier so watch out for this. These limitations are offset by the economic price of £199, so for occasional use or as a second set to fit in your pocket or glove compartment it offers good value for money.

My thanks go to Ray Withers Communications Ltd. for the loan of the review sample.

requiring a recharge. On transmit, the peak deviation was accurately set at

just below 5kHz, and the harmonics reasonably suppressed. No other

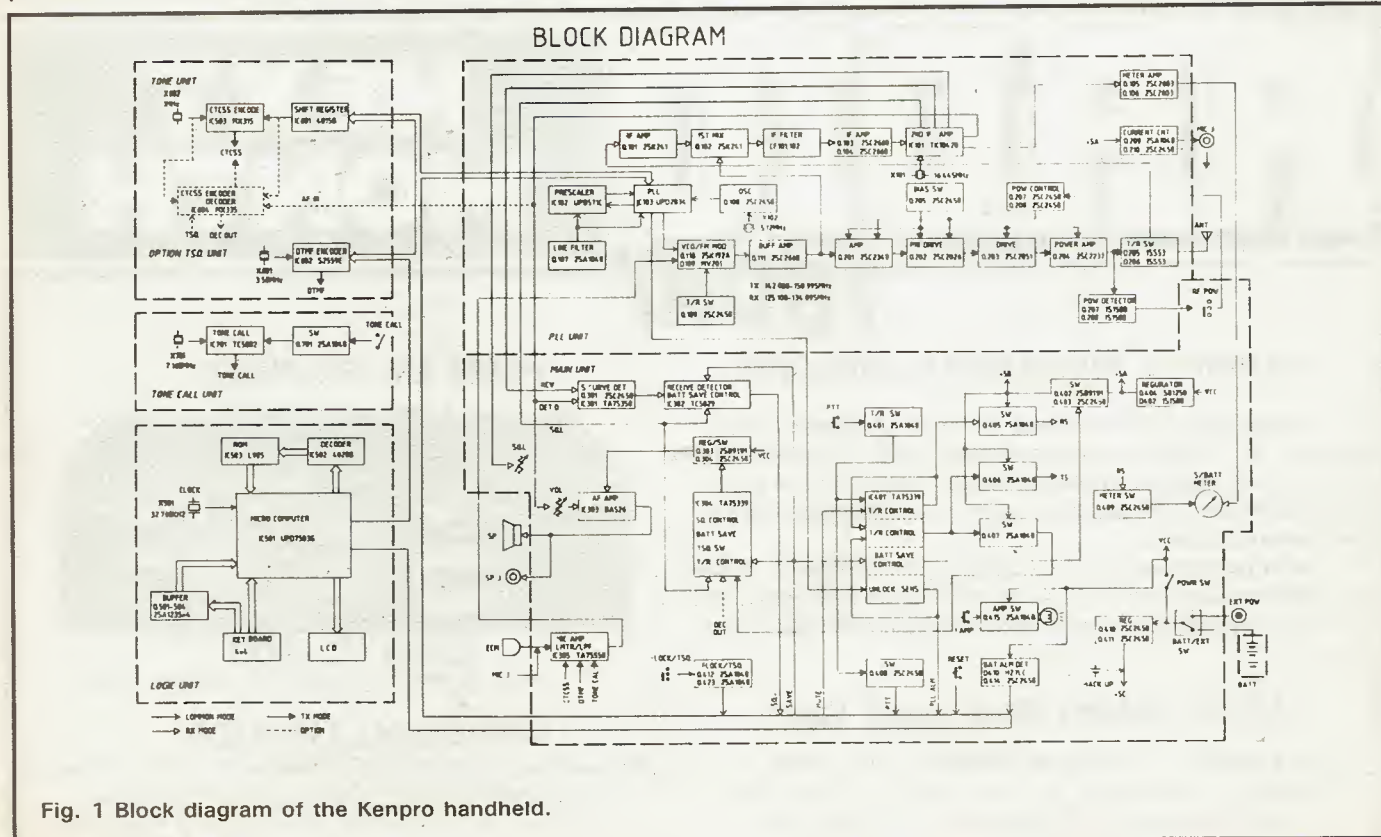

Fig. 1 Block diagram of the Kenpro handheld.

Laboratory Results

(NB All measurements performed at 145.0MHz).

Receiver

Sensitivity: 0.130uV pd (3.5dB SINAD)

Squelch Sensitivity

Threshold 0.068uV pd (3.5dB SINAD)
Maximum 0.224uV pd (25dB SINAD)

Receive Current Consumption

No signal — economizer standby	8mA
Mid volume	76
Max	146

Adjacent Channel Selectivity: Measured as increase in level of interfering signal, modulated with 400Hz at 30% system deviation, above 12dB SINAD ref. level to cause 6dB degradation of 12dB SINAD on-channel signal.

Spacing	Selectivity
+ 12.5kHz	39dB
- 12.5kHz	22dB
- 25kHz	54dB
- 25kHz	53dB

Blocking: Increase over 12dB SINAD level of signal 1MHz away to cause 6dB degradation in 12dB SINAD on-channel signal.

+ 1MHz	98dB
- 1MHz	96dB

Image Rejection: Increase in level of signal at -33.8MHz to give identical 12dB SINAD signals: 78dB

Intermodulation Rejection: Increase in level over 12dB SINAD level of two interfering signals giving identical 12dB SINAD on-channel 3rd order intermodulation product.

Spacing	Rejection dB
25/50kHz	56.5
50/100kHz	56.5

Maximum Audio Output: Measured at 1kHz on the onset of clipping, into an 8 ohm load, 9.6V supply: 357mW RMS

S-Meter Linearity

Level	pd (uV)	dB
S1	1.44	-24.0
S2	2.23	-20.2
S3	3.08	-17.4
S4	3.79	-15.6
S5	4.61	-13.9
S6	5.54	-12.3
S7	6.97	-10.2
S8	10.2	-7.0
S9	22.8	0dB ref

Transmitter

Tx Power and Current Consumption

Mode	9.6V Supply	13.8V Supply
Low Power	0.400W / 305mA	0.415W / 315mA
High Power	3.38W / 760mA	4.60W / 860mA

Frequency Accuracy:

+200Hz at switch-on

Harmonics/Spurii	Level
2nd Harmonic	-57dBc
3rd	-72dBc
4th	-83dBc
5th	-88dBc
6th	-82dBc
7th	-81dBc

All other outputs less than -90dBc

Peak Deviation: 4.93kHz

Toneburst Deviation: 3.63kHz

HAM

RADIO TODAY

NEXT MONTH

SEVENTY MEGAHERTZ SPECIAL

There was a tremendous amount of interest when the 50 to 52MHz allocation was finally released last month, but there was also a further bonus in the shape of 70MHz being doubled in width and made available to all licence holders.

Next month we will be featuring an extensive guide to 70MHz equipment — how to identify ex-PMR gear and how to convert it for use on this little used UK allocation.

50 & 70MHz Dual band Yagi

Last month we looked at 50MHz, this month it's 70MHz. If you want to have a go on both, the new Jaybeam 50/70 Yagi may be the answer.

FIRST UK REVIEWS

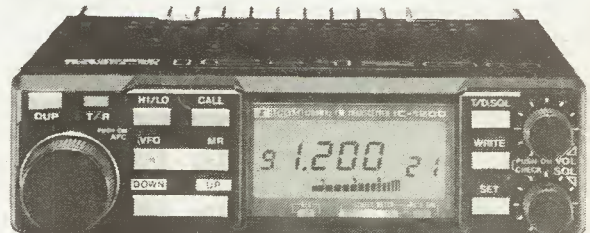

ICOM IC-1200

We look at this 10 watt FM 12GHz mobile

KENWOOD TW-4100

45 watts out on 2m and 35 watts on 70cm. If that's not enough for you it will also work full duplex crossband, and can even be used as a repeater

POSTAGE STAMP AERIAL FOR TOP BAND

My interest in 160m working was rekindled by a chance tune across the band one Sunday lunchtime. To my surprise, I came across a large net of local amateurs chatting away happily — many of them using the time honoured mode of 'amplitude

top of my 25' mast and not to have to bother about burying water tanks in the garden for an earth. The simple answer was a dipole, but there was a snag to this. A 160m dipole is 264' long and my garden was only a fifth of this size. Then I had a

Many amateurs must be faced with big ideas and small gardens. Steve Ireland, G3ZZD, is no exception, and here's his ingenious solution.

modulation'. Listening to the participants, ranging in age from their early twenties to well over 'four score and ten', I was transported back to my first days on the air, spent on this very band in a similar fashion. So when the net disappeared off for the Sunday Roast, I made a resolution. This time next week I was going to be one of the people on the net.

At the time, my sole antenna consisted of an 84 foot long dipole, fed with 600 ohm open wire feeder and in the shape of an inverted vee with the centre about 25 feet high. Not very promising material, to put it mildly. In this kind of situation, the usual solution is to connect the feeders of the dipole together and feed this against an earth or counterpoise via an ATU (See Fig. 1). The problem with this is that as the antenna is around, or less than, a quarter wave in length, the point of maximum current and radiation is at the feedpoint of the antenna. In my case, this would have been inside my flat and about four feet off the ground. Having tried this before at another QTH, also knew the results with this kind of antenna were less than inspiring. I quickly decided that a new approach was required.

What I wanted was for the point of maximum radiation to be at the

brainwave. What about putting loading coils on each of my present dipole antenna and tune this to 160m? After doing a few calculations on the back of an envelope, the idea seemed better than ever. For a start, most of the radiation from a dipole comes from a third of its length — the middle third. And my dipole was going to be about 100 feet long at most, including loading coils and end sections, not much over a third of 264 feet.

Getting out my antenna textbooks, I soon calculated the dimensions of the loading coils. The beauty of the antenna was to be the that I would keep my original dipole intact — all I had to do was to make the loading coils and end sections, connect onto it by crocodile clips, and within a few seconds I could restore it for 80 to 10m operation. And by keeping the tuned feeder would make matching easier on 160m too.

The dimensions of the antenna are shown in Fig. 2 and the loading coils in Fig. 3. The wire came from Woolworths — a very good source of cheap and durable material for antennas — and the loading coils were wound on off-cuts of plastic drainpipe, available from your local hardware store for 50p or so. To keep

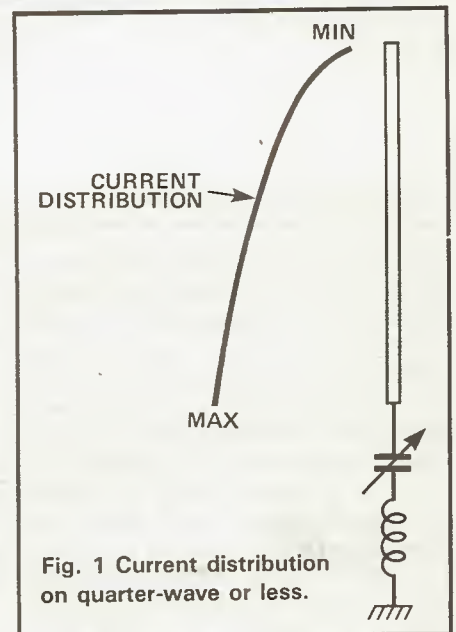

Fig. 1 Current distribution on quarter-wave or less.

the weight of the loading coils off the antenna — they weigh around a couple of pounds a-piece — attach the antenna to a convenient garden fence (wooden of course) or a stake, just before the loading coils (Fig. 4).

In common with about 80% of UK amateurs that operate HF, my antenna tuning unit is of the 'Z-match' design. Mine is home-brewed from the RSGB handbook but the dimensions are almost exactly the same as those made commercially by KW Electronics or Solid State Modules (SSM). The problems with these is that the basic design is intended for 80 to 10m use and they will not tune down as far as 160m, with the exception of a special SSM version. Now, I was going to need a balanced ATU of the Z-match type to tune my new dipole to 160m. What could I do to solve this problem?

The answer was provided by a chance glance through the small

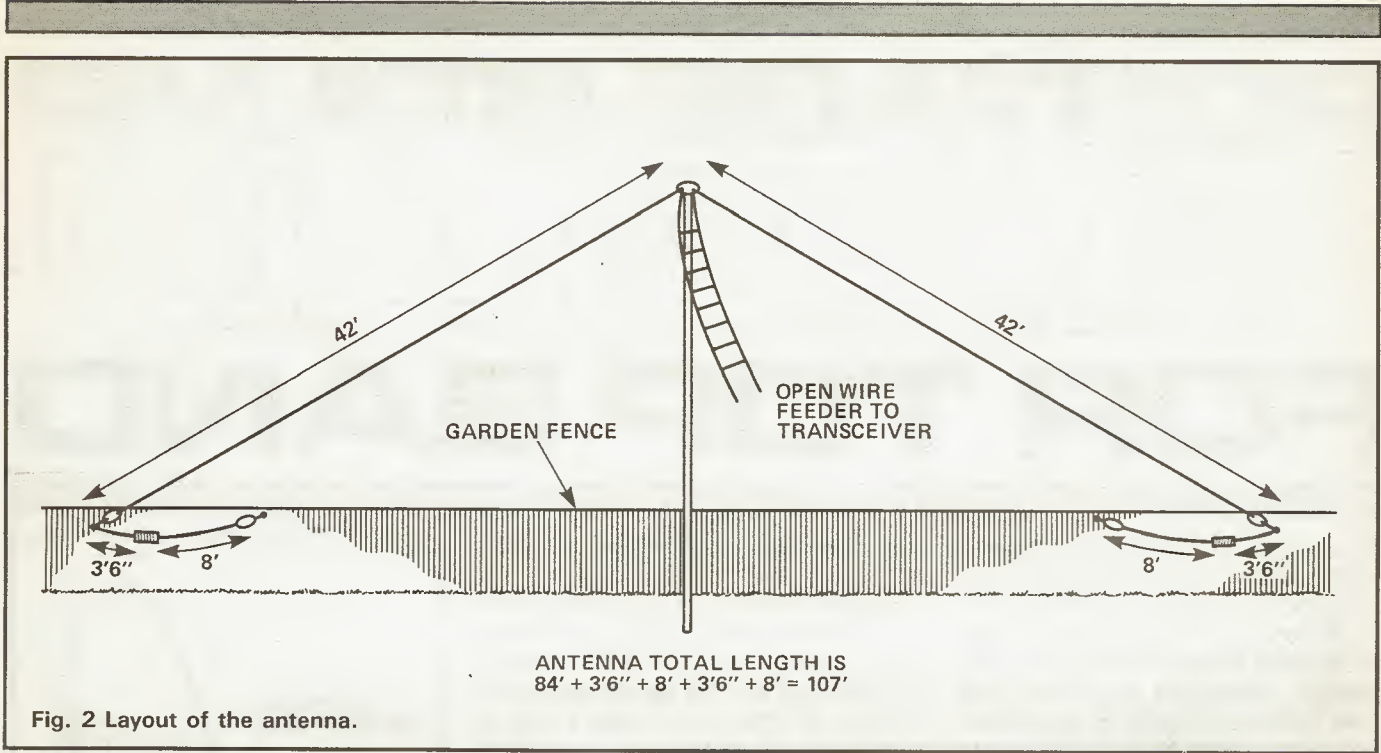

Fig. 2 Layout of the antenna.

advertises in the RSGB's journal — usually the most consistently useful section of that magazine. A small loading coil and a switch was obtained from Harry Leeming, G3LLL of Amateur Electronics, which provides a 160m facility on any Z-match variant and enabled a magnificent match to be made to my new dipole. The modifications takes about 45 minutes and only involves soldering the coil in series with the 80/40 metre output coil and earth, then drilling a hole for the switch which shorts out the extra coil when using the other bands.

The antenna tuned up easily over the whole of the 160 band. Because of electrical 'shortness' of the actual length of it, tuning on the Z-match is quite sharp. Needless to say, I got onto the local net with no problems and received 59+ reports from all over East and North London. Trying the antenna out on SSB during the evening I find I could get 57-9 reports from all round the UK with no trouble at all. My signals are usually about two S-points down on those stations with full size dipoles but then their antennas are usually at least twice as high as my 'postage stamp' dipole as well.

Z-match 160m conversion kits are available from Holdings/Amateur Electronics, 45 Johnstone Street, Blackburn BB2 1EF for £5.99 plus £1.25 postage and packing.

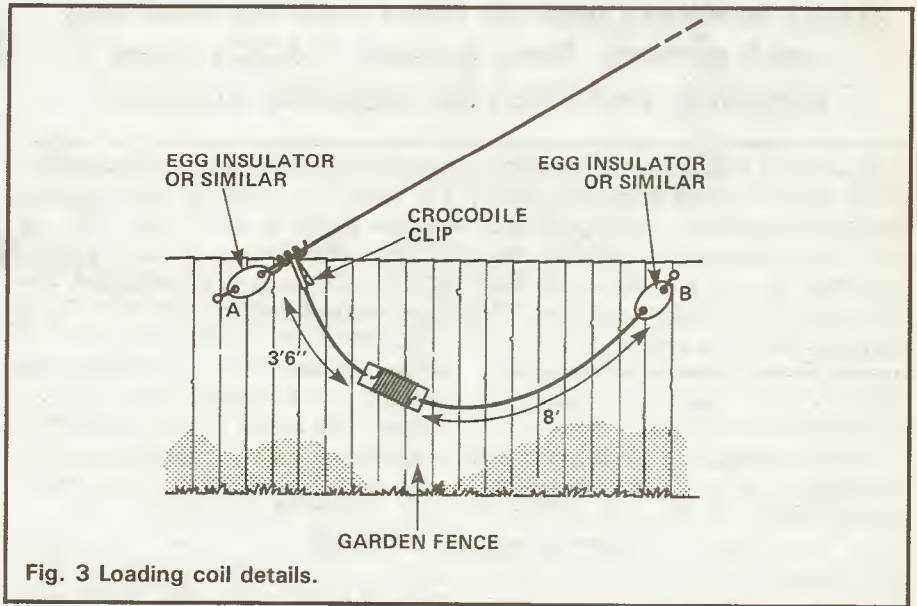
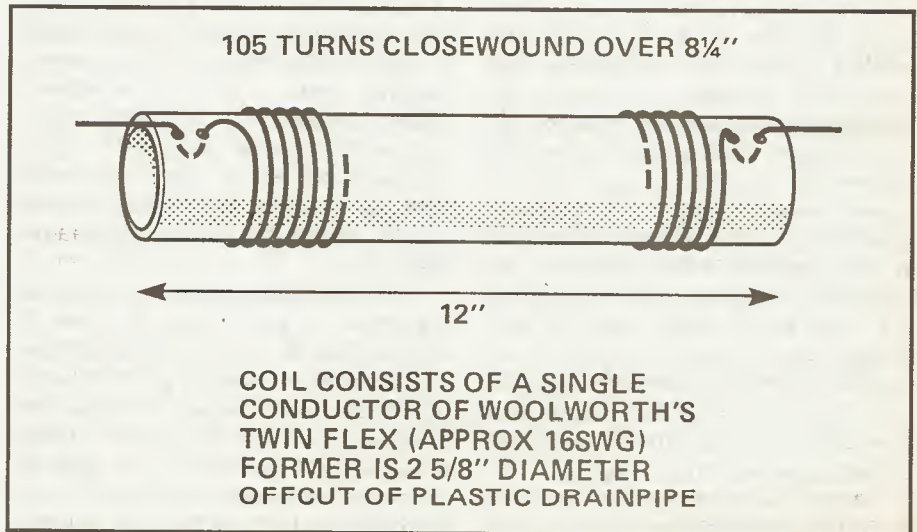

Fig. 3 Loading coil details.



KIT REVIEW

PAC-COMM

TNC 220



Front panel of the TNC

Packet radio is here to stay and as popularity goes up, prices go down. Ken Michaelson, G3RDG, jumps in at the deep end and builds one of the kit-form packet units.

I first became interested in 'Packet Radio' after a visit to a friend's house and when it was demonstrated to me I was surprised at the speed of communication when used on VHF.

So having had my attention drawn to this new mode, it was with some trepidation that I agreed to carry out a review of one of the latest types of packet radio unit.

Pac-Comm TNC-220

This was the Pac-Comm 220 (Terminal Node Controller) which arrived well packed in kit form ready to be built. I have not had all that much experience of building kits and

the sight of what was entailed was a little daunting. However, upon closer investigation of the contents and an inspection of the excellently produced reference manual, I felt somewhat heartened! The manual is a mine of information and is printed in A4 size (ie the size of this magazine). It has 70 pages of reference and discussion together with five pages of a closely detailed index. In addition, there is a double page circuit diagram, a list of parts, full size drawings of the top and underside of the PCB and five pages of parts location details, as well as 14 pages of assembly instructions. These are rather like the Heathkit manuals

of some little time ago, in that each action has a space with two brackets, '()', where you may tick the fact that you have installed a certain part. Talking of parts, there are 130 different components to be soldered, in addition to which there are 21 DIP sockets having a total 380 legs to be connected. Quite an undertaking.

The PCB is double-sided having 'plated through' holes and being silk screen printed with all the component values shown in the appropriate positions. The board measures 6.5 (D) × 5.3 (W) inches (or 16 × 13 cms if you prefer!) and is ready drilled. The case is die-cast, having overall dimensions of 7.6 (D) × 5.8 (W) × 1.5 (H) inches, ie 19 × 14.7 × 3.8 cms, and is finished in a light battleship grey matt paint. The front panel is in two shades of blue with a white slash through the centre and the rear panel is coloured in the darker of the two blues. The lettering is in white, standing out very well against the two shades.

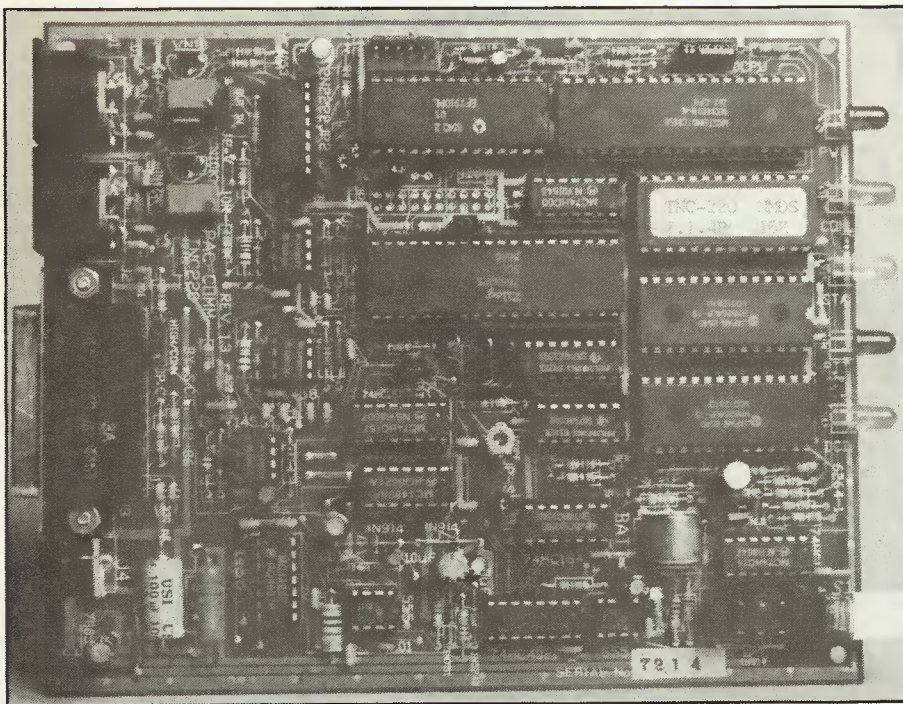

Plan view of the printed circuit board, note that the heatsink on the regulator device is usually attached to the case

Construction

And so I began. Following the suggestion in the manual I put the various parts in separate containers, using the caps of aerosol spray cans which made life much easier. Following the instructions very carefully, the whole job took me about 15 working hours. No doubt people may well be faster, but I found difficulty with the resistors as the red used for the 1k components was almost the same as the orange on the 10k variety, so as a result, I found myself checking each resistor before inserting it, yet even then I made a mistake or two. There had been a number of amendments since the PCB was designed and these were contained in several 'errata' sheets. It was a bit tricky to relate the amendments to the instructions given in the manual, but everything became clear in the end. Whilst on this subject, AMDAT tell me that all future PCBs will have the modifications incorporated in the boards before despatch, so new purchasers will not be troubled with the problem.

One thing which was emphasised several times in the instructions was that one should not operate the unit out of the case for more than a few seconds without using a heatsink on the 7805 voltage regulator, the reason being that it has to dissipate about 3.5 watts of power. When the unit is completed

the fin of the 7805 is attached with a self-tapping screw directly to the rear of the case, which acts as a heatsink, but while the testing was going on a large paper clasp (supplied with the kit) should be clipped to the device. The next job was to insert all the ICs. This was quite a difficult undertaking as it is very easy to insert an IC with one leg hanging outside the holder or bent up inside.

Switch on — zilch!

Having got everything assembled, the next thing to do was to prepare the cables which would couple the unit to my BBC micro and to the transceiver. This had to be done carefully and full directions were given in the assembly pages. The TNC-220 was powered up and con-

nected to my micro, the intention being to run it with an EPROM based program supplied by AMDAT which would give split screen operation. However, it didn't work! This never surprises me as I have attempted to build things in the past, only to find that on switch-on everything is dead. I went over everything I could think of, and followed the 'trouble shooting' paragraphs at the back of the manual, but to no avail. I then decided to return it to AMDAT and ask for their help. This I did, and in a very short space of time the unit was sent back to me in working order. The reason for its non-operation? Two dry soldered joints! Mind you, out of a total of approximately 720 connections I suppose it was not too bad. But now it was operational and connected to my Beeb and an elderly FDK Multi 11 with a colinear up at about 35 feet.

Switch on — again

This time I switched on to find the correct display on the screen; 'Pac-Comm Packet Radio Systems TNC-220' and the five lines of 'sign-on' message. After this 'cmd:' appeared and that showed that the unit was ready to accept my instructions. There are two ports on the rear panel, one for VHF which I was using, and the other for HF. The 'baud rate' between TNC and the BBC and also to and from the radio was controlled by the software, by typing 'baud' the selection of baud speeds appeared, each one being preceded by a letter, (A, B, C etc). The Beeb ran input and output on the RS423 port at 1200 baud and that had been set as a 'default' value in the software. Default rates for the output ports were 300 bauds for HF (Port 1) and 1200 bauds for VHF (Port 2), but one could alter the



Rear panel connections showing the separate HF and VHF input/output sockets

```

BT
BTEXT    *** KEN GOLDERS GREEN LONDON N.W.11 LOCATOR IO91vn DIGI QN ***

CT
CTEXT    SORRY I AM NOT HERE. PLEASE LEAVE SHORT MESSAGE 73 KEN

```

Fig. 1 TNC display showing the beacon test (upper line) and automatic message sending facilities

speeds of both the input to and the output from the TNC-220 by calling up the command 'Baud' and making one's own selection of between 300 and 9600 baud. When I say that there were 101 different commands, you can appreciate the bewilderment of a newcomer to packet radio. It was fortunate that the 'default' values chosen by the writers of the software allowed reasonable working. However, there were two commands which I had to give to the unit, and the first one was my call-sign. To get this inserted in the memory, the drill was to type 'MYCALL', (and back came 'MYCALL NOCALL') then enter 'MYCALL G3RDG', whereupon the wording was transferred to the middle section of the display, showing that the command had been accepted. A lithium back-up battery is incorporated in the circuitry so you don't have to do this every time.

The AMDAT EPROM gave a split screen display with the operating parameters at the very top showing 'MONITOR', 'PRINTER', 'ALARM' and 'DATA FLOW', all of them either 'ON' or 'OFF' according to the operator's wish and controlled by function keys 'F7', 'F8', and 'CTRL F0'. The middle section of the screen was taken up by the display of transmitted and

received information and the bottom section was used as a 'type ahead' space. Leaving all the other commands at their default values, I was now ready to attempt my first call. There are three local repeaters: GB3HQ (RSGB headquarters), GB3UP (University of Surrey at Guildford) and GB3KP at Kingston, so I typed 'C GB3KP' (C for 'connect') and pressed RETURN. The information then showed in the middle part of the screen and I could hear the relay of the transceiver clicking sending out the packet. At the same time, looking at the TNC-220, first the green LED labelled 'DCD' (data carrier detect) lit and went out and then the red LED called 'PTT' glowed. This confirmed that the data was, at least, being transmitted.

However, after all this I received '*** retry count exceeded' and underneath '*** DISCONNECTED'. Not every helpful, however it was possible to use another station to relay your message if difficulty is encountered, and I thought I would have another try, but this time through GB3UP. So I then keyed 'C GB3KP VIA GB3UP' and pressed 'RETURN'. This time I was successful and after about the second try '*** CONNECTED TO GB3KP VIA GB3UP' showed on the screen and

the green LED labelled 'CON' (converse) lit. Having now got my feet wet as it were, I went ahead and had several interesting QSOs.

Two facilities which I must mention, first there was a 'beacon' available in the TNC so that if the unit was left running, the TNC-220 would automatically send out a transmission. This could either be set to send at regular intervals or once after a specified time interval with no packet activity. The second facility was I suppose, an extension of the first, in that you could store a message to be sent automatically whenever a connect request was received from another TNC.

HF operation

Having had several contacts on VHF, I thought I would try the unit on the HF bands. Most of the activity in packet radio takes place on 14.101MHz, although it seems to be spreading both downwards to about 14.099MHz and upwards to about 14.107MHz because of congestion. Before starting it was necessary to make certain alterations in the operating parameters of the TNC-220. Whereas I had been operating on 144MHz, we now had to contend with all sorts of QRM, phase distortion and fading, so the

```

C GB3UP
*** CONNECTED to GB3UP
G3RDG is connected to the GB3UP PBeeBS (V2.4) at the University of Surrey.
Hello, KEN: last login 070507 1154 GMT, highest msg was 934.
At 1215 GMT, high msg is 934, 23 active msgs.

Menu selection S,R,L,K,H,X,N,B >
R 934
Msg# MMDD UTC T Size TO @ BBS FROM TITLE
934 0507 1151 164 G8LWY G3RDG THANKS
IT WAS NICE HAVING A CHAT WITH YOU THIS MORNING TED, I HOPE YOU GET
THIS MSGE I WILL TRY BOTH ENDINGS /EX

Menu selection S,R,L,K,H,X,N,B >
B
Thank you KEN.

```

Fig. 3 Printout of a message left for G8LWY

C GB3KP
 *** retry count exceeded

C G4SWY V GB3UP

*** CONNECTED to G4SWY VIA GB3UP

G4SWY BBS Hello Ken, Last on 1723/870503, msgs 30. Time 1306
 G3RDB Ken de G4SWY (List new Read Send J-heard X-long menu Bye) >>>
 R 94

Msg#	TR	Size	To	From	@ BBS	Date	Subject
94	N	1487	ALL	G4SWY		870324	PACKET MAP

PACKET REPEATERS

```

  1. GB3AP   Dudley
  2. GB3BP   Bristol
  3. GB3DB   Honiton
  4. GB3DP   Weymouth
  5. GB3EP   Exeter
  6. GB3HP   Winchester
  7. GB3HQ   Potters Bar (Hori ant)
  8. GB3JP   St.Helier (Jersey)
  9. GB3NP   Norwich
 10. GB3UP   Guildford (Hori ant)
 11. GB3CD   Crewe
 12. GB3KP   Kingston on Thames (Hori ant)
 13. GB3XP   New Malden (Hori ant)
 14. GB3YP   Harrogate
  
```

de G 4 N W P

G3RDB Ken de G4SWY (List new Read Send J-heard X-long menu Bye) >>>
 B
 G3RDB de G4SWY at 1310. Goodbye Ken and 73 from Derek >>>

Fig. 2 Printout of a rather useful packet repeater map received from the G4SWY mailbox via GB3UP

packet lengths had to be kept as short as possible to lessen the chances of QRM corrupting the data. I typed 'PORT 1 RETURN' and automatically the unit transferred the input/output of data from PORT 2 to PORT 1 at the same time dropping the transceiver baud rate to 300. It was much more difficult to receive a station on HF than VHF but in the end I managed to tune into the right frequency. But the tuning process was rather like having a musical memory, because I had to remember the tone of the packet and tune into my memory! (AMDAT tell me that tuning indicators will be available for the TNC-220 in the very near future.)

In due course, using the main HF rig (a Trio TS820S), I copied an Italian station sending 'CQ'. I went back to him, typing 'C IK2ARQ RETURN' and within a few seconds had connected. We had a short QSO but conditions were not all that good

and there was a lot of traffic on the channel. I am sure that in a quieter period I shall be able to have longer and completely satisfactory QSOs on HF.

Summing up

The Pac-Comm TNC-220 performed perfectly, once my dry joints had been discovered! It is excellent value for the money at a price of £149 for the kit or £169 assembled. I would not say that it was a project

for a beginner, but for anyone who has had some experience in construction it is a reasonable proposition. I enjoyed my first experience in packet radio and have now been bitten by the bug.

Thanks are due to Martin Stubbs, G8IMB, of AMDAT, 'Crofters', Harry Stoke Road, Stoke Gifford, Bristol, Avon, BS12 6QH (telephone 0272 699352) for the loan of the TNC for the purpose of this review.



METREWAVE

Time and again QSO-partners say over the air that '... it would be advertising' if they disclosed where they bought their rigs. This 'mustn't advertise' syndrome is a popular misconception. There can be no objections at all to saying that one is using an Icom IC505 and that one bought it after seeing the Thanet Electronics advertisement for it in HRT. Nor to saying that the latest Jaybeam antenna came

"A quadripartite debunking session" is the description Jack Hum, G5UM, gives to this article, in which he attempts to straighten out four popular misconceptions often to be heard on the air.

from Elliott Electronics because once again his ad in HRT told one that he stocks that brand; nor that one's chum in the next suburb had got himself that TV transmitter which he saw advertised by Wood & Douglas in this magazine. And much else. You are not advertising if you say what rig you are using and where you got it, or even that the service you enjoyed from your supplier was very impressive and a good back-up to the products they sold you.

But conversely if the service back-up happened to be lousy you would need to be circumspect in the way you said so lest you run into the quicksand of slander! Maybe the wisest counsel is to follow the old adage that '... if you can't say anything good about them then say nothing.'

There's a wider implication to the subject of so-called advertising, and it is this: the whole of the ham radio movement itself functions as a vast advertising medium simply by its collective decision to buy certain models in vast quantities. Think only of the FT101 (not really relevant on a metrowave page), or the IC240 or the TS700 and its successors, and certainly the FT290 series and you come to the conclusion that these models are world transceivers because so many people use them. Not only do you see them widely advertised in British ham journals but in overseas ones too, with suitable variants to cater for other countries' different band allocations. Much of this huge turnover derives from recommendation sales, in other words, what people say about their rigs.

May there be a quietus, then, to that phrase I mustn't advertise. You don't!

I'd SWER by it!

Now for a quixotic tilt another windmill — or, if you prefer, another sacred electronic cow, the standing wave indicator.

Although an SWR-meter is a useful piece of auxiliary equipment to have about the shack, its readings need to be treated with scepticism. Any normal metrowave antenna will, only if you are very lucky, give you a one-to-one reading on the meter, which seems to be the objective of most users of the thing. Degrees of mismatch can be tolerated to a greater extent than many operators believe. You will soon know when a mismatch situation has gone too far; the front-end protection of your transceiver will shut

the rig down. Even if this drastic condition doesn't occur you will soon discover that something is amiss when reports from distant stations turn into poor ones where before they were good ones. Another thing to put you on your guard: you start receiving complaints of TVI simply because the RF which should have gone up the spout goes elsewhere — into the telly!

The moral: do not waste too much of your hard-won RF by pumping it in to an ill-matched aerial system; but do not become paranoid about your SWR reading. Put your trust first in the results you are getting over the air and only secondly in your SWR reading. Preoccupation with SWR meters seems to have developed from the CB fraternity, who were told by their suppliers that they would enjoy better performance from their 27MHz rigs if they bought yet another accessory to go with them called a SWER meter. Thus was the SWER preoccupation transferred from the CB realm to ham radio by the many thousands of operators who moved from one to the other. With many of them it became not just a preoccupation but almost a nervous tic. The time to start worrying about your SWR is not when the meter warns you but when, as we say above, reports from distant stations start showing consistently lower levels that they had done before. If this situation is related to a poor SWR then clearly the latter needs to be attended to by checking antenna and feeder connections, and indeed feeder contents, meaning water.

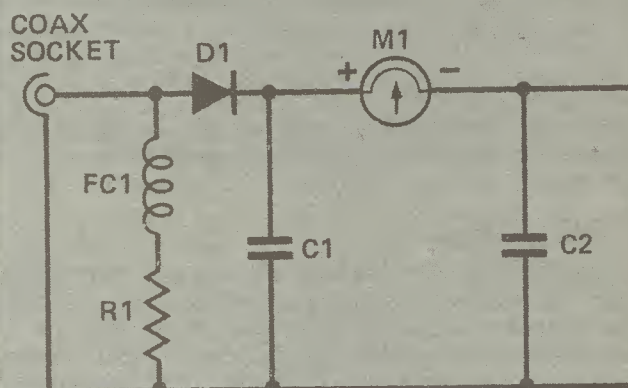

The "diode on a stalk" will sample outgoing RF from a nearby transmitter.

Components:

X any small diode rectifier such as the GEX66 (commonly used as an RF mixer).

RFC: 50 turns 28swg dcc wire close-wound on 1/4in. former.

R1: 1000 ohms

C1,C2: not critical, 1000pF upwards.

M: 0-1mA movement.

All components may be mounted on a small piece of PCB and accommodated within an instrument case with sloping front panel to present the meter for optimum visibility.

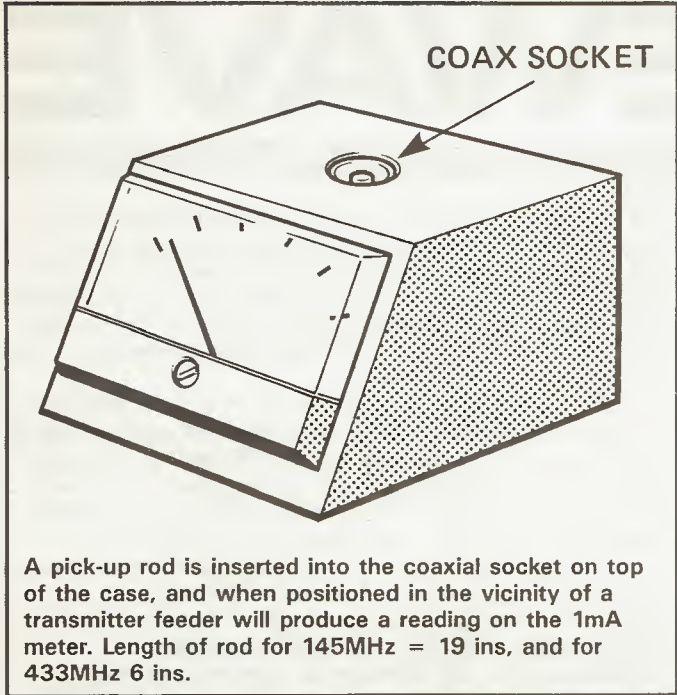

A pick-up rod is inserted into the coaxial socket on top of the case, and when positioned in the vicinity of a transmitter feeder will produce a reading on the 1mA meter. Length of rod for 145MHz = 19 ins, and for 433MHz 6 ins.

Something else the SWER addicts overlook is that anything interposed along a coaxial line between VHF transmitter and its aerial is bound to introduce attenuation, albeit slight and undetectable by distant stations. You can obviate this attenuation (if you feel it to be unacceptable) by using some other method of indicating radiated power. What better than "a diode on a stalk" for this purpose? This device is nothing more than an RF sampler consisting of a pick-up probe (19 inches of wire at 145MHz, 6 inches at 433MHz) fed to a diode which actuates a meter. Placed near the coaxial socket of a transceiver it will indicate that RF is going out. It won't measure RF as precisely as an SWR meter would do — though even the latter is hardly a precision instrument but more an indicating device. So is a diode on a stalk. It tells you that you are putting out RF, but not how much. Next, over to the third item in this quadripartite debunking session . . .

Lying jades

Turning now from one popular obsession (the "SWER meter") to another, the S-meter, one finds that belief in the infallibility of this device is if anything greater than the trust people put into SWR meters. There is only one cheap and trustworthy indicator of incoming signal strength and that is the pair of human ears with which every ham is endowed. These ears are the ultimate arbiter for assessing what an incoming signal is like. No S-meter can compare with it (or them).

The fallibility of the typical Japanese S-meter becomes all too obvious in many an operator's mind when he receives a report from a distant station that ". . . you are Readability Five but Signal Strength Nought". You can't possibly be! If you are R5 then obviously some signal exists to *make* you R5. Time and again ridiculously anomalous reports such as "RS50" are heard dished out on the 2m band simply because people put their trust in that all too fallible wagging thing on the front panel, the S-meter.

It can be said with confidence that almost every S-meter is a lying jade, and especially those provided on the average Japanese black box. They start from no logical or finite base-line and give only an approximation of the strength of an incoming signal. Two different black boxes

can present wildly different meter readings on a given signal on a given aerial.

In the audio context which represents the bulk of amateur radio communication you should give an audio report, not a visual one. Try from now on to use your ears, not your meter. You will be surprised how "S9" that FM signal from 45 miles away sounds when the meter admits to only S5. And weak and watery cw or ssb signals will register probably RS53 in your human ears when there is nothing on the clock but the maker's name, if you will pardon the ex-RAF expression. Enough of debunking the irrational use of meters, a subject so far rarely aired in these pages (though undoubtedly due for many a reiteration). Now for something very often aired here but still in need of a good and hearty "say again" and that is communication via repeater-boxes.

Thanks for the exchange

No apology is offered for reminding readers — especially newer ones who may not have got this message before — that you do *not* have a QSO through a repeater: you have an exchange.

Point fully taken that in the heat of battle on the motorways it is all too easy to say to the other person: "Thanks for the QSO through Charlie Fox (or 'XX' or whatever)". But you weren't in QSO with him at all: you were "in QSO" with the repeater, whose facilities enabled you to enjoy the exchange with the other party.

It is true enough to say that "QSO" means "I am in communication with . . ." and that when you talk through a repeater-box you are indeed in communication. But the subtle adaptation of the Q-code down the decades by the amateur radio movement has defined a QSO as being a direct contact between two self-operated stations drawing on personal skills, not via an impersonal, inanimate — but ingenious — link where no operating skill and certainly no "self training in wireless telegraphy" are required. Marvellous though it is to make a new friend via a repeater you cannot clinch the communication with ". . . a QSL, the final courtesy of a QSO", for it was the repeater you worked, not the new friend. And if you do send a QSL card it is a wasted pasteboard, valueless in any competition where verifications are required, for it verified only that "the box" did the work, not you.

So next time that PA or ON promises "My QSL sure" for the repeater exchange you enjoyed during that last lift, remind him that *your* QSL will be sure when he works you direct. And if there were a lift on, you could have probably done so anyway!

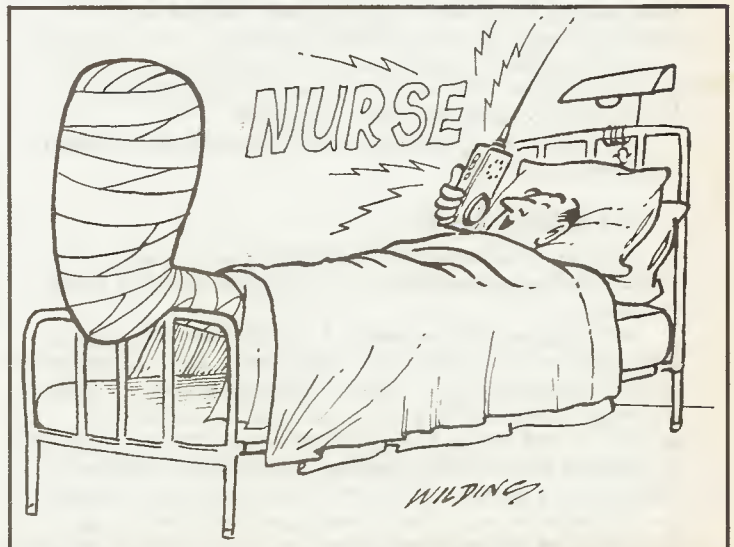

RADIO Tomorrow

- 1 Jul** SE Kent YMCA ARC: Natter night & morse test.
- 2 Jul** North Wakefield RC: Talk 'Basic logic' by G4RCH & G3ZXZ.
Yeovil ARC: Talk: 'The Miller Oscillator' by G3MYM.
Northampton RC: Visit to Pitsford.
Vale of Evesham RAC: Demonstration '10GHz & 24GHz construction and operation' by GODJA.
Mid Sussex ARS: Informal evening.
Bredhurst RTS: Construction & natter night.
E Kent RS: Visit by Thanet, test equipment demo & rig checking facilities.
East Kent RS: VHF rigs test by Paul G3VJF. Test your rig free.
- 3 Jul** Coventry ARS: Morse tuition & night on the air.
Maltby ARTS: Preparation for NFD.
Maltby ARC: Activity night on air.
W Kent ARS: Natter night.
N Bristol ARC: Natter night.
- 4 Jul** VHF National Field Day.
- 5 Jul** VHF National Field Day.
Dartford Heath DFC: Club hunt, 2.30 pm, Dartford Heath.
- 6 Jul** Atherstone ARC: DF hunt 2.
Rhyl DARC: Night on the air (GW4ARC & GW1ARC).
Welwyn/Hatfield ARC: Talk 'Ten metre band'.
Stourbridge DARS: Night on the air.
Burnham Beeches RC: Preparation for McMichael Rally.
Todmorden DARS: Visit by Police Dog Handler (must be a rough club, this one! — Dep Ed).
Southdown ARS: Barbecue at Greenwich Observatory, Herstmonceux.
Braintree DARS: Construction & natter night.
- 7 Jul** Chichester DARC: Special open meeting for the public with amateur radio demonstrations for Chichester 912 festivities.
Warrington ARC: RSGB film 'JARL visit to China'.
Wakefield DRS: Talk by G3WWF.
Fylde ARS: Talk 'The role of radio in BTs modem network' by Ray Gerrard G3NOM.
Reading DARC: Talk 'RAYNET' by Denis G4KWT.
Stevenage DARS: Open evening at SITEC.
- 8 Jul** Chiltern ARC: Natter night & /P evening.
Trowbridge DARC: Talk 'Bee keeping and Amateur Radio!'
Bath DARC: Slow Scan TV.
SE Kent YMCA ARC: 2m Fox hunt.
- 9 Jul** North Wakefield RC: Visit to British Gas Control Centre.
Northampton RC: Discussion evening.
Mid Sussex ARS: Bring & buy sale.
Bredhurst RTS: Talk 'Dayton Hamvention, Ohio' by G3VTT.
Yeovil ARC: Talk 'Am demodulation' by G3MYM.
- 10 Jul** Wimbledon DARS: Summer camp planning meeting.
Coventry ARS: Two metre DF contest.
Maltby ARTS: Talk 'The RSGB' by Mike Elliot G4VEC.
Maltby ARC: Three in a row — mini-talks by members.
Dunstable Downs RC: Junk sale.
W Kent ARS: Talk 'Air band reception'.
N Bristol ARC: VHF activity night.
- 11 Jul** IARU HF contest 48 hour duration.
Wakefield DRS: Barbecue at G4VRY.
Reading DARC: Special event station GB2DOG at Folly Court, Barkham.
- 12 Jul** IARU contest.
Sussex Mobile Rally.
Braintree DARS: Visit to Museum of East Anglian Life, Stowmarket.
Dartford Heath DFC: RSGB DF hunt qualifying event.
- 14 Jul** Keighley ARS: Informal meeting.
Bury RS: Surplus equipment sale.
Chester DARS: Talk 'Computer Interfaces' by Derek G4UXD and Roger G8GWX.
Dorking DRS: Informal meeting.
Warrington ARC: Talk 'Language Laboratories' by Paul Forster G0CBN.
Wakefield DRS: Debate.
Verulam ARC: Talk 'Antennas for DX' by J D Heys G3BDQ.
Stevenage DARS: DF hunt.
- 15 Jul** Hastings ERC: Talk 'Operation Rayleigh'.
SE Kent YMCA ARC: Natter night & committee meeting.
- 16 Jul** North Wakefield RC: Barbecue and fox hunt.
Vale of Evesham RAC: Informal meeting, Gardeners Arms, Charlton.
Mid Sussex ARS: Informal evening.
Bredhurst RTS: Construction & natter night.
East Kent RS: Natter night.
Oldham ARC: Talk 'Direction finding with simple equipment' by G8GG.
Yeovil ARC: Talk 'Direct conversion receivers' by G3MYM.
- 17 Jul** Coventry ARS: Night on the air.
Maltby ARC: Home projects night.
Sutton & Cheam RS: Talk 'Wire antennas for DX bands' by Geoff G4FKA.
W Kent ARS: Natter night.
N Bristol ARC: 80m activity night.
- 18 Jul** Bredhurst RTS: Special event station GB4PB.
- 19 Jul** McMichael Rally at the Haymill Centre near Slough. Doors open 10.30 (10.15 for disabled), many traders, car boot sale, demos, mini fairground, ATV and special event station GB4MR (on air 18th & 19th).
Southdown ARS: Foxhunt.

- 20 Jul** Rhyl DARC: Members night — funny QSOs.
Welwyn/Hatfield ARC: Fox hunt.
Burnham Beeches RC: Radio control demonstration.
Stourbridge ARS: Talk by John G4CVU.
Todmorden DARS: Natter night.
Braintree DARS: Talk 'Meters and indicators, principles & practice' by Dave G3PEN.
- 21 Jul** Midland ARS: Treasure Hunt.
Chester DARS: Talk 'Receivers — Part 2' by Dennis G3EWZ.
Warrington ARC: Open forum.
Wakefield DRS: Annual Open Pitch & Putt, Holmfield Park.
Fylde ARS: Informal meeting.
Reading DARC: Packet radio on the air night.
Rugby ATS: DF Contest.
Stevenage DARS: Comparative construction evening.
- 22 Jul** Chiltern ARC: TBA.
Trowbridge DARC: Natter night.
Bath DARC: HF night on the air.
SE Kent YMCA ARC: Visit to GODGS weather satellite station, Dover Grammar School.
- 23 Jul** North Wakefield RC: Talk 'Satellite TV' by Rob, G4APV.
Bredhurst RTS: Demo 'British Army Radio Sets 1922-1955' by Bob Warner.
Yeovil ARC: Talk 'The regenerative receiver' by G3MYM.
Edgware DRS: Informal meeting.
- 24 Jul** Maltby ARC: Amateur radio open forum.
84th East Reading Scout Troop: Special event station GB1ERS or GB7ERS from Thorness Bay, Isle of Wight, 24th July to 1st August.
QRV on 2m and 70cm SSB & FM.
W Kent ARS: Talk.
- 25 Jul** East Kent RS: Barbecue.
- 28 Jul** Keighley ARS: Talk & demo on Data transmission by G4XGN.
Reading DARC: Annual boat trip.
Chester DARS: Your questions answered.
Dorking DRS: 2m & 70cm portable operation plus barbecue at Devils Dyke.
Warrington ARC: 'Find the buffet' (!) hosted by Mike Mansfield G6AWD.
Wakefield DRS: Installing club HF beam.
Reading DARC: Annual club boat trip.
Rugby ATS: Home brew evening.
- 29 Jul** Rolls Royce ARC: Pre-rally meeting.
SE Kent YMCA ARC: Talk 'Mods to receivers for Top Band fox hunting' by G3ROO.
- 30 Jul** North Wakefield RC: Monthly meeting.
Bredhurst RTS: Construction & natter night.
Yeovil ARC: Natter night.
- 31 Jul** Wimbledon DARS: General activity evening.
Maltby ARTS: Natter night.
Maltby ARC: Junk sale.
N Bristol ARC: Natter night.
- 1 Aug** YO DX Test Contest — 24 hours duration.
Wimbledon DARS: Annual camp, Barwell Estate, Chessington — until 9th Aug.
- 2 Aug** RSGB Mobile Rally, Woburn Abbey.
YO DX Test Contest.
Rolls Royce ARC: RR ARC mobile rally, doors open 11 am.
Dartford Heath DFC: RSGB DF hunt qualifying event.
- 3 Aug** Rhyl DARC: Talk 'Avionics'.
Welwyn/Hatfield ARC: Talk 'EMC'.
- 3 Aug** Todmorden DARS: Natter night.
Burnham Beeches RC: Foxhunt.
Southdown ARS: Visit by Microwave Modules, Sutton & Cheam RS: Natter night.
Braintree DARS: Talk 'Operating OE/piste' by Melvin GOEMK.
- 4 Aug** Warrington ARC: RSGB film 'Junction transistors'.
Wakefield DRS: Car treasure hunt.
Reading DARC: Meeting with RSGB President, Chief Exec. and Zonal Rep. at Civic Centre, Kennet Room 8 pm.
Dartford Heath DFC: Pre-hunt meeting, Horse & Groom.
- 5 Aug** Trowbridge DARC: Picnic at the White Horse.
Bath DARC: TBA.
Rolls Royce ARC: Talk by Dan G8UVE.
SE Kent YMCA ARC: 160m fox hunt.
- 6 Aug** North Wakefield RC: Talk 'AC circuits' by Mark Groves.
Bredhurst RTS: The return of Louis Varney G5RV.
East Kent RS: Talk 'Once upon a time' early radio by Derek Bradford G3LCK.
Yeovil ARC: Talk 'A peak reading RF voltmeter' by G3MYM.
- 7 Aug** Maltby ARTS: Junk sale.
Maltby ARC: Activity night on air.
N Bristol ARC: Natter night.
- 8 Aug** 144MHz low power contest.
- 9 Aug** 432MHz low power contest.
Dartford Heath DFC: Club hunt, 2.30 pm, Dartford Heath.
- 11 Aug** Keighley ARS: Informal meeting.
Bury RS: Foxhunt.
Dorking DRS: Informal meeting.
Warrington ARC: Quiz.
Rugby ATS: DF contest.
- 12 Aug** Chiltern ARC: Natter night & /P evening.
Bury RS: VHF DF foxhunt.
SE Kent YMCA ARC: Summer night out.
- 13 Aug** North Wakefield RC: Night on the air.
Bredhurst RTS: Construction & natter night.
Yeovil ARC: Talk 'Polar diagrams' by G3MYM.
- 14 Aug** Maltby ARTS: Club quiz, second round.
Wimbledon DARS: Talk 'The RSGB' by Robin Sykes G3NFV (Region 7 Rep).
N Bristol ARC: 40m activity night.
- 15 Aug** Wight Wireless Rally, at The Wireless Museum, Arreton Manor, near Newport, Isle of Wight. Open from 11 am to 5 pm with talk in on S22 and 70cm via GB3IW. Also special event call GB3WM on 80m-3.670MHz. Details from Douglas G3KPO on Ryde 67665.
Oldham ARC: Special event station GB2OSS at Oldham Summer Show, also 16th Aug.
Northampton RC: Tulip Rally and Barbecue.
Dartford Heath DFC: RSGB DF hunt qualifying event.
- 16 Aug** Rhyl DARC: Talk 'Interference & how to prevent it'.
Todmorden DARS: Talk 'Ten Metres FM' by Ron Benbow G4YDI.
Burnham Beeches RC: Talk 'A new approach to sound mixing' by G4XDU.
Braintree DARS: Talk 'Meters and indicators, principles & practice' by Dave G3PEN.
- 17 Aug** Midland ARS: Visit to Droitwich transmitter.
Warrington ARC: Open forum.
Reading DARC: September contest and horse trial discussion.
- 18 Aug**

- 19 Aug Trowbridge DARC: Natter night.
Bath DARC: Fast Scan TV
Hastings ERC: Talk 'Weather satellites, propagation study.
SE Kent YMCA ARC: Meeting at the Folley — QTH of G3ROO.
- 20 Aug North Wakefield RC: Talk 'Video recorders' by Ray, G3VID.
Bredhurst RTS: Talk 'Crystals' by Erwin David G4LQI.
East Kent RS: Natter night.
Yeovil ARC: Talk 'QRP Tx output filters by G3MYM.
Oldham ARC: Talk 'Breathalysers' by G1DWA.
- 21 Aug Coventry ARS: Treasure hunt and barbecue.
Sutton & Cheam RS: Video 'The Worthing 23cms video repeater'.
Maltby ARTS: Natter night.
- 23 Aug Sutton & Cheam RS: Ten metre foxhunt.
Newbury DARS: Car boot sale at Acland Hall, Cold Ash, Newbury. Details from G3VOW on (0635) 43048.
- 25 Aug Keighley ARS: Visit to Mintex-Don, Cleckheaton.

- 25 Aug Chester DARS: Pre SSB Field Day meeting.
Dorking DRS: Informal meeting.
Warrington ARC: Talk 'The myths of ICs' by Norman Shelley G4JYP.
- 26 Aug Chiltern ARC: TBA.
SE Kent YMCA ARC: Folley on the air — G3ROOs QTH.
- 27 Aug North Wakefield RC: Monthly meeting.
Maltby ARTS: Talk 'The Prison Service' by Steve Small G4HJE.
Bredhurst RTS: Construction & natter night.
Yeovil ARC: Natter night.
Edgware DRS: Informal meeting and SSB field day briefing.
- 28 Aug Maltby ARC: Annual weekend at Spitewinter nr Matlock.
Wimbledon DARS: Activity evening.
N Bristol ARC: Bank Holiday natter night.

Will club secretaries please note that the deadline for the October 1987 segment of *Radio Tomorrow* (covering activities from 1st September to 1st November 1987) is 22nd July.

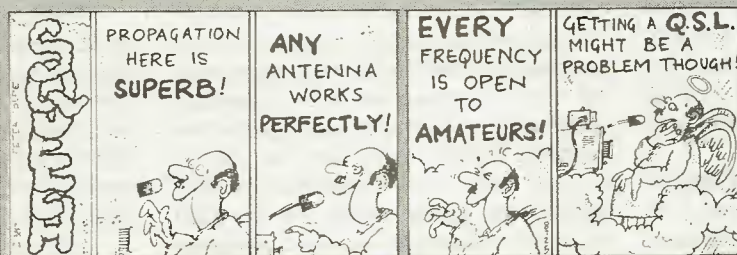

ATTENTION ALL WRITERS . . .

...or just readers who sometimes think "I could write that!"

We're looking for authors to help us keep 'Ham Radio Today' at the forefront of the radio scene. So if you've designed some novel or cost-effective gear, you've done something that is of interest to other amateurs, or you've got a controversial axe to grind, we'd like you to contact us!

If you're interested in writing for us, send us an outline of any ideas you might have and tell us a little about yourself. Write to: The Editor (submissions), Ham Radio Today, ASP Ltd, 1 Golden Square, London W1R 3AB.

Please note that we cannot be held responsible for the loss of unsolicited manuscripts. We advise all authors to keep a copy of any articles they send us.



CLUB NIGHT

Having broken into ham radio whilst working abroad I have only a scanty idea of the 'British Radio Club'. Judging by the reports published in all the amateur radio journals there are quite a few scattered around the country. All purport to promote the

at the top table rose and called the meeting to order. There were barely some fifteen members present but at this point I had received not so much as an enquiring glance. Having quietened the members down the chairman reported on a few past

by a few pursed lips around me, so did a few more. Preliminaries over, it was time to get down to the main business of the evening. Still no one had approached or spoken to me and not being a particularly gregarious person I was quietly relishing my anonymity.

The opening chairman handed over to another dignitary at the top table. He stood up and surveyed the audience, deliberately, it seemed to me, avoiding my eyes.

"Before we start the sale," he announced, "I have to ask if there is anyone here who is *not* a member of the Club?" The ominous tone in his voice made me pause for a moment but I slowly put up my hand. It now seemed that everyone in the room was noticing me for the first time.

"I'm afraid I must ask you to leave," continued the chairman. "As a Club we have made an undertaking to the authorities that only members may be present during junk sales."

Is the 'clubhouse' as welcoming as it ought to be? Stan Crabtree, G3OXC opines that it is not.

friendliness of our hobby and it is an accepted fact that many of today's licensed stalwarts first gained an insight into amateur radio by visiting and subsequently joining their local radio society.

Last autumn, during a prolonged stay in the Midlands, I decided to sample the delights of the nearest meeting. The address, day and time were well advertised and as the evening drew near I found myself looking forward to meeting some of the locals. Perhaps I would find someone I'd worked on the air.

It was a bitterly cold night and I was glad to reach the building in question. I climbed the well polished stairs of the large Victorian property and noted it held meeting rooms for other similar types of hobby groups. The Club Room door was open but it was early and no one else had arrived. Chairs had been laid out and I seated myself about half way along the far wall. RSGB maps and other data were pinned to the wall and along the top of a large bookcase were one or two vintage domestic radios. At the far end of the room I saw a chalked up notice bearing the day's date and the words 'Junk Sale'. This was obviously the right place!

People gradually began to arrive; the usual cross section of the population that enjoy our hobby. At the far end of the room was a table with a row of chairs which would presumably be filled by the committee. No one appeared to notice me but I was content to sit and take it all in.

Shortly after 8pm a gentleman

happenings and also gave news of future events. By his manner and the response of the audience it appeared he was regarded as the proverbial 'wag'. His statements were generally greeted by chuckles and an occasional retort in humorous bent. When he gave news of a club member in hospital with a collapsed lung and added that at least he wouldn't be overmodulating his rig for a while I thought this was perhaps a little too much and judging

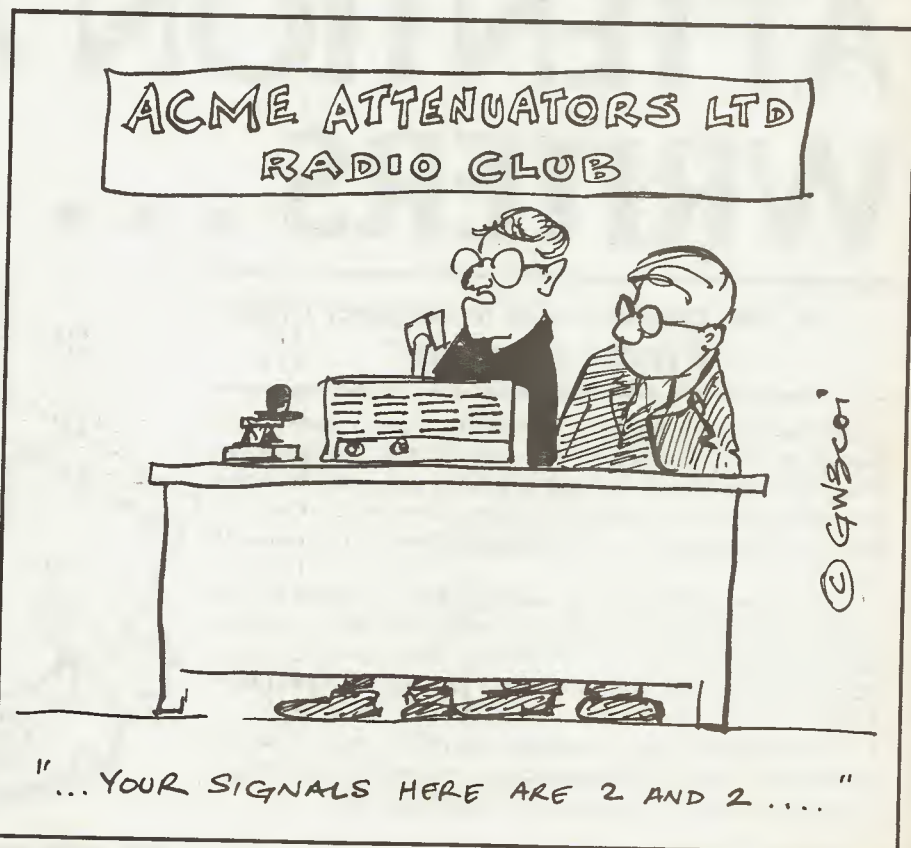

He now looked at me rather apologetically. I considered for a few moments and then said half jokingly. "I won't bid for anything — I'd just like to watch." This sounded a bit naive but I hoped he'd understand.

"I'm sorry," he was firm now. There was to be no reprieve. I made my way carefully along the row of seated club members to the coat rack. Someone at the back of the room called out. "Surely if he doesn't buy anything it's OK?" I stood, feeling like Paul awaiting judgement.

The chairman looked at me for a moment. His face then became screwed up as if in anguish at the decision he must make. He looked upwards, possibly seeking advice from above. He ignored representations from other committee members. His mind was made up. He rose again and faced us all. "I'm sorry," he said again, "but rules are rules."

And so I made my departure. As I struggled into my duffle coat I believe I noted a few looks of sympathy. As I finally made my way through the door and into the night

I think I heard the chairman call out, "come again on another evening."

Looking back now it all seems rather amusing. I did not return. Perhaps it would have been different if I had not called on a junk sale night. Perhaps not. Again, I do not remember seeing the expression 'all welcome' in the Club's announcement so perhaps they are a very close, inhibited group. Looking back I can't think why they waited so long to read out the riot act. Perhaps they thought I had inadvertently entered the wrong room; that I was in fact a keen St John Ambulance member on the wrong floor and would realise my mistake and leave of my own accord!

I smile when I compare this occasion to a typical evening at a Scottish club of which I was privileged to be a member during years spent north of the border. Immediately a visitor is recognized as such he is approached by a committee member and his name (and callsign if any) is chalked on the blackboard. Before the start of the evening's business the chairman

welcomes him on behalf of the club and calls for a round of applause. A little unsophisticated perhaps but not to the individual who has possible breached a new environment in the hope of finding out just what our hobby is all about. At this point the nearest seated member will invariably engage the newcomer in conversation and after discovering his interests will introduce him to another member with similar leanings. Finally the visitor is asked to draw the night's raffle ticket and the shouts of derision when the winner is known make him feel he's really accepted into the group. Which indeed he is.

In my present work I am inclined to travel occasionally. Despite my previous encounter I intend to drop in on the nearest club meeting whenever the opportunity presents itself. I'm hoping that perhaps next time I can endure the ordeal with more dignity. But deep down if I see a sign announcing 'Junk Sale Tonight' I think I may well weaken at the last moment and retrace my steps to the nearest pub.

Free Readers Ads!

FOR SALE

YAESU FT 2700RH 2M and 70CM FM dual bander. Absolutely mint, never used mobile, £350. **Pye PF2FMH 2M handheld,** on S20, S22, R5. New battery and homebrew drop-in charger, perfect, £45. **G4ILO, QTHR.** — Tel: Colchester 210878.

KENPRO KR500 elevation rotator, as new, complete with control unit, £100. **VHF communications 2 metre Antenna Polarisation switch unit,** £33. **Welz Diamond CP22 2 metre Collinear 6.5dB gain,** new, £20. **Mutek 6 metre filter unit,** new, £22 ono. — Tel: Paul (0293) 515201.

GOOD home required, **SS105S,** 10-80M solid-state plus accessories, £275. **TW-4000A plus MA-4000,** £375. **Standard C8800 sensitive 2M mobile,** £105. **TR-2500 plus MS1 etc,** £175.

TR-2400 etc, £95. **2 channel, high persistence Oscilloscope,** £75. **AR rotator,** plus **VHF/VHF Antennas,** £55. — Tel: 0604 858 839.

HC1400 2MFM TX/RX +E100 JR599CS, £100. **1 com 1C2E C/W case speaker/mic and base charger,** £120. **DX160,** £60. **Regency Scanner,** £80. All items ono. Going quarter so many other items. Phone for list. Tel: Phil 0742 420550.

YAESU HF VHF, two **FT757GX FTV107R 2 metre and 50MHz, FTV707, FC707, ATU DAIWA round rotator,** 2 metre 10 element cross, 10 metre, 4 element cross **YAESU desk, mic/hand mic, Datong RF speech processor,** sell complete etc. £1,500. — Tel: 0703 738630.

FOR sale, 2mm FM mobile, standard **C8900,** fully synthesized, 10 watts, full scanning, only 1 inch high, excellent condition, £125. — Chas, 764 6767.

SONY ICF 7600D digital receiver covers 150KHz to 30MHz AM and SSB also VHF FM band. As new with mains power supply, £120. — Tel: 0222 708336.

ICOM IC202, good condition with Nicads, £100. **Yaesu FT790,** as new with original packing, £250. **MM432-20 linear,** £45. **Homebrew 2 metre linear (Howes),** £12. **Twelve element ZL Special Antennas,** two, £10 each. **Power Splitter,** 2 way, £15. — Tel: Sheffield 421781.

FDK 725X 1 to 25 watts, FM dual VFO. Scanning 144-147MHz. **70CM compatible with FDK transverter.** Complete with mobile mount. Very good condition. Going multimode, £185 including carriage. **G45TB — 0726 882812 (evenings).**

HAM Multimode 2 200 channel transceiver, £120. **Eddystone 670 A G/C receiver,** £80 or will swap the

above for **Delta 1 934MHz** tranceiver. Have **BSA Bantam Motorcycle,** will swap for anything, radio wanted. **934MHz Delta 1** tranceiver. Also **Trio SM220 Monitor Scope.** — Tel: Basingstoke 468649.

FT757AT auto Antenna tuner, new, boxed, £235. Similar **Daiwa CNA2002,** £125. As new. — 0534 54186 evenings.

ICOM IC720A transceiver, mobile or home base with **ICPS15** supply, also **Toyko HC-200 Coupler** and **Yaesue YH55.** Phones all manuals boxed, mint condition, £700. — Tel: Barry 0909 481964 evenings.

PA system for sale. Ideal for radio club talks, amateur dramatics, fetes, small rallies etc. Comprising **120W H&H 2x5 channel amplifier,** reverb, indoor speakers, outdoor horns, microphone and stand, all leads and accessories, offers, £300. — Tel: Richard,

Staffordshire 0283 813709. **SHARP** MZ711 computer, with printer-plotter, data recorder, all built in and a selection of programme tapes, cost over £200, £100+. **G1KEU QTHR** — Tel: (0373) 61651, after 6 pm for offers. **AZDEN** PCS2000 2M FM mobile detachable remote controller with remote cable. Up/down microphone with key pad. 25W (5W low), large LED read out. 6 memories and priority, fit even smallest car, as new, bargain, £165. — (Hants) 0730 892143 893534.

CODAR PR30 pre-selector, £10. Yaesu FTF7 receiver, £125. Unused ZX Spectrum plus, £50. Scarab RTTY terminal unit with Spectrum interface and software, £60. Hallicrafters super Skyrider receivers, £60 and £40. — Tel: St Albans 39333.

WILL DAY following prices for national company Malden HRO equipment, original manuals, £5-£10. Speaker enclosures, £15-£20. PSU's, £5-£10. Rack mounting combined speaker/PSU's, £30. Rack mounting coil holders, £10-£20. German and Japanese World War II HRO copies, £150. — Tel: St Albans 39333.

STATION for sale, FT290. SWR meter YM38 desk mic, absorption meter. Rotor and control, Colinear ZL Special, mobile Ant and mag mount. Coaxial feeders for cash, £350. — Tel: Newton-Le-Willows 28961.

TRANSMITTER Sailor 56D HF/AM 100 watts, 24 volt, 1600-4200kHz, vgc, offers or swap WHY RDF Kodan automatic visual CR tube, full documentation 200-4,500kHz, vgc, offers or swap WHY. — Tel: (Hants) 04895 3624.

TRIO TS830S, as new condition, very little used, any trial, £750. House purchase forces sale. — Tel: 0386 858829 evenings.

FOR sale, 757GX and YM38 Scan/mic, £625 or exchange with case adjust older type TX + RX for HF and or older type communications RX anything considered provided, good condition and performance. — Tel. Hastings 813213.

FOR sale, Spectrum 144/28MHz Linear transverter, 12 watts, RPT shift, £60

ono. Pye Westminster 145MHz 6 channels, pre-amp and Toneburst, £40 ono. Scarab MPTU 1 RTTY terminal unit C/W software for CBM64 wanted Met or Jaybeam 70MHz Antenna G3VKM quarter or Tel: 0502-77 622. **TRIO** 9130 2M M/M plus extra mount, plus Heatherlite mobile mic, £350. Buyer collects or pays carriage. — Tel: Geoff, Bracknell 52601. **FOR** sale, Star 300 Baud V21, full or half Duplex acoustic modem compatible with any RS232C or RS424 Interface, £70 ono. — Tel: 953 0455, after 6 pm ask for Colin.

DRIVES 80TK full height double sided uncased ideal for BBC B etc, £55. Plus postage, 3½ inch 80TK double sided, brand new, £75. Switched mode PSU Astec, ideal for two drives, £18.50. — Tel: 06845 4693 (days), 06845 66488, after 6 pm (Gary).

FDK 750XX multi-mode TXCVR 2 years old, good condition, must sell over to finances, sensible offers for this 2 metre SSB/FM/CW 4MHz coverage set please, now cost new £449, first £300+ secures. — Tel: Eric 0604 37266.

TRIO 2200, needs small repair and microphone, £35. Spectrum +2 computer, £90. RTTY programme, £20. Morse £4. Logbook, £6. RAE math's, £5. FDK 2M base, multimode, £350. — Tel: Catford 01 461 5398.

ICOM IC251E two metre multimode transceiver, complete with Mutek front end, as new condition, £400. — Tel: Bedfordshire 05255 2207.

FDK700EX Multi, 2 metre transceiver, 25 watt mobile, as new, £150. Trio 430S HF transceiver, as new, £685 ono. GP432X 70cms, not used, £24. 6 element, 2 meter quad, £5. — Tel: Tony, Dorking 0306 885533.

FOR sale Yaesu FT780R 70cms multimode transceiver, power 10 watts + 1 watt, good condition, £325 ovno. Also Jaybeam 48 element multi-beam, £35. — Tel: 0942 818726.

T199/4A home cupter, speech syntheser, joysticks (pair), software etc, £65 or swap general coverage receiver, also base microphone with lock, £15. Also swap computer for CB40 channel handset. — Mr

D. Fryatt, 24 Roman Hackle Avenue, Wymans Brook, Cheltenham GL50 4RF.

FOR sale Pye PF1's TX and RX with batts on 432.575 Simplex, £20 pair. FP8's £50. Wanted Burndep BE600, six channel VHF handled. Also Pye PF85 or especially PFX or anything Pye WHY. — Tel: South Yorks 0302 835280.

SALE. Cordless phone Matsui model T9090 nine memories, £50. Drae morse tutor, £30. Chasis punch set with reamer, £12. New ¼ wave dual band whip Antenna 70 cms 144 megs PL259, £5. Pair Halogen spot lights, £10. — Tel: Lancing (0903) 767045.

RACAL RA317 receiver, 1-30 MHz AM/CW/SSB 4 xtal filters, lovely audio. In excellent condition, mounted in 19inch cabinet. Built to highest professional specs, originally enormously expensive but now £300 ono. — Tel: 01 405 7554 day or 0372 62268.

70CMS 19 element Tonna, unused, original and mint condition, £15. — Tel: Wrexham 755426.

TRIO TS820 transceiver with added digital readout equal to TS820S. Modified with Lowe kit to operate on 10MHz, excellent order, owners manual service manual, £450. Will deliver 50 miles. — Tel: 01-455 8831.

FT790R multimode Nicads charger with matching FL-7010 10W Linear, WE12 SP-45M, SWR-P.meter, excellent condition, £250 complete. No offers. Buyer collects. — Tel: Barrie, (04427) 4711, 6 pm to 9 pm.

FOR sale Tektronix Oscilloscope type RM547, two plug in units one dual trace DC to 30 MHz scale Illum, amplitude calibrator, 2 time bases full operating, service manual, good condition, £65 ono. — Ilkeston (0602) 307004.

TRIO TS530SP Yaesu FC902 ATU Kenwood MC500, mic Welz dummy load, H5 trap vertical with ground plane kit, £750 ovno. All boxed. — 500 8456, between 6 pm - 9 pm only.

SMC Polarphaser II, 2 metre Antenna Polarisation switch unit, £33 ono. Jaybeam 2 metre 8XY crossed Yagi, £26. 70cms 12XY crossed Yagi, £38. D15/23 23cms Yagi, £38 (all new). Welz Diamond

DPGH22 6.5dBd base, (Collinear (new), £19. — Tel: (0293) 515201.

HQ1 Mini beam for sale, £100. Or exchange for good general cover receiver. Valve type preferred. — Tel: 0843 69240 evenings.

ICOM IC735 all mode TCVR with superb general coverage, condition as new, £750. Purchaser to air test, collect. — Gregg, 2 Park Road, Granborough, near Aylesbury, Bucks. MK18 3NS.

FOR sale Trio R2000 receiver 150KHz - 29.995MGH AM/FM/USB/LSB/CW. Mint condition, boxed with all documents, £450 ono. — Mr S. P. Farey, West Winds, Bell Hill, Finedon, Wellingborough, Northants NN9 5ND.

FT290 Mutek Nicads mobile mount, £210. G4ZWP QTHR. — Tel: 0992 442794.

ICOM 720A 0-30 TX/RX, hand and desk mike, IC-SP3 speaker, £550. Yaesu FC-700 ATU, £85. Yaesu FP-700 power supply, £95. Diawa 7500X Rotator and control box and cable, £70. All above in excellent condition. — Dave, Willenhall 0902 635244.

MARINE radio telephone complete installation transmitter, receiver 24v PSV contained enclosed cabinet with sliding rack, receiver covers 150KHz to 3900KHz. Transmitter 1600KHz to 3800KHz. Working and very good condition. Full circuits, supplied, reasonable offer but prefer exchange good 70cms rig. — Tel: 0268 792079 for more details.

YAESU FT726R fitted 70cms, 2 metres, 6 metres and satellite unit, CW filter with MD-1 desk mic, SP102 speaker CW key, £1300 ono. Kenpro KR5400 Azimuth elevation rotators with dual controller, £175. Allweld SM30PM telescopic mast with header unit, £200 ono. — Tel: 061 480 1933.

FOR sale FT102 filter AM/FM 550 ovno. Also Trio R600 RX, £200 ovno. — Tel: Peter, 0908 642398 G3JXR QTHR.

WANTED

WANTED HF transceiver or separate anything reasonably priced considered. Also HF beam or complete package. Part exchange, immaculate Canon A1 plus lenses/winder

a possibility? — 06845 64854 will travel to view. **WANTED** Cobra 148 GTL DX or Nato 2000 or Super Star 360 FM/2000. — Dave Jones, 19 Queens Road, Sealand. CH5 2JN.

WANTED American valve HF receiver, off the fifties and 60's. Working or not, ie HRO 500, HRO 60, Collans. — B. Polland, 3 Deepdene Mns, Rostrevor Road, Fulham SW6 5AQ.

WANTED urgently FT707 workshop manual, loan for a few days or purchase at reasonable price. Will cover postage cost. — Ring Eddy 0734 342565 anytime G5YM.

WANTED, 2 metre 70 cms, dual bander, mobile or 70 cms mobile. — Tel: Chas 764 6767.

WANTED HF transmitter FL200B FLDx500 KW204 KW500. Viscount to make up with FRS7 for disabled. Licence at present. G1 but going FO GO GWO. Derek Rawlinson, G1XNU 0406 330596 near Spalding.

HEATHKIT stuff wanted for alternative station. DX40U or similar, VFO unit, type VF-1U HD1210 keyer unit. Broken or damaged considered. Also need some crystals for DX40. Could collect. Call Eddie on 01-445-0528 QTHR as GOAQL.

WANTED Motorola CD100 VHF mobile transceiver service, manual to buy or copy G1PJO 0778 344934 after 4.30 pm.

EXCHANGE Telequipment S51B oscilloscope, good working order for R1475 receiver in similar condition. Will travel reasonable distance from shropshire or Bedford. Phone Alan weekends 094873 218.

WANTED Pye PFX or PF85 VHF handheld. Also wanted Burndept BE600 six channel handheld. Please phone GIDRR 0302 835280 or write N. Hamilton, 25 Thornham Close, Armthorpe, Doncaster, South Yorks.

WANTED Dressler ARA 500 active Antenna. — Tel: Rochdale 43117.

WANTED Dressler ARA 500 active Antenna. — Tel: Rochdale 43117.

MMT70/28 wanted by Horsham amateur radio club. — Tel: G3SWC evenings

Rudgwick 040372.

WANTED Yaesu FT101ZD with FM board or Ham Jumbo III, vgc, please write details to Adam, PO8 Dumfries DG1 1AA.

FDK TM56B marine receiver or similar. Must be untampered with. — Tel: 0674 76503.

WANTED IC240 ICZZA or similar 10 watt 2m FM only R16 63DSV 4 Brookside, Pathfinder Village, Exeter Ex 6 6DE.

HELP FRG 9600, Commodore 64, FIF232C and optional video board. Computer programs and any other information required to get these working together. — David Forward, 13 Hobbes Close, Malmesbury, Wilshire SN16 ODA.

WANTED Yaesu FT902DM with matching speaker. Tel: Mark, Biddenden 291075.

WANTED Yaesu FT726R VHF/UHF rig, also wanted PS430S (PSU for TS430S). Have FTZ90R, 10 amp PSU, etc various bits to swap deal or WHY or will do cash deal if required. — Tel: Joe 061-202-57664, after 5 pm weekdays, anytime weekend.

WANTED hand held scanning receiver. Realistic PRO32 would be nice although anything considered. Editor /assembler also wanted for ZX81. — Tel: Simon G6UZV 01-568 7912.

WANTED ZX81 memory pack, any ZX81 add on bits. Exchange Ferrograph level meter, counter, lots Crystals valves. Laboratory EHT supply. — J. Brown, 45 Marlborough Avenue, Falmouth, Cornwall.

WANTED receiver for SWL exgov would do also 2S-232C board for Tandy TRS1 level 2 Modem disks drives and disks. — Tel: Len 0977 797063.

WANTED manual or any information Marconi receiver type 1475 and power supply. — Tel: 0795 664350 pm GIVXZ.

WANTED outer casing for Racal RA17L. Must be in good condition. — Tel: Mike 0674 76408 anytime.

WANTED Tentec Argonaut 515. Drake RZB or RZC. Marconi type 889A or 966A power units with plugs amp cables. Aerial plug AM type 161 (10H/184). G4FUY QTHR Reading 733633.

WANTED Nems — Clarke

receiver type 1037 or 2074 any manuals on similar equipment manufactured by Vitro, CEI/DEI Astro, Stoddart or WHY. — Tel: 0925 571886.

WANTED operating manual for Mullard high speed valve tester or photocopy. — Tel: 021 558 3522, Mr S. H. Fox, Birmingham.

WANTED Icom R70 + VHF convertor, Sony CRF330K or Panasonic FR8000 onward model. Only one RX requested provide excellent condition and sensibly priced. Also selling Grundig 2000 SSB adaptor, £20. Post paid. — Tel: (061) 7431570.

HELP! Avid non tehcnical S/W listener requires simple effective gen/coverage Antenna for 25ft long garden drawings gratefully received have Eddystone gen cover RVR. Many headaches with this problem many thanks happy listening! — Eric Brumby, 82 Bluebell Avenue, Peterborough. CA MBS PE13XH.

EDDYSTONE 820 or similar receiver of that make wanted. Will arrange collection anywhere. — Tel: 021 556 3324.

WANTED 11-55 receiver, in good condition, your price paid. — Tel: 0924-263389.

WANTED Nato 2000. Must not have been tampered with, £100 offered. For sale R2000 Trio, £365. — Tel: 0283 221870.

EXCHANGE

HAVE Sanyo 9300 Betamax video electronics, good recent machs suspect, also Spectrum interfaces No 2, centronics E, lightpen, currah speech, tapes tasword 2, address 80, plus 40 games. Plus 21 range mulimeter. Want anything 2m/10m, HF Linear, minibeam. — Tel: Ray G4HKE 0634 686341 evenings.

EXCHANGE 1987 Pro 32 handheld Scanner 200 frequencies memory banks with Nicads mains adapter/charger, plus Archer Indoor Scanner Antenna for 70ems portable multimode or handheld with accessories or modern HF transceiver with cash adjustment. G1 WQW. — Tel: (Norwich) 0603 867005.

EXCHANGE ICOM IC210 2 meter base station FM ¼ - 10 watts. Removable PSU for

mobile, ⅝ over ⅝ TLT Colinear. 10 meter ICB-1050 with Xtal filter fitted for FT707 FT77 or similar multimode multiband HF rig only. Please ring after 6 pm. — Ginzs 0952 607542, Telford. **EXCHANGE** manuals for telequipment D54, Eddystone 880 RX, venus SSTV monitor, EM1 WM1 scope, EMI PM25 labatory supply 100-2,500 volts metered, 8/3 valves TT21 valves, lots crystals. Mullard valvetester manual circuit etc. WHV only exchanges. J. Brown, Marlborough Avenue, Cornwall TR11 4HS. **EXCHANGE** FT2092 4 watts output 6 months old, also have 25W 2 metre FM mobile and G4MH mini-beam wanted HF mobile or 6 metre gear, anything considered for sale brother HR5 printer, new unused unwanted gift, £75. — Phone and leave message on Sheffield 465145.

EXCHANGE Yaesu FRG 7700 receiver, with matching FRT 7700 ATU and two VHF converters, in perfect condition, for racal 117E or similar receiver, or sell £250. London 01 350 0438.

EXCHANGE Yaesu FT209R 2m hand/held for 2m or multi mobile. — Tel: (0277) 233881, after 7 pm.

SUPERSTAR 360FM suitable for 10 metre conversion reace **RS-107** test master **CTE 767** Linear amplifier Nevada **TC27RX** pre-amp Sadelta Echo Master plus Bremi three way switcher plus other accessories exchange for CW decoder for use with receiver. — Tel: Cumbria 0657 4362.

EXCHANGE Cybernet Delta 934 and 3 element Nevada gutter mount aerial for communication receiver FRG7700 preferred WFA Steele, 35 Birdhill Avenue, Reading Berks (0734) 871105.

SWAP my 1954 BSA Bantam motorcycle with spare engine for anything radio. Wanted Eddystone 940RX SM220 Scope Trio R599RX FR101 RX for sale B40 RX, £50. — Wright 12 Norn Hill Basingstoke, Hants RG212HD Tel: Basingstoke 468649.

EXCHANGE Yaesu FT726R only 2 metre fitted, workshop manual, vgc, less than 1 year's old, exchange for FT757 or similar HF Genrial coverage transceiver complete. — Tel: 0604-43344, Paul GISBA.

EMPORIUM GUIDE

BIRMINGHAM

BUSINESS COMMUNICATION
IS EASY IN HRT.
FOR ADVERTISING PHONE
SUE CURTIS ON 01-437-0699

BIRMINGHAM

 **R. WITHERS COMMUNICATIONS** 
584 Hagley Road West
Oldbury, Warley B68 0BS
(Quinton B'Ham) Tel: 021-421 8201/2/3
Opening hours 9-5.30pm Late nights Thurs-Fri.
Send just £1.00 (refundable against purchase)
for latest catalogue + our exclusive products & used list.

BIRMINGHAM

HEWARD'S HOME STORES LTD.
(Est. 1963)
822/4 Kingstanding Rd., Birmingham B44 9RT.
Tel: 021-354 2083
G4RJM with 38 years in The Radio Trade
Ham Equipment urgently wanted!
Open: Mon-Sat 9-6

CHESHIRE

DW ELECTRONICS G3 XCF
Amateur Radio Supplies
71 Victoria Rd, Widnes 
Tel: 051-420 2559
Open Mon-Sat 9.30-6 (closed Thurs)
We supply Yaesu, Icom, Tonna, Jaybeam,
Microwave Modules, Datongs, etc.

DEVON

AGRIMOTORS
Merton CB & Radio Centre
Merton Garage & Post Office, Merton.
Nr. Oakhampton EX20 3DZ.
Open 6 days 9-6
(Sundays by appointment)
Specialists in 934MHz
Suppliers of all 27MHz and 934MHz equipment

DORSET

BUSINESS COMMUNICATION
IS EASY IN HRT.
FOR ADVERTISING PHONE
SUE CURTIS ON 01-437-0699

KENT

Thanet
ELECTRONICS
2 Stanley Road, Herne Bay, Kent
Tel: (0227) 369464
Open Mon-Sat 9-5.30pm
except Thursday 9-1pm

LANCASHIRE

AMATEUR ELECTRONICS/HOLDINGS G3LLL.
YAESU, JAYBEAM, DRAE, DATONG, BLACK STAR COUNTERS,
ETC. FT 101 EXPERTS.
6JS6C 6KD6 12BY7A Original type approved
valves & our own Double Balanced Mixer and
new band WARC Kits for original FT 101 MK1-E.
S.A.E. List. Full Yaesu range. 15 mins Junction
31 M6. Free parking. Call and consult G3LLL
without obligation. Holidays? Phone, check
we are open before calling
45 JOHNSTON STREET, BLACKBURN BB2 1EF.
(0254) 58595. CLOSED THURSDAY.

LEICESTERSHIRE

ELLIOTT ELECTRONICS
for the Radio Enthusiast
26-28 BRAUNSTONE GATE,
LEICESTER. 
TEL: 553293
Open: Mon-Sat 9.00am to 5.30pm

LONDON

DRESSLER UK LTD
191 Francis Rd., Leyton, E10
Open 9-5.30 Monday-Friday 10-5 Saturday
Authorised dealers for:
Dressler, Yaesu, Icom, Standard, Kenwood,
Datong, SCM, Microwave Modules, Tonna
Tel: 01-558 0854/556-1415 Telex: 8953609

MERSEYSIDE

ARE COMMUNICATIONS LTD
For Yaesu Icom & Kenwood
Phone us for the best deals on all
amateur radio equipment.
38 Bridge St, Earlestown,
Newton-le-Willows, Merseyside.
Phone Peter G4KKN on 09252-29881
Opening hours Tuesday-Saturday 10am-5pm

MIDDLESEX

CB EXCHANGE
FOR RIGS ACCESSORIES AND REPAIRS
PART EXCHANGE WELCOME
475 STAINES RD, BEDFONT
MIDDLESEX.
(Nr Barclays Bank)
01 890 0900 or 0836 204604
WE RARELY CLOSE





NORFOLK

D.P. HOBBS (Norwich) Ltd
13 St. Benedicts Street, Norwich
Tel: 615788
Open Mon-Sat 9-5.30
Thurs 9-1pm. 
Stockists of:
YAESU, FDK, ICOM, JAYBEAM
& Electronic Component Specialists

NOTTINGHAMSHIRE

SP ELECTRONICS
48 Limby Road
Huckhall, Nottingham
Tel: (0602) 640377
Open Monday-Saturday 8.30-5.30

SURREY

GUILDFORD COMMUNICATIONS
34 Aldershot Rd., Guildford
Open Mon-Fri 8am-6.30pm
Sat 8am-5.30pm
Secondhand wanted
   
ASDEN
0483-574434

SUSSEX

G.W.M. RADIO LTD
40/42 Portland Road, Worthing,
Sussex Tel: 0903 34897
Constantly changing stock of interesting items for
callers. Receivers, test equipment, components etc.
Pye pocketfone PFI TX units with battery and
circuits £12 inc. p&p. Meters survey radiac No.2
portable radiation detectors untested. no
information available £15 inc. p&p.

YORKSHIRE

Amateur Electronics UK
Alan Hooker
42 Netherhall Road,
Doncaster 
Tel - 0302 25690
Large stocks of electronic
components.

N. WALES

**NORTH WALES AMATEUR
RADIO MART**
AMATEUR RADIO — CB RADIO — MARINE
RADIO — P.M.R.
25 ABBEY STREET
RHYL
Open Monday-Saturday: 11am-5.30pm
All repairs and accessories available ex
stock. Mail order welcome. 
Tel: 0745-51579

HAM RADIO CLASSIFIED TODAY

Lineage: 48p per word VAT inclusive (minimum 15 words) Semi Display: (minimum 2 cms) £7.35 per single column centimetre. Ring for information on series bookings/ discounts. All advertisements in this section must be prepaid. Advertisements are accepted subject to the terms and conditions printed on the advertisement rate card (available on request).



01-437 0699 Ext 289. Send your requirements to: Ham Radio Today Class. Dept., ASP Ltd., 1 Golden Square, London W1R 3AB

ACCESSORIES



TEL: 061-445-8918 061-434-5701
Telex: 666762 PAMACO G

WHOLESALE DEALERS

contact us today for best service, widest range and latest CB products.

WE DELIVER NATIONWIDE — OPEN EVERY DAY, SUNDAY BY APPOINTMENT

Pama House, 433 Wilmslow Road, Manchester M20 9AF

Giant range of CBs. and accessories delivered to your shop by Securicor.

FOR SALE

IAMBIC MORSE KEYS WITH TWIN PADDLE

Electronic keyer with built-in twin paddle unit. Can be used as Iambic keyer or as single paddle keyer. Extremely quiet screened reed relays keying circuit.

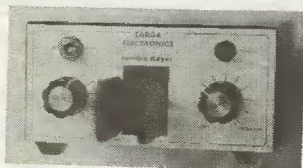

Wide range speed control. Adjustable sidetone, volume and tone. 'Tune' switch. Kit version available.

Runs from 12v D.C. supply or 240v mains P.S.U. available. Size - 100m.m.(W) x 155m.m.(D) x 55m.m.(H) inc. paddles. Ready built units have 100 hour soak test for reliability. Kits have ALL components supplied and paddle unit pre-assembled. Ready built keyer £49.90. 240v P.S.U. £7.50. Kit version £34.90. Prices are inclusive of all charges. Prompt despatch on all units.

TARGA ELECTRONICS 3 Raven Avenue, Tibshelf, Derbyshire, DE5 5NR.

SOFTWARE

GIFTU SSTV TX/RX

STATE OF THE ART SPECTRUM SOFTWARE

- * 8, 16, 24, 32, 48 and 96 SECOND SSTV
- * COLOUR TEXT AND GRAPHICS TRANSMIT
- * LIVE BRIGHTNESS AND CONTRAST CONTROLS
- * FRAME STORES FOR SAVING AND PRINTING
- * 9 TEXT MEMORIES—ADD TEXT TX TO YOUR SSTV SYSTEM
- * GOOD RX PERFORMANCE ON HF AND VHF

£12.00 ON CASSETTE

£14.00 ON MICRODRIVE

PEARSONS COMPUTING,

42 Chesterfield Road, Barlborough, Chesterfield, Derbyshire SH3 4TT.

TEL: 0246 810652

AS SEEN IN JULY 87 HRT

EQUIPMENT

USED AMATEUR EQUIPMENT?

Buy, Sell & Exchange!

SELLING? I pay the BEST POSSIBLE PRICES for your Clean Used Equipment!

BUYING? I have the BEST SELECTION of top Quality Used Equipment Available!

For the Deal You've been looking for,
Phone Dave, G4TNY
On 04024 57722 or 0836 201530
9am to 7pm, Monday to Saturday.
Or send SAE for lists.

G4TNY AMATEUR RADIO

132 Albany Road, Hornchurch, Essex RM12 4AQ

CARDS, STICKERS

QSL CARDS. - try me for quality and price. S.A.E. for samples. A.W. Bailey (G3YNI) Breardown Press, Wick Lane, Lympsham, Somerset.

01-437 0699
= RESULTS

RTTY

RTTY - AMTOR - AX25

Programs and Interfaces

for

Dragon & TRS 80 C

Programs from £10.50

Interfaces from £16.75

Full AX25 Packet system only

£99.00

ALSO RTTY for Amstrad
464,664 & 128 Program -
£9.50

Send A4 size S.A.S.E. for full catalog

PNP COMMUNICATIONS
The Old Boatyard, Robinson Road,
NEWHAVEN, East Sussex BN9 9BL
Telephone (0273) 514761

RIGS AND TWIGS

DELUXE WALKIE TALKIES 49 MHz, long range. £24.99/pair (normally £31.49). Satisfaction or refund. 48 hrs delivery. Xenon (HR9), 24 Wharnclyffe Street, Barnsley, Yorkshire.

TEST EQUIPMENT

CAVITY WAVEMETERS AS REVIEW IN FEB H.R.T.

144 MHz to 2500 MHz, and 430 MHz to 2500 MHz.
10 GHz Wavemeter Kits. Electronic Weather Stations. Solid Brass Based Morse Keys.

S.A.E. for more information to:-

PAUL SERGENT G4 ONF
6 GURNEY CLOSE,
COSTESSEY,
NORWICH NR5 0HB

(0603) 747782
Prestel no: 603747782

MISCELLANEOUS

HEATHKIT U.K. spares and service centre. CEDAR ELECTRONICS, Unit 12, Station Drive, Bredon, Tewkesbury, Glos. Tel: 0684 73127.

ACCESSORIES

WHOLESALE

CB radios, aerials & accessories delivered to your shop by Securicor. Contact for price list.

Pama House, 433 Wilmslow Road, Manchester M20 9AF.



OPEN EVERY DAY, SUNDAY BY APPOINTMENT

NATIONWIDE DELIVERY DEALERS

contact us today for Best Service, Widest Range & Latest CB Products
Tel: 061-445-8918
061-434-5701
Telex: 666762 PAMACO G

COMPUTER SUPPLIES

DISKS

3.5" DS unbranded	£1.26
5.25" Memorex branded SS/DD	£0.74
5.25" 96 tpi DS, unbranded, labels etc	£0.43
SEE 10 storage box 5.25" or 3.5"	£1.85

RIBBONS

Imagewriter	£2.65	Cannon PW 1080A	
Citizen 120D	£3.50		£2.69
Epson MX/RX/FX80		Citizen MSP 10	£4.90
	£2.60	Epson LX 80/86	£2.50
Epson MX/RX/FX100		Kaga Taxan	£2.69
	£3.10		

Please add 15% VAT, carriage free

T-systems Ltd

The Signal Cabin, 61 High Street, Orpington, Kent BR6 0JF
Tel: 0689 22196

COURSES

RADIO AMATEUR LICENCE

Start training now - No previous knowledge required. Study for 3-6 months. Post Coupon now for free brochure - without obligation:

Radio & Telecommunications Correspondence School, 12 Moor View Drive, Teignmouth, Devon.
Tel: 06267 - 79398.

(HRT/8)

NAME:

ADDRESS:

..... POST CODE.....

DEADLINES

28TH JULY
OCTOBER ISSUE
25TH AUGUST
NOVEMBER
ISSUE
30TH SEPTEMBER
DECEMBER
ISSUE

SERVICE MANUALS

TISHR 76 CHURCH ST.
LARKHALL 884585/883334
LANARKS ML9 1HE

Every published service sheet from the 30s to date. Worlds largest selection of service manuals. Spectrum repair service manual £5.00 Sole M.O supplier T.V Video repair manuals. Newnes & T.V Technic Technical Books. **FREE** review service sheet/price list. Enquiries large SAE.

SERVICE MANUALS. Amateur radio, test, audio, TV, video etc. Thousands stocked. SAE enquiries. Mauritron (HRT), 8 Cherrytree Road, Chinnor, Oxon.

AERIALS

NEW SHOP LUTON: Come to us for your aerial requirements! We also repair, install and calibrate amateur equipment. Wide range of CB & p.m.r. also available. Ring 0582-458310.

ANTI-T.V.I. Aerials, traps for beams or wire aerials, baluns, kits etc. Data 26p large SAE. Aerial guide £1. G2DYM Upwoman. Tiverton, Devon EX16 7PH (03986) 215.

VACANCIES

WANTED RADIO ENGINEER

Due to an ever increasing range of



products we are now looking to expand our service department. Prospective Candidates should have a sound background in Radio and computer servicing techniques. They will be involved in all aspects of Servicing, using modern test equipment in extensive workshops at our main office. If you are interested in joining our expanding Company please contact us with your CV, at the address below.

ICOM (UK) LTD., Unit 9, Sea Street, Herne Bay, Kent. CT6 8LD
Tel: 0227 363859

CLASSIFIED COUPON

HAM RADIO TODAY, CLASSIFIED ADVERTISEMENT
DEPT, No 1 GOLDEN SQUARE, LONDON W1R 3AB
PLEASE DEBIT MY ACCESS/BARCLAYCARD NO. EXPIRY DATE -



.....

FOR SALE

SOFTWARE

WANTED

EQUIPMENT

AERIALS

OTHERWISE STATE

Rates: Lineage 48p per word (VAT inclusive) minimum £7.20 semi-display £7.35 per single column cm. No reimbursements for cancellations. All ads must be pre-paid.

Name

Address

..... Daytime Tel. No:

Signature Date.....

THE LONDON AMATEUR EMPORIUM
FOR EVERYTHING RADIO

191 FRANCIS ROAD
LEYTON, LONDON E10 6NQ
TELEX 8953609 LEXTON G
OPEN MON -
SAT 9AM - 5.30PM
INTEREST FREE
HP FACILITIES AVAILABLE
ON MANY ITEMS
PROMPT MAIL ORDER

PHONE
01-558 0854
01-556 1415

dressler
FOR ICOM

dressler
FOR YAESU

IC28E/IC48E

VERY LATEST MINI-MOBILE
25/45 watts. RX 138-174MHz
£££ unbelievable value.



ICOM R7000 25MHz-2000MHz

SPECIAL OFFER!! COMPLETE WITH



FREE
ARA 500.
ACTIVE ANTENNA
WORTH £139.00
£969

NEW

A NEW
VERSION
OF THIS
POPULAR
PORTABLE
inc. Nicad
+ charger

YAESU FT 290 MKII



£425

ICOM MICRO 2
HANDHELD

ICOM IC-02E

ALSO
AVAILABLE
IC275E

ICOM IC-735



EPOA



£275



£854

SPECIAL OFFER

ALL SONY UK SUPPLIED

SONY AIR 7

PORTABLE-AM-FM
144-174MHz
108-136MHz
150KHz-2194KHz

£249



DUAL BAND
FT727R
£P.O.A.



FT23/
FT73
£P.O.A.



BUY A R71 FOR
£825 AND RECEIVE
AN ARA30 FREE
WORTH £129.00

WIDE RANGE OF YAESU/ICOM,
TRIO/KENWOOD, H.F., V.H.F., U.H.F.
SCANNING RECEIVERS AND
TRANSCEIVERS IN STOCK ICOM ICA2 ALL
CHANNELS TX/RX 5 WATTS, 108-135 AND
175 MHz £450 — COMMERCIAL,
PROFESSIONAL, MARINE, CELLULAR
AND AMATEUR RADIO SALES AND
SERVICE.

SONY ICF 200ID

76-108 MHz
116-136 AIRBAND
160KHz-29995MHz
FM - AM - SSB 32 MEMORIES
INC PSU

£325



SONY ICF 7600D

76-108MHz
162kHz-29995MHz
MEMORIES, FM, AM, SSB.

£169



FRG 8800 £575



NEW

FT767 YAESU



FRG 9600 £475



FULL HF
GENERAL COVERAGE
TRANSCIVER
£1395

ACTIVE ANTENNAS

dressler - ara 30 -
active antenna

200 kHz . . . 40 MHz

Professional electronic circuitry with very wide
dynamic range. Meets professional demands
both in electronics and mechanical ruggedness.
120 cm long glass fibre rod. Circuit is built into
waterproof 2.5 mm thick aluminium tube. Ideal
for commercial and swl-receiving systems. £129.
See Review in August Issue p.15



**DRESSLER
ARA 500
ACTIVE ANTENNA**

50MHz to 1300MHz
Gain 17dB Typical

TECHNICAL SPECIFICATIONS
FOR ARA 500

Gain 17dB Typical (14-17dB)

Frequency Range 50-1300MHz

Noise Figure 1dB at 50-180MHz
1.5dB below 300MHz
2.0dB below 350MHz
2.7dB below 400MHz
3.0dB below 500MHz
3.8dB below 650MHz

£139.00

Operation is possible up to 1300MHz
with gain of 10dB

Noise 4-6dB
Intercept Point 3rd Order: +18dbm at Input
Post £3.00 or Securicor £7.00 extra



LINEARS

SPECIAL OFFER !!

10 only
D200S - £925

D200 2 MTR 500W SSB
D200S 2 MTR 750W SSB
D70 70 CMS 550W SSB

£858

see panel above

£1030

Carriage Free Securicor



PRE-AMPS - NEW MODELS

MODEL	FREQ.	NOISE	GAIN	POWER	PRICE
EVV1296C	1.25-1.3GHz	0.9-1.2	16-18dB	100W	£162
EVV700SMD	430-440MHz	0.5-0.9	15-18dB	500W PEP	£124
EVV2000SMD	144-146	0.6-0.9	16-18dB	1KW PEP	£124
EVV200VOX	144-146	0.6-0.9	16-18dB	450W PEP	£112
EV2GAAS	144-146	0.6-0.9	15-18dB	100W PEP	£75
VV INTERFACE FOR ABOVE PRE-AMPS					£31

RECEIVE PRE-AMPS

MODEL	FREQUENCY	NOISE	GAIN	PRICE
EWPA 560	50-600-1GHz		16.5dB-1dB	£79
EWPA 560(N)	50-600-1GHz		16.5dB-1dB	£89
IP3 order	+18dBm			
ERPA 1296	1.25-1.30	0.8	17-18dB	£120
ERPA 435	430-440	0.5	15-18dB	£70
ERPA 144	144-146	0.7	16-18dB	£66
ASA 12	0-1GHz		Masthead Antenna Switch	£59



**DAVTREND LTD
SANDERSON CENTRE
GOSPORT, HAMPSHIRE
PO12 3UL
0705 520141**

MAKE SURE YOU RUN THE BEST PSU AVAILABLE WHEN DXING, Our range includes ...

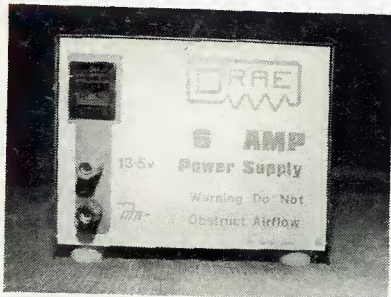

6 amps 13.8V
Price **£65.00**

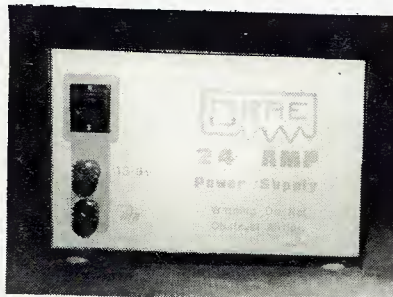

24 amps 13.8V
Price **£125.00**

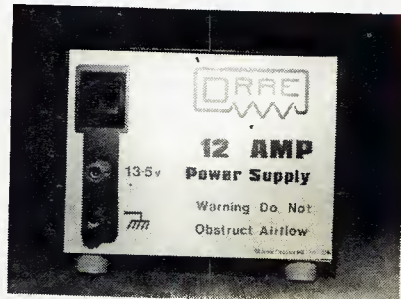

12 amps 13.8V
Price **£86.50**

All PSUs are fully regulated, short circuit protected and incorporate an overvoltage crowbar circuit.

BENCH POWER SUPPLIES

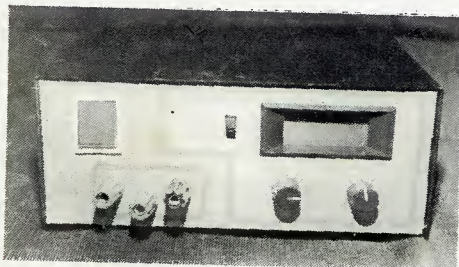

- BP 301** 0 to 30 volts continuously variable at 20mA to 1 amp. **£89.34**
- BP 302** 0 to 30 volts continuously variable at 40mA to 2 amp. **£114.11**

AERIAL SWITCHES/WAVEMETER

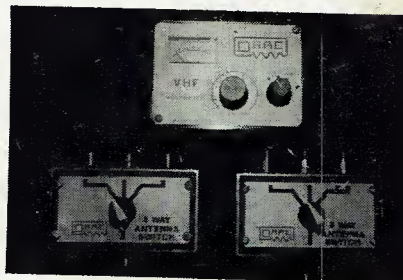

- VHF WAVEMETER **£27.50**
- 3 WAY VHF SWITCH SO239 **£15.40**
- 3 WAY UHF SWITCH N TYPE **£19.90**
- 2 METRE PRE SET ATU (not shown) **£14.50**

..... and now the **NEW DRAE SSTV SYSTEM**

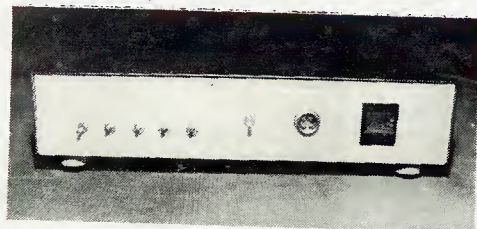

- ★ FOUR STORAGE MEMORIES
- ★ 128 x 128 PIXELS
- ★ VIDEO or UHF outputs
- ★ 13.8 Volts OPERATION

Prices for TX & RX Unit £320.00 RX only £195.00 TX Module £135.00

CUSTOM BUILT POWER SUPPLIES?

Enquiries welcomed from O.E.M. & Commercial Manufacturers: we manufacture: Switch Mode PSUs, DC to DC converters, AC to DC converters. Products already supplied for telecommunications equipment, radio manufacturers, medical equipment used on ships and aircraft. Ring Dave White now for full details

0705 520141

