

RADIO

ALL NEW
FT290

TODAY

MORSE
DECODER
PROJECT



▶ ALSO REVIEWED INSIDE: ▶ Sony ICF7600D Portable Receiver ▶ KW Corsair High Performance HF Rig ▶ Regency HX2000 Hand-held Scanner ▶ ▶ ▶ ▶ ▶

R. WITHERS COMMUNICATIONS LTD

Manufacturers, importers and suppliers of world famous communications products

584 HAGLEY ROAD WEST OLDBURY, WARLEY, BIRMINGHAM B68 0BS

021-421 8201/2/3. CELLNET 0860 323056. PRESTEL MBX 214218216 FAX 0215614074

Amateur Radio. Business Radio. Radio Telephones. Sales. Service Accessories and antenna systems.



YAESU



**THE TECHNICALLY ORIENTATED
RADIO COMMUNICATIONS
SPECIALISTS.**

**THE MODERN
CONVENIENT WAY
TO PURCHASE**

Please add £2.50 p&p for accessories, £5 for transceivers,
Send £1.00 for Raycom catalogue (refundable) or send
a large S.A.E. for latest used list and information.



★ **TOP TWENTY** ★

The following RWC Best-Sellers are normally Ex-stock at our Hagley Road Branch, and are offered to privileged customers (subject to status) at these special rates. The RWC Card is available for most adult current bank account and creditcard holders. Your credit limit is 24 times your monthly payment. A 10% deposit is required on initial **Instant Credit** Purchases but existing RWC Creditcard holders need not pay a deposit. Once a RWC Cardholder you will be entitled to access the RWC **CARDHOLDERS SPECIAL BARGAIN LIST. Please note that all Cash prices are less than current list and in many cases are the lowest prices in the UK.**

(Prices correct at time of going to press. E&OE).

**APPLY FOR YOUR CARD NOW. ** INSTANT CREDIT UP TO £1000.00
AVAILABLE TO LICENSED AMATEURS AND ENTHUSIASTS. APR 32.9%**

YAESU MULTIMODE + HANDHELDS

	CASH PRICE	P/MONTH
3 YAESU FT290R MULTIMODE	£369.00	£14.00
9 FT203R + FNB3 2MTR SUPER HANDHELD	£255.00	£10.00
4 FT209RH + FNB4 2MTR 5 Watts H/H	£315.00	£12.00
16 ALINCO ALM203E H/H C/W 30W AMP	£239.00	£9.00
19 FT709R + FNB3 70CMS KEYBOARD H/H	£319.00	£12.00

YAESU AND ICOM MOBILES + DUAL BANDERS

7 FT2700R 25W 2+70CMS MOBILE	£399.00	£15.00
13 IC3200E 25W 2+70CMS MOBILE	£499.00	£20.00
20 IC290D 25W 2MTR MULTIMODE	£539.00	£21.00
2 NEW IC28E 25W FM MOBILE (RWC mod)	£349.00	£14.00
12 FT726 ALL MODE MULTI BAND V-UHF	£999.00	£42.00
17 IC271H 2MTR MULTIMODE 100 WATTS	£989.00	£38.00

YAESU AND ICOM HF MOBILE/FIXED

5 IC735 ALL BAND 100W SUPER-RIG	£925.00	£34.00
6 FT757GX ALL BAND (C/W RWC mod)	£949.00	£33.00
15 IC745E ALL BAND HF TRANSCEIVER	£915.00	£37.00

RECEIVERS

11 FRG8800 ALL MODEL ALL BAND RX	£625.00	£22.00
1 FRG9600 MK2-RWC SCANNING V-UHF	£499.00	£18.00
14 ICOM ICR71 ALL MODE HF SUPER RX	£799.00	£30.00
10 ICOM ICR7000 25-1300MHz SCANNING RX	£925.00	£35.00
18 BEARCAT NEW 100XL H/HELD SCANNER	£219.00	£9.00
8 BEARCAT DX1000 SW 10-30MHz ALL MODE	£329.00	£13.00

**CALL US NOW
FOR BEST PRICES
AND SUPER DEALS**

THIS IS JUST A SMALL SELECTION OF THE STOCK WE HAVE AVAILABLE. AT RWC YOU WILL GET THAT BETTER DEAL. WE ALSO HAVE THE BEST UPDATED WEEKLY USED LIST FULL OF BARGAINS ALL OF WHICH CARRY OUR FAMOUS THREE MONTH WARRANTY. **Plus our VERY SPECIAL package Deals!**

Please call us by telephone for a free brochure, Creditcard application leaflet or any other information. You may also order any of the above goods by AMERICAN EXPRESS, VISA, ACCESS, Diners Club on our 24hr answerphone. RWC Ltd are licensed Credit Brokers. Full written details on request.

OR POP INTO OUR HAGLEY RD. SHOP FOR A NO-OBLIGATION DEMONSTRATION OF ANY OF THE ABOVE PRODUCTS. PLUS THE THOUSANDS OF OTHER LINES IN STOCK . . . (Junc. 3 M5.)

DON'T FORGET!!! CHRISTMAS IS JUST AROUND THE CORNER, AND PRICES COULD GO UP AGAIN.

Tel: 021 421 8201 (24hr answerphone)

Telex: 334303 G TXAGWM



HAM RADIO CONTENTS

TODAY

VOLUME FIVE NO 1 JANUARY 1987

Consultant Editor
Steve Ireland, G3ZZD
Editor
Dave Bradshaw, G1HRT
Assistant Editor
Dave Bobbett, G4IRQ
Advertisement Manager
Dave Gadsden, G4NXV

Published by:
Argus Specialist Publications Ltd.,
1 Golden Square,
London W1R 3AB
Telephone 01 437 0626
Distributed by:
SM Distribution Ltd.
Printed by:
The Garden City Press Ltd.
Design by:

 Argus Design Ltd.

 ABC

Subscriptions: UK £17.30; o/seas sur £21; USA sur \$28; o/seas air £39. Ham Radio Today, Subscriptions Dept., Infonet Ltd., Times House, 179 The Marlowes, Hemel Hempstead, Herts HP1 1BB (tele: 0442 48432).

Ham Radio Today is normally published on the first Friday in the month preceding cover date. The contents of this publication including all articles, designs, plans, drawings and programs and all copyright and other intellectual property rights therein belong to Argus Specialist Publications Limited. All rights conferred by the Law of Copyright and other intellectual property rights and by virtue of international copyright conventions are specifically reserved to Argus Specialist Publications Limited and any reproduction requires the prior written consent of the Company. © 1987 Argus Specialist Publications Ltd.
All reasonable care is taken in the preparation of the magazine contents, but the publishers cannot be held legally responsible for errors. Where mistakes do occur, a correction will normally be published as soon as possible afterwards. All prices and data contained in advertisements are accepted by us in good faith as correct at the time of going to press. Neither the advertisers nor the publishers can be held responsible, however, for any variations affecting price or availability which may occur after the publication has closed for press.

REGULAR COLUMNS

LETTERS.....	10
RADIO TODAY	12
Full details of the new all-British all-mode receiver - a Japanese beater?	
TECHNOLOGY ROUNDUP	51
Crystals revealed	
LISTENING ON	52
DXing on medium wave and tropical bands	
RADIO TOMORROW	55
Update your diary here	

CONSTRUCTION

2-80 TRANSVERTER	22
The cheap way to 80m - transmitter strip alignment	
MORSE DECODER	28
Morse meets the micro with this cheap morse to centronics decoder	
AUDIO CW FILTER	49
An AF alternative to costly crystals	

FEATURES

MAKE YOUR OWN PCBs.	19
Doing it the professional way, with G3WPO	
WHITE NOISE	42
A traditional Christmas ghost story, specially for radio clubs...	
ATV PART 4	57
Get yourself on the telly with the final part of our series	

REVIEWS

REGENCY SCANNER	15
The radio that reaches frequencies others cannot	
SONY 7600D	24
Small box - big spec	
NEW FT290	36
Not just a face-lift, but a brand new rig. Chris Lorek, G4HCL takes the covers off	
KW CORSAIR.	44
A CW buff's super-rig, emanating from the colonies	
NEXT MONTH IN HAM RADIO TODAY	56
Free Readers' Ads	60
Classified Ads	64
Emporium Guide	65
Advertisers' Index	66

Seasons Greetings to ICOM users the world over

NEW! IC-MICRO TWO, Mini-handportable.

This is the smallest handportable transceiver from ICOM. The MICRO-TWO, 2 metre FM measures only 148 x 61 x 31mm. with BP22 battery pack (not shown here). The MICRO-TWO is a hand-size transceiver which will equally fit most pockets.

On the top panel a clear LCD readout gives frequency and memory channel number. Tuning is made easy using up/down toggle switches to select 1MHz, 100kHz or 12.5kHz steps as well as the 10 memory channels. Full repeater and reverse duplex operation facilities are featured including repeater access tone. An automatic power saving function reduces battery power consumption when in receive mode. Output power is 1 watt or 100 milliwatts (low) with the BP22 nicad pack.

The ICOM MICRO-TWO is the ultimate in 2 metre miniature handheld transceivers, yet despite it's small size the receiver sensitivity and performance has not been compromised. This handy transceiver comes complete with the BP22 nicad pack (not shown here), A.C. wall charger, helical antenna. Most existing ICOM accessories can also be used.

An optional extra, the BC50 desk charger will rapidly charge the BP22 battery in just one hour. Other options include the BP23 long-life, low-power and BP24 medium-life, high-power nicad battery packs. Contact us or your local ICOM dealer for more details on this exciting new product.

Actual Size Photograph.

This shows the non-standard low capacity battery pack. N.B. Standard battery pack is normally the higher capacity BP22 as mentioned in text.



MICROWAVE MODULES LTD

CONVERTERS

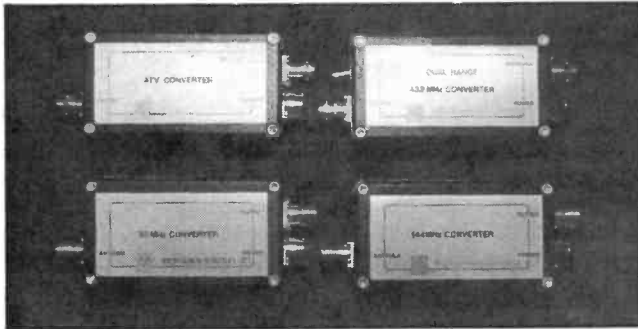

MMC50/28	6m down to 10m Converter	35.65 A
MMC144/28	2m down to 10m Converter	36.65 A
MMC432/28-S	70cm down to 10m Converter	39.90 A
MMC432/144-S	70cm down to 2m Converter	39.90 A
MMK1296/144	23cm down to 2m Converter	129.95 B

Just want to listen on a Band? See what it's like before you buy one of our Transverters. Our converters are well proven, are excellent value for money and give reliable service. A choice of popular I.F.'s and inputs are available.

70cms LINEAR AMPLIFIERS



MML432/30-L	70cm 30W Linear, 1 or 3W input	169.05 C
MML432/50	70cm 50W Linear, 10W input	149.50 C
MML432/100	70cm 100W Linear, 10W input	334.65 D

QRV on 70cms and need a little more power? Our Linears provide the signal and quality you demand. The MML432/30LS has switched inputs for 1 or 3 watts (ideal for the FT708, FT790R, etc). If you have a 10 watt TX and require a modest output then the MML432/50 will give you 50 watts. QRO? Our MML432/100 is just what the doctor ordered. Running a pair of devices in the output a cool 100 watts is delivered to your aerial system. The 30 and 50 watt Linears both have receive pre-amps fitted.

TRANSVERTERS

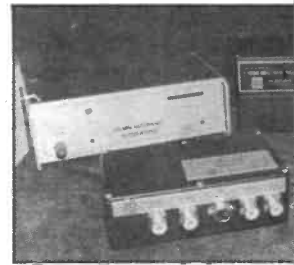

Designed to meet the most rigorous requirements the new MMT144/28R and MMT50/144 Transverters are guaranteed to give satisfaction. Satellite operation? Certainly our MMT432/28S is just what you need. Perhaps the challenge of 23cms appeals to you. If so our MMT1296/144 will meet your requirements. Whatever your needs be sure our Transverters are designed by experts to the most demanding standards.

MMT432/28-S	70cm Linear
MMT1296/144-G	23cm Linear
MMX1286/144	1268MHz Tr
MMT50/144	6m Linear Tr
MMT144/28	2m Linear Tr
MMT144/28-R	2m Linear Tr

WEATHER SATELLITE EC



Our METROSAT equipment is professional market but we know our friends have bought this superb receiving signals from both the 1691 MHz band (METROSAT) and the 137.00MHz (NOAA). We have seen other systems demonstrated and seen the best.

AMATEUR TELEVISION



MMC435/600	70cm ATV Converter, UHF output	35.65 A
MTV435	70cm ATV 20W Transmitter	197.80 B

Join the growing number of ATV enthusiasts. Our MTV 435 will give a full 20 watts peak signal. It has two inputs and an inbuilt test generator. To complement this our MMC435/600 gives you amateur TV signals on any domestic UHF TV. It all helps to keep you in the picture.

RF PREAMPLIFIERS

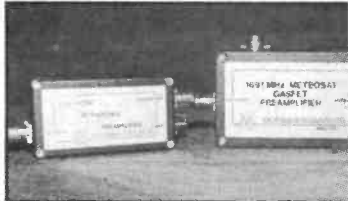

MMG144V	2m RF Switched GaAs
MMG1296	23cm GaAsFET Preamp
MMG1691	1690MHz GaAsFET Pre

Feedback is always necessary to stay on top if you have any problems or ideas please speak to our reps at any of the rallies or even one of our retail outlets. Club Lectures: Sorry if we haven't been able to answer all the mail or visit all the clubs. The response has been overwhelming.

Hope to see some more next year. Best 73's Mick.

BUY THE BEST. A GOOD DEAL. REMEMBER OUR PRICE.

Postage/Packing Charges: A = £1.84 B = £3.91 C =



WELCOME

MICROWAVE

BROOKFIELD DRIVE, AINTREE

Telephone: 051-523 401

CALLERS ARE WELCOME

D

A SELECTION OF OUR PRODUCT RANGE FOR THE CONNOISSEURS OF AMATEUR RADIO



Transverter	195.50 B
Transverter	258.78 D
Transmit Up-Converter	195.50 D
Transverter, 20W o/p	245.00 B
Transverter, 10W o/p	129.95 B
Transverter, 25W o/p	236.90 B

Learning C.W.? The MMS1 will help to achieve the pass slip you require. It sends letter, numbers or both, in groups of 1, 5 or 50 characters. Use the MMS2, and a key and it will even tell you what you've sent! RTTY enthusiasts will love the MM2001. It gives the full range of 45.5, 50, 75, 100 baud ASCII rates and will also provide 110, 300, 1200 baud ASCII range for computer systems. It plugs straight into your UHF TV and gives superb results.

MICROPROCESSOR PRODUCTS



MM2001	RTTY to TV Converter	189.00 B
MM4001-KB	RTTY Transceiver with keyboard	299.00 D
MMS1	The Morsetalker	115.00 B
MMS2	Advanced Morse Trainer	169.00 B

EQUIPMENT

PRICES	
ANTENNA	333.50
1691 MHz.	
GAASFET	
PREAMP	129.95
1691-1375	
CONVERTER	145.00
137MHz	
RECEIVER	424.35
FRAME	
STORE	908.50
14" COLOUR	
MONITOR	286.35
137MHz	
AERIAL	69.00
137MHz	
PREAMP	46.00

is designed and built for the
now a lot of our amateur
b equipment. Its capable of
e geostationary satellites on
(SAT), and the orbiting satel-
A series, etc). You may have
ated at rallies - now come

Two meters must be the most popular VHF allocation to UK amateurs and to meet their requirements we produce a full range of linears giving 30, 50, 100 and 200 watts output. Input powers are 1 or 3 watts for the 30 watt linear, 10 watts for the 50 watts, 1, 3, 10 or 25 for the 100 watt range and 10 or 25 for the 200 watt unit. All of our two meter linears are fitted with RF receive preamps.

2 METER LINEAR AMPLIFIERS



MML144/30-LS	2m 30W Linear, 1 or 3W input	94.30 B
MML144/50-S	2m 50W Linear, 10W input	106.95 B
MML144/100-S	2m 100W Linear, 10W input	149.95 C
MML144/100-HS	2m 100W Linear, 25W input	159.85 C
MML144/100-LS	2m 100W Linear, 1 or 3W input	169.95 C
MML144/200-S	2m 200W Linear, 3, 10, 25W input	334.65 D

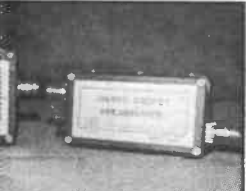

Are you unable to hear all that's going on? Perhaps you feel that your receiver is just a bit 'Deaf'. One of our preamps will soon make amends. The two meter version is RF switched and allows you to run 100 watts through.

GAASFET Preamp	37.90
Amplifier	75.00
Preamp	129.95

All of our Transverters and some Linears come supplied with attenuators where needed. However, they are sold as a separate item, so if you need a 3, 7 or 10dB attenuator and just give us a ring.

ATTENUATORS



MMR3/25	3dB 25 Watt Attenuator	19.95 A
MMR7/3	7dB 3 Watt Attenuator	14.50 A
MMR15/10	15dB 10 Watt Attenuator	14.50 A

REAL ALWAYS MAKES SENSE.
PRODUCTS ARE BRITISH

£4.60 D = £5.98 ALL PRICES INCL VAT 15%

MODULES Ltd

1, LIVERPOOL L9 7AN, ENGLAND
Tel. 628608 MICRO G
PLEASE TELEPHONE FIRST

HOURS:
MONDAY-FRIDAY
9-12.30, 1-5.00
E & O.E.

CALL US NOW FOR DETAILS OF ABOVE.

IF YOU BUY a kit or module from us the chances are it will be from the top best sellers listed below. We are pleased to say that they just sell and sell and sell... **Shouldn't you have at least one in your shack?**

70cms Modules

		Assembled	Kit
70FM05T4	500mW NBFM Transmitter	63.40	39.85
70FM05R5	NBFM Receiver	75.40	59.95
70FM10	10W Power Amplifier	56.45	45.50
70LIN3/LT	500mW Linear Amplifier	39.90	30.55
70PA2/S	RF Switched Pre-Amplifier	30.56	19.10
70PA5	GaAS FET Pre-Amplifier	23.60	14.75
TVUP2	70cms TV Converter	38.40	28.75
TVM1	70cms TV Modulator	11.60	7.25

24cms Modules

		Assembled	Kit
1250DC50	TV Down Converter	79.95	—
1250PA2	TV Pre-Amplifier	49.95	—
1240 TVT	Frequency Locked T'mitter	145.00	—
UFM01	420 MHz FMTV Exciter	41.25	28.25
VIDIF	IF Processor/Demodulator	63.75	—
SCT-2	Transmit Sound Modulator	16.50	—
SCR-2	Receive Sound De-M'lator	24.95	—
VDBP1	Pre-Emp/De-Emp Module	10.50	—

2M Modules

144PA4	2M MOSFET Pre-Amplifier	17.20	10.75
144PA4/S	RF Switch Pre-Amplifier	31.20	19.50
144LIN25B	RF Switched 25W Linear	49.20	35.75

General Accessories

TB2	Toneburst	7.50	4.70
PT3	Piptone	8.45	5.10
MPA2	Microphone Pre-Amplifier	6.25	4.60

All prices include VAT but please add £1.00 for postage and handling. Delivery is usually from stock or within 28 days.

A copy of our full list of modules and kits for practising amateurs is available for the cost of an A4 size SAE

Unit 12-13
Youngs Industrial Estate
Aldermaston, Reading
Berkshire RG7 4PQ
Telephone: (07356) 71444 Telex: 846630



WOOD & DOUGLAS
VHF/UHF COMMUNICATIONS PRODUCTS



**NEW FROM SONY
AIR-7 MONITOR**
AM 150KHz-2194KHz AM 108-136MHz
WFM 76-108MHz NFM 144-174MHz

The new Sony Air-7 is a superb new monitor having features so far unmatched in a single hand-held monitor by any other manufacturer. Its frequency coverage makes it ideal for airband, public service or marine band monitoring, plus normal domestic use. Highly sensitive, this receiver does everything you could ever desire in one package. The LCD digital display means clear frequency display even under bright illumination and the PLL circuitry ensures drift free reception. Frequency is selected by keypad entry or electronic tuning and there is provision for disabling the keyboard. 10 memories are provided for each of the 4 main ranges (40 in total) and comprehensive scanning is provided in the bands 108-174MHz. Either full band or memory scanning is possible at a rapid rate. Additionally, delays may be programmed into each memory channel, certain channels only may be scanned and any channel can be designated the "priority" channel. Accessories include BNC helical, battery cartridge shoulder strap etc. Options available: - rechargeable battery cartridge £15.95; Mains PSU/charger £15.

£249

PLEASE NOTE, unlike some versions on the market, these are not "grey imports" and therefore have both the full frequency coverage and the backing of SONY UK. No other amateur radio dealer in the UK can offer you this guarantee. Be warned!

SONY 2001D + AIRBAND OPTION & AC PSU!



£329

Angus McKenzie in Amateur Radio Magazine says "probably represents the best portable radio that one can get" and "far superior to anything that I have tried". We can only agree with his comments. It is a truly superb communications receiver that is completely portable covering 0.15-30MHz, 76-108MHz(WFM) plus 116-136MHz AM airband. We can only touch on the features here such as Synchronous detector on AM for reduced interference; Switchable USB/LSB with separate filter; 55mHz first IF for good image response; both electronic and manual tuning the latter with dual speed; signal metering; RF gain control; 32 programmable memories with scanning; search facility; 4 event timer; 24/12 hour clock; LCD readouts, mains power supply included, etc. etc. We have used this radio extensively on the office desk and it is a delight to be able to listen to the DX on 14MHz; the matters on 35mHz and the latest news from Radio Australia. For home use an external aerial socket is provided and under these conditions it compares well with even the most exotic receivers. In stock now!

ALSO IN STOCK A.N-1 ACTIVE AERIAL KIT £49.00
CARRIAGE ON ALL ABOVE £2.50



**JUST PUBLISHED 26-2250MHz No-Gaps!
THE COMPLETE VHF/UHF
FREQUENCY GUIDE**

- ★ MARINE CHANNELS
- ★ CIVIL & MILITARY AIR
- ★ POLICE, FIRE, AMBULANCE
- ★ SPACE VEHICLES
- ★ HAM RADIO REPEATERS
- ★ UHF TV CHANNELS
- ★ FULL DUPLEX DETAILS
- ★ PMR
- ★ RADIOPHONES

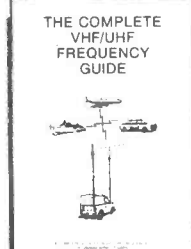

£4.95
p&p 70p

At last the only "COMPLETE" vhf/uhf frequency guide available to the UK radio enthusiast. Not just a collection of random frequencies put together in haphazard fashion but a professionally prepared and printed guide based on the very latest information available. 64 pages packed with a mass of information about this fascinating part of the frequency range. Whatever you want to know, if its between 26 and 2250MHz this guide will quickly take you to it. In fact it would be difficult to imagine any enthusiast not having a copy of this beside him! The book very clearly lays out comprehensive details of all the services that use this part of the radio spectrum with their allocations and where applicable the separate mobile and base station frequencies. It would be impossible to list everything that this publication covers but it includes the following:- All UK marine frequencies with coast station listings; civil airport and ATC frequencies; Military air including air to air and air to ground including Red Arrows; Police; Fire and Ambulance mobiles and base with duplex cross references; NASA voice channels; Russian Space spot frequencies; Weather satellites, PMR; Outside broadcast channels BBC/ITA; 2m and 70cm repeater listings; UHF TV channels; BT radiophones; new band 3 PMR allocations and much more. There is no gaps (like some publications that have attempted to copy us and then got it wrong!!); every part of the spectrum is accounted for. No radio shack is complete without this invaluable guide. Send or phone today for your copy.

— OTHER TITLES —

VHF/UHF AIRBAND FREQUENCY LIST	£3.95
OCEANIC HF AIRBAND SUPPLEMENT	£2.95
WORLD RADIO TELETYPE HF FREQUENCY LIST	£3.95
AIR TRAFFIC CONTROL	£6.99
AIRBAND RADIO HANDBOOK	£4.99
WORLD RADIO AND TV HANDBOOK	£17.95
SHORTWAVE BROADCASTING GUIDE (times & frequencies)	£4.95

RETAIL & MAIL ORDER:- 18-20, Main Road, Hockley, Essex SS5 4QS.

Tel: (0702) 206835, 204965

RETAIL ONLY:- 12, North Street, Hornchurch, Essex RM11 1QX.

Tel: (04024) 204965

Visa and Access by telephone. 24 hour securicor £6.50 extra.

dressler

FOR ICOM

THE LONDON AMATEUR EMPORIUM FOR EVERYTHING RADIO

TRIO KENWOOD TR751E



£525

YAESU FT 290 MKII



A NEW VERSION
OF THIS POPULAR PORTABLE

TRIO KENWOOD
TS440
HF INC AUTO ATU



£1050



VERY LATEST MINI-MOBILE
25/45 watts. RX 138-174MHz
£££ unbelievable value.

ICOM
R7000 25MHz-2000MHz



COMPLETE WITH FREE ARA 500
ACTIVE ANTENNA WORTH £129.00
£959

FRG 9600 £429



SONY ICF 200ID

76-108 MHz
116-136 AIRBAND
160KHz-29995MHz
FM - AM - SSB 32 MEMORIES
INC PSU

£325

NEW FT767 YAESU



FULL HF GENERAL
COVERAGE TRANSCEIVER
+ 6M-2M+70cm
£1395

TRIO KENWOOD
TS940S
INC AUTO ATU



£1925 ALSO AVAILABLE
TL922 LINEAR INC TUBES £1225

SONY ICF 7600D

76-108MHz
162kHz-29995MHz
MEMORIES, FM, AM, SSB.



£164

SONY AIR 7
PORTABLE-AM-FM
144-174MHz
108-136MHz
150KHz-2194KHz



£249

TRIO KENWOOD
TS780

70cm-2 metres



£950

dressler

FOR TRIO/KENWOOD

ACTIVE ANTENNAS

A MUST FOR ALL SERIOUS SWLS
dressler - ara 30 -
active antenna
200 kHz . . . 40 MHz

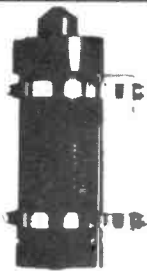

Professional electronic circuitry with very wide dynamic range. Meets professional demands both in electronics and mechanical ruggedness. 120 cm long glass fibre rod. Circuit is built into waterproof 2,5 mm thick aluminium tube. Ideal for commercial and swl-receiving systems. £120.00

NOW A NEW LOWER PRICE

**DRESSLER
ARA 500
ACTIVE ANTENNA**

50MHz to 1300MHz

Gain 17dB Typical

**TECHNICAL SPECIFICATIONS
FOR ARA 500**

Gain 17dB Typical (14-17dB)

Frequency Range 50-1300MHz

Noise Figure
1dB at 50-180MHz
1.5dB below 300MHz
2.0dB below 350MHz
2.7dB below 400MHz
3.0dB below 500MHz
3.8dB below 650MHz

£129.00

Operation is possible up to 1300MHz
with gain of 10dB

Noise 4-6dB
Intercept Point 3rd Order: +18dbm at Input

LINEARS

D200 2 MTR 500W SSB
D200S 2 MTR 750W SSB
D70 70 CMS 550W SSB

£858

£1018

£1030

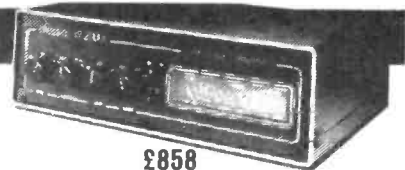

PRE-AMPS - NEW MODELS

MODEL	FREQ.	NOISE	GAIN	POWER	PRICE
EVV1296C	1.25-1.3GHz	0.9-1.2	16-18dB	100W	£154
EVV700 SMD	430-440MHz	0.5-0.9	15-18dB	500W PEP	£117
EVV200FB	144-146	0.6-0.9	16-18dB	700W PEP	£95
EVV2000GAAS	144-146	0.6-0.8	16-18dB	1KW PEP	£105
EV2GAAS	144-146	0.6-0.9	15-18dB	100W PEP	£75

VV INTERFACE FOR ABOVE PRE-AMPS

£31

RECEIVE PRE-AMPS

MODEL	FREQUENCY	NOISE	GAIN	PRICE
EWPA 560	50-600-1GHz		16.5dB-1dB	£79
EWPA 560 (N)	50-600-1GHz		16.5dB-1dB	£89
IP3 order			17-18dB	
ERPA 1296	1.25-1.30	0.8	15-18dB	£114
ERPA 435	430-440	0.5	16-18dB	£65
ERPA 144	144-146	0.7		£60
ASA 12	0-1GHz		Masthead Antenna switch	£59

OPEN: MON -
SAT 9AM - 5.30PM

INTEREST FREE

HP FACILITIES AVAILABLE

ON MANY ITEMS

PROMPT MAIL ORDER



191 FRANCIS ROAD
LEYTON · E10

TEL. 01-558 0854 / 01-556 1415

TELEX 8953609 LEXTON G

dressler

LETTERS

RSGB — wrong

Dear HRT, Why do those who support the RSGB right or wrong, in reply to criticism of it, direct their comments not at the issues raised but at the individuals raising them. Is it that they are unable to respond to the issues?

We do need a strong RSGB but it must be 'open', 'responsible', democratic and 'accountable'.

At present the RSGB is none of these.

Ian Abel, G3ZHI

. . . and right?

Dear HRT, Mr Ian Abel is of course fully entitled to air his opinions, but I feel that he has not given much time for the changes he wants to take place, either because of, or despite, his membership of RSGB.

He is however going too far when he mentions an RSGB staff member who was presumably only carrying out her employers' instructions and who cannot reply, even if she wished to demean herself to do so. It is the lowest form of journalism to introduce personalities into the discussion, and I am surprised you published same, although you did add a postscript of your own.

As Ian probably knows only too well Ms Norman has been a loyal Society worker, for many years, and quite likely knows more about Amateur Radio than he does. She is not licensed, but the possession of a callsign does not mean that one is the fount of all knowledge, as Ian ably proves each time he applies ink to paper.

I am delighted to learn that he intends resigning, then the time at the AGM can be spent on issues vital to our hobby like Interference and Planning Permission, rather than childish political squabbles about who wears the President's chain of office, and whether the elected Council should make decisions without canvassing members on each occasion.

Your other correspondent in the December issue, Mr. Dick, is good enough to half-admit his mental state. He is dissatisfied over lack of attention by the RSGB to certain

views of his, but does not consider it relevant to let us know what they are, so we can decide who is being unreasonable. Having dismissed much of the contents of 'Radcom' as trivia, he has the cheek to suggest that failure to print his pearls of wisdom indicates a paranoid state of mind!

I have for some time considered that quality is more important than quantity, and feel that the RSGB in particular, and Amateur Radio in general, would be well rid of gentlemen such as this. They are welcome to form their 'liberal amateur radio society', whatever that means. They never tell us what the constitution of same would be, or what their intentions would be vis-a-vis the licensing authority.

They would however do well to do some thinking before they expect to be taken too seriously. Just a couple of points — although anyone can contact his MP or a government Department, before they could claim credibility they would have to provide proof of how many amateurs they claim to represent. Also, they could not enter international contests or exchange QSL cards with bureaux worldwide, until such time as they were recognised by the IARU. These are the people who set themselves up as experts without any real in-depth knowledge, and it is rather laughable. I, and I feel most amateurs of any real responsibility, would much sooner leave the future of our hobby in the hands of the RSGB, despite its few warts, rather than a few malcontents who seem incapable of seeing beyond their own personal grievances and petty jealousies.

R G Sewell

Just like everybody else, both the RSGB and Ms Norman, are always welcome to air their views here in the letters page — however at the time of writing no such letter has been received.

As for the comment concerning introducing personalities into a discussion, it seems to me that if there were no personalities then there would be no discussion — hence the two are interconnected. It is far more dangerous for any organisation to

place itself above criticism than to participate in a discussion — which is why we publish letters which are critical of us here at HRT.

Asst Ed, G4IRQ

Kits and bits

Dear HRT, Thank you for your letter of 15th October relating to my inability to obtain a BF245 FET.

As regards your policy on 'single source' projects many of my friends and readers of Argus Specialist Publications feel that this policy smacks of pure commercialism.

As you are no doubt aware — many Hams have quite a collection of components and can usually make up most projects without extra purchases except for one or two items and these are usually available (without postage) from local suppliers.

It is against all traditions of project building over the years in Amateur Radio to be so restricted and I think you will find that this deters 'would be' buyers of your mag.

Mr G Henshall, Liverpool

Unfortunately this is a 'heads I win, tails you lose' situation for us.

If we publish a project with no kit option then many readers are stumped because either they don't have access to PCB-making equipment or there are few (if any) component shops in their area. When we do decide upon a kit (and it is just an option, nobody is compelled to buy it!) then we find that somebody, somewhere will have local supply problems if they go it alone. As for the approach 'smacking of pure commercialism' I would point out that no supplier does it for free, whether it is a kit manufacturer or the shop 'round the corner'. We would welcome comments from our readers on this topic — would you prefer to have the option of a project kit, or not?

Asst Ed, G4IRQ

QSL-ing with C5 — The Gambia

Dear HRT, The RSTG regularly receives large numbers of QSL-cards

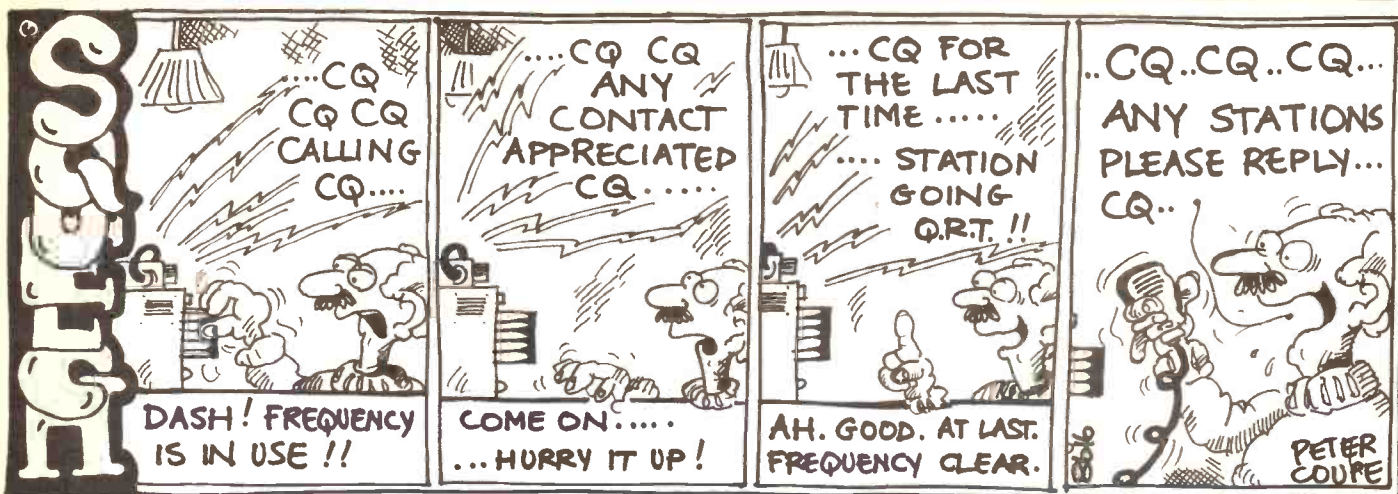

for C5 calls, which for the one or other reason cannot be processed.

Most of the active hams here are expatriates, who come to The Gambia on short-term contracts rarely exceeding two years.

Cards sent "via the bureau" are normally forwarded by sea mail and may take a year or more to reach The Gambia. The risk that your QSL-partner has meanwhile left the country is therefore considerable.

The following suggestions may assist in obtaining confirmation of a C5 contact.

1. QSL only directly and by air mail
2. enclose a self-addressed envelope and 2 IRCs
3. check the validity of the C5 call worked in the latest International Call Book, it seems that the C5 prefix is a favourite with pirates.

All QSL cards received by the Radio Society of The Gambia will be distributed promptly to such members who either still are in The Gambia or whose forwarding address is known. All other cards can be returned only if return airmail postage (two IRCs) has been enclosed — there is no outgoing seamount from here, so cards will have to be returned by air.

The address of the RSTG is: Radio Society Of The Gambia, P.O. Box 2470, Serrekunda, via Banjul, The Gambia, West Africa.

Juergen Rosenstock C53CR

Do you know Goliath?

Dear HRT, I am engaged on a programme of research into a Very Low Frequency, transmitting radio station established in Germany late autumn 1941.

The station called "Goliath", was near the village of Kalbe (Saxony, Prussia) and partially straddled the River Milde.

I seek any information, no matter how small or seemingly trivial. Any drawings, photographs, technical details or personal memories by German or Allied personnel would be especially welcome. Any documents loaned to me would be treated with care and postage refunded.

My address is:
Mr T F Bernascone
(GOLIATH RESEARCH PROJECT)
Teesside Polytechnic
Borough Road
Middlesbrough
Cleveland TS1 3BA

T F Bernascone

TO: 'DISILLUSIONED G1', MANCHESTER

Your letter came as no surprise to me, my young friend - there will always be those who decry 'youth' — it may be that they feel superior having gone further in the process of natural decay or (more likely!) that they are jealous of your early prowess! I would suggest that you take no notice of them, neither derogatory remarks or evil 'jamming' activities — such tiny minds have little persistence, especially if no notice is taken of their behaviour! You, of course, don't have to listen to, or work them!!

Having encouraged and trained a vast number of young amateurs into the fraternity, might I suggest that you review your own operating procedures with a view to removing any grounds for their comment?

It isn't a particularly good point to stress your age (proud though you may be to have achieved a licence at a relatively early age!) leave the matter until you meet fellow Hams at club or social events, and at such take up the attitude of being 'all ears' on discussions and talks, there will be many future years when wider horizons may enable you to make comment and suggestions which will,

then, prove most acceptable! The great majority of amateurs you will find are keen to help the beginner and will always behave with courtesy and consideration towards others who manifest the true 'Ham Spirit'.

You are quite *wrong* to go QRT! — giving into the offending types is no way to meet their 'tiny-mindedness' — get on the air, ignore their efforts, and QSO anyone who you can raise! I am sure you will find your detractors only represent a lunatic fringe and are not remotely symptomatic of the amateur fraternity as a whole!

In case you wonder at my grounds for writing this, I would explain that I have been in Amateur Radio for 70 years having built my first receiver at the age of 8! — the true OT would *never* behave as those you mention appear to do!

73 — keep your chin up.

Brian Herbert, G2WI

Ageist? Not us

Dear HRT, After reading the letter in November's HRT I felt I must write and say that by no means are all Amateurs ageist. I am now 17 and have been licenced since I was 15, and have had nothing but help and encouragement from all the local amateurs.

I do believe that it is in many ways harder for young amateurs to get on the air because of financial and many other reasons.

I hope that the 'disillusioned G1' will be able to continue with his hobby and have as much enjoyment in the future as I have had over the last two years.

If any other young amateurs would like to write to me I would be pleased to try and set up some link between young amateurs around the country.

Nigel Knapton, G1IKE

RADIO TODAY



The Matlock Mole does it again!

As you can see from the photo, we have been able to obtain much fuller information on the forthcoming Lowe Electronics HF receiver which we brought to your attention last month.

The new receiver, called the HF-125, offers continuous coverage from 30kHz to 30MHz, on AM, USB, LSB and CW and sports a variety of filters even in the standard package — which is expected to sell for something in the region of £350. A 2.5kHz filter is used for SSB and there is a 400Hz audio filter for CW buffs. For normal AM reception you can select a 4, 7 or 10kHz filter to suit the conditions, with the rig automatically selecting the appropriate filter for you when you change mode. So the 2.5kHz filter is selected on SSB and the 7kHz filter is initially switched in for AM, although the user can 'interrogate' the rig to see which filter is in use and change to one of the others if desired.

Frequency readout is by means of an LCD (which also serves to show which filter is in use) displaying the VFO frequency in normal use or the contents of the 30 memory channels available. Initial selection of the MHz range required is by means of two Up/Down buttons with a conventional tuning knob acting as the 'fine tune' facility. The tuning knob is a good bit more 'intelligent' than this though, the stepping rate being matched to the mode in use (15.6Hz per step on SSB/CW for example), and the stepping increment being increased as the rate of knob rotation rises — so there is no need to get out an electric drill to wind from one end of the band to the other.

Other features include a noise blanker, an RF attenuator, tone control and an overall size of 255(W) x 100(H) x 200(D) mm which is roughly 10x4x7¾ inches. Options available for the standard rig consist of the D-125 combined FM and synchronous AM detector boards, P-125 Nicad & charger pack with active aerial and the K-125 'Genie' keypad frequency controller.

Further details (which we must point out are provisional at this early stage) are shown in the table.

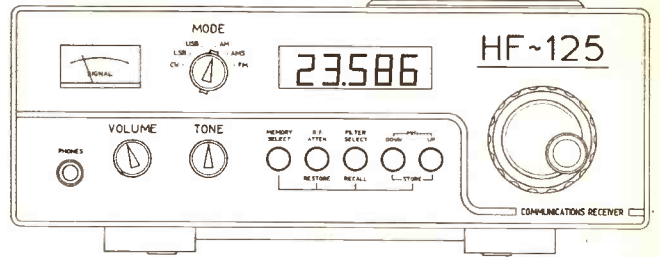

HF-125 Receiver-Provisional Specification

Frequency coverage	30kHz to 30MHz continuous coverage.
Detection modes	AM SSB (USB, LSB and CW). FM and Synchronous AM (optional).
Tuning	By spin-wheel, continuous tuning in 15.6Hz steps. Step size increases with faster tuning rate. Megahertz quick selection by up/down push buttons. Keypad frequency entry (optional).
Memories	30 frequency memories with lithium battery back-up for approx. 10 years.
Filter bandwidths	2.5kHz, 4kHz, 7kHz, 10kHz. 400Hz audio filter for CW.
Sensitivity	SSB mode: 0.3uV for 10dB S/N. AM mode: 0.7uV for 10dB S/N @ 70% mod. (Typical values for frequencies above 500kHz).
RF attenuator	User selectable 20dB attenuator.
Noise blanker	Permanent operation, 0.4ms blank period.
Tone control	Flat response at mid-point, with progressive HF roll-off at clockwise rotation and LF roll-off at anticlockwise rotation.
Dynamic range	Greater than 90dB at 50kHz from tuned frequency (both inter-modulation distortion and reciprocal mixing).
Image/spurious responses	Greater than 80dB rejection.
Audio output	0.75W into internal loudspeaker. 1.25W into external 4ohm loudspeaker.
Connections	Aerial input: 50ohm via SO-239 socket. 600ohm + Gnd terminal. Active whip aerial (optional). External loudspeaker output...3.5mm jack. Headphone output (100mV).....6mm jack. Record output (100mV).....3.5mm jack. 12V DC power input.....2.1mm jack.
Power supply	External 12V DC supply at approx 250mA. AC mains adaptor supplied. Internal Nicad batteries and charger to give around 10 hours operation (optional).
Options	FM and Synchronous AM modes (D-125). Nicad pack, charger and active whip aerial (P-125). "Genie" keypad frequency controller (K-125).
Size	Approx. 255x100x200mm (WxHxD).

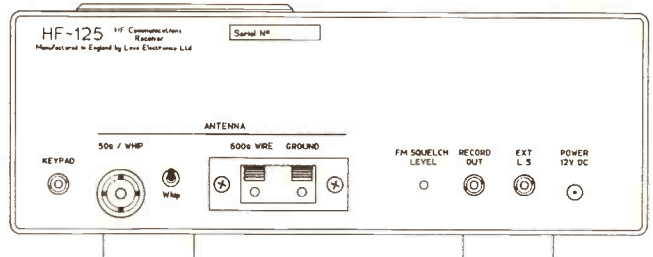

The Leicester show

More of a Radio Yesterday feature now I suppose, but we would like to say 'thank you' to all the readers who came to visit us at the HRT stand and made the exhibition such a success. Both the Friday and Saturday were very busy with Friday's pre-opening queue stretching back for some considerable distance and, we suspect, consisting of quite a few people who wanted to avoid Saturday's rush! Nevertheless there was enough room for everyone. Chris Lorek, G4HCL, was there terrorising the assembled multitudes as he gave live colour Amateur TV demonstrations using the 'HRT' ATV system — so many visitors enquired whether it was 'real ATV' or 'just video' that we decided to stick a callsign on the camera! Great fun was had by all — see you there next year?



'I dunno how to plug it in either!' Chris Lorek and Ads Manager Dave Gadsden grapple with leading edge technology.

AX25 Packet for Dragon

Grosvenor Software have launched a new packet package for owners of Dragon 32/64 and Tandy Color computers. Developed by Mike Kerry, G4BMK, the system is a complete implementation of version 2 of level 2 AX25, but is also capable of communicating with stations using the earlier version 1 implementation. The complete package consisting of software in either disc or ROM cartridge form, plus a

1200 Baud modem for use on VHF costs £99 and the software can be supplied separately for £49. An HF adaptor (essentially a filter unit) will also be available in the near future at around £30, all prices being inclusive of p&p and VAT. We have been told that there is a BBC Micro version on the drawing board which should be available in two or three months time.

Further details can be obtained by sending an SAE to: Grosvenor Software, 2 Beacon Street, Seaford, East Sussex, BN25 2JZ.

New Greenweld cat

Seems to be the time of year for new catalogues as the winter building season comes upon us. The latest one is from Greenweld of Southampton whose 1987 edition contains nine pages of bargain buys, a draw for a three day holiday and about 80 pages of electronic goodies for the enthusiast ranging from components to computer accessories. Available from Greenweld Ltd, 443 Millbrook Road, Southampton, SO1 0HX for £1 including postage.

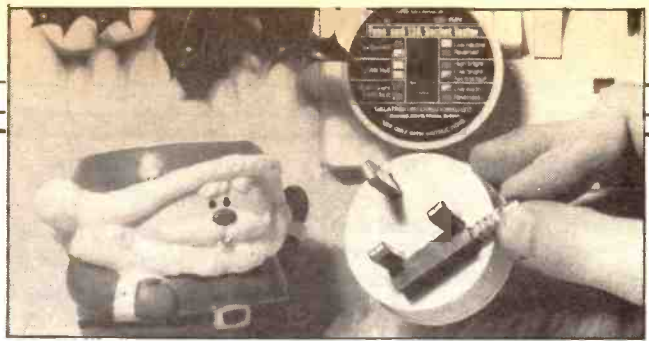

Fast fuse and socket tester

Galatrek of Llanwrst, North Wales have brought out a 13 amp socket tester for those of use who spend the occasional weekend rewiring the shack. It's about the same size as a normal plug and can test for six different mains fault conditions — the price is £14.95 including p&p and VAT. Unfortunately the model Father Christmas in the photo is not included and we can only assume that the top of his head is missing because he didn't use one of Galatrek's mains testers! Further information on the socket tester (and presumably Father Christmas too) from: Galatrek International Ltd, Scotland Street, Llanwrst, Gwynedd, North Wales, LL26 0AL. Tel: (0492) 640311.

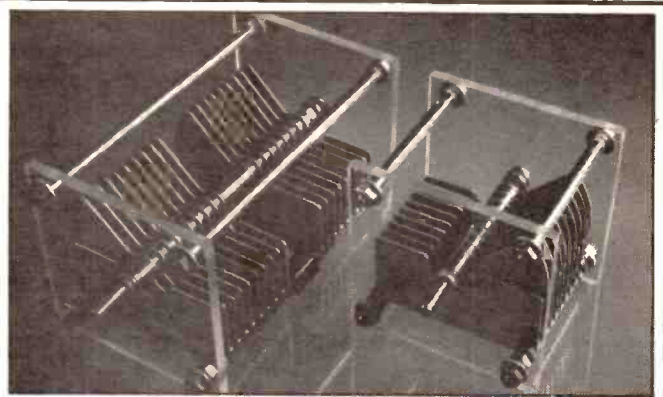

High power variables

Another seasonal touch comes from Telecomms of Portsmouth in the shape of these elegant toast racks, which cunningly double as QRO variable capacitors. The TC-250 has a range of 13 to 250pF whilst its bigger twin-gang relative (the TC-500) covers the same range on each section. Both versions use 2mm air gaps which gives them a breakdown voltage of 7.8kV. The TC-250 costs £18.95 and the TC-500 is £22.42 — both prices include VAT. Further details from Telecomms, 189 London Road, Portsmouth, PO2 9AE. Tel: (0705) 698113.



Catch them young

Peter Beardow G1SHV, Communications Project Manager for the Virgin Atlantic Challenger II record speed run, casts a professional eye over two budding electronics engineers at the Surbiton District Scouts JOTA station GB2BG. Scouts visiting the JOTA station were invited to construct a simple device to obtain a credit towards qualifying for an Electronics badge. The kits of parts for the project were provided by the Wimbledon and District Radio Society.

Babani book bank

Well an index really! If you are interested in things technical then you will no doubt also be interested to learn that Babani Ltd will be happy to send you a copy of their latest technical book list free, gratis and for nothing! Their address is Bernard Babani (publishing) Ltd, The Grampians, Shepherds Bush Road, London W6 7NF. If you really can't wait then you could phone them on 01-603-2581 or 01-603-7296.

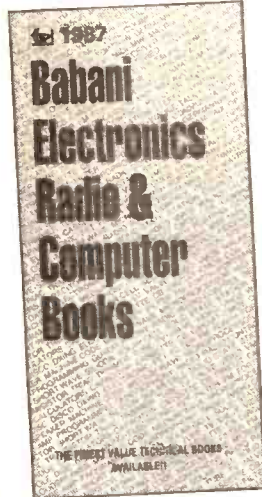

Sorry about the misprint!

It looks as though the brain and the fingers weren't connected up properly again last month. We gave the wrong phone number for Technibond Ltd in the 'Making Your Own PCB's' article. The correct number is (0494) 448791 and not as shown in the article — our apologies to the owner of the number which we published, namely Queen Hithe Press of Kings Square, High Wycombe.

WASR Award

If you've been roamin' in the Gloamin airwave, or taking the high and the low ether roads, why not apply for the 'Worked All Scottish Regions' award? As you'd imagine, you'll have to be able to show proof that you've had two-way contact with at least one station in each of the Scottish regions sometime since May 1st 1975. And if you're not too sure of the Scottish regions, here's a list: Borders, Central, Dumfries & Galloway, Fife, Grampian, Highlands and Islands, Lothian, Strathclyde and Tayside. Contact with Aberdeen Amateur Radio

Society, GM3BSQ, may be substituted for any one region.

If you think you qualify, send a list of claimed regions and contact details, countersigned by a radio club secretary or chairperson, to GM4BKV, S. Sutherland, 67 Greenfern Road, Mastrick, Aberdeen AB2 6TP. The cost of the award is UK £1 or IRCs to that value.

Whilst we're on the topic of Aberdeen Amateur Radio Society, who administer the WASR Award, they'd like us to mention that their club meets are at 35 Thistle Lane, Aberdeen, at 7.30 pm every Friday.

AKD Move House

AKD — the RFI filter people, have now moved to new premises in Stevenage and have also introduced the first of a series of new products. The new HFC1 HF converter is designed to fit the FRG9600 super-scanner to give it coverage of 100kHz up to 60MHz. Using a

double balanced mixer and low pass filter combination, the unit simply plugs directly into the aerial socket and a flying lead takes power from the rigs 8v supply connector. The remarkable thing about the unit is its size, measuring only 90(L)x25(H)x25(W)mm (that's 3½x1x1 inches) — the price is £49 exactly and can also be supplied with BNC

type connectors instead of the PL259/SO259 combination. Also from AKD comes the offer of a free EMC helpline service which is available from 10am to 12 noon every weekday on their usual telephone number. AKD's address is: AKD, Unit 5, Parsons Green Estate, Boulton Road, Stevenage, Herts, SG1 4QG. Tel: (0438) 351710.

B.N.O.S. ELECTRONICS

1986 PRICE LIST

2M LINEARS

LP144-3-50	125.00
LP144-10-50	125.00
L144-1-100	172.50
L144-3-100	172.50
L144-10-100	150.00
L144-25-160	230.00
L144-3-180	270.00
L144-10-180	270.00
LPM144-1-100	197.50
LPM144-3-100	197.50
LPM144-10-100	175.00
LPM144-25-160	255.00
LPM144-3-180	295.00
LPM144-10-180	295.00

NEW LOW-PASS FILTERS

F50-L/U	24.95
F70-L/U	24.95
F144-L/U	24.95
F144-L/N	28.50
F432-L/N	28.50

70CM LINEARS

L432-1-50	195.00
L432-3-50	195.00
L132-10-50	155.00
L432-3-100	295.00
L432-10-100	295.00
L432-25-100	255.00
LPM432-1-50	235.00
LPM432-3-50	235.00
LPM432-10-50	195.00
LPM432-3-100	335.00
LPM432-10-100	335.00
LPM432-25-100	295.00

6M LINEARS

LP50-3-50	135.00
LP50-10-50	135.00
LPM50-10-100	195.00

4M LINEARS

LPM70-10-100	195.00
--------------	--------

POWER SUPPLIES

12/6A	69.00
12/12A	115.00
12/25A	169.00
12/40	345.00

NEW PROFESSIONAL VARIABLE VOLTAGE MODELS AVAILABLE

NICADS

Format	Capacity (Ah)	1-9	10-24	25-49
AAA	0.18	2.23	2.12	2.01
N*	0.15	2.00	1.90	1.81
½AA	0.10	1.50	1.43	1.35
¼AA	0.24	1.20	1.14	1.08
AA	0.50	1.23	1.17	1.11
AA (Super)	0.60	1.35	1.28	1.22
AA*	0.50	1.25	1.19	1.13
½A*	0.45	1.40	1.33	1.26
RR	1.20	2.38	2.26	2.15
C	2.20	3.10	2.95	2.80
D (SUB)	1.20	3.25	3.09	2.93
D	4.0	5.75	5.46	5.19
D*	4.0	5.80	5.51	5.23
F	7.0	8.63	8.20	7.79
PP3	0.11	5.25	4.99	4.74

Available direct or from all good radio dealers. SAE for more details.



Delivery Free (For orders over £10) those under add £1 to order total Securicor 'B' available at £5 extra



DON'T FORGET OUR NEW ADDRESS
BNOS ELECTRONICS LTD. DEPT PW,
STEBBING, ESSEX CM6 3SL. Tel (037186) 681

Regency HX2000 Scanner—Review

Man is a naturally curious animal. Some may say the more intelligent one is, the more curious one becomes, continually wanting to

something I could easily slip into my inner jacket pocket. As the stallholder was watching and I knew I wouldn't get away with it,

Handheld scanners are a bit of a rarity; Chris Lorek, G4HCL, looks at one of the few to make it to our shops, and probably into a few Christmas stockings.

know more and more. Others may say they are just rather nosy! All around us the airwaves are filled with radio signals, amateurs are well aware of this of course, but capturing those hidden messages still remains a wondrous pastime, especially finding radio channels with something 'different' from the 'run of the mill' going on. Is it any wonder that many radio amateurs dream of finding a scanner receiver in their Christmas stocking!

Handheld Scanners

There are several scanner receivers on the market, the majority of which are designed for a fixed installation, drawing power from an external source. Three popular models have been reviewed in the Oct 86 edition of HRT, which all give a wide frequency coverage but still tie you down to a base or mobile installation. Miniaturisation of circuitry is always on the increase, with the result that scanners have been getting smaller and smaller, but until the last few years handheld scanners have been limited to crystal controlled operation of a few user-fitted channels. The first synthesised handheld scanners were big and bulky, they certainly made a bulge in your pocket and weighed you down a bit into the bargain. Not the sort of thing you could carry around an air show comfortably. When I first handled the Regency HX2000 scanner at the Woburn rally I knew that it was something different,

pleasantries were exchanged and a sample was instantly provided.

Features

The set measures a small 77mm(W) x 175mm(H) x 39mm(D), and weighs 420g with nicads installed. It comes in a smart two-tone grey case which could easily be mistaken for one of the modern portable cellular phones at first glance. A detachable belt clip is fitted to the rear. The frequency coverage is 60-89MHz, 118-174MHz, and 406-495MHz, this gives coverage of the 4m, 2m, and 70cm amateur bands as well as many other two-way commercial and aeronautical frequency bands. Twenty memory channels are provided, each capable of storing frequency and AM/FM mode.

Any number of memory channels may be scanned for activity, for instance you may scan channels 4-18 inclusive, 15-20, 1-8 and so on, but not individually selected channels. You may however lock out any channel within the programmed range, which gives far greater flexibility. Scanning stops when a signal is found and dependant upon the setting of a 'Hold/Delay' facility, either permanently halts the scan or resumes a few seconds after the signal disappears. A 'Priority Watch' samples channel 1 every few seconds, locking onto it if a signal is found.

Scanning between any two programmed frequencies is possible

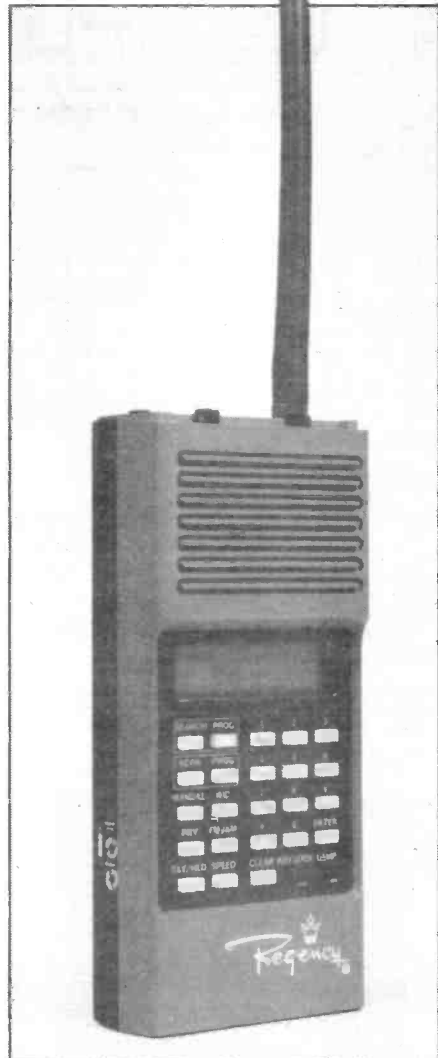

in 5kHz, 10kHz, and 12.5kHz steps, with AM or FM selectable on any range. When an active frequency is found, the scanner will lock onto it either permanently, or resume scanning a few seconds after the signal disappears — again depending on the setting of the 'Hold/Delay' function. You may if you wish enter the newly-found active frequency into one of the memories simply by pressing the 'Enter' button followed by the memory channel number.

The display is a large, liquid crystal affair, with a switchable backlight for night use. It displays the frequency, AM/FM mode, memory

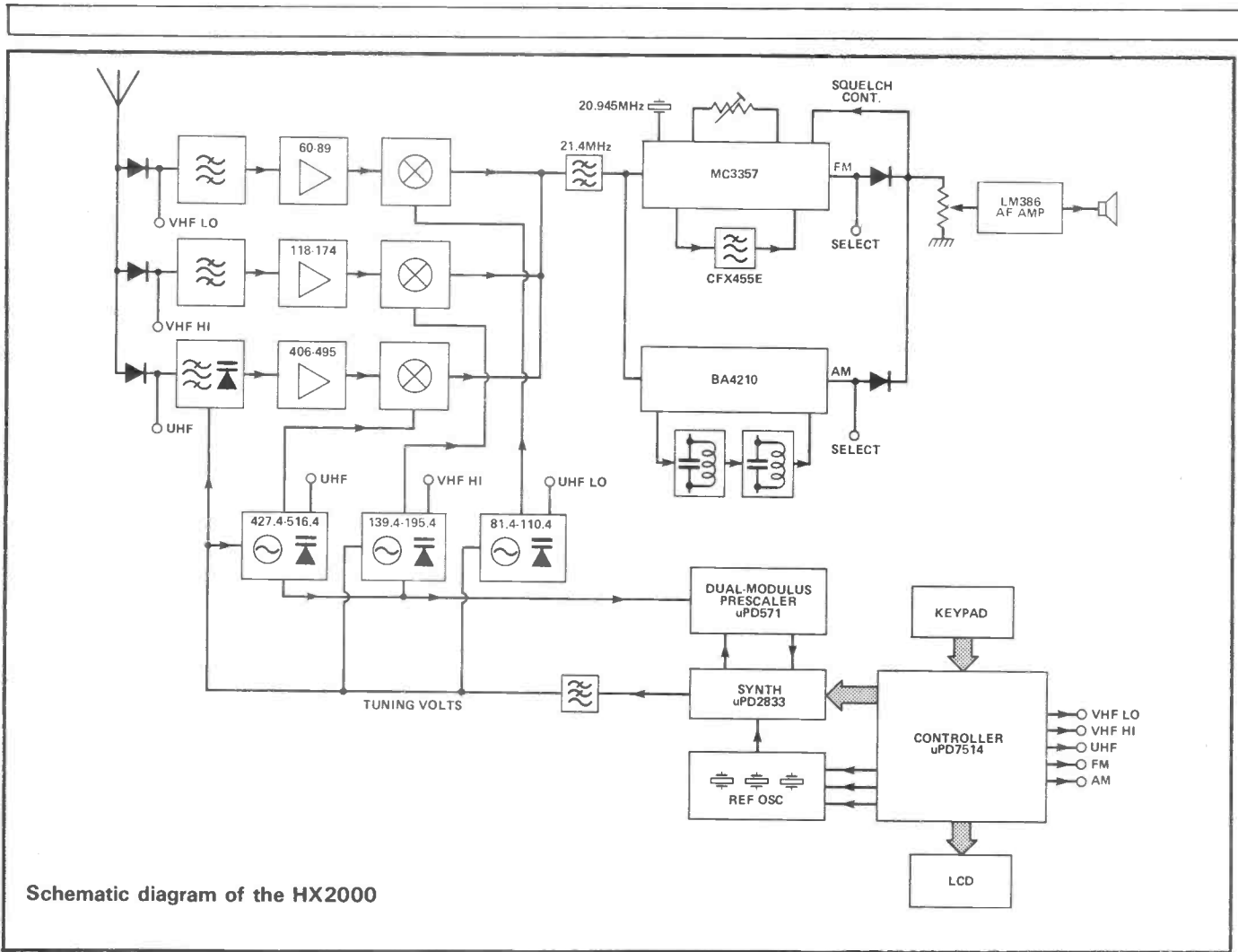

The Regency HX200 Scanner

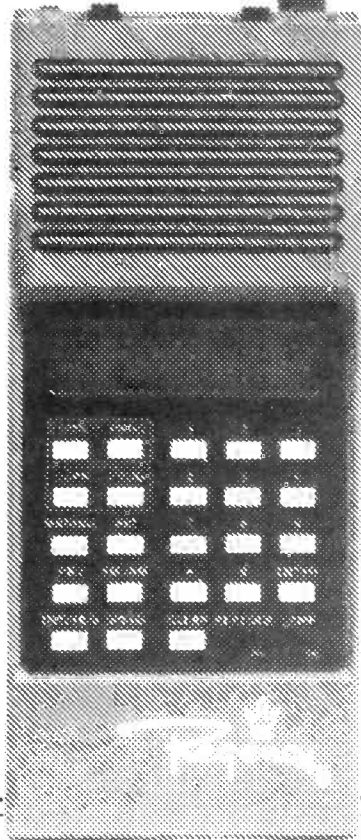

channel number, search, scan, and hold or delay modes, frequency incremental step in use, channel lockout, and on top of that finds room for a low battery warning message too.

Slider controls are provided for volume and squelch, 3.5mm sockets are fitted on the top to allow connection of an external aerial and earphone. 2.5mm jack sockets on the side allow in-situ nicad charging and for the connection of an external 6v power source (more about his later). The set comes provided with a flexible screw-on helical, four AA size nicads and mains charger, a protective case cover, plastic belt clip, earphone, and instruction booklet.

Initial Thoughts

Despite the smart looking case, it does still look a little 'plasticky' in construction, but then any alternative would no doubt make it far heavier so maybe I'm being my usual fussy self. The plastic belt clip I feel would not last too long, though

I resisted the temptation to perform a destructive test on it! I would have thought that a BNC would have been a better choice for an aerial connector than the jack socket fitted, especially at UHF. However this could allow a more convenient changeover between fixed and portable operation, saving you trying to find somewhere to store the disconnected helical. I liked the clear LCD display, and the slider controls also were easier to use than the fiddly little knobs so often seen on small handhelds nowadays. The protective case cover is made from a strange rubbery fabric which does not look particularly smart, but would give the set far better drop protection than the usual plastic cases often supplied.

The nicad charger is a two-pin wall plug type power supply, requiring a shaver adapter for use in this country. It provides 6V at up to 200mA into a 2.5mm jack plug, could this be right! AA nicads require only 45mA charging current. I also had a few worries about the identical external power connector. A circuit

diagram (separately requested) of the scanner showed that a current limiting resistor is fitted in line to the nicads to protect against excessive current, but also showed that the external power socket was connected through a diode to the nicad terminals. This would mean that the nicads MUST be removed before connecting an external power source, although this was not made clear in the operating booklet. However as long as you remove the batteries, this facility enables the charger to double as a base supply.

In Use

Apart from the points regarding the nicad charging, I found the scanner very easy to use, 'user friendly' I believe is the current hi-tech phrase. For instance, to manually enter 145.750MHz FM into channel 10, you press 'Manual' followed by 1 4 5 . 7 5 0, a flashing cursor prompts you for each successive digit, then 'Enter', 'AM/FM' flashes asking you for the mode, and the cursor blinks next to 'CH' prompting you to enter 1 0 the desired memory channel number. Similarly when searching for activity, flashing prompts for frequency, increment and search makes operation child's play. In fact, *even* the

editor G1HRT was using the set within seconds of grasping it from my hands, it was quite a while before I managed to retrieve it — clearly showing its addictiveness!

The set was very light, it could easily be carried around almost without knowing it was there. The earphone facility allowed me to wander around on shopping trips or whatever whilst quietly scanning around, it certainly makes a change from personal stereo listening! The set seemed fairly sensitive, comparing reasonably with the average 2m or 70cm handheld. This did sometimes create problems though, on the lower frequencies around 70MHz there was an abundance of urban man-made noise which invariably stopped the scan sequence. Walking past the many computer stores here in Cambridge using the set showed this up very nicely, but even when operating at home into an external aerial I sometimes wished for a tighter maximum squelch setting. I also found a slowly varying instability on VHF as the batteries started getting low which again was a little annoying, but then I'm starting to be very critical again.

The loudspeaker volume was just about sufficient for normal handheld use, but operating in a noisy environment did require use of

the earphone. For mobile use, an external speaker with a built-in amplifier such as the type obtainable for personal stereo home use would be needed.

When scanning the UHF ranges, I found a strange buzzing signal was received on some frequencies, this turned out to be image reception of UHF television signals, 42.8MHz above the displayed frequency. Also when operating using an external aerial from home, I occasionally suffered with cross modulation breakthrough from local military aircraft that come down to 100ft AGL, terrifying the neighbourhood kids. These are of course local effects but they show that every receiver designed to cover so many frequencies in such a small size must suffer one or two compromises.

Inner Technicalities

No circuit information is provided with the set, so the technically inquisitive please read on, others feel free to ignore the following totally! Fig. 1 shows the inner workings in a G4HCL-generated block diagram form. Three voltage-controlled oscillators covering low VHF, high VHF and UHF are diode switched under microprocessor control to generate 21.4MHz above the desired frequency in each case. A uPD571C dual-modulus prescaler together with a uPC2833 synthesiser, divide the VCO signal to a fixed reference where they are phase compared with the crystal-generated reference frequency. These NEC IC's together take only 18.6mA of current and provide a state of the art method of generating a spurious-free oscillator signal, previous generations of UHF dual-modulus divider IC's have been very expensive and power hungry, rendering a mixer-type synthesiser (with its inherent spurious problems) necessary in the past.

One of the three varicap-tuned signal frequency amplifiers is also diode switched into circuit, which amplifies the receive signal frequency range and applies it to a bipolar transistor where it is mixed with the VCO signal. A monolithic dual crystal filter provides broad selectivity and the filtered signal is then passed to MC3359 and BA4210A ICs for FM and AM detection respectively, each having further filtering incorporated in its own

LABORATORY RESULTS

Sensitivity/Image Rejection

Sensitivity measured as μV pd to give 12dB SINAD, FM 3kHz dev; AM 80% mod. Image rejection measured as dB increase in image frequency signal needed to give 12dB SINAD on tuned frequency.

Frequency (MHz)	FM Sensitivity (μV)	AM Sensitivity (μV)	Image Rej. (dB)
60	0.31	0.72	12
68	0.29	0.69	17
78	0.30	0.67	25
87.5	0.32	0.71	26
118	0.18	0.47	9
128	0.18	0.46	9
138	0.17	0.44	9
145	0.21	0.59	9
160	0.21	0.59	23
170	0.22	0.61	32
406	0.67	1.9	0
430	0.34	1.3	6
440	0.33	1.3	7
450	0.33	1.3	6
460	0.34	1.3	5
470	0.46	1.7	5
490	0.95	2.8	2
495	0.97	3.0	2

associated circuitry. The selected audio output is diode switched and applied to an LM386 audio amplifier.

An 80-legged uPD7514 custom IC performs all the housekeeping and memory functions whilst memory backup uses a two-cell nicad, hence obviating the need for lithium battery replacement every few years.

Laboratory Results

A sensitivity check was first carried out and this confirmed the excellent results obtained on the air. At 490MHz and above the performance starts to drop off a little but this of course is the UHF TV band in this country and hence is of little relevance here. The FM adjacent channel selectivity was surprisingly good for such a set. This degraded a little on AM, due to bandpass tuned circuits being used rather than a ceramic 455kHz filter, but it was still far better than some of the popular handheld crystal airband receivers for instance.

The good blocking performance surprised me, as did the high cross-modulation rejection, showing my AM military aircraft breakthrough was purely due to extreme proximity effects. What was a little disappoint-

Unwanted Signal Rejection

Rejection ratio of interfering signal, modulated 400Hz at 1.5kHz dev (FM), 30% mod (AM), causing 6dB degradation of 12dB SINAD on-channel signal.

Adjacent Channel Selectivity

FM	+ 12.5kHz	51dB
	- 12.5kHz	33dB
	+ 25 kHz	62dB
	+ 25 kHz	59dB

AM	+ 12.5kHz	36dB
	- 12.5kHz	17dB
	+ 25 kHz	47dB
	- 25 kHz	41dB

Blocking rejection

FM 78MHz from 80MHz	70dB
FM 145MHz from 150MHz	68dB

Cross Modulation Rejection

145MHz FM from 350MHz AM	90dB
450MHz FM from 120MHz AM	94dB

Current Consumption

Scanning, no signal	73mA
Receiving, mid volume	83.5mA
Receiving, max volume	102mA

Maximum Audio Output

FM, 5kHz deviation received signal, AM 80% mod similar, (2.5kHz FM, 50% of quoted output);
 Into 3 ohm load: 27mW;
 Into 8 ohm load: 40mW;
 Into 15 ohm load: 56mW.
 Increasing load resistance above 15 ohms reduced output level.

ing however, was the image rejection, ie reception of signals at the 'other side' of the intermediate frequency difference. This explains the UHF TV breakthrough, but also shows the general failing in many scanner receivers in this respect. The front end selectivity stages are varicap tuned to track the programmed frequency and a high IF

helps, but without the use of several stages of high-Q front end tuned circuits or a UHF first IF, the problem remains.

The battery consumption was higher than expected although this still allows around five and a half hours of use following a nicad charge. The low audio output confirmed the effect noted in everyday use, this is probably due to the audio IC operating from a much lower voltage than it is capable of using. The low battery indicator, which in fact coincides with the set being rendered inoperative, occurs at 4.68V which gives little margin when using four 1.2V nicad cells.

Conclusions

Designing a receiver such as this must impose many performance limitations, but I feel that the HX2000 exhibits a good compromise in many respects, yet with performance exceeding my expectations in others. Only the image rejection lets it down, but to be fair this is a common failing with many scanners, only the use of circuitry requiring more current and more space would get over this. I was pleased with the overall performance and it certainly proved its worth by the sheer fact of its versatility. It kept me happily occupied on several business trips!

My thanks go to Garex Electronics for the loan of the review set at such short notice.

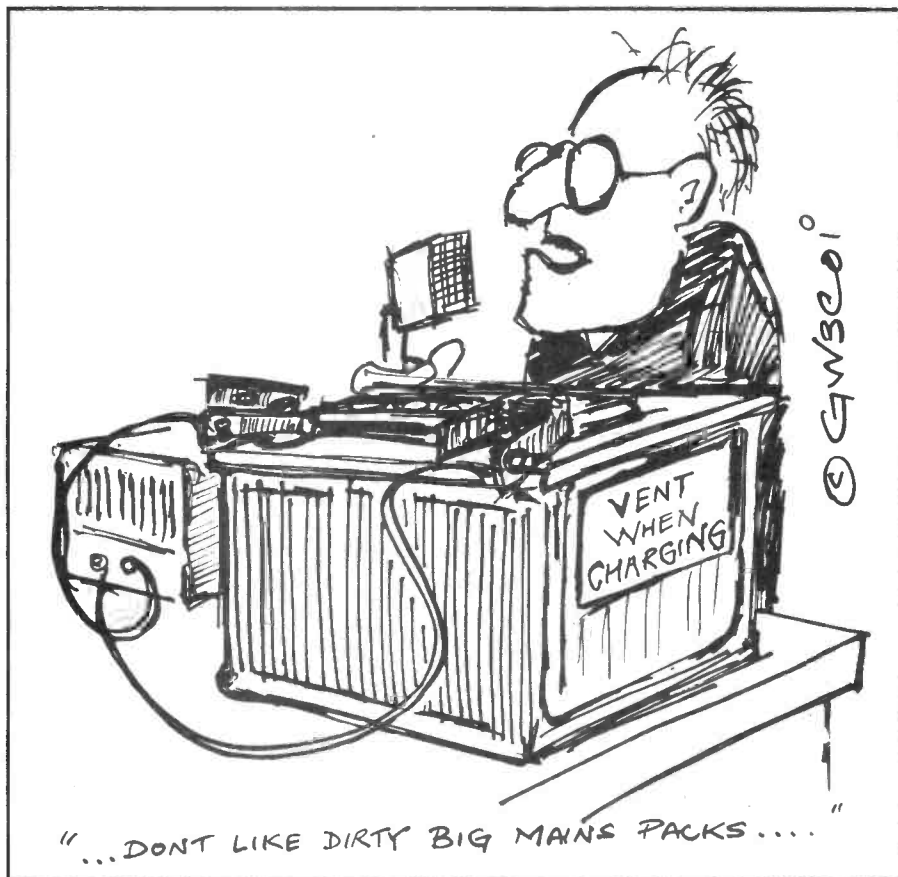

Design and Make Your Own PCBs

If you want to produce a professional looking PCB, either because you feel the need, or are going to produce lots of boards, or even publish something, then you will be looking at

have photographic reduction facilities to be able to produce the final boards. Hence you will normally work at 1:1 — personally I find it much easier at actual size as you get

3, 4.06 and 5.08mm, with track widths of 0.7, 1.0, 1.5, 2 and 3mm for general use. They are not cheap (a roll of 100 symbols is around £8 and tracks are about £1.50 per 16mm reel) but they do last a long time and can be used again if you are careful in the way they are applied. As well as full rolls, you can get smaller ones (Maplins supply these) but they are relatively more expensive — you will be surprised at the speed with which they are used up, especially on double sided boards!

Thinking of getting professional help with your PCBs? Tony Bailey, G3WPO, shows the way.

using pre-cut symbols and tracks of some description that are later photographically transferred to the PCB. This does involve some expense but the results are well worth it. Once you have had some experience in laying out circuits using a pen, then you may well want to go over to this method anyway.

Whatever type of symbols you use, they are laid out on a sheet of dimensionally stable, translucent polyester film, usually working over a precision 0.1" grid for accuracy. The master layout, which is a positive, is then placed over some copper clad board which has been coated with a layer of photosensitive lacquer and which is also etch resistant. In amateur PCB making, you will be using a positive coating with unwanted etch resist being dissolved off when the board is developed. It is possible to have negative resists for certain applications.

Two types of symbols are usually used — one is similar to dry transfer lettering where the symbols are held on a thin film and transferred by pressure to the polyester sheet, the other uses die-cut individual pads made from a pressure sensitive crepe material and held in rolls on an adhesive backing. Tracks come in both dry transfer types and crepe rolls and all symbols are available in many sizes and shapes.

You can also have the choice of working at 1:1 sizing or 2:1. For commercial layouts, 2:1 is invariably used as it gives much more accurate and neat layouts but you have to

have a better feel for component spacing and sizing.

Which type of symbols you use is up to you. I don't like dry transfer symbols because although they are easy to apply, you can't move them once they are in place. You will almost certainly find that this has to be done at some stage during a board layout, especially when alterations are needed after a first attempt doesn't work because you left some components out. They are also fragile and disintegrate when touched, and if you use crepe tracks, the pressure sensitive adhesive on the back of the tracks will pull off dry transfers if you touch them. Hence I use them very infrequently.

The big advantage of die-cut symbols and tracks is that you can move them around quite a few times (officially not recommended but it doesn't cause any problems for the amateur) so a layout can be modified quite easily. One of the major suppliers of symbols are Chartpack Ltd and their products are available through several outlets. There is a vast range of symbol and track widths available and all sorts of shapes for specific applications. Symbols for IC's and other multi-legged beasts can be obtained — in fact these are made on a pressure sensitive backing film which is left on the artwork so you don't get the same problems as with dry transfer types.

The home constructor can make do with a fairly small selection of pads for his designs. I would suggest pad diameters of around 2.03, 2.54,

You will also need a roll of 16 pin DIL IC symbols (about £5 for 100) — these can be cut down to 14 and 8 pin, or used end to end for 20 pin and larger — they are also cut down the middle so that they can be used for 0.6" spacing DILs. Other symbols available are edge connectors, transistor pads, teardrops and junctions.

An artwork knife (scalpel and blades) is *essential* for laying out the symbols and is used for moving them around and cutting tracks. Die cut symbols can either be applied directly from the roll with pressure, or (and I find this easier) they can be transferred to a piece of masking tape and then moved to their correct positions on the layout using the tip of the scalpel.

The crepe tracks (they resemble the very old fabric insulating tape) are quite flexible and can be laid in straight lines or curves to suit your requirements. When cutting the tape at a junction with a pad, do be careful not to apply too much pressure with the scalpel blade. The knack will come with experience and will avoid cutting right through the pad and the symbol — besides destroying the symbol for future use, it may also provide a 'track-break' when etching later. Make sure that the track doesn't obscure the central hole in the symbol pad as this will provide the drill point later.

More equipment . . .

Once you have produced your master artwork, you can use it to transfer the track pattern to a photographically sensitised PCB board. The best results are obtained by exposing a photographic image of the master because the thickness of the pads and tracks does cause some slight light diffusal around the edges when it is being exposed, so giving a slightly less sharp image on the PCB. In practice, providing the master artwork is held in intimate contact with the photoresist coating by pressure from foam, the results are perfectly acceptable. The photo-sensititive coating is normally Ultra Violet sensitive and for a positive resist, exposed areas can later be dissolved away in a developer, usually a dilute solution of sodium hydroxide, leaving the wanted track pattern.

The photosensitive board can either be purchased ready made in single or double sided form or made up at home using clean copper clad board and an aerosol or liquid photo-sensititive coating. The latter are obtainable from various sources, but I personally have never had much success with them, there is a definite knack required to get an even coating and I don't seem to have it. If you don't get the coating even, you stand the risk of having some of the tracks vanish later on. This method is worth a try, being much cheaper than the ready made boards, especially if you make a mess of a presensitised PCB and have to throw away several pounds worth of capital. It is also worth bearing in mind that ready made boards deteriorate slowly and should be used within three months or so.

Exposure

Having got your board you have to expose it. This is where a bit more cost comes in as you really need a UV exposure unit and commercial ones are not all that cheap (£50 and up), but they do come with a timer covering the usual 6 to 10 minute period of exposure. It is possible to make your own in a wooden enclosure as the UV lamps are obtainable individually but you need to make sure that the illumination of the exposure area will be even by using some reflective material and a

diffuser and of course you can time the exposure manually.

You can use a photoflood or even sunlight if you want to put up with very long exposure times but these methods tend to be erratic and daylight without sun can require unusably long exposure times. Another possibility is to use a health type UV lamp; once a method for holding the artwork and board against each other has been worked out, the exposure will always be constant as long as conditions remain the same each time.

To expose the board on a proper UV lightbox, the black plastic protective film is peeled off the board and the master artwork is placed (track side up) against the photoresist so that the image is the correct way round. This is then placed face down onto the exposure unit, the lid is closed using the foam on the underside to give an even pressure and the timed exposure made. Some care should be taken when handling the sensitised board — as long as the light is subdued you should be OK, but don't wave it around in sunlight.

Developing the image

The next stage is to remove unwanted resist using a developer, the exposure having rendered the exposed resist soluble. The developer is usually a dilute solution of sodium hydroxide, the board simply being placed in the solution and agitated whereupon the unwanted resist dissolves in a few minutes — don't be tempted to rub it with your fingers to speed things up as, other than dissolving your finger, you are also likely to remove wanted resist.

Safety

Like ferric chloride, sodium hydroxide (otherwise known as caustic soda) is not nice stuff to get on you or your clothes, so handle it with care. If you feel a soapy liquid on your hands then wash it off *immediately* with lots of cold water and always seek medical advice if you should get some in your eyes.

Also, when making up the solution to the specified dilution, *always* add the crystals or pellets to the water, *never* the other way round as the reaction is exothermic

(generates heat) and can cause caustic solution to spit back over the user. Caustic soda is obtainable in sufficiently pure form from Chemists (Boots) as drain cleaner and is sold, quite cheaply, in tubs.

Try to make up the solution in small quantities (roughly two level plastic measuring teaspoons added to 600ml of cold water) as required and discard after use (wash away with lots of water) as it rapidly absorbs carbon dioxide from the air and forms sodium carbonate in the solution — effectively weakening it. If you do try to store it for a week or so, then use a plastic bottle full up to the top, do not use glass as the solution will attack it! If the solution is too weak, the image will not develop at all, and if too strong, all the resist including the wanted bits is likely to be dissolved away.

When all the unwanted resist has dissolved, pick up the board using plastic tongs (being careful not to touch any resist) and wash for at least 5 minutes under cold running water to remove all traces of developer, then leave to dry off. You may find on examination that there are small areas where tracks are touching that shouldn't, or a bit of resist hasn't fully dissolved — these can be carefully removed using a pointed scribe or a compass point. It is worth checking the board carefully *before* etching as it is much easier to correct than when etched. Any areas where there are track breaks can also be touched up with an etch resist or spirit marking pen and left to dry.

The board is now etched in the normal manner, washed and dried. I find it best to drill the board before the resist coating is finally removed as you will have to clean it again anyway after drilling. There should be pilot etched areas at the centre of each pad from the artwork so that you get a properly centred hole each time — if you can see that some of these haven't etched out (as often happens) a quick pop with a centre punch is called for. When all the holes are drilled and the board is cut to the correct size, the resist can be removed with meths and thoroughly cleaned afterwards.

If you are in a screaming hurry it is possible to solder directly at this point as the resist will disappear as soon as heat is applied — it leaves a bit of a messy result but the joints



are good. Alternatively, it can be tin plated using the electro-deposition method or sprayed with protective solderable lacquer. Tin plating has the advantage that it considerably enhances solder flow during assembly leading to much better joints.

Double sided boards

All the above remarks about making PCB's using master artwork have assumed that the design is single sided, so you may be wondering how on earth you make a double sided board and get the two lots of artwork to line up? This is how you do it. Take a strip of spare PCB material of the same thickness as you are going to use, about 6mm wide and a bit longer than the board. Tape one piece of the artwork to it along the longer side with the tracks facing away from the strip. The remaining piece of artwork is then taped to the other side of the strip so that all the holes line up. The sensitised PCB is then placed between, taped in place (outside the track area) and exposed on each side separately.

UV light safety

Ultra Violet light (known as Ultra Violent light in some circles!) is damaging to the human eye and *under no circumstances* should you look directly at the light source or operate a light box with the cover off.

Ground planes

Those PCB's which utilise a continuous ground plane on the top side require that you clear away the copper around component lead entry points that are not earthed. For small one off boards you can do this with a drill of suitable size twisted

between the fingers, having determined which holes need clearing. Wrapping a piece of Elastoplast around the shank of the drill will avoid blisters if you are doing a lot of holes. You can also purchase a special tool that fits around the outside of a 1mm drill and will route out a circle of copper for you.

The elegant way to do it is to produce another piece of artwork with all the clearance holes on it. This is normally done by using suitable diameter pads as though you were laying out another board, each one placed over a pad on the inverted track side artwork that needs to be cleared. A (non UV) light box over which you can work will make alignment much more accurate — again this could be made quite easily.

When all the pads are in place, the artwork is photographically reversed so that the pads become clear areas and the rest opaque. This is quite easy to do at home as you can buy reversal film that is UV sensitive and can be developed using a cheap aerosol spray (both from RS Components). With a bit of juggling, you can also produce combinational artwork that has both a groundplane and tracks on it but this isn't recommended for the beginner.

Complete PCB making kits

You can go out and buy everything you need to make a PCB as a complete kit. There are two that I know of. The first is a Prototyping kit sold by Cirket which includes a UV exposure unit, thus making it a bit expensive at first. It also contains a precision grid, developer, pre-sensitised PCB's, etching chemicals and trays, plus a 12v drill, collets, bits, materials for making photographic labels/developer, rub-down

transfers and full instructions, all for around £146.

The other one is the CM100 system, obtainable from both Cirket and Maplin, but cheaper at £70 from the latter. This does not require a UV exposure unit but instead makes use of Autopositive photographic film which is exposed using a photoflood supplied (also used for the UV photoresist). It is intended for reproducing layouts that have been published in magazines and will copy these in positive form ready to use with the presensitised PCB supplied. Thus you will have to buy any symbols yourself if you are actually preparing any layouts. Included in the kit is the Seno etching system already referred to and various other things required, including a liquid crystal thermometer.

I would personally tend to buy everything separately over a period of time but you may prefer the convenience of the kit if you can put up with what you get. All the kit chemicals etc can be replenished separately.

Suppliers of PCB materials

Cirket Holdings plc, Park Lane, Broxbourne, Herts EN10 7NQ. Tel: 0992 444111.

Stock: Plain/sensitised PCB's, symbols, chemicals, complete PCB making kits, drills, drafting film, polyester film, Seno system, Autopositive film. Catalogue available at W H Smiths.

RS Components Ltd — Electromail, Dept 101, PO Box 33, Corby, Northants NN17 9EL. Tel: 0536 204555. Stock: Plain/sensitised PCB's, symbols, chemicals, exposure units, tin-plating chemical, HSS/tungsten drills and stands, prototyping boards, UV sensitive reversal film. Tin coating 551-514 for 750g-4l of solution. Aerosol lacquer 554989. Invaluable catalogue costs £2.50.

Maplin Electronic Supplies Ltd, PO Box 3, Rayleigh, Essex SS6 8RL. Tel: 0702 552911.

Stock: Plain/sensitised PCB's, symbols, chemicals, photosensitive spary, complete PCB making kit, exposure units, drills, Seno system. Catalogue available at W H Smiths. The phone number for Technibond (suppliers of TEC200 copier film) was incorrect last month. The correct number is (0494) 448791.

Transverter Eighty Metres from TWO

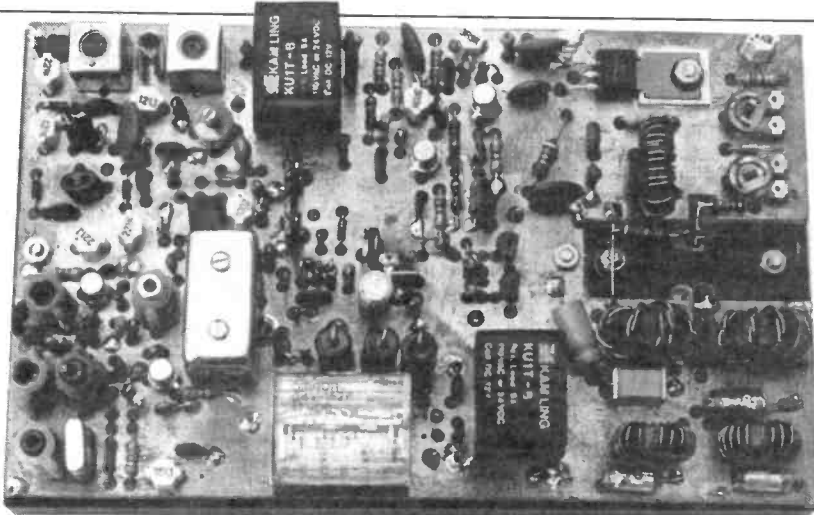

The finished article — the 2 to 80m transverter.

In the final part of the Two to Eighty metre transverter project we show how to fit the PCB to the heatsink and give the transmit strip alignment details.

Last month we looked at construction and alignment of the receive section. In this part we turn to the transmit section by first mounting the PCB on the heatsink and connecting the PA.

1. Drill the holes for the PCB mounting and IRF120 PA device in the heatsink as shown in the drawing (page 31, December HRT). You can if you wish drill only the two T03 mounting holes and use the T03 insulating washer to mark the holes for the gate and drain. Be sure to get these two holes nearer the edge of the heatsink. Deburr all holes on both sides and then clear off the anodising around the area of the two PCB mounting holes on the ribbed side.

2. Solder into the PCB two one inch lengths of tinned copper wire for

subsequent connection to the gate and drain of the PA device.

3. Insert a 6BA x 12mm long RH screw into each of the PCB mounting holes on the heatsink from the ribbed side and tighten up with a lockwasher and two half nuts. Smear a small amount of heatsink compound on both sides of the T03 insulating washer and place it in position on the ribbed side of the sink. Carefully place the IRF120 on top of the washer, taking care not to handle the gate pin during this and subsequent operations (this is static sensitive).

4. Pass a 12mm x 6BA RH screw plus plain 6BA washer through the outside IRF120 flange mounting hole and insert an insulating bush into the heatsink on the other side. Add a lockwasher and one nut to tighten. Repeat with the other hole but add

a solder tag on top of the insulating bush before fixing. Bend up the tag.

5. Check with a multimeter that the case of the IRF120 is isolated from the heatsink.

6. After checking that there are no protruding wires on the underside of the PCB, fit it into place and secure with a lockwasher and nut. Solder the tag of the IRF120 to the wire coming from near T3 and cut off any excess.

7. Bend the source pin of the IRF120 close to the PCB and solder directly to the top foil — it will assist the efficiency of the PA if this connection is improved by the addition of a small piece of copper, brass or tin foil to extend the earthing area between the pin and PCB surface.

8. Solder one end of C52 to the IRF120 tag with as short a lead as possible, then solder one end of R52 to C52, again with short leads and finally the other end of R52 to the gate pin.

9. Connect a 50ohm dummy load and power meter to the HF antenna connection and check that both RV4 and RV5 are turned fully anticlockwise. Place an ammeter in series with the power leads (capable initially of measuring up to 1 amp). Earth the PTT pin to switch to transmit. Make a note of the current reading (should be around 200mA), then slowly rotate RV4 until the current has increased by 100mA. Then repeat with RV5 until a further 300mA increase is observed. These readings should increase smoothly with no jumps — any erratic jumps with RV5 either indicate a faulty preset or that the PA is unstable, due either to an incorrect transformer winding/connection (T3/4) or other construction fault.

10. Remove the PTT connection and

increase the ammeter setting so that you can read up to 5 amps. Then connect up the 2 metre transceiver. On FM or continuous carrier CW with the power output set to between 1 to 3 watts, switch to transmit on 2 metres at 144.65MHz. A power output of at least 15W or more should be achieved. Adjust RV1 carefully until the power output starts to drop by about 1 or 2 watts. If the power doesn't drop then either the 2m rig is delivering more than the required power or the value of R45 will have to be increased (say to 150/220 ohms) to reduce the drive to the mixer. Peak the cores of L6/7 to 144.650MHz. Total current consumption on transmit should be approximately 4 to 5 amps at maximum output and a supply of +13.8V DC.

11. If you cannot get any power output, make a careful check of all components and soldering in the driver/PA areas. If the PA or driver will not take any current when the bias presets are adjusted, check that around 5.6V is present on ZD1. If so and volts are present at one end of the 22k resistor feeding the gate of

either driver or PA, but no volts are on the actual gate, then it is probable that the gate has been punctured during assembly and the device concerned will have to be replaced. Otherwise, a logical fault finding progression and the services of an oscilloscope should provide a location for the fault. High current consumption with drive applied but no power output would point to T3/4 or some other part of the output circuit.

Voltage checks are provided but these are only a guide and may differ in practice, especially the gate bias voltages on Q9/10. A 30kohm/volt analogue meter was used for the measurements, which were taken on receive.

The transverter should now work on SSB — with the relays changing over as soon as modulation is applied. The delay before changing back to receive can be set with RV3. Note that due to slightly different hold-in voltages, all the relays will not drop out at exactly the same time. If you seem to have too much drive on SSB, make sure that your rig

(if it is of a type with a Hi/Lo power switch) does actually reduce power on SSB and not on CW/FM only.

Applying 10W of SSB directly to the PCB will result in the demise of the input circuits. It is possible to use a higher power rig to drive the board, but the connection to the rig will have to initially pass through a relay-switched (controlled via the PTT pin) external power attenuator to reduce input transmit power to 1 watt.

In use, the receive gain should be set so that the 2 metre rig is not overloaded at night when signals on 80 metres are at their strongest.

If transmit is controlled directly by the PTT connection rather than via the RF VOX, note that about 130mA will pass through the PTT switch from the relays — if this is too much, add an external PNP switching transistor to control the PTT line.

A complete kit of parts for the transverter is available from Cirkit Distribution, Park Lane, Broxbourne, Herts EN10 7NQ priced at £59.70 inc VAT and post. It includes a ready drilled/tinned PCB and all components required, including heatsink.

A KELLY ELECTRONIC AND COMMUNICATION EQUIPMENT 0527 71165
 3 STOKES ROAD ASTON FIELDS
 BROMSGROVE WORCS B60 3EQ
**BEST PRICES EVER ON
 ALINCO MOBILES & HANDHELDS**
 We will sell your equipment on commission basis. Part exchange trade in? 3 month warranty on all second hand equipment sold.
 Please ask for the best deal to suit you. We also stock, Microwave Modules, DRAE, Tal Aerials, RSGB publications, Mutek, Starmaster keys.
**MANY SPECIAL OFFERS
 RING FOR DETAILS
 OPEN 6 DAYS A WEEK
 EVENINGS BY APPOINTMENT
 24hr Answerphone**

Books for radio amateurs
FDK
ELLIOTT ELECTRONICS
 THE 'HAM SHACK'
 AUTHORIZED DEALER
 AERIAL ACCESSORIES AND MASTS
 JAYBEAM AMATEUR ANTENNAS
 APPOINTED DISTRIBUTOR
INSTANT HP AVAILABLE
 OSY OLD MAN TO
RIGS, ANTENNAS, SWR BRIDGES, POWER SUPPLIES, TEST GEAR, COMPONENTS, MORSE KEYS, COAXIAL CABLES, ROTATORS, MICS, PLUGS AND SOCKETS, SWITCHES
 Call us on (0533) 553293
 OR COME AND LOOK AROUND AT
 26/28 Braunstone Gate, Leicester

80m TRANSVERTER

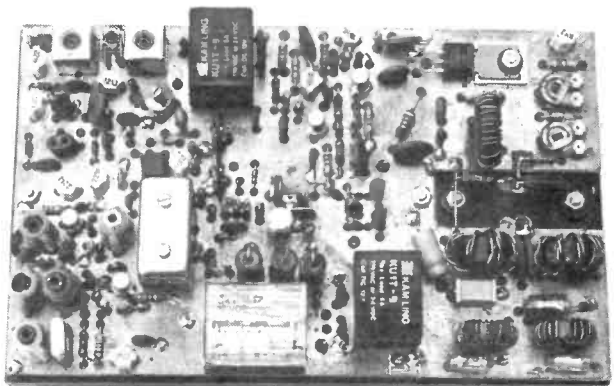

As featured in this Issue!

An inexpensive method of getting onto the popular 80m band using your existing 2m multimode transceiver. This kit is designed for use with a low power 1-3w 144MHZ input, making it a suitable companion for such rigs as the FT290R. The transverter will provide a minimum of 10w output at 80m. Kit includes all components including P.A. transistor and heatsink.

Stock No. 41-03409 **£59.70** inc. V.A.T. & Post.

Cirkit Distribution Ltd

Park Lane, Broxbourne, Herts EN10 7NQ
 Telephone (0992) 444111 Telex: 22478

Review— **Sony ICF7600D**

The thought of reviewing a small receiver like the Sony ICF 7600D left me a little sceptical. How could such a small package work well? Having been brought up in the world of the AR88D and the CR100 where one needed a long wire and an ATU it seemed a little beyond me that a radio so small would be more than

many MHz. So we just press the 'FM' button on the front panel, select the frequency, press the 'Execute' function and away we go! However, here in the UK most of our medium and long wave broadcasters give their wavelengths and not their frequencies, so if we programme in 197 (metres) we end up on longwave

3. Shortwave 1.615-29.995MHz in 5kHz steps
4. VHF 76.0-108.0MHz in 100kHz steps

**switchable 10kHz option available for receivers being used in the USA.*

All of these 'steps' are internationally agreed channels, so there is no problem of not being able to listen to the station of your choice.

If you wanted to programme in your favourite net on one of the amateur bands however, don't be surprised when the receiver defaults to the nearest 5kHz. For example, your local club has a Sunday net on 3.712MHz, so you programme this in and what happens? Well the synthesiser defaults to the nearest 5kHz channel and you end up on 3.710MHz. Although this sounds terribly alarming it's not that bad, one of the function switches on the receiver allows you to compensate for this and I will explain its operation later. So much for the frequency coverage of this receiver, it's 'channelised' as many things are nowadays, but in most cases it's very convenient.

You don't have to be big to be beautiful — Mick Senior, G4EFO, gives a listeners-eye view of Sony's hi-tech portable.

a mere 'toy' on the shortwave bands.

This receiver measures 7 (W) x 4¾ (D) x 1¼ (H) inches and immediately puts paid to the old story that 'big is beautiful'. It is a portable receiver which has great versatility and I have reviewed it with the SWL and traveller in mind. In this review you will not find great lists of facts and figures that would baffle all but the most scientific mind and need a fully equipped radio laboratory to prove or disprove. It is an honest 'hands on' appraisal of a useful little receiver giving the user a big window to the world.

instead of the bottom end of medium wave. This, I must admit, is a small problem and I do notice that more and more stations are giving their medium wave frequencies as well as wavelengths.

The frequency coverage is programmed in steps like most synthesised radios. Its steps and bands are listed below:

1. Longwave 153-519kHz in 3kHz steps
2. Mediumwave 502-1610kHz in 9kHz steps*

Photo. 1 The Sony ICF 7600D — front view

Frequency Coverage

On VHF the receiver covers from 76MHz to 108MHz and this covers the broadcasting band in the States and Western Europe. I find it a little puzzling why it goes only to 76MHz, because if it had gone down to below 68MHz it would have been very useful for listening to Eastern Block DX. On LF, MF and shortwave the coverage is continuous from 153kHz to 29.999MHz.

The receiver is fully synthesised and the frequencies are programmed in from the front panel in a manner similar to operating a calculator. On VHF and shortwave this presents no real problems, after all we are all used to our local radio station announcing its VHF frequency in so

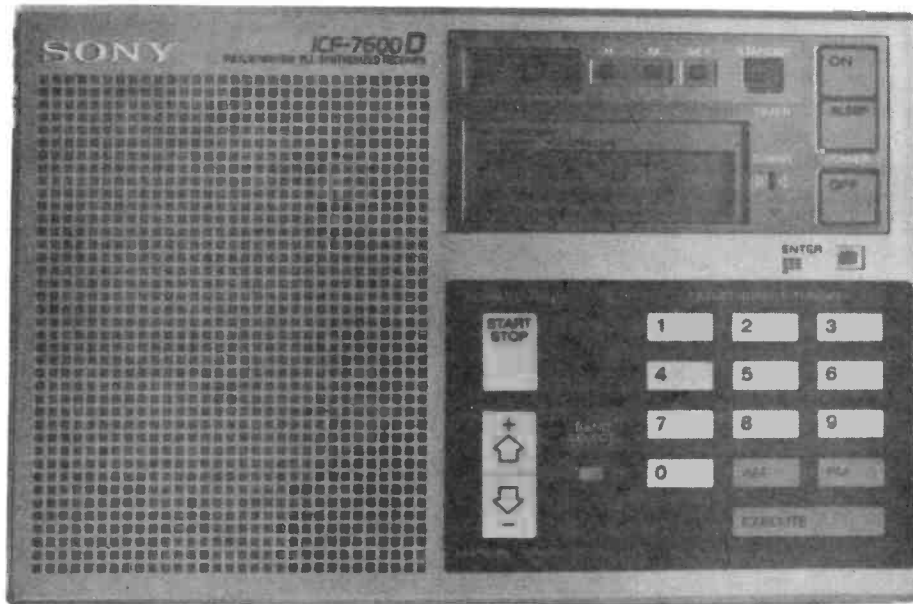

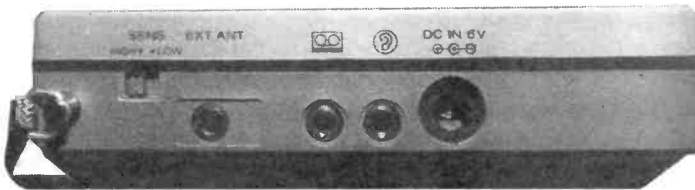

Photo. 2 Left side

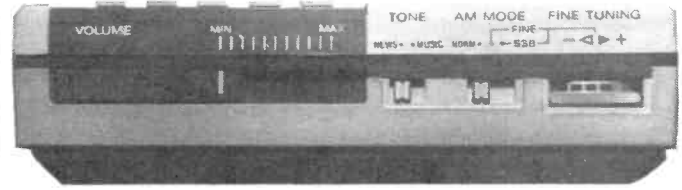

Photo. 3 Right side

Functions

Photo 1 shows the front of the receiver with its various controls and below I have given a brief explanation of their functions. The instruction book supplied with the receiver is very comprehensive and covers all the operating points.

1. Clock. This operates in 24 or 12 hour mode and it also has an alarm function.
2. On/Off. Switches to control the radio.
3. LCD. Display that tells you the frequency mode of reception and whether you are on short, medium, long or VHF. Alongside the LCD is a tuning LED indicating maximum signal strength.
4. Enter. This button allows you to enter your chosen frequency into the memory.
5. Tuning. On this panel you can enter your chosen frequency mode or select one of the 10 preset memories.
6. Band Select/Tuning. By using just the up/down tuning buttons the receive frequency is altered in channelised steps. When the 'band select' button is used in conjunction with the manual tuning buttons, various frequency bands can be selected. These include: VHF, LW, MW and the 75, 60, 49, 41, 31, 25, 21, 19, 16, and 13m broadcast bands.
7. Start/Stop. This button allows you to scan any of the preset bands mentioned above.

Further controls are found on the left side of the set (see Photo 2). The sensitivity switch is, in reality, an attenuator. This allows the received signal to be varied by approximately 10 to 12dBs, and helps to reduce the effects of cross modulation and other strange mixes when operating the receiver near to high power transmitters. Next to the sensitivity switch is the external antenna jack socket which is used for attaching a longwire or perhaps an external VHF beam antenna. A point to remember however, is when an aerial is plugged into this socket it disconnects the internal LW/MW ferrite rod aerial, so

you will not be able to receive broadcasts on these bands. The tape socket, which is next in line, allows the user to tape their favourite programmes. For the technically minded the output spec from this socket is .775mV (-60dB) into 1 kilohm. Next to this is the earphone socket which allows personal reception of programmes — I wish more people would use this function when out in public places! The socket has an impedance of 8ohms. The other socket on this side is for an external power supply, its requirements are 6 volts, but don't worry, Sony supply a PSU as standard with this receiver.

Photo 3 shows the right hand side of the receiver. The controls available on this side start with the volume control on the left, which gives an output of up to 200mW at 10% harmonic distortion. This may not sound much but in practise there is more than sufficient output.

The tone control is a two-way slide switch, the circuit consisting of a simple filter network which tailors the audio response for either music or speech. I mentioned the Mode/Fine tuning control earlier in the text: when in the 'norm' position the receiver will tune its pre-selected

channels but when you select 'fine' and use the fine tuning control, the receiver frequency can be tuned plus or minus 5kHz which allows the receiver to be tuned in between the preset channels, although this function does not operate on VHF. The final position on this switch is for SSB/CW reception and is perfectly adequate for this use. The fine tune control operates when switched to SSB.

Practical Tests and Observations

The manual supplied with this receiver doesn't give any performance figures and being a portable receiver it is difficult to conduct proper tests without completely dismantling the radio. I have however conducted some signal tests and these figures combined with practical evaluation results give a good indication of the receiver performance.

An early review in the WRTV Handbook described the receiver as one of the best and I would certainly go along with that assessment, however the WRTV Handbook also says "...sensitivity only so-so. Early

The complete 7600 package, radio, handbook, earplug, aerial & PSU.



samples unstable on SSB" which I did not find to be the case. The sensitivity is very good even when used with its own built in telescopic aerial and the sensitivity and stability were very good on the model that I had. The measured sensitivity was better than 4uV for 10dB S+N/N on the shortwave bands which translated into laymans terms, meant that whilst holidaying in Peterborough I was able to hear all the members of the Billingham and District net in Sussex on 80m with the telescopic aerial. On medium wave the sensitivity drops to around 10uV, but this is still good enough to hear the Hilversum 3 network loud and clear on 675kHz from my home in deepest Sussex.

The image rejection on AM was good and measured at better than 50dB — a further 10dBs being added when the pre-amp was switched out. The sensitivity switch operates on all bands and gives a 10dB signal increase at VHF. On VHF the sensitivity once again was good with plenty of French stations being audible on its own telescopic aerial. The measured sensitivity was better

than 1.0uV (S/N ratio 20dB). The only complaint that I would have about the VHF section is that the AM rejection is poor, I could hear my own local fire service transmitter loud and clear. When the receiver was put onto the signal generator it confirmed the initial practical findings, I certainly would not have expected this. Looking at it from the viewpoint of those people who like listening in to the emergency services it's very good. When external aerials are connected to this receiver the performance is really pretty good, with some promising DX being heard on VHF.

Summary

The recommended retail for this receiver is £179.99 inc VAT, which I feel is a little high. Perhaps around the £150 mark would make it more attractive although talking to my local Sony dealers they appear to sell quite a few ICF7600D's. In all, I think that it makes an excellent companion for the traveller who wishes to keep in touch with the world or just listen to the local radio station. It's just about small enough to slip

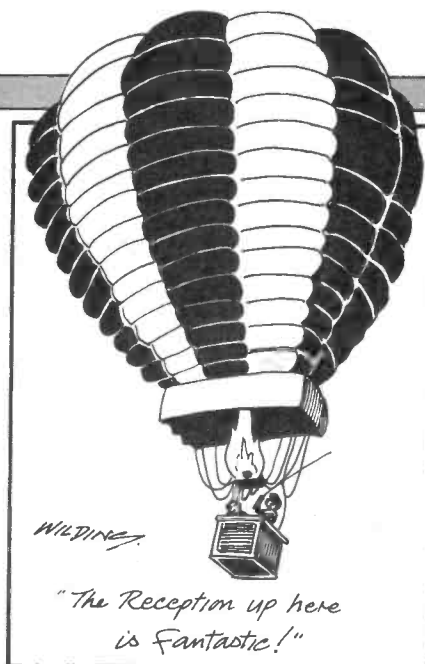

into a jacket pocket, although its weight of just under 1½ lbs (including batteries) does make it feel a little bulky. The receiver comes supplied with a receiving handbook, carrying case, power supply, longwire aerial, earphone, 12v lead for use in the car and an external aerial plug. It is simple to use and its audio quality is good. Perhaps 9 out of 10 to Sony would be fair for this remarkable little receiver.

AKD

TEL.
0438 351710

Unit 5
Parsons Green Estate
Boulton Road
Stevenage
Herts SG1 4QG

MAIL ORDER DEPT.
Stock Items Normally
Despatched within 48 hours,
21 days latest.

People said we had disappeared from the face of the earth. They were wrong WE MOVED!!

Our new larger premises allow us to hold bigger stock and to introduce **NEW** products. Watch this space over the coming months.

Still going strong in its 4th year at the original price. How do we do it?

WA1 WAVEMETER £24.95



Our Waveabsorption meter for 2 Mtr transmitters meets licensing requirements range 120Mhz to 450Mhz, very sensitive, can also be used as field strength meter within its range. Requires PP3 type battery (not supplied).

HFC1

CONVERTER

£49.00

GPA1

PRE-AMP £24.95



For the FRG 9600/965 our new HF Converter, connects to the aerial socket, and powered direct from the 8 Volt a/p of the FRG 9600. Tune from 100, 1Mhz to 160Mhz, gives tuning range of 100Khz to 60Mhz, uses double balanced mixer, with low pass filter on input.

* Can be supplied with BNC termination for other scanners *

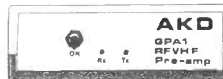

2 Mtr RF Pre-amp using BF961 dual gate FET 18 db gain: Low noise, 2Mhz Bandwidth SO Z39 termination 25 watts through power. Failsafe switching, can be left in line when not required, auto RF sensing even at ½ watt, can be factory tuned between 28-170Mhz.

* Can also be tuned for 6-4 mtrs *

A SELECTION OF OUR MOST POPULAR FILTERS (SEND SAE FOR FULL RANGE DATA SHEET)

RBF1

A range of UHF notch filters (for inner only) stocked at the following frequencies: 435MHz (70cms) channel 36 (for radar blips), 846MHz (RAF Boulmer interference) can be factory tuned from 420MHz to 890MHz. **£6.75 each**

To order quote RBF1/ followed by type.

HPF1

Low insertion loss high pass filter with capacitive braid breaker for use with UHF TV, VIDEO & PRE-AMPS. **£6.75 each**

HPFS

High pass filter with transformer braid breaker, better performance than HPF1 but the insertion loss is a little higher. 1-2db best for severe problems for UHF only. **£7.00 each**

TNF2

A range of notch filters specifically tuned for the frequency of interference on inner and outer bandwidth >1Mhz (2Mhz above 100Mhz). VERY LOW INSERTION LOSS TYPICALLY <0.5db. Stocked for the following frequencies: 14Mhz, 21Mhz, 27.5Mhz (CB), 29Mhz, 50Mhz, 71Mhz, 145Mhz. Also spot tuned at any frequency to 300Mhz. **£6.75 each**

To order quote TNF2/ and the frequency.

BB1

Transformer braid breaker >25db at 30Mhz, often used with other filters in our range for very severe interference. Ideal at the input of VCR and PRE-AMPS. **£6.75 each**

IDEAL FOR CLUBS OR EMC GROUPS FOR EVALUATION OF INDIVIDUAL SITUATIONS

DK1 FILTER KIT

Kit of all filters in our range (11 in all) except for RBF1/ 846Mhz. **£41.70**

WE ALSO STOCK TORROID RINGS @ £2.50 PER PAIR.

RSGB NOW STOCK OUR FILTERS AND MEMBERS CAN OBTAIN THEM AT A DISCOUNT FROM RSGB HQ.

ALL PRICES QUOTED ARE CORRECT AT TIME OF GOING TO PRESS AND INCLUDE VAT, POSTAGE & PACKING

ALL OUR PRODUCTS CARRY THE USUAL 2 YEAR GUARANTEE

ALSO AVAILABLE FROM LEADING AMATEUR RADIO DEALERS

* EMC PROBLEMS *

PHONE OUR TECHNICAL HELPLINE ON THE ABOVE PHONE NO. BETWEEN 10am & 12 NOON ANY WEEKDAY.

Props: RT & VEL Wagstaffe. Technical Adviser: John Armstrong

FARNBOROUGH COMMUNICATIONS

97 OSBORNE ROAD, NORTH CAMP,
FARNBOROUGH, HANTS

Your mail order enquiries for YAESU and ICOM range of products are always welcome and are dealt with promptly and politely. Call us now for that little extra service.



Stockist of Drae psu's, Jaybeam and Cue Dee Antennas, Microwave Modules, Oskerblock SWR, CDE, RSGB publications, quality cables, our own TVI filters, Welz, Bencher, Mirage amps.

Open Monday to Saturday 10am-6pm

ACCESS + H.P. Available + BARCLAYCARD

Telephone: Farnborough (0252) 518009

RADIO SOFTWARE 48K SPECTRUM & SPECTRUM 128

RTTY

QSO Review, Printer Dump, Type Ahead, Memories, etc. Transceive £8.50
Both Require Filter. Receive Only £8.50

C.W.

Self Tracking B/30 WPM, Type Ahead, Memories, etc. Transceive £8.50
Receive Only £8.50

SLOW SCAN TV

Save to Printer, Brightness, Contrast & Inverse Controls,
Tuning Aid, etc. Receive Only £7.00

FILTERS

Unboxed RTTY Only £6.00 C.W. Only £7.00
Boxed RTTY/C.W. Switchable £11.50
Ditto with Tuning LED £13.50

TERMINAL UNITS

No space to fully describe this superb unit £45.00
(Send for Full Details and Specification)

S.A.E. for full details of these and other Products.

J.E.P. ELECTRONICS LTD

New Road Complex, New Road, Kidderminster, DY10 1AL
Tel: (0562) 753893

AMATEUR ELECTRONICS UK

G6XBH
G1RAS
G8UUS

R.A.S. (Nottingham)
Radio Amateur Supplies
Tel: 0602 280267



Visit your Local Emporium

Large selection of New/Used Equipment on Show

AGENTS FOR:

F.D.K.
AZDEN
ICOM
YAESU
ALINCO
KENPRO

ACCESSORIES:

Welz Range
Microwave Modules
Adonis Mics
Mutek Pre-Amps
Barenco Mast Supports

DRAE products
BNOS Linear and
PSUs

Agents for VODAPHONE & CELLNET

AERIALS: Tonna, Halbar, Jaybeam, New Diamond Range of Mobile Whips

Bring in your secondhand equipment for sale

JUST GIVE US A RING

Monday: CLOSED Tuesday-Saturday: 10am to 5pm

3 Farndon Green, Wollaton Park, Nottingham NG8 1DU
Off Ring Rd, between A52 (Derby Road) & A609 (Ilkeston Road)

MORSE CODE PREPARATION

Cassette A: 1-12 wpm for amateur.

Cassette B: 12-25 wpm for professional examination preparation.

Each cassette is type C90.

Price of each cassette (including booklets) £3.95
Morse key with separate battery (PP3) — driven solid-state oscillator and sound transducer produces clear tone for sending practice.

Price of key with electronic unit £8.95
Price includes postage etc. Europe only

MH ELECTRONICS (Dept H)

12 Longshore Way, Milton, Portsmouth PO4 8LS

FOR DISPLAY ADVERTISING

PLEASE RING DAVE GADSDEN

G4NXV

01-437-0626

NEW BBC LOCATOR AND WORLD MAP

This program displays a world map with day-light and darkness zones updated every few minutes and realtime clock.

Accepts an input of lat&long, QTH or Maidenhead locator, NGR or one of nearly 250 world-wide placenames.

Prints distance, bearing, VHF contest score (50km rings), reciprocal bearing and, distances over 1600km, the long path distance and bearings. It marks the distant station on the map and draws the great circle to it. Converts locators and NGR to lat&long, and lat&long to Maidenhead locator.

Tape £7. For other computers we have our original locator program (no map) at the same price.

TX-3 RTTY/CW/ASCII TRANSCIVE PROGRAM

This is a really top-class program with almost every feature you could imagine. Full details are in the previous two adverts. It doesn't need an expensive T.U. (though it works superbly with one). For **BBC-B** and **CBM64**, tape £20. If you already have our RTTY/CW transceive program, return it with your order for a £10 discount.

TIF1 INTERFACE

Specially designed to reduce computer noise, this has 2-stage switchable filters on receive and outputs for MIC, PTT and KEY on transmit. Kit £15 (assembled and tested PCB + connectors and cables but not MIC connector or box), complete assembled, boxed with all connections £25 (state rig). Using more than 1 rig? No problem, state extra rigs and add £3 for each.

For the listener we have the RX-4 MULTIMODE RECEIVE PROGRAM

Lots of features and performance for receiving RTTY, CW, SSTV, AMTOR. Spectrum needs no hardware, **BBC-B**, **CBM64** and **VIC20** use TIF1 or a TU on RTTY and CW. Tape £25.

All our BBC-B and CBM64 programs are also available on disc at £2 extra. (BBC: state 40/80 track). Prices include VAT and p&p, 1st Class inland, airmail overseas, normally by return. Eire, C.I., BFPO deduct 13%.

technical software (HRT)

Fron, Upper Llandwrog, Caernarfon LL54 7RF
Tel: (0286) 881886



Microchip Morse Decoder

Very many amateur shacks are now equipped with some sort of computer, and morse reading programs are readily available for most of the popular types. A

sending is displayed as a space, and any unrecognisable characters are displayed as an asterisk. Word wrapping is prevented by printing a CR/LF sequence if a space is

memory (RAM) is provided. This is unusual, but the Z80 itself contains sufficient register storage for our needs, provided that certain restrictions are understood. Firstly, there can be no PUSH or POP's to the stack. There can be no stack without RAM! Secondly, no subroutines may be used, since without a stack there is nowhere to store the return address. Similarly interrupts cannot be used, though this does release the I register for other purposes. In fact a trick method of calling subroutines is used, as follows:

A nifty gadget to decode and print morse (via a Centronics printer) from Phil Green, G4PHL.

disadvantage of using the home micro in this way is that the machine is fully occupied for long monitoring periods, preventing its use for other purposes. Few machines offer true multi-tasking, so the morse reader must be interrupted if any locator, bearing, or logging programs need to be run. By the time a station has been located and the beam set up accordingly, the contact may well have finished.

decoded after the 70th character typed (the interrupt page register is used for this count!).

The software can track accurately between about 8 to 24 wpm, but as in any decoding program, does need reasonable quality morse. It can therefore be usefully employed as a training aid by attaching a practise key to the input. All alphabetic characters, numbers, and punctuation signs are catered for as well as the barred procedural characters.

This circuit can be regarded as a simple morse-to-centronics converter which releases the main station computer for more interesting tasks, and gives a hard-copy printout for later perusal. The circuit hardware is based on an idea from the Zilog handbooks, this being the simplest Z80 implementation imaginable. Comprising of only four chips, it is a well tried and tested circuit with the benefit of having very little to go wrong. Constructors with little experience in microprocessors can approach this project with confidence, especially since all the chips used have been seen on sale at various rallies for a fraction of the normal retail price. Never pay more than 50p for a Z80!

```
LD IY,$+7 ; IY holds return
                address
JP SUB        ; call the subroutine
//           ; next instruction...
//
```

The subroutine itself would be arranged as follows:

```
//           ; code ...
//           ; ... code
JP (IY)      ; Pseudo return
                instruction
```

System Considerations

A glance at the memory-map will reveal that no read-write

Operation

When the power is first applied, the power-on-reset operates and the title "Morse to Centronics converter" is displayed on the printer. If good morse is then applied to the port A input, using a logic low for tone, and logic high for no tone, the decoded text will be printed out. A pause in

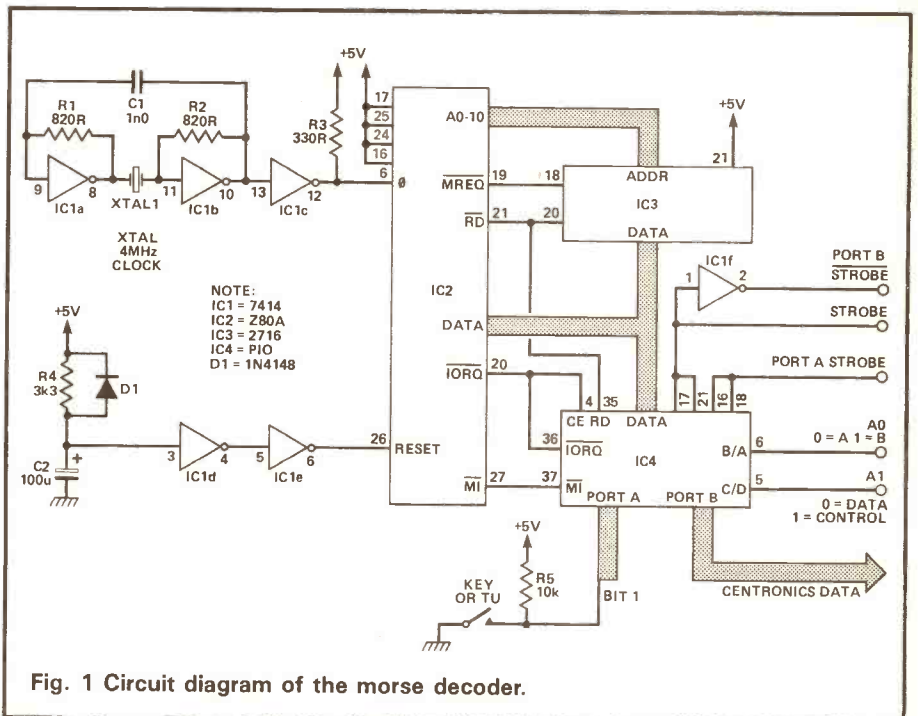

Fig. 1 Circuit diagram of the morse decoder.

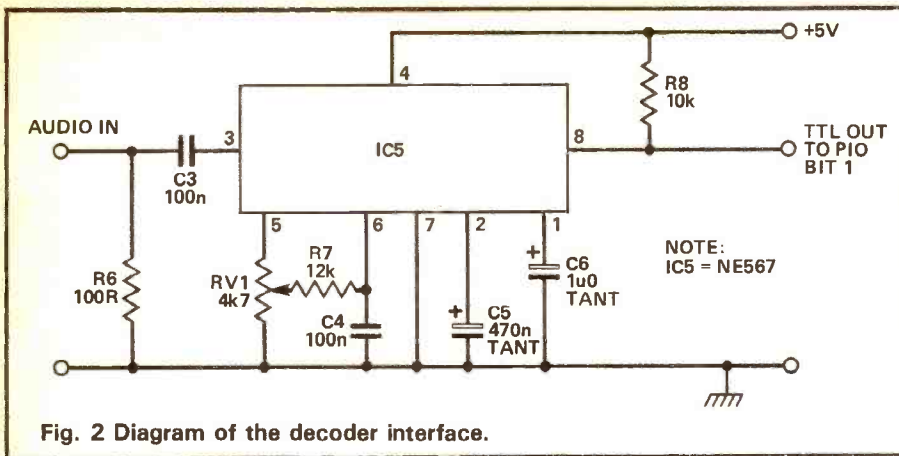

Fig. 2 Diagram of the decoder interface.

Provided the IY register is not used during the subroutine, this works fine. Remember we cannot PUSH IY to save it!

Construction

The four IC's used are the Z80 itself, a parallel input/output chip, a 2716 EPROM containing the morse reading software, and a 7414 TTL chip which provides the 4MHz clock and power-on reset.

Veroboard was used for all of the prototypes, however almost all the

tracks are cut adjacent to each IC pin, interconnections being individually wired. The physical layout of the board is not at all critical, and could be made a little larger if required. Wiring should follow the table provided, veropins being used for the power connections. Where two connections are made to one pin, for example the data lines and address lines 0 and 1, it is easier to thread two wires through first before soldering. Lay all the wiring neatly between the IC's rather than taking the shortest route between two pins.

Insert the 7414 first, apply power, and listen for the 4MHz clock or a harmonic on your communications receiver, to confirm operation. When inserting the larger chips, be careful not to bend any pins under the chip.

The input/output connectors were fashioned from 16 pin turned DIL sockets, by cutting them to form two eight-way strips. These can be conveniently mounted directly alongside the PIO. Suitable plugs can be made in a similar manner by cutting a 16 pin header.

An alternative to Veroboard is the specially designed PCB, available through our Reader Services Department. Details of how to order it are available at the end of the article.

It is important the IC sockets are used for projects like this one since this encourages experimentation and allows for the occasional "blow-up" without too much disappointment. Junk box and surplus components can be tested on the board without risk of damaging anything expensive.

4MHz crystals were used in all the prototypes since these were to hand, however 3.579MHz colour burst crystals would probably suffice giving a reduced speed coverage of say 7 to 20 WPM without altering the software. If this is acceptable then by all means use them and save a little. 4.433MHz British colour crystals may work equally well for

0000	3E	4F	D3	02	3E	0F	D3	03	AF	ED	47	21	A8	A1	7E	23
0010	B7	28	0C	D3	01	11	00	18	1B	7A	B3	20	FB	18	EF	3E
0020	14	47	0E	01	21	00	00	FD	21	2E	A0	C3	E5	A0	30	40
0030	24	7C	CB	3F	CB	3F	CB	3F	B8	38	0B	FD	21	42	A0	C3
0040	E5	A0	30	DB	18	F5	FD	21	4D	A0	C3	E5	A0	38	E1	2C
0050	78	CB	3F	BD	38	10	FD	21	5D	A0	C3	E5	A0	30	F0	7C
0060	85	67	2E	00	18	CA	7C	CB	3F	B8	CB	11	26	00	18	09
0070	2C	7D	CB	3F	CB	3F	B8	30	20	FD	21	80	A0	C3	E5	A0
0080	30	EE	24	78	CB	3F	BC	38	42	FD	21	90	A0	C3	E5	A0
0090	38	F0	7D	8C	6F	26	00	18	D7	79	FE	01	28	16	FD	21
00A0	A5	A0	C3	07	A1	11	00	0C	1B	7A	B3	20	FB	FD	21	B4
00B0	A0	C3	07	A1	2E	00	26	00	FD	21	BF	A0	C3	E5	A0	30
00C0	F5	24	78	CB	3F	BC	30	F0	C3	46	A0	78	CB	3F	80	BD
00D0	38	07	78	85	CB	3F	47	18	07	FD	21	E0	A0	C3	07	A1
00E0	2E	00	C3	46	A0	50	59	06	05	0E	00	DB	00	E6	02	81
00F0	4F	D9	08	01	8E	00	0B	78	B1	20	FB	08	D9	0F	10	EB
0100	79	FE	06	42	4B	FD	E9	79	D9	01	32	00	21	40	A1	ED
0110	B1	01	31	00	09	7E	D3	01	D9	ED	57	3C	ED	47	79	FE
0120	01	20	19	ED	57	FE	46	38	13	3E	0D	D3	01	11	00	0C
0130	1B	7A	B3	20	FB	3E	0A	D3	01	AF	ED	47	0E	01	FD	E9
0140	01	06	17	15	0B	03	1D	09	1F	07	18	0A	1B	04	05	08
0150	19	12	0D	0F	02	0E	1E	0C	16	14	13	30	38	3C	3E	3F
0160	2F	27	23	21	20	2E	6A	2D	4C	35	BA	7A	73	47	2A	52
0170	29	00	20	41	42	43	44	45	46	47	48	49	4A	4B	4C	4D
0180	4E	4F	50	51	52	53	54	55	56	57	58	59	5A	5B	5C	5D
0190	34	35	36	37	38	39	30	3D	2E	2F	2C	40	2D	21	3F	3A
01A0	3E	29	3C	2A	00	00	00	00	47	34	50	48	4C	20	4D	6F
01B0	72	73	65	20	74	6F	20	43	65	6E	74	72	6F	6E	69	63
01C0	73	20	43	6F	6E	76	65	72	74	65	72	2E	20	20	38	2D
01D0	32	34	20	57	50	4D	2E	0D	0A	0A	00	FF	FF	FF	FF	FF
01E0	FF	FF	FF	FF	FF	FF	FF	FF	FF	FF	FF	FF	FF	FF	FF	FF
01F0	FF	FF	FF	FF	FF	FF	FF	FF	FF	FF	FF	FF	FF	FF	FF	FF

Fig. 3 Hexadecimal listing of the EPROM contents.

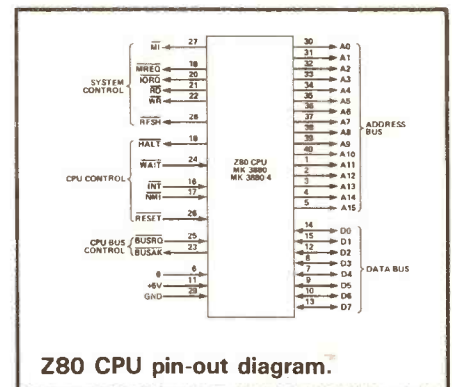

Z80 CPU pin-out diagram.

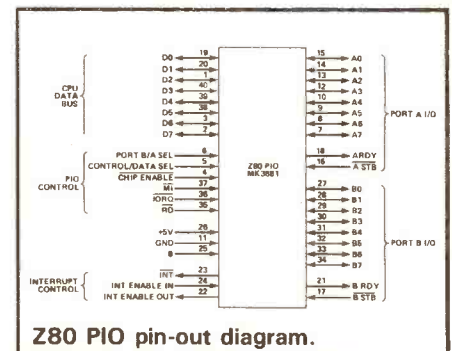

Z80 PIO pin-out diagram.

Memory and I/O Map

EPROM: 0000 — 07FF reflected at 2k intervals
I/O 00 — 03 reflected at 4 byte intervals
PORT A: data — 00 software configured for key or TU input
 control — 02
PORT B: data — 01 software configured for Centronics output
 control — 03

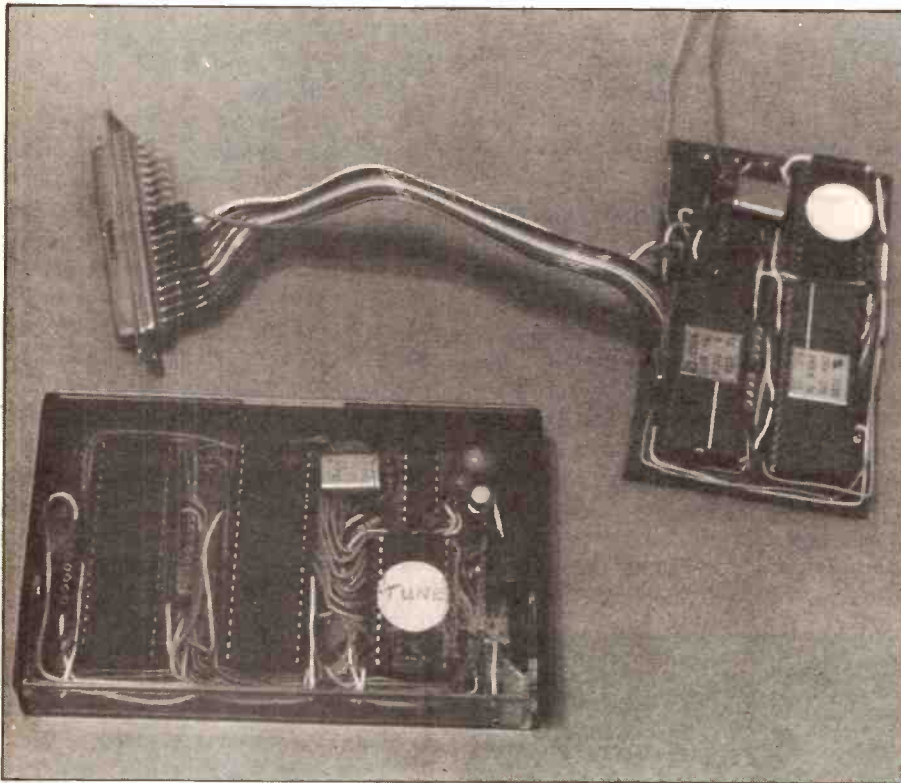

Photos of the prototype decoder boards.

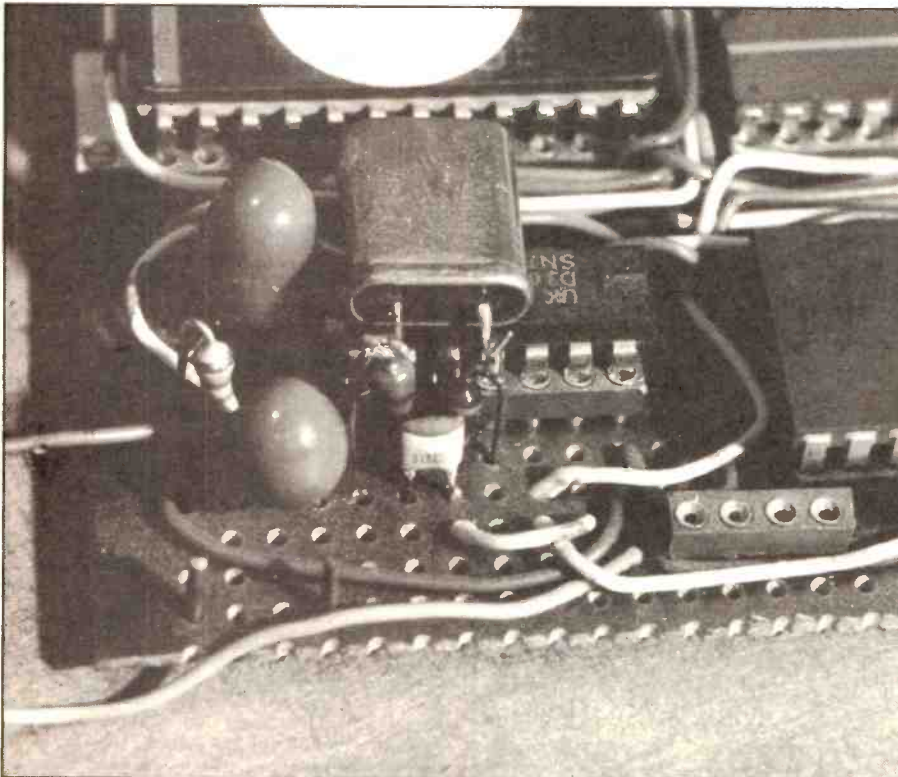

say 10 to 30 WPM. If in doubt about a crystal in the junk box, try it! Avoid spending a lot on simple projects. That way you can build more!

A simple NE567 type of terminal unit is sufficient, and a sample circuit is provided. Others have appeared elsewhere in magazine articles and there is scope here for further experimentation. In the absence of a signal the input port pin should be pulled high by, say, a 10k resistor if the TU does not default to this condition. Output is via a ribbon cable carrying 8 bits of data and a strobe signal. No busy signal is required from the printer due to the limited speed requirements.

Other Uses

The board will adapt very easily to other uses simply by changing the EPROM, and has been used, among projects, as an RS232 to Centronics converter (and vice versa), a code converter, a musical box, an EPROM blower interface and a musical doorbell. The author can supply details of the software that is available if you send him an SAE at the address given below. Don't be frightened of microprocessors and associated chips, or regard them as useful only within a computer. They are after all only components, and cheap and readily available components at that!

EPROMs may be programmed from the hex listing shown, or pre-programmed EPROMs may be purchased from the author for £3 each at: 6 Yews Close, Worrall, Sheffield S30 3BB.

The author would like to thank Geoff Taylor, G4KPU, for building the second prototype, and Stewart Ward, G6BCM, for photographing both prototypes.

Special PCB

The PCB for this project is available from our readers services department, price £9.40 including VAT and P&P. Orders should be sent to: Argus Specialist Publications Ltd, Readers' Services, 9 Hall Road, Hemel Hempstead, Herts HP2 7BH. Credit card orders can be placed on 0442 211882 (office hours only, for the present). Please remember to quote the board reference number, which is R8701-1, or you're liable to get the wrong PCB! Please allow up to 28 days for delivery.

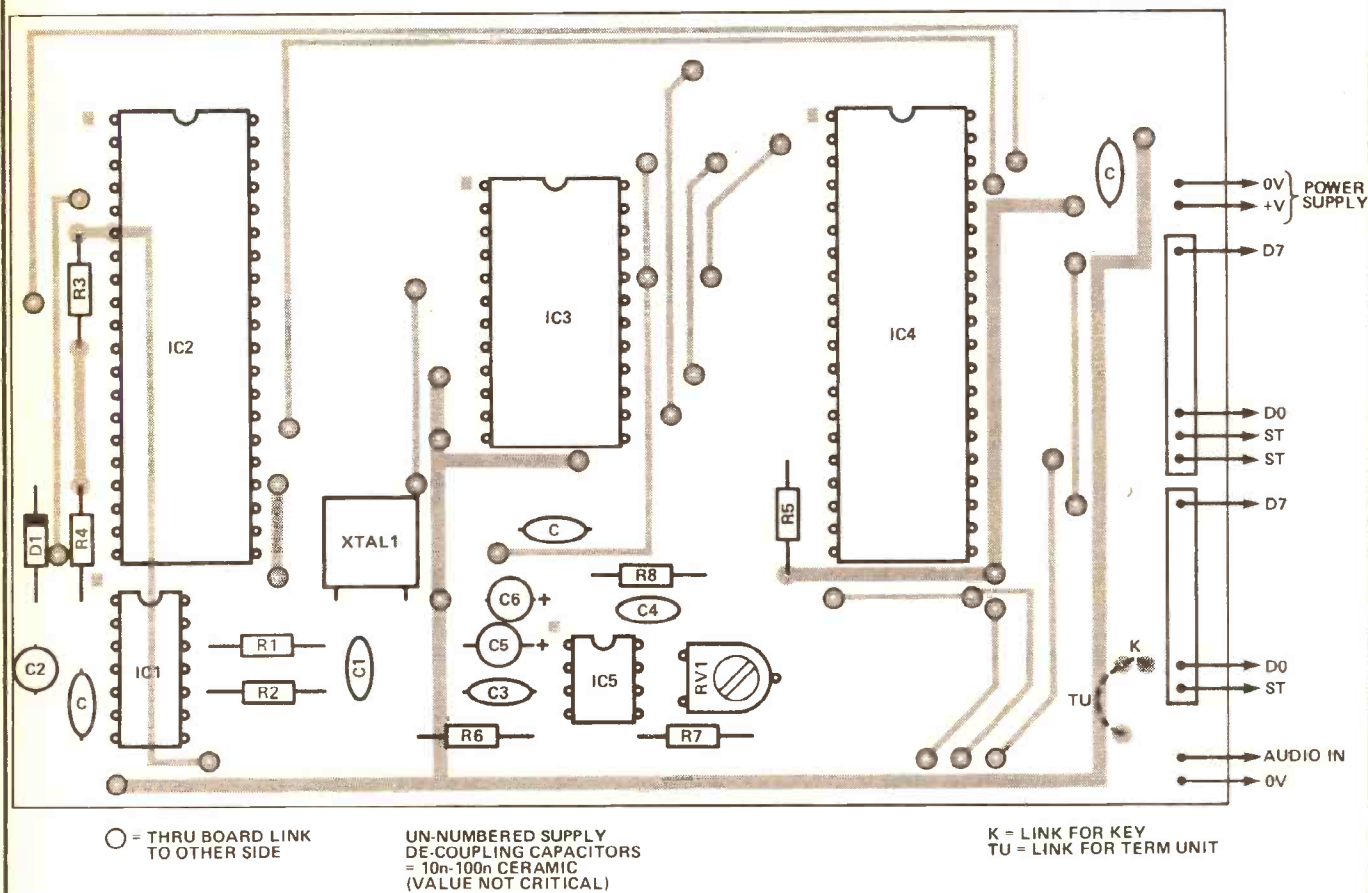

Fig. 4 Component placement for the decoder

Components List

RESISTORS

R1,2	820R
R3	330R
R4	3k3
R5,R8★	10k
R6★	100R
R7★	12k
RV1★	4k7 preset potentiometer

CAPACITORS

C1	1n0
C2	100u 12V electrolytic
C3★,C4★	100n
C5	470n tantalum
C6	1u0 tantalum

SEMICONDUCTORS

IC1	7414
IC2	Z80A CPU
IC3	2716 programmed EPROM
IC5★	NE567
IC4	280PIO
D1	1N4148

MISCELLANEOUS

XI 4MHz (or close) crystal
Centronics printer plug; circuit board (PCB or stripboard); wire, etc.

★ Denotes an item used in the terminal unit — may be omitted if not required.

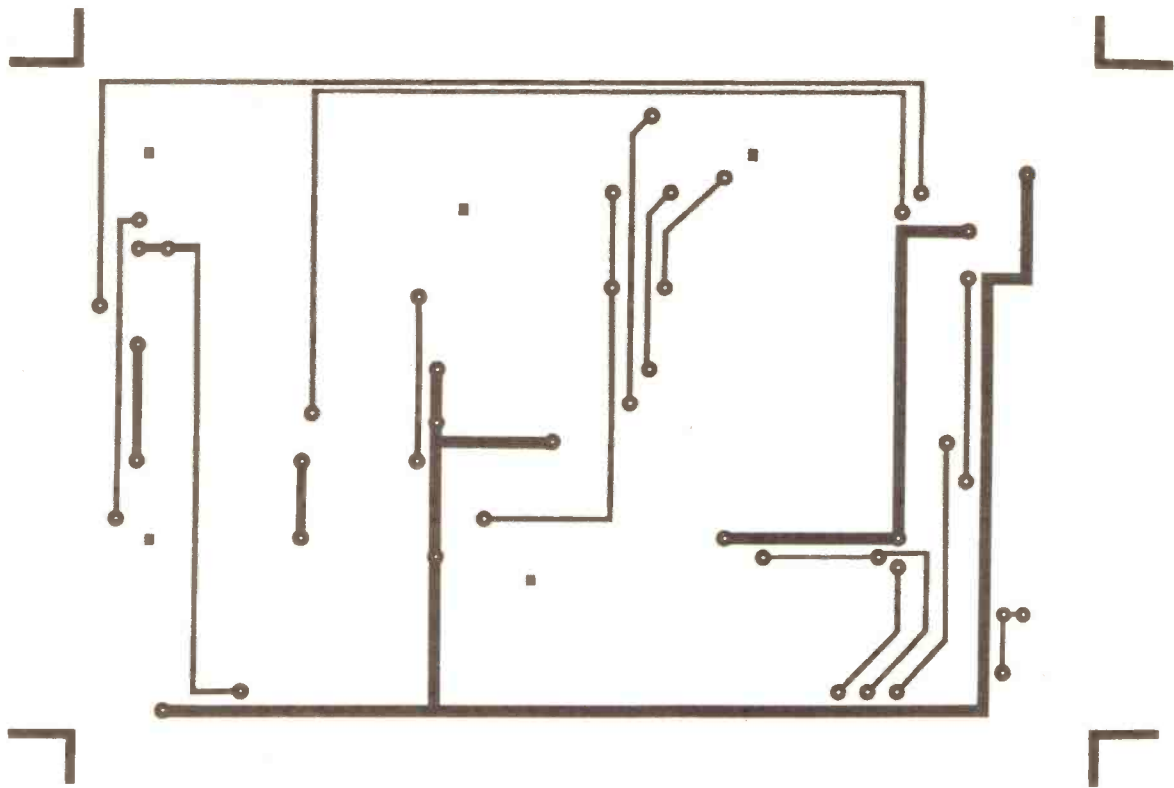

Fig. 5 Topside PCB track layout (full size).

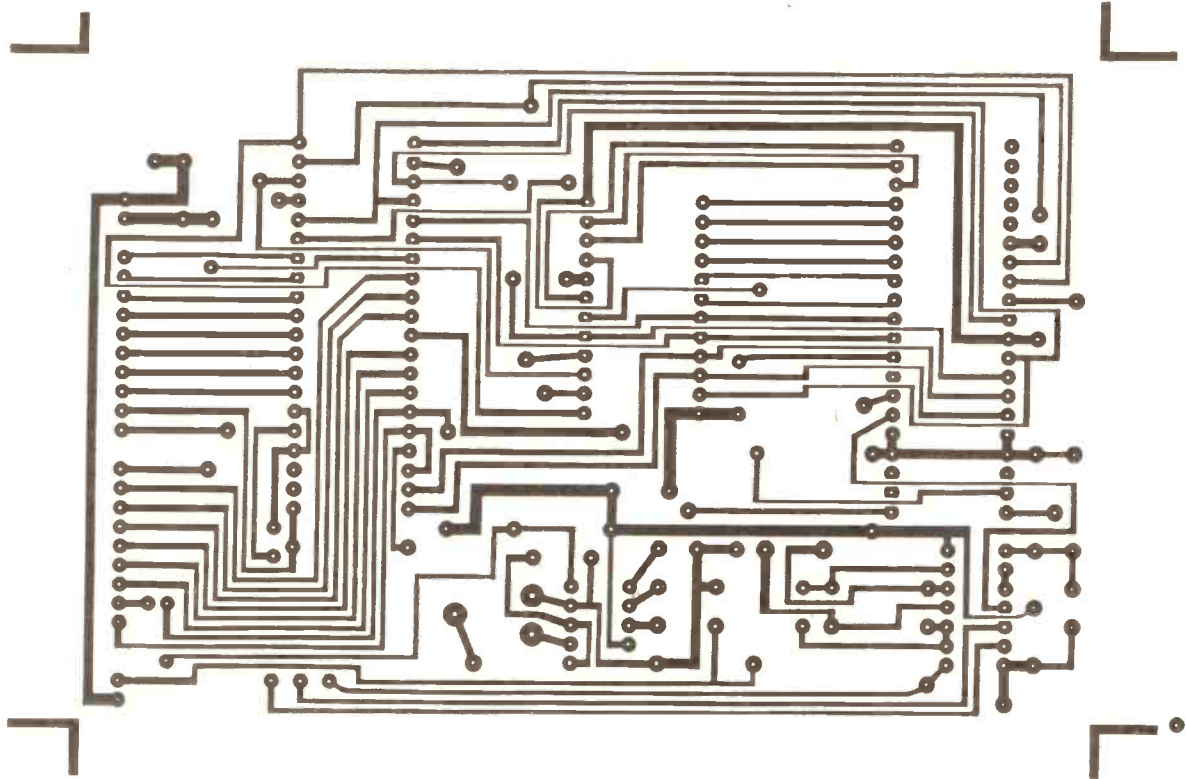

Fig. 6 Underside PCB layout (full size).

QUARTZ CRYSTALS

STOCK CRYSTALS	
CRYSTALS FOR 2 METRES	
HC25 £2.15 FOR ONE CRYSTAL	£1.96 WHEN 2 OR MORE PURCHASED
HC6 £2.15 FOR ONE CRYSTAL	£2.05 WHEN 2 OR MORE PURCHASED
TX CRYSTALS	RS CRYSTALS
HC6/U 8MHz 30PF	44 MHZ SERIES RES
HC25/U 12MHz 30 & 40PF	44 MHZ SERIES RES
HC25/U 18MHz 25 & 20PF	14/15 MHz 20 & 30 PF
HC25	SCANNER XTLS (NOT SR9)
	full list available on request please send SAE.

4 METRE CRYSTAL FOR 70.26 IN HC6/U AT £2.40 each
 TX 8.78250 RS29.78000

70CM CRYSTALS £5.00/pr of £2.50 each
 For Pye PF1 PF2 & PF70 series Wood & Douglas and FDK MULTI U11 SUB(433.2) SU20
 RB0 RB2 RB4 RB6 RB10 RB12 RB13 RB14 RB15. ALSO for MULTI U11 ONLY SU16
 SU18

CONVERTER CRYSTALS IN HC18/U AT £2.85 each.
 22,000, 38,666, 42,000, 70,000, 96,000, 101,000, 101,500, 116,000

FREQUENCY STANDARD £2.75 each
 7.06/U 1000kHz 3.50MHz 5.00MHz 10.00MHz 10,700MHz HC18/U 10000kHz
 100.0MHz 10.70MHz 48.00MHz 100.00MHz Also HC6/U455kHz £3.25 each

ONEBURST, I.F. & MPU CRYSTALS IN HC18 £2.25 each.
 7.168MHz (for 1750 Hz Tone), 10.245 (for 10.7 I.F.) 3.2768 5.0688 14.3180 15.00000

YAESU CRYSTALS for FT101's FT901 & etc £4.00 each
 Many available ex stock (A list is available on request please send S.A.E.)

P.O. Box 19
 Erith
 Kent DA8 1LH

ALL PRICES ARE EX VAT PLEASE ADD 15%

FUNDAMENTALS		MADE TO ORDER CRYSTALS	
FREQUENCY RANGE	PRICE	FREQUENCY RANGE	PRICE
5 TO 50 KHZ	£21.00	3rd OVT 21.00	TO 65.00 MHZ £4.55
50 TO 150 KHZ	£11.00	5th OVT 60.00	TO 110.0 MHZ £5.10
150 TO 500 KHZ	£7.80	5th OVT 110.00	TO 125.0 MHZ £7.40
160 TO 999 KHZ	£11.90	7th OVT 125.00	TO 175.0 MHZ £10.00
1 TO 1.5 MHz	£10.75		
1.5 TO 2.0 MHz	£5.10		
2.0 TO 6.0 MHz	£4.75		
6 TO 21 MHz	£4.55		
21 TO 25 MHz	£6.50		

Unless otherwise requested fundamentals will be supplied for 30pf load capacitance and overtones for series resonant operation.

HOLDERS - PLEASE SPECIFY WHEN ORDERING - else HC25/U supplied for XTLS above 3 MHz HC13/U 6-200 kHz HC6/U & HC33/U 170 KHz-175 MHz HC18/U & HC25/U 2-175 MHz

DISCOUNTS: Price on application for 10+ units to same frequency/spec. or bulk purchases of mixed frequencies. We supply FREE xtals for use in U.K. repeaters.

COMMERCIAL CRYSTALS: available on fast delivery and at competitive prices. Please send for list stating interests

EMERGENCY SERVICE: for XTALS 1 to 125 MHz. Add the surcharge for each XTAL. Days refer to working days. 4 days +£12.6 days +£7.8 days +£5.13 days +£3.

CRYSTAL SOCKETS HC25 £0.20 ea. HC6 £0.25 ea. MINIMUM ORDER CHARGE £1.50 unless ordered with crystals

TERMS: Cash with order post inc. to U.K. & Ireland. Cheques & P.O.'s to QSL LTD.
 A stamped addressed envelope with ALL enquiries please.

Telephone: 01-318-4419 24Hr Ansafone: Dartford (0322) 330830
 Telex: 8817271 GECOMS-G (Attention QUARTSLAB)



SPECTRUM COMMUNICATIONS

MANUFACTURERS OF RADIO EQUIPMENT AND KITS

CB TO 10 FM CONVERSION BOARDS, suits all UK FM CB rigs to give 29.31 to 29.70MHz. Size only 63x40x13mm. Built and aligned board SC29 £15. Or send your rig and we'll fit it. £28 inc. return P&P for mobiles. £31 inc. for base rigs.

MULTIMODE CB CONVERSIONS, send your 120 channel rig and we'll convert it to give 28.01 to 29.70MHz in straight sequences without gaps. Colt 1200DX, Cobra 148, Hy Gain 5, Multimode 2, Major M360, Tristar 747 & 777, Super Star 360, Concorde, etc., £62 inc. return P&P. Jumbo or Colt Excaltur 1200, £65 80Channel rigs such as Stalker 9 or Major M588 are modified to give 28.31 to 29.70MHz in straight sequence without gaps. £45.00 inc. return P&P. 200 Channel in 4 bands of 50 are converted to give 28.00 to 30.00MHz or 28.00 to 29.70MHz as required. Super Hy Gain 5, Lafayette 1800, Super Star 2000. £45.50 inc. return P&P. Nato 2000 £52.50, Super Star 2000-5x40CH £70. Colt 1600, 4x40CH, £65.50.

FREQUENCY MODEM adds FM to synthesized rigs with 455KHz IF. Type FM 455, PCB kit £6.50, PCB built £9.50.

FREQUENCY DEMODULATOR adds FM to receivers with 455KHz IF, suits R600 & R1000, FRG7 & FRG7000. Type FD455, PCB kit £5.50, PCB built £7.50.

FREQUENCY MODULATOR adds FM to synthesized rigs or rigs with clarifier. Type FM1000, PCB kit £3.00, PCB built £4.00.

RECEIVE CONVERTERS 2, 4 or 6 Metre aerial input with 10 metre IF or 4, 6, 10 or 20 metre aerial input with 2 metre IF, 26dB gain, low noise with OSC output. Types RC2-10, RC4-10, RC6-10, RC4-2, RC6-2, RC10-2, RC20-2, PCB kit £17.25, PCB built and tested £24.50, Boxed kit £25.00. Boxed built and tested £35.25.

TRANSMIT CONVERTERS, 2, 4 or 6 M, aerial output with 10 M, IF, 10.25mW to 1W drive 500mW output, matches receive converters. Types TC2-10, TC4-10, TC6-10, PCB kit £16.50, PCB built £25.75. Boxed kit £25.50. Boxed built £38.00.

TRANSMIT & RECEIVE CONVERTERS, combination boxed unit, 500mW output, types TRX2-10, TRX4-10, TRX6-10. Boxed kit £49.00, Boxed built and tested £89.50.

TRANSCEIVE CONVERTER, single board version of receive & transmit converters, 500mW output, with repeater shift facility. Types TRC2-10, TRC4-10, TRC6-10, PCB kit £39, PCB built and tested £54, Boxed kit £54, Boxed built and tested £83.25.

TRANSMIT AMPLIFIER, unswitched, suitable for Transmit Converters, Transceive Converters and MEON, 500mW in, 20W min output. Types TA2U2, TA4U2, TA6U2 PCB kit £40.50, PCB built & tested £48.75. Boxed kit £45.00, boxed, built and tested £53.00.

RECEIVE PREAMPS 2, 4, 6 or 10 metre, RF & DC switched, 0-2dB variable gain, low noise, 100W handling. Types RP2S, RP4S, RP6S, RP10S. Also masthead version DC coax fed, types RP2SM, RP6SM, PCB kit £12, PCB built and tested £16.75, Boxed kit £20.25, Boxed built and tested £27.00

NOISE SQUELCH squelches rig when noise is high. Allows reception between noise bursts. Type NS1000, PCB Kit £7.25, PCB Built £10.25.

VAT & P&P INC PRICES
 Delivery within 14 days subject to availability. 24 hr answering.

UNIT B6, MARABOUT INDUSTRIAL ESTATE,
 DORCHESTER, DORSET. TEL: 0305 62250

Attention FT757, FT77 and FT707 owners ...

A RECOMMENDATION FROM G3LLI

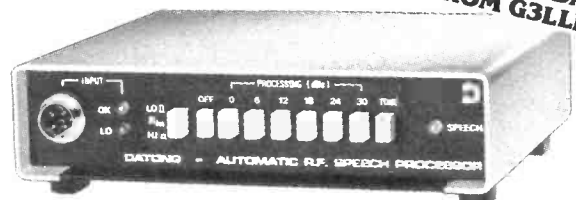

Modern solid state rigs designed to have a **CLEAN** output can not be 'flat topped' by screaming into the mic. But a vast increase in average output can be obtained without objectionable distortion by using the **DATONG AUTOMATIC RF SPEECH PROCESSOR** - gives push button selection of up to 30db of clipping. **CALL IN AND LISTEN TO THE TAPE WE MADE WITH 2 FT757s and S1 signals** - certainly with my voice the Datong is more effective than any legal linear. Datong auto RF speech processor, £82.80 p.p. Ready wired for FT757, FT707 or FT77. With connecting lead - (no mic plug to solder!).

HEAR THE TAPE. (OR BUY THE PROCESSOR) AT:



AMATEUR ELECTRONICS/HOLDINGS,
 45 Johnston Street, Blackburn BB2 1EF.
 (0254) 59595.

AMATEUR ELECTRONICS LTD.,
 504 Alum Rock Road, Alum Rock,
 Birmingham B8 3HX.
 021-327-1497/6313.

WEST LONDON COMMUNICATIONS

61 FAIRFIELD ROAD,
 WEST DRAYTON
 West Drayton
 447767 (STD 0895)
 (10 Lines)
 3 MILES FROM LONDON AIRPORT

STORNO 800 PMR SETS EX MET
 POLICE CHOICE OF 20 £90 EA.
 CB RADIO CHOICE OF 20 £10-£16 EA.
 AERIALS FROM £2.50 EA.
 STORNO CAR PHONES 900SA
 CHOICE 20 £100

WANTED. Best prices paid for second hand equipment.

Please note it is illegal to operate a transmitter without a licence.
 The following equipment does not meet D.T.I. approval, all sets are sold without crystals and sold as seen and without warranty.

SHOP OPENING SOON IN ONGAR, ESSEX
20th DECEMBER

PYE MOTORPHONE CHOICE OF 10 £15 EA.
 PYE CAMBRIDGES AM/FM CHOICE OF 20 £10 EA.
 PYE 2945 HIBAND FM £200 EA.
 PYE WESTMINSTER AM/FM CHOICE OF 25 £25 EA.
 PYE F30 BASE STATION CHOICE OF 5 £50 EA.
 PYE UHF BORESTATION TRANSMIT & RECEIVE £10 EA.
 PYE VANGUARDS CHOICE OF 25 £3-£5 EA.
 STORNO 700 EX CAR PHONES CHOICE OF 10 .. £20 EA.
 GEC BASE STATION CHOICE OF 10 £5-£10 EA.
 STORNO 600 EX CAR PHONES CHOICE OF 20 .. £15 EA.
 STORNO FM LOW BAND SETS CHOICE OF 10 .. £25 EA.
 PYE CAMBRIDGE BOOK MOUNTS AM/FM (CHOICE OF 20
 COMPLETE WITH CONTROL GEAR) £10 EA.
 STORMO 700 DASH MOUNT LOW BAND FM £30 EA.
 CLEAR TONE SET HI-BAND FM £25 EA.
 OLYMPIC AM HI-BAND £30 EA.
 HI REPEAT HI-BAND FM £30 EA.

Name

Address

Postcode

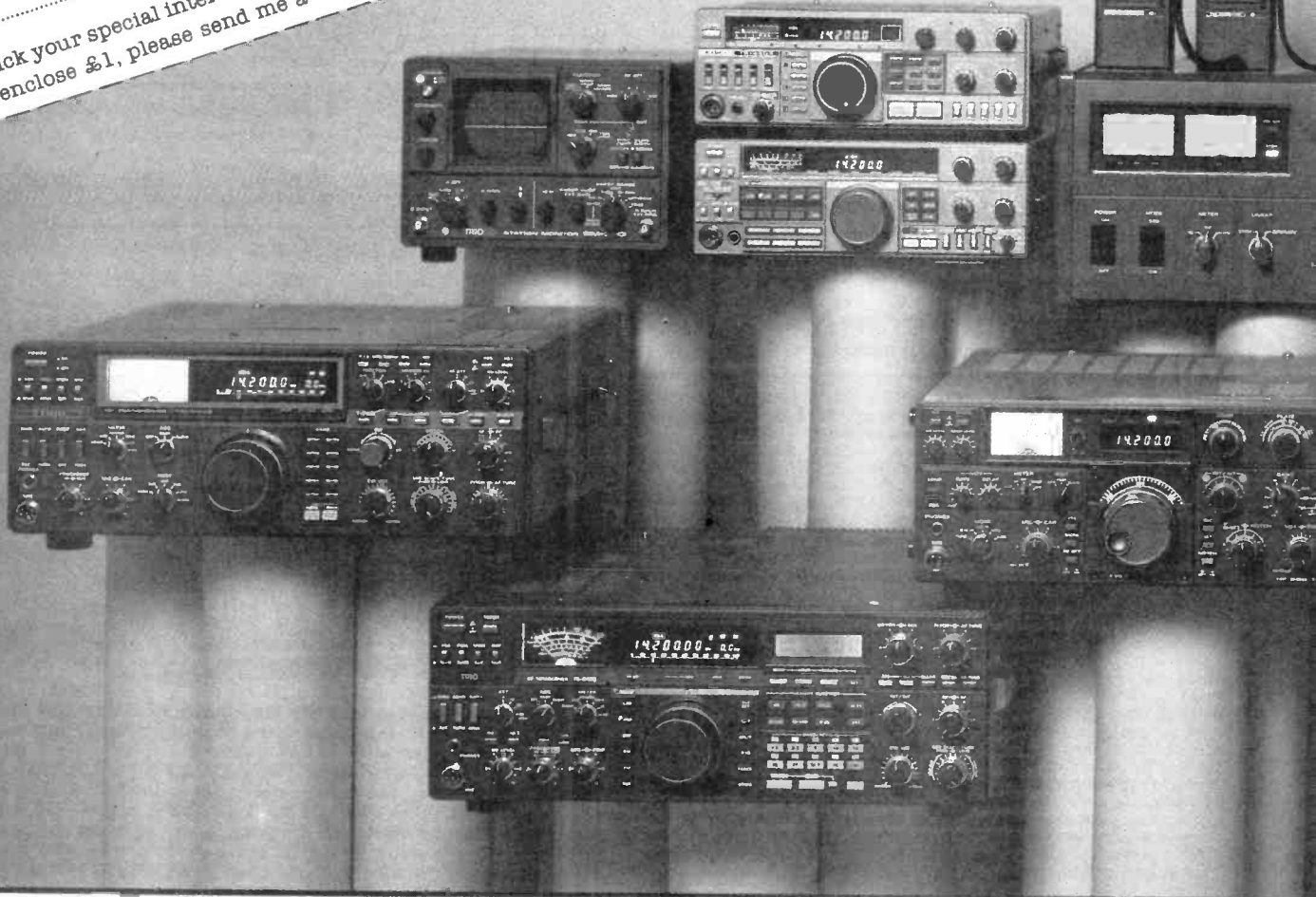
 Receivers VHF/UHF HFTick your special interest
I enclose £1, please send me a copy of the Lowe Catalogue and current Price List.

- 1 TS940S HF transceiver.** Modes >USB, LSB, CW, FSK, FM, AM. Frequency range >transceive 160 to 10 metres, receive 150 kHz to 30 MHz. Power input > 250 watts PEP, AM 140 watts. Power supply > internal psu, 240 VAC. Features > 40 memories, 2 VFOs, provision for internal ATU, keyboard frequency entry, SSB IF slope tuning, CW variable band width, CW full break-in, IF notch filter, Audio filter, variable CW pitch, optional voice synthesizer etc.
- 2 TS950S HF transceiver.** Modes > USB, LSB, CW, FSK, AM. Frequency range > transceive 160 to 10 metres, receive 150 kHz to 30 MHz. Power input > 250 watts, AM 80 watts DC. Power supply > internal psu, 240 VAC. Features > 8 memories, 2 VFOs, optional internal ATU, CW full break-in, SSB IF slope tuning, CW variable band width, IF notch filter, audio filter etc.
- 3 TS440S HF transceiver.** Modes > USB, LSB, CW, FSK, FM, AM. Frequency range > transceive 160 to 10 metres, receive 100 kHz to 30 MHz. Power input > 200 watts PEP, AM 110 watts DC. Power requirement > 13.8 VDC, transmit 20 amps. Features > 100% duty cycle, optional internal ATU, CW full break-in, IF shift, notch filter, 100 memories, keyboard frequency entry, manual or automatic bandwidth selection optional voice synthesizer etc.
- 4 TS430S HF transceiver.** Modes > USB, LSB, CW, AM and optional FM. Frequency range > transceive 160 to 10 metres, receive 150 kHz to 30 MHz. Power input > SSB 250 watts PEP, CW 200 watts DC, FM 120 watts, AM 60 watts. Power requirement > 13.8 VDC, transmit 20 amps. Features > 8 memories, 2 VFOs, memory and programmable band scan, IF shift, notch filter etc.
- 5 TS830S HF transceiver.** Modes > USB, LSB, CW. Frequency range > 160 to 10 metres. Power input > 220 watts PEP, CW 180 watts DC.

Power requirement > 240 VAC. Features > pair of 6146B valves in PA, variable band width tuning, notch filter, IF shift, RF speech processor etc.

6 TS830SP HF transceiver. Modes > USB, LSB, CW. Frequency range > 160 to 10 metres. Power input > 220 watts PEP, CW 180 watts DC. Power requirement > 240 VAC. Features > pair of 6146B valves in PA, IF shift, notch filter etc.

7 SM220 station monitor. Features > TX and RX waveform monitoring, trapezoid linearity check, two tone test generator, wide band oscilloscope, panoramic display (band scan) with optional BSS unit having 40 kHz/200 kHz sweep width. Versatile and invaluable station accessory.

8 TL922 HF linear amplifier. Modes > SSB, CW, RTTY. Frequency range > 160 to 10 metres. Power input > SSB 2000 watts PEP, CW 1000 watts DC. Drive > 80 watts or more for full output. Power requirement > 240 VAC, 14 amps. Features > class AB2 grounded grid amplifier using a pair of EIMAC 3-500Z valves.

9 TS670 Quad band transceiver. Modes > USB, LSB, CW, AM and optional FM. Frequency range > 40, 15, 10, 6 metres. Power output > USB, LSB, CW, FM 10 watts, AM 4 watts. Power requirement > 13.8 VDC, 4 amps. Features > 80 memories, 2 VFOs, keypad frequency selection, optional general coverage receive board etc.

10 TM201A two metre mobile. Mode > FM. Frequency > 144 to 146 MHz. Power output > 25 watts. Power requirement > 13.8 VDC, 6.5 amps. Features > compact, 2 VFOs, 5 memories, priority alert, memory and programmable band scan, full repeater facilities, includes external speaker, mobile mount and up/down microphone.

11 TM411E seventy centimetre mobile transceiver. Mode > FM. Frequency > 430 to 440 MHz. Power output > 25 watts. Power

requirement > 13.8 VDC, 6.9 amps. Features > digital code squelch, tilting front panel, 2 VFOs, 5 memories, priority alert, memory and programmable band scan, full repeater facilities, includes external speaker, mobile mount and up/down microphone.

12 TM211E two metre version of TM411E mobile transceiver.

13 TM2550E two metre mobile transceiver. Mode > FM. Frequency range > 144 to 146 MHz. Power output > 45 watts. Power requirement > 13.8 VDC, 9.5 amps. Features > large display, illuminated keypad, optional digital channel link, high output power, optional voice synthesizer etc.

14 TH41E seventy centimetre handheld transceiver. Mode > FM. Frequency range > 430 to 440 MHz. Power output > 1 watt or 150 mW. Power requirement > 7.2 VDC from supplied nicad pack. Features > compact, slim and lightweight, thumbwheel switch frequency selection, full repeater facilities etc.

15 TH21E Two metre version of TH41E.

16 TR2600E two metre handheld transceiver. Mode > FM. Frequency range > 144 to 146 MHz. Power output > 2.5 watts or 0.3 watts in low power position. Power requirement > 8.4 VDC from supplied nicad pack. Features > compact and lightweight, 10 memories, memory scan, programmable band scan, keyboard frequency selection, digital code squelch, full repeater facilities etc.

17 TR2600E Seventy centimetre version of TR2600E. Note, does not include nicad or mains charger.

18 TS711E two metre base station transceiver. Modes > USB, LSB, CW, FM. Frequency range > 144 to 146 MHz. Power output > 25 watts. Power requirement > internal

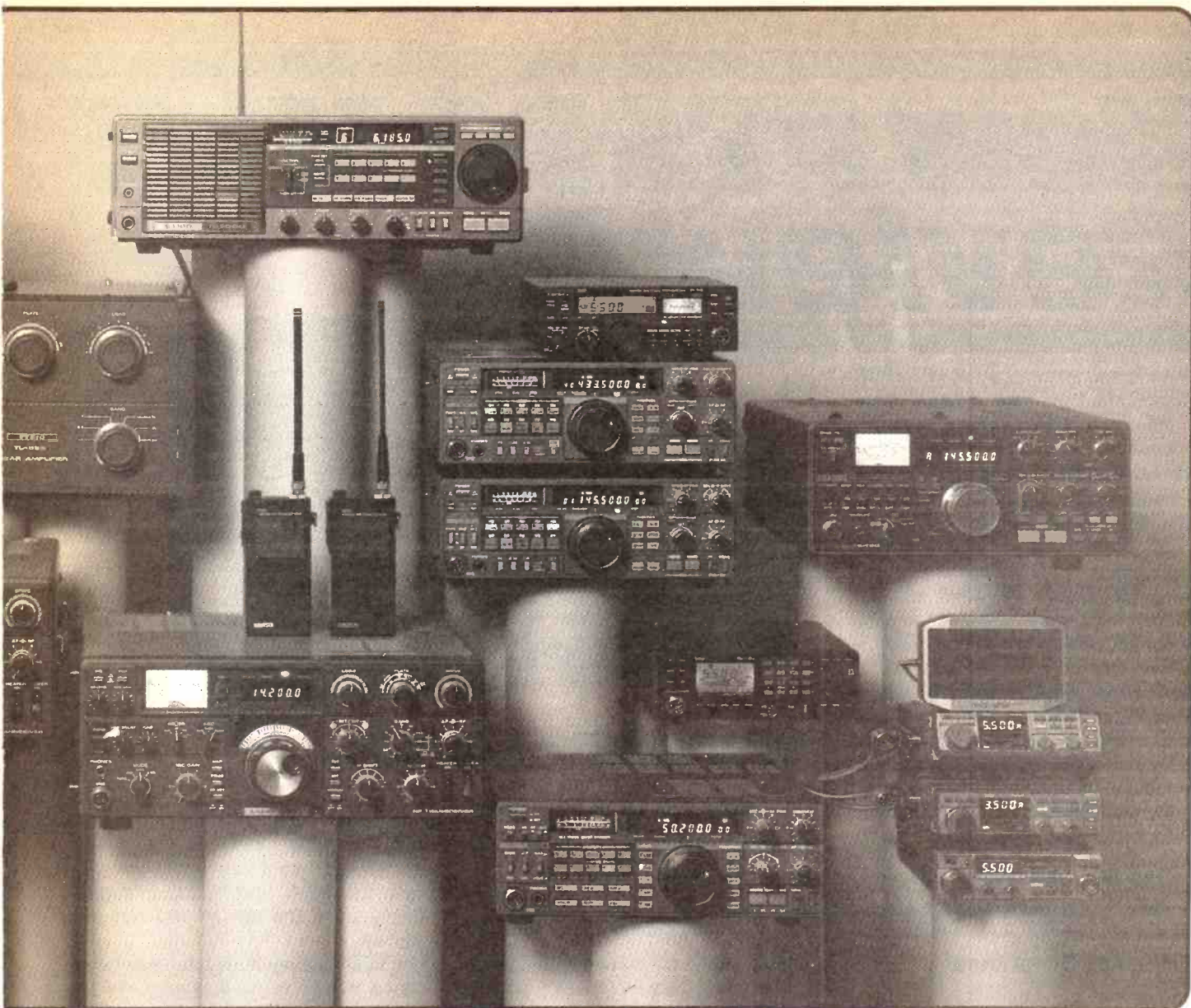

power supply 240 VAC or 13.8 VDC at 6.5 amps. Features) 10 Hz step dual VFOs, IF shift, auto mode selection, 40 memories retaining frequency, mode, simplex or repeater shift, tone burst. Programmable band scan, memory scan, free running or stepping VFO, digital code squelch etc.

19 TS811E seventy centimetre version of TS711E.

20 TR781E two metre mobile/base station transceiver. Modes) USB, LSB, CW, FM.

Frequency range) 144 to 146 MHz. Power output) 25 watts. Power requirement) 13.8 VDC at 6 amps. Features) auto mode selection according to band plan, excellent receive performance, 2 VFOs, 12.5 kHz steps on FM, alert channel, all mode squelch, memory frequencies can be transferred to VFO, optional digital channel link, optional voice synthesizer, full repeater facilities etc.

21 TS780 dual band base station transceiver. Modes) USB, LSB, CW, FM.

Frequency range) 144 to 146 and 430 to 440 MHz. Power output) 10 watts. Power requirement) 240 VAC or 13.8 VDC at 5 amps. Features) full coverage of two metres and seventy centimetres in one transceiver, 10 memory channels, 2 VFOs, memory scan, band scan, IF shift, full repeater facilities, VOX operation, free running or click stop VFO etc.

22 R2000 general coverage receiver.

Modes) USB, LSB, CW, FM, AM. Frequency range) 150 kHz to 30 MHz. Power requirement) 240 VAC or 13.8 VDC. Features) optional internal VHF converter covering from 118 to 174 MHz, 10 memories storing frequency, band and mode. Memory scan, programmable band scan, all mode squelch, tone control, slow or fast AGC, high and low impedance aerial terminals, remote switching from internal clock (tape recorder), receiver muting etc.

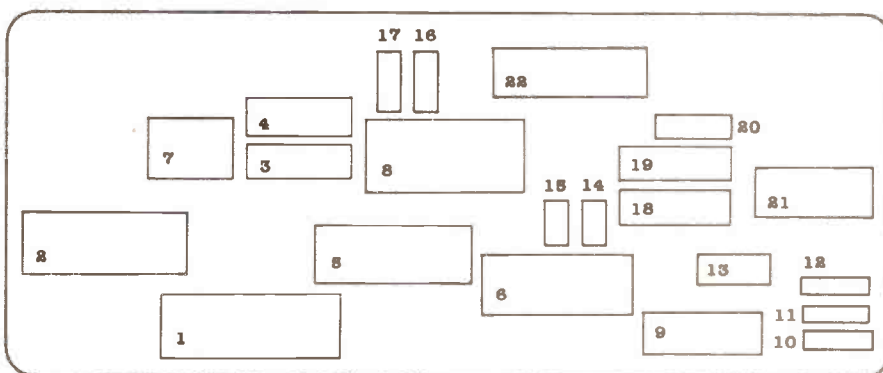

the TRIO range

from

LOWE ELECTRONICS LTD.

Chesterfield Road, Matlock, Derbyshire DE4 5LE

Telephone 0629 2817, 2430, 4057, 4995

Telex 377482 LOWLEC G

New FT290 MkII

Review

When Yaesu introduced the FT290R transceiver, they took a large share of the 2m market, where a multi-purpose set was very attractive to both newcomers on the band as well as seasoned operators of FM-only sets who wished to give SSB a try. It has many facilities and allows a reasonable compromise for operating mobile, fixed, and 'sling-it-over-your-shoulder' portable. It was inevitable that eventually a Mark II version was introduced and 'Ham Radio Today' have been fortunate in obtaining one of the first models to arrive in this country, just in time to let you consider whether it is worth twisting Father Christmas's arm!



Operators view of the new '290, bigger display and cleaner layout make the rig more 'fumble-free'

It may be the same size — it may have the same name, but don't let that fool you. Chris Lorek, G4HCL, investigates this brand new rig from Yaesu.

Vive le Difference!

It's exactly the same size, the same weight, covers the same frequency range with the same power and modes of operation, but more expensive, selling at £399 at the Leicester Show. So how does it differ? At first glance it appears to be simply a cosmetic face-lift — even the specifications are roughly the same, but first impressions can certainly be deceiving. Many amateurs moaned at the FT290R for its 'fiddly' operating requirements. For instance, to switch on the dial light, the noise blanker or the low-power mode required a fumble around the back of the set, not the ideal thing to do on the road or operating portable with the set in a carrying case! Yaesu must have done their homework, as many of the shortcomings have been completely ironed out, the end result being a set offering much the same in the way of facilities, but with a higher degree of operating ease. Internally the set is completely different and a glance

at the block diagram (Fig. 1) will show the increase in circuit complexity. The internal photographs reveal a totally different construction method has also been used, employing chip components to fit all the new circuitry inside the box.

The aerial supplied is now sensibly a helical whip, mounted at the top of the set by means of a BNC connector. How many FT290R owners are there out there with an unbroken telescopic whip? An optional helical was the norm for portable use, but this suffered from the inconvenience of having to unscrew it every time an external aerial was connected at the rear to avoid damaging the PA. Many amateurs operated the set mobile as well, which usually meant lots of messing around at the back of the set but not any more! With the MkII you simply unclip the battery pack and clip on an optional 25W stage, this automatically disconnects the helical, makes RF and ALC (Automatic Level Control) connections to the 25W power amplifier stage, and

even switches on the dial lights for you! A mobile mount is of course also available so if you wish you may leave the 25W unit in the car and simply slide the set in and out as needed.

The LCD display is much larger and hence easier to read, especially at odd angles as would sometimes be encountered in mobile or portable use. The front panel, although having one less knob to twiddle than its predecessor, sports a separate clarifier control, no more pressing buttons to use the main dial for this purpose. A minimum SSB step size of 25Hz makes tuning easier and allows far better FSK performance for RTTY etc, when using SSB.

What Does It Offer?

As with its predecessor, the set is described as an all-mode multi-purpose transceiver. The equipment is designed to allow it to be used either as a transportable, mobile, or base station set, operating from a battery supply of between 8-15.8v DC. A plastic clip-on battery pack is provided, which houses nine 'C' cells and a small PCB with switching circuitry to allow charging of nicads or use of an external supply. An optional 25W amplifier, the FL2025,

may be clipped on in place of the battery pack which transforms the set into a higher power mobile or base set, not surprisingly you cannot use the batteries with the amplifier fitted!

Modes of operation are FM, USB, LSB, and CW. FM frequencies may be stepped in 50kHz, 25kHz, and 12.5kHz increments, whilst the other modes use 2.5kHz, 100Hz, and 25Hz steps, controlled from the front panel knob or from the Up/Down buttons on the fist mike. Further panel-mounted buttons allow so-called 'Giant Steps' (!) of 100kHz and 1MHz. Two digital VFO's are incorporated, each storing frequency, mode, frequency step, and TX offset information. Nine memories allow storage of frequency, mode, and TX offset and odd split-frequency working is possible by using memories 1 and 2. The standard 600kHz repeater shift is of course incorporated and full reverse repeater operation is available at the push of a button, another improvement over the earlier set.

Any of the selected memories may be scanned for activity, or the entire band searched in selected steps when using one of the VFO's, the scan halting for a few seconds on an unscquelched frequency before resuming. Priority scan of memory channel 1 is possible, where that frequency is briefly sampled every

two seconds. A 'Call' button keys the transmitter whilst sending a 1750Hz tone (a 'phantom bleep!') and the use of a second function-control facility allows you to operate on low power and switch in an all-mode noise blanker. A small meter, identical to the previous '290, gives an indication of receive signal strength and transmit power and indicator LEDs show transmit mode and receive busy' states. A nice touch is that the green busy LED doubles as a transmit modulation monitor and the TX LED starts flashing away when the nicads are getting low, whether you are on transmit or not.

In Use

Without further ado, the set was unpacked and connected up in the shack. Within a few seconds I had got used to operating the many functions, without needing to read the instruction book — showing that the operating modes had been well thought out. About the only thing I had trouble getting used to was manual stepping through the modes by repeated button pushing, I have always been used to separate buttons for each mode or a rotary knob. However I quickly learned that by keeping one VFO programmed to FM on the upper part of the band, and the other on SSB in the lower portion, I didn't have to touch the



Rear panel — the aerial socket has migrated to the front panel where it belongs

mode button at all.

Tuning on SSB using the 25Hz steps was a great improvement over the earlier set, the analogue clarifier was also easier to use in following drifting stations or for quick 'tweaks' when in a net with the odd off frequency station. The 2.5kHz steps were useful in quickly searching a frequency range for activity as well as getting from the calling channel to a working frequency. I found that I very rarely used the 100Hz steps, finding it easier to give the 'Up' or 'Down' buttons on the microphone a press instead.

On FM, the 12.5kHz steps were optimum for general tuning around, but in my area and many others, local nets occur on wierd frequencies by today's standards, often on multiples of 10kHz from days gone by. It was infuriating to be able to hear a distorted QSO and not be able to resolve it — even if you tune onto frequency on SSB mode and then switch to FM the set jumps to the nearest 12.5kHz step! Also when

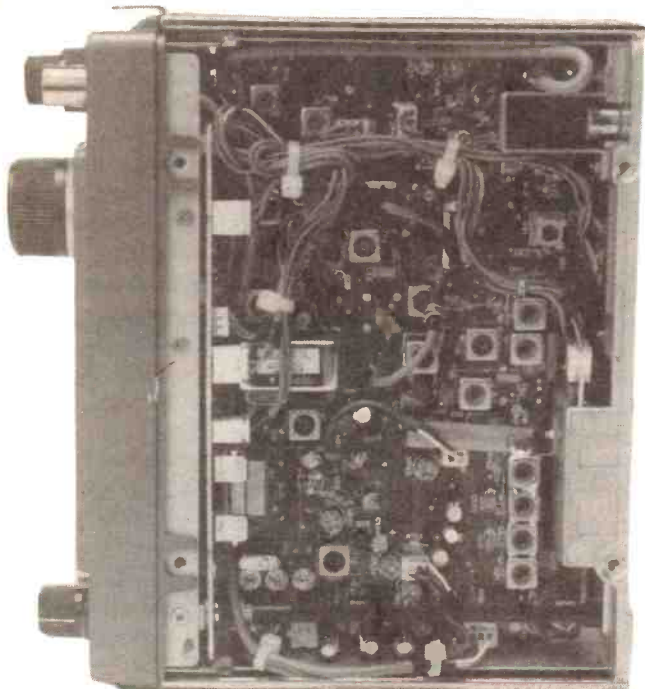

Top view — cleaner inside too, surface mounted components are just one of the new features

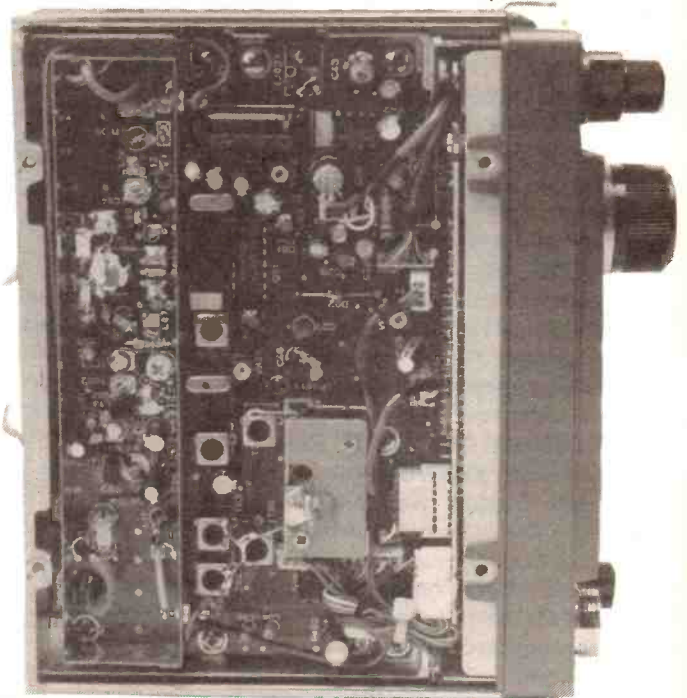

Under view — the trend towards dealer-only servicing continues

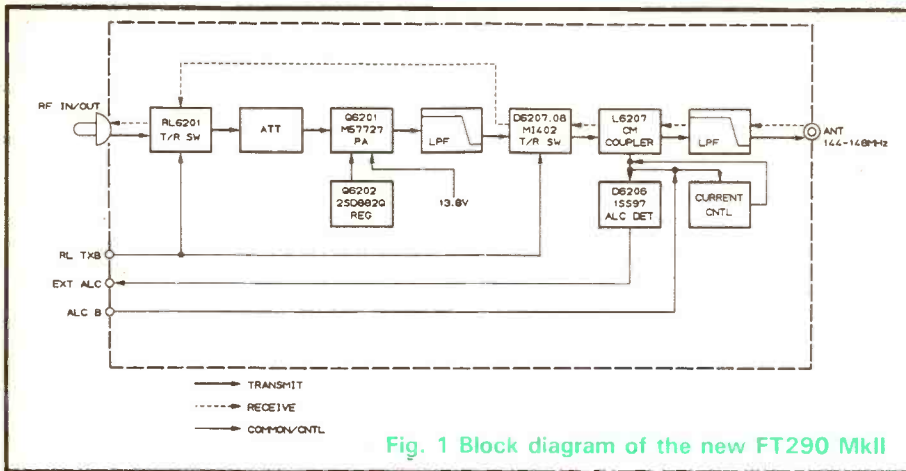

Fig. 1 Block diagram of the new FT290 MkII

scanning on FM, the set will only stop when the signal is on frequency — an off-channel signal, although strong enough to raise the squelch, will not halt the scan. These latter features could be considered very nice of course, but may not fulfill some operating needs. However after a little playing about, I found I could tune in any frequency on SSB, store it in a memory, recall the memory, change mode and then restore it, hence gaining access to it in memory mode at least.

Because the memories store mode as well as frequency, I appreciated the facility allowing me to monitor S20 FM for local activity while checking 144.300 SSB on priority scan, giving the best of both worlds. The squelch operates on all modes which is very useful in this respect.

On The Road

The set was then placed in my car to see how it performed mobile. The FL-2050 amplifier was not available at the time of review, so operation was carried out both barefoot and with a remote mounted A200 25W amp (HRT Sept '86) to get an idea of the 'balance' between receive sensitivity and Tx 'range'. After programming the memories with S20, repeater and local natter channels, the two VFO's being set to 144.3 SSB and 145.25 FM, I set off with great expectations. The toneburst button was reasonably placed, but after continually fumbling around looking for the 'Rev' button to check repeater inputs I decided to use this only from home and programmed reverse channels in immediately following the repeater channels, which gave an ideal arrangement. A press of the 'Up'

button on the mic was all that was needed, at the expense of losing the odd memory.

Using the set barefoot, that is with no external RF amplification, I found no problems in reception of DX signals but of course the low power gave a weak signal into distant repeaters. Adding a 25W linear ensured good reciprocity, where received signals nicely matched the reception of my transmissions at the other end and I did not feel the need for an external preamp at all. SSB mobile was tested, although no QSO's resulted — probably due to aerial polarisation differences. The noise banker reduced S5 ignition noise down to inaudibility, resulting in receiving the GB3VHF beacon either perfectly or completely drowned in noise. The main knob was lightly detented, allowing easy SSB tuning under bumpy road conditions.

The frequency display was very clear, at night the back illumination worked well, but I really must have a moan about the tiny S-meter. Other Yaesu sets use a very clear bargraph type display on their LCD's so why could they not have incorporated it into this one? Maybe someone overproduced little meters! Not very useful and it seems to me still to be an afterthought in the design. Having had my little grumble, I must say it was still very readable even at night, giving a fairly sensible indication of signal strength although a little lazy on weaker stations. Adequate receiver audio was available on all modes, but the internal speaker did rattle a little on high volume settings, an external speaker at face level was used to much better effect.

On transmit, audio reports varied

from *woolly* to *superb*, though no-one whom I regularly worked commented on any difference from my usual high-spec commercial equipment audio until I told them I was using a different rig!

Inside The Box

Out came the screwdrivers and laboratory test equipment, to see what the *real* difference was. At first glance inside the set one gains an impression of '*there's not much in there!*'. A diecast chassis construction houses two main analogue circuit boards, with further digital control circuitry mounted at right angles on the front panel moulding. The discrete components such as coils and filters are mounted on the circuit boards topsides, but a maze of chip resistors and capacitors fill the undersides and the hidden control boards. Eight separate sheets of circuit diagrams are given as compared to one slightly larger sheet for its predecessor, need I say more?

A study of the block diagram shows a double conversion super-heterodyne on FM, with IFs of 13.9885MHz and 455kHz, on SSB/CW only the first IF is used. The received signal is passed through a varicap-tuned dual gate FET bandpass front end amplifier (a 3SK122L) into the 3SK74L mixer, through two monolithic dual-crystal filters to give roofing selectivity and then to the noise blanker gating. Here the signal is split two ways, on SSB/CW it passes via the multi-pole crystal filter and IF amplifiers to a uPC1037H, where it is demodulated, the carrier injection frequency being altered to suit the mode. Note that a 700Hz offset is used for CW. The AGC-derived squelch controls the recovered audio gating and a uPC575 IC amplifier boosts the



The clip-on NiCad holder — ingenious design but the plastic hinge lugs are rather vulnerable

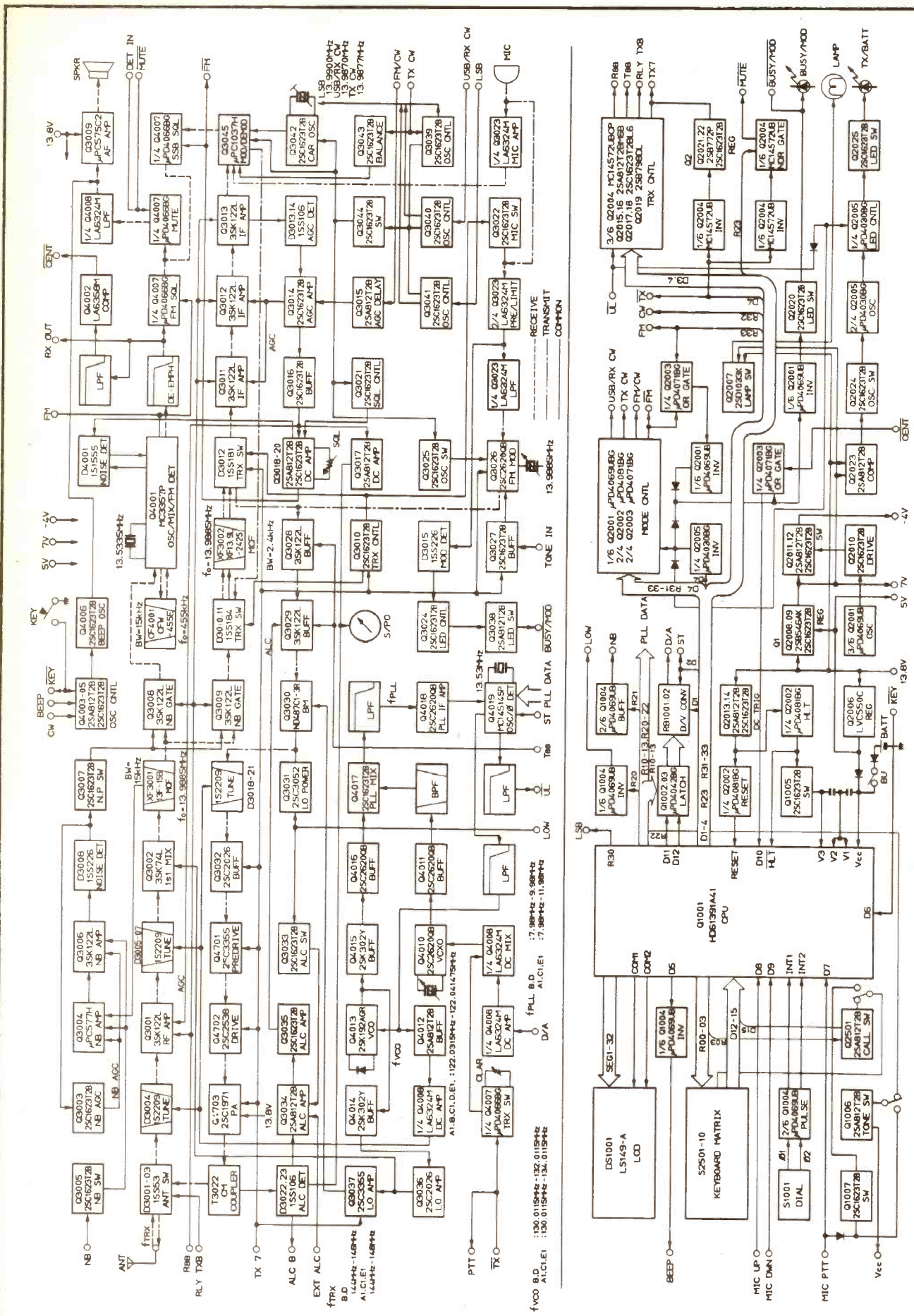

Fig. 2 Block diagram of the optional FL-2025 25W RF PA



Exactly the same dimensions and weight as before, but a completely new design

audio to loudspeaker level.

On FM, the first IF signal is passed to an MC3357 IF subsystem IC (rather a strange choice as it is now getting a little dated), where the signal is amplified, downconverted to 455kHz and passed through a CFW455E ceramic filter and demodulated. Noise derived squelch gating is used and the audio is then passed to the common audio amplifier stages. AGC derived signal strength metering is used for all modes.

Frequency generation is performed by a Motorola MC145145 synthesiser under serial control from a custom HD61391A41 microprocessor, which also provides all the 'housekeeping' functions. A wax-encapsulated VCO generates the final frequency minus 13.9885MHz. The synthesiser steps this in coarse increments, fine steps being performed by a digital-analogue converter driving a VCXO (variable crystal oscillator) mixing with the VCO signal to produce a lower 8MHz nominal signal to be fed to the synthesiser IC.

On FM transmit, a further 13.9885MHz VCXO is frequency modulated with the amplified and clipped microphone audio to produce direct FM and this is mixed with the PLL generated frequency to achieve 145MHz. CW transmission employs on/off keying of this oscillator, simultaneously driving an audio tone oscillator, which is fed to the speaker to give CW sidetone. On SSB, the common receive carrier-oscillator is used with the uPC1037 to generate a double sideband signal, which is fed via the crystal filter to remove the carrier and unwanted sideband and mixed with the PLL signal to achieve 145MHz.

Clip-on Parts

The add-on battery case provided is made from a dark grey plastic, which hinges and splits into two sections to enable battery fitting. A very economic form of

construction is used which I feel lets the radio down, the mechanical rigidity is such that I don't believe it will stand much rough treatment without breakage, particularly the small securing tabs on the underside. A very primitive, but novel, plastic extender rod allows the set's dial lamp to be switched on by mating with a similarly primitive rod inside the set which bears against a small push switch. However the battery case design is such that the set may be used table-top (or hill-top!) portable with the set upright, resting on its base. This was not possible with its predecessor due to inter-connecting plugs and sockets fitted to the underside.

Although not tested, the matching FL-2025 amplifier may also directly clip on the back in place of the battery pack. This houses a block M57727 PA module with associated low pass filters, switching and ALC circuitry. The ALC is usefully passed back to the FT290R to control the peak drive power, although the RF input from the set is first passed via a power attenuator to reduce the input drive. RF is connected via a chassis mounted phono plug, the inner conductor of this mechanically switching the set's BNC RF feed out of circuit.

Laboratory Tests

The set was subjected to the rigours of signal generators and spectrum analysers to see how it would perform under demanding circumstances. The receiver strong signal handling was fairly good, as the laboratory results show, equalling and sometimes exceeding higher cost mobile sets. The adjacent channel selectivity on FM would allow it to handle 12.5kHz spacing reasonably. On SSB, I was a little disappointed to see the filter selectivity broaden out at around the -45dB mark, three different signal generators were used to confirm this, each giving similar results. Further checks showed that this was not due to reciprocal mixing, where synthesiser noise causes an apparent degradation, but due to the filter passband selectivity and any IF signal hop-over occurring. In fact, Yaesu have slightly degraded their SSB selectivity specification to 5.2kHz at -60dB, compared with

the original rig's 4.8kHz at -60dB. This should not produce many problems in normal 2m usage in the majority of cases, but is worth bearing in mind if you decide to use it with a transverter to get onto the more crowded HF bands. The sensitivity was quite good, you should not need to fit a preamp for normal use and was well controlled throughout the band, showing the varicap tuned front end was doing its stuff.

On transmit, the output spectrum was fairly clean in terms of harmonics and synthesiser mixing products, the SSB two-tone tests showed the PA stages to be nicely linear with no excessive spreading noted. Of particular interest was that under ALC conditions, where the set compensates for the operator excitedly shouting into the mike, the 3rd order products actually *reduced* in level due to phase cancellation in successive stages. The power output with changes of frequency and supply voltage was very accurately controlled and the battery voltage warning LED started flashing at 8.55V, giving a useful warning that your nicads were about to breathe their last.

Peak FM deviation was too high at low audio frequencies, though within reasonable limits at mid-range. A rising pre-emphasis response up to 1.95kHz was noted, where the audio rapidly started falling off. This would account for the odd 'woolly' report noted on the air, but would help in keeping adjacent channel power down when using 12.5kHz offset channels.

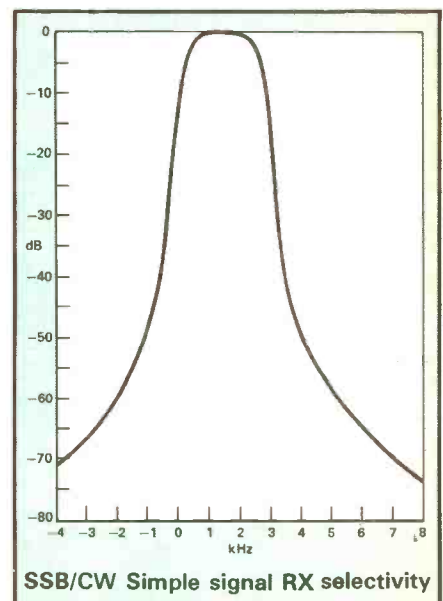

Conclusions

Japanese manufacturers are increasingly surprising radio users with their ability to squeeze more and more into small boxes. The FT290R MkII is deceiving in this respect, possibly making you think it is just a cosmetic change where this is certainly not so. The rig is far easier to operate whilst offering a more rugged set through the use of chip components. No servicing or adjustment details are provided with the set apart from circuit diagrams.

I was pleased with the rig; as with the original set it should be incredibly popular with amateurs looking for a multi-purpose 2m rig and transverter driver for the UHF bands. At just under £400, comparing its price with that of a separate mobile, portable and base station makes it an even more appealing compromise. I wonder when we will be seeing all the second-hand Mk I's?

Our grateful thanks go to R. Withers Communications of Birmingham for the timely loan of the review set.

Tx SSB Two-tone intermod distortion: +3dB into ALC

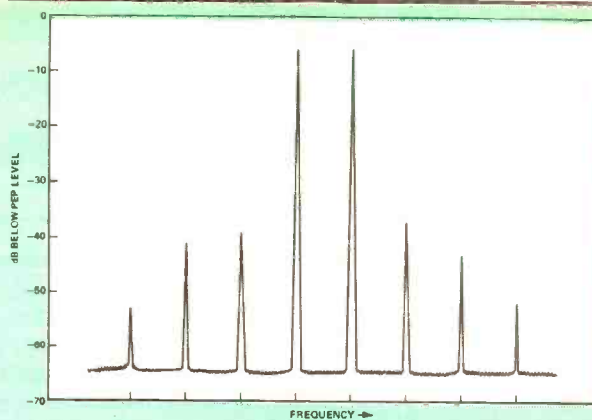

Tx SSB Two-tone intermod distortion: onset of ALC

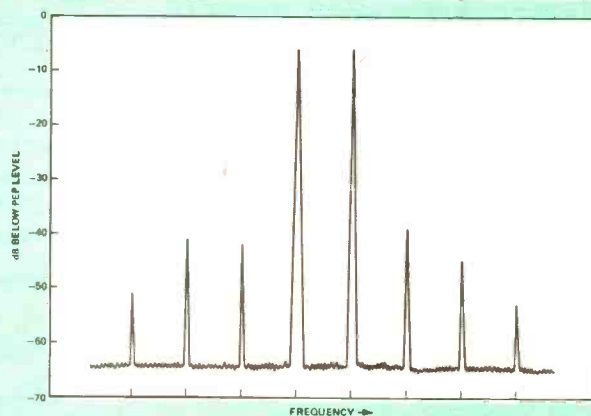

Laboratory Results

Receiver

Sensitivity — Signal level in uV pd giving 12dB SINAD signal

Freq.	SSB/CW	FM
144	0.135	0.160
145	0.135	0.160
146	0.135	0.160

Adjacent Channel Selectivity:

FM selectivity — Level of increase in interfering signal above 12dB SINAD ref. modulated with 1.5kHz of 400Hz audio tone, to cause degradation of on-channel 12dB SINAD signal to 6dB SINAD.

Separation	Rejection
+ 12.5 kHz	52dB
- 12.5 kHz	44dB
+ 25 kHz	76dB
- 25 kHz	76dB

Blocking Rejection — Increase in interfering signal level above 12dB SINAD ref. to degrade on-channel signal from 12dB SINAD to 6dB SINAD

Spacing	SSB/CW	FM
100 kHz	99dB	92dB
1 MHz	102dB	98dB
10 MHz	102dB	98dB

S-Meter Linearity:

S1	0.41 uV pd
S5	1.50
S9	4.55
S9+	260.00
S9++	23.00 mV

Max. Audio Output: (Measured at onset of clipping)

Speaker Load	3 ohm	8 ohm	16 ohm
5 kHz Dev. FM	1.2W	920mW	400mW
SSB/CW	670mW	670mW	520mW

RX DC Current Drawn (in mA)
Dial lamp current: 88mA extra

	SSB/CW	FM
Squelched	129 mA	108 mA
Vol Mid.	191	201
Vol Max.	456	488

Intermodulation Rejection — Increase in level above 12dB SINAD ref. of two interfering signals to produce 12dB SINAD on-channel signal

Spacing	SSB/CW	FM
12.5/25 kHz	90.5dB	56dB
25/50 kHz	90.0dB	71dB
50/100 kHz	89.5dB	71dB

First IF Rejection: 81dB all modes
Half IF Rejection: 99dB all modes

Transmitter

Power Output and DC Current Drawn:

(SSB PEP and CW/FM power outputs similar to within +/-0.5dB).

Freq MHz	10.8V		13.8V	
	High	Low	High	Low
144	2.68W/1.08A	0.38W/0.55A	2.68W/1.08A	0.38W/0.55A
145	2.68W/1.08A	0.37W/0.60A	2.70W/1.08A	0.37W/0.61A
146	2.69W/1.18A	0.35W/0.61A	2.70W/1.10A	0.36W/0.62A

Spurious Emissions

2nd Harmonic	-65 dBc
3rd Harmonic	-67 dBc
4th Harmonic	-82 dBc
5th Harmonic	-85 dBc

All other harmonics or other spuri: less than -85 dBc.

FM Deviation: 6.45kHz peak (at 400Hz), 5.3kHz peak (at 1kHz).
Toneburst Deviation: 3.20kHz
TX Frequency Accuracy: +74Hz measured 20mins from switch on.

WHITE NOISE

Jan declared it was Duddy's fault and Duddy swore it was Frank's, but whoever, there we were, stuck with a Bonk Hill Amateur Radio Clubnight on Christmas Eve. Our hall had been

prone until Duddy and Jan gave it the kiss of life in 1975. Only Oliver has died and come back to life more often than the Bonk Hill Amateur Radio Club, and I was, as you might

semiquavering key, you might say.

"Brrr-h!" shivered Jan, as I stood behind him, both of us looking through the glitterdusted window. "Seasonal, eh?" The others clustered around. Snow was falling like a lorryload of mushrooms being tipped against the black glass. "Can't see my car, hardly."

Frank pointed a nose like a whippet's straight up my left nostril. "How about a carol and — and —" he hesitated, short of humour, "and a ghost story from someone, eh?"

Duddy trotted across the hall and waved his hands over the snoring

A Christmas ghost story for radio hams everywhere, by Trevor Artingstoll, G0JOE. Not for the squeamish!

booked "as for November" and that meant for four Wednesday evenings. The fourth Wednesday in December was on the eve which Santa Claus gallops into the home straight on his toys delivery scam. The Manager was sorrowful but as firmly against cancellation as he was against giving the Club its ackers back. "No way, gentlemen," he insisted. "The world an' its uncle want this hall Christmas Eve an' the Club got first chance. Sorry!"

Came the night, it was as bad as the committee feared. There was Duddy, Hon Sec, never been known to miss a meeting; Chairman Jan, flannelling away as per usual; Honest John Treasurer, always looking and sounding like a lost BBC gardening expert; Frank Fanatic, the QRP CW DX-er extraordinary and reputedly a household name in Chunking, where I've heard they own one of the three amateur band TRX's in the whole of China; "Tinker" Bell the soldering whizz; and yours truly, telling this mournful tale. The other forty-odd members sensibly stayed by their fireplaces waiting to nick Santa's christmas drinkies as soon as the kiddies went byebyes.

The club had been first formed in the early Twenties. Then, bottles were black boxes and grizzled Fullerphone survivors from the trenches sweated excitedly over the latest in basket coils and prophesied the early demise of radio amateurism "as we know it" if bottles took over from spark coils.

They did and nowt much changed except that the club died in 1939, reincarnated in 1948, staggered on until 1955, died again and remained

in all of its deaths. Like many G2's in such clubs I like to sit back, look as benevolent as anyone like me can look, and let the lads get on with it. Not so much a silent key as a



gas fire. "This hall's been up a hundred years. Should have a resident ghost after all that time."

"Was it always a meeting hall?" asked Tinker curiously.

"As long as I've lived here. And that's about — let's see — thirty two. According to the odd minutes of meetings the Club's met here since Hitler was a lad. Used to be an infant school."

"Ghosts!" snorted Honest John. "I've yet to see one and I know I never shall. Wouldn't believe it if I did see one. Go to a psychiatrist."

Frank snickered, looking in my direction meaningfully. "There could be a real evil one watching us right now. Maybe planning to materials and scare the bejeezus out of us. He swung away from the window and sat down. "I was here the night Jimpy Bennet fell off the twig. Right there, where you're standing."

Tinker stepped quite quickly to one side, away from the hallowed spot. "It was on a Christmas eve! One moment he was arguing about checking gain compression points with a tuned audio meter. The next..." here his voice fell full seven

decibels," ... dead! Brain haemorrhage!"

"Dead?" echoed Jan, coming over to us and dropping into an armchair. "I never heard of any member dying -er- on the job, so to speak."

"Yonks back, that's why," replied Frank, looking inwards and obviously reading a few decades off the timebase printed on his mind's screen. "Just after the war it'd be; forty years ago." Some mental picture made his lips turn down. "We were in Special Ops together. He was a hard man. No mercy in him... Used his knife a lot... We called him The Butcher...!"

Clearly still scanning the same internal scene, he muttered very low, "Bled from every hole in his head. Nose; mouth; ears. Even his eyes bled!"

A respectful and rather horrified silence fell in which Frank completed his peep into a grisly past. Arising, our grim historian moved towards the door of the radio equipment store. "Think I'll play with the Frog... "The door opened, then closed behind him. Presently the rustling of white noise signified that

he was snooping around the radiospace of Chunking yet again. It cut out as the earphone jack snicked in.

Tinker swore. "Damm it! Left the coffee jar." Jan and Honest John arose as one from their chairs, being fond of a hot tippie clubnights. "Wait a bit though —"

"—Yes, in the kitchen. Saw a jar as we came in," interrupted Duddy helpfully. They all left like homing pigeons, passing me as if I wasn't there.

Drifting across the hall towards the wall of the equipment store I passed through it. "Frankieboy! Hey, Frankie!"

He raised his head, adorned with a big, rubber-padded cans, took me in and started to howl terribly. One after the other his screams came. Like brakes screeching. Towards the end it sounded more as if he was gargling.

"Jimpy! O Christ! It's Jimpy! Go! Back! Get away — for God's sake! Ahhh-h!... The blood... BLOOD!!!"

I'm not so hard. I don't much like giving it to people I know.

KW TEN-TEC CORSAIR II

NO FRILLS, "GIMMICKS", OR UNUSED FACILITIES - FOR THE SERIOUS PHONE/CW OPERATOR WHO WANTS THE LOWEST NOISE, CLEANEST AND MOST SELECTIVE AMATEUR hf TRANSCEIVER ON THE WORLD MARKET



Price £1147.24 (including VAT and delivery) MADE IN U.S.A.

Other KW-TEN TEC winners

The KW-TEN TEC ARGOSY II ssb/cw transceiver **£548.84**

The KW-TEN TEC CENTURY 22 cw only transceiver **£342.13**

The KW-TEN TEC TITAN Linear Amp. 2kw pep, 1kw ccs, **£2119**

Plus The KW-TEN TEC RX235 Receiver, 300kHz to 29.999MHz **£544**

Model 920 Air band Walkie Talkie, Model 3100 series Mobile Whips 4229 2kw ATU Kit, 229 2kw ATU READY MADE, MODEL 209 Dummy Load. etc.

KW TRAPS (original and best) for KW Trap Diple.
KW TRAP DIPLE (now in 27th year of manufacture)
KW BALUN, KW ANTENNA SWITCH. etc.

ALL BACKED BY THE KW SERVICE (trusted by Radio Amateurs and Government Services for more than 30 years).

The above prices include VAT and UK carriage.

VISA, ACCESS

WRITE OR PHONE FOR DETAILS

Hire Purchase

KW TEN-TEC LTD

Vanguard Works, Jenkins Dale, Chatham, Kent, ME4 5RT

Tel: 0634 815183 Telex: 965834 — A/B KW COMM G.

KW Ten Tec Ltd is an associate Company of Ten Tec Inc. of USA and a subsidiary of KW Communications Ltd.

KW Corsair MKII — Review



Tony Bailey, G3WPO, investigates the latest version of KW's Ten-Tec HF transceiver. Better than the competition? — Read on!

Back in November 1984, we reviewed the Ten-Tec Corsair, an American HF Bands transceiver for those wanting performance but without all the (possibly unnecessary) frills that usually come with the Japanese black boxes. Since then, the MkII version has appeared, offering improved performance and some extra facilities over that of the MkI. It should be mentioned at this stage that although you won't find the rig crawling with memories, synthesisers, split frequency operation and all the other 'gadgets' of the oriental designers, you will still have to dig in your pocket for around £1350 (inc VAT) for the privilege of owning a Corsair and matching power supply. So, is this expense justified by its performance?

First impressions

The review sample came with

the matching 240v ac power supply/speaker (although the Corsair itself does have an internal speaker), a full set of four IF crystal filters and the matching KR1B twin paddle keyer, which in conjunction with the Corsair has a simple programmable memory. The appearance of the transceiver has undergone a facelift since the MkI and although basically the same layout, with one extra rotary control, the colour scheme is now two-tone grey with the light shade predominating. I like it — it is a refreshing change from the Japanese look-alikes and gives an immediate impression of quality and class.

The controls are all reasonably sized, well spaced and practical — no miniaturised switches or fiddly concentric controls to hassle over. I also have no doubt that the oriental version of a Corsair would be accommodated in a box half the size of this

one, but to me, a lot of the appeal would then be lost. Incidentally, the appearance of the transceiver is not unlike that of some Drake equipment. On the front panel, there are the usual controls for AF gain, power on/off, RF gain and band select.

The Corsair II covers all the current amateur bands from 1.8 through to 30MHz with a basic 500kHz tuning range from the VFO — thus 10m is covered in 4 segments. The mode switch selects either normal or inverted sideband according to the normal amateur convention and has both a CW and a lock (Manual Tx) position. It does not offer inbuilt FM or AM facilities, nor are these available as options. This is a specific choice to maintain the performance on SSB and CW without concessions to the requirements of these little used modes on HF. I doubt that this will concern the buyer that the Corsair is aimed at.

Front panel functions

The main VFO tuning knob is similar to that used on other Ten-Tec

equipment and gives around 20kHz per revolution. I couldn't find any trace of backlash in the reduction mechanism, the only criticism being that VFO tuning is very dead in feel and cannot be spun, although it did its job perfectly well. The frequency readout is via a 6-digit LED behind a filter running the length of the top of the front panel. The main MHz and kHz digits are displayed in orange (previously red) but the 100Hz digit is still in green, a choice which I find odd. It doesn't really add anything to the display and if chosen to differentiate the 100Hz from the other digits, could have been better achieved using another decimal point instead.

Also mounted along the display section are the meter function select switch (Ic, SWR, power and processing level) together with smaller rotary controls for noise blanker level, blanker width, ALC and processing level. The width control is an additional function to the MkI, and there is also a keyer speed control which wasn't present before. The VOX controls have been relegated to the rear panel to make room for the extra front panel controls. As with the MkI, PBT (passband tuning) is offered, together with RIT (on Rx, Tx or both) plus two rates of IRT shift (either $-1.5/+2$ kHz or $+/-4.5$ kHz). AGC (hang type) can be set for fast, slow or off, and a pull switch selected attenuator offers 10dB of attenuation when operative; what actually happens is that the front end RF amplifier is bypassed when the attenuator is in circuit.

A bank of five 3-position lever switches controls the RIT functions, plus filter select and AGC. The speed at which the Rx/Tx changeover operates is also selectable between VOX (for SSB only) and either fast or slow for QSK (full break-in) CW operation. This latter feature is one of the main reasons that someone will purchase a Corsair. It has excellent CW facilities in terms of break-in and is operative for full listen-through when set to 'fast' up to speeds as fast as I could key it. The RF changeover circuit is essentially solid state using PIN diodes to handle the 100W of RF, thus being very fast and silent — well almost silent as there is a relay which clicks (quietly) over when you first key and drops back a short while after you stop. Its presence is a refinement from Ten-Tec and dis-

connects the PA from the antenna during receive to make sure that no noise from the biased-off PA can get through to the receiver. Normally the PA is left connected with volts on it but biased-off so that it presents a high impedance state and doesn't load the antenna. An additional control is that for the audio filter which alters the skirt selectivity. When fully screwed in, it has a narrow bandwidth around 200Hz centred on 750Hz, and skirts of 24dB/octave.

Performance

To review the MkII it is necessary to repeat much of what was said about the MkI, especially the fact that it boasts a plain ordinary down-to-earth mixer type VFO system. No digital synthesiser here, so why do I say *boast*?

Well, if performance is what you are after (and on receive one major aspect is the ability to copy weak signals) then you avoid the digital synthesiser like the plague! The only reason I can see why the Japanese like them so much is a) that they are cheaper to mass-produce than mechanically orientated VFO's and b) that they can be used to offer memory/scanning facilities with little

problem. Unfortunately, the average digitally synthesised VFO also mass-produces noises which will mask weak signals, and inflicts other side effects on the receive performance. These effects are often quite plainly audible when you listen to a CW signal which has been modulated by the phase and amplitude noise from the synthesiser. The effectiveness of the crystal filters is also reduced with the skirt selectivity appearing to be worse.

With a mixer type VFO these effects are very much reduced and where time and trouble has been taken during design to keep phase noise low on the variable oscillator, superb results are obtainable, achieving very clean mixer oscillator injection. This is the case with the Corsair and the results are immediately plain when you listen to the superbly clean CW reception that is obtained.

The VFO itself covers 5-5.5MHz and it is this which determines the overall stability of the rig. Rather than using the conventional capacitive tuning, it is instead permeability tuned, where the inductance is varied rather than the capacity of the circuit. The VFO output is mixed with an appropriate crystal oscillator to generate a frequency either 9MHz

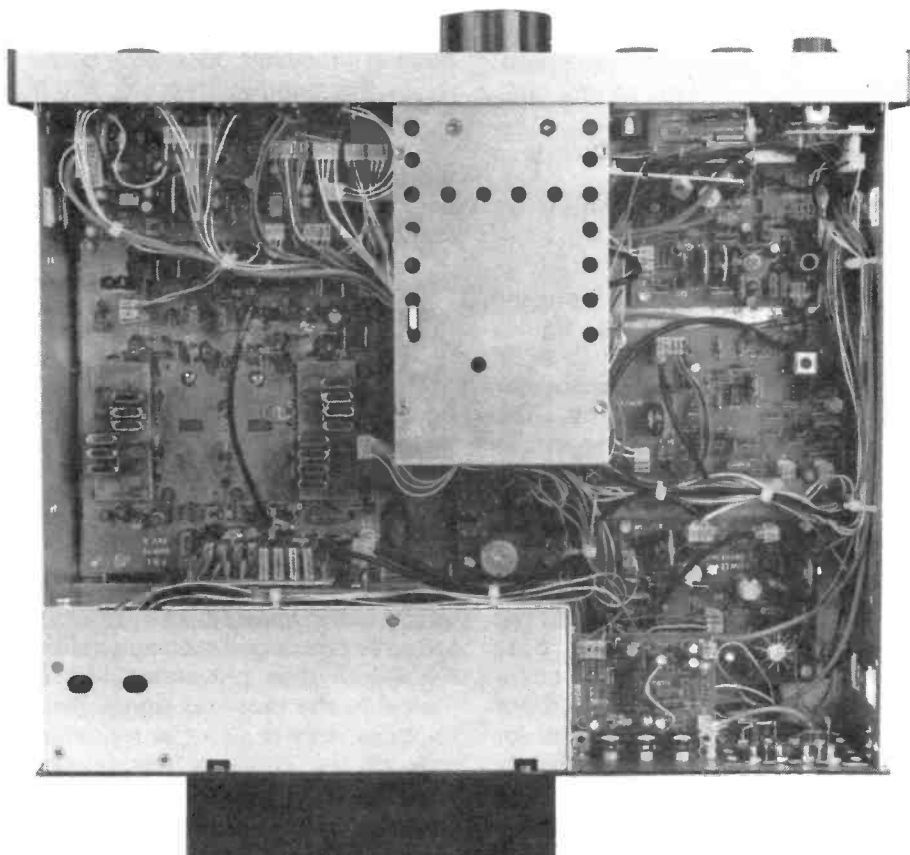

Internal view from above.

IF options

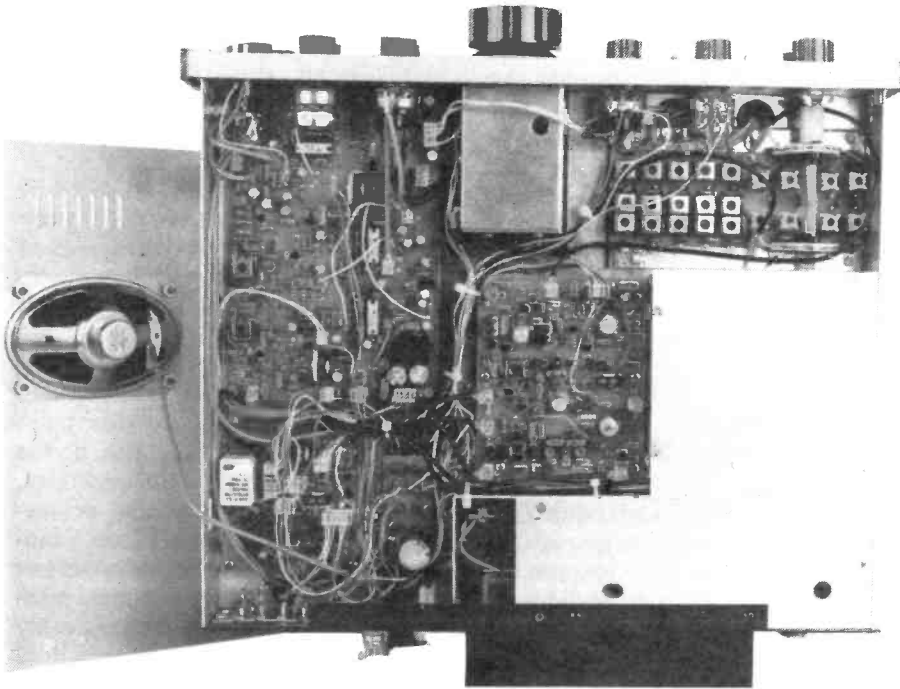

Underside view.

above or below the wanted frequency. Each output from the mixer/VFO module is filtered by bandpass circuits to remove the unwanted mixer products, except on 20m where the VFO output is used directly with 9MHz to give 14-14.5MHz. The stability of the free running VFO is very good and given a 30 minute warm-up period stayed well within $\pm 100\text{Hz}$ at any time.

Sensitivity and Filtering

Switched bandpass filters are used at the front end for each band before the signal is passed to the RF input circuits. Depending on the front panel switch setting, signals are then either passed through an RF amplifier or via a resistive attenuator using PIN diode switching. The manual gives the sensitivity as $0.25\mu\text{V}$ for 10dB S/N+N with the amplifier in and $0.8\mu\text{V}$ with it out. For most applications with a decent antenna system, the RF preamplifier can be left out of circuit up to about 20m, but above this the preamp will probably be needed. The best dynamic range will of course occur with the preamplifier switched out and this was measured at 94dB for two-tone at 100kHz spacing (slightly better than the Mk1 measured by the same method). This is a good result and indicates that the Corsair is unlikely to give problems arising from

strong signals causing in-band inter-modulation products.

The first IF filter is at 9MHz and is used for both transmit and receive paths in conjunction with a bi-directional amplifier. This filter sets the overall bandwidth of the system and acts basically as a roofing filter as it is followed later by further (narrower) filtering if required, depending on the mode. The bandwidth at the first IF is 2.4kHz from an 8-pole unit (the Corsair I had a standard 4-pole unit with an 8-pole option) which also sets the transmit bandwidth of the low level SSB signal.

Noise blanker

Following the filter, we move on to the noise blanker. This is a modified unit over the Mk1 and has variable width now as well as level settings. With the width control 'off', it is fixed at $400\mu\text{s}$ and this can be varied up to 5ms if needed, mainly for 'Woodpecker' type interference. There is a clever bit of circuitry which, when longer pulses are selected, only allows one such pulse every $80\text{-}100\text{ms}$ thus preventing lots of 'holes' in the received signal. As it happens, this is also the repetition rate of the Russian Woodpecker signals. The level at which the interference pulse will initiate the blanking action is set by the level control.

The main IF selectivity at 6.3MHz uses up to four further narrowband crystal filters. This rig had all the optional filters fitted, but a single 2.4kHz 8-pole unit for SSB and CW is supplied as standard. The options are 1.8 , 0.5 and 0.25kHz bandwidths, all of which are selected by PIN diode switching from the 'Xtal' switch on the front panel. Which set of filters you get (assuming they have all been fitted) depends on the mode, with the three widest ones in use for SSB and the three narrowest for CW. These filters are not of the hermetically sealed type you get from Yaesu for example, but are built up on small PCB's from individual crystals and cost about $\pounds 52$ for each complete filter unit.

Used in conjunction with the various filters is the 'passband tuning' facility whereby a front panel control adjusts the position of one of the second IF filters with respect to the fixed-position of first IF filter. With the wider SSB filters you effectively get variable bandwidth as the filters overlap, and this can be done on the high or low side of the signal. It becomes more difficult to use with the narrow filters and you have to re-tune using the IRT control to peak the signal in the centre of the passband. The main IF PCB handles most of the receive functions including RF gain, notch and bandpass facilities, AGC and S-meter plus the transmit sidetone. Most of the RF circuitry is based on discrete semi-conductors with IC's for the AF side. This does mean that the RF part can be designed to do exactly what the designer wanted, rather than what the chip manufacturer thought he would want!

The AGC system is audio derived (as with SSB there is no carrier to provide a reference for the gain controlling circuits) and uses a 'hang' type generator. Those of you who have played with the Plessey chips such as the SL1621 will know that this system is very effective for SSB and CW use, although some people hate it! What it does is to provide a very rapid attack control voltage which will hang at the same level for about two seconds after the signal goes. If no signal reappears during this time then the AGC decays to zero in a few milliseconds, bringing

back full receiver gain immediately. It has the major advantage of removing noise bursts during speech pauses and to some extent also acts as a noise limiter. The decay time can be altered from the front panel to only 0.2 secs if a fast release is wanted. The S-meter derives its drive voltage from the AGC loop and is calibrated from S1 to S9+40dB with S9 set at the standard of 50uV pd.

Spurii

Any receiving system using mixers will generate unwanted signals which become audible as sprogies when tuning around with no antenna connected. The manual actually lists the major ones where these are greater than 10dB S+N/N which occur at 1.838, 21.3 and 28.98MHz. There are of course others but none were found at levels greater than the minimum specified.

Transmit

No microphone is supplied with the Corsair and a Shure 444 was used for this review (directly plugging into the 4-pin socket). Various microphones are available from KW ranging in price from £25-£38. You can use either PTT or VOX, with the latter having the usual adjustments now fitted on the rear panel. The VOX is very quiet in action of course with only the sound of the small relay mentioned earlier. The Corsair features an audio-type clipper/compressor processor with a front panel level control, used in conjunction with a calibration level on the S-meter. It works quite effectively in practice.

The transmit signal is generated quite conventionally firstly as DSB, then filtered to SSB at 9MHz in the bi-directional first filter and thence up to signal frequency. A driver stage gives low level RF, controlled by the ALC system, and then amplified up to a final level of 200W input by a pair of MRF458's in the RF power amp. The ALC control voltage is derived from the SWR sensing board and fed back to a diode attenuator on the input to the low level RF stages. In use, the drive level is adjusted until the ALC LED just lights on peaks, or on key-down on CW (for full power operation). The ALC control sets the threshold for operation — fully clockwise allows full power while fully anticlockwise reduces maximum ALC limited power to about 80W. A bank of switched low pass filters removes harmonics before RF power passes to the antenna via the PIN diode switch already mentioned.

A few other controls not mentioned so far — 'Lock' puts the transceiver into transmit for checking SWR, tuning up etc, in conjunction with the built-in Power/SWR meter forward and reflected calibrations on the S-meter. The notch filter functions at audio frequencies and allows a steep notch of some 50dB to be placed anywhere within the audio passband with very little practical effect on the intelligibility of speech. On CW, heterodynes are easily reduced to very low or non-existent levels. There is a slight rearrangement of the rear panel over the Mk1, besides the repositioned VOX controls, the necessary sockets for the optional keyer paddle have also been provided.

Power supply

This review model came with the matching Model 260 PSU but it can of course be used with an external PSU capable of providing upwards of 18 amps at 13.8v DC. Although the actual transceiver has ALC as a method of preventing over-driving, such a feature does not cater for all possible conditions which could cause the output devices to take more current than is good for them. Load conditions exist (such as a highly reactive antenna which cannot be made to absorb much RF power) which can grossly overload the PA transistors current capability and cause their early demise. The only protection against this problem is to provide a current trip feature in the PSU itself which will remove power immediately excess current is detected.

The Model 260 has a built-in breaker circuit and KW can also supply the Model 1140 circuit breaker separately for use with an external PSU (priced at around £15) — if you value your PA devices then this is highly recommended for some peace of mind. The matching PSU comes in an identical style case to the Corsair itself and with a built-in speaker. Using this disables the internal Corsair speaker — it doesn't sound a lot different but has the advantage that it faces you rather than the sound coming via the louvres on the side and underside of the main rig.

Keyer

The optional keyer paddle (type KR1B priced at £52) is of the twin paddle type, housed in a smallish matching case. I am not overfond of the paddle design but it does work OK in practice. It also has a short memory feature capable of storing up to about 40 characters, operated by a slide switch on the keyer unit front paddle. It is perfectly feasible to use another paddle if you want, together with the memory feature, as instructions are given on how it operates in the manual. The nominal speed range is 8 to 50 wpm although this version only went up to about 32 wpm in practice. The keyer speed is set on the Corsair front panel although the speed setting is very compressed with most of the change happening over

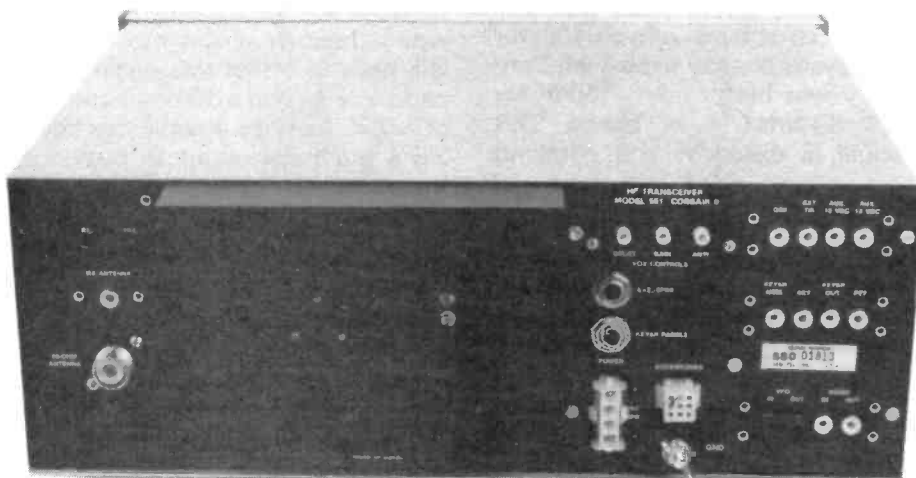

Rear view.

about the top third or quarter of its travel.

The key is unusual in that the pressure is controlled by small solenoids pulling against each paddle, with a pot on the rear which varies the current and thus the pressure. To be quite honest, I didn't like the paddle 'feel' but others might. It tends to be noisy in operation especially if you have the paddle pressure set high.

The memory function is good for calling CQ but has one nasty little feature. Without instructions to the contrary, the only way to initiate it after a recording had been made was to quickly flip the program/send switch to 'program' and back again. This sends the memory contents, but if you leave it in the 'program' setting for a little too long, it assumes you are going to program it again and the memory disappears!

In use

Like the MkI, the rig was used over a period of eight weeks on both SSB and CW on most bands where there was some activity. Again, no problems were encountered and complimentary reports were received on the SSB quality. Not surprising since at full power the 3rd order IMD products are some 40dB down on peak power, good by any standards. The QSK facility was a joy to use and the full complement of filters in conjunction with the PBT and notch filters made disposal of QRM very easy. If you can't afford the narrow CW filter options, the variable skirt selectivity audio filter is very effective on CW and can be used with some limitations on SSB. It doesn't of course have the skirt rejection of a crystal filter but is still a lot of help. You can also play around with the selectivity using the PBT in the absence of the narrow filters.

The Noise Blanker is rather more



The Model 260 PSU

effective than the original version and coped very well with all the normal impulse interference on 80m with the width at minimum. The Woodpecker seemed to be having a holiday whenever I was on so I can't comment on its effectiveness directly. However, a test pulse generator used to simulate the Woodpecker was blanked very well so it should work on the real thing.

All the other features did as required and I can't really say much more than that. The receive performance is very good, clean and free from IMD problems even on 40m for the reasons already explained. Sensitivity was better than 0.25uV for 10dB S+N/N on all bands. The manual is excellent and contains

plenty of photographs, check voltages, circuits and alignment instructions, together with copious notes on operation and how to get the best out of the rig. Obviously written by experienced amateurs who know what you will want to know.

Conclusions

As a rig primarily for the CW operator it can be highly recommended and has very good SSB capability as well. You may consider that its price is high for what you get in facilities and appearance compared with a Japanese black box but you will have to offset this against the performance and a different country of origin. Perhaps anyone considering a purchase ought to convince themselves by either paying a visit to KW and getting hands on experience, or finding someone with a Corsair who will let them play with it.

The standard Corsair Mk II costs £1147.22 and the PSU costs £203.09 — a total price of £1350.31 including VAT and delivery.

Thanks are due to KW Communications for the loan of the Corsair and its accessories.



Corsair MkII — front view with PSU.

Audio Filter for CW

In the mid 1970s, the rig in my shack was the well known FT200. This was generally quite an effective piece of equipment, but as the main mode of operation at GM3HBT has always been CW on the HF bands, the lack of a narrow CW filter in the

into service. This op-amp filter made an enormous difference to reception of CW, but in experimenting with it the following facts became evident: (1) The filter had 4 switchable stages, providing bandwidths of approximately 180, 120, 95, and

effectively was when there was a strong adjacent signal within the IF passband (2.4kHz). Even when that signal was not itself audible through the filter, it had the effect of acting on the AGC to suppress the received signal in sympathy with the offending adjacent signal, thus making reading the CW somewhat difficult.

A cheap and effective alternative to crystal IF filters for CW from Tom Hall, GM3HBT.

IF circuit was a noticeable drawback and with the FT200 there was no option for adding one.

CW Audio Filters

However, at that time a reasonably priced audio filter was available by MFJ, which was normally intended to be fitted between the rig and the speaker so one of these was purchased and put

85Hz. In use, it became clear that, for me at any rate, the setting which was by far the most effective for all normal operating was a bandwidth of 120Hz, ie two stages of filtering. (2) Although the MFJ worked well between the rig and speaker, I found that the optimum position appeared to be achieved when it was inserted at the top end of the volume control. (3) The only operating condition which the filter could not cope with

Since those days, I have used the TS520S, TS530S, FT77 and now a Corsair, all of which have had a facility for fitting an optional narrow 500Hz CW IF filter which, in each case, had been fitted. Remembering my success with the MFJ (which had been sold with the FT200), I built a little two-stage switchable op-amp filter on a scrap of Veroboard and added it first of all to the TS520S, which when used together with the narrow CW filter gave quite superb results. So much so that each

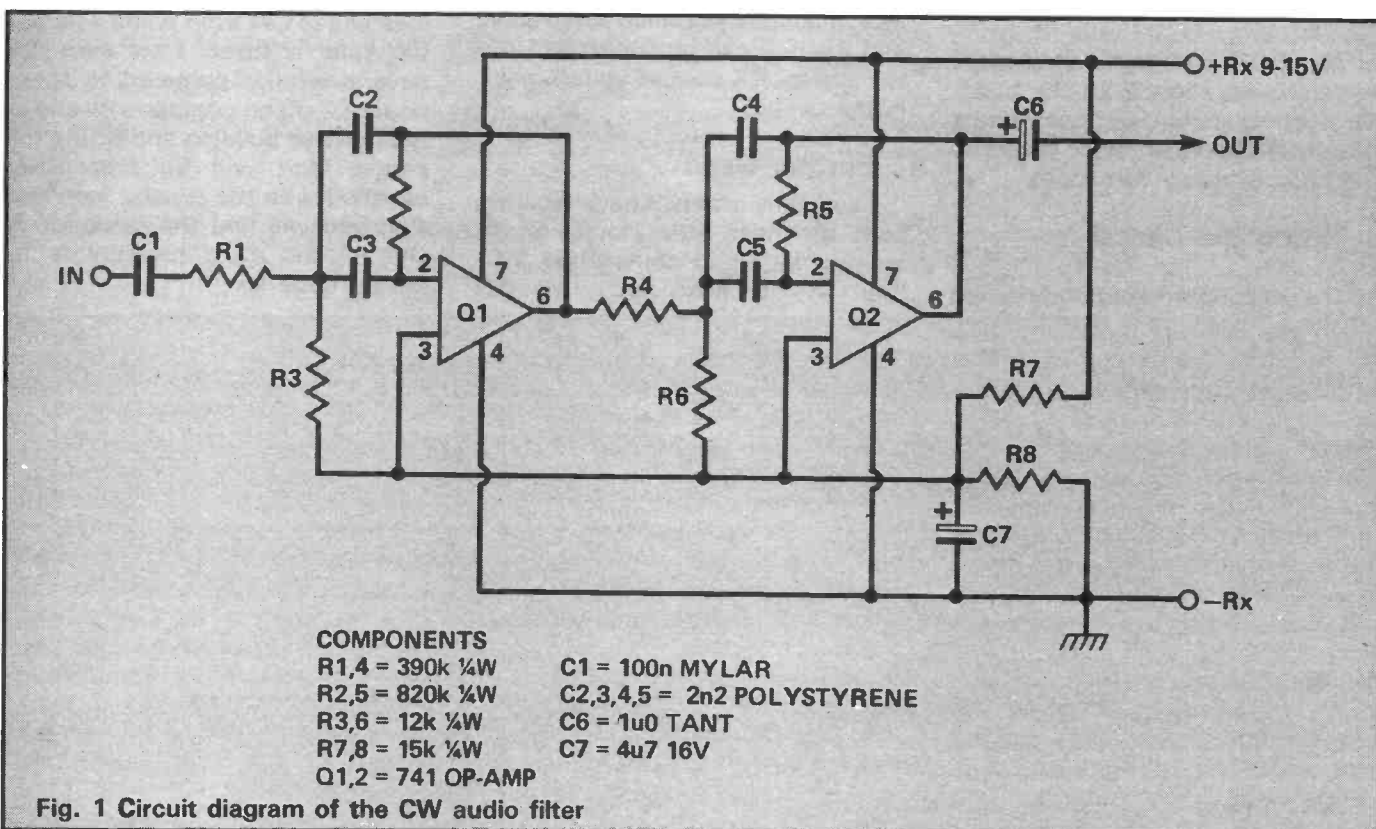

rig since has had my little homebrew filter fitted, not to mention an R1000, and FT7700 and the rigs of several friends, all of whom have been delighted by the results. I suppose a little pcb could be designed for the filter, but it is so easy to fit on a small piece of Veroboard that I never took the trouble to do so.

The Circuit

The circuit of the filter is shown in Fig. 1 and the method of inserting it into the audio circuit of a rig in Fig. 2. If the components are taken from normal 5% tolerance stock, the results are very good, but if you have access to measuring equipment and can select R and C values so that there is a closer match between the stages, then so much the better. The formula which gives the centre frequency is:

$$f_c = \frac{1000}{2\pi C} \sqrt{\frac{R1+R3}{R1 \times R2 \times R3}} \text{ Hz}$$

Where resistance is in kilohms and capacitance in microfarads. With the values shown, this is 740Hz. If you are a purist, then slight variation of the value of R3/R6 will result in a filter frequency which is exactly the same as the rig sidetone — I have even made R3/R6 miniature pots to achieve this and find it a useful touch. The bandwidth is around 120Hz.

The circuit is built on a small piece of Veroboard, about 2.25" by 1.25". No layout is shown, as constructors usually have their own favourite methods of using Veroboard.

Fitting the Circuit

The completed module can be

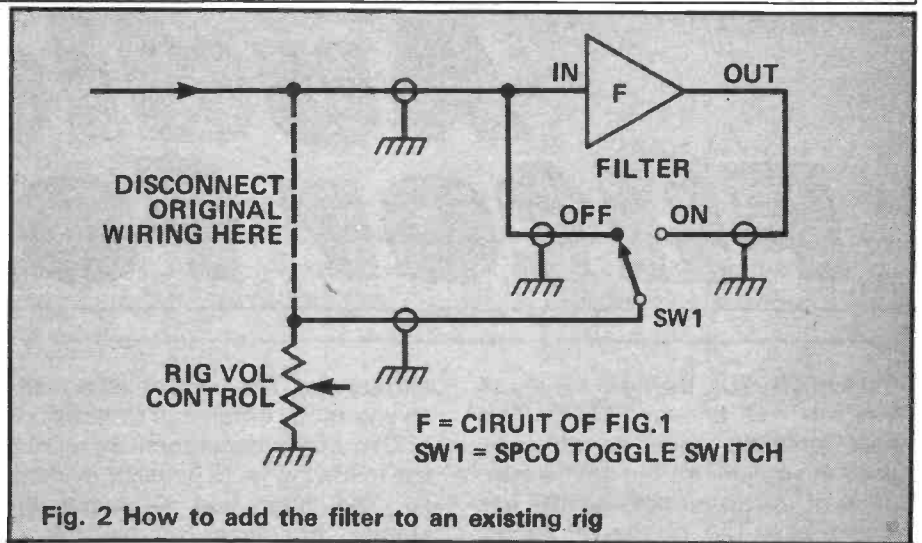

Fig. 2 How to add the filter to an existing rig

fitted in any convenient small space inside the rig. I always use double-sided sticky pads for this, which means that if subsequently deciding to sell the rig it may be returned to the *as new* condition without leaving tell-tale holes. By doing this the wiring can be easily returned to the original, unless of course the purchaser is so impressed that they want to keep the filter in!

I have nearly always been able to use a redundant front panel switch (eg an unused CAL button) to switch the filter in and out of circuit, if not then a little toggle switch fitted on the rear panel can be used. Wiring to the audio stages and switch should be in miniature screened audio cable and the unit can be connected into the nearest RX positive voltage point in the circuit.

Further Uses

Like many others, I have recently built the neat little Howes DcRx receiver for a QRP transceiver. This has, in common with all DC

receivers, a not too spectacular selectivity, but with the addition of a two/three stage filter as described (switched to provide 'wide and narrow' selectivity), I have been delighted by the results. This modification can be made by removing the original connection between the junction of R12/C13 and the top end of VR1, then inserting a two/three stage filter as shown in Fig. 3. The DcRx now has virtually the feel of a superhet — another worthwhile project!

I think it is a pity that very few commercial rigs have the facility for optional audio filters, when they can make such a decided improvement in listening to CW even when a narrow CW filter is fitted. I am sure that anyone who is prepared to spend under £2.00 on components and an hour or two building and fitting this simple unit will be more than satisfied with the results. I am sure that you will find the reception of CW all the more pleasurable for having done so.

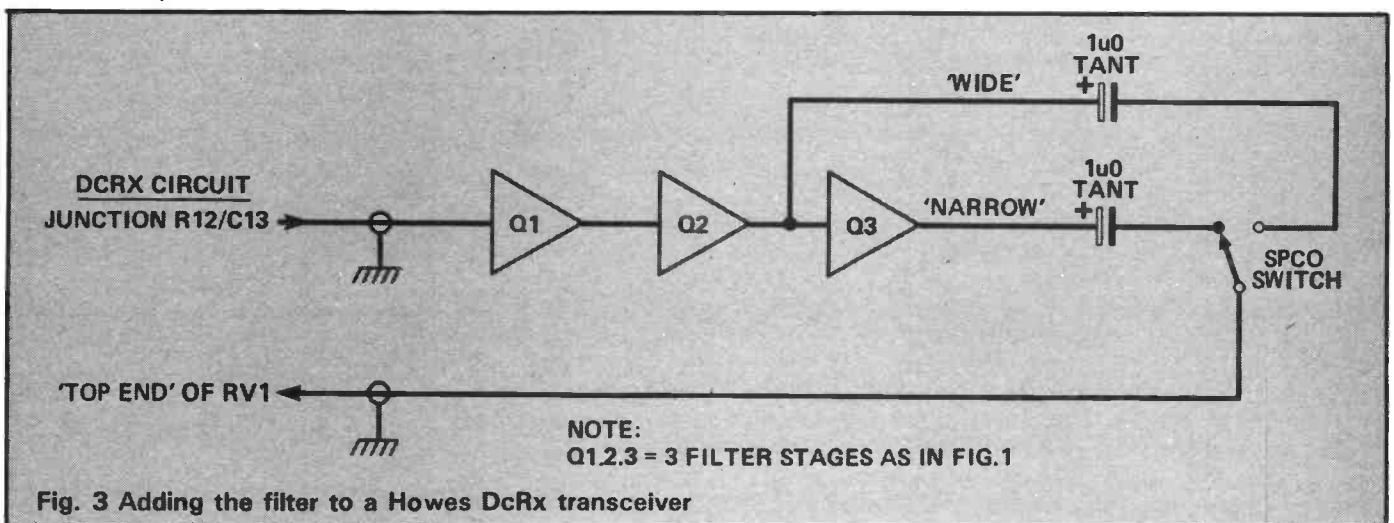

Fig. 3 Adding the filter to a Howes DcRx transceiver

Technology Roundup

Quartz crystals may be as old as the hills but they utilise state-of-the-art technology in their manufacture. They are widely used in amateur radio as frequency determining

reliable and often find many uses based on these factors alone.

How do they Work?

Quartz exhibits what is known as

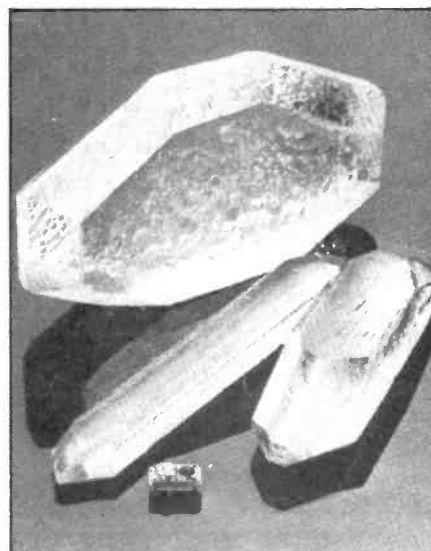

What's up to the minute yet as old as the hills? Ian Poole, G3YWX, introduces some rather useful bits of old rock.

elements in oscillators or filters and as their technology advances they are able to meet the more exacting requirements placed on them. Crystals with better specifications, higher values of Q, higher operating frequencies and lower ageing rates are now being produced. In addition to this the average cost per crystal is falling both in real terms and actual cost.

What is Quartz?

Quartz is a form of silicon dioxide which has crystallised into a hexagonal structure. Although silicon dioxide is the most common mineral on earth, it is found only rarely in the form of quartz. As quartz, it is a unique mineral exhibiting all the properties required to enable it to be used for frequency control or filtering.

Why Use Crystals?

Crystals are widely used because they exhibit a combination of properties required by frequency determining components. They possess exceedingly high values of Q often around and sometimes as high as 100,000, values which are unheard of for any other form of resonator. This gives them an extremely good performance when used in filters enabling them to surpass other components in terms of performance. They also exhibit very high degrees of stability with respect to temperature and time, making them very useful as resonators in oscillators. In addition to this they are both cheap and

the *piezo electric* effect which means that any mechanical stress applied to the crystal will cause a voltage to appear at its plates and likewise any voltage applied will create mechanical stress. The crystal is cut so that mechanical resonances occur within it at precise frequencies and these are translated to the electric circuit by using the piezo electric effect. Therefore the crystal can be made to become a high quality electric resonator suitable for a variety of applications.

Crystal Manufacture

The way in which a crystal is made will determine many of its characteristics. Therefore careful manufacture and the use of accurately controlled processes is essential. Here, up to date technology has produced dividends in improving both performance and the ease of manufacture.

The first stage is to cut a round blank from the right grade of specially cultured quartz. The correct orientation of the crystal lattice within the blank is essential as this will determine factors including the mode of oscillation and temperature stability. The most common orientation or cut is known as the AT cut which is used because it gives optimum temperature stability for most applications.

Once the blank has been produced it then has to be lapped to the correct thickness as this determines the crystal's resonant frequency. The lapping is done using a very fine paste so that an extremely good finish is given.

However, even after lapping the surface is still not smooth enough due to discontinuities in the crystal lattice which cause ageing and loss of activity. Therefore the blank is chemically etched to give the required finish.

The crystal then has to be mounted both mechanically and electrically. This involves creating electrodes which are made by depositing silver or gold onto the crystal surfaces. In fact the mass of the electrodes can be used to trim the frequency of the crystal to exactly what is required.

All that then remains is to bond the crystal to its mount. This is done in such a way as to keep losses to a minimum, thereby ensuring the highest value of Q. The crystal is placed in its holder which is then either evacuated or filled with an inert gas to prevent any chemical activity with the edge of the crystal lattice which causes ageing.

Current Applications

Crystals are still used in great numbers despite the fact that synthesisers are almost universally used in VHF transceivers and sets with banks of crystals are considered to be rather 'old hat'. Nevertheless crystals are essential in order to generate the reference frequency signals for synthesisers and they are also widely used in fixed frequency RF oscillators as well as in microprocessor clock oscillators and a host of other applications. In view of their cost and performance they will undoubtedly still be in general use for many years to come.



Listening On...

If you are into DXing you may find that offering your receiver a Beverage will help you reach parts other aerials cannot reach. As well as the 'Tropical Bands', our eavesdropper visits Latin America, the Caribbean and the States — on medium wave!

for the middle of the medium-wave band however, would be well over 500 feet long and is therefore clearly impractical! Again, a random-length long wire *can* be used on medium wave, though in this case a good ATU is a must as the wire will almost certainly be very short in terms of wavelength.

There are two main types of specialist antennas used by medium wave DXers, both of which are directional. The first is the Beverage which also requires a lot of space. The theory books will tell you that for a Beverage to work well it should be several wavelengths long, but in practice quite good results can be obtained from Beverages of only one half wavelength. For the middle of the medium wave, this still means they should be about 150 metres in length and this should be regarded as a minimum. However the big advantage over a half-wave dipole is that the Beverage works best when at a low height, typically about 8 to 12 feet above the ground. A dipole should be at least a half-wave high, or about 500 feet, again clearly impractical! It is often possible to string out several hundred feet of

So far in this series of articles, I have concentrated on what the average listener can hear in the way of broadcast stations on a fairly simple communications receiver, or without sophisticated antennas. By the time this is read though, we will be in the depths of winter and so this month we will look at DXing for broadcast stations on the LF bands, by which I mean the so-called 'Tropical Bands' at roughly 60, 90 and 120 metres as well as long and medium wave.

highly praised, the CR100 and the B40.

Antennas for life

As far as antennas for the tropical bands are concerned, a random length long wire will usually suffice, though if you get hooked on the bug of tropical bands DXing I would recommend something a little better. A half-wave dipole for the 60 metre band (cut for 4.8MHz — roughly the middle of the band) is about 97 feet long and should give very good results. A half-wave dipole

Do you have a suitable receiver?

If you have a transistor portable receiver covering these frequencies you may hear one or two of the stronger stations, such as 'Africa Number 1' in the 60 metre band, but without a reasonable quality communications receiver you will largely be wasting your time trying to find real DX stations on these frequencies. Even the present range of amateur transceivers with general-coverage receivers such as the Yaesu FT757 or Trio TS430S, while excellent on short wave, tend to be very insensitive on frequencies below 1.8MHz. I used an ex-government communications receiver called an R206 for a number of years with excellent results on the LF bands though it was very unstable on frequencies above about 14MHz! I know a number of people who have had equally good results with such ancient receivers as the AR88, the AR88LF version being particularly

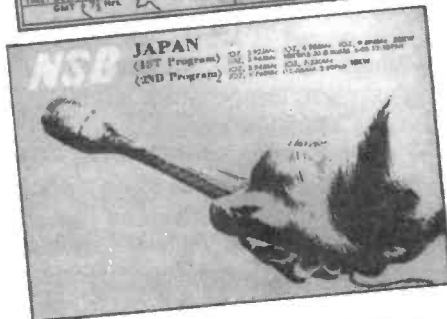

wire along the top of a wall or fence or even through trees where it would not be possible to put up a long wire 'in the clear', as long as the wire itself is insulated this doesn't matter. The Beverage is directional off the end of the wire if terminated, or is bi-directional along the axis of the wire if un-terminated. This statement is very approximate and in fact for Beverages which are short in terms of wavelength there are several lobes on either side. The impedance is typically several hundred ohms, so some sort of matching transformer is required if your receiver has a 50ohm input. The big advantage of the Beverage is that it is a very quiet antenna; static crashes which can be very loud on medium wave on other antennas are largely attenuated on the Beverage.

The second 'specialist' medium wave antenna and more practical for most people, is the frame or loop antenna. This consists of about 7 or 8 turns of wire on a three or four foot square wooden or plastic frame (or about 16 to 18 turns on a two foot square frame) tuned with a 400 or 500pF variable capacitor. Some experimentation will probably be required but given suitable values, it is possible to get the antenna to work and be resonant over the whole of the medium wave. It should be constructed on a stand so that the loop can be made rotatable, or it can be put on a rotator out of doors. The frame antenna is largely omnidirectional but has two very deep nulls, so it is used to null out interference rather than peak up the required signal. It works best of course, when the interfering station and the station you wish to receive are at 90° to each other, but since the nulls are very sharp it can be made to differentiate between two stations co-channel with each other even when they are coming from almost the same direction (eg two North American stations in different states).

'Tropical' DXing in the winter months

To go back briefly to the tropical bands, DXing on these bands can be rewarding at any time of year. In the summer for instance, very good signals are often received in the late evening from African stations and from South American countries in the early morning, though both are often marred by high levels of static. It is generally only possible to receive stations in the Far East and Pacific area on these bands in the winter months, though. The main reason for

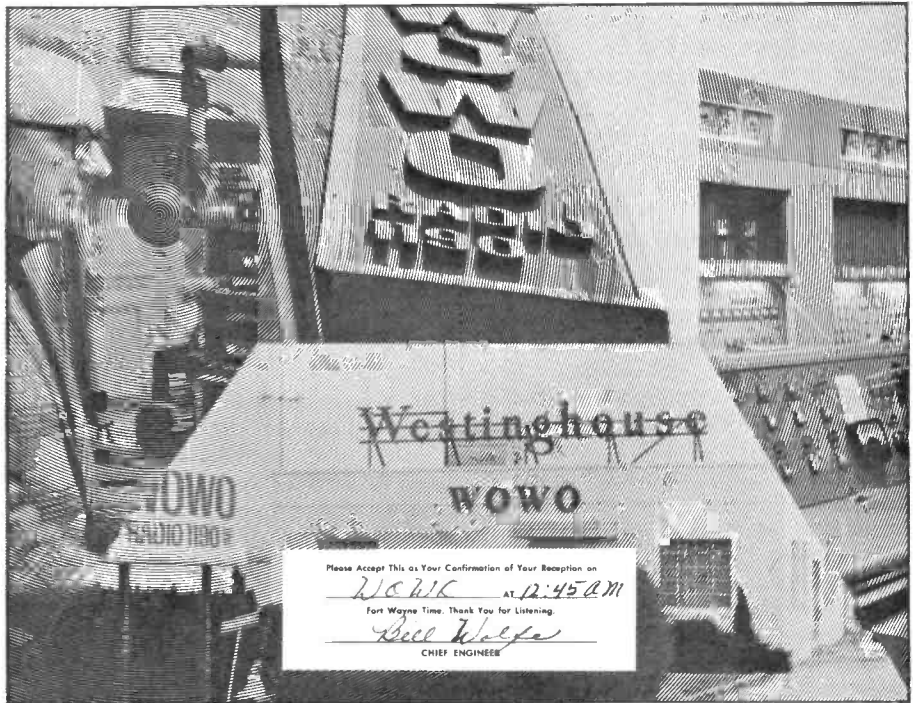

Spectacular medium wave DX is possible during sunspot minimum as these QSLs show — in the past, even Californian stations have been confirmed in Southern England.

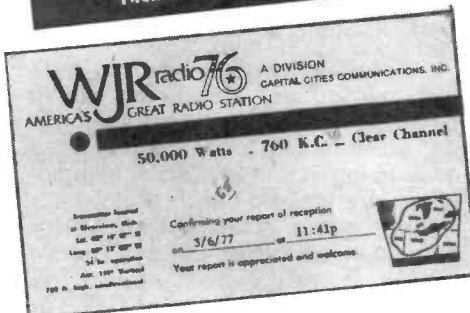

this is that it is necessary to have a darkness path between the transmitter and receiver on these frequencies and these conditions only occur for a few months in the northern hemisphere winter. The time to listen for Far Eastern and Pacific stations is at the time of so-called *grey-line* propagation, ie from about an hour before local sunset until an hour after, and again around local dawn. In practice a good time is around 1600 GMT in the early and late winter and as early as 1330 GMT in mid-winter.

One of the best-received stations from this area is Radio Singapore on 5052kHz, which also has the advantage that its programmes are in English, they sign-off for the day with the Singapore national anthem just after 1600 GMT. For a number of years Radio Singapore has also been testing a second transmitter on 5010kHz, sometimes in parallel with 5052kHz, and this can be a useful check to be certain that it is Radio Singapore that you are listening to. There are several stations from Malaysia on the 60 metre band too: their English service is on 4985kHz from a 10kW transmitter at Penang which also signs-off at 1600 GMT. If you are very lucky you may also hear Radio Malaysia's service in English from Kota Kinabalu, Sabah, in East Malaysia on 4970kHz, but this one is very rare! Other English-language

stations from this area are the National Broadcasting Commission of Papua New Guinea (programmes are in Pidgin English as well as more standard English!) which is on 4890kHz, but note that they sign-off at 1400 GMT. So it is a very rare catch indeed and only really possible for about a month around mid-winter.

Finally, Australia has a frequency in the 60 metre band which it uses for domestic broadcasting on 4920kHz. Unlike the others mentioned so far, this one is more usually received in Britain in the early mornings, via long-path reception — try around 0700 or 0800 GMT if conditions are very good. This frequency is a relay of Brisbane's local radio service, presumably intended for the sheep-farmers in the outback of Queensland and it can be quite a thrill to hear local news about Brisbane, or what is on at the local cinema from such a vast distance!

DXing down on medium wave

On medium wave, arguably the most interesting target for DXing is North America. Canadian and USA stations can be found every 10kHz on the medium wave, from 540kHz to 1600kHz. They are therefore generally on different frequencies from their European counterparts, which are on frequencies that are exact multiples of 9kHz. So with a receiver having good selectivity, it is often possible to receive North American stations reasonably in the clear, depending on the frequency. For example, one of the most consistently well-received North American stations in Britain is CJYQ in St John's, Newfoundland, on 930kHz. It is comparatively well-received for several reasons, firstly Newfoundland is the closest part of the North American continent to Britain, but perhaps more importantly it is 3kHz away from the nearest European stations, which are on 927kHz. On the other side of CJYQ the Europeans are on 936kHz. CJYQ is generally the first North American station to fade-in in the evening: the earliest I have heard it is around 1930 GMT in the middle of winter one year, although a far more likely time is from about 2130 or 2200 onwards.

One of the best-received stations from the USA is WINS in New York, on 1010kHz. The main problem here is interference from the Dutch station on 1008kHz, which is extremely strong in most parts of

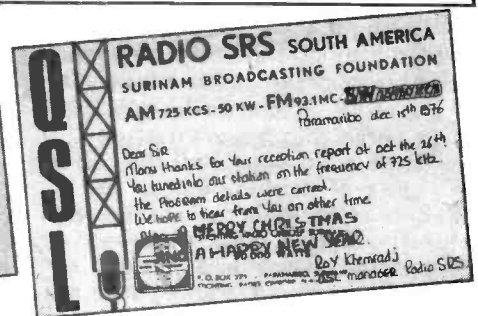
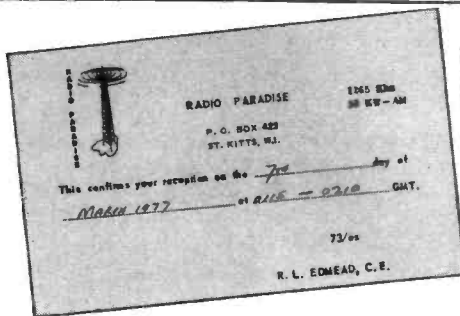

50kW can go a long way, but a frequency change by Radio SRS, Surinam to 600kHz has made this already difficult station even more of a catch.

Britain, even when nulled out on a loop antenna. However, after the Dutch station closes down for the night, WINS can often be heard at good strength. Their format is 'all news, all the time' with plenty of adverts and station IDs (identifications). As on all frequency bands, conditions can vary considerably from one day to the next. A good rule of thumb is that if CJYQ is weak and watery by 2330 GMT, forget it, get a good night's sleep and try again the next night!

At the bottom of the sunspot cycle, ie around now, some fairly spectacular DX is possible on the medium wave. At least two Californian medium wave broadcast stations were heard in southern England during the last sunspot minimum, and some people have the QSLs to prove it. If you're lucky enough to be DXing on a night of good conditions, when there seems to be an American-sounding voice every 10kHz along the dial, here are some stations to look for: WSM, Nashville, Tennessee, on 650kHz; WJR, Detroit, Michigan, on 760kHz; WCFL, Chicago, Illinois, on 1000kHz; WOWO, Fort Wayne, Indiana, on 1190kHz and WOAI, San Antonio, Texas, on 1200kHz.

None of these stations will be there every day, indeed some may only be audible for one or two days a year in Britain, but if conditions are good they should be audible at least occasionally, and they are a lot more distant than the run-of-the-mill east coast stations.

Some Latin American and Caribbean stations

Sometimes, when conditions are not particularly good for North America, a number of South American stations can be heard. It is quite easy to log stations in Brazil (especially), Venezuela and Colombia, though some of the other South American countries are a bit more tricky. If you hear Spanish on 930kHz though, instead of CJYQ in

Canada, the chances are it is Radio Monte Carlo in Montevideo, Uruguay, although beware: the lower-power Radio Maracay in Venezuela is on the same frequency! Yet another station also on 930kHz which sometimes makes an appearance in Europe is Radio Antilles, a 300kW commercial station on the island of Montserrat. This broadcasts in several languages, including English and French and it also relays BBC World Service and Radio Canada International programmes for the Caribbean area. Despite being much higher power than the other stations on the same frequency it is only rarely heard in Europe. Which stations are audible on any given night depends on the prevailing propagation conditions, although with a good loop antenna it is sometimes possible to differentiate between different DX stations on the same frequency.

Finally, two other stations in the Caribbean area deserve a mention, as they present quite a challenge to the medium wave DXer. Firstly, Radio Paradise on the island of St Kitts, which broadcasts mainly religious programmes in English, used to be very frequently heard in Britain when it was on 1265kHz, despite strong interference from the Deutschland-funk transmitter on 1269kHz. Now however, Radio Paradise is on 825kHz and it is far less frequently logged. Another station that changed frequency, this time from 725kHz to 600kHz, is Radio SRS in Surinam. This was a difficult station to hear at the best of times, but now it is on the same frequency as more powerful Brazilian and Colombian stations.

I hope this introduction to DXing for broadcast stations on the lower frequency bands has inspired a few people to have a go at this fascinating aspect of the hobby. You can learn a lot about propagation and also get quite a thrill out of listening to stations thousands of miles away which are broadcasting only to a local audience. Good luck and good listening!

RADIO Tomorrow

Your at-a-glance guide to what's happening around the clubs, on the air and in general radio-wise.

- 1 Dec** Basingstoke ARC: Clandestine Radio, by G3VA.
Felixstowe DARS: Computer evening.
Welwyn Hatfield ARC: AGM.
Braintree ARS: Film Show.
Central Lancashire ARC: Xmas junk sale and AFS 2m contest planning.
Todmorden DARS: Social with talk by George Dobbs (mems only).
Worcester DARC: Talk on RAYNET.
- 2 Dec** Worksoop ARS: junk sale.
E. Lancashire ARC: AGM.
Fylde ARS: equipment construction competition.
Wakefield DRS: On the air.
Warrington ARC: Talk "Chirpsound and frequency management" by CPO McDonald of HMS Inskip.
- 3 Dec** Fareham DARC: Talk "Decoding Morse With A Micro" by G6TJT.
- 4 Dec** Spen Valley ARS: The Breathalyser(!)
N. Bristol ARC: Natter night and Committee Meeting.
S. Lakeland ARS: Film show.
Horsham ARC: AGM.
Shefford DARS: Constructors Contest.
- 5 Dec** Maltby ARS: activity night on air.
Dunstable Downs RC: Junk sale.
Coventry ARS: Talk "All about RAYNET".
Harrow RS: Activity Night.
- 8 Dec** Southdown ARS: AGM.
Milton Keynes DARC: Radio and Radar Navigation Aids.
Sheffield ARC: Christmas Social.
S. Cheshire ARS: Annual Social.
- 9 Dec** Dartford Heath DFC: Pre-hunt meeting.
Midland ARS: Christmas Party.
Chester DRS: Your Questions Answered.
Wakefield DRS: Mastermind Quiz.
Warrington ARC: Talk "Computer Security", by G3NFB.
Verulam ARC: Activity Night.
Dunstable Downs RC: Junk Sale.
- 10 Dec** Crawley ARC: Fish & Chip Supper.
Stockport RS: AGM.
Chiltern ARC: Xmas Party.
Trowbridge DARC: Main Meeting.
- 11 Dec** N. Wakefield RC: On the air.
Edgware DRS: Grand Junk Sale.
Pontefract ADARS: Video, Visit to China.
- Bredhurst RTS: Talk "An HF Vertical" by Mac, G3ZHZ.
Southgate ARC: AGM.
- 12 Dec** Maltby ARS: A direct conversion receiver for 80m.
N. Bristol ARC: Region 20 rep visit.
Coventry ARS: Night on air.
- 13 Dec** Three Counties ARC: Christmas Party.
- 14 Dec** Dartford Heath DFC: DF Hunt.
- 15 Dec** Milton Keynes DARS: Long Range Navigational Aids (USAF).
Felixstowe DARS: Family Social.
Welwyn Hatfield ARC: Christmas Social.
Braintree ARS: Christmas Social.
Worcester DARC: Xmas Skittles Night.
Pontefract DARS: Club Party Night.
Stourbridge DARS: Talk "QPR Kits" by G3ZOM.
Braintree ARS: Christmas Party.
- 16 Dec** Worksoop ARS: Computer Night.
Dartford Heath DFC: EGM at the Horse & Groom.
Biggin Hill ARC: Christmas Dinner.
Chester DRS: Construction Contest.
Wakefield DRS: Bermuda by G4JMT.
Chichester DARC: Christmas Social.
Fylde ARS: Hot Pot Supper.
Verulam ARC: AGM.
Warrington ARC: Open Forum.
- 17 Dec** Hastings ERC: Christmas Social.
Fareham DARC: Lecture "VSWR Facts and Fallacies".
Burton Upon Trent DRS: DF.
Cheshunt & District ARS: Cheese & Wine & Video Evening.
South DARC: Test Gear Demo.
SE Kent (YMCA) ARC: Christmas Social.
- 18 Dec** Bredhurst RTS: Christmas "booze-up".
Solihull ARS: Christmas Social.
Spen Valley ARS: Anti-Christmas Anti-Social.
S. Lakeland ARS: Christmas Night Out.
Shefford DARS: Chairman's Social.
- 19 Dec** N. Wakefield RC: Christmas Dinner.
Maltby ARS: Annual junk sale and Xmas buffet.
N. Bristol ARC: VHF Activity Night.
Coventry ARS: Social at Bull & Butcher.
- 23 Dec** Chester DRS: Christmas Buffet.
Wakefield DRS: Christmas Social.
Warrington ARC: Social with food.

- 29 Dec Felixstowe DARS: Social.
 30 Dec Wakefield DRS: On the air.
 2 Jan N. Bristol ARS: Xmas Party.
 Maltby ARS: Activity night on air.
 N. Bristol ARC: Xmas Party.
 5 Jan Todmorden DARS: Construction Competition.
 6 Jan Loughborough DARS: Cross band working from home QTH.
 Fylde ARS: AGM.
 Warrington ARC: Open Forum.
 Chester DRS: AGM.
 7 Jan Trowbridge DARC: AGM.
 Three Counties ARC: Talk "SEB Telecoms" by Steve Frost G4VNM.
 8 Jan Pontefract DARS: AGM.
 Bredhurst RTS: Talk "Antique Sound Recordings" by Colin Johnson of Radio Kent.
 Horsham ARC: Homebrew Evening;
 Edgware DRS: AGM.
 Spen Valley ARS: Rifle Shooting.
 9 Jan N. Bristol ARS: Talk (to be arranged).
 Coventry ARS: The (indoor) direction finding game.
 Wimbledon DARS: Social Evening.
 Maltby ARS: Building a multimode transmitter for top band.
 N. Bristol: Talk (TBA).
 13 Jan Loughborough DARS: Magazine reviews.
 Walsop ARS: Duff Xmas Present Sale.
 Warrington ARC: Talk "All at sea with electronics" by Jim Phillips GW3PRA.
 Chester DRS: Talk by the winner of the construction contest.
 14 Jan Fareham DARC: Morse Testing.
 15 Jan Pontefract DARS: Film "The Electronic Mountain".
- 16 Jan Coventry ARS: Night on the air.
 N. Bristol ARC: VHF Night in the morse room.
 20 Jan Loughborough DARS: Forum — Computers in Ham Radio.
 21 Jan Hastings ERC: Talk on British Rail Traction Engines by Brian Cornwall.
 Fareham DARC: AGM.
 Three Counties ARC: Treloar Hospital Radio by Paul Le Feuvre G0DBS.
 22 Jan Spen Valley ARS: Talk — Development of Sound Recording, by Tom Anderson G6DLA.
 Pontefract DARS: Annual Junk Sale.
 Bredhurst RTS: Junk Sale.
 23 Jan Coventry ARS: Annual Dinner.
 Bredhurst RTS: Christmas Dinner/Dance.
 Maltby ARS: Computers in Amateur Radio.
 26 Jan Felixstowe DARS: Visit to Hospital Radio Ipswich.
 27 Jan Loughborough DARS: Construction Evening.
 Worksop ARS: Talk on home brew solid state, by Bernard, G4SHU.
 Waterside SWC: TBA.
 28 Jan Fareham DARC: Talk "Satellite update" from David, G6XHR.
 30 Jan N. Bristol ARS: AGM.
 Coventry ARS: Night on the Air.
 Maltby ARS: A simple absorption wavemeter for 144MHz & higher.
 N. Bristol ARC: AGM.

Will club secretaries please note that the deadline for the February 1987 segment of Radio Tomorrow (covering radio activities from 1st February to 1st April 1987) is 17th December.
 The contacts list will appear next month.

If an advertisement is wrong we're here to put it right.

If you see an advertisement in the press, in print, on posters or in the cinema which you find unacceptable, write to us at the address below.

The Advertising Standards Authority. ✓

ASA Ltd, Dept 3 Brook House, Torrington Place, London WC1E 7HN

HAM RADIO TODAY **NEXT MONTH**

FT290 Auto-tone
A multi-mode multi-mod

Desert Island DX
Setting up a DXpedition — even to near shores — can be a lot of hard work!

HF Rx Project
Use the winter evenings to build your own all mode multi-band receiver

Famous Names
First of an occasional series on the people who really made radio

Co-ax Aerials For UHF
Make robust radiators for 70cm

Note: whilst all the above articles are in an advanced state of preparation, we cannot guarantee they will actually appear due to restrictions on space, etc.

BINDERS
 FOR YOUR VALUABLE COLLECTION OF HAM RADIO TODAY MAGAZINES

• SMART • EASY TO USE • TOP QUALITY

To ASP Readers Services, PO Box 35, Wolsley House, Wolsley Road, Hemel Hempstead, Herts HP2 4SS (0442-41221)

£5.20 inc P&P

Please supplyHam Radio Today Binders @ £5.20 inc. P&P



Total £ (Please make cheques payable to ASP Ltd.)

Years Required — 198.....198.....198.....198.....

Name

Address

Please allow 21 days for delivery

AMATEUR TELEVISION

A transmitter is of course no use without some method of generating video signals to transmit, your contacts would of course like something to watch wouldn't they? If you own a video recorder and are lucky

Don't try plugging the UHF output from the Spectrum into your transmitter, it doesn't work very well! You must tap off the baseband video feed to the internal UHF modulator and then feed this to your trans-

each other, enabling you to fit the buffer in the original modulator case, hence providing a neat set-up.

Circuit Test Card Generator

If you don't own a suitable computer or if you would like an instant test source without the need for program loading each time, the Circuit test card generator kit has proved popular with many ATVers. There however are one or two very important points which you should note concerning its construction.

Apart from being impressed at the good packing and instructions that come with the kit, you will not feel too impressed when you try it out! Firstly, there are two wire links described as being necessary on the board but link 'A' is *not* required and in fact the board will not operate if this is fitted. Secondly, several amateurs have found that their boards exhibit a 'race' condition between the data latch and multiplexer select lines. By delaying the select line for a few nanoseconds, by placing a small capacitor of 100-470pF between IC1 pins 12 and 1, you can get over this problem. The third 'quirk' concerns the width of the sync. pulses and subsequent positioning of the testcard. The turn-off characteristics of Q2 sometimes cause the pulses to be extended, fitting an 820R resistor (not 180R as sometimes recommended) between Q2 base and emitter will correct this.

Building the board requires a fine tip soldering iron and much patience,

Chris Lorek, G4HCL, rounds off his ATV series with a look at the various options for generating video signals. Take your pick from a purpose built test-card generator, a low-cost camera or a humble microcomputer!

enough to have some home videos to transmit, then by all means make use of them if the remainder of family approve! Most video machines give a 1V p/p output plus a separate audio output at the rear. Twisting the arm of a friendly ATV operator with a camera could set you up with a small collection of recorded material or several video rental outlets will hire you a camera for the weekend. Remember the licencing requirements for periodic call sign identification though!

For a 'stand alone' ATV station there are several methods of video generation, the easiest being the once-mighty, but now possibly little used, home computer.

Sinclair Spectrum Use

This is undeniably the most popular home computer with amateurs in this country, there is even a specific amateur radio users group for them. Keen program writers will certainly be able to generate many useful video sources from them. For the remainder of us who don't relish all night 'bug-hunting', the Worthing Video Repeater Group have produced an excellent program for the 16K and 48K Spectrums, providing a multitude of test cards, maps, station details and so on. These are available from G8XEU for £6.00

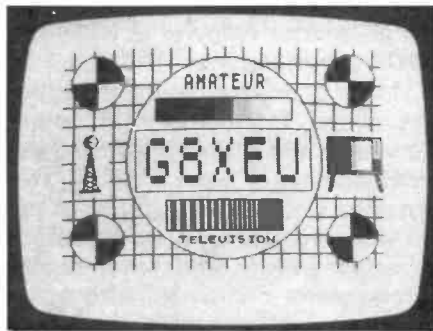

Worthing Group's Spectrum program

mitter via a suitable level setting potentiometer. This has been successfully accomplished by some amateurs, however the Spectrum circuitry sometimes objects to being presented with a low impedance load and a small buffer circuit is required for correct interfacing. Fig. 1 shows a suitable buffer and thanks are due to G8DHE for this 'fix'. Depending upon your soldering dexterity, component leads may be trimmed short directly soldered to

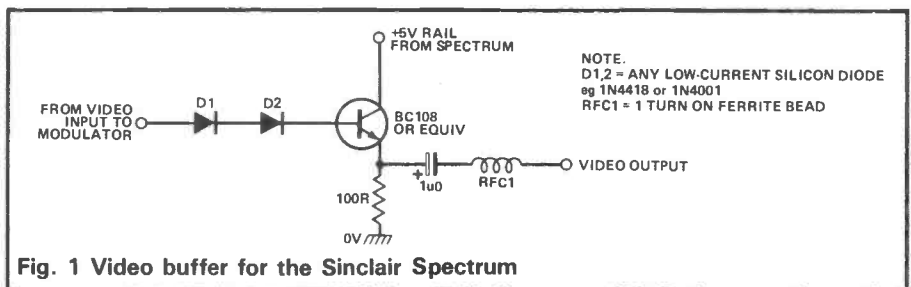
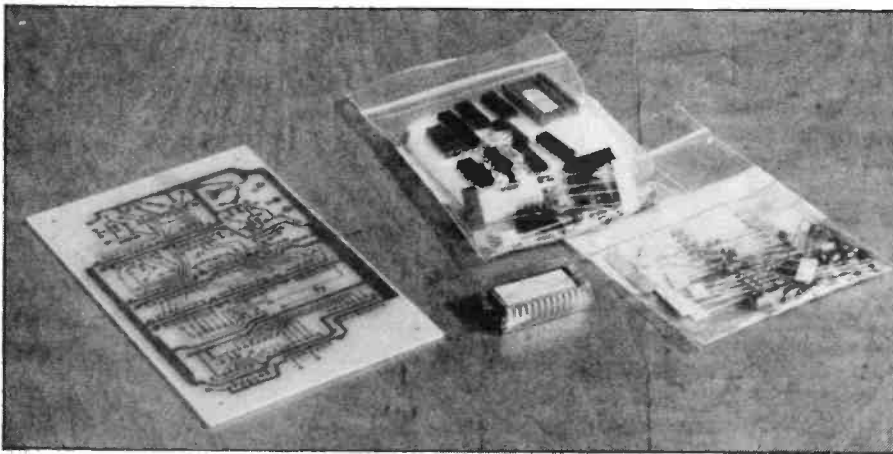

Fig. 1 Video buffer for the Sinclair Spectrum



it took me around two and a half hours to ensure a good job was made. The end result was worth the effort though and more than one 23cm repeater is known to be using this board due to the good results obtained. A plug-in Eprom is required to give the final image and this is not supplied with the kit but that enterprising Worthing group can supply a range of eight different styles costing £5.00 each, as well as add-on accessories for the unit.

The VK4901 Camera

Now we've got you started, let's move onto making you a TV star. As

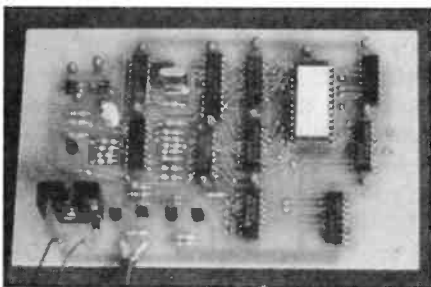

The Cirkit test card kit, built up

promised in Part 1, here are details of this little unit which are now becoming available and look set to take over from where the 'Lynx' camera left off. The VK4901 should be easy to obtain, Astley Video Services amongst others are already known to have had them for sale at rallies. The camera operates from a 12V supply normally fed via the coax cable and was introduced several years ago to be used in small closed circuit TV security applications. It has an automatic light sensitivity control (obviating the requirement for an iris adjustment) and operates from 3 to 30,000 Lux, so you won't need floodlights in your shack any

more! It gives a VHF AM modulated output with 6MHz FM intercarrier sound which in itself is of little use, but read on . . .

Inner Workings

To produce the modulated carrier the unit must of course first generate baseband sound and vision, Fig. 2 shows the basic line up. 2V peak to peak video is generated which is fed via an emitter follower to R3140, a 220R potentiometer. The slider of R3140 is connected to the output of the 6MHz intercarrier FM sound generator and is then applied to the VHF modulator via L5160. By removing L5160 and tapping off at the R3140 point we may feed the output to a transmitter and have instant 23cm video combined with inter-carrier sound. The source impedance here will be in the order of 50-100ohms, hence matching reasonably well into most 75ohm video systems including the DC 24 FMS transmitter.

Surplus cameras are normally

preset to 6MHz sound which is the most commonly used standard, but you can tune L5238 to 5.5MHz if you wish. Fig. 3 shows other adjustment points and the location of the components involved in our modifications. If you do not want the inter-carrier sound facility simply remove C2236, a 5p6 capacitor feeding R3140. In this case amplified audio from the built-in microphone is available across C2230, a 47p capacitor.

Power for the camera can be supplied by feeding it up the coax as originally designed. However, this requires the PSU to be well de-



The Cirkit test card on-screen result

coupled for RF and overall a separate power feed is recommended. 12V DC is normally tapped off from the modulated RF in the camera by L5171, remove this 4uH7 coil and apply +12V nominal directly to the original connection point at the opposite side to the coax socket connection of course. An internal regulator circuit is used to provide a stabilised 9V supply as the absolute regulation of the applied voltage is not of great importance. The current

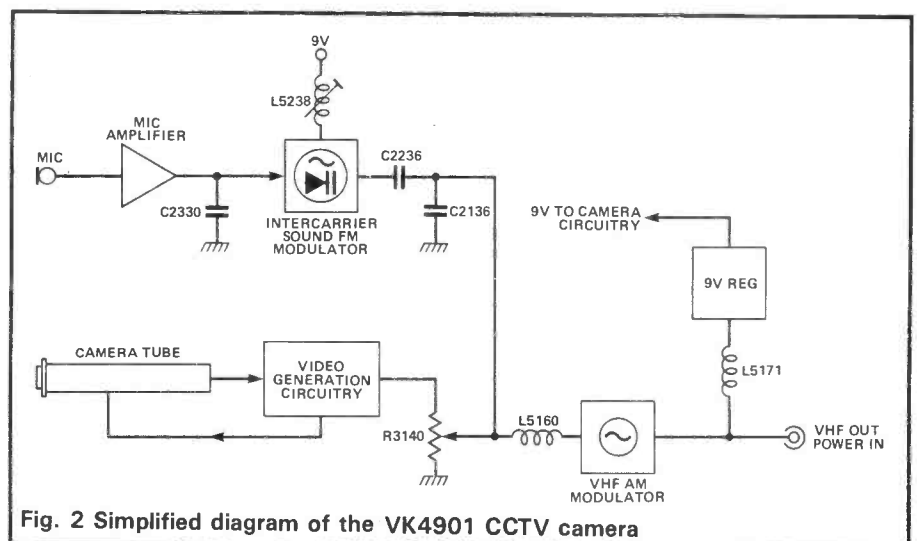
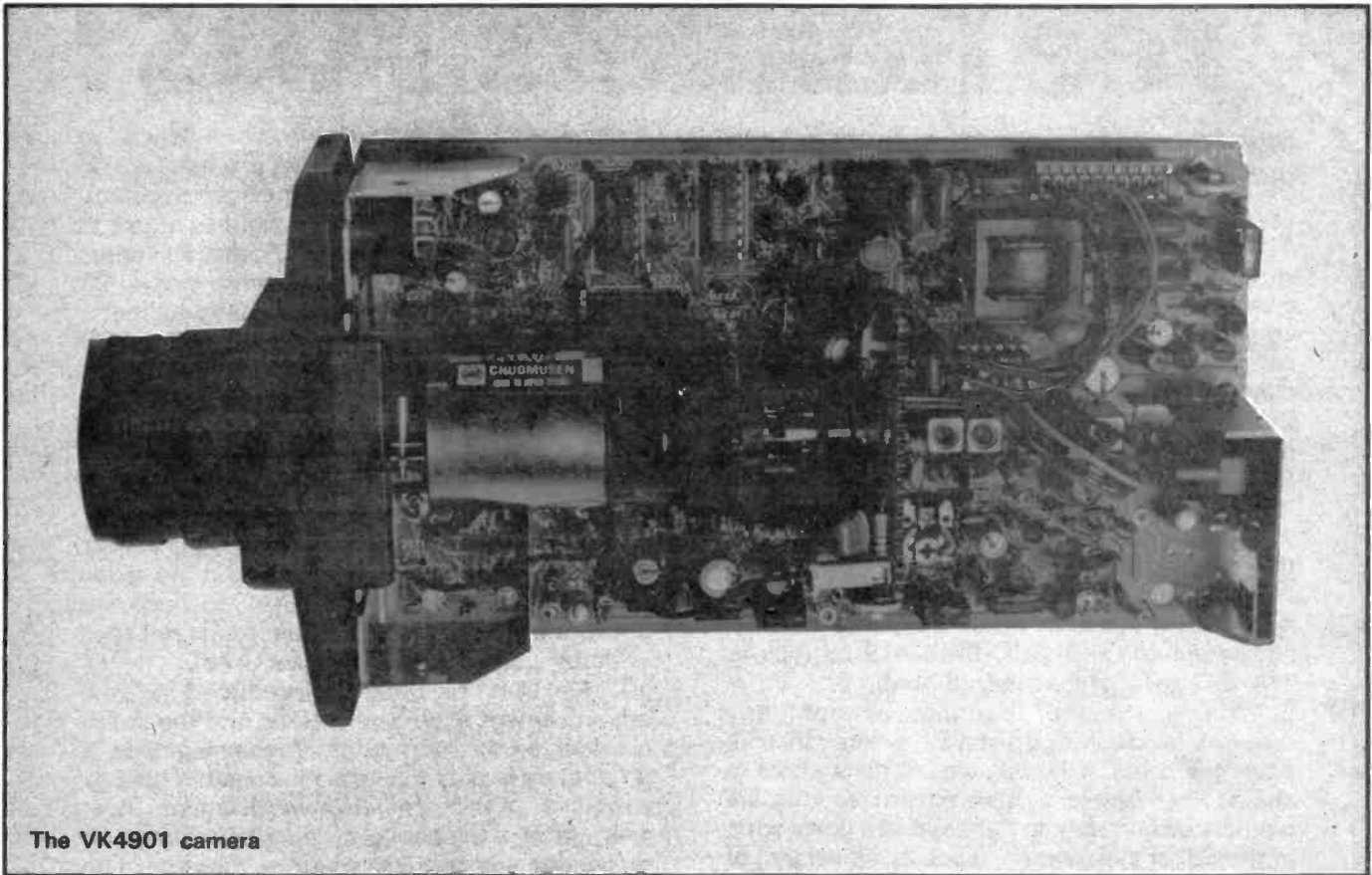

Fig. 2 Simplified diagram of the VK4901 CCTV camera



The VK4901 camera

drawn in operation is 200mA maximum.

Final Thoughts

This concludes the series on starting 23cm ATV and I hope that it may spur a few amateurs to have a go on a mode which is increasing in popularity. Equipment can be relatively cheap, aerials are far less

obvious than for other bands and as more TV repeaters are set up ATV activity is on the increase. Finally, if you're within range of GB3PV you'll be able to see how ugly my shack looks!

Suppliers

The Astec modules, received motherboard and complete kits of

parts are available from Comex Systems Ltd, Comet House, Unit 4, Bath Lane, Leicester LE3 5BF (0533 25084).

Members of the BATC may obtain receiver PCB's at low cost from the Membership Services Dept.

The 23cm TV preamp kits are available from Camtech Electronics, 8 Wortham Place, Haverhill, Suffolk, CB9 0HP (0440 62779). Kit price £22.50 +£1.00 p/p.

The DC 24 FMS transmitter is available from DC to Light, 15, Bursley Way, Bradwell, Newcastle-Under-Lyme, Staffs. ST5 8JQ (0782 639406).

Spectrum programs and Test Cards Eproms from the Worthing and District Video Repeater Group, Mr. R. Stephens G8XEU, Toftwood, Mill Lane, High Salvington, Worthing, Sussex. (0903 67228).

Surplus surveillance cameras from Astley Video Services, 34 Withington Dr, Astley, Manchester. M29 7NW (061 790 4649); also Topline Trading Techniques, Audley House, High Street, Horningsea, Cambridge. Tel: (0233) 861153.

Test card generator kit available from: Criket Holdings PLC, Park Lane, Broxbourne, Herts. Tel: (0992) 444111.

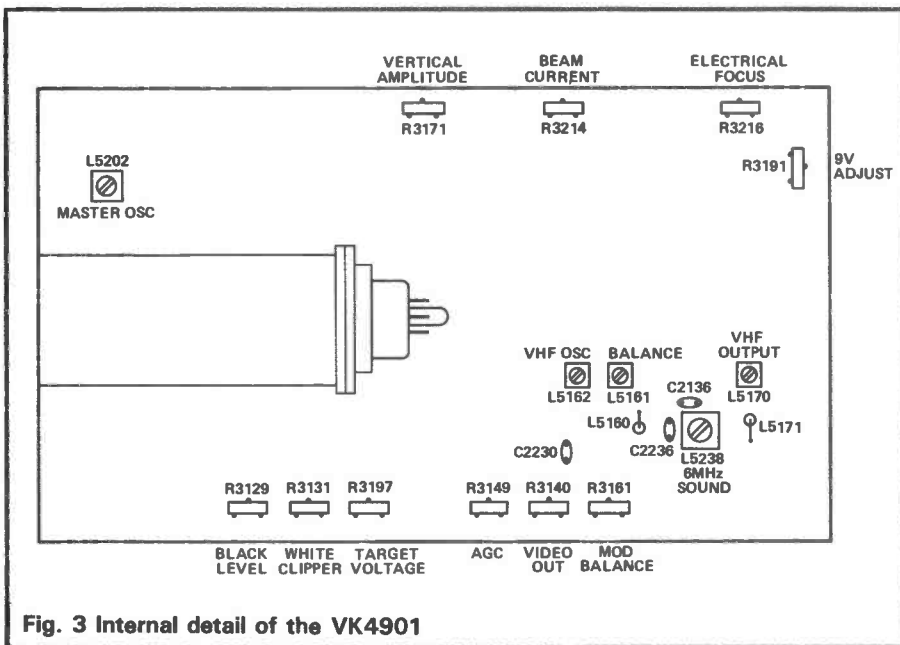

Fig. 3 Internal detail of the VK4901

Free Readers' ADS!

YAESU FRG 7700. General coverage receiver and FRT 7700 tuner, both boxed, little used. £240. Yaesu LF filter FF5 unused. £5. YW-3 SWR power meter unused. £10. Phone 0253 68981 (Lancs)

DATONG AD270 indoor active antenna, complete, £25. No 1 Kent Gardens, Hetton Le Kent, Tyne Wear, DH5 9LA.

DRAE slow scan transceiver mint cond. £250. Ring Worcester 775206.

2 MTR's FM mobile transceiver, standard C8800, 1 or 10 watts, fully synthesised, mobile mount, ideal base or mobile, scan on rig and mike, memory. Excellent condition. £115. Phone evenings, or weekends, Chas 764 6767.

TRIO TH21E with original packing, used twice only. Nicads, charger, BNC adaptor. £145. G1010. Phone 044 46 42122.

TRIO TS820S and complete station, mint condition. £600. Also Trio TR2400 2m handheld with accessories £195. Tel Ayr (0292) 285281.

SONY stereo amplifier tuner TA1630, 100 watts per channel, £70. Trio 94S9DS receiver, good working order. £40. KN Viceroy serves Mark 3, paintwork bad needs overhaul, schematic included no mic, £70. Phone Ian, Dundee 0382 623500.

ADVANCE 052200 mainframe oscilloscope, not working, £45.00 ovno, AVO transistor and diode tester, £15.00 ono. BBC model B computer with Sanyo colour monitor, dot matrix printer and cassette recorder, includes all manuals and some software, £475.00 ovno. Mr K. L. Phillips, 01 743 0811.

RS COMPONENTS 1986 data update pack, only £5.75, including p&p. 01 751 0940, Paul G1GMZ.

EDDYSTONE S770R receiver for sale 19 Mc/s-165 Mc/s 6 ranges with muting CW. AM NFM FM, later model black facia Eddystone lighthouse emblem on top, unmarked, pristine condition. Re-valved, re-condensed, re-aligned,

works, standard. £90, buyer collects. Eyles, Malvern 62385.

TRIO LF30A. Low pass TVi filter, brand new in the box, unused. £20. Tel Chris 0562 754388, (Kidderminster, Worcs).

COMMUNICATION receiver, realistic DX302 0.15-30MHz, USB/LSB AM digital readout, mains, battery. Morse practise output, triple conversion, wide, narrow, IF selectivity, as new. £110. C. J. Graham, 8 Oaktree Drive, Ecclefechan, Dumfries, DG11 3EH. Telephone 057-63-494.

YAESU FT290RH handheld rig for sale, rave reviews in press, complete with MMB21 and FBA5 with FNB4 nicad pack, costs over £300 new, will accept £200. Contact Dave on Plymouth (0752) 263276. Handheld scanner considered in PX with cash balance.

IC505 6m transceiver, boxed, as new, £250 ovno. TS430S HF transceiver, few minutes use, RX only, boxed, as new, unmodified, £495. AT230 ATU, £95. Generator 1.2kVA 110/220V ac, 12V dc, hardly used, £120 ono. Telephone Dunstable (0582) 606983.

TOWER self standing 40ft lattice, £100; Teletype computer terminal, £20; FTDX401, top band mod, external VFO, speech proc, offers! Wanted - cheap RTTY terminal eg ZX81 plus software, hardware. Brunel University Ars, c/o Students Union, Brunel University, Kingston Lane, Uxbridge, Middlesex UB8 3PH.

YAESU FT707 transceiver for sale, £315, excellent condition, see it to believe it, 100w output, 3.5-300MHz; AM, SSB, CW/W/N not a scratch. Please phone Adam, 01 874 2142, G0FJJ.

ADVANCE Q1 signal generator, 7.5-250MHz, £25. 5BM254M pa valves, £1 each, gun brass pounder key with slate base, £25. Racal RA17L handbook, £6; HRO series handbook, £4; Pye Bantam HP1FM handbook, £5; Pye Westminster W15FM hand-

book, £5. Phone 0437 2015, evenings.

AMT-2 terminal unit, as new, AMTOR, RTTY, CW, plus software for Apple IIE micro, £195. Tel Southport (0704) 69410.

HAM INT Jumbo Multimode, vgc, boxed, 240v ideal for 10m, £110 inc p&p or exchange for as new Sigma IV plus cash adjustment. Mr P. Hawkins, 4 Albert Road, Cinderford, Glos.

1KW FOUR valve 240v linear amplifier, two meters, plate and load, SWR adjustment control variable output fan etc, £200 with two spare valves or exchange old mechanical one armed bandit/s. 021 747 6842, Birmingham.

KENWOOD TR2500 case spkr mic, needs new display, £150; 2M (MM) converter, £15; FRG7 receiver, £80; 5/8 mag mount, £10, JVC TMP3 3" colour monitor, new, £150; Marantz CD54B, new, £150; Technics SUV4X, 60 plus 60w, £125. Call Bob Ingatestone, (0277) 35 43 78.

SOMMERKAMP FT2772D like the 101ZD, good condition, DC converter, microphone, just had new valves. Buyer tries and collects. £425 ono. Also a matching ex-speaker SP901 at a reasonable price to the buyer of the FT2772D. Warwick 497497, anytime.

TS700 2M multimode TX/RX, FM, AM, SSB, 10w VFO and 2 Xtal channels, RPT shift. 250v or 12v. £220. Phone 021 327 0606.

934MHz COMMTEL transceiver with mobile antenna and extras, £330 ovno. Buyer collects or pays postage + insurance. AR88D receiver, £60, buyer collects or exchange for Revco PA2 in-line pre-amp. Trio 120V-HF transceiver, £270. SPC-300D AJU, £170. Tel (0704) 892088.

YAESU FRG7700 receiver and FRT7700 antenna tuner as new condition, original packing, manual and WRTV handbook. Warminster (0985) 215230, evenings. £250.

YAESU FTG7 communications receiver in mint condition, complete with the Partridge variable frequency antenna system, £76. Griffiths, 97 Hunter Street, Briton Ferry, Neath, West Glamorgan. 0639 812377.

FT790R 70cm multimode complete with nicads, charger, case and accessories, vgc, £285. Bob, G4OAC QTHR, Rochdale 50174.

TRIO R-600 synthesised receiver, £210 ono. Also Yamaha PSS401 portatone keyboard, 3½ octaves + octave down, 10 voices, 6 rhythms, £65, or both for £260, to include 100 miles delivery. Tel: Bury St Edmonds (0284) 704152, evenings, weekends.

TRIO R-1000 communications receiver, 200KHz-2MHz coverage, handbook, £150. Can be seen. Edinburgh, Midcalder (0506) 880279.

HAVE PHOTO relay alarm module with infra-red pulsed beam, separate emitter and receiver heads, control module, 250v AC, internal relay, brand new. £20 post paid. Phonw (0207) 544342, evenings, weekends.

ICOM IC24G 2m 10w FM transceiver, as new, boxed with manual, plus 7/8 mobile whip, £180. Tel 0475 673748, evenings and weekends.

HYGAIN TH3JNR three element beam antenna, 10/15/20 metres and CD45 rotator complete with 25 metres 8-way control cable, excellent condition. Buyer collects. £320. G4MBP. Phone Cheltenham (0242) 527651.

PYE PF5UH 70cms crystallised R6, ni-cad, leather case, £43.00. Pye PF2 UB, three channel (less crystals), speaker/mike, ni-cad, £40.00. Or £70 the pair ono. Both excellent condition. Technical details/information, etc included. Please telephone: Roy G0BZT on Sedgley (09073) 78792.

MICROWAVE modules, 25 watt linear amplifier, suit FT207/8, FT290 etc. 3SK88 front end. £30 ono. Phone

Mike G4JXX, 021 773 8139. **FRG9600**. All mode scanning receiver, 60-900MHz, 5 months since new. £300. Telephone Bishop Auckland 663324.

FOR SALE. Tono 550 communication terminal, manual, 12 Novex monitor, PSU books, RTTY Today World Press Services, Radio Teletype Press Broadcast, Introducing RTTY, all 2-year old, good condition. £275 ono. Buyer collect, phone Chelmsford 0245 356531.

SALE: WPO DSB-2 transceiver, fully built, tested c/w digital display, £100 ono. WPO VHF Minisynth, all crystals, built, tested, £45. Pye W15AM 70.26MHz, £30. Pye Bantam, FM 156MHz, untested, £20. Ex-WD MF156 transceiver c/w accessories, £40. G3VKM QTHR. Tel 050277 622.

ICOM 745PS15 mint, SH6, £820. Telephone Robby, 0698 459301, after 6 pm.

FOR SALE. 2 ele tribander 10.15.20, full size aerial, £120. 6 months old. 021 354 2877, Birmingham, phone after 6pm.

COLOUR GENIE computer, used once, ready to go on air, RTTY/CW, split screen, type ahead new recorder, b/w TV. £140. Will split or exchange for KW2000A or KW2000B. Pay difference, buyer collects. Ill health forces sale. G3ZLN, Ipswich 49139, Noel.

HEATHKIT SB104 solid state transceiver. SB604 P.S.U./Spkr. SB644 remote V.F.O. SB634 SWR/PWR, 24hr clock, console. £375. Heathkit Apache TX-1, Mohawk RX-1, SB19U sideband adapter, one complete TX1 spares or repair. £95. DX200 receiver, mint. £75. Richardson, Becksyde, Cowmoor Bridge, Stockton Lane, York YO3 9JA. Tel 424817.

HW101 PSU, GWO, £80. Minox B camera, £60. Marconi TF144G signal generator, sensible offers over £30. ICZE sp/mic, nicads, vgc, £140. All items buyer collect. G3GZH, telephone 0582 872407. Whipsnade.

D.N.T. B40FM 40 channel CB ideal for 10 metre conversion, £25. Complete b/w darkroom, enlarger, electronic timer, dishes, chemicals, etc. £35. G3GZH, telephone 0582 872407. Whipsnade.

U.S.A. Ima meter 2 3/4" round-body, £3; others flexible drives

7 1/2", 10 1/2", M,F 1/4" ends, £2 each. YAESU FSP1 8ohm speaker, mobile, extension, £4.50. Wanted — Service manuals F.D.K. expander 430 (late) and 750E. Can post. G3MBL (Bury St Edmonds) 0284 60984.

YAESU FT726R. 2m + 70cm narrow CW, filter fitted with 90 watt tono linear, pristine condition, boxed with manuals. £650 ono. Tel evenings (0203) 456128, Coventry.

FOR SALE. Oscilloscope, Hitachi dual beam model V-152F 15MHz, probes, carry case, vgc. £175. Phone 031 668 3451, after 6 pm.

SUPERSTAR 2000. Mint condition, offers over £130, also Cobra 148 GTL PX 20+—KC shift no gaps!, G.W.O, £95 ono. Tristar 777, G.W.O SKCSHIFT. Offers around £90. W.H.Y. Tel 0934 511604.

IC7LOA TCVR amateur bands plus general coverage RCVR, vgc, used regularly. £550. Tel East Grinstead (0342) 312374, GOCJU.

FT290R YAESU 2m portable transceiver, complete with carry case, ni-cads, charger and rubber ant. Boxed, one year old, used very little, £255. Phone Leic (0533) 875192 (Evenings).

FOR SALE. AR2002 receiver, as new £350. London. Tel 228 4835.

OSKERBLOCK SWR/Power meter ohm, 75/52 ohm, £22. 2 meter converter, £12. Semi-automatic bug Key KY102, £8. Pair 7.1 Wight traps, £7. 8 years Rad/Com 1978-1986, £6 per year. All post paid, Trio TL911, 2KW HF linear amp, revalved. £300 + carr. GM3CAN QTHR. Phone Bonnybridge 8124269.

3 **WATT** amplifier's. £2.00. Tel 383380. 16 Low Hatters Close, Downham Market, Norfolk.

AR2002 scanner, almost new, boxed, £360 or would exchange Realistic DX400 plus £200. Cash adjustment, buyer collects. Phone Blackpool (0253) 27406.

BRITISH NATIONAL Radio and Electronics course for sale or WHY. Cost £50; never used, ring Stan, Carvell 021 744 9371, daytime 021 459 4913.

FOR SALE. CWR610 RX unit CW/RTTY. Prince Green monitor, £175 complete. Tel Don 0227 721400.

FRG9600 25-905MHz mint condition, £375 ono. P. Spencer, 39 Fen Road, Heighington, Nr Lincoln, LN41JL, Tel 0522 792640.

WANTED

WANTED. Yaesu 7700 receiver or similar, reasonable price please. Mr Harris, 6 Panddy View, Trelewis, Treharris, Mid Glam, S. Wales. Tel. Treharris 411664.

A FREE GIFT. Can anybody supply me with a copy of the Complete Frequency Coverage for the Whole Audible Radio Range and it's Allocation. Please, I will copy and return or you copy for me, I will pay all expenses, and will give yo a free gift for your help. Please call Brian, Brighton (0273) 559373.

WANTED. 902DM with handbook, etc. Fair condition, fair price. G3ICG. QTHR. Phone Ipswich 0473 688491, anytime.

WANTED. **COBRA** 148, superstar 360, Hy-Gain V. Must be in perfect condition. Tel Belfast 795783.

WANTED. **EDDYSTONE** EC10 MKII manual to buy, borrow or copy. Geof Tonge, 19 Longmeadow Road, Saltash PL12 6DW. 075 55 3533.

WANTED. Ham Radio Today, February 1983 edition. Exchange C-scope 3000 ADC metal detector, cost £250 for HF, VHF, UHF, WHY? Phone Colin, Sedgley 64486.

WANTED. Urgently by handicapped operator. Kenwood T-599S TX, either cash or exchange for my converted Cobra 148 GTL-DX 28.0MHz to 29.7MHz, m/mode, inc CW or any of three 2 metre FM, Mobile rigs, Peter G1TX1, 2 Mayes Close, Norwich, NR5 9AR.

UEL COB. Handheld AM/VHF transceiver, does anyone have circuit details or technical information that I can borrow to copy? or will pay for copy and postage etc. Phone George, Runcorn 09285 75904.

WORDPLEX word processor, technical information and/or circuit details required. Borrow to copy or pay for copy and postage, etc. Phone George on Runcorn 09285 75904.

WANTED. Operators manual for Yaesu FR DX 400 or photocopy. Tel Burley 2447. QTH 33 Warmes Lane, Burley, Hants BH24 4EH.

WANTED. Good Multi band receiver, capable of receiving marine, air, emergency services etc. Age not important, also person willing to teach raw beginner amateur radio. Willing to pay modest amount, please contact A. M. Guy 16 Goulbourne Road, St Georges Shropshire TF2 9LE.

STINGY FATHER desperately needs cheap 2m hand-held or 2m mobile multimode for son's 18th birthday. Phone Jeremy, Berkhamsted (04427) 71386.

WANTED. Service manual for W15U Pye Westminster, original or photocopy, also April 1986 edition of Ham Radio Today. Please write to Mr A. Holmes, 61 Surtees St, Bishop Auckland, Co. Durham. DL14 7DJ.

WANTED. Quality receiver, by enthusiast returning to hobby, RA71 or similar etc. Cash waiting, will collect, N.W. area. Please phone Rob (051) 263 3026.

WANTED. Yaesu FT780R 70cms mobile. Phone evenings, Chas, 01 764 6767.

WANTED. Integrated circuit type MC1349P, G3ADS, 21 Newcome Road, Farnham, Surrey GU9 9DJ. Phone 0252 710501.

WANTED. Heathkit AFM-TI tuner (working); S33H amplifier (spares, cheap); General coverage receiver, working, (Eddystone, Marconi, Hallicrafters, etc) must be cheap. Avometer model 8 or similar, cheap. Have Pye L75B battery (90v+1 1/2v) receiver. Sale or exchange. Birmingham (021) 770 9510.

WANTED. Top quality loop antenna for medium wave. Good price for best available. Ring (0772) 704009, after 6pm.

WANTED. RACAL MA144 ATU, condition not important, but must be original and no mod's. Top price paid, will collect, distance no object. £1 or G. Land. Also RA63G SSB adaptor. Write or phone. G. Fitz-Gerald, E16DP. 40 Maigue Way, John Carew Park, Limerick, Ireland. Tel 061-43584.

WANTED. KW109 Super match ATU, must be ex cond. Tel Pete, Nuneaton 343680.

WANTED. Free standing external digital display for FRG7 plus instructions. One was by MG Communications, approx

year 1980. 31 Edward Ave, Jacksdale, Notts. NG16 5LB. **WANTED.** Discone antenna, 25MHz 500MHz, good condition. Phone 0476 66047.

WANTED. General Coverage Communications receiver JRC NRD525 or JRC NRD515 or Panasonic RF900 or Sony CRF 330/320 or Sony ICF 2001D. Either one in good condition. Tel Bristol (0272) 570330 or 663222.

WANTED. Trio all band SSB transmitter, model MOTX 310. Ring John 0772 715045.

WANTED. FTV901 complete with all module if possible. Phone after 6pm (0268) 24453 or day (0268) 3040 extn 637 Ron.

WANTED. Buy or borrow handbook on Heathkit DX-100v. G4VGS QTHR 02774 4177. D. A. Whitbread, 284 Perry St, Billericay.

WANTED. Pye Westminster model W15U. Serviceability immaterial but must be complete. Phone 0689 29116 (Kent).

WANTED. Sommerkamp 788DX or 30-40 HD PSU or any F707 accessories or SPC3000/TU SPC300UTU in exchange for 48K Spectrum, micro drive, interface I, book and leads, boxes and cassettes, b&w monitor 12". Also have Plustron TVRDL TV, radio and music centre combination, portable, will exchange. All or most if offers good equipment and genuine deals. As well as reasonable financial offer I would like to swap a KW107 for a SPC300 or the KW107 plus KW227 ATU for a good working SPC300. G4XPP, QTR.

WANTED. Any information on NDI HC1400 2m FM TXRX owners manual, service info required. Also mobile mounting bracket for above rig. Please contact Jerry, GOCUO QTHR 091-4107884 (Co Durham).

QUALITY digital general coverage receiver required. Will consider up to half original cost. Offers to Mr Welsh, Maldon (0621) 54547 (Essex).

RADIO/RADAR EQUIPMENT WANTED by private collector: Receivers CR100, BC348, HRO Senior, Collins 75A4, APR4 and tunint units, and any radar surplus units including transmitters, receivers, modulators, indicator

units, etc. Will collect. P. Bristow, 6 Finmere, North Lake, Bracknell, Berks.

WANTED. Ham Radio Today, December 1984 or photocopies of part 4 Alpha Transceiver and Project Omega, money will be refunded.

WANTED. Front panel (Plastic and fascia) Cobra 148GTL DXII. D. Jones, 6 Ashfield Road, Shotton, Deeside, Clwyd CH5 1AQ.

WANTED. Pye model M78F personal battery receiver. This set has the Pye rising sun emblem with a black and cream plastic case. Fair price paid. Please contact Stan, G3XON, 14 Dagden Road, Shalford, Guildford, Surrey GU4 8DD. Tel Guildford (0483) 36953.

WANTED. FP707, FP700, FP757 HD or similar 20amp commercial power pack. G3KNA, phone 0274 873122.

WANTED. Doctor DX cartridge for C-64. Must be in GWO with instructions. Phone after 6pm, Andrew, G1SKT, 0902 753567 (Wolverhampton).

WANTED. Yaesu FRG7 or FRG7700 receiver, reasonable price for blind son. Phone (0272) 657666. (Bristol)

WANTED. IC211E, preferably with Mutek front end, must be in very good condition, with manual. For sale FM03 FM IF strip for IC720/A. New with CCT and all instructions. £40 (Cost £80 from Thanet) G4CTE QTHR. Phone Grimsby (0472) 840367.

HRO. Can you, with love and devotion, mend mine? Phone Julian 01 876 8113, Kew, Surrey, evenings.

WANTED. HF linear amplifier, commercial or home brew. Any condition considered. Tel 0608 811102.

WANTED. Lowe Mk1024 electronic keyer with memory, also Sony TV-511UK and Sony KV-9000UB. Must be in first class condition. Phone 0206-394336. Essex.

WANTED. Good quality used equipment, HF, VHF, UHF WHY? Cash waiting for the right article. I have lots to sell, swap and part ex. Phone 0924 495916 or write Martyn Bolt, 112 Leeds Road, Mirfield, West Yorks, WF14 0JE (G4SUI).

HF TRANSCEIVER wanted with or without general coverage receiver. Also any associated equipment, late

model/s, 2m rig also. Please call after 6pm. G3GZT. 0273 503869, giving details and prices.

WANTED. FT225RD, cash paid for rig in any cond, prefer with Mutek and memory unit. Also 144MHz QRO valve linear home brew considered. Also Mirage MP2 meter. Will collect any distance. G4JBH QTHR. 0935 23873, evenings.

WANTED urgently, KW EZEe match antenna tuner, your price paid, all letters answered. Art Smyth, 8 Cleave Crescent, Morwenstow, Bude, Cornwall EX23 9JH.

EXCHANGE

EXCHANGE Sanyo video 5000, mint, Beta, low mileage, incl 5 tapes for FR50B or 9R590S or FR100 or JR500 or CB multimode or sell for £78. Ring 0634 63752 or 660037.

EXCHANGE Mint Trio 9130, 10 hours TX only, plus 100 watt mm linear for good HF transceiver + ATU or sell £550. Colin PO Box 79, Gloucester.

EXCHANGE BBC B computer, boxed, unused, 2xSony ICF 7600D receivers, 48K spectrum Plus, lots of software, hardware, wafer drive, Datong active antenna, RC oscillator, Harrier base station CB. **WANTED** 2M base rig, FT209 R/H, NC15 base charger, 2M+70cm linears, UHF wave meter, 23cm ATV gear or WHY. G6RBK 0923 662817, after 9pm.

EXCHANGE Yaesu FT7 HF transceiver plus FP12A PSU in nice condition for Trio TS700G, 2 meter, multimode transceiver or similar rig. Don't be shy, give us a ring. Allness 882941 or write G. Matthew, 2 Old Milnafua Road, Alness, Ross-Shire IV17 0TW.

EXCHANGE Prinz Compere Super 8 projector and Chinon Classic 722 auto 200m lens cine camera all as new for medium duty rotator or HF TX, ATU 100W +. Mr J. Graham, Clintpark, Ecclefechan, Dumfries. Phone 057 63 615.

EXCHANGE Eddystone 640C receiver 1-30MHz BFO etc and Pye pocket fons 2PF WFMB with batts, mics, etc, will convert to 2M or Marine, G.W.O. Swap for compact VHF/UHF receiver or Murphy CB home bse and H/base mic. Phone

Mike, after 6pm, 0243 56523. **VOIGTLANDER VSL 3-E** 1.8/50 power winder, Tamron mount, 2x converter, Tamron 28-70 wide angle, new. Tamron 80-210 macro zoom, Vivitar 2500 bounce zoom thyristor flash, Hitacon auto 3000C cut off bounce flash, mint; EXCHANGE for modern digital communication receiver ie. Yaesu 4-600.

EXCHANGE Ham International Jumbo compatible for 10mtrs swap for Yaesu FRG700. Phone evenings, 01 783 0521, ask for Adam.

PENTAX ME Super 35mm SLR camera, with 135mm, 28mm lenses, flashgun, and tripod. All as new. Will exchange for 70cms multimode transceiver. Phone Stuart (Gippy) after 5pm weekdays, anytime weekends 0604 847009.

EXCHANGE Spectrum 48K new condition, with RTTY/CW program for HF amateur band, RX in good condition, FL200B, FL400B, WHY. Chris, Falkirk (0324) 26210.

EXCHANGE TS430S PS430 for HF TXCR preferably Icom to operate Amtor RTTY. S. Hudson (0480) 53775.

70cms TRANSCEIVER wanted, exchange for 3½" reflector telescope. F460 Pye base station, UHF, tuned 456MHz. Requires retuning to 432MHz. £40 ono. G8BSK, 290 Priory Road, St Denys, Southampton SO2 1LS.

EXCHANGE. Wanted Commodore 64 or 128, also disk drive. Exchange for Ham International Concorde II and HI TW232 DX microphone, and/or fully automatic electronic GGG incubator. All as new and boxed with instructions. (Never been tampered with!). Phone John 084 82 314.

EXCHANGE ATV station, microwave modules MTV435 transmitter and ATV converter. RCA2000 camera 16mm lense. KGM 12 inch monitor with maintenance handbooks, for 70cms multimode transceiver. Phone Johnstone 24930.

EXCHANGE. Inflatable yacht tender complete with floor boards, anchor LJ's etc, with 2hp Suzuki ob engine, all as new. Worth £250 for good HF rig, cash adjustment if required. Tel (0562) 67026 (Kidderminster) anytime.

HAM RADIO CLASSIFIED TODAY

Lineage: 48p per word VAT inclusive (minimum 15 words) **Semi Display:** (minimum 2cms) £7.35 per single column centimetre. **Ring for information on series bookings/ discounts.** All advertisements in this section must be prepaid. Advertisements are accepted subject to the terms and conditions printed on the advertisement rate card (available on request).



01-437 0699 Ext 289. Send your requirements to: Ham Radio Today Class. Dept., ASP Ltd., 1 Golden Square, London W1R 3AB

COURSES

RADIO AMATEUR LICENCE

Start training now - No previous knowledge required. Study for 3-6 months. Post Coupon now for free brochure - without obligation:

Radio & Telecommunications Correspondence School, 12 Moor View Drive, Teignmouth, Devon. Tel: 06267 - 79398.

(HRT/J)

NAME:

ADDRESS:

..... POST CODE.....

AERIALS

ANTI-T.V.I. Aerials, traps for beams or wire aerials, baluns, kits etc. Data 26p large SAE. Aerial guide £1. G2DYM Uplowman, Tiverton, Devon EX16 7PH (03986) 215.

NEW SHOP LUTON: Come to us for your aerial requirements! We also repair, install and calibrate amateur equipment. Wide range of CB & p.m.r. also available. Ring 0582-458310.

CB AND ACCESSORIES

THE NORTH'S Leading C.B. Distributors including 934 Mhz equipment. Please ring 0388-528464. Ian Fisher Communications, CB Works, Stanhope, Co. Durham DL13 2YT.

COMPUTER EQUIPMENT

*** **68008 SINGLE BOARD COMPUTER**, contains:- Disc Interface, Colour Display, 8K Monitor, Megabyte RAM, 2 Serial/Parallel Ports, RTC, runs SK-DOS-68K. Bare P.C.B. or built. Also 6809 Micro-Set System. S.A.E. Ralph Allen Eng, Forncett-End, Norwich.

SERVICE MANUALS

SERVICE MANUALS. Amateur radio, test, audio, TV, video etc. Thousands stocked. SAE enquiries. Mauritron (HRT), 8 Cherrytree Road, Chinnor, Oxon.

COILS AND CHOKES

MAXI - Q

COILS AND CHOKES PREVIOUSLY MADE BY DENCO

SAE PRICE LIST

8 BRUNEL UNITS, BRUNEL ROAD, GORSE LANE IND ESTATE, CLACTON, ESSEX CO15 4LU. TEL: (0255) 424152

FOR SALE

G3LL's 6M BARGAINS
 FT690R £329 p.p., 6M units for FTV 901 £139 p.p. J-Beam 4 E1. (Callers only) £43. Valves type approved Yaesu FT 101 Mk1-B 6JS6C NEC £30.75 p.p. FT 401 6KD6 (Green banded) NEC £33 p.p. 6146B G.E. FT 901/101ZD £27.25 p.p. NEC 12BY7A £10 p.p. **Improve your FT 101 MK1/E** Double balanced mixer £17 p.p. 3 band WARC kit £16 p.p. State Model.
HOLDINGS/AMATEUR ELECTRONICS, 45 Johnston Street, Blackburn BB2 1EF Tel: (0254) 59595.

CARDS, STICKERS

G4TJB qsl cards
 Personal and standard designs. SAE Samples, 100 Matt colour DIY £2.50, Gloss £3.50. **LOGBOOKS** £2.20 (mobile £1.20). **BURO ENVELOPES** £1.00 (20). **NAVY SPECIAL MOBILE AND BASE HF ANTENNAS.** SAE for details:
G.C. PATTERSON G4TJB, 24 Portlehead Road, Worle, Weston Super Mare, Avon BS22 0UX.

QSL CARDS. - try me for quality and price. S.A.E. for samples. A.W. Bailey (G3YNI) Breatdown Press, Wick Lane, Lympsham, Somerset.

ICOM PORTABLES

ICOM PORTABLES MRZ DESK TOP PSU FOR ICOM PORTABLES: 2E/4E/02E/04E

Incorporating overvolts protection; overcurrent shutdown:-
 £51.95 + £3.00 carriage.
 (Reviewed page 8 July 'HRT')
 Models available for PMR/Marine Icom's. MRZ 6 amp (continuous) 12v. DC PSU: £59.95.
MRZ FOR ICOM & YAESU EQUIPMENT, MRZ COMMUNICATIONS LTD. 248, Uttoxeter Road, Longton, Stoke on Trent, ST3 5GL Tel: 0782-619658 (24 hours)

MISCELLANEOUS

HEATHKIT U.K. spares and service centre. CEDAR ELECTRONICS, Unit 12, Station Drive, Bredon, Tewkesbury, Glos. Tel: 0684 73127.

INSTRUMENT REPAIRS. Oscilloscopes, generators, multimeters and more. Viking Electronics, Potkins Lane, Orford, Suffolk IP122SS Tel: 0394 450006

**Our next copy deadlines are as follows:-
 March Issue
 23rd December
 April Issue
 28th January**

CLASSIFIED COUPON

(HAM RADIO TODAY) Classified Ad Dept. ASP Ltd, No.1 GOLDEN SQ. LONDON W1R 3AB. PLEASE DEBIT MY ACCESS/BARCLAYCARD No.

.....

EXPIRY DATE..... FOR £.....
 FOR..... INSERTIONS



- FOR SALE COURSES COILS & CHOKES AERIALS CB & ACCESSORIES OTHER Please state

Lineage 48p per work (inc VAT). Minimum 15 words. Semi display £7.35 per single column centimetre. (Minimum 2cms). No reimbursements for cancellations. All ads must be pre-paid.

Name

Address

..... Tel. No. (Day).....

Signature Date.....

EMPORIUM GUIDE

BIRMINGHAM

AE AMATEUR ELECTRONICS LTD

510-512 Alum Rock Road, Alum Rock, Birmingham B8 3HX.
Tel: 021-327 1497/6313

YAESU DISTRIBUTORS TO THE UK.



BIRMINGHAM

CENTRE ELECTRONICS

345 Stockfield Road, Yardley, Birmingham B25 8JP
Specialist in the sale and service of Ex Government and Vintage Radio and Test Equipment.
(Many spares in stock).
Telephone enquiries to 0676 32560



Special delivery service Shop open Thursdays, Fridays and Saturdays

BIRMINGHAM

R. WITHERS COMMUNICATIONS

584 Hagley Road West
Oldbury, Warley B68 0BS
(Quinton B'Ham) Tel: 021-421 8201/2/3

Opening hours 9-5.30pm Late nights Thurs-Fri.
Send just £1.00 (refundable against purchase)
for latest catalogue + our exclusive products & used list.

BIRMINGHAM

HEWARD'S HOME STORES LTD.
(Est. 1963)

822/4 Kingstanding Rd., Birmingham B44 9RT.
Tel: 021-354 2083

G4RJM with 38 years in The Radio Trade
Ham Equipment urgently wanted!
Open: Mon-Sat 9-6

CHESHIRE

DW ELECTRONICS G3XCF

Amateur Radio Supplies
71 Victoria Rd, Widnes  Tel: 051-420 2559

Open Mon-Sat 9.30-6 (closed Thurs)
We supply Yaesu, Icom, Tonna, Jaybeam, Microwave Modules, Datongs, etc.



DEVON

AGRIMOTORS

Merton CB & Radio Centre
Merton Garage & Post Office, Merton.
Nr. Oakhampton EX20 3DZ.
Open 6 days 9-6
(Sundays by appointment)
Specialists in 934MHz
Suppliers of all 27MHz and 934MHz equipment

ESSEX

SELECTRONIC

The UK's leading suppliers of 934MHz personal radio equipment
203 High Street, Canvey Island, Essex
Tel: 0268 691481
(Open Mon-Sat 9-5.30)
Amateur radio equipment also in stock

KENT

Thanet ELECTRONICS

2 Stanley Road, Herne Bay, Kent
Tel: (0227) 369464
Open Mon-Sat 9-5.30pm
except Thursday 9-1pm



LANCASHIRE

AMATEUR ELECTRONICS/HOLDINGS G3LLL

YAESU, JAYBEAM, DRAE, DATONG, BLACK STAR COUNTERS, ETC. FT 101 EXPERTS
6JS6C 6KD6 12BY7A Original type approved valves & our own Double Balanced Mixer and new band WARC Kits for original FT101 MK1-E S.A.E. List. Full Yaesu range. 15 mins Junction 31 M6 Free parking. Call and consult G3LLL without obligation.
45 JOHNSTON STREET, BLACKBURN BB2 1EF.
(0254) 59595. CLOSED THURSDAY.



LEICESTERSHIRE

ELLIOTT ELECTRONICS
for the Radio Enthusiast

26-28 BRAUNSTONE GATE,
LEICESTER.
TEL: 553293

Open: Mon-Sat 9.00am to 5.30pm



LONDON

DRESSLER UK LTD
191 Francis Rd., Leyton, E10

Open 9-5.30 Monday-Friday 10-5 Saturday

Authorised dealers for:
Dressler, Yaesu, Icom, Standard, Kenwood, Datong, SCM, Microwave Modules, Tonna
Tel: 01-558 0854/556-1415 Telex: 8953609



MERSEYSIDE

ARE Communications Ltd
FOR - YAESU, ICOM & KENWOOD

Phone us for the best deals on all amateur radio equipment.
38 Bridge St., Earlestown,
Newton-Le-Willows, Merseyside.
Phone: Peter G4KKN on 09252-29881
Opening hours Tuesday-Saturday,
10am-5pm

NORFOLK

D.P. HOBBS (Norwich) Ltd
13 St. Benedicts Street, Norwich
Tel: 615786

Open Mon-Sat 9-5.30
Thurs 9-1pm.  Stockists of:
YAESU, FDK, ICOM, JAYBEAM & Electronic Component Specialists



NOTTINGHAMSHIRE

SP ELECTRONICS

48 Limby Road
Huckhall, Nottingham
Tel: (0602) 640377
Open Monday-Saturday 8.30-5.30

N. IRELAND

Put your name
where it will be seen.
Ring 01-437 0699
for
Advertising details.

SCOTLAND

JAYCEE ELECTRONICS
JOHN GM30PW

20 WOODSIDE WAY, GLENROTHES
FIFE KY7 5DF
Tel: 0592 756962
Open: Tues-Sat 9-5

Full Range of YAESU & TRIO Goodies.
Quality Secondhand Equipment in Stock.
JAYBEAM - MICROWAVE MODULES - LAR







SURREY

GUILDFORD COMMUNICATIONS
34 Aldershot Rd., Guildford

Open Mon-Fri 8am-6.30pm
Sat 8am-5.30pm

Secondhand wanted

ASDEN
0483-574434

N. WALES

NORTH WALES AMATEUR RADIO MART

AMATEUR RADIO - CB RADIO - MARINE RADIO - P.M.R.
25 ABBEY STREET
RHYL





Open Monday-Saturday: 11am-5.30pm
All repairs and accessories available ex stock. Mail order welcome.
Tel: 0745-51579



EMPORIUM GUIDE

W. MIDLANDS

DEWSBURY ELECTRONICS
 RXs, from YAESU, JRC, ICOM.
 Stockists of microwave modules, B.N.O.S., M.E.T.,
 GAMMA, DATONG, ICS, TASCO.
 Open Mon-Sat, 9-30-5.15
 176 Lower High Street
 Stourbridge (0384) 390063







WORCESTERSHIRE

A. KELLY
 Electronics & Communication equipment.
 3 Stoke Road, Aston Fields, Bromsgrove,
 Worcs B60 3EQ.
 RSGB Publications, Mutek, DRAE, Microwave
 Modules, Star Masterkeys, TAL aerials, Alinco.
 OPEN 6 DAYS A WEEK EVENINGS
 BY APPT. 0527-71165.

YORKSHIRE

Amateur Electronics UK
 Alan Hooker
 42 Netherhall Road,
 Doncaster 
 Tel - 0302 25690
 Large stocks of electronic
 components.



EMPORIUM GUIDE COUPON

Price per insertion (+ VAT): £16.80 for 1-5, £16.00 for 6-11, £15.25 for 12 or more.
 Please enter details of your retail business below:

COMPANY NAME TELEPHONE NO:.....
 ADDRESS OPENING HOURS:

.....

OTHER INFORMATION (briefly)

ADVERTISERS INDEX

AKD	26	KW Ten-Tec	23
Allweld Engineering	67	Low Electronics	34, 35
Amateur Electronics	43	MH Electronics	27
BNOS	14	Microwave Modules	6, 7
Cirkit	33	Quartz lab	33
Dewsbury Electronics	68	R.A.S. Nottingham	27
Dressler UK	9	Spectrum Communications	33
Elliot Electronics	43	Technical Software	27
Farnborough Communications	27	Thanet Electronics	4, 5
Garex Electronics	67	Waters & Stanton	8
JEP Electronics	27	West London Communications	33
A Kelly	42	Ray Withers Communications	2
		Wood & Douglas	8

GAREX THE SCANNER SPECIALISTS

JIL SX-400

THE PROFESSIONAL SCANNER



- Basic coverage 26-520MHz
- AM, NFM & WFM
- Expandable from 100kHz to 1.4GHz with SSB and CW
- Computer control options
- IF output terminals
- Specifications set by professionals

£649

REGENCY MX-8000

THE WIDER RANGE SCANNER



- The receiver with the most Megahertz for your money
- Covers: 25-550MHz, 800MHz-1.3GHz
- AM & NFM & WFM on all bands
- Computer interface socket
- 20 memories
- Compact size
- 12v dc operation
- Up/down step control knob

£487

REVCO RS-2000E

THE VERSATILE SCANNER



- Covers: 60-180MHz, 380-520MHz
- AM & NFM on all bands
- Search & store of active channels
- Channel activity counter
- 70 memories
- 12v dc & 240v ac

£279

REGENCY HX-2000E

THE HAND-HELD SCANNER



- Covers: 60-90MHz, 118-175MHz, 406-496MHz
- AM & NFM on all bands
- Full scan & search functions
- 20 memories
- Nicads, charger & whip antenna included

£279

JIL SX-200N

THE SUPERIOR SCANNER

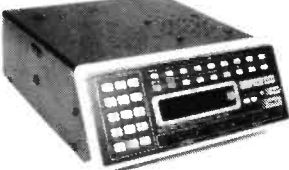

- The choice of the professionals
- Proven reliability
- Covers: 26-88MHz, 108-180MHz, 380-514MHz
- AM & NFM on all bands
- Positive action keyboard
- 16 memories
- 12v dc & 240v ac

£325

DON'T FORGET THE ANTENNA!

All receivers need a good antenna and the ideal one for a scanner is the REVCONE, a 16 element disccone. Made in Britain by Revco, a company that has been manufacturing quality antennas for the last 25 years, the REVCONE covers 50-500MHz, is extremely well made and very good value at just £29.95. Also available - the RADAC dipole nest, 25-500MHz with extra performance £69.95



PRE-AMPLIFIERS

Broadband antennas usually have no gain, so pre-amps are often desirable. One mounted at the masthead amplifies the weak signals but not the noise generated in the feeder cable. The REVCO PA2 in-line masthead pre-amplifier gives useful gain from 10MHz to over 1GHz. Includes special mains PSU £49.95. The MUTEK BBBAS00u is intended for use at the receiver's input. Requires 12v DC at a few mA £35.50



GAREX ELECTRONICS

MAIN DISTRIBUTOR OF REVCO PRODUCTS. PRICES INCLUDE UK P&P and 15% VAT. Ask for details of our interest free credit.

Extensive range of PYE radiotelephone spares - S.A.E. for list.

7 NORVIC ROAD, MARSWORTH, TRING, HERTS. HP23 4LS. Phone 0296 668684. Callers by appointment only.

Ask for our list of second-hand scanner bargains.

PROFESSIONALS AND DISCERNING RADIO AMATEURS ALWAYS CHOOSE



THE TOWER PEOPLE

COMPACT LATTICE TOWERS—SLIMLINE TUBULAR MASTS

Telescopic—Tiltover, Fixed—Mobile from 3M to 60M.
Over 50 Models, suitable for a wide range of civil and military applications such as:

- Radio Communications
- Amateur Radio
- CCTV and Surveillance
- Meteorological Monitoring
- Aero & Marine Nav Aids
- Flood Lighting etc.

Purpose designed using 4.5m and 3m section modules for low retracted heights and cost effective shipping. Engineered to B.S.I. standards and hot dip galvanised to BS729 for protection. Wind loads are based on BS CP3 CHAP V PT 2 1972 for wind speeds up to 100mph/160kph.

RELIABILITY—QUALITY—KNOW HOW.

SEND S.A.E. FOR FULL DETAILS.

WE DESIGN—WE MAKE—WE SELL—DIRECT. No Middle Man. At manufacturers prices—you get best value.

ALSO SPACE SAVER 3ele 4 BAND AQ6-20 BEAM
169-00 + 7-00 CARR.

Stock items normally sent within 7 days:
HP TERMS AVAILABLE

ALLWELD ENGINEERING

Factory 6, 232 Selsdon Road,
South Croydon, Surrey, CR2 6PL
Tel: 01-680 2995 (24 hr) 01-681 6734

DEWSBURY ELECTRONICS

**AT LAST!!! AN FM BOARD FOR THE TS-930 S
AND MANY OTHERS**



NOW FROM THE MAKERS OF THE WORLD FAMOUS STAR MASTERKEYS,
AN 'FM BOARD' FOR THE TRIO TX-930s.

THIS EASY TO FIT READY BUILT BOARD, ENHANCES ALREADY SUPERB FACILITIES
AVAILABLE ON THE TRIO TS-930s.

EASILY FITTED TO THE TS-930s. THE FM BOARD IN NO WAY DEGRADES THE
PERFORMANCE OF THE TRANSCEIVER, ALL MODES INCLUDING FM ARE READILY
AVAILABLE.

SUPPLIED AS A READY BUILT UNIT, COMPLETE WITH CONCISE AND EASY TO FOLLOW
FITTING INSTRUCTIONS, CAN BE INSTALLED IN LESS THAN 90 MINUTES, OR FOR A
MODERATE CHARGE, DEWSBURY ELECTRONICS WILL BE HAPPY TO FIT THE UNIT.
COLLECTION AND DELIVERY ARRANGED. FOR FULL DETAILS AND SPECIFICATION,
PLEASE SEND S.A.E.



STAR MASTERKEY CMOS MEMORY KEYS
8 MEMORIES, BEACON MODE, DIRECT &
GRID BLOCK KEYING. FULL DETAILS
IN PREVIOUS ADS. STILL ONLY
£95.00.



STAR MASTERKEY MK II
DOT - DASH MEMORIES IAMBIC
OR SIDE SWIPE, SEMI AUTOMATIC
MODE, 12 VOLT OR INTERNAL BATTERY
PRICE £54.70.

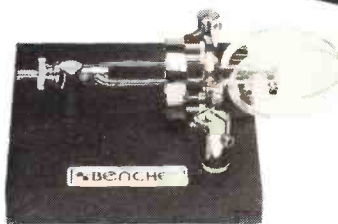

FULL RANGE OF BENCHER KEYS

POST, PACKING AND INSURANCE ON EITHER KEYS £3.00.

FULL RANGE OF TRIO PRODUCTS STOCKED
We are also stocked of DAIWA — MET ANTENNAS — POCOM — JRC — TAR — TASCOS TELEREADERS
MICROWAVE MODULES — ICS AMITOR AEA PRODUCTS DRAE

Dewsbury Electronics, 176 Lower High Street, Stourbridge, West Midlands.
Telephone: Stourbridge (0384) 390063/371228.
TELEX: 337675 TELPES G

Instant finance available subject to status. Written details on request.

