

HAM

AN ARGUS SPECIALIST PUBLICATION

JULY 1986 £1.20

RADIO

TODAY

**BARGAIN
HUNTER'S
GUIDE TO USED
VHF/UHF RIGS**

**TO BUILD: A
'PROFESSIONAL'
PARAMETRIC
EQUALISER**

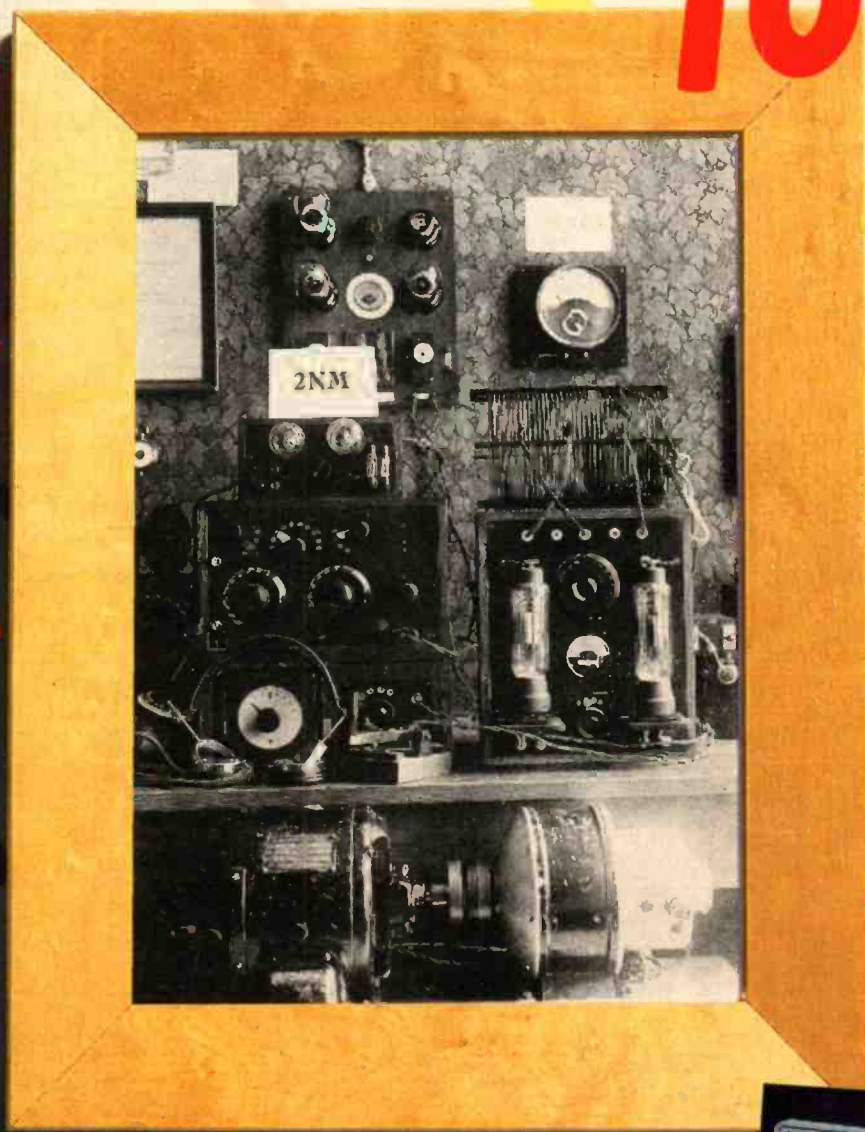

**MULTI BAND
HF ANTENNA**

**REVIEW -
KW TEN-TEC
CENTURY 22**

*Amateur Transmitters
of the '20s*

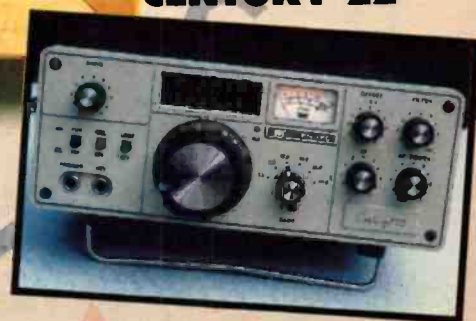

HAM RADIO CONTENTS

TODAY

VOLUME FOUR NO 7 JULY 1986

Consultant Editor
Steve Ireland, G3ZZD
Editor
Dave Bradshaw, G1HRT
Deputy Editor
Julie Darby, G1CKF
Advertisement Manager
Dave Gadsden, G4NXV

Published by:
Argus Specialist Publications Ltd.,
1 Golden Square,
London W1R 3AB
Telephone 01 437 0626
Distributed by:
SM Distribution Ltd.
Printed by:
The Garden City Press Ltd.
Design by:

 Argus Design Ltd.

ABC

Subscriptions: UK £17.30; o/seas sur £21; USA sur \$28; o/seas air £39. Ham Radio Today, Subscriptions Dept., Infonet Ltd., Times House, 179 The Marlowes, Hemel Hempstead, Herts HP1 1BB (tele: 0442 48432).

Ham Radio Today is normally published on the first Friday in the month preceding cover date. The contents of this publication including all articles, designs, plans, drawings and programs and all copyright and other intellectual property rights therein belong to Argus Specialist Publications Limited. All rights conferred by the Law of Copyright and other intellectual property rights and by virtue of international copyright conventions are specifically reserved to Argus Specialist Publications Limited and any reproduction requires the prior written consent of the Company. © 1986 Argus Specialist Publications Ltd.

All reasonable care is taken in the preparation of the magazine contents, but the publishers cannot be held legally responsible for errors. Where mistakes do occur, a correction will normally be published as soon as possible afterwards. All prices and data contained in advertisements are accepted by us in good faith as correct at the time of going to press. Neither the advertisers nor the publishers can be held responsible, however, for any variations affecting price or availability which may occur after the publication has closed for press.

REGULAR COLUMNS

LETTERS4
SQUELCH5
RADIO TODAY7
RADIO TOMORROW18
PRACTICALITIES32
LISTENING ON....	.36

CONSTRUCTION

A FOLDED G5RV AND BALANCED ATU22
<i>A well known design but in 60 feet? David Pritchard, G4GVO, describes how.</i>	
A PARAMETRIC EQUALISER FOR COMMUNICATIONS USE.39
<i>Maximise the information in your signal with this 'professional' standard design by Tony Bailey, G3WPO, and Frank Ogden, G4JST.</i>	



FEATURES

USED VHF/UHF RIGS10
<i>Hugh Allison, G3XSE, guides you through the best buys on the rally bring and buy stands.</i>	
INTERFERENCE40
<i>Our war continues with Steve Price, G4BWE, looking at the receiving side of an amateur station.</i>	
AMATEUR TRANSMITTERS OF THE '20's52
<i>John Heys, G3BDQ, investigates the development of the Tx from 1920-1925.</i>	

REVIEWS

THE ICOM SM10 MICROPHONE14
<i>Chris Lorek, G4HCL, finds that this is not just another mic!</i>	
REVIEW: KW TEN--TEC CENTURY 2228
<i>Tony Bailey, G3WPO, puts this HF CW rig through its paces.</i>	
ADVERTISEMENT INDEX24
STOP PRESS51
NEXT MONTH IN HRT57
FREE READERS ADS58
CLASSIFIED64
EMPORIUM GUIDE65

LETTERS

THE HEIGHT OF APRIL FOLLY?

Sir, Referring to the photograph on page 28 of the April 1986 issue (reprinted nearby).

The variation in the height of the long wire is due to the natural expansion and contraction of copper. Telephone and electricity overhead conductors are erected to a sag chart based on whether the copper is of solid or stranded construction; whether it is hard or soft drawn; whether it contains cadmium; its cross sectional area; the span length; and the air temperature at the time of tensioning. The conductors are expected to constantly expand and contract as the air temperature varies. So pole heights are decided by the ground clearances required on the hottest possible day.

My guess is that the antenna in the article is of stranded copper. Its length is near or over the recommended maximum span for its cross sectional area and the 1986 height if measured during the coldest week in April will be 58-59ft.

W Carter, G6WSX.

TRUTH IN APRIL FOOLS

Sir, I was flattered to be quoted by Mike Bedford, G4AEE, in his otherwise most interesting article "100kHz And Down" (May '86 HRT) but must sadly report that Mike fell for my 1984 April Fool article which was titled "Underground Aerials" published in the April '84 Amateur Radio. My reference in that article to the so called "Kondratieff Anomaly" was pure hokum, moonshine or whatever you like to describe it. I purposely put a 'window' for underground antennas at around 6.8MHz for that was the frequency where so many pirates may be found. I just hoped they would bury their antennas, use many calories in digging the trench etc and then find they were not getting out at all!

There was a Peter Kondratieff, call-sign EU3AN in 1930, but I must assure everyone that he certainly knew nothing about buried antennas. This must be a lesson to technical writers and a warning that they must not fly to earlier published literature without first checking source material. It has become common-



place to regard anything published as being true, and this is a dangerous outlook, especially when the reference article was published in an April issue of a magazine. Sorry Mike. I just could not let this go by or else many other writers will be quoting your article and lifting little bits of nonsense out of it. I hope this letter puts the record straight.

Finally, I must mention that there is a serious article on underground antennas in the latest ARRL Antenna Compendium. I have been in correspondence with its author and it seems that a lot of what I dreamed up in my April Fool piece really has turned out to be true! Truth is truly stranger than fiction. Unfortunately, there is no window on any specific frequency, just an increasing attenuation with burial depth and rising frequency.

J D Heys, G3BDQ.

THE CRITICS

Sir, It is a well known fact that most amateurs only contact the RSGB to complain about the late arrival of their Radio Communication. However, some things are happening in the hobby which are giving cause for concern.

1. The RIS now have a policy to ultimately close down an amateur who is causing interference that cannot be cured.
2. Despite no reported case of interference, 27000 radio amateurs are denied access to 50MHz because

they might cause interference to Antwerp TV viewers.

3. Despite being informed in November 1985 that they had the contract, the RSGB have not been ready to run morse tests nationally from April 1986. Tests have now all but stopped and the RSGB are not expected to resume a national morse test service until July.

4. The DTI did not amend the licence schedule for class Bs so they could continue with the morse experiment after 1st April 1986. Class Bs wait for this to be done. (See Stop Press).

There is no doubt about it, the fact that RSGB have always said leave it to us, do not contact your MP or the DTI, has now proven to have got us into the present mess. Before RSGB get involved in expensive litigation, perhaps amateurs should now put pen to paper and write to the DTI/MPs about issues concerning amateur radio. The CB lobby were not slow to exploit this avenue and it does work.

Ian Abel, G3ZHI.

Sir, Is the RSGB trying to alienate itself from whatever percentage of British radio amateurs it claims to represent?

For some years now, I have devoted a great deal of time on behalf of the RSGB ensuring that (in company with my partner, G4ILD who is *not* a party to this letter, dated 10th April) five evenings per week were available for class B and SWLs to develop themselves to the required 12wpm morse speed. I have on a number of occasions complained to the RSGB that there was an element of unfairness in the whole structure of the morse test. Passages are sent by hand from someone who could possibly be below his best and people living near coast stations find the resultant cost of a trip to be far less than that for the unfortunates living miles inland.

Now we have the RSGB doing the job. Things must get better surely? Don't you believe it.

Prior to the Potters Bar take-over, my listeners knew that although it may cost them a day's wages to travel to the examination centre, they could at least attend more or less to their own convenience. Recently, one of my students asked the RSGB for a

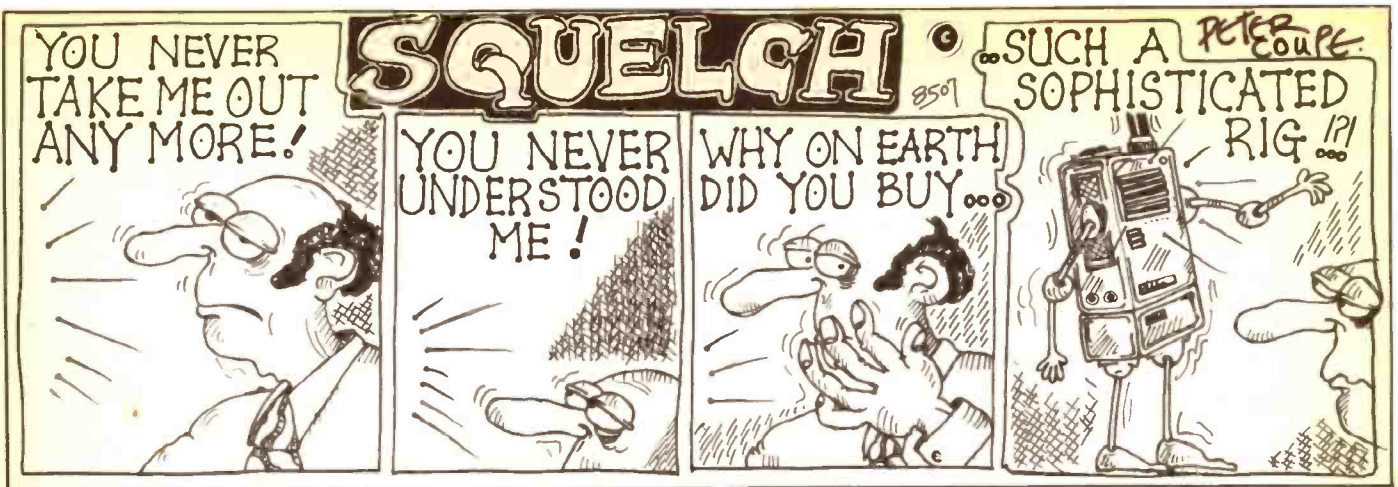

date to take his exam. He was told June at Longleat. Far from representing a days lost wages, it represented an almost 600 mile round trip!

We have received no indication from the RSGB concerning the frequency or venue of these exams. If the best they can do is to produce a pair of examiners at major rallies then they would better serve the amateur radio community by admitting that they have bitten off far more than they can chew and hope that the duties will be taken over by a more responsible body.

What sort of pass rate do they expect to achieve? After finally realising that he is competent at the necessary 12wpm (15wpm in the case of my own broadcasts), the student is regarded as being something of a thorn in the side of the untouchable authority. He is grudgingly told he may — provided he is prepared to travel whatever distance is involved and on a Sunday — kneel at the feet of those chosen by the RSGB to prove his ability.

Geo Longden, G3ZQS.

A CRITIC OF THE CRITICS

Sir, I have been intending for some months to comment on your magazine and your survey gives me the ideal opportunity.

I am concerned by what appears to me to be anti-establishment and anti-RSGB prejudice on the part of your correspondents, encouraged and even in some cases initiated by your editorial staff and writers.

I can understand why a young and/or inexperienced readership, many with little knowledge of the running of anything, should misunderstand and question the operation and administration of such an organisation as RSGB. (Indeed, before I get too patronising, I should say that some aspects worry me too, even though I have been an RSGB member for 20 years). It is natural for most young people to think they could run things better than the established order and

some of them end up doing so, in due course becoming a part of the same "establishment" themselves!

My attitude is that I support RSGB because:

- it is a long established national society.
- it is highly respected by the amateur movement nationally and internationally.
- it is acknowledged as representing amateur opinion by the licensing and examining authorities, their international equivalents and by the international amateur radio administration.

Naturally, it does not do everything right but it is strong, unified, well organised and capable, and has a wealth of experience and expertise stretching back to the days when radio was wireless. Those are not qualities to be mocked or easily replaced.

If you continue with the publication of critical and damaging articles and editorial comment, even in a magazine now three years old? The main effects will be:

- by lending support to half formed ideas and criticisms, to lead more malleable, less experienced, or revolutionary groups of amateurs into believing that the changes they want coincide with the wishes of amateurs country and world wide, and can be achieved quickly, easily and without risk to the movement.
- to weaken the only viable and national movement we have, by reducing recruitment and encouraging discontent and fragmentation of the membership.
- to reduce the effectiveness of the only seriously regarded national amateur movement with the very people who must see it as strong, united, resourceful, serious and of importance in the community — the government and the licensing authorities.

John Butcher, DA1DC, G4GWJ.

The above is the first part of a letter that came attached to a completed readers survey. It seems particularly

pertinent to publish Mr Butcher's comments in the light of the previous two letters.

IMPROVING IRON DESIGN

Sir, May I, through the pages of your magazine, make a plea to soldering iron manufacturers? We must all at some time or another have inadvertently burnt something or ourselves on an iron we didn't know or had forgotten was switched on. Surely it would be feasible to produce a soldering iron with some kind of indicating illumination visible from all angles — possibly through a translucent plastic cap at the mains lead end of the handle using a neon bulb. I can hardly believe that something so simple has never been thought of already by some manufacturers, but I've never seen one! A much more flexible and burn proof mains lead would also be a great advantage. This type of lead is available on professional equipment, but not readily available to the amateur.

Having just looked through the pages of catalogues from two of the largest distributors of components and tools to the home constructor, I have been unable to find a soldering iron with just one of these attributes — let alone both!

I L Liston-smith, G4JOT.

STAND PROUD WITH YOUR VALVES

Sir, On page 24 of the May issue, G3GDU observes that "when the transmitter is complete, the lack of a brand name and the fact that it uses valves may cause some embarrassment". To whom, I wonder? Presumably to the black box appliance operator at the other end of the QSO?

To be able to claim "its a home brew transmitter using valves" is something to be very proud of, not embarrassed about! Should the time come when we actually feel embarrassed because we are not using the latest all-bells-and-whistles-

multi-knob-black-box, then amateur radio will be well and truly dead.

A R Williams, G3KSU.

CAN ANYONE HELP?

Sir, Does anyone have a circuit or handbook on the Cossor double beam oscilloscope type 3398. I need to borrow one to help me rebuild one in my club, run by Ken Smith, G3JIX. I can send it back with thanks and postage for the person. Please send it to 35 Connaught Road, Margate, Kent CT9 5TW. Thank you.

Kirk Wilson, aged 14.

CONVERSATION STOPPERS

Sir, I have a suggestion and a grizzle, both of which I shall try to express in a constructive way. The suggestion was born of an idea coming to me after looking for a VHF rig construction project that didn't presuppose the possession of an MSc and a test equipment lab. We really must fight the black box invasion. We didn't emerge from the caves and float up to the Moon with the philosophy of let-the-other-guy-do-it. Amateurs are making rigs today which were giving professors of electronics headaches a mere decade or so back.

This doesn't merely apply to VHF. The whole fabric of amateurism seems to me to be under threat from 'Takeaway Radio'. So how about initiating a set of graded constructional projects in amateur radio which describe the most primitive techniques for getting on the air? By these I mean resistors made from mains cable; capacitors from tin lids; batteries from unwanted lemons; switches made of tin strip pierced with nails; sockets of dried clay or plaster of Paris: detectors using potatoes, etc. I don't know if similar rough approaches work for transistors, valves, diodes, chokes, etc but it would be interesting to put out a general call for ideas in these areas.

Most of what I have described above, of course, has already been published. But in obscure periodicals at obscure times and in obscure patterns. Wouldn't it be useful to initiate a systematic, classified approach to this kind of construction, one absolutely dead centre to the amateur tradition? Perhaps even a yearly prize for the most primitive, working radio component?

The original idea for this came from a friend telling me how to listen in with a piece of wire, a razor blade and a safety pin, all stuck into a lemon. He had read it somewhere and thought it unlikely. As an amateur, temperamentally as well as occupationally, I dislike knowing that if I were to be cast away on some isle

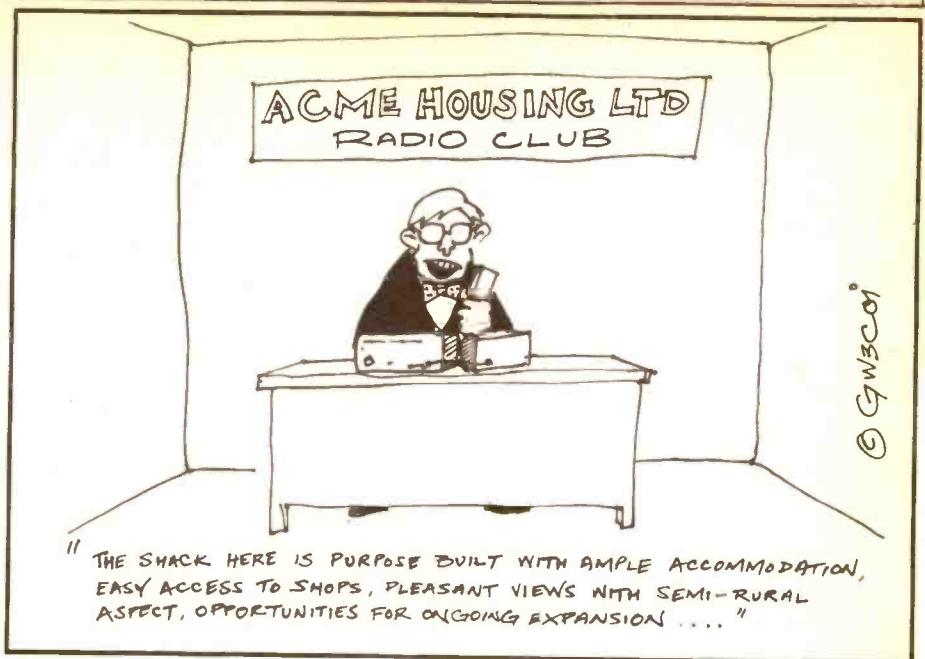

little of what I know about radio now could help in getting me off it. Yet I can't help feeling also that there seems to be an underlying trend towards technological simplicity which one day will allow those in similar plight to 'phone home' with the aid of driftwood, seashells, and some lengths of wet string.

The grizzle is as follows. Why don't responsible amateurs (an RSGB group?) concentrate a little more on raising standards of phone on 2 metres? Some of it is as bad as CB and where is there worse? I cite as examples:-

Uncle Tom Copley, the ten minute monologist, interspersing his gems of wit and wisdom with profuse thanks to his YL for the tea she is proffering; comments on the weather and questions his listeners are expected to remember when his self-indulgent ramblings are completed. On letting go the PTT switch, he wanders away to harvest the petunias. I could say more but fear a libel suit.

The Great Maskelyne, the frustrated memory freak persisting in handing over half a dozen call signs in toto to the next guy wilting beneath the load. You know, "This is GODSTRUTH handing over to GOTOGO, G1YUK, GOBORE, etc"

G4Wally, a CB-er who has made it into our elite (chuckle) but keeps slipping. "Give us a break on that one." Whatever that means.

The Gottago guys who never quite make it. ". . . I must go - G9000 G7COR". "G7COR G9000 Yair - gotto go - G7COR G9000". "G9000 G7COR Bye! G9000 G7COR". "G7COR G9000 OK then - see yer - G7COR G9000".

The Hi-hi boys. "Yeah - chuckle - so I tol' 'im - chuckle - 'e was

the one - chuckle - an' 'e tol' me - chuckle." The chuckles do not denote actual laughter but act as gravestones for laughter that once was and as signposts for laughter which ought to be - in the sender's opinion! Truly ghastly is a frequent situation arising when his listeners agree with him even if they don't feel terribly amused and the waves groan beneath hand-to-hand chuckling.

What is needed is a kind of conversational Q code only far more flexible with built-in signals to the other guy(s) that you do or don't want to rap. Allied with it should be heavy emphasis on limiting every transmission, and the introduction of standard pauses to allow newcomers to a net to make contact.

I was an army signaller, trained to net onto cycles and to converse as if words cost a Krugerrand each. I am not pleading for a return to these Victorian values and even less am I urging 'Austere Rapping'. I am not suggesting much interference with most of what exists. The actual standard of politeness and camaraderie I have found to be unfailingly high whenever and wherever I switch on my personal black box. What is missing - surprisingly for an amateur body penetrated by so many professionals - is the aim to keep it short and snappy unless specific signals are given to make it otherwise. And even then, Uncle Tom, do let go the PTT whilst thinking. I promise not to give you a break!

Trevor MacDiarmid Artingstoll, G1RRP.

Please address correspondence to:
Ham Radio Today,
1, Golden Square,
LONDON W1R 3AB.

RADIO TODAY

New 'Clamp On' RF Choke

EMC Datacare have announced the availability of their new D910 radio frequency choke, which may prove useful in reduction of amateur breakthrough in domestic appliances. With the recent tightening up of DTI involvement in cases of domestic interference complaints, many amateurs have started to become prepared for the fateful ring on the doorbell. Often, diplomacy is the most important factor in resolving cases, but the ability to quickly effect a cure to the equipment is very beneficial.

The EMC D910 differs from the usual ferrite toroid available in that it may be clamped onto connecting leads without the need for disconnection. Often neighbours are wary of someone "messaging about", unplugging wires from their expensive equipment. The suppressor may be fitted in seconds, and may be used on input coaxial cables to video recorders, televisions, hi-fi input lines and speaker leads, even on video monitors used in the amateur shack to prevent timebase radiation causing problems with HF reception.



The common mode chokes are built up from pairs of ferrite 'U' cores, and may be installed on cables of up to 10mm diameter without the removal of connectors, indeed it is not necessary to have access to the ends of the cable. For large or rigid cables, several pairs of cores are required, for smaller flexible cables multi turn chokes may easily be fashioned.

The D918 kit is available which consists of eight pairs of cores together with the necessary

assembly hardware and specific application hints to resolve breakthrough problems, this is priced at £25.30. This is, of course, a more expensive approach to winding a few turns on a standard toroid, commonly available at less than 50p each, but it may prove useful in the odd circumstance.

Requests for further information should be addressed to Richard Marshall, EMC Datacare Ltd, Power Court, Luton, Beds, LU1 3JJ (phone 0582 450747).



TV Convention Report

At the recent BATC Convention at Crick, the Deputy Editor was given a guided tour of the above two outside broadcast units. One is owned by Brian Summers, G8GQS, treasurer of BATC, the other by a little known company called Independent Television News. Can you spot the advances in technology?

Also at the Convention, which had expanded to a marquee in the grounds of the hotel, was the prototype of the new Drae SSTV transceiver. This has a variety of new facilities including four memories. We hope to

be reviewing this in the very near future. Wood and Douglas had on display their new 24cm frequency locked 2mW Tx with audio output. Other traders present included Astley Video Services, Jaybeam, Poole Logic, Barenco, A Kelly, DC To Light and Microwave Modules. As well as stands for the Remote Imaging Group, slow scan enthusiasts and BATC, there was a lot of interest in the displays put on by the Worthing and District Video Repeater Group and the Home Counties ATV Group. All in all, everything to delight the amateur television enthusiast. Shame about the weather...



Pirate Ship Goes For 'Pieces of Eight'

In November '85 the captain of the MV Communicator decided that he was more than a minute away from his next pay cheque so he promptly weighed anchor and sailed into territorial waters whereupon he was escorted into Harwich by the DTI chartered

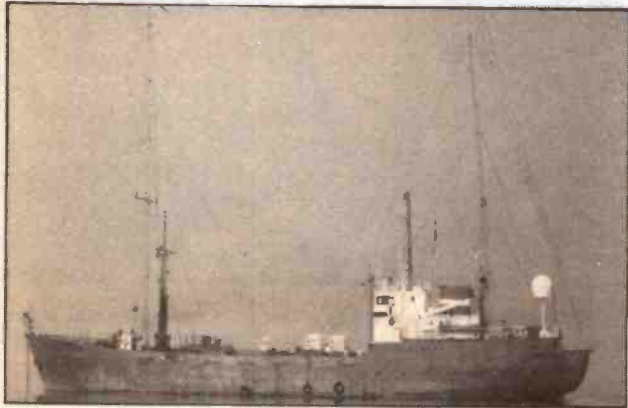

vessel, the Dioptic Surveyor. So ended the brief history of yet another seaborne pirate station — Laser 558. The station which arrived in a blaze of publicity from the States survived just over 12 months on the high seas. Lack of advertising revenue and a 'blockade' by the Dioptic Surveyor forced the demise of the mid Atlantic jukebox.

Now the Frinton based company East Anglian Production (Jumbo Records and Tapes) has successfully purchased the vessel said to be worth £250,000, for just £35,000. Ray Anderson, the new owner, claims to have acquired a bargain. He explained that the Communicator is a fully equipped broadcasting station with two powerful 25kW medium wave transmitters, full broadcast studio facilities and an onboard satellite communications system.

A spokesman said that one of the conditions of sale was that the ship could not be used for any illegal activities such as off shore broadcasting to the UK. At present the ship was being refitted and made seaworthy. A couple of film companies are interested in making a rock music film centred around the station. But it was likely that the boat would head for the Mediterranean where it would be used as an all day summer only English speaking station. Could this be another prime example of government assistance to private industry?

Air Aid

There can't be many people in the western world who haven't heard of Band Aid, Live Aid, Sports Aid, Fashion Aid and all the other appeals to raise money for the starving in Africa. Well, the latest on the list is Air Aid, a campaign being launched by Kenny Johnson, and which is based in Guernsey.

Kenny is alerting CBers, and amateur radio operators that a massive 'radio-in' will take place on the weekend of the 18th, 19th and 20th July. The event already has the approval of the Band Aid office and it is likely that it will attract worldwide attention as interest has been shown in Germany, Italy and the USA.

The idea is that money to be donated will be pledged over the

air for famine relief — in the case of amateur radio, it is hoped that a 'special events' station will be established. Apparently, the International Police Association are trying to find ways and means of helping, but Kenny is also hoping that international business organisations will also be willing to help.

Kenny would like to thank various companies for their tremendous help with the project including Aurigni Air Services, Viceroy Hire Cars, Radio Guernsey, Radio Jersey and everyone else who has been of assistance.

If anyone else would like to help in any way, they can contact Kenny at 24a Vauvert, St Peterport, Guernsey, CI (28508 or 53406), or his partner, Clive Ogier, on Guernsey 49479.

10m FM Activity

Enthusiasts in the South have formed the Southern 10m FM Group with the prime objective of keeping 28MHz active during sunspot minimum. They intend doing so by publishing a regular newsletter to act as a focus for information covering propagation, technical tips, availability of equipment, members' for sale or wanted ads, who worked whom, when and where info and any other news pertaining to 10m FM. One year's subscription is £1 which will ensure that you are supplied with the six newsletters to be published during the year. Membership is open to anyone and everyone interested in '10', including listeners and class B operators who are of course able to work crossband.

Subscriptions and written contributions to the newsletter are welcomed by the editor, Jim Hicks, G4XRU, 33 Hayling Rise, Worthing, BN13 3AL.

Southern
10
METRE FM
Group

Icom Accessories Available

If you have an Icom transceiver or receiver and a BBC B, Commodore 64 or 128, you can now mix the two with a little help from Jaytee Electronic Services Ltd. They have developed a range of interfaces and software which will enable control of the ICR7000 and IC735 via a serial interface and ICR71, IC751, 271, 471 and 1271 via a parallel interface plus a communications interface (the ICX 309 or Jaytee equivalent). Commodore users will also need an adaptor for either interface.

The software is supplied with each interface together with a "comprehensive instruction manual". These enable 18 possible functions (21 for the Beeb) to be undertaken from your micro's key-

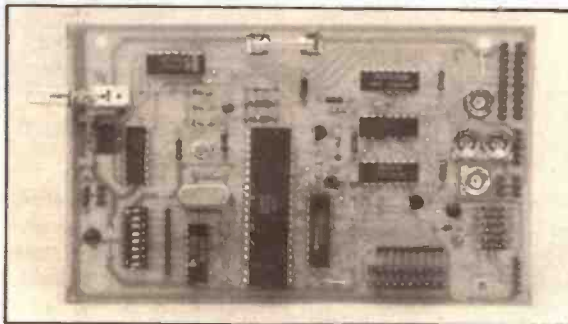

board including scanning, memory storage and frequency movement. For prices and full details contact Jaytee at 143 Reculver Road, Beltinge, Herne Bay (phone 0227 375254).

Another Icom dedicated accessory is the MRZ desk PSU. This can be used with any Icom handheld transceiver particularly the amateur range — IC2E, 4E,

02E and 04E. The battery pack is removed and the body "slides firmly onto the mounting on the PSU". With an external microphone plugged into the miniature phone socket, the transceiver is ready for base station use.

The unit incorporates over volts protection and over current shutdown as well as supplying a regulated voltage. There will soon

be available a unit which will include a battery charging system for BP3 packs. The cost of the basic desk PSU is £75.50 and more information can be gleaned from MRZ Communications Ltd, Newton House, 248 Uttoxeter Road, Longton, Stoke on Trent (phone 0782 619658).

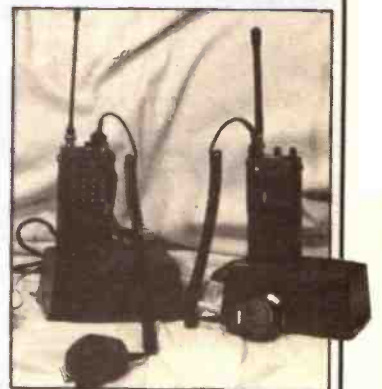

50MHz Portable in 1949

Amateurs in the UK made good use of the 50MHz allocation until it was withdrawn in 1949. Here G2UX (left) and friends on Wimbledon Common operate a 50MHz 'portable' rig employing a self regenerative receiver and transmitter connected to a fishing rod vertical antenna. Courtesy Wimbledon DARS.



Events and Expeditions

Although at rather short notice, this one should, perhaps, not be missed by VHF/UHF fanatics. It is the annual Scandinavian VHF/UHF meeting held over the weekend of 6th to 9th June at the Solli Tourist Centre, Geilo, which is about midway between Oslo and Bergen in Norway. The programme includes talks on antenna and noise figure measurements, FM TV, packet radio and receiver front end design with added attractions of the locator systems debate, homebrew equipment display and bring and buy. If you want to know more Lars Breie, LA9BM, has provided an emergency number to call on 010 47 67 85802 or try Jan-Martin, LA8AK, on 010 47 42 81178. If you can't make it, listen out for some impromptu DXpeditions to the rarer locators in the area...

Another callsign to listen out for this time on the 7th June is GB4LAD which is being operated by Dunstable Portable Amateur Radio Group in conjunction with Dunstable Downs RC. They will be on air for the duration of the Luton and Dunstable hospital fete. The group are being privately sponsored to raise money for an extension unit for a surgical laser and would therefore like to make as many contacts as possible. Operation on 1.8, 3.7, 14 and 144MHz is intended. For further details contact Tony, G0COQ, on 0582 508259.

Stroud ARS have organised an expedition to the island of Steepholme (locator IO8IKD) in the Bristol Channel over the weekend 7th and 8th June. Between about midday Saturday and 4pm Sunday, they will be using the callsign G4SRS operating on 2m (FM and SSB) and on SSB on 40, 80 and 160m, with occasional forays onto 10, 15 and 20m. The HF equipment includes a Yaesu FT101ZD and Trio TS520 and long wire aerials. Since this island is unin-

habited those working towards WAB award may like to know the square number: ST26. Although Marconi used the island for some of his early experiments, the expedition will be confined to normal contacts. A special QSL card will be available.

The 17th Elvaston Castle mobile radio rally will be held as in previous years on the show-ground of Elvaston Castle Country Park on 8th June. Elvaston Castle is situated about 5 miles SE of Derby, on the B5010 which runs between the A52 and A6 roads. Admission is free, although a car parking charge of 45p is levied by the local authority. Talk in will be available on 144 and 432MHz by GB2ECR.

Attractions include more than 90 trade stands, a grand bring and buy sale and a flea market. Arena attractions, demonstrations and children's entertainments should make it a family event not to be missed. Further details from John Robson, G4PZY, on 0332 767994 or Ian Cage, G4CTZ, on 0332 799452. In past years, the rally has attracted an attendance in excess of 18/20,000 visitors.

Lowe Electronics will be displaying their wares at the Post House Hotel, Ipswich Road, Norwich on the 22nd June from 2 till 4.30pm. A 2m talk in is being provided by Norwich ARC on S22, listen out for the callsign G8LOW/P from 1.30. The first 50 people to arrive will be supplied with free coffee and biscuits!

Moving on to the first week in July and a couple of conferences you might like to attend. The first is being held between 1st and 4th July. It is an international conference on radio receivers organised by the Institution of Electronic and Radio Engineers (IERE) and will be held at the University of North Wales, Bangor. The conference will cover most recent advances in receiver and system design as well as illustrating current trends.

Digital techniques and

receiver ICs are particularly important and will be covered in depth in a session which will also include papers on automatic signal acquisition, coherent demodulators and receivers based on a structured building brick approach to the signal processor. Other sessions will cover receiver ICs, mobile radio, radio systems in general and receive design. Other 'state-of-the-art' topics such as automatic signal classification, packet radio systems and design techniques for low cost receivers will be considered by a number of individual authors.

Six renowned experts will present tutorial lectures on 'leading edge' subjects such as frequency synthesis and phase locked loops, modulation and coding, cryptography and gallium arsenide applications in receiver design. The RSGB is arranging a number of live demonstrations and a small exhibition of commercial radio receiver equipment has been laid on.

For further information and registration forms, please contact the Conference Secretariat, IERE, 99 Gower Street, London WC1E 6AZ (phone 01 388 3071).

The second conference is being organised by AMSAT UK and has been opened to members of the RSGB. It takes place on the weekend of 5th and 6th July at Surrey University, Guildford. The colloquium will include lectures by "some of the world's experts for the job" plus a mini trade show of satellite wares and an insight to "the complete gambit of the amateur satellite hobby." Contact Ron Broadbent for further details of the agenda and booking at AMSAT UK, London E12 5EQ (please include an SAE).

Sorry!

Unfortunately, in our news item on the Hamnet Hull changes last month, we got the phone number wrong. It is 0482 465150. Apologies to those inconvenienced.

Making The Modula?

As mentioned in the Modula converters article published last month, CPL Electronics can supply complete kits and partial kits for the project. The complete kit including PCBs, display, case and all the components for the receiver etc costs £142 plus £2 p+p. However, they can supply the complete set of PCBs for £14 plus p+p as well as a variety of other partial kits. For further details contact the company by writing to 8 Southdean Close, Hemlington, Middlesbrough, TS8 9HE, or phoning 0642 591157.

If you are having difficulty obtaining the MC1350 IC, CPL can supply it and the SL1621 separately, not as part of a kit. The SL1621 can also be supplied by Gothic Crellon Ltd, Trafalgar House, PO Box 301, 28 Paradise Circus, Birmingham (021 643 6365), although it is unknown whether they will handle individual orders.

Jaybeam Putting Up More Antennas

Jaybeam Ltd of Northampton have announced a new product

The latest addition to their range is a duobander for 4 and 6m. The DB4 is a four element yagi with a boom length of 3.06m and a turning radius of only 2.1m. Being made of "high quality aluminium" with 1" elements incorporating the "high Q" traps ensures that the antenna only weighs 9.5kg. The DB4-4/6 costs £100 plus VAT.

New Business Expanding

A Kelly, the relatively new amateur radio retailer in Worcestershire has been expanding. They've just opened a domestic retail shop in Bromsgrove and taken on Andy (right), G8HAC, as sales and workshop manager. The shop includes a workshop where all secondhand equipment is tested before being sold. Both Andy and Alan (left) are regular stallholders at many rallies throughout the year.



Used VHF/UHF Rigs



If you cast your mind back to the January '86 issue of HRT you may recall that the editorial staff's collective New Year's resolution was to demonstrate that amateur radio can be cheap. Since then we have been treated to excellent articles on converting cheap PMR (Private

2m rig. An awful lot of these could really deviate a long way if incorrectly set up; indeed, some were actually designed to deviate 15kHz or more. Just to make matters worse, there was often only one potentiometer in the whole transmit audio line up, normally a set deviation

control. The lack of audio gain, and indeed the lack of audio gain control, can result in either a highish average audio but too much deviation (often accompanied by angry over deviation pips when using repeaters) or correct max deviation and low average audio, which can be just as impossible to handle at the other end.

The simple solution is, believe it or not, a CB style "power mike". I always thought that there would, one day, be a use for them! Turn the

An alternative to modifying PMR gear is to know what to look for amongst the older VHF/UHF rigs on the bring and buy stands at rallies. Here Hugh Allison, G3XSE, gives the low down on the five most freely available second-hand amateur transceivers.

Mobile Radio) gear and also to cheap ways of going HF. The person who hasn't been catered for is the newly licensed "class B" holder of limited financial means and wary of getting 'duff' gear. What could he/she reasonably be expected to come away with by way of a ready working rig after attending a rally armed with, say, £50-60?

Obviously, there will be one off examples of various oddball items, and it would be beyond the capabilities of an article of this length to detail all the cheaper rigs normally available second-hand, although most of the following applies to many rigs of the era. After some discussion it was decided that only rigs freely available (ie four or more examples for sale) at three major rallies during 1985 would count. If the rigs noted at rally one were not available at rally two they were deleted from the list, and similarly for rally three. The rallies chosen were Leeds, Elvaston Castle and Longleat, giving good country wide coverage.

Yaesu FT2

This is a prime example of an earlyish Japanese crystal controlled

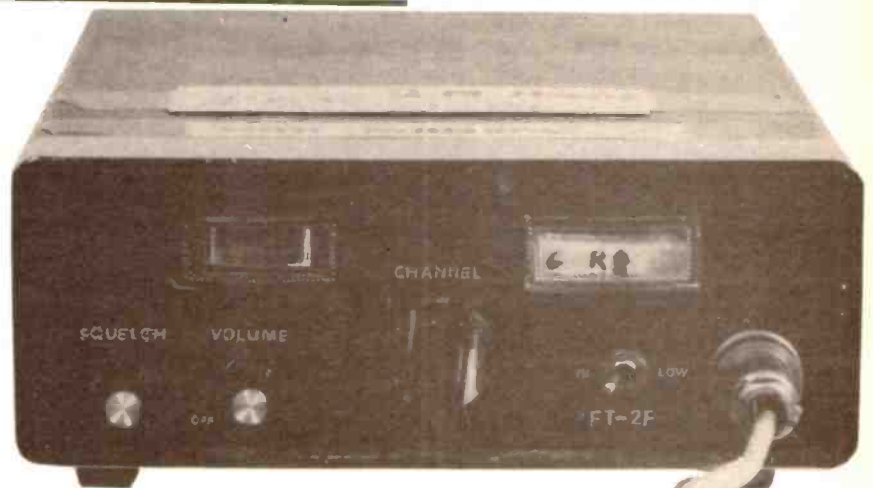

The FT2 — a touch to deviant for the beginner perhaps?



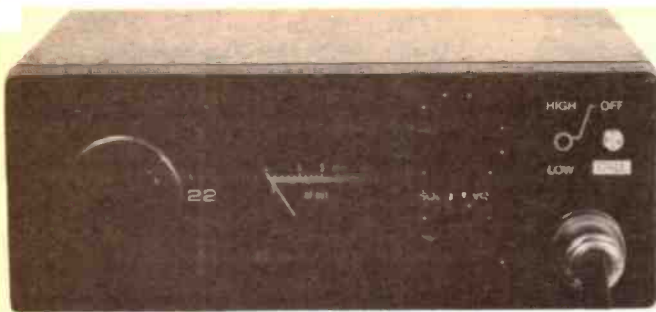

The Liner 2 "10 watt SSB" 2m rig. If you have 10W out, it may be all over the spectrum!

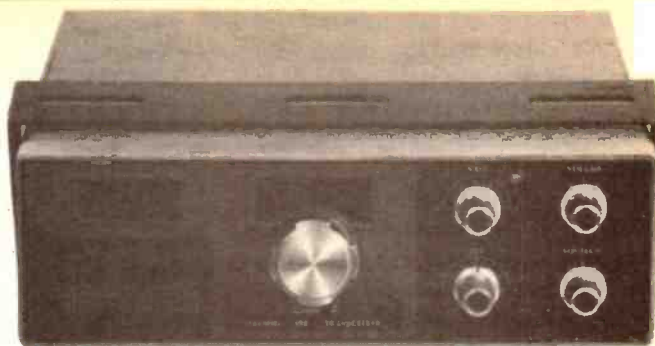

Icom's IC22A — such a nice rig for the price.

power mike gain up fairly high, set the deviation pot in the rig for a reasonable deviation, say 5kHz or so, and then re-set the power mike gain in conjunction with comments received over the air.

A lot of FT2's came complete with a switch on the rear marked AOS. This doesn't refer to our satellite term Acquisition Of Signal, as some people think, but stands for Automatic Over Signal. These rigs came from the "Houston, we have a problem" moonshot era, and if you didn't have a bleep at the end of your over your rig was not considered fit for use! Most of the rigs now available on the second-hand market will have been modified to transfer the tone to the start of the transmission. If you can get the cover off prior to purchase, have a swift look at the bottom end, component side, of the receiver board. If Q118 is marked on the board but not present, the tone will be at the end of transmission; if it's there, it will be at the start! It should be a 7400.

If the FT2 bleeps a lot and has a rats nest inside — watch out!

Obviously the foregoing does not apply if another tone burst board has been fitted. This could be a wise move since the tone oscillator was not noted for its stability. The FT2F and FB were very similar. The FT2 Auto is great fun — it has channel scan with rows of red lights flashing on and off. The scan and/or scan stopping circuitry is a bit unreliable but easy enough to repair, given a circuit diagram. Your complete beginner would be well advised to run up an FT2 Auto prior to purchase to check all is well, and then never run it on a supply above 13.8 volts.

A very common failing with the FT2 series was the audio chip

coming over all dead. This was the notorious AN212, also used in some "Beltek" rigs, and are virtually impossible to obtain. Luckily, the LM380 is an electrical equivalent, though unfortunately not pin for pin compatible. For a while a little printed circuit board was available "holding" the LM380 and arranged such that the wires neatly went down the right holes. If this board is installed, fair enough, don't be put off. If the LM380 is hanging in the breeze in an untidy rats nest, beware.

£60 bags an auto, others cheaper with the right channels.

Two crystals per channel are required, with X24 in the Tx, ie 6MHz crystals are used. In receive it's recommended to use signal frequency +10.7 all divided by 3, ie 52MHz. Receiver sensitivity is nothing special, 20dB quieting for a microvolt, and the filter is a teeny bit wide, 15kHz at the 6dB points, 50dB at 25kHz. Price range, second-hand £45 to £55 maximum, and only then if fitted with the channels you want. An auto is worth just a bit more, £60 should bag you one.

Icom IC22A

These are super, really good rigs. Sensitive, most examples today will give respectable performance, typical figures about 20dB quieting for half a microvolt. Lots and lots of receive audio with no real vices and all components still obtainable. Genuine 10 watts out on transmit with punchy communications quality audio. It has a good, built in tone burst. A small, nice looking rig which is ideal for mobile use as well as the shack.

Troubles? Well, a few. I've repaired some that have, again, duff audio chips but the NEC one used in

the 22A is freely available. Some 22As have a 2 pin power connector, others have wires coming out the back. The latter type have a very tight locking grommet and the wire often frays here causing dead sets. The 22 ohm resistor in the far left hand corner (when the front is facing you) is often not soldered, and can cause havoc.

One real pain of a fault, peculiar to the 22A, is the 'S' meter bulb going a total short circuit. Since this is a 12 volt bulb straight across the supply, fuses pop intermittently and/or if using a current regulated power supply, things seem to stop happening. What happens is that the bulb blows and, during use afterwards, vibration etc causes the remains of the filament to snap away. This bounces about inside the bulb shell and eventually gets lodged up the stem of the "Y" filament support, causing a virtual short circuit. The solution is simple, when the 'S' meter stops lighting up, either snip the wire to it (the bulb is a wire ended type) or replace it, pronto.

A good buy for £60.

The IC22A is crystal controlled, again two crystals per channel, with Tx at 18MHz, ie X8, and receive required frequency minus 10.7 all divide nine. As for a price guide: at Leeds there was one at £50, three at £60 and one at £65, but that was dripping with extras and good channels. A good buy for around our £60 maximum.

Liner 2

Excuse me a minute, I don't feel too well. 2m SSB for £50 might sound a bargain but beware. Beware, in this case, the demon tweaker brigade. Billed as a 10 watt SSB rig, they weren't really. Most will chuck out five, six or maybe seven watts,

and this isn't good enough for the turn 'em all, tune for maximum smoke type. He will connect up his power meter and see less than 10W. Off with the covers, turn everything in sight whilst watching the power meter and — here comes the sad bit — he will achieve more indicated power. The problem is, it's not in the band. The PA is notoriously unstable and, at the slightest provocation, will chuck out tons of rubbish all over the spectrum. I've seen some real horrors. One showing 10W on a power meter will probably be giving out less on 2m than a clean example showing 6W.

I will never air one using my callsign until it has proved itself on a spectrum analyser. Unfortunately this is an expensive bit of kit and will not be available to your average newcomer. The best you can do is to connect up a power meter and whistle into the mike, whilst slowly increasing the level of your whistling. If the power meter shows a nice responsive gentle increase of power out for increased audio in, with no residual power showing with no audio input, then all is probably well. Only two or three definitive power levels, say two watts then a non-linear jump to four or five, then ten, or power showing with no audio going in means it's time to visit the repair depot.

Beware the demon tweekers — no 10W out!

With a Liner 2, knocks on the door and reports of TVI do not normally mean the TV is at fault. Similarly, complaints from other spectrum users should be taken seriously. There are some important people who have allocations only a few MHz up from our 2m chunk, who get very cross at Donald Duck noises occupying their channels!

In use, it is a real pain. You tune in 10kHz switched lumps and VXO (ie fine tune) in between with another knob. This is tiring when used at home, and distracting when driving. Don't be too impressed with claims about a fitted pre-amplifier on the receive side. It needs it, but you can get a good pre-amp kit for under a fiver. Quite a few have an extra range extending crystal fitted (normally with the change over switch fitted on the back panel). This



Surprise, surprise! The Standard C430 70cm rig seems to be around in abundance.

is quite a useful mod and is worth having.

£50 is your top whack. Don't pay funny money and don't tweak the transmit strip. Quite honestly I'd rather get a Mitzuko 2m SSB hand portable at £45 to £55 and add a linear. You will sleep better at night if you have a clear conscience!

Standard C430

This was a surprise; I would not have expected a mobile 70cm rig to have met our freely available criteria and our £60 limit, but at every rally there were loads of them. For those not in the know, this is a small, very compact FM rig, about 3½" x 2½" x 10", which is ideal for a small car.

Don't be confused with other, similar rigs that Standard made for 2m, which only wanted one crystal per channel, this needs two. Take care, the first IF is 11.7MHz and xtal frequency and receive frequency

required minus 11.7 all divide 24, ie 17MHz. Tx is also X24, ie 18MHz. When originally supplied new these had some weird and wonderful channels fitted — you have been warned.

Good value but check the crystals.

When buying, check there is a B9A plug in the accessory socket. This should have a 10uF 10 volt capacitor twix pins 1 and 4, negative to pin 1. Overall, quite acceptable, though you probably will not like the restricted low level audio that the internal speaker gives when mobile, but it's nothing an external one will not cure. Good value at £60. I'm pleased with mine, if that's a recommendation.

Trio/Kenwood TR3200

This was another surprise. This is a 70cm, crystal controlled portable. A bit tiring for week kneed little me to cart about for portable use (about the size of a large library book and heavy). Dead reliable rigs that, true to Trio tradition, give very little trouble. Tone burst in, high and low power switch gives typically a bit over a watt on high and a couple of hundred milliwatts on low. Tons of audio and good life from a battery pack of ten NiCads. Your scribe bought a perfect example at Elvaston for £60 with two antennas, twelve good useful channels, good NiCads, a charger and a 12 volt power lead. The receiver is surprisingly sensitive. All in all good value for money. These were changing hands in 1984 for a lot more.



A big but reliable 70cm rig is the TR3200.

OPEN 6 DAYS A WEEK AND EVENINGS BY APPOINTMENT! 24Hr Answerphone



Pictured above are Anne (G1LKA), Alan (G4LVK) and Andy (G8HAC). We are the team to assist your every need in amateur radio. Visit the Bromsgrove shop or see us at many of the mobile rallies this year.

Specialising in both new and secondhand equipment why not call in for a friendly chat and discuss your requirements. We will buy your used gear or if you prefer we are willing to sell it on a commission basis. ALL SECONDHAND EQUIPMENT THAT LEAVES OUR WORKSHOP IS FULLY TESTED AND CARRIES A THREE MONTH WARRANTY.

We are stockists of: DRAE - STARMASTER KEYS - MICROWAVE MODULES - TAL AERIALS - RSGB PUBLICATIONS - MUTEK and much much more.

Special Package Deals 2MT Handheld
ALINCO ALM203E and 30W PA.
£249.95 ring for details

FOR ALL YOUR AMATEUR RADIO REQUIREMENTS CONTACT US FIRST!

WE STOCK THE NEW ALINCO ALR-206E
£295.00 inc. VAT



A. KELLY, 3 STOKE RD, ASTON FIELDS, BROMSGROVE, WORCS. B60 3EQ

SPECIAL PRICES ON SURPLUS EQUIPMENT

Eddystone 770R 19-165MHz in 6 bands £145.00
Racal RA17L Receiver 500kHz/30MHz in 30 effective bands £200.00. Racal RA98 SSB Adaptor for RA17/117 £69.00. Racal LF adaptor 20kHz to 1MHz £65.00
All above receivers p&p £15.00 adaptors £5.00. Ask for manual prices
PCR Receiver LW/MW/SW built in P.S.U. £45.00 p&p £5.00 Pye Pocket phone PF1 RX £6.50 p&p 50p Tx batts new £1.50 Rx Battis £1.00 each p&p 50p any no.
AVO valve tester with databook £40.00 p&p £5.00 AVO Transistor tester CT537 with instructions £40.00 p&p £5.00. AVO multimeters from £28.00. Creed Model 75 Teleprinters £22.00 p&p £5.00. Marconi TF995/A/35 SIG Gen 1.5-220MHz AM/FM £95.00 p&p £15.00. Marconi TF 144H/4s 10kHz-72kHz £110.00 p&p £15.00. Wayne Kerr S121 AF Sig Gen 10Hz-120kHz. As new £55.00 10ft whip aerial £4.00 p&p £1.50. 100W mains inverter 12v in 240v output £20.00 p&p £4.
All above Tested and Guaranteed for 6 Months.
New 19 range 2A/1KV AC/DC digital Multimeter DM105 £29.95. New 28 range 10A 1KV AC/DC DMM DM6010 £39.95. New Meteor 600 Frequency counter 600MHz £126.00 Meteor 1500 covers 23cm £199.00 now in stock. Also 100MHz £99.00 1GHz £175.00 p&p £2.00. H100 Co-Ax 80p metre p&p 5p metre min 50p.
Various scopes/sig gens/counters/meters/always in stock SAE for test equip list or £1.00 for Radio/Equip catalogue includes £1.00 off voucher.
ADD VAT at 15% to ALL PRICES
Our Leicestershire Warehouse now open Saturdays only - phone Watford for information.

WEIRMEAD LTD, 218 St Albans Rd, Watford, Herts. 0923 49456
Access/Visa Welcome

OMNI ELECTRONICS

'VISIT SCOTLAND'S NEWEST COMPONENTS SHOP'.

We stock a wide range of general electronic components, send now for our 21 page catalogue price 20p + 12p p&p or call at the shop Mon-Fri 9.00am-6pm. Sat 9am-5pm.

174 Dalkeith Road, Edinburgh, EH16 5DX
Tel: 031-667 2611

QUARTZ CRYSTALS

STOCK CRYSTALS

CRYSTALS FOR 2 METRES
HC25 £2.15 FOR ONE CRYSTAL £1.96 WHEN 2 OR MORE PURCHASED
HC6 £2.15 FOR ONE CRYSTAL £2.05 WHEN 2 OR MORE PURCHASED

TX CRYSTALS RS CRYSTALS CHANNELS IN STOCK
HC6/U 8MHz 30PF 44 MHz SERIES RES RO TO R7 S11, S20 TO S23
HC25/U 12MHz 30 & 40PF 44 MHz SERIES RES RO TO R7 S8, TO S23 & S32
HC25/U 18 MHz 25 & 20PF 14/15 MHz 20 & 30 PF RO TO R7 S8, TO S23 & S32
HC25 SCANNER XTLS (NOT SR9) RO TO R7 S8, TO S23 & S32

full list available on request please send SAE

4 METRE CRYSTAL FOR 70.26 IN HC6/U AT £2.40 each
TX 8.78250 RS29 78000

70CM CRYSTALS £5.00/pr of £2.50 each
For Pye PF1 PF2 & PF70 series Wood & Douglas and FDK MULTI U11 SUB(433.2) SU20 RB0 RB2 RB4 RB6 RB10 RB12 RB13 RB14 RB15. ALSO for MULTI U11 ONLY SU16 SU18

CONVERTER CRYSTALS IN HC18/U AT £2.85 each.
22,000, 38,666, 42,000, 70,000, 96,000, 101,000, 101,500, 116,000

FREQUENCY STANDARD £2.75 each
HUG/U 1000kHz 3.50MHz 5.00MHz 10,000MHz 10,7000MHz HC18/U 10000kHz 7,000MHz 10,700MHz 48,000MHz 100,000MHz Also HC6/U455kHz £3.25 each

TONEBURST, I.F. & MPU CRYSTALS IN HC18 £2.25 each.
7,168MHz (for 1750 Hz Tone), 10,245 (for 10.7 I.F.) 3.2768 5.0688 14.3180 15,00000

YAESU CRYSTALS for FT101's FT991 & etc £4.00 each
Many available ex stock (A list is available on request pse send S.A.E.)

FUNDAMENTALS		MADE TO ORDER CRYSTALS		OVERTONES		PRICE
FREQUENCY	RANGE	PRICE	3rd OVT	FREQUENCY	RANGE	PRICE
5 TO	50 kHz	£21.00	21.00	TO 65.00	MHz	£4.55
50 TO	150 kHz	£11.00	5th OVT	60.00	TO 110.00	MHz
150 TO	500 kHz	£7.80	5th OVT	110.00	TO 125.00	MHz
160 TO	999 kHz	£11.90	7th OVT	125.00	TO 175.00	MHz
1 TO	1.5 MHz	£10.75				
1.5 TO	2.0 MHz	£5.10				
2.0 TO	6.0 MHz	£4.75				
6 TO	21 MHz	£4.55				
21 TO	25 MHz	£6.50				
			DELIVERY	2 TO	175.00 MHz	2 TO 3 weeks
				5 TO	999.9 kHz	6 to 8 weeks
				1 TO	1.499 MHz	3 to 4 weeks

Unless otherwise requested fundamentals will be supplied for 30pf load capacitance and overtones for series resonant operation.

HOLDERS - PLEASE SPECIFY WHEN ORDERING - else HC25/U supplied for XTLS above 3 MHz HC13/U 6-200 kHz HC6/U & HC33/U 170 kHz-175 MHz HC18/U & HC25/U 2-175 MHz

DISCOUNTS - Price on application for 10+ units to same frequency/spec. or bulk purchases of mixed frequencies. We supply FREE xtals for use in U.K. repeaters.

COMMERCIAL CRYSTALS - available on fast delivery and at competitive prices. Please send for list stating interests.

EMERGENCY SERVICE - for XTALS 1 to 125 MHz. Add the surcharge for each XTAL. Days refer to working days. 4 days +£12, 6 days +£7, 8 days +£5, 13 days +£3.

CRYSTAL SOCKETS HC25 £0.20 ea. HC6 £0.25 ea. MINIMUM ORDER CHARGE £1.50 unless ordered with crystals.

TERMS - Cash with order post inc. to U.K. & Ireland. Cheques & P.O.'s to OSL LTD.
A stamped addressed envelope with ALL enquiries please.

OSL P.O. Box 19 Erith Kent DA8 1LH **ALL PRICES ARE EX VAT PLEASE ADD 15%**

Telephone: 01-318-4419 24Hr Answerphone: Dartford (0322) 330830
Telex: 8817271 GECOM-S (Attention QUARTSLAB)

Icom SM10 Microphone— not just another mic!



The compressor/graphic equaliser desk top microphone looks impressive but does it really make any difference?
Chris Lorek, G4HCL, sounds it out...

Take a listen around the bands and, even within the confines of 'communications' bandwidths, you will notice that everybody's voices are different. The world would be a strange and rather boring place if they were all the same. However, this has not been realised by designers of commercial transceivers. To be fair, it would be impossible to tailor each transceiver to its operator, in these days of mass production. Hence you will hear some signals on the band that are really powerful in audio, whereas others who are using exactly the same equipment sound thin and difficult to copy. We can't all have voices that are perfectly rounded between 300Hz to 2.7kHz.

Many studies have been performed of the frequency range of the human voice. Even in the early days of radio amateurs using SSB (ref 1) emphasis has been placed in getting the message through with good readable audio. DX chasers will tell you, it is the high frequencies in

your audio that pass the most intelligence. This is quite true (ref 2), but in a pile-up it is the most readable signal that gets understood, not unfortunately the 'thin' but strong signal. If this were the case, I'm sure British Telecom would be quick to start rolling off our telephone line responses on the LF side! Good communication requires a balance of

low and high frequencies, the low frequencies give 'fullness' to our speech whilst the higher frequencies add the intelligence, together they give us the effect of readability.

The 'typical' human voice frequency spectra are illustrated in Fig. 1, where you see that the maximum amplitude occurs in the range 200–700Hz, with a noticeable dip around 1kHz. When struggling against QRM it would be useful to retain the lower frequencies whilst boosting the intelligence giving higher frequencies by the exact amount required according to the operator's voice and the prevailing radio conditions (ref 3).

It has been shown that audio in the range of 1kHz passes the most information. This can easily be demonstrated if you have a car radio with a graphic equaliser, then try increasing it, and notice which settings give the best readability. Unfortunately you can see from the graph that we have rather a 'dip' centred on this component in our voices!

Variable Bass and Treble

Lately this has been noted by amateur radio equipment manufacturers. The FT102, for instance, has preset adjusters to vary the low and high frequency components of the transmitted audio. Slowly but surely accessories are becoming available to enable amateurs to shape their audio to give the best communications potential. The latest in this line is the Icom SM10, described as a

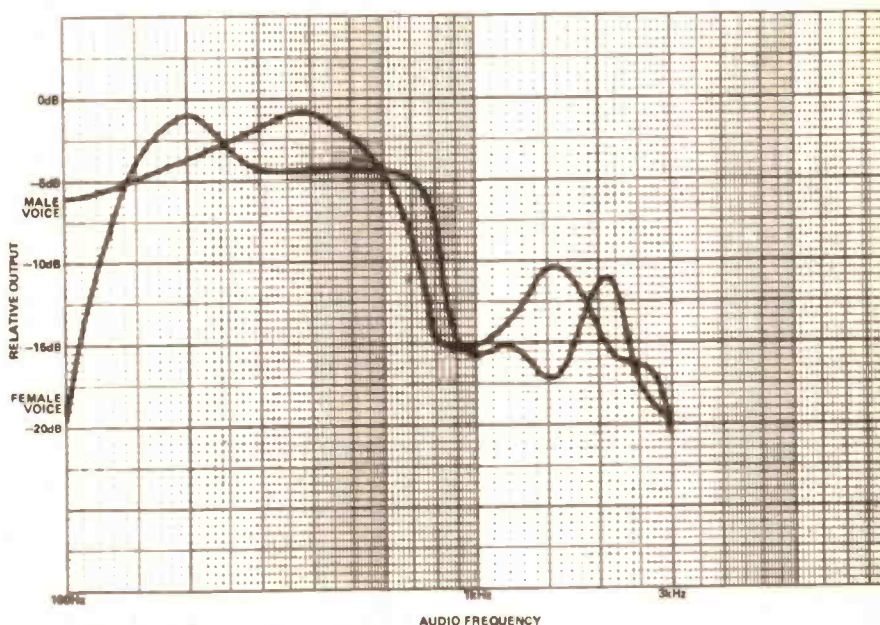
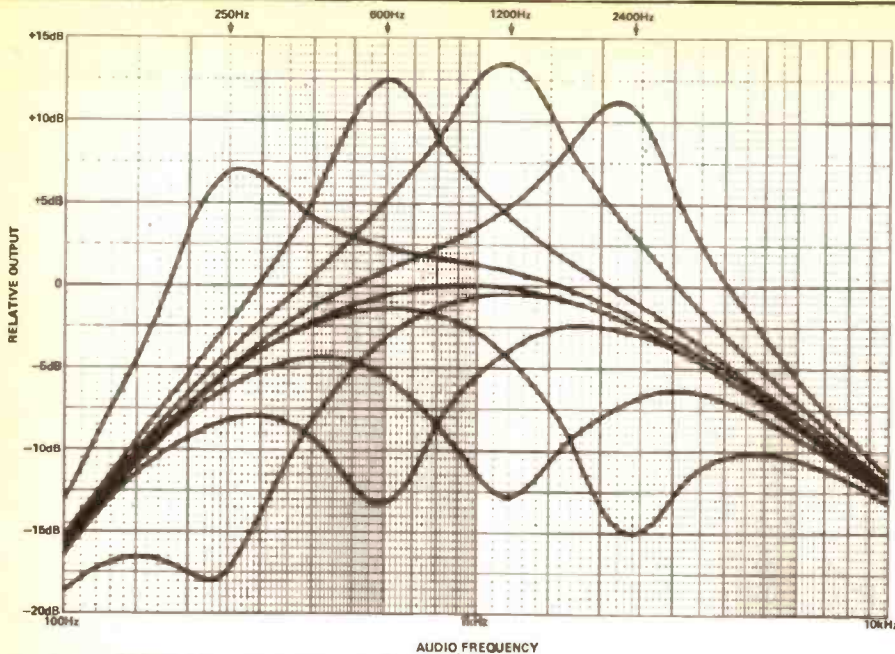

Fig. 1 Typical human voice spectra.



The Icom SM10 frequency response.

"Compressor/Graphic Equaliser Desk Top Microphone", guaranteed to look technical and impress visitors to your shack. Does it work as well as it looks, and would it perform a useful purpose? There's only one way to find out I thought...

Offerings

The microphone unit is presented in a smart grey base, with all the electronic circuitry fully shielded and the electret element housed at the end of a gooseneck surrounded by a sponge windshield. The base measures 230mm(w) x 110mm(d) x 30mm(h), which is possibly a touch on the large side but does allow the controls to be spread out nicely. The instructions provided state the microphone is suitable for the Icom IC27A/E/H, IC37A, IC45A/E, IC47A/E, IC120, IC271A/E/H, IC471A/E/H, IC735, IC745, IC751, IC1271, and the IC3200A/E, with a dire warning *not* to attempt use with any other transceiver. *However, don't stop reading if you don't own an Icom!*

A four band switchable equaliser is fitted, with a stated +/-12dB range centred on 250Hz, 600Hz, 1200Hz and 2400Hz, controlled by four slider controls calibrated in five marked divisions for 12dB cut/boost. A compressor amplifier is also fitted which may be switched to 10dB, 35dB, and 45dB compression from the top panel. A rotary knob sets the audio output level to the transceiver, a VU meter giving an indication of modulation level.

Tx keying is performed by a momentary action PTT button, this may be overridden by an adjacent 'lock' button which acts as a 'waffle' control keeping the Tx keyed until the PTT button is pressed again. Up/down click-action buttons are provided towards the rear of the panel for transceiver frequency control. Power for the unit is taken from the 8V transceiver supply present at the microphone socket. A brief instruction leaflet printed in English and Japanese is provided but with no circuit diagram or microphone connections.

Deja Vue

At the risk of upsetting Messers Icom, I believe the unit is a classic example of 'badge engineering', or OEM production to the businessmen (original equipment manufacture to those not in the know). A look at the Adonis AM-6000 unit, a well respected name in microphone technology, shows remarkable similarities right down to the colour of the knobs but with the absence of the up/down buttons. I thought the styling looked somewhat familiar!

After reading the instructions I felt a little dismayed that the unit would not, apparently, operate with the Icom IC505 transceiver I wished to test it with. Circuit diagrams were studied of the IC505 together with Icom sets that were stated as suitable for connection - I could see no reason why the two were

incompatible. I crossed my fingers and it plugged in. Lo and behold it worked perfectly with no smoke from either end.

Further investigation was performed with an oscilloscope and multimeter, and my conclusion was that this unit should, with plug rewiring, operate with most modern Icom, Yaesu or Trio/Kenwood transceivers in terms of modulation and Tx switching. The up/down function if required would need slight internal rewiring of the unit connections, which would probably invalidate any guarantee.

Testing...Testing

The microphone was initially tried on the Icom IC505 6m transceiver with favourable results when compared with the supplied hand microphone. However, the average user of this sort of microphone would use it for possibly more demanding applications such as HF DX chasing or weak signal VHF SSB operation. A patch lead was made to enable use with my FT107M system and comparison with the Shure 444 microphone in normal use, as well as the standard Yaesu MH-1 microphone with switchable tone control, on bands from 160m up to 23cm.

The compressor and output controls were initially set up by monitoring the transceiver ALC and transmitted signal on a HF oscilloscope. It was found that for normal use the compressor control would be set to the MID position, ie 35dB compression. This permitted me to speak around 15cm from the mic element and only just hit the compressor on peaks of speech. This ensured good quality audio with the safeguard of operating just below the ALC threshold of the transceiver, and gave a clean punchy signal.

During DX chasing, the 'high' compression level was useful although it did bring up slight room echo and other background noises. When operating under high ambient noise levels, such as crossbanding or with other receivers monitoring in the shack, the 'low' position made operation possible but necessitated speaking very close to the mic element.

Adjustment of the equaliser is best done with reports from other stations. An old friend was 'collared' on 2m and realised what he had let himself in for after 20 minutes of

suffering wierd audio emanations from my station. In the end it was certainly worth it. The best response in my case was around 3dB boost of 250Hz, 4dB cut of 600Hz, 4dB boost of 1200Hz and 2dB boost of 2400Hz. This proved the most acceptable for both ragchew QSO's as well as operation in heavy QRM, the typical reply being "When you switched the equaliser in you became easier to listen to", any 'thinness' in the audio instantly became extinct. Comparing microphones in nearly all cases listeners preferred the equalised SM10 to be switched in.

In communication under marginal signal conditions, an improvement in readability was noticed in every case, even with 20dB of RF speech clipping also used externally to the SM10. Running 100W on HF with an aerial 2m away from the unit showed no problems with RF feedback.

Laboratory Tests

What can you test on a microphone I thought? Well the element itself is an electret condenser with inherent high quality of reproduction and audio flatness, and any tests of this would show little, so concentration was placed on the compressor and equaliser. The element was disconnected and replaced by a laboratory standard audio oscillator, the output of the



unit was connected to an audio millivoltmeter and scope for measuring response, and a selective voltmeter and audio spectrum analyser to measure distortion and noise output.

The overall response with the equaliser out was gently rounded with maximum gain centred in the middle of the average transceiver audio passband. This did not vary at all when the equaliser was switched in with all controls centred. Each frequency band was varied in turn by +/-4 divisions and the response plotted in each case. These together with the normalised response are shown in Fig. 2.

The output level was adjustable from 0-27mV RMS at 1kHz, harmonic distortion was less than 0.1%, and signal to noise ratio in a

300-3000Hz bandwidth was greater than 60dB, both measured flat. This did not degrade under extreme settings of compression and output level.

Conclusions

The technical performance of the unit lives up to its specifications, the final quality of transmission being limited by the transceiver and not due to the limitations of the SM10 electronics. The equalisation component at 250Hz would, I feel, have been more usefully placed higher in frequency, say 400Hz or so, as most transceivers cut off sharply below 300Hz. A useful boost/cut is still available though, due to the broad response.

I believe the usefulness of the SM10 depends on what you use your equipment for, but remember that you are judged by others on the signal you emanate. A unit such as this can do wonders to improve on it in virtually every case. Many amateurs are content to use a £3000 station and a £10 microphone. At the end of the review period, it was not sent back, Messers Thanet Electronics received a G4HCL cheque instead, 'nuff said?

My thanks go to the many amateur friends who helped in on-air tests, especially G1SEP, and to Thanet for the review sample.

References

1. 'Quality Transmissions', S S Bee, Radio Communication Feb 68
2. 'The Universal Voice Channel', Lenkurt Demodulator vol 13 No 3
3. 'Equalize Your Microphone And Be Heard!', Bob Heil, K9EZO, QST Jul 82.

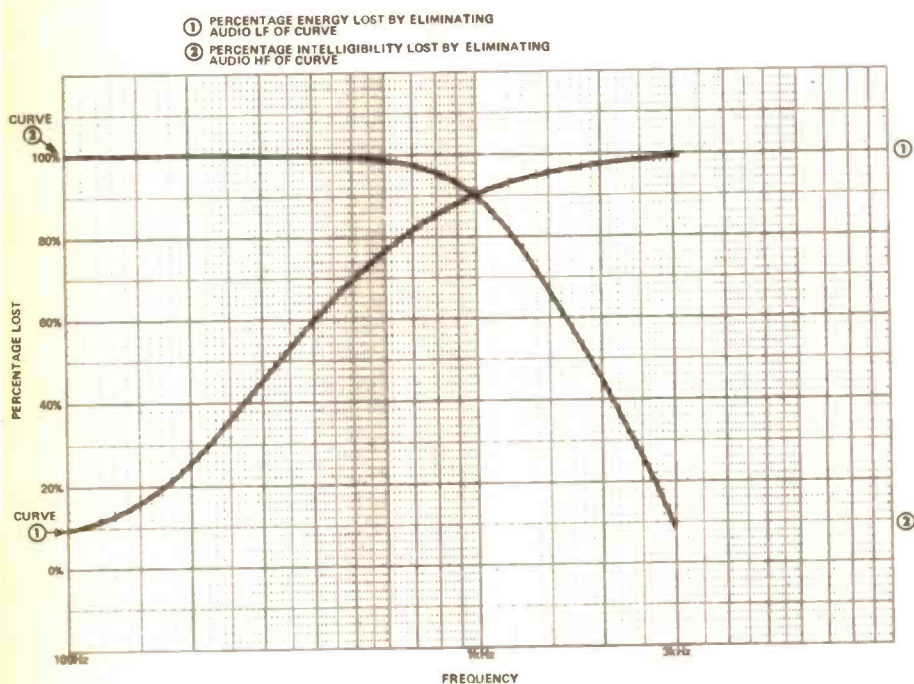

Fig. 2 The effect of bandwidth reduction.

B. BAMBER ELECTRONICS

Pye Base Station Type F30AM High Band & Low Band	£220
Pye Base Station Type F30FM High Band & Low Band	£250
Pye Base Station Type F401 AM High Band & Low Band	£300
Pye Reporter Type MF6AM High Band & Low Band	£90
Pye Europa Type MF5FM High Band & Low Band	£90
Pye Olympic Type M201 AM High Band & Low Band	£65
Pye Motofone Type MF5 AM High Band & Low Band	£45
Pye Westminster Type W15AM High Band & Low Band	£50
Pye Westminster Type W15AM Mid Band	£25
Pye Westminster Type W15AM Air Band Crystaled 3 channels, complete	£75
Pye M294 FM High Band	£200
Pye M293 AM High Band & Low Band	£180
Pye M296 UHF	£220
Pye Base Station Type F9U UHF	£90
Pye Base Station Type F9AM High Band	£90
Pye Base Station Type F25FM High Band	£90
Pye Base Station Type F412 UHF	£200
Pye Base Station Type F414 UHF	£200
Pye Base Station Type F461 UHF	£90
ITT Base Station Type 30LRU43A UHF	£150
Pye Pocket Type PF2FM High Band & Low Band Less Mike, Battery & Aerial	£25
Pye Pocketfone Type PF2AM High Band & Low Band Less Mike, Battery & Aerial	£25
Pye Pocketfone Type PF2UB UHF Less Mike, Battery & Aerial	£25
Pye Pocketfone Type PF5 UHF Less Battery	£25
Pye Pocketfone Type PF8 UHF Less Battery	£45
Pye Pocketfone Type PF9 UHF less Battery	£45
Pye Pager Type PG1 AM Low Band	£35
Pye Mains Power Unit Type AC15	£25
Pye Mains Power Unit Type AC200	£120
Pye Power Amp. Type A200 High Band & Low Band	£50
Pye Controller Type PC1	£85
Pye Controller Type M81	£195
Pye Westminster Type W30 AM Low Band Complete with control gear	£45
Pye Westminster Type LW15 FM High Band Less control gear	£40
Weatherproof mobile P.A. speakers 9" with mounting bracket, 8 ohm 15 watt	£10
Pye Pocketfone Receiver Type PF1 UHF with battery & manual	£6
Pye Pocketfone Type PF1 UHF Rx/Tx with manual less Battery	£20
Pye Signal Generator Type SG5U 370 Mhz to 470 Mhz	£90
Pye Signal Generator Type SG5V 70 Mhz to 170 Mhz	£90
Airtech UHF Filter Duplexer, 3 Cavity Type. Model M450-3A/14	£25

PLEASE NOTE It is illegal to operate a transmitter without a licence. Secondhand Pye equipment does not meet DTI approval. All sets are sold less crystals, mikes, speakers, power leads, etc. unless otherwise stated.
CARRIAGE on RT equipment - Mobiles £2.00 each, Base Stations £15.00 each.
Please add V.A.T. to the total order including carriage.

VISA

5 STATION ROAD, LITTLEPORT, CAMBS CB6 1QE
PHONE ELY (0353) 860185



Parametric EQ



Fed up with mics that don't
sound right?
Is your rig lacking in response?
Do you have trouble cutting through
the QRM and working DX?
Yes?

**NEW
SUMMER CAT
OUT NOW!**

price **£54.15 inc.**

Then we have the answer

The Parametric Equaliser is NOT a standard audio processor but is the communication equivalent of the Graphic Equaliser used by the professional studios and as such can make an amazing difference to the quality of your transmission or reception.

The Equaliser has three frequency parameters; A level control which acts on the overall response from 2kHz downwards and two frequency controls for the high and low end of the spectrum, above and below 1kHz. These provide cut and boost of $\pm 12\text{dB}$ at any particular frequency within 200Hz to 1.1kHz and 1kHz-3.5kHz. The input is conditioned by a VOGAD IC to provide constant output from any mic. The unit is supplied in kit form and comes complete with PCB, all components, pots, hardware and a custom punched, painted and screen printed case.

Cirkit Distribution Ltd

Park Lane, Broxbourne, Herts EN10 7NQ
Tel: (0992) 444111 Tlx: 22478

Books for radio amateurs

FDK

ELLIOTT ELECTRONICS

INSTANT HP AVAILABLE

QSY OLD MAN TO

THE 'HAM SHACK'

JAYBEAM AMATEUR ANTENNAS

APPOINTED DISTRIBUTOR

RIGS, ANTENNAS, SWR BRIDGES, POWER SUPPLIES, TEST GEAR, COMPONENTS, MORSE KEYS, COAXIAL CABLES, ROTATORS, MICS, PLUGS AND SOCKETS, SWITCHES

Call us on (0533) 553293
OR COME AND LOOK AROUND AT
26/28 Braunstone Gate, Leicester

AERIAL ACCESSORIES AND MASTS

PLEASE MENTION HRT WHEN REPLYING TO ADVERTS.

RADIO Tomorrow

Your at-a-glance guide to what's happening around the clubs, on the air and in general radio-wise.

- | | |
|--|--|
| <p>1-6 Jun GB2NM Centenary special event station at the Chalk Pits Museum.</p> <p>1 Jun Southend DRS Amateur Radio And Electronics Rally, at the Rocheway Centre, Rochford, Essex. Trade stands, bring and buy refreshments, RTTY demonstrations and family amusements. Talk in on S22. Details Ron, G6SOH, or Brian, G4RDS.
Mid Ulster ARC: meets at the Guide Hall, Castle Hill Gilford, at 3pm.
RSGB 432MHz Trophy and SWL contest.
Basingstoke ARC: VHF NFD arrangements.</p> <p>2 Jun Felixstowe DARS: visit to St Mary le Tower in Ipswich.
Southdown ARS: meeting.
Todmorden DARS: car treasure hunt for the G4HYY trophy.
Leeds DARS: meets every Monday at the Yarnbury Rugby Club, Brownberrie Lane, Horsforth, Leeds.
Stourbridge DARS: informal.
Sheffield ARC: video of Oscar 10 Satellite at the Firth Park Pavilion.</p> <p>3 Jun Worksop ARS: visit to Scunthorpe club.
Dartford Heath DFC: pre hunt meeting.
Fylde ARS: top band DF hunt.
Wolverhampton ARS: Electricity In Water by G3RVA.
Bourne ARS: meets twice a month at the Village Hall, Edenham, Bourne starting at 7.30pm.
Chichester DARC: meeting.
Bury RS: meets every Tuesday at the Mosses Centre.
E Lancashire ARC: lecture/demo at the Conservative Club, Cliffe Street, Rishton.
Warrington ARC: meets every Tuesday at the Grappenhall Community Centre, Bellhouse Lane.</p> <p>4 Jun Fareham DARC: The G6NZ Lecture.
Havering DARC: informal.
Cheshunt DARC: NFD final arrangements.
S E Kent (YMCA) ARC: natter nite.
Wirral ARS: Regulated Power Supplies by G3UZU at the Clubroom, Ivy Farm, Arrowe Park.
Binstead ARS: meets every Wednesday at the Scouts HQ in Drill Hall Lane, Binstead. Details G4VJF QTHR.
Fishguard DARS: meets every Wednesday at 7.30pm at the Club Shack, Further Education Centre, Ropewalk, Fishguard. Visitors welcome.</p> | <p>5 Jun Horndean DARC: SSTV.
N Wakefield RC: visit to Spen Valley junk sale.
Preston ARS: test your rig night with G3SYA.
Sandwell ARC: meets every Monday and Thursday at their premises in Broadway, Oldbury, Warley.
Barry College of FE RS: meets every Thursday in the College Annexe, Weycock Cross, Barry.
Pontefract DARS: visit to Spen Valley junk sale.
Bredhurst RTS: construction and natter night at the Parkwood Community Centre, Parkwood Green, Rainham.
Salop ARS: natter night at the Olde Bucks Head, Frankwell, Shrewsbury at 8pm.</p> <p>6 Jun Taunton DARC: meets every Friday at 7.30pm in the Basement, County Hall, The Crescent, Taunton.
Clifton ARS: meeting.
Loughton DARS: meeting at the site.
Nunsfield House ARG: rally preparations.
Borders ARS: meeting.
Dunstable Downs RC: meets every Friday.
Aberdeen ARS: HF NFD preparations on site.
Radio Society of Harrow: Chairman's Lecture.
Coventry ARS: Nuclear Power by a representative of the CEGB.</p> <p>7-8 Jun RSGB HF national field day.
Three Counties ARC: portable at the Lurgashall Fete.
Wolverhampton ARS operating a demonstration station at 21st Tipton carnival and show.
Dunstable Portable ARG and Dunstable Downs RC operating GB4LAD — a privately sponsored station to raise money for a surgical laser for the Luton and Dunstable Hospitals — on 1.9, 3.7, 14 and 144MHz. Details from GOCOQ on 0582 508259.</p> <p>8 Jun Dartford Heath DFC: DF hunt.
17th Elvaston Castle mobile radio rally in the showground of the Country Park, 5 miles SE of Derby on B5010. Admission free, car park 45p, with over 90 trade stands bring and buy and flea market. Plus fun for all the family. Further details from G4CTZ on 0332 799452.</p> <p>9 Jun Southdown ARS: meeting.
Morecambe Bay ARS: SSTV by GOAUF.
Milton Keynes DARC: Long Range Aircraft Communications.
Coulsdon ATS: an open invitation to any who would like to know more about amateur radio</p> |
|--|--|

- and the club. Demonstrations of VHF, HF, RTTY and ATV.
- 10 Jun** Sheffield ARC: RSGB region rep G4EJP.
Chester DRS: surplus equipment sale.
Delyn RC: meeting at 8pm at the Daniel Owen Centre, Mold.
Keighley ARS: informal.
Kidderminster DARS: VHF NFD preparations.
Dorking DRS: informal.
Newbury DARS: Intermodulation, Phase Noise and Dynamic Range by G3RZP.
Bromsgrove ARS: Lecture.
Verulam ARC: activity evening.
Bury RS: meeting.
- 11 Jun** Wakefield DARS: 2m DF hunt.
Three Counties ARC: Cellular Radio by G9TDW.
Fareham DARC: on the air natter nite.
Farnborough DRS: canal trip.
Lothians RS: AGM.
Wirral DARC: practice DF hunt.
Havering DARC: VHF NFD briefing and crystal set competition.
Crawley ARC: informal.
Cheshunt DARC: natter nite.
Stroud ARS: meeting.
S E Kent (YMCA) ARC: top band DF hunt.
- 12 Jun** Conwy Valley RC: AGM.
N Wakefield RC: on the air.
Edgware DRS: meeting.
Stirling DARS: meeting at the Argyle Centre, Princes Street, Stirling.
Bredhurst RTS: VHF/UHF DXing with G4DCV.
- 13 Jun** Salop ARS: Modern Day Receivers by G3EWZ.
Amateur Radio and Computer Club: meeting at the Crown in Bishops Waltham.
Wimbledon DARS: constructors competition.
Clifton ARS: meeting.
Nunsfield House ARG: rally round up.
Aberdeen ARS: super sale of good equipment.
Radio Society of Harrow: activity night.
Coventry ARS: night on the air.
- 14 Jun** Milton Keynes DARS: BSI and TVI by G1NXH.
- 15 Jun** Radio Society of Harrow participating in Capital Venture Day, Battersea Park, from 10am till 5pm. Using GB4CVD working mainly HF. Futher details from G8XBZ or G3YXZ.
- 16 Jun** Felixstowe DARS: social.
Todmorden DARS: Radio Reminiscences by G3JWN.
Stourbridge DARS: surplus sale.
- 17 Jun** Worksop ARS: Mystery Lecture by G3MGX.
Midland ARS: Microwaves by G8MWR.
Fylde ARS: post mortem on DF hunt.
Wolverhampton ARS: Lightning Protection.
Bourne ARS: meeting.
Chichester DARC: club meeting.
Chester DRS: barbeque.
Biggin Hill ARC: Moonbounce Operation.
- 18 Jun** Fareham DARC: Basic Digital Techniques by G4ITF.
Hastings ERC: Medical Electronics.
Havering DARC: Louis Varney, G5RV, Lecture.
Cheshunt DARC: meeting.
S E Kent (YMCA) ARC: natter nite.
Wirral ARS: surplus sale, venue to be announced.
- 19 Jun** N Wakefield RC: fox hunt and barbeque.
Preston ARS: Analysis by G3ZXC.
Bredhurst RTS: construction and natter night.
Salop ARS: natter night.
- 20 Jun** Ayr ARG: summer natter night.
- Winchester ARC: Spectrum by G4CFY.
Loughton DARS: informal.
Nunsfield House ARG: Mobile ATV.
Clifton ARS: meeting.
Borders ARS: meeting.
Dunstable Downs RC: The Scene Of The Crime by G8XTW.
Aberdeen ARS: competition winners talk about their projects.
Radio Society of Harrow: Let's Build A Satellite film.
Coventry ARS: Using A Micro For RTTY/AMTOR by G3WHO.
- 21 Jun** Wolverhampton ARS: demonstration station at Danesmore School, Ashmore Park.
- 22 Jun** Wolverhampton ARS: 2m DF hunt.
- 23 Jun** Morecambe Bay ARS: Raynet.
- 24 Jun** Maltby ARS: visit to Stones brewery, Sheffield.
Chester DRS: Cellular Radio by GW1ATZ.
Delyn RC: meeting.
Wolverhampton ARS: night on the air and your problems solved.
Keighley ARS: Antennas by Ant Products.
Kidderminster DARS: bring and buy sale.
Dorking DRS: Amateur TV — a live demonstration by G6YPM on Ranmore Common.
Bromsgrove ARS: club night.
Verulam ARC: DTI Interference Forum led by Raymond Brooks.
Wakefield DARS: RSPB talk and slides on wild birds.
E Lancashire ARC: informal.
- 25 Jun** Three Counties ARC: computer night.
Fareham DARC: on the air natter night.
Lothians RC: forward planning.
Wirral DARC: film night — Troposcatter Communications in the Oil Industry and Amateur Satellite Operation.
Havering DARC: Meteor Scatter by Ken Willis, G8VR.
Crawley ARC: Weather Satellites by G4TVC.
Cheshunt DARC: meeting.
Stroud ARS: meeting.
SE Kent (YMCA) ARC: setting up portable equipment for outdoor operations.
- 26 Jun** Greater Peterborough ARC: SWL evening.
Edgware DRS: VHF NFD briefing.
Glossop DARG: return to Dinting.
Stirling DARS: meeting.
Coulson ATS: meeting.
Bredhurst RTS: KW Communications.
Salop ARS: Operating Via Satellites by G3MWQ.
- 27 Jun** Wimbledon DARS: Space Exploration of the Solar System by Dr G Hunt.
Clifton ARS: meeting.
Nunsfield House ARG: treasure hunt.
Aberdeen ARS: HF NFD debriefing plus natter night on the air.
Radio Society of Harrow: activity night.
Coventry ARS: A Testing Time?! Bring your rigs and equipment.
- 28-29 Jun** RSGB Summer 1.8MHz contest from 2100 Sat to 0100 Sun CW only.
- 28 Jun** Three Counties ARC: summer barbeque.
Stourbridge DARS: barbeque.
- 30 Jun** Felixstowe DARS: Malcolm Appleby, G3ZNU, chairman of the RSGB VHF committee.
Sandwell ARC: Amateur Radio on the Burma Railway by G3BA.
- 1 Jul** Dartford Heath DFC: pre hunt meeting.

- Bourne ARS: meeting.
Chichester DARC: annual summer social at Goodwood.
Wolverhampton ARS: junk sale.
E Lancashire ARC: meeting.
Warrington ARC: meets every Thursday.
- 2 Jul Fareham DARC: Weather Satellites by G8VOI.
S E Kent (YMCA) ARC: natter night.
Fishguard DARS: meets every Wednesday.
- 3 Jul Horndean DARC: A G6NZ Special Lecture.
Hastings ERC: barbeque.
Worsop ARS: visit to Newark RC.
Horsham ARC: HF Aerials and Feed Systems by an expert.
Preston ARS: preparation for VHF NFD.
Barry College of FE RS: meets every Thursday.
Bredhurst RTS: construction and natter night.
Salop ARS: natter night.
- 4 Jul Borders ARS: meeting.
Loughton DARS: The Story Of Laser 558.
S Manchester RC: meets every Friday.
Aberdeen ARS: junk sale and VHF NFD preparations.
Clifton ARS: meeting.
Coventry ARS: preparing for VHF NFD.
- 5-6 Jul **RSGB VHF national field day.**
Amateur Radio and Electronics Hobby Fair at the Wembley Conference Centre.
- 6 Jul Dartford Heath DFC: DF hunt.
- 7 Jul Basingstoke ARC: An Introduction to Packet Radio by G4NNS.
Southdown ARS: barbeque.
Morecambe Bay ARS: night on the air.
Sheffield ARC: summer junk sale.
Todmorden DARS: chat night.
- 8 Jul Chester DRS: The FT726R by G4UXD.
Delyn RC: meeting.
Keighley ARS: informal.
Kidderminster DARS: Lowe Electronics display.
Newbury DARS: Satellite Operation by AMSAT UK.
Wakefield DARS: junk sale.
Wolverhampton ARS: Aerial Rotators.
- 9 Jul Three Counties ARC: The History of UoSAT by G8VLY.
Fareham DARC: on the air natter night.
Wirral DARC: annual barbeque.
Havering DARC: informal.
Crawley ARC: informal.
Stroud ARS: meeting.
S E Kent (YMCA) ARC: treasure hunt.
Stourbridge DARS: informal.
- 10 Jul N Wakefield RC: visit to Kirksall Road fire station.
Edgware DRS: Microwaves by G60DA.
Stirling DARS: meeting.
Bredhurst RTS: CM Howes Communications.
Salop ARS: fox hunt.
- 11 Jul Wimbledon DARS: Great Western Railway by D Kinsella.
Aberdeen ARS: rag chew night.
Clifton ARS: meeting.
Coventry ARS: night on the air.
- 12-19 Jul GB2CHI special event station operating throughout the Chichester 911 Festivities.
- 13 Jul **Sussex Mobile Rally at Brighton Racecourse.**
Aberdeen ARS operating GB4BGG at Beechgrove Gardens open day.
- 14 Jul Southdown ARS: meeting.
Milton Keynes DARC: Triffid UK TRC471 radio relay vehicle.
Coulson ATS: Cellular Radio Update by

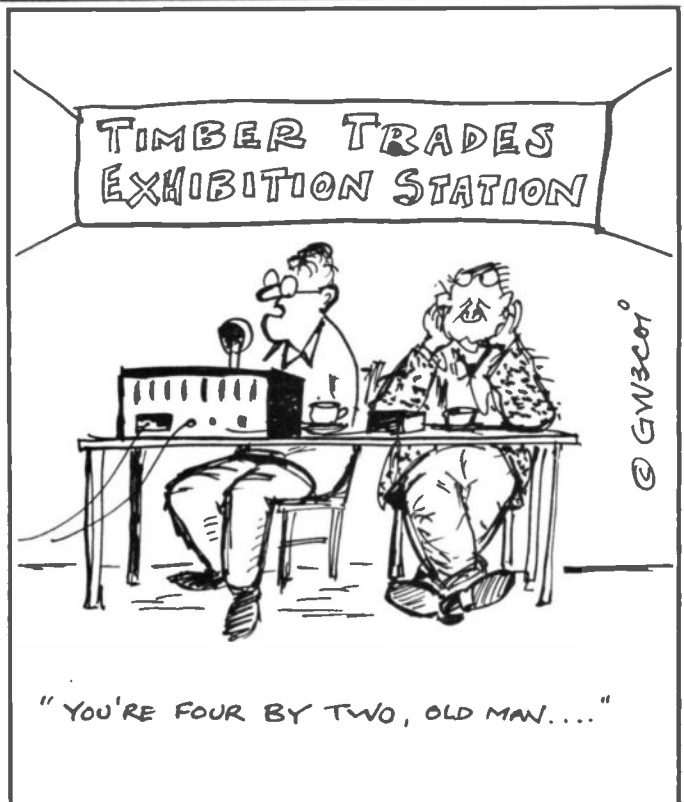

- G6YYT.
Sheffield ARC: DF hunt and pub meeting.
Felixstowe DARS: social.
- 15 Jul Worksop ARS: Packet Radio by G4KAL.
Midland ARS: RID by G4PZA.
Chester DRS: treasure hunt.
Bourne ARS: meeting.
Biggin Hill ARC: computer night.
Wolverhampton ARS; visit to BBC transmitting site at Droitwich.
- 16 Jul Fareham DARC: junk sale.
Havering DARC: DF hunt.
S E Kent (YMCA) ARC: natter nite.
Hastings ERC: Converting CB Equipment.
- 17 Jul N Wakefield RC: on the air.
Preston ARS: informal.
Greater Peterborough ARC: junk sale.
Bredhurst RTS: construction and natter night.
Salop ARS: natter night.
- 18 Jul Ayr ARG: summer natter night.
Winchester ARC: topical quiz by G6DIA.
Borders ARS: meeting.
Clifton ARS: meeting.
Bury RS: junk sale.
Coventry ARS: night on the air.
- 20 Jul **5th McMichael mobile rally at the Haymill Centre, Burnham, near Slough. Traders stands, flea market, demonstrations and much more besides.**
- 21 Jul Morecambe Bay ARS: VHF evening.
Stourbridge DARS: treasure hunt.
Todmorden DARS: chat night.
- 22 Jul Chester DRS: visit to British Aerospace Broughton.
Delyn RC: meeting.
Kidderminster DARS: on the air night.
Dorking DRS: informal at the Plough, Coldharbour.
Wakefield DARS: pitch and put competition.
- 23 Jul Three Counties ARC: CW Operating by G4RRA.

Fareham DARC: on the air natter night.
 Wirral DARC: Eileen Medley DF hunt.
 Havering DARC: informal.
 Crawley ARC: members evening at the Leisure Centre.
 Stroud ARS: meeting.
 24 Jul N Wakefield RC: rally meeting.
 Edgware DRS: informal.
 Bredhurst RTS: meeting.
 Salop ARS: Oscilloscopes by G3VZG.
 25 Jul Clifton ARS: meeting.
 Wimbledon DARS: general activity night.
 Coventry ARS: night on the air.
 26 Jul RSGB 432MHz low power contest.
 27 Jul RSGB 144MHz low power contest.
 28 Jul Felixstowe DARS: Hospital Radio by Pam and Bryan Hoyer of Ipswich Hospital Radio.

29 Jul Chester DRS: A Journey Around The Western Isles by Paul, GM4TZO/MM.
 Keighley ARS: fox hunt.
 Wolverhampton ARS: night on the air.
 E Lancashire ARC: informal.
 30 Jul Fareham DARC: portable planning.
 Havering DARC: meeting.
 31 Jul Preston ARS: informal.
 Coulsdon ATS: a general morse/RAE help night.
 Bredhurst RTS: construction and natter night.
 Salop ARS: natter night.

Will Club secretaries please note that the deadline for the September segment of Radio Tomorrow (covering radio activities from 1st August to 1st October) is 21st July.

Contacts

Aberdeen ARS	Don	04676251
Abergavenny & NH ARC	GW4XQH	0873 4655
Aberporth ARC	GWODPR	023987 274
Alyn and Deeside ARS	GW4RKX	0244 660066
Amateur Radio & CC	Trevor	04895 81032
Athertone ARC	Roy	0203 393518
Axe Vale ARC	Bob	029 74 5282
Ayr ARG	GM3THI	Ayr 42313
Barking RES	R. Woodberry	01 594 4009
Barry College RS	John	065679 710
Basingstoke ARC	Dave	07356 5185
Bath DARC	G4UMN	Frome 63939
Biggin Hill ARC	GOAMP	0689 57848
Borehamwood Elstree ARS	Tony	01 207 3809
Braintree ARS	G6CJA	0376 45058
Bredhurst RTS	Kelvin	Medway 376991
Brighton DARS	Peter	0273 607737
Bristol ARC	G4YOC	Bitton 4116
Bristol (Shirehampton) ARC	Ron Ford	0272 770504
BT (Reading) ARC	G4MUT	0734 693766
Bury RS	Allan	0204 706191
Cambridge DARC	D. Wilcox	0954 50597
Cheshunt DARC	G4VMR/G4VSL	092084 250
Chester DRS	Alan	0244 336639
Chichester DARC	C. Bryan	0243 789587
Clifton ARS	RA Hinton	01 301 1864
Conwy Valley ARC	G4VVW	0492 636376
Coulsdon ATS	Alan	01 684 0610
Coventry ARS	Robin	0203 73999
Darenth Valley RC	Sec	0322 63368
Dartford Heath DFC	Pete	0322 844467
Denby Dale DARC	G3SDY	0484 602905
Derwentside ARC	G1AAJ	0207 520477
Donegal ARC	EI3BOB	074 57155
Dorking DRS	John	0306 77236
Droitwich DARC	G4HFP	0299 33818
Dudley ARC	John	0384 278300
Dunstable Downs RC	Phill Morris	0582 607623
East Kent ARS	Stuart	0227 68913
East Lancashire ARC	Stuart	0254 887385
Edgware DRS	John	Hatfield 64342
Exeter ARS	Roger Tipper	0392 68065
Fareham DARC	Alan	0329 288139
Farnborough DRS	Mr Taylor	0252 837581
Felixstowe DARS	G4YQC	0473 642595
Fishguard DARS	Bernard	0348 872671
Fylde ARS	PRO	0253 737680
Galashiels DARS	GM3DAR	0896 56027
G. Peterborough ARC	Frank	0733 231848
Halifax DARS	D. Moss	0422 202306
Harrow RS	Tony	01 861 0419
Hastings ERC	Dave Shirley	0424 420608
Haverhill DARS	Rob Proctor	0787 281359
Havering DARC	GOBOI	04024 41532
Hornsea ARC	Norman	0262 73635
Horsham ARC	Pete Head	0403 64580
Inverness ARC	Brian	0463 242463
Keighley ARS	G1IGH	0274 496222
Kidderminster DARS	Tony	0562 751584
Kingston DARS	G3ODH	Epsom 26005
Lagan Valley ARS	Jim	0846 682474
Leeds DARS	G1EBS	0274 665355
Leighton Linlade RC	Pete Brazier	052 523 270
Lothians RS	Robin	0506 890177

Loughborough ARC	Philip	0509 412043
Loughton DARS	G6FWT	01-508 7190
Maidenhead DARC	John	0628 28463
Maidstone YMCA S/C ARS	G4AYD	0622 29462
Maltby ARS	Ian Abel	0709 814911
Medway ARTS	Tony	0634 578647
Midland ARS	G8BHE	021382 0086
Mid Sussex ARS	G1FRF	0791 82937
Mid Ulster ARC	Sam	0762 22855
Mid Warwickshire ARS	G4TIL	Southam 4765
Milton Keynes DARS	Dave	0908 501310
Morecambe Bay ARS	G3PER	Heysham 52659
N. Cornwall RS	J. West	0288 4916
N. Staffs ARS	G6MLI	0782 332657
N. Wakefield RC	Steve	0532 536633
Newbury DARS	G3VOW	0635 43048
Nunsfield House ARG	G4PZY	0332 767994
Oswestry DARC	Brian	0691 831023
Plymouth ARC	G4SCA	0752 337980
Pontefract DARS	GOAAO	0977 43101
Preston ARS	George	0772 718175
Rhyl DARC	GW1AKT	Nantglyn 469
Salisbury RES	Neil	0980 22809
Salop ARS	Simon	0743 67799
Sheffield ARC	John	Sheffield 581786
Sandwell ARC	G4UMY	021 422 1554
Shefford DRS	G4PSO	Hitchin 57946
S. Bristol ARS	Len Baker	0272 834282
S. Cheshire	Chris	07816 73185
S. Lakeland ARS	Dave	0229 54982
S. Manchester RC	Dave	061 973 1837
S. Tyneside ARS	G4XWR	S. Shields 543955
S. E. Kent (YMCA) ARC	John	0304 211638
Southdown ARS	P. Henly	0323 763123
Stevenage DARS	G4ISO	0462 892765
Stirling DARS	MOBFS	0259 217702
Stockton DARS	John Walker	0642 582578
Stockport RS	Mel	061 224 7880
Stourbridge DARS	G3ZOM	K/ford 288900
Stowmarket DARS	M. Goodrum	0449 676288
Stroud ARS	GODZM	045 3832773
St Helens DARC	A. Riley	051 430 9227
Swale ARC	B. Hancock	0795 873147
Taunton DARC	A. Moxon	0823 78903
Telford DARS	Tom Crosbie	0952 597506
Three Counties ARC	Keith, GOBTU	0730 66489
Tiverton (SW) RC	Alan	0392 881569
Todmorden DARS	G1GZB	070 6817572
V White Horse ARS	Ian White	Abingdon 31559
Verulam ARC	Gerry	St Albans 52003
WACRAL	G4NPM	0795 873147
Wakefield DRS	G4VRY	0532 820198
Warrington ARC	Paul	0925 814005
Welland Valley ARS	J. Day	0858 32109
Welwyn Hatfield ARC	Dave	07073 26189
West Kent ARS	B. Guinnessy	0892 32877
Westmorland RS	G. Chapman	0539 28491
White Rose ARS	G4YEK	0423 884481
Willenhall ARS	G4LWI	0902 782036
Wimbledon DARS	G3DWW	01 540 2180
Winchester ARC	Gordon	0703 772191
Wirral ARS	Cedric	051 625 7311
Wirral DARC	Peter	051 677 7376
Wolverhampton ARS	Keith	0902 24870
Worcester DARC	D. Batchelor	0905 641733
Worksop ARS	G4ZUN	0909 486614
308 ARC (Surbiton)	Dave Davis	01 399 5487

A Folded G5RV and Balanced ATU

The G5RV multiband dipole is recognised by thousands of amateurs as one of the most versatile and effective antennas in use today. Indeed, there is every reason to suppose that it is still gaining in popularity if the number of commercialised packages regularly adver-

impedance. However, experiments proved that the G5RV could be folded back on itself within a 60' span without affecting its performance on all bands between 160-10m, even when fed by 75 ohm twin feeder or coax into the 300 ohm matching length (see later).

bare copper wire is used for the antenna, plastic spacers are recommended as bamboo is a poor insulator in wet weather. However, if insulated wire is used, bamboo is perfectly satisfactory.

Many amateurs employ the matching system of 34 feet (or 29 feet 6 inches) of 300 ohm ribbon into 75 ohm coax, often for ease of routing into the shack. While this method will work perfectly well with the folded G5RV, far superior results will be obtained using open wire feeder shown in Fig. 1 and employing a balanced ATU.

Perhaps it is relevant to point out that the G5RV is, after all, a *balanced* system and as such requires a *balanced* transmission line. In his original designs described in the RSGB Handbook, Louis Varney details quite explicitly the function of the 300 ohm ribbon matching length, so there is no need to dwell on it here. However, it is pertinent to ask why some amateurs persist in using (or trying) baluns in an already matched feeder, or why fairly long (and therefore lossy) coaxial cable is employed. In the latter case, Les Moxon, G6XN, has explained that much money may be saved, and fewer decibels lost, by not using coax.

If you've only got a small garden, you can still use the popular G5RV. Dave Pritchard, G4GVO, describes how and explains how to make it a more effective balanced system.

tised is any criterion. Since its inception by Louis Varney, G5RV, some forty years ago, many amateurs have found that the antenna works extremely well not only in its full length configuration, but as inverted vee, and when its ends are dropped to accommodate a small space. In recent years the half size version has also enjoyed a measure of popularity, though in certain instances not with great success.

Dropping the ends of a dipole to fit a limited space is an age old technique. Sometimes though this is undesirable or even impossible where the slope of a roof or other obstruction is encountered, and very often the extreme narrowness of gardens prohibits its erection as an inverted vee. These and other considerations often pose problems for the amateur with restricted space, and it is for him (or her) that this article, hopefully, will prove useful.

The Folded G5RV

The concept of folding the ends of a dipole back on themselves is as old as the idea of dropping the ends, but both have their limitations in respect of resonance, angles of radiation and, in some cases,

How To Put It Together

Fig. 1 shows the basic layout of the antenna. Each 51' 'leg' of the dipole is folded back on itself at a spacing of 12 inches, using light bamboo canes or plastic lengths as spacers. At 30 feet from the feed point, the wire is securely taped to a spacer and the remaining 20 feet folded back as shown. Although any convenient method of fixing the wire to the spacers may be used, the author found it easier to drill 1/16 inch holes half an inch from top and bottom of the spacers, and secure them with a few inches of tie-wire.

It is worth mentioning that if

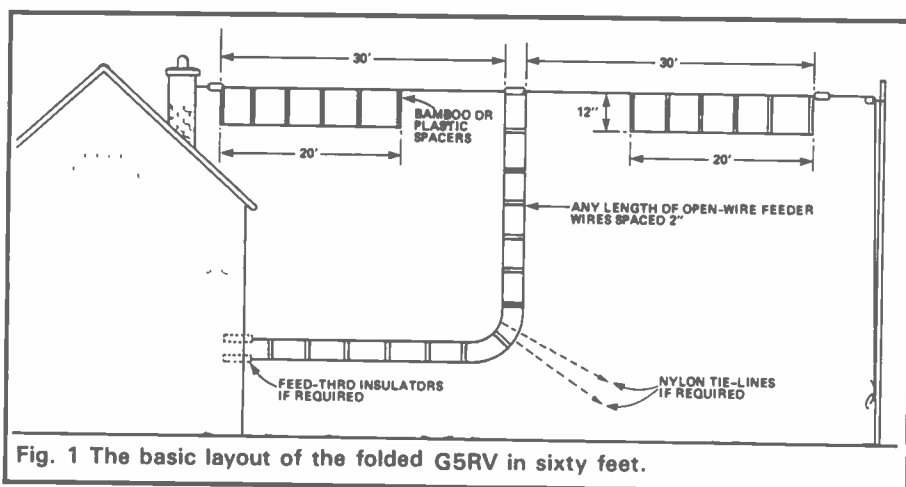

Fig. 1 The basic layout of the folded G5RV in sixty feet.

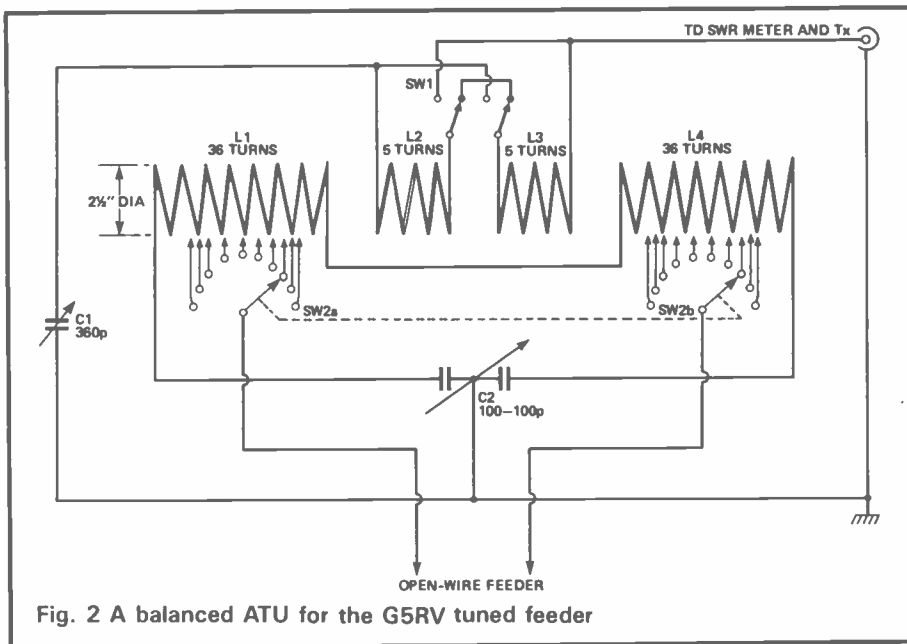

Fig. 2 A balanced ATU for the G5RV tuned feeder

It is of course understandable that in certain locations coax is the only answer. But where it is used for appearance's sake, or to reduce the fear of RFI, it is worth explaining that open wire feeder made from thin, plastic stranded wires spaced at 2 inches by homemade or commercial spacers is not necessarily unsightly. Furthermore, when correctly made and installed, the currents in each line cancel themselves out, thus reducing considerably any risk of interference. In addition, 2 inch open wire feeder may conveniently be led over the tops of doors and other wooden openings as a temporary measure if desired.

The Balanced ATU For Open Wire Feeder

Fig. 2 shows the wiring diagram of the balanced ATU. It is strongly recommended that a wooden or plastic cabinet be employed in order to preserve the high Q of the coil — quite apart from ease of construction. It should measure 14 inches wide, 8 inches high and 12 inches deep.

The tune capacitor, C1, may be a wide spaced receiver type for powers up to 200 watts, but a transmitting type is recommended when you use legal limit powers. The capacitor is mounted on the base of the unit at the extreme left. C2, split stator load capacitor, is situated on the right. The switch, SW1, which connects the link windings in series or parallel, is mounted at the top centre. Switch SW2a/b, located just

below, is a two bank, two pole, ten-way component, of a heavy duty type, preferably with ceramic insulation.

The coil is the heart of the unit and it is worth taking care over its construction, which is shown in Fig. 3. An 'X' section of perspex measuring 3x13 inches is recommended for the former, with 1/16 inch holes drilled at 1/16 inch spacings along lines 1/4 inch from each side to accommodate a 2 1/2 inch diameter winding. Although two pieces of perspex are shown for constructing the former — suggested for rigidity — one piece of perspex drilled as shown will suffice, provided that on completion the turns are held securely in position by a suitable adhesive.

85 turns of 18 swg enamel wire are wound on a 2 1/2 inch diameter

former, after ensuring the wire is smooth and free from kinks. On completion, the windings are steadily released and carefully introduced into the holes of the former.

To make the main coils and link windings, 37 turns are counted from the left and the wire cut in the centre, leaving the end of a L1, a coil of 36 turns, and the beginning of L2. Another six turns are counted and the wire cut again in the centre, thus completing L2, with five turns. L3 is made in the same way as L2, leaving L4 to be made with 36 turns. On completion, the ends are dressed off uniformly and cleaned and tinned in readiness for the wiring connections. As suggested, a spot of suitable adhesive will hold the turns in place and, when ready, the former may be mounted on perspex or ceramic pillars at the rear of the cabinet.

Coils L1 and L4 are tapped outwards from the link windings at 3, 6, 9, 13, 16, 19, 23, 26, 29, and 32 turns respectively. 20 swg insulated wire is suggested for all connections, and it is useful, though not obligatory, to employ similar lengths from the tapping points to the switches to preserve symmetry. The common connections to the feeders may be made to a pair of Belling-Lee coaxial sockets mounted horizontally at the top end of the front panel in any convenient position. Coaxial plugs and sockets are recommended as they are inexpensive yet adequate for the purpose.

Adjusting The ATU

For 80 and 40 metre operation SW1 is usually set in the series

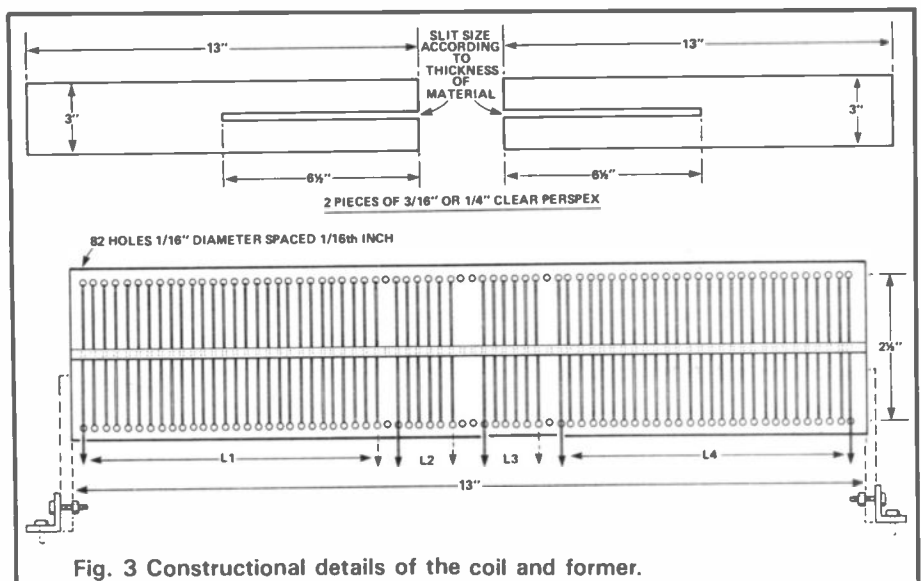

Fig. 3 Constructional details of the coil and former.

position, thus connecting the link coils as one winding of ten turns. SW2a/b may be placed between tappings 23 to 32 for 80m, while 40m may require it set between 13 and 19.

For the higher frequencies, including 20, 15 and 10 metres, SW1 is put in the parallel position, thus utilising the five turns of L2 only as the link winding, while SW2a/b is turned to tappings 9, 6 and 3 respectively.

It must be recognised that all these settings are only approximate and intended as a starting point. Don't panic if the unit tunes up perfectly well on any permutation of switching, as much depends on the length of the feeder and the location of the antenna. With an SWR meter between the unit and transmitter, just enough power is admitted to obtain a reading while the various settings are tried and minimum SWR achieved. The transmitter may then be tuned for its usual power in the normal way.

With the folded G5RV fed with open wire feeder from this unit, the author's highest SWR was 1.3:1 on

the CW end of 20m; on all other bands it displayed a gratifying 1.1:1.

Top Band Operation

The balanced ATU is not of course used for 160 metre operation, as in this case the feeders are strapped together in the shack, thus turning the system into a Marconi T type antenna. Under these conditions the vertical section of the feeder (now effectively a single wire) radiates most of the power whilst the dipole acts predominantly in a capacitive function. If sufficient feeder is employed, the Pi tank network of the transmitter should load into it perfectly well; if not, a simple L match tuner is all that is required for efficient operation on this band.

Conclusion

The system described here was employed at G4GVO for a number of years. During that time excellent top band reports were received on both AM and CW. 80 metre operation with a KW2000B consistently produced outstanding inter-G and con-

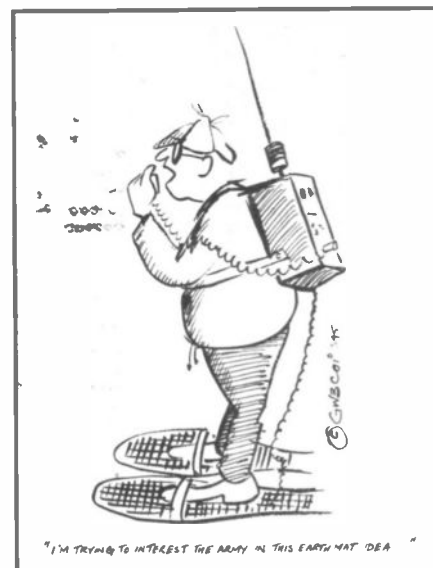

tinental reports, whilst W and VE were worked on several occasions with similar success. 20 metre SSB has raised VK with few problems, whilst 15 and 10 metre reports were also very encouraging.

The author hopes that these findings will prove equally encouraging and helpful to those amateurs with small gardens, and that they too will enjoy similar success.

REG WARD & CO LTD
1 Western Parade
Axminster Devon EX13 5NY

South Wests Largest Amateur Radio Dealer

Official Agents Yaesu, Trio, Icom, FDk.
 : Complete range stocked:
 : Full demonstration facilities:
 : Mail/Phone orders on all items:
 : Barclaycard, Access, Instant Credit:

APPROVED TRIO DEALER

Ancillary equipment: Adonis, AKD, AOR, Bencher, BNOS, Cap. Co. Datong, Diawa, Drae, Hansen, Hinound, JIL, Kempro, Microwave Modules, Mutek, SEM, Snare, Tolyco Hypower, Tono, Toyo, Welz, Wood & Douglas
 Aerials by: G. Whip, Hygain, Jaybean, Mini Products, Rexco, TET, Tonna.

New complete range Wood & Douglas Kits
 TAU Tuner SPC 3000

ICOM **FDK**

Cables, plugs, sockets, insulators, etc.
 Opening hours: Tues-Sat 9.5.30 (lunch 1-2) Closed Mondays

Tel: Axminster (0297) 34918

ADVERTISERS' INDEX

A. Kelly	13
Allweld	25
ACE Communications Ltd	17
Bamber Electronics	17
BNR & ES	24
Cirkit Holdings	17
Dewsbury Electronics	IBC
Elliot Electronics	17
Interbrooks	33
ICS Electronics	25
HiTec Worldwide	33
KN Ten Tec Ltd	25
Linkbrook	45
Microwave Modules	OBC
Omni Electronics	13
Quartzlab Marketing	13
Thanet Electronics	34/35
Reg Ward	24
Weirmead Ltd	13
Withers Communications	IFC

BECOME A RADIO AMATEUR

Train now for the Radio Amateur Licence examination. No previous knowledge needed, only a few hours per week of home study for 3 to 6 months. Post coupon now for details or tel. 062 67 6114 (24 hr service)



British National Radio & Electronics School P.O.Box 7, Teignmouth, Devon, TQ14 OHS

FREE brochure without obligation from:—
British National Radio & Electronics School
 P.O. Box 7, TEIGNMOUTH, DEVON, TQ14 OHS

CACC

Name

Address

HRT/7 BLOCK CAPS PLEASE

ICS

presents the brilliant **ALINCO**

2 METRE TRANSCEIVERS



ALR-206E 25 WATTS 2 METRE MOBILE

- 144-146 MHz FM
- 25 watts output
- 10 memory channels, band scan
- All programming from key pad on microphone
- Back lit LCD frequency display with LCD 'S' metre
- Frequency selection from front panel or microphone
- Mobile mount included

The ALR-206E features micro processor controlled versatility and programming from the microphone in a compact package.

ALR-206E Price: £295 inc VAT. (p & p £2.50)

Isopole 144 omni-directional antenna: Price £39.95 (p & p £2.50)



ALM-203E
3/5 WATTS
2 METRE
HANDHELD

- 144-146 MHz FM
- 3 watts with NiCad, 5 watts with DC/DC converter
- 10 memory channels
- Programmable band scan
- Switchable 150-160 MHz Rx (marine band)
- 'S' metre
- Toneburst
- NiCad charger

ALM203E Price: £239 inc VAT (p & p £2.50)



ELH-24B

30 watt amplifier

Built in Ga As FET Pre-amp

INCREDIBLE OFFER
save **OVER £58.00**
purchase ALM-203E
and ELH-24B together
for just **£249.95**
(p & p £4)

ICS

ICS Electronics Ltd.
PO Box 2
Arundel
West Sussex BN18 0NX
Telephone: 024 365 590



Please send SAE for further details
12 months parts +labour warranty
Dealers throughout UK
Prices may vary with
exchange rate
Callers by appointment

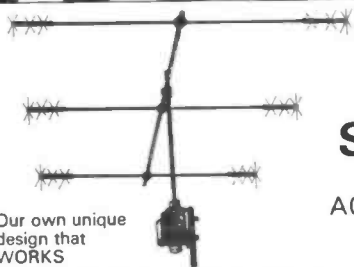

ALTRON

COMPACT Spacesaver ANTENNAS

AQ6 20, 2 Ele and 3 Ele
4 BAND, 6, 10, 15, 20 M

AQ40, 2 Ele, 40M! **NEW**

Our own unique
design that
WORKS

CLOSE COUPLED—HI 'Q'—CAPACITY HAT LOADED YAGI
Special features:

- Unique Altron fully sealed coils for max stability
- Resonant length elements for improved VSWR (1-1)
- Selectively detuned for optimum performance and gain (no gimmick quad needed)
- Easy trim spokes with lock nuts and spares
- Minimized wind load and weight
- Double insulated elements

Typical performance

Antenna model	AQ-20/2E	AQ6-20/3E	AQ40/2E
Forward Gain Dbd	3.8 to 4.8	5.5 to 7.5	3.8
Front to Back Db	13 to 15	16 to 18	12
Side Null Db	25	25	20
VSWR (typical)	1.1:1	1.1:1	1.1:1
Weight	7.5lb	12lb	12lb
Wind load	2ft ² 0.18M ²	3ft ² 0.27M ²	3ft ² 0.27M ²
Turning radius	76"/1930mm	96"/2438mm	114"/2895mm

PRICE + p&p £114.50 (4.50) £169.00 (7.00) £149.50 (7.00)

PRICES ARE INCLUSIVE OF VAT. TERMS. CWO. ACCESS. VISA

WE DESIGN—WE MAKE—WE SELL DIRECT. You get best value

Callers welcome.
Open Mon-Fri 9am-5
Sat 9am-12.15pm

ALLWELD ENGINEERING

Unit 6, 232 Selsdon Road
S Croydon CP2 6PL

Telephone: 01-680 2995 (24 hr) 01-681 6734

STOCK ITEMS NORMALLY DESPATCHED WITHIN 7 DAYS



KW TEN—TEC CENTURY—22

A TOP OF THE RANGE WINNER

A 50-watt, 6-Band CW Transceiver
that combines excellent performance, Reliability
Simplicity of operation, and low cost.



- ★ Full Break-in (OSK)
- ★ Full Band coverage — 3.5, 7, 10.1, 14, 21, 28.0—28.5 MHz
- ★ Total Solid State
- ★ Sidetone, adjustable for volume and pitch
- ★ 50 watts input
- ★ Offset Receiver Tuning
- ★ 6 Pole Variable Audio Filter
- ★ Linear Crystal Mixed VFO
- ★ Receives CW and SSB
- ★ Receiver sensitivity .5uV, typical
- ★ Operates on 12VDC

For further information on the above, together with
THE CORSAIR II, THE ARGOSY II, KW TRAP DIPOLE AND
TRAPS, 8 ATU's, KW BALUN and ANTENNAS please contact:

KW TEN-TEC LIMITED, Vanguard Works, Jenkins Dale,
Chatham, Kent, ME4 5RT. Telephone 0634-815173
HP & CREDIT CARD PURCHASE FACILITIES AVAILABLE.

Review - KW Ten-Tec Century 22



As light relief from the plethora of all-singing, all-dancing rig reviews, Tony Bailey, G3WPO, takes a look at the Century 22 — a six band HF, not-very-black-box transceiver.

Ten-Tec are well known in the USA and amongst QRP enthusiasts the world over for their range of transceivers, which cover QRP CW only to advanced multiband SSB/CW rigs. Ten-Tec, which stands for Tennessee Technical, is imported into this country by KW Communications — a name once very familiar to amateurs after introducing one of the first black box transceivers, the KW2000. They also manufactured the Viceroy, Vanguard and Vespa transmitters.

The Century 22 is a CW only, HF transceiver with an output of over 20W. It is one of the few non Japanese 'black boxes' available (although it is actually cream and grey/brown) and doesn't really have much competition if you are looking for a ready built QRP/medium power CW only rig costing under £350. For your money you get six bands (80-10m including 30m but not the other two WARC bands or 160m), full break-in, 20W minimum output but with control down to official QRP

powers and a nicely built and finished rig.

It bears a distinct similarity to the Argosy SSB/CW rig (reviewed August 1983 HRT), but with fewer switches and, since it has no SSB facility, sound controls have different functions. We will have a look at the circuit later, but the rig is basically a direct conversion (dc) receiver with adjustable (and effective) audio filtering for selectivity covering 500kHz of each amateur band. You can listen to SSB transmissions on all bands except 28MHz where only 100kHz of the SSB section is covered. It is also possible to decode RTTY and SSTV although you couldn't transmit these modes without some mods to the circuitry in the case of RTTY. It is one of the few dc rigs to possess an S meter (although it would be better described as a tuning/level indicator) and it comes with RIT and RF gain as well. An internal keyer board and calibrator are options for the receiver.

There is no internal PSU so it

needs an external supply of +13.6V at 5A max. Like all dc sets, the PSU must be well regulated with little ripple if hum modulation problems are to be avoided. KW kindly supplied the matching Ten-Tec model 979 PSU to go with it. The major advantage of this is that you do get thyristor overcurrent protection built in — a very good idea with solid state PA's and the possibility of using poorly matched antennas under portable conditions (see later).

First Impressions

The rig arrived packed with lots of foam and first impressions were of a nicely finished piece of equipment for the relatively low price. It is very light in weight at 6lb (2.7kg) making portable operation a viable option. The front panel is a cream coloured, textured plastic extrusion with the various controls neatly laid out.

The frequency readout is analogue using a combination of a large main tuning knob — calibrated in kHz from 0-100 — and a slide rule indicator illustrating the 100kHz segment of the 500kHz coverage you are currently in. The 'pointer' consists of a red rectangular LED travelling behind a filter marked from 0-5 (top; for those bands which start at exact MHz) and from 5-0 (bottom; for 80m). The combination is effective and easy to get used to. I found the tuning a little dead in 'feel' but there was very little backlash and the thumb indent on the front of the knob made fast tuning easy. The slide rule dial can be set exactly during calibration via a knurled protrusion under the tuning knob.

On the left of the panel is the drive control which allows power variation from the nominal 20W output down to tens of mW. Below

it are three push-buttons: 'lock' — a latching Tx button used for tuning up (only an ATU since the PA is broadband and requires no tuning) and SWR readings etc; 'cal' — for the optional callibrator; and FWD/REF for the metering circuit allowing direct readout of SWR and relative power (on a scale from 0-1).

Knobs Not Buttons

At the bottom are two standard ¼" jack sockets, one for phones (direct from the AF amplifier — instructions are given in the manual for fitting an attenuator for low impedance phones) and the key. It is nice to see the key socket on the front, after all you don't put the mic socket on the back of an SSB rig do you? It is duplicated on the rear panel as a phono socket.

To the right of the main tuning knob is the bandswitch, which has a nice positive feel to it, and above this the S meter. It is calibrated in S units from S5 to S9 +40dB, and indicates SWR from 1:1 to 3:1 at about ⅔ fsd. Relative power shows on a scale from 0-1. The readings automatically change between Tx and Rx when keying.

Incremental Receiver Tuning (RIT) is provided from a centre detent control. It is marked as 'offset' — a more correct description for a dc transceiver. Its function is to make sure that the receive carrier centre frequency is offset from that on transmit, otherwise you won't hear anything if the other station is zero beat with you. It has a stated range of +/- 2kHz.

Next to this is the *filter* control. This adjusts the skirt slope of a four pole active audio filter which has a bandwidth of 200Hz centred on 750Hz. In its widest (clockwise) setting, it is best suited to listening to SSB and general tuning around, then being narrowed down once you find a station to work.

This leaves the RF gain and AF/power controls. The former isn't strictly an RF gain in the normal sense but a pin diode dc controlled RF attenuator located at the front end. As well as providing volume control (at up to 1 watt output) pulling out the AF/power control switches off the rig.

Around The Back

On the rear are a row of phono sockets for the key and two +12V

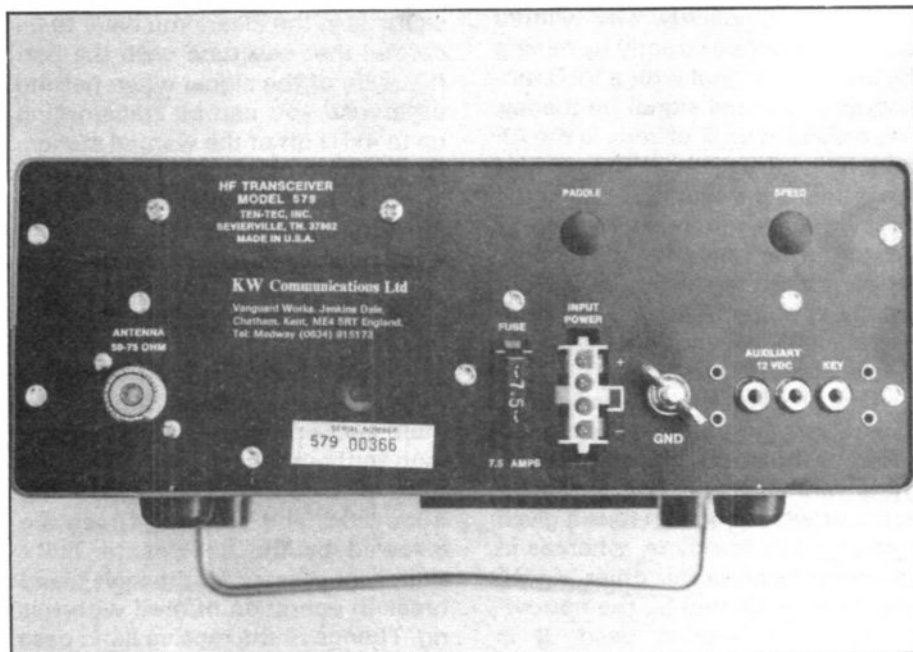

The back panel of the rig. Note the blanked holes for the optional keyer module.

DC accessory sockets. Next is a 7.5A fuse — the first I have seen using the automotive plug-in type and GND post for attaching an external earth. The manual does make a point that an external earth may be necessary to prevent RF pickup causing problems with the rig, as well as for safety purposes.

DC power comes in through an amp mate-n-loc connector — the necessary connector is supplied but you have to fit the lead to it following the instructions given. The antenna connection is via an S0239 socket. There are also a couple of blanked holes marked 'paddle' and 'speed' for use with the optional keyer module.

This leaves the sidetone level and pitch controls which are located on the side of the cabinet and accessible through holes using a small bladed screwdriver.

Perusing The Innards

On the top part of the aluminium chassis is the PA, mounted on a sub-chassis of ⅛" plate to act as a heat sink. To the left of this space is available for the callibrator and keyer options.

On the other side is the rest of the circuitry, split between four PCBs. Immediately behind the tuning knob is the main VFO (or PTO as it is actually permeability tuned) in a screened compartment. Also screened off are the low pass filters and metering circuits for the transmit side of things.

The boards are well made and wired but do not carry any printed location information, which will make servicing a little more difficult. The manual does indicate the location of various presets which may need to be adjusted. As an aside, Ten-Tec are the only manufacturers I have ever seen that specifically state you can have a go at sorting out faults during the warranty period *without* invalidating the warranty! Probably a case of professional amateurs realising what inevitably happens . . .

The speaker is mounted on the lower panel of the two part case and a tilt-up bail is provided.

Direct Conversion Technique

As I have mentioned, the Century 22 has a direct conversion receiver. For those unfamiliar with this method, the normal superhet receiver mixes a VFO output with the incoming (or outgoing) signal to produce a fixed difference frequency which is called the IF signal — typically 9 or 10.7MHz. All subsequent signal amplification is carried out at this frequency and eventually mixed again with another signal at the IF frequency in a product detector to produce demodulated audio (for SSB/CW signals). You can also reverse this process to produce SSB or DSB/CW for transmit when building a transceiver.

In a direct conversion set, the IF

is left out completely. The wanted audio is produced directly by mixing the incoming signal with a VFO running at the actual signal frequency. This results in an IF of zero, ie the AF modulation frequency. The reverse can produce a transmit signal in the same manner. To raise the signal strength after detection, all amplification is then normally carried out directly at audio frequencies, rather than at an RF intermediate frequency as in a superhet.

One problem that arises with all dc receivers currently on the market is that of the audio 'image' present. There are always two possible places at which you can tune a given signal for a heterodyne, whereas in a superhet receiver this other 'signal' would be eliminated by the narrow-band crystal filtering used. It is possible to overcome this limitation in a dc set, but no-one seems keen (yet) to actually implement the circuitry needed!

Having two signals means that there is always the chance of QRM from another signal close by that wouldn't be heard on a superhet. Alternatively, you can treat the problem as an advantage and say that you have a choice of tuning to whichever heterodyne from the

signal is in the clear! You have to be careful that you tune onto the correct side of the signal when netting otherwise you can be transmitting up to 4kHz off of the wanted station. One way round this is to zero beat the incoming signal with the Offset at zero, then tune the Offset to whichever sideband is clear of QRM.

How It Works

In the Century 22, the incoming RF signal first passes through the multi-section low pass filters, common to the transmit path. There are four of these covering 80m, 40/30m, 20m and 15/10m. These are followed by the solid state Tx/Rx switch, necessary for the high speed break-in operation offered with this rig. Thence to the receive band pass filters — in this case one per band — selected by the main bandswitch.

From this point, things become a little different from a standard dc set. An intermediate mixing stage is introduced, rather than direct mixing, with a VFO derived LO immediately at signal frequency.

To get multiband coverage in this type of receiver one has to go through a stage of mixing a VFO covering the tuning span required

with a fixed crystal oscillator. This results in one of the mixing products being at signal frequency, the other can be filtered out (you could also adopt a PLL mixing technique which would remove the need for the filtering but can introduce other problems). The Century 22 does this, but in two stages rather than one. It has a local oscillator covering 6-6.5MHz which is in fact a PTO (Permeability Tuned Oscillator where the inductance is varied rather than the capacitance). This is mixed with one of six crystal oscillators appropriate to the band in use and on the high side of signal frequency.

Taking the 20m band as an example, the xtal oscillator is on 20.500MHz and, if things were standard, this would be mixed with the PTO at 6-6.5MHz to give 14.5-14 MHz output, then mixing directly with the signal for a demodulated output. Instead however, the output from the xtal oscillator is first mixed with the signal itself so that the output from the first (double balanced diode) mixer will be at 6.5-6MHz for 20m. This could be regarded as a first variable IF. In fact Ten-Tec then introduce some wide band tuned RF amplification at this stage, so that you have a distinct

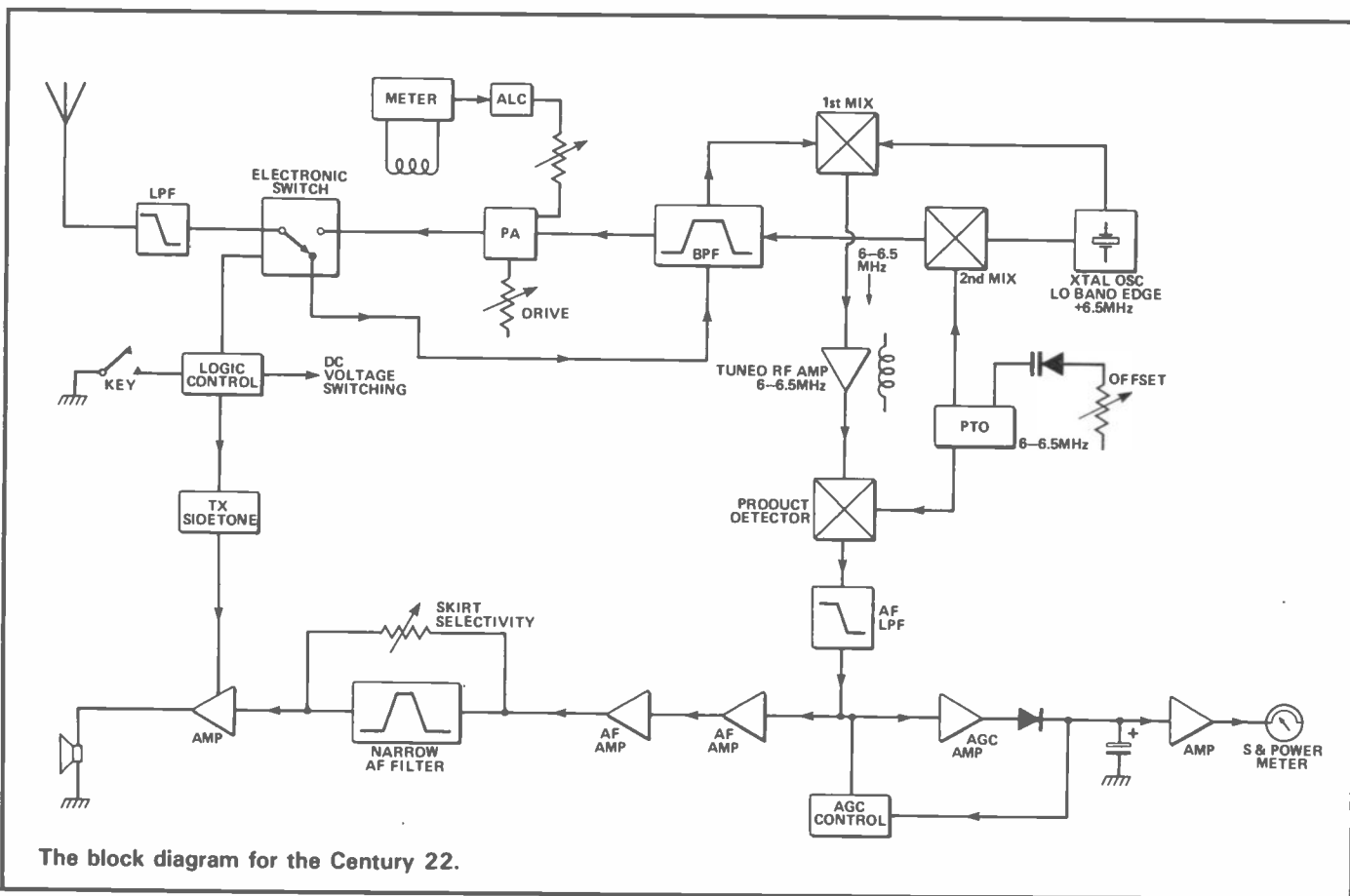

The block diagram for the Century 22.

similarity to a superhet receiver (but no IF narrowband selectivity of course). The RF amplifier is a high level bipolar (2N3866) which will have good strong signal handling capabilities.

The amplified RF signal at 6-6.5 MHz is then low pass filtered and goes onto a further double balanced diode mixer. There the PTO signal — also at 6-6.5MHz — is introduced, resulting in a demodulated signal at AF frequency. This is further passively low pass filtered and followed by two stages of IC AF amplification. The main AF chip is the ubiquitous LM380N and the total AF amplification offers up to 1W to the speaker.

The main selectivity, as in any dc set, is then realised by the use of an audio band pass filter whose skirt attenuation is effectively varied by bypassing it to a variable degree with a potentiometer. It is a four pole filter with a slope of 24dB per octave, centre frequency 750Hz and a nominal bandwidth of 200Hz. With the control fully clockwise the bandwidth is very wide but at full anti-clockwise, the full effect of the filter is realised.

S Meter

Adding an S meter and AGC to a dc set has always been a problem but the Ten-Tec method does work. The secret is to avoid any sudden dc shifts in the audio circuit as this will result in a massive click and probably oscillation as well. The filtered low level audio is amplified by an op-amp, rectified and used to switch on a transistor which progressively shorts out the detected output from the second mixer. It has a limited control range but is a considerable improvement over a dc set with no AGC at all. A further op-amp controls the S meter.

Turning To Tx

To achieve the low level transmit signal, the xtal oscillator and PTO are mixed in an IC mixer (MC1496) directly, and routed (via switching diodes) back through the receiver band pass filters to remove the other mixing product. I noted that the actual PCB differs from the circuit in the manual. The manual shows a UPC1037 mixer, rather than the 1496 actually used and they are not

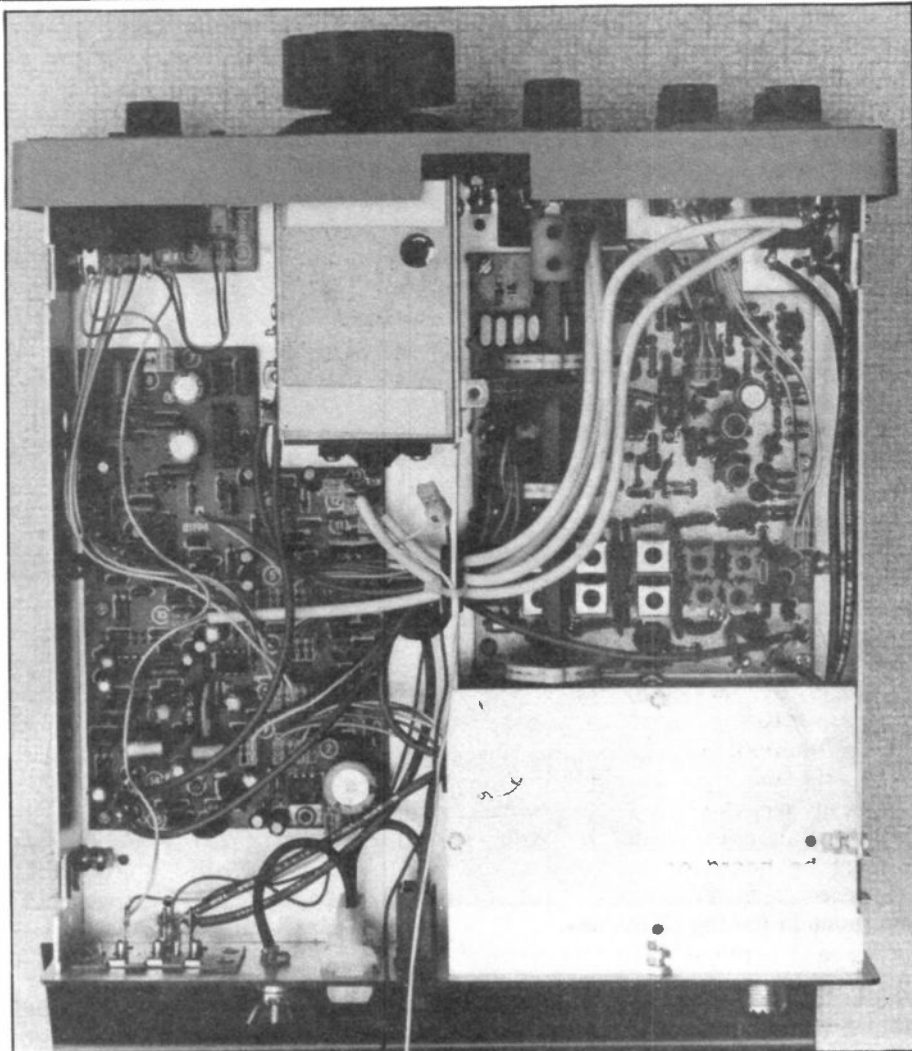

The underside of the transceiver. The VFO is in the shielded box at the top of the chassis.

pin compatible, so this isn't just a replacement but a design change. This is not abnormal but it means that you shouldn't necessarily believe the manual diagram when attempting repairs!

The low level signal then passes to the PA module, whose stated maximum output power is at least 20W, using a pair of 2SC1969 bipolars (the circuit shows MRF 475's but the 1969's are very close replacements). The whole PA is broadband using classical ferrite transformers — it also works in a linear fashion with a stiff bias supply.

The built in SWR metering uses a classical current sense head and also provides a form of ALC for the PA to prevent overdriving (when you will get unwanted key clicks and other horrors). A small portion of the forward sensed voltage is used to control a diode attenuator at the input to the PA module. The *drive* control is set so that a LED indicator on the front panel just illuminates at

maximum power output to give the correct setting — anything above this can generate clicks.

The solid state Tx/Rx control circuit is very simple, using bipolar transistors, but amazingly effective in operation. The diodes which handle the actual RF power in the switch are 1N4007's (as used in the Corsair). These have very similar characteristics to PIN diodes and are a useful alternative if you are building your own solid state switch (as well as being a fraction of the cost of the pukka thing).

Manual

A comprehensive operating manual is supplied giving full details of all the controls and procedures to be followed, including advice on PSUs, if the Ten-Tec models are not used. Circuit diagrams are provided but there are no circuit description or fault-finding/alignment details. The Corsair manual is much better in this

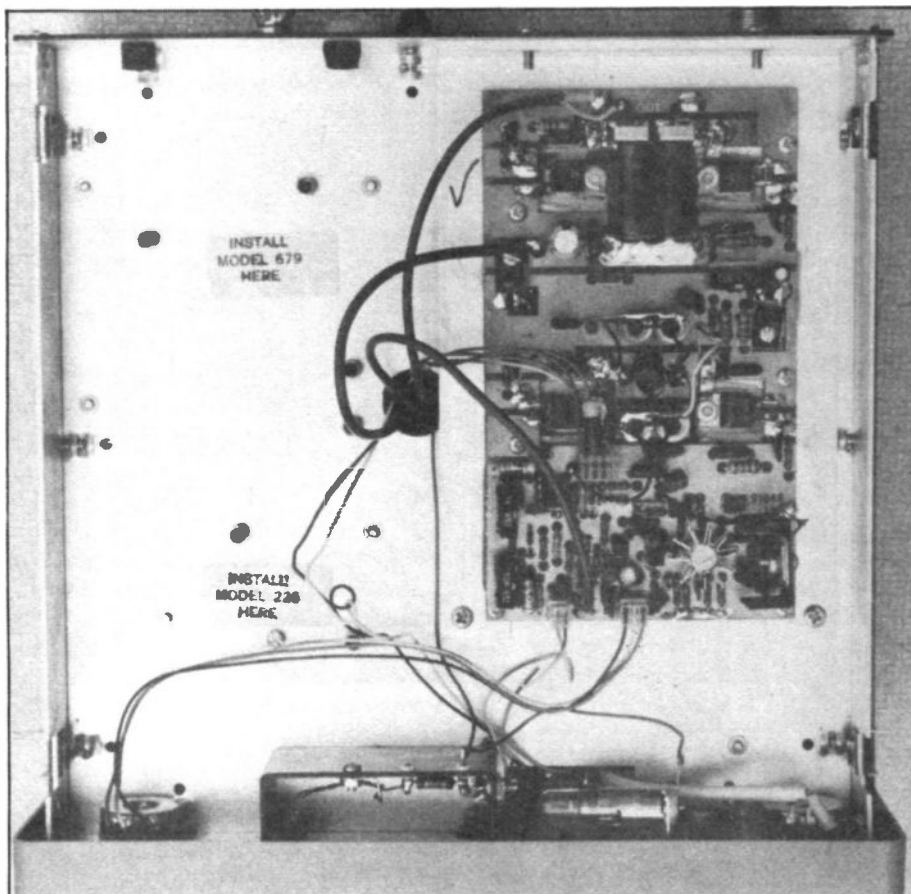

Not much in the top of the box.

respect. The warranty is quite detailed and unusual in many respects. Apart from allowing the owner to make repairs, PA transistor replacement is covered on a very reasonable sliding scale basis. KW, of course, handle repairs in this country.

There is one potentially disastrous mistake in the section "Condensed Operating Instructions" which deals with power inputs. It tells you to attach the Molex connector on the rear of the rig to +12V at one end *and* -12V at the other, rather than 0V. This wouldn't do the rig much good.

In Use

The Century 22 was used on the air over a period of four weeks for general (mainly 20m) QSOs and the odd contest foray, as well as general monitoring of both CW and SSB. An ATU was used for the sake of the PA and the whole set up fed a full size G5RV at about 30 feet.

I can honestly say that I enjoyed using it very much. The only problem I encountered was with one of my two keyers which would not operate

the transceiver. The reason was that the key output was via a bipolar transistor and the voltage offset on this was too much for the Century 22 — the other keyer used a FET and worked perfectly. To be fair, this is specifically covered in the manual and you are warned that a low resistance type of keyer is required or a reed relay.

The received signal sensitivity was more than adequate and of course quality was very good, as one would expect from a dc set. The audio filter was very effective in removing QRM, though not as effective as a crystal filter in a superhet as far as skirt selectivity goes — but then one isn't paying for this facility. As AF filters go, this is a very good example. No adverse reports were received on the transmitted signal. SSB transmissions were quite adequately resolved with the filter towards the wide end of course, and the AGC system coped with these perfectly.

Various measurements were made on the rig and in all respects it performed to specification. Little problem was experienced with breakthrough of broadcast band

signals — a known hazard with dc receivers by direct demodulation in the mixer — possibly due to the double mixing technique involved and helped by the effective band pass filtering at the receiver front end. This was true even without the benefits of the additional selectivity of an ATU in circuit on receive.

Measurements And Sproggies

There are a few sproggies within the receiver. On 80m, these were at 3.5 and 3.75MHz although they were invariably masked by the high received signal strengths on 80m. A low level sproggy appeared at 21.25MHz, but nothing else of any consequence.

The sensitivity quoted was "0.5uV for 10dB S+N/N, typical" — this was met on all bands (assuming the figure to be pd across 50 ohms rather than emf) except 28MHz where it was about 0.75uV. These measurements were made with the filter at its broadest position where the S/N is worst. At narrowest bandwidth the sensitivity improved to 0.2uV pd or better, on all bands, which is excellent performance.

The method of mixing does provide an 'image' response at the first mixer (for 3.5MHz this would be 16.5MHz). These responses were on average -100dB down, so not much chance of problems here.

Most dc sets have the problem that the VFO frequency (normally directly at signal frequency) leaks back through the mixer and appears at the antenna socket to be re-radiated. This would be a problem for a local listener who happens to be on the same frequency as yourself. The double mixer technique used here keeps this re-radiation to really negligible amounts — below -80dBm on all bands. A simple single mixer rig would be at least 40-50dB worse than this.

The VFO itself is very stable (within 100Hz after warm up) and linear — the built in reduction drive gives about 19kHz/rev. The quoted spec gives +/- 5kHz of dial reading uncalibrated and in fact the overall error was exactly 10kHz over the 500kHz swing without any re-calibration. On the optional calibrator, I found that calibrating the 0-100 scale at 0 for exact frequency (at the bottom of the band), gave within +/- 1kHz of each frequency across

the whole of a further 200kHz swing. This is very good for a non synthesised VFO.

It would be advisable to have a crystal calibrator available as otherwise you could be transmitting outside the band if you work very near the band edges. The standard frequency transmission on 10MHz is available on that band for calibrating. If this is done, the accuracy of the read-out on other bands depends on how near the crystals are to their nominated frequency and the VFO linearity in other 100kHz segments. The worst error was found on 10MHz and was -2.5kHz . This error would unfortunately be transferred to all the other bands if calibrated at 10MHz, the exact error depending on precise band crystal frequencies.

As an example, calibrating at 10.000MHz, gave the bands (when nominally transmitting at the lower band edge) as 3.5007, 7.0005, 10.1009, 14.0025, 21.0021 and 28.0025MHz. So in this case you would be safe with a 10MHz calibration. You could of course use a frequency counter near the rig for calibration — the receive and transmit frequencies with the offset at 0 were within 20Hz of each other. The Offset function itself gave a maximum of $+2.5/-1\text{kHz}$ at the 500 end of the scale and $+2.5/-2.3\text{kHz}$ at the 0 end.

To be fair, the S meter circuit is not sophisticated and could not be expected to achieve ideal accuracy. S9 was indicated at around 18uV pd (the accepted standard is 50uV on HF) and the first 'S5' calibration at 5uV. The maximum of S9 +40dB couldn't be reached on this model but S9 +30dB occurred at 90uV. This gives an S scale varying from about 3 to 6dB per S unit. It is, however, a very accurate indicator of correct tuning within the AF filter passband (as the S meter input is derived from after the filter).

The RF gain control could provide around 50dB of attenuation at maximum setting.

On the transmit side the maximum output power of 20W was maintained on all bands at the onset of ALC except at the top end of 28MHz. There it dropped to 8W at 28.5MHz, but still maintained 20W up to 28.3MHz, so was perfectly acceptable.

For 'legal' QRP enthusiasts, the minimum RF output with the drive control at minimum varied on each

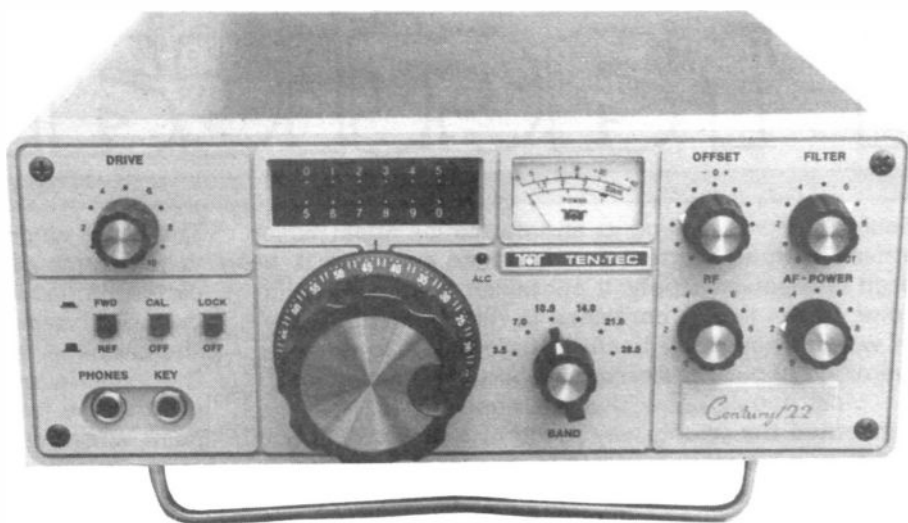

A well built and designed rig.

band. The lowest was 5mW on 28MHz, rising to a peak at 250mW on 10MHz and then dropping to 10mW on 80m. If you want to use the internal relative power meter for a guide, the first calibration marker on the 'Power' scale gave a consistent 3W output on all bands when properly matched.

Spurious outputs were better than -50dBc on all bands at full output.

It is advisable to place the Ten-Tec power supply in a well ventilated location — it gets quite hot even while the rig is on receive only (the Argosy 225 PSU had the same problem) and very hot after a long Tx session. If you are using your own

A close up of the power amplifier situated in the top of the box.

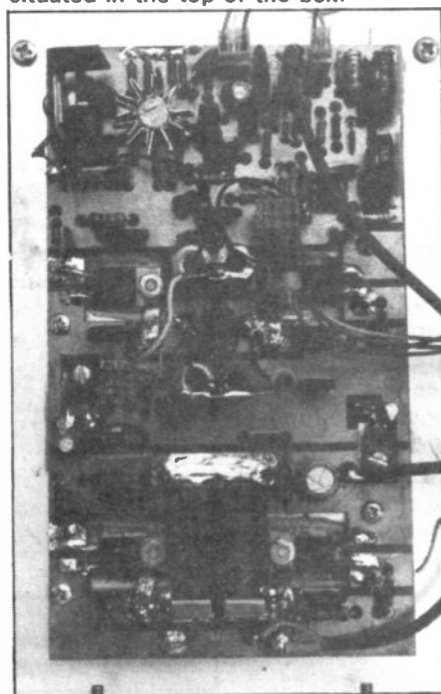

PSU, it will need to be capable of at least 5A output current and well regulated at around 13.6V. Some form of protection against excess current is always a wise precaution with solid state PAs. If your PSU doesn't have this, KW can supply the Ten-Tec circuit breaker as an add-on at £15.55 inc. This is a wise investment since it will protect the PA especially when used into a mismatched load (say on portable operation) but still enable the rig to be operated safely at reduced power.

Conclusions

The KW Ten-Tec Century 22 is a well built and designed CW only transceiver with considerable performance advantages over a conventional direct conversion design. It meets its specification and is pleasant and reliable in use, making CW operation easier with its full break-in facilities. 'Official' QRP level operation is no problem, with a bit more power available if required.

I would not hesitate to recommend this to any CW enthusiast who doesn't want to lay out a fortune for unused facilities. It does have a different 'feel' and look to the more familiar Japanese offerings — some may say less sophisticated mechanical engineering — but it is performance of the innards which matter in the long run. Ten-Tec also have a good enough reputation to make disposal to another QRP enthusiast no problem should the day come when you want to sell it.

Thanks to KW Electronics of Chatham, Kent for the review sample.

Practicalities

Recently, I was looking at an information sheet which arrived with an electrolytic smoothing capacitor to be used in a power supply. It contained a warning about some of the liquids contained in the capacitor, many of which I had never heard of before. It also gave warnings about the correct usage of the capacitor.

Most people know that if a capacitor is connected the wrong way round in a power supply it will fail — probably in a rather spectacular fashion. However, this sheet went on to give several further reasons for failures in electrolytic capacitors. Apart from the normal failure rate these include exceeding the surge voltage, temperature too high and finally,

Ian Poole, G3YWX, offers a simple NiCad battery charger circuit and looks at some perennial problems with capacitors, relay coils and vertical aerials with suitable solutions.

application of excessive ripple current. This last point is one which is often forgotten or not mentioned. Whilst in many situations — such as bypass or coupling applications — this may not be a problem, when designing and building power supplies this should be taken into consideration.

On most of the larger electrolytic capacitors intended for use in power supplies, there is a maximum ripple current rating. This will often be stated on the can, but if not it will most certainly be mentioned in the manufacturer's data sheet and should therefore be known by the supplier. If this value is exceeded then the capacitor will get hot and also its life will be considerably reduced.

Unfortunately the ripple current is not just the current drawn from the supply by the load, but owing to the way in which the supply operates it may be three or four times that value. How much it is multiplied by is dependent upon the various values of components in the circuit.

Suppressing Back EMF in Relay Coils

Even in these days of high technology there is still a place for the lowly relay. It is often difficult to achieve a very low on resistance and a very high off resistance with semiconductors. In cases like this, the relay comes in very useful. However there is one point to be taken into account — the back EMF generated by the coil when the current is switched off. If this is not suppressed it can have a disastrous effect on the semiconductor devices around it. Recently I was reminded of this when I forgot to solder in the suppression components onto the relay and soon blew up the voltage regulator IC that was supplying it!

Fig. 1 shows typical circuits for switching relays.

The diode across the relay coil performs the transient voltage suppression. When the relay is on and current is flowing through the coil, the diode will be reverse biased and does not affect the operation of the circuit. A back EMF is set up when the current flowing through the coil is stopped. If the diode was not there, a large voltage would develop across the point where current was being broken either causing arcing at the switch or possible breakdown of the transistor, and transient voltage spikes on the power rail. When the diode is in circuit, the back EMF is such that it forward biases the diode giving a path through which the current can flow and avoiding large voltage spikes.

When choosing a suitable diode for suppressing the back EMF of a relay coil almost any diode will suffice provided that its peak inverse voltage rating is in excess of the relay operating voltage. I always feel safer using a diode such as one in the 1N4000 series because it is capable of handling fairly high surge currents. It will be more reliable than signal diodes used on smaller relays.

Earths for HF Verticals

One form of aerial which is neat and effective for multi band operation is one of the many trapped verticals which are on the market today. They are compact, not too unsightly and can easily be fitted into the smallest of gardens. In many instances it is convenient to mount them at ground level and use an earth connection instead of a radial system. Whilst this solution can often be satisfactory, the aerial will only perform well if the earth system is efficient.

Some years ago when living in North Leeds, I used one of these verticals mounted at ground level. Despite burying a considerable amount of metal of various sorts as well as some radials, it refused to perform up to expectations. The reason for this was quite simple: about 18in below the surface of the soil there was a layer of sandstone (or millstone grit for any geologists who may be reading). Consequently the conductivity of the ground was low, reducing the

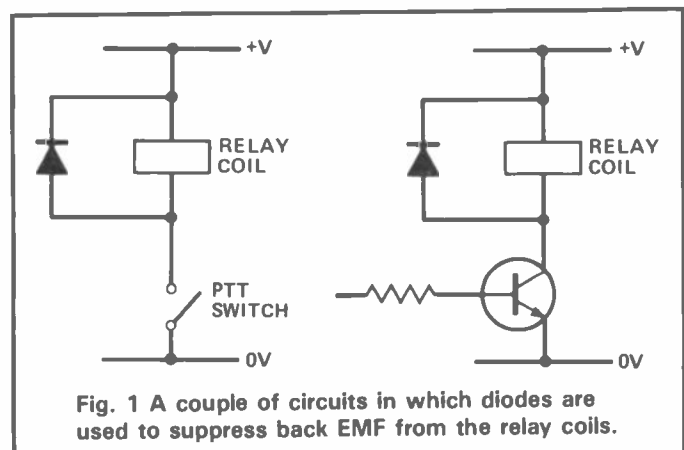

Fig. 1 A couple of circuits in which diodes are used to suppress back EMF from the relay coils.

efficiency of the earth and the overall aerial system. However there were some friends of mine not many miles away who were able to make a far more efficient earth because of the local conditions. Using exactly the same sort of aerial they were able to get far better results.

If you live in an area where it is not possible to make a suitably efficient earth the other alternative is to use a radial system. The aerial can then be raised above ground level and avoid all the losses from nearby objects. Whilst full size radial systems do involve large lengths of wire going in all directions, there are loaded radial systems available.

Quick and Easy NiCad Charger

Amateur equipment seems to be increasingly more compact and more efficient — making it easier to operate portable. In addition to this, the large lead acid batteries which used to be required are now a thing of the past as Nickel Cadmium batteries are widely available to provide an effective source of power. As their capacity is limited, typically about 2 amp hours for a type C cell, they will require re-charging at fairly frequent intervals

In cases like these, it is quite an easy matter to utilise a standard power supply to charge the NiCads by adding only a resistor and battery holder. This is a particularly attractive proposition because many stations which use NiCads are also likely to possess a 12 volt power supply for powering various pieces of base station equipment.

Fig. 2 One arrangement for charging NiCads.

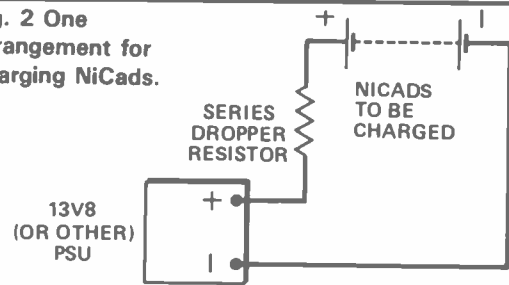

The series resistor must be included in the circuit because the NiCads have a very low internal resistance. The current from the power supply must be limited to that recommended by the manufacturer so that the cells are not damaged by overcharging.

The value of the series resistor can easily be calculated if you know the charging current and the voltage drop which it is required to drop. Take an example where four type C cells need to be charged. Each cell has a voltage of 1.8 volts, giving a total of 4.8 volts and a typical charging current would be 0.25 amps. Therefore, if a 13.8 volt supply is to be used, the voltage to be dropped is 9 volts. As this voltage has to be dropped at a current of 0.25 amps the series resistor which is required is 35 ohms and it must be capable of dissipating more than 2.25 watts. The resulting charger is quite suitable for most applications and has the advantage of costing only a few pence against a commercially made charger which would cost in the region of £10.

RADIO & RTTY BOOKS

NEW BOOKS

RADIO DATABASE INTERNATIONAL Worldwide shortwave broadcasting stations at a glance. Frequencies, times, language, etc. given for stations between 2-26.1MHz. Parts 1/2 together £12.50 + £1.20 p&p

GUIDE TO UTILITY STATIONS 1986 Now lists 15,003 SW frequencies Aero, CW, Fixed, Commercial, RTTY, FAX, etc. stations, plus call signs and much more. The most comprehensive frequency book available. £16.00 + £1.45 p&p

UK TABLE OF RADIO FREQUENCY ALLOCATIONS 20kHz-400GHz. Cover LW, MW, SW, VHF, UHF & etc. £12.00 p&p FREE

BEST OF MONITORING TIMES 1984 Many great articles on SWL. £9.95 + 65p p&p

DIAL-SEARCH The Listener's check-list and guide to European Broadcasts on MW, LW, VHF and SW. £3.00 + 30p p&p

RADIO BEACON HANDBOOK Worldwide listing of 8,500 Long and MW Beacons by call sign, frequency, station and more. £8.05 + 35p p&p

AERAD - EUROPE & MIDDLE EAST Lists all airports and the VHF frequencies used £5.00 + 65p p&p

US MILITARY RADIO COMMUNICATIONS Details and frequencies used on HF. Part 1 £10.00 + 65p p&p. Parts 2 & 3 £8.05 + 65p p&p each. All 3 Parts £26.50 p&p FREE

HANDBOOK FOR RADIO OPERATORS Maritime bands manual £3.95 p&p FREE

RADOTELETYPE PRESS BROADCASTS Full details, frequencies & times of Press Agencies £11.05 + 65p p&p

CLANDESTINE CONFIDENTIAL £5.25 + 60p p&p

AIR TRAFFIC RADIO Guide to UK air traffic control £2.00 + 35p p&p

Two or more books Post & Packing FREE (UK & Euro only). Ask for our free catalogue of all books covering all titles. Delivery normally from stock within 14 days.

INTERBOOKS, PWD12, Stanley, Perth PH1 4QQ. Tel: (0738) 628575

If an advertisement is wrong we're here to put it right.

If you see an advertisement in the press, in print, on posters or in the cinema which you find unacceptable, write to us at the address below.

The Advertising Standards Authority. ✓

ASA Ltd, Dept 3 Brook House, Torrington Place, London WC1E 7HN

NEW FROM KENPRO



TRADE ENQUIRIES WELCOME

FULLY COMPUTERIZED HAND HELD KT220 EE/T

With facilities not yet available in other brands, look at the outstanding list of features and incorporating Kenpro's Legendary quality. This is a **Top Line** transceiver which should be amongst the most expensive, but our low overheads make it the **Best Value** for money available today.

- ★ Built in LCD Clock
- ★ 10 Memories for 10 Repeaters
- ★ 4 Scan Models * "Scanlock" locks out unwanted channels
- ★ 3.5 - 5 Watts Output
- ★ 1750 Tone Burst
- ★ CTCSS, DTMF, & Auto Dial
- ★ Very Sensitive L/Noise Rcvr
- ★ Auto Battery Save Function

Don't forget the trusty economy version continues to be available.

KT 220 C/W ST ACC Basic	£229.00
KT 220 C/W Nicads etc	£249.00
KT 200 C/W ST ACC Basic	£165.00
KT 200 C/W Nicads etc	£189.00
KT 400 C/W Nicads etc	£209.00

Full range of accessories available Post, PK & Ins Transceivers £5.00

HP/PERSONAL LOANS

RWC

HI-TEC WORLDWIDE LIMITED

Importers, Exporters and Distributors of Specialist Communications

584 Hagley Road West, Quinton, Birmingham B68 OBS.
Tel: 021-421 8201 (24hr) Telex: 334303 TXAGWM-G.

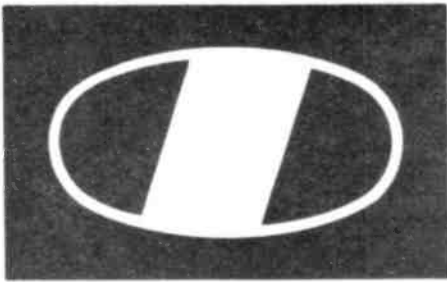

ICOM

25-2000MHz, Commercial Above and beyond



ICOM introduces the IC-R7000, advanced technology, continuous coverage communications receiver. It covers Aircraft, Marine, F.M, Broadcast, Amateur Radio, Television and Weather Satellite bands. The IC-R7000 incorporates FM wide/FM narrow, A.M., upper and lower SSB modes of operation with six tuning speeds - 0.1, 1.0, 5, 10, 12.5, 25KHz. Frequency coverage 25-1000MHz and 1025-2000MHz (25-1000MHz and 1260-1300MHz guaranteed specification).

With the IC-R7000 you have normal tuning capability with the front panel tuning knob or for quick tuning of a desired frequency by using the front panel key-pad. A total of 99 memory channels are available for storage of received frequencies and operating mode.

Memory channels can be called up by pressing the memory switch then rotating the memory channel knob or by direct keyboard entry.

A sophisticated scanning system provides instant access to specific frequency ranges. By depressing the Auto M switch, the IC-R7000 automatically memorises frequencies that are in use, whilst in the scan mode and can be recalled later. The scanning speed is adjustable and the scanning system includes memory selected frequency ranges or priority channels. All functions including memory channel readout are clearly shown on a dual-colour fluorescent display with dimmer switch. Other features include dial-lock, noise blanker, S-meter and attenuator.



Thanet ICOM Thanet ICOM Thanet ICOM Thanet ICOM Thanet ICOM Thanet ICOM Thanet ICOM Thanet ICOM

IC-R7000

Commercial quality receiver and all competition



Actual Size

Options include: RC12 infra red remote controller, voice synthesizer, external loudspeaker, HP1 headphones and the ICOM AH-7000 super wideband omnidirectional discone antenna.

There are two ways of using this advertisement, one is to cut out the life-size photograph of the R7000 and paste it to the side of an old shoe box, who knows if your shack is dimly lit visiting Amateurs will be impressed by your excellent choice. The alternative (and one we strongly recommend) is if you are an Amateur or SWL call us on free HELPLINE 0800-521145 for the location of your local ICOM dealer where you can see and actually buy the competitively priced R7000, you have the choice.

Computer Control The IC-R7000 can be easily connected to a computer terminal via a very simple interface. Receiver control is performed serially in the IC-R7000 by ICOM's C1-V communication interface system. Operation is possible with a personal computer that has an RS-232c serial port.

H = HELP	↔ Frequency Steps
F0 Frequency	↑ ↓ V Up/Down (arrows)
F1 Select Mode	M Memory Channel
F2 Freq/Memory Scan	↑ ↓ Memory Up/Down
F3 Mode Scan	↑ ↓ VFO/Memory
F4 VFO → Memory	B Bargraph Select
F5 Memory Write	⊞ Occupancy On/Off
F6 Memory Clear	⊞ Scan Stop Off/On
F7 Set 'SIG' Level	S Change Set
F8 Memory File Read	DEL Speech (If fitted)
F9 Memory File Write	Q Quit





Listening On...

Our listener covers radio stations operating from the Middle East, Australia, Southern Africa and Europe, with some news of the latest religious stations in the USA and a detailed look at Radio Sweden International.

Several new radio stations have appeared on the air in recent months. In the first Listening On . . . in the May 1986 issue, I mentioned that "World Harvest Radio International", a new religious station in the USA, should by now be on the air. Well, it is, and "Sweden Calling DXers" has reported that NDXE in Alabama — which, you will remember, was planning to be the first short wave stereo station in the world — is hoping to begin operations on 4th July, USA Independence Day. According to the World Radio and TV Handbook, NDXE plans to use the Kahn stereo system.

Meanwhile, in California, construction of yet another short wave religious station, which has been allocated the callsign KVOH, is well under way. This station is owned by an organisation called the "High Adventure" missionaries, who also run a station in southern Lebanon called the "Voice of Hope" (hence the callsign of the Californian operation). The Lebanese station can often be heard in the UK in the evenings on 6215kHz, with programmes in Arabic, English, French and other languages.

One of the most popular commercial stations in the Middle East for the last 15 years has been Radio Monte-Carlo. Although owned by a company in Monaco, this Middle East service (as opposed to their French and Italian services on LW and MW) has until recently been broadcast only from a 1200kW medium wave relay transmitter on Cyprus. Now, however, RMC programmes are also being broadcast on 9795kHz from about 0500-1000 GMT and, at times, on 15465kHz, although at the time of writing the use of this frequency is quite irregular. RMC's

Middle East programmes are in Arabic and French, with popular Arabic and European pop music and news bulletins, all presented in a very slick French style, with plenty of advertisements and jingles.

To cover the vast distances in Australia short wave is used for domestic audiences, in addition to medium wave and VHF in the cities. Two new stations have recently opened in Australia's Northern Territory, VLSA in Alice Springs

and, more recently, VLSK in Katherine. According to Radio Australia's "Talkback" programme, VLSK broadcasts on 5025kHz at 2230-0730 and 2485kHz at 1930-2230 and 0730-1430 GMT. Apparently reception reports have been received from as far away as the USA, though I do not know whether either of these stations have yet been heard in Europe. It would be quite an achievement to be able to identify these stations, as they are intended only for reception in the Northern Territory of Australia and therefore antennas giving a very high angle of radiation are used. However, on short wave, nothing is impossible . . .

Another new station on the air, also with a local flavour, is Radio Tanzania Zanzibar. This relays Zanzibar local programmes in Swahili on 11734.4kHz and can be heard with fair reception when conditions are good to that part of the world around 1700-1815 GMT.

The Sultanate of Oman also has a new short wave transmitting site, at Thumrait (also called "Midway", apparently because it is half way

Radio Monte-Carlo which started broadcasting its Arabic service on short wave in March, also broadcasts commercial programmes in French and Italian from this transmitter site on long wave and medium wave.

Long. 7°26
Lat. 43°44

RADIO MONTE-CARLO
Principauté de MONACO

QRH : 1466 kc	205 m	400 kw	CALL 3 AM 2
» 6035 kc	49 m 71	30 kw	» 3 AM 3
» 7140 kc	42 m 02	30 kw	» 3 AM 4

between Salalah and Oman's northern border). So far, only test transmissions consisting of relays of Omani radio's home service have been broadcast (these have been heard on 17795kHz at 0900-1400 and have also been reported in the 31 metre band) but perhaps a separate external service will be inaugurated in the future. As with all test transmissions, though, the frequency used and time of usage, has been rather variable.

Radio Sweden International

During the summer of 1985, Radio Sweden International put out a series of broadcasts in a number of languages under the general title of "Radio Sweden Europe" over their new 600kW transmitter located at Solvesborg. The transmitter, which was only officially inaugurated on 30th May 1985, replaced a 37 year old, 150kW one at Horby, which had been used for Swedish overseas service programmes for many years.

Quadrupling the output power and improving the antenna system, has resulted in an enormous increase in received signal strength over a large area of Europe. From all accounts, the response from listeners to the "Radio Sweden Europe" experiment was very encouraging, so I wouldn't be at all surprised if the experiment is repeated this summer. Last year's programmes consisted of ideas for tourists in Sweden, weather and shipping forecasts, phone-in programmes on all sorts of subjects including the nuclear debate and so on. In short, it had the intimacy of a local radio broadcast, but was broadcast to an international audience — a very successful formula.

The Solvesborg transmitter, which operates on 1179kHz (the old Horby frequency), is located in the province of Blekinge in the south of Sweden, on the end of a narrow promontory surrounded on three sides by the waters of the Baltic Sea. Apparently the water-side location was chosen to help the radiated signal, as below the twin 440 foot towers there is an extensive buried copper wire ground plain system, terminated by copper plates actually in the sea water.

For environmental reasons (an important consideration in "Green conscious" Scandinavia) the area of the Solvesborg transmitter station is not railed off, but can still be used for recreation or as pasture. However, with an ERP of 2 megawatts in some directions, I hope the sheep do not stray too close to the feeder wires! Three hundred yards away is a small building containing the transmitters, antenna matching equipment, the switching gear and cooling equipment. From the building a buried feeder cable runs to the two self-supporting masts which each weigh 70 tons, contain 8 kilometres of angle iron



radio sweden

25 years of Sweden Calling DX-ers

February 1948 — February 1973



"Sweden Calling DXers" 25th anniversary was celebrated in February 1973, when this QSL card was sent to contributors to the programme.

and are held together by 13000 bolts. They were erected by riggers working for the WIBE company in just 12 weeks.

They are fed by a series of eight vertical wires connected to each tower about half way up, while the towers are electrically earthed at the bases. In this way the radiation pattern can be adjusted so that maximum radiation is approximately east-west, with a null to the south-east. This is because Radio Sweden shares the use of 1179kHz with Radio Bucharest, and according to the frequency plan is only permitted 400kW in the direction Romania. By using a 600kW transmitter and providing a null

in this direction, however, there is gain in other directions: 2000kW to the west and just a little less than this to the north-east.

Here in Britain, we get the advantage of that gain and the Solvesborg transmitter is audible even during daylight over a large part of the country, with Swedish Radio's First Programme (in Swedish) switching to Radio Sweden International programmes in English, Swedish, German, French, Spanish and Russian during the evening. According to Radio Sweden, during daylight hours about 15 million inhabitants are covered while after dark the coverage increases to

The Radio Maputo studio building in Maputo, Mozambique.

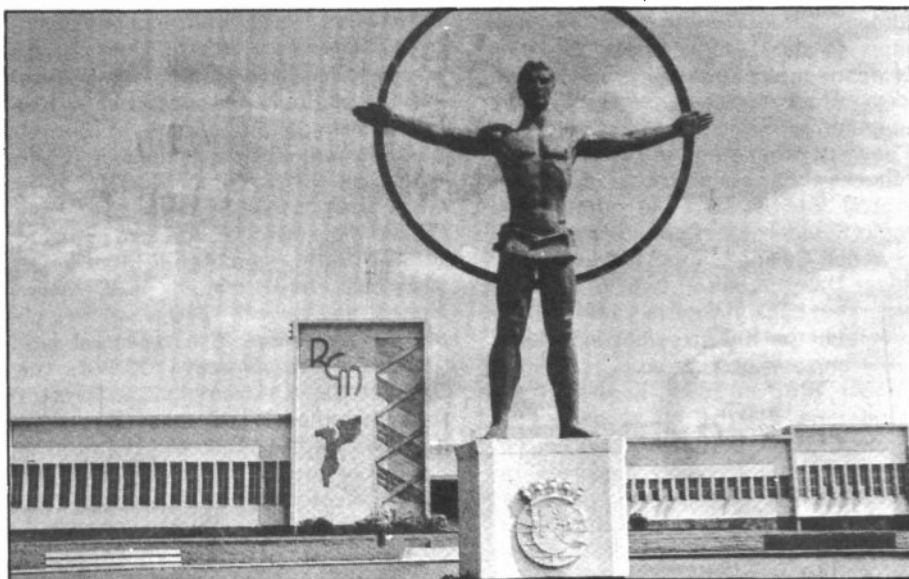

AUSTRIAN ARMY-TRAINING TRANSMITTER



OEY 21
OEY 52

R 4524

SCHULUNGSENDER
des Österreichischen Bundesheeres
Gubriegelstraße 45 A 1102 WIEN

Austrian Army School Radio transmitting programmes in German for the Austrian army, with entertaining and training programmes.

about 165 million.

The 600kW transmitter is manufactured by AEG-Telefunken of West Germany and uses pulse duration modulation — a special form of AM — giving almost 70% efficiency. Further power is saved by using DAM — Dynamic Amplitude Modulation: a system whereby the carrier power is only at its maximum during peaks of modulation. During pauses in speech, or quiet passages of music, the carrier power is reduced. This is the same technique as used at Radio Netherlands' Flevo transmitter site, mentioned in the last column. A 10kW Marconi transmitter, previously used at Horby and at Sundsvall in central Sweden in the 1970s, is used as a standby should the 600kW unit fail. The station is totally automated and controlled from Horby, from where Radio Sweden International still runs two 500kW short-wave transmitters.

At the time of writing, English language programmes are broadcast on medium wave at 1700-1730, 1830-1900, 2100-2130 and 2300-2330, though there may well be special "Radio Sweden Europe" broadcasts again at different times to this. Any changes to Radio Sweden International's transmission schedule are always announced in their programme "Sweden Calling DXers", as is news of other stations' programme or frequency changes and some features of general interest to radio enthusiasts. Radio Sweden International claim that "Sweden Calling DXers" is the world's oldest DX programme, having been inaugurated back in February 1948. They celebrated the 1000th edition in October 1969 and by now are up to edition number 1896 in July! At present the programme can be heard about ten minutes after the start of each English language broadcast on Tuesdays on medium wave.

It can also be heard on short wave 6065kHz (a frequency Radio Sweden has used for several decades) in the 1700

and 2100 broadcasts, and is also repeated on Wednesday mornings in a transmission at 1130-1200 on 9630kHz. This is the present summertime schedule of Radio Sweden International programmes, a change from that printed in the May Listening On . . .

Radio Sweden International asks for reception reports, especially on their Solvesborg medium wave transmitter, which should be sent to Radio Sweden International, S-105 10 Stockholm, Sweden, (adding "AM department" if you are sending a reception report on the medium wave transmitter). QSL cards are sent out on request to verify correct reception reports.

Some Programmes To Listen For . . .

One country that has been quite difficult to hear on the broadcast bands in recent years is Mozambique — until now that is. My guess is that they have had a visit from an engineer recently, because suddenly two of their transmitters are being widely heard again, even if they are a little off their correct frequencies. Radio Maputo, the external service of Radio Mozambique, can be heard with a programme in English primarily intended for listeners in South Africa on 9618kHz at 1800 to 1900 GMT. Their home service, called simply "Radio Mozambique", can also be heard on 9618kHz, and additionally on 11818kHz, from around 1630 when signals fade-in, until 1740 when they go off the air. There is a newsreel programme in Portuguese at 1700 GMT. The fact that Radio Mozambique is 2kHz off frequency means that those who have receivers with good selectivity and preferably good IF notch filters will be better reception of this station than they would if Radio Mozambique was exactly on channel.

Before independence Radio

Mozambique, or "LM Radio" as it was called in those days (LM stood for Lourenco Marques, the former name of Maputo) was South Africa's equivalent of Radio Luxembourg, with pop music programmes presented in English for the South African audience. The style of their English programmes has changed somewhat now, although there is still a lot of American black rock and disco music played, which is presumably unobtainable in South Africa itself.

There is a five hour programme in English every evening from Radio Riyadh in Saudi Arabia, intended mainly for expatriate workers in the country listening on VHF and medium wave. It is also broadcast on 9740kHz for listeners throughout the Gulf area, and this frequency can be heard further afield too. The English programmes, which consist mainly of pop music, request programmes, etc, are broadcast on 9740kHz for listeners throughout the Gulf area, and this frequency can be heard further afield too. The English programmes, etc, are broadcast at 1600-2100 GMT. At 1830 there is a news bulletin, followed by the Saudi Arabian late-night chemists opening rotal Riveting stuff. The address, if you want to have a request played by Layla, is Radio Riyadh, European Service, Riyadh 11161, Kingdom of Saudi Arabia.

If you wish to brush up on your CW, morse code classes are given at 0900 GMT on the Austrian Army School Radio. Despite its name, this is a genuine broadcast station, which carries entertainment and training programmes for the Austrian army. It signs on at 0830 daily except Saturday and Sunday on 5035 and now on a new frequency of 3378kHz. When I heard them recently they were asking for reception reports (presumably of 3378kHz) to be sent to PO Box 289, A-1010 Vienna, Austria. All announcements are in German, and the station identifies as "Ein Schulungssender des Österreichischen Bundesheeres".

If your German is not quite good enough to take advantage of the "Schulungssender" morse courses, you may prefer to tune into Deutschlandfunk's 'German by radio' course for beginners, called "Auf Deutsch Gesagt". Deutschlandfunk have even placed advertisements in a British daily newspaper to encourage people to listen. It is broadcast on Wednesdays and Saturdays at 1730-1745 on one frequency only: 1269kHz medium wave (236 metres). In addition there is a daily English language programme about life in Germany at 1815-1900 on the same frequency. A free textbook for the language course is available from DLF, English Service, PO Box 640, D-5000 Cologne 51, West Germany, which is also the address to which reception reports and comments on their programmes can be sent.

A Parametric Equaliser for Communications Use

This parametric equaliser is not a standard audio processor, it is the communications equivalent of graphic equalisers used by professional studios to adjust the frequency balance of recordings. Having become commonplace in hi-fi set ups over the past few years,

allowing direct microprocessor control of the equaliser with up to 12 frequency bands in 0.5 or 1dB steps!

Radio Use

Why should you need an equaliser for amateur radio use? Well, a very large number of

communications audio bandwidth, assumed to be 300Hz to 3kHz, and are not really suitable for putting in series with the microphone lead — the ideal method of using one in our hobby.

This design for a communications equaliser is of the parametric type. This means that the parameters are totally variable — you can not only vary the cut or boost at a given frequency but the frequency at which this occurs is also totally variable!

What we have done is to provide two variable frequency bands of operation with one covering 200Hz-1.1kHz, the other 1kHz-3.5kHz. Within either of these bands you can set a cut or boost of +/- 12dB which will correct for most of the deficiencies in microphones or rigs. In addition, we have added a 'shelf' function.

This shelf function is intended to correct the common fault where the whole of the lower end of the audio spectrum from 2kHz downwards needs correction. What it will do is to cut or boost the response from 2kHz down but with an increasing effect as the frequency gets lower. For example, with full boost there is about 2dB lift at 2kHz and around 10dB at 300Hz, at full cut virtually all the lower frequencies will be removed. Once this overall correction is applied to about the right level, it would be possible to boost or cut within the shelf range using the other controls to get it exactly right. At an extreme, it is possible to almost turn a tenor voice into a soprano!

All this is intended to adjust microphone response. You can get a crystal mic to sound like an expensive dynamic, or adjust your transmission quality to BBC levels for

Fed up with microphones that don't sound quite right? Is your rig lacking in frequency response? Maybe your voice is not quite of the tonal quality required for getting through the QRM and working that DX? Possibly you would like a better frequency response out of your receiver? If your answer is 'yes' to any of these questions, then this project — designed by Tony Bailey, G3WPO, and Frank Ogden, G4JST — is just the thing for you.

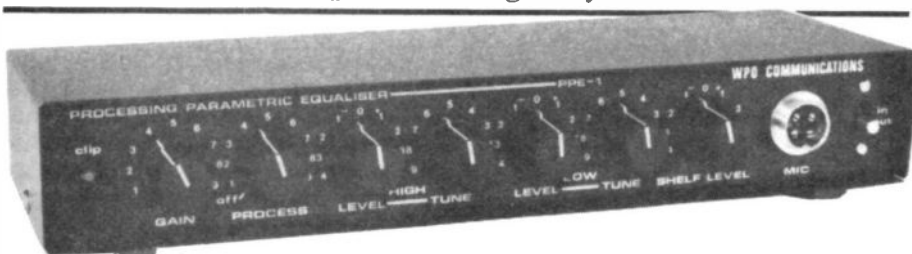

they enable you to adjust the total frequency balance of a recording to suit factors such as the balance of the original recording, room acoustics and personal preferences — in a manner much more specific than a simple tone or separate bass/treble controls.

In the case of the professional/hi-fi units, the equipment offers the facility to boost or cut the frequency response (or leave it unaffected or 'level') at a number of specific frequencies throughout the audio range. A typical set of controls would be 31.3Hz, 62.5Hz, 125Hz, 250Hz, 500Hz, 1kHz, 2kHz, 4kHz, 8kHz and 16kHz, with boost/cut available of +/- 13dB. There is even a dedicated chip available now (the LMC835 from Maplin at about £20),

transmitter audio responses are not all that they could be especially if you have voice with say lots of high frequency content or very bassy. Unfortunately nearly all women sound the same when using SSB, mainly because manufacturers adjust the response to suit the masculine voice. Some rigs are well known for problematic frequency response, such as the TS700 2m rig, and many people will have added a series capacitor in the microphone lead to overcome the excess bass content.

One alternative is to change the microphone or its capsule in an effort to get a better response, but this is somewhat of a hit and miss method. Hi-fi equalisers, however, only cover a few of the frequencies within the

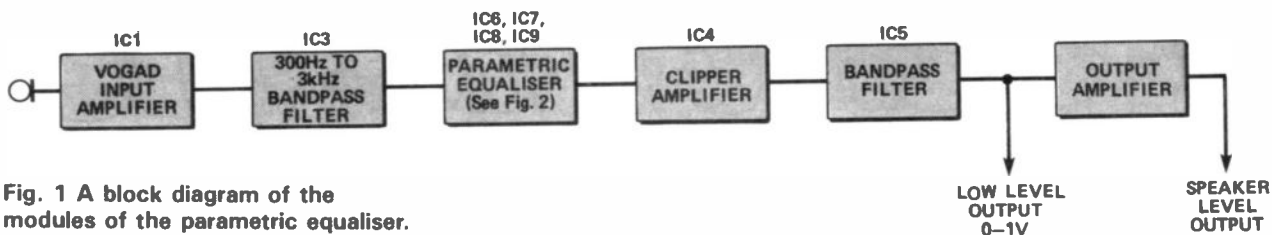

Fig. 1 A block diagram of the modules of the parametric equaliser.

the locals, or punch for DX working.

To remove the need for input level adjustments, the mic input is conditioned through a VOGAD (Voice Operated Gain Adjusting Device) chip, which has high or low Z inputs possible. A processor function is also available although the efficiency of the equaliser itself — which introduces almost negligible distortion — renders use of this facility unlikely. It would probably only be used when the input is already fairly correct in frequency response.

Not content with all the above facilities, we have added an internal 1W audio amplifier. This allows the equaliser to be used as an add-on to the output of a receiver — either from a low-level input or a speaker — for modifying the receiver audio where this is poor (into an external speaker). You can also hear the effects of adjusting the equaliser using a microphone and a pair of headphones.

The Circuit Design

The signal to be processed goes to the VOGAD circuit, IC1, via the appropriate high or low Z input, or the speaker output/attenuator network. This IC features a strong

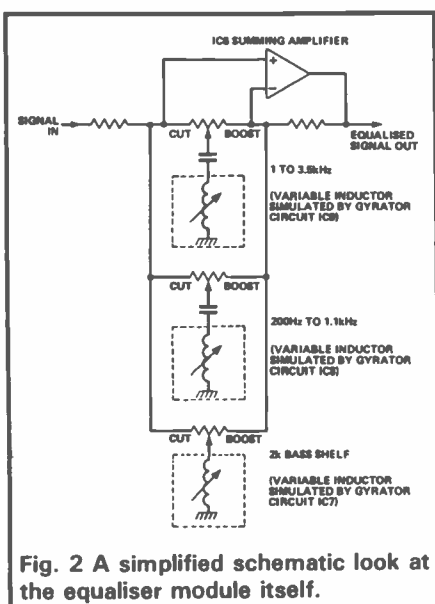

Fig. 2 A simplified schematic look at the equaliser module itself.

AGC action resulting in an almost constant level of audio of around 100mV on pin 8 — for an input signal in the range 1-100mV input pins 4 or 5. A differential signal could be applied between these two pins if required. C9/R5 controls the AGC time constant as this is fairly critical for optimum performance — a fast attack is essential.

IC3 is configured as a 0.3-3kHz, two pole bandpass filter. It restricts subsequent processing to frequencies within this passband. While this is not important to the equaliser section, the functioning of the speech clipper will be impaired, if used. Frequencies outside the band have no communications value and when applied to a clipper stage, they can produce audible intermodulation products which reduce intelligibility at high clipping levels.

The parametric equaliser itself comprises four chips, IC6-9. The functional blocks are gyrators. These are circuits which transpose the current/voltage relationships in a reactive component to simulate one with an opposite phase, ie they turn capacitors into inductors and vice versa.

The capacitors which are changed into inductors — variable ones at that — are C26, 27 and 28. The circuit node between each capacitor and its associated resistor

— the one connected to the inverting terminal of the op-amp follower — is equivalent to an inductor with its imaginary end earthed. A further capacitor connected to this point will produce a series resonant LC circuit etc. The resistor mentioned earlier controls circuit Q.

The equaliser circuit uses two of these gyrator inductors as series resonant LC circuits connected to a summing amplifier, IC6. Both circuits are tunable and can boost or cut the amplifier gain at a resonant frequency selected on each range. The tuning ranges are given in Fig. 2.

A third gyrator, around IC7, is configured as a straight inductor connected across the summing amplifier and has a fixed value. Its Q is high (because R31 is relatively low in value) and it enables a positive or negative variable slope to be put in on all frequencies below 2kHz. The maximum slope in either boost or cut approaches 6dB/octave.

Q1 and D1 provide clipping action on the signal when switched in, the LED connected in the collector of Q1 indicating that clipping is taking place. Amplifier IC4 allows adjustment of clipping level up to a maximum of around 12dB with the equaliser section set to flat. Note: excessive use of the equaliser in any of its boost positions can result in too high clipping levels at

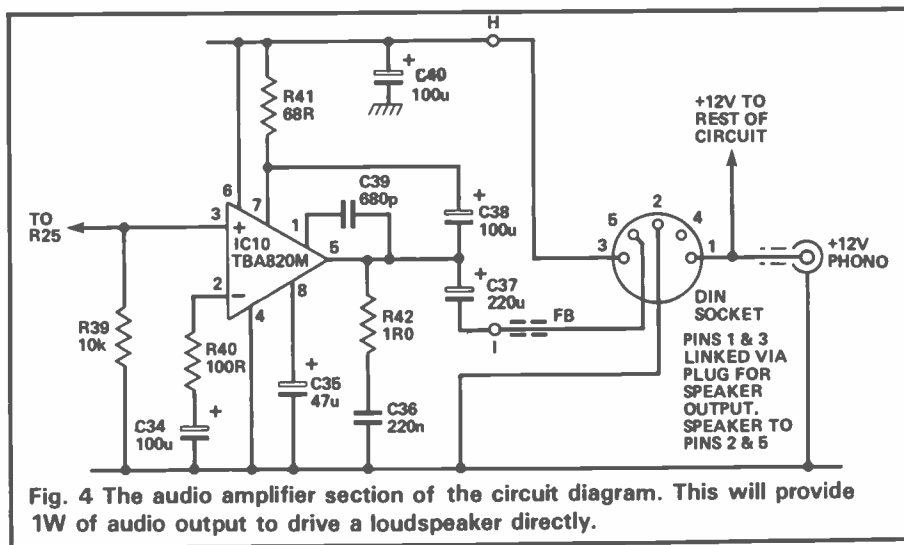

Fig. 4 The audio amplifier section of the circuit diagram. This will provide 1W of audio output to drive a loudspeaker directly.

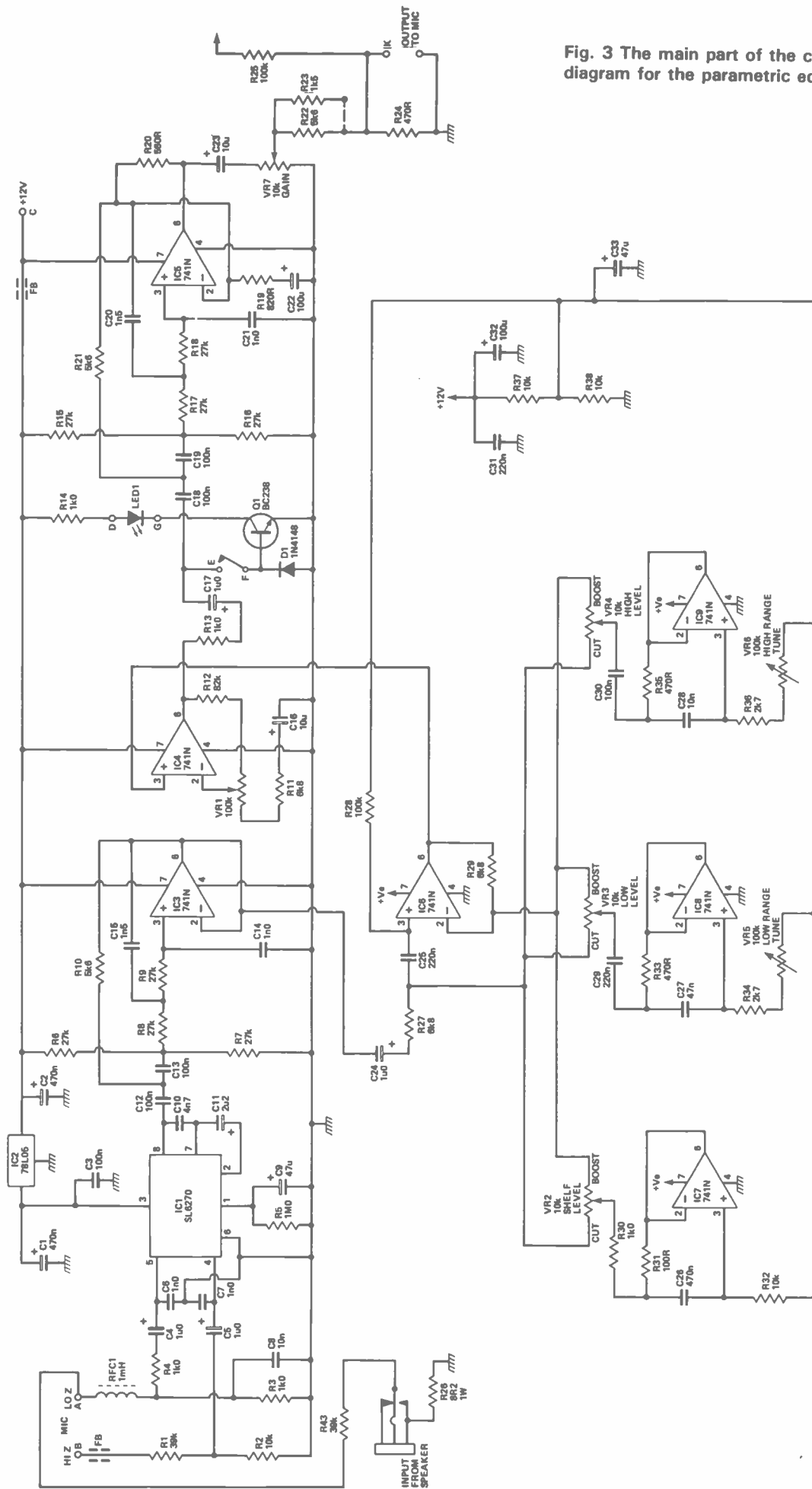
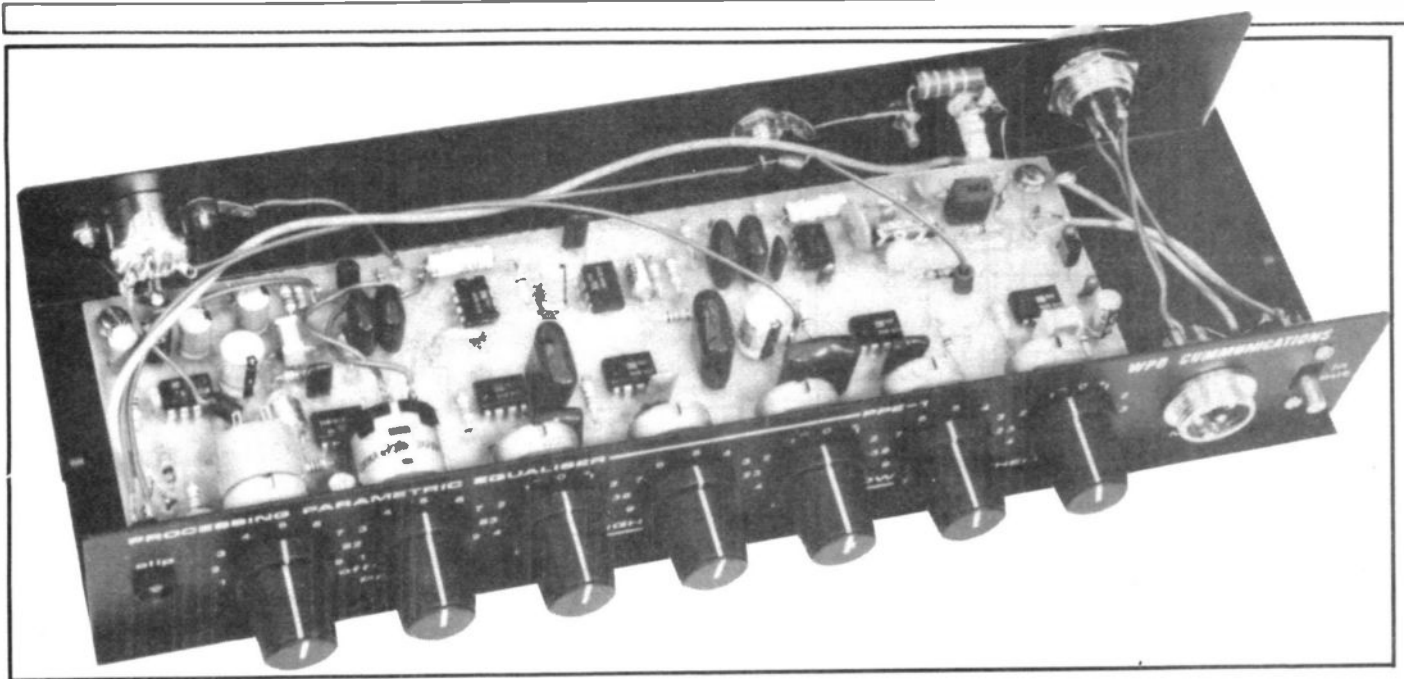

Fig. 3 The main part of the circuit diagram for the parametric equaliser.



the frequencies selected. The amount of clipping could exceed 25dB, which is far too much to be useful. Care should be exercised when using the parametric equaliser and clipper sections together.

The 0.3-3kHz bandpass circuit, IC5, ensures that out-of-band products produced by the clipper stage, when in operation, are minimised. This circuit also provides around 4dB of gain to ensure that Icom equipment with its high level mic input is properly driven. The output level is around 1V peak-to-peak at the top of VR7.

Finally, IC10 provides 1W of audio output to drive a loudspeaker directly.

The unit requires around 9 to 12V at about 40mA, a lot more if a loudspeaker is used. Regulator IC2 provides the +5V necessary to operate the VOGAD circuit (this could be +6V if necessary).

Construction

The equaliser is built on one single sided PCB size 201x69mm. This accommodates nearly all the circuit except for a few resistors which are externally mounted. The seven potentiometers are all mounted along the front of the board and protrude out from the front panel so no interwiring is needed. The whole assembly then mounts inside a custom built case which is screen printed with the appropriate legends. For those who don't want to make their own PCBs, these are available ready made, drilled and tinned, or a complete kit including

the case can be purchased (details at the end).

The PCB is simple enough to make yourself, if you have the facilities, by using an etch resist pen. Once the PCB is to hand, construction can commence. There is no alignment required so the circuit should work first time.

1. Insert and solder the 15 1mm dia connection pins shown as black circles on Fig. 5, the component overlay diagram. These are inserted from the underside of the board and pushed home using a blunt tool against the head.

2. Insert and solder all the fixed value resistors. These should lie flat against the board where mounted horizontally, and with short leads where vertical.

3. Solder in the fixed wire links on top of the PCB (by point J and under VR4), then the link under VR7 and above R22/R23. Make this link in the form of a loop of insulated wire on top of the PCB so that it can be cut if necessary later on — it controls the overall output level from the equaliser. Note: if Icom or other rigs are to be driven, *do not* fit R22/23/24 or the looped link but use wire link in place of R22 instead so that the slider connects directly to point K.

4. Insert and solder D1 observing its polarity, then RFC1.

5. Insert and solder all capacitors, observing the polarity of the electrolytics.

6. Finally, do the same for all integrated circuits, observing their orientation.

7. Take each of the potentiometers in turn and remove (using a hacksaw) excess spindle so that 6mm of the unthreaded spindle remains. Screw one M7 nut onto each spindle.

8. Solder each pot into place, ensuring that it is vertical. Log pots are coded 'A' and linear ones 'B'.

9. Check all component placings, and clip off all protruding wires on the underside of the board so that they do not exceed 1mm.

You will now need a case for the equaliser board. If you buy the kit, this comes with a suitable steel case. It also has mounting bushes already fitted where necessary. You can of course make your own from aluminium.

Wiring In

1. Mount the five pin DIN socket on the left rear using 6mm long 6BA screws, lockwashers and nuts. You should remove a small amount of the paint behind one of the nuts to get a good earth contact before fitting.

2. The 3.5mm socket used for the speaker input — for use with your communications receiver — requires a small modification before fitting. As supplied, it will be a break contact type and this has to be altered so that it *makes* contact when the plug is inserted. If this is not done then the low Z input will be shortened to earth when no socket is used. This can be done using a pair of pliers quite easily. You could of course omit the connection completely if you don't intend using a speaker input.

3. Removing some paint behind each, fit the 3.5mm socket and phono sockets on the rear panel.
4. This leaves the rear panel mic socket to be fitted. This should be of the same type that matches the mic to be used and two are required in total (one of the front panel as well and also two matching plugs). These are hard wired in parallel as far as all

- the connections such as scan, PTT, etc are concerned, with only the actual mic input being re-routed through the equaliser.
5. Scrape off some paint from the top of the rear left bush on the base of the case so that the PCB underside is in direct contact with it. Place the PCB over the rear bushes and loosely fix in place using M3 x 6mm

- screws and lockwashers, inserted from the top.
6. Scrape some paint off the top of the mounting bush on the right of the front panel. Then mount the slide switch on the right of the panel using two M2 6mm screws. Attach the supplied LED in its hole on the left of the panel.
7. Fix the remaining mic socket to

Fig. 5 The complete component overlay.

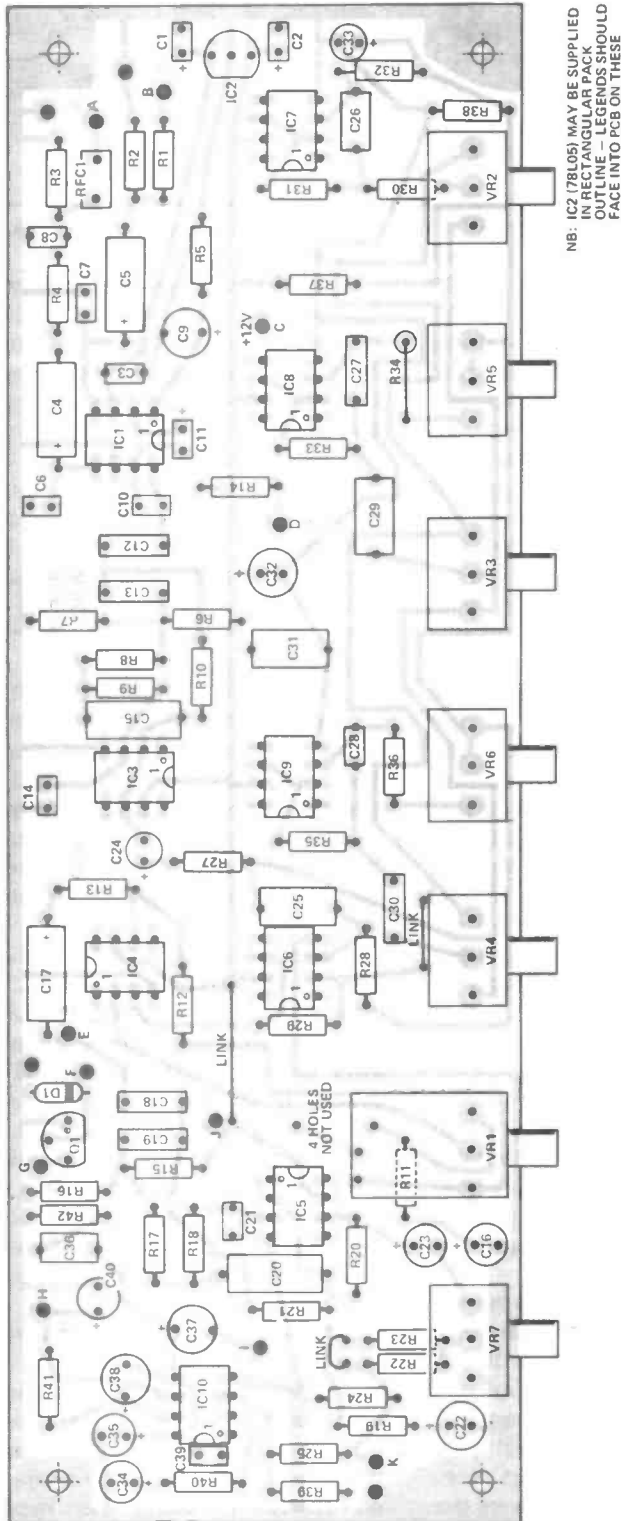
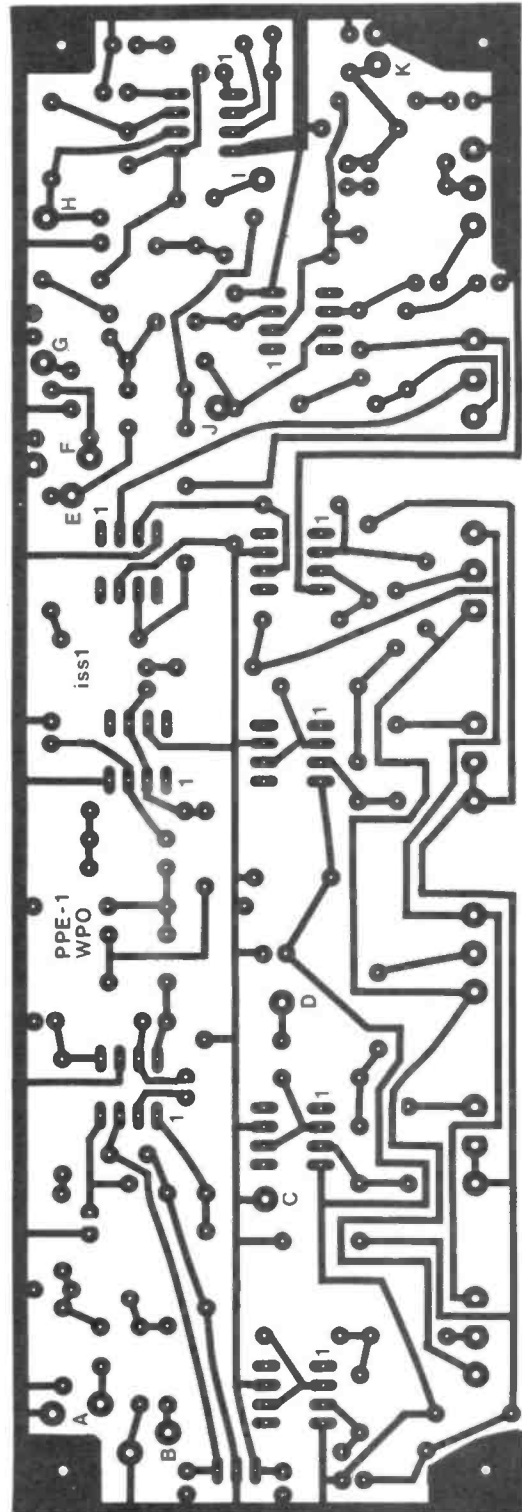

Fig. 6 The foil pattern at size.



the front panel, again scraping some paint off the rear of the panel so that the socket is in good electrical contact.

8. Carefully slide the front panel over the pot spindles adjusting their positions carefully if required until the panel will slide fully into place. Screw one M3 x 6mm screw into the centre mounting bush from the underside to fix the panel. The PCB is then secured using two M3 x 12mm screws inserted from the underside in the other two mounting holes, followed by M3 lockwashers and nuts on the topside.

9. Adjust the positions of the nuts behind each pot so that the pot is near vertical against the rear of the panel, then add an M7 washer to each pot and tighten up using another M7 nut. The knobs, which are not supplied with the kit, should be suitable for fitting to 6mm spindles.

10. The whole assembly may now be fully wired. You will need to locate the microphone output pin for whatever microphone you are using (this should be in the rig's instruction manual). Once this is known, all the other connections on the socket should be wired in parallel from the front to the rear sockets (don't forget that the rear socket is a mirror image of the front when wiring!) using insulated wire.

11. Continue wiring as per Fig. 7 (consult the circuit diagram Fig. 2 if in doubt over any connection) and don't forget the ferrite beads. You will also be able to establish from the manual whether the mic is low or high impedance and wire to the correct input (A is low and B is high Z). The DIN speaker outlet has its plug wired so that +12V is connected to the TBA820M audio amplifier when speaker output is required.

12. The lid can be fitted after the unit is tested and is fitted with a welded stud for earthing via a flying lead back to the stud on the back panel. Use an M3 nut, lockwasher and solder tag on each stud and a suitable length of insulated wire so that the lid can be removed easily.

Testing

The only 'adjustment' to be made is to check that the output level from the unit is correct for your rig. If you know that you have one of the high input level types then you will have already made the appropriate modifications to the board.

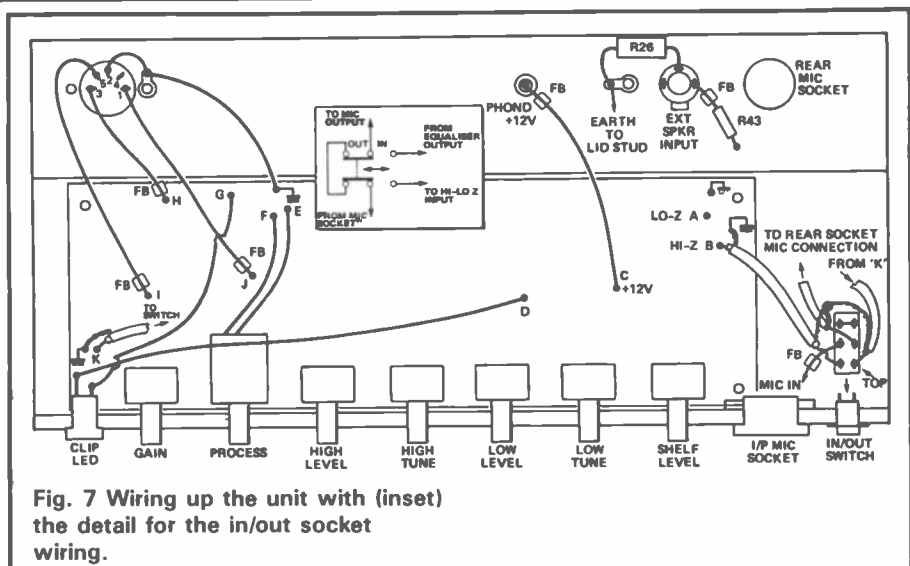

Fig. 7 Wiring up the unit with (inset) the detail for the in/out socket wiring.

Apply power to the unit at the phono DC socket and connect up. You will need a lead from the socket on the back to the front of your rig. This should be made up using suitable screened cable and two matching plugs — screening is particularly important to keep RF out of the unit.

Set all pots, except the processor which should be 'off', to mid position and the gain control to setting 4. Using either a monitor receiver or another station on the air, establish whether the audio level being monitored is close to normal (use the 'in/out' switch to assist) with the gain control somewhere between settings 3-7. If it is still too high even at setting 3, then cut the link under VR7 to reduce the output, and try again. One of these settings should suit the great majority of microphones. If you find that the output is still too high then a further voltage divider can be made from two resistors and wired between point K and earth, or R22 can be increased in value.

Using The Equaliser

Once you have it set up, you can start adjusting the various controls for best response, again using someone to help you. It is best to get the opinion of more than one person of course!

There are combinational settings which you cannot use without introducing distortion. One such is full boost or cut on all controls but you would never want to use this setting anyway. With the three Level controls, clockwise *boosts* and anti-clockwise rotation *cuts*. Likewise the two Tune (frequency) controls

increase frequency with clockwise rotation.

It will usually be best to leave the two high and low variable frequency control Level settings at mid travel. This is the setting where the equaliser does not affect anything — at this setting the Tune controls have no effect. Initially adjust the Shelf level for best overall effect. You can then adjust the other two controls to 'tweak up' the overall response. Depending on the final settings, you may well have to re-adjust the Gain level to compensate for the cut or boost you have introduced.

Keep a note of optimum settings to save having to do it all again at some later stage. You will discover that settings for say local FM transmissions are very different to those required for DX SSB contacts, so you will need to enlist the help of several stations to get all the settings you need.

The Processor can be activated by switching clockwise past 'off'. You probably will not need it unless you find that your mic response is very close to optimum in the first place. If this is the case, some processing can be introduced. The level should be adjusted so that the Clip LED illuminates on peaks only. If you have a fair amount of boost in circuit then you will find that the LED stays on nearly all the time; the clipping level will be high with distortion introduced and you will be better off without it.

When used with a receiver, the equaliser can be adjusted to compensate for receiver audio deficiencies in much the same way as transmit. With the receiver speaker output connected to the

3.5mm socket, you should adjust the receiver output volume to a point at which the equaliser output just stops increasing (ie there is sufficient input to make the VOGAD circuit take over). The rest of the controls can then be adjusted as required. Alternatively, the input from the receiver can be made via its low level AF output socket (if it has one) and taken to the high or low Z input as appropriate on the front mic socket.

Kits

Kits of parts for this project are available from Cirkit Distribution, Park Lane, Broxbourne, Herts. EN10 7NQ. The kit is supplied with PCB, all components and hardware plus the finished case. 4 pin mic sockets are supplied as standard. Any other types and their plugs will have to be ordered separately. Knobs are not supplied (suitable types are stock no 21-86203 together with caps 21-10021) and a +12-16V DC power supply will be required. The kit costs £54.06 including VAT and post. The PCB alone can be purchased for £6.50 inclusive.

Components List			
RESISTORS			
R1,43	39k	C14,21	1n 100% mylar
R2,32,37,38,39	10k	C15,20	1n5 polystyrene
R3,4,13,14,30	1k	C16,23	10uF electro radial
R5	1M0	C22,32,34,38,40	100uF electro radial
R6,7,8,9,15,16,17,18	27k	C24	1uF electro radial
R10,21,22	5k6	C25,29,31	220n mylar 10%
R11,27,29	6k8	C26	470n polyester
R12	82k	C27	47n mylar 10%
R19	820R	C28	10n mylar 10%
R20	560R	C33,35	47uF electro radial
R23	1k5	C36	220n polyester
R24,33,35	470R	C37	220uF electro radial
R25,28	100k	C39	680pF cer
R26	8R2 1W	SEMICONDUCTORS	
R31,40	100R	Q1	BC237, BC238 or BC239
R34,36	2k7	D1	1N4148 or similar
R41	68R	IC1	SL6270C
R42	1R0	IC2	78L05 or 78L06
		IC3,4,5,6,7,8,9	741N
		IC10	TBA820M
All resistors 0.25W 5% carbon film unless otherwise stated.		MISCELLANEOUS	
VR1	100k log pot with rotary switch	LED1 amber or red LED with bezel; RFC1	
VR2,3,4	10k lin pot	1mH Toko choke; one 5 pin DIN socket; one	
VR5,6	100k log pot	5 pin DIN plug; one phono socket; one	
VR7	10k log pot	phono plug; one 3.5mm jack socket; one	
CAPACITORS		3.5mm jack plug; one DPCO slide switch;	
C1,2	0.47uF tant bead	two mic sockets as required; two mic plugs	
C3	100n cer	as required; seven knobs (6mm spindle); four	
C4,5,17	1uF electro axial	rubber feet; a case and lid; six ferrite beads;	
C6,7	1n cer	14 M7 pot nuts; seven M7 pot washers; two	
C8	10n cer	M2 pan head 6mm screws; five M3 pan	
C9	47uF tant bead	head 6mm screws; two M3 pan head 12mm	
C10	4n7 mylar 10%	screws; six M3 plain washers; six M3	
C11	2.2uF tant bead	lockwashers; two 6BA 6mm RH screws; two	
C12,13,18,19,30	100n mylar 10%	6BA lockwashers; two 6BA half nuts; three	
		solder tags; 15 PCB connection pins and	
		wire, both coloured and screened audio.	

AMATEUR RADIO & ELECTRONICS



HOBBY FAIR

Admissions: Adults £2.00 O.A.P's & Children £1.00 Under 5's FREE
Family Ticket £4.50
Opening Times: Saturday 10.30 - 6p.m. Sunday 10a.m. - 4p.m.

Saturday 5th. & Sunday 6th. July 1986.

At the Wembley Conference Centre

CATERING AND BAR FACILITIES AVAILABLE ALL DAY.

The first major two day event in the SOUTH of ENGLAND.

THIS IMPORTANT NEW DATE IN THE AMATEUR RADIO CALENDAR PROVIDES
STAR RAFFLES, BRING & BUY WITH LOTS OF BARGAINS GALORE.

Over 200 TRADE STANDS FROM ALL OVER THE COUNTRY.

RTTY - SATELLITE T.V. & COMMUNICATIONS - MICROWAVES -
HOBBY COMPONENTS - 934 Mhz - AMATEUR TELEVISION AND
LOTS, LOTS MORE.....

Organisers: Amateur Radio Promotions Ltd., Woodthorpe House, Clappgate Lane, Birmingham B32 3BU. Telephone: 021 - 421 5516

Interference

Life would be very simple for the amateur radio operator if there was only one kind of interference and therefore a single, simple cure for it. The fact is, however, that there are many different types of interference, each with its own distinctive characteristics and devious ways of infiltrating communications equipment.

that the ratio of signal strengths is therefore 1000:1!

You'll often hear an operator boast about his or her receiver by saying something like, "its got a 0.25uV sensitivity for 10dB signal to noise ratio." Well, taken by itself that performance figure, which would no doubt have been obtained by the manufacturer using a signal



Continuing our war on interference, Steve Price, G4BWE, takes an intimate look at the radio amateur's receiving system. Ensure yours rejects the signals you don't want and modify the offending equipment around the house!

Amateur radio transmitters can also prove to be generators of interference, as many operators have unfortunately discovered. In this part, we will look at how the amateur's receiving system may be used to reject certain forms of interference and how to modify other equipment which generates it. Finally, we will examine how an amateur transmitter can interfere with domestic entertainment systems and detail some well proven cures for the common problems.

The Receiver

Tune across a crowded HF band and you will hear a jumble of signals and noise. As the rig's 'S' meter dances up and down its scale, we are aware that the AGC (automatic gain control) circuitry is continuously modifying the receiver's gain in response to varying signal levels. What comes out of the rig's loudspeaker is therefore a very compressed sound 'picture' which tells us little about the relative strength of the various signals. Hence the need to look at the S meter reading if we wish to know exactly how strong a particular signal is. The reality of the situation is that a very loud signal will develop 1mV (one thousandth of a volt) at the antenna socket, perhaps even more, whereas a truly weak signal gives only about 1uV (one millionth of a volt). It doesn't take a mathematical genius to work out

generator, sounds mighty impressive. Unfortunately, it tells us nothing about how the rig will cope with a mixture of real signals on the HF or VHF bands. In practice, we need other transmissions, one of which may be 1000 times stronger and spaced only a few kilohertz away!

The first form of interference that can ruin reception is termed 'adjacent channel' and manifests itself as the 'splatter' we hear when there is a strong signal just a fraction to one side of the QSO we're trying to copy. Every type of transmission occupies a certain amount of spectrum 'space' or 'bandwidth'. In the case of SSB, the bandwidth is about 2.5kHz and this figure is derived from the fact that the information carried by the signal consists of a filtered 'voiceband' stretching from approximately 300-2800Hz. An SSB, receiver should contain an IF filter which matches this bandwidth within +/- 250Hz (ie the filter should have a -6dB bandwidth of between 2.25kHz and 2.75kHz). As there is no useful information transmitted outside of the voiceband referred to above, the receiver's filter must reject all other frequencies very effectively. Otherwise, adjacent transmissions may also find their way through to the loudspeaker and thereby, impair copy.

This is where the concept of 'shape factor' comes in. A really high quality crystal filter designed for SSB will possess a flat pass band

response over about 2kHz, +/- 1dB. The -6dB bandwidth will be, let's say, 2.5kHz, whereas the -60dB bandwidth might be only 4kHz. The 6/60dB shape factor is calculated by dividing the -6dB and -60dB bandwidths ie $4/2.5=1.6$. A low shape factor figure indicates that the filter's response falls off steeply either side of the passband, thus rejecting adjacent transmissions. Fig. 1 illustrates this point by showing how two different IF filters one good and the other rather poor, would cope in practice. Both filters pass the wanted transmission (signal A) but only the good filter adequately rejects the adjacent transmission.

The IF filter contained within a modern SSB transceiver is used not only on receive, but also forms part of the SSB generator on transmit. The requirements of the transmitter dictate that a filter of fairly high quality must be employed, because using an inexpensive filter having poor shape factor would result in inadequate sideband suppression. The same cannot be said for many of the general coverage HF receivers now on sale. These products will typically employ a much cheaper ceramic filter that cannot possibly provide the best obtainable shape factor. Also, where the receiver is designed to cater for reception of AM transmissions, a filter of at least 6kHz bandwidth must be fitted. This is because AM contains both an upper and a lower sideband. The intending purchaser should therefore

check that the receiver is also fitted with a separate, narrower filter for SSB. The same problem may also be encountered with an older receiver which was designed prior to the widespread adoption of SSB and is therefore equipped with only a wide AM filter.

Filtering Continuous Waves

CW is different matter altogether because a morse transmission consists only of an on/off, 'keyed' carrier at a single frequency. Strictly speaking, a CW signal will still spread either side of the carrier frequency by a small margin and so CW can therefore be said to contain both a lower and an upper sideband. The precise bandwidth of a CW signal depends on such factors as the shape of the keying envelope, short term transmitter frequency stability, and also the speed at which the morse is being sent. However, even when taking all these variables into account, the total bandwidth occupied by a morse transmission will rarely exceed 100Hz.

Clearly, the 2.5kHz bandwidth of the SSB filter is over 20 times greater than that necessary for CW. The keen morse operator will therefore employ a narrow CW filter having a -6dB bandwidth of between 125 and 600Hz. Many transceivers now feature such a filter or alternatively, an IF shift facility may be provided which enables the bandwidth of the rig's IF strip to be adjusted using a front panel control. Finally, it is possible to employ a specialised audio filter that is

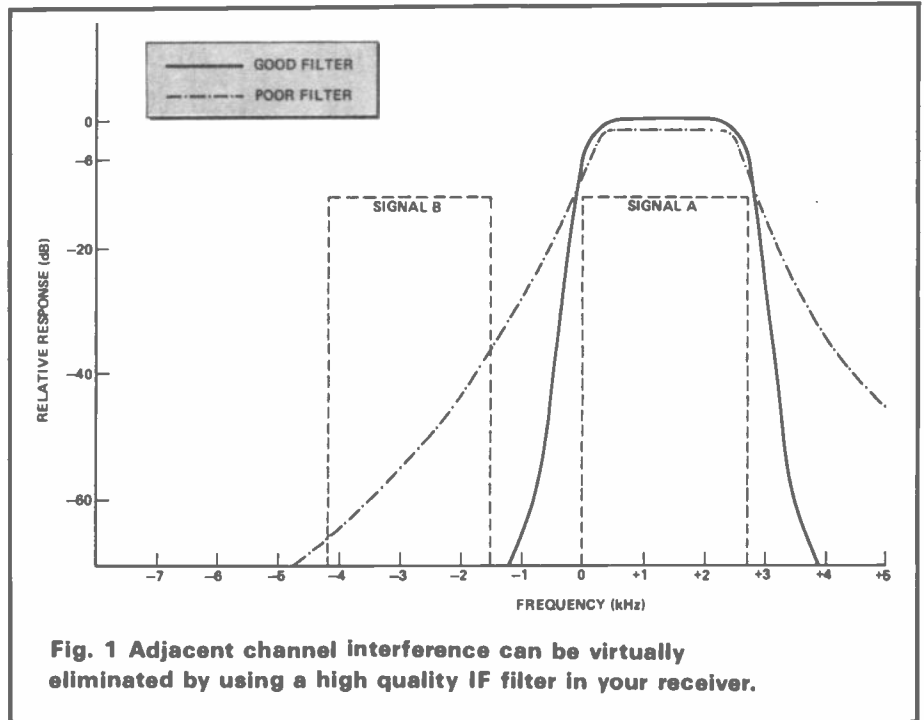

Fig. 1 Adjacent channel interference can be virtually eliminated by using a high quality IF filter in your receiver.

inserted between the receiver's external loudspeaker socket and a separate loudspeaker.

Fig. 2 shows how a narrow CW filter with good shape factor may be used to separate closely spaced CW transmissions. It also illustrates the fact that a much wider SSB filter will allow more than one CW signal to pass through the receiver, along with any noise energy contained within the greater bandwidth. It should be borne in mind, however, that each CW transmission will give rise to a slightly different pitch of note at the receiver's output and so the experienced operator may still be able to separate the signals using the complex 'filters' contained within his brain!

Other Modes

So far we've only considered SSB and CW, but adjacent channel interference and background noise can prove to be a problem with all forms of transmission. Therefore, in order to obtain optimum performance from RTTY, AMTOR or data modes, it is necessary to consider the use of high quality filters which have characteristics that match the tone frequencies and bandwidth of each mode. Where a communications terminal, or 'interface' is employed to link a transceiver with a home computer, improvements in the system can often be obtained by placing an additional audio filter at the terminal's input. A fully tunable filter with variable bandwidth, such as the Datong FL2 or FL3 would prove ideal.

Adjacent channel interference is not the only problem that may be encountered when using a typical HF or VHF receiver. The terms 'image response', 'cross modulation', 'blocking' and 'reciprocal mixing' all refer to distortions that may occur as a direct result of imperfections in the receiver. Generally speaking, the greater the mix of strong signals presented to the antenna socket of a receiver, the more chance there is that 'rogue' signals and increased levels of background noise will find their way through to the loudspeaker. Therefore, the use of a tunable preselector between the

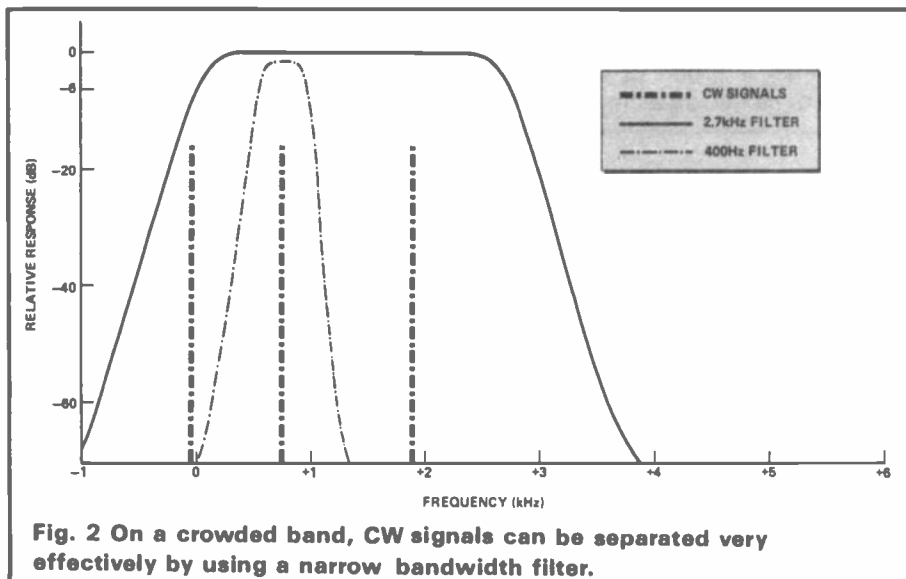

Fig. 2 On a crowded band, CW signals can be separated very effectively by using a narrow bandwidth filter.

antenna and the rig can often lead to enhanced performance. The pre-selector will contribute additional front end selectivity, which is particularly desirable where the receiver employs fixed tuned, wide bandwidth, 'half octave' input filters. A better impedance match between the antenna and the receiver may also be obtained.

The Antenna

When two different transmitters are operated on the same frequency it is virtually impossible to separate their signals using filters within the receiver. However, if the signals arrive at the receiving site from different directions, we can exploit the directivity of the receiving antenna to boost the level of the wanted signal relative to that of the interfering transmission.

This technique works best on VHF and UHF where most signals are propagated in a predictable manner as ground waves. Fig. 3 shows a plan view of a horizontal dipole. This is one of the simplest antennas we could use to receive SSB transmission which are normally horizontally polarised. The dipole possesses a figure of eight directivity pattern with two points of minimum sensitivity, or 'nulls', which coincide with an imaginary line drawn through the axis of the antenna rods.

The wanted signal A arrives almost broadside on to the antenna and so is not attenuated. Signal B however, suffers quite considerable attenuation because it arrives from the direction of minimum sensitivity, and is said to be 'nulled out'. Clearly, if some form of rotating mechanism is provided for the dipole we can exploit the nulls as a means of rejecting interfering signals. Unfortunately when a dipole is positioned vertically for reception of FM transmissions, the nulls also occur along a vertical line and so the only signals we can reject are those emanating from satellites flying directly overhead, or stations buried underground!

A multi-element beam antenna (eg a Yagi) provides forward gain attenuation of signals arriving from behind the antenna (hence the term, 'front to back ratio') and also nulls. Fig. 4 illustrates a situation where there are three signals (A, B and C) arriving at the beam from different

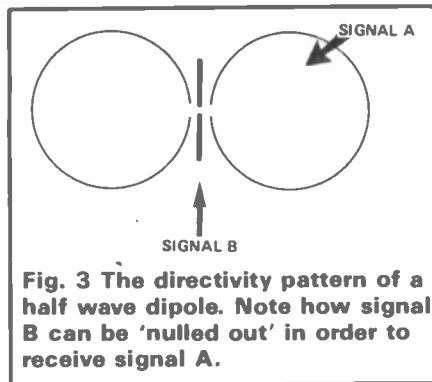

Fig. 3 The directivity pattern of a half wave dipole. Note how signal B can be 'nulled out' in order to receive signal A.

directions. Signal A will be amplified by the forward gain of the antenna whereas signal B is attenuated by a null. Signal C arrives at the 'rear lobe' of the antennas directivity pattern and is attenuated by a factor related to the beam's front to back ratio, which will lie in the region of 20dB.

An HF dipole also exhibits nulls but these will tend to be less pronounced due to the unpredictable manner in which signals propagated by ionospheric refraction arrive at the aerial. Trying to rotate a large HF dipole can also prove rather problematic! The more complex HF antennas such as three element beams and cubicle quads do, however, offer useful forward gain coupled with reasonable front to back ratios. These properties are employed to good effect by operators seeking to eliminate interference on crowded bands like 20m.

So far we have looked at the interference caused by unwanted radio signals but there are many other forms of interference and these can be grouped under a number of broad headings.

Electrical Appliances

Whenever a pair of contacts is opened or closed so as to interrupt or

initiate the flow of current in an electrical circuit there is a discharge of energy which may result in the generation of electromagnetic radiation. This radiation will be spread over a wide range of frequencies covering nearly the whole of the radio spectrum. However, the energy level will often peak at certain points within the spectrum due to resonances in the circuitry that are controlled by the contacts.

The operation of the ignition system in a petrol driven vehicle is very similar to that of a turn of the century spark transmitter — so it's hardly surprising that ignition interference causes problems particularly when radio gear is operated actually inside vehicles. Each time a spark plug 'fires', there is a discharge of electrical energy from the circuit connected to it. This circuit consists of the spark coil secondary, which has a significant capacitance between its windings, and the plug leads, which represent small inductances. Together, these reactances form what amounts to a tuned circuit and so each time a spark is generated, high frequency damped oscillation occurs. The amplitude of the resultant interference peaks at around 40 to 100MHz but is wideband in nature and can be detected on all amateur bands through 1.8MHz to 1296MHz.

An effective way of reducing ignition interference is to add series resistance to the high tension circuit, thereby reducing the 'Q' of the reactive elements present. For this reason, resistive spark plug leads are now fitted to most new vehicles and this is the first item for anyone contemplating mobile operation to check on. Special spark plug connectors with built in series resistors are also available and these

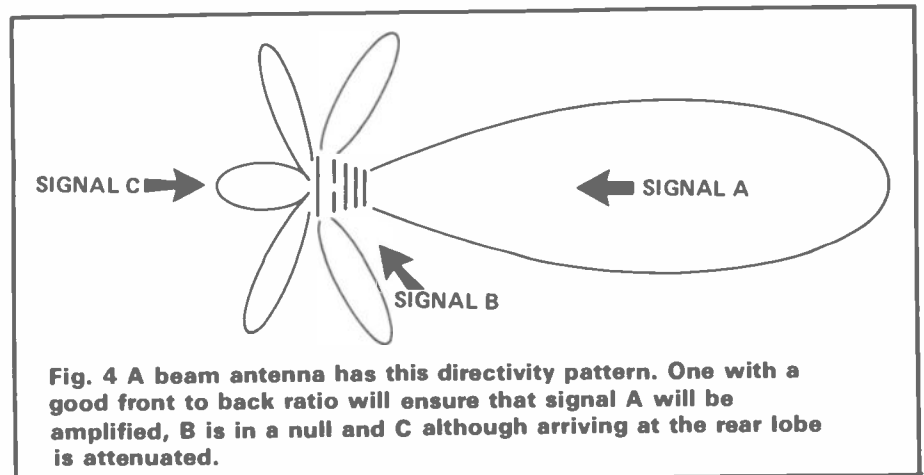

Fig. 4 A beam antenna has this directivity pattern. One with a good front to back ratio will ensure that signal A will be amplified, B is in a null and C although arriving at the rear lobe is attenuated.

are certainly worth trying. It must be borne in mind that the vehicle body serves as a screen to prevent much of the radiation from the ignition system escaping. However, this screen can only be fully effective when there is good electrical continuity between all parts of the structure. It is therefore worthwhile checking that the bonnet has a good connection to earth and in some cases the addition of a flexible copper earth strap between the bonnet and a convenient part of the vehicle body (eg near the hinge fixings) may bring rewards.

Sources and Solutions

Practically all items of electrical equipment found in vehicles and also in the home are potential sources of wideband interference. Electric motors used in vacuum cleaners, refrigerators, etc, light switches, dimmers and thermostats all contain contacts which interrupt current flow. In the case of lamp dimmers and triac controlled motors, semiconductor switches are employed, but these may also generate interference. The easiest and, in the majority of cases, the most effective way of suppressing the generation of RF energy is to wire a capacitor across the supply connections to the offending equipment. In the case of mains powered electric motors and lamp dimmers a capacitor of between 10 and 100nF having a voltage rating of at least 750V should prove suitable. It is a good idea to wire a small, fixed resistor of around 22 ohms in series with the capacitor which will then add damping, thus preventing the capacitive reactance causing new resonances (see Fig. 5).

Warning: great care must be taken when working on mains equipment and remember that adequate suppressor components may already be fitted. If in doubt, leave well alone! Various items of electrical equipment contained within motor vehicles aside from the ignition system components eg windscreen wiper motors, may also be suppressed with shunt capacitors. A good starting value is 1uF (non electrolytic) of at least 63 volt rating. A series resistor will not be required where this higher value of capacitance is employed, but the addition of a 10uH high current RF choke in series with the supply lead

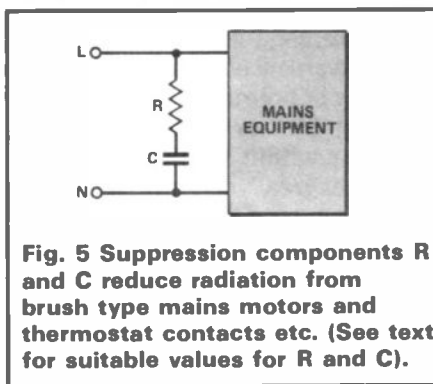

Fig. 5 Suppression components R and C reduce radiation from brush type mains motors and thermostat contacts etc. (See text for suitable values for R and C).

to the unit may well improve suppression, particularly at VHF, as Fig. 6 illustrates. A suitable choke can be made by winding about 20 turns of 22swg enamelled copper on a short length of ferrite rod (diameter not critical). The exact value of inductance obtained is unimportant and the figure of 10uH serves only as a rough guide.

In order to combat electrical interference, many receivers and transceivers contain noise blanker systems which are designed to remove interference pulses of short duration by a gating action which effectively mutes the receiver when a pulse occurs. A well designed noise blanker can work wonders, particularly for the mobile operator.

The TV Bug

Within every domestic 625 line television receiver there is a synchronised oscillator which runs continuously at a frequency of 15625Hz. The output from this stage is used to drive line deflection coils attached to the cathode ray tube, so causing the electron beam to be deflected, or 'scanned', horizontally across the tubes face, thus generating the line structure of the TV picture. The cathode ray tube also requires a very high final anode voltage (18 to 25kV for a colour receiver) in order to accelerate electrons travelling towards the phosphor coating on the inside of

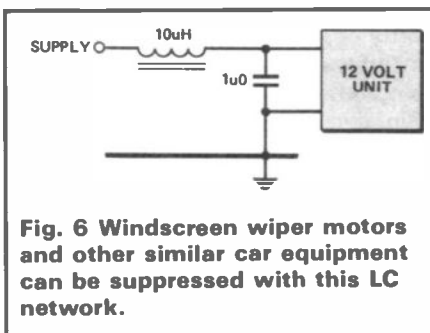

Fig. 6 Windscreen wiper motors and other similar car equipment can be suppressed with this LC network.

the tube face. It is convenient to employ the 15625Hz output of the line oscillator, fed through a step-up transformer (the 'line output transformer') in order to generate this extra high tension (EHT) voltage. Also, the designers of modern TV receivers have found it possible to extract power from the line output transformer which is then switched-mode regulated and fed to other stages. This ingenious technique makes for greater power supply efficiency and therefore reduced mains consumption.

The net result of all this is the generation of power levels, at line frequency, in the region of 20W. Because of the switching nature of the system, much harmonic energy is present. Indeed, the line output transformer itself may be designed to resonate at the 3rd or 5th harmonic of the 15625Hz line frequency. Despite the presence of screening within the TV receiver, harmonics tend to escape and are radiated at significant levels. Fig. 7 depicts the 'comb spectrum' of harmonic energy released by a TV receiver. Each vertical line represents a single harmonic of the line frequency, the 'teeth' of the comb being spaced 15625Hz apart. As the frequency rises, the harmonics become weaker and for this reason TV interference only causes problems on the lower frequency bands — 1.8MHz and 3.5MHz (160 and 80m) being by far the worst affected.

We are, of course, dealing with very high order harmonics (for instance it is the 225th harmonic which causes interference at 3.516MHz!) the field strength attributable to an individual TV receiver at a particular MF, or HF frequency is minimal. Unfortunately, as the receiver sections of amateur transceivers are necessarily made very sensitive, and also because most of us live next to a television viewer (or have somebody living with us who may wish to watch TV while we are indulging in the far more interesting pursuit of topband DX) TV harmonic radiation nearly always makes itself known, particularly during the evenings. Furthermore, in built up areas, where there may be a large number of television receivers operating simultaneously, the line oscillator of each receiver will be running at precisely the same frequency — as

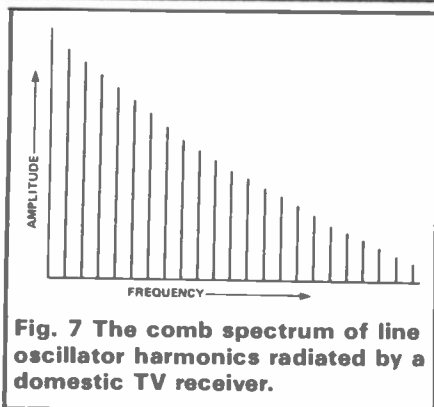

Fig. 7 The comb spectrum of line oscillator harmonics radiated by a domestic TV receiver.

dictated by synchronising pulses originating from the TV station. Therefore, the radiation from separate TV receivers will tend to reinforce, thus increasing the average level of interference.

Things would not be so bad if it were possible to tune between the harmonics, or alternatively, employ a notch filter to remove an offending harmonic. In practice, however, each harmonic contains a considerable amount of sideband energy due to the presence of 50Hz TV field synchronising pulses and also video information. These tend to amplitude modulate the line frequency harmonics and cause 'spreading'. Nevertheless, CW operators will find that the use of sharp receiver filters can improve matters considerably. This is because the harmonic sideband energy is fairly evenly spread and so using a narrow IF, or audio filter, will reduce the level of interference by providing a narrow 'window' through which the wanted signal is allowed to pass, accompanied by only a minimum amount of interference.

Home Computers

During the last five years an electronics revolution has taken place. All new developments bring with them their share of technical problems and in the case of home micros, radio interference generation is, perhaps, the major bugbear.

Within every home computer, there is a clock oscillator running at a fundamental frequency of between 2 and 16MHz. This oscillator drives the microprocessor which in conjunction with other complex ICs generates a plethora of digital pulse trains. These pulses are in effect, the result of a complex division of the clock oscillator frequency and they cover a very wide range of

frequencies. Because each pulse is nearly rectangular in shape ie it has almost vertical edges, there is a large amount of harmonic energy present (see Fig. 8). The nature and strength of the resultant harmonics depends to a degree, on the computers operating speed and the type of ICs it employs. For instance, a machine such as the BBC micro contains large numbers of low power Schottky TTL devices (coded 74LS--). The term 'Schottky' indicates that special fast switching hot carrier diodes are employed within the IC as a means of speeding its operation. In consequence, a typical home computer will radiate a large number of very closely spaced harmonics. The interference spectrum stretches from the lowest radio frequencies, through all HF bands and up into the VHF range. Indeed, most home computers will cause significant problems on 79 MHz (4m).

Nearly all home computers on sale in the UK are built into completely unscreened plastic cases, although it is interesting to note that in the USA, stringent regulations formulated to minimise radio interference dictate that even the cheapest home micros must be almost fully screened. The field strength attributable to an individual computer is not very great and so the resultant interference will be propagated over a distance measured in yards, rather than miles. Of course, this fact provides no comfort whatsoever to the radio amateur who wishes to use a computer as part of his station. A considerable range of software is currently available for RTTY, CW data modes and SSTV. Also, the hardware often required to provide an interface between the transceiver and particular makes of home computers is readily obtainable, or may be home constructed.

If the operator wishes to make full use of communications software it will be necessary to screen the computer in some way, as this is the only means of eliminating interference. In the case of small, single board computers such as the Sinclair ZX81 and Spectrum, it is a relatively simple matter to remove the computer's PCB from its plastic enclosure, which is then discarded, and re-house the PCB in an aluminium or diecast box. It may not be possible to retain the original keyboard, but a replacement

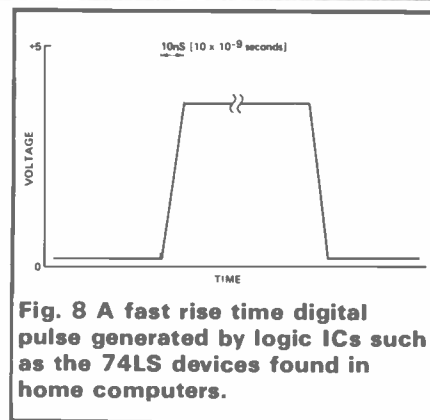

Fig. 8 A fast rise time digital pulse generated by logic ICs such as the 74LS devices found in home computers.

keyboard (probably of higher quality) may be purchased for a reasonable sum. The new keyboard and any connecting lead(s) between it and the computer will also require screening, unless of course the new keyboard is small enough to fit onto the screened box containing the rest of the computer.

Any diecast or aluminium enclosures used for screening purposes must be connected to the system ground (ie the 0V rail) and the positive power lead entering the computer should be decoupled using a 100nF ceramic capacitor. Do not, however, try decoupling any data address or control lines as this will almost certainly prevent the computer operating correctly. Ribbon cables used to link the computer to peripherals (eg interfaces, printers, disc drives, keyboard, etc) may be screened by wrapping them in aluminium foil, and then connecting the foil to ground.

Needless to say, before attempting to implement any of the screening measures detailed above, the computer should be operated in close proximity to the station transceiver so as to gauge the degree of interference generated on each band. After all, you may be lucky and discover that your computer has been designed to meet the US interference regulations mentioned earlier.

It is important to remember that if a television receiver is employed as a monitor for the computer, this may also generate interference. Small screen monochrome receivers of recent design do not radiate as much RF as large colour sets, and some of the specialised 'video monitors' are built into metal enclosures which provide significant screening to an ordinary domestic television receiver, however, as these receivers do not necessarily contain a mains

isolating transformer, any such modification could, therefore, be highly dangerous.

Finally, those intending to use a home computer alongside their transceiver should be aware that radiation from the transmitter may cause the computer to malfunction. However, screening the computer kills two birds with one stone by preventing transmitter radiation from entering the micro.

The Woodpecker

The Russian 'woodpecker', which is in fact a sophisticated long range radar system designed to detect and track military aircraft and inter-continental missiles, utilises a small number of very high power HF transmitters which emit regular pulses of wideband RF energy. It has been estimated that these transmitters have a peak power capability in the region of 10MW (yes — ten megawatts!). Each pulse has a duration of approximately 15us and the pulses are repeated at a rate of either 10 or 16Hz — 10Hz being most common. Luckily the



woodpecker transmissions are intermittent and occur in bursts lasting less than a minute. Only the HF bands with 14MHz bearing the brunt are plagued by woodpecker interference, which is so called because the repetitive clicking noise it makes resembles that heard when a woodpecker hammers the bark of a tree.

Unfortunately, the noise blankers mentioned in the section covering electrical interference are designed to eliminate pulses of much shorter duration than those emitted by the woodpecker and so they are generally ineffective when it comes to dealing with this menace. Special

add-on blanker units, designed specifically to cope with the woodpecker are available, however, and the Datong SRB2 (reviewed in February '84 HRT) is perhaps the most sophisticated.

As with the TV and electrical interference, a narrow bandwidth filter can improve matters considerably where CW reception is concerned. It is important, however, that any audio filter employed should be of the 'low Q' variety because the woodpecker pulses will encourage a high Q filter to 'ring', thus actually degrading reception. Last, but not least, it is important to realise that because the woodpecker pulses are of such high intensity, they tend to affect operation of the receiver's AGC. This causes a marked reduction in the receiver's sensitivity and can have the effect of almost completely masking the wanted signal. Where a switch is provided to disable the AGC, operating this control may offer some improvement. Alternatively, adjustment of the RF gain control and/or any input attenuator(s) could prove beneficial.

SUBSCRIPTIONS

Take out a subscription to Ham Radio Today and make sure you get your copy every month.

Subscription rates are

UK	£17.30
Overseas surface mail	£21
USA surface mail	£28
Overseas airmail	£39

Send your order and money to
HRT Subscriptions Department,
Infonet Ltd,
Times House,
179 The Marlowes,
Hemel Hempstead,
Hertfordshire.
HP1 1BB

Cheques should be made payable to ASP Ltd and credit card orders can be taken over the phone, ring Infonet on 0442 48435.

STOP PRESS

Morse For All Class B Licensees

The Department of Trade and Industry have announced that all class B licensees may now use morse code. This follows the apparently successful conclusion of the one year experiment which 6000 class B operators participated in by obtaining their letter of variation. The restriction insisted upon in the experiment that CW could only be used at your home QTH has been lifted - you can use CW /A, /P and /M if you can manage it!

The DTI have revised the amateur licence and removed footnote A which restricted use of CW to class A operators. This concession is of course limited to the frequencies above 144MHz that class Bs are allowed to operate on and they recommend that we follow the guidelines the RSGB set out for the experimental period.

Amateur Transmitters of the '20s

From the 'prehistoric' days of amateur radio at the end of the last century to 1914, spark transmission reigned supreme. Receiving equipment had no 'gain' and was almost always of the simple detector type, often using crystals. However, war seems to foster the impetus and incentive to develop new ideas rapidly and the period 1914-1918 saw the thermionic valve — and particularly the triode valve — revolutionise wireless communications.

For the first time, continuous radio waves of discrete frequency could be generated easily and amplification obtained using feedback or regeneration in receivers. Receivers using several stages of AF and even RF amplification could be built. Transmitters able to generate fairly stable CW or telephony signals became possible at low or high power levels using valves. So when in 1920, amateur radio enthusiasts were again being licensed to operate, they largely abandoned their spark transmitters.

At first the number of licences granted was small (fewer than a dozen by October 1920) but the number of call signs later grew rapidly. Ex-government wireless equipment became available and by 1921 amateurs were operating over a wide range of wavelengths. Most of them were licensed to work on

1000 and 180 metres, but some stations were authorised to use 3000 and 700 metres. Power levels were generally limited to 10 watts input although a few stations were allowed up to 100 watts.

In the USA, 200m was already being used for 'DX' work and during the spring of 1921 and through the following winter many American

John Heys, G3BDQ, traces the development of amateur transmitters through the first half of the 'roaring' twenties.

amateurs were trying to get their signals over to Europe. Many of them were still using high power spark as were a dwindling band of lower powered British spark enthusiasts.

Amateur Spark Rigs

The magazine 'Amateur Wireless and Electrics' carried an interesting article in August 1922. This described the "Sterling" aircraft pattern spark transmitter, whose circuit is given in Fig. 1.

It was powered by a six volt battery and the current into the induction coil primary was of the order of 2 to 5 amps. The coil could produce a ¼ inch spark and the tuned circuit included a spirally wound copper ribbon. This together with the self capacity of the aerial tuned to about 200 metres. The helix inductance was arranged as an RF auto-transformer (auto-jigger in those days!) with the antenna via a hot-wire ammeter tapped towards its earthy end. The capacitor C1 had to withstand very high voltages and was made up from thin tin or copper foil separated by large rectangular pieces of glass. Discarded photo-

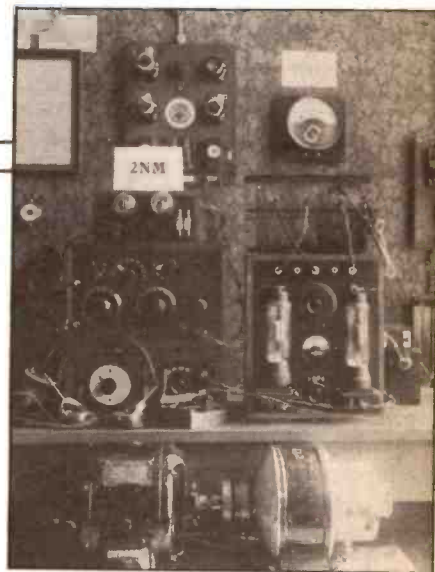

Station 2NM (No not our 2NM Gerry Marcuse!) in Finland 1924. The transmitting valves were Telefunken RS5s and the power oscillator ran at 20 watts when using 1000 volt unrectified AC!

graphic plates were often used to make similar capacitors. C2 is wired across the contact breaker or 'interrupter' and it helped to reduce sparking at the contact points. The range of this transmitter was said to be about 30 miles when conditions were good, and remember that the

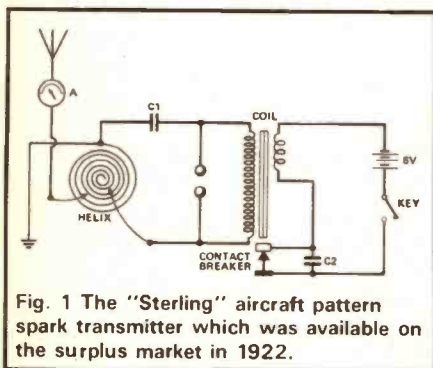

Fig. 1 The "Sterling" aircraft pattern spark transmitter which was available on the surplus market in 1922.

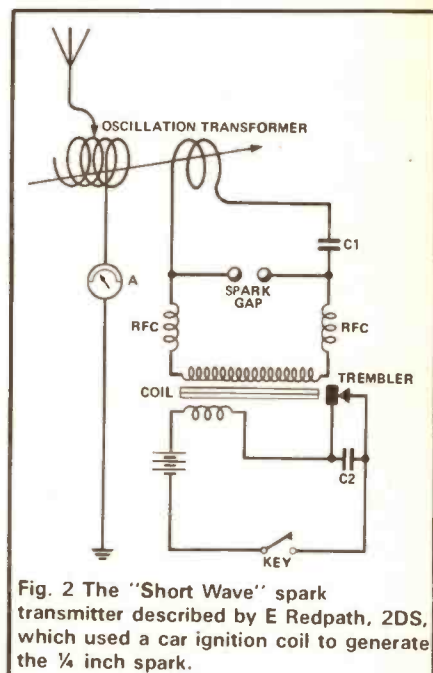
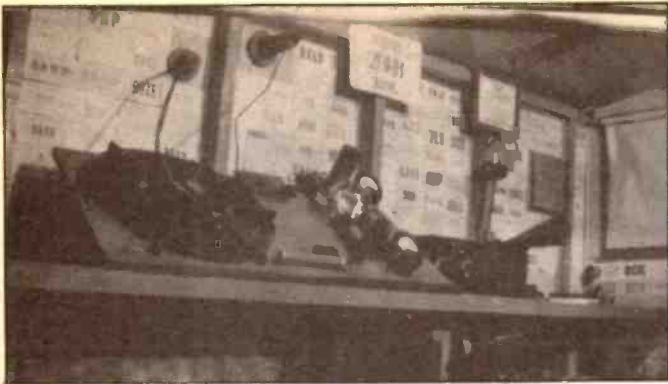
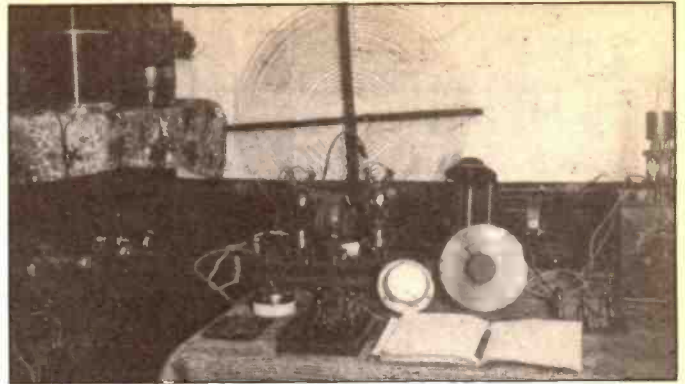

Fig. 2 The "Short Wave" spark transmitter described by E Redpath, 2DS, which used a car ignition coil to generate the ¼ inch spark.



American 2BRB's high power valve transmitter in 1922 which put signals across to Europe. The coil was in the form of a helix and was a type much favoured for spark transmitters.



Another helix used by French amateur 8DY in 1923/4. His two 'horned' transmitter valves were in parallel to achieve more output.

maximum length of aerial allowed at that time in this country was 100 feet.

Another spark transmitter design entitled "Building a Short Wave Transmitter" appeared in the August 26th issue of the same journal. This was designed for use on the 180 metre 'Short Wave' band and as Fig. 2 shows was altogether a more sophisticated piece of equipment. The article was written by E. Redpath, 2DS, who suggested the use of a motor car ignition coil to generate the spark. He also gave the full instructions for making a coil which could generate the 15000 to 20000 volts needed for a healthy 1/4 inch spark. The capacitor C1, which had a nominal capacity of 0.005uF (5000pF), used 16 sheets of metal foil each being 13x12mm in size and glass separators 3mm thick. The RF coils were wound on 6 inch square wood formers; the primary winding having just two turns and the secondary having between eight and twelve turns depending upon the aerial length. Very thick 7/22 wire was used to make the coils and they were arranged on a hinge so that the coupling between them could be adjusted.

The author suggested the use of a 2V bulb in the earth lead to check the RF output. One can only imagine the cacophony of QRM around 180 metres in those areas where a few spark enthusiasts were operating. Listening for weak CW signals anywhere close to that wavelength would have been impossible.

The proven DX capability, at low power using valve transmitters putting out narrow band CW, helped persuade amateurs to abandon their spark gear. The Post Office eventually issued new transmitting permits early in 1924 which finally outlawed

the use of spark by amateurs. By then spark had fallen out of favour and transatlantic QSOs using valved transmitters were becoming commonplace. Spark transmitters were still installed on many ships years later, since these would get through when all else failed!

The Airways Circuit

The infant Commercial Airways had by 1921 half a dozen radio stations located the length of Britain from Lympe in Kent to Renfrew in Scotland. These stations could maintain communications with civil aircraft and used both CW and telephony. A detailed description of these stations and the gear used appeared in 19th February 1921 issue of 'Wireless World' and the circuit of the basic 250 watt transmitting units was adapted by many amateurs in this country and overseas.

The Airways transmitter was designed to operate on a 1400 metre wavelength and were just simple high powered, self excited oscillators. The circuit (see Fig. 3) shows that they used a minimum of com-

ponents and did not even have a tuning capacitor! The coil L1 together with the capacitance of the antenna determined the operating frequency. At such low frequencies even considerable aerial movement in windy weather would have little effect upon the frequency stability, but amateur use of the circuit down to say 180 metres would be tricky to say the least.

The keying arrangement is interesting. By opening up the grid return, the valve was prevented from oscillating. Such a primitive keying technique overcame the need for a key or relay in the HT negative line — a system which could prove lethal! Rotary high voltage generators supplied the HT for the valve so it was not possible to primary key the AC mains supply. The 'bread-board' transmitter to be seen in the photograph nearby of the American 2BRB's shack around 1922 was, according to his QSL card, "a 250 watt rig based on the British Aviation hook-up".

The helix inductors so much favoured by the early spark enthusiasts were used by these operators when they went over to CW work. The 2BRB transmitter and also the rather 'haywire' rig built by French amateur 8DY in 1923/4 both used helix inductors. The French transmitter appears to have used a pair of 'horned' triodes in parallel.

Amateur Telephony

In 1922 a firm named 'The City Accumulator Co.' managed to acquire a large quantity of ex-government wireless gear, amongst which were many Army Transmitters Mark III. These transmitters were 30 watt two valved units designed for operation between 300 and 1800 metres. A 'posh' morse key with

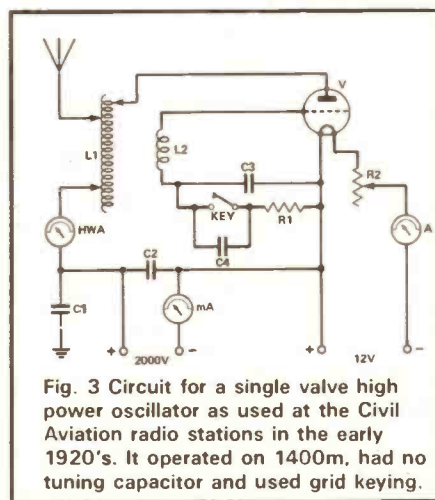

Fig. 3 Circuit for a single valve high power oscillator as used at the Civil Aviation radio stations in the early 1920's. It operated on 1400m, had no tuning capacitor and used grid keying.

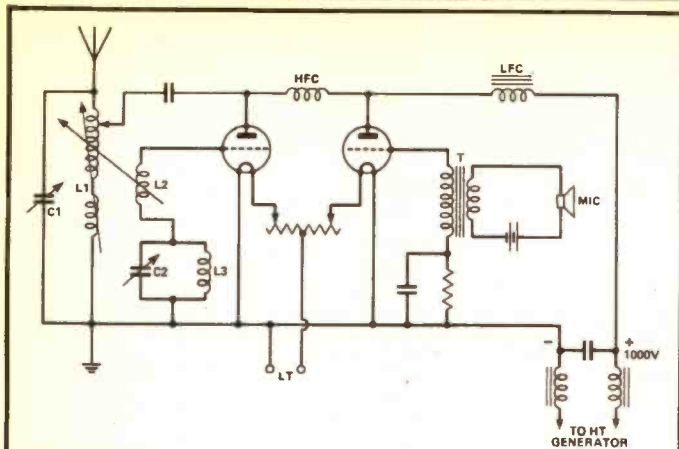

Fig. 4 Circuit of the Army Surplus Transmitter Mark III which L W Pullman, 5LP, modified for use on the amateur bands. Heising choke modulation is a feature of this transmitter which 5LP powered with a hand-driven generator!

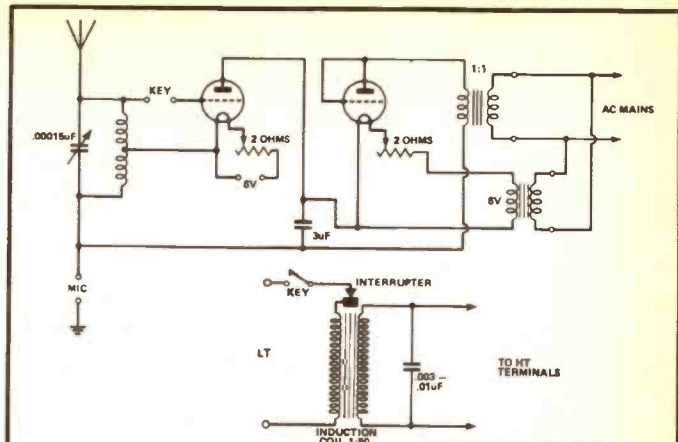

Fig. 5 A simple transmitter powered from an AC mains supply when used for telephony or from an induction coil when tonic train morse transmissions were made. A carbon mike in the earth lead provided the modulation.

platinum contacts, a hot-wire aerial meter and a milliammeter were included in the offer made by the firm in many advertisements. The transmitters were guaranteed to be in working order and were priced at £3.5.0d. A multiplication factor of 50 is needed to judge their cost at today's prices. The Mark III rigs were snapped up and a full description of a suitably modified transmitter ready for the amateur bands was written by LW Pullman, 5LP, of Golders Green and published in 'Amateur Wireless' in January 1923.

Pullman did a complete re-wind of the Mark III coils to put it on 180 metres and then he had a useful little phone rig. The oscillator was modulated by using the Heising choke control system and an unusual feature was that the core of the LF choke used could be adjusted. By so doing, the modulation depth and the speech quality characteristics could be varied. A carbon microphone was used and the 1000 volts of HT needed was supplied somewhat amazingly by a hand driven Evershed and Vignoles generator. 5LP disarmingly stated that its use obviated the trouble and expense of a motor generator or rectifier, but he failed to mention the problems arising from turning the generator, holding the mike and speaking all at the same time!

The choke control modulation used by 5LP was then a real 'state of art' feature early in 1923 and many people resorted instead to what was perhaps the earliest and simplest modulation method and just put a carbon microphone into the transmitter earth lead. This crude system could only be used (water

cooling of the mike for higher powers has been noted!) with lower powered transmitters for obvious reasons and it worked by changing the aerial current in sympathy with the speech. Fig. 5 shows the circuit for a typical 'low tech' CW and telephony transmitter deriving its HT from the mains. Keying is again achieved by opening up the oscillator grid circuit and unusually the aerial connects to the grid end of the oscillatory circuit. A valve with its grid and anode strapped together works as a rectifier and a modicum of smoothing comes from the 3uF capacitor.

If only morse transmission were required the AC power pack might be dispensed with and instead an AC (rough) voltage could be generated with a special induction coil (using

fewer and thicker turns than usual) which could give out about 400 volts on its secondary. The transmitter when powered from such a supply was said to be transmitting 'tonic train'. We now would just call it a very dirty T1 note! Another curiosity regarding the oscillator circuit in Fig. 5 is that the valve filament is above earth potential and is tapped down the tuned circuit. The valves used in such simple transmitters included ordinary 'R' types, the ES2, the 'B' or the AT25. To increase the power several valves were put in parallel. Short microphone leads were also essential!

100 Metres and Down

The winter of 1923-24 saw the first amateur transatlantic QSOs. Earlier attempts to work over 'the

One of Cecil Goyder's QSL cards dating back to before his successful record breaking QSO with New Zealand. He had worked 17 different USA States including Colorado during the 1923/4 winter and had been heard across the Atlantic on 19 out of the 20 nights set for tests.

MILL HILL SCHOOL, LONDON, N.W. 7.
10 miles north of London.

TO G2PC
YOUR SIGS ^{HRD} ^{WKO} } HERE AT *many times* G.M.T. ON 1924
STRENGTH *USA* QRM QRN QSB QSS QRH
TRANSMITTER
Fuller 250 Watt tube in balanced Hartley circuit with *7000* volts rectified A.C. on plate.
Radiation *200* m. ? amps.
" *on 100 m. 200* m. ? amps.
" *250 watt* *2000* m. ? amps.

RECEIVER USED
18W det + step (Feb 25)
AERIAL. 8 wire flat top 48ft. lead, cage lead in 45ft. lead. Aerial 25ft. above roof of 55ft. building.
COUNTERPOISE. 8 wire on roof with cage lead in and tapered ground.

DX—Colorado, Illinois, (Georgia), Algeria, (Italy), Switzerland, Spain, Ohio (France), (Holland), (Denmark), WNP. (1) (2) (3) (4) (8) (9) districts, 16 states.

Heard 19 out of 20 nights of tests, 16 by 1ANA
As I do not had a why many yanks that it might be interesting to know us say getting there C.K. got over 19 miles of lat which is one more than R.S.G.B. station!

REMARKS *Dear Gm. I have rec'd a report from G2PC who says had little trouble reading G2PC 200, 50V and G2PC on detector only. As I do not had a why many yanks that it might be interesting to know us say getting there C.K. got over 19 miles of lat which is one more than R.S.G.B. station!*

Best 73 Gm.
C. W. Goyder.

Fig. 6 Circuit of the 250 watt transmitter used by Cecil Goyder, G2SZ, to make the historic first QSO with New Zealand. A wavelength of 95 metres were used and the transmitter had a well smoothed 2500 volt HT supply.

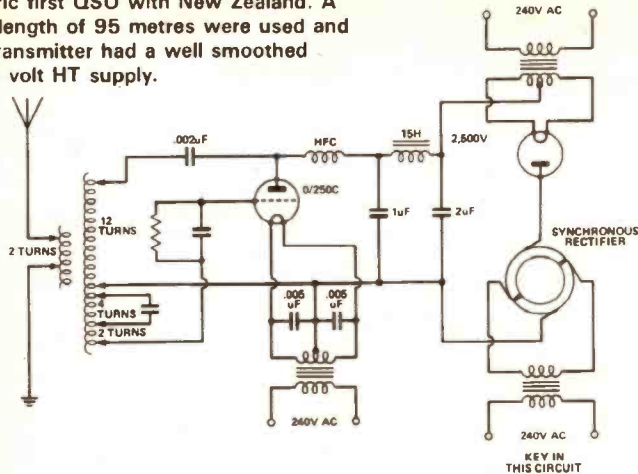

Pond' had been unsuccessful when the wavelength used was around 200 metres. Americans Schnell and Reinartz together with the Frenchman Deloy made the first and historic America-Europe contact in November 1923. It was the result of the planned reduction of the wavelength used from 200 to 100 metres and below. Numerous contacts between Europe and North America followed, and during the month of April 1924 a schoolboy at Mill Hill School (where there was a flourishing wireless club) worked 40 American stations using a 250 watt transmitter. The boy was Cecil Goyder using the callsign 2SZ, and he continued using the school equipment for some time after he left to continue his education elsewhere.

Goyder had realised that the American amateur stations with the purest notes were the easiest ones to copy through the QRM and QRN so he determined to do his utmost in that direction. The AC from the mains supply was stepped up to more than 2.5kV and at first roughly rectified by a synchronous rotary rectifier. Goyder discovered that this kind of rectification was not good enough so he followed it with a valve rectifier and some choke capacitor smoothing. His 12 turn oscillator coil had five different tapping points and such a large number of variables entailed much time and effort to tune up for correct frequency, stability and maximum power output. It is interesting to note that he used a small five plate capacitor tapped across just four turns of the coil to get correct tuning. This gave a 'bandsread' effect and also meant

that there was not a very high RF potential across the capacitor.

His antenna circuit was tuned by a combination of aerial/counterpoise capacitance and the inductance of a small tapped coil loosely coupled to the oscillator. Keying was done in the AC line to the HV transformer. The coils were made with ¼ inch diameter copper tube; the use of which became almost a ritual for many years even by amateurs making low powered rigs!

Even Shorter Wavelengths!

The tumbling of the wavelengths used by amateurs which allowed the first real DX working prompted investigations into further reduction down to below 95 metres. A British pioneer in this work was J H D Ridley, 5NN of Norwood. Through

An early QSL card from J H D Ridley 5NN when he used a wavelength of 200 metres. In the spring of 1925 he was transmitting on 18 metres and was heard in Australia during the hours of daylight.

the spring of 1925 Ridley had his station working on 45 and 24 metres and eventually a special test transmission on 18 metres was received in Melbourne Australia at 4.45pm on April 26th 1925. Earlier DX working to the Antipodes and elsewhere had always been done during the hours of darkness, so this 18 metre contact opened the way towards easy daylight long distance working.

Ridley's transmitter circuit is shown in Fig. 7a and Fig. 7b is a photograph of the actual rig arranged on its 'breadboard'. Like Goyder, 5NN, had a high power licence and could use the Mullard 0/250C and 0/250F triode valves in his modified Meissner oscillator arrangement. In an article which was published in 'Wireless World' in July 1925 Ridley stated that the advantages of the Meissner circuit included very stable operation at all powers, ease of adjustment, freedom from harmonics, absence of 'key thump' and a freedom from the effects of a swinging aerial! There were certainly no coil taps to fiddle with but his three (interacting no doubt) variable capacitors must have presented quite a challenge. His coils were wound with 16swg wire on a 4" diameter ebonite tube at five turns to the inch.

Again, Ridley was an amateur to recognise the advantages of a clean CW note and his 2000 volts HT supply was rectified by a pair of Marconi U.100 valves and smoothed with chokes and an 8uF capacitor. He said in his description that the note obtained was absolutely pure

BRITISH WIRELESS RELAY LEAGUE STATION.

J. H. D. RIDLEY, 106, Woodside Green, S. Norwood, London, S.E. 25.

INTERCOMMUNICATED
YOUR SIGNALS WORKED HERE ON *9th Sept 1923 AT 4-30 AM. SST*

RECEIVER	NOTES	TRANSMITTER
✓ 1 VALVE REINARTZ	QRN <i>that</i>	STANDARD BURNDDEPT
1 .. BURNDDEPT	QRM ..	200 METER.
2	QSS	ACTUAL WAVE 205
3	STRENGTH <i>5-10</i>	INPUT <i>10</i> MA 1000V.
4	NOTE <i>V.G. 1780V</i>	RADIATION <i>1</i> AMPS.
5	WAVE	
	CALL HEARD	

AERIAL: 38 ft. high; 98 ft. long; 6-wire Cage, 5½ in. Diameter.
EARTH: Network of Wires 2 ft. Deep in Ground under Aerial.
REMARKS: *P8c QSL.*

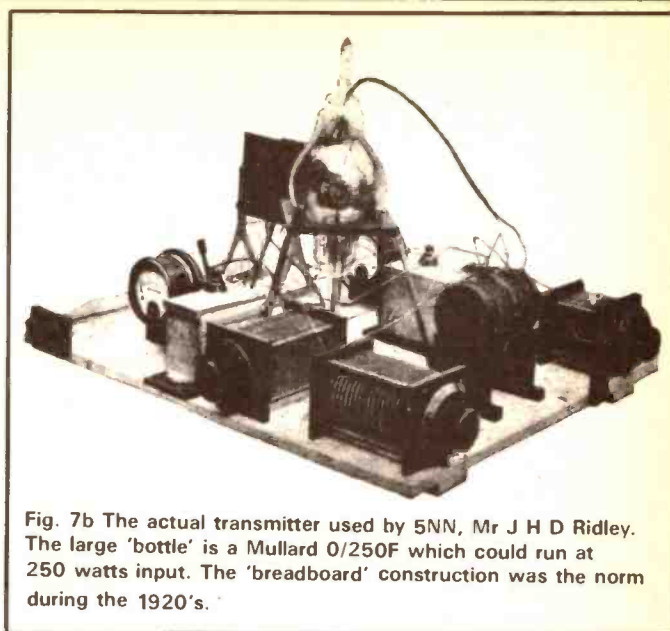
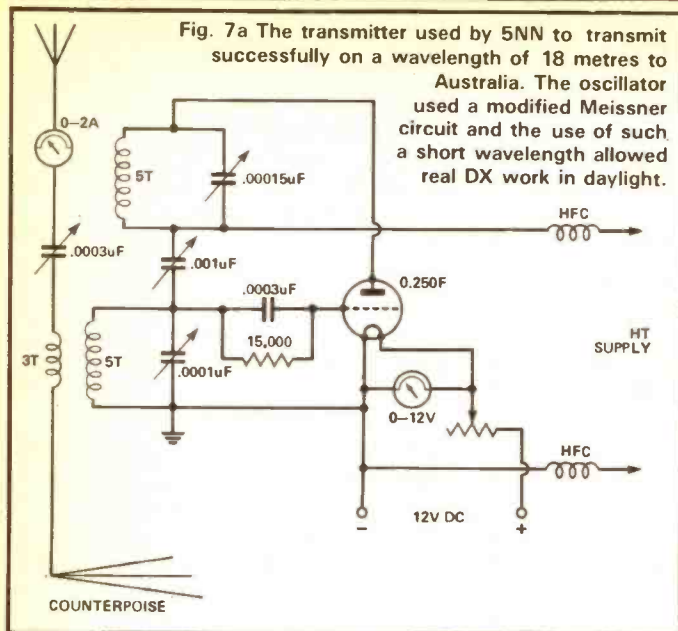

and had the advantage over other types of emission in that it was more easily read through jamming and atmospherics, (QRM and QRN). His antenna was carefully coupled to the grid coil and a variable capacitor tuned it against a counterpoise.

Taking power from the grid circuit seems unusual to amateurs of my later generation who generally coupled their anode circuits to get RF output. In the Meissner circuit shown the big triode ran at 75mA anode current and 50mA grid current! With a grid current of this order his grid leak resistor had to dissipate almost 40 watts. Another unusual feature of this transmitter was that the valve filament was supplied from a 12 volt accumulator supported on porcelain feet to reduce leakage capacity to earth! Although not shown on the circuit, the transmitter was keyed in its negative HT line; no relay being used.

Further Points on Transmitters

Throughout the 1920 and 1925 period single valve (or valves in parallel) power oscillators were used as transmitters. I have not come across a single amateur design published then which used a Master Oscillator/Power Amplifier (MOPA) arrangement. Such transmitters no doubt existed for they were used by the broadcasting and larger commercial stations. It was perhaps problems of neutralisation and the low power gain of available valves which inhibited amateur construction of other than power

oscillator rigs. The inevitable drift and chirp of the signals from the amateur transmitters did not prevent copy on the simple 'straight' TRF receivers in common use. The signals from most stations then just could not have been copied on receivers having the selectivity available today.

The earlier antenna arrangements involved a direct connection to the tuned circuit of the oscillator but these were replaced by more sophisticated coupling circuits when the operating wavelengths fell below 100 metres. Lead acid accumulators and dry batteries were used to power transmitters throughout the five year period but by 1925 many amateurs were using mains power supplies. It must be remembered that at that time only a minority of homes had a mains supply and many of those that did were on DC!

The primitive modulation techniques used carbon mikes in earth leads, etc gave way to Heising choke modulation and some amateurs were putting out very good quality signals. The general use of carbon microphones prevented really fine quality but nevertheless some stations had outstanding results with them. Even the BBC used carbon mikes for a time but they were of the transverse current type.

Soldered connections were seldom made, wires were either connected to screw terminals or clipped into place. An open construction technique using thick wooden bases (breadboards) was normal and the modified rubber called ebonite was the most used insulating material. It

was easy to drill or burn out (a foul and smelly operation!) and it took a polish well. Ebonite was the standard material for front panels, knobs, coil forms etc. The high power stations used porcelain stand-off insulators to support coils and other components at high RF or DC potentials. Amateur operators were generally ignorant of their true operating frequency for the wavemeters in use were primitive. On the higher frequencies (45 metres and down) an accuracy of one tenth of a metre of wavelength was acceptable!

A lot of components needed to build a transmitter could not be easily or cheaply obtained so they were often fabricated by the amateur. Variable capacitors, high voltage fixed capacitors, and just about all coils including induction coils and transformers and other small parts were home made. Non-inductive resistors were a problem. At that time the ubiquitous carbon composition resistor was not being made so wire wound types had to be used. A line of carbon black ink on a bit of card was good enough for a receiver grid leak but not for a transmitter which had a considerable grid current. The grid resistor used in the Airways transmitter was made from platinoid wire wound on grooved ebonite.

All valves were expensive and there were even firms which specialised in replacing burnt out valve filaments. Many of the antique QSL cards in the writer's collection mention valves "blowing up" and no doubt the long suffering bottles were often expected to push out many

5BH lived in Burnley and his 1923/4 shack was well filled with gear.



more watts than they were designed to do. The high power triode then available were all high impedance types which ran at very high anode voltages and passed few milliamps. A 20W valve would be designed to have 1000 volts HT and only 20mA of anode current. This is quite a contrast with our 'high perveance' low HT/high current beam tetrodes. Neither must we forget that a 250 watt transmitting valve at that time would have cost the amateur the equivalent of a month's wages. Today a month's average wage will be enough to buy a transceiver having 100 watts RF output!

Photographs of typical amateur stations during the early 1920's show a wide variation in layout and design techniques. The shacks were often crammed with gear and little space seemed to be available for the key or the log book.

After 1925 amateur radio really began to 'grow up' and those later developments in transmitter design up to the year 1930 will be dealt with in the second part of this article.

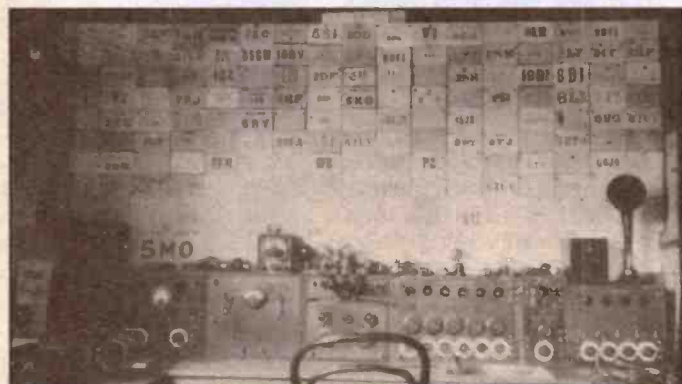

The shack of British station G5MO, Newcastle in 1924. QSL cards on his wall are much in evidence.

HAM RADIO TODAY

G3LLL ON THE YAESU FT290R

Harry Leeming describes some modifications, servicing and repairs to the most popular 2m mobile transceiver.



STARTING YOUNG

The journal of Geoff Petitt, GU0BGP, aged 15.

TRIO TS440S HF TRANSCEIVER

A mini TS940S? Chris Lorek, G4HCL, finds out.



PROJECTS

AN LED 'SCOPE' INDICATOR FOR RTTY

LOW COST EFFECTIVE 6m BEAM ANTENNAS

Free Readers' ADS!

WANTED

WANTED any two metre amateur rig around £120 to £150, must be working and in good condition. Also a small slim jim antenna for around £5. Phone Walsall 32503.

WANTED FRG7 or similar with or without mods. May exchange for Praktica B100 electronic with 135mm f2.8 and 50mm f1.8, cost £110. Apply Dave Bracken, G1LCX, 4 Smallman Street, Cottonfields, Stafford ST16 3PF, no phone.

WANTED Yaesu FT 77 100 watts, also power supply, all in good condition, good price paid. Telephone 242663, reversed call accepted. Mr William McCann, 1 Ross Road, Belfast 12, N. Ireland.

WANTED I am unemployed and have £40 to get started in SWL. Have you an R107 or R1155 with PSU? Replies from fairly local area, please: carriage prices sickening! Please write Mr Hawkins, 111B Parkers Square, Southgate, Runcorn, Cheshire, WA7 2SG.

WANTED FT290R with Mutek front end fitted, also nicads, charger, mobile bracket, also BNOS linear's LPM350 LPM3100 or similar and a Diawa CN620A P/SWR meter. Tel: Neil 0726 66093.

WANTED Pye microphone as supplied with Pye Westminster or Motorphones. Can anyone supply one or give me details of a supplier. Anything considered, any help appreciated. Contact C. Messer, 2 Willersley Ave, Sidcup, Kent, DA15 9EW, postage refunded to you.

STILL wanted, circuit diagram for Sommerkamp FT100 transceiver. Expenses gladly refunded. GODLN, 01-657 0716 evenings.

WANTED Murphy type 618 Tx (AP100333) and power unit (AP100336). Marconi Elettra Rx (type 2232B) (similar to Eddystone 840). Aerial plug AM type 161 (104/184). Type 889A or 966A power units with plugs and cables. G4FUY QTHR, phone Reading 733633.

WANTED by hobbyist. Plug-in modules CX1442 (two) plus CX1443 by Solartron to fit CD1400 CRO, also service and operators manuals for the CD1400. Contact Fox, 46 Lovett Way, St Raphael's Neasden, London NW10. Sorry no phone.

£10.00 to anyone who can supply me with a circuit diagram for a Lunar Electronics 2M10-150P 2m linear amplifier. Someone must have one somewhere!! Mark, G4RGB QTHR, or phone Medway (0634) 30822.

ATU wanted, FRT7700 or AT1000 or similar for receive and QRP. Fair prize paid for mint unit. Phone Tom on 0536 522007 or write 5 Centre Parade, Kettering, Northants, NN16 9TL with details and price, etc.

MULTI-MODE CB wanted. Cobra, Ham, President or Jumbo base station or rig in this classification. Also ATU for QRP and compact speech processor. Phone Tom 0536 522007 or write 5 Centre Parade, Kettering, NN16 9TL. Fair price paid, no rubbish.

WANTED QSLs to swap 1-4-1 for CB buff while skip is low will QSL back 100%. Write SE16, Box 22, Carlisle, Cumbria CA6 4QT.

INFORMATION and circuit diagram on Admiralty receiver patt 100339 A MF/HF 60kHz-31MHz in eight bands made by Pye Marine Ltd in 1955. All expenses refunded. G8BUR, 47a Dale Ave, Stratford upon Avon, Warwickshire, tel: 0789 298924.

WANTED IC22A, IC240 or similar small FM mobile rig 2m or 70cms, details please to G3DSV, phone 06476 753.

WANTED five pounds offered for complete service manual for "International Video Corporation" (I.V.C.) reel to reel video recorder, model 801-PSM or two pounds for circuit or photostat. Phone Wickersley 541606 anytime. Nev Kirk, 54 Allendale Road, Rotherham S65 3BY.

WANTED circuit or manual for communication receiver star SR 550. Phone 0924 404410

WANTED KW 204 transmitter or similar transmitte in good working order, fair price paid. Please write to N. Rowley, 11 Brewer Road, Bulkington, Nuneaton, Warks CU12 9RF.

WANTED Sony ICF2001D or ICF7600D in good condition or similar digital 150-30,000K receiver, portable an advantage, cash waiting for the deal. Please telephone Graham on (0344) 53670 evening week-ends thanks.

WANTED Trio 7010 or similar 2m SSB rig about £100 and slim jim also PF2UB pocket-phone and UHF Westminster, anything reasonable considered, cash waiting. Phone Steve, 051 334 4301.

WANTED B2 spares, particularly Coil socket, meter, power plugs (cable plug 2A). Have several round and edge meters 200uA upwards, also 270v 250mA 6v 10A PSUs. R. K. Mildren, 13 Queens Crescent, Bodmin, Cornwall.

WANTED NATO 2000 in good condition, urgent, Trio 9600 and VC10 converter, cash waiting. Phone 0283 221870 or 9600. For sale, FRG7000, offers over £175, digital read out 0-30MHz. Phone 0283 221870, also Marco 737, many extras, 0283 221870.

WANTED facsimile-program for Spectrum 48K. Offers to ON4ABT, Postbus 135, 2500 Lier (Belgium).

WANTED dual bander, can exchange either Rotel hi-fi stack system or Smith Corona electric typewriter plus Marantz professional stereo portable/mains cassette recorder. Yaesu FT2700, Trio or Icom, any considered. Tel: 0603 867005, ask for Jean.

WANTED to buy or borrow. Circuit diagram and/or manual for Azden PCS-3000 transceiver. Contact Martin Lines, G1SEO, Hook 3911 ext 298 day, Reading 875358 night.

WANTED manual for Swan 100mx transceiver, will pay all postage, copying, etc charges. Please, I'm desperate. Phone Tony on (Bristol) 0272 719163.

WANTED article, PCB, or kit for Omega Rx/Tx SSB board.

Ring Desford 4279, Leicestershire.

WANTED Yaesu FT 77 100 watts, also PSU and TS 700 transceiver, top price paid. Telephone Belfast 242663.

WANTED Trio TR7930 2 meter rig, must be in excellent condition. Also Signal Communications Co R532 air-band receiver and Yaesu YR-901 keyboard. Phone Colchester 394336, Essex.

WANTED 934MHz CB transceiver to buy or hire or someone to build receiver for 943MHz (crystal controlled approx 3 channels). Reasonable fee offered. Tel: Worcester 641748 or write Briar Cottage, Lwr Broadheath, Nr Worcester.

R107, R1155, B28, any one of these valved receivers wanted with or without conversion for home use. Good price paid. 0379 3694 evenings.

WANTED 'S' meter and case for AR88 Rx, als knobs for Canadian VRL Rx and BFO switch for R1155. C.M. Duncan, Roadside Cottage, Hoswick, Sandwich, Shetland or phone (09505) 405.

WANTED for newly starting school amateur radio club. Any very cheap or free HF Rx in any working or nearly working condition. Contact B. Powell, BR85756, Royal Villas, Fonthill Road, Lansdown, Bath BA1 5RP or phone after 9 pm, 0225 310173.

WANTED software tape or listing for conversion of text to allophones using 16K ZX81 and SPO256 speech IC. Steve, 0253 823522 after 6pm, 0253 48513 9 am to 5 pm.

AR2001 wanted, willing to exchange multimode FT790R 70cm in very nice condition or extra equipment for AR2002, plus above and SP400 2m/70cm PRO SWR/PWR meter and 200 page VHF/UHF 29M-1000M book of channels or AR2002 for TRS80 M100 24K-LAP computer plus +. 0473 85526.

WANTED any information on Malden Electronics digital counter model 7735. Also Advance Electronics frequency divider, type

TCD40, 1-40 MHz. Any prescalers for the above? Please send to Brian Dudhill 12, Eilam Road, Rotherham S61 3PG S/Yorks. Tel Roth (0709) 554665 Collect.

WANTED HF/VHF Tx/Rx equipment Trio/Yaesu preferred. Plus HF mini beam plus rotator. SWR^o meter. Details, price and condition to R Wooding G4HKE 1, Stable Close, Chatham, ME5 8LQ, Kent.

WANTED for FT101ZD FM/AM modules PB-2218 and PB-2040. Telephone 0622 681294 or write 4A Maple Avenue, Maidstone, Kent ME16 0DD.

WANTED KR600RC rotator, 2 element triband quad, ie Gemquad, pair 813's and bases, pair 500pF 20kV encap ceramic capacitors or 0.001uF 5kV discs. Three 0.01uF 3kV d/c, twelve 0.01uF 1kV d/c, Phone 0625 527250 - Roger.

WANTED circuit diagrams, workshop manuals etc for IC-240 and Superscan SS240 scanner. Reasonable prices paid or can photocopy and return. H. Colborn, G8TMA, 6 Days Ground, Shrivenham, Swindon SN6 8ET.

EXCHANGE Trio TH4IE hand held 70cm mains charger, two rechargeable battery packs, one dry battery pack, speaker mike and cash adjustment for Yaesu FT790 multimode 70cm transceiver or similar. Tel John, G1RZR, Nottingham (0602) 277906.

INSTRUCTION wiring diagrams etc for Collins TCS Rx/Tx 1/2 COL 46195, COL 52245, reverse charge accepted, will pay reasonable sum for same or photocopy. Phone 061 231 5028 after 5.30 pm.

WANTED Alpha kit, part built, or complete, either 20 or 160 metre version, any condition considered. G4OPT, Lytham 0253 739509.

WANTED IC720A, IC745 etc, around £500. Limited budget, all letters answered. Also consider TS430S, TS1309 etc. Mr T. Waters, 42 Tregundy Road, Perranporth, Cornwall TR6 0EF.

WANTED large orange WWII CRT-3 "Gibson Girl" dinghy distress transmitter, any other tactical/distress beacon items. Also Racal tactical items, especially MA945, MA985/6,

VHF/UHF manpacks, encryption/security equipment, antennas, batters. Any condition considered. Racallector, 120 Birmingham Road, Redditch, Worcs B97 6EP.

WANTED one Ham Radio, Dec 1984. Mr Barfield, 91 Ollerton Road, New Southgate N11 2JY.

WANTED instruction manual for Millard high speed valve tester complete with data lists for all types of valves (control settings), also AR40 medium duty rotator. Please write to Mr S.H. Fox, 123 Unett Street, Smethwick, Warley, W Midlands B66 3TA.

WANTED Trio TR7930 2m transceiver, must be in excellent condition. Phone 0206 394336 (Essex).

WANTED Yaesu FT102 TRX preferred AM/FM board and narrow band CW SSB and AM filters fitted together with mike. Write, no phone, housebound, Jess, G4GOF QTHR, Bergheim, Battery Hill, Fairlight Cove, Hastings.

WANTED by private collector, good original condition receivers BC348, CR100, R1155, APR4 (and accessories), Collins 75A4 and any WWII airborne radio/radar equipment. Will collect. P. Bristow, 6 Finmere, North Lake, Bracknell, Berks RG12 4WF.

WANTED hand held scanner. Must have air band included and search facility. Contact Tom Valentine, 38 Grampian View, Montrose, Angus DD10 9SX (Scotland).

WANTED mains PSu for R1155 Rx. Doncaster 27915.

WEIGHTLIFTER wants Racal RA17 working or not. WHY. Good price paid. Can collect by arrangement. Phone Ray, 05143 00359, Lancs.

WANTED valve receivers, valve hi-fi amplifiers, tuners etc. Any early quality hi-fi like Quad, Leak, Lowther, Tannoy, Decca, Ortofon, Sugden, SME, Wharfedale, Stentorian, Radford etc. Also valves from "R" type to KT88, any considered except TV/early crystal sets, compact wartime receivers, transceivers, clandestine "spy-sets". Please telephone John 01-833 3008.

WANTED operating manual for realistic PRO-2008 8ch microprocessor scanner receiver or loan for copying. Promise all expenses and

same day return. G3FAU, 0438 352932.

WANTED FRG8800 or R-2000 urgent for cash, also FT707 and accessories urgent, NATO 2000 £80 for a good one, might consider a Belcom Phone 0283 221870. **WANTED** National Company manuals and catalogues, original only, for equipments, radios, and HRO series of receivers. Also Sinclair ZX80 computer. Phone St. Albans 39333.

WANTED by pensioner returning to amateur radio. Labgear LG300 MK two transmitter and companion modulator power supply. Alternatively would be interested in Labgear LG50 transmitter manuals or info with either if possible. Phone 0272 642101 anytime.

WANTED Racal MA144 aerial tuning unit. Must be complete, condition not important. Above average price paid. Distance no object, will collect UK/EI. Tel Ger EI6DP Limerick, Eire 061-43584 or reply to 40, Maigne Way, John Carew Park, Limerick, Ireland.

WANTED Manual or retuning data for Pye F460UHF base Tx/Rx for 70cm. Also data for retuning UHF Starphones. G8BSK 290 Priory Road, St Denys, Southampton SO2 1LS.

WANTED manual and circuit for REC FR-50B. T H De Courcy, 27 Highbury Avenue, Salisbury, Wilts.

YAESU FC902 coupler wanted also matching accessories for my FT101ZD III including transverter. Cash for mint units. Collect reasonable distance. Phone Tonbridge 356712.

WANTED information, circuit diagram or any information for Communicators model NI-440DX 40 channel FM mobile transceiver. Manufactured by Mickey Industry, Tokyo, Japan. Expenses refunded. Able to photocopy. D N Wellings, Nordheide, Shurton, Stogursey, Bridgwater, Somerset, TA5 1QE. Phone 0278 732099.

EXCHANGE

EXCHANGE Rotel hi-fi stack system in cabinet plus 5 inch Benkson b/w TV, still under warranty, battery, mains or car for a Yaesu Trio or Icom dual

bander. Tel: 0603 867005. **EXCHANGE** Toshiba HX10 64K computer cassette player etc, 4 months old, unwanted gift, for any 2m equipment. Anything considered or sell £80 ono. Contact Dave Thirsk 0845 567228 any time.

EXCHANGE or sell Eddystone model EC10 for Yaesu FRG-8800 (general coverage) or similar (cash adjustment). Tel: Bristol (0272) 663222. **EXCHANGE** Yaesu FT208R, case helical YM24A speaker mike 1/4 wave whip PA3 adapter charger all boxed. FNB2 battery pack NC1A multimode for 70cm multimode or 2m to 70cm transverter or WHY. Tel: Durham 701429.

EXCHANGE my TRS-80 model III twin disk drive computer with spreadsheet and wordprocessing software for HF transceiver or VHF/UHF scanner. Write to B. McCracken, 34 Oldhall Drive, Kilmacolm, PA13 4RF, or phone (050587) 3727 after 6 pm.

HAVE Canon FTB SLR camera, case, electronic flash and wide angle lens with case, virtually as new. Exchange for 2m hand held (not crystal) or Microwave advanced Morse tutor in good condition. Stratford on Avon (0789) 204614.

EXCHANGE FT203R hand portable in vgc with FNB-3 battery, helical antenna, soft case and homebrew speaker, mike, c/w, handbook for FT-200 or any similar HF Tx/Rx. Simon, GOEHU, phone Derby (0332) 515908.

EXCHANGE both my IC211E with mutek front end, remote keypad, memory and FT730s 70cms FM mobile, both immaculate, boxed, for FT757GX or FT901DM etc. Small cash adjustment possible. Keith, G6HHV, 051 3275804, Merseyside, any reasonable time. Might sell separate.

EXCHANGE comprehensive coarse fishing outfit; carbon pole rods, reels, boxes, all tackle, value £350+, for Yaesu FT290 or IC202 plus IC2E or TS700G, WHY. Would prefer two rigs SSB and FM. Please help. Phone 01-733 3533 after 3.30 pm weekdays.

TEKTRONIX d/beam scope 561A probes, manuals, 600MHz plug-ins £110. ICL

letter quality printer £65 and Honeywell dot matrix £115, both used with BBC. P/ex for BBC B or Sony ICF 7600D. Tel: 078-42 51409 after 8 pm.

EXCHANGE MM 432 28S transverter for FC-102 ATU. Tel 0952 57670.

EXCHANGE Laboratory oscilloscope Heath kit 5" model 10-12, good condition with leads. Scopex 4S6-6Hz oscilloscope solid state not working but in very good condition. Codar PRO30RF preselector Drae 3 way antenna switch as new, will exchange all for RTTY terminal or WHY. Phone 051 334 6859.

EMIGRATING to VK-land. Have Icom 2111 with mutek front end and ICRM-3 keypad/memory. Require HF rig with FM or able to fit FM for transverter driver, digital display. Anything considered, cash adjustment possible or sell £395 ovno. Keith 051 327 5804, Merseyside.

SWAP my Amstrad CPC464 home computer with TV adaptor, lots of software for general coverage receiver with digital readout or sell £180 ono. Mr M. Jackson, 6 Pilning Close, Peak Lane, Fareham PO14 3BW, Hants.

EXCHANGE Electronic megger, genuine Elliott brothers old brass key, power pack 13.8V 5-7 amp, all mint. Wanted frequency counter or keyboard with rhythm unit. Telephone 0482 55906.

EXCHANGE two Pye base station Tx units, one originally on 161MHz other on 70.000 MHz, both AM working no xtals for any portable radio equipment for use by youth organisation. Telephone 091 4170705.

EXCHANGE 'B' reg Yamaha DT125LC, excellent order, low mileage, value £750, for HF rig + PSU all mode with gen cover Rx same value. Tel 0209 843029.

EXCHANGE 48K Spectrum computer, as new, little used, with books, tuition tape, Masterfile and RTTY/CW receive program + terminal unit for 70cm/2m h-held, must be good condition. Contact Paul, G4RVM, Lincoln 37751.

EXCHANGE FT290R, nicads, case, rubber duck for QRP CW/SSB rig such as Argonaut 509 or FT7 as FT290R in VGC would appreciate rig in fairly

decent condition please. A. David, c/o Davis, 1 Milvoaig Street, Glasgow G23 5HY.

EXCHANGE my mark one Cobra 148GTLDX, covers 26.515 to 28.500, for Sony ICF2001 and PSU. Please write to Steve, PO Box 8, Castletown, Isle of Man.

EXCHANGE FT1012D AM for FT1012D FM, FT901 DM or FT902 DM, cash adjustment where necessary. Would consider exchange with FT225 RD or similar 2 metre multimode. Telephone Darlington (0325) 54772.

EXCHANGE hi-fi system Tannoy MK1 15 inch dual concentric speakers in BBC cabinets, NAD 3020A amp Pioneer turntable value £330, for 2m complete fixed station or 2m multimode. Tel Bristol 513613 office hours, ask for Gary.

EXCHANGE AMR217B VHF scanner, Ham Jumbo Convert 210m, Colour TV 20" R/C. T/text h and p Oscilloscope dual beam MOD175A needs slight attention low volt PSU, want FT77 + PSU FT1012D FM + PSU KW2000B + PSU etc or WHY. N. Kelly, PO Box 8, Castletown, Isle of Man.

EXCHANGE Sanyo 5000 Beta video recorder, working but needs some attention, plus some tapes, for a HF linear 50 to 100V for a Yaesu FT7 plus PSU, would consider home brew. You must be able to collect as I am disabled. Ring 01-568 0844, C. Rolls, GOEBC QTHR, or WHY.

EXCHANGE automatic telephone exchange unit, Ericson 10-line complete with manual, cost original over £980, appx size 24" x 12" x 10", can be wired for priority secrecy or conference. Will exchange for good scanner Rx tran/cv or what have you?? Contact 0204 43958, 0706 211721.

EXCHANGE piano, Seeger, good condition, swap for Rascal RA17 receiver or similar. Could deliver. Runcorn 61439.

EXCHANGE for good receiver. One or both of my 2m rigs, as going QRT on VHF Trio 7930 5/25W FM mobile/base + scan hand mic, or FDK 750E 1/10W multimode. WHY? Tel Bridgnorth 3790 (Shropshire).

EXCHANGE my vintage wireless equipment for Nikor AI camera lenses, or will purchase same for cash. Sherborne (0935) 815616.

EXCHANGE Zenit B plus 3 lenses including Tamron 135mm, as new, etc, plus cash for 12 volt solid state amateur band 144MHz Rx and or VHF band/s communications Rx Eddystone pref postage refunded. 121 Mays Lane, Stubbington, Hants PO14 2ED.

EPROM blower ITT and eraser, blows 10 at a time, offers. Might exchange for 2m hand held or 70cm. Also Commodore SX64 portable computer, built-in disk drive and colour monitor, only 2 months old £425. Tel 0533 715160, Leicester, anytime.

EXCHANGE Dressler D200C, excellent condition for AOR 2001, or MMT 144/28R, or MML 144/100HS, or Trio MC85, or very heavy duty rotator, or PS430, or Synthesised hand-held 2 metre rig, only equipment in GWO considered. Telephone John (04612) 3249 weekends QTHR GM6TVR.

FOR SALE

FOR sale. Ham International Jumbo, first class condition, multi-mode operation, ideal for conversion to 10 metres. Operates from 240V, only £100 ovno. Ring or write 0983 407451, Mr S. Drudge, 17 Station Gardens, Brading, Isle of Wight PO36 0DZ.

FOR sale. Trio R820 Rx, CW filter if required. You know it's good, £400 ono, or swap for SM220 monitor scope plus cash. Exchange my YG88C CW filter for YG 88A AM filter. Mr Wright, 12 Wom Hill, Basingstoke, Hants RG21 2EP.

FOR sale. Metal encased valves:- 6L7, 6SK7 three, 6K8, 6V6, 0Z4, 1N71, 12SK7, 12SQ7, £2 each. E88CC, 6L6 metal, 3B/240M STC, £3 each. Xtals:- 98.1, 99.75kHz, 100kHz, B7G, 100kHz 10X, 100kHz wire, £2. Tel. Alan, G3MBL (0284) 60984, Bury St Edmunds.

FOR sale. Welz SP250 SWR power meter 2KW, £35. Trio LF30A low pass filter, £12. Both not used Tx. Also brass morse key, plus practise oscillator, £12. Lowe HF5 with radials, £20. BRS87757 after 6pm 051 260 9723.

SELLING up. Trio 510SD HF Tx/Rx, 80-10 metres, vgc, £260. Complete RTTY system with ST5 TU, £50. TTL computer, PSU, heavy duty, £15.

Px possible, WHY, G4RSA, 21 Rede Ave, Fleetwood, Lancs, FY7 8DG, or daytime phone 0253 41033 ext 257.

YAESU FT707 HF transceiver, good condition, £265 ono. Standard C58 2m multimode ni-cads, case + charger, £195 ono. Heathkit HW101 HF transceiver, 10-80m, 100 watts o/p, £175 ono. Icom IC215 FM, portable mobile, £75 ono. Phone 0782 46440.

FOR sale. Ham International Jumbo base station. Ham International Concorde II mobile rig. CTE International Jumbo aristocrat, 600W, mains linear. All perfect, in every respect - untampered. VIC 20 computer, with oodles of hard and software. Phone 084 82 314. Reasonable offers please.

HAM Jumbo AM/FM/SSB. 26.060-28.310MHz stepless. Also Colt 485DX AM/SB 26.965-27.855MHz. Both good condition. Will swap both for sensitive Ham Concord 3. Send offer details to Larry KD43 PO Box 3 Keswick, Cumbria CA12 England.

C5800E/W standard. The only rig that does not require a replacement front end! Daiwa PS120M, PSU, 12 amps, 3-15V. Extended H/S for maximum op. 01-886 3548 (eve) 01-242 1234 ext 2891 (day) G6ZNU not QTHR. Bargain, little used base, only £420.

FOR sale. Yaesu FT790R multimode, complete with case, ni-cads, charger plus extra mini helical aerial. Offers around £275 please, buyer collects or pays postage. Phone Tony (G6HPQ) on Southend (0702) 351936.

ICOM 211E with RM3 remote keypad, with memories, very clean and boxed, £400. Phone Harwich (025-55) 53510.

TET HB23M 2 element, tri-band, mini beam, complete with Hirschman rotator and controller, with 3-section tubular mast and cable. Buyer collects, £130. G4UCH QTHR, tel: (0272) 3296. Reason for sale, too much QRM from XYL!

SONY air band FM, AM, synthesized receiver, PSB, air 7. Cost £170, sell £95. C Houston, Air NZ, Scarsdale Place, Kensington, London W8 5SR.

ICOM ICB-1050 converted 10FM, £35. Tristar 777,

26.515MHz to 27.855MHz, with K/C shift, £65. Tristar 747, same frequencies, K/C shift added, £45. Both for conversion to 10m, Eddystone EC10 receiver, £45. Tamworth (Staffs) 250038.

SCOPES Tektronix 533A, 15MHz, dual trace, £65. 555, 30MHz, dual beam, £90. Marconi 8010/8, AM, signal generator, 10 to 485MHz, £75. TF1101, RC oscillator, 20Hz to 200kHz, £30. Advance, HI AF gen, £35. Pye Olympic, low band AM, £59. Brighton 416963.

YAESU FT480R 2 metre multimode transceiver, plus manual, excellent condition, £295 ono. Also Cushcraft 2 metre, 10 element, X beam and Jaybeam, 5 element X beam offers. Tel Barnoldswick (0282) 812579.

PRESIDENT Adams HF transceiver, AM, USB, LSB, built in scanner and VSWR meter, exchanger for any 2 meter/70cm transceiver/receiver or sell, £80. Telephone 0532 623569.

FOR sale. Yaesu 7700, general coverage receiver, 0-30MHz, with memory unit, LED readout display, with AM/FM/USB/LSB & CW. Also Yaesu VHF converter, FRV-7700 and Yaesu antenna tuner, FRT-7700 and Kenwood SP-520, communication extension speaker, all in boxes with instructions. All 4 items all new, price £300 the lot. Phone Mr N. Barlow 0407-860675 Glenside, Lon St Ffraid, Trearddur Bay, Holyhead, Gwynedd LL65 2YR North Wales.

YAESU FT101E MKIII, new bands, 350Hz, CW, filter, just back SMC overhaul, £350. Heath, 0-12V, 5", 5MHz, lab scope, £30. All collect or carriage as housebound. Jess E. Sussex QTHR, no phone, G4GOF.

YAESU YC601 digital readout, £65. FV101B ext., VFO, £60. FC901, antenna tuner, £85. SP101BP, ext speaker with phone patch, ideal connect tape recorder, £35. All collect or carriage extra as housebound. Jess E. Sussex QTHR, no phone, G4GOF.

MULTI 800D 144 MHz to 147.995MHz, FM transceiver, 1 to 25 watts output, 800 channels (5kHz steps), price £130, C/W handbook & mic. KW2000B transceiver, 1.8 to

28MHz, C/W, power supply & handbook, price £220. Buyers to collect, phone Ipswich 79479.

MARANTZ PM230 (gold), amp with CD input, Marantz ST320L (gold) tuner dual 505/1, improved with Nagaoka MP11. Reason for sale, want a Linnsondek, offers over £150 to Dave Bracken, G1LCX, 4 Smallman Street, Cotonfields, Stafford ST16 3PF, no phone.

FOR sale. Mini stereo/mono, solid state amplifier, 25x25 watts at 8 ohms of very good quality, in makers box, with instructions, in new condition, £39 including post/packing, phone 051-931 1001.

COLT Excalibur home base, covers 26.065-27.995MHz, AM, FM, LSB, USB, fitted UK40 eeprom, £150 ono. Phone Hednesford, Staffs 4539.

SELLING Cossor CDU150 DB Scope, 35 meg, solid state, probes, complete manual, £160. Collect or pay carriage, 061 761 2952.

SELL, exchange, Hammond tonewheel organ. Two manuals, many voices effects, drawbars, pedals, solid state amplifier, twin cone speakers, leslie, complete with all circuits test manual, all enclosed in polished instrument case, £550. Collected. 061 761 2952.

TWO VDU'S digital decscope, teletype compatible (model 33). 110, 600, 1200, 2400, 9600 bauds selectable. With interface cable (no connection details) both in working order, one suitable for spares, £35 the pair. Phone Chirs, G1DEY 01-888 8903 (Wood Green).

FOR sale. Realistic PRO2003, 60 channel scanner, covers air ham marine utility and standard FM broadcast bands, as new, boxed with manual. Freq range 68-512, current price £299, will sell for £190 ono, telephone 228 4835 SW11 AM unit for FT 101Z series, £30. G4ZIP, Les, tel 01 890-4666

FOR sale. Yaesu FRG7, general coverage receiver, 0-30MHz, in first class condition, boxed, also Yaesu FRT7700, ATU, to complete your listening station, no mods, original, £150 secures both items, phone Tadley 2476.

YAESU FT790 virtually unused, with 10dB gain linear,

£265 or exchange for FT290 and amp. Telephone Cambridge (0223) 63684.

LOW band Pye Westminster, ideal to mod for four or six metres, complete, £20. After 6pm, phone Epping 78710 (Essex).

YAESU FT290R excellent condition, mobile mount, 7/8 whip, SWR and power meter, battery charger, 1/4 flexi whip, brand new slim jim and pole with fixtures, £250. Tel Bedford 852302.

REGENCY digital flightscan, 108-135MHz airband, 16 channel scanner, £80. Samatron V Vektor, VHF to UHF convertor, £40. Mutek BBBA 500U pre-amp, with quality BNC connectors, £25. Also revcone, discone and 15' mast available. Mr Drew, 227 Southmead Road, Westbury-on-Trym, Bristol. Tel (0272) 506208

TOKYO Hypower 2-10W in, 45W, 70cms linear, £120. Icom SP3 speaker, £45 (new). Icom HM7 hand mic, £16 (new). Xerox 400 telecopier (fax), £20. MET, 432/17T, 17ELE, X, Yabi, new, £37. Microwave modules, MMLinear (144 30LS), £69. Phone Paul, G4XHF, (0293) 515201.

DX160 communications receiver, new condition, 0.15-30MHz, for sale, £60 ono. Offers for Junkers hand key, S20R Hallicrafters comm receiver, 550kHz to 43 MHz, or swap all items WHY, John, The Lizard 290711.

EDDYSTONE 840C general coverage, HF communications receiver 500kHz-30MHz. Excellent original condition, £50. Tel 0380-830428 (Wiltshire)

3 KW! Kubota generator only used for one contest, 240V, 115U and 12V outputs. Substantial saving on new price, £525 ono. Phone 0905 620041 anytime.

IC740 HF transceiver fitted, FM, Curtis keyer, 9 bands, twin VFOs, speech processor, IF shift and notch filter, £650, or exchange for FT757GX. Phone Geoff, 0373 812274 Somerset.

EDDYSTONE 880/4 professional communications receiver, 0.5-30.5MHz in 30 ranges of 1.0MHz superb condition. Now surplus to requirements, £275 or near. Buyer must collect. Telephone (0242) 524217.

ACTIVE antenna Sony AN-1, comprising of telescopic aerial, with FET low noise amp for SW reception and ferrite bar antenna for receiving MW and LW control box with connecting leads and 40 feet of coaxial cable brand new, boxed £48. Tel 01-485 4251.

FDK 430X 70cms expander matching unit for FDK multi 750X/XX, as new condition, boxed, £140. MBM48 J beam 48ELE 70cms antenna, £20. George, GW1FEA QTHR, 0244 543954, Clwyd, N. Wales.

RTTY terminal unit BARTG ST5 machine or computer with dot matrix printer complete with paper £100. TV BW camera type Ikegami CTC 5000 with superb 25mm 1:14 macro lens £100. All extras free. Phone Dave, GM3WIL, 0292 79217.

TRIO R820 Rx CW filter fitted, transceives with TS820 TS520 A1 condition £400, or will exchange for Trio SM220 monitor scope plus cash. Exchange Trio YG88C CW filter for Trio YG88A AM filter. Mr Wright, 0256 468649.

DATONG morse tutor £40. Datong RF clipper £25. Microwave MMT 432/144 £75. RF amplifier 10/40W FM-SSB £45. Cobra FM transverter QM70 144-70cms £25. Emotator rotator unused £75. CDE TR44 rotator used £45, both heavy duty. Mr Kemish, 0449 675610 (Ipswich), evenings.

RTTY TO TV converter MM2001, excellent condition, all leads, manual, £130 ono. 0235 847313, 105 Bradstocks Way, Sutton Courtenay, Oxon.

RACAL RA17RX with side-band adapter and manual £175. Panasonic RF3100L 32 band receiver £120. Yaesu FT7 HF Tx/Rx £220. Mizuho MX 2 2m SSB/CW handheld with speaker mic £50. Trio 7010 SSB/CW Tx/Rx manual £90. PCR broadcast Rx £20. HRO Rx 0.9-30MHz £30. Tel: 0278 684042.

FT290 with mobile mount and 10 watt PA, as new, £250. Wurlitzer 630TA theatre style organ, 2 keyboards plus synthesiser, fantastic beast, solid rosewood, £1500 ono. Wanted FR100 in good condition and complete RTTY terminal send/receive. G3LET, 0705 750387 (Hants).

500 valves for sale. Oltals. 5 pin yank. 6K6GT, 50L6GT, 25L6GT. Many others, SAE for lists please. All unused, boxed. Wanted, circuit details of 'Foreland' Marine VHF Tx/Rx. A.E. Jeffrey, 42 Dennis Rd, Padstow, Cornwall PL28 8DF. **CREED** 7E printer and 656 tape reader. Will swap for 70cm SWR power meter and absorption wave meter. Please contact Ian, 0920 871677 or write, 54 Woodcroft Avenue, Stanstead, Abbots Ware, SG128JQ G8NCZ. I have given up RTTY.

MICROWAVE Modules TV Tx MTV 435 70cm, 20W PEP output, as new condition, £135 ono. Ring G4BFJ 07373 60415.

TRIO TS530S all band SSB CW transceiver. New condition. MC50 desk microphone, new spare valves. Low pass filter, headphones, owner's and workshop manuals. Buyer to air test, collect any day after 2 pm, £500. Gregg, 2 Park Road, Granborough, Bucks MK18 3NS. **FT790R** £240 spotless. **FT290R** £180. Thandar TF200 + TP600 freqcounter £170 b/new. SP-400 pow/meter 130-500MHz £50. Audio/vis logic probe £10. New lots of test equipment plus lots new components, just ask. Many amateur books/mags. The total shack must go. 04738 5526.

FOR SALE. Advance main-frame storage oscilloscope type OS 2200 with OS 2006 and OS 2007 plug-ins with manual, not working requires new transformer hence very low price £125 ovno. Mr K.L. Phillips, 3 Linden Court, Frithville Gardens, London W12 7JJ. Tel 01-743 0811.

FOR SALE. 10m converted CB sets. Ham Concorde II £90. Ham Multimode II £80. Ham Black-shadow £40. Later set no FM, others AM/FM/SSB. Contact John, G4YM2, Preston (0772) 30336 evenings). **FOR SALE.** Trio TS700G 2m all mode transceiver with service manual and vox control unit and mic all as new and excellent condition £280. Buyer inspects and collects. Tel 0246 36496.

JR radio control five channel 35MHz FM four Servos rate switches special helicopter set with facility for counteracting tail rotor torque only used four

times cost £265 will accept £20 ono. Telephone G1SJD Skelmersdale 0695 25138. **FT290R** 2 metre all mode, nicads, charger, £250. MM 144/30 LS linear £60. **FT708** hand held plus accessories £160. G3RCO QTHR, Seaton 21016.

COMPLETE RTTY station ME80K computer with integral monitor and data recorder. All software for RTTY Tx/Rx and CW. All connecting leads and modem plus handbooks supplied 48W useable memory £185 ono. Also 30A 13.8V DC power supply, offers? GOAYZ, phone 0705 589560.

ANTENNA PDL II horizontal vertical 10/11 metre CB remote rotator £80. slim line winch tower lay down £125. Wanted, Nordmende TV or similar for UK Europe reception. Uxbridge 54116, Middlesex.

AMSTRAD CB901 converted to work on 29.3 to 29.6 MHz, as new, £40. Maidstone 63918.

YAESU FRG 7700 £250. Two metre base receiver £35. FDK 141-171 MHz receiver hand held cost £159, a bit deaf £100. Fantavox airband converter £10. Tandy CB hand held £70. Tandy DX 400 £110. CB base station £70. Mike, 01-674 0513 Thursdays 6-9 pm.

MICROWAVE Modules 144/432R transverter £110 ono, will swap for Trio TH41E hand held, cash adjustment. Solidisk SWR 128 sideways RAM for BBC B brand new £100 ono. 16K sideways RAM for BBC B £20 ono. Julian Tether, Highview, Culworth OX17 2AX, tel 0295 768152, Prestel MBX 919998417.

BUG-KEY. Similar Vibroplex £22, hand held CB transceiver Harrier WT2 40ch fair condition £24, BC221 mains powerpack £3. Wanted: HF SSB transceiver, also cheap communications receiver, ham bands or general coverage. Tel Thanet (0843) 69068.

AR88D recently serviced, matching speaker, operation manual, numerous spares. Buyer to collect. £80 ono. Contact B. Turner, 1 Godley Lane, Dilhorne, S-O-T, Staffs, phone Cheadle 753442.

BURNDEPT BE471 3 channel UHF Tx/Rx hand held. C/W

charger. Also service sheet. Xtalled for RBO RB11 and 1 spare £75 or exchange 2m FM hand held Tx/Rx. Contact GOCUO QTHR, telephone 091 4107884 anytime.

YAESU FT901D with memory, AM and FM fitted. WARC band modification kit (not fitted). Also FC902 ATU and Yaesu mike, all for £620. Wanted, general coverage receiver. Phone Bournemouth (0202) 481273 evenings.

YAESU FT290R excellent condition, mobile mount, 7/8 whip, SWR and power meter, nicad charger, 1/4 flexi whip. Brand new Slim Jim and pole with fixtures £250. Bedford 0234 852302.

DX5V HF multiband vertical antenna. Never been used hence still in original packing £50 ono. 0705 266126.

REALISTIC DX-160 communications receiver plus speaker and headphones. Also Datong active antenna AD270 with mains power unit. Boxed with receipt, cost £51 in January, accept £125 for both, genuine reason for sale. Phone Hoddesdon 0992 461594.

FOR SALE. FDK 700AX 5-10-100kHz steps 144/148 excellent, boxed, £130. Belcom LS102 checked and serviced by R. Withers, unused since, boxed, £180. Mr T. Waters, 42 Tregundy Road, Perranporth, Cornwall TR6 0EF.

FT290R, mobile mount, boxed, £230. PF2UB, SU8, RB10, RB14, £50. W+D 70cm 10 watt PA/preamp, £35. W+D 70cm ATV Tx/Rx 10 watt, complete, circuits, £100 ono. Rigonda 6" TV mains/12 volts, £25. B+W TV camera, 12 volts, £25. All working. G8FRL QTHR, (0223) 61222 ext 601 (office).

FOR SALE. Realistic PRO 2008 scanning receiver, 8 channels FM 68-88MHz, 144-148MHz, 148-174MHz, 410-450MHz, 450-470MHz, 470-512MHz with Discone antenna and coax, boxed, as new, £100. Tel 0732 882982 after 7 pm.

TS700 2 mtr m/mode, FM/AM/CW/SSB base station, 10 watts output. 240/12 volt operation with mike and vox unit. VGC might take HF receiver in p/exch or £230 ono. Bournemouth (0202) 302698.

TELEPRINTER Creed 444 +

paper £20. TX mic £10. Altai multimeter new 10 amp DC £10. Vic 20 computer + 16K RAM £40. 12V RF power reducer £10. Pye PFI Rx RB4 £4. J Beam 48 ele 70cm £20. G8KOM, tel Littlewick Green 2453.

FOR SALE. RTTY transceiver MM4000 756 ASCII keyboard Toni tuner £145 ovno. Mr W. Bevan, 10 Hilltop Crescent, Harrogate HG1 3BZ.

TWO Burndept UHF hand-helds £10 each. Two Pocketfone 70 single channel UHF transceivers one crystalised RB6 £25 pair. Two pairs Tx/Rx PF1 transceivers with nicads working condition £10 pair. No 3 Peacock Court, Chapel Street, Wellesbourne, Warwicks CV35 9QX.

FOR SALE. Sony ICF-7600D world band scanner receiver with AC/DC mains adaptor and instruction book in maker's box in mint condition. This is a good quality radio. Price £95 including post. Ring 051 9311001.

FOR SALE. Datong morse keyboard MK VGC £85. Tel Weymouth 0305 786930.

FOR SALE. Standard C7800 70cm mobile FM transceiver £170. Phone 0762 337743 after 6 pm.

PRESIDENT Grant converted CB rig to 10 metres AM/SSB with mike perfect £37. Two stereo wood cabinet speakers £12 the pair. Morse key Hi-mound model HK100 bug type, new £15. Various mikes. Collect or carriage extra. Phone Bradford, West Yorkshire (0274) 728219.

YAESU 290R £250, AMT-2 TV plus CBM64 EPROM software, £175, joystick VFA plus joystick ATV £35, Oskerblock SWR/power meter 50/75 ohms 1.8-144 £10. Chas, 01-764 6767.

EKCO radio model A52 for A/C mains only 200/250 volts 40/100 cycles splendid condition except broken cord station finder £60. Phone 01-290 1415.

ICL monitor hi-res professional computer monitor (green phosphor) £100, very smart. Wanted, info on BCC manpack A14B (manual preferred) borrow or buy. Also wanted, dead CB radios. Gerry, 132 Drovers Way, Woodley, Reading, Berks RG5 3PS, write only - no callers.

Free Readers' ADS!

Buy, sell or exchange your gear through our free service to readers

CONDITIONS

1. These advertisements are offered as a free service to readers who are not engaged in buying or selling the same equipment or services on a commercial basis. Readers who are should contact our advertising department who will be pleased to help.

2. Advertisements will be inserted as and when space becomes available.

3. The insertion of advertisements will be on a first-come, first-served basis, subject to condition (2). As a result, it will not be possible to guarantee the insertion of a particular advertisement into any particular issue of the magazine.

4. Readers should either write out their advertisement in BLOCK CAPITALS or type it, underlining any words that are to appear in bold.

5. The magazine cannot accept any responsibility for printers' errors in the advertisements; however, we will do our best to ensure that legibly written advertisements are reproduced correctly. In the event of a gross error, at the Editor's discretion, a corrected version of the advertisement will be printed (at the advertiser's request) at the earliest issue in which space is available.

6. The magazine or its publishers will not accept responsibility for the contents of the advertisements, and by acceptance of these conditions,

the advertiser undertakes to indemnify the publisher against any legal action arising out of the contents of the advertisement.

7. The magazine reserves the right to refuse to accept or to delete sections of advertisements where this is judged necessary.

8. Advertisements are accepted in good faith; however, the publisher cannot be held responsible for any untruths or misrepresentations in the advertisement, nor for the activities of advertisers or respondents.

9. Advertisers must fill in their names, addresses and (if available) telephone number in the space provided, and sign the form to indicate acceptance of these conditions (forms returned without a signature will not be used).

10. All that is to be reproduced in the advertisement should be entered into the space provided on the form printed in the magazine — note that a **photocopy is not acceptable**. All advertisements must give either a telephone number and/or address for respondents to contact, and this must be included in the wording of the advertisement.

11. Advertisements must be 40 words or less in length (telephone numbers normally count as two words, exchange or exchange code plus number).

Name

Address

.....

.....

I accept the conditions above.

Signature

Send this form to: Free Readers Ads, Ham Radio Today,
1 Golden Square, London, W1R 3AB

ENTER YOUR ADVERTISEMENT HERE:

Lineage:

46p per word VAT inclusive (minimum 15 words)

Semi Display: (minimum 2 cms)

£7.00 per single column centimetre

Ring for information on series bookings/discounts

All advertisements in this section must be prepaid.

Advertisements are accepted subject to the terms and conditions printed on the advertisement rate card (available on request)

01-437 0699

EXT 289

Send your requirements to:

Duncan Neilson

Class. Dept.,

ASP Ltd.,

1 Golden Square,

London W1R 3AB



SOFTWARE

TERMINAL UNITS

Improve your computer decoding of CW & RTTY signals (all known software). Switched tuning, constant output for 10Mv to 5V input. Three outputs:-

Audio, TTL & open collector load (active high or active low). Narrow bandwidth internal loudspeaker — tuning metre — requires 12-16V DC supply.

Available only from the manufacturers at £45 inc. For full details & specifications SAE to:

JEP ELECTRONICS
NEW ROAD COMPLEX
NEW ROAD,
KIDDERMINSTER
DY10 1AL

Tel: 0562-753893

BBC MICRO + ZX SPECTRUM

Radio amateur programmes. Prefixes. Locators. Bandplans. Times. New Contest Logger for BBC with disc. Many capabilities. Also DUPLICATE CHECKER

Phone PEYSOFT on
HORSHAM 0403-69835.

TERMS

CLASSIFIED ADVERTISING TERMS & CONDITIONS

Our terms for new advertisers (semi-display and lineage) are strictly proforma payments until satisfactory reference can be taken up (excluding recognised advertising agencies). Cheques PO's should be crossed and made payable to:

ARGUS SPECIALIST PUBLICATIONS LTD.

and send together with the advertisement to:

THE CLASSIFIED DEPT., L/H,
NO: 1 GOLDEN SQUARE, LONDON
W1R 3AB.

There are no reimbursements for cancellations. Advertisements arriving too late for a particular issue will be inserted in the following issue unless accompanied by instructions to the contrary.

All advertising sales are subject to Government regulations concerning VAT. Advertisers are responsible for complying with the various legal requirements in force eg: The Trade Description Act, Sex Discrimination Act & The Business Advertisements (Disclosure) Order 1977.

FULL TERMS & CONDITIONS OF ADVERTISING AVAILABLE ON REQUEST

SSTV — RTTY — AMTOR — CW

The **RX-4 Multimode** receive program now features SSTV 8, 16, 32 sec. frames. Keyboard grey scale adjustment. RTTY 4 baud rates, any shift.

RTTY and AMTOR selectable unshift-on-space. Tones directly displayed on a tuning scale for really easy and accurate tuning.

CW selectable software filters and controllable autotrack to 250 wpm.

All text and pictures can be stored, recalled, saved and printed.

Spectrum needs no hardware. **BBC-B, CBM64, VIC20** use the same interface as our RTTY and CW transceive program, see below.

Tape £25, disc £27 (BBC: state 40 or 80 track).

RTTY and CW TRANSCIVE

Split screen, type ahead, 26 large saveable memories, auto CR/LF, CW to 250 wpm, QSO review and more.

For **BBC-B, CBM64, VIC20**. Tape £20, disc £22. Interface kit £5, ready-made with all connections £20 (state rig if transceive).

Both these programs can use a T.U. on CW and RTTY instead.

Great Morse Tutor, Logbook, Locator, RAE Maths programs, too.

More details about everything in previous adverts.



technical software (HRT)



Fron, Upper Llandwrog, Caernarfon, Gwynedd, LL54 7RF. Tel 0286 881886

COMPONENTS

R.F. Transistors. Specialist Components for Transmitters. Unelco Capacitors. Sparague Mica Trimmers (500V). **Sole Agent for solid state Microwave R.F. Transistors supplied to full specification.** Full 2N range supplied. Special SD range 1W-100WATT output 1 to 100 MHz. Pre-amplifiers for 2 meters and 70cms. Power Amplifiers with and without switching. Aligned and ready for use. Due to exchange fluctuations we cannot price. Send S.A.E. for full lists.

Phone: (0243) 823603. Modular Electronics, 1 Coniston Close, Felpham, Bognor Regis, Sussex.

PARTS FOR YOUR PROJECT!

Top quality - competitive rates. We can supply you. Cash, cheque or Access/Barclaycard with your order to: Businessland, Unit 15, Mochdre Industrial Estate, Newtown, Powys. Tel: (0686) 24846.

AERIALS

AERIALS, TRAPS for beams or wire aerials, baluns, kits etc.. Data 24p large SAE. Aerial guide £1. G2DYM Uplowman, Tiverton, Devon EX16 7PH. (03986) 215.

RF DEVICES AT ROCK

BOTTOM PRICES!

Over 30,000 RF devices at low prices

REPLACEMENT RF TRANSISTORS

MRF454 HF/SSB 80W	£18.20
MFR450 HF/SSB 50W	£11.60
MRF238 VHF/FM 25W	£12.80
MRF475 HF/SSB 20W	£2.99
2SC1969 HF/SSB 18W	£2.50
2SC2043/1307 HF 16W	£2.00
2SC1947 VHF 3.5W	£7.60
2SC1946A VHF 32W	£14.30

REPLACEMENT RF POWER MODULES

MS7704/SAU3 UHF 15W	£36.00
MS7712/SAV7 VHF/FM 25W	£39.00
MS7713/SAV8 VHF/SSB 15W	£39.00
MS7716/SAU4 UHF/SSB 15W	£49.00
MS7719 VHF/PMR 15W	£29.00
MS7727 VHF/SSB 38W	£45.00
MS7749/SAU11 934/FM 7W	£29.00

Send £1.00 p&p and S.A.E. for full list.

All prices inc. VAT

Many IC's and other types in stock.

RWC Ltd.

584, Hagley Rd West, Dept HR
Quinton, Birmingham B68 0BS
021 421 8201 (24hr Answer phone)

COPY DEADLINES

SEPT	—	30th
ISSUE		JUNE
OCT	—	4th
ISSUE		AUG
NOV	—	1st
ISSUE		SEPT

PHONE 01-437-0626
FOR DETAILS

FOR SALE

NEW STOCK! Sinclair 16K rampacks for ZX81, £6 including VAT and postage. Halbar, Unit 1, Bury Walk, Bedford MK41 7BW.

BOOKS AND PUBLICATIONS

SERVICE MANUALS

Ham Concorde 2, Ham multi-mode 2, Ham Jumbo 2, Ham Viking, Ham Puma, Cobra 148 GTL DX, PC 879 and PB010. Colt 1600 DX, Tristar 777, York 863, York 861.

All above at £6.00 + £1.00 p&p each.

Other, rigs and spare parts available.

10m conversion for FMCB rigs

£30 + £1.50 p&p

Details on request.

CBT

1 Prince of Wales Road,
Swansea. (Tel: (0792) 463821.

SERVICE MANUALS

SERVICE MANUALS. Amateur radio, test, audio, TV, video etc. Thousands stocked. SAE enquiries. Mauritron (HRT), 8 Cherrytree Road, Chinnor, Oxon.

CB AND ACCESSORIES

THE NORTH'S Leading C.B. Distributors including 934 Mhz equipment. Please ring 0388-528464. Ian Fisher Communications, CB Works, Stanhope, Co. Durham DL13 2YT.

FOR THE SERIOUS RADIO ENTHUSIAST — H.R.T. —
PHONE 01-437 0626 FOR CLASSIFIED ADVERTISING.

EQUIPMENT

RTTY

COURSES



USED AMATEUR EQUIPMENT?
I BUY, SELL AND EXCHANGE!
 SELLING? I pay the BEST POSSIBLE PRICES for clean used equipment!!
 BUYING? I have the BEST SELECTION of TOP QUALITY USED
 EQUIPMENT AVAILABLE!!
 Whether buying or selling phone Dave, anytime, for a deal you've been
 looking for on
 HORNCHURCH (040 24) 57722 ANYTIME or send SAE for latest list to:
 G4TNY AMATEUR RADIO 132 Albany Road, Hornchurch, Essex RN12 4AQ

PNP Communications

**Modular Communications
Interface
for
RTTY Morse AMTOR**

Mod/DemodKit £14.50
 built P.C.B. £18.50
 PSU/Pre-amp/FilterKit £11.50
 built P.C.B. £15.50
 Morse DemodulatorKit £12.50
 built P.C.B. £18.00
 Bargraph tuning indicator
Kit £8.10
 built P.C.B. £10.75

Software available for:-
 CPC464, Acorn Atom, BBCB,
 Dragon 32/64, Commodore 64,
 VIC 20, TRS80C.

Send a large (A4) S.A.E. for full Cat.

Please add VAT at the current rate.
 Access & Barclaycard (VISA)
 welcome.

62, Lawes Avenue, NEWHAVEN,
 East Sussex BN9 9SB.
 Tel: (0273) 514465

**COURSES - RADIO AMATEURS
EXAMINATION** City & Guilds.
 Pass this important examination
 and obtain your licence, with any
 RRC Home Study Course. For
 details of this and other courses
 (GCE, professional examination,
 etc.) write or phone — THE RAPID
 RESULTS COLLEGE, Dept JN4,
 Tuition House, London SW19
 4DS. Tel: 01-947 7272 (9am-5pm)
 or use our 24 hr Recordacall Ser-
 vice 01-946 1102 quoting Dept.
 JN4.

MISCELLANEOUS

HEATHKIT U.K. spares and ser-
 vice centre. CEDAR ELEC-
 TRONICS, Unit 12, Station Drive,
 Bredon, Tewkesbury, Glos. Tel:
 0684 73127.

MORSE TUTOR

For Spectrum/QL/BBC:- WD Morse Tutor

(cassette £4, microdrive/£5.25" disc £6)

From absolute beginner to beyond RYA and
 Amateur Radio receiving. Adjust pitch. Set speed
 to your test level (4-18 wpm). Learn from single
 characters, via groups with wide spaces to ran-
 dom sentences; decrease spacing to normal.
 Write down what you hear, then CHECK on
 Screen or Printer (or speech for Spectrum fitted
 with Currah Micro-speech). Also own message,
 random figures, letters or mixed. Punctuation in
 own message or single characters. Discs may be
 40 or 80-track (SPDOS for Spectrum). Price
 includes postage in Europe, £1 extra outside.
 WD Software, Hilltop, St Mary, Jersey.
 Tel: (0534) 81392

CARDS, STICKERS

HIGH CLASS QSL CARDS. Com-
 petitive prices, free artwork. SAE
 for samples stating ham or
 breaker to: J.S. Coates, 57 Worrall
 Street, Morley, Leeds LS27 0PJ.

Q.S.L. CARDS - try me for quality
 and price. S.A.E. for samples. A.W.
 Bailey (G3YNI) Breatdown Press,
 Wick Lane, Lympham, Somerset.

FOR SALE

NICADS

AA/HP7 Rechargeable Cells
 4 for £2.30 or 10 for only £5!
 (ex. equip. tested & guaranteed)
 Universal Nicad Charger £8
 with battery test facility and LED indicators for
 any combination PP3, AA, C&D cells
 Above prices inclusive of p&p — goods sent by
 return
 Croydon Discount
 Electronics (H)
 40 Lower Addiscombe Rd.
 Croydon CRO 6AA

**ADVERTISERS PLEASE NOTE — WE WORK WELL IN
 ADVANCE OF PUBLICATION SO DON'T DELAY —
 PHONE 01-437-0626 FOR ADVERTISING**

EMPORIUM GUIDE

AVON



6 GOLF CLUB
 LANE,
 SALT FORD,
 BRISTOL
 Tel: 02217 2402
 Open Tues Sat 9am - 9pm
 Close Mondays

BIRMINGHAM

CENTRE ELECTRONICS

345 Stockfield Road, Yardley, Birmingham B25 8JP
 Specialist in the sale and service of Ex Government
 and Vintage Radio and Test Equipment.
 (Many spares in stock).
 Telephone enquiries to 0676 32560

Special delivery
 service

Shop open Thursdays, Fridays
 and Saturdays

BIRMINGHAM

HEWARD'S HOME STORES LTD.

(Est. 1963)
 822/4 Kingstanding Rd., Birmingham B44 9RT.
 Tel: 021-354 2083
 G4RJM with 38 years in The Radio Trade
 Ham Equipment urgently wanted!
 Open: Mon-Sat 9-6

BIRMINGHAM



R. WITHERS COMMUNICATIONS

584 Hagley Road West
 Oldbury, Warley B68 0BS
 (Quinton B'Ham) Tel: 021-421 8201/2/3
 Opening hours 9-5.30pm Late nights Thurs-Fri.
 Send just £1.00 (refundable against purchase)
 for latest catalogue + our exclusive products & used list.

BIRMINGHAM

AE AMATEUR AE LTD ELECTRONICS

510-512 Alum Rock Road, Alum Rock,
 Birmingham B8 3HX.
 Tel: 021-327 1497/6313
 YAESU DISTRIBUTORS
 TO THE UK

CHESHIRE

DW ELECTRONICS G3 XCF

Amateur Radio Supplies
 71 Victoria Rd, Widnes
 Tel: 051-420 2559 ICOM
 Open Mon-Sat 9.30-6 (closed Thurs)
 We supply Yaesu, Icom, Tonna, Jaybeam,
 Microwave Modules, Datongs, etc.

EMPORIUM GUIDE

DEVON

AGRIMOTORS

Merton CB & Radio Centre
Merton Garage & Post Office, Merton,
Nr. Okehampton EX20 3DZ.
Tel: (08053) 200
Open 6 days 9-6 (Sundays by appointment)
Specialists in 934MHz
Suppliers of all 27MHz and 934MHz equipment

LONDON

DRESSLER UK LTD

191 Francis Rd., Leyton, E10

Open 9-5.30 Monday-Friday 10-5 Saturday

Authorised dealers for:

Dressler, Yaesu, Icom, Standard, Trio/Kenwood,
Datong, SCM, Microwave Modules, Tonna
Tel: 01-558 0854/856-1415 Telex: 8953609

NOTTINGHAM

FOR THE ENTHUSIASTS
GUIDE
PHONE 01-437-0626
FOR ADVERTISING DETAILS

EIRE

RADCOM ELECTRONICS

25 RIVERSFIELD, MIDLETON, CO. CORK
Suppliers of YAESU, ICOM, DATONG,
BNOS, DRESSLER, MU-TEK, S.E.M.
RF CABLES, CONNECTORS, ANTEN-
NAS, ROTATORS, KEYS, METERS &
LOTS MORE.
RING (021) 632725

W. MIDLANDS

DEWSBURY ELECTRONICS

RXs. from YAESU, JRC, ICOM.
Stockists of microwave modules, B.N.O.S., M.E.T.,
GAMMA, DATONG, ICS, TASCOS

Open Mon-Sat 9.30-5.15.
176 Lower High Street
Stourbridge (0384) 390063

SURREY

GUILDFORD COMMUNICATIONS

34 Aldershot Rd., Guildford

Open Mon-Fri 8am-6.30pm
Sat 8am-5.30pm

Secondhand wanted



ASDEN

0483-574434

ESSEX

SELECTRONIC

The UK's leading suppliers of 934MHz
personal radio equipment
203 High Street, Canvey Island, Essex
Tel: 0268 691481
(Open Mon-Sat 9-5.30)
Amateur radio equipment also in stock

MERSEYSIDE

ARE Communications Ltd
FOR - YAESU, ICOM & KENWOOD
Phone us for the best deals on all amateur
radio equipment.

32 Bridge St., Earlestown,
Newton-Le-Willows, Merseyside.
Phone: Peter G4KKN on 09252-29881
Opening hours Tuesday-Saturday,
10am-5pm

SCOTLAND



SCOTCOMMS

OPEN TUES-FRIDAY 10am-12.30pm. 2pm-5pm
SAT: 9am-1pm. 2pm-4pm. CLOSED MONDAY

25 Morton Street, Edinburgh 15
Tel: 031-657-2430

KENT

Thanet

ELECTRONICS
2 Stanley Road, Herne Bay, Kent
Tel: (0227) 389484

Open Mon-Sat 9-5.30pm
except Thursday 9-1pm



NORFOLK

D.P. HOBBS (Norwich) Ltd
13 St. Benedicts Street, Norwich
Tel: 615786

Open Mon-Sat 9-5.30
Closed Thurs
Stockists of:



YAESU, FDK, ICOM, JAYBEAM
& Electronic Component Specialists

SCOTLAND

JAYCEE ELECTRONICS

JOHN GM30PW

20 WOODSIDE WAY, GLENROTHES

FIFE KY7 5DF

Tel: 0592 756962

Open: Tues-Sat 9-5



Full Range of YAESU & TRIO Goodies.

Quality Secondhand Equipment in Stock.

JAYBEAM - MICROWAVE MODULES - LAR

LANCASHIRE

AMATEUR ELECTRONICS U.K./HOLDINGS



63LLL

Yaesu, Tel, Jaybeam, Frequency
Counters, Drex, Datong, FT101
Experts. Repairs. 6JS6C, 12BY7A,
8KD8, RF Clipper, Double Balanced
Mixer, Wave Kit etc. S.A.E. List 15
min. Junc. 31 MB. Free parking.
48 Johnson Street
Blackburn BB2 1EF
(0254) 88896
CLOSED THURSDAYS

NOTTINGHAMSHIRE

SP ELECTRONICS

48 Limby Road
Huckhall, Nottingham
Tel: (0602) 640377

Open Monday-Saturday 8.30-5.30

WORCESTERSHIRE

A. KELLY

Electronics & Communication equipment.
3 Stoke Road, Aston Fields, Bromsgrove,
Worce B60 3EQ.
RSGB Publications, Mutek, DRAE, Microwave
Modules, Star Masterkeys, TAL aeriels, Alinco.
OPEN 6 DAYS A WEEK. EVENINGS
BY APPT. 0527-79556.

DEWSBURY

ELECTRONICS



NEW

NEW



THE NEW STAR MASTERKEY ELECTRONIC CMOS MEMORY KEYS

Following the outstanding success story of the Dewsbury Electronics' STAR-MASTERKEY with over 500 units in use world wide, by amateurs, and at sea by professional operators, many users requested memory facilities at a reasonable price. So here it is. The STAR-MASTERKEY CMOS Memory Keyer.

- * Features full iambic keying.
- * Eight 50-character memories
- * Automatic Repeat on one memory (CQ calls etc.).
- * Memory retention for battery life.
- * Ultra low current drain.
- * Uses four AA size cells.
- * Switchable Auto-character Spacing.
- * Dash & dot memories
- * Compact 3" high, 6" wide, 7" deep.
- * Direct & grid block keying sockets for both solid state & valved PAs.
- * Switchable Sidetone Oscillator with loudspeaker & headphone socket.
- * Loads memory from paddle "OFF AIR".
- * Speed & weight controls.
- * Adjustable sidetone pitch & volume.
- * Comes complete with batteries.
- * BRITISH BUILT & FULLY GUARANTEED.

Price £95.00. Post, packing and insurance £3.00.
VIBROPLEX, HI-MOUND & BENCHER KEYS AVAILABLE.

FULL RANGE OF TRIO PRODUCTS STOCKED
We are also stockists of DAIWA—MET ANTENNAS—MUTEK—WOOD & DOUGLAS—TASCO TELEREADERS—
MICROWAVE MODULES—ICS AMTOR—AEA PRODUCTS—DRAE

Dewsbury Electronics, 176 Lower High Street, Stourbridge, West Midlands.
Telephone: Stourbridge (0384) 390063/371228.

Telex: 337675 TELPES G

Instant finance available subject to status. Written details on request.



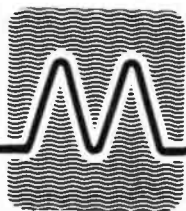

MICROWAVE MODULES LTD

THE NEW 50MHz TRANSVERTER



General:
 Input Frequency Range: 144-148MHz
 Output Frequency Range: 50-54MHz
 Modes of Operation: SSB, FM, CW, FSK, AM
 Input/Output Impedance: 50 ohm
 RF Connectors: SO239
 Power Connector: 5 pin DIN 240 degree
 DC Power Requirements: 13.8 volts at 4 Amps peak

Transmit Section
 Output power: 20 watts at -23dB 3rd order IM
 15 watts at -28dB 3rd order IM
 10 watts at -32dB 3rd order IM

Input level range: 150 milliwatts to 15 watts
 ALC range: 20dB
 Level of spurious output: better than -65dB

Receive Section
 Conversion gain: 10dB ± 1dB
 Noise figure: better than 3.8dB
 Input 3rd order intermod intercept point: better than +10dB
 Spurious response rejection: better than -80dB

PRICE £245.00 inc VAT

Transit power output of 20 Watts

This power level of 20 watts, when used in conjunction with a typical antenna of 7dB gain, gives an ERP of 100 watts (the maximum permissible in UK). This power level is also ideal for driving a grounded-grid amplifier.

Purity of transmission

The MMT50/144 transverter has been optimally designed to ensure that spurious radiation falling with the 88-108MHz broadcast band are typically better than 90dB below full output. This has been achieved by the use of 16 poles of filtering, well-balanced mixing and push-pull amplification.

Exceptional large signal receiver performance

The 50MHz transverter enjoys a uniquely high overload characteristic of typically +12dBm (third order intercept point at transverter input). This has been achieved by the use of parallel FET's in the front end driving a balanced pair of

FET's in the mixer. Given that the background sky noise at this frequency represents an equivalent noise figure of greater than 8dB, the low noise figure achieved in the transverter ensures that external noise is the limiting factor. The conversion gain of 10dB is provided to ensure that the 144MHz transceiver in use will detect the weakest of signals, while not being subjected to overload in the presence of strong signals on the 50MHz band. In other words, a system of impressive dynamic range is guaranteed.

Further features

The transverter will accept a drive level at 144MHz of between 150 milliwatts and 15 watts. The automatic level control (ALC) ensures that the 20 watt output signal is of consistently high quality. An LED bargraph display indicates the relative transmit output power, and the RF VOX control allows the operator to select the "hang" time to anything from 20 milliseconds to 1.5 seconds.

		Total inc VAT	Post Rate			Total inc VAT	Post Rate
MML28/100-S	10m 100W Linear, 10W input	129.95	C	MMT432/28-S	70cm Linear Transverter	195.50	B
MML144/30-LS	2m 30W Linear, 1 or 3W input	94.30	B	MMT1296/144-G	23cm Linear Transverter	258.75	D
MML144/50-S	2m 50W Linear, 10W input	106.95	B	MMX1286/144	1268MHz Transmit Up-Converter	195.50	D
MML144/100-S	2m 100W Linear, 10W input	149.95	C	MMC50/28	6m down to 10m Converter	35.65	A
MML144/100-HS	2m 100W Linear, 25W input	159.85	C	MMC144/28	2m down to 10m Converter	35.65	A
MML144/100-LS	2m 100W Linear, 1 or 3W input	169.95	C	MMC144/28-HP	2m High Performance Converter	47.90	A
MML144/200-S	2m 200W Linear, 3, 10, 25W input	334.65	D	MMC432/28-S	70cm down to 10m Converter	39.90	A
MML432/30-L	70cm 30W Linear, 1 or 3W input	169.05	C	MMC432/144-S	70cm down to 2m Converter	39.90	A
MML432/50	70cm 50W Linear, 10W input	149.50	C	MMK1296/144	23cm down to 2m Converter	129.95	B
MML432/100	70cm 100W Linear, 10W input	334.65	D	MMK1691/137.5	1690MHz WX Satellite Converter	145.00	B
MMC435/600	70cm ATV Converter, UHF output	35.65	A	MMG144V	2m RF Switched GaAsFET Preamp	37.90	A
MTV435	70cm ATV 20W Transmitter	197.80	B	MMG1296	23cm GaAsFET Preamp	75.00	A
MM2001	RTTY to TV Converter	189.00	B	MMG1691	1690MHz GaAsFET Preamp	129.95	B
MM4001-KB	RTTY Transceiver with keyboard	299.00	D	MMD1500P	1500MHz Divide by Ten Prescaler	119.60	A
MMS1	The Morsetalker	115.00	B	MMR3/25	3dB 25 Watt Attenuator	19.95	A
MMS2	Advanced Morse Trainer	169.00	B	MMR7/3	7dB 3 Watt Attenuator	14.50	A
MMT50/144	6m Linear Transverter, 20W o/p	245.00	B	MMR15/10	15dB 10 Watt Attenuator	14.50	A
MMT144/28	2m Linear Transverter, 10W o/p	129.95	B				
MMT144/28-R	2m Linear Transverter, 25W o/p	236.90	B				

Postage/Packing Charges: A = £1.84 B = £3.91 C = £4.60 D = £5.98

ALL MICROWAVE MODULES PRODUCTS ARE FULLY GUARANTEED FOR 12 MONTHS (INCLUDING PA TRANSISTORS)



WELCOME

MICROWAVE MODULES LTD

BROOKFIELD DRIVE, AINTREE, LIVERPOOL L9 7AN, ENGLAND

Telephone: 051-523 4011 Telex: 628608 MICRO G

CALLERS ARE WELCOME, PLEASE TELEPHONE FIRST

HOURS:
MONDAY-FRIDAY
9-12.30, 1-5.00
 E. & O.E.