

HAM

AN ARGUS SPECIALIST PUBLICATION

JULY 1985 £1.20

RADIO

TODAY

2 into 1 = FT2700RH

How well do VHF and UHF go together in Yaesu's new dual bander?



Multi-operator contesting

Correspondence Courses – can they help you pass the RAE?

PROJECT PROJECT PROJECT PROJECT
A transverter from 2m to 70cm using the Cirkit VHF-UHF converter

DATA
ICS AMT-2 AMTOR unit reviewed



Win an SMC
'Oscar Two' 10m FM rig
See inside...

Build yourself a micron transceiver at a price you can afford



£241 FOR 6 BANDS/INTERNAL ATU/DIGITAL DISPLAY AND CASE

OUR LATEST TRANSCEIVER KIT setting new standards in QRP performance. The MICRON is a 6 band CW only 8/10W output rig covering 80,40,30, 20,15 & 10 metres (bottom 200kHz of each). A 0.25uV sensitivity receiver with AGC, S Meter, very stable VFO with IRT, IW AF o/p to speaker and 3 position LC filter + selectable attenuator. Silent solid-state Rx/Tx switching with fast semi break-in + sidetone. Fully variable RF power o/p + optional SWR metering. + 12v required.

PLUS fully finished smart CUSTOM CASE and hardware with UNIQUE facility for optional internal TRANSMATCH ATU and Full Frequency DIGITAL DISPLAY. The MICRON uses a high grade solder masked/screen printed pcb with comprehensive instructions using a step-by-step assembly manual designed for the relative newcomer. Mostly prewound coils and minimal test equipment needed for alignment.

EXPORT A PLEASURE!

PRICES: FULL KIT with all options including Case/Hardware/ATU/Metering/Digital display at an all-in £241. Or, 6-band pcb kit complete at £145 or with case is £182.50 and the options of INTERNAL ATU at £37, and DISPLAY at £38.50.

QRP for under £40?

ONLY NEEDS +12v. SPEAKER + KEY/MIC TO BE ON THE AIR!

FOR THE LESS AMBITIOUS, why not try our DSB80 kit? A 2W + DSB or CW VFO controlled TRANSCEIVER kit for either 80 or 160m at a ridiculous £39.95 for a complete pcb kit - over 1000 sold to date! It has a very sensitive receiver and is ideal for beginners. Punched aluminium CASE and HARDWARE for the DSB80 at £25.95, and digital display at £29.50 - all three kits for £85.00.

NEW! The MICRON MATCH ATU Kit, developed from the MICRON ATU, with its own case, connectors, etc. Suitable for SWL or QRP (15W) from 1.8 -30Mhz. With air spaced capacitors for only £39.95 inc.

2M FM UNDER £70?

We also make a popular 2M FM Tx/RX kit - 6 channel crystal control at 1W RF o/p. Receiver at £39.50 and Tx at £34.50 ex crystals - both for £69.95. Optional PLL VFO available at £38.50.

OTHER KITS: DSB2 - enhanced version of the DSB80 for any single band 160 - 15m, DSB/CW 2W+ at £69.50 basic kit. SPEECH PROCESSOR - very popular kit at £14.65 to help get the DX! ALPHA - our 50W monoband SSB/CW Transceiver with case and display at £179.95. OMEGA - 9 band 100W multimode for the specialist constructor - write for details.

Why not join the ranks of satisfied customers building our Projects? All of our kits come with copious instructions, all components, pcb, wire, pots, etc, and many are designed for beginners. Our Products are used world wide and can help YOU get on the air. KITS are sent in 7-10 days but please allow up to 28 days for popular items. All prices include VAT and Post. OVERSEAS - Europe use UK prices and Rest of World UK + 5% for carriage, etc. CREDIT CARD orders can be left on our 24hr Answering Service. For our 40+ page CATALOGUE please send 50p in stamps. Kit Debug service available.

WPO COMMUNICATIONS



UK DESIGN AND MANUFACTURE

20 FARNHAM AVENUE, HASSOCKS G3WPO
WEST SUSSEX BN6 8NS MAIL ORDER ONLY



24hr Anaphone

07918 6149

APPROVED TRIO DEALER

WARD ELECTRONICS

CLOSED MONDAY

422 BROMFORD LANE, WARD END BIRMINGHAM B8 2RX TEL: 021-328 6070

TRIO IN BIRMINGHAM



TS430S
Deservedly popular HF Transceiver
NOW £769



NEW TRIO
TS940S



NEW * As Reviewed *
G3LIV RTTY+AMTOR
BBC 'B' £112.50

| | | |
|--------------------|--------------------|--------------------|
| TS930S £1350 | TS780 £981 | TH21E £188 |
| TS830S £832 | TR9130 £499 | TH41E £214 |
| TS530SP £735 | TW4000A £536 | TR2600E £281 |
| TS130S £633 | R2000 £479 | R600 £299 |

G3LIV SSTV PCB+Prog for BBV 'B' £17.50
G3LIV BBC RTTY TU for BBC 'B' £75.00
G3LIV AMTOR Add-on for BBC 'B' £43.00
Universal RTTY TU £45 ideal any computer.
AFSK PCB £2.75 RTTY PCB £6.80
Also NEW SCARAB RTTY KITS available.
CBM 64/VIC Connectors £2.50

DAIWA ROTATORS AND SWR METERS • HOKUSHIN ANTENNAS • RSGB BOOKS
COMMODORE - BBC - ACORN - TATUNG COMPUTERS • ICS AMTOR
G3LIV, SSTV and RTTY COMPUTER INTERFACES • SCARAB • G3WHO SOFTWARE

AMT-2
£229



CBM 64 ROM £51.75

AMTOR/RTTY/CW/ASCII

all in one neat performance racked unit.
Easily driven from most computers.
Mosoft CBM64 Logbook £7.95
also Morse Trainer, Typing Trainer
Scarab NEW CW For CBM64 £10.50
G3W HO BBC Software RTTY Tape £7.50
RTTY ROM £20. AMTOR ROM £27

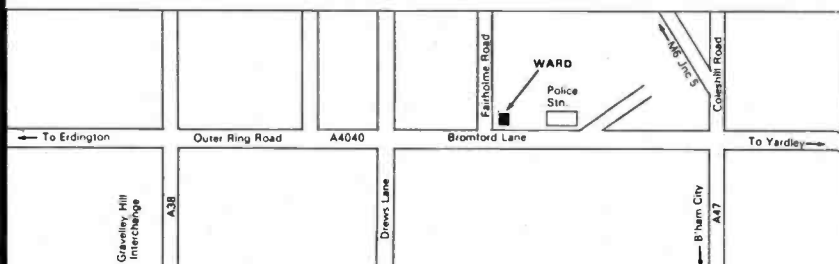

HAM RADIO CONTENTS

TODAY

VOLUME THREE NO. 7 JULY 1985

Editor
 Steve Ireland, G3ZZD
Editorial Assistant
 Julie Darby, G1CKF
Group Editor
 Dave Bradshaw, G1HRT
Advertisement Manager
 Dave Gadsden, G4NXV
Classified Sales Executive
 Caroline Faulkner
Publisher
 Peter Welham
Chairman
 Jim Connell



Design by

MM DESIGN

Published by:

Argus Specialist Publications Ltd.,
 1, Golden Square,
 London W1R 3AB.

Telephone: 01-437 0626

Distributed by:

SM Distribution Ltd.

Printed by:

The Garden City Press Ltd.

Subscription Rate

UK £17.00

O/Seas Sur: £18.50

USA Sur: \$25.00

O/Seas Air: £33.50

Ham Radio Today,
 Subscriptions Dept,
 Infonet Ltd,

Times House,
 179 The Marlowes,
 Hemel Hempstead,
 Herts HP1 1BB

Tel: (0442) 48432



Ham Radio Today is normally published on the first Friday in the month preceding cover date. The contents of this publication including all articles, designs, plans, drawings and programs and all copyright and other intellectual property rights therein belong to Argus Specialist Publications Limited. All rights conferred by the Law of Copyright and other intellectual property rights and by virtue of international copyright conventions are specifically reserved to Argus Specialist Publications Limited and any reproduction requires the prior written consent of the Company. © 1985 Argus Specialist Publications Ltd. All reasonable care is taken in the preparation of the magazine contents, but the publishers cannot be held legally responsible for errors. Where mistakes do occur, a correction will normally be published as soon as possible afterwards. All prices and data contained in advertisements are accepted by us in good faith as correct at time of going to press. Neither the advertisers nor the publishers can be held responsible, however, for any variation affecting price or availability which may occur after the publication has closed for press.

REGULAR COLUMNS

| | |
|----------------------|-----|
| LETTERS | .4 |
| RADIO TODAY | .6 |
| PRACTICALITIES | .34 |
| METREWAVE | .48 |
| RADIO TOMORROW | .55 |

CONSTRUCTION

| | |
|--|-----|
| 2m to 70cm TRANSVERTER | .16 |
| <i>Custom build your own, based on the Cirkit VHF-UHF converter.</i> | |

| | |
|--|-----|
| MEET THE MICRON! | .42 |
| <i>In Part 3, Frank Ogden, G4JST, and Tony Bailey, G3WPO, complete the basic construction and alignment.</i> | |

FEATURES

| | |
|--|-----|
| CORRESPONDENCE COURSES FOR THE RAE | .12 |
| <i>"Can they help you pass the RAE?" asks teacher, Sharon Metcalfe, G6LCC.</i> | |

| | |
|--|-----|
| HAM RADIO IN GERMANY | .26 |
| <i>Nigel Roberts, G4IJF, and Angelika Voss, G5CCI, survey the scene and find some interesting contrasts with the UK.</i> | |

| | |
|---|-----|
| GETTING STARTED ON SATELLITES II | .30 |
| <i>Put together a transmitting 'up link' station with G2UK, Chairman, AMSAT-UK.</i> | |

| | |
|---|-----|
| MULTI-OPERATOR CONTESTING | .51 |
| <i>Multi-operator techniques assessed by HF contest committee's Nigel Cawthorne, G3TXF.</i> | |

REVIEWS

| | |
|---|-----|
| ICS AMT-2 AMTOR UNIT | .22 |
| <i>A worthy successor to the AMT-1? Ken Michaelson, G3RDG investigates for HRT.</i> | |

| | |
|---|-----|
| YAESU FT2700RH VHF/UHF FM TRANSCEIVER | .36 |
| <i>Chris Lorek, G4HCL, AMIEE, goes fully duplex with Yaesu's new dual bander.</i> | |

| | |
|---|-----|
| COMPETITION! WIN AN SMC 'OSCAR TWO' 10m FM TRANSCEIVER | .33 |
|---|-----|

| | |
|-------------------|-----|
| ADDENDUM | .32 |
| STOP PRESS! | .50 |

| | |
|------------------------|-----|
| Free Readers Ads | .58 |
|------------------------|-----|

| | |
|----------------------|-----|
| Emporium Guide | .63 |
|----------------------|-----|

| | |
|------------------|-----|
| Classified | .64 |
|------------------|-----|

| | |
|---------------------------|-----|
| ADVERTISEMENT INDEX | .66 |
|---------------------------|-----|

Due to lack of space, we regret that 'A Look at the BBC Outside Broadcasts' part 2 has had to be held over.

LETTERS

KEYED UP

Sir, the article 'Got a Good Fist?' in April's HRT I found heartening and goodly to peruse. G3ZZD and co. are to be complimented on their attempted CW revival.

I personally refuse to become a 'computerised CW clone', whatever the enviable benefits, if any. The essence of friendly communication via amateur radio is surely by conveying, either by morse or speech, the *individuality, mood and temperament* of the sender of the transmission. This is virtually impossible with the current trend for computer and paddle produced robotic flux, which, though intelligible if the operator is skilled, remains completely impersonal.

Reading through the article on 'fist' operating, I hope other hand key aficionados share my mirth. For over twelve months, I have religiously sought and craved a decent hand key. It would seem that such an implement is unobtainable in this highly technological and gigahertzic era. Would that I'd somehow acquired one of the reliable and responsive keys I'd the pleasure of using between 1943 and 1953.

I have toured emporiums and rallies all to no avail. At the moment, I hobble along on 20m with a totally degenerate and inadequate plasticised unit. I estimate key point cleaning time to be transmitting time divided by two.

Prior acquisitions have included the 'death and glory boy' (it chose the former!) from Hi-mound at £84. Also, I have had the Swedish hand made

key plus various others. They all seem blighted by the same 'bugs' (pardon me!) — after a day or so in service, they won't hold their settings and speed work becomes impossible by virtue of fast 'sooting up' contacts.

When will a manufacturer offer a hand key wherein all the basic requirements have been incorporated? By the 'basic requirements' I refer to the need for very hard contacts, as durable as most car ignition points, and free from any trace of fragmentation (ie the transformation of a dot into a dash when the key contacts meet) a tough, tensile return spring, endowed with a fine setting capability and a finely threaded and lockable gap setting that can be adjusted to suit *any* taste.

Why are we lumbered with such mediocre accessories?

G4WRV

Glad you liked the article and sorry about the problems with limp seeming morse keys. I suggest you seek out John Wilkes at rallies, as I know that several of the problems that you mention he has attempted to overcome, particularly that of 'soft' contacts.

Your problem with contacts that 'soot up' makes me think that you are using an older type of valve Tx or transceiver. Whatever, it sounds like you are keying quite a heavy current. A simple 'keying relay', such as fast operating (1-2mS) dry reed relay, with contacts that can stand about 1A, connected between the Tx and your key should cure this.



COMPUTER SLAV

My name is Andrija Kolundzic and I am a radio amateur, YU1PUR, with an interest in computing. I would like to exchange information, programs and literature concerning the personal computer Commodore 64; I would be interested in contact either using MODEM or RTTY. Here, in Belgrade, I have organised the first and biggest club for fans of personal computers, in which I have been instructing pupils in courses of BASIC and machine language for Sinclair and Commodore computers. Up till now, I have instructed 3000 pupils and at the moment, I am working with some 2000 new pupils!

In addition to this, I have been popularising personal computers on Belgrade and Yugoslavia by having similar courses on TV and radio every week, in fact every three days! I am thus engaged in trying to transmit my knowledge and experience to the public. Now I am engaged in writing a

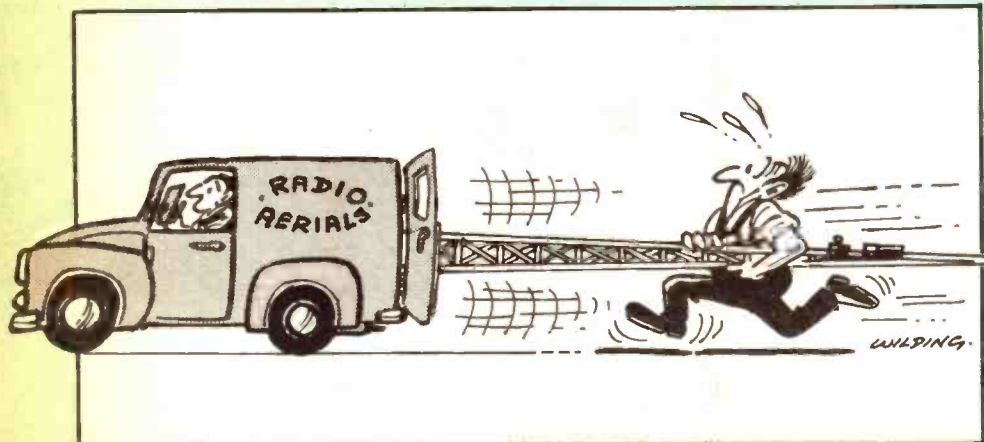

book on BASIC and machine language for the Sinclair Spectrum and Commodore 64, which is going to be the first of this type in Serbo-Croat (usual language in Yugoslavia).

I own Sinclair Spectrum, Commodore 64 and VIC 20 computers, three disc drives, units VC1541 and printers VC1515, VC1526, MPS 801, Coex 80 F/T and over 100 original programs. I have also two MODEMs, Westridge 6420 and VICMODEM, which I wish to communicate through the telephone with. I am ready for co-operation of any kind of exchange of programs, information or literature.

You can contact me at the following address: Andrija Kolundzic, Vojvode Brane 31/4/44, 11000 Belgrade, Yugoslavia, or you can telephone and leave your message by automatic answering system. My phone number is 011/424-435 (011 is the area code number for Belgrade).

Andrija Kolundzic, YU1PUR

SWISS WIND UP

Sir, I have just got to put pen to paper. The subject? The use of 'repeaters' for DX QSOs.

Before anyone jumps up waving their arms in disgust, let me explain I fully agree with the general view that repeaters are best used by mobile stations for extended local working.

My experience on the 24th February '85 was an education to say the least. I, realising that a 'lift' was in progress, put the rig and 30W linear in the car and 'homebrew' half wave antenna on the roof and drove to some high ground. I then put out a CQ call via the local repeater, GB3NB, only to be informed "No way are (any of) these stations going to work DX through this repeater". Do not forget, I was a 'mobile' station.

On my second call, I was answered by an 'HB9CHE'. After about 2 minutes, we QSY'd and managed to make direct contact (a struggle but we made it). On returning home, I made out the details on a QSL card and duly posted it to Switzerland.

This morning, I received a card from HB9CHE, telling me that he had no QSO with me on that date or time.

Now, do I think that someone in the 'NB' area used me for a joke? "No, surely not, responsible 'hams' don't do that sort of thing, do they?" So, must I assume I inadvertently worked an 'HB' pirate station?!

G. Pemberton, G1BVV

Please address correspondence to:
Ham Radio Today,
1. Golden Square,
LONDON W1R 3AB.

TELLING THE TRUTH?

Sir, I have taken 'Ham Radio Today' since the first copy hit the stands. It must improve I told myself. Now, after receiving May's issue I can take no more. Far from improving, it has gone down hill. Perhaps G3WPO, G4JST and the Rev Dobbs have shares in the publishing company. Take away their articles each month, and you have nothing left.

May's Letters column is nearly half taken up by two letters — one on racism on CB (hardly ham radio) and one from some guy listing gear he has had stolen (wow). Into the good stuff — man runs Seagull engine on wet string, a full page advert from Western Electronics which I can't read because of bad copy, the good old Rev Dobbs takes up four pages (1W into a sardine tin), BBC Outside Broadcasts (good ham stuff this), 7 1/2 pages of G3WPO and G4JST building yet another piece of useless kit and then the DX trip to Lord Howe ('South Seas Sojourn'). This must be good I thought, until I read the article, sorry tale of an aircraft trip. Four pages of complete rubbish, like filling pockets with gear to avoid excess baggage, G3CW/V8ANT cycling over VK, VK9LH who paints pictures but is going to build a house. Pilot serves biscuits. G3ZAY might find it good but let's be quite honest the article is padded crap.

When is someone in this country going to publish a real ham radio magazine? Stateside we have 73's, CQ etc but they are too expensive to import.

I know you won't publish this letter as it is too near the truth, OK, but if you wish to continue you must concentrate on ham radio topics instead of building up business for Tony Bailey, Frank Ogden and the G-QRP Club. Some of us would consider 400 watts to be QRP, but something we have to live with.

R T G Freeman, G4SDJ.

Let me address your points one by one. The letter on racism on CB was printed because this regrettably has overspilled into amateur radio — see my remarks underneath the letter. The Reverend George Dobbs has never written for HRT before writing the article in the May issue. Regarding the Micron, this is one of the most popular projects G4JST/G3WPO have ever designed and was specifically requested by readers of HRT. Incidentally, their constructional articles are among the most popular articles we run. A number of our readers expressed a desire for a couple of articles on professional broadcasting, written from a radio amateur's view-point and Mick Rump's article was a direct result of this.

You obviously have not seen much of 'CQ' or '73', the American magazines you seem so much in favour of. I am a fan of these magazines myself. Ironically, Martin's 'South Seas Sojourn' has been accepted by the editor of 'CQ' magazine for American publication and is a fairly typical example of their 'radio overseas' type feature.

So you think 400W is QRP and hard to live with? Can't you work DX with less?

If you can give me some concise idea of the type of articles you would like to see in HRT, rather than making emotional statements, I would be pleased to consider them.



Reader Dean St Hill has set up a station at the St. Michael Boy Scout HQ in Barbados under the callsign 8P6BBS, but badly needs the manuals for a Heathkit HW104 transceiver. If anyone can loan HRT a set of manuals for a week, we will photocopy them and forward to Dean.

RADIO TODAY

The WINNER of our COMPETITION for the Tokyo Micro-7 70cm handheld transceiver (May '85 issue) was G. Bowers of Sunderland, whose choice was A,F,B,E,C,D. Congratulations!

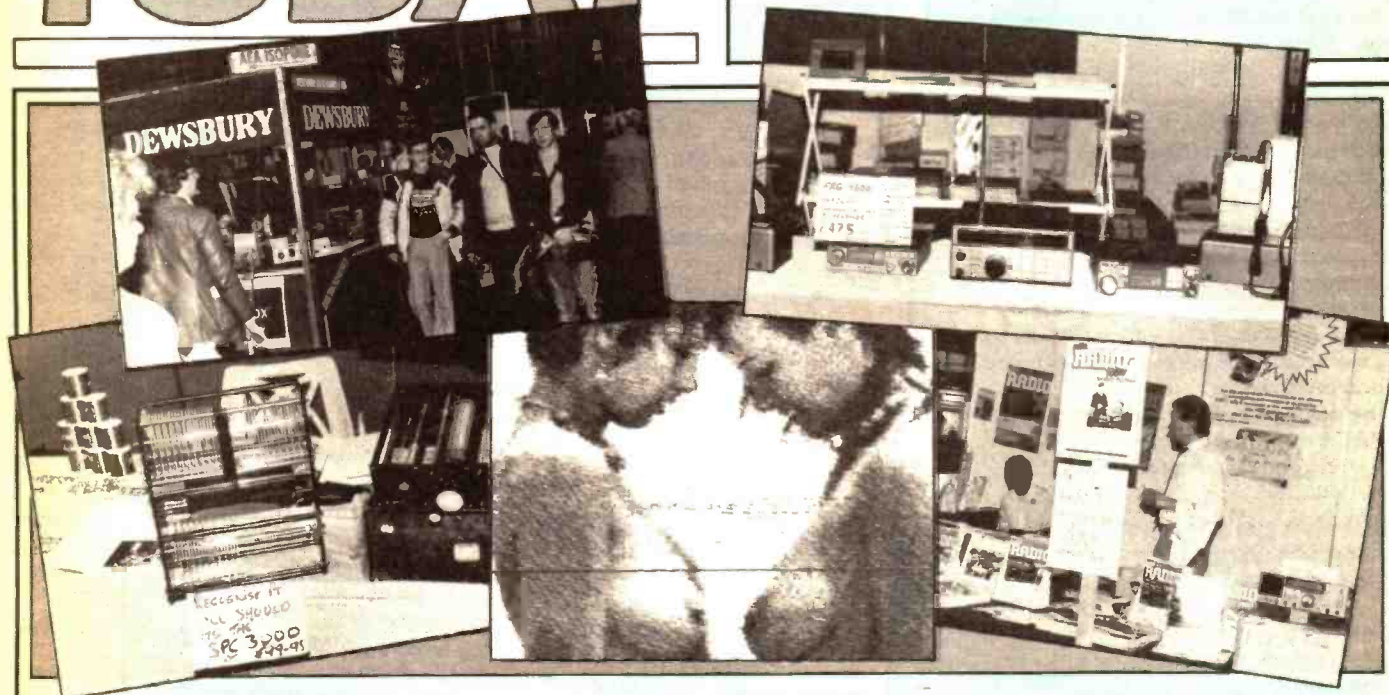

Did You Go To The RSGB National Convention?

Well, we did, along with something in excess of 10,000 people. The actual attendance figure is not known as the counting machine at the NEC entrance went haywire mid morning Saturday. RSGB officials could be seen wandering around tearing out their hair in hand fulls...

Down at our stand, A23, the action was pretty hot, A large number of people queued to take advantage of our amazing subscriptions offer and see G3WHO and G3LIV's demonstration of packet radio — using both the ICS AMT1 and G3WHO's incredible program for the BBC 'B' to give (almost) 'stand alone' AMTOR operation. Interested parties noticed clocking the demo' included BARTG's Ian Wade, noted authority on AMTOR and running the Packet Radio Workshop at the Convention.

(Talking of 'Packet', Rev Paul Butcher, alias G4NWH of RAMTOP, who was going to give our 'Packet' demonstration, was regrettably unable to be with us due to an overload of weddings at the church for which he is the Minister...)

People also dropped by to praise/berate us over various articles and projects. Some good suggestions for articles were made to the editor, which we hope to get together in the near future.

With the connivance of G3LIV, a caption competition for the nearby (SSTV) picture of two young ladies was set up, the prize being a year's subscription to HRT (no, not Playboy!). After much deliberation, we decided the winning entry was G8TKY's "My front end is more sensitive than yours!" He was given a close run by "We've both got a set of matched pairs" (G3COP), "Don't look now, but I think we're on SSTV" (G6YZZ) and "The front-to-back ratio of these

lobes are better than last month's 8 element Yagi design" (G4EFO). The picture caused quite a lot of laughter, even among some members of the fairer sex. Although, a certain Editorial Assistant was heard to mutter 'sexist' — and rightly so!

Overall, the general consensus of opinion among the visitors was that the convention was a good one. Although, a number of complaints were heard about the lack of gangway space between stands, particularly on Saturday afternoon when the convention was at its fullest and the situation literally approached a crush.

Satellite reception, especially that of weather satellites, continues to grow in popularity, with Timestep Electronics and Cirkit joining Microwave Modules in producing systems for this field. Both the former manufacturers use a home computer and monitor for display purposes.

VHF/UHF 'dual banders' were the order of the day on most Yaesu agents stands with the FT2700RH (reviewed in this issue) and Thanet Electronics were displaying the new Icom IC-3200E. Chris Lorek, G4HCL, author of the FT2700RH review, spent some time trying out the IC-3200E on the clever demonstration facility on the Thanet stand.

The fleamarket was the usual madness and after trying (and probably failing) to take a few photos of new products there, the editor sought refuge on the HF Committee stand. There he found himself involved in a (friendly) DX contest which involved identifying CW stations on a very (deliberately) noisy tape. To his amazement he managed to finish considerably above the bottom of the table and above a few old rivals. The HF Committee will be running a similar set up at the HF Convention and all are recommended to give it a try.

Sunday evening came around quite quickly, finding everyone in a state of exhaustion but keen to repeat the whole thing next year. See you there!

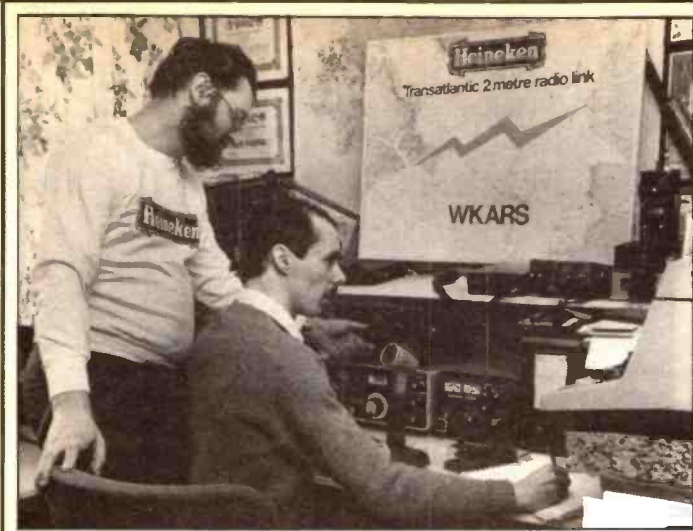

Heineken Helps Amateur Group Refresh Parts Others Cannot Reach!

Heineken, makers of the well known lager, have stepped in to help West Kent ARS set a world record by making a direct transatlantic QSO on 2m. The group will be travelling to western Ireland in mid August to set up a temporary station 1500ft up a Galway mountainside.

The aim is to transmit to the east coast of America and Canada, using high power to 4 stacked and bayed long Yagis. Schedules have been arranged with several groups with transmissions around the clock from 19th to 30th August. The group will be operating on CW, AMTOR and SSB with HF set up to assist the attempt.

Dave Green, G40TV, who first mentioned the plan in February's Radio Today, says "We're obviously delighted to have Heineken's support. We'll need a bit of luck to overcome the obvious technical problems associated with a 2m contact over such a long distance. If we don't get the high pressure we need, it will be really tough going."

So You Want To Become A Radio Amateur.

The City and Guilds of London Institute have published the revised syllabus for the RAE to start from May 1986.

The main changes to the syllabus are a decrease in the emphasis on Electrical Theory and an increase on practical applications. More attention will be given to operating practice and new topics, such as band planning, are introduced.

Copies of the new syllabus and a set of sample questions can be obtained from the Sales Section, City and Guilds Inst., 76 Portland Place, London W1N 4AA. The cost is £1.50 incl and please quote subject number 765 with your order.

BTI are looking into ways of making the Morse test more cost effective. This could lead to cheaper tests in certain circumstances.

The Morse code test will be put out to tender by the DTI. The RSGB are known to be interested in conducting the test. BTI, though, hope to keep it and are to expand the

present service.

Presently, most morse tests, some 4,000 per year, worth £60,000 to BTI, take place at the different BTI coast stations around the country. These coast stations were to have been de-manned of operating personnel but now BTI have decided to keep a skeleton staff on each site. When the stations are unmanned they will be remotely operated from another coast station, therefore the location will still be available for morse tests.

However, for most amateurs to go to a coast station there can be considerable travelling involved with its costs plus a day off work and the £15 fee this can easily add up to £70.

BTI are looking into making much more use of group testing both at radio rallies and radio clubs. This would mean the test could take place at the weekend or in the evening with the examiner travelling to the venue. Given a minimum of 20 candidates,

the cost per person could come down to around £7-£10.

Mr Godfrey, head of BTI Examinations, would like to hear from rally organisers and club secretaries who would be interested in participating in such a scheme. Group testing is already available at the NEC. BTI also hope to increase the use of volunteer morse examiners: presently they operate only in the Isle of Man and remote parts of Scotland.

With the expected growth in amateurs wishing to take the Morse exam, due to the new practice facility for class 'B's, it would be hoped the new proposed scheme will be much more efficient preventing the long waiting lists which have been common at most coast stations.

The coast station individual test fee would remain at £15.

Mr Stuart Godfrey can be contacted at BTI Examinations, MR25, 43 Bartholomew Close, London E1 7HP. G3ZHI

Repeater News

The Repeater Management Group (RMG) have announced that they are looking at three proposals to cover the area north of London, where there is inadequate VHF repeater coverage. This is particularly poor on the stretch of the M1 near the Luton turn-offs.

Three groups are involved: NW London, Hemel Hempstead, and Luton and the M1; although the RMG is aiming to ensure the best coverage from one repeater.

Following a meeting at the NEC between G4HCL and G3XDV (RMG chairman) the Cambridgeshire Repeater Group have been asked to participate in Britain's first packet radio repeater system. This will consist of one unit in the Cambridge area, linked via 2.3GHz to another unit in the Bedford area, with also a link, via suitable protocol, to GB3PT, at Barkway. It is hoped that the work will be done in close collaboration with the amateurs at Cambridge University. Details will follow later. G4HCL.

The DTI have given the go ahead to the RSGB transmitting the GB3RS news broadcasts on 3 VHF and 3 UHF repeaters for an experimental period of one year. The repeaters to carry the broadcasts are GB3CF (Leicester), GB3SL (South London) and GB3NI (N. Ireland) on 2m and GB3HO (Horsham), GB3SK (Canterbury) and GB3PY (Cambridge) on 70cm. The experiment will begin towards the end of the summer.

Did You Know . . .

● Philips have been asked to supply 115 million Dutch Guilders (£26.5 million approx) worth of colour TV sets to the Peoples Republic of China.

● British Telecom have just ordered more than 14000 miles of optical fibres plus other telecoms equipment from 6 British cable and electronics firms. Called 'Lightlines' these fibres will be used to interconnect local exchanges.

● Marlon Brando (the actor who commands enormous fees to star in films playing the same role) is a radio amateur with shacks in both his Tahiti and Californian homes.

● British Telecom has started a Marineline which provides local inshore weather information of all the UK coastal areas. So anyone living on or near the coast can now ascertain the gale warning (and do something about it) hopefully before it happens.

● A further 11 pirate radio stations have been raided recently. 10 stations in London were closed down and KFM in Stockport was raided for the fifth time since last autumn.

● Apparently, the term 73 came into existence as long ago as 1853 when it meant 'my love to you! However, in 1857 it became officially defined as 'fraternal greetings between operators'. It finally became 'best regards' in 1895.

First Lady Visits Sussex Clubs

Even if you loathe the RSGB, a meeting with this year's President, Joan Heathershawe can be quite a revelation. Although the editor has never met her, even the most cynical of his acquaintance who have, are impressed by her genuine charm and openness. Mike Jones, G6GOS, went down to Sussex to meet Joan.

The members of two Sussex amateur radio clubs had a pleasant surprise when Joan Heathershawe, G4CHH, who, if you didn't know is the first lady to become president of the RSGB, visited them recently. Joan soon set aside any fears of official stand-offishness and put members at their ease with her warm and charming personality — it wasn't long before she was being (affectionately) referred to as "Aunty Joan."

Joan's trip to Sussex began with a visit to the Hastings Electronics and Radio Club, who have their club rooms in part of the Ashdown Community Centre. The centre is located in a valley but HERC overcome the consequent propagation problems by purchasing a surplus 70ft radio tower from HM Coastguard and mounting it on the roof. An odd place to put a tower you might think, but then the roof is strong enough owing to the original intended use of the building (not a community centre!) and HERC always were an ingenious lot anyway. For example, how many clubs do you know whose portable contest station includes a 80ft hydraulic crane as an antenna support, no they are not rich, just well organised.

As the club chairman, Terry, G4FET, explained to Joan, HERC involves itself in a wide range of activities including RAE courses, morse tuition, annual barbecue, contests, monthly lectures, newsletter, exhibitions (designed to attract new members) and two junk sales per year, the latter very successful in swelling the club coffers.

After the formalities were over, Joan joined the



members for their regular "Friday Chat Night", which is about as informal and relaxed as you can get and Joan blended in with the spirit of evening without batting an eyelid.

The following afternoon, the president was invited to open the new club rooms of the **Southdown Amateur Radio Society**. Like Hastings, the rooms form part a large community centre in Hailsham and were initially designed for use as a emergency control centre for various services, including Raynet. It was the club's strong support for Raynet and the service that it offers the community that lead to them being offered the rooms by the Wealden district council — other clubs take note!

Southdown, like HERC is involved in a wide range of radio activities, many of which would not have been possible but for the acquisition of good quality rooms, which can be used most evenings. Both are an excellent example of the way our clubs can and do fit in with the community, to the mutual benefit of all concerned.

Software 'Refresh'

Our bi-monthly look at the latest software releases for radio enthusiasts.

SATPACK: The Satellite Tracking Package for education and the enthusiast, intended for the BBC micro. Two discs have been produced, in co-operation with the University of York. These are being marketed by AMSAT-UK, so as to directly benefit the amateur space programme.

Disc 1: **'Orbital Prediction'** is a suite (a number of related programs) that, apparently, allows the prediction of satellites in circular or elliptical orbits.

Disc 2: **'UOSAT-2 Telemetry'** is a suite that allows the user to decode data from the University of Surrey's amateur satellite, UOSAT-2.

A third disc will allow the user to graph the data from disc 2 and look for correlations.

The SATPACK is being produced to coincide with the launch in September, of a major new, nationally co-ordinated, package of hard-

ware, software, info and texts on 'Satellites in Education' by the MEP and the University of Surrey. Enquiries with an SAE to: Ron Broadbent, G3AAJ, Secretary AMSAT UK, 94 Herongate Road, Wanstead Pk, London NE12 5EQ.

WD Morse tutor: this is intended for the Sinclair Spectrum, QL or the Acorn BBC 'B' and is available both on cassette at £4 or microdrive 5.25" disc for £6.

The tutor claims to be suitable for the absolute beginner and to take the tutee up beyond the speed necessary for the Morse test. Features include adjustable pitch and set speed level from 4-18wpm, after you have learnt the alphabet from the tutor's single character system.

Tutees progress from single characters via groups with wide spacing to 'random sentences'. You write down what you hear, then check on screen or printer (or speech with a Spectrum fitted with Curran microspeech). The above price includes postage

if you live in Europe. Further details of this and other WD Software are available on 0534 81392 or by writing to WD at 'Hilltop', St Mary, Jersey.

BLT Software 'Locator' programs: The first is intended for the BBC 'B' or Electron computers. The SUNLOC/MOONLOC, on cassette for £5(UK), is a suite of two programs for predicting the positions of the sun and moon and are primarily intended for 'moon bounce' working.

Both programs apparently give the azimuth (direction) and elevation of the sun/moon, hour by hour or even minute by minute, plus Greenwich Hour Angle and declination. The moon program also gives the EME 'doppler shift' on a signal, plus an indication of the 'age' of the moon, and the position in it's orbit. BLT claim you can also have great fun demonstrating 'The Land of the Midnight Sun'!

The second program entitled SUPER LOCATE is an advanced locator program in-

tended for HF and VHF enthusiasts and is for the BBC Electron only. The program is actually divided into two parts, which you can apparently 'toggle' between at any time. The first part converts the between any of the following: latitude and longitude, UK national grid, Worked All Britain code, old European 5 figure QTH locator and the GM4ANB 'Maidenhead' locator.

The second part is a VHF/UHF contest scoring program, in which you may enter either 5 or 6 figure locators in any mixture. The display apparently gives the distance in kilometres, the radial-ring score and the outgoing bearing. The program gives automatic page totals after 25 entries for RSGB type logsheets, but this can be altered as required. Full validation is included to reject 'impossible' locators.

Further details on these and the BLT Software range are available from R Sterry, G4BLT at 1 Wavell Garth, Sandal Magna, Wakefield, West Yorks (0924 255515).

The One and Only Verulam Club Contest

In November 1973, the large and very active Verulam Amateur Radio Club ran a contest on 160m phone to celebrate the diamond jubilee of the RSGB. The simplicity of the contest attracted a large number of entrants and was thought so successful that the club decided to make it an annual event. Over the last ten years, the event has grown and grown. During this time, the contest format also underwent a metamorphosis; 2m was included as well as 160m and the rules were changed so as to attract radio clubs and societies into entering.

SECTION 1 1.8MHz

Transmitting Section

| Position | Callsign | Points | | | |
|----------|----------|--------|----|---------|-----|
| 1 | *G2BBC | 1,003 | 9 | *G6UQ/A | 548 |
| 2 | G3UJV | 870 | 10 | *G3WSC | 534 |
| | *G3VER | 849 | 11 | G4SUP | 528 |
| 3 | *G4TLH | 816 | 12 | G3NOM | 520 |
| 4 | *G3ASR | 752 | 13 | G4IUZ | 486 |
| 5 | *G3RR | 683 | 14 | G3TBR | 471 |
| 6 | G4OGB | 562 | 15 | G3KAU | 436 |
| 7 | G4MET | 558 | 16 | G4RLF | 339 |
| 8 | *GW4CC | 549 | 17 | *G2OA/A | 279 |

Receiving Section

1 N. Henbrey RS28198 710 2 J. Goodrick RS44395 500

Check logs received with thanks from *G3IIU/A, G2PA, G4XJS.

Last year's contest was run in two sections on consecutive weeks; the first on 160m and the second on 2m. Each section lasted a fun packed four hours, from 2000-0000GMT. 3 pts was scored per contact, with a bonus of 5 pts for the first member worked or heard from each club. A bonus of 25pts was given for each club station proper (ie Hastings ERC station, G6HH) and 50 pts for working G3VER. This year, HRT have decided to combine forces with Verulam and stage a joint contest, along similar lines, with them. Watch this space for details of this year's wacky event! Meanwhile, here are last years results... Well over a hundred stations were active, but the logs received were much lower in number. Perhaps we can find some suitable inducement for contestants this year...

SECTION 2 144MHz

| Position | Callsign | Points | | | |
|----------|----------|--------|----|----------|-----|
| 1 | G3UFB/A | 1,162 | 11 | GW4EZW/P | 566 |
| 2 | *G8HRC/P | 942 | 12 | G4WSL | 486 |
| 3 | G4RLF/P | 879 | 13 | G4NRJ | 429 |
| 4 | *G4MHC | 862 | 14 | *G2OA/A | 420 |
| | *G3VER | 837 | 15 | G4PUR | 408 |
| 5 | G6CSY/P | 740 | 16 | G2PA | 398 |
| 6 | *G4CRA/A | 731 | 17 | G6BYP | 392 |
| 7 | *G8LWU | 661 | 18 | G4GOU | 339 |
| 8 | G3ZVW | 642 | 19 | *G3ERD | 316 |
| 9 | G6XGI | 628 | 20 | G4IDF | 159 |
| 10 | *G4HRC/A | 593 | 21 | G6BQJ | 156 |

Receiving Station

1 N. Henbrey RS28198 363

Check logs received with thanks from *G3IIU/A, G6OHS. * Denotes club station.

News in Brief

● The DTI have recently replied to the RSGB on the subject of broadcast 'intruders' in the 7MHz amateur band.

...the present state of affairs in HF broadcasting can best be described as semi-regulated anarchy, successive attempts to plan...over the years having failed. It would be tempting providence to express confidence that the latest attempt, the 1984-7 conference, will succeed where the others failed but...there are some grounds for optimism.

"If a satisfactory regulatory regime can be achieved it should reduce the need, which many administrations currently perceive, to broadcast out-of-band at HF. Thus there may be some grounds for optimism in the longer term; in the short term (we) doubt whether anything effective can be done."

Arrow Electronics in Scotland

Arrow's Glasgow shop is under the management of Bill McLimpsey, who has recently acquired the coveted callsign GOARO, after several years as G6. Bill's experience is far longer than his few years licensed would indicate.

A stocky, genial, engineer, Bill has been involved in electronics all his working life. His interest in electronics started at 13 and carried on into his national service in the Army at the end of which he ended up as an instructor in radar and small arms. After his national service, Bill entered the radio and TV trade becoming a service engineer and ending up as a service manager of one of the largest R and TV companies in Glasgow.

Bill's interested in amateur radio was revived with the emergence of CB and he quickly became one of the



best known specialist service engineers in Glasgow, eventually taking on service for nearly all the CB outlets in the Glasgow area, with hundreds of sets handled weekly.

In 1980, needing more space, better parking etc, and realising that many of his customers were becoming licensed amateurs Bill joined Arrow's Peter Clarke in a joint marketing operation at 51 Hyndland Street. The Hyndland Street shop is very well situated, being only a short distance from the Clyde Tunnel with it's adjoining motorway links and is located in an area where a great deal of urban renewal has taken

place. (Hyndland Street boasts some excellent restaurants!) Yaesu Musen equipment is Bill's main line with Icom as close second. For some strange reason, Icom has not yet found a following in Scotland, but Bill is helping many amateurs to discover it's technical excellence.

An unusual and endearing feature of Bill's operation is each Monday night the shop is cleared for action and Bill and Jim take the floor for RAE classes. Their pass rate is quite phenomenal: of the last class of 19 they achieved 17 passes, with several distinctions.

Lightweight Mobile Headset

Some time ago, HRT's Dave Gadsden crossed paths with an executive of a company who sold headsets and boom microphones, primarily to industry. On finding that he was speaking to a Ham Radio enthusiast, he pushed a brochure into Dave's hands, saying that his firm sold a number of their cheapest headset/microphones to radio amateurs. The specifications seemed quite attractive and are reproduced here.

The 'ultra lightweight

headset DMH 120' has a weight of 75g, a microphone impedance of 500 ohms (the mic. is bi-directional 'dynamic' type with a frequency response of 200-5,000Hz) headphone impedance of 32 ohms each and the connectors are standard 6.3mm jacks, 2 pole for the mic, 3 pole for the (stereo) headphones.

The headset currently retails at £18.95 plus VAT and details of the availability and details of the manufacturers, 'Technical Products' on 0983 291553.

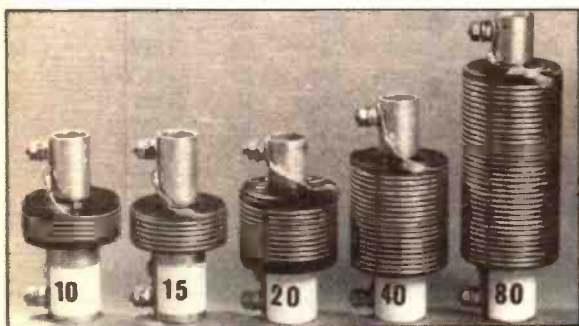

New from the G2DYM stable, makers of the 'anti-TVI' trap dipoles, are a full range of LC type aerial traps for 10, 15, 20, 40 and 80m. These are available in pairs for trap dipoles or separately for unipoles. The capacitor part of the trap is obtained by accurately setting the central aluminium

tubes concentrically in epoxy resin and the formers later cast and machine threaded to take 1.5m lacquered copper wire. The 10, 15 and 20m traps retail at £9 each, the 40m at £10 and the 80m at £12.50. Further details from G2DYM at 'Uplowman', Tiverton, Devon, EX16 7PH.

The Sad Story of TAU Systems

Astute readers may have noticed the disappearance of advertisements for the fabulous but somewhat expensive ATUs marketed by Tau Systems. Word on the grapevine that the designer Tony Johnston, G40GP, had resigned from the company, was followed a couple of months later by news that Tau had gone bust. Sensing a story full of drama and intrigue, the editor decided to get to work. As he was reaching for the phone, Tony Johnson called the office...

According to Tony, he left Tau because of 'personal and financial differences' (as they say in the trade). A very disgruntled G40GP then decided to beat Tau at their

own game and set up manufacturing ATUs on his own; as soon as he could get together the production facilities. Meanwhile, Tau continued to sell ATUs but went slowly bankrupt. A meeting of the creditors was apparently recently called by Tom Williams, Tau's MD.

Tony has formed a company under the banner of ATUs UK and is currently marketing the basic 'SPC 3000' module at £99 — around 2/3 of the original Tau kit price — and a new miniaturised version, the SPC 3000 measuring 9"x3"x9" and capable of handling 300W, for £70. Work is presently being carried out on an automatic version.

Cirkit Catalogue Now Available

The Spring '85 catalogue for the electronics hobbyist is now out on the newsagent's shelves, priced £1.15. It lists over 4000 different components and includes a wide range of products new to Cirkit, such as BBC 'B's, computer add-ons, calculators, tools, modules and kits. The kits include a heart rate monitor and a VHF weather satellite receiver.



★ Awards ★

★ Worked All Britain Scheme

This reasonably well known award is based on the OS maps of Great Britain and N Ireland and is available to SWLs and amateurs. Four contests are scheduled throughout the year, the remaining ones being on the 23rd June a VHF/UHF QRO and QRP and on the 3rd November, the LFCW contest on 40, 80 and 160m.

The classes of entry are a) single/multi-operator b) single/multi-band c) mobile d) SWL. Contest exchanges should consist of signal report, serial number and the WAB area based on the National Grid Ref.

Further details can be

obtained from Steve Lawrence, 7 Ashfield Road, Market Harborough, Leic, enclosing a large SAE.

★ Ipswich RC Golden Jubilee

Throughout 1985, the Ipswich club are celebrating their 50th anniversary. Part of these celebrations is the presentation of a special award certificate for contacts amounting to 50 points made during the year. The points are awarded thus: G station — 1pt, Suffolk based — 2pts, Ipswich RC member — 3pts and club station calls G4IRC, G1IRC and GB2IRC — 5pts. These contacts can be made on any band using any mode.

Applications should be made to Alan Owen, 102 Constable Rd, Ipswich and should

include a list of contacts confirmed by a club official or rep of your national body and 6 IRCs.

★ Surrey Police RS 'All Surrey Award'

With four classes requiring between 20 and 50 contacts with base stations in Surrey, this is similar to the WAB but instead of areas, certain towns are needed. Extra points are awarded for special event call signs GB4SPF, GB8SPF and G4SPF. There are no conditions on the bands or modes used. A certified checklist is all that is required and the award costs 50p.

Richard Hook (G6LVB) is the award manager, Operations Room, Surrey Police HQ, Mount Browne, Sandy Lane, Guildford.

★ Stourbridge DARS 'STARS'

A slightly different award again, this one requires the amateur or SWL to work at least 9 members of Stourbridge DARS and be able to make the word STARS by taking 1 letter from the suffix of 5 contact's call signs. A further 2 contacts must be made with the club stations G6OI and/or G6SRS. There are various conditions as to the bands, details of which can be obtained H1on with the club stations G6OI and/or G6SRS. There are various conditions as to the bands, details of which can be obtained along with a list of society members from the award manager John Sheils, 6 Ombersley Rd, Halesowen.

Western Electronics

(UK) Ltd

OPENING HOURS:
mon-fri 09.00-17.00
sat 09.00-12.00

2 METRE AERIALS

LR1/2M Collinear beam antenna 12.20
CS/2M Collinear 54.02
LW9/2M 2 ele. Windy dipole type 19.55
LW10/2M 10 ele. Windy dipole type 28.30
PBM14/2M 14 ele. Windy dipole 68.95
Plus a very wide range of beam antennas, 6 element, 7 element, 8 element, etc.
Prices Your Fair Dealer

ICOM carriage paid

IC-751 HF Transceiver Multimode All Band 1175.00
IC-746 HF Transceiver Multimode All Band 850.00
IC-730 HF Transceiver 10-80 metres 625.00
IC-271 2m Multimode Base Station 660.00
IC-04E 2m Handheld Keyboard entry 245.00
IC-04E 70cm Handheld Keyboard entry 255.00
IC-120 1296MHz FM Mobile 1 watt 470.00

KENWOOD

TS-930S HF Transceiver carriage paid 1280.00
TS-930S+ATU HF Transceiver with Automatic ATU 1440.00
TS-530S HF Transceiver 699.00
TS-430S HF Transceiver 739.00
TR-2500 2m Handheld 250.00
TR-9400 70cm Transceiver
TR-9130 2m All Mode 25w Transceiver

YAESU

FT-757GX HF All Mode Transceiver carriage paid £ 749.00
AC PSU 170.00
Automatic ATU 275.00
Heavy Duty PSU 190.00
SPECIAL PACKAGE PRICE FT/PP/PC-757GX 1199.00
New Communications Receiver 529.00
2m Computerised Handheld 230.00
VHF/UHF Multiband Multimode 660.00
2m Multimode Portable 229.00

REMEMBER!

If the equipment you want is not shown here, give us a ring for our free catalogue and unbeatable prices.

THE ONE STOP HAM SHOP - INSTANT CREDIT

GREAT DEALS START
AT WESTERN

At Least
5% OFF MRP
ON MOST ITEMS

WESTERN MASTS AND TOWERS

ALUMAST carriage paid
2x 4 Aluminium Mast comprising 2 x 10' sections weighing only 11kg per section 319.70
10 ft additional sections up to 250 ft max. 105.95

NEW LOW PRICES on the originals!

SUPER ULTIMAST (carriage paid)
UM-1 two section, 31 ft Tilt over, Modular Mast Telephone Mast 240.00

WESTOWER

Telescopic Masts from 25 ft to over 100 ft
Prices start from 24.00

ROTATORS

105TSX Emoto rotator (360° circle dial) carriage paid 149.90
105FSX Preset Controller Unit for 105TSX 49.45
502SAX Emoto rotator (360° circle dial) 208.85
1102MXX Emoto rotator 297.85
1103MXX Emoto rotator 303.60
1102MSAX Emoto rotator circle dial 418.60
1103MSAX Emoto rotator (heavy duty) circle dial 424.35
WE-1145 Rotator for V/UHF antennas 39.95

WESTERN ANTENNAS

DX-7/2 7MHz, 2 Ele., Yagi, Gamma Matched, 20' Boom £ 264.50
DX-7/3 7MHz, 3 Ele., Yagi, Gamma Matched, 40' Boom 389.85
DX-51 Rotary Dipole for 20, 21, 18 and 14MHz 100.05
DX-6V 10-80m Multi-band Vertical plus 30m 109.25
DX-31 Dipole 10/15/20m, 2Kw, p.e.p. 89.70
DX-32 2 element 10/15/20m, 2Kw, p.e.p. 138.00
DX-33 3 element 10/15/20m, 2Kw, p.e.p. 201.25
DX-34 4 element 10/15/20m, 2Kw, p.e.p. 282.90
DX-31/32 Conversion Kit 55.20
DX-32/33 Conversion Kit 67.85
DX-33/34 Conversion Kit 86.25
DX-103 3 element 10m Yagi 97.75
DX-4K Converts DX-31/2/3/4 to 40m Dipole 121.90
DX-27/1 Rotary Dipole for 27MHz C.B. 73.60
DX-27/3 3 element Beam for 27MHz, Gamma Matched 14.95
DX-240 2 element Quad 2, 10, 15 and 20m 46.00
DX-260 2 element Quad 2, 10, 15, 16 and 20m 200.00
SPECIAL OFFER to clear TWO ONLY — ASAHI 10 & 15M 3 element beams. Phone JOHN for the ridiculously LOW PRICES.

Photograph by PAUL BUCKNALL

NOW OPEN SATURDAYS

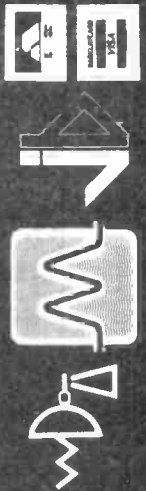

Agents:
NORTHERN IRELAND
Tom & Norma Greer
G14TGR - G14TBP
Drumbo (023126) 645

Western Electronics (UK) Ltd

FAIRFIELD ESTATE, LOUTH, LINCOLNSHIRE LN11 0JH, ENGLAND
Telephone Louth (0507) 604955 Telex 56121 West G

CORRESPONDENCE COURSES—

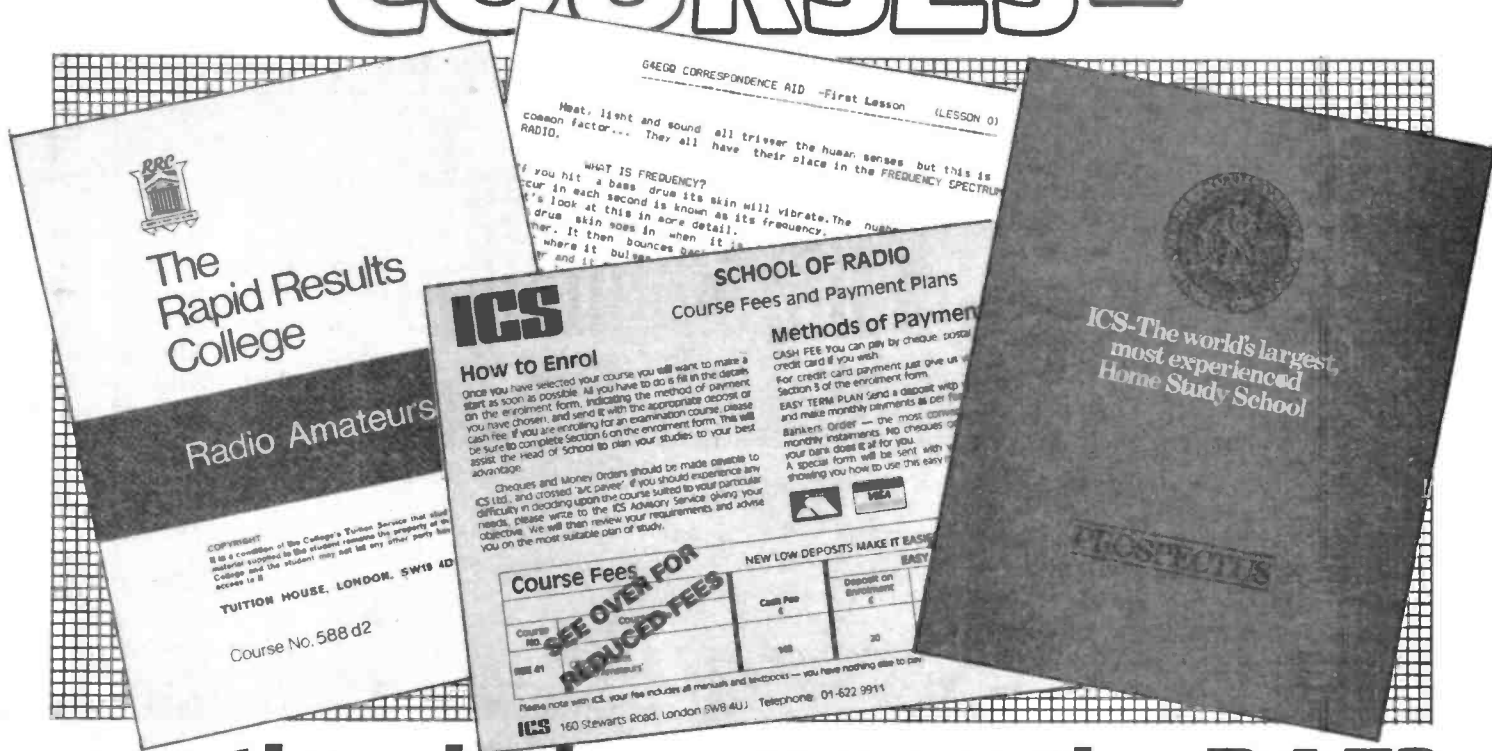

can they help you pass the RAE?

If you are thinking of trying for the RAE but can't get to evening classes because of shift work or transport problems etc, you may have thought of taking a correspondence course. Indeed a

contacted many of those correspondence colleges who advertise regularly in the radio magazines. Several of those to whom he wrote never replied and when they were later contacted by telephone, still

ICS, The Rapid Results College RRC, the British National Radio and Electronics School and Pete Pennington, G4EGQ. Under the circumstances, these four seem to be the only ones worth sending your hard earned savings to!

Not everyone is lucky enough to have a class for the Radio Amateurs' Examination at the local Tech' or radio club. Even if these are available, attendance may not be possible due to domestic or work commitments. Unless you are prepared to go it alone with the RSGB's RAE manual or have a friendly local amateur with time on their hands, the answer is... a correspondence course. Sharon Metcalfe, BSc, a teacher and G6LCC, has been trying some out.

quick scan of the advertisement section at the back of any radio or electronics magazine will probably reveal a number of courses. The problem is, that unless you know of one by personal recommendation, how do you choose a good course?

On my behalf, the editor of HRT

never sent information. (Perhaps they don't want your custom? At best, they certainly don't seem reliable!) Consequently, I received impressive packets of general information and selected extracts of the actual course notes from International Correspondence Schools

In all cases, there was an introductory leaflet describing how the course tutors could be sent 'mock' questions for marking and queries on the various subjects covered by the course, for further explanation. On this latter point G4EGQ's course has the edge, in that he and his team of radio amateurs offer actual tutorials each week for those students able to travel to the Dover YMCA through whose auspices the course originated). This personal contact must be the next best thing to (a) friendly local amateur(s). (The sad thing is that if you had access to this kind of help, you probably wouldn't need a correspondence course in the first place! Such is life...)

To make a comparison of different courses, I specially requested the course organisers to send me the actual lessons on semiconductor theory and radio receivers. The first of these I wanted to consider in light of the level at which the electronics was pitched (ie did you need an A-level in Maths to understand their notes?) and to see how well the lessons followed the present RAE syllabus, with transistors and integrated circuits replacing valves. I asked for the lessons on radio receivers in order to check how well the course was *actually suited to the RAE*, as opposed to it being primarily designed for general electronics and covering 'domestic' receiver theory.

So, what do you actually get for your money? The ICS course was the first I looked at. The general introductory booklet extolls the virtues of being able to study at your own pace and states that a number of tests, marked by your tutor, are an integral part of the course. 'Information Forms' on which you may write for further help on difficult points are also supplied by ICS, and in my opinion are likely to be needed with some regularity.

Professional Design

The course notes for the two chosen topics were to be found in two staple-bound A4 books and the text and diagrams were professionally laid out. However, here all similarity between the two books, apparently part of the same course, must stop. The 'Radio Receiver' book is extremely readable, the sections follow through in a logical manner and the text is set with key words in a margin, with the rest of the text indented. There are clear spaces between sections and the text is interspersed with explanatory diagrams.

However, the book on Transistors and Semiconductor Diodes is a rather different kettle of fish. It is unfortunately made up of page after page of textbook-style notes, with all the diagrams in the middle of the book. The idea is that this middle section is detachable for easier reference. However, since the diagrams are numbered, rather than titled, and you therefore have

to keep the number of the diagram in your head whilst looking for it, this is unfortunately rather counter productive. Since these two books (out of fifteen) are apparently written by different specialist authors, as they vary so widely in styles, one is tempted to wonder whether all the different sections are written by different authors. If you like the style of some parts of the course, you may find yourself disliking the presentation of others. The problem is that a situation of this kind may have an effect on the number of times you are prepared to read certain sections and thus affect your studying.

Looking firstly at the Radio Receivers book in detail, I can foresee problems from the ninth page, where the equation of a sinusoid is quoted. Since this introduces maths well above that required for the RAE (close to A-level Pure Maths, I'd say) this is most off-putting. There is an appendix to help clarify some of the maths, but my point is that maths of this level has no place in the RAE syllabus and therefore should not have to be mentioned in a course apparently designed specifically for the RAE.

Another problem was that the designs of radio receivers talked about most were those for the domestic broadcasting bands. Fortunately, this book does have most of the emphasis on transistorised circuitry rather than valved, but there is a curious mixture of NPN and PNP circuitry, without any distinction being made apparent. This book is not one to dip into for specific information on a topic, for

unless you are extremely well up on electronics you will get lost unless you start at the beginning and work through.

The book on Transistors and Semiconductor Diodes is unfortunately no better. There is a section dealing with the mobility of electrons and holes in semiconductors which I would estimate to be written at a standard of at least 'A' level.

Beyond the RAE

As a general comment I would have to describe these lessons apparently having been developed as part of a good electronics course, useful to someone who has passed the RAE and wants to learn more. Much of the work would aid students of A-level electronics courses but is well beyond the RAE requirements and could serve to confuse candidates, rather than clarify and expand the RAE manual.

My final point is with regard to the questions set in the text as in a 'self-test'. There were only seven and five set in the whole of the two books respectively. These questions entailed writing notes on various difficult topics, including covalent bonds, Fermi levels, barrier potentials and 'negative resistance' *all outside the RAE syllabus*. What about multiple choice questions on aspects of the topics covered in the RAE?!

As a final comment, in all fairness, the general outline of the course states "The ICS course gives you all the theory needed to enjoy this fascinating hobby to the

Courses examined

International Correspondence School.
160 Stewarts Road.
LONDON SW8 4UJ

01-622-9911

Rapid Results College.
Tuition House.
LONDON SW19 4DS

01-946-1102 (24hr)

British National Radio and Electronics School.
PO Box 7.
TEIGNMOUTH
Devon TQ14 0HS

062-687-2598 (24hr)

Pete Pennington, G4EGQ.
146 Elms Vale Road.
DOVER
Kent

SAE with all enquiries, please.

full, and certain subjects are covered in even greater detail than the exam requires."

The **Rapid Results College** produce four neatly bound paperback books to cover the RAE course. They all appear to be of the same format, with clear diagrams interspersed into the text at appropriate points. The text is not over technical and there are revision questions at the end of each section. However, it is on the *type* of questions provided that I have the most complaint. I can accept that essay-style answers enable a tutor to identify a student's problems, but surely there could be more than just a few multiple choice questions added in for practice. Even the final revision papers are for the old style of RAE exam (three hours in which to answer two compulsory and six out of eight other questions, answering in full with diagrams as necessary). Surely it takes practice of the right type of questions to aid examination preparation?!

Missing pieces

The **Rapid Results College** course appeared to have half of the syllabus on radio receivers missing, unless I was not sent the full section. The receiver circuitry described used valves throughout, and this part of the course starts by jumping confusingly in with both modulators(!) and de-modulators grouped together so you couldn't easily use this section to supplement the RAE Manual. Indeed the book details the 'anode bend' detector and the 'leaky grid' detector at length, showing just how out of date the course is when compared to the current RAE syllabus. There appears to be four short lines on FM, with no mention of how this is detected in a receiver. Semiconductor receiver circuitry and FM detection *could* be included in another course booklet, in which case I must apologise, although then I would have to question the order in which the course is presented. Nothing was supplied on general receiver principles eg multiplier stages, mixers and superhet principles.

The semiconductor book fares little better, for although lecture 8 on Thermionic Valves admits that it is not needed for the actual RAE,



most subsequent lectures tend to refer back to valves. Another irritation is that resistivity is measured in Ohm-cm in the course, whereas the Standard International Units used in the RAE use Ohm-m and this could cause confusion in calculations.

Misunderstanding could arise over the statement on semiconductors that "Silicon and germanium are tetravalent, that is they contain four electrons." This needs the addition of the phrase 'in the outer shell' to be technically correct. Admittedly this fact is not specifically required for the RAE but even if it is included as an 'extra', it should surely be right so as not to contradict any other reading around the subject. The working of the PN junction is also not explained clearly.

Easy Reading?

The course was shown to a seventeen year old, studying for three science A-levels, who had passed the December 1984 RAE. His rather blunt comment regrettably sums up my darker feelings about the course: "With the constant use of outdated technology and misleading essay-style questions, I think it is unsuitable (for prospective RAE candidates) and archaic." Oh dear!

The **British National Radio and Electronics School** course is presented in twenty lessons each in an A4 bound booklet. The ones I received were nice to look at, with clear diagrams but, on a closer inspection, I found the style of writing rather dry and textbook-like, while some of the circuit diagrams had too little explanation for 'easy reading'. An extreme and

unfortunate example of this was found the **Radio Receiver** booklet where, following a block diagram of a superhet receiver two typical circuits for frequency conversion are captioned with "Two illustrative examples are given in Fig. 16.4 which, it is thought, are self explanatory." I felt that this would not be true for a less informed student.

The 'Radio Receiver' book was unfortunately written in the reverse order to the one I prefer, with the terms and practicalities stated first and the theory and explanations coming later. This could be rather offputting for someone who may have never heard of half the terms and is suddenly confronted with two pages of them.

For example on semiconductors, I was sent two booklets one entitled "Basic Electronics lesson 11" and other "Amateur Radio lesson 12". I was assured that the RAE course was one designed specifically as such, so perhaps the inclusion of the former was a mistake. Actually, looking at lesson 11, I would have to say that this is one of the most up to date courses I have seen and included FET and MOSFET theory in some detail. That being said, unless you have brushed up on your algebra, you could find the maths a little daunting. It is nice to see six pages of simple application circuits eg sawtooth generator, relay driver (using a transistor as a switch) and power supply stabiliser circuit, although I would have to suggest that, except for the stabiliser, they are not the most useful ones for a radio amateur. They are not really essential for the RAE itself, although a spokesman for BNR&ES said that all their courses were designed to

go beyond the level of exams for which they are intended. While this is admirable, and indeed they can claim to have never had a candidate fail the RAE, it could again provide unnecessary difficulties for the less academically minded student.

Lesson 12 appeared to contain much the same work as lesson 11, but with a different presentation, a little reminiscent of the RSGB Communications Handbook. The only additional material to the RAE syllabus is the biasing of transistors and load lines, the latter of which is in considerable detail and would only be understood by students of A level Electronics in my opinion.

Scruffy, But. . .

In comparison with the other courses, the course by **Pete Pennington, G4EGQ**, looks scruffy but when you consider the actual content (and wait till you hear the price) I don't think that you'll mind. This course is *not* designed as a self contained course, as are the others which I have considered so far, but to be used as a supplement to the RAE Manual, for those who can't attend or who have not got regular classes at their local Tech'. The notes are produced in 'sets' of A4 pages stapled at one corner, each set covering a different topic, with references back to the same chapter heading in the Manual. In fact, to keep the cost of the course down, each set is to be returned with the questions for marking at the end of each set. This shouldn't be a problem, for you are encouraged to make your own notes before returning the printed ones. Indeed, writing your own notes is one of the things I advocate as an aid to memorising facts.

The notes appear very much Pete Pennington's own teaching notes, as if he were perhaps missing an evening class, and have extra notes scribbled in alongside the other text and hand-drawn diagrams, a few of which are unfortunately a little blurred.

One big bonus that this has over other courses, *if you live within travelling distance of Dover*, is weekly tutorials are given by Pete and his team of helpers at the Dover YMCA.

This to one side, the major bonus of the course is that the

notes are written in a pleasantly readable and casual style. The course keeps the maths simple and is up to date, probably because it is easier to substitute a new section in these notes than in a professionally produced bound book. Indeed Pete makes a special point of keeping up to date, especially with regard to the licensing conditions. On the subject of assessment, although there are a few essay-style questions included for the tutor's benefit in identifying

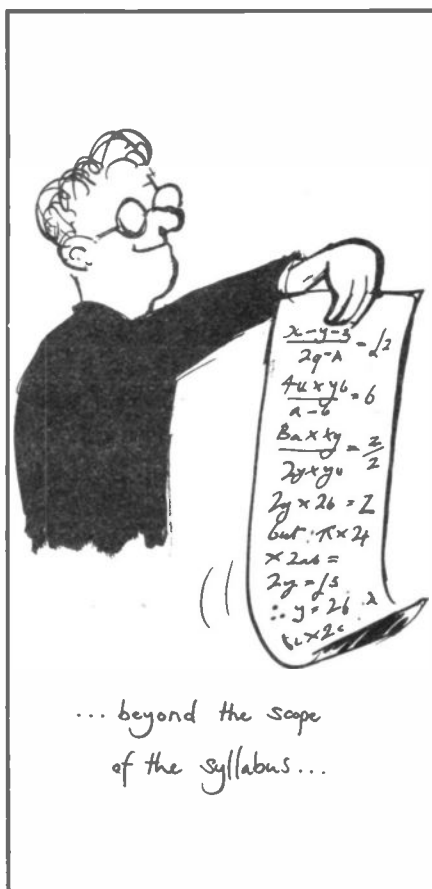

understanding/mathematical problems, the majority of the questions are multiple choice. Since all the material in the notes appears to be extremely relevant to the actual exam and factually correct, there is really nothing else to say here.

Drawing Parallels

So it is time to draw a few, albeit limited, comparisons. The main one must surely be the cost, after all, once you pass the RAE you will still want enough money in the bank to buy or build your first rig! The longest course (ICS) is the dearest at £148. They also do a monthly instalment plan, which works out about £30 dearer

overall. This seems pricey if you just want to pass the RAE, but remember that this course contains much work of a higher standard which may be of use in your job, for example. That being said, this high level of work may put off an 'average' RAE candidate.

The RRC course costs less than the ICS at £65, is of about the right standard but relies too heavily on outdated valves in my opinion and doesn't seem from the information submitted to cover all topics of the RAE syllabus. The BNR and ES course is also priced at £65 and although some parts might be hard going, the course does have the advantage of being up to date. On the plus side, the BNR and ES spokesman said that in addition to the multiple choice self-test questions which come every three or four lessons, the course tutors supplied actual City and Guilds past papers. Once the RAE had been passed, this college also can supply a Morse course on cassette but it will cost you an extra £30 for the privilege.

G4EGQ's course, although not self contained and rather crudely presented must come as the 'bargain' of the bunch. You will have to enrol with the annual membership of the YMCA Radio Club at £6 (less if you are under 21) plus £3 for the enrollment to the postal RAE course, plus sending three 2nd class postage stamps for each of the 16 lessons and your own postage back at £10.40 (spread throughout the course), making a grand total of £19.40 for the actual course. To study in this way, you will also need to buy an RAE Manual at £3.42 (though you may be able to borrow one). This is a course by which you can gain valuable help aimed entirely at the RAE.

In conclusion, I would have to say that if you simply want to help in passing the RAE and have relatively little money, you probably can't beat G4EGQ's course. Since the whole system is run by volunteers who just want to help others to get started, I feel that this follows the whole spirit of amateur radio.

Which ever method you choose to study for your RAE, correspondence or any other, let me conclude by wishing you good luck!

A 2m to 70cm TRANSVERTER using the Cirkit VHF-UHF converter

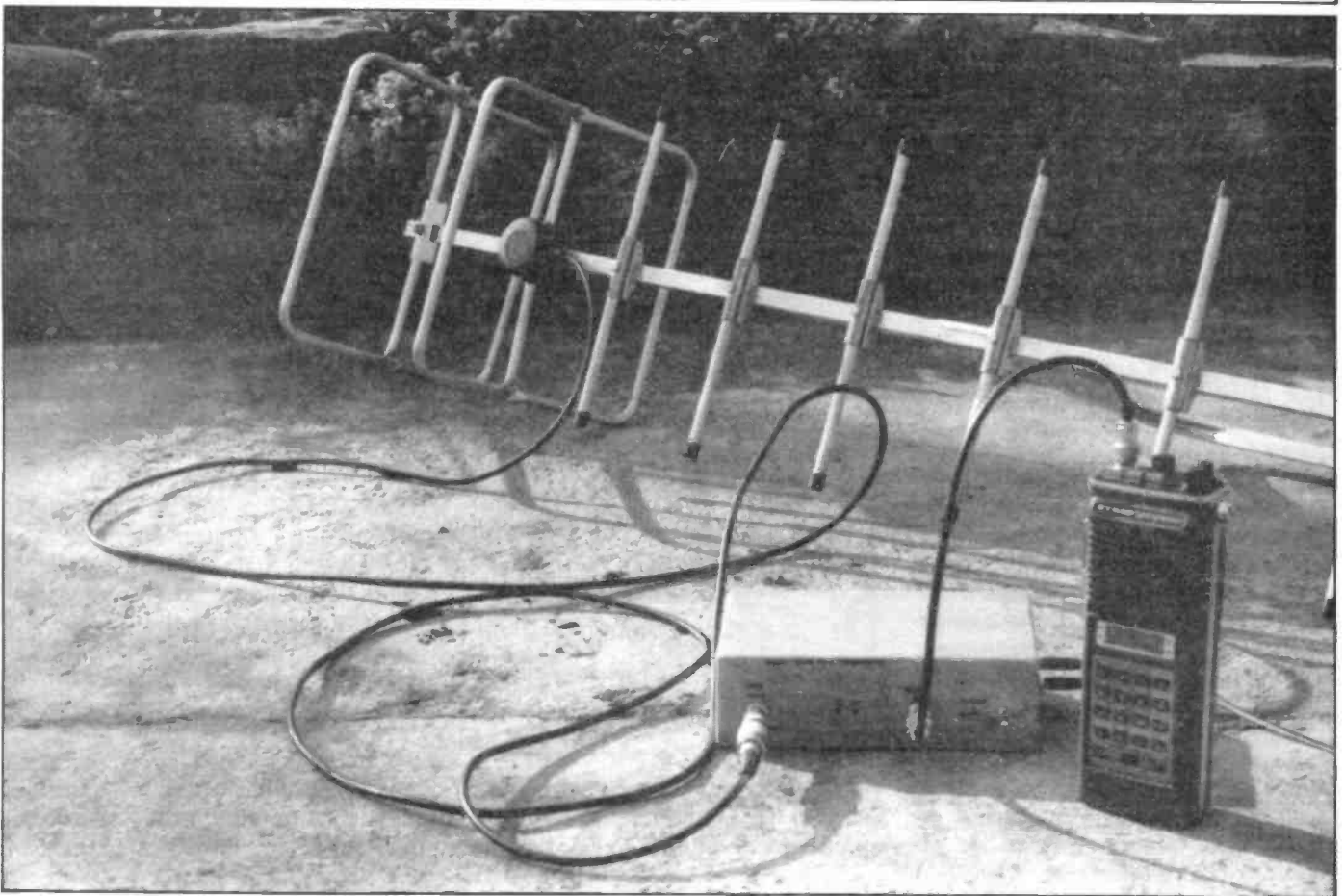

Several months ago, after just over a year on 2m, I decided that I would like to experiment with another band. Being a G1 with no aspirations HF-wise at present, there was

available could be split into two very distinctly different categories; either very expensive synthesised FM rigs or crystalised, 'Pocketfone' type portables. As far as I was con-

I finally decided that I would have to be content to just listen on 'seventy' whilst saving up for that synthesised rig, and the Cirkit UHF to VHF receive converter kit for

Do you remember the constructional project in March '85 from Cirkit for a VHF-UHF converter? Well, Russell Davies, BSc, GW1CDH, has adapted this as a basis for a 2m to 70cm transverter...

of course only one thing to do — move up in frequency to UHF.

This initially presented a problem of choice, because it seemed to me that the 70cm equipment

cerned, the former was definitely not possible for financial reasons and I felt that the latter could hardly give me, a newcomer, any real idea of what the band was like.

around £25 seemed to be just the job for this purpose. This excellent kit appeared as a project in the March, 1985 issue of HRT and if the detailed instructions are follow-

ed, then construction and alignment should present no problem whatsoever.

As far as I was concerned, the most interesting part of the converter was the stable, spurious-free oscillator. Running at 288MHz, not only is it suitable for mixing with 433MHz to give 145MHz as the tuneable IF (ie receiver frequency), but it will also work the other way around and mix with a 145MHz signal to give a 433MHz output. Therefore, it is quite easy to see that the converter can become a transverter by applying, on transmit, 145MHz drive (at the correct level) to the mixer.

The mixer used in the converter is a Mini-Circuits SBL-1, which is bi-directional and could be used in the above fashion. However, I found it more convenient to use two separate mixers for receive and transmit and switch the local oscillator from one to the other. This arrangement means that only a minimum of alterations to the actual converter board are necessary.

Fig. 1 shows a simplified block diagram of the transverter. On receive, the 70cm aerial is connected to the converter, which amplifies any incoming signals and mixes them down to 2m, the LO being applied to the receive mixer as shown. On transmit all the relays are switched over, applying RF to the attenuator and transmit mixer. The SBL-1 requires no more than 5mW of drive and may be damaged by excess power, so choosing the correct attenuator resistor values for a particular input power is important. Table 1 gives the formula needed for this calculation but note that these only apply when both the input and output impedances are 50 ohms.

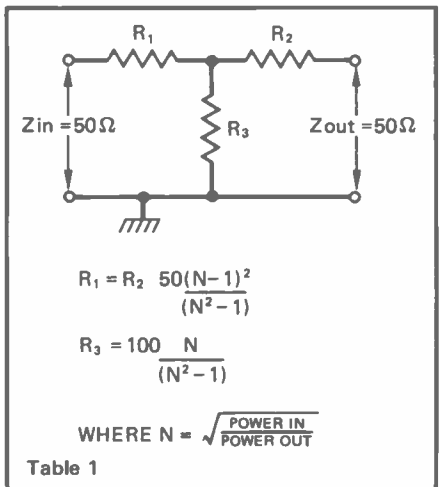

The desired output from the mixer is selected by a tuned amplifier, which drives a filter and further stages of power amplification. It is necessary to ground the receiver input and output on transmit, as shown, to prevent RF from the PA from destroying the pre-amp and mixer.

converter board, cut the wide track between the tap on L8 and pin 8 of the mixer and also cut the +12V track close to C22 to remove the power supply to the pre-amp section.

Automatic receive/transmit switching is provided by the RF sense and relay control section of

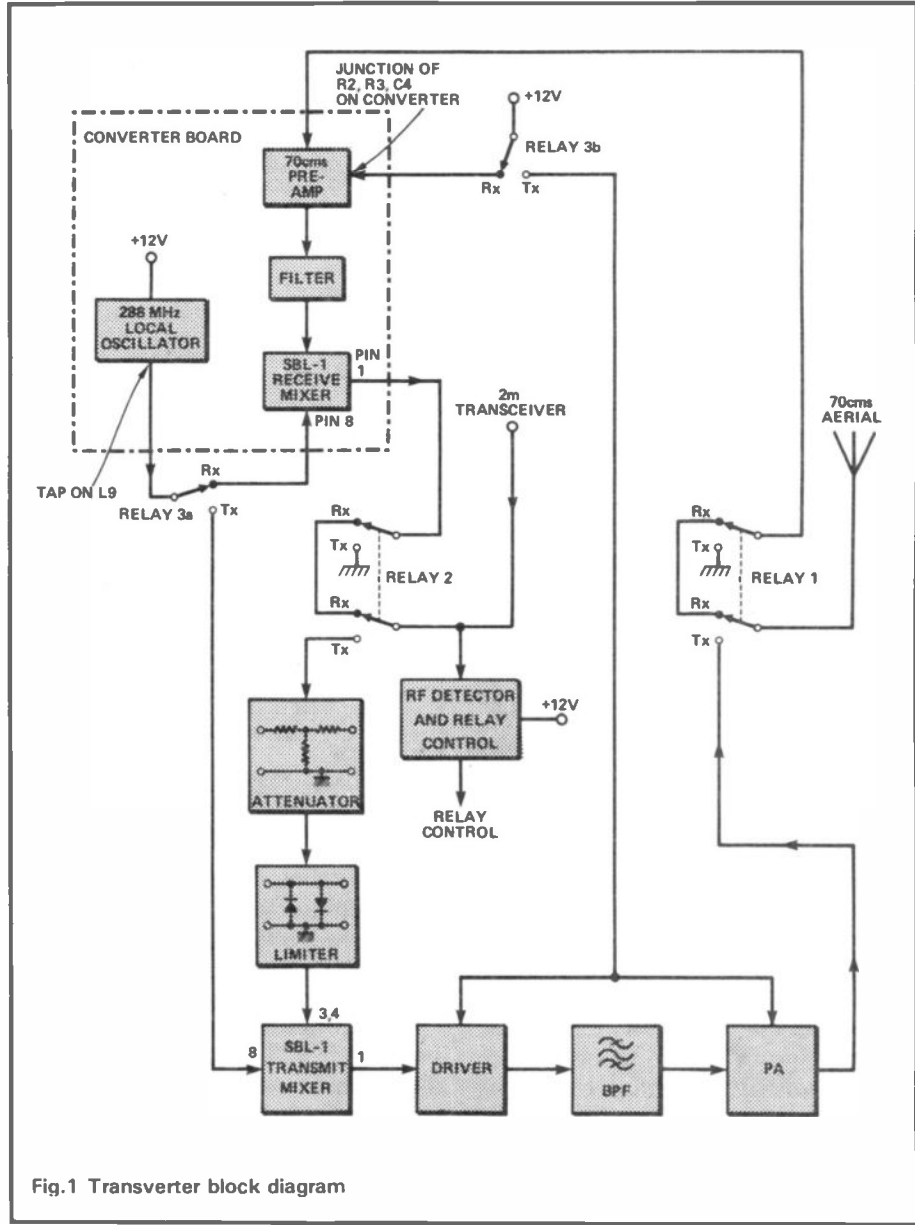

Fig.1 Transverter block diagram

In addition to this, local oscillator and power supply switching between receiver and transmitter must be arranged and all this can be accommodated with 3 DPDT relays. (Each of the changeover relays were mounted on small separate PCBs, drilled and etched to suit the particular relays chosen or to hand. Kam Ling OUB type subminiature relays from Cirket (stock no. 46-70050) were used in the prototype.) To isolate the oscillator on the

the circuit of Fig. 2. This is of fairly standard design and will allow switching of external amplifiers for a higher power output, if required.

PA Kit for FM

Since my capabilities do not extend to the design of medium power UHF output stages, I decided to rely on the superior experience of Wood and Douglas to come up with the goods. For FM use, W & D can supply a 50mW to

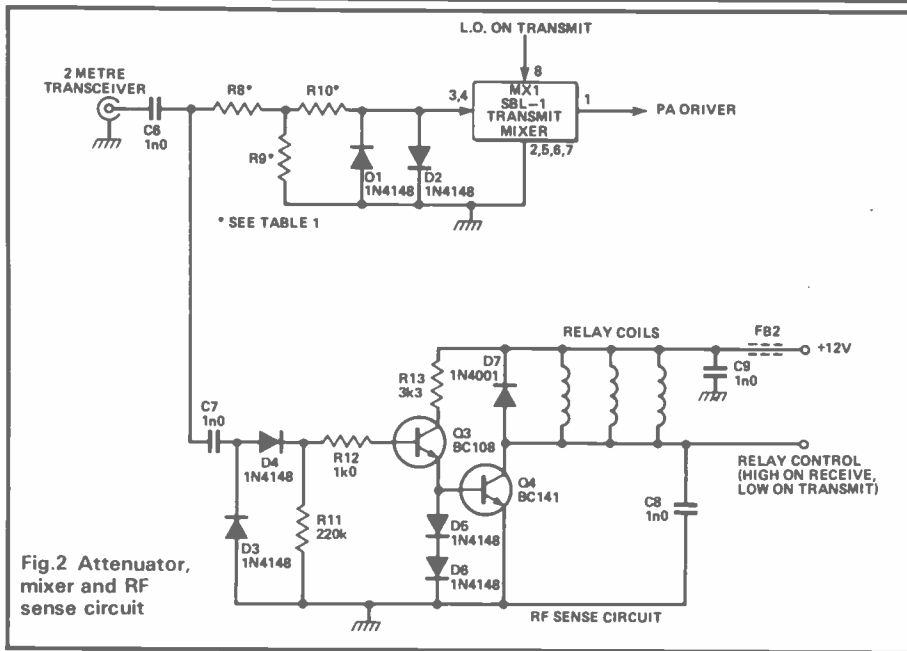

Fig.2 Attenuator, mixer and RF sense circuit

harmonic of the 2m input is not picked up and amplified by the output stages – resulting in simultaneous transmission on two quite separate frequencies within the 70cm band!

Dealing with Repeater Shift

The first contact that you want to make on the 'new' band is via the local repeater, but this is not quite as easy to accomplish as it may first appear. The problem is that you need to transmit on a frequency 1.6MHz higher than the repeater output, which you will soon discover is not usually possible even if your 2m rig can accommodate any shift in addition to the

500mW PA kit (the 70FM1) but since the transmit mixer output is only a few milliwatts, a further driver stage is obviously necessary. After a bit of thought, the circuit of Fig. 3 was put together using a BF173 and the old faithful 2N3866. This is probably not of optimum design but it should, once peaked, easily give well over 100mW of RF out with a 12 to 14 volts supply.

I suppose the whole philosophy behind this project is 'Have a go – it might work!' You could even try using the PA strip out of a PF1, or something similar, instead.

Good bandpass filtering at the output is essential, a 252MN1111A (or similar) two chamber helical filter from Cirkit (stock number 17-1111) being a good foolproof device to use. This has the added advantage that due to the filter insertion loss of around 5dB, the output power is reduced to close to 50mW – just right for the Wood & Douglas 70FM1 PA.

Please note that the W & D 70FM series of PAs are not designed for linear operation so any transverter employing them will be unsuitable for single sideband transmissions.

All circuits should be assembled on double sided earth plane PCBs with careful attention paid to the usual important points of RF construction, namely plenty of decoupling capacitors on power supply leads etc; good isolation between the input and output of each stage; all component leads to

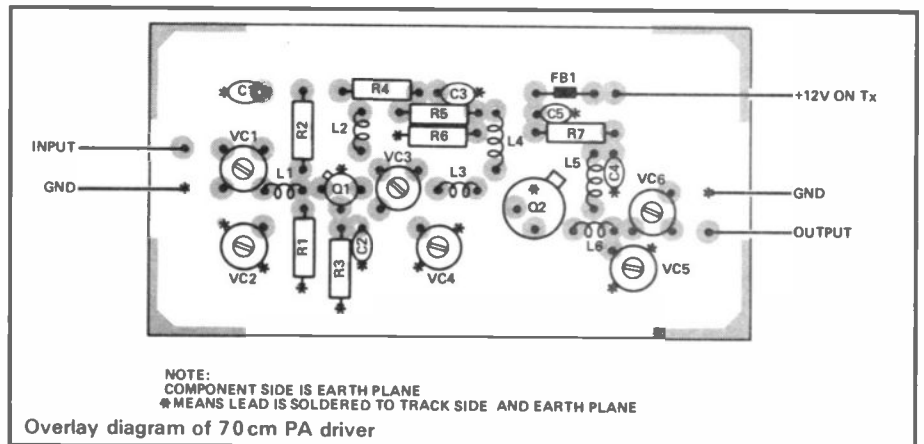

NOTE: COMPONENT SIDE IS EARTH PLANE
* MEANS LEAD IS SOLDERED TO TRACK SIDE AND EARTH PLANE
Overlay diagram of 70cm PA driver

be as short as possible and all signal connections to be made with miniature RG95 type coaxial cable, or similar. Some screening is required, particularly in the area of the attenuated and PA driver boards. See the layout and overlay diagrams for details.

Special care must be taken to ensure that, on transmit, the third

standard – 600kHz.

The 70cm repeater inputs start at 434.600MHz (RB0) and go up to 434.975MHz (RB15) which means that, using the crystal supplied with the converter, your 2m rig will have to be capable of transmitting out of band up to 146.975MHz.

Many imported rigs designed

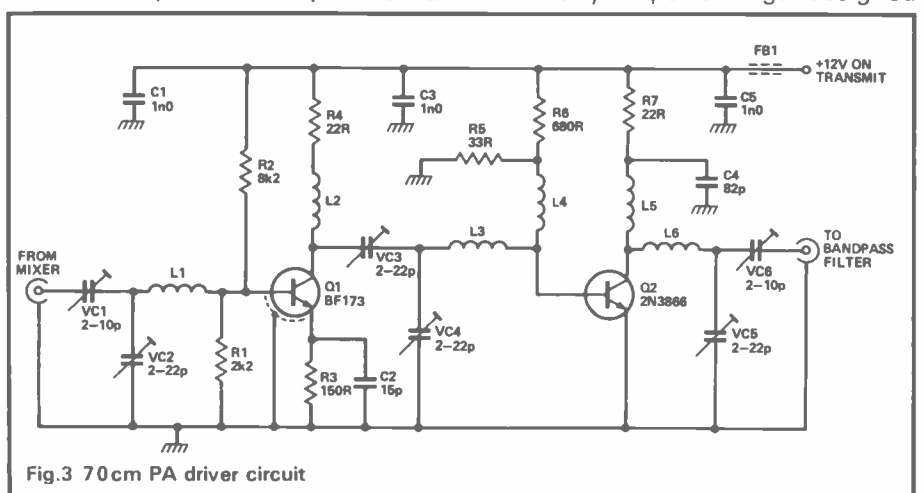
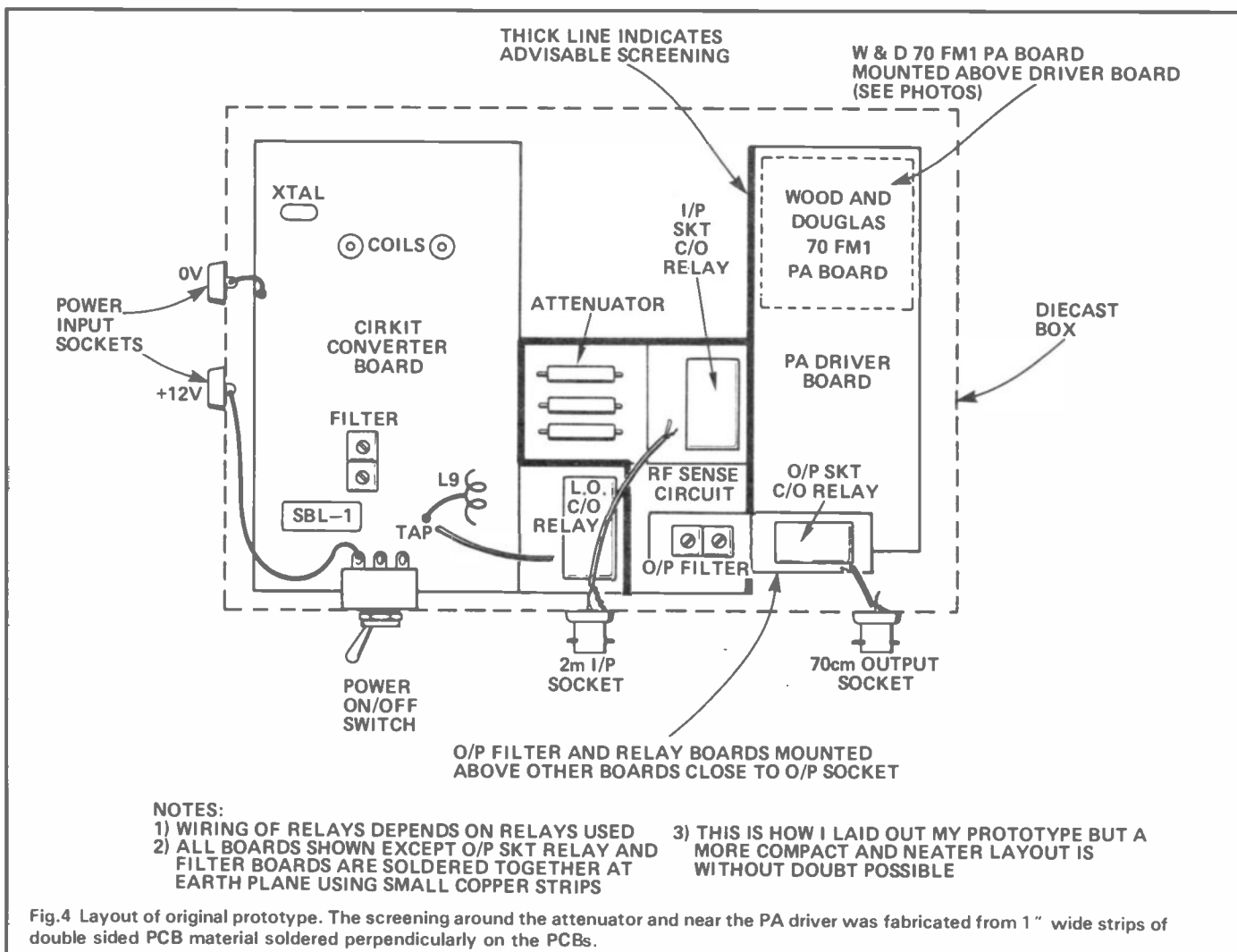
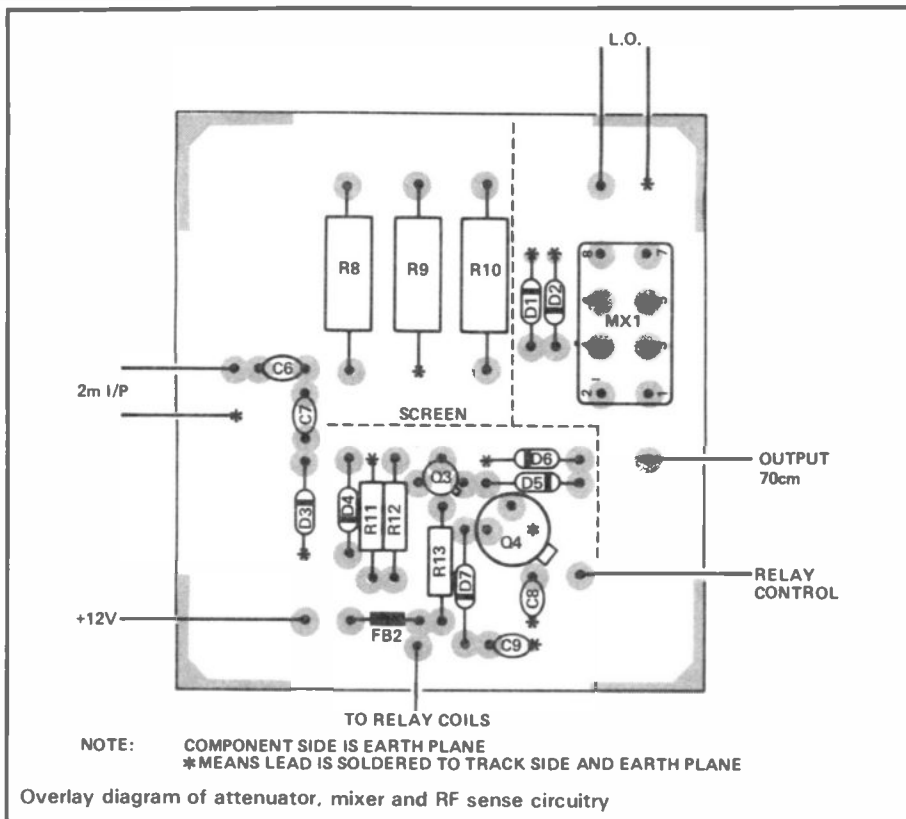

Fig.3 70cm PA driver circuit

for other markets will cover up to at least 148MHz but you should not use these to transmit appreciable power outside amateur bands *even into a transverter* simply because your input signal (and callsign!) is bound to be radiated to a certain extent. I therefore wish to present two (of probably many) alternative solutions to the repeater problem, both of which unfortunately require an extra crystal.

1. If your rig is capable of any repeater shift, then switch in a 96.3333MHz crystal in place of the 96.000MHz crystal in the local oscillator of the Cirkit VHF-UHF converter, when using repeaters. The 1.6MHz shift can then be achieved within the limits of the 2m band, with repeater inputs from 145.600 to 145.975MHz and outputs from 144.000 to 144.375MHz.

2. If you are stuck with the standard 2m repeater shift (ie 600kHz)



then some sort of 'repeater mode' switch is needed on the transverter instead. When selected, this would bring in extra TR circuitry so that, say, a second local oscillator crystal in the Cirkit converter (or a second local oscillator) is switched in on *transmit* and the output is 1.6MHz higher than the receive frequency.

If possible, try to aim for a certain degree of correspondence between the transverter input and output frequencies to aid frequency read-out on 70cm; for example, if you are receiving and transmitting

on 433.475MHz, then you could arrange by your choice of LO frequency that your 2m rig displays something fairly sensible like 144.475MHz. A 'look up' table of output versus input frequencies stuck in a prominent place in the shack will save a lot of brain ache when changing frequencies!

Finally, *please* take all the ideas presented here as just that — *ideas!* Everything described is open to further development and would, without doubt, benefit from it. Having made this point however, I have been more than pleasantly surpris-

ed by the performance of my very basic 'prototype' arrangement.

If I have made a few people consider trying a spot of homebrew as a genuine alternative to a lot of expensive ready-made gear then this article has served its purpose. It really is possible with a little effort to end up with a truly useful addition to the shack; which, if you think about it, can be virtually wholly constructed from a couple of kits, a 'borrowed' PA and a few other (mostly pre-aligned) components. Now what could be more simple than that?

COMPONENTS LISTING

RESISTORS

| | |
|---------|-----------------------------|
| R1 | 2.2k |
| R2 | 8.2k |
| R3 | 150R |
| R4,7 | 22R |
| R5 | 33R |
| R6 | 680R |
| R8,9,10 | 1 watt carbon — see table 1 |
| R11 | 220k |
| R12 | 1k |
| R13 | 3.3k |

All resistors 0.25W carbon unless otherwise stated.

CAPACITORS

| | |
|----------------|---------------|
| C1,3,5,6,7,8,9 | 1n ceramic |
| C2 | 15p ceramic |
| C4 | 82p ceramic |
| VC1,6 | 2-10p trimmer |
| VC2,3,4,5 | 2-22p trimmer |

INDUCTORS

All wound with 24swg silver plated copper wire air spaced 3mm inside dia. turns spaced 1/2 wire dia.

| | |
|----|-------------|
| L1 | 2 turns |
| L2 | 5 turns |
| L3 | 1 1/2 turns |
| L4 | 9 turns |
| L5 | 6 turns |
| L6 | 2 turns |

SEMICONDUCTORS

| | |
|--------------|--------|
| Q1 | BF173 |
| Q2 | 2N3866 |
| Q3 | BC108 |
| Q4 | BC141 |
| D1,2,3,4,5,6 | 1N4148 |
| D7 | 1N4001 |
| MX1 | SBL-1 |

MISCELLANEOUS

3 miniature PCB mounting DPDT 12V relays (Cirkit OUB stock no. 46-70030 could be used); FB1,FB2 and FX1115 ferrite beads; RG95 miniature 50 ohm coax; 252 MN1111A helical filter (Cirkit 17-1111); Cirkit VHF-UHF converter; case (BIM 5006 from Maplin or Cirkit); on-off switch; sockets and PCB pins as required.

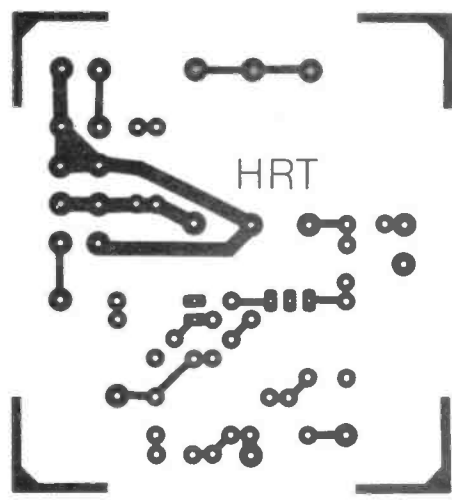
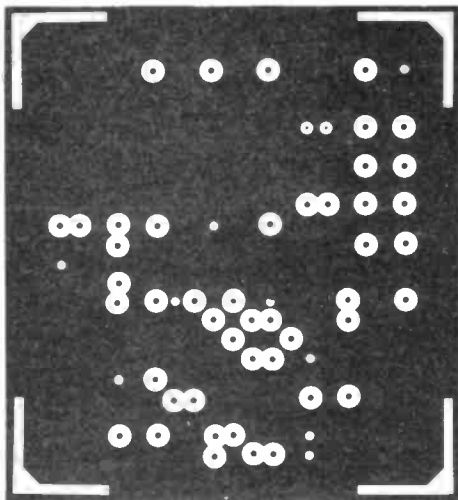
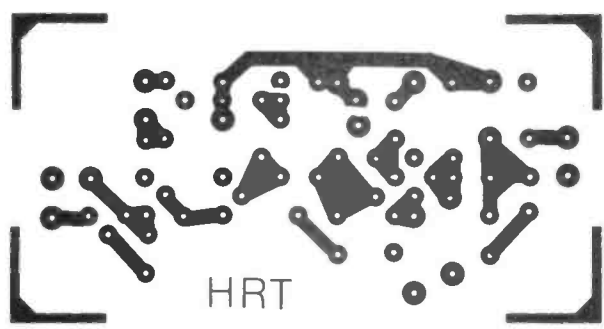
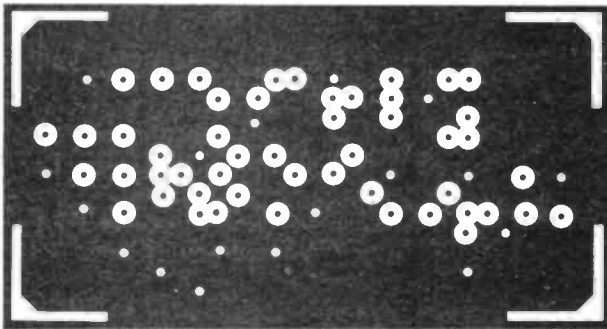

Foil patterns. Those for the 70cm PA driver PCB are shown at top and the Attenuator/mixer/RF sense PCB at bottom. Please note that etched areas are shown in white.

REG WARD & CO LTD
1 Western Parade
Axminster Devon EX13 5NY

**South Wests
Largest Amateur
Radio Dealer**



Official Agents Yaesu, Trio, Icom, FDK.
:Complete range stocked:
:Full demonstration facilities:
:Mail/Phone orders on all items:
:Barclaycard, Access, instant Credit:

APPROVED
TRIO
DEALER

Ancillary equipment: Adonis, AKD, AOR, Bencher, BNOS, Datong, Diawa, Drae, Hansen, Hinound, JLL, Kempco, Microwave Modules, Mutek, SEM, Snare, TAU, Tolcyo Hypower, Tono, Toyo, Welz, Wood & Douglas
Aerials by: G. Whip, Hygain, Jaybeam, Mini Products, Rexco, TET, Tonna.

New complete range Wood & Douglas Kits
TAU Tuner SPC 3000



ICOM



Cables, plugs, sockets, insulators, etc.
Opening hours: Tues-Sat 9.5.30 (lunch 1-2) Closed Mondays

Tel: Axminster (0297) 34918

RAINBOW COMMUNICATIONS

MENU

1. 1/2 wave verticals for 10m £11.90
2. Centre-loaded mobile whips from £7.00
3. 25 watt linear amps from £17.00
4. P.S.Us from £14.00
5. Repairs
6. 10m FM Conversions

WANTED URGENTLY!
2nd hand VHF+HF equipment, part X welcome

**BNOS. AKD.
SUN. ALTRON.
JAYBEAM.**

OPEN TILL 8PM MON-SAT
SOUTH LONDON'S BUSIEST EMPORIUM

EVERYTHING FOR 10 FM

68
Gorringe Park Ave
Mitcham Surrey

Ask for
Howard (G4VWR)
or WIN (xxxxxx)
01-840 1904

If an advertisement is wrong we're here to put it right.

If you see an advertisement in the press, in print, on posters or in the cinema which you find unacceptable, write to us at the address below.

The Advertising Standards Authority. ✓

ASA Ltd, Dept 3 Brook House, Torrington Place, London WC1E 7HN

RADIO and RTTY BOOKS

CONFIDENTIAL FREQUENCY LIST

New 6th edition lists 10,000 worldwide frequencies/stations that are used throughout the SW spectrum. Covers Aero, CW, Fixed, RTTY, etc. £11.90 + £1 p&p.

MARITIME RADIO COMMUNICATIONS

Tune into the world of shipping. Lists hundreds of frequencies worldwide on SW bands incl. coastal stations. £9.50 + 60p p&p.

U.S. MILITARY RADIO COMMUNICATIONS

Not only lists frequencies used worldwide, but gives much background information which opens up a new world for SWL. £10.80 + 85p p&p.

EMBASSY RADIO COMMUNICATIONS

Frequency register of diplomatic SW radio... Under each country frequencies are listed, mode, call signs, locations, etc. £5.80 + 60p p&p.

Ask for new free catalogue

INTERBOOKS, HRT2, Stanley, Perth PH1 4QQ. Tel: 073882-575

Books for radio amateurs

AERIAL ACCESSORIES AND MASTS

ELLIOTT ELECTRONICS

for the Radio Enthusiast

INSTANT HP AVAILABLE
WRITTEN BY NALS ON 06/04/81

QSY OLD MAN TO

JAYBEAM AMATEUR ANTENNAS

RIGS, ANTENNAS, SWR BRIDGES, POWER SUPPLIES, TEST GEAR, COMPONENTS, MORSE KEYS, COAXIAL CABLES, ROTATORS, MICS, PLUGS AND SOCKETS, SWITCHES

Call us on (0533) 553293
OR COME AND LOOK AROUND AT
26/28 Braunstone Gate, Leicester

APPOINTED DISTRIBUTOR

BECOME A RADIO AMATEUR

Train now for the Radio Amateur Licence examination. No previous knowledge needed, only a few hours per week of home study for 3 to 6 months. Post coupon now for details or tel. 062 687 2598 (24 hr service)

British National Radio & Electronics School P.O. Box 7, Teignmouth, Devon, TQ14 OHS

FREE brochure without obligation from:—

British National Radio & Electronics School
P.O. Box 7, TEIGNMOUTH, DEVON, TQ14 OHS

Name

Address

BLOCK CAPS PLEASE

QUARTZ CRYSTALS

| CRYSTALS FOR 2 METRES | STOCK CRYSTALS | FUNDAMENTALS | MADE TO ORDER CRYSTALS |
|---|--|--|---|
| <p>HC25 £2.15 FOR ONE CRYSTAL £1.96 WHEN 2 OR MORE PURCHASED</p> <p>HC6 £2.15 FOR ONE CRYSTAL £2.05 WHEN 2 OR MORE PURCHASED</p> <p>TX CRYSTALS</p> <p>HC6/U 8MHz 30PF : 44 MHz SERIES RES : R0 TO R7 S11, S20 TO S23</p> <p>HC25/U 12MHz 30 & 40PF : 44 MHz SERIES RES : R0 TO R7 S8, TO S23 & S32</p> <p>HC25/U 18 MHz 25 & 20PF : 14/15 MHz 20 & 30 PF : R0 TO R7 S6, TO S23 & S32</p> <p>HC25 : SCANNER XTLS (NOT SR9) : R0 TO R7 S8, TO S23 & S32</p> | <p>full list available on request please send SAE</p> <p>4 METRE CRYSTALS FOR 70, 28 IN HC6/U AT £2.40 each</p> <p>TX 8.78250 RS 29.78000</p> <p>70CM CRYSTALS £5.00/pr or £2.50 each</p> <p>For Pye PF1 PF2 & PF70 series Wood & Douglas and FDK MULTI U11 SUB(433.2) SU20 RBO RB2 RB4 RB6 RB10 RB11 RB13 RB14 RB15.</p> <p>ALSO for MULTI U11 ONLY SU12 SU16 SU18</p> <p>CONVERTER CRYSTALS IN HC18/U AT £2.85 each.</p> <p>22,000, 38,666, 42,000, 70,000, 96,000, 116,000, 101,500, 116,000</p> <p>FREQUENCY STANDARDS £2.75 each</p> <p>HC6/U, 1000kHz 3.50 MHz 5.00 MHz 10.000 MHz 10.700 MHz</p> <p>HC18/U 10000kHz 7.00 MHz 10.70 MHz 48.00 MHz 100.00 MHz</p> <p>Also HC6/U 455 kHz £3.25 each</p> <p>ONEBURST, I.F. & MPU CRYSTALS IN HC18 £2.25 EACH</p> <p>7.168 MHz (for 1750 Hz Tone), 10.245 (for 10.7 I.F.)</p> <p>3.2768 5.0688 14.3180 15.0000</p> <p>YAESU CRYSTALS for FT101's FT901 & etc £4.00 each</p> <p>Many available ex stock (A list is available on request please send SAE.)</p> | <p>5 TO 50 kHz £21.00 3rd OVT</p> <p>50 TO 150 kHz £11.00 5th OVT</p> <p>150 TO 500 kHz £7.80 5th OVT</p> <p>160 TO 999 kHz £11.90 7th OVT</p> <p>1 TO 1.5 MHz £10.75</p> <p>1.5 TO 2.0 MHz £5.10</p> <p>2.0 TO 6.0 MHz £4.75</p> <p>6 TO 21 MHz £4.55</p> <p>21 TO 25 MHz £6.50</p> | <p>21.00 TO 65.00 MHz £4.55</p> <p>60.00 TO 110.00 MHz £5.10</p> <p>110.00 TO 125.00 MHz £7.40</p> <p>125.00 TO 175.00 MHz £10.00</p> <p>2.0 TO 175.00 MHz 2 TO 3 weeks</p> <p>5 TO 999.9 kHz 6 to 8 weeks</p> <p>1 TO 1,499 MHz 3 to 4 weeks</p> |

Unless otherwise requested fundamentals will be supplied for 30p/load capacitance and overtones for series resonant operation.

HOLDERS:—PLEASE SPECIFY WHEN ORDERING— else HC25/U supplied for XTLS above 3 MHz HC13/U 8-200 kHz HC6/U & HC33/U 170 kHz 17.5 MHz HC18/U & HC25/U 2-175 MHz

DISCOUNTS: Price on application for 10+ units to same frequency/spec or bulk purchases of mixed frequencies. We supply FREE xtals for use in U.K. repeaters.

COMMERCIAL CRYSTALS: available on fast delivery and at competitive prices. Please send for list stating interests

EMERGENCY SERVICE: for XTALS 1 to 125 MHz. Add the surcharge for each XTAL £1.50 to working days 4 days +£12, 6 days +£7, 8 days +£5, 13 days +£3

CRYSTAL SOCKETS: HC25 £0.20 ea. HC6 £0.25 ea. MINIMUM ORDER CHARGE £1.50 unless ordered with crystals

TERMS: Cash with order post inc. to U.K. & Ireland. Cheques & P.O.'s to QSL LTD.

A stamped addressed envelope with ALL enquiries please.

ISL

P.O. Box 19
Erith
Kent DA8 1LH

ALL PRICES ARE EX VAT PLEASE ADD 15%

Telephone: 01-318 44119 24 Hr Ansafone: Dartford (0322) 330830
Telex: 8817271 GECOMS-G (Attention QUARTSLAB)

Terminal Condition!

— reviewing the ICS AMT-2

The AMT-2 is the latest result of the continuous development program carried out by ICS Electronics Ltd of Arundel, West Sussex, and as such, I am pleased to say, is a worthy successor to its 'parent';

ASR 33 and my AMT-1 for some time, but now use a BBC computer as a terminal unit.

The software provided by ICS is in the form of an EPROM which makes the AMT-2 act as an *in-*

narrow to wide bandwidth). The tones, both input and output, are IARU recommended (1275/1445 Hz) switchable polarity, but high tone versions are also available (2125/2295 Hz).

Despite the growing interest in the 'packet' mode of data communications, AMTOR has no real rival yet for HF working and some activity can also be found on VHF. In the first of two reviews on new AMTOR equipment, Ken Michaelson, G3RDG, tries out the latest from ICS Electronics.

the AMT-1. As an owner of the AMT-1, I am in the fortunate position to comment on the offspring with the parent on the bench beside it.

In reality, this is a review of two items; two parcels arrived by post, one containing the AMT-2 and the other software provided to operate the unit, when used with a micro-computer. I should stress at this point, that it is not strictly necessary to have this extra software, contained in an EPROM, in order to operate. This unit can, and does, operate with the insertion into the computer, of a short program supplied by ICS with the unit. The program alone will control the AMT-2, and the computer is then referred to as a *dumb terminal*. In fact, the unit can be controlled quite satisfactorily from the keyboard of a Teletype ASR 33 teleprinter, still obtainable in reasonably large quantities on the surplus market, provided it has an RS232 input and output capability. I operated in this manner with an

telligent terminal, giving split-screen display with 'type ahead' capability while receiving, message buffers (memories), real time clock display, switchable unshift on space word etc. Care needs to be taken to insert the EPROM the correct way round, ensuring that *all* the pins enter the socket.

Modes and Facilities

Before carrying on with the review, I think that a few facts should be given about the AMT-2, and to this end I will quote very briefly from the specification. The unit required 11-13.5 volts DC at 350 mA. It will operate in any of four modes, receiving or transmitting: Morse Code (1-100wpm), RTTY CCITT No.2 (1-100 Bauds), ASCII CCITT No.5 (110 Bauds) and AMTOR CCIR 476 (in FEC mode, ARQ mode, ARQ/FEC standby and ARQ listen). The sensitivity of the AMT-2 is 20mV RMS and it has a bandwidth of 300Hz with a 4 pole dual position filter (switchable from

The AMT-2 has optional AFSK or FSK (reversible), and the voltage level for the input is RS232. There are two terminal buffers, 1800 characters capacity on transmit and 80 characters on receive. The data rate from the terminal is 300/1200 baud selectable. It is physically quite a small unit, about half the size of my AMT-1, measures 241 x 160 x 35mm and weighs approximately 600 grams. The case, which splits open horizontally, is made of high-impact plastic and is black in colour.

The lead between the computer and the unit is supplied with the software package, and is about 1 metre long, with DIN plugs at either end. However, the leads from the transceiver FSK and audio (in and out) to the AMT-2 have to be made up by the buyer, as does the power lead. I would recommend that screened cable be used for both interfacing leads, taking care that the screening gets connected to pin 2 of the 'transceive' DIN plug. Two clear tables are printed in the owners manual giving the connections.

Having arranged all the wiring and checked the pin numbers, there is one *most* important point which must be observed. The RS232 port on the BBC 'B' has a five way DIN socket, and the DIN plug on the lead between the BBC 'B' and the AMT-2 can unfortunately be inserted into the computer in any

position. The DIN plug *must* be inserted into the BBC 'B' such that the gap in the DIN plug skirt is *uppermost*.

Setting Off

Having done all the necessary interconnections, I switched both of them on. I started by using the software supplied by ICS which is called up by typing '* AMT2'. Immediately, below a line saying that it was the 'BBC B AMT 2 SYSTEM 1985 ICS', I was asked for my callsign, and then my Selcall. The AMT-2 is then in the Command mode, and the proper screen display appears.

The AMT-2 display is in 40 columns as opposed to the 80 column used in the AMT-1/G3WHO pro-

by the illumination of a LED on the lefthand column of the front panel. In fact, there are six LEDs, but if we count 'ARQ' and 'FEC' as one mode, and the 'CMD' position as 'Escape', then the four modes are shown. In order to commence operating, the 'Escape' key is pressed, which displays the Menu. At the same time, the CMD LED comes on. At this point, one can choose the 'time out' period from the default figure to any number of seconds from 1 to 99. This is done by pressing 'T', followed by the desired number. The same procedure is adopted to change the Baud speed when sending or receiving RTTY, except that in this case the letter 'B' is pressed.

For 100 bauds, one presses '00' as there are only two digits

To do this, one presses 'R' for RTTY and the Menu disappears, to be replaced by the transmit area, and the status line will show '----RTTY--'. The status line also shows 'C' and 'W' at the commencement. 'C' means that the CW mode is in operation and can be disabled by using Shift/F4, which acts as a toggle, reverting to it if you so desire. 'W' is 'Word Mode', about which more later. The default Baud speed is 45, but any other baud speed up to 100 can be inserted by pressing 'B' followed by the desired speed. (100 is 00, as in CW speed).

It will be seen from the above, that pressing 'Control F4' will send 'CQ DE G3RDG', having put in the G3RDG at the start. I duly transmitted and without much delay a station came back, IOVVP, who was a good 589. There are two bandwidths in the AMT-2 as I mentioned earlier, narrow and wide, the narrow one giving a bandwidth of 300Hz, and the wide one (presumably) sufficiently wide to allow copy commercial transmissions.

I tuned in IOVVP first with the switch in the wide position, as in my own opinion, this makes tuning easier. Other operators may think differently. Having got the station in tune, I then switched to narrow and trimmed up the tuning. The LED tuning indicator is of the 'panadaptor' type, giving a very good illumination of the LEDs. Tuning is quite different to my own AMT-1, which gives — more or less — just two dots to tune. The QSO continued on straightforward lines and 'Vince', for that was his name, wished me '73' etc at the end, with the usual remark, 'QSL 100% via Buro'!

On To AMTOR

Having used the AMT-2 for a RTTY contact, I now decided to try AMTOR. To enter the AMTOR mode, I pressed 'Escape' thus returning me to the command mode with the menu displayed, and then pressed 'A'. The 'ARQ' and 'STBY' LEDs lit up and I decided to call LA90K, the Norwegian mailbox station on 14075kHz. A very important point to remember at this is that it is no use turning the dial or readout to show '14075kHz', which is the calling frequency for AMTOR contacts on the 14MHz band, as if you do, you will never get a



Parent and offspring. ICS AMT-2 on top of the renowned AMT-1

gram. I suppose it is a matter of choice as to which mode one prefers, as there are 'pros' and 'cons' about both. With the 40 column display, in my opinion, one requires a high definition monitor. Whereas the G3WHO 80 column program uses colours in the display, the software for the AMT-2 by G4CJO does not. This means that if one wants more clarity than a standard TV set provides, it is not necessary to buy a colour monitor, but just a green display one, which is considerably cheaper (something of the order of £80-£100). Using the BBC computer, the facilities of a tape unit, disc drive and/or a printer are available from the program.

I will comment on the software package later in the article, but for the moment I will deal with the AMT-2. It is a sophisticated, microprocessor controlled terminal unit having, as mentioned above, four modes of communication. The operation of each of these is shown

that can be entered. And again, the same method is followed in the case of receiving or sending Morse, but in this case the letter is 'S'.

The ICS software provides a printed slip to put above the function keys of the BBC 'B' and the program allows three variations of the ten function keys: used on their own, used in conjunction with the Shift key and used in conjunction with the Control key. Thus there are 30 different commands which can be given to the AMT-2. In fact only 21 are used, making the operation perhaps a little less complicated. There are six pre-programmed messages in the software as follows: 'CQ DE your call', 'SELCAL: your selcal'. 'PSE K', 'RYRY', 'THE QUICK BROWN FOX' and 'TIME IS UTC'. These are selected by pressing 'Control' and 'F4' to 'F9'.

However, I now decided to set things in motion and tuned the transceiver to 1490kHz approximately, to attempt an RTTY QSO.

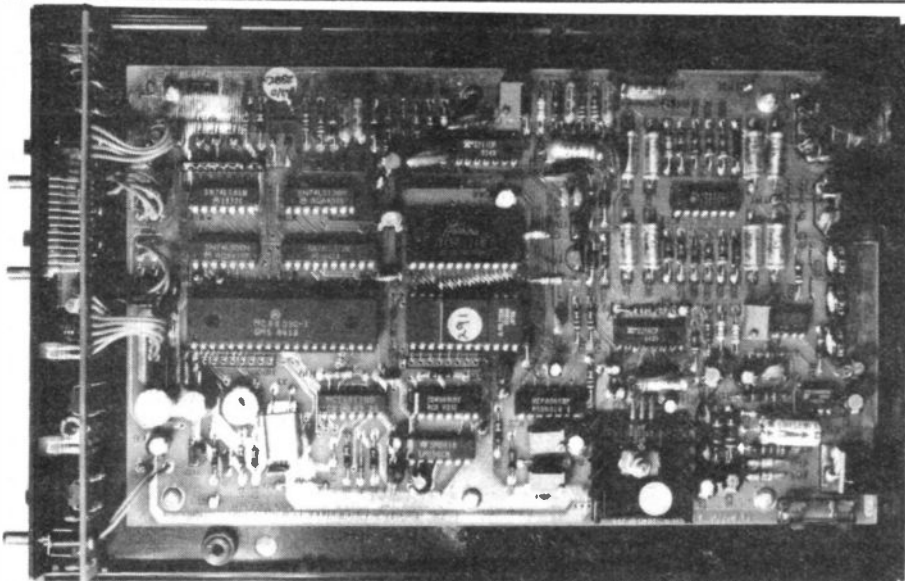

Inside the terminal unit.

contact, except by accident. We are working on USB all the way through the amateur band frequency segments for AMTOR purposes with the AMT-2, and so the dial reading has thus to be set at approximately 1.445kHz *below* the nominal frequency. For example, the actual dial reading for contacts on the calling frequency of say, 3588, is 3586.6kHz, and in the case of 14075kHz, it is 14073.6kHz. It is possible, of course, to use LSB on the AMT-2 merely by switching the normal/reverse switch to reverse. In which case, the readings would be 1.445kHz *above* the nominal readings.

However, using FO (ARQ call), I keyed LAOK and at the same time typed into the buffer for transmission, 'DE G3RDG +?'. It is necessary to press 'Return' after the '+?' in AMTOR otherwise the last group (+?) will be lost and the other station will not come back. LAOK returned my call, and, since I had 'local echo' enabled, the transmission 'DE G3RDG +?' duly appeared in the receive portion of the screen, followed by 'Hello Ken no traffic for you etc +?'. The reply to this was 'QRT +?' and LAOK signed off wishing me '73'.

I then went over to the 80 meter band, and tuned to the calling frequency of AMTOR *less* 1.445kHz, as mentioned above. I called G3PLX using his Selcall GPLX and went through the same procedure. This was also satisfactory. I found that it was far easier to tune in AMTOR signals using wide shift than the narrow shift.

Whether this was due to the amount of local QRM or something in the unit I am not sure — I think it is unlikely to be the unit as one could tune RTTY transmissions satisfactorily using narrow shift.

Tuning in an AMTOR signal with wide shift gave the perfect 'strobe' effect, flashing on and off in sympathy with the signal, but in the narrow shift position, it was almost impossible to get the correct tuning point. In order to prove or disprove this, the unit was tried on three different transceivers with the same effect. This problem did not seem to affect the ability of the unit to operate in the AMTOR mode. In fact, tuning in using the wide shift position made it very easy to 'copy' a station.

Tuning Around

I next tried reception of commercial broadcasts at the acknowledged shift of 425Hz. Leaving the filter switch in the wide position, it was found that the correct display for reception was when all tuning LEDs were alight. It was found possible to have a tuning 'condition' when the two ends of the display were lit more brightly than the centre — the whole display must be *evenly* lit for the unit to be correctly 'in tune'. A type of 'squelch' effect operates on RTTY, in that there is no illumination of the display or output to the screen/printer unless a RTTY signal is tuned in. This prevents trying to print (or rather form) on 'noise', and seems to me to be a very great advantage.

As mentioned before, any Baud

speed can be accommodated from 1-100, and it is only necessary to go into the command mode, press 'B' followed by the desired speed, and then return to RTTY by keying 'R'. No difficulty was found in the copying of commercial transmissions, and the provision of the normal/reverse switch made it a simple matter to change the shift as necessary.

The third method of operation is morse code. In this mode, again, the speed of reception/transmission can be altered simply by pressing 'escape' followed by 'S' and the desired speed. In addition, using the ICS software, it is possible to increase or decrease the speed of the morse, at the rate of one word per minute movement by pressing 'F0' for 'faster' and 'F1' for 'slower'. Wonderful!

The reception of morse transmission was easy enough so long as a little care was taken in tuning in a signal. It was necessary to get a flashing LED, (a single one) into the centre of the display area and behold, text appeared on the screen. The setup as it stood was in 'transmit' position. That is to say, any key which was pressed automatically keyed the transmitter and sent the morse character *at the speed which had been determined at the start*. Let me say this. The best computer in the world cannot compare with the human brain, and hand sent morse can vary in evenness an awful lot. I have met CW 'types' who tell me that they can recognise another man's transmission by the way he or she uses the morse key. Therefore, in my opinion, the CW reception availability was only suitable for copying machine sent morse, or those amateurs who really send *perfect* morse.

The AMT-2 did a perfect job of copying any commercial morse that I chose to tune in, but when it came to reception of hand sent morse in the context of an amateur type QSO, things were a little difficult. I do not say that it was impossible to have a contact due to this, but any variation in the dash/dot ratio of the other stations morse seemed to put the microprocessor off its stroke. However, I did manage one QSO on 80m, though it was admittedly a short one.

The fourth method of data communication available through

the AMT-2 is ASCII - (American Standard Code for Information Interchange), and I must confess that I had no opportunity to use this method. The speed is set in this mode at 110 bauds, so there is no need to worry about this.

There are several commands preceded by 'Escape' which add to the versatility of the unit and these are as follows: by keying 'Escape F 1' (enable) or 'O' (disable), one can switch the FEC receive mode on or off. This means that if there are a lot of FEC transmissions on the channel that the user does not want to copy, keying 'Escape F O' cuts them out. The same thing applies to 'Escape L 1' (enable) or 'O' (disable). This switches the local copy on the screen on or off. Again with 'Escape N 1' (enable) or 'O' (disable), the automatic new line can be turned on or off. If the letter 'Q' is pressed in the Command or Menu mode, then the current settings of all the parameters will be shown. The first parameter is the software version number.

There is, in addition, a facility which I have never come across before, and that is a self text sequence. By keying the letter 'Z' followed by 'O' through '7', eight tests of the unit can be carried out. These range from setting up the demodulator centre frequency to a transmit/receive changeover test, to enable the transmit preset to be adjusted for optimum delay. These and several other options are available to the owner and are fully described in the user manual.

Having commented on the unit

to acknowledge an incoming call, identify the callsign of the calling station, accept a message, acknowledged the message, close down, and then dump the message either to disc, tape or printer, indicating the time of reception. This mode will respond to both ARQ and FEC, (if enabled), and will reply in the appropriate mode.

Further, keying 'V' allows the user to view the messages which were dumped to disc or tape. If the printer is enabled, the messages will also be sent to the printer. As an added bonus, word processor files may also be read/printed while in this mode. Quite extraordinary, this. I used 'view' as a word processor to prepare this article, and I was able to read what I had written while actually operating with the chip!

Yet More Options!

There is still more. As mentioned above, there are 21 different options obtained by keying either F0 through F9, Shift/F0 through Shift/F9 and Control/F0 through Control/F9. I shall not list them here, but Fig.1 shows the layout.

I have only one gripe with regard to the EPROM. When copying text, either ARQ listen, or RTTY, or having an actual QSO, error characters are shown on the screen by a white square. This is ASCII code 26 (hex 1A). On a dumb terminal, such as this would be if the simple program supplied with the AMT-2 as standard were used, this code would have no effect, but the

enabled, only up to and including the last *space* or *return* is sent. This, of course, allows the current word being typed to be corrected using the delete key and the word is not sent until terminated with *space* or *return*. It is therefore necessary, as mentioned above, to use return after '+?' in ARQ, and always before STANDBY or RECEIVE, so as not to lose the last word. (Plus-query-return soon becomes a habit, but you can use the '_' which achieves the same thing in one operation). Finally it is worth mentioning that RTTY, ASCII or CW with Word Mode enabled, you will not hear a character each time a key is pressed — they will be sent as a group when *space* or *return* is typed. ICS recommend that the Word Mode always be enabled when using CW. This ensures correct inter-letter spacing within words, since the text is sent a whole word at a time. I think you will agree that there are enough facilities in this ICS software to satisfy the most critical of us!

All in all, it has been a memorable experience. I have used the AMT-2 for the past month, and having got used to the various controls, as compared with my own AMT-1, I am very impressed. The fact that ICS have been able to reduce the price of the unit in these inflationary days, and give more facilities is, in itself, quite extraordinary. The AMT-2 is beautifully made, as can be seen from the nearby photographs, and at a price of £229.95 plus £2.50 postage and packing can't be bad value for

| CONTROL | MEM0 | MEM1 | MEM2 | MEM3 | CQ | SEL CAL | PSE K | RY | QBF | TIME |
|------------|--------------|---------|----------|--------|--------------|--------------|-----------|----------------|----------------|---------------|
| SHIFT | WRITE MEMORY | USOS | PRINTER | WORD | CW ID ON/OFF | CW ID SEND | LOAD FILE | RECORD ON DISK | CLOSE FILE | SET CLOCK |
| AMTOR | ARQ CALL | STANDBY | FEC | ARQ | BREAK IN | LETTER SHIFT | | | CLEAR TRANSMIT | CLEAR RECEIVE |
| RTTY/ASCII | TRANSMIT | RECEIVE | TRANSMIT | LISTEN | | | | | | |
| CW | FASTER | SLOWER | TUNE | | | | | | | |

Fig. 1 Aide-memoire from ICS which can be slipped underneath ornamentation near the 'function' keys of the 'BBC B' when using the optional E-PROM.

itself, a few words might not be amiss about the accessory EPROM which is available also from ICS, and which I used in the review. When used with the BBC 'B', it is also possible to save the contents of four memories to either tape or disc by keying 'P'. These memories can be retrieved by keying 'G'. In addition to this, there is the facility of 'Auto AMTOR'. If one keys 'U', it initiates the automatic mode of operation, which enables the setup

software EPROM has been made to display a white square in this mode. Speaking personally, I find this very offputting. I feel the legibility of the received text would be vastly improved if the error code was not made to print anything.

I mentioned that I would comment further on 'Word Mode'. This is a most interesting facility. With the 'Word Mode' disabled, any text in the transmit buffer will be sent to the AMT-2. With the 'Word Mode'

the amount of technology contained within. If I didn't already possess the AMT-1, I would be out to get one right away.

The cost of the software EPROM for the 'Beeb' is £44.95 plus £1.00 postage and packing.

Thanks are due to ICS Electronics Ltd, PO Box 2, Arundel, West Sussex BN18 0NX for the loan of the AMT-2 and the software EPROM for the purpose of this review.

Ham radio today



in Germany

Before the Second World War, amateur radio was a very popular hobby despite the fact that the Ger-

und Empfangsdienst) seems to have done little to discourage it.

After the Second World War,

went on to say that "although representations for restoration of amateur privileges have been made by German amateur radio organizations, it has not been found in the interests of the Allied governments to permit amateur radio activity on the part of German citizens." Ironically enough, the German authorities now issue DA callsigns to members of NATO forces stationed in West Germany.

After mid 1945 Germany was of course partitioned into 'East' and 'West'. Due to the difficulty in obtaining up-to-date information about East Germany, most of the rest of this article will concentrate on West Germany. However, a later section deals with the situation in East Germany as best as the authors understand it.

Following the formation of the Federal Republic, a law 'Gesetz ueber den Amateurfunk vom 14. Maerz 1949' was passed, which authorised the issue of amateur radio licences in West Germany. East German amateurs had to wait another four years before amateur radio was finally restored to them in February 1953.

The Situation Today

Licences in the Federal Republic nowadays are of three

When you hear or work a German station, have you ever wondered what the experience of amateur radio is like for them? Nigel Roberts, G4IJF alias DJ0QD, and Angelika Voss, G5CCI alias DF2XV, describe ham radio today and yesterday in Germany.

man government would not issue any licences to individual operators, restricting legal operating to club stations. As this was a somewhat unsatisfactory state of affairs, many German amateurs resorted to operating without a licence, issuing themselves with callsigns similar to those of the legal club stations.

Prior to 1928, German amateurs used the prefix EK, with three-letter suffixes issued to legal club stations while unlicensed operators used two-letter suffixes. When the prefix was changed to D in 1928, both licensed and unlicensed stations started using 3-letter suffixes. It seems that unlicensed operating was considered normal practice in those days, and the national amateur radio society (then known as DASD, Deutscher Amateur Sende-

Germany was occupied by the Allied Forces and amateur radio activity was restricted to servicemen of the occupying powers. Callsigns used were in the D2, D4 and D5 series which had been held by Germans before the war, but no German nationals were allowed licences. This, however, did not dampen the enthusiasm of the pioneers who campaigned for the restoration of amateur radio and meanwhile operated without licences — something they were not exactly unaccustomed to!

Their own callsigns having been taken over by the occupying forces, these enthusiasts resorted to using DA as their prefix. A news item in QST for June 1948 entitled 'DA Calls Not Authorized' warned US operators against working any of the growing number of "stations signing calls with the prefix DA". It

Table 1 — West German Callsign Prefixes

| Class B | Class A | Class C |
|----------------------------|----------------|-----------------------|
| DF, DJ, DK, DL DA1, DA2 | DH DA1, DA2 | DB, DC, DD, DG DA4 |

classes, B, A and C — in that order! The West German equivalent of our 'A' licence is the Klasse B licence. You have to pass a technical examination in three parts and achieve 12 wpm on CW. The examination is broadly similar in content to the British RAE (fulfilling international requirements) except that it devotes a whole section to operating practice. If anything, it is more difficult to pass than the British exam, as the pass mark is higher. (See Table 2).

Klasse 'B' licence holders have callsigns with DL, DK, DJ, and DF prefixes. The German 'B' Klasse licence is radically different from its British equivalent. In fact, the German VHF phone only licence, our 'B' licence, is the 'Klasse C' licence with no code requirement, and a lower pass mark than 'A' and 'B' in the technical section of the exam. 'C' callsigns have DB, DC DD and DG prefixes. (DB0 calls are usually given to club stations and repeaters).

The German Klasse A licence has no UK equivalent, being roughly a VHF plus limited HF licence. To get a class A (DH) call, one needs 6 wpm CW and a pass-mark mid-way between 'B' and 'C'. The DH licence is a relatively recent innovation, and is already proving a sensible half-way house between the two licence classes and is an alternative that the UK could do well to consider, in place of the controversial 'novice' licence proposal.

On the whole, the process of getting a licence is considerably easier and quicker in Germany than it is in Britain. Licences are issued

by the regional offices of the Federal Post Office who also administer the exam and the morse test. There are no fixed dates for the exam — regional offices will actually put on exams according to demand. Exam papers are usually marked on the day and licences issued to successful candidates as soon as the results become available. It is not uncommon for people to take their exam in the morning and come back in the afternoon to collect their licence! The morse test may be taken at the same time as the written exam, or at a later date.

The fee for the exam is DM 40

licence, which is a nice bonus. If successful the applicant simply exchanges his or her old licence for the new one without having to pay any extra licence fees. The annual licence fee is DM 36 (£10) which is usually split into 12 instalments of DM 3 and, where possible, added to the amateur's monthly telephone bill!

There is also, incidentally, an SWL exam which is voluntary. It is administered by the DARC and those who pass are allocated special receiving station numbers with the prefix DE (E for Empfang — receiving). Other SWLs use their DARC membership number as their receiving station 'callsign'.

Active National Society

The West German national society is the DARC (Deutscher Amateur Radio Club) with head-

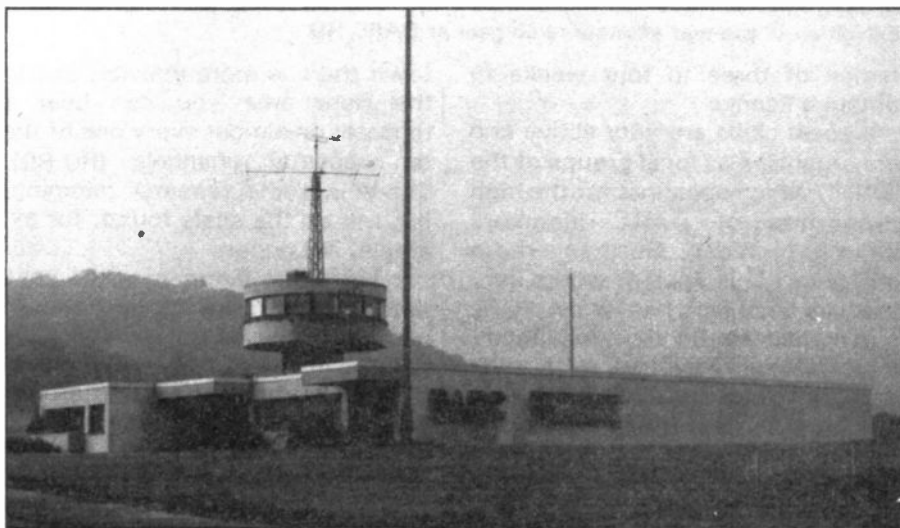

The rather strange looking headquarters of the DARC at Baunatal

(about £11). This includes the morse test if it is taken as part of the exam; if the morse test is taken separately the fee for this is DM 20 (£5.50). This re-test fee also includes a retake of the technical exam if the applicant needs a higher pass mark for the new class of

quarters located in the small town of Baunatal, just off the A44 motorway. It publishes the magazine CQ-DL (formerly known as DL-QTC) which is sent monthly to all members. The DARC also fulfills an important rôle for the foreign visitor, in that it administers the issue of guest licences on behalf of the licensing authority. Callsigns cost DM 15 for a three month period and are in the format DL/-own call, DC/-own call- or DH/-own call-, depending upon the class of licence issued. Although the DARC recommends allowing six weeks for one's application to be processed, experience has shown that it normally takes in the

Table 2 — Examination pass marks for German RAE

| Licence class | Technical part (%) | Operating procedures (%) | Rules and Regulations (%) | Morse (wpm) |
|---------------|--------------------|--------------------------|---------------------------|-------------|
| C | 50 | 65 | 65 | — |
| A | 65 | 65 | 65 | 6 |
| B | 75 | 65 | 65 | 12 |

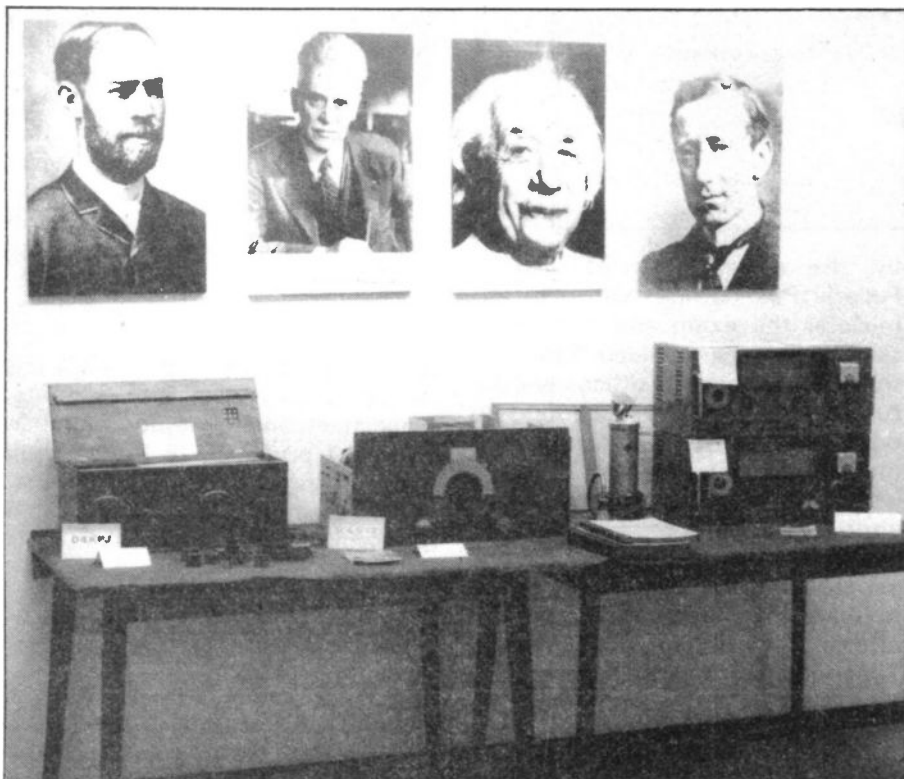

Exhibition of pre-war amateur radio gear at DARC HQ

region of three to four weeks to obtain a licence.

Local clubs are very active and are organised as local groups of the DARC, which accounts for the high proportion of DARC members amongst West German radio amateurs. This system works very well, as each club has its own QSL sub-manager who receives incoming cards from Baunatal, distributes them at meetings and collects outgoing cards for dispatch to the bureau in Baunatal. Another nice feature is that a fair percentage of the individual's DARC subscription is passed on to the local club; unlike in the UK, where the flow of cash from a local club to the RSGB is in the other direction, in the form of affiliation fees.

German amateurs are a friendly and hospitable lot, and English is very widely spoken, although not quite to the standard found in the Netherlands and Scandinavia. In addition there are quite a few native speakers of English active on the bands (DJ0QD for one, and most DAs), so QSOs in English are not hard to find, though a little bit of German helps a lot. Two metre repeaters are more numerous in Germany than in the UK, they tend to cover a smaller service area and are much quieter than UK 2m machines. However, in the larger

town there is more activity, and in the Ruhr area you can hear a repeater on almost every one of the ten -repeater channels (R0-R9). There is some repeater jamming, but not on the scale found, for example, in London.

The West German police have authority to make routine checks on motor vehicles for non-approved radio equipment. All radio equipment, with the exception of amateur radio gear must have type approval, known as an FTZ number. These spot checks are designed to eliminate illegal 27MHz operation. It is also very important not to install any transceiver until you have the correct licence, which you should carry at all times. Otherwise your gear may be confiscated by the police or frontier patrol and held until you can produce a licence for it.

Behind The Iron Curtain

Amateur radio in East Germany, like in the USSR, is very highly club oriented, although there are also many well equipped individual stations. Furthermore, all amateurs and SWLs must be members of the national society which is a division of GST (Gesellschaft fuer Sport and Technik), the national "sports and

technical society".

Although anyone is allowed to *listen* to the amateur radio bands in East Germany, only holders of SWL 'licences' are allowed to send reports (ie QSLs), work for awards or take part in the listener sections of contests. To obtain such a licence, the listener has to take a simple exam, administered by the GST. They have to show that they are familiar with operating procedures and regulations and are capable of handling amateur equipment — the latter point has to be demonstrated in a practical exam. The SWL licence usefully doubles up as a novice licence: licensed SWLs may operate club stations under the supervision of the designated training officer of their club.

Berlin Game

Berlin is in a rather special situation. Amateurs driving from the Federal Republic to West Berlin must cross East Germany and, at the moment, East Germany only has reciprocal licensing agreements with other Eastern European countries. Fortunately, special arrangements exist which allow the legal transport of transceivers. On entry to East Germany, you may buy a 'visa' for your rig which cost 5 DM (West German money, of course) and is valid for a return journey. It does *not* allow operation of the equipment except in an emergency. Anyone found in possession of transmitting equipment in East Germany without the correct documentation is likely to be in for a hard time, and probably will end up, at least, paying an extremely large fine.

Finally, here are the answers to some questions which we have been asked by British amateurs and think shed a more personal light on German amateur radio today.

Q. Why do Germans forever wish you '55'?

A. '55' means "good luck", "good DX" or "much success". It is believed that its derivation has something to do with the word *punkt*, which means both "dot" and "point" so 55 (=) symbolises "many points", that is, say, a high contest score.

Q. Why do Germans always seem to be out portable?

A. They're not always! German stations tend to sign /P, not /A, when they operate from alternative premises — for example, a friend's house or a holiday QTH. The use of /A is restricted to operation from a more permanent second QTH which has been registered with the postal authorities, such as one's office or shop, a college address or a second home.

Q. What are DOK numbers?

A. DOK stands for "Distrikts-Ortskenner". DOK numbers are a system of reference numbers given to local clubs (Angelika's old club was E03). Each club has its own DOK number consisting of a letter, denoting the DARC district, and a two-figure number. For example, M50 means that the club is in the Kiel District (M) and was the 50th club to be founded in that particular district. Several awards are available for working DOK numbers. Special events stations may be allocated a special event DOK, as unlike in Britain, special



Karl Diebold, DJ1 BM, general manager (geschäftsführer) of DARC in his office

event callsigns are not usually issued.

We hope you've found this article interesting, informative, a little surprising and would like to finish by wishing you 73, 55, 88 (as appropriate).

Nigel Roberts is a software engineer who divides his time between the British Isles and West Germany. Angelika Voss is a freelance translator in addition to teaching German at the University of Essex.

HAM

RADIO TODAY

NEXT MONTH

RECEIVING WEATHER SATELLITES

A practical guide to this fast growing and fascinating pastime by Mike Christieson, G8FCD.

THE MULTIMATE KEYER

Customised and programmable iambic keyer/keyboard sender/morse trainer. Ideal for individual or club use. Revolutionise next NFD!

SHED TO SHACK

Thinking of turning the garden shed into a radio room?

BEGINNERS PROJECT

COMBINED SWR BRIDGE/WAVEMETER FOR 2m

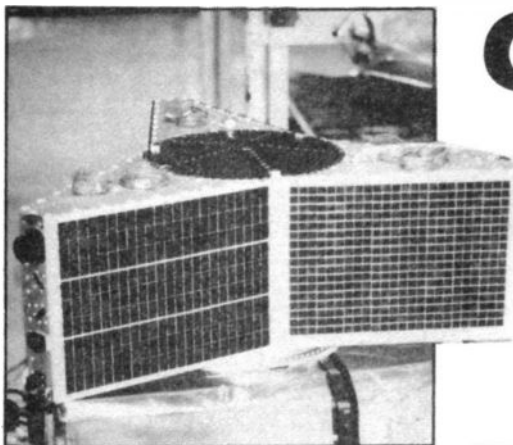

The AMSAT-III A satellite.

Getting started on amateur SATELLITES Part 2

The first part of this series dealt with the requirements for receiving signals from amateur radio satellites and the principles of satellite orbits, their timing and production. In this article, we will consider the requirements for transmitting up to them.

In the second part of this series, Arthur Gee, G2UK, Chairman of AMSAT-UK, tells how to put together a station capable of transmitting up to amateur satellites.

As I said last time, the purpose of these articles is to show how with pretty simple gear, one can get going on amateur satellite communication. Once you have got a taste of this mode of amateur radio communication, it's pretty certain you will have got enthusiastic enough to want to push on into communicating via or receiving the more complex satellite systems. But for now, we will take the case of the most reliable and easiest satellite to currently get working with, viz., the Russian RS 8 satellite. This satellite is still running well, with good strong signals for the most part, and appears as though it will continue to give reliable service for a year or two yet.

RS8 is a *Mode A* satellite; that is to say, it receives signals from earth in the 2m satellite band and retransmits them back to earth in the 10m band. The satellite has a good beacon on 29.4 MHz and may be easily found when overhead. The first frame of the beacon telemetry gives a clue to whether the transponder is switched on or not. The Russians take good care of their amateur radio satellites, turning them on or off ac-

ording to battery state, over use by high powered earth stations (the use of high power tends to flatten the satellite's batteries!) If the two last morse code characters in the first line are zeros, the transponder is off. If they are figures, it is on.

To begin with, we will confine

transmitting to an overhead orbit, as when starting to receive the satellite's signals. This means we want to send our 2m signals upwards into space, not horizontally, as is usually the case when transmitting amateur radio signals. It is worth going to some trouble, to begin with, by making up an aerial which will do this. The aerial can also of course be used to receive UOSAT 1 and 2. With a bit of adjustment — making the elements

The author's vertical radiating antenna system for overhead satellite passes.

This is based on a 2m crossed dipole array (see text).



long enough to tune the 136 to 138MHz band — it can be used for receiving weather satellite signals — increasingly popular with radio amateurs these days. (*We hope to run an article on receiving weather satellites in the near future — Ed.*)

First The Antenna

For several years, the writer has used a crossed dipole type of array mounted above an artificial earth, consisting of a metal 'mat' made from a circle of expanded metal. This is illustrated in the accompanying photos. As can be seen, the mat of expanded metal is strengthened by being fixed to a radial frame of metal rods fixed to a circular length of rod around the rim. This can be easily made up using galvanised steel wire or one can get it made up at the local metal pre-fabricators or blacksmiths. The photos give a good indication of how it is assembled. The size and detailed construction are not critical. In the writer's case, the artificial earth is about 4ft in diameter. Arrangements must be made at the centre for a short metal mast to support the crossed dipole antenna.

The antenna elements are supported on a wooden structure as shown, with four thick rectangular Paxolin strips fixed to the ends of the wooden cross. Each strip has a hole through it through which the associated element passes. The inner ends of the elements are secured on four small stand-off insulators screwed to the wooden cross. Coat the wooden cross with a coat or two of marine varnish to protect against weather and damp. The elements can be cut from old TV aerial tubing and are 18" in

length, separated from each other by a gap of about 1" between the elements at the centre, thus giving an overall length of each dipole of 38".

The dipoles have to be cross-connected by a phasing stub of 75 ohm coaxial cable as shown in the accompanying diagram, in the same way as the 10 metre antenna, described in the first part of this series, was made up. The length of the stub should be 10½" long. A matching section of 50 ohm coaxial cable is required to match the crossed dipoles to the 75 ohm cable from the transmitter — or receiver. The length of this matching section should be 11¾" long.

Setting Up

The height at which the crossed dipole is mounted above the earth mat will determine the radiation. In the writer's case, satisfactory vertical radiation was obtained with the dipole 20" above the mat. It should be noted that no connection need be made to the earth mat, nor to the short mast supporting the antenna. When complete, the array can be placed on the shack or garage roof or other horizontal surface.

Well, so much for the aerial. What do we need in the way of a transmitter? As we have said, we want to keep things as simple as possible and our expenditure on equipment as low as we can, to start with at any rate. So we will concentrate on working overhead orbits only using the aerial we have just described. This will radiate 2m signals up to the satellite for quite a reasonable period whilst it is

Arrangement of the crossed dipole element support and matching stub.

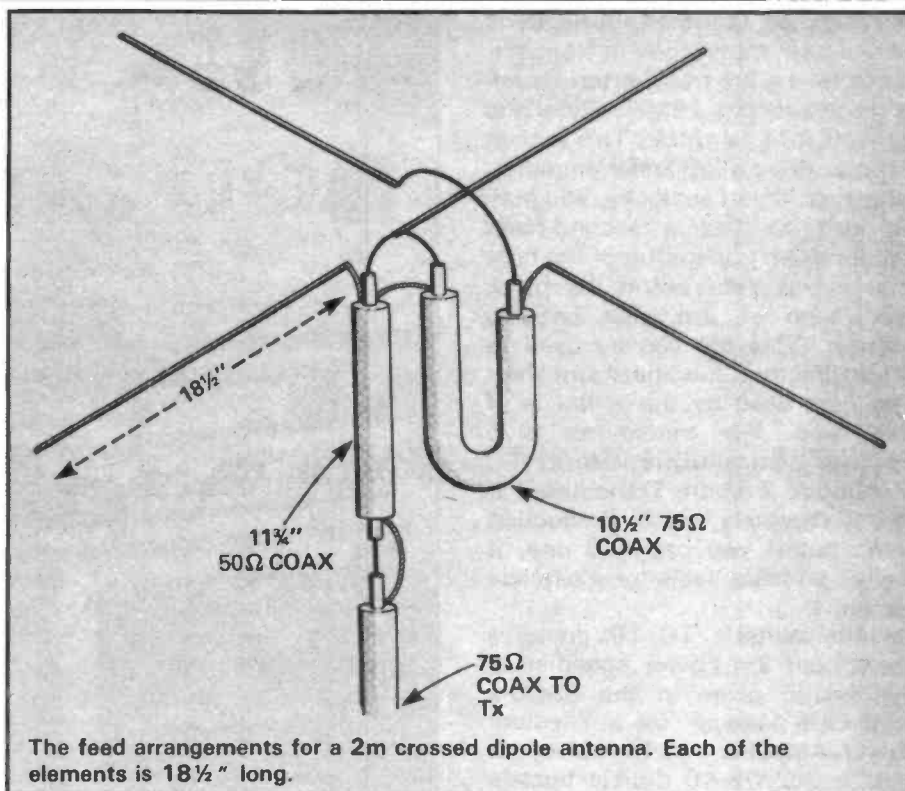
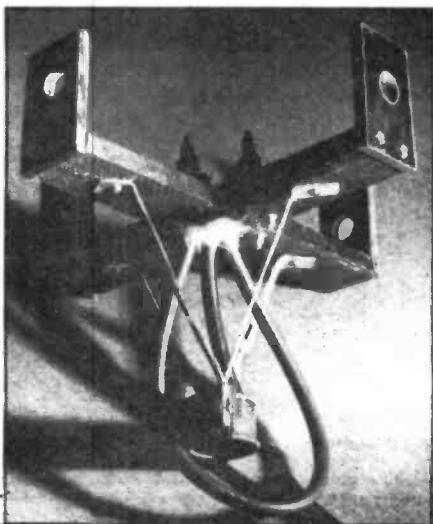

overhead, or nearly overhead, and we can use our 10m aerial as described in the first article for receiving the 'down signals'.

What Transmitter?

The next thing we have to consider is what transmitter power do we need and what sort of transmitter?

There are two ways of approaching the question of what sort of transmitting station to use. We can either use a low power transmitter and a high gain aerial array, or we can use a high power transmitter and a low gain aerial. As the 2m crossed dipole array is a low gain antenna, we are obliged to adopt the second alternative.

It is generally accepted that the Effective Radiated Power — the ERP — required to access most amateur radio satellites is around 100 watts. The ERP is the antenna gain times the transmitter output power. 100 watts ERP is equivalent to a 10 watt output transmitter feeding a 10dB gain antenna. As our crossed dipole has very little gain, we shall need a transmitter giving an output of nearly 100 watts or so. So we shall have to go for a transmitter with about that power, which is quite a lot for an amateur type 2m transmitter of today. Bought as a

commercially made unit, this would be quite expensive — more than one would want to spend on our preliminary attempts to start satellite communication. However, it is quite possible to work into RS8 with considerably less than 100 watts ERP and the writer's transmitter has an output nearer 50 watts than 100. *101d 2m AM/CW transmitters with QQV06-40 PAs capable of this level of RF can often be found at junk sales or rallies — Ed.)*

As with our satellite receiving equipment, our satellite communication transmitter must be tuneable to some extent, so that we can put signals anywhere in the amateur satellite band. For RS8 the transmitter needs to cover the range 145.91 to 146.00 MHz. Either SSB or CW can be used for satellite communication, but CW is by far the most popular to start with and gives much more reliable results when using lower power than SSB, so stick to CW.

So, the question of what type of transmitter to use resolves itself into something essentially which fits in with the above parameters. If you have a 2 metre transceiver which is tuneable over the frequencies specified above, you can use the transmitter section of this to feed a linear amplifier giving 50 or up to 100 watts, if you don't mind

the expense. Another possibility is to use a HF transceiver or transmitter to feed a 2m transverter. Usually these accept a 28MHz signal and convert it to 144MHz. This is then used to drive a 2m linear amplifier. However, if you are lucky, you may be able to find a second-hand separate 2m transmitter of the type that was available before the 'black box' type of 2m gear became popular. This too can be used to drive directly a 2m linear amplifier. The gear used by the writer is of this type. The transmitter is a Telford Communications TC Multimode 2 Metre Transmitter. It is unfortunately not in production now, but if you can find one, it makes an ideal basis for a satellite station.

The writer's TC 10 drives a home built 2m power amplifier to the design given in the RSGB's 'VHF-UHF Manual' for a 'Medium Power Amplifier for 144 MHz'. It uses a QQV06-40 double tetrode valve and has given years of trouble free service.

One final point to conclude this article. You may be thinking 'well,



The 2m satellite transmitter as used by the author, an old Telford TC10.

suppose there isn't a satellite in an overhead orbit at a convenient time, what do we do then'? Well, that takes us on to the next phase of our satellite experience in which we have to use a *directive* antenna system, such as the Yagi shown in one of the photos illustrating the first article. But before you attempt this, get some experience on overhead orbits first. There will be some 'passes' at a convenient time, as the orbits of the satellites referred to, progress several degrees with each orbit, so they will be overhead — more or less — at a time during each day. Get some experience on the overhead orbits first and then start to stretch your wings with more complicated procedures once you have acquired some experience with the easier modes. In this way, you can be assured of avoiding the disappointments many hopeful participants in satellite communications seem to experience when they first try their hand at it. Take it stage-by stage and keep it simple. You should have no difficulties 'getting going' then.

Addendum

Modifications to the Totsuko TR2100M Feb '85

Step 2 under the heading 'Mods For Frequency Stability' on p31 should read

2. Removal of D2 on VXO board, I discovered quite by chance...

Step 3 should read

3. Replace varicap diode D1 on VXO board with a varicap diode BA121.

DSB 80 Revisited Feb '85

The foil pattern for the DSB 80 PCB was printed at an incorrect size. A correct version is shown nearby.

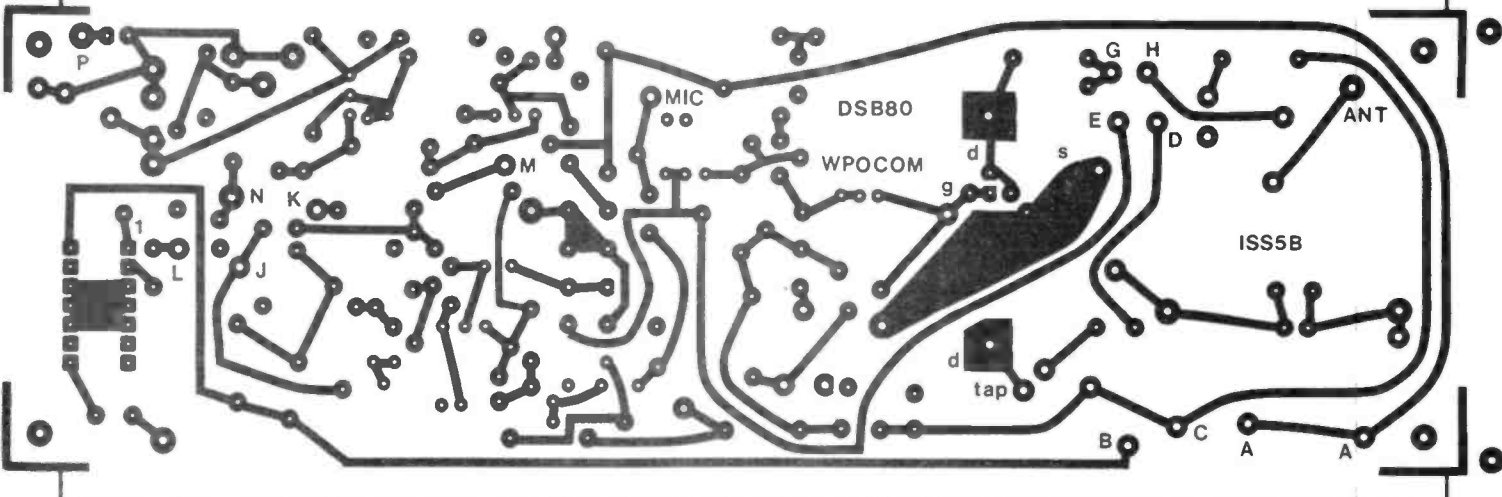

COMPETITION

Win an SMC 'Oscar Two' 10m FM rig!



What do *you* know about 10m FM?

1. Which countries have a number of 10m FM repeaters?
 A Germany and America
 B Germany, Holland and America
 C America, France and Belgium

2. Of the following modes of 10m propagation, which is known to be affected by sunspot activity?
 D Tropospheric
 E Space wave
 F Sporadic 'E'
 G F2 layer

3. What is the most commonly used spacing for the input and output frequencies on a 10m repeater?
 H 100 kHz
 I 150 kHz
 J 200 kHz

4. What is the generally recognised calling frequency for 10m FM?
 K 29.7 MHz
 L 29.6 MHz
 M 29.4 MHz

5. Is it possible to work a station through an American repeater who is using a 2m handheld?
 N Yes
 O No

6. What is the favoured mode of polarisation on 10m FM?
 P Vertical
 Q Horizontal

Complete fully and carefully. If you are the winner, this will act as a label for your prize. Post to SMC 'Oscar Two' Competition, Ham Radio Today, No.1 Golden Square, LONDON W1R 3AB. Closing date: first post, 5th July '85. Don't forget to follow the advice on the How To Enter section, including writing your choice of the answers on the back of the envelope!

Name

Address

.....

.....

..... post code

Your choice of question answers ie C,D,I etc

.....

Did you read 'Working 10m FM' in March HRT? Ten FM can be a fascinating mode of operation. One minute you're chatting to the bloke at the end of the road and the next, with a 9J2 in downtown Lusaka.

Well, this could be your chance to explore the mode at practically no cost.

The lucky winner of this month's competition will receive a prize of the very popular 'Oscar Two' transceiver, marketed by South Midlands Communications of Southampton and currently retailing at £65.

| 'OSCAR TWO' features | |
|--|--|
| ★ 5W RF output with very low spurious emissions (better than -40dB typical). | triple filtering. ★ Excellent sensitivity (typically 0.2uV for 12dB sinad) and selectivity (+/- 4.25kHz at -6dB). |
| ★ Dual conversion receiver with | ★ Repeater shift built-in as standard. |

How To Enter

Look at the list of questions nearby, designed to test out your knowledge of 10m FM operation. Each question has a number of possible answers. Choose which you think are the correct answers and write them in sequence on the coupon below. For example, if you think the answer to question 1 is B and question 2 is D, your sequence will begin B,D. . . **IMPORTANT:** write your choice of the order on the back of your envelope in addition to the coupon. Send your entry to SMC 'Oscar Two' Competition, Ham Radio Today, No.1 Golden Square, LONDON W1R 3AB. Closing date is first post on 5th July '85.

Complete the coupon fully and clearly — if you are the winner this will be used as a label. All correct entries will be placed in the HRT competition hat (size 14) and the winning entry drawn by the editor himself. You may enter as many times as you like, but each entry must be on an official coupon — not a copy — and sealed in a separate envelope.

The Rules

Entries will not be accepted from employees of Argus Specialist Publications, South Midlands Communications or Garden City Press. This restriction also applies to employees' families and agents of the companies.

The 'How To Enter' section forms part of the rules.

Practicalities

One weekend some months ago, I was rather amused by a quick exchange which I had in a contest which was taking place at the time. As often happens in these furors, I had given my callsign and the other station had it slightly wrong — G4YWX instead of G3YWX. When I went back to him, I repeated my callsign several times emphasising the 3. When I had finished transmitting I was rather amused to hear him say 'OK G3YWX we got you old timer'.

Ian Poole, G3YWX, tackles his favourite subject — speech processing — and gives tips on crystals and wire plus some info on transistors and dipoles.

This occasion of audio confusion brings me nicely onto my first point, and a subject which has fascinated me for some time — that of speech processing. Whilst many possess new transceivers which have fully processed audio, there are still a great number of older transmitters around like mine which do not. It is possible even by a few small changes to improve the punch of the audio and this can be very useful especially when conditions are not good or the QRM is high.

There are basically three ways in which a signal can be processed. The first is probably the most obvious, and certainly the most talked about is to clip the peaks from the signal and limit its maximum amplitude, enabling the *average* amplitude to be raised. The second is to compress the signal by reducing its dynamic range. This is slightly different to clipping and is effectively a method of reducing the gain of an amplifier as the signal becomes larger — a form of audio automatic gain control. This can be done instantaneously or there can be a time constant introduced. The third method is to reduce the

transmitted audio bandwidth so that only the required frequencies are transmitted. Many of the older transmitters have a fairly wide audio bandwidth and this can be tailored to give a more 'punchy' signal. Whilst the first two methods require additional circuitry to be constructed, the third one only requires that certain values of components within the transmitter audio chain are changed.

Recently, I have been experimenting with the low frequency response of a speech processor which I designed. Although the standard frequency response for communications purposes is taken to be 300 Hz to 3 kHz, this can be usefully reduced. I found that by reducing the low frequency response ie, by raising the frequency at which the response starts to fall off, interesting and favourable results were achieved.

It is generally accepted that 'pre-emphasis' as it is called is advantageous before speech clipping and I found that in practice raising the -3dB point from 300 Hz to 600 Hz gave a definitely more punchy audio signal. The only drawback to this modification was a slight degradation in the naturalness of the transmitted audio.

Transistor Identification

Over the years, most radio amateurs will accumulate a wide range of spare parts in the proverbial junk box. Whilst resistors have a standard colour code, and capacitors will be marked with a colour code of the actual value, transistors may not be quite so easy to identify without a databook.

Unfortunately, data books are expensive and not everyone has one, or has it to hand at the required time. Because of this, it is often very useful to have an idea of what function a particular device is intended to perform. This can sometimes be found from the transistor type number.

There are three main systems for giving transistors type numbers. One is American, another, Japanese, and the third, European. It is the European system which gives the most information about the transistor. As shown nearby in Table 1, it consists of two letters followed by a serial number. The first letter indicates the type of semiconductor used in the device. The second gives the intended function and the remaining three characters, the serial number. This serial number will be totally numeric if the transistor is intended for consumer equipment, but if it is intended for industrial applications, the first character of the serial number will be a letter.

As an example let us take the BC107. The first letter 'B' indicates that it is a silicon device, the 'C' indicates it is a low power audio frequency transistor, and the serial number '107', having no letter included, indicates it is intended for consumer applications. Similarly a BLY33 is a silicon RF power transistor for industrial equipment.

Table 1 European System for Transistor Identification

| 1st Letter | 2nd Letter |
|--------------------|--|
| A Germanium | A Low power/signal diode |
| B Silicon | B Variable Capacitance diode |
| C Gallium Arsenide | C low power, audio frequency transistors |
| | D Power audio frequency transistor |
| | F Low power high frequency transistor |
| | L Power, high frequency transistor |
| | S Low power switching transistor |
| | U Power switching transistor |
| | Multiplier diode |
| | Z Voltage reference diode |

Serial Number

Three figures (100-999) for devices intended for consumer equipment.

One letter and two figures (10-99) for devices intended for industrial equipment.

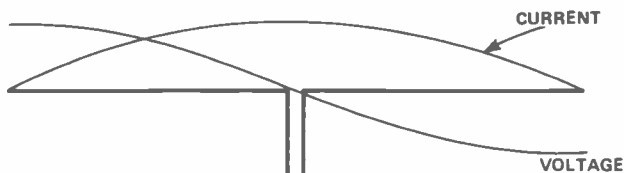

Fig. 1 Current and voltage distribution in a dipole.

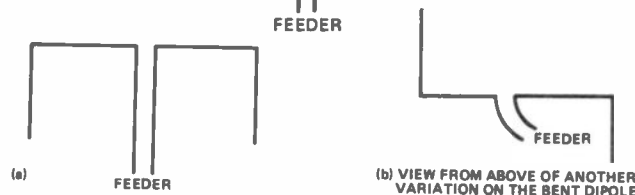

Fig. 2 Bending a dipole to save space.

Bent Dipoles

Most of us probably have pipe dreams about owning a large field on the top of a hill somewhere and being able to put up large aerials on tall towers to easily reach those distant stations which we can normally only just about hear, let alone 'work'. However, most of us, except for a chosen few, have to return to the reality of being able to put up a modest aerial into an even more modest garden or loft.

Fortunately, it is possible to get away with bending the ends of dipoles or many other types of aerial as well without affecting its operation unduly. Looking at the current distribution in the aerial shown in Fig. 1, it can be seen that for a half wave dipole, most of the current is carried in the wire close to the centre of the antenna. The current flowing in the wire is what actually causes the antenna to radiate and therefore the centre section is the part of the aerial which contributes most of all to the radiation from the aerial. If the ends of the aerial are bent downwards as in Fig.2a, or to either side as in Fig.2b, the radiation from the aerial will be only affected marginally.

Overtone Crystals

It is interesting to note that when using crystals in an overtone mode, the frequency at which they oscillate is slightly different to that which would be generated if they were made to oscillate at their fundamental frequency. This fact proved to be a stumbling point for me a few years back when I was modifying a valve radio telephone for 2m operation. The local oscillator circuit shown in Fig.3 was

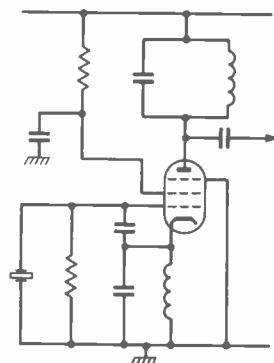

Fig. 3 Circuit of valve oscillator in which the crystal is oscillated at its fundamental frequency.

constructed, the anode circuit tuned for 45 MHz operation, and the circuit turned on, only to find that the frequency of operation was slightly incorrect. When the circuit was investigated with an oscilloscope, I found that the anode circuit was operating at 45 MHz, whilst the grid and cathode circuits were oscillating at 15 MHz. The solution to the problem was to tune the grid/cathode circuit so that oscillation only occurred at the required frequency.

Even though the circuit used valves, it serves to illustrate a point which would be true for transistors as well. It is well worth including a tuned circuit into the feedback path of a crystal oscillator, not only to ensure that it oscillates at the correct overtone, but also to ensure that the crystal is not provoked into oscillating in another mode as well as the required one — which would cause spurious signals to be present in the oscillator or, even, transmitter output.

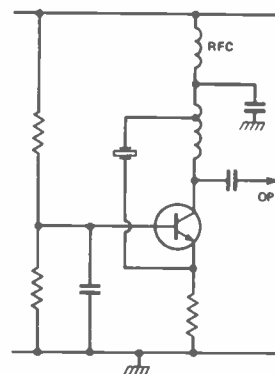

Fig. 4 Circuit of transistor oscillator showing how the feedback path may be tuned, thereby ensuring the crystal operates in the required overtone mode.

Removing Knots From Lengths Of Wire

In almost every radio amateur's shack, there is one of the proverbial junk boxes, an Aladdin's Cave of sorts, and filled with all manner of bits and pieces. Caught up amongst everything else, there are no doubt odd lengths of wire, thrown in to be used at a later date. However, as often happens, the wire becomes full of kinks and bends which are difficult to remove.

Some years ago, I came across a very simple yet effective way of removing these kinks. It is done by simply winding the wire once round a suitable screwdriver shaft or other suitable implement, and then pulling the wire so that the entire length is pulled once around the shaft (Fig. 5). By doing this, the wire loses all its kinks and can then be re-used.

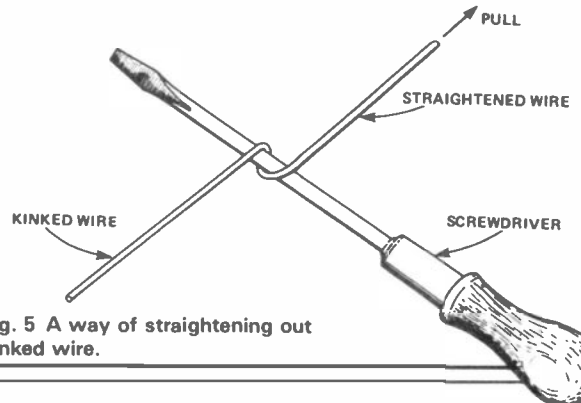

Fig. 5 A way of straightening out kinked wire.

TWO INTO ONE =



FT2700RH

The author puts much time into trying to prevent his car from looking too much like a mobile 'mission control', so the suggestion of his reviewing one of the latest dual band radios (only *one* box instead of two!) was accepted with great delight.

TW4000A, it is approx 60% of the size and gives, in my opinion, far greater facilities. Coverage is from 144 to 146MHz, and 430 to 440MHz in 25 or 12.5kHz steps. The TW4000A gives 5kHz or 25kHz steps, and like it or not, the use of 12.5kHz channel spacing is

Is your dashboard overloaded with radio equipment? Well, compact dual band transceivers for VHF/UHF FM operation are pretty much in vogue at the moment, with Trio, Yaesu and now Icom all producing models. Chris Lorek, BSc, AMIEE and G4HCL, found some space in his car for the Yaesu FT2700RH...

On unpacking the box, the small size of the FT2700RH was the first thing that struck me. How do they fit it all in? The '2700RH measures a tiny 150mm wide by 50mm high x 168mm deep, and would fit very nicely into a standard car radio aperture if required. In fact, securely bolting such a radio into the superstructure of a dashboard would certainly not be a bad idea and it would take a very determined thief to attempt to get it out. A simple fold-over flap, concealing the fascia of the transceiver, could be used when parked for added peace of mind.

Compared to its main rival at present, the Trio/Kenwood

growing, certainly in the London area, for instance, due to the frequency congestion on 2m. At my home QTH (near Cambridge) over a weekend there are certainly times when every single FM simplex channel above 145MHz has an audible signal on it, as well as many of the frequencies in the all mode section below 145MHz. Finding a channel to natter on can often be rather difficult with 25kHz spacing.

Facilities Offered

The output power on both 2m and 70cm is a nominal 25 watts, with a low power switched facility provided, and the receiver has good

sensitivity to ensure reciprocity. Channel control is by a large rotary switch: this has 50 click stop positions per revolution, and also can be controlled by 'up-down' buttons fitted to the top of the microphone case, which I found the most convenient to use when mobile. A 'lock' switch is fitted to the rear of the mike to stop accidental shifts in channel.

Ten memory channels are available, each capable of storing any frequency on transmit and/or receive. For instance, it is possible to program repeater shifts and even cross band frequencies. These may be selected as 'active' or not by depression of the 'M' switch, giving 'lockout' when in the scanning mode but still enabling selection by the up/down switches on the mike.

Selectable Scanning

Scanning of 'active' memory channels, on 2m or 70cm, may be carried out by depression of one of the mike control switches for more than a second, stopping automatically when a signal is found. A preset switch on the underside of the radio selects either one of the two modes of scanning, ie either the scan stays stopped until the signal disappears, or the scanning resumes after six seconds have elapsed. I found the latter mode particularly useful to get an idea of what was happening on other channels, whilst (mainly) listening to the local 2m repeater. A programmable scan is also available which scans frequencies between those programmed in memories 9 and 0, in addition to a 'priority' channel watch, which checks any selected memory channel every six seconds for activity, locking onto it if a signal appears.

Two VFO's are fitted, A and B, both capable of operation on 2m or 70cm. A '-/+ ' repeater offset switch selects the correct frequency offset, depending upon whether 2m or 70cm is in use, this operates on both the VFO's and on any single-frequency programmed memory channel. A 'reverse repeater' switch gives full reverse operation. A 1750 Hz toneburst is

selectable; either manually on depression of a front panel mounted push switch, the tone being transmitted for the duration of the press, or automatically by a preset switch on the underside of the radio.

A novel feature is the *full duplex* facility, selectable on VFO operation by depression of the 'dup' switch, allowing true telephone style cross-band operation. For instance, it is possible to transmit on 70cm on VFO B whilst simultaneously receiving on 2m on VFO A, very useful when communicating with a similarly equipped station. This was demonstrated to a CB user colleague and brought forth a gasp of amazement! An optional voice synthesizer is available, which is fitted to the review sample. It gives a spoken announcement of the operating mode and frequency, either on command by the microphone-mounted push button, or automatically each time the user changes frequency or mode of operation. Again this is selectable by a small preset switch on the underside of the radio.

Further panel mounted switches control high/low output power, display illumination, access to a programmable 'call' channel, and an optional sub-audible tone encoder facility, a system not presently used in this country by amateurs, but in the future who knows? The on/off switch is combined with the volume control, and a concentric squelch control is fitted.

The display is a green back-lit LCD, with a dual colour 'S meter' section. A very clear frequency indication is given, together with a read-out operating mode such as memory channel, which VFO is in use and whether normal reverse repeater, duplex, call channel, or programmable memory scan have been selected. A lithium battery back-up is fitted to ensure that programmed memory channels are re-

Memory 'back-up', tone burst, scanning mode and the optional voice synthesiser are selected by switches on the FT2700RH underside.

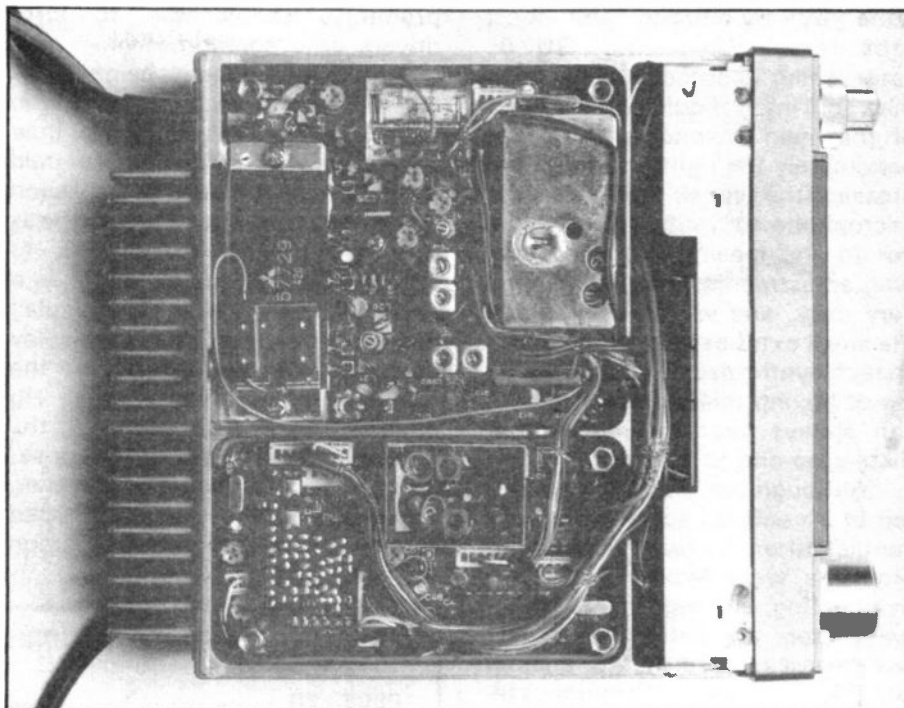
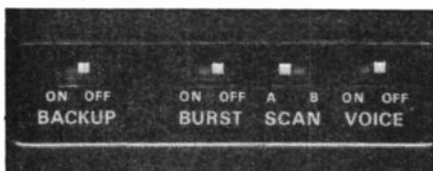

The neat and tidy interior of the FT2700RH, viewed from the top. For information on the construction see 'Technical Appraisal'.

tained after power has been removed; and also, a nice touch, that the last programmed frequency and operation mode is still selected when power is re-applied. A soft 'bleep' accompanies manual mode and frequency changes, and is also given when a signal is found when the transceiver is in scan mode.

On The Air

It was decided to mount the radio in the driver side glove compartment, using a soft mount rather than the supplied mobile mount which, incidentally, was found to be very easy to use, I resisted the temptation to bolt the '2700RH into the dashboard, relying on the anti-theft system in my car instead. (The last two 'yobbos' who tried were caught red handed by the police and actually put inside. No-one else has tried since!)

After familiarising myself with the operating modes, I used it mobile for a period of about three weeks, and very quickly decided that it was rather easy to steer, change gear, natter, QSY, and smash the car up at the same time! The main problem initially was that with so many facilities available on small 'soft touch' controls, it was very easy to accidentally select a different operating mode without realising it. It was correcting these unknown mistakes that required taking my eyes off the road to look

at the display; then press the relevant buttons on the front panel to revert back to the mode desired. Operating the radio by 'feel' was extremely difficult on even a slightly bumpy road as only a minute depression on each button was needed to operate it and I really felt Yaesu had slipped up here. A more positive action would have been much better for mobile user, although the system utilised is excellent for base station working.

I then found that in normal mobile usage, only a relatively small number of operating frequencies were required for general monitoring, and these were quickly stored, whilst stationary, in the memory channels. Reverse repeater frequencies of the local 2m and 70cm boxes were stored in the channels adjacent to the normal frequencies, and with this set-up the rig was found to be extremely simple to use, bearing in mind the limitations, by operation of the up/down buttons on the microphone. The only other thing I could possibly have wished for was a toneburst on/off button on the microphone.

Although it was not apparent from the 'temporary' manual (at the time of this review, the official manual was not available in this country), it was found possible to QSY from any memory channel, by automatically entering VFO mode. The majority of my operation was

done by monitoring the local repeaters, S20, and SU20, establishing contact there, and then QSYing if required. By a twist of the main channel knob to approximately the right position, then pressing the 'speak' button on the microphone to verify where I had got to and making any necessary final adjustments, I found QSYing very easy, and would recommend the small extra extravagance of the speech synthesizer if you are thinking of buying this radio. Besides, it can always keep you amused if there's no-one to talk to!

Although the '2700RH was fitted in a confined space with poor ventilation of the rear heatsink, no problems were encountered with overheating; although the radio actually has an automatic power reduction circuit to protect against just this occurrence. My journeys included several trips past radiotelephone communal radio sites, and much operation within a hundred yards of a 70cm repeater. No problems were encountered with either de-sensitisation or off-channel reception.

Audio Quality

Reports of transmitted audio quality varied somewhat initially, but after experimentation I found that holding the mike around eight inches away from my mouth gave the best results. I believe that the mike gain is rather high for mobile use as supplied, and the mike did in fact pick up (some) background voices but surprisingly not much road and wind noises. On receive, an external speaker was used due to the mounting position of the rig, the internal speaker pointing downwards, and although there was adequate volume, the volume control was always around the half to two-thirds position. There was a small amount of ignition interference noted on weak 2m signals which I did not expect, although it was never enough to cause annoyance.

The microphone socket securing ring came loose during use, (maybe smaller Japanese fingers haven't got as much spanner handling force as us), but otherwise the set operated perfectly. The LCD display was viewable from most angles when mounted below eye level, but blanked out when viewed from below which is only

probably troublesome to lorry drivers who sometimes have sets mounted above head height. The 'on-air' testing was carried out in mild weather, but knowing how LCD displays behave when cold prompted me to check its operation at low temperatures. The set was thus frozen to -6 deg C, to simulate being kept overnight in a car outside in winter. The display operated but was slow to display changes; for instance when the PTT was operated, the rig developed power instantly but the Tx power level indicator took a second or two to display the power. The voice synthesizer still chirped away merrily and correctly upon demand.

Technical Appraisal

The radio is constructed on a solid one-piece aluminium die-cast chassis, which gives good mechanical strength as well as good RF shielding and heat dissipation, the latter very important when the physical dimensions are so small. Flying leads are used for the aerial and power connections, letting you mount the radio in a variety of spaces which otherwise would not usually be possible due to the usual circumstance where connectors stick out of the back panel. Connection and disconnection were made very easy, although I did not like the fact that there was no strain relief provided on the

YAESU FT2700RH LABORATORY RESULTS

RECEIVER

| Sensitivity for 12 dB SINAD | 144 MHz | 0.150 uV |
|-----------------------------|---------|----------|
| | 145 MHz | 0.155 uV |
| | 146 MHz | 0.166 uV |
| | 430 MHz | 0.197 uV |
| | 435 MHz | 0.162 uV |
| | 440 MHz | 0.170 uV |

S-Meter linearity

| | 145 MHz | 435 MHz |
|------|----------|----------|
| S1 | 0.372 uV | 0.240 uV |
| S2 | 0.902 uV | 0.543 uV |
| S3 | 1.18 uV | 0.692 uV |
| S4 | 1.43 uV | 0.841 uV |
| S5 | 1.68 uV | 0.988 uV |
| S6 | 1.88 uV | 1.17 uV |
| S7 | 2.37 uV | 1.38 uV |
| S8 | 2.82 uV | 1.62 uV |
| S9 | 3.76 uV | 2.16 uV |
| S9 + | 6.24 uV | 3.55 uV |

Adjacent Channel Sensitivity

Measured as degradation of a 12dB SINAD by an interfering signal modulated with 3kHz deviation of 400Hz audio.

| Frequency | +25 kHz | -25 kHz | +12.5 kHz | -12.5 kHz |
|-----------|---------|---------|-----------|-----------|
| 145 MHz: | 86.0dB | 86.0dB | 17.5dB | 15.0dB |
| 435 MHz: | 71.5dB | 72.5dB | 14.5dB | 18.5dB |

Blocking Performance

Measured as above.

| 145 MHz: | 435 MHz: |
|-------------------|-----------------|
| +0.5 MHz: 74 dB | +1 MHz: 67 dB |
| -0.5 MHz: 74.5 dB | -1 MHz: 67 dB |
| +1.0 MHz: 75.5 dB | +2 MHz: 76 dB |
| -1.0 MHz: 74.5 dB | -2 MHz: 75.5 dB |
| +2.0 MHz: 84 dB | +4 MHz: 94 dB |
| -2.0 MHz: 83 dB | -4 MHz: 93 dB |

3rd Order Intermodulation Distortion rejection (ratio of increase over 12dB SINAD level, of two interfering signals).

| | 145 MHz | 432 MHz |
|-------------------|---------|---------|
| +25 kHz, +50 kHz | 76.5 dB | 69.0 dB |
| +50 kHz, +100 kHz | 78.5 dB | 68.5 dB |
| -25 kHz, -50 kHz | 78.0 dB | 69.5 dB |
| -50 kHz, -100 kHz | 80.0 dB | 69.0 dB |

aerial leads next to the metal on the in-line sockets. The metal could chaf through the insulation and braid of the leads, if the radio was very frequently moved in and out of the car. An ample length of thick DC power lead was provided, fused in each lead, a nice touch, which would protect the radio if an earth fault developed in the engine compartment. As well as plenty of mobile installation material, a nice chrome plated bracket was provided for base station use to tilt the radio upwards.

Internally, a hybrid construction method is used, with surface mounted components glued and soldered on the underside of the boards, and discrete components

such as coils, larger transistors, filters etc mounted on the topside. This would increase reliability over the traditional methods of assembly, but in some cases would make component replacement extremely difficult for a repair workshop and probably almost impossible for the average amateur. Luckily, most faults would not normally be on the 'chip' components, but make sure that you buy from a dealer with service backup facility! Board size is made even more compact by many interconnections on internal plugs and sockets.

The PCB mounting pillars are unfortunately made of unplated metal which will cause electrolytic corrosion — particularly encourag-

ed by condensation which would occur in typical mobile usage — and this could cause mixing problems in full duplex use after several years, as one pillar is mounted right next to an aerial input. However I must stress that I am being very critical here, and generally the internal construction is very good indeed, bearing in mind the size and intended use of the transceiver.

The manual as supplied was a preliminary photocopied affair, and whilst giving very good operating instructions and a circuit diagram, no other technical information was provided, which was rather a disappointment. It would be useful on ownership to know which potentiometer to adjust, for instance, to reduce the microphone gain. SMC Ltd, the suppliers of the review set, were contacted and stated that a full manual is in production and will be supplied with each set bought from them in the future.

Receiver Ramifications

On 2m, the receive signal enters and is passed via a diode, Tx/Rx switch to a FET front-end amplifier, responsible for the reasonable sensitivity, measured at 0.155 uV for 12dB SINAD. It then goes through four stages of filtering to ensure rejection of out-of-band signals into what appears to be a block double balanced mixer, giving the very good 3rd order IMD rejection measured. This latter effect occurs when, for instance, a strong station on S21 mixes in your receiver with another strong station on S22 to give a combined signal on S20 and S23, with both stations' audio present, one twice as loud as the other. Very few problems of this nature should occur with this transceiver, and in fact never occurred in the 'on-air' tests.

On 70cm, the receive signal this time passes through a changeover relay, giving lower loss than a diode switch at this frequency; then into a two stage FET front end amplifier with distributed selectivity, giving again a reasonable sensitivity of 0.162 uV for 12dB SINAD. A double balanced mixer is again used, although the higher front end gain gave a lower 3rd order IMD rejection on 70cm, although still good.

After the mixers, the 2m and

Maximum Loudspeaker Output Power

| 1 kHz mod freq. For 3kHz dev. | 8 ohm load | | 4 ohm load | |
|----------------------------------|------------|------------|------------|------------|
| | Power | Distortion | Power | Distortion |
| 5kHz dev. | 462 mW | 1.25% | 1.06 W | 1.10% |
| | 992 mW | 15.2% | 2.11 W | 12.1% |

Conducted Spurious from Rx ant conn.

430 MHz; -39.5 dBm (112 nW) 440 MHz; -36.5 dBm (224 nW)
144-146 MHz; Less than 5 nW

TRANSMITTER

Tx Output Power - 2700PH

High Power:

| Supply Voltage | 144 | 145 | 146 | 430 | 435 | 449 | MHz |
|----------------|------|------|------|------|------|------|-----|
| 10.8 V | 22.1 | 20.8 | 19.4 | 12.3 | 13.1 | 13.4 | W |
| 12.0 V | 26.1 | 25.2 | 24.0 | 20.3 | 20.8 | 21.3 | W |
| 13.2 V | 28.8 | 28.7 | 27.8 | 22.3 | 23.2 | 24.0 | W |
| 13.8 V | 29.8 | 29.6 | 29.1 | 22.4 | 23.4 | 24.2 | W |
| 15.0 V | 31.2 | 31.2 | 30.9 | 23.0 | 23.9 | 24.6 | W |

Low Power: 144-146 MHz Within 0.1 W of 4.0 W all voltages
430-440 MHz Within 0.1 W of 3.8 W all voltages

Peak Deviation

(1kHz mod freq.)
145 MHz; 4.7 kHz 435 MHz; 4.8 kHz

Harmonics/Spurii

| | 2nd Har. | 3rd Har. | 4th Har. | Other Spurii |
|----------|----------|----------|----------|---|
| 145 MHz; | -78dB | -82dB | -90dB | -90dB |
| 435 MHz; | -71dB | -84dB | -90dB | 145MHz; -70dB * 290MHz; -67dB * 580MHz; -60dB * Others -90dB |

* See Text

Tx Toneburst

Deviation; 145 MHz; 3.9 kHz 435 MHz; 4.0 kHz
Frequency; 1750Hz to within 0.1Hz

Frequency Accuracy

145 MHz; 144.999941 MHz 435 MHz; 435.00232 MHz

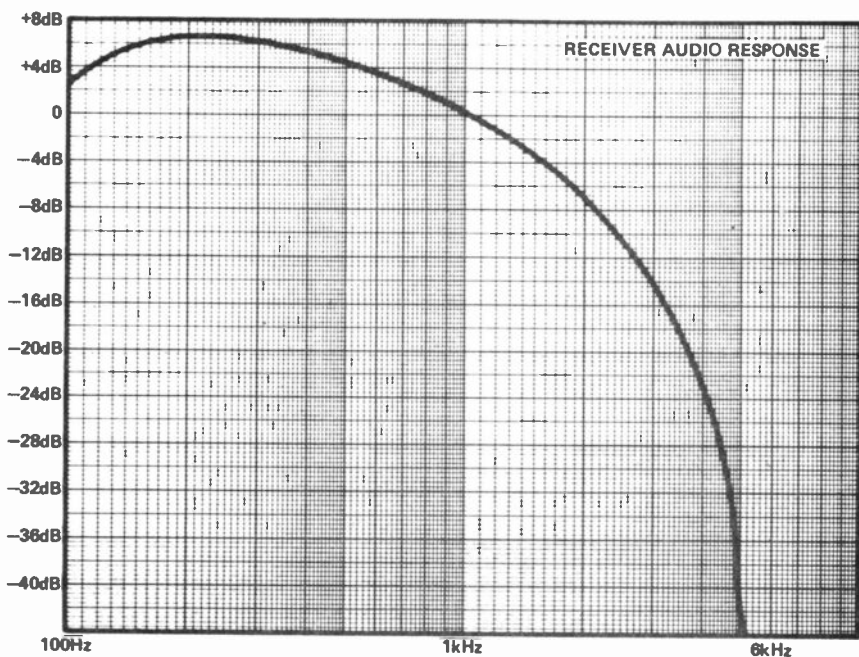

FT2700 RH receive (top) and transmit audio responses.

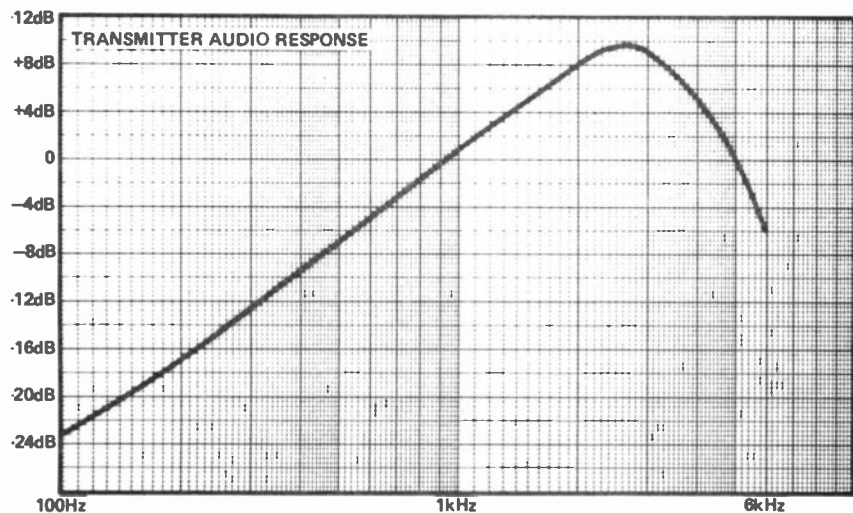

70cm signals are switched under the microprocessor control into a common IF amplifier, although the 'temporary' manual stated that independent IF stages are used for each band. The 21.6MHz IF signal is passed via two 2-pole crystal filters, and is further amplified, mixed to 455kHz, filtered again in a ceramic filter, detected and so on. A noise squelch is used, stopping the squelch lifting on ignition noise from the occasional passing motorcyclist. This samples noise at a frequency above that used for voice communication, and cuts off the loudspeaker audio when that small range of frequencies are present. In the past, this has occasionally caused problems on 12.5kHz channel usage, when an inaudible beat between two signals separated by 12.5 or 10kHz would shut the

squelch on some rigs! This effect was measured on the FT2700RH, and it was found that the designers had settled on 5.9kHz as the noise detection frequency, so no problems of this nature should be found in usage. The minimum signal the squelch could be set to raise on was an almost undetectable 1dB SINAD, again very good.

Load Speaker?

A uPC2002 IC audio amplifier was used and this has the capability of at least 4W of audio, so it was surprising to find that a maximum of just over 2W into a 4 ohm speaker, and 1W into 8 ohms was possible. I feel this may cause problems particularly if used in a noisy van into its own speaker, and would recommend an external

speaker mounted in a suitable prominent position. The internal speaker gave quite satisfactory performance in base station use, though. The audio response at lower volume levels was well shaped and free from excessive distortion.

One strange result occurred when I was using the set at home, with a further 70cm Rx scanning in the shack. The shack set would always stop scanning on a weak signal 200kHz lower than the frequency set on the 2700. A quick check with a calculator showed that leakage from the 2700's local oscillator, 21.6MHz lower than its set frequency, was falling on the image, 60dB down and 21.4MHz lower than the shack rig's set frequency.

With this in mind, the leakage from the aerial socket of the 2700 on 70cm was measured and found to be between 0.1 and 0.22 mW depending on the frequency, and was negligible on 2m. This could cause a few problems, depending upon how the rig is to be used, although a bandpass or simple coax notch filter could be used to solve this. Again I must state that I am being very stringent in my comments and certainly other radios particularly with a lower IF including my shack rig (a converted CB rig!) might well be far worse.

The S-meter display has ten segments, eight black and the two final ones red, with 1 to 9 labelled beneath, presumably S1-9 with one segment over. As usual with FM rigs, this was virtually useless having only a limited range, with about 1.4dB difference between most segments. A fully readable signal could be received without any 'S' indication. To simulate mobile operation with separate aerials having finite isolation, 0.25W of 145MHz was fed into the 70cm Rx port with no degradation apparent on a 12dB SINAD non-harmonically related signal, and similarly 0.25W of 435MHz was fed to the 2m port with no degradation of the wanted signal.

The adjacent channel rejection was good at 25kHz spacing, but a little poor at 12.5kHz. The 70cm measurements were slightly worse than on 2m, due to reciprocal mixing of the close-in noise; but because of the lower level of activity on 70cm, this should not be as



important. Even though a strong signal 12.5kHz away would raise the squelch, on scanning the centre frequency only would be stopped on when tested. Blocking performance by signals well separated in frequency was reasonable but could be better, and the image rejection was good.

Transmitter Technicalities

On transmit, the microphone signal is amplified and mixed when required with the toneburst signal. The latter is crystal controlled and was very accurate in frequency when measured, the deviation was at a sensible shift of 3.9kHz and should cause no problems in accessing any repeater. The automatic toneburst length was rather long at 880mS, but the (tiny) controlling switch for this was in a stupid position underneath the radio, the top of which was flush with the case making switching more difficult. However, the vast majority of repeaters in Britain only require a tone on initial access, so an auto toneburst is in the reviewer's eyes rather an annoyance than a benefit, a push switch as fitted to the front panel being preferred.

The transmit audio is then passed to the respective voltage controlled oscillator in use for the band selected, modulating the carrier frequency directly. The audio was again well shaped, with a peak at 2.5kHz before being 'rolled off' and ensures that higher frequency FM sidebands do not splatter onto adjacent channels. The peak deviation was well controlled, being just under the maximum recommended level of 5kHz peak on both bands. This was a welcome relief to me, as

many Japanese VHF/UHF transceivers are sent out with gross overdeviation (I have measured up to a very unsociable 9kHz on some!).

The VCO signal is further amplified before being passed to a 'Block' type PA module, now very common in transceivers. These save space and factory alignment time, are easy to replace if they blow up, but are rather expensive. From there, the 25W signal is passed via the Tx/Rx switching and low pass filtering to the aerial connection, this being an in-line N-type on 70cm and in-line 'UHF' type on 2m.

Maximum transmit power varied only slightly with changes in voltage supply, only falling noticeably when the supply dropped below 11V. Low power was very well regulated to around 4W. On 2m, there was a reasonable margin above the rated 25W but on 70cm the output was slightly low, as measured on an accurate thermistor power meter and attenuator.

Harmonics are well down in level and the only spurious outputs noted were on 70cm operation when the set got hot (60 deg C and above) at multiples of 145MHz, the worst falling at 435MHz (plus 145MHz being 60dB down — about 25uW) and around about TV channels 33 and 34. This could be removed under test by flexing the top panel of the radio at the front and was possibly due to a minor earthing problem. The noise floor, ie the wideband radiated noise from the transmitter, was measured as -91dB over +29MHz to -14MHz on 2m, and a surprisingly better -96 dB over +16MHz to -14MHz on 70cm, both measured

in a 10kHz bandwidth, which would only have the effect of desensitising other amateurs or services if they were fairly close.

The power shutdown was tested, by leaving the radio on constant transmit on a tabletop, running at 25W on 70cm. Automatic low power occurred 23 minutes later with a heatsink temperature of 67.2 deg C. The radio then cycled between high and low power, showing it was adequately protected. Frequency accuracy was very good, being 59Hz low on 145MHz and 232Hz high in 435MHz, with repeater offsets to the same degree of accuracy due to the synthesized method of offset as opposed to a separate mixer crystal being used. Between 25 deg C and 65 Deg C, the frequency did not drift by more than 300Hz from nominal, perfectly adequate for FM usage.

Conclusions

I have been used to operating with separate radios on 2m and 70cm in the car, and have often found it personally useful to operate on one band, whilst listening for a pre-arranged call, or for general activity, at a lower volume setting, on the other band. This unfortunately is not practical on the FT2700RH. However, I must say that my method of operation does get a little confusing at times, to say nothing of the effort and concentration involved in grabbing the 70cm mike to say "hang on, I'm in QSO on 2m at the moment" whilst talking on 2m and driving a car (yes, I know I'm mad!) at the same time. The FT2700RH is not 'two rigs in one', but it comes very close.

The full duplex facility and 12.5 kHz channel spacing are two of its particularly good points, and quite honestly I can't justifiably find any real bad points apart from maybe the push buttons, but then I'm a right fussy so-and-so as you can probably tell from the test results!

If I had the inclination and the spare cash to buy a dual band rig at the moment, I would not have any hesitation in purchasing this one.

My thanks go to South Midlands Communications Ltd of Southampton for the loan of the review set.

Meet the MICRON!

Part 3

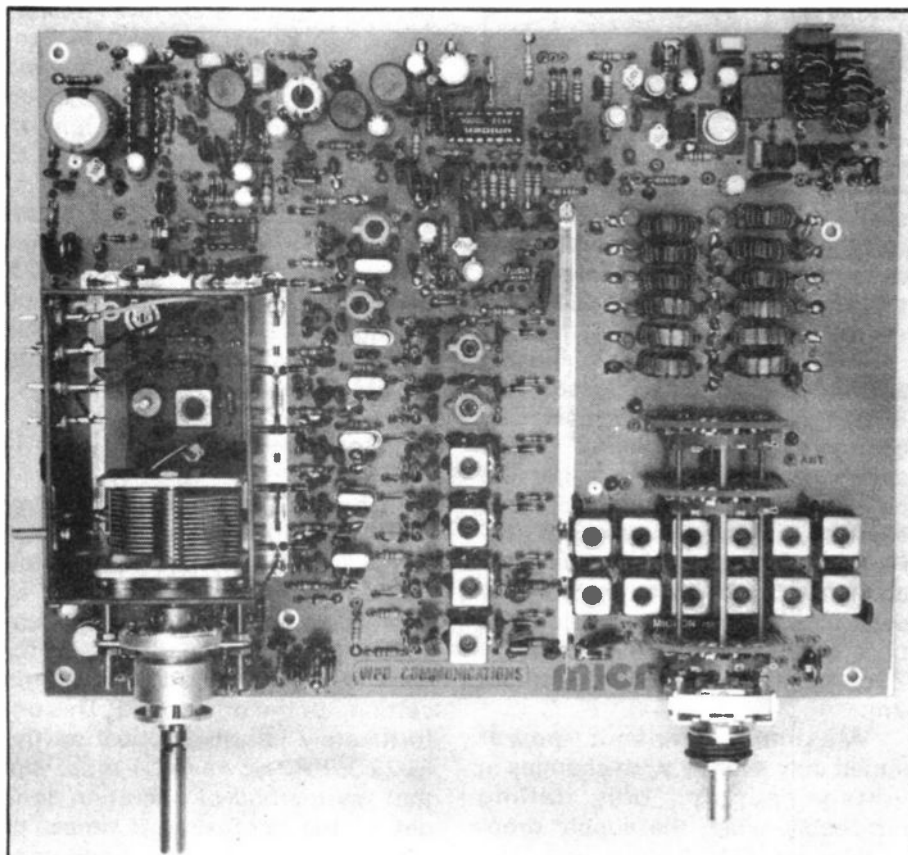

The main MICRON PCB.

The first two parts of 'Meet the Micron' (May, June '85) described consecutively the circuitry of the Micron and the major part of the construction of the main PCB.

This month, Frank Ogden, G4JST, and Tony Bailey, G3WPO, complete basic construction of this six band 0-10W CW transceiver. Read on!

24. Repeat the previous set of instructions for T6. Solder this into place, not forgetting to solder the right hand lead to the top as well as the underside of the PCB.

25. Now wind T1 (to the right of IC1) — this is a single winding with a tap which is formed by winding with two lengths of wire. Take a 17cm length of 0.2mm enamelled copper wire and wind 8 turns onto a small two hole balun core in the

same manner as you did with T1. Mark one of the curved edges of the core for later identification. Strip back the insulation from each wire to within 2mm of the core. Now take a 10cm length of the

same wire, strip 5mm of insulation off one end, pass the stripped end through the hole at the marked end towards the wire already there, and twist it with the *other* wire. Solder these two wires together, then use the free end of the wire to make 4 turns on the core (you will pass the wire through the core a further 7 times to do this).

Trim the three wires back to about 8mm, and strip the remaining wire back to within 2mm of the

core. Now insert all three leads of T1 into the PCB so that *the marked side is to the left (adjacent to C31)*, with the transformer standing vertically. Leave the base just above the PCB so that the right hand lead can be soldered to the top, then solder all three leads on the underside.

26. T2 is wound in a similar manner to the previous transformer, but with less turns. Mark one edge as before, then take a 10cm length of 0.2mm diameter enamelled copper wire, and wind 4 turns for the primary, exactly as you did with T1. Strip the insulation, and using 7cm length of the same wire, join this to the existing winding, as before, then wind a total of two turns (three more passes through the core). Trim the wires back to 8mm, strip and insert into place with the marked edge to the *right (adjacent to C76)*. Solder into place with the left hand lead soldered directly to the PCB top.

The remaining components (Tx/Rx switching-power control & meter switching), are now inserted, starting at the top left hand side of the board.

27. Insert and solder D55-56, C135-146, 183-185, R134, 138-153, 155-157 and 176-178.

28. Carry on with RV6, RV7 and RV8. Then Q51, Q40, Q44, Q38, Q43, Q42, D49, IC7 and Q41 — Q45 is left out at the moment and inserted at a later stage.

29. The switch wafers are now fitted. Remove one wafer from its bag, insert it into the PCB at position S1a/S1b, with the actual switch wafer facing the front of the board. Make sure the switch fits into the PCB holes and solder into place. Repeat with the other two switch wafers. The switch mechanism will be fitted during testing.

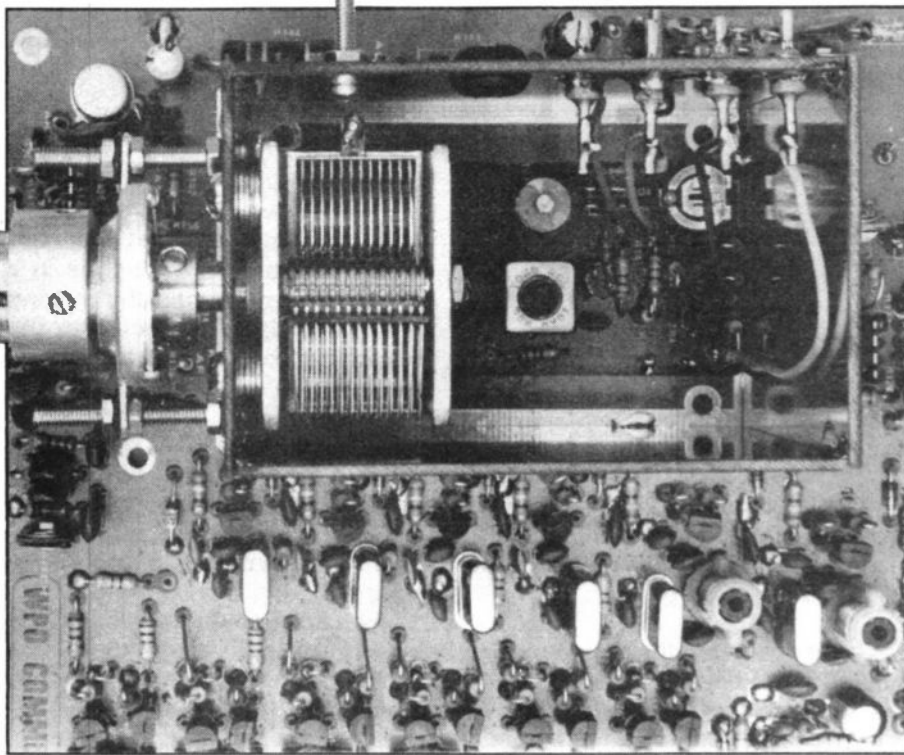

Close up of VFO construction on main PCB. Note the short component leads.

30. Cut a brass or tinplate screening strip 120 x 25mm, and solder into place (at each end and the centre) positioned along the marked line.

31. The VFO screening enclosure is now built and fitted. There are five tinned rectangles of double sided PCB material needed to make this enclosure (supplied with the kits/PCB from WPO Communications). These should be cut following the drawings and drilled as shown. Separate these into the two large pieces, and, of the three pieces left, two are the same size with the other just a little longer — the latter is the lid and should be put to one side.

Take the smaller piece, drilled with several holes, and with reference to the drawing, insert a 25mm long 6BA bolt from the rear of the board through the rightmost hole. Place a 6BA lockwasher on the other side, and then a 6BA nut and tighten up. Repeat with the leftmost hole. Remove any temporary connections still made to VC1, and cut off the right hand solder tag of this capacitor (as viewed from the spindle end). Using a hacksaw, shorten the spindle of VC1 by 5mm, and deburr the cut end (be very careful not to get any swarf in the capacitor vanes). The

capacitor is then mounted on the PCB (from the rear) using a 4BA 9mm thread length roundhead bolt at each of the three screw positions, with 4 x 4BA plain washers as spacers on each bolt, located between the rear of the PCB and the front of the capacitor — it is essential that these are used otherwise the bolts will foul the vanes and damage them. Tighten up securely.

Take one of the larger plates (the one without holes) and place the longer side on the main PCB so that the right hand side of it is parallel with the outer left hand edge of the series of broken lines etched into the upper surface of the PCB. Hold the piece previously assembled with the capacitor against the front of this, so that its rear edge is positioned as in the drawing.

These two plates should then be lightly soldered into place — at each lower outside corner — to the main PCB. Check that all the edges are parallel and run solder along the entire length of each of the outer lower edges. Also solder the inside lower edge of the front piece to the main PCB. Position the remaining smaller piece at the rear and, using the larger remaining plate held temporarily in place on the left to get the position correct. Solder the rear side edge. Do not fix the remaining

plate yet. Solder the upper top two corners together ensuring that the sides align perfectly.

Take a length of 18 swg tinned copper wire and solder one end into the hole marked 'TO VC1'. Bring this wire under the capacitor and up through the hole in the left hand tag, ensuring that it cannot touch the capacitor body. Solder, and cut off the excess.

32. Take a 7.5cm length of green wire, strip the ends and solder one end into point J. Then take a 15cm length of miniature coaxial cable, strip the ends as illustrated, and make the braid into a pigtail at each end. Solder the centre to point H and the braid to the nearby earth pin.

33. Take the remaining side plate, and solder in the 4 solder-in feedthroughs at the positions shown. They are inserted from the rear of the plate, and the silvered part on the outside of each feedthrough soldered all round the edge to the surface of the plate. Then fix the grommet in place.

34. Insert a 6BA 12mm long round head screw from the rear of the plate through each of the two remaining holes. Place a 6BA lockwasher and nut on the other side, and tighten up. Solder this plate into position to finish the VFO enclosure (lower outside edge and top corners). Thread the coax through the grommet, and then, on the inside of the feedthroughs, connect the green wire to C189, the yellow wire from point F to C186, the yellow wire from point N to C187, and the blue wire to C188.

35. Run a 6BA nut on to each of the screws projecting from the front of VFO enclosure, so that the front of each nut is approximately 12mm from the front of the enclosure. Slide the reduction drive onto the screws and against the nuts, then clamp both grub screws in the bush onto the capacitor spindle as far back as it will go. Make sure both nuts are touching the flanges, then place a 6BA lockwasher and nut on each and tighten up. Check that the drive rotates smoothly.

You should now have all the components on this main PCB in place with the exception of Q49,

Q45 and the switch mechanism.

36. Take a 20cm length of red wire, strip the ends and connect between point AG (by IC7) and the other point AG by the front of the switch mechanism. Use another 5cm length of red wire to connect points AQ and AS (at right of PA area). Then a 10cm length of blue wire to link points AY (to left of VFO) and Y (by RV4).

37. Link point AN (near IC7) to point AX (left of VFO) using a 12cm length of green wire. Then use a 19cm length of red wire to link point G (top of board) with C186 (on VFO enclosure).

38. Take a 28cm length of miniature coaxial cable, strip the ends and pigtail the braids as before. Use this to link points AT (top right hand side) and E (left of front switch wafer). Solder the braids to the nearby pins. Note: the attenuator is installed later.

39. Strip another 18cm length of coaxial cable and link point AU (top right hand side) to AV (left of top switch wafer), earthing the braids as before.

40. Use a 14cm length of coaxial cable to link point D (left of centre switch wafer) to point C (to right of IC1).

The next stage is to build up the small phase comparator on its PCB (PCB is identified as 'MCOMP' on its screen print).

1. Insert and solder 1mm PCB connection pins from the underside through holes V and the earth connection above, U and the earth connection to its left.

2. Insert and solder R100 — 94. Note that the component holes below R97 are not used at present.

3. Insert and solder C102 — 107, D43 — 44 and RFC3 — 4.

4. The two CMOS integrated circuits used in this section are sensitive to static charges. Providing you do not handle the pins while inserting the ICs into the board, you should not experience any problems — hold by the ends of the plastic package while you put them

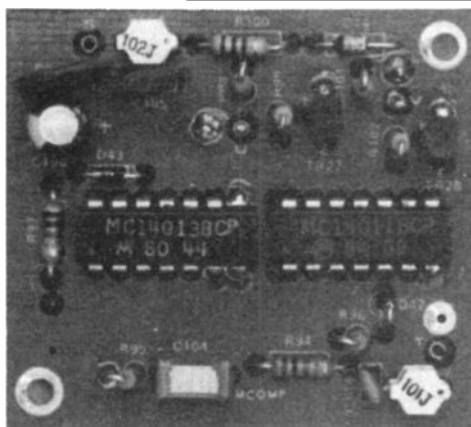

PLL phase comparator PCB

in. Don't forget to solder the appropriate pins to the top of the PCB. Insert and solder IC3, IC4 and Q27 — 28.

5. Using short lengths of yellow insulated wire, link the two holes on the underside of the PCB marked 'x', and the three holes marked 'z' (see drawing).

6. Solder a 9cm length of yellow wire into point S. Take a 23cm length of screened audio cable and strip one end *only*. Insert and solder the centre conductor to point T and the braid to the nearby earth hole, Strip off the outer insulation from the other end, pigtail the braid, but do not strip the centre conductor yet. Leave this end free until alignment of the VCOs are completed.

7. Ensure that all leads on the underside of the comparator PCB are trimmed back to within 2mm of the board. Place the PCB onto the screws projecting from the left hand side of the VFO enclosure (see drawing) and fix in place using a 6BA lockwasher/nut on each of the bolts.

8. Solder the yellow wire to point S immediately under this board.

9. Solder the centre conductor of the coaxial cable coming from the grommet to point V, and the braid to the nearby earth pin.

10. Take a 20cm length of miniature coaxial cable and strip the ends as before, pigtailling the braids. Connect one end to point U on the comparator PCB and the nearby earth pin, and the other end to point R (under IC1) and the nearby earth pin.

This now completes the main assembly, and alignment is now undertaken.

Fitting the Bandswitch

The switch mechanism should be fitted now. Firstly, set each wafer by hand so that the slot through the centre of each is in a horizontal position *and* the moving wiper finger is in contact with the 'fingers' at the right of top centre (they may be in this position already). Now, remove the mechanism from its packaging, unscrew the nuts, and remove the washers, metal and plastic spacers. Replace the metal spacers (the other parts removed are no longer required).

Fit a knob to the spindle end for the moment, and turn the mechanism fully anti-clockwise. Then check that you have got six positions by rotating the knob. If there are more or less than six, there is an indexing finger behind the locknut which can be moved until there are six positions available, with a stop at each end. Insert the mechanism into the wafers as far as it will go (note: if you remove the mechanism for any reason, be careful not to lose the two spacers!).

Preliminary Alignment

The next job is to roughly align the VCOs for each band used. If you are only adding a limited number of bands at the moment, then just carry out the alignment for those fitted. Note that if you fit more bands at a later date, the alignment will have to be repeated for *all* bands, although this only takes a short time.

1. Make up a temporary variable voltage control by connecting one end of the (unconnected at present) RIT control potentiometer to the PCB top foil at a convenient point. Connect the wiper (centre) tag to point P, and the remaining end to the +12V supply.

2. Connect the frequency display module, or your frequency counter, to point Q (under IC1) and the adjacent earth pin, using miniature coax.

3. Apply power — now, using a

multimeter, adjust the voltage on the wiper of the potentiometer to 9V \pm 0.1V. Do not re-adjust this control while alignment is in process.

4. Using a spade ended trim tool, adjust the core of L15 (bottom left of screen) until the counter reads approximately 3.71MHz.

5. Turn the switch one position to the right (40m) and adjust the core of L16 for a reading of 7.21MHz.

6. Continue turning the switch and setting L17 for 10.21MHz and L18 for 14.21MHz.

7. Using a hex ended trim tool, set L19 for 21.21MHz, and L20 for 28.21MHz. These two cores will be somewhat more critical in adjustment than the others.

8. Remove power and remove the temporary voltage control. Adjust the cores of L13 and L14 so that they are projecting out of the coil about 2mm. Disconnect the counter from point Q. Temporarily connect the braid of the counter lead to the right hand side of R23 (up and to the right of IC5). Reapply power, and, with the switch mechanism on 10m (fully clockwise) hold the centre conductor of the counter lead against the left hand side of R23. Check that the counter reads 29.000MHz \pm 5kHz. If no reading, or unstable, adjust the core of L20 until you get a reliable reading.

9. Switch to 15m, and check that the counter reads 22.000MHz \pm 5kHz. Again, adjust the core if necessary.

10. Switch through the other bands and check that all oscillators are working — readings should be 15.000MHz (20m), 11.000MHz (30m), 8.000MHz (40) and 4.500MHz (80), all \pm 5kHz. If no readings on any bands, check that the DC supply voltage is present on the band in question by reference to the circuit diagram, and particularly that you have the correct component values specified. Also, check that the diodes are the correct way round.

11. Remove power and the connection to R23. Then strip 5mm of

insulation off the screened cable coming from the comparator PCB, and connect to point P, with the braid to the nearby earth pin.

12. Reconnect the counter to point Q. Reconnect the IRT control to the VFO as before. Apply power and switch to 80m. Turn the VFO capacitor while observing the counter and check that the frequency follows the rotation over 3.49 to 3.71MHz (give or take a few kHz at the moment). If this does not happen, check some of the other bands. If no frequency control is observed on any band, then the fault will lie either on the comparator board, or possibly in the mixer section of IC1 used for the loop mixer. Check voltage readings in both these sections for clues to the fault. Also check that you have soldered all connections on the top of the comparator PCB where you should have. If control only exists on some bands, then the fault is likely to lie in the crystal oscillators or VCO section.

13. Go back to 80m and turn the VFO capacitor to full mesh (clockwise). With the IRT control at mid-travel, adjust the core of L37 (inside VFO box) for a reading of 3.710MHz \pm 1kHz. Turn the capacitor to fully unmeshed and adjust TC1 for a reading of 3.490MHz \pm 1kHz. Repeat these adjustments until these readings are achieved at both ends of the capacitor travel.

If you are not using 80m at present, then use the top end of one band that you have for the previous part of the alignment (7.21, 10.21, 14.21, 21.21 or 28.21MHz).

14. Set the counter to 3.710MHz and, while monitoring the voltage on point P with your multimeter, adjust the core of L15 for a voltage reading of 9V \pm 0.1V.

15. Switch through the other bands and, without adjusting the VFO capacitor, set each core (L16 – 20) so that a voltage reading of 9.0V \pm 0.1V is achieved at point P.

16. Remove power and reconnect the volume control and the speaker to the board. Connect the 'S' meter into circuit. Use a 17cm length of red wire to link the +ve terminal of the meter to point AZ. Connect the -ve terminal of the meter to the tinned area just in front of the VFO enclosure using a 14cm length of black wire.

'Peaking' the Receiver

The next stage of the alignment is best made using a signal generator, or off-air signals and involves peaking up the receiver bandpass filters. If a generator is available, use this set to the middle of each band in turn. If no generator is available, connect an aerial to the

Close up of bandswitch on main PCB. The receiver bandpass filters are at top LHS.

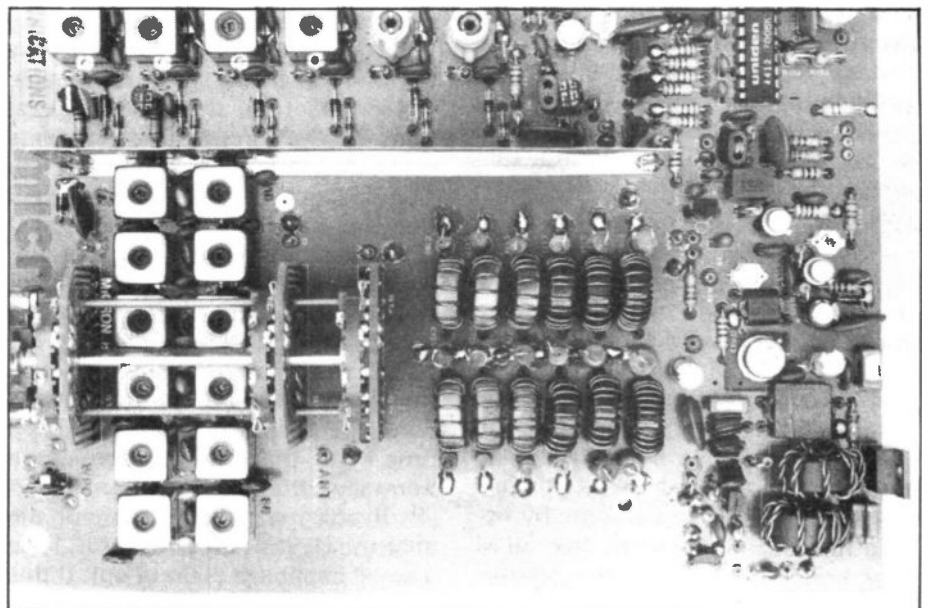



antenna input and find a suitable mid-band signal.

1. Apply power and turn the volume control to about $\frac{1}{4}$. Switch to 80m and either tune to the generator signal, or tune around until you find a signal on the 80m band close to 3.6MHz. Using the spade ended trim tool, carefully peak the cores of L1 and L2 at this frequency.

2. Change to 40m, but set the receiver to 7.05MHz, and peak the receiver around this frequency, using L3 and L4 (the bandpass filters have a bandwidth of 100kHz for 40m to reduce the effect of strong adjacent broadcasting stations).

3. Carry on with 30m (10.1MHz), 20m (14.1MHz), 15m (21.1MHz), and 10m (28.1MHz). Allow for propagation conditions if using 'off-air' signals — you are unlikely to find signals on 10m or 15m during periods of low sunspot activity, or at night on 20m during the winter. Likewise, 80m is very inactive during weekdays.

4. When this is complete, find a very strong signal on 40m, and set the 'S' meter to read full scale using RV4.

Note that you may suffer from direct broadcast demodulation, especially on 40m if using a non-resonant length of wire for an aerial. This can be overcome by fitting the 'balance' control (which is rear panel mounted in the Micron case) at this stage as follows:

5. Use an 8cm length of blue wire to connect point A (right of IC1 by R1) to the centre tag of VR1. Then use another 8cm length of black wire to connect either of the other two tags to the earthy end of R105 on top the board (above IC1). Temporarily connect the remaining tag of VR1 to the +12V supply.

On adjusting this control, a point will be found (fairly sharp) where the direct demodulation disappears. This point *may* change from band to band, hence the reason for the accessibility of the control. *This balance control should be left at mid travel if not specifically set for a null — at either end of its travel the receiver sensitivity may be reduced.*

If no signals are received on any band, firstly check that you have all the switch wafers correctly orientated, and that there are no 'shorts' by whiskers of braid across the ends of pieces of coaxial cable interconnecting the various sections of the circuit. If these tests prove negative, check whether any signals can be received by connecting the antenna directly to point D (most likely you will receive untunable broadcast stations). If so, then there is a fault in the preselector circuit or the switching, or possibly the cores of the preselector filter are too far off-tune for the band (try adjusting them a little at a time with the antenna connected normally until you hear signals).

If still no signals, connect the antenna directly to pin 1 of IC1 via a small capacitor (10n or so). If this results in signals, suspect T1 (win-

dings reversed? or shorted turns through winding too tightly ?).

6. Turn RV3 (above VFO enclosure) fully clockwise (towards point AP or the 'earthy' end). Find a strong CW signal or tune into a broadcast signal carrier. You will find that the AGC overshoots initially with the signal reducing in strength far more than it should initially. While listening, slowly advance RV3 until this initial overshoot is removed — this should occur with RV3 at rather less than half travel. Watching the 'S' Meter may help you to make this adjustment, especially with a CW signal — adjust RV3 until the meter just remains steady and doesn't kick up when the signal is being keyed.

Transmitter alignment

The next stage is to work through the transmitter stages.

1. Insert and solder Q45 (BC237) (below VFO enclosure). Connect an 8cm length of yellow wire to point AF (below VFO enclosure).

2. Turn RV7 (Level preset — below VFO enclosure) fully anti-clockwise. Apply power and find a signal on receive. Earth the keying lead coming from point AF — the receiver should mute completely and return to receive after about 80mS when the key lead is received from earth. If not, check with a multimeter that there is +12V present on the collector of Q45 when keyed. If no voltage, there is a fault, component error or short in the circuit area immediately under the VFO enclosure. Also double check that Q45 is the correct type of transistor.

3. While keying, turn up RV7 (Level) until there is a comfortable sidetone level. The Pitch may be adjusted with RV6 to approximately 800Hz. If no sidetone, there is a fault around Q42/43.

The power control circuit is checked next.

4. Strip the ends of a 32cm length of blue wire, a 35cm length of red wire and 8cm length of green wire. Connect one end of the blue wire to point AL (between two large resistors on left), one end of the red

wire to AK (bottom left of PCB), and one end of the green wire to AM (top right of screen).

5. Slide 2cm lengths of the sleeving supplied over the blue, green and yellow leads. Solder the blue lead to the base of Q39 (TIP34A — see drawing) and slide the sleeving over the joint. Solder the green lead to the emitter of Q39, and sleeve the joint. Solder the red lead to the collector of Q39, but do not sleeve yet.

6. Solder a 16cm length of blue wire to point AH (below VFO enclosure), and a 28cm length of green wire to BA (bottom right of PCB). Connect the blue wire to the centre tag of the Drive control VR4 (10k 1in), and the green wire to the left hand tag (looking from the back of the control). Connect an 11cm length of black wire from the remaining tag in VR4 to the top of the PCB just in front of the VFO enclosure.

7. Adjust RV5 so that the wiper is nearest point AG. Connect a multimeter on the 15V or more DC range to the collector of Q39. Apply power and key the transceiver. Observe the voltage on the meter as the Drive control is rotated — it should vary from 0V up to the DC supply voltage less about 0.5V. If nothing happens, double check that the connections to Q39 and the components/soldering around IC7/Q40/Q41.

8. The next adjustment should be carried out with either the PSU you are going to use, or at the voltage that will be delivered by it — we recommend 13.8V. Turn the Drive control fully clockwise (maximum) and while watching the voltmeter, adjust RV5 until you can just see the voltage start to fall on the collector of Q39. If this adjustment is not done properly, you may get key clicks with the drive control at maximum.

9. The next adjustment is to set the Tx IRT — RV1 is adjusted so that the frequency on transmit is the same as receive when the IRT control is at mid-position. First, find a steady carrier with *Micron* on receive and set the IRT pot to mid travel. Then, while connecting C189 on the VFO enclosure (2nd

feedthrough from the rear) to the +12V supply using a temporary lead, adjust RV1 so that the received frequency is identical when the +12V supply is connected to the feedthrough to that without it. Be careful that you are listening to the same side of the carrier in both cases. This adjustment can be carried out again when the PCB is in its case, and the IRT centre position can be seen on the front panel.

Having completed this, remove power.

10. Connect a 7cm length of red wire to the collector of Q39 (which already has one lead soldered to it), then pass the free end down through the sleeving already on the other wire. Pull the sleeving up over the transistor lead. Then connect the other end to point AR (below Q48).

This nearly completes all receiver and transmitter adjustments except for the fitting of the attenuator, spot switch and the optional preamplifier (see later).

COMPONENTS LISTING — continued from the last issue.

| | | | |
|----------------------------|---|-----------------------------|---|
| L25.26 | 20 turns on Amidon T50-2 | | Comparator PCB (small) & 5 plates for VFO enclosure |
| L27.28 | 14 turns on Amidon T50-2 | Switch Mechanism (1 off) | RS Wafer switch mechanism ref. 327-311 |
| L29.30 | 12 turns on Amidon T50-2 | | RS PCB mount 2 pole-6 way ref. 327-608 |
| L31.32 | 12 turns on Amidon T50-6 | Switch Wafers (3 off) | Jackson Bros ref. 4511/DRF 6/30.1 |
| L33.34 | 9 turns on Amidon T50-6 | Slow motion drive (1 off) | Size 120 x 25 mm |
| L35.36 | 8 turns on Amidon T50-6 | Brass screen 30 swg (1 off) | 0.2 mm enamelled copper |
| L37 | TOKO Shielded coil type KANK3333R | Wire | 0.25 mm enamelled copper |
| TRANSFORMERS | | | |
| T1 | Wound on Fair-Rite Balun Core type 28-43002402. 12 turns tapped at 4 turns from earthy end, using 0.2 mm dia en. copper wire | | 0.56 mm enamelled copper |
| T2 | Wound on Core as T1. 6 turns tapped at 2 turns from earthy end. Wire as T1 | Nuts and bolts etc | 0.8 mm enamelled copper |
| T3 | Wire and core as T1. Primary 8 turns, secondary 2 turns | | 18 swg tinned copper |
| T4 | Wound on 10 mm square ferrite balun core using 0.25 mm dia. enamelled copper wire. Primary 8 turns, secondary 2 turns. | | 2 mm screened audio RG174 A/U Coaxial cable |
| T5.6 | Bifilar transformer using 0.8 mm dia. enamelled copper wire. 2 x 7 turns wound on Fair-Rite core type 59-61001101. See text for full details. | | Various coloured connecting wires |
| MISCELLANEOUS ITEMS | | | |
| FB (1 off) | Miniature ferrite bead (for Q46) | | Insulated sleeving |
| M1 (1 off) | Meter 200 uA type 9007 | Trim tools | 3 of 4 BA round head 9 mm screw length |
| PCB & VFO enclosure | MICRON — Current issue consisting of: Main PCB (large) | Grommet | 2 off 6 BA round head 25 mm screw length |
| | | | 2 off 6 BA round head 13 mm screw length |
| | | | 2 off 6 BA round head 6 mm screw length |
| | | | 8 off 4 BA plain washer |
| | | | 12 off 6 BA shakeproof washer |
| | | | 12 off 6 BA half nut |
| | | | 1 off insulating bush — small |
| | | | 1 off insulating washer — small |
| | | | 1 off insulating washer — large |
| | | | 4 off Pot. washers |
| | | | 4 off Pot. nuts |
| | | | 1 off hex ended type |
| | | | 1 off spade end type |
| | | | 1 off 4 mm internal diameter |

Metre wave

In this Metrewave, your contributor proposes to break a lifetime's habit of not writing in the first person singular. Few journalists like to use the word 'I', they are trained to regard themselves as sieves which filter facts and opinions. The word 'I' has started wars, ended friendships and provoked many useful discussions.

All this is an introduction to a unique experience which befell me recently. I was invited by the

Jack Hum, G5UM, advises on starting up a VHF group and delves into the history of the 'very highs'.

Leicestershire VHF Group to speak on the subject of the 'metre waves', then and now, and to describe how that self same VHF Group came into being. Research for the lecture and its presentation dredged up so many facts on the way things were, that several people asked me to set them down on paper before they became irretrievably lost.

In The Beginning . . .

This article is an attempt to do just that. Already a hint of 'how things once were' is given by the use of that term "VHF Group". What is a VHF group? What is, or was, its purpose? And how many of them remain in existence today?

To answer these questions, one needs to 'hark back' a decade or two to the period of British amateur radio history when operation on the metre wavelengths was the exception. All those years ago, amateur radio communication meant not those esoteric metre-waves. Quite the contrary, it meant the romance of talking across the world on short-wave; to make friends with people in other lands whom you might never see; of doing it all, probably on CW, with equipment built by your own hands.

Romantic no doubt. But for many British operators, the romance began to pall for two cogent reasons — contacts became stereotyped ("rubber stamp QSOs") and the QRM got worse. Where could operators go? Did life exist in those stratospheric megacycle allocations (*sounds more impressive than VHF bands!* — Ed. Asst.) that were written into the licence? Wouldn't it be interesting to sample them rather like the mountain climber who tackled Everest

"because it was there"?

The reaction of a 'horny handed son' of the morse key on learning of a colleague intending to explore the 'very highs' was, "you must be slightly peculiar to want to do that. You can only talk to the next street, up there. If you're lucky, across the town". It was against this prejudice and uninformed outlook that the enthusiasts for VHF found they had to battle; to prove that something was going on "up there".

Clearly, converting the prejudiced would be a big job. And so the concept of the VHF group came into being, to serve two major purposes. One of them was to serve as a gathering point for like-minded but often geographically scattered metre-wave enthusiasts. The other was to act as a propaganda medium to persuade the generality of radio hams that there was something in this VHF business after all.

All of which reads strangely in 1985 when there are more VHF people about than HF ones, and when, in contrast to then, the approach to the metre-waves is almost universally via the omnipresent "black box".

Twenty years ago it wasn't like that at all. Only ten years ago the range of available black boxes was limited and repeaters were a very new concept, few in number. Considerable justification existed for lively

Table 1. A possible winter programme for a VHF group. (The list is by no means exhaustive!)

| | |
|------------|--|
| September: | "Printed circuits made easy" by a Veroboard representative. |
| October: | "New integrated circuits for VHF and UHF" by a representative from Plessey. |
| November: | "How to generate megawatts at microwave" by a representative from a microwave heating company. |
| December: | In recess. |
| January: | "The practical construction of a printed circuit exciter board" by a transmitting amateur professionally engaged in this work. |
| February: | "How our local repeaters work" by a representative from the district repeater group. |
| March: | "Earth-Moon-Earth working" by none other than G3WDG (see HRT May and June 1984). |
| April: | "The last twenty years on the metre-waves" by an old timer member. |

VHF groups all over the country to tell the metre-wave story. The groups that formed soon grew in number and membership. Some, like the London VHF Group, attracted many knowledgeable and influential metre-wave pioneers. Others, in smaller catchment areas, nevertheless managed to draw in enough enthusiasts to make themselves viable.

A further hazard to the potential of a proposed VHF group was the likely reaction of established local radio societies. Some saw such a group as an upstart challenger to their existence. Others preferred the hand of welcome, as indeed they did with the repeater groups that were to come along in later years.

Few, if any, established radio clubs continued their intransigence towards intended VHF groups. They recognised not only that these groups had a *raison d'être*, but also many of their members were keen to join, to find out what all this VHF business was about.

Another respect in which a VHF group differed from an established radio society was that it came into being as a lecture unit, and remained very informal in its customs and practices. Even the need for a constitution was often regarded as superfluous. If you went to a VHF group meeting, you would pay your pittance at the door. How much you paid was determined by the cost of the meeting place (if any), the cost of circularising (inescapable) and the cost of visiting lecturers.

But how did you go about getting that meeting place and attracting those potential lecturers? Without venue and subject matter, no VHF group! In practice, these two problems have been found to almost solve themselves in towns of some size. You got your meeting place by asking the local education authority for a room to be used once a month for "lectures of scientific interest". In case this approach failed, you took the precaution of enlisting the aid of local hams who were in education and had access to empty classrooms after school hours. By these means the accommodation problem was solved — often for free.

But what of the lecture roster? In many areas sufficient local talent could be tapped to fill a VHF group's lecture list for months ahead, if it didn't, Britain's home-built repeater chain could never have been forged. ("... the biggest collective effort in

designing and building ever to occur in the amateur metre-wave communication: a remarkable demonstration of the self-help ethic". HRT, November 1983, remember?) Tap this talent to build your lecture programme. Then look for speakers from further afield; some suggestions are given in Table 1.

Leicestershire Group's History

Now from the general to the specific. And more particularly to the genesis of a VHF group, in Leicestershire. Extract from a G5UM diary for Friday March 10, 1967: "... two new ones on the net tonight in G3UCY and G3OCH, making six of us in all".

A couple of months later the G5UM diary had this entry: "G3UCY, G3RYN and I had an interesting talk on the 2m net about the possibility of forming a Leicestershire VHF/UHF Group. Later, on 70cm, G8ANK also expressed favour of it. All it needs is a circularising effort and a place to meet, preferably at little or no cost".

Within a month the wish was fulfilled. A local transmitting amateur, a member of the teaching profession, made a room available at a city technical college. Within a couple of months, the Group was born — 25 present at its opening meeting that September of 1967.

Thereafter, monthly meetings were the norm, attracting always two dozen or more transmitting amateurs from all over the county. There was "... a record attendance of 42 for the G3BKQ talk on FETS, on which he has done a lot of work. Many new faces" reported the G5UM diary for March 21, 1968, at a time when the FET was new, unknown and certainly untried by the majority of metre-wave enthusiasts of the day.

In addition to the FET, single sideband was very new to the metre-wave spectrum at that time, so new in fact that there was a belief abroad that it might not catch on. "Let's segregate its peculiar Donald Duck noises to a spot frequency where they won't worry everyone else" went the argument. Thus for a considerable time the few intrepid experimenters in SSB on "Two" were confined to 145.41MHz.

Even more adventurous was the thought of applying semiconductor technique to SSB at VHF. Could it be done and if so how, when nearly all SSB on "Two" was performed with valves? Here indeed was a *raison d'être* for a VHF group, where such new "frontiers of technology" could be explained and discussed. A G5UM diary entry illustrates this well: "April 18, 1968: Tonight there were 38 at the meeting to hear G3MNQ on his SSB exciter using semiconductors throughout". That was indeed state of the art sixteen years ago!

Another diary entry during that year records an especially significant date in the history of the metre-waves — it tells how the national society's VHF Committee was at that time "... discussing the possibility that the 2m band might become available to Class B licensees as soon as it's promulgated in the London Gazette". Today's thousands of Class B operators may learn with surprise that the "B" licence originally permitted the use only of the 432MHz band and higher frequencies. This early

Table 2. A suitable programme for the summer months.

| | |
|---------|---|
| May: | Visit to regional police headquarters communications site. |
| June: | Coach outing to a distant place of interest such as the Jodrell Bank Radio Telescope, the Science Museum radio department in London, or in a completely non-radio context but still with scientific interest, the National Railway Museum, in York. |
| July: | Annual summer supper at a rural or riverside teahouse. No music, but the programme can include a tall story session, or a "My most amazing QSO" session, plus raffle of items acceptable to male and female visitors. |
| August: | Visit to local radio station transmitter and/or studio; or visit to airport control radio unit. |



Leicestershire VHF Group, guests of Mid Cheshire ARC, having a natter after visiting the Jodrell Bank Radio Telescope.

Class B licence lasted for four years before it was extended to embrace "Two".

Don't devote the activities of a VHF group or any sort of club for that matter — entirely to high technology. A break for frivolity is no bad thing, by way of contrast. Three months after the G3MNO lecture (above) a diary entry records just such a break: "Thursday July 18, 1968: First VHF Group social at Blakeshay Farm Tea House, 47 present, 9/6d a head. Big contingent from Birmingham. Mrs G8BOA did the raffle: a dozen boxes of sweets for the ladies, and sundry heaps of junk for the OMs!"

Another record of the participation of the distaff (the other half) side in local metre-wave activities appears in a subsequent entry in a G5UM diary: "Friday Feb 14, 1969: Surprise on The Net tonight when Monica checked in with her new callsign G8CJA", a reference to one of the very earliest of women Class B operators. Fifteen years later G8CJA

remains an active participant in Leicestershire VHF Group meetings and organisation. Her husband G8BTU is, with G3OVH one of its joint secretaries and event arrangers.

In the last thirty years plus, the VHF group has been largely technically based. What is its future when the mass of today's VHF communications are less interested in advanced technical matters than were yesteryear's? Without doubt, a bright one if given a somewhat different slant from "the way it was".

To appeal to today's potential members, the programme of summer events on Table 2 could remain; but there might be a case for diluting the 'tech-content' of the winter programme. In Table 1 you could retain the talks about repeaters and about the early days of VHF. But you could inject a popular bias into the remaining available dates in a variety of ways. Invite representatives from leading suppliers to show and demonstrate their latest black or grey boxes. Invite antenna and mast specialists to talk about their products (the antennas at least can be brought into meeting places even if the masts can't!) Ask the providers of accessories, such as SWR units, to let the members into their innermost secrets. Even battery manufacturers have something to reveal to amateurs — how to care for and feed NiCads!

Yes, the VHF group idea is still alive and well. If it is not in evidence in your locality sound out your nearby contacts on "Two" and "Seventy" to assess their degree of interest in it. You might receive a considerable, and positive, surprise.

STOP PRESS

Rockall On The Air?

Tom Maclean, ex Transatlantic oarsman, who is intending living on Rockall, the 70' rock outcrop some 250 miles west of the Hebrides, would seem to be taking some amateur radio equipment with him. It is believed that Tom has an amateur licence but at the time of going to press, we were unable to confirm this.

Tom will be living in a 5'x3'x4' tent

on a small ledge on Rockall for some 2 months. The outcrop is totally barren, devoid of all other life with the exception of birds and he will be the first recorded human to actually live there!

Talking to John Timpson on Radio 4's 'Today' programme, Tom announced that he will have some amateur radio gear with him to pass the time, although the frequency coverage and the nature of this equipment was regrettably not

mentioned.

The DXCC status of Rockall is that it currently would be counted as Scotland. However, this has not always been the case and if operation took place, this would give grounds for reopening enquiries into its country status. With the island being claimed by Britain, Denmark and Iceland, this looks to be an interesting situation.

'Allo John, Want To Buy A Licence?

On 13th May, three men were given fines totalling between £300 and £350 each for attempting to obtain by deception amateur radio licences from the DTI and for offences under Section 1 of

the Wireless Telegraphy Act, 1949. They were also ordered to forfeit amateur radio equipment in two cases and CB equipment in the third case, with a total value of over £2000.

The men, Mr B Boyle, Mr R Glasco and Mr H Dyer all living in S London, had pleaded guilty to all the charges.

Their lawyer explained that Mr Glasco had been approached in an amateur radio shop in Merton, SW London, and offered a City and Guilds Institute RAE pass certificate. Each of the men paid £200 for their certificate and then applied for licences.

Multi-operator CONTESTING

Most major HF and VHF contests have both single operator and multi-operator sections. Operating in the 'Multi-op' section of a contest can be a great experience for newcomer and old-timer alike! In the single operator section of a con-

Table 1 shows a list of some of the major international contests that have multi-operator sections. The exact definition of "multi-operator" can vary from contest to contest and it is advisable to check the exact details of the rules for

scale of the multi-operator contest envisaged. For NFD, much of the planning activity will centre around logistics: where can we find a site? — who has got a tent? — where can we find a reliable generator? — who will be doing the cooking? Long before the station gets on the air, there is a whole pile of details of this kind that need to be sorted out. Once these have been sorted out, operator schedules and contest operation tactics planning then become necessary.

During the last year, we have run a series of articles exploring radio contesting on both HF and VHF. In the concluding article, Nigel Cawthorne, G3TXF, looks at the philosophy and practice behind running a successful multi-operator and multi-station contest entry.

test, everything has to be done by one operator alone, without any assistance — all the operating, logging and record keeping! Multi-op contesting is different. In the multi-operator section in general, any number of people can team up to work the contest.

Multi-operator contest operating can be great fun because it brings together a group of enthusiasts who work together to keep the station on the air during the contest, usually with the objective of making the biggest score possible. The numbers of operators making up a multi-op contest range from just two operators to the other extreme where a large club entry may involve dozens of operators and SWLs, all actively taking part.

The multi-op. contest well known to almost all UK amateurs is the RSGB's National Field Day event, held annually in early June. This is a multi-operator event in the widest sense because many people can support the club entry in different ways. NFD is a 24 hour CW contest which is operated from a 'portable' location. Mains power is not allowed — generators or batteries have to be used. NFD is a club event which requires a lot of good teamwork to get and keep the station on the air for the full 24 hours.

each contest. The first and most essential stage in any multi-operator contest entry is the planning which should start many weeks before the actual contest.

Careful Planning

The amount of planning required will depend on the actual

Operator Schedules

Major international contests can last up to 48 hours viz the 'CQ WW' DX contest. It is very important to avoid all the operators in a multi-op event falling asleep at the same time. A well organised multi-operator contest station is never off the air during the contest. No matter how slow the QSO rate, the station should be manned and

| Contest | Society | Month | Date — Time |
|-----------------|-------------|-----------|---|
| AFS | RSGB | January | second Sunday 13z to 17z:3.5 MHz only |
| ARRL-CW | ARRL | February | third full weekend Sat 00z to Sun 24z |
| ARRL-SSB | ARRL | March | first full weekend Sat 00z to Sun 24z |
| CQ-WPX-SSB | CQ Magazine | March | last full weekend Sat 00z to Sun 24z |
| CQ-WPX-CW | CQ Magazine | May | last full weekend Sat 00z to Sun 24z |
| Nat Field Day | RSGB | June | usually first weekend Sat 16z to Sun 16z |
| All Asia SSB | JARL | June | third full weekend Sat 00z to Sun 24z |
| IARU Radiosport | IARU-ARRL | July | second full weekend Sat 00z to Sun 24z |
| WAE-DX-CW | DARC | August | second full weekend Sat 00z to Sun 24z |
| All Asia CW | JARL | August | last full weekend Sat 00z to Sun 24z |
| WAE-DX-SSB | DARC | September | second full weekend Sat 00z to Sun 24z |
| CQ-W-Wide SSB | CQ Magazine | October | last full weekend Sat 00z to Sun 24z |
| CQ-W-Wide CW | CQ Magazine | November | last full weekend Sat 00z to Sun 24z |

Table 1. Major international contests that have "multi-operator" sections. Many other smaller contests also have multi-operator categories.

actively CQ'ing or searching at all times. Spare equipment should be readily available to cover breakdowns. Drawing up an operator schedule before the contest is essential to ensure adequate operator coverage.

Table 2 shows a typical operating schedule for a 24 hour period within a major international contest, such as CQ WW CW/SSB or one of the ARRL contests. This is only a plan. In practice, the timing and definition of activities is not necessarily as regimented as might be implied by the table. The table illustrates a number of tasks that need to be carried out at all hours of the day and night, and that they should be done on a rotation basis by different members of the team. The details in this particular operator schedule are based on a visit made to Jersey two years ago for the CQ WW CW contest.

One important point to consider at this stage is that a HF multi-operator contest station actually consists of two stations. The main station has, usually in close proximity, a 'spotting station'. The latter may consist simply of a single receiver plus operator, who spends his/her time searching the bands for 'multiplier' stations that the main station has not worked. A note is made of the frequency of the wanted stations and passed on to the main station. A rough table should be drawn up at the beginning of the contest to ensure that there is always someone at both the main station and the spotting station at all times.

Usually the most difficult time of day is around 4 am. Those who have been operating through the night start to get tired and slow down. The "graveyard shift" needs to be planned carefully to avoid everyone being dead tired at the same time! The writer has, to



Broadband 'solid state' transceivers, like the TS930S used at GJ3SXW, are becoming universal for multiband contests, with their 'no-tune' band change ability.

his embarrassment fallen asleep with headphones on at about this time of day on several occasions!

One useful way of combating operator fatigue and keeping interest and enthusiasm alive during slow or very late periods is the use of target sheets.

QSO Target Sheets

Most contests are annual events. The logs for one year's contest can be analysed to produce very useful data for future years and the QSO target sheet is an example of this. The log from the previous year's contest is broken down into quarter, half and one hour periods and the QSO rate for the periods are then plotted on a graph. If you have entered the contest for a number of years, the QSO rate for each period of time for each year can be plotted.

If you have never entered the particular contest before, borrow some logs from the nearest (successful) contest group to your location and work out target sheets on the basis of their previous attempts. This can give you a direct and visually impacting indication of progress through the contest in

comparison with the previous years if you also plot your QSO rate as you go along.

Where there are significant changes to the station from one year to the next (eg if a significant increase in antenna height has been made since last year) then the targets for each of the periods can be adjusted accordingly. The writer has found that 15 minute target periods for most contests are a convenient length. Translated into the operator's mind, the target tells him that in the next 15 minutes he should be aiming to get a given number of QSOs. For NFD, this might vary between 5 and 10 QSOs per quarter hour, depending on the time of day.

The use of previous year actual performance graphs is a useful tool for supporting operator morale, particularly when everyone is tired. If the QSO rate is falling off, it may be encouraging to know that it did exactly the same thing at the same time in last year's contest. If the opposite is happening and the QSO rate is very much lower than it was at that time in the previous year's contest, then explanations need to be sought: is it propagation conditions? — is it different levels of activity? — is it different antennas? — or is it the operator? Knowing how one is doing in comparison to 'previous years' is perhaps the best guide to improving performance.

Operator Changes

The length of operating periods will depend in the final analysis upon operator skill and fatigue. Too frequent changes of operator on a given band are to be avoided. There is a 'run-up' time, during which an operator new to a band that has already been worked for some time is getting the 'feel' of the band. If stations are being searched for, much time can be wasted identifying stations which have been worked before — and which would have been immediately recognised by the operator that had been previously working the band.

Experienced contest operators who are tuning up and down a band searching for stations will quickly develop a feel for the band and be able to quickly re-recognize stations that they have been hearing again and again on the sweeps of the band. It will only take part of a

| Time GMT | Main Station | Bands | Spotting Station | Check-logs Dup sheets | Sleep/Eating/Antenna work |
|----------|--------------|--------------|------------------|-----------------------|---------------------------|
| 00-05 | G3MXJ | 160,80,40 | GW3WVG | GW3WVG | G3SXW,G3TXF |
| 05-09 | G3SXW | 80,40,20,15 | G3TXF | G3TXF | G3MXJ,GW3WVG |
| 09-12 | G3TXF | 20,15,10 | G3MXJ | G3SXW | GW3WVG |
| 12-16 | GW3WVG | 15,10 | G3SXW | G3TXF | — |
| 16-20 | G3MXJ | 80,40,20,15 | G3TXF | GW3WVG | — |
| 20-24 | G3SXW | 160,80,40,20 | G3MXJ | GW3WVG | G3TXF |

Table 2. Typical operator schedule table. Only intended as a plan. In practice, multi-operator contesting never turns out exactly as planned. This plan did not envisage all the antennas at GJ3SXW being blown down at 2130z on the Saturday evening!

callsign, a particular operating style (keying first on CW or accent on SSB) or a particular quality of signal for the operator to immediately recognize a station. It is therefore often better to combine an operator change with a band change, so that the new operator starts on the new band. Another approach to this problem, if a band change is not desired is having an overlap period, of say, 30 minutes between operators. The new operator listens in to the old, sees what propagation is like and scrutinizes the log and check log sheets for what is being worked.

Where "pile-ups" are being run, then operator change timing is perhaps less important, so long as the QSO rate does not drop with the new operator.

Band changes will be subject to radio propagation conditions. For this reason, if no other, the operating schedule set out before the beginning of the contest will be varied and modified as the contest progresses.

Radio propagation conditions are not the only force of nature that can severely alter even the best planned contest operators schedule. During the recent visit to Jersey for the CQ WW CW Contest in November 1983 made by G3MXJ, G3SXW, G3TXF and GW3WVG, the entire antenna installation was blown down by a tempest force gust of wind at 2130 hours on the Saturday evening. The station GJ3SXW was off the air for 19 hours out of the 48 hour contest. Never mind what the original operating plan had said!

Contest Paperwork

Logging the QSO. There are as many different and preferred contest logging techniques as there are contest operators! Firstly, we have the "single QSO ticket" technique, favoured by a number of clubs. The operator fills out a QSO ticket for each QSO made which is then passed to the logger, who might be an SWL newcomer, who then makes the log entry (and, possibly check log) from the data on the QSO ticket. This type of system can be used where there is a main operator and second operator at the same station. The logged QSO ticket is then kept as a separate record of the QSO as well as the

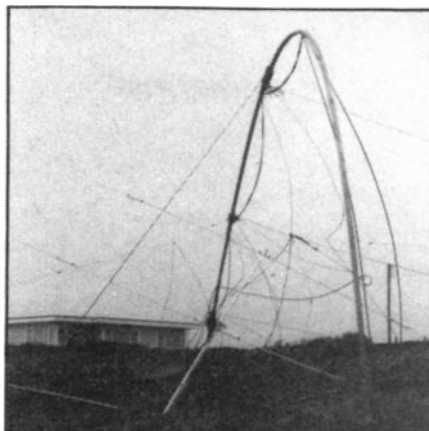

The best planning in the world can be upset by bad weather. A single freak gust of wind put GJ3SXW off the air for 19 hours.

main contest log, which has been filled in by a second operator.

Alternatively, a multi-op contest team might use single log sheets with up to 100 QSOs per side. These would be more appropriate for contests where QSO numbers are very large. The final choice will depend on the type of contest and the operators' own preferences. The HF Contest Logsheet HFCI produced by the RSGB are a very convenient size of logsheet with room for 40 QSOs per page. These logsheets are the preferred type to be used for all of the RSGB's HF Contests.

Checksheets. Checksheets kept up-to-date in a contest identify both 'multipliers' and stations that have already been worked on the different bands. Many contests involve searching for 'multipliers': to the uninitiated, the multiplier is the factor by which the points gained from working a number of stations is multiplied by to get the final score. The nature of the 'multiplier' will depend on the particular contest. It is important to know which multipliers have already been worked and which are still needed. Typical multipliers are the "DXCC Countries plus CQ Zones" of the CQ WW DX Contests of the "States of the USA and Provinces of Canada" for the ARRL Contests. Keeping close track of the multipliers worked should be an absolute priority.

The purpose of these checklists is not only to inform the operators which stations have already been worked, so as to avoid wasting time working them again but, after the contest, the duplicate check-sheet is used to ensure that no duplicate QSOs are claimed in the

final score. Duplicate QSOs in RSGB contests are heavily penalised. Excessive duplicate QSOs in many of the major international contests can lead to disqualification.

Keeping a fully accurate duplicate QSO checksheet going all through a major contest is a very labour intensive task. Home computers are now often finding themselves as part of a multi-operator team. However, 'on-line' duplicate checking during contests can often be more practically done by manual methods.

Where there are sufficient operators in the team, and when one of the defined tasks in the operator schedule is to keep the 'live' records up to date, both the main operator and, where applicable, the spotting station operator should know *at all times* what has and has not worked.

Paperwork Strategy. Multi-operator contest entries produce at least hundreds and more, usually thousands, of QSOs that have to be carefully and accurately logged. Whatever method of actual logging is chosen, there should be two prime objectives:

- a) To have an accurate station log, which is a statutory requirement of the Licence Conditions.
- b) To prepare an accurate and checked contest entry log for sending to the organisers of the contest.

The HF Contest logsheet produced by the RSGB referred to above, is a standard format which can be used for many international contests as well as for the RSGB series of HF Contests. CQ magazine, the ARRL and the DARC

G3MXJ operating the main station at GJ3SXW whilst check logger G3SXW attempts a balancing trick . . .



also produce their own log sheet formats.

Where separate band logs have been kept, the checking of the logs for duplicate contacts can be shared between different members of the team. One member of the multi-operator team should be clearly nominated as being responsible for seeing that the log gets submitted in time! A careful check should be made of the deadline for contest entries. Some entries have to actually reach the contest organisers by a certain date, others have simply to be posted by a certain date. Make sure that you know which applies — and that you have the correct address for the contest organisers! Finally, make sure that there is enough postage on the log envelope. After a major multi-operator contest entry, it may be worthwhile using recorded delivery, just to be that bit more certain that the log will arrive at its destination.

Club Entries

An important side of multi-operator contest events for clubs is that they allow newcomers to the hobby and SWL's to gain first hand experience of HF or VHF contest operating. In years gone by many an SWL's first contact with HF contest operating was through NFD.

Apart from NFD which is still the main HF "multi-operator" event in the UK, there is relatively little participation by UK operators in the multi-operator categories of the major international contests. Next time your club is looking for helpers and operators for NFD, put up your hand and volunteer!

Another variant of the 'Club Entry' contest is where individuals operating from their own stations but combine their scores into one "Club Score". In the UK, the very popular example of this is the Affiliated Societies Contest (AFS) run by the RSGB on 80m CW on a Sunday in early January each year.

AFS is a four hour contest designed specifically for inter-G activity. Club teams are made up of up to five individuals who combine their score into one. This is a very well supported contest. Some clubs field two, or even three "teams" of five.

Club entries to the major international contests such as CQ WW

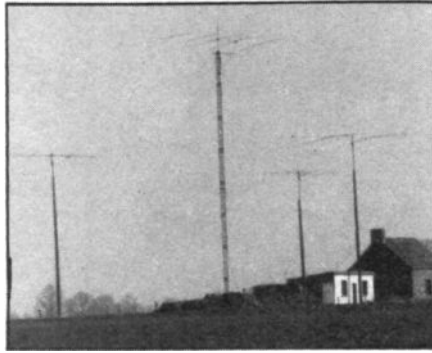

The impressive array of monoband beams at multi-op. station F3TV, including a 5ele array for 20m at 100' (centre).

or the ARRL Contests are done on a similar basis, except that there is no limit to the number of individual scores that go to make up the entry. Club scores are listed in the results. To facilitate adjudication on a club basis, the club secretary should send a summary of the club entry in addition to the individual members logs.

'Multi-Multi'

Multi-multi contest operating means that more than one band is being fully worked at any one time. In practice, this means that there are a number of different stations at one site using a common callsign, but working independently on different bands. This category of contesting is not for the faint hearted! Typically for the CQ WW Contests, a multi-multi contest station will consist of six main stations, one for each band from 160m to 10m, with a corresponding number of back-up stations and equipment. Just think of the logistics!

This type of massive contest operation is usually mounted *only* for the major international contests. Among the successful multi-multi stations on the east coast of the USA in recent years have been K1OX, N2AA, W2PV, W3AU, W3LPL, N5AU. Outside the USA and the USSR, multi-multi contest operating is less common. In Europe, a recent major multi-multi contest operation was mounted by a large group of Finns on the Aaland Islands as OHOW during both the CW and SSB CW Worldwide Contests in 1982. In addition to involving about 60 Finnish operators, this enormous project including the building of seven 100ft towers!

During major worldwide contests, those 'big gun' signals that dominate frequencies with loud and consistent signals for hours on end are often from multi-multi stations.

Co-interference Problems

Operating several transmitters from one site for a multi-operator contest can result in co-interference problems. In a multi-operator single transmitter contest, where a spotting station is permitted — as in the CQ Worldwide Contests — the spotting station has to be able to find/make contacts for multipliers on a band other than that being used by the main station. Ideally the main station and the spotting station should be able to operate without any co-interference problems.

Before the contest starts, it is as well to check out all the likely operating combinations. Spotting on higher bands with the main station on a lower band can produce problems with harmonics, as well as problems through the overloading of receiver 'front-ends'.

Solutions to co-interference problems include: repositioning the antennas, increasing the spacing between antennas, changing the combination of equipment used (solid state receivers of the broadband type may be more prone to co-interference problems than the more ancient valve receivers!) and the use of band-pass filters/band-reject filters in feed lines.

Even in the best planned multi-operator contest operation, there will always be some restriction on operating flexibility. If the main station is CQ'ing and working a string of stations on, say, 7.005 MHz, the spotting station will find it difficult to hear/work multipliers within a few kHz of any of the frequencies 14.010MHz, 21.015 MHz or 28.020 MHz!

There is one well known UK contest station which regularly uses two different stations into one 14/21/28 MHz quad antenna on different bands (using separate feeders for each quad loop, of course!). Even with this close coupling of antennas, a satisfactory spotting station performance can be achieved.

RADIO Tomorrow

Your at-a-glance guide to what's happening around the clubs, on the air and in general radio-wise.

| | | |
|---------|---|---|
| 1-2 Jun | HF National Field Day 1600hrs – 1600hrs. CW only on 1.8, 3.5, 7, 14, 21 and 28MHz. | |
| 1 Jun | Three Counties ARC: <i>Amateur Radio Insurance by Mr Gibson.</i> Wolverhampton ARS: GB2WWM will be on the air to celebrate the Wolverhampton Millenium. Activity on HF, VHF, SSB and CW. Special QSL card will be sent to all confirmed contacts. | 6 Jun |
| 2 Jun | Spalding DARS: mobile rally. Wirral DARC: DF hunt no. 3 | Denby Dale DARS: rally committee meeting at the Pie Hall, Denby Dale. Hornsea ARC: natter night. Wirral DARC: D & W at the Greave Dunning, Greasby. N Wakefield RC: on the air night. Inverness ARC: meets every Thursday at 7.30pm at the Cameron Youth Club, Planefield Road, Inverness. Horsham ARC: meeting, ring Pete for details. |
| 3 Jun | Horndean DARC: <i>Raynet by G4JXD.</i> Rhyl DARC: <i>Visit to the Communications Room at regional Police HQ.</i> Worcester DARC: <i>Test Your Spec – Rig Inspection.</i> Southdown ARS: <i>Kits for Radio Amateurs.</i> Hazelrigg ARC: meets ever Monday at the Community Centre, Hazelrigg. G4YPT usually in operation. Natter group and refreshments. Leighton Linsdale RC: meeting. Todmorden DARS: car treasure hunt for G4HYY trophy. Basingstoke ARC: <i>Antennas by G8CKN.</i> Alyn and Deeside ARS: drink and waffle at Shotton Social Club, Shotton Lane, Shotton, starting at 8pm. N Staffs ARS: natter night plus new Class B CW at the Howard Clowes Memorial Hall, Dawlish Drive, Bentilee. | Maidenhead DARC: lecture at the Red Cross Hall, The Crescent, Maidenhead, starting at 7.30. Preston ARS: <i>AMTEXT - an introduction to Packet Radio by G3WRI. The meeting starts at 7.45pm at the Lonsdale Club, Fulwood, Preston.</i> 7 Jun Coventry ARS: <i>Visit to IBM at Warwick.</i> Loughborough AREC: junk sale and open forum. Clifton ARS: meets every Friday, ring Secretary for further details. S Manchester RC: meeting. Dunstable Downs RC: <i>Trip to Mullard Observatory.</i> Nunfield House Community Assoc. ARG: rally preparation in room 7, Nunfield House, Boulton Lane, Alvaston, starting at 7.45pm. Maltby ARS: DF hunt. |
| 4 Jun | Bury RS: informal. Loughborough AREC: constructors group. Fylde ARS: <i>Gliding as a Sport by Chairman of local Gliding Club.</i> Chichester DARC: <i>HF Wire Antennas by G5RV.</i> Wolverhampton ARS: junk and equipment sale. E Lancashire ARC: computer and RTTY night. | 8-9 Jun Special event station at the Great Amwell Traction Engine rally run by Cheshunt DARC. |
| 5 Jun | Wirral ARS: <i>AMTOR by George Metcalfe, G6VS.</i> Worthing DARC: meets every Wednesday at the Parish Hall, South St, Lancing, starting at 7.30pm. Cheshunt DARC: natter night. Fareham DARC: <i>The Oscilloscope.</i> Exmouth ARC: meets at the Scout Hut, Marpool Hill, at 7.30 all visitors welcome. | 9 Jun RSGB 432MHz Trophy Contest. 16th Elvaston Castle mobile radio rally. Over 90 trade stands, flea market, bring and buy, refreshments and showground for the younger members of the family. Starts at 10am. 10 Jun Alyn and Deeside ARS: treasure hunt. N Staffs ARS: HF night on the air. Mid Warwickshire ARS: fox hunt. 11 Jun Chester DRS: <i>Design and Construction of a 15m Converter by G3EON.</i> Westmorland RS: meeting Kidderminster DARS: VHF NFD planning. Loughborough AREC: constructors group. Wolverhampton ARS: <i>discussion night – How I came into Amateur Radio.</i> |

| | | | |
|--------|--|---------|--|
| | Bury RS: two films — The Nuclear Fuel Cycle and Roll Call! a film about surveillance systems. | 25 Jun | Mid Warwickshire ARS: <i>G5UM Awards</i> . Chester DARC: <i>PCB Photo Etching by G8OJQ</i> . Loughborough AREC: constructors group. Wolverhampton ARS: night on the air. Verulam ARC: <i>Contesting by G3FXB</i> . E Lancashire ARC: <i>Japanese Morse</i> . Bury RS: informal. Kidderminster DARS: HF night and RTTY demo. |
| 12 Jun | Cheshunt DARC: 2m Portable on Baas Hill Common. Farnborough DRS: <i>VHF/UHF aerals by G8CKN</i> . Fareham DARC: natter night on the air. Stroud ARS: meeting. Denby Dale DARS: rally open meeting. Hornsea ARC: <i>Data Transmission by G4EEV</i> . Wirral DARC: <i>The Regional Rep's Duties by G3XSN</i> . | 26 Jun | Three Counties ARC: HF and VHF stations on the air. Cheshunt DARC: club project with G4ZCX. Farnborough DRS: VHF field day preview. Fareham DARC: natter night on the air. Stroud ARS: meeting. Denby Dale DARS: visit to Leeds ARC. Hornsea ARC: <i>Contest Operating and Logging</i> . Wirral DARC: The Eileen Medley Challenge Cup DF hunt. |
| 13 Jun | N Wakefield RC: lecture/visit. Abergavenny and Nevill Hall ARC: meets every Thursday at the Pen-y-Fal Hospital, above male ward 2. | 27 Jun | N Wakefield RC: monthly meeting. Greater Peterborough ARC: SWL, RTTY evening. |
| 14 Jun | Loughborough AREC: HF night on the air. S Manchester RC: meeting. Nunsfield Hse CA ARG: mobile ATV treasure hunt, loosely based on the TV series but without the helicopter! Bromsgrove DARC: main meeting at the Avoncroft Centre. Coventry ARS: night on the air. Maltby ARS: <i>Homebrew Construction by G8DRQ</i> . | 28 Jun | Loughborough AREC: <i>Contest Operation</i> . S Manchester RC: <i>Visit by Region 1 Rep</i> . Nunsfield Hse CA ARG: preparation for top band DF hunt. Bring along a portable for adjustment if no equipment. Bromsgrove DARC: construction meeting. Coventry ARS: night on the air. Maltby ARS: field event activity night at Micklebring. |
| 17 Jun | Rhyl DARC: <i>QRP Operating by George Dobbs, G3RJV</i> . Worcester DARC: informal. Leighton Linsdale RC: meeting. Todmorden DARS: informal natter. Alyn and Deeside ARS: drink and waffle. N Staffs ARS: informal. | 30 Jun | Buxton Mobile Rally at the Pavilion Gardens, Buxton. Admission by programme 50p. Wide range of facilities, all the usual stands and RSGB bookstall. Nunsfield Hse CA ARG: top band DF hunt starting at 2pm from Nunsfield House. Horndean DARC: <i>Working CW by G4DFG</i> . Hazelrigg ARC: meeting every Monday. Basingstoke ARC: VHF NFD arrangements. Alyn and Deeside ARS: NFD arrangements. N Staffs ARS: informal meeting. Wolverhampton ARS: meeting. Worcester DARC: club night. Todmorden DARS: natter night. |
| 18 Jun | Chester DRS: barbeque — bring along your steaks and partners. Loughborough AREC: constructors group. Fylde ARS: informal plus morse. Maidenhead DARC: preparations for VHF NFD. Wolverhampton ARS: <i>Demonstration of RTTY and AMTOR by G1DIL</i> . Bury RS: informal. | 1 Jul | Fylde ARS: equipment construction contest. E Lancashire ARC: fox hunt. |
| 19 Jun | Wirral ARS: technical talk. Cheshunt DARC: natter night. Fareham DARC: <i>Aerials and Planning Permission</i> . Exmouth ARC: meeting. Denby Dale DARS: noggin n' natter. Hornsea ARS: RSGB film. Wirral DARC: The Telegraph, Mount Pleasant Rd, Wallasey D & W. N Wakefield RC: fox hunt. | 2 Jul | Wirral ARS: surplus equipment sale. Worthing DARC: meets every Wednesday. Cheshunt DARC: natter night. Fareham DARC: <i>AMTOR and Packet Radio Techniques</i> . Exmouth ARC: meeting. Denby Dale DARS: noggin n' natter. Hornsea ARC: preparing for VHF NFD. Wirral DARC: annual barbeque on Heswall shore. |
| 20 Jun | Chichester DARC: Goodwood Evening Rally. Preston ARS: <i>Receiving Satellite Pictures by Peter Dunne</i> . | 3 Jul | N Wakefield RC: on the air night. Inverness ARC: meets every Thursday. Horsham ARC: pre VHF field day natter. Maidenhead DARC: lecture, ring PRO. Preston ARS: preparations for VHF NFD and natter night. |
| 21 Jun | Sutton and Cheam RS: quiz vs Coulsdon club. Loughborough AREC: third 160m DF hunt. Dunstable Downs RC: planning for NFD. S Manchester RC: mid summer night DF contest. Nunsfield Hse CA ARG: rally round up. Coventry ARS: 160m DF demonstration. Maltby ARS: <i>Three in a Row lectures</i> . | 4 Jul | GB4CSB — 75 years of scouting in Chester. Operating HF and VHF from Eaton Hall, Chester (home of the Duke of Westminster). QSL card available. S Manchester RC: preparing for VHF NFD Nunsfield Hse CA ARG: final preparations for VHF NFD. |
| 23 Jun | SE Kent (YMCA) ARC: Mid Summer Rally at the YMCA Centre, operating a special event station, GB0IYY between 10.30 and 4pm. | 5-7 Jul | |
| 24 Jun | Alyn and Deeside ARS: surplus equipment/junk sale. N Staffs ARS: computer night. | 5 Jul | |

MUGTHORP A.R.S.



"...SO CAN I HAVE A BIG HAND FOR OUR C.W. CONTEST TEAM..."

Clifton ARS: meeting.
Coventry ARS: treasure hunt and barbeque.
Maltby ARS: treasure hunt.

6-7 Jul VHF National Field Day, details later.

- 8 Jul Alyn and Deeside ARS: DF hunt.
N Staffs ARS: natter night plus special event station GB4SOT.
- 9 Jul Mid Warwickshire ARS: fox hunt.
Kidderminster DARS: *Radio on the Burma Railway by G3BA.*
Chester DRS: surplus equipment sale.
Westmorland RS: meeting.
Wolverhampton ARS: meeting.
Bury RS: informal.
- 10 Jul Three Counties ARC: *Aerial Topics with Practical Wireless (who?)*.
Fareham DARC: natter night on the air.
Stroud ARS: meeting.
Denby Dale DARS: *The IARU by G3PSM.*
Hornsea ARC: natter night.
Wirral DARC: *Raynet talk and presentation by G4EFP and G8RXB.*
Farnborough DRS: *HF Antennas by G5RV.*
- 11 Jul N Wakefield RC: *AMTOR by G3PSM including demonstration.*
Abergavenny and Nevill Hall ARC: meets every Thursday.
- 12 Jul Clifton ARS: meeting.
Bromsgrove DARC: main meeting.
Coventry ARS: open night.
Maltby ARS: *Cheap QRP HF Transceiver by G4BVV.*
- 14 Jul Wirral DARC: DF hunt.
- 15 Jul Alyn and Deeside ARS: D & W.
Worcester DARC: informal.
N Staffs ARS: construction help night.

- 16 Jul Todmorden DARS: informal natter.
Chester DRS: treasure hunt starting at 7pm.
Fylde ARS: *Visit to County Police HQ control and communications rooms.*
Wolverhampton ARS: meeting.
Bury RS: informal.
- 17 Jul Wirral ARS: problems night.
Fareham DARC: *VHF/UHF linear amplifiers by G4XZL and G8VOI.*
Exmouth ARC: meeting.
Denby Dale DARS: noggin n' natter.
Wirral DARC: The Lighthouse, Wallasey, D & W.
- 18 Jul Preston ARS: informal meeting.
Greater Peterborough ARC: junk sale.
- 19 Jul Sutton and Cheam RS: *Amateur Radio - The Early Days by G2MI.*
Clifton ARS: meeting.
Coventry ARS: open night.
Maltby ARS: DF hunt.
- 21 Jul Anglian Mobile Rally at Colchester.
McMichael ARS Mobile Rally at Stoke Poges.
- 22 Jul Alyn and Deeside ARS: *Contest arrangements and The Use of Computers in Radio by G3VQT.*
N Staffs ARS: VHF night on the air.
- 23 Jul Chester DRS: *DX Trip to the Orkneys.*
Wolverhampton ARS: meeting.
Bury RS: informal.
- 24 Jul Three Counties ARC: *QRP and Home Construction by G4BCY.*
Fareham DARC: *ATV by G8VOI.*
Stroud ARS: meeting.
Denby Dale DARS: holiday special.
Farnborough DRS: *RTTY by G8WMM.*
- 25 Jul N Wakefield RC: monthly meeting.
- 26 Jul Clifton ARS: meeting.
Bromsgrove DARC: construction meeting.
Coventry ARS: open night.
Maltby ARS: *The Early Days of Amateur Radio by G3ZHI.*
- 29 Jul N Staffs ARS: informal night.
- 30 Jul Chester DRS: rig on the air.
Wolverhampton ARS: meeting.
E Lancashire ARC: informal.
Bury RS: informal.
- 31 Jul Fareham DARC: *Planning for Portable Operation during the summer break.*
Exmouth ARC: meeting.
Denby Dale DARS: holiday special.
Wirral DARC: the 'Revenge' DF hunt for the G8PMF rose bowl.
- 1 Aug N Wakefield RC: on the air night.
Preston ARS: informal meeting.

Will club secretaries please note that the deadline for the September segment of Radio Tomorrow (covering radio activities from 1st August to 1st October) is 24th June.

Contacts

| | | |
|----------------------|--------------|-------------|
| Abergavenny & NH ARC | GW4XQH | 0873 4655 |
| Alyn and Deeside ARS | GW4RKX | 0244 660066 |
| Antrim DARC | GI4FUM | 084 9464672 |
| Axe Vale ARC | Roger Jones | 040 486 468 |
| Barking RES | R. Woodberry | 01 594 4009 |
| Bath DARC | G4UMN | Frome 63939 |
| Basingstoke ARC | Dave | 07356 5185 |
| Braintree RS | J. Roberts | 0376 44857 |
| Brighton DARS | Peter | 0273 607737 |

| | | |
|-----------------|--------------|-------------|
| Bristol ARC | G4YOC | Bitton 4116 |
| Bury RS | Bryan | 0282 24254 |
| Cambridge DARC | D. Wilcox | 0954 50597 |
| Cheshunt DARC | Roger Frisby | 0992 464795 |
| Chester DRS | Alan | 0244 40055 |
| Chichester DARC | C. Bryan | 0243 789587 |
| Clifton ARS | Mr Hinton | 01 301 1864 |
| Coventry ARS | R. Tew | 0203 73999 |
| Denby Dale DARS | G3SDY | 0484 602905 |
| Donegal ARC | EI3BOB | 074 57155 |

| | | | | | |
|----------------------|--------------|--------------|---------------------|--------------|-----------------|
| ▶ Droitwich DARC | G4HFP | 0299 33818 | Nunsfield HCA ARG | G4PZY | Derby 767994 |
| Dudley ARC | John | 0384 278300 | Preston ARS | George | 0772 718175 |
| Dunstable Downs RC | Phill Morris | 0582 607623 | Oswestry DARC | Brian | 0691 831023 |
| East Kent RS | Stuart | 0227 68913 | Reading DARC | Chris | Reading 471761 |
| East Lancashire ARC | Stuart | 0254 887385 | Rhyl DARC | GW1AKT | Nantglyn 469 |
| Edgware DARS | John | 01 306 4342 | Sheffield DRS | G4PSO | Hitchin 57949 |
| Exeter ARS | Roger Tipper | 0392 68065 | S. Bristol ARS | Len Baker | 0272 834282 |
| Fareham DARC | Brian | 0329 234904 | S. Lakeland ARS | Dave | 0229 54982 |
| Farnborough DRS | Mr Taylor | 0252 837581 | S. Manchester ARC | Dave Holland | 061 973 1837 |
| Fylde ARS | PRO | 0253 737680 | Southdown ARS | P. Henly | 0323 763123 |
| G. Peterborough ARC | Frank | 0733 231848 | Stockton DARS | John Walker | 0642 582578 |
| Halifax DARS | DL Moss | 0422 202306 | Stowmarket DARS | M. Goodrum | 0449 676288 |
| Harrow RS | Dave Atkins | 0923 779942 | St. Helens DARC | A. Riley | 051 430 9227 |
| Hastings ERC | Dave Shirley | 0424 420608 | Swale ARC | B. Hancock | 0795 873147 |
| Haverhill DARS | Rob Proctor | 0787 281359 | Telford DARS | Tom Crosbie | 0952 597506 |
| Hazelrigg ARC | G1HDV | 274 2413 | Three Counties ARC | R. Hodgson | 0428 77368 |
| Hornsea ARC | Norman | 0262 73635 | Tiverton (SW) RC | G. Draper | 03634 235 |
| Horsham ARC | Pete Head | 0403 64580 | Todmorden DARS | Mr Gamble | 070 681 2494 |
| Inverness ARC | Brian | 0463 242463 | V White Horse ARS | Ian White | Abingdon 31559 |
| Kidderminster DARS | Tony | 0562 751584 | Verulam ARC | Secretary | St Albans 59318 |
| Leighton Linlade RC | Pete Brazier | 052 523 270 | WACRAL | G4NPM | 0795 873147 |
| Loughborough ARC | Philip | 0509 412043 | Wakefield DRS | G8PBE | 0924 378727 |
| Loughton DARS | G6FWT | 01 508 7190 | Welland Valley ARS | J. Day | 0858 32109 |
| Maidenhead DARC | PRO | Marlow 6421 | Welwyn Hatfield ARC | Dave | 07073 26138 |
| Maltby ARS | Ian Abel | 0709 814911 | West Kent ARS | J. Green | 0892 32877 |
| Medway ARTS | Andy Wallis | 0634 363960 | Westmorland RS | G. Chapman | 0539 28491 |
| Midland ARS | G8BHE | 021382 0086 | Willenhall ARS | G4LWI | 0902 782036 |
| Mid Sussex ARS | G1FRF | 0791 82937 | Wirral ARS | Cedric | 051 625 7311 |
| Mid Ulster ARC | DF Campbell | 0762 42620 | Wirral DARC | Gerry Scott | 051 630 1393 |
| Mid-Warwickshire ARS | G4TIL | Southam 4765 | Wolverhampton ARS | Keith | 0902 24870 |
| N. Cornwall RS | J. West | 0288 4916 | Worcester DARC | D. Batchelor | 0905 641733 |
| N. Staffs ARS | G6MLI | 0782 332657 | Worthing DARC | Jim Hicks | 0903 690415 |
| N. Wakefield RC | S. Thompson | 0532 536633 | 308 ARC (Surbiton) | Dave Davis | 01 399 5487 |

Free Readers' ADS!

WANTED

WANTED, mobile mount for FT290, 2 metre 4-5 ele beam 30W linear amp, 2 metre FM1SSB 0.5-2.5W drive. Phone Southport 0704 69410.

WANTED Trio PS30 DC power supply for Trio TR9130 any condition. Tele 0449 672710 Stomarket.

WANTED Cobra 2000GTL mint condition. Will part exchange Cobra 148GTL DX in good condition plus Piezo DX 344 base microphone, or buy outright. Sensible prices please. Write to R. Fensome, 86 The Grove, Woodside, Luton, Beds. LU1 4LR. Phone (0582) 454055.

WANTED FT290R preferably un-modified and in good clean condition. Phone John on 0579 43749 (Liskeard Cornwall) after 7pm G3XHX QTHR.

WANTED Denco octal plug-in coils and Eddystone plug-in

coils and bases. Also wanted Hac, Globe-king, Johnsons, Codar and RSC shortwave sets, kit or built. Ring Geoff on 0272 844584.

WANTED FT101 or FT101E must be in good condition. Might consider other low priced HF rig. Also want Yaesu FT290R or other 2m multimode. David (040 24) 57722 eves.

WANTED Info on Cossor 1035 Scope. War-time or pre-war "Radio Times" and wireless magazines, and books. Douglas Byrne, 52 West Hill Road, Ryde, IOW. Po331LN. Tel Ryde (0983) 67665.

WANTED FRG7700 HF receiver original condition with or without accs. Gloucester Area, Tel 0452 423908.

WANTED Racal RA63H SSB adaptor, Racal RA137A LF converter, Racal SA77 CRT. Tuning display complete with

handbooks. Also rack unit to fit above equipment. Telephone 0203 26252.

WANTED Partridge joystick antenna with Joymatch ATU in working cond. For OAP. Tel 0783 267125 Tyne & Wear.

WANTED FT707 PSU ATU also good communication set R2000 or R1000. Cash waiting. Phone 0283 221870.

WANTED 144MHz beam at least 5 elements for £5. Telephone 051 727 4605.

WANTED Icom IC701-PS speaker PSU for 701. Any condition working or not sale - DSB160 transceiver LCD digital display changeover relays nicely cased £45. Steve G4MJW 0227 369444 (Herne Bay).

NEEDED urgently for v/old Eddystone receiver - schematic/service/data/info only identification marks: Royalty plate/serial No:

MH54012 will buy. Phone Mr Henderson, 0223 61222, ext 471.

CELESTION SPEAKER WANTED: 3ohm elliptical (3.5" x 7") red transfer on back 'Celestion made in England', and has ridged lines radiating from centre of diaphragm. Pale bronze/yellow colour. Price negotiable, please contact Mark, G4RGB QTHR, or Telephone: Medway (0634) 30822.

WANTED any information on Mullard valve tester type E760013. Cash waiting will sell or swap if anyone can make use of it. Anything considered. Write Ken Brown, 44 Tenby Court, Monkton, Pembroke, Dyfed, S. Wales SA71 4JF.

WANTED 3 gang tuning capacitor (variable) 0-30 or 0-50 PF. These may be separate with through spindles for ganging or complete unit.

G8BSK 290 Priory Road, St Denys, Southampton SO2 1LS.

WANTED FM board for FT707. Fair price for fair board. Telephone Peter 091-416 7841 evenings or weekends.

WANTED Yaesu FT92DM must be in absolutely mint condition. Good cash price paid G3BRD Seaford (0323) 897313.

PRACTICAL Wireless 1980-1984 25 copies £5. Wanted all-band active aerial unit, your price. Contact Mr Clark, 77 Edge Avenue, Scartho Road, Grimsby.

WANTED xtals 6.755MHz, 8.6775MHz. Wanted time base module type CX1443 for a Solatron CD1400 scope. Tel 0582 62621.

WANTED 200-200PF split-stator variable capacitor. Vane spacing (fixed to moving) 2mm or greater. Required to built ATU. Phone Ken, Manchester 061 748 6109 after 6pm.

WANTED FDK multi 700E user's handbook, circuit diagrams or leaflets urgently required to repair Rx/Tx. Beg, borrow or buy if price reasonable. Send goodies or letter to: Andy, G11MUZ, 18 Blackmountain Grove, Springmartin, Belfast, N. Ireland.

WANTED 70cm mobile transceiver FM or multimode. Would consider TW4000A or similar. Must be in vgc. N Purkins, 32 Astral Road, Hesse, North Humberside HU13 9DD, Tel: 0482 644122.

WANTED KW109 ATU must be in good condition. Also Drake desk mic type 7075. Phone Pete G3VDU Nuneaton 343680.

WANTED Yaesu FC-707 ATU and FTV707 must all be good unmarked condition for best price. Ring 0692-670600 after 18.00 hrs.

WANTED valves Cosmos SP18, A45, any valve made by 362 Radio Valve Co, London. Thorpe K4. HT choke by Rich and Bundy or Andrew Bryle, approx 10H 120mA. Taylor, 14 Willow Walk, Canewdon, Rochford, Essec. Phone 03706 598.

WANTED Yaesu YK901 keyboard to use with Yaesu YR901 CW/RTTY reader. Panasonic DR48 digital general coverage receiver. Also FRT-7700 ATU FRV-7700 VHF converter. Type C/F 7700 memory unit.

Phone Colchester 394336 (Essex).

WANTED VHF or HF transceiver exchange 1600 Beetle engine overhauled, very little used. Bristol 0272 673626.

WANTED RTTY program for Apple two computer with disc drives. Phone Atherton 895787.

WANTED YAESU memory unit for FRG 7700, in mint condition. Phone (Tyne-side) (091) 263 9460.

WANTED Avo valve tester model VCM 163. Ring Mr Standing, Colne 863326. 2 Elm St, Colne, Lancs.

WANTED May 1978 (seventy Eight) practical wireless magazine. Mr Beech 66, Newpool Road, Knypersley, Stoke on Trent, Staffs. ST8 6NS.

WANTED We buy Yaesu FT77 and Icom 720 Write to Marco Medicins Sans Frontieres, 24-26 Deschampheler Street, 1080 Brussels, Belgium. Tel 02/425 03 00 Thank you.

WANTED Belcom LS202L Cash Urgent, also Multimode 360 channel. 0283 221870 or NATO 2000.

WANTED FT101ZD with FM, or Trio TS530S. Also FC902 ATU wanted 2m and 70cm Multimode, Base or Mbile. Also FRG-7 or similar. Dave, 04024 57722.

WANTED Very old wireless magazines, books, catalogues, QSL-cards, war-time or pre-war "Radio Times". Douglas Byrne, G3KPO, 52 West Hill Rd, Ryde, IOW PO33 1LN. tel 0983 67665.

WANTED 70CM beam antenna. Anything considered: Linear amplifier 70cm with or without pre-amp to suit Yaesu 790R: 2m Linear with or without pre-amp 1-10 watts input. 70cm SWR meter. Cash waiting. Phone 021 745 3429.

WANTED TRANSFORMER WTB165764 for Hartley electromotives Oscilloscope T436. Crowhurst, 41 Mill Dam Lane, Burscough, Ormsirk, Lancs. Phone 0704 894299.

WANTED recordings of Pirate or Offshore radio, cassette or open reel. Can supply tape if needed. Ring Nick 01 997 2367.

WANTED National Panasonic DR49 Digital coverage receiver. Also Yaesu YK901

keyboard. Tel 394336 (Colchester Essex).

WANTED 2-metre all mode base or portable transceiver. Also morse tutor required. Phone Geoff 0484 846631.

WANTED any info on converting Dymar 880 Tx/Rx to 2m. Will reimburse to costs. Also wanted crystals for FDK quartz 16 transceiver. Please contact Mr K Johnson on Penketh (0925 72) 2998 evenings only.

WANTED RTTY software/hardware for ZX81. Also cheap crystal 2m or 70cm hand held. Contact Richard Meal, GW6TAM, (QTHR) 0554 820282 Mon-Thur 5-8pm.

WANTED operators manual for Mullard High Speed Valve Tester. (Oscilloscope type) Write to: Mr Fox, 123 Unett Street, Smethwick, Warley, W. Midlands B66 3TA.

WANTED Yaesu FT225RD all mode 2m transceiver. Ewin Bailey, 23 McCallum Gardens, Strathview Bellshill, Lanarkshire. 0698 747448.

WANTED information on Siemens S-Schrieber-F morse printer T Typ73 T184. PE211. Also manual for Collins AN/URC-32 radio. Mr Cooper, 13 Churchfield Road, Outwell near Wisbech, Bams. PE14 8RL.

WANTED IC240 in good working condition, details and price to WG Jones GW4KJW 24, Underhill Crescent, Abergavenny. Gwent NP7 6DF.

WANTED 10-METRE multimode (convertable CB rig considered). Also HF SSB gear (KW2000, G2DAF) homebrew or non-working equipment considered, providing complete and in good mechanical order. Also Require HF tribander, 2 or 3 element Yagi. Phone Roger GW4BCD, 065671 8963.

WANTED 1 Plessey IC6 13 2. Delay line of 400 NSEC, Belfuse 04020 0400 05 Paying by cheque or remittance. Contact Kusri Subagio, Tverkenstrasse 3/50 1, A-1090 Vienna, Austria.

WANTED YEASU FT757 in May/June 85. Will consider perfect down to soiled, scratched, ex-demo or slightly defective exaple. Cash may also req'r ATU in exchange/(Cash adjust) for 10m FM converted CB. Please ring

G4 YSS Scarborough (0723) 863137 (Evenings weekends).

WANTED SPACE COMMUNICATIONS information wanted on reception of space chuttle and other current space projects. Please reply by Airmail all mailing charges will be refunded. Contact M Shepherd, 38 Weston Avenue, Mount Albert, Auckland, New Zealand.

WANTED KW2000B/E. Must be in good condition. GOAXZ Telephone Bardon Mill (Northumberland) 467.

WANTED scrap non-working or parts for AR88. Valves. Urgently want 'S' meter genuine, but any to fit will do very urgently want details. How and where to connect 'S' meter to AR88. 2M co-linear any converters for any bands. All costs paid. Write: Mr Parkes, 1 Silkstone View, Platts Common, Barnsley, South Yorkshire.

WANTED FT720 70cm module or 2m module. 0376 29089 Henry.

WANTED conversion details to put a Cobra 148GTLDX on IOM. Also any interesting ods to do. To an FT200 with a Europa B transverter. M Kessel, 4 Harington Drive, Weston, Coyney, S-O-T, ST3 5ST.

UNIDEN CR2021 receiver wanted. Telephone Wayne Searle 01-452 3025, 39 Teignmouth Road, London NW2 4EB.

WANTED circuit diagram, service manual etc., for an Airmec 201A modulation meter. naturally all your expenses refunded. Please contact G8RSZ, 2, Lintin Close, Heighington, Lincoln, Lincs, LN4 1RW or phone Lincoln (0522), 792495.

CELESTION SPEAKER **WANTED** 3ohm elliptical 3.5" x 7" red transfer on back Celestion made in England; and has ridged lines radiating from centre of diaphragm. Pale bronze/yellow colour. Price negotiable. Please contact Mark, G4RGB QTHR, or telephone: Medway (0634) 30822.

£150 OFFERED for modern double beam scope 20MHz. Also wanted, 500MHz frequency counter G3ZVC board. Unfinished board OK if parts complete. John, Farnborough 549387.

WANTED National Panasonic DR49 general coverage receiver. Also Yaesu YK901 keyboard. Phone Colchester 349336 Essex.

WANTED for restoration project power supply unit for 3 mark II "B2" suitcase transceiver (Spy set). Spare B2 receiver available and would consider exchange for above. Mr P Daly, 12 Stella Avem Glasnevin, Dublin 9. Phone 01-370305.

WANTED circuit diagram for Polmar SS120 transceiver board. Number unknown has been converted for 10 Mter use only! Phone Ken 01-898 3183 daytime or write to 36 Hamilton Rd, Twickenham, Middx. TW2 6SQ.

WANTED service manual, buy or borrow for Ultra Cub IP4B7-PH walkie talkie. G8EVG, QTHR or phone 0602 820517.

WANTED 30-35 FEET TOWER heavy duty, Versa tower or similar design. Phone Rochester (0889) 590664.

WANTED can anyone help with information on Heathkit service oscilloscope model OS-2 any literature, instruction manual etc. Will pay postage and any other costs involved. Contact by phone or letter to Mr M Hudson, Flat 5, 6 Augusta Gdns, Folkestone. Phone 0303 42099.

EXCHANGE

EXCHANGE for amateur band Tx/Rx base station equipment Commodore Pet 2001/8k computer integral screen, drive £85 Commodore Pet 2001 upgraded 4000 series 32k, green screen, sound box detachable key board £185. Commodore 4040 twin disk drive £375. Wirksworth 3207.

WANTED any of following equipments FR-50B, FT75B, IC205. In exchange for VIC20 Computer cassette deck. Psu leads, manual etc. v.g.c. Hardly used. Tel 0258 53670 (evenings).

EXCHANGE PHOTO COPIER complete with 64 rolls of paper, loads of ink, toner, and two machines for spares. Would consider anything to do with amateur radio or why. Phone John on 0705 261399 anytime.

HAM INTERNATIONAL CONCORDE MK2 USB, LSB AM UKFMCB CW. Ideal for 10m conversion. Swap for portable

or hand-held receiver or cash. Any offers, please to 82 Victoria Road Newbuildings, Londonderry, N. Ireland. All offers replied. Will pay postage to Mainland UK.

FOR SALE

AR88, S-meter, original speaker, manual, spare valves, £35. **ASR33**, manuals, stand, £40. **HF5** antenna £35. **Wanted R1000**. **G4LLQ**, Tel 0608 811102 (Oxon).

ICOM IC740 nine band HF transceiver FM and marker options fitted. Complete with PS15 supply. £625. or would accept part exchange with a receiver. The above is complete with boxes and in mint condition. Phone 0604 48091 **G3KLV** Northampton.

YAESU FT290R nicads, charger case, CW foot switch, stand, flexible whip. Mint condition £220. Heatherlite mobile boom microphone, up/down buttons, wired 290R. Little used £16. Wanted morse keys any type or condition for collection. Tel Leeds (0532) 585806 **G4VZD**. QTHR.

EDDYSTONE general coverage receiver model 940, GC also instruction manual including speaker and phone £120 ono. Tel Rochdale 0706 352335.

FT101E 100W 250Hz CW filter, inverter for 12V mobile with mic and spare PA bottles £425. Contact Mr Kitchen, 18 Welch Road, Newton, Hyde, Cheshire.

TRIO TR7730 25W 2m FM XCver inc mike and manual £140. **Yaesu FL2100B** HF linear amp inc manual exc condx £280. **Daiwa DK210** keyer plus Hi-mound MK704 paddle £40. **Hi-mound MK706** paddle £15. All items vgc. Telephone (Leeds) 0532 659227.

SWAN TCVR 100MX 80m-10m CW SSB good receiver output to PA which needs attention new driver transistors, swap KW2000 etc sell £120 ono; enquiries Grieveson, 30 Rozel Court, Beck Row, Bury St Edmunds IP28 8AX.

TRIO 2300 145MHz FM portable transceiver, 80 channel, plus repeater shift £95 ono. Microwave modules MMC 432MHz to 144MHz receive converter £15 ono both carriage and insurance paid. **G3TDJ**, Bude 0288 3701 QTHR.

YAESU FT209RH 2m as new

— 3 months old, complete with case, NiCads and charger £220 ono. Purchaser will collect or extra for carriage. Telephone Blackpool (0253) 592248.

TR9130 Mint £450; **FT790R** NiCads charger case £220; **PF1's** n/call on RB6 £30; **FC757ATU** automatic+FS1-4Rswitch £200; **TF995A/3/S** sig-gen M/FM/CW 1.8 to 220MHz £60; **Advance RMS** V/meter .001V to 300V offers? **Dragon 32** computer swap for 2m or 70cm. Handheld or WHY? Phone Ian 0602 783203.

DATONG FL1 frequency agile filter unit unwanted gift used twice £40 or exchange for **FL3/ANF**, cash adjustment. **Puma 21** watt linear suit **FT290**, **TR2500**, as new, boxed £27. New charger for **FT290** £6. York (0904) 53173 **G6MNX** QTHR.

YAESU YM38 desk microphone £16. **Micronta 3-30MHz** triple meter power modulation, SWR tester, boxed as new only £12; computer chess game, complete with power supply and chessmen, boxed £9. **G6MNX**, QTHR, York (0904) 53173.

FT-7 for sale, five band HF rig. Excellent condition, can be used mobile or base, £190. Tel Dave 0782 315763.

Computer Commodore CBM4008 hardly used £180. **Cassette deck** £10. Telephone **Atherton 895787** 6pm-10pm.

PR2003 scanner, 70MHz to 500MHz. 60 memories 5kHz and 12.5kHz scan steps. 10 months old, vgc so £160 ono or exchange for HF/VHF gear, why. Phone Tony on (0272) 719163 Bristol.

FOR SALE Trio R1000 general coverage receiver £160 Bargain. Tel Newcastle-on-Tyne (091) 2673507.

SX400 Scanning receiver, covers 26MHz to 520MHz, has data interface socket for computer and converter socket for extended coverage. Had couple of hours use only new boxed £489. Telephone 01485 4251.

AVANTI PDL-2 quad beam for 10m £50. Telephone 0952 57670.

FOR SALE Gemscan scanning receiver 60-179 MHz 380-519 MHz. 70 memories. Mains or 12VDC input. Realistic offers please. Allen **G3DRN** QTHR 01-947 3914.

YAESU FT101ZD recent overhaul plus **FC902 ATU** £450. **FT77** £400. Both can be seen working. Deliver radius 30 miles. Phone evenings 01-572 0465.

BELCOM LS102 frequency readout 26-28MHz AM-FM USB-LSB good condition. £180 or swap for Uaesu **FT209R** with cash adjustment. Phone Tony Wrexham 757435 or PO box 97, Wrexham. Clwyn, N. Wales.

OSCILLOSCOPE telequipment **D43**, double beam, 15 MHz band width v.g.c. Complete with manual circuit diagram. All test leads and set of spare valves (Boxes) £75. Telephone Dave (0908) 501310 **G3ZPA** QTHR.

YAESU FT230R 2M transceiver 25W FM complete with mobile mount, and mic. Mint condition £180 o.n.o. Phone Mr Beynon 04468 261.

T1154 transmitter, working but dusty. Selling on behalf of air training corps. Offers. Tel Kings Langley 65823.

TS 930 Trio Kenwood transceiver with general coverage and with fitted automatic ATU. The ultimate. Cost £1,515. Unmarked and in pristine condition. Save £500. Handbook and original carton £995. **G4IOF**. Tel 01-486 8286 (work), 01-722 7040 (home).

LISTENING POST clear out. Send for list. Valves ATU, audio filter, **VOM 240 VAC**, relays, high current panel, meters, data cassette player. 3 channel music colour. 2500 watts per channel. Rout 3/137 Champion St, Christchurch, New Zealand.

ICOM 02E hand held transceiver with speaker mike. Used once £185 ono, or exchange for 2m multimode with cash adjustment upto £150. ring 01-348 3336.

TRS80 level II, expansion chassis monitor, floppy tape, printer manuals and software £125 ono. **ZX81** 16k manual, leads, power pack and some software £25. Tel Melton Mowbray 68337 after 6pm and weekends.

YAESU FT102 SP102 FC102 AM/FM board, fitted narrow CW-filter **MD-1** desk mike medical reasons force sale of my HF station rig and was bought Dec '84. £895 ovno Telephone (0266) 41353.

FT101 10-160MHz GWO clean ideal first rig CW filter fan desk mic. Buyer inspects and collects £250 no offers, "Ted" G4TLIY QTHR Malmesbury Wilts. 2935 evenings/weekends.

JAYBEAM ANTENNA dual band beam. Yagi 6 element 2m 12 element 70cm as new. Cost £44 accept £30. Phone Southampton (703) 863709.

PANASONIC RF3100 32 band receiver as new under guarantee. £160. Phone Bookham 56741 (Surrey).

SMC HF5 five band vertical antenna with radial kit used for only one month. In original box with instructions £65. Also Jaybeam tene element crossed Yagi £35. Phone Winchester 760247 G4SVC.

HY GAIN V 11m, high mid, low bands AM/FM/USB/LSB. Ham int hypower 3/4 ant. Leson DT251 mic breimi 5A PSU matcher, TV1 filters. All offers considered! Entrance university Forces Sale. Also Yaesu FRG7000 g.c., and M12uhg KX2 ATU, microwabe band convertor K40 mobile antenna K40 speech processor + many others. Amstrad stack module stereo (sliding deck) g.c. Offers. Tony Sheach, 8 Straum Road, Portree, ISLE of Skye. IV5 9EG or (0478) 2548.

QUAD 9HIGL version for 20, 15, 10 eight resin coated bamboos 8ft boom cast alloy X end pieces, four tuned traps £50 ono. Or swap eg power supply G4SQA QTHR Tel Peterborough 0733 232211.

PADDLE KEY new unused. Heavy black polished steel base. Highly polished precision brass fittings. Single paddle, silver and brass contacts. Beautiful piece of equipment for the shack £25 + £2 post. Crowhurst, 41 Mill Dam Lane, Burscough, Ormskirk, Lancs. 0704 894299.

TEKTRONIX 2215 solid state dual trace 60MHz with manuals. As new £300. Advance TC16 80MHz counter timer £50. Fluke 8020A DMM with case. May be able to deliver. Brightlingsea 5344 Essex.

MBA-RC AEA morse, baudot. ASC code reader converter transmitter £95 ono. I need Yaesu Y0901 scope monitor or similar. AF Sephton 16, Bloemfontein Ave, Shepherds Bush, London W12 7BL. 01-749 1454.

TRIO 29130 144MHz multimode TCR. Usual facilities, 25 watts output plus 7/8 gutter mount aerial. £350 ono. STC Starphone 450MHz rig £15. 15 rolls 5-track paper tape £1 each. Hugh G1BUE. St. Albans 32759 evenings and weekends.

FOR SALE Cobra 148GTL DX 26.060-28.345 AM FM USB LSB CW plus UK FM with turner M+2/V microphone 10KC upshift for 'A' channels. Variable power 0£16 watts. Switchable bleep. Professional conversion. Excellent condition £180 ono. Contact Dick Eastbourne 509738.

FOR SALE Yaesu FT227 mobile FM 2m rig 10W output. Scanning from mic 5 memories, nice condition. Offers around £130. Telephone 0482 802706.

FL2100Z HF Linear, 1200W PEP, 9-bands, mint cond, with orig packing £495 ono. 4m Europa-B transverter 100W PEP output, including matching CPS10 PU, could be modified to 6m £85. Mutek SLNA 14S 2m pre-amp £25. Phone 01-578 4484.

DATONG 2 converter complete with 12 volt mains power unit £30. Global AT1000 aerial tuner, suitable any shortwave receiver £28. Yaesu FRV-7700D converter £50. All with makers details, good condition and post paid. Letters only please. Mr Moore, 76 High St, Ide, Exeter. EX2 9RW.

AR40 ROTATOR modified for fixing to flat plate, £20. G4NRG. Brentwood (0277) 810831. Wanted bird 43 high power VHF/UHF elements. Please ring G4NRG. Brentwood (0277) 810831.

ATTENTION 35mm slide enthusiasts lecturers. Imatronix digital 2500S auto dissolve projector controller for sale. Will flash, slow/fast dissolve.

Two projectors automatically. Includes manual and 'optional' hand controller £100 ono. Or WHY amateur g.w.c. Tel 01-478 5903 evenings.

RAE MATHS programme BBC micro £5 with documents. Have you QRP CW(14MHz) rig? Artingstoll. Tel Ingrebourne 44641.

YAESU FT101 HF transceiver £200 ono. trio JR310 amateur bands rx £75 ono. Ed-dystone 840C communications rx £75 ono. OKI microline 80A printer (Cen-

tronics interface) £100 ono. Used 4C x 250B's tested £4 each. Much other equipment. Phone Graham G4DML 0376 27568.

HW100 transceiver with power supply and manual. Spare valves £93 ono. Datong model RF/CM RF speech processor £17 ono. Phone Ron G8JK Kington Blount (0844) 51567.

TRIO 9000 2m multimode 10W, perfect condition, original box. Reason for sale — going HF. Also 9-element portable Tonna + 2 x 3/4 Wetz base station colinear £315 complete or will split. Swindon (0793) 727369.

DRAKE C-line all xtras £550. Standard C58 CW MML 30W case, NiCads mobile mount, unique base station mount. £275. HO10 'scope £30. FC102 CW PSU £140. Datong preamp £10. Datong clipper £20. Shure 201 £10. Offers G4JBH QTHR. Yeovil 23873.

YAESU FT221R Mutek fitted mint £295. Trio TS820 + SP820 + VFO820 + CW XTAL filter + Workshop manual, mint £450. Exchange either for TS430, FT757GX, FT780 + Cash Adj. Phone Chris G4UDG, Kidsgrove 72100.

IC251E 2m multimode base station immaculare condition with manual £410. 144MHz QM70 linear amp 10W in 40W out £28. 144MHz Sota RF switched pre-amp £6. Tel 021 7449993 after 6pm.

FT101Z(FM) fan filter. H/book, little used so FCC £425. See, collect or insurance and carriage your arrangements. Samson ETM3 squeeze keyer v.g.c. £f25. Wanted Icom720A with PU GW3ASW QTHR — write 55 Aberdare Road, Cwmbach, Aberdare Mid Glam.

VINTAGE VALVES (3)PX4 (3)AC/HL (2)83 (2)6V6 6 x 5 ZPP3/250 1W3 41 MH 41 MHL PEN46 U08 EL38 GZ32 VP13A. Buyer collects £10 ono. Bagshot (0276) 75512.

HEATHKIT TWOER AM 2m transceiver £12. FT7 £200. Swap MM4001KB RTTY XCVR for Gencov RX or sell £175. Wanted 1155RX BC348RX 50' pole GW3COI Abersoch 2675.

YAESU FT102 with AM/FM board, never txed, boxed for last year. Immaculate hence

£600. Neil GM1 JTA (031) 229 8449 evenings.

YAESU FT290R multimode complete with 25W micromodule linear and pre-amp power supply 3/4 mobile whip, carrying case, mobile gutter mount £260. Tel 0204 43958. OR 0204 22919.

VHF/UHF Yaesu FT720RV/RU complete 2m/70cm mobile FM rig including switching unit and all connecting cables. As new, boxed with manual £249. Tono MR-150W 150W 2m linear £95. SMC Oscar2 10FM rig £30 or £350 the lot. G4WVX. Tel 06286 64415.

KW202 RX xtal calibrator Q multiplier, notch facility top band to 10m £110. Advance audio sig gen £25. Heath RF/1U sig gen £20. Odd copies *Ham Radio Today*, *Practical Wireless*. Collection only. Mr Pryse, 36 Hard Road, Byfleet, Surrey KT14 7NH.

FOR SALE Yaesu FRG-8800 receiver and active antenna. Genuine reason for sale, 2 months old £395 — no offers. Reply by letter only. Mr FR Murphy 75, Gt. Peter Street, Westminster, London SW1.

S ONLY ICF 2001 synthesised receiver with mains adaptor and instruction book £125. 0384 891264 (Midlands).

FR 7700 receiver with FRV7700 tuner FRT 7700 VHF convertor all as new and boxed £295. Ring Mr Clark on Bolton 594584.

EQ300 HEIZ microphone equalizer, boost your audio, wired Yaesu 8-pin, £30 ono. Also reace UH-74 50MHz, 144MHz, 70cm VSWR and 10 W power meter, mint, £15 ono. Both £40 ono. Ring 01£247 6097 daytime only.

COMPLETE 934MHz STATION comprising Reftec model 2 transceiver, 7.5dBi base colinear, SWR/power meter, additional external S-meter, noise cancelling, additional microphone, magnetic mount 3dBi colinear. £299 or exchange for Icom IC120 23cm transceiver in v.g.c. Carriage extra unless exchange. Mr Lancaster, Ruislip, Middx. tel 01-845 4008.

YAESU FT101B 160-10m transceiver £275 ono. SWR meter dummy load ATU for quick sale £12 ono. Phone Richard G4IWZ on Abingdon 22222 office hours. Also Yaesu FR101S receiver £190 ono.

Free Readers' ADS!

Buy, sell or exchange your gear through our free service to readers

CONDITIONS

1. These advertisements are offered as a free service to readers who are not engaged in buying or selling the same equipment or services on a commercial basis. Readers who are should contact our advertising department who will be pleased to help.

2. Advertisements will be inserted as and when space becomes available.

3. The insertion of advertisements will be on a first-come, first-served basis, subject to condition (2). As a result, it will not be possible to guarantee the insertion of a particular advertisement into any particular issue of the magazine.

4. Readers should either write out their advertisement in BLOCK CAPITALS or type it, underlining any words that are to appear in bold.

5. The magazine cannot accept any responsibility for printers' errors in the advertisements; however, we will do our best to ensure that legibly written advertisements are reproduced correctly. In the event of a gross error, at the Editor's discretion, a corrected version of the advertisement will be printed (at the advertiser's request) at the earliest issue in which space is available.

6. The magazine or its publishers will not accept responsibility for the contents of the advertisements, and by acceptance of these conditions,

the advertiser undertakes to indemnify the publisher against any legal action arising out of the contents of the advertisement.

7. The magazine reserves the right to refuse to accept or to delete sections of advertisements where this is judged necessary.

8. Advertisements are accepted in good faith; however, the publisher cannot be held responsible for any untruths or misrepresentations in the advertisement, nor for the activities of advertisers or respondents.

9. Advertisers must fill in their names, addresses and (if available) telephone number in the space provided, and sign the form to indicate acceptance of these conditions (forms returned without a signature will not be used).

10. All that is to be reproduced in the advertisement should be entered into the space provided on the form printed in the magazine - note that a **photocopy is not acceptable**. All advertisements must give either a telephone number and/or address for respondents to contact, and this must be included in the wording of the advertisement.

11. Advertisements must be 40 words or less in length (telephone numbers normally count as two words, exchange or exchange code plus number).

Name

Address

.....
.....

ENTER YOUR ADVERTISEMENT HERE:

| | | | |
|--|--|--|--|
| | | | |
| | | | |
| | | | |
| | | | |
| | | | |
| | | | |
| | | | |
| | | | |
| | | | |
| | | | |
| | | | |
| | | | |

I accept the conditions above.

Signature

Send this form to: Free Readers Ads, Ham Radio Today,
1 Golden Square, London, W1R 3AB

EMPORIUM GUIDE

AVON

Booth Holdings Bath

6 GOLF CLUB LANE, SALT FORD, BRISTOL
Tel: 02217 2402
Open Tues Sat 9am-9pm
Close Mondays

RING 557732 BRISTOL

Radio Communications
Amateur P.M.R. Marine

UPPINGTON
Tele-Radio Services Ltd

12-14 PENNYWELL ROAD, BRISTOL, BS5 9TJ

KENT

Thanet
ELECTRONICS

95 Mortimer St, Herne Bay
Tel: (0227) 369464

Open Mon-Sat 9-5.30pm
except Thursday 9-1pm

SCARAB SYSTEMS
AMATEUR RADIO SOFTWARE

 STOCKISTS

38 Stafford Street, Gillingham 0634-570441
please see main advertisement

LANCASHIRE

AMATEUR ELECTRONICS U.K./HOLDINGS



G3LLL

Yaesu, Tel, Jaybeam, Frequency Counters, Drea, Datong FT101 Experts, Repairs, 6J86C, 12BY7A, 6X4, RF Clipper, Double Balanced Mixer, Warc Kit etc. S.A.E. List 15 min. Junc. 31 M8. Free parking. 46 Johnston Street Blackburn BB2 1EP 0254 59596 CLOSED THURSDAYS

LONDON

DRESSLER UK LTD

181 Francis Rd, Leyton, E10

Open 9-5.30pm Monday-Friday 10-5 Saturday

Authorised dealers for:

Dressler, Yaesu, Icom, Standard, Trio/Kenwood, Datong, SCM, Microwave Modules, Tonna
Tel: 01-558 0845/556-1415 Telex: 8853609

PROTEL AERIALS AND COMMUNICATIONS

Manufacturers and suppliers of aerials and accessories, DXTV equipment and aerials also other specialist aerials. Large range of bracketry and masts also available.

28-297 Bellards Lane, N12. Tel: 01-455 4441
TRADE ENQUIRIES WELCOME
10m conversion for FMCB rigs £30 + £1.50 p&p
Details on request.

MIDDLESEX



AMCOMM

Authorised Icom dealer

OPEN 10am - 5.30pm TUES-SAT. CLOSED MONDAY

NORTHOLT RD., S. HARROW
MIDDLESEX
TEL: 01-422 0985

W. MIDLANDS



DEWSBURY ELECTRONICS

Rxs. from YAESU, JRC, ICOM
Stockists of microwave modules, B.N.O.S., M.E.T.,
GAMMA, DATONG, ICS, TASCO.

Open Mon-Sat 9.30-5.15
178 Lower High Street
Stourbridge (0384) 390063

HEWARD'S HOME STORES LTD. (Est. 1963)

822/4 Kingstanding Rd., Birmingham
B44 9RT. Tel. 021-354 2083
G4RJM with 38 years in The Radio Trade
Ham Equipment urgently wanted!
Open: Mon-Sat 9-6

WARD ELECTRONICS

DIAWA
LOWE PRODUCTS
COMMODORE
COMPUTERS



HOKUSHIN
ICS AMTOR/
RTTY EQUIPMENT
RSGB BOOKS

G3LIV PCB'S FOR SSTV/RTTY
FOR RADIO ENTHUSIASTS
422 Bromford Lane, Ward End
Birmingham B8 2RX
Tel: 021-328 6070 (Closed Monday)

R. WITHERS COMMUNICATIONS

584 Hagley Road West
Oldbury, Warley B69 0BS
(Quinton B'Ham) Tel: 021-421 8201/2/3

Opening hours 9.00-5.30pm. Late nights Thurs-Fri.
For all your communication requirements send SAE for
latest used list and latest info.

NORFOLK

D.P. HOBBS (Norwich) Ltd
13 St. Benedicts Street, Norwich
Tel: 615788

Open Mon-Sat 9-5.30
Closed Thurs
Stockists of:

YAESU, FDK, ICOM, JAYBEAM
& Electronic Component Specialists

NOTTINGHAM

R.A.S. (NOTTINGHAM)

P. Owen G8JUS
3 FARNDON GREEN; WOLLATON PARK
NOTTINGHAM: TEL: 0802 280267

Open: Tues-Fri 10-5.30. Sat 9-5

YAESU: FDK: ICOM: TONNA
HALBAR: WELZ: ANTENNAS & OWN GW5 H.F.

SCOTLAND

JAYCEE ELECTRONICS

JOHN GM30PW

20 Woodside Way, Golethroes, Fife KY7 5DF

Tel: 0592 756962

Open: Tues-Sat 9-5

Quality secondhand equipment in stock. Full range of
TRIO goodies. Jaybeam - Microwave Modules - LAR.



SCOTCOMMS

OPEN TUES-FRIDAY 10am-12.30pm. 2pm-5pm
SAT: 9am-1pm. 2pm-4pm. CLOSED MONDAY
25 Morton Street, Edinburgh 15
Tel: 031-657-2430

SURREY

GUILDFORD COMMUNICATIONS

34 Aldershot Rd., Guildford

Open Mon-Fri 8am-6.30pm

Sat 8am-5.30pm

Secondhand wanted





ASDEN
TOTSUKO



0483-574434

TYNE & WEAR

Approved
Dealer

ALYNRONICS



129 Chillingham Rd, Newcastle-upon-Tyne

Tel: 091-276 1002

Open: Tues-Sat 10am-6pm

YORKSHIRE

• RADIO AMATEURS AND CB PEOPLE TALK TO •

LA COMMUNICATIONS CENTRE

34 NEW BRIGGATE LEEDS LS1 6NU
ELECTRONIC COMPONENTS - TELEPHONES
VIDEO - AUDIO LEADS - STYL!
LEEDS 452657 the PROFESSIONALS!

TRIO ICOM YAESU
LARGE RANGE OF ACCESSORIES

4 Cross Church St, Huddersfield Tel: 0484 20774

Open 6 days 9 5 30

Closed Weds Thurs 9am 8pm

G4MH Mini Beam, Trio & Yaesu

Always a good selection of new & 2nd hand equipment in stock

Amateur Radio Shop

Lineage:

35p per word (minimum 15 words)
Semi Display: (minimum 2 cms)
 £7.00 per single column centimetre
 Ring for information on series bookings/discounts
 All advertisements in this section must be prepaid.
 Advertisements are accepted subject to the terms and conditions printed on the advertisement rate card (available on request)

01-437 0669
EXT 323
 Send your requirements to:
 Caroline Faulkner
 ASP Ltd.,
 1 Golden Square,
 London W1

EQUIPMENT

SELLING YOUR USED EQUIPMENT?

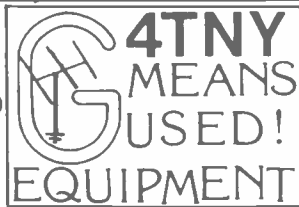

WANT THE BEST PRICE?

Then phone Dave, G4TNY! Why? Because if you call me, you'll be offered the best possible deal on your used gear! How? Phone me and tell me what you feel is a FAIR MARKET PRICE for your equipment. I'll probably agree! Most amateurs know what their gear is worth and feel quite insulted when they get offered 'silly' prices! With G4TNY this won't happen! We'll negotiate a selling commission, which dependant on the condition and 'saleability' of your equipment, could be as little as TEN PERCENT of your agreed market value!! That's not all! Then I'll pay you **CASH NOW!! — NO WAITING MONTHS FOR THE SMALL ADS!!**

BUYING USED EQUIPMENT? IT'S THE BEST WAY!

Whatever you're looking for, phone me last — for the best deal available, ANYWHERE! As you can imagine, with a service such as that above to offer the modern Radio enthusiast we have the BEST USED EQUIPMENT AVAILABLE! At the FAIREST prices. My low overheads see to that! I only buy the best, all equipment is fully tested and inspected before sale, and I'LL UNASHAMEDLY GUARANTEE EVERYTHING I SELL!! CALL SOON!

Phone Hornchurch (04024) 57722, Anytime. Or send SAE for list to:

G4TNY
Part Exchange

G4TNY AMATEUR RADIO

G6TNY
Mail Order

132, Albany Road, Hornchurch, Essex. RM12 4AQ.

FM BROADCAST EQUIPMENT.

A special range of high quality transmitters, power amplifiers, stereo encoders, UHF repeater links, compressors, antennas etc. Built to high specifications at an economic price. VHF/UHF data and telemetry systems (MPT 1309) available ex-stock. Full catalogue available. CyberScan International, 3 Eastcote View, Pinner, Middx HA5 1AT. 01-866 3300.

COURSES

COURSES - RADIO AMATEURS EXAMINATION City & Guilds. Pass this important examination and obtain your licence, with any RRC Home Study Course. For details of this and other courses (GCE, professional examination, etc.) write or phone — THE RAPID RESULTS COLLEGE, Dept. JN2, Tuition House, London SW19 4DS. Tel: 01-947 7272 (9am-5pm) or use our 24 hr Recordacall Service: 01-946 1102 quoting Dept. JN2.

ALARMS

BURGLAR Alarm Equipment. Please visit our 2,000 sq. ft. showrooms or write or phone for your free catalogue. C.W.A.S. Ltd, 100 Rooley Avenue, Bradford BD6 1DB. Telephone 0274 731532.

ANTENNAS

G2VF DIY loop Antennas for H.F. long and medium wave bands. SAE for details: Rylands, HRT, 39, Parkside Ave., Southampton SO1 9AF.

SERVICE MANUALS

SERVICE MANUALS. Amateur Radio Test, Audio, Television, Video etc. S.A.E. enquiries, Mauritron (HRT), 8 Cherrytree Road, Chinnor, Oxfordshire.

CARDS/STICKERS

PLASTIC / MEMBERSHIP / CARDS, laminated cards, lapel badges, all made to your specification. **KARDLINE**, P.O. BOX 206, Wootton Bassett SN4 7EZ. Tel: 0793 853406.

LISTENER & QSL CARDS. Quality printing on coloured & white Glass Card at competitive prices. S.A.E. for samples: S.M. Tatham, "Woodside", Orchard Way, Fontwell, Arundel, W. Sussex.

QSL CARDS. Many designs, reasonably priced. Free samples, please state if S.W.L. DEROGA PRINTING, Whitewell Rd., Sparham, Norwich NR9 5PN.

HIGH CLASS QSL CARDS. Competitive prices, free artwork. SAE for samples stating ham or breaker to: J.S. Coates, 57 Worrall Street, Morley, Leeds LS27 0PJ.

RTTY

RTTY - CW - AMTOR

Now on the Dragon
Complete set of Programs & Hardware

to convert your DRAGON 32/64 into a complete communications terminal.

Morse transceiver
 Program (Cassette) £10.75
 Interface (Module) £17.50

RTTY
 Program (Cassette) £12.00
 Terminal unit of modules £39.00

AMTOR
 Program (Cassette) £39.00
 Clock/Switch Module £18.00

Programs also available in Cartridge. Hardware available in kit or fully boxed form.

For full details send 2x 17p stamps to:-

PNP Communications (HT)
 62 Lawes Avenue, Newhaven East Sussex BN9 9SB
 Tel: (0273) 514465
 Prices include postage but not VAT

MORSE S/WARE

MORSE (SPECTRUM 48K)
 Randomly generated letters and/or numbers at users requested speeds and spacing visual and audible presentation. £5.50 cassette or SAE for details: Educational Software 20 Beaufort Rd. Camberley GU15 1NF

SOFTWARE

BBC MICRO SOFTWARE. RTTY/CW Transceiver. Send/Receive Morse tutor. Super locator. Sun/Moon Prediction. Multifile. Disc menu/Catalogue. Utilities. TV info. Please send two SAE/IRC for details for details and BLT SOFTWARE, 1 Wavell Garth, Sandal Magna, Wakefield WF2 6JP.

BEEBCOM (see Micro/Net, May 1985). BBC to BBC file transfer over air, error free, using no special hardware. Tape plus manual £6. With source code, £10. Demonstration, £1 SAE for details. **STATE CALLSIGN WITH ORDER, CTP SOFTWARE, 107A Shacklwell Lane, London E8 2BK.**

KITS

TRUTONE MODULES
 For serious repeater users
 Toneburst and timer module combined on one board. For operating a transceiver with any 2 metre F.M. repeater in the UK. Accurately times transmission providing both visible and audible warnings at end of pre-determined period when user is about to time-out through repeater. SAE for details. Price £12.50. Timeout or toneburst board supplied separately at £7.50 each. All prices inc P&P.
TRUTONE MODULES, 58 Norman Rd., Salford, Bristol BS10 3BH.

COMPONENTS

R.F. Transistors. Specialist Components for Transmitters. Unelco Capacitors. Sparague Mica Trimmers (500V). **Sole Agent for solid state Microwave R.F. Transistors supplied to full specification.** Full 2N range supplied. Special SD range 1W-100 WATT output 1 to 100 MHz. Pre-amplifiers for 2 meters and 70cms. Power Amplifiers with and without switching. Aligned and ready for use. Due to exchange fluctuations we cannot price. Send S.A.E. for full lists.
 Phone: Selsey
 (0243) 823803. Modular Electronics, 1 Coniston Close, Felpham, Bognor Regis, Sussex.

RESISTORS, CAPACITORS. 1,000 mixed carbon film 1/8w, 1/4w, 1/2w, 2%, 5%, 10% resistors £2.95 + 50p p&p. Sae for list. D.J. Hooker, Romney Marsh Electronics, Clark Rd., Greatstone, Romney Marsh, Kent TN28 8PB.



HAM RADIO TODAY, JULY 1985 ADVERTISERS INDEX

| | | | |
|----------------------------|--------|--------------------------------|--------|
| BNR & ES..... | 21 | Quartslab Marketing | 21 |
| Crawton Leather..... | 65 | Rainbow Communications..... | 21 |
| Cyberscan..... | 65 | Rapid Results College | 65 |
| Dewsbury Electronics | O.B.C. | Reg Ward & Co..... | 21 |
| Educational Software | 64 | R. Withers Communications..... | I.B.C. |
| Elliot Electronics | 21 | Technical Software | 65 |
| G4TNY Electronics | 64 | Ward Electronics | I.F.C. |
| Interbooks..... | 21 | W D Software..... | 64 |
| Larkin | 64 | Western Electronics..... | 11 |
| Lecmar Electronics | I.B.C. | Wood & Douglas..... | I.B.C. |
| Modular Electronics..... | 64 | WPO Communications..... | I.F.C. |
| PNP Communications | 64 | | |

Don't forget, when calling an advertiser, mention
Ham Radio Today — it helps them and us.

73's Dave Gadsden, G4NXV, Advertisement Manager

R WITHERS COMMUNICATIONS

584 HAGLEY ROAD WEST, OLDBURY, WARELY
B68 0BS (QUINTON, BIRMINGHAM)
Tel: 021-421 8201/2 (24-HR ANSWERPHONE)



Raycom Limited

Made to measure R.F. amplifiers - off the peg! For the first time a choice of linear or class 'c' designed to match your hand-held or portable radio.

★ **INPUTS FACTORY ADJUSTABLE FROM 500mW TO 5 WATT - ALL AMPS SET FOR 1-3 WATTS**

★ **ALL UNITS HAVE RF RELAY CHANGEOVER + SWITCHABLE SSB/FM HANG TIME.**

★ **FULL 12 MONTH PARTS AND LABOUR WARRANTY.**

★ **STATUS LED'S**

8 MODELS AVAILABLE 3 UHF/5 VHF 15 WATTS TO 45 WATTS LINEAR OR CLASS 'C' SENDS S.A.E. FOR DETAILS

All units are Toshiba or Mitsubishi RF power modules as used in all new VHF/UHF radios



Quality British construction
Real Value for money.

IF YOU REQUIRE A DRIVE LEVEL OTHER THAN 1-3 WATTS PLEASE STATE AT TIME OF ORDERING PLEASE ADD £2.50 POST + PACKING TELEPHONE ORDERS ON VISA + ACCESS CARDS. PLEASE MAKE CHEQUES PAYABLE TO R WITHERS COMMS.

FROM ONLY £48.50 + P&P

THE AMAZING MULTI-P6+ MOBILE VHF-UHF ANTENNA

ACCLAIMED FOR ITS HIGH QUALITY RUGGED ENGINEERING - 6 MODES OF OPERATION - ON OR OFF THE VEHICLE (FREE SPACE DESIGN) BRITISH DESIGNED AND MADE BY A.R.M. ANTENNAS.

BASIC PACKAGE £34.50 + 2.50 P+P

COMPLETE PACKAGE £39.25 + 2.50 P+P INCLUDES COLINEAR ELEMENT

STILL AVAILABLE - THE LOWE TX40G ON 10 METRES FM WITH REPEATER SHIFT. ONLY £52.50 + 2.50 P+P WHILE STOCKS LAST.

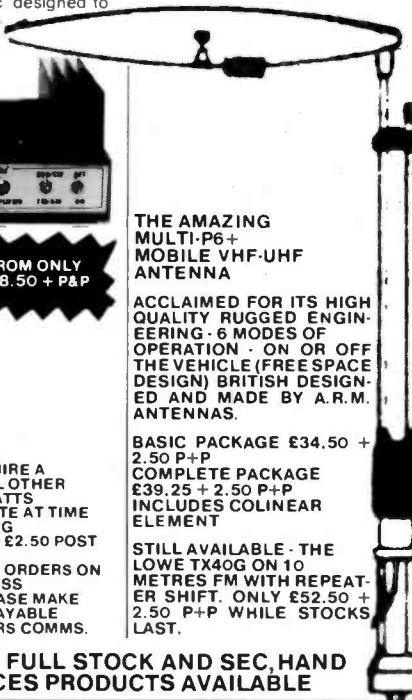

PLEASE TELEPHONE FOR FULL STOCK AND SEC. HAND LIST, MANY BARGAIN PRICES PRODUCTS AVAILABLE

"THE FASTEST GROWING AMATEUR RADIO DEALERS IN THE UK"

10 FM CORNER

FULL RANGE OF YAESU, ICOM, TRIO ETC. SOME AT PRE-INCREASE PRICES - PHONE FOR LATEST STOCK LEVELS.

HAVE APPOINTED R.W.C. AS THEIR SOLE DISTRIBUTORS FOR THIS FANTASTIC NEW PRODUCTS FOR 1985

WE'VE DONE IT! 10FM FROM OVER 90% OF LEGAL FM C.B.'s.

★ **MODS ANY CB WITH THE SANYO LC7136 OR 7137 SYNTH. CHIP TO TEN MTRS FM INCLUDING REPEATER SHIFT.**

MEASURES ONLY 5 1/2" x 3/4"

SIMPLE TO INSTALL - REQUIRES JUST A SOLDERING IRON, SIGNAL SOURCE PLUS SIMPLE TEST GEAR. ONLY EIGHT WIRES TO SOLDER.

EVERY BOARD FACTORY TESTED

KITS NOW AVAILABLE £17.50 + 1.00 P&P ALSO FORDNT/LCL @ £12.95

COVERS 29.3-29.690MHz (ON MOST SETS - SORRY NOT MULTI-MODES)

SUITABLE FOR AMSTRAD, CYBERNET, BINATONE, LOWE TX40, COLT, PLANET, COLT, LCL, FIDELITY, COBRA, HARRIER, MIDLAND, MUSTANG, UNIDEN + DOZENS MORE. (not multi-modes)

NOTE: WE CAN FIT THE BOARD FOR YOU FOR A FURTHER £19.50 BUT ENCOURAGE YOU TO FIT IT YOURSELF.

MAIL ORDER - PLEASE INCLUDE £1 FOR POST/PACKING + ALLOW 7-10 DAYS FOR DELIVERY. TWO OR MORE - POST FREE. BOTH PRODUCTS COPYRIGHT FBX-RWC 1984. PATENT APPLIED FOR. SHOPCALLERS WELCOME. LATE NIGHTS THURS + FRI TILL 7. ACCESS/VISA WELCOME



ONLY **£22.50** + P/P

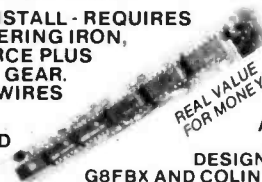

IDEAL FOR SWLs AND BEGINNERS! FROM A PROVEN DESIGN BY BILL SPARKS G8FBX AND COLIN HORRIBIN G3SBI

WOOD & DOUGLAS

- NEW CATALOGUE
- NEW PRODUCTS
- NEW PRICES

For those of you who missed the NEC here are details of a few of the new products that we introduced:-

70FM3B — The popular 70FM3 500mW to 3 Watt 70cms power amplifier has been updated to have rf switched automatic PIN changeover. The board fits a standard miniature diecast box and is sufficiently compact to allow direct connection to your hand-held's aerial socket. The module has facilities for line powering and has our standard 'straight through' mode with power supply disconnected.

AF1 — A small audio amplifier board consuming very low quiescent current. The unit is intended to complement the CWF1 CW filter where it would act as an audio buffer. The board also boasts an externally activated mute circuit.

144LIN30 — The popular 144LIN25B linear has been updated to yield in excess of 30W for 3W drive at 145 MHz.

Details of these and other new products are included in the 1985 catalogue. This will be posted to you on receipt of an A5 stamped self addressed envelope. Kits are usually available by return of post but please allow 28 days for any unforeseen shortages. Place your order by post or by telephone using your credit card. Please include £1.00 to cover order handling and postage.

Our products are kits or assembled kits consisting of circuit board and all components to mount on the board. We do not include external hardware such as boxes, connectors, etc.

If your purchase does not work when assembled then apart from being surprised we will offer to service the module for a small charge depending on the complexity of the project. So please remember...

ANYONE CAN SELL A KIT... REPUTATION SELLS OURS

UNIT 13, YOUNGS INDUSTRIAL ESTATE

ALDERMAMTON, READING RG7 4PQ

TEL: (073 56) 71444 TX: 848702



COMMUNICATION RECEIVER



uniden MODEL CR-2021

A compact communications receiver with full professional specifications and facilities.

- FULL FREQUENCY COVERAGE OF 150KHz to 29.999MHz and 78 to 108MHz.
- MAXIMUM SENSITIVITY ON AM/SSB/CW, also FM, with NARROW/WIDE FILTER.
- MEMORY FOR ANY 6 AM/SSB and 6 FM FREQUENCIES, plus AUTOMATIC SCANNING BETWEEN ANY TWO FREQUENCIES.
- KEYBOARD ENTRY OF FREQUENCY SHOWN ON LCD DISPLAY.
- EXTERNAL SOCKETS FOR AERIAL, EARTH, HEADPHONES and LOUDSPEAKER.
- OPERATION FROM INTERNAL BATTERIES, 12V DC, or 240V AC.
- ONLY £189.75 inc VAT and P&P.

Please allow 7-14 days for delivery

LECMAR ELECTRONICS

Vectis Yard, Cowes, Isle of Wight

Tel: (0983) 293996

DEALER ENQUIRIES INVITED

BARCLAYCARD ACCESS

DEWSBURY

G4CLX

ELECTRONICS



FRG 8800 £559



TRIO R600 £299



NRD 515 £965

APPROVED
TRIO
DEALER

IF IT'S TRIO IT MUST BE DEWSBURY

A FULL RANGE ALWAYS IN STOCK



TRIO R2000 £479



IC - R 71E £699

NEW PRODUCT NEWS

**IF YOU'RE THINKING ABOUT C/W
YOU MUST READ THIS!**

- ★ Iambic Keyer
 - ★ Dash/Dot Memory
 - ★ Keying Speed 1 — 55 wpm
 - ★ Built In Side Tone Oscillator And Speaker
 - ★ Headphone Socket
 - ★ Variable Weight Control
 - ★ Side Tone Volume And Pitch Control
 - ★ Switchable Automatic/Semi Automatic Keying/Tune Control
 - ★ Operation From Internal Batteries Or 9 — 15v. External Supply
 - ★ Low Current Drain
 - ★ British Made
 - ★ Selectable Positives or Negative Keying
- 5 YEAR GUARANTEE**
Only £49.95 + £3.00 P&P To Include External Power Leads And Plugs.



**POCOMOTOR AFR2000
RTTY ALL MODE DECODER**

AFR8000 with built-in display now available.
Write for details.

(Now with CW option) From £425



STAR MASTER — KEYER

Stockists of DAIWA — MET ANTENNAS — MUTEK — WOOD & DOUGLAS — TASCOS TELEREADERS —
MICROWAVE MODULES — ICs AMTOR — AEA PRODUCTS — DRAE

Dewsbury Electronics, 176 Lower High Street, Stourbridge, West Midlands.

Telephone: Stourbridge (0384) 390063/371228

Telex: 337675 TELPES G



Instant finance available subject to status. Written details on request.