

HAM

AN ARGUS SPECIALIST PUBLICATION

JUNE 1985 £1.20

RADIO

TODAY

Starting out on Amateur Satellites?

Put together a receiving and transmitting station with Arthur Gee, G2UK, President of AMSAT-UK

A fresh look at the Trio TS520 series

Keep your hands on the wheel with our mobile microphone!

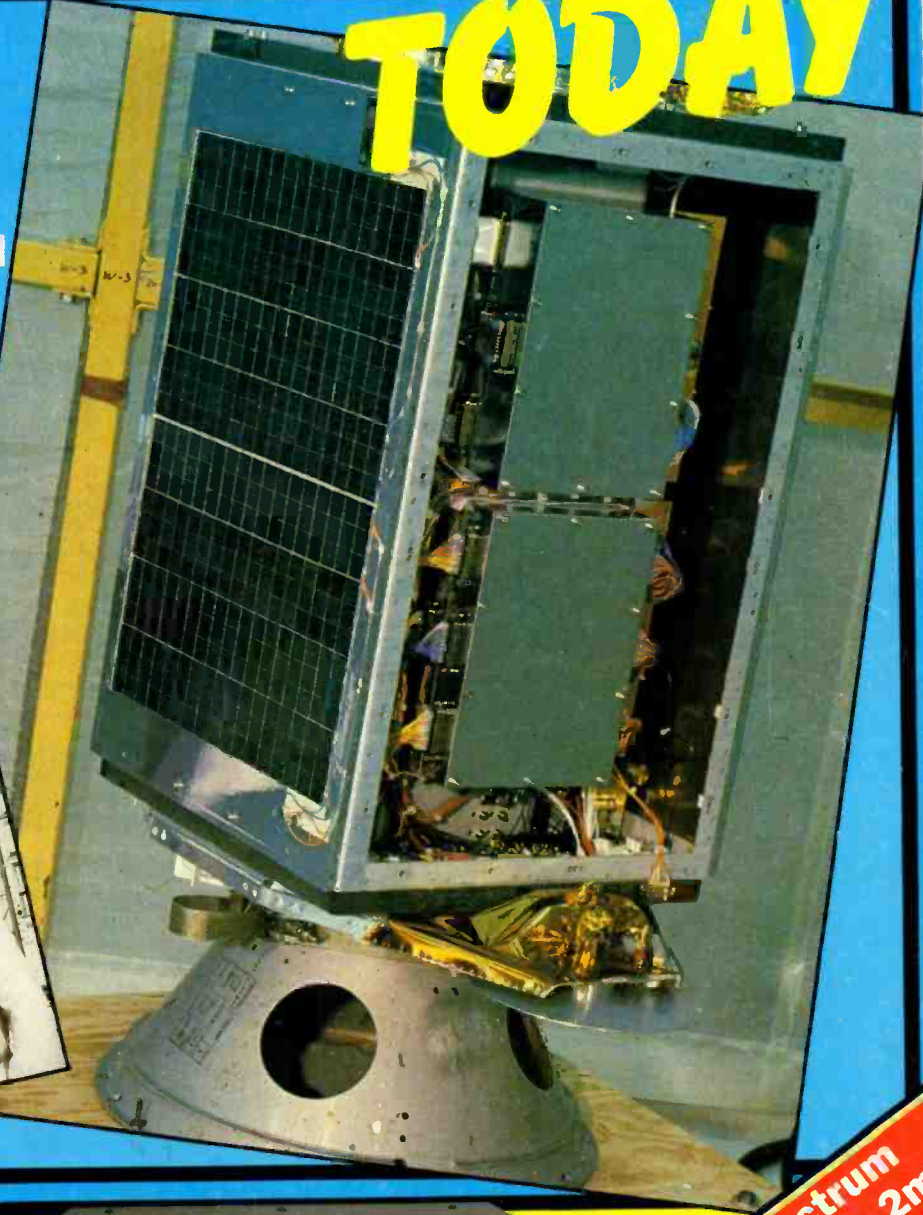

REVIEW REVIEW REVIEW
Angus McKenzie investigates the Icom IC745 – quality and value for money?



Win a Spectrum Communications 2m transverter boxed kit
Details inside . . .



DRESSLER (U.K.) LTD., 191 FRANCIS ROAD LEYTON E10

TEL 01-558 0854 TELEX 8953609 LEXTON G
01-556 1415

HP FACILITIES AVAILABLE



EAST LONDON HAM STORE WHERE YOUR POCKET COUNTS

PROMPT MAIL ORDER



FREE DELIVERY ON ALL RIGS: Phone us last for best prices

 ICOM R71	 SX400	<p>TELEPHONE US NOW FOR THE KEENEST PRICES</p>	<p>25mHz - 550mHz</p>  AOR 2001
 ICOM IC751	 ICOM ICO2E ICO4E + FULL RANGE OF ACC.'s	 ICOM IC745	 ICOM IC271E
 FT757GX+FC757+FP757HD	 TW4000 2m + 70cms	 TR9130	 FT726 THE SATELLITE TRANSCIVER

Communications Terminal New Tonno 777 Tx/Rx, use it with any Micro with RS232. AMTOR/RTTY/CW. For £399. Also Tonno Q5000 AMTOR/RTTY/CW/Keyboard + 5" Monitor. P.O.A. London's only MET stockists. Also many others in stock. Also available TONNA ANTENNAS, DATONG, MUTEK & DIAWA. Also VAT FREE on all exports of Amateur Radio, Video & T.V.



 Swedish Key £60.00	<p>NEW</p>  THE LATEST FRG 8800 FRV 8800 in stock	 TS 711E FULL FEATURE 2m T.C.V.R.	 TH21 ONE OF THE MOST POWERFUL NEATEST AND SMALLEST 2M PORTABLES. TR2600 INCLUDING DIGITAL CODE SQUELCH
--	---	---	--

dressler - ara 30 - active antenna
200 kHz . . . 40 MHz

Professional electronic circuitry with very wide dynamic range. Meets professional demands both in electronics and mechanical ruggedness. 120 cm long glassfibre rod. Circuit is built into waterproof 2,5 mm thick aluminium tube. Ideal for commercial and swl-receiving systems.



£90

KENWOOD TRIO TM201A SPECIAL OFFER
£295.19
FOR ONE MONTH ONLY £265.00



VHF POWER AMP.
D200 2MTR. 300w F.M. 550w SSB **£675**
D200S 2MTR. 400-500w 1Kw. D.C. in **£799**
D70 70cms 325w F.M. 500w SSB **£799**
NEW MODEL DUE TO ARRIVE
1296 MWZ. 1w-in-10w out.

MAST HEAD PRE-AMPS GAAS FET
POWER HANDLING UP TO 1KW
-7 to -9dB NOISE
15 to 19dB GAIN
0.2dB INSERTION LOSS



EVV200 GAAS 2MTR. 750W SSB
EVV2000 GAAS 2MTR. 1KW SSB
EVRPS receive 2MTR. only
EVRPS receive 70cm.
EVV700 GAAS 70cm. 500W SSB
EVV70 GAAS 70cm. 100W
EVV2 GAAS 2MTR. 100W
VV200VOX GAAS 2MTR. 250W SSB
INTERFACE
DRESSLER ASA12 Mast Head Coaxial 2 in 1 out Switch with 'N' Connector
1Hz-1GHz 1KW. PEP 0.15dB Insertion Loss

**£80
£90
£50
£49
£90
£60
£60
£85
£21
£45**

HAM RADIO CONTENTS

TODAY

VOLUME THREE NO. 6 JUNE 1985

Editor
Steve Ireland, G3ZZD
Editorial Assistant
Julie Darby, G1CKF
Group Editor
Dave Bradshaw, G1HRT
Advertisement Manager
Dave Gadsden, G4NXV
Classified Sales Executive
Caroline Faulkner
Publisher
Peter Welham
Chairman
Jim Connell



Design by
MM DESIGN

Published by:

Argus Specialist Publications Ltd.,
1, Golden Square,
London W1R 3AB.
Telephone: 01-437 0626

Distributed by:

SM Distribution Ltd.

Printed by:

The Garden City Press Ltd.

Subscription Rate

UK £17.00

O/Seas Sur: £18.50

USA Sur: \$25.00

O/Seas Air: £33.50

Ham Radio Today,

Subscriptions Dept,

Infonet Ltd,

Times House,

179 The Marlowes,

Hemel Hempstead,

Herts HP1 1BB

Tel: (0442) 48432



Ham Radio Today is normally published on the first Friday in the month preceding cover date. The contents of this publication including all articles, designs, plans, drawings and programs and all copyright and other intellectual property rights therein belong to Argus Specialist Publications Limited. All rights conferred by the Law of Copyright and other intellectual property rights and by virtue of international copyright conventions are specifically reserved to Argus Specialist Publications Limited and any reproduction requires the prior written consent of the Company. © 1985 Argus Specialist Publications Ltd. All reasonable care is taken in the preparation of the magazine contents, but the publishers cannot be held legally responsible for errors. Where mistakes do occur, a correction will normally be published as soon as possible afterwards. All prices and data contained in advertisements are accepted by us in good faith as correct at time of going to press. Neither the advertisers nor the publishers can be held responsible, however, for any variation affecting price or availability which may occur after the publication has closed for press.

REGULAR COLUMNS

LETTERS	4
RADIO TODAY	6
MICRO' NET	21
RADIO TOMORROW	37
BOOKEND	56

CONSTRUCTION

AN RF NOISE BRIDGE FROM A-Z.	14
<i>Find out how to build and use this simple, useful device.</i>	
A SAFE MOBILE MICROPHONE	34
<i>Keep your hands on the wheel!</i>	
MEET THE MICRON!	40
<i>In part 2, Frank Ogden and Tony Bailey take us through the major part of the construction.</i>	

FEATURES

STARTING OUT ON AMATEUR SATELLITES?	10
<i>Find out how to receive supra-stratospheric objects with G2UK, Chairman of AMSAT-UK.</i>	
A FRESH LOOK AT THE TRIO TS520 SERIES	24
<i>A profile and advice on maintenance from Hugh Allison, G3XSE.</i>	
BUGGED BY MORSE?	28
<i>Prof. Cy Schweiper says, "don't let morse drive you dotty!"</i>	
T2FD RESURRECTED	29
<i>Discover this very useful and flexible HF multiband antenna.</i>	

REVIEWS

HAVE ANTENNA WILL TRAVEL	33
<i>The editor goes travelling with 'Jim'!</i>	
ICOM IC745 - QUALITY AND VALUE FOR MONEY?	48
<i>Angus McKenzie investigates Icom's cheapest HF base transceiver.</i>	
COMPETITION! WIN A SPECTRUM COMMS 10-2 TRANSVERTER	19
ADDENDUM	23
Bumper Free Readers Ads	58
Emporium Guide	63
Classified	64
ADVERTISEMENT INDEX	66

Due to lack of space, we regret that 'A Look at the BBC Outside Broadcasts' part 2 has had to be held over. The results of our sexist SSTV caption competition will be announced in Radio Today, July.

LETTERS

MORE 2 M ON THE CHEAP

Sir, I read G4RPS article on a CB/2m transverter with great interest. I have been running such a beast for nearly a year now and perhaps I can spell out some of the pitfalls should anyone else like to try it. My rig is actually concocted from various 10/2m transverter designs in the RSGB VHF/UHF manual and uses a DNT M40 CB rig as a prime mover. The system suffers from 3 basic problems:

FM broadcast interference.
CB breakthrough.
Narrow bandwidth.

The FM broadcast interference stems from the fact that the IF image ($145 - 2 \times 28 = .89\text{MHz}$) lies at the bottom of the FM broadcast band. Depending on where you live and your precise choice of tuning, you are likely to get Radio 2 splattered across several channels somewhere (in my case S21-S23). The only way to get rid of this is to use good 2m filters in the transverter and preferably a bandpass filter in the aerial lead. This (latter in particular) is doubly important since this image frequency is produced on *transmit* as well, though I've failed to make any impression on my own FM broadcast receiver.

The only way to get rid of CB breakthrough once you've encased everything in the most RF tight boxes you can, is to shift the CB IF frequency. This is easily done on the DNT M40 rig by interposing a 4 bit adder between the channel switch and PLL divider and simply adding 40. This shifts the whole frequency range up 40 channels to 28.0 to 28.39MHz. The PLL will easily lock over the full 27.6 to 28.30MHz range IF set correctly.

The choice of 28.0 to 28.39MHz as an IF allows the use of stock crystals for the transverter mixer. Crystal frequencies of 13.000, 13.0333 and 13.0666 (available from PR Gollidge of Devon) when multiplied by 9 give mixer frequencies of 117.0, 117.3 and 117.6MHz giving 3 bands of

145.0-145.39	repeater inputs
145.3-145.69	simplex
145.6-145.99	repeater outputs.

Switching out the 40 channel adder on the lowest range gives 144.6 to 144.99MHz. The only other way to avoid CB breakthrough is not to live near any superwallies with 100 watt burners.

Lastly, having fitted 10,695MHz crystal filter in an effort to make any sense of CB, I find myself with a rig with a genuine 10kHz bandwidth (the DNT M40 has 2 455kHz filters as well). This makes for excellent selectivity but I am endlessly twiddling the fine tuning knob (like G4RPS I get the (odd) 5kHz shift by pulling the transverter crystal) and only a few stations are unintelligible through over deviation.

Bob Everett, G1DWC.

TERRESTRIAL INTELLIGENCE

Sir, With reference to G3OSS' article, 'CQ ET' (April '85 issue).

A very clever argument of scientific fact put forward to make an enlightening article. I have on good authority been told there will be an excellent lift condition starting early morning on April 1st, declining rapidly about mid-day, most suitable for the article's application.

I take this opportunity to say that HRT is a very informative magazine and it is a pleasurable relief to see that some radio amateurs have a sense of humour — keep it up!

I look forward to April '86 cover dated issue.

D J Tyler

NEVER THE TWAIN . . .

Sir, With reference to Mr Peter Copeland's letter entitled 'Amateurs and CBers Together?' Why tell us how appalled he is with CB? Aren't there enough CB magazines he can send his views to? I, for one, am fed up with reading about CB and novice licences and hope wholeheartedly that it never happens. CB surely was designated as Citizens Band radio, as the name suggests — not novice Amateur Radio!

With a little work, anyone can take and pass the RAE if they are interested in amateur radio and, after all, a class 'B' licence is already a novice licence to people who have not taken their morse test. 27MHz was thrust upon the government as Citizen's Band radio — not as a stepping stone to amateur radio. The RSGB did not get involved in bringing about CB; why should they now be asked, as Mr Copeland suggests, to sort it out. The amateur fraternity after all pay for the services of the RSGB; if people who use CB want the same services, what is wrong with them founding a similiar society to sort out their own problems? If people are so dumbfounded after taking the RAE, it seems to suggest that a little more on practices and procedures should be put into the examination,



although I personally believe that anyone who sits and listens to the amateur bands (for a reasonable length of time) before starting transmission will not be dumbfounded for long.

Chris, GM1KHU

We have received a number of letters in a similar vein to the above. In Peter Copeland's defence, it seems to me that he was speaking as a CBER-turned-radio-amateur, like many new licencees, who was looking back with some sadness on his own particular route into amateur radio (Don't say, aaah, you cynics).

SYMPATHETIC EAR

Sir, After reading HRT April 85, the letter from Mr D J Burton, entitled 'Angry SWL', I must say that I wholeheartedly agree with him. No wonder he feels angry if he has been treated like the man in the corner with the pointed cap, just because he has been content to be a listener. A very large percentage of us were listeners at one time or another, in my case, 18 years and mostly with homebrew equipment for 2m and 70cm, using such devices as Nuvistors etc.

Like Mr Burton, I was content to just listen, and why not? I never had any harassment from licensed amateurs, in fact I was welcomed into their hobby. As time went on, I decided to take the RAE as an external candidate, passed and became licensed. Also, I am sure that the 3 years my niece put in as an SWL put her in good stead for the RAE which she passed with distinctions. Unfortunately, being only 13 years old, she has 12 months to wait before applying for a licence.

Anyway, Mr Burton don't despair, I can assure you that most licensed amateurs have nothing but the highest respect for SWLs. I certainly have, having been one. Enjoy the hobby, and good luck with the RAE.

Frank Blakely, G6TNO

There is no better way to learn about the practices and procedures of the hobby than listening on the amateur bands. If I were teaching an RAE class, my first (strong) recommendation would be the purchase of a shortwave receiver with these facilities — and the first class would be devoted to where and how to obtain one, according to the money available!

Please address correspondence to:
Ham Radio Today,
1, Golden Square,
LONDON W1R 3AB.

Sir, I have read quite a few issues of HRT recently, and nothing seems to stir the passions of your readers more than those intrepid souls who propose the introduction of 27MHz SSB CB and Novice Amateur Licences.

Unlike your local readers, I am qualified to discuss both of these controversial subjects, objectively and with first hand experience. My qualifications are as follows:

- 1) I am a licenced SSB CB operator, and my official call sign (QAQ 110) was issued in 1977.
- 2) I was a licenced novice amateur for two years, (VK4 VOK).
- 3) I am now the holder of a Full Call (class A) licence. (VK4 FOX).

27MHz SSB CB

Unlike your government, which appears to "dance to the tune" of the RSGB, our government occasionally displays complete independence of thought. They displayed this in 1977 when 27MHz AM/SSB CB was sanctioned in Australia. The reaction was immediate and predictable. Literally thousands of "pirates" and newcomers clamoured for licences. DOC was so completely overwhelmed, they were advising applicants to use their motor vehicle registration numbers for call signs, until such time as the backlog was eliminated. With 12 watts pep, a decent antenna and a rising sunspot cycle, our golden age of CB had arrived!

In no time at all, people with no previous radio experience were discovering the joys of "DXing". From coast to coast, from neighbouring New Zealand and from exotic places such as Mexico and Alaska, new friendships developed. Clubs proliferated all over the country and everybody had a ball.

Naturally this state of euphoria was not shared by the amateur fraternity. Many were appalled! Overnight, their sacred preserve had been trampled, desecrated and overrun by an uncouth, unruly mob, with scant regard to the serious, measured, almost ritualised customs of the amateur. It was positively profane, old man!

However, every cloud has a silver lining: as the sunspot cycle peaked and then declined, so did the golden age of CB. Some operators got bored with it all and either sold or packed away their gear. Some persisted and tried to bring back the good times by building bigger and better beams, and sometimes adding illegal linears to their armoury. Many like myself, decided to have a serious look at "Ham Radio".

NAOCP (Australian Novice Licence)

During the CB boom, some astute members of the Wireless Institute of Australia realised, out there in the CB jungle, was a huge untapped resource of potential amateurs. The problem was, how does one get these blokes to look beyond the rather confined world of CB to the far greener pastures of amateur radio? Obviously, the biggest hurdle would be the daunting proficiency examination for the amateur licence.

The world's oldest amateur radio club, the WIA, came up with an approach which was both novel and inspired. With the full support of DOC, a bridging licence was formulated. This licence would be known as the Novice Amateur Licence. As in the higher classes, the syllabus would consist of; a) Regulations, b) Morse Code, and c) Theory.

There were no concessions made with Regulations. All classes have the same paper. The minimum standard for Morse was set at 5 wpm. The Novice Theory, while easier than the standard set for the higher classes, is still very comprehensive! Much more demanding than the one set for American Novices. For this higher standard, the Australian Novice was rewarded with CW (10 watts) and 'phone (30 watts PEP) on the following HF frequencies: 28.100-28.600MHz, 21.125-21.200MHz, and 3.525-3.625MHz. Unlike the American Novice licence, the Australian licence does not expire after 12 months.

This new class of licence was initially greeted with a cool reception. Like some of your readers, many Australian amateurs were just as critical of it. Now, after a period of 9 years the following facts emerge: the total of Australian amateurs has more than doubled! The percentage of amateurs in our population is now more than 3 times greater than yours. The theory, that our Amateur organisations would become top-heavy with novices, has been dispelled. On current figures, less than 10% of our amateurs are novices. This proves that most novices are only too keen to upgrade, given the right encouragement and opportunity.

Our Limited (class B) amateurs have taken full advantage of the Novice Licence. By passing the 5 wpm Morse test, thus upgrading to the new Combined Licence, they now can enjoy the same privileges on HF as the Novice. This in turn, was a great incentive for them to get stuck into the Morse. We now have the interesting situation where three of the four grades of Australian amateurs can converse on the same frequencies.

Tony Taylor, VK4FOX

RADIO TODAY

DON'T FORGET

Straight Key evening
80m CW on Thursday 30th May

Starting roughly at 1900 BST, on suggested frequencies: 3.520-3.580MHz, QRP around 3.550MHz.
Call CQ SKE.

VHF CONVENTION SUCCESS

Over 2600 enthusiasts visited the 30th National VHF Convention at Sandown Park on Saturday 23rd March. It was opened by the RSGB President Joan Heathershaw, G4CHH, and included 48 trading and exhibiting stands, three lecture streams and various informal meetings.

The lectures were as diverse as building VHF/UHF equipment, ATV repeaters, BARTG's Ian Wade on Packet Radio, microwaves and satellite TV. The Remote Imaging Group held its inaugural meeting with the stated aim of providing information and ideas on weather satellites. G3REH is the man to contact for homebrew system designs, the newsletter and predictions. The 6m Group also met, under the aegis of G3COJ, for discussions.

Most of the trade stands were kept busy with enquiries, particularly the antennae specialists. Joan Heathershaw, captured working hard on the RSGB Bookstall, said that "the RSGB stand has been very busy with booksales and enquiries and the lectures were well supported." Report by G4TVC and photos by Robert Darby.



Shielded Balanced Twin Feeder for HF

Back in May '84, we ran an article by Brian Herbert, G2WI, called "The Dextrous Dipole". Brian used for the feeder of this antenna, a balanced, screened 75 ohm cable supplied with a KW trap dipole, which at the time of publishing the article had become unavailable. This type of feeder combines the advantages of both coaxial and conventional low impedance balanced feeder. Not only do you have a balanced feed, but the screen can be earthed to virtually eliminate any radiation from the feeder and thus minimise the possibility of RFI from this source.

After considerable looking, Brian and the editor have managed to track down a source of suitable cable. This is Belden Cable Type 9272 (twisted pair, colour coded) and is available from Wadsworth Electronics Ltd, Central Avenue, East Molesey, Surrey (01-941 4716). The cable has a nominal impedance of 78 ohms and an attenuation at 1.8MHz of 0.9dB/100 feet to 4.5dB/100 feet at 28MHz. The 9272 is available in 100' lengths for £32.64, including carriage.

News in Brief...

- The Nene Valley RC are going on a minor DXpedition to the Old Lighthouse on Lundy Island in the Bristol Channel between 11th and 18th May. They will be operating on all the HF bands, 2m and 70cm using the callsign GB4LI. Special arrangements can be made for the Worked All Britain award on 40, 80 and 160m. For full details of times, frequencies and QSL, other than the RSGB, write to G4NWZ c/o Lionel Parker, G5LP, 128 Northampton Road, Wellingborough in Northants.

- Further up the west coast at Mulberry Harbour in Conwy, the Clwyd County Raynet Group will be operating a special event station on 8th May to commemorate the building of the Mulberry Harbour caissons. The station using the callsign GB2MHC, will be operational from 10 to 2200 on all bands and contacts will be acknowledged with a special QSL card.

- Also in Wales, this time in Llantrisant, the home of the Royal Mint, there will be a special event station, GBOLTF, operational on the 5th and 6th May. The station is one of the many attractions of the town's annual festival and will be working on SSB and CW on HF, mainly on 80 and 20m from approximately 10 till 6 both days. There may also be activity on 2m during the evenings. A special QSL card will be available from GW3POM, QTHR.

- The Drayton Manor Mobile Radio Rally on 12th May is set in the beautiful Drayton Manor Park, Tamworth in Staffs. The organisers, Midland ARS, have ensured that all aspects of amateur radio will be represented. There's a zoo in the grounds and other children's entertainment provided. The doors open at 11am and for further details ring Norman, G8BHE, on (021) 422 9787.



● Again on the 12th May there's the **Swindon Radio and Electronics Rally** at Oakfield School in Marlowe Avenue. Admission is 50p with car parking free and the fun starts at 10. Swindon DARC have planned for a childrens filmshow and other family attractions. Ken, G8SFM, is the contact man, on Leighton (066 689) 307. Ken has also managed to arrange for Morse tests to be taken at the rally. Send in the normal application form and the fee (£15 payable to BTI) to Ken at Tamarisk, Tetbury Lane, Leighton, Glos GL8 8UP.

● The **East Suffolk Wireless Revival** on the 26 May aims to entertain the whole family. Not only are there the usual attractions for the radio amateur, but also an aerial testing range, vintage radio and model aircraft flying display. The venue is the Civil Service Sportsground, Straight Road, Bucklesham, Ipswich and more information can be obtained from Jack, G4IFF, on (0473) 44047.

● Another rally being held on the 26th May is the **Plymouth Amateur Radio Rally**. A wide variety of attractions are planned and the 'essential' licensed bar and other refreshments will be available. The Devonport Secondary School in Park Avenue is the place to be from 10 onwards. Lost souls can be talked in on S22 and RB2 by G3PRC.

● Five members of the Goole RES have been lent a car by Renault (UK) Ltd. to drive to Britain's most northerly, southerly, easterly and westerly points on May 3, 4 and 5th — a round trip of about 2000 miles. They'll be operating continuously on 2m using either G8HSG (and GM8HSG) or a special callsign GB8RBT/M (**Round Britain Trip!**). It's thought unlikely that the exercise has been tackled by amateur radio enthusiasts before, especially in one weekend, and the society hopes that sponsorship will raise money for the restoration appeal at Goole Parish Church and the NSPCC. Special QSL cards will be issued, hopefully on the promise of a donation.

Dunnet Head near John O'Groats is earmarked for 'capture' on Saturday morning, with the westerly tip of Britain, Ardnamurchan Point, next in line in the afternoon. The Lizard will be the furthest south they will attempt and Lowestoft should be ticked off by Sunday afternoon. The intrepid 'volunteers' manning the wheel and the microphone will be G6KCE, G8IOH, G8ERX, G6REL and journalist, G6VBU, Steve Anderson reports.

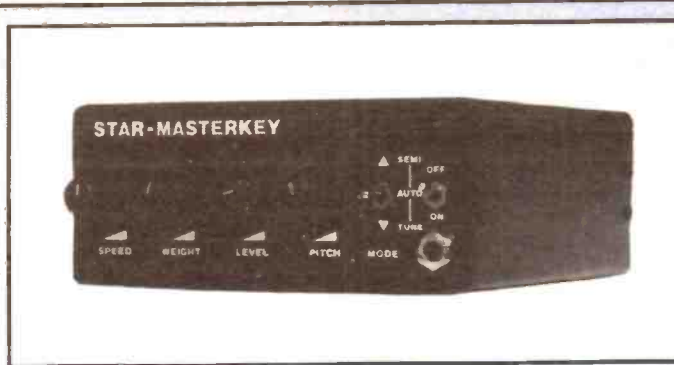

Five Star CW

Although we are promoting the ancient art of brass pounding with Straight Key Evening on the 30th May, this doesn't mean that electronic keys are forgotten! In fact, one of the latest keys to come on the market was drawn to our attention by Dewsbury Electronics. Called the **Star Masterkey**, it is designed apparently, for both the old hand (ouch!) and the newcomer. It is an all British product with full iambic and semi-automatic keying. Dewsbury also claim that the keyer can be used successfully with older valve equipment and the latest in solid state transceivers, the user being allowed 'to select either positive or negative keying'. The Star Masterkey has dash/dot memories and a speed range from 1 to 55 wpm.

It has a built in sidetone oscillator and loudspeaker which enable monitoring of your Morse and a headphone socket is provided for practising. The keyer can be powered by internal batteries or 6-15V external supply and comes in a nice svelte black case — and with a 5 year guarantee.

The Star Masterkey costs £49.95 (plus £3 p and p) and includes a DC power lead and 'all the necessary plugs'. Dewsbury can supply further details on Stourbridge (0384) 390063.



● Angus McKenzie recently became aware of the problem. rang the HRT offices to tell us that work was commenced at Trio headquarters and a modification on the TS711E microphone amplifier was quickly developed to overcome this. Lowe Electronics (0629 2430) can fit this modification to early (unmodified) models of the UK importer Lowe Electronics '711E.

Obituary

Dave Jones, GW3SSY, died on 13th March 1985 aged 45 years. He was secretary of the Abergavenny and Nevill Hall ARC and amongst other radio activities, ran a number of highly successful classes for the RAE. Back in December 1983, Dave wrote a very popular article for HRT on passing the licence conditions section of the RAE and was a regular contributor to our 'Radio Tomorrow' pages. Our condolences to his family and all who knew him.

Too Efficient Repeater?

GB3GD was recently reduced in power on the instructions of the Repeater Management Group. The power reduction was necessary because the new repeater had caused severe interference to users of the co-channel Stoke on Trent repeater, 140 miles away.

The interference was the direct result of the Isle of Man Repeater Group erecting an aerial (a 3dB 'white-stick' colinear) which was totally unsuitable for covering a small island from a site 2000ft asl.

The use of the aerial was directly contrary to:-

1. The assurances on coverage given to the RMG when arguing against the initial decision to reject the proposal, on the grounds that it would not fit in with the rest of the network.
2. The specific advice on suitable and unsuitable aerials given to the group by the RMG on a number of occasions.
3. The repeater group's formal application to the RSGB which stated that a dipole would be used.
4. The repeater group's Site Clearance Form on which the DTI based their acceptance of the licence application. This, too, referred to a dipole.

The RMG are continuing to advise on suitable aerials, which are expected to give better coverage of the Island than the colinear did, but without the unnecessary interference to the rest of the network.

It has been the declared intention of the IOMRG, and is RMG policy, that GB3GD's primary purpose is to improve the extremely difficult VHF communication on the Island itself, rather than to facilitate inter-G/GW/GM/GI/EI working on FM.

**GB4HRT
will be on HF/VHF
ON 30th MAY, ALL
DAY!**



If you don't want to build our fabulous 'Micron', you could try the latest product from Ten-Tec of Tennessee, USA. Providing a variable RF output of up to 20W on six bands, including 30m, the Century 22 is a dedicated CW-only transceiver with full break-in and variable audio filtering from 3kHz to 300Hz. Further details from KW Electronics on 0634 815173.

Changes In Standards

The British Standards Institute (BSI) have revised the British Standard 905 on sound and TV broadcast receivers: electromagnetic compatibility. The aim is to bring the present standard on limiting interference into line with international ones.

caused by TV games. A new second part refers to the limits of immunity of sound radio and TV receivers in the HF band, frequencies 26 to 30MHz. It also describes the methods of measurement and the limits of immunity of TV receivers from tuned frequency interference (ghosting).

The first part specifies the new limits of spurious signals caused by radio and TV broadcast receivers and has a new section devoted to interference

Copies of the new standard are available from the Sales Dept, BSI, Linford Wood, Milton Keynes MK14 6LE and cost £16.20(!) each (half price for subscribing members).

Super Duper Scanner

The FRG9600 is Yaesu's new all mode scanning receiver with an extremely wide coverage of 60-905MHz - no gaps - and 100 keypad programmable memory channels. If the price can be kept at around the present level, the '9600 looks set to challenge the supremacy of the AOR2001 and SX400 scanners.

In addition to FM wide (for FM and TV broadcasts), FM narrow (for two-way business and amateur communications), the FRG9600 also provides SSB

(single sideband) reception up to 460MHz, allowing monitoring of amateur CW and SSB. A front panel tuning knob is provided to simplify tuning of SSB and narrowband AM. Seven

tuning/scanning rates between 100Hz and 1000kHz assure fast and efficient scanning while still permitting easy tuning of narrowband signals.

The scanning system allows either full or limited (keypad programmed) band scanning as well as memory channel scanning, with auto-resume. In addition to carrier sensing scan stop, audio scan stop sensing is also selectable to avoid stopping on inactive 'carrier-only' channels. Scanning steps are selectable, with the wide steps indicated on the front panel display. Signal strength is indicated by a 2-colour graphic S-meter on the display. A 24 hr clock/timer is included, along with a recorder output, for automatic power on/off switching and recording. Additional jacks provide CPU



band selection outputs, multiplexed (FM wide) output, AF and RF mute and other control signals for maximum expansion potential with future options or for those who wish to provide their own add-on hardware for special applications.

The Yaesu CAT System provides a direct control link to the CPU in the FRG9600, allowing operators to add virtual-

ly unlimited customised control functions in software using almost any personal computer and a Yaesu FIF CAT interface.

The FRG9600 requires 12V DC, which may be provided using the optional PA-4B/C AC adapter from the AC line. Further details are from Yaesu importers, Amateur Electronics UK and SMC.

Holiday In Malta?

Summertime is holiday time. *Connie Baker, G4WUV, and her OM recently paid a visit to the increasingly popular island of Malta and received an excellent welcome from the amateur community.*

"After spending my entire 2 weeks in Malta last year with my eyes pinned firmly and constantly on the roof tops of the houses which we passed. We noticed many a strange stare from the local population, who were very curious to know what my husband and I were looking for.

"Defeated, I found I had to give up, in desperation, my search for 'Amateur Radio Operators'. Much to my dismay, most of the television antennas very much resemble 2 metre beams, and all seemed to have rotators attached to help with the reception of the many television stations which are within their range. Trying to distinguish the difference between the two, whilst travelling on a bus — which was doing a very good impression of a racing car — was to say, at the very least, an extremely difficult task.

"To add to my horror, when I returned to England what should I find in the latest issue of HRT? There was a letter by Mr W Gatt, 9HIDU, which gave me all the information I desperately required to help me with my lonely quest in finding the elusive Maltese Amateur. So this year, armed with this new information and a copy of Mr Gatt's letter under my arm, I set out once again with a new found determination to Malta. Convinced that this year I would find at least one amateur.

"All went well with the holiday and plans were made to attend a club meeting of the MARL on the first day available,



which happened to be on a Tuesday. We managed to survive the bus journey once again from our hotel to Valletta, then caught the connection to the town of Attard (the bus drivers had not improved on their driving habits). We alighted from the bus and again produced the now slightly tattered letter to find that it did not state an address, just a box number. Undeterred, we asked a local television engineer the location of either the club or Mr Gatt's house, to which he promptly replied that the gentleman was on holiday in Australia and the club had closed for the day. Being a helpful Maltese, he directed us to another amateur Mr Carmen French, 9HIGP, the president of the MARL. After spending the entire afternoon in the company of Carmen, who displayed almost overwhelming hospitality, we arranged to attend a club meeting on the following Sunday.

"What followed on Sunday can only be described as a mixture of unbelievable friendship and goodwill from all the people present. Of course, the frantic exchange of QSL cards and the promise of many future schedules followed, as we left after a marvellous experience."

Would You Like A Lecture In Data Comms?

With the ever increasing interest in amateur data communications, particularly in RTTY, AMTOR and Packet Radio, radio clubs are always looking for speakers to give talks on these topics. BARTG has set up the 'Datatalk Register', which contains details of speakers, their specialist topics, and the geographical areas they are able to cover. For a copy of the register, club secretaries can write (enclosing an SAE please) to Ian Wade, G3NRW, 7 Daubeney Close, Harlington, Dunstable, Beds LU5 6NF. Speakers wishing to be included on the register should also write to Ian at this address.

Wanted Electrical Volunteers!

Voluntary Services Overseas, or VSO as they are colloquially known, have informed us that they urgently require 6 electrical 'experts' to take up posts in the Third World. Volunteers must have the relevant technical qualifications, either City and Guilds full TEC or HNC, plus work experience.

Four of the jobs involves training of local people in Belize, Sri Lanka, the Maldives Islands and Kenya. Another is required to work in a University department in Egypt. The final vacancy involves establishing a

maintenance system for sophisticated equipment in the Belize government hospital service.

The volunteers should be aged between 23 and 65 and be available for two years from September. Married couples can be posted if both serve as volunteers, but otherwise you should have no 'dependents', such as children. A British or EEC passport is necessary, and volunteers receive "local pay" and free accommodation.

For further details write to the Enquiries Unit, VSO, 9 Belgrave Square, London SW1X 8PW or ring 01-235 5191.



The Wirral DARC will be providing a special event station at the International Waterways Festival from 25 to 27 May at the Boat Museum, Ellesmere Port. The club has been granted the callsign GB2IWF and will be on the

amateur bands throughout the 3 days. Contacts with any amateurs in the visiting craft would be particularly welcome and various aspects of amateur radio will be demonstrated to the public.

Radio amateurs in Guernsey will be celebrating the 40th anniversary of the liberation of the Channel Islands from German occupying forces by operating a special event station GB2LIB from the 9 to 11th May. The event station will be operating from the ancient fortification of Castle Cornet which dominates the entrance of St Peter Port harbour, the site of both Ger-

man and the liberators' landing. The station will be on the air for 24 hours on the 9th, liberation day itself, and from 1000 to 1700 on the 10 and 11th. Operation will be on 2m and the HF bands, the exact bands will be determined by radio conditions on the day.

All contacts will be acknowledged by a special QSL card and a souvenir pack.



WPO COMMUNICATIONS

20 FARNHAM AVENUE, HASSOCKS G3WPO
WEST SUSSEX BN6 8NS MAIL ORDER ONLY

24hr
Anasphone

07918 6149



DSB/CW DSB80 2w+

Still our most popular kit with over 1000 sold! Suits beginners and will build a sensitive 80 metre VFO controlled Tx/Rx for DSB or CW — kit can be modded for 160m if preferred. Basic pcb kit (only needs psu/mlc/speaker) complete £39.95. Punched case & Hardware @ £25.95 and digital display option at £29.50. All above for £85.00. +12v operation.



only
£39.95
Basic Kit

2W + DSB CW DSB2 ANY SINGLE BAND 160-15m

QRP Transceiver with mini-PLL VFO. Semi Break-in CW, AF filter etc. ANY SINGLE BAND 160-15M. Digital display option. Basic pcb Kits (2) £68 only needs psu (12v) mic + key/speaker. Kits with case (punched but unfinished) hardware £91.50 or with case plus display £118.00 (160/180m) or £123.00 (40-15m). SPECIAL OFFER best selling 20m DSB2 basic kits only £65.



NEW

NOW OUR BEST SELLING KIT!!

micron



OUR LATEST TRANSCEIVER KIT, sets new standards in QRP performance — LOOK AT THESE FEATURES — a 6 band CW only 8/10W output rig covering the 80, 40, 30, 20, 15 & 10m bands (bottom 200kHz of each). 0.25uV sensitivity receiver, featuring AGC, with S Meter. Stable 2 speed VFO with IRT (Spot facility). 1W AF output to speaker, and 3 position LC filter + switchable attenuator. Silent solid state Rx/Tx switching with fast semi break-in and shaped keying. Sidetone facility. Fully variable RF power output from 0W to full power metering. Needs +12v/14v supply.

PLUS CUSTOM punched & painted aluminium case/hardware and speaker with unique facility for optional INTERNAL ATU (Transmatch type) & SWR metering. DIGITAL READOUT option. The MICRON uses a compact single pcb design with easy step-by-step assembly instructions and drawings designed for the relative newcomer - minimum test equipment needed! Mostly pre-wound coils and transformers.

PRICES: Basic pcb kit inc. VFO capacitor/drive/enclosure, for 2 bands (state which) £99.45 - extra bands £11.75 each. Full pcb kit for 6 bands Tx/Rx £145. Case £46.20. COMPLETE KIT WITH CASE/6 BANDS £182.50. Optional extras - Digital readout (LCD) kit £33.56, and ATU KIT (for internal mounting) with SWR/Power metering at £37.00. COMPLETE KIT/CASE WITH DISPLAY AND ATU - £241.00.

NEW - Micro Match ATU Kit 160-10m with punched aluminium case - SWL or 20W max. Use with any of our QRP RIGS £39.95 inc.

PROFESSIONALLY CONDITIONED AUDIO WITH A PARAMETRIC EQUALISER THE ULTIMATE PUNCH!

NOT TO BE CONFUSED WITH STANDARD AUDIO PROCESSORS! FULLY TUNABLE High AND Low frequency plus

12dB BOOST/CUT controls & SHELving provides distortionless tailoring of YOUR voice, microphone and rig. Hi-Lo Z I/p with VOGAD. Variable gain and switchable internal PROCESSOR. PLUS, it has an INTERNAL 2W AF Amp plus speaker/rec input for correcting and modifying your Rx audio if you prefer. +12v supply needed. BYPASS switch. State 4 or 8 pin I/p socket. Complete with case. PRICE £53.45 IN KIT form or £72.45 READY BUILT.

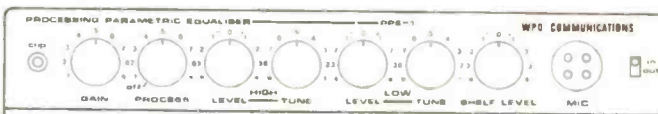

NEW

ALPHA — SINGLE BAND SSB/CW 50W TRANSCEIVER KIT



160m
or
20m

NEW LOW PRICE — £179.95 complete! to quote a customer "Very pleased with the kit, and you must be congratulated on the standard of the design, which is excellent". 90dB+ Dynamic range, PLL VFO, Digital display, Blanking, IF Gain, Custom Finished Case with mobile bracket etc etc. Join the ALPHA builders! Comprehensive Instructions & drawings.

VFO & OTHER KITS

MINISYNTH — As used in the DSB2. 1 band simple PLL VFO — versions for most bands and i.f.'s. Full kit with tuning cap ONLY £31.00. VHF MINISYNTH, 2 Meter version with 2MHz coverage for Rx & Tx. repeater options — full kit £38.50. SPEECH PROCESSOR — very popular kit to get through to the DX — ONLY £13.90. 1-30MHz RF PREAMP — 15dB gain (usable with G3ZVC/G4CLF I.f.'s) — Kit only £15.00 2M FM Tx/Rx £69.95. Unique MORSE MEMORY at £52.45 CATALOGUE 50p in stamps please. Allow 7-28 days for delivery. EXPORT - Europe use UK prices. Rest of Work UK + 5%.

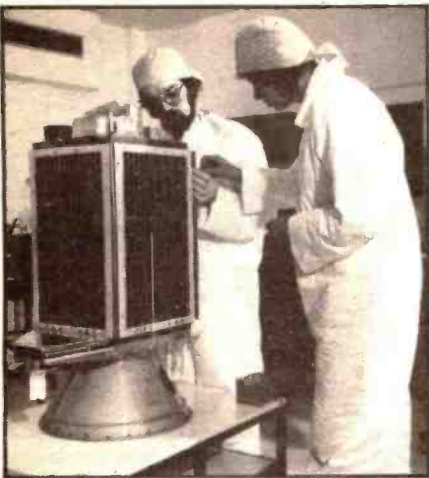

UOSAT 'B' undergoing pre-flight checking at the University of Surrey.

You only have to listen on the bands, or give a talk at a Radio Club, to realise that a large number of folk are interested in communicating by, or listening to amateur radio satellites, but they just do not know how to go about getting started. This really is not surprising because amateur radio

Getting started on amateur SATELLITES

OSCAR 10 — with no results at all! I had to explain to him that OSCAR 10 is the last type of satellite to try and cut one's teeth on! "Can you afford a long — very long — phone call?" I asked him. "OK, keep the £1000 worth of gear and the aerial system, but put them away in a safe place for possible use later on. Let's start right at the beginning", said I!

By far the best thing to do is to first learn how to *receive* satellite

are not so good for satellite working, as you do want to be able to continuously tune over the satellite frequency range (ie not miss out small increments of the band).

The difficulty of lack of a suitable tuneable receiver can be got over by using a 2m converter into a receiving section of a HF transceiver or into a general coverage — or amateur bands — shortwave receiver — usually into the 28 to 30 MHz band. This will give you a good, versatile satellite receiving set-up without the outlay of too much cash and probably using our existing equipment as a basis. Both the two UOSAT's can be found on 145.825MHz.

To receive UOSAT 1 and 2, all you need in the way of an aerial is a horizontal half wave dipole antenna for 2m or a quarter wave ground-plane type of antenna, like that shown in the photo nearby. This should present no problems in home construction to even the newest radio amateur or shortwave listener.

The next thing you need to know in order to hear the UOSATs is "when will they be over my location?". To appreciate this problem,

There has been a reasonable amount written about amateur radio satellites, but much of this has been rather inaccessible for the beginner. In the first of a number of features on satellites to appear shortly in HRT, Arthur Gee, G2UK, Chairman of AMSAT-UK, tells how to get started on receiving amateur satellites.

satellite communications involves a 'whole new ball game'. Everything is different from normal amateur radio techniques. You can't just go out and buy a 2m FM 'black box', and hitch it up according to the instruction manual, or go and get an HF transceiver and connect it up to a commercially made aerial system and be on the air satellite-wise. No, you've got to start at the beginning and work through, learning about the new techniques involved step-by-step and then assemble your satellite station piece-by-piece. It is hoped in this short series of articles to explain just how to go about this process.

The writer recently had a long phone call from an amateur who said he had "read all the books" on satellites and gone out and bought over £1000 worth of gear and connected it up to an equally expensive commercial satellite aerial system and had been trying to work

signals. In actual fact, the receiving side of amateur radio satellite communication is the most difficult. Once you have overcome all the various receiving problems, you are *more* than half way there.

Fortunately, there are two very good satellites operating in the 2m satellite band (145.8-146 MHz) which give out good strong signals, and are very easy to locate and receive. These are UOSAT 1 and UOSAT 2, built and operated by the Electronics Department of the University of Surrey and often referred to by their American designations of OSCAR 9 and 11, respectively. These can be received on simple equipment, using a simple aerial. You can tune these two satellites in on any 2m *tuneable* receiver. Unfortunately, the latest trend in 2m receivers is for switched channels to be provided, usually for FM operation, with, occasionally, the same facility for SSB. These

Fig. 1 The track of orbit around the earth. θ = the angle of inclination. An important point to remember is that the earth rotates from west to east but the track of the satellite stays the same in space.

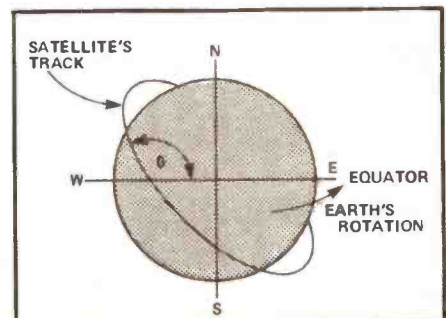

we must consider a few facts about satellite flight paths, tracking and orbital predictions. Let's have a look at Fig.1. The circle represents the earth's circumference. The horizontal line marks the equator; the vertical line is the north-south line; and the elliptical line represents the track of the satellite.

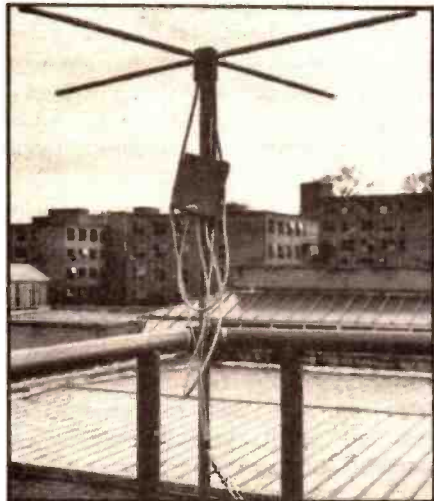

2m ground plane antenna at the University of Surrey used for monitoring UOSAT satellites.

We will suppose the satellite is travelling from south to north. After launch, the satellite being 'free' in space continues to travel along its orbital path until such time as the satellite's velocity falls off and it falls back into the earth's atmosphere and is burnt up. We need not go into the details of what determines the characteristics of the orbit at this stage. We will assume it is a simple circular orbit. We will also assume that the satellite is travelling up from the equator over the north pole down towards the equator. Then further south to cross the Antarctic regions and back over the equator again. The time taken to do this is called the Orbit Time or its Period. That part of the orbit in which the satellite is travelling north is known as the *ascending path* and the part in which it is travelling south is the *descending path*. The point on the satellite's orbit where the satellite crosses from the south to the north hemisphere is called the ascending node, and the similar point where it crosses the equator going from the northern hemisphere to the southern hemisphere, as the descending node. For the UOSATs, the Period is about 95 minutes. We should also note that the angle between the orbital path and the

equator is known as the *angle of inclination* — an important parameter.

Now, remembering that the orbital path remains the same in space and does not change in position, you will note that the earth on the other hand is rotating around on its N-S axis, so that any place on the earth's surface is in fact passing beneath the orbital path in an easterly direction. So at each crossing of the equator, the satellite is over a different place on the earth's surface — depending on how fast the satellite is travelling in its period. The satellite's path consequently appears to move to the west with each orbit. The amount the satellite's path apparently progresses towards the west is known as its *increment*, which is measured in degrees of a circle, ie in degrees of longitude. For the UOSATs, this is 23.86 degrees between each successive orbit.

Now, if we know the exact time the satellite crosses the equator when its path is in its ascending mode, and if we know

the inclination and the increment, we can calculate when the satellite will be overhead at any time in the future. From this information, orbital prediction calendars can be produced. If you are a home computer buff, you can have a great time working these predictions out for yourself, but this is hardly 'beginners stuff'!

In addition to our orbital prediction calendar, we need a Polar Projection Map of the northern hemisphere of the World and a Plotting Sheet. As can be seen from Fig.2, this consists of a map of the northern hemisphere centred on the North Pole. The track of the satellite is shown on a transparent cursor, which is pivoted at its centre and rotates around the North Pole. On this cursor is marked the track of the satellite and a time scale (on the orbital path predictor marketed by AMSAT-UK, differing cursors are available for each satellite). From the illustration, you will see there is also an oval overlay with figures on it. This indicates the area in which the satellite can be expected to be heard, taking into

Fig.2 Polar projection map of northern hemisphere. This is obtainable from AMSAT-UK (see text for address) and is an essential tool for predicting orbital paths.

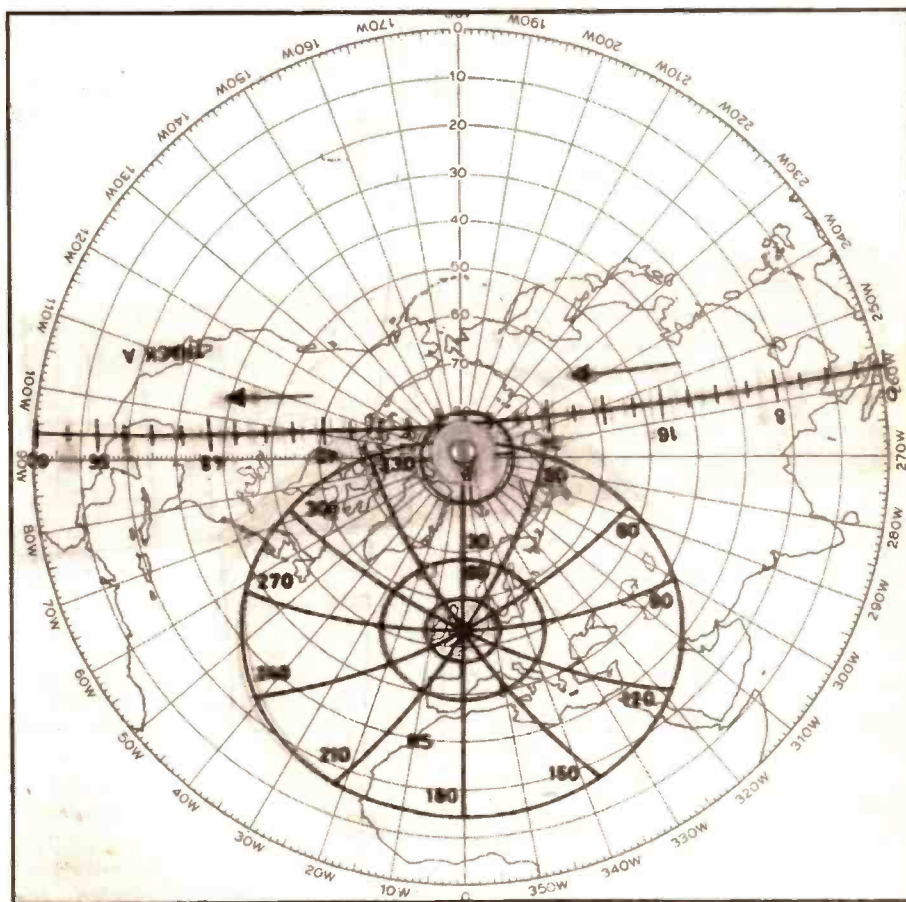

account its height and so on. This overlay is centred by the user over the location of their QTH on the map.

These orbital path predictors, Orbital Calendars, etc. can be obtained from AMSAT-UK, 94 Herongate Road, Wanstead Park, LONDON E12 5EQ; which is the HQ of AMSAT-UK, the organisation looking after the interests of British amateur radio satellite users, and of which membership is a 'must' for those wishing to participate in this field of amateur radio communication. The predictor kit consists of the map, which should be glued on to thick card and a cursor for the appropriate satellite. A small pivot can be made up from a nut and bolt, the latter being inserted through the north pole point.

The Orbital Predictor kit is used as follows: from our Orbital Calendar, we look up the day's date and find the entry for the satellite we intend using. As we shall be using the simplest of aerials, we want to know when the satellite will be nearest to us, preferably overhead if possible. For example, suppose we want to listen to UOSAT 1 (OSCAR 9) on January 28th. Using our predictor, we swing the cursor round until the line indicating UOSAT 1's track passes over our QTH. The track of the satellite is shown by arrows on the cursor and the time taken by UOSAT 1 to come up over the equatorial horizon, over our QTH and off below the horizon again, is indicated on the cursor. It is just over 47 minutes — half UOSAT 1's period. The beginning of the track — zero (0) on the cursor — lies over 340 degrees W (west) on the equator. Now if we refer to our orbital calendar for 28th January 1985 (see Fig.3) we see that there is an entry for 341 degrees of 15:02:34, which means that UOSAT 1 will come over 341 degrees W on the equator at 15 hours, 2 minutes and 34 seconds GMT.

The time taken for UOSAT 1 to reach our QTH is indicated on the cursor. The figures on this show the time of the satellites passage and we can see that it should be overhead about 16 minutes after crossing the equator. We add this figure to our calendar figure, which will give us the time we can expect

to hear UOSAT overhead. It should be noted too, that from our Orbital Predictor we can see the direction in which the satellite is travelling and its position at different points in time during its orbit. This is useful when we use directional aerials, instead of the simple ones such as the dipoles or ground-planes we are considering at the moment.

So, get your 'plotter kit' and your orbital calendar and play around with it until you get the hang of the thing. Don't worry at the moment about all the strange noises you hear from UOSAT 1 and 2 (OSCAR 10). Just get used to tuning in the signals and finding them from their orbital predictions. Once you have mastered this technique, you have really got over the most difficult part of understanding how to go about getting started on amateur radio space communication.

educational and experimental projects only. They are not for communication purposes, ie for sending signals up to them to be re-transmitted and received down on earth again at some distant location. The type of satellite which enables this to be done is one with a piece of equipment called a "transponder". This is a radio receiver, a radio transmitter and the associated power supplies, control units and so on, and it is via these satellites that amateur radio satellite communications take place.

In the beginning, the early satellites of this type usually received signals in the 2m band ie the ground station transmitted up to the satellite on 2m and these signals were converted in the transponder on the satellite into 10m signals and re-transmitted back to earth, where they were received on a 10m receiver. This

Sat 26 Jan OSCAR9	01:42:23 141 < 03:16:45 165 < 04:51:07 188 < 06:25:29 212 < 07:59:51 235 < 12:42:56 306 > 14:17:18 330 > 15:51:40 353 > 17:26:02 17 >
Sun 27 Jan OSCAR9	02:52:12 158 < 04:26:34 182 < 06:00:56 206 < 07:35:18 229 < 12:18:23 300 > 13:52:45 323 > 15:27:07 347 > 17:01:29 11 >
Mon 28 Jan OSCAR9	02:27:39 152 < 04:02:01 176 < 05:36:23 199 < 07:10:45 223 < 13:28:12 317 > 15:02:34 341 > 16:36:55 5 > 18:11:17 28 >

AMSAT-UK
London E12 5EQ
The Radio Amateur Satellite Organisation of the United Kingdom
Affiliated to the Radio Society of Great Britain

**AMATEUR SATELLITE
ORBITAL CALENDAR**

FOR
DECEMBER 1984 - JANUARY 1985
ISSUED FREE TO MEMBERS

SATELLITE OSCAR-10

Satellite: oscar-10
 Catalog number: 14129
 Epoch time: 84285.31833048
 Thu Oct 11 07:38:23.753 1984 UTC
 Element set: 135
 Inclination: 25.79° deg
 RA of node: 173.7928 deg
 Eccentricity: 0.6049373
 Arg of perigee: 313.6483 deg
 Mean anomaly: 10.0786 deg
 Mean motion: 2.05851004 rev/day
 Decay rate: -1.2e-06 rev/day²
 Epoch rev: 1000
 Semi major axis: 26105.978 km
 Anom period: 699.535087 min
 Apogee: 35522.428 km
 Perigee: 3937.468 km
 Ref perigee: 2475.30473030
 Thu Oct 11 07:18:48.697 1984 UTC
 Beacon: 145.8100 MHz

**NON-MEMBERS PRICE £1.00 + Postage
APPLY AMSAT-UK. LONDON. E12 5EQ.**

Fig.3 Orbital calendar. If we look at the entry for 28th Jan at 15 hours, 2 minutes and 34 seconds GMT, UOSAT 1 will come over the equator at 341 degrees W.

So far, we have considered the question of receiving 2m signals from UOSAT 1 and 2 — satellites which are intended solely for

could be either a separate 10m receiver specially built for the purpose, or the 10 metre band on a multiband amateur radio SW rec-



G2UK's 10m crossed dipole array can be seen at mid RHS. At the top of the picture is a 2m 4 ele. yagi used for transmission when the required satellite pass is near the horizon.

either, or the receiver section of a HF transceiver. These 10m signals were not particularly strong in the early days, and the performance of many SW receivers and transceivers begins to fall off badly at this frequency, so it was often necessary to put a 10m pre-amplifier between the receiving aerial and the SW receiver. Nowadays however, signals are stronger and pre-amplifiers are not so often necessary. You will find considerable references to them in the various literature available on satellite communications.

There were a whole series of satellites using the "2 metre up and 10 metre down" mode, commonly known as *mode A*, to begin with, such as OSCAR 6, 7 and 8, and several Russian ones, such as RS1 to RS8 etc. The earlier ones have unfortunately ceased to function but there are still several Russian ones working well and there are more of this type to be launched in the future. Bearing the aforesaid in mind, I think it is worthwhile starting off with your satellite project to begin by learning to com-

municate via mode A. Once you have mastered the technique of finding and hearing the UOSATs on 2m, try next to receive the Russian mode A satellites. At the moment, the easiest to find of these

Fig.4 Constructional details of 10m crossed dipole array, suitable for satellite reception.

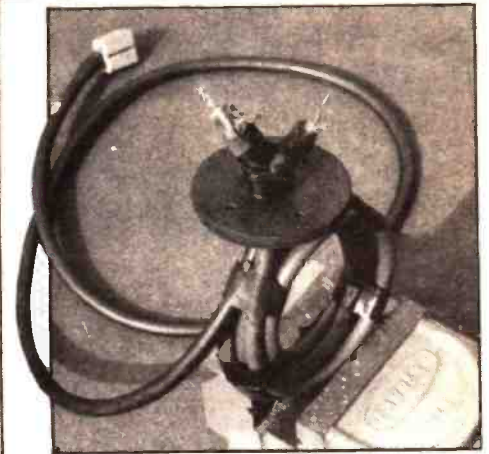
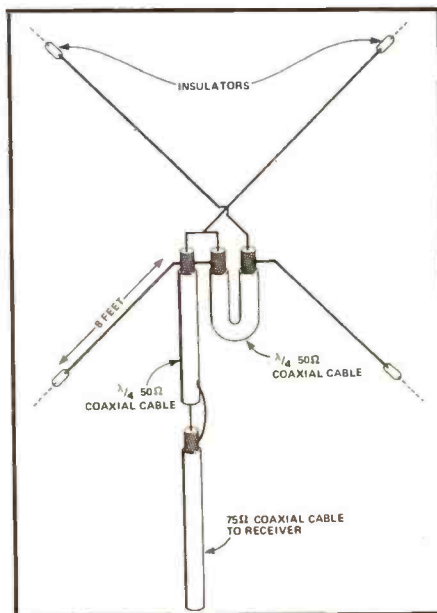

The phasing sections of the 10m crossed dipole should be coiled up and fixed with tape.

satellites is RS8, which generates a beacon signal on 29.502 MHz. One important thing to bear in mind is that the output of these satellites is not on one specific frequency, as with a conventional VHF/UHF repeater, but will be spread right across the satellite segment of 2m.

As we have already indicated, you may have to 'hot up' your 10m receiving set-up a bit. You can use a 10m half wave dipole antenna, but you will do better to use a 'turnstile' or a crossed dipole type antenna. This can be strung as shown in the nearby photo from the end of the house roof, as is used by the writer, or made from rods and supported from a pole about ten feet high. Details of construction are shown in Fig.4. You will note in the figure that a phasing stub is used to match the two half wave elements to one another. This type of aerial works very well. The arms of the dipoles can be made up from any suitable aerial wire; each arm is 8ft long. The phasing sections are of 50 ohm — or thereabouts — coaxial cable and are 4 ft long. They should be coiled up and fixed with tape as shown in the photo above.

If you still have trouble with weak signals, then try a simple 10m pre-amplifier, which you can either buy (for example, Cirket market a 10m pre-amp module, as do WPO Communications) or make up yourself. There are numerous designs given in the satellite literature.

Well, so much for the receiving side of getting started on the satellites. In the next installment, we will deal with the transmitting side of things. Good listening!

Building and using a NOISE BRIDGE

The instrument to be described, although quite simple and straightforward from a constructional point of view, is an accurate and very versatile item of test equipment. It can be useful for checking antenna feedpoint impedances, testing input and output matching impedances in a variety of different

Although the bridge cannot truly separate the resistive and reactive components of impedance, as one American amateur once said "The RF bridge takes over from where the SWR bridge leaves off."

Construction

The bridge was built into an

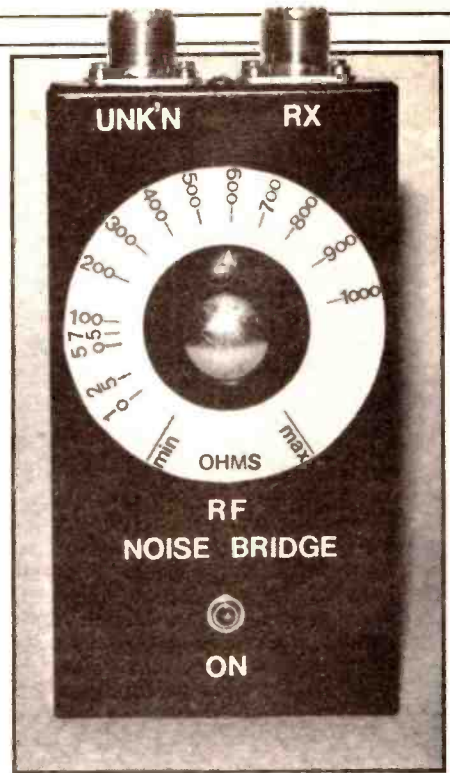

ching lid. The two SO239 sockets are mounted at one end of the box, sufficient clearance being given to allow the lid to fit properly. Drilling details for the case and lid are given later. Depending upon personal preference, the outer surfaces of the case and lid can be given a professional finish by a coat of car-type aerosol spray paint, after drilling.

As the success of the bridge depends upon the correct construction of T1, a detailed description will be given. T1 should be constructed before starting to build the rest of the circuit board assembly.

The three windings on T1 are made using a technique known as trifilar winding. This means that all three windings are wound on as a single winding, as opposed to a single wire, as in normal winding practice.

To begin, three lengths of 26swg enamelled copper wire, each approximately 12 inches long, are cut and laid closely side-by-side to form a bundle of three wires. One end of the bundle is anchored off in a vice or suitable clamp. The other end of the bundle is tied around a pencil or small screwdriver. The bundle of wires is then pulled gently to line up the wires in a straight line, and the pencil or screwdriver is rotated in the hands, thus twisting the bundle of wires. The twisting operation should continue until about 6 twists per inch

Next to a good multimeter and a grid dip oscillator, the most flexible piece of test equipment for the shack is probably an RF noise bridge. In the first of a number of specially commissioned projects describing simple test equipment, Duncan Walters, G4DFV, describes the construction and uses of this practical piece of gear.

radio and test equipments, as well as being useful to test the activity of quartz crystals. Additionally, the unit will function as a wideband noise source, which is very useful when servicing and aligning receivers. The bridge provides a good range of impedance measurement from 10 to 1000 ohms, which covers the four most commonly used 'standard' values of 50, 75, 300 and 600 ohms.

Many circuits of simple noise bridges have been published in magazines over the years. Whilst it would be optimistic to expect such simple circuits to provide the sort of facilities found in high-grade professional RF bridges (costing hundreds of pounds), there is little doubt that the simple noise bridge can provide a very useful means of finding out a good deal about impedances of antennas, etc.

aluminium box measuring 5 1/8 x 2 3/4 x 1 1/2 inches, with a mat-

Fig. 1 Constructing T1, the toroid transformer.

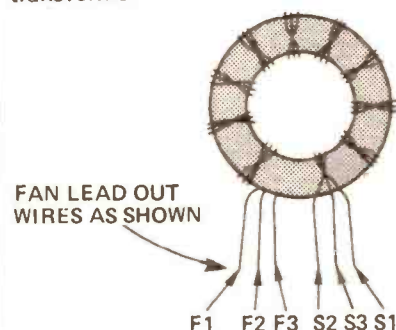

WINDING DETAILS:—

9 TRIFILAR (3 WIRES) TURNS OF 26swg ENAMELLED COPPER WIRE ON AMIDON T-50-2 CORE AS SHOWN BEFORE WINDING, APPROX 3 x 1FT LENGTHS OF 26swg ENAMELLED WIRE SHOULD BE TWISTED TOGETHER TO APPROX 6 TWISTS PER INCH

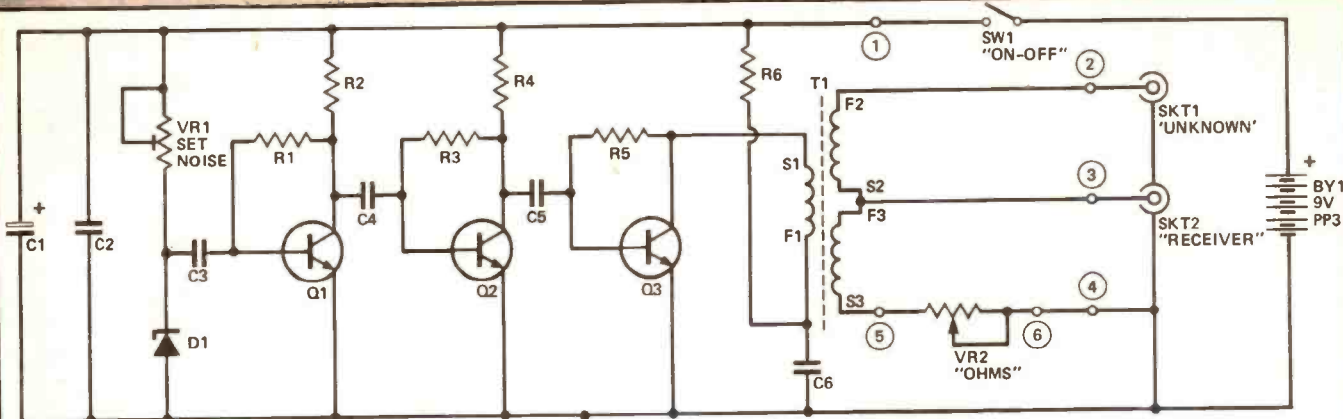

Fig. B Full circuit diagram of the noise bridge.

NOTE: CIRCLED NUMBERS REFER TO P.C. BOARD NUMBERED PINS

HOW IT WORKS

Most of the published circuits that are based on semiconductors mainly follow the same format of a noise generator fed into a wideband amplifier, the output of which is coupled into an impedance-measuring bridge circuit of one form or another. Looking at the block diagram of Fig. A, it can be seen that this noise bridge is no exception to the rule, the circuit being based on well-tried and tested ideas of the past. Looking at the bridge part of the block diagram, it can be seen that the noise is coupled into the bridge by means of a coupling winding from the output of the wideband amplifier. Noise is induced into a centre-tapped secondary which feeds two resistances R1 and R2, which share a common earth connection. Between the centre tap and earth is connected a detector, which in practice is a radio receiver capable of listening to the noise.

The operation of the bridge is as follows: whilst R1 and R2 are of different values, the bridge is unbalanced and noise will be heard in the receiver; however, if the two values are equal, then the balance is set and a null (a minimum of noise) is heard at the receiver. By making one of the resistances variable, a range of resistance measurement becomes possible by substituting the other resistance with an unknown value of resistor, adjusting the variable resistance until a null is detected. By then checking the setting of the variable

resistance, the unknown resistance can be found. In this noise bridge the ratio of each half of the secondary winding must be exactly 1:1 in order that accurate readings can be taken.

Fig. B shows the full circuit diagram of the unit. Noise generated within the junction of D1 is coupled via C3 into a three-stage, resistance-capacity coupled wideband amplifier, based around Q1, 2 and 3. Output from Q3 is induced into the bridge from the primary winding of toroidal transformer T1. The core chosen for T1 is an easily-available Amidon type T-50-5, providing a useful wideband of noise transfer, from below 0.5 to above 30 MHz. Output of the bridge at VHF is low, so measurement at these frequencies is not recommended with this cir-

cuit, which was designed to cater for HF only.

The centre-tapped secondary of T1 is actually two cross-mounted secondaries of equal turns to the primary, thus maintaining electrical symmetry. The finish of winding 2 is coupled to an S0239 socket, this being the connection for the 'unknown' impedance to be measured. The start of winding 3 is connected to earth via VR2. The centre tap, formed at the junction of winding 3 finish and winding 2 start, is also fed to an S0239 socket. This is for the connection of the receiver to be used as a noise detector. Capacitors C1, C2 and C6 effectively decouple the supply rail, whilst VR1 affords a means by which to peak the noise level generated by the zener diode D1.

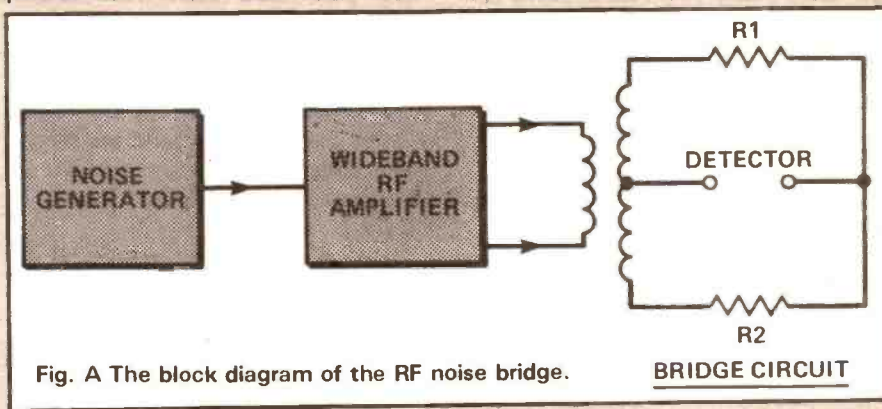

Fig. A The block diagram of the RF noise bridge.

are achieved. Trim off the bent ends of the bundle, leaving about 10 inches or so of twisted wire.

With reference to Fig. 1, take the core in one hand, and thread the bundle of wire through the hole, leaving about 1 1/2" remaining, to act as leads. Now bring the wires to take up the slack. Try to keep the wire as close to the core as possible. This forms one turn. Wind on a total of nine turns altogether, spacing them evenly around the core as you go, as in Fig 1. Leave about 1 1/2 inches of wires at the finish to act as leads and trim off the excess. Unless self-fluxing enamelled wire is used, it will be necessary to

remove the enamel in order to make connection. The best way to do this is to use a piece of medium-grade sandpaper and scrape off the

enamel on the leads until bare copper shows. A knife is not recommended due to the risk of cutting into the wire, or yourself, or both!

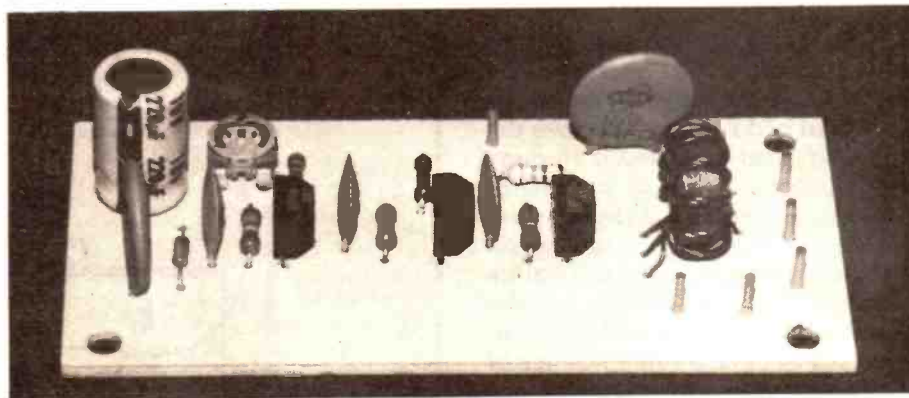

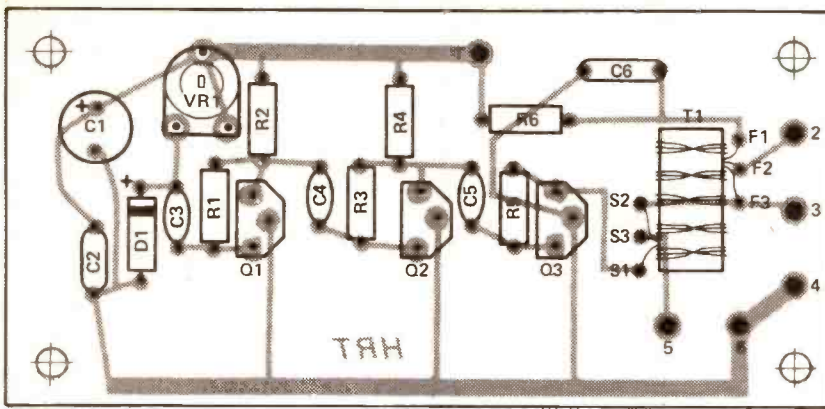

Fig. 2 Component overlay.

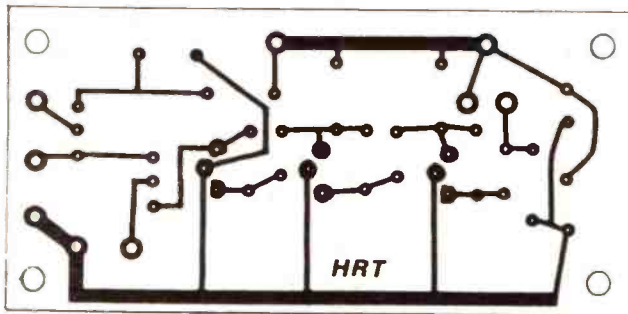

Fig. 3 Foil pattern, etched areas shown in black.

After the leads have been bared of enamel, it is advisable to tin them with solder. The leads have to be sorted out into the correct order for threading into the printed circuit board. A multimeter set to an ohms range, or a simple continuity tester is required. Taking each wire of the 'start' leads in turn, check which wire continuity is made through to the 'finish' leads. When the first one is found, label this S1 at the start lead, and F1 at the finish end. Continue until the other two windings have been checked in a similar way. Label these ends S2, F2 and S3, F3. Fan them out in the order as shown in Fig 1. This is the order in which they need to be inserted into the circuit board.

PCB Assembly

Beginning where we left off with transformer T1, pick up the prepared and drilled PCB and taking each lead of T1 in turn, remove the attached label and feed it through the appropriate hole in the board. Reference to Fig.2 will show where each lead has to go. Once all six leads are through, pull them tightly so that T1 rests down on the board, albeit in a vertical position. Bend the leads over the trackside of the board, crop and solder.

The rest of the components and pins can now be fitted. After the 6 pins have been inserted and soldered, the resistors, preset and diode are inserted, cropped and soldered. The capacitors follow, observing the polarity of C1. Lastly, the three transistors are fitted and soldered in. The finished circuit board assembly should look like Fig 2.

Before proceeding further, check the board for any unsoldered, dry or suspect joints, as

well as any solder bridges or whiskers of copper turnings from the drilling operation. It's surprising that even the most experienced constructors amongst us can easily overlook these areas.

After the case and lid have been drilled to the details of Fig.5, the two SO239 sockets should be mounted in the holes at the end of the box, and fixed into position with eight 6BA screws, washers and nuts. One screw should be fitted with the solder tag as shown in the wiring diagram of Fig.4. This is the common earth connection. The variable resistor VR2 and on-off switch SW1 should be fitted to the lid in their respective holes. The fixing nut of VR2 should be really tight, to prevent the control from slipping round.

The printed circuit board assembly should then be mounted in the box. This is fitted on to four 6BA screws inserted from the rear of the box, each screw having a 1/8 inch spacer slid on to stand the board off from the bottom of the box. If not readily obtainable, these can be simply made by cutting up lengths of old ballpoint pen plastic case and rubbing the roughly cut edges down with sandpaper. The circuit board assembly is then fitted on to the screws in the position shown in Fig.4, and fastened down with four washers and nuts.

Wiring

Wiring details for the unit are shown in Fig.4. The wiring to the two SO239 sockets should be kept

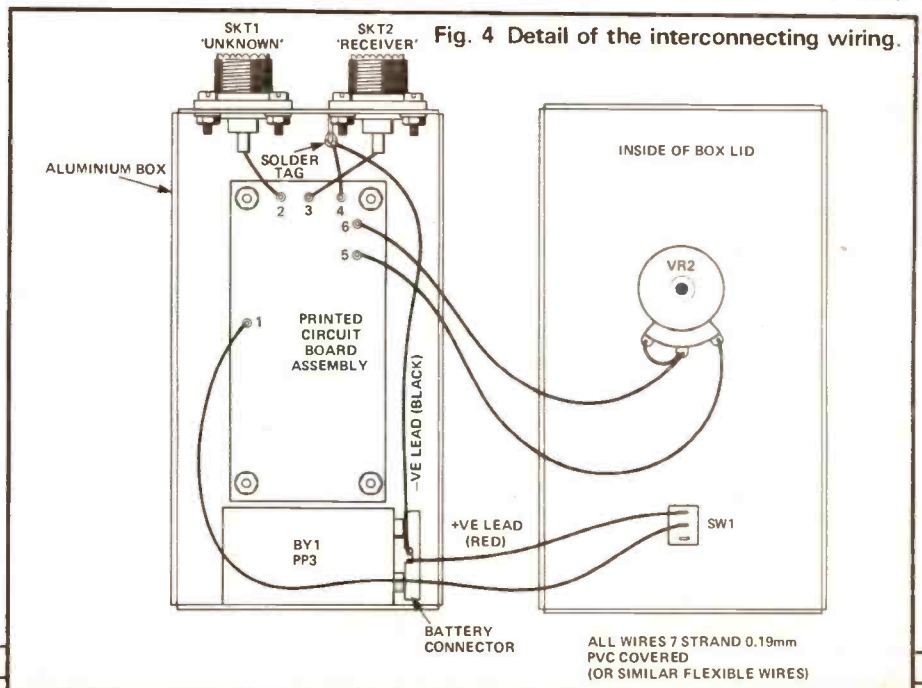

Fig. 4 Detail of the interconnecting wiring.

as short as possible, as well as the earth wire from pin 4 to the solder tag. All other wiring between the box and lid should be kept reasonably short and be left just long enough to afford easy access to the inside of the box with the lid removed. The battery, B1, a PP3, is fixed in the bottom of the box by means of a small piece of double-sided sticky tape, or a small amount of 'Blu-Tak'. After wiring is complete, double check this against the diagram.

Testing and Setting Up

Before applying power to the bridge, set VR1, the preset, to mid-travel. Connect a multimeter set to 50 or 100mA FSD in series with the positive lead of the battery and the circuit. Switch on. If all is well, the current drawn should be between 10 and 15mA. If the reading is unusually low, say 5mA, or abnormally high, say 40mA, then something is wrong. Check over the wiring, component layout and underside of the circuit board for open or short circuits. Connect a PL259 plug, with a short coaxial lead no longer than 6 inches, and terminating in two crocodile clips, to the 'unknown' SO239 socket of the bridge. Remove the multimeter and restore normal connections to the battery.

Connect a patch lead, with a PL259 plug from the 'receiver' socket to the receiver being used as a detector. Set the receiver to about 1.9MHz preferably, or the lowest frequency possible, if the receiver does not go down as low as topband. Switch on both receiver and noise bridge. Set VR2 to mid-position. Adjust the RF gain and AF gain controls of the receiver to obtain a good S9 or more signal on the signal strength meter and a loud but comfortable hiss from the loudspeaker. Noting the position of the S-meter pointer, with a small screwdriver or trimming tool, adjust VR1 slider slowly, both sides of the mid-position. A point will be found where the noise increases to a maximum. This may only be indicated by a very slight movement of the S-meter pointer, but is the correct setting for VR1. Leave the preset at this setting.

Connect a pair of 100 ohm carbon resistors in parallel across the crocodile clips on the leads from

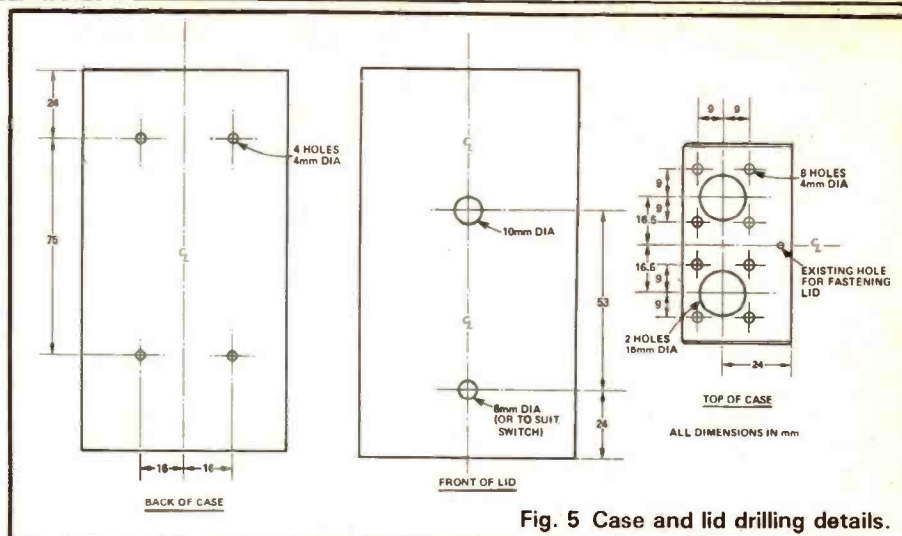

Fig. 5 Case and lid drilling details.

the plug inserted in the 'unknown' socket. Listening to the hiss from the receiver, as well as observing the signal strength on the S-meter, rotate VR2 knob slowly anti-clockwise, until a point is reached where the hiss suddenly goes quieter (ie the level of it drops). This is 'the point of null' where the bridge balances out and this test shows that the bridge is functioning.

If a null cannot be found, rotate VR2 over the full range of travel. If a null is found nearer the other end of the travel, then VR2 wiring has been reversed during assembly and needs to be put right. If no null is detectable at all, again check all the wiring, especially to SK1, SK2, and earth. Ensure that the receiver and 'unknown' connections are made into the correct sockets. If there still is no sign of obtaining a null, then the fault must lie either in the joints of the circuit board with the leads from T1, or that the leads are not in their correct holes as shown in Fig 2. If this is so, T1 will require removal from the board, checking, and re-inserted.

If all is well, and a good null is obtainable, the lid on the case may be fitted!

Prior to the calibration procedure being undertaken, a temporary dial should be attached to the front of the lid. This is best made from thin white card, such as a piece of plain postcard, cut into a circle of about 2 1/2 inches diameter. A central hole of about 3/8 inch diameter should be cut to allow it to fit over the fixing nut of VR2. Two small pieces of the double-sided tape will hold the card dial in place.

Calibration must be done with

carbon resistors — under no circumstances use wire wound. Although fixed resistors of the carbon type are useful, it would be necessary to have a very large amount in order to get the calibration points for the bridge and would entail connecting them in series and parallel arrangements to obtain the necessary resistances.

The nicest way out of this problem is to use an instrument called a Decade Resistance Box, which will deliver a range of resistances from 0 to 999 ohms in units, tens and hundreds. Not everyone has access to such a device (you could try asking around your local radio club), so the next best thing is to use a 1k carbon pot in conjunction with a multimeter set to ohms x 1 or better still, ohms ÷ 100 range.

The procedure for calibration is as follows. Remove the two 100 ohm resistors held in the crocodile clips in the 'unknown' lead. Switch on both receiver and bridge as before. Connect the 1k calibrating pot across the multimeter, (don't forget to set the meter to zero ohms first), and adjust the pot to read 10 ohms on the meter. Taking care not to disturb this setting, disconnect it from the meter and transfer it to the crocodile clips. Listening to the receiver and observing the S-meter as before, rotate VR2 knob slowly anti-clockwise until a sharp null is obtained. Still watching the S-meter, carefully swing VR2 control either side of this point, until the exact centre of the null is found. With the pointer knob set at this point, looking at the dial from directly above the knob, and at right angles to the front of the lid, make a pencil mark on the

dial where the point of the knob lies. Mark the number '10' above this mark.

Remove the 1k pot from the crocodile clips and transfer it to the multimeter again. This time, set the pot to read 25 ohms on the meter, transfer it to the crocodile clips once more, and adjust VR2 for a null as before. Mark this position with a '25' on the dial.

This procedure must be repeated a further 12 times, in order to calibrate the bridge through the whole range, each time setting the 1k calibrating pot to a different value. The points of calibration are 10, 25, 50, 75, 100, 200, 300, 400, 500, 600, 700, 800, 900, and 1000 ohms. It will be found that as the resistance becomes higher, the null will become less sharp, and it may become necessary to reduce the RF gain of the receiver to obtain a better null.

Once the bridge has been calibrated, the temporary dial can be removed and used as a pattern for making a permanent one. Thin card can be used again for the new dial and numbers can be put on with 'Letraset'. The new dial should be fitted and lined up before permanently fixing in place.

Components Listing

RESISTORS

R1, R3, R5	150 K
R2, R4	1 K5
R6	470 R
VR1	5k mini skeleton horiz preset
VR2	1k 1 in potentiometer
All resistors	0.125W 5% carbon film

CAPACITORS

C1	220MFD 10V Electrolytic (radial leads)
C2, C6	100nF 18V ceramic
C3, C4, C5	4n7 ceramic

SEMICONDUCTORS

Q1, Q2, Q3	Mullard BF184 'Lockfit'
D1	BZY88C 6V2 Zener Diode

TOROID CORE

T1	Amidon T-50-2
----	---------------

Approx 3' 26swg enamelled copper wire for T1; aluminium case 5 1/4 x 2 3/4 x 1 1/2 inches with lid and screws (Norman Rose type BA1); 2 S0239 sockets, (4 hole fixing); single pole on/off toggle miniature switch; PP3 battery; battery push-on connector; 8 x 6BA 1/2" cheese head brass screws; 4 x 6BA 5/8" cheese head screws; 12 x 6BA Everlock washers; 1 x 6BA solder tag; approx 2' flexible connecting wire (7/0.19mm PVC covered or similar); 12 x 6BA full nuts brass; large pointer knob; Letraset numbers; white card; 4 x 6BA x 1/4" spacers; 6 'Veropin' PCB pins; single sided fibre glass copper laminate board size 84 x 41mm.

Uses

As mentioned in the introductory paragraph, the RF noise bridge performs a number of very useful tasks in the workshop and amateur shack. These are highlighted below:

Antenna Feedpoint Impedance Measurement

To unknown feed impedance of any antenna, simply connect the antenna direct to the 'unknown' socket of the bridge. Set the receiver to the frequency required for the antenna to operate at, connect the receiver to the bridge, switch on and adjust VR2 for a null. The impedance of the antenna is read off the scale on the dial. If the feedpoint impedance is not at the required value, then VR2 can be set to the correct reading and the antenna length adjusted until a null is obtained.

Quartz Crystal Checking

The bridge functions well as a tester of quartz crystals. With the receiver connected as before, the crystal to be tested should be connected with short leads to the unknown socket of the bridge. VR2 should be turned fully clockwise (maximum resistance). The receiver should be adjusted and tuned into the frequency printed on the crystal. The 'hiss' at this point should take on a form of 'ringing' sound; if the BFO of the receiver is switched in this will become more apparent. Depending on the amount of 'ringing', the activity of the crystal will be shown. One favourable aspect of this is that it will cause overtone crystals to 'ring' at their fundamental frequencies.

Unknown crystal frequencies can be found by tuning the receiver through the bands until a 'ringing' is detected. If the aerial is disconnected from your receiver, so that no signals apart from any generated very close to the receiver can be heard, and the bridge placed in close proximity to the aerial socket, the crystal 'signal' should be easily heard. No ringing indicated either a defunct crystal or the frequency is out of the bands covered by the receiver. This is one application where a general-

coverage receiver would score over an amateur-bands only set.

Matching Impedance Testing

The input and output impedances of radio receivers and transmitters can be ascertained by using the bridge. Using the detecting receiver tuned to the operating frequency of the receiver or transmitter under test, the input or output of the equipment is connected into the 'unknown' socket. The variable VR2 is rotated, a null obtained, and the impedance simply read off the dial. One cautionary word. Under no circumstances should the RF output from a transmitter be coupled into the bridge, as this will damage the instrument, or transmitter, or both!

1/4-Wave Stubs For Filters and Matching Applications

Quarter-wave, open circuited stubs, used in applications such as TVI filters, can be resonated by using the bridge as a noise source. A short length of coaxial lead is connected between the bridge and receiver, which should be tuned to the frequency which the stub is required to attenuate. The piece of coaxial cable forming the stub should be cut longer than the required 1/4 wavelength, and one end connected across the terminals of the receiver, in parallel with the lead from the bridge. VR2 should be turned to maximum resistance. By carefully listening to the receiver and observing the S-meter, snip 1 inch at a time off the unconnected end of the stub. As soon as a null begins to appear, trim off only 1/4 inch at a time, until the point is reached of maximum null or thereabouts. The stub is now resonant at this frequency, and can be transferred to wherever it is to be used.

Use as a Wideband Noise Source

As mentioned earlier, the 'receiver' output socket provides sufficient wideband noise at a suitable amplitude for use in the alignment of receivers. Simply connect the receiver under test to this socket via a suitable length of screened lead. If required, an attenuator can be put in series with this feeder without adversely affecting the bridge in any way.

COMPETITION

2m on the cheap!

- win a Spectrum Comms TRC2-10 transverter

In this month's competition, devised by Tony Naylor, G4CFY, of Spectrum Communications in conjunction with the editor, you have the chance to win a super Spectrum Comms boxed 10 — 2m transverter kit, as featured in '2m on the cheap?' in our March '85 issue.

1. Which is the most thrilling way to work a DX station?

A on commercial equipment
B on homemade equipment

2. Can equipment built from kits perform as well as commercial equipment?

C Yes
B No

3. What would be an adequate noise figure for a 2m receiver?

E 1dB G 3dB
F 2dB H 4dB

4. How much receive converter gain is required with a modern HF transceiver?

I 20dB K 32dB
J 26dB

5. What method of connecting a transverter to a rig is likely to be the most popular?

L separate IFs
M combined IFs

6. Transmit/receive switching should be accomplished by either:

N PTT line switching
O RF carrier sensing

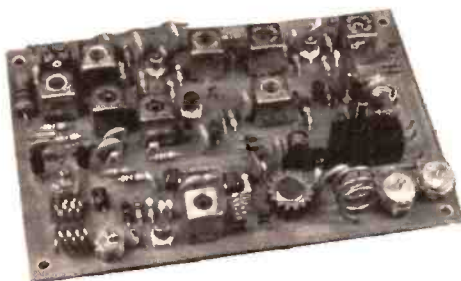

Spectrum TRC2-10 features

- * Linear all mode operation.
- * Repeater shift + semi-duplex operation.
- * Will take drive from 10mW — 1W. Suits most transceivers, FT101, TS530S etc.
- * Low cross modulation + wide dynamic range.

How To Enter

Look at the list of six multi-choice questions nearby. Choose which of the answers you feel is correct and list on the coupon below. For example, if you feel that the answer to question 1 is A, and question 2 is C, then your list will begin A,C, . . . and so on. All entries coinciding with our list will be put into a hat and ceremonially drawn by HRT's Julie. No bribes will be accepted!

To be eligible to win, the coupon must be completed *fully and clearly*. **IMPORTANT:** write your choice of the order on the back of your envelope in addition to on the coupon.

Send your entry to: 2m Transverter Competition, Ham Radio Today, No. 1 Golden Square, LONDON W1R 3AB. Closing date is first post on 7th June '85.

You may enter as many times as you like, but each entry must be on an official coupon — not a copy — and sealed in a separate envelope.

The Rules

Entries will not be accepted from employees of Argus Specialist Publications, Spectrum Communications, Garden City Press. This restriction also applies to employees' families and agents of the companies.

The 'How To Enter' section forms part of the rules.

Spectrum 2m Transverter Competition

Name

Address

..... post code

Your list of multi-choice answers
A,C,E etc.

How much output power do you prefer for general use?
½W 2½W 10W 25W

If you were to buy this kit, would you prefer it to include the necessary repeater shift crystal?
Yes No

Do you agree with CBs being converted to 10m as transceivers or used as transverter drivers?
Yes No

What colour front panel would you prefer on a kit?
White Grey Black Blue

Prize supplied by
SPECTRUM COMMUNICATIONS

Complete fully and carefully — if you are the winner this will act as a label for your prize. Post to 2m Transverter Competition, Ham Radio Today, No. 1 Golden Square, LONDON W1R 3AB. Closing date: first post, Friday 7th June '85. Don't forget to follow the advice in the How To Enter section, including writing your choice of the answers to questions on the back of the envelope.

HAM

RADIO

TODAY

ONLY
£11.45
INC. P&P!

The most effective route yet to your Class A amateur licence!

MORSE COURSE

Professionally produced for HAM RADIO TODAY by Shirley Hesketh G4HES and Ron Ray G3NCL, this advanced interactive learning system makes use of the stereo cassette format to provide tuition to the 12wpm test standard.

With its carefully designed structure, we think that the HRT MORSE COURSE is more effective than either morse classes or electronic morse generators.

Based on TWO C-60 cassettes, it offers the controlled prompting so necessary for the initial stages of morse tuition, followed by carefully paced test material to bring the student up to speed. Full tuition notes are provided with the cassettes.

To receive your MORSE COURSE simply fill in the coupon below and return it to: 'HRT MORSE COURSE', Argus Press Software, No. 1 Golden Square, London W1R 3AB.

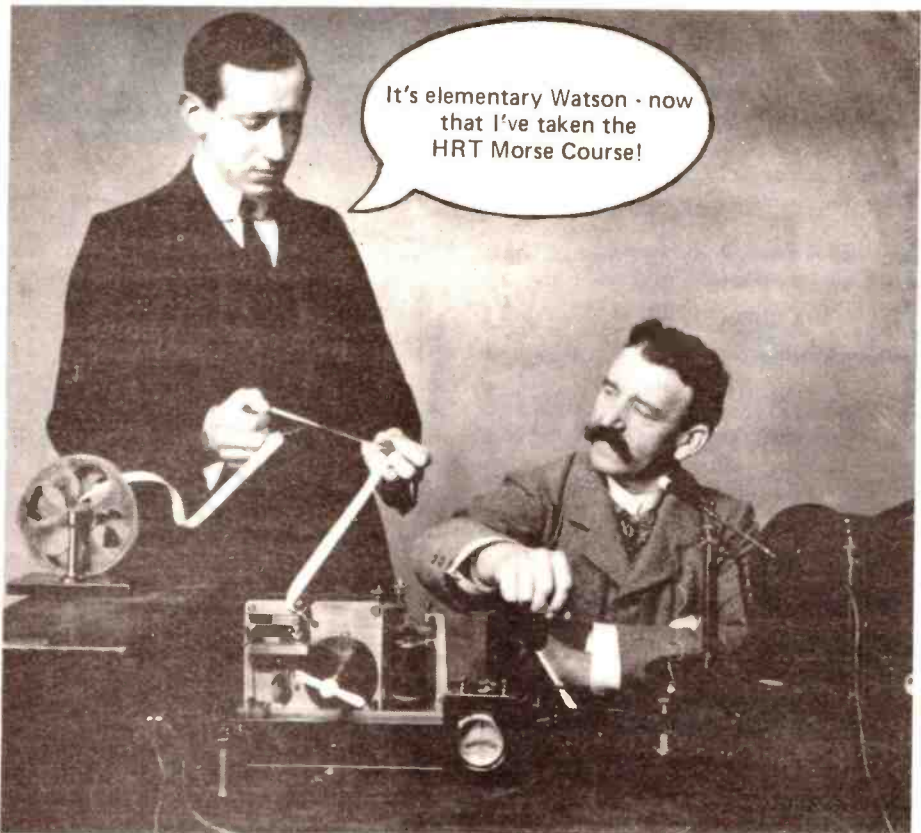

Photograph reproduced by kind permission of Marconi Ltd

Please send me the 'HRT Morse Course' at £11.45 all inclusive of P & P and VAT. I enclose cheque/PO for £..... (payable to APS Ltd) OR Debit my Access/Barclaycard (delete as necessary).

Please use BLOCK CAPITALS
Name (Mr/Mrs/Miss)

Address

..... Postcode

Signature

Date

Please allow 21 days for delivery

MICRO' NET

As I sit here writing this month's Micro' Net, I am doing so in the wake of what can only be described as the computer world's nearest equivalent of a Severe Ionospheric Disturbance — I am talking of course about the much publicised

able. From the viewpoint of specialist users such as radio hams, this could be nothing but good news as the economies of large scale production would result in more advanced machines at reasonable prices — which

having both modes resident in the machine at the beginning of your listening session. Recognising that the licence regulations will probably need to be changed, there is also the possibility of these 'larger' machines being used to support selective electronic mailbox facilities.

This month, Dave Bobbett, G4IRQ, speculates on the shape of the micro' to come, as it will affect the radio enthusiast, and scrutinises the novel GB3RY data repeater.

trials and tribulations of Acorn Computers Ltd. which took place in the early part of this year. I am not about to embark upon a blow-by-blow account of the demise of what was, or is, one of the main market contenders in the UK, reams have already been written in that very subject. However, because by definition most of Micro'Net's readers have vested interest in keeping at least half an eye on the technological horizon, I suspect that the majority of people have been asking themselves "Whatever is going to happen next?"

The Implications . . .

Up until a few months ago, the general consensus of opinion regarding the future of computer development was that the dividing line between 'serious' computers and home micros would become increasingly blurred, until a point was reached where the two would become virtually indistinguish-

able. From the viewpoint of specialist users such as radio hams, this could be nothing but good news as the economies of large scale production would result in more advanced machines at reasonable prices — which didn't require expansions or add-ons before they could be integrated into popular ham radio applications. Unfortunately, unless of course the recent happenings are simply a hiccup, it looks as though that isn't going to happen and it seems more likely that the two-tier (ie home and 'serious') format will continue, or, at best, be replaced with a three-tier structure, where 'intermediate' machines will be targeted at the middle ground (ie hobbyist, serious domestic users).

Should the latter case come about then, we radio-users should at least be thankful because, even if these 'intermediate' machines still need interface boxes to go between them and a rig running RTTY or Packet Radio, at least there should be sufficient RAM on board to support multi-mode software packages. After all, morse often lives cheek by jowl with RTTY on the bands, so it would make sense to get over the problem of having to constantly load and re-load the appropriate program, by

More Packet Perpetrators!

In addition to the information which has already been published in HRT, a number of other stations have now joined BARTG's register of those who are already interested or are actively participating in Packet Radio activity. A copy of the latest list additions appears in Fig.1 and if my maths does not deceive me, it seems that 64 stations have contacted BARTG's Ian Wade, G3NRW, in order to join the fray. Whilst Fig.1 is only an update, I will endeavour to include a complete list of 'Packet Perpetrators' in a future edition of Micro'Net, so that newcomers will be able to find out what the level of activity is likely to be in their area.

It is certainly encouraging to see how many people have taken to the mode despite the relatively high initial outlay and the rather depressing exchange rate involved in buying equipment in dollars. Incidentally, if you want to assess the level of activity on VHF, or you've just received a sparkling new Terminal Node Controller and would like to worry your friends with funny noises, then the frequency to go for appears to be 144.675 MHz, which is recognised as being the data transmission calling frequency. Whilst I'm on the subject of levels of interest, readers might also like to know that since BARTG passed its 2,500 membership mark a few months ago, it means that about 1 in 10 of active UK amateurs are currently members of this organisation, which is pretty good going in anybody's terms and no doubt reflects the growing popularity of using micros in the shack — congratulations BARTG!

Fig. 1 Newcomers to BARTG's register of Packet Radio enthusiasts.

G1BUO G1BZ1 G1CSZ G1DJI G1DMF G1DSU G1JKF G1JVY G1JWX G1KTT
G2AFD
G3EPT G3FVR G3KRW G3PDK G3SXE G3TAA G3TYG
G4ARY G4BHV G4DRS G4EJO G4FUG G4JEA G4JLP G4KMF G4LLQ G4L00 G4MOH G4NWH
G4PFF G4PS0 G4SHP G4SQI G4TAW G4VXF G4WYG
G6ALB G6ANV G6CSY G6IAH G6KWA G6MKK G6NEW G6NDR G6PVS G6TQT G6TUL G6UAX
G6XIP G6ZLM
G8AFN G8CIV G8DXJ G8FVR G8GML G8JKV G8NKV G8OFA G8SBU G8RGD G8VCN G8WDR
GM1GLA

CODE	FUNCTION
HLP	HELP MENU.
AAH	110 Baud ASCII in & out. or - 110 Baud RTTY in & out.
AAL	150 Baud ASCII in & out.
AAN	300 Baud ASCII in & out.
AAT	1200 Baud ASCII in & out.
RRN	50 Baud RTTY in & out.
CON	300 Baud ASCII in & 50 Baud RTTY out. or - 50 Baud RTTY in & 300 Baud ASCII out

Fig.2 Data Repeater Codes and their Functions.

Signals Which Go Burble In The Night

For those people who live within the Leicester area and have access to both UHF equipment and either RTTY or ASCII code generating equipment, there is a rather interesting experiment going on with the GB3RY Data Repeater. I'm not too sure whether I should be calling this unit a Data Repeater or a Digipeater, but because RTTY is involved, I'll stick to the former for the time being.

Whatever the correct term may happen to be, this device is capable of repeating an RTTY QSO or an ASCII code QSO through the same box, but the clever part is that there are a number of other options available to the user once the repeater has been initially accessed and set up using either 50 Baud RTTY or 300 Baud ASCII. For example an ASCII user may wish to send data at any of the optional 110, 150, 300 or even 1200 Baud rates, so owners of the old 110 Baud electromechanical ex-computer Teletype machines aren't entirely left out of things. By the same token, computer owners can transmit data at the same speed as a typical micro's cassette system normally loads it.

The designers have clearly given a

great deal of thought to what are probably the two most common data modes in the bands (ie 300 Baud ASCII and 50 Baud RTTY) and have then gone on to implement a system which is capable of translating an input in one format into an output in the other format; by doing this, a station using 300 Baud ASCII is able to have a QSO with another station which only uses 50 Baud RTTY - with the repeater taking care of the translation! Because of the speed differences, I can only assume that the 'box' stores a significant part of an incoming 300 Baud ASCII signal so that it can be sent out again at 50 Baud, which would imply that there must be a maximum message size after which the repeater's data buffers would be full. However, for normal two fingered 'real time' typing, I suspect that this isn't a problem and is only encountered when you want previously written information to be transmitted in one large chunk.

Repeater access is achieved by sending 'GB3RY ??? DE G4IRQ' and must be followed by both a 'Carriage Return' and a 'Line Feed' character. If you are using a micro, then you must send an ASCII code 13 followed by ASCII code 10. These codes are expressed in decimal by the way and not hexadecimal. It is probably wise to check your manual just to make sure

neither of these characters are automatically suppressed or that there are any other quirks hidden away. The reason I say that is because the BBC micro normally removes any ASCII 10 codes from data which is sent to its serial port and other machines may do the same, with the result that no 'Line Feeds' would be transmitted (on the Beeb this problem can be solved by the use of the *FX6,0 command - see p.408 & 424 of the manual). The three ??? are replaced by one of the codes shown in Fig.2 and in the event of you forgetting which code it does want, you can send the repeater 'GB3RY HLP DE G4IRQ' CR LF and the box will jog your memory.

The audio tones for 50 and 110 Baud RTTY are the normal 1275/1445Hz tone combination, so there should be no great problems there. On the other hand, ASCII should be transmitted to the repeater using the CCITT standard tones of 980/1180Hzm, whereupon the data will come back in a 1650/1850Hz tone pair. Land-line lubbers will probably recognise these tone combinations as being the 'Originator' mode used in acoustic and direct connect modems for 300 Baud bulletin boards working to type CCITT V21 standard. If you are into hacking to any extent, you probably already have the audio generating part of the hardware. Please note that these CCITT tones are *not* the same as the tones used by British Telecom for their Prestel system and so a dedicated Prestel modem could not be adapted - and perhaps I should also mention that the standard BELL tone groups as used in the USA for their computer links are not suitable either.

There seem to be an awful lot of "don'ts" regarding ASCII transmission. Basically, if you have a CCITT modem you can bet your boots that it will be suitable as long as you can think of some way of interfacing it to the transceiver. As we've seen in the past, it is always wise to watch out for square-wave inputs to transmitters - otherwise you might end up with a signal the width of Radio Caroline's!

On a final note, if the GB3RY experiment is popular, perhaps several other similar experimental repeaters may spring up in the wide open spaces of 'seventy'.



Address Box

To contact Micro'Net please write to either the editorial offices or:

DG Bobbett
PO Box 49
Colchester
Essex
CO4 3SF

INTRODUCTORY ELECTRON OFFER

From Scarab Systems

New from Scarab Systems, UK's leading radio software and hardware house, comes two exciting programs.

Electron QTH Locator. This large program comprises two parts and you can 'toggle' between them at any time. The first includes a point to point distance locator, radial ring score and outgoing and return bearings plus the Maidenhead Universal Locator system. The second part is a scoring log. **£7.50 (HF and VHF/UHF).**

Electron Morse Tutor. Among many fantastic features are variable sending speed, spacing factor, comprehensive word vocabulary, selective letter sending and much, much more. **£6.50.**

FREE!

Super locator map of Western Europe with every Electron program — while stocks last.



RTTY/3 Spectrum. Now even more facilities. Software upgrade **£7.50.**

All prices include VAT and are correct at the time of going to press.

Trade enquiries welcome.

Scarab Systems produce many other top quality programs and equipment for the radio amateur. Use the coupon now for details.



SCARAB SYSTEMS

39 Stafford Street, Gillingham, Kent ME7 5EN.
Tel: (0634) 570441

Please send me:

- QTH Locator for Electron/BBC* and my free gift £7.50 + 25p postage
- Morse Tutor for Electron/BBC* and my free gift £6.50 + 25p postage
- RTTY/3 Spectrum £7.50 + 25p postage
- Free details of other equipment and programs.

*Delete where necessary.

I enclose a cheque/postal order for

I wish to use my Access/Visa Card No.

Name

Address

.....

Tel. No.

Signature

I understand that if I am not fully satisfied I can return the equipment within 21 days for full reimbursement. 14 days delivery. HRT



RTTY and CW TRANSCEIVE with NO TERMINAL UNIT

This fantastic program interfaces direct with your rig, slashing the cost of previous systems. Split screen, type ahead, all the usual features and more. Tape and kit for the very simple interface for only £17.50. Connectors and ready-made interfaces available. For CBM64 and VIC20 (+ at least 8k). BBC-B coming soon. CW-only version for SPECTRUM £10.

And four superb programs for **CBM64, VIC20, BBC-B, SPECTRUM**
LOCATOR QTH or Maidenhead locator or lat/long. Distances, headings, contest points, converts between locator and lat/long. Tape £6.

LOGBOOK Date, band, mode, call and remarks. Superfast callsign search. Easy, fast updating of files. Screen/printer output. Tape £6.

MORSE TUTOR Britain's best. Learn fast in easy stages from absolute beginner to over 40 wpm. Join the hundreds who have succeeded with this program. Tape and full learning guide £6. For **ZX81-16k** also.

RAE MATHS All the practice and testing you need. Tape and comprehensive reference sheet detailing all you need to know £8. VIC20 needs expansion (any). For **ZX81-16k** also. Don't let maths make you fail. PASS with this program.

All programs are very easy to use and come with full instructions.

Prices include p&p 1st Class by return. Add £1 per tape if outside UK or Ireland.

technical software (HRT)

Fron, Upper Llandwrog, Carnarfon, Gwynedd LL54 7RF. Tel: 0286 881886

WOOD & DOUGLAS

- NEW CATALOGUE
- NEW PRODUCTS
- NEW PRICES

For those of you who missed the NEC here are details of a few of the new products that we introduced:-

70FM3B — The popular 70FM3 500mW to 3 Watt 70cms power amplifier has been updated to have rf switched automatic PIN changeover. The board fits a standard miniature diecast box and is sufficiently compact to allow direct connection to your hand-held's aerial socket. The module has facilities for line powering and has our standard 'straight through' mode with power supply disconnected.

AF1 — A small audio amplifier board consuming very low quiescent current. The unit is intended to complement the CWF1 CW filter where it would act as an audio buffer. The board also boasts an externally activated mute circuit.

144LIN30 — The popular 144LIN25B linear has been updated to yield in excess of 30W for 3W drive at 145 MHz.

Details of these and other new products are included in the 1985 catalogue. This will be posted to you on receipt of an A5 stamped self addressed envelope. Kits are usually available by return of post but please allow 28 days for any unforeseen shortages. Place your order by post or by telephone using your credit card. Please include £1.00 to cover order handling and postage.

Our products are kits or assembled kits consisting of circuit board and all components to mount on the board. We do not include external hardware such as boxes, connectors, etc.

If your purchase does not work when assembled then apart from being surprised we will offer to service the module for a small charge depending on the complexity of the project. So please remember ...

ANYONE CAN SELL A KIT ... REPUTATION SELLS OURS
UNIT 13, YOUNGS INDUSTRIAL ESTATE
ALDERMASTON, READING RG7 4PQ
TEL: (073 56) 71444 TX: 848702



Addendum

The 'Supernotch' (November '84)

We have recently discovered through a reader's letter that the Veroboard layout contained two errors.

1. There are two links from the lower left-hand side which should connect the pulse output from pin 3 of IC5 to pins 5 and 13 of IC3. The link to pin 13 is correct but the link to pin 5 is shown as going to pin 6. This latter link should thus go one strip higher.

2. A cut is needed (but not shown) in the copper strip between the flying lead going to the track of RV2 which is on the immediate right (and same track) as C11 and the top end of R19.

A fresh look at the Trio TS520 series of transceivers

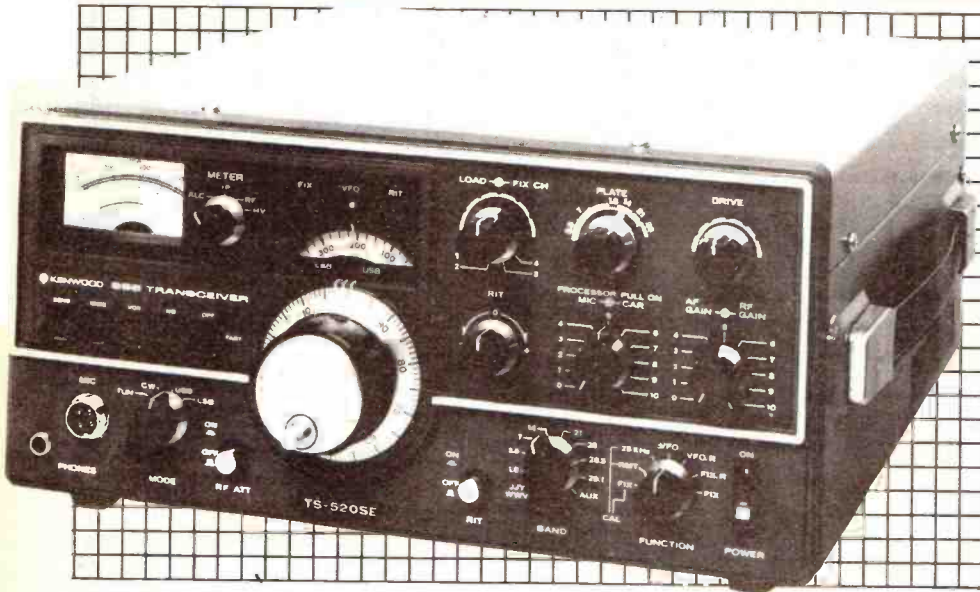

Well, what can you say about a classic rig? The most often used words when discussing the TS520 series with owners, whilst researching this article, were 'reliable' and 'good workhorse'. The scarcity of

ble conversion with switched mixing crystals and a band pass first IF of 8.895-8.295MHz and a second IF of 3.395MHz, whilst the TS530S system is based on a phase locked loop oscillator and is

Over the last ten year's, the two most indisputably popular commercial series of HF transceivers have been the Yaesu FT101 and the Trio TS520. The former was covered by HRT back in 1983/4 and now Hugh Allison, G3XSE, gives a specially commissioned update on the fabulous '520.

these rigs on the second-hand market, considering the thousands and thousands sold, and Trio's apparent re-birth of the model as the current TS530, supports my belief that these rigs are still cherished by their owners, and rightly so.

Many amateurs view the TS530S as a further link in the TS520 chain, although in fact it bears little circuit resemblance at all, barring that rugged valve driver and PA stage. The TS520 series used the, at the time, standard frequency generation method of dou-

single conversion with an IF of 8.83MHz.

Technically, the TS530S owes much to the TS830S rather than the 520, and as such only represents a follow on by virtue of its being a 'no frills' reasonably priced HF rig rather than an 'all-bells-and-whistles-top-of-the-range' rig. People probably also tend to confuse the two because the 530 has also earned itself a reputation for reliability — and looks similar in those postage stamp photo's used in adverts!

There were quite a number of variants of the TS520 series over the years. For the purists amongst you, UK Trio importers, Lowe Electronics have kindly provided a list of variants and their differences, and this is reproduced elsewhere. Check that the variant you buy has the facilities you want. All versions cover the 80 to 10m pre-WARC bands only, ie, 80, 40, 20, 15, and 10, and have a built-in mains power supply. Physically, the rig is a bit big and heavy by today's standards, but this is not unconnected with the overall reliability. I am not being unkind when I say that it was built like the proverbial small brick establishment!

All the '520s controls are convenient and easy to use. I can still recall the trepidation I experienced when setting up my TS520 for the first time, a very long time ago now, but after only a day or two of operation, the tuning up process seemed to happen without thought. Incidentally, I think I must have set the rig up correctly the first time, since the first contact was with an Australian on 20m SSB. You can't work much further than that!

I'll not bore you with the precise technical details of the TS520, take it from me that the rig performs to its basic published specification of better than 0.2uV sensitivity for 10dB S+N/N on all bands. Practically, the receiver will normally hear anything that you are able to work with the transmit section, and it does not drift at all. Oscar satellite buffs working on '2m in, 10m out' mode will just about get away with using the receiver side on ten, but the excellent 10m pre-amp kit available from AMSAT-UK will certainly make things easier.

One CW buff contacted during

preparation of this article regretted buying the accessory 200Hz CW filter for his '520, not because there was anything wrong with it, merely that it was too narrow for practical operation. After following drifting stations up and down the band for a while, the owner re-invested in a 500Hz filter and stuck with that.

The transmit section gives good clean audio at the other end, provided the microphone is a reasonable quality high impedance type. Trio, in their wisdom, did not supply a matching mike with the rig, and I've come across some real horrors connected up to rigs. I used to use a Shure 444 with my '520 and never had any complaints at all about the quality of transmission.

The transmitter has the only three valves in the rig, one driver and two PA bottles. The rigs came fitted with ES2001 types in the PA which were 6146B valves in disguise. A lot of bumf has been written about the pros and cons of different makes of PA valves. Suffice it to say that Lowe Electronics fit either Toshiba or GE types and find that these require minimal re-neutralisation. Lowe point out that the most important thing to do when replacing the output bottles

is to re-set the PA bias. Full instructions are in the handbook and it's not a difficult job. In practice the PA bottles seem to go on forever, and only give up after several years of abuse. I suggest keeping an eye on the bias current and re-setting when required.

On the subject of abuse, your scribe is fully qualified to discuss maltreatment of HF rigs. The aerial installation at chez G3XSE is a one hundred meter run of one eighth inch square copper wire, varying in height from 15 to 30 feet. This just gets shoved into the aerial socket of the rig and the PA valves are left on with it (*Aargh! — Editor*). Although presenting a surprisingly good match on some bands, on others it doesn't! Little problems like a poor VSWR doesn't stop me working a band, and I am happy to report that my TS520, after five years of habitual neglect, still gives the same power out as it did when new. I should add at this point that I would *not* recommend this procedure — particularly with semiconductor rigs and other old valve type rigs, which often use rather delicate TV sweep tube type PAs — viz early FT101s, FT200s etc. An ATU with a long wire antenna is really essential!

Mobile Operation

Some variants of the rig came factory fitted with a 12V inverter, and there was also a kit to fit it into other variants. Lowe state that this kit is not now in stock, so a would-be purchaser of a rig for mobile operation would be well advised to get a variant already fitted out. Incidentally, it's quite possible for a rig to work OK on the mains and not on 12V (although rare, I have come across inverter failures), so check the rig on 12V prior to purchase if this facility is important to you.

As previously stated, the rig is big, and you need a lot of enthusiasm to fit one into a modern sized car — this certainly isn't a rig for the glove box! Talking of enthusiasm, the rig is certainly an enthusiastic consumer of amps, so don't run the rig with the engine off. I've had to jump start a fellow amateur's car in the evening after he had spent a lunch hour on-the-air.

Having said the above, the tough valves in the PA are far less worried about mis-matched mobile aerials than modern all solid state rigs, so if you can fit it in, it's well worth considering.

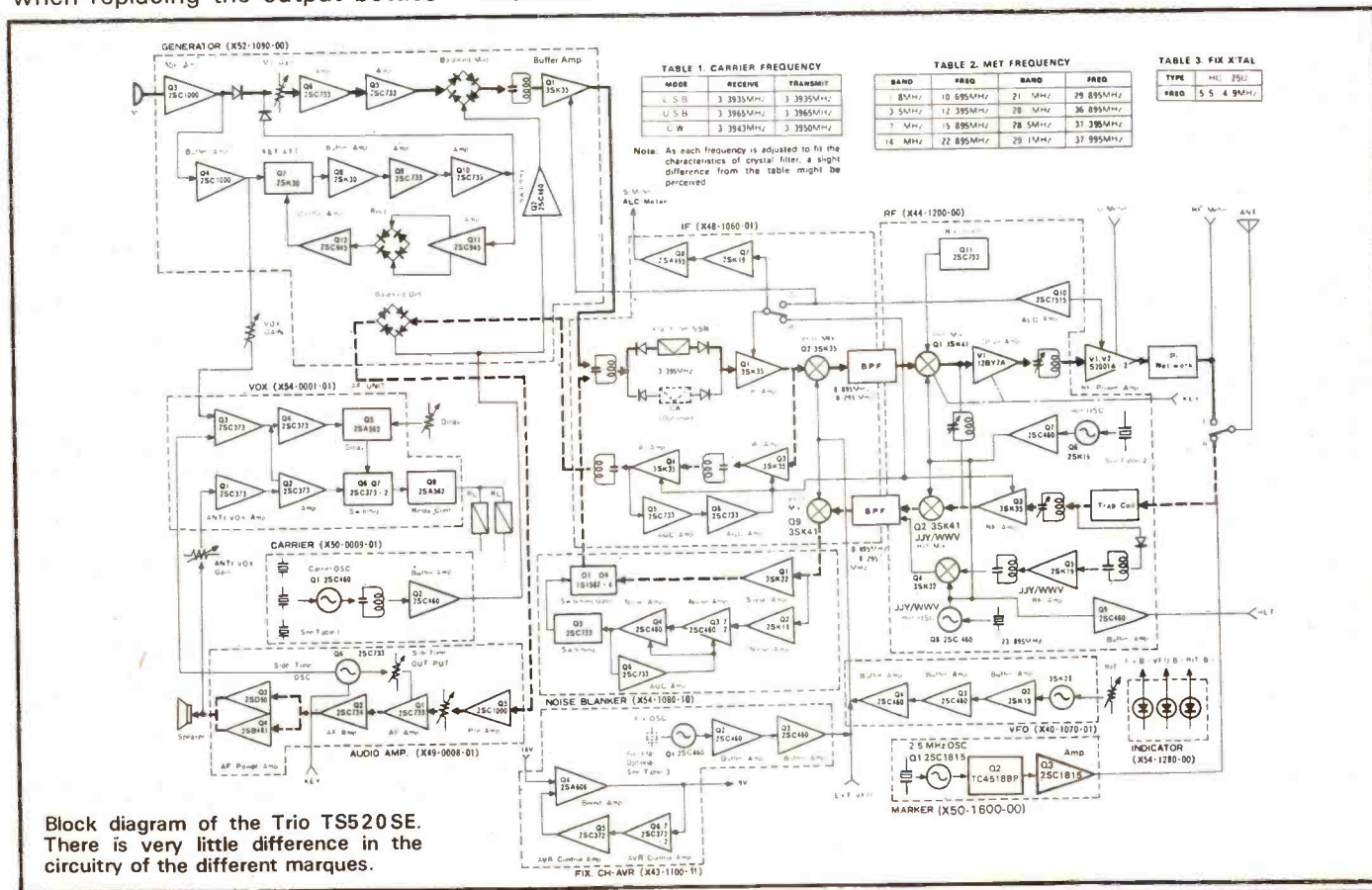

Block diagram of the Trio TS520SE. There is very little difference in the circuitry of the different marques.

Model progression in TS520 series

TS520	Covers 80-10 metre bands. Powered by mains or 12V DC (inverter included in original specification). Provision for connection of transverter for VHF/UHF. No provision for connection of DG5 digital readout. (The DG5 was introduced later, with the TS520S).
TS520S	Covers 160 to 10 metre bands. Powered by mains, but 12V inverter available as extra cost option. Provision for connection of DG5 digital readout. Provision for transverter.
TS520SE	Economy version of TS520S. No provision for 12V inverter (hence cheaper power transformer manufacture). No provision for transverter connection on rear panel, although the Rx input and low level drive are still available inside the transceiver. Change of circuit on voltage regulator board to remove the 6V negative supply inverter. Removal of separate heater switch — but introduction of a most useful function of CW wide/narrow filter switching from front panel. Provision retained for connection of DG5.

Modifications

An article by yours truly was recently published in this magazine which detailed using a CB set to convert SSB rigs to run FM on transmit and receive. The TS520 series was, in fact, used as the test-bed for the original development of the idea, so '10 FM' mods are quite feasible.

Filters of various bandwidths are still available from Lowe, as is their own modification kit to add the 'new' 10MHz band to the rig. Many years ago, your scribe wrote an article on doing this 'mod' yourself (published in Short Wave Magazine), but the 'official' kit from Lowe is so reasonably priced that this is probably the easiest way of adding the band. Full instructions come with the kit, which is fairly easy to incorporate. You are only adding a crystal and a handful of coils. There is no official kit to add any other new bands to the rig, and the provision of only one 'aux' position on the bandswitch precludes the easy incorporation of all the new bands.

An 'add-on' accessory that was available some time ago was a digital frequency display. This merely plugs into various sockets on the back of the rig and works well. These units are today as rare as the Kohinoor diamond, and it's a lucky man indeed who can buy one secondhand. I recently saw one change hands for £50, which was about their price when new, if my memory serves me.

The rig has plenty of space in-

side it and is an ideal recipient of modifications, the only difficult area to work on being the coil pack. A few years back naughty people changed the 28 to 28.5MHz crystal for one just a bit lower in frequency. Now that the whole 'illegal' CB scene is over, many unlicensed owners are trying to dispose of their rigs before they get free holidays to HMG establishments courtesy of the new Telecommunications Act, so this may be a good source of second-hand rigs. Since it will only be necessary to purchase a crystal to restore the unit to its former glory, assuming the correct crystal has been lost, it shouldn't be too difficult a job. External VFOs were recently sold off quite cheaply, and a secondhand one is often reasonably priced around £35.

Servicing

There are two common faults on these rigs. Fortunately both are cheap and easy to repair, so, at the risk of upsetting repair establishments throughout the country, I'll describe them to you.

The most common fault, found in about 50% of all rigs I have repaired, is concerned with the (PA) screen grid switch. This is located on the back panel and is normally only used to disable the PA stage when using the rig to drive transverters. Due to lack of use, the switch tends to go open circuit. This has the devastating result of no output at all on transmit and causes much heartache. Often

a quick couple of flicks of the switch will restore the action, or, in stubborn cases, a squirt of contact cleaner should do the trick. A couple of times I have had to take the switch to bits and clean it up with a swiss file, but this is rare. Incidentally, several '520's I have repaired have had poor soldered joints to this switch, so the terminals are often worth a glance when the covers are off. Look for *dull* grey dry joints.

The common fault on the rig is perfect receive operation, perfect SSB transmit but no CW transmit. This is due to RF absorption on the wires 'twix morse key and rig. Later handbooks suggest screened wire between the '520 and key, and this is a good idea. What happens is that the RF energy being radiated from the rig on transmit is picked up on non-screened leads and burns out a resistor in the '520. Fortunately the resistor is easy to find, as it is soldered to the key socket — any sign of charring of this is an indication of trouble. Check the value for your particular version in the handbook, since it's value was changed during the long production run of the '520s.

Apart from the above, all other faults found in these rigs are purely random failures. If you can't repair the TS520 yourself, Lowe are happy to repair them for you. The engineer that repairs them at Lowe told me that he rarely sees any, so this is either an indication of their ease of repair (ie owners repair them themselves) or the sheer reliability of the beast. I suspect the latter.

Price Guide

If you get a basic, non top-band non mobile power supplied rig without digital display or external VFO for £250/£275 you have done reasonably well, assuming it's working and comes complete with handbook. Obviously you are free to buy or sell at any price you choose, but £300 to £350 would be a fair price to pay for one in very good condition. Incidentally, one owned by a smoker can look really horrible after several years. Very gentle rubbing with a soft cloth, lightly dampened with a very mild water/washing up liquid mixture can work wonders — make sure the rig is dry again before use!

HAM

RADIO TODAY

NEXT MONTH

TWO INTO ONE = FT2700R

We explore how well VHF and UHF go together in Yaesu's new dual bander.

PROJECT! PROJECT! PROJECT! PROJECT!

BUILD A 2m TO 70cm TRANSVERTER
using the Cirkit VHF-UHF converter

PLUS

MULTI-OPERATOR CONTESTING

CORRESPONDENCE COURSES
Can they help you pass the RAE?

D A T A
ICS AMT-2 AMTOR UNIT REVIEWED

AMATEUR ELECTRONICS UK

G6XBH



R. A. S. (Nottingham)
Radio Amateur Supplies
Tel: 0602 280267

G8UUS



Visit your Local Emporium

Large Selection of New/Used Equipment on Show

AGENTS FOR:

ICOM
YAESU
FORTOP ATV

ACCESSORIES:

F.D.K.
AZDEN
Barenco Mast Supports
DRAE P8U and
Wave Meters
Microwave Modules

Welz Range
Adonis Mics
Mutek Pre-Amps

AERIAL: Tonna, Halbar, New Diamond Range of Mobile Whips

PLUS OWN

'Special' Q.R.P. GW5 HF5 Band Beams
JUST GIVE US A RING

Monday: CLOSED Tuesday-Saturday: 10.00am to 5.00pm

3 Farndon Green, Wollaton Park, Nottingham
Off Ring Rd. between A52 (Derby Rd.) & A609 (Ilkeston Rd.)

RECRUITMENT HAM RADIO TODAY

Address the people you
need to recruit.

Ensure your vacancies get
maximum exposure,
radio/TV engineers,
communications,
computing, electronics.

Reach a dedicated
audience now.

Contact *David Gadsden*
for display or
Caroline Faulkner
for Classified.

RAINBOW COMMUNICATIONS

MENU

1. 1/2 wave verticals for 10m £11.90
2. Centre-loaded mobile whips from £7.00
3. 25 watt linear amps from £17.00
4. P.S.Us from £14.00
5. Repairs
6. 10m FM Conversions

WANTED URGENTLY!

2nd hand VHF+HF equipment, part X welcome

SOUP OF THE DAY

Lucas 10M FM RIG
Only £45.

EVERYTHING FOR 10 FM

68
Goringe Park Ave
Mitcham Surrey
Ask for
Howard (G4VWR)
or WIN (xxxxxx)
01-640 1904

OPEN TILL 8PM MON-SAT

SOUTH LONDON'S BUSIEST EMPORIUM

Bugged by morse?

The trouble and bother of learning morse code when you've no natural aptitude can only really be appreciated by someone else with no natural aptitude. And yet, these apparently unlucky people manage to read and speak their mother tongue. So why do they find the business of a few simple dahs and dits so elusive? One theory is that

morse communication. The idea behind this is that morse will thus be seen as something very much worth having — and far from its ancient and out dated image.

The following listing is an attempt to set out some of the better but often unconsidered advantages of the mode which was originally devised as a poor substitute for the

Can't learn morse code? Cy Schweiper, W0NKY, Professor of Psychology at Hicksville University, Ohio, has investigated this phenomenon.

their subconscious tells them that once they have got their full ticket, all the work they're doing will be seen as futile, as they never intend to use morse — thus the subconscious issues instructions that it will not allow its owner to waste his time. So, you have the very sorry spectacle of a brain in self-induced turmoil.

All this may seem to be very much a storm in a teacup, but it is a little known fact that many aspiring hams have sought professional advice in their struggle for morse proficiency and some have indeed taken psychiatric help. Arguably the best answer is not hypnotism, drugs or 'brain washing' but a careful, calm 'psychotherapeutic' delineating of the actual qualities of

human voice — if Samuel Finley Breeze Morse could see it now, he would be suitably startled! No attempt has been made to put the list in order of importance, as opinions on this will obviously differ. So, **Morse enables** . . .

1) a person to have a short QSO without giving offence — when using voice it appears rude to terminate a contact abruptly, whereas somehow CW makes this sound OK.

2) persons with different regional accents to converse without misunderstanding. (There *are* accents present with CW, but they are much more subtle than voice ones.)

3) a level of confidentiality that is largely impossible on voice — of course, the more successful articles like this are, the less privacy can be claimed!

4) QRM to be dealt with much more successfully with simpler equipment — eg earphones can provide a very useful selectivity by their self resonance.

5) contacts are possible in a room where other activities are taking place eg TV watching.

6) ham radio to be possible from poor /A or /P locations — much has been written about how a few watts of CW will 'get through'.



7) skeds to be kept with greater ease — it is much easier to find your partner's CW call and the QRM as it can be read over a wider bandwidth (a paradox which can be readily demonstrated).

8) you to announce your presence or arrival on a voice net without the need to break into the conversation.

9) a QSO to be had at most times, as there is invariably room on the CW end of any band.

10) a QSO to be quite lengthy using one topic — in other words, you need never run out of things to talk about because at 20 wpm, time flies.

11) one to have a subtle sense of achievement after each QSO. This obviously has something to do with the creation of communication with an acquired skill, and so is approaching the feeling of an artist.

12) a fone man to continue a QSO that has been jeopardised by the breakdown of audio.

13) those in a hurry and with limited time for hamming to continue to send while eating with the free hand!

A regular reading and contemplation of the above will cure all but the most stubborn of cases. If the symptoms still persist, a lifelong confinement to FM and SSB working on the VHF/UHF bands is highly likely.

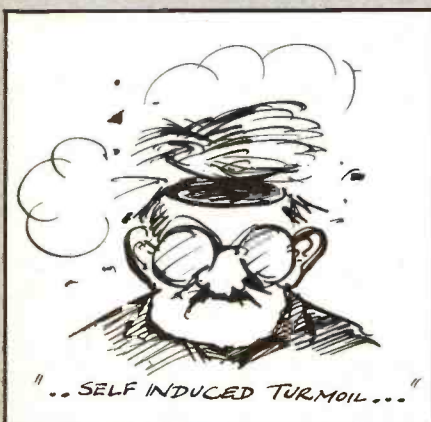

Resurrecting the T2FD

Some antenna types achieve a brief period of popularity and prominence, then they seem to be forgotten by the amateur fraternity. This is quite natural for we are

the T2FD is *not* a folded dipole. Some folk call it a 'squashed rhombic' but I prefer to regard it as a 'leaky' transmission line, which, because of its terminating resistor

If you've got a postage stamp for a garden and are interested in HF multiband operation or general shortwave listening, the long forgotten T2FD demands your consideration. John Heys, G3BDQ, has been using one with excellent results...

always looking for new ideas to read about and perhaps test out in practice. Terminated centre-fed 'slopers', also known as T2FD's (tilted, terminated, folded dipoles) were first described in QST (June 1949) then again in CQ Magazine in 1951. Through the 'fifties' and into a few years of the following decade, they were used with success all over the world. Now it is difficult to find any references to them in modern antenna literature; and such references that exist are brief, very generalised and do not offer full design details.

My first antenna in this genre was made and tested in 1951. It was less than 12 feet long, was strung up from a ceiling hook and then down to my bed post, and it used a home-brew 30 watt (approx!) non-inductive resistor which had been concocted from a frightful mixture of Plaster of Paris and carbon black. This tiny antenna was connected to my 150 watt input CW open chassis (TVI?) rig and a tentative CQ was made on 14 MHz. The call brought back a W2 station who gave me a 569 report! This early half sized version ought not to have even worked on 14 MHz as it was cut for 28 MHz, but somehow it loaded up and radiated.

At first glance (Fig.1), the antenna appears to be a folded dipole with the addition of a non-inductive terminating resistor in the middle of the top wire, but in fact

is not frequency conscious and will operate across a 4:1 frequency range. Over this range it also present an almost constant and low SWR.

A Multiband Antenna

Having such a wide frequency bandwidth makes the antenna very useful, for this means that a T2FD cut for 7 MHz will also cover all the bands from that frequency up to 28 MHz. The T2FD will also cover a large part of the radio spectrum outside our amateur bands, so an intending user must make sure that his rig does not generate any significant out-of-band signals. A

Table 1 The SWR readings obtained on the prototype T2FD

7.05 MHz	=	1:1.5
7.1 MHz	=	1:1.4
10.1 MHz	=	1:1.1
14.0 MHz	=	1:1.3 (see text)
14.2 MHz	=	1:1.6 (see text)
18.1 MHz	=	1:1.6
21.0 MHz	=	1:1.4
21.2 MHz	=	1:1.5
24.9 MHz	=	1:1.5
28.0 MHz	=	1:1.5
28.5 MHz	=	1:1.6
29.0 MHz	=	1:1.6
29.5 MHz	=	1:1.6

similar antenna when cut for 3.5 MHz would be useful up-to-and-including 14 MHz.

The termination resistor *must* be non-inductive, or the antenna may not perform in a uniform way over its frequency range and will certainly exhibit wildly changing feed impedances. The resistor must be between 390 and 410 ohms and have a power rating of at least one third of the transmitter output power, should AM or constant carrier (FM or RTTY work) be contemplated. For low duty-cycle operations such as on SSB or CW, the resistor rating can be reduced to about one quarter of the power to the antenna.

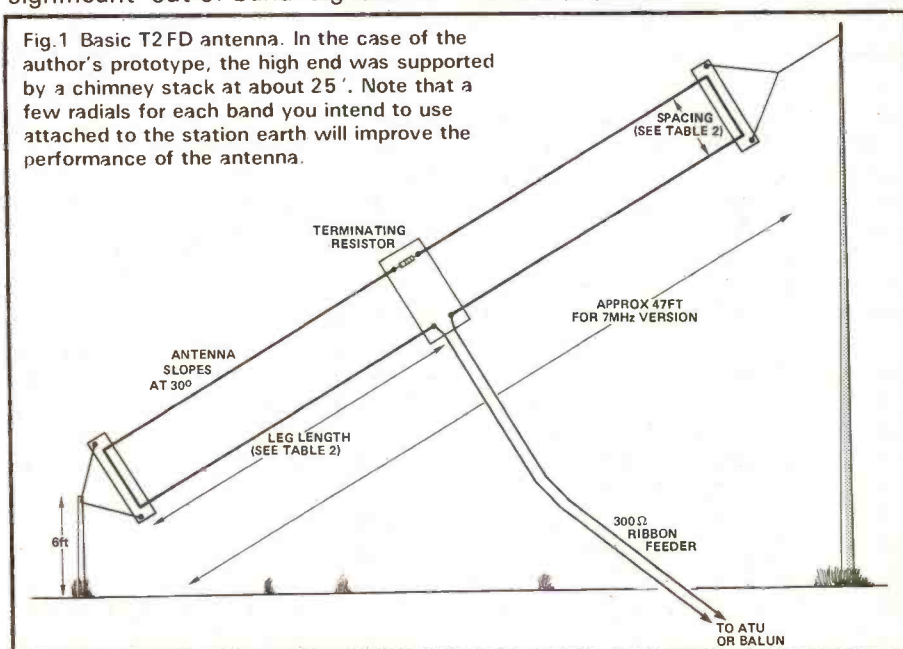

For the best results, the antenna should slope down from a single support with a tilt angle of between 20 and 40 degrees (ideally 30 degrees) to a short anchor point some 6 feet above ground. Following some successful tests with a tilt angle of 30 degrees, the experimental antenna was slung up horizontally. It then worked like a dipole and exhibited the dipole radiation pattern, with its two main lobes of radiation at right angles to the run of the wire. The vertically

which did not even use the optimum value of terminating resistor!

With 300 ohm feed, the antenna must have a terminating resistor of around 400 ohms, as has been already outlined. A 600 ohm open wire feed may be used instead; then the resistor will also have to be about 600 ohms. With feed line impedances of less than 100 ohms, the terminating resistor value becomes very critical — to within ± 5 ohms and such a feed is

representing under half an 'S' point. My ideas on the working of the T2FD may be far from the truth but they are better than *no* kind of explanation; that is all you seem to get from other sources.

Across the 4:1 frequency range of the antenna, the impedance at the shack end of the feeder remains reasonably constant. If 300 ohm ribbon is used, this may be taken straight to the ATU so a low impedance suitable for modern transceivers can be obtained. The writer however decided to use a simple 4:1 step-down balun made from a short piece of ferrite rod and this allowed a direct connection to a TS530S transceiver. Table 1 shows the measured SWR on the different bands when using this arrangement without an ATU.

Later, the station ATU was used between the balun and the rig, and then the 75 or so ohms at the balun was transformed to 50 ohms and a near perfect 1:1 match on all bands. I would suggest that the balun and ATU together are essential for users of equipment with solid state output stages; better to be safe than sorry!

Table 2 Terminated aperiodic antenna (T2FD) dimensions

Band	Length of each leg	Spacing
1.8 MHz	89ft 8 ins	5ft 4 ins
3.5 MHz	46ft 10 ins	2ft 10 ins
7.0 MHz	23ft 5 ins	1ft 4 ins
10.0 MHz	16ft 5 ins	11 ins
14.0 MHz	11ft 8½ ins	8½ ins

See text for design data covering other frequencies

polarised components of the sloper version were not present and the all-round DX capability was diminished.

Theory of the T2FD

This aperiodic (without a natural 'period' or resonance) antenna was developed by the US Navy in the 1940s, and four of them were in use at a Naval Station at Long Beach, California. Field strength measurements showed that they out-performed the Marconi type antennas previously used there. Another Naval Station to use the T2FD had the callsign NDM. A commercial user was a broadcast station on the Japanese island of Kyushu, where it was found to be superior to the half wave centre fed antenna formerly used. It had a signal advantage of between 4 and 8 dB at various test receiving locations.

For the amateur, the T2FD's great advantage is the small amount of space needed. A garden just 45 feet long will easily accommodate a 7 MHz version, and, as has already been mentioned, a 28 MHz T2FD would fit into even one of the 'postage stamp' gardens that so many unfortunates seem to possess. The 1951 CQ DX Contest was won by W4ESK, who used an 80 metre T2FD that had been hastily erected for that band only hours before the contest began and

not recommended.

I have never found anything recorded which really explains how the antenna works. My own theory is that it really relates to the spacing between each wire of an open wire line. When such a spacing is large in terms of a fraction of a wavelength, a considerable proportion of the power along the line will be radiated. The wider the spacing, the greater will be the radiation from the feeder wires.

In the T2FD, the feed line at the antenna centre opens out to a very wide spacing and so radiation is enhanced along what are now the antenna wires. To make the antenna aperiodic or non-resonant, the feeder (actually now the antenna) must be suitably terminated. The ends of the feeder are quite far apart (from almost a half wave on the design frequency and greater at higher frequencies) and a pair of long conductors must run back to meet the terminating resistor at the centre. The antenna currents in the wires going to the resistor are in phase with those on the lower section, as in a folded dipole, and they contribute towards the total radiation.

About one third of the applied power is dissipated as heat in the resistor. This may at first seem a dreadful waste, but in fact it only represents a power loss of about 1.5 to 2 dB; a loss not normally noticed on received signals and

Design and Construction

Table 2 gives the dimensions for aperiodic tilted antennas on five amateur bands. In each case, the band represents the *lowest* usable without bad mismatch and/or feed problems. For any other frequencies, the following basic design data can be used, remembering that any antenna will remain useful at up to four times the design frequency.

Length of each leg from the centre in feet (not including the wire across the two end spreaders:

50,000 divided by the lowest operating frequency in kHz and then multiplied by 3.28.

Spacing between the radiating wires in feet:

3,000 divided by the lowest operating frequency in kHz and then multiplied by 3.28.

The writer's experimental antenna was designed for 7 MHz and was made with PVC covered wire having an external diameter of

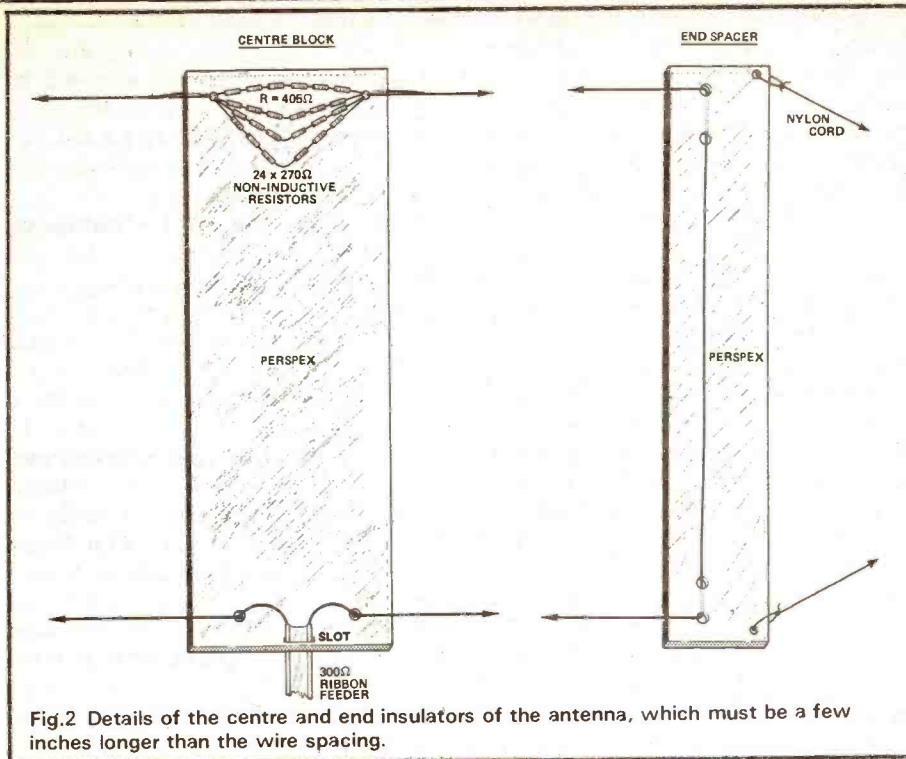

Fig. 2 Details of the centre and end insulators of the antenna, which must be a few inches longer than the wire spacing.

3mm. The wire itself was made from 62 strands of tinned copper and is strong and flexible. This wire may be obtained from W H Westlake, of Holsworthy, Devon, an advertiser in most of the amateur radio magazines. The feeder was a length of the new slotted 'weatherproof' 300 ohm ribbon (BOFA GMP6) from the same supplier. Feeder length of the T2FD is not critical but follows normal practice. Avoid any resonant lengths, such as a quarter wave, or multiple of quarter waves, on one of the bands to be used. The writer found that about 25 feet of feeder was satisfactory. Again, as with all feeders make sure that this comes away from the antenna at right angles for ten feet or more and thus maintain the 'balance' of the antenna.

Flat pieces of 4mm perspex about 18 inches long and three inches wide were used for the two end spacers. In the centre of the antenna, a similar piece of the same material — but six inches wide — was used. There is no need to put in any intermediate spreaders if the antenna is made correctly and properly tensioned. The diagrams (Fig. 2) showing the centre section and one end piece should make things clear.

For anyone contemplating making up a similar antenna, a problem will be finding a high wattage non-

inductive resistor for the centre termination. If you are a QRP merchant never running more than about 5 watts out, there is really no problem — a 2 watt 390 ohm carbon resistor will be ideal. If, however, you run 100 watts of CW and SSB something bigger will be needed. I used 24 one watt carbon film resistors, each of 270 ohm, in a series parallel arrangement. This consists of four lines, each of six resistors, all four lines begin in parallel. To play it safe, I would suggest that 2 watt resistors be used which would allow a safe dissipation of 487 watts — enough for AM or high duty cycle RTTY operations.

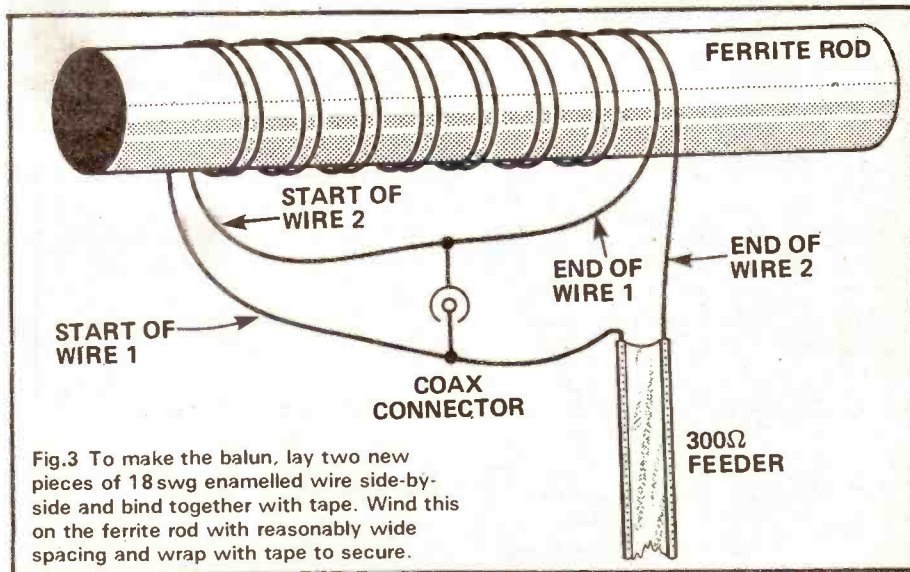

Fig. 3 To make the balun, lay two new pieces of 18 swg enamelled wire side-by-side and bind together with tape. Wind this on the ferrite rod with reasonably wide spacing and wrap with tape to secure.

Sometimes high power non-inductive resistors are advertised as surplus or in the small ads. columns of magazines. Such an advertisement appeared recently and G3BDQ is now the owner of several 400 ohm 80 watt resistors!

Whatever resistors are used they should be weather-proofed. The now easily obtainable Silicon-Rubber sealant is ideal. All the resistors in the 'chain' should be liberally coated with this stuff which not only keeps out moisture but also seems quite heat resistant. A hot soldering iron has no effect upon it at all. When complete the T2FD may be checked by connecting your multimeter across the shack ends of the feeder. The meter should read 405 ohms if the chain of 270 ohm resistors was used. Any breaks, 'burn-outs' or high resistance joints can be looked for at any time after the antenna is in use by just using an ohmmeter.

On pages 51 to 53 of Moxon's book "HF Antennas for All Locations" are described some simple and easy to make baluns. They use ordinary ferrite rod and short lengths of new enamelled wire. Fig. 3 shows my 'Chinese copy' of G6XN's design: the pair that I made and used with the T2FD worked perfectly showing no sign of overheating and having no unwanted resonances.

One oddity arose when testing the antenna. The SWR on the 14 MHz band for some reason lay between 1:2.5 and 1:3 and was not really acceptable. Making a new balun with a different number of turns had no effect, neither did

any lengthening or shortening of the feeder. Eventually it was discovered that on 14 MHz my T2FD showed some inductive reactance.

A variable capacitor was connected over the 300 ohm feeder in the shack and the reactance was then tuned out. A check of the capacitance needed allowed the substitution of a fixed mica 140 pF capacitor which could be easily brought into action when using 14 MHz by the judicious use of a 'croc' clip. Using this capacitor, the SWR came down to 1:1.3 on 14 MHz and 1:1.6 at 14.2 MHz. These low SWR readings were achieved just using a G6XN type balun and no ATU.

At the present time our Licence only allows the use of 'no gain' horizontally polarised antennas on the 18 and 24 MHz bands, so the T2FD with its large vertical radiation component should not be used.

The Antenna In Action

First tests were made with output powers of no more than 50

watts, for the 24 watt dissipation of the antenna terminating resistor was kept in mind. Later, becoming bolder (some may say reckless!) the full output from a TS530S was used on all bands. The resistors survived, and frequent test showed that their nominal 405 ohms was unchanged. At no time however was the key held down for more than a few seconds at the full 100 watts output; to do so would have invited disaster.

There was no need for high power, for, on the 7 MHz band, using QRP less than 5 and often as low as 2 watts, brought back really big reports from all over the UK and Europe. Five watts of SSB enabled a fine QSO with GJ3EML and three watts of CW gained a "20 dB over 9" from G4DMC. For inter-'G' work and into Europe on 7 MHz, the aperiodic antenna seemed better than any other wire system used by G3BDQ on that band. It is to be highly recommended for NFD.

The SWR was very low on 10 MHz and some fine contacts were made on that band, the best being with JP1BTA when using only 30 watts. All Europe of course

was easily workable on 14 MHz both CW and SSB, and during the short time used for testing, Brazil and the Eastern USA were also contacted. On 21 and 28 MHz conditions very, very flat, so most of the contacts made were the so-called 'short skip' stuff. A 589 report from ZC4CZ (Cyprus) on 28 MHz was a welcome addition to the Log.

For the SWL

Finally, this antenna is *ideal* for a keen SWL. It will work over a very wide range of frequencies without any ATU and can be easily be squeezed into most locations; only needing one support mast or chimney stack. My 7 MHz design will cover seven amateur bands and in addition *all the SW broadcast bands above that frequency*. The performance of the T2FD will not 'cut off' suddenly below 7 MHz and can be used for receiving down to at least 3 or 4 MHz. The SWL need not worry about high power resistors and the like — a quarter watt carbon job will suffice!

AN ARGUS SPECIALIST PUBLICATION

electronics today

INTERNATIONAL

JUNE 1985 £1.10

TIME DOMAIN ANALYSIS

Circuit Design On Your Home Micro

Plus:

- Low Cost Audio Mixer
- Second Processor For The Acorn Electron
- The Heat Pen

AUDIO... COMPUTING... MUSIC... RADIO... ROBOTICS...

OUT NOW

Have antenna will travel . . .

Over the last four or five months, due to the problems of buying a flat, the editor has led a rather nomadic existence. Desiring to keep in touch with some friends on 2m FM, an antenna was needed that could be carried in a ruck-sack pouch, and could be taken down and then put up again at very short notice - and without disintegrating as a result of this.

Initially, a vertical 1/2 wave dipole made out of 14 swg copper wire was used. The performance of this was not particularly satisfactory, particularly when hung from a curtain rail or lampshade, usually the only available antenna supports at my various temporary homes. In desperation, a 5 ele Yagi was pressed into service on one occasion resting on two chairs. Not only was the performance only marginally better than the dipole (probably due to various metallic items of furniture in very close proximity) but with a length of around 4', it was hardly portable. The situation seemed desperate...

Enter 'Jim'

Around this time a friend passed on to me a neat plastic tube about 8" long with a length of 300 ohm ribbon protruding from the end.

"You need 'Jim' more than me," he said.

"Eh?" I replied, both touched and



confused.

"It's a 'Slim Jim' type antenna. I know you're not keen on 'omni' antennas but at least you'll be able to talk to me."

Clutching the antenna to my chest, I went straight 'home' (ha-ha) to try it. And he was right...

Enough of this sentimentality and

down to a few facts. The antenna in question was a 'Travelling Jim' from ARM Antennas. The antenna outperformed my disintegrating dipole by a considerable amount. I won't bore you with spurious 'S' meter reports but signals that were noisy and difficult to read on the dipole fully quieted my 2m 'box' on the 'Jim'. On one occasion 'Jim' was hanging from a lampshade in the centre of my parent's lounge (a central lampshade is a far better 'Sky-hook' than a curtain rail - the close proximity of a brick cavity wall can lose you 3 - 4 'S' points with ease) in Eastbourne. An old friend was then worked through GB3KN - some 40-50 miles distant - with 25W to the Travelling Jim from a location only just above sea level. Supplied with 4m of cable and a PL259 plug, the ARM Travelling Jim costs £7.95 and is available from Ray Withers Communications, 584 Hagley Road West, Oldbury, Warley, West Midlands.

A similar antenna could of course be home brewed at a lesser cost. That being said, the ruggedability of the ARM 'Jim' would take some considerable ingenuity to reproduce. 300 ohm ribbon is relatively inexpensive and easy to work with but the PCB stub and plastic casing arrangement would prove a little taxing. Of course, if you have a friend like me with a soft heart and a spare Travelling Jim...

BECOME A RADIO AMATEUR

Train now for the Radio Amateur Licence examination. No previous knowledge needed, only a few hours per week of home study for 3 to 6 months. Post coupon now for details or tel. 062 687 2598 (24 hr service)



British National Radio & Electronics School P.O. Box 7, Teignmouth, Devon, TQ14 OHS



FREE brochure without obligation from: -
British National Radio & Electronics School
P.O. Box 7, TEIGNMOUTH, DEVON, TQ14 OHS

Name

Address

HRT/6

BLOCK CAPS PLEASE

FARNBOROUGH COMMUNICATIONS

FOR ALL YOUR AMATEUR REQUIREMENTS



Instant HP Terms. Ask for details!

Call Mick G4MPW for best bargains.

Call and bargain with MICK G4MPW
DRAE ● MICROWAVE MODULES ● J.BEAM
SHURE MICS ● ADONIS MICS ● WELZ ●
OSKERBLOCK ● BENCHER ● TVI FILTERS
● CABLES ● MIRAGE AMPS
● RSGB PUBLICATIONS ●
AND SO MUCH MORE



97 - Osbourne Road, North Camp
Farnborough. Tel: 0252 518009
Mon-Sat 10-6



A safe mobile microphone

Home construction of microphone assemblies for use with commercial transceivers is popular among radio enthusiasts, but is sometimes mechanically difficult to achieve. This article describes a low-cost microphone assembly that requires

connector parts and requires only the construction of a small cover plate; and secondly, the powering of an electret capacitor microphone capsule, the operation of the 'push to talk' line, and the audio connection is all achieved with a single co-ax

aspects of the microphone are not dependent on the electrical method of connection, and screened multiway cable may be employed if this is more suitable to the user.

Mechanical Construction

At a recent 'rally', I purchased two small electret capacitor microphone inserts for 50p each, of the type commonly used for cassette recorders. These have three connections, ground, a 1.5V supply, and the audio output at a level similar to the output of a dynamic microphone and at a similar 600 ohms impedance. The electret capsule has a few advantages over a conventional dynamic insert. It uses a pre-ionised membrane diaphragm, mounted so as to form a small value capacitor relative to an adjacent fixed plate. This ionised diaphragm possesses a fixed charge and when sound causes it to move, the capacitance will change. Since the charge cannot alter, but the capacitance is changing, a voltage variation will appear across this capacitor and because of the fixed relationships between charge, voltage and displacement, the voltage appears directly proportional to sound amplitude. This makes the capacitor

Mobile operation on the VHF/UHF bands must be one of the most popular activities in our hobby. Operating with a standard fist mike from the car can be an alarming experience, whilst purpose designed commercial microphones are often expensive. Brian Frost, G6UTN, offers a cheap 'homebrew' alternative.

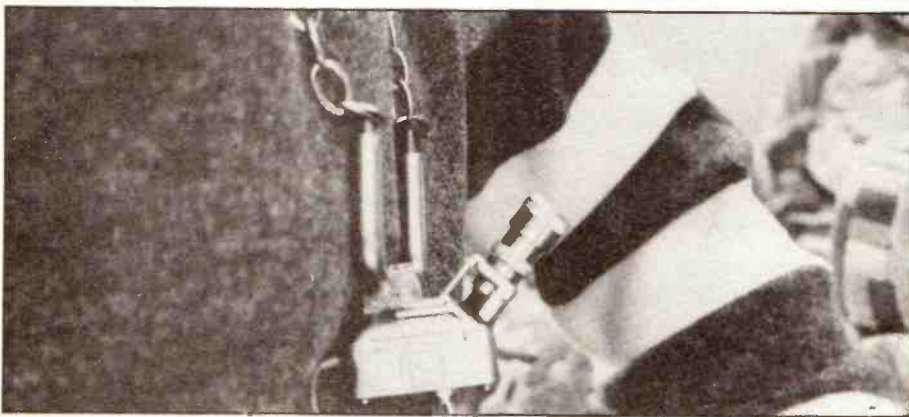

only simple tools, a few connector parts and should be easily made.

My initial motivation was the requirement for a cheap and safe mobile microphone to be used with my FT290 to enable 'hands-off' operation whilst driving; a top priority after the first corner taken in fourth gear resulted in a hasty dropping of the original microphone, only to have it fly away on its coiled lead, bounce off the gear lever and handbrake, before finally coming to rest underneath the seat!

Many others have trodden this path, constructing small, fixed microphones for mobile use, but my design may be of interest for two reasons. Firstly, the microphone unit is assembled by using simple, readily available, con-

necting cable, which is more easily obtainable, smaller and flexible than screened multiway cable.

Of course, the mechanical

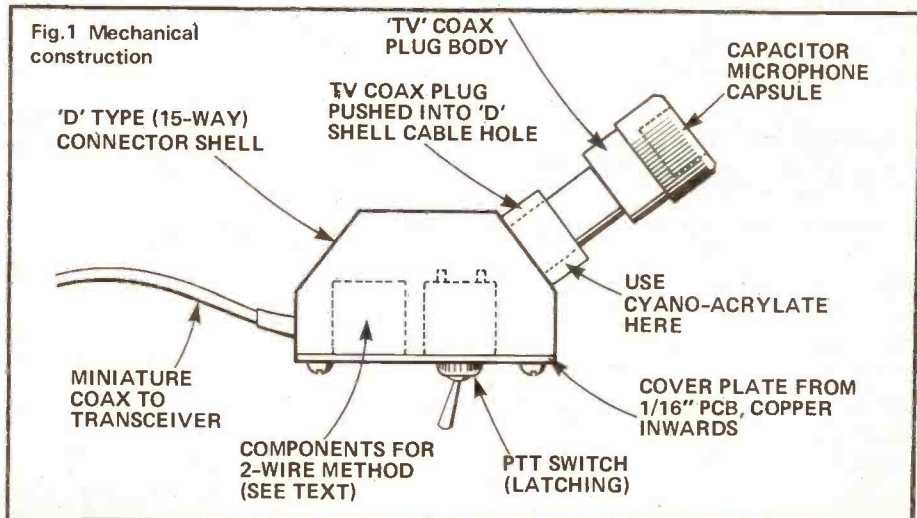

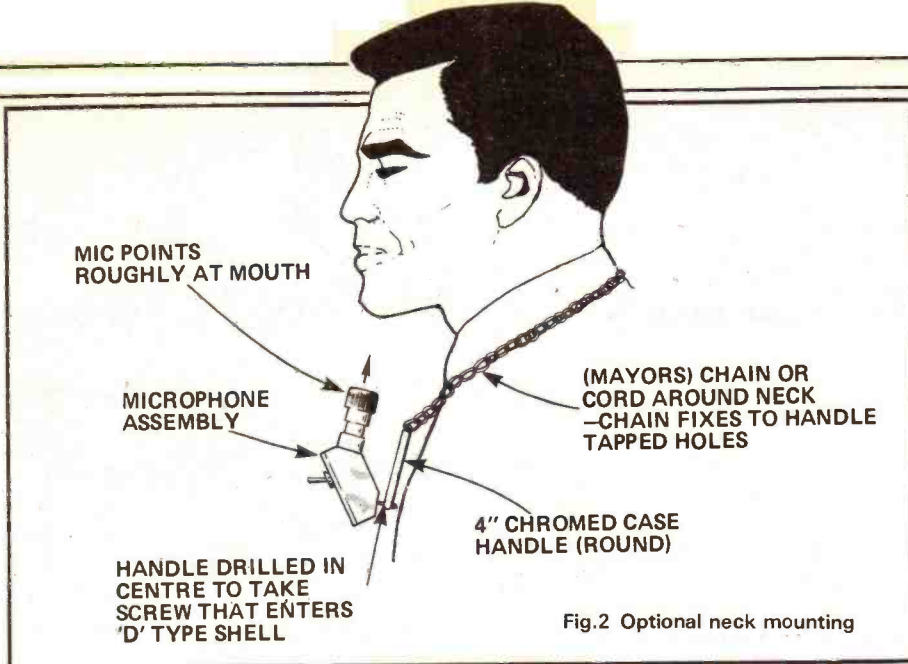

Fig. 2 Optional neck mounting

microphone capable of high quality; and despite the necessity of an in-built FET transistor required to buffer the high resistance of the diaphragm, it is very simple and rugged as well as being much lighter than a dynamic insert.

My first problem was how to house the 8mm diameter capsule containing the insert elegantly. A rummage through the connector box showed that its small size enabled it to fit inside the bodies of most audio connectors. After a number of false starts, the problem was finally solved as shown in Fig. 1. Sorting through the junk box revealed a shell from a 15-way 'D' type connector, the connector pattern similar to the 25-way version in use for RS232 connections between computers and peripherals.

This shell is the metal die-cast version and with the connector removed, it provides a surface with two tapped holes that can be covered with a small plate and thus be used to mount a small PTT (press-to-talk) switch. The cable entry clamp on the shell has a hole that admits a TV co-ax plug as a good fit. After removing the inner assembly from a TV co-ax plug I had to hand, the electret capsule was fitted into the screwed top.

So far then, the only work that is required is to make up the cover plate to replace the 'D' connector and to drill this to take a sub-miniature toggle switch (for PTT) that is small enough to fit inside the shell. In fact, this leaves a small amount of room for the new components that are required if you wish to use the single co-ax method. The TV co-ax plug is fitted

permanently into the cable entry of the shell, either by using the existing cable grip screws, or as I did, by a small amount of Cyanoacrylate adhesive. Prior to this, I cleaned and sprayed the shell with some motorcar 'touch up' paint, which removed its 'die-cast' appearance.

By this time the cover plate is ready to screw on, the only wiring required is to the appropriate microphone plug in your transceiver. A piece of 3 core screened

cable will be required. This will allow the microphone capsule to be powered from the transceiver (if it has a DC output pin on the microphone connector as in the case of FT 290; if not, 2 core screened cable can be used with a small watch cell in the connector shell to the capacitor microphone).

'Hands Off'

The microphone unit is now finished, and although looking somewhat unusually shaped, does fit well into the hand with its PTT switch. So what of 'hands-off' operation? To achieve this, a single chrome type case handle of the sort used in pairs on the front panel of rack mounted equipment will be required; one about 100 mm between mounting centre, together with a piece of chain — such as that used for basin plugs etc! Drill the handle with one central hole as shown in Fig. 2. The hole allows the connector shell to mount onto the case handle with a single screw; the chain is then attached to the ends of the case handle and the assembly worn around the neck (see also nearby photo). In use, the handle lies flat on the chest (well,

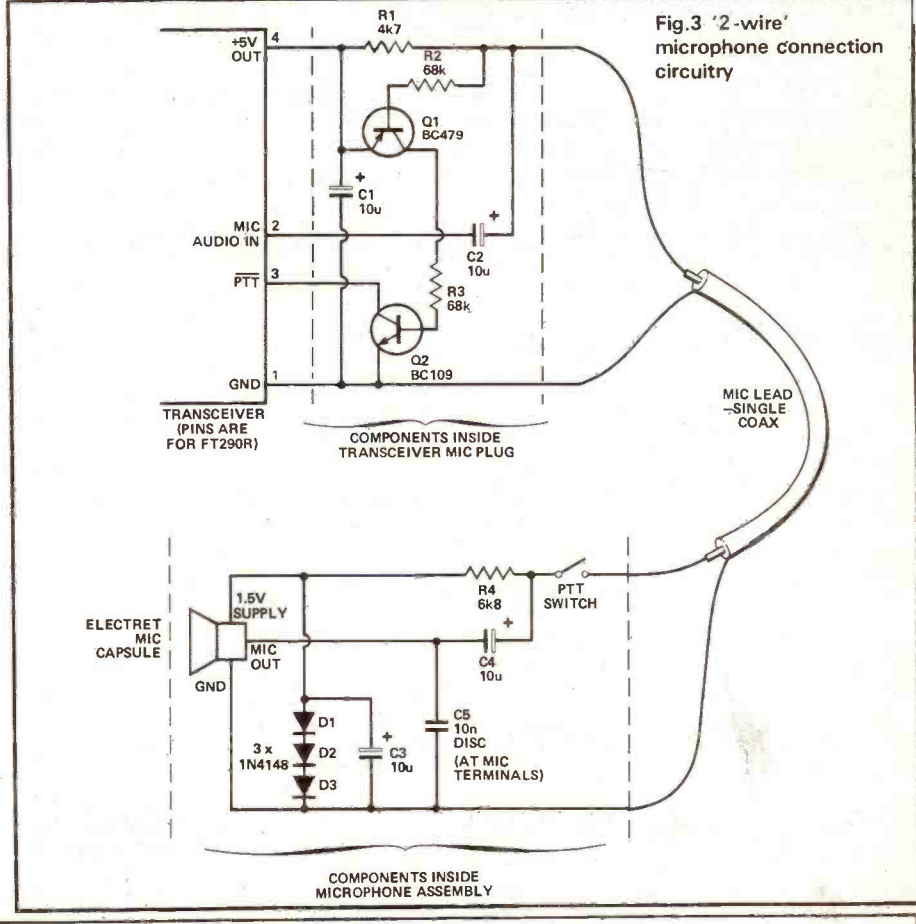

Fig. 3 '2-wire' microphone connection circuitry



on a man anyway) and the microphone assembly is then held at a reasonable angle, about 200mm from the mouth. The PTT switch projects forward (ie away from you) and is easily accessible.

In use, it is very comfortable, allowing you to move freely in the car and gear changes become enjoyable once again. Remember, though, that excessive noise level inside the car will degrade your transmission due to the increased distance between your mouth and the microphone.

Operation of the Microphone using Single Core Co-ax

This method allows the operation of the transceiver PTT line, the powering of the microphone capsule and the audio connection, all to be made along single core co-ax cable. This not only has the advantage that extension leads are readily made, but that very lightweight co-ax with considerable flexibility, such as the 2mm dia type that I used, can be accommodated.

The principle is straightforward and is shown in the circuit diagram of Fig.3. Transistor Q1 monitors the voltage drop across R1, which

passes the current necessary to power the microphone when the PTT switch is closed. Q1 then switched on, in turn switching on Q2 and pulling the transceiver PTT line to low to cause the transceiver to transmit. DC current flows via R1, along the co-ax and via R4 to cause a voltage drop across D1, 2 and 3, so giving 1.5V, decoupled by C3, to provide power to the electret capsule. The audio output is coupled via C4 back onto the co-ax and is superimposed in the DC supply, to be coupled back off from the co-ax at the transceiver end by C2 C5 prevents RF pick-up in the microphone lead from affecting the electret capsule. Not all transceivers may have a DC output, in which case perhaps two small watch type cells can be substituted. The current drain of the unit is very small, since current is taken only when transmitting and even then is only around 300uA.

Housing the additional components at the microphone end is easy, but more room is required at the transceiver end in the microphone plug. This is achieved as shown in Fig.4. Obtain the audio 'DIN' plug with a plastic cover. With the internals removed, the cover should be found to be a tight fit over the body of an existing microphone connector after the cable clamp has been removed. This creates enough space within the DIN plug body to assemble the components.

Other Transceivers

There are a few points worth noting about the circuit which will help in modifying this for other microphone capsules, other power supplies or transceivers. Since audio from the microphone passes along the co-ax with the power supply, any lack of smoothing or any noise on this supply will be in-

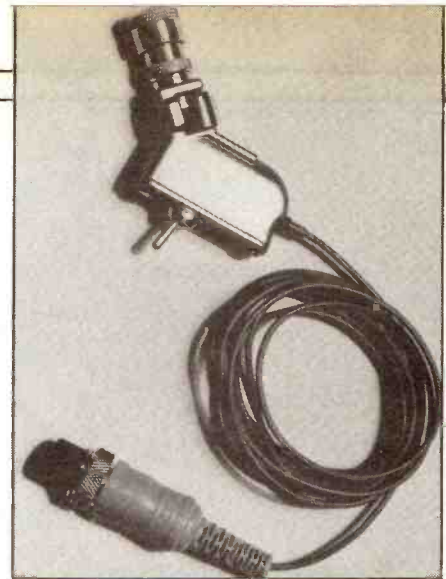

distinguishable from real audio and on my FT290, a slight whine had to be cured by adding C1 (Fig.3) to decouple it. In severe cases R1 could be split into two, a capacitor added to the junction or even a regulator or watch cell used. If this problem is apparent, there will be noise on the carrier that remains even when the electret is disconnected.

If the DC supply across the capsule is not sufficient, then R1 and R4 should be reduced; their paralleled value should not fall much below 1K however, or the audio output of the capsule will be loaded. If the supply voltage is higher than the 5V from my FT290, R1 and R4 should be increased as required.

If there are RF pick-up problems apparent, for example feedback on SSB or a hum that varies as the microphone lead is moved about, there are some improvements that can be made to improve this situation. Ensure firstly that the electret capsule's ground connection is taken to the co-ax plug body (by trapping a piece of tinned copper wire between the two for example) and that the die-cast shell is also grounded. Then solder a small ceramic disc capacitor (about 1 to 10nF) across the microphone capsule audio output, at the audio input pin of the transceiver in the plug, and this should cure any problems caused by RF leakage.

If the PTT operation appears to be erratic, it is probable that the current sensing circuit is being affected by RF and again a small ceramic disc capacitor can be added from the base of each transistor to the emitter. In my case, only one capacitor across the audio output from the capsule was necessary.

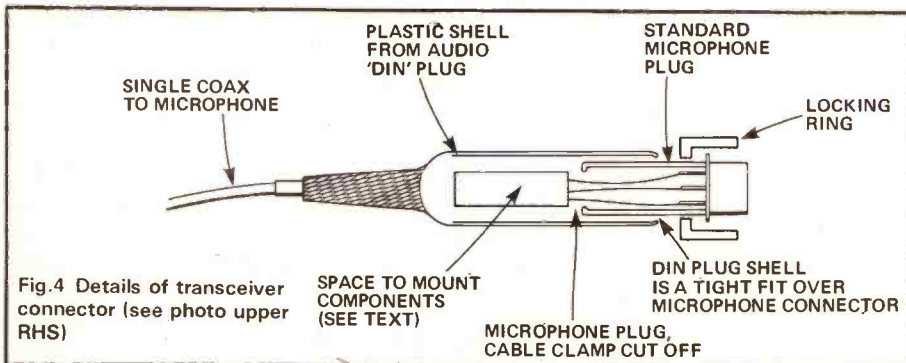

Fig.4 Details of transceiver connector (see photo upper RHS)

RADIO Tomorrow

Your at-a-glance guide to what's happening around the clubs, on the air and in general radio-wise.

- 1 May** Three Counties ARC: *Horizontal FM* by G4RRA.
Wirral ARS: *DF Techniques*.
Worthing DARC: meets every Wednesday at the Parish Hall, South Street, Lancing at 7.30pm.
Cheshunt DARC: *The RSGB with G3VPK, zone C rep*.
Wirral DARC: Eastham Ferry Hotel drink and waffle.
Fareham DARC: natter night on the air.
S E Kent (YMCA) ARC: natter night.
Stroud ARS: formerly the S Cotswold ARS and recently moved to Nelson School, Stratford Lodge, Stroud. Morse classes and G4SRS on the air.
- 2 May** Cray Valley RS: *The Micro Ham* by G6CSY.
Inverness ARC: meets every Thursday at 7.30pm at the club rooms, Cameron Youth Centre, Planefield Road, Inverness.
Horsham ARC: *HF Propagation* by G3LTP at the Guide HQ, Denne Road, Horsham starting at 8pm.
North Wakefield RC: on the air night. Please note the change of venue to the White Horse pub, Thorpe Road, East Ardsley, 8pm start.
- 3 May** Dartford Heath DFC: AGM.
Wirral ARS: Annual Dinner at the Heatherland Restaurant, Thurstaston.
Coventry ARS: visit.
Maltby ARS: *Getting on 23cm* by G6OYL.
Axe Vale ARC: meeting.
West Kent ARS: Construction Contest.
Radio Society of Harrow: activity night on 10m.
Clifton ARS; meets every Friday, ring Secretary for details.
S Manchester RC: *winner of the home construction contest tells all!*
- 5 May** Southgate ARS: RAYNET raft race.
- 6 May** Horndean DARC: *Salvage of the SS Great Britain* by G4BEQ.
Rhyl DARC: *ATV Demonstration* by GW8XLL.
Leighton Linlade RC: DF Hunt.
Todmorden DARS: HF Demonstration station G4WYT. The club meets at the Queen Hotel, Todmorden at 8pm, all welcome.
Basingstoke ARC: *Questions and Answers on Technical Problems* at the Forest Rings Community Centre, Winklebury, Basingstoke starts 7.30pm.
- 7 May** Dartford Heath DFC: pre hunt meeting.
- Chichester DARC: *24cm ATV*.
E Lancashire ARC: *The Tornado Fighter Aircraft*.
Bury RS: informal.
Loughborough AREC: constructors group.
Fylde ARS: *A Few Words about the RSGB* by G3XSV.
8 May Farnborough DRS: *HF Contest Operating* by G8VR.
Cheshunt DARC: natter night.
Wirral DARC: club station on the air.
Fareham DARC: *Computers in Radio* by G6UXW. Venue — Porchester Community Centre, room 12 from 7.30pm.
Exmouth ARC: meeting at the Scout Hut, Marpool Hill, Exmouth at 7.30pm. Visitors most welcome.
GB2 MHC special event station organised by Clwyd County RAYNET Group. It will operate from 1000 to 2200 on all bands.
S E Kent (YMCA) ARC: *White Stick Operating*.
9 May Edgware DRS: informal.
Southgate ARC: *Wind Loading and Safety of Towers* by G3UDO of Allweld.
Abergavenny and Nevill Hall ARC: meets every Thursday at Pen-y-Fal Hospital, above male ward 2 starting at 7.30pm.
- 10 May** Coventry ARS: night on the air.
Maltby ARS: *Slow Scan TV*.
Loughborough AREC: RTTY Evening.
Dunstable Downs RC: DF Hunt on 160 and 2m.
S Manchester RC: *Microwaves* by G3PFR.
- 11-18 May** Nene Valley RC Lundy Island Expedition. Callsign GB4LI on all HF bands, WAB on 40, 80 and 160m and 2m and 70cm.
- 11 May** Glasgow Amateur Radio Exhibition at the Cardonald College, starting at 11am. Extensive parking available, many stalls and a lecture schedule. Further details from W of Scotland ARS, GM4JDU on 050 581 2708.
- 12 May** Dartford Heath DFC: club hunt.
Wolverhampton ARS: 144MHz DF hunt.
Drayton Mobile Rally.
Wirral DARC: DF hunt.
Swindon Radio and Electronics Rally '85 organised by Swindon DARC at the Oakfield School, Marlowe Avenue, Swindon. Starting at 10am, admission is 50p (parking free). There are refreshments and attractions for the family. Talkin on S22 and GB3TD, further details from

- 13 May Ken, G8SFM, on Leighterton (066 689) 307. Southgate ARS: *AMTOR*. Hazelrigg ARC: meets every Monday from 7.15 to about 9.30 at the Community Centre in Hazelrigg Village. Visitors and new members welcome. Milton Keynes DARS: *Testing for Performance by G8ASP*.
- 14 May Wolverhampton ARS: open meeting. Wakefield DRS: *CW Operating*. Chester DRS: Secret Listeners plus W0ORE Lecture videos. Westmorland RS: AGM. Bury RS: *So You Want to Build a Power Unit by G4KLT*. Loughborough AREC: constructors group. Three Counties ARC: Junk Sale. Wirral ARS: display of members homebrew equipment. Cheshunt DARC: *Radio Paging by G6AXO of Harlow RS*. Wirral DARC: Bassett Hound D+W Fareham DARC: natter night on the air. S E Kent (YMCA) ARC: *Causes and Cures of TVI*. Stroud ARS: meeting starting at 8pm.
- 15 May N Wakefield RC: Royal Observer Corp, York, visit. Chichester DARC: club meeting. S Manchester RC: Preparing for Contest.
- 16 May Sutton and Cheam RS: AGM. Coventry ARS: *Microwaves*. Maltby ARS: Visit by Lowe Electronics. Loughborough AREC: social — darts and ale.
- 17 May Mid Ulster ARC Rally starts at 12 noon in the Thomas Doran Training Centre. All proceeds to charity and a good day's fun and entertainment for all is promised. Further details from G11 CFS QTHR.
- 19 May Rhyl DARC: activity night. Worcester DARC: informal. Leighton Linlade RC: *934MHz Aerials by G6IXH*. Todmorden DARS: informal natter.
- 20 May Fylde ARS: Equipment Sale. Midland ARS: *Aerials for the Small Garden with G3BA*. Chester DRS: *Talk on NARSA by Peter Denton*. Bury RS: Video Quiz Bury vs Warrington RC. Loughborough AREC: constructors group. Wolverhampton ARS: committee meeting.
- 21 May Farnborough DRS: HF Field Day Preview/natter night. Cheshunt DARC: natter night. Ipswich RC: Planning for the East Suffolk Wireless Revival. Fareham DARC: *GB3PH by the Group*. Exmouth ARC: meeting. S E Kent (YMCA) ARC: *More on Anything (perhaps brass pounding?) by G3LCK*.
- 22 May N Wakefield RC: social night. Edgware DRS: Constructors contest and NFD briefing. Greater Peterborough ARC: Preparations for VHF NFD, on 2m and 70cm hopefully!
- 23 May Coventry ARS: night on the air. Loughborough AREC: Second 160m DF. Dunstable Downs RC: *Weather Satellites by G8LOK*. S Manchester RC: AGM.
- 24 May Wirral DARC special event station GB2IWF to mark the international waterways festival at Ellesmere Port boat museum — HF, VHF and UHF.
- 25-27 May
- 26 May Maidstone YMCA ARS 1985 Biennial Mobile Rally at the 'Y' Sports Centre, Melrose Close, Cripple Street, Maidstone. Doors open at 11 am with a talkin on S22. Refreshments available and many attractions. Plymouth Amateur Radio Rally from 10 am at the Devonport Secondary School, Park Avenue, Devonport. Stalls include second hand. Talkin on S22 and RB2. East Suffolk Wireless Revival 1985 at the Civil Service Sportsground, Straight Road, Bucklesham, Ipswich. An entertaining day out for all the family. Further details from G4IFF, Jack, on 0473 44047. Mid Warwickshire ARS: natter night. Wakefield DRS: Bring and Buy Sale. E Lancashire ARC: informal. Chester DRS: *Coaxial Cable by G2JT*. Bury RS: informal. Loughborough AREC: constructors group. Verulam ARC: *Clandestine Wireless (SOE) by John Brown, G3EUR*.
- 28 May Three Counties ARC: home computer night — bring along your micros. Cheshunt DARC: *Contest Operations 'Primer'! with G3WFM*. Wirral DARC: pre-season practice DF hunt from: Heswall layby from 8pm. Fareham DARC: natter night on the air. S E Kent (YMCA) ARC: club project. Stroud ARS: meeting. N Wakefield RC: monthly meeting.
- 29 May Edgware DRS: Straight Key Evening 1985 on 3.5 MHz CW. Catch the HRT team (G3ZZD, G4NXV and G1CKF) on the air as GB4 HRT from 0900 to 2200 based at the Milton Keynes DARS meeting place.
- 30 May Coventry ARS: VHF DF contest.
- 31 May HF National Field Day from 1600-1600, CW on 1.8, 3.5, 7, 14, 21, + 28 MHz
- 1-2 Jun Three Counties ARC: *Amateur Radio Insurance by Mr Gibson*.
- 1 Jun Spalding DARS Mobile Rally.
- 2 Jun Horndean DARC: *RAYNET by G4JXO*.
- 3 Jun Rhyl DARC: visit to the Communications Room at the NW Police HQ. Worcester DARC: Test Your Spec — Rig Inspection. Southgate ARS: *Kits for Radio Amateurs*. Hazelrigg ARC: meets every Monday at the Community Centre, Hazelrigg. G4YPT usually operational, refreshments available and always a natter group. Leighton Linlade RC: meeting. Todmorden DARS: Car Treasure Hunt for G4HYY Trophy. Basingstoke ARC: *Antennas by G8CKN*. E Lancashire ARC: *Japanese Morse*. Bury RS: informal. Loughborough AREC: constructors group. Fylde ARS: *Gliding as a Sport by the Chairman of Blackpool and Fylde Gliding Club*. Chichester DARC: *HF Wire Antennas by G5RV*. Wirral ARS: *AMTOR by G6VS*. Worthing DARC: meets every Wednesday at the Parish Hall South Street, Lancing starting at 7.30 pm. Cheshunt DARC: natter night. Fareham DARC: *The Oscilloscope*. Exmouth ARC: meeting.

- 6 Jun N Wakefield RC: on the air night.
Inverness ARC: meeting.
- 7 Jun Horsham ARC: ring Pete for details.
Coventry ARS: night on the air
Loughborough AREC: Junk Sale and Open Forum.
Clifton ARS: meeting.
S Manchester RC: meeting.
Dunstable Downs RC: trip to Mullard Observatory.
- 9 Jun **RSGB 432 MHz Trophy Contest.**
- 11 Jun Mid Warwickshire ARS: Fox Hunt.
Chester DRS: *Design and Construction of a 15m Converter by G3EON.*
Westmorland RS: meeting.
Loughborough AREC: constructors group.
- 12 Jun Cheshunt DARC: 2m Portable on Baas Hill Common.
Farnborough DRS: *VHF/UHF Aerials by G8CKN.*
Fareham DARC: natter night on the air.
Stroud ARS: meeting.
- 13 Jun N Wakefield RC: lecture/visit.
Abergavenny and Nevill Hall ARC: meeting.
- 14 Jun Loughborough AREC: HF night on the air.
S Manchester RC: meeting.
- 17 Jun Rhyl DARC: *QRP Operating by George Dobbs, G3RJV.*
Worcester DARC: informal.
Leighton Linslade RC: meeting.
Todmorden DARS: informal natter.
- 18 Jun Chester DRS: Bar-B-Que.
Loughborough AREC: constructors group.
Fylde ARS: informal and morse.
- 19 Jun Wirral ARS: technical talk.
Cheshunt DARC: natter night.
Fareham DARC: *Aerials and Planning Permission.*
- 20 Jun Exmouth ARC: meeting.
N Wakefield RC: Fox Hunt
Chichester DARC: Goodwood Evening Rally.
- 21 Jun Sutton and Cheam RS: Quiz vs Coulsdon club.
Loughborough AREC: Third 160m DF Hunt.
Dunstable Downs RC: planning for VHF NFD.
S Manchester RC: mid summer night DF contest.
- 23 Jun **S E Kent (YMCA) ARC: Mid Summer Rally at the YMCA Centre, operating a special event station, GB0IYY between 10.30am and 4pm.**
- 25 Jun Mid Warwickshire ARS: *G5UM Awards.*
E Lancashire ARC: informal.
Chester DRS: *PCB Photo Etching by G8OJQ.*
Loughborough AREC: constructors group.
- 26 Jun Three Counties ARC: HF and VHF stations on the air.
Cheshunt DARC: club project with G4ZOX.
Farnborough DRS: VHF NFD preview.
Fareham DARC: natter night on the air.
Stroud ARS: meeting.
- 27 Jun N Wakefield RC: monthly meeting.
- 28 Jun Loughborough AREC: *Contest Operation.*
S Manchester RC: *Visit and Talk by Region 1 Rep.*
- 30 Jun **Buxton Mobile Rally at the Pavilion Gardens, Buxton. Admission by programme - 50p. A wide range of facilities all the usual stands and an RSGB bookstall.**
- 1 Jul Horndean DARC: *Working CW by G4OFG.*
Hazelrigg ARC: meeting.
Basingstoke ARC: VHF NFD arrangements.

Will club secretaries please note that the deadline for the August segment of Radio Tomorrow (covering radio activities from 1st July to 1st September) is 28th May.

Contacts

Axe Vale ARC	Roger Jones	040 486 468	N. Cornwall RS	J. West	0288 4916
Barking RES	R. Woodberry	01 594 4009	N. Wakefield RC	S. Thompson	0532 536633
Bath DARC	G4UMN	Frome 63939	Preston ARS	George	0772 718175
Basingstoke ARC	Dave	07356 5185	Oswestry DARC	Brian	0691 831023
Braintree RS	J. Roberts	0376 44857	Reading DARC	Chris	Reading 471761
Brighton DARS	Peter	0273 607737	Rhyl DARC	GW1AKT	Nantglyn 469
Bristol ARC	G4YOC	Bitton 4116	Shefford DRS	G4PSO	Hitchin 57949
Bury RS	Bryan	0282 24254	S. Bristol ARS	Len Baker	0272 834282
Cambridge DARC	D. Wilcox	0954 50597	S. Lakeland ARS	Dave	0229 54982
Cheshunt DARC	Roger Frisby	0992 464975	S. Manchester ARC	Dave Holland	061 973 1837
Chichester DARC	C. Bryan	0243 789587	Southdown ARS	P. Henly	0323 763123
Coventry ARS	R. Tew	0203 73999	Stockton DARS	John Walker	0642 582578
Donegal ARC	E13BOB	074 57155	Stowmarket DARS	M. Goodrum	0449 676288
Droitwich DARC	G4HFP	0299 33818	St. Helens DARC	A. Riley	051 430 9227
Dudley ARC	John	0384 278300	Swale ARC	B. Hancock	0795 873147
Dunstable Downs RC	Phill Morris	0582 607623	Telford DARS	Tom Crosbie	0952 597506
East Kent RS	Stuart	0227 68913	Three Counties ARC	R. Hodgson	0428 77368
Edware DARS	John	01 306 4342	Tiverton (SW) RC	G. Draper	03634 235
Exeter ARS	Roger Tipper	0392 68065	V White Horse ARS	Ian White	Abingdon 31559
Farnborough DRS	Mr Taylor	0252 837581	Verulam ARC	Secretary	St Albans 59318
Fylde RS	PRO	0253 737680	WACRAL	G4NPM	0795 873147
Halifax DARS	DL Moss	0422 202306	Wakefield DRS	G8PBE	0924 378727
Harrow RS	Dave Atkins	0923 779942	Welland Valley ARS	J. Day	0858 32109
Hastings ERC	Dave Shirley	0424 420608	West Kent ARS	J. Green	0892 32877
Haverhill DARS	Rob Proctor	0787 281359	Westmorland RS	G. Chapman	0539 28491
Hornsea ARC	Norman	0262 73635	Willenhall ARS	G4LWI	0902 782036
Horsham ARC	Pete Head	0403 64580	Wirral ARS	Cedric	051 625 7311
Kidderminster DARS	Tony	0562 751584	Wirral DARC	Gerry Scott	051 630 1393
Leighton Linslade RC	Pete Brazier	052 523 270	Wolverhampton ARS	Keith	0902 24870
Maltby ARS	Ian Abel	0709 814911	Worcester DARC	D. Batchelor	0905 641733
Medway ARTS	Andy Wallis	0634 363960	Worthing DARC	Jim Hicks	0903 690415
Mid Ulster ARC	DF Campbell	0762 42620	308 ARC (Surbiton)	Dave Davis	01 399 5487
Mid-Warwickshire ARS	G4TIL	Southam 4765			

Meet the **MICRON!** Part 2

Before you attempt to build this transceiver, please read the following notes carefully. The great majority of the *Micron* is built on a single double sided PCB obtainable from WPO Communications, the underside carrying all the tracks,

is blue in colour. This is designed to prevent you soldering where not required, and also virtually prevents 'solder bridges' (unwanted connections caused by excess solder) being formed. *Do not* attempt to solder directly to the blue portions

Before Starting Work

You will require a modern soldering iron designed for printed circuit work, with a bit diameter not exceeding 2.5mm. We recommend the use of 22swg multicore solder rather than 18swg — *under no circumstances* should acid cored solder be used for this type of construction.

The great majority of faults in constructed kits are due to poor soldering causing intermittent or sometimes no contact between the component lead and the printed circuit track. *Never* take the solder to the joint on the soldering iron bit! The correct technique is to apply the bit to the joint to be soldered so that it is in contact *both* with the *component lead* and the PCB track — after about 1 second, the solder is then applied to the junction of the

In part 2, Frank Ogden, G4JST, and Tony Bailey, G3WPO, describe the major part of the construction of this six band 0 — 10W HF CW transceiver.

and the topside (or foil side) is where the components mount, with a few exceptions. The foil side acts as a continuous ground plane to which some of the component leads are directly soldered and ensures stability of the various RF circuits. Besides being screened with the component positions, the foil side and the track side have been covered with a 'solder mask' which

of the board on either side, *only* to the bright tinned parts.

A smaller PCB which amounts on the side of the VFO enclosure is used for the PLL VFO phase comparator circuitry. This part of the circuit generates a lot of RF noise and harmonics, from the reference VFO, and so a separate board has been utilised for this. Again, this PCB is screened and solder masked.



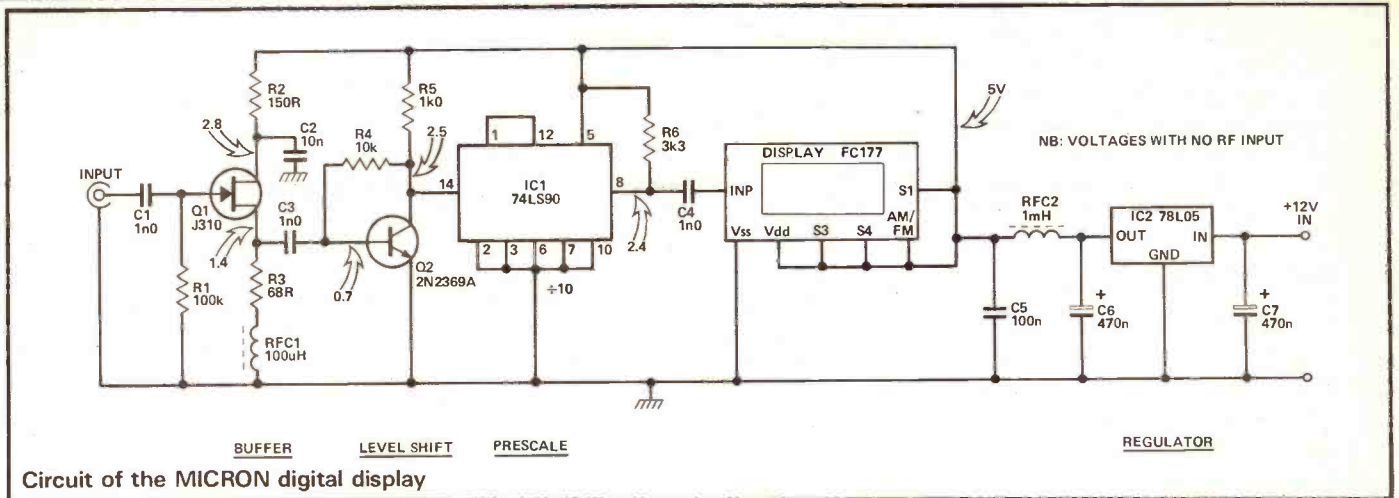

bit and the lead and allowed to flow onto both, only removing the bit when it can be seen that the solder has flowed to make a perfect joint. The result should be a 'bright' joint. Dull or 'grainy' surfaced joints are almost certainly 'dry' and should be resoldered by reheating and then applying a little more solder.

If it appears difficult to achieve a good joint, the component should be removed and the lead cleaned with a sharp knife or Emery paper before resoldering.

Always remove excess leads after soldering, never before — you may cut the lead too short and have no soldered connection at all!

There are a number of very important general points which should be observed regarding the mounting of components. Unless instructed otherwise, horizontal mounting resistors and capacitors lie flat against the PCB top surface, thus achieving the shortest possible. Vertical mounting resistors and capacitors have one end flush against the PCB — always observe the layout diagram as to which end is in which hole. This can be important where RF is involved as the wire end of the resistor can act as an antenna, either radiating or picking up unwanted signals above the PCB.

Capacitors, such as disc ceramics, should be pushed into the PCB as far as they will easily go, without placing too much strain on the leads where they enter the body. In some cases, this will mean that they can go right against the PCB surface, in others a few millimetres above. Never allow a component to have more than 5mm of its leads above the PCB.

Those resistors which have one

end earthed by soldering to the top foil should have their leads pushed through both holes prior to soldering, and in some cases are soldered on both sides of the PCB — always be guided by the blue solder mask — if the hole or pad is covered by blue resist then it is not soldered — if it is bright and tinned then it is.

Some components, mainly disc ceramic and electrolytic capacitors, which have earths to the top foil have their 'earthy' lead bent out at right angles to the body and that lead is then soldered to the top foil in the unmasked area nearby. For these components, bend the lead at right angles, temporarily insert it into the PCB, and cut the earthy lead to a length which just brings it inside the solderable area on the board before finally soldering in place.

Not all earths are made to the top foil, and in many cases you will find holes on top of the PCB which could be soldered if they were not covered with resist. These points have earths on the track side and no attempt should be made to solder to the top side as well.

Transistors, other than Q48 (2N3553), Q49 (2SC1969) and Q39 (TIP34A) are pushed into their holes until the underside of the device is 5mm above the PCB upper surface. If the leads are left longer than this, you stand a good chance of instability, especially in the RF sections.

Specific instructions for various components are given where necessary together with drawings. Note that these instructions are a condensed form of those actually available with the kits which are more comprehensive and include full component iden-

tification and component-by-component assembly details.

Starting Assembly

The Micron is built in several stages, with checks along route for functioning. This has the advantages that you will find easier if any faults have to be eliminated by dealing only with a part of the circuit at a time.

After soldering each component, cut off the excess leads on the underside of the PCB close to the solder joint. There are a number of connection pins to be inserted into the PCB — these are used for later connections of coaxial and other cables. To insert these, they are pushed into the hole from the underside of the board as far as they will go, then pushed hard home with a blunt nosed tool, so that the flat head is resting against the track. Then solder them in, if necessary on both sides of the board.

Insert and solder pins at the following points: H and the hole immediately above it (VFO), AL (to left of VFO), AZ (above VFO), AP (above VFO), AF (below VFO), AK (below VFO), the hole below AB (top left edge), the hole above AE (top left edge), the hole below AD (below IC6), P and the hole to its right (top left of screen), R and the hole to the left of it (below IC1), A (to right of IC1), AV and the hole above it (left of S1a), D and the two holes to the left of it (below AV).

Then 'ANTENNA' and the hole above it (right of S1e), E and the hole above it (left of S1c), AU and the hole above it (top right corner), AT and the hole to the left of it (below AU), Q and the hole to the

left of it (below IC1), AM and the hole to the right of it (to top right of screen). The 8V regulator is built first — this is located just above the screen on the right of the board.

1. Insert and solder C39, observing polarity (either the longer leg is +ve, or marked +). Repeat with C40.

2. Insert and solder IC2 (78L08), making sure that the flat side faces C40. Like many other component connections, don't forget to solder the centre lead of IC2 to the top foil. Temporarily connect a lead to '+12V' (above point AM by IC2) and another lead to the earth plane on the PCB — use the tinned area just above R154 around the mounting hole. Connect up to a +12 to 14V power supply (observe correct connections!), switch on, and check using a multimeter that there is 8V +/- 0.2V present on the output pin of IC2. If a lot less, or 0V, then there must be a short somewhere which should be easy to spot at this stage. When satisfied, disconnect from the power supply.

Next, the audio amplifier stages are built and checked, starting with the resistors. Some other components are also inserted at this stage. All horizontal mounting resistors have 10mm spacing between leads — this spacing is easily made by gently bending the leads over with your fingers at right angles to the body. Always mount resistors close against the PCB. Vertical mounting resistors should be orientated with the body on the circled part of the resistor outline and resting against the PCB. Don't forget to solder leads to the top foil where required as explained earlier.

Assembly starts at the top left hand side of the board, working left to right.

3. Insert and solder R154, R103-133, R92-93, R179-180 and R1. Note that the hole just above R154 is not used at present.

4. Next, the semiconductors in this area are soldered in. Make sure that you have pin 1 in the correct place on each integrated circuit, and that the transistor outlines correspond to the board markings. Transistors should be inserted so that the underside of the body is *no more* than 5mm above the PCB upper surface. *Do not* attempt to use holders

for any IC's. Again, don't forget to solder IC pins to the top foil where required.

Insert and solder IC6 (LM380N), IC1 (KB4412), and IC5 (741N). Then insert and solder Q33-37 (BC238) and Q31-32 (BC239).

5. Remove Q29 (VN2222KM) from its foil wrapping and holding it by the body only, insert and solder into place. Then solder in Q30 (BC239).

6. Next, the diodes in this area are fitted. See the drawing for orientation details of those that are mounted vertically, and the symbol representing them on the PCB. Taking care when bending the leads, insert and solder D53-54 (OA91). Then carry on with D6, D45-48 and D58 (1N4148).

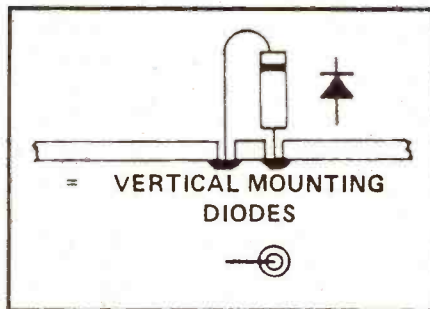

7. Now insert and solder L24, L23 and L22. These should rest against the PCB.

8. Now the capacitors are inserted — watch the polarity of all polarised capacitors (electrolytic and tantalum) when inserting. Insert and solder C31, 67, 96-97, 99-102, 108-134, 145, 148 and 188.

9. Insert and solder RFC11, RV4, RV2, RV3 and L21.

10. Take a 4.5cm length of yellow wire and strip 5mm of insulation off each end. Insert (from above the PCB) into the holes joined by the dotted lines close by C131 and solder into place. Now take a 22cm length of audio cable and strip 15mm of insulation off each end. Twist the outer braid into a pigtail, and then tin both conductors. Place the centre conductor into hole 'AC' (to the right of IC6), and solder, then solder the outer braid directly close by pins 3, 4 and 5 of IC6.

11. Similarly take a 26cm length of

audio cable, strip and tin, the solder the centre conductor into hole 'AB' (above L24). The braid is soldered to the pin below 'AB'. The free ends of these cables are now taken to VR3 (10k log pot with switch) and connected as shown in the illustration.

12. Take another length of audio cable 19cm long, strip both ends and tin as before. Connect the centre of one end to hole 'AD' (below IC6) and the other centre to the hole to the right of the '+12V' connection already used (below IC2). Then solder the braids to the pins near each end of the cable.

13. Take a 20cm length of audio cable, strip and tin one end as before, but strip 25mm of insulation off the other end before stripping the centre insulator back 5mm and tinning. The short end centre conductor goes to 'AE' and the braid to the pin nearby. The other end connects to your speaker — either use the one supplied with the case kit or any suitable speaker with an impedance of 4 or 8 ohms (any polarity markings [+/-] on the speaker can be ignored).

14. Turn the volume control just fitted to minimum (fully anticlockwise) and reconnect the PCB to the power supply. Switch on and turn up the volume until you hear noise — this verifies that the audio amplifier is working. Place your finger on pin 15 of IC1 (KB4412) — you will probably hear a lot of hum, again further proof that the amplifier stages are working.

15. If there is a total lack of noise during the above tests, first run through the voltage checks shown on the circuit diagram — these may help to locate where the fault lies, especially if wildly different to those indicated. If touching pin 2 or pin 6 of IC6 produces no result, then the fault could lie with this IC, or in the connections of the volume control if pin 6 produces hum, but pin 2 does not. Any voltage on the base of Q35 at this stage will mute the receiver.

16. Disconnect the power supply. Take a 12cm length of yellow wire and strip as before. Use this link holes 'X' (above IC1) and 'W' (by RV2) above the PCB. Then use

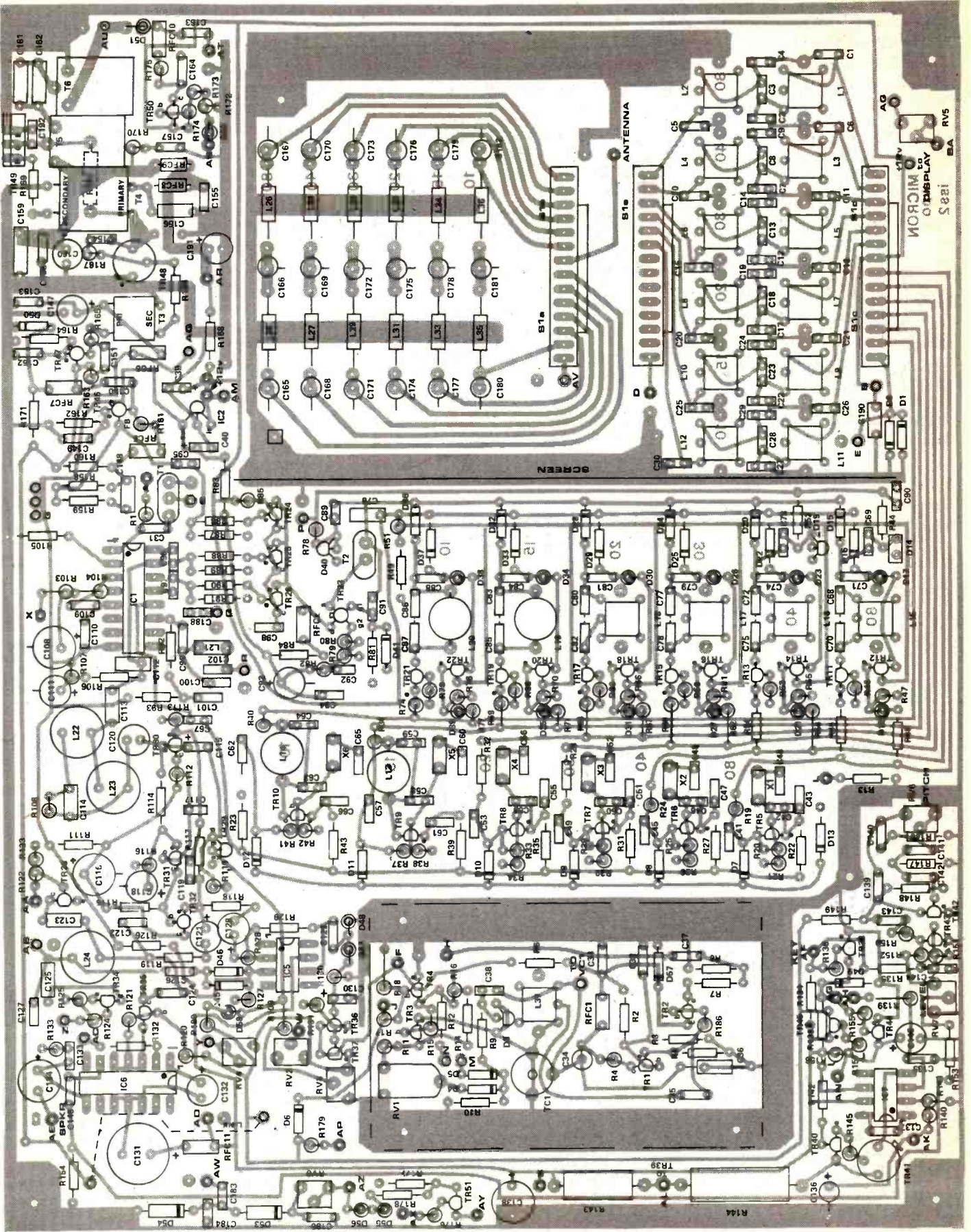

Overlay diagram for the main MICRON PCB

another 12cm length of yellow wire to connect hole 'F' (underneath IC5 at the top of the VFO section) to the first hole immediately to the right of hole 'G' (above and to the right of IC1). Set both RV2 and 3 to mid travel. Reconnect the power supply and switch on. Using a metal screwdriver, touch pin 15 of IC1 — this should result in noticeable AGC action on the noise level coming from the speaker, showing that the AGC is working. If this test fails, then there is a fault somewhere in the circuit between D45/46 and Q36/37. Have you soldered D47/48 in the correct way round? 17. Remove power. Take two lengths of blue wire, each 33cm long and strip 5mm off each end. Connect one end of each to holes 'Z' and 'AA' (either side of L24). Reconnect power, and then connect each of the blue wires in turn

Second Stage

The next section to be built is the Reference VFO.

1. Insert and solder the following resistors in the VFO section. R2-16 (R13 is located just above the PITCH control) and R186.
2. Insert and solder Q3-4 (BC238) and D3 (BB204). Insert Q1 (BF240) — the leads on this transistor may be in a straight line depending on supplier; if so, the centre lead is bent towards the rounded edge of the package before insertion — and Q2 (BC238).
3. Insert and solder D4-5 (1N4148) and D57 (4V7 Zener).
4. Insert and solder RFC1 (1mH — marked 102), TC1, RV1 and L37 (KANK3333R).
5. Insert and solder C32-38. Be careful not to damage the body of

drawing. Set this to mid travel, and also set the preset RV1 to mid-travel.

The next stage involves the rough alignment of the VFO. You will require a frequency counter covering up to 1MHz, or, if you have purchased the digital display option, you may use this for alignment. If the latter is to be used, then you should build and test this module before carrying on.

Using about 24cm lengths of yellow insulated wire, with the ends stripped as usual, temporarily attach VC1 to the board. The solder tag attached to the stator (non-moving) vanes of the capacitor go to the point marked 'TO VC1', and the other lead, soldered to the tag on the underside of the capacitor, attaches to the PCB foil, just to the left of C136 at the lower left on the board (this is only a temporary connection). If the counter is to be used then attach a coaxial lead, or use its probe, to point H and earth the braid or probe clip. If the display module is being used, then use its coaxial input connection soldered temporary to point H and the nearby earth pin.

Apply power to the board (and the display module is used). Set the core of L37 about 2mm into the former (with reference to the top of the can) and TC1 to mid-mesh. Set VC1 to maximum capacitance (fully meshed), then adjust L37 until the counter reads 0.79MHz (within a few kHz). Turn VC1 fully unmeshed, and adjust TC1 for a reading of 1.01MHz (plus or minus a few kHz). Then fully mesh VC1 again, and readjust L37 for a reading of 0.79kHz. Repeat this process until you are covering 0.79 — 1.01MHz over the full travel of VC1.

Adjusting VR2 (IRT) should vary the frequency over approximately ± 3 kHz at mid-setting of VC1. RV1 will be set at the final alignment stage. At this stage, disconnect the power and remove the connections to VC1, the IRT control and the volume control, and place to one side (be careful not to leave VC1 where bits of wire can get into it!).

Next, the majority of the remaining circuitry is built in one go, commencing with the crystal oscillators (located to the right of the VFO).

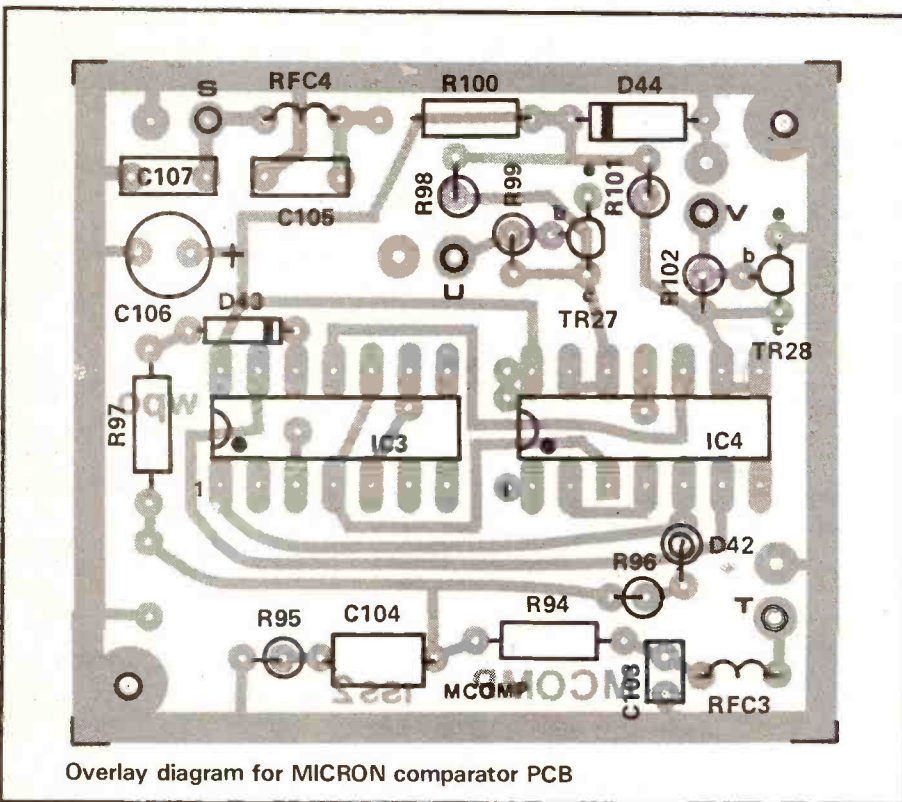

Overlay diagram for MICRON comparator PCB

to +12V. As this is done, the bandwidth of the audio amplifier should audibly decrease when either is connected — with both blue wires to +12V the bandwidth should be even narrower. Failure of this test would indicate a fault with Q33 or 34, or in the components immediately connected to them.

This completes the initial tests on the audio stages.

these polystyrene capacitors with heat.

6. Take a 7.5cm length of yellow wire, strip each end and attach one end to point N. Take a similar length of blue wire, strip, and attach to point M. Then take a 15cm length of Green wire, strip, and attach to point L (above the PITCH control). Temporarily attach the free ends of the wires to the RIT control (VR2 — 5k lin) as per the

COMPONENTS LISTING

RESISTORS — fixed value

RESISTOR VALUE	VALUE
R1, 9, 10, 44, 52, 78, 82, 114, 129, 131, 139	100k
R2, 3, 79, 112, 141, 155	47k
R4, 83, 85, 100, 113, 145, 160, 186	100R
R5, 7, 14, 16, 18, 46, 49, 54, 60, 64, 69, 74, 86, 88, 90, 103, 111, 116, 156, 179	1k
R6, 23	220R
R8, 87, 89, 91	150R
R11	2k7
R12, 51, 115, 134	6k8
R13, 15, 104, 109, 121, 123, 125, 136, 149, 172, 173, 177, 180	4k7
R17, 94, 96, 97, 122, 124, 142, 146, 147, 178	10k
R19, 24, 28, 32, 36, 40, 93, 105, 138, 175	470R
R20, 25, 29, 33, 37, 41	33k
R21, 26, 30, 34, 38, 42, 81, 168	27k
R22, 27, 31, 35, 39, 43	390R
R45, 53, 59, 63, 68, 73, 120, 135, 153, 154	22k
R47, 55, 61, 66, 70, 76	560R
R48, 56, 62, 67, 71, 77, 106, 157, 159, 163, 167	1k5
R50, 57, 58, 65, 72, 75	Not used
R80, 165	68R
R84, 161	330R
R92, 119	3k9
R95, 132, 151, 171, 174	2k2
R98, 101	8k2
R99, 102, 110	1M0
R107, 118	680R
R108	5k6
R117	680k
R126	470k
R127	820k
R128	1k2
R130, 148	2M2
R133, 169	2R2
R137	1k Carbon Composition
R140	0.5W 5% 82k
R143	150R Carbon Film 5% 0.5W
R144	68R Carbon Film 5% 1.0W
R150	1M2
R152	330k
R158	12k
R162	82R
R164, 166	15R
R170	1R0
R176	150k
R181	68R metal film 2%
R182, 189	91R metal film 2%
R183, 185	62R metal film 2%
R184	240R metal film 2%

Unless otherwise stated, all resistors are 5% tolerance carbon film 0.25W. 1% types may be supplied in place of 2 & 5% types.

PRESET VARIABLE RESISTORS

RV1	4k7 or 5k 10mm horiz. mount
RV2, 3, 5	4k7 or 5k 10mm vert. mount

RV4, 6, 7, 8

47k or 50k 10mm vert. mount

VARIABLE PANEL MOUNTING RESISTORS

VR1	50k lin. track
VR2	5k lin. track
VR3	10k log track with switch
VR4	10k lin track with switch

FIXED CAPACITORS

C1, 5	2200pF mylar 10%
C2, 4	470pF disc cer.
C3	33pF disc cer.
C6, 10	3300pF mylar 10%
C7, 9, 17, 19, 38, 64, 72, 83, 119	100pF cer. disc
C8, 23, 58, 63	2p2 cer. disc
C11, 15, 16, 20	1000pF mylar 10%
C12, 14, 22, 24, 100, 102	56pF cer. disc
C13, 28	4p7 cer. disc
C18	3p3 cer. disc
C21, 25, 68, 192	330pF cer. disc
C26, 30, 42, 46, 50, 54, 59, 73, 90, 117	220pF cer. disc
C27, 29, 77	27pF cer. disc
C31, 37, 41, 45, 49, 53, 57, 62, 67, 70, 71, 74, 75, 78, 79, 81, 82, 84, 85, 87, 88, 94, 99, 109, 143, 145, 149, 150, 151, 152, 154, 158, 163, 164	10n cer. disc
C32, 35, 124, 139, 140, 141, 142	10n mylar 10%
C33, 76, 98, 101, 105, 107, 110, 126, 129, 133, 137, 148, 153, 155, 185, 190	100n cer. disc
C34, 180, 182	100pF polysty.
C36, 168, 170, 175	470pF polysty.
C39, 40, 130, 144	0.47uF tant. bead 16V
C43, 47, 51, 55, 86	150pF cer. disc
C44, 48, 52, 56, 60, 61, 65, 66, 89, 91	47pF cer. disc
C69	120pF cer. disc
C80	68pF cer. disc
C92, 95, 96, 97, 103, 184	1n cer. disc
C93, 106, 111, 138, 146, 147	47uF electro radial 16V
C104, 123, 125, 159	220n block polyester
C108, 116	220uF 10V radial electro.
C112, 113, 122, 127	47n mylar 10%
C114	33n mylar 10%
C115	2.2uF tant. bead 35V
C118, 121, 132, 160, 191	10uF electro. radial 16V
C120, 128, 136	1uF electro. radial 35V
C131	1000uF electro. radial 16V
C134	100uF electro. radial 16V
C135	22n mylar 10%
C156, 161, 162	100n block poly.
C157	4n7 mylar 10%
C165, 167, 169	820pF polysty.
C166	1500pF polysty.

1. Insert and solder R23 and R19-43.

2. Insert and solder Q5-10 (BC238), D7-D12 and D13 *.

3. Insert and solder C41-66.

4. Take coils L14 (10m) and L13 (15m), and remove the small square plastic protrusions projecting from the base on each side, using wire cutters. Insert and solder each coil in place into place. Insert and solder X1-6.

Next, the VCO's and buffers are built. Again, if only some bands are being fitted, some of the following components can be omitted.

5. All of the following are band independent. Insert and solder R49, 51 and 78-91.

6. Carry on with C76, 89, 91-94, 98. Q23-26, RFC2 and D40-41. Then C90 (lower right hand corner of this section adjacent to the screen).

7. All the following components are band dependent — again follow the circuit and parts list if only some bands are fitted. Insert and solder R45-48, 53-56, 59-64, 66-71, 73-74, 76-77.

8. Insert and solder the following (see the drawing for how to bend the leads on all vertical mounting diodes) D39-15. Now insert D14 (160m), with the legend printed on it facing the front edge of the PCB and solder into place. Then R52, and R44.

9. Carry on with Q11, 13, 15, 17, 19-22. (Q18/16/14/12 are not inserted at present). Then C69-75, 77-88.

10. Remove the small protruding square lugs on the lower sides of L20 (10m) and L19 (15m) then solder each into place. Carry on and insert into place L18, L17, L16 and L15. Make sure they are seated against the PCB before soldering into place on the underside, then solder the left hand side of the can of each of the top of the PCB — hold the soldering iron so that it rests against the can and the board, and leave until the solder flows properly (you will not damage the in-

ductor). Then insert and solder Q12, 14, 16 and 18.

11. Next, the receive bandpass filters are fitted. These are located at the lower right of the PCB and the transformers are fitted first. NOTE: If all bands are being fitted, then it is only necessary to solder the left hand sides of L12 and L11, plus the right hand sides of L2 and L1 to the board on the *top* side to ensure proper earthing.

Otherwise, it is essential to solder the left hand edge of *each* transformer fitted, to the top of the PCB, and also the right hand edges of L2 and L1 *as each transformer is fitted* — failure to do this will probably result in incorrect operation due to lack of earths to some of the capacitors. In either case, the lugs on the *underside* of the board must be soldered on *all* transformers, however many bands are fitted. Insert and solder L2, 4, 6, 8, 10, 12, 1, 3, 5, 7, 9 and 11. Check that you have followed the instructions above with regard to soldering the cans.

12. Carry on with C30-1 (in reverse order) and C190. Finish with D1, D2, and RV5. The next stage is to wind the inductors for the Low Pass Filter section, located at the right centre of the board. The procedure for each is the same — the length of wire stated for each inductor is taken (all wound using 0.56mm diameter enamelled copper wire), then wound onto the appropriate colour core, as shown in the drawing. The total number of turns on each core is counted as the number of turns visible on the *outside* of the core — the drawing therefore has four turns.

When you have wound it, distribute the turns over about $\frac{3}{4}$ of the core, then place the ends through the holes in the PCB, align the coil so that it is parallel with the longer edges of the board, and with the bottom of the coil against the PCB, cut off the leads on the underside so that about 4mm protrudes from the underside. Then remove the coil, strip off the insulation from each end for about 5mm, then re-insert the coil and solder into place.

13. 80-30m (L25-30) are wound on red cores. Start with L25 and 26, 20 turns, using 35cm of wire for each. Then L27 and 28, 14

C171,173,178	270pF polysty.	QUARTZ CRYSTALS	
C172	560pF polysty.	X1	4.500 MHz)
C174,176,181	220pF polysty.	X2	8.000 MHz)
C177,179	150pF polysty.	X3	11.000 MHz)
C183	22pF cer. disc	X4	15.000 MHz)
C186,187,188,189	1n solder — in feedthrough		HC18 /U 30pF Parallel
		X5	22.000 MHz)
		X6	29.000 MHz)
			HC18 /U Series
		RF CHOKES	
PRESET VARIABLE CAPACITORS		RFC1,4	1mH TOKO type 7BS
TC1	36pF max 7.5mm dia film trimmer	RFC2	3.3uH TOKO type 7BS
		RFC3,7	100uH TOKO type 7BS
VARIABLE PANEL MOUNT CAPACITOR		RFC5	2.2uH TOKO type 7BS
VC1	Jackson 365pF max. Type 00.	RFC6	10uH TOKO type 7BS
		RFC8	6 turns 0.25mm dia. en copper wire wound on ferrite bead.
TRANSISTORS		RFC9	2 turns 0.56mm dia. en copper wire wound on ferrite bead.
Q1,24,25,26	BF240, or BF241	RFC10	150uH TOKO type 7BS
Q2,3,4,5,6,7,8,9,10,12,14,16,18,20,22,27,28,33,34,35,36,37,38,40,42,43,44,51	BC238 or BC239		
Q11,13,15,17,19,21	BC307 or BC308	INDUCTORS	
Q23	3SK45 or 3SK51	L1,2,3,4,5,6,15,18	TOKO Shielded coil type KANK3334R
Q29	VN2222 KM	L7,8,9,10,11,12	TOKO Shielded coil type KANK3335R
Q30,31,32	BC239	L13,14	TOKO S18 coil 0.3uH
Q39	TIP34 A	L16	TOKO Shielded coil type KXNK4173AO
Q41	BFY50 or BFY51	L17	TOKO Shielded coil type TKACS34342
Q45	BC327 or BC328	L19	TOKO S18 coil 0.45uH
Q46,47	2N2369 A	L20	TOKO S18 coil 0.18uH
Q48	2N3553	L21	TOKO RF Choke type 7BS 470uH
Q49	2SC1969	L22,23	TOKO RF Choke type 10RBH 1H
Q50	MPSA92	L24	TOKO RF Choke type 10RBH 220mH
DIODES			
D1,2,4,5,6,7,8,9,10,11,12,16,17,18,21,22,23,25,26,27,29,30,31,33,34,35,37,38,39,41,42,43,45,46,47,48,50,52,55,56,57	1N4148		
D3,19,40	BB204B		
D13	4V7 400mW Zener Diode		
D14	KV1215		
D15,20,24,28,32,36	BA244 or BA482		
D44	12V 400mW Zener diode		
D49	5V6 400mW Zener diode		
D51	1N4007		
D53,54	OA91		
INTEGRATED CIRCUITS			
IC1	KB412		
IC2	78L08		
IC3	4013B		
IC4	4011B		
IC5	741N		
IC6	LM380N		
IC7	CA3140E		
		Note: L25-L36 are all wound using 0.56mm dia. enamelled copper wire.	
		Amidon 50-2 cores are red in colour and diameter 13mm	
		Amidon 50-6 cores are yellow in colour and diameter 13mm	

Due to a lack of space, some of the listing has been held over till next month.

turns, using 26cm of wire. Then L29 and 30, 12 turns, using 23cm of wire. 20-10m (L31-L36) are wound on yellow cores. L31 & 32 are each 12 turns, using 23cm of wire for each. L33 & 34 are 9 turns, using 19cm of wire, and L35 & 36 are each 8 turns, using 17cm of wire for each.

The capacitors of this section are inserted next. Be careful when soldering these that you do not in-

advertently touch their plastic bodies with the soldering iron — this will almost certainly cause an internal short and the component will have to be replaced. These capacitors all mount vertically, in a similar manner to vertical mounting resistors. Ignore any red colouring at one end of these capacitors — this is *not* a polarity indication.

14. Insert and solder C165-182.

15. To the left of C165, at the hole marked with a square, insert a 1mm PCB connection pin through the board and solder both sides. Next, the PA stage is built up.

16. Insert and solder R158-175.

17. R137 (1k, 0.5 watt) which is located beneath T4 and T5 is mounted on the *underside* of the board. Bend its leads over until they align with the holes, then insert from the underside until it is flat against the board, solder into place, then cut off the excess leads flush with the board on the top.

18. Insert and solder RFC5-7, 10, C95, 147, 149-164, 191-192 and D50-52 (1N4007).

19. Thread a miniature ferrite bead over the base (centre) lead of Q46. Insert into place until the transistor is resting on the bead, and solder in. Insert and solder Q47, Q48 (with the device flat against the PCB) and Q50 (bend the centre lead towards the round side before inserting) — Q49 is inserted later. The coils and RF chokes remaining are now wound. Be careful when winding these that you do not strip off the insulation on the wire by pulling hard on it — this leads to shorted turns!

20. Take one of the remaining ferrite beads and using a 12cm length of 0.25mm diameter enamelled copper wire, wind 6 turns through the bead to form an RF choke (RFC8). Insert into the PCB, trim off the leads on the underside, remove, strip off 5mm of insulation and solder into place. Similarly, take a 6cm length of 0.56mm diameter enamelled copper wire to make RFC9, wind 2 turns through the remaining ferrite bead, cut to length, strip and solder in.

21. Next T3 is wound on one of the three, small, two hole balun cores. Firstly, mark one end of the core with either a small blob of paint, nail varnish or something similar to identify the primary end. Take a 17cm length of 0.2mm diameter enamelled copper wire and pass through one hole of the core so that 10mm protrudes from the marked end. Thread the long end back through the other hole so that both wires are coming from the same

end of the core. This is now one turn — in other words, one turn consists of passing the wire through the core twice, with both wires protruding from the same end. Now wind on another 7 turns, each turn passing through both holes as with the first turn, giving a total of eight turns. Trim the ends to the same 10mm length.

Now wind the secondary. Take a 7cm length of the same wire, and pass one end through one of the holes so that 10mm protrudes from the end *opposite* to the end of the primary wires are coming from. Pass the longer end back through the other hole, giving one turn, and then wind on one more turn, giving two in total.

Strip the insulation off each wire to within 2mm of the core body, and insert into the holes on the PCB so that the marked end is at the end marked 'PRI', with the core resting flat against the PCB. Solder the leads into place, noting that one is soldered both top and bottom. Trim off excess leads.



22. T4 is now wound, but on the larger 10mm square ferrite balun core. One end is already marked red, so this will be the primary end. Take a 28cm length of 0.25mm diameter enamelled copper wire and thread through, in a similar manner to the previous transformer, so that 10mm protrudes from the red marked end. Wind on a total of 8 turns, exactly as the previous transformer, and trim the ends. Then use a 9cm length of the same wire and wind a 2 turn secondary, exactly as previously, and again trim the ends. Strip off the insulation as you did before, then insert and solder into place with the red marked end as the 'primary'.

23. The two Bifilar transformers, T5 and T6 are now wound. A bifilar winding is simply one that has been

made from two pieces of closely twisted wire, used as a single winding, rather than one piece of wire. You will require a hand drill and a vice for this to make life easier, although it can be made using a vice and a pair of pliers.

Take two lengths of 0.8mm diameter enamelled copper wire, each 24cm long. Holding the wires parallel, fix one pair of ends in a vice firmly. Clamp the other ends in the jaws of a hand drill, then rotate the drill so that the wires twist together. Carry on twisting until you have 5 twists every 2cm (or 6 twists per inch), as near as you can. If you don't have a drill, use pliers to do it by hand. Remove from the clamps, and repeat the process with another two lengths of wire.

Take one of the 13mm dia grey ferrite cores, and in a similar manner to winding the low pass filter coils, pass the wire through the hole, leaving 15mm protruding, then wind 7 turns of the twisted wire into the core (so that you can see 7 turns of wire on the outside of the core). Be *very* careful when doing this that you do not inadvertently remove any of the insulation by scrapping against the core, as it is a little awkward to wind until you get the knack. Untwist the two free ends carefully, so that you have four ends of wire, then scrape off the insulation from each to within 2mm of the core body on each.

Using a multimeter on its ohm range, put one probe on one of the wires from one pair, then find out which end of the other pair does not conduct (ie which wire is not the other end of it). Loosely twist these two together. Then following the drawing, solder one wire to the other, after bending it as shown (to avoid both wires of the joined pair having to go through the PCB). This coil is T5 — insert it into the three holes in the PCB with the joined pair as the centre (it doesn't matter otherwise which way round the wires are inserted).

PCBs

The printed circuit boards for the MICRON (main, comparator and VFO enclosure plates) are available from WPO Communications for £29.45 the set inc post. In addition, the full manual covering the basic 6-band kit construction can be obtained for £5.00 inc post.

REVIEW: Icom IC745



quality and value for money?

We were all very surprised when Icom suddenly dropped the IC740 transceiver which had been a very successful and well recommended model. However, shortly after the 740's disappearance came the IC745, released soon after its big brother, the IC751.

the 751, but with reduced facilities. As well as being able to transmit on all amateur bands from 160 to 10m, the IC745 facilities include general coverage from 100kHz to 30MHz. AM, CW, upper and lower sideband and RTTY are incorporated in the basic ver-

which can store both frequency and mode. Sixteen memories are included, again retaining both frequency and mode. The memory is switched on or off by a push button and the memory number is selected using a large rotary switch.

The main tuning knob, which runs very freely indeed and without any trace of backlash, can be selected to give 10Hz or 1kHz steps. On the 10Hz position, 50Hz stepping is automatically selected when the dial is turned fairly fast. The step size remains the same on all modes.

Press buttons on the front panel select power, compressor, VOX, RF pre-amp, amateur bands or general coverage (Rx only), VFO A or B, VFO A=B (replacing A with B), simplex or duplex operation, transmitter incremental tuning and

Over the last ten years, Icom have firmly established in the amateur radio market alongside Trio and Yaesu, earning a reputation for quality. The Icom IC745 is their current cheapest HF transceiver and offers 'popular' facilities, such as FM and general coverage receive as standard. Angus McKenzie recently put the '745 through its paces...

The 745 bears similarities to both the 740 and 751, its performance being very similar to that of

the 751, but with reduced facilities. As well as being able to transmit on all amateur bands from 160 to 10m, the IC745 facilities include general coverage from 100kHz to 30MHz. AM, CW, upper and lower sideband and RTTY are incorporated in the basic ver-

RIT (rotary incidental tuning varies the frequency by ± 1 kHz approx). For filtering, there are press buttons turning on the IF shift/passband tuning (with variable slider to its left), narrow filter — this selects the SSB filter on AM and the narrow CW filter on CW and RTTY — and notch filter — again with slider for tuning.

There is push button sequential selection of mode and a memory 'write', which inserts the VFO frequency into a chosen memory channel when the VFO is selected. The scan on/off switch either enables a scan of the memories or operates a program scan between memories 1 and 2, when the IC745 is in VFO mode.

Concentrically mounted pots control the Rx, AF and mic gain, treble control, squelch and RF output power. Rotary switches select memory, metering — SWR, set SWR, RF output, compressor level, ALC and PA current — and the received signal level.

A miniature rotary adjusts the noise blanker from off to 'normal' to 'wide'. Similar rotaries adjust the noise blanker threshold and AGC, which has a very wide variation in recovery time. Others adjust the (optional) electronic keyer speed and VOX delay time. A digital display on the front panel indicates the complete frequency in 100Hz steps. It also displays the operational states of the rig.

At the front of the top panel are a number of controls including the output monitor, crystal markers (at 25 or 100kHz steps) marker level pot, and a calibrator for setting the frequency accurately against an external standard, eg WWV, and anti-vox level. The loudspeaker is mounted underneath the top panel and so throws sound upwards, which I feel considerably helps the quality of audio reproduction. On the underside of the rig is a pull forward bail type stand, which conveniently raises the front. The mic socket is a standard Icom eight pin locking type and next to it is a quarter-inch headphone jack. A strong carrying handle is provided on the left side and four miniature feet are provided on the right, which make the '745 very easy to transport.

Phono sockets are provided on the rear panel for external ALC input and external relay operation

(short on Tx and open on Rx). There are receiver input and receive relay output sockets which are normally linked with a short external phono/phono link. A socket is provided for when the rig is tuned below 1.6MHz and the low frequency antenna input is required. Another is for the transverter transceive terminal, which has an output level of only 30mV on Tx and an input on Rx direct to the mixer. At the bottom of the panel is a 'spring' earth terminal and the main antenna interconnection is via an SO239 socket.

On the other side of the enormous heat sink (which includes a cooling fan) is a large 24 pin accessory socket with the standard interconnections for controlling an Icom auto ATU or linear. This socket is also used for the external audio in/out and other control functions. A stereo quarter-inch keying jack connects a 'paddle' key, if the electronic keyer board is fitted. A 3.5mm jack supplies audio to an external speaker. The AC mains input socket on the optional built-in PSU is on a standard IEC mains connector. This PSU is provided with a short flying lead to deliver its 13V DC output back into the rig again. The basic rig accepts 13.8V DC only, unless you buy the mains option.

Laboratory Tests

On all amateur bands the Rx input sensitivity measured superbly on SSB, being 1dB more sensitive than the IC740. Apparent sensitivity on FM, though, was very poor due to the excessively wide FM filter present. We spent hours measuring the RF intercept point at different spacings. Whilst it is superb with widely spaced signals, it seemed to measure less and less well as the spacing was reduced.

We checked these readings on both 80m and 10m with very similar results. With the two interfering carriers at 20 and 40kHz apart, we noted that the intercept point had deteriorated by 25dB (sinad method) and for 10/20kHz by 50dB. Finally at 5/10kHz spacing, the intercept point had degraded by 66dB. On 80m the 5/10kHz spacing results showed a 60dB inferiority. Note though, that the S5 method gives considerably less deterioration in the measurements,

which is a little puzzling.

We had a long look at the circuitry and found that the 70MHz first IF roofing filters were too wide and, also within this IF are two AGC controlled FETs providing massive gain in front of the second mixer. We then reduced the RF gain until the input sensitivity was degraded by around 3dB, and found that the reproduced audio level had sunk so low that the audio gain control had to be flat out and one's ear very close to the speaker.



The calibrator, 'monitor' and VOX controls are located on a small panel on top of the '745 just behind the fascia.

When we did this and repeated the intercept point measurements, we noted an improvement of the apparent intercept point by 30dB — the point actually measuring out at -16 dBm for 5/10kHz spacing. It was apparent that too much AGC is being applied to the second IF amplifier, which follow immediately after the switchable SSB filters at around 9MHz. I am unable to understand why Icom, in an otherwise excellently designed rig, have made up so much gain in the first IF, rather than after an SSB filter. The effect of all this is that whilst the front end is superb, at LF, very strong signals off-channel, within 20kHz or so, can cause blocking. This is a great pity.

I am sure the effect could be minimised if one could modify the point at which AGC acts on the second IF amplifier. You could then back off the first IF gain as required, without losing audio level. In which case, the blocking and close in intercept point characteristics would be far better. Japanese rigs which need to be able to accept an FM option all tend to show this 'roofing filter' problem. Even if AM is included but

the FM mode abandoned, a 6kHz wide crystal filter placed immediately after the first mixer could dramatically improve the performance.

We checked the reciprocal mixing performance at various spacings from the tuned frequency to determine the amount of noise sidebands produced by the synthesised first local oscillator. For spacings 30kHz and greater from the frequency the '745 was tuned to, the rig gave better results than many analogue type VFO ones; at 100kHz offset, the noise floor was surprisingly low. Nearing the tuned frequency, sideband noise deteriorated to the extent that it was not too good at 5kHz spacing. Most non-synthesiser rigs are very much better at this point, although this IC745 is better than many other alternatives with synthesisers.

The SSB selectivity was superb — the -80dB bandwidth was almost no wider than the -60dB one at 3.4kHz — yet the 3dB down bandwidth was 2.4kHz. This leads to superb rejection of adjacent channel signals, *as long as the IF blocking problem does not come into play*. The CW filter gave an even better performance, with the 500Hz wide model measuring as such from -3dB right down to below -70dB! This is one of the finest CW filters that I have yet tested and I would say is virtually ideal. Other CW filter options are also available.

On FM, I have to report that in

my opinion the review sample was unsuitable for coping with 10kHz spacings on 10m if an adjacent channel signal is rather stronger than the wanted one; although 12.5kHz spacing was acceptable, and 25kHz spacing excellent. I cannot see why Japanese manufacturers in general do not install narrower FM filters on their HF transceivers. *Every* model that I have measured has this problem and I have received continual complaints from 10m FM operators regarding this. The AM selectivity was fairly wide, and about right for acceptable quality audio from this mode.

We found the RF preamp gain to be around 9dB, the actual sensitivity improvement gained being around 7dB at best. With the RF preamp off, something I would advise on all bands below 21MHz, the RF intercept point became even better, which is quite amazing.

Amazing AGC

We checked the AGC characteristics in three positions, the fast and slow extremities of the control, and a middle position. On the fast position, full recovery was provided in around 200mS, whilst on medium it was 700mS, rising to around 4S on slow. This gives an excellent degree of variation for almost all purposes. We noted that gain recovery on weaker signals took considerably longer, for example around 12S from -85 to -115dBm. The AGC threshold oc-

curred well below 1uV, so even fairly weak signals come up almost to full output level; unless of course the RF gain control is backed off. The output constancy of the audio from fairly weak to very strong signals was excellent throughout.

On FM, full limiting was reached at an extremely low level, far below the 12dB sinad sensitivity point, which is slightly baffling. FM quieting at the latter point only improved by 2.5dB, showing that distortion was very low on weak signals. However, the capture ratio was rather inferior to that of some other rigs. This simply means that there will be slight interference if another weaker FM carrier is on channel with the wanted one. FM audio distortion was excellent and at very low levels.

We pen charted three FM responses because the response with tone control at maximum was clearly ridiculous, the HF end actually stepping up with reference to mid region, and extending to 5kHz and beyond. With the tone control at minimum, we can see a slightly better response — but again note the step up in the 1.6kHz region. The FM sensitivity readings were taken with tone control at minimum to be as fair as possible to the rig. However, the very fact that it is possible to have a flat response up to 5kHz shows an overwide filter and discriminator, and the lack of any lowpass audio filter in the FM de-emphasis. All these contribute to the poor subjective selectivity.

The AM wide response again

Excellent AGC characteristics of the IC745

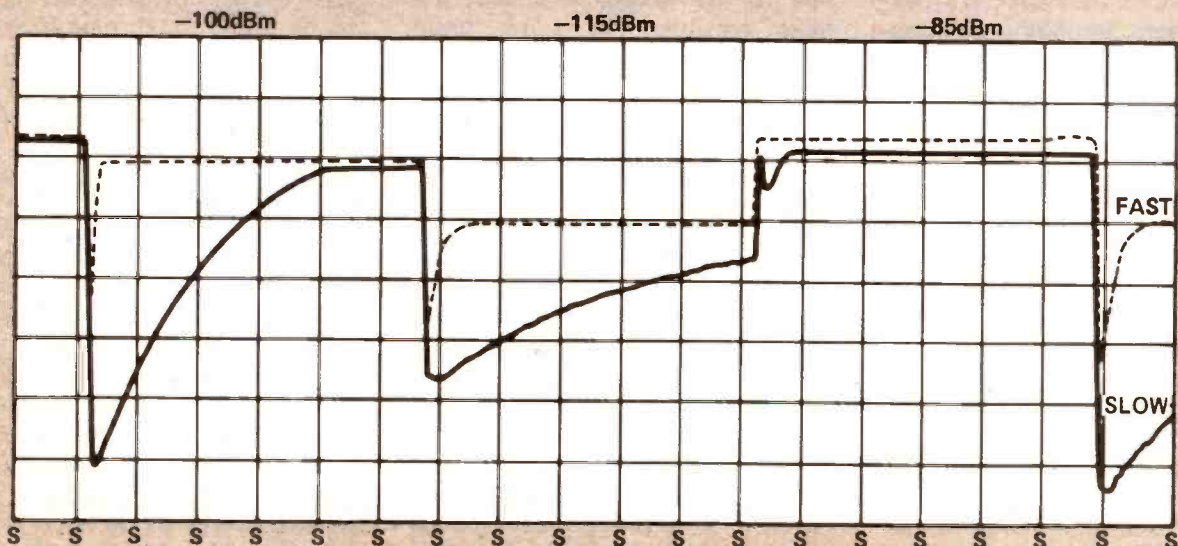

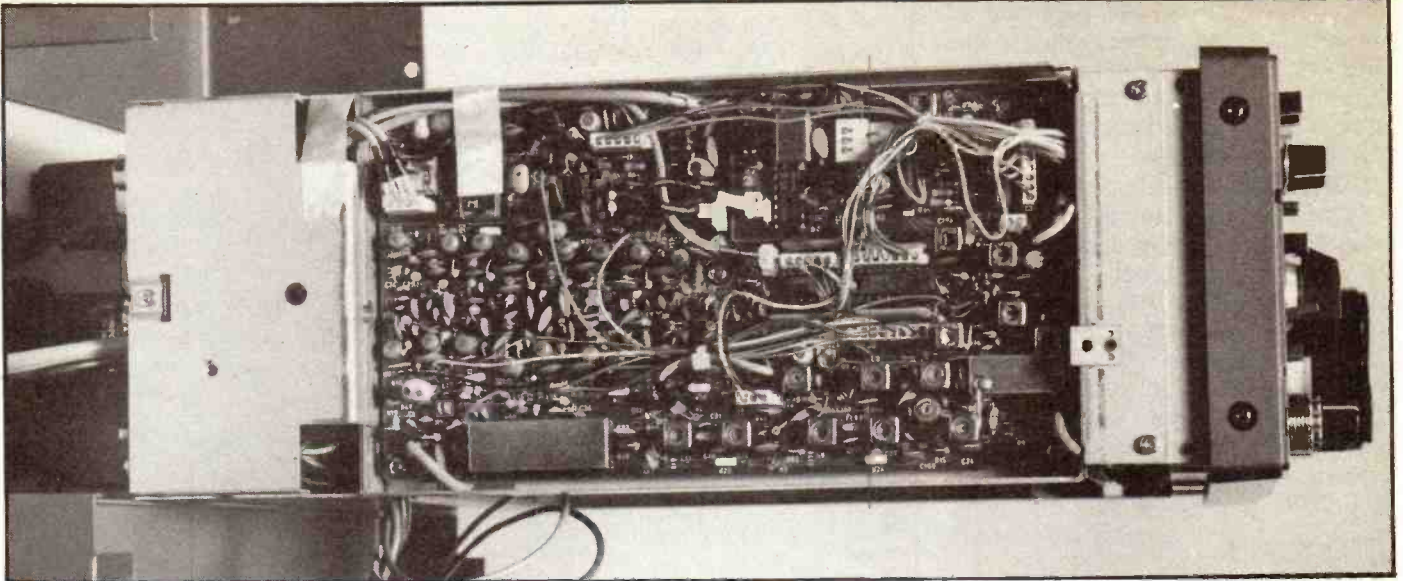

The standard of construction of the IC745 is high, most of the components being mounted on two PCBs, one side mounted, shown here.

shows a steep cut below 200Hz. The HF end extends reasonably to around 3kHz, attenuating very rapidly above this frequency and thus indicating good selectivity (plot taken with tone control at max).

AM distortion at input levels of around 1mV measured better than on the R71 and IC751 rigs, but even so it was rather high. The distortion at 300Hz reached 6%, even at low modulation depths, and when increased to 90% modulation, distortion was somewhat higher. With an input level of -24dBm (14mV) distortion was just not good enough, some 18% THD being reached, with 1kHz modulation at 90% depth. Bear in mind that there is no antenna input attenuator, and you only lose 9dB gain with the preamp switched off, this sort of level can easily be reached on strong AM broadcasts.

The SSB response after the product detector was very flat indeed, preserving the excellent shape of the IF filter. Product detector distortion measured at a very low and commendable level.

Excellent IF Shape

The 'S' meter measurements were taken on SSB with the RF preamp switched in. We noted a 34dB difference between S1 and S9 which is excellent. Above S9, the meter was rather non-linear but fairly satisfactory.

The maximum audio output

power at 3.1W into 8ohms should be satisfactory for most users, and quite a lot more power was available into 4ohms, which could be extremely useful.

We spent considerable time checking out the transmitter with a very esoteric spectrum analyser, the new Marconi 2382. I devised a natty way of plotting the complete audio response from the microphone input socket to the SSB carrier output. This involved setting the maximum output carrier level at around 10W, to keep it well below the ALC threshold, the output power control at maximum but with the mic gain appropriately ad-

justed. It can be seen that the pass-band from 400Hz to 2.5kHz was superb and is within 1.25dB linearity. Note that at around 3.5kHz, the response is right down to -80dB showing a superb filter. From the plot you can see that the response is also 80dB down by 600Hz on the opposite side band. Thus the sideband rejection is also superb. The carrier breakthrough was around -42dB which is very satisfactory.

All the two tone intermodulation plots were taken at 28.55MHz, as this band usually gives the worst results. If we look at the plot for 125W PEP, we can see the third order products at -28dB. This is barely adequate for a solid state rig and considerably in-

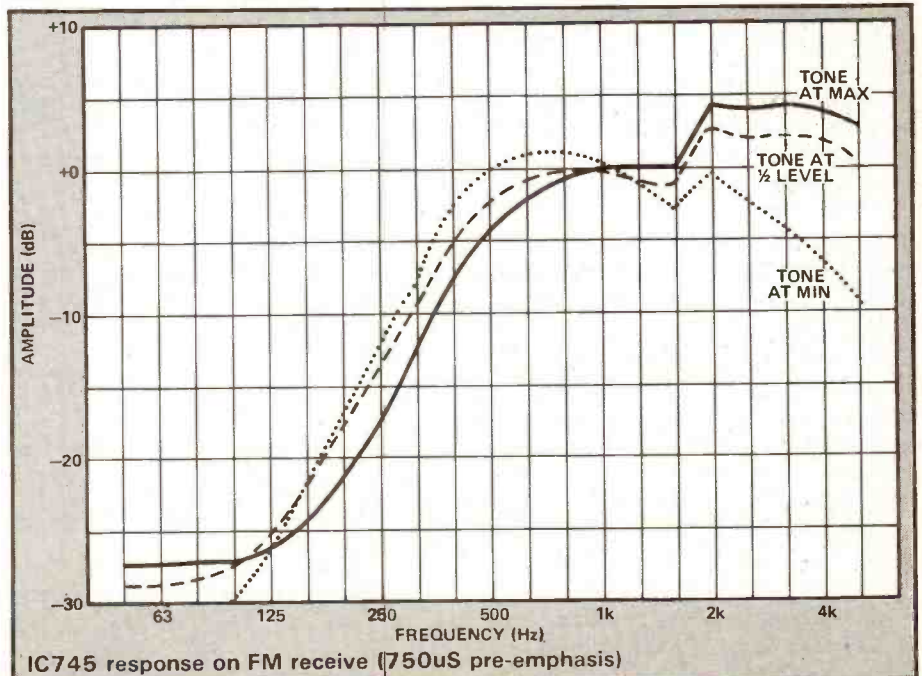

ferior to typical results given by a valve PA. Higher order products do not fall quite as rapidly as they might. Note however the presence of audio-distortion products within the IF filter passband.

We then reduced the power to 100W PEP, and whilst the third order product has greatly improved, the higher order ones only slightly improve. We retook the 100W PEP plot but with the compressor switched in. The plot shows the dramatic degradation in the audio distortion within the IF passband caused by the compressor distortion. At 40W PEP, the IPs do not show the improvement over higher levels that I would like to see.

We took another plot from a 1kHz tone into the mic. socket with output carrier set at 100W. Note the audio distortion components in the passband and the sideband rejection, the carrier breakthrough also being easily visible. You can see that around the 1kHz RF carrier, there appears to be ripple present caused by mains induction and inadequate smoothing from the optional internal power supply.

We had a good look at this and took a plot at 100Hz per division with 10Hz resolution bandwidth, to show the amplitude modulation of the main carrier due to the power supply ripple. If we add up the RMS values of the different ripple components, we can estimate that the power supply is causing 6% AM ripple modulation, which is fairly high. I suggest that a really large capacity external PSU should give a much better performance than this. I would, therefore, recommend that you buy the internal PSU option only if you really must have this for easy portability.

The maximum power output on SSB was around 125W PEP, well into ALC. On CW we measured 116W. The same orders of output power are available on all bands. The frequency accuracy is virtually dependent on the setting of the calibrator pot. Having set it for as near zero beat as we could on Rx, the CW transmitted carrier was well within 10Hz, which is excellent. On all the old bands, harmonic rejection from a 100W output carrier was never worse than -65dB, again excellent, especially at LF. No spurious were noted on these bands. At 10.12MHz,

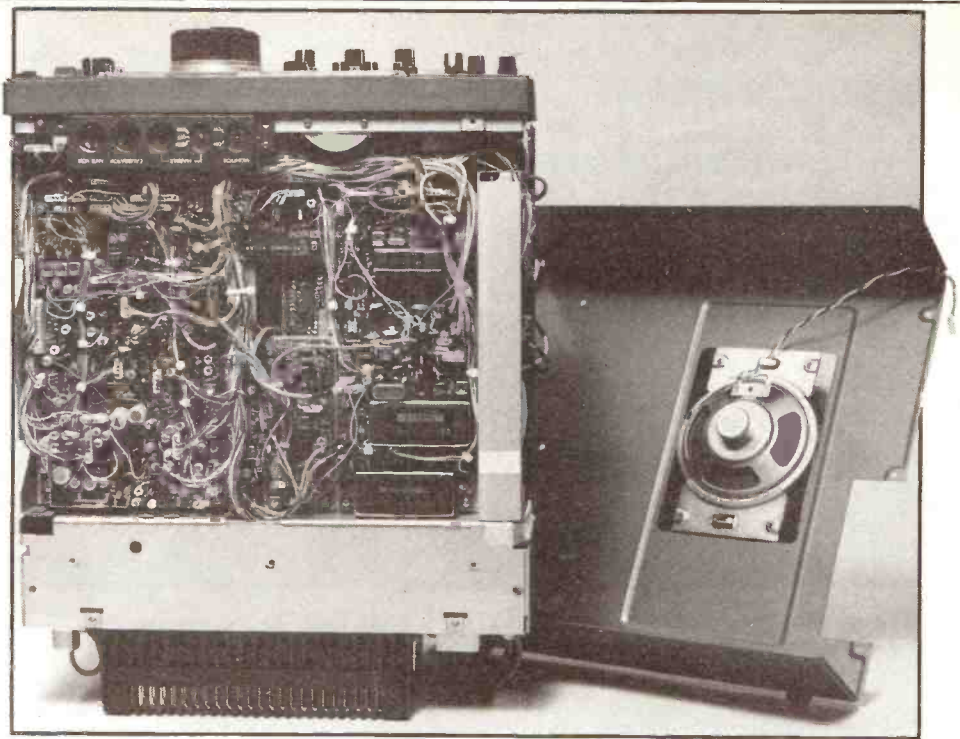

IC745 from the top

though, we noted spurious of approximately ± 1 MHz of -60dB, but I do not consider this to be too serious. On the 18MHz band sprogs at ± 9 MHz (IF) were noted at -56dB, which again is not too worrying, and on the 24MHz band, sprogs were noted at ± 4.2 MHz approximately at -60dB.

The Final Analysis

To conclude: the transmitter performance is good for a solid state PA rig and the IF filters are superb. Most welcome is the flat audio passband through to the balanced modulator from the mic socket.

The rig does not transmit AM

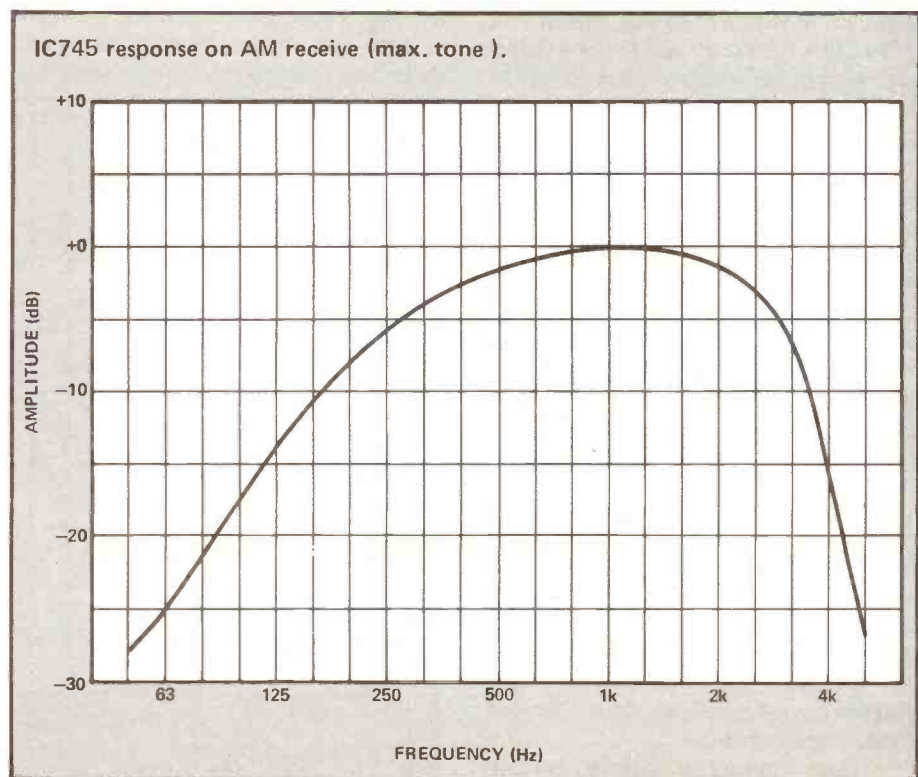

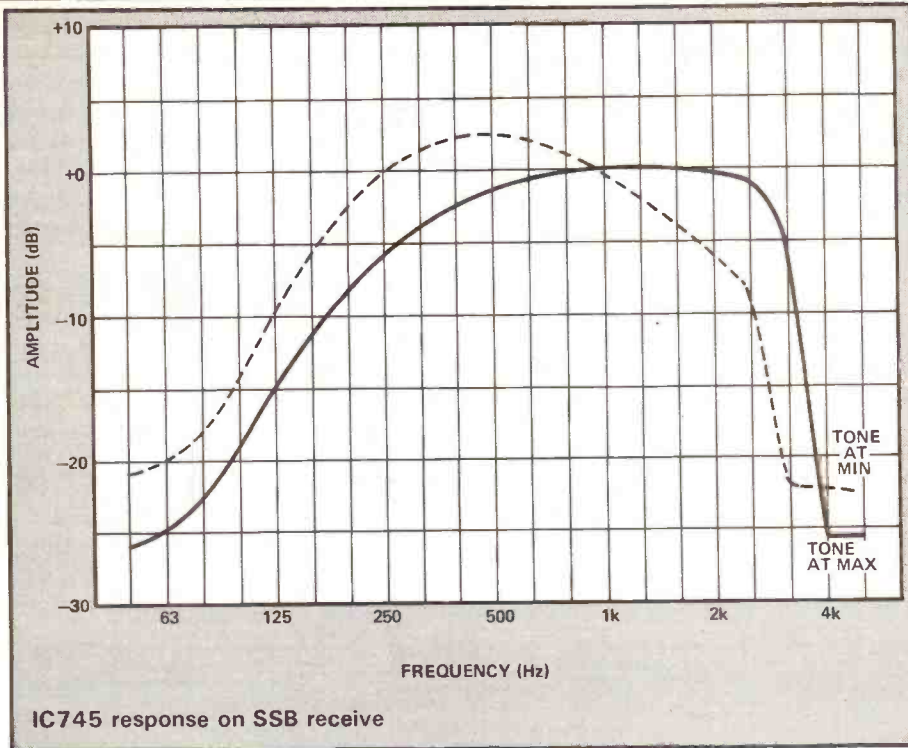

although the deviation is normally set too high.

On The Air

The RF sensitivity, even on 10m, was excellent. Ironically, it was too good at LF and can only be reduced by switching out the RF preamp as there is no antenna attenuator. However, since there are phono breakpoints on the back for the Rx input, you could add your own switchable attenuator which you will probably need for serious operation on LF. Whilst the basic RFIM was good under normal circumstances, there seemed to be an awful lot of 'muck' around at LF, particularly on 40m. There was a very audible improvement in reception when the preamp was switched out, but this did not improve the performance sufficiently — no doubt due to the IF blocking problem. The IF selectivity on CW and

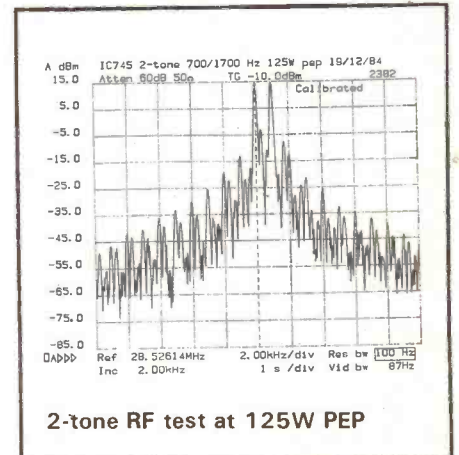
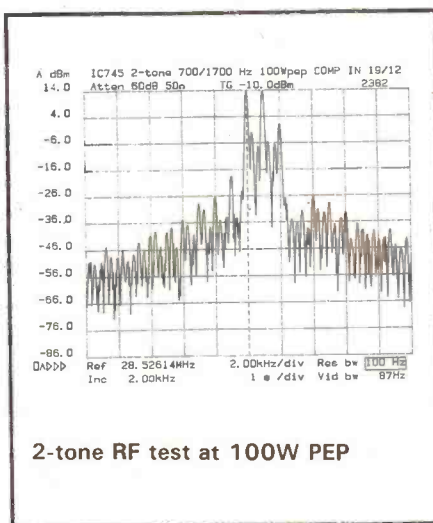
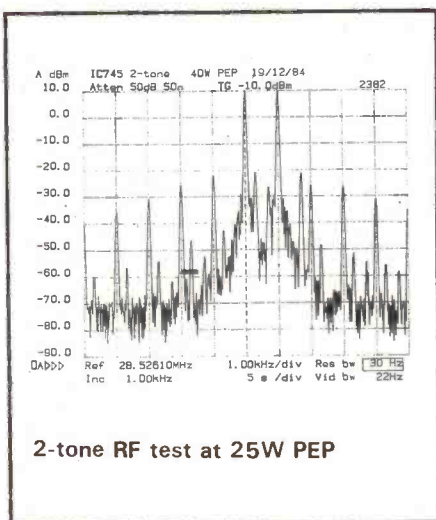
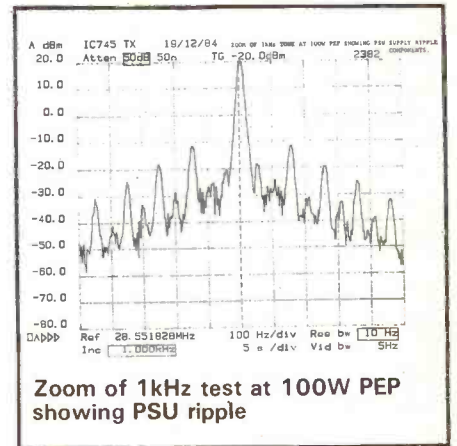
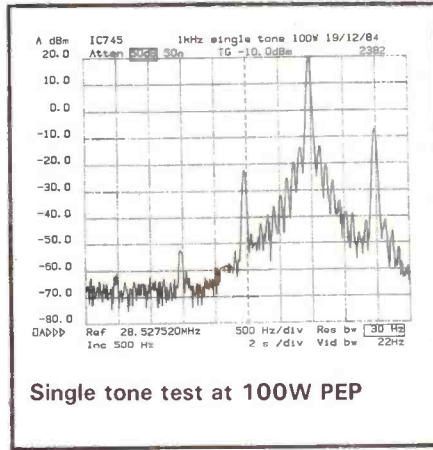
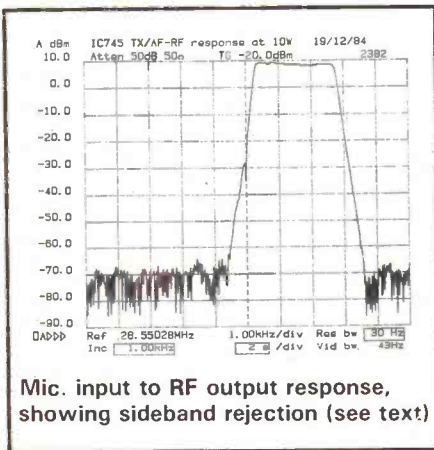

and, unfortunately, a fault on the FM option board — no output power — precluded any FM

transmission test. The circuit is similar to that of the IC751, whose FM quality is extremely good,

SSB was stunningly good and careful use of the bandpass tuning slider improved adjacent interference even more. The IF shift position always gave a wider response, but the BPT is superb for use on a crowded band.

I was very disappointed with the tunable notch filter, because the rejection was insufficient, probably due to the Q being much too low — a sizeable chunk of audio was sucked out when I attempted to tune out an annoying carrier. AM selectivity was excellent, but I could only describe the quality of the AM quality as adequate, for the AGC seemed to be following the envelope of any high modulation present. When tuning across top band, I noted that the rejection of medium wave signals seemed better than on some other rigs.

The receiver sounded very lively, and performed extremely well under most conditions. My main reservation is that of the first IF blocking problem. Plenty of audio

power was available and all the controls worked well. I found the mode button a little annoying, as changing from one mode back to the previous one meant cycling all way round the shop. The variable AGC was a delight to use and I much prefer it to that on the IC751. Memories were easier to use than usual and it was helpful that one could VFO from a memory frequency. The VFO tuning rate speeds up when the tuning knob is turned fast and I found this facility helpful.

The noise blanker worked better than that of any other current HF rigs, provision of bandwidth variation for its detector, combined with variable threshold, is a definite asset. The blanker actually knifed out some annoying thermostat in-

terference far better than my usual HF gear, enabling me to continue to receive some weak SSB stations on 10m. I only use the tone control away from the maximum treble position on FM, and for this I preferred it almost fully counter-clockwise. Variable squelch worked on all modes.

Icom have designed some extremely useful interfacing facilities, which are available on the rear panel. By shorting two pins on the 24 pin accessory socket, the transverter socket is enabled and the PA disabled. Unfortunately, the Tx output level on this is absurdly low — 30mV — and will require an unusually high transverter input sensitivity, which may be at the expense of noise floor problems way

ICOM IC745 LABORATORY TESTS

RF Gain but figure due to reciprocal noise problem)

RECEIVER TESTS

Sensitivity; SSB at 28.55MHz for 12dB Sinad
Preamp off; -118dBm
Preamp on; -125dB

Sensitivity; FM 1kHz Modulation, for 12dB Sinad
Preamp off, 3kHz Deviation; -110dBm
Preamp on, 3kHz Deviation; -115dBm
Preamp on, 5kHz Deviation; -118dBm

Selectivity; SSB, bandwidth for given level drop

3dB Bandwidth	2.4kHz
6dB Bandwidth	2.5kHz
40dB Bandwidth	3.2kHz
60dB Bandwidth	3.4kHz
70dB Bandwidth	3.4kHz
80dB Bandwidth	3.4kHz
90dB Bandwidth	3.4kHz
100dB Bandwidth	3.4kHz

Selectivity; CW, bandwidth for given level drop

40dB Bandwidth	500Hz
60dB Bandwidth	500Hz
70dB Bandwidth	500Hz

Selectivity; FM

+/- 12.5kHz	+39.5/+48.5dB
+/- 25.0kHz	+75/+75dB

Capture Ratio, FM; 5.5dB

Two Tone RFIM Performance: intercept point at 28.55 MHz

	S5 Method	12dB Sinad Method
+100/+200kHz spacing	+6dBm	+10dBm
+20/+40kHz spacing	+3dBm	-15.5dBm
+10/+20kHz spacing	-29dBm	-40dBm
+5/+10kHz spacing	-44dBm	-56dBm

at 3.65 MHz

	12dB Sinad Method
+100/+200kHz spacing	+12.5dBm
+20/+40kHz spacing	-4dBm
+10/+20kHz spacing	-29.5dBm (-19dBm with less RF Gain)
+5/+10kHz spacing	-47.5dBm (-16dBm with less

Reciprocal Mixing at 28.55kHz, SSB. Level required to degrade on channel 15dB Sinad product to 12dB Sinad product

+100kHz offset	115dB ratio
+50kHz offset	109dB ratio
+30kHz offset	105dB ratio
+20kHz offset	100dB ratio
+10kHz offset	91dB ratio
+5kHz offset	77dB ratio

S Meter; Levels required to give following readings at 28.55MHz, preamp on

	FM	SSB
S1	-105dBm	-109dBm
S3	-100dBm	-102dBm
S5	-98dBm	-94dBm
S7	-97dBm	-83dBm
S9	-95dBm	-75dBm
S9 + 20	-92dBm	-64dBm
S9 + 40	-86dBm	-49dBm
S9 + 60	-49dBm	-17dBm

Product Detector Distortion, SSB at 28.55MHz; 0.9%

Audio Distortion, FM at 1V output

2.5kHz Deviation;	1.1%
0.5kHz Deviation;	1.5%

T Notch filter, SSB. 2 Tones 200Hz apart
Maximum rejection; 12dB

Maximum Audio Output power of a 1kHz Tone at 10% THD

8 ohm load;	3.1W
4 ohm load;	5.0W

TRANSMITTER TESTS

Maximum output power, SSB; see text
Maximum output power, CW; 116W
Maximum output power, FM; not working
Frequency Accuracy; Determined by position of "Calibrate" control
Harmonics; see text

off frequency. I do wish Icom could standardise on a much higher level here, for example, 1 mW output into 50ohms, which would make life a lot easier for everyone.

You should bear in mind that the auto band switching information provided on the accessory socket allows very convenient operation with several Icom accessories. I strongly recommend the IC AT500 automatic ATU, which works very well with this rig. Using the separate LF antenna socket for an aerial connection, you can tune right down to long wave with reasonable sensitivity.

I connected my CW paddle to the rig, which was fitted with the electronic keyer option and the electronic keying, with speed control facilities and excellent semi break-in operation, was superb. However, it has to be said that the rig will not work on AMTOR unless fairly heavily modified.

The front panel layout is very good, and the presentation excellent — it was always reasonably obvious how to obtain any desired function. Many rigs are cluttered

and often one has to resort to the manual. The instruction book is excellent and includes copious block diagrams and circuits, even showing board layouts for maintenance purposes.

Conclusions

It seems to me that I am never totally happy with any HF transceiver. There are always problems here and there, and which seem to differ in each respective model that I look at. I quite often seem to find either a rig with a very poor front end, good IFs and excellent audio; or with a superb front end, but with IF problems that cause the rig to be considerably inferior to what could have been if this aspect of the performance had been properly optimised.

There is so much that is excellent about this rig and it seems a shame that I have had to come down fairly hard on the IF blocking problem. I completely fail to understand why Icom appear to have made this particular design mistake. The IC745 needs very lit-

tle redesign to optimise gain between the first and second IFs and the incorporation of a first IF 6kHz bandwidth filter could have been such an advantage. Even so, this rig is undoubtedly most recommendable and I think you will find it difficult to find a rig that, on the whole, performs better and provides such excellent ergonomics.

If you are a serious HF operator, and your prime interest lies in the LF bands, I feel that you would do well to look at the Tentec Corsair and the Trio TS930 S.

The basic price is £898 inc. VAT, the internal mains PSU type ICPS35 £165; electronic keyer board type EX243 £42; narrow SSB filter type FL44A £89; FM unit EX242 £35.50; and CW 500Hz filter type FL52A (others available) £89. All prices include VAT.

I would like to take this opportunity of thanking Thanet Electronics for the loan of the review sample and for all their co-operation, and my colleague, Jonathan Honeyball, (G1LMS) for assisting me in taking so many plots and measurements.

AN ARGUS SPECIALIST PUBLICATION
JUNE 1985 £1.10

ELECTRONICS

M O N T H L Y

The Newcomer's Magazine for Electronic Projects

PULSE METAL DETECTOR
Seeking for change in the scenery ...

Mains powered **VISUAL DOORBELL**
The bulbs! The bulbs!
Deaf people (and hill froaks) see the light

Can you manage a **Flanger?**
A musical effect for guitars and synthesisers

Get it write ... **VOLTAGE PROBES**
built in a ballpoint

Metal Detector

EXPLORING THE SHORT WAVE BANDS
Listening all over the world
— no licence required

OUT SOON

BOOKEND

THE LID OFF LASER 558

By P A Rusling

Published by Pirate Publications, 1984

The pirate radio station, Laser 558, now based in 'international waters' off the Thames Estuary, has been sur-

rounded in mystery and rumour, mainly because of the apparent secretiveness of the New York backers. This book attempts to relate the full story of how the station was commissioned and built, with the help and knowledge of Mr Rusling. According to his account (!), he seems to have been one of the main instigators of the project and the one who succeeded where others failed in getting Laser off the ground, or rather, on the sea.

Pirates of the airwaves, CB conversions and some practise RAE questions are reviewed this month by GICKF.

Mr Rusling goes into some detail of how the organisation was set up; the ship bought and equipped and the employment of the first of what was to be many crews. It also illustrates the measures that these 'pirates' have to take to avoid the British authorities.

The book is written in a very familiar style and assumes that the reader has some historical knowledge of pirate or 'free' radio. The other characters in the story aside from Mr Rusling are presented in rather subjective terms — either good or bad. There is also a lot of unnecessary personal information which tends to get the way of the story and look like personal advertising.

Because the subject of the book is illegal in this country, the author has to be fairly vague about names and places. But some 'sensitive' topics are dealt with a little too subtly and become obscure to the reader. Mr Rusling does not seem to fear the present organisation behind Laser (despite his belief that his pub was deliberately burnt down, see *Radio Today* December 84), since he names them and occasionally 'assassinates' their characters.

There is detailed information on the ship's crossing of the Atlantic and the precautions taken for anchoring. The chapter on the problems with aerials would catch the attention of radio amateurs since they initially chose to raise the antenna with a helium filled balloon. However, after the loss of 2 balloons through bungling, this idea

was dropped. Other ideas seemed to have fallen foul of the politics within the company. It is a shame there was not more of the theory behind these ideas, perhaps in the appendix.

The ship's equipment is explained in a fairly concise and not too technical way but the book tends to concentrate

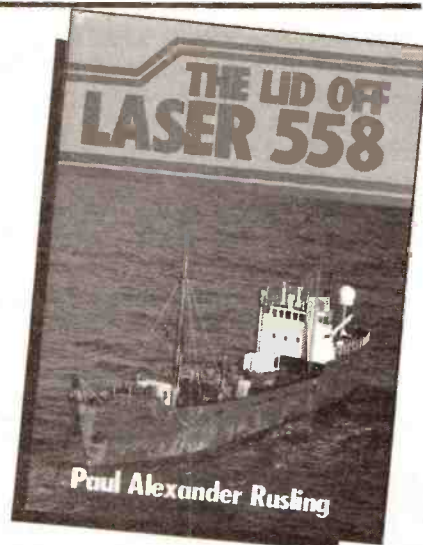

on the music production rather than the radio transmission side. There is also a detailed and rather confusing account of the various changes of crew and DJs, once the ship seems to have arrived at its anchorage. Threats of mutiny, near loss of the ship in gales and arrest of some of the participants are all part of this 'life on the ocean wave'.

This is not an expose as such — it is more of a critique of what can, and does, go wrong when setting up a 'free radio' station. Because it is written from one insider's viewpoint, no account is taken of the other side's story. It could be said that this is only half the story of Laser 558 and one wonders what has been missed from the story simply because Mr Rusling was not informed of it.

That being said, it is a very readable book for any one interested in radio in general. There are many photographs, some of which do not (quite) 'fit' the text. Anyone with a eye for proof-reading must be very forgiving!

The book is available from some bookshops and Pirate Publications Ltd., PO Box 19, Herne Bay, Kent CT6 5XD. It costs £9.95 for the hardback, £6.95 for the semi-soft back.

FEEDBACK SPECIAL EDITIONS:

The Best of 'Feedback'; ICB1050 10m conversion and update; LC7137' IC conversions to 10m, DNT M40 and multimode conversion.

Published by Bury RS

The Bury Radio Society have enterprisingly brought out three 'special' editions of their journal, 'FEEDBACK'. The first is a compilation, a kind of 'best' of Feedback, containing some amusing slices of life on the airwaves over Lancashire, along with several 'useful' projects, ranging from an UHF spectrum analyser to a 'Time Out' Indicator!

However, my attention was drawn away from this to the other two special editions, having heard quite a lot about the conversion of various legal and illegal CB sets to 10m recently. As Malcolm Pritchard, G3VNO, PRO of Bury RS, explained, there were three aims behind these: to encourage more activity on 10m; to overcome the trend towards expensive 'black boxes' by pointing out the cheapness and pleasure derived from modifying a 27MHz set; and to try and encourage 'responsible' operation on 10m.

These two FM manuals certainly make every effort to achieve these aims and manage to do so by making it interesting reading. The March 1983 Special Edition, reprinted in February 1984 (a sign of its popularity) concentrates on modification details for the ICB 1050. There is a reprint of the original inspirational article, which gives both technical explanation and clear modification details for changing the frequency synthesis of the ICB1050 to suit 10m and goes on to describe the changes for channels 1 to 8.

Two alternative methods of conversion are also described: the first, by changing the crystals; another by putting in CMOS 'adders'. There is also a modification for adapting the channel read-out to give a more suitable display for 10m.

There are a few receiver improvements for the ICB 1050 such as changing the ceramic filter to a crystal one, and fitting a 'noise' squelch. The magazine then goes on to discuss the adaption of CB aerials and amplifiers to 10m, and finally tells you how to set the deviation of your modified set — without needing tons of test equipment.

The second 10m manual delves in-

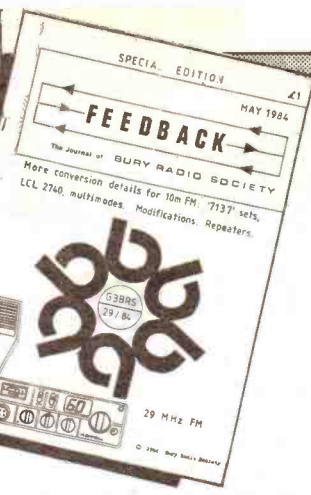

QUESTIONS AND ANSWERS — 103 Self Test Multiple Choice Questions based on the RAE syllabus by P A Bubb, G3UWJ

This booklet of 26 pages, although not the 'real thing' does give the student a fair idea of the type of question they will face in the RAE. It gives you some experience of 'sussing' out multiple choice questions, which, with the scarcity of old RAE papers is very useful. These are not the easiest type questions to answer, despite what some people say — the answers you are provided with are never quite what you would have said. The booklet makes for a useful general aid to revision, since knowing your performance at the questions can be used to highlight areas of weakness in your knowledge. The questions tend to concentrate on the second paper, 'Operating Practices, Procedures and Theory', rather than the licensing conditions. It also avoids the more (literally) awkwardly worded questions that are the talking point of many recently licensed amateurs. This is nice for would-be RAE candidates but is not realistic! The answers are given in the back of the booklet, although there is no explanation with them.

The booklet is available for Peter Bubb (Tuition), 58 Green Acres, Bath, Avon BA1 4NR and costs £2.75 post paid.

to the insides of a variety of available, and still very cheap adaptable CB sets. Rather than give a blow-by-blow account of each 'rig' and its conversion, the authors have based the modifications on components basic to several transceivers. Firstly, they use the LC7137 synthesiser IC, going into the theory in some detail since this is a more complicated modification than that of the ICB1050. This IC already includes a simple repeater shift section which can be used if desired. There are a few minor mods specific to particular makes which are explained. The DNT M40/LCL 2740 is separately detailed for conversion, since it is considered 'one of the nicer sets' and is already very popular.

There are a number of modifica-

tions for the channel read-out of sets using the LC7137 IC. Details of operating on 10m FM are given along with bandplan and beacon and repeater frequencies. Finally, there is an explanation of a 'multimode' transceiver conversion (Major), along with all the necessary precautions necessary in conversions of this kind. A general taste of this variety of conversion was given in the Basil Spencer article in August '84 issue of *HRT*.

On the whole, three very interesting and entertaining booklets. 'The Best of Feedback' costs a mere 50p when ordered with either of the other two, which cost £1.25 each (£2.25 the pair). They are obtainable from The Editor, 'Feedback', Bury Radio Society, Mosses Centre, Bury, Lancs.

At last, a magazine that gets to the core of it.



As the proud owner of an Apple, you know that really helpful magazines don't grow on trees.

But now there's Orchard Computing. Orchard is a brand new quarterly put together specifically to suit the Apple user.

It brings you the very best in useful routines, business and games software.

And not a word of it that isn't directly relevant to you.

So if you like an Apple a day, take Orchard quarterly.

It's just what the doctor ordered.

Orchard COMPUTING

Britain's best buy for Apple users

Free Readers' ADS!

FOR SALE

MOBILE HOME south of France. Plumbed in, electricity, gas, water and English toilet. Sleeps six. Large capacity fridge, swimming pool, tennis, restaurant, supermarket. £165 per week for Van. Apply early for reciprocal licence. G4LNM QTHR. Phone 0622 812829.

FTV107R 2m/70cm plus satellite working, converted by SMC for UK 70cm repeater operation including FRB707 relay box £50 off new price £375. Or PX 2m multimode cash either way. Wanted FC902 ATU G4WLD John 01-857 8096.

FR101S receiver 160m to 10m. Also fitted; 2m and 6m converters, FM board, 500Hz CW filter, with manual and box £150. SMC 12V 25A PSU £50. Trio MC60 desk microphone £25. Ring Dursley (0453) 811454 after 6pm.

ICOM IC255E 2m FM 25W transceiver mobile mount scanning mic, boxed £120. Icom IC202S 2m SSB portable transceiver boxed £105. Tel: Earls Colne (07875) 3442.

SELL Grandstand 935MHz transceiver 8W out, good condition working order. Handbook, microphone, cost £399 accept £280. Base station, new condition £30. Protel base microphone model AM601, £15. Cobra power microphone £10. Sirtel echo chamber £15. Phone 0474 872743.

UNIDEN 2020 SSB transceiver built in 12V PSU recently overhauled. Cheap introduction to HF and mobile working. £240 ono. Telephone Lincoln (0522) 753180.

TRIO TS930 transceiver, simply excellent, complete with manual £925. Wrasse slow scan converter type SC-422A, 3 memories, colour Rx + Tx, superb picture quality £510. Sony monochrome video camera with 300m lens £75. Double beam scope. Telequipment type 43 £67. New brain computer type AD £147. 2 Sanyo taperecorders £6 each. G4GPL. Home

01-953 6921, work 01-953 9021.

YAESU FT221R 2m base AM/FM/SSB, 15W out. Sell for £300 ono. Tel Mick on 0895 443524 (Uxbridge).

TWO METRE portable receiver crystallised RO-R7 plus two empty channels scans plus rechargeable PP3 batteries £50. 44MHz crystals £1.50 each. Scanning receiver 76-87 156-168.100 MHz £80 without antenna mike. De-Wynter, 2 Woodside, Wimbledon, London SW19 or ask Jane 946 2967.

PRESIDENT Grant AM/FM/SSB transceiver 27MHz, plus power supply, homebase aerial silverrod, mobile aerial advanti moonraker. Swap for 2m handheld or sell for £115. Tel Basingstoke 476961 (0256).

HEATHKIT digital multimeter IM102 £35. BC221J mains PS £20. 813 plus base £10. 829 £10. 6AG7(4) £1 each. Various other valves, too numerous to list. Prefer buyer collect DMM and BC221. G3AAH. 021 451 3369 Birmingham.

FOR SALE Somerkamp FT767-707, FP700 PSU, FC767 ATU, FV767DM VFO scan and 12 memory. Std mic and scan mic. Complete with manuals and boxed £500. Phone Mr Buckle, on Bolton 28904 after 6pm.

EDDYSTONE 940 receiver, 0.5MHz to 30MHz. Good clean condition with handbook and some spare valves. £70 or offers? Mr Haig, Tel Paignton (0803) 552819.

SELLING: realistic DX160 general coverage receiver. Onyce FC155 digital frequency readout unit with SWR/power/FS meter, used with DX/60, including mains unit. Mizuho KX2 antenna tuning unit. £75 the lot ono, all good condition. Mr Head, telephone (evenings) (054853) 500.

HEATHKIT HW7 QRP transceiver £60. Heathkit resistance capacitance bridge model C-3U £10. Heathkit digital multimeter IM-1212 £30. All in good working order

and with manuals. To be collected or postage at cost. GM3SPT Telephone 0324 822828.

MICROWAVE MODULES 4m, transverter 2m IF 10w out. Excellent condition £150. 80ch transceiver 6w £15, 18 ele 70cms beam, £15, 23cms bedm 22el home brew circular PO1 £8. Memory phone 42 £30. Tel. Herts (0923) 662567.

PHILIPS PROFESSIONAL pal colour TV pattern generator, UHF/VHF, model PM5508. Good condition cost over £500 but will sell for £250 ono. Please write including phone number, Norman, Coach-House, Livilands Court, Stirling.

CENTRONICS 352 200CPS dot matrix printer 18 months old. Plus all manuals £220 ono. Two Creed 75rp's £15 each. Swop Commodore 64 tape for BBC A/B Jbeam 4 ele Quad 2m £20. Ringo Ranger £15. Ring Glenn G6VRQ 0734 863881 after 7pm.

TS130V TL120, VFO120, SP120, all mint, boxes £475, no split. YP150Z dummy load wattmeter £50. SEM tranzmatch with Ezitune £70. BNOS 25A PSU, four months old £100. GWhip multimobile with 40m and 80m coils, whips £35. G4WBW telephone Alsager 6226.

MICROLINE 80 matrix printer VGC £140. Kempston interface for ZX Spectrum £20. Buyer must collect. Phone Andy 01-953 5294.

MAGAZINES PW, PE, SW, etc £5 the lot. Old sig gen £5. High reliability electric motors with heatsinks, computer type, offers. Box of old Boroughs L5000 computer IC boards, offers. Reel to reel recorder £8. Tapes £7. Herts (0923) 662567.

MICROWAVE MODULES 2m/23cms transverter 2W out (new model) £165. Trio/Kenwood SM220 scope/station monitor (as new) £210. Metalfayre 2m 6ele cross Yagi (new) £27. Phone Paul Crawley (0293) 515201.

SHIMIZ SS105S plus TL120 200W PED linear plus 13.8V

8.5A and 13.8V 10A PSUs cost £750 new, price £600. Ham International Concorde II converted from 11 to 10m, 4 band multimode £250. ZX-Spectrum 48K plus interface I, microdrive, and Scarab RTTY interface, software, cost £275, sell £200. Mr Bolton, 10 Bowness Rd, Coniston Park Est, Timperley.

DIGITAL frequency meter Zetagi C500 £84. Datong D70 morse tutor £35. Test set LCR bridge 373A £34. KW2000B and ac PSU indistinguishable from new! Wanted Trio 530S or Trio 830S excellent condition only. Telephone anytime Harvey 0229 856669 (Cumbria).

ICOM 720A general coverage transceiver £600, PSU 20 with built in speaker £125, Diawa automatic ATU CNA1001 £125, all boxed and mint condition. Telephone Coventry 21810.

YAESU FT ONE HF Tx, all bands all modes, Diawa cross needle ATU, complete HF setup £900. Tandy TRS80 computer VDU, tapecass, books, progs + ZX81 £60. Call 53 Maple Road, Penge, SE20.

AKAI cassette recorder auto rev cont. play, Ham Jumbo, legal stamped, transceiver and frequency counter PR I AS Midnust speakers, stands, 2 boxed sets records. All mint, value over £900; will swop for Icom 7071E Trio 2000, FRG 7700M or similar. Ring Bramley (near Basingstoke) 882825.

IC215 2M portable FM transceiver, mic, NiCads, charger, carrying case, h/book, original packing, Helical ant. VGC £95. Tel 0272 624864. **ICOM IC-120** 23cm transceiver, as new. Your gain at £250. Andy Emmerson, G8PTH, Northampton 0604 844130.

PET 2001 32k computer built in tool kit. £75 oir swap ham gear. Bob. Canvey Island 697906.

HAM SHACK for sale, concrete Compton sectional shed 8'x8' fully lined. £230 ono. Neath 59213, GW4JQQ.

DATONG D70 morse tutor,

good condition £30. Mutek 2m pre-amp, SLNA 144S, as new, £28. Sharp PL1251 pocket computer, with cassette and printer unit, complete with case and manuals, £90. G8AWV, Tel 01-751, 2262 after 6pm.

TWO METRE handheld receiver, crystallised 8 channels £45. Portable Tandy CB cost £170, accept £120. Sony portable communications receiver £110. Scanner £80; 27MHz pre amp £10; DeWynter, 2 Woodside, Wimbledon, London SW19. For details phone 946 2967. Ask for Jane.

TRIO TR2300, high quality 2m portable/mobile transceiver 144-146, 80 channels. Complete with, NiCads, charger, rubber duck, soft leather carry case, manual. £130 ono. G0AMF. Tel Seaford (0323) 898515.

KDK 2030 2m FM transceiver. Full scanning facilities, 10 memories etc. Complete with mobile mount mic, handbook and original packing £150. Rotator and 7 element 2m beam, never used outside £45 or the lot for £185. Phone G4ANW 0730 61859.

FV107 external VFO for FT107, brand new £50. SP107 matching loudspeaker £20 both boxed. TR10 TS130V, 1.8kHz filter, TL120 amplifier, VFO120 external VFO, SP120 matching speaker, mobile mount £475. G-Whip multi mobile aerial 10m-80m £35. Ring Dursley 811454 after tpm.

20-25 AMP 0-19V power supply unit, bully protected, £40. Post extra. Prefer buyer collects. Tel. 0253 45431 (Blackpool).

RADIO SHACK, 80' tower any antenna from 160m dipole to EME array possible £40 000 ono. Includes stone house SW Wales. Fitted kitchen, 3 bedrooms, double glazing, central heating, good garden, greenhouse, sheds, workshop for further details phone 0554 890502 - within easy reach of coast, bus + rail.

POWER SUPPLY 20amp 13.8V over voltage protection £50 ono. Wanted Icom IC251/211 or Yaesu FT225/221 with MuTek front end, also Trio 7850 cash waiting. G6LOH, Julian Tether, Highview, Culworth, OX172AX. Banbury 768152.

SOMMERKAMP FR500 FL500 for sale £190. Good condition, with spare valves. Buyer collects or pays carriage. Wanted FT707 transceiver. GM6JIC, QTHR. Tel 0563 34383.

YAESU FT107 HF transceiver, FP107 matching PSU, Yaesu ATU and/or Diawa automatic ATU. Also Falcon 505 model helicopter plus all accessories and full 6 channel Sanwa radio control. Also glider, prefabricated body and wings, 4 channel radio including servos. Offers?? 02403 22713.

FOR SALE Shure 444 £20, Dragon 32, G4BHK RTTY program, recorder, 30 cassettes £7. Complete TVDX station, 20" television, tuner and amps £30. Sell, swop WHY. Wanted 70cm, 2m and 10m equipment, condition not important, but must work. 0293 515711.

SOMMERKAMP TS788DX 100 W PEP 26.0 29.999MHz AM/FM CW USB/LSB remote mic control, internal speaker. Also remote mic speaker, scanner F/S, mint condition. Sota PSU is amp, 3 el Rhodes Schartz beam, H/D Hirschman H/D Rotator with remote control. The lot for £450 or will separate. Tel 051-428 1114 6 pm to 9 pm, Mon-Sat only.

YAESU FTV107R unused CW 2m module. Fits most HF rigs £120. Tokyo Hy-power HL160V 2m linear, 3 or 10W input 160+out. Built-in pre-amp, mint condition £180 ono. PSU ex-computer 13.8V 30A continuous, protected £70. Wanted 2m valve linear, 70cms pre-amp. Phone Reading (0734) 596485 after 8pm.

FOR SALE Sommerkamp FT7B HF rig £275. FDK multi 750E 2m multimode rig £150. Wanted Yaesu FT77 or similar HF rig with transverter socket. Also MM 10m to 2m transverter. Phone Southport (0704) 74792.

YAESU 707 FC707 ATU, 2 ele quad £500. KDK2030, isopole ant, complete station £200. Sickness forces sale. No offers. TS250 trail 7000 miles £300. KW EZE £90, or £1000 the lot. Harris, 29 Terrence Avenue, Newquay, Cornwall.

SPECTRUM 48K CW cassette recorder, manuals and some software. Telephone Pete

01-444 8712 evenings. £85. **PANASONIC DR31** 32 band shortwave receiver, excellent condition £110. Tel (0448) 61052.

DRAGON 32 with RTTY transceive program, works without terminal unit. Joysticks, basic programming and some games. As new condition £95. G3TSO (Cirencester) (028 575) 532. **EDDYSTONE S504** receiver 0-30MHz in five bands £45. Avometer model 40 £20. Turner mic type 224L dynamic cardioid £15. Phone 01-543 0179.

EDDYSTONE communication receiver S770U 150-500MHz with manual £50. Buyer collects. Phone Darlington (0325) 464041.

FT77 100W transceiver 15 months old hardly used in excellent condition with built in marker and separate speech processor unit. Genuine reason for sale moving QTH. £400. G8ETW, 3 The Grove, Market Deeping. Tel 0778 342886. **CLEARANCE SALE** Icom 251E + mutek front end, £450. Trio TS120V HF transceiver £280. Trio AT120 ATU £65. Trio TL120 amplifier £140. MMT432/144R transverter £130. Jaybeam antenna TB3 still boxed £180 ring G4TVH David Brown (0604) 847658 with offers.

BC639A 95MHz-160MHz. Marconi Atalanta 15kHz-4MHz, also one for spares. New secondhand valves, nuvistors, acorns disc-seals photocells Jones plugs+sockets. Early transistors, CRTs exchange, offers Dave Skilton 40 Mid-street, South Nutfield, Surrey. Nutfield Ridge 2888.

YAESU FT-290R for sale as new only used once. Good reason for selling and accessories £300 ono. Tel Dean 42013.

ICOM IC21A with fitted tone burst £95 ono. Tel: Dean 42013.

BUTTERNUT HF6V, American multiband vertical brand new £85. Jaybeam quad-8 as new £35. Avanti PDLII, 11-metre quad beam, first class condition £45. Kenwood SP-30 speaker, switched filters, brand new £30, AEA BT1 £45. Aerials collect/carriage. 01-472 9058 evenings, weekends.

YAESU FT7 HF Tx/Rx mint

cond £190 ono. Tel Chesterfield 0246 36496 G4HMW. **PAIR SKYFON NV7** handheld transceiver, single channel crystallised for 10 metres boxed as new £40. Commtron NATO CXX 120ch AM/FM transceiver ideal for 10 metres unused £45. Phone Southport 0704 69410.

SONY ICF-2001 fully synthesized FM/AM/SSB communications receiver, 150kHz-30MHz 76-108MHz power supply, as new boxed £85, pair Skyfon NV7 handheld transceivers, single channel crystallised for 10 metres £40. Phone Southport 0704 69410

NEW KW 2000 series PA coil, switch and choke £25. Pair unused 5763D £6. 33 used sub-miniature receiver valves £10. Unused Jackson PA anode tuning capacitor £4 or £40 the lot. All plus p&p. G3PXV, phone Mereside (0703 129) 403.

YAESU FT480 2m multimode, very good condition, original packing, mobile mount £300 ono. Dave G4SVS 01-462 7092

FOR SALE Yaesu FT757GX 500-30MHz Tx/Rx coverage, 3 months old little use. Boxed plus technical manual and MH-1B8 mic £650. Ring 01-471 0669 after 5pm ask for Danny.

FDK700EX 25w FM mobile with mount, orig box no mods. inc 5/8 mobile whip. Property late G8BOC, £160 ono. Phone aylesbury (0296) 33020.

HF RECEIVER realistic DX300 150Hz to 30MHz, digital readout, AM/USB/LSB. SWL contest award winner, exc cond cost £250 - accept £90. Phone eves or wkend. Dave 01-311 1544 South East London.

DRAGON 64, dual disks, joystick, 7 cartridges including fig-forth logo, 16 tapes, over 40 games etc on disk, OS9, Stylograph, Dynacalc, RMS, Basico9, ED/ASS/DEBUG, 'C', Pascal, disk Doctor/Test, Disassembler etc., books, cables, mint, list £1644 sell £400. Bob Welwyn 4454.

TRIO 2M SSB transceiver TR-YO10 plus mobile mount, including 5/8 wave gutter mount whip, good condition £75. Bob Welwyn 4454 evenings or weekends.

YAESU FT726R base station 2m, 70cm sat duplex brand

new 2 weeks old. Sell for good offer or part exchange for NEC PC8201 portable computer plus cash. Ring 8am to 9pm Peter Witnessham 526. Buyer collects or pays carriage. Whatever.

FT707 ATU PSU unit good condition £475 lot. Zeneth speech and mic processor for CB £20. Computer Spectrum Sinclair ZX cost £125, £65 ono. Phone 0283 221870.

FOR SALE Kenwood TS530S VFO240, SP230, MC50, complete and unmarked £650. Ring Stuart G400K 0642 211685.

YAESU FT707 £320; FP707 £85; FV707AM £95; FC707 £65. Telephone Bristol 422702.

600 VALVES. Includes British and American types. Octal U.X. prewar included. SAE for lists. Wanted circuit and data for "Foreland" marine transceiver. Also KW Viceroy MKIII handbook for sale. BC348M internal mains pack. Mr Jeffrey, 42 Dennis Road, Padstow, Cornwall PL28 8DF.

BUILDING OMEGA? Have CIF-PU VFO boards. QRP PA LP filter boards, Audio filter logic, ant/co, notch and preselector boards. All boxed WKF. Just needs casing. Final alignment worth £400 sell £300 or swap HF Rig WLY? Tel: G4PLM 0530 812102 (Leicestershire)

B40 GENERAL coverage receiver for sale (used on warships etc); full working order; very good condition £75 ono. May deliver near Manchester. Tel Brian G4NXW Rossendale (0706) 224617.

SOLID STATE 200W PEP mobile 3-30MHz linfar with pre-amp, Cobra 148 SWR powermeter, 3 element mini beam, low pass filter £190. Or p/x for 2m multi-mode FT290R or similar cash adjustment if necessary. Mr Ray, 40 Little Harlescott Lane, Shrewsbury.

TEN-TEC Argosy transeiver fitted with type 223 noise blanker, type 224 CW filter, type 225 PSU and Ten-Tec type 227 ATU. Ten-Tec type 215 microphone and stand. A complete home base or mobile CW/SSB station for £500 or near offer. D R Saunders 061-430 5196 evenings.

SALE BC348 internal mains power pack. Valves all types Octals. USA, British types example 6K6GT £1 SAE for lists.

pse. Wanted handbook for KW Viceroy MkIII. Also handbook circuit for "Foreland" marine transceiver. Mr Jeffrey, 42 Dennis Road, Padstow, Cornwall PL28 8DF.

COBRA 148GTL DX (26.360-28.540), Zenith speech-processor, communicator NI-440DX FM-CB, mobile-ant, AR 5/8 wave base-ant, 5T07 amp power pack. All in vgc. Cost £400. £250 ono or swap for AR2001 or why. Tel Carl (0792) 843079.

YAESU FRG 7700 general coverage receiver with FRT-7700 atu and FRV 7700 VHF converter £375. Whaley Bridge 2005 after 7pm.

SELLING DRAKE R4C T4XC NB4 all CW filters and band xtals, fan spare valves etc £550. HO10 scope £35 Dx6V vertical £30. Datong RFA preamp £15 9 ele tonna £10. All ono, post extra. G4JBH QTHR Yeovil 23873. **FOR SALE** major M588 (modified)

26.515MHz-28.045MHz suitable for ham conversion. £60 Tom Valentine phone 0674 76503.

BC3423/N 1.5 to 18MHz as new, beautiful performer, CW PSU £40. BC221 wavemeter as new £18. Signal geny 100kHz to 30MHz £20. Phillips VCR+12 cassettes £10 or swap WHY I want anything for ZX81 inc software. Valves for AR88D. How to fit S-meter to same. Also 2m co-linear. Parkes 1 Silkstone View, Platts Common, Barnsley. All letters answered.

HEATHKIT HW12A 80m SSB transceiver 200W in absolutely unmarked condition. Complete with PSU speaker, spare PA valves, manuals, (and mobile mount!!) £85. G3UEG Harlow (0279) 27788.

ICOM SP3 speaker £30; Icom RC11 remote control for R71 receiver £35; at 1000 antenna tuner £27; all boxed as new. 01-570 5603.

FTV107R CW 2m 70m modules satellite incorporated. 70cm repeater operation modified by SMC for full cover. FRB707 relaybox included £330 ono. Consider 2m homebase multimode in partex, cash either way prefer newish Trio or Icom 25W minimum essential vgc. John G4WLD 01-857 8096.

EQ300 Heil microphone

equalizer. Give your station more talk power. Wired by Ammcom for Yaesu 8pin, easily changed to suit any rig/mike. Mike gain plus 20dB boost or cut at 470Hz and 2400Hz. Can be processed £35 ono. 01-247 6097 (Daytime).

YAESU FRD101 digital complete receiving station. Complete loud speaker, headphones, HP5 vertical aerial with Lowe radials seen perfect working order £250 ono. Ring Mr Mountford, on Rock 266106.

EDDYSTONE 8400 receiver 3.30MHz £80 Sommerkamp FL200B transmitter manual & leads £80. Super 8 projector & reel £60 or exchange 70cms m/mode rig. Phone Brian G6SYN 0747 860 839 (Mere, Wilts) E/nings, W/ends.

GRANDSTAND 934 and 27MHz two band transceiver 8W out. With microphone and handbook good condition. Cost £399, accept £280 ono. Murphy 27MHz base station new condition with handbook £30. Phone Stone 0474 872743.

KENWOOD (Trio) TR9130 144MHz multimode. TCUR excellent condition, plus mike and 7/8wave gutter mount aerial £375. 15 rolls 5-track paper tape, suit RTTY £1 each. 450MHz STC Starphone. Suit 70cms? £15. G1BUE St. Albans 32759 eves and wk/ends.

SHURE model CB43 hand mic. Brand new, boxed £12. Wanted Ten-Tec 263 VFO. Tel 0795 873100.

SOMMERKAMP FT7B 80-10 mobile Tx/Rx matching Yaesu FP12 PSU/ext sp. £350 (0924) 451537 (W.Yorks).

RACAL RA17 communications receiver excellent condition £175. Collected. 51 Wells Road, Barnwood, Gloucester. Sorry no telephone.

RECEIVERS Eddystone 840C comm Rx 500kHz-30MHz with circuit diagram £85. Codar CR70A comm Rx needs service but is in full working order £25. PSU 13.8V, 5amp £10. Or £105 the lot. Tel 654 1361 Croydon.

FOR SALE Yaesu FRG770 mint condition also Yaesu FRT7700 £250. Super star 360FM untouched mint condition absolutely original best offer over £100. Consider exchange HF equipment. Phone Brian 01-515 5517.

TELEPRINTER. Friden flex-owriter model 1F. Built in paper tape. Working. Includes spares. Requires 110VBAC. Buyer inspects. Any reasonable offer secures or swap anything aeronautical, Avtonic. What have you? Godfrey. G4GLM. 63 The Drive, Edgware, Middlesex, HA8 8PS. Telephone: 01-958 5113.

SONY AVC3200CE TV camera with viewfinder plus Sony AV3620CE reel to reel video recorder both in excellent condition £90 ono. Plus postage. Thetford (0842) 61523.

2M SET Trio TR7800 excellent condition, never used £120 nono. Pete 01-390 5928. After 6.30pm weekends.

AKG D509 microphone £20; shure 5885B unisphere microphone £20; NRD NDH515 24CH memory unit £125; Racal dual diversity unit MA168B with handbook £45; Sparkrite SX2000 electronic ignition £20; Garrard 401 turntable £40. All carriage extra. Telephone Halsall (0704) 840328.

FOR SALE Trio R1000 £125, Trio JR500S £50, Yaesu FRG7 £120, Lowe SRX30D £100, Lafayette HA55A and HA700 offers, rotating aerials with mast £50 ono. Buyer to dismantle, various speakers offers, Tel Walton-on-Thames 246968 evenings.

FOR SALE Trio 2200GX 2m FM Tx/Rx with Nicads and charger and power supply £60. 68 Princess Street, Broadheath, Altrincham, Cheshire.

RADIO SHACK TRS80 level 2 monitor, printer, two computers, ZX80. £120 the lot or exchange IC202S, AEA MM2 memory keyer £70. Ring Dave 06284 72086.

JAYBEAM C8 70cms colinear new, unboxed MKII £74. Met 14T element 2m beam £22. Met 17T 70cm beam £18. 3 months old, Trio TR2500 mint with ST2 base charger £245. 01-540 3959 anytime.

HAVE 12, 5 1/4" double sided, double density 16 vector, 80 track floppies. Brand new unused £10. Wanted FV2000 ext VFO for FT200. Ring 04952 56560, ask for Carl.

AR88, S-meter, original speaker, manual, spare valves, £35. ASR33, manuals, stand, £40. HF5 antenna £35.

EXCHANGE

EXCHANGE Hameg 203.5 20MHz oscilloscope brand new 3 probes. Realistic DX302 digital communications receiver 30kHz-30MHz. 48K Spectrum, qwerty keyboard, RTTY/CW cassettes. 960ch 27MHz transceiver L S B / U S B / F M / A M / K W 100watt linear p.supply all new unmarked exchange for modern mobile transceiver. Ring Birmingham 021 783 8609.

EXCHANGE Telescope 3½" reflector, short tube, with 2 eyepieces, tripod, finder scope, filter, camera adaptor, inverter, and fitted case. Mint condition. Exchange for FT290R, LS-202E, C58, FT209 R or WHY. Please write, Philip Hawkes, 62 Charlotte Gardens, Collier Row, Romford, Essex RM5 2ED.

EXCHANGE IBM golf ball electric typewriter with spare golf balls and full fox of 12 ribbons, list price £840, for HF transceiver 1.8MHz to 30 MHz. Straight swap, typewriter as new, registered with IBM company. Ring Mr Haines, 0482 658716.

EXCHANGE Telequipment dual trace oscilloscope type D51 for Yaesu FT208 or Trio TR2500 2m handheld in good condition. Tel Derby 701477.

HRO 1945 vintage Rx covering 0.1 to 30MHz with manual. Overhauled but retaining original octal valves. Exchange for trio R600, R1000, R2000, Yaesu FRG 7700 or Century 210 or sell. Phone 0256 478731 before 21:30.

SALE OR SWOP Calgil rotator, built in cooker hood brand new, Cannon gas miser fire. would like Trio R1000 MW144/30LS MMC 144/28 2m converter. Phone Rob Highcliffe 77194.

BBC MODEL B + Software speech synthesiser, computer cassette and few extras. Would exchange for HF transceiver such as FT7B. Any other radios (HF) where cash adjustment could be arranged. Contact Jon 051-638 3401 after 6pm.

MATT SKIPP sync sound system Sankyo CME 660 zoom pulse camera, Phillips N2214 stereo pulse recorder transfer strobe track stripe extra head readers sync sprockets Thomas A.1.

Craven film counters wanted FRG 7700 or amateur bands receiver. Rankin, 29 Primrose Drive, Shrewsbury.

EXCHANGE offered LAP HF omni match all bands incl WARC rated 250W plus triple meter SWR power modulation unit rated 500W. Wanted digital comm receiver or 144MHz equip WHY. Contact John G3OAZ, QTHR, Tele 0256 465126.

FT7 for exchange or sale. Wanted FT101B/E GW3COI Abersoch 2675.

EXCHANGE Trio TS9500 UHF all mode transceiver comprising Kenwood PS20 Kenwood system base B09 Kenwood SP120 speaker 88 element Jaybeam for HF transceiver. Tel Swansea 0792-883854 after 5.30pm.

WANTED

WANTED Shure 444 mic high impedance. Will exchange for Shure HO1B low impedance. Will pay difference. Tel Ipswich 49139 G3ZLN.

WANTED as a package deal. Inoue IC 700R receiver IC700T transmitter IC700PS power unit/speaker. Complete with companion microphone and operating manuals. Realistic price please as now retired. Phone Stephenson 0272 642101 (Bristol).

WANTED diagram for crystal calibrator for wireless set No.19. Thank you. C. Callaerts, 1 Clos des Cytises, 1410 Waterloo, Belgium.

IS THERE a licenced amateur reading this who might enjoy writing to an RAE student? I am seventeen and need a licenced brain to pick! Please write for more details: Jonathan Baker, 67 East Street, Selsey, West Sussex. PO20 0BT.

WANTED Yaesu 'YK901 keyboard to go with Yaesu YR-901 CW, RTTY reader must be in nice condition. Tel 394336 Colchester, Essex.

WANTED air and marine receivers, have Fujium portable RDF 2m marine FM LW MW BFO etc, to sell or exchange. Phone 0274 676556 after 6pm.

WANTED any information on RTTY or AMTOR using Tandy TRS80 Model 1 48K computer with disk drives and printer. Porter, 47 Milford Avenue, Wick, Bristol, phone Abson 2641.

WANTED for Yaesu FT 301

transceiver external VFO FV-301 or other suitable VFO wanted non-working HRO receivers and parts. Tel St Albans 39333.

WANTED YAESU FT290R multimode. Chris Smith, 35 Allendale Road, Earley, Reading RG6 2PD. Telephone Reading 661075 evenings after 6.30, daytime Rdg 875123 ext 6207.

WANTED URGENTLY Yaesu FTV 707 with 70cms module in good condition. Prompt payment in UK funds or US dollars at sellers option. Will arrange collection. All offers replied to by airmail. Oakley, 524 DJ, PO Box 99111, Mombasa, Kenya.

WANTED Gonset G-75 AC PSU model 3349 or complete transceiver model 3338 with AC PSU also National HRO matching speaker in 10" metal case G2ABC QTHR. Tel: Truro 78393.

WANTED Fascimilie equipment, anything considered. Possibly Muirhead machine or anything with D649 chassis. Must be in reasonable order with info if poss. Also anything to do with weather satellite reception — books, magazines, articles, etc surplus to Req, good prices paid. Contact G4PLM QTHR.

PYE VANGUARD Hi & Lo band service manual or details required. Also service sheets for Heathkit DX100U transmitter. PG Robins, 290 Priory Road, St Denys, Southampton SO2 1LS.

WANTED 707 Yaesu or Belcom LS102L urgent, cash waiting. For sale NATO 2000 FM/AM/SSB/LSB £120 ono. Write Mr Tarleton, 499 Burton Road, Midway, Burton on Trent.

WANTED TRIO DG-5 digital display. Any condition considered. Tel Roger 04626 2187 (evenings).

WANTED old ARRL handbooks Also valve data manuals. Write Richard Marris, 35 Kingswood House, Farnham Road, Slough, Berks SL2 1DA.

WANTED 80-10M trapped vertical antenna with radials. Also wanted FT707 power supply Tel 0443 431864.

SWL WANTS HF receiver general coverage, digital, no modifications. 5 Egremont Road, Exmouth, Devon EX8 1RX.

WANTED microphone and receivers head gear assy

no.15 telephone hand set no.11 and pouch all for an 88 set. 14MHz to 30MHz and 180kHz to 430kHz coil packs for an HRO-Mx phone 0632 693955 Keith G4MSF QTHR. **WANTED** B2 or A MK3 or any suitcase radios, manuals or incomplete sets. Also interested in any ex WD radios. Please telephone 01 949 2317.

WANTED Kenwood TS530S, TS530SP TS830S, must be excellent or better! Selling KW2000B AC PSU, LRC tester 373A; Yashica FR2 35mm motorised camera F1:2.8/28, F1:1.4/50 all absolutely mint condition. Details from Harvey 0229 85669.

WANTED WWII unmodified units R1124C, R1125, R1084, R1188/AR77, TR1196 — Tx type 22 Rx type 25, T1154 test oscillator types 51,11,12,12A, W1191. Control units A1134A, 10A/11841. Please contact G3UZH QTHR. Tel 0642 470623.

WANTED manual or circuit for Cossor 1035 Mk3 oscilloscope for loan or purchase. Benson, 54 Ena Crescent, Leigh, Lancs.

WANTED service information and/or spares for hallicrafters S37 Rx (130-210MHz). Tel 0272 696788.

MOTOROLA RX R390 order no 13602 PH53 handbook urgently required. Will defray postage, photocopy costs. Jennings, Little Berwick, Lympne Hythe, Kent. 0303 66651.

WANTED circuit diagram for WKS 1001 or WKS 1001 transceiver any condition will pay reasonable price plus postage. Please contact Mr Martin Fuller, 37 Greenfield Close, Eccles, Nr Maidstone, Kent ME20 7HU or tel Maidstone 70485.

WANTED VG Rx1155 also realistic DX200 or DX300 telephone Waldock, Rotherham, (0709) 63232.

WANTED B.40 or AR.88 receivers, must be in good condition and working. Cash waiting. Send details to Peter Burbeck, 11 Westbere House, Sholden Gardens, St Mary Cray, Kent BR5 4RD.

WANTED ICOM IC-202 microphone complete with lead and plug also manual, copy will do. Contact George G8YGO, phone Coniston 0966 41285 after 6pm.

Free Readers' ADS!

Buy, sell or exchange your gear through our free service to readers

CONDITIONS

1. These advertisements are offered as a free service to readers who are not engaged in buying or selling the same equipment or services on a commercial basis. Readers who are should contact our advertising department who will be pleased to help.

2. Advertisements will be inserted as and when space becomes available.

3. The insertion of advertisements will be on a first-come, first-served basis, subject to condition (2). As a result, it will not be possible to guarantee the insertion of a particular advertisement into any particular issue of the magazine.

4. Readers should either write out their advertisement in BLOCK CAPITALS or type it, underlining any words that are to appear in bold.

5. The magazine cannot accept any responsibility for printers' errors in the advertisements; however, we will do our best to ensure that legibly written advertisements are reproduced correctly. In the event of a gross error, at the Editor's discretion, a corrected version of the advertisement will be printed (at the advertiser's request) at the earliest issue in which space is available.

6. The magazine or its publishers will not accept responsibility for the contents of the advertisements, and by acceptance of these conditions,

the advertiser undertakes to indemnify the publisher against any legal action arising out of the contents of the advertisement.

7. The magazine reserves the right to refuse to accept or to delete sections of advertisements where this is judged necessary.

8. Advertisements are accepted in good faith; however, the publisher cannot be held responsible for any untruths or misrepresentations in the advertisement, nor for the activities of advertisers or respondents.

9. Advertisers must fill in their names, addresses and (if available) telephone number in the space provided, and sign the form to indicate acceptance of these conditions (forms returned without a signature will not be used).

10. All that is to be reproduced in the advertisement should be entered into the space provided on the form printed in the magazine - note that a **photocopy is not acceptable**. All advertisements must give either a telephone number and/or address for respondents to contact, and this must be included in the wording of the advertisement.

11. Advertisements must be 40 words or less in length (telephone numbers normally count as two words, exchange or exchange code plus number).

Name

Address

.....

.....

I accept the conditions above.

Signature

Send this form to: Free Readers Ads, Ham Radio Today,
1 Golden Square, London, W1R 3AB

ENTER YOUR ADVERTISEMENT HERE:

EMPORIUM GUIDE

AVON

Booth Holdings Bath

6 GOLF CLUB LANE,
SALTFORD,
BRISTOL
Tel: 02217 2402
Open Tues Sat 9am - 9pm
Close Mondays

W. MIDLANDS

DEWSBURY ELECTRONICS
RXs from YAESU JRC ICOM
Stockists of microwave modules B.N.O.S. M.L.T.
GAMMA DATONG ICS TASCOS
Open Mon-Sat 9.30-5.15
176 Lower High Street
Stourbridge (0384) 390063

NOTTINGHAM

SP ELECTRONICS
48 Limby Road
Huckhall, Nottingham
Tel: (0602) 640377
Open Monday-Saturday
8.30-5.30

SCOTLAND

JAYCEE ELECTRONICS
JOHN GM30PW
20 Woodside Way, Gelsenrothes, Fife KY7 5DF
Tel: 0592 756962
Open: Tues-Sat 9-5

Quality secondhand equipment in stock. Full range of TRIO goodies. Jaybeam - Microwave Modules - LAR.

KENT

THANET ELECTRONICS
95 Mortimer St, Herne Bay
Tel: (02273) 69464

Open Mon-Sat 9-5.30pm
except Thursday 9-1pm

WARD ELECTRONICS

DIWA LOWE PRODUCTS COMMODORE COMPUTERS
HOKUSHIN I.C.S. AMTOR/RTTY EQUIPMENT RSGB BOOKS
G3LIV PCB'S FOR SSTV/RTTY FOR RADIO ENTHUSIASTS
422 Bromford Lane, Ward End
Birmingham B8 2RX
Tel: 021-328 6070 (Closed Monday)

SURREY

GUILDFORD COMMUNICATIONS
34 Aldershot Rd., Guildford
Open Mon-Fri 8am-6.30pm
Sat 8am-5.30pm
Secondhand wanted

ASDEN TOTSUKO
TRIO ICOM
0483-574434

SCARAB SYSTEMS AMATEUR RADIO SOFTWARE

ICOM STOCKISTS
39 Stafford Street, Gillingham 0634-570441
please see main advertisement

R. WITHERS COMMUNICATIONS

584 Hagley Road West
Oldbury, Warley B68 0BS
(Quinton B'Ham) Tel: 021-421 8201/2/3
Opening hours 9.00-5.30pm. Late nights Thurs-Fri.
For all your communication requirements send SAE for latest used list and latest info.

TYNE & WEAR

Approved Dealer
ALYNRONICS
ICOM
129 Chillingham Rd, Newcastle-upon-Tyne
Tel: 091-276 1002
Open: Tues-Sat 10am-6pm

LANCASHIRE

AMATEUR ELECTRONICS U.K./HOLDINGS



Yaesu, Tel, Jaybeam, Frequency Counters, Drae, Datong, FT101 Experts, Repairs, 6JS6C, 12BY7A, 8KDB, RF Clipper, Double Balanced Mixer, Warc Kits etc. S.A.E. List 15 min. Junc. 31 M6. Free parking.
45 Johnaton Street
Blackburn BB2 1EF
(0254) 59595
CLOSED THURSDAYS

NORFOLK

D.P. HOBBS (Norwich) Ltd
13 St. Benedicts Street, Norwich
Tel: 615786
Open Mon-Sat 9-5.30
Closed Thurs
Stockists of:
YAESU, FDK, ICOM, JAYBEAM
& Electronic Component Specialists

YORKSHIRE

TELECOM
6 New Street, Barnsley
South Yorkshire
Tel: (0226) 5031
Specialists in Yaesu, Icom
and So-Kamp

LONDON

DRESSLER UK LTD
191 Francis Rd, Leyton, E10
Open 9-5.30pm Monday-Friday 10-5 Saturday
Authorised dealers for:
Dressler, Yaesu, Icom, Standard, Trio/Kenwood,
Datong, SCM, Microwave Modules, Tonna
Tel: 01-558 0845/556-1415 Telex: 8953609

Eastern Communications

31 Cattle Market Street
NORWICH
OPEN: 9.30-5.30 Mon-Fri
9.30-5 Sat
(0603) 667189
MAIL ORDER
ICOM

**DON'T LEAVE IT TO CHANCE!
— GIVE YOUR BUSINESS A BOOST
BY ADVERTISING IN HRT
PHONE 01-437 0699 FOR DETAILS**

• RADIO AMATEURS AND 'C.B.' PEOPLE TALK TO •

LAE 34 NEW BRIGGATE LEEDS LS1 6NU
COMMUNICATIONS CENTRE

ELECTRONIC COMPONENTS - TELEPHONES
VIDEO - AUDIO LEADS - STYL
LEEDS 452657 the PROFESSIONALS!

TRIO ICOM YAESU
LARGE RANGE OF ACCESSORIES

4 Cross Church St. Huddersfield Tel: 0484 20774
Open 6 days 9-5.30
Closed Weds. Thurs 9am-8pm
G4MH Mini Beam, Trio & Yaesu
Always a good selection of new & 2nd hand equipment in stock

Amateur Radio Shop

Lineage:

35p per word (minimum 15 words)

Semi Display: (minimum 2 cms)

£7.00 per single column centimetre

Ring for information on series bookings/discounts

All advertisements in this section must be prepaid.

Advertisements are accepted subject to the terms and conditions printed on the advertisement rate card (available on request)

01-437 0669

EXT 332

Send your requirements to:

Caroline Faulkner

ASP Ltd.,

1 Golden Square,

London W1

MOBILE MICS

HEATHERLITE MOBILE MICS

Made to help you drive safely

Reasonably priced to suit your rig. head/neck band, electret mic. control box, variable gain, scanning buttons, plug-fitted —superb quality. Priced from £20.50 inc.

FULLY GUARANTEED

Ring for details —

Heather G8SAV (0401) 50921

EQUIPMENT

SELLING YOUR USED EQUIPMENT?



WANT THE BEST PRICE?

Then phone Dave, G4TNY! Why? Because if you call me, you'll be offered the best possible deal on your used gear! How? Phone me and tell me what you feel is a FAIR MARKET PRICE for your equipment. I'll probably agree! Most amateurs know what their gear is worth and feel quite insulted when they get offered 'silly' prices! With G4TNY this won't happen! We'll negotiate a selling commission, which dependant on the condition and 'saleability' of your equipment, could be as little as TEN PERCENT of your agreed market value!! That's not all! Then I'll pay you **CASH NOW !! — NO WAITING MONTHS FOR THE SMALL ADS!!**

BUYING USED EQUIPMENT? IT'S THE BEST WAY!

Whatever you're looking for, phone me last — for the best deal available, ANYWHERE! As you can imagine, with a service such as that above to offer the modern Radio enthusiast we have the BEST USED EQUIPMENT AVAILABLE! At the FAIREST prices. My low overheads see to that! I only buy the best, all equipment is fully tested and inspected before sale, and I'LL UNASHAMEDLY GUARANTEE EVERYTHING I SELL!! CALL SOON!

Phone Hornchurch (04024) 57722, Anytime. Or send SAE for list to:

G4TNY Part Exchange **G4TNY AMATEUR RADIO** G6TNY Mail Order
132, Albany Road, Hornchurch, Essex. RM12 4AQ.

MISCELLANEOUS

CONTINENTAL DX-pedition/holiday plans? Start with "GB NEWS 1985". For copy, send 2 x 13p stamps. GB Car Club, FREE POST 3, Romsey, Hampshire, SO5 8ZT.

SERVICE MANUALS

SERVICE MANUALS. Amateur Radio Test, Audio, Television, Video etc. S.A.E. enquiries, Mauritron (HRT), 8 Cherrytree Road, Chinnor, Oxfordshire.

SOFTWARE

VIC20 PROGRAMS WORLD LOCATOR, morse tutors and transceive CW on 3.5K. S.A.E. for details, G4SDJ 2 Merriefield Close, Broadstone, Dorset.

ANTENNAS

G2VF DIY loop Antennas for H.F. long and medium wave bands. SAE for details: Rylands, HRT, 39, Parkside Ave., Southampton SO1 9AF.

COURSES

COURSES - RADIO AMATEURS EXAMINATION

City & Guilds. Pass this important examination and obtain your licence, with any RRC Home Study Course. For details of this and other courses (GCE, professional examination, etc.) write or phone — THE RAPID RESULTS COLLEGE, Dept. JN2, Tuition House, London SW19 4DS. Tel: 01-947 7272 (9am-5pm) or use our 24 hr Recordacall Service: 01-946 1102 quoting Dept. JN2.

MORSE S/WARE

MORSE (SPECTRUM 48K)

Randomly generated letters and/or numbers at users requested speeds and spacing visual and audible presentation. £5.50 cassette or SAE for details:

Educational Software
20 Beaufont Rd.
Camberley GU15 1NF

COMPONENTS

R.F. Transistors, Specials Components for Transmitters, Unico Capacitors, Sparague Mica Trimmers (500V). Sole Agent for solid state Microwave R.F. Transistors supplied to full specification. Full 2N range supplied. Special SD range 1W-100 WATT output 1 to 100 MHz. Preamplifiers for 2 meters and 70cms. Power Amplifiers with and without switching. Aligned and ready for use. Due to exchange fluctuations we cannot price. Send S.A.E. for full lists.

Phone: Selsey
(0243) 823603. Modular Electronics, 1 Coniston Close, Felpham, Bognor Regis, Sussex.

RESISTORS, CAPACITORS.

1,000 mixed carbon film 1/4W, 1/2W, 1/2W, 2%, 5%, 10% resistors £2.95. 50 mixed ceramic tube capacitors £1.00. p&p 50p. D.J. Hooker, Romney Marsh Electronics, Clark Road, Greatstone, Romney Marsh, Kent, TN28 8PB.

TO FILL THIS SPACE

PHONE CAROLINE ON 01-437 0699

Rates of charge! —

35p per word (minimum of 15 words) semi-display £7.00 per single column cm.

PHONE 01-437 0699 with your requirements

RIGS/ACCS/AMPS

Q.E.D. COMMUNICATIONS, 30 The Brow, Woodingdean, Brighton, Sussex. Rigs — Accessories — Components. Catalogue 30p. Tel: (0273) 309127.

CARDS/STICKERS

QSL CARDS. Many designs, reasonably priced. Free samples, please state if S.W.L. **DEROGA PRINTING**, Whitewell Rd., Sparham, Norwich NR9 5PN.

HIGHCLASSQSLCARDS. Competitive prices, free artwork. SAE for samples stating ham or breaker to: J.S. Coates, 57 Worrall Street, Morley, Leeds LS27 0PJ.

LISTENER & QSL CARDS. Quality printing on coloured & white Glass Card at competitive prices. S.A.E. for samples: S.M. Tatham, "Woodside", Orchard Way, Fontwell, Arundel, W. Sussex.

HOLIDAYS

SELF-CATERING CHALETs. Explore by day, DX by night. My aeriels, your rig £15-£120 per chalet per week. Green, Goats, 'Chylean' Tintagel, Cornwall PL34 0HH. Tel: (0840 212262).

CARDS

QSL CARDS. Gloss or tinted cards. SAE for samples to TWROG Press, Dept HR, Penybont, Gillilydan, Blaerall, Ffestiniog, Gwynedd.

TO FILL THIS SPACE

PHONE CAROLINE ON 01-437 0699

RTTY

RTTY - CW - AMTOR

Now on the Dragon
Complete set of Programs & Hardware

to convert your DRAGON 32/64 into a complete communications terminal.

Morse transceiver
Program (Cassette) £10.75
Interface (Module) £17.50

RTTY
Program (Cassette) £12.00
Terminal unit of modules £39.00

AMTOR
Program (Cassette) £39.00
Clock/Switch Module ACCESS & VISA £18.00

Programs also available in Cartridge. Hardware available in kit or fully boxed form.

For full details send 2x 17p stamps to:-

PNP Communications (HT)
62 Lawes Avenue, Newhaven East Sussex BN9 9SB
Tel: (0273) 514465
Prices include postage but not VAT

DON'T LEAVE IT TO CHANCE!

—GIVE YOUR BUSINESS A BOOST BY ADVERTISING IN HRT

PHONE 01-437 0699 FOR DETAILS

HAM RADIO TODAY

CLASSIFIED ADVERTISEMENT — ORDER FORM

IF YOU HAVE SOMETHING TO SELL DON'T TURN THE PAGE — TURN TO US!

RATES OF CHARGE: 35p per word (minimum of 15 words) semi-display £7.00 per single column cm. & 15% VAT

Or Debit my Access/Barclaycard (Delete as necessary)

Advertise nationally in these columns over 60,000 readers for only 35p per word (minimum charge 15 words). Simply print your message in the coupon and send with your cheque or postal order made payable to Argus Specialist Publications Ltd. to:

CLASSIFIED DEPT. HAM RADIO TODAY
1 Golden Square, London W1R 3AB.
Tel: 01-437-0699.
Please indicate classification required.

Name

Address

.....

.....

Tel. No (Day).....

--	--	--	--	--	--	--	--	--	--	--	--	--	--	--	--	--	--	--	--	--



or debit my Access/Barclaycard (delete as necessary)



ATTENTION ALL WRITERS . . .

... or just those of you who sometimes think "I could do better than that!"

We want to hear from you!

The magazine you hold in your hand is part of ASP's electronics group of titles. These include *ETI*, *Ham Radio Today*, *Digital and Micro Electronics*, and our new magazine, *Electronics*. All these magazines are looking for new authors, so if you've designed something for yourself that you think may be of interest to others, or if you've a subject you'd like to write a feature article on, then drop us a line with an outline of what you have in mind.

We particularly need:

- Projects for the Commodore Vic 20 and 64, the Amstrad, the BBC A and B, and the Electron computers;
- Simple projects that do something useful, perhaps in a novel or instructive way;
- Radio projects (not necessarily for radio amateurs);
- Features on amateur satellite radio.

If you're interested in writing for us, send an outline of your proposed article to: Dave Bradshaw, Group Editor (Electronics), Argus Specialist Publications, 1 Golden Square, London W1R 3AB.

Please note that while we take ever care, we cannot be held responsible for the loss of unsolicited manuscripts. We advise all authors to keep a photocopy or carbon copy of any article they send us.

HAM RADIO TODAY, JUNE 1985 ADVERTISERS INDEX

BNR & ES	33	PNP Communications	65
Coates QSLS	65	QED Communications	65
Dewsbury Electronics	OBC	Rainbow Communications	27
D.J. Hooker Components	64	Rapid Results College	64
Dressler U.K. Ltd	IFC	RAS Nottingham	27
Educational Software	64	Rylands	64
Farnborough Communications	33	Scarab Systems	23
GB Car Club	64	Self-Catering Chalets	65
G4 TNY Electronics	64	SM Tatham QSLS	65
Heatherlite Microphones	65	Technical Software	23
Mauritron	64	Twrog Press QSL's	64
Microwave Modules	IBC	Wood & Douglas	23
Modular Electronics	64	WPO Communications	9

Don't forget, when calling an advertiser, mention
Ham Radio Today — it helps them and us.

73's Dave Gadsden, G4NXV, Advertisement Manager

2 METRE MULTIMODE TRANSVERTER MMT 144/28-R



NEW RELEASE

FEATURES

- 25 Watts TX Output
- GaAsFET RF Stage
- Transmit ALC Circuit
- 13.8V DC Operated
- Repeater Shift (normal, simplex, reverse)
- High Level DBM Mixer
- LED Bargraph Power Meter
- RF Vox — Adjustable Delay & PTT Override

SPECIFICATION

GENERAL

INPUT FREQ RANGE	: 28-30MHz
OUTPUT FREQ RANGE	: 144-146MHz
REPEATER SHIFT	: Simplex, normal, reverse
DC REQUIREMENTS	: 13.8V DC at 6 Amps

TRANSMIT SECTION

OUTPUT POWER	: 25 watts +/- 1dB
INPUT LEVEL RANGE	: 1/4mW to 300mW
ALC RANGE	: 20dB
MODES OF OPERATION	: SSB, FM, CW, AM, FSK
SPURIOUS OUTPUTS	: -65dB or better

RECEIVE SECTION

Gain	: 22dB +/- 1dB
N.F.	: 2dB or better
3RD ORDER INTERCEPT	: +19dBm (output)

DESCRIPTION

This new transverter has been designed to allow users of existing HF band transceivers to establish a first-class transceive facility on the 144 MHz band.

The MMT144/28-R incorporates many new and exciting features which combine to make this product simply superb.

RECEIVE SECTION

An NEC GaAsFET is employed in a noise-matched configuration feeding a high level double balanced mixer via a bandpass filter. IF gain is achieved by a JFET post amplifier. This combination produces a good signal to noise ratio, excellent immunity to overload and cross modulation, resulting in a rugged receive system having a third order output intercept point of +19dBm.

Two separate low-noise oscillators, operating at 116.00 and 115.40 MHz are included, running from a regulated 8.2 volt supply. Selection of the wanted oscillator is achieved by a quad op-amp circuit, controlled by the front panel mounted 'MODE' switch. This provides simplex, repeater and reverse repeater operation. The output of each oscillator feeds a JFET buffer amplifier via the quartz crystal which acts as a filtering element to reduce amplitude noise and reciprocal mixing products. The resultant high level injection is extremely pure and free-from harmonics.

TRANSMIT SECTION

The incoming 28MHz signal, in the range 1/4mW to 300mW, is initially fed to the RF VOX circuit, ALC control circuit and the input level control.

This signal is then fed into a pair of MOSFETs in a balanced mixer configuration, together with the local oscillator injection, to produce the wanted signal in the range 144-146MHz.

This signal is then amplified by several linear stages up to the specified output power of 25 watts. A visual indication of relative output power is provided by a front panel mounted LED bargraph display.

A rear panel mounted level control allows the user to adjust the sensitivity of the transverter to suit the transceiver in use, and a front panel mounted RF VOX delay control allows adjustment to suit SSB/FM modes.

The ALC circuit has a 20dB dynamic range and has been incorporated to ensure that a particularly clean signal is produced by the transverter. This is an important feature which will virtually eliminate compressed signals and the resultant problems caused to local stations.

PRICE: £215 inc. VAT (P&P £3.50)



MICROWAVE MODULES LTD.
Brookfield Drive, Aintree, Liverpool L9 7AN,
England.
Telephone: 051-523 4011.
Telex: 628608 MICRO G.



WELCOME

HOURS:
MONDAY-FRIDAY
9-12.30, 1-5.00
E. & O.E.

DEWSBURY



ELECTRONICS



FRG 8800 £559



TRIO R600 £299



NRD 515 £965

IF IT'S TRIO IT MUST BE DEWSBURY

A FULL RANGE ALWAYS IN STOCK

APPROVED
TRIO
DEALER



TRIO R2000 £479

APPROVED
TRIO
DEALER



IC - R 71E £699

NEW PRODUCT NEWS

IF YOU'RE THINKING ABOUT C/W
YOU MUST READ THIS!

- ★ Iambic Keyer
 - ★ Dash/Dot Memory
 - ★ Keying Speed 1 — 55 wpm
 - ★ Built In Side Tone Oscillator And Speaker
 - ★ Headphone Socket
 - ★ Variable Weight Control
 - ★ Side Tone Volume And Pitch Control
 - ★ Switchable Automatic/Semi Automatic Keying/Tune Control
 - ★ Operation From Internal Batteries Or 9 — 15v. External Supply
 - ★ Low Current Drain
 - ★ British Made
 - ★ Selectable Positives or Negative Keying
- 5 YEAR GUARANTEE**
Only £49.95 + £3.00 P&P To Include External Power Leads And Plugs.



POCOMOTOR AFR2000
RTTY ALL MODE DECODER

(Now with CW option) From £425



STAR MASTER — KEYER

Stockists of DAIWA — MET ANTENNAS — MUTEK — WOOD & DOUGLAS — TASCOS TELEREADERS — MICROWAVE MODULES — ICs AMTOR — AEA PRODUCTS — DRAE

Dewsbury Electronics, 176 Lower High Street, Stourbridge, West Midlands.

Telephone: Stourbridge (0384) 390063/371228

Telex: 337675 TELPES G



Instant finance available subject to status. Written details on request.