

HAM RADIO HORIZONS

Welcome Back:
W9KNI's DX Diary

August 1980 / \$1.50

Adapting Old
Receivers
For
Modern
Modes

New Feature
— airTime

It's About
Time —
GMT, That Is

Plus
• Q & A section
• Bill Orr
• Much
• More

A Shopping Guide To



Wattmeters

Move over imports, here's the new TEN-TEC

DELTA

the notable change in hf transceivers



All new, all **nine** hf bands and only \$849!

DELTA — the symbol of change—the name of a great new TEN-TEC transceiver. A transceiver for changing times, with new features, performance, styling, size and value **TOTAL SOLID-STATE**. By the world's most experienced manufacturer of hf solid-state amateur radio equipment.

ALL 9 HF BANDS. First new transceiver since WARC. 160-10 Meters including the three new hf bands (10, 18 & 24.5 MHz). Ready to go except for plug-in crystals for 18 and 24.5 MHz segments (available when bands open for use). **SUPER RECEIVER.** New, low noise double-conversion design, with 0.3 μ V sensitivity for 10 dB S+N/N.

HIGH DYNAMIC RANGE. 85 dB minimum to reduce overload possibility. Built-in, switchable, 20 dB attenuator for extreme situations.

SUPER SELECTIVITY. 8-pole monolithic SSB filter with 2.4 kHz bandwidth, 2.5 shape factor at 6/60 dB points. And optional 200 Hz and 500 Hz 6-pole crystal ladder filters. Eight pole and 6-pole filters cascade for 14 poles of near ultimate skirt selectivity. Plus 4 stages of active audio filtering. To sharpen that i-f response curve to just 150 Hz bandwidth. 4-position selectivity switch.

BUILT-IN NOTCH FILTER. Standard equipment. Variable, 200 Hz to 3.5 kHz, with notch depth down to -50 dB. Wipes out interfering carriers or CW.

OFFSET TUNING. Moves receiver frequency up to ± 1 kHz to tune receiver separately from transmitter.

"HANG" AGC. For smoother, clearer, receiver operation.

OPTIONAL NOISE BLANKER. For that noisy location, mobile or fixed.

WWW RECEPTION. Ready at 10 MHz.

"S"/SWR METER. To read received signal

strength and transmitted standing wave ratio. Electronically switched **SEPARATE RECEIVER ANTENNA JACK.** For use with separate receiving antenna. linear amplifier with full break-in (QSK) or transverters.

FRONT PANEL HEADPHONE AND MICROPHONE JACKS. Convenient **DIGITAL READOUT.** Six 0.3" red LEDs. **BROADBAND DESIGN.** For easy operation. Instant band change—no tuneup of receiver or final amplifier. From the pioneer, TEN-TEC.

SUPER TRANSMITTER. Solid-state all the way. Stable, reliable, easy to use.

200 WATTS INPUT. On all bands including 10 meters (with 50 ohm load). High SWR does not automatically limit you to a few watts output. Proven, conservatively rated final amplifier with solid-state devices warranted fully for the first year, and pro-rata for five more years.

100% DUTY CYCLE. All modes, with confidence, 20 minutes max. key-down time. Brought to you by the leader in solid-state finals, TEN-TEC.

QSK — INSTANT BREAK-IN. Full and fast, to make CW a real conversation.

BUILT-IN VOX AND PTT. Smooth, set-and-forget VOX action plus PTT control. VOX is separate from keying circuits.

ADJUSTABLE THRESHOLD ALC & DRIVE. From low level to full output with ALC control. Maximum power without distortion. LED indicator.

ADJUSTABLE SIDETONE. Both volume and pitch, for pleasant monitoring of CW.

SUPER STABILITY. Permeability tuned VFO with less than 15 Hz change per F° change over 40° range after 30 min. warmup—and

less than 10 Hz change for 20 Volt AC line change with TEN-TEC power supply.

VERNIER TUNING. 18 kHz per revolution, typical.

SUPER AUDIO. A TEN-TEC trademark. Low IM and HD distortion (less than 2%). Built-in speaker.

SUPER STYLING. The '80s look with neat, functional layout. "Panelized" grouping of controls nicely human engineered for logical use. New, smaller size that goes anywhere, fixed or mobile (4 $\frac{3}{4}$ "h x 11 $\frac{3}{8}$ "w x 15"d). Warm, dark front panel. Easy-to-read contrasting nomenclature. Black "clam-shell" aluminum case. Tilt ball.

MODULAR/MASS-TERMINATION CONSTRUCTION. Individual circuit boards with plug-in harnesses for easy removal if necessary. Boards are available.

FULL ACCESSORY LINE. All the options: Model 282 200 Hz CW filter \$50, Model 285 500 Hz CW Filter \$45, Model 280 Power Supply \$139, Model 645 Dual Paddle Keyer \$85, Model 670 Single Paddle Keyer \$34.50, Model 247 Antenna Tuner \$69, Model 234/214 Speech Processor & Condenser Microphone \$163, Model 215 PC Ceramic Microphone \$34.50, Model 283 Remote VFO, Model 287 Mobile Mount, and Model 289 Noise Blanker available soon.

Experience The Notable Change In HF Transceivers. Experience DELTA. See your TEN-TEC dealer or write for full details.

TEN-TEC, INC.
SEVIERVILLE, TENNESSEE 37862
BENTLEY BLVD. LINCOLN AVE. CHICAGO, ILL. 60646

Rack Attack from DenTron

Components are the latest in communication systems adapting to your stations' needs. The DTR-3KA and DTR-1200L are equipped with heavy-duty handles for easy rack mounting and rack brackets that can be easily removed. The DTR-1200L linear amplifier provides 1200 watts SSB and 1000 watts CW input continuous duty. It features large 3 1/2" shadow box, back lit meters for easy reading, and tuned input for compatibility with solid state or tube transceivers. The DTR-3KA antenna tuner handles a full 3KW PEP. It features a built in 2KW dry dummy load with thermostatically controlled forced air cooling, a remote sensor box to insure meter accuracy and 50 OHM impedance. Component racks available at your DenTron Dealer.

DTR-1200L Linear Amplifier

Frequency Ranges:

80 Meter Band	3.45 - 4.6 MHz
40 Meter Band	6.00 - 9.0 MHz
20 Meter Band	10.00 - 16.00 MHz
15 Meter Band	20.95 - 23.50 MHz
10 Meter Band	Export Model

Modes:

USB, LSB, CW, RTTY, SSTV

Power Input:

1200W - SSB, 1000W - CW

Power Requirements:

234/117 VAC 50/60 Hz

RF Drive Power:

150 Watts maximum and 65 watts minimum for 1 KW DC input.

DG Plate voltage:

Idle + 2300V approximate

Duty Cycle:

100% SSB, CW, RTTY, SSTV

Input Impedance:

50 Ohms nominal

Input VSWR:

1.5 to 1 average

Output Impedance:

50 Ohms nominal

Antenna load VSWR:

2 to 1 maximum negative going, adjustable from front panel

ALC:

IMD - greater than 30 db down
Harmonics - greater than 40 db down

Spurious Emissions:

IMD - greater than 30 db down
Harmonics - greater than 40 db down

Switchable 12VDC accessory output voltage

Multimeter:

Plate Voltage	0 - 3000VDC
Plate Current	0 - 500ma
Relative Output	Adjustable

Front Panel Plate Voltage Switching

FCC Type Accepted

Size:

5 1/2" H x 17" W x 13" D (19" W with rack brackets)

Weight:

46 pounds

DTR-3KA Antenna Tuner

Frequency Coverage: 1.8 - 30 MHz continuous

Built in 2 KW PEP Dummy Load - Forced Air Cooled

Input Impedance: 50 ohms (Resistive) to transmitter

Antenna Inputs

Coax 1, 2 & 3 - unbalanced—may range from a few ohms to a high impedance

Long wire - low to high impedance

Balanced line - 75-660 ohms

Power Capability: 3000 watts P.E.P.

Wattmeter: 200 watts forward

2000 watts forward

200 watts reflected

Accuracy: ± 5%

Remote sensor box

3 1/2" backlit meters

Dummy Load: with manual or automatic forced air cooling.

Integral 3KW Balun



DenTron
Radio Co., Inc.
1605 Commerce Drive
Stow, Ohio 44224
(216) 688-4973

THIS MONTH'S

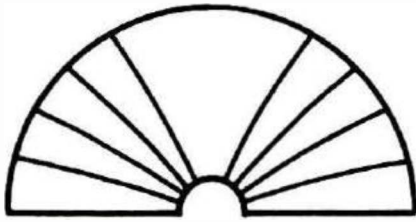

HORIZONS

A Guide To Wattmeters

Here's an article to keep in mind when you go shopping for a device with which to check the power output of your transmitter. Some of these devices measure reflected power too, and a few are calibrated to indicate VSWR. The characteristics of most commonly available models are given in a table for your convenience, and the author throws in information about dummy loads, too, along with some history. It all starts on page 12.

How To Get DX QSL Cards

You've probably read many articles on the DX QSL problem. In this issue we present a comprehensive review of all facets of sending and receiving DX QSLs — what to do and what not to do — and what's currently available to the dedicated DXer in accomplishing this objective. The article is by Randy Padawer, WA4FJF, who has given a pretty good account of his own DX operating ability.

Adapting Old Receivers For Modern Communications

If you have an old friend sitting on a shelf or tucked away under your workbench, dust it off and make room on your operating desk. Here's a description of a couple of adaptors you can make that will let your buddy of the 1940s and 1950s listen to today's SSB and fm communications with ease. NIRM shows you how, starting on page 32.

Hong Kong Hams

Here's a bit of information about a society of Radio Amateurs in an exotic land, and a look at the rules they live by. To help make a QSO with Hong Kong all the more memorable, they offer a couple of beautiful award certificates. The description of the colors alone will make you want to hang one on your wall.

DXer's Diary

Here's the first of a new series of articles by top DXer W9KNI. You've enjoyed his tales of DX lore in earlier issues of *Horizons*, and it's a pleasure to welcome him back. In this issue, he'll take you right into his shack to share a lonely vigil in search of a rare one. In spite of the hour, it's not a dull session — start on page 42.

Ham Radio Techniques

This month, Bill takes you on a trip to yesterday's inexpensive rigs and do-it-yourself receivers. He describes replicas of a one-tube transmitter and a three-tube receiver that worked a lot of the world in the 1930s, and can still make a good showing if properly treated. A word of caution, however: You will have to do plenty of digging and have a lot of patience to get the parts. They're not something that you can find at your local Radio Shack or Heath store. The nostalgia starts on page 46.

Timeliness

Sure, I know the feeling — you've accepted this business that you have to learn Morse Code, and it really wasn't all that bad (especially after you've passed the test). Then, there was that theory and operating procedures to bone up on, not to mention bands to memorize; that didn't stop you. But then you run head-on into this thing called GMT! What's worse, they have more hours on their clock than you do on your old reliable Big Ben (or even on the newer versions of it). What's going on? W1XU has an explanation of those wierd tick-tocks, starting on page 55.

Airtime

"Airtime" is a subjective listing of upcoming operating events and awards. Items are selected by the editor for their novelty or interest to the neophyte contester/wallpaper chaser.

If your group is planning an event which might be right for "Airtime", please send a notice to the "Airtime" editor at least three months in advance. See page 63.

The Cover

Here's a collection of power-measuring devices — some new and some that have been around for some time — useful to determine how well your transmitter is working. It's to call attention to our focus on wattmeters in this issue. Photograph by WINLB.

HAM RADIO HORIZONS August 1980, Volume 4, Number 8. Published monthly by Communications Technology, Inc., Greenville, New Hampshire 03048. Telephone (603) 878-1441. Second Class Postage paid at Greenville, New Hampshire and at additional mailing offices. ISSN 0147-8818.

Subscription price: Domestic, one year, \$12.00; two years, \$20.00; three years, \$27.00. Canada and Worldwide, one year, \$12.00; two years, \$22.00; three years, \$30.00, payable in United States funds.

Subscription inquiries and changes of address should be directed to *Ham Radio Horizons*, Greenville, New Hampshire 03048. Please include address label from most recent issue if possible.

NEW MFJ Multi-Sensor SWR/Peak Wattmeters

MFJ-825 lets you monitor SWR, Peak/Average power, for HF, VHF, QRP rigs. Plug in up to 3 sensors of your choice. Connect and operate up to 3 rigs simultaneously. Switch selects rig to monitor.

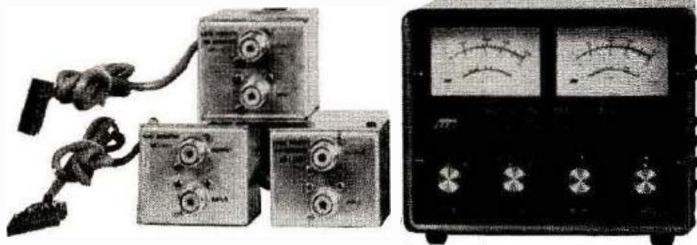

Multi-Sensor SWR/Peak Wattmeter
monitors HF, VHF, QRP rigs.

\$119⁹⁵

This NEW MFJ-825 Deluxe Power Sentry is MFJ's exclusive Multi-Sensor SWR/Peak Wattmeter.

With one unit you can monitor SWR, peak, average power for HF, VHF, or QRP rigs.

Secret is plug-in sensors. Plug in up to 3 sensors of your choice (HF, VHF, or QRP, see below). Connect and operate up to 3 rigs simultaneously. Front panel switch selects rig to monitor.

Comes with one sensor of your choice. Use sensors remote or mount in cabinet.

Read forward and reflected power on separate meters. 2 ranges. 2% meter movements.

Read SWR from 1:1 to 6:1. Has SWR sensitivity control, lighted meters, battery check.

Black, etched front panel, rugged metal cabinet. 6-3/4 x 5-3/8 x 5-3/4 in. 9V battery or 110 VAC with optional AC adapter, \$7.95.

MFJ-820 POWER SENTRY, \$69.95. Same as MFJ-825 but less peak function, only one meter,

plug in one sensor at a time.

Comes with one sensor of your choice (see specs below). Use remote or mount in cabinet.

Monitor forward/reflected average power, 2 ranges. SWR 1:1 to 6:1. 2% meter movement.

Has range/mode, reflected/forward power switches, SWR sensitivity control.

Lighted meter (req. 12 V). Black, etched panel, metal cabinet. 3-7/8 x 5-3/8 x 4-1/2 in.

PLUG-IN SENSORS: \$29.95 ea.

Plug up to three in MFJ-825, one in MFJ-820.

MFJ-830 HF SENSOR. 1.8 to 30 MHz. 200/2000 watts, forward, 20/200 watts reflected, full scale. 5 watt SWR sensitivity. Accuracy, $\pm 5\%$.

MFJ-831 VHF SENSOR. 50 to 175 MHz. 20 and 200 watts full scale forward and reflected power. 5 watt SWR sensitivity. Accuracy, $\pm 7.5\%$.



MFJ-832 QRP HF SENSOR. 1.8 to 30 MHz. 2 and 20 watts full scale forward and reflected power. 500 MW SWR sensitivity. Accuracy, $\pm 7.5\%$.

MFJ-833 HI-PWR VHF SENSOR. Same as MFJ-831 but 200/2000 W fwd. 20/200 W ref.

Alum. cabinet. 50-239. 2-1/2 x 2-5/8 x 2-1/4 in. Order from MFJ and try it. If not delighted, return within 30 days for refund (less shipping).

One year unconditional guarantee.

Order yours today. Call toll free 800-647-1800. Charge VISA, MC. Or mail check, money order. Add \$4.00 each for shipping and handling.

CALL TOLL FREE ... 800-647-1800

Call 601-323-5869 for technical information, order/repair status. Also call 601-323-5869 outside continental USA and in Mississippi.

MFJ ENTERPRISES, INC.
BOX 494, MISSISSIPPI STATE, MS 39762

MFJ Tunable SSB/CW Filter

Instantly zero in SSB/CW signals with tunable peak, notch, lowpass filter.

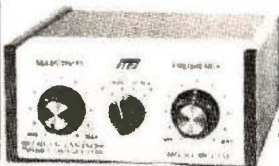

\$59⁹⁵

Peak, notch or lowpass signals, zero in with freq. control, adjust bandwidth for minimum QRM. Double tuned for extra steep skirts.

Linear freq. control tunes 300 to 3000 Hz. Output is constant as bandwidth is varied flat to 40 Hz. Tight notch to 70 db. 5x2x6 in.

Hear off frequency calls with simulated stereo. Plugs in phone jack. 2 watts out. 110VAC or 9-18 VDC. One year unconditional guarantee.

Try it. If not delighted, return within 30 days for refund (less shipping).

Order your MFJ-751 today. Call toll free 800-647-1800. Charge VISA, MC. Or mail check, money order for \$59.95 plus \$3.00 shipping.

CALL TOLL FREE ... 800-647-1800

For technical information, order/repair status, in Miss., outside continental USA, call 601-323-5869.

MFJ ENTERPRISES, INC.
BOX 494, MISSISSIPPI STATE, MS 39762

NEW MFJ VERSALOAD MFJ KW DUMMY LOAD

Lets you tune up fast into 50 ohm resistive load. Extend life of finals. Reduce QRM. Includes transformer oil. 1 KW CW, 2 KW PEP for 10 minutes. Low VSWR to 400 MHZ.



Includes high quality transformer oil.

Low VSWR to 400 MHZ.
1 KW CW, 2 KW PEP.

\$29⁹⁵

New MFJ-250 VERSALOAD kilowatt dummy load lets you tune up fast. Extends life of transmitter finals. Reduces on-the-air QRM.

Run 1 KW CW or 2 KW PEP for 10 minutes, 1/2 KW CW or 1 KW PEP for 20 minutes. Continuous duty with 200 watts CW or 400 watts PEP. Complete with derating curve.

Quality 50 ohm non-inductive resistor. Oil cooled. Includes high quality, industrial grade transformer oil (contains NO PCB).

Low VSWR to 400 MHZ: Under 1.2:1, 0-30 MHZ. 1.5:1, 30-300 MHZ. 2:1, 300-400 MHZ.

Ideal for testing HF and VHF transmitters.

SO-239 coax connector. Vented for safety. Removable vent cap. Has carrying handle. 7-1/2 inches high, 6-5/8 inches diameter.

Order from MFJ and try it -- no obligation. If not delighted, return it within 30 days for refund (less shipping). One year unconditional guarantee.

Order today. Call toll free 800-647-1800. Charge VISA, MC or mail check, money order for \$29.95 plus \$4.00 shipping for MFJ-250.

Don't wait, tune up fast and save those finals and reduce on-the-air QRM, order today.

CALL TOLL FREE ... 800-647-1800

Call 601-323-5869 for technical information, order/repair status. Also call 601-323-5869 outside continental USA and in Mississippi.

MFJ ENTERPRISES, INC.
BOX 494, MISSISSIPPI STATE, MS 39762

WHEN OUR CUSTOMERS TALK... WE LISTEN.



John Fail, KL7GRF/6
Long Beach, CA



Vernelle "Red" Irwin, K9KUW
Kenney, IL



Harry Belock, AA2X
Great Neck, NY

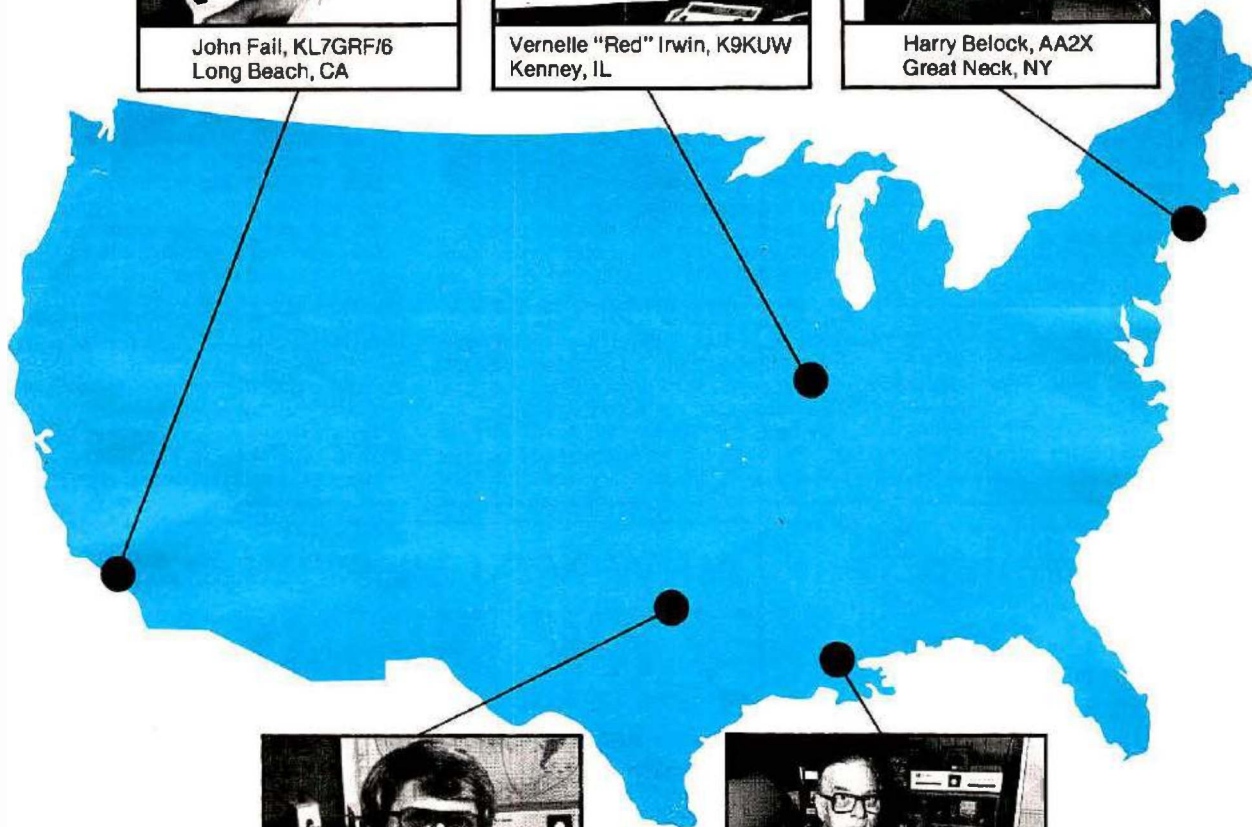

Tom Gentry, K5VOU
Dallas, TX



John Whitaker, W5HEZ
Baton Rouge, LA

And we respond with unexcelled RTTY equipment.

One reason RTTY equipment designed by HAL is always state-of-the-art quality is our open channel of communications with customers.

We want to hear the "What if's . . ." and "How about's . . ." that come from active and dedicated RTTY operators. Our engineers have combined

customer ideas with their own to create the most advanced equipment features and capabilities in the industry.

It adds up to greater enjoyment of RTTY operation and a dependability factor backed with a full one-year warranty.

Write or give us a call. We'll be glad to send you our new RTTY catalog.



HAL COMMUNICATIONS CORP.

Box 365
Urbana, Illinois 61801
217-367-7373

For our European Customers Contact:
Richter & Co., D3000 Hannover 1
Transradio, S.A., 6816 Bissone/Lugano

August, 1980
Volume 4, Number 8

HAM RADIO HORIZONS

CONTENTS

T.H. Tenney, Jr., W1NLB
Publisher

Editorial Staff

Thomas F. McMullen, Jr., W1SL
Managing Editor

Martin Henft, WB1CHQ
Administrative Editor

Robert Schneider, N6MR
Joseph J. Schroeder, W9JUV
Alfred Wilson, W6NIF
Assistant Editors

W.E. Scarborough, Jr., KA1DXQ
Production Manager

Publishing Staff

J. Craig Clark, Jr., N1ACH
Assistant Publisher
Advertising Manager

James H. Gray, W1XU
Assistant Advertising Manager

Susan Shorrock
Circulation Manager

Cassette tapes of selected articles
from *Ham Radio Horizons* are available to
the blind and physically handicapped
from Recorded Periodicals
919 Walnut Street, 8th Floor
Philadelphia, Pennsylvania 19107

Microfilm copies
are available from
University Microfilms, International
Ann Arbor, Michigan 48103

Copyright 1980 by Communications
Technology, Inc. Title registered
at U.S. Patent Office

Ham Radio Horizons
is published monthly by
Communications Technology, Inc.
Greenville, New Hampshire 03048
Telephone 603-878-1441
ISSN 0147-8818

All About Wattmeters	12
John D. Edwards, WB2IBE	
Getting That Rare QSL	22
Randy Padawer, WA4FJF	
Modern Voices for An Old Receiver	32
Douglas A. Blakeslee, N1RM	
Hong Kong Radio Amateurs	38
Anthony R. C. Green, A4GXR/G4HRD/VP2EZ/VS6EZ	
DXers Diary	42
Bob Locher, W9KNI	
Ham Radio Techniques	46
William I. Orr, W6SAI	
DX Horizons	51
William E. Kennamer, K5FUV	
It's About Time	55
James H. Gray, W1XU	
Questions and Answers	60
Airtime	63
Robert Schneider, N6MR	

Activities Calendar	76	Ham Radio Techniques	46
Ad Check	78	Horizons Locator	72
Ad Scan	70	Newsline	11
Advertiser's Index	78	Product Showcase	65
Airtime	63	Propagation Chart	75
DX Column	51	Questions and Answers	60
DX Forecaster	74	This Month's Horizons	2
Focus and Comment	6		

FOCUS & COMMENT

This month, I'm pleased to relinquish this page for a guest editorial by Joe Schroeder, W9JUV, assistant editor, and editor of *HR Report*; his words are timely and of great import.

"It is sometimes fashionable to say that the spirit of Amateur Radio has gone, and today's Amateur is an uninformed, uninvolved appliance operator. What took place Friday evening, May 23rd, on 75 meters was a stinging rebuttal to that gloomy assessment. Every night that week, AMSAT members and other interested Amateurs had been meeting on 3850 at 0200Z for a progress report on the launch of AMSAT's Phase-III satellite. After one of the French Ariane launch vehicle's four rocket motors failed during launch that morning, and put Phase III (with a lot of other expensive space projects) into the Atlantic Ocean near Devil's Island, the group met once again — to commiserate with each other over the disaster.

What began as a wake quickly turned into an almost unprecedented outpouring of support. With AMSAT's President, Tom Clark, W3IWI, as net control, most of the active North American participants in Phase III's development were joined by perhaps one hundred other check-ins from across the United States, Canada, and even Cuba. There were eulogies for the Phase-III bird and the loss of its unique capabilities, to be sure, but the predominant message over the following several hours was, "Let's keep moving ahead!" And this message came, significantly, not only from the already involved AMSAT membership but from bystanders — many of whom checked in to say: "I haven't been on OSCAR yet but always admired what you guys were doing. With your loss today it's time I became involved, so my check for membership plus a contribution is in the mail. How else can I help?" Needless to say, such support provided a priceless boost for those who'd heard their efforts of the past several years splash down in the ocean just twelve hours earlier. And, this support shows that the real Amateur Radio spirit, which has too often been passed off as dead, is alive and well and growing.

What does the loss of Phase III mean to AMSAT, and along with AMSAT, to the Amateur community? It means the loss of years of very hard work by a relatively small group of Amateurs in a half dozen countries. It means the loss of the \$150,000 in hard cash that AMSAT invested in Phase III. It means the loss of more than a year, and possibly several years, before a new free-world Amateur satellite can be put up to replace OSCAR 7 (still operational well beyond its designed lifetime but showing its age), and OSCAR 8.

What's needed to keep our space program going? First and foremost, money, and plenty of it. Space efforts cost money, and the kind of sophistication that makes our "Amateur" satellites suitable traveling companions for the best efforts of the pros cannot be accomplished on a shoestring. The Phase III investment brought AMSAT's treasury to a dangerously low point, and it's going to need rapid infusions of new money if we are not going to lose momentum. The second need is participation — people to volunteer for all kinds of tasks from bookkeeping and basic administrations to state-of-the-art design work and computer programming. Finally, AMSAT needs members, for, by joining, an Amateur becomes not only a contributor but an *involved* contributor.

The response to AMSAT's needs was almost instantaneous after the news of Phase III's loss. Following the pledges on the Friday-night net, AMSAT's mail box has been bulging with new member applications and contributions. Within a few days, Amateur Electronic Supply in Milwaukee, Ham Radio Center in St. Louis, and the Ham Radio Publishing Group had all pledged \$1,000 each to AMSAT, and many more industry contributions are expected.

What can you do? Join AMSAT. Annual dues are only \$20 a year; life memberships are now \$200. Contributions to AMSAT are tax deductible. AMSAT, Box 27, Washington, D.C. 20044, is the place to send your check. Do it today and help demonstrate that Amateur Radio spirit is as real now as it ever was!"

Joe Schroeder, W9JUV
Assistant Editor

FM...SSB...CW...

ICOM Does it All!

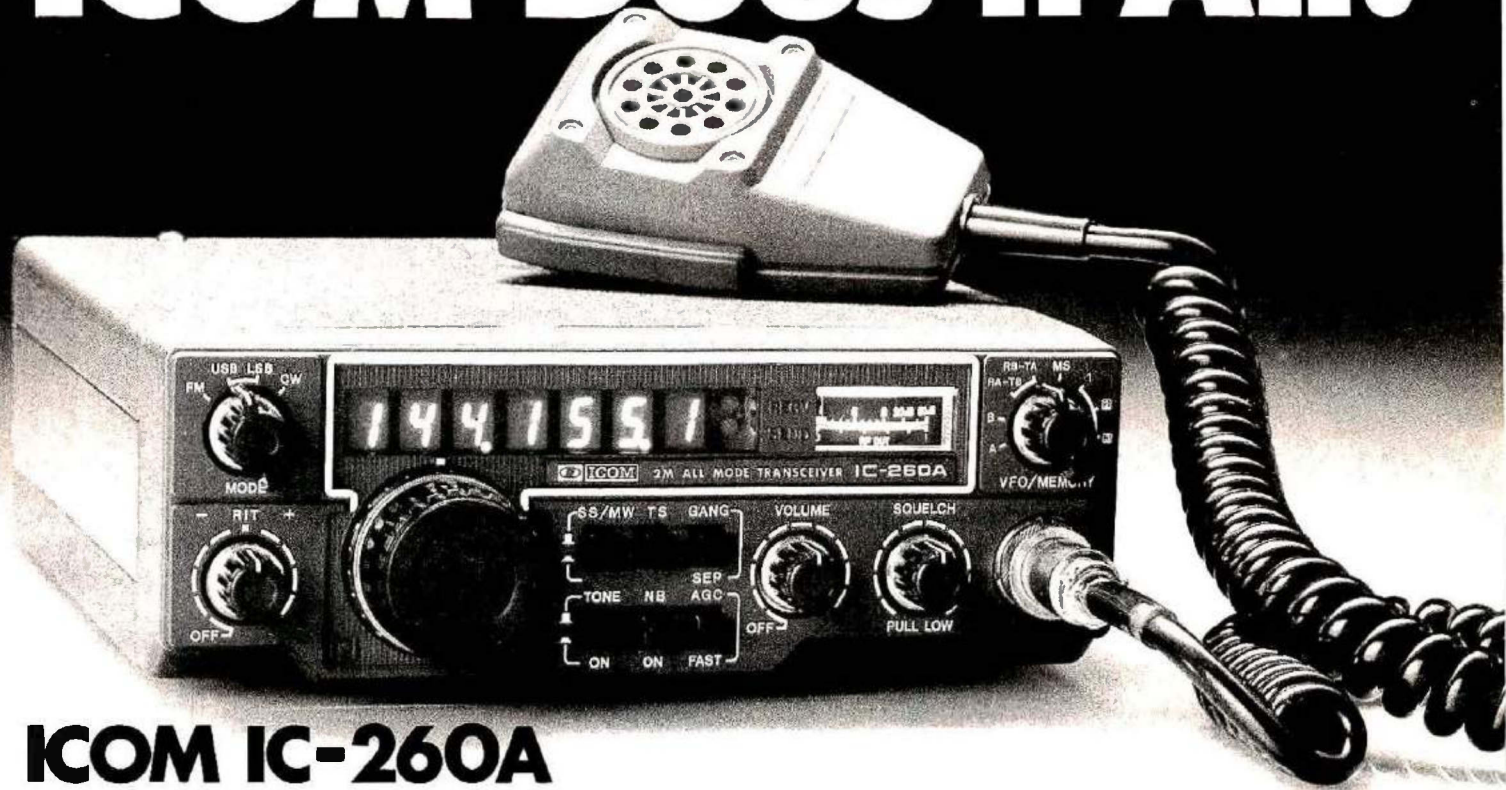

ICOM IC-260A

Enjoy VHF mobile at its best. Sideband, FM or CW, the ICOM IC-260A does it all. The ICOM IC-260A contains all the features a mobile operator would want in a compact 2 meter mobile package with FM, SSB, CW operation. Features customers ask for most including:

- 3 memories built in (quick access to your favorite frequencies).
- Memory scan — automatically stops on an active frequency programmed in the memories.
- Programmable band scan — scan the whole band, or any portion of it you desire (adjustable scanning speed).

- Squelch on SSB, the 260A will automatically and silently scan the SSB portion of the band seeking out the SSB activity on 2.
- 600kc repeater offset built in. Easy repeater operation on the FM portion of the band.
- Variable repeater split — with the 2 built in VFOs, it's possible to work the odd splits plus accommodate future repeater band plan changes.
- Multimode operation — USB, LSB, CW, and FM. Great for getting into OSCAR, plus enjoying SSB rag chewing as well as repeater operation (including the new subband).

- With optional 117/12V supply, the 260A makes a flexible functional base for SSB/OSCAR/FM operation

The RF amplifier and first mixer circuits using FETs, and other circuits provide excellent Cross Modulation and Intermodulation characteristics. The IC-260A has excellent sensitivity demanded especially for mobile operation, high stability, and with Crystal Filters having high shape factors, exceptional selectivity.

The transmitter uses a balanced mixer in a single conversion system, a band-pass filter and a high-performance low-pass filter. This system provides distortion-free signals with a minimum spurious radiation level.

HF/VHF/UHF AMATEUR AND MARINE COMMUNICATION EQUIPMENT



ICOM

ICOM AMERICA, INCORPORATED

Sales Service Centers located at:

2112 116th Avenue NE
Bellevue, WA 98004
Phone (206) 454-8155

3331 Towerwood Dr., Suite 307
Dallas, TX 75234
Phone (214) 620-2780

ICOM INFORMATION SERVICE

2112 116th Ave., N.E.
Bellevue, WA 98004

Please send me: IC-260A specifications sheet; full color ICOM Product Line Catalog; List of Authorized ICOM Dealers.

NAME _____ CALL _____

ADDRESS _____

CITY _____ STATE _____ ZIP _____

You may send a machine copy of this form

Amateur Radio

Just getting started? This book is ideal for you. It will help you get your first license. Or if you already have your ticket, the book will serve as your handy station manual. Written by Bill Lowry, W1VV, it includes a brief description of major activities, equipment and procedures to help the new ham decide where to begin, what equipment to buy initially, and how to make contacts with other hams after the station is assembled. Most importantly, this book tells the beginner how to study for the test, and presents the facts that must be learned in order to pass the written part of the exam. It includes complete FCC rules and official study guide for all license classes. Also included is a colorful call-area wall map.

Just \$6.95

• *Amateur Radio Poster.* Add this beautiful poster to your amateur radio station. Rich-in-color lithograph is produced from artwork shown on Amateur Radio book. Suitable for framing.

Just \$3.50

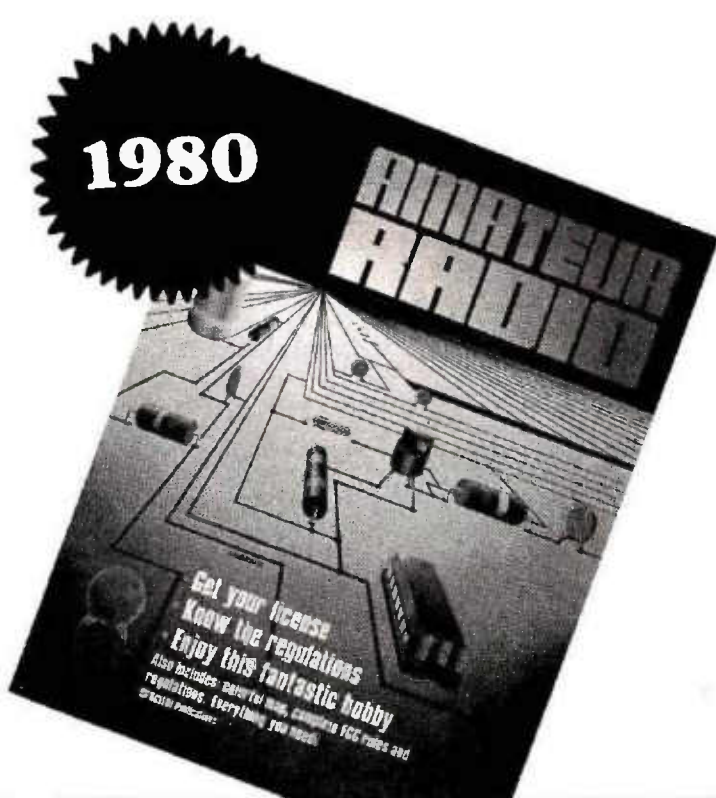

LOOKING FOR A SPECIAL BOOK?

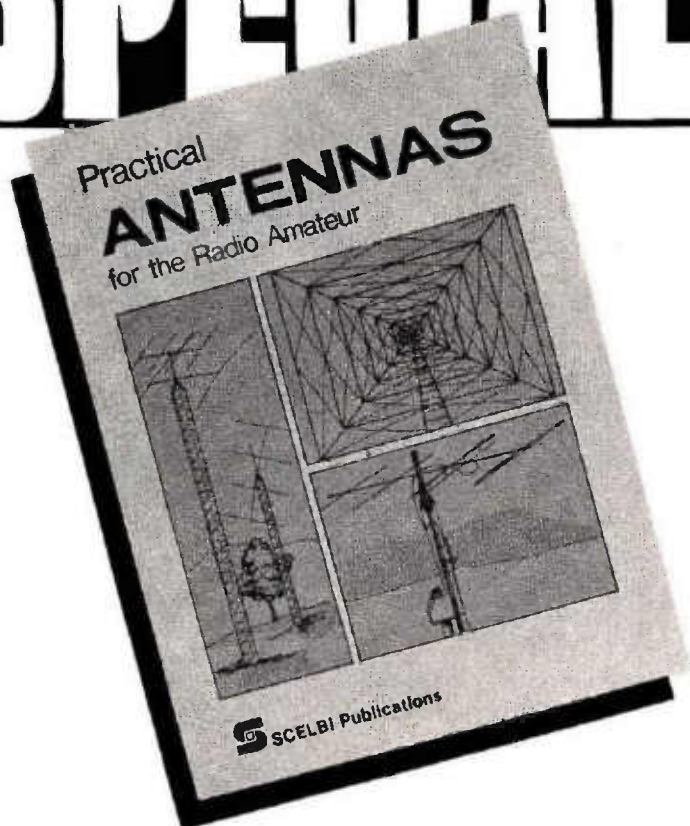

Practical Antennas for the Radio Amateur

Brand new antenna book in a new easy-to-read format with big diagrams. You've never seen an antenna book quite like this! Written by well-known author, Robert Myers, W1XT, it tells you how to choose, use and build your antenna system. Here's what you get: How to build practical beams, quads and wire antennas . . . Computer-generated beam headings to every known country in the world . . . Charts and tables to eliminate tricky calculations . . . Practical ideas for the newcomer . . . OSCAR antennas . . . Complete bibliography of magazine articles on antennas . . . Antenna safety . . . Trick antennas for portable work . . . Tips on how to keep your antenna up. Durable vinyl cover. *Only \$9.95*

Ham Radio's Bookstore

Greenville, NH 03048

Amateur Radio Poster Practical Antennas

Name _____

Street _____

City _____ State _____ Zip _____

Please enclose proper amount for books plus \$1.00 shipping or credit card information.

Order NOW!!

Reliability
Service 
Experience

KENWOOD
TR 7800



Check our price last!

ICOM HAND-HELDS



IC-2A
\$229.50



IC-2AT
\$249.50

ALLIANCE
HD-73
\$109.95
prepaid

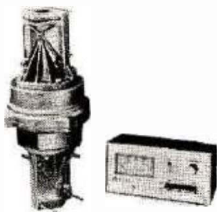

KENWOOD
TR-2400



Check our price last!

PREPAID SHIPPING
CONTINENTAL 48 ONLY



Quantities limited. Michigan residents add 4% sales tax. Please include your area code and telephone number with any correspondence.



RSE
HAM
SHACK

1207 W. 14 MILE, CLAWSON, MI 48017
(313) 435-5660

31155 PLYMOUTH, LIVONIA, MI 48150
(313) 522-4232

MAIL ORDER TELEPHONE
(313) 435-5660

Our smart machine
reads sloppy copy.

New! Includes 24-hour UTC clock, 110 and 300 baud ASCII, & tuning eye!



Kantronics

Field Day[®]

\$449.95

If someone tells you they offer the same features we do, check them out with the list below. Kantronics offers the finest in state-of-the-art technology through over 35 dealerships in the United States, Canada and West Germany.

- Morse copying ability
- 3 to 80 WPM Morse range
- Computer programs for improving sloppy Morse
- Radioteletype copying ability - 60, 67, 75 and 100 WPM Baudot
- ASCII radioteletype ability - 110 and 300 WPM baud
- Copies any shift of RTTY
- 24-hour UTC clock available in any mode
- Entire unit contained in one package
- Automatic code-speed tracking
- Full 10-character, large-size display
- Displays code speed
- Tuning eye for faster tuning
- Full year limited warranty
- Internal speaker
- Requires no TV set for use
- Advanced demodulator circuits
- Internal 200 Hz bandwidth filter
- All letters, numbers and punctuation plus 8 special Morse characters and 5 special RTTY characters
- 15-day trial period.

Send for our free brochure that explains the Field Day system of Morse and RTTY decoding. Or you can order from one of our dealers or our factory today. Our number is below, give us a call.

Special SWL model - \$464.95

Free

Code
Reading
Made
Simple

Okay, tell me more.

Name
Address
City

State

Zip

Kantronics

1202 E. 23rd Street (913) 842-7745
Lawrence, Kansas 66044

WILSON SYSTEMS, INC. MULTIBAND ANTENNAS

WV-1A **\$64⁹⁵**
FACTORY DIRECT

**4 BAND
TRAP VERTICAL
(10 - 40 METERS)**

No bandswitching necessary with this vertical. An excellent low cost DX antenna with an electrical quarter wavelength on each band and low angle radiation. Advanced design provides low SWR and exceptionally flat response across the full width of each band.

Featured is the Wilson large diameter High-Q traps which will maintain resonant points with varying temperatures and humidity.

Easily assembled, the WV-1A is supplied with a hot dipped galvanized base mount bracket to attach to vent pipe or to a mast driven in the ground.

NOTE: Radials are required for peak operation. (See GR-1 below)

SPECIFICATIONS

- 19' total height
- Self supporting—no guys required
- Weight — 14 lbs.
- Input impedance: 50 Ω
- Powerhandling capability: Legal Limit
- Two High-Q traps with large diameter coils
- Low angle radiation
- Omnidirectional performance
- Taper swaged aluminum tubing
- Automatic bandswitching
- Mast bracket furnished
- SWR: 1.1:1 or less on all

GR-1 **\$14⁹⁵**

The GR-1 is the complete ground radial kit for the WV-1A. It consists of 150' of 7/14 stranded aluminum wire and heavy duty egg insulators, instructions. The GR-1 will increase the efficiency of the WV-1A by providing the correct counterpoise.

33-6 MK **\$64⁹⁵**

Now you can have the capabilities of 40-meter operation on the SYSTEM 36 and SYSTEM 33. Using the same type high quality traps, the 40-meter addition will offer 150 KHZ of bandwidth at less than 2:1 SWR. The new 33-6 MK will fit your present SY36, SY33, or SY3 and use the same single feed line. The 33-6 MK adds approximately 15' to the driven element of your tri-bander, increasing the tuning radius by 5 to 6 feet. This addition will offer an effective rotatable dipole at the same height of your beam.

SY-40A
\$374⁹⁵

- ★ 3 MONOBANDERS on 1 Boom
- 4 elements on 20 mtrs FULL SIZE
- 4 elements on 15 mtrs
- 5 elements on 10 mtrs

The System 40A is the answer to the DXer who does not have space to stack monobanders yet wants the advantages they offer. Through the use of a switchable matching unit, only one feed line is required and complete coverage of both the phone and cw bands are available with only one setting.

Max. Pwr. Input.....	Legal Limit	Matching Method.....	Split Beta	Surface Area.....	12.1 sq. ft.
VSWR @ Res.....	1.2:1	F/B Ratio.....	CALL	Wind Loading @ 80 mph.....	309 lbs.
Impedance.....	50 ohm	Boom.....	2" x 26"	Assem. Weight.....	75 lbs.
Feed Method.....	Balun Supplied	Longest Element.....	36'	Shipping Weight.....	84 lbs.
Gain.....	CALL	Turning Radius.....	22'6"		

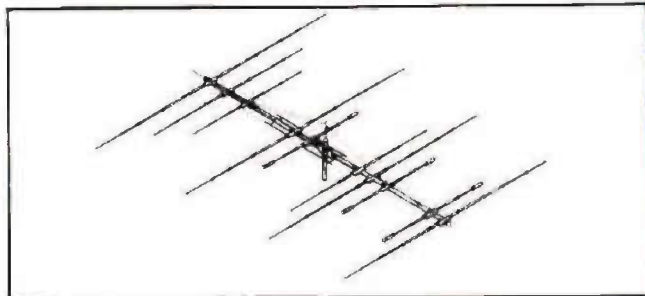

SY-36
\$219⁹⁵

A trap loaded antenna that performs like a mono-bander! That's the characteristic of this six element three band beam. Through the use of wide spacing and interlacing of elements, the following is possible: three active elements on 20, three active elements on 15, and four active elements on 10 meters. No need to run separate coax feed lines for each band, as the bandswitching is automatically made via the High-Q Wilson traps. Designed to handle the maximum legal power, the traps are capped at each end to provide a weather-proof seal against rain and dust. The special High-Q traps are the strongest available in the industry today.

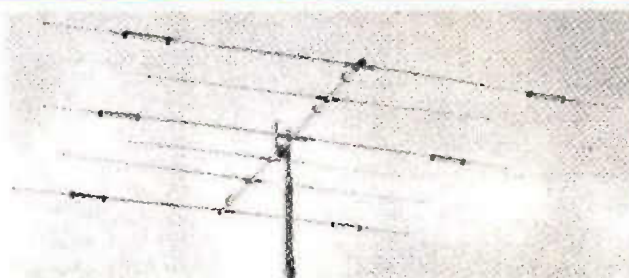

Band MHz.....	14-21-28	Boom I.O.D. x Length.....	2" x 24'2 1/4"	Wind Loading @ 80 mph.....	215 lbs.
Maximum Power Input.....	Legal Limit	Number of Elements.....	6	Maximum Wind Survival.....	100 mph
Gain (dBd).....	CALL	Longest Element.....	29'6 1/4"	Feed Method.....	Coaxial Balun (Supplied)
VSWR @ Resonance.....	1.3:1	Turning Radius.....	18'6"	Assembled Weight (approx.).....	53 lbs.
Impedance.....	50 ohm	Maximum Mast Diameter.....	2"	Shipping Weight (approx.).....	62 lbs.
F/B Ratio.....	CALL	Surface Area.....	8.6 sq. ft.		

SPECIFICATIONS

SY-33
\$164⁹⁵

Capable of handling the Legal Limit, the SYSTEM 33 is the finest compact tribander available to the amateur. Designed and produced by one of the world's largest antenna manufacturers, the traditional quality of workmanship and materials excels with the SYSTEM 33. New boom-to element mount consists of two 1/8" thick formed aluminum plates that will provide more clamping and holding strength to prevent element misalignment. Superior clamping power is obtained with the use of a rugged 1/4" thick aluminum plate for boom to mast mounting. The use of large diameter High-Q Traps in the SYSTEM 33 makes it a high performance tri-bander and at a very economical price. A complete step-by-step illustrated instruction manual guides you to easy assembly and the lightweight antenna makes installation of the SYSTEM 33 quick and simple.

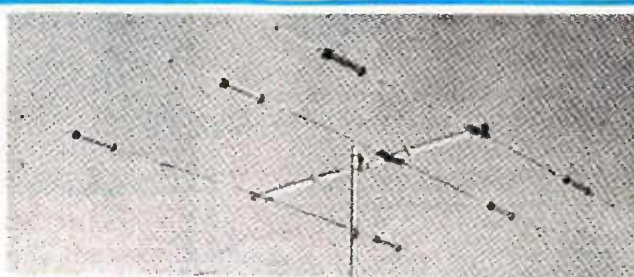

Band MHz.....	14-21-28	Boom I.O.D. x Length.....	2" x 14'4"	Wind Loading @ 80 mph.....	114 lbs.
Maximum Power Input.....	Legal Limit	Number of Elements.....	3	Assembled Weight (approx.).....	37 lbs.
Gain (dBd).....	CALL	Longest Element.....	27'4"	Shipping Weight (approx.).....	42 lbs.
VSWR at Resonance.....	1.3:1	Turning Radius.....	16'9"	Direct 52 ohm load.....	No Balun Required
Impedance.....	50 ohm	Maximum Mast Diameter.....	2" O.D.	Maximum Wind Survival.....	100 mph
F/B Ratio.....	CALL	Surface Area.....	5.7 sq. ft.		

**ORDER
FACTORY DIRECT
1-800-634-6898**

Prices Effective 8-1-80 to 8-31-80

**W S I WILSON
SYSTEMS, INC.**

4286 S. Polaris Ave., Las Vegas, Nevada 89103

Prices and specifications subject to change without notice.

NEWSLINE

AMSAT'S PHASE III SATELLITE WAS LOST May 30 when one of the four Viking rocket engines on the French Ariane launch vehicle lost power just after liftoff, sending it into the Atlantic. Liftoff was at 1429:42Z, a few seconds before the Friday launch window closed, following a countdown delayed by rain and minor technical difficulties. After the launch, the on-board computer was unable to hold course because of uneven thrust, and only a minute or so into the flight the Ariane exploded from either fuel tank rupture or range officer command. Amateurs throughout the world heard the sad event unfold via the ALINS net on 10, 15, and 20.

About \$150,000 And Thousands of hours worth of work by Amateurs in many countries is now on the ocean bottom, along with the "Firewheel" experiment. Phase III was not insured, because companies won't write such insurance until after the launch vehicle has four successful flights. This was Ariane's second flight. Fortunately, a duplicate Phase III structure had been built and, along with a full set of solar panels, circuit-board art, software and circuit design, is available for another Amateur satellite. One could probably be assembled in less than a year. See the guest editorial on page 6 of this issue for more on this turn of events.

AMATEUR RADIO'S EMERGENCY COMMUNICATIONS ability is being put to the test more than ever this season, and, in many instances, is receiving excellent publicity for their work. With the summer hardly started, we note the following:

Amateur Radio Communications was deeply involved in the aftermath of the eruption of Washington state's Mt. St. Helens volcano last May 18. First word of the disastrous explosion that blew several thousand feet off the mountain's top at 8:31 A.M. local time came from an Amateur whose camper was on the mountain's slope. After describing the beginning eruption, he ended his transmission with, "I'm getting the hell out of here!" He, along with two other Amateurs and about 70 others, has been unaccounted for since.

About 200 Amateurs, half of them in locations near the eruption or working directly with rescue crews as search and welfare observers, and the other half serving at various key locations around the state, worked around the clock after the volcano blew. Many were involved in sample gathering and prediction work, an activity that has gone on since the initial eruption on March 27, as well as handling all kinds of traffic for various local, state, and federal agencies.

Amateur Radio's contribution during the emergency has received excellent media coverage. TV and radio stations have sought Amateur assistance for their newscasts, and the opening of another cross-state 75-meter emergency communications link was taped for an evening newscast.

The Seven Tornadoes that devastated Grand Island, Nebraska, on June 3 triggered a full-scale Amateur Radio emergency communications effort. Amateurs from across Nebraska brought in portable equipment and emergency power to that stricken city of 31,000. In- and out-bound health and welfare traffic was handled on 20, 40, and 75. On 3978 and 2982 AJ0A and WB0MSU in Grand Island bore the brunt of the load.

3975 Through 3980 kHz Was Cleared by the FCC for Grand Island tornado traffic. Central U.S. Amateurs were warned that other than disaster-related communications were illegal in that band segment for the duration of the emergency. When such emergencies occur, check WIAW's usual frequencies for emergency bulletins announcing such bans.

FCC's Grand Island Monitoring facility was spared by the barrage of tornadoes, which leveled much of downtown Grand Island and part of the city's residential section.

A Strong Earthquake Hit Baja California early Sunday evening, June 8, wiping out almost all communications throughout the region. Registering 6.9 on the Richter Scale and centered about 65 miles to the southeast of San Diego, the quake (and a 6.6 aftershock that came several hours later) killed at least two and left hundreds homeless. The shock was felt in Arizona and California's Central Valley, but no injuries or damage were reported in the U.S.

Amateur Radio Immediately stepped into the communications gap, with the 34-94 repeater in Tijuana and 37-97 machine near Mexicali handling the bulk of the VHF traffic, and a good number of southern California Amateurs crossed the border with portable equipment and emergency power to supplement the efforts of their Mexican neighbors. Two-meter simplex and the HF bands were also employed in the emergency.

THE ANNUAL SIMULATED EMERGENCY Test has been rescheduled from early October to the third weekend in October — this year the 18th and 19th. This adjustment avoids conflicts with several other early October events and with the Canadian Thanksgiving celebration. Individual groups may, of course, hold their SETs on any two-day period between September 1 and October 31.

An Amateur's Guide to Wattmeters

RF Power Measurement — A bit of history

The art of rf power measurement has been of greatest concern since the first transmitter was born — and when the first Amateur needed to tune up his rig, he started scheming about expensive but practical ways of doing what was done in the laboratory by means of precision galvanometers and other devices.

Even a spark transmitter needed some means of indicating how much energy was being sent up the "aerial" wire, because this was a measure of coupling, which not only determined the strength of the signal but also, to some extent, the wavelength of the transmission.

One early device was a simple piece of wire that became heated from the energy flowing through it, **Fig. 1**. As the spring-loaded wire expanded from the heat, the expansion was mechanically coupled to a pointer, causing it to move. It was slow in responding, to be sure, but adequate for tuning up the "coupler" and feeders.

A later version of the "hot-wire" ammeter is shown in **Fig. 2**. In this case the heat of the wire causes electrical current to be generated in a thermocouple, and the current is indicated by a microammeter calibrated in amperes. This system had a faster response time, was more reliable than the mechanical arrangement of **Fig. 1**, and the calibration could be very accurate. You'll still find these meters at surplus houses and flea markets. A very useful instrument can be made by placing one of these

in a box with coaxial connectors on each end. The meter, connected in series with the center conductor of the coax, will indicate the current flowing, and, since you know the impedance of the line (if it is matched), you can calculate the power quite accurately with Ohm's law: $W = I^2R$.

Amateurs (and commercial stations) often used two of these meters, one in each wire, to indicate the power in twin-lead or "ladder-line" feeders, **Fig. 3**. This system also indicated an unbalance in the feedline, which was of paramount importance in many installations.

It was not practical for Amateurs to calculate exact power in this manner, however, because, while the theoretical impedance of the homemade "open feeders" was usually known, such systems were often operated with a considerable VSWR, so the actual operating impedance was pretty much of a guess. Most hams just simply "tuned for max."

Another system was practical to use in power measurements, however, as in **Fig. 4**. Here, the impedance of a properly installed vertical antenna, with a good ground system, is quite accurately known from theory. A meter in series with the base of the antenna will provide an rf current reading that can be used to determine power to a precise degree. Many a-m broadcast stations still use this method to determine output power, and remotely controlled stations have a pickup device to sense antenna current and send a reading over telephone lines to the studio or other monitoring point.

A common low-voltage lamp bulb, such as a No. 49 or 47, also found its way into Amateur power-measuring circles. As shown in Fig. 5A, a loop is placed adjacent to, or between, the conductors of a twin-lead feeder. Energy coupled from the wires to the loop will cause the bulb to light, and its brilliance is an indication of how much power is being sent through the feedline. This system is sensitive to the size of the loop with relation to frequency, as well as to any SWR that might be on the line. In fact, a simple SWR indicator can be made by using two loops and lamps, facing opposite directions as in Fig. 5B. A "reading" is taken by comparing the relative brilliance of the "forward" lamp with the "reverse" one. The connection between the loops and one wire of the feedline is necessary to prevent capacitive pickup which could cause a "neon-like" glow in the bulbs.

Toward the end of the era of open-wire feedline, in the late 1950s, M.C. Jones, a firm in Bristol, Connecticut, brought out a versatile power and SWR monitoring system for Amateur (and commercial) use. The basic idea is shown in Fig. 6, and the circuit is called a "Micromatch." The principle is relatively simple: A resistor is placed in series with the rf feedline, and a capacitive voltage divider is placed across the line. A meter (with a diode detector, and rf chokes for decoupling) connected between points A and B will read the power being transmitted, and any out-of-phase components (caused by a mismatch) will be ignored. Reversing the positions of the transmitter and load ports of the instrument allowed VSWR to be read. Later models performed the switching internally, creating a more convenient instrument, and for the first time, hams began to get grey hairs over VSWR.

The increasing use of coaxial cable for transmission lines (brought about by the booming TV industry and the subsequently mushrooming TVI complaints), created a demand for a coaxial version of the Micromatch, and one was developed (see this month's cover photograph) with a remote sensing element connected to a metering and switching circuit.

The need for accuracy at frequencies in the vhf and uhf region led to the development of a means of measuring forward and reflected power in coaxial cable, and the Bird Electronics Thruline[®] wattmeter is a prime example. A greatly simplified version of their circuit is shown in Fig. 7. A loop is placed inside a section of coaxial transmission line, and energy picked up by it is detected and metered. The actual circuit is more complex than this, having precisely spaced probe conductors, precision resistors, and decoupling and calibrating networks. The probe, or "slug" as it is known in the trade, is reversible, thus will indicate reflected power, which can be used to calculate VSWR.

Another type of circuit that is much used in Amateur and commercial wattmeters is shown in Fig. 8. In this case, the rf-carrying conductor passes through a ferrite core. The core has a few turns of wire around it, thus creating a simple transformer. The induced current is detected by a diode and measured by a microammeter.

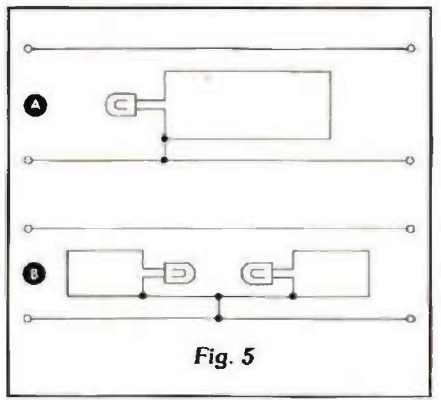
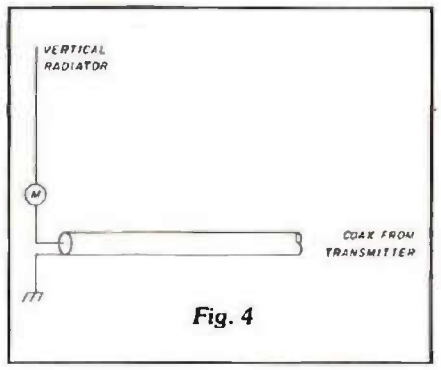
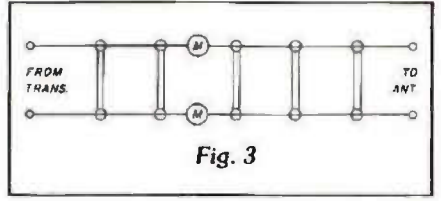
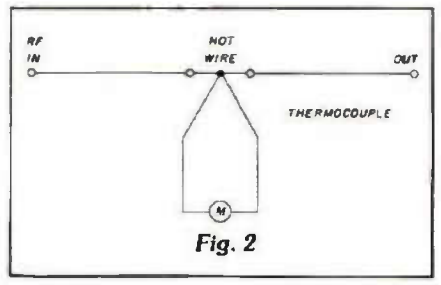
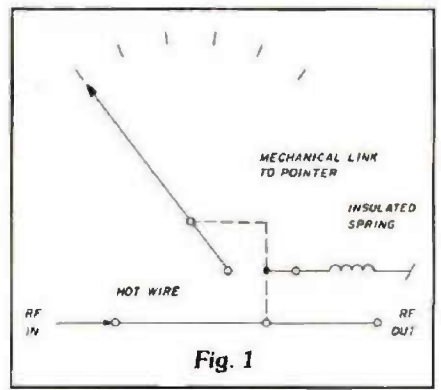

This is a simplification of a circuit that was developed in Germany just before World War II, and found its way to the U.S. after the end of the conflict. This circuit, often erroneously called a "bridge," was described in an article, "An Inside Picture of Directional Wattmeters," by Warren J. Breune, in *QST* for April, 1959. It uses the toroidal-core transformer as a pick-up device, and the capacitive and resistive networks on either side of the core are designed to allow accurate measurement of either forward or reflected power. Variations of this circuit can be found in many "wattmeters" and "SWR bridges" described in Amateur literature, and some commercially made meters use this circuit with only small changes.

What's ahead for the Amateur? It's doubtful if the basic energy-sampling schemes will change much. The present devices are simple and reliable. However, as stated elsewhere in the article, digital displays are the "in" thing now, so there may be several versions of power/SWR meters with LEDs, liquid-crystal displays, or simple bar-graph presentations. Whatever the method, they'll have one purpose: to help you get the most out while putting the least in, otherwise known as improving the efficiency of your rig.

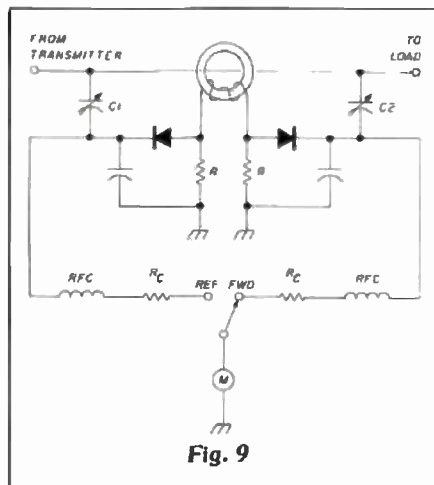
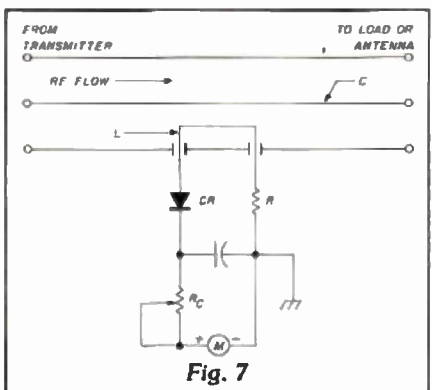
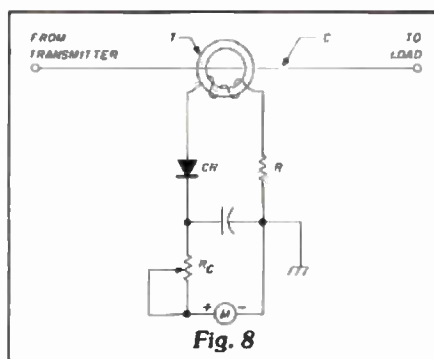
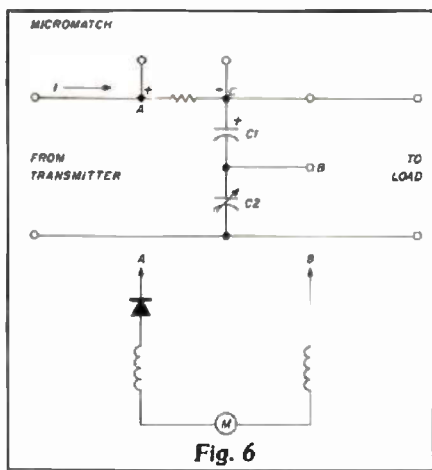

Wattmeters

BY JOHN EDWARDS, WB2IBE

A shopper's guide to use with catalogs, flea markets, surplus houses, or just plain horse trading.

Power. It's something every ham and potential ham spends a lot of time thinking about. For those still working toward their first ticket, power can mean dreams of having a kilowatt at their disposal. Novices, on the other hand, have the more practical concern of squeezing every ounce out of their available 250 watts. Technicians spend countless hours hooking up mobile amplifiers and pioneering ways of getting economical power on 1215 MHz. Completing the circle, many Amateurs are finding that less power can actually be more fun, and are playing around with milliwatts, looking forward to the day when they can apply for a QRP DXCC or WAS. There's no doubt about it, power is the lifeblood of Amateur Radio.

But, for all the effort being channeled into the problems and benefits of power, how many hams actually know how to measure those all-important watts flowing through their station's system? Not many, judging by some of the nuggets of misinformation one hears tossed out over the air and at club meetings. So, for all of you who don't know your forward from reflected power, or a sensing element from an examination element, this article is dedicated to you.

The basics

Let's start with the fundamental question: "What is a wattmeter?" Obviously, an rf wattmeter measures watts of radio-frequency energy. That is, it senses the rf power flowing out of

your transmitter, and tells you how much of this force is being directed to your antenna. Since power is measured in "watts" (named after the English scientist James Watt), the meter used to measure power is quite logically called a "wattmeter."

Like most Amateur equipment, wattmeters come in a broad price and size range, from little \$10 "CB testers," which are best suited for checking converted 40-channel rigs on 10 meters, to multi-thousand dollar laboratory wattmeters used for high power measurements on microwave frequencies. The spectrum of choices is wide and, seemingly, endless. Most Amateurs, however, are interested in something in between these two extreme examples.

The type of meter you need, and will want to buy, depends on the sort of operating you do. Since wattmeters are what is known as "frequency sensitive," the meter that gives a very accurate reading on 7 MHz may be useless up on 144 MHz. Therefore, most types of inexpensive wattmeters (under \$100) come in two general classifications: those that cover 160-10 meters, and those designed to work on 6 and 2 meters. Other specialty wattmeters are available for most ham bands from 220 MHz on up. Remember, however, that as the frequency rises, so does the price.

But, what should you do if you operate on many bands all across the spectrum? Buy a shack-full of watt-

meters? After a while, things could get pretty crowded — and expensive! A better alternative is buying an "adaptable" wattmeter.

Adaptable wattmeters

As their name implies, adaptable wattmeters are, well . . . adaptable. By using interchangeable elements (or slugs, as they are more commonly called), these meters (such as the Bird Model 43 or Dielectric Communications 1000A) can not only operate across a wide frequency range (2-1000 MHz), but also at many different power levels. This latter fact can be quite important. Say you suddenly get the urge to do some QRP operating. Unless you want to use a magnifying glass to see your wattmeter's needle move, using a slug that enables the meter to give a full-scale reading at 5 watts can be quite handy.

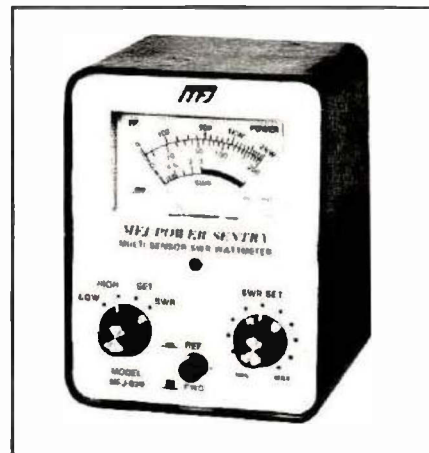

Before you run out to buy an adaptable type of wattmeter, let's mention the device's one drawback — its price. A new adaptable wattmeter will cost you from about \$120 to \$140 not including the elements, which run about \$36 for the low bands and \$42 for vhf-uhf. Fortunately, there are ways to cut costs. Since meters don't change styles like transceivers, and aren't very susceptible to breakdown, you can usually obtain a used wattmeter, at reasonable cost, either at a flea market or from a fellow ham who may no longer have need for one. Many stores and clubs also run "slug banks," where, for a nomi-

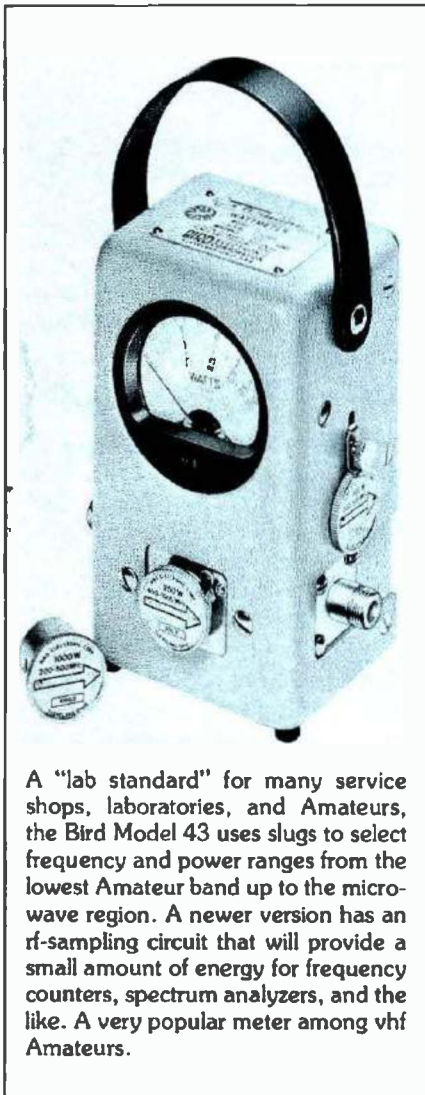

A "lab standard" for many service shops, laboratories, and Amateurs, the Bird Model 43 uses slugs to select frequency and power ranges from the lowest Amateur band up to the microwave region. A newer version has an rf-sampling circuit that will provide a small amount of energy for frequency counters, spectrum analyzers, and the like. A very popular meter among vhf Amateurs.

nal fee, you can swap elements according to your specific needs. Ultimately, however, the question of whether or not you actually need an adaptable wattmeter remains up to

you, your operating habits and your financial resources.

Meters with PEP

Unless you confine your on-air activity strictly to CW or a-m, at some point you're going to want to measure your rig's SSB output. Unfortunately, most wattmeters measure only average-power. For instance, if you currently use a wattmeter whose needle flutters madly all over the scale while you talk, you know the difficulty of reading an average-power meter while transmitting SSB's peak-envelope-power (PEP). Besides watching an inaccurate reading, it's just plain impossible to follow an average-power meter on SSB. Because of this unhappy situation, more and more wattmeter manufacturers are including PEP settings on their units.

Meters equipped to read PEP contain an additional "time constant" circuit. These extra components permit the instrument to sample the PEP energy flowing out of the transmitter by feeding a constant voltage source to the meter. This voltage allows the meter to register and hold (at a readable level) the maximum power your rig is generating on voice peaks. By the way, don't be disappointed if your meter shows a power level substantially lower than your transmitter manufacturer's advertisements claim. When a company promises 200 watts, they usually mean 200 watts input, not output. Since man has never created a 100 per cent efficient transmitter, there will always be a loss between input and output power. Power measurement, as you see, can also be a very "creative" science.

Because of the additional circuitry needed for measuring peak envelope power, a PEP wattmeter requires an external power source. While a transmitter's output energy is all that's needed to power a CW or a-m type meter, the time constant and amplifier circuitry in a PEP wattmeter require outside help. Depending upon the specific model, you will either need batteries or ac power to run your meter in the PEP mode. One word of warning here: if you're the type of operator who likes to continuously monitor his output, your PEP meter's batteries will not last very long — perhaps only a month of ordinary operating. Therefore, in the long run, buying a meter that has a built-in ac

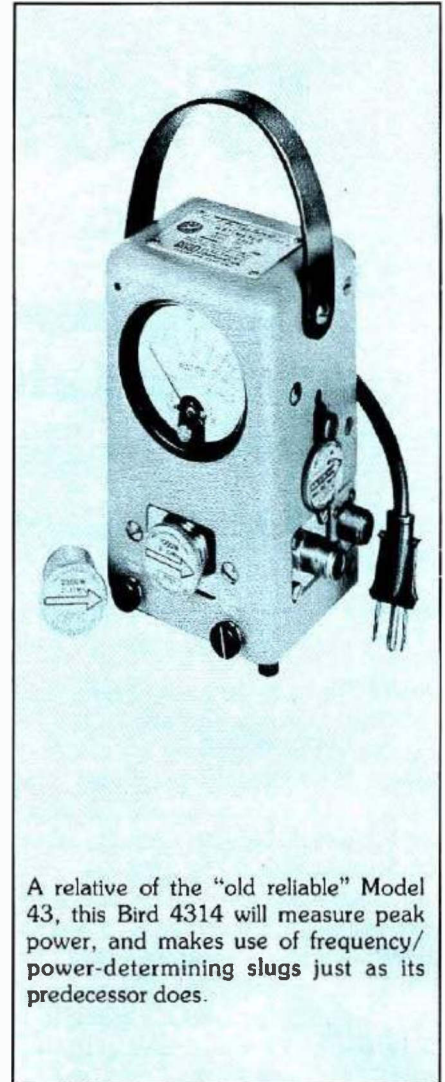

A relative of the "old reliable" Model 43, this Bird 4314 will measure peak power, and makes use of frequency/power-determining slugs just as its predecessor does.

power supply, or adding an ac adaptor, will save you money. Of course, for portable operation (like Field Day), you may still find battery power more convenient.

SWR measurement

Up to this point, we've ignored one important wattmeter function — standing-wave-ratio measurements. Actually, SWR measurements have little to do with wattmeters. Indeed, many wattmeters, such as the adaptable-types, don't measure SWR at all. It's just that many manufacturers feel that hams would find an SWR meter handy, and, since much of the circuitry can be shared with a wattmeter, include one in the same package.

As with wattmeters, the obvious and fundamental question regarding SWR meters (or bridges, as they sometimes are called), is, what is an SWR meter? Well, just as a wattmeter measures power, an SWR meter



The DenTron W-2 is a neat package that fits at your operating position, connected to a remote sensing circuit that can be tucked away out of sight or convenient to the rf cables.

measures the ratio of standing waves on a transmission line. While a complete explanation of SWR and all of its intricacies is beyond the scope of this article, suffice it to say that a high SWR (generally considered anything over 3:1) is bad, especially when your rig is an SWR-sensitive, solid-state job.

Causes of a high SWR are many and varied. It can be due to your antenna being out of tune, touching, or in close proximity to another object, or simply not matched to the feedline you are using. If you're using loading coils, they could be damaged or broken. The problem may not be in your antenna at all, but in the transmission line. Short and open circuits or faulty covering or insulation can all lead to transmission-line failure. But, in general, a high SWR should serve as a warning signal to you that something is wrong with your antenna system and should be investigated at the nearest opportunity.

On the other hand, one should be careful not to go "SWR crazy." There are few more pathetic creatures than the ham who pulls his hair out by the roots as soon as he sees his SWR rise above 1.25:1. Many things can cause your SWR to momentarily rise. Rain or ice on the antenna, the slow aging of the system — even morning dew can throw the SWR off slightly. Experiencing a fit at every such instance can easily lead to an ulcer. Anyway, it's impossible to maintain a perfect 1:1 SWR across a band. If you do manage to get such a reading, either you've developed a breakthrough in antenna technology, or you have a broken meter.

Like wattmeters, SWR bridges are frequency sensitive. Only, in this case, the meter has to be adjusted from band to band (or even within bands) for proper operation. To calibrate an SWR meter, just push in the button marked CAL, or pull out the SENSITIVITY knob (depending on the particular model), and with the transmitter on, turn the knob until the meter's needle is lined up with the "SWR SET" marking on the dial. Returning the meter to the "NORMAL" position, the reading then showing on the dial is the indicated SWR level.

Dummy load

Although obviously not meters, dummy loads play an important role in helping you measure your transmitter's output power. In many ways, a dummy load is to power appraisal what WWV is to frequency measurement. Just as a standard-time/frequency station helps you to calibrate your rig's operating frequency, a dummy load — with its virtually per-

fect 50-ohm resistance — gives you an unvarying standard to judge your transmitter's output by. And, only with a dummy load can you properly evaluate your antenna system's performance by using the load as a "model antenna" to compare SWR and power readings against.

For more Amateur applications, dummy loads come in two classifications: the type looking like a baby oil drum, filled with either transformer or mineral oil, or the "solid" type, employing a dry power-absorbing dielectric. All things being equal, the oil-type is the cheapest, while the solid variety is more compact and impossible to tip over and spill. But, unless you confine your power measure-



The Heath Cantenna is a valuable part of any shack. An oil-filled dummy load, it has a diode and meter jack to provide relative-power indications for tune-up purposes. Power rating is 1 kW.

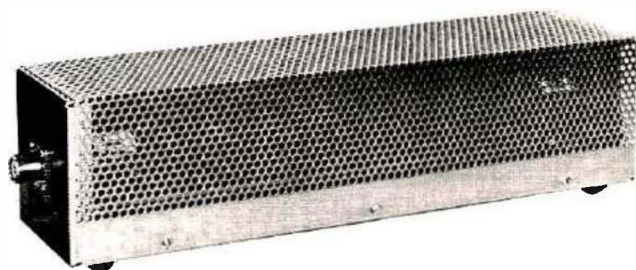

An air-cooled dummy load from DenTron, the DL-1000.

ments to under 200 watts or so, solid-dummy-load prices can soar into the hundreds of dollars; oil types average around \$25 and will handle a kilowatt or more.

One oil-type dummy load, in particular, has a very useful accessory. The Heath "Cantenna" features an external phono jack, which can be used in conjunction with a VTVM or VOM to measure relative power. So, if you're not interested in a calibrated reading, and just want to see a relative reading from band to band or with a new modification, a Cantenna and a VOM may actually eliminate your need for a separate power meter.



The Thermaline[®] wattmeters by Bird are available new, and many used ones show up at flea markets from time to time. These dummy loads have a detector and meter built in, and they come in a variety of frequency ranges and metering capability, so be sure to read the specifications closely before you buy.

Dual-meter wattmeters

One of the more popular types of wattmeters to appear on the market within recent years is the dual-meter wattmeter. Looking more like a refugee from an fm radio station console than for a ham shack, the dual-meter unit is certainly a very impressive station accessory. But there's more to these meters than just a fancy exterior — they're really quite practical, too. The dual meters divide up two equally important jobs: one meter displays output power just like any other watt-

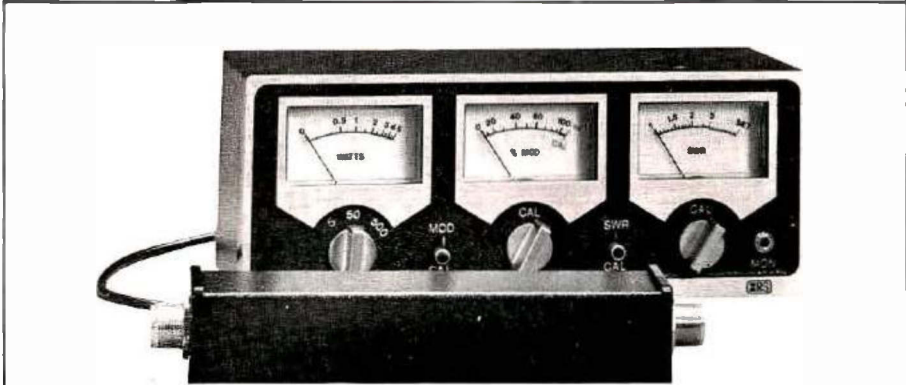

Besides measuring power and SWR, this meter will show the percentage of modulation of an a-m rig. In addition, the front panel monitor jack, with an earphone, lets the user listen to his signal.

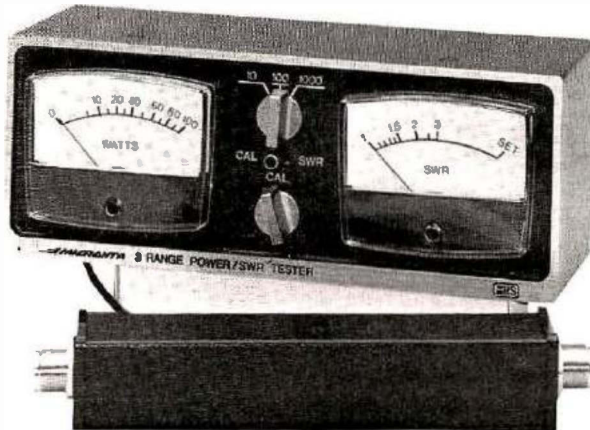

Dual meters allow you to peak your transmitter to maximum output while simultaneously noting SWR. Very handy for tweaking an antenna tuner.



The Drake WH-7 wattmeter is styled to match the new TR7 and R7 transceiver and receiver from R.L. Drake Co.

meter, while the other dial will register either your SWR, or reflected power in watts, depending upon the model. Reflected watts, incidentally, is the term for power that's bouncing back to your transmitter because of a high SWR. In this case, however, the reflected energy is expressed in watts, instead of a standing-wave ratio.

Monitoring your output with a dual wattmeter can be a lot of fun, but they really prove their worth when it comes to tune-up time. Fiddling with an antenna tuner has been known to reduce even the most experienced ham to tears. By the time you get through fooling around with all the controls on your transceiver and tuner, then flickering your wattmeter's settings back and forth to check SWR and output power, then again resetting the rig and tuner, your initial desire to get on the air can be mightily diminished. While a dual-meter wattmeter won't eliminate all of this work, it can make the task substantially easier. You'll still have to twist all those knobs, but at least you'll enjoy watching the wattmeter's forward reading rise and the reflected power lower, simultaneously, as your tuner provides a match to your antenna/feedline system. This will also save you wear and tear on your finals, since you'll spend less time in the transmit position loading-up into an untuned antenna.

Digital wattmeters

Just above, we referred to dual-meter wattmeters as being impressive. But, while the sight of two meters moving in step with your signal can be very pleasing, an even more sparkling sight is a digital wattmeter flashing your output in big, red LED digits. It really makes your 200 watts seem more powerful, even if it won't help you snag that 9Q5 any sooner. At any rate, a digital wattmeter sure makes a nice partner to a new digital transceiver.

Unfortunately, manufacturers haven't been as quick in producing digital wattmeters as they have transceivers. Perhaps part of the problem is cost. Maybe most companies just don't feel Amateurs are willing to pay two to three times the cost of an analog (dial-type) meter for one that works digitally. In any case, the introduction of digital wattmeters has been slow and sporadic.



A pair of sophisticated digital microwave power meters. As advancing technology reduces prices, digital wattmeters will become commonplace on ham bands.

Yet, in spite of its cost and scarcity, the digital wattmeter is appealing for basically the same reasons that make other types of digital equipment attractive. Digital wattmeters are easy to read from a distance, are extremely precise, and have no "parallax" problem (the slightly different readings you get from an analog meter when you look at it from different angles). Still, even with these benefits, it will probably be at least a few more years be-

fore we see the digital wattmeter become a standard accessory in most ham shacks.

In conclusion

While digital wattmeters aren't all that common yet, analog meters have certainly taken their place in the ham station, alongside the microphone and key, as one of the hobby's most popular accessories. An Amateur station without a wattmeter is like 20

Table 1. Wattmeter manufacturers.

Akigawa (American Distributor)
Macaw Electronics, Inc.
P.O. Box 66
Carlsbad, California 92008

B&W
Barker & Williamson, Inc.
10 Canal Street
Bristol, Pennsylvania 19007

Bird
Bird Electronics Corp.
30303 Aurora Road
Cleveland, Ohio 44139

Dalwa
(U.S. Agent) — Bell Industries
J.W. Miller Div.
19070 Reyes Ave.
Compton, California 90224

DenTron
DenTron Radio Co., Inc.
2100 Enterprise Parkway
Twinsburg, Ohio 44087
(216) 425-3173

Dielectric Communications
Dielectric Communications
Raymond, Maine 04071

Drake
R.L. Drake Company
540 Richard Street
Miamisburg, Ohio 45342
(513) 866-2421

Heath (Heathkit)
Heath Company
Benton Harbor, Michigan 49022

MFJ
Box 494
Mississippi State, Mississippi 39762

Mirage
P.O. Box 1393
Gilroy, California 95020

Radio Shack
Radio Shack
One Tandy Center
Fort Worth, Texas 76102

Swan
Swan Electronics
305 Airport Road
Oceanside, California 92054
(714) 757-7525

Yaesu
Yaesu Electronics Corp.
15954 Downey Ave.
Paramount, California
(213) 633-4007

Table 2. Dummy loads.

Brand	Model	Frequency Range MHz	Maximum Power	Approximate Suggested Price	Notes
Bird	8164	0-2500	100	\$125	continuous duty solid
Bird	8166	0-2500	150	\$150	continuous duty solid
Bird	8135	0-4000	150	\$89	continuous duty oil
DenTron	"Big Dummy"	1.8-300	2000	\$29	oil
Drake	DL-1000	0-30	1000	\$39	30 second to five minute duty. solid
Drake	DL-300	0-30	300	\$19	30 second to five minute duty. solid
Heath	HN-31 "Cantenna"	1.5-400	1000	\$19	VOM-VTVM kit. oil

Note: For combination dummy load-wattmeters, see Table 3

Table 3. Some popular wattmeters.

Brand	Model	In-line?*	SWR?	Frequency MHz	Connector	Maximum Power	Full Scale Accuracy %	Approx. Suggest. Price	Notes
Akigawa	APM-1H	Yes	Yes	1.8-60	SO-239	2000	± 10	\$100	PEP reading
Akigawa	APM-1V	Yes	Yes	50-150	SO-239	200	± 10	\$100	PEP reading
Akigawa	PM-2H	Yes	Yes	1.8-60	SO-239	2000	± 10	\$90	
Akigawa	PM-2V	Yes	Yes	50-150	SO-239	200	± 10	\$90	
Akigawa	PV-3HV	Yes	Yes	3-150	SO-239	1000	± 10	\$55	Dual meters
Akigawa	PM-4HV	Yes	Yes	3-150	SO-239	1000	± 10	\$45	Lightweight, portable
Akigawa	MM-1	Yes	Yes	3.5-150	SO-239	1000	± 10	\$50	Multimeter plus watt/SWR meter
B&W	333	No	No	0-300	SO-239	250	± 10	\$103	Includes solid dummy load
B&W	334A	No	No	0-300	SO-239	1000	± 10	\$185	Includes solid dummy load
B&W	374	No	No	0-300	SO-239	1500	± 10	\$225	Includes solid dummy load
Bird	43	Yes	No	Determined by slug	Quick-Change	Determined by slug	± 5	\$130	Basic meter (slugs)
Bird	4360	Yes	No	1.8-30	SO-239	2000	± 10	\$30-\$40	
Bird	4362	Yes	No	140-180	SO-239	250	± 10	\$95	
Bird	4381	Yes	Yes	Slugs	Quick-Change	Slugs	± 5		Digital readout
Daiwa	CN-620	Yes	Yes	1.8-150	SO-239	1000	± 10		Dual reading meter
Daiwa	CN-720	Yes	Yes	1.8-150	SO-239	1000	± 10		Dual reading meter
Daiwa	CN-630	Yes	Yes	140-150	SO-239	200	± 10		Dual reading meter
DenTron	W-2	Yes	No	1.8-30	SO-239	2000	± 5	\$99	Dual meters
Dielectric Communications	1000A	Yes	No	Determined by slugs	Changeable	Determined by slugs	± 5	\$125 + slugs	
Drake	WH-7	Yes	Yes	1.8-50	SO-239	2000	± 5	\$89	
Heath	HM-102	Yes	Yes	1.8-30	SO-239	2000	± 10	\$49	Kit
Heath	HM-2102	Yes	Yes	50-160	SO-239	250	± 10	\$49	Kit
Heath	HM-2140	Yes	Yes	1.8-30	SO-239	2000	± 5	\$74	Dual meters PEP/kit
Heath	HM-2141	Yes	Yes	50-175	SO-239	300	± 7.5	\$79	Dual meters PEP/kit
MFJ	820	Yes	Yes	Determined by sensors	SO-239	Determined by sensor	Determined by sensor	\$70	PEP reading
MFJ	825	Yes	Yes	Determined by sensors	SO-239	Determined by sensor	Determined by sensor	\$120	PEP reading
MFJ	830 (sensor)			1.8-30		2000	± 5	\$30	Sensors for 820/825
MFJ	831 (sensor)			50-175		200	± 7.5	\$30	
MFJ	832 (sensor)			1.8-30		20	± 7.5	\$30	
Mirage	M	Yes	Yes	1.8-30	SO-239	2000	± 5		5-year guarantee
Radio Shack	21-520	Yes	Yes	3-30	SO-239	1000	± 10	\$39	Dual meters
Radio Shack	21-522	Yes	Yes	3-30	SO-239	500	± 10	\$34	Dual meters, modulation meter, and aural monitor
Swan	WMD6200	Yes	Yes	3-30	SO-239	200	± 10	\$226	Digital readout
Swan	WMN200	Yes	Yes	50-150	SO-239	200	± 10	\$45	
Swan	WM200A	Yes	Yes	50-150	SO-239	200	± 1	\$97	PEP
Swan	SWR1A	Yes	Yes	3.5-150	SO-239	1000	± 10	\$29	
Yaesu	YP-150	No	No	3.0-30	SO-239	150	± 10	\$78	Includes solid dummy load

*In-line: Can the meter be left in the line to continuously monitor output, or is it only suitable for test measurements?

meters without QRM, or 15 meters minus the "Woodpecker" — unnatural.

Before I tie the ribbon on the topic of wattmeters, I've neglected to mention the all-time favorite, simplest power reading device ever designed — in use since the dawn of wireless communication. This virtually fool-proof unit is completely guaranteed to work, or just return it to your nearest supermarket or hardware store for your money back. You see, you take this 200-watt lightbulb, solder two leads to the end of it . . . Oh, well, with a soft-white coating, at least it's the easiest indicator to read, especially in the dark!

HRH



Vacationitis? Hand-Held Transceivers Are Prescribed For Holiday Hamming

KITTY INVITES YOU to come in and see BARRY'S complete line of hand-held transceivers.

YAESU



FT-207R

ICOM



IC-2A

TEMPO



S-1, 2, 5

NICE FOR TRAVELLING . . .

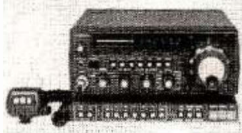

FT-707



FT-107

OR AT HOME . . .

Our lines include:

AEA	DRAKE	MURCH
ALLIANCE	ETO	ROBOT
ANTENNA	EIMAC	ROHN
SPECIALISTS	E-Z WAY	SHURE
ASTRON	HUSTLER	STANDARD
B & W	HY-GAIN	SWAN
BIRD	ICOM	TEMPO
COLLINS	KDK	TRI-EX
COMMUNICATIONS	KLM	YAESU
SPECIALISTS	KANTRONICS	VHF ENGINEERING
CUSHCRAFT	MFJ	AND MORE . . .
DSI	MIRAGE	
DENTRON	MOSLEY	

BUSINESSMEN: Ask about BARRY'S line of business-band equipment. *We've got it!*

Amateur Radio License Classes:
Wednesday & Thursday: 7-9 pm
Saturday 10 am-Noon

The Export Experts Invite Overseas orders

¡ AQUÍ SE
HABLA
ESPAÑOL !

— We Ship Worldwide

BARRY ELECTRONICS

512 BROADWAY, NEW YORK, N.Y. 10012

TELEPHONE (212) 925-7000

HI-Q BALUN

- For dipoles, yagis, inverted vees & doublets
- Replaces center insulator
- Puts power in antenna
- Broadbanded 3-40 MHz
- Small, lightweight and weatherproof
- 1:1 impedance ratio
- For full legal power and more
- Helps eliminate TVI
- With SO-239 connector



\$10.95

HI-Q ANTENNA CENTER INSULATOR

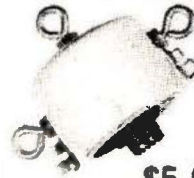

Small, rugged, lightweight, weatherproof
Replaces center insulator
Handles full legal power and more

\$5.95 With SO-239 connector

HI-Q ANTENNA END INSULATORS



Rugged, lightweight, injection molded of top quality material, with high dielectric qualities, and excellent weatherability. End insulators are constructed in a spiral unending fashion to permit winding of loading coils or partial winding for tuned traps.

May be used for
• Guy wire strain insulators
• End or center insulators for antennas

\$4.95 • Construction of antenna loading coils or multiband traps

Patent No.
4,081,350

DIPOLES

MODEL	BANDS	LENGTH	PRICE WITH HI-Q BALUN	WITH HI-Q CENTER INSULATOR
Dipoles				
D-80	80/75	130'	\$28.95	\$24.95
D-40	40/15	66'	25.95	21.95
D-20	20	33'	24.95	20.95
D-15	15	22'	23.85	19.95
D-10	10	16'	22.95	18.95
Shortened dipoles				
SD-80	80/75	90'	31.95	27.95
SD-40	40	45'	28.95	24.95
Parallel dipoles				
PD-8010	80, 40, 20, 10/15	130'	39.95	35.95
PD-4010	40, 20, 10/15	66'	33.95	29.95
PD-8040	80, 40/15	130'	35.95	31.95
PD-4020	40, 20/15	66'	29.95	25.95
Dipole shorteners - only, same as indicated in SD models				
S-80	80/75		\$11.95/pr.	
S-40	40		\$10.95/pr.	

All antennas are complete with HI-Q Balun or HI-Q Antenna Center Insulator, No. 14 antenna wire, ceramic insulators, 100' nylon antenna support rope (SD models only 50'), rated for full legal power. Antennas may be used as an inverted V, and may also be used by MARS or SWLs.

Antenna accessories — available with antenna orders

Nylon guy rope, 450# test, 100 feet \$3.49
Ceramic (Dogbone Type) antenna insulators .70/pr.
SO-239 coax connectors .55

All prices are postpaid USA 48
Available at your favorite dealer or order direct from:

**Van
Gorden
Engineering**

BOX 21303, S. EUCLID, OHIO 44121

Dealer Inquiries Invited





Recipe for Obtaining QSL Cards

BY RANDY PADAWER, WA4FJF

Tips for increasing your QSL returns from DX stations.

"Congratulations OM! I was listening on 20 to that elusive Zanyomiban DXpedition and heard you break right through the pack. That was one heck of a fight. But now that you've worked him, old friend, the second battle has just begun . . ."

There are several things a successful DXer must know to achieve the goals he's set for himself. Although some of this seemingly mysterious knowledge must be gained through actual operating experience, much can be learned from one "who's been there," so to speak.

That's the objective here. Read carefully and you just might improve that QSL return percentage.

Figuring the percentage

The rumblings out in ham land have already begun. Someone, somewhere, is asking, "What's a QSL percentage?" A simple answer is at hand. Break out your logbooks and QSLs right now and start figuring.

Beginning with the very first DX worked, make a list of every country worked. Next, check off the countries from which QSLs have been obtained. Count each country only

once. By dividing the number of countries confirmed by the number worked, you'll arrive at a certain QSL percentage expressed as a decimal:

1. Divide the number of countries from which you have QSLs by the total number of countries worked. Example: $37 \text{ confirmed} \div 56 \text{ worked} = 0.6607142$. . .

2. Round off this value to two digits to the right of the decimal point, i.e., 0.66.

3. Multiply by 100 to arrive at the percentage. Example: $0.66 \times 100 = 66$. In this case, the QSL return is about 66 per cent. The simplified formula is:

$$\text{percent return} = \frac{100 \times \text{number confirmed}}{\text{number worked}}$$

Of course, this numerical value will change with each new country or QSL. Most DXers have fluctuating returns in the 45-65 per cent range. Between 65-80 per cent is excellent, and above 80 per cent is superior.

Although luck certainly plays a role in the number of DX stations that will

actually respond to a stateside station's request for QSLs, you'll find that those hams at the top of the ARRL's DXCC Honor Roll hold percentages, for the most part, of around 95 per cent or better. If your percentage is below 50 or so, you need help. Read on.

The Bureau

Most every country on the air today has a system to allow its Radio Amateurs to send and receive QSL cards in bulk. In this way costs are reduced considerably to all involved. The United States also has its system, known as the "bureau." The main incoming bureau is run by certain clubs and individuals in each call area, who are coordinated by the American Radio Relay League.

There's a very large probability that you have cards at your district's incoming bureau at this very moment. Don't scoff; if not claimed within the year, the cards are burned. Yes, *burned!* Each ARRL bureau, it seems, gives every unclaimed card a glorious yet inhumane end in one perfect flame. For this reason, it might be wise to grab several 5 × 7 inch (13 × 8 cm) end-clasp envelopes, self-address them, write your call prominently in the upper left-hand corner, and send them off together in a very large envelope to your incoming bureau (Table 1).

Even if your bureau doesn't have a resident QSL burner it does have a circular file, otherwise known as the common wastebasket, which serves the purpose as well if not better. So get that envelope to the bureau tonight! You'll be glad you did.

Everything has its drawbacks, and the beloved QSL bureau is no exception. It seems that card returns take forever. Unless you've been an avid DXer for a long time, don't expect your first envelope chock full of QSLs for at least 12-16 weeks or longer. Some cards may take up to one year or more through the bureau. But, who can complain — the service is practically free.

One thing that's not free is sending cards overseas. There are several ways of doing this, ranging from cheap-cheap to out-of-sight.



Above, photo shows author WA4FJF and his DX station in Tennessee. Randy is 18 years old and holds the Advanced Amateur license. Randy's DX operating has resulted (at this time) in 175 confirmed out of 203 countries worked (86 per cent). Randy's mom and dad are also hams, WA4YQJ and WB4FJE, respectively. Randy plans a career in the field of journalism. Good luck, OM! Right, a reproduction of a QSL card received from Aldo Medde, ISØIKR, in Sardinia. The photo doesn't do justice to the hand-painted rendering of a Sicilian farmer.

ARRL members can take advantage of their outgoing bureau. They will ship cards to other bureaus for \$1 per pound or portion of a pound of QSLs. In other words, if you're sending 4½ pounds of wallpaper, you must remit \$5. However, it isn't often that the ARRL outgoing bureau receives that many cards from one DXer at one time, as it takes an average of some 150 cards to weigh one pound. A recent QST label is also required to prove membership.

You don't need to be a member of anything to take advantage of another, slightly more expensive, but still reasonably priced, system. Jesse Bieberman, W3KT, who in addition to personally managing cards for many, many DX stations and running the third district's incoming QSL bureau, also finds time to oversee an outgoing bureau for all DXers. For eight cents a card, or sixteen per dollar, W3KT will distribute QSLs to bureaus and managers around the world.

In addition to these large outgoing bureaus, several other outgoing systems, organized by various DX clubs





and individuals, occasionally advertise in several of the Amateur magazines.

Generally, QSLing solely through the bureaus will produce only a 40-50 per cent return. Of course, the major advantage of the system is its economy. The primary disadvantage, in addition to the extended time period involved, is the fact that there's no guarantee that needed stations will reply.

If, by chance, you want DXCC quickly, well . . . you're out of luck. But all is not lost. That's right — there's no need to wait forever for cards "via buro." (However, keep envelopes on file at your incoming bureau, anyway. I'm told the fireburner is hot and ready.)

The QSL manager

There are still yet a few divine recompenses for leading today's modern, inflated, mobile life, and one of them is, in fact, the unsung hero to the DXer. All of Amateur Radio wor-

ships him — the Greek God of the Airwaves: the DX QSL manager.

These unpaid, charitable souls are, for the most part, DXers like you and me, with the added distinction that they donate their time to checking, filling out, and mailing QSL cards to DXers in foreign countries. This saves the DX much valuable time and practically ensures eager DXers a prompt response.

The QSL manager system is very efficient. At regular intervals, the DX station who employs such a volunteer sends him photocopies of his log along with a supply of blank QSLs. If the manager is stateside, as most are, the only thing required of U.S. Amateurs is a self-addressed, stamped envelope (SASE) and the card filled with correct information. A truly fantastic service both to the DX and the DXer! The return card is shipped as soon as possible, usually within 2-4 weeks.

In some cases, the DX station may use a non-stateside manager. In such instances, International Reply Coupons (IRCs) or the proper return postage must be provided. (More about this later.) It's not wise to send your QSL direct or via the bureau to a station who uses a manager.

Accurate lists of QSL managers are presently offered by various individuals. Gary Yarus, WBØMSX, offers a computerized printout of over 3300 managers. Updated weekly, the listing is available for \$1.75 (U.S./Canada/Mexico) or \$2.80 (all other countries). A book, *The Directory of QSL Managers*, updated quarterly, is offered for \$5 from Franz Langner, DJ9ZB.

So now when Z4AT says, "QSL via W1NERD," you know what to do. Shoot the SASE and card to the manager and rest easy knowing you've bagged a new one.

Using QSL managers and the bureau system exclusively, expect at least a 50-60 per cent QSL return (with almost 100 per cent of the managed QSLs returned). Of course, not every DX station uses a manager.

Experience tells

If you happen to work a DXpedition, let's say, on several different bands or modes, and want to QSL for



What looks like an auto license plate is actually a QSL from American Samoa from KS6FF, who placed all the necessary QSL information on a sticker attached to the plate.

WESTERN SAMOA
APIA

1AU

75 0617 14 79 *sch*

OPERATOR
PHIL S WILLIAMS
PO BOX 1009
APIA, WESTERN SAMOA

THE HEADQUARTERS OF THE UNITED NATIONS, NEW YORK



4U1UN

United Nations Staff Recreation Council
Amateur Radio Club
United Nations, Box 90
New York, NY 10017

TO	DATE	TIME GRT	BAND MHz	MODE SSB	RST	OP
WA4FJA	6-14-79	1527	14	SSB	4-3	<i>WZLW</i>

FRENCH GUIANA
30 AVE DESIRÉE CATHÉDRALE

FY7YE

COME WING QSO

CALL	DATE	GMT	MODE	RST
WA4FJA	06/14/79	1527	SSB	4-3

THY QSL

MANO DE LEYNE
BY W3JLW

EASTER ISLAND
POST 12

CE0AE

POSTAL SERVICE

QSO WITH	DATE	GMT	MODE	RST	Q WAY
WA4FJA	26.01.77	1855	SSB	5-7	516

PEL WASHUP
WASHUP

PEL DAVID L. WOOD, G4JW
#2801 G1 FASDR
PARROQUÍ
VALLE DE PAROQUÍ, CHILE

PEL OSL The *Dr. Lema*

Table 1. Incoming DX QSL bureau system (courtesy ARRL).

First call district: Hampden County Radio Association, P.O. Box 216, Forest Park Station, Springfield, MA 01108.

Second call district: North Jersey DX Association, P.O. Box 8160, Haledon, NJ 07508.

Third call district: Jesse Bieberman, W3KT, RD 1, P.O. Box 66, Valley Hill Road, Malvern, PA 19355.

Fourth call district (one letter suffixed calls such as W4, N4, etc. only): National Capitol DX Association, P.O. Box DX, Boyce, VA 22620.

Fourth call district (two letter suffixed calls such as WA4, AA4, KM4, etc. only): Sterling Park Amateur Radio Club, P.O. Box 599, Sterling Park, VA 22170.

Fifth call district: ARRL W5 QSL Bureau, P.O. Box 1690, Sherman, TX 75090.

Sixth call district: ARRL Sixth District DX QSL Bureau, P.O. Box 1460, Sun Valley, CA 91352.

Seventh call district: Willamette Valley DX Club, P.O. Box 555, Portland, OR 97207.

Eighth call district: Columbus Amateur Radio Association, Radio Room, 280 East Broad Street, Columbus, OH 43215.

Ninth call district: Northern Illinois DX Association, P.O. Box 519, Elmhurst, IL 60126.

Tenth call district: WØ QSL Bureau, Ak-Sar-Ben Radio Club, P.O. Box 291, Omaha, NE 68101.

Hawaii: John Oka, KH6DQ, P.O. Box 101, Aiea, Oahu, HI 96701.

Alaska: Alaska QSL Bureau, 4304 Garfield Street, Anchorage, AK 99503.

each contact, simply fill out the cards and drop them in an envelope to the QSL manager with an SASE — right? Wrong! I tried it once and found something very interesting. Often, when handling cards for a major DXpedition, the QSL manager will have help — sometimes a lot of help, like a whole radio club! The cards are divided by band and mode and taken to many different ham shacks to be verified. When this is the case, and your envelope arrives with three QSLs and one SASE your request may be returned. So a word to the wise — QSL each contact separately with a different outside envelope and SASE when sending through a QSL manager. He'll appreciate it and, above all, you'll get those prized cards much sooner.

To bolster that sagging QSL percentage into the "superior" range, why not try . . .

Sending direct

Yep, bypass those slow, risky bureaus and send the card right to the fellow's doorstep. It's a little more expensive than the previous methods but almost entirely reliable.

HOWEVER (a very big "however," so put your eye to the page and look closely), *always follow the DX station's instructions implicitly when*

sending direct. If not, you may land the gentleman in jail!

As one of my friends in a third-world country recently said, "In the book of *A Few Of Our Favorite Things Over Here*, ham radio rates a couple of paragraphs in a chapter entitled 'plagues.'" Of course, the vast majority of the developing nations fully appreciate the well-trained pool of high-frequency operators that Amateur Radio provides during times of emergency. But the fact that localities still exist whose governments are unfriendly toward any public radio installations requires that stateside operators follow several simple rules when mailing QSLs direct.

The first rule, already stated, is repeated again because of its paramount importance — *follow the other fellow's instructions*. If the DX doesn't want you to send your card, *do not* take the liberty of being nice and sending it along anyway with your request for his. By doing so, the gentleman might have a bit of explaining to do to his postal authorities. In all probability, you may never hear a station request the QSL not be sent direct, but the main point cannot be stressed enough. He knows what is best for him. Read and heed!

Continuing that line of thought, which takes into consideration the

possible plight of the DX station, rule two should be followed conscientiously: *Always provide sufficient return postage to defray the DX station's expenses when you send QSLs direct.**

Unless return postage is provided, DX stations would have to foot the bill for hundreds and, in some cases, thousands of contacts per month. With soaring postal rates that would be an impossible burden, even for the richest ham.

That doesn't mean you should send mint Uncle Sam issues — they aren't good anywhere but here in the U.S.A. and its possessions. Of course, you could always hire worldwide associates who will provide new stamps for your contacts. However, unable to afford the international network scheme, most hams use the simplest substitute available. IRCs, which are available at most post offices for 42 cents each, are small slips of paper which can be cashed for stamps in most countries of the world. Simple to buy, true enough, but very, very expensive. It takes an average of three IRCs to send a card from a foreign country to the States. Always enclose a self-addressed envelope for the DX station to use when he sends you his card. At the DX end, all the op must do is verify the QSO, seal the envelope, take it to the post office along with fifty others from hams who've done the same, and forget his troubles until the next batch. By cashing those wonderful little IRCs for stamps, the DX station's postage costs are way down and he doesn't have to think about food or utility bills each time he speaks with a stateside DXer.

More on IRCs and money

Warning: don't send IRCs that are folded, torn or taped, mutilated by even something as small as a pin or staple hole, stamped on the right side instead of the left (the post office af-

*It also helps to include a self-addressed envelope with your card. The idea is to reduce the DX station's workload. **Editor**

*One notable exception to this would be anyone (usually an American citizen) with an APO or FPO address, such as USACC-Saudi Arabia, APO New York 0961 or the like. These are employees of the U.S. government living on American bases who use regular U.S. Postal Service issues. Anything more than an SASE to these stations would be excess and may not arrive with the card.

fixes its postmark on each IRC), or anything else. Many countries will not accept such IRCs and are very picky about it.

As I said, it takes an average of three IRCs per DX station to ensure a return. That amounts to \$1.26 per card plus the 31¢ stamp. Multiply this by the number of DX stations worked and it adds up to more than just beans. For this very reason, here's another alternative that many big guns prefer, and that is the good old American deep-dish dollar trick.

Aha! The grumblings out there have resumed. And this time it's not you newcomers, but rather a couple of old line DXers of late-fifties/mid-sixties vintage who happened to sneak in and read this article without anyone noticing. Well, I noticed! Anyway, since it's impolite to argue with one's readers, let me fill in the blanks for you newcomers.

Not too long ago, when IRCs were just coming into vogue, many DX stations requested a greenback from each station wanting a QSL. Many stateside hams were appalled. "Imagine having to buy a QSL," was the argument that echoed across the bands. Back in those halcyon days, IRCs were much cheaper — less than a quarter each.

Well, times have changed and, as everyone knows, everything has risen in price since that era when a-m'ers fought SSB wars. It's a different world today, and now it is actually cheaper to send a buck. Another advantage is that, since IRCs don't exchange for even near their original purchase cost, one dollar is worth much more to the DX station. So, nowadays, when a DX station requests a green stamp, no one stages an endless tirade prophesying the demise of Amateur Radio.

...here's another alternative that many big guns prefer, and that is the good old American deep-dish dollar trick.

One thing, however, hasn't changed. American money is not welcome in the socialist countries of the world. Also, never send money to any station in Africa or Asia, unless

the station specifically gives the go-ahead. To do so without the other operator's permission could result in the suspension of his license. When in doubt, don't send money — both you and the DX will be better off. However, Pacific, South and Central American, Caribbean, and the non-socialist European stations readily appreciate American currency in lieu of the IRCs. There is, however, always some risk of the greenback being ripped off somewhere along the line, but steps can be taken to avert this (more about this later).

All of Amateur Radio worships him — the Greek God of the air-waves: the DX QSL manager.

Sending mint stamps

If IRCs are too expensive, and red-blooded Yankee dollars are unwanted, then try sending mint stamps of the DX country. This is the most effective approach because of its convenience to the DX station. All he must do is slip the card into the self-addressed envelope with the stamp you've provided and drop it into a mailbox. A return in the 90-100 per cent range is practically ensured. But where can an average ham acquire needed mint stamps of the proper denomination?

George Robertson, W2AZX, runs the *DX Stamp Service*. Write or call him for his latest price list which, incidentally, is often more economical than greenbacks and most always is cheaper than IRCs. If you're too impa-

tient to go this route, consider your local coin and stamp dealership. Explain to the dealer your intention and he may help you out. He has the latest currency exchange list and

knows the denomination you need. Depending on the retailer, you may or may not wish to use this route.

Worried that the IRCs, buck, or stamps may be ripped off in transit? Well, this brings us to the third, last, and most important rule to follow when sending cards direct. It's a pity that many Amateurs, even the old-timers, sometimes do not follow this rule, and that is *Never, ever, hint on the outside envelope that the correspondence has anything at all to do with Amateur Radio!*

In other words, break that habit

you've had since your Novice days of writing on each envelope "Amateur Radio Station AB1CDE" of ARS C61DM" before the address. If you're a Novice, break the habit now, even if everyone else is doing it.

Don't include call signs

There are several reasons for simply writing names and addresses and not call letters. First off, call letters can't help but might confuse an overseas post office. More important, some of those folks down at the Zanyomiban Postal Authority have wised up. Yep, every time they process a letter with Amateur calls on the outside, they pilfer it for the goodies inside. Forget about receiving his card!

However, the most important reason is the DX operator's privacy and safety. In countries that neither support nor suppress Amateur Radio operations, a negative word about town, such as "Some such-and-such has a radio in his home and is a subversive you-know-what," would ensure the immediate revocation of the gentlemen's license, or worse.

*There's an exception to every rule, and this rule is no exception. When sending cards via a QSL manager it's okay to address the envelope "ARS DX1DX, C/O . . ." in this one instance, this aids the QSL manager, who may handle cards for many DX stations.

What to do if no full name or address is available? Try the foreign edition of the *Radio Amateur Callbook*. Available for \$14.95, it lists hundreds of thousands of addresses by country and is updated yearly (quarterly with supplements available by subscription). For addresses of stateside managers, try the U.S. edition, which is available for \$15.95. In all probability you'll find your answers there. If not, try the DX columns in *QST*, *73*, and *CQ* magazines. Each runs a monthly column listing upcoming DXpeditions, operating news, and QSL information.

One more trick

You've tried just about everything and still no luck. It might sound crackers, but find a clear spot on 20 meters and try a very topical CQ such as, "CQ anyone that knows anything about 7D9AA from W4DUMB," again and again. You might be pleasantly surprised. It will take fifteen minutes or longer, but somebody on the band has 7D9AA's QSL card complete with name and address. You weren't the only station to work him. A little time spent in research might result in a quick reply.

Don't play post office

Here's yet another opportunity for you to benefit from someone else's grave errors. This incident involves an honest-to-goodness DX station, FC9UC, Jean, on the French island of Corsica located in the Mediterranean Sea. Over a year ago, a neighbor of mine, Ray, WB4TCH, worked Jean. He included three IRCs and a self-addressed envelope with his QSL card. The outer envelope was addressed, "Jean Lanfranchi, Casamozza, 20290 Corse, Corsica, Mediterranean Sea." Several months passed and Ray still had not received the return QSL.

Being a persistent soul, Ray sent another QSL with the IRCs and SASE to the same address. Again, no luck. This was repeated yet again (meanwhile, Ray was going broke), but this time his envelope was returned, stamped *incomplete address*. Infuriated, Ray telephoned the nearest post office. The sympathetic fellow on the other end of the line gave it to Ray straight: "There's no telling what happened to your letters, sir." The rea-

son? It seems that because Ray had added "Mediterranean Sea" to the address, his QSLs had been sent astray.

Corsica, in fact, receives its mail through its mother country, France, even though — take a look at the map — the island is closer to Italy. This tale has a happy ending, though. Ray QSLd again, eliminating the "Mediterranean Sea" from the address and received his card in three weeks. That's the lesson to be learned here — don't include continents or bodies of water in any address. The post office people are paid to find out where each country is and route its mail accordingly. (Moral of the story: don't play post office.)

Logging systems

Almost every DXer uses his own method of logging contacts and keep-

*Brighten his day,
include a photograph
of yourself
at the helm of
your station.*

ing records on QSLs sent and received. Most feel that their own system is best, and no two are exactly alike. Numerous articles on cross-referencing have appeared over the years in the various ham publications (see *Additional reading* at the conclusion of this article.)

Operating aids

Without elaborating on my own method, I'd like to suggest one little trick because it's simple and very cheap. The ARRL publishes a free list of all presently recognized DX countries, listed alphabetically by prefix. Whenever a country is worked, a red check is placed next to that prefix. When confirmed, a green check is added. In this manner, you can see at a glance which countries have yet to respond. Also, when a call is heard, the country can be easily identified

with the list. A very useful piece of literature, the ARRL list also includes the official rules of the ARRL's DXCC Award Program, a deleted countries list stating when each was eliminated, and a prefix cross-reference chart. Write the ARRL and request the *DXCC Operating Aid CD-216* immediately. Not many things in life are free these days.

A *5-Band DXCC/WAS Log Book* is available for \$2.25 from the YASME Foundation, an organization devoted to Amateur Radio DXing and DXpeditioning. An excellent operating aid, it shows instant progress made on each band for each country and state. Complete with blank spaces for adding new countries and prefixes, it can be ordered through Ruben Hughes, WA6AHF, YASME's official QSL manager.

A slightly more complete and cross-referenced logbook for DXCC progress on five bands is available from Richard Norley, WA1CFT for \$5.00 (U.S./Canada) or \$6.00 (all other countries).

Requirements of the QSL card

Can your card help a DX station achieve various awards? If not, then you may be stirring up trouble for yourself. Similarly, you want the DX op's QSL to qualify you for credit. The QSL card should be, above all, complete.

For DXCC purposes, the card should contain the calls of both stations involved, the date, time, frequency or band, and operating mode. If any of this vital information is lacking, don't try to submit the card to any awards committee for credit.

In addition, if the said card is to be submitted for any of *CQ Magazine's* awards such as Worked All Zones (WAZ) or Worked-Prefix Award (WPX), the card *must* contain a signal report and the words "confirming two-way contact," "2-way," "2X," or the word "QSO" somewhere on the card.

Never, but never, attempt to "correct" an incomplete QSL by writing on it. Most awards committees, I'm told, hire professional handwriting analysts, bloodhounds, and, on occasion, the FBI to check their applicants' cards. Forging is grounds for elimination from the program forever. Best not risk it. Simply write the DX station

or his manager, if he has one, and state the problem politely, requesting a new card. Include return postage and self-addressed envelope as well, plus details of the contact so that he may re-verify it.

STOP! I told you *not to touch that QSL*. The ARRL bloodhounds are on your trail . . .

The final touch

That DX station to which you're sending a card will, at the time he verifies it, be wading through hundreds of similar requests. Every envelope is the same with the same insides: QSL; IRCs; self-addressed envelope; a hastily scratched "tnx qso" written somewhere on the card — all very tame, boring, and discouraging.

Why not take the time to brighten his day? Include a photograph of yourself at the helm of your station. Any major film processing company can make fifty or a hundred or more prints of the same color photograph quite reasonably, believe it or not. Check it out — it may surprise you. If a photograph is impossible, send a cheery note on a separate sheet of paper.

What's that? That YL you worked hardly spoke a word of English? Use a piece of pretty stationery, draw a flower with a smiling face, and write "88" next to it. She'll understand that.

If you'd like to express yourself in the DX station's own tongue, obtain Joe Mikuckis' book, the K3CHP's DX QSL Guide. It shows you how to fill out QSL cards, write about yourself, your rig, etc., in fifty-four different languages. It's available for \$3.95.

That final personal touch, if you can appreciate the DX station's heavy workload, might be the bright light of an otherwise dreary, envelope-stuffing day.

Catch this band opening

The rest of this magazine will wait until that quiet moment after dinner when you can snuggle into the easy chair and really enjoy the articles. But right now, *do it!* There's a band opening on 15-meter CW. It may be that Zanyomiban operation again, and I'm sure many of you don't have that one yet (not even W6AM), so go right to it and I hope you'll have the prized QSL on the wall in no time at all.

Where to write

American Radio Relay League
225 Main Street
Newington, CT 06111

CQ Magazine
14 Vanderverter Avenue
Port Washington, L.I., NY 11050

Franz Langner
C. Kistnerstrasse 19
7800 Freiburg Breisgau,
Federal Republic of West Germany

Gary Yarus
921 North Clay Avenue
Kirkwood, MO 63122

George Robertson's
DX Stamp Service
83 Roder Parkway
Ontario, NY 14519

Jesse Bieberman
RFD 1 — Valley Hill Road
Malvern, PA 19355

QST (see American Radio
Relay League)

Richard M. Norley
P.O. Box 543
Derry, NH 03038

73 Magazine
Peterborough, NH 03458

YASME Foundation
c/o Rubin Hughes
17494 Via Alamos
San Lorenzo, CA 94580

The *Radio Amateur Callbooks* and *K3CHP's DX QSL Guide* may be obtained through Ham Radio's Communications Bookstore, Greenville, NH 03048.

Further reading

Conklin, Bill, K6KA, "Zulu Time," *ham radio (the ham notebook)*, March, 1973, page 56.

Fisk, James R., W1DTY, "How to Design QSL Cards," *Ham Radio Horizons*, February, 1978, page 12.

Gray, Jim, W1XU, "Far Horizons — DX, Sport of Kings," *Ham Radio Horizons*, March, 1980, page 12.

Linkous, Rod, W7OM, "DX: DX QSL-ing," *CQ*, July, 1978, page 68.

Sundstrom, Thomas, W2XQ, "Collecting QSLs," *Ham Radio Horizons*, February, 1978, page 22.

Tlapa, Dick, K9DNR, "QSLs — How to Get Them in a Hurry," *QST*, November, 1977, page 58.

HRH

SWAN METERS

THE TOP OF THE LINE

PEAK READING WATT METER WM-2000A reads power in 200, 1000, 2000 watt ranges. 3.5-30 MHz. Reads average or PEP power output. Includes expanded VSWR scale.

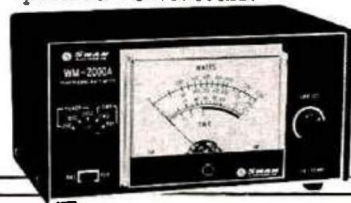

IN-LINE WATT METER WM-2000 reads power in 200, 1000, 2000 watts. 3.5-30 MHz. Incl. expanded VSWR scale.



MOBILE WATT METER HFM-200 with remote directional coupler reading 20 or 200 watts. 3.5-30 MHz. Illuminated, with VSWR scale.



SWR BRIDGE SWR 1A with dual reading meters. 1000 watts RF. 3.5-150 MHz. Reads relative power output.



Available only through authorized dealers.



A division of Cubic Communications, Inc.
305 Airport Rd. • Oceanside, Ca. 92054
(714) 757-7525

SSB and FM

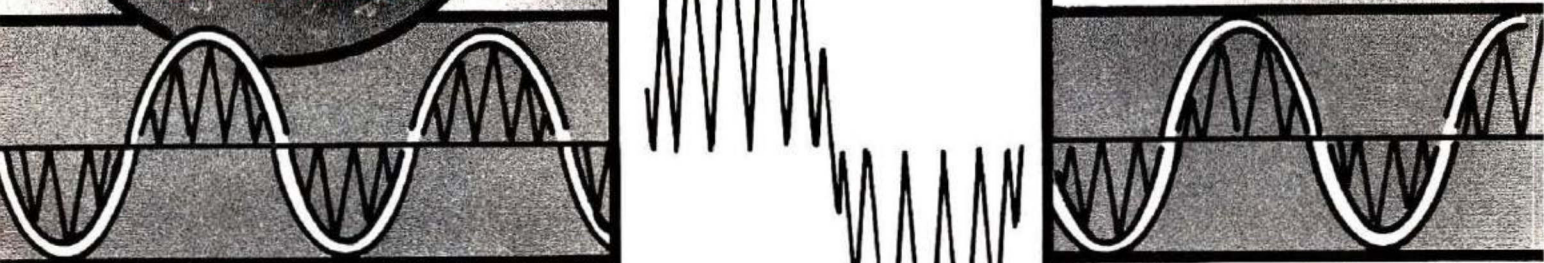

Adaptors

**DOUG
BLAKESLEE** **N1RM**

My friend John, who had let his Amateur license lapse years ago, came by recently. He claimed that he would like to become active again, but that he found everyone today was on single sideband (SSB), which was difficult to tune in on his old Hallicrafters receiver. He clearly loved that old receiver which had done yeoman service when amplitude modulation (a-m) was king.

"Gee," I remarked, "building an SSB adaptor shouldn't be a major undertaking." I grabbed a pad and started sketching out a circuit. But John called a quick halt, saying that he had no interest in chopping up his pride and joy. Nevertheless, a little work with the sketch pad indicated that an SSB receiving adaptor could be built which would be a stand-alone unit.

Then my imagination took over. I recalled Jim Fisk's article which lauded some older receivers in the premier issue of *Ham Radio Horizons*.¹ Anyone working on a limited budget might be interested in a unit to upgrade an older receiver. In fact, I was interested; I've owned an R-390A receiver for years. It has a very high level of signal from the intermediate-frequency (i-f) amplifier chain compared with the signal from the beat-

frequency oscillator (BFO). Such a condition makes tuning SSB signals very difficult, and use of automatic gain control (agc) impossible. Articles have been written about modifying the inner workings of the R-390s, but that would be like taking a knife to an old friend.

An outboard SSB receiving adaptor was a great idea. Better yet, why not include provision for reception of frequency modulation (f-m)? With a vhf or uhf converter, I could receive not just 200 or 500, but every possible repeater channel.

The receiving adaptor that evolved was purposely made modular in design so that it could be constructed for SSB or fm alone, as well as for both. Frequency-determining elements are limited to the BFO crystals and the fm-detector tuned circuit. Although my unit was designed for receivers with an intermediate frequency of 455 kHz, it can be used up to 11 MHz.

The circuit

The receiving adaptor which evolved from those first sketches proves how modern integrated-circuit (IC) technology has reduced both the complexity and cost of receiver projects. If built with tubes, a unit as large as the original receiver and using twelve to fourteen tubes would have been required.

The solid-state adaptor circuit uses three ICs and three transistors. A

block diagram of the unit is shown in Fig. 1. Separate detectors are employed for SSB and for fm. The SSB unit is an integrated-circuit product detector. A product detector is a type of mixer where the output is the product of two input signals, in this case the difference between the i-f signal (from the receiver) and the BFO. Separate crystal-controlled oscillators are used to generate appropriate BFO frequencies for upper and lower sideband re-

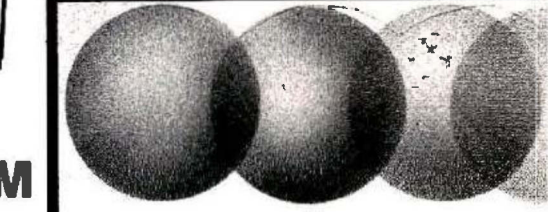
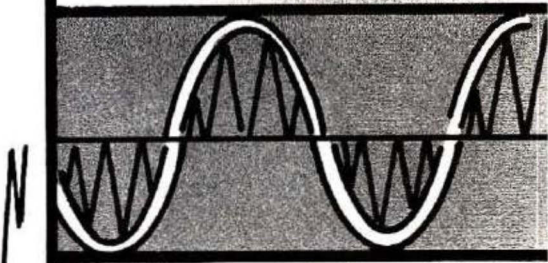

ception. The product detector is followed by a transistorized audio preamplifier so that the SSB section will have a level of output similar to that produced by the fm section.

For fm reception, a complex IC is used which contains a limiter, detector, squelch, and audio preamp all in one package. The limiter is a three-stage circuit with very high gain so that as little as 3 microvolts of signal will cause noise and other amplitude variations to be removed. It is the limiter that produces the "quieting" effect of fm. The fm detector is set to the intermediate frequency with a single tuned circuit. The audio-output level from the detector is not high, so an audio preamplifier is contained within the IC. It also has a squelch function to shut off the audio stage when no signal is being received.

Those Hard-To-Get Parts

Transistors and integrated circuits — available from Jameco Electronics, 1021 Howard Avenue, San Carlos, California 94070.

Crystals — type GP from International Crystals, M/S Dept., Box 34297, Oklahoma City, Oklahoma 73132.

Large ferrite beads and rf chokes — Radiokit, Box 429, Hollis, New Hampshire 03049.

The schematic diagram of the SSB detector is shown in Fig. 2. A 1496 or 1596 balanced modulator/mixer IC is used. This detector has excellent dynamic range (ability to handle signals which vary widely in signal strength) and sensitivity. The circuitry used is that recommended by the manufacturer² with two exceptions. The gain of the detector is raised by connecting a capacitor from pin 2 to pin 3, rather than a resistor as suggested by Hayward.³ And the output is decoupled through an rf choke rather than a resistor. The IC has separate inputs for i-f and BFO signals. One signal input, pin 1, is used for the receiver, while the other, pin 4, is returned to ground via a 0.1- μ F bypass capacitor. The same scheme is employed for the BFO, with the signal coupled to one input, pin 8. The other — pin 7 — is bypassed to ground. The IC has push-pull output stages, which are connected to 2700-ohm load resistors via pin 6 and 9. The demodulated output is taken from pin 6.

Output from the product detector is fed to an audio preamplifier, Q1. The gain of this stage is low because the 470-ohm emitter resistor is not bypassed for audio frequencies. Depending upon the level at which the product detector is operated, more gain may be needed from the pre-amp. It can be obtained by adding a 15- μ F electrolytic or tantalum capacitor as shown in Fig. 2.

The BFO uses a dual-gate mosfet transistor for each oscillator. Jfet types, such as the popular MPF-102 and 2N4416, will also work well in this circuit, which was described recently by DeMaw.⁴ Feedback to sustain oscillation is via the 470-pF capacitor connected from the gates to ground, and via the 0.1 μ F output-coupling capacitor. If the product detector is to be used with an i-f in the megahertz range, the only changes needed are in the BFO circuit. The values of the feedback capacitors should be reduced proportionally (made smaller in value) as the frequency of operation is raised. Also, RFC2 can be reduced to 1 mH.

Input to the limiter section of the fm detector, U1 of Fig. 3, is via pin 1. A tuned circuit is required for the detector section, connected to pins 9 and 10. I used an i-f transformer salvaged from an old transistor radio. Typical inductor/capacitor values are given in

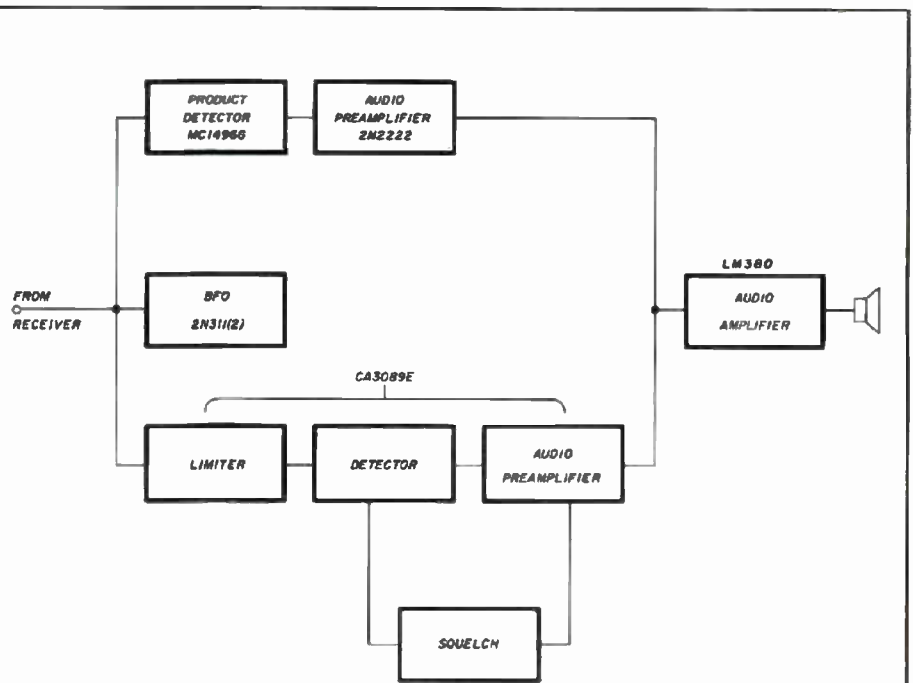

Fig. 1. Block diagram of the receiving adaptor.

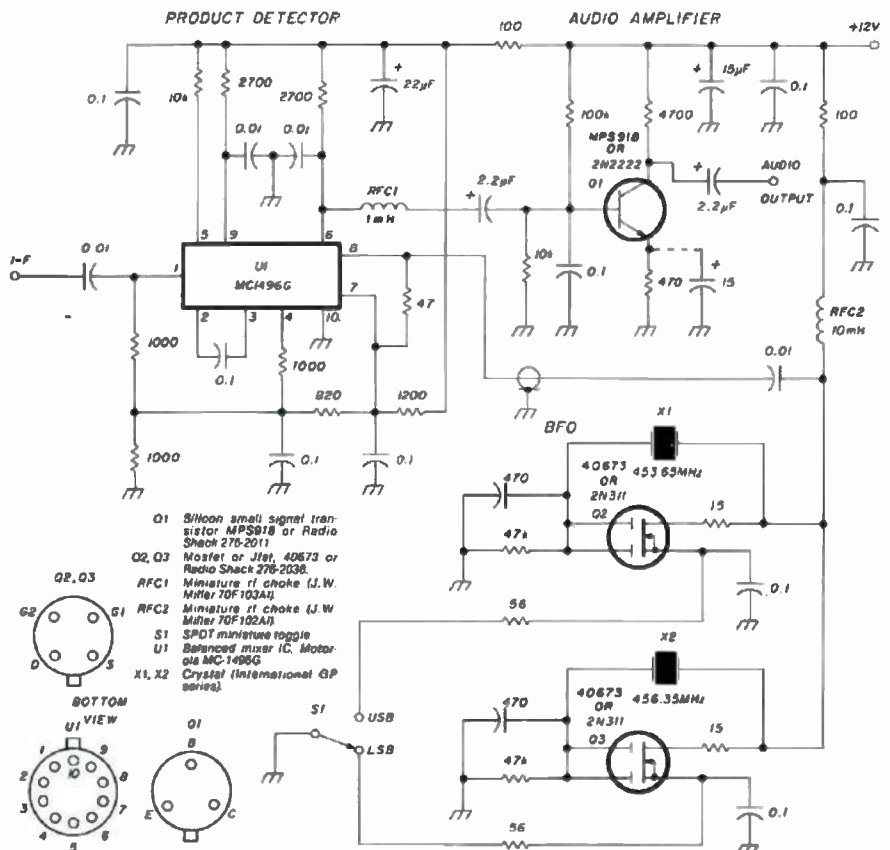

Fig. 2. Schematic diagram of the SSB detector. Unless otherwise noted, resistors are 1/4 or 1/2 watt composition and capacitors are disc ceramic except those with polarity marked, which are tantalum or electrolytic.

the caption for Fig. 3. The squelch circuit of U1 is a simple design intended for entertainment applications. It works, but it does not perform as well as the noise-operated squelch designs found in fm communications receivers. Audio output is taken from pin 6 through a resistor/capacitor network which attenuates any i-f energy.

The audio amplifier is shown in schematic diagram form in Fig. 4. The LM380N IC is used. This IC is capable of 2 watts audio output. However, in this application the output is limited to approximately 0.5 watt to eliminate the need for a heat-sink and so the entire unit can be operated from 12 volts. The connections to and from the volume control are made with shielded cable to eliminate hum pickup.

Interconnections between the detectors and the audio amplifier are shown in Fig. 5. Shielded cable such as RG-174/U subminiature coaxial cable should be used for the i-f and audio leads. If the unit is built for either fm or SSB only, the mode switch, S1, can be eliminated. RFC1 and 2, plus the associated 0.1 μ F bypass capacitors are included to eliminate any rf pickup from a nearby transmitter. If the unit is to be used for receiving only, these components can be eliminated.

The unit may be powered by any 12-volt source that will provide at least 300 mA. An on-off switch and light-emitting-diode (LED) power indicator are included, but they are optional. Provision is made for an attenuator on the input line from the receiver. The requirement for an attenuator is discussed later in the text.

Construction

Many of the components for this project can be found at your local Radio Shack store. Unfortunately, not all. The crystals, ferrite beads, and special integrated circuits must be obtained by mail (see box).

Radio Shack "universal" circuit boards (276-151) are used, one for the SSB detector and one for the fm detector and audio amplifier. The parts layouts are shown in Figs. 6A and B. These boards contain patterns for two integrated circuits plus a number of "islands" which are large enough for four circuit connections each. The first step is to determine where holes should be drilled. They

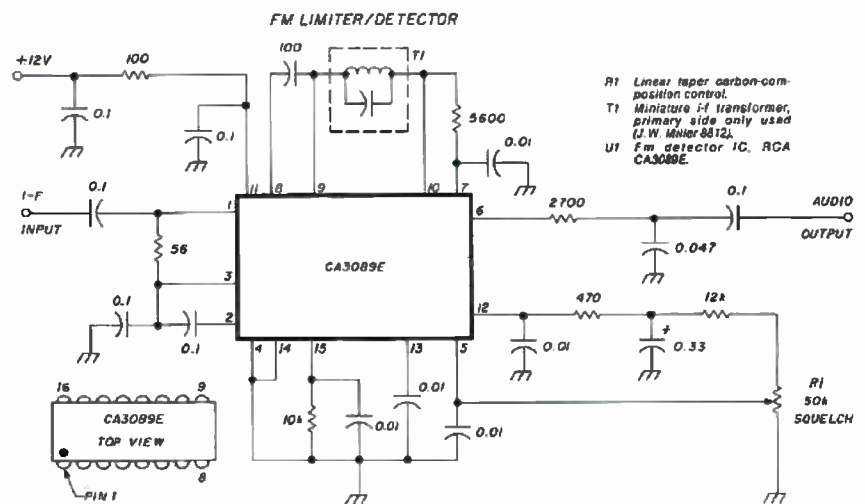

Fig. 3. Schematic diagram of the f-m detector. Unless otherwise noted, resistors are 1/4 or 1/2 watt composition and capacitors are disc ceramic. The capacitor with polarity marked by a plus sign is tantalum.

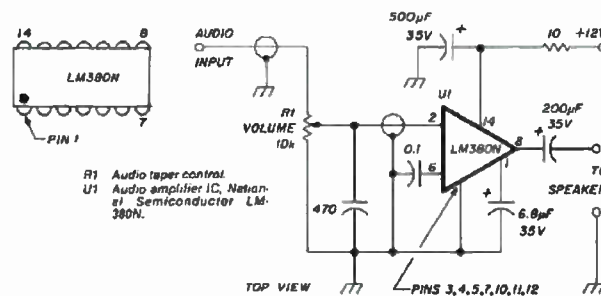

Fig. 4. Schematic diagram of the audio amplifier. Resistors are 1/4 or 1/2 watt composition and capacitors are disc ceramic except those with polarity marked, which are electrolytic.

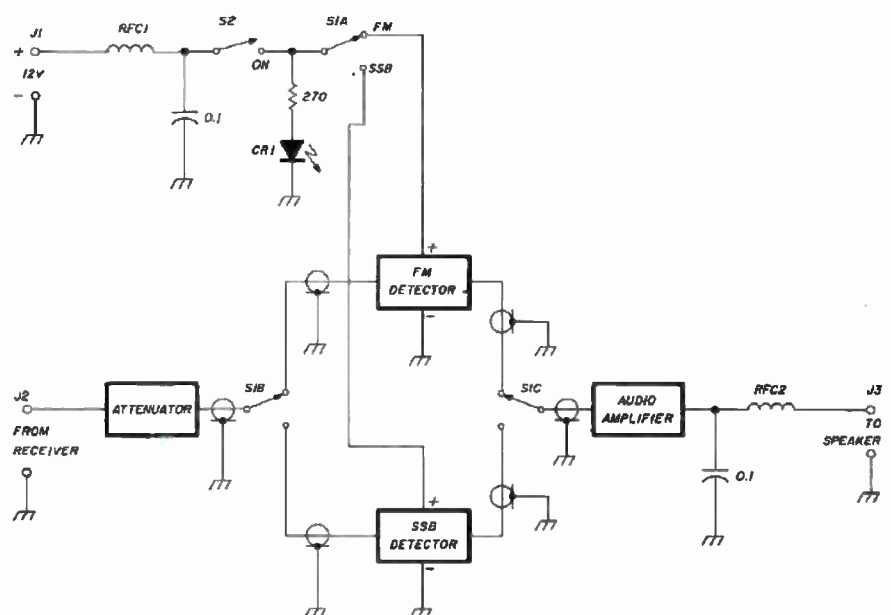

Fig. 5. Interconnections between the various sections of the receiving adaptor. Capacitors are disc ceramic. CR1 is a light-emitting diode. The jacks are miniature phono types. S1 is a 3PDT miniature while S2 is an SPST type. RFC1 and RFC2 are five turns of enameled wire around a jumbo ferrite bead.

zons.⁵ A unit from a local hobby store will be equally suitable. Holes should be drilled in the cabinet for controls, jacks, and switches. Then the finished unit can be assembled.

Connection and adjustment

Before power is applied, check the power connector with an ohmmeter set to read thousands of ohms (x1000). Connect the positive (red) lead to the + 12 volt line and the negative (black) to ground.* When first connected, the ohmmeter should read a low value. As the capacitors in the circuit charge, the indicated resistance should slowly rise to several thousand ohms. If not, there is a short circuit somewhere in the unit or a component has been incorrectly installed. If the resistance check indicates no problem, it is safe to apply 12 volts.

Power may be obtained from an inexpensive battery eliminator such as the Radio Shack 22-124. Or, the *Ham Radio Horizons* power supply can be used.⁶

Connections to the receiver will vary from unit to unit. Military receivers such as the SP-600 and R-390 are ideal because they have i-f output jacks and i-f stages with both narrow and wide selectivity (2 kHz is optimum for SSB while 12 to 16 kHz is appropriate for Amateur fm). The receiving adaptor requires very little signal level; 10 to 100 μ V is all that's needed. The R-390 i-f output was approximately 0.1 volt — far too much — so an attenuator was added at the input of the receiving adaptor. Attenuators of various types are shown in Fig. 7. The R-390 required some 40 dB of attenuation.

Receivers without an i-f output jack require a minor modification. This can be accomplished in several ways, as shown in Fig. 8. A wire snaked

*Not all ohmmeters have the internal battery connected so that the red lead is positive. You can test yours in the following manner: Obtain a diode that has the cathode plainly marked with either a band or a + sign (a rectifier diode for a power supply will do nicely). Connect the black lead to the cathode (banded or +) wire, and the red lead to the other wire (anode). If the meter reads a relatively low value, say, hundreds of ohms or less, than the red lead from the ohmmeter is truly positive. Just to double check, reverse the leads; the meter should read high, several thousand ohms. (If it reads a low or high value both ways, the diode is defective!) Editor

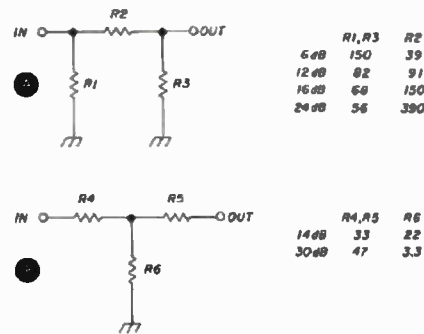

Fig. 7. Pi (A) and T (B) resistive attenuators. The attenuation figures are approximate because standard resistor values are employed.

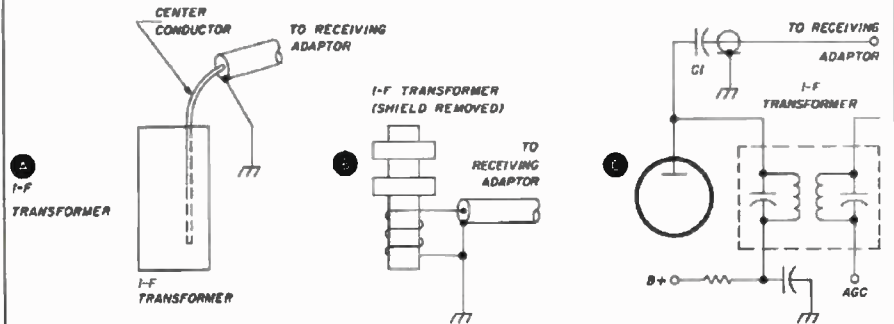

Fig. 8. The simplest pickup method involves inserting the center conductor of a miniature coaxial cable into an i-f transformer, A. Leave the insulation on the conductor, and ground the shield of the coax to the receiver chassis. For more signal pickup, remove the housing from the i-f transformer and wind ten turns of wire around below the transformer windings, B. Ground one end and connect the other to the coaxial cable running to the receiving adaptor. A gimmick capacitor made from short lengths of insulated wire twisted together with three twists can be used as a coupling capacitor, C1, in C. Here, also, coaxial cable is used to connect to the receiving adaptor.

down inside an i-f transformer (Fig. 8A) may suffice. If enough output is not obtained, the i-f transformer shield can be removed and several turns of wire added to form a pickup loop (Fig. 8B). Or, a capacitive connection can be made to an i-f amplifier stage via a "gimmick" capacitor (Fig. 8C). If you use either Fig. 8B or C, minor reworking of the i-f transformer may be required.

If the receiver has a narrow-band crystal or mechanical filter which cannot be switched out, an alternative strategy is needed. Separate cables should be used, with the fm detector connected before the filter and the SSB detector after the filter. In general, the older receivers use multistage i-fs with selectivity provided by interstage transformers. If one connection is desired, a point in the middle of the i-f chain is appropriate. For best SSB selectivity, a point at the end of the i-f,

just before the detector, is best. Some experimentation may be necessary to find the connection point (or points) that yield the best results.

The SSB detector has no adjustments so that it should start working as soon as the adaptor is connected. If no audio output is noted, check the BFO for proper operation. The second harmonic of the 455-kHz crystals (910 kHz) can be heard with a broadcast receiver. If crystals in the megahertz range are used, they can be monitored using a general-coverage shortwave receiver. If the audio level is low, it can be boosted with a bypass capacitor as described earlier in the text. If the audio is loud and distorted, the detector is probably being overdriven. Try an attenuator at the input to the receiving adaptor.

The fm detector can be adjusted with an off-the-air signal. Use a vhf converter in front of your receiver,

and tune in the output of a local repeater. Adjust the fm detector for maximum audio level; the points of minimum distortion and maximum audio output occur simultaneously. If all signals sound distorted, the i-f chain of the receiver may be too selective. Try a tap point closer to the "front end." Overdrive of the fm IC is difficult to detect because of the action of its limiters. The only sign of overdrive I noted was that the squelch function stopped working.

The fast agc action of receivers intended for a-m reception is also suitable for fm. However, it is not pleasant on SSB, as the noise level will be heard between syllables and pauses in speech. To eliminate this problem, it is desirable to lengthen the time constant of the receiver agc system. Inspection of the schematic diagram for a tube receiver will show a line that runs from the detector to the grids of the i-f and rf tubes. This is the agc bus. It typically has a time-constant capacitor of 0.1 μ F or less. The value of this capacitor should be raised by a factor of 10 or more (to 1 μ F, for example) by paralleling a second capacitor. The agc line usually contains negative voltage, so observe polarity if a polarized capacitor is used. The minus (-) connection on the capacitor goes to the agc line and the plus (+) to ground. Experiment with various capacitance values until the S-meter doesn't drop during syllables when receiving SSB.

When poking around on the inside of a tube type receiver, remember it's not a transistor circuit. Dangerous voltages are present; think safety and keep one hand in your pocket.

In operation

The R-390A is a joy to use with the receiving adaptor. Gone is the constant fiddling with the BFO and rf-gain controls to tune in an SSB station. Eliminated, too, is reaching for the rf gain each time a station of different signal strength comes on. On 2-meter fm, it's fun to reply to those using 2000-channel transceivers that your setup has many more channels — in fact, *all* channels. And when you're tired of the repeater chatter, you can drop down to the low end of the band and tune in the vhf SSB stations with the flip of a switch.

Ole John hasn't an excuse left to prevent him from getting back on the air.

References

1. James R. Fisk, W1HR, "Get On The Air On A Budget," *Ham Radio Horizons*, March, 1979.
2. Roy Hejhall, K7QWR, "An Integrated Circuit Balanced Modulator," *ham radio*, September, 1970.
3. Wes Hayward, W7ZOI, and Doug DeMaw, W1FB, *Solid-State Design For The Radio Amateur*, ARRL, 1977, page 98.
4. Doug DeMaw, W1FB, "A Universal Solid-State BFO," *QST*, November, 1979.
5. Doug Blakeslee, N1RM, "All The Parts You'll Ever Need," *Ham Radio Horizons*, November, 1979.
6. Doug Blakeslee, N1RM, "Power To The Projects," *Ham Radio Horizons*, December, 1977.

HRH



Front view of the SSB/fm receiving adaptor.

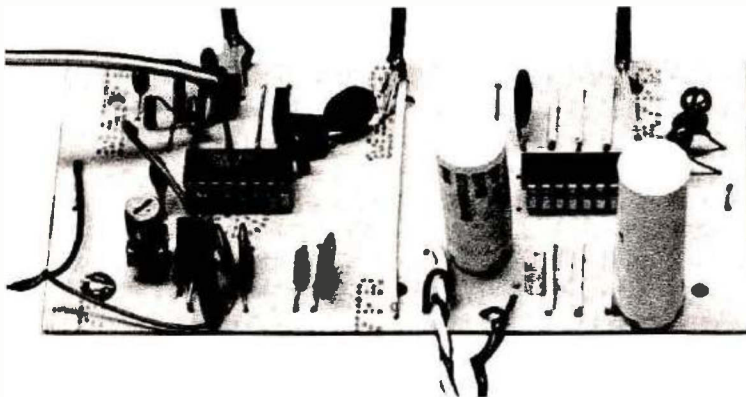

The assembled f-m detector and audio-amplifier board.

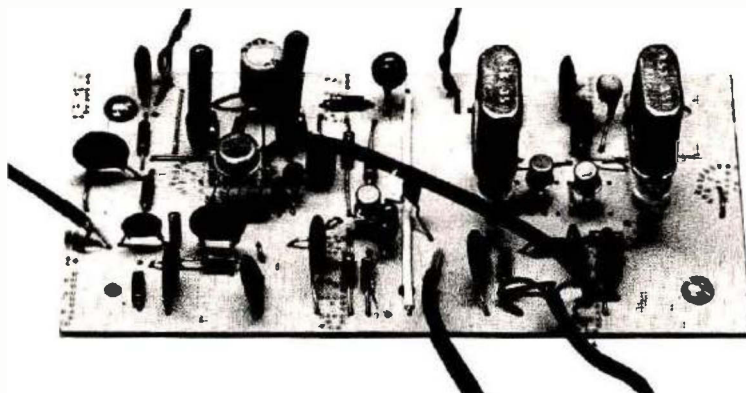

The SSB detector assembly before mounting in the case.



Interior view of the receiving adaptor.

Hong Kong

Amateur Radio Transmitting Society

ANTHONY GREEN
A4XGR, G4HRD,
VP2EZ, VS6EZ

The 50th anniversary of the founding of HARTS occurred in 1979, and at the time there were thirty-eight licensed members in the Colony including four members still holding VS6 calls who are presently out of the Colony but may return later. We also have five call signs allocated to various colleges and clubs. SWL interest is small, but we have over twenty non-transmitting members. There are also a number of Amateurs here who do not belong to the club.

The club meets every Tuesday, at 17:00 local time at the China Fleet Club on Arsenal Street in Wanchai. The blue and cream building is opposite the Hong Kong Island police headquarters; our members can be found in the far corner on the first floor. All visitors, SWLs, and licensed Amateurs are most welcome.

We have one repeater on 2 meters, which is owned and operated by the club. It is situated at Tate's Cairn in Kowloon at a height of 580 meters above sea level, and provides good coverage over most of the Colony. There is a possibility of more repeaters at a later date, when funds permit. Our repeater input is 145.0 MHz with output on 145.6 MHz, with a CW ID of VS6HK every five minutes. In August, 1979, I worked three YD3 stations in Surabaya, Indonesia, on 144.120 MHz fm. This is the farthest any Hong Kong 2-meter operator has had two-way communications.

The most interesting project for the keen vhf DX operator is the agreement in principle that I obtained from the Telecommunications Authority here to permit a 2-meter input with 6-meter transmit output, and with the reverse function on 6-meter receive. This would then permit far greater 6-meter activity than at present with the five 6-meter-equipped stations. However, we have no funds or equipment for this project at this time. Possibly the reason for lack of 6-meter activity here is that most of the European op-

erators do not want to purchase equipment which they cannot take back and use in Europe. However, the installation of a cross-band repeater would relieve us of that problem, though it would mean being able to operate only on a single 6-meter transmit frequency. Careful selection of a suitable 6-meter receiver input frequency should permit access by Australian stations, as well as other areas in the Pacific.

Complaints by DX stations that they seldom hear VS6 stations should, in the near future, be reduced by a small amount. One of the local colleges has been running the British Radio Amateurs' course, and, in 1978, twenty-nine applicants passed it, so all they need is to pass the Morse test of 12 WPM to gain a license here. In May, 1979, there were seventy-four candidates for the Radio Amateurs' course.

Our frequency allocations and power restrictions in general follow the United Kingdom pattern. There is no Novice or vhf-only class of license here, but the club is making representations to the Telecommunications Authority to permit the use of 2 meters and above to those passing the British R.A.E., and visiting Amateurs who do not qualify for license because of their short stay, so that the bands are subject to greater use.

We are permitted to use the bands, modes, and power levels shown in Table 1.

Hong Kong has reciprocal licensing with a number of countries, but does not issue licenses to short-term visitors. Applicants have to show that they will be in the Colony longer than three months. The license fee is H.K. \$50 (Hong Kong) a year, which is approximately U.S. \$10. To get a VS6 license, one has to submit a form obtainable from the Telecommunication Authority, 4th Floor, General Post Office, Hong Kong Island.

The following are the countries for which reciprocal licenses will be issued:

Austria (for holders of license showing Morse test has been passed)
Belgium
Brazil (Class A only)
British Commonwealth Countries
Denmark (Licenses A & B only)
Finland (General Class only)
France (All types except F1)
Germany (Federal Republic) (Licenses A & B only)
Israel (Licenses A & B only)
Luxembourg
Monaco (3A2 Series only)
Netherlands (Licenses A & B only)
Portugal, Azores, Madeira (Licenses B & C only)
South Africa (only licenses issued after 1/1/63)
Sweden (Certificates A & B only)
Switzerland (Categories D1 & D2 only)
U.S.A. (Advance, Extra, General or Conditional only)

Table 1.

1.8-20 MHz	A1 only	10-watts dc input
3.5-3.9 MHz	A1, A2, A3,	150-watts dc input,
7.0-7.1 MHz	A3A, A3H,	or 400-watts PEP
14-14.35 MHz	A3J, F1,	
21-21.45 MHz	F2, F3	
28-29.7 MHz		
50.05-51.5 MHz	A1, A2, A3, F1	50-watts dc input
50.025-52.110 MHz	F2, F3, A3J	or 133-watts PEP
144-146 MHz	A1, A2, A3, F1,	20-watts dc input,
	F2, F3, A3J	or 53-watts PEP



The Firecracker Award is printed on pseudo parchment with a black border, red dragons, red and black firecrackers. The top line of writing is in red, the rest is in black.

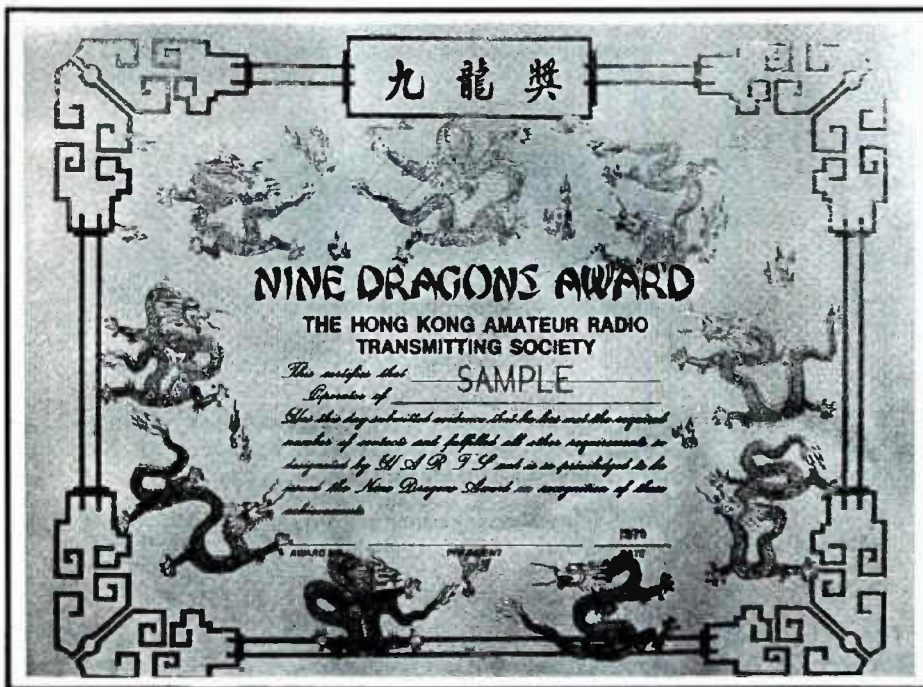

The new Nine Dragons Award is printed on brilliant red card, the border of dragons is in gold leaf, and the Chinese and English writing is in black.

tion logbook, certified as correct by the applicant's radio club, or, if there is no local club, certification of corrections by two other Amateurs will be accepted in lieu. The claim should be submitted to our Awards Manager, P.O. Box 541, G.P.O. Hong Kong, enclosing \$2. After processing, the award will be returned by seamount.

To celebrate the 50th anniversary of the club, we are issuing a new award. Called the "Nine Dragon Award," it is named after Kowloon — an Anglicised version of the Chinese name for that area which, literally translated from the Cantonese, means Nine Dragons.

The details of the award are as follows:

This award is available to licensed Amateurs and SWLs on a heard basis.

Only contacts on or after January 1, 1979, are valid.

Do not send QSL cards. Only log data which is certified correct by the Awards Manager or officer of a National Radio Society is required. Details of log data must include station call sign, date, time in GMT, band, mode, and signal reports both given and received.

Claims may be made within the following categories: CW only, CW and phone, or phone only. (If requested, the Award will be endorsed accordingly.)

All stations require one contact with nine different countries in any of the nine listed zones. One contact of the nine must be a VS6 Hong Kong station. The listed zones are 18, 19, 24, 25, 26, 27, 28, 29, 30. However, an additional requirement for stations within these nine zones is that they work (SWL, hear) two stations in each zone, i.e. a total of eighteen contacts of which two contacts must be VS6 stations.

The fee for the Award is U.S. \$3.

All applications must be addressed to Awards Manager, Hong Kong Amateur Radio Transmitting Society, P.O. Box 541, General Post Office, Hong Kong.

Awards will be returned by seamount.

HRH

To collect the Hong Kong "Firecracker Award," Amateurs have to work a minimum of six different VS6 calls on any band by any mode, but

stations in zones 18, 19, and 24-28 must work 10 different VS6 stations. SWLs may also claim the award. Submission of a full extract from the sta-



Drake R7 Synthesized General Coverage Receiver



Full 0-30 MHz coverage, with no gaps or range crystals required. Continuous tuning from vlf thru hf. State of the art a-m, ssb, RTTY, and cw. Transceives with Drake TR7.

- ★ Complete transceive/separate functions for use with TR7.
- ★ Multi-function antenna selector/50 ohm splitter for dual receive with the TR7.
- 100% solid state broadband design, synthesized with PTO.
- Covers range 0 to 30 MHz. Both digital and analog readout.
- Special front-end circuitry with high level mixer and 48 MHz 1st i-f.
- Complete front-end bandpass filters operate from hf thru vlf.
- 10 dB pushbutton-controlled broadband preamp for ranges above 1.5 MHz.
- Various front panel switch-selected optional selectivity filters.
- Low distortion "synchro-phase" a-m detector improves international SW.
- Tunable i-f notch filter reduces heterodyne interference.
- Full electronic passband tuning system.
- Digital readout may be used as a 150 MHz counter.
- Built-in power supply: 100, 120, 200, 240 V-ac, or 13.8 V-dc.
- Built-in speaker, or external Drake MS7 speaker may be used.
- Built-in 25 kHz calibrator for calibration of analog dial.
- Low level audio output for tape recorder.
- Select up to eight crystal-controlled fixed channels. (With Aux7).
- Optional Drake NB7A Noise Blanker available.

Accessories available for use with Drake R7:

- MS7 Speaker • SL300 Cw Filter, 300 Hz • SL500 Cw Filter, 500 Hz • SL1800 Ssb/RTTY Filter, 1800 Hz • SL6000 A-m Filter, 6.0 kHz • SL400 A-m Filter, 4.0 kHz • NB7A Noise Blanker • Aux7 Range Program/Fixed-Frequency Board • R7/TR7 Interface Cable Kit • R7 Service/Schematic Book.

Drake 7-Line Accessories



Drake L7
Continuous Duty
160-10 Meters
2kW
Linear
Amplifier

Temperature controlled for "key-down" operation covers any WARC expanded or new hf amateur bands, MARS, etc.

- 2 kW PEP, 1 kW cw, RTTY, SSTV full rated continuous duty
- Covers 160-10* meter amateur band, plus future hf band WARC expansions and MARS, embassy, government, etc. • The Drake L7 includes a pair of rugged Eimac 3-500 Z triodes. • Accurate built-in rf wattmeter. • Temperature controlled two speed high volume fan. • Adjustable exciter agc feedback. • By-pass switching. • Bandpass tuned input circuitry. • 120/240 V ac, 50/60 Hz.

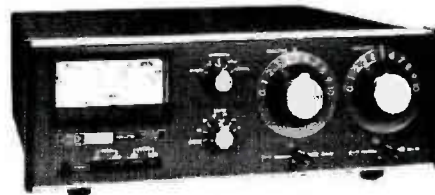

Drake
MN2700

2 kW Matching Network

Manages rf radiation by impedance match to antenna, measurement of rf power and VSWR, reduction of harmonic radiation, and antenna selection.

- 160 thru 10 meters frequency coverage — plus MARS, future expansions, etc. • Matches antennas fed with coax, balanced line, or random wire. (Use Drake Balun for balanced line.)
- Antenna by-pass switching also selects various antennas.
- Extra harmonic reduction to help fight TVI — "pi-network" low-pass filter type circuitry is a Drake exclusive. • Accurate rf wattmeter/VSWR bridge. • 2000 watts PEP, 1000 watts average. Continuous duty.

Ask about the 250W Drake MN7 and Drake B1000 Balun

Specifications and prices subject to change without notice or obligation.

For a FREE Drake Full Line Catalog contact your favorite Drake Dealer.

R. L. DRAKE COMPANY



540 Richard St., Miamisburg, Ohio 45342, USA
Phone: (513) 866-2421 • Telex: 288-017

Model
1514



Drake WH-7 Directional RF Wattmeter

1.8-30 MHz

Specifications

Frequency Coverage	1.8-30 MHz
Line Impedance	50 ohm resistive
Power Capability	2000 W continuous
Jacks, Removable Coupler	Two SO239 input and output connectors
Semiconductors	Two power meter rectifiers
Accuracy	± (5% of reading + 1% of full scale)
VSWR Insertion	Insertion of wattmeter in line changes VSWR no more than 1.05:1
Shipping Weight	3 lbs (1.4 kg)
Dimensions	5.3"H x 6.9"W x 7.5"D (13.5 x 17.5 x 19 cm)

Drake directional, through line wattmeters, using printed circuits, toroids, and state of the art techniques, permit versatile performance and laboratory accuracy, yet at a lower cost.

Removable coupler provides remote metering, and allows convenient positioning of coaxial cable.

WH-7 wattmeter makes possible quick, accurate adjustments of antenna resonance and impedance match, when placed between transmitter and matching network.

Drake WH-7: Designed for user convenience and high accuracy. This instrument includes three calibrated scales for rf power to satisfy applications from QRP to high power (0-20, 0-200 and 0-2000 watts full scale) A fourth calibrated scale provides direct reading VSWR information, and is switch selected from front panel. The WH-7 is styled to match the 7-line.

Drake "Dry" Dummy Loads—no oil required

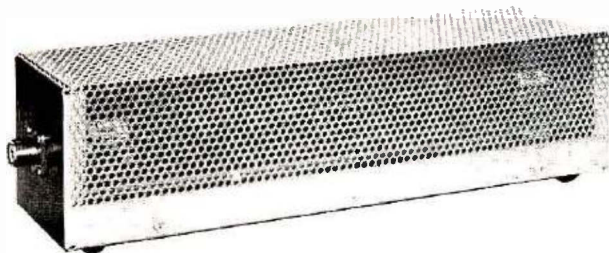

Model 1551 Drake DL-1000

- 1000 watts for 30 seconds, with derating curve to 5 minutes. Designed to accept Drake FA-7 cooling fan for extended high power operation.
- VSWR of 1.5:1 max. 0-30 MHz.
- Provided with SO-239 coax connector, and rubber feet for desk or bench use.
- Size 14" x 3.6" (35.6 x 9.1 cm). Wt. 2 lbs (910 g)



Model 1550 Drake DL-300

- 300 watts for 30 seconds, with derating curve to 5 minutes.
- Built-in PL-259 coax connector for direct connection to rear of transceiver or transmitter-no jumper coax necessary.
- VSWR of 1.1:1 max. 0-30 MHz 1.5 max. 30-160 MHz.
- Ideal as bench test device for amateur or commercial hf and vhf gear.
- Small size fits conveniently in any field service tool box. 6.7" x 2.08" (17.0 x 5.3 cm). Wt. 11 oz (310 g)

Specifications and prices subject to change without notice or obligation.

For a FREE Drake Full Line Catalog contact your favorite Drake Dealer.

R. L. DRAKE COMPANY



540 Richard St., Miamisburg, Ohio 45342, USA
Phone: (513) 866-2421 • Telex: 288-017

DXer's Diary



Getting up in response to an alarm clock at 2 AM is clearly cruel and unusual punishment. Your body is at its lowest ebb, and so is your mind. Clearly, this is grounds for certification as not having all one's marbles, but common behavior for a dedicated DXer. I groan, throw the sheets back, and grope for the clock before my long-suffering wife is awakened. I catch the alarm button as I swing my legs out, and reach for my bathrobe,

trying to conserve what little body heat is left, while my feet probe the darkness seeking my slippers.

Soon, I'm staggering down the stairs. On my way past the kitchen, I put the water on to boil — a cup of decaffeinated coffee will help warm me up and let me go back to sleep when my watch is over. I head to the shack in the basement, and turn on the gear. It's old, tube gear, and takes time to warm. I return to the kitchen for my coffee, and soon am back in front of the rig, sipping my java.

VK9NV is the prey tonight — Norfolk Island. Norfolk is an interesting place — a smallish island, about four miles across, and with a small permanent population of about 1200 people. It is the home of the Norfolk Island Pine, and, more interesting perhaps, of some of the descendants of the *Bounty* mutiny.

It seems that at one point some time ago, the population of Pitcairn Island, the original home of the de-

scendants of the mutineers, threatened to exceed the capability of Pitcairn to support it. So, the colony was split, with some of the people remaining on Pitcairn while the rest moved to Norfolk. Later, some of the people returned to Pitcairn, but some remained on Norfolk, and their descendants live there to this day.

In any case, Norfolk is a rare country for the DXer — a fine catch in any season. And, VK9NV is the only ham there, and he has been inactive for several years.

But, recent DX bulletins have suggested that he has returned to the air. One bulletin had him at 14047 kHz at 0820 GMT. A week later, a different bulletin showed him on 14012 kHz at 0810, on a different day.

Well, Ed, W9DWQ, John, K9MM, and I all need him. As soon as we spotted this renewed activity, a council of war was held on our DX repeater. But, we all dreaded the inevitable result — a night watch; 0800 GMT is 2 AM, Central Standard Time. We had all done it before, and we knew the price. But, a new country is a new country, and worth the price. (Clear grounds for certification . . .)

John volunteered to lead this one.

"Okay, I'll take Monday; Bob for Tuesday; and Ed for Wednesday. Then it's my turn again. Let's watch from oh-eight hundred Zulu till oh-nine hundred. Is there anybody else on the channel that would like to take a shift?"

The silence was deafening. Maybe not all hams are crazy after all.

"Okay, then, let's do it. All right for you fellows? Ed?"

Ed asked if I would switch with him, as Thursday was to be a very heavy day for him and he wanted to be at his best. I agreed.

So here I am, sipping coffee and asking myself the important questions of life, like, "What the heck am I doing here when I could be in bed?"

I ease the antenna around to the bearing for Norfolk from Chicago, 255°, and begin searching the band.

There aren't too many signals — I start copying a few to see what's coming in. Hmm. There's ZL4NH parked on 14001 having a good rag chew with somebody. That's Pat in Dunedin, New Zealand, a terrific CW op. We've had several fine chats. A couple years ago he discovered golf, and

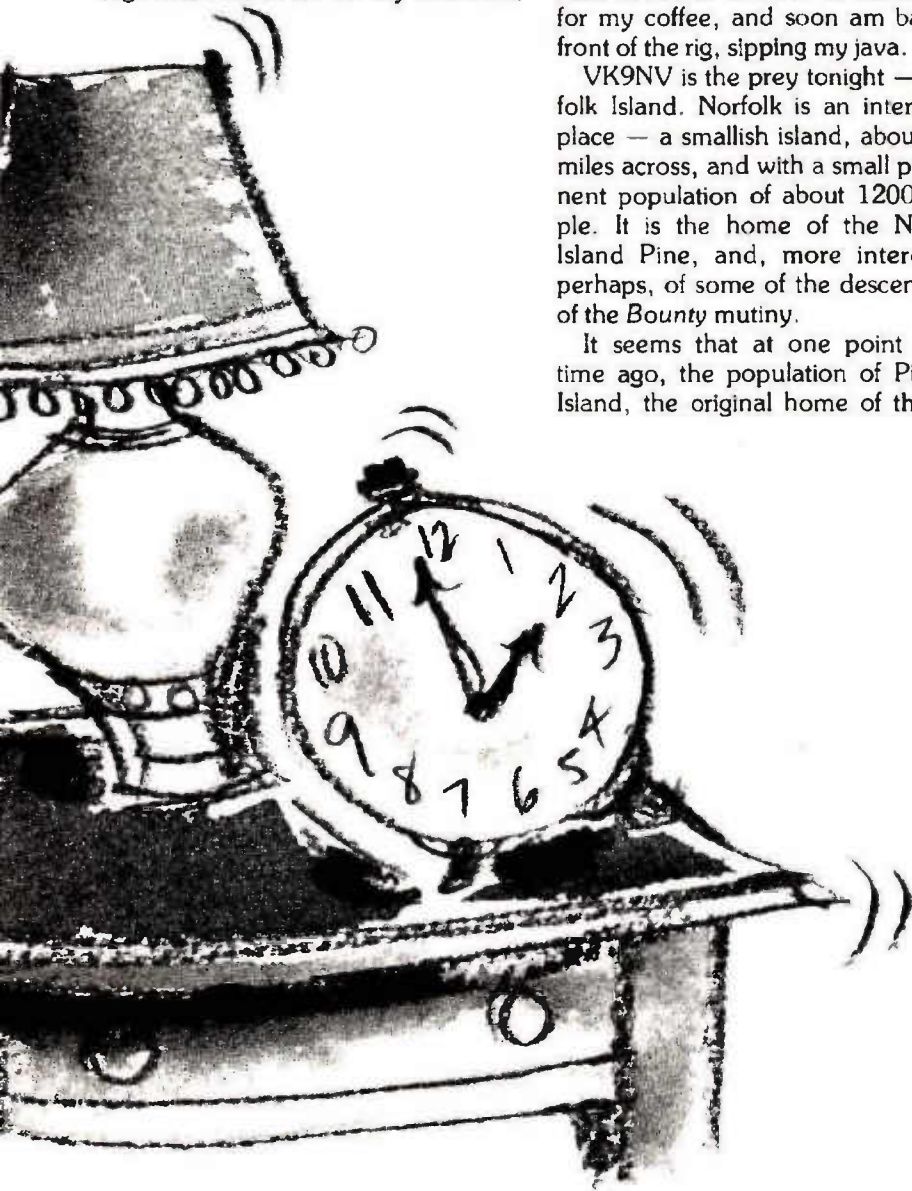

Night Watch

BY BOB LOCHER, W9KNI



sold the gear to pursue his new avocation. But sure enough, after a while he was back. Hmm, he's working a night owl, W6; nothing for me there.

Let's see. Are there any VKs? New Zealand is a better path for us — one of our most reliable, but if there's a disturbance, we don't always get the VKs. But, 4NH's fine signals suggest that all's well.

Yes — there's VK3MR. Fine, a nice, strong signal. That's good — he's on almost exactly the same bearing as Norfolk Island, and is a little farther. No problem with propagation tonight.

Uh, I snap my head back up; almost asleep there. Man was not meant to get up at 2 AM. I start turning the knob again.

There aren't too many signals on the band — but they are all DX. I can hear W signals, but they are very weak, just a trace of backscatter. The Norfolk Islander hasn't shown enough of a pattern to stake out a particular frequency — I need to watch the whole CW band, so it's a break not having to listen to the loud Ws.

I slowly tune up from the bottom. It's slow going. I stop at each signal

and wait for some indication of who or where he is.

"QTH HR Sidney" rules out Norfolk. Too bad I don't know what the Islander's name is. If I knew that, when I hear "Name HR Chuck" I can tune on if I know my man's name is Frank. But I don't, so I listen to each signal until I'm sure it's not VK9NV.

Wait, what's that one? "QTH HR Espiritu Santo . . ." That's got to be a YJ8, the New Hebrides. Yes . . . "KØHGB DE YJ8CT KN." I don't need a YJ8, but that's good pickings. Maybe someone in the club needs it. I pull out the club "need list." Yes, two people need it, Ralph and Sally. Ralph doesn't want 2 AM calls for DX, but Sally does. Let's see. He's above 025. That's okay for Sally; she's about ready for her Extra, but still holds the Advanced. I dial her number, and let the phone ring once — no sense in rousing the whole household. Her husband is licensed, but no DXer — I don't think he's on the air at all anymore.

I sit patiently on the YJ8's frequency — I can hear the KØ weakly in the background.

"QRZ from KC9TH?" says a sleepy

feminine voice on the repeater.

"Yeah, Sally, good morning. KC9TH from W9KNI. YJ8CT, 14034 short path. I hope you still need that?"

"Oh fine, Bob. W9KNI from KC9TH. Yes, I sure do, and thanks for the call. How loud is he?"

"Oh, he's a good S7. He's not transmitting right now, he's working a Ø. No — there he goes, back to the Ø. You got him?"

"No. Wait a minute . . . is he the one saying 'thanks Pete for QSO'?"

"Yup. You got him. Good hunting. KC9TH from W9KNI."

"Thanks."

I resettle the headphones, and keep tuning. Hmm. There's a weak one. "569 HR in Capetown . . ." Okay, it's a ZS in South Africa. Pretty early for the long path to open, but why not? Besides, on the strength of that signal, you could argue that the path really isn't open.

I face a dilemma: my coffee cup is empty. Should I make another cup to help keep watch, or should I skip it. But, if I skip it I'll never make it through the watch. If I get another

cup, I might not get back to sleep. It's only 2:30; half an hour to go. I groan, and head for the kitchen.

I return to the rig, cup in hand, and begin again my vigil.

"Thanks a lot, Bob. That was a real goodie."

"Oh. Okay, fine, Sally, real glad you got him. That was fast work. I'll scratch that one off your list. KC9TH here is W9KNI."

"Roger. W9KNI from KC9TH. Okay, well, thanks again. He was easy. As soon as he signed, I waited a moment, and heard two stations calling him dead zero on each other, so you couldn't copy either one. So I moved up about 200 hertz and called, and he came right back. What are you doing up at this awful hour?"

"I'm stalking VK9NV on Norfolk. Ed and John and I are doing a picket-fence routine, and it's my turn tonight. But nothing so far. You already got Norfolk, I think?"

"Yes, I was lucky. When I was a Novice, I called CQ one night on 15

meters and had a VK Novice who was there on vacation call me. I didn't even know it was a rare one at the time. You want me to help you look?"

"Naw. I appreciate it, Sally, but you go on back to bed. That way only one of us will be grouchy tomorrow."

"Okay, Bob, but it surely won't be me. I'll be grinning from ear to ear all day because of that new one. I think I'll stop at the library tomorrow and read up on the New Hebrides a bit. Espiritu Santo — the Holy Spirit. Sounds like an interesting place. Okay, I'm off. Cheers, thanks again, and good luck with that VK9. W9KNI here's KC9TH off and clear. 'Night."

"'Night, Sally. KC9TH, W9KNI clear."

I pull the receiver back to the bottom of the band, and start the slow upward sweep again. There's a fast station, passing out contacts contest style. Okay, it's AE3H/KX6, the Marshall islands. What the heck, let's see if the rig is still working. Not many

calling him. I'll just get about half a kilohertz above him, and avoid those fellows on his spot. Here goes:

"De W9KNI W9KNI AR"

"W9KNI 5NN 5NN DE AE3H/KX6K"

"AE3H 5NN TU 73 DE W9KNI"

"R SK QRZ DE AE3H/KX6 K"

Just like they say, it's always easy to work the ones you don't need. I log the contact. Hmm, 0850 Zulu. My watch is nearly over. I'm at 14075, so I spin the dial back to the bottom, and begin another sweep. It goes faster now — I recognize some of the signals, and I don't have to read as much to be sure that they're not VK9. In no time, the digital clock is reading 0900 Zulu. Time for bed with nothing to show for it. Oh well, Sally's happy anyhow, and maybe tomorrow night John will find him.

I turn off the gear, and go upstairs. I leave my coffee cup in the sink, a silent memorial to a lost dream, and head for my bed. I climb in and lie there — wide awake now, and cursing my fate — I am a DXer. **HRH**

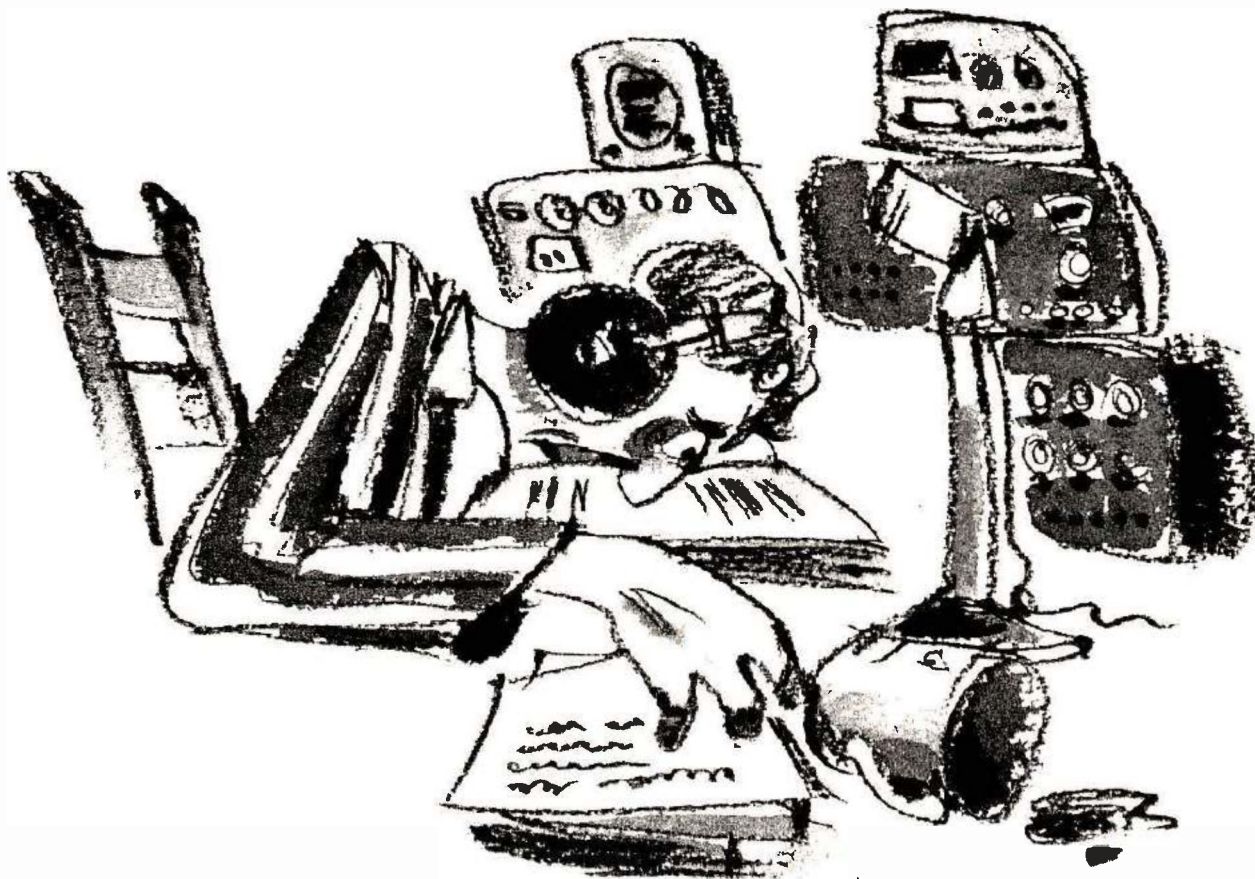

Ham Radio Techniques

BY BILL ORR, W6SAI

1932 had been a desperate year. The country was impoverished. Unemployment stood at 15 million, or more than a quarter of the work force. Sales ebbed and costs were cut by laying off workers. Purchasing power shrank, leading to more layoffs. It was a vicious, downward spiral, and the average weekly wage of those lucky enough to have a job was only sixteen dollars. Schools had closed because of a lack of funds. Morale was at rock bottom. By the savage winter of '32, banks were closing and a complete financial collapse seemed inevitable.

Perhaps 1933 would be better. A new President was in the White House. The Bank Holiday had stabilized the financial world and Congress had passed the National Industrial Recovery Act, the Civilian Conservation Corps, the Agricultural Adjustment Act, and the Tennessee Valley Authority. Banks were back in business and, while the depression was to linger on, the mood was more upbeat. Perhaps it was true that "Happy Days Are Here Again."

.

It was a clear, cold day in spring, 1933, and the clocks were striking 1 o'clock as I stepped out of the Dey Street subway station. Making my way up to ground level, I walked north along Church Street. On each side of the walk, newspaper stands held the latest newspapers and magazines, which were being whipped about by the vile wind. *Ballyhoo, De-*

lineator, Radio News, The Woman's Home Companion, and the Literary Digest were in danger of having their covers ripped off. Newspapers such as the *New York Sun* and *World Telegram* were being reduced to trash before they could be sold.

I evaded the last few of the horse-drawn delivery carts still to be seen in lower New York City, and dodged a Mack "Bulldog" truck dumping a load of coal down a chute into a sidewalk hole. The driver of the truck shouted unintelligible commands to someone under the streets as the coal thundered downwards.

Burrowing within my sheepskin coat and heavy cap, I pushed forward into the wind which stung my eyes. In a moment, I had passed Fulton Street and had reached Vesey Street, turned left towards the Hudson River, and finally reached a small, grimy store. The windows were lined with dirt and the black and gold sign above the entrance was just barely readable through years of neglect, street dust, wind abrasion, and searing summer sunlight.

"LEEDS," proclaimed the sign. "All Your Radio Needs." I pushed open the door and entered the store. The warmth of the building, pleasant at first, slowly became hot, then oppressive, then intolerable. I shed my coat and looked about me. From front to back of the narrow room ran a sales counter and beneath the glass were samples of modern, 1933 radio parts and tubes. I examined the dis-

play as if it were filled with expensive jewels. It would take shrewd buying to build up a ham station for less than ten dollars, but I was sure it could be done.

My project was made easier in that Amateur Radio didn't know about single sideband, transceivers, keyers, rotary beams, digital readouts, integrated circuits, frequency standards, DXCC, coaxial cable, relays, VFOs, or bandswitching. The whole thing was really very simple.

With the introduction of the all-electric broadcast receiver, plenty of old battery sets were available to be robbed for components. Battery tubes were available for pennies, and "Radio Row" was going to solve my problem for me, as it did for many Amateurs who had a few spare dollars to spend.

Leeds, for example, was closing out kits for the Pilot "Wasp" receiver, rendered obsolete by the new ac tubes. The kit of parts cost only \$3.50, less three 201A tubes. These (tested and guaranteed for five days) could be purchased for 10 cents apiece. Those with more adventure in their soul could buy untested tubes for a nickel apiece.

I could afford tested tubes and the "Wasp" kit. After Leeds, a stop at a nearby, unnamed store allowed me to paw over a dusty pile of receiver carcasses stacked in the sidewalk area. I could have a whole chassis for 25 cents, or could "rob" parts for 5 cents per part. A careful examination of the

merchandise, and the use of a screwdriver and pliers, netted me some husky tube sockets and rugged tuning capacitors. And, an extra expenditure of 15 cents bought me a UX-245 audio tube, thought by some hams to be the equivalent of the genuine UX-210 transmitting tube which sold for the astronomical price of six dollars.

You can see that a thrifty, high-school age Radio Amateur could do a lot with a few dollars in those dim, dead days which still remain in the cherished corner of my memory.

A 1933-style ham station

The winds of change were sweeping through ham radio. Within six or seven years, the advancing art and improved economy would bring about equipment that would seem familiar to today's ham. But 1933 was a year of flux, the old had not yet died and most Amateurs ran low power — a 100 watt transmitter was a novelty. Five to ten watts could do the job and that would be plenty for me and thousands of other active hams. The world was at our fingertips!

First, the transmitter: This was the easiest thing to build. While down-to-earth construction information was lacking, most radio clubs or knowledgeable hams had drawings of workable circuits pirated from a QST design for a low-power 160 meter transmitter¹. While interest in 160 was lacking, a modified design useful for 80 meters was very desirable and a popular circuit is shown in Fig. 1. Technically speaking, this is a series-fed Hartley oscillator reduced to utter simplicity. Only a few basic components are required, and the little transmitter delivers seven watts when operated with a 300-volt plate supply². A very high-C tuned circuit is used to minimize the effects of capacitance changes and to provide dynamic stability to the oscillator. The few components are firmly screwed to a heavy board which is isolated from the operating table so that any vibration caused by manipulation of the key would not be imparted to the oscillator.

The transmitter is keyed in the filament return circuit. Since no wave-shaping is included, the keying is hard and local Amateurs may be distressed by the keying clicks if they operate close to the frequency of the little transmitter.

The transmitter coil and antenna pickup coil are wound with No. 12 (2.1 mm) enamel-coated copper wire, and the transmitter itself is wired with No. 16 (1.3 mm) tinned wire.

The transmitter is intended to be used with a 66-foot (20 meter) Marconi antenna and a good ground connection. For those Amateurs interested in making a replica of this transmitter, a voltage-regulated power supply *must* be used to obtain a pure note, and the frequency of the transmitter should be carefully monitored to make sure it is well within the CW portion of the 80 meter band. With the constants given, the transmitter will hit 3500 kHz with the tuning capacitor about 80 per cent meshed.

Antenna loading is increased until the transmitter note deteriorates under keying. A little experiment with antenna tuning and loading will allow maximum power output and opti-

mum keying characteristic to be achieved. Plate current will be 40 to 50 mA.

Pilot "Wasp" receiver kit

This is a rare bird, indeed. The number of receivers (or kits) sold was small, and the number sold by Leeds Radio Company as a close-out item was very small. Perhaps less than a thousand receivers and kits were sold before the design became obsolete. This replica³ preserves the original design and provides today's Amateur with an insight on the operation of the cranky, unpredictable, yet sensitive regenerative receiver.

A schematic of the "Wasp" is shown in Fig. 2. Three 201A triode tubes are used as detector and first and second audio stages.

The mechanical construction of most 201A tubes left a lot to be desired, and hams spent hours trying various tubes as detectors to find one that would regenerate properly yet not be microphonic. The tube was very sensitive to mechanical vibration and merely tapping the tube would

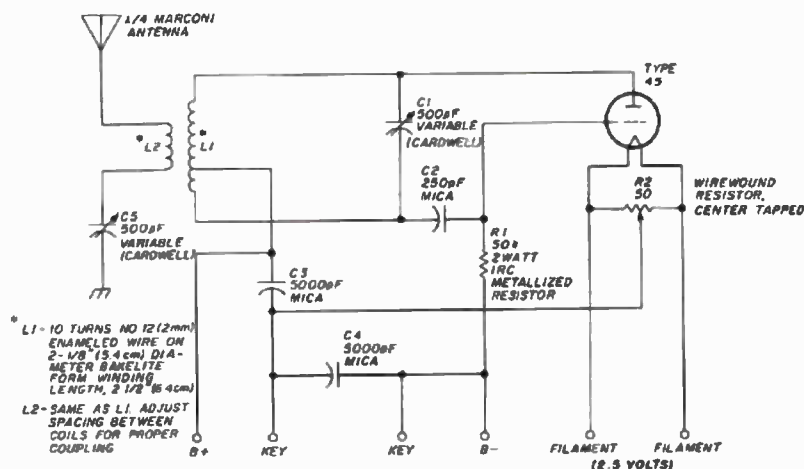

Fig. 1. The series-fed Hartley oscillator. Operating in the 80-meter band with a plate supply of 300 volts, this transmitter provides a 7-watt signal. In addition to the components listed above, also needed are five Fahnestock clips, a 4-prong tube socket, and two brown "beehive" insulators to support the coil. Antenna is connected to a series-tuned circuit which is inductively coupled to the oscillator coil.

result in a loud *clang* in the headphones, and the signal, so painfully tuned in, would disappear to pop up at another point on the dial. Hams mounted their receivers on rubber pads and tried all sorts of subterfuges to protect their pet 201A from vibration. The ham who found a tube reasonably free of mechanical microphonics was a lucky fellow, indeed.

Receiver tuning is not complicated. Sensitivity is adjusted by means of the regeneration control. When on the verge of oscillation, the detector is very sensitive and any CW signals heard by a modern receiver can be heard on this little set. Selectivity and overload are another story. The former is determined by the upper frequency limit of the human ear, and the regenerative detector is extremely sensitive to overload from a strong nearby signal. Loose coupling to a very short antenna helps solve this problem. Ten to fifteen feet of antenna wire will do a good job with this tiny set.

Build a 1932-style station

Sufficient information is given in this article to duplicate the transmitter and receiver. For best results, the transmitter should be run from a voltage-regulated power supply. A series-tuned Marconi antenna can be used, with the antenna coil loosely coupled to the tank coil of the transmitter. An auto headlamp in series with the antenna lead will give you an indication of power output. Short out the bulb after tuneup or it will add a "chirp" to your signal.

A short, separate wire should be used for the receiver, because the Marconi antenna will badly overload the little set. Or, the Marconi can be used if coupled to the receiver through a very small series capacitor. Beware of "dead spots." When the receiver is inadvertently tuned to antenna resonance, it will stop oscillating!

A few hours' time spent tuning the receiver will pay big dividends. A far greater problem is obtaining the parts to build the set. Vintage radio parts are still obtainable at flea markets and

in the junk boxes of old-time Amateurs. The quarterly bulletin of the Antique Wireless Association⁴ has a classified ad section that can be a gold mine when obsolete parts are required.

Since the transmitter is merely an oscillator coupled to the antenna, it is frequency-sensitive to any antenna movement. If the antenna swings in the wind it may add a peculiar "yoop" to the signal, that is hard to track down unless you have gained expertise with these simple transmitters.

Finally, the most important thing to remember is that a self-excited oscillator such as described must be continually monitored when transmitting for purity of note and frequency stability. Dirty key contacts can raise havoc with the note, and vibration from keying or from vibration of the transformer in the power supply can cause the note to mush up. Overloading the 245 tube can cause severe frequency drift. But when intelligently operated, the little transmitter can give a good account of itself. Back in 1932, transmitters of just this type were able to contact Hawaii, New Zealand, and the East Coast with remarkable regularity. Surely you can do as well today!

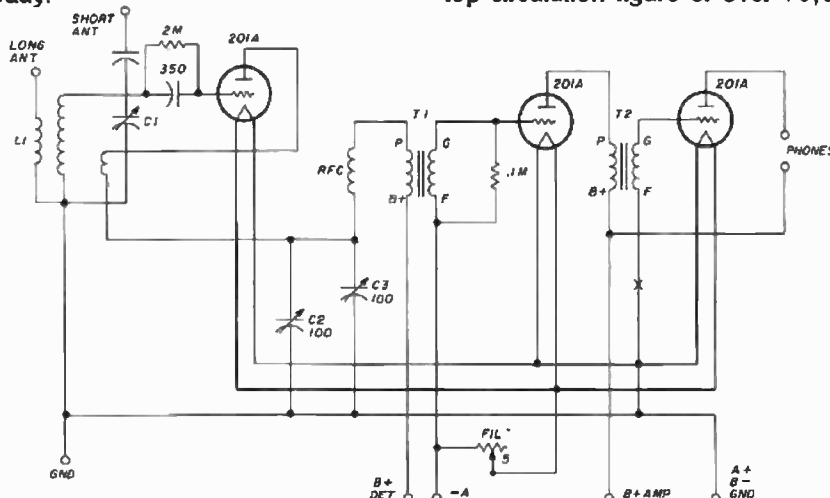

Fig. 2. The Pilot "Wasp" schematic. Filament supply is 5 volts at 3/4-ampere, dc. Detector plate voltage is 22½ to 45. Amplifier voltage is 67 to 90. For greatest audio power, a small 4½ volt "C" battery is placed at point "X" to bias the grid negative. Magnetic earphones having an impedance of 2000 ohms are used. Coil L1 is one of a set of 4 Pilot coils that cover 20 to 500 meters. Capacitor C1 is a 250 uufd (pF) straight-line-frequency capacitor. Capacitors C2 and C3 are 100 uufd (pF) Pilot midget variable capacitors. For shortwave reception, only C2 is used, C3 being set at zero. For long wave (broadcast) reception, C2 is set at full capacitance and regeneration is controlled by C3. Transformers are Pilot 3-to-1 audio transformers. Filament control is 5 ohms, wirewound. The "short antenna" terminal is used for short-wave reception, and the "long antenna" terminal for broadcast reception.

Sources

It's fun, instructive, and easy to build up old-time ham gear. Finding the components is part of the challenge. And there are several old-time magazines available from collectors, libraries, and flea markets. Some of the best sources of circuitry and interesting designs are:

QST magazine. The years 1932 to 1938 are a wonderful source of old-time transmitter design. A few simple receiver designs are also suitable for modern reproduction.

Radio magazine. Published in California, but now out of print, *Radio* was brim-full of "breadboard" transmitters and receivers. A fascinating picture of ham radio in pre-war years.

R/9 magazine. Now out of print, a west-coast publication that eventually was merged with *Radio*. Again, a great source of early ham equipment design.

Short Wave Craft magazine. Out of print. By far the best source of pre-war ham circuitry is this unusual magazine. Devoted equally to ham radio and short-wave listeners, it boasted a top circulation figure of over 70,000

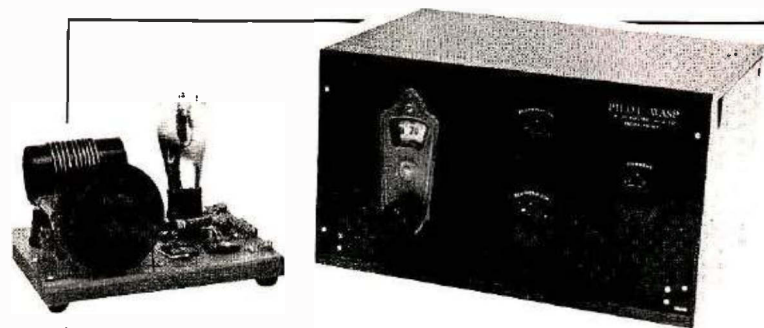

Above, the "economy" ham station of 1933. On the left is the single tube Hartley transmitter for 80 meter CW using a UX-245 tube. This vest-pocket oscillator would deliver a husky 7 watts into a 66-foot long Marconi antenna. On the right is the Pilot "Wasp" receiver, available in kit form. The polished wood cabinet cost an extra dollar. The receiver covered the short wave range by means of plug-in coils and used three 201A tubes; one as a regenerative detector and two as audio amplifiers. The replica transmitter was built by W6SAI and the receiver by W6ME.

Below, the Hartley transmitter for 80 meter CW operation. All parts are firmly screwed to the "breadboard." In the good old days, a breadboard was actually used. Now it is cheaper to cut the foundation from a well-seasoned piece of lumber. A series-tuned antenna circuit is built up on a smaller piece of wood and positioned so that the antenna coil is parallel to the transmitter coil. Coupling is adjusted by moving the coils in relationship to each other. A 201A, 171A, or 112A tube may be substituted for the 245 if the plate voltage is reduced to 200 and filament voltage adjusted accordingly.



Left, the chassis of the Pilot "Wasp" receiver. At right is the 201A detector tube, with grid-leak and plug-in coil. At the left are the two audio stages and bakelite-encased Pilot audio transformers. When run from an automobile storage battery and B-batteries, this receiver provided quiet, hum-free operation that would surprise users of modern radio equipment. Drawback of receiver was that most 201A tubes were microphonic and would pick up any vibration transmitted to the tube through the receiver chassis. Some hams mounted their receivers on rubber pads to reduce microphonics. This marvelous replica was built by Bob Chasin, W6ME.

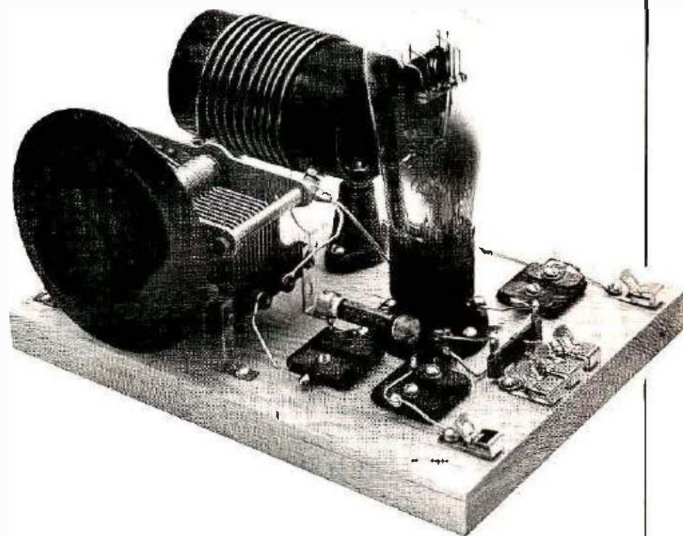

— over three times that of *QST* and greater than *QST*, *Radio*, and *S/9* combined! Chock full of interesting circuits, it covered single sideband, coaxial cables, blind landing systems for aircraft, transatlantic telephone circuits, microwave power generation, and other eye-popping subjects that few 1932-style hams had heard of. In addition, countless two- and three-tube transmitters and receivers were the staple material of this eccentric and unusual publication.

Armed with a portfolio of these magazines and the ability to dig up old-time components, you can duplicate today, for pennies, the most exotic

equipment designs of fifty years ago. You'll have fun doing this, experience the problems that the early radio hams overcame and learn a lot about the operation of communication equipment in the process. Remember that all electronic equipment works on basic principles formulated over a century ago by Faraday, Maxwell, and Hertz. If these famous scientists were magically brought back to life today, they might marvel at an all-solid-state, high-frequency, multi-band transceiver with digital readout, but they would certainly understand the principles of operation as the basic fundamentals of electronics stand unchanged from the very beginning.

Additional good reading

I have mentioned that from time to time I would point out good sources of information of interest to most radio Amateurs. For example:

The DX Bulletin. 306 Vernon Ave., Vernon, Connecticut 06066. This weekly publication keeps you abreast of the latest DX news, DXpeditions, QSL addresses, Contests, Awards and other topics of importance to the serious DXer. Yearly subscription rates are \$22 US, Canada, and Mexico, \$30 all others (air mail).

Mail-A-Prop. Produced by George Jacobs, W3ASK, Box 1714, Silver

IC Keyer

The World's Greatest Sending Device



Adjustable to Any Desired Speed

Now available from Palomar Engineers — the new Electronic IC KEYER. Highly prized by professional operators because it is **EASIER, QUICKER, and MORE ACCURATE.**

It transmits with amazing ease **CLEAR, CLEAN-CUT** signals at any desired speed. Saves the arm. Prevents cramp, and enables anyone to send with the skill of an expert.

SPECIAL RADIO MODEL

Equipped with large specially constructed contact points. Keys any amateur transmitter with ease. Sends Manual, Semi-Automatic, Full Automatic, Dot Memory, Dash Memory, Squeeze, and iambic — **MORE FEATURES** than any other keyer. Has built-in sidetone, speaker, speed and volume controls, **BATTERY OPERATED**, heavy shielded die-cast metal case. Fully **ADJUSTABLE CONTACT SPACING AND PADDLE TENSION.** The perfect paddle touch will **AMAZE** you.

Every amateur and licensed operator should know how to send with the IC KEYER. **EASY TO LEARN.** Sent anywhere on receipt of price. Free brochure sent on request.



Send check or money order. IC KEYER \$117.50 in U.S. and Canada. Add \$4.00 shipping/handling. Add sales tax in California.

Fully guaranteed by the world's oldest manufacturer of electronic keys. **ORDER YOURS NOW!**

Palomar Engineers

Box 455, Escondido, CA. 92025 • Phone: [714] 747-3343

Spring, Maryland 20902. This bi-weekly newsletter covers day-by-day propagation conditions in advance, provides band-opening patterns, keeps track of the sunspot cycle, and provides information on abnormal propagation conditions in easy-to-understand language. A "must" for the serious operator. Write to George for a few sample newsletters and subscription information.

And, for the home-builder and nostalgia buff: The large list of old-time and surplus radio components sold by Joe Harms, W4BLQ, Box 158, Edgewater, Florida 32032. Send an SASE (self-addressed, stamped envelope) with 30¢ postage on it for Joe's great list. Use a business-size envelope (4 × 9½ inches). Want a brass-base UV-199 tube? Or perhaps a 2J38 magnetron? Or, how does a Sears "Silver-tone" radio strike you? Or a dictionary of electrical words and phrases published in 1889? Joe has all of these and thousands of other fascinating items, old, new, and not-so-new.

Finally, builders will be interested in the catalog of coils and inductors available for 30¢ postage from J. W. Miller Division of Bell Industries, Box 5825, Compton, California 90224.

Footnotes

1. Grammer, "A Low-Power 1715-kc. CW Transmitter," *QST*, March, 1932.
2. Additional background information on the little transmitter is given in "1929-1941 the Golden Years," *ham radio*, April, 1976.
3. The receiver shown in the photographs was built by Bob Herbig, W6ME, from authentic old-time parts. Send Bob an SASE and he'll send you data on crystal sets, loose couplers, and old-time regenerative receivers that he re-creates. His address is: 4178 Chasin St., Oceanside, California 92054.
4. Antique Wireless Association. Write to Bruce Kelly, W2ICE, Main St., Holcomb, New York 14469 for information about the Association and their quarterly bulletin. **HRH**

DX Horizons

By Bill Kennamer, K5FUV

A check of last year's logbooks reveals that late August marked the ending of the summer doldrums, with many good DX openings noted. This fall is also expected to produce good conditions, with openings to all parts of the world. This will be another year when a good operator with modest equipment and antennas will work many countries.

The DX Net

The DX Net is an organized gathering designed to let many stations contact DX stations in a controlled environment. Many DX stations like this method, and use it exclusively, while others check in from time to time to allow newcomers a chance to make a DX contact. Many such nets exist on various bands, and provide a valuable service for DX and DXers alike. One such net is the Afrikaner Net, which meets at 1800 UTC daily on 21.355 MHz. Herb Lehman, WA6BJS, is one of the net control stations on the net, and he offers the following information:

"For those of you wishing to use the services of a DX net, please consider that it is much like a club meeting. There is a chairman — the net control station — who must be addressed, and your call recognized, before you are entitled to speak. Be

aware that there are several hundred stations grouped on the frequency, and their rights to work the DX must be considered.

"To this end, keep your microphone closed until you have listened long enough to determine exactly what is going on, what DX is available, and the entire method of operation, which will be apparent if you will just show reasonable patience and keep your fingers off the 'Go' button (and that advice holds true for any frequency, anytime — Editor). The characters who preemptorily demand to know, 'What's going on here?' 'What net is this?' 'Who's on frequency?' are as welcome as ants at a picnic, and do nothing but advertise their lack of intelligence and consideration of others. Above all, do not be a policeman; that is the prerogative of Net Control. If there is interference let Net Control handle it.

"In listing the following, I draw from my eight years' experience as Net Control for the Afrikaner group.

DO . . .

. . . be on frequency at least three districts before yours is called.

. . . have the calls and QSL info for the stations of your choice written down in advance, along with signal reports. On the Afrikaner group, DX and QSL info is given at least four times during the Net operation. Signal

strength may be observed while the DX is reporting to the preceding station.

. . . give your call sign *once* only, and listen. You can't hear Net Control if you are talking when he is listing your district.

. . . when your turn comes up, immediately call the station of your choice, giving his call once only, your call twice, with appropriate phonetics, and his report. Get your report, QSL, and immediately address your second choice, following the same procedure. If you do not wish a second contact, turn it back to Net Control. Each call should take no more than 15 seconds, if QRM is not present.

DON'T . . .

. . . break — for any reason — once the net is underway. Remember, any action that holds up the net will deny someone a chance to work some of the DX. While you may be first today, you will be last tomorrow, and may get pushed out of shape if you lose a good one for someone else's lack of consideration.

. . . call anyone that you can't readily copy, QRM excepted. None of the DX is rare expedition type, and will be available again, so don't sweat it.

. . . answer when Net Control asks for confirmation of a particular call *unless you are that exact call*. Close is not good enough. Anyone attempting

to sneak another call through under these circumstances is automatically eliminated for that day, as Net Control will be unable to hear him.

. . . unless DX asks for it, repeat your call or his even though you must ask for a repeat of your report. If you do need a repeat, simply ask, don't wait or ask Net Control.

. . . unless asked by the DX, give more than your call and his report. No need to thank Net Control or say anything more. Remember the fellow at the end of the line, and keep it as brief as possible.

. . . call from other than the state asked for by Net Control. Each Net Control, in his own way, apportions the number of calls among the states in as fair a manner as possible. If Net Control calls for Missouri, and you throw in your call, and it later shows you're in Colorado, your contact will be scrubbed. Also, due to recent call-sign scrambling by the FCC, if your call sign is inappropriate to the district you're in, sign portable.

"In conclusion, if you have been a participant in the never ending DX pile-ups, forget all of it, particularly the attendant bad manners, before taking part in a net operation. Follow to the letter all instructions of the Net Control for the net of your choice, and you will learn that patience and consideration will bring you more DX contacts than you ever thought possible, with less strain on your vocal cords and nervous system." — WA6BJS.

Mali

In the May issue, we reported the story of Jan Wilholt, TZ4ZQS. At that time, it was expected that he would be in Mali for two years. However, during his vacation in Europe, his job situation changed, and he left Mali on April 17.

As a result of Jan's accelerated departure, Jack, ON6BC, his QSL manager, made plans to visit Jan during the last few weeks of his stay. With the help of the Northern California DX Foundation, QRZ DX, and others in Europe and the U.S., an amplifier, antennas, spare rig, and keyer were

provided. The antennas were hand-built by ON5JY, and allowed Jack to substantially increase the signal from TZ4AQS.

Operation began on 10-meter CW on April 1. At his first sitting, Jack worked 1000 QSOs before taking a break. This was in spite of a balky keyer paddle that required frequent cleaning.

While Jack was there, his host insisted on taking a short sightseeing trip. This resulted in rolling their vehicle over four times. Needless to say, this cut the sightseeing trip somewhat short.

Antenna work was difficult at best. The intense heat required frequent rest and replenishment. At one point, the outside temperature reached 43 degrees Celsius (110° F).

Jack's trip was very successful, allowing a great many to put a TZ contact into the log. With Jan and Jack's departure, there will be a significant decrease in activity from Mali.

Turkey

Kadri Basak, TA1MB, a very popular DXer, is a TV news cameraman in Istanbul, Turkey. He is quite active, and can often be found between 14.240-14.260 MHz, between 0400 to 0600 UTC. Soon he will be receiving an FT-101E, which should provide quite an improvement to his station.

Spain

Add another Royal Personage to the list of Amateur Radio operators around the world. King Juan Carlos of Spain is now active as EA0JC. He's using Drake equipment with a Telrex antenna. EA5AX has been working a list operation with him on 3.700 MHz, much to the delight of European amateurs.

QSL Problem?

Many are reporting problems in re-

ceiving QSLs direct from certain DX stations. Although not a cure-all, some of the following ideas may help:

1. Don't put call signs on the envelope or return envelope. To do so is a sure way for mail to be diverted in some parts of the world. Call signs are often a direct tip-off to what's inside, and it's well known that return postage is included. In fact, if at all possible, obtain the full name, so that a letter won't look suspicious. Also, it's not a bad idea to leave the return address off altogether. Chances are still 50-50.

2. Be careful about what type of return postage is sent. Check with the DX station and see what can be redeemed in his country. This is very important for several reasons: If the wrong type is sent, it can result in difficulties for the DX station. In some countries, especially in Africa and Asia, the "Green Stamp" (U.S. dollar), if found in the mail or possession of a native, can result in severe punishment. It could also mean loss of his license. The advice here is *don't*, unless you ask first.

IRC's may cause problems of another kind. Have you ever taken a couple of hundred cards down to the post office with IRCs? Can you imagine the look one would get at a post office in some rare location? In this case, if it can be done safely, the Green Stamp would be more easily redeemable.

One of the best ways to provide return postage is to find a proper denomination stamp from that country. These can be bought at a DX stamp store, or possibly a local stamp store. This has the advantage of allowing the DX station to process the card and put it in the envelope, and requires no extra steps for redemption by the DX station.

3. QSL promptly. If you're going direct, many things can happen to change circumstances, so lessen the opportunity for anything to go wrong by cutting down the time factor at your end.

4. Be careful with second requests.



A shot of Heard Island from the beach, March, 1969.
(Photo courtesy of W7IJ.)



Terry, WB0WNG, who helps as Net Control on both the Afrikaner Net and the W7PHO Family Hour. He's also a straight "A" student in his spare time. (Photo courtesy of W6AED/7.)



From left, ON6BC, Jack, TZ4AQS, Jan, and ON5NT, Ghis, at Ghis's shack during planning for the April TZ4AQS operation. (Photo courtesy of ON5NT.)

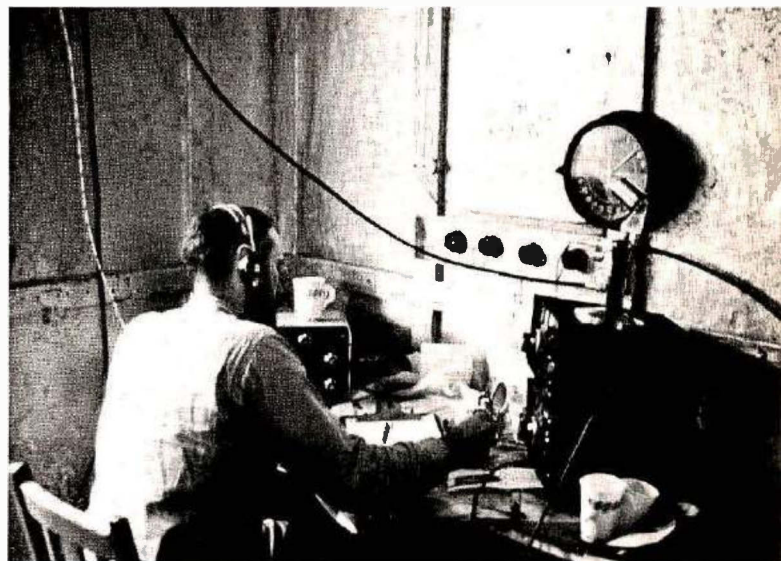

Henry Reising operating at VK0WR, Heard Island, in 1969. 2800 contacts were made on this expedition (Photo courtesy of W7IJ.)

You will find that most cards do get answered, although occasionally I have seen a direct card take nine months. I'm sure a few have taken longer. However, second requests can cause another problem in getting a speedy return. If a steady stream of Green Stamps and IRCs keeps flowing in with second requests, it is easy to see how someone could move a little more slowly than necessary. So, use patience to as great a degree as possible. Don't even begin thinking about the card until several months have passed. I can think of one rare DX station that QSLs only once each year.

These ideas may not help your nerves a lot as you wait for that rare one to come back, but the important thing to remember is that it doesn't matter how long it takes to get the card — it only matters that you have it.

Club News

Want to meet others of like mind? Do you like programs about DX? Then visit a local DX Club. If one of the clubs below is in your area, contact an officer for meeting details.

Madison, Wisconsin, DX Club officers for 1980 are: President, Herb Jordan, W9LA; Vice President, Ken Dixon, W9XM; Secretary, Ed Toal, K9QXY; Treasurer, Gary Turner, WD9CPX.

The Southern California DX Club 1980 officers are: John Browning, W6SP, President; Joe Merdler, N6AHU, Vice President; Perry Esten, W6PN, Secretary; Fried Heyn, WA6WZO, Treasurer; Bob Kogen, W6DN, Membership.

The Arkansas DX Association's officers are: President, Rex Parker, AC5I; Vice President, Andy Toth, W5LQN; Secretary-Treasurer, M. L.

Young, W5QKR. Also, check their DX Info Net on Monday, 0100 UTC, at 3.815 MHz. It's open for both member and non-member check-ins.

The Fraser Valley DX Club announces new officers for 1980. They are: Al Johnson, W7EKM, President; Terry Paton, VE7BFO, Secretary-Treasurer; Henry Thel, VE7WJ, Awards, DX and Contest Committee; Dick Moen, N7RO, Vice President.

Until Next Month

As always, news is important to us, as well as any photos you may care to share. Any news and photos may be sent to DX Editor, c/o Ham Radio Horizons, Greenville, New Hampshire 03048. Thanks to all who provided information to QRZ DX, from which much of this column came.

QSL Information

Station	QSL Via				
A35DX	N6DX	HP2XSG	WB2DCP	T2XYL	c/o Weather Station, Funafuti, Tuvalu
A35OM	N6OM	HT1MAT	Alberto Matamoros, Apartado No. 1474, Managua, Nicaragua	VK0KH	VK5WV
A4XIQ	K2IJL	H31LR	WB3KGY	VP2AJ	WB2TSL
A7XD (from March 1, 1980)	Mike Smedal, Box 4747, Doha, State of Qatar. Arabian Gulf. No IRC; Green Stamp okay	IA5LXW	I5HCH	VP2AZG	WB4SXX
A7XM	DJ9ZB	IP5ONU	I5HCH	VP2E (1980 SSB WPX Only)	K8ND
CK8NP (magnetic North Pole)	KA7CQM	IY4FGM	I4BFY	VP2EEV	K8ND
C21BS	Bob, Box 162, Republic of Nauru. No IRC; Green Stamp okay	J3AAG	KA4LZX	VP2EEW	WD8ALG
C21EF	Nede Flores, Box 450, Republic of Nauru	J3AE	K1EM	VP2KJ	WB2TSL
C5ABV	N4BPP	J6LJS	K1EM	VP2MFL	K5BDX
C5ACW	OZ5QU	K6LPL/KH3	Don Johnson, c/o Hess Oil, Box 811, Castries, St. Lucia, Windward Islands	VP2MFY	K5BDX
DA1WA/HB0	DX to DJ0LC, U.S. to Stephen Hutchins, Box 4573, APO NY 09109	KC6TR	N6AHU	VP2MGQ	N4MO
DU1MRC	JA1SGX	KG4US	Box 101, E. Carolines, SF, California 96942	VP2MO	KA4BOT
D68AQ	Box 501, Moroni	KH2AD/KC6W	Marine Barracks, Box 32, FPO NY 09593	VP2MVP	KA0GTK
EC9AA	Box 556, Ceuta, Spain	KH3AA	W6TPC	VP2SAB	W2MIG
FG0DYM/FS	W3HNK	LA5YJ	Box 69, APO SF, California 96305	VP2VEJ	WB3KGY
FG0UG/FS	W3HNK	LA7AH	WB1DQC	VQ9TT	KB5MZ
FH8OM	DJ1TC	N5RM/NH0	WD4ARY	W5JMM/SU	W5JMM
FM7WE	K4FJ	OD5FB	N5RM, 1979, 1980 Callbook only	W7KEU/OA8	WB7TAZ
FM7WS	Box 661, Fort de France	ON4UN	WA2QAU	WB8HYL/HB0	WB8HYL
FM0FJE	F5VU	OY9R	N4ANV	YV0USB	K2TV
HB0XX	HB9XX	PJ2CC (WPX SSB 1980 Only)	K2IJL	ZB2CJ	G3ATU
HB0YY	DL1BU	P29NPS	N4RV	ZB2EO	K3MNV
HD1MM	K1MM	TA2HIA	Box 3107, Port Morsby	ZL2BCF/A	Doug Pratt, 45A Bamber St., Wanganui, New Zealand
HD0E (1980 WPX SSB Only)	K7CA/HC1, Box 289, Qunito, Ecuador	TG9ML	Box 3, Cevizli, Turkey		
HI6XQL	YASME	TG9XGV	K5BDX	3A0CWF	I2CWF
		TU2IN	K4CLA	3B8DB	K5BDX
		TU2IZ	K3HBP	3D6BS	N7RO
		TY9ER	Pierre, Box 642, Gagnoa	3D2DB	N6DX
			DL8DC, Rudolf Lux, Lindenweg 16, 6686 Eppelborn, West Germany. Use large envelope	4K1A	UQ2OC
				4S7EA	WB9OQU
				4S7JA	VE3IPR
				4S7RS	DK9KL
				4U1ITU (1980 ARRL DX Phone Only)	W1RR
				4Z4XB	KA5BBL
				5B4HF	KC5I
				5W1CF	N6DX
				7X4AN	DJ2BWZ
				8P6CG	1980 Callbook
				8Q7AP	N6NI
				9G1RU	HB9BFN
				9J2LL	I2SB
				9K2DX	W6LV
				9N1MM	N7EB



it's about time

jim gray
WIXU

The subject matter of this article is the result of a letter and a direct request from a California ham who was genuinely puzzled about *time*. He asked:

"Can you suggest, or do you have, some reading material which will give me information regarding GMT (or Universal Coordinated Time)?

Right now, it's 1745 GMT, or 10:45 AM Pacific Standard Time. I have two pieces of material: one tells me to add 8 hours, and the other tells me to subtract 8 hours, to convert 1745 GMT to 10:45 AM PST; no matter which way I go, it doesn't work out.

Another example: I have a schedule that tells me a broadcast originates at 0230 GMT from Athens, Greece. How do I convert that to PST?

In any event, whatever authentic reading material you might present on how to understand and interpret GMT would be appreciated very much." (Signed) Ed . . .

Well, Ed, you're not alone. I've been a ham for 30 years and *still* have difficulty converting GMT to EDT or EST and back again. For six months I think I have it made, and then along comes daylight-saving time . . . Ugh! That throws me off again. I'd like to tell you a little story that happened to me two years ago because I think it illustrates the problem.

My wife and I had decided to take a trip to England for our anniversary, so we planned the details months in advance. One of the things I did was to set my watch to GMT . . . for *two* reasons: The first, a very practical one: I keep my station logs in GMT, and don't have a station clock, so it's natural to set the watch to GMT. That way, I can just look at it and tell what time to log for each QSO. (Oh, I'll admit that it *is* sort of fun to confuse my non-ham friends when they ask what time it is.) The other reason is that I figured by using GMT regularly I'd be in great shape when we got to England, because the clocks there are GMT, and no transition would be required. The practice of converting back and forth from GMT to local time ought to be good for me, and sort of lock in the conversion, as well — or so I thought.

When we finally arrived, we met G3OSB — Alan Taylor — a good friend who just happened to live in Greenwich where the famous GMT originated! Naturally, as we passed the observatory on the way to Alan's home, I triumphantly waved my watch under Alan's nose and pronounced: "At last, I know what time it is — 7 PM!"

Alan quickly responded, "Oh no it's not; it's 8 PM — we're on Summer Time over here!" Drat! Foiled again!

Alan quickly reassured me that, as we passed the observatory grounds we were, indeed, on GMT, but that all of England had changed to "local" summer time, as does most of Europe.

The other confusing thing about England in summer is that it stays light until 10:30 PM, and dawn arrives about 3:30 in the morning! Plan on learning to sleep in semi-daylight, if you go over there.

Back to GMT and the conversion business. The easy way out, of course, is to buy a clock that has all of the world's time zones on it. Another

way is to get one of those convenient World Time Calculators.*

Times past

Man has always needed a measure of time to live by — to work, to play, to arrange meetings, to carry on the process of living, to communicate. The earliest measures of time were sun dials of one sort or another, and, perhaps not surprisingly, the sun is still used today to reckon time. Local noon is the time when the sun is at the zenith, that is, exactly overhead. For this reason it is obvious that only places on the same meridian of longitude could have exactly the same time at any given moment. Points west or east of that place would be later or earlier. Therefore, in order to establish an early standard of reckoning, it was necessary to decide at which point on earth "official" time would be established so that all other

I still have difficulty converting GMT to EDT or EST and back again.

points could use that as their reference location, and reckon their own times accordingly.

The Greenwich observatory in London, on the zero meridian, was chosen as the reference point, and all time was henceforth calculated from Greenwich. The time at which the sun was at the zenith was called noon, and the elapsed time from one noon to the next was called the apparent solar day. However, because the earth, in its orbit around the sun, moves irregularly, the apparent solar day is sometimes longer and sometimes shorter, so it was decided to take an average of all apparent solar days during the year 1900, and call that the *mean solar day*. Simon Newcomb, the great astronomer, set up the mathematical tables to calculate the mean solar day.

Passage of time can be measured by the passage of a star across a particular location. The time between successive passages of that star is called a *sidereal day*. The solar day is a bit longer than the sidereal day because it takes the earth a bit more than one complete rotation to bring the sun to the zenith, due to the earth's orbit around the sun.

In 1925, the beginning of each day at noontime was abolished, and countries around the world agreed to begin each day at midnight — at least the astronomers agreed, and the rest of us followed along.

Standard time

Because it was necessary for people to be able to keep appointments "on time," they had to determine and agree what the time was at a particular place. As we've seen, that isn't easy, because places east and west of each other are not on the same time. Finally, it was decided to establish time zones — for convenience only — where all cities, towns, villages, and crossroads within that zone would be considered to be on the same time, although in fact they are not — according to the sun.

The world's time zones often follow geographical and political boundaries, in spite of the fact that they are supposed to be exactly on the north-south lines of the earth called meridians of longitude. The earth is larger at the equator than it is at the poles if we measure along the lines of latitude — something like the fact that a belt around your waist is going to be tightened to a different point than it would be around your chest, shoulders, or neck. However, since the earth rotates once — 360 degrees — in 24 hours, it is obvious that it rotates 1/24th of 360 degrees, or 15 degrees, in one hour. Regardless of where you are on earth, the sun moves across the sky at 15 degrees per hour. However, because of the difference in size of the earth between equator and poles, fifteen degrees is a different number of kilometers or miles as you travel east and west, depending on how far north or south of the equator you may be. At our latitude (42 degrees north), 15 degrees is about 900 miles. Therefore, if you figure that the United States is about 3600 miles from coast-to-coast, that

*\$2.95 from Ham Radio's Bookstore, Greenville, New Hampshire 03048.

would be about four increments of 900 miles, and four increments of 15 degrees — totalling 60 degrees. Because the eastern coast of Maine and the western coast of California do not exactly fall along the 15 degree longitude meridians (which start at Greenwich, England) the U.S. Time ZONES likewise do not fall on the exact meridians, either, but they are four in number: Eastern, Central, Mountain, and Pacific.

Because places in the Eastern time

For some silly and arbitrary reason, humans decided to make clocks with only twelve hours on their faces...

zone are roughly five increments of fifteen degrees (or 75 degrees) west of Greenwich, Eastern Standard Time is five hours earlier than Greenwich Mean Time. The earth rotates from west to east, making it appear that the sun and stars move from east to west; thus, as you move toward the east, the hour becomes later, and as you move toward the west, the hour becomes earlier.

Central Time is one hour earlier than Eastern Time; Mountain Time is one hour earlier than Central Time; and Pacific Time is one hour earlier than Mountain Time. When it is 8 PM in New York, it is 7 PM in Chicago, 6 PM in Denver, and 5 PM in Los Angeles. That seems easy enough, so let's go the other way — toward the east. Parts of eastern Canada, Puerto Rico, and some of the islands are on Atlantic Standard Time, meaning they are one hour *later* than Eastern Standard Time, so it would be 9 PM in Halifax, for example, or in San Juan. By the time we get to London (five hours ahead of New York) it is 1:00 AM on the following day.

All of this would be simple and straightforward if people and politicians didn't get involved. Around about the time of the second World War, it was discovered that too much energy was being used to light the war production plants and homes during the hours of darkness. People ordinarily got up in the morning at daylight, and went to bed after dark, so it was decided to arbitrarily adopt something called *double daylight-saving*

time, taking advantage of the extra hours of daylight in the summertime and making the time for people to go to work and come home more in accordance with the hours of natural light. Ordinary daylight-saving time advances the clock one hour, but war time advanced it two hours! After hostilities ceased, time went more-or-less back to normal, or, at least it seemed that way.

In Europe, the equivalent to our daylight-saving time is called *summer*

time, hence the clock is advanced one hour. This is how it got to be 8 PM, and not 7 PM, in England when we visited there.

The Twenty-four-hour clock

Because of the fact that there are twenty-four hours in each day, it seems only reasonable that each clock have twenty-four hours on its face, right? Wrong! For some silly and arbitrary reason, humans decided to make clocks with only twelve hours on their faces and call the same

Before 1833, the railroads used local sun time for their stops and schedules and places even a few miles apart were on different clock times.

twelve hours by different names — AM and PM. Ante Meridiem (before meridiem — meaning before the sun crosses the zenith at noon) and Post Meridiem (after meridiem — meaning after the sun crosses the zenith at noon).

The military, and others, decided to go back to the natural way of counting hours so that no one could ever become confused as to whether a particular hour was AM or PM. If you say 2300 hours, you know it has to be during darkness, if hours start at

0000. Likewise 1100 hours has to be during daylight, if noon is 1200. To figure time by the twenty-four system, just add twelve to the time your watch says after noon, and add a couple of zeros. Example: 3 PM, add 12, gets you 15, and two zeros makes it 1500 hours. Neat! You can figure 8 PM by adding 12, which will get you 20, and two zeros makes it 2000 hours. Isn't that simple? Now you are ready to consider a very interesting phenomenon — the International Date Line.

Losing, or gaining, a day

Sailors who used to sail around the world on their voyages kept scrupulous time accounts in order to navigate their vessels by the sun and stars. Their chronometers were the best that money could buy — yet they gained or lost a *complete day* after a 'round-the-world voyage — a day they couldn't account for. Here's why.

Remember when we travel eastward, we advance the hour; it gets later and later for each degree eastward we travel. Let's try starting out in London (GMT) at noon, and travel eastward through Asia, across Japan, and into the Pacific. As the hours and degrees go by, we finally reach a point exactly 180 degrees around — opposite our starting point — and it is exactly midnight. At this point we jump to the following day — right?

Sure we do, and that is no problem because we went eastward. We started on the first of May, and when it became midnight, we proceeded to the 2nd of May.

Now, let's travel westward from Greenwich, with the hours growing earlier as we go. It's noon on May 1st when we start, and by the time we get to New York it has become 7 AM. In Los Angeles it is 4 AM, and when we reach that same point 180 degrees around, it is midnight; and then we jump to just *before* midnight on April

30th. Whoops . . . what happened? Going around one way we proceed from May 1st to May 2nd, and the other way we proceed from May 1st to April 30th! What to do?

Fortunately, that has been figured out in advance, and that 180-degree meridian is called the *International Date Line* because when you cross it, you change the date! Going westward, you travel backwards in clock time, but suddenly — on crossing — add a whole day! When you cross that International Date Line going eastward, subtract a whole day. That's one of the skull-twisters of the time game — or dating game, if you must have your pun!

Communications time

Because of all these strange doings,

it has become desirable, even if not necessary, for hams to standardize on one time system — so that for record-keeping purposes (we used to call it logging, before they did away with that) we can be sure when it was that we talked to each other, and on what date. Therefore, we adopt Greenwich Mean Time (GMT) — now sometimes called Universal Coordinated Time) as the standard. It has become the reference, and every place on earth takes its time from that reference. Hams keep their logs in GMT so that if they want a QSL, or want to send one, they can write the time of contact, and it will be the same in both stations' logs.

Railroad time

Before 1883, the railroads used

local sun time for their stops and schedules, and places even a few miles apart were on different clock times. This could mean, I suppose, that even if the trains weren't running on schedule, it would be pretty hard to prove! After 1883, railroads adopted the time-zone system, along with almost everyone else. One small matter remained to be resolved, however, and that is the business of daylight-saving time.

What to do about daylight-saving

Most places in the country go along with it, and dutifully change their clocks twice a year. Some communities, however, refuse to do so. Thus, it's possible for it to be one o'clock in a town across the river from a city

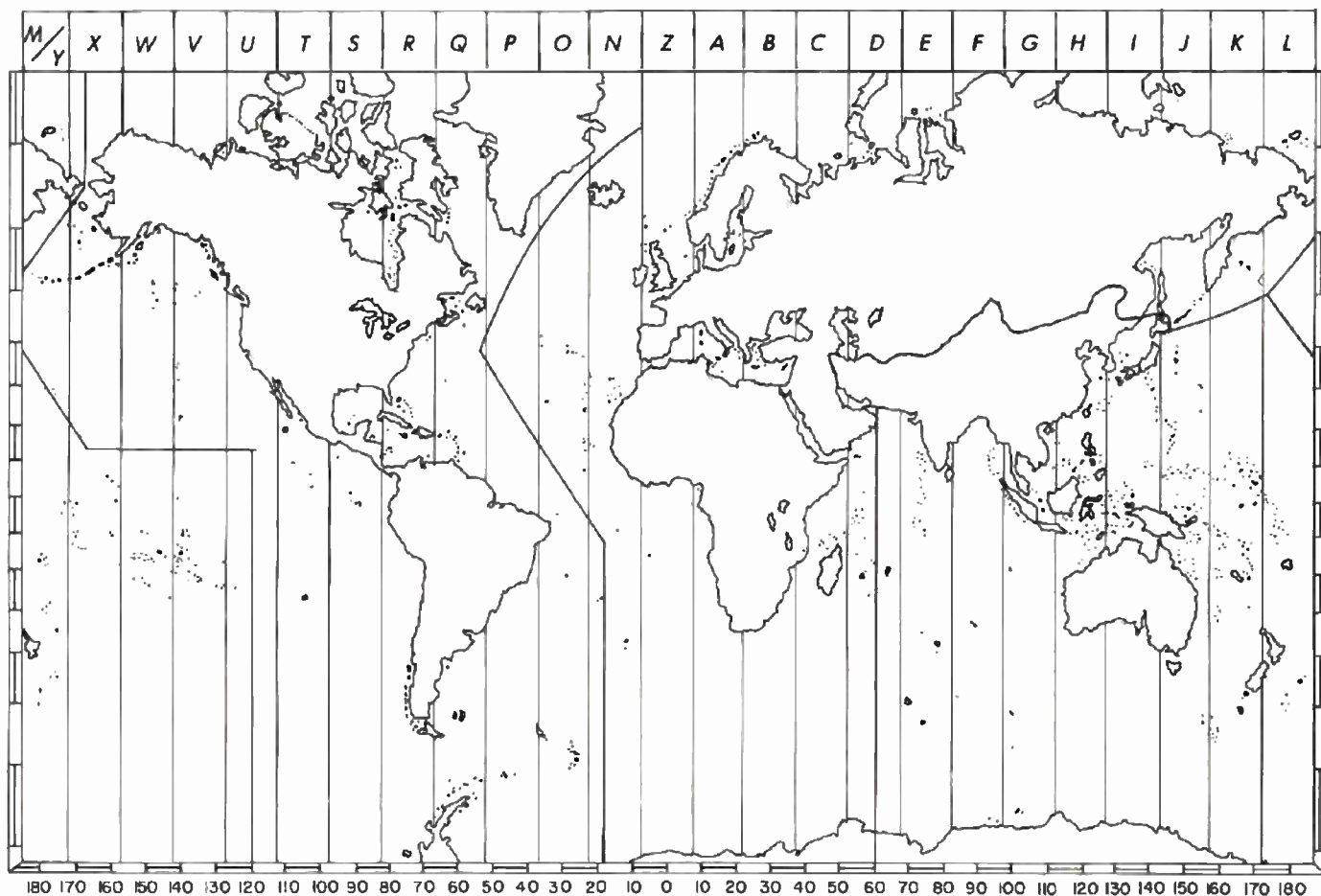

International Time Zones

Each time zone is distinguished by a single letter of the alphabet. Z or "Zulu" time designates the Greenwich zone.

WORLD TIME CALCULATOR

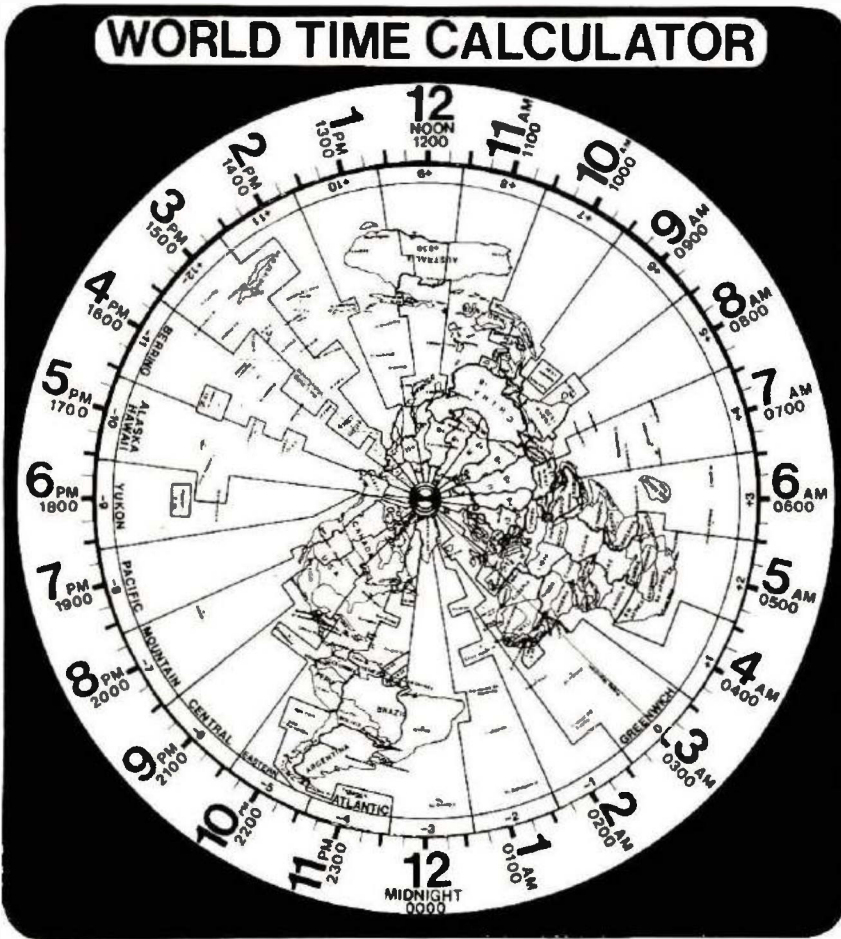

The World Time Calculator, by Van Gordon Engineering. Available from Ham Radio's Bookstore (see page 56 for price and address).

where it is still 12 o'clock. If you live in a place that changes, okay; if not, then still okay, because you'll be using GMT anyway. Now, all that you have to do is remember how far ahead (or behind) GMT your own local time zone is when you are on Standard Time or Daylight Time:

	Standard	DST
New York (EST)	+5 hours	+4 hours
Chicago (CST)	+6 hours	+5 hours
Denver (MST)	+7 hours	+6 hours
Los Angeles (PST)	+8 hours	+7 hours

To find GMT (UTC) add that number of hours to local time. If you want to find GMT when you are on daylight-saving time, add one hour less.

World Time Calculator

When you look at the world time calculator (see photograph), notice that there are "jigs and jogs" in the time meridians. These are to take into account the political boundaries and country affiliations of islands and pos-

sessions — and sometimes just whimsy. However, the idea was (and perhaps still is) to inconvenience as few people as possible.

To determine the time anywhere in the world, position your time zone to the local hour on the outer circle. You can then read the time anywhere in the world just by looking at the place you are interested in, and following its time zone to the outer time circle, and reading off their local time. The + / - numbers show how many hours ahead or behind GMT that zone is.

If you are on daylight-saving time, just use the calculator as before to find the DST in the other country. For zones still on standard time, convert your local time to standard, and set your zone at that hour.

Better still, buy one of those fancy clocks, and let it do all the work. You only have to set it twice a year!

And a good time was had by all . . .

HRH

INTRODUCING A DUAL TIME CALCULATOR CHRONOGRAPH WRIST WATCH

If its capability
doesn't astound you,
its price will.



Casio C-80 \$49.95

- It's A Calculator for Business, Shoppers, Students
 - New touch keys allow correct entry by any size finger
 - Four function calculator (+/-/×/÷)
 - Indicator shows math function in use
- It's A Chronograph for Competitors and Sports Fans
 - Times to 24 hours with 1/100th second accuracy
 - Has time-out feature and also gives lap/split time
 - Gives first and second place times
 - Weighs only 1 ounce
- It's A Dual Time Watch For Travellers, Pilots, Sailors
 - Set second time zone in AM/PM or 24 hour time
 - Accurate to ±15 seconds per month
 - Calendar with day of week and date

The Casio C-80 is the ultimate in technology. Its computer brain is protected against shock by a tough polysulfone plastic case. Average battery life is an amazing 15 months. Its mineral glass crystal resists scratches.

Buy with Confidence

We've become a leading media merchandiser by offering advanced technology products, prompt delivery, and a 30-day, no-risk, money-back guarantee. If this product isn't everything you expect, simply return it in new condition in 30 days or less for a complete refund.

Order Today

Charge customers can call toll free 24 hours a day. Order product number 130

(800)854-3831 In California (800) 432-7451

DWS marketing international

350-A Fischer Avenue Dept. A02.

Costa Mesa, California 92626 (714) 540-4444

Call our toll-free number for quickest service or send your check, money order, or credit card info. Please allow time for checks to clear. We accept VISA, M.C., A.E., D.C. charge cards. Add \$2.50 for insured postage & handling for first product & \$1.00 for each additional product. Calif. residents add 6% sales tax.

© DWS marketing international 1980

Questions & Answers

Entries for this column must be by letter or post card, only. No telephone requests will be accepted. All entries will be acknowledged when received and those judged to be most informative to the most Amateurs will be answered by return mail. Questions must relate to Amateur Radio.

Readers are invited to send a card naming the question they feel is most useful in each issue. Each month's winner will receive a prize, and there will be a prize for the most popular question of the year. In case of two or more questions on the same subject, the one arriving here the earliest will be used.

The Winners!

It's good to be able to report that we've gotten some votes on questions from our readers, and now have a couple of winners. From the March issue, we have KA2AEY of Hilton, New York, as the winner with his question about tape recording CW and SSB off the air. The winner from the April issue is K1VOL, of Bath, Maine, with a question about baluns. Congratulations to both, and we have a nice prize for you — an autographed copy of Bill Orr's *Radio Handbook*, 21st edition. You'll find this handbook very useful around the hamshack and in studying about electronic and Amateur Radio theory and building practices. We all thank both of you for participating in our Questions and Answers section of *Hori-*

zons, and thanks also go to you readers who took the time to cast a vote.

Neutralization

When you replace a final tube in a transceiver, you have to neutralize it in many rigs. How do you neutralize the final, especially if you don't have a VTVM as called for in my Kenwood instruction book? Will poor neutralization cause SSB distortion and key clicks? — A. Jozsa, WA1UZH.

Neutralization is a means of counteracting the internal capacitance between elements in vacuum tubes (some transistor circuits require it too). This capacitance provides a feedback path that can allow the tube to oscillate or be on the verge of oscillating. This can cause spurious signals to be transmitted, as well as distortion and key clicks.

The process of neutralization involves using some type of indicator to determine the presence of rf energy feeding through the tube when the plate (and screen) voltage is removed. In old-time transmitters, where the final amplifier was separate from the rest of the rig, it was easy to apply drive to the output connector, and check for rf at the input by means of a diode detector and meter (with plate voltage removed, of course). Many other methods are described in various Amateur handbooks. Modern, one-piece transceivers and compact transmitters, however, do not allow such easy access to the various parts of the circuit, so you must follow the

method recommended by the manufacturer.

A VTVM is simply a voltmeter with a very high input impedance. One of the new fet-input multimeters should do as well, or you can borrow (or offer to rent) a VTVM from a fellow ham or a service shop. After all, you shouldn't need to replace your final amplifier tube more than once every year or two. If your rig is eating tubes more often than that, either there's something wrong inside or you're pushing it to the limit too often.

Legal linears?

Is linear amplifier operation on the 10-meter band now illegal? — J. L. Erisman, W0EBY.

Not at all. Linear amplifiers can be used by an Amateur on the 10-meter Amateur band. The only restrictions on their use are the power ratings for your class of license — 250 watts input for Novices (and Technicians operating under Novice privileges) or 1000 watts input for General, Advanced, and Extra.

It is, however, illegal to manufacture and sell an amplifier that will operate on the 10-meter band. This ruling came about because CB operators were buying Amateur linear amplifiers and using them on 11-meters, where the legal input is 5 watts. Since there is no practical way to make an amplifier that will work on 10 meters but will not work on 11 meters, the FCC has banned the sale of "10-meter" amplifiers. Note, however,

that there is no restriction on an Amateur building and using his own amplifier. (It's a very big project and involves hazardous high voltages, so it's not a project recommended for beginners — anyone who has no experience in equipment building should seek plenty of help and advice from an old-timer who knows the ropes.)

Relays and T/R

What is the purpose of relays and T/R switches, and how do they work? — Stephen Serio.

Steve, that's a good question, and the answer will benefit a lot of newcomers, but you didn't give us your return address!

Think of a relay as a switch, controlled by electricity instead of your hand. Anything you can turn on or off by hand, such as the lights in your house, a motor, the burners on an electric stove, can be turned on and off by a relay. An advantage of relays is that they can do more than one thing at a time. For instance, suppose you had a transmitter with three power supplies — a 150-volt one for all audio stages, another of 250-volts for all low-powered radio-frequency stages, and a 1000-volt supply for the high-powered section. You could turn them all on with separate switches, but it would take you a second or two to do it. Further, if you forgot one, your transmitter would not work.

A relay can have many contacts that are all closed at once by an electromagnet. The electromagnet is operated by a single switch which you close or open as desired. You could then use just one motion to turn on all three power supplies. The switch can be the one on your microphone, or possibly a switch on a panel of the rig, or even a footswitch you can step on if you want to keep both hands free. There are even circuits that will amplify your voice and cause it to close the relay — this type of control is called VOX, for Voice Operated Xmit ("xmit" is ham shorthand for "transmit").

A T/R switch is another time-saving device that is used to switch the antenna between the transmitter

and receiver. Old-time ham stations had a large knife-switch that you had to reach over and throw, hooking the antenna to the transmitter, before you could send. As relays became more reliable and less expensive, many hams started using them to take the place of the switch, thus eliminating one more motion the operator had to make. Modern equipment has specially designed relays that switch the antenna as soon as you push the button on your microphone or close the transmit switch on the rig.

There are electronic antenna switches, too, called T/R switches, and they have no moving parts. The switching is done by changing voltage levels on a tube or transistor circuit that is hooked to the right parts of the transmitter/receiver. The advantage of this type of T/R switch is that it makes no buzz or click when it is turned on, and it is very fast-acting. Many designs for electronic T/R switches have been published in Amateur handbooks and magazines over the past several years.

Recommended reading

Doug Blakeslee, N1RM, "Station Interfacing," Parts 1 and 2, April and May, 1980, issues of *Ham Radio Horizons* (back issues \$2 each).

Break-in?

What is meant by semi break-in and full break-in? I see it in all the advertisements. — C. Milman.

Let's start with full break-in, because it is easiest to visualize. This means that the other station can break into your transmission while you are sending. It is very useful in message handling. For example, you are in the middle of a message and the other station missed a letter. He can close his key for a moment, or send a string of dots, to get your attention — you will be able to hear him between the dots and dashes of your own sending (at least you will if your rig is equipped with a good T/R switch, see the previous question and answer in this column). When you hear him, you can stop sending. He will then ask you to

repeat what he missed, and you do so — a lot of time is saved.

In casual rag-chewing, full break-in allows the other guy to interrupt you to make comments or ask a question, just as if you and he were standing face-to-face and talking.

Semi break-in is similar to full break-in, but not quite as fast. The other station can still interrupt you, but not between dots and dashes. He'll have to get your attention between words, when your pauses are slightly longer. The difference between the two systems is usually caused by the receiver circuitry — some receiver circuits are paralyzed by the rf from the transmitter portion of the rig, and take a large part of a second to recover from this paralysis; other receiver circuits recover in less than 0.001 second, allowing you to hear signals between dots and dashes. Naturally enough, the fast-recovery type of circuit is often more complicated and more expensive than is the slower one.

Remote control

If a licensed Amateur has a tone-controlled rig in his home, and a mobile rig to activate the tone-control circuitry in the home rig, can he call in and allow his XYL to answer? Once activated, the home rig is voice-controlled, and is reset to standby status with a timer. — R. Miller, WD9JOD.

I hope I've properly summed up your question, Robert. On the face of it, it sounds like a nice system to allow you and your XYL to communicate, but let's look at what can go wrong.

In the first place, you are not in control as much as you might think. How do you shut the rig off if something goes wrong while your wife is transmitting? If you were on the premises, you could pull the plug or hit the OFF switch. A licensed Amateur must be in complete control.

Secondly, what is to prevent some neighborhood prankster from obtaining your tone-code and activating the rig, thus eavesdropping on everything that is said in the house? There hasn't been a tone-control system made that

CALL TOLL FREE

For the best deal on

•AEA•Alliance•Ameco•Apple•ASP
•Avanti•Belden•Bencher•Bird•CDE
•CES•Communications Specialists
•Collins•Cushcraft•Daiwa•DenTron
•Drake•Hustler•Hy-Gain•Icom•IRL•KLM
•Kenwood•Larsen•Macrotronics•MFJ
•Midland•Mini-Products•Mirage•Mosley
•NPC•Newtronics•Nye•Panasonic
•Palomar Engineers•Regency•Robot
•Shure•Standard•Swan•Tempo
•Ten-Tec•Transcom•Yaesu

Icom IC-255A ... call for
BANG-UP July 4 price!

Kenwood TR-2400 .. in
stock, delivery NOW!

FT-227RA closeout...
only \$299!

Apple II (or plus) .. \$999
with 48k \$1199

Macrotronics RTTY/CW
software and system for
Apple ... Now in stock



CALL TOLL FREE
(outside Illinois only)
(800) 621-5802



Hours:

9:30-5:30 Mon., Tues., Wed. & Fri.

9:30-9:00 Thursday

9:00-3:00 Saturday



ERICKSON
COMMUNICATIONS, INC.
5456 N. MILWAUKEE AVE.
CHICAGO, IL 60630 (312) 631-5181

can be kept secret for more than two or three transmissions. A real sharp electronics sleuth can break even a complicated tone-code in a few seconds.

Then, too, what's to keep unscrupulous couples from putting together such a system, and then using it whether or not it was activated by the ham husband. All they would have to do is say that he turned it on, and then use it by the hour for any purpose they desire. If you think people would not abuse such a system, listen on 11 meters for a while and become educated. If a system can be abused, people will do so; even the FCC has learned this lesson after the 11-meter mess.

Sorry, but the system just will not fly until every Amateur in the world becomes as well-intentioned and honest as you are. A good solution is to help your XYL get her ticket. You'll both benefit; you will have someone to share your hobby with, and she will better understand Amateur Radio.

Lightning

What is the best way to protect my equipment from lightning damage? I installed an antenna switch between my antenna and the rig, but the SWR went up, so I took it out. I wanted the switch because it grounded the antenna when I was not using it. Lately, I have been disconnecting the coax from the rig when not in use. — Greg Arnette, KA1DVE.

You have hit upon the best system, but it is not the most convenient one. No system will completely protect your equipment from lightning damage when the antenna or coax is connected, even if it didn't cause high SWR. (You should find out why that switch is not working right, and put it back in, because it will protect your receiver from static "spikes" caused by lightning some distance away.)

But, when it comes to a nearby strike, the only thing you can do is provide a good, short path to ground. In looking at your sketch, it appears to me that lightning hitting your antenna will follow the coax cable to your rig, and then find ground somewhere. If

the cable is not connected, lightning can still get to the vent pipe (it has just come through several thousand feet of air, so an inch or two of plastic insulation isn't going to stop it!) and follow it to ground, tearing up your house as it goes. You must provide a path *outside* your house!

Run a good, heavy ground strap from the base of that antenna down the roof, over the side, and directly to a ground rod driven into the soil. Old RG-8 coaxial-cable braid will do nicely, and you can either leave the vinyl jacket on or take it off. A single ground rod such as those sold at TV service shops will be good, but two or three of them spaced a few feet apart and tied together with braid will be better. A long piece of copper pipe driven deep is even better, but expensive!

Recommended reading

Karl Thurber, W8FX, "Lightning and The Hamshack," July, 1978, *Ham Radio Horizons*.

James R. Fisk, W1HR, "Fire Prevention In The Hamshack," April, 1978, *Ham Radio Horizons* (back issues \$2 each).

Emergencies

What are the rules concerning emergency communications? Is an Amateur allowed to go out of his band to transmit an emergency message if that is the only way possible? — J. P. Ross, KA3BRO.

Yes, you can go out of the Amateur bands in a real emergency. You can yell for help on any frequency where you can get someone's attention. But you had better be prepared to prove in court or an FCC hearing that it was truly an emergency, involving possible loss of life or destruction of property. Considering the number of hams that are using the airwaves, your chances of getting attention are really better in the Amateur bands than anywhere else. Many boats and ships have standby rigs that will work on the ham bands for that very reason.

HRH

airTime

ROB SCHNEIDER, N6MR

Illinois QSO Party

The 18th Annual Illinois QSO Party, sponsored by the Radio Amateur Megacycle Society, will be held from 1800Z August 2 to 2300Z August 3, with a rest period between 0500 and 1200Z August 3. Activity will be on all bands; stations can operate both CW and phone. The same station may be worked on each band and mode, but no repeater contacts are allowed.

Certificates will be awarded to the three highest-scoring stations in Illinois in Single-Op, Multi-Op, Multi-Multi, Portable, Mobile, and Novice/Technician CW categories. Top scores in similar categories from each state, province, or country from which two or more entries are submitted will also receive certificates. Club awards will be issued as per ARRL Section Sweepstakes rules.

Illinois stations will give an RST and their counties as a contest exchange, all others should send an RST and their states, provinces, or countries.

The most active frequencies should be about 60 kHz from the low band edges on CW; 3975, 7275, 14275, 21375, and 28765 kHz on phone; and about 25 kHz from the low end of each Novice band, especially on the hour and half hour.

Score one QSO point per contact (two points if station worked is a Novice, or Technician licensee in a Novice band). Illinois stations multiply QSO point total by total number of states (50 maximum), VE/VO call areas (10 maximum), and no more than five non-W/K/VE/VO DX countries worked for a total of 65 possible multipliers. Illinois portables or mobiles away from their normal QTH may add 200 to their final scores for each county of operation from which 10 or more contacts were made.

Non-Illinois stations multiply QSO points by the number of Illinois counties worked. They may only count Illinois stations for QSO points. Non-Illi-

nois stations may also take extra bonus multipliers for each group of eight QSOs with the same county.

Legible logs must be submitted along with a summary sheet listing all claimed multipliers and calculations of score. Operator(s) name, address, call, and operating category must be typed or clearly printed.

Entries must be postmarked no later than September 15, 1980, and sent to RAMS/K9CJU, 3620 N. Oleander Avenue, Chicago, Illinois 60634. Include a business-size SASE for a copy of the results.

Kaskaskia Island

The only inhabited portion of Illinois on the Missouri side of the Mississippi River — Kaskaskia Island — will be on the air during the Illinois QSO Party, August 2nd and 3rd. The St. Charles (Missouri) Amateur Radio Club will have a multi-rig station set up on the historic island, signing KØBM/9 KI, and a handsome 8 × 10 certificate will be issued to all stations worked.

Kaskaskia Island was settled in the early 17th century when a church was established there by Father Marquette and the French explorer Joliet. A decisive Western-frontier battle was won on the island on July 4, 1775, when British troops were defeated by the revolutionary forces led by George Rogers Clark. Kaskaskia Island also houses the "Liberty Bell of the West."

KØBM/9 KI will be operating on the designated calling frequencies for the Illinois QSO Party. To receive the special certificate QSL, send a 9 × 12 SASE to WDØGSY, Mike McCrann, 25 Elm Street, St. Peters, Missouri 63376.

Two-meter QSO Party

Sidewinders On Two are sponsoring their 3rd Annual SWOT QSO Party, which will run from 0000Z August 1 to 2359Z August 7. The 2-

meter-only event is open for the first time to all Amateurs with operating privileges on 2.

The person with the highest final score will receive the 1980 SWOT trophy. Certificates will be awarded to the highest scorer in each ARRL section from which two or more entries are submitted.

To receive contact credit, stations must exchange call signs and a geographic designator (Unit). Units consist of a four- or five-digit number indicating the station's geographic location in latitude and longitude rounded down to the next whole number (e.g., W7CKL located at 32 degrees 7 minutes north and 110 degrees 55 minutes west would send 32110). Non-competing stations may be counted for contact and multiplier credit if they give their location specifically enough for the competing station to determine a Unit. SWOT members will add the suffix "X" to their geographic Unit to aid in multiplier calculation.

All contacts must be made on either CW or SSB. A station may be worked once on each mode for QSO score. Contacts must be made direct, without the aid of repeaters, satellites, or retransmission of any kind. EME (moonbounce) contacts may be counted if they meet all other requirements. All contacts must be made from one geographic Unit — portable and mobile stations operating from several Units may claim the highest score made from a single Unit.

Scoring

- Total SWOT member QSOs multiplied by their different geographic Units multiplied by two equals the SWOT member credit.
- Total non-SWOT member QSOs multiplied by their different geographic Units equals the non-SWOT member credit.
- Sum of credits from (a) and (b) equals the final score.

Logs need not be submitted unless requested. Send an itemized summary including operator's name, call sign, address, ARRL section, and SWOT number (if a member) to W7CKL, Val Taylor, 3849 N. Houghton Road, Tucson, Arizona 85715. Entries must be postmarked no later than September 1, 1980.

HRH

JUST GETTING STARTED?

do it right with

MADISON ELECTRONICS AND KENWOOD

The folks at Madison Electronics have long been happy to serve the newest members of the amateur community, and are proud to present these two "Getting started" packages. Pick the one that's right for you, and get started right.

STARTER PACKAGE 1



Here's your chance to start with one of the hottest new rigs around and receive a free accessory in the deal. The TS120S solid state transceiver, featuring 80-10 meters, SSB and CW with VOX and IF shift. Small enough to go mobile! Top it with a free Palomar Keyer, and you're on your way.

TS-120S	\$699.00
PALOMAR KEYER	our gift
TOTAL	\$699.00

STARTER PACKAGE 2



You simply can't buy better reliability, performance and reputation than the 520 series from Kenwood, and the TS520 SE is no exception. This is a just plain good radio at a tremendous savings, when you consider the free CW filter (YK-88) and microphone (MC-50) too.

TS 520 SE	\$629.00
MC-50 MIC	our gift
YK-88 CW FILTER	
TOTAL	\$629.00

MADISON

Electronics Supply, Inc.

1508 McKinney • Houston, Texas 77002 • (713) 658-0268

INTIMIDATED BY MORSE CODE?

\$99.95

INTRODUCTORY PRICE



**THE NEW AEA
MODEL MT-1
COMPUTERIZED
MORSE TRAINER
MAKES MORSE
CODE EASY AND
FUN TO LEARN.**

- Automatic Speed Increase, User May Program: Starting Speed, Ending Speed, Practice Duration; 5 Letter code Groups or Random Space; Common or All Characters.
- Precise Speed Control 1 to 99 WPM (Tailor to Your Exact Requirements).
- 24,000 Character Answer Book Available (\$2.00) For 10 Starting Positions.
- Random Mode For Practice (No Answers).

KT-1 Computerized Keyer With All Features of Above Trainer is Also Available in Same Package For \$129.95.

Advanced Electronic Applications, Inc., P.O. Box 2160, Lynnwood, WA 98036. Call 206/775-7373.

AEA Brings you the Breakthrough!

ANTENNA BOOKS by Bill Orr, W6SAI ALL ABOUT CUBICAL QUAD ANTENNAS

The cubical quad antenna is considered by many to be the best DX antenna because of its simple, lightweight design and high performance. In Bill Orr's latest edition of this well known book, you'll find quad designs for everything from the single element to the multi-element monster quad, plus a new, higher gain expanded quad (X-Q) design. There's a wealth of supplementary data on construction, feeding, tuning, and mounting quad antennas. It's the most comprehensive single edition on the cubical quad available. 112 pages. ©1977.

RP-CQ Softbound \$4.75

THE RADIO AMATEUR ANTENNA HANDBOOK

by William J. Orr, W6SAI and Stuart Cowan, W2LX

If you are pondering what new antennas to put up, we recommend you read this very popular book. It contains lots of well illustrated construction projects for vertical, long wire, and HF/VHF beam antennas. But, you'll also get information not usually found in antenna books. There is an honest judgment of antenna gain figures, information on the best and worst antenna locations and heights, a long look at the quad vs. the yagi antenna, information on baluns and how to use them, and some new information on the increasingly popular Sloper and Delta Loop antennas. The text is based on proven data plus practical, on-the-air experience. We don't expect you'll agree with everything Orr and Cowan have to say, but we are convinced that *The Radio Amateur Antenna Handbook* will make a valuable and often consulted addition to any Ham's library. 190 pages. ©1978.

RP-AH Softbound \$6.95

BEAM ANTENNA HANDBOOK

Here's recommended reading for anyone thinking about putting up a yagi beam this year. It answers a lot of commonly asked questions like: What is the best element spacing? Can different yagi antennas be stacked without losing performance? Do monoband beams outperform tribanders? Lots of construction projects, diagrams, and photos make reading a pleasurable and informative experience. 198 pages. ©1977.

RP-BA Softbound \$5.95

Please add \$1.00 to cover shipping and handling.

HAM RADIO'S BOOKSTORE
GREENVILLE, N. H. 03048

Product showcase

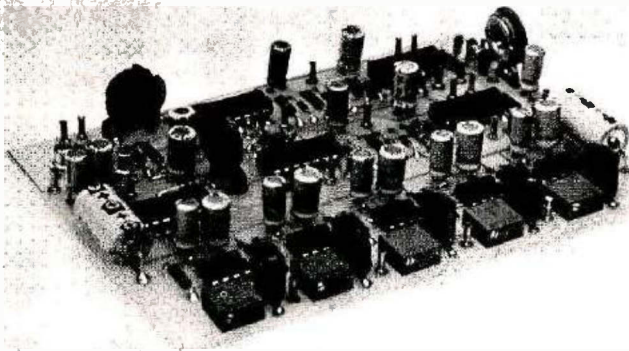

TTC100-Touch-Tone® Decoder/Control Board

The Model TTC Touch-Tone® Decode/Control Board is designed to remotely switch a control function in a repeater or other radio system by means of a 3-digit, Touch-Tone control code. The board can be used for various ON/OFF applications including: Transmitter ON/OFF, autopatch ON/OFF, PL® ON/OFF, HI/LO power, Audio ON/OFF, and for selective calling using individual codes, etc. The audio tone input to this board can be from the repeater's receiver, an auxiliary receiver, land-line link, or any other audio source. The TTC100 can also be used for two separate, two-digit control sequences — ON, and a single digit which turns both off, or two separate two-digit control sequences — ON, each with a unique single or dual digit OFF code for control of two separate functions. Multiple boards can be used to switch any number of functions.

The TTC100 employs a unique digital anti-falsing design which prevents

false triggering of the control function by stray noise, voice, or other tones. Also, the correct tones must be entered in the correct sequence or the circuit will not trigger.

The output switching circuitry can be jumper-wired to produce a 5-V TTL level trigger pulse, or latch ON or OFF. Two transistor switches are provided to trigger external circuitry, i.e. relays, external logic, etc. These transistor switches can sink as much as 100 mA each. The three-digit code can be changed in the field with a minimum of effort by changing jumper-wires and retuning the decoders. Five phase-locked loop tone decoders are provided on the board for flexibility in tone selection. Multi-turn cermet trim pots are used for ease of "setability" and maximum stability. Low-current-drain CMOS logic is used, which is TTL compatible.

High stability components are used in the PLL Tone Decoder stages to ensure optimum performance over wide temperature ranges. Write Spectrum Communications, 1055 W. Germantown Pike, Norristown, Pennsylvania 19401.

Automatic Scan Module For the FT-207R

Users of the Yaesu FT-207R can now automatically scan both the four memory channels and the entire band without pushing the "UP" or "DOWN" buttons each time the carrier drops off. This missing feature in the handheld is much desired in both Europe and North America, where large numbers of repeaters are located.

An easy installation of the AS-1 module requires rewiring the "BUSY-SCAN" switch, and installing four wires. This is about a 15 minute job. Heat-shrink tubing and all necessary wires are provided with the AS-1. Complete step-by-step instructions are included with each module.

The only sacrifice is that you can no longer scan for a "clear" channel. The "clear" position becomes the normal mode of operation, which was the "BUSY" position of the switch. The "BUSY" position becomes the automatic scan mode. Once switched into this mode, the unit will pause for 0.5 seconds after the carrier disappears or when squelch action occurs. Operation is much the same as a conventional pocket-scan receiver. The scan can be disabled by momentarily pressing the push-to-talk button.

Once the unit is in the scan mode, you can either scan the memory channels or the band, and hear all the action without ever touching the buttons again. The AS-1 is available from Engineering Consulting Service, P.O. Box 94355, Richmond, British Columbia, Canada, V6Y 2A8. Send \$25 check or money order, and the AS-1 will be shipped prepaid.

PRODUCT SHOWCASE

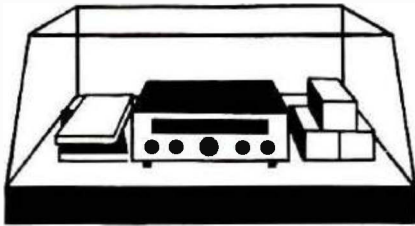

New Ten-Tec "Argonaut" 515

Latest in the famous Ten-Tec "Argonaut" QRPP line, the Model 515 brings the performance level of the 1980's to low-power operation.

Featuring a new super-sensitive receiver front end, the 515 has $0.35 \mu\text{V}$ sensitivity, four-pole crystal-lattice filter with 2.4-kHz bandwidth, a unique optional combination CW filter and variable-notch filter in an out-board cabinet, and a new heterodyne VFO with a new permeability-tuned oscilla-

tor which provides increased calibration accuracy. Argonaut's band coverage (80-10M) has 10-meters split into new 500-kHz segments, and crystals included for 28- and 28.5-kHz segments (others optional). Other features include: offset tuning with LED indicator, resonate control, direct frequency readout, QSK instant CW break-in, adjustable sidetone level and pitch, "S"/SWR meter, low distortion audio, and built-in speaker.

The broadband transmitter section features a newly designed no-tune final for instant band change, five watts input, new LED output indicator set for two-watts voice operation, TVI filter, automatic 750 Hz CW offset, automatic sideband selection (reversible), and PTT.

New styling in black and bronze colors, with new knob design and tilt-up bail make the Argonaut 515 a handsome addition to any QRPP enthusiast's operating position.

For full information, see your dealer or write Ten-Tec, Inc., Highway 411 East, Sevierville, Tennessee 37862.



Isotron Antennas

The manufacturers of Isotron antennas claim their antennas employ a unique, new embodiment of an old principle to bring you compact, space-saving features without sacrificing performance. Ideal for apartment or condominium dwellers and usable indoors on TV-type masts and conveniently attached to your chimney or house.

The manufacturer states the Isotron 80 covers a selectable 100-kHz of the 80-meter band, yet it weighs a mere eight pounds (3.6 kg) and is only 4½ feet (1.3 meters) tall! The Isotron 40 covers 250-kHz of the 40-meter band (and that's almost *all* of it), yet is only 3-feet (0.9 meter) tall and weighs a mere four pounds (1.8 kg)! With either antenna, you can pinpoint your desired center frequency at 1:1 SWR.

They are directly fed with 50-ohm coax and don't require any radials or any matching devices. Everything you need, including mounting brackets, is included. The Isotron 80 is rated at 1000 watts PEP, and the Isotron 40 can take 2000 watts PEP.

All of the radiating surface can be mounted high and in the clear with no drooping ends or close-to-ground losses. The pattern is omnidirectional.

Isotron 40 price is \$44.95; Isotron 80 is \$54.95. Write to Bilal Company, Star Route, Florissant, Colorado 80816.

O.K. Machine and Tool Wire-Wrapping Kit

New Wire-Wrapping Kit features selected items of particular value to the prototype engineer and hobbyist alike. The kit includes a unique new wire-wrapping tool, a 50-foot (15 mm) roll of wire-wrapping wire, two 14-pin DIP sockets and two 16-pin DIP sockets. Specially featured is a new high-quality PC Board Model H-PCB-1.

The tool, model WSU-30 is a combination tool that wraps and unwraps 30 AWG (0.25 mm) wire on .025 (0.63 mm) square pins, plus strips 30 AWG wire using the handy, built-in stripper. The wire is top-quality,

Kynar-insulated, silver-plated copper. The DIP sockets are for plug-in packaging of integrated circuits and feature gold-plated three-level, wire-wrapping pins .025 inches (0.63 mm) square on .100 inch (2.54 mm) centers, phosphor-bronze, leaf-spring contacts, and U.L. recognized, glass-filled thermoplastic bodies. The H-PCB-1 is the first in a new series of top quality PC boards for the serious Amateur. The 4 × 4-1/2 inch (100 × 114 mm) board is made of glass-coated epoxy laminate and features solder-coated 1 oz. copper pads. In addition, the board has 22/22 edge connector contacts on standard .156 spacing.

Available complete in one kit,

Model WK-3B is \$16.95 at your local electronics outlet or directly from O.K. Machine and Tool Corporation, 3455 Conner Street, Bronx, New York 10475.

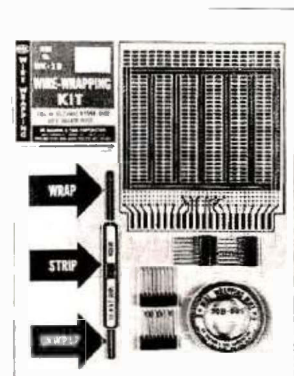

Hamtronics Transmitting Converters

Now, the popular Hamtronics® transmitting converters and heavy-duty linear power amplifiers are available as complete units, in attractive eggshell-colored, enameled aluminum cases, with BNC fittings for exciter and antenna connections. These units, which are compatible with virtually any 10-meter or 2-meter SSB, CW, or fm exciter, provide an rf output of 30 to 45 W PEP with as little as 1 mW input. Models are available for 432-450 MHz, which includes operation on the new phase III OSCAR and for 6 meters and 2 meters. These units provide a versatile arrangement

for getting on either satellite or terrestrial operation.

Best feature of all is the price! Not only does it cost \$30 less than when purchasing individual units, but a complete high power unit is available for much less than the cost of most 10 watt transverters on the market. Units are available either wired and tested or in kit form, starting at only \$199.95. Matching receiving converters are also available for either transceive or crossband operation.

A complete new catalog on these other vhf/uhf transmitting and receiving modules for fm and SSB is yours for the asking. Write Hamtronics, Inc., 65F Moul Road, Hilton, New York 14468.



New Right Angle Hi-D Jax by Switchcraft

Compact, new, two- or three-conductor jacks with built-in right-angle mountings have been introduced by Switchcraft, Inc., Chicago, a Raytheon company. Called right-angle Hi-D Jax jacks, the new phone jacks are designed so the plug axis will be parallel to the printed circuit boards to which they are mounted.

Available with or without shunt circuits, right angle Hi-D Jax jacks may be used with military or commercial phone plugs with a 0.25-inch diame-

ter finger. Two-conductor jacks mate with Switchcraft #250 and #420 plugs, or equivalent, and 3-conductor jacks mate with Switchcraft #267 or #482 plug or similar.

New, fully enclosed, right-angle Hi-D Jax jacks provide the same termination economy on printed circuit boards as does standard Switchcraft Hi-D Jax jacks, with added features of stable stand-off mountings and a sleeve circuit that can be insulated from metal panels by using a flat, non-conductive washer. For further information, write Switchcraft, Inc., 5555 No. Elston Ave., Chicago, Illinois 60630.

When it comes to AMATEUR RADIO QSL's...

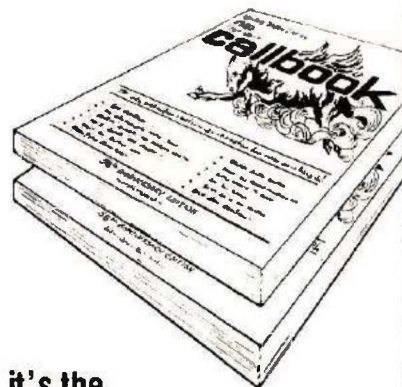

it's the
ONLY BOOK!
US or DX Listings

1980 callbooks

Here they are! The latest editions. World-famous Radio Amateur Callbooks, the most respected and complete listing of radio amateurs. Lists calls, license classes, address information. Loaded with special features such as call changes, prefixes of the world, standard time charts, world-wide QSL bureaus and more. The new 1980 Radio Amateur Callbooks are available now. The U.S. Edition features over 400,000 listings, over 120,000 changes from last year. The Foreign Edition, over 315,000 listings, over 90,000 call changes. Place your order now.

	Each	Shipping	Total
<input type="checkbox"/> US Callbook	\$16.95	\$1.75	\$18.70
<input type="checkbox"/> Foreign Callbook	\$15.95	\$1.75	\$17.70

Order both books at the same time for \$34.65, includes shipping.

Order from your favorite electronics dealer or direct from the publisher. All direct orders add \$1.75 for shipping. Illinois residents add 5% Sales Tax.



SPECIAL LIMITED OFFER!
Amateur Radio
Emblem Patch
only \$2.50 postpaid

Pegasus on blue field, red lettering. 3" wide x 3" high. Great on jackets and caps. Sorry, no call letters.

ORDER TODAY!

RADIO AMATEUR
callbook INC.
Dept. EB 2
925 Sherwood Drive
Lake Bluff, IL 60044



the Ultimate 1:1 BALUN

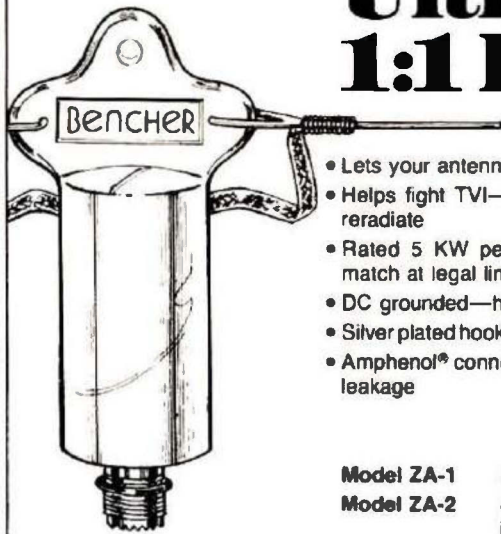

- Lets your antenna radiate—not your coax
- Helps fight TVI—no ferrite core to saturate or reradiate
- Rated 5 KW peak—accepts substantial mismatch at legal limit
- DC grounded—helps protect against lightning
- Silver plated hook-up braid; Custom molded case
- Amphenol® connector; Rubber ring to stop water leakage

Model ZA-1 3.5-30 mHz \$15.95
 Model ZA-2 optimized 14-30 mHz includes hardware for 2" boom \$17.95

Available at selected dealers, add \$2.00 postage and handling in U.S.A.
 WRITE FOR LITERATURE

BENCHER, INC.

333 West Lake Street, Dept A
 Chicago, Illinois 60606 (312) 283-1808

PRODUCT SHOWCASE

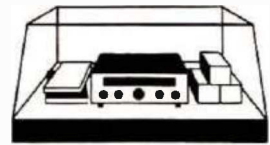

Design of Transistor Circuits, With Experiments

Design of Transistor Circuits, With Experiments, a 508-page textbook by Dr. Keats A. Pullen, Jr., provides the background and explanations necessary to teach the reader the art of designing transistor circuits. It is particularly useful in helping experimenters, Amateurs, scientists, and engineers, whose principal areas of activity are in fields other than electronics, to develop an understanding of electronic circuits. Simple, yet valid, explanations of the way solid-state devices work and how they should be used are backed up with experiments that can be performed by the reader to verify the correctness of the statements. The sound, basic understanding developed will make the study of other books on electronics easier, including those on microcomputers — integrated circuits constructed of arrays of transistor circuits. Concepts rarely encountered in standard textbooks are shown to be important in the practical application of active devices.

Topics covered include basic theory, differences between linear resistances, and the non-linear resistances on which solid-state devices are based, the relationships and applications of npn and pnp transistors, field effect devices, special purpose devices, evaluation of measurement devices, and special measurement problems. Six appendices provide information about the Ebers-Mill model for an active device, useful circuits, instruments, and components; suggested supply sources for parts; additional experiments; and the characterization of active devices.

Design of Transistor Circuits, With Experiments, Keats A. Pullen, Book No. 21626, 508 pages. Available from Ham Radio's Bookstore, order 21626, \$12.95 plus \$1 shipping and handling.



Radio World



CENTRAL NEW YORK'S FASTEST GROWING HAM DEALER







Featuring Yaesu, Icom, Drake, Ten-Tec, Swan, DenTron, Midland, KDK, MFJ, Microwave Module, Tempo, Astron, KLM, Hy-Gain, Mosley, Larsen, Cushcraft, Hustler, Mini Products, Bird, DSI, Mirage, Vibroplex, Bencher, Info-Tech, Universal Towers, Callbook, ARRL, Astatic, Shure. We service everything we sell! Write or call for quote. You Won't be Disappointed. We are just a few minutes off the NYS Thruway (I-90) Exit 32

Warren
K2IXN
Call Toll Free: 1-800-448-7914

ONEIDA COUNTY AIRPORT TERMINAL BUILDING
ORISKANY, NEW YORK 13424

Bob
WA2MSH
New York State Residents Call: 315-337-2622 or 315-337-0203

Hobbyists

Here is an interesting general electronics hobby magazine. It's loaded with lots of interesting simple circuits and ideas, not only about radio, but in all phases of electronics including test gear, audio, remote control and security systems. We are sure that you will find a number of worthwhile projects in this British magazine.

For a sample copy, please send \$1 to cover postage and handling costs. Your dollar is applied to the cost of the subscription when ordered.

1 Year (12 issues) \$20.00

Radio & Electronics Constructor
Greenville, NH 03048



Xitex Introduces "Smart TU" For ASCII/Baudot/Morse

Xitex Corporation has just announced the addition of the UDT-170, Universal Data Transceiver, to its data-products line for RTTY and Morse operation. The UDT-170 connects directly between the user's ASCII or Baudot teletypewriter or video terminal, and the station transceiver. For the user who does not currently have an RTTY or video terminal, the Xitex SKT-100 video terminal is recommended.

The UDT-170 is actually the combination of a microprocessor-based data converter plus a high performance RTTY Terminal Unit (TU). In the receiver mode, the TU takes the RTTY or Morse signal from the receiver audio output and converts it to a dc signal which is fed to the data converter portion of the UDT-170. Here, two single chip microcomputers are used to convert the ASCII, Baudot, or Morse input signal into an RS232 or

60-milliamp output signal which has been regenerated to match the mode (ASCII or Baudot), Baud rate, and line length of the user's terminal.

In the transmit mode, the serial output from the keyboard on the user's terminal is fed into the data converter in the UDT-170 where it is continuously buffered and regenerated in the desired output mode (ASCII, Baudot, or Morse) and data rate.

The UDT-170 will operate at any FSK shift from less than 100 Hz to over 1000 Hz; Baudot rates of 60, 67, 75, and 100 wpm; ASCII rates of 110 or 300 Baud; Morse rates from 1 to 150 wpm with "Auto Track"; and line lengths from 40 to 80 characters. Other features include a two-digit LED display for the copy rate (Morse only) and buffer states, and an optional CW "Ident" feature for RTTY operation.

The UDT-170 is packaged in an RFI protected metal enclosure, and operates on either 115 or 230 Vac, 50/60 Hz. For additional information contact Xitex Corporation, 9861 Chartwell Dr., Dallas, Texas 75243.

Seven* new finger talkers

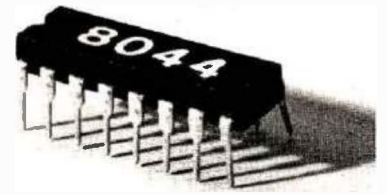

from CURTIS

* EK-480: C-MOS Deluxe Keyer	\$134.95
* EK-480M: Above plus speedometer	149.95
* I-480: InstructoMate	124.95
* M-480: MemoryMate	124.95
* IM-480: Instructo-MemoryMate	179.95
* KB-480: Morse KeyboardMate	199.95
* KB-480M: Morse Keyboard	349.95
8044: Keyer-On-A-Chip (sockets 8043)	14.95
Apr '75 MR, Feb '76 QST, Radio Hdbk 75, ARRL Hdbk 77-79	
8044-3: IC, PCB, Socket, Manual	24.95
8044-4: Semi-Kit	54.95
8045: Morse Keyboard-On-A-Chip IC	59.95
8045-1: IC, PCB, FIFO, Sockets, Manual	89.95
8045-2: Semi-Kit	159.95
8046: Instructokeyer-On-A-Chip IC	49.95
8046-1: Semi-Kit	79.95
8047: Message Memory-On-A-Chip IC	39.95
8047-1: IC, PCB, RAM, Sockets, Manual	69.95
(add \$1.75 on above for postage and handling)	
IK-440A: Instructokeyer (Mar '76 QST)	224.95

Curtis Electro Devices, Inc.
Dept. H (416) 464-7223
Box 4600, Mountain View, CA 94040

hy-gain

HG-52SS Self-Supporting Crank-Up Tower

The Hy-Gain Model HG-52SS is a 52 foot self-supporting crank-up tower designed for antenna loads of up to 90 square feet in winds up to 50 mph. This all steel constructed tower is not dip galvanized after fabrication to ASTM specifications. Features include extra-strength diamond web bracing and an improved guide system for the telescoping sections, which provides rigid, close tolerance structural support while leaving the tube ends open for complete surface galvanizing and unobstructed moisture drainage. Rotators, including the Hy-Gain 300 and CDE Telemeter, can be mounted inside the top section on the rotor mounting plate included with the tower. The HG-52SS is easily raised and lowered by manual or optional electric winch system. A thrust bearing is available which bears to the top section and accommodates winds up to 2 inches in diameter. The HG-52SS is easily erected on a limited area site, and can be readily retracted to a 21 foot height for service of the antenna. Hy-Gain manufactures a complete line of Crank-Up towers from 33 to 70 feet. Write for complete details today.

HG-52SS
\$399 List Price
Call for your price

TH60XX
Tri-Band Beam
\$370.95 List Price
\$229.95
with Tower purchase!

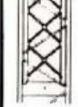
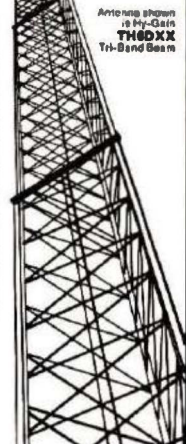

Hy-Gain
Diamond Web
Bracing for the
ultimate in
structural
strength.

TEXAS TOWERS

1300 Summit Ave. Plano, Texas 75074
9 a.m. - 5 p.m. Mon-Fri, 9 a.m. - 1 p.m. Sat.

TELEPHONE: (214) 423-2378

A Texas Communications Products Company ITEKDDMI



Cushcraft Tri-band Yagi

Cushcraft has introduced a compact, three-element Yagi for 10, 15, and 20 meters, the model A3.

The new tri-bander is rated for a full 2000 W PEP, with 8 dB forward gain and a front-to-back ratio of 25 dB. Elements are mounted on a 14-foot boom, with the longest element measuring 27 feet 9 inches.

The A3 is both easy to assemble and durable, with taper-swaged elements and zinc-plated stainless-steel element clamps. A new pictorial manual comes with the beam to further simplify construction.

Price of the A3 is \$199.95. For more information write Cushcraft Corp., P.O. Box 4680, Manchester, New Hampshire 03108.

SLEP MAIL-ORDER SPECIALS

TEN-TEC

515 ARGONAUT, 5W SSB/CW TRANSCEIVER	\$379.00
545 OMNI-A ANALOG, SERIES B TRANSCEIVER	\$845.00
546 OMNI-D DIGITAL, SERIES C, NEW MODEL	\$1,045.00
570 CENTURY 21, 70W CW TRANSCEIVER	\$310.00
580 DELTA, 9 BAND, NEW MODEL	\$745.00
444 HERCULES, 1 KW LINEAR AMPLIFIER W/PS	\$1,395.00
210 POWER SUPPLY ARGONAUT	\$32.00
255 POWER SUPPLY, DELUXE, ALL TRANSCEIVERS	\$149.00
280 POWER SUPPLY, ALL TRANSCEIVERS	\$125.00
208 NDTCH/CW FILTER 515	\$37.00
214 ELECTRET MIKE FOR 234	\$34.50
215PC MIKE WITH PLUG, COILED CORD	\$32.00
217 900 HZ FILTER 545/546	\$49.00
218 1.8 KHZ FILTER 545/546	\$49.00
219 250 HZ FILTER 545/546	\$45.00
234 SPEECH PROCESSOR	\$112.00
243 REMOTE VFO 545/546	\$125.00
247 ANTENNA TUNER	\$63.00
248 NOISE BLANKER 545/546	\$44.00
249 NOISE BLANKER 540/544	\$28.00
276 CRYSTAL CALIBRATOR, 57P	\$26.00
277 ANTENNA TUNER/SWR BRIDGE	\$80.00
282 250 HZ FILTER 580	\$45.00
283 REMOTE VFO 580	\$159.00
285 500 HZ FILTER 580	\$42.00
289 NOISE BLANKER 580	\$37.00
645 ULTRAMATIC KEYS ALL MODELS	\$80.00
670 KEYS CENTURY 21	\$32.00

ICOM

251A TRANSCEIVER 2M AC/12V MULTI-MODE 10W	\$625.00
551 TRANSCEIVER 6M AC/12V MULTI-MODE 10W	\$390.00
551D TRANSCEIVER 6M BOW, 12V W/EX107, 108	\$585.00
720 HF TRANSCEIVER, GENERAL COVERAGE	WRITE
255A 2M FM 25W TRANSCEIVER 12V	\$345.00
260A 2M FM/SSB 10W 12V	\$429.00
PS-20 P/S 20 AMP 551D	\$170.00
EX-05 FM OPTION 551, 551D	\$100.00
EX107 VOX OPTION 551	\$49.00
EX 108 BAND PASS TUNING OPTION 551	\$98.00
EX-1 RELAY INTERFACE FOR 701	\$35.00
RM-2 REMOTE CONTROLLER 211, 245, 701	\$125.00
HM-8 TOUCH TONE MIKE, 251A, 255A, 260A	\$39.00
SM-2 DESK MIKE 211, 701	\$32.50
IC-2A H. T. WITH NICADS, CHARGER, ANT	\$210.00
IC-2AT H. T. WITH TOUCH-TONE, NICADS, ETC	\$235.00

TEMPO

S-1T H. T. WITH TOUCH-TONE 2M	\$299.00
S-5T H. T. WITH TOUCH-TONE 1/5W 2M	\$359.00
S-2T H. T. WITH TOUCH-TONE 220 MHZ	\$359.00
TS-CC CARRY CASE ALL MODELS	\$16.00
TS-HA HELICAL ANTENNA 2M	\$9.00
TS-HA2 HELICAL ANTENNA 220 MHZ	\$9.00
HENRY 1KD5 LINEAR AMPLIFIER	\$675.00
HENRY 2RD5 LINEAR AMPLIFIER	\$925.00

DRAKE

TR-7/DR-7 DIGITAL TRANSCEIVER	\$1,385.00
PS-7 POWER SUPPLY TR-7/DR-7 DELUXE	\$269.00
PS-75 POWER SUPPLY TR-7/DR-7	\$179.00
SP-75 SPEECH PROCESSOR TR-7/DR-7	\$148.00
SL-300, SL-500, SL-1800, SL-6000 FILTERS, EACH	\$49.00
FA-7 FAN, TR-7	\$29.00
RV-7 REMOTE VFO	\$175.00
MS-7 SPEAKER	\$39.00
7077 DESK MIKE W/PLUG TR-7	\$46.00
AUX-7 RANGE PROGRAM BOARD TR-7	\$42.00
NB-7 NOISE BLANKER TR-7	\$82.00
MN-7 ANTENNA TUNER 250W, 160-10M	\$159.00
MN-2700 ANTENNA TUNER 2KW 160-10M	\$269.00
CS-7 REMOTE CONTROLLED ANTENNA SWITCH	\$158.00
WH-7 WATTMETER 2KW 1.8 - 30 MHZ	\$89.00
B-1000 BALUN 4:1 MN-7, MN-2700	\$29.00
DL-300 DRY DUMMY LOAD 300W	\$26.95
DL-1000 DRY DUMMY LOAD 1KW	\$53.00
L-7 AMPLIFIER WITH P/S AND TUBES	\$1,175.00
TVS300LP LOW PASS FILTER 1KW	\$26.00
R-7/DR-7 RECEIVER, DIGITAL, 0-30 MHZ	\$1,295.00
R-7/DR-7 CABLE INTERFACE KIT	\$29.50
AK-75 MULTI-BAND DIPOLE ANTENNA 160-10M	\$29.95

ORDER BY MAIL OR PHONE, BILL SLEP, 704-524-7519. WE PAY SHIPPING TO 50 STATES, APO, FPO — MASTER CHARGE, VISA OR CHECKS ACCEPTED. SAVE MONEY BY ORDERING TODAY AT THESE LOW DISCOUNT PRICES.

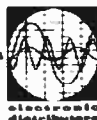

SLEP ELECTRONICS COMPANY

P.O. BOX 100, HIGHWAY 441, DEPT. HH
OTTO, NORTH CAROLINA 28763



YOU CAN LIVE BETTER for less! For list of available reports, write The Brown House, Ltd., Box 40H, Watts, OK 74964.

KENWOOD INTERNATIONAL USER'S CLUB — Details S.A.S.E. N8RT, Pohorence, 9600 Kickapoo Pass, Streetsboro, OH 44240.

QSLs — Clean, distinctive designs — raised printing, design flexibility — samples 50 cents (refundable) — K3QK, 191 Irwin, Pittsburgh, PA 15202.

REWIND JUNK TRANSFORMERS — for any voltage! Manual shows how. \$3.00. Guaranteed. Harrit, Box 495HR, Great Neck, N.Y. 11022.

VERTICAL USERS: Hustler endorses it! MorGain, Cushcraft, Palomar bought it! "Most interesting . . . very well put together . . ." says Ham Radio Publishing Group. 21 nationwide dealers are advertising it! What is it? Send 15c stamp for details about "The Comparison of Relative Performance of Commercial Trap Vertical Installations Under Less than Ideal Geographic Conditions." Danrick Enterprises, Dept. 10H, 213 Dayton Ave., Clifton, N.J. 07011.

SCANNERS, CRYSTALS at low Wholesale Prices! Wholesale to Everybody! Prompt Service! Send stamped envelope! Alford's, Box 339-A1, Middlesex, N.C. 27557.

THE MOR-GAIN HD DIPOLES are the most advanced, highest performance multi-band HF dipole antennas available. Patented design provides length one-half of conventional dipoles. 50 ohm feed on all bands, no tuner or balun required. Can be installed as inverted VEE. Thousands in use worldwide. 22 models available including two models engineered for optimum performance for the novice bands. The Mor-Gain HD dipoles N/T series are the only commercial antennas specifically designed to meet the operational requirements of the novice license. Our 1-year warranty is backed by nearly 20 years of HD dipole production experience. Write or call today for our 5-page brochure. (913) 682-3142. Mor-Gain, P.O. Box 329N, Leavenworth, KS 66048.

MOBILE IGNITION SHIELDING provides more range, no noise. Literature. Estes Engineering, 930 Marine Drive, Port Angeles, Wash. 98362.

NEW, Exciting Amateur Operators' Picture Yearbook, sponsored by the First United Pentecostal Church, Inc. Send call sign, address, photo, and \$20 to Lee Kent, WD0FFZ, P.O. Box 236, Malden, MO 63863. You will receive one copy of the book for each \$20. Tell everyone.

QSL's — No stock designs! Your art or ours; photos; originals. 50¢ for samples, details (refundable). Certified Communications, 4138 S. Ferris, Fremont, MI 49412.

MOBILE HF ANTENNA 3.2 — 30 MHz inclusive, 750 watts PEP, center loaded, tuned from the base, eliminating coil changing or removing from mount. Less than 1.5 to 1 VSWR thru entire coverage. 129.95 ea. plus shipping. Contact your local dealer, if none in your area order direct. Antek, Inc., Route One, Hansen, Idaho 83334. (208) 423-4100. Master Chg. and VISA accepted. Dealer and factory rep. inquiries invited.

RATES Regular classified is available to commercial advertisers at 50¢ per word; and to non-commercial advertisers at 15¢ per word. Display classified (1 inch deep x 2 1/4 inches wide) is \$85, or at the 12x rate is \$50. All Ad Scan payable in advance. No cash discounts or agency commissions allowed.

HAMFESTS Sponsored by non-profit organizations receive one free regular classified ad (subject to our editing). Repeat insertions of hamfest ads pay the standard rate.

WRITE No special layout or arrangements available. Material should be typewritten or clearly printed (not all capitals) and must include full name and address. We reserve the right to reject unsuitable copy. HORIZONS cannot check each advertiser and thus cannot be held responsible for claims made. Liability for correctness of material limited to corrected ad in next available issue.

DEADLINE 15th of third preceding month.

SEND MATERIAL TO: Ad Scan, Ham Radio Horizons, Greenville, N. H. 03048.

YAESU FT-207R OWNERS: We have an automatic scan module for your rig. 15 minutes to install; scan restarts when carrier drops off; busy switch controls automatic scan on-off; includes module and instructions. Model AS-1. Send \$25 to Engineering Consulting Services, P.O. Box 94355, Richmond, B.C., V6Y2A8 Canada.

TO SELL: Mirage B1016 2 meter linear amplifier with pre-amp, like new — \$195. Yorx AM-FM stereo 8-track, good condition, \$75. Wilson Mark II with rubber duck antenna, case, assorted crystals — \$185. Radio Shack variable DC supply, good condition — \$15. Mitchell Rakoff, 6433 98th St., Rego Park, NY 11374. Phone: (212) 830-0097.

SMART PEOPLE plan ahead! Prepared for troubled times? Secluded country retreat, haven for your family in war, insurrection. Write: KA2CFO, Box 141, Great Valley, N.Y. 14741.

LEARN CODE THE EASY W6PHA WAY! Former USAF Code Champ gives unique, simple system allowing all ages to learn quickly. Booklet, \$3.00 ppd. Free information with each order offering discounts on Globalman hand keys, code practice oscillators, electronic keyers. Will correspond with booklet purchasers. Global America, P.O. Box 388RH, El Toro, California 92630.

MAKE CODE EASY! Supplement your code program with a self-improvement hypnosis cassette. Tape #3, Learning the Code; Tape #4, Breaking the Speed Barrier. Send \$10.95 each to The John Wolf Self Hypnosis Center, P.O. Box 497, Hayden Lake, Idaho 83835.

FREE Ham Radio Insider Newsletter! Send large SASE: W5YI, Box #10101-H, Dallas, Texas 75207.

CODE got you stumped?

RELAX and worry not! Learn international Morse Code the EASY. Rus Farnsworth way. No books, no gimmicks, just listen & learn. Using the word method, based on modern psychological techniques, you can zoom past 13 w.p.m. in less than half the time! Available in cassettes @ \$10.95 and LP records at \$9.95 — you get over two hours of instruction!

EPSILON RECORDS

P.O. Box 626
San Jacinto, CA 92383

CB TO 10 METER CONVERSIONS. SSB/AM/CW. Let a specialist convert your rig, or buy one complete. Write Conversion Engineering, Box 183, Sandwich, Massachusetts 02563.

HAMS: Try the new *Ad Scan!* Non-commercial ads only 15¢ per word. Commercial ads, as before, are 50¢ per word. Payment with ad, please.

DISTINCTIVE QSL's — Largest selection, lowest prices, top quality photo and completely customized cards. Make your QSL's truly unique at the same cost as a standard card, and get a better return rate! Free samples, catalogue. Stamps appreciated. Stu Goodman, K2PRZ Print, P.O. Box 412, Rocky Point, N.Y. 11778, (516) 744-6260.

HAM RADIO REPAIR, alignment. Hassle-free from anywhere via UPS. Expert, prompt, reasonable. Modern lab. "Grid" Gridley, W4GJO, Route 2, Box 138B, Rising Fawn, GA 30738.

CB TO 10 METER PROFESSIONALS — Your rig or buy ours — AM/SSB/CW. Certified Communications, 4138 So. Ferris, Fremont, Michigan 49412; (616) 924-4561.

HAM: Are you in the Mail Order Business? Read this condensed wealth of information and AVOID LEGAL PROBLEMS. "Mailorder Laws and Regulations." Order today. Only \$3.00. Write: MHM Mailorder Service, Box 5, Morton Grove, Ill. 60053-H.

QSLs & RUBBER STAMPS — All Top Quality Merchandise! QSLs: Glossy Inks and Cardstock. Rubber Stamps: Report Forms, Call Letter, Address. Card Samples and Stamp Information 50¢. Ebbert Graphics 5H, Box 70, Westerville, Ohio 43081.

QSLs SECOND TO NONE. Same day service. Samples 50 cents. Include your call for free decal. Ray, K7HLR, Box 331, Clearfield, UT 84015.

MAGAZINE SAMPLES! For a free list of over 135 magazines offering a sample copy, send a stamped, addressed envelope to: Publishers Exchange, P.O. Box 1368, Dept. 26A, Plainfield, NJ 07061.

QSL INSURANCE. No more QRL DX operators, managers, or bureaus. New product called "Confirmation Mailer" is your best guarantee in Amateur Radio of receiving a fast direct reply. \$5.50 brings you 30 Policies! Bob Zittnan, K9UJA, P.O. Box 94973, Schaumburg, IL 60193.

QSLs with class! Unbeatable quality, reasonable price. Samples: 50¢ refundable. QSLs Unlimited, 1472 SW 13th Street, Boca Raton, FL 33432.

DX — YOU BET! The DX Bulletin — Best weekly DX info in the world — send for FREE sample copy. The DX Bulletin, 306 Vernon Avenue, Vernon, Connecticut 06066.

"CADILLAC" of QSL's — FAST 100-\$9.95 — Our Design. Send \$1.00 for samples — Refundable. MAC's SHACK, P.O. Box 43175, Seven Points, Texas 75143.

STOP LOOKING for a good deal on amateur radio equipment — you've found it here — at your amateur radio headquarters in the heart of the Midwest. Now more than ever where you buy is as important as what you buy! We are factory-authorized dealers for Kenwood, Drake, Yaesu, Collins, Wilson, Ten-Tec, Atlas, ICOM, DenTron, MFJ, Tempo, Regency, Hy-Gain, Mosley, Alpha, Cushcraft, Swan and many more. Write or call us today for our low quote and try our personal and friendly Hoosier service. HOOSIER ELECTRONICS, P.O. Box 2001, Terre Haute, Indiana 47802. (812) 238-1456.

ELECTRONIC BARGAINS, CLOSEOUTS, SURPLUS! Parts, equipment, stereo, industrial, educational. Amazing values! Fascinating items unavailable in stores or catalogs anywhere. Unusual FREE catalog. ETCO-059, Box 762, Plattsburgh, N.Y. 12901.

FOR SALE: Argonaut 509, S-30 speaker/cw filter, \$300; 405 linear, 251 P.S., \$225; mint package, \$475; Drake TR22C, fully crystallized, \$140; Drake SSR-1, \$210; Kenwood R599 with cw filter/2M conv., \$240; add UPS, WA7ZYQ, 208-245-2070.

COMING EVENTS

NEW JERSEY QSO Party: 2000 UTC Saturday, August 16th to 0700 UTC Sunday, August 17th; and from 1300 UTC Sunday, August 17th, to 0200 UTC Monday, August 18th. Contact station once on each band. Phone and CW are same contest, but separate bands. New Jersey stations call CQ New Jersey (phone) or CQ NJ (CW), and sign DE NJ (CW) or New Jersey Calling (phone). Frequencies: 1810, 3535, 3900, 7035, 7135, 7235, 14035, 14280, 21100, 21355, 28100, 28610, 50.0-50.5; 144-146. Suggest phone on even hours; 15 meters on odd hours; 160 meters at 0500 UTC. Exchange QSO number, RST, QTH (ARRL section or country). NJ stations will send county for their QTH. Logs must show UTC date and time, band, emission, and be received no later than September 13, 1980. Send to: Englewood ARA, Inc., P.O. Box 528, Englewood, N.J. 07631.

RADIO EXPO '80' — Lake County Fair Grounds, Rt. 45 & 120. September 8 and 7. Advance tickets \$2.00, \$3.00 at gate. Write Radio Expo Tickets, P.O. Box 1532, Evanston, IL 60204. Exhibitor information call (312) BST-EXPO.

NORTH CAROLINA: Cape Fear ARS Hamfest, August 16th and 17th, main officer's club, Fort Bragg, N.C. Prizes; Saturday night social, and QCWA luncheon meeting Sunday. Talk-in on 148.31/.91; 147.93/.33; and 148.52 simplex. Tickets \$1 advance, \$2 door. S.A.S.E. to Marie Presler, WA4YMM, P.O. Box 35171, Fayetteville, North Carolina 28303.

KENTUCKY — Bluegrass A.R.S. hosts the Central Kentucky Bluegrass Hamfest, August 10, 1980, at the Fasig-Tipton Sales Paddock, Newton Pike, Lexington, Kentucky. Gates open 8 AM. Admission \$3 advance, \$3.50 at gate, includes parking. Prizes, forums, exhibits, flea-market. Food service available. Talk-in 146.18/.78. Details from Edward Bono, WA4ONE, Bluegrass Hamfest, 2077 Dogwood Drive, Lexington, Kentucky 40504.

MAINE: Sandy River ARC Hamfest & Flea Market, Saturday and Sunday, August 16th and 17th, 1980 at the Fair Grounds in Farmington, Maine. Admission \$1, no charge for tailgating. Commercial dealers welcome. Door prizes both days, and a raffle at 1 P.M. on Sunday. Free camping 5 P.M. Friday until Sunday afternoon. Snacks and refreshments during both days, plus a lobster or chicken dinner late Saturday afternoon. Talk-in on 146.37/.97 and 146.52. For map and information, S.A.S.E. to Charles Stenger, W1HTG, Box 111, East Dixfield, Maine 04227.

PENNSYLVANIA — South Hills Brass Pounders and Modulators Hamfest, Sunday, August 3, 1980 at the South Campus of Allegheny Community College, off Route 885 in West Milflin Borough, south of Pittsburgh. Air-conditioned indoor facilities, outdoor flea market, dealers, forums, demonstration, food, prizes. Doors open 11 AM. Talk-in 146.13/.73 and 146.52 simplex. For information contact Doug Wilson, WA3NZP, 185 Orchard Avenue, Ensworth, PA 15202.

PRODUCT SHOWCASE

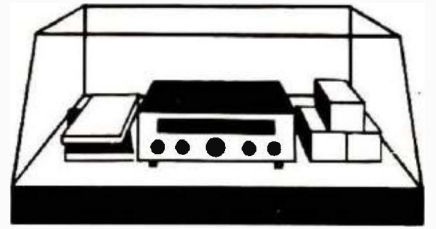

Heathkit Multiple Outlet Box

If you have ever started a home do-it-yourself project only to run out of electrical outlets, Heath Company has a solution. Heath, world's largest manufacturer of electronic kits, has introduced a new six-socket Multiple Outlet Box kit.

This easy-to-build kit provides you with additional electrical outlets for your equipment in workshop, basement, garage, dark room, or ham radio shack — anywhere that extra outlets are needed. It features six three-hole outlets: five switched for killing power to equipment not in use, and one unswitched for clock or computer-memory save. The kit includes fuse, fuse holder, and six-foot cord. Mail-order priced at \$12.95, the Multiple Outlet Box is designed to handle a 10 ampere maximum load on 120 Vac lines.

The Multiple Outlet Box is just one of nearly 400 build-it-yourself electronic kits featured in the latest Heathkit catalog. For a free copy write: Heath Company, Dept. 350-300, Benton Harbor, Michigan 49022. (In Canada write: Heath Company, 1480 Dundas Highway East, Mississauga, Ontario L4X 2R7.) Or, pick up your free copy at the nearest Heathkit Electronic Center (units of Veritechnology Electronics Corporation in the U.S.A.). See the white pages of your telephone directory for the store nearest you.

Erratum: The telephone number and address of RADIOS INTERNATIONAL (page 66 June Horizons) has been changed. The new telephone number is (813) 623-2631.

HRH LOCATOR

TO HELP YOU FIND YOUR LOCAL AMATEUR RADIO DEALER

Arizona

POWER COMMUNICATIONS CORP.
6012 N. 27th AVENUE
PHOENIX, AZ 85017
602-242-6030 or 242-8990
Arizona's #1 "Ham" Store, Kenwood, Yaesu, Icom, and more.

California

JUN'S ELECTRONICS
11656 W. PICO BLVD.
LOS ANGELES, CA 90064
213-477-1824 Trades
714-463-1886 San Diego
The Home of the One Year Warranty
— Parts at Cost — Full Service.

SHAVER RADIO, INC.
1378 S. BASCOM AVE.
SAN JOSE, CA 95128
408-998-1103
Atlas, Kenwood, Yaesu, KDK, Icom, Tempo, Wilson, Ten-Tec, VHF Engineering.

TELE-COM
15460 UNION AVENUE
SAN JOSE, CA 95124
408-377-4479

Connecticut

HATRY ELECTRONICS
500 LEDYARD ST. (SOUTH)
HARTFORD, CT 06114
203-527-1881
Connecticut's Oldest Ham Radio Dealer.

THOMAS COMMUNICATIONS
95 KITTS LANE
NEWINGTON, CT 06111
203-667-0811
Authorized dealer for Kenwood, Yaesu, Drake, Icom, etc. - CALL US.

Delaware

DELAWARE AMATEUR SUPPLY
71 MEADOW ROAD
NEW CASTLE, DE 19720
302-328-7728
Icom, Ten-Tec, Swan, DenTron, Wilson, Tempo, KDK, and more.
One mile off I-95, no sales tax.

Florida

AGL ELECTRONICS, INC.
1898 DREW STREET
CLEARWATER, FL 33515
813-461-HAMS
West Coast's Only Full Service Amateur Radio Store

AMATEUR RADIO CENTER, INC.
2805 N.E. 2ND AVENUE
MIAMI, FL 33137
305-573-8383
The Place For Great Dependable Names in Ham Radio

RAY'S AMATEUR RADIO
1590 US HWY. 19 SOUTH
CLEARWATER, FL 33516
813-535-1416
Sales and Service. Your Complete Amateur Radio Store.

SUNRISE AMATEUR RADIO
1351 STATE RD. 84
FT. LAUDERDALE, FL 33315
(305) 761-7676
"Best Prices in Country.
Try Us — We'll prove it."

Illinois

AUREUS ELECTRONICS INC.
1415 N. EAGLE STREET
NAPERVILLE, IL 60540
312-420-8629
"Amateur Excellence"

ERICKSON COMMUNICATIONS, INC.
5456 NORTH MILWAUKEE AVE.
CHICAGO, IL 60630
312-631-5181
Outside Illinois 800-621-5802
Hours 9:30-5:30 Mon., Tues., Wed.,
Fri.; 9:30-9:00 Thurs.; 9:00-3:00 Sat.

KLAUS RADIO, INC.
8400 NO. PIONEER PARKWAY
PEORIA, IL 61614
309-691-4840
Let Us Quote Your Amateur Needs.

Kansas

ASSOCIATED RADIO COMM
8012 CONSER
OVERLAND PARK, KS 66204
913-381-5900
America's No. 1 Real Amateur Radio Store. Trade - Sell - Buy.

Maryland

THE COMM CENTER, INC.
LAUREL PLAZA RT. 198
LAUREL, MD 20810
800-638-4486
Kenwood, Drake, Icom, Ten-Tec, Tempo, DenTron, Swan & Apple Computers.

Massachusetts

TEL-COM, INC.
675 GREAT RD., RT. 119
LITTLETON, MA 01460
617-486-3040
The Ham Store of New England
You Can Rely On.

Minnesota

PAL ELECTRONICS INC.
3452 FREMONT AVE. NO.
MINNEAPOLIS, MN 55412
612-521-4662
Midwest's Fastest Growing Ham Store. Where Service Counts.

New Hampshire

EVANS RADIO, INC.
BOX 893, RT. 3A BOW JUNCTION
CONCORD, NH 03301
603-224-9961
Icom, DenTron, Yaesu, Drake.
We service what we sell.

New Jersey

RADIOS UNLIMITED
P. O. BOX 347
1760 EASTON AVENUE
SOMERSET, NJ 08873
201-469-4599
New Jersey's Fastest Growing Ham Store.

HRH LOCATOR

Continued

ROUTE ELECTRONICS 46
225 ROUTE 46 WEST
TOTOWA, NJ 07512
201-256-8555
Drake, Swan, DenTron, Cushcraft,
Hy-Gain, Hustler, Larsen and more.

WITTIE ELECTRONICS
384 LAKEVIEW AVE.
CLIFTON, NJ 07011
201-772-2222
Same location for 62 years.
Full-line authorized Drake dealer.

New Mexico

**PECOS VALLEY AMATEUR
RADIO SUPPLY**
115 W. WALNUT STREET
ROSWELL, NM 88201
505-623-7388
Your DX, Contest and Antenna
Headquarters featuring A.E.A., Hy-
Gain, Azden, Butternut, and Most
Major Brands.

New York

GRAND CENTRAL RADIO
124 EAST 44 STREET
NEW YORK, NY 10017
212-599-2630
Drake, Kenwood, Yaesu, Atlas,
Ten-Tec, Midland, Hy-Gain,
Mosley in stock.

HAM-BONE RADIO
(Oiv. Stereo Repair Shop)
3206 ERIE BOULEVARD EAST,
SYRACUSE, NY 13214
315-446-2266
We Deal, We Trade,
We Discount, We Please!
2-Way Service Shop on Premises!

HARRISON RADIO CORP.
20 SMITH STREET
FARMINGDALE, NY 11735
516-293-7990
"Ham Headquarters USA®"
since 1925.
Call toll free 800-645-9187.

RADIO WORLD
ONEIDA COUNTY AIRPORT
TERMINAL BLDG.
ORISKANY, NY 13424
800-448-7914
315-337-2622 } NY
315-337-0203 } Res.
New & Used Ham Equipment. See
Warren K2IXN or Bob WA2MSH

Ohio

UNIVERSAL AMATEUR RADIO, INC.
1280 AIDA DRIVE
COLUMBUS (REYNOLDSBURG)
OH 43068
614-866-4267
Complete Amateur Radio Sales and
Service. All major brands - spacious
store - near I-270.

Pennsylvania

**HAMTRONICS, DIV. OF
TREVOS ELECT.**
4033 BROWNSVILLE RD.
TREVOS, PA 19047
215-357-1400
Same Location for
More Than 30 Years.

LaRUE ELECTRONICS
1112 GRANDVIEW STREET
SCRANTON, PENNSYLVANIA 18509
717-343-2124
ICOM, Bird, Cushcraft, CDE,
Ham-Keys, VHF Engineering,
Antenna Specialists.

SPECIALTY COMMUNICATIONS
2523 PEACH STREET
ERIE, PA 16502
814-455-7674
Service, Parts, & Experience
For Your Atlas Radio.

Dealers:

You should be
here too! Contact
HORIZONS today
for complete details.

TOLL FREE 800-258-5353

TOWERS

by ALUMA

HIGHEST QUALITY
ALUMINUM & STEEL

60 Ft. Aluminum
Crank-Up
Model T-60-H

40' Steel
Crank-Up
Model SHO-40

- ★ TELESCOPING
(CRANK UP)
- ★ GUYED (STACK-UP)
- ★ TILT-OVER MODELS

Easy to install. Low Prices.
Crank-ups to 100 ft.

EXCELLENT FOR
HAM COMMUNICATIONS

SPECIAL
Four Section 50 Ft.
Van Mounted Crank-Up
Aluma Tower

Over 36 types aluminum
and steel towers made—
specials designed and
made—write for details



ALUMA TOWER CO.
Box 2806 MH
VERO BEACH, FLA. 32960
PHONE (305) 567-3423
TELEX 80-3405

Upgrade Your CW Easily

DATONG



Model D70
MORSE TUTOR

- Produces random five character groups: all letters, all figures, or mixed.
- Calibrated variable speed (5% to 37 words per minute) and variable delay (up to 3 seconds) between letters for optimum learning efficiency.
- Internal loudspeaker, plus personal ear-piece for private listening. And pocket size.
- Battery operated therefore always ready for use. Current drain is very low for long battery life.
- Eleven IC, CMOS circuit for long internal battery life.
- Built-in tone oscillator for sending practice (key required).

\$159.95 Including Pre-Paid
Shipping &
Full Insurance
Dealer Inquiries Invited
Made in England • 90 Day Warranty
Visa Mastercard Accepted

(Exclusive Importers of DATONG FL-1's)

AR Technical Dedicated
Products to Experience
Corp.

Box 82
Birmingham, Michigan 48012
Telephone 313/644-5698



**A FLEA GROWS IN HAMERICA!
YES, A NATIONAL MARKET PLACE
FOR DEALINGS IN USED GEAR.**

1879 POST RD. P.O. BOX 66, SOUTHPORT, CT 06490

HGM matches Buyers with Owners of used equipment. Perfectly! Register gear you want to sell or buy, nationally, for only \$3.73. At least once a week, HGM compares Buyer specifications to all available equipment registered by Owners. For each perfect match, HGM writes Buyers the particulars about the gear. Buyers contact Owners directly, and all negotiations are strictly between Owners and Buyers.

HGM GUARANTEE. Just \$3.73 per registration to "sell" or a "buy", and your Registration remains active for 17 unique matchings or 17 months. No HGM commissions! We cannot warrant or guarantee any equipment found through HGM since everything is between Owners and Buyers. But we do guarantee unique matchings and 17 matchings or months. A fabulous service for the smallest service!

REGISTER NOW. Use this form or facsimile and enclose the \$3.73 fee for each Registration. OWNERS: Describe unit by Type, Brand, and Model. Indicate exact Sell Price and purchase date. BUYERS have two choices. Choice #1: Type of Gear, indicate Type and one Price Range. Example: Transceiver, \$700-899. Choice #2: Specific Unit, regardless of price, indicate specific Brand and Model you want. Example: Transceiver, Ten-Tec, Century 21.

YES, hamgearmart, I need your help! I understand your Guarantee, and I'm enclosing \$3.73 with this Registration. Enter my Registration immediately. Please register me as a

OWNER <input type="checkbox"/>		BUYER <input type="checkbox"/>	
SELL PRICE	TYPE OF GEAR	PRICE RANGES	
GEAR YEAR	XCVR SCOPE ETC	A 40 - 99	
PURCHASED	BRAND NAME	B 100 - 199	
NEW/USED	MODEL NUMBER	C 200 - 299	
		D 300 - 399	
		E 400 - 524	
		F 525 - 699	
		G 700 - 899	
		H 900 - 1099	
		I 1100 - 1399	
		J 1400 AND UP	
NAME	CALL	CLASS	
ADDRESS	TELEPHONE		
CITY	STATE	ZIP	
1879 Post Road, P.O. Box 66 Southport, Connecticut 06490			

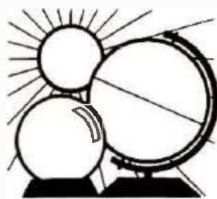

DX FORECASTER

Last-minute information

This month there will be *two* eclipses: one of the sun (an annular eclipse on August 10th) and one of the moon (a penumbral eclipse on August 26th). The annual eclipse of the sun will begin at 16 hours and 15 minutes (approximately) UTC and will end at 22 hours and 10 minutes. The path of annularity will be from central and western South America, starting at about 22 degrees south latitude, and ending in the eastern Pacific at about 2 degrees north latitude. Other locations will observe only partial eclipse conditions. Maximum conditions will occur approximately at 18 hours UTC.

The penumbral eclipse of the moon will begin at approximately 1 hour, 42 minutes UTC, will reach a maximum at approximately 3 hours, 31 minutes, and will end at about 5 hours 21 minutes. The beginning will be visible in the western Indian Ocean, Africa, extreme western Asia, Europe, Atlantic Ocean, eastern North America, South America, most of Antarctica, and the eastern South Pacific. The end will be visible in extreme western Europe and Africa, the Atlantic Ocean, North America (except the extreme northwestern part), South America, the eastern Pacific, and most of Antarctica.

The annular eclipse of the sun will be very interesting from the standpoint of communications for the following reasons: it occurs at a time when there is a possibility of some solar flare activity, together with an unsettled geomagnetic field, and during midday in the eastern United States. Thus, the opportunity to observe changing propagation conditions under almost ideal circumstances will be present. One should look for changes in signal strength, particularly on the trans-equatorial path to South America and Africa, as well as to Oceania, and even Australia and New Zealand, as daytime propagation conditions turn into nighttime propagation conditions. It is

expected that D-layer absorption will decrease, making the 40-meter band particularly good for DX at an unusually early time of day, while 10, 15, and 20 meter bands may shift toward the west earlier than expected under normal conditions.

The lunar eclipse will be less interesting from a radio standpoint, although it occurs within about one day of perigee, which will interest EME participants. For the rest of us, it will be nice to watch, starting about 9:45 in the evening in the eastern U.S. (8:45 Central, and 6:45 Pacific daylight time) and — barring cloudy conditions — should present an interesting sight.

The forecast for DXers will be somewhat abbreviated this month, but — in general — you may look for the following conditions on the HF bands.

Band-by-band forecast

Ten meters will begin to provide good openings during the daylight hours for short and long skip. Look for particularly good transequatorial openings from about early afternoon until sundown.

Fifteen meters will be much like ten meters, but a bit more "solid" — with good signals both on long skip to most areas of the world, and on short skip beyond about 750 miles (1200 km).

Twenty meters will be open around the clock on most days, and will be the long-skip/short-skip workhorse of the HF DX bands. Signals will peak in the morning and afternoon hours, but will be readable to one area or another all the day and night.

Forty meters is going to start coming back strong, except for the high QRN levels, during the evening hours. This is a *nighttime* band, so plan on losing some sleep if you're a DXer. Look eastward during the late evening hours, westward during the early morning hours.

Eighty and One-sixty meters will become active once again for DX purposes during the nighttime hours, with strong openings into the south. However, European openings may be expected, although on fewer days of the month. Once again, QRN will limit your ability to hear the weak ones on days of thunderstorm activity. Happy DX, and use the chart to help on a particular path at the time and band of your choice.

HRH

RADIO WAREHOUSE

No Frills, Just Low Prices

\$439⁹⁵



TR-9000

KENWOOD



\$359⁹⁵

TR-2400

ICOM IC-255 A

*309⁹⁵

HM-8 TOUCHTONE® MIKE

*34⁹⁵



ICOM 720

in stock

Call or Write for Quote
All Major Brands

P.O. BOX 2728
DALLAS, TX 75201

Telephone: (817) 496-9000

HAM CALENDAR

August

Sunday	Monday	Tuesday	Wednesday	Thursday	Friday	Saturday
<p>1980 Jacksonville Hamfest and ARRL Florida State Convention — The Orange Park Kennel Club, Jacksonville, Florida — 2,3</p> <p>Stroben County Radio Amateurs — Twenty-second annual Tri-State F.M. Picnic and Hamfest — Angola, Indiana — WB9VIT 3</p> <p>South Hills Brass Pounders and Modulators Hamfest — South Campus of Allegheny Community College, West Mifflin, Pa., Pennsylvania — WA3ZNP — 3</p>	<p>Florida Ham News — Swap Net By the Boward ARC 146.31 911 at 7:30 PM</p> <p>Glenhurst Radio Society Transmits Amateur Radio News — 222.66/224.26 MHz via WRZAPG and 21.400 MHz USB</p> <p>West Coast Bulletin, Edited & Transmitted by W6ZL 8:00 PM PST 35-40 MHz A 1, 22 WPM</p>	<p>AMSAT Eastcoast Net 3850 kHz 9:00 PM EDT (10:00Z Wednesday Morning)</p> <p>AMSAT Mid Continent Net 3850 kHz 9:00 PM CDST (0200Z Wednesday Morning)</p> <p>AMSAT Westcoast Net 3850 kHz 8:00 PM PDT (0300Z Wednesday Morning)</p>	<p>AMSAT Eastcoast Net 3850 kHz 9:00 PM EDT (10:00Z Wednesday Morning)</p> <p>AMSAT Mid Continent Net 3850 kHz 9:00 PM CDST (0200Z Wednesday Morning)</p> <p>AMSAT Westcoast Net 3850 kHz 8:00 PM PDT (0300Z Wednesday Morning)</p>	<p>AMSAT Eastcoast Net 3850 kHz 9:00 PM EDT (10:00Z Wednesday Morning)</p> <p>AMSAT Mid Continent Net 3850 kHz 9:00 PM CDST (0200Z Wednesday Morning)</p> <p>AMSAT Westcoast Net 3850 kHz 8:00 PM PDT (0300Z Wednesday Morning)</p>	<p>AMSAT Eastcoast Net 3850 kHz 9:00 PM EDT (10:00Z Wednesday Morning)</p> <p>AMSAT Mid Continent Net 3850 kHz 9:00 PM CDST (0200Z Wednesday Morning)</p> <p>AMSAT Westcoast Net 3850 kHz 8:00 PM PDT (0300Z Wednesday Morning)</p>	<p>AMSAT Eastcoast Net 3850 kHz 9:00 PM EDT (10:00Z Wednesday Morning)</p> <p>AMSAT Mid Continent Net 3850 kHz 9:00 PM CDST (0200Z Wednesday Morning)</p> <p>AMSAT Westcoast Net 3850 kHz 8:00 PM PDT (0300Z Wednesday Morning)</p>
<p>St. Cloud Radio Club's Annual Ham-Fest — Wherry Park Senior Center, St. Cloud, Minnesota — W4DQTO — 10</p> <p>Central Lakes Area West Virginia — W4BCTD — 10</p> <p>Hamfesters Radio Club's 60th annual Hamfest — Santa Fe Park, Wilkes Springs, Illinois — WB2ZSP — 10</p> <p>The Bluegrass Amateur Radio Society's annual ARRL Central Kentucky Bluegrass Hamfest — Fossil Tip-on Sales Padlock, Lexington, Kentucky — WA4QNE — 10</p>	<p>Florida Ham News — Swap Net By the Boward ARC 146.31 911 at 7:30 PM</p> <p>Glenhurst Radio Society Transmits Amateur Radio News — 222.66/224.26 MHz via WRZAPG and 21.400 MHz USB</p>	<p>AMSAT Eastcoast Net 3850 kHz 9:00 PM EDT (10:00Z Wednesday Morning)</p> <p>AMSAT Mid Continent Net 3850 kHz 9:00 PM CDST (0200Z Wednesday Morning)</p> <p>AMSAT Westcoast Net 3850 kHz 8:00 PM PDT (0300Z Wednesday Morning)</p>	<p>AMSAT Eastcoast Net 3850 kHz 9:00 PM EDT (10:00Z Wednesday Morning)</p> <p>AMSAT Mid Continent Net 3850 kHz 9:00 PM CDST (0200Z Wednesday Morning)</p> <p>AMSAT Westcoast Net 3850 kHz 8:00 PM PDT (0300Z Wednesday Morning)</p>	<p>AMSAT Eastcoast Net 3850 kHz 9:00 PM EDT (10:00Z Wednesday Morning)</p> <p>AMSAT Mid Continent Net 3850 kHz 9:00 PM CDST (0200Z Wednesday Morning)</p> <p>AMSAT Westcoast Net 3850 kHz 8:00 PM PDT (0300Z Wednesday Morning)</p>	<p>AMSAT Eastcoast Net 3850 kHz 9:00 PM EDT (10:00Z Wednesday Morning)</p> <p>AMSAT Mid Continent Net 3850 kHz 9:00 PM CDST (0200Z Wednesday Morning)</p> <p>AMSAT Westcoast Net 3850 kHz 8:00 PM PDT (0300Z Wednesday Morning)</p>	<p>AMSAT Eastcoast Net 3850 kHz 9:00 PM EDT (10:00Z Wednesday Morning)</p> <p>AMSAT Mid Continent Net 3850 kHz 9:00 PM CDST (0200Z Wednesday Morning)</p> <p>AMSAT Westcoast Net 3850 kHz 8:00 PM PDT (0300Z Wednesday Morning)</p>
<p>The North Alabama Hamfest — Von Braun Civic Center in Huntsville, Alabama — 17</p> <p>5th Annual New Delaware Hamfest — Glenhead Park, Bear, Delaware — K3HPB — 17</p> <p>Mid-Atlantic Amateur Radio Club's Annual J.B.M. Hamfest — Route 304 Drive-in Theater, Monongomerville, Pennsylvania — WB3VAT — 17</p> <p>Warren Amateur Radio Association 23rd Hamfest — Trumbull Branch, Kent State University, Warren, Ohio — KB8NY — 17</p> <p>The Lafayette, Indiana Hamfest — Tipperance County Fairgrounds, Lafayette, Indiana — W9PEG — 17</p>	<p>Florida Ham News — Swap Net By the Boward ARC 146.31 911 at 7:30 PM</p> <p>Glenhurst Radio Society Transmits Amateur Radio News — 222.66/224.26 MHz via WRZAPG and 21.400 MHz USB</p>	<p>AMSAT Eastcoast Net 3850 kHz 9:00 PM EDT (10:00Z Wednesday Morning)</p> <p>AMSAT Mid Continent Net 3850 kHz 9:00 PM CDST (0200Z Wednesday Morning)</p> <p>AMSAT Westcoast Net 3850 kHz 8:00 PM PDT (0300Z Wednesday Morning)</p>	<p>AMSAT Eastcoast Net 3850 kHz 9:00 PM EDT (10:00Z Wednesday Morning)</p> <p>AMSAT Mid Continent Net 3850 kHz 9:00 PM CDST (0200Z Wednesday Morning)</p> <p>AMSAT Westcoast Net 3850 kHz 8:00 PM PDT (0300Z Wednesday Morning)</p>	<p>AMSAT Eastcoast Net 3850 kHz 9:00 PM EDT (10:00Z Wednesday Morning)</p> <p>AMSAT Mid Continent Net 3850 kHz 9:00 PM CDST (0200Z Wednesday Morning)</p> <p>AMSAT Westcoast Net 3850 kHz 8:00 PM PDT (0300Z Wednesday Morning)</p>	<p>AMSAT Eastcoast Net 3850 kHz 9:00 PM EDT (10:00Z Wednesday Morning)</p> <p>AMSAT Mid Continent Net 3850 kHz 9:00 PM CDST (0200Z Wednesday Morning)</p> <p>AMSAT Westcoast Net 3850 kHz 8:00 PM PDT (0300Z Wednesday Morning)</p>	<p>AMSAT Eastcoast Net 3850 kHz 9:00 PM EDT (10:00Z Wednesday Morning)</p> <p>AMSAT Mid Continent Net 3850 kHz 9:00 PM CDST (0200Z Wednesday Morning)</p> <p>AMSAT Westcoast Net 3850 kHz 8:00 PM PDT (0300Z Wednesday Morning)</p>
<p>Annual LaPorte County Hamfest — County Fairgrounds, west of LaPorte, Indiana — K9DZE — 24</p> <p>Gloucester County ARC's Second Annual Hamfest — Gloucester County College, Sewell, New Jersey — KN2QMO — 24</p> <p>Fox River Radio League Hamfest — Kane County Fairgrounds, St. Charles, Illinois — W9ZGP — 24</p>	<p>Florida Ham News — Swap Net By the Boward ARC 146.31 911 at 7:30 PM</p> <p>Glenhurst Radio Society Transmits Amateur Radio News — 222.66/224.26 MHz via WRZAPG and 21.400 MHz USB</p>	<p>AMSAT Eastcoast Net 3850 kHz 9:00 PM EDT (10:00Z Wednesday Morning)</p> <p>AMSAT Mid Continent Net 3850 kHz 9:00 PM CDST (0200Z Wednesday Morning)</p> <p>AMSAT Westcoast Net 3850 kHz 8:00 PM PDT (0300Z Wednesday Morning)</p>	<p>AMSAT Eastcoast Net 3850 kHz 9:00 PM EDT (10:00Z Wednesday Morning)</p> <p>AMSAT Mid Continent Net 3850 kHz 9:00 PM CDST (0200Z Wednesday Morning)</p> <p>AMSAT Westcoast Net 3850 kHz 8:00 PM PDT (0300Z Wednesday Morning)</p>	<p>AMSAT Eastcoast Net 3850 kHz 9:00 PM EDT (10:00Z Wednesday Morning)</p> <p>AMSAT Mid Continent Net 3850 kHz 9:00 PM CDST (0200Z Wednesday Morning)</p> <p>AMSAT Westcoast Net 3850 kHz 8:00 PM PDT (0300Z Wednesday Morning)</p>	<p>AMSAT Eastcoast Net 3850 kHz 9:00 PM EDT (10:00Z Wednesday Morning)</p> <p>AMSAT Mid Continent Net 3850 kHz 9:00 PM CDST (0200Z Wednesday Morning)</p> <p>AMSAT Westcoast Net 3850 kHz 8:00 PM PDT (0300Z Wednesday Morning)</p>	<p>AMSAT Eastcoast Net 3850 kHz 9:00 PM EDT (10:00Z Wednesday Morning)</p> <p>AMSAT Mid Continent Net 3850 kHz 9:00 PM CDST (0200Z Wednesday Morning)</p> <p>AMSAT Westcoast Net 3850 kHz 8:00 PM PDT (0300Z Wednesday Morning)</p>
<p>3rd Annual Rockford Hamfest and Illinois State ARRL Convention — Wenebago County Fairgrounds, Pecatonica, Illinois — WD9VF — 31</p> <p>Five Flags Amateur Radio Association, Inc.'s 1980 Ham-A-Rama — Pensacola Municipal Auditorium, Pensacola, Florida — W4RQH — 31</p>	<p>Florida Ham News — Swap Net By the Boward ARC 146.31 911 at 7:30 PM</p> <p>Glenhurst Radio Society Transmits Amateur Radio News — 222.66/224.26 MHz via WRZAPG and 21.400 MHz USB</p>	<p>AMSAT Eastcoast Net 3850 kHz 9:00 PM EDT (10:00Z Wednesday Morning)</p> <p>AMSAT Mid Continent Net 3850 kHz 9:00 PM CDST (0200Z Wednesday Morning)</p> <p>AMSAT Westcoast Net 3850 kHz 8:00 PM PDT (0300Z Wednesday Morning)</p>	<p>AMSAT Eastcoast Net 3850 kHz 9:00 PM EDT (10:00Z Wednesday Morning)</p> <p>AMSAT Mid Continent Net 3850 kHz 9:00 PM CDST (0200Z Wednesday Morning)</p> <p>AMSAT Westcoast Net 3850 kHz 8:00 PM PDT (0300Z Wednesday Morning)</p>	<p>AMSAT Eastcoast Net 3850 kHz 9:00 PM EDT (10:00Z Wednesday Morning)</p> <p>AMSAT Mid Continent Net 3850 kHz 9:00 PM CDST (0200Z Wednesday Morning)</p> <p>AMSAT Westcoast Net 3850 kHz 8:00 PM PDT (0300Z Wednesday Morning)</p>	<p>AMSAT Eastcoast Net 3850 kHz 9:00 PM EDT (10:00Z Wednesday Morning)</p> <p>AMSAT Mid Continent Net 3850 kHz 9:00 PM CDST (0200Z Wednesday Morning)</p> <p>AMSAT Westcoast Net 3850 kHz 8:00 PM PDT (0300Z Wednesday Morning)</p>	<p>AMSAT Eastcoast Net 3850 kHz 9:00 PM EDT (10:00Z Wednesday Morning)</p> <p>AMSAT Mid Continent Net 3850 kHz 9:00 PM CDST (0200Z Wednesday Morning)</p> <p>AMSAT Westcoast Net 3850 kHz 8:00 PM PDT (0300Z Wednesday Morning)</p>

ALPHA

Next best isn't even close.

Like the Royal Gorge bridge at Canon City—the world's highest, suspended 1053 feet above the Arkansas River—an **ALPHA** hf linear amplifier is in a class by itself. Whatever's "next best" isn't even close!

A "next best" amplifier **CAN T** give you **No Tune Up** convenience with maximum legal power in all modes. ONLY **ALPHA 374A** AND **ALPHA 78** CAN.

"Next best" can't deliver full CW break-in capability AND maximum legal power in all modes, either. ONLY **ALPHA 77Dx** AND **ALPHA 78** CAN.

Nor will "next best" provide you the protection of a **TWO YEAR** (limited) **FACTORY WARRANTY** for amateur service, or an unequivocal "**key-down-no-time-limit**" full kilowatt power rating. You'd probably have to settle for 90 days and an ambiguous reference to "**continuous duty**", BUT YOU GET THAT WARRANTY AND RATING WITH EVERY **ALPHA!**

IF NEXT BEST ISN'T GOOD ENOUGH FOR YOU, ALPHA IS THE ANSWER.



RF TECHNICIANS AND ENGINEERS!

ETO offers an exceptional opportunity to work on exciting new projects while enjoying life in "the garden spot of the Rockies." We need a few self-starters with proven ability and hands-on rf/hf power experience to develop and produce new equipment for existing medical, communications, and industrial/

scientific applications. Please send resume.

ETO EHRHORN TECHNOLOGICAL OPERATIONS, INC.
P.O. BOX 708, CANON CITY, CO 81212
(303) 275-1613

AD CHECK

... for literature, in a hurry — we'll rush your name to the companies whose names you check.

Place your check mark in the space between name and number. Example: HRH 150.

AR Tech. ___ 687	Kantronics *
A. E. A. ___ 677	Kenwood *
Aluma ___ 589	MFJ ___ 082
Barry *	Madison ___ 431
Bencher ___ 629	Microcraft ___ 774
Bilal ___ 817	Microwave Filter ___ 637
Curtis Electro ___ 034	OK Machine *
Cushcraft *	Palomar Eng. *
DWS Marketing *	RSE Ham Shack ___ 607
DenTron Radio ___ 259	Callbook ___ 100
Digitrex ___ 823	Constructor *
Drake *	Radio Warehouse *
E. T. O. *	Radio World *
Engineering Consulting *	S-F A. R. S. ___ 640
Erickson *	Step ___ 232
Grove ___ 848	Spec. Comm. ___ 335
Hal ___ 057	Swan ___ 111
Ham Gear Mart *	Switchcraft ___ 849
HRB ___ 150	Ten-Tec *
Hamtronics ___ 246	Texas Towers *
Heath ___ 060	Van Gorden ___ 737
Icom *	Wilson Sys. ___ 787
Jensen ___ 293	Xitex ___ 741

*Please contact this advertiser directly.

Limit 15 Inquiries per request.

AUGUST 1980

Please use before September 30, 1980

Tear off and mail to
HAM RADIO HORIZONS — "Ad Check"
 Greenville, N. H. 03048

NAME _____

CALL _____

STREET _____

CITY _____

STATE _____ ZIP _____

AU-GUSTO

ALPHA 76, 374, 78 In Stock Call
 Cushcraft "boomer" 69.95
 OMNI-J2 Meter Antenna 39.95
 Bird 43 and slugs, UPS paid in USA stock
 Microwave Modules, Less 10% off list
 stock
 Telrex TB5EM, in stock 425.00
 Telrex TB6EM. 540.00
 Complete Line Monobanders.... stock
 New Telrex TB5ES, 2KW
 Pep version. 315.00
 Robot 800 Keyboard 699.00
 Bencher Paddles, Standard 39.95
 Bencher Paddles, Chrome 49.95
 Vibroplex Paddles and bugs. ... stock
 Lunar 6M-2M-220 In-line Preamps stock
 Janel QSA-5 41.95
 HAM-X Tailtwister Rotor 239.00
 HAM-4 Rotor. 169.00
 Cetron or GE 572B 32.00/ea
 GE, AMPEREX, Raytheon 6146B . 9.95
 Motorola HEP170. 0.29
 Mallory 2.5A/1000 PIV Epoxy diode 0.19
 Sprague 100MFD/450VDC Cap... 2.00
 Aerovox 1000PF/500V Feedthru Cap 1.95
 Adel Nibbling Tool. 8.45
 Technical books: Ameco, ARRL, Sams,
 TAB, Rider, Radio Pub., Callbook,
 Cowan, WRTVH, etc. Call
 New Belden 9405 (2#16) (6#18) 8 wire
 Rotor cable, heavy duty for
 long runs 0.38/ft
 8448 8 wire Rotor Cable 0.24/ft
 9888 Double Shield RG8 Foam . 0.56/ft
 8214 RG8 Foam 0.32/ft
 8237 RG8 Regular. 0.28/ft
 8267 RG213 0.36/ft
 9251 RG8 A/U 0.42/ft
 Belden #8000 14GA
 Stranded Antenna wire. 0.10/ft.
 Amphenol Silverplate PL259 (831SP)
 1.00
 Bertex RG8X 52 OHM, KW ... 0.19/ft.

Need a schematic?
 We've got 'em — \$2.00

ICOM IC 2A HANDHELD
 W/TTP, battery pack, Rubber Duck
 and charger \$229.00

Looking for antique parts?
 Write specific need to W5GJ.

THIS MONTH'S SPECIALS:

New IC720, AC — Call
 New ICOM, IC251A — 2M \$599.00
 IC551D — 6M-100W \$599.00
 IC551 \$399.00

Kenwood TS-180S/DFC — SSB
 Call for quote
 Bearcat 250, 220 299.00
 Bearcat 300 399.00

MASTER CHARGE • VISA

All prices fob Houston except where indicated. Prices subject to change without notice, all items guaranteed. Some items subject prior sale. Texas residents add 6% tax. Please add postage estimate. \$1.00 minimum.

MADISON

Electronics Supply, Inc.

1508 McKinney • Houston, Texas 77002
 713/658-0268

AD INDEX

A R Technical Products	73
Advanced Electronics Applications	64
Aluma Tower Company	73
Barry Electronics	21
Bencher, Inc.	68, 80
Curtis Electro Devices	69
DWS Marketing International	59
DenTron Radio Co., Inc.	1
Digitrex Electronics	80
Drake Company	40, 41
Ehrhorn Technological Operations	77
Erickson Communications	62
Grove Enterprises	79
Hal Communications Corp.	4
Ham Gear Mart	74
Ham Radio's Bookstore	8, 64, 80
Heath Company	Cover IV
Icom	7
Jensen Tools & Alloys	80
Kantronics	9
Trio-Kenwood Communications, Inc.	Cover III
MFJ Enterprises	3
Madison Electronics Supply	64, 78
Microcraft Corporation	80
Microwave Filter, Inc.	79
Palomar Engineers	50
RSE Ham Shack	9
Radio Amateur Callbook	67
Radio & Electronics Constructor	68
Radio Warehouse	74
Radio World	68
S-F Amateur Radio Services	80
Step Electronics Company	70
Swan Electronics	31
Ten-Tec	Cover II
Texas Towers	69
Van Gorden Engineering	21
Wilson Systems, Inc.	10

Foreign Subscription Agents for Ham Radio HORIZONS

Ham Radio Austria
 F. Gast
 Hauptplatz 5
 A-2700 Wiener Neustadt
 Austria

Ham Radio Holland
 MRL Electronics
 Postbus 88
 NL-2204 Delft
 Holland

Ham Radio Belgium
 Stereohouse
 Brusselsesteenweg 415
 B-8218 Gent
 Belgium

Ham Radio Italy
 G. Vulpatti
 P. O. Box 37
 I-22053 Cento
 Italy

Ham Radio Canada
 Box 400, Goderich
 Ontario, Canada N7A 4C7

Ham Radio Switzerland
 Karin Ueber
 Postfach 2454
 D-7850 Loerrach
 West Germany

Ham Radio Europe
 Box 444
 S-194 04 Upplanda Vasby
 Sweden

Ham Radio France
 SM Electronic
 20 bis, Ave des Clavons
 F-91030 Aseville
 France

Ham Radio UK
 P. O. Box 63, Harrow
 Middlesex HA3 8HS
 England

Ham Radio Germany
 Karin Ueber
 Postfach 2454
 D-7850 Loerrach
 West Germany

Holland Radio
 143 Greenway
 Greenvale, Johannesburg
 Republic of South Africa

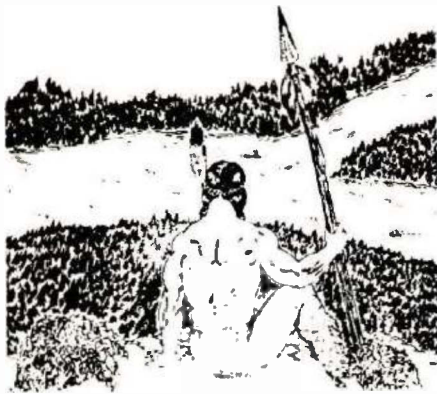

UNADILLA

FULL POWER - QUALITY

HAM ANTENNA ACCESSORIES
at your dealer

the Big Signal
W2AU
Balun

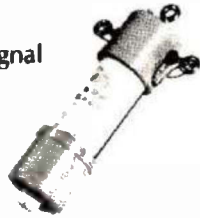

LONDON:
VICTORIA:
CONCEPCION:
BUENOS AIRES:
COL. ANAHUAC:
HELSINKI:

AMCOMM 01 804 1166
Scalar 725 9677
Telecom Trans Chile 25471
Multi-Radio 773-1266
Radiac 2-50-32-40
Erikoismediat (90) 611258

the Old reliable
W2VS Traps

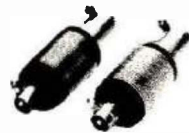

HAMS - call for our
free catalog PC-80

DEALERS - join over 400
dealers world-wide. Call
us today for no-risk deal.

HAMFEST MANAGERS -
UNADILLA cooperates!
Call us.

US - TOLL-FREE 1-800-448-1666
NY/Hawaii/Alaska/Canada -
COLLECT 1-315-437-3953
TWX - 710-541-0493

Ask for Hugh Gunnison, WA2ZOT,
or Bonnie, or Emily.

For over 20 years, the choice
of Hams, Armed Forces and
Commercial Communications - world-wide.



5-Band
Antenna
Kit

- Lo-Pass Filter 2000W
- Quad Parts
- Baluns / Traps
- Insulators
- Wire & Cable
- Connectors

UNADILLA / REYCO Division Microwave Filter Co., Inc., E. Syracuse, NY 13057

TALK IN
146.16/76
146.52

N.W. INTERSECTION
OF ILL. RT. 45 & 120
GRAYSLAKE ILL.

10TH

RADIO EXPO

SEPT. 6TH AND 7TH

FIRST WEEKEND AFTER LABOR DAY
WA9ORC/R

SPONSORED BY THE CHICAGO FM CLUB.

**LARGEST EVER
SOMETHING FOR ALL!**

HUGE MANUFACTURER DISPLAY BLDG.

FLEA MARKET/INDOORS AND OUTDOORS

SPACE FOR ALL/BRING TABLE AND CHAIRS

SEMINARS and TECHNICAL TALKS

LADIES PROGRAMS and PRIZES

THOUSANDS OF DOLLARS
WORTH OF DOOR PRIZES!

FREE PARKING AND OVERNIGHT CAMPING
TICKETS GOOD FOR BOTH DAYS

\$3.00 AT GATE—\$2.00 ADVANCED
ADVANCED TICKETS SEND \$10 S.A.S.E. AND \$2.00 FOR EACH TO
BOX 1532 EVANSTON, ILL. 60204 (312) 278-3976

FEDERAL FREQUENCY DIRECTORY

2 - 420 MHz Inclusive

OVER 100,000 FREQUENCY ALLOCATIONS
FROM OFFICIAL U.S. GOV'T RECORDS.

UNCLASSIFIED UNDER THE FREEDOM
OF INFORMATION ACT

AIR FORCE	JUSTICE	STATE DEPT.
ARMY	TREASURY	FAA
NAVY	NASA	INTERIOR
COAST GUARD	FCC	AGRICULTURE

ALL LISTINGS ARRANGED BY
FREQUENCY, AGENCY AND LOCATION

A BIBLE FOR SHORTWAVE BUFFS
AND SCANNER LISTENERS

Order Now..

Only.. \$14.95

Postage Paid within continental U.S.
Add \$2.00 if mailed overseas.

All payments must equal U.S. Exchange.

Grove Enterprises, Inc.
Route 1, Box 156A
Brasstown, NC 28902

Dealer Inquiries Invited

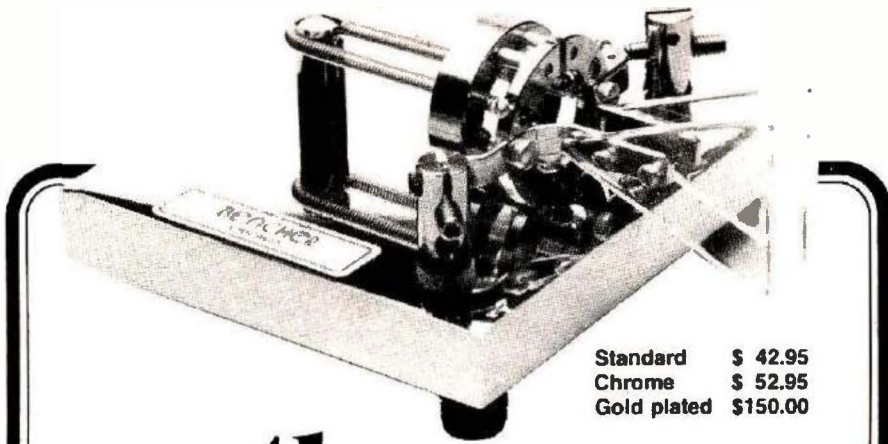

Standard \$ 42.95
 Chrome \$ 52.95
 Gold plated \$150.00

the Ultimate IAMBIC PADDLE

- Full range of adjustment in tension and contact spacing.
- Self-adjusting nylon and steel needle bearings.
- Gold plated solid silver contact points.
- Polished lucite paddles.
- Precision-machined, chrome plated brass frames.
- Standard model has black, textured finish base; deluxe model is chrome plated.
- Heavy steel base; non-skid feet.

WRITE FOR LITERATURE

BENCHER, INC.

333 W. Lake Street, Dept. A
 Chicago, Illinois 60606 • (312) 263-1808

At selected dealers or add \$2.00 handling. Quotation for overseas postage on request.



**FREE!
 NEW
 CATALOG
 OF
 HARD
 TO
 FIND
 PRECISION
 TOOLS**

Jensen's new catalog is jam-packed with more than 2000 quality items. Your single source for hard-to-find precision tools used by electronic technicians, scientists, engineers, schools, instrument mechanics, laboratories and government agencies. This popular catalog also contains Jensen's world-famous line of more than 40 tool kits. Send for your free copy today!

JENSEN TOOLS INC.
 1230 SOUTH PRIEST DRIVE
 TEMPE, ARIZONA 85281



... at last ...
your shack organized!

A beautiful piece of furniture — your XYL will love it!

\$16450 S-F RADIO DESK
 Deluxe - Ready to Assemble

Designed with angled rear shelf for your viewing comfort and ease of operation.
 FINISHES: Walnut or Teak Stain.
 Floor Space: 39" Wide by 30" Deep

Additional Information on Request.
 Checks, Money Orders, BankAmericard and Master Charge Accepted.

F.O.B. Denver City. (In Calif. Add 6% Sales Tax.)
 — DEALER INQUIRIES INVITED —
S-F Amateur Radio Services

4384 KEYSTONE AVENUE • CULVER CITY, CALIF. 90230 — PHONE (213) 837-4870

Digitrex Electronics

PA-19 Wideband Preampifier

- 2 to 200 MHz Bandwidth: 3dB Points
- 19 dB Gain!
- 50 Ohms Input & Output Impedance
- Tiny PC Board Size! 7/8" x 1-5/8" x 1"
- Absolutely No Tuning Required
- Extremely Stable
- Draws only 20mA @ 12VDC
- Great Way to Increase Sensitivity of Receivers, Counters, etc.
- Fully Assembled and Tested
- Instructions Provided, Full Warranty

only **\$8.95**

• 50 Shipping/Handling

Portable 600 MHz Frequency Counter

- 1 600 MHz Range
- 1 KHz or 100 Hz Resolution
- Assembled and Tested
- Full Lifetime Warranty
- Size 5" L x 2 1/2" W x 1 1/2" H
- BNC Whip Antenna Opt. \$8.95

\$89.95 ppd
Class and 1

C.O.D. Orders Welcome
Digitrex Electronics
 8412 Fernlee, Royal Oak
 Michigan 48073 313-651-9247

• 75 mV Sensitivity

Microcraft's New RTTY READER



Decodes RTTY signals directly from your receiver's loudspeaker. • Ideal for SWLs, novices & seasoned amateurs. • Completely solid state and self-contained. Compact size fits almost anywhere. No CRT or demodulator required. . . . Nothing extra to buy! • Built-in active mark & space filters with tuning LEDs for 170, 425 & 850 Hz FSK. • Copies 60, 67, 75, & 100 WPM Baudot & 100 WPM ASCII. • NOW you can tune in RTTY signals from amateurs, news sources & weather bulletins. The RTTY READER converts RTTY signals into alphanumeric symbols on an eight-character moving LED readout. Write for details or order factory direct.

RTTY READER KIT, model RRK \$189.95
 RTTY READER wired and tested, model RRF \$269.95

Send check or money order. Use your VISA or MasterCard. Add \$5.00 shipping and handling for continental U.S. Wisconsin residents add 4% Wisconsin State Sales Tax.

Microcraft Corporation Telephone: (414) 241-8144
 Post Office Box 513HRH, Thiensville, Wisconsin 53092

**NOT A
 SUBSCRIBER?**

DO IT TODAY!

Use the handy card between
 pages 56 & 57.

Hand-shack.

**Synthesized,
big LCD,
10 memories,
scanning, DTMF**
Touch-Tone®

TR-2400

Put a ham shack in your hand. The TR-2400 is the ideal hand-held for 2 meters FM. It features a large LCD readout that can be read in direct sunlight or in the dark, 5-kHz-step PLL synthesized operation, 10-channel memory, scanning, and 16-button autopatch DTMF encoder.

TR-2400 FEATURES:

- Large LCD digital readout**
 Readable in direct sunlight (better than LEDs). Readable in the dark (with lamp switch). Virtually no current drain (much less than LEDs) and display stays on. Rugged and dependable in hot or cold temperature ranges. Shows receive and transmit frequencies and memory channel.
- 5-kHz-step frequency selection**
 PLL synthesized keyboard channel selection system. No "5 up" switch needed. Selects from 144.000 to 147.995 MHz.
- UP/DOWN manual scan**
 Single or fast continuous 5-kHz steps from 143.900 to 148.495 MHz for Amateur and MARS or CAP simplex or repeater operation.
- 10 memories**
 Retained with battery backup (only 0.8 mA). "MO" memory may be used to shift the transmit frequency any desired amount to operate on repeaters with nonstandard split frequencies.
- Built-in autopatch DTMF (Touch-Tone™) encoder**
 Uses all 16 buttons of keyboard while transmitting.



- Automatic memory scan**
 Checks all 10 memory channels. Programmable to lock automatically on either BUSY (signal present) or OPEN (no signal) channels.
- Subtone switch**
 Activates subaudible tone encoder (not Kenwood-supplied).



- Repeater or simplex operation**
 Convenient mode switch shifts transmit frequency +600 kHz or -600 kHz or to the frequency stored in "MO" memory.
- Reverse operation**
 Nonlocking switch shifts receiver to transmit frequency and transmitter to receive frequency.
- Extended operating time**
 With LCD and overall low-current circuit design. Only draws about 28 mA squelched receive and 500 mA transmit (at 1.5 W RF output), for longer operating time between charges.
- Two lock switches**
 Prevent accidental frequency change and accidental transmission.
- BNC antenna connector**
 Easy to connect external antenna.
- LCD "arrow" indicators**
 Show "ON AIR," "MR" (memory recall), "BATT" (battery status), and "LAMP" switch on.
- High-impact case and zinc die-cast frame**
 Extremely rugged with antenna counterpoise.
- External PTT microphone and earphone connectors**
 Easily accessible on right side of transceiver.
- Compact and lightweight**
 Only 2-13/16 inches wide, 7-9/16 inches high, and 1-7/8 inches deep. Weighs only 1.62 pounds (including antenna, battery, and hand strap).

- Microphone PTT and audio terminals
- Charger terminal
- Earphone Jack

STANDARD ACCESSORIES INCLUDED:

- Flexible rubberized antenna with BNC connector
- Heavy-duty (450-mAh) NiCd battery pack
- External-standby (PTT) plug
- AC charger
- Hand strap
- External-microphone plug
- Earphone

NOTE: Price, specifications subject to change without notice and obligation.

OPTIONAL ACCESSORIES:

- ST-1 base stand (shown) which provides 1.5-hour quick charge and automatic switch to trickle charge, floating charge (operate while charging), 4-pin connector for dynamic microphone, and SO-239 antenna connector
- BC-5 DC quick charger (1.5 to 2.0 hours)
- LH-1 deluxe leather case (top-grain cowhide)
- PB-24 extra battery pack with charger adapter
- BH-1 belt hook

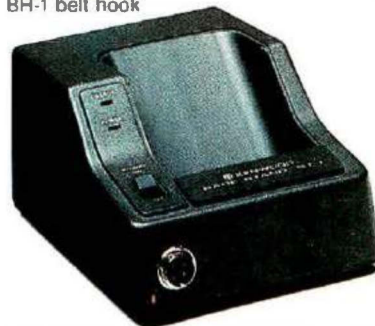

Announcing the Heathkit VF-7401 2-meter FM Digital Scanning Transceiver



LED indicates 5 kHz position.

The 0 kHz/5 kHz Switch gives you an effective choice of 900 2-meter channels in 5 kHz steps.

Dim/Bright Switch for bright illumination of frequency read-out and meter for daytime, and lower intensity for safe mobile operation at night.

The Manual Scan Switch lets you choose your frequency manually, or have the VF-7401 find an active channel for you.

Optional Micoder II Microphone/Auto Patch Encoder lets you phone through repeaters with auto patch input. Draws power from the 7401, so no mike battery is necessary.

The Squelch Control also functions as the receiver's sensitivity control to stop scanning only upon reception of "full-quieting" signals, skipping the weak ones.

The 100 kHz Selector button controls the VF-7401's tuning in 100 kHz increments. The 7401's 1 MHz Selector button lets you choose any 1 MHz segment of the 2-meter band.

The 10 kHz Selector advances in 10 kHz steps. In Scan, as it recycles from "9" to "0," it also causes the 100 kHz readout to advance by one digit. Depress once to resume scan function.

Lock/Latch Switch. In Scan Latch mode, a channel latch-up signal inhibits scan circuits when signal is detected, and the 7401 stays on that frequency. If it detects a 4-8 second break in received signal, scanning resumes. In the Scan-Lock mode, once the receiver scans to a signal, it remains on that channel until reset.

More features that make the VF-7401 the 2-meter rig that belongs in your shack and vehicle

No more searching through repeater guides while mobiling in unfamiliar territory - your new Heathkit VF-7401 will find the active channels for you. It will even alert you to band openings. You're going to enjoy building your VF-7401... and you're going to love using it. The VF-7401, the ultimate 2-meter rig... from the more than 200 Hams at Heath.

- Adjustable, 15-watt (nominal), solid-state, narrow-band FM Transceiver. Fully synthesized digital circuitry provides full band coverage without need for added crystals.

- All-new, state-of-the-art circuits provide the exciting, exclusive features of 1 MHz bandwidth scanning, and Scan Lock/Latch capability on 2-meters.
- A receiver hotter than Heath's HW-2036A features dual-gate MOSFET front-end to minimize overload and adjacent-channel interference.
- "Power-up" on a pre-programmed frequency of your own choice, such as your favorite repeater.
- Convenient detachable mike using 4-pin connector.

- Power to the Micoder II Microphone (if used) eliminates need for a battery.
- Sturdy SO-239 rear-panel antenna jack.
- Chassis-mounted power and external speaker plugs.
- Improved synthesizer, eliminating need for panel mounted sync lock light.
- Tuning for Power Amplifier and output power level adjustment is accessible without removing case.
- Capability of mobile or base operation (with Model VFA-7401-1 AC Power Supply - 13.8 V at 4A nominal, transmit).



SEND FOR FREE CATALOG

The new VF 7401 is featured in the latest Heathkit Catalog. For a free copy write: Heath Company, Dept 348-684, Benton Harbor, MI 49022. Or visit the nearest Heathkit Electronic Center in the U.S. or Canada where Heathkit products are displayed, sold and serviced. See the white pages of your phone book for location. In the U.S., Heathkit Electronic Centers are units of Veritechnology Electronics Corporation.

This device has not been approved by the Federal Communications Commission. This device is not, and may not be, offered for sale or lease, or sold or leased until the approval of the FCC has been obtained.



Heathkit®

THERE'S MORE FOR THE HAM AT HEATH!