

JUNE 1990 / \$2.95

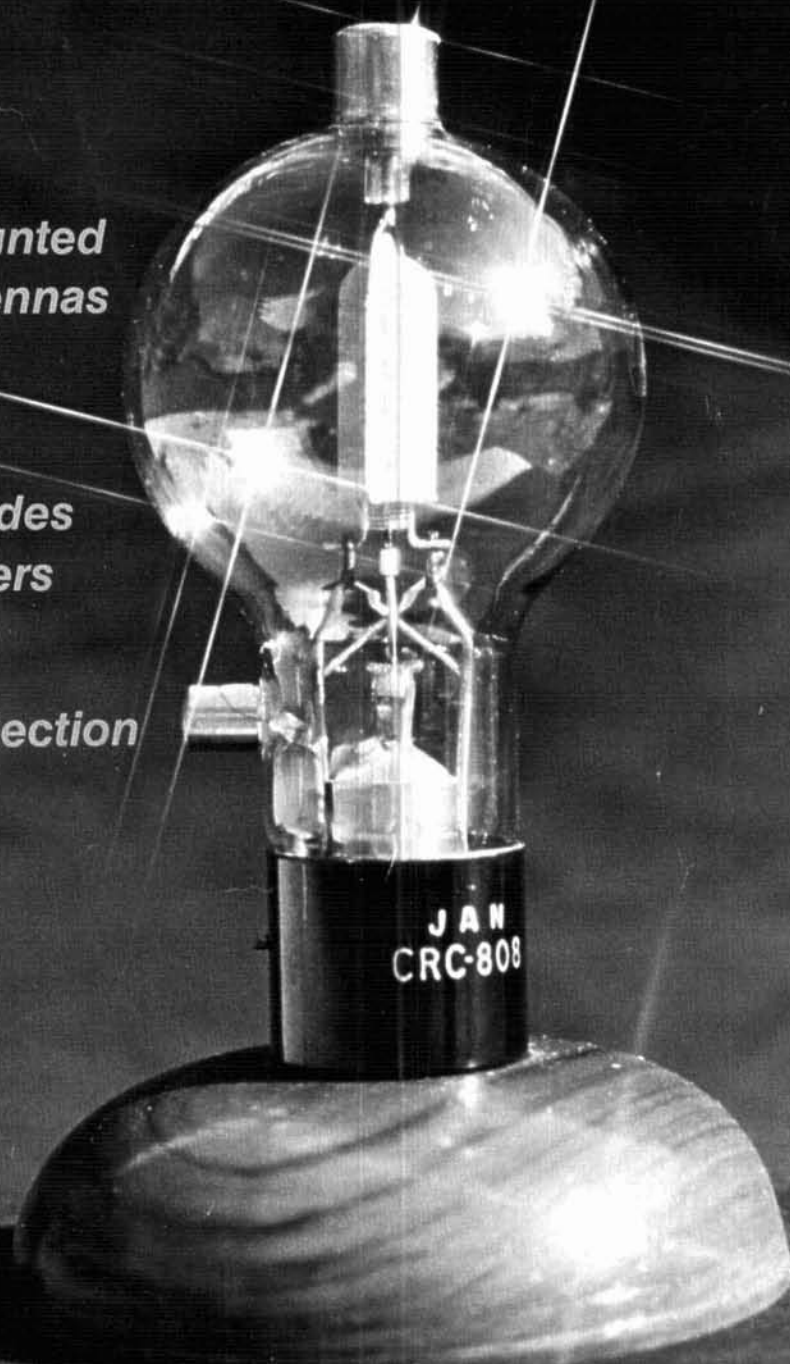
Special this Month:
Three Weekender Projects

HAM RADIO

*Ground-Mounted
Vertical Antennas*

*Varactor Diodes
from Rectifiers*

*The Series Section
Transformer*



ICOM

IC-765 HF Transceiver



MAKE YOUR DREAMS A REALITY!

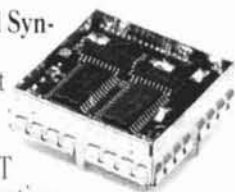
ICOM incorporated your most requested features with modern technology's best designs to produce the remarkable IC-765 dream rig. Its combination of excellent performance and superb reliability truly open a new dimension in HF operating enjoyment.

THE HF FOR TODAY'S ACTIVE AMATEUR.

Includes: ***Band Stacking Registers.** Each band's VFO's retain the last selected frequency, mode and filter choice when changing bands. Produces the equivalent of 20 VFO's; two per band. Great for multiband DX'ing! ***99 Fully Tunable Memories.** Store frequency, mode and filter selections. Each one can be returned and/or reprogrammed independent of VFO operations. Memories 90-99 also store split Tx/Rx frequencies. ***10Hz Readout.** Perfect on-the-dot frequency selection for nets, DX skeds and data communication modes. ***Full QSK Break-in.** For super CW operations!

*Direct Digital Synthesizer (DDS).

Assures ultra-fast PLL switching and lock-in for excellent PACKET and AMTOR operations.



***Maximum Operation Flexibility!** The three step attenuator cuts multi-station overloads. ***Built-in AC Supply.** The IC-765 is 100 percent duty cycle rated for cool operation and superb performance on all modes! ***Fully Automatic Antenna Tuner.** With built-in CPU and memory for extremely fast tuning and one-touch operation. Wide tuning range. ***CW Pitch Control.** Total operating comfort and convenience for successful contesting and DX'ing. An iambic keyer with adjustable speed and weight is also built into the IC-765! ICOM also included ***Narrow 500Hz CW**

Filters. The FL-32A and FL-52A deliver razor sharp selectivity. A serious DX'er's delight! 250Hz FL-53A and FL-101 optional.

The IC-765 **General Coverage Receiver** covers all bands, all modes and is backed by ICOM's full one-year warranty at any one of our four North American Service Centers. The IC-765 turns your dreams into reality!

ICOM

First in Communications

ICOM America, Inc., 2380-116th Ave. N.E., Bellevue, WA 98004
Customer Service Hotline (206) 454-7619
3150 Premier Drive, Suite 126, Irving, TX 75063
1777 Phoenix Parkway, Suite 201, Atlanta, GA 30349
ICOM CANADA, A Division of ICOM America, Inc., 3071 -
#5 Road, Unit 9, Richmond, B.C. V6X 2T4 Canada

All stated specifications are subject to change without notice or obligation. All ICOM radios significantly exceed FCC regulations limiting spurious emissions. 765489



Food for thought.

Our new Universal Tone Encoder lends its versatility to all tastes. The menu includes all CTCSS, as well as Burst Tones, Touch Tones, and Test Tones. No counter or test equipment required to set frequency—just dial it in. While traveling, use it on your Amateur transceiver to access tone operated systems, or in your service van to check out your customers' repeaters; also, as a piece of test equipment to modulate your Service Monitor or signal generator. It can even operate off an internal nine volt battery, and is available for one day delivery, backed by our one year warranty.

- All tones in Group A and Group B are included.
- Output level flat to within 1.5db over entire range selected.
- Separate level adjust pots and output connections for each tone Group.
- Immune to RF
- Powered by 6-30vdc, unregulated at 8 ma.
- Low impedance, low distortion, adjustable sinewave output, 5v peak-to-peak
- Instant start-up.
- Off position for no tone output.
- Reverse polarity protection built-in.

Group A

67.0 XZ	91.5 ZZ	118.8 2B	156.7 5A
71.9 XA	94.8 ZA	123.0 3Z	162.2 5B
74.4 WA	97.4 ZB	127.3 3A	167.9 6Z
77.0 XB	100.0 1Z	131.8 3B	173.8 6A
79.7 SP	103.5 1A	136.5 4Z	179.9 6B
82.5 YZ	107.2 1B	141.3 4A	186.2 7Z
85.4 YA	110.9 2Z	146.2 4B	192.8 7A
88.5 YB	114.8 2A	151.4 5Z	203.5 M1

- Frequency accuracy, $\pm .1$ Hz maximum - 40°C to + 85°C
- Frequencies to 250 Hz available on special order
- Continuous tone

Group B

TEST-TONES:	TOUCH-TONES:	BURST TONES:			
600	697 1209	1600	1850	2150	2400
1000	770 1336	1650	1900	2200	2450
1500	852 1477	1700	1950	2250	2500
2175	941 1633	1750	2000	2300	2550
2805		1800	2100	2350	

- Frequency accuracy, ± 1 Hz maximum - 40°C to + 85°C
- Tone length approximately 300 ms. May be lengthened, shortened or eliminated by changing value of resistor

Model TE-64 \$79.95

COMMUNICATIONS SPECIALISTS

426 West Taft Avenue, Orange, California 92667
(800) 854-0547/ California: (714) 998-3021



KENWOOD

Weight-less!

TH-26AT/46AT

144 MHz/450 MHz

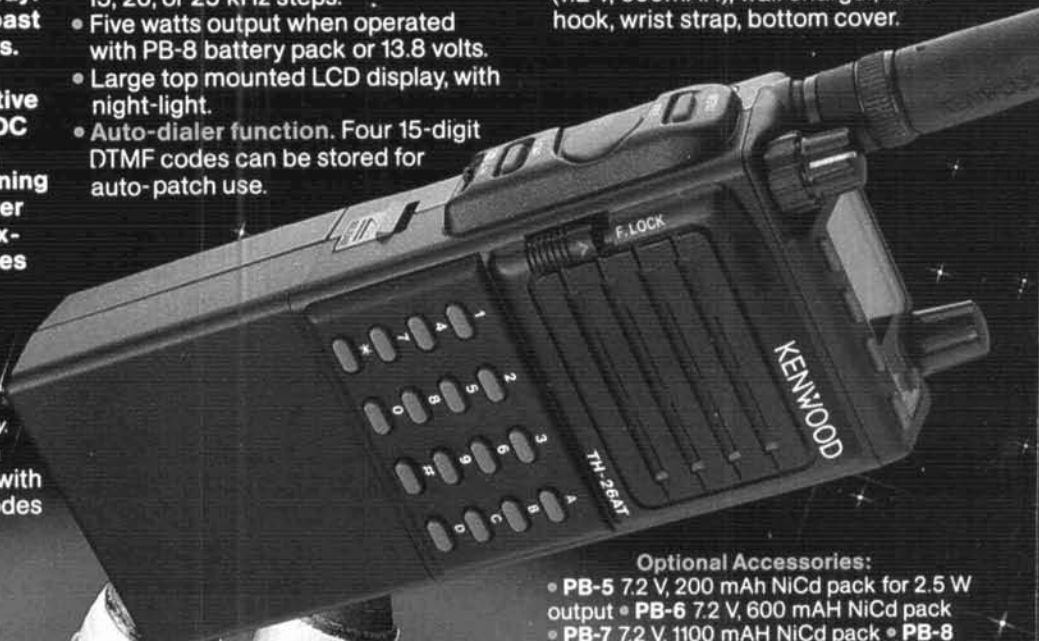
Compact Portable FM transceivers

Quick! Grab one before it gets away! These new compact portables boast a whole set of brand-new features. The new DTMF encode/decode squelch system (DTSS) for selective calling, four 15 digit auto-dialer, DC direct-in capability (with optional PG-3F or PG-2W), versatile scanning functions, wide-range of DC power sources, 5 W capability, and an extensive list of exciting accessories make this radio the one to grab!

- Frequency coverage:
TH-26AT: 136-173.995 MHz;
TH-46: 438-449.995 MHz.
(TH-26AT modifiable for MARS/CAP. Permits required.) TX on Amateur band only.
- **NEW!** Dual Tone Squelch System (DTSS) enables selective calling with 3-digit DTMF codes! The DTSS codes can be stored in channels 1-3.
- Multi-function scanning. Band and memory channels can be scanned, with time operated or carrier operated scan stop.

- 21 memory channels. Store everything you need, including CTCSS and DTSS codes. Ten channels can store RX and TX frequencies independently for odd split operations.
- Frequency step selectable for quick QSY. Choose from 5, 10, 12.5, 15, 20, or 25 kHz steps.
- Five watts output when operated with PB-8 battery pack or 13.8 volts.
- Large top mounted LCD display, with night-light.
- Auto-dialer function. Four 15-digit DTMF codes can be stored for auto-patch use.

- T-ALERT for quiet monitoring. Tone Alert beeps when squelch is opened.
- Auto battery saver, and economy power mode to extend battery life.
- Automatic repeater offset.
- Supplied Accessories: Flex antenna, PB-10 battery pack (7.2 V, 600mAh), wall charger, belt hook, wrist strap, bottom cover.



Optional Accessories:

- PB-5 7.2 V, 200 mAh NiCd pack for 2.5 W output
- PB-6 7.2 V, 600 mAh NiCd pack
- PB-7 7.2 V, 1100 mAh NiCd pack
- PB-8 12 V, 600 mAh NiCd for 5 W output
- PB-9 7.2 V, 600 mAh NiCd with built-in charger
- PB-10 7.2 V, 600 mAh (works with BC-2 wall charger)
- PB-11 12 V, 600 mAh OR 6 V, 1200 mAh, for 5 W OR 2 W
- BC-10 Compact charger
- BC-11 Rapid charger
- BT-6 AAA battery case
- BT-7 AA battery case
- DC-1/PG-2V DC adapter
- HMC-2 Headset with VOX and PTT
- SC-24, 25, 26 Soft cases
- SMC-31 Speaker mic.
- SMC-33 Speaker mic. w/remote control
- TSU-7 CTCSS encode/decode unit
- PG-2W DC cable w/fuse
- PG-3F DC cable with filter and cigarette lighter plug
- WR-1 Water resistant bag

KENWOOD U.S.A. CORPORATION
COMMUNICATIONS & TEST EQUIPMENT GROUP
P.O. BOX 22745, 2201 E. Dominguez Street
Long Beach, CA 90801-5745

KENWOOD ELECTRONICS CANADA INC.
P.O. BOX 1075, 959 Gana Court
Mississauga, Ontario, Canada L4T 4C2

KENWOOD

...pacesetter in Amateur Radio

Complete service manuals are available for all Kenwood transceivers and most accessories. Specifications, features and prices subject to change without notice or obligation.

HAM RADIO

JUNE 1990

Volume 23, Number 6

Publisher & Editor-in-Chief:

T.H. TENNEY, JR., W1NLB

EDITORIAL STAFF

Editor:

TERRY NORTHUP, KA1STC

Consulting Technical Editors:

Marty Durham, NB1H

David McLanahan, WA1FHB

Alfred Wilson, W6NIF

Robert D. Wilson, WA1TKH

Associate Editors:

Peter Bertini, K1ZJH

Tom McMullen, W1SL

Joseph J. Schroeder, W9JUV

Production Editor: Susan Shorrock

Copy Editor: Peggy Tenney, KA1QDG

Editorial Assistant: Beth McCormack

Editorial Review Board:

Forrest Gehrke, K2BT

Michael Gruchalla, P.E.

Hunter Harris, W1SI

Bob Lewis, W2EBS

Mason Logan, K4MT

Vern Riportella, WA2LQQ

Ed Wetherhold, W3NQN

PUBLISHING STAFF

Assistant Publisher:

J. CRAIG CLARK, JR., NX1G

Advertising Manager:

Marty Durham, NB1H

Advertising Production Manager:

Dorothy Sargent, KA1ZK

Circulation Manager: Susan Shorrock

Circulation: Marion Tuttle

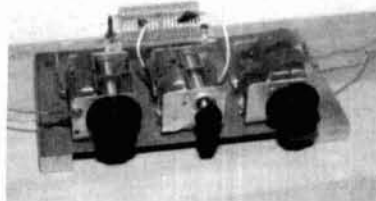
Traffic Manager: Phil Alix, N1FPX

Book Store: Priscilla Gauvin

Cover photo: Michael A. Covington, N4TMI.



N4TMI, page 44



W7CSD, page 59

FEATURES

GROUND-MOUNTED VERTICAL ANTENNAS	11
<i>W.J. Byron, W7DHD, and F.S. Chess, K3BN</i>	
Microwaves: MICROWAVE BASICS	22
<i>Bob Atkins, KA1GT</i>	
The Weekender: PHASOMETER	28
<i>Joel Eschmann, K9MLD, and Tom Rehm, K9PIQ</i>	
INEXPENSIVE SSB FOR 10 METERS	30
<i>Phil Salas, AD5X</i>	
Ham Radio Techniques: WARC 1992	35
<i>Bill Orr, W6SAI</i>	
VARACTOR DIODES FROM RECTIFIERS	40
<i>Hugh Wells, W6WTU</i>	
The Weekender: PRECISION CRYSTAL FREQUENCY CHECKER	44
<i>Michael A. Covington, N4TMI</i>	
Practically Speaking: SAFETY STANDDOWN FOR THOSE WHO SERVICE HAM GEAR	48
<i>Joseph J. Carr, K4IPV</i>	
THE SERIES SECTION TRANSFORMER	55
<i>Charles J. Michaels, W7XC</i>	
The Weekender: ANTENNA TUNER WITH A NEW TWIST	59
<i>Bob Baird, W7CSD</i>	
Elmer's Notebook: ELEMENTARY ELECTRONICS—WRAPPING UP AC THEORY	63
<i>Tom McMullen, W1SL</i>	
DIVERSITY RECEPTION ON HF DIGITAL COMMUNICATION	67
<i>Stephen Hall, WM6P</i>	

DEPARTMENTS

PUBLISHER'S LOG	4	DX FORECASTER	73
BACKSCATTER	9	FLEA MARKET	76
COMMENTS	10	NEW PRODUCTS	81
HAM NOTEBOOK	57	ADVERTISERS INDEX	82
		READERS SERVICE	82

HAM RADIO Magazine (ISSN 0148-5989) is published monthly by Communications Technology, Inc. Main Street, Greenville, New Hampshire 03048-0498 Telephone: 603-878-1441 FAX: 603-878-1951. **Subscription Rates:** United States: one year, \$22.95; two years, \$38.95; three years, \$49.95; Canada and Mexico: one year, \$31.00; two years, \$55.00; three years, \$74.00. All other countries: one year, \$35.00 via surface mail only. All subscription orders payable in U.S. funds, via international postal money order or check drawn on U.S. bank. **International Subscription Agents:** page 77.

Microfilm copies are available from Buckmaster Publishing Mineral, Virginia 23117. Cassette tapes of selected articles from HAM RADIO are available to the blind and physically handicapped from Recorded Periodicals, 919 Walnut Street, Philadelphia, Pennsylvania 19107.

Copyright 1990 by Communications Technology, Inc. Title registered at U.S. Patent Office.

Second-class postage paid at Greenville, New Hampshire 03048-0498 and at additional mailing offices. *Send change of address to HAM RADIO, Greenville, New Hampshire 03048-0498.*



A New Direction

I have just returned from what turned out to be my most difficult trip ever to the Dayton HamVention™. During the course of the weekend we announced that *Ham Radio* Magazine had been sold to the publishers of *CQ* Magazine. It was no fun to meet with many hundreds of you and pass on the news that we would no longer be sending our magazine along each month. But it was a very rewarding experience to listen as you told us just how much *Ham Radio* has meant to you.

It's been an extremely productive twenty-two years and I like to think that *Ham Radio* has met most of the goals that the late Jim Fisk, W1HR, and I set for ourselves as we embarked on our new venture back in 1968. As Jim pointed out in his first editorial, there is a very real danger in just publishing state-of-the-art material if you first don't give your readers a clear grasp of the current technology upon which the new ideas are based. We have worked very hard over the years to ensure that a *Ham Radio* reader would be offered this carefully planned balance of information.

This will be your last issue of *Ham Radio*, the last of 268 consecutive regular issues of the finest technical journal ever published for the Amateur. Beginning next month you'll receive *CQ* Magazine, with the addition of a good measure of the very material for which *Ham Radio* was so well known—the most competent technical articles and projects the Amateur will find anywhere.

Why the change? I began to think pretty seriously about this idea a short while ago when Dick Ross, K2MGA, publisher of *CQ* Magazine, asked if we would be interested in being acquired by his organization. By combining the strengths of each publication, *Ham Radio* and *CQ*, the Amateur community stands to gain. Although we both serve the same audience, our two publications have really been complementary rather than competitive as far as the reader was concerned. One was heavily involved with the technical side of Amateur Radio, while the other was directed mostly to the operator.

Both organizations have their strengths. *CQ* has more of the support services, such as typesetting and in-house subscription fulfillment, that help a publisher lower costs. *Ham Radio* has a very strong marketing and direct mail operation that can be used to add to the strength of the whole operation. The **HAM RADIO** Bookstore is unequaled in our industry. It can play an even greater part if it serves the readers of not one but the two strongest independent Amateur magazines, as well as three other *CQ* Communications monthlies.

I would like to thank the many people who have contributed to the success of *Ham Radio* over the last two decades. I hesitate to start naming names because there are so many, and I don't want to leave anyone out. Certainly, we all owe a tremendous debt to Jim Fisk. He set standards for the entire Amateur Radio publishing industry, standards all of us must continue to work very hard to meet.

The Amateur Radio industry has been very good to us. Without advertising support right from the start, there never could have been a *Ham Radio* magazine. Just as important has been the industry's encouragement to continue our task of keeping Amateurs at the forefront of modern telecommunications.

Last, but not least, have been all of you—our readers. You have done your job superbly. Your letters and phone calls have kept us on our toes and have ensured that we never strayed far from the original ideals that we set for ourselves.

What's ahead for the *Ham Radio* reader? A very exciting future. Although I will not be at the helm, I think that I am not out of place to say that you can expect to see the best of what is good in the magazine you already know molded into an even better product. The expanded *CQ* will incorporate the best efforts of two of the most experienced publishing staffs anywhere in the Amateur world. Terry, KA1STC, and Craig, NX1G, will still be here doing their usual excellent job along with a number of other members of the *Ham Radio* team who have contributed so much to our efforts. But now they will have the resources of the *CQ* organization to further their efforts even more. The results should be outstanding.

Skip Tenney, W1NLB

P.S. *CQ* Publisher Dick Ross, K2MGA, said he would love to hear any of your suggestions or comments about all that is happening and how he might best meet your needs in the future.

KENWOOD



TS-950SD

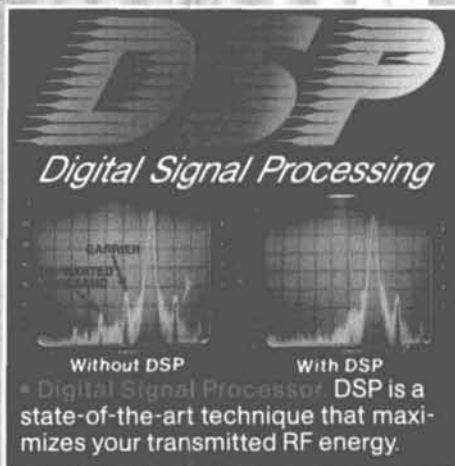
"DX-clusive" HF Transceiver

The new TS-950SD is the first Amateur Radio transceiver to utilize Digital Signal Processing (DSP), a high voltage final amplifier, dual fluorescent tube digital display and digital meter with a peak-hold function.

- Dual Frequency Receive Function. The TS-950SD can receive two frequencies simultaneously.
- New! Digital AF filter. Synchronized with SSB IF slope tuning, the digital AF filter provides sharp characteristics for optimum filter response.
- New high voltage final amplifier. 50 V power transistors in the 150-watt final section, resulting in minimum distortion and higher efficiency. Full-power key-down time exceeds one hour.
- New! Built-in microprocessor controlled automatic antenna tuner.
- Outstanding general coverage receiver performance and sensitivity. Kenwood's Dyna-Mix™ high sensitivity direct mixing system provides incredible performance from 100 kHz to 30 MHz. The Intermodulation dynamic range is 105 dB.
- Famous Kenwood interference reduction circuits. SSB Slope Tuning, CW VBT (Variable Bandwidth Tuning), CW AF tune, IF notch filter, dual-mode noise blanker with level control, 4-step RF attenuator (10, 20, or 30 dB), switchable AGC circuit, and all-mode squelch.

Complete service manuals are available for all Kenwood transceivers and most accessories. Specifications, features and prices subject to change without notice or obligation.

The Ultimate Signal.



Digital Signal Processor DSP is a state-of-the-art technique that maximizes your transmitted RF energy.

- High performance IF filters built-in† Select various filter combinations from the front panel. For CW, 250 and 500 Hz, 2.4 kHz for SSB, and 6 kHz for AM. Filter selections can be stored in memory!
- Multi-Drive Band Pass Filter (BPF) circuitry. Fifteen band pass filters are available in the front end to enhance performance.

- Built-in TCXO for the highest stability.†
- Built-in electronic keyer circuit.
- 100 memory channels. Store independent transmit and receive frequencies, mode, filter data, auto-tuner data and CTCSS frequency.
- Digital bar meter.

Additional Features: • Built-in interface for computer control • Programmable tone encoder • Built-in heavy duty AC power supply and speaker • Adjustable VFO tuning torque • Multiple scanning functions • MC-43S hand microphone supplied

Optional Accessories

- DSP-10 Digital Signal Processor *
- SO-2 TCXO * • VS-2 Voice synthesizer
- YK-88C-1 500 Hz CW filter for 8.83 MHz IF*
- YG-455C-1 500 Hz CW filter for 455 kHz IF*
- YK-88CN-1 270 Hz CW filter for 8.83 MHz IF
- YG-455CN-1 250 Hz CW filter for 455 kHz IF*
- YK-88SN-1 1.8 kHz SSB filter for 8.83 MHz IF
- YG-455S-1 2.4 kHz SSB filter for 455 kHz IF*
- SP-950 External speaker w/AF filter
- SM-230 Station monitor w/pan display
- SW-2100 SWR/power meter
- TL-922A Linear amplifier (not for QSK)

* Built-in for the TS-950SD
† Optional for the TS-950S

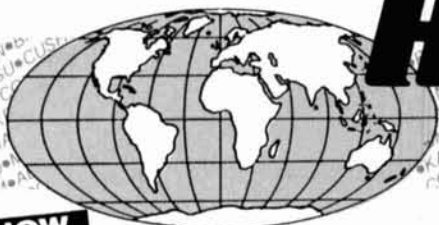
KENWOOD U.S.A. CORPORATION
COMMUNICATIONS & TEST EQUIPMENT GROUP
P.O. BOX 22745, 2201 E. Dominguez Street
Long Beach, CA 90801-5745
KENWOOD ELECTRONICS CANADA INC.
P.O. BOX 1075, 959 Gana Court
Mississauga, Ontario, Canada L4T 4C2

KENWOOD

...pacesetter in Amateur Radio



For A HRO 72 Page
Communication Equipment Catalog
Send \$1.00 to any HRO Store



HAM RADIO OUTLET

LARGEST HAM OUTLET IN THE WORLD

NOW

9 STORE BUYING POWER



Advanced Electronic Applications

PK-232 Multi-mode Data Controller
Now with PakMail function



- NEW IBM Fax Screen Display Program Available
- Transmit/Receive on Six Modes
- CW/RTTY/ASCII/AMTOR/Packet/FAX
- IBM and Commodore terminal programs available
- Radio Ports for HF and VHF

In Stock for Quick Delivery
Free Shipment

Kantronics/KAM



True dual port - simultaneous HF/VHF packet operation

- Personal Bulletin Board
- RTTY/ASCII/AMTOR/CW/Weather Fax
- Programmable MARK and SPACE tones
- Terminal programs for PC compatibles and Commodore
- WEFAX programs for PC, Commodore, and Macintosh

One-year Warranty

CALL FOR LOW, LOW PRICE



MA-40
40' TUBULAR TOWER

~~\$809~~ SALE! \$629

MA-550
55' TUBULAR TOWER

~~\$1369~~ SALE! \$999

- Handles 10 sq. ft. at 50 mph
- Pleases neighbors with tubular streamlined look

TX-455 SALE! \$1389

- 55' FREESTANDING CRANK-UP
- Handles 18 sq. ft. at 50 mph
- No guying required
- Extra-strength Construction
- Can add raising and motor drive accessories

TOWERS RATED TO EIA SPECIFICATIONS
OTHER MODELS AT GREAT PRICES



OR-2300

- Reliable Worm Gear Drive
- Stainless Steel Hardware
- Reversal Delay Circuit & Variable Speed Control
- Fits Most Towers



VHF/UHF SOLIDSTATE AMPLIFIERS

Contemporary design, quality and a 5 year warranty on parts and labor. 6 months on the RF Final transistors.

All amplifiers have GaAsFET receive pre-amps and high SWR shutdown protection



Full MFJ line stocked in depth!

MFJ ... making quality affordable
All MFJ Tuners Stocked!



MFJ-949D 300 Watt Tuner

- Built-in dummy load
- New peak and Average Lighted 2-color Cross-Needle SWR/Wattmeter
- Built-in antenna switch, balun
- Covers 1.8-30 MHz



MFJ-1278 Multi-mode

- All 9 digital modes
- Easy Mail™ Personal Mailbox
- 20 LED Precision Tuning Indicator
- Includes free power supply
- Includes free eprom upgrade

Call now for all MFJ products ... wattmeters, dummy loads, coax switches, keyers, clocks, speaker/mics, software, books and more! One year unconditional guarantee.



GEOCHRON
GLOBAL TIME INDICATOR

SALE

- Detailed illuminated map shows time, time zone, sun position and day of the week at a glance for any place in the world...
- Continuously moving - areas of day and night change as you watch.
- Mounts easily on a wall. Size: 34 1/2" x 22 1/2".

\$1295 \$1159.95
DELIVERED IN U.S.

All Major Brands in Stock Now!

CALL TOLL FREE

IN CALIFORNIA CALL STORE NEAREST YOU

Call any time zone 800 number during business hours from coast to coast.

MID-WEST/WEST
ANAHEIM, 9 to 5:30 PST

SOUTHEAST
ATLANTA, 9 to 5:30 EST

MID-ATLANTIC
WOODBRIIDGE, 9 to 5:30 EST

NEW ENGLAND
SALEM, 9 to 5:30 EST

1-800-854-6046

1-800-444-7927

1-800-444-4799

1-800-444-0047



Toll free including Hawaii. Phone Hrs: 7:00 am to 5:30 p.m. Pacific Time, California, Arizona and Georgia customers call or visit nearest store. California, Arizona, Georgia and Virginia residents please add sales tax. Prices, specifications, descriptions subject to change without notice.



For A HRO 72 Page
Communication Equipment Catalog
Send \$1.00 to any HRO Store



HAM RADIO OUTLET

LARGEST HAM OUTLET IN THE WORLD

NOW
9

STORE BUYING POWER

icom IC-765



100W GENERAL COVERAGE RECEIVER
HF ALL BAND TRANSCEIVER
Maximum Operation Flexibility

SALE! CALL FOR PRICE

icom IC-781

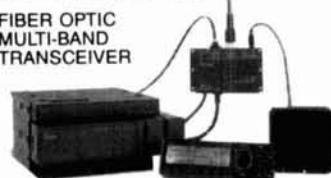


THE ULTIMATE
150 W, ALL BAND
HF TRANSCEIVER

GREAT PRICE!

icom IC-901

FIBER OPTIC
MULTI-BAND
TRANSCEIVER



2 METER AND 440 MHz
EXTRA-LARGE MULTI COLOR LCD
HM14 TOUCH TONE MICROPHONE

CALL FOR PRICE

icom A Models 25 WATTS
H Models 100 WATTS
IC-275A/275H, 138-174 MHz

IC-475A/475H, 430-450 MHz



LOW PRICE!

HAM RADIO OUTLET NATIONWIDE TEAM



**RAPID DELIVERIES
FROM STORE NEAREST YOU**

icom HAND-HELD
VHF/UHF
**MICRO
SIZE**



IC-32AT Dual Band Hand Held
IC-2GAT 2 Meter HT 7 WATT
IC-2SAT, 2MTR
IC-3SAT, 220 MHz
IC-4SAT, 440 MHz

icom IC-2400A

2m, 440 MHz



VHF/UHF DUAL BAND
FM TRANSCEIVER

icom IC-228A/H

2 METER MOBILES
IC-448A
440 MHz MOBILE



FM TRANSCEIVER
20 Memories with Memory
Channel Lock-Out.

icom IC-725



100W GENERAL COVERAGE RECEIVER
HF ALL BAND COMPACT TRANSCEIVER

GREAT PRICE



All Major Brands in Stock Now!



Bob Ferrero W6RJ
President/Owner
Jim Rafferty N6RJ
VP-National
Sales Manager

ANAHEIM, CA 92801
2620 W. La Palma
(714) 761-3033, (213) 860-2040
Between Disneyland &
Knotts Berry Farm

ATLANTA, GA 30340
6071 Buford Hwy.
(404) 263-0700
Larry, Mgr. WD4AGW
Doraville, 1 mi. north of I-285

BURLINGAME, CA 94010
999 Howard Ave.
(415) 342-5757
George, Mgr. WB6DSV
5 miles south on 101 from SFO

OAKLAND, CA 94606
2210 Livingston St.
(415) 534-5757
Rich, Mgr. WA9WYB
IS-880 at 23rd Ave. Ramp

PHOENIX, AZ 85015
1702 W. Camelback Rd.
(602) 242-3515
Gary WB7SLY, Mgr.
East of Hwy. 17

SALEM, NH 03079
224 N. Broadway
1-800-444-0047
Curtis, Mgr. WB4KZL
28 miles north of Boston exit 1 I-93

SAN DIEGO, CA 92123
5375 Kearny Villa Rd.
(619) 560-4900
Tom, Mgr. KM6K
Hwy. 163 & Claremont Mesa Blvd.

WOODBIDGE, VA 22191
14803 Build America Drive
(703) 643-1063 1-800-444-4799
Linda, Mgr. KB4ZYT
Exit 54, I-95 South to US RT 1

VAN NUYS, CA 91411
6265 Sepulveda Blvd.
(818) 988-2212
Al, Mgr. KBYRA
San Diego Fwy, at Victory Blvd

WALK IN STORE HOURS
10 AM-5:30 PM
CLOSED SUNDAYS

CALL TOLL FREE

(FROM MOST AREA'S)
INSIDE CALIFORNIA CALL STORE NEAREST YOU

Call any of our 800 numbers coast to coast from most parts of the country..

MID-WEST/WEST
ANAHEIM, 9 to 5:30 PST

SOUTHEAST
ATLANTA, 9 to 5:30 EST

MID-ATLANTIC
WOODBIDGE, 9 to 5:30 EST

NEW ENGLAND
SALEM, 9 to 5:30 EST

1-800-854-6046

1-800-444-7927

1-800-444-4799

1-800-444-0047



Toll free including Hawaii. Local phone hours: 9:30 AM to 5:30 PM, Arizona, California, and Georgia customers call or visit nearest store. Arizona, California, Georgia and Virginia residents please add sales tax. Prices, specifications, descriptions subject to change without notice.

BEST OF MFJ

MFJ, Bencher and Curtis team up to bring you America's most popular keyer in a compact package for smooth easy CW



MFJ-422B

\$129.95

The best of all CW world's -- a deluxe MFJ Keyer using a Curtis 8044ABM chip in a compact package that fits right on the Bencher iambic paddle!

This MFJ Keyer is small in size but big in features. You get iambic keying, adjustable weight and tone and front panel volume and speed controls (8-50 WPM), dot-dash memories, speaker, sidetone and push button selection of automatic or semi-automatic/tune modes. It's also totally RF proof and has ultra-reliable solid state outputs that key both tube and solid state rigs. Use 9 volt battery or 110 VAC with MFJ-1305, \$12.95.

The keyer mounts on a Bencher paddle to form a small (4-1/8 x 2-5/8 x 5 1/2 inches) attractive combination that is a pleasure to look at and use.

The Bencher paddle has adjustable gold plated silver contacts, lucite paddles, chrome plated brass and a heavy steel base with non-skid feet.

You can buy just the keyer assembly, MFJ-422BX, for only \$79.95 to mount on your Bencher paddle.

Deluxe 300 W Tuner



MFJ-949D is the world's most popular 300 watt PEP tuner. It covers 1.8-30 MHz, gives you a new peak and average reading Cross-Needle SWR/Wattmeter, built-in dummy load, 6 position antenna switch and 4:1 balun -- in a compact 10 x 3 x 7 inch cabinet. Meter lamp uses 12 VDC or 110 VAC with MFJ-1312, \$12.95.

Antenna Bridge

Now you can quickly optimize your antenna for peak performance with this portable, totally self-contained antenna bridge.

No other equipment needed -- take it to your antenna site. Determine if your antenna is too long or too short, measure its resonant frequency and antenna resistance to 500 ohms. It's the easiest, most convenient way to determine antenna performance. Built in resistance bridge, null meter, tunable oscillator-driver (1.8-30 MHz). Use 9 V battery or 110 VAC with AC adapter, \$12.95.

MFJ-204B
\$79.95



Super Active Antenna

"World Radio TV Handbook" says MFJ-1024 is a "first rate easy-to-operate active antenna ... quiet ... excellent dynamic range ... good gain ... very low noise ... broad frequency coverage ... excellent choice."

Mount it outdoors away from electrical noise for maximum signal, minimum noise. Covers 50 KHz to 30 MHz.

Receives strong, clear signals from all over the world. 20 dB attenuator, gain control, ON LED. Switch two receivers and aux. or active antenna. 6x3x5 in. Remote unit has 54 inch whip, 50 ft. coax and connector. 3x2x4 in. Use 12 VDC or 110 VAC with MFJ-1312, \$12.95.

VHF SWR/Wattmeter

MFJ-812B
\$29.95
Covers 2 Meters and 220 MHz. 30 or 300 Watt scales. Also reads relative field strength 1-170 MHz and SWR above 14 MHz. 4 1/2 x 2 1/4 x 3 in.



MFJ Coax Antenna Switches



\$34.95 MFJ-1701



\$21.95 MFJ-1702B



\$59.95 MFJ-1704

Select any of several antennas from your operating desk with these MFJ Coax Switches. They feature mounting holes and automatic grounding of unused terminals. They come with MFJ's one year unconditional guarantee.

MFJ-1701, \$34.95. Six position antenna switch. SO-239 connectors. 50-75 ohm loads. 2 KW PEP, 1 KW CW. Black alum. cabinet. 10x3x1 1/2 inches.
MFJ-1702B, \$21.95. 2 positions plus new Center Ground. 2.5 KW PEP, 1 KW CW. Insertion loss below .2 dB. 50 dB isolation at 450 MHz. 50 ohm. 3x2x2 in.
MFJ-1704, \$59.95. 4 position cavity switch with lightning/surge protection device. Center ground. 2.5 KW PEP, 1 KW CW. Low SWR. Isolation better than 50 dB at 500 MHz. Negligible loss. 50 ohm. 6 1/4 x 4 1/4 x 1 1/4 in.

"Dry" Dummy Loads for HF/VHF/UHF

MFJ has a full line of dummy loads to suit your needs. Use a dummy load for tuning to reduce needless (and illegal) QRM and save your finals.

MFJ-260B, \$28.95. VHF/HF. Air cooled, non-inductive 50 ohm resistor. SO-239 connector. Handles 300 Watts. Run full load for 30 seconds, derating curve to 5 minutes. SWR less than 1.3:1 to 30 MHz, 1.5:1 to 150 MHz. 2 1/2 x 2 1/2 x 7 in.
MFJ-262, \$69.95. HF. 1 KW. SWR less than 1.5:1 to 30 MHz. 3x3x13 in.
MFJ-264, \$109.95. Versatile UHF/VHF/HF 1.5 KW load. Low SWR to 650 MHz, usable to 750 MHz. Run 100 watts for 10 minutes, 1500 watts for 10 seconds. SWR is 1.1:1 to 30 MHz, below 1.3:1 to 650 MHz. 3x3x7 inches.

MFJ Ham License Upgrade Theory Tutor



MFJ Theory Tutor practically guarantees you'll pass the theory part of any FCC ham license exam. Versatile MFJ software is the best computer tutor ever tailor-made for ham radio. You can study the entire FCC question pool, selected areas and take (or print) sample tests. Auto. saves each study session (ex. sample tests), gives you all FCC test graphics (ex. mono.), explanations of hard questions, pop-up calculator, weighted scoring analysis, color change option and more. Order MFJ-1610-None, MFJ-1611-Tech; MFJ-1612-Gen.; MFJ-1613-Adv.; MFJ-1614-Ex. for IBM compatible. For Macintosh: MFJ-1630-N; MFJ-1631-T; MFJ-1632-G; MFJ-1633-A; MFJ-1634-E, \$29.95 per license class. MFJ-284 or MFJ-286

MFJ Speaker Mics

MFJ's compact Speaker/Mics let you carry your HT on your belt and never have to remove it to monitor calls or talk. You get a wide range speaker and first-rate electret mic element for superb audio on both transmit and receive. Earphone jack, handy lapel/pocket clip, PTT, lightweight retractable cord. Gray. One year unconditional guarantee. MFJ-284 fits ICOM, Yaesu, Santec. MFJ-286 fits Kenwood.



MFJ-1278 Multi-Mode Data Controller

MFJ-1278 Use computer to transmit/receive in all 9 digital modes: Packet, AMTOR, ASCII, CW, RTTY, FAX, SSTV, Contest Memory Keyer and Navtex receive. Easy-Mail™ Personal Mailbox, Built-in printer port, 20 LED tuning indicator, AC power supply, Host/KISS, 32K RAM, Multi-gray level FAX/SSTV modem, CW key paddle jack and tons more. Options include 2400 baud modem (MFJ-2400, \$79.95) and software starter packs with computer cables, \$24.95 each, for IBM compatible, Commodore 64/128, Macintosh and VIC-20.



12/24 Hour LCD Clocks

\$19.95 MFJ-108B **\$9.95** MFJ-107B

Huge 5/8 inch bold LCD digits let you see the time from anywhere in your shack. Choose from the dual clock that has separate UTC/local time display or the single 24 hour ham clock.

Mounted in a brushed aluminum frame. Easy to set. The world's most popular ham clocks for accurate logs. MFJ-108B 4 1/2 x 1 x 2, MFJ-107B 2 1/4 x 1 x 2 in.

Cross-Needle SWR/Wattmeter

MFJ Cross-Needle SWR/Wattmeter has a new peak reading function! It shows you SWR, forward and reflected power in 2000/500 and 200/50 watt ranges. Covers 1.8-30 MHz.

Mechanical zero adjusts for movement. SO-239 connectors. Lamp uses 12 VDC or 110 VAC with MFJ-1312, \$12.95.

Deluxe Code Practice Oscillator

MFJ-557
\$24.95

MFJ-557 Deluxe Code Practice Oscillator has a Morse key and oscillator unit mounted together on a heavy steel base so it stays put on your table. Portable because it runs on a 9-volt battery (not included) or an AC adapter (\$12.95) that plugs into a jack on the side.

Earphone jack for private practice, Tone and Volume controls for a wide range of sound. Speaker. Key has adjustable contacts and can be hooked to your transmitter. Sturdy. 8 1/2 x 2 1/4 x 3 3/4 in.

AC Volt Monitor

MFJ-850
\$19.95
Prevent damage to rig, computer or other gear. Monitor AC line voltage for potentially damaging power surge or brown out conditions. Expanded 95-135 volt 2-color scale. Plugs into any AC outlet. 2% accuracy. 2 1/4 x 2 1/4 x 1 1/2 in.



Nearest Dealer/Orders: 800-647-1800

MFJ MFJ ENTERPRISES, INC.
Box 494, Miss. State, MS 39762
(601) 323-5869; FAX: (601) 323-6551
TELEX: 53 4590 MFJ STKV

• One year unconditional guarantee • 30 day money back guarantee (less s/h) on orders from MFJ • Add \$5.00 each s/h • FREE catalog MFJ . . . making quality affordable

© 1990 MFJ Enterprises, Inc.

Backscatter



No New Novices? NO WAY!

Let's assume for the sake of argument that a code-free Amateur license is inevitable, and such a license will be closely related to what the FCC has proposed in PR Docket 90-55. The FCC's version of a Communicator class license would require a written exam based on — but more comprehensive than — the present Technician exam. At the same time the Novice license would be abolished as an entry into Amateur Radio.

I am firmly convinced that such a code-free license would indeed attract some and perhaps many valuable new members to the Amateur fraternity. I am equally convinced that shutting off the much less technically demanding Novice entry into our service would prove at least as damaging as the code-free license could prove beneficial. My conviction is based on a recent personal experience.

My wife, a very bright lady with a Master's degree in Marketing Communications, is taking a basic electronics course. The course is required by her electronics manufacturer employer, who wants his key non-technical employees to understand the language of their field. After helping her cope with series and parallel resistances, inductive reactance and resonant circuits, and seeing how many hours she spends studying to prepare for this class, I have a new and profound appreciation for the difficulty many of us have experienced — even at the Novice level — in becoming licensed Amateurs!

The things she's learning in her electronics course are comparable to what is required for the present Technician license. If, as the FCC proposes, technical expertise of this level will be required for *any* entry into Amateur Radio, the door will literally be slammed in the faces of thousands of interested but not technically oriented would-be Amateurs. These are people who, once they became directly involved through on-the-air and at-the-bench Novice level activities, would eventually pick up much of the technical knowledge required for upgrading in a much more pleasant environment than that offered in textbooks and classrooms.

One of the principal reasons for the FCC's desire to eliminate the Novice as an entry into Amateur Radio is its determination that there's been a good deal of cheating in the Novice licensing process since Novice enhancement has made Novice privileges so much more attractive. Because there was a stipulation when the legislation enabling us to run the Amateur examination program was passed that there should be no charge for administering Novice exams, it doesn't seem likely that VEC organizations could or would be able to assume the financial burden of a formal Novice examination program. However, there surely must be some way to clean up Novice licensing short of abolishing it!

For example, why not require that Novice exams be administered only by accredited Volunteer Examiners, working on their own, but with the results forwarded to Gettysburg through the accrediting VEC? The overall added workload for the VEC would be minimal. As a VE with the DeVry VEC myself, I can't imagine any of my fellow VEs jeopardizing their reputations or the reputation of the DeVry VEC by entering into a conspiracy to give some lazy would-be Novice a free ride! And that's just one possible solution — surely others can come up with equally good or better ways to restore integrity to Novice licensing.

Whatever we do in our efforts to restore vitality to the Amateur service, let's not shut off one established and vital source of new blood in our attempts to open up a new one!

Joe Schroeder, W9JUV

Comments

Freebanders Versus Licensed Amateurs

Dear HR

In March's "Backscatter," I think Bill Orr, W6SAI, brings up a good point in questioning if a no-code VHF license will do that much to increase the ranks of Amateur Radio. But I can't agree completely that the "freebanders" now operating between 26 and 29 MHz are, in his words, "a lot of happy people enjoying the fruits of Amateur Radio the easy way." I agree that they may be happy people on the air communicating via radio, but I disagree that they are enjoying the fruits of Amateur Radio. At least not all of the fruits. Yes, they may be communicating with other freebanders all over the world and so they have 3 MHz to do it in — but what about when the sunspot cycle changes and that portion of the spectrum is dead most of the time?

We hams simply move down to 15 or 20 meters and continue on. The freebander will have only the freebander down the street to talk to. What about the other fruits Amateur Radio has to offer — like packet, SSTV, ATV, RTTY, traffic handling, coordinated emergency communications, repeater operation, and homebrewing your own equipment? If just talking on the air when the skip's in is all you want, then freebanding may be OK, but if you really want to enjoy the different aspects that radio communication has to offer, then an Amateur Radio license is the only way to go.

My main concern with the freebanders is that they're moving up into 10 meters, and causing a lot of QRM in the CW portion of the band. As long as they stay below 28 MHz, I have no quarrel with them, but when they start encroaching on our frequencies, I get quite concerned. If they aren't afraid to move into 10 meters illegally, when 10 is dead, I guess there is nothing to keep them from also moving to 15 or 20 or any other ham band.

On second thought, Bill Orr just may be correct. Maybe they will enjoy the fruits of Amateur Radio for free unless we, the Amateur community, get busy



and ask the ARRL and the FCC to get their heads out of the sand and do something about it!

**Bill Harris, K5MIL,
Roanoke, Texas**

More on AM phone

Dear HR

Reading the letter by KH6CC and KH6B ("AM alive and well") in the March issue brought back some happy memories I'd like to share. I received my first ticket, W8QXF, in May of 1937 and couldn't wait to get my rig on the air. It was a 6L6 Triton oscillator for CW on 80 and 40 meters. The Triton was a crystal-controlled oscillator that could be tuned to either its fundamental or second harmonic frequency and was not too efficient. I sure raised some blisters making that jewel, soldering with a plumber's iron borrowed from my dad and heated over the gas flame in Mother's stove.

My good old Sky Buddy could receive the 160-meter phone band and I would often listen up there and wish that I too could work phone. Money was scarce and there was no way I could buy a modulation transformer. However, an article about Heising Modulation in *The ARRL Handbook* got me thinking. A visit to the friendly radio repairman, not a ham himself, got me a 20-H filter choke from a defunct AM radio. That filter choke, a new crystal for 160, another 6L6, a telephone mike, and miscellaneous small parts from old radios got me on phone. I spent many happy nights on AM phone with my four-tube (including rectifier) rig. I wonder how many remember those transcontinental

hookups where we East Coasters would start a net and absorb newcomers across the continent until we had a clear channel and could work distances not otherwise available in the late evenings?

I feel that we lost something by jumping on the SSB bandwagon. I was KH6RD during 1947 and 1948, operating 10 meters only. This was during one of the sunspot cycles and the QRM in the islands was tremendous. There may have been fewer hams then but a large percentage were on 10 meters and all districts would be open at the same time. A ham in Los Angeles and I decided to experiment with the Very Narrow Band FM using reactance modulators. We used slope detection, with sharp crystal filters, and found that we could reduce frequency deviation to such a low figure that the signal sounded like an unmodulated carrier but was perfectly readable when tuned to the middle of the filter slope. What was more important was that we could copy through the heaviest QRM on the band. I think it's a shame that more was not done in VNBFM for ham use. The equipment was simple, with excellent audio, and used little more space than a CW signal. The modern narrow bandpass filter, with a second filter shifted to put its slope in the middle of the passband, or more elaborate limiters and phase lock loop detection should do a superb job with very narrow frequency shift.

We would all benefit by setting aside a portion of the 10-meter band for use of homebrew equipment only on AM, VNBFM, and CW. Make this sub band available to new licensees as well as nostalgic old timers. Limit power input to 100 watts to keep a level playing field. This could put some of the magic back into the hobby for new recruits. Those who choose not to home brew would still have privileges they now have. These modes are simple enough to be homebrewed by almost anyone and, who knows, might start many a kid on an engineering career as it did with me.

**Earl Smith, W1BML,
Groton, Connecticut**

GROUND-MOUNTED VERTICAL ANTENNAS

A little history and some theory

By W.J. Byron, W7DHD, P.O. Box 2789, Sedona, Arizona 86336 and F.S. Chess, K3BN, 4946 Manor Lane, Ellicott City, Maryland 21043

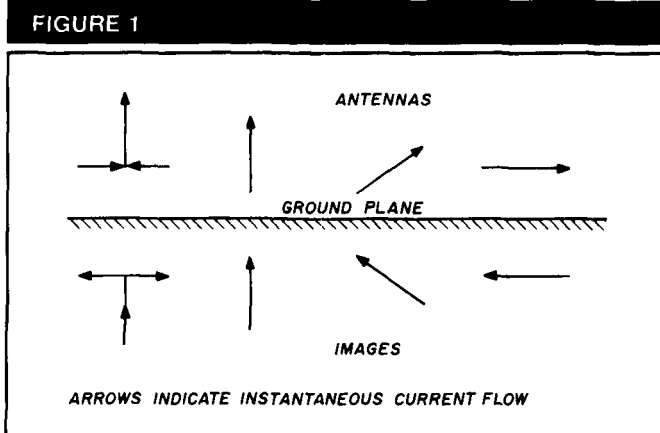
Vertical antennas date from the beginnings of radio. They were ground mounted with the exception of one highly successful and innovative system, the "Zepp." Its origin seems to have been forgotten, and the Zepp name has come to mean something quite unrelated to the original. In the twenties, when Amateurs were herded into the spectrum above 1.5 MHz ("200 meters and below"), the Zepp proved both practical and useful as a horizontal antenna. The originals, though, were often several thousand feet in length. They hung straight down from the gondola of a Zeppelin (hence the name) — vertically, of course!

In those very early days, "spark" transmitters were used. They operated on enormous wavelengths (sometimes kilometers), and a number of them were run at many kilowatts with surprisingly high efficiencies — 80 percent was rather common. POZ, at Nauen, Germany operated at 150-kW output, 85-percent efficiency at the transmitter. Because of the extreme shortness of the antenna and the long wavelengths, antenna efficiency was probably less than 5 percent at most, resulting in an antenna current of over 1,000 amperes! There were also "arc" transmitters, and two different types of mechanically-generated radio frequency transmitters, but these appeared a decade or more later!

Why vertical?

Vertical antennas were (and are) the only way to launch a low frequency radio field from a location on or near the ground. The techniques, practices, and experiences of earlier antenna pioneers are still germane today — especially when the subject is verticals. There's not much that's really new after all this time. Our instruments and some techniques have simply been upgraded.

There's a notable, fundamental difference between the behavior of verticals and horizontal antennas operated near ground. The "images" shown in **Figure 1** are in phase for the vertical, but they are opposing in the horizontal case.



Current filaments and their images over "perfect" ground.

Thus, while the vertical can be operated right on the ground, the horizontal can't because the image tends to cancel the antenna current. It would cancel completely if there were such a thing as "perfect earth." The perfect earth concept is used extensively for preliminary designs. Ground conditions, when known, aid in final designs.

Because the first transmitting antenna was made by Marconi (apologies to Tesla, Popov, and probably others who could have been first) the base-fed short vertical antenna is called (you guessed it) a "Marconi." It's defined as follows:

A Marconi is a current-fed antenna (usually vertical) whose overall length is a quarter-wave or less, and is loaded by various means so that it exhibits series (90 degree) resonance.

Those "various means" may include series inductors, capacitive top hats, or mixtures of both. Most of the early systems used a combination approach. There were two main reasons for this. The first was that erecting a quarter-wave high antenna for a wavelength of 5,000 meters was impossible then, and would be nearly so today. The second involves the "logarithmic decrement" of the antenna, about which there will be more later. Because it was related to the bandpass — those were very broad signals — it was of great importance to control (always to decrease) the value

of the logarithmic decrement, hence the bandpass. In practical terms, this meant that inductance had to be added in order to decrease the log decrement, which was subject to government regulations. In 1919, the United States Department of Commerce limited the log decrement to 0.2 maximum.

Ever narrower bandpass

All spark transmitters functioned by the periodic discharging of a capacitor bank through a spark gap. The spark gap was either in series with an antenna which was the *only* frequency-determining element in the system (Marconi's early method), or coupled to a secondary circuit which contained the antenna and various resonating components — usually inductors. When a charge was delivered to either of these two basic types, the circuit plus antenna (or the antenna itself) would "ring," losing some of its energy with each cycle because of radiation and circuit losses. The decrease in amplitude was a constant fraction of the preceding cycle amplitude. That constant was the logarithmic decrement, and is related to what we now call the "Q" of an antenna — except that it is inverse. The larger the Q, the smaller the log decrement. The main factor controlling the log decrement was the amount of inductance in the system (as with Q, which is X_L/R), thus most of the early verticals were base loaded even though they had very large top hats. It was the only practical way to control the log decrement; the only place you could introduce inductance conveniently was at the base. The large (even by today's standards) top-loading capacitances were the smaller part of the total loading when the wavelength was several kilometers. Some of those early top-loading schemes resulted in 0.05- μ F capacitance. The pioneers taught us something very important — how to construct base-loading inductors with an intrinsic Q of 5,000 or more. Such numbers are possible when the frequency is below, say, 100 kHz, where Litzendraht ("Litz") wire is practical. Litz wire loses its effectiveness above a few hundred kHz. Modern OMEGA antenna systems use Litz wire-loading coils; they are also combination base and top loaded.

An about-face

Nowadays we try to increase the bandwidth of a vertical, just to avoid having to retune when a rather large frequency shift is made. The signal bandwidth is controlled by the modern design of both the transmitter and receiver. It's a challenge to have a wide antenna bandwidth while maintaining high efficiency. It's especially difficult when the antenna is physically short, as is usually the case with vertical antennas for 80 and 160 meters. This is particularly true when they are placed over good ground systems.

We mentioned before that the antenna current for POZ was over 1,000 A (references exist which mention 1,200 A). Today, using more or less typical transmission line impedances of 50 or 75 ohms, a 1,000-A line current would represent 50 to 75 MW. But we know that the power was "only" 150 kW. Why the large current? Obviously, there were very low impedances involved. A characteristic of LF and VLF Marconi antennas is their low feedpoint impedances, given little ground loss. Their actual radiation resistances were extremely low, usually a fraction of an ohm. A resistance of 50 milliohms was rather common. That's because they were all physically very short.

How do we calculate radiation resistance?

The radiation resistance of a half-wave doublet constructed of "infinitely thin" wire (a necessity for the original derivation) is approximately 73.2 ohms.* That value has been known since the 1880s. Therefore, the radiation resistance of half a very thin doublet would be 36.6 ohms. This is the generally accepted value for a full length quarter-wave vertical antenna. unachievable though it is. We deal with values less than that because the length necessary for resonance is also a function of the length-to-diameter ratio of the element. The outcome is resonant lengths that are shorter than the equivalent "free space" lengths. The net result is an antenna that will always be of lower resistance than that achieved for the thin wire. Figure 2 shows the manner in which it changes.²

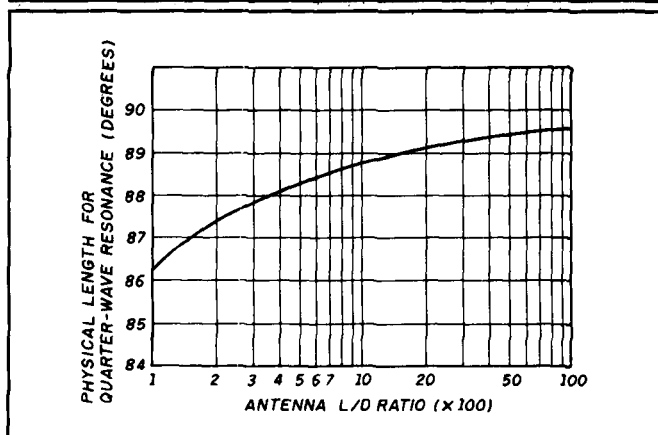
It has been difficult to determine the expected radiation resistances of variously loaded short verticals, although some complicated calculations do exist. Occasionally, a curve is published titled "Radiation Resistance of a Vertical Antenna versus Height," with no indication as to the form of antenna (or what length-to-diameter ratio) it relates to. It's usually presented on linear graph paper, though the function is a steep transcendental one which makes it hard to interpret at both ends of the curve. Typically it's been calculated for what we'll call the "base-loaded" case, and is of no use whatsoever for any other type of loading (like top, center, or combination).

Simple but workable derivations

Figures 3 through 6 illustrate methods for estimating the radiation resistances of various antennas with different forms of loading. Two of them were first presented in *Ham Radio* in 1983.³ The derivation starts with one-half of the theoretically derived resistance of a free space half-wave dipole (36.6 ohms). If you assign 1 A as the value of the base current and assume that the current distributes itself sinusoidally, then the area of the profile will be 1 ampere-radian.

The rationale for the derivations is that by allowing for no

FIGURE 2



Graph of free-space length of quarter-wave resonance versus the ratio of the length-to-diameter of an element.

*This information can be found in several sources. We used one of Schelkunoff's antenna books.

AEA's NEW ET-1 ECONO-TUNER™

Meet Your Match

Meeet your match with AEA's new ET-1 Econo-Tuner. A quality, economical antenna tuner for under \$150, the ET-1 is designed to match virtually any receiver, transmitter or transceiver from 1.8 to 30 MHz with up to 300 watts of RF power.

Versatile. The ET-1 is compatible with almost ANY antenna including verticals, dipoles, inverted vees, beams and mobile whips that are fed by coax cable, balanced lines or a single wire. For easy connection to balanced lines, a 1:4 balun is built-in.

Tuning Options. A front panel switch control allows you to switch between two coax-fed antennas (direct or through the tuner). You can also switch to a balanced line or wire antenna. The BYPASS position allows you to switch to a dummy load (such as AEA's DL-1500 dry dummy load)

or a direct connected coax antenna. In the BYPASS position, COAX 1 OUT or COAX 2 OUT can be selected so that the tuner is bypassed, but not the meter circuit.

Dual-Movement Meter.

The ET-1 features a precision dual-movement meter to simultaneously monitor power and SWR.

AEA Quality. Unique engineering designs have made AEA one of the leading innovators in the amateur radio industry. That same quality and superior technical support make the ET-1 your best deal for an antenna tuner.

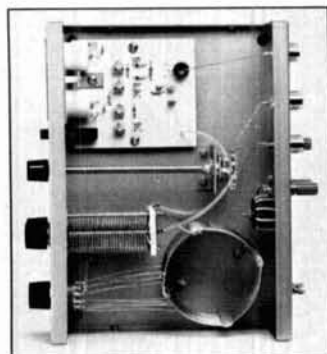
AEA provides technical support from the factory or through your personal computer and modem on CompuServe's HamNet. If you are already a CompuServe member, just type GO HAMNET at any CompuServe prompt. For a free introductory CompuServe membership, call 1-800-848-8199 and ask for representative #48.

AEA Brings You A Better Experience.

Advanced Electronic Applications, Inc.

2006-196th St. SW/P.O. Box 2160 Lynnwood, WA 98036 206-775-7373

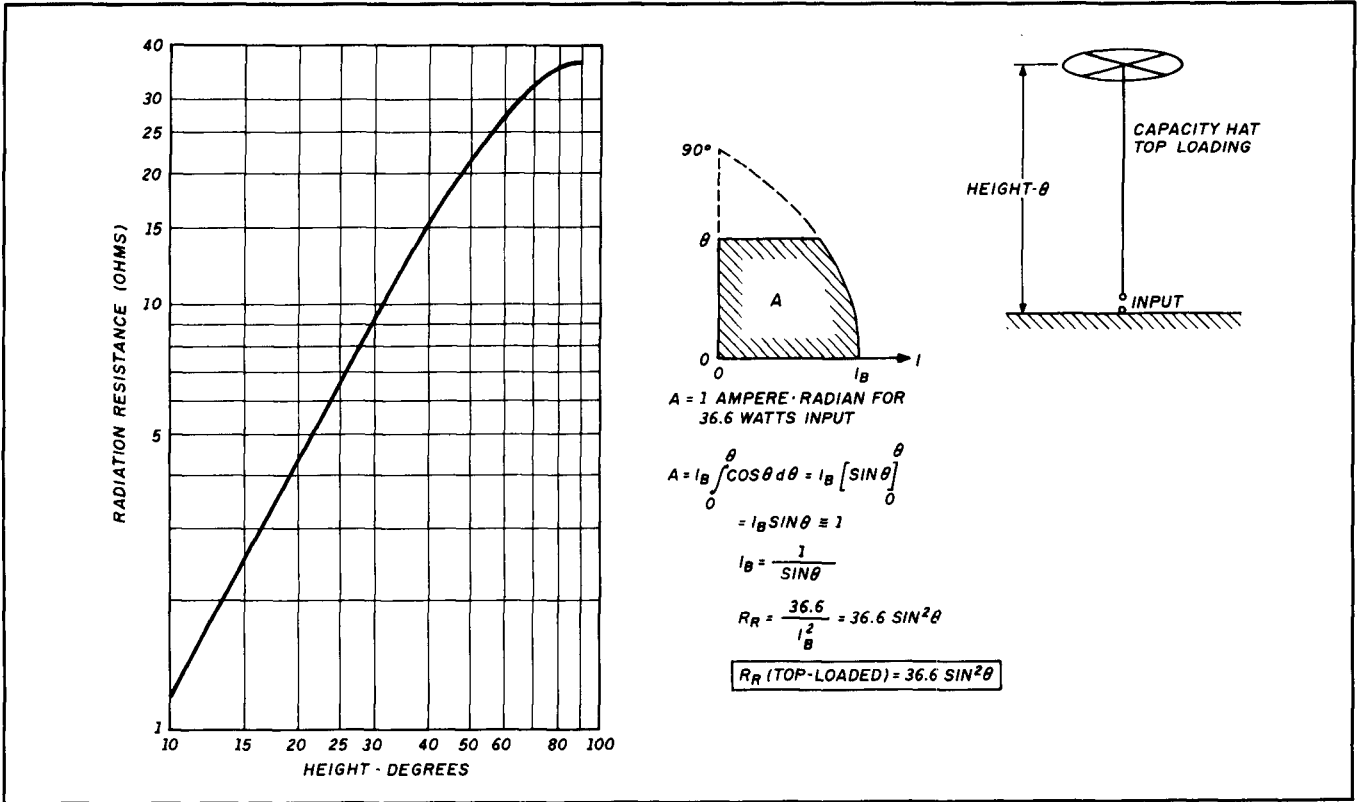
Specifications subject to change without notice or obligation. Copyright 1990. Dealer inquiries invited.



ET-1 Econo-Tuner inside view.

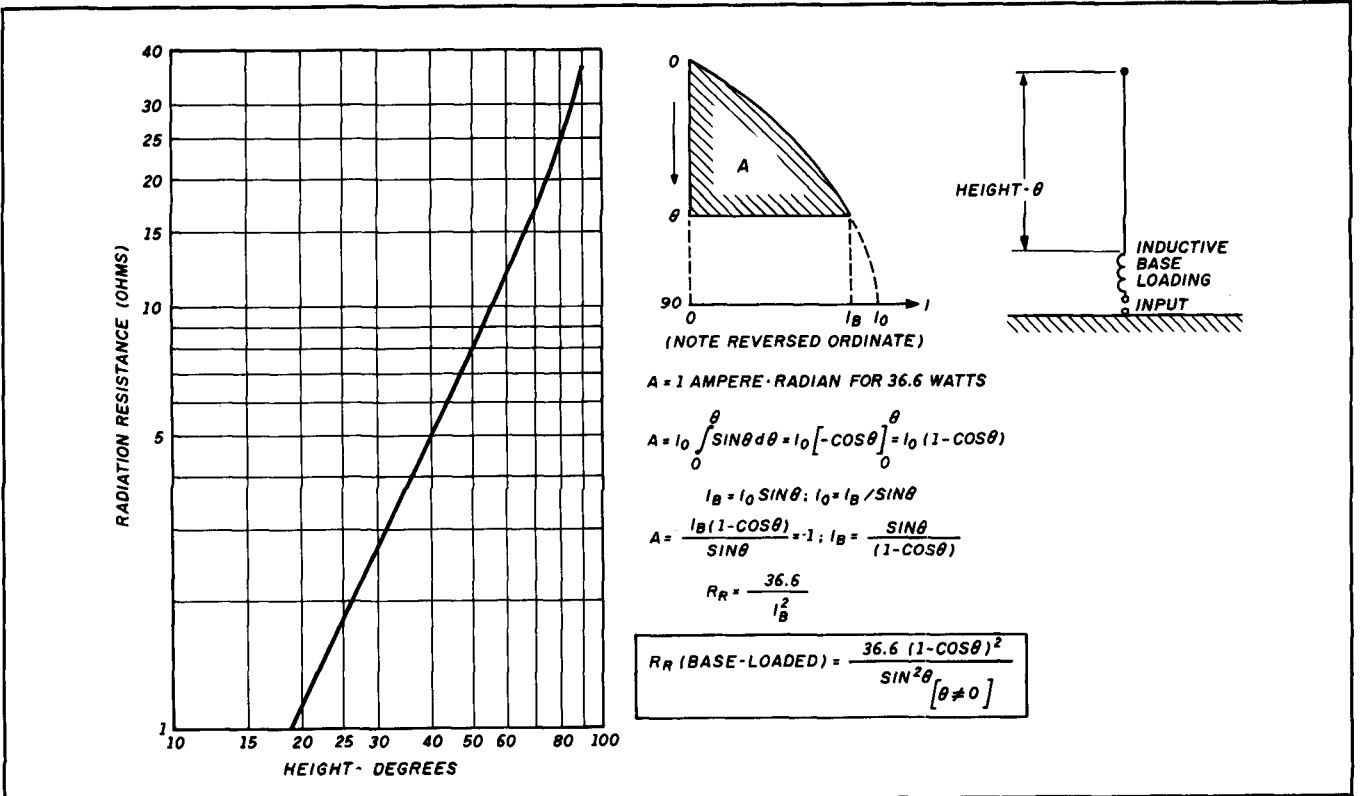


FIGURE 3



The curve and its derivation for the top-loaded Marconi vertical. The curve is computed from the expression in the rectangular box.

FIGURE 4



The curve and its derivation for the base-loaded Marconi vertical.

INTRODUCING OUR NEW COMPUTER-CONTROLLED REP-200 REPEATER

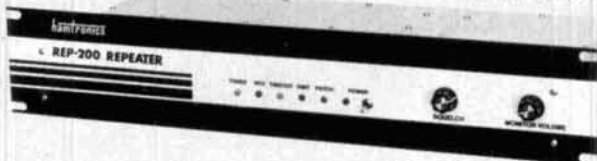
If you always thought a computer-controlled repeater had to be expensive, LOOK AGAIN! You could easily spend this much just for a controller.

As always, Hamtronics strives to give superb performance at modest cost! In this case, a premium repeater with versatile computer control, autopatch, and many dtmf control features at less than many charge for a bare-bones repeater!

We don't skimp on rf modules, either! Check the features on R144 Receiver, for instance. GaAs FET front-end, helical resonators, sharp crystal filters, hysteresis squelch.

We completely re-thought the whole idea of what a repeater should be, to give the best features at the lowest cost.

ONLY \$1295!

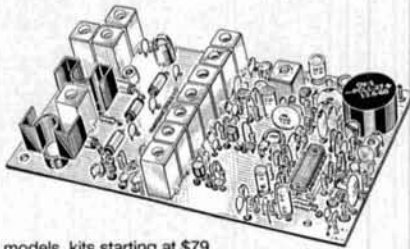


- Available for the 10M, 6M, 2M, 220MHz, 440MHz, 902MHz ham bands. FCC type accepted models also available for vhf and uhf commercial bands.
 - Rugged exciter and PA, designed for continuous duty.
 - Power output 15-18W (25W option) on 2M or hi-band; 15W on 220MHz; 10W on uhf or 902MHz.
 - Accessory add-on PA's available with power levels up to 100W.
 - Five courtesy beep types, including a pleasant multi-tone sequence.
 - AUTOPATCH: either open or closed access, toll-call restrict, auto-disconnect.
 - Reverse Autopatch, two types: auto-answer or ring tone on the air.
 - DTMF CONTROL: over 45 functions can be controlled by touch-tone. Separate 4-digit control code for each function, plus extra 4-digit owner password.
 - Owner can inhibit autopatch or repeater, enable either open- or closed-access for repeater or autopatch, and enable toll calls, reverse patch, kerchunk filter, site alarm, aux rcvr, and other options, including two auxiliary external circuits.
 - The cwid message, dtmf command codes, and owner-specified default parameters for cor and cwid timers and tones are burned into the eeprom at the factory.
 - Cw speed and tone, courtesy beep and tail timers, and courtesy beep type can all be changed at any time by owner-password-protected dtmf commands.
 - Many built-in diagnostic & testing functions using microprocessor.
 - Color coded led's indicate status of all major functions.
 - Welded partitions for exciter, pa, receiver, and controller. PEM nuts for covers.
 - 3-1/2 inch aluminum rack panel, finished in eggshell white and black.
 - Auxiliary receiver input for independent control or cross linking repeaters.
- There are many other features, too numerous to mention. Request catalog for full details.

HIGH PERFORMANCE XMTRS & RCVRs FOR REPEATERS, AF & DIGITAL LINKS, TELEMTRY, ETC.

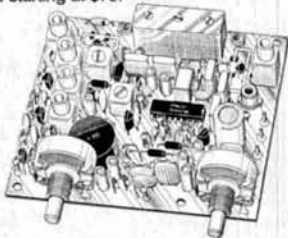
FM EXCITERS: kits \$99, w/t \$169. 2W continuous duty. TCXO & xtal oven options available. FCC type accepted for com1 uhf & hi bands.

- TA51 for 10M, 6M, 2M, 150-174, 220MHz.
- TA451 for uhf.
- TA901 for 902-928MHz, 0.5W out (w/t only, \$169).
- VHF & UHF AMPLIFIERS. For fm, ssb, atv. Output from 10W to 100W. Several models, kits starting at \$79.



FM RECEIVERS: kits \$139, w/t \$189.

- R144/R220 FM RECEIVERS for 2M, 150-174, or 220MHz. GaAs FET front end, 0.15uV sensitivity! Both crystal & ceramic if filters plus helical resonator front end for exceptional selectivity: >100dB at ±12kHz (best available anywhere!) Flutter-proof hysteresis squelch; afc tracks drift.
- R451 UHF FM RCVR, similar to above
- R901 902-928MHz FM RCVR. Triple-conversion, GaAs FET front end.
- R76 ECONOMY FM RCVR for 10M, 6M, 2M, 220MHz, w/o helical res. or afc. Kits \$129.
- Weather satellite & AM aircraft rcvrs also available.



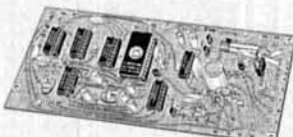
If you prefer a plain-vanilla or kit repeater, you couldn't find a better value than our original REP-100 REPEATER

Same fine rf modules as REP-200 but with COR-4 Controller. Can add autopatch, dtmf decoder, CTCSS, either now or later. Kit only \$675, w/t \$975.

ACCESSORIES

COR-3 REPEATER CONTROLLER kit. Features adjustable tail & time-out timers, solid-state relay, courtesy beep, and local speaker amplifier\$49

CWID kit. Diode programmed any time in the field, adjustable tone, speed, and timer, to go with COR-3\$59

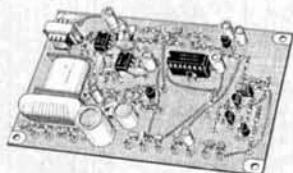


NEW COR-4 kit. Complete COR and CWID all on one board for easy construction. CMOS logic for low power consumption. Many new features. EPROM programmed; specify call ..\$99



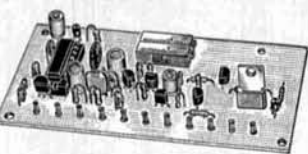
NEW TD-3 SUBAUDIBLE TONE DECODER/ENCODER kit. Adjustable for any tone. Designed especially for repeaters, with remote control activate/deactivate provisions\$24

TD-2 TOUCH-TONE DECODER/CONTROLLER kit. Full 16 digits, with toll-call restrictor, programmable. Can turn 5 functions on/off. Great for selective calling, too!\$79



AP-3 AUTOPATCH kit. Use with above for repeater autopatch. Reverse patch & phone line remote control are std. \$79

AP-2 SIMPLEX AUTOPATCH Timing Board kit. Use with above for simplex operation using a transceiver\$39



MO-202 FSK DATA MODULATOR kit. Run up to 1200 baud digital signals through any fm transmitter with full handshakes. Radio link computers, telemetry gear, etc.\$39

DE-202 FSK DEMODULATOR kit. For receive end of link.\$39

9600 BAUD DIGITAL RF LINKS. Low-cost packet networking system, consisting of new MO-96 Modem and special versions of our 220 or 450 mHz FM Transmitters and Receivers. Interface directly with most TNC's. Fast, diode-switched PA's output 15 or 50W. Call for more info on the right system for your application!

GaAs FET PREAMPS

at a fraction of the cost of comparable units!

LNG-(*)

ONLY \$59
wired/tested



FEATURES:

- Very low noise: 0.7dB vhf, 0.8dB uhf
 - High gain: 13-20dB, depends on freq.
 - Wide dynamic range - resist overload
 - Stable: low-feedback dual-gate FET
- *Specify tuning range: 26-30, 46-56, 137-150, 150-172, 210-230, 400-470, or 800-960 MHz.

LNW-(*) MINIATURE GaAs FET PREAMP



ONLY \$24/kit, \$39 wired/tested

GaAs FET Preamp similar to LNG, except designed for low cost & small size. Only 5/8" W x 1-5/8" L x 3/4" H. Easily mounts in many radios.

*Specify tuning range: 25-35, 35-55, 55-90, 90-120, 120-150, 150-200, 200-270, or 400-500 MHz.

LNS-(*) IN-LINE PREAMP



ONLY \$79/kit, \$99 wired/tested

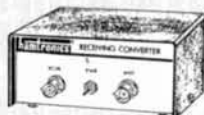
GaAs FET Preamp with features similar to LNG series, except automatically switches out of line during transmit. Use with base or mobile transceivers up to 25W. Tower mounting brackets incl.

*Specify tuning range: 120-175, 200-240, or 400-500 MHz.

HELICAL RESONATOR PREAMPS

Preamps with 3 or 4 section helical resonators reduce intermod & cross-band interference in critical applications. MODEL HRA-(*) \$49 vhf, \$94 uhf.

*Specify tuning range: 142-150, 150-162, 162-174, 213-233, 420-450, 450-470.



RECEIVING CONVERTERS

Low noise converters to receive vhf and uhf bands on a 10M receiver. Choice of kit with case & BNC jacks, kit with pcb only, or w/t unit in a case. Other models available for other in/out ranges & atv. Request catalog for complete listings.

VHF input ranges available: 136-138, 144-146, 145-147, 146-148, 220-222, 222-224; kit less case \$39, kit w/case \$59, w/t in case \$89.

UHF input ranges available: 432-434, 435-437; kit less case \$49, kit w/case \$69, w/t in case \$99.

902-928 MHz converts down to 422-448 or 430-450 range. Same price as uhf.

TRANSMITTING CONVERTERS

XV2 for vhf and XV4 for uhf. Models to convert 10M ssb, cw, fm, etc. to 6M, 2M, 220, 432, 435, and for atv. 1W output. Kit only \$79. PA's up to 45W available. Request catalog for complete listings.

OUR 27TH YEAR!

hamtronics, inc.

65 MOUL RD. - HILTON NY 14468-9535
Phone: 716-392-9430 -- FAX: 716-392-9420

Hamtronics is a registered trademark. Copyright 1989, Hamtronics, Inc. All rights reserved.

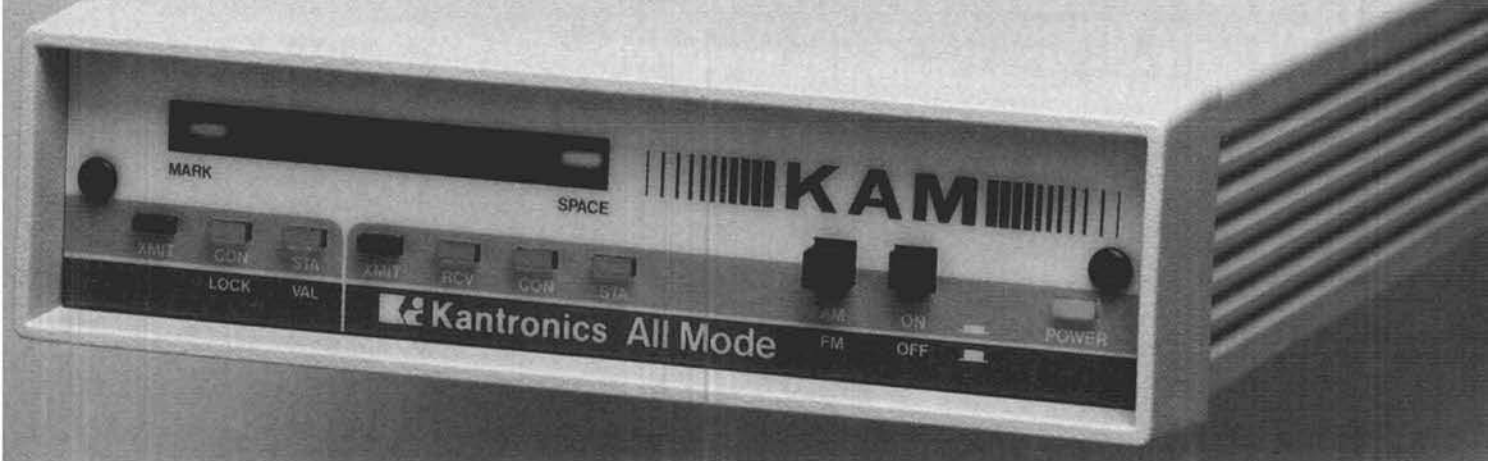
- For complete info, call or write for FREE 40-page catalog.

Send \$2 for overseas air mail. For casual interest, check reader service; allow 3-4 weeks.

- Order by mail, fax, or phone (answering machine off hrs).

- Min. \$3 S&H charge for first pound plus add'l weight & ins.

- Use VISA, Mastercard, check, or UPS C.O.D. (\$3 fee).



If You Want the Most Advanced TNC Today...

In 26 countries around the world, tens of thousands of amateurs know that Kantronics is the leader in bringing tomorrow's technology to their stations today. They also know they will always be among the first to incorporate just-introduced features and modes with Kantronics software and firmware updates.

And, they know that Kantronics is unique in its ability to seek out, develop and incorporate the most advanced features into each of five different TNC models before anyone else. Why? Because every program Kantronics writes, and every unit Kantronics designs and produces are born right here at the factory in the U.S.A.

Meet Your Mailman

In this age of telco LANS, E-mail and FAX,



PPBS is just one of the firsts Kantronics delivered.

you will know you have mail in your **Personal Packet Mailbox™** when your KAM "STA" LED is blinking. New firmware level 2.85 has also added a handy automatic mailbox user-

connect. So save your computer and monitor life by turning them off when you are away, and never miss a beat on the airwaves.

Version 2.85 KAMs have increased Packet Cluster™ compatibility, **KA-NODE™** path preservation, **KA-NODE** recognition of the "NET" nodes and HF baud rates from 50 through 300! And there are three new mailbox commands: *List Mine, Read Mine* and *Kill Mine*.

and Tomorrow...

Will the Real Dual-Port Please Stand Up?

Read our lips. The **KAM™** is the only true dual-port when it comes to packet. Your Personal Packet Mailbox™ is accessible from both HF and VHF! Version 2.85 has dual-port compatibility with RLI/MBL boards and KISS mode for both ports. You can monitor HF and VHF packet operations at the same time. Users can even gateway from HF to VHF (or in reverse) through your KAM.

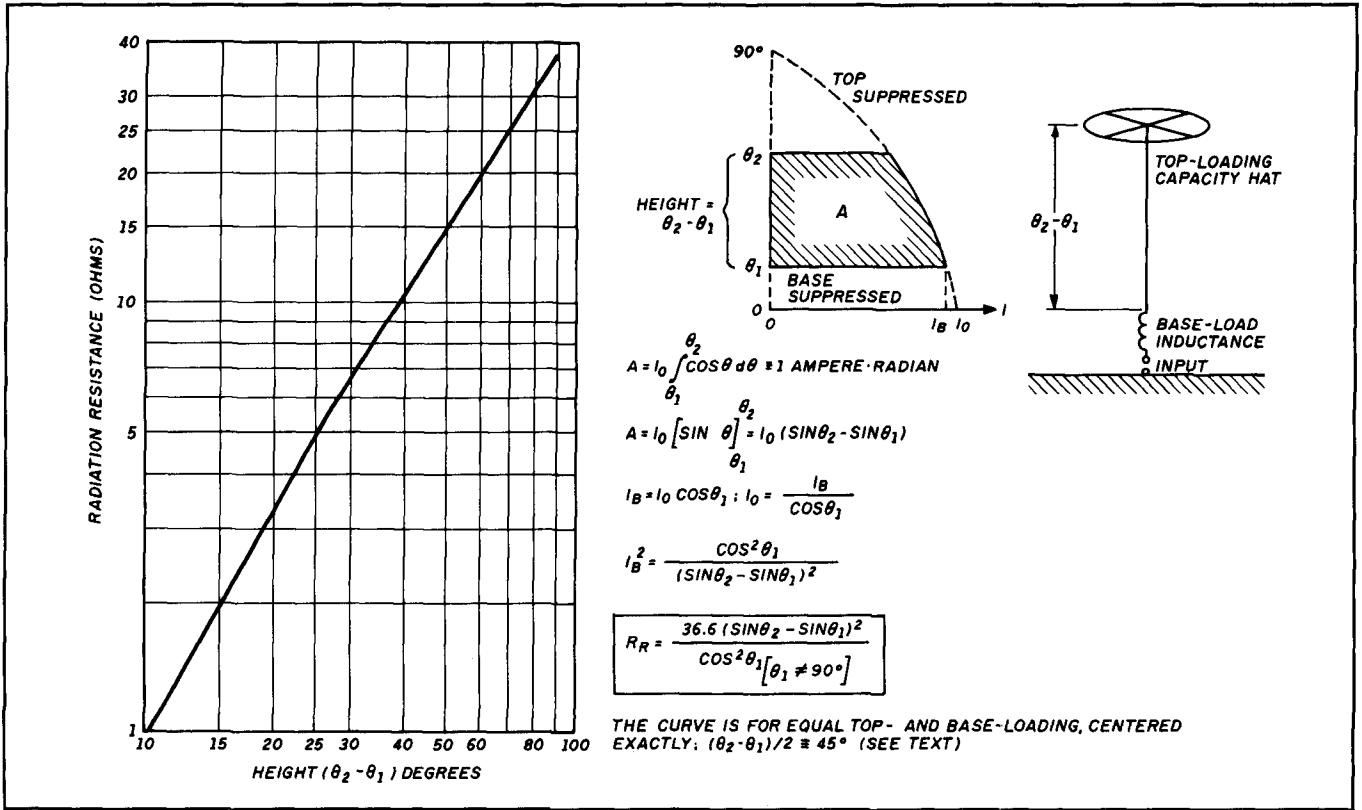
Kantronics All-Mode™ (KAM) has Packet, WEFAX, ARQ, FEC, RTTY and CW reception. But we have five models to suit your particular taste. Ask your dealer for the best choice today...and tomorrow.

Kantronics
RF Data Communications Specialists

1202 E. 23rd Street Lawrence, Kansas 66046
(913) 842-7745

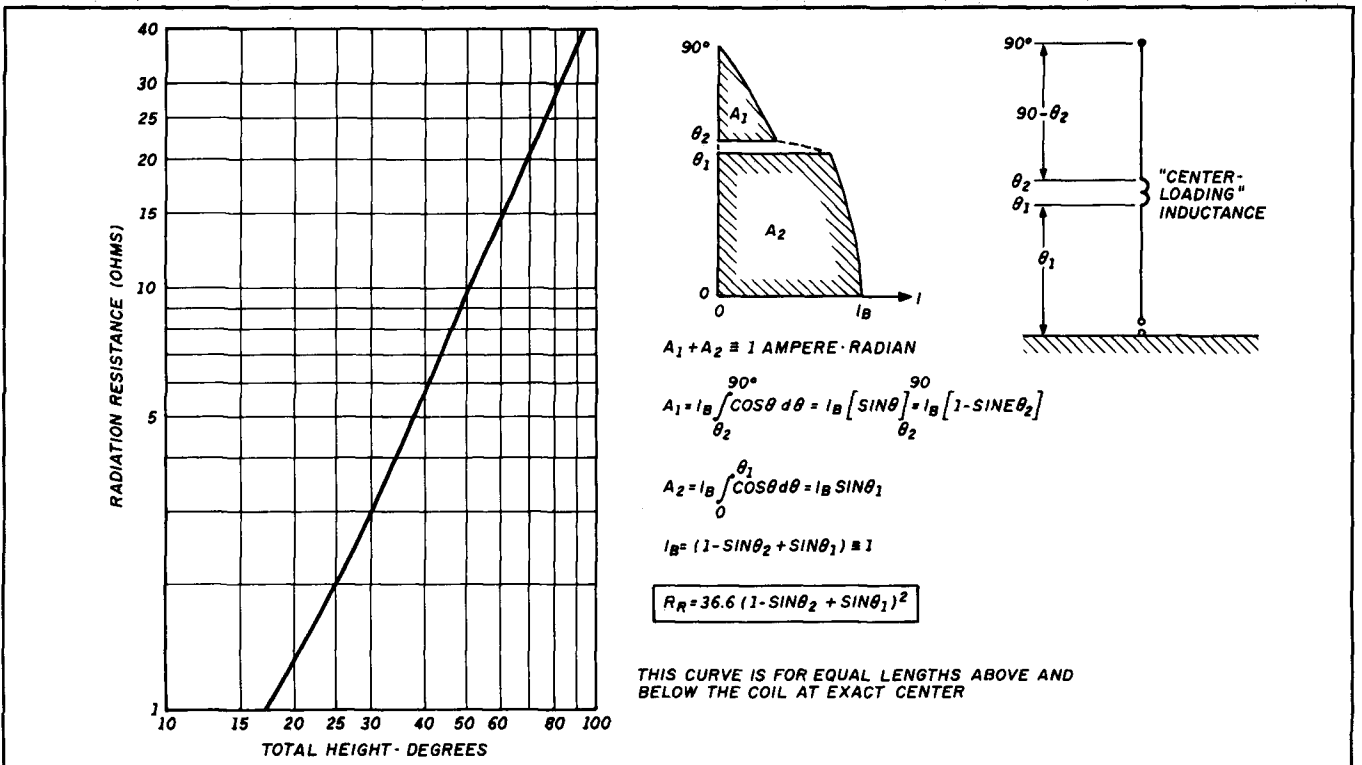
Packet Cluster™ is the copyrighted software of Pavilion Software
KAM™, All-Mode™, KA-NODE™, and Personal Packet Mailbox™,
are trademarks of Kantronics Company, Inc.

FIGURE 5



The curve and its derivation for a combination base and top-loaded Marconi vertical. This curve is for a combination of equal suppression at the top and bottom. This case and that of the "center-loaded" will produce a family of curves.

FIGURE 6



Curve and its derivation for the center-loaded case. The curve is for a coil in the exact electrical center. Technically this is a "segmented" antenna.

losses other than radiation, any configuration of loading will produce one or more profiles, the sum of which must total 1 ampere-radian for any single antenna. A trigonometric-algebraic expression evolves for the base current in each case. This expression is squared and divided into 36.6 watts, the assumed power input for 1 A in the reference antenna. The quotient is the radiation resistance as a function of the exposed element lengths expressed as angles. These derivations provide very good estimates of the radiation resistances, and can be calculated by anyone who has a handheld scientific calculator.

There are four derivations. The last one, shown in **Figure 6**, presents calculations for the "center-loaded" case. It's of limited use, for two reasons. First, few center-loaded verticals exist in which the top section is the same diameter as that of the bottom — a requirement for the derivation. It's usually a thin "whip." Second, the rules governing the way the derivations were performed may not fit the case as well as they do in the first three. It's difficult to determine the amount of "standing wave" that exists on the loading coil, if any at all.* We believe there is some standing wave on the loading coil, and intend to make some measurements to confirm it.

However, the existence of this wave may not be important, because the whip actually contributes almost nothing to the transmitted field. Almost all of the signal comes from the section below the coil. Thus you may estimate the radiation resistance of the antenna by using the expression for the top-loaded vertical with the length set equal to that of the bottom section plus the coil. Those who build a center-loaded vertical would be well advised to use a top hat and to place the coil — which would be considerably reduced in value because of the increased top capacitance — directly under the top hat, or to eliminate the coil entirely and resort to top loading alone. It's interesting to note that the coil under the top hat configuration isn't new; it was covered by a United States patent in 1909!

The combination top and base-loaded case (**Figure 5**) was solved for equal loading at the top and bottom; the radiating portion of the antenna is in the exact electrical center. A simple BASIC program for the computation appears as **Figure 7**. Both this concept and that of the center-loaded antenna will produce a family of curves. You can modify the program to generate the rest of the family.

Probably the most important characteristic of the top-loaded versus base-loaded vertical is that for heights up to about 30 or 40 degrees, the radiation resistance of the top-loaded vertical is nearly four times larger than that of the base-loaded system. This means that the top-loaded antenna would be four times as efficient as the base-loaded antenna erected over identical ground systems. We don't recommend using base loading in just any situation, except as a tuning network or part of a mostly top-loaded combination. These derivations also revealed that all other combinations of top and base loading result in radiation resistances between those two curves.

In 1977 Jerry Sevick, W2FMI, published what may be the best article in recent literature on short ground radials for short verticals.⁴ Jerry tested many combinations of short (Marconi) verticals over several radial systems. One of his figures, shown here as **Figure 8**, plots measured values of

FIGURE 7

```

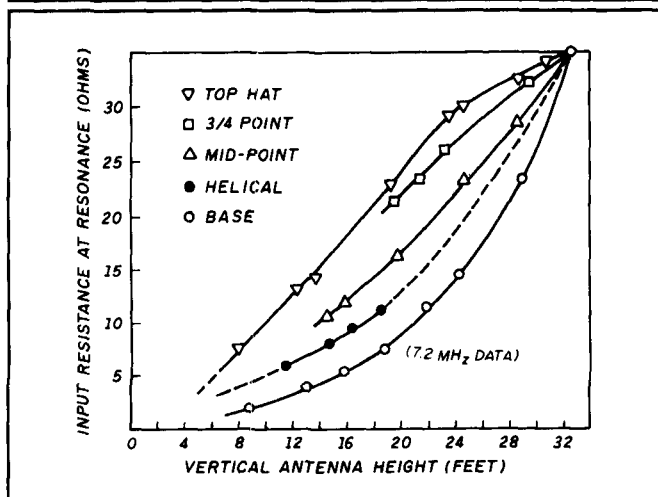
10 A = 45:B=45:
20 TH1 = 3.14159*A/180
30 TH2 = 3.14159*B/180
40 M = SIN(TH1):N = SIN(TH2)
50 RR = 36.6*(N-M)^2/(COS(TH1))^2
60 LPRINT USING "###.##  ###.##";B-A,RR
70 A = A-5:B = B+5
80 IF (B-A)=<90 THEN GOTO 20 ELSE END

```

0.00	0.00
10.00	0.95
20.00	3.29
30.00	6.54
40.00	10.42
50.00	14.81
60.00	19.61
70.00	24.83
80.00	30.48
90.00	36.60

Short BASIC program to calculate the curve in **Figure 5**. The column lists first, the total length (B-A), and the second, its radiation resistance (R). Notice that at 90°, both the top and base loadings disappear, and the resultant is the resistance of a quarter-wave antenna.

FIGURE 8

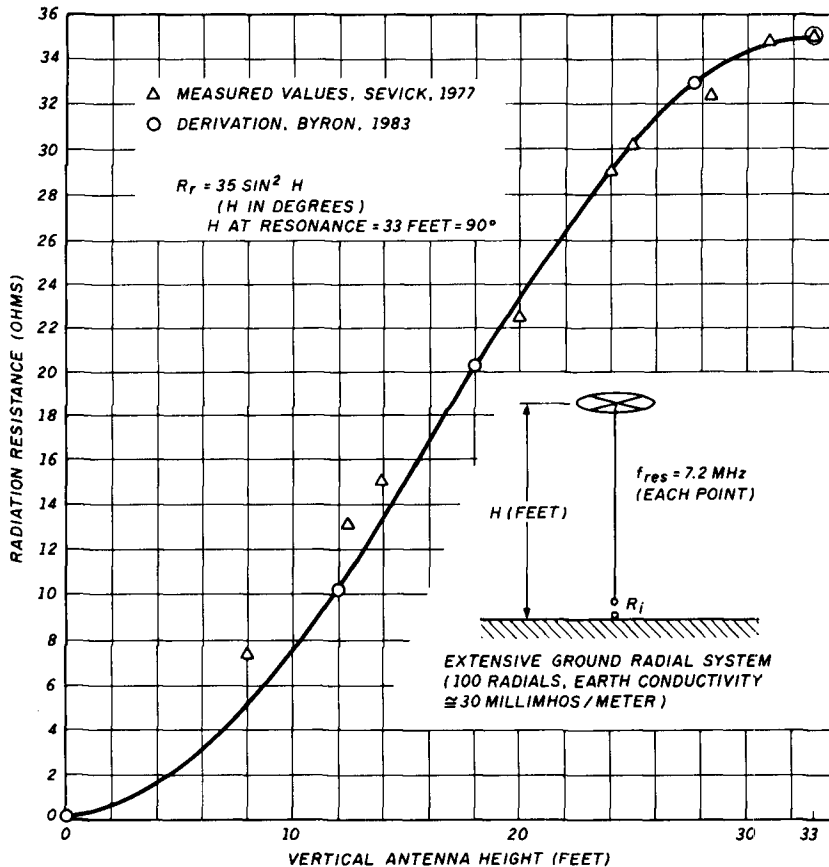


Measured values from Jerry Sevick's (W2FMI) antennas erected over a nearly lossless ground system for several representative types from his 1973 article, "Short Radial Systems for Short Verticals," in QST. Used with permission of the author.

input impedance (resistance in these cases) over a very good ground system of 100 quarter-wave terminated radials. The earth conductivity was higher than 30 millimhos per meter; it doesn't get much better than that! We're sure it was a result of Jerry's well-fertilized back lawn. The curve for the top-loaded antenna (the top curve) gives a value very close to its radiation resistance because there's virtually no parasitic ground loss and no coil resistance. The other curves

*Work by Robert Lewis, W2EBS, and the late Edmund Laport corroborates this finding.

FIGURE 9



A plot of the measured values from Figure 8 (the top curve) curve-fit by the derivation from Figure 3. As there was little ground-loss, and because there was no inductance, the points for the top-loaded system represent radiation resistances.

reflect the effects of the various loading coils. Even the construction of a coil of large wire (like no. 10) will contribute several ohms of parasitic resistance, depending on the frequency and inductance. This *cannot* be ignored. The RF resistance of a 13.8- μ H coil constructed of no. 16 silver-plated copper wire measured 1.6 ohms at a frequency of 7.2 MHz.

Proof of performance

Figure 9 shows the top-loaded antenna data from Figure 8 as "curve fit" by the expression for top-loaded verticals from Figure 3. We did this to demonstrate that the coefficient (36.6) is just that — a coefficient set as a consequence of this particular derivation method. If the original dipole radiation resistance calculations had yielded, say, 32 ohms, then it would have appeared in the derivations. Jerry's full length vertical measured 35 ohms. This becomes the new coefficient and illustrates how you'd use these expressions. Notice how well the experimental data (from 1977-78) fit the curve (essentially from 1982) as published in 1990, even though a refinement to accommodate the decreasing L/D ratio for the points below about 14 feet in height wasn't performed. Given the absence of measured values for a full length vertical (the usual circumstance), a good starting coefficient for verticals of, say, 1-1/2 or 2 inches diameter would be 35. The arbitrary assignment of 35.0 wouldn't

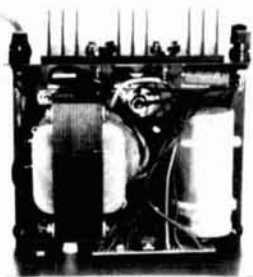
produce an error of more than 3 or 4 percent in almost any case, and probably less. Simply substitute 35 for 36.6 in all the derivations.

A surprise

We've all been told over the years that a shortened antenna results in a narrower bandpass than that of a full-sized vertical. This is quite obviously true for a base-loaded vertical, but might not be true for the top-loaded system. In 1989, Frank Chess made some calculations for top-loaded systems and calculated the inductance of the vertical section. He computed both the inductive reactance (X_L) and the radiation resistance (R_R) as the element was shortened. He assumed it to be over zero-loss ground. Consequently, as the element is shortened, resonance is restored by increasing the size (capacitance) of the top hat. The results are very interesting. As a matter of fact, they're startling. The Q of the vertical *decreases* as it's shortened down to a physical length of a little over 60 degrees, and then it increases (see Figure 10). We leave this as conjecture; we haven't performed any experiments for confirmation. However, if this is true, a totally top-loaded vertical over a good ground system resonant at a 62-degree electrical height may have a wider intrinsic bandpass than that of a full-sized quarter-wave vertical for a reasonable length-to-diameter ratio of, for instance, 200 or so.

ASTRON POWER SUPPLIES

• HEAVY DUTY • HIGH QUALITY • RUGGED • RELIABLE •



INSIDE VIEW — RS-12A

SPECIAL FEATURES

- SOLID STATE ELECTRONICALLY REGULATED
- FOLD-BACK CURRENT LIMITING Protects Power Supply from excessive current & continuous shorted output
- CROWBAR OVER VOLTAGE PROTECTION on all Models except RS-3A, RS-4A, RS-5A.
- MAINTAIN REGULATION & LOW RIPPLE at low line input Voltage
- HEAVY DUTY HEAT SINK • CHASSIS MOUNT FUSE
- THREE CONDUCTOR POWER CORD
- ONE YEAR WARRANTY • MADE IN U.S.A.

PERFORMANCE SPECIFICATIONS

- INPUT VOLTAGE: 105-125 VAC
- OUTPUT VOLTAGE: 13.8 VDC \pm 0.05 volts (Internally Adjustable: 11-15 VDC)
- RIPPLE Less than 5mv peak to peak (full load & low line)
- Also available with 220 VAC input voltage



MODEL RS-50A



MODEL RS-50M



MODEL VS-50M

RM SERIES



MODEL RM-35M

19" x 5 1/4" RACK MOUNT POWER SUPPLIES

MODEL	Continuous Duty (Amps)	ICS* (Amps)	Size (IN) H x W x D	Shipping Wt. (lbs.)
RM-12A	9	12	5 1/4 x 19 x 8 1/4	16
RM-35A	25	35	5 1/4 x 19 x 12 1/2	38
RM-50A	37	50	5 1/4 x 19 x 12 1/2	50

• Separate Volt and Amp Meters

RM-12M	9	12	5 1/4 x 19 x 8 1/4	16
RM-35M	25	35	5 1/4 x 19 x 12 1/2	38
RM-50M	37	50	5 1/4 x 19 x 12 1/2	50

RS-A SERIES



MODEL RS-7A

MODEL	Continuous Duty (Amps)	ICS* (Amps)	Size (IN) H x W x D	Shipping Wt. (lbs.)
RS-3A	2.5	3	3 x 4 1/4 x 5 1/4	4
RS-4A	3	4	3 3/4 x 6 1/2 x 9	5
RS-5A	4	5	3 1/2 x 6 1/2 x 7 1/4	7
RS-7A	5	7	3 3/4 x 6 1/2 x 9	9
RS-7B	5	7	4 x 7 1/2 x 10 3/4	10
RS-10A	7.5	10	4 x 7 1/2 x 10 3/4	11
RS-12A	9	12	4 1/2 x 8 x 9	13
RS-12B	9	12	4 x 7 1/2 x 10 3/4	13
RS-20A	16	20	5 x 9 x 10 1/2	18
RS-35A	25	35	5 x 11 x 11	27
RS-50A	37	50	6 x 13 3/4 x 11	46

RS-M SERIES



MODEL RS-35M

MODEL	Continuous Duty (Amps)	ICS* (Amps)	Size (IN) H x W x D	Shipping Wt. (lbs.)
• Switchable volt and Amp meter RS-12M	9	12	4 1/2 x 8 x 9	13
• Separate volt and Amp meters RS-20M	16	20	5 x 9 x 10 1/2	18
RS-35M	25	35	5 x 11 x 11	27
RS-50M	37	50	6 x 13 3/4 x 11	46

VS-M AND VRM-M SERIES



MODEL VS-35M

- Separate Volt and Amp Meters • Output Voltage adjustable from 2-15 volts • Current limit adjustable from 1.5 amps to Full Load

MODEL	Continuous Duty (Amps)			ICS* (Amps)	Size (IN) H x W x D	Shipping Wt. (lbs.)
	@13.8VDC	@10VDC	@5VDC	@13.8V		
VS-12M	9	5	2	12	4 1/2 x 8 x 9	13
VS-20M	16	9	4	20	5 x 9 x 10 1/2	20
VS-35M	25	15	7	35	5 x 11 x 11	29
VS-50M	37	22	10	50	6 x 13 3/4 x 11	46

• Variable rack mount power supplies

VRM-35M	25	15	7	35	5 1/4 x 19 x 12 1/2	38
VRM-50M	37	22	10	50	5 1/4 x 19 x 12 1/2	50

RS-S SERIES

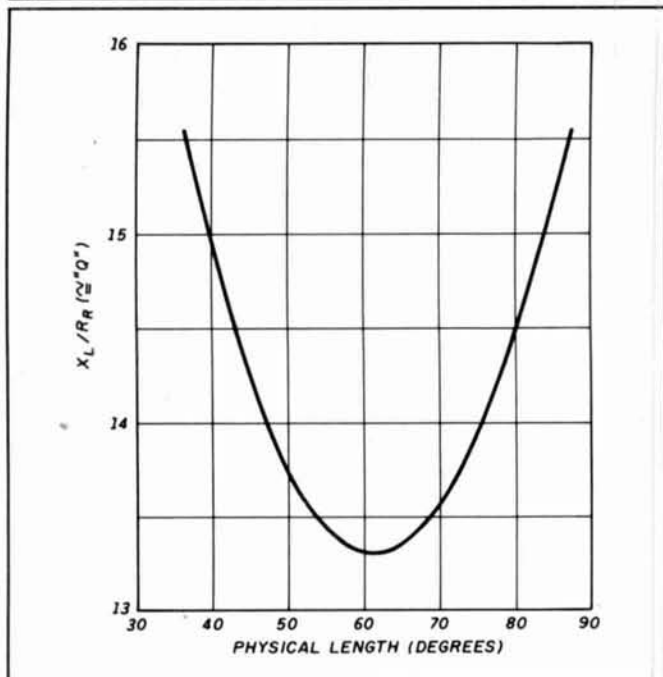


MODEL RS-12S


- Built in speaker

MODEL	Continuous Duty (Amps)	ICS* Amps	Size (IN) H x W x D	Shipping Wt. (lbs.)
RS-7S	5	7	4 x 7 1/2 x 10 3/4	10
RS-10S	7.5	10	4 x 7 1/2 x 10 3/4	12
RS-12S	9	12	4 1/2 x 8 x 9	13
RS-20S	16	20	5 x 9 x 10 1/2	18

FIGURE 10



The curve for the "Q" of a top-loaded antenna as calculated by one of the authors (Chess, K3BN) in 1989. As a full-length vertical is shortened, it is assumed to be brought to resonance by a top-hat. The inductive reactance (X_L) of the vertical section is calculated along with its radiation resistance (R_r) in each case.

With few exceptions, the behavior of most antenna systems is influenced by the ground beneath it. 

REFERENCES

1. Walter Schulz, K3OQF, *Wireless Antenna History*, Wilhelm Herbst Verlag, 1988. Available from the HAM RADIO Bookstore for \$16.95 plus \$3.75 shipping and handling.
2. Jonathon Zenneck, *Wireless Telegraphy*, translated by A. E. Seelig, McGraw-Hill, 1915. An original derivation was done by Heinrich Hertz in 1888.
3. W.J. Byron, W7DHD, "Short Verticals for the Low Bands," *Ham Radio*, May 1983. See Figures 5 and 6.
4. Jerry Sevick, W2FMI, "Short Ground Radial Systems for Short Verticals," *QST*, April 1978.

FROM BEVERAGES THROUGH OSCAR

A bibliography 1909 to 1988
52,880 references in 92 chapters!

The only complete reference guide to Amateur articles in the world! Revised and up-dated from the softbound edition, this microfiche reference lists 80 years worth of information from 297 different sources that include QST (since 1945), the RSGB's magazine RADCOM (since 1979) and all issues of **HAM RADIO**, **CQ**, and **73**. Includes 5,000 key-word index and author and callsign cross references. Unbelievable value. Worth much more than is being charged!



FBTO-microfiche **\$49.95**
Please enclose \$3.75 shipping & handling



HAM RADIO
GREENVILLE, NH 03048

(603) 878-1441
FAX (603) 878-1951

CONTINUOUS COVERAGE ANTENNAS FOR COMMERCIAL & AMATEUR SERVICE

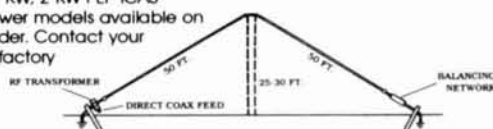
Model AC 1.8-30

1.8 to 30 MHz

- SWR Max 2:1, 1.4:1 average from 1.8 to 30 MHz
- Can be installed in approximately 80 ft. space
- Ideal for commercial services for multi frequency operation without the need for antenna tuners or additional antennas
- Handles 1 KW, 2 KW PEP ICAS
- Higher power models available on special order. Contact your dealer or factory

\$19800

SHIPPING & HANDLING
ADD \$4.00



U.S. Patent No. 4,511,898

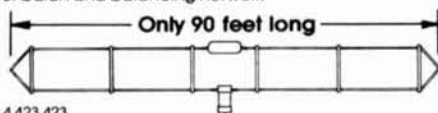
Model AC 3.5-30

3.5 to 30 MHz

- SWR less than 2:1 from 3.5 to 30 MHz
- Complete assembled. Balun terminated with standard SO-239 connector
- Power capability 1 KW - 2 KW PEP ICAS. Higher power model is available on special order.
- Designed for 50 ohm feedline
- Weather proof balun and balancing network

\$19800

SHIPPING & HANDLING
ADD \$4.00



U.S. Patent No. 4,423,423

ALL OUR PRODUCTS MADE IN USA



BARKER & WILLIAMSON

Quality Communication Products Since 1932

At your Distributors. Write or Call.

10 Canal Street, Bristol, PA 19007

(215) 788-5581

Make the most of your general coverage transceiver with **Monitoring Times!**

Every month Monitoring Times brings everything you need to make the most of your general coverage transceiver: the latest information on international broadcasting schedules, frequency listings, international DX reports, propagation charts, and tips on how to hear the rare stations. Monitoring Times also keeps you up to date on government, military, police and fire networks, as well as tips on monitoring everything from air-to-ground and ship-to-shore signals to radioteletype, facsimile and space communications.

ORDER YOUR SUBSCRIPTION TODAY before another issue goes by. In the U.S., 1 year, \$18; foreign and Canada, 1 year, \$26. For a sample issue, send \$2 (foreign, send 5 IRCs). For MC/VISA orders (\$15 minimum), call 1-704-837-9200.

MONITORING TIMES

Your authoritative source,
every month.

P.O. Box 98 A
Brasstown, N.C. 28902

Microwaves

Bob Atkins, KA1GT

MICROWAVE BASICS

This isn't the column I had originally planned for this month. Instead I've written in response to a number of letters from Amateurs who want some very basic information on microwaves. Because it's easy for me to forget that not everyone knows about the microwave bands, I'll devote column space this month to an introduction to microwaves. My own personal preference is towards weak signal work, so this may be reflected in my descriptions of microwave activity. However, other modes (like ATV, FM repeaters, and packet) can be found on the bands.

What are "microwaves?" As a working definition, consider microwaves to be electromagnetic waves with a frequency greater than 1000 MHz or a wavelength less than 30 cm. That defines the lower frequency limit, but how high in frequency do microwaves go? The answer to this question is somewhat nebulous; an upper limit would be somewhere around 300 GHz (300,000 MHz). Within this region there's a subdivision referred to as millimeter waves. It's the area between 30 and 300 GHz, where the wavelength is less than 1 cm. United States Amateurs have 11 bands allocated above 1 GHz, with a combined bandwidth of 23 GHz (23,000 MHz), so you can see that there's plenty of room! I'll define and describe these Amateur bands later. At this point, you just need to know that they exist and have an idea of their size.

Before dealing with any of the technical aspects of microwaves, it may be helpful to try to answer a question which has been posed to me quite frequently. What is the attraction of working on the microwave bands? This is a difficult question and probably has as many answers as there are active microwave Amateurs. The microwave bands provide the challenge of exploration. Many of the bands are sparsely populated; indeed some of them have



never been worked at all! There's a real opportunity to be "first" on a band, make the first contact over a given path, discover a new mode of propagation, or make a real technological contribution to state-of-the-art operation. Even if you don't do any of these things, there's a sense of personal satisfaction and achievement in being one of the pioneers on the newly developing bands. The low population of the bands lends itself to other characteristics. For instance, there's no QRM, and in my opinion the overall operating standards are higher. Listening to some of the poor conduct on the HF bands is a distressing experience. I've never heard any discourtesy, deliberate interference, or other undesirable conduct on the microwave bands. The low population also encourages a sense of community and cooperation between those Amateurs who are on the microwave bands. It's in everyone's interest to help develop activity — even if it's just so there's someone to talk to on the air! In a way, microwave operation is a throwback to the very early days of ham radio — not in technology, but in spirit.

Now let's move on to some of the technical aspects of microwave operation and see how they differ from those found on the lower bands. Perhaps the most obvious difference is the shorter DX range. While many paths in excess of 1000 km have been worked, such DX is rare. I'll cover this in more detail later, but for now it's enough to know that range will be a few hundred kilometers. Such DX work uses antennas with high gain (>20 dBi), and hence a very narrow beamwidth. Consequently, you have to know where the DX is in order to point the antenna with sufficient accuracy to work it! As a result, a lot of microwave

work is based on prearranged schedules, or relies on liaison at lower frequencies (often 144 MHz). Much of the activity on the microwave bands is concentrated during contests, local activity nights, or local nets. For example, the Pack Rats group in the Philadelphia area has a 1296-MHz net every Monday night at 9:30 p.m. on 1296.1 MHz.

The importance of a good QTH site is paramount on the microwave bands (especially at the higher frequencies); thus there's a lot of portable operation from mountaintops. As typical microwave TX power is low (maybe 1 watt), and antennas are small (a 3 or 4-foot parabolic dish on 10 GHz is about the practical limit), portable operation is quite convenient. Photos A and B show examples of portable operation on 3456 and 5670 MHz by members of the North Texas Microwave Society.

For those not interested in working DX, the microwave bands offer one other unique feature — bandwidth, and lots of it. For example, the 10-GHz band is 500 MHz wide and ideally suited for high speed digital data links which can rapidly use up bandwidth. Because microwave antennas are highly directional, and DX propagation is difficult, a number of high speed data links can use the same frequencies, even when they are close to each other geographically. Similar factors apply to other wide bandwidth modes. Who will be the first Amateur to transmit high speed digital HDTV signals on the air? One mode uniquely permitted on the microwave bands is pulse modulation. Though this mode is prohibited on all bands below 1000 MHz, it's allowed on all the microwave bands except for 1240 to 1300 MHz and 10 to 10.5 GHz.

As I mentioned earlier, there are 11 Amateur microwave allocations. I'll take a look at each one and try to describe their characteristics. Some of these bands have full or partial ARRL-recommended band plans. In general, narrowband weak signal work takes place on frequencies related to harmonics of 1152 MHz (for historical reasons involving frequency multiplying).

- 1240 to 1300 MHz, or the 23-cm band. This is the most populated

PHOTO A



N5JJZ/5 demonstrates portable operation on 5760 MHz.

PHOTO B



North Texas Microwave Society Expedition on 3456 MHz. Elevation is controlled by jacking up the rear of the van! WA5TNY is seen adjusting the dish.

microwave band, and the one most like the VHF/UHF bands in its operational characteristics. Novice operation is permitted between 1270 and 1295 MHz. Conventional vacuum tubes (2C39) can be used to generate power, and power levels of 100 watts aren't uncommon. Antennas are generally of the Yagi type (or loop Yagi where 1-wavelength loops replace the usual 1/2-wavelength elements like a multi-element quad). Antennas are quite small; a 25-element Yagi is a little over 6 feet long. Fixed station operation is common, and a well-equipped station can expect a DX range of several hundred kilometers under flat conditions. The California/Hawaii path has been worked on this band (3977 km) using modest power and antennas (N6CA's 100-watt, 44-element loop Yagi to KH6HME's 25-watt, 4 by 25-element Yagis). Under good conditions, distances of up to 100 km can be worked with

power levels of less than 1 watt. The narrowband calling frequency is 1296.1 MHz. The ARRL band plan has allocations for repeaters, satellite uplinks, ATV, and digital communications, and there's activity on all these modes. Much commercially built equipment is available for this band — from complete multi-mode transceivers costing well over \$1000, to low power transverter kits in the \$140 price range.

- **2300 to 2310 MHz and 2390 to 2450 MHz**, or the 13-cm band. Activity here is much lower than on 23 cm, though it's growing and quite well established in some areas (like North Texas and Philadelphia). Quite a lot of operation takes place from fixed stations. Power can still be generated with cheap vacuum tubes (2C39s, \$10 surplus) at levels of 20 to 30 watts. Antennas are usually of the Yagi type, but some parabolic dishes are in use. Range is less than at 23 cm, but considerable distances can be worked with low power under good conditions (W8YIO's 30-mW, 8-foot dish to WA8TXT's 200- μ W, 4-foot dish. There were strong signals at 135 km; the path could have been worked using 2-foot dishes). The narrowband calling frequency is 2304.1 MHz. Commercially built equipment is available. The mode S satellite downlink is in this band (2401 MHz).
- **3300 to 3500 MHz**, or the 9-cm band. Activity is very low, but growing slowly. Conventional vacuum tubes don't work well at these frequencies and power must be generated using solid-state devices or exotic vacuum tubes, like traveling wave tubes or klystrons. Parabolic dishes are the most common antennas. Much of the equipment is homebrew, though there are now some commercial transverter kits available. Some TVRO (satellite TV) equipment can be modified for use in this band, providing excellent performance at low cost. The narrowband calling frequency is 3456.1 MHz.
- **5650 to 5925 MHz**, or the 6-cm band. Activity here is very low. There are a few stations on the band with homebrew systems

(often containing surplus commercial parts). Currently, there's no readily available commercial equipment for this band. The narrowband calling frequency is 5670.1 MHz.

- **10 to 10.5 GHz**, or the 3-cm band. Second only to the 23-cm band, this microwave band has one of the highest levels of activity. This band is popular because it's easy to get on using wideband equipment based on Gunn oscillators. A Gunn oscillator is a resonant cavity containing a Gunn diode. When a DC voltage (about 9 volts) is applied across the diode, oscillation occurs at the resonant frequency of the cavity. Power output is in the 10 to 100-mW range. Complete commercial wideband systems (Known as "Gunnplexers"TM) are available for a few hundred dollars. A homebrew system can be built for a few tens of dollars and not much technical microwave knowledge is required. Antennas are usually parabolic dishes 1 to 3 feet in diameter. Any line-of-sight path can be worked using such equipment, but almost all obstructed paths require the presence of enhanced propagation modes (ducting) which occur infrequently. The world record of 1000+ km was made using such a wideband system. In addition to wideband systems, there are an increasing number of narrowband systems coming on the air which use conventional transverter techniques. This is in large part due to the availability of commercial (SSB electronics) transverter components (local oscillators, transmit and receive mixers). Kits are available for a few hundred dollars; built and tested units cost about double. Power output is in the 100 to 200-mW range, and this is enough to work many obstructed (non line-of-sight) paths of several hundred kilometers on a regular basis. Such paths would be difficult, if not impossible, to work using wideband equipment. Most of the operation is still done from portable stations on hilltops, but a number of stations are developing fixed station capabilities. Several stations have employed ATV and digital modes on this band. The

ARRL has a 10-GHz contest which takes place every year over two weekends in August and September. Last year the leading station (W6HHC) made 78 contacts with 17 different stations and a best DX of 266 km. Thirty-one stations made contacts in excess of 100 km. Oscar 9 carried a beacon on this band (10.470 GHz). The narrowband calling frequency is 10.361 GHz.

- **24 to 24.25 GHz**, or the 1.5-cm band. There isn't much regular operation on this band. The majority of activity involves Gunn oscillator-based systems, though some narrowband transverters have been built. This is the lowest frequency band at which attenuation by the atmosphere (oxygen and especially water vapor) is a significant factor in propagation, amounting to about 0.2 dB/km.
- **47 to 47.2 GHz**. This band has no alternative wavelength name. It's the lowest frequency Amateur millimeter wave allocation. Atmospheric attenuation is significant at about 0.4 dB/km. There is Amateur activity, but it's confined to one or two stations.
- **75.5 to 81 GHz**. This is the highest frequency band on which I am aware of Amateur activity. Atmospheric absorption amounts to about 0.4 dB/km.
- **119.98 to 120.02 GHz**. There's no known Amateur operation at this level. Atmospheric absorption is around 2 dB/km.
- **142 to 149 GHz**. No known Amateur operation — there's atmospheric absorption of around 2 dB/km.
- **241 to 250 GHz**. No known Amateur operation — atmospheric absorption is in excess of 5 dB/km.
- **Above 300 GHz**. This is the highest band (if it can be called that, as there is no upper limit). I know of no Amateur RF work in this region, but if you go up high enough in frequency this "band" includes lightwave (laser) communications, where there is activity.

Many of these bands are shared by radiolocation (radar) services and you must tolerate interference from them. In practice, this isn't a problem. There are also some nearby radio astronomy bands which are protected from

PHOTO C



Members of the North Texas Microwave Society with their 10-GHz equipment assembled before the first weekend of an ARRL 10-GHz cumulative contest.

Amateur interference.

How do you get started on the microwave bands? Again, this question has no simple answer; much depends on the individual involved. First, and most important, I'd recommend joining a local group active on microwaves. I can't stress this point too strongly. The group not only provides help and encouragement, but also gives you a number of stations to work. **Photo C** shows members of the North Texas Microwave Society with their collection of 10-GHz equipment, ready for one leg of the ARRL 10-GHz contest. If a local microwave group doesn't exist, try to find a VHF/UHF group. You'll probably find some microwave knowledge and interest there, even if there's no activity. If you can't find either, try to find another ham interested in developing microwave capabilities. You can share knowledge, help each other with construction, and be certain of someone to work once you get your station built! What can you do if you really can't find any help? If all else fails, write to me and I'll try to put you in touch with someone in your area. If I don't know of anyone, I can put your call and address in this column with a plea for help. If that fails, you'll just have to change QTH! It's also important to read up on the subject. There are some good microwave books covering both theory and practice; I'll list a few at the end of this article.

Where should you start to work? I

suggest either 23 cm or 3 cm. If you want to work from a fixed station, and you want to find the most activity, 23 cm is the band of choice. While the microwave characteristics of operation on the band make it somewhat different from lower frequencies, much of the equipment and propagation will still seem familiar to VHF/UHF operators. Activity is high enough to make random contacts possible, particularly in urban areas and during activity periods and contests. Most transverter systems use a 144-MHz IF, so a VHF transceiver or transverter is required. Commercial equipment is widely available and a lot of homebrew designs have been published. Check out the "UHF and Microwave Equipment" chapter of a recent *ARRL Handbook* for ideas. Of course it's not necessary to start out with a complete transverter system. Operation using a receive converter and tripler from 432 MHz is quite possible using CW and FM. It's not as convenient as a transverter, but is cheaper, easier to build, and quite capable of yielding equal results. A low power 432 to 1296-MHz tripler can be built using 1N914 diodes (10 cents each!) and, despite a power output of less than 1 watt, I have personally used such a tripler to work distances of > 50 km.

On the other hand, if you like the idea of hilltop/portable operation, and want to try out a band with very different characteristics and equipment from the

lower bands, then 3 cm is the band of choice. You won't make any random contacts on this band, so you must be in contact with at least one other interested Amateur. There are two main modes of operation on 10 GHz. First, there are wideband systems with IF bandwidths of 50 kHz or more, which use free running cavity-stabilized Gunn oscillators and usually operate using FM. Second, there are narrowband systems with IF bandwidths of 3 kHz and less, which use frequency multiplication and mixing from lower frequency crystal-controlled sources and operate using SSB and CW. For low cost experimentation, ATV, or digital operation, the wideband Gunnplexer route is best. You can purchase a complete Gunn oscillator-based transceiver from a commercial source for a few hundred dollars. Alternatively, you can build a basic Gunn oscillator/mixer system from a few pieces of waveguide and a couple of diodes for a total cost of around \$20. By combining this equipment with a simple power supply and the IF strip from an FM radio (or even an FM radio itself), you can construct a complete transceiver. Some Amateurs are working on ways to convert surplus Gunn oscillator-based microwave radar detectors, automatic door openers, and intruder alarms to Amateur use at low cost. For serious DX and weak signal work under all conditions, narrowband operation is preferred, though it's more expensive and requires a little more microwave knowledge. Narrowband operation will also make possible many more paths than will wideband operation. Wideband systems are quite capable of DX operation under good propagation conditions. (In fact, the world and United States DX records are held by Amateurs using wideband equipment.)

Equipment is available from a number of suppliers. Take a look through this issue of *Ham Radio*; I'm sure you'll find advertisements for companies who specialize in equipment for the microwave bands. All should be able to give you information on microwave equipment, and some may even be able to help you find active microwave stations in your area. If you have trouble finding a specific piece of equipment, I may be able to help. However, it's hard to keep up to date, so check out the ads in the Amateur Radio publications first.

I hope this information is helpful to newcomers who are interested in the microwave bands. There isn't room to

print any detailed technical information about how to build simple microwave equipment this month. I hope to return to this topic in the future and try to present some simple projects.

Recommended reading

The following publications are recommended for those who want to learn more about microwaves. Some of these books are available from the HAM RADIO Bookstore.

The RSGB VHF/UHF Manual. Lots of information on theoretical and practical aspects of VHF/UHF and microwave operation. Recommended to anyone interested in these bands. (Available from the HAM RADIO Bookstore for \$29.95 plus \$3.75 shipping and handling.)

The Gunnplexer Cookbook, by Bob Richardson, published by the Ham Radio Publishing Group. A practical book which describes a large number of projects based on the Microwave Associates Gunnplexer system for 10 GHz. A good start for the newcomer to 10-GHz wideband operation. (Out of print.)

The RSGB Microwave Manual. I still haven't seen this one, but on the basis of its authorship it should be a valuable reference. (Available from the HAM RADIO Bookstore for \$35 plus \$3.75 shipping and handling.)

10 GHz — A Constructional Project, by Chuck Houghton, published by the San Diego Microwave Group and priced at \$15. A collection of notes mostly relating to wideband operation on 10 GHz and some information relevant to narrowband work. Lots of detailed construction information with a little bit of theory. Includes test equipment, use of converted intruder alarms, antennas, homebrew and commercial Gunn oscillators, and more. Some components (IF boards, Gunn diodes, etc.) are also available from this group. Contact Chuck, WB6IGP, at 6345 Badger Lake, San Diego, California 92119.

The RSGB Microwave Newsletter Technical Collection. A collection of technical items from the RSGB microwave newsletter. Covers practical design information for the bands 1296 MHz to 24 GHz. Includes information on oscillator sources, antennas, filter design and test equipment. (Out of print.)

The ARRL also publishes a series of conference proceedings from the Central States VHF Society, Microwave Update, and Mid-Atlantic States VHF

Conferences. These publications cover all aspects of operation, theory, and practice on the bands from 50 MHz to lightwave. A good way to keep up with the state-of-the-art technical developments by those in the forefront of VHF/UHF and microwave work. Some, but certainly not all, of the material may be a bit advanced for absolute beginners. (Available from the HAM RADIO Bookstore. Check current book flyer and advertisements in this issue for prices.)

And, of course, back issues of *Ham Radio*. Check out the 5-year cumulative index which appeared in the December 1989 issue. You might also want to read some of the "New Frontier" columns which appeared in *QST* from 1980 to 1989.

Microwave news

As I've mentioned before, microwave operation often takes place on local nets so operators can have a good idea of when and where they'll find activity. WD4MBK has sent along information on a new 1296-MHz net in the Southeast. Dexter McIntyre, WA4ZIA, of Stanfield, North Carolina, has started a net which meets on 1296.090 MHz at 9:30 p.m. every Wednesday evening. The net is held in conjunction with the East Coast 70-cm net which meets on 432.090 MHz at 9:00 p.m., also on Wednesday evenings. On the first night of the 1296-MHz net, there were seven check-ins from five states (Georgia, Florida, Tennessee, South Carolina, and North Carolina). The best DX was a 500-mile contact between W4ODW and WA4ZIA. Stations interested in participating in the 1296-MHz net can check into the earlier 432-MHz net, where net control (WD4MBK) will take a list which will be passed on to the 1296-MHz net controller (WA4ZIA). At 9:30, WA4ZIA will call and listen on 1296.090, while listening simultaneously on 432.110 MHz for stations who wish to join the 1296-MHz net. Stations further to the north (Virginia, Maryland, New Jersey, and Pennsylvania) should look for K4CAW (North Carolina). He will call and listen on 1296.090 at 9:30 p.m. for check-ins from the north.

WA4ZIA has also become operational on 3456 MHz with 5 watts to a W3HQT loop Yagi. To eliminate feed-line losses, the 3456 transverter and power amplifier are mounted at the antenna on top of his tower. In his first week on the band, he worked W4OJK

ELENCO & HITACHI PRODUCTS AT DISCOUNT PRICES

NEW!

RSOs (Real-Time & Storage Oscilloscopes) From HITACHI

The RSO - its the new solution

View, Acquire, Test, Transfer and Document Your Waveform Data

NEW!

Compact Series Scopes

4-Channel, 100MS/s Model

Introductory Price

100MS/s (25MS/s on 4 channels simultaneously), 100MHz, 4kw x 1ch., 2kw x 2ch., 1kw x 4ch. **VC-6145 \$4,695.00**

Compact, Full Feature Models

40MS/s, 100MHz, 4kw x 1ch., 2kw x 2ch.

VC-6045 \$3,049.00

20MS/s, 50MHz, 2kw x 2ch.

VC-6025 \$2,295.00

Low Cost/High Value Models

20MS/s, 50MHz, 2kw x 2ch.

VC-6024 \$2,049.00

20MS/s, 20MHz, 2kw x 2ch.

VC-6023 \$1,749.00

RSOs from Hitachi feature such functions as roll mode, averaging, save memory, smoothing, interpolation, pretriggering, cursor measurements, plotter interface, and RS-232C interface. With the comfort of analog and the power of digital.



Delayed Sweep
Lightweight (13lbs)
2mV Sens
3 Yr Warranty

Model V-1065
Shown

This series provides many new functions such as CRT Readout, Cursor measurements (V-1085/1065/665), Frequency Ctr (V-1085), Sweeptime Autoranging and Trigger Lock using a 6-inch CRT. You don't feel the compactness in terms of performance and operation.

- V-660 60MHz Dual Trace **\$1,195**
- V-665 60MHz Dual Trace w/Cursor **\$1,345**
- V-1060 100MHz Dual Trace **\$1,425**
- V-1065 100MHz Dual Trace w/Cursor **\$1,695**
- V-1085 100MHz Quad Trace w/Cursor **\$2,045**
- V-1100A 100MHz Quad Trace w/Cursor **\$2,295**
- V-1150 150MHz Quad Trace w/Cursor **\$2,775**



V-422 40MHz Dual Trace \$795

V-212

Hitachi Portable Scopes

\$435 DC to 50MHz, 2-Channel, DC offset function, Alternate magnifier function

DC to 20MHz Dual Channel

V-525 CRT Readout, Cursor Meas. **\$1,025**

V-523 Delayed Sweep **\$995**

V-522 Basic Model **\$895**

20MHz Elenco Oscilloscope



\$375

MO-1251

- Dual Trace
- Component Tester
- 6" CRT
- X-Y Operation
- TV Sync
- 2 p-1 Probes

FREE DMM

with purchase of ANY SCOPE

SCOPE PROBES

P-1 65MHz, 1x, 10x **\$19.95**

P-2 100MHz, 1x, 10x **\$23.95**

Elenco 35MHz Dual Trace

Good to 50MHz

\$495

MO-1252



- High luminance 6" CRT
- 1mV Sensitivity
- 6KV Acceleration Voltage
- 10ns Rise Time
- X-Y Operation + Z Axis
- Delayed Triggering Sweep
- Includes 2 P-1 Probes

All scopes include probes, schematics, operators manual, and 3 year (2 yrs for Elenco scopes) world wide warranty on parts & labor. Many accessories available for all Hitachi scopes. Call or write for complete specifications on these and many other fine oscilloscopes.

WE NOW CARRY COMPLETE LINE OF FLUKE MULTIMETERS Models

- 21F 83
- 23F 85
- 25F 87
- 27F 8050A
- 73 8060A
- 75 8062A
- 77F + More

CALL FOR SPECIAL PRICING

True RMS 4 1/2 Digit Multimeter M-7000 \$135
 .05% DC Accuracy
 .1% Resistance with Freq. Counter and deluxe case

10 Function Multimeter CM-365 \$65
 AC + DC Voltage & Amps
 Resistance to 2000MΩ
 Diode, Logic, & Trans test
 Capacitance to 200uF

Digital Capacitance Meter CM-1550 \$58.95
 9 Ranges
 .1pF-20,000uF
 .5% basic acy
 Zero control with case

Digital LCR Meter LC-1801 \$125
 Measures:
 Coils 1uH-200H
 Caps .1pF-200uF
 Res .01-20M

Function Generator Blox #9600 \$28.95
 Provides sine, triangle, square wave from 1Hz to 1MHz
 AM or FM capability

Triple Power Supply XP-620 Assembled \$65 Kit \$45
 2 to 15V at 1A,
 -2 to -15V at 1A
 (or 4 to 30V at 1A)
 and 5V at 3A
 Contains all the desired features for doing experiments.
 Features short circuit protection, all supplies.

Wide Band Signal Generators SG-9000 \$129
 RF Freq 100K-450MHz
 AM Modulation of 1KHz
 Variable RF output
SG-9500 w Digital Display and 150MHz built-in Counter \$249

AC Current Meter ST-1010 \$69.95
 1000 Amps
 Data & Peak hold
 8 Functions
 Deluxe Case

Decade Blox #9610 or #9620 \$18.95
 #9610 Resistor Blox
 47 ohm to 1M & 100K pot
 #9620 Capacitor Blox
 47pF to 10MFD

Quad Power Supply XP-580 \$59.95
 2-20V at 2A
 12V at 1A
 5V at 3A
 -5V at .5A
 Fully regulated and short circuit protected
XP-575 without meters \$39.95

LEARN TO BUILD AND PROGRAM COMPUTERS WITH THIS KIT!
 INCLUDES: All Parts, Assembly and Lesson Manual
Model MM-8000 \$129.00

Digital Triple Power Supply XP-765 \$249
 0-20V at 1A
 0-20V at 1A
 5V at 5A
 Fully regulated, Short circuit protected with 2 limit control, 3 separate supplies
XP-660 with Analog Meters \$175

GF-8016 Function Generator with Freq. Counter \$249
 Sine, Square, Triangle Pulse, Ramp, .2 to 2MHz
 Freq Counter .1 - 10MHz
GF-8015 without Freq. Meter \$179

Starting from scratch you build a complete system. Our Micro-Master trainer teaches you to write into RAMs, ROMs and run a 8085 microprocessor, which uses similar machine language as IBM PC. You will write the initial instructions to tell the 8085 processor to get started and store these instructions in permanent memory in a 2816 EPROM. Teaches you all about input and output ports, computer timers. Build your own keyboard and learn how to scan keyboard and display. No previous computer knowledge required. Simple easy to understand instruction teaches you to write in machine language.
ROBOTICS KIT FOR ABOVE (MM-8010) \$71.95

WE WILL NOT BE UNDERSOLD!
 UPS Shipping: 48 States 5%
 (\$10 Max) IL Res., 7% Tax

C & S SALES INC.
 1245 Rosewood, Deerfield, IL 60015
 (800) 292-7711 (708) 541-0710

15 Day Money Back Guarantee
2 Year Warranty Prices subject to change
WRITE FOR FREE CATALOG


(95 miles) and K4EJQ (115 miles — path open about 10 percent of the time).

Microwaves and no-code

While it's often difficult to be topical in a column written so far in advance of publication, I'm quite sure that the code versus no-code issue will still be under debate when you read this. On February 16th, the FCC issued a notice of proposed rule making (NPRM) in their docket number 90-55. If you haven't read this document, and are concerned with the future of ham radio, please do so. Basically, it calls for dropping the Novice and Technician class licenses and establishing a Communicator no-code license entitling the holder to all privileges on 222 MHz and above. While the debate may be fierce (there are those who argue with a fervor usually reserved for politics and religion), it seems that some kind of no-code license will be the outcome. You may ask what this has to do with microwaves. Well, all the no-code proposals allow — in fact, are actually targeted towards — newcomers to the bands where more activity is badly needed. Much of the fine work done in the UK on the microwave bands has been through the efforts of Amateurs there who hold no-code licenses. (Indeed, my first license was a UK no-code, though my contributions to microwave activity were negligible!)

The microwave bands are being eyed increasingly by commercial interests as technology makes their use more practical. If we don't occupy the bands we'll have little grounds for objection if we start to lose them. If a no-code license can increase microwave activity, then I welcome it. Even if it doesn't, I don't think a limited no-code license will do harm.

If you feel strongly on the issue of a no-code license, I urge you to send your comments to the FCC (but do read the text of their proposal first). I favor the idea of the Communicator license, but I think dropping the Novice and Technician classes, with their low speed CW requirements, would be a mistake. Whatever your views, make them known to the FCC, and if the eventual outcome is a new group of no-code Amateurs, then let's make sure we welcome them to ham radio without prejudice and encourage them to join us on the microwave bands (and learn CW!).

Finally, thanks again to all of those who have taken the time to write. The direction and content of this column depends on your letters, so keep them coming. If you send photos, please be sure to include all the information about the photo on the back. Black and white prints are preferred, but color is okay. Next month I plan to discuss tropospheric scatter propagation on the microwave bands. 

New AOR Scanner

**1000 Channels.
8-600MHz,
805-1300
MHz**



- Continuous coverage (except UHF TV 600-805)
- AM, FM and wide band FM tuning modes
- 10 Scan Banks, 10 Search Banks
- Selectable Priority Channel
- Selectable Search Increments, 5-955KHz
- Permanent memory backup
- 25 Day Satisfaction Guarantee. Full refund if not Satisfied
- No Frequencies cut out
- All normal accessories included.
- Size: 6 7/8" H x 1 3/4" D x 2 1/2" W. Wt. 12 oz.

AR1000
Total Price, Freight Prepaid (Express Shipping Optional)
\$499

ACE COMMUNICATIONS

10701 E. 106th St. Indpls., IN 46256
Toll Free 800-445-7717

Visa and Mastercard (COD slightly higher)
FAX (317) 848-8794

✓ 112

WACOM DUPLEXERS

Our Exclusive Bandpass-Reject Duplexers
With Our Patented
B_p B_r CIRCUIT® FILTERS



provide superior performance... especially at close frequency separation.

Models available for all commercial and ham bands within the frequency range of 30 to 960 MHz.


CALL 817/848-4435

WACOM PRODUCTS, INC.

P.O. BOX 21145
WACO, TEXAS 76702 • 817/848-4435

✓ 113

NEED BATTERIES? CALL THE EXPERTS



MR. NICAD

WHERE QUALITY COMES FIRST

E. H. YOST & CO.
7344 TETIVA ROAD
SAUK CITY, WI 53583

(608) 643-3194 FAX: (608) 643-4439

NEW FOR ICOM®

CLONE BATTERY PACK
9.6V 1350 mAh \$69⁰⁰
8 Cell Empty AA Case \$21⁹⁵
Complete with 8 600 mAh NICADS \$37⁹⁵

✓ 110

PHASOMETER

Joel Eschmann, K9MLD, 6964 Meadowdale Drive, Hartford, Wisconsin 53027 and Tom Rehm, K9PIQ, 11653 N. Pinehurst Circle, Mequon, Wisconsin 53092

No, it's not another SWR bridge. The PhasoMeter is a discriminator that detects the relative phase between voltage and current waves in an RF transmission line. When used with a zero-center meter, it provides an accurate indication of resonance and also shows which side of resonance you're tuned to. If you're tuned below resonance, the meter will deflect to the left; if you're tuned above resonance, it will deflect to the right. At resonance, both voltage and current are in phase and the meter reads zero. The further you are from resonance, the greater the amount of deflection. The amount of deflection is also proportional to RF power. The device connects in series with the transmission line or at the antenna feedpoint. You can leave the PhasoMeter "in line" permanently if you wish; there are no batteries to wear out.

Some practical applications include:

- Use as a tuning aid for remote antenna tuners (like the K9MLD design in *Ham Radio*, October 1988¹) by indicating directly which direction to slew the inductor. This has proven to be invaluable for mobile operation.
- Providing the essential pickup discriminator for construction of an automatic antenna tuner or an audible

antenna-tuning indicator for the visually impaired.

- Help in tuning phased arrays to a conjugate impedance match.
- Checking the health of your present antenna. The PhasoMeter is sensitive enough to see your antenna flapping in the breeze — a feat difficult to achieve with an SWR bridge.

Calibration

Calibration requires a dummy load or other flat resistive load. Run 100 to 150 watts through the PhasoMeter into a dummy load. The load end should be the end opposite the point where C4 is attached. Adjust C5 for zero deflection. If you don't obtain a null, move C5 to the other side of T1 and repeat the procedure. That's all there is to it! Calibration should hold to within a few kHz across the entire band.

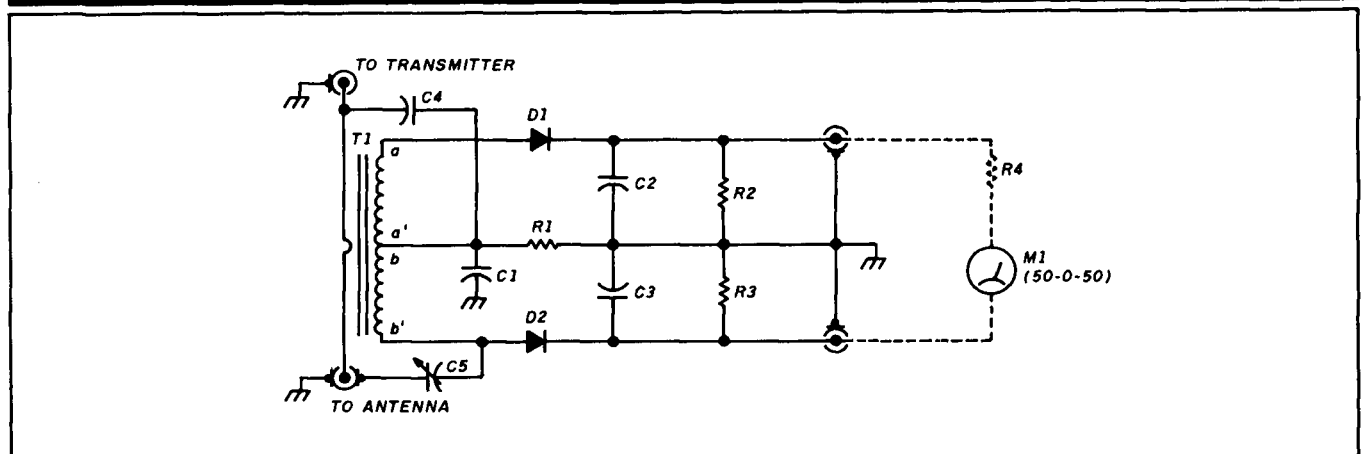
The design in **Figure 1** is optimized for 75-meter operation, with reduced sensitivity on 40 meters. If 40 meters is your band, wind T1 with eight turns.* The basic circuit looks like the early FM detectors, and it is just that. The principle is the same—but now, with the PhasoMeter, you can look into the activity going on in the coaxial cable.

Aids mobile operation

K9MLD has found the PhasoMeter very useful in a mobile

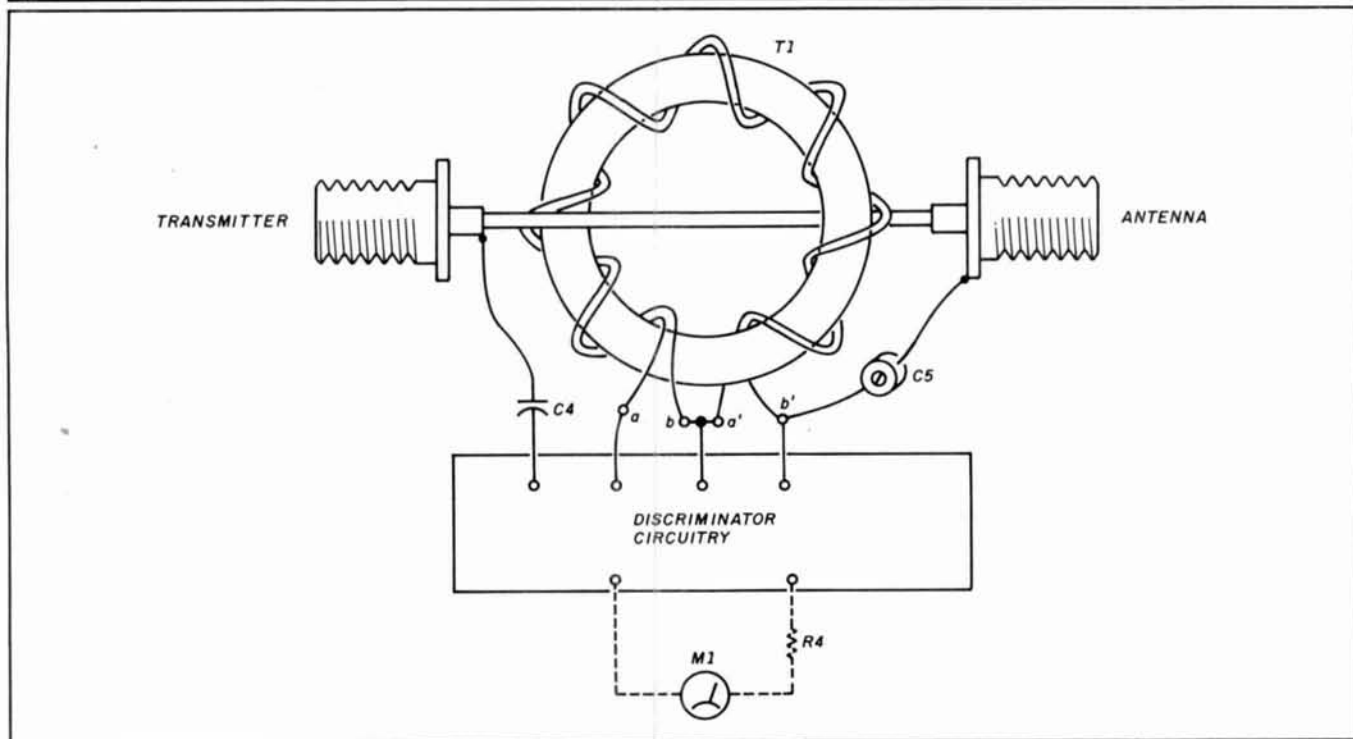
*For optimum performance, T1 should be tailored for the band used. Ed.

FIGURE 1

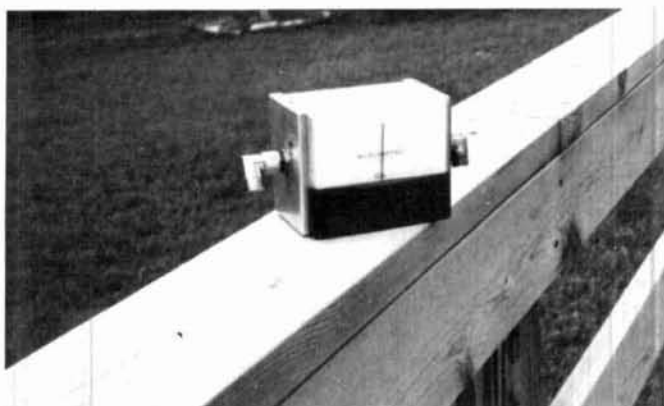


Schematic of PhasoMeter optimized for 75-meter operation, with reduced sensitivity on 40 meters.

FIGURE 2



Pictorial representation of the pickup toroid and its windings. Note: For clarity, continuity between the connector bodies isn't shown.



A typical PhasoMeter unit.

installation which uses a manual motor-driven tuner.¹ Changing frequency and retuning the antenna while mobile can be a real chore. This unit makes it simple. The zero-center meter clearly indicates the direction to tune to obtain resonance.

Figure 2 shows how to assemble the unit. The toroidal core and detection circuitry should be located within an inch or so of each other. The meter can be remote to your dashboard or the whole unit can be mounted next to the transmitter. We've built a number of these meters and found the performance to be equal, regardless of the structure. A typical unit is shown in Photo A.

Future plans

We are working on an addition to the PhasoMeter that will automatically drive a motor-driven tuner to resonance.

PARTS LIST

Parts list

- C1 100-pF silver mica capacitor, 100 volt, 5 percent
- C2,C3 0.1- μ F 100-volt, 5-percent capacitor
- C4 5-pF silver mica capacitor, 500 volt
- C5 6 to 50-pF trimmer (Radio Shack)
- D1,D2 1N914 diode
- M1 50- μ A, zero-center meter
- R1 12-k, 10-percent, 1/4-watt resistor (a 2.5-mH choke may be substituted for increased sensitivity)
- R2,R3 100-k, 10-percent, 1/4-watt resistor
- R4 10-k, 10-percent, 1/4-watt resistor
- T1 Amidon T-50-2 bifilar wound with 15 turns of no. 26 gauge wire*

*Amidon Associates, 12033 Otsego Street, North Hollywood, California 91607.

PC board available for \$3.50 plus \$1.50 shipping and handling from FAR Circuits, 18N640 Field Court, Dundee, Illinois, 60118.

Though this type of design has been around a while, the earlier models used a "bang bang" style of servo. The new design will servo the motor and slew into the point where the motor is at rest. When the motor-driven reactor approaches resonance, our design will slow the motor down, come into position at the proper point, and stop — instead of stopping abruptly and over-shooting the mark.

We have described a discriminator-type device that attaches to your transmission line and has many potential uses. You now have a tool that will make tuning your antenna system even easier and keep it operating at peak performance. *hp*

REFERENCES

1. Joel Eschmann, K9MLD, "The Weekender: Remote Tuner For 75-Meter Mobiles," *Ham Radio*, October 1988, page 36

INEXPENSIVE SSB FOR 10 METERS

Modify this CB radio for your 10-meter needs

By Phil Salas, AD5X, 1517 Creekside Drive, Richardson, Texas 75081

Ten meters is becoming an exciting place again. The sunspot cycle is heading for good times over the next few years, and now Novices and Technicians can operate phone over a limited portion of this band (28.3 to 28.5 MHz). There's an inexpensive way for everyone to get on board. It'll give you a chance to dust off the old soldering iron and get your own rig on the air.

CB radios are still very reasonable. Though the SSB rigs are a little more costly, they're still a good bargain. I purchased a brand-new Cobra 146GTL from Fordham for about \$150. Converting this unit to the 10-meter ham band is a relatively simple 1 to 2-hour job. The results are well worth it.

The Cobra 146GTL is a fully synthesized 40-channel AM and SSB radio. It has an RF gain control, automatic noise limiting, and noise blanking. The receiver is robust and doesn't suffer overload from nearby CB radios. The SSB filter is an eight-pole centered at 10.695 MHz. The transmitter puts out 12 watts PEP on SSB and 4 watts on AM.

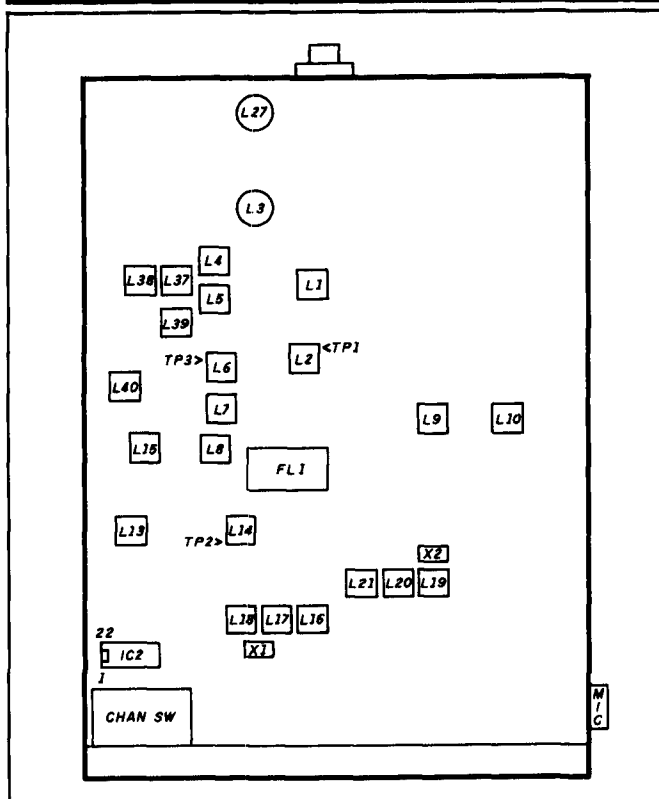
There are three main areas of modification. The first involves changing the receiver voice lock control circuitry to permit continuous tuning of both transmitter and receiver. Next you'll modify the synthesizer circuitry to permit operation on 10 meters. Your final step will be to retune the transmitter and receiver for optimum performance on the 10-meter band. Before you start, remove the top and bottom covers. You might also want to extend the wires going to the speaker. You'll be turning the unit over quite a bit, and the original speaker wires are too short. Refer to **Figure 1** for parts placement and become familiar with their locations. Find these same parts on the schematic diagram supplied with your 146GTL. Make sure your unit is in working condition before attempting these modifications.

Voice lock modification

CB radios only permit transmit operation on what are basically 10-kHz fixed steps. When you're receiving there's usually a receive voice lock or clarifier control that permits a ± 1 kHz tuning range. This is necessary because of slight

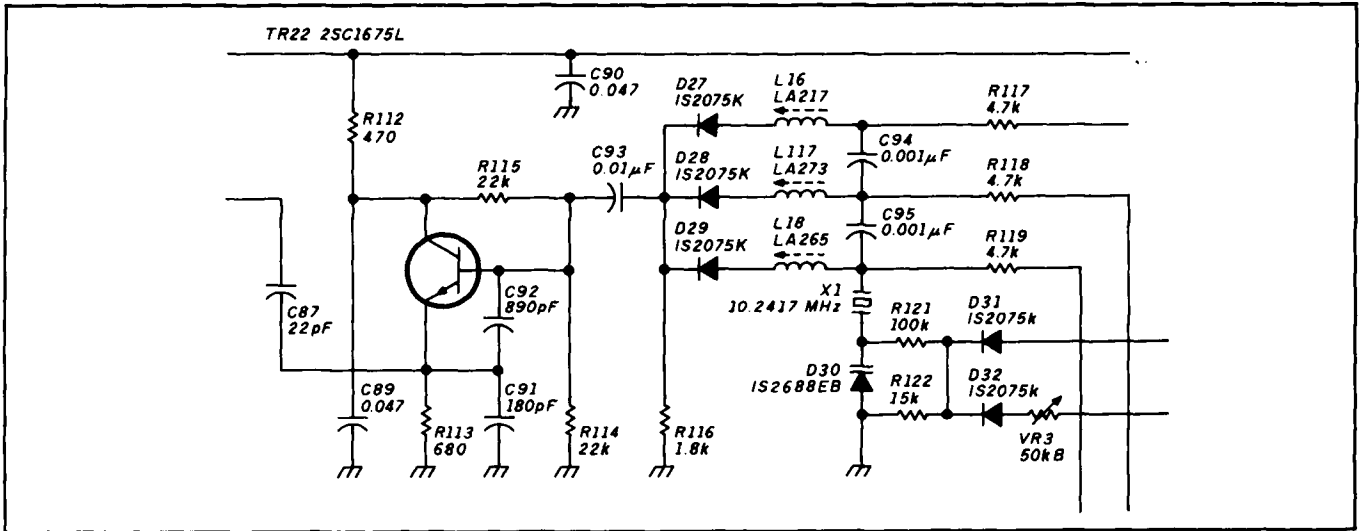
differences in frequency accuracy between radios. Though it's not really necessary for AM operation, you must be tuned precisely to the received signal when operating SSB to prevent severe audio distortion. The trick is to adjust the voice lock circuitry so that it has enough range to cover the whole 10-kHz channel and also work on both transmit and receive.

FIGURE 1



Parts location layout for the Cobra 146GTL.

FIGURE 2



Partial schematic for the reference oscillator in the Cobra 146GTL.

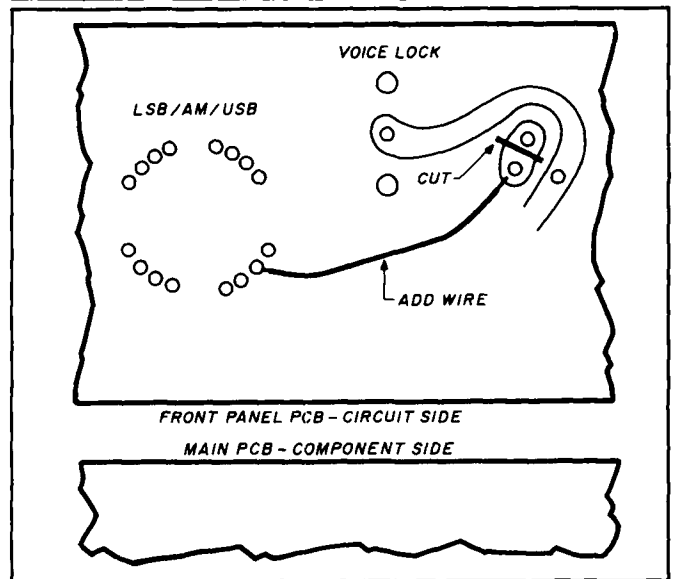
Figure 2 is a schematic of the reference oscillator for the synthesizer in the 146GTL. Diode D30 is a varactor diode (voltage variable capacitor). On receive the voice lock control applies a variable voltage through isolation diode D31 to varactor diode D30. This variable voltage changes the capacitance of D30 which then pulls the frequency of synthesizer crystal X1. On transmit the voice lock voltage is removed and a fixed voltage is applied through isolation diode D32 to varactor diode D30.

First disable the fixed voltage applied during transmit. This is done most easily by cutting D32 out of the circuit. This is located just beneath crystal X1. Next refer to Figure 3 which is a partial drawing of the circuit side of the front panel pc board. Modify this board by cutting the circuit pad near the voice lock control and adding a wire from the cut pad to one terminal of the LSB/AM/USB switch. This modification will keep the voice lock variable voltage available during receive and transmit.

As I mentioned before, the total tuning range of the voice lock circuitry is only ± 1 kHz. Varactor diode D30 doesn't have enough capacitance range to cover any more than this. Fortunately, you can make a very inexpensive varactor diode. Simply replace D30 with four 1N4000 diodes connected in series as shown in Figure 4. Note that the diode polarities are opposite that of D30. The voice lock circuitry now becomes a current source for these diodes. At very low currents the diodes don't conduct, and look like an open circuit or very low capacitance. As you increase the current through the diodes, they begin to conduct. The more the diodes conduct, the more they approach a short circuit. Remember that a short circuit looks like a very high capacity. I found that three series-connected diodes gave me ± 5 kHz tuning range while four series-connected diodes gave me a ± 7.5 kHz tuning range. Four diodes makes tuning a little more sensitive but gives you some channel overlap.

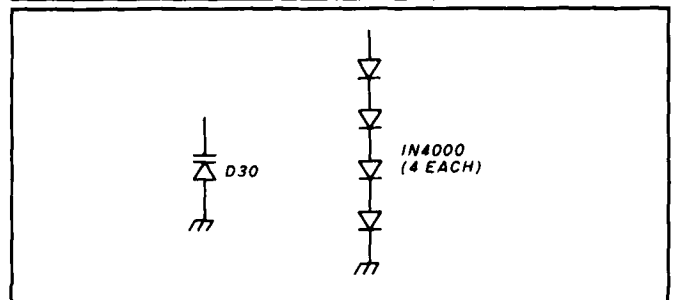
The Cobra 146GTL uses crystal X1 to determine the USB, LSB, and AM frequencies. To keep the frequencies the

FIGURE 3



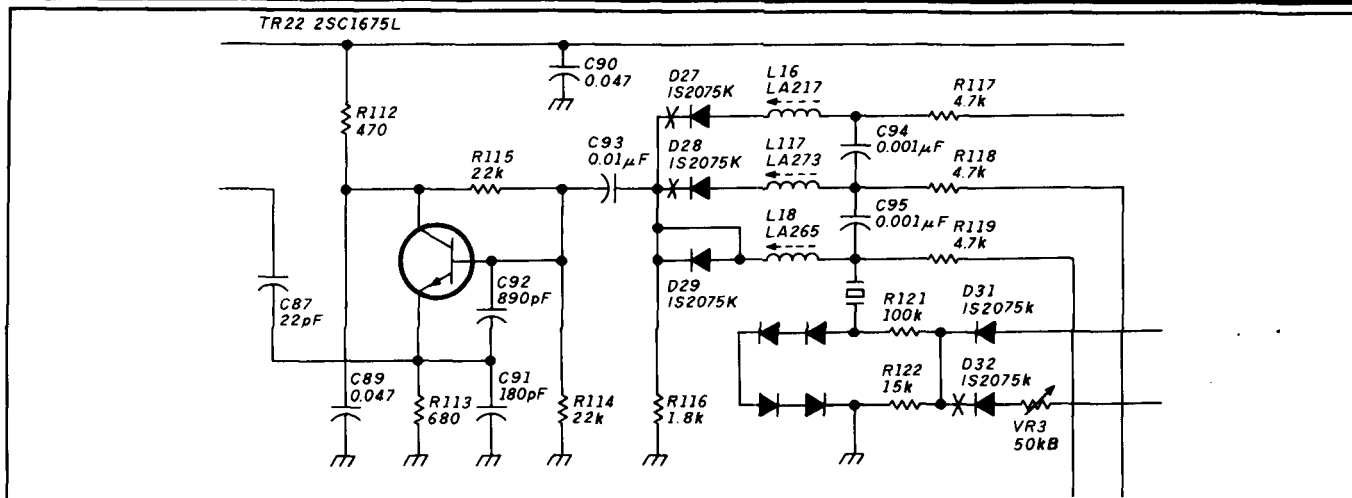
Partial drawing of the trace side of the front panel circuit board.

FIGURE 4



Replacing D30 with four 1N4000 series diodes.

FIGURE 5



Schematic of the modified reference oscillator.

same for all three modes, the crystal is pulled by inductors L16, L17, and L18 — depending on which mode you're in. Unfortunately, the combination of the inductor pulling and the voice lock pulling is a little too much for the crystal oscillator circuit in the USB and AM modes. Consequently, the oscillator may stop while you're tuning with the voice lock control. To compensate, I modified the circuit to use inductor L18 (the LSB inductor) for all three modes. Do this by cutting one end of diodes D27 and D28 and replacing diode D29 with a short circuit (a piece of wire). You can still operate all three modes, but there will be a slight frequency change when you switch modes.

Your final hardware modification involves replacing crystal X1. An 11.1-MHz crystal will move the operation of the 146GTL to 28.3 to 28.74 MHz. For each 100 kHz you move the crystal frequency, the radio operating frequency will move 200 kHz. For example, if you want the radio to operate from 28.5 to 28.94 MHz, use a crystal frequency of 11.2 MHz. I ordered my replacement crystal from JAN Crystals for \$5. When you order the crystal, specify that it must be a synthesizer crystal for the Cobra 146GTL in an HC-18 package with a frequency of 11.100 MHz. When your crystal arrives, unsolder crystal X1 and replace it with the new one. **Figure 5** is the schematic of the final modified synthesizer reference oscillator.

Tuning up

Two of the necessary adjustable inductors (L14 and L27) in the Cobra 146GTL are filled with wax. You can remove this wax easily with a small bladed X-ACTO™ knife. I was able to remove virtually all the wax in just a few minutes by picking at it with the knife.

It's best to perform the following adjustments with a digital voltmeter and an oscilloscope. If you use an analog voltmeter, make sure that it is high impedance. You can use a CB-style power/SWR meter in place of the oscilloscope for the final output power tuning; however, the oscilloscope is really necessary for setting up the synthesizer circuitry.

Make sure the microphone is plugged into the radio. The receiver won't function without the mic.

Proceed as follows:

Make sure the crystal oscillator is operating. You should see about 50 mV p-p of signal with the oscilloscope connected to pin 13 of IC2. This is a broadband circuit and will operate easily with the new 11.1-MHz crystal. If it's not working, recheck your modifications.

Set the channel selector to channel 19. Locate TP2. This is the bare end of resistor R93 and is located next to L14 (see **Figure 1**). Attach your digital voltmeter between TP2 and the 12-volt return. Carefully adjust L14 in a counterclockwise direction (for less inductance) until you read 3.25 volts at TP2. As you begin to adjust this inductor, the voltage will start out low (less than 2 volts) and then increase. When you reach 3.25 volts, connect the oscilloscope to pin 22 of IC2 and peak the observed voltage with L13. You should see approximately 130 mV p-p at this point.

If the voltage at TP2 becomes intermittent while you're tuning L14, leave the inductor at the last stable voltage position and peak the voltage at pin 22 of IC2 with L13. Then go back and finish readjusting L14. Follow this by peaking the observed voltage with L13 at pin 22 of IC2.

Now connect the oscilloscope to TP3. TP3 is one end of resistor R105 and is located next to L6 as shown in **Figure 1**. Adjust L15 for maximum voltage at TP3. *Note: Adjust L15, not L6!* You should see about 80 mV p-p at TP3.

Connect the oscilloscope to pin 11 of IC5. Press the transmit button and adjust L39 for maximum voltage. This should be about 50 mV p-p.

Finally, connect the oscilloscope to the center conductor of the output connector on the radio. With the transmit button depressed, adjust L38, L37, and L27 for maximum output. This completes the transmitter alignment.

The receiver alignment is also simple. Attach your oscilloscope probe to one of the speaker leads. Set the channel selector to channel 19 and attach a 10-foot section of random wire to the radio's antenna terminal. Tune around for a clear area and then peak L3, L4, L5, L6, L7, and L8 for maximum noise as seen on the oscilloscope. Make sure you don't press the transmit button since you don't have a proper antenna!

Attach your oscilloscope probe to TP1. This is one end of resistor R10 and is located adjacent to L2, as shown in Figure 1. Now adjust L1 and L2 for maximum noise. This completes the radio alignment.


Antennas

Any 10-meter antenna will work. But for mobile use I wanted a discreet antenna that I could remove when I parked the car. I purchased a center-loaded CB magnetic mount antenna from K-Mart for about \$15. I removed 1-3/4 inches from the top part of this antenna to resonate it at 28.5 MHz. The entire antenna is only about 2 feet high!

Operation

What can you do with a 2-foot antenna and 12 watts PEP on 10 meters? It depends on band conditions. I work all over the United States and down into South America quite regularly. If I can hear a station I can work it, unless I'm competing with someone running higher power and a better antenna system. My best results seem to occur when I call CQ and state that I am "QRP mobile." My contacts are always amazed when I tell them what I'm running.

Summary

It's hard to beat 10 meters during the sunspot highs. Over the next few years you can have quite a bit of fun with this rig, for almost half what you'd spend for a 2-meter handie-talkie! The modifications I've described can be done easily in one evening. Give it a try. If you're like me, you'll wish you had a longer drive to work! 

W6SAI BOOKS

by noted HR columnist Bill Orr, W6SAI.

ALL ABOUT VERTICAL ANTENNAS

Theory, design, construction and operation are fully covered for vertical antennas. Grounds and their importance get extra emphasis. Construction data for 25+ antenna designs. 192 pages ©1986 1st edition

RP-VA

Softbound \$10.95

THE RADIO AMATEUR ANTENNA HANDBOOK

Covers all kinds of antennas from HF to VHF, horizontal to vertical. Compiled from years of W6SAI's extensive writings. Great reference volume to have on hand. Chock full of proven antenna designs that work! 190 pages ©1978 1st edition

RP-AH

Softbound \$11.95

INTERFERENCE HANDBOOK by WA6FOG

With homes rapidly filling with vulnerable electronic equipment, knowing how to solve interference problems is a must. WA6FOG has years of experience and tells you everything you need to know to solve even the thorniest interference problem. © 1981 1st edition

RP-IH

Softbound \$11.95

THE RADIO HANDBOOK 23rd edition

Great technical resource to have available in your Ham workshop. Full of all kinds of projects, antennas and the best compilation of HF and VHF amplifiers in the Amateur Radio field. Includes new easy-to-use charts, graphs and tables. Best value in Amateur Radio today. 1200 pages ©1986 23rd edition

22424

(Reg \$29.95 SAVE \$3)

Hardbound \$26.95

Please enclose \$3.75 shipping and handling

HAM RADIO

Greenville, N.H. 03048



Order today! (603) 878-1441
or "FAX" us (603) 878-1951



Published Bi-Monthly

Read All About Your Favorite Modes Of Digital Communications!

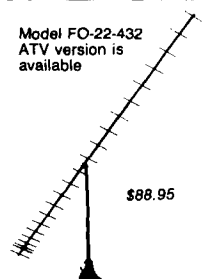
★ **Subscribe Today!** ★

Digital Digest
4063 N. Goldenrod Road
Winter Park, FL 32792

\$1600 Per Year
U.S. \$22.00 Elsewhere

Payable in U.S. Funds Only / Check or M.O. Preferred

THE K1FO 22 ELEMENT 432 MHz YAGI



Model FO-22-432
ATV version is available

\$88.95

ELECTRICAL SPECIFICATIONS:

Measured gain	15.6 dBd
E Plane beamwidth	23 deg
H Plane beamwidth	24 deg
Sidelobe attenuation	
1st E-Plane	-17.5 dB
1st H-Plane	-15.5 dB
SWR	1.14:1 typical
ATV version	41.4:1 422-439MHz
F/B ratio	22 dB
Impedance	50 ohm

MECHANICAL SPECIFICATIONS:

Length	14ft
Boom	1" 6061 T-6 Aluminum
Elements	3/16" Aluminum rod
Wind survival	90+ MPH
Max I	up to 1.5' diameter
Element Insulators	Black Delrin
Stainless Steel hardware	
(except U-bolts)	
Coax connector	N-type

ALSO AVAILABLE

FO-12-144, FO-16-220, FO-25-432, FO-33-432, FO-11-440
POWER DIVIDERS STACKING FRAMES

We supply those hard to find parts for the home builder
3/16" Delrin Insulators \$12/100, Stainless keepers \$10/100
Add \$5 UPS S/H for each antenna
\$7 west of Mississippi
PA residents add 6% state sales tax.

RUTLAND ARRAYS

1703 Warren Street • New Cumberland, PA 17070
(717) 774-5298 7:10 P.M. EST

Enjoy This Martin TOWER and HAZER

Never climb again with this tower and elevator system. MARTIN TOWERS are made of aluminum and specifically engineered for use with THE HAZER. All bolted construction, no welds. Easy to install hinge base, walk up erection, next plumb with leveling bolts in base. Mount antennas and rotor on HAZER in vertical upright position, then winch to top of tower for normal operating position. Guy wires fasten to HAZER or above HAZER at top of tower. Safety lock system operates while raising or lowering. Never can fall. Photo shows HAZER and antenna at top.

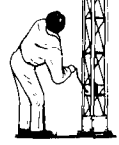
SPECIAL TOWER PACKAGE prices include everything but rotor and antenna: 50' M-18 alum. tower kit form, hinged base, concrete footing section, HAZER kit, Phillystran guy wires, turnbuckles, earth screw anchors, 10' mast, thrust bearing, tool kit, rated at 15 sq. ft. antenna load @ 70 MPH. **\$1925.95** FOB Boonville.

50' M-13 alum tower, same pkg as above	\$1637.95
40' M-13 alum tower, same pkg as above	1463.90
30' M-13 alum tower, same pkg as above	1294.25
HAZER 2 for Rohn 25 - Hvy duty alum 12 sq ft wind ld	311.95
HAZER 3 for Rohn 25 - Std alum 8 sq ft wind ld	233.95
HAZER 4 for Rohn 25 - Hvy galv stl 16 sq ft wind ld	291.95

Satisfaction guaranteed. Call today and charge to Visa, MasterCard or mail check or money order. Immediate delivery.

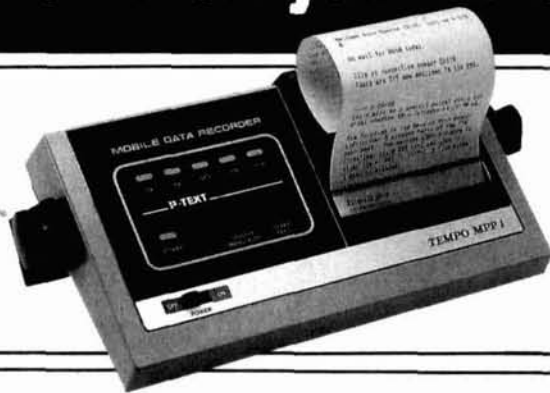
Glen Martin Engineering, Inc.
R 2, B322, Boonville, MO 65233

816-882-2734
FAX: 816-882-7200



✓ 161
✓ 162

HENRY RADIO IS THE PLACE ...THE BEST PLACE to fill all your data communications needs



The TEMPO MPP1 TNC/printer. . .\$249

A unique new mobile data printer. It incorporates a packet controller with a 40 column thermal printer that operates on 13.6 VDC and interfaces with any mobile radio. In a recent user test it proved to have about twice as much audio level range tolerance as other TNCs. It is also an ideal unit for emergency work and a commercial version is perfect for dispatching service, emergency and police vehicles.

The FSTV-430A, AEA's newest

The exciting FSTV-430 fast scan television transceiver makes getting on ATV easy and inexpensive. . .live or taped. Almost any video camera can be used. Simply plug it into the FSTV-430, connect to your 70 cm antenna and you're on the air. Use a standard TV for receiving signals and, of course, an amplifier will extend your range. It's reliable, portable and light weight and can be used in-station or mobile from any 12 VDC source. The only license required is a technician or higher.



The PK232/MBX by AEA

...the only controller offering Morse Code, Baudot, ASCII, AMTOR, Packet, and facsimile Transmission & Reception plus the ability to monitor the new Navtex marine weather and navigational system. . .7 modes in one controller. The PK-232 makes any RS-232 compatible computer or terminal the complete amateur digital operating position. All decoding, signal processing and protocol software is on ROM. Only a simple terminal program (like those used with telephone modems) is required to interface the PK-232 with your computer.

Here's a value you can't beat. . .the basic 8088



- 101 Keyboard
- Monochrome monitor
- 640K of RAM
- 360K floppy
- 2 serial & 1 parallel port

An excellent starter for both packet and business at the incredibly low price of \$595. Or for anyone requiring an extremely high speed unit at a comparably low price ask us about the models 80286 and 80386. They are perfect for business or data communications and we can configure them to your requirements. And, of course, these systems are covered by a one year warranty.

If you have any questions concerning these units, or would like to discuss your requirements with a knowledgeable specialist, please call and ask for Fred, N6SFD. We also carry a large selection of excellent commercial products for data communications and emergency systems as well as a complete inventory of amateur equipment and linear power amplifiers.

Try our new 24 hour "Bulletin Board Service"
... (213) 826-4954



Henry Radio

2050 S. BUNDY DR. • LOS ANGELES, CA 90025 • (213) 820-1234
Toll free order number: (800) 877-7979 TELEX: 67-3625(Henradio) FAX: (213) 826-7790

Ham Radio Techniques

By Bill Orr, W6SAI

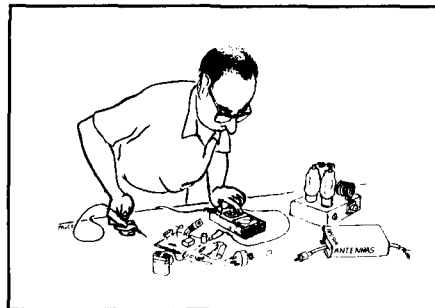
WARC 1992

In 1992, if all goes as planned, a World Administrative Radio Conference (WARC) will convene in Geneva, Switzerland. The Amateur Radio bands will be examined closely once again by the participants, some of whom view the Amateur frequencies as a happy hunting ground. We were lucky at the last WARC. We retained our traditional HF bands and gained new narrow bands at 10, 17, and 24 MHz. Good long range planning by the United States delegates and observers, in cooperation with delegates from other countries, brought us this triumph.

Now we must run the gauntlet of a new conference held during perplexing and rapidly changing times. Our technical and political worlds are in flux, and this situation raises some important questions. In view of the amazing changes in Eastern Europe, are the costly, spectrum-consuming shortwave broadcasts of special interest stations like Radio Free Europe and Radio Liberty still necessary? Are the propaganda broadcasts of Radio Moscow, Radio "Free" Cuba, and numerous other countries relevant?

Sadly, the "radio" portion of the cold war has been growing instead of shrinking. Many countries are, or will soon be, on the air with megawatt HF broadcast transmitters operating into huge curtain arrays. Transmissions are made around the clock in many foreign languages. Radio Peking, for example, broadcasts to the world in over 40 languages including Serbo-Croatian, Urdu, and Bulgarian. I wonder what common bond the speakers of these languages have with China that would induce them to listen to these broadcasts? It seems to me that many countries squander megawatts of valuable energy broadcasting their views to the world.

The upshot of all this is that the international shortwave broadcast bands are a mess. The stations are layers deep! It's interesting to contemplate the



return on the investment of these broadcasts. It must be very low. Regardless, many countries (including the United States) are upgrading their shortwave facilities with more power, bigger antennas, and better studios.

No doubt there will be enormous pressure at WARC '92 for an expansion of the present shortwave broadcast bands to accommodate all the new voices and provide more elbow room. I think they should do the reverse. Let's clean up the present bands by cutting down on repetitive broadcasts! Eliminate multiple transmissions of the same program in a particular band. Place a cap on the power war. Treat the bands as a valuable resource instead of a propaganda dumping ground.

During the cold war decades, the world grew tired of propaganda. Most people aren't fooled by what they hear on the shortwave radio. For years, casual listeners were amused by the "news" broadcasts from Radio Moscow. Megawatts of energy, large transmitting facilities, and a huge staff were committed to these broadcasts. They went on 24 hours a day, 365 days a year, blanketing the world with bombast in every known language. Any educated listener knew he was hearing hogwash. For years the Pacific Service of Radio Moscow bruised the ears of listeners in the Americas with broadcasts of such poor audio quality and high distortion that the programming was virtually unintelligible. Yet the broadcasts went on. It seemed the desire was to transmit something — anything — whether the transmission was readable or not.

It would be helpful if the forthcoming WARC were to examine some of the gross abuses occurring in the HF broadcast spectrum. If these bands were being used properly, there would be plenty of room for all. Spectrum conservation would help to take the heat off the Amateur bands.

From a technical viewpoint, the same can be said of the fixed service bands. More and more communicators are using satellite transmission. In the meantime, time-honored marine CW stations (like Radio San Francisco, KFS) are on the verge of closing down. SSB has supplanted AM; SITOR is rapidly replacing FSK and CW. This means there's more space available in the fixed service and maritime bands. And, if all goes well, the military requirement for HF radio should decrease as the armed forces of the world shrink!

Great opportunities for Amateur Radio lie ahead if our representatives prepare themselves beforehand and work in harmonious conjunction with Amateur Radio societies around the world to establish a strong and realistic position. Of course, this means we must get our own house in order!

Yes, the next year or so will certainly be interesting as far as the future of Amateur Radio is concerned. Stay tuned.

The ON4UN Yagi design program

Computers can be a great help in determining the electrical and physical properties of an antenna. In past columns I've discussed the antenna programs available from Brian Beezley, K6STI. These are user friendly derivatives of MININEC, a program developed at the Naval Ocean Systems Center at Point Loma, California. The K6STI programs provide modeling and optimization facilities that are very helpful to the antenna designer. They also include a small library of predesigned antennas.

John Devoldere, ON4UN, and Roger Vermet, ON6WU, have compiled a software package which takes you through all the aspects of Yagi design

FIGURE 1

DESIGN #	10	ELEMENTS: 3	NAME: FREDA	BOOM: 0.249 WVL			
FREQ.	GAIN	F/B	RESIST	REACT.	SWR	FOM	
-1.5%	7.4	20.5	28.8	-12.6	1.5	9.0	ANT. Q = 14
-1.0%	7.4	23.4	29.1	-9.0	1.3	9.4	
-0.5%	7.4	23.9	28.8	-5.3	1.1	9.7	SWR BW > 3 %
0.0%	7.5	24.4	28.0	-1.4	1.0	9.9	
+0.5%	7.5	25.4	26.8	2.8	1.2	9.9	F/B BW > 3 %
+1.0%	7.6	22.8	25.2	7.5	1.4	9.5	
+1.5%	7.7	19.2	23.4	12.5	1.8	8.9	
ELEMENT	LENGTH	POSITION	PHYSICAL BOOMLENGTH				
REFLECTOR	0.510217	-.105595	28 Mhz ->	2.63 m.	OR	8.6 ft	
DRIV. EL.	0.483032	0.000000	24 Mhz ->	2.99 m.	OR	9.8 ft	
DIR # 1	0.452359	0.143370	21 Mhz ->	3.52 m.	OR	11.5 ft	
DIR # 2	0.000000	0.000000	18 Mhz ->	4.12 m.	OR	13.5 ft	
DIR # 3	0.000000	0.000000	14 Mhz ->	5.27 m.	OR	17.3 ft	
DIR # 4	0.000000	0.000000	10 Mhz ->	7.37 m.	OR	24.2 ft	
			7 Mhz ->	10.51 m.	OR	34.5 ft	
EL. LENGTHS ARE FOR EL. DIAM. OF .0010527 WAVELENGTHS (7/8 INCH ON 14.2 MHz).							
S = SELECT THIS DESIGN			C = CONTINUE			M = MENU	

The "generic" design for a three-element beam. Length and position of the elements are given in wavelengths. Gain (dBi), front-to-back ratio, and input impedance are provided over a band of frequencies.

— electrical as well as mechanical. This is not strictly a modeling program; it consists of a comprehensive database of 100 different HF Yagis from two to six elements. There are Yagis for every application: wideband, narrowband, gain optimized, front to back optimized, and so on.

Working from the program's main menu, you can browse through the database and select a Yagi design that meets your needs. You can specify maximum boom length, minimum gain, or other parameters. You can modify the design as you see fit. As an aid, a well-written program outline is provided on the disk.

The Figure of Merit

In addition to the usual parameters, the ON4UN program expresses each Yagi design in terms of a Figure of Merit (FOM) which combines the main performance of a Yagi in one figure:

$$FOM = gain (dBi) + 0.1 \times (worst\ lobe\ front\ to\ back) - (1 - SWR)$$

The Figure of Merit is an ideal tool for rapidly evaluating the overall (gain, F/B, and SWR) bandwidth performance of a Yagi. Armed with the FOM of the various antennas in the ON4UN data-

base, you can quickly find an antenna that will fill your needs.

If you want to add your own design to the existing database, the program provides an empty database with room for up to 100 records. That should satisfy even the most unusual antenna requirements!

Once you've selected a design, the program provides the dimensions for untapered ("generic") elements (see Figure 1). The program also provides a tapering schedule and matching data for gamma, omega, and hairpin matches.

Mechanical design of the Yagi

A novel and valuable section of the ON4UN program concerns Yagi mechanical aspects. Element strength, boom strength, weight and balance, wind loading and torque moment can be determined easily for a given design. All of these characteristics are illustrated in the program for Design no. 10: a three-element 40-meter beam which provides better than 7-dBi gain and 20 dB or more F/B ratio over the entire band. The boom length is only 24.5 feet! SWR across the 40-meter band is less than 1.8:1.

The ON4UN database

It's both instructive and entertaining to browse through the ON4UN program database. Each antenna has been given a woman's name. I like CYBIL (Design no. 15) for 20 meters. It offers a very good F/B ratio and excellent gain. The antenna fits on a 20-foot boom and can be considered a classic design which can be scaled to other bands (see Figure 2).

The 10-meter contest operator may wish to choose JOAN (Design no. 95), a wide-spaced (1.03 wavelength), six-element stagger-tuned beam. This antenna provides 11.6-dBi gain with an excellent F/B ratio. It covers the range 28.0 to 28.75 with less than 2:1 SWR. Not bad!

Summary

All in all, the ON4UN program is a valuable tool for the Amateur interested in antenna performance. The YAGI DESIGN software comes in MS-DOS format. For more information contact either John Devoldere, Poelstraat 215, B9220 Merelbeke, Belgium; B.W. Jorden, K7KI, 6861 Kenanna Place, Tucson, Arizona 85704; or HAM RADIO Bookstore, Greenville, New Hampshire 03048-0498.

FIGURE 2

DESIGN # 15 ELEMENTS: 3 NAME: CYBIL BOOM: 0.288 WVL

FREQ.	GAIN	F/B	RESIST	REACT.	SWR	FOM	
-1.5%	7.4	23.8	36.0	-15.3	1.6	9.2	ANT. Q = 18
-1.0%	7.5	24.5	34.1	-11.2	1.4	9.5	
-0.5%	7.6	25.2	31.8	-6.7	1.2	9.9	SWR BW > 3 %
0.0%	7.7	26.1	29.3	-1.6	1.0	10.3	
+0.5%	7.8	21.9	26.6	4.0	1.3	9.7	F/B BW > 3 %
+1.0%	7.9	18.4	23.9	10.1	1.6	9.1	
+1.5%	8.0	15.6	21.2	16.9	2.2	8.4	

ELEMENT	LENGTH	POSITION	PHYSICAL BOOMLENGTH			
REFLECTOR	0.512185	-.156638	28 Mhz ->	3.04 m.	OR	10.0 ft
DRIV. EL.	0.485799	0.000000	24 Mhz ->	3.46 m.	OR	11.3 ft
DIR # 1	0.458877	0.131112	21 Mhz ->	4.07 m.	OR	13.3 ft
DIR # 2	0.000000	0.000000	18 Mhz ->	4.76 m.	OR	15.6 ft
DIR # 3	0.000000	0.000000	14 Mhz ->	6.09 m.	OR	20.0 ft
DIR # 4	0.000000	0.000000	10 Mhz ->	8.52 m.	OR	28.0 ft
			7 Mhz ->	12.15 m.	OR	39.9 ft

EL. LENGTHS ARE FOR EL. DIAM. OF .0010527 WAVELENGTHS (7/8 INCH ON 14.2 MHz).
 S = SELECT THIS DESIGN C = CONTINUE M = MENU

Three-element Yagi for 20 meters. Boom length is 20 feet. Design may be scaled to other bands by program.

FIGURE 3

DESIGN # 14 ELEMENTS: 3 NAME: CHRISTY BOOM: 0.288 WVL

FREQ.	GAIN	F/B	RESIST	REACT.	SWR	FOM	
-1.5%	7.2	21.8	44.6	-13.3	1.4	9.0	ANT. Q = 11
-1.0%	7.2	22.6	42.9	-10.0	1.3	9.2	
-0.5%	7.2	23.1	30.7	-6.2	1.3	9.3	SWR BW > 3 %
0.0%	7.3	23.7	38.3	-2.0	1.0	9.7	
+0.5%	7.4	24.5	35.5	2.6	1.2	9.7	F/B BW > 3 %
+1.0%	7.5	25.4	32.6	7.8	1.4	9.6	
+1.5%	7.6	21.6	29.6	13.6	1.7	9.1	

ELEMENT	LENGTH	POSITION	PHYSICAL BOOMLENGTH			
REFLECTOR	0.514716	-.165057	28 Mhz ->	3.04 m.	OR	10.0 ft
DRIV. EL.	0.487664	0.000000	24 Mhz ->	3.46 m.	OR	11.3 ft
DIR # 1	0.454808	0.122693	21 Mhz ->	4.07 m.	OR	13.3 ft
DIR # 2	0.000000	0.000000	18 Mhz ->	4.76 m.	OR	15.6 ft
DIR # 3	0.000000	0.000000	14 Mhz ->	6.09 m.	OR	20.0 ft
DIR # 4	0.000000	0.000000	10 Mhz ->	8.52 m.	OR	28.0 ft
			7 Mhz ->	12.15 m.	OR	39.9 ft

EL. LENGTHS ARE FOR EL. DIAM. OF .0010527 WAVELENGTHS (7/8 INCH ON 14.2 MHz).
 S = SELECT THIS DESIGN C = CONTINUE M = MENU

Design no. 14 covers lower half of 10-meter band with low SWR (see Figure 6).

FIGURE 4

DESIGN # 14	NAME: CHRISTY		ELEMENTS = 3

FREQ. = 28.5 MHz	WAVEL.: 10.5193 m.	BOOM: 3.03 m or 9.93 ft	
DRIVEN ELEMENT REACTANCE= -2 ohm.			

ELEMENT/POSITION	CENTIMETERS	INCHES	WAVELENGTHS
-----	-----	-----	-----
POSITION REFLECTOR	-173.6	-68.4	-.165057
LENGTH REFLECTOR	544.4	214.3	0.517526
POSITION DRIV. ELEM.	0.0	0.0	0.000000
LENGTH DRIV. ELEM.	511.1	201.2	0.485876
POSITION DIR # 1	129.1	50.8	0.122693
LENGTH DIR # 1	471.5	185.6	0.448200
THESE LENGTHS ARE FOR A CONSTANT DIAMETER OF 7/8 INCH OR 2.2225 CM.			
1=MENU 2=FREQ.CHANGE 3=TAPER 4=MATCH 5=DESIGN 6=CHANGE DR. EL			

Program provides element length and boom position. Next step is to determine effect of tapered element (about 1 inch).

A three-element Yagi for 10-meter DX

Last month's column featured a wideband Yagi that covered the whole 10-meter band. It provided moderate gain and good front-to-back ratio. For the serious DXer, the lower portion of the band holds the greatest interest and Design no. 14 (CHRISTY) in the ON4UN program provides an ideal Yagi beam (Figure 3) for this type of operation. Gain is 7.3 dBi with an F/B ratio of 38 dB at the design frequency of 28.5 MHz. The design requires a 10-foot boom (Figure 4).

Elements are mounted above the boom by means of a flat plate measuring 6 x 2 inches; U bolts hold the element to the plate and the plate to the boom. The elements are made of 7/8 and 3/4-inch tubing with a wall thickness of 0.058 inch. The elements are telescoping. The slight degree of taper increases the element length 1 inch from the generic design.

A gamma matching section is used, as shown in Figure 5. The gamma is made of an aluminum tube. The center conductor of RG-8/U is inserted into the tube to form the gamma capacitor.

The match is excellent (see Figure 6). SWR at 28 MHz is 1.35, at 28.5 MHz it's unity, and at 28.9 MHz it's 1.65. The F/B ratio is better than 21 dB over this frequency range, peaking at 38 dB at the design frequency.

You say you'd like a bigger beam with more gain? Just look in the ON4UN library and make your choice!

FIGURE 5

GAMMA MATCH DESIGN	

INPUT DATA	

DESIGN FREQUENCY :	28.5 MHz.
FEEDLINE IMPEDANCE :	50 ohm.
ANTENNA POWER :	1200 WATT.
Z-ANT RESISTIVE PART :	38.30 ohm.
Z-ANT REACTIVE PART :	-2.00 ohm.
ELEMENT DIAMETER :	.875
GAMMA ROD DIAMETER :	.375
SPACING (CENTER TO CENTER) :	3
	STEP UP RATIO = 5.91
RESULTS	

GAMMA ROD LENGTH :	54.0 cm OR 21.3 inch.
SERIES CAPACITOR :	99 pF.
VOLTAGE ACROSS SERIES CAPACITOR :	276 Volts.
CURRENT THROUGH SERIES CAPACITOR :	4.9 Amp.

After taper is determined, program provides data for gamma match, including voltage and current rating of series capacitor.

Errata

In my March column, my post office box was given as 7805. The correct address is Box 7508, Menlo Park, California 94025.

Also in March, I stated that the radiation resistance of a folded Marconi was four times that of a single-wire Marconi. This is incorrect; the radiation resistance of the two antennas is the same. The feedpoint impedance of the folded Marconi, however, is four times that of the single wire equivalent.

Thanks to the many sharp-eyed readers who caught these goofs!

The Dead Band Quiz

K4COF proposed the following: Can the three hands of a conventional analog clock ever trisect the circle? In a nutshell, for an ideal analog clock (that is, one where each hand moves continuously and uniformly), the answer is no.

If the hands are detented, KA0PGA points out that two "obvious" solutions are 4:00:40 and 8:00:20. WD8KBW follows up with the statement that there are 22 non-integer solutions; W0NI says one of these is 9:05:2524...hours with only a 0.172-degree error in the second hand.

FIGURE 6

DESIGN #	GAMMA MATCH						
FREQ. DIFF (%)	-1.5%	-1.0%	-0.5%	0.0%	+0.5%	+1.0%	+1.5%
FREQUENCY	28.073	28.215	28.358	28.5	28.643	28.785	28.928
R(ANT)	44.6	42.9	30.7	38.3	35.5	32.6	29.6
X(ANT)	-13.30	-10.00	-6.20	-2.00	2.60	7.80	13.60
R(OUT)	57.90	56.40	58.50	50.00	44.80	38.30	31.30
X(OUT)	13.20	9.10	-10.80	0.00	-3.90	-6.40	-7.20
SWR	1.33	1.23	1.29	1.00	1.15	1.35	1.65

Program provides gamma match specifics at seven frequencies, plus antenna impedance data.


AE2P and George McHugh indicate that 2:54:33 and 9:05:27 are close. KM4AS wonders about 11:38:10.9090... and 12:21:49.0909....

KØYXE, KE6VK, and others sent a BASIC program which lists all the permutations and combinations of clock hands and the error in angularity of a large number of approximate clock values that come close, but aren't exact.

I can't thank each reader who sent

in solutions and comments personally, but I appreciate the time and effort put into all the replies. I read and enjoyed each one!

To date, the following have responded to this quiz: Jay Harvey, KAØPGA; Paul Bunnell, KE6VK; Stan Kadron, W4UGW; George McHugh; Franklin Antonio, N6NKF; John Fowler, AA5HR; Les Moskowitz, AE2P; Dave Roberts, WØNT; Paul Lalli, AA5AN; Irene Kott,

WØ8E; Wayne Cooper, AG4R; Dan Hopper, K9WEK; Mike McDermott; Ron Romer, N1BHE; Bill Shanney, KJ6GR; Bob McGraw, W2LYH; Art Lashbrook, WX6L; Al Weller, WD8KBW; Tim Bratton, K5RA; John Bellah, KØYXE; Bryan Suits, WB8WKN; Don Miller, KM4AS; and Ted Kroener, KA1PL. 

HAM LICENSE PREPARATION

WRITTEN TEST STUDY GUIDES

All word-for-word questions, multiple choices... answers. Choose Novice, Technician, General, Advanced or Extra Class Answer explanations supplied!

\$4.95 Each version + \$1.50 shipping.

All five manuals: \$22.95 postpaid.

HAM RADIO Q&A MANUAL

All 1,932 questions, multiple choices and answers found in every ham license exam, Novice through Extra Class.

\$9.95 Shipped postpaid.

MORSE CODE TEST PREPARATION

Set contains two 2-hr. cassette tapes

Code Teacher, 0-5 WPM \$9.95

General Code, 3-15 WPM \$9.95

Extra Code, 12-21 WPM \$9.95

Plus \$1.50 shipping per set.

All Manuals/Code Tapes: \$49.95

New SPart 97 Ham Rules: \$ 2.95

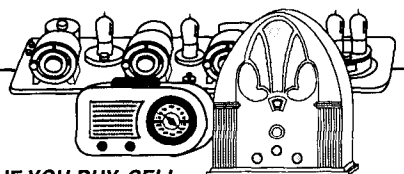
Order shipped same day received!

Credit card phone orders: 10 a.m. - 2 p.m.

W5YI MARKETING

P.O. Box #565101 - Dallas, TX 75356

Tel: (817) 461-6443 - 24 hours



IF YOU BUY, SELL
OR COLLECT OLD RADIOS, YOU NEED...

ANTIQUE RADIO CLASSIFIED

FREE SAMPLE COPY!

Antique Radio's Largest Monthly Magazine

Classifieds - Ads for Parts & Services

Articles - Auction Prices-Flea Market Info.

Also: Early TV, Ham Equip., Books, Telegraph,

Art Deco, 40's & 50's Radios & more...

Free 20-word ad each month. Don't miss out!

6-Month Trial - \$11.

1-Year: \$20 (\$30 by 1st Class)

Foreign by air - Canada: \$32; Mexico: \$30; Other: \$60.

A.R.C., P.O. Box 802-A5, Carlisle, MA 01741

✓ 115

Ampire Mastmounted RF or Coax switched GaAs fet Preamplifiers.

Helical filtered preamps for out of band rejection

2 meter—19db gain • .75db noise figure
• handles 160 watts transmitted power.

70cm—16db gain • .75db noise figure
• handles 100 watts transmitted power.

Model 146 covers entire 2 meter band
• RF switched • 13-20VDC

Model 1460S covers a 3db bw of 1.4 mhz

Model 146CP, 1460SCP, and 160cp
powered with 12vdc thru coax

Model 160 covers 149-174mhz • no helical filter

Model 440 tunable from 420-450mhz
• 10mhz bandpass • RF switched • 132vdc

Model 440cp powered with 12vdc thru coax

Models 146's and 160 \$179

Models 440's \$189

Shipping for 1 unit — \$5.00
Each additional unit — \$2.50

Ampire Inc.

10240 Nathan Lane

Maple Grove, MN 55369

(612) 425-7709

✓ 116

VARACTOR DIODES FROM RECTIFIERS

A new application for rectifier diodes

*Hugh Wells, W6WTU, 1411 18th Street, Manhattan
Beach, California 90266*

Many circuit applications, like frequency synthesizers and RF resonators, require varactor diodes for tuning. The name varactor comes from a combination of words like voltage-variable capacitor and voltage-reactance diode. Varactor diodes, also called varicaps, provide remote tuning capability through a voltage change as opposed to the mechanical movement of a variable capacitor.

Unfortunately, varactor diodes aren't always easy to find. But it occurred to me that rectifier diodes might work as substitutes. To find out, I set up an experiment to classify various diodes for capacitance as a function of applied voltage.

How they work

When a diode is made, a conduction barrier is formed at the junction of its P and N materials. This barrier is called the depletion layer. Applying voltage to the junction causes the barrier to narrow or widen, depending upon the polarity and magnitude of the applied voltage. This voltage application is referred to as forward and reverse bias. With forward bias the barrier narrows, allowing conduction to take place. When the bias is reversed, the barrier widens and serves as an insulator. The percentage of barrier movement under voltage control is predominately a function of material doping. Rectifier diodes are heavily doped to enhance a high forward current; this results in small reverse-biased barrier width changes.

Widening the barrier produces an effect which is similar to that achieved by increasing the spacing between plates of a capacitor — the capacitance value is reduced. Reverse-biased diodes exhibit a decrease in capacitance between their terminals as the applied voltage is increased.

Experimental results

Because rectifier diodes weren't designed for varactor applications, the capacitance value tends to vary somewhat from one device of a given type to another. But sufficient similarity exists to satisfy most Amateur applications. As expected, point contact diodes exhibited a lower value of capacitance than diffused junction diodes. Point contact diodes also have a smaller percentage of capacitance value change for a given applied voltage range. **Table 1** shows the values obtained from samples of various diodes. I observed that a minimum voltage from 0.5 to 1 volt was required for the diode to start acting like a capacitor. Below the minimum voltage value the diode dissipation was high, but decreased as the voltage was increased. As the applied voltage was increased, a value was reached where the capacitance stopped decreasing, as if saturation had occurred. I met the objective for characterization by limiting the experiment to a maximum of 16 volts. However, a higher voltage might have provided some additional data. The voltage range obtained for controlling the capacitance change seemed to be independent of the peak reverse voltage (PRV) value of the diode.

Measurement method

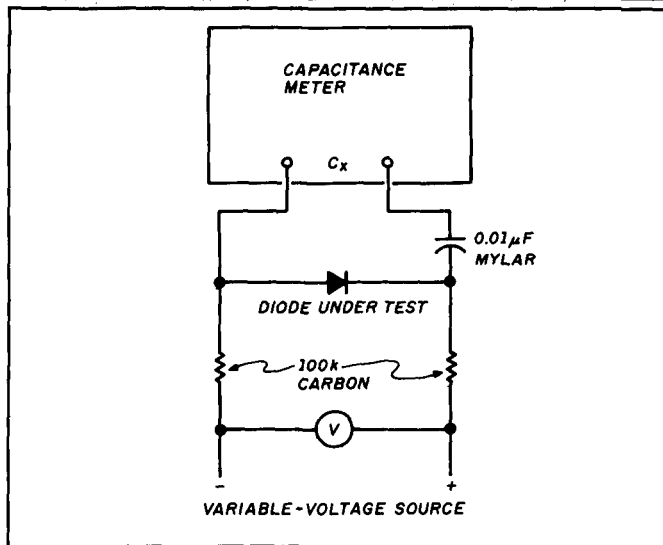
Measuring low picofarad values of capacitance with accuracy is difficult, particularly when the capacitance value being measured is nearly equal to the stray circuit capacitance value. I attached a power supply to the diode to provide the DC bias needed for varying the capacitance. My objective was to identify obtainable capacitance values and range as a function of the applied voltage.

I used both digital and analog capacitance meters to

TABLE 1

Diode	Diode capacitance values in pF.							
	Voltage, volts							
	0.5	1	2	3	4	5	10	16
	Capacitance, pF							
1N34	4	3.5	2	-	-	0.5	-	-
1N92	170	160	140	120	90	70	19	13
1N295	3	2	1	0.5	0.5	-	-	-
1N305	-	5	4	3	2.9	2.8	2	2
1N457	13	11	7	6	5.5	5	4	3
1N485A	20	18	14	12	10	9	7	6
1N538	27	26	24	23	20	17	13	11
1N540	55	49	45	38	30	26	19	16
1N645	-	10	8	6.5	6	5	4	4
1N914	4	3	2	2	0.5	0.5	0.5	0.5
1N1692	160	180	170	150	130	115	80	60
1N1763(RAY)	-	60	40	35	33	30	25	22
1N1763(RCA)	-	40	32	28	26	24	20	17
1N2069	-	27	24	20	18	17	13	11
1N2071	-	18	16	15	12	11	8	7
1N4001	34	28	19	10	7	6	4	3
1N4002	15	10	8	7	6	6	5	4
1N4003	20	18	15	12	11	10	8	7
1N4004	35	31	26	22	18	16	12	10
1N4007	25	22	18	15	14	13	10	8
1N4148	3.5	2.5	0.8	-	-	0.5	0.5	0.5
1N5415	-	100	80	70	60	50	38	32
2E4	40	35	29	23	-	16	11.5	9
SR3011	-	20	12	10	9	8	6	5

FIGURE 1



Diode capacitance test circuit. C_x is a 5-pF ceramic reference capacitor.

correlate the data. I chose a 5-pF ceramic capacitor as a reference. My purpose here was to validate my measurement technique. The test circuit is shown in Figure 1. I used a 0.01- μ F mylar capacitor between one diode lead and the meter terminal to provide DC isolation between diode and meter. Two 100-k carbon resistors provided capacitance isolation and DC from the power supply. Higher resistance

values had no noticeable effect on the measurement. I assumed that, being reverse biased and drawing little or no current, the diode would have the same voltage across its terminals as the voltage measured at the power supply. All measurements were made below 1 MHz.

Observations

For VHF and UHF applications, it's desirable to test the diode's performance at the application frequency. I have noted experimentally that some diodes have a dissipation factor high enough to prevent their use in UHF applications. Also, the figure of merit (Q) of rectifier diodes doesn't seem to be as high as commercial varactor devices.

Although I didn't test it as part of this experiment, I assume that the base-collector junction of a UHF transistor would exhibit suitable varactor characteristics for UHF applications.

The applied RF voltage from a resonant circuit should be only a small percentage of the varactor's DC control voltage. Large RF voltage swings could cause the diode to conduct. This would result in waveform distortion and Q loss. Therefore, when used in a resonant circuit, the RF voltage applied to the diode would have to be expressed as a negative ratio from that on the inductor. A series-connected capacitor with a value nearly equal to the varactor will provide an approximate voltage ratio of 2:1. Zener diodes operated below their zener voltage value should exhibit varactor characteristics.

I couldn't measure the junction capacitance of microwave diodes like the 1N82A. The junction appeared to be conducting as a result of the AC signal from the capacitance meter, whether or not reverse DC bias was applied.

K. Weiner
DUBNOUHF-COMPENDIUM
Part III and IV

JUNE BO

SAVE TIME & MONEY
SHOP BY MAIL
OR CALL TODAY!

ANTENNAS

BEVERAGE ANTENNA HANDBOOK by Victor Misek, W1WCR

Misek delves deep into the secrets of the single wire Beverage and SWA (Steerable Wave Antenna) with helpful hints and tips on how to maximize performance based upon wire size, height above ground, overall length and impedance matching. Transformer design information for both termination and feedline matching is completely revised. ©1987 80 pages 2nd Edition.

 VM-BAH Softbound \$14.95**HF ANTENNAS FOR ALL LOCATIONS** by L.A. Moxon, G6XN

As a rule, Hams in the UK are subject to more restrictive antenna regulations than we are. As a result, they have done extensive work on optimizing performance of less than full sized antennas. This book is divided into two parts. Part I covers theory and how antennas work. Part II puts theory to work with beams, wire arrays, invisible antennas, mobile, portable antennas plus much more. ©1982 1st Edition.

 RS-HF Hardbound \$14.95**YAGI ANTENNA DESIGN** by Dr. James Lawson, W2PV

W2PV was known world-wide as one of the most knowledgeable experts on antenna design and optimization. Loop antennas, The effects of ground, Stacking, Practical design and Practical Amateur Yagi antennas. Every Ham should get a copy for their bookshelf. ©1986 1st edition.

 AR-YD Hardbound \$14.95**THE AMATEUR RADIO VERTICAL HANDBOOK** by Cpt. Paul H. Lee, USN (Ret.), N6PL

Based upon the author's years of work with a number of different vertical antenna designs, you'll get plenty of theory and design information along with a number of practical construction ideas. Included are designs for simple 1/4 and 5/8-wave antennas, as well as broadband and multi-element directional antennas. ©1984, 2nd edition.

 CQ-VAH Softbound \$9.95**W1FB's ANTENNA NOTEBOOK** by Doug DeMaw, W1FB

Antennas have been one of DeMaw's passions in Amateur Radio. He has worked with countless designs of all shapes and configurations. This fully illustrated book give you how-to instructions on a number of different wire and vertical antennas. Also includes information on radial systems, tuners, balun and impedance transformers. ©1987 120 pages.

 AR-AN Softbound \$7.95**LOW BAND DX'ING** by John Devoldere ON4UN 2nd Edition

Based upon years of practical on-the-air experience, learn the secrets of how ON4UN has been so successful on the low bands. Extensive coverage is given to transmit and receive antennas. Dipoles, inverted V's, slopers, phased arrays and Beverages. Also covered propagation, transmitters, receivers, operating, software and an extensive Low Band bibliography.

 AR-UN Softbound \$9.95**EASY-UP ANTENNAS for Radio Listeners and Hams** by Ed Noll W3FOJ

This book covers basic do-it-yourself antennas for SWL's, AM and FM BCB'er's, present and prospective Hams and scanner listeners. Includes dipoles, verticals, beams, long wires, and several special types and configurations. Also has time saving look-up dimension tables, constants and other helpful hints for antenna design. 1st edition 164 pages ©1988.

 Z2495 Softbound \$16.95**NOVICE ANTENNA NOTEBOOK** by Doug DeMaw W1FB

Novices have long wondered what is the best all around antenna for them to install. Up until now, this was a difficult question to answer. Aimed at the newly licensed Ham, DeMaw writes for the non-engineer in clear concise language with emphasis on easy-to-build antennas. Readers will learn how antennas operate and what governs performance. Also great reading for all levels of Amateur interest. 1st Edition ©1988.

 AR-NAN Softbound \$7.95**ANTENNAS** by John Kraus, WBJK

Kraus' classic antenna book has been extensively revised and up-dated to reflect the latest state-of-the-art in antenna design and theory. Includes over 1,000 illustrations and nearly 600 worked examples and problem solutions. Chapters cover basic concepts, print sources and point source arrays, dipoles, helices, broadband and frequency independent antennas, special applications and tons more of information. 2nd edition 917 pages ©1988.

 MH-35422 Hardbound \$59.95**ARRL ANTENNA BOOK** by Jerry Hall, K1TD, 15th Edition

The 15th edition of this antenna classic represents over two years of hard work by editor K1TD. It's doubled in size too--from over 300 to over 700 pages big! 950 figures and charts cover just about every subject imaginable. Some of the highlights are: Chapters on Loop antennas, multi-band antennas, low frequency antennas, portable antennas, VHF and UHF systems, coupling the antenna to the transmitter and the antenna, plus p-l-e-n-t-y more. 15th edition 900+ pages ©1988.

 AR-AM Softbound \$17.95**ARRL ANTENNA COMPENDIUM** Vol. 1

QST gets far more antenna articles than it can publish. This collection is taken from the best submissions and represents a wide range of subjects -- from quads and loops to general information -- this book has it! ©1985 1st Edition.

 AR-AC Softbound \$9.95**ANTENNA IMPEDANCE MATCHING** by ARRL

One of the most comprehensive books ever written on the use of Smith charts in solving impedance matching problems. 224 pages full of helpful information and solutions to tricky matching problems. ©1989.

 AR-IMP Hardbound \$14.95**ANTENNA COMPENDIUM** Vol. 2

includes MS-DOS program listings

Antennas are the #1 topic of interest among amateurs. ARRL annually receives far more antenna articles than it can use in QST. So, they decided to publish them in THE ANTENNA COMPENDIUM. These never before published articles run the range from simple, easy-to-construct antennas to sophisticated designs. Six program listings are included. You can also get the programs on a MS-DOS disk for an additional charge. ©1989 1st edition 208 pages.

 AR-AC2 Softbound Book Only \$11.95 FAR-AC2 (MS-DOS) Disk Only \$9.95 AR-FAC2 BUY 'EM BOTH SPECIAL Book & Disk \$17.95

by W6SAI & W2LX

- RP-WA **WIRE ANTENNA HANDBOOK** - Wire antennas for all installations \$11.95
- RP-CQ **ALL ABOUT CUBICAL QUAD ANTENNAS** - "The" quad book \$ 9.95
- RP-VA **ALL ABOUT VERTICAL ANTENNAS** - Everything you want to know \$10.95
- RP-AH **THE RADIO AMATEUR ANTENNA HANDBOOK** - Complete guide to antennas \$11.95

1990 EDITIONS

1990 RADIO AMATEUR CALLBOOKS

NORTH AMERICAN EDITION

Fully updated and edited to include all the latest FCC and foreign government call signs and addresses for Hams in North America. Includes plenty of handy operating aids such as time charts, QSL bureau addresses, census information and much more. Calls from snowy Canada to tropical Panama. Now is the time to buy a new Callbook when you'll get the most use out of your investment. ©1989.

 CB-US90 Softbound \$27.95**INTERNATIONAL EDITION**

QSLs are a very important part of our hobby. All sorts of awards, including the coveted DXCC, require confirmation of contact before the award can be issued. Of special interest, addresses are being added daily for Hams in the USSR and other countries. While by no means complete, it's a start and will be of tremendous help in getting QSLs. Handy operating aids round out this super book value. ©1989.

 CB-F90 Softbound \$29.95

BUY 'EM BOTH SPECIAL

 CB-USF90 **Reg. \$57.90 Only \$52.95 SAVE \$4.95****THE 1990 ARRL HANDBOOK**

Revised and updated with the latest in Amateur technology, now is the time to order your very own copy of the world famous ARRL HANDBOOK. In addition to being the definitive reference volume for your Ham shack, there are plenty of projects for every interest in Amateur Radio -- from antennas for every application to the latest state-of-the-art projects -- you'll find it all in the 1990 HANDBOOK. Over 1100 pages ©1989.

 AR-HB90 Hardbound \$22.95

NEW BOOKS

**1990-91 ARRL REPEATER DIRECTORY**

Bigger and better! Over 14,000 listings including 1400 digipeaters -- every Ham should have a copy of this book in their car or shack. Handy resource book has listings by frequency and location. Invaluable aid while travelling. ©1990.

 AR-RD90 Softbound \$5.95 AR-2RD90 (Buy 2 & Save) \$9.95**MICROWAVE HANDBOOK - Vol. 1****Components and Operating Techniques**
edited by M.W. Dixon, G3PFR

The microwave region has experienced an explosion in interest in the last few years. This new RSGB book contains simple and easy-to-understand theory explanations, projects and practical designs that have been tested and debugged. Includes: operating techniques, system analysis and propagation, antennas, transmission lines and microwave semiconductors and tubes. Great reference book! ©1989.

 RS-MHB Softbound \$34.95**1990 ANTENNA BUYER'S GUIDE**

edited by Peter O'Dell, WB2D, CQ Magazine

Looking for the latest in antennas? It's all here in the CQ Antenna Buyer's Guide. Crammed full of articles, product information and a who's who section listing all of the antenna manufacturers and importers. Get yours now and get to work on your 1990 antenna projects before -- winter comes!

 CQ-ANT Softbound \$4.95**RADIO AMATEUR CALLBOOK SUPPLEMENT**

both NA and DX listings

Includes all the latest calls and address changes for hams around the world. Invaluable aid to getting coveted QSLs from rare DX stations. This is the only way to be fully up-to-date. Over 300 pages ©1990.

 CB-SUP90 Softbound \$9.95**HAM RADIO BOOKSTORE**

GREENVILLE, NH 03048

CATALOG #K90

*Software Orders -- Don't forget to tell us
which computer you have*

BOOK SPECIAL

NEW SOFTWARE

ON4UN PRACTICAL YAGI DESIGN (MS-DOS)

by John Devoldere, ON4UN

This comprehensive Yagi design program is based upon tested antennas, not theoretical un-proven models. Contains 100 different HF antennas, designed, tested and optimized by ON4UN. Also contains a number of classic designs by noted antenna experts W2PV, W6SAI and others. Includes mechanical design of elements and of the rotating mast. Fully detailed "Read me" file is designed to help the user get maximum results from the program. ©1989

☐ F0N-YAGI (MS-DOS) 5 1/4" & 3 1/4" Disk Avail. \$59.95

WA9GFR COMMUNICATIONS ENGINEERING

Version 3.1 by Lynn Gerig, WA9GFR

Interesting program that will allow you to predict communications ranges based upon your station's operational capabilities. Useful from 3.5 MHz to 3.5 GHz. Also includes helpful Smith chart program for any type of matching network. Provides impedance results in both tabular and high resolution Smith chart graphics. Great value at a low price.

☐ FGFR-DOS (MS-DOS) \$19.95
☐ FGFR-C64 (Commodore C-64) \$19.95

MICROSMITH Smith Chart Utility Program (MS-DOS)

by Wes Hayward, W7ZOI

MicroSmith is a working Smith chart that has been optimized for impedance matching applications. The user can modify all variables to meet specific matching goals. Includes a clear and concise tutorial that all levels of interest will find helpful. Complete text explanations with graphs aid full comprehension of the material.

☐ FWH-MS (MS-DOS) \$29.00

MFJ EASY-DX Program and Packet interface

(MS-DOS computer)

Here's a unique tool that organizes your DXCC quest into a simple easy-to-use format. Enter a call. Easy-DX gives you azimuth and sunrise-sunset time. It also tells you whether or not you need the contact for a new country, band or mode. Packet radio users get a built-in terminal program designed to make the most of Pavilion Software's Packet Cluster™ system or any other packet net. When connected, Easy-DX alerts you when a country you need is spotted. Comes on two 5.25" disks. Hard drive recommended. Latest version will be shipped. ©1990

☐ FMFJ-EDX (MS-DOS) \$39.95

BEST SELLERS

RADIO HANDBOOK 23rd Edition

by Bill Orr W6SAI

Projects include: GaAsFET preamps for 902 and 1296 MHz, easy-to-build audio CW filter, Economy two 3-500Z amplifier, 160 meter amplifier, multiband amp using two 3CX800A7's, and a deluxe amplifier with the 3CX1200AJ tube. New antenna projects include: efficient Marconi design for 160 and 80 meters, computer generated dimensions for HF-Yagis, and a 2 meter slot beam. Get your copy today. 23rd edition ©1986

☐ 22424 (Reg. \$29.95) Hardbound \$26.95

THE "GROUNDS" FOR LIGHTNING

EMP PROTECTION by Roger Black

This 116 page text contains a comprehensive analysis of proper grounding and protection against lightning and other EMP disasters. Includes information for all kinds of electronic gear. Of special interest to Hams are chapters on low inductance grounds and connections, guy anchor grounding, and how to ground inside of shack. 1st edition 116 pages ©1987

☐ PP-GLEP Softbound \$24.95

TOMMY ROCKFORD BOOKS by Walter Tompkins, K6ATX

These thrilling stories introduced a whole generation of Hams to the wonderful world of Amateur Radio. Great reading, and gift ideas, for all levels of Amateur Radio interest. Each story is full of action packed excitement.

☐ AR-DV Death Valley QTH Softbound \$4.95
☐ AR-SO SOS At Midnight Softbound \$4.95
☐ AR-CQ CO Ghost Ship Softbound \$4.95
☐ AR-DX DX Brings Danger Softbound \$4.95
☐ AR-GC Grand Canyon QSO Softbound \$4.95
☐ AR-MQ Murder by QRM Softbound \$4.95
AR-TR All 6 books, Reg. \$29.70 SAVE \$4.75 \$24.95

Orders (603) 878-1441

FAX - 24 Hr. Line
(603) 878-1951



BOOKS & SOFTWARE



1990 EQUIPMENT BUYER'S GUIDE edited by Peter O'Dell, WB2O, CQ Magazine

Here's the latest listing of equipment available from all of the different manufacturers. Full of handy-to-have information, facts and tidbits. Great reference to have when you are shopping around for a new rig. ©1989

☐ CQ-EQP

Softbound \$4.95

THE ARRL ELECTRONICS DATA BOOK

by Doug DeMaw, W1FB

The ARRL's new DATA BOOK was written with you in mind. Noted author DeMaw gives you the benefit of his years of experience in this handy reference manual. Fully updated, chock-full of the latest information every ham needs at their fingertips. Useful for all Amateurs, RF engineers, technicians and experimenters. ©1989 2nd Edition.

☐ AR-DB

Softbound \$11.95

PASSPORT TO WORLDBAND RADIO 1990 Edition

Brand new and fully revised. Expanded to 416 pages, the book now includes a bigger and better buyer's guide, an interview with James Michener, an exciting real life drama of one SWL's escape from Iran plus much more. Also includes all the latest broadcast schedules from countries around the world. 416 pages. ©1989.

☐ IBS-RD189

Softbound \$14.95

FROM SPARK TO SPACE a pictorial Journey Through The History of Amateur Radio

The ARRL has published FROM SPARK TO SPACE to commemorate its 75th anniversary year. Starting at Amateur Radio's roots, you relive the thrill and can almost smell the ozone and hear the racket from spark transmitters. Taking you on a sentimental journey through WW 1, the roaring Twenties, the Depression, WW 2 up to OSCAR 1's launch and a look at the future, this book will be a fascinating experience for all Radio Amateurs. Chock full of pictures! ©1989, 1st edition.

☐ AR-FSS

Hardbound \$19.95

NOVICE NOTES

Just what the doctor ordered for the new Radio Amateur. Taken from the pages of QST, this anthology is full of information for the beginner. Covers just about every question a new Amateur could have. Plenty of helpful information on how to get on and get a signal out of your shack plus much more. ©1989, 1st edition.

☐ AR-NN

Softbound \$5.95

THE COMPLETE DX'ER NEW 2nd edition

by Bob Locher, W9KNI

Revised and up-dated, Locher's DX'er Diary is one of the most readable books ever written about Amateur Radio. Share in the joys of working a new station, feel the frustration of having missed out. Learn from the top CW DXCC Honor Roll DX'er what it takes to get on the Honor Roll. Hints, tips and tricks taken from years of on-the-air experience, written in a folksy, down to earth style. Great for the beginner, fun for the experienced DX'er. ©1989, 2nd edition.

☐ ID-CDX

Softbound \$11.95

MICROWAVE UPDATE 89 - Oct. 5-8, 1989

Some of the most up-to-date work in microwave communication was presented at the Arlington, Texas conference. A partial listing of the papers includes: 900 MHz transverter, TVRO EME operation, LNA update. No tune transverter for 2304 MHz, High power tube amplifiers for 2304 MHz, 10 GHz slot antenna, and more. A total of 30 papers from some of the best UHF operators in the country -- all in one book! ©1989, 1st edition, 214 pages.

☐ AR-MU89

Softbound \$11.95

1989 CENTRAL STATES VHF SOCIETY 23rd CONFERENCE

proceedings July 1989

Here are the papers that were presented at the July 1989 meeting of the Central States VHF Society. A brief listing of the papers presented include: EME performance measurements, Parabolic templates, Selection of an Optimum Dish Feed, 432 MHz EME portable, US to Europe Six meter propagation models and 24 GHz antenna range. 27 different articles should cover just about everyone's interests in VHF and UHF operation. ©1989, 1st edition, 168 pages.

☐ AR-VHF89

Softbound \$11.95

8th COMPUTER NETWORKING CONFERENCE - October 1989

It's sometimes hard to believe that packet radio has come so far in a few short years! Papers presented in this state-of-art book are at the forefront of packet technology. Several papers are presented on TCP/IP and ROSE networking. Others include high speed RF networking, 1 mbps packet data link, Adaptive link level protocol, TAPR RADIO Project plus much, much more. Stay packet up-to-date! ©1989, 1st edition, 22 pages.

☐ AR-CNC8

Softbound \$11.95

NIGHT SIGNALS by Cynthia Wall KA7IT

This action packed adventure story is written in the tradition of the famous Tommy Rockford series. Marc Lawrence is stranded high in the Cascades. His leg is broken and his radios are not working. When he doesn't show up for his sked with Kim, a local high school senior, she mobilizes rescue forces and conducts one of the largest rescue efforts the Northwest has ever seen. Great adventure story for all levels of interest. Great gift idea. ©1989.

☐ AR-NS

Softbound \$4.95

WORLD RADIO TV HANDBOOK

Loaded with all the latest call signs, frequencies and other important information for radio and TV broadcasting around the world. Covers LF, MF, shortwave and TV services. Also has equipment reviews and other special features. ©1989, 44th Edition.

☐ GL-WRTV90

Softbound \$19.95

TRANSMISSION LINE TRANSFORMERS by Jerry Sevicik, W2FMI

Contains a complete explanation and discussion of transmission line transformers and how to use them. Written by one of the experts in the field -- this book is full of helpful information. ©1990 2nd Edition 272 pages.

☐ AR-TLX

Softbound \$19.95

FDlog! (for the Macintosh Computer) version 1.5

Includes Voice and CW keyer

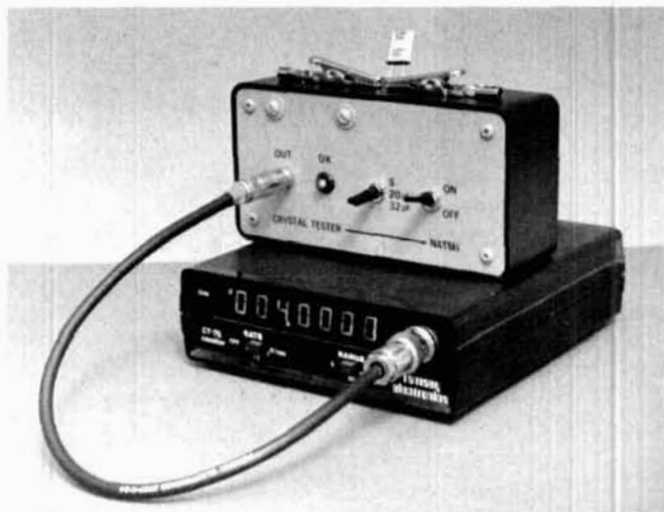
Here's a great contest logging program written to take advantage of all of the Macintosh's capabilities. Written originally for ARRL's Field Day, FDlog! can also be used as a log and dupechecker for just about any other contest -- at no extra cost! Includes ten message voice and CW keyer. Great value for the Mac user. Requires a Mac 512E and system 6.02 or newer. 1.1 MB of RAM recommended for voice keyer. Version 1.5 ©1989.

☐ FDSO-MAC (Macintosh)

\$49.95

PLEASE ENCLOSE \$3.75 FOR SHIPPING AND HANDLING

PRECISION CRYSTAL FREQUENCY CHECKER

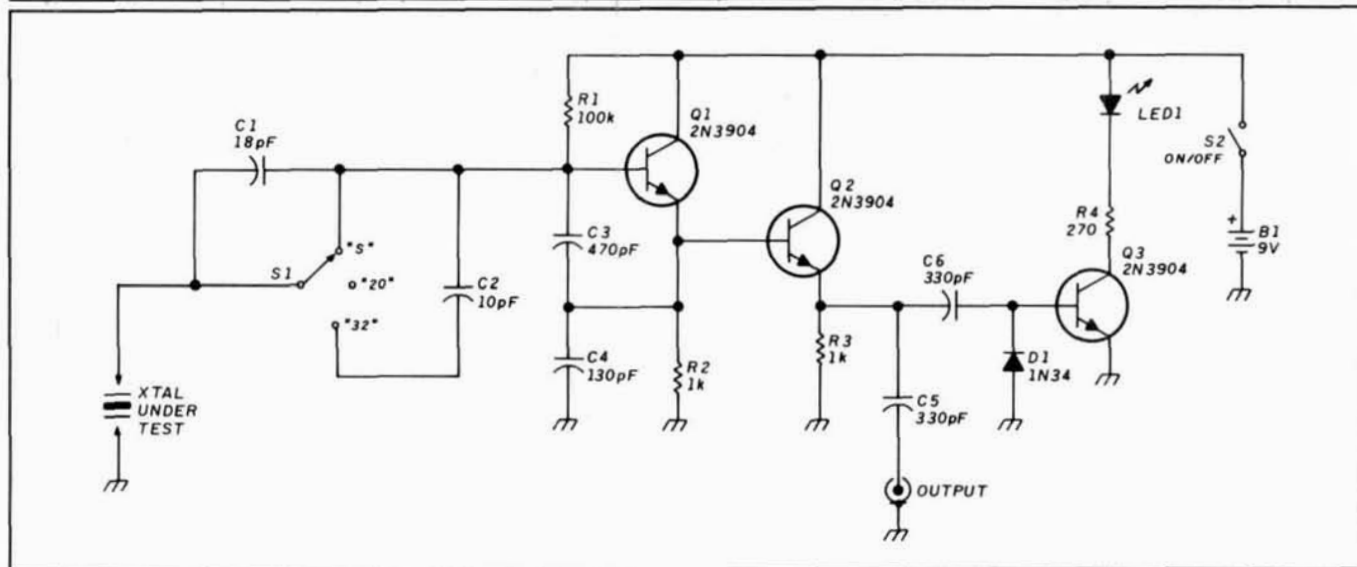


By Michael A. Covington, N4TMI, 285 Saint George Drive, Athens, Georgia 30606

Most crystal checkers perform a simple "yes/no" quality test or may give a relative indication of activity. I've designed one that teams up with a frequency counter to give precise frequency readings under three different load capacitances: series, 20 pF, and 32 pF. It can also measure inductance, though with a bit less accuracy. And even without the frequency counter, this checker will tell you whether or not a crystal oscillates.

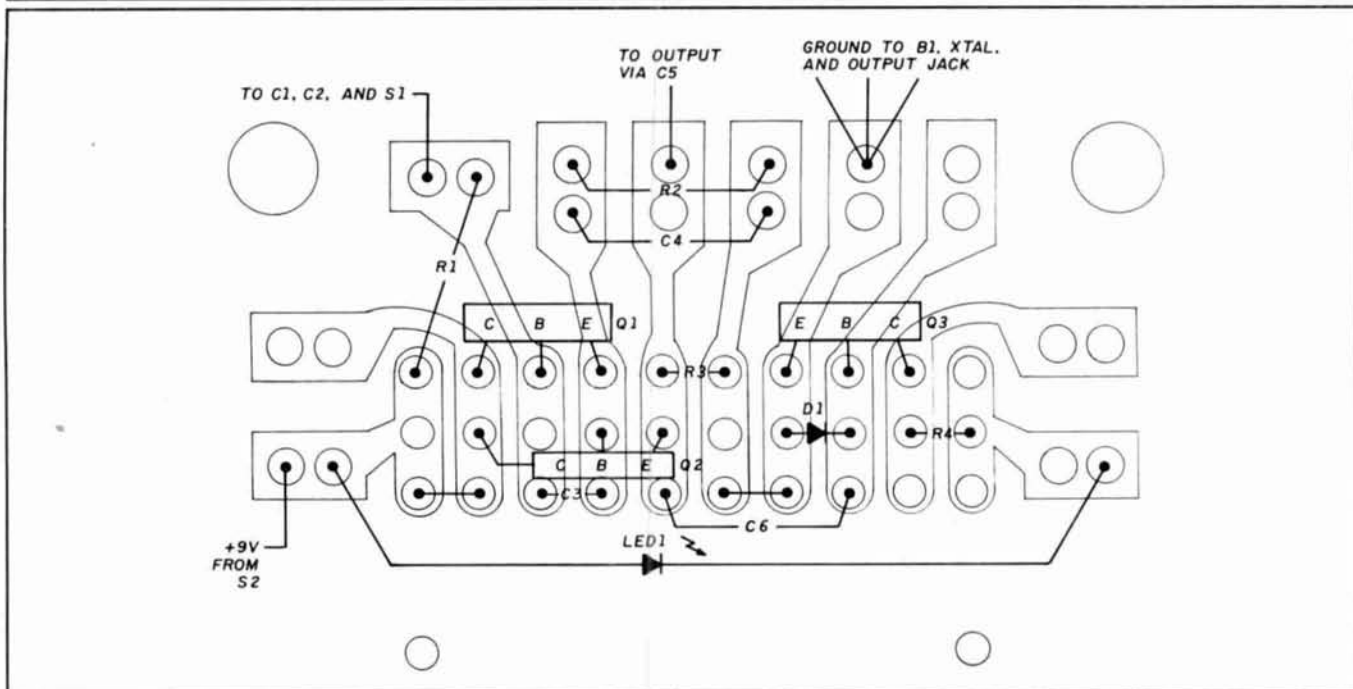
This project really is a "weekender." You can find all the parts at Radio Shack, if they're not already in your junkbox. The circuit is a Colpitts oscillator (see Figure 1); capacitors

FIGURE 1



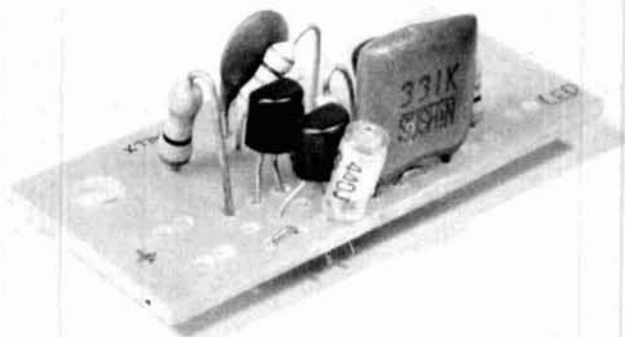
Circuit is a Colpitts oscillator with buffer amplifier.

FIGURE 2



Parts placement diagram. View is from top (component side).

PHOTO A



Circuit board is half of a ready-made board from Radio Shack (RS no. 276-159A).

PHOTO B



To test a coil, measure resonant frequency with 32 pF.

were chosen to work with most crystals from 2 to 20 MHz. Q1 oscillates and Q2 buffers its output. For the yes/no test, D1 and Q3 rectify the signal from the oscillator and use it to light an LED. It's normal for this LED to dim or go out when there's a load (like a frequency counter) connected to the output jack.

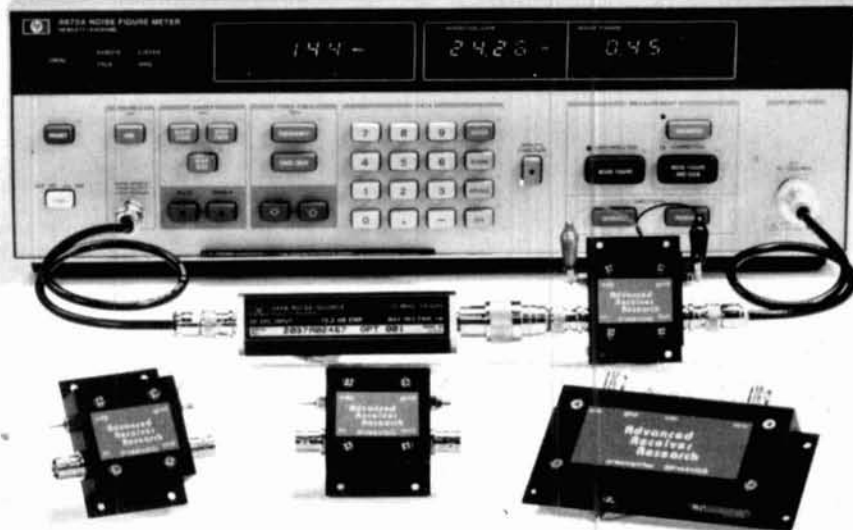
When setting the load capacitance, the SPDT center-off switch S1 lets you connect the crystal directly to the oscillator, through an 18-pF capacitor, or through parallel 18 and 10-pF capacitors. Allowing for 2 to 4 pF of stray capacitance, this gives load capacitances near the nominal 20 and 32 pF. The direct connection gives a high load capacitance that puts the crystal very close to series resonance.

Most of the circuit is compactly built on half a Radio Shack 276-159A printed circuit board (see Figure 2 and

Photo A). The tester is housed in a Bakelite™ box with a metal front. For reliable measurements, keep leads to S1 and the crystal as short as possible. Use alligator clips as a universal low capacitance crystal socket.

It's easy to test a crystal. Simply clip it in place, hook up the frequency counter, turn on the tester, and flip S1 to find out which load capacitance gives the correct frequency. This procedure also tells you how much the crystal can be "pulled" by changing the capacitance. The 20-pF load gives the highest frequency; the series connection gives the lowest. Overtone crystals will oscillate at the fundamental

High Performance vhf/uhf preamps



Receive Only	Freq. Range (MHz)	N.F. (dB)	Gain (dB)	1 dB Comp. (dBm)	Device Type	Price
P28VD	28-30	< 1.1	15	0	DGFET	\$29.95
P50VD	50-54	< 1.3	15	0	DGFET	\$29.95
P50VDG	50-54	< 0.5	24	+12	GaAsFET	\$79.95
P144VD	144-148	< 1.5	15	0	DGFET	\$29.95
P144VDA	144-148	< 1.0	15	0	DGFET	\$37.95
P144VDG	144-148	< 0.5	24	+12	GaAsFET	\$79.95
P220VD	220-225	< 1.8	15	0	DGFET	\$29.95
P220VDA	220-225	< 1.2	15	0	DGFET	\$37.95
P220VDG	220-225	< 0.5	20	+12	GaAsFET	\$79.95
P432VD	420-450	< 1.8	15	-20	Bipolar	\$32.95
P432VDA	420-450	< 1.1	17	-20	Bipolar	\$49.95
P432VDG	420-450	< 0.5	16	+12	GaAsFET	\$79.95

Inline (rf switched)						
SP28VD	28-30	< 1.2	15	0	DGFET	\$59.95
SP50VD	50-54	< 1.4	15	0	DGFET	\$59.95
SP50VDG	50-54	< 0.55	24	+12	GaAsFET	\$109.95
SP144VD	144-148	< 1.6	15	0	DGFET	\$59.95
SP144VDA	144-148	< 1.1	15	0	DGFET	\$67.95
SP144VDG	144-148	< 0.55	24	+12	GaAsFET	\$109.95
SP220VD	220-225	< 1.9	15	0	DGFET	\$59.95
SP220VDA	220-225	< 1.3	15	0	DGFET	\$67.95
SP220VDG	220-225	< 0.55	20	+12	GaAsFET	\$109.95
SP432VD	420-450	< 1.9	15	-20	Bipolar	\$62.95
SP432VDA	420-450	< 1.2	17	-20	Bipolar	\$79.95
SP432VDG	420-450	< 0.55	16	+12	GaAsFET	\$109.95

Every preamplifier is precision aligned on ARR's Hewlett Packard HP8970A/HP346A state-of-the-art noise figure meter. RX only preamplifiers are for receive applications only. Inline preamplifiers are rf switched (for use with transceivers) and handle 25 watts transmitter power. Mount inline preamplifiers between transceiver and power amplifier for high power applications. Other amateur, commercial and special preamplifiers available in the 1-1000 MHz range. Please include \$2 shipping in U.S. and Canada. Connecticut residents add 7-1/2% sales tax. C.O.D. orders add \$2. Air mail to foreign countries add 10%. Order your ARR Rx only or inline preamplifier today and start hearing like never before!

Advanced Receiver Research

Box 1242 • Burlington, CT 06013 • 203 582-9409



ATV CONVERTERS • HF LINEAR AMPLIFIERS



HF AMPLIFIERS per MOTOROLA BULLETINS
 Complete Parts List for HF Amplifiers Described in the MOTOROLA Bulletins.
 AN758 300W \$160.70 EB63 140W \$ 88.65
 AN762 140W \$ 93.25 EB77A 300W \$130.20
 AN779L 20W \$ 83.79 EB104 600W \$448.15
 AN779H 20W \$ 93.19 AR305 300W \$383.52
 AR313 300W \$493.00

UNIVERSAL DIGITAL FREQUENCY READOUT
 FK-1 (Wired/texted) \$149.95
REPEATER CONTROLLER
 RC-1000 (Wired/texted) \$239.95
HEAT SINK MATERIAL
 Model 99 Heat Sink (6.5 x 1.2 x 1.6) \$ 22.00
 CR1-8 Copper Spreader (8 x 8 x 3/8) \$22.00
 We also stock Hard-to-Find parts

AMATEUR TELEVISION CONVERTERS
 ATV2 420-450 \$443.95 Kit
 ATV3 420-450 (GaAs-FET) \$ 49.95 Kit
 ATV4 902-928 (GaAs-FET) \$ 59.95 Kit
AUDIO SQUELCH CONTROL for ATV
 SIL \$ 39.95 Kit
2 METER VHF AMPLIFIERS
 35 Watt Model 33A \$ 79.95 Kit
 75 Watt Model 875A \$119.95 Kit
 Available in kit or wired/texted

POWER SPLITTERS and COMBINERS
 600 Watt PEP 2-Port \$ 69.95
 1000 Watt PEP 2-Port \$ 79.95
 1200 Watt PEP 4-Port \$ 89.95
100 WATT 420-450 MHz PUSH-PULL LINEAR AMPLIFIER - SSB-FM-ATV
 KEB67-PK \$159.95
 KEB67-PCB (PC Board) \$ 18.00
 KEB67-I (Manual) \$ 5.00

CHIP CAPS - Kemet/ATC
METALCLAD MICA CAPS - Unelco/Semco
RF POWER TRANSISTORS
MINI-CIRCUIT MIXERS
 SBL-1 (1-500MHz) \$ 6.50
 SBL-1X (10-1000MHz) \$ 7.95
ARCO TUNING CAPACITORS
 VK200-20/4B RF Choke \$ 1.20
 56-590-65-3B Ferrite Bead \$ 1.20
 Broadband HF Transformers

For detailed information and prices, call or write for our free catalog.
CCl Communication Concepts Inc.
 508 Millstone Drive • Xenia, Ohio 45385 • (513) 426-8600
 FAX (513) 429-3811

SUPER LONG PLAY TAPE RECORDERS

12 Hour Model — USES D-120 TAPE \$119.00*

Modified Panasonic Slimline, high quality AC-DC provide 6 continuous hours of quality recording & playback on each side of cassette for 12 hours total. Includes • Voice level control • Digital counter, etc. TDK D-120 Cassette Furnished.

PHONE RECORDING ADAPTER

Records calls automatically. All Solid state connects to your telephone jack and tape recorder. Starts recording when phone is lifted. Stops when you hang up. **\$28.50*** FCC APPROVED

VOX VOICE ACTIVATED CONTROL SWITCH

Solid state. Self contained. Adjustable sensitivity. Voices or other sounds automatically activate and control recorder. Uses either recorder or remote mike. **\$28.50***

*Add for ship & hdg. Phone Adapter & Vox \$1.50 ea. Records \$4.00 ea. Cal. Res. add tax. Mail order. VISA, M/C, COD's OK. Money Back Guarantee. Qty. disc. avail. Dealer Inquiries invited, Free data.

AMC SALES INC. Dept. 9335 Lubec St.
 Box 928, Downey, CA. 90241.
 Phone (213) 869-6519
 FAX (213) 923-1478

EVERY ISSUE of HAM RADIO

now available on microfiche!

The entire run of Ham Radio Magazine (March, 1968 thru last year) is ready to ship to you in one, easy to use format.

Our 24x microfiche is easy to read and very compact. We offer a hand held reader for \$75, and a desk model for \$220. Libraries have these readers.

As a bonus, you will receive Ham Radio Horizons (3/77 thru 12/80) free.

Everything is included, front cover to back - ads too!

Annual updates will be offered for \$10.

Send \$205 payment (visa/mc accepted) to:

BUCKMASTER

BUCKMASTER PUBLISHING
 Route 3, Box 56
 Mineral, Virginia 23117
 703/894-5777 visa/mc 800/282-5628

TABLE 1

The frequency marked on a crystal isn't always the frequency at which it oscillates. The frequency measured by the crystal tester may be different yet, because the tester doesn't operate in the overtone mode. Here are some kinds of common crystals. F refers to the frequency marked on the crystal.

Type of crystal	Marked frequency (F, MHz)	Operating frequency (MHz)	Measured frequency (MHz)	Load capacitance
General purpose	1 to 20	F	F	Various
General purpose	20 to 60	F	F/3	Usually series
General purpose	55 to 100	F	F/5	Usually series
CB transmit	26.965 to 27.405	F	F/3	Series
CB receive*	26.510 to 26.950	F	F/3	Series
Scanner	30 to 50	F+10.7	(F+10.7)/3	Series
Scanner	140 to 175	(F-10.7)/3	(F-10.7)/9	Series
Scanner	440 to 470	(F-10.7)/9	(F-10.7)/27	Series
Scanner	470 to 500	(F-10.7)/10	(F-10.7)/30	Series

*CB receiving crystals are 455 kHz below the designated channel.

PARTS LIST

Capacitors (ceramic disk or polystyrene, 10 volts, ±20 percent)

- C1 18 pF
- C2 10 pF
- C3 470 pF
- C4 100 to 150 pF
- C5,C6 330 or 470 pF

Resistors (1/8 watt, ±5 or 10 percent)

- R1 100,000 ohms
- R2,R3 1000 ohms
- R4 270 ohms

Semiconductors

- Q1,Q2,Q3 2N3904 (or equivalent) NPN silicon transistor
- D1 1N34 germanium diode
- LED1 Light-emitting diode

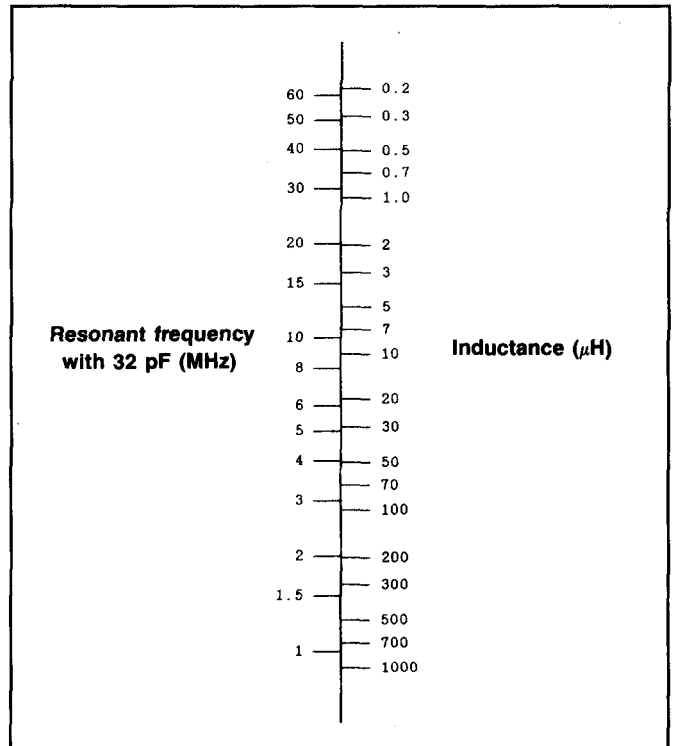
Other

- S1 SPDT center-off (three position) switch
- S2 SPST switch
- B1 9-volt battery
- Connector and holder for B1
- RCA phono jack for output
- Two alligator clips to hold crystal
- Circuit board (Radio Shack 276-159A)
- Enclosure

frequency. For instance, a 27-MHz CB crystal oscillates at 9 MHz (see Table 1). Of course, you can use a crystal whose load capacitance is different from that for which it was ground or use an overtone crystal on its fundamental frequency.*

You can also test coils. Just connect a coil in place of the crystal, set S1 for a 32-pF load, and measure the frequency (see Photo B). Now find the inductance using the nomograph in Figure 3. You may find it more useful to remem-

FIGURE 3



Computer-generated nomograph converts measured frequency to inductance.

ber the frequency than the inductance. It's the frequency at which the coil will always resonate with a 32-pF capacitor. Bear in mind that this measurement is inexact because the load isn't precisely 32 pF and the internal capacitance of the coil isn't taken into account. **77**

*An overtone crystal oscillates near, but not exactly at, an odd multiple of the fundamental cut. Expect to see a small shift of several kHz when overtone crystals are operated in their fundamental mode. Ed.

Practically Speaking

By Joseph J. Carr, K4IPV

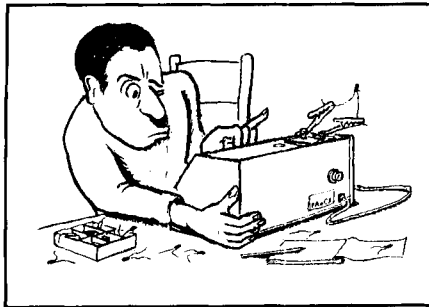
SAFETY STANDDOWN FOR THOSE WHO SERVICE HAM GEAR

I think it's a good idea to discuss matters of ham radio safety every so often, especially as they pertain to equipment and antennas. Unfortunately, from time to time we hear about a fellow Amateur Radio operator who was killed while working on a linear amplifier or installing an antenna.

A number of years ago, I wrote an article on electrical safety for *Ham Radio* (before I started writing "Practically Speaking"). A footnote added by the technical editor indicated that, during the week he was working on the manuscript, he needed to repair a high voltage DC power supply. The HV OUT line got loose, and snapped and barked around on the concrete floor like a venomous viper. (Hmmm...just where was that safety article?) If you've seen this material before, please bear with me. There are many who haven't read this information. Besides, a review of basic safety doesn't hurt anyone. (Even the United States Navy staged a one-day operations standdown for review of safety matters.)

The electronic equipment related to ham radio is inherently dangerous. If it's not used in accordance with some basic common sense rules, operation can lead to injury or even death. There are three situations to consider: *burns*, *macroshock*, and *microshock*.

Electrical accident incidents can cause first, second, and third-degree burns. These burns can occur in two ways: from the flash that results when an electrical arc occurs, or when current flows through body tissue. Any experienced emergency room physician can testify that ordinary 60-Hz power can cause burns. RF can also burn you. A physician, who also happens to be a ham, once told me that high power RF burns tend to be more serious because they penetrate deeper into the body. I recall one chap



(wearing Bermuda shorts) who was working in his basement and sat on his 600-ohm parallel transmission line while he performed some adjustments. Unfortunately, he hadn't disconnected it from the transmitter. Someone else accidentally tripped the rig, intending to tune up and go on the air. After the cursing and screaming was over, the fellow found burns running parallel down the calf of his leg.

Macroshock is the type of electrical shock we all must take care to avoid. It results from direct contact with an electrical source. If you touch the 110-volt AC line while grounded, a very painful and possibly *fatal* shock will occur. Macroshock doesn't require the conduit of wounds or other breaches of the skin to enter the body.

Microshock is a more subtle form of electrical shock, and at one time it wasn't even recognized. However, the increased use of electrical equipment in hospitals during the fifties and sixties led some authorities to speculate that as many as 1,200 people a year were being accidentally electrocuted by tiny currents from hospital equipment that went unnoticed by the medical staff. Microshock is electrical shock caused by currents too minute to affect persons with intact skin, but able to inflict damage if introduced to the body through a wound. Microshock isn't normally a problem for hams.

For all forms of electrical shock to occur, there must be a difference in electrical potential between two points on the body. In other words, two points of contact must exist between the victim and the electrical source. That's why you sometimes see harmless "hair raising" exhibits, where people touch an electrostatic high voltage (>100,000 volts!) and their hair stands on end.

These potentials are essentially "monopolar" with respect to the demonstrator, so no current flow exists. Similarly, some of the less prudent electricians will work a circuit "hot" (without turning off the power), feeling safe because they take care not to ground themselves or in any other way come between the hot wire and ground, or across two hot wires. Even so, *this is an extremely unsafe practice and must be discouraged at all times!*

In addition to electrical shock, there are other safety concerns you must consider when working with electricity. One major problem is fire. Overloaded or defective electrical circuits can spark, overheat, and/or cause a fire. Many fires every year are traced to faulty wiring or malfunctioning electrical equipment.

Electrical faults will also damage the equipment, the building where it is housed, or other equipment. A short circuit that isn't protected by a fuse may cause more damage in the shorted equipment, and may also affect building wiring and electrical components. In extreme cases, a fire may result. When fuses and circuit breakers aren't used, or are defeated ("penny in the fuse box" syndrome), there is a severe fire hazard and the level of damage done to any equipment involved will most certainly increase.

Less recognized, but nonetheless possible, is the hazard of *explosion* from electrical faults. There are at least two mechanisms which can cause explosions of this type. First, an overloaded circuit or electrical component may build up internal pressure (often from gas released when the device is severely overheated) and rupture. High power transformers and the main ripple filter capacitors inside high power RF amplifiers are types of equipment that can explode.

The second mechanism of explosion is sparking that occurs in the presence of flammable gases or vapors. If an electrical circuit is disconnected while operating, or if certain faults exist, then a spark may result. If that spark occurs when either flammable gases, oxygen, or vapors (like gasoline and certain waxes) are present, then a violent and dangerous explosion may result. Note

that oxygen isn't flammable itself, but vigorously promotes burning of other materials.

Besides the obvious danger of "shrapnel" wounds from the casing of an exploding device, there's also the possibility of injury from splattering boiling oil. In addition to the burns it can cause, this oil can be dangerous for other reasons. Certain older capacitors and transformers were built using PCB oil as an internal coolant. *PCB oil is a potent carcinogen.* Do not downplay the importance of this statement — PCB is dangerous stuff! Although most PCB-bearing electrical devices are now out of service, some are still around. Take care when handling older equipment. Be especially suspicious of elderly high power RF amplifiers. Should you find one of these devices, it would be a good idea to ask a competent person to dispose of the equipment. A PCB spill can close a building until a proper cleanup routine is completed; this can take a long time. Once when I published a PCB warning, a fellow wrote to me claiming the problem was overblown. I'll leave it to the experts; they still classify PCBs as dangerous.

What to do for the victim of an electrical shock

Death by electrical shock often occurs as a result of a phenomena called ventricular fibrillation (V.Fib.). This is an arrhythmic heartbeat; the heart merely quivers instead of beating. Unfortunately, a heart in V.Fib. is incapable of sustaining its blood-pumping effectiveness, so the victim dies within a few minutes — unless a person trained in cardiopulmonary resuscitation (CPR) is nearby.

Before you aid a victim of electrical shock, be sure that he is no longer in contact with the current, or that the current is turned off! Otherwise, when you touch him to administer aid, you will also become a victim!

As soon as the victim is clear of the electrical current, yell for help and initiate CPR. CPR won't bring him out of V.Fib., but it will provide life support until properly equipped and trained medical personnel can be summoned. They'll use a defibrillator to shock the victim's heart back into correct rhythm. They'll also use drugs and intravenous (IV) solutions to re-establish his body's balance.

None of these actions can be per-

formed by an untrained person. In fact, even CPR can't be performed effectively by someone who hasn't learned the technique. Everyone who works near, on, or around electrical or electronic equipment should learn CPR. Teenage and adult family members should learn CPR, too. After all, who's going to save you if an electrical accident occurs at home in your hamshack or workshop? The local Red Cross, the Heart Association, some community colleges, and most local hospitals can direct you to certified CPR courses. It's impossible to learn CPR from watching medical shows on TV; get trained by a knowledgeable instructor!

How much current is fatal?

I once worked in a hospital electronics laboratory. One day I heard an intern claim that the 110 volts AC from a wall socket wasn't dangerous. Apparently he was told in medical school that it's not the voltage that kills; it's the current. I asked the doctor if he had ever heard of Ohm's law. According to Ohm's law, the current is the quotient of voltage and resistance, or $I = E/R$. It seems that doctor wasn't aware of this formula. The 110 volts AC available in residential wall sockets is the most common cause of electrocution in the United States. Also, medical studies reveal that the 50 to 60-Hz frequency used in AC power distribution almost worldwide is the most dangerous range of frequencies.

Higher and lower AC frequencies are less dangerous than 60-Hz AC, but they're not safe! Medical experts who've studied electrical shock say the killing factor is current density in a certain area of the right atrium of the heart called the sinoatrial node. Any flow of current through the body which causes a high level of current to flow in that section of the heart can induce fatal V.Fib. In general, the following rules of thumb are accepted for limb contact electrical shocks through intact skin (macroshock):

1 to 5 mA	Level of perception
10 mA	Level of pain
100 mA	Severe muscular contraction
100 to 300 mA	Electrocution

Keep in mind that these figures are approximations and are *not to be accepted as guidelines to approximate "assumed risk."* Under certain circumstances, death can occur with considerably lower levels of current. For

example, the risks escalate tremendously when you're sweating and standing in salt water.

Is high current at low voltage safe?

I once attended a design review meeting on a 100-watt commercial VHF mobile transceiver. One design specification called for insulation of low voltage (28 volts DC), high current (30 A) DC power supply terminals. One of the engineers present remarked that including this specification was like asking him to insulate the battery terminals of his car. His comment implied that low voltage can never hurt you. There are two false premises at work in his opinion.

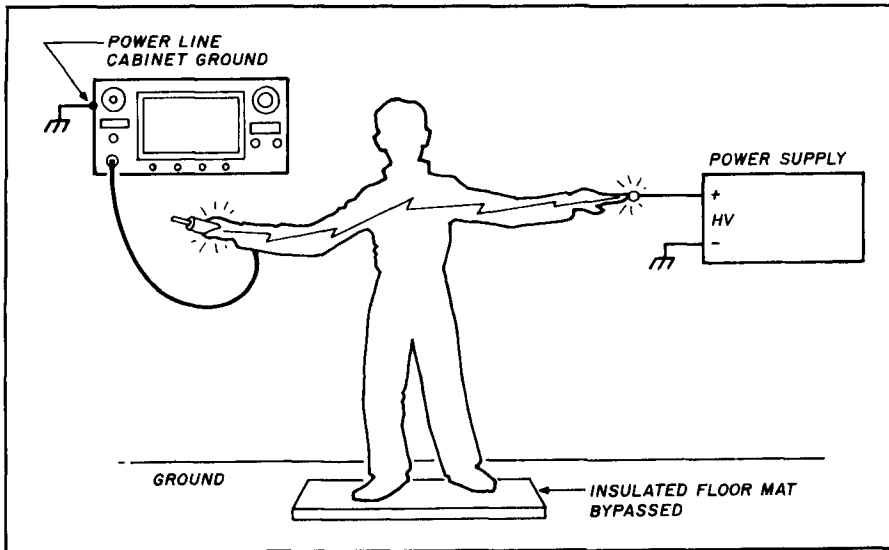
First, although low voltage, high current points rarely cause electrical shock, it's possible for a dangerous shock to occur when the person has a very low electrical skin resistance (very sweaty) or an open wound. I know of an electronics technician who was injured severely when he cut himself on a +5 volts DC, 30-A computer power supply terminal. Although this case didn't result in electrocution, a large amount of current flowed in his arm, causing severe pain and some physical damage.

Second, high current is extremely dangerous if you are wearing jewelry! A two-way radio repair shop once used 12-volt batteries and battery chargers for the troubleshooting bench supply for mobile service. A technician working on the battery rack dropped a wrench, and it fell onto the battery making contact from (-) to (+) through his watchband. The large current turned the watchband red hot, giving him some serious second and third-degree burns. *Don't assume that low voltage, high current power supplies are harmless!*

Mechanisms of electrical shock

To raise your consciousness about how shock can occur, look at scenarios of electrical shock that might affect hams. Figure 1 shows the direct approach to fatal electrical shock. Imagine that you're grounded through conductive shoes and you touch an electrically hot point. You needn't be outdoors to be affected. A concrete garage, shop, or basement floor is a reasonably good conductor, as are wet

FIGURE 1



Shock scenario where a grounded instrument probe creates a path for current.

leather and some types of rubber shoes.

Figure 2 shows an indirect shock scenario that electronics workers should always keep in mind. Consider the grounded instrument probe (in this case an oscilloscope). When you grasp that probe, you may be grounded through the scope shield and the power cord ground conductor. If you touch a "hot" point, you'll get shocked — and may be killed.

A related scenario is shown in Figure 3. Here you see an AC/DC consumer appliance, like a low cost radio or TV set. Note that the oscilloscope probe ground is connected to the set ground, which also happens to be one side of the AC power line. Everything is fine as long as the AC plug is oriented correctly in the wall, and if the wall socket is wired correctly. But if you put the plug into the wall receptacle backwards, there will be an explosive short circuit which could electrocute the operator.

The fatal antenna erection job has contributed to the deaths of many hams. It isn't good practice to erect an antenna near a power line! NEVER! Every year we hear stories of people who were electrocuted when an antenna they were working on fell across the power lines, when they tried to toss a wire antenna over the power line in order to raise the antenna above them, or when a ladder they were using fell across the power lines. These foolish tactics will kill you. Incidentally, this is why OSHA-approved industrial

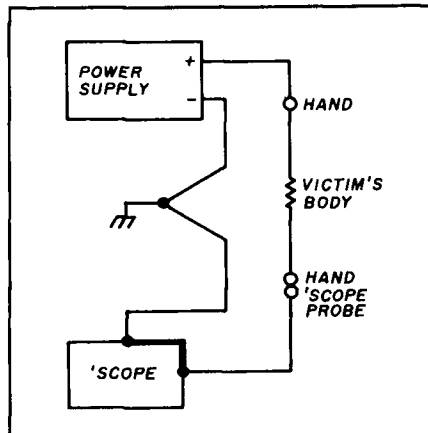
ladders are made of wood or other nonconductive material — not of aluminum like consumer ladders.

Some cures for these problems

Figure 4 is a schematic of the usual United States residential AC electrical system. Industrial electrical systems are a bit different at the service entrance, but become much like those in Figure 4 when the power is distributed throughout the building. The power company distributes energy through high voltage lines. When it arrives at a point a short distance from the customer, it is stepped down in a "pole pig" transformer to 220 volts AC center tapped. The center tap (C.T.) of the transformer secondary is grounded, and therein lies the root of the problem. The two ends of the 220-volts AC secondary are brought into the building as a pair of 110-volts AC hot lines. Tapping across the two lines produces a 220-volts AC outlet; tapping from the ground line (i.e., transformer C.T.) to either hot line produces a 110 volts-AC outlet.

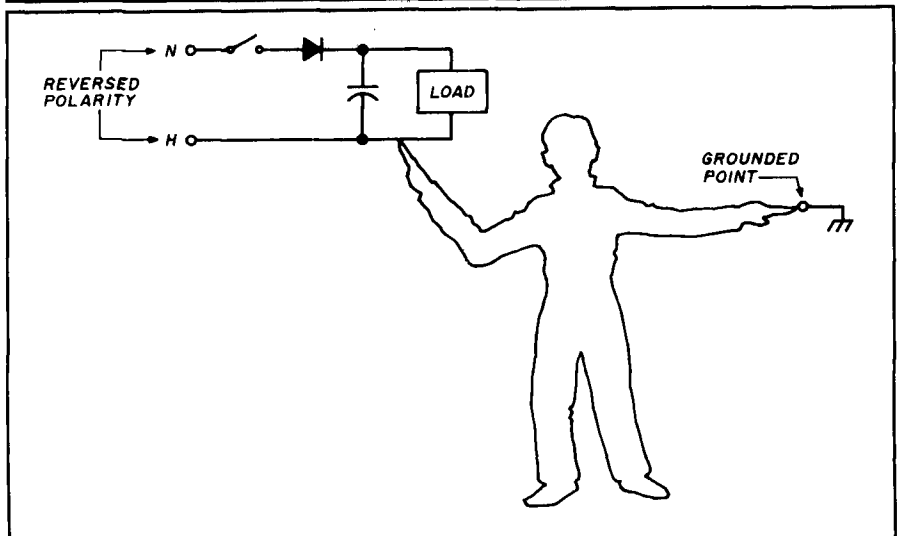
The electrical ground system in the United States is ground referenced; that's the problem. The solution is to make the little local electrical system non-ground referenced. This is done in hospital operating rooms, and in some intensive care units, for patient safety reasons. It should also be implemented on radio service benches, especially if AC/DC power supplies (damnable devices!) are ser-

FIGURE 2



Equivalent circuit for Figure 1.

FIGURE 3



Shock scenario for AC/DC power supplies.



Out of State 1-800-882-1343

(213)390-8003 FAX 213-390-4393

HOURS M-F 9:00 - 5:30 SAT 9:00 - 5:00 SE HABLA ESPANOL
QUICK SERVICE CENTER FOR REPAIR NEEDS

3919 SEPULVEDA BOULEVARD, CULVER CITY, CALIFORNIA 90230

ICOM IC-781



HF Equipment	List	Jun's
IC-781 Super Deluxe HF Rig	\$5995.00	Call \$
IC-765 New, Loaded with Features	3149.00	Call \$
IC-735 Gen. Cvg. Xcvr	1099.00	Call \$
IC-751A Gen. Cvg. Xcvr	1699.00	Call \$
IC-725 New Ultra-Compact Xcvr	949.00	Call \$
IC-726 HF/50 MHz All Mode	1299.00	Call \$
Receivers		
IC-R9000 100 kHz to 1999.8 MHz	5459.00	Call \$
IC-R7000 25-1300 + MHz Rcvr	1199.00	Call \$
IC-R71A 100 kHz - 30 MHz Rcvr	999.00	Call \$
VHF		
IC-228A/H New 25/45w Mobiles	509./539	Call \$
IC-275A/H 50/100w All Mode Base	1299./1399	Call \$
IC-28A/H 25/45w, FM Mobiles	469./499	Call \$
IC-2GAT, New 7w HT	429.95	Call \$
IC-2SAT Micro Sized HT	439.00	Call \$
IC-901 New Remote Mount Mobile	1199.00	Call \$
UHF		
IC-475A/H 25/75w All Modes	1399./1599	Call \$
IC-48A FM Mobile 25w	509.00	Call \$
IC-4SAT Micro Sized HT	449.00	Call \$
IC-4GAT, New 6w HT	449.95	Call \$
IC-04AT FM HT	449.00	Call \$
IC-32AT Dual Band Handheld	629.95	Call \$
IC-3210 Dual Band Mobile	739.00	Call \$
IC-2500A FM, 440/1.2 GHz Mobile	999.00	Call \$
IC-24AT New 2m/440 mini HT	629.95	Call \$
IC-2400 144/440 FM	899.00	Call \$
220 MHz		
IC-3SAT Micro Sized HT	449.99	Call \$
IC-375A All-Mode, 25w, Base Sta.	1399.00	Call \$
1.2 GHz		
IC-12GAT Super HT	529.95	Call \$

KENWOOD TS-950SD



HF Equipment	List	Jun's
TS-950SD New Digital Processor HF	\$4399.95	Call \$
TS-940S/AT Gen. Cvg. Xcvr	2499.95	Call \$
TS-440S/AT Gen. Cvg. Xcvr	1449.95	Call \$
TS-140S Compact, Gen. Cvg. Xcvr	949.95	Call \$
TS-680S HF Plus 6m Xcvr	1149.95	Call \$
TL-922A HF Amp	1982.95	Call \$
Receivers		
R-5000 100 kHz - 30 MHz	1049.95	Call \$
R-2000 150 kHz - 30 MHz	799.95	Call \$
RZ-1 Compact Scanning Rcvr.	599.95	Call \$
VHF		
TS-711A All Mode Base 25w	1059.95	Call \$
TR-751A All Mode Mobile 25w	669.95	Call \$
TM-231A Mobile 50w FM	459.95	Call \$
TH-225A New 2m HT	399.95	Call \$
TH-26AT Compact 2m HT	369.95	Call \$
TM-731A 2m/70cm, FM, Mobile	749.95	Call \$
TM-621 2m/220, FM, Mobile	729.95	Call \$
TM-701A 25w, 2m/440 Mobile	599.95	Call \$
TH-75A 2m/70cm HT	TBA	Call \$
UHF		
TS-811A All Mode Base 25w	1265.95	Call \$
TR-851A 25w SSB/FM	771.95	Call \$
TM-431A Compact FM 35w Mobile	469.95	Call \$
TH-46AT Compact 440 FM, HT	399.95	Call \$
TH-45AT 5w Pocket HT NEW	389.95	Call \$
TH-55 AT 1.2 GHz HT	524.95	Call \$
TM-531A Compact 1.2 GHz Mobile	569.95	Call \$
220 MHz		
TM-3530A FM 220 MHz 25w	519.95	Call \$
TM-331A Compact Mobile	469.95	Call \$
TH-315A Full Featured 2.5w HT	419.95	Call \$

YAESU FT-1000D



HF Equipment	List	Jun's
FT-1000D Top Performer	\$4399.00	Call \$
FT-747 GX Economical Performer	889.00	Call \$
FT-757 GX II Gen. Cvg. Xcvr	1280.00	Call \$
FT-767 4 Band New	2299.00	Call \$
FL-7000 15m-160m Solid State Amp	2279.00	Call \$
Receivers		
FRG-8800 150 kHz - 30 MHz	784.00	Call \$
FRG-9600 60-905 MHz	808.00	Call \$
VHF		
FT-411 New 2m "Loaded" HT	406.00	Call \$
FT-212RH New 2m, 45w Mobile	499.00	Call \$
FT-290R All Mode Portable	610.00	Call \$
FT-23 R/TT Mini HT	351.00	Call \$
UHF		
FT-712RH, 70cm, 35w Mobile	536.00	Call \$
FT-811 70cm built-in DTMF HT	410.00	Call \$
FT-790 R/II 70cm/25w Mobile	681.00	Call \$
VHF/UHF Full Duplex		
FT-736R, New All Mode, 2m/70cm	2025.00	Call \$
FEX-736-50 6m, 10w Module	294.00	Call \$
FEX-736-220 220 MHz, 25w Module	322.00	Call \$
FEX-736-1.2 1.2 GHz, 10w Module	589.00	Call \$
FT-690R MKII, 6m, All Mode, port.	752.00	Call \$
Dual Bander		
FT-4700RH, 2m/440 Mobile	996.00	Call \$
FT-470 Compact 2m/70cm HT	576.00	Call \$
Repeaters		
FTR-2410 2m Repeaters	1154.00	Call \$
FTR-5410 70cm Repeaters	1154.00	Call \$
Rotators		
G-400RC light/med. duty 11 sq. ft.	242.00	Call \$
G-800SDX med./hvy. duty 20 sq. ft.	390.00	Call \$
G-800S same/G-800SDX w/o presets	322.00	Call \$



ALINCO

DJ-160T
2 METER H.H.

DR-570T
2M/70CM MOBILE

DR-510T Dual Band Mobile
DR-110T 2 Meter Mobile
DJ-500T 2m/440 HT
DJ-100T Mini 2 Meter HT



Heath

HW2P
2m/440
MICRO-DELUXE HANDHELD

Call About The Complete
Line Of Pre-assembled
And Kit Form Amateur
Equipment



JUN'S BARGAIN' FEST

IC-28H, 2m Mobile List \$499.00
SALE \$379.95

YAESU FT470 List \$576
SALE \$ CALL

IC-3210 Dual Band Mobile List \$739.00
CALL FOR SUPER SALE PRICE

IC-2400 2m/440 Mobile List \$899.00
CALL FOR SUPER LOW PRICE

Thanks to all HAM RADIO
MAGAZINE subscribers for
your support over the past
22 years!

Your friends on the HR Staff

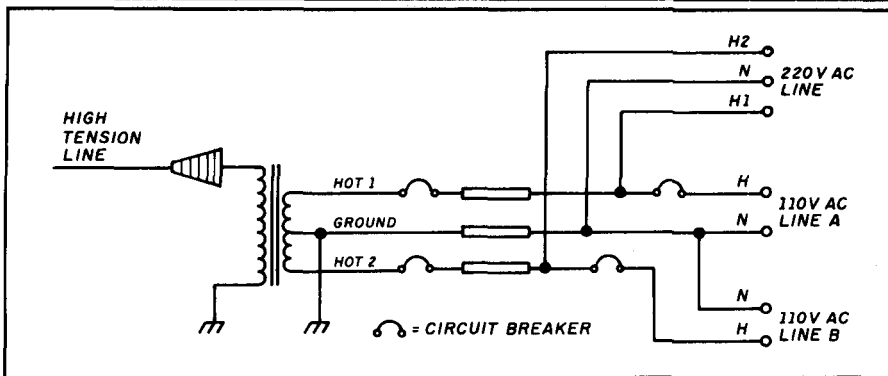
U.S. AMATEUR RADIO MAIL LISTS

Labels, floppy disks, CD-ROM, mag tape.
• Newly licensed hams
• All upgrades
• Updated each week

BUCKMASTER PUBLISHING

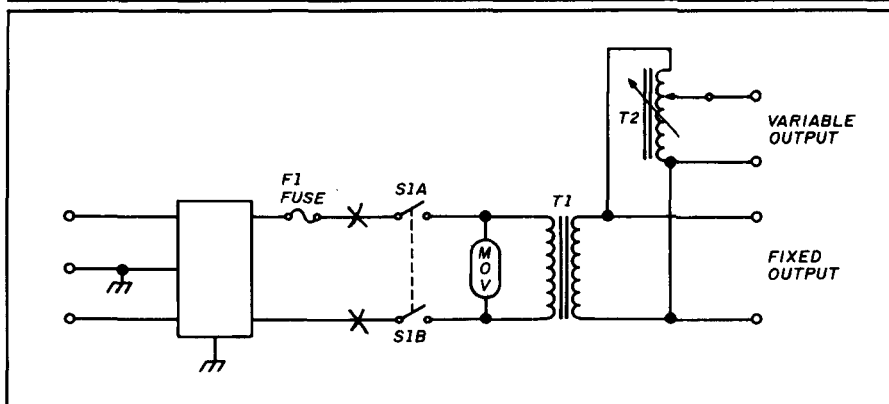
Route 3, Box 56
Mineral, Virginia 23117
703/894-5777 visa/mc 800/282-5628

FIGURE 4



Residential AC electrical system.

FIGURE 5



Workbench electrical system.

vised. Figure 5 shows the wiring for such a system. Transformer T1 is one of two types of isolation transformer. A 1:1 transformer gives a 110-volts AC isolated (non-ground referenced) AC line from a 110-volts AC standard line; a 2:1 transformer does the same thing from a 220-volts AC line.

The second transformer, T2, is an autotransformer used for varying the voltage on the AC line. It will typically allow you to set the output voltage from 90 to 140 volts AC with a 110-volts AC line voltage applied. This transformer is used by servicers to set the voltage higher or lower than normal to check radio operation or expose problems.

If you work on radio transmitters, you might want to place an electromagnetic interference (EMI) filter in the line at the points marked "X." The EMI filter is an LC-section that attenuates RF, but doesn't affect the 60-Hz power.

The "MOV" is a metal oxide varistor. It's used to clip the amplitude of high voltage line transients (100 microseconds or so) that could either damage or interfere with the operation of the

equipment on the bench.

The circuit breaker or fuse protects the bench equipment and the transformer. It's always placed in the hot line, and can also be placed in both lines. However, fuses and circuit breakers should *never* be placed in the neutral line only. The switching shown in Figure 5 breaks both lines. I prefer this approach because hot and neutral lines can be reversed accidentally, leaving you in the position of breaking a neutral while the hot line remains alive.

Some general points on safety

There's only one way to ensure that the AC line won't shock you — disconnect it. Make it your practice never to work on equipment that has the plug inserted into the power outlet. Don't trust switches, fuses, circuit breakers, or other people. If someone were to hand you a pistol, claiming that it was unloaded, the first thing you'd do is check it yourself. The same advice holds true for an electrical connection

(which can kill you just as efficiently as a loaded and cocked pistol).

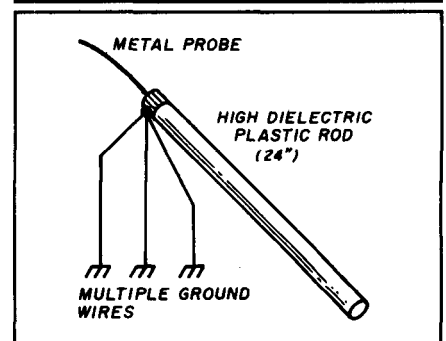
It's sometimes recommended that you work on high voltage devices with your left hand in your pants pocket. Supposedly, the "left hand to either leg path" is the most deadly. Even so, working with one hand in your pocket is awkward. I don't think anyone is able to work on a circuit safely with just one hand. It's better to use both hands, arrange a safe work environment, and use good techniques.

What's a safe work environment? It's one where the power system is isolated. The floor should be insulated by a carpet, treated masonite, a plastic cover, a rubber mat, wooden planking, or some other material. Also remember to keep the floor dry. Use an isolation transformer on the workbench for servicing radios.

When working on high voltage DC circuits, like those inside linear RF amplifiers, remember that capacitors store electrical charge. All filter capacitors must be discharged manually after the power is turned off. Also remember that the capacitor must be discharged several times. Even when a short circuit is placed across the capacitor terminals, all of the energy is not removed the first time it is discharged. Some energy is stored in the dielectric, even after the main charge is dissipated.

How do you short the capacitor terminals? With a screw driver? With an alligator clip lead? No! Use a shorting stick (Figure 6). Do not make the stick out of wood! Use a dielectrically competent plastic material instead. Be sure to use more than one ground line. If one of the lines falls off while you're working, there will be one or more lines left to carry off the charge. Be sure to wear eyeglasses or safety goggles to

FIGURE 6



Capacitor discharge wand.

MAGGIORE ELECTRONIC LAB.

Manufacturers of Quality Communications Equipment

- Repeaters
- Links
- Remote Base
- VHF, UHF
- Receivers
- Transmitters
- Antennas



- Standard and Computerized Controllers
- Standard and Computerized Auto Patches
- Duplexers

Hi Pro 'E' EXPANDABLE REPEATER SYSTEM

- A NEW CONCEPT IN REPEATER DESIGN, THE Hi Pro "E" IS AN EXPANDABLE REPEATER WITH THE FOLLOWING FEATURES: A BASIC REPEATER WHICH WOULD INCLUDE A COMPLETE RECEIVER, TRANSMITTER, COF, FRONT PANEL CONTROLS AND INDICATORS, LOCAL SPEAKER AND MIC JACK AND CAPABLE OF FUTURE EXPANSION. ALL HOUSED IN AN EXTREMELY RUGGED, ENCLOSED, 19-INCH RACK MOUNTABLE CABINET.
- THIS SYSTEM CAN BE EXPANDED AT TIME OF PURCHASE OR CAN BE AN AFTER-PURCHASE ADD ON. THE ADD ONS ARE—HIGHER POWER, 110/220 VAC POWER SUPPLY, IDENTIFIER, AUTO PATCH, OR COMPUTER CONTROLLERS. IN ADDITION TO THESE ADD ONS AN ADDITIONAL RECEIVER AND TRANSMITTER CAN BE MOUNTED INTERNALLY FOR USE AS CONTROL LINKS, REMOTE BASE OR DUAL BAND OPERATION, ETC.
- AN EXTENSION PANEL IS AVAILABLE FOR LOCAL MONITORING OF THE REPEATER AND CONTAINS ALL NECESSARY METERING, STATUS LIGHTS AND INDICATORS. ALL ADD ONS ARE AVAILABLE FROM THE COMPANY AND ARE COMPLETE INCLUDING INSTRUCTIONS.

MAGGIORE ELECTRONIC LAB.

600 Westtown Rd.

West Chester, PA 19382

Phone (215) 436-6051



Telex 499 0741 MELCO
FAX 215-436-6268

WRITE OR CALL FOR OUR COMPLETE CATALOG

2-1000 MHz In One Sweep!

AVCOM's New PSA-65A Portable Spectrum Analyzer

The newest in the line of rugged spectrum analyzers from AVCOM offers amazing performance for only \$2,855.

AVCOM'S new PSA-65A is the first low cost general purpose portable spectrum analyzer that's loaded with features. It's small, accurate, battery operated, has a wide frequency coverage - a must for every technician's bench. Great for field use too.

The PSA-65A covers frequencies thru 1000 MHz in one sweep with a sensitivity greater than -90 dBm at narrow spans. The PSA-65A is ideally suited for 2-way radio, cellular, cable, LAN, surveillance, educational, production and R&D work. Options include frequency extenders to enable the PSA-65A to be used at SATCOM and higher frequencies, audio demod for monitoring, log periodic antennas, carrying case (AVSAC), and more.

For more information, write, FAX or phone.

SWEEP RATE controls the speed of the sweep across the CRT.

VERT is used to position the display on the screen.

SCALE selects an amplitude sensitivity of either 10 dB/DIV or 2 dB/DIV.

CENTER FREQUENCY 4 digit LCD display

TUNING adjusts the center frequency of the analyzer so that signals of interest appear at the center of the display and their frequency is read out on the LCD.

REFERENCE LEVEL adjusts input attenuator and IF gain. Calibrations in dBm and dBmV are provided.

ZERO SPAN instantly places analyzer in zero span mode and activates audio demodulator for convenient monitoring.

SPAN controls the width of the spectrum being displayed and automatically selects optimum resolution filter.

RF INPUT accepts signals to be observed from less than 2 MHz to greater than 1000 MHz.

VAR SPAN reduces the width of the spectrum being displayed for closer signal examination and enhanced amplitude accuracy.

AUXILIARY supports present and future optional accessories for the PSA-65A.

AUDIO DEMOD activates audio demod board and sets audio level.

AUDIO OUT drives low impedance earphone or speaker. Internal speaker provided with optional demod.

BAT CHG switch recharges PSA-65A to 80% capacity in approx. 6 hours.

POWER switch has 3 positions: Battery Operation, Standby and AC Line Operation. Ext. DC Power switch on rear panel for 12 volt operation.

Portable, attractively styled package and ergonomically engineered front panel.

Large bright screen for outdoor and indoor use.

AVCOM

BRINGING HIGH TECHNOLOGY DOWN TO EARTH

500 SOUTHLAKE BOULEVARD
RICHMOND, VIRGINIA 23236
804-794-2500 FAX: 804-794-8284

WHY IS THIS TOUGH OLD BIRD STILL THE INDUSTRY STANDARD WATTMETER?

Simple. No one's been able to improve on the basic Bird Model 43 THRU LINE® directional wattmeter since its inception — not even us. Rugged, reliable and accurate, it's also extremely versatile and easy to use. With Bird precision plug-in elements, it measures forward and reflected CW power from 100mW to 10,000W, 0.45 to 2,300 MHz, with ± 5% of full-scale



who else but
BIRD

accuracy. It even has built-in remote-reading capability, can be used for RF signal sampling and its QC (Quick Change) connectors are interchangeable in the field without affecting calibration. There's a model that reads AM peak power too, the new 43P ... or you can retrofit your trusty Model 43 for it in about 15 minutes. Contact us or your Bird distributor for details.

30303 Aurora Rd., Cleveland, Ohio 44139 • 216/248-1200 • TLX: 706898 Bird Elec UD • FAX: 216/248-5426
Western Sales Office: Ojai, CA 805/646-7255

© Copyright 1989 Bird Electronic Corp.

124

**VHF
COMMUNICATIONS**

9:00 am - 5:30 pm
weekdays

Weekends and evenings
by appointment.

**280 Tiffany Avenue
Jamestown, New York 14701**

Western New York's finest... another radio dealer!

1-800-752-8813 (For Orders Only)

125

RFI KIT

Use ferrite beads to keep RF out of your TV, stereo, telephone, etc. Kit includes one dozen beads, one dozen toroids 1/2" to 1 1/4" diameter, three "split beads" and our helpful RFI tip sheet. Everything needed to fix most RFI problems. \$15 + \$4 S&H U.S. and Canada. 7 1/4% tax in CA.

Free catalog and RFI tip sheet on request.

PALOMAR ENGINEERS

Box 455, Escondido, CA 92025
Phone: (619) 747-3343

126

NEW!

The classic "Antenna Bible"
now in a thoroughly-revised, much-enlarged
edition

ANTENNAS

2nd edition
by John Kraus, W8JK
Ohio State University

Covers both theory and its applications to practical systems. With design formulas, tables and references. Over 1000 illustrations.

"Modern, complete, a classic", *Microwave Journal*.

917 pages, hardcover. \$51.95

Add \$2.50 per book for shipping and handling U.S., \$5.00 elsewhere.

CYGNUS-QUASAR BOOKS
P.O. Box 85, Powell, Ohio 43065
Tel. 614-548-7895

127

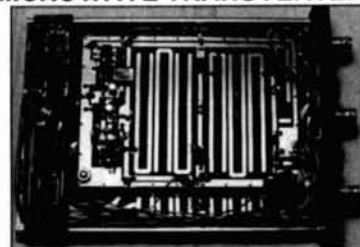
prevent eye damage from the flying sparks.

The power cord ground is the only ground available to the equipment chassis when you have it running on the bench. This is insufficient for safety. My workbench has a grounded 5/16-inch bolt on the back edge. When I work on high power RF equipment, I ground the chassis to that ground point with a heavy cable. Don't overlook this ground. When only the power line ground is used, high power RF "travels" to strange places and can cause problems. I recall a time in a hospital electronics lab when we serviced an electrosurgery generator. These devices are high power (500 watt) 1-MHz (or so) RF power oscillators. (Some of them were spark gap "transmitters" as late as the early 1980s!) I forgot the ground rule and kicked the "transmit" switch. Bright blue RF sparks flew from every inch of the metal trimmed Formica™ workbench. Although the sight was spectacular, it scared the dickens out of me. (Note to Chuck, my ham colleague, who was there: no snickering!)

Conclusion

There's no such thing as complete, failure free safety protection. This statement is especially true when you're dealing with high power electrical devices like RF power amplifiers. But proper recognition of the mechanisms of danger and proper management of the risks will ensure that the environment is as safe as possible.

MICROWAVE TRANSVERTERS



SHF 1240 Complete Transverter

SHF SYSTEMS No tune linear transverters and transverter kits for 902, 1269, 1296, 2304, 2400, 3456 MHz. All use 2m I.I.g.13.8V. Kits include mixer and L.O. P.C. boards, xtal and all components. Built units include I.F./D.C. switchboard, connectors and compact low profile housing. Other frequency options in amateur band available.

SHF 900K	902-906 MHz	50mW	Kit \$129	Built \$250
SHF 1240K	1296-1300 MHz	10mW	Kit \$139	Built \$240
SHF 1269K	1268-1272 Oscar Mode L	10mW	Kit \$130	Built \$240
SHF 2304K	2304-2308 MHz	10mW	Kit \$195	Built \$320
SHF 2401K	2400 MHz Mode S rcv Conv		Kit \$150	Built \$250
SHF 3456L	3456-3460 MHz	10mW	Kit \$195	Built \$320
SHF LOK	540-580 MHz L.O.	50mW	Kit \$ 64	

CALL OR WRITE FOR COMPLETE CATALOG
DOWN EAST MICROWAVE

Bill Olson, W3HOT

Box 2310, RR1 Troy, ME 04987
(207) 948-3741



128

THE SERIES SECTION TRANSFORMER

By Charles J. Michaels, W7XC, 13431 N. 24th Avenue, Phoenix, Arizona 85029

Here's the problem. You've just put a half-wave dipole for 40 meters at 52 feet, connected 70 feet of RG-213 (50 ohm) coax, and trimmed the antenna to resonance at 7.15 MHz — but the best VSWR you can get is 1.6:1. Although the calculated extra 0.05-dB loss (above the 0.38-dB calculated matched loss — see **Appendix A**) is negligible, you don't like the VSWR and your transceiver doesn't either.

Check the input impedance curve of a half-wave dipole versus height (0.375 wavelength in this case) in almost any antenna text and you'll find that you should have about 85 ohms for a VSWR of 1.7:1 at the antenna, and 1.62:1 through 70 feet of RG-213 line (see **Appendix B**). What to do?

How about a balanced L net at the antenna? Hmm, two coils and a capacitor in a weather protective box. Weight, wind load?

How about a stub matching system? Gosh, that RG-213 is heavy enough now!

Or how about a quarter-wave matching section? Let's see,

$$Z_o = \sqrt{Z_L Z_i} = \sqrt{50 \times 85} = 65.2 \text{ ohms}$$

Sixty-five ohm coax? Not exactly a standard item!

Is a transmatch the only answer? No!

A solution

This, and many other matching problems, can often be solved by using a series section transformer. The technique uses a calculated length of feedline, ℓ_2 , removed at a calculated distance, ℓ_1 , from the load, and replaced by a piece of feedline with an impedance different from that of the main line (see **Figure 1**). This technique can also provide a match to loads that include reactance. Furthermore, it becomes *part* of the feedline rather than an addition.

Calculation

Use the aforementioned problem as an example. Your first task is to determine feasibility. The ℓ_2 section of line must have a characteristic impedance either less than

or greater than

$$Z_1 \sqrt{VSWR}$$

In this case the antenna VSWR is 1.7:1 and, because

$$50 / \sqrt{1.7} = 38.3 \text{ ohms}$$

and

$$50 \sqrt{1.7} = 65.2 \text{ ohms}$$

the ℓ_2 section must have an impedance of either less than 38.3 ohms or greater than 65.2 ohms. RG-11 at 75 ohms is standard, so the system is feasible.

To simplify the calculations, normalize the load impedance R_L and X_L , and the Z_2 impedance to the main line impedance Z_1 as follows:

$$n = Z_2/Z_1 \quad (1)$$

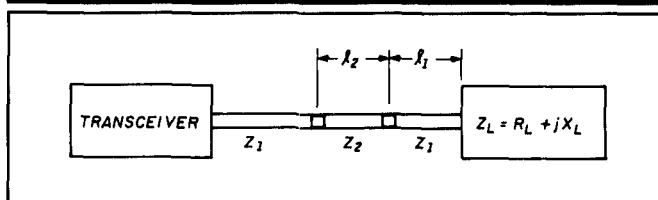
$$r = R_L/Z_1 \quad (2)$$

$$x = X_L/Z_1 \quad (3)$$

Because Z_2 is 75 ohms, R_L is 85 ohms, X_L is zero ohms (a dipole is a pure resistance at resonance), and Z_1 is 50 ohms using **Equations 1, 2, and 3**, $n = 75/50 = 1.5$, $r = 85/50 = 1.7$ and $x = 0/50 = 0$.

The angular length of section ℓ_2 , or ℓ_2° , is calculated as follows:

FIGURE 1



Series section transformer. Z_1 is the main-line characteristic impedance. Z_2 is the matching-section characteristic impedance. See text for calculation of Z_2 , ℓ_1 , and ℓ_2 .

$$\ell_2^\circ = \arctan B$$

where:

$$B = \left[\frac{(r - l)^2 + x^2}{r \left(n - \frac{l}{n} \right)^2 - (r - l)^2 - x^2} \right]^{1/2}$$

For the example:

$$B = \left[\frac{(1.7 - 1)^2 + 0^2}{1.7 \left(1.5 - \frac{1}{1.5} \right)^2 - (1.7 - 1)^2 - 0^2} \right]^{1/2} = 0.842$$

A trigonometry table of tangents or a scientific calculator indicates that a tangent of 0.842 corresponds to an angle of 40.11°. This angle is converted to feet of transmission line by **Equation 5**.

$$\ell' = (2.733 \times \ell^\circ \times V_f) / F \quad (5)$$

where:

- ℓ' = length in feet
- ℓ° = length in degrees
- V_f = velocity factor of line
- F = frequency in MHz

In the example, velocity factor V_f is assumed to be 0.66 for both the RG-213 and RG-11. Quality coax is usually very close to specification. Using **Equation 5**:

$$\ell_2' = (2.733 \times 40.11 \times 0.66) / 7.15 = 10.12', \text{ or } 10' 1.4''$$

The angular length of section ℓ_1 is calculated as follows:

$$\ell_1^\circ = \arctan A \quad (6)$$

where:

$$A = \frac{\left(n - \frac{r}{n} \right) B + x}{r + xnB - l}$$

For the example,

$$A = \frac{\left(1.7 - \frac{1.7}{1.5} \right) 0.842 + 0}{1.5 + 0 - 1} = 0.441$$

0.441 is the tangent of 23.8°.

Again using **Equation 5**,

$$\ell_1' = (2.733 \times 23.8 \times 0.66) / 7.15 = 6', \text{ or } 6' 0''$$

The design is now complete.

If you find the quotient is negative when calculating B of **Equation 4**, then Z_2 is too close to Z_1 . This may happen when reactance is present in the load, despite initial indications of feasibility.

When calculating A of **Equation 6**, the result can be a negative number implying a negative angular length. In this case, add 180° to the negative angle to obtain the correct length.

Implementation

Cut the RG-213 coax line 6' from the antenna and insert a 10' 1.4" length of RG-11 line. You can do this neatly with PL-259 connectors and barrels weatherproofed by wrapping the connectors and barrels with RTV compound. If you use connectors and barrels, include their lengths in the ℓ_1 and ℓ_2 lengths.

You may shorten the remaining RG-213 line to the station if you wish, as 10' 1.4" has been added. Because the addition is small, it's probably not worthwhile to shorten

- (4) this line. In VHF applications, take extra care to include the connector and barrel lengths in the calculations.

Other applications

This system is applicable to both coaxial and balanced lines. In fact, because a wide range of balanced line impedance is available through your choice of conductor diameter and spacing, balanced lines offer a wide range of matching section parameters.

You can also use this system at the sending end, when it may be necessary to match a line of other than the 50 ohms for which your transceiver, VSWR meter, and low pass filter are designed.

Appendix A—Loss total

RG-213 at 7.15 MHz has 0.55-dB loss per 100 feet. Therefore, 70 feet of matched line has $0.7 \times 0.55 = 0.38$ -dB loss.

$$\text{Loss total} = 10 \log_{10} \left[\frac{B^2 - C^2}{B(1 - C^2)} \right]$$

where

$$B = 10L_m/10$$

L_m = loss matched in dB

and

$$C = \frac{S_\ell - 1}{S_\ell + 1}$$

where

S_ℓ = VSWR at load

$$C = \frac{1.7 - 1}{1.7 + 1} = 0.25926$$

$$B = 10^{0.38/10} = 1.09144$$

$$B = 10^{0.38/10} = 1.09144$$

$$\text{Loss/Total} = 10 \log_{10}$$

$$\left[\frac{1.09144^2 - 0.25926^2}{1.09144(1 - 0.25926^2)} \right] = 0.43$$

0.43 - 0.38 = 0.05 additional loss due to 1.7:1 VSWR

Appendix B—VSWR

S_i = VSWR at generator end of line

S_ℓ = VSWR at load end of line

$$C = \frac{S_\ell - 1}{S_\ell + 1}$$

$$B = 10L_m/10$$

L_m = loss matched in dB

$$S_i = \frac{B + C}{B - C}$$

$$C = \frac{1.7 - 1}{1.7 + 1} = 0.25926$$

$$B = 10^{0.38/10} = 1.09144$$

$$S_i = \frac{1.09144 + 0.25926}{1.09144 - 0.25926} = 1.62$$

VSWR at input to line is 1.62:1 

Cleaning Electronic Hardware

Try Tarn-X™ to clean and brighten tarnished or dirty coaxial connectors and similar electronic hardware. Tarn-X is claimed to contain acidified thiourea, detergent, and corrosion inhibitors. You can find it in department stores.

The manufacturer recommends wiping Tarn-X on with a cloth or cotton ball, but I've found it effective as a reusable dip. Many parts require dipping in Tarn-X for only 30 seconds to a minute and then rinsing in hot water. The rest can usually be cleaned up with a few swipes with an old toothbrush or fingernail brush and redipping.

I've used this stuff for about 10 years, and my first bottle (I have two) is still going strong!

David McLanahan, WA1FHB

More on Elevated Radials: H.H. Beverage's 1921 Counterpoise System

Bill Orr's November 1989 column in *Ham Radio* touched upon the advantages of using elevated radials. This reminded me of an earlier article by H.H. Beverage, 2BML, that appeared in a 1921 issue of an RCA catalog. It described an aerial and counterpoise system, suggested by a Mr. Alexander, using a coupled ground wire. Details of 2BML's flat top antenna system of 1921 are shown in **Figure 1**.

Adding this coupled ground wire was the secret to improving antenna efficiency. Most Amateurs, and many broadcast stations (KGO was one of them) were already using the counterpoise at this time. Old boilers, model T cars, and other scrap metal buried 6 feet down served as the only antenna ground references for many stations until the elevated counterpoise became popular. Besides finding they were "getting out" better, operators also noticed that their antenna currents



were higher when using the counterpoise.

Beverage's system

Having permission to operate above 200 meters, 2BML chose to tune his flat top on 280 meters (1071 kHz). With a fair ground, his measurements showed a system resistance of around 70 ohms and 0.5-A antenna current. But with the elevated counterpoise attached, the system resistance dropped to 10 ohms!

The ground lead tap on the inductor was adjusted to cancel the capacitive reactance of the elevated counterpoise. The inductor was wound, using 3/8-inch tubing, into a 20-turn 15-inch diameter coil. Each time an adjustment was made the system was retuned for input power and frequency. With both the earth and counterpoise connected, a system resistance of 4 ohms and an antenna current of 8 A was obtained!

With 8 A of RF current going into the antenna, the counterpoise wire current (I_c) was about 6 A, and the earth ground

current (I_g) was about 2 A. The counterpoise capacitance to ground was about 700 pF, and the antenna capacitance to ground was about 500 pF.

Conclusions

In the "old days" your antenna ammeter was your power meter. You put up an antenna, connected a ground and tuned for maximum antenna current. If you were "in the chips," you were the proud owner of a thermo-coupled RF ammeter. You proudly told your listener, "I'm radiating 1.2 TCA amps" to my four-wire flat top up 80 feet, OM!" This meant you were in between the Ford coil (spark) group, and the guys with a kW or two. When you decided to change from an "earth warmer" ground to a counterpoise, you became listed in the "Calls Heard" columns printed by *QST* every month. For March 1922 they listed six pages of logged heard or worked stations — spark or CW. Big DX was here!

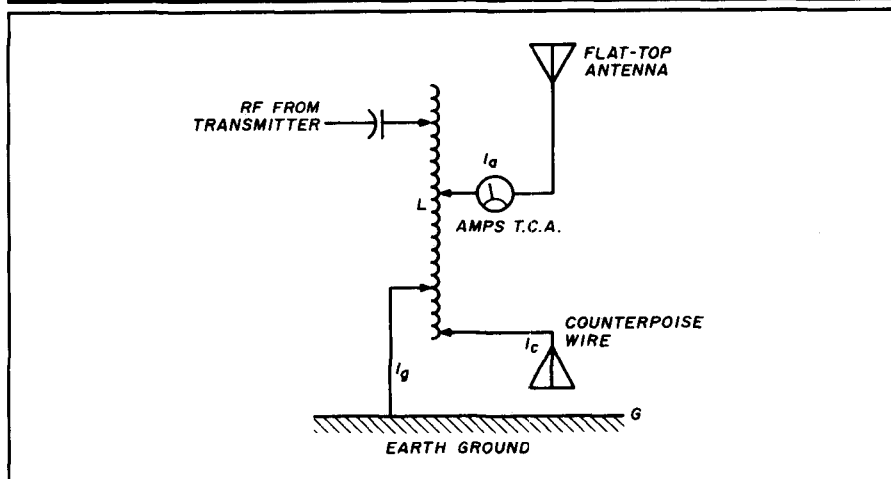
Going from a good ground to a counterpoise raised your signal about 10 dB. Adding the 2BML circuit gave you 3 or so more dB.

Take your pick. Rent a backhoe and bury a few thousand feet of copper, or put up a few elevated radials on 160 meters.

Dave Atkins, W6VX

*Amps measured by a thermo-couple ammeter. Ed.

FIGURE 1



2BML "flat-top" antenna system of 1921. Large inductor allowed matching antenna to transmitter and also permitted tuning-out capacitive reactance of counterpoise radial.

WE SHIP WORLDWIDE

Barry Electronics Corp.

WORLD WIDE AMATEUR RADIO SINCE 1950
Your one source for all Radio Equipment!

For the best buys in town call:
212-925-7000
Los Precios Mas Bajos en Nueva York
WE SHIP WORLDWIDE!



SEE You June 3rd
HOSARC, Flushing, NY

KITTY SAYS: WE ARE NOW OPEN 7 DAYS A WEEK.
Saturday & Sunday 10 to 5 P.M.
Monday-Friday 9 to 6:30 PM Thurs. to 8 PM
Come to Barry's for the best buys in town.



FT-767GX, FT-757GXII, FT-747GX,
FRG-8800, FT-736R, FT-1000,
FT-4700RH, FT 212/712RH, FT-470

KENWOOD

ANTENNAS
A.S. AES, Cushcraft, Hy-Gain,
Hustler, KLM ME7Z, Mosley,
UNEL, M000L0X, TDNA,
Butternut Multi-Band

TS440SAT, R-5000, TS-940 5SAT, TM 231A/
431A, TM-2570A/50A, TR-751A, Kenwood
Service Repair, TM-731A, TS-711R/11A,
TH25AT, TH25A, TM-631A, TM-331A,
TS140S, TS680S, FZ-1, TS-790A, TS9950D,
TH-75A, TH2646AT

AMPLIFIERS STOCKED:
RF Concepts
Mirage
TE Systems

MARINE RADIOS
ICOM M5, M56, M700TY, M800
AVIATION PORTABLE ICOM A-20



IC-32AT
IC-H16A/118
MOTOROLA RADIOS
COMMERCIAL RADIOS
TH-75AT
FT-470

Panasonic

Wanted: HF Radio Technician

VoCom/Mirage/Alinco
Tokyo Hy-Power/TE SYSTEMS
Amplifiers & 5/8 HT Gain
Antennas IN STOCK

G&G ELECTRONICS ART-1,
Air Disk, SWL, Morse Coach

Professional Soldering Station 48 Watts \$79

METRON KW HF Mobile Amplifier Stocked

Alpha Delta Products Stocked

EIMAC 3 500Z
572B, 6JS6C
12B7YA &
6146B

BIRD Wattmeters & Elements IN Stock

AEA 144 MHz
AEA 220 MHz
AEA 440 MHz
ANTENNAS

Computer Interfaces
Stocked: MFJ-1270B,
MFJ-1274, MFJ-1224, AEA
PK-88, MFJ-1278T, PK-232 MBX,
WIFAX, DRSI PRODUCTS

MOTOROLA AUTHORIZED DEALER
KACHINA COMMUNICATIONS DEALER

AUTHORIZED SONY DEALER
DIGITAL FREQUENCY COUNTERS
OPTOELECTRONICS model 1300 HFA, D-1300MHz
2210 H, 0-2200 MHz

Long-range Wireless Telephone for support in stock

BENCHER PADDLES
BALUNS, LOW PASS FILTERS IN STOCK

MIRAGE AMPLIFIERS
ASTRON POWER SUPPLIES
Belden Wire & Cable, Int'l Wire
OPTO KEYS STOCKED



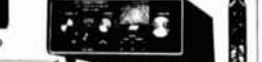
IC-R71A, 751A, 781, 280H, R-7000, R1, R72, R100
IC-765, 275AH, 3220A, 475AH, 735, IC-901,
IC-229H, IC725, IC-2400A/2500A



Simplex Autopatch SDI-50 Will Patch
FM Transceiver To Your Telephone. Great For
Telephone Calls From Mobile To Base. Simple
To Use. SDI-50

Connect Systems (CSI)
PRIVATE PATCH V, Duplex 8200,
CS700

TUNERS STOCKED:
NYE MBV-A 3 Killowatt Tuner



COMMERCIAL & HAM REPEATERS STOCKED. WRITE FOR QUOTES

Kartronics KAM, KPC 8,
KPC 2420, KPC IV,
DVR 2.2

SHORTWAVE RECEIVERS STOCKED

JRC-NR0-525,
JST135

HEIL EQUIPMENT IN STOCK

COMET ANTENNAS STOCKED

Hi-Gain Towers & Antennas, and Rotors will be shipped direct to you FREE of shipping cost!

New TEN TEC Corsair II, PARAGON OMNI V

SIX Towers, Antennas, Mobile Radio mounts, Stocked, Call.

AMERITRON AUTHORIZED DEALER

MAIL ALL ORDERS TO: BARRY ELECTRONICS CORP., 512 BROADWAY, NEW YORK CITY, NY 10012 (FOUR BLOCKS NORTH OF CANAL ST.)

New York City's LARGEST STOCKING HAM DEALER
COMPLETE REPAIR LAB ON PREMISES

"Aqui Se Habla Espanol!"
BARRY INTERNATIONAL TELEX 12-7670
MERCHANDISE TAKEN ON CONSIGNMENT FOR TOP PRICES

Monday-Friday 9 A.M. to 6:30 P.M. Thursday to 8 P.M.
Saturday & Sunday 10 A.M. to 5 P.M. (Free Parking)

IRT/LEX-"Spring St. Station" Subways: BMT-"Prince St. Station", IND-"F" Train-Bay Station
Bus: Broadway #6 to Spring St. Path-9th St. 6th Ave. Station.

COMMERCIAL RADIOS STOCKED: ICOM Motorola, MAKON, Standard, Yaesu. We serve municipalities, businesses, Civil Defense, etc. Portables, mobiles, bases, repeaters.

ALL SALES FINAL

We Stock: AEA, APRF, Alinco, Ameco, Ameritron, Antenna Specialists, Assatic, Astron, B&K, B&W, Benchner, Bird, Butternut, CDE, CES, Cushcraft, Dawa, Eimac, Henry, Hill, Hustler, Hy-Gain, Icom, KLM, Kantronics, Larsen, MJF, J.W. Miller, Mirage, Nye, Palomar, RF Products, Saxton, Shure, Tempo, Ten-Tec, TUBES, Yaesu, Vibroplex, Duplexers, Repeater, Scanners, Radio Publications, Uniden, Kenwood, MAxon, RFC.

WE NOW STOCK COMMERCIAL COMMUNICATIONS SYSTEMS
HAM DEALER INQUIRES INVITED. PHONE IN YOUR ORDER & BE REIMBURSED

COMMERCIAL RADIOS Stocked & serviced on premises.
Amateur Radio Courses Given On Our Premises, Call
Export Orders Shipped Immediately. TELEX 12-7670

FAX: 212-925-7001

LINK COMM

NEW PRODUCT RLC-6

FEATURES:

- 3 HUB OR CHAIN LINKS
- LINK CW/VOICE ID'ING #
- S-COM 5K/6K CONNECTION
- CONNECTS TO MOST ALL REPEATER CONTROLLERS
- REQUIRES ONLY 3 LOGIC LINES FOR CONTROL

MC ONLY \$149.95 VISA

LED DISPLAY BOARD \$19.95
S-COM CABLE \$ 9.95

LINK COMM 306 SO 20TH BOZEMAN MT 59715 (406) 587-4085

CONTROLLER SPECIFIC

SMART REPEATER & LINK CONTROLLER

- DTMF MUTING
- INTELLIGENT ID'ER
- AUXILIARY OUTPUTS
- EASY TO INTERFACE
- REPEATER & LINK COURTESY TONES
- LOW POWER, 22ma @12V
- TELEMETRY RESPONSE TONES
- ALARM MONITOR INPUT
- SYNTHESIZED LINK/REMOTE BASE CAPABILITY WITH OPTIONAL P1-10/S SYNTHESIZER BOARD

SRC-10 - \$149.00/P1-10/S - \$39.00

REPEATER/LINK AUDIO MIXER INTERFACE

- FIVE AUDIO INPUTS
- THREE ADJUSTABLE AUDIO OUTPUTS
- CTCSS DECODER ON UAI-20 ONLY
- CONTROLLED DTMF ROUTING
- LOW POWER, 19ma @ 12V
- EASY TO INTERFACE
- LINK MONITOR-MIX/MONITOR MUTE CONTROL

UAI-10 - \$44.00/UAI-20 - \$89.00
ASSEMBLED & TESTED
ONE YEAR WARRANTY

CREATIVE CONTROL PRODUCTS

3185 Bunting Avenue
Grand Junction, CO 81504
(303) 434-9405

TOWERS by ALUMA

- TELESCOPING CRANK-UP
- GUYED STACK-UP
- TILT-OVERS

Easy to install. Low Prices. Crank-ups to 100 feet.

Over 36 types aluminum towers made—specials designed and manufactured—write for details.

EXCELLENT FOR AMATEUR COMMUNICATIONS

Mobile Truck Type

Roof Top Aluminum Type

Mobile Trailer Type

SPECIAL Four Section 50 Ft Van Mounted Crank-Up Alumina Tower

ALUMA TOWER CO.
BOX 2806HR
VERO BEACH, FL 32961-2806
(407) 567-3423 FAX 407-567-3432

THE ASDOTRON

COMPACT ANTENNAS FROM 160-10 METERS

NO TUNERS!
NO RADIALS!
NO RESISTORS!
NO COMPROMISE!

FOUR EXCELLENT REVIEWS JUST DON'T HAPPEN BY CHANCE.

CALL US FOR A FREE CATALOGUE.

*See review in Oct. 73, 1984 *Sept. 73, 1985
*March 73, 1986 *Dec. 88, CQ

BILAL COMPANY
137 Manchester Dr.
Florissant, Colo. 80816
(719) 687-0650

Amplifier Repair

Alpha - Ameritron - AMP - Henry
Dentron - Heathkit - TenTec - Etc.

35 Years Experience as the Service Manager with a major manufacturer

Authorized TenTec Dealer K4BWC

OMEGA ELECTRONICS
4209 Live Oak Road
Raleigh, NC 27604
919-832-1025

Visa & Master Card

ANTENNA TUNER WITH A NEW TWIST

Bob Baird, W7CSD, 3740 Summers Lane, Klamath Falls, Oregon 97603

find that the circuit commonly used in commercially built antenna tuners or transmatches leaves something to be desired (see Figure 1). Most use a tapped coil and selector switch. This can create problems, because on 10 meters a fraction of a turn on the coil may be critical. Also, you can't tap much closer than one turn. As compensation, the better units use a roller coil for continuous tuning. However, roller coils are expensive.

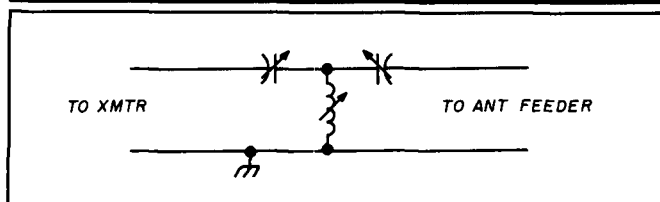
There's another problem with this circuit. It's basically a high pass filter. As Doug DeMaw and Bob Shriner have pointed out,¹ this sort of matching circuit does nothing for transmitter harmonics! I made note of a similar problem in an L network design some time ago. Older broadcast transmitters used "inductive" neutralization by means of a coil that was a bit too large in series with a large variable capacitor to achieve an effective variable inductor. Roller coils that operate at 10,000-volts RF or more are hard to come by. The large capacitor gave a small value of X_C and consequently a small value of IX_C , the voltage across the capacitor. This meant that the variable element for the neutralization process was a reasonably spaced capacitor which gave continuous tuning over a limited range (see Figure 2).

If you look at Figure 3, you'll notice that the series elements are inductive and the shunt element is capacitive. This is a basic low pass filter which will indeed do something for any harmonics present. Broadcast stations have been using this kind of matching network for years, for exactly the same reason. But you need two roller coils isolated from ground to build this circuit, and this would be expensive for the average ham.

How to do it inexpensively

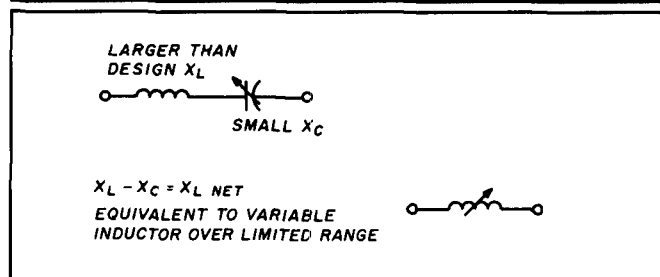
Suppose you were to replace the top of the "T" roller coils with tapped coils and series capacitors, giving a net variable L. The result is shown in Figure 4. Some time ago, I saw a nice forty-turn 2-inch diameter coil for a bargain price. I bought it, even though I had no particular project in mind. It turned out to be an Air-Dux no. 375-7433-PI, but any similar coil will do. I center tapped the coil and used it as the top of the "T." I was uncertain about the coupling effect of both

FIGURE 1



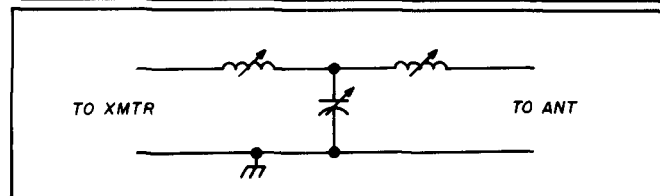
Popular and effective T match transmatch circuit used by many Amateurs. Although easy to build, this circuit is basically a high pass design and offers no attenuation of transmitter harmonics.

FIGURE 2

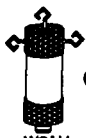


Making a fixed inductor variable. Capacitor in series with inductor is equal to smaller value inductor that is variable over a limited range. In practice a larger value inductor than the design calls for would be needed to compensate.

FIGURE 3



Low pass T match transmatch circuit offers good harmonic attenuation. Finding two suitable roller inductors can be both difficult and expensive.



UNADILLA ANTENNA MANUFACTURING CO.

PO Box 4215 BV-Andover-MA-01810
(508) 475-7831 9am-5pm EST (508) 474-8949 24HR FAX



W2AU
(1:1 & 4:1)

THE BIG[®] SIGNAL

W2DU
(HF&VHF)

Amateur Antenna Baluns

For over 20 years, preferred by Amateur, Military and Commercial Operators. Assembled with all stainless steel hardware and a built-in lightning arrester *minimizes your TVI, maximizes your power.*

Transformer Baluns

For medium power (1000 watts RF minimum) and broadband operation 3-40 MHz.

W2AU 1:1

50/50 or 75/75Ω

Dipoles, V's

Beam Models, Quads

W2AU 4:1

200/50 or 300/75Ω

Hi-Impedance Antennas

(ie: Folded Dipoles)

Non-Transformer Baluns

W2DU-HF

1.8-30 MHz

3000-9000W

1500-5000W



w/1:1 SWR

w/2:1 SWR

W2DU-VHF

30-300 MHz

2000-4000W

1200-2400W

Contact Your Local Ham Dealer Today!!!

Call or write direct for our informational

brochure on our other fine products

Trape-Antenna Kits-Filters-Center Insulators-ENDsulators™-Coaxial Relays
All products come with a 30 Day Warranty

-NOTICE-

We are the **NEW** manufacturers of the original

JAMES MILLEN™ Products
(508) 475-7831 9am-5pm EST

W6SAI BOOKS

by noted HR columnist Bill Orr, W6SAI.

ALL ABOUT VERTICAL ANTENNAS

Theory, design, construction and operation are fully covered for vertical antennas. Grounds and their importance get extra emphasis. Construction data for 25+ antenna designs. 192 pages ©1986 1st edition

RP-VA

Softbound \$10.95

THE RADIO AMATEUR ANTENNA HANDBOOK

Covers all kinds of antennas from HF to VHF, horizontal to vertical. Compiled from years of W6SAI's extensive writings. Great reference volume to have on hand. Check full of proven antenna designs that work! 190 pages ©1978 1st edition

RP-AH

Softbound \$11.95

INTERFERENCE HANDBOOK by W6FQG

With homes rapidly filling with vulnerable electronic equipment, knowing how to solve interference problems is a must. W6FQG has years of experience and tells you everything you need to know to solve even the thorniest interference problem. © 1981 1st edition

RP-IH

Softbound \$11.95

THE RADIO HANDBOOK 23rd edition

Great technical resource to have available in your Ham workshop. Full of all kinds of projects, antennas and the best compilation of HF and VHF amplifiers in the Amateur Radio field. Includes new easy-to-use charts, graphs and tables. Best value in Amateur Radio today. 1200 pages ©1986 23rd edition

22424

(Reg \$29.95 SAVE \$3)

Hardbound \$26.95

Please enclose \$3.75 shipping and handling

HAM RADIO

Greenville, N.H. 03048



Order today! (603) 878-1441
or "FAX" us (603) 878-1951

133

NUTS & VOLTS MAGAZINE

P.O. Box 1111-H
PLACENTIA, CA 92670
714-632-7721



Ham Radio
Computer Hardware
Computer Software
Plans-Kits
Schematics
Test Equipment
CB Gear
Satellite TV
Video
Components
Antique Electronics
Cable TV
Publications
Repairs-Services
New Products
Events Calendar

IF YOU ARE INTO ELECTRONICS AND SAVING MONEY IS IMPORTANT TO YOU, THEN YOU OWE IT TO YOURSELF TO TRY NUTS & VOLTS MAGAZINE. DISCOVER WHY THOUSANDS OF SMART PEOPLE NATIONWIDE TURN TO NUTS & VOLTS EACH MONTH TO MEET THEIR ELECTRONIC NEEDS. WHETHER YOU'RE BUYING, SELLING, OR JUST TRYING TO LOCATE THOSE UNIQUE OR HARD-TO-FIND ITEMS, FIND OUT HOW NUTS & VOLTS CAN HELP!

SUBSCRIBE TODAY!

CHECK MONEY ORDER VISA MC

Name _____

Address _____

City _____

State _____ Zip _____

Card No. _____ Exp. Date _____

CALL FOR ADVERTISING INFORMATION
DISTRIBUTOR INQUIRIES INVITED

Subscription Rates

U.S. FUNDS REQUIRED

3rd Class Mail - USA

One Year \$12.00

Two Years \$21.00

Lifetime \$60.00

1st Class Mail

One Year - USA \$20.00

Canada & Mexico \$22.00

Air Mail

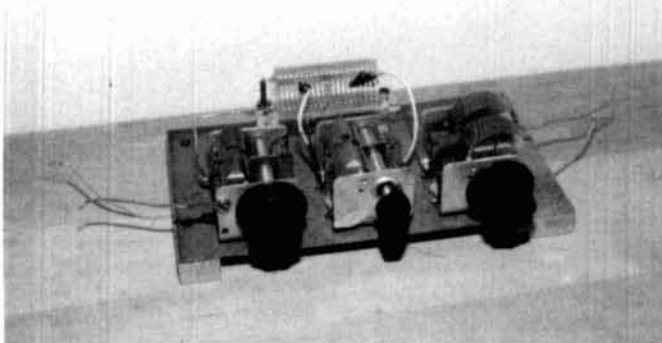
Foreign - 1 Year \$55.00

Includes one FREE 40-word
Classified Ad

Toll Free ORDERS Only Line
1-800-783-4624

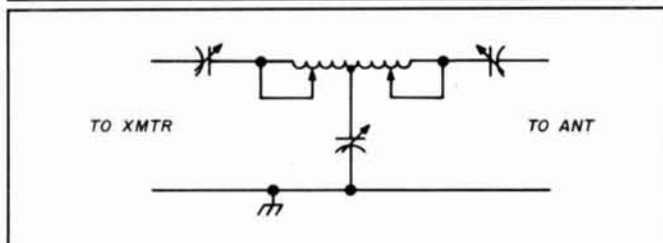
A National Publication For The Buying And Selling Of Electronic Equipment

PHOTO A



Author's breadboard version of tuner offers simple uncluttered construction and quick access to the traveling alligator clips. Note that insulated knobs and shaft extensions should be used on high power models to protect the operator from RF burns. W71JK photo.

FIGURE 4

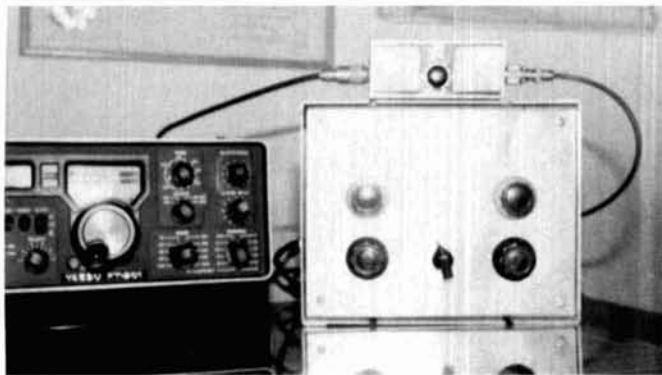


Roller inductor problem solved! Conventional Air-Dux coil, with alligator taps, is used instead of cumbersome roller inductors. The variable capacitors, salvaged from old broadcast receivers, allow finite adjustment of the inductor settings.

halves of the coil, but it worked fine. I used capacitors from old radios; many of them are available in lots of bargain sheets. Mine are two gang, but I only use one half. I used the breadboard in **Photo A** and traveling alligator clips in place of a rotary switch to determine if the circuit would really work. It did! A shielded box isn't absolutely necessary, but it might help reduce TVI. If your primary goal is to match a random length wire while camping, you can just use the breadboard.

I used the tuner briefly on an 80-meter dipole which had an SWR of 1.7:1 in the phone band, a 40-meter dipole, and

PHOTO B



Final version of tuner enclosed in shielded metal case offers better confinement of harmonic energy. Note that the capacitor bodies are RF hot and are mounted floating above ground. Cabinet is roomy enough to permit future installation of an internal SWR meter. W71JK photo.

a triband cubical quad with an SWR of greater than 1:1. I adjusted all of these easily to a 1:1 SWR. At my cabin in the woods I have a 400-foot wire, 60 feet high, fed on one end with open wire feeders (see *Ham Radio Horizons*, October 1979). I achieved a 1:1 match on all bands, 10 through 80, with this tuner.

Photo B shows the finished product in an aluminum box with two tap selector switches. The space at the top of the box is reserved for a built-in SWR meter. You needn't use a box this big; I simply had this one on hand.

High power

Obviously, this coil isn't meant for a kilowatt, nor are the capacitors. The unit works well with an FT 101. If you run a kilowatt of power, and are only interested in the 10, 15, and 20-meter bands, a ten-turn coil made out of 1/4-inch copper tubing will suffice. You could even use a hinged lid box and some husky traveling clips to avoid large contact selector switches. If you do this, you'll need medium spaced transmitting capacitors.

I hope you'll try this tuner. I've found that it really does discriminate against harmonics. **hp**

REFERENCES

1. Doug DeMaw, W1FB, and Bob Shriner, WA0UZO, "Matching the Transmitter to the Load," *QST*, February 1980, page 22.
2. Bob Baird, W7CSD, "Designing Impedance-matching Systems," *Ham Radio*, July 1973, page 58.

HUGE 88 PAGE CATALOG

- Communications Receivers
- Portable Receivers
- Amateur Transceivers
- HT's & Mobile Transceivers
- Amateur & SWL Antennas
- Scanners
- RTTY and FAX Equipment
- Books, Manuals & Accessories

Send \$1 to
Universal Radio
 1280 Aida Drive Dept. HR
 Reynoldsburg, OH 43068
 Tel. 614 866-4267

"ONLINE" U.S. CALL DIRECTORY

Hamcall service gives you *all* hams via your computer & modem. Updated each month! Only \$29.95 per year. Unlimited use - you pay for phone call.

BUCKMASTER PUBLISHING

Route 3, Box 56
 Mineral, Virginia 23117
 703/894-5777 visa/mc 800/282-5628

HI-PERFORMANCE DIPOLES

Antennas that work! Custom assembled to your center freq. as band advise ht. of center and each end - hanging inverted - V - horizontal, vert. dipole, sloping dipole - commercial quality - stainless hardware - legal power - no-trap, high-efficiency design - Personal check, MO or C.O.D. (\$3)

MPD-5*	80-40-20-15-10M max performance dipole 87' long	\$105 ppd
MPD-2	80-40M max performance dipole, 85' long	\$62
HPD-3*	160-80-40M hi-performance dipole 113' long	\$79 ppd
SSD-4*	160-80-40-20-15-10M space-saver dipole 71' long	\$125 ppd
SSD-5*	80-40-20-15-10M space-saver dipole-specify L. 42'	\$105
SSD-4*	80-40-20-15M space-saver dipole-specify L. 46'	\$93
	80' \$ 98 ppd	

*9-bands with wide-matching-range tuner.
 SASE for catalogue of 30 dipoles, slopers, and space-saving, unique antennas
 708-394-3414 **W9INN ANTENNAS**
 BOX 393 MT. PROSPECT, IL 60056

NEW BOOKS

1990 EDITIONS

1990 RADIO AMATEUR CALLBOOKS

NORTH AMERICAN EDITION

Fully updated and edited to include all the latest FCC and foreign government call signs and addresses for Hams in North America. Includes plenty of handy operating aids such as time charts, QSL bureau addresses, census information and much more. Calls from snowy Canada to tropical Panama. Now is the time to buy a new Callbook when you'll get the most use out of your investment. ©1989.

CB-US90 **Softbound \$27.95**

INTERNATIONAL EDITION

QSLs are a very important part of our hobby. All sorts of awards, including the coveted DXCC, require confirmation of contact before the award can be issued. Of special interest, addresses are being added daily for Hams in the USSR and other countries. While in no means complete, it's a start and will be of tremendous help in getting QSLs. Handy operating aids round out this super book value. ©1989.

CB-F90 **Softbound \$29.95**

BUY'EM BOTH SPECIAL
Reg. \$57.90 Only \$52.95 SAVE \$4.95

The 1990 ARRL HANDBOOK

Revised and updated with the latest in Amateur technology, now is the time to order your very own copy of the world famous ARRL HANDBOOK. In addition to being the definitive reference volume for your Ham shack, there are plenty of projects for every interest in Amateur Radio—from antennas for every application to the latest state-of-the-art projects—you'll find it all in the 1990 HANDBOOK. Over 1100 pages. ©1989.

AR-HB90 **Hardbound \$22.95**

MORE NEW BOOKS

1990 EQUIPMENT BUYER'S GUIDE edited by Peter O'Dell, WB2D, CQ Magazine

Here's the latest listing of equipment available from all of the different manufacturers. Full of hand-to-have information, facts and tidbits. Great reference to have when you are shopping around for a new rig. ©1989.

CQ-EQP **Softbound \$4**

PACKET RADIO is MADE EASY by Buck Rogers, K4ABT

Noted CQ Magazine columnist, K4ABT leads you step-by-step on how to set up a packet station. First defines and explains all the workings of packet communications. Gives you interconnection instructions for most radios, computers and MFJ/TNCs. Also includes a glossary of packet terms and definitions that are very useful to all levels of packet interest. ©1989.

MFJ-PRME **Softbound \$9.95**

SPACE ALMANAC by Tony Curtis, K3RXX

Complete database almanac is an unbelievable value! 955 pages jammed full of just about every bit of information you could want—including space stations, shuttles, unmanned satellites, rockets and astronauts to name just a few areas covered. Also includes plenty of reference tables, charts, maps, diagrams, drawings, photos and much more. 35+ pages on Ham Radio in space. ©1989.

AS-SA **\$19.95**

Please enclose \$3.75 shipping & handling

HAM RADIO'S BOOKSTORE

Greenville, NH 03048

603-878-1441 FAX (603) 878-1951



NEW SOFTWARE

WA9GFR COMMUNICATIONS ENGINEERING version 3.1 by Lynn Gerig, WA9GFR

Interesting program that will allow you to predict communications ranges based upon your station's operational capabilities. Useful from 3.5 MHz to 3.5 GHz. Also includes helpful Smith chart program for any type of matching network. Provides impedance results in both tubular and high resolution Smith chart graphics. Great value at a low price.

GFR-DOS (MS-DOS) **\$19.95**

GFR-C64 (Commodore C-64) **\$19.95**

MICROSMITH Smith Chart Utility Program MS-DOS

by Wes Hayward, W7ZOI

MicroSmith is a working Smith chart that has been optimized for impedance matching applications. The user can modify all variables to meet specific matching goals. Includes a clear and concise tutorial that all levels of interest will find helpful. Complete text explanations with graphs aid full comprehension of the material.

WH-MS (MS-DOS) **\$29.00**

W2GGE CONTEST PROGRAMS (MS-DOS)

by Jack Schultz, W2GGE

Great contest logging programs! Written in machine language for maximum flexibility and speed. Compatible with most MS-DOS PCs. Shows log, countries worked, all band score on screen. Super fast dupe checking. Prints out log, checklist, and QSLs.

GGE-AR ARRL DX Contest (6000 QSO's per contest) **\$39.95**

GGE-WPX CQ Prefix Contest (5000 QSO's per band) **\$39.95**

CONTEST PROGRAMS (MS-DOS)

by John Berg, KA1HYU and Clint Wise, W1XN

If you haven't yet done a contest with a computer, you're missing one of life's true pleasures! No more dupe or log sheets strewn around your operating table. Instantaneous scoring eliminates hours of work at the end of the contest. Print out the dupe sheets and log, fill out the entry and mail to the contest committee. The following contest logs are available (ALL MS-DOS):

BW-DX ARRL DX Contest **\$39.95**

BW-WPX CQ Prefix Contest **\$39.95**

BW-C60 CQ 160 Contest **\$39.95**

HAM RADIO'S BOOKSTORE

Please enclose \$3.75 shipping and handling.



Greenville, NH 03048 • (603) 878-1441

SATELLITE ESSENTIALS

Satellite TV is still full of the wonderment that made it so popular in the early '80s. The tinkerers are there, the programming is there, and never has the cost of becoming a dish owner been so low.

So, how do you find out about this exciting entertainment?

Through publications devoted specifically to satellite TV, that's how!

ONSAT

America's Weekly Guide To Satellite TV

OnSat is unsurpassed for the most up-to-date listings of satellite programming. Dr. Dish, Mailbag, and the Transponder Service Watch are all geared to help you make the best use of your satellite TV system. A sample issue can be obtained for only \$1.

STV GUIDE

The Complete Monthly Guide To Satellite TV

STV Guide contains over 300 pages of programming information, product reviews, home troubleshooting, and information about satellite TV. A sample issue can be obtained for only \$2.

Both OnSat and STV Guide contain listings for over 120 channels and Prime Time Grids for over 50 channels. Subscribe to either the weekly OnSat or the monthly STV Guide for only \$48 per year.

To start receiving the best in satellite TV guides and information, call toll-free (800) 234-0021. VISA® and MasterCard® accepted.

STV Guide/OnSat

PO Box 2384 • Shelby, NC 28151-2384

Elmer's Notebook

Tom McMullen, W1SL

Elementary Electronics — Wrapping Up AC Theory

In my April and May columns I looked at inductances and capacitors and the way they affect alternating current. This month I'll show you what happens when you have both of them in a circuit, and discuss some unusual terms that apply when working with complex circuits.

Current, voltage, and phase revisited

Remember that an inductance causes the voltage to lead the current through a circuit, while a capacitor has the opposite effect. But how do you calculate power in a circuit if the current isn't in phase with the voltage?

The term power factor, abbreviated pf (don't get this mixed up with picofarad, or pF) comes into play here. Power factor is usually expressed as a number less than 1, like 0.6, 0.85, and so on. Some people use it as a percentage like 55 or 92 percent. More about that later.

Power factor is determined by the ratio of true power to apparent power. **Figure 1** shows a circuit with an inductor, a resistor, and meters to measure applied voltage and the current that's flowing. Apparent power is determined by multiplying the voltage by the current, just as you do in a DC circuit. However, in this situation the result is expressed in volt-amperes, or VA, instead of watts. This difference is important, as you'll see in a moment. True power, as you might suspect, is what's being dissipated in the resistive part of the circuit.

Because the inductor stores energy in its magnetic field during one part of an AC cycle and releases it when the cycle reverses polarity, it doesn't dissipate any energy (unless the magnetic field intercepts something nearby). This means you can ignore the inductor as far as power consumed is concerned. You work only with the resistance. In the case shown in **Figure**



1, the ammeter shows 8 A flowing in the circuit; the resistor is 17 ohms. Using Ohm's Law, $P = I^2R$, $8^2 = 64 \times 17 = 1088$ watts. Note that you're using watts here, not volt-amperes. The power dissipated in the resistor is real power. You can feel it as heat when you touch the resistor. In circuits that don't have a physical resistor, there's still resistance present in wires in the inductance, transformer, electric motor, or whatever equipment you're using. The power dissipated as heat will show up as a warm (or overheated) inductor, motor, and so on. You can determine the power factor for this circuit. Apparent power equals $E \times I$, or 200×8 , or 1600 VA. You previously determined that the true power in the circuit is 1088 watts, so $1088/1600 = 0.673$, or 67.3 percent.

So why bother with volt-amperes and power factor if you know the true power in the circuit? There are several reasons to be aware of VA and pf. It's very important to provide the correct size of wire and components in a circuit. Also, you don't want to overload the circuit's AC source (generator, amplifier, etc.). If, in the preceding example, you had planned for a wire size and gener-

ator size capable of handling true power (just over 1000 watts), the extra 600 watts could do real damage.

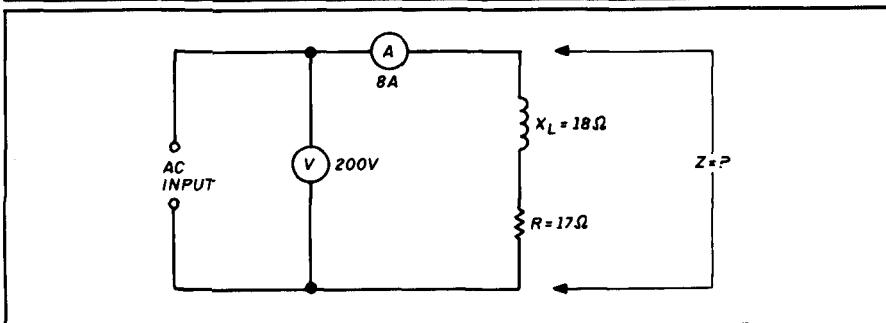
Here's another way to determine the power factor of that circuit. The circuit has an inductive reactance of 18 ohms and a resistance of 17 ohms in series. By using the information on vectors from my earlier columns, and doing a bit of intuitive reasoning, you might guess that the vector of these values would come out close to 45 degrees. (The vector is the hypotenuse of resistance plotted horizontally and the reactance plotted vertically. The resistance and reactance are only 1 ohm different in value). With a vector of 45 degrees, the impedance will be approximately 1.414 times either the resistance or the inductive reactance. Therefore, impedance (Z) = $1.414 \times 18 = 25.45$ ohms. You can work this out another way to see how close it comes. The formula says that:

$$Z = \sqrt{(R^2 + XL^2)} = \\ \sqrt{(17^2 + 18^2)} = \\ \sqrt{(289 + 324)} = 24.758 \text{ ohms.}$$

That's pretty close to our vector "guesstimate" of 25.45. Round this off to 25 ohms. With 200 volts applied to the circuit, current (I) = E/Z , or 8 A. This gives an apparent power of 200×8 , or 1600 VA, confirming your first calculation.

You can find the true power with this information by obtaining the power factor. A different way to find the pf is to use the ratio of the resistance to the

FIGURE 1



A simple AC circuit with inductance and resistance in series. The impedance, Z , is discussed in the text.

impedance:

$pf = R/Z$, or $17/25 = 0.68$. Now find the true power by multiplying. $VA \times pf$ equals the true power in watts, or $1600 \times 0.68 = 1088$ watts — which is what the resistor appears to be dissipating. Using Ohm's law again, $I = P/E = 1088/200 = 5.44$ A appear to flow in the resistor.

Where's the extra current going? It's building up a magnetic field in the inductor in one half cycle, and returning to the circuit during the other half cycle. It's not lost, but does flow in the wiring and must be taken into account.

Inductance and capacitance combined

It should be apparent that if you can get the power factor back to near 100 percent, many of the problems will disappear. Everything I've just discussed in relation to inductive reactance applies to capacitive reactance. So if capacitors cause the current to lead the voltage, why not put a capacitor in the circuit to bring things back to normal? That's exactly what's done in many cases where a severe power factor problem exists.

I've placed a capacitor in series with the inductance in **Figure 2**. The capacitor has a reactance of 12 ohms. (Remembering the discussion of the "j" operator, you can say the reactance is $-j12$.) The impedance formula now becomes:

$$Z = \sqrt{(R^2 + XL - SC)^2}, \text{ or}$$

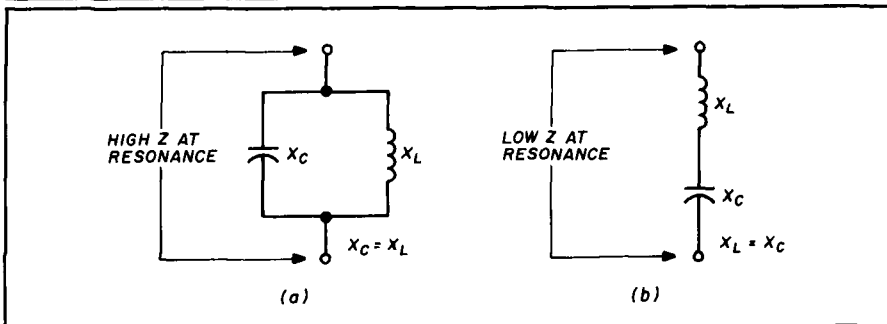
$$\sqrt{(17^2 + 18 - 12)^2}, \text{ or}$$

$$\sqrt{(289 + 36)}, = \sqrt{325}, \text{ or}$$

$$Z = 18.02 \text{ ohms.}$$

Now, put Ohm's law to work on some other numbers:

FIGURE 3



A resonant circuit results when the capacitive reactance and inductive reactance are equal but opposite. A parallel circuit is shown at (a); a series circuit at (b).

$I = E/Z = 200/18 = 11.1$ A, and
 apparent power = $E \times I = 200 \times 11.1 = 2,220$ VA, and
 true power = $I^2 \times R = 123.2 \times 17 = 2094$ watts;

therefore,
 power factor = $2094/2220 = 0.94$, or about 94 percent.

That's a significant improvement. Note that the current flow has increased because the phase difference between voltage and current is smaller.

The resistance is now the more significant part of the circuit. By selecting the right value of capacitance, you can obtain a pf that's very close to 100 percent. As usual, circuit losses will prevent perfection.

That's heavy stuff and while not directly applicable to most of what you do in Amateur Radio, it's part of AC theory — a basic foundation for all electronics.

Resonant circuits

You've seen how inductances delay current flow and capacitances advance current flow. What happens

when you connect them together, as in **Figure 3**?

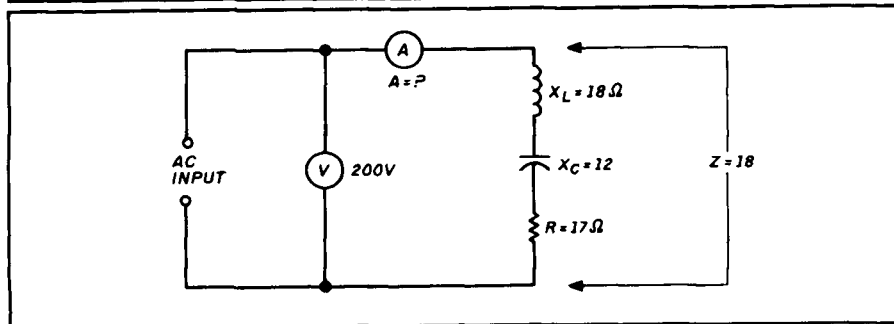
A simple explanation is that each makes up for the other's actions, or they balance each other out. Another explanation is that they form a resonant circuit. The requirement for resonance is that "the capacitive reactance and the inductive reactance must be equal and opposite at the frequency of interest." This works whether they are connected in parallel (**Figure 3a**) or in series (**Figure 3b**). This tuned circuit concept is basic to operation of radio equipment. It lets you separate one signal from another, reject a wide spectrum of signals while accepting others, and generate and amplify your transmitted signal while rejecting harmonic and spurious energy. The basic purpose of the circuit you need dictates which configuration you choose.

If you want a circuit that will reduce the signals outside a band while allowing those inside to pass, you want a parallel circuit (**Figure 3a**). This is because the parallel circuit appears as a high impedance to any signals at its resonant frequency. But off-resonance signals see a low resistance and are shunted to ground. By making either the inductance or capacitance variable, you can "tune" the circuit to a desired frequency, as is done in the front end of a receiver or in the output stage of a transmitter.

If you want to "trap" a frequency and keep it from passing, you can connect an L and C in series (see **Figure 3b**). A series resonant circuit has a very low impedance at its resonant frequency, and signals at this frequency will be shunted to ground while others will not.

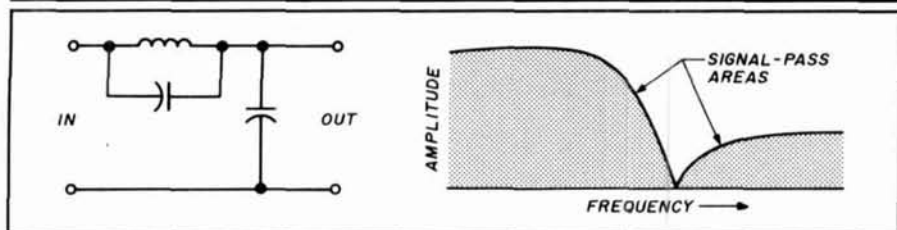
Most of the bandpass and band-reject filters used in modern Amateur

FIGURE 2



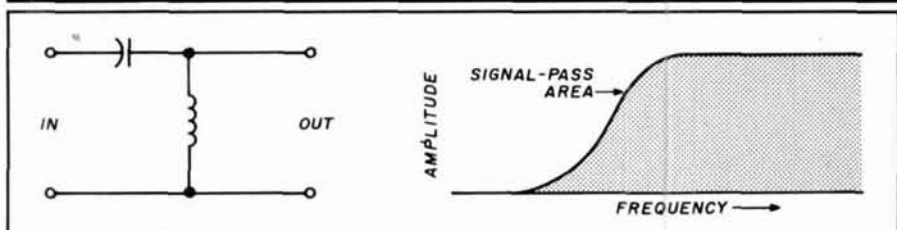
The circuit of **Figure 1** with a capacitor added in series. This changes the power factor and the current flowing, as shown in the text.

FIGURE 4



A circuit that allows low frequencies to pass while rejecting higher ones, commonly called a low pass filter.

FIGURE 5



A circuit that passes high frequencies while rejecting the lower ones, commonly called a high pass filter.

Radio equipment are variations of these circuits used in combination. These filters are used in the front end and IF stages to accept Amateur band frequencies and reject those out of the band. In the transmitter stages, they're used to get rid of harmonics and spurious signals before they reach the antenna. Modern low power filter circuits are all pretuned and switched in and out as you change bands. This means you must perform very few adjustments when changing frequency.

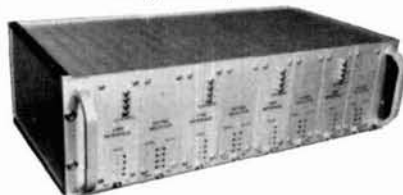
Figure 4 shows a typical low pass circuit and its resultant response; Figure 5 shows a high pass circuit and its response curve. By designing combinations of these circuits so that portions of the high and low pass areas overlap, you can create a bandpass circuit that allows only a selected part of the spectrum to pass while rejecting everything outside that band.

Further reading

Alternating current theory is far too involved to cover completely in these pages. If you choose to explore the subject further you'll encounter such interesting terms as conductance, admittance, and susceptance. You'll find ways to calculate the effects of parallel reactances, complex series reactances, and so on. For those of you who are interested, the various Amateur Handbooks have good chapters dealing with AC theory. *Radio Communications*, by R.L. Shrader (McGraw-Hill), is an excellent resource. Shrader includes self-exam questions designed to help those studying for either a commercial radiotelephone license or an Amateur radio license.

Coming soon: a packet radio update. Then I'll move on to other things you'll need to know to enjoy our great hobby. **hr**

SIGNAL-TO-NOISE Voting Comparator



Improve coverage by adding receivers

- Expandable to 32 Channels
- Continuous Voting
- 19" Rack Mountable
- Select/Disable Switches for Manual Override
- Can be used with RF Links or Dedicated Lines
- LED Indicators
- Hundreds in Service
- More

—Competitively Priced—

For more information call or write:

Doug Hall Electronics
815 E. Hudson St.

Columbus, Ohio 43211 • (614) 261-8871

✓ 138

Electronic Repair Center Servicing

Amateur Commercial Radio

The most complete repair facility on the East Coast.

Large parts inventory and factory authorized warranty service for Kenwood, Icom and Yaesu.

SEND US YOUR PROBLEMS

Servicing "Hams" for 30 years, no rig too old or new for us.

HAMTRONICS, INC.

4033 Brownsville Road
Trevose, Pa. 19047
215-357-1400



SURPRISE!



We have the largest collection of commercial (non PD) ham radio software in the world. Luckily, it is for the friendliest computer in the world: MACINTOSH. Check us out, before you buy your next computer. *Simply the best!*

ZCo Corporation

P. O. Box 3720, Nashua, NH 03061
(603) 888-7200 Fax (603) 888-8452

✓ 139



Factory Authorized Dealer & Service For

**KENWOOD
YAESU
ICOM**

**Call Us For
Great Prices & Great Service**

TOLL FREE ORDER LINE 1-800-344-3144
Continental U.S. & Texas

KENWOOD, INC. SAN ANTONIO, TEXAS
THE HAM CENTER
SALES AMATEUR RADIO SERVICE

5707A Mobud San Antonio, Texas 78238 (512) 680 6110
FAX (512) 647 6007

✓ 140

THE RF CONNECTION

"SPECIALIST IN RF CONNECTORS AND COAX"
NEW FOR DAYTON 1990

Tired of low quality, unstable VHF/UHF/SHF transverters?
See the solution at booths 156/157 at the Dayton Hamfest.

Linear transverters with stable, phased locked LO's.
Choice of temperature compensation or oversized reference
crystals. Perfect for lower mounting SHF models.

Fully shielded phased locked reference oscillators with
dual outputs +7dbm @ 50 ohms.

Phased locked FM only transmitters and receivers.

83-822	PL-259 Teflon, Amphenol	1.75
PL-259/ST	UHF Male Silver Teflon, USA	1.50
UG-21D/U	N Male RG-8, 213, 214, Amphenol	3.25
UG-21B/U	N Male RG-8, 213, 214, Kings	4.00
9913/PIN	N Male Pin for 9913, 9086, 8214	
	fits UG-21D/U & UG-21B/U N's	1.50
UG-21D/9913	N Male for RG-8 with 9913 Pin	3.95
UG-21B/9913	N Male for RG-8 with 9913 Pin	5.75
UG-146A/U	N Male to SO-239, Teflon USA	6.00
UG-83A/U	N Female to PL-259, Teflon USA	6.00

"THIS LIST REPRESENTS ONLY A
FRACTION OF OUR HUGE INVENTORY"

THE R.F. CONNECTION
213 North Frederick Ave. #11
Gaithersburg, MD 20877

(301) 840-5477

VISA/MASTERCARD: Add 4%
Prices Do Not Include Shipping

✓ 141

Say You Saw It in Ham Radio

HAMS SHOULD BE SEEN AS WELL AS HEARD!!

A PICTURE IS WORTH 100 WPM/CW!

ANY LICENSE CLASS HAM CAN COMMUNICATE USING
LIVE TV ON THE UHF AND UP FREQUENCIES. TRANSMIT
ANY VIDEO SOURCE, COMPUTER, PACKET, RTTY, VIDEO
TAPE, LIVE CAMERA, NASA SATELLITE FEEDS, HAM
MEETINGS, PUBLIC SERVICE ACTIVITIES, WEATHER, ETC.

READ AND LEARN ABOUT HAM TV ACTIVITY, PROJECTS,
PUBLIC SERVICE AND VIDEO COMMUNICATIONS IN EACH
ISSUE OF AMATEUR TELEVISION QUARTERLY, DEVOTED
ENTIRELY TO HAM TV



SUBSCRIPTIONS: \$15 US, \$20 CANADA,
\$25 ELSEWHERE. SAMPLE \$4

ATVQ

AMATEUR TELEVISION QUARTERLY MAGAZINE

1545 LEE ST. SUITE 73

DES PLAINES, IL 60018

708-298-2269

20th ANNUAL INDIANAPOLIS HAMFEST™

**And CENTRAL DIVISION ARRL CONVENTION
And COMPUTER SHOW**

July 7-8, 1990

Marion County Fairgrounds — Gates open 6:00 AM both days

2 Full Days of: Commercial Exhibitors, Large Flea Market, Hourly Awards, Forums

FREE: Parking, Kids Awards, Camping, Womens Awards

**Indiana's Largest Electronic Flea Market,
Amateur Radio and Computer Display**

INDIANAPOLIS HAMFEST, P. O. Box 11776, Indianapolis, IN 46201

For Information Call: (317) 356-4451

DIVERSITY RECEPTION ON HF DIGITAL COMMUNICATION

*Stephen M. Hall, WM6P, 664 Bristol Avenue,
Simi Valley, California 93065*

The use of diversity reception in radio communication isn't new to either commercial or Amateur stations. It's been used successfully since the 1940s to improve RTTY signal copy. In the past, this technique normally involved switching between two or more receivers based on strength of the received signals. In the reception of high frequency packet radio, signal strength alone is usually insufficient to judge the quality or completeness of a received packet of digital data.

I've conducted some experiments to evaluate the improvement in reception on HF packet radio when multiple antenna polarity diversity is used. Here are the results of those tests.

Initially, I assembled two parallel HF packet stations to measure and compare the performance of different modems and terminal node controllers (TNCs) available to Amateur packeteers. I extended these tests to include enhancements in reception using two antennas and two receivers, both tuned to the same frequency. The antennas I used in the test were a horizontally polarized four-element beam at 60 feet and a 1-wavelength Zepp, center fed with kW twin lead and a balanced tuner. The Zepp was supported by the common tower in a sloper configuration; polarization was primarily vertical. During my early tests, I used two Kantronics KAMs with individual video displays. I placed them side by side, so I could observe the performance of each parallel system in real time. The receivers I used in various parts of the tests included a Kenwood TS-

930S, Kantronics KT-120, and Collins 51J-3 (R-388). I tested various modes, among them were AMTOR, RTTY, and packet.

I observed deep fades on both horizontal and vertical polarization, but the fade wasn't normally seen on opposing polarities at the same time. At times the fading was as great as 40 dB on 14 MHz; it would alternate or cycle between polarizations at rates of between approximately 1/2 to 4 seconds per cycle.

My observations of the two video terminals on RTTY and AMTOR modes revealed reception errors which alternated between displays. The incidence of simultaneous error reception was less frequent. It appeared that a large improvement in copy would be achieved if the two channels' signals could be merged into a single display. On packet, I saw frames from the same station alternating regularly between terminals. I was seeing unique packets — those copied on one TNC but not the other — on a single screen more frequently than I was seeing them on both terminals' screens simultaneously.

The use of an additional antenna which would take advantage of a second polarity appeared to be a technique worthy of greater investigation. After several hours of observation, I could see the obvious benefits of this technique. Fortunately, a program was developed which would let me measure the improvements using my computer.

This terminal program lets me gather statistics using an

IBM-AT computer. I can interface two communication ports on the computer to two terminal node controllers. The system can then count the total number of packets received by each KAM and the number of packets received uniquely by each one. I'm able to measure the improvement provided by an addition of a second channel or system.

I ran tests to measure systematic errors in the software, like the failure of the computer to properly count packets common to both channels and unique to each. No errors were observed. Then I ran further systematic tests to establish that all variations between channels would be due to antenna performance alone. I took off-the-air audio from a single receiver and fed it to both KAMs. I observed diversity between the KAMs alone; one unit consistently received 1 percent more packets than the other. I didn't find this surprising. What was surprising was that when two terminal node controllers were used in parallel, 14 percent more unique packets were received — even though the TNCs were demodulating the same audio. I was observing TNC diversity. These observations were consistent with those I had made using the two video terminals without the aid of the computer. The addition of a second TNC contributed 434 additional packets out of an average of 3064 received by the two units.

At this point, I connected the second antenna to allow polarity diversity reception. I ran tests at different times over several days on 14.109 MHz on the SKIP-NET packet network. I chose SKIP-NET because most of the stations in this net are generally in the pattern of both antennas. I pointed the beam northeast from my southern California receiving location. The Zepp antenna slopes in a similar direction, but the pattern is difficult to predict because of its wavelength.

The station received an average of 3344 packets using diversity; 2935 were received on the vertically polarized antenna and 3753 were received by the channel using the horizontally polarized beam. I believe that the difference in performance between the two antennas was due to antenna gain rather than polarization. I used both receivers and KAMs in a series of configurations to rule out the possibility that the differences were due to anything other than those contributed by the antennas. On the average, only 1305 packets of 3344 average total packets were received on both channels — an incidence level of 39 percent. Use of the second channel added 61 percent more unique packets. This seems to indicate that if the majority of net users were to incorporate this improvement, network loading would be significantly improved due to the elimination of many retries.

My observations on other digital modes appeared to demonstrate similar improvements, but I was able to gather statistics using fairly simple computer techniques only with packet. Because data with errors won't be presented to the output of the TNC, all data counted by the computer is known to be good. This isn't the case with monitored AMTOR or RTTY. Other techniques would have to be used with these modes to use a computer to gather statistics. If new terminal unit software were written for AMTOR which would allow users to take advantage of diversity, it's possible that even larger gains could be realized than those on packet, as individual AMTOR character groups could be compared or combined.

It would be impractical to use additional transmitter power

or a single higher gain antenna to obtain improvements of this magnitude. Improving existing nondiversity performance by using more power would only load the frequency further and slow the passage of traffic on the network. An inherent advantage in using diversity is that it doesn't require that both stations participate. A single user may add the capability and enjoy the results independent of other stations. Other techniques that have been proposed to improve HF packet, like changes in baud rate, frequency shift, or modulation technique, would require substantial changes to all Amateur packet stations to maintain compatibility within the network. This would be difficult to achieve as there are large numbers of stations using the current standards.

Because there's more to communicating on packet than data reception, the TNC must acknowledge each received information frame while connected when this technique is used in other than monitor mode. If two TNCs are used, they must work in concert to maintain a proper connection with another station. This would require new software within the two interconnected TNCs, or a dual port TNC to monitor two incoming signals from two independent receiver/antenna systems. One TNC port would act as a primary; the second TNC would contribute packets not received on the primary channel. The TNC's microprocessor would compare data received on each channel and send acknowledgments for correct frames received on either channel.

Other statistics showed that, based on total packets received and independent of the use of diversity, the gain antenna received 27 percent more packets than the Zepp.


The experimental installation

I used the following hardware to add diversity to my station. When I included the second channel, I added a second receiver. I already owned a TS-930S, which has proved to be a good performer on HF packet. Kantronics provided a monoband KT-120 for my tests, and I also tested a Collins 51J-3 purchased at the Dayton Hamvention® for \$100. Both proved quite suitable for packet reception. I used my existing 66-foot Zepp without modification with excellent results.

With suitable controller software, you need no other equipment. Only one video display is normally required for diversity packet or AMTOR, though I used two in the experimental configuration. Even when I grouped the lesser antenna, TNC, and receiver as the second channel, their contribution accounted for a 56-percent improvement when compared with the primary beam antenna, TNC, and better receiver.

Conclusions

Because I anticipated only modest gains using this technique, the tremendous improvement in reception which resulted was a surprise. I hope that suitable software for the currently available TNCs will be developed by the packet community or the manufacturers of multimode controllers which will allow diversity to be incorporated in HF packet stations. I have spoken with TNC manufacturers who wish to add this capability to their dual port designs. In some cases, this will be as simple as making firmware upgrades available on EPROM.

I wish to thank Phil Anderson, W0XI, and Karl Medcalf, WK5M, of Kantronics for their generous support of both time and equipment, which allowed me to pursue these experiments in digital diversity. 

MADISON ★ ★ ★ SHOPPER

CALL FOR ORDERS: 1 (800) 231-3057
1 (713) 520-7300 or 520-0050

NEW BEGINNING MAY 15
1 (713) 729-7300 or 729-8800
FAX 1 (713) 358-0051

TEXAS ORDERS CALL COLLECT.
ALL ITEMS ARE GUARANTEED OR SALES PRICE REFUNDED.



New Yaesu FT-1000D Trades wanted
Kenwood TH215A, TH25AT Trade in your old HT
TS440 S/AT Call
New Kenwood TM 731A, mobile Call
ICOM IC 24AT Call



TS 790A Superior 2 Meter 70 cm Rig. Call
1.2 GHz Option Available 99.00
BW VS 300A 12.00
Penta 6146B 79.00
Penta 572B 99.00
Penta 3-500Z 12.00
Penta 811A 79.00
Penta 4CX250B 2695.00
Icom 765 629.00
NYE MB5A Tuner 33.00
Alpha Delta Transirap HV 489.00
CSI Private Patch V

Ampire VHF, UHF GaAsFET preamps Call
831SP-PL259 Silverplate (Amphenol) 1.50
82 61 N Male (Amphenol) 3.50
82-202-1006 N Male (9913) 3.50
Double Female UHF 1.00
UG176 RG8X each 40
Surplus Elbow PL259 SO239 each \$1
Receiving tubes 50-90% off list price Call
3 Amp RF Meter, 2.5" Round New, Boxed 30.00
25 pF/10KV Doorknob Cap 5.00
100mFd/450V axial cap 4.00
Throat Mike (new m4 surplus) 5.00
Yaesu FT 747, 757/II Call
GGTE Morse Tutor 18.00



New Kenwood TS 950-SD Call
Ameco PT 3 Pre Amp 99.00
Larsen 2-meter on glass 49.95
Anteco 2M, 5/8, Mag Mount, Comp 25.00
YAESU FT-1000D Call for price



Kenwood TS 1405 Call for trade
Van Gordon Windom WA2 44.00
Bird 43, elements/stock Call
Thousands of panel meters 3.95 up CALL
Belden 9913, 8267, 8214 Stock Call
MICA Capacitors Call

USED EQUIPMENT

All equipment, used, clean, with 90 day warranty and 30 day trial. Six months full trade against new equipment. Sale price refunded if not satisfied.

(800) 231-3057

POLICIES

Minimum order \$10.00. Mastercard, VISA, or C.O.D. All prices FOB Houston, except as noted. Prices subject to change without notice. Items subject to prior sale. Call anytime to check the status of your order. Texas residents add sales tax. All items full factory warranty plus Madison warranty.

Bird and Belden products in stock. Call today.

3621 FANNIN
HOUSTON, TEXAS 77004

MADISON

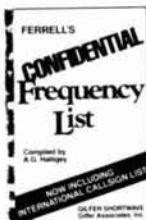
JUNE 1
12310 ZAVALLA STREET
HOUSTON, TEXAS 77085

143

GILFER — first in Shortwave

GILFER'S FAMOUS "CONFIDENTIAL FREQUENCY LIST" — \$19.95

Popular Communications magazine says: "Can't imagine anyone attempting to listen to HF voice or CW/RTTY communications without a handy copy." Recognized worldwide as the indisputable leader and most comprehensive list of SW in the 4-28MHz region. Over 30,000 frequencies with call sign, country, details covering aero, marine, embassy, weather, press, feeders, INTERPOL, time, channel marker and more. Now includes special section on worldwide FAX and RTTY stations. Charts also included. Add \$2 USA; Overseas add \$4 surface, \$10 air.



VISIT GILFER'S STORE

Easy to find, accessible from New York City. Take Garden State Parkway (NE portion of N.J.), Exit 172. Gilfer is in the center of Park Ridge, opposite the Borough Hall. Store hours: M-F 10am-5pm, Sat. 10am-3pm.



GILFER SHORTWAVE

52 Park Ave, Park Ridge, NJ 07656, Ph 201/391-7887

144

COMET

ANTENNAS FOR THE PROFESSIONAL AMATEUR

"NEW" DUAL & TRI BAND SUPER "LINEAR" ANTENNAS

MODEL	FREQUENCY	GAIN	POWER	LENGTH	USE
CA-2X4Z	146 MHz	8.2dB	200W	15' 4"	BASE/REPEATER
	446 MHz	11.5dB			
CA-2X4FX	146 MHz	4.5dB	200W	5' 11"	BASE/REPEATER
	446 MHz	7.2dB			
CA-2X4M	140-155 MHz	4.5dB	150W	5'	MOBILE
	440-460 MHz	7.0dB			
CA-2X4SR	146 MHz	3.8dB	150W	3' 4"	MOBILE
	446 MHz	6.2dB			
CX-901	146 MHz	3.0dB	150W	3' 6"	BASE/REPEATER
	446 MHz	6.0dB			
	1.2 GHz	8.4dB			
CX-801	146 MHz	3.0dB	100W	3' 3"	MOBILE
	446 MHz	6.8dB			
	1.2 GHz	9.6dB			
CA-630TN	146 MHz	2.15dB	150W	1' 5"	MOBILE
	446 MHz	2.15dB			
	1.2 GHz	5.5dB			

NEW! ULTRA COMPACT SWR/POWER METERS



CM-200 144-150 MHz
CM-300 200-250 MHz
CM-400 420-460 MHz
CM-420 140-460 MHz
CM-900 850-950 MHz
CM-1200 1250-1350 MHz

DEALERS INQUIRIES WELCOME

CALL YOUR DEALER



1275 N. Grove St.
Anaheim, CA 92806
(714) 630-4541
FAX (714) 630-7024

142



PacComm

- Advanced Technology
- Enduring Value

New!

MICROSAT PSK

The 1st Non-Kit Satellite Modem!

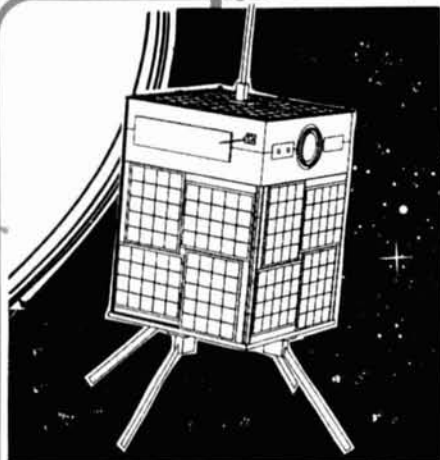
Featuring high performance at low cost!

Only \$219⁹⁵

- Completely assembled and tested - not a kit!
- Supports 1200 baud MSK transmit and PSK receive for MICROSAT access
- Supports 1200 baud PSK transmit and receive for terrestrial use
- Receives 400 baud satellite telemetry signals
- Doppler shift compensating radio tuning interface
- Easily attaches to any TNC modem disconnect header, cable provided
- Telemetry signals output via RS-232 port

AVAILABLE IN DECEMBER

For complete info & specifications
Call (813) 874-2980 To Order, Call
Toll Free: 1-800-223-3511
Major Credit Cards Accepted!



PacComm • 3652 West Cypress Street • Tampa, Florida 33607

Please send more info on the MICROSAT PSK Modem FREE Catalog

Name _____ Call _____

Address _____ Ph# _____

State _____ Zip _____ Card# _____ Exp. Date _____

MONEY BACK GUARANTEE! Add \$4.00 shipping/handling per order. FL residents add 6% sales tax.
Major Credit Card give number, expiration and signature. FAX: 813-872-8696

✓ 149

NEMAL ELECTRONICS

- *Complete Cable Assembly facilities MIL-STD-45208
- *Commercial Accounts welcome- Quantity pricing * Same day shipping most orders
- *Factory authorized distributor for Alpha, Amphenol, Belden, Kings, Times Fiber

Call NEMAL for computer cable, CATV cable, Flat cable, semi-rigid cable, telephone cable, crimping tools, D-sub connectors, heat shrink, cable ties, high voltage connectors.

HARDLINE 50 OHM

FXA12 1/2" Aluminum Black Jacket.....	89/ft
FLC12 1/2" Cablewave corr. copper blk jkt	1.69/ft
FLC78 7/8" Cablewave corr.copper blk jkt	4.25/ft
NM12CC N conn 1/2" corr copper m/ft	25.00
NM78CC N conn 7/8" corr copper m/ft	54.00

COAXIAL CABLES (per ft)

1180 BELDEN 9913 very low loss	55
1102 RGB/U 95% shield low loss foam 11ga	36
1110 RGBX 95% shield (mini 8)	17
1130 RG213/U 95% shield mil spec MCV jkt.....	39
1140 RG214/U dbl silver shld mil spec.....	1.85
1705 RG142B/U dbl silver shld, teflon ins	1.50
1310 RG217/U 50 ohm 5000 watt dbl shld	98
1450 RG174/U 50 ohm .100" od mil spec	14

ROTOR CABLE-8 CONDUCTOR

8C1822 2-18ga and 6-22ga	25
8C1820 2-18ga and 6-20ga	39

Prices do not include shipping, \$3 minimum, Visa/Mastercard \$30 min, COD add \$3.00
Call or write for complete price list. Nema's new 40 page CABLE AND CONNECTOR SELECTION GUIDE is available at no charge with orders of \$50 or more, or at a cost of \$4 with credit against next qualifying order.

NEMAL ELECTRONICS, INC. 12240 NE 14th Ave. N. Miami, FL 33161
(305) 893-3924 Telex 6975377 24hr FAX (305)895-8178

CONNECTORS-MADE IN USA

NE720 Type N plug for Belden 9913	\$3.95
NE723 Type N jack for Belden 9913.....	4.95
PL259AM Amphenol PL25989
PL259TS PL259 teflon ins/silver plated.....	1.59
PL258AM Amphenol female-female (barrel).....	1.65
UG175/UG176 reducer for RG58/59 (specify).....	.22
UG21DS N plug for RG8,213,214 Silver.....	3.35
UG83B N jack to PL259 adapter, teflon	6.50
UG146A SO239 to N plug adapter, teflon	6.50
UG255 SO239 to BNC plug adapter, Amphenol.....	4.29
SO239AM UHF chassis mt receptacle,Amphenol.....	89
UG88C BNC plug RG58, 223, 142.....	1.45

GROUND STRAP-GROUND WIRE (per ft.)

GS38 3/8" tinned copper braid40
GS12 1/2" tinned copper braid50
GS200 1-1/2" heavy tinned copper braid	2.00
HW08 8ga insulated stranded wire39
AW14 14ga stranded Antenna wire CCS14

✓ 148

BLACK DACRON® POLYESTER ANTENNA ROPE

- UV-PROTECTED
- HIGH ABRASION RESISTANCE
- REQUIRES NO EXPENSIVE POTTING HEADS
- EASY TO TIE & UNTIE KNOTS
- EASY TO CUT WITH OUR HOT KNIFE
- SIZES: 3/32" 3/16" 5/16"
- SATISFIED CUSTOMERS DECLARE EXCELLENCE THROUGHOUT U.S.A.

LET US INTRODUCE OUR DACRON® ROPE TO YOU • SEND YOUR NAME AND ADDRESS AND WE'LL SEND YOU FREE SAMPLES OF EACH SIZE AND COMPLETE ORDERING INFORMATION.

Dealer Inquiries Invited



MANUFACTURED BY
synthetic textiles, inc.
2472 EASTMAN AVE., BUILDING 21
VENTURA, CALIFORNIA 93003
(805) 658-7903

✓ 147

SYNTHESIZED SIGNAL GENERATOR

MADE IN USA



MODEL
SG-100F
\$429.95
delivered

- Covers 100 MHz to 199.999 MHz in 1 kHz steps with thumbwheel dial • Accuracy +/- 1 part per 10 million at all frequencies • Internal FM adjustable from 0 to 100 kHz at a 1 kHz rate • External FM input accepts tones or voice • Spurs and noise at least 60 dB below carrier • Output adjustable from 5-500 mV at 50 Ohms • Operates on 12 Vdc @ 1/2 Amp • Available for immediate delivery • \$429.95 delivered • Add-on accessories available to extend freq range, add infinite resolution, AM, and a precision 120 dB attenuator • Call or write for details • Phone in your order for fast COD shipment.

VANGUARD LABS

196-23 Jamaica Ave., Hollis, NY 11423
Phone: (718) 468-2720 Mon. thru Thu.

✓ 148



Custom Call Sign

AMATEUR RADIO

W1AW

1923-H EDWARD LN
MERRICK, NY 11566

- Adheres to glass (interior) or metal
- Instant transfer car to car
- 2 1/4"x8" flexible plastic sign for cars, trucks or RVs. "Amateur Radio" + your call in white lettering. Order Magnetic or Suction mounted version. Choose black, blue or red background. \$8.50 ea.; 2/\$15 ppd. Quick delivery.

BATTERIES "R" US...

You've bought our replacement batteries before...
NOW YOU CAN BUY DIRECT FROM US, THE MANUFACTURER!



ICOM
CM2, BP2 7.2v @ 500MAH
CM5, BP5 10.8v @ 500MAH
SUPER
7S 13.2v @ 1200 MAH \$63.95
8S 9.6v @ 1200 MAH \$59.95
(base charge only-1" longer)
ICOM CHARGERS AVAILABLE

FOR ICOM: CONVERTIBLE BATTERY



8 Cells — Alkaline
or NICAD Holder
Complete with (8)
Alkaline Batteries
\$26.00

BP-7
13.2v @ 500MAH \$61.95
13.2v @ 600MAH \$64.95
BP-8
8.4v @ 800MAH \$61.95
8.4v @ 1000MAH \$64.95



JUNE SPECIAL

LESS 10% ON ALL
KENWOOD
REPLACEMENT
BATTERY PACKS

KNB-1
PB-1
KNB-4
PB-6 (KNB-5)
PB-7 (KNB-6)
PB-8 (KNB-7)

Look for JULY's
Special of the month.



CUSTOM MADE BATTERY
PACKS & INSERTS
Made to your specifications.
Introductory Offer!
KENWOOD INSERTS
PB-21-\$13.75, PB-25-\$20.00,
PB-26-\$20.00
ICOM INSERTS
BP-5-\$23.00, BP-3-\$17.45,
BP-7, BP-8



MasterCard and Visa
cards accepted. NYS
residents add 8 1/4%
sales tax. Add \$3.50
for postage and
handling.



SOURCE FOR ALL YOUR COMMUNICATION
BATTERY REPLACEMENT NEEDS.

W & W ASSOCIATES

29-11 Parsons Boulevard, Flushing, N.Y. 11354

WORLD WIDE DISTRIBUTORSHIPS AVAILABLE. PLEASE INQUIRE.

In U.S. & Canada Call Toll Free (800) 221-0732 • IN NYS (718) 961-2103 • Telex: 51060 16795 • FAX: (718) 461-1978

MADE IN
THE USA

Send for free
catalog &
price list!

✓ 145

Improve Your World Image



PC HF FACSIMILE 4.0 \$99

A complete facsimile reception system
for the IBM PC or Compatible. Receives
up to 16 intensity levels.

Includes:

Demodulator Software
Frequency List
80 Page Manual
Tutorial Cassette
Interpretation Guide

Features:

Print on Epson, or HP Laser Jet
Disk Save, Zooming, Image processing
Unattended Image Capture and much more

PC GOES/WEFAX \$250

Designed to receive images directly from
U.S. and Soviet meteorological satellites.
Includes all of the above feature plus
a complete orbital tracking system and
resolution of up to 256 gray levels.

Software Systems Consulting
150 Avenida Cabrillo, "C", San Clemente, CA 92672
(714)-498-5784

✓ 123

Go First Class on GAP Airwaves with the CHALLENGER DX-V or New CHALLENGER DX-VI

Unique Multiband Antennas that Utilize the Patented
GAP Elevated Launch Technology

The Revolution in Antenna Design

That...

- Launches RF from an elevated
- Eliminates earth loss
- Comes pre-tuned. No adjustments necessary
- Uses 3 short radials = 25 feet
- Assembles in less than 30 minutes
- Is self supporting w/drop in ground mount and is 31 feet high

but has NO!!!

- Traps
- Coils
- Transformers
- Baluns
- Resistors
- or Base Insulators

Challenger DX-V \$199*

Total bandwidth on
40, 20, 15, 10 meters
80 kHz on 80 meters

Challenger DX-VI \$219*

Total bandwidth on
40, 20, 15, 12, 10 meters
130kHz on 80 meters

Best of all the ENTIRE antenna is always active!!

To Order Call—(407) 388-2905

*Plus shipping and handling
Florida residents add 6% tax



GAP
ANTENNA PRODUCTS
6010—Bldg J
N. Old Dixie Highway
Vero Beach FL 32967

✓ 146

MADISON "NEW" SURPLUS

CALL FOR

ORDERS: 1 (800) 231-3057
1 (713) 520-7300 or 520-0050

1 (713) 729-7300 or 729-8800
FAX 1 (713) 358-0051

TEXAS ORDERS CALL COLLECT.

ALL ITEMS ARE GUARANTEED
OR SALES PRICE REFUNDED.



Receiving Tubes \$1.00-\$5.00
4-1000A 150.00
GE 8072 195.00
100TH 35.00
833A 75.00
6CL6 9.00
4CX1000A 400.00
4CX1500B 400.00
5CX1500A 750.00
Eimac 3CX2500A3 400.00
Syl 3CX2500F3 400.00
4CX10000 1000.00
807 5.00
SK 516 75.00
SK 806 50.00
New RG-9B/U 40' w/N male . . . 50.00

New RG-14A/U 40' w/HN male 50.00
Surplus Elbow PL259-SO239 . . . 1.00
Double Male BNC 4.00
UG-201 A/U Adapter N male/
BNC female 4.00

USED EQUIPMENT

All equipment, used, clean, with 90 day warranty and 30 day trial. Six months full trade against new equipment. Sale price refunded if not satisfied.

(800) 231-3057

POLICIES

Minimum order \$10.00. Mastercard, VISA, or C.O.D. All prices FOB Houston, except as noted. Prices subject to change without notice. Items subject to prior sale. Call anytime to check the status of your order. Texas residents add sales tax. All items full factory warranty plus Madison warranty.
Bird and Belden products in stock. Call today.

Amphenol Silver Plate PL259 . . . 1.50
8261 N Male 3.50
N Male For 9913 3.50
3 Amp RF Meter 2.5" new boxed
Other sizes available . . each 30.00
25 pf 5. KV Door Knob 15.00
200 pf 7.5 KV Door Knob 20.00
.001 μ f 10 KV Axial 1.95
.0015 μ f 10 KV Axial 1.95
Throat mike (new) 5.00
600 Ω military ear piece (new) . . . 5.00
455 kHz if xformer 50
Cinch 12 pin plug (fit Drake) . . . 2.00
PHC 10 amp switching 12 amp max
4 pounds 69.00
Ameco Books, Hi-Pass Filters . . Call

3621 FANNIN
HOUSTON, TEXAS 77004

MADISON

JUNE 1
12310 ZAVALLA STREET
HOUSTON, TEXAS 77085

Engineering Consulting's computer controlled Ham Shack
See system variables, control & reprogram all via packet!
Ultra Comshack 64 Repeater Controller
HF & VHF Remote Base*Autopatch*CW Practice*Rotor Control
*Voice Meters*Paging*Logging*Polite ID's*Packet Voice B.B.S.

Model CS64S \$359.95
Includes: Interface, disk, cables, Manual
Ultra Options

FT 757; 767; 980; 736; 747
TS 440; 940; 140
IC 735; 761
VHF
FT 727R; 767; 736
TS 711; 811; 680

Controller Features
*Change variables remotely from touchtones or Packet
*Unlimited voice vocabulary!
*Alarm Clock, auto execute
*Individual 4 digit user codes
*Disk & Printer logging of users, tel #'s, lapsed time
*18 Rotating Polite ID's
*16 External relay controls
*2, 5, & CTCSS Tone Paging
*CW Practice with voice
*Security mode, T.tone mute
*Voice announces each user call sign when logging on

Autopatch & Reverse
*1000 (18 digit) tel #'s stored
*Quick dial & quick answer
*Directed, general page
*Selected restricted patch
*Telephone control input
Dual Combined Remotes
*18 Macro/Scan memories
*Scan up/down; 100Hz steps
*Monitor & lock modes
*Operate splits, combine HF & VHF radios as Dual VFO's
*Automatic mode selection
*Talking S Meter; Voltmeter
*Voice Beacon rotating msg.

Decode-A-Pad
Touchtone to RS232
300 Baud Interface
Use with all computers
Decodes 16 touchtones
Includes Basic program
DAP \$99.95

12 Volt C64 SWITCHER
Crystal 60Hz
9VAC SV. 2A.
C64 & 1541
DCPS \$129.95

Computer Control
YAESU FT-727R
Mini Cat
Allows H.T. to scan 100 Channels & programs H.T. for field use! Digital "S" Meter; comment fields; auto resume & delay; Scan Lock-outs; Loads FT727 in 15 sec. Hardware, cables, & disk included for C64 or IBM
Model 727 \$49.95

Touchtone Decoder
4 digit sequence; & QUAD expansion 4 relay option
2"x3" TS DQ
8/20 V & audio in; Field Program 50,000 Codes; Mom. & Latching; DPDT Relay; Wrong digit reset; LED for digit valid & latch; inc. 24 Pin connector
QUAD option adds: four 2 Amp. relays; 5 digit master on/off control for each relay.
TS DQ \$89.95 QUAD \$99.95

Model 727 \$49.95

AUDIO BLASTER
IC02; 04; 2AT; FT-727; 411; 209; 470; 73/23; U16; TH25
Miniature Audio Amp.
Module installs inside all H.T.'s
1 watt audio amp | When it needs to be loud! Installs in 15 Min. Used by police, fire!
Model AB1S \$24.95

New Digital Voice Recorder
*Records 32 or 64 Sec. studio quality audio
*Use for auto CQ, ID tail, Mailbox, Local or logic control; Up to 16 selectable messages!
Includes: 1 Watt audio amp; 1 Meg RAM; Mic & Spkr Jacks, vol. control; Req. 9 to 12V; Interfaces to Ultra Com Shack 64 Ver 8.0; Provides Digital Voice CQ, ID tail, Mailbox, bulletins
DVM \$179.95

ENGINEERING CONSULTING
583 GANDLWOOD ST.
BREA, CA 92621
TELEPHONE: 714-671-2009
FAX: 714-255-9984

We accept: C.O.D.'s
MasterCard, VISA, Disc
AMERICAN EXPRESS
add \$4.00 S/H U.S.A.
*Ca. residents add 6%



HAM BOOKSTORE RADIO

GREENVILLE, NH 03048

(603) 878-1441
FAX (603) 878-1951



Please enclose \$3.75 shipping & handling

LOW BAND DX'ING COMPUTER PROGRAMS

by John Devoldere, ON4UN

Just about every interest or need is covered—from antenna design and optimization to general operating programs. Antenna programs include: shunt and series input L network design, feedline transformer, shunt network design, SWR calculation, plus 11 more! General Ham programs include: sunrise/sunset, great circle distances, grayline, vertical antenna design program, sunrise calendar plus 9 more! The best value in computer software available today.

- © 1986.
- UN-Apple IIe/IIc \$39.95 ea.
- UN-MS (MS-DOS) \$39.95 ea.
- UN-CPM/Kaypro \$39.95 ea.
- UN-C-128 (COMMODORE) \$39.95 ea.
- UN-MAC (MACINTOSH) \$49.95

LOW BAND DX'ING

by John Devoldere, ON4UN

Now Available! The new, 2nd edition of the definitive book on Low Band DX'ing. Based upon years of practical on-the-air experience, learn the secrets of how ON4UN has been so successful on the low bands. Extensive coverage is given to transmit and receive antennas with clear concise explanations and plenty of illustrations—dipoles, inverted V's, slopers, phased arrays and Beverages—they're all in this book. Also covered: propagation, transmitters, receivers, operating, software and an extensive Low Band bibliography. Going to be a best seller! Get yours today. © 1987 2nd Edition. 200 pages. Softbound \$39.95

AR-UN

ON4UN PRACTICAL YAGI DESIGN (MS-DOS)

by John Devoldere, ON4UN

This comprehensive Yagi design program is based upon tested antennas, not theoretical un-proven models. Contains 100 different HF antennas, designed, tested and optimized by ON4UN. Also contains a number of classic designs by noted antenna experts W2PV, W6SAI and others. Includes mechanical design of elements and of the rotating mast. You can also add to the database your own designs. Fully detailed "Read.me" file is designed to help the user get maximum results from the program.

© 1989.
 ON-YAGI (MS-DOS)

\$59.95

Garth Stonehocker, KØRYW

SUMMER SHORT SKIP SIGNALS

Each summer during June, July, and August, plus a week or so into May and September, short skip DX is enhanced. Short skip is propagation from the E region of the ionosphere, about 100 km above the earth. The geometry of propagation from a transmitter to a receiver, with a reflection height of 100 km tangent at the earth at each end (zero takeoff angle), defines the maximum distance for a hop at 2000 km (1200 miles). This enhancement results as the ionization produced near that height is moved horizontally (bunched together) by the electrojet current from the geomagnetic electric field into high density ion clouds. The clouds average in area about 40 by 500 miles wide and 6 miles thick.

These thin ion clouds are embedded in the regular E layer created during the daylight hours by the sun's ultraviolet light. The E layer supports a maximum signal frequency of 3.8 MHz at local noon during sunspot maximums. A signal can be increased up to 19 MHz and still be reflected if it hits a cloud because of the higher ion density and this reflection. Yes, reflection. The regular E is gradually bent down, or refracted, while the sharper edge of the thin cloud causes a more mirror-like reflection downward. The location of the ion clouds is similar to that of scattered weather clouds in the sky — hence the name sporadic E (Es). Because the E layer increases with the number of sunspots, the embedded Es clouds' ion density also increases. This is the only sunspot effect on mid-latitude Es. It is almost constant, and occurs every summer.

There are areas of the world where sunspots affect Es propagation because of increased geomagnetic disturbances. Larger numbers of higher intensity Es clouds develop where the geomagnetic and geographic equators are widely spaced in latitude — near Southeast Asia, South America, and Africa. The greater electrojet current that develops in these areas leads to this increased Es cloud



formation. Es also varies with the number of sunspots on the equatorward edge of the auroral zone, where particles enter the E region from the solar wind. The solar wind increases when the sun's spots flare (brighten). As a result, many clouds of Es which help with VHF auroral propagation develop in this region.

Now look at short skip Es signals. For a given distance, Es signal strength is an average of 12 dB greater than that of regular E signals as a result of the mirrored reflection. The signal strength is usually compared to the free space loss or signal decrease with distance at the frequency of transmission. A formula for relating this in decibels (dB) is:

$$L_b = 20 \log_{10} d + 20 \log_{10} f + 98.88 \quad (1)$$

where d is distance in miles, f is frequency in MHz, and 98.88 is a constant set by a relationship to the reference antenna used in the measurements, the units used for d and f , and the normalized path attenuation in the locations where the measurements were made. Therefore, the formula can be used at any location, one hop distance, or any frequency band. Just subtract the dB for L_b from the free space loss of this formula:

$$L_f = 20 \log_{10} d + 20 \log_{10} f + 36.58 \quad (2)$$

The units in **Equation 2** are the same as those in **Equation 1**. These formulas for the E region can be used to obtain the signal loss or, inversely, the signal strength's lowest value at a probability of near 10 percent.

Last minute forecast

The higher frequency bands will be best the first two weeks of June. The lower bands become strongest during the third and fourth weeks. Expect dis-

turbances from the 5th to 8th due to solar flares, and from the 10th to 14th and the 20th to 24th as a result of decreasing solar flux and coronal holes. As the month passes, the build-up of thunderstorm noise will be increasingly evident towards the evening of each day. Es propagating modes will also build up during the month. The moon will be full on June 8th and at perigee (its closest approach) on June 21st. Summer solstice occurs on the 21st at 1533 UTC. The Aquarid meteor shower starts around the 18th, peaks about the 28th, and lasts until August 7th. The maximum radio echo rate will be 34 per hour.


Band-by-band summary

Six meters will provide occasional openings to South Africa and South America around noontime via multihop short skip E_s propagation.

Ten meters will have long skip conditions for many hours in the afternoon during the peak times of the 27-day solar cycle. Otherwise, look to sporadic E short skip and multihop openings around local noon for DX on this band. (Evening transequatorial openings usually don't occur in the summertime.)

Twelve, 15, and 17 meters, almost always open to some southern part of the world, will be the main daytime DX bands. Operate on 12 first; then move down to 15. DX is considered 5000 to 7000 miles on these bands. You may find some long one hop transequatorial propagation paths early in the month.

Twenty, 30, and 40 meters will support DX propagation from most areas of the world during the daytime and into the evening hours most days. DX on these bands may be either long skip to 2500 miles or short skip E_s to 1250 miles per hop. There are many good hours of DXing ahead during the long summer days.

Thirty, 40, 80, and 160 are all good for nighttime DX. Although the background thunderstorm noise is becoming noticeable, these bands are still quiet enough to provide good DX working conditions. Sporadic E propagation may contribute to enhanced conditions at local sunset and will occur more often during the next three months. 

WESTERN USA

GMT	PDT	N	NE	E	SE	S	SW	W	NW
0000	5:00	10	17	15	10	10	10	10	10
0100	6:00	10	17	15	10	12	10	10	10
0200	7:00	10	20	17	10	12	10*	10*	10
0300	8:00	10	20	17	12	15	10	10	10
0400	9:00	10	20	17	12	20	10	10	10
0500	10:00	12	17	15	15	20	10	10	10
0600	11:00	12	15	10	15	20	10	10	12
0700	12:00	15	15	10	15	20	10	10	12
0800	1:00	15	17	12	17	20	10	12	12
0900	2:00	17	20	20	17	20	12	15	15
1000	3:00	17	17	15	20	20	12	15	15
1100	4:00	20	15	12	17	20	15	17	17
1200	5:00	17	15	10	15	20	15	17	20
1300	6:00	15	12	10	12	20	17	20	17
1400	7:00	15	12	10	10	30*	17	17	17
1500	8:00	15	12	10	10	30	17	17	17
1600	9:00	15	10	10	10	30	17	17	20
1700	10:00	15	10	10	10	17	12	17	17
1800	11:00	17	10	10	10	15	10	20	17
1900	12:00	17	10	10	10	12	10	12	15
2000	1:00	20	12	12	10	12	10	10	15
2100	2:00	17	12	12	10	10	10	10	12
2200	3:00	15	15	15	10	10	10	10	12
2300	4:00	15	15	15	10	10	10	10	10

JUNE

MID USA

MDT	N	NE	E	SE	S	SW	W	NW
6:00	17	15	15	10	12	10	10	10
7:00	17	17	15	10	15	10*	10*	10
8:00	15	17	17	10	15	10	10	10
9:00	15	20	17	12	17	10	10	10
10:00	10	20	17	12	20	10	10	12
11:00	10	30	15	15	20	10	10	15
12:00	10	17	15	15	20	10	10	15
1:00	10	20	20	15	20	10	10	15
2:00	12	17	17	17	20	12	12	17
3:00	12	17	15	17	20	12	15	17
4:00	15	15	12	20	20	15	15	20
5:00	15	15	10	17	20	15	15	17
6:00	17	15	10	15	20	17	17	17
7:00	17	12	10	12	30	15	17	15
8:00	20	12	10	10	30	15	17	15
9:00	17	12	10	10	30	17	17	15
10:00	15	12	10	10	17	17	17	20
11:00	15	12	10	10	17	12	20	17
12:00	15	10	10	10	15	10	20	17
1:00	15	12*	10	10	15	10	12	15
2:00	15	12	12	10	15	10	10	15
3:00	17	12	12	10	12	10	10	12
4:00	17	12	12	10	10	10	10	12
5:00	27	15	15	10	12	10	10	12
6:00	20	15	15	10	10	10	10	10

EASTERN USA

CDT	EDT	N	NE	E	SE	S	SW	W	NW
7:00	8:00	12	15	15	10	15	10*	10*	10
8:00	9:00	12*	15	15	10	15	10	10*	10
9:00	10:00	15	17	17	10	17	10	10	10
10:00	11:00	15	30	17	12	20	10	10	12
11:00	12:00	15	20	17	12	20	10	10	15
12:00	1:00	15	30	15	15	20	10	10	15
1:00	2:00	15	20	15	15	20	10	10	17
2:00	3:00	15	17	20	17	20	12	12	17
3:00	4:00	15	17	15	17	20	12	15	20
4:00	5:00	15	15	12	17	20	15	15	17
5:00	6:00	12	15	10	15	20	17	17	17
6:00	7:00	12	15	10	12	30	15	17	15
7:00	8:00	10	12	10	10	30	15	17	12
8:00	9:00	10	12	10	10	30	15	17	12
9:00	10:00	10	12	10	10	30	15	17	15
10:00	11:00	10	12	10	10	30	17	17	15
11:00	12:00	12	12	10	10	30	17	17	20
12:00	1:00	12	12	10	10	20	15	20	17
1:00	2:00	15	12*	10	10	17	12	20	17
2:00	3:00	15	12	10	10	15	10	20	15
3:00	4:00	17	12	10	10	15	10	10	15
4:00	5:00	17	12	10	10	15	10	10	12
5:00	6:00	30	12	12	10	15*	10*	10	12
6:00	7:00	15	15	15	10	15	10	10	12
7:00	8:00	15	15	15	10	15	10	10	10

The worldwide acceptance of professional Ramsey service and lab equipment is giving us a chance to take a fresh look at the always-growing lineup of economical Ramsey ham kits and Mini-kits. Now that we're set up in our new factory building, we're working to make all our kits more fun and interesting than ever to build and to use. As we release both new kits and familiar ones with new step-by-step assembly manuals, we first want to say THANK YOU to all of you who have built our kits from brief instruction sheets. YOU are the people who showed us that U.S. hams, hobbyists and young newcomers really DO want to save money, learn and have fun by building your own electronic gear. Thanks!

If you've built our kits before, send us a SASE with your next order (marked with kit model number), include proof of purchase, and we'll be glad to send you the new instruction book as soon as it is ready.

If you can't make it to a major hamfest soon, call us, fax or mail your order for some of those kits that you've been wanting to try out. Check our Condensed Kit Listing on this page: Ramsey Kits are easier and more fun than ever!

Our Order Terms remain simple and friendly, and we hope to hear from you soon.

73 from the Hams at Ramsey!

John, N2HWA/VP5JR
Jim, KB2FEC

Bruce, WA2TMC
Tom, WA2YTM

COM-3
THE COMMUNICATIONS
SERVICE MONITOR THAT
WORKS HARDER FOR LESS.



TERMS: 10-day money-back guarantee • MC, Visa, personal checks welcome • COD is USA only and costs an extra \$4, and we need certified check or cash on COD's over \$50 • All shipping is UPS, so we need street address • Try to plan a \$20 order or add \$3 for handling on under-\$20 orders • NY customers must add 7% sales tax • Add 6% for shipping to a maximum of \$10 • Customers outside USA, add 15% • **Warranty:** 90 days on kit parts, 1-year parts & labor on factory-wired units.

• **A \$25 CMOS ELECTRONIC KEYSER WITH SIDETONE!**
Why pay the same price for a "code practice oscillator" when the CW-7 will give you an ear for perfectly-formed CW and will also key your rig? Manual includes money-saving ideas on making keyer paddles too!
CW-7 Electronic Keyer Kit, \$24.95 □ Case and Knob Kit, \$12.95

• **GET IN ON 30 METER CW FUN!**
Build a compact HR30 direct conversion receiver or QRP30 transmitter or both and enjoy leisurely 10.1 Mhz. DXing on family or business trips! Like our other popular QRP transmitters, our new 30-meter model features 8-10 KHz. VXO tuning, switch for choosing between 2 crystals, receiver protection T-R jack and comes with 10.107 Mhz. crystal.
HR-30 Receiver Kit, \$24.95 □ QRP-30 VXO Transmitter Kit, \$29.95

• **RAMSEY TRANSMITTER KITS
FEATURE INTERNATIONAL QRP FREQUENCIES!**
That's right — your QRP-80, 40 or 20 Meter Transmitter comes complete with a 3.060, 7.040 or 14.060 crystal, plus front-panel switching for an additional crystal of your choice.

• **A TRUE HF-VHF ACTIVE ANTENNA FOR \$25!**
You can pay lots more for an active receiving antenna, but we think you'll be happier with the price as well as the HF-VHF switchable performance of our new AA-7 Active Antenna. Includes whip antenna.
AA-7 Active Antenna Kit, \$24.95 □ Case and Knob Kit, \$12.95

• **RAMSEY Factory-Wired VHF POWER BOOSTERS:**
These rugged RF power amps with receiver preamp turn your favorite 2M or 220 MHz. HT into a 25-40 watt powerhouse for a fraction of the cost of a mobile rig! Install several permanently for versatile VHF work.

• **ATTENTION TEACHERS & SCOUT LEADERS:**
Ask for our new pamphlet ED-1 which details special support and pricing for group kit-building projects. Please specify number of kids to be involved and age range.

CONDENSED KIT & PRODUCT LISTING ■ ASK FOR FREE CATALOG!

RAMSEY

FREQUENCY COUNTERS

"If it's built by Ramsey, it's Reliable."

- CT-70 139.95 20Hz-550MHz Frequency Counter
- CT-90 169.95 10Hz-600MHz Frequency Counter
- CT-50 189.95 5Hz-600MHz Frequency Counter
- CT-125 189.95 10Hz-1.25GHz Frequency Counter

CT-90 9 DIGIT 600 MHz



\$169.95 W/WRD INCLUDES AC ADAPTER

FREQUENCY COUNTER ACCESSORIES

- QV-1 59.95 D.1 PPM Oven Time Base
- ET-1 11.95 External Time Base Kit
- BP-4 8.95 NiCad Pack for all Counters
- RA-1 14.95 Ham/SWL Receiver Adapter Kit (For CT-50 only)
- PS-1 89.95 1.5 Ghz. Prescaler (wired & tested)
- PS-1 59.95 600 Mhz. Prescaler (Kit: 49.95)
- PS-2 69.95 Audio Frequency Multiplier (Kit: 49.95)
- PR-2 49.95 Broadband Amplifier: low noise, high gain
- LP-1 16.95 Low Pass Probe
- HP-1 16.95 HI-Z Probe
- DC-1 13.95 Direct Probe
- AW-1 8.95 Telescoping Whip Antenna
- RF-1 19.95 Sniff-It RF Probe for VOM//VTVM//Counters/Scopes
- TB-7 4.95 Tilt Ball Kit for Counters
- HK-1 5.95 Heavy Duty Transformer for Counters, MM7 Kit
- CT001 1.00 Booklet: "How to Use Your Frequency Counter" (booklet free upon request with SASE)

SWL AND MONITORING RECEIVERS

See also our versatile FR-146 FM receiver for 135-175 Mhz.

- SR-1 24.95 4-11 Mhz. AM Shortwave Receiver Kit
- CSR-1 12.95 Shortwave Receiver Case Kit
- AR-1 24.95 AM 108-138 Mhz. Aircraft Band Receiver Kit
- CAR-1 12.95 Aircraft Receiver Case Kit
- SC-1 24.95 Automobile AM Radio Shortwave Converter Kit
- CSC-1 12.95 Case Kit for SC-1
- CLG-1 2.95 Quality Cigarette Lighter Power Cord

HAM HF-BANDS KITS & STATION ACCESSORIES

- CW-7 24.95 CMOS CW Keyer with Built-In Sidetone
- CA-CW 12.95 Case and knob kit for CW-7 Keyer
- HR-20 24.95 Amateur 20 Meter Receiver Kit
- HR-30 24.95 Amateur 30 Meter Receiver Kit
- HR-40 24.95 Amateur 40 Meter Receiver Kit
- HR-80 24.95 Amateur 80 Meter Receiver Kit
- HR-160 24.95 Amateur 160 Meter Receiver Kit
- CHR-1 12.95 Case and Knob Kit for HR-series Receiver Kits
- QRP-20 29.95 VXO 20 Meter Transmitter Kit with 14.060 crystal "A"
- QRP-30 29.95 VXO 30 Meter Transmitter Kit with 10.107 crystal "A"
- TK-30 39.95 6-watt 10.1-10.120 Mhz. 2-crystal VXO Transmitter
- QRP-40 29.95 VXO 40 Meter Transmitter Kit with 7.040 crystal "A"
- QRP-80 29.95 VXO 80 Meter Transmitter Kit with 3.560 crystal "A"
- CQRP-1 12.95 Case and Knob Kit for Transmitters
- AA-7 25.00 Active Antenna Kit for HF and VHF
- CA-AA 12.95 Case and Knob Kit for AA7 Active Antenna

"HR-" receivers are NE602-based direct-conversion for SSB, CW, RTTY reception.



HAM & MONITORING VHF-UHF KITS AND ACCESSORIES

- FR-146 29.95 Amateur 2-Meter and FM 135-175 Receiver Kit
- FR-10 29.95 Amateur 10 Meter FM Receiver Kit
- FR-220 29.95 Amateur 1.25 Meter (220 Mhz.) FM Receiver Kit
- CFR-7 12.95 Case and Knob Kit for FM Receiver Kits
- SA-7 14.95 Broadband Preamp Kit (20 db. 100 KHz-1GHz.)
- PR-10 17.95 Ham Two-Meter Preamp Kit
- PR-20 17.95 220 Mhz. Preamp Kit
- PR-40 17.95 440 Mhz. Preamp Kit
- PA-10 69.95 Two-Meter Power Booster (wired & tested)
- PA-20 69.95 220 Mhz. Power Booster (wired & tested)
- PA-44 79.95 440 Mhz. Power Booster (late Spring 1990)
- PA-1 27.95 2-Meter Power Amplifier Kit
- TR-1 6.95 RF-Sensed T-R Relay Kit
- PM-64 49.95 Packet Radio Kit for Commodore 64/128 HF or VHF
- JM-7 12.95 RF Modulator/6-Meter ATV Kit

MAJOR HOBBY & FUN KITS

- MM-5 24.95 25-Tune MelodyMaker/3-Door Doorbell-Annunciator
- FM-7 29.95 Stereo FM Transmitter [NEW for 1990!]
- SS-7 29.95 Speech Scrambler Kit
- CSS-7 12.95 Speech Scrambler Case Kit
- CT-127 29.95 Binary Thermometer Kit
- SG-7 89.95 SPEED-Y Personal Radar Kit (Yes, it REALLY works!)

THOSE FAMOUS & FUN RAMSEY MINI-KITS . . .

- FM-1 5.95 FM Wireless Kit
- FM-2 7.95 FM Wireless Kit with Mike Preamp Stage
- MC-1 2.95 Sensitive Mike Cartridge
- FM-3 16.95 Wireless FM Minimize Kit with case, battery
- FM-4 12.95 High-Power FM Mike Kit
- PB-1 14.95 Telephone Transmitter Kit
- FR-1 14.95 FM Receiver Kit (tunes approx. 70-130 Mhz.)
- BN-9 5.95 "Super Sleuth" Multi-Purpose 2-watt LM380 Amp Kit
- ML-1 8.95 Color Organ Kit
- MB-1 4.95 "Mad Blaster" Kit (also can be LOUD code oscillator!)
- BL-1 3.95 LED Blinky Kit (flashes 2 jumbo LED's)
- WL-1 6.95 Whisper Light Kit
- SM-3 3.95 Siren Kit
- UT-5 5.95 Universal 555 Timer-Oscillator Kit (Many applications)
- VS-1 6.95 Voice Activated Switch Kit
- MD-3 16.95 Microwave (1.3 Ghz.) Intrusion Alarm Kit
- TS-1 6.95 Touch Switch Kit (makes 2 complete touch switches!)
- TD-1 5.95 Tone Encoder-Decoder Kit
- LB-5 9.95 Infra-Red Beam Communications Receiver Kit
- LB-6 8.95 Infra-Red Beam Communications Transmitter Kit

AND . . . WHILE YOU'RE GETTING YOUR ORDER TOGETHER, remember that your local ham club or repeater association can save many service \$\$\$ for members with an E-Z Pay Lease on . . .

- COM-3 2795.00 Professional Communications Service Monitor
- COM-7 3495.00 Spectrum Analyzer
- RSC-10 2495.00 Synthesized Signal Generator



FLEA MARKET

RATES Noncommercial ads 10¢ per word; commercial ads 60¢ per word both payable in advance. No cash discounts or agency commissions allowed.

HAMFESTS Sponsored by non-profit organizations receive one free Flea Market ad (subject to our editing) on a space available basis only. Repeat insertions of hamfest ads pay the non-commercial rate.

COPY No special layout or arrangements available. Material should be typewritten or clearly printed (not all capitals) and must include full name and address. We reserve the right to reject unsuitable copy. Ham Radio cannot check each advertiser and thus cannot be held responsible for claims made. Liability for correctness of material limited to corrected ad in next available issue.

DEADLINE 15th of second preceding month.

SEND MATERIAL TO: Flea Market, Ham Radio, Greenville, N. H. 03048.

BEGINNER'S RADIO CLEARINGHOUSE. On a space available basis, we are going to offer you, OUR SUBSCRIBER, free of charge, a chance to find a home for your used equipment with a new Ham. Please send us a short description of what you want to sell along with price, name, address and phone number. Please limit your ad to 20 words or less.

SMALL DUAL CONVERSION solid state FM crystal controlled receiver on 462.875 or 441.475 MHz. Has 10.7 MHz and 455 kc solid state IF filters. Comes complete with regulated power supply and XR-2211 FSK demodulator. Will make good modem receiver. Schematic included. Can also be converted to other freq. Several on hand. \$24.95 each plus \$3.50 s/h. Buddy L. Holmes, 117 Halstead Road, Ocean Springs, MS 39564. Phone (801) 875-5211.

FOR SALE: Kenwood remote VFO model VFO-120. Mint with manual. \$75.00. Fred Weigel, WD4BBZ, 2249 Evangelina, Deltona, FL 32725, (904) 789-3869.

FOR SALE: 2510B mode B satellite transverter. \$400.00 OBO. N1EHT, Jeanne, VT (802) 229-4035. Will ship.

HAM CALL HATS: Quality Baseball caps attractively printed with call and name, only \$6.50. White front, mesh back. Red, green, royal or navy. Visa/MC accepted. Include name, number, expiration date, signature and telephone. No COD. Send to: Edmonds Screen Printing, 2555 Greenwood Road, Independence, OR 97351. Please include \$1.50 postage and handling. Print or type color, call, name and OM or YL. \$5.00 less for 2 or more to same address. Send SASE for information on club T-shirts, sweatshirts or jackets. KA7FJF, Earl, (503) 838-1849.

COMMODORE-128 PROGRAM Amateur Satellite tracking program uses Keplerian data supplied by NASA free. Tracks up to 8 satellites simultaneously. Program supports printing schedules, modes, and predictions for Satellites. SATRAK128 V1.1, \$26.50 includes shipping. Other information on this or other programs for the C128, requires a business size SASE. Reid Bristol, WA4UPD, PO Box 0773, Dept HR, Melbourne, Florida 32936-0773.

WANTED: 8873 Tube and Socket. SK20 heat link. G2DRT.

FOUR ACRES of flat Arizona land in the beautiful San Pedro Valley about ten miles from Sierra Vista via excellent road. Water on property with power and telephone at boundary. Zoning provides for antenna towers. Would make ideal antenna farm for retirement. \$20,000. Write K1YSE, Box 1538, Bisbee, AZ 85603 for details.

WANTED FOR MUSEUM: Early microcomputers, SWTPC 6800, Sphere, Altair MITTS 6800 and other early micros. Also early microcomputer magazines. David Larsen, KK4WW, Blacksburg Group, PO Box 1, Blacksburg, VA 24063-0001. (703) 231-6478/763-3311.

WANTED: Ham equipment and other property. The Radio Club of Junior High School 22 NYC, Inc. is a nonprofit organization, granted 501(C) (3) status by the IRS, incorporated with the goal of using the theme of Ham Radio to further and enhance the education of young people nationwide. Your property donation or financial support would be greatly appreciated and acknowledged with a receipt for your tax deductible contribution. Meet WB2JKJ and the "22 Crew" at Knoxville, TN Hamfest on the incredible story of the first 10 years of education thru communication at the core of the Big Apple. Write us at: PO Box 1052, New York, NY 10002. Round the clock hotline: VOICE (516) 674-4072, FAX (516) 674-9600.

BATTERY PACK REBUILDING: Don't pitch it—mail it—for FAST—PROFESSIONAL Rebuilding! Satisfaction guaranteed! ICOM: BP2/BP3 \$19.95, BP5 \$25.95, BP7/BP8/BP70 \$32.95, KENWOOD: PB21 \$15.95, PB21H \$21.95, PB25/25H/26 \$24.95, YAESU: FNB9 \$19.95, FNB10 \$23.95, FNB44A \$36.95, TEN-TEC: \$24.95 "U-DO-IT INSERTS" ICOM: BP3 \$16.95, BP5 \$22.95, BP7H \$27.50, KENWOOD: PB21 \$12.95, PB24/25/26 \$19.95, TEMPO: S1-15/SERIES \$22.95, YAESU: FNB44A \$32.95, FNB10 \$18.95, AZDEN: 300 \$19.95, "NEW PACKS" ICOM: BP5 \$43.95, BP8 (Base Charge Only) 39.95, YAESU: FNB2 \$19.95, FNB11/FNB14 \$44.95, SANTEC: 1421/200 \$22.95, TELEPHONE/PAGER/COMPUTER/COMMERCIAL PACKS—Free catalog. Add \$3.00 shipping/order. PA +6%. VISA/MC add \$2.00. CUNARD, RD 6, Box 104, Bedford, PA 15522. (814) 623-7000.

VIBROPLEX COLLECTOR'S GUIDE. W1M0's new illustrated reference. Key Histories, identification guide, patents, more. 87 pages. Only \$14.95 plus \$2.00 s/h. Free info. Artifax Books, Box 88-H, Maynard, MA 01754.

KITS: QPR CW TRANSMITTER. 1 watt with crystal. 80m or 40m. \$19.00 each. Code practice oscillator. \$9.00. (\$14.00 with key). Both great for Novice classes. SASE for info. WD8OYG (301) 586-2177. SR1, Box 2C, St. Leonard, MD 20685.

ATTENTION—HIRING! Government jobs—your area. \$17,840-\$69,485. Call 1-602-838-8885. Ext R15752.

TEN-TEC. New boxed latest 1990 production models, USA made 562 Omni V, 585 Paragon Transceiver, Titan 425 1.5 KW and 420 Hercules 1KW linear amplifiers, antenna tuners models 238, 253, 254, 239, 240 dry dummy loads, 2510B satellite station, mobile HF antennas, keys, cabinets, filters and accessories. VISA/MC or check, for best deal write/phone Bill Slep (704) 524-7519, Slep Electronics Company, Highway 441, Otto, NC 28763.

1990 IDAHO HAM DIRECTORY. Calls, counties, phone numbers, names, addresses. \$10.00. Ken Hastings, Box 434, Nampa, Idaho 83653.

WANTED: Rotary Inductor Johnson 226-1-4 or equivalent, 275 turns of 1/8" x 3/16" rectangular wire edge wound 35" OD. Spacing between turns increases toward one end. Old catalog listing 22.5 micro H. Calvin A. Hoerneman, 704 Apple Drive, Mechanicsburg, PA 17055. (717) 766-3465.

FOR SALE: Teletype Model 43 with books and one box of paper \$100. New Wilson SY33 Tribander antenna and 33-6 MK 40-meter modification kit. \$295. YOU SHIP. R. Davis, W9XK, Colfax, IN 46035. (317) 324-2442.

"SOFTSTART" Protect your valuable tubes and power supply diodes from DANGEROUS inrush surge currents. Can be retrofitted into most amplifiers. Completely assembled Amateur net for "SOFTSTART" is \$49.95 plus \$5.00 shipping in the 48 states. OMEGA ELECTRONICS, 4209 Live Oak Road, Raleigh, NC 27604. (919) 231-7373.

FREE LIST of low cost ham equipment. Write to Jim Braddy, WA4DSO, 3037 Audrey Drive, Gastonia, NC 28054.

WANTED: BUY & SELL. All types of Electron Tubes. Call toll free 1-800-421-9397 or 1-612-429-9397. C & N Electronics, Harold Bramstedt, 6104 Egg Lake Road, Hugo, MN 55038.

CHASSIS AND CABINET KITS. SASE. K31WK, 5220 Harmony Grove Rd, Dover, PA 17315.

ATTENTION: EASY WORK—Excellent Pay! Assemble products at home. Details. 1-602-838-8885. Ext. W15752.

RTTY JOURNAL published 10 times per year for those interested in digital communications. Read about RTTY, AMTOR, MSO'S, PACKET, RTTY DX and Contesting. Plus technical articles concerning the digital modes. \$12.50 per year (foreign higher). RTTY JOURNAL, 9085 La Casita Ave, Fountain Valley, CA 92708.

CUSTOM MADE EMBROIDERED PATCHES. Your design, any shape and colors. Free ordering information, price list and random sample. HEIN, 79602 Manitou Trail, Glen Arbor, MI 49636-9711.

AVANTEK ATF10135, \$12.00, MMIC's, P.C. board, SASE: WA3IAC, 7148 Montague St, Philadelphia, PA 19135.

"HAMLOG" COMPUTER PROGRAM. Full features, 18 modules. Autologs, 7-band WAS/DXCC, Apple, IBM, CP/M, KAYPRO, Tandy, C128 \$24.95. HR-KA1AWH, POB 2015, Peabody, MA 01960.

IMRA International Mission Radio Association helps missionaries. Equipment loaned. Weekday net, 14,280 MHz, 1-3 PM Eastern. Nine hundred Amateurs in 40 countries. Rev. Thomas Sable, S.J., University of Scranton, Scranton, PA 18510.

WANTED: Henry VBC 3000. Dick (716) 386-4092.

INTERESTED IN PUBLIC SERVICE? Join your Local Radio Emergency Associated Communications Team. In Pennsylvania call (717) 938-6943 or write REACT, 1160 Old Trail Rd, Eters, PA 17319.

RUBBER STAMPS: 3 lines \$5.00 PPD. Send check or MO to G.L. Pierce, 5521 Birkdale Way, San Diego, CA 92117. SASE brings information.

ELECTRON TUBES: Receiving, transmitting, microwave... all types available. Large stock. Next day delivery, most cases. DAILY ELECTRONICS, PO Box 5029, Compton, CA 90224. (213) 774-1255.

ATTENTION: EARN MONEY READING BOOKS! \$32,000/year income potential. Details 1-602-838-8885. Ext Bk15752.

RECONDITIONED TEST EQUIPMENT \$1.25 for catalog. Walter, 2697 Nickel, San Pablo, CA 94806.

COMING EVENTS

Activities — "Places to go . . ."

SPECIAL REQUEST TO ALL AMATEUR RADIO PUBLICITY COORDINATORS: PLEASE INDICATE IN YOUR ANNOUNCEMENTS WHETHER OR NOT YOUR HAMFEST LOCATION, CLASSES, EXAMS, MEETINGS, FLEA MARKETS, ETC. ARE WHEELCHAIR ACCESSIBLE. THIS INFORMATION WOULD BE GREATLY APPRECIATED BY OUR BROTHER/SISTER HAMS WITH LIMITED PHYSICAL ABILITY.

JUNE 1-2: GEORGIA: 1990 ARRL Georgia State Convention and SE Packet Conference, Heritage House Motel & Convention Center, Albany. Admission \$3. Free parking. For information Albany ARC, POB 1205, Albany, GA 31702. (912) 883-7910, M.F. 9-5.

JUNE 2: ONTARIO: Central Ontario Amateur Radio Flea Market, Bingham Park, Kitchener, Ontario, Canada. Contact Ray Jennings, VE3CZE, 61 Ottawa Cres., Guelph, Ontario, N1E 2A8, Canada. (519) 822-8342.

JUNE 2: KANSAS: The Pittsburg Repeater Organization's annual Hamfest, Lincoln Center, 709 West 9th Street, Pittsburg, 8 AM to 3 PM. Admission \$5.00 includes chicken dinner. Contact Ken Johnston, 2402 Wall Avenue, Joplin, MO 64804. (417) 623-1895.

JUNE 2-3: WASHINGTON: The Apple City ARC's Hamfest, Rocky Reach Dam, Wenatchee. Registration: Amateurs \$5; Others \$1. Under 12 free. Free camping and trailer spaces, many area attractions. Mail registration to Bob Lathrop, Treasurer, 919 N. Woodward Drive, Wenatchee, WA 98861.

JUNE 3: NEW YORK: Hall of Science ARC's Electronic Hamfest and Computerfest, Hall of Science Parking Lot off 47th avenue and 111th Street, Flushing Meadow Park, Queens, 9 AM to 3 PM. Donation Buyers \$3. Sellers \$5/space. For information call Steve Greenbeamer, WB2KDG (718) 898-5599 or Phil Kubert, N2HYE (213) 777-8648 EVENINGS ONLY.

JUNE 3: CONNECTICUT: The Newington ARL's 7th annual Ham Radio and Computer Flea Market, Newington HS, Rt 173, Willard Avenue. 9 AM to 2 PM. Admission \$3. For information SASE to NARL Hamfest, PO box 165, Pleasant Valley, CT 06063. (203) 523-0453.

JUNE 9: MICHIGAN: The Independent Repeater Association's annual Hamfestival, 44th Street Armory, Byron Center. 8 AM to 4 PM. Admission \$3/advance; \$4/door. For information write I.R.A., 562—92nd Street SW, Byron, Center, MI 49315.

JUNE 9: MICHIGAN: CMARA's 16th annual Hamfest, Midland Community Center, Midland. 8 AM to 1 PM. Admission \$3. For information SASE to CMARA Hamfest, PO Box 67, Midland, MI 48840. (517) 631-9228 evenings and weekends.

JUNE 9: NORTH CAROLINA: The Forsyth ARC's 3rd annual Hamfest, Computer and Electronics Fair, Benton Convention Center, 301 West 5th Street, Winston-Salem. 9 AM to 3 PM. Admission \$4/advance; \$5/door. Wheelchair accessible. For information SASE to Jim Rodgers, N1DRI, W.S. Hamfest, PO box 11361, Winston-Salem, NC 27116 or call (919) 760-2493, 9 AM to 10 PM.

JUNE 10: ILLINOIS: The Six Meter club of Chicago will hold its 33rd annual Hamfest, 91st and Wolf Road, Willow Springs, southwest of Chicago. Registration \$3/advance; \$4/gate. Gates open 6 AM. Advance tickets from Mike Corbett, K9ENZ, 606 South Fenton Avenue, Romeoville, IL 60441 or any club member.

JUNE 10: ILLINOIS: The Egyptian Radio Club's EGYPTIAN-FEST, at their clubgrounds, Chouteau Place Road, Granite City. 6 AM to 3 PM. Contact Carl Waller, WB9YDK, PO Box 562, Granite City, IL 62040. (618) 345-6469 for details.

NEW OSCAR

BRIDGES HAMISPHERE

- Coming soon to a shack near you.
- Signals from space.
- Catch some free.
- We know how.
- You can too!
- Join AMSAT
- Free brochure for SASE

AMSAT
PO BOX 27
WASHINGTON, DC 20044

✓ 152

**Foreign Subscription Agents
for Ham Radio Magazine**

Ham Radio France
SM Electronic
20 bis, Ave des Clarions
F-89000 Auxerre
France

Ham Radio Canada
C.A.R.F.
P.O. Box 356
Kingston, ON
Canada K7L 4W2
Prices in Canadian funds
1 yr. \$38.00, 2 yrs. \$67.00
3 yrs. \$90.00

Ham Radio Japan
Katsumi Electronic Co., Ltd.
27-5 Ikegami
4 Chome, Ota-Ku
Tokyo 146, Japan
Telephone (03) 753-2405

Ham Radio England
c/o R.S.G.B.
Lambda House
Cranborne Road
Potters Bar
Herts EN6 3JW
England

**1990 U.S. CALL DIRECTORY
(on microfiche)**

Call Directory - by callsign\$10
Name Index - by last name\$10
Geographic Index - by state/city\$10
All three - \$25

\$3 shipping per order

BUCKMASTER PUBLISHING

Route 3, Box 56
Mineral, Virginia 23117
703/894-5777 visa/mc 800/282-5628

✓ 153

**THE MOST POWERFUL
HANDHELD LCR METER
w/ DISSIPATION FACTOR
ANYWHERE!**

**MONEY BACK
GUARANTEE**
If for any reason you are not
fully satisfied with this
product, please return within
30 days to obtain a refund
of your purchase price.
Call 1-800-654-9838
for details.



\$ 249.00

**BENCH-UNIT PERFORMANCE
...AT 20% OF THE PRICE**

FEATURES:

- * Drop-Proof, Heavy Duty.
- * Inductance: 200uH to 200H.
- * Capacitance: 200pf to 20mf.
- * Resistance: 2 to 20M ohms.
(max. resolution: 1 milliohm).
- * Dissipation Factor Measurement ($D=I/Q$).
- * 120Hz & 1KHz Test Frequencies.
- * SMD or chip type component test probes available.

APPLICATIONS:

- * Quality Control of transformers (opens, shorts).
- * Finding opens and shorts of transmission lines.
- * Capacitance & resistance measurement for SMD or chip type components.
- * Precision measurement of milliohm applications.
- * Phase Detection, Mutual inductance & Ratio of Turns for transformers.

Now ARI gives the ultimate in Handheld LCR Meters. For details, call **(800)654-9838**

ARI

AMERICAN RELIANCE INC.

9241E, VALLEY BLVD, ROSEMEAD, CA91770
TEL: (818) 287-8400 FAX: (818) 287-8855

✓ 154

JUNE 10: OHIO: The Goodyear ARC's 23rd annual Hamfest and Family Picnic, Wingloof Lake Park, Akron. 8 AM to 4 PM. Family admission \$4.00/advance; \$5.00 at gate. For tickets and information contact William F. Dunn, W8IFM, 4730 Nottingham Lane, Stow, OH 44224. (216) 673-8502.

JUNE 10: PENNSYLVANIA: The 17th annual Central PA Ham and Computerfest, sponsored by the Milton and Central Susquehanna ARCs, Winfield Fireman's Fairgrounds. 8 AM to 5 PM EST. Donations \$4/gate. For information Jerry Williamson, WA3SXQ, 10 Old Farm Lane, Milton, PA 17847. (717) 742-3027 or Bob Stahl, KQ3KR, 452 Fourth Street, Northumberland, PA 17857. (717) 473-7050.

JUNE 16: NEW JERSEY: The Raritan Valley Radio Club's 19th annual Hamfest and Computer Show, Watchung Hills HS, Warren. Gates open 8 AM. Lookers \$4 donation. Spouse and kids free. For further information call Dave, KA2TSM (201) 763-4849 or John, WA2C (201) 968-5070.

JUNE 16-17: MONTANA: The Valley ARC of Glasgow is sponsoring a Father's Day Ham Picnic. Contact Linda Gray, N7FSH (406) 228-2324.

JUNE 17: MARYLAND: The Frederick ARC's annual Hamfest on Father's Day, Frederick County Fairgrounds. 8 AM to 4 PM. Admission \$4. Spouse and kids free with one paid admission. For information Ernie Hansen, K3VVV, PO Box 589, Mt. Airy, MD 21771.

JUNE 17: INDIANA: The Lake County ARC's annual Fathers' Day Hamfest, Industrial Building of Lake County Fairgrounds, Crown Point. 8 AM to 2 PM. Admission \$3.50. For information contact Ken Brown, KE9TC, 918 Chippewa, Crown Point, IN 46307. (219) 663-5035.

JUNE 17: MICHIGAN: The Monroe County Radio Communications Association's 1990 Hamfest, Monroe County Fairgrounds, Monroe. Tickets \$3/advance; \$4/gate. Handi parking and wheelchair accessible. Contact Fred Lux, WD8ITZ, PO Box 982, Monroe, MI 48161. (313) 243-1053.

JULY 4: PENNSYLVANIA: Firecracker Hamfest sponsored by the Harrisburg RAC, Bressler Picnic Grounds, Harrisburg. Starts 8 AM. Admission \$3. Contact Dave Dormer, KC3MG (717) 939-4957 for reservations.

LAUREL ARC monthly (except December) Amateur exam sessions for all license classes. No fee is charged. Pre-registration is required. Call (301) 725-1212, Maryland Radio Center, 8576 Laureldale Drive, Laurel, MD 20707.

THROUGHOUT 1990 the Major Armstrong Memorial Amateur Radio Club (MAMARC) will sponsor events commemorating Major Edwin Howard Armstrong's achievements in the field of radio broadcasting. The club is seeking other Amateur operators around the world who are willing to research Major Armstrong's accomplishments and become official MAMARC special events stations. Major Armstrong was a pioneer responsible for the creation of Wideband FM and the inventor of the superhetrodyne receiver. If you are interested in participating and becoming an official MAMARC special event station contact Barry Group, N2HDW, MAMARC, c/o 100th Birthday Committee, PO Box 581, Alpine, NJ 07620. Please SASE.

YOUTH LINK NET. Open to all Hams under age 18. Saturdays at 2000 UTC, 28.425 MHz. For more information contact Net Control, George Manning, WB5NMH, 602 Glendale St. Burkburnett, TX 76354.

FREE 1989-90 Florida two meter repeater directories are currently being distributed by the Hernando County Amateur Radio Assn. of Brooksville, FL. Ask for one at any official Florida Welcome Center or SASE to Repeater Directory, Hernando County ARA, POB 1721, Brooksville, FL 34605-1721.

AMATEUR EXAMS. July 14, September 8, November 17. St. Mary Medical Center, 3333 No. Seminary Street, Galesburg, IL 61401. 12 Noon to 2 PM. For information contact Larry Heller, KA9PCU, 1436 Brown Avenue, Galesburg, IL 61401. (309) 342-5977.

Monthly Ham Exams. The MIT UHF Repeater Association and the MIT Radio Society offer monthly ham exams, all classes Novice to extra: next-to-last Wednesday of each month. (JUNE 20) 7:30 pm, MIT Room 1-150, 77 Mass Avenue, Cambridge, MA. reservation requested a couple of days in advance, walk-ins welcome; call the shack (617) 253-3776, or Nich Altenbernd (617) 437-0320. Exam fee \$4.95. Bring copies of your current license (if any) and Certificates of Completion (if any), two forms of picture ID, and a completed form 610, available from the FCC: (617) 770-4023.

AMATEUR RADIO CLASSES: For those people interested in obtaining a Novice (basic level) Ham license or upgrading to Tech/General, the Chelsea Civil Defense, in cooperation with QRA Radio Club, will sponsor Amateur Radio Communications classes evenings at Chelsea High School starting MARCH 7, 1989. For more information write Frank Masucci, K1BPN, 136 Grove Street, Chelsea, MA 02150. Please enclose your telephone number.

WRITE FOR FREE BOOK CATALOG

Ham Radio's Bookstore
Greenville, NH 03048

MININEC USERS

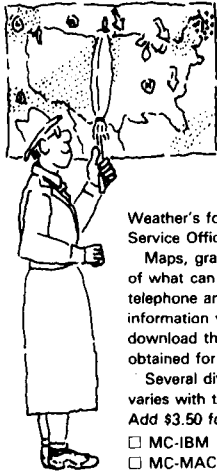
Tired of counting pulses?

ELNEC gives you all the power of MININEC, full plotting and analysis features, easy menu-driven input, and *no fussing with pulses!* Just tell ELNEC which wire to place a source or load on, and the distance from the end (in percent), and it's there to stay. Use ELNEC's powerful features to add, delete, and modify sources, loads, wires, and ground media, and the sources and loads stay where you put them - not on some obscure "pulse number" that moves every time a wire is changed. ELNEC has a host of other features to make antenna analysis fast, accurate, and easy. Like *true current sources* for phased array analysis. Change wire lengths without recalculating end coordinates. And much more.

Here's the best news: ELNEC is just \$49 postpaid (USA, Canada, Mexico). Two versions are available, optimized for coprocessor or non-coprocessor systems.

Roy Lewallen, W7EL
P.O. Box 6658
Beaverton, OR 97007

157



WEATHER SOFTWARE

ACCU-WEATHER FORECASTER is a menu driven program that allows the user to tap into Accu-Weather's extensive computerized database. In addition to Accu-Weather's forecasts, you can get hourly updates from National Weather Service Offices nationwide.

Maps, graphs, pictures, charts, and narrative descriptions are just part of what can be downloaded to your MS-DOS computer. To save telephone and hook-up charges, tell your computer first exactly what information you want. Then call ACCU-WEATHER; the computer will download the files you want and save them to disk. Information can be obtained for the entire United States or a specific geographical region.



Several different services are available from ACCU-WEATHER. Price varies with the service and time of day that the computer is accessed. Add \$3.50 for shipping and handling.

<input type="checkbox"/> MC-IBM	\$89.95
<input type="checkbox"/> MC-MAC	\$89.95

Please enclose \$3.75 shipping & handling

HAM RADIO BOOKSTORE

GREENVILLE, NH 03048

603-878-1441

Say You Saw It in Ham Radio

**KENWOOD
★SPECIAL★**

TS-140S
Price \$789
cash price



TEL-COM★

Electronic Communications

NEW ENGLAND'S FACTORY-
AUTHORIZED SALES & SERVICE
FOR

KENWOOD  **ICOM**

Also displaying the popular accessories needed to complete a HAM STATION . . .

- ARRL PUBLICATIONS • AEA PRODUCTS • AMPHENOL
- ALPHA DELTA • ASTRON • AUSTIN ANTENNAS • AVANTI
- BELDEN • BENCHER • B & W • DAIWA • ALINCO
- HUSTLER • KLM • LARSEN • MIRAGE • ROHN
- TELEX/HY-GAIN • TOKYO HY-POWER LABS
- TRAC KEYERS • VIBROPLEX • WELZ • ETC.

DIAMOND

- Power Meters
- Dry Loads
- Antennas
- Duplexers

OPEN SIX DAYS A WEEK   WELCOMED

Telephone 508/486-3400, 3040

675 Great Rd., (Rte. 119) Littleton, MA 01460
1/4 miles from Rte. 495 (Exit 31) toward Groton, Mass.

✓ 155

CABLE TV CONVERTERS

Why Pay A High Monthly Fee?
Save \$100's A Year

- All Jerrold, Oak, Hamlin, Zenith, Scientific Atlanta, and more.
- 60 Day Money Back Guarantee
- Shipment within 24 hours
- Visa/MC and C.O.D.

WE WILL BEAT ANYONE'S PRICE
No Illinois Orders Accepted

Electronic Engineering

P.O. Box 337, Barrington, IL 60011
FREE CATALOG
1-800-542-9425
INFORMATION
1-708-540-1106

✓ 159

SUPER PERFORMANCE BATTERIES

UPDATED SUPER ICOM

SUPER ICOM BP-7S. 13.2 volts, 1200ma triple the capacity of the Icom BP-7. 5w output.

SUPER ICOM BP-8S. 9.6 volts, 1200ma. 50% more capacity than the Icom BP-8.

Both are rapid base charge only, or slide in wall charger. 4 inches high. BP-7S or BP-8S. \$65.00

SUPER KENWOOD

SUPER KENWOOD PB-25S/PB-26S. 8.4 volts, 900ma. double the capacity of the PB-25/PB-26 for the 2500/2600/3500/3600. Charge with either the standard wall charger or drop in charger. 3 inches high. \$65.00.



Exact replacement FNB-2 Nicad pack for Yaesu FT-404R/207R/208R/708R \$22.50

SPEAKER/MICS

Icom HM-9 \$35.00
Yaesu MH12A2B \$31.00

SUPER YAESU

SUPER YAESU FNB-4SH. 12 volts, 1000ma. double the capacity of the Yaesu FNB-4. 5 watt output. Rapid charge only. \$71.00

SUPER YAESU FNB-3S. 9.6 volts, 1200ma. triple the capacity of the Yaesu FNB-3. 3.5 watt output. Rapid or wall charge. \$65.00

Both are perfect for the Q3, Q9 and 727 series radios and are 4 inches high.

Inserts for:
Kenwood PB-25, 25H, 26 \$25.00
Icom BP-3 \$18.95
Icom BP-5 (500ma) \$24.95
Icom BP-7 (500ma) \$29.50
Icom BP-8 \$29.50

Full line for Yaesu 411/811/470, FNB-10/11/12/14 available. Add \$4.00 shipping & handling for first pack. CT residents add 8% tax.

Complete line of NICAD packs for Icom, Kenwood, Yaesu, Tempo, Santic, Azden, Cordless Telephones, Alkaline, Nicad & Gell-Cells. All NICAD packs include 1 year guarantee. Commercial Radio Packs available. For all your battery needs, write or call today for a complete catalog. Dealer inquiries invited.

MADE BY HAMS FOR HAMS



IPGRIPHX Inc.
149 Palmer Road • Southbury, CT 06488

(800) 634-8132 In CT (203) 264-3985 FAX: (203) 262-6943



✓ 160

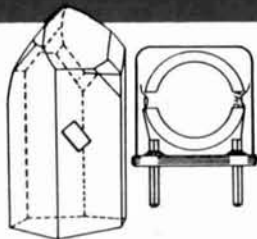
When performance & price really count...



The pulse of dependable communications



Reliability & Quality
From Start To Finished Product



QUARTZ CRYSTALS/OSCILLATORS FOR ELECTRONIC — INDUSTRIAL

- Micro-Processor Control
- Computers/Modems
- Test/Measurement
- Medical

COMMUNICATIONS — REPLACEMENT

- Mobile/2-way/Channel Elements
- Pagers
- Marine
- Aircraft
- Telemetry
- Monitors/Scanners

AMATEURS

- CB
- Hobbist
- Experimenter

COST EFFECTIVE
MODERATE PRICING
FAST DELIVERY



Replacement Crystals Catalog

Custom Made Crystals Catalog

The Pulse of Dependable Communications

Crystek Crystals offers their new 16 page FREE catalog of crystals and oscillators. Offering state-of-the-art crystal components manufactured by the latest automated technology. Custom designed or "off the shelf." Crystek meets the need, worldwide. Write or call today!

CRYSTEK CORPORATION
DIVISION OF WHITEHALL CORPORATION

2351/2371 Crystal Dr. • Ft. Myers, FL 33907
P.O. Box 06135 • Ft. Myers, FL 33906-6135
TOLL FREE 1-800-237-3061
(813) 936-2109



Advanced Antenna Analysis Program

ELNEC is an all-new, powerful, easy-to-use antenna analysis program. Antenna description and changes are fast and easy.

ELNEC is completely menu-driven. All antenna descriptions and changes are done without exiting the program. Add, delete, modify sources, loads, and wires with a few keystrokes.

ELNEC uses the power of MININEC, yet completely frees you from the tedious chore of counting "pulses". Simply tell ELNEC which wire and where you want a source or load to go -- ELNEC puts it there and keeps it there, even when wires, sources, and loads are added, deleted, or changed.

ELNEC is full-featured, with plotting, printing, saving and recalling files, and much, much more. Beamwidth, main lobe, sidelobe analysis are shown on the plot. An exclusive feature, ELNEC has true current sources for phased array analysis.

ELNEC runs on any PC-compatible computer with at least 360k of RAM, and CGA, EGA, or Hercules. Plots print on Epson-compatible 8.9 or 24 pin printers. Two versions are available, optimized for systems with and without a coprocessor.

ELNEC is an incomparable value at only \$49.00 postpaid (USA, Canada, and Mexico). Specify coprocessor or non-coprocessor version. Order or write for more information from:

Roy Lewallen, W7EL
P.O. Box 6658
Beaverton, OR 97007

✓ 164



OPTO Iambic Keyer



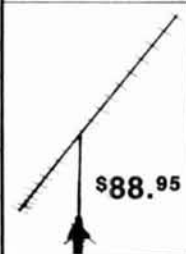
- Ultra compact 5" x 5 1/4" x 1 1/2"
- OPTO isolated output
- Battery or DC powered
- Full function Iambic Keyer
- Adjustable speed and weight
- One Year Ace Systems Warranty

- See Your Ace Dealer -

- Amateur Electronics Supply
 - Barry Electronics
 - KJI Electronics
 - Madison Electronics
 - Oklahoma Comm. Center
 - R. F. Enterprises
 - R & L Electronics
 - Rivendell Electronics
- Ace Systems • RD 1 • Box 83 • Wilcox, PA 15870
(814) 965-5937

✓ 165

The Finest 432 MHz Yagis EME — Tropo — Weak Signal The FO-22



\$88.95

ELECTRICAL SPECIFICATIONS:
Measured gain 15.8 dBd
E Plane beamwidth 2 x 11.5 deg
H Plane beamwidth 2 x 12 deg
Sidelobe attenuation
1st E Plane sidelobe -17.5 dB
1st H Plane sidelobe -15.5 dB
F/B ratio 22 dB

MECHANICAL SPECIFICATIONS:
Length 14 ft
Wind survival: 90 + MPH
Wind Surface Area 78 sq. ft.
Coax connector: N-type
Mast: up to 1 1/2" diameter
Element insulators: UV resistant black Delrin
Stainless steel hardware (except plated keepers and U-bolt)

All stainless option for FO-22 (keepers and U-bolt) \$10.78

ALSO AVAILABLE The incomparable FO-25 and FO-33 STACKING FRAMES POWER DIVIDERS

We supply those hard to find parts for the home builder
Delrin insulators \$12/100. Plated keepers \$4/100. Stainless \$10/100
Avid \$6 UPS. S/H for single or pair of Antennas.
\$8 west of Mississippi
PA residents add 6% state sales tax

RUTLAND ARRAYS
1703 Warren St. • New Cumberland, PA 17070
(717) 774-5298 7-10 PM EST

✓ 163

PC SSTV V2.0 \$149.95

Turn your IBM PC or compatible into a complete slow scan TV system. You don't need another computer to send and receive images in up to 64 shades of gray. Works with most popular graphics cards and printers.

Includes:

Demodulator Software Modulator Tutorial Cassette 75 Page Manual

Requires:

Ham transceiver Graphics Card Tape Recorder Parallel Port Serial port
Slow Scan Formats: 8, 12, 17, 24, 36, 48, 72 sec.



Software Systems Consulting
150 Avenida Cabrillo, Suite C
San Clemente, CA 92672
(714) 498-5784

✓ 167

Model WLA24M 5-1000 MHZ PREAMPLIFIER

For analyzers, scopes, radio/TV, ICOM R-7000, scanners, etc. Gain 23 dB, Noise Fig. 3 dB, Pout (1dB) 18 dBm, 12-15 VDC. Usable 2-1100 MHz, with input protection, in cast aluminum case. Pull signals from noise. Only \$109 + \$4. Bypass switch & 430/50 MHz conv. available. Mast mount WLA24T \$169.



WILAM TECHNOLOGY
P.O. Box 5174, MASSENA, N.Y. 13662
(315) 769-8334

✓ 168

YAGI OPTIMIZER

The YO program automatically optimizes Yagi dimensions for maximum forward gain, best pattern, and minimum SWR. YO updates radiation patterns at the central design frequency and band edges during optimization. A scale drawing of the Yagi changes shape as the design proceeds. YO is extremely fast, and can compute several trial designs per second. After optimization, high-resolution patterns may be displayed or printed in several formats. YO includes a powerful gain-F/B-SWR trade-off mechanism, minimization of all sidelobes, frequency scaling, and full EGA color. YO has models for gamma, T, hairpin, and beta matches, element tapering, and element mounting plates. A library of Yagi designs and extensive documentation are included. YO is intuitive, graphical, and highly interactive.

YO 3.0 features improved accuracy, faster computation, optimization of single Yagis over ground, and stacked Yagis in free space. YO 3.0 is 2-4 times more accurate and 20-65% faster than YO 2.0. Optimize a Yagi at its exact installation height for improved F/B and SWR. Optimize take-off angle. Account for antenna interaction by optimizing an identical pair of stacked Yagis for maximum gain and low sidelobes.

YO 3.0 is \$130. YOjr 1.0 (basic features) is \$65. Add 6-1/4% for California orders, \$5 for overseas. For IBM PC.

Send check or international money order to:
Brian Beezley, K6STI, 507-1/2 Taylor, Vista, CA 92084

✓ 166

NEW PRODUCTS

Cushcraft D3W Rotatable WARC Dipole and Ten-3 10-Meter Yagi

Cushcraft's new D3W world ranger dipole covers 30, 17, and 12 meters on the new WARC bands. It's a sturdy, rotatable dipole that's easily mounted on any mast from 1-1/2 to 2 inches in diameter with your existing triband or other antennas. The D3W features high performance, high-Q traps, heavy wall tubing, and rugged stainless steel hardware.

This rotatable WARC dipole features automatic frequency selection for either 12, 17, or 30 meters, is rated for 2000 watts PEP, is 34 feet long, and weighs 11 pounds.

The Cushcraft Ten-3 is a high performance 8-dB three-element Yagi with 8-dB forward gain. The beam also offers a front-to-back ratio of 25 dB.

The Ten-3 has an 8-foot boom, and takes a mast size of 1-1/2 to 2 inches, and can be installed on a simple mount with only a light rotator. The redi match system provides 50-ohm feed for a standard PL259 connector. The antenna is power rated for 2000 watts PEP. All tubing is heavy wall, hard drawn, bright finish aluminum.

For additional information contact Cushcraft Corporation, PO Box 4680, 48 Perimeter Road, Manchester, New Hampshire 03108. Telephone (603)627-7877.

Circle #301 on Reader Service Card.

Ameritron AL-82 Linear Amplifier

Ameritron announces its full legal power linear amplifier with two 3-500Z transmitting tubes. The AL-82 features dual illuminated meters. The grid current meter gives a constant reading; the multimeter displays plate voltage and current, peak RF output power, and drive power/ALC.

The Pi-L tank circuit permits full impedance matching over the 160-meter band. The tuning capacitors and bandswitch have a 35-percent safety factor to avoid tank circuit component failure.

The cooling system keeps the components and 3-500Z tubes safely below the manufacturer's ratings, even while operating at 1500-watts output with a steady carrier. The filament supply has inrush current limiting to ensure maximum tube life. Complete shielding and bypassing helps prevent TVI and RFI.

The AL-82 covers 160, 80, 40, 20 and 15 meters and gives 80-percent rated output on 12 and 17 meters. It can be modified to cover

10 meters upon presentation of an Amateur license. An export model is also available.

For more information write Ameritron, 921 Louisville Road, Starkville, Mississippi 39759 or call Ameritron at (601)323-9715, FAX (601)323-6551.

Circle #302 on Reader Service Card.

ELNEC Advanced Antenna Analysis Program

Roy Lewallen, W7EL, announces ELNEC — a new full-featured antenna modeling and analysis program for PC-compatible computers. ELNEC eliminates the tedious and error-prone procedure of counting "pulses" to determine where sources and loads are placed that is found in other MININEC-based programs. It also provides true current sources for phased array analysis. The program was designed to be user friendly and is entirely menu driven. Users can add, delete or modify wires, sources, loads, and ground media with a few keystrokes while the program automatically keeps sources and loads where you originally placed them. Other features include azimuth and elevation plotting; saving and recalling antenna descriptions; beamwidth, gain, sidelobe, front/back and front/sidelobe analysis, current distribution, and SWR (50- or 75-ohm systems). Plots can be printed on Epson-compatible 8/9 or 24 pin dot-matrix printers. All features except plotting are available on nongraphics systems, and pattern data are presented in tabular form. Plotting requires CGA, EGA, Hercules, or compatible capability. Two versions are available, optimized for coprocessor or non-coprocessor systems (specify when ordering). Price is \$49, postpaid (United States, Canada, Mexico) from Roy Lewallen, W7EL, PO Box 6658, Beaverton, Oregon 97007.

Circle #303 on Reader Service Card.

SA Series Programs for IBM PCs

Fundamental Services offers the first in a series of stand-alone (SA) ham programs for IBM PCs and compatibles. The SA series has pull-down menus, mouse support, help windows, color displays, and fast assembler subroutines.

"SALOG" is a logger for all bands and modes, the grid locator system, round table QSOs, and net control. Generated logs can be edited and printed.

"SAQSL" prints QSL cards and labels using

logs from SALOG. You can print two sizes of continuous form cards and two sizes of labels for QSOs.

The SA series is available from Fundamental Services, 1546H Peaceful Lane N., Clearwater, Florida 34616. The cost is \$19.95 each plus \$2 shipping and handling; Florida residents add 6-percent sales tax.

Circle #304 on Reader Service Card.

ICOM's New IC-24AT Dual Band Mini Handheld Transceiver

ICOM announces its new 440-MHz and 144-MHz dual band mini handheld, the IC-24AT. Features include:

- Five-watt power output
- Built-in clock
- Crossband full duplex capability
- Forty double-spaced memory channels
- DTMF autodial memory

The IC-24AT also has an external DC power jack, repeater functions, priority watch, and a variety of scan functions. Available options include the UT-50 CTCSS encoder/decoder unit, and UT-51 CTCSS encoder unit.

For details contact ICOM America, Inc., 2380 116th Avenue NE, PO Box C-90029, Bellevue, Washington 98009-9029.

Circle #305 on Reader Service Card.

AEA's New AT-3000 3-kW Antenna Tuner

AEA has a new AT-3000 3-kW antenna tuner, which incorporates the features of the AT-300 300-watt antenna tuner in a high powered package.

Features include:

- 3,000 watts continuous duty cycle
- Front panel switch to select two unbalanced (coax-fed) antennas, a dummy load or a balanced antenna
- Peak and average reading cross-needle meter which shows forward power, reflected power, and SWR

The AEA AT-3000 antenna tuner is available through AEA authorized dealers. For details contact: Advanced Electronic Applications, Inc., 2006 196th Street SW, PO Box 2160, Lynnwood, Washington 98036. Telephone (206)775-7373.

Circle #306 on Reader Service Card.

**ORDER
TOLL-FREE
-800-821-7323**

**DEPENDABLE SERVICE
AT THE RIGHT PRICE . . . EVERYTIME**

MasterCard—VISA—Discover—COD

Missouri
RADIO CENTER

KENWOOD

NEW! 

TS-950SD
TRANSMIT THE ULTIMATE SIGNAL

- Digital Signal Processing
- Dual Frequency Receive
- Digital AF Filter • 100 Memories

CALL FOR DETAILS AND ORDER TODAY!

YAESU



FT-100
THE BEST OF THE BEST

- 200 Watts Output
- All Amateur Bands
- Dual Receive
- DDS-Direct Digital Synthesis

CALL FOR ALL THE DETAILS!

ICOM **NEW!**



IC-765 NEW HF TRANSCEIVER

- Built-in Automatic Antenna Tuner and Power Supply
- 99 Memories • 100 W Output
- 160-10M/General Coverage Receiver
- Band Stacking Registers

ALINCO **NEW!**



DR-570T
VHF/UHF TWIN BANDER

- 45W on 2M/35W on 70cm
- Receive on both Bands at Same Time
- Extended Receiver Range
- More Features for the Money Than Anyone Else

CALL TODAY!

KENWOOD



TS-140S AFFORDABLE DX-ing!

- HF Transceiver With General Coverage Receiver
- All HF Amateur Bands
- 100 W Output
- Compact, Lots of Features

YAESU



FT-736R VHF-UHF BASE STATION

- SSB, CW, FM on 2 Meters and 70 cm
- Optional 50 MHz, 220 MHz or 1.2 GHz
- 25 Watts Output on 2 Meters, 220 and 70 cm
- 10 Watts Output on 6 Meters and 1.2 GHz • 100 Memories

ICOM **NEW!**

IC-725 NEW ULTRA-COMPACT HF TRANSCEIVER



- USB/LSB/CW, AM Receive
- Optional Module for AM Transmit and FM TX/RX
- 160-10M Operation • 100 W Output
- Receive 30 kHz to 33 MHz
- 26 Memories with Band Stacking Registers

AMERITRON



AL-80A AMPLIFIER

- Full Kilowatt Output
- 160-15 Meters
- 3-500 Z Tube for Maximum Life
- Precise and Easy Tuning
- Step-Start Inrush Protection™

SPECIAL SALE!

KENWOOD

TH-225A
HIGHER POWER 2 METER H.T.



- Now 5 Watts Output
- Odd Off Sets
- Wideband Frequency Coverage
- Same Accessories as TH-215

CALL TODAY!

YAESU **NEW!**

FT-470 COMPACT DUAL BAND FM HANDHELD (2M/70CM)



21 Memories for Each Band
Dual VFO's for Each Band
Up to 5 Watts Power
Built-in CTCSS
Built-in 10-Memory DTMF Autodialer

ICOM **NEW!**

IC-24AT COMPACT DUAL BAND, FM



- 140-150 MHz; 440-450 MHz
- 5W Output
- Crossband Full Duplex
- 40 Double-Spaced Memories
- 4 DTMF Code Memories

CHECK OUT ALL THE FEATURES!

ASTRON



- RS7A . . . \$49
- RS12A . . . \$70
- RS20A . . . \$89
- RS20M . . \$109
- VS20M . . \$124
- RS35A . . \$139
- RS35M . . \$159
- VS35M . . \$174
- RS50A . . \$199
- RS 50M . . \$219
- RM50M . . \$259
- VS50M . . \$232

uniden
HOT WINTER SPECIAL



HR-2600 10 Meter Mobile

\$229.95 Delivered

Great Deals On Scanners Too!
CALL

ASA



PK-232 MULTI-MODE TNC

- AMTOR, ASCII, Baudot, CW, FAX, NAVTEX, Packet
- PAKMAIL™ Mailbox With Third Party Traffic
- Two Radio Ports

THE ORIGINAL MULTI-MODE TNC

ICOM

2 Meter Sale
Your Favorite Mobiles At Tremendous Savings!

IC-228A, 25 watts
IC-228H, 45 watts
IC-28A, 25 watts
IC-28H, 45 watts

DON'T WAIT—CALL TODAY
SAVE SAVE SAVE

MFJ SALE MFJ
LARGEST STOCK OF ALL YOUR MFJ FAVORITE ACCESSORIES
CALL TODAY FOR BEST PRICE



MFJ-1278
Multi-Mode Data Controller
CALL FOR EXTRA SAVINGS

102 N.W. Business Park Lane Kansas City, MO 64150 Call Toll Free—9am - 6pm Mon.-Fri. 9am - 2pm Sat.
Send SASE For Used List In Missouri Call—816-741-8118

CUSHCRAFT • DIAMOND **WANTED: QUALITY USED GEAR, CASH OR TRADE** **HUSTLER • HYGAIN**

ICOM • KANTRONICS • KENWOOD • MFJ • LARSEN • ASTRON • MIRAGE/KLM • RFCONCEPTS • UNIDEN • YAESU

OEI OPTOELECTRONICS

The only name in HANDI-COUNTERS

Check These Incredible Features
On The All New UTC3000

- **10Hz to 2.4GHz Range.**
Simply amazing!
 - **10 Digit LCD Display.**
1Hz resolution to over 150 MHz direct.
Readable in bright sunlight.
 - **RF Signal Strength Bargraph.**
16 Segment, Zero, & Full Scale adjustment.
SEE the input signal!
 - **Super Sensitivity.** <1mV 10-200MHz,
<5mV to 2GHz for efficient antenna pickup.
 - **6 Functions.** Frequency, Period, Ratio
Time Interval, Average, & Prescale.
 - **Hold Button.**
"Locks in" your exact Measurement FAST!
 - **Extruded Aluminum Enclosure.**
Designed to fit every hand.
 - **Priced Right! Only \$375.**
Includes Nicads, AC Charger/Adapter.
- Or Select Our Most Popular
HANDI-COUNTER, the model 2210
that set the standard in handheld
frequency counter technology!
Value Priced at only \$239.

Professionals and Hobbyists all over
the world have chosen OEI for 16
years! **Shouldn't YOU?**

HANDI-COUNTERS! ...Only from OEI!
Choose the model that fits your needs...
and your budget! **CALL NOW!**



UTC3000



Period Average Mode



Display Showing All Annunciators

Model	UTC3000	2600H	2210	1300H/A	2400H	CCA	CCB
Function	Freq, Period Ratio, Interval, Avg, Prescale	Frequency	Frequency	Frequency	Frequency	Frequency	RF Indicator
Range	10Hz-2.4GHz	10MHz-2.4GHz	10Hz-2.2GHz	1MHz-1.3GHz	10MHz-2.4GHz	10MHz-550MHz	10MHz-1.8GHz
Display	10 Digit LCD w/Function Annunciators	10 Digit LCD	8 Digit LED	8Digit LED	8 Digit LED	8 Digit LED	•
RF Signal Strength Indicator	16 Segment Adjustable Bargraph	16 Segment Adjustable Bargraph	•	•	•	LED with Adjustable Threshold	10 Segment Adjustable Bargraph
Price	\$375.	\$325.	\$239.	\$179.	\$189.	\$299.	\$119.
Sensitivity: <1 to <10mV typical. Time Base: ± 1.ppm.; ± .5ppm. add \$75 - LED Models; ±.2ppm add \$80. - LCD Models. Nicads & AC charger/adapter included. (9v Alkaline - CCB.) Carry Case, Antennas and Probes extra. One year parts & labor warranty on all products.							

OEI OPTOELECTRONICS

5821 NE 14th Avenue • Ft. Lauderdale, FL 33334

Toll Free Order Line:
1-800-327-5912

FL(305)771-2050 • FAX(305)771-2052



Visa, MC, COD, Cash, M.O. accepted. Personal Check allow 3 weeks. 5% Shipping, Handling, (Maximum \$10) U.S. & Canada. 15% outside continental U.S.A. In FL add 6% sales tax.



YAESU

Power ... and More!

FT-212RH

Frequency Synthesized
VHF/UHF FM
Transceiver

The compact, versatile FT-212RH is a 45 watt, 2 meter mobile that boasts a lot more than just high power. Inside its sturdy compact frame hides an impressive array of performance features plus high reliability...like 18 general purpose memories; one-touch call channel memory; two scanning range memories; CTCSS on any of the 37 standard tone frequencies may be programmed into any memory channel. Choice of standard, or optional, high performance tone encoding microphones. The FT-212RH and its 35 watt UHF counterpart, the FT-712RH are packed with state-of-the-art refinements... power and more!



- **Frequency Range:** 140-174 MHz on receive (144-148 MHz TX—Modifiable for MARS and CAP). Specifications guaranteed on amateur bands only.
- **Power Output:** 45 watts output with selectable 5 watt low power.
- **CTCSS:** Access any of the 37 standard CTCSS tone frequencies, plus 97.4 Hz can be displayed, selected and programmed into any memory for transmission.
- **19 Memories:** Each memory stores either programmable repeater shift or independent TX and RX frequencies.

- **Automatic Repeater Shift (ARS):** Enables selection of repeater transmitter offset automatically when tuned to a standard repeater subband.
- **Programmable Scanning:** Scans band, band segment or

memories. Scan auto-resume with carrier drop or after 5-second pause.

- **Tuning Steps:** Operator selectable steps in 5, 10, 12.5, 20 and 25 KHz increments.
- **CAT System Control:** Provides for external control of VFO frequency, mode and memory functions from operator's personal computer.
- **Amber Backlit LCD Display:** Automatically controls the brightness of the display backlighting and pilot lamps.
- **Tone Encoding Microphone:** Choice of standard, or optional high performance DTMF tone encoding microphones.
- **Digital Voice System (DVS-1):** Optional system which allows local and remote digital voice recording and playback.



FT-4700RH

Dual Band VHF/UHF
Trunk Mountable
FM Transceiver

- **Frequency Range:** 140-174 MHz on 2m (modifiable for MARS and CAP); 430-450 MHz on 70cm.
- **Power Output:** 50 watts on 2m; 40 watts on 70cm. Selectable 5 watts low power on both bands.
- **Full Duplex Cross Band Operation:**
- **Dual Receive:**
- **CTCSS Encode/Decode:**
- **Remote Control Kit Included:**
- **Amber Backlit LCD Display** and controls with dimmer switch.
- **20 Memories:**
- **Dual Antenna Ports:**
- **Programmable Scanning:**
- **MH-15C8 Mic** standard; MH-15D8 Mic optional.

For information on these and Yaesu's full line of products, call our literature desk toll-free at 1 (800) 999-2070.

YAESU
Performance without compromise.

KENWOOD

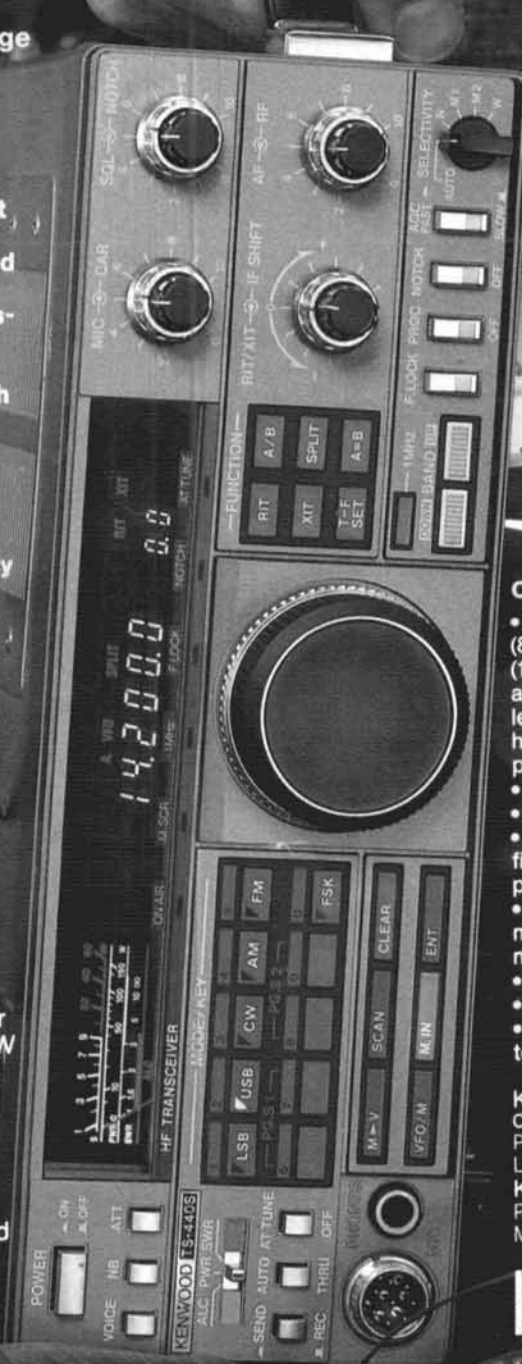
The DXpeditioner!

TS-440S

Compact high performance HF transceiver with general coverage receiver

Portable reliable performance and ease of use makes the TS-440S your obvious "low bands" choice. It is "Every Ham's" rig to go — ham shack, portable or mobile. But don't let the small size fool you — there's lots of "big rig" performance packed into this package. Built-in antenna tuner option. Continuous duty transmitter. Super DynaMix™ front end. Five filter functions. The TS-440S is at your service wherever you wish to operate.

- Covers all Amateur bands
General coverage receiver tunes from 100 kHz–30 MHz. Easily modified for HF MARS operation.
- Direct keyboard entry of frequency
- All modes built-in
USB, LSB, CW, AM, FM, and AFSK. Mode selection is verified in Morse Code.
- VS-1 voice synthesizer (optional)
- Built-in automatic antenna tuner (optional). Covers 80–10 meters.
- 5 IF filter functions
- Superior receiver dynamic range
Kenwood DynaMix™ high sensitivity direct mixing system ensures true 102 dB receiver dynamic range. (500 Hz bandwidth on 20 m.)
- 100% duty cycle transmitter
Super efficient cooling permits continuous key-down for periods exceeding one hour. RF input power is rated at 200 W PEP on SSB. 200 W DC on CW, AFSK, FM, and 110 W DC AM. (The PS-50 power supply is needed for continuous duty.)
- Computer interface port
- Adjustable dial torque
- 100 memory channels
Frequency and mode may be stored in 10 groups of 10 channels each. Split frequencies may be stored in 10 channels for repeater operation.
- TU-8 CTCSS unit (optional)



- MC-43S UP/DOWN mic. included
- Superb interference reduction
IF shift, tuneable notch filter, noise blanker, all-mode squelch, RF attenuator, RIT/XIT, and opt. filters fight QRM.
- Dual SSB IF filtering
A built-in SSB filter is standard. When an optional SSB filter (YK-88S or YK-88SN) is installed, dual filtering is provided.
- VOX, full or semi break-in CW
- AMTOR compatible



Optional accessories:

- AT-440 internal auto. antenna tuner (80 m – 10 m) • AT-250 external auto. tuner (160 m – 10 m) • AT-130 compact mobile antenna tuner (160 m – 10 m) • IF-232C/IC-10 level translator and modem IC kit • PS-50 heavy duty power supply • PS-430 DC power supply • SP-430 external speaker
- MB-430 mobile mounting bracket
- YK-88C/88CN 500 Hz/270 Hz CW filters
- YK-88S-88SN 2.4 kHz/1.8 kHz SSB filters
- MC-60A/80/85 desk microphones
- MC-55 (8P) mobile microphone
- HS-4/5/6/7 headphones
- SP-41/50B mobile speakers
- MA-5/VP-1 HF 5 band mobile helical antenna and bumper mount
- TL-922A 2 kw PEP linear amplifier
- SM-220 station monitor (no pan display)
- VS-1 voice synthesizer
- TU-8 CTCSS tone unit
- PG-2C extra DC cable.

KENWOOD U.S.A. CORPORATION
COMMUNICATIONS & TEST EQUIPMENT GROUP
P.O. BOX 22745, 2201 E. Dominguez Street
Long Beach, CA 90801-5745
KENWOOD ELECTRONICS CANADA INC.
P.O. BOX 1075, 959 Gana Court
Mississauga, Ontario, Canada L4T 4C2

KENWOOD

...pacesetter in Amateur Radio