

SEPTEMBER 1989 / \$2.95

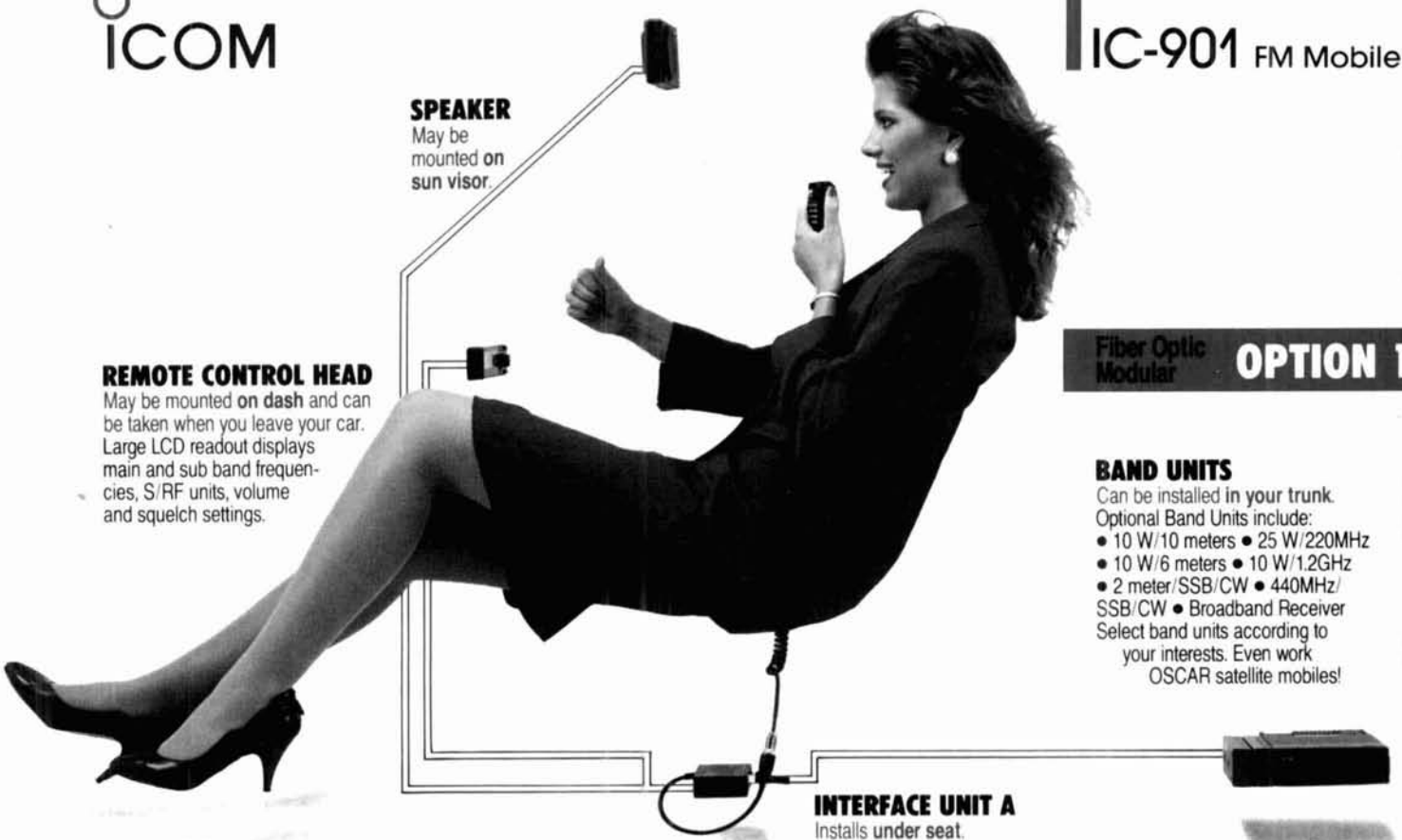
NEW ► HAM RADIO



Hand held PRO CX

ICOM

IC-901 FM Mobile



SPEAKER
May be mounted on sun visor.

REMOTE CONTROL HEAD
May be mounted on dash and can be taken when you leave your car. Large LCD readout displays main and sub band frequencies, S/R/F units, volume and squelch settings.

Fiber Optic Modular **OPTION 1**

BAND UNITS
Can be installed in your trunk. Optional Band Units include:
• 10 W/10 meters • 25 W/220MHz
• 10 W/6 meters • 10 W/1.2GHz
• 2 meter/SSB/CW • 440MHz/SSB/CW • Broadband Receiver
Select band units according to your interests. Even work OSCAR satellite mobiles!

INTERFACE UNIT A
Installs under seat.

THE WORLD'S MOST VERSATILE MOBILE

ICOM'S NEW IC-901 OFFERS THREE EASY-TO-OPERATE TRANSCEIVER CONFIGURATIONS

The IC-901 can be (1) field-combined as a fully separated and fiber optic-linked system with multiple trunk-located band units, (2) a single-cabinet transceiver for dashmounting or (3) a remote-controlled unit for underseat installation.

Compact Transceiver **OPTION 2**

Control head is installed directly to the interface unit, making one compact unit.



Entire unit may be mounted in dash.

Under the Seat **OPTION 3**



Dual band and interface unit can be installed under seat.

Remote Control on visor.

The IC-901 is supplied with 50 watts 2-meter and 35 watts 440MHz FM band units covering 138-174MHz Rx and 140-150MHz Tx plus 440-450MHz Rx/Tx. Adding more band units is a snap. They install easily out-of-sight in your trunk for security!

Outstanding Features Include: Full duplex operation, simultaneous dual band reception, ten memories per band, program-

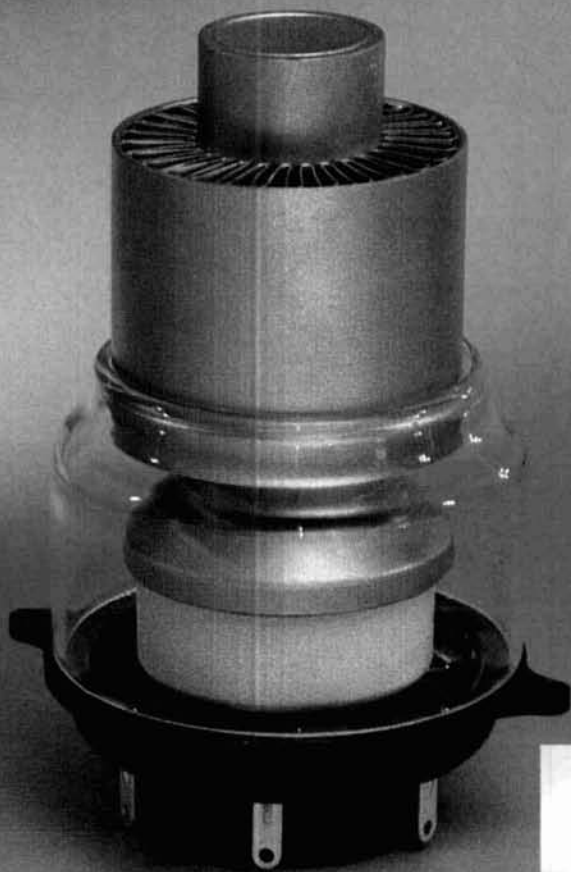
mable band and memory scanning with skip function, any Tx offset, and much more.

The IC-901 also features a clever new **DTMF Calling System** which silently monitors a busy frequency or repeater for stations calling you. Squelch automatically opens when a signal with the same DTMF code you present is received.

Optional Pager Function. When activated, your IC-901 transmits a six-digit DTMF code to call others. Its last three digits identify you as the calling station.

ICOM America, Inc., 2380-116th Ave. N.E., Bellevue, WA 98004
Customer Service Hotline (206) 454-7619
3150 Premier Drive, Suite 126, Irving, TX 75063
1777 Phoenix Parkway, Suite 201, Atlanta, GA 30349
ICOM CANADA, A Division of ICOM America, Inc.,
3071 - #5 Road, Unit 9, Richmond, B.C. V6X 2T4 Canada
All stated specifications are subject to change without notice or obligation. All ICOM radios significantly exceed FCC regulations limiting spurious emissions. 901689

ICOM
First in Communications



The 3CX1200A7 continues the EIMAC tradition of serving AMATEUR RADIO.

EIMAC was right there to meet Ham requirements of 1500 watts PEP with its 3CX1200A7 tube. Leading manufacturers count on its proven performance and reliability.

Low-cost power for small spaces

The rugged 3CX1200A7 takes size into consideration and, by design, is recommended as a single, low-cost alternative for a pair of EIMAC 3-500 Z tubes for new amplifier designs.

General Specifications

The EIMAC 3CX1200A7 is a high-mu, compact, forced air cooled triode for zero-bias class AB2 amplifiers.

- 2.9" dia. x 6.0" long
- Plate dissipation: 1200 watts
- Glass chimney SK-436 available
- Standard EIMAC SK-410 socket available

More information is available on the new EIMAC 3CX1200A7 tube from Varian EIMAC, or any Elec-

tron Device Group worldwide sales organization.

Varian EIMAC
1678 S. Pioneer Road
Salt Lake City, Utah 84104
Telephone: 801 • 972-5000

varian 
eimac salt lake division

KENWOOD

...pacesetter in Amateur Radio

DX-celence!

#1 Rated HF!



TS-940S Competition class HF transceiver

TS-940S—the standard of performance by which all other transceivers are judged. Pushing the state-of-the-art in HF transceiver design and construction, no one has been able to match the TS-940S in performance, value and reliability. The product reviews glow with superlatives, and the field-proven performance shows that the TS-940S is "The Number One Rated HF Transceiver!"

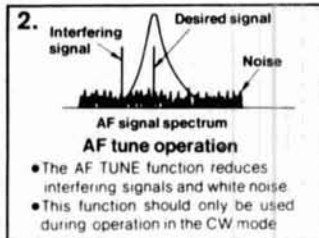
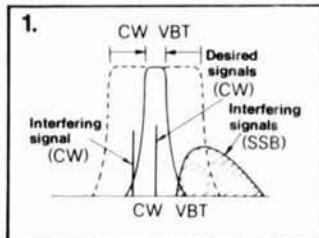
- 100% duty cycle transmitter. Kenwood specifies transmit duty cycle **time**. The TS-940S is guaranteed to operate at full power output for periods **exceeding one hour**. (14.250 MHz, CW, 110 watts.) Perfect for RTTY, SSTV, and other long-duration modes.
- First with a full one-year limited warranty.
- Extremely stable phase locked loop (PLL) VFO. Reference frequency accuracy is measured in **parts per million!**

Optional accessories:

- AT-940 full range (160-10m) automatic antenna tuner
- SP-940 external speaker with audio filtering
- YG-455C-1 (500 Hz), YG-455CN-1 (250 Hz), YK-88C-1 (500 Hz) CW filters; YK-88A-1 (6 kHz) AM filter
- VS-1 voice synthesizer
- SO-1 temperature compensated

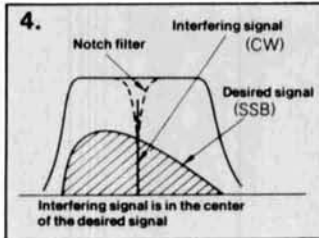
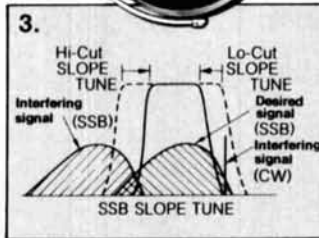
Complete service manuals are available for all Kenwood transceivers and most accessories. Specifications, features, and prices are subject to change without notice or obligation.

- crystal oscillator
- MC-43S UP/DOWN hand mic.
- MC-60A, MC-80, MC-85 deluxe base station mics.
- PC-1A phone patch
- TL-922A linear amplifier
- SM-220 station monitor
- BS-8 pan display
- IF-232C/IF-10B computer interface.



1) **CW Variable Bandwidth Tuning.** Vary the passband width continuously in the CW, FSK, and AM modes, without affecting the center frequency. This effectively minimizes DRM from nearby SSB and CW signals

2) **AF Tune.** Enabled with the push of a button, this CW interference fighter inserts a tunable, three-pole active filter between the SSB/CW demodulator and the audio amplifier. During CW QSOs, this control can be used to reduce interfering signals and noise, and peaks audio frequency response for optimum CW performance.



3) **SSB Slope Tuning.** Operating in the LSB and USB modes, this front panel control allows independent, continuously variable adjustment of the high or low frequency slopes of the IF passband. The LCD sub display illustrates the filtering position.

4) **IF Notch Filter.** The tunable notch filter sharply attenuates interfering signals by as much as 40 dB. As shown here, the interfering signal is reduced, while the desired signal remains unaffected. The notch filter works in all modes except FM.

- Complete all band, all mode transceiver with general coverage receiver. Receiver covers 150 kHz-30 MHz. All modes built-in: AM, FM, CW, FSK, LSB, USB.
- Superb, human engineered front panel layout for the DX-minded or contesting ham. Large fluorescent tube main display with dimmer; direct keyboard input of frequency; flywheel type main tuning knob with optical encoder mechanism all combine to make the TS-940S a joy to operate.
- One-touch frequency check (T-F SET) during split operations.
- Unique LCD sub display indicates VFO, graphic indication of VBT and SSB Slope tuning, and time.
- Simple one step mode changing with CW announcement.
- Other vital operating functions. Selectable semi or full break-in CW (QSK), RIT/XIT, all mode squelch, RF attenuator, filter select switch, selectable AGC, CW variable pitch control, speech processor, and RF power output control, programmable band scan or 40 channel memory scan.

KENWOOD

KENWOOD U.S.A. CORPORATION
2201E. Dominguez St., Long Beach, CA 90810
P.O. Box 22745, Long Beach, CA 90801-5745

HAM RADIO

SEPTEMBER 1989
Volume 22, Number 9

Publisher & Editor-in-Chief:
T.H. TENNEY, JR., W1NLB

EDITORIAL STAFF

Managing Editor:

Terry Northup, KA1STC

Technical Editor:

Marty Durham, NB1H

Consulting Editor:

Robert D. Wilson, WA1TKH

Associate Editors:

Tom McMullen, W1SL

Joseph J. Schroeder, W9JUV

Alfred Wilson, W6NIF

Production Editor: Susan Shorrock

Copy Editor: Peggy Tenney, KA1QDG

Editorial Assistant: Beth McCormack

Editorial Review Board:

Peter Bertini, K1ZJH

Forrest Gehrke, K2BT

Michael Gruchalla, P.E.

Bob Lewis, W2EBS

Mason Logan, K4MT

Vern Riportella, WA2LQQ

Ed Wetherhold, W3NQN

PUBLISHING STAFF

Assistant Publisher:

J. Craig Clark, Jr., NX1G

Director of Advertising Sales:

Henry S. Gallup, N1GCF

Advertising Production Manager:

Dorothy Sargent, KA1ZK

Circulation Manager: Susan Shorrock

Circulation: Therese Bourgault

Traffic Manager: Phil Alix, N1FPX

Book Store: Maribeth Buchanan

Cover Illustration: Hans Evers, PA0CX

Tom McMullen, W1SL, is on vacation this month. His "Elmer's Notebook" column returns next month.



W6SAI, page 20



K4IPV, page 62

FEATURES

HF MOBILE ANTENNAS

9

Robert Sherwood, NC0B

The Weekender: KEEPING AN EYE ON YOUR SIDEBAND PEP

17

John Fielden, GW4NAH

Ham Radio Techniques: THE LOG PERIODIC ANTENNA FAMILY

20

Bill Orr, W6SAI

PROTECT YOUR AMATEUR STATION FROM LIGHTNING

25

Richard Little, KY9L

K4EF LONG WIRE ANTENNA DESIGNS

32

Everett Brown, K4EF

Practically Speaking: VERTICALLY POLARIZED ANTENNAS — PART 2

45

Joseph J. Carr, K4IPV

The Weekender: CARD FILE STATION FOR 40 METERS

56

Ed Marriner, W6XM

INTRODUCTION TO WAVEFORM GENERATORS — PART 1

62

Joseph J. Carr, K4IPV

AN IMPROVED AGC CIRCUIT

72

W.C. Loudon, W8WFH

MEASURING THE ACCURACY OF A PARABOLIC ANTENNA

85

Lester A. Wagner, W8BBO, and Glen Grewell, W8FP

DEPARTMENTS

BACKSCATTER	4	HAM MART	90
COMMENTS	6	FLEA MARKET	92
HAM NOTEBOOK	30	DX FORECASTER	96
PRODUCT REVIEW	80	ADVERTISER'S INDEX	98
NEW PRODUCTS	84	READER SERVICE	98

HAM RADIO Magazine (ISSN 0148-5989) is published monthly by Communications Technology, Inc. Greenville, New Hampshire 03048-0498 Telephone: 603-878-1441. **Subscription Rates:** United States: one year, \$22.95; two years, \$38.95; three years, \$49.95; Canada and Mexico: one year, \$31.00; two years, \$55.00; three years, \$74.00. *All other countries:* one year, \$35.00 via surface mail only. All subscription orders payable in U.S. funds, via international postal money order or check drawn on U.S. bank. **International Subscription Agents:** page 94.

Microfilm copies are available from Buckmaster Publishing Mineral, Virginia 23117. Cassette tapes of selected articles from HAM RADIO are available to the blind and physically handicapped from Recorded Periodicals, 919 Walnut Street, Philadelphia, Pennsylvania 19107.

Copyright 1989 by Communications Technology, Inc. Title registered at U.S. Patent Office.

Second-class postage paid at Greenville, New Hampshire 03048-0498 and at additional mailing offices. Send change of address to HAM RADIO, Greenville, New Hampshire 03048-0498.

Backscatter



More Cause for Thought

Last November I talked about the potential health hazards of electromagnetic radiation. While there is good reason to be concerned, too little is known at this time to determine if there is a direct link between electromagnetic radiation and cancer, or other diseases. Within the last few months, however, the story has received broad coverage in a number of different sources.

Paul Brodeur, author of *The Zapping of America* published in 1977, recently had a three-part series published in *The New Yorker* magazine on June 12th, 19th, and 26th that discusses the alleged hazards of electromagnetic (EM) radiation at length. Brodeur addresses a number of areas he feels are potential problems. They are: high voltage power lines, electrical wiring, radar, and video display terminals (VDTs).

High voltage power lines are a threat due to the high level electromagnetic field that surrounds them. Brodeur quotes research that claims these electromagnetic fields could alter the body's intricate, disease-fighting immune system and weaken its ability to destroy cancer cells.

Brodeur takes the Air Force to task for locating its PAVE PAWS radars near two major population areas — Cape Cod, Massachusetts and Sacramento, California — without having completed a study of the bioeffects of those radars. Finally, there is the ubiquitous computer VDT. Again, the threat is from various types of high level EM radiation.

Brodeur's series will be published this fall by Simon and Schuster as *Currents of Death: Power Lines, Computer Terminals and the Attempt to Cover Up Their Threat to Your Health*. Unfortunately, the sensational title does little to enhance the stature of Brodeur's piece.

Picking up on Brodeur's lead, both *TIME* and *NEWSWEEK* have run reports on EM radiation threats. The *NEWSWEEK* piece, published in its July 10th issue on page 77, was titled "An Electromagnetic Storm," with the subhead "Overblown charges about power lines and VDTs." Quoting from the article, "The reality is a bit more complicated. Scientists are only beginning to fathom the body's exquisite sensitivity to electromagnetic energy. The evidence linking exposure to disease is far less than Brodeur implies." Summing up, the article says: "Brodeur and many of those he criticizes seem to agree: we're not quite sure what we're up against, and we need urgently to find out." *TIME*'s piece ran in the July 17th issue and discusses many of the same points. The Department of Energy does not have enough information at this time to take any regulatory action regarding electromagnetic fields. If there is a link between certain illnesses, *TIME* asserts that appliances and electronic equipment will need to be redesigned, homes rewired, and the power distribution infrastructure completely rebuilt.

The New York Times ran a long article in its Tuesday, July 11th, "Science Times" section. While shedding little new light on the subject, the *Times* piece gives the reader a better explanation of the potential risks, and includes suggestions on how to limit exposure to electromagnetic fields. *The Times* also emphasizes that "prudence over panic" is the best course of action to follow.

I have also just received a press release from Congress's Office of Technology Assessment (OTA), dated Monday, June 19th, that discusses possible biologic effects of electromagnetic radiation. The report states that a number of different studies have demonstrated that "under specific circumstances even weak electric and magnetic fields can affect living cells and systems."

The OTA points out, however, that the health risk is much more complex and uncertain than that from other hazards like toxic chemicals and other known carcinogenic (cancer-causing) substances. Researchers do not know what parameters are the most important — "field strength, change in field strength over time, currents induced in the body, exposure, duration, or some other variation."

The OTA calls for careful work to establish, beyond a reasonable doubt, whether or not there is a relationship between certain illnesses and electromagnetic fields. The valuable 102-page OTA report is titled *Biological Effects of Power Frequency Electric and Magnetic Fields*. It is available from the U.S. Government Printing Office (GPO), Superintendent of Documents, Washington, DC 20402, stock #052-003-01152-2, for \$4.75. Another important document, *Health Effects of Transmission Lines*, covers many types of EM radiation. The 393-page report is available from the GPO for \$11. Ask for stock #052-070-06461-7, serial no. 100-22.

Finally, the ARRL Southwestern Division Convention, scheduled for August 25th-27th in Los Angeles, California, will be holding the first-ever Physician's Panel on Radiation Hazards. Wayne Overbeck, Ph.D., N6NB, will be the moderator. The panel consists of:

- W. Ross Adey, M.D., K6UI, internationally respected scientist in bioeffects research. Dr. Adey is the recipient of prestigious

(Continued on page 89.)

KENWOOD

...pacesetter in Amateur Radio

NEW!

Affordable DX-ing!

TS-140S

HF transceiver with general coverage receiver.

Compact, easy-to-use, full of operating enhancements, and feature packed. These words describe the new TS-140S HF transceiver. Setting the pace once again, Kenwood introduces new innovations in the world of "look-alike" transceivers!

- Covers all HF Amateur bands with 100 W output. General coverage receiver tunes from 50 kHz to 35 MHz. (Receiver specifications guaranteed from 500 kHz to 30 MHz.) Modifiable for HF MARS operation. (Permit required)
- All modes built-in. LSB, USB, CW, FM and AM.
- Superior receiver dynamic range Kenwood DynaMix™ high sensitivity direct mixing system ensures true 102 dB receiver dynamic range.



- New Feature! Programmable band marker. Useful for staying within the limits of your ham license. For contesters, program in the suggested frequencies to prevent QRM to non-participants.
- Famous Kenwood interference reducing circuits. IF shift, dual noise blankers, RIT, RF attenuator, selectable AGC, and FM squelch.

- M. CH/VFO CH sub-dial. 10 kHz step tuning for quick QSX at VFO mode, and UP/DOWN memory channel for easy operation.
- Selectable full (QSK) or semi break-in CW.
- 31 memory channels. Store frequency, mode and CW wide/narrow selection. Split frequencies may be stored in 10 channels for repeater operation.
- RF power output control.
- AMTOR/PACKET compatible!
- Built-in VOX circuit.
- MC-43S UP/DOWN mic. included.

Optional Accessories:

- AT-130 compact antenna tuner • AT-250 automatic antenna tuner • HS-5/HS-6/HS-7 headphones • IF-232C/IF-10C computer interface
- MA-5/VP-1 HF mobile antenna (5 bands)
- MB-430 mobile bracket • MC-43S extra UP/DOWN hand mic. • MC-55 (8-pin) goose neck mobile mic. • MC-60A/MC-80/MC-85 desk mics.
- PG-2S extra DC cable • PS-430 power supply
- SP-41/SP-50B mobile speakers • SP-430 external speaker • TL-922A 2 kW PEP linear amplifier (not for CW QSK) • TU-8 CTCSS tone unit
- YG-455C-1 500 Hz deluxe CW filter, YK-455C-1 New 500 Hz CW filter.



TS-680S

All-mode multi-bander

- 6m (50-54 MHz) 10 W output plus all HF Amateur bands (100 W output).
- Extended 6m receiver frequency range 45 MHz to 60 MHz. Specs. guaranteed from 50 to 54 MHz.
- Same functions of the TS-140S except optional VOX (VOX-4 required for VOX operation).
- Pre-amplifier for 6 and 10 meter band.



Complete service manuals are available for all Kenwood transceivers and most accessories. Specifications, features, and prices are subject to change without notice or obligation.

KENWOOD

KENWOOD U.S.A. CORPORATION
2201 E. Dominguez St., Long Beach, CA 90810
P.O. Box 22745, Long Beach, CA 90801-5745

Comments



Documenting extraordinary accomplishments

Dear HR

Your article on the "Bloody Beams" was great — not only from its technical perspective, but also knowing how one or two clear thinking individuals can win out over the "it's impossible/we can't do that" establishment.

Perhaps with your encouragement United States hams who played a key role in World War II electronics could document their experiences. One story that hasn't been written is how we achieved the extraordinary quality/functionality of our electronic equipment? This is something that we have now lost to the Japanese.

Dr. William H. Taubert
V.P., Beatrice/Hunt-Wesson, Inc.
Fullerton, California

The right formula

Just a note to let you know I think you have hit upon the right mix in articles. Referring to May 1989 issue of *HR*, I see everything from soup to nuts in way of construction articles — from the complicated to the simple, which is the way it should be. Carry on.

John L. McDonald, W6SDM,
Camarillo, California

Initiation rites

Dear HR

Is it possible that some of us do not have an aptitude for the code?

Psychologists tell us that the two hemispheres of the brain serve different functions. The left hemisphere is supposed to deal with analytical processes while the right side deals with speech, music, art, and the like. As one who can't dance, find the beat

in rock music, or copy code well, I believe that code, like music is a right-brain activity. The theory portion of the exam is a left-brain process. To be a "good" amateur, one must have talents that some of us were not born with.

I started to try to learn the code in 1948. By 1953, I got a Novice ticket. I built a working 8-tube superhet receiver and a 75-watt transmitter. Alas, I could not copy off-air code, and never made a Novice contact. In 1956, after getting my First-Class Radiotelephone ticket, I also passed my Technician exam. I worked 6-meter phone, but no CW. My Technician license expired in 1961 and I became inactive.

Over the years, I tried to increase my code speed, but gave up each time after weeks and weeks of practice. In 1987, I practiced daily for about 10 weeks. The theory wasn't a problem, so I passed my Advanced in July. Incentive licensing does work, so I studied code for an entire year and passed my Extra in 1988. I can copy the practice tapes, but I cannot copy CW off air. Most operators seem to send at about 30 to 35 WPM. I might as well try to copy RTTY by ear. I don't even own a key and have yet to make a CW contact. CW is too intimidating for this individual who must have a walnut for a right brain.

Does CW make someone a better operator? Just listen to the antics of the idiots in the pile-ups or the grouches of 75 meters and tell me that knowing CW made them into better Amateurs.

For me, the code requirement is analogous to a fraternity hazing. Forty years is a very long initiation.

Donald J. Sinex, KI6YE,
Huntington Beach, California

A winner!

Dear HR

Many thanks for *The Radio Handbook* by Bill Orr, W6SAI. It was a real surprise to win in the April drawing.

Keep up the good work with the magazine. I have been a subscriber since the very first issue.

Kenneth L. Frank, WB5AKI,
Copperas Cove, Texas

The old man's disease

Dear HR

Its not trying to work 100 countries, or sending out QSLs, or getting QSLs from the bureau. Its not running off at the mouth on 2 meters, or getting on the soap box on 75, and hitting the green keys day and night. Oh, no. We did all of that years ago. But you hear the old-timers say, "Packet radio is not for me. I am too old for that stuff." I can remember that same kind of talk when SSB first came on line.

But, some old-timers are having a ball on packet radio now. They are chasing each other from one BBS to another. You must work DX to do this, and you don't spend your time talking because you have to find the BBS where your buddy left a message for you. Then you send your answer.

I was one of those guys who became "uptight" when I was in a packet connect. Seems there are more BBS mail boxes than mail. So now we can do something we have not done before.

You old has-beens should quit running down packet radio and get with what's here (and not what's coming down the pipe). You are not too old; you are too bullheaded. You don't have to upgrade, just degrade.

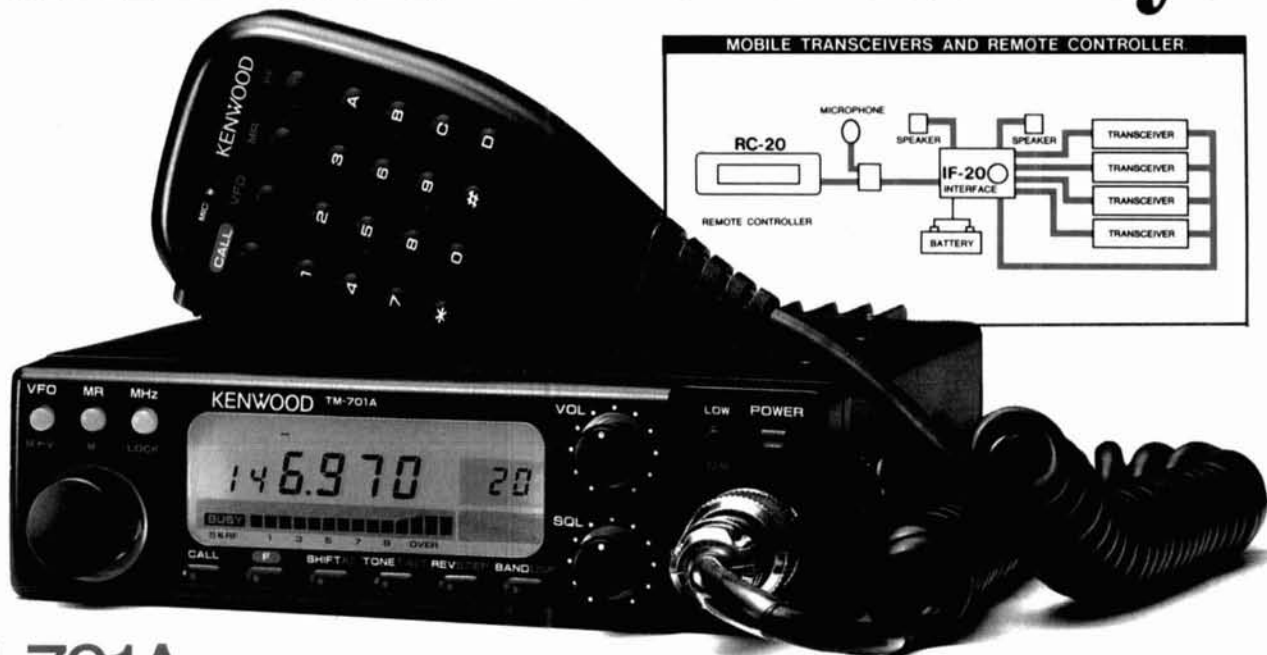
W. E. Huffman, K0CVT,
Moravia, Iowa

KENWOOD

...pacesetter in Amateur Radio

Affordable
Breakthrough!

Dual Band Afford-ability!



TM-701A

Dual Bander

The TM-701A combines two radios into one compact package. You get 25 watts on 2 meters and 70cm, 20 memory channels, tone encoder built-in, multiple scanning, auto repeater offset selection on 2 meters, and a host of additional features!

- **20 multi-function memory channels.** 20 memory channels allow storage of frequency, repeater offset, CTCSS frequency, frequency step, and Tone On/Off status, CTCSS and REV, providing quick and easy access during mobile operation.
- **25W on 2m and 70cm.**
- **Selectable full duplex-cross band (Telephone style) operation.**
- **Easy-to-operate front panel layout.**
- **Multi-function DTMF mic. supplied.** Controls are provided on the microphone for CALL (Call Channel), VFO, MR (Memory Call or to change the memory channel) and a programmable function key. The programmable key can be used to control one of the following functions on the radio: MHz, T.ALT, TONE, REV, BAND, or LOW power.
- **Easy-to-operate illuminated keys.** A functionally designed control panel with individually backlit keys increases the convenience and ease of operation during night-time use.

- **Optional full-function remote controller (RC-20).**

A full-function remote controller using the Kenwood bus line may be easily connected to the TM-701A and mounted in any convenient location. The new controller is capable of operating all front panel functions.

- **Built-in dual digital VFO's.**

a) Frequency step selection (5, 10, 15, 20, 12.5, 25kHz)

b) Programmable VFO

The user friendly programmable VFOs allow the operator to select and program variable tuning ranges in 1 MHz band increments.

- **Programmable call channel function.**

The call channel key allows instant recall of your most commonly used frequency data.

- **Programmable tone encoder built-in.**

- **Tone alert system—for true quiet monitoring.**

When activated this function will cause a distinct beeper tone to be emitted from the transceiver for approximately 10 seconds to signal the presence of an incoming signal.

- **Easy-to-operate multi-mode scanning.**

a) VFO scan

Band scan, Programmable band scan.

b) Memory scan plus programmable memory channel lock-out

c) Dual scan

Dual call channel scan
Dual memory scan
Dual VFO scan

d) Scan stop modes

Time operated scan (TO)
Carrier operated scan (CO)

- e) Scan direction

- f) Alert

When the AL switch is depressed memory channel 1 is scanned for activity at approximately 5 second intervals.

- **MHz switch.**
- **Lock function.**
- **Repeater reverse switch.**

Optional Accessories

- **RC-20** Full-function remote controller
- **RC-10** Multi-function remote controller
- **IF-20** Interface unit handset • **MC-44** Multi-function hand mic. • **MC-44DM** Multi-function hand mic. with auto-patch • **MC-48B** 16-key DTMF hand mic. • **MC-55** 8-pin mobile mic.
- **MC-60A/80/85** Desk-top mics. • **MA-700** Dual band (2m/70cm) mobile antenna (mount not supplied) • **SP-41** Compact mobile speaker • **SP-50B** Mobile speaker • **PS-430** Power supply • **PS-50** Heavy-duty power supply • **MB-201** Mobile mount • **PG-2N** Power cable • **PG-3B** DC line noise filter • **PG-4H** Interface connecting cable • **PG-4J** Extension cable kit • **TSU-6** CTCSS unit

KENWOOD

KENWOOD U.S.A. CORPORATION
COMMUNICATIONS & TEST EQUIPMENT GROUP
P.O. BOX 22745, 2201 E. Dominguez Street
Long Beach, CA 90801-5745
KENWOOD ELECTRONICS CANADA INC.
P.O. BOX 1075, 959 Gana Court
Mississauga, Ontario, Canada L4T 4C2

BEST OF MFJ

MFJ, Bencher and Curtis team up to bring you America's most popular keyer in a compact package for smooth easy CW



MFJ-422B

\$129⁹⁵

The best of all CW worlds - a deluxe MFJ Keyer using a Curtis 8044ABM chip in a compact package that fits right on the Bencher iambic paddle!

This MFJ Keyer is small in size but big in features. You get iambic keying, adjustable weight and tone and front panel volume and speed controls (8-56 WPM), dot-dash memories, speaker, sidetone and push button selection of automatic or semi-automatic/tune modes. It's also totally RF proof and has ultra-reliable solid state outputs that key both tube and solid state rigs. Use 9 V battery or 110 VAC with MFJ-1305, \$9.95.

The keyer mounts on a Bencher paddle to form a small (4 1/8 x 2 5/8 x 5 1/2 inches) attractive combination that is a pleasure to look at and use.

America's favorite paddle, the Bench, has adjustable gold-plated silver contacts, lucite paddles, chrome plated brass, and a heavy steel base with non-skid feet.

You can buy just the keyer assembly, MFJ-422BX, for only \$79.95 to mount on your Bencher paddle.

Artificial RF Ground

MFJ-931
\$79⁹⁵

You can create an artificial RF ground

and eliminate RF "bites", feedback, TVI and RFI when you let the MFJ-931 resonate a random length of wire and turn it into a tuned counterpoise. MFJ-931 also lets you electrically place a far away RF ground directly at your rig - no matter how far away it is - by tuning out the reactance of your ground connection wire. 7 1/2 x 3 1/2 x 7 in.

Antenna Bridge MFJ-204B \$79⁹⁵

Now you can quickly optimize your antenna for peak performance with this portable, totally self-contained antenna bridge.

No other equipment needed - take it to your antenna site. Determine if your antenna is too long or too short, measure its resonant frequency and antenna resistance to 500 ohms. It's the easiest, most convenient way to determine antenna performance. Built-in resistance bridge, null meter, tunable oscillator-driver (1.8-30 MHz). Use 9 V battery or 110 VAC with AC adapter, \$9.95.

Super Active Antenna

"World Radio TV Handbook" says MFJ-1024 is "a first rate easy-to-operate active antenna ... quiet ... excellent dynamic range ... good gain ... very low noise factor... broad frequency coverage ... excellent choice."

Mount it outdoors away from electrical noise for maximum signal, minimum noise. MFJ-1024 covers 50 KHz to 30 MHz

Receives strong, clear signals from all over the world. 20 dB attenuator, gain control. ON LED Switch two receivers and aux. or active antenna. 6x23x5 in. Remote unit has 54 inch whip, 50 ft. coax and connector. 3x2x4 in. 12 VDC or 110 VAC with

MFJ-1024 \$129⁹⁵ MFJ-1312, \$9.95.

MFJ Coax Antenna Switches



\$34⁹⁵ MFJ-1701



\$21⁹⁵ MFJ-1702



New \$59⁹⁵ MFJ-1704

Select any of several antennas from your operating desk with these MFJ Coax Switches. They feature mounting holes and automatic grounding of unused terminals. They come with MFJ's one year unconditional guarantee. MFJ-1701, \$34.95. Six position antenna switch. SO-239 connectors. 50-75 ohm loads. 2 KW PEP, 1 KW CW. Black aluminum 10x3x1 1/2 inch cabinet. MFJ-1702, \$21.95. 2 positions. Cavity construction. 2.5 KW PEP, 1 KW CW. Insertion loss below .2 dB. 50 dB isolation at 450 MHz. 50 ohm. 3x2x2 in. MFJ-1704, \$59.95. 4 position Cavity Switch with Lightning/Surge protection device. Center Ground position. 2.5 KW PEP, 1 KW CW. Extremely low SWR. Isolation better than 50 dB 500 MHz. Negligible loss. 50 ohm. 6 1/4 x 4 1/4 x 1 1/4 in.

"Dry" Dummy Loads for HF/VHF/UHF



MFJ-260 \$28⁹⁵

MFJ-262 \$69⁹⁵

New MFJ-264 \$109⁹⁵

MFJ has a full line of dummy loads to suit your needs. Use a dummy load for tuning to reduce needless (and illegal) QRM and save your finals. MFJ-260, \$28.95. Air cooled, non-inductive 50 ohm resistor. SO-239 connector. Handles 300 watts. Run full load for 30 seconds, derating curve to 5 minutes. SWR less than 1.3:1 to 30 MHz, 1.5:1 30-60 MHz, 2 1/2 x 2 1/2 x 7 in. MFJ-262, \$69.95. Handles 1 KW. SWR less than 1.5:1 to 30 MHz. 3x3x13 in. MFJ-264, \$109.95. Versatile UHF/VHF/HF 1.5 KW Dry Dummy Load. An MFJ first. Gives you low SWR to 650 MHz, usable to 750 MHz. You can run 100 watts for 10 minutes, 1500 watts for 10 seconds. SWR is 1.1:1 to 30 MHz, below 1.3:1 to 650 MHz. 3x3x7 inches. SO-239 connector.

New MFJ-1286 Gray Line DX Advantage

\$29⁹⁵ MFJ-1286



Snag rare DX for only \$29.95! The MFJ-1286 is a computerized DXing tool that predicts DX propagation. Even the casual DXer can work rare DX by knowing when conditions are best for DX. The Gray Line is the day/night divider line where the most amazing DX happens every day. Now you'll know exactly when to take advantage of it.

Gives detailed world map. Shows Gray Line for any date/time, UTC in 24 user chosen OTHs, time zones and more. IBM compatible. Any graphics.

MFJ's Speaker/Mics

For Kenwood, Icom, Yaesu, Santelec

MFJ-284 or MFJ-286 \$24⁹⁵

MFJ's compact Speaker/Mics let you carry your HT on your belt and never have to remove it to monitor calls or talk.

You get a wide range speaker and first-rate electret mic element for superb audio on both transmit and receive.

Earphone jack, handy lapel/pocket clip, PTT, lightweight retractable cord. Gray. One year unconditional guarantee.

MFJ-284 fits Icom, Yaesu, Santelec. MFJ-286 fits Kenwood.

12/24 Hour LCD Clocks



\$19⁹⁵ MFJ-1088 \$9⁹⁵ MFJ-1078

Huge 5/8 inch bold LCD digits let you see the correct time from anywhere in your shack. Choose from the dual clock that has separate UTC/local time display or the single 24 hour ham clock.

Mounted in a brushed aluminum frame. Easy to set. The world's most popular ham clocks for accurate logs. MFJ-1088 4 1/2 x 1 x 2; MFJ-1078 2 1/4 x 1 x 2.

Lighted Cross/Needle SWR/Wattmeter MFJ-815 \$69⁹⁵

MFJ Cross-Needle SWR/Wattmeter shows you SWR, forward

and reflected power in 3 ranges (20/200/2000 watts forward/5/50/500 reflected). Push button range selection. 1.8-30 MHz. Mechanical zero adjust for movement. SO-239 connectors. Light requires 12 VDC or 110 VAC with MFJ-1312, \$9.95.

Deluxe Code Practice

New Oscillator MFJ-557 \$24⁹⁵

MFJ-557 Deluxe Code Practice Oscillator has a Morse key and oscillator unit mounted together on a heavy steel base so it stays put on your table. Also portable because it runs on a 9 volt battery (not included) or an AC adapter (\$9.95) that plugs into the side.

Earphone jack for private practice. Tone and volume controls for a wide range of sound. Speaker. The key has adjustable contacts and can be hooked to your transmitter. Sturdy. 8 1/2 x 2 1/4 x 3 3/4 in. One year unconditional guarantee.

MFJ AC Voltage Monitor

\$19⁹⁵ MFJ-850 New

Prevent damage to rig, computer or other gear. Monitor AC line voltage for potentially damaging surge/brown out conditions on 2-color expanded 95-135 volt scale.

Plugs into any AC outlet. 2% accuracy. 2 1/4 x 2 1/4 x 1 1/2 inches.

MFJ ENTERPRISES, INC.

P.O. Box 494, Mississippi State, MS 39762
(601) 323-5869; TELEX: 534590 MFJSTKV
Nearest Dealer or Orders only: 800-647-1800

• One year unconditional guarantee • 30 day money back guarantee (less s/h) on orders from MFJ • Add \$5.00 each s/h • Free catalog

MFJ

MFJ ... making quality affordable

HF MOBILE ANTENNAS

Methods to help you improve radiation efficiency

By Robert Sherwood, NC0B, Sherwood Engineering Inc., 1268 South Ogden Street, Denver, Colorado 80210

In these days of miniaturization, HF mobile operation is more practical than ever before. Rigs are smaller, and DC inverter power supplies are virtually nonexistent. Are popular, small, antenna resonators a good choice also, or is too much given up in this critical area?

Background

My early days of low-band HF mobile go back to the early sixties when tube equipment was standard, and there was a mystique surrounding the hardware required to get a station to function from one's car. A typical installation consisted of an AF-67 transmitter with 6146 final, a dynamotor (motor generator) to supply 250 and 650 volts, and a converter to receive 160 meters on a standard AM radio. I noticed that mobile antennas seemed to bring out regional biases — hams running mobile in Northern Ohio favored base-loaded whips as long as possible, while those in the greater Cincinnati area worked the top band with center-loaded whips and capacitive hats.

160-meter whip antenna

Several Cincinnati hams pooled their resources to create a community mobile of sorts; the equipment, car, and effort were supplied by K8CRJ, K8IBQ, K8RRH, and WA8ADB (now NC0B). Our antenna construction was based initially on a Master Mobile 75-meter 5-foot whip and its matching resonator, which was 6 inches long and 1-3/4 inches in diameter. We discarded this no. 18 wire coil and modified its phenolic insulator to hold a 5-inch diameter plastic tube wound with 100+ feet of no. 16 close-spaced wire to resonate on 160. We added a 6-inch diameter capacitive hat that let us make minor adjustments to the antenna system's resonant frequency. The frequency wasn't easily changed once we had tuned it by removing turns from the coil. No one knew how efficient the antenna actually was, but it performed satisfactorily with daytime groundwave ranges of 50 to 75 miles to a base station.

For the next 20 years, my homemade mobile antennas evolved around variations of this same design. Discussion of HF mobile operation in *The ARRL Antenna Handbook* referred to maintaining the Q of the coil high, so I eventually abandoned the close-wound coil on a solid form. Even though the effect of plastic tubing on Q wasn't known, it was obvious that weather degraded coil operation severely. If the antenna coil got a little wet, the AF67 pi network started tuning backwards. The rig wouldn't load at all in a real down-pour. If today's broadband fixed-tuned PAs had existed then, the transmitter would have barely functioned given the slightest bit of inclement weather.

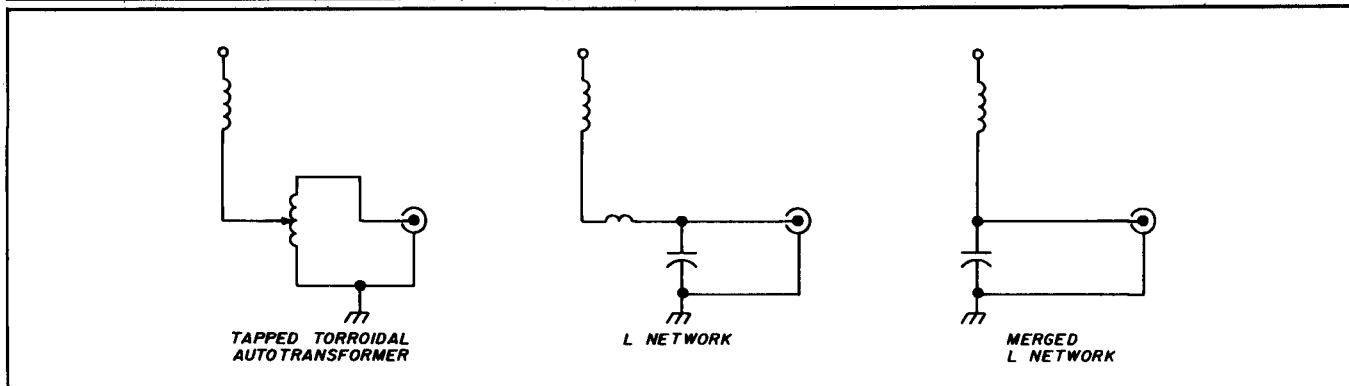
40-meter system

The original Master Mobile insulator was long enough to support half of a B&W 3033 10-inch coil made from six turns per inch of no. 12 wire. Because it was of ribbed construction rather than solid form design, this coil exhibited much less wind resistance than previous units. With a 3 to 6-foot base section and a 5-foot whip, the system resonated without additional top loading on 40 meters. It seemed desirable, however, to continue to use a capacitive hat, since what was advantageous on 160 would be an asset on 40 meters, too. Because my tendency was to assume that bigger was better, I built hats from 12 to 24 inches in diameter. The latter seemed to be the practical limit, especially since the consensus was that a hat should be kept out of the coil field, and that meant mounting it up the whip as much as 2 feet above the coil.

A side benefit of the open-air coil was a virtual lack of environmental effects. Rain didn't detune the coil, and it took a blinding snowstorm to pack it to the point where it wouldn't load.

A 5-foot whip let 5 inches of B&W coil resonate easily on 40 meters, even without a capacitive hat. This meant that I could make two resonators from one coil stock. Since resonance of a short, loaded antenna isn't a 50-ohm impedance, I chose an L network to provide a 50-ohm match. The added coil was simply an extra turn or two in the resonator, with an appropriate capacitor on the high impedance side of the network (across the coax feedpoint). That value was typically 470 pF on 7.2 MHz, 1200 pF on 3.8 MHz, and 2400 pF on 1.8 MHz, depending somewhat on the base

FIGURE 1



Matching options.

section length and mounting position (see Figure 1).

From a mechanical standpoint, this enhanced antenna with its large center loading coil and capacitive hat 2 feet up the whip put quite a physical stress on the bumper or deck mount, so I used a nylon guy line to keep things stable. However, I didn't use springs at the base because they allowed too much lateral sway.

Onward and upward

Once I had a well-developed 40-meter system using 5 inches of coil, I decided it was time to improve my design for 75 and 160 meters. Because 3-inch diameter no. 12 wire coils worked so well on 40, I chose 10 inches for 75 meters. Because it takes four times the inductance to tune a given whip when the frequency is halved, I knew that 10 inches of coil would require a longer whip or top loading. A 2-foot capacitive hat let me tune the antenna with less than 75 μ H, even on the low end of the CW band at 3500 kHz. As with the 40-meter resonator, moisture had very little effect on the operation of the coil with six turns per inch spacing.

In 1984, world class mobile DXer KD0U asked if I would make him reproducible 40 and 75-meter resonators. He had 87 countries confirmed and was trying for mobile DXCC. His antenna had to be able to handle a solid-state Metron linear, which produced 600 watts output. Once the project was under way, we were asked by the Dayton Hamvention™ Antenna Forum to present quantitative data on our findings on the 40-meter version in 1985, and the 75 and 160-meter designs in 1986.

Although subjective evaluations of these antenna systems had been acceptable for over 20 years, we needed hard data to truly evaluate what progress had been made toward the goal of transmitting the strongest possible signal on low-band HF mobile.

Comparative and absolute measurements

There are two basic ways to measure antenna performance, comparative and absolute. On 7 MHz, the only method available was the comparative one; I didn't have access to a field-strength meter that would tune that high in frequency. Seventy-five meters was a different case because I could use a broadcast station's field-strength meter to measure absolute signal intensity.

We performed initial 7-MHz measurements in Denver at a large city park with room to make comparisons, using

two mobile systems. One mobile was the transmit reference. The other, parked half a mile away, was the receive site. The reference system was a commercial 40-meter antenna with a bumper-mounted 5-foot base section. We tuned it to 7.2 MHz carefully, using a Bird wattmeter. Once it was adjusted for best possible match, we set the forward minus reflected power to 50 watts. We put a resonant antenna on the receiving end tuned for a perfect match at 7.2 MHz. We then inserted a laboratory-grade step attenuator into the receive coax line. Next, we set the received reference carrier from the commercial antenna for exactly S9, substituted a second commercial antenna for the first, and reset the receive S-meter to S9. Surprisingly, there was a difference of only 1/2 dB in favor of the second commercial antenna.

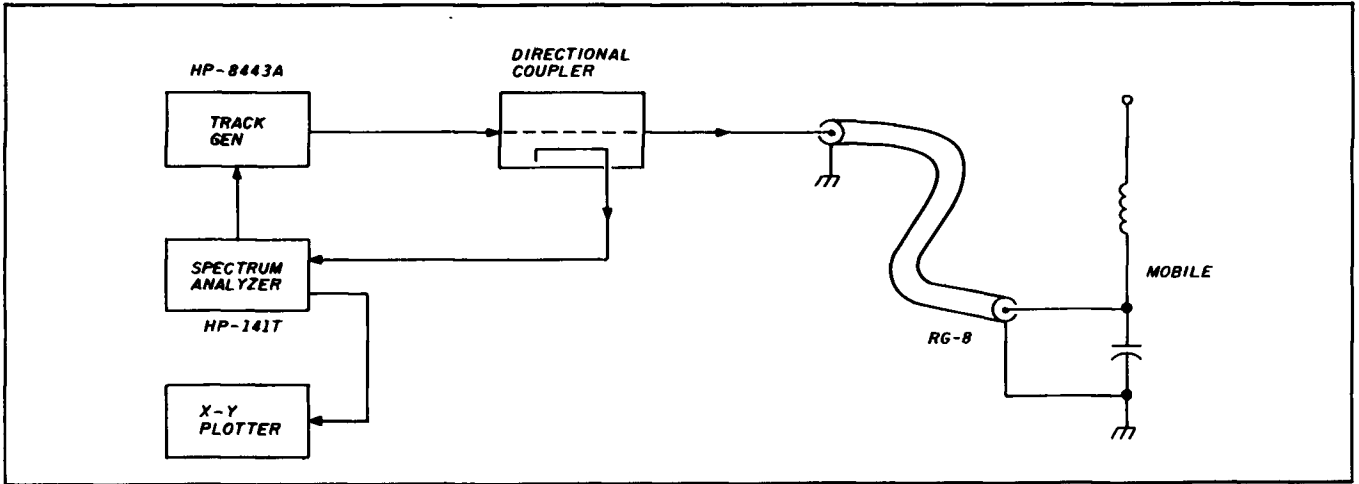
We continued by mounting a homemade antenna (now called the SE-40) in place of the commercial reference, and tuning it to 7.2 MHz. We measured its radiated signal both with and without a 24-inch capacitive hat. Without the hat, the signal registered 5 dB greater than the reference. With the capacitive hat attached and coil requirements reduced by about 40 percent, the signal was 6 dB stronger than the reference. With this much more signal radiated, it wasn't surprising that its coil ran very cool — barely above ambient. We also noted that a 40-percent reduction in coil size (and therefore coil loss) increased the signal only an additional 1 dB.

This implies that ground losses were now predominant in limiting radiation efficiency. We also found that the usable bandwidth of the antenna system with the hat was significantly greater than without; we investigated this later at the lab.

Tests on 3.8 MHz

We moved our testing to 3.8 MHz, again setting up a commercial antenna to radiate a signal with 50 watts of power. We adjusted the received carrier to S9 and recorded the attenuator setting. Then we removed the commercial antenna and substituted a homebrew antenna (SE-75) with 10 inches of open-air coil, a 5-foot whip, and 2-foot diameter capacitive hat mounted 2 feet above the coil. Its measured signal was 4 dB above reference. In this case the hat was necessary to resonate a 5-foot whip with the inductance available. To resonate without a hat required an 8-foot whip,

FIGURE 2



Instrumentation for measuring antenna bandwidth.

which measured 5 dB above reference, but was an impractical mechanical choice. As before, the B&W coil ran near ambient, while the commercial antenna got quite hot after a couple minutes of 50-watt carrier.

We made all tests using the same base section, appropriate coil, and accompanying whip. Additional measurements were later made with K7AYC and N0EYK to determine the effect of increasing base section length. Though it may not be completely obvious, you can change the length below the coil of the center-loaded antenna without changing its resonant frequency significantly. Feed impedance changes somewhat, necessitating a modest change in the shunt capacitor for a 1:1 match, but the length below the coil is rather removed from resonance effects. This is because the reactance of a short whip is very high, and the large inductance needed to cancel this reactance predominates.

We assembled a test setup identical to that used earlier, and repeated our measurements. We varied base section length in increments of 16 inches with both the commercial antenna and open-air coil SE-40 and SE-75. All antennas showed the same 1-dB improvement in radiated signal with a 16-inch increase in base length. Compare this to switching from a 5-foot whip and hat to an 8-foot whip to pick up 1 dB, and it becomes obvious where to add additional length. It was only practical to go to a second 16-inch extension; the system became unwieldy beyond that and would be practical only in a fixed mobile/portable environment. One thing became obvious: a 7-1/2 foot base section, 18-inch 75-meter coil/insulator assembly, and 5-foot whip with 24-inch capacitive hat looks impressive going down the highway! While I've never mobiled using more than a 6-foot base section and the aforementioned antenna assembly, a typical comment at gas stations is: "What you got there, satellite TV?"

Swept VSWR measurements

The next series of measurements we made on our antennas was swept VSWR. Because we're in the filter business, a tracking generator/spectrum analyzer is usual laboratory equipment. By adding a Mini Circuits directional coupler and a length of RG-8, we could run a cable to a parked mobile (see Figure 2) and take large amounts of

FIGURE 3

RETURN LOSS	VSWR
0 dB	∞
6 dB	3:1
10 dB	1.9:1
14 dB	1.5:1
20 dB	1.2:1
26 dB	1.1:1
32 dB	1.05:1
40 dB	1.02:1

Return loss as a function of VSWR.

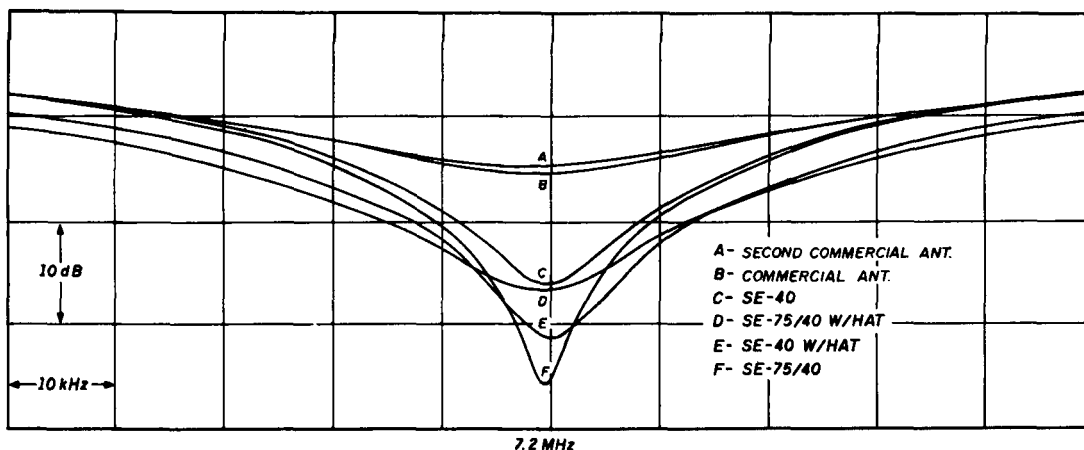
data on antenna bandwidth quickly. We plotted the output with an XY recorder for analysis.

With the test equipment set up to measure return loss, we attached a precision 50-ohm termination to the bridge output port, and measured a return loss of over 40 dB. An open circuit set the infinite VSWR reference line, and 25, 75, and 100-ohm terminations were attached to verify operation. All functioned as expected, so we connected the coax from the mobile. We also attached a 50-ohm termination on the car end, and measured over 35-dB return loss. We then attached the antennas, tuned them, and swept them for return loss.

Since the homemade antenna could be adjusted to nearly 1:1 by selecting the base shunt capacitor, it could always be adjusted for 25 to 30-dB return loss. We set the commercial antenna for the best match using its whip length tuning. On 40 meters it could be reduced to just a 15-dB return loss, or 1.4:1 VSWR. The 75-meter match was similar; it reached 14-dB return loss, or 1.5:1 VSWR. Of course you could add a capacitor across the coax with the commercial system, too. When we did this, the best match could be brought down to a 25-dB return loss and a VSWR better than 1.2:1, as shown in Figure 3.

After observing bandwidth plots, we noted that the best match at one particular frequency didn't necessarily give the widest bandwidth at a specified VSWR limit of, say, 1.7:1. If you do a lot of frequency changing, you might want to

FIGURE 4



Bandwidth measurements for six antenna configurations.

tune an antenna for the most power output over a measured bandwidth.

When tuned for lowest spot frequency VSWR, an SE-75 system showed a bandwidth of 10 kHz with a 1.7:1 VSWR limit. Retuning for a better average match increased this 1.7:1 bandwidth to 15 kHz, though the match at resonance was worse. The commercial antenna's 1.7:1 bandwidth (without added capacitor) was 7 kHz.

Adding a capacitive hat on an SE-40 also improved the usable bandwidth. There was a typical increase on 40 meters from 50 kHz to 75 kHz at 1.7:1. By comparison, the commercial unit showed about 35-kHz bandwidth. (See Figure 4.)

In 1985, a ham at the Dayton Hamvention™ bought one of these 40-meter antennas, and he and his friend rushed out to the parking lot to compare signals — one with a SE-40 and the other a commercial unit. They happened to have identical rigs, parked about 100 feet apart. About an hour later the gentleman returned to inform me that he and his friend had been on the air getting comparative reports, and the new antenna definitely was running about an S unit stronger.

Additional measurements

We took the next step in the measurement process in 1986 with a field-strength meter. K7AYC and I made measurements in a remote area of Arapahoe County near Denver using increments of 1/4 to 1 mile. With 100 watts of power as reference, we calibrated the field-strength meter and adjusted it for maximum readings at 1/4-mile points. We recorded test data on both 75 and 160 meters because this instrument tuned from 500 kHz to 5 MHz.

We used ground conductivity charts in the *ITT Reference Data for Radio Engineers* to calculate the theoretical groundwave signal for a 1000-watt broadcast station with a quarter-wave antenna and 120 quarter-wave radials. Then we compared this data with actual measurements made on 1600 kHz from a local broadcast station's construction permit proof of performance. Its measured signal strength in mV/meter at 1 mile correlated well with theoretical calculations for average terrain in Colorado. However, unlike the

TABLE 1

Signal strength as a function of frequency.

Frequency (kHz)	Signal strength (mV/M)
Theoretical	186, 1 mile, 1 kW
Typical reference—1600	165, good soil
KRXY—1600	160
NØSL—1800	110
160 mobile—1841	31
Typical reference 3800	112, good soil
75 mobile—3868	66

measurements of power and antenna current that a broadcast station makes, field-strength readings are much more variable and inaccurate. We weren't looking for 2-percent accuracy in field-strength values, but a general idea of what level of efficiency was obtainable with an optimized mobile antenna. Field-strength measurements vary with the weather, the season, and the water table. One local station had such difficulty maintaining its pattern that it was forced to move its antenna towers farther away from a grove of cottonwood trees that ran along a creek. The trees' sap content would change periodically and distort the licensed pattern out of FCC specifications. So much for antenna operation being an exactly predictable science!

The ITT book also gives data on groundwave field strengths for different vertical antennas. A quarter wave should give an E-field strength of 186 mV/M over perfectly conducting ground for 1 kW of RF. The correction factor for power is proportional to the square root of power in kW times the 186 mV/M figure. For our 100-watt test level, the correction factor is 3.16 times the measured values.

In the real world, with good soil, a value of 165 mV/M is reasonable on the high end of the broadcast band. We also obtained test data from the chief engineer of KRXY, which is licensed on 1600 kHz in Denver, as well as field-strength measurements made by NØSL on a top-loaded 50-foot vertical on 1.8 MHz. Measurements are summarized in Table 1.

ICOM

IC-4KL



GIVE YOUR SIGNAL A BOOST!!!

ICOM's all new IC-4KL solid state HF linear amplifier represents a hefty step forward in modern electronic technology and futuristic station design.

It installs in a limited space, interconnects in a breeze and delivers band-commanding performance in the most reliable top-of-the-line fashion. Give your signal a power boost with ICOM's IC-4KL!

GLOBE SPANNING POWER.

The rugged IC-4KL delivers 1000 watts output with full 100 percent duty cycle.

Covers 160-15 meters. A power boost that will be heard around the world!

ALL SOLID STATE AND FULLY AUTOMATIC.

No lethal high voltages required. No warm-up, no tune-up, no fumbles. Fully automatic and overload-protected. Just switch on and operate. Follows band selections on your ICOM transceiver. Add ICOM's optional EX-627 and setup even selects the proper antenna. The ultimate HF amplifier!

AUTOMATIC ANTENNA TUNER BUILT-IN.

Advanced design and wide impedance matching range. Internal CPU stores previous settings on each band for rapid single-button operation. Automatically seeks for and memorizes new settings if SWR changes or antennas are swapped.

FULL CW BREAK-IN.

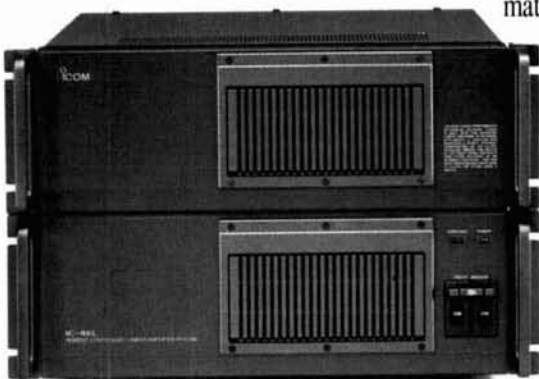
The IC-4KL uses extremely quiet and high speed relays. A DX'er's winning edge and a Packeteer's delight!

UNIQUE MODERN DESIGN.

Husky RF/PS unit rolls conveniently under desk or into nearby corner. All you see is a small remote control featuring dual multi-functioned meters for SWR and output watts.

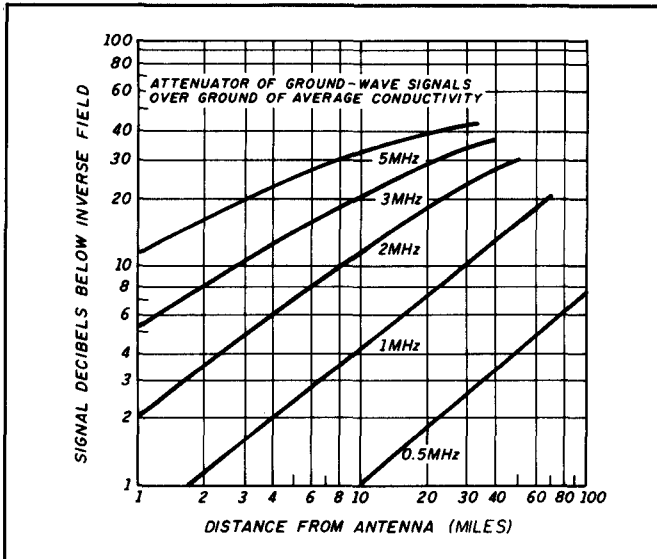
The IC-4KL comes complete with a remote control unit, RF/PS deck and nine feet of interconnecting cable for easy installation. The IC-4KL... Big Signal Performance backed by a one-year warranty at any one of ICOM's four North American Service Centers.

ICOM America, Inc. 2380-116th Ave. N.E. Bellevue, WA 98004
Customer Service Hotline (206) 454-7619
3150 Premier Drive, Suite 126, Irving, TX 75063 1777 Phoenix Parkway Suite 201
Atlanta, GA 30349 ICOM CANADA, A Division of ICOM America, Inc.
3071 - #5 Road, Unit 9 Richmond, B.C. V6X 2T4 Canada
All stated specifications are subject to change without notice or obligation. All ICOM radios significantly exceed FCC regulations limiting spurious emissions. 4KL689



ICOM
First in Communications

FIGURE 5



Distance from antenna (meters). (Taken from *Radio Electronic Transmission Fundamentals*, B. Whitefield Griffith, McGraw Hill.)

When you compare E-field values of mobile antennas with reference values obtainable over good soil and a full quarter wave with 120 radials, the figures don't look too bad. Referenced to an antenna over a theoretically perfect conductor, groundwave losses at 2 MHz over good soil are about 2 dB, and approximately 8 dB on 4 MHz due to dielectric losses in the soil. When you compare the mobile signal levels to a fixed antenna over real ground, the 160-meter level is 15 dB down from a full-sized system and the 75-meter level is only 5 dB down (see **Figure 5**).

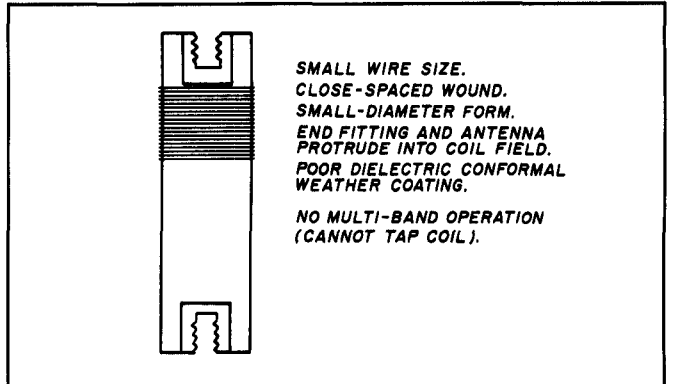
This means that groundwave range to a good base station is 100 to 125 miles for the prototype 160-meter coil used for these tests, and 200 watts of SSB. Compared with the 50 to 75-mile range of the 50-watt AM mobile mentioned earlier, this is a reasonable range increase. It may be interesting to note that it takes a rather elaborate 2-meter operation to better those ranges — unless your repeater is on a mountaintop.

Hardware hints

Here are a few reasons why these lower loss mobile antennas perform better than their smaller counterparts. Coils need to be air wound with only polystyrene ribs for support. Spacing of less than six turns per inch makes the coil susceptible to detuning and degradation from moisture (see **Figures 6 and 7**). Also, when we tried tighter spacing coils on 75 meters to allow a larger inductance and the option of no capacity hat, we noted spurious resonances that fell in the Amateur bands when the coil was tapped down for higher frequencies. While our initial coil support insulators were made from linen phenolic, its high cost and difficult machining problems necessitated a change to Lexan™.

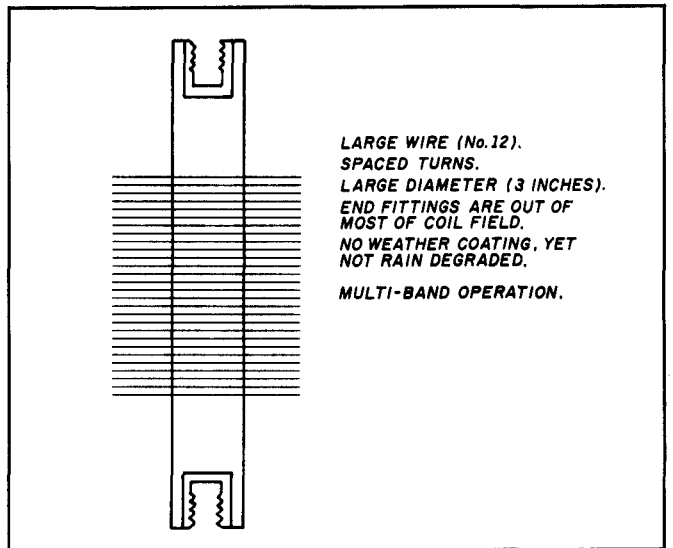
This polycarbonate plastic is stronger, cheaper, and easier to machine. I think it looks better, too. The insulator should be considerably longer than the coil itself to keep the threaded brass inserts out of the coil's immediate field. This

FIGURE 6




Characteristics of low-Q resonator.

FIGURE 7

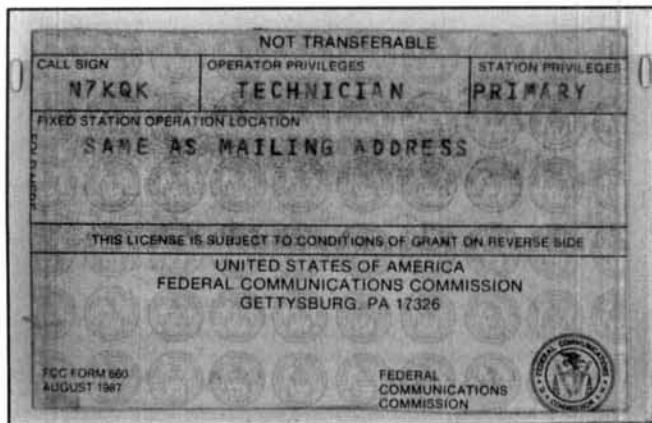


Antenna High = Q SE-40/SE75 antennas.

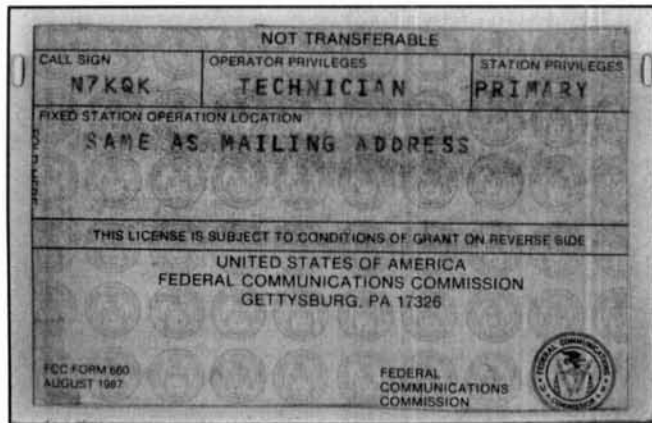
will also keep stainless steel antenna parts out of the field. Making frequency adjustment and band changes by shorting out turns with a clip lead may appear to be poor engineering, but so far any attempts at having multiple taps go to a switch have seriously detuned the coil.

You could argue that 6 dB isn't too much to give up to get the advantage of a small and aesthetically pleasing mobile antenna. Most will find that a signal that's an S-unit stronger often makes the difference between enjoyable mobiling and spending most of the time trying to find someone who can hear you. Add a good RF speech processor and a crisp microphone to this, and the difference is startling. Stations will start calling you! After you've done everything else, couple in a mobile kilowatt linear, and imagine that you're sitting in the passenger seat watching KD0U attack a pileup and come out with a contact and a new country against base station signals. The challenge is there waiting for you. 

This is an Amateur Radio License



This is an Amateur Television License



That's right, they are exactly the same. Your technician or higher class amateur radio license gives you the right to own and operate your own amateur television station.

It's Easy....

If you can operate a video camera, you can operate the new AEA Model FSTV-430. The FSTV-430 transceiver connects to the video output of your camera and transmits and receives live or taped video. You can even use two cameras for studio-like operation from your shack.

Fast Scan Television with the new FSTV-430 from AEA gives you live, color television that rivals broadcast quality. In fact, the AEA Vestigial Sideband (VSB) technique is similar to that used by broadcasters.

Inexpensive...

The video camera or cam-corder you bought is the most expensive part of a fast scan television system. The AEA Model FSTV-430 is the only transceiver you need. Connect the camera, a 430 MHz antenna, (an amplifier if you want stronger signals) and you're on the air.



And Fun....

Think about it. You can share more than just conversation with your amateur friends. Show your friends the new transceiver you bought, that special antenna project you're working on, or just chew the fat.

For more information on the FSTV-430 and other exciting amateur television products, please contact
Advanced Electronic Applications, Inc.
 P.O.Box C-2160
 Lynnwood, WA 98036
 206-775-7373

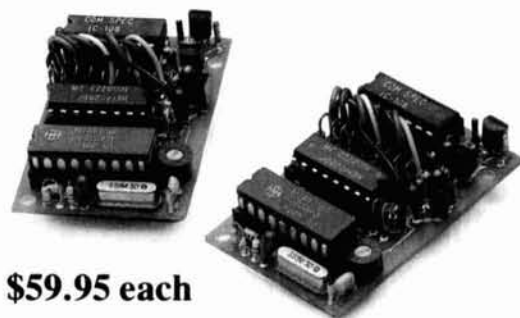
AEA Retail \$499.95
Amateur Net \$439.95



Eureka!

We just struck gold with a miniature, high quality and very reliable DTMF decoder at a rock bottom price of \$59.95. Our DTD-1 will decode 5040, 4 digit codes with the security of wrong digit reset. It contains a crystal controlled, single chip DTMF decoder that works great in bad signal to noise environments and provides latched and momentary outputs. Why carry that heavy gear when its size is only 1.25 x 2.0 x .4 inches and it comes with our etched in stone, legendary, one year warranty.

Instead of sifting through the field...searching, use our super quick one day delivery and cash in on a rare find.



\$59.95 each

**COMMUNICATIONS
SPECIALISTS**

426 W. Taft Ave., Orange, CA 92665-4296
Local (714) 998-3021 • FAX (714) 974-3420
Entire U.S.A. 1-800-854-0547



KEEPING AN EYE ON YOUR SIDEBAND PEP

By John Fielden, GW4NAH, Penthouse 1,
Glyn Garth Court, Glyn Garth, Anglesey, LL59 5PB
U.K.

Single sideband is probably the most widely used mode on the Amateur bands today, yet few people can measure their peak output power. The quantity needs to be maximized for best reception at the other end, but at the same time limited to the "linear" capability of the RF power amplifier. Exceeding this may result in distortion, splatter, and license violation.

A modern SSB receiver's S-meter can "hold" signal peaks for comfortable observation, even if it is only of short duration. Unfortunately transmitters have no equivalent, and the only easy recourse for observing peak output on the RF-power/SWR meters that most of us have is to whistle. This is the only noise humans can produce which approaches the sine wave with which our meters are calibrated. This gives acceptable readings on constant power modes (FM, CW, FSK) but is useless and even misleading on SSB, because our whistle is just not that pure.

The error is down to the inability of a moving coil meter, and indeed our eyes, to follow the rapid transients of the voice. The transient voltages are, however, produced accurately by the SWR bridge, so the only modification required is to lengthen the response of the moving coil meter. The add-on module described here performs this function simply and accurately.

Circuit description

In **Figure 1**, the resistance of RV1+RV2 replaces the meter of an existing VSWR instrument; the voltage developed across these presets is fed via R1/C1 to the noninverting input of operational amplifier (op amp) A1. Its output, appearing at pin 1, charges C3 via CR2 and R6, with a rise time constant of 0.1 second, whereas C3 can discharge only through R7 with a decay time constant of 10 seconds. The voltage across C3 is buffered by voltage follower A2 to pin 7 and via CR3 to the moving coil meter of the existing VSWR instrument, and also via R5 as 100-percent feedback to the inverting input of A1. The total circuit has unity gain, causing the output voltage to rise quickly and exactly to the peak of an input voltage, but then holds the output for a few seconds after the input drops. C2 cre-

ates a slight phase advance in the feedback loop to prevent overshoot on rapid transients. The small voltage across CR1 of approximately 0 to 6 volts is used to balance out voltage and current offsets in the op amps via RV3, R3, and R4. The LM358 dual op amp was chosen because it can operate down to zero output on a single DC supply of 4 to 25 volts. CR4 protects against supply reversal and C4 provides a low supply impedance. CR5 and C5 protect the meter from overload and RF, respectively.

Construction

The module can be constructed from readily available components on a small pc board (the commercial version* measures 55 x 30 mm), which can be mounted inside an existing RF-power/VSWR instrument. It may be fixed there with BluTack™ or a bolt, spacer, and nut arrangement, but do so only after calibration. Placement is not critical, except where the SWR instrument is combined with an antenna tuner; in that case the module should be placed away from and shielded from the strong RF fields which exist around tuner coils, capacitors, and their leads.

Interconnections

Undo both leads from the moving coil meter (only from the forward power meter if there are two). Check that the negative lead is grounded; in most instruments it is, but you can find the odd one where the positive lead is grounded, and this has consequences when supplying power to the module. Now ascertain that the meter resistance falls within the range of RV1 + RV2, which is 0 to 2200 ohms. All commercial VSWR meters I have encountered so far do, but some homebrew models using meters with 100 μ A or less full scale deflection do not. In that case, make RV2 10 k.

Next, connect the former meter leads to the input terminals of the module and the module's output to the meter, carefully preserving polarities. A DPDT switch or PTT-

*The PEP module is available from Technical Software, Fron, Upper LLanwrog, Caernarfon, at 12 pounds, Incl. Vat, P & P. The pc board alone can be ordered from the HAM RADIO Bookstore for \$7.00 post paid.

Reprinted with permission from *RADIO COMMUNICATIONS*, January 1989, Ed.



INSIDE VIEW — RS-12A

ASTRON POWER SUPPLIES

• HEAVY DUTY • HIGH QUALITY • RUGGED • RELIABLE •

SPECIAL FEATURES

- SOLID STATE ELECTRONICALLY REGULATED
- FOLD-BACK CURRENT LIMITING Protects Power Supply from excessive current & continuous shorted output
- CROWBAR OVER VOLTAGE PROTECTION on all Models **except RS-3A, RS-4A, RS-5A.**
- MAINTAIN REGULATION & LOW RIPPLE at low line input Voltage
- HEAVY DUTY HEAT SINK • CHASSIS MOUNT FUSE
- THREE CONDUCTOR POWER CORD
- ONE YEAR WARRANTY • MADE IN U.S.A.

PERFORMANCE SPECIFICATIONS

- INPUT VOLTAGE: 105-125 VAC
- OUTPUT VOLTAGE: 13.8 VDC \pm 0.05 volts (Internally Adjustable: 11-15 VDC)
- RIPPLE Less than 5mv peak to peak (full load & low line)
- Also available with 220 VAC input voltage



MODEL RS-50A



MODEL RS-50M



MODEL VS-50M

RM SERIES



MODEL RM-35M

19" x 5 1/4" RACK MOUNT POWER SUPPLIES

MODEL	Continuous Duty (Amps)	ICS* (Amps)	Size (IN) H x W x D	Shipping Wt. (lbs.)
RM-12A	9	12	5 1/4 x 19 x 8 1/4	16
RM-35A	25	35	5 1/4 x 19 x 12 1/2	38
RM-50A	37	50	5 1/4 x 19 x 12 1/2	50
• Separate Volt and Amp Meters				
RM-12M	9	12	5 1/4 x 19 x 8 1/4	16
RM-35M	25	35	5 1/4 x 19 x 12 1/2	38
RM-50M	37	50	5 1/4 x 19 x 12 1/2	50

RS-A SERIES



MODEL RS-7A

MODEL	Continuous Duty (Amps)	ICS* (Amps)	Size (IN) H x W x D	Shipping Wt. (lbs.)
RS-3A	2.5	3	3 x 4 1/4 x 5 3/4	4
RS-4A	3	4	3 3/4 x 6 1/2 x 9	5
RS-5A	4	5	3 1/2 x 6 1/4 x 7 1/4	7
RS-7A	5	7	3 3/4 x 6 1/2 x 9	9
RS-7B	5	7	4 x 7 1/2 x 10 3/4	10
RS-10A	7.5	10	4 x 7 1/2 x 10 3/4	11
RS-12A	9	12	4 1/2 x 8 x 9	13
RS-12B	9	12	4 x 7 1/2 x 10 3/4	13
RS-20A	16	20	5 x 9 x 10 1/2	18
RS-35A	25	35	5 x 11 x 11	27
RS-50A	37	50	6 x 13 3/4 x 11	46

RS-M SERIES



MODEL RS-35M

MODEL	Continuous Duty (Amps)	ICS* (Amps)	Size (IN) H x W x D	Shipping Wt. (lbs.)
• Switchable volt and Amp meter				
RS-12M	9	12	4 1/2 x 8 x 9	13
• Separate volt and Amp meters				
RS-20M	16	20	5 x 9 x 10 1/2	18
RS-35M	25	35	5 x 11 x 11	27
RS-50M	37	50	6 x 13 3/4 x 11	46

VS-M AND VRM-M SERIES



MODEL VS-35M

MODEL	Continuous Duty (Amps)			ICS* (Amps)	Size (IN) H x W x D	Shipping Wt. (lbs.)
	@13.8VDC	@10VDC	@5VDC			
VS-12M	9	5	2	12	4 1/2 x 8 x 9	13
VS-20M	16	9	4	20	5 x 9 x 10 1/2	20
VS-35M	25	15	7	35	5 x 11 x 11	29
VS-50M	37	22	10	50	6 x 13 3/4 x 11	46
• Variable rack mount power supplies						
VRM-35M	25	15	7	35	5 1/4 x 19 x 12 1/2	38
VRM-50M	37	22	10	50	5 1/4 x 19 x 12 1/2	50

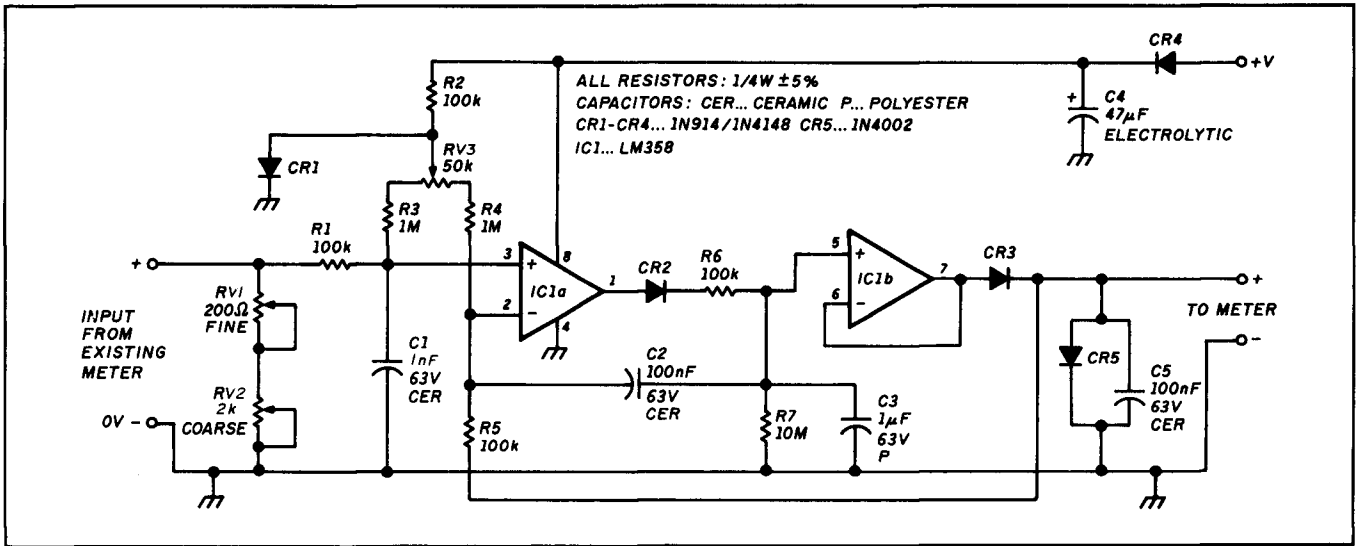
RS-S SERIES



MODEL RS-12S

MODEL	Continuous Duty (Amps)	ICS* Amps	Size (IN) H x W x D	Shipping Wt. (lbs.)
• Built in speaker				
RS-7S	5	7	4 x 7 1/2 x 10 3/4	10
RS-10S	7.5	10	4 x 7 1/2 x 10 3/4	12
RS-12S	9	12	4 1/2 x 8 x 9	13
RS-20S	16	20	5 x 9 x 10 1/2	18

FIGURE 1



Schematic of the PEP measuring add-in circuit.

operated relay can be inserted to switch the PEP module in and out for SSB and other modes, respectively. Another method of reducing the peak holding feature of the module is to reduce R7, say by switching a 220-k resistor across it.

Power, anywhere from 4 to 25 volts DC at little more than 1 mA, must now be connected. If the negative meter lead was found to be grounded, a suitable voltage source, say 9 or 13.8 volts that is "on" when transmitting, can be found on the back of most transceivers. Use a single wire to connect that voltage, preferably through a 2700-ohm current-limiting resistor, to the positive terminal on the module. The coax shield will take care of the negative return.

In the rare case where the positive meter terminal is found to be grounded, a floating power supply must be used. In either case, three Duracell™ pen light cells would typically last nine months if left on continuously, or for years if switched on only when used. In all of the following adjustments, remember that the meter will travel upscale rapidly, but settle back slowly. Do wait for the meter to settle before reading.

First, the op amp offsets must be balanced out. For the commercial module this was done at the factory and RV3 was sealed. If you have built your own, or must replace the LM358 for any reason, a procedure is suggested below. A small positive meter reading with zero input is not an indication of an offset error and upscale readings will be correct.

Next, a calibration level must be established. With the PEP module out of the circuit, your transmitter in a constant carrier mode (CW, FM), and your SWR meter between the transmitter and a dummy load, pass some RF power through the meter. Increase the output to where a stable forward power reading (preferably over half scale) is obtained. Make careful note of the power reading and do not change the transmitter power setting until calibration is complete. Now reconnect the PEP module, set RV1 and RV2 to zero (fully CCW), apply DC power to it, and switch the transmitter back on at the power setting previously established as calibration level. Advance the "fine" preset

PARTS LIST

Capacitors

- C1 1 nF, 63 volts ceramic
- C2,C5 100 nF, 63 volts ceramic
- C3 1μF, 63 volts polyester
- C4 47μF, 16 volts DC electrolytic

Diodes

- CR1-CR4 1N914/1N4148
- CR5 1N4002
- IC1 LM358


Resistors

- R1,R2,R5,R6 100 k, 5 percent, 1/4 watt
- R3,R4 1 meg, 5 percent, 1/4 watt
- R7 10 meg, 5 percent, 1/4 watt
- RV1 200 ohm Mouser Electronics Part no. 32RH202
- RV2 2 k Mouser Electronics Part no. 32RH302
- RV3 50 k Mouser Electronics Part no. 32RH405

RV1. If, with RV1, you can exceed the calibration reading previously noted, adjust to this reading. If the meter does not rise far enough upscale, set RV1 to about mid-travel and slowly advance the "course" preset to the calibration reading. RV1 will now allow more precise adjustment.

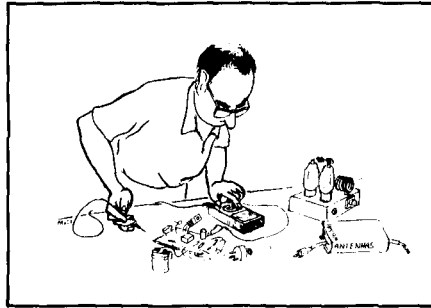
This calibration makes sure that RV1+RV2 presents the same load to the SWR instrument as the moving coil instrument previously did, so the input voltage to the module is unchanged. The module has exactly unity gain, so this voltage is repeated at the output, i.e., across the meter. Consequently the original meter calibration, nonlinearities and all, remains unchanged. On fast peaks, however, such as are encountered when speaking on SSB, the module will hold a peak long enough for the meter to rise to it and for you to check it.

Results

The results will probably surprise you. Without the module, normal speech will show peak meter readings of, say 30 percent of what an oscilloscope would indicate. With the module, it's 100 percent. A whistle, without the module, will show 80 or 90 percent, not 100 percent. Another interesting example is produced by tapping the mic with a pencil. The unmodified meter will show no reading, but with the module, full power will be indicated. 

Ham Radio Techniques

Bill Orr, W6SAI



THE LOG PERIODIC ANTENNA FAMILY

Bill Orr, W6SAI

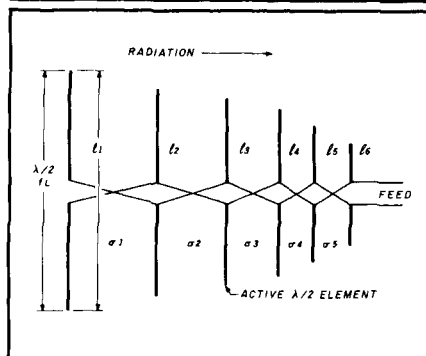
In 1957, D. E. Isbell and R. H. DuHamel published papers on the design of log periodic (LP) antennas.^{1,2} There was a flurry of interest among Radio Amateurs, who adapted some interesting VHF LP antennas from the original design. But it wasn't until 1973, when the log periodic dipole (LPD) array was published by P. D. Rhodes,³ that this class of antenna became practical for HF Amateur use.

Now that two new ham bands are available at 18 and 24 MHz, interest in the log periodic antenna is growing. How else can an active Amateur cover five bands? (How about a center-fed Zepp? — NX1G). The log periodic antenna's principal virtue is that it can cover a frequency span of 2:1, or more, while maintaining good power gain and front-to-back ratio over the whole range.

The log periodic dipole beam shown in Figure 1 is a popular configuration for VHF television antennas. It's also used on the VHF/UHF ham bands. The pattern is directed toward the apex. The bandwidth of operation can be roughly defined as the frequencies at which the outer dipole elements are about one-half wavelength long. The element lengths and the relative spacing δ are arranged in a geometric progression with a taper factor τ .

The dipoles are fed at their centers from a parallel wire transmission line transposed in such a way that successive dipoles are 180 degrees out of

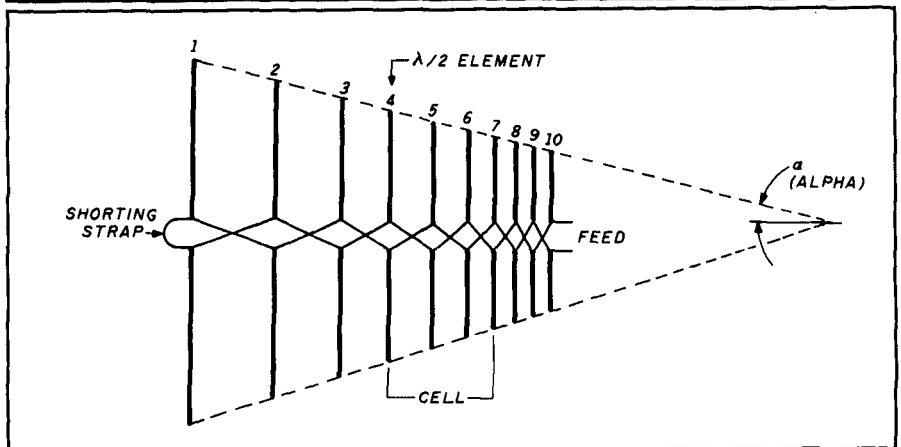
FIGURE 1



A six-element LPD beam. Element spacing (δ) and element length (λ) are determined by design factors, the longest element (λ) being about a half wavelength at the lowest operating frequency (f_l).

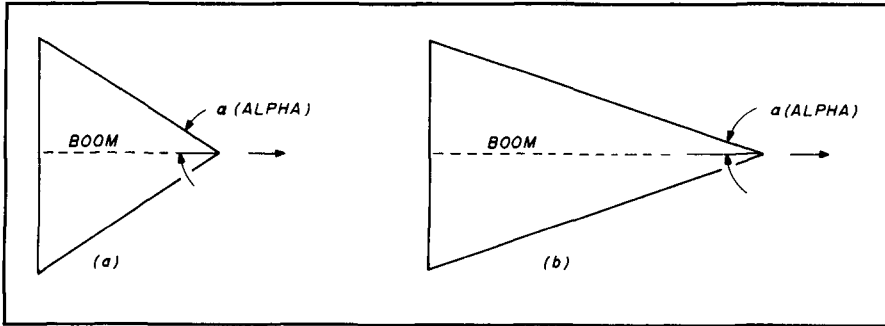
phase. A broadband structure is formed, with most of the radiation coming from those elements which are about a half wavelength long at the operating frequency. In a ten-element log periodic antenna that covers a 2:1 frequency span; perhaps only four of the ten elements are active at a given frequency within the operating range (see Figure 2). The shorter than resonance elements tend to act as directors and the longer than resonance elements as reflectors. The current distribution in the structure is such that only a "cell" (active region) of elements is active on a given frequency. The cell of active elements moves back and forth along the array as the operating frequency is changed. The gain and bandwidth thus bear a definite relationship to the length and included angle of the structure. The smaller the

FIGURE 2



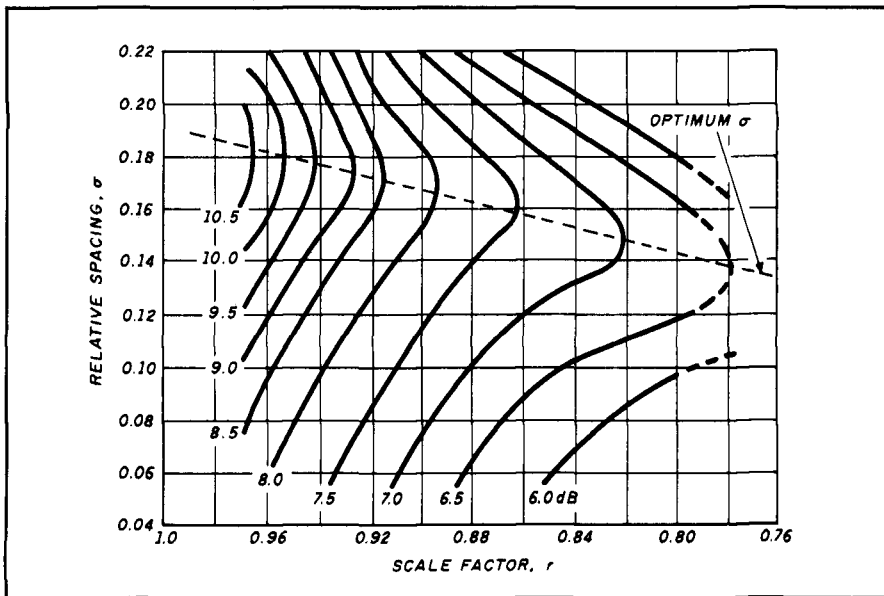
Log periodic active region (cell) encompasses elements a half wave long and a few shorter elements. Other elements have small induced currents and are not major contributors to the radiated energy. Shorting strap on longest element improves front-to-back ratio.

FIGURE 3



Increase in boom length and decrease in apex angle (α) mean more elements in a cell and increased gain. A greater frequency span also requires a longer boom (B). High gain on a short boom (A) restricts frequency span.

FIGURE 4



Reproduction of graph showing corrected gain figures for LPD array. Graph is in *Antenna Engineering Handbook*, Johnson and Jasik, First Edition, pages 14-28. (Illustration courtesy Gary Breed, K9AY, Editor, *RF Design* magazine.)

included angle the more elements in a cell, the longer the antenna, and the higher the power gain. (See Figure 3.)

The HF log periodic dipole antenna

Antenna boom length is of secondary importance in the VHF region, where a high gain, wide bandwidth log periodic array can be constructed on a boom about one or two wavelengths long. But because of the large size of the antenna, things begin to get out of hand quickly when you consider HF operation.

LPD array gain can be expressed in terms of the number of elements in the cell, the relative element spacing, and the scaling factor used. In general,

power gains from 5.5 to 10.5 dBi (3.36 to 8.36 dBd) are the minimum and maximum gain limits of practical HF log periodic designs. (The larger arrays produce the higher gain figures.)

A representation of LPD antenna gain is expressed in Figure 4, Chapter 10 of *The ARRL Antenna Book*.⁴ This chart was extracted from an early work of Carrel,⁵ which was later found to provide inaccurate directive gain computations.⁶ My Figure 4 shows a corrected graph.

High gain LPD arrays are defined in the relative spacing region of 0.12 to 0.22 and large values of scaling factor (0.98 to 0.92). Unfortunately, these figures produce large array sizes that are almost impossible to achieve in an

Amateur HF installation. One look at an HF LPD array at a military base quickly disproves the idea that a block-buster LPD rotary antenna can be placed in a typical backyard!

Practical HF LPD beams

However, all is not lost if those of us who use wideband LPD arrays are content to settle for a modest gain figure, while still retaining good front-to-back ratio and reasonable boom length. Ace Collins, K6VV, has described three LPD arrays (summarized in Table 1). These arrays can be built on boom lengths that approximate a single band Yagi beam.⁷

ATN Antennas of Birchip, Australia makes two commercial LPD beams that cover 13 to 30 MHz.* One design is on a 28-foot boom and has eight elements; another design covers the same range and has six elements on a 20-foot boom. The DJ2UT multiband antenna, built on a 20-foot boom, is a variation of the LPD design that covers 13 to 30 MHz.**

The ARRL Antenna Book (pages 10-5 and 10-6) describes a very small LPD design with a 10-foot boom that covers 18.06 to 29.7 MHz. It has just five elements and (according to the graph in Figure 4) provides only 3.2-dB gain over a dipole. It's doubtful that placing this amount of aluminum up in the air is worth the unspectacular power gain.

LPD power gain

You can compute the power gain of a LPD antenna from the design formulas and Figure 4. This figure can be expressed in terms of boom length for Amateur use in the HF region — much in the way it's done for conventional Yagi antennas. When compared on a band-by-band basis with a Yagi, the tradeoff of gain for bandwidth becomes apparent. For example, a three-element Yagi for 14 MHz provides about 6.5-dBd gain and is built on a 17-foot boom. At that boom length a typical 14 to 30-MHz LPD provides 3.5-dBd gain. The Yagi wins by 3 dB!

At 28 MHz, you can build an eight-element Yagi on a 45-foot boom which will provide nearly 10-dBd gain. An equivalent LPD on that boom provides only 7-dBd gain. The long Yagi wins by 3 dB.

* ATN Antennas, 56 Campbell Street, Birchip 3486, Australia.
** Sommer GmbH, Kandelstrasse 35, D-7809 Denzlingen, F.R.G. Sommer Antennas, W4/DJ2UT, PO Box 847, Cowpens, SC 29330.

TABLE 1

Three LPY designs by K6VV (QST, November 1988). Shorting strap on longest element is 8" long. Average feedpoint impedance is 64 ohms. Design constant (τ) = 0.9, spacing constant (δ) = 0.05, average gain (from Figure 4) = 4.61 dBd.

11-element array 13.5—30 MHz Boom = 25 feet			9-element array 17.5—30 MHz Boom = 16 feet		7-element array 20—30 MHz Boom = 12 feet	
Element number	Length feet	Spacing feet	Length feet	Spacing feet	Length feet	Spacing feet
1	36.44	3.64	28.94	2.78	24.53	2.45
2	32.80	3.28	26.05	2.50	22.08	2.21
3	29.52	2.95	23.44	2.25	19.87	1.99
4	26.57	2.66	21.10	2.03	17.89	1.79
5	23.91	2.39	19.00	1.82	16.10	1.61
6	21.52	2.15	17.09	1.64	14.49	1.45
7	19.37	1.94	15.38	1.48	13.04	-
8	17.43	1.74	13.84	1.33	-	-
9	15.69	1.57	12.46	-	-	-
10	14.12	1.41	-	-	-	-
11	12.71	-	-	-	-	-

The LPD array swaps bandwidth for power gain at any frequency, when compared with a Yagi of equivalent boom length. While the power gain figures of both types of antennas are approximate, the examples shown are indicative of the relative gain performance of these interesting antennas.

The LPD antenna has a couple of advantages. First, it allows a solid-state transmitter to operate efficiently over a wide frequency range without an antenna tuner. Second, it maintains its front-to-back characteristics over the complete operating range — something many Yagi designs can't do.

Is the tradeoff of power gain for bandwidth worth it? You'll have to answer that question yourself.

The log periodic Yagi (LPY) array

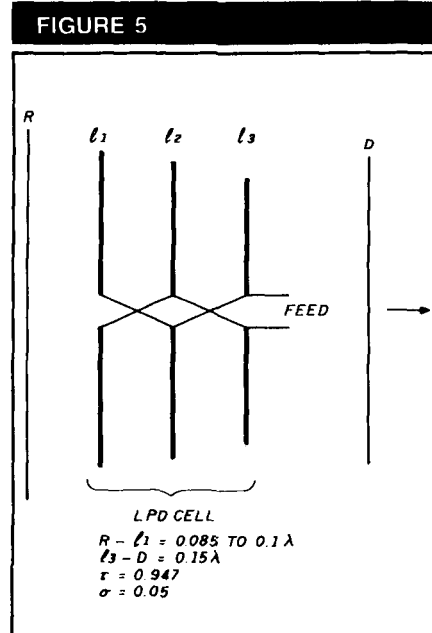
Peter Rhodes, K4EWG, and J. R. Painter, W4BBP, have described an interesting hybrid antenna.⁸ It's designed for single band use, and combines an LPD cell with parasitic elements. The designers claim this configuration achieves higher gain and greater directivity over a single Amateur band than either an LPD or a Yagi array alone (see Figure 5). Best of all, these attributes are achieved with a boom comparable in length to that of a small Yagi. They claim a gain figure of 11.5 dBd for a 14-MHz LPY with a boom length of 26.5 feet. A four-element Yagi on the same boom would provide about 7.3-dBd gain. This gives an apparent signal advantage of about 4 dB for the LPY array over the Yagi. It sounds almost too good to be true!

The log periodic cell in the K4EWG/W4BBP LPY is designed for a single Amateur band, rather than a wide range of frequencies. A three-element log periodic cell provides a power gain of about 3 to 4 dBd over the design range. According to Leo Johnson, W3EB, adding a single reflector and a director provides another 4.5 dB.⁹ If the gain figures are added, the resulting overall gain for the array is about 8.5 dBd. A second director boosts the gain an additional 1.5 dB, for a grand total of 10 dBd.

This agrees roughly with the gain fig-

ure proposed by K4EWB. Personally, I can't verify the gain of an LPY antenna. I know of no computer program that considers this antenna type and I'll reserve my judgment until somebody comes up with one. (I look forward to hearing from a programmer who can combine the virtues of the Yagi with the LP cell in one program and arrive at meaningful results.)

I must admit the LPY concept is tempting. I know that Burt, KV4AD, has a W3EB-type LPY beam on 12 meters, and I have heard his rock-crushing signal. Photo A shows a seven-element 10 to 30 MHz LP4 antenna. Perhaps I'll build one of these antennas and try it out on 10 meters. There's no substitute for experience!



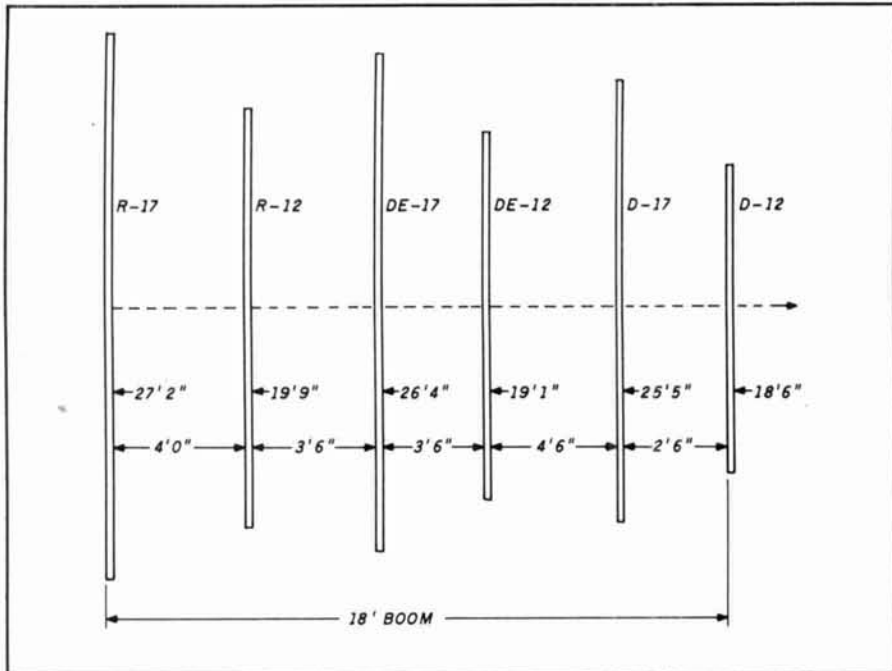
The log periodic Yagi design of K4EWG and W4BBP. Parasitic reflector and director(s) boost gain of LPY cell and improve front-to-back ratio.

A two band Yagi for 18/24 MHz

Brad Butcher, W9WPV, designed and built a two-band, interlaced, three-element array for 18 and 24 MHz. It's shown in Figure 6. The beams are built on an 18-foot boom and fed with separate gamma matches and coax lines. The SWR on each band is about 1.1:1; the front-to-back ratio on either band is better than 20 dB. You make your band selection at the operating position with a coax switch. This array, plus a conventional tribander, can provide coverage of the five popular HF bands with a minimum of fuss.

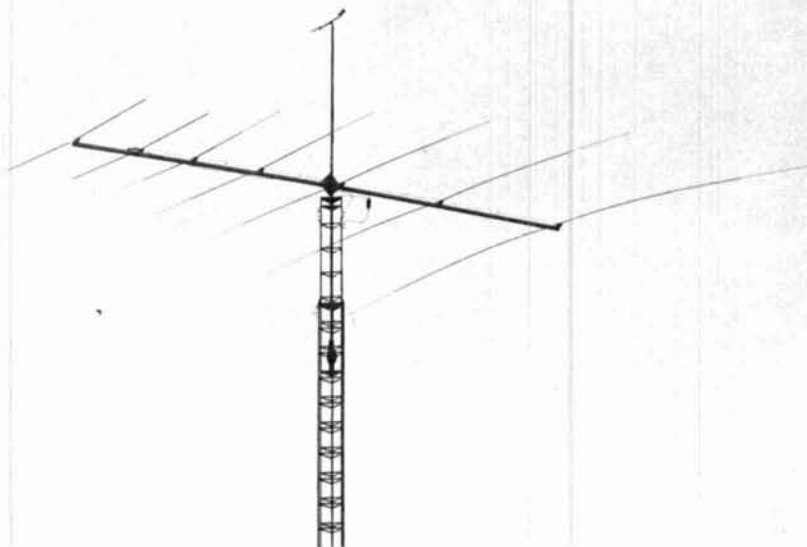
Did I hear someone ask about stacking this beam over a tribander on one tower? If I were to do this, I'd want at least 6 feet — and preferably 10 — between the antennas. Maybe some-

FIGURE 6



Dual Band (17/12 meter) beam of W9WPV. See August column for gamma match data. 17-meter gamma approximately 2'6" long. 12-meter gamma approximately 2'0" long.

PHOTO A



Seven-element LPY beam on 30-foot boom covers 10 to 30 MHz. Six-element cell plus director provides good gain and F/B ratio. Longest element is 42'9"; shortest element is 12'6". Director is 13'6-1/2". (Type KLM-10-30-7LP.)

one will try a stacking experiment to see how it works out!

The Dead Band Quiz

What with all the ionospheric fade-outs, solar storms, and summer lull in DX, there should have been plenty of time to solve the latest quizzes. Many thanks to those who have written to me.

I appreciate your comments and regret that I don't have the time to write and thank you all individually. I also appreciate your suggestions for future topics in this column!

The March quiz (the "black box") has several solutions. The simplest is a "star" of five 0.5-ohm resistors. Jack Cleary, N2JHS, and Curt Anderson,

K3GCM, found this solution. Ed Clegg, W3LOY, pointed out that a "pentagon" of 1.25-ohm resistors would also do the job.

The April quiz dealing with coax lines was quickly solved by W9BT1, WB4HXE, W5DS, KC2KB, N3GDE, W2RJW, W4EIN, K7FC, W7FSP, KJ6GR, VE4KZ, WB6BYU, and WX4D. They knew that the impedance between the shields was zero. Replies are still coming in. I'll try to list them in my next column.

Thanks to all and 73! 

REFERENCES

1. D.E. Isbell, "Log Periodic Dipole Arrays," *IRE Transactions on Antennas and Propagation*, Volume AP-8, No. 3, May 1960, page 0260.
2. R.H. DuHamel, "Log Periodic Antennas and Circuits," *Electromagnetic Theory and Antennas*, E.C. Jordan, Editor, Pergamon Press, New York, 1963, pages 1031-1050.
3. P.D. Rhodes, "The Log Periodic Dipole Array," *QST*, November 1973, pages 16-22.
4. G. Hall, Editor, *The ARRL Antenna Book*, 15th edition, 1988, page 10-3.
5. R.L. Carrel, "The Design of Log Periodic Dipole Antennas," *IRE Int. Conv. Rec.*, volume IX, 1961, pages 61-75.
6. Butson and Thompson, "A Note on the Calculation of the Gain of Log Periodic Dipole Antennas," *IEEE Transactions on Antennas and Propagation*, volume AP-24, January 1976, pages 105-106.
7. A. Collins, "Log Periodic Dipole Arrays for the Upper HF Bands," *QST*, November 1988, pages 21-28.
8. P.D. Rhodes and J.R. Painter, "The Log Yagi Array," *QST*, December 1976, pages 18-21.
9. L.D. Johnson, "Log Yagis Simplified," *Ham Radio*, May 1983, pages 78-82.

Foreign Subscription Agents for Ham Radio Magazine

Ham Radio France
SM Electronic
20 bis, Ave des Clarions
F-89000 Auxerre
France

Ham Radio Canada
C.A.R.F.
P.O. Box 356
Kingston, ON
Canada K7L 4W2
Prices in Canadian funds
1 yr. \$38.00, 2 yrs. \$67.00
3 yrs. \$90.00

Ham Radio Japan
Katsumi Electronic Co., Ltd.
27-5 Ikegami
4 Chome, Ota-Ku
Tokyo 146, Japan
Telephone (03) 753-2405

Ham Radio England
c/o R.S.G.B.
Lambda House
Cranborne Road
Potters Bar
Herts EN6 3JW
England

NYE

Takes the fear out of full power antenna tuners, and the guesswork out of PEP measurement with these two MUST SEE PRODUCTS!!

MB-V-A



Discover this durably built, feature packed MB-V-A Antenna tuner. You'll find operating conveniences that make antenna tuning a snap and value engineered to do the job over wide operating ranges. Compare quality, features and the NYE VIKING TWO YEAR WARRANTY.

RFM-003



Get correct easy to read measurements of PEP for SSB, AM, and Pulse along with full time completely automatic SWR display with this unique Power Monitor System. Two models to choose from: The RFM-003 for 3KW indication and The RFM-005 for 5KW.

CHECK THE FEATURES:

- **Pi Network.** Low Pass Pi Network tuning 1.8-30 MHz. Heavy duty silver plated continuously variable inductor with 25:1 vernier dial. 7000 volt variable capacitor and 10,000v switch selected fixed capacitors on output side. Tunes 40-2000 ohms loads. Good Harmonic suppression!
- **Automatic SWR.** Hands free metering of SWR. No reset or calibration needed. Separate power meter—300 or 3000 w f.s. automatically switched. Easy to read 2.5" recessed and back-lighted taut band meters.
- **Antenna Switch.** PUSH-BUTTON antenna switching to (4) antennas (2 coax, single wire and twin lead). Coax bypassed on first coax output. We designed this switch to take the power. Rated at 10KV and 20 amps.
- **3 KW Balun.** Trifler wound triple core torroid gives balanced output to twin feeder from 200 to 1000 ohms and unbalanced output down to 20 ohms.
- **Maximum Power Transfer.** Match your transmitter output impedance to almost any antenna system for maximum power transfer. Amplifiers only run at their designed Q when properly matched.
- **Model Options.** MB-IV-A1 includes all MB-V-A features less antenna switch and balun. MB-IV-A2 is identical to MB-IV-A1 with the addition of a triple core balun.
 - 1.8 MHz will not tune on some antennas
- **(3) Modes** — Peak Average and Peak and Hold with a unique non-drift Sample & Hold Analog memory circuit.
- **(2) Ranges** — Automatically switched power scales to 5 KW.
- **Fully Automatic SWR** — Full time meter displays ratios directly without drift.
- **Built-in ALO** — Protect your amplifier tube investment with this fast acting lockout.
- **Remote Couplers** — Six feet remotes the interchangeable calibrated couplers.
- **True RMS Conversion** — H.F. couplers use forward biased full wave detection.
- **Rugged Construction** — Heavy gauge aluminum construction. Top quality glass epoxy PCB. This meter is built to last.
- **Accuracy** — Guaranteed to $\pm 5\%$ F.S.
- **Warranty** — TWO FULL YEARS.
- **Added Features** — Switchable reverse power all mode metering — Full status LED Display — Adjustable ALO is switchable SWR/REFL power — Heavy duty Nicad batteries charged by the applied RF for the field and a charger is supplied for fast charging and backlighting of the taut band meters for the ham shack.

OTHER NYE VIKING PRODUCTS

Phone Patches — Electronic and Memory Keyers — Squeeze Keys — Straight Keys — Code Practice Sets — SWR Wattmeter for the blind — Low Pass Filters — All Band Antennas and more . . .
ASK FOR A FREE FULL LINE CATALOG.

TO ORDER, CALL YOUR FAVORITE DEALER

Amateur Electronic Supply
Ham Radio Outlet
Henry Radio
Madison Electronics
EGE
R&L Electronics
rf enterprises
Barry Electronics

C-Comm
Ross Distributing
Quement Electronics
LaCue Communications
Ham Station

In Europe: Kneisner & Doering,
Braunschweig, W-Germany



Wm. M. Nye Co. Inc.
1614 130th Ave. N.E.
Bellevue, WA 98005
TEL: (206) 454-4524
FAX: (206) 453-5704

PROTECT YOUR AMATEUR STATION FROM LIGHTNING

By Richard Little, KY9L, Cellular Systems Group, Motorola, Inc., 1501 West Shure Drive, Arlington Heights, Illinois 60004

More lightning damage occurs to electronic equipment than is generally realized, because much of it is manifested in post-stress failures weeks or months after the damaging surge. Even if you have lightning insurance, these kinds of failures are rarely covered, nor is the lost time and aggravation. Surge damage is real, but it doesn't need to happen.

Most books and articles on the subject of lightning protection recommend extensive arbitrary cross bonding of grounds — often in ways that increase the flow of surge current through the equipment. I take exception to these practices. Thorough study of the problem as it relates to Amateur Radio shows that:

- Most Amateurs cannot afford the kind of installation that would permit them to operate safely with outside antennas during a thunderstorm.
- It is practical to ground an Amateur station in a way that can completely eliminate direct surging of the equipment while the shack is shut down.
- The techniques for eliminating surges during shutdown are consistent with providing at least modest protection if the operator is caught unaware of an impending storm.

I'd like to share some information on an improved method of lightning control that can eliminate damage while your station is shut down and provide some degree of protection if lightning strikes when you're operating.

Do you carry lightning insurance on your ham equipment? Does it cover the decrease in reliability that so often follows a lightning strike? It would be better if your equipment never receives this kind of exposure. But short of packing the equipment back in its shipping containers every time you leave the shack, what are your alternatives?

When the static charge at the base of a cloud builds up to around a hundred million volts, it can jump ("step" is a better word) 150 feet or so as a small arc toward a pocket of opposite charge in the surrounding atmosphere. Within about 50 μ s it may step again and again, extending the

small arc farther and farther along the previously ionized trail. If such an arc ultimately establishes itself to something on the ground, a massive surge of current will rush through the ionized path to neutralize the charge. The extremely high voltage forces the surge of current to rise to a peak value of 10 to 100 kA in 0.1 to 10 μ s. It then decays to half crest in 20 to 200 μ s. Most strokes consist of several of these surges, each neutralizing more and more of the cloud, but the first one is the largest and the one that usually damages electronic equipment. The fast leading edge (20 kA/ μ s typical, with 1 percent exceeding 100 kA/ μ s) can result in the top of a tower momentarily "jumping" a million volts with respect to its base. This is why lightning has no problem jumping across switch contacts and guy wire insulators, or even right through the wall of a house from an ungrounded exterior coax.

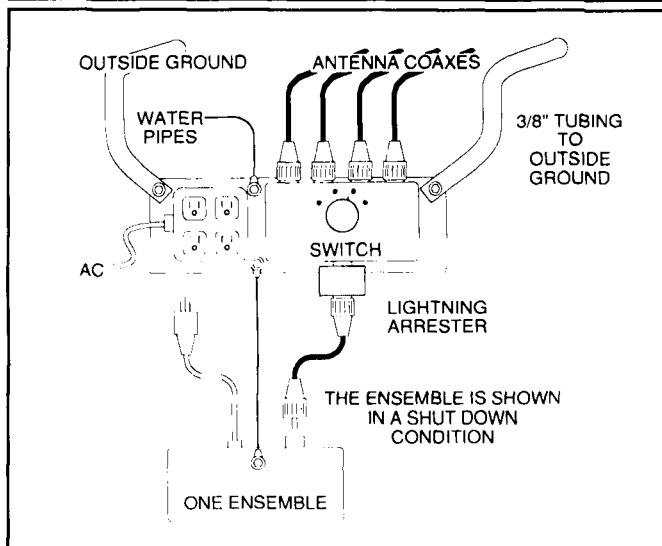
What kinds of protection?

Personal safety is your first concern. This means tying all grounded objects together to prevent side flashing between them, and perhaps augmenting the ground. Secondly, Amateur antennas expose our homes to more and larger surges so you may wish to add some protection to your more expensive non-Amateur equipment like stereos, TVs and VCRs, and home computers. You can provide excellent shutdown protection for your Amateur equipment and perhaps, depending on your pocketbook, some tolerance should you not shut down in time.

For safety of people!

I'm often asked if the antenna grounding should be kept separate from the house ground. Absolutely not! **I strongly encourage integrating everything into a common ground.** I don't think any lightning professional would disagree. The same reasoning is behind universal building codes which tie electrical ground, phone line protector ground, water pipes, and TV cable together. While bond-

FIGURE 1



Installation showing the station (ensemble) in a shutdown condition. All grounds are located at a small ground window.

ing them together may increase electrical surging in the house should the antenna get hit, it also makes the surge path more predictable. Everything moves (electrically) more or less together, proving safer for people as well as your equipment. This ground should include:

- Outside ground, made up of:
 1. Tower ground (including guy anchors)
 2. Radials
 3. Ground stakes (several recommended)
 4. Step voltage protection (if used)
 5. Chain link fence (if within 20 feet of other grounds)
 6. Rain gutters
 7. Well casing
 8. Connections to inside ground (at least two recommended)
- Inside ground, made up of:
 1. Water pipes, power ground, cable TV feed and phone line protector. (These should already be integrated, but if not, DO IT! Cross bond if in doubt!)
 2. Duct work
 3. Structural (like basement I beams)
 4. Shack ground, including:
 - a. connections to outside ground
 - b. coaxes where they enter the shack
 - c. open wire feedline shorting switch (if required)
 - d. grounds of each of the power outlets feeding the equipment
 - e. rotor control box (otherwise provide with a three-wire cord)
 - f. all equipment that is provided with ground lugs
 - g. equipment desk (if metal)

I'll discuss the shack ground in more detail later.

Protecting non-Amateur equipment

Use three-way surge-protected power strips for any expensive electronic equipment; those strips housed in metal cases are more convenient for making auxiliary ground connections. Plug the TV, VCR, and all video accessories into a common strip and ground the braid of the coax feed to that strip using a short bonding strap. For a home

computer, plug the computer and **all** of its peripherals into a common strip. If your system incorporates a phone line modem, acquire a secondary phone line protector and ground it directly to that strip with a short bonding strap.

Shutdown protection: surge isolation

For simple shutdown protection, pick a central point where it's convenient to bond all of the shack ground items listed — including all the antenna coax braids — and call that point "shack ground." If you arrange these connections into a neat, small, "ground window" (see **Figure 1**), you will also have a degree of surge attenuation. In any case, the antennas, rotor, and other equipment each bear separate consideration.

Equipment grounds

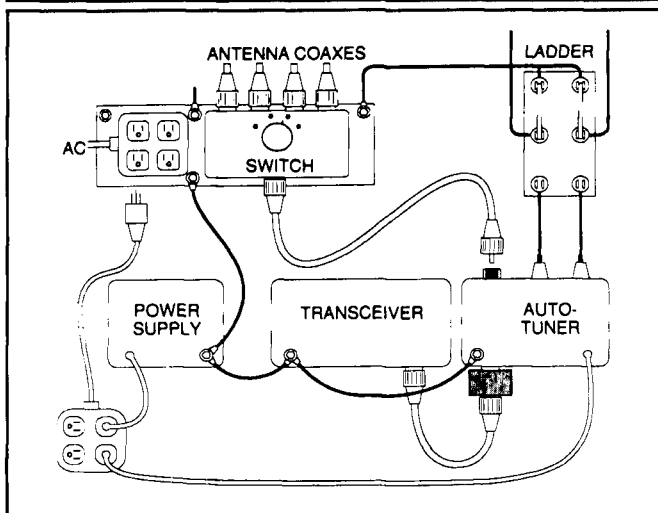
You can organize your shack into one or more equipment ensembles, each having just one connection to shack ground in addition to antenna(s) and power cord(s). **Figure 2** shows an example of a grouping with one connection to the shack ground. Most of you will prefer a single ensemble in which all of the equipment grounds are connected to a steel desk or a "bus bar," or otherwise cross bonded to one another and then grounded to shack ground *via a single wire*. Of course, a tuner that's being treated as "antenna," as depicted in **Figure 3**, must not be in conductive contact with any of the equipment of an ensemble (except via common shack ground when shut down, or coax when not shut down).

Connections between different ensembles are not permitted. If a power supply, a speaker, a microphone console, a keyer, or a computer interface connects to more than one transceiver, they must all be part of the same ensemble. One word of caution: A more elaborate ensemble tends to be less surge tolerant. Each ensemble may incorporate its own multiple outlet power strip, which simplifies shut down.

Antenna grounding and switching

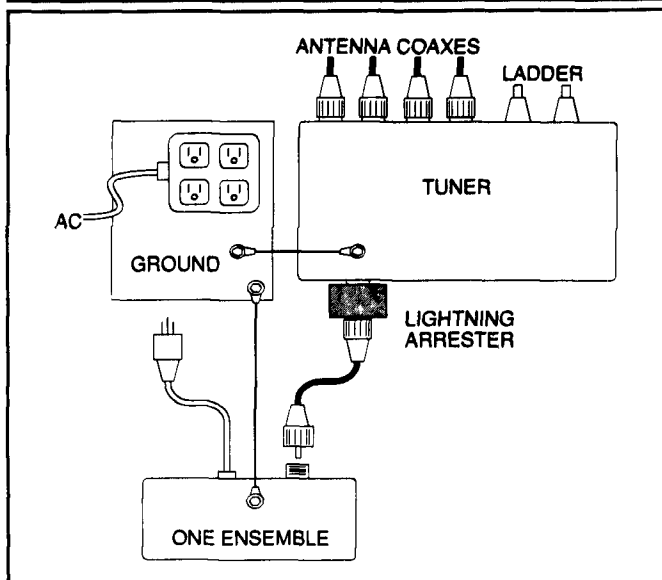
Bond the shields of all antenna coaxes to shack ground. A properly grounded coaxial switch will work. Including the antenna switches and/or the tuner as part of the antennas (as shown in **Figure 3**) minimizes the number of discon-

FIGURE 2



An ensemble using only one connection to the ground window.

FIGURE 3



Antenna tuner is treated like an antenna and must be isolated from the rest of the ensemble, except for the common ground.

nects required during shutdown. This also cuts down on HF "RF in the shack," particularly if the antenna isn't truly balanced or isolated by a feedline choke.

Tuners, built in transceivers, and autotuners are treated as part of an ensemble, as shown in Figure 2. In these cases, if any of your antennas are not well balanced or isolated, reduce RF in the shack by defining the shack ground as close as practical behind the ensemble to minimize the length of the single wire between the ensemble (preferably the tuner) and shack ground. Counterpoise wires must attach to shack ground, not directly to the ensemble.

Make sure antenna switches are the grounding type and able to ground all antennas at shutdown. Use a DPDT knife switch to disconnect *and ground* a ladder line if you use one. A remote coax switch that uses a separate control cable is best treated as a "rotor controller." Those switches using the coax for control and power are best treated as "equipment," thus the antenna coax will be disconnected and its center conductor grounded during shut down.

Rotor controller

The rotor can't avoid surging; neither can the controller, unless the rotor cable is disconnected and all its wires are grounded at shut down. Short of that, the rotor and its controller have an intrinsic degree of surge tolerance that the following procedure neither helps nor harms. You can modify them to improve this tolerance, but these modifications are beyond the scope of this article. However, to protect the rest of your equipment, and for your own safety:

- If it has a two-wire power cord, ground the controller to shack ground and pull the plug when you shut down.
- If it has a three-wire power cord, surge protect your grounded outlet box, and leave the rotor controller plugged in at all times.

Shutdown performance

This is a rudimentary ground scheme; it provides excellent surge isolation when shut down, but only modest surge attenuation otherwise. To shut down:

- Unscrew the antenna coaxes where they enter each equipment ensemble. Switches are unacceptable for this purpose.
 - Pull the power plugs that feed each equipment ensemble from the shack-grounded outlet box. Again, switches are unacceptable.
 - Ground the antennas, including all the center conductors.
 - Disconnect the phone line from a phone patch or from a computer/modem that's part of an ensemble.
- Check your work! There should now be but *one* ground path from each ensemble to shack ground.

Improving surge attenuation

Few of us can afford the full surge protection that would permit us to operate with impunity during any storm. Surge damage to equipment can occur in the following ways:

Coax differential voltage. The surge generates a difference in potential between the sheath and center conductor. This can damage a receiver, a transmitter, or just the coax.

Coax chassis surging. The sheath "whiplashes" the entire rig with respect to its other external connections like keyers, computer interfaces, phone patches, shared speakers, and microphone consoles, damaging the interfacing circuitry in either the rig or a peripheral, or both.

Coax chassis ground surging. The surge enters via the coax and leaves via either power or ground, causing destructive internal voltages in the equipment.

Power surging. A surge injected by an antenna stroke generates a large electric transient between AC hot, AC common, and/or the power panel ground. The three-way protector minimizes this.

Telephone line surging. A surge injected by an antenna stroke generates large voltage spikes on the equipment with respect to the telephone lines. A secondary phone line protector minimizes this.

The damage may be apparent immediately, or randomly after the fact. It could show up hours, days, or months later. Often a "zapped" rig exhibits poor reliability forever after.

For surge attenuation, the first prerequisite is three-way surge protection on the AC outlet boxes, secondary telephone line protectors grounded at those outlet boxes, and coax arresters between the antennas and the equipment ensembles. After that, the protection depends upon:

- The magnitude of the stroke.
- How well shack ground is developed into a small ground window — including the lengths of the coax sheath bonds and the AC outlet box bond. Short is important! Fat (wide) also helps. This is because lightning propagates like RF — on the surface of a conductor more than within the conductor, i.e., skin effect.
- The quality of the outside ground.
- How well the coax sheaths are grounded at the tower base, thus diverting sheath surge current into outside ground.
- The surge tolerance of the specific radio equipment.

The inside ground

Figure 1 shows how I have developed a *small* ground window at a point directly behind my operating desk. Commercial installations often provide a heavy copper plate for mounting the surge-protected power panel, the phone line protectors, and the coax terminators/arresters. A very low

HITACHI SCOPES AT DISCOUNT PRICES



V-212
\$419

List \$560
Save \$141

20MHz Dual Trace Oscilloscope

All Hitachi scopes include probes, schematics and Hitachi's 3 year warranty on parts and labor. Many accessories available for all scopes.



V-425
List \$995 **\$835**

- DC to 40MHz
- Dual Channel
- CRT Readout
- Cursor Meas
- DC Offset
- Alt Magnifier
- Compact Size



V-1060
List \$1595 **\$1,359**

- DC to 100MHz
- Dual Channel
- Delayed Sweep
- CRT Readout
- Sweep Time
- Autoranging
- Trigger Lock
- 2mV Sensitivity

			LIST	PRICE	SAVE
V-223	20MHz	D.T., 1mV sens, Delayed Sweep, DC Offset, Vert Mode Trigger	\$770	\$695	\$75
V-422	40MHz	D.T., 1mV sens, DC Offset Vert Mode Trigger, Alt Mag	\$875	\$725	\$150
V-423	40MHz	D.T., 1mV sens, Delayed Sweep, DC Offset, Alt Mag	\$955	\$825	\$130
V-660	60MHz	D.T., 2mV sens, Delayed Sweep, CRT Readout	\$1,195	\$1,095	\$100
V-1065	100MHz	D.T., 2mV sens, Delayed Sweep, CRT Readout, Cursor Meas	\$1,895	\$1,670	\$225
V-1100A	100MHz	Q.T., 1mV sens, Delayed Sweep, CRT Readout, DVM, Counter	\$2,295	\$2,045	\$250
V-1150	150MHz	Q.T., 1mV sens, Delayed Sweep, Cursor Meas, DVM, Counter	\$3,100	\$2,565	\$535

ELENCO PRODUCTS AT DISCOUNT PRICES

20MHz Dual Trace Oscilloscope



\$369
MO-1251

- 6" CRT
- Built in component tester
- TV Sync

50MHz Logic Probe LP-700
Logic Pulsar LP-600
Your Choice **\$23**

SCOPE PROBES

P-1 65MHz, 1x, 10x **\$19.95**
P-2 100MHz, 1x, 10x **\$23.95**
Fits all scopes with BNC connector

35MHz Dual Trace Oscilloscope



\$495
MO-1252

- High luminance 6" CRT
- 1mV Sensitivity
- 6KV Acceleration Voltage
- 10ns Rise Time
- X-Y Operation • Z Axis
- Delayed Triggering Sweep

Top quality scopes at a very reasonable price. Contains all desired features. Two 1x, 10x probes, diagrams and manual. Two year guarantee.

Autoranging DMM



M-5000
\$45

- 9 Functions
- Memory and Data hold
- 1/2% basic acc
- 3 1/2 digit LCD

True RMS 4 1/2 Digit Multimeter



\$135
M-7000

- .05% DC Accuracy
- .1% Resistance with Freq. Counter and deluxe case

Multimeter with Capacitance and Transistor Tester



\$55
CM-1500

- Reads Volts, Ohms, Current, Capacitors, Transistors and Diodes with case

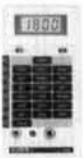
Digital Capacitance Meter



CM-1550
\$58.95

- 9 Ranges
- .1pf-20,000ufd
- .5% basic accy
- Zero control with case

Digital LCR Meter



LC-1800
\$125

- Measures Coils 1uH-200H
- Caps .1pf-200uf
- Res .01-20M

AC Clamp-On Current Adapter



ST-265
\$25

- 0-1000A AC
- Works with most DMM

Bench DMMS



M-3500
3 1/2 digit **\$125**
.1% accy

M-4500
4 1/2 digit **\$175**
.05% accy

SOLDERING STATION



SL-30
\$99

- Digital display
- Temp range: 300F-900F
- Grounded tip
- Overheat protect

Solderless Breadboards



- 9430 1,100 pins **\$15**
- 9434 2,170 pins **\$25**
- 9436 2,860 pins **\$35**
- All have color coded posts

9436 SHOWN

Low Cost Multimeter



M-1600
\$25

- 3 1/2 digit LCD
- 1% DC Accy
- 10A Scale
- Auto zero
- /polarity

Wide Band Signal Generators



SG-9000 **\$129**

- RF Freq 100K-450MHz
- AM Modulation of 1KHz
- Variable RF output

SG-9500 with Digital Display and 150MHz built-in Freq Ctr \$249

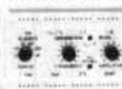
3 1/2 Digit Probe Type DMM



M-1900
\$39

- Convenient one hand operation
- Measures DCV, ACV, Ohms
- Audible continuity check, Data hold
- with batteries and case

Function Generator



Blox
#9600
\$28.95

- Provides sine, tri, squ wave from 1Hz to 1MHz
- AM or FM capability

Decade Blox



#9610 or #9620
\$18.95

- #9610 Resistor Blox 47 ohm to 1M & 100K pot
- #9620 Capacitor Blox 47pf to 10MFD

Digital Triple Power Supply



XP-765
\$249

- 0-20V at 1A
- 0-20V at 1A
- 5V at 5A

Fully Regulated, Short circuit protected with 2 Limit Cont., 3 Separate supplies

XP-660 with Analog Meters \$175

Quad Power Supply



XP-580
\$59.95

- 2-20V at 2A
- 12V at 1A
- 5V at 3A
- 5V at 5A

Fully regulated and short circuit protected

XP-575 without meters \$39.95

10MHz XT 100% IBM® Compatible



MODEL PC-1000
\$595

5 Year Warranty

- 150W Power Supply
- 256K RAM
- Expandable to 640K
- Monochrome Monitor
- Monographic Video Card
- Parallel Printer Port

FREE spreadsheet and word processor
3.XXMS DOS and GW Basic add 75.00

Four-Function Frequency Counters



F-100 120MH
\$179

F-1000 1.2GH
\$259

- Frequency, Period, Totalize, Self Check with High Stabilized Crystal Oven Oscillator, 8 digit LED display

GF-8016 Function Generator with Freq. Counter



\$249

- Sine, Square, Triangle Pulse, Ramp, 2 to 2MHz
- Freq Counter .1 - 10MHz

GF-8015 without Freq. Meter \$179

WE WILL NOT BE UNDERSOLD!

UPS Shipping: 48 States 5%

(\$10 Max) IL Res., 7% Tax



C & S SALES INC.

1245 Rosewood, Deerfield, IL 60015

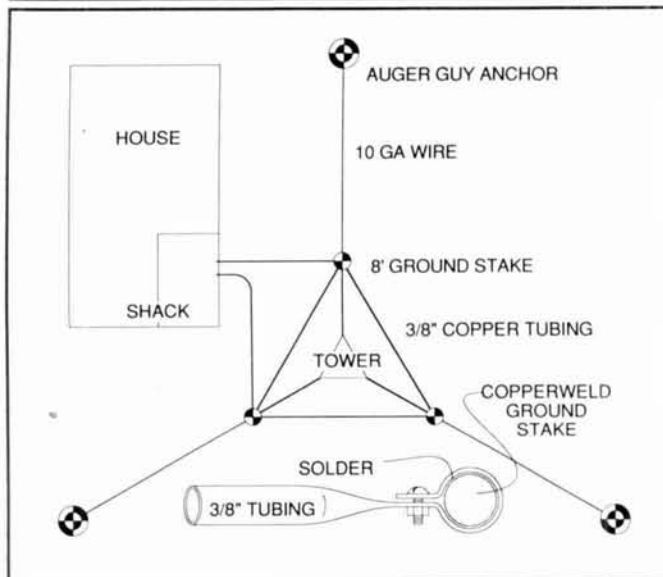
(800) 292-7711 (312) 541-0710

15 Day Money Back Guarantee

2 Year Warranty Prices subject to change

WRITE FOR FREE CATALOG

FIGURE 4



Layout of a "good" outdoor grounding system.

inductance between these items and careful ensemble isolation (except at the window) are essential for good surge attenuation.

I've also cross bonded my water pipes, gas pipe, conduit, boiler, and water heater extensively, using heavy braid (sheath from scraps of RG-8/U) and stainless hose clamps, which may help reduce intermodulation TVI. The conduit that feeds the shack has braid jumpers across all of its joints and to the power panel.

Outside ground

In commercial work we use no. 2 gauge wire (no strands smaller than no. 17 gauge) for any conductor that must carry full strike current without vaporizing, and no. 6 gauge for miscellaneous grounds like rain gutters and chain link fence. At home I use 3/8" copper tubing between the tower legs and each of three ground stakes, between the stakes, and to inside ground (see Figure 4). I flatten the ends and either drill for bolts, or wrap around a stake and drill, bolt, and solder as in Figure 4. My stakes are 8 feet long, 10 feet apart, and at least 6 feet from the house. They are driven so the tops are a foot below grade; the tubing is also about a foot deep. In addition, my guy anchors, well casing, and power ground augment my shack ground.

Experts recommend you put a no. 2 gauge perimeter wire around the house below the frost line several feet from the house, with ground stakes at the corners. This is primarily to equalize the slab step voltage, but it also augments outside ground. Without this wire around the foundation, any equipment (including insulated cables or a steel desk) within several inches of the slab may side flash to it. Use a wood desk on a slab and keep the cables off the floor!

Experts also bury a grid of no. 6 gauge wires below places where people might walk during a storm. Without this grid, a stroke could produce a "step voltage" gradient in the ground such that the surge current would prefer to take a path through a body — from one foot to the other. Unless you have a fully developed outside ground, stay away from it during storms!

Setting priorities

Your first priority is people protection. This means using increased grounding and taking care to ensure a good, well-integrated ground system. Next, you'll want to provide surge protection on the AC power lines of your expensive electric equipment so you needn't suffer the aggravation that follows surge damage. You'll want to hook up your Amateur gear in such a way that it's immune from surging if properly shut down. You may wish to provide a degree of surge attenuation for your radio equipment in case you are caught unaware of an approaching storm. This, in large measure, will depend on circumstance and, perhaps, your pocketbook. You can obtain the most protection for your money by adding a small ground window in your shack, combined with a modest outside ground. Thereafter, augmenting the outside ground will add still more improvement.

I hope the information I've presented here starts you off in the right direction. Check the bibliography at the end of the article for valuable source material.

BIBLIOGRAPHY

1. FCC Part 68, "Connecting to the Telephone Network."
2. IEEE Standards 587-1980, "Surge Voltages in AC Power Circuits."
3. *Electrical Protection Guide for Land-based Radio Facilities*, David Bodie, Joslyn Electronic Systems, Santa Barbara Research Park, P.O. Box 817, Goleta, California 93017, March 1976, \$3.00.
4. *Fundamental Considerations of Lightning Protection, Grounding, Bonding, and Shielding*, FAA, Washington, DC, July 28, 1978.
5. *Surge Protection Test Handbook*, Technical Staff of Keytek Instrument Corp., 12 Cambridge Street, Burlington, Massachusetts 01830, 1982.
6. *The Grounds for Lightning and EMP Protection*, Roger R. Block, Polyphaser Corporation, 1425 Industrial Way, Gardnerville, Nevada 89410-1237, 1987 (Available from the HAM RADIO Bookstore for \$19.95 plus \$3.75 shipping and handling.)

AMATEUR TELEVISION

SMILE! YOU'RE ON TV



Only
\$329



Designed and built in the USA
Value + Quality
from over 25 years
in ATV...W6ORG

With our all in one box TC70-1, 70cm ATV Transceiver, you can easily transmit and receive live action color and sound video just like broadcast TV. Use any home TV camera or VCR by plugging the composite video and audio into the front VHS 10 pin or rear phono jacks. Add 70cm antenna, coax, 13.8 Vdc and TV set and you are on the air...it's that easy! TC70-1 has >1 watt p.e.p. with one xtal on 439.25, 434.0 or 426.25 MHz & properly matches Mirage D15, D24, D100 amps for 15, 50, or 70 watts. Hot GaAsfet downconverter varicap tunes whole 420-450 MHz band to your TV ch3. Shielded cabinet 7x7x2.5". Req. 13.8 VDC @ .5A Transmitters sold only to licensed amateurs, for legal purposes, verified in the latest Callbook or send copy of new license. Call or write now for our complete ATV catalog including downconverters, transmitters, linear amps, and antennas for the 70, 33, & 23cm bands.

(818) 447-4565 m-f 8am-5:30pm pst.

Visa, MC, COD

P.C. ELECTRONICS

Tom (W6ORG)

2522 Paxson Ln Arcadia CA 91006

Maryann (WB6YSS)

Ham Notebook

Finding the source of computer-generated interference

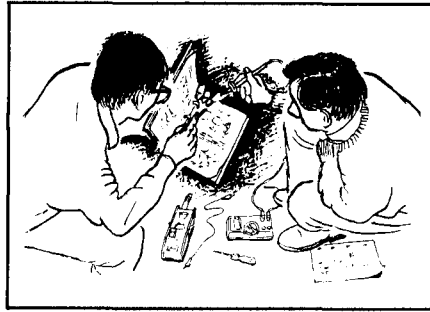
Using a computer system near an Amateur Radio receiver (operating a packet radio station, for example) is likely to cause receiver interference. To pinpoint the source of the interference, go through this quick check list while listening to the noise in the receiver:

1. **Disk drive:** Does the noise appear only when the disk drive is transferring data? Does the noise disappear when the drive is turned off? Does the noise change in intensity when you move the drive cables?
2. **Monitor:** Does the noise stop when the monitor is turned off? Does the noise stop if you move the cables?
3. **Printer:** Does the interference occur only when the printer is running a print job, and stop when the printer is turned off?
4. **TNC:** Does disconnecting the audio cable solve the problem? Does turning off the TNC solve it?
5. **Computer:** Does turning off only the computer remove the interference?

If this procedure fails to find your culprit, tune a portable AM radio to an unused portion of the band and use it to sniff out the source of the problem. You'll probably be surprised at the variety of different computer-generated noises the receiver picks up. Concentrate on the type of noise affecting your radio receiver and ignore the rest, since it's not impairing your reception. Move the AM receiver near cables, power cords, and disk drives to find out where the noise originates.

I used this technique and found that my interference problem occurred only when my Commodore 64 was on. The interference was in the form of RF coming from the computer itself. I wrapped a piece of brass window screen and cardboard insulation around the motherboard and soldered the screen to a ground connection. This solved the problem completely and took only about an hour to do.

Dean F. Poeth II, K8TM



HOMEBREW DIPLEXER

There are now several good dual band (144/430 MHz) antennas available. Unfortunately, many of the dual band rigs have separate antenna input sockets for each band. How do you cope with the problem of getting one plug into two sockets? The answer is a simple bit of circuitry called a diplexer. This device sorts out the various frequencies and routes them to the appropriate rig. They are available commercially at a rather high price. But those that I have measured, while safe to use, don't show up too well on separation and also tend to have an unacceptable loss when placed in circuit.

The circuit

The circuit of a homemade diplexer, which is well within the construction capabilities of the newcomer to homebrewing, is shown in Figure 1. It

consists of three coaxial sockets and four series-resonant circuits. I hope you'll remember that a series-resonant circuit has a very low impedance at resonance and a high impedance off resonance. How does the circuit work?

Consider a 144-MHz (2 meter) signal coming in on the antenna socket SK2. The tuned circuit L2/C2 is resonant at 144 MHz and, having a low impedance, passes the signal to the 2-meter output SK1. The tuned circuit L3/C3, being resonant at 433 MHz, exhibits a high impedance at 2 meters and so stops the 144-MHz signal from reaching the 70-cm output socket SK3. On 433 MHz the opposite action takes place.

More protection

The action already described will do a fair job, but it can be improved upon.

PARTS LIST

Capacitors

Trimmers

C1,3 5 pF
C2,4 15 pF

Inductors

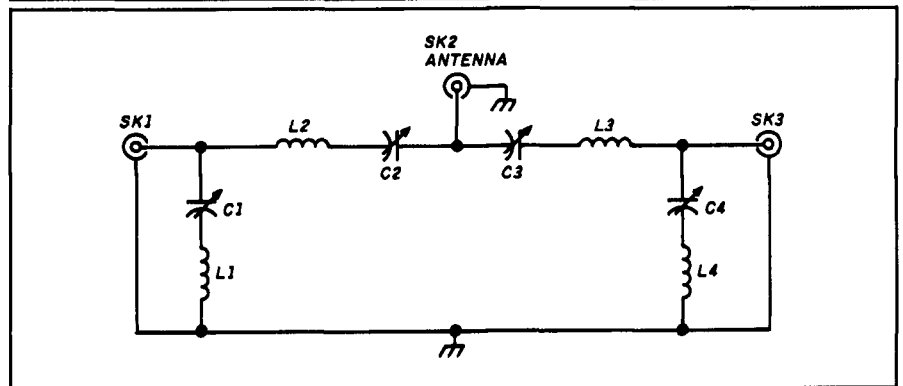
Air spaced, self-supporting

L1,3 3 turns 22 a.w.g., 6 mm diameter, 12.6 mm long
L2,4 5 turns 22 a.w.g., 6 mm diameter, 20 mm long

Miscellaneous

Sockets, BNC, N, etc., as required (3 off); die-cast box; nuts, bolts, washers, and solder tags.

FIGURE 1



Circuit diagram of the 144 MHz/430 MHz diplexer.

The tuned circuit L1/C1, which is connected from the 2-meter output to earth, is series resonant at 433 MHz and so any signal at that frequency which manages to find its way through L2/C2 is shorted to earth. As it has a high impedance off resonance, L1/C1 has no effect on the 144-MHz signals. The tuned circuit L4/C4 is series resonant at 144 MHz and removes any leakage which reaches the 70-cm output socket at that frequency.

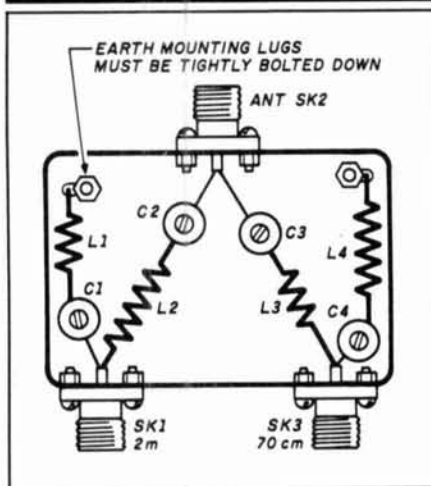
Specification

How well does the circuit do its job? The insertion or through loss was measured at less than 0.1 dB on 144 MHz, and was slightly higher at 0.17 dB on 433 MHz. When you consider that you need a loss of 3 dB to lose one S point of signal strength, these losses can be disregarded. The blocking of 144 MHz at the 70-cm output, and of 433 MHz at the 2-meter output, was greater than 60 dB. This means there's an unwanted output of 1 μ W for every watt of power applied, which is more than satisfactory.

Construction

The unit can be built in a small die-cast box; a suitable layout is shown in Figure 2. The trimmer capacitor types

FIGURE 2



A layout suitable for operation at fairly low powers.

required will depend on the transmitter powers to be used. Ceramic piston and compression types are suitable for low powers; for higher powers air-spaced trimmers (e.g., Jackson C804 series) will be necessary. Ed.

Tuning the unit is simple. First connect the rigs to the correct output sockets. **DO NOT TRANSMIT** until all the following steps are completed.

Tune the 144-MHz rig to a strong signal and adjust C2 for the highest S-meter reading. Tune the 433-MHz rig to a strong signal and adjust C3 for the best S-meter reading.

Now connect the 144-MHz rig to the 70-cm output on the diplexer and the 433-MHz rig to the 2-meter output. Tune to a strong 144-MHz signal and adjust C4 for **minimum** S meter reading. Tune to a strong 433-MHz signal and adjust C1 for **minimum** S-meter reading. For safety, run through all the above steps a second time, then reconnect the rigs to the correct outputs and the job is completed. **lyr**

Glen Ross, G8MWR

Reprinted with permission from Practical Wireless, PW Publishing Ltd., October 1988. Ed.

INTRODUCING...

Special Introductory Offer

Just **\$19.95** Per Library

(Reg. Retail Value \$24.95)

PLUS FREE BONUS
(See Details)

THE NEW AZIMUTH AWARDS QSL LIBRARY

New Handsome Custom Albums To Collect, Protect & Organize Your Hard-Earned QSL Cards... Plus Special Albums for DXCC, WAS/WAC, & WAZ Radio Awards

Throw out the shoe boxes. Get your QSLs organized with the new Azimuth Awards QSL Library. The perfect way to display the cards for your prestigious awards—for easy viewing. Each padded vinyl album comes complete with 20 heavy duty crystal-clear, slip-in pocketed vinyl pages (each holds 6 cards).

Now available for the most prestigious awards in amateur radio... order all and organize your cards for each award.

- DX Century Club • Worked All Zones • Worked All States & Continents • & a general QSL Album for any purpose!

Looks great in your shack! Need more pages? Order extra pages (20/pack). Satisfaction Guaranteed! If not completely delighted return your purchase in 10 days for a money-back refund.

Call or Send For Your Azimuth QSL Award Library Today!

SEND TO: Azimuth Awards Library, Dept. HR9A
11845 W. Olympic Bl., Suite 1100, Los Angeles, CA 90064
1-213-473-1332 for Information

FREE BONUS WITH TWO OR MORE ALBUMS!

Get The New Azimuth Awards Base Tracking Software for the IBM-PC (\$24.95 value) **Free!** Exclusive new program helps you stay on top of contacts by band, cards sent and received and much, much more to monitor your radio award progress.

Azimuth QSL Awards Library—Each just \$19.95 plus \$2.50 shipping & handling

Specify: 1) DXCC 2) WAZ 3) WAS/WAC 4) Standard Album

Extra 20 Page Packs Just \$12.95 (\$2.50 S&H)

Enclose check or money order (Cal. Res. add 6.5% tax.)

VISA or MasterCard. (Foreign orders triple S&H)

Credit Card Orders Call Today Toll Free

Nationwide 1-800-882-7388
(9AM to 6PM PST)

Allow 4 to 6 Weeks Delivery

© MCMXXXIX Azimuth Communications Corporation



SYNTHESIZED SIGNAL GENERATOR

MADE IN USA



MODEL SG-100F
\$429.95 delivered

- Covers 100 MHz to 199.999 MHz in 1 kHz steps with thumbwheel dial
- Accuracy +/- 1 part per 10 million at all frequencies
- Internal FM adjustable from 0 to 100 kHz at a 1 kHz rate
- External FM input accepts tones or voice
- Spurs and noise at least 60 dB below carrier
- Output adjustable from 5-500 mV at 50 Ohms
- Operates on 12 Vdc @ 1/2 Amp
- Available for immediate delivery • \$429.95 delivered • Add-on accessories available to extend freq range, add infinite resolution, AM, and a precision 120 dB attenuator
- Call or write for details • Phone in your order for fast COD shipment.

VANGUARD LABS

196-23 Jamaica Ave., Hollis, NY 11423
Phone: (718) 468-2720 Mon. thru Thu.

K4EF LONG WIRE ANTENNA DESIGNS

Simple antennas provide exceptional performance

By Everett Brown, K4EF, 6710 Highway 329,
Crestwood, Kentucky 40014

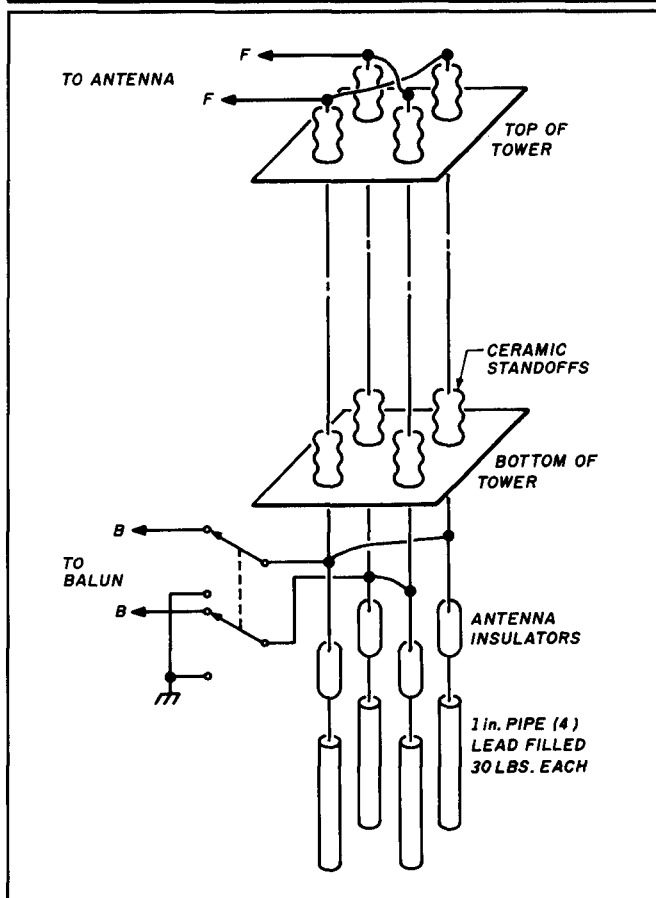
My interest in long wires was sharpened in the mid-1970s when I acquired my first solid-state transceiver that required no tuneup. It seemed to me that transmitter technology had left antenna development behind. Wouldn't it be a great improvement to have a single high performance all band antenna fed with a single coaxial cable? Think of the convenience! When operating in contests you could switch bands with no time lost. During a QSO, you could check quickly to see if another band was open. You'd be free to operate on any Amateur HF frequency, without the limitations imposed by antenna bandwidths and high SWR. You could explore every nook and cranny of our extensive frequency allocation and find new friends who rarely leave "home" frequencies. I felt long wires offered the best opportunity to achieve that ideal.

After many months of testing performance on the air and experimenting with numerous configurations, I came to the following conclusions:

- Under skip conditions, V antennas were vastly superior to straight long wires or dipoles. This wasn't due to azimuth gain — they excelled in any direction. Ground wave measurements weren't at all similar to measurements taken during skip contacts.
- A resonant wire, approximately center fed and an odd number of half waves in length, offered a consistent impedance in the vicinity of 200 ohms. If additional wire legs resonant on other frequencies were added, the impedance varied only slightly. If the feedpoint was moved from the center of the element as much as 1/8 wavelength there was surprisingly little shift in impedance.

These findings suggested a whole family of new antenna designs, but I concentrated on my ideal — all bands, one coax. My final design was highly successful and I published it with the associated test and measurement results in the Amateur literature.¹ The final design had one drawback. It occupied about ten acres; not many urban Amateurs could fit it into their backyards. Despite this, I received letters from

FIGURE 1



Detail of the 4-wire 200-ohm feedline and grounding relay.

rural users in many states, and from as far away as VK-land. The Australians were particularly pleased. The antenna performed flawlessly on the commercial frequencies they used in addition to Amateur bands for communications in remote areas.

These antennas are also appealing because they don't require expensive hardware which would oxidize outdoors. I used a single 40-foot wooden mast and aluminum electric fencing wire, which I bought in quarter-mile rolls from commercial suppliers. Trees provided the only other supports.

Antenna feed

Feeding a 200-ohm antenna is simple. It requires a 4:1 balun and 50-ohm coaxial cable. Of course, because commercial baluns usually aren't perfect, a word of caution is in order. I suffered a 3:1 SWR on 10 meters for a year before a nearby lightning strike caused the balun to explode like a hand grenade, littering the yard with plastic fragments. Many of the letters from users of identical antennas had reported unity SWR. That lightning strike was a great help. A new balun cured my SWR problem. After the strike, I took more precautions. These involved moving the balun from the top of the mast to the bottom, and installing a 200-ohm open wire line with a relay which grounded the antenna and disconnected the balun automatically when the transceiver was turned off. The 12 volts DC for the relay was supplied by the transceiver power supply. I recommend you try this procedure if you're in an area that experiences frequent electrical storms. Figure 1 shows the details. Four no. 10 copper wires are arranged in a square on 2-inch centers and the diagonally opposite wires are joined together at each end of the line. This line has much lower loss than coaxial cable — a worthwhile bonus. I removed the bolts from the ceramic standoffs and fed the wires through the holes, so the insulators acted as guides. The shelves holding the standoffs had 1-inch holes on the wire centers, providing plenty of clearance. I captured the wires above the top insulators with brass washers that I silver soldered to the wire. If this sounds like a lot of work, there's a shortcut. There was 200-ohm twin lead on the surplus market a few years ago, which would work well in this application. However, finding it is difficult.

The Novice license now allows operation on four HF bands. Old-timers, their backyards already bulging with antennas, may not want to add more for WARC bands. It appears there's an urgent need for multiband antennas to gain access to these new bands, without adding significantly to the hardware already in our yards.

I've come up with some antennas which I think get to the heart of this problem. They're all 200-ohm impedance designs which can be fed with 4:1 baluns and 50-ohm coaxial cable. Most can fit into an urban backyard. You'll notice a few monobanders among the designs. They occupy more space than a conventional dipole; so why use them? The answer is performance. They provide more capture area, and a configuration that has proved superior in extensive on-the-air testing.

Another feature of these antennas is the 90-degree apex angle, suggesting a V antenna. A V antenna which yields bidirectional gain is fed with the legs in phase. These are fed out of phase, and this makes them quite different electrically. I couldn't measure any directivity when I used these antennas under skip conditions.

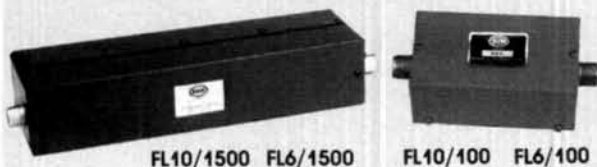
The antenna diagrams in the figures show top views of the antenna wires. Their lengths are identified in feet. The two small circles at the wire ends are the connection points for the 4:1 balun.

Monobanders for the Novice

Perhaps you already have several Novice bands covered and wish to add one more. You may want to operate on just one band. In either case, one of the designs in Figure 2 is for you. These designs require three times the wire of a conventional dipole — and for good reason. The configuration and

T.V.I. problems?

Low pass T.V.I. filters from Barker & Williamson



Model	Power (Watts)	Cut Off Frequency	Frequency of Maximum Attenuation	Minimum Attenuation	Frequency Range	Price
FL10/1500	1000	34 MHz	52 MHz	70 db	1.8 - 30 MHz	\$36.95*
FL10/100	100	44 MHz	57 MHz	60 db	1.8 - 30 MHz	\$29.50*
FL6/1500	1000	55 MHz	63 MHz	70 db	6 meter	\$49.50*
FL6/100	100	55 MHz	63 MHz	50 db	6 meter	\$34.50*

All above to match 50 ohm transmitters and antennas.

*Add \$2 shipping and handling

ALL OUR PRODUCTS MADE IN USA



BARKER & WILLIAMSON

Quality Communication Products Since 1932

At your Distributors write or call

10 Canal Street, Bristol PA 19007

(215) 788-5581



Engineering Consulting's computer controlled Ham Shack See system variables, control & reprogram all via packet! Ultra Comshack 64 Repeater Controller HF & VHF Remote Base* Autopatch* CW Practice* Rotor Control *Voice Meters* Paging* Logging* Polite ID's* Packet Voice B.B.S.

Model CS64S \$359.95
Includes: Interface, disk, cables, Manual
Ultra Options

NEW! Add Duplex Remote Base operation & monitor mode from any telephoneTLCN.....\$159.95
External relays: 3 DPDT relays +5 Open Col. Trans. SwCS 8.....\$89.95
*Rotor control D.C. to digital display & Voice; for all rotors.....HM1.....\$59.95
*Packet & BBS; Voice Meters & Alarm inputs; 8 On/Off. PK8.....\$159.95
*Slave Packet Interface & cable Links PK8 to 2nd C64.....PK1.....\$89.95
*EPROM Autobot CART, custom with your system.....CART.....\$109.95
*C64 & 1541 12V. Switching supply crystal controlledDCPS.....\$129.95
*Manual(REFUNDED) MN1.....\$20.00

Controller Features
*Change variables remotely from touchtones or Packet
*Unlimited voice vocabulary!
*Alarm Clock, auto execute
*Individual 4 digit user codes
*Disk & Printer logging of users, tel #'s, elapsed time
*18 Rotating Polite ID's
*16 External relay controls
*2-tone & sub tone Paging
*CW Practice with voice
*Security mode, T.tone mute
*Voice announces each user call sign when logging on

Autopatch & Reverse
*1000 (18 digit) tel #'s stored
*Quick dial & quick answer
*Directed, general page
*Selected restricted patch
*Telephone control input
Dual Combined Remotes
*18 Macro-Scan memories
*Scan up/down; 100Hz steps
*Monitor & lock modes
*Operate splits, combine HF & VHF radios as Dual VFO's
*Automatic mode selection
*Talking S Meter; Voltmeter
*Voice Beacon rotating msg

Computer Control
YAESU FT-727R
C64 OR IBM Mini Cat
Allows H.T. to scan 100 Channels & programs H.T. for field use! Digital "S" Meter; comment fields; auto resume & delay; Scan Lock-outs; Loads FT727 in 15 sec. Hardware, cables, & disk included for C64 or IBM
Model 727 \$49.95

Touchtone Decoder
4 digit sequence; & QUAD expansion 4 relay option
2"x3" TSDD
8/20 V & audio in; Field Program 50,000 Codes; Mom. & Latching; DPDT Relay; Wrong digit reset; LED for digit valid & latch; inc. 24 Pin connector
QUAD option adds: four 2 Amp. relays; 5 digit master on/off control for each relay.
TSDD \$89.95 QUAD \$99.95

Decode-A-Pad
Touchtone to RS232 300 Baud Interface
Use with all computers
Decodes 16 touchtones
Includes Basic program
DAP \$99.95

12 Volt C64 SWITCHER
Crystal 60Hz
9VAC 5V, 2A.
C64 & 1541
DCPS \$129.95

AUDIO BLASTER IC02;04;2AT;FT-727R 411;209;470;73;23;U16
AB15 ← Miniature Audio Amp. Module installs inside all H.T.'s; 1 watt audio amp! When it needs to be loud! Installs in 15 Min. Used by police, fire!
Model AB15 \$24.95

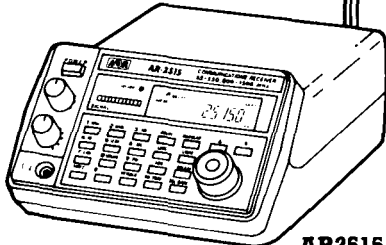
New C64 "Packet Talker"
Stores messages on disk for up to 300 users; touchtone commands recall & speak your stored messages on repeater or packet freq. Works with all Packet TNC's; Converts all packet messages to VOICE!
Inc. disk & Interface **PKTA \$189.95**

ENGINEERING CONSULTING
583 CANDLEWOOD ST.
BREA, CA. 92621
TELEPHONE: 714-671-2009
FAX: 714-255-9884

We accept: C.O.D.'s
MasterCard, VISA, Disc
Discover, Express
Add \$3.00 SH U.S.A.
*Ca. residents add 6%

New from AOR

**2000 Channels
5MHz to 2000MHz**



AR2515

- Covers 5MHz to 2000MHz in AM/FM/Wide FM modes. Continuous coverage.
- 2000 Channel Memory. 1984 Scan Frequencies & 16 Search Groups.
- Scan/Search speeds up to 36 channels or increments per second.
- Built in RS 232 computer interface.
- 25 Day Satisfaction Guarantee. Full Refund if not Satisfied.
- Size 3 1/2" H x 5 3/4" W x 7 1/4" D. Wt.: 2 lb. 10 oz.
- Supplied with AC & DC power cords. Telescopic antenna.

Total Price, Freight Prepaid (Express Shipping Optional)
*Upgrades of AR2002's to AR2515 specs Available

\$695.00



COMMUNICATIONS

10707 E. 106th St. Indpls., IN 46256

Toll Free 800-445-7717

Visa and MasterCard

(COD slightly higher)

In Indiana 317-849-2370 Collect FAX (317) 849-8794

172

RELY ON JAN FOR 3-WAY HELP:

- TECHNICALLY CORRECT CRYSTALS TO YOUR SPECS.
- QUICK TURNAROUND WITH HUGE INVENTORY, PROMPT SERVICE, AND OUR EMERGENCY ORDER PLAN.
- LOW PRICES.

QUARTZ CRYSTALS FOR
TWO-WAY — INDUSTRY
MARINE — AMATEURS
SCANNERS — CBs
MICROPROCESSORS



FOR FREE CATALOG,
CALL OR WRITE:

JAN CRYSTALS

P.O. BOX 06017

FORT MYERS, FL 33906

(813) 936-2397

SINCE
1965



TOLL-FREE: 1-800-237-3063

IN FLORIDA: 1-800-226-XTAL
FAX ORDERS: 1-813-936-3750

173

FIGURE 2

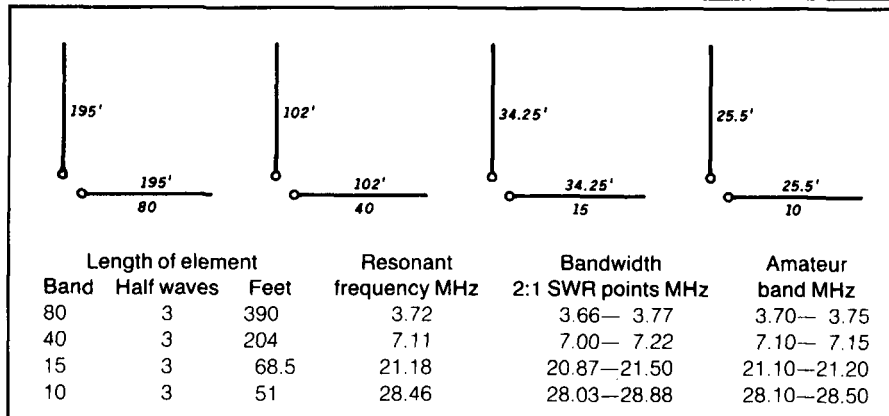


FIGURE 3

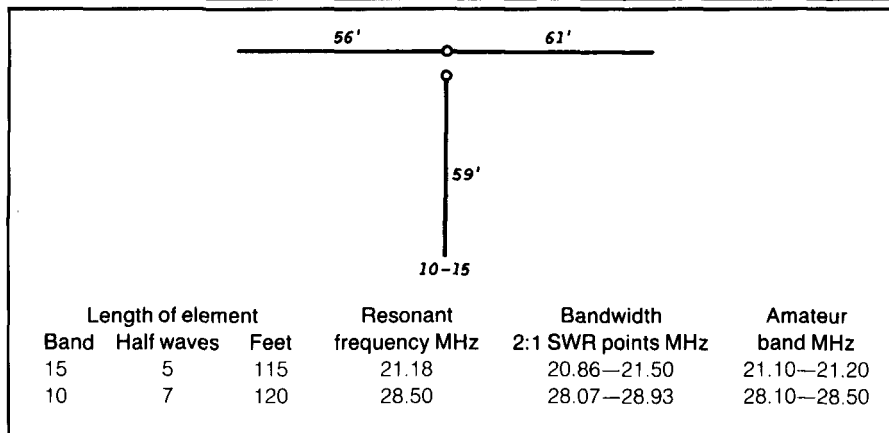
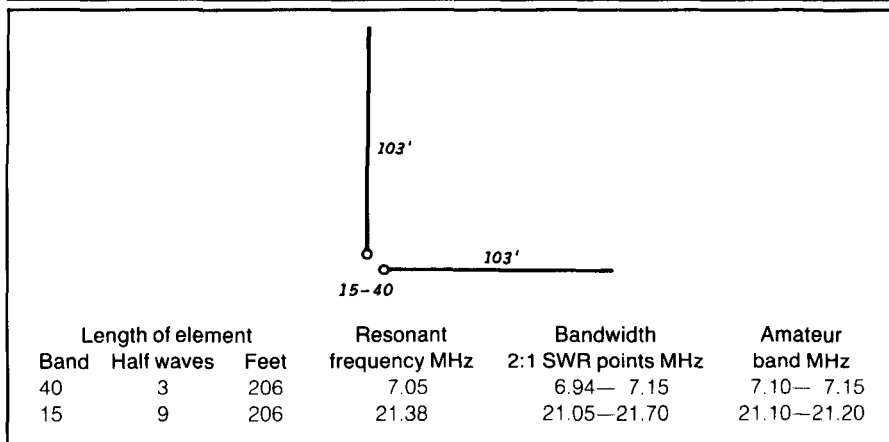
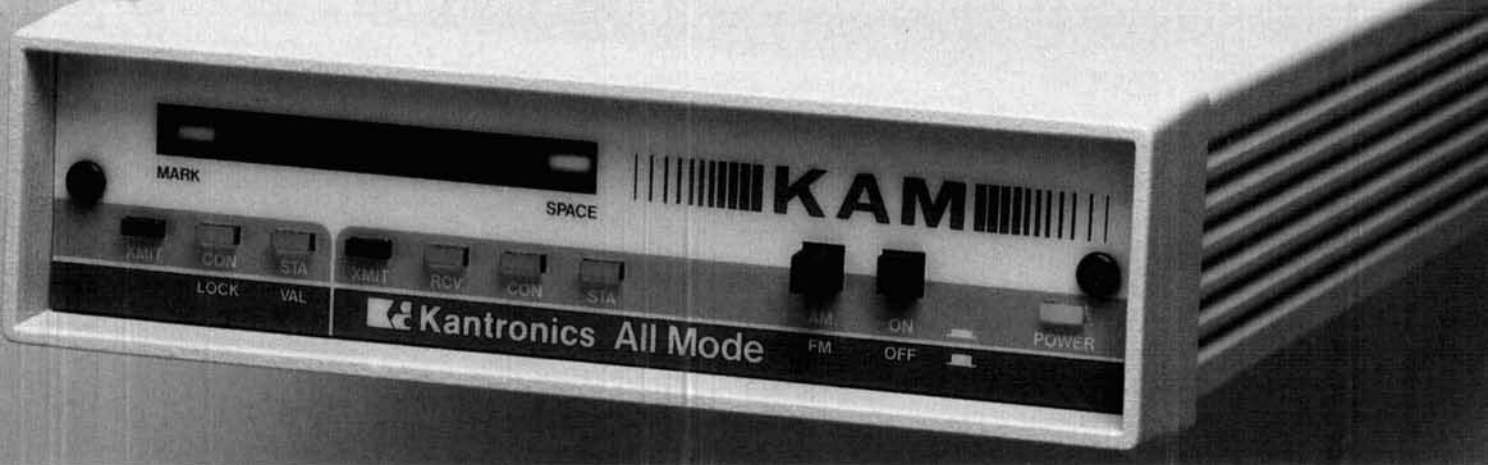


FIGURE 4





If You Want the Most Advanced TNC Today...

In 26 countries around the world, tens of thousands of amateurs know that Kantronics is the leader in bringing tomorrow's technology to their stations today. They also know they will always be among the first to incorporate just-introduced features and modes with Kantronics software and firmware updates.

And, they know that Kantronics is unique in its ability to seek out, develop and incorporate the most advanced features into each of five different TNC models before anyone else. Why? Because every program Kantronics writes, and every unit Kantronics designs and produces are born right here at the factory in the U.S.A.

Meet Your Mailman

In this age of telco LANS, E-mail and FAX,



PBBS is just one of the firsts Kantronics delivered.

you will know you have mail in your **Personal Packet Mailbox™** when your KAM "STA" LED is blinking. New firmware level 2.85 has also added a handy automatic mailbox user-

connect. So save your computer and monitor life by turning them off when you are away, and never miss a beat on the airwaves.

Version 2.85 KAMs have increased Packet Cluster™ compatibility, **KA-NODE™** path preservation, **KA-NODE** recognition of the "NET" nodes and HF baud rates from 50 through 300! And there are three new mailbox commands: *List Mine, Read Mine* and *Kill Mine*.

and Tomorrow...

Will the Real Dual-Port Please Stand Up?

Read our lips. The **KAM™** is the only true dual-port when it comes to packet. Your Personal Packet Mailbox™ is accessible from both HF and VHF! Version 2.85 has dual-port compatibility with RLI/MBL boards and KISS mode for both ports. You can monitor HF and VHF packet operations at the same time. Users can even gateway from HF to VHF (or in reverse) through your KAM.

Kantronics All-Mode™ (KAM) has Packet, WEFAX, ARQ, FEC, RTTY and CW reception. But we have five models to suit your particular taste. **Ask your dealer for the best choice today...and tomorrow.**

Kantronics
RF Data Communications Specialists

1202 E. 23rd Street Lawrence, Kansas 66046
(913) 842-7745



CALL US NOW!

In 1937, Stan Burghardt (WØIT), because of his intense interest in amateur radio, began selling and servicing amateur radio equipment in conjunction with his radio parts business. We stand proud of this long-lasting tradition of **Honest Dealing, Quality Products and Dependable "S-E-R-V-I-C-E"!**

Above all, we fully intend to carry on this proud tradition with even more new product lines plus the same "fair" treatment you've come to rely on. Our reconditioned equipment is of the finest quality with **30, 60** and even **90-day** parts and labor warranties on selected pieces. **And always remember:**

— WE SERVICE WHAT WE SELL —

- | | | | |
|---------------------|-----------|------------|----------------|
| AEA | B & W | Daiwa | Palomar |
| Alinco | Belden | Hustler | Radio Callbook |
| Ameritron | Bencher | Kantronics | Ritron |
| Amphenol | Bird | Kenwood | Rohn |
| Ampire | Butternut | Larsen | Telex/Hygain |
| Antenna Specialists | Centurion | MFJ | Ten-Tec |
| Astron | CES | Mirage/KLM | Unadilla/Reyco |
| | Cushcraft | Mosley | Yaesu |

Write today for our latest Bulletin/Used Equipment List.

YOUR HAM DOLLAR GOES FURTHER AT...

CALL OR WRITE FOR SPECIAL QUOTE

When it comes to **FAST DELIVERY, HONEST DEALING** and **PROMPT/DEPENDABLE S-E-R-V-I-C-E** back-up. We don't just advertise it — **WE GIVE IT!**

we'll treat you

SELECTION
SERVICE
and
SATISFACTION!

STORE HOURS:
9-5 P.M. (CST)
MONDAY thru FRIDAY
OPEN SATURDAYS
from 9-1 P.M. (CST)
CLOSED
SUNDAYS/HOLIDAYS



182 N. Maple
P.O. Box 73
Watertown, SD 57201



"AMERICA'S MOST RELIABLE AMATEUR RADIO DEALER"

SELL-TRADE

New & Reconditioned HAM EQUIPMENT

Call or Write Us Today For a Quote!
You'll Find Us to be Courteous, Knowledgeable and Honest

PHONE (605) 886-7314

FAX (605) 886-3444



Get the most of HF Mobileing

Yaesu FT-747GX

SPECIAL OFFER!

CALL TODAY FOR SPECIAL QUOTE

MAKE CIRCUIT BOARDS THE NEW, EASY WAY



WITH TEC-200 FILM

JUST 3 EASY STEPS:

- Copy circuit on TEC-200 film using any plain paper copier
- Iron film on to copper clad board
- Peel off film and etch

SATISFACTION GUARANTEED
convenient 8½ x 11 size

5-Sheets for \$3.95
10 sheets only \$5.95

add \$1.25 postage — NY res. add sales tax

The MEADOWLAKE Corp.

DEPT. W, P.O. Box 497
I Northport, New York 11768

THE RF CONNECTION

"SPECIALIST IN RF CONNECTORS AND COAX"

Part No.	Description	Price
321-11064-3	BNC 2 PST 28 volt coaxial relay, Amphenol Insertion loss: 0 to 0.75GHz, 0.10dB Power rating: 0 to 0.5GHz, 100 watts CW, 2 kw peak Isolation: 0.1 GHz/45db, 0.2 GHz/40db, 0.4 GHz/35db	\$25 used tested
83-822	PL-259 Teflon, Amphenol	1.75
PL-259/ST	UHF Male Silver Teflon, USA	1.50
UG-21D/U	N Male RG-8, 213, 214, Amphenol	3.25
UG-21B/U	N Male RG-8, 213, 214, Kings	4.00
9913/PIN	N Male Pin for 9913, 9086, 8214 fits UG-21D/U & UG-21B/U N's	1.50
UG-21D/9913	N Male for RG-8 with 9913 Pin	3.95
UG-21B/9913	N Male for RG-8 with 9913 Pin	5.75
UG-146A/U	N Male to SO-239, Teflon USA	6.00
UG-83A/U	N Female to SO-239, Teflon USA	6.00

"THIS LIST REPRESENTS ONLY A FRACTION OF OUR HUGE INVENTORY"

THE R.F. CONNECTION
213 North Frederick Ave. #11
Gaithersburg, MD 20877

(301) 840-5477

VISA/MASTERCARD: Add 4%
Prices Do Not Include Shipping

PC HF FACSIMILE 4.0 \$99



Actual VGA Screen Photo

The best computer FAX system just got better!

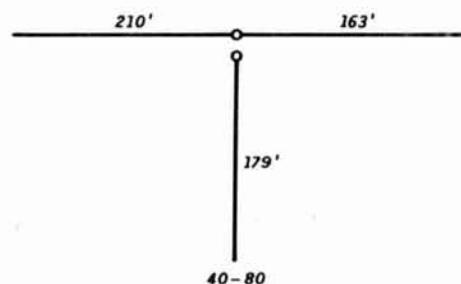
A complete facsimile reception system for the IBM PC or Compatible. Receives up to 16 intensity levels.

- Includes:**
- Demodulator Software
 - 80 Page Manual
 - Tutorial Cassette
 - Frequency List
 - Interpretation Guide

Features:
Print on Epson, or HP Laser Jet
Disk Save, Zooming, Image processing
Unattended Image Capture and much more

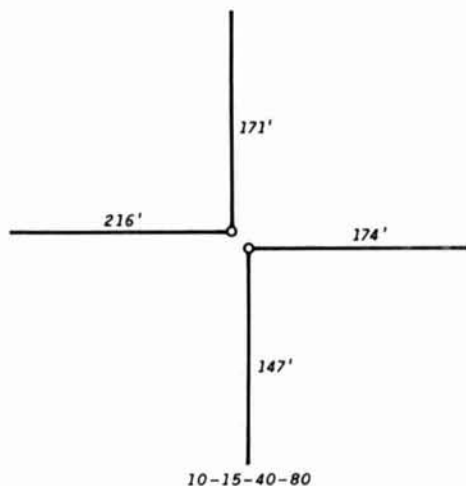
Software Systems Consulting
1303 S. Ola Vista, San Clemente, CA. 92672
(714)-498-5784

FIGURE 5



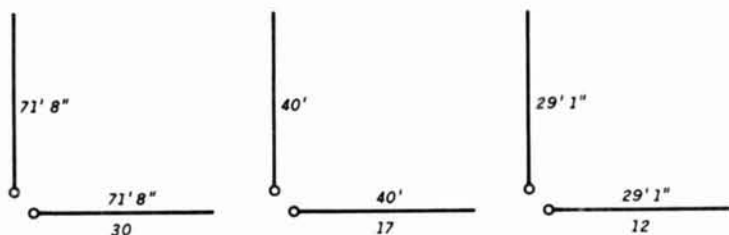
Length of element			Resonant frequency MHz	Bandwidth 2:1 SWR points MHz	Amateur band MHz
Band	Half waves	Feet			
80	3	389	3.73	3.68—3.79	3.70—3.75
40	5	342	7.12	7.01—7.23	7.10—7.15

FIGURE 6



Length of element			Resonant frequency MHz	Bandwidth 2:1 SWR points MHz	Amateur band MHz
Band	Half waves	Feet			
80	3	390	3.72	3.67—3.78	3.70—3.75
40	5	345	7.06	6.95—7.16	7.10—7.15
15	15	345	21.32	21.00—21.64	21.10—21.20
10	21	363	28.40	27.97—28.82	28.10—28.50

FIGURE 7



Length of element			Resonant frequency MHz	Bandwidth 2:1 SWR points MHz	Amateur band MHz
Band	Half waves	Feet			
30	3	143.3	10.12	9.97—10.27	10.10—10.15
17	3	80	18.14	17.87—18.41	18.06—18.16
12	3	58.2	24.95	24.58—25.32	24.89—24.99

NEW SUPER LONG PLAY TAPE RECORDERS

12 Hour Model — \$119.00*
USES D-120 TAPE

Modified Panasonic Slimline, high quality, AC-DC Recorders provide 6 continuous hours of quality recording & playback on each side of cassette for a total of 12 hours. Built-in features include:
• Voice level control, • Digital counter, etc. TDK DC 120 Cassette Furnished.



PHONE RECORDING ADAPTER

Records calls automatically. All Solid state connects to your telephone jack and tape recorder. Starts recording when phone is lifted. Stops when you hang up. **\$28.50*** FCC APPROVED



VOX VOICE ACTIVATED CONTROL SWITCH

Solid state. Self contained. Adjustable sensitivity. Voices or other sounds automatically activate and control recorder. Uses either recorder or remote mike. **\$28.50***



*Add for ship & hdg. Phone Adapter & Vox \$1.50 ea. Recorders \$4.00 ea. Cal. Res. add tax. Mail order, VISA, M/C, COD's OK. Money Back Guarantee. Qty. disc. avail.. Dealer Inquiries Invited. Free data. © AMC SALES INC. Dept. 9335 Lubec St., Box 928, Downey, CA 90241 Phone (213) 869-8519



- Complete Monitoring of Video and Audio before and during Transmit.
- FM, AM, or both Modes of operation.
- VU Meters for Audio and Video Monitoring.
- Band Change any time and still use the main Control Unit.
- Low Loss coax is NOT required for any Band.
- Built in White Clipper
- AGC in the MIC Amp.
- SMOOTH TOUCH Control on all Switches.
- EASY to Use
- Many More FEATURES.

CALL or WRITE For Full Information.

T.D. Systems
6419 Rock Springs
Arlington, Texas 76017

(817) 483-4994

**PC Study Aid for the
Amateur Radio Exams**

Study for your Novice license or upgrade to a higher class the easy way, with individually tailored studying that analyzes your performance and concentrates where you need it.

Program Features:

- Runs on IBM Personal Computers and compatibles with minimum 256K RAM and graphics capability.
- Contains entire question pool for each license class. New Novice and Technician pools are available now!
- Work with the entire pool, selected areas, or automatic selection of questions in your weak areas.
- Includes full screen graphics, explanations on appropriate questions and a pop up calculator.
- Logs multiple study sessions and allows resuming at a later time. Returns to review missed questions if desired.
- Creates randomly generated or custom tests and analyzes results showing areas for additional study.
- Prints random written tests and answers with Epson/IBM compatible printers.

Public Domain disk also available with excellent Morse code tutor as well as a contest logger, propagation predictors, beam plotter and others. Cost is \$3 to cover materials and handling, \$2 if shipped with QSO TUTOR.

Call or write to order:

QSO Software
208 Partridge Way
Kennett Square, PA 19348
215-347-2109

\$29.95 per Class

VISA & M C accepted

"Thanks to your study program I was able to handle the examination confidently and passed with flying colors. If the Extra Class program is as helpful as the Advanced Class was, I look forward to working with it."
W4NDP

"Using QSO Tutor made studying for the exam enjoyable and interesting, thanks to your program I passed the technician test with a perfect score."
NIGME

"I easily passed my Advanced Class test on the first try thanks to your great software!!!"
W4WOM

"Thanks for thinking of us hams. Your program has eliminated the worry of the Theory part of the test for me."
K4RHW

"As a computer professional, I can recognize a quality piece of software. As a student I can appreciate a study tool that helps me gain the confidence I needed to pass the amateur exams. By the way, I passed with 100% of the questions answered correctly."
Dan Detenre Jr.

New!

Now Available - Commercial Radiotelephone license Tutor similar to above. \$39.95. Commercial Radar endorsement \$29.95.

• PA residents add 6%
Price includes shipping
3 1/2" Disk add \$2 each

163

**Look at our MOBILE MARK™
"ON WINDOW" Line****VHF
(140-175)**

- No Hole
- Easy to Mount
- Rugged
- Superior Performance
- Radiator Snaps On and Off
- Competitively Priced

**UHF
(420-520)**

- 3 db gain
- No Hole
- Easy to Mount
- Rugged
- Superior Performance
- Radiator Snaps On and Off
- Competitively Priced

MODEL OW 3-150
140-174 MHz
MODEL OW 3-220
210-250 MHz

- 3 db gain
- No Hole
- Easy to Mount
- Rugged
- Superior Performance
- Swivel Vertical Adjustment
- Radiator Removal Without Loss of Vertical Adjustment
- Competitively Priced



MOBILE MARK, INC.
COMMUNICATIONS ANTENNAS

3900-B River Road
Schiller Park, IL 60176
312-671-6690

**brings imagination and innovation to
antennas and has been
since 1948 !!**

164

capture area provide better performance, and they don't have the nulls of a dipole. They are good performers in all directions.

Dual band Novice

This antenna is tailored for the 10 and 15-meter Novice bands (see **Figure 3**). It's compact and will fit into most backyards. Use one band or the other, without any antenna tuning or switching; the SWR remains low. The cost is also low. All you'll need is under 200 feet of inexpensive wire, coaxial cable, and a balun. Total cost, including insulators and rope, can run as little as \$50.

Figure 4 shows an antenna for 15 and 40-meter coverage that uses a little more wire for about the same cost as the preceding design. It's simple to install, and has just two legs. The antenna is resonated in both bands by 206 feet of wire. One antenna does double duty and, like all of these designs, it provides low SWR and excellent performance. If you can't fit the wires onto your property with the 90-degree apex angle, you can make it a straight, center-fed long wire. The SWR will continue to be low; however, the antenna becomes directional and performance suffers on some headings. But this may be your best compromise.

Unfortunately, there isn't a wire length of reasonable dimensions which will resonate on both 80 and 40. The solution is to revert to the three-leg design in **Figure 5**, which provides a different length for each band. The two resonances fall almost in the center of the Novice segments and this, together with the large area of the array, makes it a very efficient performer. It's ironic that resonances also fall in the 15 and 10-meter bands, but the feedpoint is far removed from the current loops resulting in high SWR on these bands.

All band Novice

The antenna in **Figure 6** gives access to all four Novice HF bands. And, when you upgrade to General, it stands ready to serve in other segments. Though I haven't shown it here, the 363-foot element resonates at the high end of 80. This opens 3.9 to 4 MHz up to SSB. In addition, the 345-foot length resonates at the top of the 10-meter band, allowing SSB operation above 29 MHz. This antenna is large, but don't let that deter you. If you have friendly neighbors, you may be able to run unobtrusive wires through the trees over their properties. I did this for a number of years using inexpensive electric fencing wire.

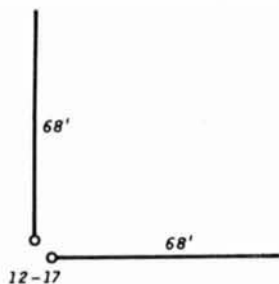
WARC monobanders

The monobanders in **Figure 7** are for the ham who wants to add a WARC band. If you cut the wire lengths carefully to the measurements shown, and your antenna is reasonably in the clear, the resonance will fall almost dead center in the band. This will give you a low SWR from band edge to band edge. These element lengths give no resonances on other HF Amateur bands, and shouldn't interfere with existing antennas.

Dual band WARC

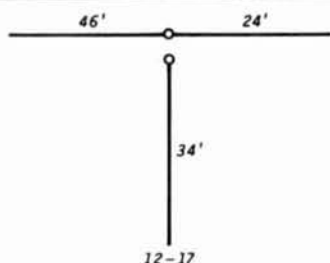
Are you a General who hasn't tried 12 or 17? Here are two antennas which give you both 12 and 17. They are compact and can be erected in the average backyard. I've given two alternatives in **Figures 8A and B**. Choose the one which best suits your layout. If you have a tower available, use it as the main support with the legs coming down like an inverted V. A flat top, however, is preferable. None of the element lengths

FIGURE 8A



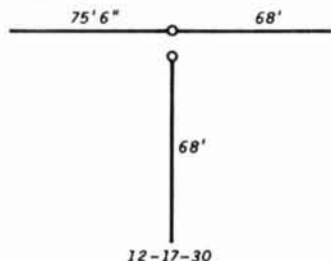
Length of element			Resonant frequency MHz	Bandwidth 2:1 SWR points MHz	Amateur band MHz
Band	Half waves	Feet			
17	5	136	17.90	17.63—18.18	18.06—18.16
12	7	136	25.14	24.76—25.52	24.89—24.99

FIGURE 8B



Length of element			Resonant frequency MHz	Bandwidth 2:1 SWR points MHz	Amateur band MHz
Band	Half waves	Feet			
17	3	80	18.14	17.87—18.41	18.06—18.16
12	3	58	25.02	24.65—25.40	24.89—24.99

FIGURE 9



Length of element			Resonant frequency MHz	Bandwidth 2:1 SWR points MHz	Amateur band MHz
Band	Half waves	Feet			
30	3	143.5	10.11	9.96—10.27	10.10—10.15
17	5	136	17.90	17.63—18.18	18.06—18.16
12	7	136	25.14	24.76—25.52	24.89—24.99

1989 CALLBOOKS



THE QSL BOOK!

Continuing a 68 year tradition, we bring you three new Callbooks for 1989, bigger and better than ever!

The North American Callbook lists the calls, names, and address information for 495,000 licensed radio amateurs in all countries of North America, from Canada to Panama including Greenland, Bermuda, and the Caribbean islands plus Hawaii and the U.S. possessions.

The International Callbook lists 500,000 licensed radio amateurs in countries outside North America. Its coverage includes South America, Europe, Africa, Asia, and the Pacific area (exclusive of Hawaii and the U.S. possessions).

The 1989 Callbook Supplement is a new idea in Callbook updates, listing the activity in both the North American and International Callbooks. Published June 1, 1989, this combined Supplement will include thousands of new licenses, address changes, and call sign changes for the preceding 6 months.

Every active amateur needs the Callbook! The 1989 Callbooks will be published December 1, 1988. Order early to avoid disappointment (last year's Callbooks sold out). See your dealer now or order directly from the publisher.

- North American Callbook
incl. shipping within USA \$29.00
incl. shipping to foreign countries 35.00
- International Callbook
incl. shipping within USA \$32.00
incl. shipping to foreign countries 38.00
- Callbook Supplement, published June 1st
incl. shipping within USA \$13.00
incl. shipping to foreign countries 14.00

SPECIAL OFFER

- Both N.A. & International Callbooks
incl. shipping within USA \$58.00
incl. shipping to foreign countries 68.00

Illinois residents please add 6½% tax.
All payments must be in U.S. funds.

RADIO AMATEUR **callbook** INC.

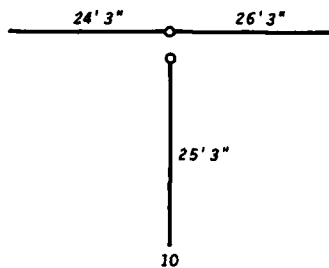


Dept. F
925 Sherwood Dr., Box 247
Lake Bluff, IL 60044, USA

Tel: (312) 234-6600

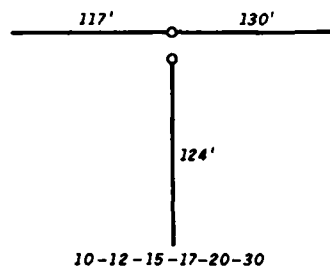


FIGURE 10



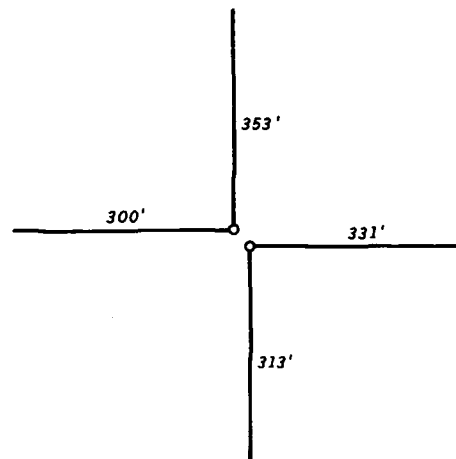
Length of element			Resonant frequency MHz	Bandwidth 2:1 SWR points MHz	Amateur band MHz
Band	Half waves	Feet			
10	3	51.5	28.18	27.76—29.76	28.00—29.70
		49.5	29.32		

FIGURE 11



Length of element			Resonant frequency MHz	Bandwidth 2:1 SWR points MHz	Amateur band MHz
Band	Half waves	Feet			
30	5	241	10.10	9.95—10.26	10.10—10.15
20	7	241	14.19	13.98—14.40	14.00—14.35
17	9	241	18.27	18.00—18.54	18.06—18.16
15	11	254	21.21	20.89—21.53	21.00—21.45
12	13	254	25.08	24.71—25.46	24.89—24.99
10	15	254	28.95	28.52—29.30	28.00—29.70

FIGURE 12



Length of element			Resonant frequency MHz	Bandwidth 2:1 SWR points MHz	Amateur band MHz
Band	Half waves	Feet			
80	5	613	3.97	3.50—4.03	3.50—4.00
	5	631	3.86		
	5	666	3.66		
	5	684	3.56		
	5	613	7.18		
40	9	613	7.18	6.80—7.30	7.00—7.30
	9	631	6.98		
30	13	631	10.00	9.95—10.25	10.10—10.15
20	19	666	14.00	13.79—14.35	14.00—14.35
	23	613	18.42		
17	23	613	18.42	17.62—18.70	18.06—18.16
	23	631	17.89		
12	31	613	24.84	24.46—25.21	24.89—24.99
	35	613	28.05		
10	37	631	28.81	27.63—29.24	28.00—29.70
	39	666	28.77		
	39	684	28.02		

DX-ing, contests, pile-ups, traffic handling.

When you need to command attention, you will with the SB-1000 Linear Amplifier from Heath. And you'll do it for a cost that no one else can match.

From our recent DX-pedition to Taiwan, operators easily controlled pileups with the SB-1000 and nothing more than a dipole antenna. This means that when conditions are tough, you know you can depend on your SB-1000 to lift your signal above the rest. Whether you're using a dipole or stacked monoband beams.

Proven output power

We don't play games by using old rating methods to make you pay for input power you don't get at the antenna. What you do get is 1000 watt output of peak

envelope power on SSB and 850 watts on CW. Even 500 watt output on RTTY.

On the chance that someone might doubt our claims, at hamfests we demonstrate that with only 80 to 100 watts of drive, our SB-1000 develops more output than even the world-famous Heath SB-220!

Designed for today, the SB-1000 offers quiet, compact tabletop operation at rated output. That's only 1.7dB (or about $\frac{1}{3}$ of an S-unit) below

the maximum legal power limit.

"I built it myself!"

Because you build the Heathkit SB-1000 Linear Amplifier yourself, you not only enjoy cost savings, you have the unique opportunity of knowing your equipment inside and out.

A top quality amplifier, cost savings, bragging rights, plus industry-recognized Heathkit manuals and technical assistance from our licensed ham consultants, should you ever need it. An offer that's hard to pass up.

See the SB-1000 and our complete line of amateur radio products in the Spring Heathkit Catalog. Call today for your free copy.

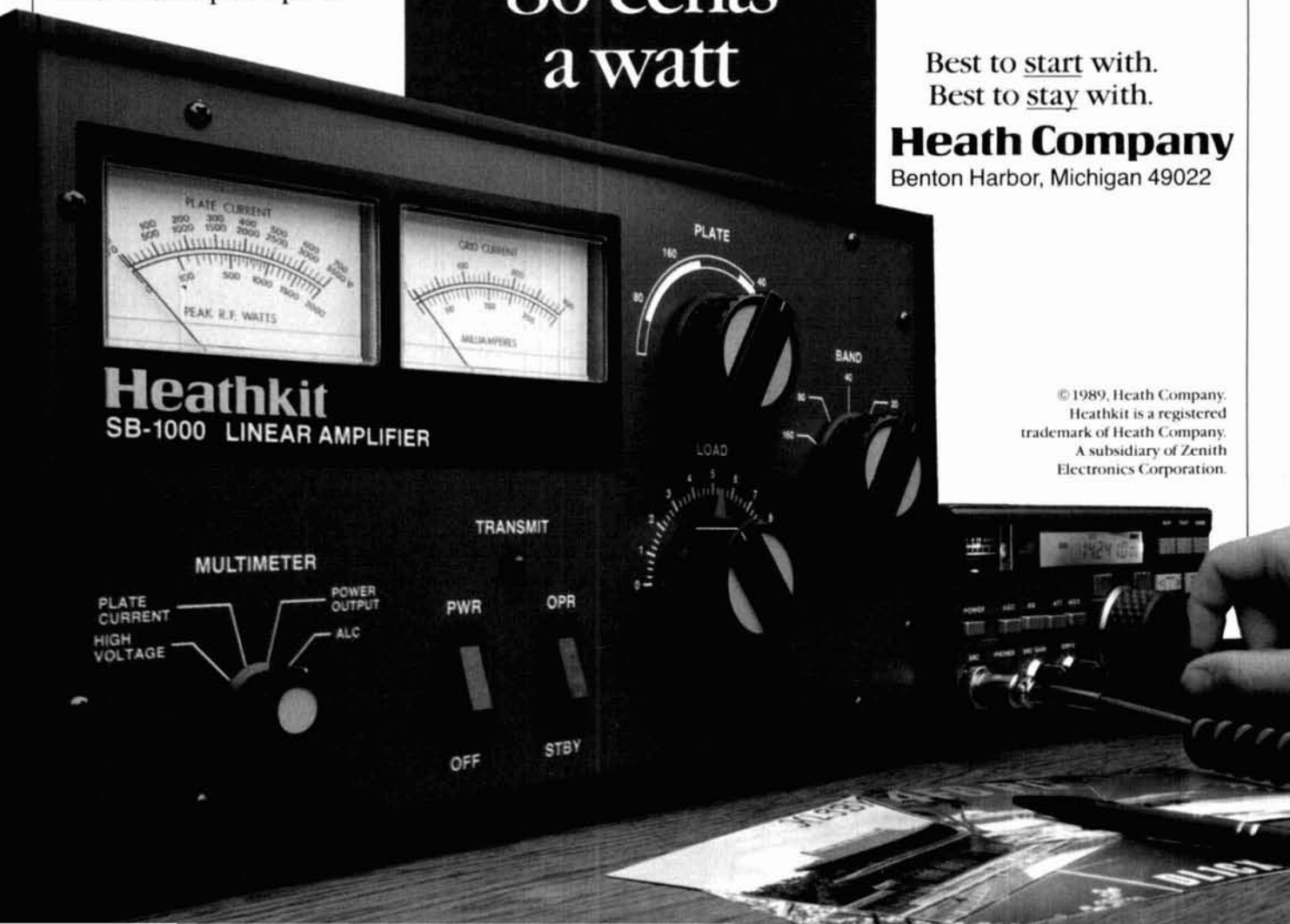
1-800-44-HEATH
(1-800-444-3284)

Best to start with.
Best to stay with.

Heath Company

Benton Harbor, Michigan 49022

Top
performance
for less than
80 cents
a watt



© 1989, Heath Company.
Heathkit is a registered
trademark of Heath Company.
A subsidiary of Zenith
Electronics Corporation.

on the three-leg design resonate on or near other Amateur bands, so it shouldn't pose a problem for your Yagis or other antennas. The three-leg design also provides a somewhat lower SWR. On the other hand, the two-leg design will resonate on 40, 20, and 10 meters, and should be kept clear of other antennas on those bands.

Triband WARC

Here's your chance to put up one antenna with capabilities on all WARC bands! (See Figure 9.) While these designs will function satisfactorily when installed as inverted Vs, it's preferable to make them flat tops. Unlike a dipole, which has a single current loop at the center, these antennas have at least three current loops (including one in the center). The current loops provide maximum radiation.

Broadband 10-meter monobander for general coverage

Because this band is so much wider, it poses problems of band coverage with narrowband antennas. The design shown in Figure 10 will cover the entire band. Don't use a coaxial balun; it will limit your bandwidth. If you wind your own, use the Amidon iron powder kit with eight bifilar turns instead of the usual ten. On this HF band, worry about coaxial cable losses. RG-58, with a run of 100 feet and transceiver output of 100 watts, will deliver only 56 watts to the antenna. By comparison, Belden 9913 or equivalent will deliver 85 watts to the antenna in similar circumstances on 10 meters.

Six band general coverage

The simple antenna in Figure 11 will deliver six of the nine HF bands! It provides the traditional DX bands, plus all WARC frequencies. The resonances fall within all the bands but 17 and 12, where they are slightly on the high side. However, the antenna bandwidth amply covers these two WARC bands with an SWR of less than 2:1. A commercial balun will handle this design; but if you use a kit and wind your own, I suggest once again that you use eight turns instead of the usual ten. The fewer turns will slightly lower SWR on 10 and 12 meters.

Eight band general coverage

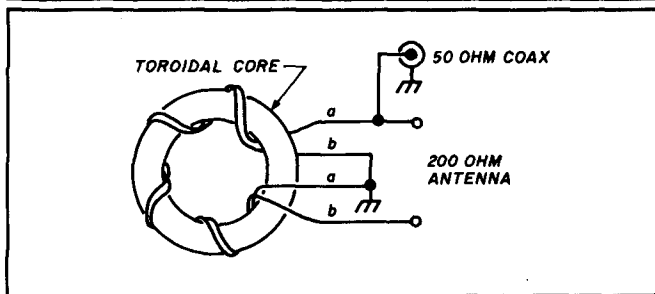
This is the "Monster." It covers about ten acres (see Figure 12). Since the publication of the details of this design¹ it has been used in many states and DX locations. Nearly all users reported SWR readings on each band similar to those I had experienced.

All of the preceding antennas require a 4:1 balun to give a good match with RG-58 or RG-8 type 50-ohm coaxial cable. I have provided several options.

Toroid balun

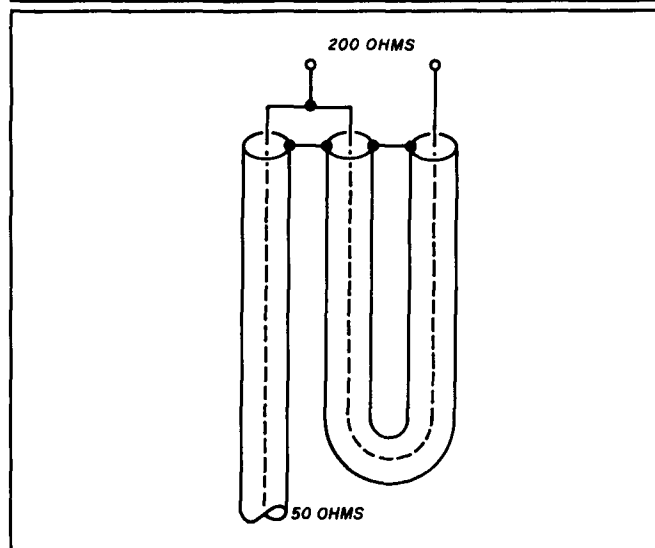
There are a number of commercial baluns available from Amateur equipment distributors. Be sure you get a 4:1, not a 1:1 (see Figure 13). If you'd like to wind your own, you can order a kit from Amidon Associates or Radiokit.* They come with instructions suggesting they be packaged in PVC pipe. I recommend you wrap the core with Scotch® no. 27 glass electrical cloth tape. You can get epoxy potting material from your local electrical supply house and completely encapsulate the unit. The final professional touch for the ultimate in reliability is to do the potting in a high school or college science

FIGURE 13



Detail for winding a 4:1 balun.

FIGURE 14



Detail for making coaxial balun.

lab, and immediately place it in a vacuum jar. This removes all bubbles or moisture.

Coaxial balun

You can make your balun of coaxial cable for **some** of the monoband antenna designs I've described. Details are shown in Figure 14. The U section may be coiled and secured with tape; its length is as follows:

Coaxial cable length U section

Band	Solid	Foam
80 Novice	87'2"	104'4"
40	45'7"	54'7"
30	32'1"	38'5"
17	17'10"	21'6"
15	15'4"	18'5"
12	13'	15'7"
10 Novice	11'5"	13'8"

Conclusion

I hope you'll give one of these long wire antenna designs a try. Pick a band (or bands) that your existing antenna system doesn't cover, and put one to the test. I'll look for you on the air!

REFERENCES

1 E.S. Brown, K4EF, "Antenna Design Using the Long Wire Principle, *Ham Radio*, May 1977, page 10

*Amidon Associates, 12033 Otsego Street, North Hollywood, California 91607.
Radiokit, Box 973, Pelham, New Hampshire 03076. (603) 633-2235

**LIMITED
SUPPLY**
ICOM 228H

Call for
special price!



TEL-COM★

Electronic Communications

NEW ENGLAND'S FACTORY-
AUTHORIZED SALES & SERVICE
FOR

KENWOOD  **ICOM**

Also displaying the popular accessories needed to complete a HAM STATION . . .

- ARRL PUBLICATIONS • AEA PRODUCTS • AMPHENOL
- ALPHA DELTA • ASTRON • AUSTIN ANTENNAS • AVANTI
- BELDEN • BENCHER • B & W • DAIWA • ALINCO
- HUSTLER • KLM • LARSEN • MIRAGE • ROHN
- TELEX/HY-GAIN • TOKYO HY-POWER LABS
- TRAC KEYERS • VIBROPLEX • WELZ • ETC.

OPEN SIX DAYS A WEEK   WELCOMED

Telephone 508/486-3400, 3040

675 Great Rd., (Rte. 119) Littleton, MA 01460

1 1/4 miles from Rte. 495 (Exit 31) toward Groton, Mass.

**LIMITED
SUPPLY!**

**Kenwood
TH 25 AT**

Call for
Special Price

✓ 158



R-7000 Widespan Panadaptor

Panadaptor especially designed for the R-7000 receiver. For use with a standard scope. Variable span width from 1 to 10 Mhz. Uncover unknown elusive signals. Complete with all cables, & 90 day warranty. \$349.95 Shipped. Pa. res. add 6%.

GTI Electronics

RD 1 BOX 272
Lehighton, Pa. 18235
717-386-4032

✓ 159

THE MULTIPLE RECEIVER SOLUTION



4 Channel Signal-to-Noise Voter

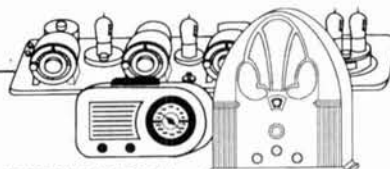
- Expandable to 32 Channel by Just Adding Cards
 - Continuous Voting
 - LED Indicators of COR and Voted Signals
 - Built-in Calibrator
 - Remote Voted Indicators Pinned Out
 - 4 1/2 x 6 Double Sided Gold Plated 44 Pin Card
 - Remote Disable Inputs
 - MORE
- Built, tested and calibrated with manual

\$350.00

Telephone interface now available
For more information call or write.

DOUG HALL ELECTRONICS
Voter Department
815 E. Hudson Street
Columbus, Ohio 43211
(614) 261-8871

✓ 160



IF YOU BUY, SELL
OR COLLECT OLD RADIOS, YOU NEED...

ANTIQUE RADIO CLASSIFIED

FREE SAMPLE COPY!

Antique Radio's Largest Monthly Magazine
Classifieds - Ads for Parts & Services
Articles - Auction Prices-Flea Market Info.
Also: Early TV, Ham Equip., Books, Telegraph,
Art Deco, 40's & 50's Radios & more...
Free 20-word ad each month. Don't miss out!

6-Month Trial - \$11.

1-Year: \$20 (\$30 by 1st Class)

Foreign by air - Canada: \$32; Mexico: \$30; Other: \$60.
A.R.C., P.O. Box 802-A5, Carlisle, MA 01741

✓ 161

here is the next generation Repeater
2 meters - 220 - 440

MARK 4CR

The **only** repeaters and controllers
with REAL SPEECH!

No other repeaters or controllers match Mark 4 in capability and features. That's why Mark 4 is the performance leader at amateur and commercial repeater sites around the world. Only Mark 4 gives you Message Master™ real speech • voice readout of received signal strength, deviation, and frequency error • 4-channel receiver voting • clock time announcements and function control • 7-helical filter receiver • extensive phone patch functions. Unlike others, Mark 4 even includes power supply and a handsome cabinet.

NEW OPTION

RS-232 for Repeater Control
using MODEM or Packet TNC

Create messages just by talking. Speak any phrases or words in any languages or dialect and *your own voice* is stored instantly in solid-state memory. Perfect for emergency warnings, club news bulletins, and DX alerts. Create unique ID and tail messages, and the ultimate in a real speech user mailbox — only with a Mark 4.



MICRO CONTROL SPECIALTIES

Division of Kendecom Inc.
23 Elm Park, Groveland, MA 01834 (508) 372-3442
FAX 508-373-7304

Call or write for specifications on the
repeater, controller, and receiver winners.

✓ 156

NUTS & VOLTS

MAGAZINE

P.O. Box 1111-H
PLACENTIA, CA 92670
714-632-7721



Ham Radio
Computer Hardware
Computer Software
Plans-Kits
Schematics
Test Equipment
CB Gear
Satellite TV
Video
Components
Antique Electronics
Cable TV
Publications
Repairs-Services
New Products
Events Calendar

IF YOU ARE INTO ELECTRONICS AND SAVING MONEY IS IMPORTANT TO YOU, THEN YOU OWE IT TO YOURSELF TO TRY NUTS & VOLTS MAGAZINE. DISCOVER WHY THOUSANDS OF SMART PEOPLE NATIONWIDE TURN TO NUTS & VOLTS EACH MONTH TO MEET THEIR ELECTRONIC NEEDS. WHETHER YOU'RE BUYING, SELLING, OR JUST TRYING TO LOCATE THOSE UNIQUE OR HARD-TO-FIND ITEMS, FIND OUT HOW NUTS & VOLTS CAN HELP!

SUBSCRIBE TODAY!

CHECK MONEY ORDER VISA MC

Name _____

Address _____

City _____

State _____ Zip _____

Card No. _____ Exp. Date _____

CALL FOR ADVERTISING INFORMATION
DISTRIBUTOR INQUIRIES INVITED

Subscription Rates

U.S. FUNDS REQUIRED

3rd Class Mail - USA

One Year \$12.00
Two Years \$21.00
Lifetime \$60.00

1st Class Mail

One Year - USA ... \$20.00
Canada & Mexico .. \$22.00

Air Mail

Foreign - 1 Year ... \$55.00

Includes one FREE 40-word
Classified Ad

A National Publication For The Buying And Selling Of Electronic Equipment

✓ 124

Practically Speaking

Joseph J. Carr, K4IPV

VERTICALLY POLARIZED HF ANTENNAS: PART 2

Last month I introduced a series on vertical antennas. I discussed the basic theory and configuration of the "standard" quarter-wavelength vertical antenna. This month I'll take a look at some practical issues involving the much-needed ground system for the vertical, and vertical antenna construction details.

Vertical antenna ground systems

The vertical antenna works well only when placed over a good ground system. The usual way to provide a good ground for a vertical is to use a system of radials like that shown in **Figure 1**. A view from above shows 16 quarter-wavelength radials arranged to cover a full circle around the antenna. Each radial is a quarter wavelength, so each will have a length (in feet) of $246/F_{MHz}$. All the radials are connected together at the base of the antenna, and the ground side of the transmission line is connected to this system. The radials may be placed on the surface or underground. A friend of mine placed an extensive radial system on the bare dirt when his house was being built. When the sod was laid down, he had a very high quality underground radial system.

If you decide to use an above-ground radial system, be sure to make provisions to prevent people from tripping over it. You may be liable if people trip over your radials and injure themselves — even if the person is an intruder or trespasser!

Some experts prefer to place a copper wire screen at the center of the radial system. The minimum screen size is about 2 meters (6 feet) square. Use solder to connect it to the radials at the points shown in **Figure 1**. Other experts drive ground stakes into the ground at these points. Still another

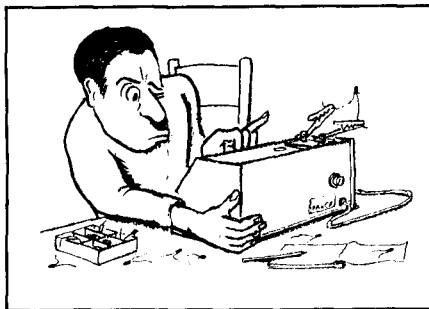
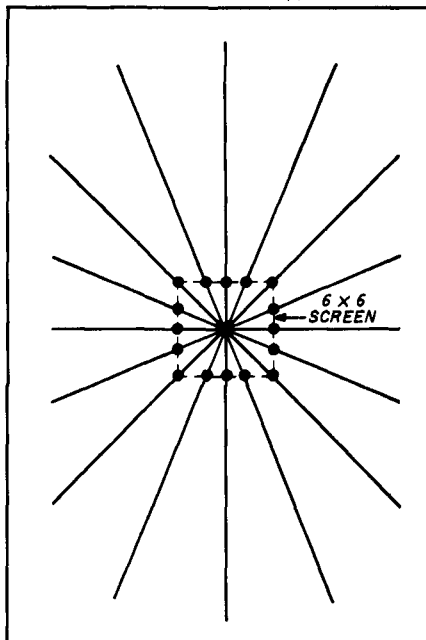


FIGURE 1



Basic ground radial system.

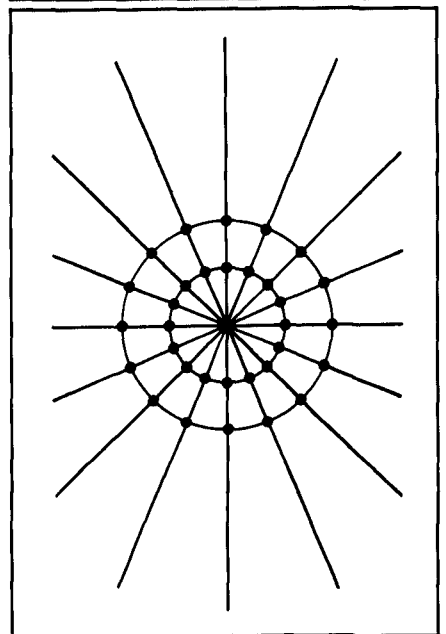
method is shown in **Figure 2**. Here you see a "spider web" of conductors shorting the radials at points a meter or two from the antenna. Again, some authorities recommend that ground rods be driven into the earth at the points indicated.

The exact number of radials you use depends in part on practical matters — like how much money you have to spend, or how many you can physically install. Use at least two radials per band; four per band is preferred for simple, low cost systems. However, be aware that even four radials is considered a compromise. The general rule is: the more radials, the better. But

there's also a law of diminishing returns as the number of radials increases. **Figure 3** shows the approximate field intensity (mV/meter) as a function of the number of radials. Notice that the field intensity doesn't increase as rapidly per extra radial when the total number of radials is above 20 or so. The Federal Communications Commission requires AM band (550 to 1620 KHz) stations to use 120 radials, but that number isn't necessary for Amateur stations. A practical upper limit of 16 radials is usually accepted for Amateur radio work, and your antenna can work well with fewer.

For vertical antennas mounted above ground, there's an optimum height for the base of the antenna. This height is a quarter wavelength above the actual ground plane. Unfortunately, that distance may or may not be the actual physical height above the surface. Depending upon ground conductivity and ground water content, the height may be exactly a quarter wavelength above the surface or

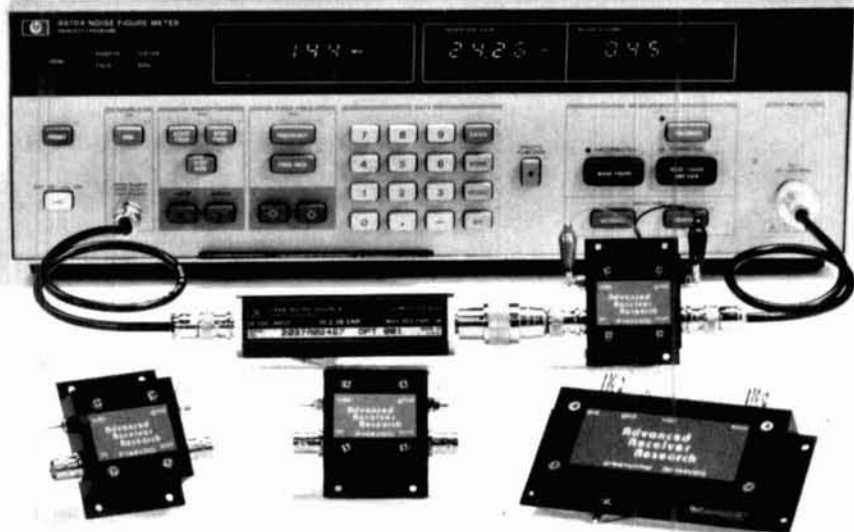
FIGURE 2



Spiderweb ground radial system.

High Performance

vhf/uhf preamps



Receive Only	Freq. Range (MHz)	N.F. (dB)	Gain (dB)	1 dB Comp. (dBm)	Device Type	Price
P28VD	28-30	<1.1	15	0	DGFET	\$29.95
P50VD	50-54	<1.3	15	0	DGFET	\$29.95
P50VDG	50-54	<0.5	24	+12	GaAsFET	\$79.95
P144VD	144-148	<1.5	15	0	DGFET	\$29.95
P144VDA	144-148	<1.0	15	0	DGFET	\$37.95
P144VDG	144-148	<0.5	24	+12	GaAsFET	\$79.95
P220VD	220-225	<1.8	15	0	DGFET	\$29.95
P220VDA	220-225	<1.2	15	0	DGFET	\$37.95
P220VDG	220-225	<0.5	20	+12	GaAsFET	\$79.95
P432VD	420-450	<1.8	15	-20	Bipolar	\$32.95
P432VDA	420-450	<1.1	17	-20	Bipolar	\$49.95
P432VDG	420-450	<0.5	16	+12	GaAsFET	\$79.95

Inline (rf switched)	Freq. Range (MHz)	N.F. (dB)	Gain (dB)	1 dB Comp. (dBm)	Device Type	Price
SP28VD	28-30	<1.2	15	0	DGFET	\$59.95
SP50VD	50-54	<1.4	15	0	DGFET	\$59.95
SP50VDG	50-54	<0.55	24	+12	GaAsFET	\$109.95
SP144VD	144-148	<1.6	15	0	DGFET	\$59.95
SP144VDA	144-148	<1.1	15	0	DGFET	\$67.95
SP144VDG	144-148	<0.55	24	+12	GaAsFET	\$109.95
SP220VD	220-225	<1.9	15	0	DGFET	\$59.95
SP220VDA	220-225	<1.3	15	0	DGFET	\$67.95
SP220VDG	220-225	<0.55	20	+12	GaAsFET	\$109.95
SP432VD	420-450	<1.9	15	-20	Bipolar	\$62.95
SP432VDA	420-450	<1.2	17	-20	Bipolar	\$79.95
SP432VDG	420-450	<0.55	16	+12	GaAsFET	\$109.95

Every preamplifier is precision aligned on ARR's Hewlett Packard HP8970A/HP346A state-of-the-art noise figure meter. RX only preamplifiers are for receive applications only. Inline preamplifiers are rf switched (for use with transceivers) and handle 25 watts transmitter power. Mount inline preamplifiers between transceiver and power amplifier for high power applications. Other amateur, commercial and special preamplifiers available in the 1-1000 MHz range. Please include \$2 shipping in U.S. and Canada. Connecticut residents add 7-1/2% sales tax. C.O.D. orders add \$2. Air mail to foreign countries add 10%. Order your ARR Rx only or inline preamplifier today and start hearing like never before!

Advanced Receiver Research

Box 1242 • Burlington, CT 06013 • 203 582-9409



152

THE ISOTRON
COMPACT ANTENNAS FROM 160-10 METERS

NO TUNERS!
NO RADIALS!
NO RESISTORS!
NO COMPROMISE!

FOUR EXCELLENT REVIEWS JUST DON'T HAPPEN BY CHANCE.
CALL US FOR A FREE CATALOGUE.

*See review in Oct. 73, 1984 *Sept. 73, 1985
*March 73, 1986 *Dec. 88, CQ

BILAL COMPANY
137 Manchester Dr.
Florissant, Colo. 80816
(719) 687-0650

NEW!
The classic "Antenna Bible"
now in a thoroughly-revised, much-enlarged edition

ANTENNAS

2nd edition
by John Kraus, W8JK
Ohio State University

Covers both theory and its applications to practical systems. With design formulas, tables and references. Over 1000 illustrations.
"Modern, complete, a classic", *Microwave Journal*.

917 pages, hardcover. \$51.95
Add \$2.50 per book for shipping and handling U.S., \$5.00 elsewhere.

CYGNUS-QUASAR BOOKS
P.O. Box 85, Powell, Ohio 43065
Tel. 614-548-7895

153

BLACK DACRON® POLYESTER ANTENNA ROPE

- UV-PROTECTED
- HIGH ABRASION RESISTANCE
- REQUIRES NO EXPENSIVE POTTING HEADS
- EASY TO TIE & UNTIE KNOTS
- EASY TO CUT WITH OUR HOT KNIFE
- SIZES: 3/32" 3/16" 5/16"
- SATISFIED CUSTOMERS DECLARE EXCELLENCE THROUGHOUT U.S.A.

LET US INTRODUCE OUR DACRON® ROPE TO YOU • SEND YOUR NAME AND ADDRESS AND WE'LL SEND YOU FREE SAMPLES OF EACH SIZE AND COMPLETE ORDERING INFORMATION.

Dealer Inquiries Invited



synthetic textiles, inc. 2472 EASTMAN AVE., BUILDING 21
VENTURA, CALIFORNIA 93003
(805) 658-7903

157

PRESENTING
THE K1FO 33 ELEMENT 432 MHz YAGI

Model FO-33-432

\$174.95

ELECTRICAL SPECIFICATIONS:
Measured gain 17.8 dbd
E-Plane beamwidth 18 deg
H-Plane beamwidth 18 deg
Side-lobe attenuation
1st E-Plane -17 dB
1st H-Plane -16 dB
SWR 1.15:1 typical
F/B ratio 23 dB
Impedance 50 ohm

MECHANICAL SPECIFICATIONS:
Length 241.4in.
Boom 1.25" O.D. 6061 T6 Aluminum
Elements 3/16" Aluminum rod
Wood survival 90+ MPH
Mast up to 2" diameter
Element Insulators Black Delrin
Stainless Steel hardware (except U-bolts)
Coax connector N-type

ALSO AVAILABLE
FO-12-144, FO-16-220, FO-22-432, FO-25-432, FO-11-440
POWER DIVIDERS STACKING FRAMES

We supply those hard to find parts for the home builder
3/16" Delrin insulators \$12/100, Stainless keepers \$10/100
Add \$6 UPS SH for each antenna
\$8 west of Mississippi
PA residents add 6% state sales tax.

RUTLAND ARRAYS
1703 Warren Street • New Cumberland, PA 17070
(717) 774-5298 7-10 P.M. EST
Dealer inquiries are invited

148

Electronic Repair Center Servicing

Amateur Commercial Radio

The most complete repair facility on the East Coast.

Large parts inventory and factory authorized warranty service for Kenwood, Icom and Yaesu.

SEND US YOUR PROBLEMS

Servicing "Hams" for 30 years, no rig too old or new for us.

HAMTRONICS, INC.

4033 Brownsville Road

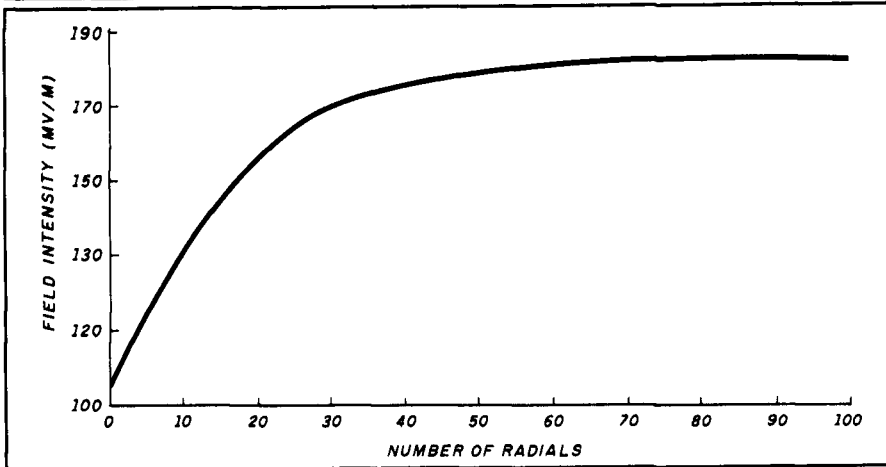
Trevose, Pa. 19047

215-357-1400



154

FIGURE 3



Effect of the number of radials on the effective radiation of the antenna.

slightly lower. Find the optimum height by experimenting; remember that it will vary over the course of the year if climatic changes are the norm in your location.

Vertical antenna variants

So far, the vertical antennas I've considered have been standard quarter-wavelength models. Let's take a look at several variations. Figure 4 shows the vertical half-wavelength dipole. The vertical dipole is constructed in exactly the same manner as the horizontal dipole, but is mounted in the vertical plane. In general, the section of the radiator closest to the ground should be connected to the shield end of the coaxial cable transmission line.

Like the horizontal dipole, the approximate length of the vertical dipole is calculated from:

$$L_{ft} = \frac{468}{F_{MHz}} \quad (1)$$

Where:

L_{ft} is the length in feet, and

F_{MHz} is the operating frequency in megahertz.

Of course, each leg of the vertical dipole is one-half the calculated length.

The vertical dipole antenna is used in many locations where it's impossible to mount a horizontal dipole properly, or where a roof or mast-mounted antenna is impossible to install because of logistics or a hostile landlord and/or homeowners' association. Some row and townhouse dwellers, for example, have been successful with the vertical dipole. In the 1950s and 1960s, the vertical dipole was popular among European

Amateurs because of space restrictions in many locations.

Vertical dipole construction is relatively straightforward. First, find or build a vertical support structure. In the system shown in Figure 4, the support is a wooden or heavy wall PVC mast. Thin wall PVC pipe whips around too much in the wind and requires more guy line support than is reasonable; so avoid it for this application. Ropes and insulators at either end support the wire elements from the ends and keep the antenna taut. If neighbors are a problem, try to find some white thick wall PVC pipe that you can use to build a fine flagpole (be patriotic), and simply hide a vertical dipole inside it. If your home doesn't have metal siding and is tall enough, a support from the roof structure (or soffits) will make a proper support.

One problem we liability-conscious people need to consider when using a vertical dipole is the high impedance voltage at the ends of a half-wavelength dipole. Anyone touching the antenna is likely to receive a nasty RF burn or shock.

Coaxial vertical construction is similar to that of the vertical dipole in that it uses a pair of vertical radiator elements. It can even be argued that it's a form of vertical dipole. However, with the coaxial vertical antenna, the radiator that's closest to the ground is coaxial with the transmission line and the main radiator element (see the example in Figure 5A). An insulator at the feedpoint separates the two halves of the radiator. In most cases, the top radiator is smaller in diameter than the

coaxial sleeve (also called the "shield pipe" in some publications). For the most part, the reasons for this arrangement are mechanical rather than electrical. The coaxial cable transmission line passes through the sleeve and is itself coaxial to the sleeve.

The overall length of the coaxial vertical antenna is one-half wavelength, consisting of two quarter-wavelength sections. Both the radiator and the sleeve are a quarter wavelength long. The starting length of each is found (approximately) from:

$$L_{ft} = \frac{246}{F_{MHz}} \quad (2)$$

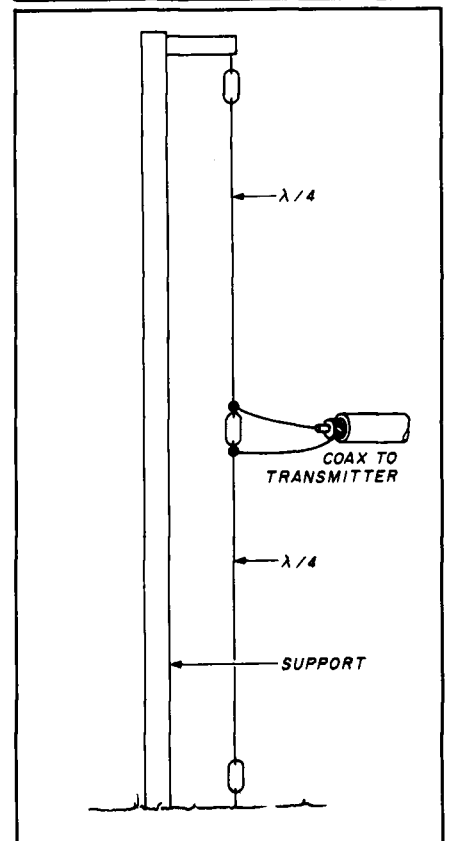
or,

$$L_{meters} = \frac{72}{F_{MHz}} \quad (3)$$

These equations are similar to the one used to calculate half-wavelength antennas, but they are reduced by a factor of 2.

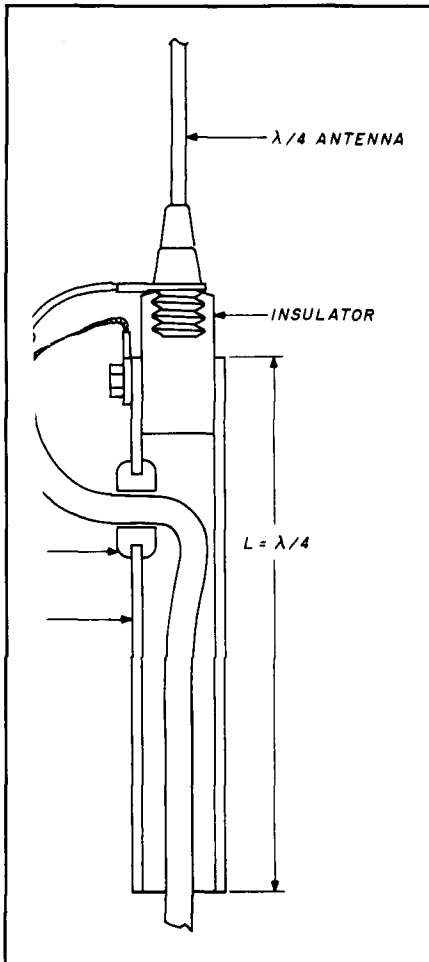
The coaxial vertical antenna was once popular with CB operators and was called the "colinear antenna." You can sometimes find hardware from these antennas at hamfests or surplus

FIGURE 4



Simple half-wave vertical dipole.

FIGURE 5A



Commercially used system for feeding a coaxial half-wave antenna.

markets and modify the pieces for Amateur Radio use. If you're building a 10-meter band antenna, it's a simple matter to cut the 11-meter CB antenna for operation on a slightly higher frequency. But it's a little more difficult for the lower frequency bands, and it's likely that only the insulator and mounting assembly are salvageable. Keep in mind, however, that adjacent sizes of aluminum tubing are designed so that the inner diameter (ID) of the larger piece is a slip fit for the outer diameter (OD) of the smaller piece. This lets you connect adjacent sizes of aluminum tubing together without special couplers. I find that salvaged insulator assemblies with just 6 to 10 inches of the former radiator and sleeve can be cut off, and new radiators from "adjacent size" tubing can be installed.

The configuration in Figure 5A is the construction technique used by commercial antenna manufacturers for VHF and CB colinear vertical dipoles.

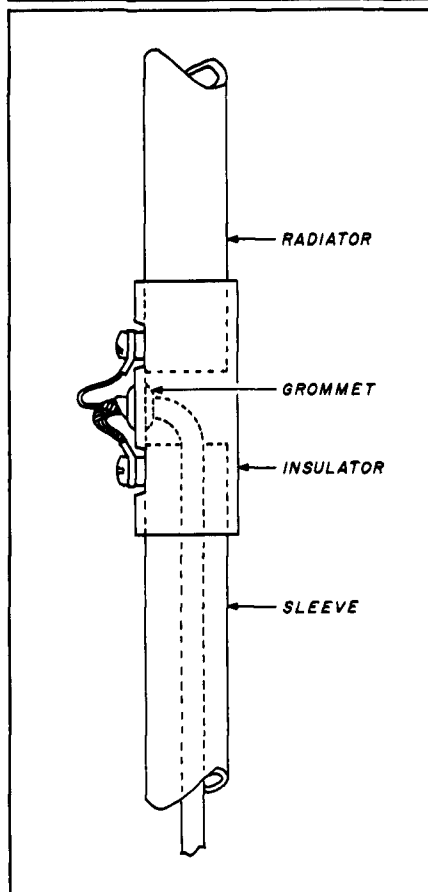
This method is a little difficult for those who don't have access to a machine shop for making the center insulator. You'll need to find another construction method to make this antenna practical.

Figure 5B shows a construction method that has been used by Amateurs with good results. The radiator and shield pipe (sleeve) are joined together in an insulating piece of thick wall PVC plumbing pipe, Lucite™, or Plexiglas™ tubing; 6 to 10 inches of tubing are needed.

Leave a gap of about 2 inches between the bottom end of the radiator pipe and the top end of the shield pipe to keep them electrically insulated from each other, and to allow the coaxial cable to be passed through to the outside world. Drill a hole in the insulator pipe for this purpose.

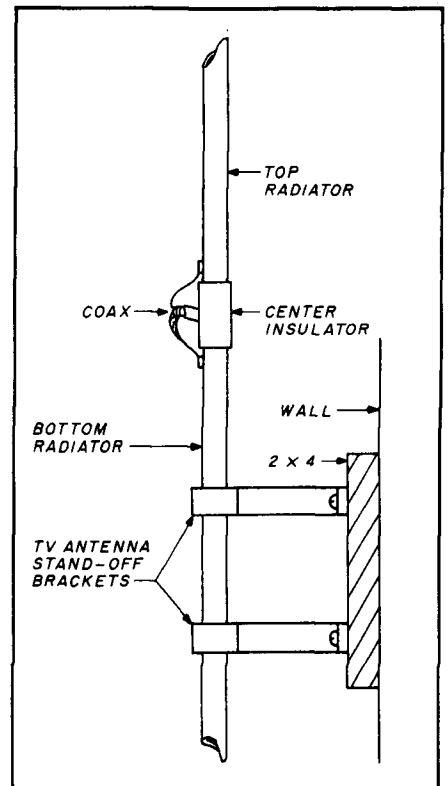
Fasten the aluminum tubing pieces for the radiator and the sleeve to the insulator using at least two heavy machine screws for each. You can use one of the machine screws on each piece as the electrical connection

FIGURE 5B



Homebrew method for feeding a coaxial half-wave vertical.

FIGURE 5C



Antenna mounting scheme.

between the coaxial cable and the pipes, as long as you cut a larger hole in the insulator at that point to admit the washer that provides the electrical pathway between the screw head and the aluminum pipe. If you omit the washer, and depend on the contact between the machine screw and the pipe, your connection will probably be intermittent and cause you quite a bit of aggravation.

Mounting the homebrew coaxial vertical antenna can be a "pain in the neck." Normally this antenna is mounted high in the air, so some form of support is needed. Fortunately, you can use small area metal supports connected to the sleeve. Figure 5C shows one popular mounting method that uses a pair of television antenna standoff mounting brackets to support the sleeve. You can buy these brackets in sizes from 6 to 24 inches. Note that a 2 x 4 piece of lumber is used between the building wall and the brackets. This wood serves as an insulator, so it should be varnished or painted. Attach it to the wall with lag bolts, wing bolts, or some other secure anchoring method. Keep in mind that the forces on the brackets increase tremendously during windstorms.



"You're miles ahead with Larsen."

Rick Woodsome, Communications Consultant Woodsome and Associates, Boulder, Colorado

When the directors of the Coors International Bicycle Classic needed a sophisticated mobile communications system, they turned to communications consultant Rick Woodsome. As a communications specialist, Woodsome knows what it takes to make a communication system work.

That's why he turned to Larsen Antennas.

"You don't pull off the largest sports event in the Western Hemisphere without good communication. And you don't have good communication without the right equipment.

"Larsen antennas were instrumental in making last summer's Coors Classic an overwhelming success. They were key to our entire communication network.

"Without Larsen, it would have been uphill all the way."

Rick Woodsome



Larsen Antennas The Amateur's Professional™

See your favorite amateur dealer or write for a free amateur catalog.

IN USA: Larsen Electronics, Inc., 11611 N.E. 50th Avenue, P.O. Box 1799, Vancouver, Washington 98668 (206) 573-2722.

IN CANADA: Canadian Larsen Electronics, Ltd., 149 West 6th Avenue, Vancouver, B.C. V5Y 1K3 (604) 872-8517.



THE AMATEUR'S PROFESSIONAL.

Larsen Külord® and Külduckie® antennas provide amateurs the same advantages enjoyed by commercial two way radio users. Both combine top performance with the long range dependability you want.

See

your dealer for the complete line of Larsen antennas and permanent and temporary mounts.

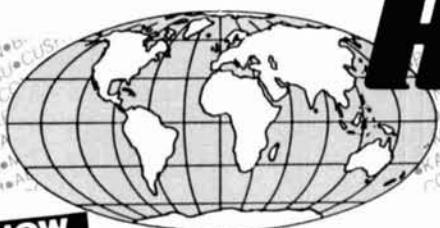
You can buy with confidence, because they're all backed by Larsen's No Nonsense Warranty for a full six months.

For a professional approach to amateur radio, tune in to Larsen.



WORLDWIDE DISTRIBUTION

For A HRO 72 Page
Communication Equipment Catalog
Send \$1.00 to any HRO Store



HAM RADIO OUTLET

LARGEST HAM OUTLET IN THE WORLD

NOW
9

STORE BUYING POWER

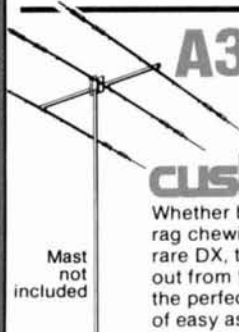


GEOCHRON
GLOBAL
TIME
INDICATOR

SALE

- Detailed illuminated map shows time, time zone, sun position and day of the week at a glance for any place in the world.
- Continuously moving - areas of day and night change as you watch.
- Mounts easily on a wall. Size: 34 1/2" x 22 1/2".

~~\$1295~~ **\$1159.95 DELIVERED IN U.S.**



A3 DX THAT STANDS OUT FROM THE CROWD
10, 15, 20 Meters

cushcraft

Whether busting pileups, rag chewing or hunting rare DX, the A3 stands out from the crowd with the perfect combination of easy assembly, the right size, rugged durability and great performance.

- Boom Length 14 ft., Weight 27 lbs.
- Wind Surface Area 4.36 ft.

Most not included

REG. 399.00

SALE 269.95

Plus Shipping

SALE



rconcept
VHF/UHF SOLIDSTATE AMPLIFIERS

Contemporary design, quality and a 5 year warranty on parts and labor.
6 months on the RF Final transistors.

All amplifiers have GaAsFET receive pre-amps and high SWR shutdown protection.



MA-40
40' TUBULAR TOWER
~~\$899~~ **SALE! \$629**

MA-550
55' TUBULAR TOWER
~~\$1369~~ **SALE! \$999**

- Handles 10 sq. ft. at 50 mph
- Pleases neighbors with tubular streamlined look

TX-455
55' FREESTANDING CRANK-UP

- Handles 18 sq. ft. at 50 mph
- No guying required
- Extra-strength Construction
- Can add raising and motor drive accessories



Shown with optional MARB rotor base

TOWERS RATED TO EIA SPECIFICATIONS
OTHER MODELS AT GREAT PRICES
IN STOCK FOR QUICK DELIVERY



MADE IN U.S.A.



PARAGON 585

- Ten-Tec QSK cw, real FSK and sideband audio
- Select any filter in any mode
- TX 160 through 10 meters • All mode superiority
- RX 100 kHz to 30MHz • A premier HF rig



TITAN 425

- Pair 3CX800A7 • External Power Supply
- Performance at legal limit
- 3 MS QSK, 1.6 to 22 MHz • Assures "Loaf Along"
- With authorized modification through 29.999 MHz

IN STOCK NOW! FREE SHIPMENT!



Advanced Electronic Applications

PK-232 Multi-mode Data Controller

SALE CALL



- NEW IBM Fax Screen Display Program Available
- Transmit/Receive on Six Modes
- CW/RTTY/ASCII/AMTOR/Packet/FAX
- IBM and Commodore terminal programs available
- Radio Ports for HF and VHF

In Stock for Quick Delivery
Free Shipment

Kantronics/KAM



True dual port - simultaneous HF/VHF packet operation

- Personal Bulletin Board
- RTTY/ASCII/AMTOR/CW/Weather Fax
- Programmable MARK and SPACE tones
- Terminal programs for PC compatibles and Commodore
- WEFAX programs for PC, Commodore, and Macintosh

One-year Warranty

CALL FOR LOW, LOW PRICE

FREE SHIPMENT
Most items over \$100 UPS surface

All Major Brands in Stock Now!

CALL TOLL FREE
IN CALIFORNIA CALL STORE NEAREST YOU

MID-WEST/WEST
ANAHEIM, 9 to 5:30 PST
1-800-854-6046

SOUTHEAST
ATLANTA, 9 to 5:30 EST
1-800-444-7927

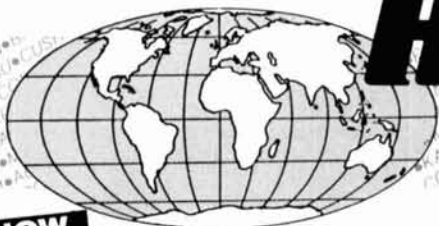
MID-ATLANTIC
WOODBIDGE, 9 to 5:30 EST
1-800-444-4799

NEW ENGLAND
SALEM, 9 to 5:30 EST
1-800-444-0047



Toll free including Hawaii. Phone Hrs: 7:00 am to 5:30 p.m. Pacific Time. California, Arizona and Georgia customers call or visit nearest store. California, Arizona, Georgia and Virginia residents please add sales tax. Prices, specifications, descriptions subject to change without notice.

For A HRO 72 Page
Communication Equipment Catalog
Send \$1.00 to any HRO Store



HAM RADIO OUTLET

LARGEST HAM OUTLET IN THE WORLD

NOW

9 STORE BUYING POWER

ICOM IC-765



100W, 100kHz to 30MHz
HF ALL BAND TRANSCEIVER
Dual VFO system

SALE! CALL FOR PRICE

ICOM IC-781



THE ULTIMATE
150 W, ALL BAND
HF TRANSCEIVER

GREAT PRICE!

ICOM IC-900 MULTI-BAND MOBILE



YOU CAN OPERATE SIX BANDS
WITH ONE CONTROLLER!
2 MTR 25/45W, 440 MHz 10 MTR, 6 MTR,
220 MHz & 1.2 GHz 10 MEMORIES
ARE YOU READY FOR
1.2 GHz OPERATION?

ICOM A Models 25W,
H Models 100 W

IC-275/A275H, 138-174 MHz
IC-375A, 220 MHz
IC-475A/475H, 430-450 MHz



LOW PRICE!

ICOM IC-735



100 W, 100 KHz-30 MHz
Dual VFO Receiver

CALL FOR LOW, LOW PRICE

BULLETIN

ege has
joined the
**HAM RADIO OUTLET
NATIONWIDE TEAM**



NOW LOCATED IN
SALEM, NH
WOODBRIDGE, VA

THIS GIVES YOU EVEN
BETTER RESPONSE WITH
LOW-LOW OUTLET PRICES
& RAPID DELIVERIES
COAST TO COAST.

ICOM HAND-HELD VHF/UHF



IC-02AT IC-2AT 2MTR
IC-3AT 220 MHz
IC-04AT IC-4AT 440 MHz

ICOM IC-725



100W, 30kHz to 33MHz
HF ALL BAND TRANSCEIVER
GREAT PRICE



Bob Ferrero W6RJ
President/Owner
Jim Rafferty N6RJ
VP-National
Sales Manager

ANAHEIM, CA 92801
2620 W. La Palma
(714) 761-3033, (213) 860-2040
Between Disneyland &
Knotts Berry Farm

ATLANTA, GA 30340
6071 Buford Hwy
(404) 263-0700
Larry, Mgr. WD4AGW
Doraville, 1 mi north of I-285

BURLINGAME, CA 94010
999 Howard Ave.
(415) 342-5757
George, Mgr. WB6DSV
5 miles south on 101 from SFO

OAKLAND, CA 94606
2210 Livingston St.
(415) 534-5757
Rich, Mgr. WA9WYB
IS-880 at 23rd Ave. Ramp

PHOENIX, AZ 85015
1702 W. Camelback Rd.
(602) 242-3515
Bob K7RDH, Gary WB7SLY, Mgr.
East of Hwy 17

SALEM, NH 03079
224 N. Broadway
(603) 898-3750 1-800-444-0047
Curtis, Mgr. WB4KZL
28 miles north of Boston exit 1 I-93

SAN DIEGO, CA 92123
5375 Kearny Villa Rd
(619) 560-4900
Tom, Mgr. KM6K
Hwy 163 & Claremont Mesa Blvd

WOODBRIDGE, VA 22191
14803 Build America Drive
(703) 643-1063 1-800-444-4799
John, Mgr. WB4GJZ
Exit 54, I-95 South to US RT 1

FREE SHIPMENT
Most items over \$100
UPS surface

STORE HOURS 10 AM-5:30 PM
CLOSED SUNDAYS

VAN NUYS, CA 91411
6265 Sepulveda Blvd.
(818) 988-2212
Al, Mgr. K6YRA
San Diego Fwy. at Victory Blvd

All Major Brands in Stock Now!

Call any of our 800 numbers coast to coast from most parts of the country.

CALL TOLL FREE
IN CALIFORNIA CALL STORE NEAREST YOU

MID-WEST/WEST
ANAHEIM, 9 to 5:30 PST

SOUTHEAST
ATLANTA, 9 to 5:30 EST

MID-ATLANTIC
WOODBRIDGE, 9 to 5:30 EST

NEW ENGLAND
SALEM, 9 to 5:30 EST

1-800-854-6046 1-800-444-7927 1-800-444-4799 1-800-444-0047



Toll free including Hawaii. Phone Hrs: 7:00 am to 5:30 p.m. Pacific Time. California, Arizona and Georgia customers call or visit nearest store. California, Arizona, Georgia and Virginia residents please add sales tax. Prices, specifications, descriptions subject to change without notice.

BATTERIES "R" US...

You've bought our replacement batteries before...
NOW YOU CAN BUY DIRECT FROM US, THE MANUFACTURER!



ICOM
 CM2, PB2 7.2v @ 500MAH
 CM5, PB5 10.8v @ 500MAH
 SUPER 7S & 8S
 13.2v @ 1100MAH
 9.6v @ 1200MAH
 (base charge only - 1" longer)
Introductory Offer!
 SUPER 7S & 8S - \$64.95 each

SEPTEMBER SPECIAL!

ICOM-8(S)
 Replacement Battery.
 An additional 10% OFF
 orders received in the
 month of September.

Look for next month's
OCTOBER Special!



YAESU/MAXON
 * FNB-10 7.2v @ 600MAH
 * FNB-12 12v @ 500MAH
 * FNB-10(S) 7.2v @ 1000MAH
 * same size case as FNB-12
Introductory Offer!
 P4W 11v @ 500MAH - \$22.63
 FNB-2 11v @ 500MAH - \$22.63



CUSTOM MADE BATTERY PACKS & INSERTS
 Made to your specifications.
Introductory Offer!
KENWOOD INSERTS
 PB-21 - \$13.75, PB-25 - \$20.00,
 PB-26 - \$20.00
ICOM INSERTS
 BP-5 - \$23.00, BP-3 - \$18.95,
 BP-7, BP-8



MasterCard and Visa
 cards accepted. NYS
 residents add 8 1/4%
 sales tax. Add \$3.50
 for postage and
 handling.



**SOURCE FOR ALL YOUR COMMUNICATION
 BATTERY REPLACEMENT NEEDS.**

W & W ASSOCIATES

29-11 Parsons Boulevard, Flushing, N.Y. 11354

WORLD WIDE DISTRIBUTORSHIPS AVAILABLE. PLEASE INQUIRE.

In U.S. & Canada Call Toll Free (800) 221-0732 • IN NYS (718) 961-2103 • Telex: 51060 16795 • FAX: (718) 461-1978

Prices subject to change without notice.

**MADE IN
 THE USA**

Send for free
 catalog &
 price list!

✓ 147

PRESENTING

THE K1FO 12 ELEMENT 144 MHz YAGI

Model FO-12-144



\$134.95

ELECTRICAL SPECIFICATIONS:
 Measured gain: 12.6 dBi
 E-Plane beamwidth: 34 deg
 H-Plane beamwidth: 37 deg
 Side-lobe attenuation:
 1st E-Plane: -18 dB
 1st H-Plane: -15 dB
 SWR: 1.13 (typical)
 F/B ratio: 22 dB
 Impedance: 50 ohm

MECHANICAL SPECIFICATIONS:
 Length: 179 in.
 Boom: 1.375" 6061 T-6 Aluminum
 Elements: 14" Aluminum rod
 Wind survival: 120 MPH
 Mast: up to 2" diameter
 Element Insulators: Black Delrin
 Stainless Steel hardware
 (except U-bolts)
 Coax connector: N-type

ALSO AVAILABLE

FO-16-220, FO-22-432, FO-25-432, FO-33-432, FO-11-440

POWER DIVIDERS STACKING FRAMES

We supply those hard to find parts for the home builder
 1/4" Delrin insulators \$15/100, Stainless keepers \$13/100
 Add \$5 UPS S/H for each antenna
 \$7 west of Mississippi
 PA residents add 6% state sales tax

RUTLAND ARRAYS

1703 Warren Street • New Cumberland, PA 17070
 (717) 774-5298 7-10 P.M. EST

Dealer inquiries are invited

✓ 188

SMART REPEATER & LINK CONTROLLER

- DTMF MUTING
- INTELLIGENT ID'ER
- AUXILIARY OUTPUTS
- EASY TO INTERFACE
- REPEATER & LINK COURTESY TONES
- LOW POWER, 22ma @ 12V
- TELEMETRY RESPONSE TONES
- ALARM MONITOR INPUT
- SYNTHESIZED LINK/ REMOTE BASE CAPABILITY WITH OPTIONAL PI-10/S SYNTHESIZER BOARD

SRC-10 - \$149.00/PI-10/S - \$39.00

REPEATER/LINK AUDIO MIXER INTERFACE

- FIVE AUDIO INPUTS
- THREE ADJUSTABLE AUDIO OUTPUTS
- CTCSS DECODER ON UAI-20 ONLY
- CONTROLLED DTMF ROUTING
- LOW POWER, 19ma @ 12V
- EASY TO INTERFACE
- LINK MONITOR-MIX/MONITOR MUTE CONTROL

UAI-10 - \$44.00/UAI-20 - \$89.00

ASSEMBLED & TESTED
 ONE YEAR WARRANTY

CREATIVE CONTROL PRODUCTS

3185 Bunting Avenue
 Grand Junction, CO 81504
 (303) 434-9405



✓ 149

G5RV MultiBand Antenna

10 thru 160 Meter
 Factory Wired & Tested

Introductory Price
 \$39.95 Plus \$4 Shipping

Authorized
 TenTec
 Dealer

K4BWC



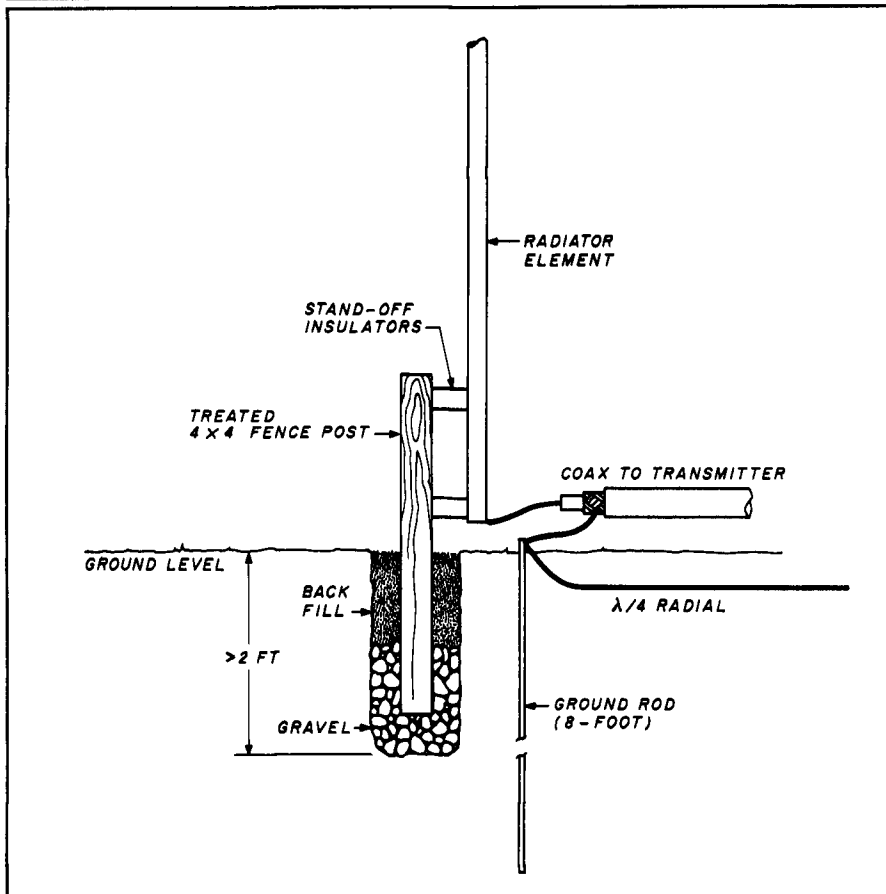
Visa & Master Card

OMEGA ELECTRONICS

4209 Live Oak Road
 Raleigh, NC 27604
 919-832-1025

✓ 150

FIGURE 6



Basic ground installation of a quarter-wave vertical.

The two vertical antennas shown here can present a shock hazard to anyone who touches them. Both of those antennas are half-wavelength radiators and of the dipole form of construction. The center point is used for feeding the antenna, so it forms the low impedance point in the antenna. As a result, the ends of the antenna, one of which is close to the ground, are the high impedance points. This means the voltages at those points can be high, and also within reach of prying hands playing in the yard. It's wise to either mount the antennas so far above ground that they can't be reached, or build a small nonconductive fence around the ends of the antenna.

Vertical antenna construction

Vertical antenna installations are generally ground level or nonground mounted. In this section I'll take a brief look at both forms of mounting, concentrating on the installation of homebrew verticals rather than commercial ones. I assume that the vendors

of these antennas will provide their own instructions.

The ground-level mounted vertical is shown in Figure 6. The typical vertical antenna is 8 to 40 feet high. Thus, although the actual weight of the antenna is small, *the forces applied to the mounting structure can be quite high, especially during windstorms.* Don't be fooled by the apparent light weight of the antenna in this respect.

The mounting structure for the vertical antenna can be a metal or wooden fence post buried in the ground. Make sure at least 2 feet of the fence post are above ground. In Figure 6, a 4 x 4 wooden fence post is used as the mounting, but the principles are similar for all forms of post. Try to make sure you have a fence post hole at least 2 feet deep. In some cases, it may be possible to use 1 foot of gravel fill topped with back-filled dirt. In other cases, especially where a steel fence post is used, place a concrete plug at the bottom of the hole over a 4-inch layer of gravel.

Install the antenna radiator element

to the fence post with standoff insulators. You may have to omit these insulators, as they are difficult to find. Given that varnished or painted wood isn't a very good conductor, it's not unreasonable to bolt the radiator directly to the 4 x 4 fence post. Use 5/16-inch (or larger) bolts; make sure they're long enough to fit through both the antenna element and the 4 x 4 post. Bolts 5/16 inch in diameter and 6 or 8 inches long will probably work best. Use at least two bolts, one at the bottom of the antenna radiator element and one near the top of the fence post. A third bolt, halfway between the other two, wouldn't be out of order.

Generally, no matching is necessary if the antenna is a quarter wavelength. Although the feedpoint impedance isn't exactly 52 ohms, it's close enough (37 ohms) to form a reasonable match for 52-ohm coaxial cable (with VSWR ≈ 1.4:1). The center conductor of the coaxial cable is connected to the radiator element, while the shield is connected to the ground system. Two ground methods are used in the example shown in Figure 6. The first is an 8-foot ground rod driven into the earth at the base of the antenna; the second is a system of quarter-wavelength radials. Remember that the ground system is absolutely essential.

Figure 7 shows a method for installing a vertical antenna above ground. A wooden support (2 x 4 or 4 x 4) is put up in a manner similar to the one in Figure 6, but a deeper hole is used to counter the longer length. The support can also be affixed to the side of a building wall, shed, or other pre-existing structure. Once you've decided on your support, attach the radiator element using the method described for the previous antenna.

Electrical connections to the antenna are also shown in Figure 7. Because the antenna is above ground level, an electrical counterpoise ground consisting of a system of radials is absolutely essential; provide at least two radials per band. Use a small L bracket to support the radials and provide an SO-239 coaxial connector for the coax. This connector is a chassis-mounted type with its center conductor connected to the radiator element. Fasten the connector shield to the bracket; this connects it to the radial system.

In some installations the antenna support structure will require guy wires

Hi Pro Repeaters ELCO

MAGGIORE ELECTRONIC LAB.

Manufacturers of Quality Communications Equipment

- Repeaters
- Links
- Remote Base
- VHF, UHF
- Receivers
- Transmitters
- Antennas



- Standard and Computerized Controllers
- Standard and Computerized Auto Patches
- Duplexers

Hi Pro 'E' EXPANDABLE REPEATER SYSTEM

- A NEW CONCEPT IN REPEATER DESIGN, THE Hi Pro "E" IS AN EXPANDABLE REPEATER WITH THE FOLLOWING FEATURES: A BASIC REPEATER WHICH WOULD INCLUDE A COMPLETE RECEIVER, TRANSMITTER, COR, FRONT PANEL CONTROLS AND INDICATORS, LOCAL SPEAKER AND MIC JACK AND CAPABLE OF FUTURE EXPANSION. ALL HOUSED IN AN EXTREMELY RUGGED, ENCLOSED, 19-INCH RACK MOUNTABLE CABINET.
- THIS SYSTEM CAN BE EXPANDED AT TIME OF PURCHASE OR CAN BE AN AFTER-PURCHASE ADD ON. THE ADD ONS ARE—HIGHER POWER, 110/220 VAC POWER SUPPLY, IDENTIFIER, AUTO PATCH, OR COMPUTER CONTROLLERS. IN ADDITION TO THESE ADD ONS AN ADDITIONAL RECEIVER AND TRANSMITTER CAN BE MOUNTED INTERNALLY FOR USE AS CONTROL LINKS, REMOTE BASE OR DUAL BAND OPERATION, ETC.
- AN EXTENSION PANEL IS AVAILABLE FOR LOCAL MONITORING OF THE REPEATER AND CONTAINS ALL NECESSARY METERING, STATUS LIGHTS AND INDICATORS. ALL ADD ONS ARE AVAILABLE FROM THE COMPANY AND ARE COMPLETE INCLUDING INSTRUCTIONS.

MAGGIORE ELECTRONIC LAB.

600 Westtown Rd. West Chester, PA 19382 Phone (215) 436-6051

Telex 499 0741 MELCO
 FAX 215-436-6268

WRITE OR CALL FOR OUR COMPLETE CATALOG

5-1000 MHz PREAMPLIFIERS

	NF	G	P(1 dB)	\$
WLA20M*	2dB	15dB	0dBm	73
WLA21M	3	13	8	57
WLA22M	4	11	12	61
WLA23M	4	22	12	87
WLA24M	3	23	18	109
WLA25M	5	11	20	82
WLA26M	6	21	24	199

Add \$4 for S&H; *BW 1-500 MHz



WILAM TECHNOLOGY, Div. of
WI-COMM ELECTRONICS INC.
 P.O. Box 5174, MASSENA, N.Y. 13662
 (315) 769-8334

ANTENNA ANALYSIS

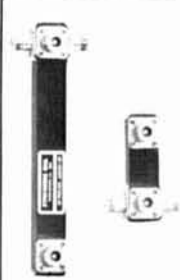
The new MN program will analyze almost any antenna made of wire or tubing. Compute forward gain, F/B, beamwidth, sidelobes, current, impedance, SWR, near-fields, and far-fields, in free space or over realistically-modeled earth. Plot antenna radiation patterns on your graphics screen. MN can compute the interaction among several nearby antennas. The 5-1/4" MN disk contains over 100 files, including libraries of antenna and plot files, a file editor, and extensive documentation. MN is an enhanced, easy-to-use version of MININEC for IBM-PC. \$75 (\$80 CA & foreign).

YAGI OPTIMIZER

The remarkable new YO program automatically adjusts Yagi element lengths and spacings to maximize forward gain, optimize pattern, and minimize SWR. Radiation patterns at band center and edges are updated on your screen during optimization. YO is extremely fast, computing several trial Yagi designs per second with 8087. YO is a complete Yagi design package for IBM-PC, containing models for gamma and hairpin matches, element tapering, mounting plates, and frequency scaling. A library of Yagi files and extensive documentation are included. \$90 (\$95 CA & foreign).

To order, send a check to:
 Brian Beezley, K6STI, 507-1/2 Taylor, Vista, CA 92084

VHF-UHF POWER DIVIDERS



RF power dividers provides the best way to feed in-phase 2 and 4 antenna arrays to maximize system gain and at the same time reduce losses to a minimum. Covering 144 thru 1296 MHz, this series of VHF/UHF power dividers are premier RF devices designed for a long service life with low SWR and broad operating bandwidth.

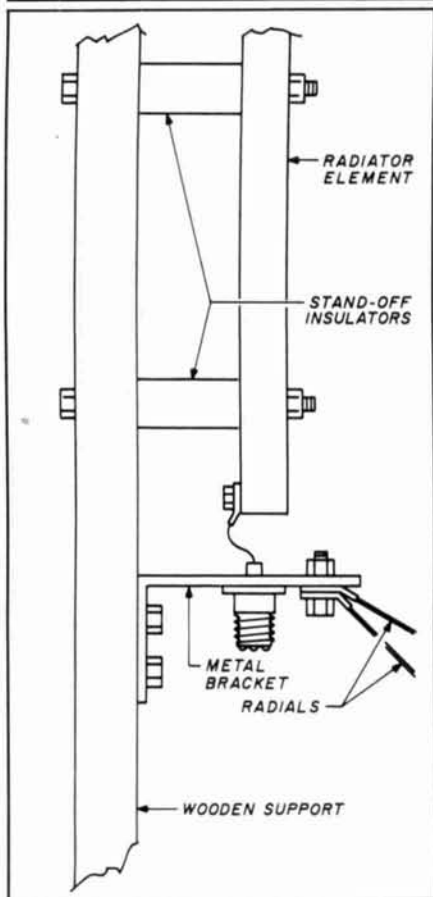
Extruded aluminum body with a durable enamel finish in addition to silicon sealing at connector flanges results in a ruggedized unit for all array installations. Available with N-type connectors only, these units are unconditionally guaranteed for 2 years.

MODEL	CONFIG.	PRICE
144-2P	(2 ports)	\$54.00
144-4P	(4 ports)	\$61.00
220-2P	(2 ports)	\$53.00
220-4P	(4 ports)	\$60.00
430-2P	(2 ports)	\$51.00
430-4P	(4 ports)	\$59.00
902-2P	(2 ports)	\$51.00
902-4P	(4 ports)	\$59.00
1296-2P	(2 ports)	\$52.00
1296-4P	(4 ports)	\$60.00

SHIPPING NOT INCLUDED

STRIDSBURG ENGINEERING, CO.
 P.O. Box 7973 • Shreveport, LA 71107 • USA
 Phone: (318) 865-0523

FIGURE 7




Scheme for mounting an elevated vertical with an elevated radial system.

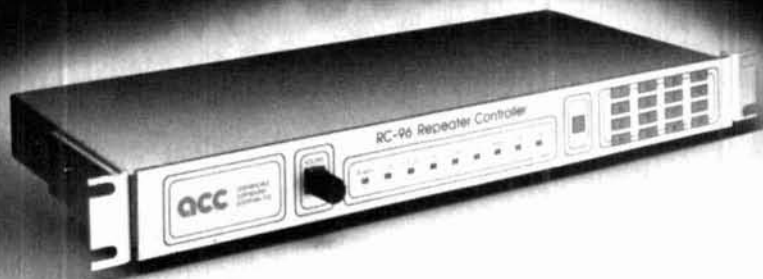
to keep the structure stable. Don't use the radials as guy wires. The type of wire that usually works well for radials is too soft and too easily stretched for guy wire service. Use regular steel guy line, available where TV antenna supplies are sold, for this antenna. Make the lengths nonresonant and break the guy lines up with egg insulators, if necessary, to achieve nonresonance.

Next month...

I'll look at two topics in the final installment of this three-part series. One is the 5/8-wavelength vertical antenna. These verticals have a generally lower angle of radiation than quarter-wavelength antennas, and may offer many Amateurs a superior "DX solution" over the quarter-wavelength model. The second issue that I'll address is safety.

I can be reached at POB 1099, Falls Church, Virginia 22041; I'd like to have your comments and suggestions for this column. 

"Become Enlightened, Not Lightning'd!"



Flash! The RC-96 Repeater Controller two year warranty now includes lightning coverage.

The '96 is tough. A three-terminal gas discharge tube across the phone line and transient suppressors on each input and output signal stop lightning from taking your system down. The '96 is so well protected that its proven performance in the field allows us to offer two year warranty coverage which includes damage caused by lightning!

You'll hear thunderous applause when you install a '96 controller on your repeater. Remote programming will let you easily make changes to your repeater from anywhere without a trip to the hill. Change codes, autodial numbers, ID and tail messages and more, with reliable storage in E²PROM memory.

Your users will be thunderstruck by the outstanding patch and auto-dialer, with room for 200 phone numbers. The talking S-meter will let them check their signal strength into the repeater. Remote base support for up to six bands allows linking your repeater to others. Plus support for pocket pagers and a bulletin board.

Your technical crew will light up when they see the built-in keypad and indicators. And the ease of hookup with shielded DIN cables. With pots and DIP switches easily accessible at the rear of the unit.

Rugged, capable, easy to hook up. The RC-96 Repeater Controller - an enlightening experience for your repeater.

acc advanced computer controls, inc.

2356 Walsh Avenue, Santa Clara, CA 95051 (408) 727-3330

✓ 146

Iron Powder and Ferrite TOROIDAL CORES

Shielding Beads, Shielded Coil Forms
Ferrite Rods, Pot Cores, Baluns, Etc.

Small Orders Welcome
Free 'Tech-Data' Flyer

AMIDON Associates Since 1963

12033 Otsego Street, North Hollywood, Calif. 91607



CARD FILE STATION FOR 40 METERS

By Ed Marriner, W6XM, 528 Colima St., La Jolla California 92037

I'd like to tell you about a 40-meter CW transceiver I use for portable QRP. It consists of a direct conversion receiver and a 1-watt transmitter (see **Figure 1**).

A direct conversion receiver is very good for portable use. It has disadvantages as a home station if there are other stations within a mile of you. A strong signal nearby will block and modulate across the band.

The direct conversion receiver VFO is tuned just off frequency from the incoming signal. This difference in frequency produces a clean, strong, and solid audio tone signal.

You'll find when tuning that adjacent signals may superimpose themselves on the received signal if the band is crowded. You could use an audio filter; however, this would add to the complexity of the receiver. Tuning to one side or the other of the received signal sometimes deletes the unwanted signal. Your only other alternative for solving the interference problem is to find a crystal filter for a regular superhetrodyne receiver. Unfortunately, this is almost impossible because parts are becoming hard to get.

Even though the direct conversion receiver has some drawbacks, it gives me a lot of enjoyment during the day when there are few signals on the band. Best of all, these receivers are simple.

Power supply

I'd like to suggest that you start by using a 12-volt battery for the power supply. Doing so solves a lot of problems. You can experiment with a 12-volt regulated supply later. I use a regulated supply built in a Ten-Tec box and keep it at least a foot away from the receiver. It's been recommended that toroid chokes be used in both positive and negative leads when using AC supplies with a direct conversion receiver. I didn't find it necessary. Don't try to build the power supply and transceiver on the same chassis. If you do you're bound to have AC-modulated hum. Transistors love to pick up this hum from the chassis ground.

I built my transceiver in a 3 × 5-inch wooden card file box. You might want to use a larger chassis.

Audio amplifier

I used a Radio Shack telephone amplifier (catalog no. 43-231) which is often on sale for \$7.00. I found it was a great choice. The amplifier contains a 2N2222 audio preamplifier driving an LM386. I was able to use the whole board by removing it from the case. (Just two screws hold it in place.) I also used the loudspeaker; it can be pried from the case. I could have used the amplifier volume control, but I used a standard 10-k potentiometer for panel mounting instead.

PC boards

I made my own circuit board using drafting dots and tape. You can hacksaw the board using two pieces of angle iron for support. Make sure you file the edges until they're smooth. Polish the copper with steel wool before putting on the tape.

I used to put the components on the fiber side of the board. Now I put them on the copper side; this makes it easier to remove or change them. There are times when leads coming through holes are covered with solder and still aren't making contact. It's easier to solder the components if you tin the copper side.

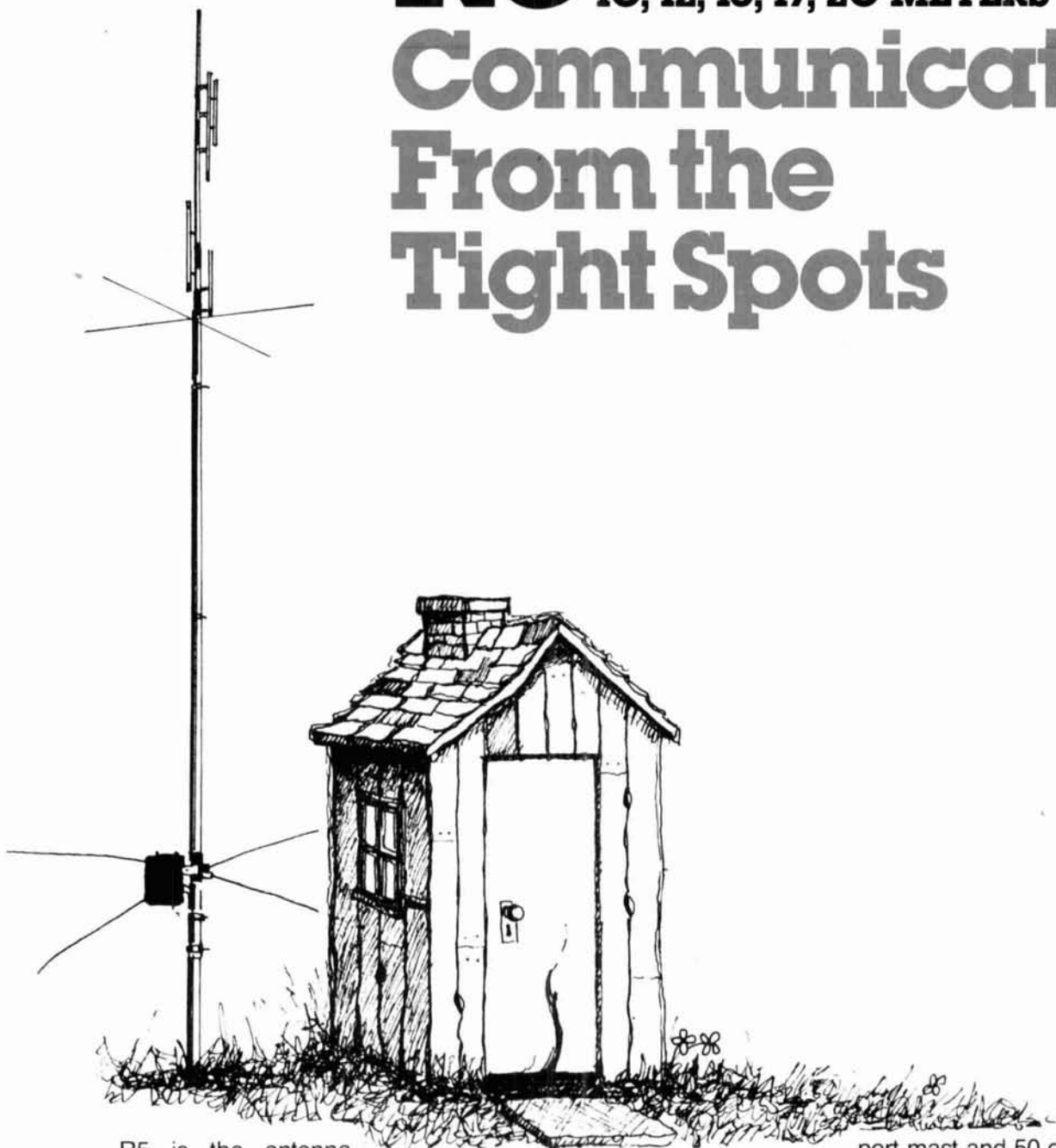
Once the board circuitry tape is pasted on, I put the board in a plastic tray and pour ferric chloride over it. Place a 75-watt lamp over the tray to heat the fluid. The Radio Shack board etches in about 20 minutes. Many military-type boards have thicker copper and are very difficult to etch. The process may take up to an hour. I found both the board and etchant at Radio Shack.

Coil construction

I find winding and tuning the toroid coils the most difficult part of construction. Everyone has various sizes in their junkboxes and this makes a grid dip oscillator (GDO) a must. The T-68 or T-50 coils are the most popular. For 40 meters use the red-painted ones. You can start by winding 35 turns of no. 28 wire on the coil. Fasten the coil to a 50-pF variable capacitor, then put one loop of hookup wire

R5 10, 12, 15, 17, 20 METERS

Communicate From the Tight Spots



R5 is the antenna designed for space age living, on small city lots, apartments, condominiums or for travel in motor homes. If you have limited space, or galaxies of space, R5 will give the most performance from your transceiver.

R5 electrical halfwave, only 16' 4" tall design allows the antenna to be mounted virtually

anywhere, without compromising performance. It easily handles 1800 watts of power with a solid state matching network giving full band coverage of 10-12-15-17-20 meters.

Easy set-up makes this antenna ideal for portable or fixed installations. It performs without a rotator, or tower. A simple sup-

port mast and 50 ohm cable is your connection to ham friends around the world.



**AVAILABLE THROUGH DEALERS
WORLDWIDE**

48 Perimeter Rd. P.O. Box 4680
Manchester, N.H. USA 03108
Tel. 603-627-7877 Telex 4949472
Fax 603-627-1764

COMPUTER SOFTWARE

LOW BAND DX-ING COMPUTER PROGRAMS

by John Devoldere, ON4UN - 30 programs for Apple II, MS-DOS, Commodore C-128 and Kaypro CPM Computers

Just about every interest or need is covered—from antenna design and optimization to general operating programs. Antenna programs include: shunt and series input L network design, feedline transformer, shunt network design, SWR calculation, plus 11 more! General Ham programs include: sunrise/sunset, great circle distances, grayline, vertical antenna design program, sunrise calendar plus 9 more! © 1986.

- UN-Apple II \$39.95
- UN-MS (MS-DOS) \$39.95
- UN-CPM/Kaypro \$39.95
- UN-C-128 (COMMODORE C128) \$39.95
- UN-MAC (MACINTOSH) \$49.95

N6RJ's ELECTRONIC SECOND OP for MS-DOS computers, V1.01

by Jim Rafferty N6RJ

The world famous SECOND OP is now available in a state-of-the-art computerized data base. This program, written for MS-DOS computers, is a must for DX'ers, contesters and all Amateurs interested in reliable DX communication. Data can be displayed either in columnar format or in full screen displays. Unknown call signs can be entered and compared to the ITU call sign allocation for easy identification. There's plenty more too such as: postal rates, beam headings and QSL bureaus to name just a few. Great program to have in your shack. Order yours today. ©1988. MS-DOS computers. 5 1/4" and 3 1/2" versions available. Please specify on your order.

- CB-RJ (MS-DOS Computers) \$59.95



By
Chip Lohman
NN4U FOR C-64
AMATEUR RADIO COMPUTER SOFTWARE

MASTER LOG New Version

Master Log creates a file of 2100 individual records with up to 13 different entries per record. It can do a search and select based upon time, frequency, mode and keeps track of DXCC and WAS status, prints QSL labels and can search its whole file in less than 5 seconds! Complete documentation is included to help you learn and use this truly state-of-the-art logging program. ©1988.

- HD-ML (For C-64) \$28.95

SUPER LOG

Super Log gives you all the advantages of a computerized data base without significantly changing the traditional log format. Super Log also allows you to print out either selected contents or the whole log. Will print QSLs.

- HD-SL (For C-64) \$19.95

CONTEST LOG

This disk contains four different contest programs; ARRL Sweepstakes, Field Day, Universal WW Contest log, plus a dupe checking routine. Automatically enters date, time, band and serial number for each contact. When the contest is over, the program will print your results listing all duped and scored contacts in serial sequence with all the necessary information as well as completed score at the bottom of the page.

- HD-CL (For C-64) \$24.95

DX EDGE MS-DOS AND C-64 software

Particularly helpful in determining long path and grey line openings. Super fast speed and dazzling graphics make this program a treat to use. The MS-DOS version also includes a close up (zoom) feature for detailed examination, a MUF calculator and a great circle bearing routine. All call sign prefixes and country names are built into the data base for easy pinpointing of locations. MS-DOS version also color compatible. Requires 2 disk drives, 348k of memory. Hercules, CGA or EGA graphics and DOS 2.1 or later.

- XN-DOS (IBM or compatible computers) \$34.95
- XN-C64 (C-64 computer) \$34.95
- XN-DX (slide rule version) \$22.95

HAM RADIO'S BOOKSTORE

Please enclose \$3.75 shipping and handling.

Greenville, NH 03048

(603) 878-1441

Amplifier Repair

Alpha - Ameritron - AMP - Henry
Dentron - Heathkit - TenTec - Etc.

35 Years Experience as the
Service Manager with a
major manufacturer

Authorized
TenTec
Dealer

K4BWC



Visa & Master Card

OMEGA ELECTRONICS

4209 Live Oak Road
Raleigh, NC 27604
919-832-1025

✓ 138

Factory Authorized Dealer & Service For

KENWOOD YAESU ICOM

Call Us For
Great Prices & Great Service

TOLL FREE ORDER LINE 1-800-344-3144
Continental U.S. & Texas

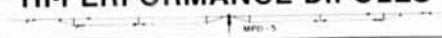
KENCOM, INC. THE HAM CENTER SAN ANTONIO, TEXAS

SALES AMATEUR RADIO SERVICE

5707A Mobud San Antonio, Texas 78238 (512) 680-6110
FAX (512) 647-8007

✓ 139

HI-PERFORMANCE DIPOLES



Antennas that work! Custom assembled to your center freq. no band - advise fit of center and each end - hang as inverted "V" - horizontal, vert. dipole, sloping dipole, commercial quality - stainless hardware - legal power - no trap, high efficiency design. Personal check, MO or C.O.D. (\$3)

MPD-5*	80-40-20-15-10M max performance dipole 87' long	\$105ppd
MPD-2	80-40M max performance dipole, 85' long 562	95 \$68 ppd
HPD-2*	160-80-40M hi performance dipole 113' long	\$75 ppd
SSD-8*	160-80-40-20-15-10M space saver dipole 71' long	\$125 ppd
SSD-5*	80-40-20-15-10M space saver dipole-specify L 42'-\$105 52'-\$108 ppd	
SSD-4*	80-40-20-15M space saver dipole-specify L 46'-\$93 60'-\$ 96 ppd	

*9 bands with wide matching range tuner.
SASE for catalogue of 30 dipoles, slopers, and space saving, unique antennas
WINN ANTENNAS
312-394-3414 BOX 393 MT. PROSPECT, IL 60056

✓ 140

U.S. AMATEUR RADIO MAIL LISTS

Labels, floppy disks, CD-ROM, mag tape.

- Newly licensed hams
- All upgrades
- Updated each week

BUCKMASTER PUBLISHING

Route 3, Box 56

Mineral, Virginia 23117

703/894-5777 visa/mc 800/282-5628

✓ 141

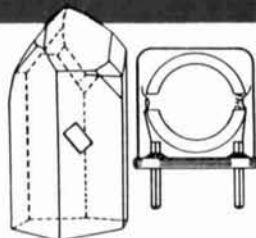
When performance & price really count...

CRYSTEK CRYSTALS

The pulse of dependable communications



Reliability & Quality
From Start To Finished Product



QUARTZ CRYSTALS/OSCILLATORS FOR ELECTRONIC — INDUSTRIAL

- Micro-Processor Control
- Computers/Modems
- Test/Measurement
- Medical

COMMUNICATIONS — REPLACEMENT

- Mobile/2-way/Channel Elements
- Pagers
- Marine
- Aircraft
- Telemetry
- Monitor/Scanners

AMATEURS

- CB
- Hobbies
- Experimenter

COST EFFECTIVE
MODERATE PRICING
FAST DELIVERY



Replacement Crystals Catalog

Custom Made Crystals Catalog

The Pulse of Dependable Communications

Crystek offers their new 16 page FREE catalog of crystals and oscillators. Offering state-of-the-art crystal components manufactured by the latest automated technology. Custom designed or "off the shelf," Crystek meets the need, worldwide. Write or call today!

CRYSTEK CORPORATION

DIVISION OF WHITEHALL CORPORATION

2351/2371 Crystal Dr. • Ft. Myers, FL 33907
P.O. Box 06135 • Ft. Myers, FL 33906-6135

TOLL FREE 1-800-237-3061
(813) 936-2109



✓ 137

SUPER PERFORMANCE BATTERIES

UPDATED SUPER ICOM

SUPER ICOM BP-7S, 13.2 volts, 1200ma triple the capacity of the Icom BP-7, 5w output

SUPER ICOM BP-8S, 9.6 volts, 1200ma, 50% more capacity than the Icom BP-8

Both are rapid base charge only, or slide in wall charger, 4 inches high, BP-7S or BP-8S, \$65.00

SUPER KENWOOD

SUPER KENWOOD PB-25S/PB-26S, 8.4 volts, 900ma, double the capacity of the PB-25/PB-26 for the 2500/2600/3500/3600. Charge with either the standard wall charger or drop in charger, 3 inches high, \$65.00.



Exact replacement FNB-2 Nicad pack for Yaesu FT-404R/207R/208R/708R \$22.50

SPEAKER/MICS

Icom HM-9 \$35.00
Yaesu MH12A2B \$31.00

SUPER YAESU

SUPER YAESU FNB-4SH, 12 volts, 1000ma, double the capacity of the Yaesu FNB-4, 5 watt output. Rapid charge only, \$71.00

SUPER YAESU FNB-3S, 9.6 volts, 1200ma, triple the capacity of the Yaesu FNB-3, 3.5 watt output. Rapid or wall charge, \$65.00

Both are perfect for the 03, 09 and 727 series radios and are 4 inches high.

Inserts for:
Kenwood PB-25, 25H, 26 \$25.00
Icom BP-3 \$18.95
Icom BP-5 (500ma) \$24.95
Icom BP-7 (500ma) \$29.50
Icom BP-8 \$29.50

Full line for Yaesu 411/811/470, FNB-10/11/12/14 available. Add \$4.00 shipping & handling for first pack. CT residents add 8% tax

Complete line of NICAD packs for Icom, Kenwood, Yaesu, Tempo, Santec, Azden, Cordless Telephones, Alkaline, Nicad & Gell-Cells. All NICAD packs include 1 year guarantee. Commercial Radio Packs available. For all your battery needs, write or call today for a complete catalog. Dealer inquiries invited.

MADE BY HAMS FOR HAMS



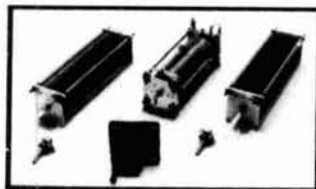
PERIPHERX Inc.
149 Palmer Road • Southbury, CT 06488

(800) 634-8132 In CT (203) 264-3985 FAX: (203) 262-6943



✓ 131

1500+ WATT TRANSMATCH KIT \$169.95



BASIC KIT—INDIVIDUAL ITEMS

1 - rotary inductor 28µh \$59.00
2 - 6:1 ball drives \$13.00 ea.
1 - 0-100 turns counter \$65.75
1 - turns counter, economy (Groth) ... \$19.95
2 - variable capacitors
25-245 pf 4500 v \$44.00 ea.

OPTIONS—

enclosure (pictured in Sept. 86 CQ) \$78.00
4:1 balun kit \$22.50

dials, terminals, chassis, ceramic standoffs, hardware, toroids, amp components, B&W coil stock, etc.

OTHER KITS

G3RUH, PSK Packet Modem, Satellite and Terrestrial \$111.00
G3RUH, OSCAR 13 Telemetry Demodulator \$144.95
QRP 20, 5w, 20 meter Transceiver (HR 1/89) \$124.95
W1FB 160/80 Pre Amp (QST 8/88) \$19.95
K9CW Memory Contest Keyer \$109.00
Yaesu FRG-9600, .1 to 60 MHz Converter \$84.95
20m CW, 15w Transceiver (H.R. 6/87) \$159.95
50W 75M SSB SCVR \$179.95
Factory Wired
Complete Ameritron/Ten-Tec Line CALL
B&W PT-2500A Amp \$1,670.00
B&W VS 1500A Tuner \$388.00
Nel-Tech DVK-100A (Free Repeat Option) \$240.00
Cary LK 800C CALL

RADIOKIT • P.O. Box 973-H Pelham, NH 03076 • (603) 437-2722
Shipping Extra Catalog \$1.00
VISA/MasterCard

✓ 132

1989 U.S. CALL DIRECTORY

(on microfiche)

Call Directory - by callsign \$8-
Name Index - by last name \$8
Geographic Index - by state/city \$8

All three - \$20

\$3 shipping per order

BUCKMASTER PUBLISHING

Route 3, Box 56
Mineral, Virginia 23117

703/894-5777 visa/mc 800/282-5628

✓ 133

Repeater Solar Power



The \$319.95 Bullet-Tested QRV Solar Power Supply keeps your repeater on the air round the clock or powers your 100w HF station 60 hrs a month. Control circuit speeds charge, protects gel cells & sealed batteries. Fully assembled, QRV, portable. Easily expanded.

Add \$10 S&H Info \$1
AntennasWest
(801)373-8425 Box 50062 Provo UT 84605

✓ 134

PACKET

MASTER PACKET RADIO: the hands on guide

by Dave Ingraham, K4TWJ

Appeals to all levels of packet radio enthusiasts from novices to experts alike. Full of illustrations and written in a simple, easy-to-understand style. Topics covered include: a basic primer, home computers and data communications terminals, a survey of equipment available, how to set up a station plus much more. 208 pages © 1988 1st edition.

□22567

Softbound \$12.95

YOUR GATEWAY TO PACKET RADIO

by Stan Horzepa, WA1LOU

Beginners will find the complete easy-to-understand explanations eliminate many of the frustrating aspects of packet operation. Full of helpful hints and tips that come from thousands of hours of on-the-air experience. 208 pages © 1987.

□AR-PKT

Softbound \$9.95

THE PACKET RADIO HANDBOOK

by Jonathan Mayo, KR3T

Providing you first with packet basics, this book progresses through the inner workings and operational aspects of packet to a look at future technology still in developmental stages. Also includes: using bulletin boards, traffic handling on packet, modulation methods and networking principles, protocols (both AX.25 and VADCG) and a thorough discussion of the various TNCs and accessories available. © 1989 2nd Edition 218 pages.

□T-3222

Softbound \$15.95

ARRL COMPUTER NETWORKING CONFERENCES 1-4

Pioneer Papers on Packet Radio 1981-1985

Written during the formative years of Packet development, these papers (too numerous to mention them all) cover: theory, practical applications, protocols, software and hardware subjects. You also get a complete up-to-date collection of all published "Gateway", the ARRL Packet Radio newsletter. As big as the ARRL HANDBOOK. © 1985 over 1000 pages.

□AR-CNC

Softbound \$17.95

5th COMPUTER NETWORKING CONFERENCE PAPERS

© 1986

□AR-CNC5

Softbound \$9.95

6th ARRL COMPUTER NETWORKING CONFERENCE

© 1987

August 1987

□AR-CNC6

Softbound \$9.95

7th ARRL COMPUTER NETWORKING CONFERENCE

© 1988

□AR-CNC7

Softbound \$11.95

PACKET COMMAND

by Buck Rogers, K4ABT

This book is a basic look at packet radio from the inside out. Similar commands are grouped together with simple easy-to-understand explanations. © 1988 58 pages, 1st Edition.

□KT-PC

Softbound \$2.95

ADVANCED PACKET

by Buck Rogers, K4ABT

This book looks at the more advanced side of packet operation. Includes 2400 baud data transfer, FAX and WEFAK, packet cluster information and more. © 1988, 58 pages, 1st Edition.

□KT-AP

Softbound \$2.95

DIGITAL COMMUNICATIONS WITH AMATEUR RADIO

special AEA edition by Jim Grubbs, K9EI

Starts with a basic review of digital communications and techniques and includes a complete description of what packet radio is all about. TNCs, operating modes, networking are all fully covered in easy-to-understand terminology. Also covered are accessories, innovations and interesting organizations you can join. © 1988, 1st Edition, 160 pages.

□AEA-PKT

Softbound \$9.95

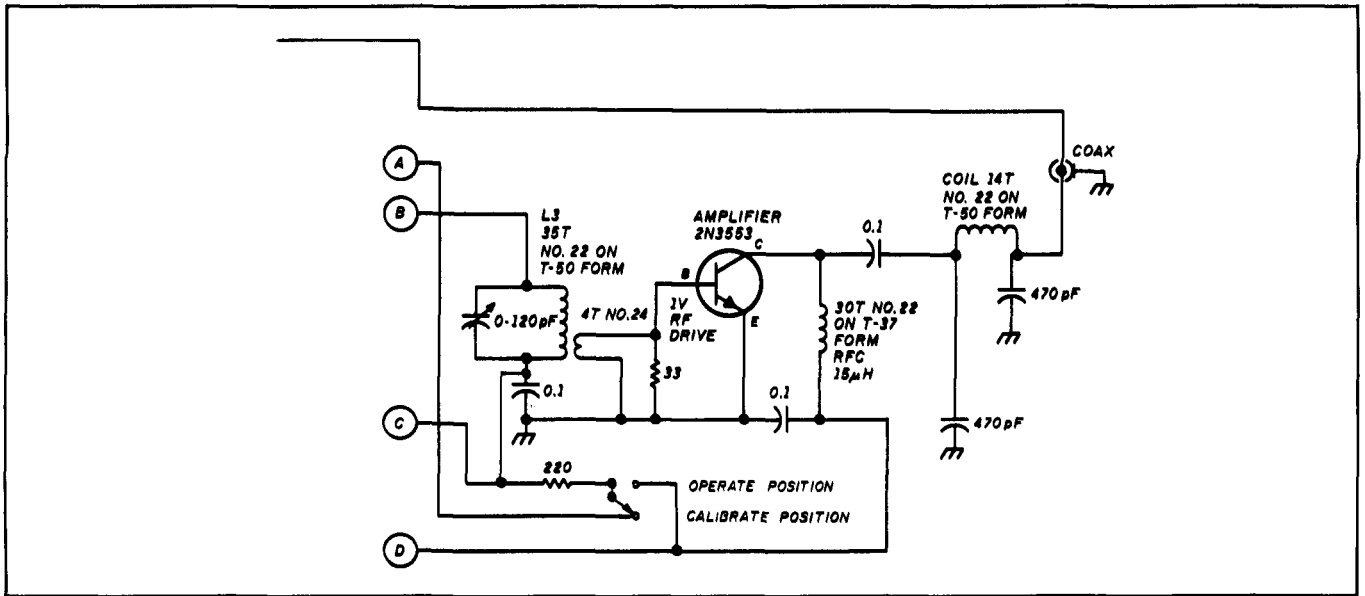
Please enclose \$3.75 shipping and handling.

HAM RADIO'S BOOKSTORE

Greenville, NH
03048

(603) 878-1441

FIGURE 1



through the hole. Put a loop of wire around the dipper coil and clip to the loop around the toroid coil, which has been set to 50 to 75 pF. Adjust the turns for resonance for 40 meters.

You can detect the resonant frequency of the transmitter variable frequency oscillator (VFO) by using the GDO as a field-strength meter. Because of the large capacitance in the Colpitts VFO, the tuning coil will have less turns than the mixer coil. Use the capacitance shown for the VFO gate to ground (see Figure 1) and to the coil. It will affect the frequency and output. You'll need 1.4 volts rms on pin 2 of the mixer to get a good signal from the VFO.

The 1000-ohm resistor and 0.01-μF capacitors act as an RF filter from the mixer output. You can use a 2.5-mH RF choke, but I found it wasn't necessary.

Transmitter

The transmitter is straightforward. The oscillator coil is peaked to obtain 1 volt of RF drive to the 2N3553. The output of the final matches 50-ohm coax line.

Parts are hard to find these days. I've listed some places to try here. Perhaps an ad in *Ham Radio* might net you some hard-to-find parts.

Toroids

Palomar Engineers, Box 455, Escondido, California 92025.
Amidon Electronic Supply, 12033 Otsego Street, North Hollywood, California 91607.

Transistors

All Electronics Corp., P.O. Box 567, Van Nuys, California 91408.
Circuit Specialists, P.O. Box 3047, Scottsdale, Arizona 85271.
RF Parts, 1320 Grand Avenue, San Marcos, California 92060.

Variable capacitors

Fair Radio Sales Company, 1016 East Eureka Street, Lima, Ohio 45802.

Search the magazine ads and write for surplus. You might also try radio swap meets.



GREAT GIFT IDEA

HAM RADIO LOG BOOKS

back by popular demand!

Room for over 2100 QSO—that's over twice as many as the other log books. For contesters, each page contains 30 QSO's for easy counts. You also get the latest up-to-date frequency spectrum chart. ITU call sign list and ARRL DXCC list. Spiral bound to lay flat on your desk. Unquestionably the best log book value around. © 1988.

HR-LB.....Spiralbound \$2.95
HR-3LB Special Buy 3
Save 22%.....Get 3 \$6.95



Please enclose \$3.75 shipping & handling

HAM RADIO BOOKSTORE
GREENVILLE, NH 03048 (603) 878-1441

MOVING?

Let circulation know
60 days in advance.

Ham Radio
Greenville, NH 03048-0498
603-878-1441

INTRODUCTION TO WAVEFORM GENERATORS PART 1

By Joseph J. Carr, K4IPV, P.O. Box 1099, Falls Church, Virginia 22041-1099

Waveform generator circuits are used to produce a large variety of waveforms needed in circuits and projects of interest to Amateur operators. The astable (also called free running) multivibrator (AMV) may produce square waves, triangle waves, or other non-sinusoidal waveforms. The AMV is a circuit that produces a periodic waveform (i.e., one that repeats itself).

The monostable multivibrator (MMV), or one-shot, circuit is a class of waveform generator that is not free running. This circuit produces only a single pulse when triggered, so it isn't periodic. (Note: In the strictest sense, astable multivibrator circuits produce only square waves. Current common usage, however, broadens the scope of the term considerably.)

The subclass of AMV and MMV circuits I'll discuss here is based on IC devices like voltage comparators, operational amplifiers, integrators, and so forth. Because these circuits are based on the charge and discharge properties of resistor-capacitor networks, it's prudent to review the operation of simple RC networks. Since they also depend on the properties of the op amp voltage comparator, I'll review comparator theory.

Review of RC networks

Take a look at **Figure 1A**. Assuming that the initial condition is as shown, switch S1 is in position A and is open circuited. Initially, there's no charge stored in capacitor C (i.e., $V_c = 0$). However, if switch S1 is moved to position B, voltage V is applied to the RC network. The capacitor begins to charge with current from the battery, and V_c begins to rise towards V (see curve V_{cb} in **Figure 1B**). The instantaneous capacitor voltage is found from:

$$V_c = V[1 - e^{-T/RC}] \quad (1)$$

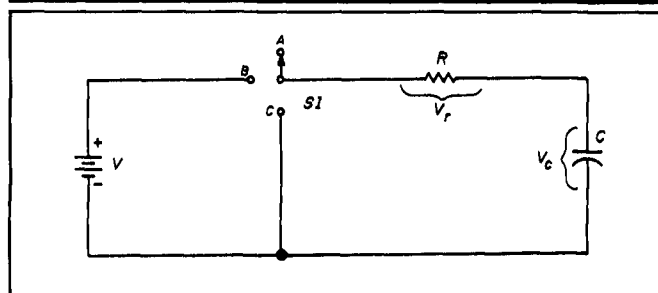
Where:

V_c is the capacitor voltage

V is the applied voltage from the source

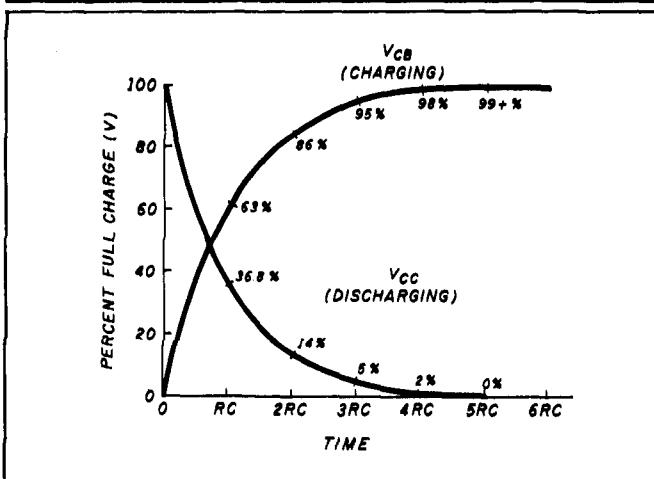
T is the elapsed time (in seconds) after charging begins

FIGURE 1A



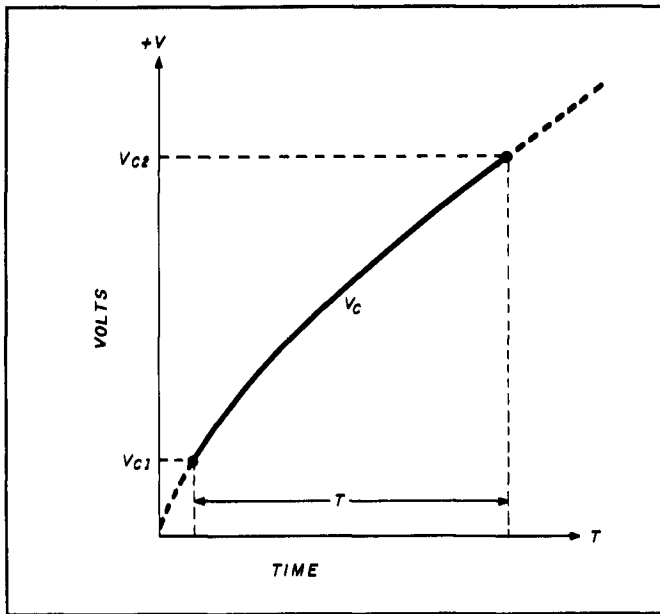
Basic RC network, no voltage applied.

FIGURE 1B



Graph illustrating charge and discharge time constants.

FIGURE 1C



Graph of a common charge cycle encountered in waveform generators.

R is the resistance in ohms

C is the capacitance in farads

The product RC is called the RC time constant of the network. If R is in ohms and C is in farads, then the product RC is specified in seconds. The capacitor voltage rises to approximately 63.2 percent of the final value after 1RC, 86 percent after 2RC, and >99 percent after 5RC. By definition, a capacitor in an RC network is considered "fully charged" after five time constants.

If switch S1 in Figure 1A is next set to position C, the capacitor begins to discharge through the resistor. In the discharge condition:

$$V_c = V[e^{(-T/RC)}] \quad (2)$$

Voltage Vc drops to 36.8 percent of the full charge level after one time constant (1RC), and to very nearly zero after 5RC.

Now look at Figure 1C. This graph represents a situation commonly encountered in waveform generator circuits. In this graph, the capacitor is required to charge from some initial condition (Vc1), which may or may not be zero volts, to a final condition (Vc2), which may or may not be the fully charged 5RC point. This all occurs in a specified time interval, T. The question is: "What RC time constant will force Vc1 to rise to Vc2 in time T? Assuming that Vc1 < Vc2 < V:

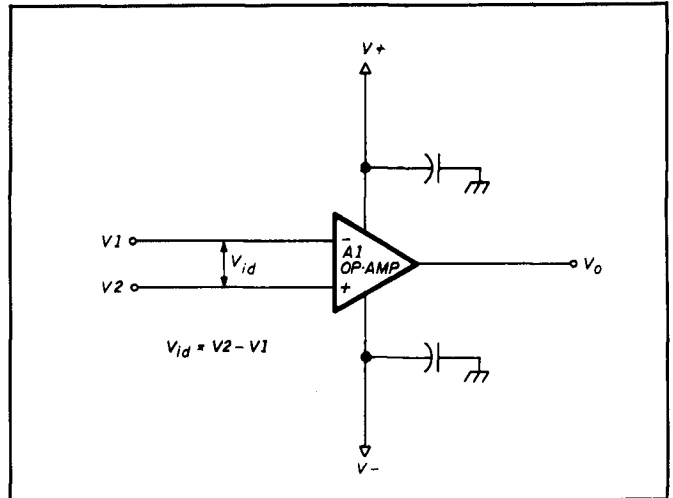
$$V - V_{c2} = (V - V_{c1})[e^{(-T/RC)}] \quad (3)$$

or, doing a little algebra and rearranging terms:

$$RC = \frac{-T}{\ln \left[\frac{V - V_{c2}}{V - V_{c1}} \right]} \quad (4)$$

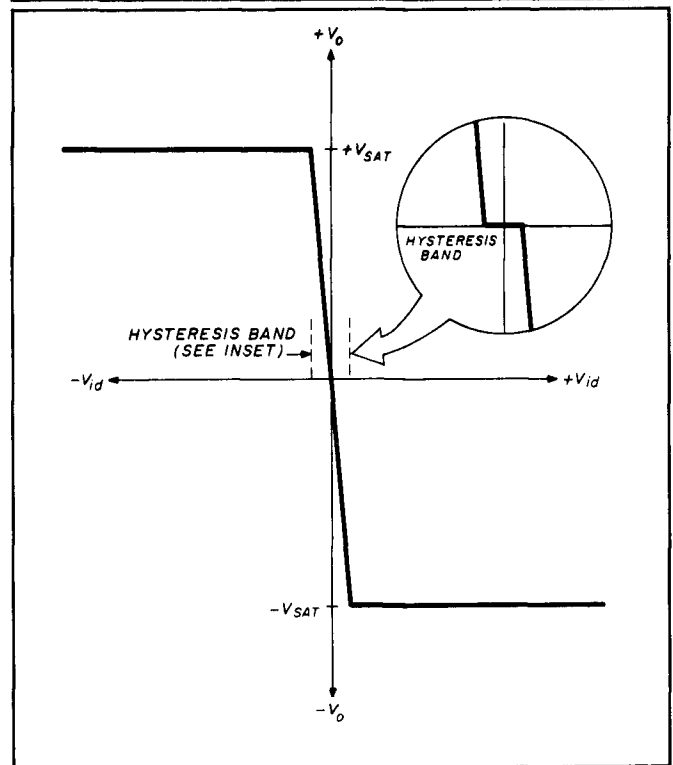
You can use Equation 4 to derive the timing or frequency setting equations of many different RC-based waveform generator circuits. The key voltage levels will most often be comparator trip points, or critical values set by the design of the circuit.

FIGURE 2A



Basic voltage comparator using an op amp.

FIGURE 2B

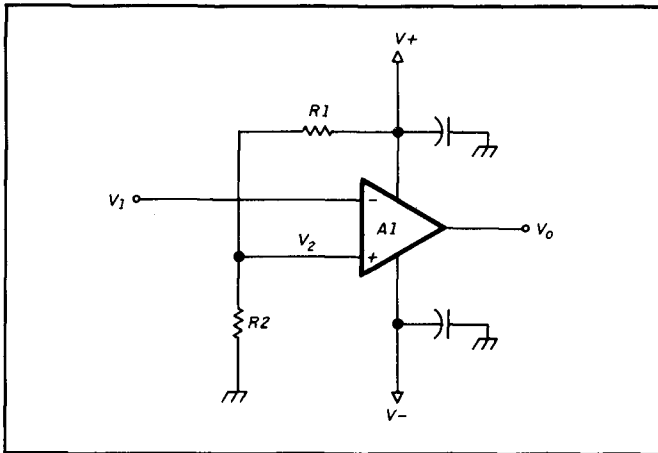


Graph depicting the transfer function of the comparator.

Voltage comparators

A voltage comparator is basically an operational amplifier without a negative feedback network (see Figure 2A). The open loop gain of the operational amplifier is very large, on the order of 200,000 to 300,000 for most common, low cost integrated circuit (IC) devices. Without a negative feedback, the operational amplifier functions as a very high gain DC amplifier with an output that saturates when a very tiny input potential is present.

FIGURE 3A



Simple method for biasing either input to the comparator to a specific voltage.

The voltage comparator is used to compare two input voltages and issue an output signal that indicates their relationship ($V_1 = V_2$, $V_1 > V_2$, or $V_1 < V_2$). In Figure 2A potential V_1 is applied to the inverting input, and V_2 is applied to the noninverting input. If $V_1 = V_2$, then $V_0 = 0$. Otherwise, the output voltage obeys the relationships shown in Figure 2B, which is the transfer function of the comparator. According to the normal rules for operational amplifiers, making V_1 larger than V_2 causes the input voltage to look like a positive input to the inverting input, so the output potential is saturated at $-V_{sat}$, just below V_- . Alternatively, when V_1 is smaller than V_2 the input voltage looks like a negative input potential, so the output is saturated at $+V_{sat}$ just below V_+ . In Figure 2B, there's a small hysteresis band around zero where no output changes occur. This is an unfortunate defect in practical operational amplifiers.

The biased comparator

Figure 3A shows a method for biasing either comparator input to a specific reference voltage. This circuit is called a voltage level detector. Although in this case the noninverting input is biased and the inverting input is active, the roles can just as easily be reversed. Bias voltage V_1 is found using the voltage divider equation:

$$V_1 = \frac{R_2 (V_+)}{R_1 + R_2} \quad (5)$$

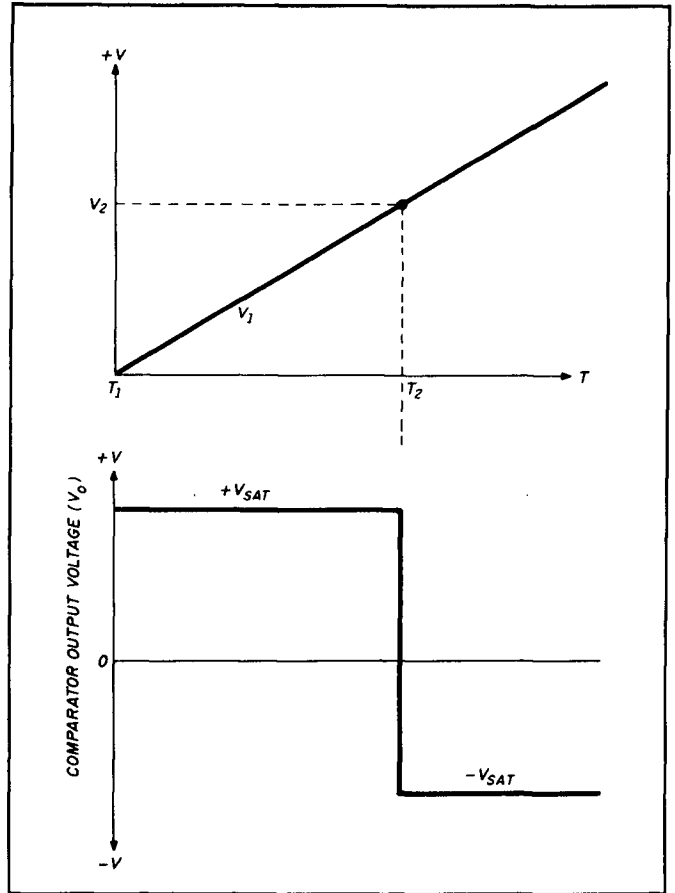
Figure 3B shows what happens when the noninverting input is biased to a positive voltage, V_2 . At time T_1 the voltage applied to the inverting input (V_1) begins to rise, but $V_1 < V_2$, so the output of the comparator is saturated to $+V_{sat}$. The V_1 potential continues rising until time T_2 when $V_1 = V_2$, so the output snaps toward zero; an instant later $V_1 > V_2$, so the output is saturated at $-V_{sat}$.

In the circuit presented in the section that follows, the noninverting input is biased through a resistor voltage divider, but the source potential is V_0 . Thus, V_2 will always be a fraction of V_0 , and of the same polarity. That configuration (see Figure 3C) is sometimes called a Schmitt trigger.

Monostable multivibrator circuits

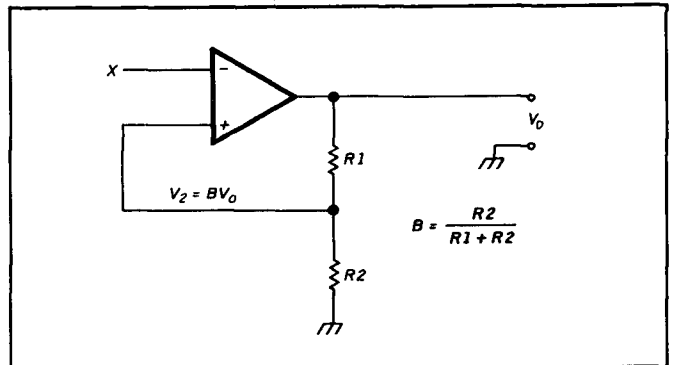
The monostable multivibrator (MMV) has two permissi-

FIGURE 3B



Graph illustrating the output of the comparator as the noninverting input is biased to a positive V_2 .

FIGURE 3C



Basic schematic of a Schmitt trigger.

ble output states (HIGH and LOW), but only one of them is stable. The MMV produces one output pulse in response to an input trigger signal (see Figure 4). The output pulse (V_0) has a duration, T , in which the output is in the quasi-stable state. The MMV is also known under several other names: one-shot, pulse generator, and pulse stretcher. The name "pulse stretcher" is derived from the fact that the output duration (T) is longer than the trigger pulse ($T > T_c$).

Monostable multivibrators have a wide variety of applications in electronic circuits. Besides the pulse stretcher, the MMV also serves to lock out unwanted pulses. Photo

THE MOST AFFORDABLE REPEATER

ALSO HAS THE MOST IMPRESSIVE PERFORMANCE FEATURES

(AND GIVES THEM TO YOU AS STANDARD EQUIPMENT!)

KIT, ONLY \$675
WIRED \$975
VHF OR UHF



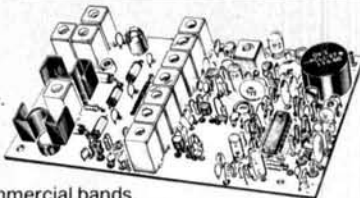
FEATURES:

- **SENSITIVITY SECOND TO NONE!** GaAsFET front end on vhf models gives 12dB SINAD of 0.12uV (vhf), 0.15uV (220). UHF model 0.25uV std, 0.1uV with optional helical resonator preamp.
- **SELECTIVITY THAT CAN'T BE BEAT!** Both 8-pole xtal filter & ceramic filter for > 100dB at only ±12kHz. Helical resonator front end to combat desense & intermod.
- **CLEAN, STABLE TRANSMITTER,** up to 18W output standard; 50W with accessory power amplifier.
- **FCC TYPE ACCEPTED** for commercial high band and uhf.
- **Courtesy beep,** field-programmable CWID, flutter-proof squelch, automatic frequency control to compensate for off-frequency transmitters (all standard features).
- **Full range of options** available, such as autopatch, phone line or radio remote control, sub-audible tones, duplexers.

HIGH PERFORMANCE TRANSMITTERS & RECEIVERS FOR REPEATERS AUDIO & DIGITAL LINKS, TELEMTRY, ETC.

•FM EXCITERS:

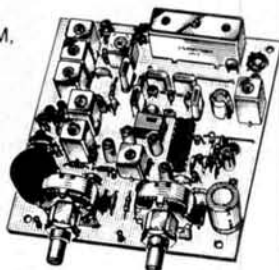
- Kits \$99, w/t \$179. 2W continuous duty. TCXO & xtal oven options available.
- **TA51 for 10M, 6M, 2M, 150-174, 220 MHz.**
 - **TA451 for uhf.**



- FCC type accepted for commercial bands.
- Call for latest information on 900 MHz transmitters.
 - **VHF & UHF AMPLIFIERS.** For FM, SSB, ATV. Output from 10 to 50 Watts. Several models, kits starting at \$79.

•R144/R220 FM RECEIVERS for 2M,

- 150-174, or 220 MHz. GaAs FET front end, 0.12uV sensitivity! Both crystal & ceramic filters plus helical resonator front end for exceptional selectivity: > 100dB at ±12kHz (best available anywhere)! Flutter-proof squelch. AFC tracks drifting transmitters. Kit \$149, w/t \$229.



- **R451 UHF FM RCVR.** Similar to above. Tuned line front end, 0.25uV sens. (0.1uV with optional hel. res. preamp). Kit \$149, w/t \$229.
- **R901 FM RCVR FOR 900 MHZ.** Triple-conversion, GaAs FET front end, 0.2uV sens. Kit \$169, w/t \$259.
- **R76 ECONOMY VHF FM RCVR** for 10M, 6M, 2M, 220. Without hel res or afc. Kits only \$129.
- **Weather satellite & AM Aircraft receivers also avail.**

FCC TYPE-ACCEPTED TRANSMITTERS & RECEIVERS AVAILABLE FOR HIGH-BAND AND UHF. CALL FOR DETAILS.

- Send \$1 for 36 page catalog by return mail. (Send \$2.00 or 4 IRC's for overseas mailing)
- Order by phone or mail • Min \$3 S & H per order
- Use Visa, Mastercard, Check, or UPS COD.

GaAs FET PREAMPS at a fraction of the cost of comparable units!

LNG -(*)

GaAs FET PREAMP



ONLY \$59!
Wired/tested

FEATURES:

- **Very Low Noise:** 0.7dB VHF, 0.8dB UHF
- **High Gain:** 13-20dB, depending on frequency
- **Wide Dynamic Range:** to resist overload
- **Stable:** new-type dual-gate GaAs FET

* Specify tuning range desired: 26-30, 46-56, 137-150, 150-172, 210-230, 400-470, or 800-960 MHz.

LNW -(*)

MINIATURE GaAs FET PREAMP



ONLY \$24/kit,
\$39 Wired/tested

GaAs FET Preamp similar to LNG, except designed for **low cost & small size.** Only 5/8"W x 1-5/8"L x 3/4"H. Easily mounts in many radios.

* Specify tuning range desired: 25-35, 35-55, 55-90, 90-120, 120-150, 150-200, 200-270, or 400-500 MHz.

LNS-(*)

IN-LINE PREAMP



ONLY \$79/kit,
\$99 Wired/tested

GaAs FET Preamp with features similar to LNG series, except **automatically switches out of line during transmit.** Use with base or mobile transceivers up to 25W.

*Specify tuning range desired: 120-175, 200-240, or 400-500 MHz.

HELICAL RESONATOR PREAMPS

Low-noise preamps with helical resonators **reduce intermod & cross-band** interference in critical applications.

MODEL HRA-(*), \$49 vhf, \$84 uhf.

* Specify tuning range desired: 142-150, 150-162, 162-174, 213-233, 410-454, or 454-475.

ACCESSORIES



COR-3 REPEATER CONTROLLER kit. Features adjustable tail & time-out timers, solid-state relay, courtesy beep, and local speaker amplifier.\$49

CWID kit. Diode programmed, adjustable tone, speed, and timer, to go with COR-3.\$59

NEW COR-4 kit. Complete COR and CWID all on one board for easy construction. CMOS logic for low power consumption. Many new features. EPROM programmed; specify call letters. \$99

NEW TD-3 SUBAUDIBLE TONE DECODER/ENCODER kit.\$24

TD-2 DTMF DECODER/CONTROLLER kit. Full 16 digits, with toll-call restrictor, programmable. Can turn 5 functions on/off. Great for selective calling, too!\$79

AP-3 AUTOPATCH kit. Use with above for repeater autopatch. Reverse patch and phone line remote control are std.\$79

AP-2 SIMPLEX AUTOPATCH Timing Board kit. Use with above for simplex operation.\$39

MO-202 FSK DATA MODULATOR kit. Run up to 1200 baud digital signals through any fm transmitter with full handshakes. Radio link computers, telemetry gear, etc.\$39

DE-202 FSK DEMODULATOR kit. For receive end of link.\$39

9600 BAUD DIGITAL RF LINKS. Low-cost packet networking system, consisting of new MO-96 Modem and special versions of our 220 or 450 MHz FM Transmitters and Receivers. Interface directly with most TNC's. Fast, diode-switched PA's output 15 or 50W. Call for info on the right system for your application!

RECEIVING CONVERTERS



	Antenna Input Range	Receiver Output
	28-32	144-148
	50-52	28-30
	50-54	144-148
VHF MODELS	136-138	28-30
	144-146	28-30
	145-147	28-30
Kit with Case	\$59	146-148 28-30
Kit less Case	\$39	220-222 28-30
Wired w/case	\$89	220-224 50-54
		222-224 28-30
UHF MODELS	432-434	28-30
Kit with Case	\$69	435-437 28-30
		432-436 144-148
Kit less Case	\$49	432-436 50-54
Wired w/case	\$99	439-25 61-25
		902-928 422-440
		902-922 430-450

See catalog for full line of 2w transmitting converters for vhf & uhf. Kits only \$79. Linear Amplifiers avail. up to 50 w.

Our 26th Year

hamtronics, inc.

65-H MOUL ROAD • HILTON NY 14468-9535

Phone: 716-392-9430 Hamtronics® is a registered trademark

WE SHIP WORLDWIDE
Barry Electronics Corp.
 WORLD WIDE AMATEUR RADIO SINCE 1950
 Your one source for all Radio Equipment!



May We Help You With the Best in Commercial and Amateur Radios? Lew W2BIE, Tom, Kitty WA 2BAP, and Jan KB2RV.
 SEE You Sept. 17th-LIMARC, Old Westbury, NY

KITTY SAYS: WE ARE NOW OPEN 7 DAYS A WEEK. Saturday & Sunday 10 to 5 P.M.
 Monday-Friday 9 to 6:30 PM Thurs. to 8 PM
 Come to Barry's for the best buys in town.



ONV Safety belts in stock
YAESU
 FT-767GX, FT-757GXII, FT-747GX, FRG-8800, FT-736R, FRG-9600, FT-4700RH, FT-212/712RH, FT-470

For the best buys in town call: **212-925-7000**
 Los Precios Mas Bajos en Nueva York
WE SHIP WORLDWIDE!



ICOM
 IC-R71A, 751A, 781, 284V, 36A, 48A, Micro214, R-7000, IC-765, IC-375A, 275A/H, 3210A, 475AH, 735, IC-901, IC-288H, IC725

KENWOOD



TS40SGIAT, R-5000, R-2000, TS-940, SGIAT, TM 280A/K431A, TM-2570A/50A/30A, TR-751A, Kenwood Service Repair, TM-701A, TS-7118/11A, TM30530A, TH205AT, TH111A, TM-601A, TM-321A, TS-1405, TS8805, RZ-1, TS-790A

Butleg ANT. Products
 NEL TECH DVK-100 Digital Voice Keyer
 FLURKE 77, 83, 85, 87 Multimeters

Media Mentions - Amateur Radio Counselor
VoCom/Mirage/Alinco Tokyo Hy-Power/TE SYSTEMS Amplifiers & 5/8 HT Gain Antennas IN STOCK

MICROLOG-ART 1, Air Disk, SWL, Morse Coach

Professional Soldering Station 48 Watts \$79
METRON KW HF Mobile Amplifier Stocked

Alpha Delta Products Stocked
EIMAC 3 500Z, 572B, 6JS6C, 12BY7A & 6146B

AEA 144 MHz, AEA 220 MHz, AEA 440 MHz ANTENNAS
BIRD Wattmeters & Elements In Stock



AMPLIFIERS STOCKED: RF Concepts, Mirage, TE Systems
IC-32AT, Motorola Radius R-100, TH-75AT, FT-470

ALINCO DJ-500T, DR-110T
FREQUENCY COUNTERS: 1MHz-1.5GHz
COMMERCIAL 5 HAM REPEATERS STOCKED: WRITE IN QUOTES
 Kantronics UTU, KAM, KPC II, KPC 2400, KPC IV, KAM

MOTOROLA AUTHORIZED DEALER KACHINA COMMUNICATIONS DEALER
AUTHORIZED SONY DEALER
 DIGITAL FREQUENCY COUNTERS Optoelectronics model 1300 H/A, D-1300MHz
 2210 Hz, 0-2000 MHz
 Long range Wireless Telephone for export in stock

BENCHER PADDLES, BALUNS, LOW PASS FILTERS IN STOCK
MIRAGE AMPLIFIERS, ASTRON POWER SUPPLIES Saxton Wire & Cable, In'l Wire
OPTO KEYERS STOCKED



SANGEAN Portable Shortwave Radios
 Hy-Gain Towers & Antennas, and more will be shipped direct to you FREE of shipping cost!
 16 Towers, Antennas, Mobile Radio mounts stocked. Call
AMERITRON AUTHORIZED DEALER

SMART PATCH
 CES Complex Autopatch S-10 SA Will Patch FM Transceiver To Your Telephone. Great For Telephone Calls From Mobile To Base Simple To Use. \$105AS105AS!

PRIVATE PATCH V, Duplex 8000
TUNERS STOCKED: NYE MBV-A-3 Killowatt Tuner



MFJ-989C
COVERCALL COAXIAL STOCKED
SHORTWAVE RECEIVERS STOCKED

Ten-Tec Tuner 238
COMET ANTENNAS STOCKED

Radios for Business, Gov't, 2-way, etc. Stocked & serviced, call for great prices!
HEIL EQUIPMENT IN STOCK

NEWEN'S STOCK COMMERCIAL COMMUNICATIONS SYSTEMS
 HAM DEALER INQUIRES INVITED. PHONE IN YOUR ORDER & BE REIMBURSED
COMMERCIAL RADIOS STOCKED & serviced on premises.
Amateur Radio Courses Given On Our Premises, Call
Export Orders Shipped Immediately. TELEX 12-7670
FAX: 212-925-7001

MAIL ALL ORDERS TO: BARRY ELECTRONICS CORP., 512 BROADWAY, NEW YORK CITY, NY 10012 (FOUR BLOCKS NORTH OF CANAL ST.)

New York City's LARGEST STOCKING HAM DEALER COMPLETE REPAIR LAB ON PREMISES

"Aquí Se Habla Español"
BARRY INTERNATIONAL TELEX 12-7670
 MERCHANDISE TAKEN ON CONSIGNMENT FOR TOP PRICES
 Monday, Friday 9 A.M. to 6:30 P.M. Thursday to 8 P.M.
 Saturday & Sunday 10 A.M. to 5 P.M. (Free Parking)
 IRT/TELEX "Spring St. Station" Subways: BMT - "Prince St. Station" IND - "F" Train-Buy Station
 Bus: Broadway #6 to Spring St. Path-9th St./6th Ave Station.

COMMERCIAL RADIOS STOCKED: ICOM, Motorola, MAXON, Standard
 YAESU. We serve municipalities, businesses, Civil Defense, etc. Portables, mobiles, bases, repeaters.

ALL SALES FINAL

We Stock: AEA, ARRL, Alinco, Ameco, Ameritron, Antenna Specialists, Astatic, Astron, B&K, B&W, Bencher, Bird, Butternut, CDE, CES, Cushcraft, Danwa, Eimac, Henry, Heil, Hustler, Hy-Gain, Icom, KLM, Kantronics, Larsen, MJF, J.W. Miller, Mirage, Nye, Palomar, RF Products, Saxton, Shure, Tempo, Ten-Tec, TUBES, Yaesu, Vitroplex, Duplexers, Repeater, Scanners, Radio Publications, Uden, Kenwood, Maxon, RFC.

2 METER AMPLIFIERS • ATV CONVERTERS

DISCOVER THE WORLD OF FAST SCAN TELEVISION:



AMATEUR TELEVISION CONVERTERS
 ATV-2 420-450 MHz \$ 44.95 Kit
 ATV-3 420-450 MHz GaAs-Fet \$ 49.95 Kit
 ATV-4 902-928 MHz GaAs-Fet \$ 59.95 Kit

Available in Kit or Assembled/Tested
 Add \$ 2.00 For Shipping and Handling

RF Amplifiers Per Motorola Bulletins
 Complete Parts list for:

140 Watt or 300 Watt HF Amplifiers per Motorola Bulletins	AN-75B, AN-76Z, EB-27A, EB-63	
CAMBION RF CHOKES	0.15 uh, 0.22 uh, 0.33 uh	
4.7 uh, 10 uh		\$ 1.20
MIXERS		
SBL-1 DBL Bal Mixer		\$ 6.50
SBL-1X DBL Bal Mixer		\$ 7.95
FERROX-CUBE DEVICE		
VK200-20/4B RF Choke		\$ 1.20
56-590-65-18 Ferrite Bead		\$ 2.20
POWER SPLITTER/COMBINER		
2-30 MHz, 600 Watts (2 Port or 4 Port)		



WIRELESS BAND TRANSFORMERS PER MOTOROLA BULLETINS

We Also Stock Hard-To-Find Parts
KEMET CHIP CAPACITORS
METALLCLAD MICR CAPACITORS
SEMICONDUCTORS
RF POWER TRANSISTORS

For detailed information, please call or write for our free catalog



121 Brown Street • Dayton, Ohio 45402 • (513) 220-9677

HAM RADIO BOOKSTORE
 GREENVILLE, N.H. 03048
 (603) 878-1441

UHF COMPENDIUM Part III and IV
 Edited by K. Weiner, DJ9HO
 This is one of the most long awaited books in Amateur Radio. It represents over two years of work and contains more than theory — it's chock full of practical, tested designs from some of Europe's most noted hams. Subjects covered include: notch filters, antennas and IF pre-amps, transistor drivers, transmit and receive converters, power amplifiers and much more. This book is guaranteed to be a best seller. Order yours today (this book is imported and supplies will vary due to shipping delays) 1989 1st Edition
KW-UHF3 Softbound \$29.95

1989-1990 ARRL REPEATER DIRECTORY
 Includes all the latest repeater listings available. Lists 13,000 repeaters, 2,200 duplexers, and 475 beacon stations from 14 MHz to 24 GHz. Get your copy of this new book today
 1989
AR-RD Softbound \$4.95

ARRL CODE TAPES
 Four new sets of code practice tapes from the ARRL. Each set consists of two 90 minutes cassettes and gives you almost 3 full hours of practice. Great way to study when you can't get on the air.
AR-1 5-10 WPM \$9.95
AR-2 10-15 WPM \$9.95
AR-3 15-22 WPM \$9.95
AR-4 13-14 WPM \$9.95

THE FABULOUS RADIO NBD
 by Brandon Wentworth, K6UJ
 Here is the story of one of WW I's most important radio stations. Written from the first hand stories and actual experiences of the men who operated NBD. Includes technical descriptions of the equipment and antennas. Great history reading.
 1984 1st edition 34 pages
BH-NBD Softbound \$4.95

NEWEN'S Radio Amateur and Listener's Pocket Book
 by Steven Money, G3FZX
 Unique collection of useful information for the Radio Amateur and hi-tech listener. Full of hard-to-find information. Includes codes, symbols, formulae, frequencies, in addition to AMTOR, packet and SSTV. Handy pocket book size. 1987 1st edition 160 pages
CRC-RA Hardbound \$19.95

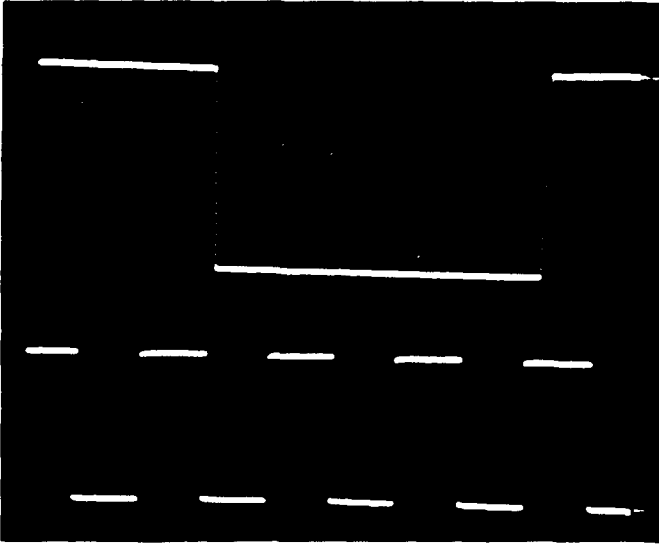
WIRELESS ANTENNA HISTORY
 A vertical design primer
 by Walter Schulz, K3DFD
 Starts with a well written history of radio's beginnings. Nine chapters cover radio from the first pioneers through the beginnings of radio astronomy. The vertical primer is a complete section on how to design, build and optimize a vertical antenna. Full of explanations and handy hints not found elsewhere. 1988 1st edition 140 pages
GL-00F Softbound \$16.95

HINTS AND KINKS for the Radio Amateur
 edited by K8CH & AK7M
 This is the twelfth collection of ideas taken from QST's most popular column. Hints and Kinks. Other's hands on experience can save you hours with suggestions on how to build a better mousetrap. Includes ideas on station accessories, operating (w. computers), antennas, shop secrets and much more! Great new edition! 1989 12th edition
AR-HK Softbound \$4.95

RADIO AMATEUR CALLBOOK SUPPLEMENT
 both NA and DX listings
 Includes all the latest calls and address changes for hams around the world. Invaluable aid to getting coveted QSLs from rare DX stations. This is the only way to be fully up to date. Over 300 pages. 1989
CB-SUP89 Softbound \$9.95

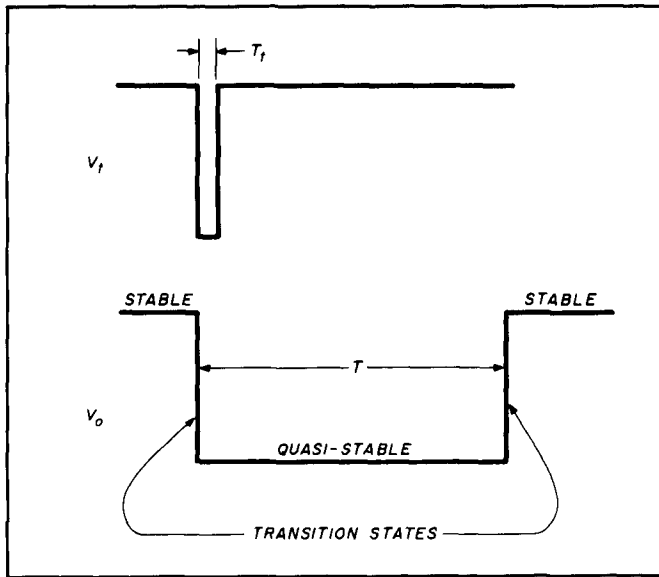
N6RJ'S SECOND OP MANUAL VERSION
 Now available in slide rule format for non-computerized hams! Fully up dated with all the latest prefxes, zones, postage and other information. GET YOUR S TODAY! 2nd edition 1989
CB-20P \$9.95
Please enclose \$3.75 for shipping and handling

PHOTO A



The monostable multivibrator responds to only the first triggered input until the MMV is reset.

FIGURE 4



Output of a monostable multivibrator (one shot). V_t is the input trigger voltage and V_o is the output response.

A shows that the output responds to only the first trigger pulse. The next three pulses occur during the active time, T , so are ignored. Such an MMV is said to be "nonretriggerable." A common application of this feature is in switch contact debouncing. All mechanical switch contacts bounce a few times on closure, creating a short run of exponentially decaying pulses. If an MMV is triggered by the first pulse from the switch, and if the MMV remains quasi-active long enough for the bouncing to die out, then the MMV output signal becomes the debounced switch closure. The main requirement is that the MMV duration be longer than the switch contact bounce pulse train; 5 ms is generally considered adequate for most switch types.

Figure 5A shows the circuit for a nonretriggerable monostable multivibrator based on the operational amplifier. This circuit is based on the voltage comparator circuit discussed earlier. When there's no feedback, the effective voltage gain of an op amp is its open loop gain (A_{vol}). When both $-IN$ and $+IN$ are at the same potential, the differential input voltage (V_{id}) is zero, so the output is also zero. But if $V(-IN)$ doesn't equal $V(+IN)$, the high gain of the amplifier forces the output to either its positive or negative saturation values. If $V(-IN) > V(+IN)$, the op amp sees a positive differential input signal, so the output saturates at $-V_{sat}$. However, if $V(-IN) < V(+IN)$, the amplifier sees a negative differential input signal, and the output saturates to $+V_{sat}$. The operation of the MMV depends on the relationship of $V(-IN)$ and $V(+IN)$.

There are four states of the monostable multivibrator that must be considered. They include the stable, transition, quasi-stable, and refractory states.

Stable state

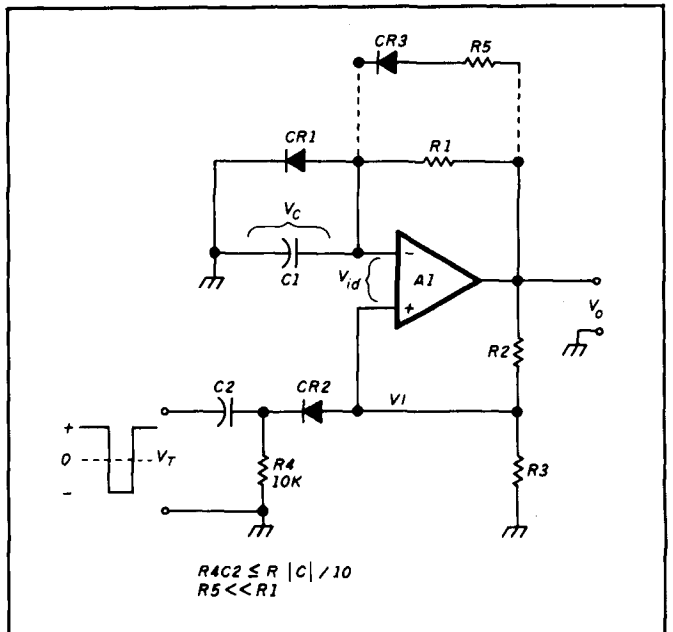
The output voltage V_o is initially at $+V_{sat}$. Capacitor C_1 attempts to charge in the positive-going direction because $+V_{sat}$ is applied to the R_1C_1 network. But because of diode CR_1 shunted across C_1 , the voltage across C_1 is clamped to $+V_{CR1}$ (for a silicon diode like the 1N914 or 1N4148, $+V_{CR1}$ is about $+0.7$ volts DC). Thus, the inverting input ($-IN$) is held to $+0.7$ volts DC during the stable state. The noninverting input ($+IN$) is biased to a level V_1 , which is:

$$V_1 = \frac{R_3 (+V_{sat})}{R_2 + R_3} \quad (6)$$

or, in the special case of $R_2 = R_3$:

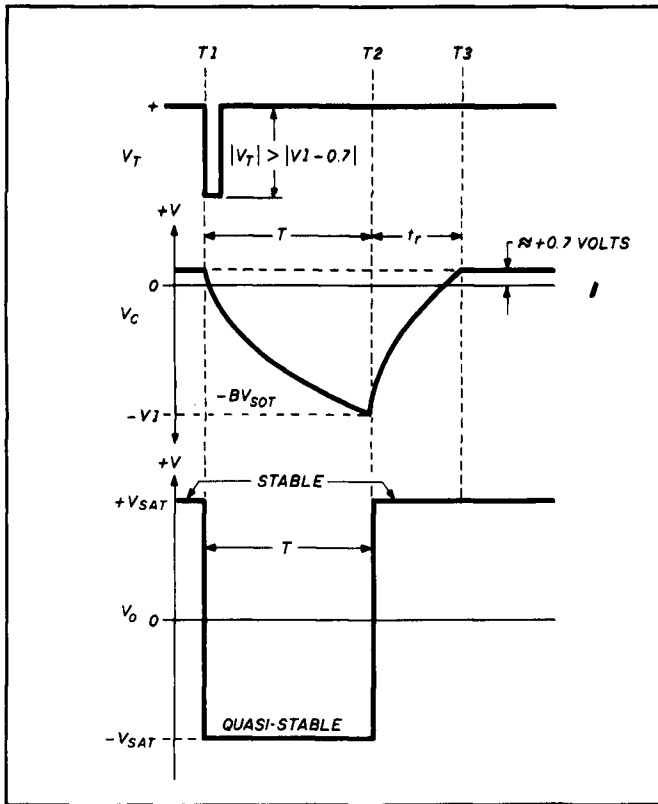
$$V_1 = \frac{+V_{sat}}{2} \quad (7)$$

FIGURE 5A



Schematic of a non-retriggerable monostable multivibrator (one-shot).

FIGURE 5B



Graphical representation of the various voltages associated with the monostable multivibrator.

The amplifier (A1) sees a differential input voltage (V_{id}) of $V_1 - V_{CR1}$, or $V_1 - 0.7$ volts:

$$V_{id} = \frac{R_3(+V_{sat})}{R_2 + R_3} - 0.7 \quad (8)$$

As long as $V_1 > V_{CR1}$, the amplifier effectively sees a negative DC differential voltage at the inverting input, so (with its high open loop gain) A_{vol} will remain saturated at $+V_{sat}$. For this discussion, the amplifier is a type 741 operated at DC power supply potentials of ± 12 volts DC, so V_{sat} will be ± 10 volts.

Transition state

The input trigger signal (V_t) is applied to the MMV of Figure 5A through RC network R_4C_2 . The general design rule for this network is that its time constant should be no more than one-tenth the time constant of the timing network:

$$R_4C_2 < \frac{RCI}{10} \quad (9)$$

At time T_1 (see Figure 5B) trigger signal V_t makes an abrupt HIGH to LOW transition to a peak value less than $V_1 - 0.7$ volts. Under this condition, the polarity of V_{id} is reversed and the inverting input sees a positive voltage: $V_1 + V_t - 0.7 < V_{CR1}$. The output voltage V_o now snaps rapidly to $-V_{sat}$. The fall time of the output signal is dependent upon the slew rate and the open-loop gain of the operational amplifier, A1.

Quasi-stable state

The output signal from the MMV is the quasi-stable state

between T_1 and T_2 in Figure 5B. It's called "quasi-stable" because it doesn't change over $T = T_2 - T_1$. But when T expires, the MMV "times out," and V_o reverts to the stable state ($+V_{sat}$).

During the quasi-stable time, CR_1 is reverse biased and capacitor C_1 discharges from $+0.7$ volt DC to zero, and then recharges towards $-V_{sat}$. However, when $-V_o$ reaches $-V_1$, the value of V_{id} crosses zero, and that change forces V_o to snap once again to $+V_{sat}$.

Equation 4 makes it possible to derive the timing equation for the MMV. The timing capacitor must charge from an initial value (V_{c1}) to a final value (V_{c2}) in time T . What value of R_1C_1 will cause the required transitions? Consider the case $R_2 = R_3$ ($V_1 = 0.5 V_{sat}$):

$$RCI = \frac{-T}{\ln \left[\frac{V_{sat} - V_{c2}}{V_{sat} - V_{c1}} \right]} \quad (10)$$

$$RCI = \frac{-T}{\ln \left[\frac{V_{sat} - ((0.5)(V_{sat} + 0.7))}{V_{sat} - 0.7} \right]} \quad (11)$$

and, for the case $V_{sat} = 10$ volts DC:

$$RCI = \frac{-T}{\ln \left[\frac{10 V - ((0.5)(10 + 0.7))}{10 V - 0.7 \text{ volts}} \right]} \quad (12)$$

Thus,

$$T = 0.69RCI \quad (13)$$

Equation 10 represents the special case in which $B = 1/2$ (i.e., $R_2 = R_3$). Although $R_2 = R_3$ may be the usual case for this class of circuit, R_2 and R_3 might not be equal in other cases. A more generalized expression is:

$$RC = \ln \left[\frac{1 + 0.7/V_{sat}}{1 - B} \right] \quad (14)$$

In which:

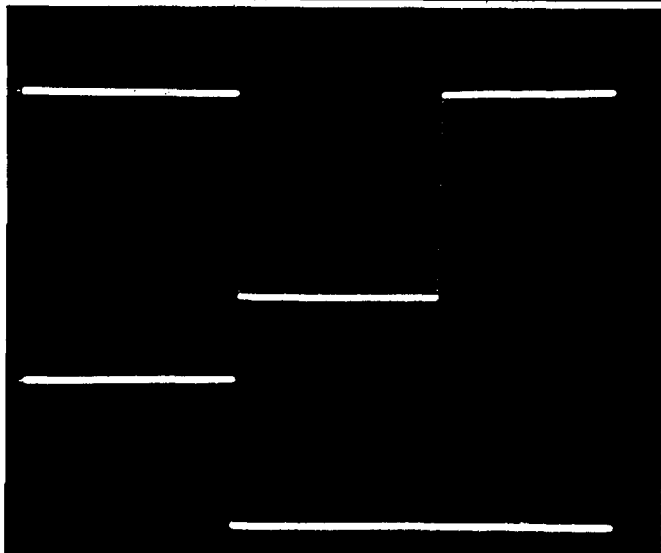
$$B = \frac{R_3}{R_2 + R_3} \quad (15)$$

When the quasi-stable state times out, the circuit status returns to the stable state, where it remains dormant until triggered again.

Refractory period

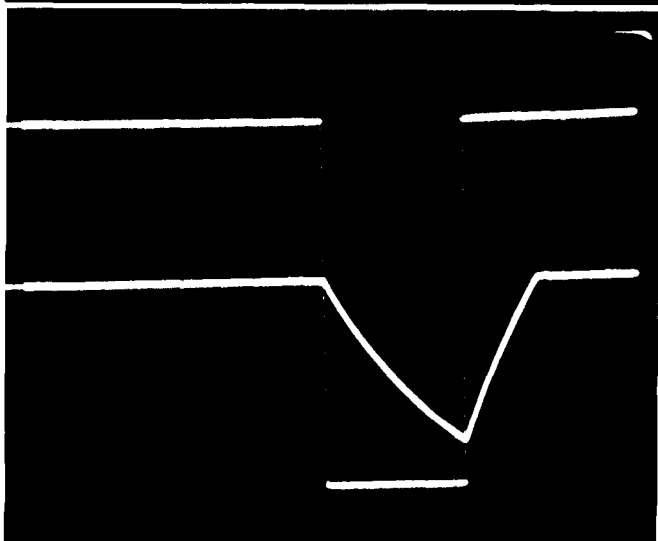
At time T_2 , the output signal voltage V_o switches from $-V_{sat}$ to $+V_{sat}$. Although the output has timed out, the MMV isn't ready to accept another trigger pulse. The refractory state between T_2 and T_3 is characterized by the output being in the stable state, but the input is unable to accept a new trigger input stimulus. The refractory period must wait for the discharge of C_1 under the influence of the output voltage to satisfy $V_1 < (V_1 - 0.7)$ volts. In preparing this article, I built several MMV circuits using 741 op

PHOTO B



Top trace shows the output voltage (V_o) and the bottom trace shows the trigger voltage (V_t).

PHOTO C



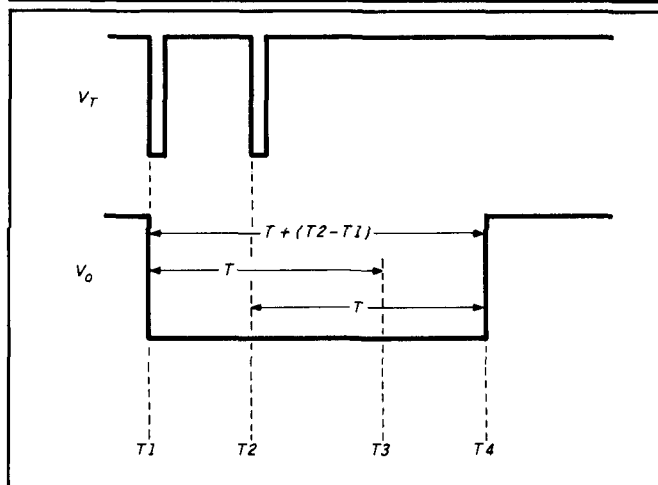
V_o is superimposed on the capacitor voltage (V_c).

amps operated from ± 12 volt DC power supplies. **Photo B** shows the output voltage (V_o) and trigger pulses (V_t). In **Photo C** the output pulse is superimposed on the capacitor voltage (V_c). The refractory period is shown as the increasing segment of V_c .

Retriggerable monostable multivibrators

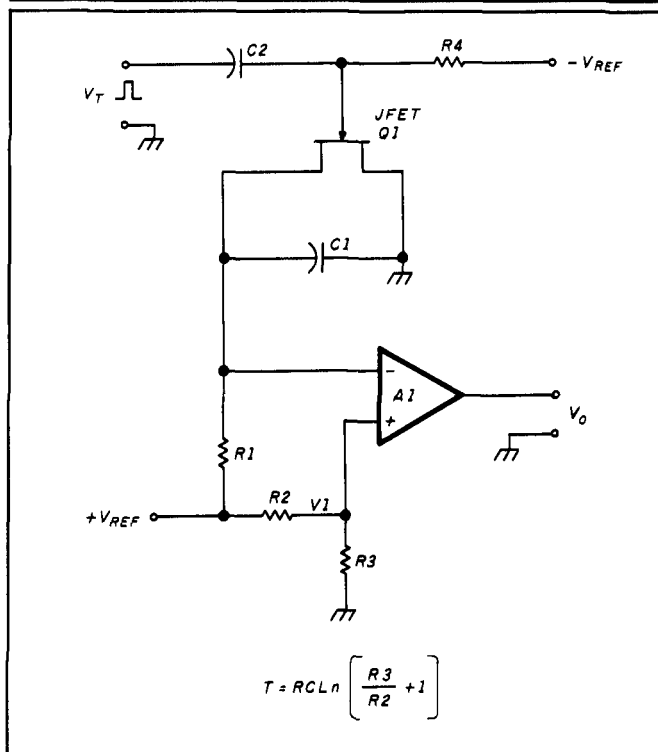
The circuit in **Figure 5A** is a nonretriggerable MMV. Once it's triggered, the circuit won't respond to further trigger inputs until after both the quasi-stable and refractory states are completed. A retriggerable monostable multivibrator (RMMV) will respond to further trigger signals.

FIGURE 6



Response of the retriggerable monostable multivibrator.

FIGURE 7A



Schematic of a basic retriggerable monostable multivibrator.

Figure 6 shows the response for the retriggerable MMV. An initial trigger signal (V_t) is received at time T_1 . The output snaps LOW and, under normal circumstances, would remain in this quasi-stable state until time T_3 , when the duration T expires. But at time T_2 , a second trigger pulse is received. The circuit is now retriggered for another duration T , so it won't time out until T_4 . The total time that the RMMV is in the quasi-stable state is $[T + (T_2 - T_1)]$. In other words, the RMMV output is active for the entire duration T , plus that portion of the previous active time which expired when the next trigger pulse was received.

Figure 7A shows the circuit for a simple RMMV based

★ ALL NEW KITS ★

RAMSEY ELECTRONICS

Quality Test Gear & Electronic Kits for Professionals and Hobbyists

2 MTR & 220 BOOSTER AMP

Here's a great booster for any 2 meter or 220 MHz hand-held unit. These power boosters deliver over 30 watts of output allowing you to hit the repeaters full quieting while the low noise preamp remarkably improves reception. Ramsey Electronics has sold thousands of 2 mtr amp kits but now, we offer completely wired and tested 2 mtr as well as 220 MHz units. Both have all the features of the high priced boosters at a fraction of the cost.



PA-10 2 MTR POWER BOOSTER (10 X power gain)
Fully wired & tested..... \$69.95

PA-20 220 MHz POWER BOOSTER (8 X power gain)
Fully wired & tested..... \$69.95

- 30 WATTS OUTPUT
- LOW NOISE PREAMP
- LOW COST
- RUGGED CAST ALUMINUM CASE
- ONE YEAR WARRANTY



PERSONAL SPEED RADAR

New low cost microwave doppler radar kit "clocks" cars, planes, boats, horses, bikes, baseballs, models, turners or virtually anything that moves. Operates at 2.6 GHz with over 1/4 mile range. LED digital readout displays speeds in miles per hour, kilometers per hour or feet per second! Earphone output permits listening to actual doppler shift. Uses two 1 lb coffee cans for antenna (not included) and runs on 12 VDC. Easy to build—all microwave circuitry is IC strip-line. Kit includes deluxe ABS plastic case with speed graphics for a professional look. A very useful and full-of-fun kit!

Complete kit SG-7
\$89.95

RADIOS

20, 40 & 80 METERS HAM RECEIVERS

Sensitive all mode. AM, CW, SSB receivers for 3.5-4.0 or 70-75 MHz. Direct conversion design using NE602 IC as featured in QST and ARRL handbooks. Less than 1 μ v sensitivity. varactor diode tuned. 50 mw audio output. Runs on 9VDC, has RF gain control. This kit is very easy to build. Lots of fun and educational—ideal for the beginner or the old pro. The optional matching case kit features a rugged ABS plastic case with screened graphics. Included are machined aluminum knobs for a well-finished professional look.

20 MTR receiver kit HR-2	40 MTR receiver kit HR-4	80 MTR receiver kit HR-6	Receiver Case CHR
\$24.95	\$24.95	\$24.95	\$12.95

QRP TRANSMITTER KITS, 20, 40 & 80 METERS

Operate a mini ham shack. These little CW rigs are ideal mates to our 40 and 80 meter receivers. Features include smooth variable tuning, one watt output and excellent keying characteristics. Runs on 12 VDC and is VSWR protected. See how far you can stretch your signal with one of these mini rigs. Optional ABS cases are available.

20 MTR QRP kit QRP-2	40 MTR QRP kit QRP-4	80 MTR QRP kit QRP-6	Case kit CORP
\$29.95	\$29.95	\$29.95	\$12.95

AIRCRAFT RECEIVER KIT

Hear exciting aircraft communications—picks up planes up to 100 miles away. Receives 110-136 MHz AM air band. varactor tuned superhet design with AGC, ceramic filter and adjustable squelch. Runs on 9V battery. 50 mw audio output. 1 μ v sensitivity. Optional matching ABS plastic case lets you take it anywhere. Features screened graphics and machined aluminum knobs for a professional look. Compact—great for airshows or for just plain hanging around the airport.

Complete kit AR-1	Receiver case kit CAR-1
\$24.95	\$12.95



SHORTWAVE RECEIVER KIT

A fantastic receiver that captures the world with just a 12" antenna! Receives 4-11 MHz in 2 MHz bands. varactor tuned. superhet design with AGC, RF gain control, and 50 mw audio output. Uses new Signetics mixer chip for less than a microvolt sensitivity, runs on 9V battery. This is a fascinating scout, school or club project, and will provide hours of fun even to the most discerning DX'er. Add the optional case kit and you have a real nice looking shortwave set.

Complete kit SR-1	Receiver case kit CSR-1
\$24.95	\$12.95

PACKET RADIO

Commodore 64/128 packet radio interface. Uses famous German Digicom software. Features EXAR IC chip set for reliable operation—runs HF or VHF tones. Includes FREE disk software, PC board, all necessary parts and full documentation.

Complete kit PC-1
\$49.95

FM COMMUNICATIONS/ 2 MTR, 10 MTR & 220 RECEIVERS

Sensitive superhet FM receiver tunes any 5 MHz segment of band. Listen to ham operations, high band police calls, weather or mobile phone calls! Easy to build receiver features varactor tuning, IC mixer stage, ceramic IF filters and dual conversion design with adjustable squelch. Less than 1 μ v sensitivity, runs on 9 V battery, with 50 mw audio output. Optional ABS case with screened graphics and machined aluminum knobs provide a nice professional look.

2 MTR kit FR-7	10 MTR kit FR-10	220 MHz kit FR-20	Receiver case kit CFR-7
\$29.95	\$29.95	\$29.95	\$12.95

NEW MINIKITS—NEW MINIKITS

BROADBAND PREAMP

A sensitive all purpose preamp, ideal for scanners, TV sets, VHF, UHF, rigs, counters, etc. Features low noise, 4 dB NF, 20 db gain, 100 KHz—1 GHz operation. Runs on 9-12 VDC. 50 ohms output.

Complete kit SA-7
\$14.95

LIGHT BEAM COMMUNICATORS

Transmits modulated infrared light up to 30 feet without lenses. Uses up to 1/4 mile using lenses. Uses 30 KHz carrier for burn-free operation. Transmits thru windows, etc. Ideal for "bugs" or listening to remote controls. Transmitter has sensitive mike input, receiver uses PIN detector and drives speaker output. Units operates on 9-12 VDC.

Transmitter kit LB-6	Receiver kit LB-5
\$8.95	\$9.95

HIGH POWER FM WIRELESS MIKE

A high power unit that will transmit up to 1/2 mile to any FM broadcast radio. Sensitive input accepts any type of mike, will pick up normal voices 10 feet away using the available mini-electric microphone cartridge. Operates on 9-12 VDC.

FM-4 kit
\$12.95



PR-2 COUNTER PREAMP

The PR-2 is ideal for measuring weak signals from 10 to 1,000 MHz • flat 25 db gain • BNC connectors • great for sniffing RF • ideal receiver TV preamp • 3 dB NF

\$49.95

wired includes AC adapter
PR-2 kit \$39.95



PS-2 AUDIO MULTIPLIER

The PS-2 is handy for high resolution audio resolution measurements. Multiplies up in frequency • great for PL tone measurements • multiplies by 10 or 100 • 0.01 Hz resolution & built-in signal preamp/conditioner

\$69.95

wired PS-2 kit \$49.95



PS-10B 1.5 GHz PRESCALER

Extends the range of your present counter to 1.5 GHz • 2 stage preamp • divide by 1000 circuitry • super sensitive (50 mV typical) • BNC connectors • 1.5 GHz in, 1.5 MHz out • drives any counter

\$89.95

wired includes AC adapter

COM-3



\$2795.00 THE COMMUNICATIONS SERVICE MONITOR THAT WORKS HARDER FOR LESS.

Introducing COM-3... the new service monitor designed by service technicians for service technicians. It works harder for less... giving you advanced testing capabilities at a very affordable price. FEATURES • Direct entry keyboard with programmable memory • Audio & transmitter frequency counter • LED bar graph frequency/error deviation display • 0.1-10,000 μ v output levels • High receive sensitivity, less than 5 μ v • 100 KHz to 999.9995 MHz Continuous frequency coverage • Transmit protection, up to 100 watts • CTS tone encoder, 1 KHz and external modulation

MINI KITS—EASY TO ASSEMBLE—FUN TO USE

<h4>tone decoder</h4> <p>A complete tone decoder on a single PC board. Features 4000-5000 Hz adjustable range via 20 turn pot, voltage regulation 561 IC. Useful for touch-tone burst detection, FSK, etc. Can also be used as a stable tone encoder. Runs on 5 to 12 volts.</p> <p>Complete kit, TD-1 \$5.95</p>	<h4>COLOR ORGAN</h4> <p>See music come alive! 3 different lights flicker with music. One light each for high, mid-range and lows. Each individually adjustable and drives up to 300 W runs on 110VAC.</p> <p>ML-1 Kit \$8.95</p>	<h4>VIDEO MODULATOR</h4> <p>Converts any TV to video monitor. Super stable, tunable over ch 4-6. Runs on 5-15V accepts std. video signal. Best unit on the market! Complete kit, JM-7 \$12.95</p>	<h4>FM WIRELESS MIKE</h4> <p>Transmits up to 300' to any FM broadcast radio using any type of mike. Runs on 3 to 9V Type FM-2 has added sensitive mike preamp stage.</p> <p>FM-1 Kit \$5.95 FM-2 Kit \$7.95</p>
<h4>40 WATT 2 mtr PWR AMP</h4> <p>Simple Class C power amp features 8 times power gain 1 W in for 8 out, 2 W in for 16 out, 5 W in for 40 W out. Max output of 50 W, incredible value, complete with all parts, less case and T-Relay.</p> <p>PA-1, 40 W pwr amp kit \$27.95 TR-1, RF sensed T-R relay kit 6.95</p>	<h4>VOICE ACTIVATED SWITCH</h4> <p>Voice activated switch kit provides switched output with current capability up to 300 mA. Can drive relays, lights, LED or even a tape recorder motor. Runs on 9VDC.</p> <p>VS-1 Kit \$6.95</p>	<h4>LED BLINKY KIT</h4> <p>Alternately flashes 2 jumbo LEDs. Use for name badges, buttons, warning panel lights. Runs on 3 to 15 volts.</p> <p>BL-1 Kit \$3.95</p>	<h4>MAD BLASTER</h4> <p>Produces LOUD ear shattering and attention getting siren like sound. Gain supply up to 15 watts of obnoxious audio. Runs on 6-15 VDC.</p> <p>MB-1 Kit \$4.95</p>
<h4>UNIVERSAL TIMER</h4> <p>Provides the basic parts and PC board required to provide a source of precision timing and pulse generation. Uses 555 timer IC and includes a range of parts for most timing needs.</p> <p>UT-5 Kit \$5.95</p>	<h4>WHISPER LIGHT</h4> <p>An interesting kit, small mike picks up sounds and converts them to light. The louder the sound, the brighter the light. Includes mike, controls up to 300 W runs on 110 VAC.</p> <p>WL-1 Kit \$6.95</p>	<h4>SIREN</h4> <p>Produces upward and downward wail. 5 W peak audio output, runs on 3-15 volts, uses 3-45 ohm speaker.</p> <p>Complete kit, SM-3 \$3.95</p>	

<h4>SUPER SLEUTH</h4> <p>A super sensitive amplifier which will pick up a pin drop at 15 feet! Great for monitoring baby's room or as general purpose amplifier. Full 2 W rms output, runs on 15 volts, uses 8-45 ohm speaker.</p> <p>BN-9 Kit \$5.95</p>	<h4>TELEPHONE TRANSMITTER</h4> <p>Low cost with professional performance. Features include: self phone line powered, tunable from 75 to 100 MHz, polarity antisensitive, compact size (1" x 1 1/2"), easily installed anywhere on the phone line or inside the instrument itself.</p> <p>PB-1 Kit \$14.95</p>	<h4>FM RECEIVER</h4> <p>For built-in applications or hobby experimentation. Full featured super-heterodyne receiver, microvolt sensitivity, 10.7 MHz IF. Integrated Circuit detector, 50 mw audio amplifier, 5V external power source, operation on standard FM broadcast band as well as large portions on each side, compact 16" square, for bug detection or reception.</p> <p>FR-1 Kit \$14.95</p>	<h4>FM MINI MIKE</h4> <p>A super high performance FM wireless mike kit! Transmits a stable signal up to 300 yards with exceptional audio quality by means of its built in electret mike. Kit includes case, mike on-off switch, antenna, battery and super-instructions. This is the finest unit available!</p> <p>FM-3 Kit \$16.95 FM-3 Wired and tested 19.95</p>	<h4>MICROWAVE INTRUSION ALARM</h4> <p>A real microwave doppler sensor that will detect a human as far as 10 feet away. Operates on 1.3 GHz and is not affected by heat, light or vibrations. Drives up to 100 ma output, normally open or closed, runs on 12 VDC.</p> <p>Complete kit, MD-3 \$16.95</p>	<h4>SPEECH SCRAMBLER</h4> <p>Communicate in total privacy over your telephone or radio. This scrambler kit features full duplex operation using frequency inversion. Runs on a 9 volt battery. Both mike and line or speaker output/inputs. Easy to connect to any radio-telephone use requires no direct connection! Easy to build, uses IC DMM circuitry. Can also be used to describe most com. scramblers.</p> <p>Complete kit, SS-7 \$29.95 Case kit, CSS-7 12.95</p>
--	--	---	---	--	--

<h3>CT-70 7 DIGIT 525 MHz</h3> <p>\$139.95 WIRE INCLUDES AC ADAPTER</p>	<h3>CT-90 9 DIGIT 600 MHz</h3> <p>\$169.95 WIRE INCLUDES AC ADAPTER</p>	<h2>FREQUENCY COUNTERS</h2> <p>Ramsey Electronics has been manufacturing electronic test gear for over 10 years and is recognized for its lab quality products at breakthrough prices. All of our counters carry a full one year warranty on parts and labor. We take great pride in being the largest manufacturer of low cost counters in the entire USA. Compare specifications. Our counters are full featured, from audio to UHF, with FE high impedance input, proper wave shaping circuitry and durable high quality epoxy glass, plated thru PC board construction. All units are 100% manufactured in the USA.</p>
---	---	---

<h3>CT-50 8 DIGIT 600 MHz</h3> <p>\$189.95 WIRE INCLUDES AC ADAPTER</p>	<h3>CT-125 9 DIGIT 1.2 GHz</h3> <p>\$189.95 WIRE INCLUDES AC ADAPTER</p>	<h3>ACCESSORIES FOR COUNTERS</h3> <p>telescopic whip antenna—BNC plug \$ 8.95 High impedance probe, light loading 16.95 Low pass probe, audio use 16.95 Direct probe, general purpose use 13.95 Tilt ball for CT-70, 90 & 125 3.95 Nicaid pack for CT-70, 90 & 125 8.95</p>
---	--	---

MODEL	FREQ RANGE	SENSITIVITY	ACCURACY	DIGITS	RESOLUTION	PRICE
CT-70	20 Hz-550 MHz	<50 mV to 150 MHz <10mV to 150 MHz <150mV to 600 MHz	1 PPM	7	1 Hz, 10Hz, 100Hz	139.95
CT-90	10 Hz-600 MHz	<10mV to 150 MHz <150mV to 600 MHz	1 PPM	9	0.1Hz, 10Hz, 100 Hz	169.95
CT-50	5 Hz-600 MHz	LESS THAN 25 mV	1 PPM	8	1Hz, 10Hz	189.95
CT-125	10 Hz-1.25 GHz	<25mV @ 50 MHz <15mV @ 600 MHz <100mV @ 800 MHz	1 PPM	9	0.1Hz, 1Hz, 10Hz	189.95
CT-90 WITH SW-1 OPTION	10 Hz-600 MHz	<10mV to 150 MHz <150mV to 600 MHz	0.1 PPM	9	0.1Hz, 1Hz, 10Hz	229.90

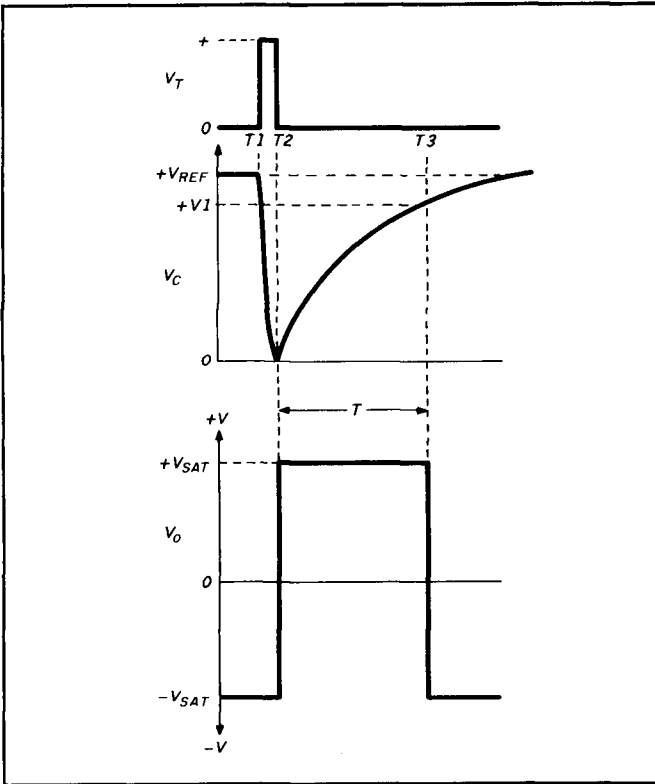
TERMS: satisfaction guaranteed • examine for 10 days: if not pleased, return in original form for refund • add 6% for shipping and insurance for a maximum of \$10.00 • foreign add 15% for surface mail • COD add \$2.75 (COD in USA only) • orders under \$20.00 add \$1.50 • NY residents add 7% sales tax • 90 days parts warranty on all kits • 1 year parts & labor warranty on all wired units.

MasterCard
VISA

PHONE ORDERS CALL
716-924-4560
FAX 716-924-4555

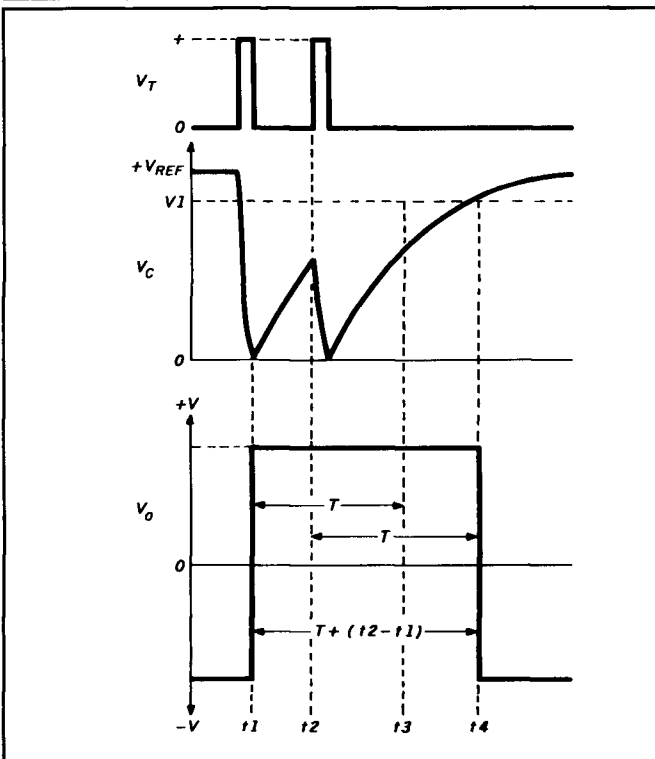
RAMSEY ELECTRONICS, INC. 793 Canning Parkway, Victor, NY 14564

FIGURE 7B



Response graph of the non-retriggerable monostable multivibrator.

FIGURE 7C



Response graph of the retriggerable monostable multivibrator.

on an operational amplifier. The two inputs are biased from a reference voltage source, +Vref. The potential applied to +IN is a fraction of +Vref. That is, $[(R3)(+Vref)/(R2 + R3)]$. The potential applied to -IN is a function of +Vref and time constant $R1C1$. If the circuit isn't triggered at turn on, capacitor $C1$ charges up to +Vref, so -IN is more positive than +IN. This situation forces V_o to -Vsat, which is the stable state. When a positive-going trigger pulse (V_t) is received (see Figure 7B), it biases junction field effect transistor (JFET) Q1 hard on. The JFET drain source channel resistance drops very low, causing $C1$ to discharge rapidly between $T1$ and $T2$. With V_c close to 0 volts DC, +IN is more positive than -IN, so the output snaps abruptly to +Vsat at time $T1$. During the interval $T2$ to $T3$, capacitor $C1$ begins charging towards +Vref, and V_o remains at +Vsat. However, once V_c reaches +V1, the output of A1 snaps back to -Vsat.

The duration, T , is found from:

$$T = R1C1 \ln \left[\frac{R3}{R2} + 1 \right] \quad (16)$$

The operation I just discussed, which is depicted in Figure 7B, is for normal nonretriggered operation. Figure 7C shows the retriggered case. Here the RMMV receives a second trigger pulse at time $T2$, which forces the JFET Q1 to turn on again, and rapidly discharge $C1$. The charging process then starts over again, and continues until the circuit times out — unless a further trigger pulse is received.

The RMMV is commonly used in alarm or sensing circuits. It's triggered by some external event, and will continually retrigger as long as that event keeps occurring. If no event is sensed prior to time-out, the RMMV returns to the stable state, and the following circuitry will be triggered to alarm status. For example, the timer MMV is retriggered every time a carrier drop is sensed. But if the same carrier stays on too long, the MMV "times out" and sends a signal to the circuit that turns off the transmitter for a short "rest period."

Part Two...

Now that you've had a refresher on RC networks, voltage comparators, and monostable multivibrators, it's time to move on to astable multivibrators. But, alas, the Editor's MMV "timed out" for this month, and we'll have to wait for part 2 to talk about the AMV circuit. *hrr*

"ONLINE" U.S. CALL DIRECTORY

Hamcall service gives you all hams via your computer & modem. Updated each month! Only \$29.95 per year. Unlimited use - you pay for phone call.

BUCKMASTER PUBLISHING

Route 3, Box 56
Mineral, Virginia 23117
703/894-5777 visa/mc 800/282-5828

atmospheric noise is minimal, and adjacent channel chatter from other signals is low, any AGC circuitry will provide satisfactory results for most modes of reception. However, when fading is prevalent, or atmospheric noise increases due to summer electrical storms and adjacent channel chatter builds up, it's important to improve the design of the AGC system. While even a well-designed AGC system won't take the place of an effective noise blanker, it will supplement the blanker and let you receive information you'd lose in the presence of adverse conditions.

I realize that many of you may question the efficacy of changing an AGC system like the one in the TS-940S. Since the system doesn't generate any clicks or pops and works satisfactorily for SSB, AM, and CW, consider that changing it runs contrary to the old adage "If it ain't broke don't fix it." My question to you is: does it work well enough for data communications — RTTY, AMTOR, and packet? After a year or more of careful record keeping and diagnosis, I concluded the system wasn't effective enough. I found that nearly every case of an RTTY "hit" or error in the copy had occurred on days when there was static from electrical storms. The major portion of the static was in the form of short duration noise pulses. While you might expect that such static errors would result from the addition of bits of data, most of the hits were caused by a loss of bits. I determined this by referring to the *Teletypewriter Code and Garble Table*.

I found these hits puzzling. If the receiver was blanking on or after noise pulses, why couldn't the blanking action be heard as it occurred? I reasoned that if the blanking action was of short duration, it could be "seen" even though it couldn't be "heard." I connected an oscilloscope to the audio output, tuned the receiver to a vacant frequency, and watched the static pulses. I saw nothing of significance until I inserted a data signal using the 100-kHz calibration standard. I tuned the receiver to obtain a 2300-Hz audio tone and synchronized the scope to the tone. As I watched a static pulse, I could see the noise peak. But there was a loss of audio information immediately following the peak which lasted from 4.5 to 12 ms, depending on the position

PARTS LIST

C1	20-pF silver mica
C2	0.001
C3,C4	0.01
C6	0.47 μ F
C7	0.1
C8	33-pF silver mica
CR1	1N914
R1,R2,R3, R4,R8	1 k
R5	1.5 meg
R6,R7,R9	470
T1	primary—30 turns no. 24 on 1/2", OD toroid—Amidon T-50-2, secondary - 2 turns no. 24
U1,U2,U3	7400
Xtal	7.5-MHz crystal
RFC	220 μ H

UNADILLA ANTENNA MANUFACTURING CO.

PO Box 4215 BV-Andover-MA-01810

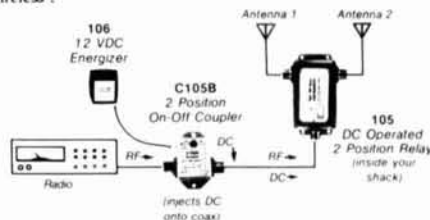
(508)
474-8949
24 Hour FAX

THE **BIG**™ SIGNAL

(508)
475-7831
9-5 EST M-F

CONVERT MULTIPLE ANTENNAS TO ONE COAXIAL FEEDLINE

Use our antenna switching kit and eliminate excess coax runs. With this kit and a single run of coax, you can switch between your antennas remotely. Use to add an antenna at a modest cost, or change direction. The InLine™ design uses advanced state-of-the-art technology incorporating microstrip techniques resulting in a relay life expectancy of at least 10,000,000 transfer operations which, when combined with weatherproof construction, offers many years of trouble free service. InLine™ coaxial relays are rugged, weatherproof devices that can be mounted virtually on any surface either indoors or outdoors, where ever the antennas are to switch two or more antennas with utmost efficiency while on a single coaxial cable is brought to the radio. The relays are available in two styles wired or "wireless".



This system operates from 1.5 to 180 MHz and handles 1250 RF watts

Other types and combinations of relays are available. Please call or write us for additional information, and start saving on your coaxial runs today!

Contact Your Local Ham Dealer Today!!!

To order direct call (508) 475-7831 or write

for our informational brochure on our other fine products
Baluns-Antenna Kits-Filters-Center Insulators-ENDulators™-Coaxial Relays
All products come with a 30 Day Warranty

-NOTICE-

We are the NEW manufacturers of the original

Grid Dip Meters **JAMES MILLEN™** Products Capacitors
(508) 975-2711 9am-5pm EST M-F

125

Make the most of your general coverage transceiver with Monitoring Times!

Every month Monitoring Times brings everything you need to make the most of your general coverage transceiver: the latest information on international broadcasting schedules, frequency listings, international DX reports, propagation charts, and tips on how to hear the rare stations. Monitoring Times also keeps you up to date on government, military, police and fire networks, as well as tips on monitoring everything from air-to-ground and ship-to-shore signals to radioteletype, facsimile and space communications.

ORDER YOUR SUBSCRIPTION TODAY before another issue goes by. In the U.S., 1 year, \$18; foreign and Canada, 1 year, \$26. For a sample issue, send \$2 (foreign, send 5 IRCs). For MC/VISA orders (\$15 minimum), call 1-704-837-9200.

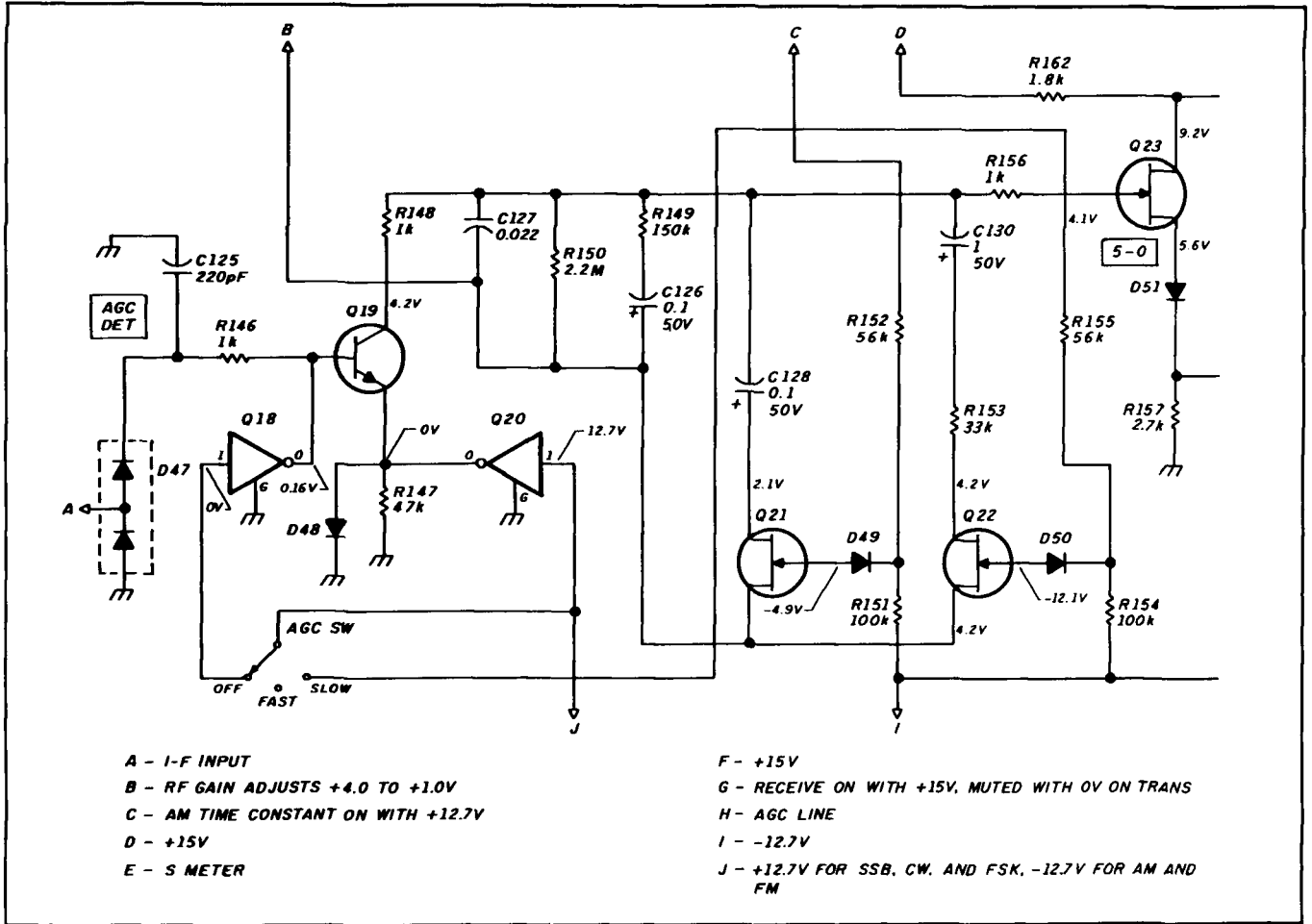
MONITORING TIMES

Your authoritative source,
every month.

P.O. Box 98 A
Brasstown, N.C. 28902

126

FIGURE 2



TS 940S AGC system.

of the AGC switch. I found that the "fast" position AGC was slower in recovering than the "slow" position.

The data loss period is made up of the sum of three time intervals. The first is due to the duration of the noise pulse. The second is the circuit group delay (the time it takes the AGC to start to react to the noise pulse), which is about 1 ms according to Rohde.¹ The third interval is the recovery time of the AGC. When the total of these three intervals is an appreciable part of the length of time it takes for a bit to be sent, the bit is lost. The duration of the noise pulse is an act of nature and, unfortunately, uncontrollable. The circuit group delay depends upon the number of resonators, and varies inversely with the bandwidth. It can't be changed without making sacrifices. But you can modify the AGC's recovery time.

Once I understood the problem, I listened closely to the receiver and noted that the lag in AGC recovery immediately following the static pulse caused a momentary quieting of the receiver. This, in turn, caused the loss of data bits. I decided that a reduction of the AGC's recovery time was required. It was necessary to come up with a reproducible test in order to work on the problem. I needed a

test that would provide a pulse duplicating the effect of a static pulse on the receiver, so I wouldn't have to rely on electrical storms to measure my progress.

I devised the pulse generator shown in Figure 1. It has a 7.5-MHz crystal oscillator gated on for 2.5 ms at 2 Hz. The low pulse rate allows the AGC system to recover between pulses. None of the other parameters are critical.

The 7.5-MHz crystal came from my junkbox; the circuits are from *QST*² and *The 555 Timer Applications Sourcebook with Experiments*.³ There's a broadly tuned circuit in the output which transforms the TTL voltage down to a usable value. I've provided outputs for the high and low level 7.5-MHz RF pulse and for the gate pulse. I built the generator on a Radio Shack perforated circuit board and mounted it in an aluminum box. I used a commercial 60-dB T pad attenuator with it to further reduce the generator low output.

The generator provided a calibrated "noise" pulse, similar to a static pulse in its effect on the receiver when connected to the antenna input. I observed considerable rounding off of the pulse envelope with the oscilloscope connected to the output of the 8.83-MHz, 455-kHz, and 100-kHz IF. This

FIGURE 2

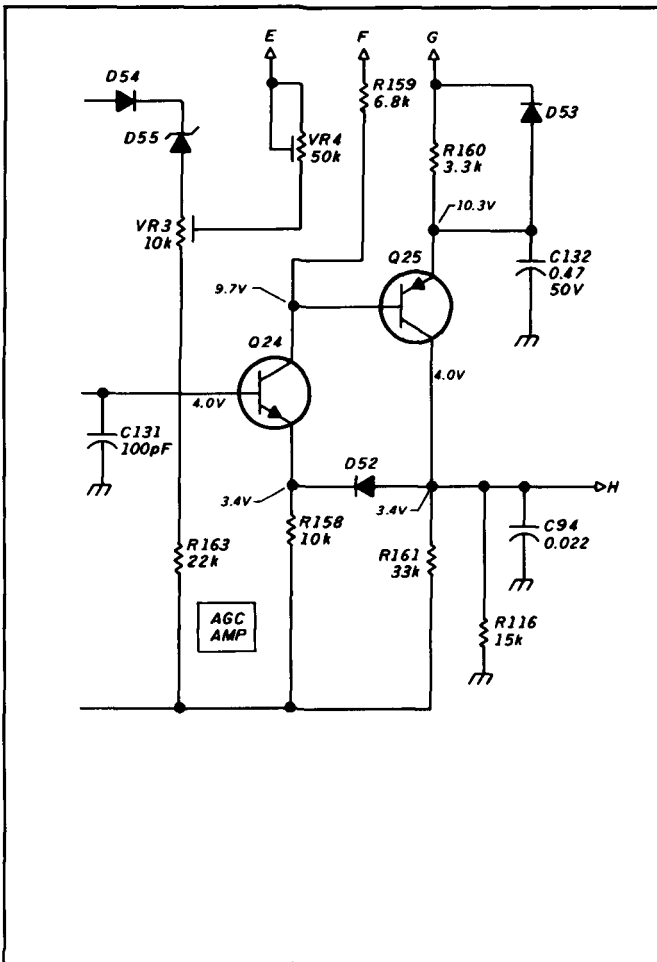


TABLE 1

TS-940S AGC circuits		
Section	Components	Function
1	R148 (1.0 k)	attack and fast
	C127 (0.22 μ F)	AGC circuit
	R149 (68 k)	
	C126 (0.1 μ F)	
2	R150 (2.2 meg)	Q19 load resistor
	C128 (0.1 μ F)	AM AGC time constant
3	C130 (1.0 μ F)	slow AGC
	R153 (33 k)	
4	Q23 FET	AGC RC net isolation
	Q24	AGC amplifier/driver
	Q25	AGC line driver, T/R

is to be expected in any transceiver with a narrow bandwidth similar to the TS-940S.

After I made my preliminary observations, I decided to make some changes in the AGC circuit and get some on-the-air experience. Details of the TS-940S AGC circuitry (reprinted with permission from the *Kenwood Service Manual*) are shown in Figure 2. I've found it convenient to think of this part of the AGC system as being made up of four "sections" of related components. Table 1 lists the key components used in the various sections, along with their nominal functions.

An incoming IF signal provided at A of Figure 2 is rectified and doubled. A positive voltage is produced on the base of Q19. The voltage, which operates time constant sections 1, 2, and 3, comes from B and is established by setting the RF gain control. Current flows to Q19 through R148 and R150. When the AGC is turned on, the drive to the AGC system at A sets the Q19 base voltage. This, in combination with the voltage from B and the drop through R148 and R150, establishes the collector current through Q19. When Q19 is driven harder by the IF signal (including noise pulses) Q19's collector goes down, dropping the voltage at the junction of R148 and R150. This causes the AGC circuits to react and lowers the AGC voltage at H to affect the transceiver's gain. The attack and decay of that volt-

age is determined by the components of the three sections.

In section 1, the attack and fast AGC components are fixed. They function in parallel with the slow components of section 3 when FET Q22 is switched on in the slow AGC position by the application of +12.7 volts to R155. When the transceiver is switched to AM receive, +12.7 volts is applied to R152 at terminal C, toggling Q21 on and connecting C128 in parallel with section 1. Kenwood recommends the slow AGC (sections 1 and 3) for most operating modes except AM.

This entire circuit has other functions beside supplying the AGC bus voltage at terminal H. For example, when you adjust the manual RF gain control, the voltage at terminal B varies from +4.0 to +1.0 volts and establishes an operating voltage to the RF and IF stages through the Figure 2 circuits. Also, when the transceiver is keyed to the transmit mode terminal G goes to 0 volts, reducing conduction through Q25, causing H to be driven to -4.0 volts, and cutting off the receiving RF and IF stages.

Using these observations as a starting point, I considered how I might approach the task of improving the data communications performance of the transceiver without altering the equipment's general circuit performance and original design concepts.

I isolated the AGC system from the RF and IF stages of the receiver by applying the square wave gating pulse (no RF) directly to the AGC input at the Q19 base. I used a 10-meg scope probe to prevent circuit loading. Figure 3 shows how the original AGC system responds to the pulsed input as measured at terminal H. Under these test conditions (2.5 ms pulse at 2 Hz), the slow AGC position recovery time is less than that of the fast position. The longer the recovery time, the greater the probability that a bit of data will be lost.

These measurements don't include the time required for the IF stages to respond to the AGC voltage, so I also made measurements with the 7.5-MHz pulse applied to the receiver antenna. They indicated that the RF output of the 100-kHz fourth IF followed the curves in Figure 3 closely. Test procedures maintained the signal below S9. Your operating procedures can also keep the input signal below S9 most of the time if you use the 30-dB input attenuator — an important part of the TS-940S.

SATELLITE ESSENTIALS

Satellite TV is still full of the wonderment that made it so popular in the early '80s. The tinkerers are there, the programming is there, and never has the cost of becoming a dish owner been so low.

So, how do you find out about this exciting entertainment?

Through publications devoted specifically to satellite TV, that's how!

OnSat

America's Weekly Guide To Satellite TV

OnSat is unsurpassed for the most up-to-date listings of satellite programming. Dr. Dish, Mailbag, and the Transponder Service Watch are all geared to help you make the best use of your satellite TV system. A sample issue can be obtained for only \$1.

STV GUIDE

The Complete Monthly Guide To Satellite TV

STV Guide contains over 300 pages of programming information, product reviews, home troubleshooting, and information about satellite TV. A sample issue can be obtained for only \$2.

Both OnSat and STV Guide contain listings for over 120 channels and Prime Time Grids for over 50 channels. Subscribe to either the weekly OnSat or the monthly STV Guide for only \$48 per year.

To start receiving the best in satellite TV guides and information, call toll-free (800) 234-0021. VISA® and MasterCard® accepted.

STV Guide/OnSat
PO Box 2384 • Shelby, NC 28151-2384

SUBSCRIBE AND RENEW TOLL-FREE

HAM RADIO



1 YR - \$22.95

2 YRS - \$38.95

3 YRS - \$49.95

Prices U.S. only



MASTERCARD



VISA BILL ME

Please have your charge card ready.

DATATEL 800™

800-341-1522

Weekdays 8 AM - 9 PM EST

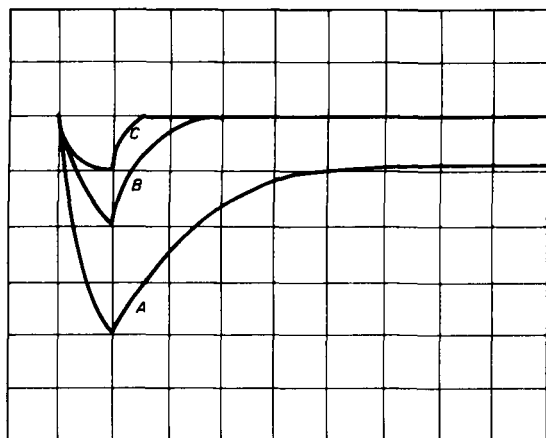
Saturdays 9 AM - 5 PM EST

IN MAINE CALL COLLECT (207) 236-2896

OUR 800 NUMBER IS FOR SUBSCRIPTION ORDERS ONLY!

For Errors or Change of Address
CALL ham radio direct at
(603) 878-1441 8-5 EST

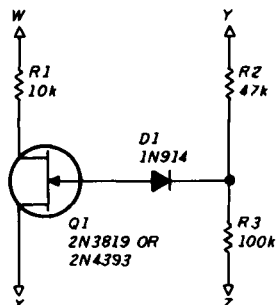
FIGURE 3



A - "FAST" AGC
 B - "SLOW" AGC
 C - NEW "FAST" AGC
 HORIZONTAL SCALE = 2 ms / DIV
 VERTICAL SCALE = 0.5 V / DIV
 2.5 ms SQUARE-WAVE PULSE of 2 Hz APPLIED TO BASE OF Q19

Graphic display of oscillogram of AGC voltage developed with applied 2.5-ms pulse.

FIGURE 4



CONNECT		TO JUNCTION OF	
		TS-940S	TS-930S
W	R156 AND C130	R722 AND C510	
X	R150 AND C126	R730 AND VR29	
Y	AGC SW "FAST" CONTACT		
Z	R154 (-12.7V)	R738 (-12V)	

New FAST AGC circuit for TS-940S and TS-930S.

In accordance with the design approach to reduce the AGC recovery time, I examined the RC time constants of section 1. Q19 load resistor R150 controls the recovery rate or discharge time for C127 and R149, the fast AGC circuit. Reducing the value of this resistor decreases the recovery time. I chose a value of 10 k. Figure 3 shows the recovery time when it's paralleled with R150. When the AGC RF-IF amplifier loop circuit is closed, the amplitude of the AGC voltage tends to be normalized due to the gain of the loop, and curves A, B, and C fall on top of one another — except for the recovery times.

Before I go on, I'd like to note that I found an error in my

WHAT'S THE BIGGEST ISSUE IN HAM TV TODAY?

THE NEXT ISSUE OF AMATEUR TELEVISION QUARTERLY

- ACCURATE reporting
- TECHNICAL information
- VALUABLE content
- QUALITY production

SUBSCRIPTIONS:

1 Year \$15 U.S., \$20 Canada, \$25 Elsewhere

1545 Lee Street, Suite 73
 Des Plaines, Illinois 60018
 (312) 298-2269

W6SAI BOOKS

published by Bill Orr, W6SAI and Stu Cowan, W2LX

BEAM ANTENNA HANDBOOK

Completely revised and updated with the latest computer generated information on BEAM Antenna design. Covers HF and Yagis and 10, 18 and 24 MHz WARC bands. Everything you need to know. 204 illustrations. 268 pages. ©1985. Revised 1st edition. RP-BA **Softbound \$11.95**

ALL ABOUT VERTICAL ANTENNAS

Theory, design, construction, operation—are fully covered. Here's what this exciting book covers: Horizontal vrs vertical—which is best? Top loaded and helical antennas, 5 high efficiency Marconi antennas for 80 and 160, verticals and TVI—Is there a problem? The effects of ground on vertical antennas and a how to make an effective ground system, the Bobtail beam, construction data for 25 different antennas, matching circuits of all descriptions—which is best, plus P-L-E-N-T-Y more! 1st edition, 192 pages © 1986 RP-VA **Softbound \$10.95**

RADIO HANDBOOK 23rd Edition

Here are some of the highlights of this exciting new edition: New easy-to-use charts for Chebyshev and elliptic filter configurations, new data on power MOS-FETS, how to use state-of-the-art OP-AMPS, and home computer RTTY to name just a few examples. New projects include: GaAsFET preamps for 902 and 1296 MHz, easy-to-build audio CW filter, Economy two 3-500Z, 160 meter amplifier, multiband amp using two 3CX800A7's, and a deluxe amplifier with the 3CX1200A7 tube. New antenna projects include: efficient Marconi design for 160 and 80 meters, computer generated dimensions for HF-Yagis, and a 2 meter slot beam. Get your copy today. 23 edition © 1986 22424 (Reg. \$29.95) **Hardbound \$26.95**

THE RADIO AMATEUR ANTENNA HANDBOOK

A wealth of projects that covers verticals, long wires, beams as well as plenty of other interesting designs. It includes an honest judgement of gain figures, how to site your antenna for the best performance, a look at the Yagi-Quad controversy, baluns, slopers, and delta loops. Practical antenna projects that work! 190 pages. ©1978. 1st edition. RP-AH **Softbound \$11.95**

Please enclose \$3.75 for shipping and handling.

HAM RADIO
 GREENVILLE, NH 03048

BOOKSTORE
 (603) 878-1441

Kenwood Service Manual. The circuit diagram for the IF unit (X48-1430-00) doesn't agree with the pc board in my transceiver. The position of R150 was interchanged with R149 on the diagram in the manual. **Figure 2** in this article shows them correctly. Some serial numbers of the 940 show R149 changed from 150 k to 68 k.

You could change R150 to 10 k permanently but this would also affect the slow AGC, and that circuit is satisfactory for all other modes of operation. I used an approach which didn't alter the original circuit or circuit board. There's an unused contact on the AGC switch in the fast position (see **Figure 2**). I used this to actuate the circuit shown in **Figure 4**. I've included a table of connections for application to the TS-940S that you can make without removing the IF circuit board.

When you move the AGC switch to the fast position, the gate of switching FET Q1 is made positive and R1 is connected in parallel with R150. With the AGC switch in the slow position, the circuit is unaltered. Inserting a single pin connector in the Y lead lets you return the entire system to the original configuration by disconnecting that lead.

Construction and installation

The parts for the circuit in **Figure 4** are mounted on a piece of Radio Shack circuit board slightly larger than a postage stamp. This is fastened to the IF unit with foam mounting tape.

Remove the bottom cover to access the IF unit, X48-1430-00. The location of every component is marked. You can make all connections to the IF unit on the exposed side of the board. Carefully clean the paint from the resistor leads and tack solder the wires of the new circuit to the exposed leads as indicated.

Remove the top and bottom covers to gain access to the contact on the AGC switch. Then remove two flat-head screws from each side of the front hinges so the front panel swings away from the chassis. Provide support for the front panel during this step to prevent damage to the panel or controls. Solder the wire lead Y shown in **Figure 4** to the spare contact using a small iron and low heat. Use the TS-940S service manual to locate the IF unit and the component parts.

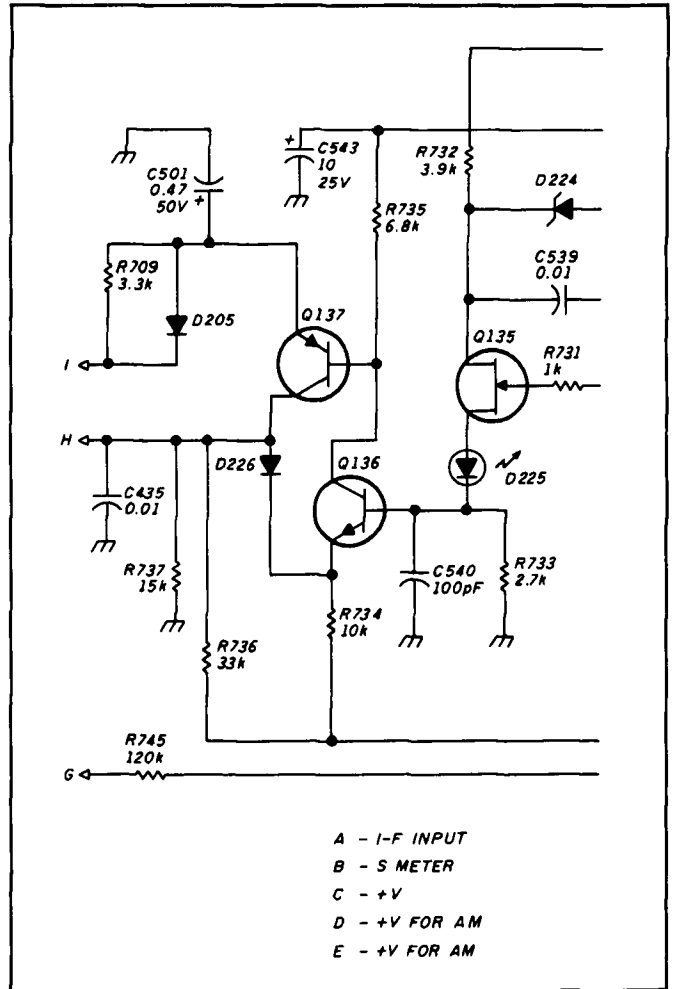
Recommendations for modifying the TS-930S

I did much of my initial work and record keeping with the TS-930S, before the TS-940S became available. As far as recovery time is concerned, I found the performances of the AGC systems much the same. The TS-930S AGC system may be modified using the same principles I used for the TS-940S. **Figure 5** is the TS-930S AGC system shown in the service manual. This system is very similar to the TS-940S. Operation is the same as that of the TS-940S and doesn't warrant additional explanation. The AGC switch is the same in the two models, so there is a spare blank contact available to operate the new fast AGC circuit. The table in **Figure 4** shows the connections to the TS-930S for the new circuit.

On-the-air testing

Preliminary tests showed that the 8.83-MHz filter is "shock" excited to oscillation at its resonant frequency by the 7.5-MHz pulse applied to the receiver antenna. This

FIGURE 5



TS-930S AGC system.

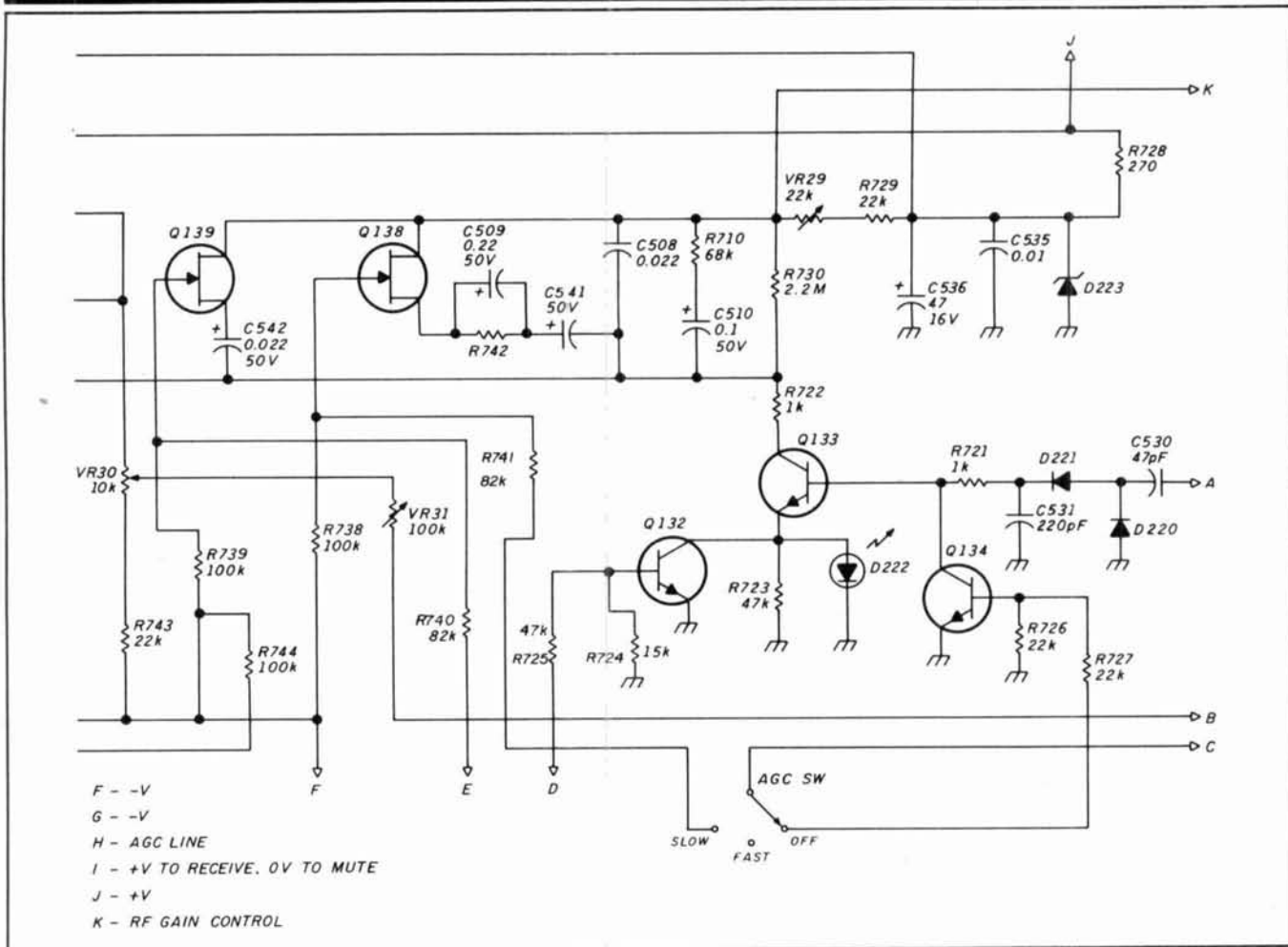
lengthened the pulse and countered the short recovery time by increasing it. Oscillation occurs whether the slow AGC is on or the AGC is off; it just becomes more obvious with the new fast AGC. Static pulses act in the same manner to cause oscillation.

I then investigated the noise blanker to determine if it would act to blank such pulses and prevent the oscillation from degrading the recovery time. (Noise blanking occurs before the 8.83-MHz filter.) NB2 was very effective in blanking the repetitive 7.5 MHz-pulse and in blanking similar single static pulses. Not all static was blanked, but not all static causes ringing. The noise blanker does act to prevent oscillation; set the level control between 0 and 2 for best results.

The slow AGC figure of merit, the change in audio output with increased signal strength,⁴ is 0 dB for signal levels from 1.55 μ V to 1.55 μ V + 110 dB. The new fast AGC causes an increase of 3 dB for the same signal range. This isn't significant.

My RTTY reception improves dramatically when I use the new fast circuit during the noisy summer months. Fast fading effects are reduced — the circuit recovers fast enough to compensate. I do notice a raspy quality on voice communications. This isn't a problem on RTTY because the

FIGURE 5



signal is like a continuous carrier. When an adjacent SSB signal tends to control the AGC and prevent reception of the wanted on-channel signal, I can switch on the new fast AGC. This allows copy between voice peaks of the other signal, and generally works unless the other station turns on its voice processor. If conditions are good, I switch on the slow AGC for the best voice quality. However, the new fast AGC outperforms the slow one for DATA/RTTY reception.

Acknowledgments

I'd like to thank Allen P. Haase, W2ECA, and John A. Kiener, W8AVH, for their expert assistance in the preparation of this article. *hr*

REFERENCES

- Ulrich Rohde, "Understanding and Handling Noise," *HAM RADIO*, November 1986, page 10
- Ken Powell, "The Weekender—A Simple Crystal Calibrator," *QST*, July 1979, page 38
- Howard M. Berlin, *The 555 Timer Applications Sourcebook with Experiments*, Sams, page 107
- Wes Hayward and Doug DeMaw, *Solid-State Design for the Radio Amateur*, ARRL, page 94

INDUSTRIAL QUALITY REPLACEMENT BATTERIES FOR COMMUNICATIONS

Nickel-Cadmium, Alkaline, Lithium, etc.

Repair Packs For
 ICOM®, KENWOOD, YAESU,
 SANTEC, AZDEN, TEMPO,
 CORDLESS PHONES...AND MORE!

NEW! I.C.E. PACK \$49⁹⁵



E.H. YOST & CO.
 EVERETT H. YOST KB9XI
 7344 TETIVA RD.
 SAUK CITY, WI 53583
 ASK FOR OUR CATALOG
 (608) 643-3194

ALLAIRE AIRPORT
 WALL TOWNSHIP
 NEW JERSEY



SHORE AREA HAM & COMPUTER FEST

SUNDAY, OCTOBER 15, 1989

Free Parking PRIZES V.I. TESTING

TALK-IN FREQ. RPTR 145.110-6 KC2Q/R
 SMPLEX 146.520
 FLY-IN FREQ. UNICOM 123.000

SPONSORS Gordon State ARA, Jersey Shore A.R.S.,
 Neptune A.R.C. and Ocean-Monmouth A.R.C.

P.O. BOX 636 EATONTOWN, NEW JERSEY 07724



516F2 SUPPLY

Collins 516F2 Power Supply
 for S-Line transmitters;
 gov't surplus. With tubes
 5U4 & 5R4, cabinet, and cables.
 34 lbs. sh. wt.



Used.....\$99.50
 (For choice of cabinet emblem, add \$10.00)
516F2 without cabinet and tubes, 23 lbs. sh. #NC-516F2, used.....\$69.50



516E2 DC Supply, solid-state
 unit powers S-Line from 24-28
 VDC input; 24 lbs. sh.
 Used.....\$49.50

Prices F.O.B. Lima, O. - VISA, MASTERCARD Accepted
 Allow for Shipping - Write for 1989 Catalog
 Address Dept. HR - Phone 419/227-6573

FAIR RADIO SALES
 1016 E. EUREKA • Box 1105 • LIMA, OHIO • 45802

PRODUCT REVIEW

PC HF FACSIMILE VERSION 4.0

PC HF Facsimile Version 4.0 from Software Systems Consulting makes a nifty addition to your ham shack. It can be used for capturing Weather Fax and other Fax formats from the HF bands without any hardware but your MS-DOS compatible computer. John Hoot, N6NHP, has developed a software program that, with the aid of a simple analog to digital demodulator, can capture real time facsimile images using your computer's own power.

The minimum system requirements to run the PC FAX program are:

- MS-DOS compatible computer with 384K memory
- CGA, EGA, HGA, or VGA card and monitor
- One serial port
- Optional printer for hard copies
- MS-DOS Version 2.1, or higher
- A good HF receiver

The A/D demodulator has a 1/8-inch phone jack on one end that connects to the earphone or speaker output of your radio; the other end has a female DB25 connector, which is connected directly to the serial port of the PC. (The software supports either COM1 or COM2). You also get a cassette tape to help you recognize FAX signals and check out the PC FAX program.

The software will run from a floppy or can be installed on a hard disk. Either way, once you've loaded the program, the interactive menus make using the PC FAX program a snap. I first used PC FAX with a CGA card and monitor and was quite impressed. Later, I replaced my CGA system with an EGA card and monitor. It made a great difference — especially on the satellite photos.



The 80-page user's manual included in the package is well written and makes it easy to be up, running, and capturing your first image in less than a half hour. It was truly exciting when I got my reception system going the first time. Using the Autostart feature, which lets the program run unattended, was even better. The program can be configured to wait for a start tone, capture a frame, write the frame to disk, wait for the next frame, and so on.

The morning after I first used the Autostart feature, I reviewed the 12 frames captured from the previous night's operation. Among them I found a photo of the entire Earth taken with infrared sensors. It showed a newly formed tropical storm. Later that morning, the weather men

announced its formation for the first time!

Once images are captured, they can be displayed in a variety of ways. Images can be viewed in color or 16 shades of grey (EGA or VGA), lightened or darkened, zoomed in on, or converted to PCX format files for editing by Paint programs or importing to many other programs, like desktop publishing.

For more information on PC FAX Facsimile Version 4.0, call or write John Hoot, N6NHP, at Software Systems Consulting, 1303 S. Ola Vista, San Clemente, California 92672. Phone (714)498-5784.

de N1GCF

S-COM 5K Repeater Controller

I'd been planning to buy an S-COM 5K Repeater Controller ever since my friend Joel, WA1ZYX, got one for his 443.800 repeater.

Once I saw Joel's 5K, I couldn't wait to order my own. It finally arrived, and I opened the box with great anticipation. One box contained the new display rack-mount cabinet with 5K controller (v1.3, S/N 681) and the audio delay module mounted inside it, one RS232 connector 25P male plug and hood, and the power connector to provide +12 to 15 volts to the cabinet. The second box held a custom 3-ring notebook with documentation on the 5K, schematics, and instructions for hooking the 5K controller to three different repeaters (more in the making I understand). It also had information using the 5K as a beacon and a circuit for positive voltage TX keying.

The front display rack-mount panel (1-3/4" x 19") is covered in chip-resistant black anodized paint. There are twelve red Hewlett-Packard AlGaAs LEDs to track important circuit status data like: receiver COR (RX), transmitter PTT (TX), CTCSS decoder (PL), control receiver COR (CT), DTMF data valid (DV), power on (ON), logic inputs 1, 2, and 3 (I1, I2, I3), and logic outputs 1, 2, and 3 (O1, O2, O3). These LEDs feature high light output while consuming only 1 mA each, which makes them perfect for natural power sites. Should you experience a power failure, all data except time and date is saved in non-volatile memory.

A conductive iridium-plated chassis box reduces RFI and houses the 5K board, display board, and audio delay module. I removed the six metal screws and took a look inside. The audio delay board is mounted to the lid of the box, the 5K board on the bottom, and the display module on the front panel. The two boards

and the module are connected by ribbon cables and connectors. A DB25S input/output connector (female) and a 2.5-mm DC power jack are mounted on the rear of the 5K board and project through the back of the chassis box. The power input has a Tranzorb™ suppressor and a ferrite bead, there are bypass capacitors on all inputs and outputs, and all power MOSFETS (logic outputs) have Tranzorbs connected to them.

All the commands can be implemented without a lot of work. Take Send ID, for instance. 99 55 * causes the ID to come on. In this case it's "ID" because I haven't programmed my callsign in yet. (The 5K is good, but not that good.) 99 11 * causes the next message to be sent at a slow rate — default, 15 wpm. The normal rate is 20 wpm. Both can be changed. A page in the CW section gives every letter and number a number code; each punctuation mark and CW speed is also assigned a number. Each com-

(Continued on page 84.)

ICOM

KENWOOD YAESU



IC-781

HF Equipment	List	Juns
IC-781 Super Deluxe HF Rig	\$5995.00	Call \$
IC-765 New, Loaded with Features	3,149.00	Call \$
IC-735 Gen. Cvg Xcvr	1099.00	Call \$
IC-751A Gen. Cvg. Xcvr	1699.00	Call \$
IC-725 New Ultra-Compact Xcvr	949.00	Call \$
IC-575A 10m/6m Xcvr	1399.00	Call \$
Receivers		
IC-R7000 25-1300 + MHz Rcvr	1199.00	Call \$
IC-R71A 100 kHz-30 MHz Rcvr	999.00	Call \$
VHF		
IC-228A/H New 25/45w Mobiles	509./539	Call \$
IC-275A/H 50/100w All Mode Base	1299./1399.	Call \$
IC-28A/H 25/45w, FM Mobiles	469./499.	Call \$
IC-2GAT, New 7w HT	429.95	Call \$
IC-2SA New Micro Sized HT	419.00	Call \$
IC-900 Six Band Mobile	639.00	Call \$
IC-901 New Remote Mount Mobile	TBA	Call \$
UHF		
IC-475A/H 25/75w All Modes	1399./1599.	Call \$
IC-48A FM Mobile 25w	509.00	Call \$
IC-4GAT, New 6w HT	449.95	Call \$
IC-04AT FM HT	449.00	Call \$
IC-32AT Dual Band Handheld	629.95	Call \$
IC-3210 Dual Band Mobile	739.00	Call \$
IC-2500A FM, 440/1.2 GHz Mobile	999.00	Call \$
220 MHz		
IC-375A All-Mode, 25w, Base Sta.	1399.00	Call \$
IC-38A 25w FM Xcvr	489.00	Call \$
IC-37A FM Mobile 25w	499.00	Call \$
1.2 GHz		
IC-12GAT Super HT	529.95	Call \$



TS-940S

HF Equipment	List	Juns
TS-940S/AT Gen. Cvg Xcvr	\$2499.95	Call \$
TS-440S/AT Gen. Cvg Xcvr	1449.95	Call \$
TS-140S Compact, Gen. Cvg Xcvr	949.95	Call \$
TS-680S HF Plus 6m Xcvr	1149.95	Call \$
TL-922A HF Amp	1749.95	Call \$
Receivers		
R-5000 100 kHz-30 MHz	1049.95	Call \$
R-2000 150 kHz-30 MHz	799.95	Call \$
RZ-1 Compact Scanning Recv.	599.95	Call \$
VHF		
TS-711A All Mode Base 25w	1059.95	Call \$
TR-751A All Mode Mobile 25w	669.95	Call \$
TM-231A Mobile 50w FM	459.95	Call \$
TH-215A, 2m HT Has It All	399.95	Call \$
TH-25AT 5w Pocket HT NEW	369.95	Call \$
TM-721A 2m/70cm, FM, Mobile	729.95	Call \$
TM-621 2m/220, FM, Mobile	729.95	Call \$
TM-701A 25w, 2m/440 Mobile	599.95	Call \$
TH-75A 2m/70cm HT	549.95	Call \$
UHF		
TS-811A All Mode Base 25w	1,265.95	Call \$
TR-851A 25w SSB/FM	771.95	Call \$
TM-431A Compact FM 35w Mobile	469.95	Call \$
TH-45AT 5w Pocket HT NEW	389.95	Call \$
TH-55 AT 1.2 GHz HT	524.95	Call \$
TM-531A Compact 1.2 GHz Mobile	569.95	Call \$
220 MHz		
TM-3530A FM 220 MHz 25w	519.95	Call \$
TM-321A Compact 25w Mobile	469.95	Call \$
TH-315A Full Featured 2.5w HT	419.95	Call \$



FT-767GX

HF Equipment	List	Juns
FT-747 GX New Economical Performer	\$889.95	Call \$
FT-757 GX II Gen. Cvg Xcvr	1129.95	Call \$
FT-767 4 Band New	1929.00	Call \$
FL-7000 15m-160m Solid State Amp	1995.00	Call \$
Receivers		
FRG-8800 150 kHz - 30 MHz	759.95	Call \$
FRG-9600 60-905 MHz	699.95	Call \$
VHF		
FT-411 New 2m "Loaded" HT	399.95	Call \$
FT-212RH New 2m, 45w mobile	459.95	Call \$
FT-290R All Mode Portable	599.95	Call \$
FT-23 R/TT Mini HT	344.95	Call \$
UHF		
FT-712RH, 70cm, 35w mobile	499.95	Call \$
VHF/UHF Full Duplex		
FT-736R, New All Mode, 2m/70cm	1749.95	Call \$
FEX-736-50 6m, 10w Module	259.95	Call \$
FEX-736-220 220 MHz, 25w Module	279.95	Call \$
FEX-736-1.2 1.2 GHz, 10w Module	539.95	Call \$
FT-690R MKII, 6m, All Mode, port.	569.95	Call \$
Dual Bander		
FT-4700RH, 2m/440 Mobile	889.00	Call \$
FT-470 Compact 2m/70cm Mobile	559.95	Call \$
Repeaters		
FTR-2410 2m Repeaters	1269.95	Call \$
FTR-5410 70cm Repeaters	1289.95	Call \$

Call For These Quality Brand Names

ASA ALINCO ASTRON Kantronics MFJ concept MIRAGE/KLM TE SYSTEMS

INSTANT CREDIT WITH ICOM PREFERRED CUSTOMER CARD



FAX 213-390-4393

ICOM IC-04AT 440 MHz HT SALE \$299.95 LIST \$499.90	ICOM IC-12AT 1.2 GHz FM, HT SALE \$339.95 LIST \$473.95
---	---

KENWOOD TM-621A CALL FOR SPECIAL PRICE	KENWOOD TM-321A CALL FOR SPECIAL PRICE
---	---

LIMITED QUANTITIES



YAESU FT-311 RM
220 MHz FM Transceiver 25W/5W
List \$439.95 **NOW \$249.95**

SE HABLA ESPANOL
FREE U.P.S. CASH ORDER
(MOST ITEMS, MOST PLACES)

(213)390-8003

3919 Sepulveda Blvd.
Culver City, CA 90230

The Greater Louisville Hamfest Association
presents
THE 1989 LOUISVILLE HAMFEST AND ARRL Kentucky Section Convention
September 30 & October 1, 1989

- NEW LOCATION:
Commonwealth Convention Center -
Downtown Louisville
- EXCITING FORUMS:
Wayne Green—W2NSD
1988 Kingman Reef/Palmyra DXpedition
by K9AJ/KH5K
Packet, Mars and more
Testing
Wuoff Hong

LODGING DISCOUNT-HYATT REGENCY
AIRFARE DISCOUNT-DELTA AIRLINES
AIR CONDITIONED EXHIBIT & FLEA MARKET AREAS

For information write:
LOUISVILLE HAMFEST
POB 34444, Louisville KY 40232

SERVICE MONITOR MEASUREMENTS MODEL FM 110

- Covers all business channels from 30MHz to 512MHz
- Monitor: 2uV, frequency error display, scope deviation display
- Generator: Calibrated output up to 10mV, Sinad display
- Built-in Tone Generator

AMAZINGLY LOW PRICE OF ONLY **\$1685.00**
FOB - BATESBURG, SC

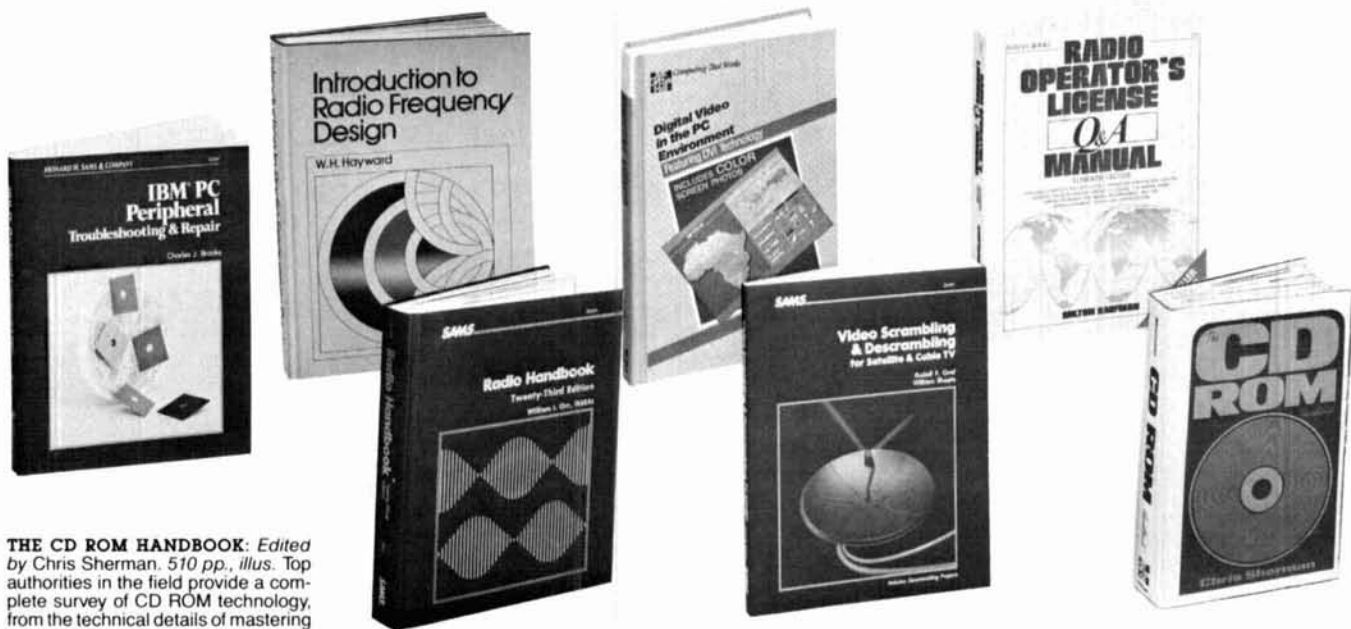


WE ACCEPT VISA, MASTERCARD & AMERICAN EXPRESS

AIE CORPORATION — MEASUREMENTS DIVISION
PO BOX 70, BATESBURG, SOUTH CAROLINA 29006 (803)532-9256



Take any 3 books for \$3⁹⁵ (values up to \$165.85)



THE CD ROM HANDBOOK: Edited by Chris Sherman. 510 pp., illus. Top authorities in the field provide a complete survey of CD ROM technology, from the technical details of mastering and manufacturing disks to the major applications, error detection and correction, and data conversion. 565/783 Pub. Pr., \$59.95

DIGITAL VIDEO IN THE PC ENVIRONMENT: Featuring DVI Technology. By Arch C. Luther. 330 pp., illus. Discover full explanations of video, audio, and optical storage media and how to combine them to create versatile, user friendly information systems with vast storage capacity in this useful guide. 391/769 Pub. Pr., \$39.95

RADIO HANDBOOK, 23/e. Edited by William I. Orr. 667 pp., 1,073 illus. and tables 7½ x 10 format. Expert contributors show you how to select, design, build, test, and operate all kinds of equipment, including mobile, marine, receiving, and electronics test equipment in this update of the classic Handbook. 584638-1 Pub. Pr., \$29.95

EMERGENCY/STANDBY POWER SYSTEMS. By Alexander Kusko. 288 pp., 116 illus. From specifications to performance data, here's everything you need to know to evaluate the need for emergency power, and prepare to meet it. Comprehensive help from equipment choices to codes and standards. 356/890 Pub. Pr., \$34.50

AMATEUR RADIO: Theory and Practice. By R. L. Shrader. 340 pp., illus. Here's a complete beginner's guide—requiring no previous background in radio or electronics—that will give you the basic theory necessary to pass any and all of the FCC Amateur Radio License exams. 571/465 Pub. Pr., \$28.95

REGULATED POWER SUPPLIES, 3/e. By I. M. Gottlieb. 423 pp., illus. This practical book provides you with everything you need to know to design and use modern regulated supplies, including regulation techniques and detailed discussions of actual circuitry. 585136-9 Pub. Pr., \$19.95

when you join the PRACTICAL ELECTRONICS BOOK CLUB

- Your one source for electronics books from dozens of different publishers
- the latest and most useful information
- discounts of up to 40% off publishers' list prices

UNDERSTANDING SECURITY ELECTRONICS. By J. E. Cunningham. Revised by J. J. Carter. 292 pp., illus. The basic principles of electronic security systems, their application, and the pros and cons of every type of system are all covered in this easy-to-understand guide. 585119-9 Pub. Pr., \$15.95

IBM PC PERIPHERAL TROUBLESHOOTING AND REPAIR. By C. J. Brooks. 272 pp., illus. Here's a complete guide to diagnosing and isolating hardware failures for disk drives, video-display monitors, keyboards, modems, printers. Provides step by step, device specific troubleshooting routines, diagrams, and flowcharts. 585098-2 Pub. Pr., \$19.95

RADIO OPERATOR'S LICENSE Q & A MANUAL, 11/e. By M. Kaufman. 553 pp., illus. This classic study guide has everything you need to pass the new FCC General Radiotelephone Operator License exams—including the most recent FCC-type sample tests and all 1986 changes to the FCC exam. 585100-8 Pub. Pr., \$19.95

OPTOELECTRONICS: A Text-Lab Manual. By M. Tischler. 213 pp., illus. These 32 clearly defined experiments teach you how to use optical electronic devices and circuits in electric power generation, data transmission, and telecommunications. Each experiment requires only standard components. 647/860 Pub. Pr., \$19.95

EXPERIMENTS IN AMPLIFIERS, FILTERS, OSCILLATORS, AND GENERATORS. By M. Tischler. 170 pp., illus. The use and application of linear integrated circuits are clearly demonstrated by these 35 experiments requiring only standard commercial and industrial grade parts. 647/801 Pub. Pr., \$22.95

CABLE TELEVISION TECHNOLOGY. By K. T. Deschler. 262 pp., illus. This timely book covers all aspects of cable television operation, from the traditional "lineman" topics to satellite antennas and fiber optic links. Also includes guides to coaxial cable testing, CATV terms, and graphic symbols. 273/782 Pub. Pr., \$18.95

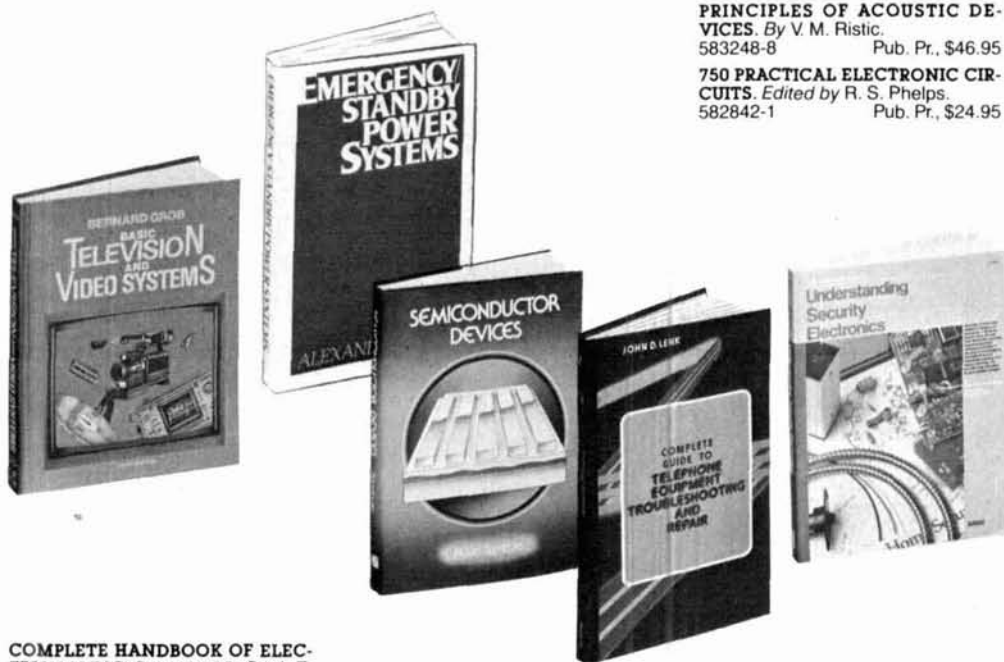
VIDEO SCRAMBLING AND DE-SCRAMBLING FOR SATELLITE AND CABLE TV. By R. F. Graf and W. Sheets. 246 pp., illus. From the theory and techniques of video encryption and decryption, to an overview of government rules and regulations, all the information you need is here in one convenient place. 585107-0 Pub. Pr., \$19.95

RF CIRCUIT DESIGN. By C. Bowick. 176 pp., illus. Experienced rf circuit designers looking for a practical approach to the design of rf amplifiers, impedance matching networks, and filters will find that this lavishly illustrated guide fits the bill. 585118-0 Pub. Pr., \$22.95

SEMICONDUCTOR DEVICES. By M. Zambuto. 402 pp., illus. Here's a well-organized and up-to-date explanation of the physical mechanisms of modern semiconductor devices. The coverage is intuitive, minimizing the use of quantum physics. 727/007 Pub. Pr., \$47.95

BASIC TELEVISION AND VIDEO SYSTEMS, 5/e. By B. Grob. 464 pp., illus. Emphasizing the principles of operation and servicing, this fully illustrated, thorough book covers all the basics, from cameras, picture tubes, and video signals to FM sound signals, cable television, and fiber optics. 249/334 Pub. Pr., \$35.95

PROGRAMMABLE LOGIC CONTROLLERS. By F. D. Petruzella. 205 pp., illus. This first look at Programmable Logic Controllers focuses on their principles and offers practical information on installation, programming, and maintenance. Features wiring diagrams, data manipulation and math instructions, and troubleshooting techniques. 496/870 Pub. Pr., \$28.50



COMPLETE HANDBOOK OF ELECTRIC MOTOR CONTROLS. By J. E. Traister. 584542-3 Pub. Pr., \$33.00

THE ILLUSTRATED DICTIONARY OF ELECTRONICS. By R. P. Turner and S. Giblisco. 584808-2 Pub. Pr., \$23.95

ADVANCED DIGITAL TROUBLESHOOTING. By A. J. Evans. 584763-9 Pub. Pr., \$19.95

ELECTRICAL SYSTEMS FOR COMPUTER INSTALLATIONS. Edited by R. J. Lawrie. 367/299 Pub. Pr., \$34.50

UNDERSTANDING FIBER OPTICS. By J. Hecht. 583896-6 Pub. Pr., \$17.95

INTRODUCTION TO RADIO FREQUENCY DESIGN. By W. H. Hayward. 582748-4 Pub. Pr., \$39.00

BATTERIES AND ENERGY SYSTEMS, 2/e. By C. L. Mantell. 400/318 Pub. Pr., \$48.50

DIGITAL FILTERS: Theory and Application. By N. K. Bose. 584509-1 Pub. Pr., \$44.95

HOW TO MEASURE ANYTHING WITH ELECTRONIC INSTRUMENTS. By J. A. Kuecken. 584537-7 Pub. Pr., \$19.95

MASTERING ELECTRONICS, 2/e. By J. Watson. 684/804 Pub. Pr., \$24.95

ADAPTIVE ANTENNAS: Concepts and Performance. By R. T. Compton, Jr. 584767-1 Pub. Pr., \$50.00

Any 3 books for \$3.95 if you join now and agree to purchase two more books—at handsome discounts—during your first year of membership.

CIARCIA'S CIRCUIT CELLAR, VOL. V By S. Ciarcia. 109/627 Pub. Pr., \$21.95

ELECTRONIC CIRCUITS COOKBOOK. By H. L. Helms. 584640-3 Pub. Pr., \$28.00

COMPLETE GUIDE TO TELEPHONE EQUIPMENT TROUBLESHOOTING AND REPAIR. By J. D. Lenk. 583851-6 Pub. Pr., \$35.00

CALCULUS FOR ELECTRONICS, 4/e. By A. E. Richmond and G. W. Hecht. 532/55X Pub. Pr., \$34.95

OPERATIONAL AMPLIFIERS AND LINEAR INTEGRATED CIRCUITS: Theory and Applications. By D. J. Dailey. 399/31X Pub. Pr., \$34.95

IBM PC TROUBLESHOOTING AND REPAIR GUIDE. By R. C. Brenner. 585123-7 Pub. Pr., \$19.95

CMOS COOKBOOK, 2/e. By D. Lancaster as rev. by H. M. Berlin. 584591-1 Pub. Pr., \$18.95

FEEDBACK AMPLIFIER PRINCIPLES. By S. Rosenstark. 539/146 Pub. Pr., \$35.95

PRINCIPLES OF ACOUSTIC DEVICES. By V. M. Ristic. 583248-8 Pub. Pr., \$46.95

750 PRACTICAL ELECTRONIC CIRCUITS. Edited by R. S. Phelps. 582842-1 Pub. Pr., \$24.95

ATE: AUTOMATIC TEST EQUIPMENT. By A. C. Stover. 617/929 Pub. Pr., \$44.95

Bob Middleton's HANDBOOK OF ELECTRONIC TIME-SAVERS AND SHORTCUTS. By R. G. Middleton. 583865-6 Pub. Pr., \$29.95

MICROELECTRONICS, 2/e. By J. Millman and A. Grabel. 423/30X Pub. Pr., \$51.95

A HANDBOOK FOR INVENTORS: How to Protect, Patent, Finance, Develop, Manufacture, and Market Your Ideas. By C. D. MacCracken. 582811-1 Pub. Pr., \$18.95

MICROPHONE MANUAL: Design and Application. By D. M. Huber. 584660-8 Pub. Pr., \$29.95

ELECTRONIC SPEECH RECOGNITION: Techniques, Technology, and Applications. Edited by G. Bristow. 079/137 Pub. Pr., \$53.95

TROUBLESHOOTING AND REPAIRING SATELLITE TV SYSTEMS. by R. Maddox. 583703-X Pub. Pr., \$26.95

John D. Lenk's TROUBLESHOOTING AND REPAIR OF AUDIO EQUIPMENT. By J. D. Lenk. 583895-8 Pub. Pr., \$21.95

THE SATELLITE TV HANDBOOK. By A. T. Easton. 585121-0 Pub. Pr., \$16.95

COMPLETE GUIDE TO VHS CAMCORDER TROUBLESHOOTING AND REPAIR. By J. D. Lenk. 585166-0 Pub. Pr., \$41.00

More Books to Choose from

ELECTRICAL AND ELECTRONIC DRAWING, 5/e. By C. J. Baer and J. R. Ottaway. 030/286 Pub. Pr., \$39.50

INTEGRATED CIRCUITS FOR COMPUTERS: Principles and Applications. By W. L. Schweber. 536/244 Pub. Pr., \$28.95

PASCAL FOR ELECTRONICS. By E. J. Pasahow. 487/243 Pub. Pr., \$17.95

TURBO PASCAL FOR ELECTRONICS. By E. J. Pasahow. 487/324 Pub. Pr., \$14.95

UNDERSTANDING IC OPERATIONAL AMPLIFIERS, 3/e. By R. Melen and H. Garland. 585120-2 Pub. Pr., \$12.95

MICROCOMPUTER TROUBLESHOOTING AND REPAIR. By J. G. Stephenson and B. Cahill. 585106-7 Pub. Pr., \$24.95

LENK'S TROUBLESHOOTING AND REPAIR OF MICROPROCESSOR-BASED EQUIPMENT. By J. D. Lenk. 585122-9 Pub. Pr., \$21.95

EASY-UP ANTENNAS FOR RADIO LISTENERS AND HAMS. By E. M. Noll. 585108-3 Pub. Pr., \$16.95

COMPACT DISC TROUBLESHOOTING AND REPAIR. By N. Heller and T. Bentz. 585099-0 Pub. Pr., \$19.95

INTRODUCTION TO TELEVISION SERVICING. By W. C. Brandenburg. 071/764 Pub. Pr., \$26.96

UNDERSTANDING AUTOMOTIVE ELECTRONICS, 3/e. By W. B. Ribbens. 584761-2 Pub. Pr., \$17.95

Here's how the Practical Electronics Book Club works to serve you:

- **Practical information . . . we make it easy to get!** For reliable hands-on information, turn to the Practical Electronics Book Club. Every 3 or 4 weeks (12-15 times a year) members receive the Club Bulletin offering more than 30 books—the best, newest, most important books from all publishers.
- **Dependable service . . . we're here to help!** Whether you want information about a book or have a question about your membership, just call us toll-free or drop us a line. To get only the books you want, make your choice on the Reply Card, and return it by the date specified. If you want the Main Selection, do nothing—it will be sent to you automatically. (A small shipping and handling charge is added to each shipment.)
- **Club convenience . . . we do the work!** You get a wide choice of books that

simply cannot be matched by any bookstore. And all your books are conveniently delivered right to your door. You also get 10 full days to decide whether you want the Main Selection. (If the Club Bulletin ever comes late and you receive a Main Selection you don't want, return it for credit at our expense.)

- **Substantial savings . . . and a bonus program too!** You enjoy substantial discounts—up to 40%!—on every book you buy. Plus, you're automatically eligible for our Bonus Book Plan which allows you extra savings on a wide selection of books.
- **Easy membership terms . . . it's worthwhile to belong!** Your only obligation is to purchase 2 more books—at handsome discounts—during the next 12 months, after which you enjoy the benefits of membership with no further obligation. You or the Club may cancel membership anytime thereafter.

Fill out the card and mail today! If the card is missing, write to:
PRACTICAL ELECTRONICS BOOK CLUB

11 West 19th Street—Dept. PRD, 4th Floor, New York, NY 10011.

mand must be followed by the * (star) key for it to be accepted. If you don't like using the *, you can program the 5K to accept the commands upon loss of COR or within a specified period of time after COR release.

The 5K can handle up to 200 macros in memory. This is probably more than enough for any repeater use. It can also handle up to 32 com-

mands in a macro chain. Since N1BAC/R is part of the New England 220 MHz Network, I plan to let the 5K do all the switching, PTT of the linking system, timing, and IDing.

The S-COM 5K Repeater Controller, wired and tested, is priced at \$195 plus \$5 shipping and handling. The plain rack cabinet (1-3/4" x 19") is \$35, audio delay module is \$79 (add \$3 for

shipping and handling without others). The display cabinet runs \$69 plus \$5 shipping and handling without the 5K board. Extra manuals are available for \$20. Contact S-COM Industries, P.O. Box 1718, Loveland, Colorado 80539-1718. Phone (303)663-6000.

de N1BAC

NEW PRODUCTS

Azimuth Awards QSL Library

Azimuth Communications Corporation has a new Azimuth Awards QSL Library for organizing and protecting your QSL cards. You can select an album for each award — DX Century Club, Worked All Zones, Worked All States, and Worked All Continents — or for your QSLs in general.



Each album is made of durable vinyl and comes with 20 scratch resistant pages, enough for 120 cards. The pocket pages hold six large 4 x 6 inch cards. Extra pages are available in packs of 20.

The cost, with Azimuth's special introductory offer, is \$19.95 — a savings of \$5 off the regular retail price of \$24.95. Extra 20-page packs are just \$12.95. Please add \$2.50 shipping and handling per album and page pack (foreign orders add \$US 7.50). California residents please add sales tax. To order contact: Azimuth Awards QSL Library, Department EJ, 11845 W. Olympic Boulevard, Suite 1100, Los Angeles, California 90064.

Circle #301 on Reader Service Card.

IC-2500A Dual Band FM Transceiver

ICOM announces the new IC-2500A dual band FM transceiver, equipped with both 440 and 1200 MHz. It features:

- Two bands in one transceiver. The IC-2500A simultaneously covers 440 to 450 MHz and 1240 to 1300 MHz.
- Cross band full duplex.
- Simultaneous dual band watch. The IC-2500A can receive on both the main and sub bands at the same time.
- AFC and RIT functions.

- 40 memory channels plus two programable call channels.
- Scan functions and priority watch.
- High power output. The IC-2500A provides a full 35 watts output on high power for 440 MHz and full 10 watts on 1200 MHz.
- Independent squelch and volume.

The optional UT-40 tone squelch unit is a pocket beep function that lets you make contact with only those stations you wish.

The IC-2500A dual band FM transceiver is priced at \$999. Contact ICOM America, Inc., 2380 116th Avenue N.E., PO Box C-90029, Bellevue, Washington 98009-9029. Phone: (206)454-8155.

Circle #302 on Reader Service Card.

XK-220 Digital Trainer

The Elenco digital trainer model XK-220 is designed for the student or hobbyist who wants hands-on training in the workings of digital theory.

Circuits are easily assembled on the 590-pin breadblock and 100-pin breadstix. The trainer has three power supplies, eight data switches, two logic switches, and eight logic indicators.



The unit has a sturdy carrying case with a parts box in the lid. The XK-220 comes complete with instructions and circuit descriptions. You supply ICSSs, wire, and circuit diagrams.

The trainer is also available in kit form with easy-to-follow instructions and a troubleshooting guide. The assembled XK-220 costs \$150; the kit is \$110. Contact Elenco Electronics, Inc., 150 W. Carpenter Avenue, Wheeling, Illinois 60090. Phone: (312)541-3800.

Circle #303 on Reader Service Card.

Kantronics Superfax II

Kantronics, Inc. announces the Superfax II. Superfax II requires the use of a Kantronics TNC using version 2.8 or later firmware. It features:

- Unattended mode.
- Semi-unattended mode.
- Manual mode.
- View from buffer or disk file, with the ability to pause display.
- Display black on white or white on black.
- Save buffer to disk, saves all scan lines.
- Print picture black on white or white on black.
- Choose 120 lpm for weather facsimile or 60 lpm for wire photo pictures.
- All scan lines are saved; however, you can choose to receive the full width of the picture including sync lines, or receive 80 or 66-percent width of picture.
- Split-screen terminal mode non-buffered keyboard input characters are sent immediately to TNC capture incoming data to disk.
- Supports CGA, EGA, VGA/MCGA and HERCULES™, also some graphics modes of the Olivetti™ and AT&T™ personal computers.
- Supports com1, com2, com3, and com4.
- Prints to printers with Epson compatible graphics modes, or use the custom setup to configure for most nine-pin graphics capable printers.
- Requires Kantronics TNC using version 2.8 or later firmware.

Superfax II is priced at \$2995 and is available from Kantronics, Inc. 1202 E. 23rd Street, Lawrence, Kansas 66046. Phone: (913)842-7745.

Circle #304 on Reader Service Card.

MEASURING THE ACCURACY OF A PARABOLIC ANTENNA

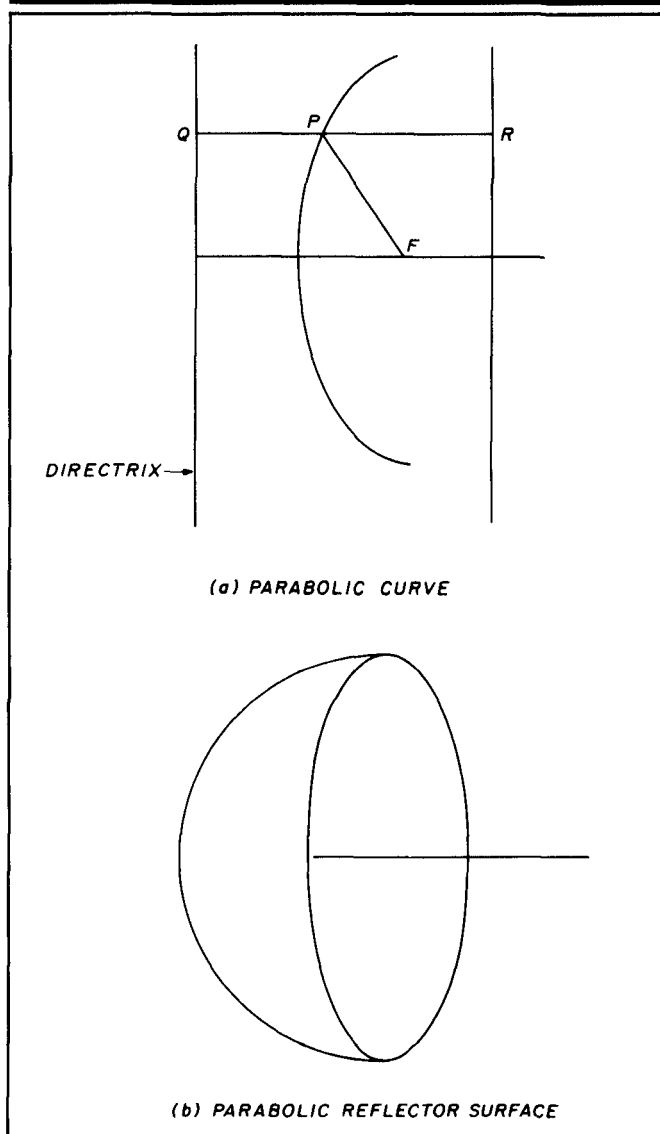
By Lester A. Wagner, WA8BJO, 463 S. Tecumseh Road, Springfield, Ohio 45506 and Glen Grewell, W8FP, 251 Estelle Avenue, Enon, Ohio 45323

The parabolic antenna is a useful design when you consider the use of the higher frequency bands and the increased interest in satellite TV and Amateur Radio reception. This type of antenna offers higher gain than other conventional antennas. Also, when you look at the fairly high cost of commercial dish antennas, a homebrew parabolic antenna seems more practical, if not a necessity for the Radio Amateur. You can make the reflector out of a mesh or screen at frequencies in the range of 1 to 5 GHz. Because a parabola isn't a simple shape like a circle or a flat plate, you'll find you have some difficulty measuring the shape of the surface. This article describes a simple method of measuring the surface of a parabolic reflector. We used a BASIC computer program to calculate the parameters necessary to determine the accuracy of the surface. We constructed a special measuring rod to ascertain, from the focus, the distance of points on the surface as determined by the computer program. This method of accuracy determination eliminates the need for a large template, which is difficult to use because of its size.

The parabolic surface

The parabolic reflector is probably the most widely used high-gain antenna. Reflecting antennas achieve gains in excess of 30 dB in the microwave region. The simplest reflector consists of two components — a large reflection surface and a much smaller feed source. According to the definition of the parabolic curve in **Figure 1A**, the distance from any point P on the parabolic curve to the focus is equal to the perpendicular distance from that point to a line called the directrix. The directrix is a line perpendicular to the axis, passing through the point which is the virtual image of the focus. Thus, in **Figure 1A**, $PF = PQ$. The parabolic reflector has a very unique property: all the waves originating from a point source at the focus arrive at a line perpendicular to the axis with equal phase. A parabolic surface is formed by rotating the top half of the curve in **Figure 1A** around the axis forming the surface as shown in **Figure 1B**.

FIGURE 1



Parabolic reflector antenna: (A) parabolic curve, (B) parabolic reflector surface.

TABLE 1

Parameters for measuring the parabolic antenna surface.
(Dimensions are in inches.)

S	L
0	58.91
2	58.93
4	58.98
6	59.06
8	59.18
10	59.33
12	59.52
14	59.74
16	59.99
18	60.28
20	60.59
22	60.95
24	61.33
26	61.74
28	62.19
30	62.67
32	63.18
34	63.72
36	64.29
38	64.89
40	65.51
42	66.17
44	66.86
46	67.57
48	68.31
50	69.08
52	69.87
54	70.69
56	71.54
58	72.41
60	73.31
62	74.23
64	75.17
66	76.14
68	77.12
70	78.14
72	79.17
74	80.22
76	81.29

The parameters which define the parabolic surface are somewhat difficult to measure. You can solve this measurement problem by defining two other measurable parameters.

We decided that determining the parameters of S and L would make surface measurement easy. These dimensions are defined in **Figure 2**. Length S is the straight line distance from the center of the parabola to the point on the surface to be measured. Length L is the distance from the focal point to a specific point on the surface of the parabola. Note that distance L isn't a simple constant radius. Distance L from the focus increases as distance S from the center of the parabola increases.

We determined parameters S and L for a 12-foot diameter parabolic antenna with a 58.9-inch focal length. We calculated value L for each 2-inch increment in distance S . We chose these dimensions because they were easy to measure. **Table 1** shows the values for S and L in inches. The

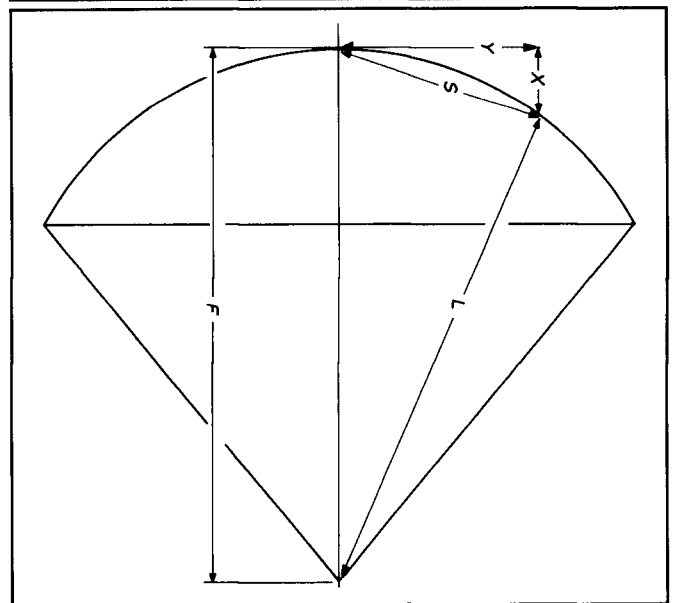
simple BASIC computer program used to calculate these values is given in the appendix so that you can compute the parameters for larger or smaller dish antennas.

The measuring element

The 12-foot diameter parabolic antenna with a focal length of 58.91 inches shown in **Figure 2** was built to receive satellite signals in the 4-GHz frequency range. The frame for the antenna was constructed from thin wall 1/2-inch conduit welded together. The conduit frame was covered with coated steel insect screening to form the parabolic reflector surface. The technique developed here is used to determine the accuracy of the surface.

As mentioned before, we designed a special measuring element to find distance L . The device is shown in **Figure 3**. Our design makes it easy to adjust its length. We built this measuring rod primarily from parts found in our junk-boxes. We used the following parts: a 39-inch length of 1/2-inch diameter PVC pipe, part of a telescoping car antenna, a flexible coupler, and a piece of 1/4-inch metal rod 35 inches long. First we cut a 1/8-inch wide, 30-inch long slot in one wall of the PVC pipe (see **Figure 3**). This slot permits the pointer to slide back and forth, indicating the total length of the measuring rod. The internal part of the device is made from the 1/4-inch rod, the telescoping antenna section, and the end cap. We connected the end cap to one end of the telescoping section. Then we attached the end cap to one end of the PVC pipe. We then fastened the other end of the telescoping section to one end of the 1/4-inch rod and soldered a short pointer to the junction of the rod and the telescoping section. The pointer can stick up out of the slot in the PVC pipe and slide back and forth as the rod is extended and shortened. We inserted the extendable rod assembly into the PVC pipe until the end cap fit

FIGURE 2



Basic geometry of a parabola.

MADISON SHOPPER

CALL FOR ORDERS

1 (800) 231-3057
1 (713) 520-7300 OR 1 (713) 520-0550
TEXAS ORDERS CALL COLLECT
FAX 1 (713) 771-7759

ALL ITEMS ARE GUARANTEED OR
SALES PRICE REFUNDED



New Icom IC 781 Trades wanted
Kenwood TH215A, TH25AT Trade in your old HT
TS440 S/AT Call



Kenwood TS 140S Call for trade
New Kenwood TM-721A, mobile Call
ICOM 228H/TTM 449.00



TS 790A Superior 2 Meter 70 cm Rig, 1.2 GHz Option Available Call
Icom 765 2695.00
Kenwood MC 60A + Heil HC-5 cartridge inst. 150.00
Icom IC-725 799.00
NYE MB5A Tuner 569.00
Alpha Delta Transtrap HV 33.00
CSI Private Patch V 489.00
Ameco PT 3 Pre Amp 99.00
Larsen 2-meter on glass 49.95
Anteco 2M, 5/8, Mag, Mount, Comp 25.00
Van Gordon Windom WA2 44.00
Bird 43, elements/stock Call
Thousands of panel meters 3 95 up CALL
Belden 9913, 8267, 8214 Stock Call
MICA Capacitors Call
Ampire VHF, UHF GaAsFET preamps Call
831SP-PL259 Silverplate (Amphenol) 1.50
82-61 N Male (Amphenol) 3.50
82-202-1006 N Male (9913) 3.50
Double Female UHF 1.00
UG176 RGBX each 40
Surplus Elbow PL259-SO239 each \$1
Receiving tubes 50-90% off list price Call
STUPH
RF Amp Meters \$15 to \$30 each
25 pF/10KV Doorknob Cap 5.00
Throat Mike (new mil. surplus) 5.00
ANBH-1 600 Ω Headphones (new mil. surplus) 5.00
New Demo Units for Sale
Kenwood R-5000 849.00

USED EQUIPMENT

All equipment, used, clean, with 90 day warranty and 30 day trial. Six months full trade against new equipment. Sale price refunded if not satisfied.

(800) 231-3057

POLICIES

Minimum order \$10.00. Mastercard, VISA, or C.O.D. All prices FOB Houston, except as noted. Prices subject to change without notice. Items subject to prior sale. Call anytime to check the status of your order. Texas residents add sales tax. All items full factory warranty plus Madison warranty.

Bird and Belden products in stock. Call today.

MADISON

Electronics Supply

3621 FANNIN
HOUSTON, TEXAS 77004



"GUARANTEED TO OUTPERFORM"
THEOR YOUR MONEY BACK!

HAM 10™ TEN METER HAM ANTENNA

The "Ham 10" ten meter antenna is designed and manufactured by American Antenna, makers of the world famous K40 Antenna. With a power handling capacity of 1500 watts and a band width of 1.5 mhz between 2:1 SWR points the "HAM 10" is the perfect compliment to all single-band ten meter rigs. The stainless steel base of the "HAM 10" is supplied with an adjustable trunk lip mount. Also available is an optional adaptable heavy duty magnamount.

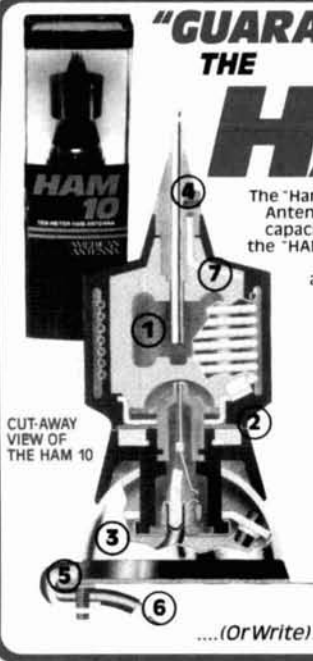
EXCLUSIVE FEATURES:

- ① HANDLES UP TO 1500 WATTS!
- ② METALPLAS CONSTRUCTION.
- ③ 30° ROTATION OF BASE.
- ④ STAINLESS STEEL WHIP AND BASE.
- ⑤ MOUNTS ANYWHERE ON ANY VEHICLE!
- ⑥ FULLY ASSEMBLED WITH 18' OF RG-58 COAX.
- ⑦ COMPUTER DESIGNED ISOLATION CHAMBER.

For A Free Brochure, Call:

1-800-323-5608
IN IL. 1 800-942-8175

....(Or Write) AMERICAN ANTENNA 1500 EXECUTIVE DR. ELGIN, IL 60123



CUT-AWAY VIEW OF THE HAM 10

✓ 116

NEMAL ELECTRONICS

- *Complete Cable Assembly facilities MIL-STD-45208
- *Commercial Accounts welcome- Quantity pricing * Same day shipping most orders
- *Factory authorized distributor for Alpha, Amphenol, Belden, Kings, Times Fiber

Call NEMAL for computer cable, CATV cable, Flat cable, semi-rigid cable, telephone cable, crimping tools, D-sub connectors, heat shrink, cable ties, high voltage connectors.

HARDLINE 50 OHM

FXA12 1/2" Aluminum Black Jacket 89/ft
FLC12 1/2" Cablewave corr. copper blk jkt 1.69/ft
FLC78 7/8" Cablewave corr.copper blk jkt 4.25/ft
NM12CC N conn 1/2" corr copper m/1 25.00
NM78CC N conn 7/8" corr copper m/1 54.00

COAXIAL CABLES (per ft)

1180 BELDEN 9913 very low loss 55
1102 RG8/U 95% shield low loss foam 11ga 36
1110 RG8X 95% shield (mini 8) 17
1130 RG213/U 95% shield mil spec NCV jkt 39
1140 RG214/U dbl silver shield mil spec 1.85
1705 RG142B/U dbl silver shield, teflon ins 1.50
1310 RG217/U 50 ohm 5000 watt dbl shield 98
1450 RG174/U 50 ohm .100" od mil spec 14

ROTOR CABLE-8 CONDUCTOR

8C1822 2-18ga and 6-22ga 25
8C1820 2-18ga and 6-20ga 39

CONNECTORS-MADE IN USA

NE720 Type N plug for Belden 9913 \$3.95
NE723 Type N jack for Belden 9913 4.95
PL259AM Amphenol PL25989
PL259TS PL259 teflon ins/silver plated 1.59
PL259AM Amphenol female-female (barrel) 1.65
UG175/UG176 reducer for RG58/59 (specify)22
UG21DS N plug for RG8,213,214 Silver 3.35
UG83B N jack to PL259 adapter, teflon 6.50
UG146A SO239 to N plug adapter, teflon 6.50
UG255 SO239 to BNC plug adapter, Amphenol 4.29
SO239AM UHF chassis mt receptacle, Amphenol 89
UG88C BNC plug RG58, 223, 142 1.45

GROUND STRAP-GROUND WIRE (per ft)

GS38 3/8" tinned copper braid 40
GS12 1/2" tinned copper braid 50
GS200 1-1/2" heavy tinned copper braid 2.00
HW06 6ga insulated stranded wire 39
AW14 14ga stranded Antenna wire CCS 14

Prices do not include shipping, \$3 minimum. Visa/Mastercard \$30 min. COD add \$3.00

Call or write for complete price list. Nemal's new 40 page CABLE and CONNECTOR SELECTION GUIDE is available at no charge with orders of \$50 or more, or at a cost of \$4 with credit against next qualifying order.

NEMAL ELECTRONICS, INC. 12240 NE 14th Ave. N. Miami, FL 33161
(305) 893-3924 Telex 6975377 24hr FAX (305)895-8178

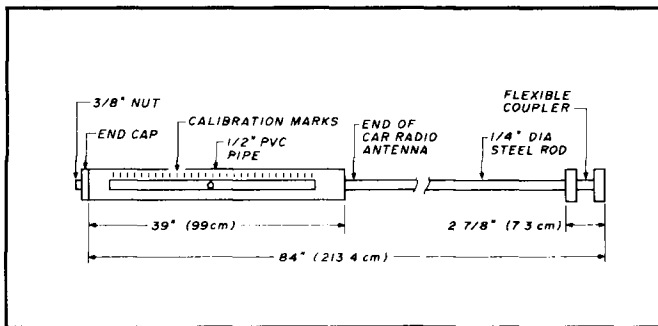
**SAY YOU SAW IT
IN
HAM RADIO**

N6KW QSL Cards

The finest QSL Cards at reasonable prices. Basic Cards, map cards, cartoon cards, photo cards and more. Your idea converted to ink or use standard designs. 747 ink colors, any card stock. Photos b/w or beautiful color. Have cards that fit your style. FREE SAMPLES - postage appreciated.

KW Litho - Dept. HR P.O. Box 17390
(817)332-3658 Ft. Worth, TX 76102

FIGURE 3



Measuring rod.

onto the end of the pipe. **Figure 3** shows the final assembly of the measuring rod. We put calibration marks on the outside of the PVC pipe to indicate the length of the rod assembly. These marks show the total length of the measuring rod, making it easy to use. You must be able to extend the measuring device from approximately 58 to 82 inches in length in order to measure the distance to any point on the parabolic surface.

We used our measuring rod to calculate the accuracy of the parabolic surface of our antenna. First, we removed the low noise amplifier (LNA) from the antenna feed. Next, we attached a connector, which mates with the connector on the flexible couple on the end of the measuring rod, to the end of the pipe that holds the LNA in place. Then we loosened the clamps holding the piece of pipe, slid the pipe toward the parabolic dish until the connector was at the focal point, and tightened the clamps to hold the pipe in place. Fastening the flexible coupler on the measuring rod to the connector on the pipe was the next step. This holds one end of the measuring rod at the focal point, leaving the other end free to be placed at any point on the surface of the parabola. You can read distance L directly from the calibrations on the measuring rod when you slide the end of the measuring rod to a point on the parabola. The most accurate position for antenna measurement is a horizontal one; that is, with the antenna pointed at the zenith.

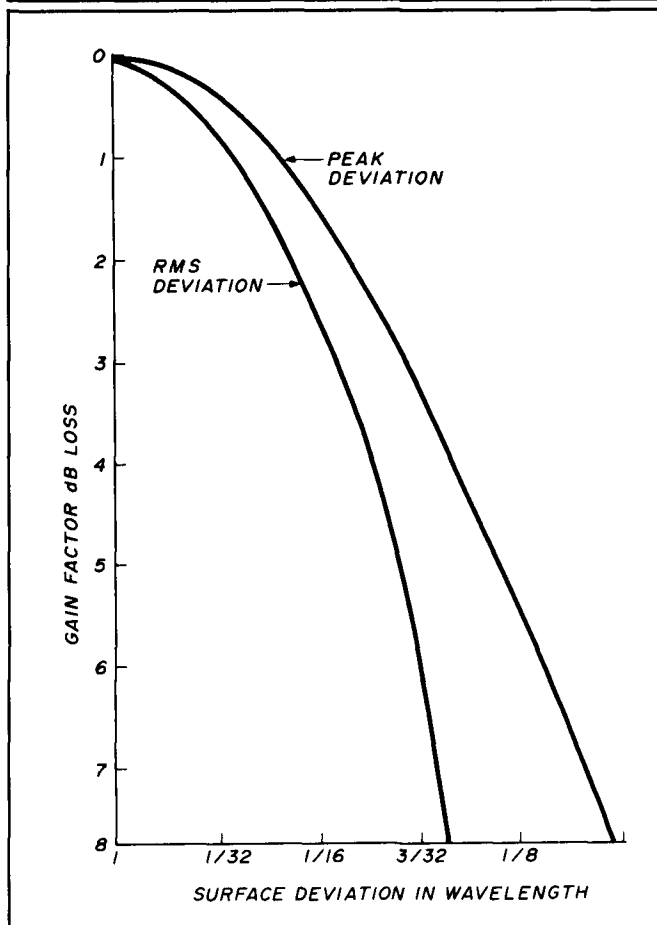
Effect of surface accuracy on performance

You may wonder how accurate the surface of a parabolic reflector antenna should be and why this accuracy is important. The accuracy of the reflector surface is important because it indicates the specifications to which the antenna must be built; it also gives an indication of the antenna's gain reduction. The surface roughness causes phase distortions in the reflected energy and this can reduce the overall antenna gain. The phase error (which can be tolerated because of surface roughness) is directly proportional to the frequency. Larger surface errors can be better tolerated at lower frequencies than at the higher ones. Ruze provides a mathematical expression which relates the surface tolerance to a reduction in gain. Deviation from the true surface can be expressed in peak deviation or in RMS deviation. The graph in **Figure 4** shows the reduction of gain as a function of surface error. One curve is for peak deviation from the surface; the other is for the RMS deviation from the surface. For a peak deviation of 1/16 wavelength, the

reduction in gain is approximately 1.5 dB; for an RMS deviation of 1/16 wavelength, the reduction is approximately 2.7 dB. The loss in antenna gain quickly increases as the surface error exceeds 1/16 wavelength RMS. Surface irregularities are caused by construction errors and external forces acting on the structure. As the frequency at which the antenna is used increases, the tolerances of the parabola become tighter. For example, a 1/16 wavelength is 0.55 inches at 1296 MHz, 0.32 inches at 2300 MHz and 0.18 inches at 4000 MHz.

Any corrections you make to the surface must be made in terms of the frame, because the surface is made of window screen. Make sure all the spokes are well fitted to the center plate. The spokes should be laid out and bent into shape before you attach them to the center plate. Once you've connected them to the center plate, check to make sure that each spoke has the correct shape. You can use the measuring element to measure points on the spokes. If the position is off, bend the spoke to bring the point into line. Changing the frame is a tedious process because bending the frame to change one point may affect other points on the frame. The measuring element lets you determine the accuracy of different points on the frame. You'll find this much easier than holding a 12-foot template in place to measure several points. The measuring and bend-

FIGURE 4



Reduction of gain due to surface errors.

ing procedure is an iterative process; repeat it until the surface's accuracy is acceptable. Our antenna's surface is within $\pm 1/8$ inch tolerance.

Conclusions

We've provided a simple method for determining the accuracy of the parabolic surface and for calculating the parameters used to check the surface accuracy. The parameters given here are for a 12-foot diameter parabolic antenna with a 58.91-inch focal length; however, you can change the computer program's parameters easily to provide data for checking parabolic antennas of other sizes. The BASIC program is written for a Commodore 64 computer, but can be applied to other home computers and programmable calculators. With increased accuracy, your parabolic antenna will provide better performance than other types of antennas at the higher frequencies.

Appendix

The surface of a paraboloid is described by the equation:

$$Y^2 = 4FX \quad (1)$$

where F is the focal length of the parabola.

To simplify surface measurement, determine the parameters of S and L. These dimensions are defined in **Figure 2**. Values X and Y are the rectangular coordinates of the points on the paraboloid.

Use the following procedure to calculate distance L (see **Figure 2**). The distance S is given in terms of F, X, and Y as:

$$S = \sqrt{X^2 + Y^2} = \sqrt{X^2 + 4FX} \quad (2)$$

By using **Equation 2** and applying the quadratic equation from algebra, you can solve for X as:

$$X = \sqrt{4F^2 + S^2} - 2F \quad (3)$$

Once you've determined X, you can find distance L using the Pythagorean theorem as in **Equation 4**:

$$L = \sqrt{Y^2 + (F-X)^2} = \sqrt{4FX + (F-X)^2} \quad (4)$$

With a specific distance S, you can calculate distance L by using the focal length. Distance L is the same for all points located at a specific distance from the center of the parabola. This describes a locus of points which fall in a circle on the parabola's surface.

We've included a listing of the computer program to calculate the parameters used in the measurements. We wrote the program to obtain the values in **Table 1** in BASIC for use on a C-64 computer. You can use this program to compute the parameters for dish antennas of different sizes.


BASIC COMPUTER PROGRAM

```
10 F= 58.909
20 FOR S= 0 TO 76 STEP 2
30 X=SQR(4*F*X+S*S)-2*F
40 L=SQR(4*F*X+(F-X)*(F-X))
50 PRINT S,L
60 NEXT S
70 END
```

where:

F is the focal length of the parabola,

L is the distance from the focus to the point on the parabola, and

S is the distance from the center of the parabola to the point of concern on the parabola. 

REFERENCES

1. J.D. Kraus, *Antennas*. McGraw Hill Book Company, New York, 1950, pages 336-346.
2. J.D. Kraus, *Radio Astronomy*, 2nd Edition, Cygnus-Quasar Books, Powell, Ohio, 1986, pages 6-57 through 6-62.
3. G.L. Hall, *The ARRL Antenna Book*, ARRL Publication, Newington, Connecticut, 1984, pages 12-16, 12-17.
4. R.C. Johnson, and H. Jasik, *Antenna Engineering Handbook*, 2nd Edition, McGraw Hill Book Company, 1984, pages 17-17 through 17-22.

(Continued from page 4.)

awards for his work, has authored numerous articles, and is associate chief of staff for research and development at Jerry L. Pettis Memorial Veterans Administration Medical Center, Loma Linda, California. He will discuss the basic science that supports our current knowledge of radiation hazards.

- Samuel Milham, Jr., M.D., Washington state epidemiologist. Dr. Milham, you'll remember, did the study that showed that hams, as well as electrical/electronic workers, suffered from higher than normal rates of certain leukemias and lymphomas (types of cancer).
- Ivan Shulman, M.D., WC2S, cancer surgeon. Shulman will discuss how the Amateur can take preventive steps to minimize the risk of exposure to the harmful effects of electromagnetic radiation.
- David Rodman, M.D., KN2M, ophthalmologist and writer for *Ham Radio* magazine. Rodman will cover his extensive work to quantify field strength measurements of both RF and 60-Hz field levels.

Again, it is important to stress that there is no "smoking gun" showing a clear, definable link between electromagnetic radiation and cancer or other diseases. There seldom is, at this early awareness stage of what may be a serious health problem. The latest reporting in the media, while prone to sensationalism and exaggeration, does emphasize the need to research this potential hazard further. In the words of one authority, "Something is going on here."

One must wonder why the ARRL's Bioeffects Committee has said almost nothing since its formation and Dr. Milham's first mention of his study of California and Washington state Amateur mortality rates in *Lancet*, April 6, 1985. (*Lancet* is a highly regarded British medical journal.) Hopefully, the ARRL will publish its policy and its findings soon. Silence, in this case, is not golden. It smacks of being afraid to "fess up" to a problem and admit that it might exist.

Is there a problem? It's likely that there is, but time, money, and thousands of hours of meticulous research are necessary to arrive at the final answers. *HR* is working on a number of different projects and will report its findings as they become known. Our intent is to inform — not fall prey to sensationalism, or blindly deny that a problem exists in the face of emerging evidence. We'll keep you, our readers, fully informed and up to date on all the latest developments.

Craig Clark, NX1G

HAM MART

Ham Radio's guide to help you find your local Amateur Radio Dealer

CALIFORNIA

A-TECH ELECTRONICS
1033 Hollywood Way
Burbank, CA 91505
(818) 845-9203

New Ham Store and Ready to Make a Deal!

JUN'S ELECTRONICS
3919 Sepulveda Blvd.
Culver City, CA 90230
(213) 390-8003
(800) 882-1343 Trades
Habla Espanol

COLORADO

ALLIED APPLIANCE & RADIO
4253 South Broadway
Englewood, CO 80110
(303) 761-7305
1 (800) 321-7305 (Orders only)

Rocky Mts Amateur/Shortwave Specialists,
Ten-Tec, Yaesu, JRC-NRD, Sony, MFJ,
KLM, and other fine gear. New and used.
Visa/MC. Antennas, books, discount prices
too!

COLORADO COMM CENTER
525 East 70th Ave.
Suite One West
Denver, CO 80229
(303) 288-7373
(800) 227-7373
Stocking all major lines
Kenwood Yaesu, Encomm, ICOM

CONNECTICUT

HATRY ELECTRONICS
500 Ledyard St. (South)
Hartford, CT 06114
(203) 527-1881

Call today. Friendly one-stop shopping
at prices you can afford.

DELAWARE

AMATEUR & ADVANCED
COMMUNICATIONS
3208 Concord Pike
Wilmington, DE 19803
(302) 478-2757
Delaware's Friendliest Ham Store.

DELAWARE AMATEUR SUPPLY
71 Meadow Road
New Castle, DE 19720
(302) 328-7728
(800) 441-7008
Icom, Ten-Tec, Microlog, Yaesu, Kenwood,
Santec, KDK, and more. One mile off I-95,
no sales tax.

FLORIDA

AMATEUR ELECTRONIC SUPPLY
1898 Drew Street
Clearwater, FL 33575
(813) 461-4267
Clearwater Branch
West Coast's only full service
Amateur Radio Store.
Hours Mon.-Fri. 9-5:30, Sat. 9-3

AMATEUR ELECTRONIC SUPPLY
621 Commonwealth Ave.
Orlando, FL 32803
(305) 894-3238
Fla. Wats: 1 (800) 432-9424
Outside Fla: 1 (800) 327-1917
Hours Mon.-Fri. 9-5:30, Sat. 9-3

HAWAII

HONOLULU ELECTRONICS
819 Keeaumoku Street
Honolulu, HI 96814
(808) 949-5564
Kenwood, ICOM, Yaesu, Hy-Gain, Cush-
craft, AEA, KLM, Tri-Ex Towers, Fluke,
Belden, Astron, etc.

IDAHO

ROSS DISTRIBUTING COMPANY
78 South State Street
P.O. Box 234
Preston, ID 83263
(208) 852-0830
Mon. 9-2; Tues.-Fri. 9-6; Sat. 9-2
Stock All Major Brands
Over 7000 Ham Related Items on Hand

ILLINOIS

ERICKSON COMMUNICATIONS, INC.
5456 N. Milwaukee Avenue
Chicago, IL 60630
(312) 631-5181
Hours: Mon. - Fri. 9-5:30, Sat. 9-3

INDIANA

THE HAM STATION
220 N. Fulton Avenue
Evansville, IN 47710
(800) 523-7731
(812) 422-0231
ICOM, Yaesu, Ten-Tec, Cushcraft, Hy-Gain,
AEA & others.

MARYLAND

MARYLAND RADIO CENTER
8576 Laureldale Drive
Laurel, MD 20707
(301) 725-1212
Kenwood, Ten-Tec, Kantronics. Full service
dealer.
Mon.-Fri. 10-7, Sat. 9-5

MASSACHUSETTS

TEL-COM, INC.
675 Great Road, Rte. 119
Littleton, MA 01460
(508) 486-3400
(508) 486-3040
The Ham Store of New England
You Can Rely On.

MISSOURI

MISSOURI RADIO CENTER
102 NW Business Park Lane
Kansas City, MO 64150
(800) 821-7323
Missouri: (816) 741-8118
ICOM, Kenwood, Yaesu
Same day service, low prices.

NEVADA

AMATEUR ELECTRONIC SUPPLY
1072 N. Rancho Drive
Las Vegas, NV 89106
(702) 647-3114
Dale Porray "Squeak," AD7K
Outside Nev: 1 (800) 634-6227
Hours M-F 9-5:30, Sat. 9-3

NEW HAMPSHIRE

RIVENDELL ELECTRONICS
8 Londonderry Road
Derry, N. H. 03038
(603) 434-5371
Hours Mon.-Sat. 10-5; Thurs. 10-7
Closed Sun/Holidays

NEW JERSEY

ABARIS SYSTEMS
276 Oriental Place
Lyndhurst, NJ 07071
(201) 939-0015
Don WB2GPU
ARRL, Astatic, Astron, B&W, Belden,
Bencher, Hustler, Kenwood, Larsen, RF
Concepts, Tonna and much, much more!
Tues.-Fri. 10AM-7:30PM
Thurs. 10AM-9:00PM
Sat. 10AM-4:00PM
Visa/MC

KJI ELECTRONICS
66 Skytop Road
Cedar Grove, NJ 07009
(201) 239-4389
Gene K2KJI
Maryann K2RVH
Distributor of: KLM, Mirage, ICOM, Larsen,
Lunar, Astron. Wholesale - retail.

HAM MART

NEW YORK

BARRY ELECTRONICS

512 Broadway
New York, NY 10012
(212) 925-7000
New York City's Largest Full Service Ham
and Commercial Radio Store.

VHF COMMUNICATIONS

280 Tiffany Avenue
Jamestown, NY 14701
(716) 664-6345
Open 8:00 AM till 5:30 PM
Evenings, Saturday and Sunday by appoint-
ment. Western New York's finest Amateur
dealer. Featuring ICOM "The World System."

OHIO

AMATEUR ELECTRONIC SUPPLY

28940 Euclid Avenue
Wickliffe, OH 44092 (Cleveland Area)
(216) 585-7388
Ohio Wats: 1 (800) 362-0290
Outside Ohio: 1 (800) 321-3594
Hours Mon.-Fri. 9-5:30, Sat. 9-3

DEBCO ELECTRONICS, INC.

3931 Edwards Road
Cincinnati, OHIO 45209
(513) 531-4499
Mon.-Sat. 10AM-9PM, Sun. 12Noon-6PM
We buy and sell all types of electronic parts.

UNIVERSAL AMATEUR RADIO, INC.

1280 Aida Drive
Reynoldsburg (Columbus), OH
43068
(614) 866-4267
Featuring Kenwood, Yaesu, Icom,
and other fine gear. Factory author-
ized sales and service. Shortwave
specialists. Near I-270 and airport.

PENNSYLVANIA

HAMTRONICS,
Div. of Trevoise Electronics
4033 Brownsville Road
Trevoise, PA 19047
(215) 357-1400
Same Location for over 30 Years

TEXAS

K COMM dba THE HAM STORE
5707A Mobud
San Antonio, TX 78238
(512) 680-6110
(800) 344-3144
Stocking all major lines. San Antonio's Ham
Store. Great Prices — Great Service. Factory
authorized sales and service.
Hours: Mon.-Fri. 10-6, Sat. 9-3

MADISON ELECTRONICS SUPPLY

3621 Fannin
Houston, TX 77004
(713) 520-7300
Christmas?? Now??

MISSION COMMUNICATIONS

11903 Aleif Clodine
Suite 500 (Corner Harwin & Kirkwood)
Houston, Texas 77082
(713) 879-7764
Now in Southwest Houston—full line of
equipment. All the essentials and extras for
the "ham."

WISCONSIN

AMATEUR ELECTRONIC SUPPLY
4828 W. Fond du Lac Avenue
Milwaukee, WI 53216
(414) 442-4200
Wisc. Wats: 1 (800) 242-5195
Outside Wisc: 1 (800) 558-0411
Mon.-Fri. 9-5:30, Sat. 9-3

Dealers:

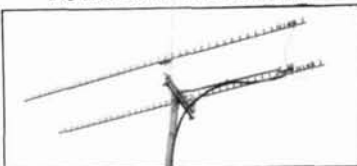
YOU SHOULD BE HERE TOO!
Contact Ham Radio now for
complete details.

FREE BOOK FLYER

Send SASE to

Ham Radio's Bookstore
Greenville, N. H. 03048

DOWN EAST MICROWAVE



MICROWAVE ANTENNAS AND EQUIPMENT

• Loop Yagis • Power Dividers • Linear Amplifiers • Complete
Arrays • Microwave Transverters • GaAs FET Preamps
• TROPO • EME • Weak Signal • OSCAR • 902 • 1269 • 1296
• 2304 • 2400 • 3456 MHz

2345 LY	45el	loop Yagi	1296 MHz	20dBi	\$99
1345 LY	45el	loop Yagi	2304 MHz	20dBi	\$80
3333 LY	33el	loop Yagi	902 MHz	18.5dBi	\$99

Above antennas assembled and tested. Kits available.

Add \$8 UPS SH, \$11 West of the Mississippi

MICROWAVE LINEAR AMPLIFIERS SSB, ATV, REPEATER, OSCAR

2316 PA	1w in 18w out	1240-1300 MHz	13.8V	\$265
2335 PA	10w in 35w out	1240-1300 MHz	13.8V	\$315
3318 PA	1w in 20w out	900-930 MHz	13.8V	\$265
3335 PA	10w in 40w out	900-930 MHz	13.8V	\$320
23LNA	preamp 0.7dB N.F.	1296 MHz		\$ 90
33LNA	preamp 0.9dB N.F.	902 MHz		\$ 90

Add \$5 shipping UPS/48

SHF systems transverters and kits available.

Write for free catalog



DOWN EAST MICROWAVE
Bill Olson, W3HQT
Box 2310, RR 1, Troy, ME 04987
(207) 948-3741



NEW! No Tune Microwave Linear Converters

Board level RX/TX transverter modules and
local oscillator: kit or assembled/tested.
Linear operation allows all modes, ATV,
SSB, Digital, Packet, FM.

Available for: 903, 1269, 1296, 2304, 3456 MHz

COMPLETE KITS

SHF 900 K	with integral LO for 902 MHz	\$125
SHF 1240 K	for 1240-1300 MHz - specify 1269 or 1296 base	\$135
SHF 2304 K	for 2300-2450 MHz - MODE S downlink package available	\$185
SHF 3456 K	for 3456 MHz	\$185
SHF-LO	LO kit only, with XTL, 540-580 MHz, +10 - +14 dBm out	\$ 60

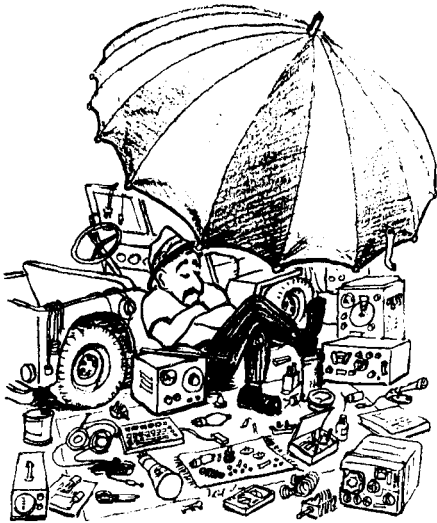
Call or write for details on complete transverters and options.

Prices subject to change.

SHF Systems
P.O. Box 666
Nashua, NH 03061
(603) 673-1573
John Molnar, WA3ETD



Down East Microwave
Box 2310, RR#1
Troy, ME 04987
(207) 948-3741
Bill Olson, W3HQT



FLEA MARKET

RATES Noncommercial ads 10¢ per word; commercial ads 60¢ per word **both payable in advance.** No cash discounts or agency commissions allowed.

HAMFESTS Sponsored by non-profit organizations receive one free Flea Market ad (subject to our editing) on a space available basis only. Repeat insertions of hamfest ads pay the non-commercial rate.

COPY No special layout or arrangements available. Material should be typewritten or clearly printed (not all capitals) and must include full name and address. We reserve the right to reject unsuitable copy. **Ham Radio** cannot check each advertiser and thus cannot be held responsible for claims made. Liability for correctness of material limited to corrected ad in next available issue.

DEADLINE 15th of second preceding month.

SEND MATERIAL TO: Flea Market, Ham Radio, Greenville, N. H. 03048.

BEGINNER'S RADIO CLEARINGHOUSE. On a space available basis, we are going to offer you, OUR SUBSCRIBER, free of charge, a chance to find a home for your used equipment with a new Ham. Please send us a short description of what you want to sell along with price, name, address and phone number. We'll run it once in a special section of the classified ads under the heading of BEGINNER'S RADIO CLEARINGHOUSE. Please limit your ad to 20 words or less.

CUSTOM MADE EMBROIDERED PATCHES. Any size, shape, colors. Five patch minimum. Free sample, prices and ordering information. HEIN SPECIALTIES, Inc., 7960 SW Manitou Trail, Glen Arbor, MI 49636. (616) 334-4385.

COLLINS KWM/HF360 Repairs and discount accessories. Kirby, KWOC. (713) 320-2324.

CCTV VIDEO CAMERAS: Color Sanyo VCC3700 \$395.00, Panasonic B&W \$219.00, others. Digital Vision PC B&W Video Digitizer \$249.00, Color \$399.00. Sampson Engineering, PO Box 550363, Dallas, TX 75355-0363. (214) 328-2730.

WANT TO KNOW the latest FCC news, operating tips, tech talk, free ads? Get America's #1 club publication monthly, lowest dues figure in U.S. for 61 services and benefits. Join the Triple States Radio Amateur Club. Send \$3.50 for six months to: TSRAC, Box 240, RD 1, Dept HR, Adena, OH 43901.

FLOOD YOUR MAILBOX! You get 100's of radio & electronic & computer specialty catalogs. Send \$10 with your name & address to: Electronic List Service, PO Box 1683, Brookline, MA 02146.

DIGITAL INDUCTANCE/CAPACITANCE meter as featured in July 1988 Radio Electronics Magazine. Inductance from 0.01 uhy to 10 mhy, capacitance from 0.10 pf to 0.10 ufd. Automatic range, automatic zero, accuracy +1-3%. Assembled \$149.95, kit \$129.95 (digital frequency counter needed during calibration). Add \$6.00 shipping. SASE for detailed specification. Almost All Digital Electronics, 5211-117th Avenue SE, Bellevue, WA 98006.

DIGITAL AUTOMATIC DISPLAYS. Any Radio. Be specific. Large 45 cent SASE. GRAND SYSTEMS, POB 2171, Blaine WA 98230.

LASER COMPONENTS! Surplus tubes, power supplies, optics. Build a working LASER for under \$75.00. Free plans with order. \$1.00 (refundable) brings list. FundServ, 1546D Peaceful Lane, Clearwater, FL 34616.

AVANTEK ATF10135, \$12.00, MMIC's, P.C. board, SASE: WA3IAC, 7148 Montague St, Philadelphia, PA 19135.

HAVE YOU WRITTEN a Good Ham or SWL Program? Our internationally known software publishing and distribution firm would be pleased to add QUALITY programs to our line. We can get your product to market, develop user documentation, provide packaging and user support, etc. Ashton ITC, PO Box 1067, Vestal, NY 13851. (607) 748-9028.

WANTED: URR 390/Alpha all band rec. Must be in good condition. Call W6BPV (408) 438-4467 collect.

HAM SOFTWARE and other "shareware" for IBM/compatibles. SASE for catalog. JK&S, POB 50521, Indianapolis, IN 46250-0521.

100 QSL CARDS \$8. \$3 thereafter. Grid square printed free. Shipped postpaid. Guaranteed correct! Free samples. Shell Printing, KD9KW, Box 50B, Rockton, IL 61072.

"HAMLOG" COMPUTER PROGRAM. Full features, 17 modules. Auto-logs, 7-band WAS/DXCC. Apple \$19.95. IBM, CP/M, KAYPRO, Tandy, C128 \$24.95. HR-KA1AWH, POB 2015, Peabody, MA 01960.

DRAKE RR2 commercial marine general coverage receiver, \$250. Drake MN-4C antenna tuner with B-1000 balun, \$100. Qubie XT-300 computer backup power supply, \$100. Josh Rovero, KK1D, 804-479-2277.

RADIO SHACK COLOR COMPUTER. Ham software and hardware. Free catalog. Dynamic Electronics, Box 896, Hartselle, AL 35640. (205) 773-2758.

REPEATER JAMMERS? Pinpoint them with our "Handi-Finder" — attaches to HT. Kits: \$24.95, or less! Club project discounts! NOARD, 29460-H Lorain, Cleveland, OH 44070. (216) 777-9460.

SOUTHEASTERN NH: Ham dream site for sale. 5 acres on west top and side of hill. Clear view to West, North, and South, 65 ft. tower will allow a clear trans-Atlantic RF path. On paved road, power and cable TV. Downtown Boston is 1 hour drive or take for commuter tieups. Rogers/WA1DFM, PO Box 309, Danville, NH 03819. (603) 642-8362 after 5 PM and weekends.

10 YEAR CLEANOUT SALE. Shack overloaded. Must vacate 2000 cu/ft area of test equipment, microwave, radios, antiques, parts, variacs, very interesting collection. Send stamp for complete list. Joseph Cohen, 200 Woodside, Winthrop, MA 02152. (617) 846-6312.

FREE Ham Gospel Tracts, SASE, Steve Forst, N3FTT, 5133 Gramercy, Clifton Heights, PA 19018.

WANTED: Ham equipment and other property. The Radio Club of Junior High School 22 NYC, Inc. is a nonprofit organization, granted 501(C)(3) status by the IRS, incorporated with the goal of using the theme of Ham Radio to further and enhance the education of young people nationwide. Your property donation or financial support would be greatly appreciated and acknowledged with a receipt for your tax deductible contribution. The new crew has arrived. Clean up, clean out and make a difference, plus tax time is fast approaching. Donate that equipment now. We depend on you. Please write us at: PO Box 1052, New York, NY 10002. Round the clock hotline: (516) 674-4072. Thank you!

QUAD ANTENNAS 10-15 meter \$139.95; 10-15-20 meter \$239.95. Lightweight fiberglass construction. Lightning Bolt Antennas, RD 2, Volant, PA 16156. (412) 530-7396.

REMOTE ANTENNA SWITCH, Dow Key DK72 single pole three throw all weather remote coaxial switch, FQ range to 500 MHz with vswr less than 1:1 at 100 MHz. This is the quality level needed for the serious HF/VHF operator needing to change/combine antennas without expensive multiple coaxial runs. Included are 4 new "N" connectors, 120 to 24 VAC wall transformer and 200 feet of rotor cable. Complete package \$90 UPS paid. Ed, W4GW. (803) 229-1133.

AMIGA/COMMODORE CHIPS: F. Agnus—\$61.50, Denise—\$56.95, Paula—\$56.95, 8520A1—\$17.95, 6526—\$12.95, 6567—\$17.95, PLA—\$12.95 and many others. Heavy duty power supply for C64 \$22.50. New, version II of the Commodore Diagnostic just out. Fantastic way to diagnose and fix all Commodore computers and 1541 drives, \$6.95 postpaid. Ask for our complete catalog on drums, diagnostics, and other exclusive products. Dealer pricing available, we ship worldwide. MCVISA. GRAPEVINE GROUP INC, 35 Charlotte Drive, Wesley Hills, NY 10977. 1-800-292-7445.

INTERESTED IN PUBLIC SERVICE? Join your local Radio Emergency Associated Communications Team. In Pennsylvania call 717-938-6943 or write REACT, 1160 Old Trail Rd, Etners, PA 17319.

WANTED: All types of Electron Tubes. Call toll free 1-800-421-9397 or 1-612-429-9397. C & N Electronics, Harold Bramstedt, 6104 Egg Lake Road, Hugo, MN 55038.

HANDICAPPED NOVICE needs HF equipment donated—anything please. KA3OUE, (412) 531-7443 anytime.

IMRA International Mission Radio Association helps missionaries. Equipment loaned. Weekday net, 14.280 MHz, 1-3 PM Eastern. Nine hundred Amateurs in 40 countries. Rev. Thomas Sable, S.J., University of Scranton, Scranton, PA 18510.

VHF-UHF-SHF. Large SASE. West Coast VHFer, POB 685, Holbrook, AZ 86025.

ANALOG AND RF CONSULTING for the San Francisco Bay area. Commercial and military circuits and systems. James Long, Ph.D., N6YB (408) 733-8329.

CIRCUIT DESIGN "Potpourri" for IBM computers and compatibles on 3.5 and 5.25 disks. Send SASE for list. W1OER, 135 Barbara Road, Waltham, MA 0154.

COLLINS S-LINE 32S3, 75S3, 516F2 power supply with solid state conversion. Package includes extra pair 6146's, Shure 444 microphone with Collins plug, AEA CK-1 memory keyer with power unit, all WARC band xtals for xmtr and Rcvr, all manuals, dust covers and spare tubes. Clean, no scratches, dents or abuse. \$1000 for all UPS paid. Let's not haggle. Ed, W4GW, 502 Gatewood Drive, Greenwood, SC 29646. (803) 229-1133.

RTTY JOURNAL—Now in our 36th year. Read about RTTY, AMTOR, PACKET, MSO's, RTTY CONTESTING, RTTY DX and much more. Year's subscription to RTTY JOURNAL \$10.00, foreign slightly higher. Order from: RTTY JOURNAL, 9085 La Casita Ave., Fountain Valley, CA 92708.

RUBBER STAMPS: 3 lines \$5.00 PPD. Send check or MO to G.L. Pierce, 5521 Birkdale Way, San Diego, CA 92117. SASE brings information.

ELECTRON TUBES: Receiving, transmitting, microwave... all types available. Large stock. Next day delivery, most cases. DAILY ELECTRONICS, PO Box 5029, Compton, CA 90224. (213) 774-1255.

RECONDITIONED TEST EQUIPMENT \$1.25 for catalog. Walter, 2697 Nickel, San Pablo, CA 94806.

COMING EVENTS

Activities — "Places to go . . ."

SPECIAL REQUEST TO ALL AMATEUR RADIO PUBLICITY COORDINATORS: PLEASE INDICATE IN YOUR ANNOUNCEMENTS WHETHER OR NOT YOUR HAMFEST LOCATION, CLASSES, EXAMS, MEETINGS, FLEA MARKETS, ETC. ARE WHEELCHAIR ACCESSIBLE. THIS INFORMATION WOULD BE GREATLY APPRECIATED BY OUR BROTHER/SISTER HAMS WITH LIMITED PHYSICAL ABILITY.

CANCELLATION NOTICE. The BARC Packet Radio Symposium scheduled for September 16 at Georgian College, Barrie, Ontario has been cancelled.

ALABAMA: September 9-10, Mobile Hamfest '89. Sponsored by the Mobile ARC, Texas Street Recreation Center. For information: Larry Early, PO Box 8404, Mobile, AL 36689. (205) 342-7601 after 6 PM.

PENNSYLVANIA: September 9, 40th annual W3PIE Gabfest sponsored by the Uniontown ARC, Club Grounds, Old Pittsburgh Road, Uniontown. For information contact UARC c/o John Cermak, WB3DOD, PO Box 433, Republic, PA 15475. (412) 246-2870.

ILLINOIS: September 10, The Bolingbrook ARS's 5th annual Ham/Computerfest, Inwood Recreation Center, 3000 West Jefferson Street, Joliet. Gates open 6 AM. Admission \$4/gate, \$3/advance. For tickets or reserved tables SASE to BARS Hamfest, PO Box 1429, Bolingbrook, IL 60439-7429.

PENNSYLVANIA: September 10, The Butler County ARA will sponsor their 12th annual Hamfest, Butler County Farm Show Grounds, Roe Airport, Butler. 9 AM to 4 PM. Free outside Flea Market. Inside admission \$1.00. Kids under 12 free. Handi parking. For information: Chairman, PO Box 1787, Butler, PA 16003-1787.

MASSACHUSETTS: September 10, SEMARA Hamfest. Free admission. For information SASE to Semara Hamfest, P-105, S. Dartmouth, MA 02748.

CALIFORNIA: September 16, The 7th annual SCRA Ham Radio flea market and auction, Sonoma County Fairgrounds. 8 AM to 2 PM. For tickets and information write Sonoma County Radio Amateurs, Box 116, Santa Rosa, CA 95402.

MICHIGAN: September 16. The Grand Rapids Amateur Radio Association's annual Electronic Flea Market and Computer Show, West Catholic High School, 1801 Bristol, Grand Rapids. Doors open 8 AM. Admission \$3. For information contact Don Hazelswart, K8BBI (616) 363-0649 or write PO Box 1248, Grand Rapids, MI 49501.

MISSOURI: September 17. The 14th annual Indian Foothills ARC Hamfest, Marshall Senior Citizens Building, Marshall. VE exams and wheelchair accessible. Contact WBOWMM, Box 721, Marshall, MO 65340.

NEW HAMPSHIRE: September 17. Flea Market sponsored by the Contoocook Valley Radio Club, Davisville. 7 AM to 3 PM. Admission \$1 buyers; \$7 sellers. For information Warren Stiles, WA1RLO, RD 7, Box 353F Deer Meadow Rd, Webster, NH 03303. (603) 648-2604.

NEW JERSEY: September 17. 41st annual Hamfest sponsored by the South Jersey Radio Association, Pennsauken High School Parking Lot, Pennsauken. 8 AM to 3 PM. Tickets \$3.50/advance; \$4/gate. Tailgate space \$5. Send check or MO with SASE to Ed Ramming, AB2Y, 4500 Westfield Avenue, Pennsauken, NJ 08110. (609) 663-5539.

OHIO: September 17. Hamfest sponsored by the 20/9 ARC, Mahoning County Joint Vocational School, Palmyra Rd, Canfield. 9 AM to 4 PM. Admission \$2. Handi parking. Contact Paul Resch (216) 793-8352. Corney Farcas (216) 793-1353.

NEW YORK: September 17. Hamfest sponsored by LIMARC, Long Island Mobile ARC, NY Institute of Technology, Old Westbury. Admission \$3. Contact Neil Hartman, WE2V (516) 462-5549 or Mark Nadel, NK2T (516) 796-2366.

OREGON: September 22-24. Walla Walla Hamfest, Milton Freewater Community Center, Milton Freewater. No admission fee. For information contact W7DP, Walla Walla Valley ARC, PO Box 321, Walla Walla, WA. Or call WA5ZAY at (509) 525-703.

CALIFORNIA: September 23. The Ventura County ARC's Hamfest, Oxnard Community Center, 800 Hobson Way, Oxnard. 8 AM to 2 PM. Buyers Free. Seller's tables \$7.50. Wheelchair accessible. For information: VCARC, PO Box 2103, Oxnard CA 93033 or call Dick, WA6JGX (805) 485-4462.

MASSACHUSETTS: September 24. Tailgate electronics, computer and Amateur Radio Flea Market, sponsored by the MIT Electronics Research Society and the MIT Radio Society, Albany and Main Street, Cambridge. 9 AM to 4 PM. Admission \$1.50. Free off street parking for 1000 buyers. For information of space reservation call (617) 253-3776.

CONNECTICUT: September 24. The 7th annual Natchaug ARC giant flea market, French Club on Club Rd, off rt. 66, Willimantic. 9 AM. Admission \$2. Under 16 free. For information Pat Rogowski, N1GBB, 90 Becker Circle, Windsor, CT. (203) 522-8028 evenings.

COLORADO: September 24. BARCFEST '89 sponsored by the Boulder ARC, Exhibit Building, Boulder County Fairgrounds, Nelson and Hover roads, Longmont. 8 AM to 3 PM. Admission \$3.

NEW YORK: September 30. The Elmira ARA's 14th annual International Hamfest, Chemung County Fairgrounds. Gates open 6 AM. Tickets at gate or from Dave Lewis RD 1, Box 191, Van Etten, NY 14889.

NEW MEXICO: September 30. Hamfest sponsored by the Northern New Mexico ARC, US Army Reserve Center, 2501 Cerrillos Rd, Santa Fe. 9 AM to 6 PM. Admission \$5. Kids under 12 \$3. BBQ lunch included. SASE to Tom Hardek, K9IKI5, PO Box 233, Los Alamos, NM 87544.

KANSAS: September 30-October 1. Kansas State ARRL Convention sponsored by the Wichita ARC. Red Coach Inn, 915 E. 53rd North, Wichita. Doors open 9 AM both days. Preregistration \$5. \$6/door. Flea Market table \$6. Package price \$20, includes registration, banquet and breakfast. Main to WA0ZWW, Vern Heinsohn, 950 Backbay Blvd, Wichita, KS 67203.

INDIANA: October 1. The Lake County ARC's annual Hamfest, Hammond National Guard Armory, 2530-173rd Street, Hammond. 8 AM to 2 PM. General admission \$3.50. For more information contact Ken Brown, WD9HYF, 918 Chippewa, Crown Point, IN 46307 or call (219) 663-5035.

ILLINOIS: October 1. The Chicago ARC will hold its semi-annual "Open House", 5801 N. Pulaski Road, Chicago. 12 noon to 5 PM local time. How to become an Amateur Radio operator and live demonstrations of equipment will be shown by experts. For info call Dean at 869-HAMS or George at 545-3622.

SOUTH CAROLINA: October 1. York County ARC's Hamfest, Joslyn Park, Rock Hill. 8 AM to 4 PM. For information York County ARS, PO Box 4141 CRS, Rock Hill, SC 29731.

INDIANA: October 8. Huntington Hamfest sponsored by the Huntington County ARS, P.A.L. Club, 2099 Riverside Drive, Huntington. 8 AM to 3 PM. Vendor setup 6 AM. Tickets \$3.50/advance; \$4/door. 8' table \$5. For tickets or tables Jim Covey, KC9GX, 1752 Kocher Street, Huntington, IN 46750.

OHIO: October 8. The Northwest Ohio ARC will hold their annual Hamfest, Allen County Fairgrounds, Rt 309, E. Lima. Admission \$3.50/advance and \$4/door. All areas handi accessible.

OPERATING EVENTS

"Things to do . . ."

September 2-4: WA7KYT, Cochise ARA will operate a special event station from the ghost town of Paradise, Arizona. Suggested freq: 3.885, 7.285, 14.288, 21.288, 28.385. Also 6 meters. Phone and CW on all bands. For a special certificate send a business SASE to WA7KYT c/o PO Box 1855, Sierra Vista, AZ 85636.

September 9-10: The Prince Georges Amateur Radio Emergency Service of Prince Georges County, Maryland, will operate a special event station at the Prince Georges County Fair. Suggested freq: SSB 3950, 7275, 14340, 18150, 21435, 24950, 28350, 50130 kHz. This is the 293rd anniversary of our county. For a special certificate send QSL to PG-ARES, PG-OEP, 7911 Anchor Street, Landover, MD 20785.

September 17: The Providence, Rhode Island, Radio Association and the New England Museum of Wireless and Steam will operate jointly to celebrate their respective 70th and 25th anniversaries. Sept 17 from 1400-2400Z and Sept 22 from 1600-2100Z, W1NTE will operate from the Massie Wireless Station at the Museum in East Greenwich on 7.030 CW using classic wireless sets. For more information SASE to New England Wireless, 697 Tillinghast Rd, E. Greenwich, RI 02818.

September 30: The West Alabama ARS of Tuscaloosa and the members of the University of Alabama ARC will sponsor a special event station commemorating college football great coach, Paul "Bear" Bryant. WAARS will operate from the campus of the University on all HF bands in the bottom 25 kHz of the General portion of each band. For a commemorative 8x11 certificate SASE with QSL to PO Box 1741, Tuscaloosa, AL 35403 or WD4DAT in callbook.

FREE 1989-90 Florida two meter repeater directories are currently being distributed by the Hernando County Amateur Radio Assn. of Brooksville, FL. Ask for one at any official Florida Welcome Center or SASE to Repeater Directory, Hernando County ARA, POB 1721, Brooksville, FL 34605-1721.

LAUREL ARC monthly (except December) Amateur exam sessions for all license classes. No fee is charged. Pre-registration is required. Call (301) 725-1212, Maryland Radio Center, 8576 Laureldaile Drive, Laurel, MD 20707.

NORTH COAST ARC 1989 LICENSE EXAMS. 12:30 PM, Saturdays October 14, December 9. N. Olmsted Community Cabin, S of Lorain on W. Park. Novice thru Extra. Walkins allowed. Talk in 145.29 repeater. For information Dan Sarama, KB8A, 15591 Rademaker Blvd, Brookpark, Ohio 44142. 267-5083 or Pauline Wells, K8FOE, Rick Wells, K8SCI, 777-9460/779-8999.

AMATEUR RADIO CLASSES: For those people interested in obtaining a Novice (basic level) Ham license or upgrading to Tech/General, the Chelsea Civil Defense, in cooperation with QRA Radio Club, will sponsor Amateur Radio Communications classes evenings at Chelsea High School starting MARCH 7, 1989. For more information write Frank Masucci, K1BPN, 136 Grove Street, Chelsea, MA 02150. Please enclose your telephone number.

THE MIT UHF REPEATER ASSOCIATION and the MIT Radio Society offer monthly HAM EXAMS. All classes Novice to Extra. Wednesday, SEPTEMBER 20, 7 PM, MIT Room 1-150, 77 Mass Avenue, Cambridge, MA. Reservations requested 2 days in advance. Contact Ron Hoffmann at (617) 484-2098. Exam fee \$4.50. Bring a copy of your current license (if any), two forms of picture ID, and a completed form 610 available from the FCC in Quincy, MA (617) 770-4023.



KENWOOD

ICOM

1-800-231-3057
713-520-7300
520-0550

MADISON Electronics Supply

FAMILY OWNED SINCE 1956
3621 FANNIN
HOUSTON, TEXAS 77004



TOWERS • TELESCOPING CRANK UP

by ALUMA • GUYED STACK UP • TILT-OVERS

Easy to install. Low Prices. Crank-ups to 100 feet

Over 36 types aluminum towers made—specials designed and manufactured—write for details.

EXCELLENT FOR AMATEUR COMMUNICATIONS

Mobile Truck Type

Roof Top Aluminum Type

Mobile Trailer Type

SPECIAL Four Section 50 Ft. Van Mounted Crank-Up Alumina Tower

ALUMA TOWER CO.
BOX 2806HR
VERO BEACH, FL 32961-2806
(407) 567-3423 FAX 407-567-3432

110



**Toroid Cores.
Iron Powder
& Ferrite.
Ferrite Beads.
Ferrite Rods.**

Free catalog and winding chart on request.

PALOMAR ENGINEERS

Box 455, Escondido, CA 92025
Phone: (619) 747-3343

111

**EXTRA!
EXTRA!**

Digital Digest

From The Publisher's Desk

Published Bi-Monthly

Read All About Your Favorite Modes Of Digital Communications!

★ **Subscribe Today!** ★

Digital Digest

4063 N. Goldenrod Road
Winter Park, FL 32792

\$16.00 Per Year
U.S. \$22.00 Elsewhere

Payable in U.S. Funds Only / Check or M.O. Preferred

NEW OSCAR

BRIDGES HAMISPHERE

- Coming soon to a shack near you.
- Signals from space.
- Catch some free.
- We know how.
- You can too!
- Join AMSAT
- Free brochure for SASE

AMSAT
PO BOX 27
WASHINGTON, DC 20044

✓ 108

MARTIN TOWERS and THE HAZER

Bring things down for safety and convenience.

Never climb again with this tower and elevator system. MARTIN TOWERS are made of aluminum and specifically engineered for use with the HAZER. Two sizes of tower: M-13 (13" wide) and M-18 (18" wide) All bolted construction, no welds. Easy to install hinge base, walk up erection, next plumb with leveling bolts in base. Mount antennas and rotor on HAZER in vertical upright position, then winch to top of tower for normal operating position. Guy wires fasten to HAZER or above HAZER at top of tower. Safety lock system operates while raising or lowering. Never can fall. Photo above shows HAZER midway on tower.

Complete tower UPS or motor freight shippable. Pre-assembled or kit form.

Send for free details of HAZER kits for Rohn 20, 25G, 45, 55 and other towers.

Special tower price: 50' M-13, hinged base, concrete footing section, HAZER kit - \$1269.60. Includes all hardware, winch, cable etc. FOB Boonville, MO.

Masts, rotors, thrust bearings, guy wire, turnbuckles also available.

Satisfaction guaranteed. Call today and charge to Visa, MasterCard or mail check or money order.

GLEN MARTIN ENGINEERING, INC.
Rte 3, Box 322
Boonville, MO 65223
(816) 882-2734 FAX 816-882-7200

✓ 179

108-1000 MHZ RADIO DIRECTION FINDING

- ★ Interference Location
- ★ Stuck Microphones
- ★ Cable TV Leaks
- ★ ELT Search & Rescue

New Technology (patented) converts any VHF or UHF FM receiver into a sensitive Doppler shift radio direction finder. Simply plug into receiver's antenna and external speaker jacks. Models available with computer interface, synthesized speech, fixed site or mobile - 108 MHz to 1 GHz. Call or write for details.

DOPPLER SYSTEMS, INC. P.O. Box 31819 (602) 488-9755
Phoenix, AZ 85046 FAX (602) 488-1295

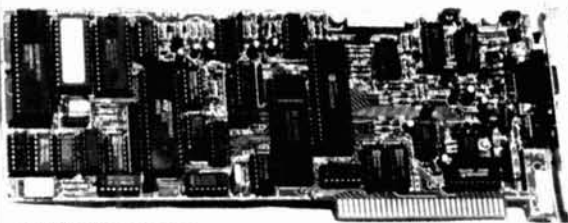
✓ 109



PacComm

- Advanced Technology
- Enduring Value

New! PC-320 / TNC-320 PACKET CONTROLLERS



Announcing the next generation of packet controllers for the serious operator! The new inboard PC-320 (shown), is designed to work with all PC/XT, PC/AT, and Tandy 1000 series computers. The TNC-320 outboard controller offers many of the same high quality features!

PC-320

\$209⁹⁵

TNC-320... \$194.95

(Wired & Tested / 1 Year Warranty)

For complete info & specifications

Call (813) 874-2980 To Order Call

Toll Free: 1-800-223-3511

Major Credit Cards Accepted!

PC-320 features . . .

- Dual modems for optimal VHF and HF operation.
- Appears as regular PC serial port (COM 1-4) - operates with any terminal program just like an external TNC.
- Dual Powered - operates from PC or external power. Continues complete operation even when the PC is turned off!
- Personal Message System- the most advanced personal mailbox available... included at no extra charge.
- Displays on-screen HF tuning indicator and simulated 'LEDs'.

PacComm • 3652 West Cypress Street • Tampa, Florida 33607

Please send PC-320 TNC-320 More Information FREE Catalog

Name _____ Call _____

Address _____

State _____ Zip _____ Card# _____ Exp. Date _____

MONEY BACK GUARANTEE! Add \$4.00 shipping handling per order. FL residents add 6% sales tax. Major Credit Card give number, expiration and signature. FAX: 813-872-8696

✓ 105

EVERY ISSUE of

HAM RADIO

now available on microfiche!

The entire run of *Ham Radio Magazine* (March, 1968 thru last year) is ready to ship to you in one, easy to use format.

Our 24x microfiche is easy to read and very compact. We offer a hand held reader for \$75, and a desk model for \$200. Libraries have these readers.

As a bonus, you will receive *Ham Radio Horizons* (3/77 thru 12/80) free.

Everything is included, front cover to back - ads too!

Annual updates will be offered for \$10.

Send \$185 payment (visa/mc accepted) to:

BUCKMASTER

BUCKMASTER PUBLISHING

Route 3, Box 56

Mineral, Virginia 23117

703/894-5777 visa/mc 800/282-5628

PC Slow Scan \$149.95

A complete slow scan television station for your IBM PC or compatible. Send and receive images in up to 10 shades of gray depending upon your graphics card and printer.

Includes:

Demodulator Modulator 75 Page Manual Software Tutorial Cassette

Requires:

Ham transceiver PC with 640K Parallel Port Graphics Card Tape Recorder Serial port
Slow Scan Formats: 8,12,17,23,34,36,48,72 sec.



Software Systems Consulting
1303 S. Olá Vista
San Clemente, CA 92672
(714) 498-5784

✓ 123

VISA



ICOM

MasterCard

VHF COMMUNICATIONS

9:00 am - 5:30 pm weekdays

Weekends and evenings by appointment.

ICOM, AEA, LARSEN, VAN GORDEN, VIBROPLEX, NYE-VIKING, FALCON COMM, LEADING EDGE, ARRL PUBLICATIONS, KAGLO, HAMTRONICS, ETC.

280 Tiffany Avenue
Jamestown, New York 14701

Western New York's finest... amateur radio dealer!
PH. (716) 664-6345

✓ 106



Sparky J Antennas

Balanced J-pole antennas that roll up small enough for your pocket or briefcase, yet have the punch of a full size half-wave radiator. A great answer for apartment dwellers or as a super emergency antenna. Don't leave home without one, because nobody beats these J's—nobody!

20 M	\$49.95
15 M	\$43.95
10 M	\$39.95
6 M	\$32.95
2 M	\$29.95
7 M	\$24.95

Add \$5 S & H

Art here is a Sparky J

Sparrow Hawk Communications
450-H Westfield Rd Alpine, UT 84004
Order direct from the factory (801) 756-7842

MasterCard

VISA

✓ 127

CATALOGS

HAM

- Transceivers
 - HF-VHF-UHF
 - Antennas
 - RTTY-Packet
 - Receivers
 - Books & Accs.
- Only \$1 Postpaid

SWL

- Receivers
 - Antennas
 - Tuners
 - Heaphones
 - RTTY-FAX
 - Books & Accs.
- Only \$1 Postpaid

Send to:

Universal Radio
1280 Aida Drive Dept. HR
Reynoldsburg, OH 43068

DX Forecaster

Garth Stonehocker, KØRYW



EQUINOX SEASON DXING

The two equinox seasons are March-April and September-October. During these two periods of a few short weeks, the maximum usable frequencies (MUFs) make fairly rapid seasonal changes. For the spring equinox, the MUFs daily curve changes from a high peak near midday to a lower, broader one across the longer daylight hours of summer. The problems caused by these changes are magnified by a more direct alignment of the solar wind stream of charged particles into the polar region and from those stored in the earth's tail, which perturb the earth's magnetic field and, therefore, the ionosphere. As a result, the signals propagating between two points via the ionospheric mode can become weakened and variable in the mid- to high latitudes and near (± 20 degrees) the geomagnetic equator.

The high latitude propagation is applicable to east-west paths like the US to EU or JA because the great circle of the path reaches as high as 67 degrees north latitude. The MUFs and the signal's amplitude variations usually decrease there. Both can be estimated from the geomagnetic A and K figures. In the equatorial region, the propagation is applicable to transequatorial path openings. Here the MUFs usually increase during the disturbance, but the signal is still weaker and variable. However, the variability is different because it's lower in amplitude changes and at a faster frequency — like flutter.

The disturbed period of last March-April is a good example of equinox season changes. The spring season is often more disturbed than the fall. This is probably because the solar flux is

more often on a decreasing trend in the spring while it tends to increase in the fall, holding the earth's magnetosphere steadier from increasing solar radiation pressure. Therefore, solar flux and geomagnetic disturbance intensity tend to have opposite trends. Several large solar flares started off the month of March with some proton events and geomagnetic disturbances indicated by the A figure of 20 to 30 units. Another on the 10th at 1922 UTC started a polar cap signal absorption, followed by a big geomagnetic disturbance of 248 A units — the largest recorded in the United States since 1960. Numerous reports of aurora, some as far south as Key West, Florida, showed the extent and intensity of this disturbance. Later in the month, another large flare on the 23rd at 1959 UTC caused a proton event in 41 minutes, and a sudden geomagnetic disturbance on the 27th at 1342 UTC. Large flares on the 24th and 26th kept the disturbance going until April 5th. A large flare at 0105 UTC on April 9th had little effect, until another occurred on the 23rd at 2155 UTC. This probably caused the geomagnetic disturbance of April 25th at 1859 UTC, which continued with minor flaring until May 7th. These are the major geophysical events of a typical high


sunspot number equinox season. I'll report the propagation problems next month.

Last-minute forecast

The higher frequency bands are expected to be best, with longer openings the second and third weeks of September. The cause will be higher MUFs resulting from the expected high solar flux. These higher MUFs also cause a decrease in signal strength. A return of transequatorial one long hop openings in late evenings, especially during geomagnetic disturbances, can really enhance signal strengths. The disturbed periods may fall on the 6th and 7th, 13th through 15th, and 22nd and 23rd. Because this is the fall equinox season, there may be more periods of disturbance than those listed. The lower bands should improve with less thunderstorm noise and summer signal absorption both day and night. Expect better openings, especially from unique DX locations, in east-west directions during the disturbances. The full moon is on the 15th and perigee on the 16th. The autumnal equinox occurs on the 23rd at 0120 UTC.

Band-by-band summary

Ten, 12, 15, 17, and 20 meters provide many openings during the daytime. The openings will be shorter as you go up in frequency, centered around noon, and mainly in southerly directions. Fifteen meters is only a transition band between 12 and 17. Twenty meters, the mainstay daytime band for northerly directions, will be useful towards the south in the evenings.

Thirty, 40, 80, and 160 meters are all good for nighttime DX. Thirty and 40 meters are the night frequencies for the east-west and northerly directions, and for distances of 1600 miles. 

GMT	PDT	WESTERN USA												
		N	NE	E	SE	S	SW	W	NW					
0000	5:00	12	30	12	10	10	10	10	10	10	10	10		
0100	6:00	12	30	15	10	10	10	10	10	10	10	10		
0200	7:00	12	30	15	10	10	10	10	10	10	10	10		
0300	8:00	15	30	15	10	10	10	10	10	10	10	12		
0400	9:00	15	30	17	12	12	10	10	10	10	10	15		
0500	10:00	20	20	15	12	15	10	10	10	10	10	17		
0600	11:00	20	30	15	15	20	10	10	10	10	20			
0700	12:00	30	30	15	15	20	10	10	10	20				
0800	1:00	30	30	17	15	20	12	12	12	20				
0900	2:00	30	30	17	17	20	12	12	12	20				
1000	3:00	30	30	17	17	20	15	15	15	30				
1100	4:00	30	20	17	17	20	15	15	15	30				
1200	5:00	30	15	10	17	20	15	15	15	30				
1300	6:00	20	15	10	12	20	17	17	17	30				
1400	7:00	20	12	10	10	20	17	17	17	20				
1500	8:00	20	10	10	10	17	17	15	15	30				
1600	9:00	30	10	10	10	12	17	15	15	30				
1700	10:00	30	12	10	10	12	15	17	17	30				
1800	11:00	30	12	10	10	10	12	17	17	20				
1900	12:00	30	15	10	10	10	10	12	12	15				
2000	1:00	30	15	10	10	10	10	10	10	12				
2100	2:00	30	17	10	10	10	10	10	10	12				
2200	3:00	17	20	10	10	10	10	10	10	10				
2300	4:00	15	20	12	10	10	10	10	10	10				

MDT	PDT	MID USA												
		N	NE	E	SE	S	SW	W	NW					
6:00	5:00	15	30	12	10	10	10	10	10	10	10	10		
7:00	6:00	15	30	15	10	10	10	10	10	10	10	12		
8:00	7:00	15	30	15	10	10	10	10	10	10	10	15		
9:00	8:00	20	30	15	10	12	10	10	10	10	10	15		
10:00	9:00	20	30	15	12	15	10	10	10	10	10	17		
11:00	10:00	30	20	17	15	17	10	10	10	20				
12:00	11:00	30	30	15	15	20	10	12	20					
1:00	12:00	30	30	17	17	20	12	15	20					
2:00	1:00	30	30	17	17	20	12	15	30					
3:00	2:00	30	30	17	17	20	15	17	30					
4:00	3:00	30	30	15	17	20	15	17	30					
5:00	4:00	17	20	10	12	20	15	15	30					
6:00	5:00	15	15	10	10	20	17	15	20					
7:00	6:00	12	15	10	10	20	17	15	20					
8:00	7:00	12	12	10	10	20	17	17	30					
9:00	8:00	15	10	10	10	17	17	17	30					
10:00	9:00	15	12	10	10	15	17	17	30					
11:00	10:00	20	12	10	10	12	15	17	30					
12:00	11:00	20	12	10	10	10	12	12	20					
1:00	12:00	20	15	10	10	10	10	12	15					
2:00	1:00	30	17	10	10	10	10	10	15					
3:00	2:00	30	20	10	10	10	10	10	12					
4:00	3:00	30	20	10	10	10	10	10	12					
5:00	4:00	30	20	10	10	10	10	10	12					
6:00	5:00	17	30	12	10	10	10	10	10					

EDT	PDT	EASTERN USA												
		N	NE	E	SE	S	SW	W	NW					
8:00	7:00	17	30	15	10	10	10	10	10	10	10	15		
9:00	8:00	20	30	15	10	10	10	10	10	10	10	15		
10:00	9:00	20	30	15	10	12	10	10	10	10	10	20		
11:00	10:00	30	30	15	10	12	10	10	10	10	10	20		
12:00	11:00	30	30	17	12	15	10	10	10	20				
1:00	12:00	30	30	15	15	17	15	17	15	12	30			
2:00	1:00	30	30	15	15	20	15	20	15	12	30			
3:00	2:00	30	30	17	15	20	15	20	15	15	30			
4:00	3:00	30	20	17	17	20	15	15	15	30				
5:00	4:00	17	15	15	17	20	15	15	15	30				
6:00	5:00	15	15	10	17	20	17	17	17	20				
7:00	6:00	12	12	10	12	20	17	17	17	20				
8:00	7:00	12	12	10	10	20	15	15	12	20				
9:00	8:00	15	12	10	10	20	15	12	20					
10:00	9:00	15	10	10	10	15	15	15	30					
11:00	10:00	20	12	10	10	12	17	15	30					
12:00	11:00	20	12	10	10	12	17	17	30					
1:00	12:00	20	12	10	10	10	12	17	30					
2:00	1:00	30	12	10	10	10	10	12	20					
3:00	2:00	30	15	10	10	10	10	10	15					
4:00	3:00	30	15	10	10	10	10	10	15					
5:00	4:00	30	17	10	10	10	10	10	12					
6:00	5:00	30	20	10	10	10	10	10	12					
7:00	6:00	17	30	12	10	10	10	10	10					

2x4Z BASE REPEATER ANTENNA

THE HIGHEST GAIN
DUAL BAND
BASE/REPEATER ANTENNA

HIGH POWER 200 WATTS

CENTER FREQUENCY

146.500 MHz

446.500 MHz

GAIN:

VHF - 8.2dB

UHF - 11.5dB

VSWR - 1.-1.2 or less

CONNECTOR:

N TYPE FEMALE

LIGHTNING PROTECTION

GROUNDING DIRECT

LENGTH: 16 FT.

WEIGHT: 5 LBS. 3 OZ.

WIND LOAD: 90 MPH

MOUNTING: UP TO 2 IN.

MAST

CAN SIMULCAST ON

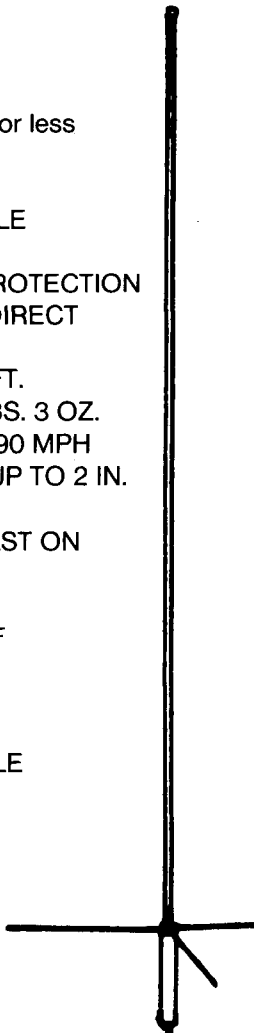
BOTH BANDS

WATERPROOF

CONNECTING

JOINTS

UPS SHIPPABLE



AMATEUR SPECIAL



1275 NORTH GROVE ST.
ANAHEIM, CALIF. 92806
(714) 630-4541

CABLE: NATCOLGLZ
FAX (714) 630-7024

✓ 104

ADVERTISER'S INDEX AND READER SERVICE NUMBERS

Listed below are the page and reader service number for each advertiser in this issue. For more information on their products, select the appropriate reader service number make a check mark in the space provided. Mail this form to ham radio Reader Service, I.C.A., P.O. Box 2558, Woburn, MA 01801.

Name _____ Call _____

Address _____

City _____ State _____ Zip _____

*Please contact this advertiser directly.

Please use before October 31, 1989.

READER SERVICE #	PAGE #	READER SERVICE #	PAGE #
___172 - Ace Communications, Monitor Div.....	34	___166 - The Meadowlake Corp.....	36
___146 - Advanced Computer Controls.....	55	___184 - MFJ Enterprises.....	8
___152 - Advanced Receiver Research.....	46	___156 - Micro Control Specialties.....	44
___182 - AEA.....	15	___102 - Missouri Radio Center.....	99
___120 - AIE Corporation.....	81	___164 - Mobile Mark Inc.....	38
___110 - Aluma Tower Co.....	93	___126 - Monitoring Times.....	73
* - Amateur Television Quarterly.....	77	* - NGKW.....	87
___169 - AMC Sales, Inc.....	37	___104 - NCG.....	98
___116 - American Antenna.....	87	* - Nema Electronics.....	87
* - Amidon Associates.....	55	___124 - Nuts & Volts.....	44
___108 - AMSAT.....	94	___178 - Wm. M. Nye Co. Inc.....	24
___134 - Antennas West.....	60	* - OMARC.....	79
___135 - Antennex.....	58	___150 - Omega Electronics.....	52
___161 - Antique Radio Classified.....	43	___138 - Omega Electronics.....	59
___180 - Astron Corp.....	18	___103 - OPTOelectronics.....	100
___175 - Azimuth Communications Corp.....	31	___176 - P.C. Electronics.....	29
* - Barker & Williamson.....	33	___105 - Pac-Comm Packet Radio Systems, Inc.....	95
* - Barry Electronics.....	66	___111 - Palomar Engineers.....	93
___153 - Bilal Company.....	46	___131 - Periphex Inc.....	60
* - Brian Beezley, K6STI.....	54	___117 - Practical Electronics Book Club.....	83
___141 - Buckmaster Publishing.....	59	___163 - QSO Software.....	38
___133 - Buckmaster Publishing.....	60	___162 - Radio Amateur Callbook.....	39
* - Buckmaster Publishing.....	95	___132 - Radiokit.....	60
___107 - Buckmaster Publishing.....	71	___187 - Ramsey Electronics, Inc.....	70
___165 - Burghardt Amateur Center.....	36	___167 - The RF Connection.....	36
___177 - C&S Sales.....	28	___148 - Rutland Arrays.....	46
___129 - Communication Concepts, Inc.....	66	___188 - Rutland Arrays.....	52
___181 - Communications Specialists.....	16	* - Sherwood Engineering.....	58
___149 - Creative Control Products.....	52	___113 - SHF Systems.....	91
___137 - Crystek Crystals.....	59	___168 - Software Systems.....	36
___142 - Cushcraft Corp.....	57	___123 - Software Systems.....	95
___154 - Cygnus-Quasar Books.....	46	___127 - Sparrow Hawk Communications.....	95
* - Digital Digest.....	94	___144 - Stridsburg Engineering Co.....	54
___109 - Doppler Systems.....	94	___118 - STV/OnSat.....	76
___160 - Doug Hall Electronics.....	43	___157 - Synthetic Textiles, Inc.....	46
___112 - Down East Microwave.....	91	___170 - TD Systems.....	37
* - Engineering Consulting.....	33	___158 - Tel-Com.....	43
___121 - Fair Radio Sales.....	79	___125 - Unadilla Antenna Mfg Co.....	73
___159 - GTI Electronics.....	43	* - Universal Radio.....	95
___151 - Ham Radio Outlet.....	50, 51	___174 - Vanguard Labs.....	31
* - Ham Radio's Bookstore.....	59, 60, 61, 66, 76, 77	___185 - Varian EIMAC.....	1
___130 - Hamtronics, NY.....	65	___106 - VHF Communications.....	95
* - Hamtronics, PA.....	46	___147 - W & W Associates.....	52
* - Heath Company.....	41	___136 - W5YI Marketing.....	58
___186 - ICOM America, Inc.....	CII	___140 - W9INN Antennas.....	59
___183 - ICOM America, Inc.....	13	___143 - Wi-Comm Electronics Inc.....	54
___173 - Jan Crystals.....	34	* - Yaesu USA.....	CIII
___119 - Jun's Electronics.....	81	___122 - E.H. Yost Co.....	80
___139 - KComm, The Ham Center.....	59		
___171 - Kantronics.....	35		
* - Kenwood USA Corporation.....	2, 5, 7, CIV		
___155 - Larsen Antennas.....	49		
* - Louisville Hamfest.....	81		
___115 - Madison Electronics Supply.....	87		
* - Madison Electronics Supply.....	93		
* - Maggiore Electronic Laboratory.....	54		
___179 - Glen Martin Engineering, Inc.....	23		

PRODUCT REVIEW/NEW PRODUCT

___301 - Azimuth Communications Corp.....	85
___303 - Elenco Electronics Inc.....	85
___302 - ICOM America, Inc.....	85
___304 - Kantronics.....	85
* - S-Com Industries.....	80
* - Software Systems.....	80

**ORDER
TOLL-FREE
1-800-821-7323**

**Dependable Service
At The Right Price . . . Everytime**

MasterCard—VISA—Discover

Missouri Radio Center

KENWOOD



TS-940 "DX-CELLENCE"

- All Band, All Mode Transceiver
- Direct Keyboard Entry
- Engineered for the DX-Minded and Contesting Ham
- Its Got It All!

YAESU



FT-767GX HF/VHF/UHF BASE STATION

- Add Optional 6m, 2m & 70cm Modules
- Dual VFO's
- Full CW Break-in
- Lots More Features

ICOM **NEW!**



IC-765 NEW HF TRANSCEIVER

- Built-in Automatic Antenna Tuner and Power Supply
- 99 Memories • 100 W Output
- 160-10M/General Coverage Receiver
- Band Stacking Registers

uniden



HR-2600

- Mobile 10 Meter Transceiver
- SSB/AM/FM/CW
- 25 Watts PEP
- New FM Offsets & PL

KENWOOD



TS-140S AFFORDABLE DX-ing!

- HF Transceiver With General Coverage Receiver
- All HF Amateur Bands
- 100 W Output
- Compact, Lots of Features

YAESU



FT-736R VHF-UHF BASE STATION

- SSB, CW, FM on 2 Meters and 70 cm
- Optional 50 MHz, 220 MHz or 1.2 GHz
- 25 Watts Output on 2 Meters, 220 and 70 cm
- 10 Watts Output on 6 Meters and 1.2 GHz • 100 Memories

ICOM **NEW!**



- USB/LSB/CW, AM Receive
- Optional Module for AM Transmit and FM TX/RX
- 160-10M Operation • 100 W Output
- Receive 30 kHz to 33 MHz
- 26 Memories with Band Stacking Registers

ASA CP-100



Complete Terminal Unit for Morse, Baudot, ASCII, AMTOR

**NOW 1/2 PRICE
CLOSEOUT SPECIAL
ONLY \$169. DELIVERED**

Software Available
Call Now—Don't Delay

KENWOOD **NEW!**



TM-231A

2 METER FM MOBILE

- 50 Watts Output
- 20 Multi-Function Memories
- Selectable CTCSS Tone Built-in
- Operate 4 Mobile Rigs with Optional IF-20 Interface and RC-20 Controller

Kantronics



KT-Series Mono-Band Radios

10-15-20-30-40-80M MODELS

SAVE BIG \$\$

Best Price and Complete Selection
Call Today!

ICOM

**IC-2GAT
IC-4GAT**

2 Meter & 440 Handhelds

- IC-2GAT RX 138-174 MHz TX 140-150 MHz 7 Watts
- IC-4GAT 440-450 MHz 6 Watts



ASTRON



- RS7A . . . \$51 • RS35M . . \$167
- RS12A . . . \$75 • VS35M . . \$179
- RS20A . . . \$92 • RS50A . . \$209
- RS20M . . \$112 • RM50M . \$235
- VS20M . \$129 • RM50M . \$259
- RS35A . . \$149 • VS50M . . \$245

KENWOOD

SALE! TH-25AT
POCKET-SIZED
AND POWERFUL



- Frequency Coverage: 141-163 MHz (Rx), 144-148 MHz (Tx)
- Front Panel DTMF Pad
- 5 Watts Output
- 14 Memories
- TH-45AT Available for 440 MHz

ALINCO SUPER SALE

**ALD-24T
2m/70cm
Dual Band
Mobile**



\$449.00 Delivered
25W, 21 Memories, Dual VFO's
At an Unbeatable Price!

ICOM

**IC-32AT
SUPER DUALBAND
FM HANDHELD**

- 5 Watts on Both Bands
- Receive 138-174 MHz 440-450 MHz
- Stores Standard and Odd Offsets



MFJ SALE MFJ

LARGEST STOCK OF ALL
YOUR MFJ FAVORITE
ACCESSORIES
CALL TODAY FOR
BEST PRICE



Extra Savings on the MFJ-1278
Multi-Mode Data Controller

102 N.W. Business Park Lane Kansas City, MO 64150
Send SASE For Used List

Call Toll Free—9am - 6pm Mon.-Fri. 9am - 2pm Sat.
In Missouri Call—816-741-8118

MOST ORDERS SHIPPED SAME DAY

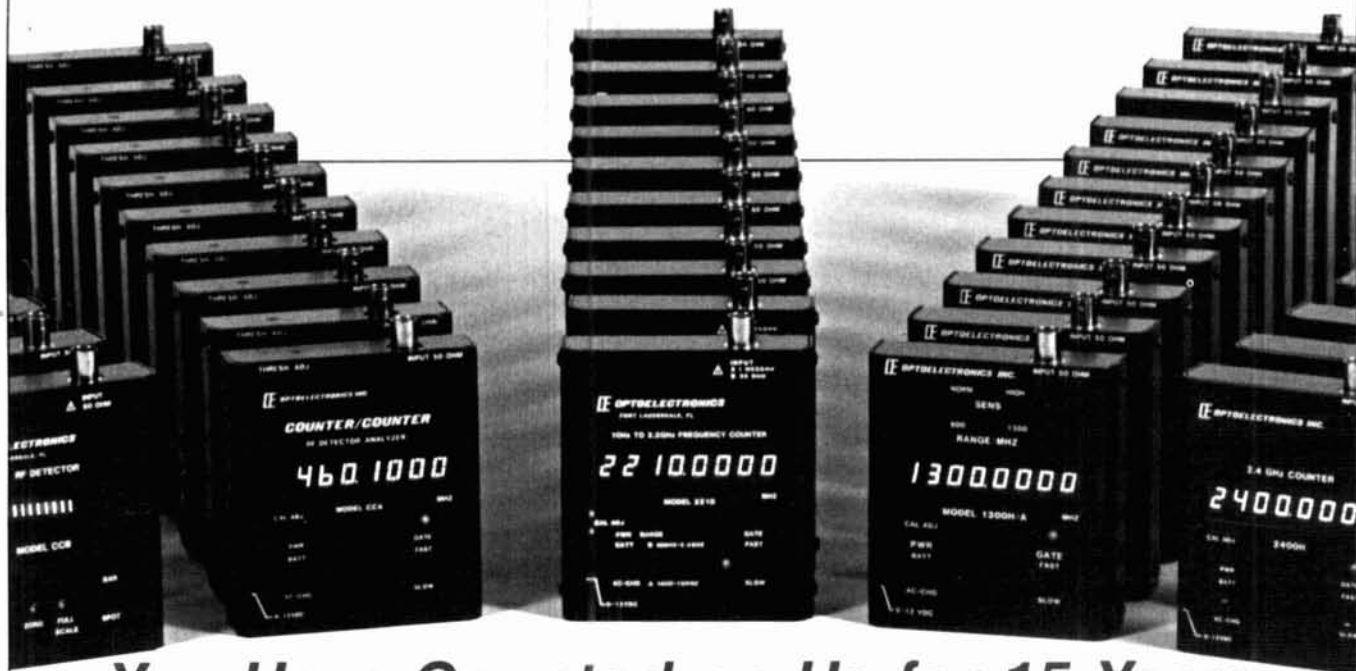
• DAIWA • HUSTLER

✓ 102 HYGAIN • ICOM •

ALINCO • ASTRON • ALPHA-DELTA ANTENNA SPEC • R & W • BENCHER • BUTTERNUT • CUSHCRAFT

KANTRONICS • KENWOOD • LARSEN • MFJ • MIRAGE/KLM • NYEVIKING • RF CONCEPTS • UNIDEN • YAESU

OPTOELECTRONICS



You Have Counted on Us for 15 Years

You have counted on OPTOELECTRONICS Hand Held Frequency Counters to be the best quality, to be affordable and reliable. We have been there for you with Frequency Counters that are compact and ultra sensitive.

And more and more of you are counting on us, technicians, engineers, law enforcement officers, private investigators, two-way radio operators, scanner hobbyists, and amateur radio operators, just to name a few.

Hand Held Series Frequency Counters and Instruments

MODEL	2210	1300H/A	2400H	CCA	CCB
RANGE: FROM TO	10 Hz 2.2 GHz	1 MHz 1.3 GHz	10 MHz 2.4 GHz	10 MHz 550 MHz	10 MHz 1.8 GHz
APPLICATIONS	General Purpose Audio-Microwave	RF	Microwave	Security	Security
PRICE	\$219	\$169	\$189	\$299	\$99
SENSITIVITY					
1 KHz	< 5 mv	NA	NA	NA	NA
100 MHz	< 3 mv	< 1 mv	< 3 mv	< .5 mv	< 5 mv
450 MHz	< 3 mv	< 5 mv	< 3 mv	< 1 mv	< 5 mv
850 MHz	< 3 mv	< 20 mv	< 5 mv	NA	< 5 mv
1.3 GHz	< 7 mv	< 100 mv	< 7 mv	NA	< 10 mv
2.2 GHz	< 30 mv	NA	< 30 mv	NA	< 30 mv

ACCURACY ALL HAVE +/- 1 PPM TCXO TIME BASE.

All counters have 8 digit red .28" LED displays. Aluminum cabinet is 3.9" H x 3.5" x 1". Internal Ni-Cad batteries provide 2-5 hour portable operation with continuous operation from AC line charger/power supply supplied. Model CCB uses a 9 volt alkaline battery. One year parts and labor guarantee. A full line of probes, antennas, and accessories is available. Orders to U.S. and Canada add 5% to total (\$2 min, \$10 max). Florida residents, add 6% sales tax. COD fee \$3. Foreign orders add 15%. MasterCard and VISA accepted.

Orders to U.S. and Canada add 5% to total (\$2 min, \$10 max). Florida residents, add 6% sales tax. COD fee \$3. Foreign orders add 15%. MasterCard and VISA accepted.

OPTOELECTRONICS INC.

5821 N.E. 14th Avenue • Fort Lauderdale, Florida 33334
1-800-327-5912 FL (305) 771-2050 FAX (305) 771-2052

TWO OF AMERICA'S MOST POPULAR FM STATIONS.



No wonder Yaesu's FT-212R Series and FT-4700RH mobiles are so popular.

Not only are the features unique and plentiful. The operation hassle-free. And the mounting options flexible. But also, each radio now features a built-in PL board. Plus *you* choose the optional mic that best fits your operating and budget needs.

FT-212R SERIES. MOBILES THAT DOUBLE AS ANSWERING MACHINES.

Let the 2-meter FT-212R and 440-MHz FT-712R take messages while you're away (with DVS-1 option)! 45-watt output (35W on 440 MHz). Built-in PL encode/decode. 18 memories. Auto repeater shift. Scanning routines. Offset tuning from any memory channel. Extended receive. Audible command verification. High/low power switch. Oversize amber display. Choice of optional mic. More.

FT-4700RH. DUAL-BAND PERFORMANCE, REMOTE-HEAD DESIGN.

Mount the FT-4700RH almost anywhere — the "brains" on your dash, visor, or door; the "muscle" under your seat. 50 watts on 2 meters, 40 watts on 70 cm. Full crossband duplex. Simultaneous monitoring of each band, complete with independent squelch settings on the main and secondary bands. Built-in PL encode/decode. 9 memories (each



band). Extended receive. Reverse repeater shift. High/low power switch. Patch cord for remote mounting. Bright LCD display. Backlit controls. Choice of optional mic. More.

Want more information? Call **(800) 999-2070** toll-free. Or ask your dealer about Yaesu's FT-212R Series and FT-4700RH mobiles today. Two of America's favorites.

Choose your optional mic: MH-15 C8 DTMF mic, or MH-15 D8 DTMF auto-dialer mic



YAESU USA 17210 Edwards Road, Cerritos, CA 90701
(213) 404-2700. **REPAIR SERVICE:** (213) 404-4884.
PARTS: (213) 404-4847.

YAESU

KENWOOD

...pacesetter in Amateur Radio

All-mode
tri-bander!

Warp Drive!



TS-790A Satellite Transceiver

The new Kenwood TS-790A VHF/UHF/all-mode tri-band transceiver is designed for the VHF/UHF and satellite "power user." The new TS-790A is an all-mode 144/450/1200 MHz transceiver with many special enhancements such as automatic uplink/downlink tracking. Other features include dual receive, automatic mode selection, automatic repeater offset selection for FM repeater use, VFO or quick step channel tuning, direct keyboard frequency entry, 59 memory channels (10 channels for separate receive and transmit frequency storage), multiple scanning and multiple scan stop modes. The Automatic Lock Tuning (ALT) on 1200 MHz eliminates frequency drift. Power output is 45 watts on 144 MHz, 40 watts on 450 MHz, and 10 watts on 1200 MHz. (The 1200 MHz section is an optional module.)

- **High stability VFO.** The dual digital VFOs feature rock-stable TCXO (temperature compensated crystal oscillator) circuitry, with frequency stability of ± 3 ppm.
- **Operates on 13.8 VDC.** Perfect for mountain-top DXpeditions!
- **The mode switches confirm USB, LSB, CW, or FM selection with Morse Code.**
- **Dual Watch allows reception of two bands at the same time.**
- **Automatic mode and automatic repeater offset selection.**
- **Direct keyboard frequency entry.**
- **59 multi-function memory channels.** Store frequency, mode, tone information, offset, and quick step function. Ten memory channels for "odd split."
- **CTCSS encoder built-in.** Optional TSU-5 enables sub-tone decode.
- **Memory scroll function.** This feature allows you to check memory contents without changing the VFO frequency.

- **Multiple scanning functions.** Memory channel lock-out is also provided.
- **ALT—Automatic Lock Tuning—on 1200 MHz eliminates drift!**
- **500 Hz CW filter built-in.**
- **Packet radio connector.**
- **Interference reduction controls:** 10 dB RF attenuator on 2m, noise blanker, IF shift, selectable AGC, all mode squelch.
- **Other useful controls:** RF power output control, speech processor, dual muting, frequency lock switch, RIT.
- **Voice synthesizer option.**
- **Computer control option.**

Optional Accessories:

- **PS-31** Power supply • **SP-31** External speaker
- **UT-10** 1200 MHz module • **VS-2** Voice synthesizer unit
- **TSU-5** Programmable CTCSS decoder
- **IF-232C** Computer interface • **MC-60A/MC-80/MC-85** Desk mics • **HS-5/HS-6** Headphones
- **MC-43S** Hand mic • **PG-2S** Extra DC cable

KENWOOD

KENWOOD U.S.A. CORPORATION
COMMUNICATIONS & TEST EQUIPMENT GROUP
P.O. BOX 22745, 2201 E. Dominguez Street
Long Beach, CA 90801-5745
KENWOOD ELECTRONICS CANADA INC.
P.O. BOX 1075, 959 Gana Court
Mississauga, Ontario, Canada L4T 4C2



Complete service manuals are available for all Kenwood transceivers and most accessories. Specifications, features, and prices are subject to change without notice or obligation.

PRACTICAL ELECTRONICS BOOK CLUB

Membership Order Card

Please enroll me as a member and send me the three choices I have listed below. Bill me only \$3.95, plus local tax, postage and handling. I agree to purchase a minimum of two additional books during my first year as outlined under the Club plan described in this ad. Membership in the club is cancellable by me any time after the two book purchase requirement has been fulfilled. A shipping and handling charge is added to all shipments.

Indicate below by number the books you want. A few expensive books (noted in the descriptions) count as more than one choice.

--	--	--

Signature _____

Name _____

Address/Apt. # _____

City, State, Zip _____

Corporate Affiliation _____

This order subject to acceptance by THE PRACTICAL ELECTRONICS BOOK CLUB. All prices subject to change without notice. Offer good only to new members. Foreign member acceptance subject to special conditions.

PRACTICAL ELECTRONICS BOOK CLUB

Membership Order Card

Please enroll me as a member and send me the three choices I have listed below. Bill me only \$3.95, plus local tax, postage and handling. I agree to purchase a minimum of two additional books during my first year as outlined under the Club plan described in this ad. Membership in the club is cancellable by me any time after the two book purchase requirement has been fulfilled. A shipping and handling charge is added to all shipments.

Indicate below by number the books you want. A few expensive books (noted in the descriptions) count as more than one choice.

--	--	--

Signature _____

Name _____

Address/Apt. # _____

City, State, Zip _____

Corporate Affiliation _____

This order subject to acceptance by THE PRACTICAL ELECTRONICS BOOK CLUB. All prices subject to change without notice. Offer good only to new members. Foreign member acceptance subject to special conditions.



No Postage
Necessary
If Mailed
in the
United States



BUSINESS REPLY MAIL
FIRST CLASS MAIL PERMIT NO. 26 NEW YORK, NY

Postage will be paid by addressee

**Practical Electronics Book Club
Dept. PRD-4th Floor
11 West 19th Street
New York, New York 10114-0144**



No Postage
Necessary
If Mailed
in the
United States



BUSINESS REPLY MAIL
FIRST CLASS MAIL PERMIT NO. 26 NEW YORK, NY

Postage will be paid by addressee

**Practical Electronics Book Club
Dept. PRD-4th Floor
11 West 19th Street
New York, New York 10114-0144**

