

RICAN

280W

OCTOBER 1988 \$2.50

HAM RADIO

Exploring
Packet Radio
with KISS

For Your Workbench:

Remote Tuner for 75-Meter Mobiles

More Fixes for the IC22S

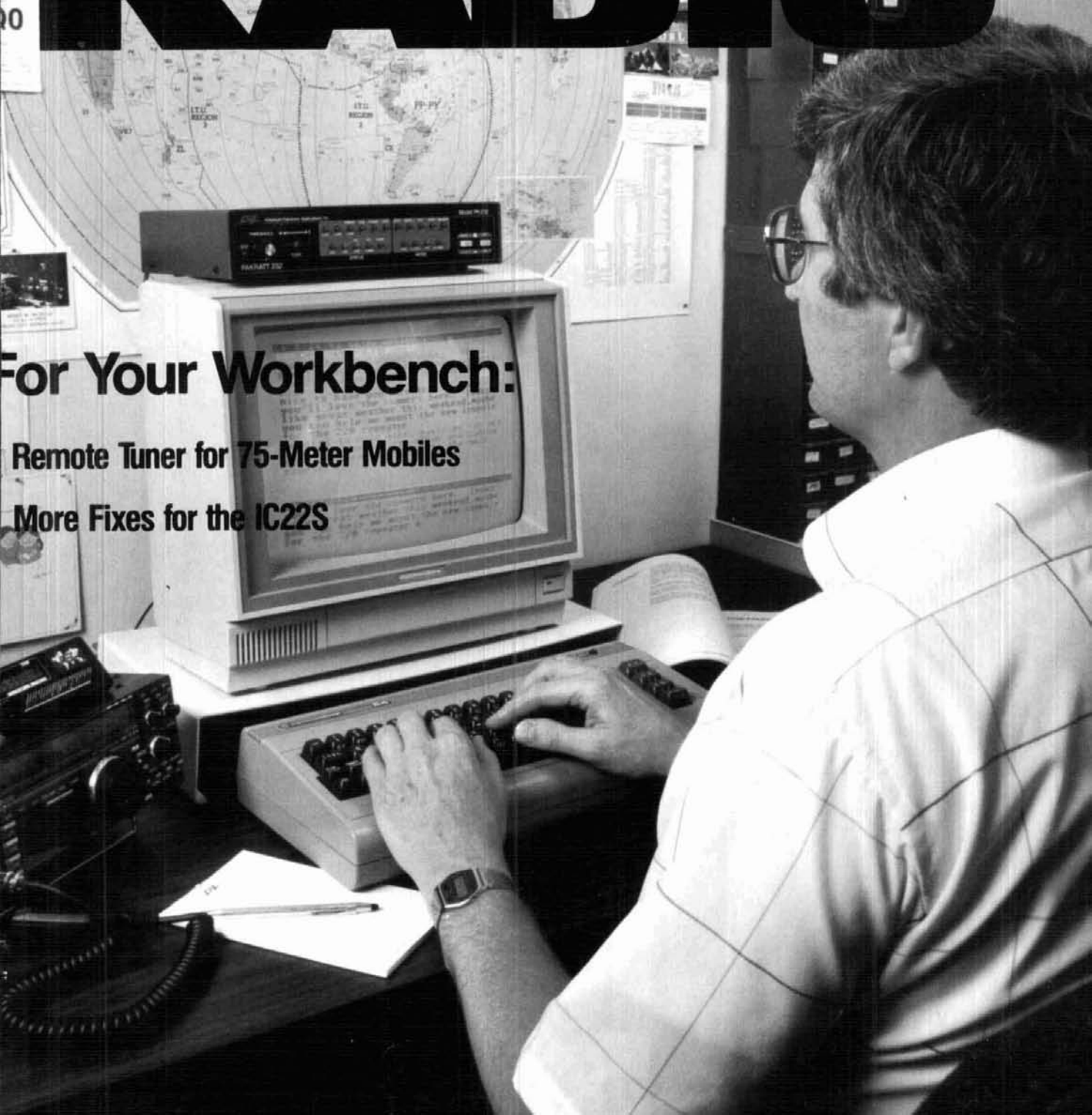

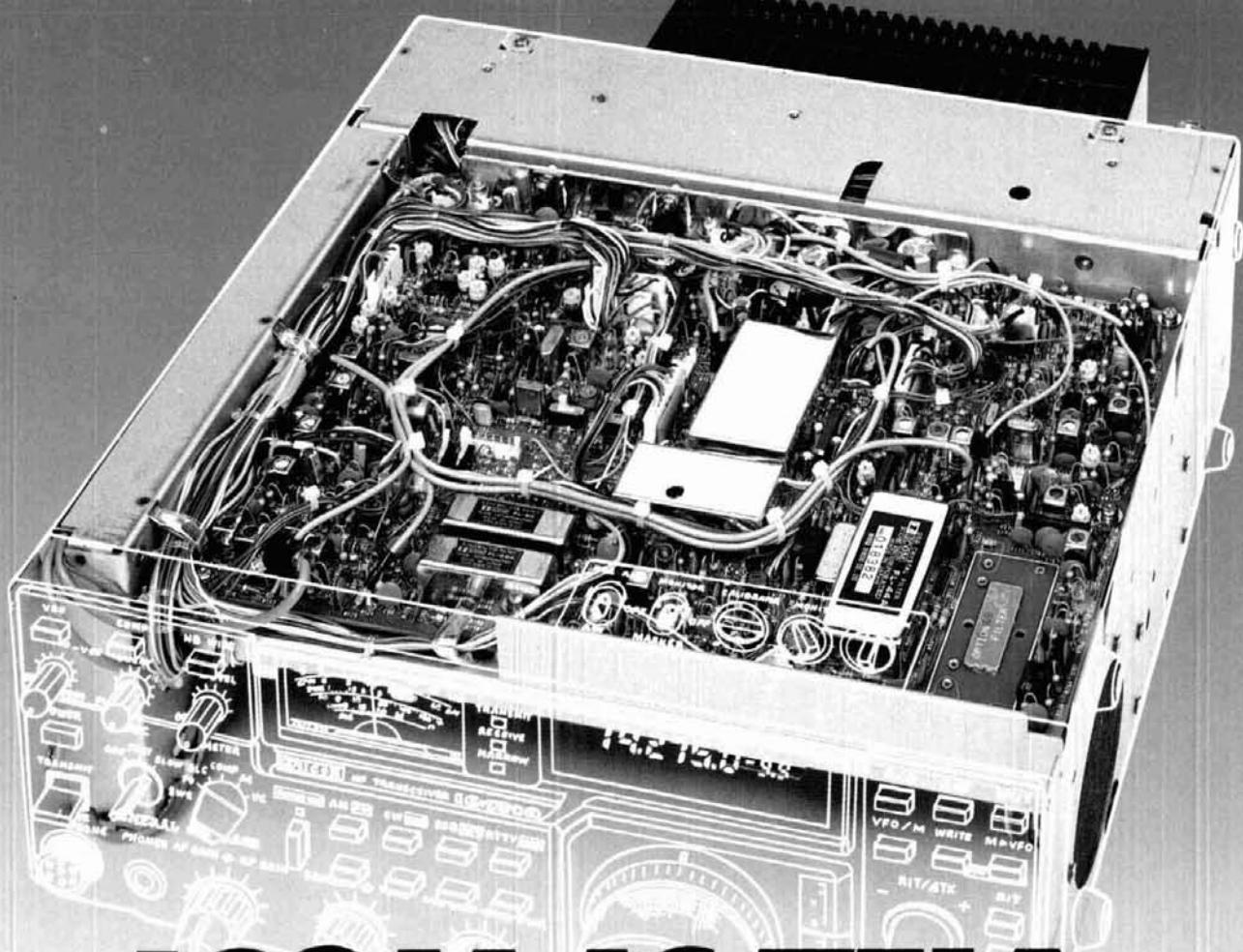

ICOM IC-751A

"IT'S WHAT'S INSIDE THAT COUNTS!"

- All HF Band Transceiver / General Coverage Receiver
- Advanced Circuit Designs
- All Modes Built-in USB, LSB, FM, AM, CW, RTTY
- Superb Frequency Stability
- Continuous Duty Operation
- Crystal Clear Signal Quality

Midsize Masterpiece! The deluxe IC-751A includes more high performance features and professional circuitry per cubic inch than any other HF transceiver. Its smooth-as-silk operation and long-term reliability produce the ideal contesting, DX'ing, mobiling and portable rig. Owning an IC-751A truly means "Going First Class!"

Unsurpassed Quality and Reliability. Quality and Reliability is important to you and it's important to ICOM. ICOM now covers you and your investment with its exclusive



one year warranty. There's more! The IC-751A's receiver boasts 105dB dynamic range for superb listening. The 100% duty cycle transmitter defies abuse and delivers 100 watts of exceptionally stable and clean RF output. Reliability. Quality. One year warranty. That's ICOM.

All Bands, All Modes Included. Operates 160 through 10 meters, it's easily modified for MARS operation, plus it includes general coverage reception from 100kHz to 30MHz. No compromise, no comparison!

32 Tunable Memories. Store both frequency and mode information. Use them to quick-access your favorite spots or as 32 preferred frequency-remembering VFOs.

A Modern Amateur's Delight! Special attractions include an electronic keyer, semi or full break-in rated to 40 WPM, panel selectable 500Hz/FL-32A CW filter, and volume control-tracking sidetone. SSB transmissions are enhanced with an RF speech processor and tone control to produce sparkling clear audio. PLUS there's a new rubberized tuning knob for velvet-smooth tuning and a full line of accessories and filters.

RF Power Control. Varies output independent of mic gain, ALC and speech processor action. Enjoy maximum "talk power" at any drive level!

To see the IC-751A, contact your local ICOM dealer.

 **ICOM**
First in Communications

ICOM America, Inc., 2380-116th Ave NE, Bellevue, WA 98004 Customer Service Hotline (206) 454-7619
3150 Premier Drive, Suite 126, Irving, TX 75063 / 1777 Phoenix Parkway, Suite 201, Atlanta, GA 30349
ICOM CANADA, A Division of ICOM America, Inc., 3071 - #5 Road, Unit 9, Richmond, B.C. V6X 2T4 Canada

All stated specifications are approximate and subject to change without notice or obligation. All ICOM radios significantly exceed FCC regulations limiting spurious emissions. 751A187

THE ALL NEW PRIVATE PATCH IV BY CSI HAS MORE COMMUNICATIONS POWER THAN EVER BEFORE

- Initiate phone calls from your HT or mobile
- Receive incoming phone calls

NEW! • Telephone initiated control . . .

- ✓ Operate your base station with complete control from any telephone
- ✓ Change frequencies from the controlling telephone
- ✓ Selectively call mobiles using regenerated DTMF from any telephone
- ✓ Eavesdrop the channel from any telephone
- ✓ Use as a wire remote using ordinary dial up lines and a speaker phone as a control head.

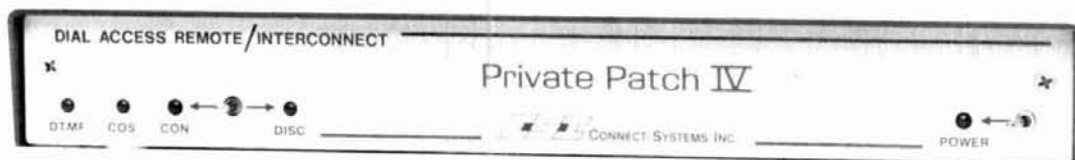

The new telephone initiated control capabilities are awesome. Imagine having full use and full control of your base station radio operating straight simplex or through any repeater from any telephone! From your desk at the office, from a pay phone, from a hotel room, etc. You can even change the operating channel from the touchpad!

Our digital VOX processor flips your conversation back and forth fully automatically. There are no buttons to press as in phone remote devices. And you are in full control 100% of the time!

The new digital dialtone detector will automatically disconnect Private Patch IV if you forget to send # (to remotely disconnect) before hanging up. This powerful feature will prevent embarrassing lock-ups.

The importance of telephone initiated control for emergency or disaster communications cannot be overstated. Private Patch IV gives you full use of the radio system from any telephone. And of course you have full use of the telephone system from any mobile or HT!

To get the complete story on the powerful new Private Patch IV contact your dealer or CSI to receive your free four page brochure.

Private Patch IV will be your most important investment in communications.

✓ = NEW FEATURE

- ✓ */# or multi-digit connect/disconnect
- ✓ Fully regenerated tone dialing
 - Pulse dialing
 - Toll protection
 - Secret toll override code
 - Busy signal disconnect
- ✓ Dialtone disconnect
 - CW identification
 - Activity timer
 - Timeout timer
- ✓ Telephone initiated control
- ✓ Regenerated DTMF selective calling
 - Ringout
- ✓ Ringout or Auto Answer on 1-8 rings
 - Busy channel ringout inhibit
- ✓ Status messages
- ✓ Internally squelched audio
 - MOV lightning protection
- ✓ Front panel status led's
- ✓ Separate CW ID level control
- ✓ 24 dip switches make all features user programmable/selectable.

- Connects to MIC and ext. speaker jack on any radio. Or connect internally if desired.
- Can be connected to any HT. (Even those with a two wire interface.)
- Can be operated simplex, through a repeater from a base station or connected directly to a repeater for semi-duplex operation.
- 20 minutes typical connect time
- Made in U.S.A.

OPTIONS

1. 1/2 second electronic voice delay
2. FCC registered coupler
3. CW ID chip



CONNECT SYSTEMS INC.
23731 Madison St.
Torrance CA 90505
Phone: (213) 373-6803

AMATEUR ELECTRONIC SUPPLY
Milwaukee WI, Wickliffe OH,
Orlando FL, Clearwater FL,
Las Vegas NV

BARRY ELECTRONICS CORP.
New York NY

EGE, Inc.
Woodbridge VA

ERICKSON COMMUNICATIONS
Chicago IL

HAM RADIO OUTLET
Anaheim CA, Burlingame CA,
Oakland CA, Phoenix AZ,
San Diego CA, Van Nuys CA,
Atlanta GA

HENRY RADIO
Los Angeles CA

INTERNATIONAL RADIO SYSTEMS
Miami FL

JUNS ELECTRONICS
Culver City CA

MADISON ELECTRONICS SUPPLY
Houston TX

MIAMI RADIO CENTER CORP.
Miami FL

MIKES ELECTRONICS
Ft. Lauderdale, Miami FL

N&G DISTRIBUTING CORP.
Miami FL

OMNI ELECTRONICS
Laredo TX

PACE ENGINEERING
Tucson AZ

THE HAM STATION
Evansville IN

WESTCOM
San Marcos CA

CANADA:
CARTEL ELECTRONIC DISTRIBUTORS
Surrey B.C.

COM-WEST RADIO SYSTEMS, LTD.
Vancouver B.C.

KENWOOD

...pacesetter in Amateur Radio

THE FIRST
144/220 MHz
Dual Bander!

Double Take!



ACTUAL SIZE FRONT PANEL

TM-621A/721A 144/220 and 144/450 MHz FM Dual Banders

Once again, Kenwood brings you another Dual Bander First! The TM-621A is the first 144/220 MHz FM Dual Bander. The Kenwood TM-621A and TM-721A (144/450 MHz) re-defines the original Kenwood "Dual Bander" concept. The wide range of innovative features includes a dual channel watch function, selectable full duplex operation, 30 memory channels, extended frequency coverage, large multi-color digital LCD displays, programmable scanning, and more!

- Extended receiver range (138,000-173,995 MHz) on 2 m; 70 cm coverage is 438,000-449,995 MHz; 1-1/4 m coverage is 215-229,995 MHz. (Specifications guaranteed on Amateur bands only. Two meter transmit range is 144-148 MHz. Modifiable for MARS/CAP. Permits required.)
- Separate frequency display for "main" and "sub-band."
- Call channel function. A special memory channel for each band stores frequency, offset, and sub-tone of your favorite channel. Simply press the CALL key, and your favorite channel is selected!

Optional Accessories:

- RC-10 Multi-function handset/remote controller • PS-430 Power supply • TSU-6 CTCSS decode unit • SW-100B Compact SWR/power/volt meter • SW-200B Deluxe SWR/power meter • SWT-1 2 m antenna tuner • SWT-2 70 cm antenna tuner • SP-400 Compact mobile speaker • SP-50B Deluxe

- 30 multi-function memory channels. 14 memory channels and one call channel for each band store frequency, repeater offset, CTCSS, and reverse. Channels "A" and "b" establish upper and lower limits for programmable band scan. Channels "C" and "d" store transmit and receive frequencies independently for "odd splits"
- 45 Watts on 2 m, 35 watts on 70 cm, 25 watts on 1-1/4 m. Approx. 5 watts low power.
- Automatic Band Change (A.B.C.) Automatically changes between main and sub-band when a signal is present.
- Dual watch function allows VHF and UHF receive simultaneously.
- Programmable memory and band scanning, with memory channel lock-out and priority watch function.
- Balance control and separate squelch controls for each band.

- Dual antenna ports.
- TM-621A has auto offset.
- Full duplex operation.
- CTCSS encode/decode selectable from front panel or UP/DWN keys on microphone. (Encode built-in, optional TSU-6 needed for decode.)
- Each function key has a unique tone for positive feedback.
- Illuminated front panel controls and keys.
- 16 key DTMF mic. included.
- Handset/remote control option (RC-10).
- Frequency (dial) lock.
- Supplied accessories: 16-key DTMF hand mic., mounting bracket, DC cable.

Complete service manuals are available for all Kenwood transceivers and most accessories. Specifications, features, and prices are subject to change without notice or obligation.



TM-721A shown with optional RC-10

- mobile speaker • PG-2N DC cable • PG-3B DC line noise filter • MC-60A, MC-80, MC-85 Base station mics. • MA-4000 Dual band 2 m/70 cm mobile antenna (mount not supplied) • MB-11 Mobile bracket • MC-43S UP/DWN hand mic. • MC-48B 16-key DTMF hand mic.

KENWOOD

KENWOOD U.S.A. CORPORATION
2201E, Dominguez St., Long Beach, CA 90810
P.O. Box 22745, Long Beach, CA 90801-5745

HAM RADIO

OCTOBER 1988

volume 21, number 10

T. H. Tenney, Jr., W1NLB
publisher
and editor-in-chief

Terry Northup
managing editor

Marty Durham, NB1H
technical editor

Robert D. Wilson, WA1TKH
consulting editor

Tom McMullen, W1SL
Joseph J. Schroeder, W9JUV
Alfred Wilson, W6NIF
associate editors

Susan Shorrock
production editor

Peggy Tenney, KA1QDG
copy editor

Beth McCormack
editorial assistant

editorial review board

Peter Bertini, K1ZJH
Forrest Gehrke, K2BT
Michael Gruchalla, P. E.
Bob Lewis, W2EBS
Mason Logan, K4MT
Vern Riportella, WA2LQQ
Ed Wetherhold, W3NQN

publishing staff

J. Craig Clark, Jr., N1ACH
assistant publisher

Henry S. Gallup, KA1RYG
advertising sales manager

Dorothy Sargent, KA1ZK
advertising production manager

Susan Shorrock
circulation manager

Therese Bourgault
circulation

Phil Alix, N1FPX
traffic manager

Maribeth Buchanan
HAM RADIO Bookstore

AEA
cover

HAM RADIO Magazine is published monthly by
Communications Technology, Inc.
Greenville, New Hampshire 03048-0498
Telephone: 603-878-1441

subscription rates

United States:
one year, \$22.95; two years, \$38.95; three years, \$49.95
Europe (via KLM air mail), \$40.00

Canada, Japan, South Africa and other countries (via surface mail),
one year, \$31.00; two years, \$55.00; three years, \$74.00

All subscription orders payable in U.S. funds, via international
postal money order or check drawn on U.S. bank

International subscription agents: page 101

Microfilm copies are available from
Buckmaster Publishing
Mineral, Virginia 23117

Cassette tapes of selected articles from **HAM RADIO**
are available to the blind and physically handicapped
from Recorded Periodicals,
919 Walnut Street, Philadelphia, Pennsylvania 19107

Copyright 1988 by Communications Technology, Inc.
Title registered at U.S. Patent Office

Second-class postage paid
at Greenville, New Hampshire 03048-0498
and at additional mailing offices
ISSN 0148-5989

Send change of address to **HAM RADIO**
Greenville, New Hampshire 03048-0498

FEATURES

9 Exploring Packet Radio with KISS

Michael Pechura, WA8BXN

17 Designing a Station for the Microwave Bands: Part Three

Glenn Elmore, N6GN

36 The Weekender: Remote Tuner for 75-Meter Mobiles

Joel Eschmann, K9MLD

38 Ham Radio Techniques: A Look at the Ground-plane Antenna

Bill Orr, W6SAI

47 Pathfinder Part Two

Ron Todd, K3FR

63 Efficiently Launch VHF/UHF Wave

Hal Silverman, W3HWC

65 The Weekender: A Code Practice Oscillator

John Pivnichny, N2DCH

71 VHF/UHF World: IMD and Splatter

Joe Reiser, W1JR

85 Practically Speaking: Standing Waves: A Review

Joe Carr, K4IPV

91 More Fixes for the IC22S VHF Radio

Brian J. Henderson, VE6ZS

109 Pi Network Equations

Mason A. Logan, K4MT

113 Elmer's Notebook: Modems and RS-232

Thomas McMullen, W1SL



N6GN, Page 17



**THE
WEEKENDER**

K9MLD, page 36
N2DCH, page 65

DEPARTMENTS

Backscatter	4	DX Forecaster	96
Comments	6	Ham Mart	100
New Products	41, 42, 102, 105, 106	Flea Market	111
Ham Notebook	82	Advertiser's Index	118
		Reader Service	118

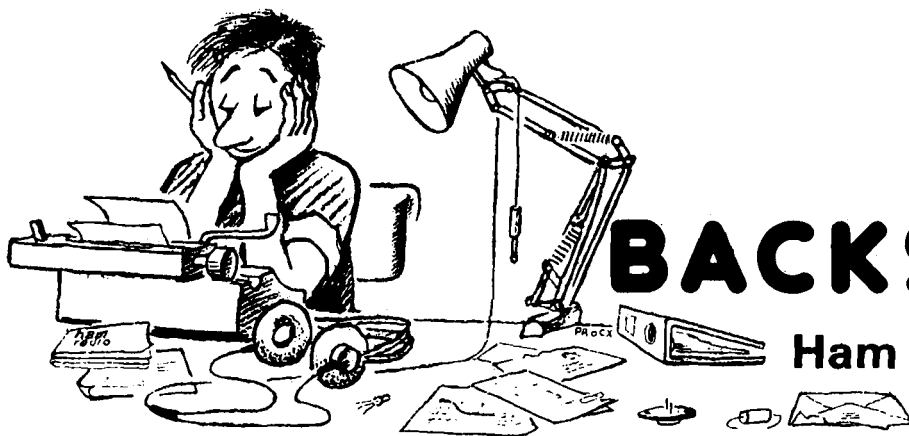

BACKSCATTER

Ham Bands Under Siege?

Over the years, a number FCC actions have created a tremendous amount of controversy in the Amateur field.

The latest bombshell is assured of being one of the most hotly contested ever. On August 4, the FCC decided to reallocate 220-222 MHz to the Land Mobile Service. The roots of this action are in a proposal made 18 months ago by the FCC Office of Engineering & Technology to "address a need to promote spectrum efficient technology and reduce overcrowding in the commercial services." During the formal comments period, thousands of negative responses were filed by hams, concerned citizens, the military and other government services. In addition, Congressional resolutions against the proposal were working their way through both the House (Resolution -317) and Senate (Resolution -127).

Then from out of the blue, six months after the formal closing date for comments, the United Parcel Service, filed comments in support of the FCC proposal. Even more remarkable was the FCC's acceptance of the UPS proposal — it was as if they were prepared and had been waiting for it. Is the FCC saying to us now that the dates they put on proposals are flexible at the Commissioner's whims? One must wonder what kind of anarchy rules the FCC or where the pressure is coming from...

What's even more scary is the thought that this could only be the opening battle in the possible war to take away all of our frequencies. Chod Harris, editor of "The DX Bulletin" editorialized in the August 2 issue that due to lack of operation on the 30-meter band, it will only be a matter of time before another service proposes to take it away from us. There is the possible threat to 160 meters from the broadcasting industry. If they can move the band up to 1700 KHz, why not 1800 KHz, or even higher still? And what about 450 MHz? We've already lost part of the band on the Canadian border. What's to prevent a proposal to take all of the band from us based upon this action.

Now is the time to act. There are three ways you can help. First, write your congressional representatives and senators expressing support for the concurrent resolutions now before them. Second, the ARRL is urging all Hams to support a proposed amendment (see below) to legislation to freeze the FCC's rules as of August 3. Send your letters, telexes, QSLs in support of the amendment to Congressmen Markey and Dingle and Senators Inouye and Hollings at the addresses below. Finally, stay informed of all developments in this and all other actions that could seriously affect our hobby!

There's no turning back now! What couldn't happen has. If we do not stand up to this threat, who knows what we'll lose next.

Craig Clark, N1ACH

Radio Spectrum Allocation Amendment Spec. The Commission shall enforce the regulations, rules, and policies in effect as of August 3, 1988, as they relate to the Amateur Radio Service in the 220-225MHz frequency band as defined in 47 CFR Section 2.106 (Table of Frequency Allocations).

U.S. HOUSE

Rep. John D. Dingel (D-MI)
Room 2221 RHOB
Washington, D.C. 20515
Tel: (202) 225-4071
Attn: John Orlando

Rep. Edward J. Markey (D-MA)
Chairman of Telecommunications and Finance Subcommittee
Room 316, House Annex II
Washington, C.C. 20515
Tel. (202) 226-2424
Attn: Gerry Salemme

U.S. SENATE

Sen. Ernest F. Hollings (D-SC)
Chairman Commerce, Science and Transportation
Room SD-508
Washington, D.C. 20510
Tel: (202) 224-0427
Attn: Ralph B. Everett

Sen. Daniel K. Inouye (D-HI)
Chairman of Communications Subcommittee
Room SH-227
Washington, D.C. 20510
Tel. (202) 224-9340
Attn: Tom Cohen

KENWOOD

...pacesetter in Amateur Radio

NEW!

Affordable DX-ing!

TS-140S

HF transceiver with general coverage receiver.

Compact, easy-to-use, full of operating enhancements, and feature packed. These words describe the new TS-140S HF transceiver. Setting the pace once again, Kenwood introduces new innovations in the world of "look-alike" transceivers!

- Covers all HF Amateur bands with 100 W output. General coverage receiver tunes from 50 kHz to 35 MHz. (Receiver specifications guaranteed from 500 kHz to 30 MHz.) Modifiable for HF MARS operation. (Permit required).
- All modes built-in. LSB, USB, CW, FM and AM.
- Superior receiver dynamic range Kenwood DynaMix™ high sensitivity direct mixing system ensures true 102 dB receiver dynamic range.



- New Feature! Programmable band marker. Useful for staying within the limits of your ham license. For contesters, program in the suggested frequencies to prevent QRM to non-participants.
- Famous Kenwood interference reducing circuits. IF shift, dual noise blankers, RIT, RF attenuator, selectable AGC, and FM squelch.

- M. CH/VFO CH sub-dial. 10 kHz step tuning for quick QSY at VFO mode, and UP/DOWN memory channel for easy operation.
- Selectable full (QSK) or semi break-in CW.
- 31 memory channels. Store frequency, mode and CW wide/narrow selection. Split frequencies may be stored in 10 channels for repeater operation.
- RF power output control.
- AMTOR/PACKET compatible!
- Built-in VOX circuit.
- MC-43S UP/DOWN mic. included.

Optional Accessories:

- AT-130 compact antenna tuner • AT-250 automatic antenna tuner • HS-5/HS-6/HS-7 headphones • IF-232C/IF-10C computer interface
- MA-5/VP-1 HF mobile antenna (5 bands)
- MB-430 mobile bracket • MC-43S extra UP/DOWN hand mic. • MC-55 (8-pin) goose neck mobile mic. • MC-60A/MC-80/MC-85 desk mics.
- PG-2S extra DC cable • PS-430 power supply
- SP-40/SP-50B mobile speakers • SP-430 external speaker • SW-100A/SW-200A/SW-2000 SWR/power meters • TL-922A 2 kW PEP linear amplifier (not for CW QSK) • TU-8 CTCSS tone unit
- YG-455C-1 500 Hz deluxe CW filter, YK-455C-1 New 500 Hz CW filter.



TS-680S

All-mode multi-bander

- 6m (50-54 MHz) 10 W output plus all HF Amateur bands (100 W output).
- Extended 6m receiver frequency range 45 MHz to 60 MHz. Specs. guaranteed from 50 to 54 MHz.
- Same functions of the TS-140S except optional VOX (VOX-4 required for VOX operation).
- Preamplifier for 6 and 10 meter band.



Complete service manuals are available for all Kenwood transceivers and most accessories. Specifications, features, and prices are subject to change without notice or obligation.

KENWOOD

KENWOOD U.S.A. CORPORATION
2201 E. Dominguez St., Long Beach, CA 90810
P.O. Box 22745, Long Beach, CA 90801-5745



COMMENTS

Remembering a great scientist

Dear HR

KR6A in his article on Hertzian Waves omitted the findings of a very great scientist. I speak here of Nikola Tesla who proved that radio waves travel as do sound waves, i.e. longitudinally.

He also proved that Hertzian Waves are transverse waves and that these exist in the gases of the antenna both transmitting and receiving.

From this it can be seen that Hertzian Waves do not travel through space.

Arnold King, Jr. W2ZT, McAllen, Texas 78504

Neutral grounding

Dear HR:

Even though I'm very busy preparing for a vacation I feel compelled to write in reference to the excellent letter in the July issue (1988) of Ham Radio by I.L. McNally, K6WX and his subject of neutral grounding. The subject is especially timely, as that same issue carries an article by Bill Orr on page 60 and gives reference to grounding the neutral at an amplifier.

There are several additional reasons for grounding the "neutral" current

carrying conductor *only* at the service entrance; these are addressed in the National Electrical Code. One of the main reasons for grounding one of the secondary wires of the step-down transformer which supplies electricity from the distribution system is for safety. Should the transformer insulation fail and the secondary not be grounded by some means, that fault could put a very high voltage (7,000 volts or more) on house wiring, as measured to ground. But precautions must also be taken when the neutral is grounded. It is sort of a case where one solution somewhat creates another problem if proper wiring practice is not followed. The problem is that should the conducting path somehow be broken between the neutral bus between the load the transformer, and a small neutral wire somewhere in the house (say 14 g. for instance) be grounded, all neutral current (which could be 100 or 200A depending on the "unbalance") will flow over that 14 g. wire (which is normally rated at about 15A current capacity for house wiring) and possibly cause a fire. Then, yet another problem can occur. When the 14 g. wire melts through, the neutral will no longer be at ground potential depending on the load across the hot to neutral, and any equipment that is connected to what was once a neutral at something close to ground potential is now possibly somewhere near 120 v.a.c. creating a real shock hazard!

There is an important difference between a *grounding* conductor and a *current-carrying grounded neutral* conductor. In addition to the reasons listed above, any ground fault breaker or receptacle I have ever worked with will trip if its neutral is grounded anywhere downstream of the ground fault protector. Don't bypass ground fault protection or disable it in order to ground a neutral somewhere. *Don't ground neutrals* for important safety reasons, not to mention ground loops, hum, and rfi problems. Proper use of 240 v.a.c. and 120 v.a.c. in a device which requires both voltages demands

a four-wire system of two hot wires, the neutral grounded current-carrying conductor, and the grounding conductor; all the excuses ("it's my wiring, I'll do with it what I want; I don't believe in the wiring code; the government isn't going to tell me what to do,") notwithstanding, including what you see in radio handbooks. I also must politely and gently chastise Bill Orr for seemingly promoting this incorrect and dangerous practice. I suggest the proper wiring methods be addressed, with schematics, in one of his very next articles.

Richard M. Lorenzen, WA0AKG,
Lincoln, Nebraska 68504

Need for basics

Dear HR

As a long-time subscriber to your magazine, let me congratulate you on your announced intentions of changing the editorial policy with regard to the type of articles we can expect to find in *HAM RADIO*.

The quality of your articles in the past has been excellent for the better educated electronic engineer, but I find too many of the average hams are not able to cope with the math and other explanations. They look at the article and lay the magazine down without reading this type of article. Pretty soon they find so little use for the magazine, they drop the subscription. I have had considerable contact with many hams in this area and that is what they have given me to understand.

Many times hams have told me they got along fine building things with tubes but they got behind on semiconductors and now they are lost. It seems to me there is a need for articles stressing basic understanding of how semiconductors work and articles on building with simple standard transistors and ICs, not the latest sophisticated ICs that are not available to most hams.

I hope your change of policy works!

Robert R. Hall, W0CRO, Minneapolis, Minnesota 55406

MFJ 3 KW Roller Inductor Tuner

... lets you get your SWR down to *absolute minimum* -- something a tapped inductor tuner just can't do ...

... plus you get a *peak reading* Cross-Needle SWR/Wattmeter, 6-position antenna switch, balun for balanced lines and 1.8-30 MHz coverage...\$239.95



MFJ-986

\$239⁹⁵

MFJ's innovative new Differential-T Tuner™ uses a differential capacitor that makes tuning foolproof and easier than ever. It ends constant re-tuning with broadband coverage and gives you minimum SWR at only one setting.

The new MFJ-986 is a rugged no-compromise 3 KW PEP Roller Inductor antenna tuner that covers 1.8-30 MHz continuously, including MARS and all the WARC bands. The roller inductor lets you tune your SWR down to the *absolute minimum* -- something a tapped inductor tuner just can't do.

A 3-digit turns counter plus a spinner knob gives you precise inductance control -- so you can quickly return to your favorite frequency.

You get a lighted Cross-Needle meter that not only gives you SWR, forward and reflected power at a glance -- but also gives you a *peak-reading* function! A new directional coupler gives you even more accurate readings over a wider frequency range.

You get a 6-position ceramic antenna switch that lets you select two coax lines and/or random wires (direct or through tuner), balanced line and external dummy load.

A new current balun for balanced lines minimizes feedline radiation that causes field pattern distortion, TVI and RF in your shack. Ceramic feedthrough insulators for balanced lines withstand high voltages and temperatures.

New Antenna Tuner Technology
MFJ brings you three innovations in antenna tuner technology: a new Differential-T™ circuit simplifies tuning; a new directional coupler gives you more accurate SWR, forward and reflected power readings; and a new current balun reduces feedline radiation.

Differential-T Tuner™:
A New Twist on a Proven Technology

By replacing the two variable capacitors with a single differential capacitor you get a wide range T-network tuner with only two controls -- the differential capacitor and a roller inductor.

That's how you get the new MFJ Differential-T Tuner™ that makes tuning easier than ever, gives you minimum SWR at only one setting and has a broadband response that ends constant re-tuning. You'll spend your time QSOing

instead of fooling with your tuner.

The compact 10¼ x 4½ x 15 inch cabinet has plenty of room to mount the silver-plated roller inductor away from metal surfaces for maximum Q -- you get high efficiency and more power into your antenna.

The wide spaced air gap differential transmitting capacitor lets you run a full 3 KW PEP -- no worries about arcing.

A New Directional Coupler:
Accurate SWR and Power Reading

MFJ's Cross-Needle SWR/Wattmeter gives you more accurate SWR and power readings over a wider frequency range with no frequency sensitive adjustments.

That's because MFJ's new directional coupler gives you up to an order of magnitude higher directivity and coupling factor than conventional circuits -- plus it gives you a flat frequency response that requires no frequency compensation.

The cross-needle meter lets you read forward/reflected power in 2 ranges: 200/50 and 2000/500 watts. The meter lamp is front-panel switched and requires 12 volts.

A switch lets you select peak or average power readings.

A New Current Balun:
Reduces Feedline Radiation

Nearly all commercially built tuners use a "voltage" balun. The "voltage" balun forces the voltages to be equal on the two antenna halves. It minimizes unbalanced currents only if the antenna is perfectly balanced -- not the case with practical antennas.

The MFJ-986 uses a true current balun to force equal currents into the two antenna halves -- even if your antenna is not perfectly balanced -- so you get minimum unbalanced currents.

The current balun gives superior balance over the "voltage" balun.

Minimum unbalanced current reduces field pattern distortion -- which concentrates your power for a stronger

signal -- plus it reduces TVI and RF in your shack caused by feedline radiation.

The MFJ-986 Differential-T Tuner™:
Get *absolute minimum* SWR

Get the tuner that incorporates the latest innovations by the world's leader in antenna tuner technology.

See your dealer today for the new MFJ-986 Differential-T™ 3 KW Roller Inductor Tuner. Include \$10 shipping/handling if ordering direct.

WHY CHOOSE AN MFJ TUNER?

Hard-earned Reputation: There's just no shortcut. MFJ is a name you can trust -- more hams trust MFJ tuners throughout the world than all other tuners combined.

Proven Reliability: MFJ has made more tuners for more years than anyone else -- with MFJ tuners you get a highly-developed product with proven reliability.

First-rate Performance: MFJ tuners have earned their reputation for being able to match just about anything -- anywhere.

One full year unconditional guarantee: That means we will repair or replace your tuner (at our option) no matter what for a full year.

Continuing Service: MFJ Customer Service Technicians are available to help you keep your MFJ tuner performing flawlessly -- no matter how long you have it -- just call 601-323-5869.

Your very best value: MFJ tuners give you the most for your money. Not only do you get a proven tuner at the lowest cost -- you also get a one year unconditional guarantee and continuing service. That's how MFJ became the world's leading tuner manufacturer -- by giving you your very best value.

Choose your MFJ tuner with confidence! You're getting proven performance and reliability from the most trusted name in antenna tuners. Don't settle for less.

Call or write for a free full-line MFJ catalog with all 10 of our tuners and tons of ham radio accessories!

FOR YOUR NEAREST DEALER
or to order call toll free
800-647-1800

One Year Unconditional Guarantee

MFJ

MFJ ENTERPRISES, INC.
Box 494, Miss. State, MS 39762
601-323-5869 Telex: 53-4590 MFJSTKV

MFJ ... making quality affordable

JDR INSTRUMENTS™

Complete customer satisfaction... simple, no-frills service... friendly, knowledgeable personnel... quality, value, reliability... now with the latest technology.



FULLY OVERLOAD PROTECTED

TRANSISTOR TESTER

9 FUNCTIONS 34 RANGES

CONDUCTANCE TESTER ADDS VERSATILITY

TEMPERATURE TESTER TO 2000° F

Our DMM-300
A remarkable value!
79⁹⁵

This full function 3.5 digit DMM offers highly accurate performance and a host of added features to help you do the job—fast. Capacitance, transistor, temperature, conductance and audible continuity in addition to the ranges you'd expect from a DMM of this quality. Temperature probe, test leads and battery included. Input impedance: 10M ohm. Basic DC accuracy: plus/minus 0.25% Approx. 7" x 3 1/2" x 1 3/4" Wt. 1 1/2 ozs.

DC VOLTAGE TO 1000 VOLTS

AC/DC CURRENT 200µA to 10A

CAPACITANCE TESTER 2000pF to 20µF

DPM-1000 \$54.95

3.5 DIGIT PROBE TYPE DMM

Custom 80 pin LSI chip provides accuracy and reliability in such a compact size. Autoranging, audible continuity and data hold feature help you pinpoint the problem quickly. Case and batteries included.

- Basic DC accuracy: plus/minus 1%
- DC voltage: 2v-500v, autoranging
- AC voltage: 2v-500v, autoranging
- Resistance: 2k ohms-2M ohms, autoranging
- Fully over-load protected
- Input impedance: 11M ohm
- Approx. 6 1/2" x 1" x 3/4" Under 3 ozs.



- ★ **2 YEAR REPLACEMENT WARRANTY**
- ★ **30 DAY MONEY BACK GUARANTEE**
- ★ **TOLL FREE TECHNICAL SUPPORT**
- ★ **NEXT DAY AIR SHIP AVAILABLE**

MODEL 2000 \$389.95

20 MHz DUAL TRACE OSCILLOSCOPE

Model 2000 makes frequency calculation and phase measurement quick and easy. The component tester aids in fast troubleshooting. Service technicians appreciate the TV Sync circuits for viewing TV-V and TV-H and accurate synchronization of the video signal, Blanking, VITS, and V/H sync pulses.

- Exceptionally bright 5" CRT
- Built-in component tester
- TV Sync filter
- X-Y operation • 110/220 volts

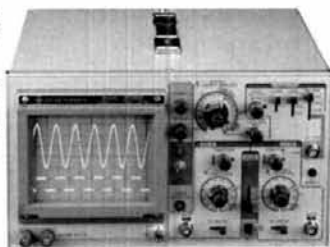

MODEL 3500 \$499.95

35 MHz DUAL TRACE OSCILLOSCOPE

Wide bandwidth and exceptional 1mV/DIV sensitivity make the Model 3500 a powerful diagnostic tool for engineers or technicians at a remarkable price. Delayed triggering allows any portion of a waveform to be isolated and expanded for closer inspection. Variable Holdoff allows stable viewing of complex waveforms.

- Exceptionally bright 5" CRT
- Delayed and single sweep modes
- Z axis intensity modulation
- X-Y operation • TV sync filter
- Fast 10ns rise time

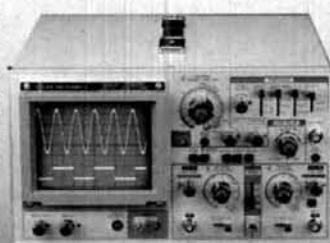

DMM-200 \$49.95

3.5 DIGIT FULL FUNCTION DMM

Get highly accurate performance at a very affordable price. Rugged construction, 20 amp current capability and 22 ranges make it a perfect choice for serious field or bench work. Lo battery indicator and tilt-stand. Probes and 2000 hour battery included.

- Basic DC accuracy: plus or minus 0.25%
- DC voltage: 200mv-1000V, 5 ranges
- AC voltage: 200mv-750V, 5 ranges
- Resistance: 200 ohms-20M ohms, 6 ranges
- AC/DC current: 200µA-20A, 6 ranges
- Input impedance: 10M ohm
- Fully overload protected
- Approx. 7" x 3 1/2" x 1 1/2" Wt. 11 ozs.



DMM-100 \$29.95

3.5 DIGIT POCKET SIZE DMM

Perfect for the field service technician. Shirt pocket size without compromising features or accuracy. Large, easy to read 1/2" LCD display. Fully overload protected for safety. 2000 hour battery life with standard 9v cell. Probes and battery included.

- Basic DC accuracy: plus/minus 0.5%
- DC voltage: 2v-1000v, 4 ranges
- AC voltage: 200v-750v, 2 ranges
- Resistance: 2k ohms-2M ohms, 4 ranges
- DC current: 2mA-2A, 4 ranges
- Input impedance: 10M ohm
- Fully overload protected
- Approx. 5" x 3" x 1". Under 7 ozs.

JDR INSTRUMENTS, 110 KNOWLES DRIVE, LOS GATOS, CA 95030
RETAIL STORE: 1256 SOUTH BASCOM AVE, SAN JOSE, CA (408) 947-8881



ORDER TOLL FREE 800-538-5000

EXPLORING PACKET RADIO WITH KISS

By Michael Pechura, WA8BXN, CIS
Department, Cleveland State University, E.
24th at Euclid Avenue, Cleveland, Ohio 44115

Learn more about
what you're sending
and how it works

Packet radio is one of the few areas left in Amateur Radio where you can do some experimentation with only a modest outlay for equipment. Those who already have a packet radio station have most of the equipment they need.

Unfortunately, most people on packet are "appliance" operators, not experimenters. I know it's easy to get on packet radio, but what do you do after connecting to all the locals on packet, reading all the messages on the bulletin boards, and watching all the Netrom "garbage" go by? Is there anything more you can do to find out about the real workings of packet, to experiment with this form of digital communication, and learn more about the interaction of your computer with packet radio? There certainly is!

There have been many articles explaining the data formats and the concept of networks, but it's also important to see packets in detail as they are being used. Fortunately, many of the Terminal Node Controller (TNC) manufacturers have begun to include a new feature in their TNCs, making experimentation and learning the details of packet easier. The feature is KISS mode (Keep It Simple Stupid!) access to the TNC. Provided to support a networking method called TCP/IP, KISS lets your computer do all of the decoding and construction of basic packet frames.

You can use KISS to really see everything in the packets being heard, and then to generate any type of packets you want. Now you can use your computer

to implement any new features you might like to put in your TNC.

There are some problems, however. With KISS you can transmit your own packets, but you shouldn't write anything to the TNC when you're in KISS mode until you fully understand the process. If you don't and send out packets with errors, they will probably be ignored by the TNCs receiving them. They also might be illegal, particularly if there isn't a valid identification transmission. Transmission of valid packets isn't really very hard, but it's important to listen and learn first.

To understand what happens in KISS mode you'll need to review what the TNC does when it's not in KISS. The TNC contains a microcomputer for the initial input of commands. When the connect command is given, the TNC transmits the right kind of packet to initiate a connection. If the connect request is successful, the lines you typed are made into packets to be transmitted. The packets received are sent to the computer to be displayed as lines of text. The TNC handles all the details of the AX.25 protocol, like sequence numbers and error handling. These details aren't important if you don't intend to experiment with packet radio.

When a TNC is running in KISS mode it receives a string of characters that make up the complete packet to be transmitted from the computer. When the TNC receives a packet it sends the whole thing to the computer, and the computer then decides what to do with it. The TNC sends all packets it hears to the computer and the computer must retransmit the lost packets. There is no command mode; the TNC acts much like a dumb modem. However, when the TNC is sent a packet to transmit, it is responsible for generating the proper error detection bits at the end of the packet. It also waits until the channel is clear before transmitting and keys the push-to-talk line. When the TNC hears a packet on the radio, it checks the error detection bits and ignores the packet if it contains an error.

The details of KISS mode

Because KISS mode is simple, the description of its interface is short. Once in KISS mode, strings of bytes are sent by the TNC to the computer for each packet it receives. The beginning and end of these strings are marked by bytes of **C0** hex. These strings are called frames and they all have this basic pattern: **C0 YY XX XX XX XX XX ... XX XX C0**

where **YY** is the type of KISS frame (normally 0 in frames from the TNC) and the **XX**'s represent bytes that form a packet. These bytes might be header information or data being transmitted in the packet. The first byte after **C0** is a command byte identifying the kind of frame. This byte will be 0 for data received from the TNC for single port TNCs.

A minor problem arises when a packet contains a byte that is hex **C0**. You must not confuse this **C0** with the one that marks the end of the packet, so the TNC will never send a byte that is within a packet with the bit pattern **C0**. If such a byte does exist it will send two bytes, **DB** and **DC**, indicating that a byte of **C0** is actually in the packet. This solution for the **C0** problem gives rise to another one — how to have the bit pattern **DB** in a packet. This is solved by never sending a byte that is part of a packet as **DB**. In its place two bytes are sent, **DB** followed by **DD**. The situation above is referred to as the transparency problem, or how to tell data from delimiters. (It's much like the programming question of how to put a quote mark in a character string that is enclosed in quotes.)

Frames sent to the TNC by the computer also use this same format, with some different values for the command byte. You must follow the rules carefully for solving the transparency problem given above. For the present, concentrate on what you can learn and do by just listening in KISS mode; don't worry about transmission details yet.

Programs for your computer

It isn't terribly difficult to write programs for KISS mode. They can be written in most languages. My favorite program language is C. BASIC is a much more widely available language, however, and the programs given here will use it.

Because the bytes from the TNC in KISS mode arrive at the computer at times determined by the TNC, the program running in the computer must be ready to receive them. *Interrupt driven serial I/O is required.*

Two popular computers for Amateur Radio are the C-64 and the IBM PC, and its clones. Because some of the syntax for BASIC is quite different for these two computers, I've provided listings for both machines. You can adapt the programs for your own machine. Interrupt driven serial I/O is standard in BASIC for the

C-64 and IBM PC. Make sure this is also the case for any other computer you might use.

Just about any TNC that supports KISS mode can be used with these programs. The difference between one TNC and the next is the set of commands used to get the TNC into KISS mode. The TNC used to prepare these programs is a Kantronics KPC-2, which can be used with either true RS-232 compatible computers or the TTL levels used by the C-64. When using another TNC, refer to its operating manual for the necessary commands.

The simplest (and sometimes most useful) program that can be written for KISS mode is one that displays, in hex, the bytes the computer receives from the TNC. This program lets you see everything there is in a frame, including the **C0** bytes at the beginning and end.

The program for the C-64 is listed below:

```
10 PRINT CHR$(147) + CHR$(5);:POKE 53280,0:POKE
   53281,0
20 OPEN 2,2,3,CHR$(7): GET# 2,A$
30 PRINT# 2,"KISS ON" + CHR$(13) + "RESET"
40 H$ = "0123456789ABCDEF"
50 GOSUB 100: A = ASC(A$)
60 PRINT MID$(H$,A/16 + 1,1) + MID$(H$,A AND
   15) + 1,1) + " ";
70 GOTO 50
100 IF PEEK(667) = PEEK(668) THEN 100
110 GET# 2,A$: IF A$ = "" THEN A$ = CHR$(0)
120 RETURN
```

Go through this program line by line noting the subtleties. This will help if you want to convert it to another version of BASIC. Line 10 uses a print statement to clear the screen with **CHR\$(147)** and set the character color to white with **CHR\$(5)**. There are single keystrokes that could be enclosed in double quote marks for these, but since they usually don't reproduce well in listings the equivalent **CHR\$** forms are used instead. The two **POKE** statements set the background and border colors to black. While these colors work best on my color monitor, you may change them if you prefer.

Line 20 opens the serial port as device 2. The 7 in the **CHR\$(7)** specifies 600 baud operation. The default of 8 data bits with no parity matches the format of data from the TNC when in KISS mode. Because 600 baud operation has been specified (the C-64 may not operate reliably at higher speeds), the TNC must also be set for 600 baud operation to the computer (**ABAUD 600** for the KPC-2 TNC). The **GET# 2,A\$** turns on the interrupt system. Any byte actually read at this time is discarded.

Line 30 sends commands to the TNC as if they had been typed during normal use of the TNC. "KISS ON" tells the TNC to turn on KISS mode. This actually happens when the TNC is reset. Using **CHR\$(13)** is the same as pressing the return key after typing KISS ON.

Next, "RESET" is sent to the TNC. Because there is no semicolon at the end of this print statement, BASIC also sends a return character to the TNC along with a line feed which the TNC ignores.

Line 40 initializes a string to the hexadecimal digits used later to display the bytes in hex.

Line 50 calls the input routine that gets one byte from the TNC as the character variable A\$. The decimal equivalent is also put in the variable A.

Line 60 prints the byte received in hexadecimal form by using the high and low order 4 bits of the bytes, each of which selects a character from the string H\$. This method is used to print a byte in hexadecimal as C-64 BASIC doesn't include such a function. After the two hexadecimal characters are printed, two blank characters are printed. A single blank could be used between the hexadecimal values instead, giving more values on a screen, but two blanks keep the values lined up in columns. You may change this as you wish. After a byte in hexadecimal has been printed, Line 70 goes back to get the next byte from the TNC.

Line 100 begins the byte input routine. It's written as a subroutine for convenience in later programs, but could be included where called in line 50 of this program because it is only called from one place.

Besides getting a byte from the TNC, this input routine overcomes two problems found in the use of GET# alone. The first is that GET# always returns immediately whether a character is available or not. Locations 667 and 668 are addresses of bytes in the input buffer of the interrupt routine. When these addresses are the same, no characters have been received. The loop of line 100 waits for a character to be received. The second problem with GET# is that it gives a null string, both when no byte has been received and when the byte received is all 0 bits.

Since a byte of all 0 bits is valid when dealing with KISS mode, line 110 replaces a null character string with a byte of all 0 bits. You can do this because at line 110 a byte has been received. Line 120 simply returns to line 50 with the received byte in A\$.

Output from this program might look like the following:

```

C0 00 92 88 40 40 40 40 00 AE
82 70 84 B0 9C 01 03 F0 4D 53
59 53 20 69 6E 20 4B 49 52 54
4C 41 4E 44 2C 20 4F 48 20 20
57 41 38 42 58 4E 2D 31 33 2F
42 20 20 57 41 38 42 58 4E 2D
31 2F 4E 20 0D C0 C0 00 9A C2
D2 D8 40 40 00 AE 82 70 84 B0
9C 01 03 F0 4D 61 69 6C 20 66
6F 72 3A 20 41 4C 4C 20 C0

```

Here there are two frames, each beginning and ending with C0. Because the C-64 uses a 40-column display, there will be only 10 bytes per line. To study the

output, run the program during periods of low activity. Pressing the RUN STOP key will halt the program and let you study what's on the screen. (By the way, don't attempt to modify the program to send the screen output to the printer. Interrupts on the C-64 are turned off when it's printing and this prevents bytes from being received properly from the TNC.)

The output may include a few initial bytes that aren't in KISS mode. This is simply output from the TNC before it was switched into KISS mode. Turn the TNC off to get it out of KISS mode.

The IBM PC version of the program is structured like the C-64 version:

```

10 CLS
20 OPEN "COM1:600,N,8,1,CS,DS,CD" AS 2
30 PRINT #2,"KISS ON" + CHR$(13) + "RESET" +
  CHR$(13);
40 H$ = "0123456789ABCDEF"
50 GOSUB 100: A = ASC(A$)
60 PRINT MID$(H$,A/16 + 1,1) + MID$(H$,A AND
  15) + 1,1) + " ";
70 GOTO 50
100 A$ = INPUT$(1,2)
110 RETURN

```

Each line performs the same functions it did in the earlier program. Although BASIC on the IBM PC does provide a function to convert to hexadecimal, it gives only one hex character for values between 0 and F. Because this would cause variations in the spacing of the output, the same method used to convert to hexadecimal in the C-64 program is used again.

The input subroutine that begins at line 100 is simpler in this version of the program, since the INPUT\$ function found in BASIC on the IBM PC does all you need it to do. The output from this program looks much like the output from the C-64 version, except that now there will be 20 hex values per line. It's also possible to substitute LPRINT for PRINT in line 60 to send the output to the printer.

Suggested modifications

Now that you can see all the bytes in the frames and have verified that the format is indeed as described, what next? You can get a copy of the format descriptions of the various packet types, and see how the bytes displayed fit these formats by decoding them by hand. You can also make modifications to let this program help decode the packets. Adding everything needed to fully decode packets results in a considerably longer program (about a page long). There are a few simple program changes that will allow you to see some of the content of the packets more easily.

Try substituting the following statements in the program. They will work in either version.

CONTINUOUS COVERAGE ANTENNAS FOR COMMERCIAL & AMATEUR SERVICE

Model AC 1.8-30

1.8 to 30 MHz

- SWR Max 2:1, 1.4:1 average from 1.8 to 30 MHz
- Can be installed in approximately 80 ft. space
- Ideal for commercial services for multi frequency operation without the need for antenna tuners or additional antennas
- Handles 1 KW, 2 KW PEP ICAS
- Higher power models available on special order. Contact your dealer or factory

\$175.00

SHIPPING & HANDLING
ADD \$4.00

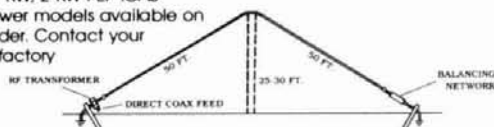

U.S. Patent No. 4,511,898

Model AC 3.5-30

3.5 to 30 MHz

- SWR less than 2:1 from 3.5 to 30 MHz
- Complete assembled. Balun terminated with standard SO-239 connector
- Power capability 1 KW - 2 KW PEP ICAS. Higher power model is available on special order.
- Designed for 50 ohm feedline
- Weather proof balun and balancing network

\$184.50

SHIPPING & HANDLING
ADD \$4.00

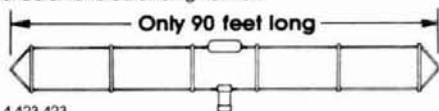

U.S. Patent No. 4,423,423

ALL OUR PRODUCTS MADE IN USA



BARKER & WILLIAMSON

Quality Communication Products Since 1932
At your Distributors. Write or Call.
10 Canal Street, Bristol, PA 19007
(215) 788-5581



AMATEUR TELEVISION

SMILE! YOU'RE ON TV



Only
\$299

Designed and
built in the USA
Value + Quality
from over 25 years
in ATV...W6ORG

With our all in one box TC70-1 70cm ATV Transceiver you can easily transmit and receive live action color and sound video just like broadcast TV. Use any home TV camera or VCR by plugging the composite video and audio into the front VHS 10 pin or rear phono jacks. Add 70cm antenna, coax, 13.8 Vdc and TV set and you are on the air...it's that easy!

TC70-1 has >1 watt p.e.p. with one xtal on 439.25, 434.0 or 426.25 MHz, runs on 12-14 Vdc @ .5A, and hot GaAsfet downconverter tunes whole 420-450 MHz band down to ch3. Shielded cabinet only 7x7x2.5". Transmitters sold only to licensed amateurs, for legal purposes, verified in the latest Callbook or with copy of license sent with order.

Call or write now for our complete ATV catalog including downconverters, transceivers, linear amps, and antennas for the 70, 33, & 23cm bands.

(818) 447-4565 m-f 8am-5:30pm pst.

Visa, MC, COD

P.C. ELECTRONICS

2522 Paxson Ln Arcadia CA 91006

Tom (W6ORG)

Maryann (WB6YSS)

```
60 IF A >= 32 AND A <= 126 THEN PRINT A$;
GOTO 50
65 PRINT " ";
```

These statements print as *characters* the bytes that are received from the TNC. Those that are normally unprintable will be displayed as dots. Quite a few funny-looking characters may be displayed, but you'll recognize some strings of characters that make sense. You should be able to recognize the text portion of the packets that would be seen if the TNC was being used normally.

Here's one output you might get while running on IBM PC:

```
....@@@...p.....MSYS in KIRTLAND, OH
WA8BXN-13/B WA8BXN-1/N.....@...p.....Mail
for: ALL .
```

Note that the spacing on the screen will be somewhat different. This output corresponds to the same bytes shown in the hexadecimal output examples above.

Another change that you can make follows. Again it will work with either version of the program.

```
60 A = INT(A/2):A$ = CHR$(A):IF A >= 32 AND
A <= 126 THEN PRINT A$;:GOTO 50
65 PRINT " ";
```

These changes will produce character output once again, but it will look different. You should be able to recognize the callsign portion of the packets (to and from callsigns and digipeaters, if any). The callsigns are shifted left 1 bit position in the packet, so the program makes them printable by shifting the bytes right 1 bit position (by dividing by 2). Sample output might look like this:

```
\.ID .WA8BXN..x&),).47.%$)*&'...'$. +
.\,.'... + .\.'...'
.\Mail .WA8BXN..x&046.379.. &&.'
```

Again, the output on the screen may be spaced slightly differently from what appears here in print. These are the same bytes, just looked at a different way.

Conclusions

These programs and their modifications should help you start using KISS mode to explore the details of packet radio. Anyone familiar with BASIC should be able to understand and modify the programs further.

Many improvements are possible; the possibilities are endless. Modifications can be made to monitor channel usage (Are the beacons really using up that much channel capacity?) or decode nonstandard packet types (What does all that "garbage" in Netrom packets really mean?). Here's a golden opportunity to experiment and put your computer and packet gear to good use when you're bored with just reading the mail.

Article A

HAM RADIO



Cards and plaque courtesy W6TC

EIMAC's new DX champion! The 3CX800A7.

Varian EIMAC continues to commit its development of reliable tubes for HAM radio.

The new, rugged 3CX800A7 power triode provides 2 kW PEP input for voice service or 1 kW cw rating up to 30 MHz. Two tubes will meet the new, higher power ratings authorized by the FCC.

Designed for today's low profile, compact linear amplifiers, the 3CX800A7 powerhouse is only

2½ inches (6.35 cm) high. Cooling requirements are modest and a matching socket, air chimney and anode clamp are available.

A data sheet and more information is available from Varian EIMAC. Or the nearest Electron Device Group sales office. Call or write today.

Varian EIMAC
301 Industrial Way
San Carlos, California 94270
Telephone: 415-592-1221





Join the fun at th

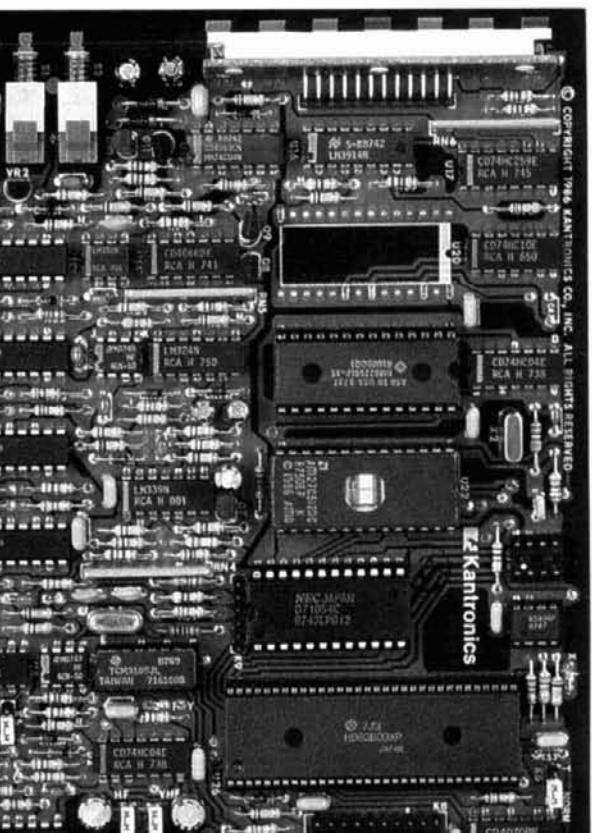

Whatever your interest, you'll find the Kantronics All Mode™ at the top of the pack. CW, Radioteletype, AMTOR, ASCII, WEFAX and Packet, "KAM handles them all." HF and VHF simultaneous operation? You bet! The KAM can operate RTTY or AMTOR on HF while communicating Packet on VHF. Believe it. It's the only true dual-port on the market.

World-Class

Swedish and German hams have noticed KAM's

engineering and are some of our biggest fans. The Japanese scrutinized our features and gave us ideas for extras like a subject field for the Personal Packet Mailbox™, listings of digipeater paths and more CW characters and functions. We are shipping KAM around the world.

Fun for Everyone

You'll be the envy of the airwaves with all the modes and features KAM brings to your fingertips. In addition to Packet, ASCII, AMTOR,



e top of the pack!

WEFAX, CW and Radioteletype, you'll have Dual-Port Operation (the only TNC offering this feature), Personal Packet Mailbox™, KA-NODE™, gateway, and digipeater operation.

You can operate non-packet modes on HF while maintaining a packet station at the same time on VHF. Or run an HF/VHF accessible personal mailbox or pc-based BBS totally dedicated to packet. Configure your KAM as an HF to VHF digipeater (gateway) or

KA-NODE. Or open your LAN to the world. All these modes and more features are waiting to be discovered. Increase your station abilities to the most advanced available.

Today and Tomorrow

KAM is packed with all the latest features of today with Kantronics-written firmware. And since we write and copyright our own firmware, we're in a position to lead you into the exciting modes of tomorrow first. We have a

history of keeping our customers current. Proof is in our firmware updates (2.7 in 1987 and 2.83 in 1988) offered at a fraction of the cost of a new purchase.

So join the fun, join the Top of the Pack.

Kantronics
RF Data Communications Specialists
1202 E. 23 St. Lawrence, Kansas 66046 (913) 842-7745

✓ 107

Kantronics All-Mode, KAM, Personal Packet Mailbox, and KA-NODE are trademarks of Kantronics Company, Inc.

Heathkit®



You're In A Separate "Class" With The SB-1400 Transceiver

The world is at your fingertips with the *NEW* Heath SB-1400 All-Mode Transceiver featuring dual VFOs and 20 memory channels. With a price tuned into your budget, the SB-1400 is an assembled SSB/CW/AM and optional FM transceiver that delivers 100W of PEP output on all nine HF amateur bands, with 100kHz-30MHz general coverage reception.

The SB-1400 is the latest addition to Heath Company's full line of amateur radio equipment – everything you need to complete your ham shack.

Heath Company also carries an extensive line of other electronic products. From computers to television sets, from test instruments to stereos, every Heathkit® product – kit and assembled – is backed by 40 years of dedicated attention to design, quality and durability.

For a *FREE* Heathkit catalog, send in your QSL card or mail the coupon below.

Yes, send me a *FREE* Heathkit Catalog.

Send to: **Heath Company, Dept. 122-704**
Benton Harbor, Michigan 49022

Name _____

Address _____ Apt. _____

City _____

State _____ Zip _____

A subsidiary of Zenith Electronics Corporation

AM-451

Heath Company

DESIGNING A STATION

FOR THE MICROWAVE BANDS: PART THREE

By Glenn Elmore, N6GN, 550 Willowside Road, Santa Rosa, California 95401

1296 MHz-10 GHz
in one compact
station

Part 1 discussed some of the advantages micro-waves can have over lower frequency signals for point-to-point communications. I presented a generalized approach using phaselock techniques which allows access to the calling frequency on each Amateur microwave band and supports linear signal conversion: SSB, CW, and other narrowband modes. You can obtain a spectrally pure and precise local oscillator signal for any of the Amateur microwave bands with a single pc board design in several separate loops, including only those components needed for a particular loop. Table 1 in Part 1 showed that you can obtain SSB operation on all the Amateur bands from 1296-24192 MHz using a 1010-MHz reference oscillator to downconvert and phaselock an available microwave oscillator, along with an appropriate i-f and microwave signal mixer.

I've demonstrated this approach with the description of a 10368-MHz SSB station. But, its broader applications shouldn't be lost in the specifics of the 10-GHz example; the technique can be used with all of the microwave bands. You can achieve 1296-MHz, 2304-MHz, and 10368-MHz operation by adding the signal mixer/filters (a harmonic mixer with 1010-MHz LO drive can be used on 2304) once circuits for the 100-MHz quartz oscillator, 1010-MHz coaxial oscillator, and 10-GHz oscillator are functioning. Operation is possible at 3456 MHz and 5760 MHz with the addition of an oscillator/downconverter and signal mixer/filter. You can add more microwave amplification for transmit and receive on a band-by-band basis.

Although Table 1, part 1 showed how to get on all

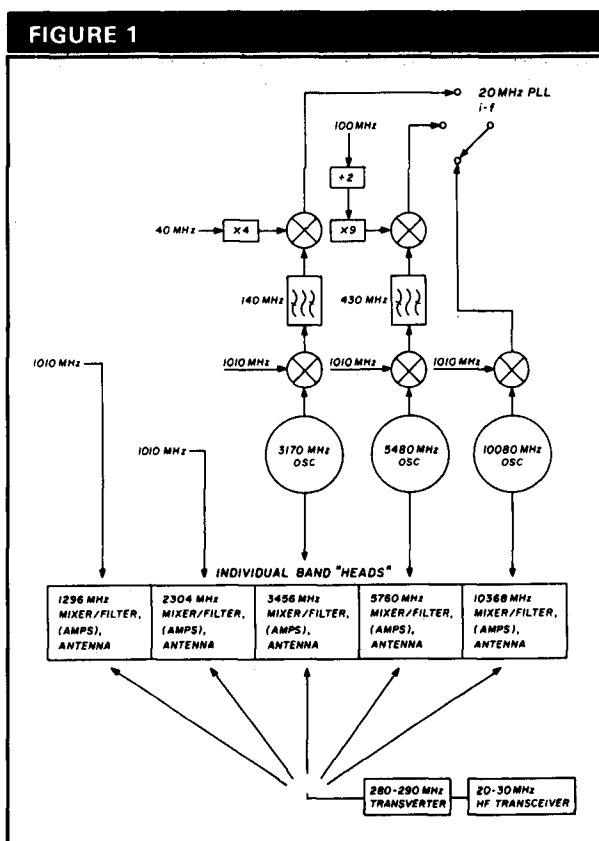

Once the 10368-MHz station using the 280-290 MHz signal i-f is built, 1296 and 2304 MHz are immediately available. The two microwave bands in between, 3456 and 5780 MHz, may be included by adding suitable VCOs at 3170 and 5480 MHz, along with harmonic mixers and circuitry to convert their PLL i-f to 20 MHz.

PHOTO A

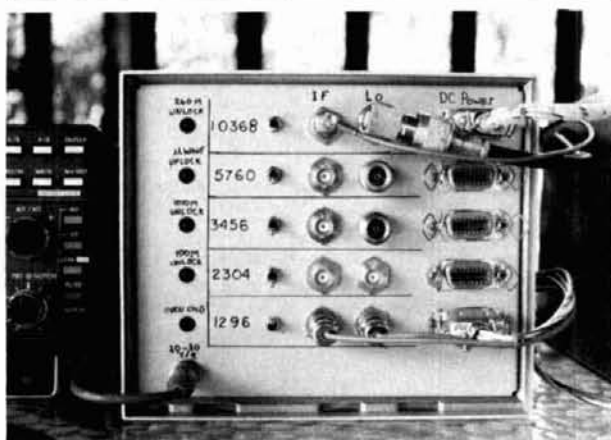

Five-band operation is easily obtained using this phaselocked transverter.

the bands using the 1010-MHz signal, some of the alternatives result in inverted tuning (high side LO) and a 432-MHz i-f. If you include a frequency conversion after the PLL harmonic downconverter, normal tuning and exclusive use of the 280-290 MHz i-f is feasible. **Figure 1** shows the block diagram for a five-band LO. You don't need to construct additional phaselock circuitry; you can use the 10-GHz phaselocking circuits for multiple bands as long as you provide similar oscillator tuning sensitivities. To change bands, simply switch the power and PLL i-f to the desired oscillator/downconverter. **Photo A** shows a phaselocked transverter with provision for five bands, having little more circuit complexity or size than previous single-band units.

You can get immediate 10368-MHz SSB operation if you have a 148-MHz transceiver and proper reference frequency to give a 10220-MHz LO. However, you'll need a 280-290 MHz i-f to take advantage of the potential multiband operation. Part 3 shows the circuits for the 260-MHz phaselocked oscillator, and the amplifier and switching circuits used to convert a 20-30 MHz Amateur transceiver to and from the 280-290 MHz intermediate frequency required for multiband microwave operation. I'll also show the two-stage GaAsFET amplifier used for the 10368 station.

260-MHz local oscillator

I'll begin the description of 280-290 MHz transverter with the 260-MHz phaselocked LO. It would have been easy to use a conventional approach because this transverter isn't very different from a low power (zero dBm) 220-MHz one. I could have used an 86.666-MHz crystal oscillator followed by a tripler and appropriate filtering, but I didn't want to compromise the frequency accuracy of the microwave station with a less

accurate unlocked i-f transverter LO. You can maintain overall frequency control by the 10-MHz frequency standard (or the 100-MHz crystal if it's operated unlocked) by using another common phaselock board and building a VCO at 260 MHz.

Obtain the 40-MHz PLL i-f by mixing the VCO output with the third harmonic of a 100-MHz reference signal. A standard double-balanced mixer (like an SRA-1) works well because it's effectively an odd harmonic mixer. A harmonic downconverter produces an appropriate i-f for locking. The oscillator uses a junction FET. (I make no claim that it's the best that can be done.) It isn't necessary to have superlative spectral purity in this application because, unlike the 1010-MHz case, no higher harmonics are used for further phaselocking; simplicity of design and ease of construction win. Even so, the spectrum of this LO when locked is good, and doesn't contribute significantly to microwave signal phase noise. The 260-MHz bandpass filters and buffer stages are present only for isolation and to keep any reference frequency derivatives from showing up on the 260-MHz signal. If you take care to separate the PLL i-f signals from the main 260-MHz output, any spurious signals are at least 75-dB down. **Photo B** shows the oscillator.

You'll need a 40-MHz reference frequency to lock this oscillator. A 20-MHz ECL reference signal drives a bipolar transistor frequency doubler, which drives an extra ECL line receiver. These circuits are located on the previously constructed 100-MHz reference board.

As with the 1010-MHz downconverter circuit, a 100-MHz bandpass filter and amplifier keeps any lower frequency signals on the ECL output from passing straight into the PLL i-f amplifiers through the harmonic mixer.

All of the locking circuits are identical to the ones used before. **Table 2**, part 1 shows component values for the loop filter. Component values for the lowpass

PHOTO B

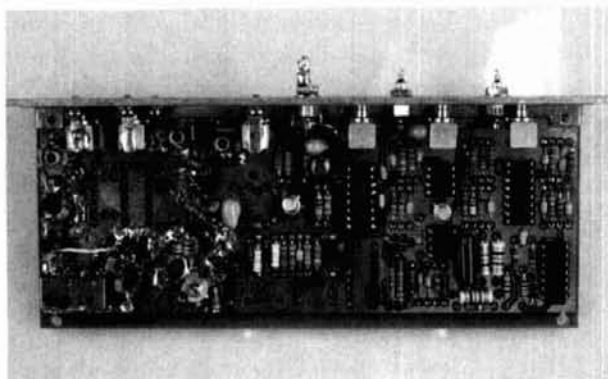

This oscillator is used in obtaining the 260-MHz LO.

Radio Shack Parts Place™

Start Your Winter Project at The Shack®

Save With Our "Hotline" Order Service



Your Radio Shack store manager can phone in a special order for a wide variety of parts and accessories not in our catalog—tubes, ICs, phono styli, diodes, crystals and much more. No postage or handling charges, no minimum order! We'll phone when your order arrives, in about a week.

Auto AC Controller & Spike Protector



Switches Up To 4 Devices **49⁹⁵**

Allows one component to act as a master switch for up to four other devices, and protects against damaging voltage spikes. Use the on/off control of a TV, VCR or stereo to turn off the entire system, or use with a clock radio or VCR for timed operations. Includes noise filter and breaker. UL listed AC. #61-2781

New Novice-Exam Preparation Kit

Everything You Need to Painlessly Prepare for The Voice-Class License

19⁹⁵

Helps you quickly prepare for the new FCC exam. You get two audio cassettes for self-paced Morse code learning plus practice exam questions and answers. #62-2402



Take Advantage of the Enhanced-Novice Privileges On Amateur Radio!

High-Grade Coax Cable in Bulk



RG Type	Ohms	Cat. No.	Price Per Foot
8*	52	276-1323	.40
8/M	52	276-1328	.25
59	75	276-1327	.18

*95% Shielding—Super-low loss

Sealant Tape. Waterproofs antenna connections. #276-1645, **2.49**

RF Connectors



Highest Quality RF Connectors/Adapters

Fig.	Description	Cat. No.	Only
1	PL-259 Plug	278-205	2/1.99
2	Reducer for RG59 and for RG8M	278-204	2/ .99
3	Reducer for RG58	278-206	2/ .99
4	M-358 "T" Coupler	278-198	3.49
	PL-258 Coupler	278-1369	1.69

We also stock TNC, BNC and F types

Computer Hookups

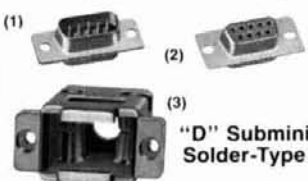

"D" Submini Solder-Type

For computers, modems and packet controllers.

Fig.	Description	Pos.	Cat. No.	Each
1	D-Sub Male	9	276-1537	1.49
2	D-Sub Female	9	276-1538	2.49
—	D-Sub Male	25	276-1547	1.99
—	D-Sub Female	25	276-1548	2.99
3	Shielded Hood	9	276-1513	1.49
—	Shielded Hood	25	276-1536	1.99

Toroid Choke Coil



Use to attenuate RFI in mike and speaker cable, phone lines, computer ribbon, antenna coax and more. It's a snap to use—just wind the cable through the core and snap closed! There's no need to remove AC cord or cable termination. With data and detailed instructions. #270-104, Pkg. of 2/6.95

Brushless 3" DC Fan



Low Noise! -34 dB Maximum

Perfect for cooling equipment sensitive to AC fields! Airflow: 27 cubic feet per minute. Requires 7 to 13.8 VDC. #273-243, **14.95**

AC-to-CEE Power Cord

For computers, office machines. UL listed. #278-1257, **3.99**



Passive Parts



- (1) **Low P_f Capacitors, 50-Pack.** Ceramic discs from 1 to 33 pF. Rated 50 WVDC. #272-806, **2.99**
- (2) **TV Colorburst Crystal.** Frequency standard of 3.579545 MHz. In HC18/W package. #272-1310, **1.69**
- (3) **335 pF Variable Capacitor.** Submini, two-section type. With knob. #272-1337, **1.69**

Audio Connectors



8-Pin Mike Plug. Great for adding accessories. #274-025, **2.19**

Headphone Adapter. Lets you use stereo headphones with Amateur radio. 1/4" stereo jack, 1/8" monoaural plug. #274-360, **1.99**

Stereo Mini Headphone Adapter. Accepts 1/8" stereo plug, plugs into 1/32" mono jack. #274-381, **1.99**

Shielded Monoaural Adapter. Accepts phono plug, plugs into 1/8" jack. #274-330, **1.69**

Auto Noise Filter, Relay and Switch



10-Amp Filter. Two L-C sections reduce ignition and alternator noise in stereos and rigs. #270-051, **12.95**

Heavy Duty Relay. Just the thing for switching mobile power supplies, lights, other high current accessories. SPST, 30 amp at 12 VDC. #275-226, **4.99**

Dual Auto-Switch Panel. Two flip-type SPSTs. Lighted with 12-volt bulbs. Rated 16A at 12 VDC. #275-707, **5.49**

Gas-Powered Soldering Iron



29⁹⁵

Lets you enjoy complete freedom of movement without cords or gas cylinders! Up to 60 minutes continuous use per tank. Adjustable temperature—equivalent of 10W to 60W. Uses butane lighter fuel. #64-2160

Antenna Rotor



Aim Your Antenna for the Best Signal

Archerotor®. Tops for many VHF beams, small HF beams and dipoles. Includes indoor control unit, weatherized rotator and hardware. Cable extra. UL listed AC. #15-1225

3-Conductor Cable. 100 feet. #15-1150 **7.95**

CB Extension Speaker



13⁹⁵

Improves CB Sound Quality

No more straining to hear calls. Rated 5 watts, 8 ohms. Includes 10-foot cable, 1/8" plug and adjustable mounting bracket. Come in today and see our complete line of CB equipment and accessories. #21-549

Desktop Weather And Time Radio



39⁹⁵

Receives local weather stations and National Bureau of Standards time signal. station WWV on 5, 10 or 15 MHz. Crystal controlled. Battery extra. #12-148

Over 1000 items in stock: Binding Posts, Books, Breadboards, Buzzers, Capacitors, Chokes, Clips, Coax, Connectors, Fuses, Hardware, ICs, Jacks, Knobs, Lamps, Multitesters, PC Boards, Plugs, Rectifiers, Resistors, Switches, Tools, Transformers, Wire, Zeners, More!

Prices apply at participating Radio Shack stores and dealers

Radio Shack
The Technology Store™
A DIVISION OF TANDY CORPORATION

FIGURE 2

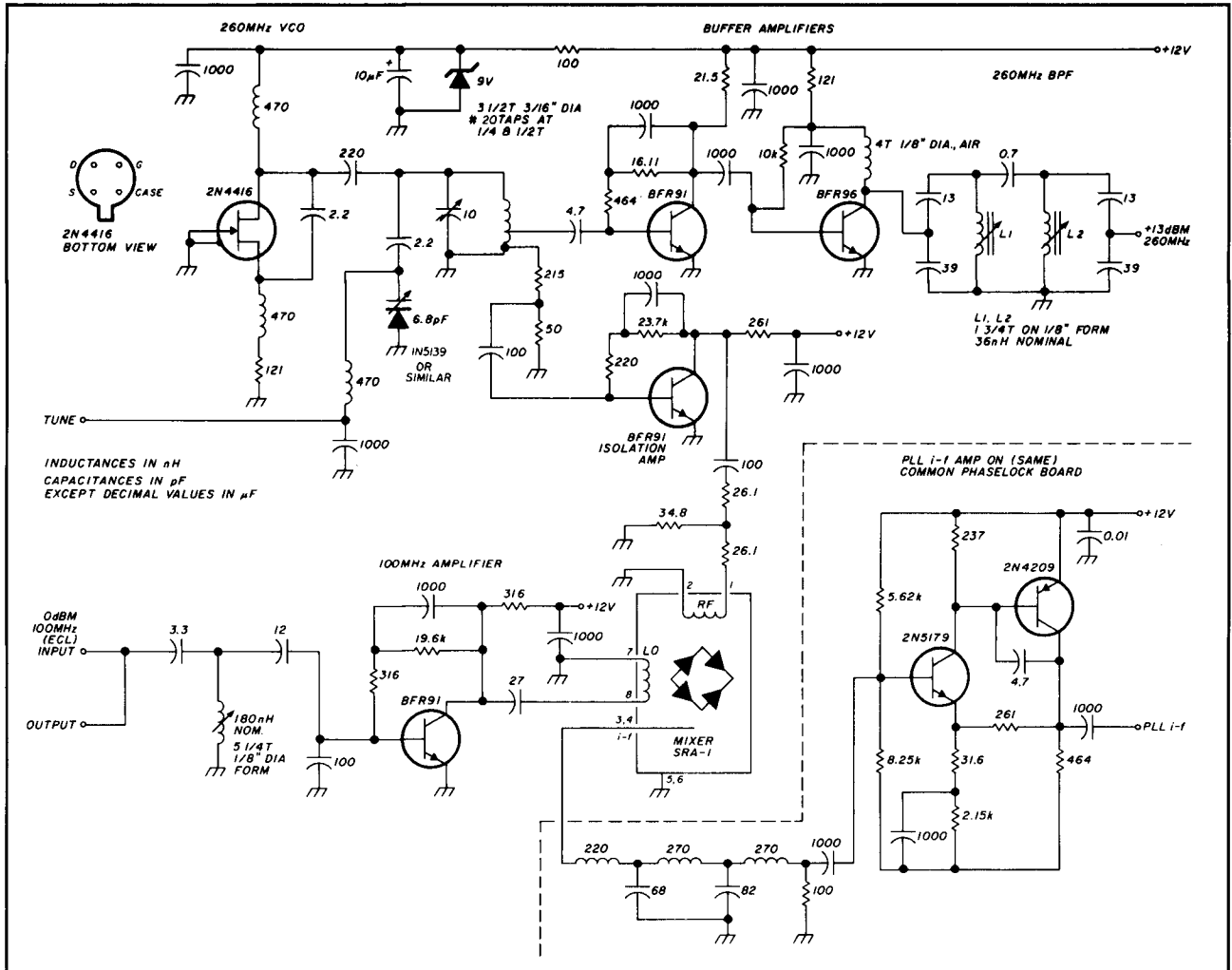

The 260-MHz phase-locked LO for the 280-290 MHz transverter uses a simple junction FET oscillator and two different amplifiers — one for the signal mixer and the other for driving the harmonic downconverter.

Discover CAROLINA WINDOW

80-10 M Use transmatch 132" overall Matching XFMR Line Isolator Vert Radiator Coax fed Assembled \$69.96

High performance Proven results \$70 Beam?

RADIO WORKS

Your Passport To a world Of new ideas And exceptional HF wire antennas

Rugged new baluns Full range of HF, UHF, mobile antennas, dunks, wire, coax, parts, line, accessories.

SEE WHAT WE'RE DOING NOW!

Contact Jim, W4THU - free discount catalog

Send \$1 for catalog by 1st Class mail. Box 6159, Portsmouth, VA 23703 (Dealer inquiries welcome)

804-484-0140

CAROLINA WINDOW

SEE THE REVIEW IN JUNE '88 WORLD RADIO MAGAZINE. Enthusiastic users say it's the best wire antenna. Outperforms wire antennas previously used. Knock-your-socks-off performance on 80 - 10. A \$70 beam?

If you hear one, you'll want one.

Made with pride by The RADIO WORKS in VA/USA

THE RF CONNECTION

"SPECIALIST IN RF CONNECTORS AND COAX"

Part No.	Description	Price
321-11064-3	BNC 2 PST 28 volt coaxial relay, Amphenol Insertion loss: 0 to 0.75GHz, 0.10dB Power rating: 0 to 0.56GHz, 100 watts CW, 2 kw peak Isolation: 0.1 GHz/45dB, 0.2 GHz/40db, 0.4 GHz/35db	\$25 used tested
83-822	PL-259 Teflon, Amphenol	1.50
UG-21D/U	UHF Male Silver Teflon, USA	1.50
UG-21B/U	N Male RG-8, 213, 214, Amphenol	2.95
UG-21B/U	N Male RG-8, 213, 214, Kings	4.00
9913/PIN	N Male Pin for 9913, 9086, 8214 fits UG-21D/U & UG-21B/U's	1.50
UG-21D/9913	N Male for RG-8 with 9913 Pin	3.95
UG-21B/9913	N Male for RG-8 with 9913 Pin	4.75
UG-146/U	N Male to SO-239, Teflon USA	5.00
UG-83/U	Female to SO-239, Teflon USA	5.00

"THIS LIST REPRESENTS ONLY A FRACTION OF OUR HUGE INVENTORY"

THE R.F. CONNECTION
213 North Frederick Ave. #11
Gaithersburg, MD 20877

(301) 840-5477 ✓ 111

VISA/MASTERCARD: Add 4%
Prices Do Not Include Shipping

Electronic Repair Center

Servicing
Amateur Commercial Radio

The most complete repair facility on the East Coast.

Large parts inventory and factory authorized warranty service for Kenwood, Icom and Yaesu.

SEND US YOUR PROBLEMS

Servicing "Hams" for 30 years, no rig too old or new for us.

HAMTRONICS, INC.

4033 Brownsville Road
Trevose, Pa. 19047

215-357-1400

VISA MASTERCARD

NYE

Takes the fear out of full power antenna tuners, and the guesswork out of PEP measurement with these two MUST SEE PRODUCTS!!

MB-V-A



Discover this durably built, feature packed MB-V-A Antenna tuner. You'll find operating conveniences that make antenna tuning a snap and value engineered to do the job over wide operating ranges. Compare quality, features and the NYE VIKING TWO YEAR WARRANTY.

RFM-003



Get correct easy to read measurements of PEP for SSB, AM, and Pulse along with full time completely automatic SWR display with this unique Power Monitor System. Two models to choose from: The RFM-003 for 3KW indication and The RFM-005 for 5KW.

CHECK THE FEATURES:

- **Pi Network.** Low Pass Pi Network tuning 1.8-30 MHz. Heavy duty silver plated continuously variable inductor with 25:1 vernier dial 7000 volt variable capacitor and 10,000v switch selected fixed capacitors on output side. Tunes 40-2000 ohms loads. Good Harmonic suppression!
- **Automatic SWR.** Hands free metering of SWR. No reset or calibration needed. Separate power meter—300 or 3000 w f.s. automatically switched. Easy to read 2.5" recessed and back-lighted taut band meters.
- **Antenna Switch.** PUSH-BUTTON antenna switching to (4) antennas (2 coax, single wire and twin lead). Coax bypassed on first coax output. We designed this switch to take the power. Rated at 10KV and 20 amps.
- **3 KW Balun.** Trifler wound triple core torroid gives balanced output to twin feeder from 200 to 1000 ohms and unbalanced output down to 20 ohms.
- **Maximum Power Transfer.** Match your transmitter output impedance to almost any antenna system for maximum power transfer. Amplifiers only run at their designed Q when properly matched.
- **Model Options.** MB-IV-A1 includes all MB-V-A features less antenna switch and balun. MB-IV-A2 is identical to MB-IV-A1 with the addition of a triple core balun.
- **1.8 MHz** will not tune on some antennas.
- **(3) Modes** — Peak Average and Peak and Hold with a unique non-drift Sample & Hold Analog memory circuit.
- **(2) Ranges** — Automatically switched power scales to 5 KW.
- **Fully Automatic SWR** — Full time meter displays ratios directly without drift.
- **Built-in ALO** — Protect your amplifier tube investment with this fast acting lockout.
- **Remote Couplers** — Six feet remotes the interchangeable calibrated couplers.
- **True RMS Conversion** — H.F. couplers use forward biased full wave detection.
- **Rugged Construction** — Heavy gauge aluminum construction. Top quality glass epoxy PCB. This meter is built to last.
- **Accuracy** — Guaranteed to $\pm 5\%$ F.S.
- **Warranty** — TWO FULL YEARS.
- **Added Features** — Switchable reverse power all mode metering — Full status LED Display — Adjustable ALO is switchable SWR/REFL power — Heavy duty Nicad batteries charged by the applied RF for the field and a charger is supplied for fast charging and backlighting of the taut band meters for the ham shack.

OTHER NYE VIKING PRODUCTS

Phone Patches — Electronic and Memory Keyers — Squeeze Keys — Straight Keys — Code Practice Sets — SWR Wattmeter for the blind — Low Pass Filters — All Band Antennas and more ...

ASK FOR A FREE FULL LINE CATALOG.

TO ORDER, CALL YOUR FAVORITE DEALER

Amateur Electronic Supply
Ham Radio Outlet
Henry Radio
Madison Electronics
EGE
R & L Electronics

Barry Electronics
C-Comm
Missouri Radio
Quement Electronics
Texas Towers
Ham Station



Wm. M. Nye Co. Inc.
1614 130th Ave. N.E.
Bellevue, WA 98005
TEL: (206) 454-4524
FAX: (206) 453-5704

KEEP IN TOUCH!

Stay in touch with the technology that is affecting our everyday lives. Four new books, easy-to-understand

for the reader who wants to learn and remain up-to-date with products impacted by new technology.

Electronic Life-Style is about electronic products that are touching our lives. It helps make sense out of the latest high-tech products, in non-technical language. This book tells what the products do and how they do it, and helps you to better use and enjoy them. Fully illustrated with photos in full color. 160 Pages, Softcover. **\$14.95**



With over 2500 modern technology terms and abbreviations, over 150 of them with illustrations, the **Technology Dictionary** is a source of knowledge for terms and definitions covering the high-technology world of electronics, computers, telecommunications, video and consumer electronics. Clear, understandable, easy to read. **\$7.95** 176 Pages, Softcover.

Need help in deciding on telephone services? **Save On Telephone Services for Home and Business** provides the answers. It discusses what services are provided by local and long distance telephone companies, and tells you how to choose and manage these services. Learn about the present nationwide telephone companies different telecommunications networks. 168 Pages, Softcover. **\$9.95**



Using Video in Your Home provides knowledge and understanding of the latest video products and what functions they provide — TV receivers, monitors, VCRs, video players, video cameras and camcorders, video systems interconnections and even a troubleshooting guide — in clear everyday language. 176 Pages, Softcover. **\$12.95**

QUANTITIES

_____ 400-32 Electronic Life-Style @ \$14.95	= _____
_____ 400-31 Save On Telephone Services @ \$9.95	= _____
_____ 400-03 Technology Dictionary @ \$7.95	= _____
_____ 400-04 Using Video in Your Home @ \$12.95	= _____
_____ TOTAL Shipping and handling per book @ \$1.50	= _____
	SUBTOTAL _____
	TAX* _____
	TOTAL _____

Mail check or money order to: Master Publishing, Inc., 14 Canyon Creek Village, MS 31, Richardson, Texas 75080. Orders in Continental U.S. shipped prepaid. Foreign orders: Prepay in U.S. funds, include shipping costs. Prices subject to change without notice.

Name _____

Address _____

City _____ State _____ Zip _____

*Texas residents add state and local sales tax on subtotal.

HR 128



Master Publishing, Inc.

© 1988 Master Publishing, Inc.

✓ 113

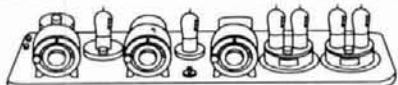

IF YOU BUY, SELL OR COLLECT OLD RADIOS, YOU NEED...

ANTIQUE RADIO CLASSIFIED

Antique Radio's
Largest-Circulation
Monthly Magazine
FREE SAMPLE COPY!



Classifieds - Ads for Parts & Services
Articles - Auction Prices-Flea Market Info.
Also: Early TV, Ham Equip., Books, Telegraph,
Art Deco, 40's & 50's Radios & more...
Free 20-word ad each month. Don't miss out!

6-Month Trial - \$11.

1-Year: \$19 (\$28 by 1st Class)

Foreign by air - Canada: \$30; Mexico: \$28; Other: \$55.

A.R.C., P.O. Box 2-A4, Carlisle, MA 01741

✓ 114

BLACK DACRON® POLYESTER ANTENNA ROPE

- UV-PROTECTED
- HIGH ABRASION RESISTANCE
- REQUIRES NO EXPENSIVE POTTING HEADS
- EASY TO TIE & UNTIE KNOTS
- EASY TO CUT WITH OUR HOT KNIFE
- SIZES: 3/32" 3/16" 5/16"
- SATISFIED CUSTOMERS DECLARE EXCELLENCE THROUGHOUT U.S.A.

LET US INTRODUCE OUR DACRON® ROPE TO YOU • SEND YOUR NAME AND ADDRESS AND WE'LL SEND YOU FREE SAMPLES OF EACH SIZE AND COMPLETE ORDERING INFORMATION.

Dealer Inquiries Invited



synthetic
textiles, inc.
2472 EASTMAN AVE., BUILDING 21
VENTURA, CALIFORNIA 93003
(805) 658-7903

✓ 115

K COMM., INC. THE HAM STORE

Stocking all major lines. San Antonio's Ham Store. Great Prices—Great Service. Factory authorized sales and service. Hours: M-F 10-6, SAT 9-3

KENWOOD

YAESU



ICOM

5707A Mobud
San Antonio, TX 78238
800-344-3144
Orders Only

✓ 116



FIGURE 3

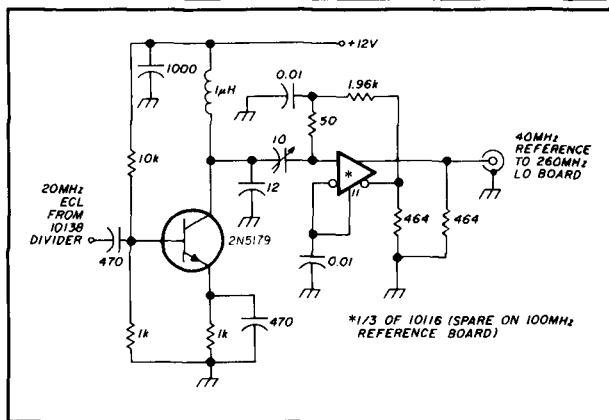

The 260-MHz locking circuitry requires a 40-MHz reference frequency. This is obtained by doubling the existing 20-MHz ECL signal in a transistor and restoring ECL logic levels with an extra 10116 line receiver.

filter after the harmonic mixer are modified to pass the 40-MHz PLL i-f. Use the jumpers marked "-" on the common phaselock board. Figure 2 shows the schematic of the oscillator/amplifier and PLL i-f. The 40-MHz reference circuit is shown in fig. 3. Figure 4 shows the spectrum of the phaselocked 260-MHz oscillator.

280-290 MHz transverter mixer, amplifiers, and switching

Figure 5 shows a block diagram for the 280-290 MHz transverter, fig. 6 is the schematic diagram and fig. 7 shows the dc biasing scheme. I tried to use easy to find parts and a design requiring a minimum of test equipment for final tuning. Broadband amplifiers are used in the hf and VHF portions of the transverter.

FIGURE 4

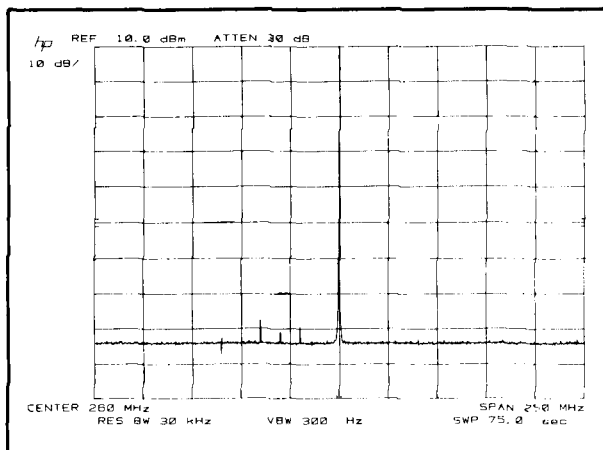

The spectrum resulting from phaselocking the 260-MHz VCO is quite clean. Both spurious signals and noise are small compared to the carrier.

Frequency selection is performed with a lowpass filter at hf and two 2-resonator filters for VHF. It's desirable to have a moderately high-gain low noise input stage to set the overall noise figure on receive at VHF. I chose an MMIC since Avantek/Mini Circuits MMICs seem to be easy to find at reasonable prices. I tried a MAR-8 (Avantek MSA-0885) first, and got good performance after taking care with grounding and construction techniques. To increase stability, I used a 30-ohm resistor in series with its output. The MAR-8 doesn't have heavy internal feedback to control its gain (and SWR), and provides a noise figure in the area of 3 dB. But this device is only conditionally stable and has *lots* of bandwidth — several GHz of it. You must control feedback paths as well as source and load impedances over a very large frequency range in order

FIGURE 5

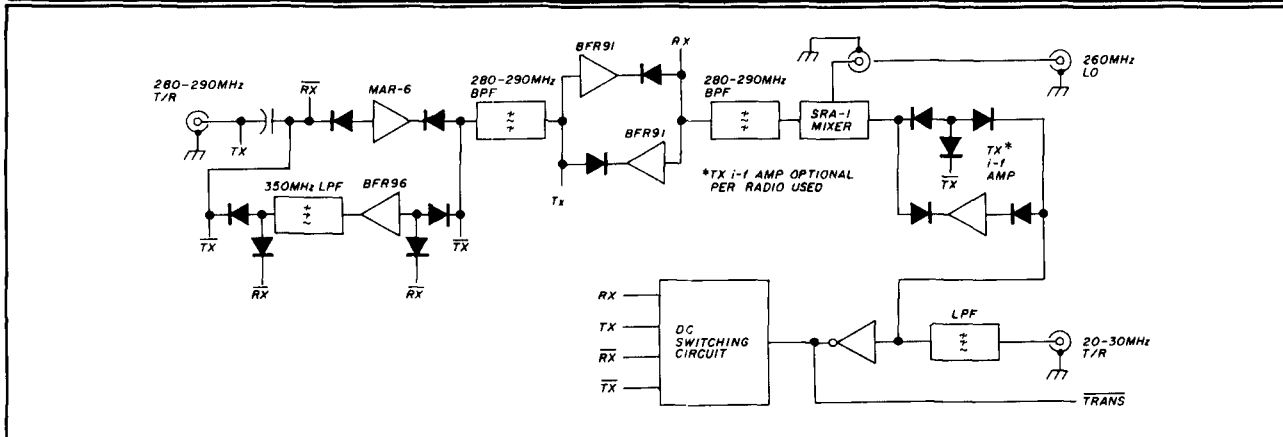

The transverter uses a conventional double balanced mixer, broadband amplifiers, and appropriate filtering to convert the 20-30 MHz hf transceiver to 280-290 MHz. Transmit/receive switching is performed by PIN diodes and a dc switching circuit, which provides bias for the appropriate stages. Transmit output power of about 0 dBm (1 milliwatt) and receive conversion gain of about 8 dB is provided.

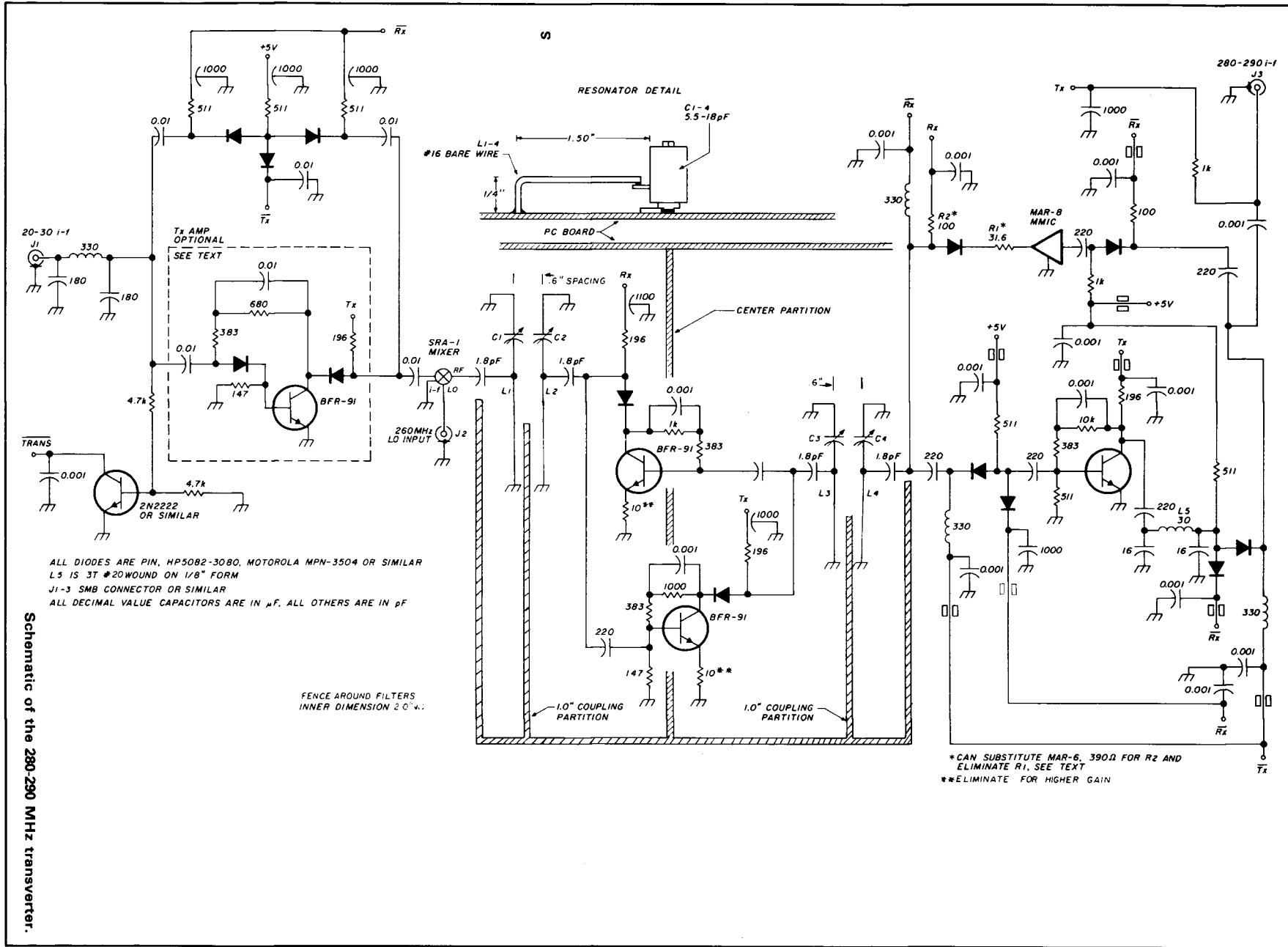

ALL DIODES ARE PIN, HP5082-3080, MOTOROLA MPN-3504 OR SIMILAR
 L5 IS 3T #20WOUND ON 1/8" FORM
 J1-3 SMB CONNECTOR OR SIMILAR
 ALL DECIMAL VALUE CAPACITORS ARE IN μ F, ALL OTHERS ARE IN pF

FENCE AROUND FILTERS
 INNER DIMENSION 2.0" x .5"

* CAN SUBSTITUTE MAR-6, 390 Ω FOR R2 AND ELIMINATE R1, SEE TEXT
 ** ELIMINATE FOR HIGHER GAIN

Schematic of the 280-290 MHz transverter.

CUSTOM CRYSTALS

Crystals for many applications

For over 37 years, ICM has manufactured the finest in quartz crystals for every conceivable purpose.

A wide selection of holders are available to fit most any requirement. Our computer database contains crystal parameters for thousands of equipment types.

Need crystals for communications, telemetry, industrial, or scientific applications? Let ICM's sales department assist you to determine which type of crystal is best for you.

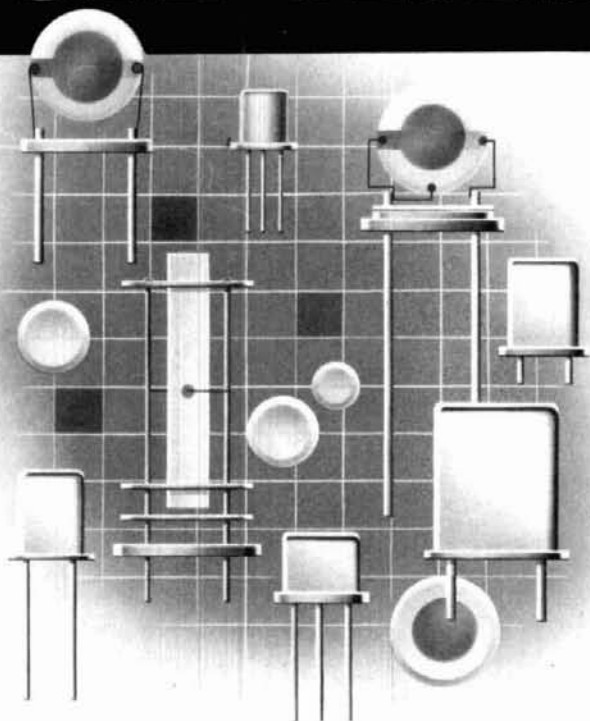

Can we solve your crystal problem?

For special purpose crystals, special holders, special sizes, call our crystal sales department. We will be pleased to provide recommended data.



International Crystal Manufacturing Co., Inc.

P.O. Box 26330, 701 W. Sheridan,
Oklahoma City, OK 73126-0330
Phone (405) 236-3741
Telex 747-147
Facsimile (405) 235-1904

THE RACK IS BACK

GO VERTICAL



- save space - go vertical
- organize your radio room
- get the professional look
- have finger tip access to your radios
- keep your equipment safe and clean
- hide all the unsightly wires
- protect your investment

NOVEK rack mounts are standard EIA 19 inch size aluminum panels and are optionally equipped with handles and/or forward facing speakers.

Now available for most ICOM, KENWOOD, and YAESU radios and accessories.

Prices start at a low \$79.95 each.

Orders: 800-368-3270 Local & tech info 703-928-3350
EEB Electronic Equipment Bank
 516H Mill St. NE, Vienna, VA 22180
(just minutes from Washington, DC)

The HF4B "Butterfly"™ A Compact Beam for 20-15-12-10 Meters

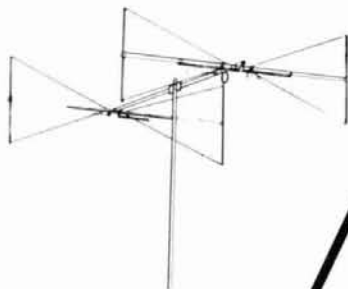

- Unique design reduces size but **not** performance.
- No lossy traps; full element radiates on all bands.
- Retrofit kit for 17 meters coming soon
- Turns with TV rotor
- Only 17 lbs.

HF ANTENNAS FROM BUTTERNUT

Butternut Verticals

Butternut's HF verticals use highest-Q tuning circuits (not lossy traps) to outperform all multiband designs of comparable size!

Model HF6V

- 80 40 30 20 15 and 10 meters automatic bandswitching
- Add-on kit for 17 and 12 meters available now
- 26 ft tall

Model HF2V

- Designed for the low-band DXer
- Automatic bandswitching on 80 and 40 meters
- Add-on units for 160 and 30 or 20 meters
- 32 feet tall - may be top loaded for additional bandwidth

For more information see your dealer or write for a free brochure



BUTTERNUT ELECTRONICS CO

405 East Market Lockhart, Texas 78644

FIGURE 7

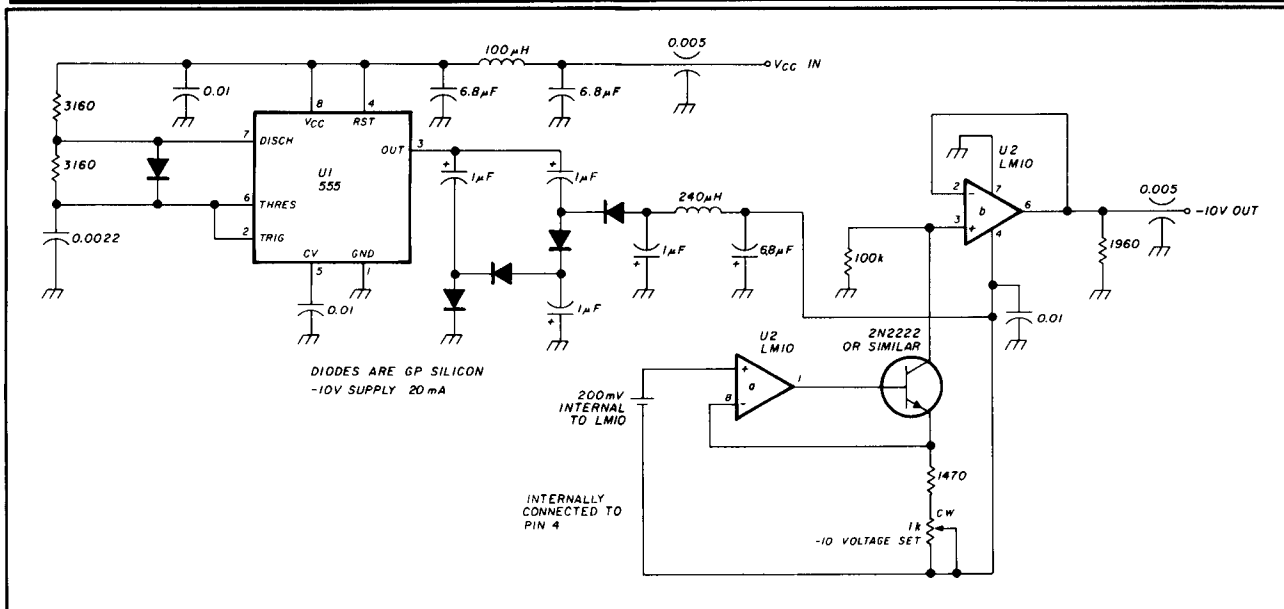

DC biasing scheme for the 280-290 MHz transverter.

to keep it from oscillating. I replaced the MAR-8 with a MAR-6 (Avantek MSA-0685) and got a better match. The MAR-6 is unconditionally stable, with better input and output match. This is important because the 280-MHz filter, if not the microwave signal mixer, requires low SWR terminations for minimum ripple and insertion loss. However, the MAR-6 has lower gain at 280 MHz than the "resistor stabilized" MAR-8. This results in a 0-3 dB conversion gain for the transverter with the MAR-6, in contrast to about 8 dB with the MAR-8. The extra gain with the MAR-8 helps the noise figure by overcoming the 280-MHz filter losses and interstage amplifier noise figure. Measured overall, transverter noise figure is about 3 dB with the MAR-8 and 5 dB with the MAR-6. If you use signal frequency amplifiers, and not just a "barefoot mixer", the lower conversion gain and higher noise figure of the MAR-6 may not be a concern. If you choose a MAR-6, change the collector bias resistor to 390 ohms and remove the 30-ohm series resistor required for the MAR-8.

I use a BFR-96 on transmit, with the appropriate collector and feedback resistances, to provide a compromise of gain and match at 280-MHz. This stage only needs about zero-dBm output to drive the signal mixer (assuming microwave LO power in the +10 dBm vicinity). The interstage amplifiers used between the two filter portions ensure a good input and output match for the filters to work against. I could have used a 4-resonator filter without interstage amplifiers instead of twin 2-resonator sections, but I felt that tuneup without test equipment would be harder. The mixer should probably look into a broadband 50-ohm

FIGURE 8

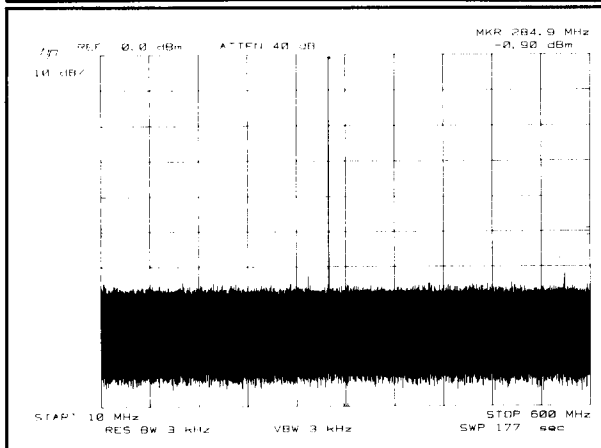

The spectrum of this transverter on transmit shows unwanted signals suppressed by more than 60 dB. At full output of about 0 dBm only the 280-MHz LO feedthrough and the second harmonic of the signal are visible.

termination instead of a filter for best signal performance and lowest conversion loss, but once again simplicity won out. Unwanted LO leakage and image signals should be at least 60-dB below maximum output. Figure 8 shows the output spectrum of the transverter on transmit.

For transmitting, special circuit versatility is necessary in the transverter's hf circuit. This is because there's no standard transvert-mode output power level for modern multiband Amateur transceivers. Some manufacturers provide outputs of 1-100 milliwatts, while others are almost 30 dB less. I used another BFR-

91 stage which can be "programmed" for various gains. The values on the schematic are right for my ICOM IC-751; it puts out about -15 -dBm maximum on SSB/CW transmit in transverter mode. If your exciter has more drive than this, you may need to eliminate the stage or put in a resistive attenuator. As shown, the transverter puts out about 0 to $+3$ dBm on voice peaks of my IC-751. The PIN diode switch lets the full mixer output reach the receiver during receive. If your station receiver has particularly low gain, you could include another amplifier stage here. This shouldn't be necessary for most applications using microwave preamplifiers. Even with a "barefoot mixer", the transverter as shown exhibits 8-10 dB conversion gain on receive. This should make up for most of the conversion loss from a microwave mixer.

The 280-290 MHz filter was designed to be easy to use and construct. The inductor is an extremely simple and reproducible wire-over-ground plane. I was concerned that most of the coupling between resonators might be between the tuning capacitors themselves, and too dependent upon construction technique and layout. However, construction with a number of different types of tuning capacitors produced similar results.

Other possibilities

Because this filter is the only block (besides the LO) which controls frequency, you should be able to obtain transverters for 144, 220, and 432 MHz by changing the filter elements. This might be attractive at 220 MHz as a frequency doubler driven by the 100-MHz reference could provide the LO. A 120-MHz phaselocked VCO with a 100-MHz downconverter reference and 20-MHz PLL i-f would work for 144 MHz. The downconverter could be a conventional mixer. A fourth-harmonic anti-parallel diode mixer with 100-MHz reference and 10-MHz PLL i-f would suffice to lock a 410-MHz VCO for 430-440 MHz operation.

Switching

Because of the number of possible bands, I devised a standard transmit/receive interface — each with its own microwave head (mixer, filter, amplifiers and T/R switch). You should get full microwave output power on transmit, with zero dBm of i-f power. I chose to use Vcc on the rf signal line to indicate transmit; this allows "daisy-chaining" control. When the hf transceiver signals transmit by pulling the NOT-transmit line low or putting Vcc on its signal line, the 280-MHz transverter amplifiers are turned on in the transmit direction, and Vcc is passed to its rf port. As a result, the connected microwave circuitry goes into transmit. For this reason, hardware for each microwave band can be located at, or near, the antenna, minimizing

feedline losses. Any band can now be selected from the operating position by connecting the i-f from the transverter. The local oscillator signals incur power losses on the way to the heads. But, excess LO power is generally available and microwave signal mixer conversion efficiencies aren't much influenced by moderate reduction of LO drive, as long as LO power is several dB greater than the maximum i-f power of zero dBm. Even at 10 GHz where losses are greatest, you can probably locate the microwave head and antenna at least 10-20 feet from the operating position if you use good quality coax. All that's required between the operating position and the head for each band is the connection of two coaxial cables, i-f and LO, and one dc power cable (where needed). This allows for continuing enhancements in the microwave heads, improved noise figure, and higher power amplifiers — without the necessity of impacting the local oscillator sections. Feedhorn/head combinations can be quickly exchanged using a single antenna during a band-change, if you provide a mount for a standard box at the *feedpoint of a reflector antenna*.

Because the 280-MHz transverter is electronically switched, transmit turnaround time should be that of the hf transceiver alone — unless there is a slower mechanical T/R switch in the microwave head. Microwave AMTOR should work with this arrangement.

Although Vcc may be indicated as 12 volts on some of the previous schematics, I actually run the entire station from the output of a low-dropout 3-terminal adjustable regulator set to *11 volts*. This tends to keep gains and amplitudes stable, and allows operation on nearly discharged 12-volt automotive batteries. A separate 5-volt regulator provides the power for the ECL logic.

Transverter construction

I built the 260-MHz VCO in the space on the common phaselock board allocated for the 100-MHz oscillator and divider circuits. Because the board was made with lots of component-side ground plane, I soldered right to the ground plane or mounted components by their leads. Lead length was kept to a minimum. To do this, use 1/8th or 1/16th-watt resistors, and other physically small components. (I find that a large pair of tweezers is a great construction aid.) The lower impedance of the broadband amplifier stages tends to make them less sensitive to parasitic capacitances, which can be layout and lead-length dependent. Be particularly careful to connect directly the ground end of the capacitors and the coils on the 260-MHz band-pass filter. A clean, phaselocked $+10$ dBm 260-MHz signal results if the phaselock downconverter and 260-MHz amplifier/filter portions are kept at a reasonable distance from one another.

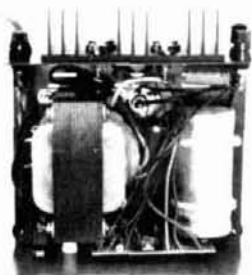

INSIDE VIEW — RS-12A

ASTRON POWER SUPPLIES

• HEAVY DUTY • HIGH QUALITY • RUGGED • RELIABLE •

SPECIAL FEATURES

- SOLID STATE ELECTRONICALLY REGULATED
- FOLD-BACK CURRENT LIMITING Protects Power Supply from excessive current & continuous shorted output
- CROWBAR OVER VOLTAGE PROTECTION on all Models except RS-3A, RS-4A, RS-5A.
- MAINTAIN REGULATION & LOW RIPPLE at low line input Voltage
- HEAVY DUTY HEAT SINK • CHASSIS MOUNT FUSE
- THREE CONDUCTOR POWER CORD
- ONE YEAR WARRANTY • MADE IN U.S.A.

PERFORMANCE SPECIFICATIONS

- INPUT VOLTAGE: 105-125 VAC
- OUTPUT VOLTAGE: 13.8 VDC \pm 0.05 volts (Internally Adjustable: 11-15 VDC)
- RIPPLE Less than 5mv peak to peak (full load & low line)
- Also available with 220 VAC input voltage



MODEL RS-50A



MODEL RS-50M



MODEL VS-50M

RM SERIES



MODEL RM-35M

19" x 5 1/4" RACK MOUNT POWER SUPPLIES

MODEL	Continuous Duty (Amps)	ICS* (Amps)	Size (IN) H x W x D	Shipping Wt. (lbs.)
RM-12A	9	12	5 1/4 x 19 x 8 1/4	16
RM-35A	25	35	5 1/4 x 19 x 12 1/2	38
RM-50A	37	50	5 1/4 x 19 x 12 1/2	50
• Separate Volt and Amp Meters				
RM-12M	9	12	5 1/4 x 19 x 8 1/4	16
RM-35M	25	35	5 1/4 x 19 x 12 1/2	38
RM-50M	37	50	5 1/4 x 19 x 12 1/2	50

RS-A SERIES



MODEL RS-7A

MODEL	Continuous Duty (Amps)	ICS* (Amps)	Size (IN) H x W x D	Shipping Wt. (lbs.)
RS-3A	2.5	3	3 x 4 1/4 x 5 1/4	4
RS-4A	3	4	3 3/4 x 6 1/2 x 9	5
RS-5A	4	5	3 1/2 x 6 1/4 x 7 1/4	7
RS-7A	5	7	3 3/4 x 6 1/2 x 9	9
RS-7B	5	7	4 x 7 1/2 x 10 1/4	10
RS-10A	7.5	10	4 x 7 1/2 x 10 1/4	11
RS-12A	9	12	4 1/2 x 8 x 9	13
RS-12B	9	12	4 x 7 1/2 x 10 1/4	13
RS-20A	16	20	5 x 9 x 10 1/2	18
RS-35A	25	35	5 x 11 x 11	27
RS-50A	37	50	6 x 13 1/4 x 11	46

RS-M SERIES



MODEL RS-35M

MODEL	Continuous Duty (Amps)	ICS* (Amps)	Size (IN) H x W x D	Shipping Wt. (lbs.)
• Switchable volt and Amp meter				
RS-12M	9	12	4 1/2 x 8 x 9	13
• Separate volt and Amp meters				
RS-20M	16	20	5 x 9 x 10 1/2	18
RS-35M	25	35	5 x 11 x 11	27
RS-50M	37	50	6 x 13 1/4 x 11	46

VS-M AND VRM-M SERIES



MODEL VS-35M

- Separate Volt and Amp Meters • Output Voltage adjustable from 2-15 volts • Current limit adjustable from 1.5 amps to Full Load

MODEL	Continuous Duty (Amps)			ICS* (Amps)	Size (IN) H x W x D	Shipping Wt. (lbs.)
	@13.8VDC	@10VDC	@5VDC	@13.8V		
VS-12M	9	5	2	12	4 1/2 x 8 x 9	13
VS-20M	16	9	4	20	5 x 9 x 10 1/2	20
VS-35M	25	15	7	35	5 x 11 x 11	29
VS-50M	37	22	10	50	6 x 13 1/4 x 11	46
• Variable rack mount power supplies						
VRM-35M	25	15	7	35	5 1/4 x 19 x 12 1/2	38
VRM-50M	37	22	10	50	5 1/4 x 19 x 12 1/2	50

RS-S SERIES



MODEL RS-12S

- Built in speaker

MODEL	Continuous Duty (Amps)	ICS* Amps	Size (IN) H x W x D	Shipping Wt. (lbs.)
RS-7S	5	7	4 x 7 1/2 x 10 1/4	10
RS-10S	7.5	10	4 x 7 1/2 x 10 1/4	12
RS-12S	9	12	4 1/2 x 8 x 9	13
RS-20S	16	20	5 x 9 x 10 1/2	18

The 280-290 MHz circuits are built using a similar technique. But, for this board I started with a bare piece of approximately 3" x 6" double-clad 1/16th-inch thick Fiberglas™ pc board material (G-10). I cut 0.100" square pads and soldered all rf components to the board instead of building much of the circuit above the ground plane, as I did with the 260-MHz oscillator. Cutting out pads is easier than it sounds. You can prepare the entire board in one sitting with a microscope. Use a small hobby knife to cut away the copper around the pads. You'll get an isolated pad by scoring through the copper, then shifting the blade and cutting a vee or trough into the top of the board around a 0.100" square. As with the 260-MHz oscillator, the small component and pad size force you to control and limit the lead length. All ground connections should first be drilled completely through the board in the MMIC area. Then solder the component or lead to be grounded on both the top and bottom, to reduce the possibility of coupling inside the board. I drilled holes to clear the packages of the MMIC and the output BFR-96 transistor. This let me solder the emitter leads to the topside ground without excess lead length. Drill a hole for these leads and solder them to the top and bottom ground planes.

Be sure to follow the dimensions when making the filter inductors and mounting the tuning capacitors. The spacing between resonators in each pair is important to set filter coupling and provide the correct 8-10 MHz bandwidth. After cutting the pads and building the interstage amplifiers, solder the pc board "fence" on both sides around the filter assembly. The hf circuitry isn't critical, but I used the same "mini-pad" technique. It's desirable to connect the 260-MHz LO signal to the mixer with a piece of small coax. Try to use coax with an O.D. of 1/8" or smaller. Use minimum length on both the mixer and connector ends to avoid radiating 260-MHz energy around the filter, where it may be amplified during transmit by the output BFR-96. Such radiation could cause the unwanted LO feedthrough to be suppressed by less than 60 dB. This radiation would be in-band and small on all of the microwave bands, but it's unnecessary.

I built the dc switching circuits on a piece of breadboard, which I mounted at one end of the transverter. I suggest using a 0.125-A fuse or foldback current limiting in the dc supply until you've finished troubleshooting and tune-up because the PNP transistors will self-destruct if their cases, or the RX or TX supply lines are inadvertently shorted when they are turned on. In normal operation, all these transistors are used as switches and have very little power dissipated. I brought out the NOT-Transmit line to allow keying when an hf transceiver providing Vcc on the signal line during transmit is unavailable. This point

may also be monitored to tell if the hf transceiver is successful in causing the microwave station to go into transmit mode.

260-MHz LO tune-up

Finish the 260-MHz LO first; you'll use it to make the 280-290 MHz circuits work. Check your wiring and measure the current to the oscillator and each amplifier stage individually. As with the other loops, the phaselock portion, from the bipolar i-f amplifier onwards, can be checked by substituting one of the previously completed loops. A moderately sensitive detector of 40-MHz energy is desirable to tune the downconverter. An oscilloscope or a 40-MHz receiver should work. If you have neither, tune the oscillator to 271 MHz by listening to the PLL i-f at 29 MHz with the station receiver, to the PLL i-f at 29 MHz and tuning the variable capacitor slowly through its range. Do this with 6 volts applied to the tuning input. Verify that the signal heard tunes with the correct sense, and that you aren't overloading the receiver. Once you hear a signal which tunes correctly, peak it by adjusting the 100-MHz bandpass filter. To verify that the 40-MHz reference signal is present, use the diode detector from part 2, an oscilloscope, or other detector. To maximize it, peak the bipolar frequency doubler's collector tuning. Once the reference and PLL i-f inputs on the ECL phase comparator are at the correct level, the loop should lock when the VCO is (re)tuned to near 260 MHz. If you have trouble getting a sufficient level on the PLL i-f, temporarily bypass the attenuators on the input and output of the isolation amplifier to increase signal levels. It may be useful to count the VCO and keep track of operation during tune-up if a VHF frequency counter is available. Once the oscillator locks correctly with both isolation amplifier attenuators connected, peak the 260-MHz output by tuning L1 and L2 on the 260-MHz bandpass filter. You should now have a clean and accurate 260-MHz LO.

280-290 MHz tune-up

After completing rf circuit construction and re-checking the wiring, apply Vcc to each of the active stages with the switching circuitry disconnected. Measure and verify proper collector or emitter current. Verify that the TX, RX lines, and their complements alternate appropriately between nearly Vcc and ground as the TRANS line is alternately shorted to ground and allowed to float.

Once individual stage biases are correct and the switching circuits are functioning, complete the transverter construction by wiring the switched lines to the rf circuits. The transverter is probably best tuned on receive by using a local signal source in the 280-290 MHz range. The second harmonic of a 2-meter trans-

ceiver may be used, or the tenth of a 10-meter transmitter. Hook up the 260-MHz LO and the station receiver to the transverter. When you identify a suitable test signal, couple it to the bandpass filter nearest the interstage amplifiers on the MMIC side (280-MHz signal connector side). Tune the pair of resonators on the mixer side for maximum response. Next, couple the signal at the MMIC output side of the filter assembly and peak the other two resonators for maximum. The transverter should now be roughly tuned and operate on both receive and transmit. You can perform fine tuning to flatten the response over the full 10-MHz range by peaking one of the resonators in each pair on a 281-MHz signal and the other on a 289-MHz signal. If a 1290-1300 MHz transceiver is available, generate these i-f signals by connecting the 1010-MHz oscillator to a double-balanced mixer filter and completing the 1296-MHz station. The Mini-Circuits SBL-1X or TFM-2 mixers are only rated to 1 GHz for full specifications, but still perform reasonably well at 1296 MHz. If you use this method, you can tune up the transverter on either transmit or receive.

10-GHz amplifier

This two-stage amplifier was the next logical step in station improvement. Low noise amplification ahead of the mixer is necessary to reduce the overall receiver noise figure on receive. Without it the noise figure is approximately: $N_{F_{rx}} = N_{F_{if}} + C_{E_{mix}} (+ 3 \text{ dB})$.

Where:

$N_{F_{rx}}$ = receiver noise figure in dB

$N_{F_{if}}$ = 288-MHz i-f receiver noise figure in dB

$C_{E_{mix}}$ = conversion loss of the microwave signal mixer

Even with an amplifier you get the additional 3 dB because, unless an image reject signal mixer is used, the noise at the image frequency is converted to the i-f and degrades the overall noise figure. The system noise figure can be essentially that of the amplifier alone by providing sufficient gain ahead of a bandpass filter which passes only the signal frequency and not the image. On transmit it's desirable to have more power than the few hundred microwatts the mixer alone can achieve; gain is required to do this. Amplifier gain is worth more than low noise figure because it overcomes other hardware noise figure problems on receive, and directly adds to output power on transmit. This can mean 2-dB of station improvement for every extra dB of amplifier gain. For these reasons, the amplifier was designed to have a compromise of good noise figure and maximum gain.

Design considerations

Neither low noise or high gain are as easy to achieve at 10 GHz as at lower frequencies. Gallium Arsenide

field-effect transistors are currently the most readily available and suitable devices. Recent volume production of 4-GHz TVRO equipment has helped reduce the price and improve the performance of these parts. Gain elements aren't the only problem — losses in all circuit components whether lumped (like chip capacitors), or distributed (like microstrip transmission lines), must be kept to a minimum. Another significant problem (though not as noticeable at lower frequencies) is radiation loss. Wires, lines, and connections are no longer small in terms of the signal wavelength. Unless you take care to avoid it, a circuit can look more like an antenna than an amplifier. Building a circuit on a 2-1/2" long circuit board at 10.368 GHz is comparable to building one on a full-size football field at 40 meters. Packaging circuits at these frequencies can be a challenge since cavities and resonances resulting from mechanical dimensions can cause unexpected results. Can you imagine connecting one end of a coupling capacitor to a goal post and the other to the 20-yard line?

I chose a NEC NE-710 for the input stage and a NE-720 (or 2SK571) for the second stage. The 710 has lower noise and higher gain, while the 720 is relatively inexpensive. The 2SK571, which may only be available in Japan, is a bargain at about 500 Yen (\$4 US) on the surplus market there. The 710 is matched and biased for near minimum noise figure while the 720 is matched for maximum gain.

About 6 of these amplifiers have been built. Consistency has been good with "tuned" gain between 15.5-17 dB and noise figure between 2.6-2.9 dB at 10368 MHz, for the group.

Construction

Unless suitable microwave test equipment is available, you should construct this amplifier after a stable narrowband 10368-MHz station is on the air. Because it needs to be made carefully, the experience gained in getting the downconverter and signal mixers operational should be useful in completing this amplifier.

The first circuits were made by "cutting and peeling" the microstrip traces from a piece of woven double-clad 1/32" TFE (Teflon™-Fiberglass-Epoxy) board material. Rogers Corporation Duroid™ with random fibers was used for the final version because it's somewhat more uniform than woven board material. The woven board material can have a slightly different dielectric constant and shouldn't be substituted for the Duroid.

Use the highest-quality 4.7-pF coupling capacitors, especially in the input stage. About 0.5-dB improvement in noise figure was obtained by changing to high-Q capacitors from run-of-the-mill ones.

FIGURE 9

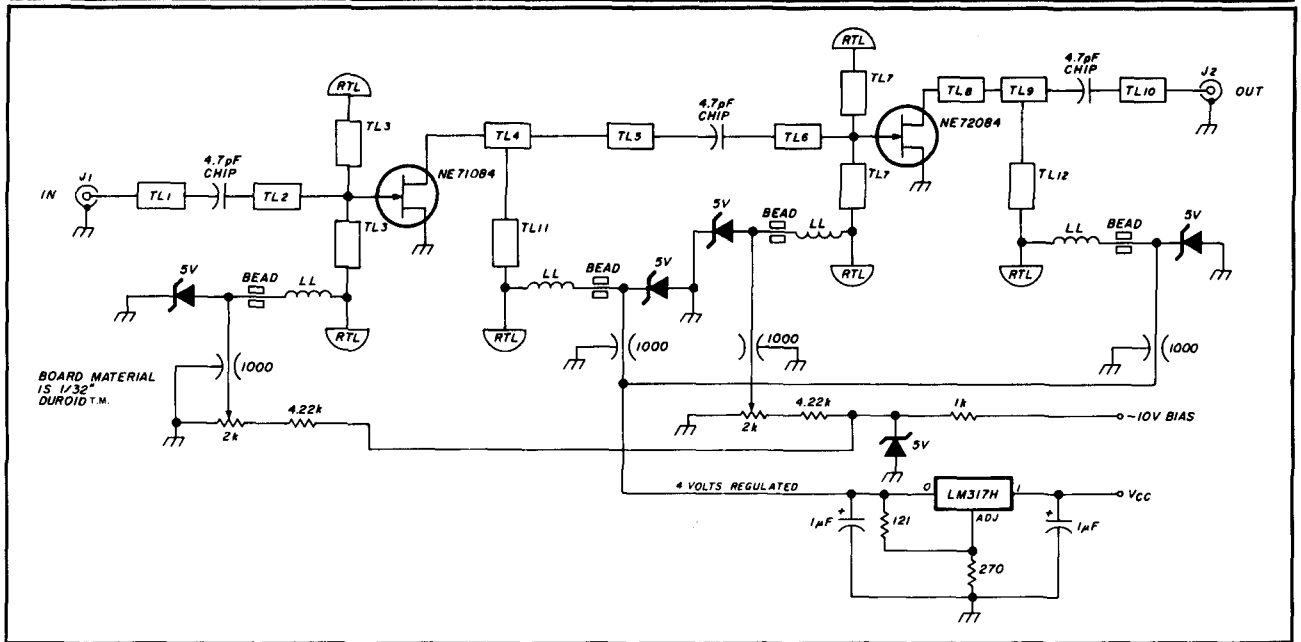

The two-stage 10-GHz amplifier uses a low noise NE710 in the input stage followed by a less expensive NE720 in the second stage.

Repeatable performance depends upon carefully controlled grounding and component mounting. This is particularly true relative to the transistors themselves. The transistor source leads are soldered to the circuit side ground trace, but front-to-back shorting wires right at the transistor package and plated-through grounding holes are present every 0.100" to maintain good grounding. Careful drilling and wire front-to-back connections should work if a plate-through pc board process isn't available. The "half-moon" radial transmission lines provide an easy way to match impedances and connect bias at the same time. The bias wire can be a resistor lead or small wire soldered right at the junction of the transmission line and the radial line. I put a ferrite bead, held in place by some silicone rubber, on each of these leads for insurance against lower frequency oscillations. The other end of these bias leads connects to its associated feedthrough capacitor. Position the beads away from the circuit board and near the feedthrough capacitors. A 5-volt zener is also connected to each of these capacitors inside the compartment for static and over-voltage protection.

Figure 9 shows the circuit diagram for the amplifier and bias supply. The bias supply (designed by Bob Dildine, W6SFH), provided negative gate bias for this amplifier and higher power transmit amplifiers during the 1987 10-GHz DX record attempts. The LM-10 allows good regulation without needing excess voltage and current to turn a zener diode on hard. Build this supply in a separate shielded enclosure. Use good

quality bypass capacitors on the input and output lines to make sure no switching frequency signals get out and contaminate the rest of the station electronics.

The SMA connectors flanges are soldered right to the board material on both top and ground plane sides. The notch in the board lets the face of the connector flange be flush with the edge of the board. The package is made from 0.030" copper sheeting cut to size, drilled for the feedthrough capacitors or connectors, and then soldered directly to the board as end and side walls. The package adds rigidity to the relatively flexible board material. Flexing can cause excessive strain and coupling capacitor breakage. Therefore, connector solder joints must be kept to a minimum. The SMA connectors are also soldered to the endwalls. Ground the gate and drain the circuits of both devices until you complete the assembly. Carefully assemble the transistors and coupling capacitors on the board with a microscope. Don't use a lot of solder. Take great care with these components; once they're soldered in place there is little chance of removing and reusing them. Interstage partitions can be made from 0.005-0.010" brass shim stock. Notch them just enough to allow clearance for the transistor package and source leads. Carefully solder them in place after the side walls (with feedthrough capacitors and protection diodes) are on. The partitions should protrude about 0.100" above the sidewalls so that the covers can be soldered on after you complete the tune-up. The covers for the interstage and output should have 20-40 ferrite beads glued to their undersides. This suppresses package

HITACHI SCOPES AT DISCOUNT PRICES!

\$100 Price Reduction



V-212
NOW \$379
was \$475
List \$560

Plus 'Free' 9600 Function Generator

All Hitachi scopes include two 1x, 10x probes and have a 3 year warranty on parts and labor



40MHz **V-425** List 995
CRT readout **\$835**



60MHz **V-660** List 1,195
Delayed sweep **\$949**



V-1060 List 1,595
Delayed sweep **\$1,285**

	List	Our Price	Save
V-223 20MHz D.T. 2mV Sens. Delayed Sweep	770	695	75
V-422 40MHz D.T. 1mV Sens. DC offset	875	695	180
V-423 40MHz D.T. 1mV Sens. Delayed Sweep DC offset	955	795	160
V-1065 100MHz D.T. 2mV Sens. Delayed Sweep	1,895	1,575	320
V-1100 100MHz Q.T. 1mV Sens. Cursor meas. DVM counter	2,295	1,995	300
V-1150 150MHz Q.T. 1mV Sens. Cursor meas. DVM counter	3,100	2,565	535

ELENCO PRODUCTS AT DISCOUNT PRICES!

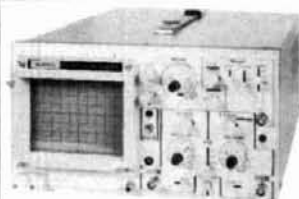

\$349
MO-1251

- 6" CRT
- Built in component tester
- TV Sync
- Much More

20MHz Dual Trace Oscilloscope

Scope Probes

- P-1 65MHz, 1x, 10x **\$19.95**
- P-2 100MHz, 1x, 10x **\$23.95**
- with 5 accessories
- 10 meg ohms input impedance
- Fits most scopes
- TL-3 BNC Minigrabber **\$3.49**



\$498
MO-1252

- High Luminance 6" CRT
- 1mV Sensitivity
- 6KV Acceleration Voltage
- 10ns Rise Time
- X-Y Operation • Z Axis
- Delayed Triggering Sweep
- Much More

35MHz Dual Trace Oscilloscope

Top quality scopes at a very reasonable price. Contains all desired features. Two 1x, 10x probes, diagrams and manual.



True RMS 4 1/2 Digit Multimeter
\$135 M-7000

- .05% DC Accuracy
- .1% Resistance with Freq. Counter & Deluxe Case

10MHz Oscilloscope



\$-3000
\$239

- 10MHz DC or AC Triggered Sweep
- Calibrated Vert & Hor
- Reads Volts & Freq

Decade Blox



9610 or 9620
\$14.95

- #9610 Resistor Blox: 47 to 1M ohm
- #9620 Capacitor Blox: 47pf to 10MFD
- Both interconnectable w/ #9600 or #9550



Low Cost Multimeter
M-1600
\$25

- 3 1/2 Digit LCD
- 1% DC Accuracy
- 10A Scale
- Auto zero/polarity



Digital LCR Meter
LC-1800
\$138

- Measures Coils (1uH-200H)
- Caps (.1pf-200uf)
- Resistors (.1 ohm-20M ohms)

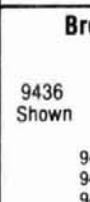

Breadboard

9436 Shown

- 9430 1,100 pins \$15
- 9434 2,170 pins \$25
- 9436 2,860 pins \$35



Multimeter with Capacitance and Transistor Tester
\$55 CM-1500A

- Reads Volts, Ohms Current, Capacitors, Transistors and Diodes w/case



Digital Capacitance Meter
CM-1550
\$58.95

- 9 Ranges
- .1pf-20,000ufd
- .5% basic accuracy
- Zero control w/case



Analog Multimeter
M-1100
\$19.95

- 19 ranges
- High Accuracy
- 10A reading
- Mirrored scale
- Krt 17.50



3 1/2 Digit Meter
Auto and Manual Ranging
28 Functions
Fully Protected

- M-1180 7% Ac \$36.95
- M-1181 1% Ac \$42.95
- M-1182 .25% Ac \$39.95



Function Generator Blox
#9600
\$24.95

- Provides sine, tri, squ wave
- From 1Hz to 1MHz
- AM or FM capability



Solderless Breadbox

550 tie pts including 2 power bus lines
#9550
\$7.50



IC Test Clips

- 16 pin \$5.95
- 20 pin \$8.25
- 24 pin \$10.75
- 28 pin \$11.75
- 40 pin \$18.50

All are gold plated to assure trouble free contact



Temperature Probe

M-110CF
\$29.95
Semiconductor type
Range -58F-302F
Fits most digital multimeters



50MHz Logic Probe

LP-700
\$23
Logic Pulser LP-600 \$23

Digital 3 Amp Power Supply



\$175
0-40V @ 1.5A
0-2V @ 3A

XP-650 with Analog Meters \$129.50

Regulated P.S. Breadboard



\$99.95 XK-400

- Fully regulated
- Short circuit protection
- 3550 test points
- 3 power supplies

• 5V @ 2A, 12V @ .3A, -12V @ .3A



GF-8016 Function Generator with Freq. Counter
\$239

- Sine, Square, Triangle
- Pulse, Ramp, .2 to 2MHz
- Frequency .1 thru 10MHz

GF-8015 without Freq. Meter \$179

Digital Triple Power Supply



XP-750
XP-785
\$239
0-20V @ 1A
0-20V @ 1A
5V @ 5A

Fully Regulated, Short Circuit Protected with 2 Limit Cont. 3 Separate Supplies

XP-660 with Analog Meters \$169.50

Quad Power Supply

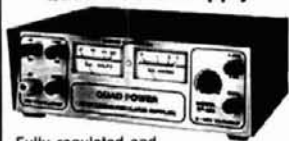

XP-580
\$59.95
2-20V @ 2A
12V @ 1A
5V @ 3A
-5V @ .4A

Fully regulated and short circuit protected

XP-575 without meters \$44.95

Four-Function Frequency Counters

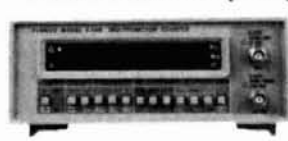

F-1000 \$259
1.2GH
F-100 \$179
120MH

Frequency, Period, Totalize, Self Check with High-Stabilized Crystal Oven Oscillator, 8 Digit LED Display

WE WILL NOT BE UNDERSOLD!



C & S SALES INC.
1245 Rosewood, Deerfield, IL 60015
Add 5% for Postage (\$10 Max) IL Res., 7% Tax

(800) 292-7711 15 Day Money Back Guarantee
(312) 541-0710 2 Year Warranty
ASK FOR FREE CATALOG

PHOTO C

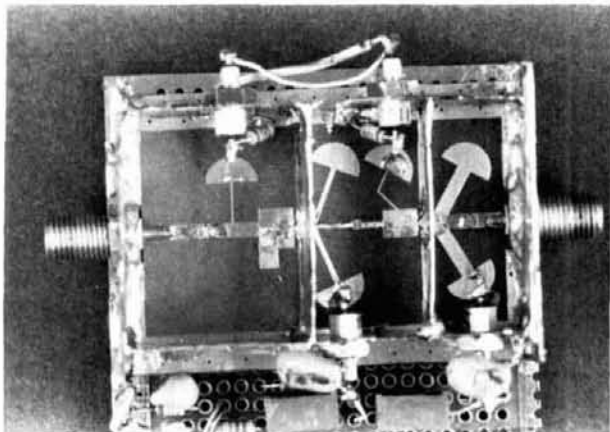

The three compartments inside a completed amplifier are visible in this photograph. A shim "tuner" can be seen in the output stage (the largest compartment).

PHOTO D

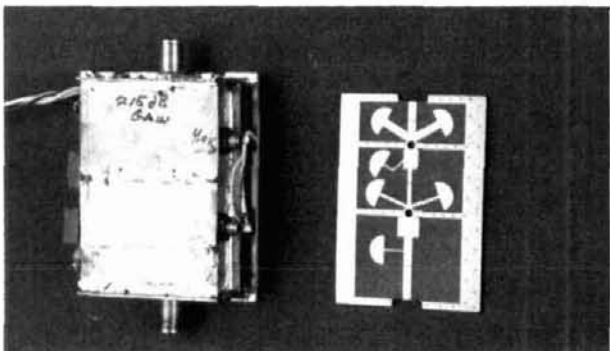

This photograph shows the amplifier before and after the addition of the copper walls, connectors, and covers. Notches for the connector flanges and holes for the transistor packages are visible on the raw board.

resonances which could degrade performance. The input compartment doesn't have these "absorbers" because any additional losses can degrade noise figure. Crazy Glue™ or similar contact adhesives seem to work and stand the temperature when the covers are finally soldered in place. Photos C and D show the completed amplifier with covers removed.

Tune-up

You can do your tune up once the amplifier and bias circuits are completed, and either a station or other microwave test equipment is available. With the gate bias pots turned all the way down for zero-volts bias, gradually increase the drain supply voltage while watching the drain current. No more than 4.5-volts maximum should be necessary; going much beyond this will cause the protection zeners to start conducting. This zero-bias drain current, IDSS, varies from device to device; note the value for both stages. Next, slowly turn the bias pots to make the gates more nega-

KEEP IT INSIDE

DMQ
5588



- Frequency Range - 13 MHz to 30 MHz
- Power Limit - 1500 Watts P.E.P.
- Diameter - 39 inches
- Wind Survival - 70 + MPH
- Surface Area - < 89 Sq. Ft.
- Antenna Finish - Heat Shrink Tubing
- Coax Connector - PL-259
- Antenna Weight - 4 lbs.
- Magnetic Design Maximum Efficiency
- 100% Copper One Piece Construction
- Military Spec Vacuum Variable Capacitor Rated at 35,000 Volts
- HI-Q Harmonic Suppression
- All Locations - Indoors or Outdoors
- Bi-Directional at 0-20 Degrees TOA
- Omni-Directional at 25-90 Degrees TOA
- High Signal to Noise Ratio
- Direct Feed 52 OHM Coax SWR < 1.5:1
- No Matching Unit, Pretuned Coax, Ground Screen or Radial System

WA2VMO A BELIEVER

WHEN YOU'RE TOLD YOU CAN'T — THE DMQ-5588 SAYS YOU CAN

OPERATION: Apply power to DMQ-5588 and adjust vacuum variable for lowest SWR.

INSTALLATION: DMQ-5588 inside ground floor apartment brick building 100W.

DX CONTACTS MADE BETWEEN 3/88 TO 5/88: S24 P43 PA0 TK9 DJ8 GW0 CP5 Y59 Z56 J37 Z08 HP9 WP4 IK4 HK6 GM4 IS EA5 JH1 C6 HK6 IK2 GD4 PJ2 HP4 CE1 524 5T5 KP4 UT4 SP3 CP3 F9 IK3 N91 UA6 UR2 UP1 Y12 UB5 IV3 EA5 TG9 GJ5 ON7 YU1 V01 DL6 J73 PY8 TL2 L21 PY5 OE4 GI0 G4 WP4 KL7

Become a Believer! For more information about this exciting new antenna, call or write DMQ today! Limited time intro offer: \$349.50 + Shipping.

221 Slater Boulevard
Staten Island, NY 10305
(718) 979-3505

✓ 128



TECHNOLOGY

COMMANDER II VHF LINEAR POWER AMPLIFIER



SPECIFICATIONS

Frequency Range—144-148 MHz

Modes—USB, LSB, RTTY, FM

Power Requirements—117/234VAC with 234VAC recommended

RF Drive Power—10-15 Watts Nominal 25 Watts Maximum

RF Output—15+ DB Gain or over 650 Watts

Input Impedance—50 OHMS

Output Impedance—50 OHMS Nominal

Antenna Load—2:1 Maximum

Harmonic Suppression Down 60DB

@ Rated Output

Intermodulation Distortion Down 30

DB Minimum

Weight—56 lbs.

Cabinet Size—14W" x 14W" x 6"

Tube—3CX800A7 Ceramic/Metal

Triode

Pressurized Chassis Forced Air Cooling

FEATURES

Reduced Ratio (6 to 1) on all Tuning Controls for Smooth and Easy Tuneup.

Front Panel Input Tuning Control Allowing a Higher Circuit "Q" for Excellent Linearity and a Very Low Input VSWR all Across the 2 Meter Band.

A Switched Multimeter for Monitoring Plate Voltage, Plate Current, and Grid Current.

External Coaxial Relay or Sequencer Needed for Transceiver Operation.

UPS Shippable.

MADE IN U.S.A. BY HAMS FOR HAMS

Direct from Manufacturer

✓ 121

\$988.00 (Coaxial Relay Extra)

Ohio Residents Add Sales Tax. VISA and Mastercard accepted. Prices or specifications subject to change without notice.

COMMAND TECHNOLOGIES, INC.

1117 West High Street, Bryan, Ohio 43506 (419) 636-0443

FIGURE 10

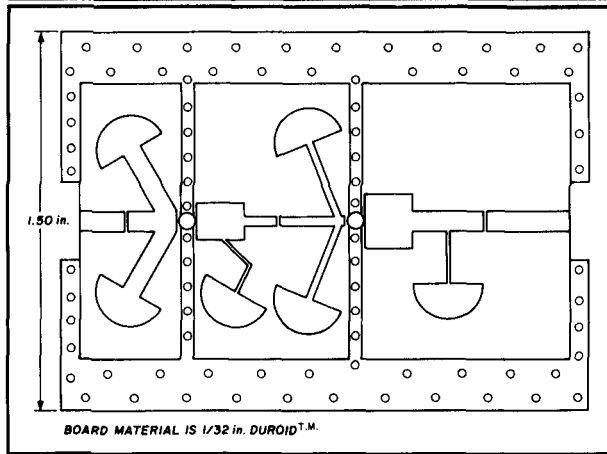

fig. 10A. The original pc board layout for the 10-GHz amplifier.

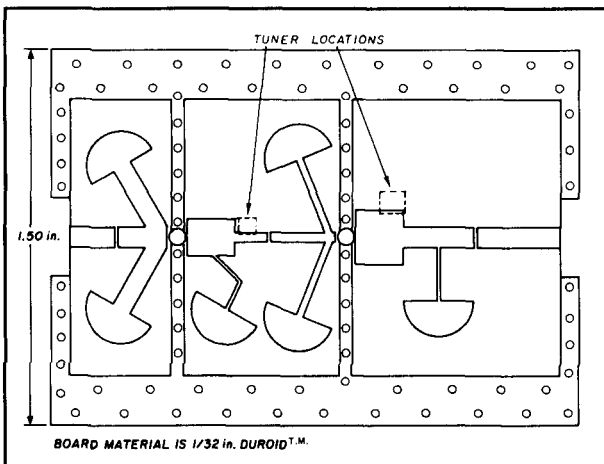
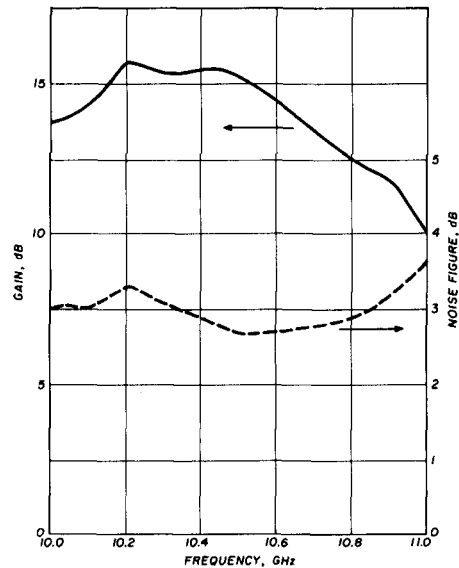

fig. 10B. The pc board layout showing approximate placement of the tuning shims. Note: The shims are glued to the board after finding the exact placement.

tive. The drain current should diminish as you do this. Set the 710-bias current to approximately 25 percent of its IDSS value and the 720 to about 50 percent. You can adjust these later for minimum system noise figure if you have access to measuring equipment, but you should be able to obtain near optimum performance with these settings.

An amplifier like this would require no tuning at lower frequencies. However, a little "tweaking" is useful at 10-GHz, as small variations in construction technique can affect performance. The need to adjust grew out of a mistake in the original design — that of not considering the extra circuit length provided by the gap over which the coupling capacitors are soldered. As a result of this error, untuned gain is about 13 dB. However, by adding small 0.05-0.100" square, 0.002" thick, brass shim stock tuners in the drain-matching circuits of the two stages, the amplifiers can be tuned for maximum gain. This also allows for small device-to-device variations in the transistors. Figures 10A and

FIGURE 11



LL Resistor Lead

TL1 .083"W x .180"L	TL8 .220"W x .188"L
TL2 .083"W x .150"L	TL9 .083"W x .280"L
TL3 .078"W x .277"L	TL10 .083"W x .350"L
TL4 .15"W x .192"L	TL11 .01"W x .250"L (Can be .210"L)
TL5 .039"W x .134"L	TL12 .01"W x .210"L
TL6 .039"W x .220"L	RTL .145" Radius half-circle
TL7 .029"W x .316"L	J1,2 Flanged SMA connector

The measured gain and noise figure of a typical amplifier. More than 15-dB gain and under 3-dB noise figure is readily available.

B show approximate positions for the tuning shims. Tune by first gluing one of the shim tuners at right angles to the end of a toothpick. Carefully use the toothpick to move the shim around, varying the amount it extends past the edge of the transmission line, as well as its location along the length of the line. While you do this, monitor a stable signal on 10368 MHz with the station-receiver S meter. Be sure to maintain contact with the drain-circuit line of the stage. Note the optimum position, turn the power off, ground all bias pins to the amplifier, and permanently solder an identical shim in the position noted. You don't need to perform input-stage tuning because the match provided is not far off, even with the capacitor-gap error. As you can see in fig. 11, minimum noise figure occurs slightly above the hamband calling frequency — but the difference is negligible.

The finished amplifier should exhibit less than 3-dB noise figure and at least 15-dB of gain. On transmit it should be able to deliver 30 milliwatts of linear power and about 50 milliwatts saturated. You may need to increase drain current to more than 50 percent of the IDSS value for maximum output.

Summary

Once the 3456-MHz and 5760-MHz local oscillators are completed, further station improvements will come in the form of better receiver preamps and more transmit power for all the bands. I anticipate that the rapid bandswitch and good system modularity will provide a good contest station, as well as one which can grow with available technology. If you want to build a similar station and try for an obscure record, QSOs on 16-18 different Amateur bands in 2-3 minutes should be possible with this equipment when augmented by a longwire antenna for the hf bands and standard VHF/UHF contest equipment. Another way to use this approach is for 900-MHz band operation. Use a 620-MHz VCO downconverted to a 20-MHz PLL i-f, with an anti-parallel diode mixer like the one used at 1010 MHz. This would give 900-910 MHz operation with the 280-290 MHz i-f.

I have ignored a couple of station components in this series. Transmit/receive switches are necessary in any station using signal frequency amplifiers. Many good units show up at flea markets and surplus stores. I also haven't provided construction information for a good ovenized frequency standard. Although the design presented here showed a 10-MHz standard, a good proportional oven around the unlocked 100-MHz oscillator may provide satisfactory results.

Thanks to Bob Dildine, W6SFH and Lynn Rhymes, WB7ABP for their interest, ideas, suggestions, and help with the station.

Some sources of microwave parts and information.

NEC transistors:

California Eastern Laboratories
3260 Jay Street
Santa Clara, California 95054
(408) 988-3500

Transistors, chip capacitors, mixers, PIN diodes, etc.:

Microwave Components of Michigan
11216 Cape Cod
Taylor, Michigan 48180
(313) 753-4581

An inexpensive (about \$7) surplus 2-8 GHz double-balanced mixer (WJ-M62H) is available from:

HSC Electronic Supply
6819 Redwood Drive
Cotati, California 94928
(707) 792-2277

Article B

HAM RADIO

short circuit

Part 2 of "Designing a Station for the Microwave Bands" in the June 1988 edition of *HAM RADIO* needs to be corrected at follows:

The schematic in fig. 1 on page 20 incorrectly shows

a connection between the 9-volt zener and the 7-nH inductor on the base of Q3. The drawing in fig. 2 shows this correctly.

Although the schematic of the 10-GHz signal mixer in fig. 11 is correct, the implementation shown in figs. 9, 10, and 19 have an error in the positions of the signal and the diode quad connections to the ring. Construction using the dimensions shown results in unnecessarily high conversion loss in the mixer at 10.4 GHz. A corrected fig. 19 is shown here.

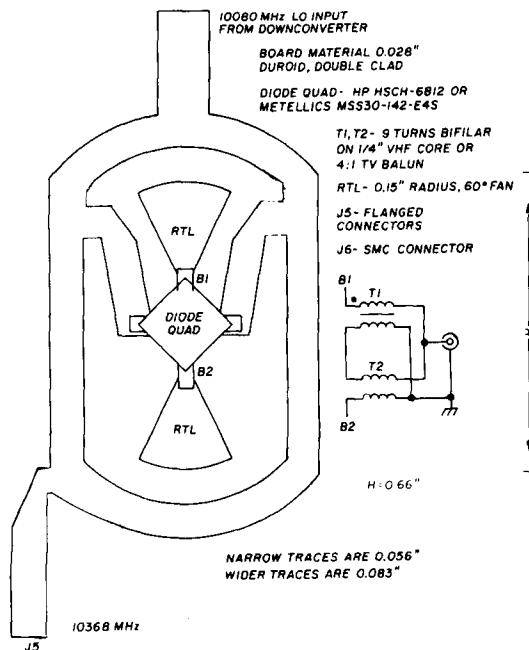

Sticky copper tape can be used to correct these errors if you've already made a board to the specifications of the original description. I apologize for any needless effort this may have caused.

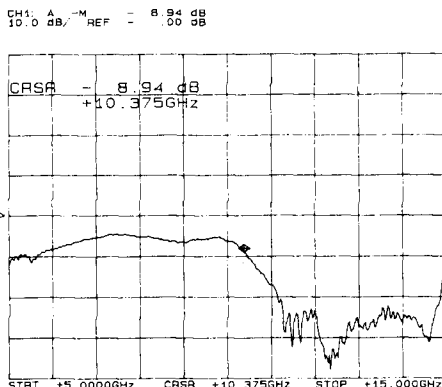

As you can see from the plot of conversion loss versus frequency, this mixer is usable but not optimum on both the 5760 and 10368-MHz Amateur bands. Details of a version which is more optimum for 10368 MHz alone is available from the author for an SASE.

Ed.



THE WEEKENDER

REMOTE TUNER FOR 75 METER MOBILES

By Joel Eschmann, K9MLD, 6964 Meadowdale Drive, Hartford, Wisconsin 53027

This article is dedicated to those 75-meter mobile operators who are tired of getting out of their cars to retune their mobile whips every time they change frequency more than 25 kHz!

I'm an avid mobile operator on all the hf bands and I have no problem with the bandwidth of my antennas on 20/15/10 meters. But when it comes to 40 and 80 meters, I get frustrated hopping in and out of my car to tune my mobile whip when I QSY. No more! Here's a breakthrough that's so cheap and simple you'll want to use this tuner everywhere, as I have.

It occurred to me that I might use my existing mobile antenna tuned to 4 MHz and add inductance at the base to allow tuning lower in frequency. I wanted to do this across the whole phone band without leaving the front seat of my car.

The schematic in fig. 1 shows that this is a very basic tuner concept found in all the text books. It was a problem finding an inexpensive motor-driven tuner that provided the correct inductance. While looking through many surplus catalogs, I came across a motor-driven Ribbon Roller Inductor at Fair Radio in Lima, Ohio. This silver-plated inductor turned out to be an excellent choice. Its gear train drives a rotary switch that can be used as a limit switch to stop the motor when the inductor gets to the end of its travel.

Use the steps that follow to modify the surplus assembly. Remove the top section of the rotary switch; you won't need it. Remove all the wiring from

FIGURE 1

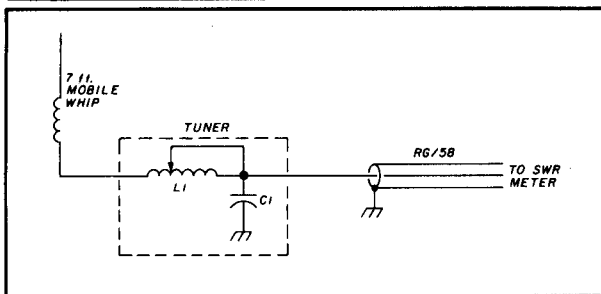

Schematic diagram of the 75-meter remote tuner.

FIGURE 2

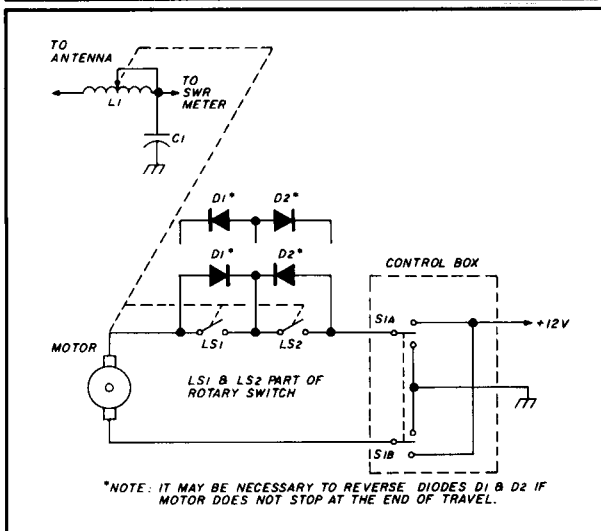

Detailed schematic of the limit switch for the roller-inductor drive motor.

parts list

D1, D2 = 1N4003
 C1 = 1000 to 1200 pF mica depending on band of coverage on 80 meters.
 = 500 to 600 pF mica for 40-meter coverage.
 S1 = DPDT switch center off
 Motor Driven Roller Inductor, part no. L401/180L is available from Fair Radio Sales Co., P.O. Box 1105/1106 E. Eureka Street, Lima, Ohio 45802. The price is \$29.95.

the remaining switch section and the motor. A large resistor is mounted on the motor support. This, too, is unnecessary and should be removed. The motor with the resistor in series was designed to run on 24 volts; by removing the resistor you can use it on 12 volts. If you find that the tuner adjustment is too fast, reinstall the resistor and it will slow the tuner down. Reassemble the remaining switch section with the original hardware and rewire it by adding two steering diodes (D1 and D2), as illustrated in fig. 2. It may be necessary to reverse the diodes if the motor doesn't stop at the end of travel.

I mounted the motor control box on top of my radio console and used a DPDT center off switch to control the motor. You should mark the control box to

indicate the direction of rotation (which raises the frequency of resonance and which lowers it). Then, taking 12 volts from the ignition switch and routing it to the box, I ran a two-conductor cable back to the tuner at the rear of my car.

A 20-gauge two-conductor cable is all you need to control the motor, as it draws only about 0.2 to 0.3A. Those of you who have automatic tuners in your rigs have probably found that they are quite limited in the amount of SWR they can handle; for those of you who don't, this one will solve all your problems. I have used three of these tuners in my car, my camper, and at home at the base of my 35-foot vertical for tuning 40 and 80 meters.

The tuner tucks away nicely in the rear of my car. I have used this unit successfully in two automobiles with no additional changes. If you wish to operate on 40 meters, just change the shunt capacitance at the input to the tuner. Select this capacitor so you can tune the entire phone band with the appropriate inductance. On 80 meters I used an 1100-pF mica cap; on 40 you'll want to start with about a 500-pF mica cap. Remember to tune your antenna at the top end of the band with no inductance added, then increase the

FIGURE 3

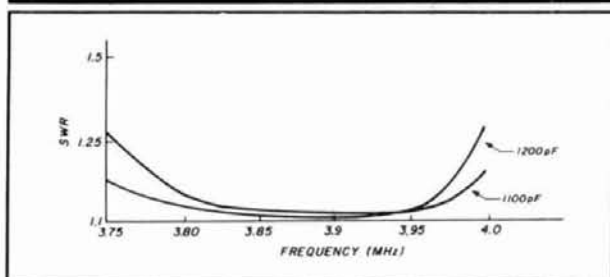

VSWR response curves for the two capacitor values indicated.

inductance as you tune lower in frequency. On 80 meters I was able to indicate a minimum SWR of 1.2 to 1 at 4 MHz and 1.1 to 1 across the band until I got to 3.8, where it started to rise again to 1.2 to 1. Increase the shunt capacitance to 1200 pF to shift the curve lower; change the cap to 1000 pF to raise the curve (see fig. 3).

The last time I talked with Fair Radio there were plenty of these tuners in stock. Let me know if you have any questions and/or enjoy this little tuner. '73 for now and happy mobilizing.

Article C

HAM RADIO

COMPUTERIZE YOUR SHACK

YAESU 747, 757GX, 757GXII, 767, 9600.
KENWOOD TS 140, 440, 940, 680, R5000.
ICOM R71A, R7000, 735, 751A, 761, 781, AND ALL VHF, UHF, CI-V.
DRIVERS FOR RADIOS ARE MODULAR.
JRC NRD 525.

COMPLETE PROGRAM ENVIRONMENT.
MENU DRIVEN AND DESIGNED FOR EASE OF USE.
SCAN FUNCTION ADDED TO RADIOS THAT DO NOT SUPPORT IT.
ERGONOMETRICALLY DESIGNED FOR EASE OF OPERATION.
MOST FUNCTIONS REQUIRE SINGLE KEYSTROKES.
PROGRAM COLOR CODED FOR EASE OF USE, ALTHOUGH WILL STILL RUN IN A MONOCHROME SYSTEM.

MENUS FOR THE FOLLOWING:

AMATEUR HF—AMATEUR VHF—AMATEUR UHF
AM BROADCAST—FM BROADCAST—TELEVISION BROADCAST
SHORT WAVE BROADCAST
AVIATION HF(SSB)—AVIATION VHF—AVIATION UHF
HIGH SEAS MARINE—VHF MARINE
MISCELLANEOUS HF, VHF, UHF
MOST POPULAR FREQUENCIES ALREADY STORED
ADDITIONAL LIBRARIES AVAILABLE
COMPLETE LOGGING FACILITY
ALL FREQUENCY FILES MAY BE ADDED TO, EDITED OR DELETED

AVAILABLE FOR IBM PC, XT, AT, 80386 256K RAM
1 SERIAL PORT AND 1 FLOPPY MINIMUM

PROGRAM WITH INITIAL LIBRARIES 99.95
RS-232 TO TTL INTERFACE ONLY (NEEDED IF DON'T HAVE MANUFACTURERS INTERFACE) 99.95
EXTERNAL INTERFACE ALLOWS 4 RADIOS 129.95
INTERNAL PC INTERFACE W/1 SERIAL & 1 RADIO PORT (CALL FOR PRICE)
SPECTRUM ANALYZER MODULE (CALL FOR PRICE)
COMPLETE SYSTEMS INCL. RADIO, INTERFACE, COMPUTER, AVAILABLE (CALL FOR PRICE)

DATA COM, INT.

8081 W. 21ST LANE
HIALEAH, FL 33016
AREA CODE (305) 822-6028

✓ 122

LET THE SUN DO THE WORK

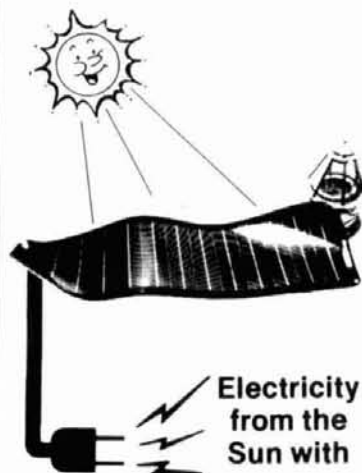

SOVONICS™
Solar Systems

- Charge batteries on stored machinery
- Light your tent
- Run fans
- Run remote transmitters
- Light signs
- Pump water for your animals
- Power for your motor home
- Run your radio without batteries
- Light your home
- Yard lights
- Charge flashlight batteries
- Light your cabin
- Run electric fences
- Charge your boat battery
- Run appliances in your home
- Charge hand held radio batteries
- Fish shanty lights
- Charge your Camcorder battery pack

ALSO: OUTSTANDING PRICES ON IBM XT COMPATIBLE SYSTEMS!

SHIPPING INFORMATION: PLEASE INCLUDE 10% OF ORDER FOR SHIPPING AND HANDLING CHARGES (MINIMUM \$2.50, MAXIMUM \$10). CANADIAN ORDERS, ADD \$7.50 IN US FUNDS. MICHIGAN RESIDENTS ADD 4% SALES TAX. FOR FREE FLYER, SEND 22¢ STAMP OR SASE.

HAL-TRONIX, INC. (313) 281-7773

12671 Dix-Toledo Hwy
P.O. Box 1101
Southgate, MI 48195

Hours
12:00 - 6:00 EST Mon-Sat

"HAL" HAROLD C. NOWLAND
WBZXH



✓ 123

HAM RADIO TECHNIQUES

Bill Orr, W6SAI

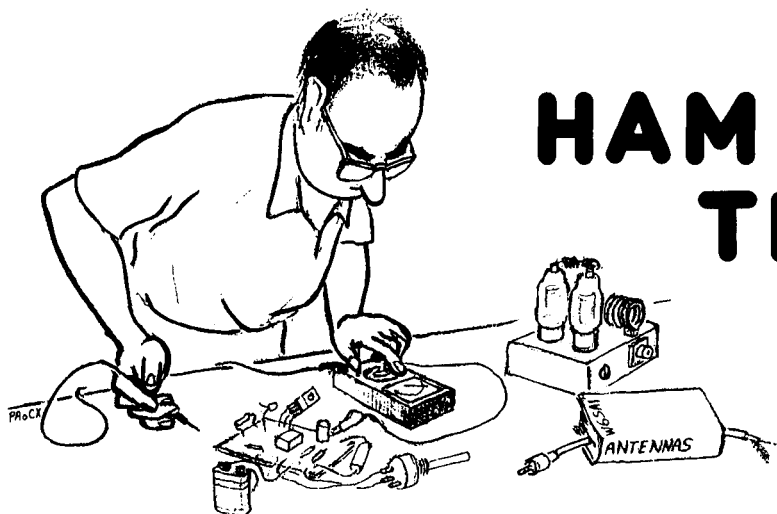

A look at the ground-plane antenna

In April I discussed "Vertical Monopoles With Elevated Radials" by Christman, Radcliff, Adler, Breakall, and Resnick.¹ Their work summarized computer studies indicating that a vertical monopole antenna with four elevated horizontal radials produces more groundwave (low angle) field strength than a conventional ground-mounted monopole with 120 buried radials. The monopole and radials were all a quarter wavelength long and the frequency of operation was 1.0 MHz. Base heights between 5 and 20 meters were investigated. Three different ground constants were used simulating average, very good, and very bad soil conductivity. For average soil, a radial height of 6 meters provided superior performance; for poor soil, a height of 8 meters was required.

The study concluded that "the use of elevated radials would provide superior performance, allowing the collection of electromagnetic energy in the form of displacement currents rather than forcing it to flow through lossy earth in the form of conduction currents."

Figure 1 shows the physical configuration of this antenna design. My remarks on the subject brought letters from readers asking for more informa-

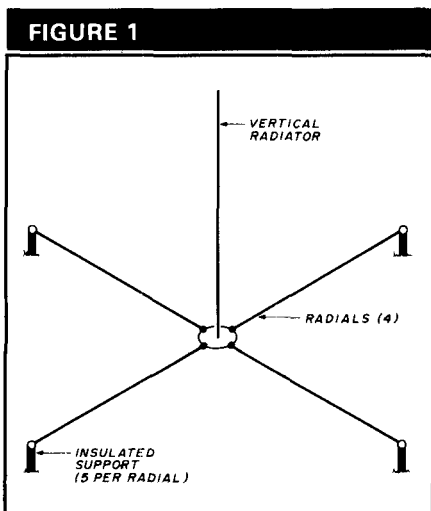

Layout of elevated radial system. Radial height is 6-8 meters at operating frequency of 1 MHz.

tion. There seems to be a great deal of interest in 160-meter vertical antennas.

The concept of above-ground radial wires has been around for a long time. Experiments conducted by Doty, Frey, and Mills^{2,3} and outlined in the 1982 bulletin of the Radio Club of America (later written up in the February 1983 issue of *QST* and also in my column), determined that the traditional ground radial system composed of a number of buried or surface wires can be equaled or bettered by using an elevated ground screen about 6.5 feet off the ground. This is shown in fig.

2. Note that this height is much less than that indicated in the layout of fig. 1.

Although the execution of this ground system is slightly different from

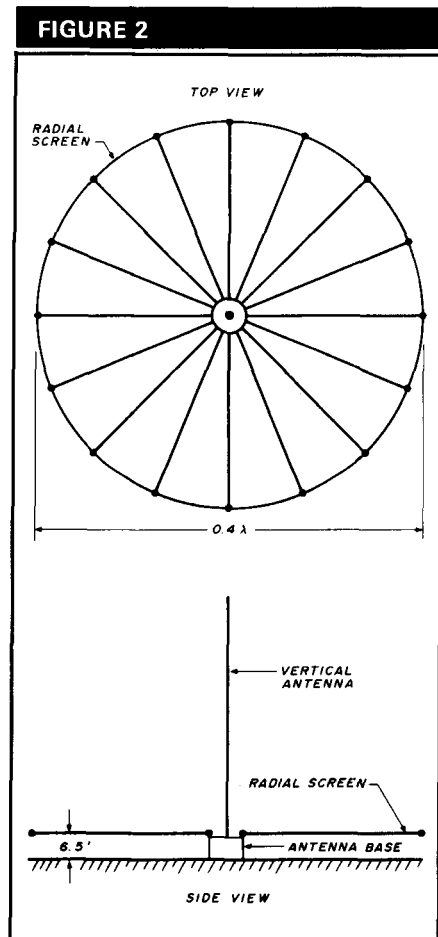

The ground radial system of Doty, et al. uses 50 radials, at least 0.2-wavelength long and 6.5 feet above ground.

the design shown in **fig. 1**, the concept seems to be the same. According to Edward Laport, former vice president of RCA and author of *Radio Antenna Engineering*, "All earth currents should enter the ground wires as displacement currents rather than conduction currents."

Enter the ground-plane antenna

The antennas shown in **figs. 1 and 2** are similar to the conventional ground-plane antenna. Then why all the fuss? A closer look at the ground-plane concept may clear the air. An excellent discussion of the ground-plane antenna was given in the "Technical Topics" column by Pat Hawker, G3VA, in the July 1981 issue of *Radio Communication*.

Pat points out that conventional wisdom (the *ARRL Antenna Handbook*, for example) claims that in order to obtain an omnidirectional pattern, the ground plane requires a metal ground disc with a quarter-wavelength radius (**fig. 3A**). The disc can be simulated with at least four straight radials equally spaced around a circle (**fig. 3B**). This implies that, as with buried radials, the more above-ground radials the better. It also suggests that such an antenna cannot be expected to function efficiently with an omnidirectional pattern with only one or two radials.

Pat refers to R.C. Hills, G3HRH, who asserts that the radial system of the normal elevated ground plane has little to do with the angle of radiation, but only provides a convenient low potential connection for the shield of the coax line. Hills states that the radials are electrically very transparent and the ground below the radials is well illuminated by the vertical antenna, so the presence of a good ground system is just as important as if the antenna were fed against ground.

G3VA comments on Hills saying, "Here the casual reader would assume that the use of four or more radials plus an extensive earth system buried in ground of good electrical conductivity

was advisable to obtain optimum results."

In summary, G3VA points out that the effectiveness of any vertical antenna in providing low-angle radiation depends to a very marked extent upon earth conductivity. But an earth system that really meets this requirement can't use a normal buried earth system because it should extend many wavelengths around the antenna, in all directions.

FIGURE 3

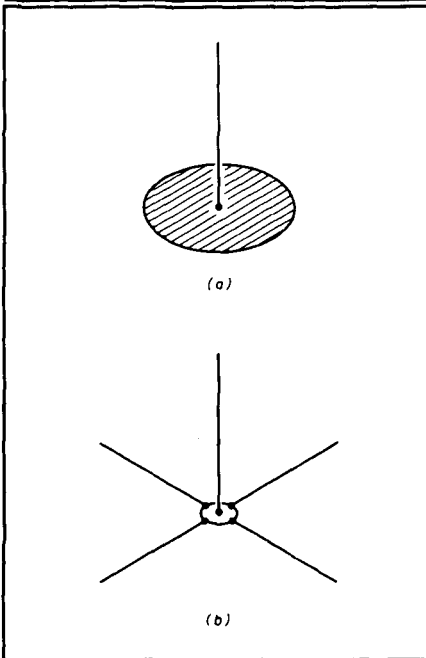

Solid ground plane having 1/4-wavelength radius (A) can be simulated by four radials, each 1/4-wavelength long (B).

Getting down to basics

The conclusion is that ground conductivity is very important, but this does not answer the puzzle of the number of radials required. As G3HRH pointed out, their prime job is to provide an rf ground point for the coax line and to bring the antenna system to resonance. So why four radials? Why not five? Or three? Or perhaps one?

Pat, G3VA, had the enviable opportunity to meet Dr. George Brown of RCA, the man responsible for the development of the ground-plane antenna. On Dr. Brown's visit to England, Pat put the question to him.

Here's what Pat had to say about this conversation:

"He (Brown) told me that the elevated ground-plane antenna was first devised in the thirties to meet an early requirement for police communications around 30 to 45 MHz. Its success was immediately evident when, at the first demonstration, the transmissions reached well beyond the anticipated service area. Now the important point was that the original design had only two radials; however, when it came to marketing the design the sales engineers reported that they could not persuade potential users that a two-radial antenna, with the two radials looking like a half-wave dipole, could possibly have an omnidirectional radiation pattern. On the classic principle that the customer is always right, George Brown and his colleagues simply added two more radials — and everybody was satisfied."

Pat's conclusion is that all that's required for the ground-plane antenna to function effectively is that the bulk of the horizontal radiation from the radials is cancelled out — and this happens with only two radials. This doesn't prove that four may not be better, but it is an indication that a two-radial ground plane certainly serves the purpose the inventor had in mind!

Separating the two problems

The experiments outlined in **fig. 1** indicate that a radial system is required for a vertical antenna in the vicinity of the earth. They show that a low, but elevated, system of radials is more efficient than a buried system. The data of **fig. 2** point to the same conclusion but indicate that a maximum of only four radials need be used, as opposed to a multiple radial design.

Looking at Dr. Brown's comments with reference to his original design, it is safe to assume that his ground-plane concept envisioned the antenna mounted several wavelengths in the air. The frequency of operation and the need for coverage to the horizon dictated that as great a height as possi-

ble be used. Two radials did the job in this special case. Since the antenna was high above the earth, the return currents entered the radials as displacement currents, and the conduction currents in the earth were quite low because of physical separation of earth and antenna.

It seems to me that a ground-plane antenna for VHF and hf use, mounted well above the ground, requires but two radials for good omnidirectional performance. On the other hand, when the base of the antenna is mounted close to the ground, the probability of return currents entering the ground as displacement currents is very high.

Dr. Brown's original work on buried ground radials was done in 1936-37. As Arch Doty, K8FCU, says in his article² "Dr. Brown's paper on buried radial wires used with vertical antennas is a true 'classic' work, the excellence of which has established practices in the field ever since. Unfortunately, its very completeness discouraged further research in the area, and the fact that it considered only one of the several possible methods of making artificial ground systems was overlooked."

The Doty, Frey and Mills group and the Christman, Radcliff, Adler, Breakall, and Resnick group have attacked the problem of above-ground radial systems using different methods. The former made physical experiments and conducted ground current measurements using relatively low radials. The latter group employed computer-modeling techniques and investigated field strength using radials at a greater height above ground. Unfortunately, neither group worked with the same radial configuration. Generally speaking, the broad result of both investigative groups was that elevated radials were superior to buried ones.

The first group indicated that 50 elevated radials, at least 0.2 wavelength long and about 6.5 feet above ground, are as effective as 120 buried uninsulated wires. The second group indicated that four radials, about 6 to 8 meters above ground and 0.25

FIGURE 4

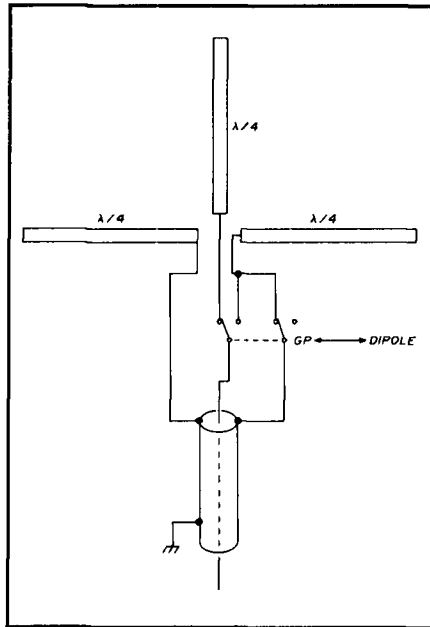

Remote double-pole double-throw relay switches from ground plane to dipole antenna.

ing scheme like that shown in fig. 4. This will permit the operator to switch from the elevated ground plane (vertical polarization) to a dipole (horizontal polarization) from the operating position. It might provide an answer to the ongoing question: which performs best, a dipole or a ground-plane antenna?

The "Dead Band" Quiz

Here's an age-old problem for the mathematics buff (see fig. 5). Engine A and engine B are on the same track on a collision course. They are 60 miles apart. Engine A is going 30 miles per hour and engine B is going 50 miles per hour.

A fast hornet starts on engine A and flies to engine B, back to engine A, back to engine B, and so on. Eventually the hornet is killed when the two engines collide. The hornet flies at 400 miles per hour. Neglecting the turnaround time of the hornet, wind, and other minor delays, how many miles

FIGURE 5

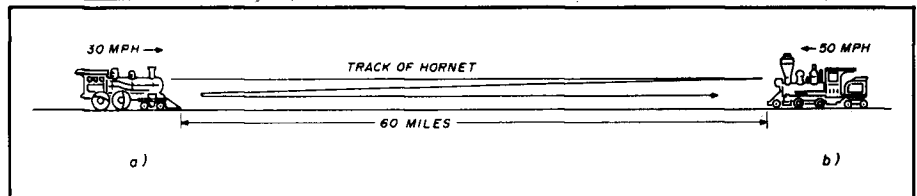

Engine and hornet problem is this month's quiz.

wavelength long, "produce more groundwave field strength" than 120 buried radials. The first group measured the distribution of ground return currents. The second group examined the radiated field strength by computer. That study indicated that there was very little improvement going from four to 120 above-ground radials.

It remains for future experimenters to study the elevated radial situation. Perhaps a compromise can be found that produces good results with a minimum number of low radials.

A ground-plane dipole combination

The concept of using only two radials for a ground-plane antenna leads to the idea of a remote switch-

does the hornet fly before it's killed in the collision?

Send me your answer to this problem. My address is Box 7508, Menlo Park, California 94025. The calls of the math buffs who provide the most persuasive solution to this puzzle will be given in this column.

References

1. Christman, et al, "Vertical Monopoles With Elevated Ground Systems," Proceedings of the Third Annual Review of Progress in Applied Computational Electromagnetics, Naval Postgraduate School, Monterey, California, March 1987.
2. Arch Doty, "Antenna Efficiency. Is a Ground the Best Ground?" Bulletin, Radio Club of America, November 1982.
3. Doty, Frey, and Mills, "Efficient Ground Systems for Vertical Antennas," QST, February 1983, page 20-25.

Article D

HAM RADIO



HAM PERFECT v 1.0

Action Software has released HAM PERFECT a new MS-DOS program for the Radio Amateur. The program will operate on all MS-DOS computers using DOS 2.1 or later and 256 K of internal RAM. HAM PERFECT is menu driven and includes the following antenna design programs: long wire, vertical, inverted V, tuned transmission lines, electrical length of harmonic wire, and dipole antennas.

A VSWR menu for system evaluation and three DX programs — call area, grid selection, and bearing and distance — is also included. Call area instantly locates any call area, city, or state out of a data base containing 476 records. Displayed are: distance and bearing, sunrise and sunset times, and grid coordinates. Grid selection converts grid to coordinates and vice versa. Bearing and distance gives great circle calculations between any two points on the surface of the earth.

HAM PERFECT sells for \$49.00 and is available from Action Software, P.O. Box 12519, Tucson, Arizona 85718.

Circle #309 on Reader Service Card.

CODEMASTER© Morse code software package

Greenlight Software Development announces CODEMASTER© — their new Morse code software package. The program is IBM compatible and designed for users, from novice to master.

Key features include:

- Menu-driven program for easy selection and use of all facilities.
- One-touch online help function.
- Windowed operating environment for simple maneuvering.
- Escape key for interruption and backtracking.

CODEMASTER© is \$19.95 postpaid and available exclusively from Greenlight Software Development, P.O. Box 2591, Eugene, Oregon 97402.

Circle #310 on Reader Service Card.

New added feature card PK-8 for the CS64S Super Comshack 64

Engineering Consulting's model PK-8 adds new features to the Model CS64S Super Com Shack repeater controller for the C-64. The PK-8 option card makes user-defined talking meters possible. Up to 2 meters per parameter file may be defined (up to 18). Inputs are provided for

talking S-meters, temperature, and battery voltage; any other varying voltages can also be sampled and spoken to the user. The PK8 increases to 16 the total number of external devices which may be activated from your touchtone commands. Two alarm inputs allow real-time Macro commands or may be used to execute alarm messages, whenever these alarm pins are grounded.

The model PK-8 is priced at \$149.95. For more information contact Engineering Consulting, 583 Candlewood Street, Brea, California 92621.

Kantronics KT series and 2.84 firmware option

Kantronics, Inc. has introduced SSB, CW transceivers. There is one each for 80, 40, 20, 15 and 10 meters.

The Kantronics KT series features are noise blanker, 20-watts PEP output, LED digital readout of the entire band in 100 Hertz steps, and receiver incremental tuning (RIT).

Kantronics has also announced a 2.84 firmware option for KAM, KPC-4, KPC-1, KPC-2, and KPC-2400 units:

- Battery Backup for PBBS contents (B.B. "smart socket," and 32K RAM 62256 are extra).
- Protection of PBBS contents during soft reset (changing MAXUsers or NUMnodes will not erase PBBS, battery backup not required).
- Direct keyboard entry of messages into PBBS (limited only by RAM allocation to PBBS).
- PBS subject field (user is prompted for a subject for message).
- Help available from PBBS and KA-Node (gives short description of how to use).
- Enhanced (J)Heard and (N)odes Heard.
- KA-Node recognition of NETROM™ network nodes in its Nodes Heard list.

All Kantronics customers who purchased a Kantronics TNC after March 1, 1988, are entitled to a free 2.84 EPROM. You must provide proof of purchase and request 2.84 when you mail in your warranty card. Be sure to provide the model, firmware level, and RAM part number. If battery backup of RAM is desired, the Battery Backup "Smart Socket" *must be used with a 62256 static RAM!* We strongly suggest using a 32K RAM even if you don't plan to use the battery backup. Both of these are available at extra cost from the factory.

Cost varies from unit to unit, and with the current version level of each.

Contact Kantronics, Inc., 1202 E. 23rd Street, Lawrence, Kansas 66046 for details.

Circle #311 on Reader Service Card.

Dressler ara 900 VHF/UHF receiving antenna

The Dressler ara 900 is a VHF/UHF active receiving antenna capable of capturing signals from 50 to 900 MHz. The ara 900 cylinder has an etched circuit board, wideband amplifier, and

impedance-matching network. The antenna's linear characteristics give it excellent intermodulation performance, negative feedback, and a low noise figure. Dimensions are 19-3/4" x 3-5/8" diameter; it can be mounted indoors or

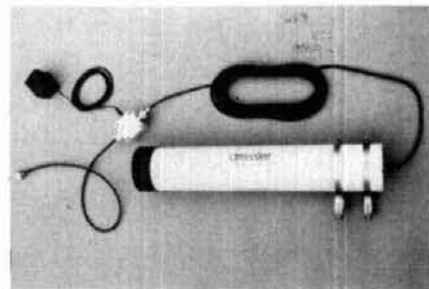

out. The supplied lead-in coax is 25' long and can be replaced by any length coax with PL-259 fittings up to 100'. The coupler terminates in an N-type connector fitting scanners like the Icom R-7000 receiver. Price including power adapter is \$189 plus \$8 shipping and handling. It is distributed by Gilfer Shortwave, 52 Park Avenue, Park Ridge, New Jersey 07656.

Circle #312 on Reader Service Card.

Hamtronics® 900 MHz transmitters

Hamtronics, Inc. has announced a series of transmitters for the 902-928 MHz ham band which complement the R901 FM Receiver.

The new TA901 Exciter runs a minimum of 1/2 watt output, sufficient to run barefoot on short to medium length paths or to drive the new LPA901 Power Amplifier. The TA901 is basically a modified version of the TA451 UHF FM Exciter but a doubler, driver, output stage line-up using surface mount microwave transistors and capacitors replace the usual predriver, driver, and output stages.

The LPA901 Power Amplifier uses a standard heatsink (as on the LPA 2-15 Power Amplifier for the vhf bands) and a broadband power module, which requires no tuning, to produce 8 to 10 watts output. It requires only 100 mW to drive from the exciter.

The TA901 Exciter and LPA901 Power Amplifier are both available off the shelf at \$269 each, wired and tested. (Because of their complexity, these units will not be offered in kit form.) A 902-MHz version of the popular Hamtronics® REP-100 Repeater is also available.

For more information on 900-MHz transmitters, contact Hamtronics, Inc., 65 Moul Road, Hilton, New York 14468-9535. A catalog of other fm transmitters, receivers, repeaters, converters, and preamps for vhf and uhf is available. Send \$1.00 to cover postage or \$2.00 for overseas mailing.

(continued on page 42)



(continued from page 41)



New SSB, CW transceivers

Kantronics, Inc. has introduced five single sideband, CW transceivers. One each for: 80, 40, 20, 15, and 10.

The Kantronics KT series transceiver features 20-watts PEP output, LED digital readout of the entire band in 100-Hz steps and receiver incremental tuning (RIT). Ask your Kantronics Authorized Dealer for information or contact Kantronics, Inc., 1202 E. 23rd Street, Lawrence, Kansas 66046.

Circle #301 on Reader Service Card.

EX-627 hf automatic antenna selector

ICOM now offers the EX-627 HF Automatic Antenna Selector which automatically selects the correct antenna for an ICOM hf transceiver's operating frequency. You can access up to seven antennas by simply pushing one button on the selector.

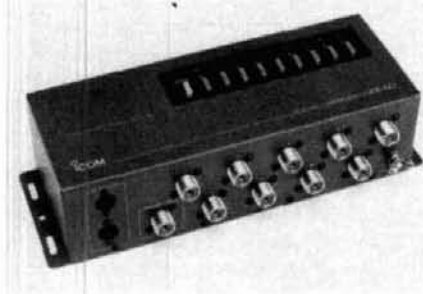

The EX-627 antenna selector:

- can be used with any transceiver to manually select up to nine antennas,
- includes connectors for a linear amplifier or antenna tuner,
- has power supplied from the transceiver through a provided accessory cable,
- comes with hardware to mount the EX-627 on the wall, the side of a desk, etc.

The suggested retail price for the EX-627 is \$315.00. For more information contact ICOM America, Inc., 2380 116th Avenue, NE/P.O. Box C-90029, Bellevue, Washington 98009-9029.

Circle #303 on Reader Service Card.

Alinco Electronics Inc.

introduces a new line of transceivers, the DJ series hand helds.

Features include:

- Ten memories.
- LCD illumination.
- Dip switch programmable sub-tones. Easily accessible dip switch is mounted on the back of the transceiver.
- Offset storage in memories.
- Built-in dc/dc converter with standard NiCd and others.
- Multiple battery packs. 2.5 watts from the factory; 6.5 watts output with optional 12 volt NiCd.



- Sixteen button DTMF pad.
- BNC antenna connection.
- Frequency coverage easily expandable for CAP and MARS.

The suggested list price of the DJ series transceivers is \$299.00.

For more information contact Alinco Electronics Inc., 20705 South Western Avenue, Suite 104, Torrance, California 90501.

Circle #302 on Reader Service Card.

Accu-weather forecaster

Metacomet Software in collaboration with Accu-Weather Inc., State College, Pennsylvania, has just announced release of its ACCU-WEATHER FORECASTER software for MS-DOS computers.

ACCU-WEATHER FORECASTER is a menu driven program that allows the user to tap into

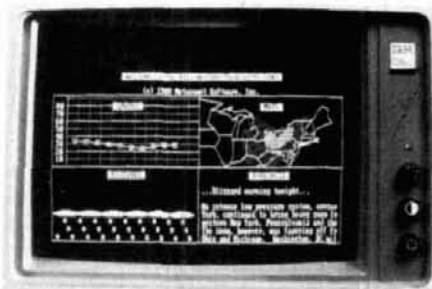

Accu-Weather's extensive computerized database. In addition to Accu-Weather's forecasts, you can get hourly updates from National Weather Service Offices nationwide.

Maps, graphs, pictures, charts, and narrative descriptions are just part of what can be downloaded to your MS-DOS computer. To save telephone and hook-up charges, tell your computer exactly what information you want. Then call ACCU-WEATHER; the computer will download the files you want and save them to disk. Information can be obtained for the entire United States or a specific geographical region.

Several different services are available from ACCU-WEATHER. Price varies with the service and time of day that the computer is accessed.

The IBM and Macintosh versions sell for \$89.95. ACCU-WEATHER is available from Metacomet Software, P.O. Box 31337, Hartford, Connecticut 06103 or the ham radio Bookstore. Add \$3.50 for shipping and handling.

Circle #304 on Reader Service Card.

144/220-MHz FM dual bander

Kenwood's all new 144/220-MHz FM Dual Bander TM-621A includes a dual channel watch function, selectable full duplex operation, 30 memory channels, extended frequency coverage, large multi-color dual digital LCD displays, and programmable scanning, with 45 watts of output on 144 MHz and 25 watts on 220 MHz.

- Extended receiver range (138.000-173.995 MHz) on 2 meters; 1-1/4 meter coverage is 215-229.995 MHz. (Specifications guaranteed on Amateur bands only. Transmit range is 144-147.995 MHz; and 220-224.995 MHz. Modifiable for MARS/CAP. Permits required.)

- 30 multi-function memory channels. 14 memory channels and one call channel for each band store frequency, repeater offset, CTCSS, and reverse. Channels "A" and "b" establish lower and upper limits for programmable band scan. Channels "C" and "d" store transmit and receive frequencies independently for "odd splits."

- Automatic offset selection on both bands.
- Dual frequency display for "main" and "sub-band."
- Automatic Band Change (A,B,C) automatically changes between main and sub-band when a signal is present.

(continued on page 102)

NEW BOOKS

ARRL ANTENNA BOOK

by Jerry Hall, K1TD, NEW 15th Edition

The all new 15th edition of this antenna classic represents over two years of hard work by editor K1TD. It's doubled in size too --from over 300 to over 700 pages big! 950 figures and charts cover just about every subject imaginable. Some of the highlights are: Chapters on Loop antennas, multi-band antennas, low frequency antennas, portable antennas, VHF and UHF systems, coupling the antenna to the transmitter and the antenna, plus p-l-e-n-t-y more. Like the 1988 HANDBOOK and new OPERATING MANUAL, the new ANTENNA BOOK is going to be a smash hit. Order yours today. 15th edition 900+ pages ©1988

AR-AM

Softbound \$17.95

NOVICE ANTENNA NOTEBOOK

by Doug DeMaw W1FB

Novices have long wondered what is the best all around antenna for them to install. Up until now, this was a difficult question to answer. Aimed at the newly licensed Ham, DeMaw writes for the non-engineer in clear concise language with emphasis on easy-to-build antennas. Readers will learn how antennas operate and what governs performance. Also great reading for all levels of Amateur interest. 1st Edition ©1988.

AR-NAN

Softbound \$7.95

THE 1989 ARRL HANDBOOK

FOR THE RADIO AMATEUR (Avail. late Oct. 1988)

Revised and updated with the latest in Amateur technology, now is the time to order your very own copy of the world famous ARRL HANDBOOK. In addition to being the definitive reference volume for your Ham shack, there are plenty of projects for every interest in Amateur Radio — from antennas for every application to the latest state-of-the-art projects — you'll find it all in the 1989 HANDBOOK. Order now and we will ship as soon as the books arrive from the printer. They make perfect gifts for the holiday season for your hard-to-buy for Ham friends or for yourself. Over 1100 pages ©1988.

□AR-H889

Hardbound \$20.95

N6RJ's ELECTRONIC SECOND OP

for MS-DOS computers

by Jim Rafferty N6RJ

The world famous SECOND OP is now available in a state-of-the-art computerized data base. This program, written for MS-DOS computers, is a must for DX'ers, contesters and all Amateurs interested in reliable DX communication. Data can be displayed either in columnar format or in full screen displays. Unknown callsigns can be entered and compared to the ITU callsign allocation for easy identification. There's plenty more too such as: postal rates, beam headings and QSL bureaus to name just a few. Great program to have in your shack. Order yours today.

©1988 MS-DOS computers. 5¼ and 3½ versions available. Please specify on your order.

□CB-RJ (MS-DOS Computers)

\$59.95

1989 AMATEUR CALLBOOKS

(Available late November 1988)

NORTH AMERICAN EDITION

Fully updated and edited to include all the latest FCC and foreign government callsigns and addresses for Hams in North America. Includes plenty of handy operating aids such as time charts, QSL bureau addresses, census information and much more. Calls from Northern Canada to tropical Panama. Now is the time to buy a new Callbook when you'll get the most use out of your investment. ©1988

□CB-US89

Softbound \$25.95

INTERNATIONAL EDITION

QSL's are a very important part of our hobby. All sorts of awards, including the coveted DXCC, require confirmation of contact before the award can be issued. Of special interest, addresses are being added daily for Hams in the USSR and other countries. While in no means complete, it's a start and will be of tremendous help in getting QSLs. Handy operating aids round out this super book value. ©1988

□CB-F89

Softbound \$28.95

BUY 'EM BOTH SPECIAL
Reg. \$54.90 Only \$49.95
SAVE \$4.95

Please enclose \$3.50 shipping & handling.

NEW BOOKS

PASSPORT TO WORLDBAND RADIO 1989 Edition

Brand new and fully revised, SWL's everywhere will want a copy for their library. Expanded to 416 pages, the book now includes a bigger and better buyer's guide, an interview with James Michener, an exciting real life drama of one SWL's escape from Iran plus much more. Also includes all the latest broadcast schedules from countries around the world. You're up-to-date if you have a copy of this new book by your radio. 416 pages 1989 Edition ©1988

IBS-RD189

Softbound \$14.95

MASTERING PACKET RADIO: the hands on guide

by Dave Ingram K4TWJ

Packet radio continues to grow at a rate that boggles the mind. This new book appeals to all levels of packet radio enthusiasts from novices to experts alike. Full of illustrations and written in a simple, easy-to-understand style. Topics covered include: a basic primer, home computers and data communications terminals, a survey of equipment available, how to set up a station plus much more. Great compliment to the other packet books available. 208 pages ©1988 1st edition

22567

Softbound \$12.95

THE ARRL SATELLITE ANTHOLOGY

Taken from the pages of the "Amateur Satellite News" column in QST. Includes the latest information available on OCSARs 9 through 13 as well as the Russian RS satellites. Full coverage is given to Phase III, OSCAR 10 and 13 satellites. Also includes an unpublished article detailing UoSAT-OSCAR 11 operation. Digital modes, tracking, antennas, RUDAK, microcomputer processing of telemetry plus much more is contained in this valuable new volume. 112 pages ©1988

AR-SA

Softbound \$4.95

22nd CENTRAL STATES VHF SOCIETY CONFERENCE PAPERS

Papers in this book were submitted for the 1988 Central States VHF Society meeting. Includes: Microwave EME, predicting 144 MHz "Es" openings, matching versus noise figure trade-offs in pre-amps, 902 MHz transverter, power amplifier and antennas, how to measure your own K index plus much more. A must publication for the active VHF'er. ©1988

AR-22CS

Softbound \$11.95

GENIUS AT RIVERHEAD a profile of

H.H. Beverage

by Alberta Wallen

Born at the very beginning of the radio age, Harold Beverage is one of radio's pioneers. Most know him from his development of the Beverage or wave type receiving antenna. Learn about the career of this brilliant engineer in this easy-to-read biography. Starting with GE in 1917 and moving to RCA in 1920, Beverage was involved in some of the most exciting aspects of radio. Of particular interest is a reprint of the famous November 1922 QST article describing the wave antenna. Includes 35 photos. 130 pages ©1988

NH-BEV

Hardbound \$15.95

THE "GROUNDS" FOR LIGHTNING & EMP PROTECTION

by Roger Block, PolyPhaser Corporation

Here's a subject that has never really been fully covered in Amateur literature. This 116 page text contains a comprehensive analysis of proper grounding and protection against lightning and other EMP disasters. Includes information for all kinds of electronic gear: radios, telephones, computers, Ethernet, CATV, TVRO, and security systems to name just a few. Of special interest to Hams are chapters on low inductance grounds and connections, guy anchor grounding, and how to ground inside the shack. Every Ham should have a copy. 1st edition 116 pages ©1987

PP-GLEP

Softbound \$19.95

Please enclose \$3.50 shipping & handling.



**HAM
RADIO** (603) 878-1441
GREENVILLE, N.H. 03048

DATATEL 800™

(800) 341-1522

(ORDERS ONLY)

GREAT HF PACKET DESERVES A GOOD MODEM



ST-7000 HF PACKET MODEM

The verdict is in and the opinion of HF Packet operators is clear . . . the HAL ST-7000 is a winner!

The HF Packet communications world is not forgiving. Selective fading, noise, and interference coupled with poor tuning indicators and simplistic phone line modems contribute to the poor performance of packet controllers on HF.

The ST-7000 makes HF Packet Work

The ST-7000 is designed specifically to greatly improve the 300 baud HF Packet performance of all packet and multi-mode controllers. Techniques developed for our government and military ST-8000 (MD-1232/G) HF modem are applied to the special problems of HF Packet radio. It's simple . . . just connect the ST-7000 to your existing packet or multi-mode controller . . . and you're ready to send data, **not** repeats.

The "standard" 200 Hz shift mode of the ST-7000 has a 6-pole input bandpass filter, an optimized detector circuit, plus a 40 db AGC system. These design features make 200 Hz HF Packet work!

The ST-7000 also includes a 600 HZ shift mode for even better performance than is offered by the 200 HZ "standard" shift mode.

Other features of the ST-7000 include:

- A new tuning indicator design assures quick and accurate tuning of HF Packet signals
- CD (carrier detect) and threshold level circuits designed specifically for 300 baud HF Packet
- A sine-wave synthesized transmit tone generator assures minimum phase distortion and splatter
- Easily interfaces with all packet and multi-mode controllers via RS-232C, TTL, or TNC VHF audio tones

Best of all, the ST-7000 is manufactured and tested entirely in the United States by HAL Communications, a company you've known and trusted for years.

The ST-7000 is available directly from the factory at a price of \$299.00, which includes a 12VDC, 0.25A power supply.

WRITE OR, BETTER YET, CALL TODAY TO ORDER YOUR HAL ST-7000.



HAL COMMUNICATIONS CORP.
P.O. BOX 365 1201 W. KENYON ROAD
URBANA, ILLINOIS 61801-0365
PHONE: (217) 367-7373
FAX: (217) 367-1701



CALL US NOW!

In 1937, Stan Burghardt (WØIT), because of his intense interest in amateur radio, began selling and servicing amateur radio equipment in conjunction with his radio parts business. We stand proud of this long-lasting tradition of *Honest Dealing, Quality Products and Dependable "S-E-R-V-I-C-E"!*

Above all, we fully intend to carry on this proud tradition with even more new product lines plus the same "fair" treatment you've come to rely on. Our reconditioned equipment is of the finest quality with **30, 60** and even **90-day** parts and labor warranties on selected pieces. *And always remember:*

— WE SERVICE WHAT WE SELL —

AEA	Belden	Icom	Nye
Alinco	Bencher	Jerold/Delhi	Palomar
Ameritron	Bird	Kantronics	Radio Callbook
Amphenol	Butternut	KDK/Encomm	Rohn
Amp Supply	Centurion	KLM	Telex/Hygain
Antenna Specialists	CES	Larsen	Ten-Tec
	Cushcraft	MFJ	Trio-Kenwood
Astron	Daiwa	Mirage	Unadilla/Reyco
B & W	Hustler	Moseley	Yaesu

Write today for our latest Bulletin/Used Equipment List.

YOUR HAM DOLLAR GOES FURTHER AT...

CALL OR WRITE FOR SPECIAL QUOTE

When it comes to **FAST DELIVERY, HONEST DEALING** and **PROMPT/DEPENDABLE S-E-R-V-I-C-E** back-up. We don't just advertise it — **WE GIVE IT!**

we'll treat you

SELECTION
SERVICE
and
SATISFACTION!

STORE HOURS:
9-5 P.M. (CST)
MONDAY thru FRIDAY
OPEN SATURDAYS
from 9-1 P.M. (CST)
CLOSED
SUNDAYS/HOLIDAYS



182 N. Maple
P.O. Box 73
Watertown, SD 57201



"AMERICA'S MOST RELIABLE AMATEUR RADIO DEALER"

SELL-TRADE

New & Reconditioned HAM EQUIPMENT

Call or Write Us Today For a Quote!
You'll Find Us to be Courteous, Knowledgeable and Honest

PHONE (605) 886-7314

FAX (605) 886-3444



Get the most of HF Mobiling

Yaesu FT-747GX

SPECIAL OFFER!

CALL TODAY FOR SPECIAL QUOTE

NOVEX

DM4061 Dip Meter *every ham needs one*



A must for every ham shack - check coils, tank circuits, antennas, use as RF generator, internal modulation, look for harmonics. 1.5 - 250 MHz 6 plug-in coils.
only \$79.95 + \$4 S&H

SWR-3P SWR/Power/Field Strength



- Measures output/SWR, while on the air
- 10 & 100 watt scales
- 1.7 to 150 MHz
- SO 239 connectors
- 5' whip antenna

only \$19.95 + \$4 S&H

PM330 RF Power Meter/Dummy Load

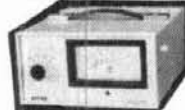

- 1.8 to 500 MHz
- 50 ohms "N"
- 5/20/120 watt ranges
- measures your HF & HT power output

only \$99.95 + \$4 S&H

FC5250 Counter *know your transmit frequency*

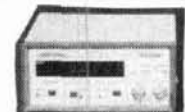

- 10 Hz to 150 MHz
- 7 digits
- Accurate to ±1 count
- Gate times 1 or 5 sec.
- HF & VHF inputs
- Excellent for audio
- AC power adapter PA9P included

only \$129.95 + \$4 S&H

Orders: 800-368-3270 Local & tech info: 703-938-3550

EEB Electronic Equipment Bank
516H Mill St. NE, Vienna, VA 22180
(just minutes from Washington, DC)

New Scanner by AOR

100 Channels 800 MHz



- Includes antenna, rechargeable battery, charger/adaptor & belt clip. Full range of optional accessories available.
- Covers 27-54 MHz, 108-174 MHz, 406-512 MHz, and 800-950 MHz
- 5 Scan Banks and 5 Search Banks.
- 25 Day Satisfaction Guarantee, Full Refund if not Satisfied.
- No Frequencies cut out.
- Size: 2" x 5 1/4" x 1 1/2" wt: 12 oz.

AR900
Total Price, Freight Prepaid
(Express Shipping Optional)
\$299.00



10707 E. 106th St. Indpls., IN 46256

Toll Free 800-445-7717

Visa and MasterCard (COD slightly higher)

In Indiana 317-849-2570 Collect FAX (317) 849-8794

MOVING? KEEP HAM RADIO COMING...

If possible let us know four to six weeks before you move and we will make sure your HAM RADIO Magazine arrives on schedule. Just remove the mailing label from this magazine and affix below. Then complete your new address (or any other corrections) in the space provided and we'll take care of the rest.

ham radio
Magazine

Allow 4-6 weeks for correction.

Greenville, NH 03048

Thanks for helping us to serve you better.

Here's my new address:

Name _____
Address _____
City _____ State _____ Zip _____

AFFIX LABEL HERE

PATHFINDER

PART TWO

By Ron Todd, K3FR, 7 Hillcrest Road, Windham, Maine 04062

Add output option menu
and file access functions
for complete operating aid

When I originally defined PATHFINDER¹ I wanted a program that would bring together three major utilities regularly used to map hf operating activities: MINIMUF², bearing/distance, and grey-line summary. Part 1 showed how these three seemingly different functions all rely on the same basic set of mathematical routines, and presented the core program of PATHFINDER. If you've read part 1, you know that PATHFINDER is a menu-driven program that reports bearing and distance, home and target terminator events, MUF for short and long path to the target specified, and the radial MUF for a given time and path length. Conditions may be changed and analysis selected at will to provide a general view of propagation modes and conditions. However, PATHFINDER is cumbersome to use because coordinates must be entered manually.

The *ARRL Antenna Handbook* is a handy reference for your target coordinates.³ At the back of the book is a listing of DXCC countries with their geographic coordinates. But, when using a reference table of location coordinates, there's still the chance that you might enter a coordinate incorrectly and waste time rerunning a simulation. There are two other features PATHFINDER might provide once you've established a latitude/longitude data file. These are a global summary report of grey-line conditions from your home location to any location in the data file which has terminator concurrency, and a summary listing of bearing and distance from the home QTH to all locations in the data file.

This month I'll give you a program to generate a data file of prefix, location name, and geographic coordinates. I'll also include the appropriate code to insert

into PATHFINDER to allow either case specific or global access to this data file. The case specific feature eliminates the need to maintain a desk reference when using PATHFINDER in a point-to-point mode. Global access lets PATHFINDER generate the world bearing and distance report, or report all QTHs on or near your grey line. I've added an expanded hard copy function which is accessed through a second menu level when you want printer output. The menu provides selection of either a chart or tabular format report of the latest MUF run, or a listing of the current conditions and locations defined.

Getting more out of PATHFINDER

The charting feature of the expanded hard copy function is, like the current list feature, built around the array MOUT which is loaded during each analysis run. The current list option of the top level menu sent the data in this array to your printer. The charting option does the same, but presents the MUF data in a simple graphic form by tabbing your printer to a specific column. In the MOUT (36) array the index is equivalent to the independent variable of the analysis, while the array content is the analysis result for each increment of the independent variable. Choose the hard copy report function after each MUF run to get your report. The tabular report is still presented on screen as the analysis is running, so you can choose to output the report or run further analyses until you have one you want to keep.

Those of you using the hard copy function have noted that the conditions under which the MUF is reported aren't listed to the printer. A third option is added to the new hard copy second level menu to allow printout of this information. With only the output enhancements added, the new top level menu looks like:

Opt: 1 = Input 2 = Anal 3 = Output 4 = Quit

and the output function select menu shows the selections available:

Opt: 0 = Top 1 = Table 2 = Chart 3 = Data

Figure 1 gives the steps and lines required to add these features to your copy of PATHFINDER, along with

Alpha Delta Transi-Trap® Surge Protectors

A proven record of effective lightning, EMP and static protection for your valuable communications equipment.

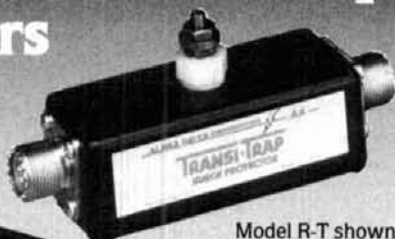

Model R-T shown

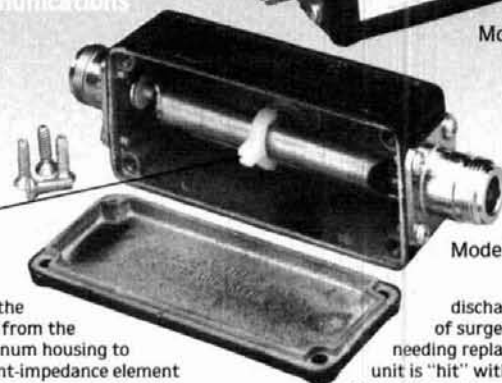

Model R-T/N shown

Special shock absorber

- **Quality.** Built of the finest materials, from the heavy cast aluminum housing to the brass constant-impedance element and marine grade brass ground hardware. Only Amphenol connectors are used (instead of cheaper off-shore connectors found in other brands) for best frequency range and VSWR performance. The ceramic gas tube Arc-Plug® cartridge is protected by a unique custom-designed nylon shock absorber for best mechanical shock and vibration protection.
- **Reliability.** Original Transi-Trap units are still in daily use after providing years of continuous protection — from mountain top communications sites to ocean-going ships' radio rooms. The Arc-Plug cartridge

discharges thousands of surges without needing replacement. If a unit is "hit" with a charge beyond its rating, it is designed to fail "short", giving an instant indication that replacement is needed. Other brands fail "open", leaving your equipment unprotected without you even knowing it.

- **Performance.** Standard "off-the-shelf" Transi-Trap units are used by every branch of the U.S. Military, many government agencies and several Western European countries. The Alpha Delta design is based on the U.S. NCS TIB85-10 Bulletin covering lightning and EMP protection for communications equipment.

Transi-Trap Protectors are designed for 50 ohms, include a replaceable Arc-Plug cartridge and have UHF connectors (also available with N-type connectors for use through 1 GHz). The low power models are most sensitive, best for RCVRs and XCVRS.

- MODEL R-T, 200 W through 500 MHz \$32.95
- MODEL HV, 2 kW through 500 MHz \$35.95
- MODEL LT, "T-type", 200 W through 30 MHz \$22.95

At your Alpha Delta dealer. Or order direct in U.S.: add \$3 for postage and handling. MasterCard and VISA accepted. Ohio residents add Sales Tax.

See Data Sheet for surge limitations.



ALPHA DELTA COMMUNICATIONS, INC.



P.O. Box 571, Centerville, Ohio 45459 • (513) 435-4772

current solutions to current problems

ATV CONVERTERS • HF LINEAR AMPLIFIERS

DISCOVER THE WORLD OF FAST SCAN TELEVISION

70 CM
33 CM

AMATEUR TELEVISION CONVERTERS

- ATV2 420-450 \$44.95 Kit
- ATV3 420-450 (GaAs-FET) \$49.95 Kit
- ATV4 902-928 (GaAs-FET) \$59.95 Kit

AUDIO SQUELCH CONTROL for ATV

- SIL \$39.95 Kit

2 METER VHF AMPLIFIERS

- 35 Watt Model 335A \$79.95 Kit
- 75 Watt Model 875A \$119.95 Kit

Available in kit or wired and tested

HF AMPLIFIERS per MOTOROLA BULLETINS

Complete Parts List for HF Amplifiers Described in the MOTOROLA Bulletins

AN758 300W	\$160.70	EB63 140W	\$88.65
AN762 140W	\$93.25	EB77A 300W	\$139.20
AN779 20W	\$83.79	EB104 600W	\$448.15

NEW!! 300 WATT 10-150 MHz Amplifier

POWER SPLITTERS and COMBINERS
(2-30MHz)

600 Watt 2-Port	\$59.95
1200 Watt 4-Port	\$69.95

100W 420-450 MHz PUSH-PULL LINEAR AMPLIFIER - 88-FM-ATV

KEB67-PK (Kit)	\$129.95
KEB67-PCB (PC Board)	\$18.00
KEB67-1 (Manual)	\$5.00

For detailed information and prices, call or write for our free catalog.

Ferroxcube Devices

VK200-20/4B RF Choke	\$1.20
56-590-65-3B Ferrite Bead	\$1.20

HEAT SINK MATERIAL

Model 99 Heat Sink (6.5x12x1.6)	\$22.00
CHS-6 Copper Spreader (6x6x1/4)	\$18.00

Add \$2.00 additional shipping

We also stock Hard-to-Find parts

CHIP CAPACITORS	
METALCLAD MICA CAPACITORS	
RF POWER TRANSISTORS	
MRF141G	\$209.20
MRF151G	\$186.80
MINI-CIRCUIT MIXERS	
SBL-1	\$6.50
SBL-1X	\$7.95
ARCO TRIMMER CAPACITORS	

Add \$2.00 for shipping and handling.



CCI Communication Concepts Inc.
121 Brown Street • Dayton, Ohio 45402 • (513) 220-9677



130



new

LOW BAND DX'ING COMPUTER PROGRAMS

by John Devoldere, ON4UN, for Apple IIe/c, MS-DOS, Commodore C-128 Apple Macintosh and Kaypro CPM Computers

Here's a collection of 30 super programs written by ON4UN. Just about every interest or need is covered—from antenna design and optimization to general operating programs. Antenna programs include: shunt and series input L network design, feedline transformer, shunt network design, SWR calculation, plus 11 more! General Ham programs include: sunrise/sunset, great circle distances, grayline, vertical antenna design program, sunrise calendar plus 9 more! Phew. When you sit down to use these programs you'll be amazed at what you have. The best value in computer software available today. © 1986.

- UN-Apple IIe/IIC \$39.95 ea.
- UN-MS (MS-DOS) \$39.95 ea.
- UN-CPM/Kaypro \$39.95 ea.
- UN-C-128 (COMMODORE) \$39.95 ea.
- UN-MAC (MACINTOSH) \$49.95

LOW BAND DX'ING

by John Devoldere ON4UN

Now Available! The new, 2nd edition of the definitive book on Low Band DX'ing. Based upon years of practical on-the-air experience, learn the secrets of how ON4UN has been so successful on the low bands. Extensive coverage is given to transmit and receive antennas with clear concise explanations and plenty of illustrations—dipoles, inverted V's, slopers, phased arrays and Beverages—they're all in this book. Also covered: propagation, transmitters, receivers, operating, software and an extensive Low Band bibliography. Going to be a best seller! Get yours today. © 1987 2nd Edition 200 pages

- AR-UN Softbound \$9.95

BUY'EM BOTH SPECIAL OFFER

Book & Software Reg. \$49.90
(\$59.90 for Mac)

Just \$44.90 (\$54.90 for Mac)

- UN-SO (specify computer) \$44.90
- UN-MSO Macintosh Special \$54.90

SAVE \$5

Please enclose \$3.50 shipping & handling

ham radio BOOKSTORE

GREENVILLE, NH 03048 603-878-1441

FIGURE 1

```

Modifications to PATHFINDER to add chart and data output to
line printer routines.

Replace line 200 with:
200 INPUT "Opt: 1-Input 2-Anal 3-Output 4-Quit ";IO

Replace lines 290 thru 320 with:
290 INPUT "Opt: 0-Top 1-Table 2-Chart 3-Data";IO
300 ON IO GOSUB 310,350,390: GOTO 200
310 LPRINT "GMT/DEG","MUF","GMT/DEG","MUF"
320 FOR IH=0 TO I-1: FOR IB=0 TO I STEP 1

Add new lines 330 thru 450.
330 LPRINT (IH+IB)*IA,MOUT(IH+IB),
340 NEXT IB: LPRINT: NEXT IH: RETURN
350 FOR IH=0 TO 2*I-1
360 LPRINT (IH*IA);TAB(6+INT(MOUT(IH)));"": NEXT IH
370 LPRINT " | 10 | 20 | 30 | 40 | 50"
380 LPRINT: RETURN
390 LPRINT "Path length =";INT(G1*3959);"miles"
400 LPRINT "Path bearing at home OTH =";INT(PB*PI)
410 LPRINT "DATE: "MID$MS,3+MO-2,3) " DG
420 LPRINT "HOME AT LAT"LT"LONG"WH" TARGET AT LAT"LT"LONG"MT
430 LPRINT "SOLAR FLUX="SX" SUN SPOT NUMBER="S9
440 IF IL=2 THEN LPRINT "TIME: ";INT(40+INT(T5)+60*T5)/100;"Z"
450 RETURN

```

Modifications to PATHFINDER to add chart and data output to line printer routines.

the changes and additions needed to add the expanded hard copy functions to the program. The scope and nature of these changes have been limited to add, delete, and replace functions. If you use a word processor, note that some of these and the later changes amount to no more than renumbering and moving some lines so that they occur in a revised sequence. This can save you some time in implementing these enhancements. If you don't use your word processor for this task, input new lines to your BASIC rather than using its RENUM command. The RENUM command will renumber all lines beyond the first target number and cause all sorts of headaches when you implement the rest of the features.

At this point you can choose either a tabular or a chart format printer listing of MUF. You can also obtain a list of the current input data so that you won't have to annotate your listings in order to remember what the output is telling you. I assume you all have fat fingers like me and would benefit from some debugging; it would be a good idea to practice the new PATHFINDER features before continuing on to the data file access features.

Blazing speed

The grey-line daylight characterization routine in PATHFINDER wasn't optimized in the original version. This makes little difference when you're doing individual specific grey-line evaluations, but will slow down the grey-line summary when it's added. Figure 2 shows modifications that create a separate subroutine to compute the solar events and merge this routine into the one needed to determine the solar driven parameters for MUF computations. Again, the changes may be done with your word processor working on an ASCII version of the program.

Data makes THE difference

PATHFINDER's prime limitation in its original form

FIGURE 2

```

Modifications to PATHFINDER to accelerate GREY-LINE computations
Change lines 1300 and 1310 to:
1300 W0=W1: L0=L1: GOSUB 5100: PRINT "At home QTH": GOSUB 7000
1310 GOSUB 8420: W0=W2: L0=L2: GOSUB 5100: PRINT "At targ QTH"

Replace lines 5000 thru 5040 with:
5000 GOSUB 5100: IF C0(I)<=86 THEN 5040 'SOLAR CHAR
5010 IF C0(I)<=2004 THEN T9(I)=1: ELSE T9(I)=9.7*C0(I)^.6
5020 X=R9(I)/T9(I): SW(I)=PI/X: G8(I)=C0A/(1+SW(I)^2): GOSUB 6100
5030 X(I)=(EXP(-X)+1)*SW(I)+G8(I): G7(I)=EXP((R9(I)-24)/2)*SB(I)
5040 RETURN

Delete lines 5050 thru 5090.

Replace lines 5100 and 5110 lines with:
5100 R9(I)=0: X=10*X2: C0(I)=COS(X): C0A=COS(6*X/7) 'DAY CHAR
5110 IF C0(I)<=86 THEN 5170 ELSE R8=6*(2+W0*P2)-BT 'DAY CR

Add new lines 5120 thru 5170:
5120 IF R8<0 THEN R8=R8+24 ELSE IF R8>24 THEN R8=R8-24 'MOON
5130 BS=COS(V2)*COS(L0): IF X<.0001 THEN X=.0001
5140 X=(SIN(V2)+SIN(L0)-86)/X: GOSUB 6000: X=6*X*P2: K9(I)=2*X
5150 BR(I)=R8-X: IF BR(I)<0 THEN BR(I)=BR(I)+24 'SUNR
5160 SB(I)=R8*X: IF SB(I)>24 THEN SB(I)=SB(I)-24 'SUNB
5170 RETURN

```

Modifications to PATHFINDER to accelerate GREY-LINE computations.

FIGURE 3

```

Program to create or edit a sequential data file.
10 DEFINT I: 'PROGRAM GENDAT.BAS, RCT 4/11/88
20 INPUT "4-Delete 5-New 6-EXIT":IO
30 ON IO GOTO 10,200,300,400,500,1000: GOTO 20
100 GOSUB 700: IF NOT EOF(1) THEN PYS="": GOSUB 800 'ADD TO END
110 GOSUB 600: BS="": INPUT "<CR> to Continue, else Done";B5
120 IF LEN(B5)=0 THEN 110 ELSE 750
200 GOSUB 700: IF EOF(1) THEN 760 'EDIT RECORD
210 INPUT "EDIT PREFIX: ";PYS: GOSUB 900: IF EOF(1) THEN 760
400 GOSUB 700: IF EOF(1) THEN 760
220 GOSUB 600: BS="": INPUT "<CR> to Continue, else Done";B5
230 IF LEN(B5)=0 THEN 210 ELSE 750
300 GOSUB 700: IF EOF(1) THEN 760 'INSERT RECORD
310 INPUT "ADD AFTER PREFIX: ";PYS: GOSUB 900: IF EOF(1) THEN 760
320 WRITE #2,PXS,Q5,L2,W2
330 GOSUB 600: BS="": INPUT "<CR> to Continue, else Done";B5
340 IF LEN(B5)=0 THEN 330 ELSE 750
400 GOSUB 700: IF EOF(1) THEN 760 'DELETE RECORD
410 INPUT "DELETE PREFIX: ";PYS: GOSUB 900: IF EOF(1) THEN 760
420 BS="": INPUT "D to Delete, else Reject";B5
430 IF NOT (BS="D" OR BS="d") THEN WRITE #2,PXS,Q5,L2,W2
440 BS="": INPUT "<CR> to Continue, else Done";B5
450 IF LEN(B5)=0 THEN 410 ELSE 750
500 OPEN "O",#1,"LATLONG.DAT": CLOSE #1: GOTO 20 'CREATE NEW FILE
600 INPUT "File#,PXS: INPUT "QTH";Q5 'CAPTURE DATA
610 INPUT "Latitude ";L2: INPUT "Longitude ";W2
620 PRINT ".... PLEASE CHECK DATA ...."
630 BS="": INPUT "<CR> IF OK, R to Redo, else QUIT";B5
640 IF LEN(B5)=0 THEN WRITE #2,PXS,Q5,L2,W2: RETURN
650 IF (BS="R" OR BS="r") THEN 600 ELSE RETURN
700 OPEN "I",#1,"LATLONG.DAT" 'OPEN FILES
710 OPEN "O",#2,"TRAP.DAT": RETURN
750 PYS="": GOSUB 800 'COPY REST OF FILE AND CLOSE ALL
760 PRINT "END OF FILE": CLOSE #1: CLOSE #2: KILL "LATLONG.DAT"
770 NAME "TRAP.DAT" AS "LATLONG.DAT": GOTO 20
800 IF NOT EOF(1) THEN INPUT #1,PXS,Q5,L2,W2 ELSE RETURN 'REARCH
810 IF PXS<PYS THEN WRITE #2,PXS,Q5,L1,W2: GOTO 800 ELSE RETURN
900 GOSUB 800: IF EOF(1) THEN RETURN 'FIND RECORD
920 PRINT "Found: ";PXS;" Q5:";L2;" Lon=";W2
930 BS="": INPUT "<CR> IF OK, N for NEXT, else to QUIT";B5
940 IF LEN(B5)<0 THEN WRITE #2,PXS,Q5,L2,W2 ELSE RETURN
950 IF NOT (BS="N" OR BS="n") THEN PYS="":
960 GOTO 900
1000 BS="": I=0 'MAKE KEY FILE, EXIT
1010 OPEN "I",#1,"LATLONG.DAT": OPEN "O",#2,"LATLONG.KEY"
1020 IF EOF(1) THEN 1090 ELSE I=I+1: INPUT #1,PXS,Q5,L2,W2
1030 AS=LEFT$(PXS,I): IF AS=AS THEN 1020 ELSE BS=AS: J=I-1
1040 IF=ASC(BS)-65: IF IP>31 THEN IP=IP-32
1050 IF IP>25 THEN 1020
1060 IF (IP=15) AND (IP<=7) THEN IP=IP+43
1070 IF (IP=0) AND (IP<=36) THEN WRITE #2,IP,J
1080 GOTO 1020
1090 CLOSE #1: CLOSE #2: END

```

Program to create or edit a sequential data file.

was that you had to know the geographic coordinates of the target station. Many serious DXers keep a listing of bearing and distance information on their desks, or use some other operating aid to help point their antennas. Sometimes these indexes include the geographic coordinates at the location of interest; often they do not. Your computer gives you an excellent card box in which to keep this information. Next, I'll tell you how to get this information into PATHFINDER.

Your computer keeps its information in files on tape or disk. When you save program data to one of these

files, the operating system arranges and catalogs the data for you so that you can find it later. Generally there are two types of files used for this information storage: sequential and random. Sequential files can usually hold any type of information in any order, but data must be accessed in the same order as written from beginning to end. Random files can be accessed at will, but may contain only strings (character data) of fixed format. While random files allow quicker access to data stored deep in the file, more complex operations are usually required to get the data into and out of it. Additionally, some dialects of BASIC don't even implement random access files. I'll present only code to generate and access sequential files.

When generating your data file, you can choose from several sources of geographic coordinates to create the locations contained in that file. My own data file was taken from Overbeck and Steffen.⁴ In addition to the ARRL publication mentioned previously, a world atlas (like those published by the Rand McNally Company or Encyclopedia Britannica, Inc.) can provide a source for the data you need. Your local library should have one of these references.

The listing in **fig. 3** is the code for GENDAT.BAS. This program creates and edits a sequential file called LATLONG.DAT that will hold the data PATHFINDER needs to set a target QTH. At the end of the program, GENDAT reads the file just edited and creates a key listing file. This file tells PATHFINDER approximately where in the data file it can find the prefix you enter, based on the first character of that prefix. The program requires that both LATLONG.KEY and LATLONG.DAT be on the default disk. This must be the same disk you are using to run PATHFINDER and BASIC.

GENDAT prompts you for the information it needs to build the data file. At the end of each entry, you'll be asked to verify the information you have supplied before the data is written to disk. Take this step seriously; any error in the data will reflect on PATHFINDER's accuracy.

Select NEW (item 5) at the first menu prompt the first time you run GENDAT. This assures the program that it will find a file when it needs to. After that you can add to the end of the file, edit an entry, insert an entry in the middle, or delete an entry by making the appropriate menu selection and answering the prompts. You needn't finish the job in one session; that's why there are selections for all functions. If you already have a satisfactory LATLONG.DAT file in the specified format, just invoke GENDAT and then select QUIT (item 6) at the first menu prompt. This will generate the key file from your current data file without changing the data file.

You can use a word processor in the program-writing mode instead of GENDAT as long as you enter the data in the order of prefix, QTH name, latitude, and longitude. But you'll have to quote the string fields (prefix and QTH

name), separate each field with a comma, and terminate each line with a carriage return. GENDAT may not be as fast or as flexible as a word processor, but it does order and delimit the data for you. If you do use a word processor, make sure you build a small program to create the key file. The code for this is in lines 1000-1090 of GENDAT.BAS. Without the key file, PATHFINDER will either fail to function or, at the very least, will take more time in finding a QTH for you. If you are a good typist and feel comfortable with your word processor then go ahead and use it; otherwise, I highly recommend that you key in and use GENDAT.

Whichever way you choose to create your data file, the prefix *must* use capitals for *all* its alphabetic characters! Another thing to remember when preparing your data file is that you *must* group all locations according to the first character of the prefix (all G's together, all U's together, all 1's, etc.) Though it's not necessary to arrange these groups alphabetically, it's easier to do so as the searching process will run a little faster and the bearing/distance and grey-line summaries will print out in order. I haven't worked out a simple way to access a country without an assigned prefix (Abu-ail), so you'll have to code it as some strange numeric or alphabetic call; try "ABU" for instance. Do not, however, use an asterisk (*) for these calls; GENDAT uses this character as a default to terminate searches.

The keys to the kingdom

Now that you have data and key files, how does PATHFINDER use this information to set QTHs? In order to minimize the search time on the sequential LATLONG.DAT file, I have implemented a key file called LATLONG.KEY. This file has up to 36 integer pairs which tell PATHFINDER how far into the data file it must read before reaching an entry with the same first character as the prefix you're looking for. The keys are based on an ordinal value assigned to the letters of the alphabet and the numerals (letters from 0-25 and numerals from 26-35). The first integer in the pair is the ordinal value of the first letter/number of the prefix; the second integer is the number of records that must be read before the program can read a record with the same prefix first character.

When you enter a prefix to PATHFINDER's prompt, the program takes the first character in the prefix, determines its ordinal number in the same way GENDAT does, and then looks in the array IKEY for the index number corresponding to this character. Using this index number the program will open the LATLONG.DAT file, read and discard that many locations, and then start checking the prefix of the data file location for a match to the prefix you requested. When the program finds a matching prefix, it displays the location associated with it and checks with you to see if it's the one you want.

Others May Try to Imitate, But...

Only One Can Be The Best



Morse Code - Baudot - ASCII - AMTOR - Packet - Facsimile - Navtex

Amateur Net Price \$319.95

It's a lesson you learn very early in life. Many can be good, some may be better, but only one can be the best. The PK-232 is the best multi-mode data controller you can buy.

1 Versatility

The PK-232 should be listed in the amateur radio dictionary under the word Versatile. One data controller that can transmit and receive in six digital modes, and can be used with almost every computer or data terminal. You can even monitor Navtex, the new marine weather and navigational system. Don't forget two radio ports for both VHF and HF, and a no compromise VHF/HF/CW internal modem with an eight pole bandpass filter followed by a limiter discriminator with automatic threshold control.

The internal decoding program (SIAM[™]) feature can even identify different types of signals for you, including some simple types of RTTY encryption. The only software your computer needs is a terminal program.



PC Pakratt Packet TX/RX Display



Facsimile Screen Display

2 Software Support

While you can use most modem or communications programs with the PK-232, AEA has two very special packages available exclusively for the PK-232....PC Pakratt with Fax for IBM PC and compatible computers, and Com Pakratt with Fax for the Commodore 64 and 128.

Each package includes a terminal program with split screen display, QSO buffer, disk storage of received data, and printer operation, and a second program for transmission/reception and screen display of facsimile signals. The IBM programs are on 5-1/4" disk and the Commodore programs are plug-in ROM cartridges.

3 Proven Winner

No matter what computer or terminal you plan to use, the PK-232 is the best choice for a multi-mode data controller. Over 20,000 amateurs around the world have on-air tested the PK-232 for you. They, along with most major U.S. amateur magazines, have reviewed the PK-232 and found it to be a good value and excellent addition to the ham station.

No other multi-mode controller offers the features and performance of the PK-232. Don't be fooled by imitations. Ask your friends, or call the local amateur radio store. We're confident the PK-232 reputation will convince you that it's time to order your very own PK-232.

Call an authorized AEA dealer today. You deserve the best you can buy, you deserve the PK-232.

Advanced Electronic Applications, Inc.

P.O. Box C-2160
Lynnwood, WA 98036
206-775-7373

AEA Brings you the Breakthrough!

WORLDWIDE DISTRIBUTION

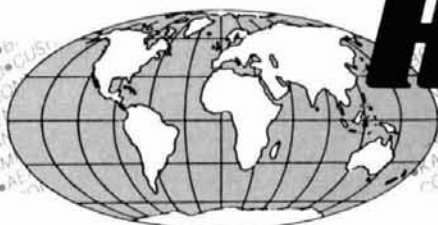

HAM RADIO OUTLET

LARGEST HAM OUTLET IN THE WORLD

GUARANTEED
QUALITY
AT COMPETITIVE PRICES

7 STORE BUYING POWER



GEOCHRON
GLOBAL
TIME
INDICATOR

- Detailed illuminated map shows time, time zone, sun position and day of the week at a glance for any place in the world.
- Continuously moving - areas of day and night change as you watch.
- Mounts easily on a wall. Size: 34 1/2" x 22 1/2".

\$1295 DELIVERED IN U.S.

KENWOOD

TM-721A DUAL BANDER

2MTR/70cm

45w 35w

EXTENDED RECEIVING
RANGE (2 m)



TM-621A DUAL BANDER

2MTR/220MHz

45w 25w

AUTOMATIC OFFSET

CALL FOR LOW, LOW PRICE

concept



Contemporary design,
quality and a 5 year warranty
on parts and labor.
6 months on the RF Final transistors.
All amplifiers have GaAsFET receive
pre-amps and high SWR shutdown protection.



MA-40

40' TUBULAR TOWER

~~-\$809~~ **SALE! \$629**

MA-550

55' TUBULAR TOWER

~~-\$1369~~ **SALE! \$999**

- Handles 10 sq. ft. at 50 mph
- Pleases neighbors with tubular streamlined look

TX-455

55' FREESTANDING
CRANK-UP

- Handles 18 sq. ft. at 50 mph
- No guying required
- Extra-strength Construction
- Can add raising and motor drive accessories

Shown with optional
Mast/Rig base.

TOWERS RATED TO EIA SPECIFICATIONS
OTHER MODELS AT GREAT PRICES
IN STOCK FOR QUICK DELIVERY

TEN-TEC



PARAGON 585

- Ten-Tec QSK cw, real FSK and sideband audio
- Select any filter in any mode
- TX 160 through 10 meters • All mode superiority
- RX 100 kHz to 30MHz • A premier HF rig



TITAN 425

- Pair 3CX800A7 • External Power Supply
- Performance at legal limit
- 3 MS QSK, 1.6 to 22 MHz • Assures "Loaf Along"
- With authorized modification through 29.999 MHz

IN STOCK NOW! FREE SHIPMENT!



Advanced
Electronic
Applications

**PK-232 Multi-mode
Data Controller**

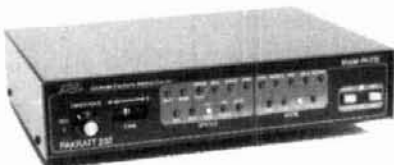

- NEW IBM Fax Screen Display Program Available
- Transmit/Receive on Six Modes
- CW/RTTY/ASCII/AMTOR/Packet/FAX
- IBM and Commodore terminal programs available
- Radio Ports for HF and VHF

In Stock for Quick Delivery

Free Shipment

A3 DX THAT
STANDS OUT
FROM THE CROWD

10, 15, 20
Meters

cushcraft

Whether busting pileups,
rag chewing or hunting
rare DX, the A3 stands
out from the crowd with
the perfect combination
of easy assembly, the
right size, rugged durabil-
ity and great performance.

- Boom Length 14 ft.,
Weight 27 lbs.
- Wind Surface
Area 4.36 ft.

Mast
not
included

REG.
319.95

SALE
259.95

Plus Shipping

FREE SHIPMENT
Most items UPS
surface

All Major Brands in Stock Now!

CALL TOLL FREE (800) 854-6046



Toll free including Hawaii. Phone Hrs: 7:00 am to 5:30 p.m. Pacific Time. California, Arizona and Georgia customers call or visit nearest store.
California, Arizona and Georgia residents please add sales tax. Prices, specifications, descriptions subject to change without notice.



WORLDWIDE DISTRIBUTION

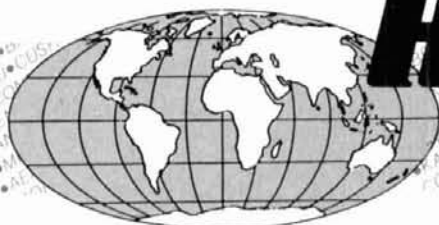

HAM RADIO OUTLET

LARGEST HAM OUTLET IN THE WORLD

FREE SHIPMENT
MOST ITEMS UPS SURFACE

7 STORE BUYING POWER

ICOM IC-761



HF SUPERIOR GRADE
TRANSCEIVER

SALE! CALL FOR PRICE

ICOM IC-781



THE ULTIMATE
150 W, ALL BAND
HF TRANSCEIVER

GREAT PRICE!

ICOM IC-900
MULTI-BAND
MOBILE



YOU CAN OPERATE SIX BANDS
WITH ONE CONTROLLER!
2 MTR 25/45W, 440 MHz 10 MTR, 6 MTR,
220 MHz & 1.2 GHz 10 MEMORIES
ARE YOU READY FOR
1.2 GHz OPERATION?

ICOM A Models 25W,
H Models 100 W

IC-275A/275H, 138-174 MHz
IC-375A, 220 MHz
IC-475A/475H, 430-450 MHz



LOW PRICE!

NOW! RAPID DELIVERIES



FROM STORE NEAREST YOU

ICOM HAND-HELD
VHF/UHF



IC-02AT IC-2AT 2MTR
IC-03AT IC-3AT 220 MHz
IC-04AT IC-4AT 440 MHz

ICOM IC-735



100 W, 100 KHz-30 MHz
Dual VFO Receiver

CALL FOR LOW, LOW PRICE

ICOM IC-R7000



25 MHz-1300 MHz
SCANNING RECEIVER

GREAT PRICE!

ICOM IC-u4AT/u2AT
440 MHz, 2MTR

Mini
Hand-Held
AT Model
w/ TT Pad

GREAT
PRICE!



All Major Brands in Stock Now!



Bob Ferrero W6RJ
President
Jim Rafferty N6RJ
VP So. Calif Div.
Anaheim Mgr.

ANAHEIM, CA 92801
2620 W. La Palma
(714) 761-3033, (213) 860-2040
Between Disneyland &
Knott's Berry Farm

ATLANTA, GA 30340
6071 Buford Hwy.
(404) 263-0700
Larry, Mgr. WD4AGW
Doraville, 1 mi. north of I-285

BURLINGAME, CA 94010
999 Howard Ave.
(415) 342-5757
George, Mgr. WB6DSV
5 miles south on 101 from SFO

OAKLAND, CA 94606
2210 Livingston St.
(415) 534-5757
Al, Mgr. WA6SYK
17N-5th Ave / 17S-16th Ave.

PHOENIX, AZ 85015
1702 W. Camelback Rd.
(602) 242-3515
Bob, Mgr. K7RDH
East of Hwy. 17

SAN DIEGO, CA 92123
5375 Kearny Villa Rd.
(619) 560-4900
Tom, Mgr. KM6K
Hwy. 163 & Claremont Mesa Blvd

VAN NUYS, CA 91411
6265 Sepulveda Blvd.
(818) 988-2212
Al, Mgr. K6YRA
San Diego Fwy
at Victory Blvd.

STORE HOURS
10 AM-5:30 PM
CLOSED SUNDAYS



CALL TOLL FREE (800) 854-6046

Toll free including Hawaii. Phone Hrs: 7:00 am to 5:30 p.m. Pacific Time. California, Arizona and Georgia customers call or visit nearest store. California, Arizona and Georgia residents please add sales tax. Prices, specifications, descriptions subject to change without notice.



ROBOT

A PICTURE IS WORTH A THOUSAND WORDS

YOU ALREADY HAVE:

- TRANSCEIVER
- ANTENNA
- COLOR VIDEO MONITOR
- AUDIO TAPE RECORDER

ADD:

- ROBOT COLOR SLOW SCAN CONVERTOR**
(Video Transceiver)

YOU NOW HAVE:

- A COMPLETE COLOR VIDEO STATION

No modifications. AM/FM/SSB;
Direct, repeater or satellite
operation. Computer interface.

SALE PRICE: \$1095.00
REGULAR: \$1295.00

NOW THROUGH DECEMBER 1, 1988

CALL TO ORDER

1.619.279.9430
VISA MASTERCARD ACCEPTED

ROBOT RESEARCH INC.
5636 RUFFIN ROAD
SAN DIEGO, CA
92123.1317 USA
TEL 619.279.9430

ONSat

"America's Weekly Guide to Satellite TV"

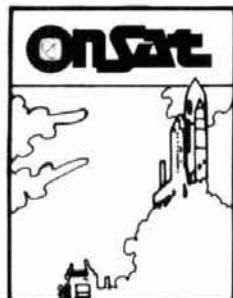

The best in satellite programming! Featuring: ★ Over 120 Channels listed ★ Weekly, Updated Listings ★ Magazine Format ★ Complete Alphabetical Movie Listings ★ Sports Specials ★ Prime Time Grids ★ Specials ★ Programming Updates!

- Only \$45.00 per year (52 weekly issues)
- 2 Years \$79.00 (104 weekly issues)
- \$1.00 for sample copy

*NC Residents must add 5% Sales Tax

Subscribe Today!

call toll free 1-800-234-0021
Visa® and MasterCard® accepted

OnSat PO Box 2347 Shelby, NC 28151-2347



STV GUIDE

The new **STV Guide** contains valuable information on zoning regulations, scrambling, plus technical tips for installing or updating a satellite system—and now a precise monthly guide to satellite TV with the latest program listings for over **90 channels!**



All this in each complete issue of **STV Guide!**

- Only \$48.00 per year (12 monthly issues)
- \$2.00 for a sample copy

*NC Residents must add 5% sales tax

Subscribe Today!

Call toll free 1-800-234-0021
Visa® and MasterCard® accepted

STV Guide PO Box 2384 Shelby, NC 28151-2384



FIGURE 4

```

Pathfinder modifications to add data file access and summary menus
Replace lines 200 and 210:
200 INPUT "Opt: 1=Input 2=Anal 3=Output 4=File 5=Quit ";IO
210 ON IO GOTO 220,240,280,460,9999: GOTO 200

Add lines 72 thru 78.
72 DIM IKEY(35): OPEN "I",1,"LATLONG.KEY" 'LOAD KEY ARRAY
74 FOR IP=0 TO 35: IKEY(IP)=1: NEXT IP
76 IF NOT EOF(1) THEN INPUT #1,IP,IKEY(IP): GOTO 76
78 CLOSE #1

Add lines 460 and 470.
460 INPUT "Opt: 0=Top 1=B/D 2=Grey 3=Target ";IO
470 ON IO GOSUB 500,600,800: GOTO 200

```

PATHFINDER modifications to add data file access and summary menus.

FIGURE 5

```

PATHFINDER modifications to add data file access functions.
Add lines 500 thru 580, 600 thru 780 and 800 thru 940.
500 OPEN "I",1,"LATLONG.DAT" 'BEARING/DISTANCE LIST
510 LPRINT "PREFIX" TAB(15) "QTH" TAB(48) "SHORT PATH" TAB(68) "LONG PATH"
520 LPRINT TAB(45) "BEARING DISTANCE" TAB(65) "BEARING DISTANCE"
530 IL=0: IF EOF(1) THEN 570 ELSE INPUT #1,PXS,QS,LT,WT
540 LPRINT PXS TAB(10) LEFT$(QS,30); GOSUB 8420
550 GOSUB 3000: I=45: IA=53: GOSUB 580: IL=1
560 GOSUB 3000: I=65: IA=73: GOSUB 580: LPRINT: GOTO 530
570 CLOSE #1: RETURN
580 LPRINT TAB(1) INT(PB*RI) TAB(IA) INT(IG1*3959);: RETURN
600 I=1: IL=0: SD=0: WD=0: LD=2: OPEN "I",1,"LATLONG.DAT" 'GREY LIST
610 GOSUB 5100: IF CO(I)<=86 THEN PRINT "NO SUN AT HOME":GOTO 780
615 LPRINT "Home Sunrise at:";INT(40*INT(SR(I))+60*SR(I))/100;"Z"
620 LPRINT "Home Sunset at:";INT(40*INT(SS(I))+60*SS(I))/100;"Z"
625 LPRINT "PREFIX" TAB(15) "QTH" TAB(48) "AT SR" TAB(63) "AT BS"
630 LR1=SR(I)-.75: LR2=SR(I)+.75: LS1=SS(I)-.75: LS2=SS(I)+.75
640 IF EOF(1) THEN 780 ELSE INPUT #1,PXS,QS,LT,WT: GOSUB 8420
645 LD=L2: WD=W2: GOSUB 5100: IF CO(I)<=86 THEN 640
650 IRR=0: IRS=0: ISR=0: ISS=0: X=SR(I): Y=SS(I)
660 IF LR1<0 THEN IRR=(X-24)>LR1: IRS=((Y-24)>=LR1)
665 IF LR2>24 THEN ISR=(X-24)>=LR2: ISS=((Y-24)>=LR2)
670 IF LR2>24 THEN ISR=(X-24)<=LR2: ISS=((Y-24)<=LR2)
675 IF LS2>24 THEN ISR=(X-24)<=LS2: ISS=((Y+24)<=LS2)
680 IF IRR OR IRS THEN 690
685 IRR=(X>LR1)AND(X<=LR2): IRS=(Y>=LR1)AND(Y<=LR2)
690 IF ISR OR ISS THEN 700
695 ISR=(X>=LR1)AND(X<=LR2): ISS=(Y>=LR1)AND(Y<=LR2)
700 IF (IRR OR IRS OR ISR OR ISS) GOSUB 720
710 GOTO 640
720 LPRINT PXS TAB(10) LEFT$(QS,30) TAB(45);
730 IF IRR THEN X=SR(I): AS="SR": GOSUB 770: GOTO 740
735 IF IRS THEN X=SS(I): AS="SS": GOSUB 770
740 LPRINT TAB(60);
750 IF ISR THEN X=SR(I): AS="SR": GOSUB 770: GOTO 760
755 IF ISS THEN X=SS(I): AS="SS": GOSUB 770
760 LPRINT: RETURN
770 LPRINT INT(40*INT(X)+60*X)/100;"Z ";AS: RETURN
780 CLOSE #1: RETURN
800 INPUT "PREFIX TO SEARCH FOR";PYS 'TARGET FROM FILE
810 IP=ASC(LEFT$(PYS,1))-65: IF IP=31 THEN IP=IP-32
820 IF IP<25 THEN PRINT "ERROR": GOTO 800
830 AS=CHR$(65+IP): IF (IP<=7 AND IP>=18) THEN IP=IP+43
840 IF (IP<0)OR(IP>35) THEN PRINT "ERROR": GOTO 800 ELSE IF=IKEY(IP)
850 OPEN "I",1,"LATLONG.DAT": IF IP<0 THEN 930
860 FOR I=0 TO IP: INPUT #1,PXS,QS,LT,WT: NEXT I: GOTO 890
870 IF EOF(1) THEN 930 ELSE INPUT #1,PXS,QS,LT,WT
880 IF LEFT$(PXS,1)>AS THEN 930
890 IF PXS<>PYS THEN 870 ELSE PRINT "Found: "PXS" in "QS
900 BS="": INPUT "CR" IF OK, N FOR NEXT, else to QUIT: BS
910 IF LEN(BS)=0 THEN LT=LT: WT=WT: GOSUB 8420: GOTO 940
920 IF (BS="N")OR(BS="n") THEN 870
930 PRINT "NOT Found"
940 CLOSE #1: I=1: RETURN

```

PATHFINDER modifications to add data file access functions.

Some prefixes have more than one location associated with them; you may check each one in sequence until you have selected the one you want. PATHFINDER continues this activity until the prefix no longer matches and then closes the file. You can cut this process short by telling the program to terminate the search. When you accept a location, PATHFINDER copies the latitude and longitude to the target location and then returns to the top level menu.

The index array is built once at the beginning of the program execution by reading in the key values from the LATLONG.KEY file. Some prefix first characters (M, Q, etc.) may not occur in the data file. GENDAT doesn't store a data pair for these characters; PATHFINDER

handles this situation by preloading the IKEY array with a default value which is overwritten by those locations which do occur. When you input a nonoccurring prefix PATHFINDER extracts the default value from the array and, knowing that the prefix does not exist, it then exits the search function.

Now add the code for the data file access. Figure 4 details the changes which must be made to the top level menu — the additional lines needed to declare and load the key array and the additional program lines that define and implement the file level menu. These changes are rather simple. The new top level menu looks like:

Opt: 1 = Input 2 = Anal 3 = Output 4 = File 5 = Quit and the file level menu is:

Opt: 0 = Top 1 = B/D 2 = Grey 3 = Target

Note that the QUIT selection in the top level menu changes to 5 to make a sensible space for the file operations.

This is a good time to do some checks. After saving the program, type in lines 500, 600, and 800 with a simple print statement and a return statement to show which target you have accessed. Now run the program and exercise the menu selections. It isn't necessary to save the program here unless you have to make corrections.

Figure 5 gives the code to accomplish the file-based functions. Insert these lines into the big hole of program line numbers preceding the hourly MUF driver at line 1000. The space provided in the original PATHFINDER coding ended up being a little too tight to maintain MODULO 10 line numbering (particularly in the grey-line list section) but, with a little squeezing of line numbers, the code fits. The function of this code is broken down into three main subroutines. Lines 500-570 generate the bearing/distance report summary; line 580 is a subroutine which is called to print the bearing and distance. The code from lines 600-780 does the grey-line summary and calls the subroutine in lines 720-760 to print a line. If the location is on your grey line, this subroutine calls another at line 770 to print the time and condition of the target grey line. The routine to search for a location in the data file is in lines 800-940.

The finished product

You'll have a fairly sophisticated operating aid after making all these modifications to PATHFINDER. Anything comparable costs a lot more than two copies of *HAM RADIO*, and chances are the MUF algorithm isn't as good and doesn't run as fast. PATHFINDER can do a lot for almost any Amateur who has his own hf equipment. I recently discovered one application in the field of antipodal DX.⁵ After entering the date and solar flux, execute a radial MUF projection with a path-length hop value of 5 and any hour you choose. The radial report will show you the MUF for each bearing to your antipode.

Try those bearings which show a MUF near the band you intend to work.

In the global modes PATHFINDER accesses the data file one location at a time and uses these locations as the target for any computation required. The bearing/distance reports are printed for each location while the grey-line summary includes only those locations which have a grey line within 45 minutes of one of your grey lines. Since the grey-line summary already takes a lot of time, there's no suggested MUF for this report. If you're interested in the MUF for a particular grey-line path, run the point-to-point MUF for that location.

You can achieve expanded utility of the file-based features by generating several data files, based on your own operating habits, and queue for a file name to use in generating the summary reports. Your summaries would take less time because they would be accessing fewer locations in your data file. For instance, you could delete all the domestic locations or all the locations that could never have a common terminator from the grey-line file you use.

Another suggestion is to make several data files based on continent or region of the world and select the one which interests you at the time. There is nothing magical about the prefix value in the data files. You might want to enter the state or country name in this field rather than a prefix. These tactics would be particularly beneficial if you use the grey-line summary frequently or want to separate bearing/distance reports for each region. Just remember that you'll have to load the key array corresponding to the data file selected.

Sorts can become complicated and, with the amount of storage a sort might require, I decided to avoid this nicety in PATHFINDER. You are welcome to implement your own to get your grey-line report in a time sequential format. If you wish to convert the data file to a random access file, note that the key array and key file offer an open door to a significant improvement in performance and expanded utility. A revision of the grey-line test ranges is another customization you may want to consider for your copy of the program. You can do this by modifying the constant (.75) in the statements on lines 630 of fig. 5. This value is a decimal hour representation of the half-width of the grey-line range. Changing these constants to .5 would give a ± 30 -minute tolerance for grey-line reporting. There's no reason to keep the test ranges symmetrical or even equal. You might benefit by skewing these tests to reflect your own preferences or station capabilities.

Once you start modifying PATHFINDER to suit your preferences, you'll appreciate the structured form of its code. There are lots of little program blocks defined as subroutines which are executed by the main program or by other subroutines. There might be a little more code required to do some functions than with a GOTO, but

FIGURE 6

```

PATHFINDER menu prompts and their functions
TOP menu:
Opt: 1=Input 2=Anal 3=Output 4=File 5=Quit
1 goto set INPUT menu
2 goto select ANALYSIS menu
3 goto select OUTPUT menu
4 goto select FILE function menu
5 QUIT the program

set INPUT menu:
Opt: 0=Top 1=Date 2=Flux 3=SSN 4=Target 5=Home
0 return to TOP level menu
1 change the DATE
2 change the solar FLUX
3 change the SUNSPOT NUMBER
4 change the TARGET coordinates
5 change the HOME coordinates

ANALYSIS select menu:
Opt: 0=Top 1=B/D 2=Grey 3=MUF
0 return to TOP level menu
1 report path BEARING and DISTANCE
2 report the endpoint GREY-LINE conditions
3 goto the MUF selection menu

MUF selection menu:
Opt: 0=Top 1=Short 2=Long 3=Radial
0 return to TOP level menu
1 project SHORT path hourly muf
2 project LONG path hourly muf
3 project RADIAL muf

FILE function select menu:
Opt: 0=Top 1=B/D 2=Grey 3=Target
0 return to TOP level menu
1 print global BEARING and DISTANCE report
2 print global GREY-LINE condition report
3 load TARGET location from file

```

PATHFINDER menu prompts and their functions.

FIGURE 7

```

PATHFINDER data prompts
PREFIX TO SEARCH FOR
enter a prefix to find for a new target
<CR> if OK, N for NEXT, else to QUIT
enter: a carriage return to accept this location
      "N" to reject this location and see others
      any other character returns to TOP level menu

What GMT hour for display
enter the time for a radial projection
(decimal hours)
1 Hop = 2488 mi (4000 Km). Long Path beyond 5
How many hops for display [0.1 to 9.9]
enter number of hops to use for radial path length
(decimal values ok)

Month number
enter the month number (1 to 12)

Day of month
enter the day of the month (1 to 28, 30 or 31)

Solar Flux [64 to 301]
enter a value for solar flux

Sun Spot Number [0 to 250]
enter a value for sunspot number

Target Latitude [- south, 89.9 max]
enter the target latitude in decimal degrees and then

Target Longitude [- east]
enter the target longitude in decimal degrees

Home Latitude [- south, 89.9 max]
enter the home latitude in decimal degrees and then

Home Longitude [- east]
enter the home longitude in decimal degrees

```

PATHFINDER data prompts.

FIGURE 8

```

PATHFINDER messages
Welcome to PATHFINDER-85
COPYRIGHT 1987 by Ronald C. Todd
PATHFINDER login and copyright message

ERROR
error message, occurs for several situations

Found: XVI in Lower Hattrap
requested prefix found

NOT Found
requested prefix not found

```

PATHFINDER messages.

FIGURE 9

```
GENDAT menu and data prompts

GENDAT MENU:
Opt: 1-Add 2-Edit 3-Insert 4-Delete 5-New 6-EXIT
1 ADD records to end of file
2 EDIT an existing record
3 INSERT records in middle of file
4 DELETE an existing record
5 initialize a NEW data file
6 generate the key file and EXIT the program

<CR> to Continue, else Done
enter a carriage return to continue with function,
otherwise return to menu

EDIT PREFIX:
enter the prefix you wish to edit

ADD AFTER PREFIX:
enter the prefix you wish to insert records after

DELETE PREFIX:
enter the prefix you wish to delete

D to Delete, else Reject
enter a 'p' if you really want to delete this record

Prefix
enter the record prefix

QTH
enter the record location name

Latitude
enter the record latitude in decimal degrees

Longitude
enter the record longitude in decimal degrees

<CR> if OK, R to Redo, else QUIT
enter a carriage return to accept input data
an "R" to redo the input data
otherwise return to function

<CR> if OK, N for NEXT, else to QUIT; B5
enter a carriage return to accept record found
an "N" to look for next occurrence of same prefix
otherwise quit the search and function
```

GENDAT menu and data prompts.

the partitioning of tasks in this manner means that debugging is easier and utility will be greater. I strongly suggest that you retain this design for your own revisions.

les Menus

Some of the original PATHFINDER users asked me to explain the menu functions. In fig. 6 you'll find a display of each of the menu prompts, along with a brief explanation of the function of each selection. A summary of the data prompts PATHFINDER uses is given in fig. 7 along with a description of what each means and, where significant, the data type expected. In fig. 8, you'll find the messages and a description of their meanings. Figures 9 and 10 give the menu functions, data prompts and messages for GENDAT. I'll be glad to answer all requests for more information accompanied by an SASE.

One other shortcoming of PATHFINDER, alluded to briefly in my original article, is error trapping. To keep the program to a reasonably publishable size, error trapping on most inputs has been minimized. This may generate some problems upon entering polar coordinates for one or both of the path end points. The solution in this case is to limit all latitudes to a magnitude of 89.99; this will be sufficiently close (0.69 miles from a pole) for most applications. In most instances, the likelihood of divide by zero and out-of-range errors have been minimized through the use of suitable decision gates in the algorithms. If you do find situations that generate errors not trapped by the code, please forward these to me. I'll

FIGURE 10

```
GENDAT messages

... PLEASE CHECK DATA ...
check input data before writing to file

END of FILE
end of file message

Found: XYI in Lower Hattrap Lat= 45 Lon=50
display of requested record found
```

GENDAT messages.

be glad to report them along with suggested code revisions. If there's sufficient interest, I might be talked into organizing a PATHFINDER user's group dedicated to maintaining and supporting the program.

Watch your language

All listings in this article are presented in Microsoft Extended Basic-80®, for a CP/M® operating system. This is a powerful and rather universal programming language, but it may have some features and syntax not shared with other BASIC dialects. Some of the constructs and statements which might not be included or may work differently in your BASIC are the DIM, DEFINT, ELSE, RESTORE, and ON GOTO/GOSUB. Your printer and disk access functions may require different approaches, but in general can be easily converted.

Several dialects of BASIC do not implement the ELSE clause for an IF/THEN construct; in that case you should place the statements executed by the ELSE condition on an intermediate line and then replace the ELSE with a GOTO branch past the intermediate line which contains the operations called for by the ELSE in this program. I normally increase the line number of the intermediate line by 5 from the source line when this is necessary. In summarizing conversions, it's best to keep your BASIC manual handy and refer to it whenever you have a question.

This version of PATHFINDER has been submitted to the ARRL Program Exchange. I would appreciate any suggestions you have for upgrades and further extensions to the program.

Thanks to all who have helped make PATHFINDER a viable reality by offering their comments and critiques.

For more updates to PATHFINDER see page 58. Ed.

references

1. Ron Todd, K3FR, "PATHFINDER: Improved MINIMUF Program," *ham radio*, May 1988, page 26.
2. R.B. Rose, "MINIMUF: A Simplified MUF Prediction Program for Microcomputers," *QST*, December 1982, pages 36-38.
3. G. Hall, ed., *ARRL Antenna Book*, 14th edition, American Radio Relay League, Newington, Connecticut 1982.
4. Wayne Overbeck and J.A. Steffen, *Computer Programs for Amateur Radio*, Hayden Book Company, Hasbrouck Heights, New Jersey, 1984.
5. Garth Stonehocker, K0RYW, "DX Forecaster," *ham radio*, March 1988, pages 78-80.

Article E

HAM RADIO

Answers to some common questions about PATHFINDER

Line 1200: The back slash "\ " is the integer division operator. It is used to assure an integer index for the array MOUT(). If your language does not support this feature then force the result of a normal division via the INT function: MOUT(INT(A0/10)) = J9.

Line 3420: This is recursive code, not an infinite loop. The line serves to force all computed longitudes into the range $-180 < = LON < = 180$. If the LON is outside the range, then 360 degrees (P1) is added or subtracted and the test repeated. When the LON is in range, execution passes on to line 3430.

Lines 8300 and 8320: These lines were referenced in the text of the article and several have found that 8320 does not exist in the listing, while 8300 is actually the start of the SSN input routine. This mixup is in the article text and not in the listing. The text should refer to lines 8400 and 8420 respectively.

Lines 300, 1040, 1160, and 1170: The STEP option on the FOR loops is a way of controlling both the increment value and the maximum iterations of the loop. The test and increment values for the loop control variable are set up to provide two MUF values per output line.

Updates to PATHFINDER release 1.10

Incorporate the following changes into your program as well as making the changes noted in the grey-line enhancements in fig.2 of PATHFINDER-Part 2. **30 'MICROSOFT BASIC version, Release 1.15, 5/12/88**

```
2040 IF K9(I) > 23.99 THEN 2100 ELSE IF SS(I) < SR(I) THEN 2060
```

```
4020 M9 = 1 + 2.5 * M9 * SQR(M9): IK = INT(G1/P5) + 1: L = 1 / (2 * IK)
```

These revisions will correct some PATHFINDER problems. Here is a new proof simulation which, if everything matches within 1.0 MHz, will demonstrate correct function.

Date is: Dec 21

Solar flux = 150.0 Sunspot number = 104

Home QTH: Lat = -87.0 Lon = 130.0

Target QTH: Lat = 80.0 Lon = -50.0

Path bearing = 0 degrees

Path length = 12920 miles

LONG PATH

GMT	MUF	GMT	MUF	GMT	MUF	GMT	MUF
0.00	23.57	6.00	13.96	12.00	12.95	18.00	24.98
1.00	23.36	7.00	14.14	13.00	11.68	19.00	24.74
2.00	21.15	8.00	13.18	14.00	11.04	20.00	24.51
3.00	16.62	9.00	13.29	15.00	11.45	21.00	24.28
4.00	14.86	10.00	13.85	16.00	25.49	22.00	24.04
5.00	14.17	11.00	13.10	17.00	25.22	23.00	23.80



29th ANNUAL TROPICAL HAMBOREE A.R.R.L. FLORIDA STATE CONVENTION FEBRUARY 4-5, 1989



TAMIAMI PARK FAIR GROUNDS

10901 S.W. 24th Street (Coral Way), Miami, Florida

HOURS: 9 A.M.-5 P.M. SATURDAY • 9 A.M.-4 P.M. SUNDAY

**FREE PARKING 15,000 VEHICLES •
1,000 INDOOR SWAP TABLES •
300 CAMPSITES WITH FULL HOOKUPS •**

**• 200 COMMERCIAL EXHIBIT BOOTHS
• COMPUTERS & SOFTWARE
• LICENSE EXAMS**

Registration: \$5.00 Advance — \$6.00 Door. Valid Both Days. (Advance deadline January 30th.)

Swap Tables, 2 Days: \$16.00 each. Power: \$10.00 per User.

All swap table holders must have registration ticket.

Campsites: \$12.00 per Day • Includes Water, Power, Sanitary Hookups & Showers.

(All RV vehicles, tent campers, vans, trailers welcome — no ground tents, please.)

**Make Checks for Registration, Swap Tables & Campsites Payable to:
Dade Radio Club & Mail As Follows:**

Tickets & Hotel Info Only: Evelyn Gauzens, W4WYR, 2780 N.W. 3rd St., Miami, FL 33125

Swap Tables, RV, Tickets & Hotel: John Hall, WD4SFG, 8670 S.W. 29th St., Miami, FL 33155

RV & Tickets Only: Dick Leisy, W4OOH, 650 W. 63rd Dr., Hialeah, FL 33012

Exhibit Booth & General Info: Evelyn Gauzens (address above) or Call (305) 642-4139 or (305) 233-0000

(BROCHURE WITH FULL DETAILS AVAILABLE DECEMBER 1st)

Super Fall Values

Virginia ICOM Day
Saturday, November 12

New Hampshire
New Store Location

hy-gain

PACKAGE DEALS

SELECT THE
TOWER, ROTOR
AND
TOWER
ACCESSORIES
GET THE
ANTENNA
FREE

SAVE UP TO
\$900

SEE THE HY-GAIN[†] AD FOR
DETAILS. CALL FOR OUR
LOW QUOTES. SOME
RESTRICTIONS APPLY.

[†] Saving based on Hy-Gain suggested
list price. Special good for orders placed
from 1 September 1988 to 31 October
1988. Free Shipping on items shipped
directly from Hy-Gain.

MFJ

1278 TNC PACKAGE DEAL
\$239.95

NOW WITH AMTOR
includes
1284 Starter Package
UPS Brown Shipping

Kantronics

KAM PACKAGE DEAL
\$336.95

includes
KAM Terminal Unit
Kanterm PC
UPS Brown Shipping

ICOM

IC 781

PACKAGE DEAL

\$5995.95

includes
ICOM 781 HF Transceiver
UPS Brown Shipping
Your Choice of a
SM10 Desk Mic
or
SP20 Deluxe Speaker

NEW PRODUCTS

Call for Quotes

IC32AT Dual Band Handheld
IC2GAT 2m, 7Watt Handheld
IC4GAT 440MHz Handheld
IC3210 Dual Band Mobile
IC228A/H 2m Mobile 25/45W

rfconcepts

CALL FOR DISCOUNTS

Model	Band	In-Out	List
2-23	2m	2-30	\$112
2-217	2m	2-170	299
2-117	2m	10-170	299
2-417	2m	45-170	299
3-22	220	2-20	112
3-221	220	2-110	299

NEW 440 AMPS
REPEATER CONTROLLER

Unarco-Rohn

BEAT THE WINTER
CALL FOR OUR
PACKAGE DEALS

25G, 45G and BX Towers
Buy the Antenna and Rotor and
save

KENWOOD

TS140

PACKAGE DEAL

\$929.95

includes
TS140 HF Transceiver
Astron RS20A Power Supply
UPS Brown Shipping
EGE One Year Extended
Warranty

TS440AT

PACKAGE DEAL

\$1379.95

includes
TS440AT HF Transceiver
MC80 Desk Mic
Astron RS20A Power Supply
UPS Brown Shipping
EGE One Year Extended
Warranty

TEN-TEC

PARAGON

PACKAGE DEAL

\$2245.00

includes
585 Paragon
NEW 961 Power Supply
705 Desk Mic
UPS Brown Shipping

YAESU

FT726R

OSCAR SPECIAL

\$1079.95

includes
FT726R 2m Transceiver
MH188 Hand Mic
430 UHF Module
SU726 Duplex Unit
UPS Brown Shipping

FT736R

\$1749.95

includes
FT736R Transceiver
220MHz Module
MH188 Hand Mic
UPS Brown Shipping

cushcraft CORPORATION

A3 10-15-20m beam..... \$248.95
A4S 4 Element HF beam 339.95
AP8 10-80m vertical 142.95
ARX2B 2m Ringo 40.95
R4 Vertical 4 Band Call
FOR OSCAR
AOP1 Oscar Pack 159.95
416TB 16 ele 435MHz .. 66.50
A14410T 10 ele 144MHz 55.95
A14420T 20 ele 144MHz 80.50
A14TMB Stacking Kit 27.95



CLOSEOUT

ALR72T
440 MHz MOBILE
\$269.95

Orders & Quotes Toll Free 800-444-4799

Prices are subject to change without notice or obligation



Yaesu's FT-736R. Because you never know who's listening.

The sky's no longer the limit.

With Yaesu's new FT-736R VHF/UHF base station, you'll experience some of the best DX happening in ham radio. Via moonbounce. Tropo. Aurora. Meteor scatter. Or satellites.

Join thousands of VHF/UHF pioneers already scanning the cosmos with their FT-736Rs. The most complete, feature-packed rigs ever designed for the serious operator.

Versatile frequency coverage. The FT-736R comes factory equipped for 2 meters and 70 cm (430-450 MHz), with two additional slots for optional 50 MHz, 220 MHz, or 1.2 GHz modules.

Multimode facilities. Every FT-736R is equipped for LSB, USB, CW, and FM operation. Wide/narrow filters for both



FM and CW are factory installed —not expensive options. There's even all-mode squelch, too!

Satellite ready. A truly turn-key satellite rig, the FT-736R includes crossband full duplex capability. Plus VFO tracking for one knob tuning on both normal and inverted transponders. And with the optional 1.2 GHz module installed, you're QRV on Modes B, J, L, and JL. *With one box.*

Exceptional receiver design. The FT-736R was designed with low noise figure and careful gain distribution,

for industry-leading sensitivity for weak signal work. And in addition to the wide/narrow CW and FM filter selection, you get IF shift. An IF notch filter. Noise blanker. Audio tone shaping control. Three-position AGC selector. And a preamp switch for activating your tower-mount RX preamplifier.

Operate Fast-Scan TV!

Install the optional TV-736 and 1.2 GHz modules, and you're ready to operate fast-scan double-sideband TV with FM audio subcarrier. Black-and-white or color!

Contester's dream! Versatility is a must in VHF contests, as openings are brief. For quick activity checks, use the separate "channel" selector for a speedy trip up the band in selectable steps (SSB or FM!). Use the two



Seriously.



Write for your free extraterrestrial QSL card at our address below.

VFOs per band to watch different areas of the band. Keep your sked frequencies stored in any of the 100 memories, which retain frequency *and* mode. And let the RF speech processor get you through tough pile ups.

Ready for computer control. The FT-736R is equipped for CAT (Computer Aided Tuning) control via the rear panel 4800 baud serial data port (our command set is included in your owner's manual). Create your own software for Doppler-corrected satellite tuning, elaborate scanning routines, or

complete frequency control *and* satellite/EME antenna tracking using our new G-5400B or G-5600B AZ-EL rotators.

Your total communications package. The FT-736R delivers 25 watts RF output on 2 meters, 220 MHz and 70 cm. And 10 watts on 6 meters and 1.2 GHz. With separate linear amplifier relay control lines for each band.

And to round out your FT-736R

station, choose from these popular accessories: Iambic keyer module. FTS-8 CTCSS unit. FVS-1

voice synthesizer. FMP-1 AQS message display. E-736 DC cable. MD-1B8 desk microphone. And our super YH-55 headphones.

Discover the FT-736R

at your Yaesu dealer

today. But first make plenty of room for exotic QSL cards. Because the ultimate DX is out there. And you *never* know who's listening.

YAESU



✓ 135

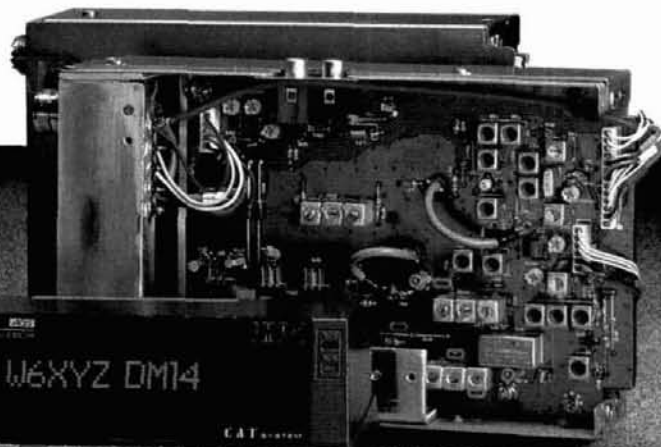

MADISON SHOPPER

CALL FOR ORDERS

1 (800) 231-3057
1-713-520-7300 OR 1-713-520-0550
TEXAS ORDERS CALL COLLECT
FAX 1-713-771-7759

ALL ITEMS ARE GUARANTEED OR
SALES PRICE REFUNDED

New Icom IC 781..... Trades wanted
Kenwood TH215A, TH25AT..... Trade in your old HT
New Kenwood TM-621A, 144/220 MHz FM..... Call



Kenwood TS 140S..... Call for trade



New Kenwood TM-221A, mobile..... Call
ICOM 28H/TTM..... 410.00



Icom 761..... 2300.00
Shure 444D..... 56.95
HEIL BM10 Boom Mike, wired 8 pin..... 69.00
HEIL HM5 Desk Mike..... 59.00
Cushcraft 124-WB (146 MHz)..... 39.00
Butternut HF6V, 80-10 vertical..... 125.00
Hustler G7-144..... 129.00
Larsen 2-meter on glass..... 49.95
Anteco 2M, 5/8, Mag. Mount, Comp..... 25.00
Van Gordon G5RV..... 44.00
Valor AB5 mobile..... 79.00
Thousands of panel meters..... 3.95 up CALL
Aerovox 1000 pf/500 V feedthrough caps..... 1.95
Transformer 120 V Pri., 1050 V/1A. (Sec. #18 Wire)..... 50.00
100 mfd/450V Axial Cap..... 2.20
120 mfd/450V Axial Cap..... 3.00
Arista SWR Bridge 3-30..... 19.95
831SP-PL259 Silverplate (Amphenol)..... 1.50
82-61 N Male (Amphenol)..... 3.50
82-202-1006 n Male (9913)..... 3.50
Double Female UHF..... 1.00
UG176 RG8X..... each 40
GE 6146B..... 14.95

Receiving tubes 50-90% off list price
GE 12BY7A..... 7.00
6MJ6..... 12.95
6KD6..... 12.95
Cetron 572B..... 88.00
807..... 3.95
8950..... 18.00
Santec Boom Mike/Headset (fits ICOM)..... 20.00
Rohn SA 25G 67 (67 inside arm)..... each 125.00

USED EQUIPMENT

All equipment, used, clean, with 90 day warranty and 30 day trial. Six months full trade against new equipment. Sale price refunded if not satisfied.

Call for latest used gear
(800) 231-3057

GNU PROD
TE Systems 2m Amp 30-160 watts GaAs fet..... \$229.00

POLICIES

Minimum order \$10.00. Mastercard, VISA, or C.O.D. All prices FOB Houston, except as noted. Prices subject to change without notice. Items subject to prior sale. Call anytime to check the status of your order. Texas residents add sales tax. All items full factory warranty plus Madison warranty.

Bird and Belden products in stock. Call today.

Measure Up With Coaxial Dynamics Model 7510 Frequency Counter/Wattmeter

This 2-in-1 laboratory/portable, compact, dual function digital frequency counter/wattmeter makes frequency and power readings easy. The optional battery pack converts Model 7510 to a portable field service instrument. The frequency counter measuring range is 10 Hz to 1.25 GHz. The wattmeter power measuring range is 100 mW to 5 kW over 2 to 1,000 MHz, determined by standard elements ordered separately.

Contact us for your nearest authorized Coaxial Dynamics representative or distributor in our world-wide sales network.



COAXIAL DYNAMICS, INC.

15210 Industrial Parkway
Cleveland, Ohio 44135
216-267-2233 1-800-COAXIAL
Telex: 98-0630

Service and Dependability... A Part of Every Product

Affordable Packet



TINY-2 is our new low-cost high-performance standard for packet controllers. Thousands already in use, worldwide. A perfect beginner's unit.

Complete, wired \$119.95
and tested, only



MICROPOWER-2 is our remarkably compact, 18-ounce unit using upgraded TAPR TNC-2 technology that requires less than 40 milliamps! For very portable operation, solar or battery, you need not pay more for a TNC that's about the size of your HT! Was \$179.95, \$159.95 now at a low

BENEFITS and features of both units:

- Optional Personal Message System (mini-BBS)...Add \$10.00
- Tiny enough for briefcase/portable, yet large enough for easy experimentation or repair.
- 1-year limited warranty, excellent customer support.
- RS-232 and TTL compatible—all connectors supplied.
- Latest AX.25 software, TCP/IP (KISS) module included.

- Fully compatible with ROSE & NET/ROM EPROMs.
- 32K RAM, 32K ROM, 4.9 MHz CPU.
- Xtal controlled modem, compatible with use on 10m HF/VHF/UHF.

TO ORDER, toll-free with major charge card, call: 1-800-223-3511

Technical support line:
813-874-2980

Pac-Comm

3652 West Cypress St., Tampa FL 33607

Please send: Tiny 2 MicroPower-2 TNC-220 info FREE Packet Catalog.

Name _____ Call _____
Address _____ City _____
State _____ Zip _____ Card Number _____ Exp. Date _____

Money Back Guarantee. Add \$3. shipping/handling per order. FL addresses add 6%. Major Credit Card: give number, expiration and signature. FAX: 813-872-8696

MADISON

Electronics Supply

3621 FANNIN
HOUSTON, TEXAS 77004



EFFICIENTLY LAUNCH VHF/UHF WAVE

By Hal Silverman, W3HWC, 14004 Prospect Avenue, Mt. Airy, Maryland 21771

Simple geometry
determines
impedance match device

The Amateur bands below 30 MHz are becoming crowded; consequently, many operators are moving to the VHF/UHF spectrum.

With higher frequencies come shorter wavelengths, distributed components, and shorter antennas. Shorter wavelengths allow for easier impedance matching between the transmission line and the antenna, or between two transmission lines of different impedances.

In the mid-fifties an article about a device called a G-line appeared in *Radio and Television News*. It consisted of a single hard-wire line with launchers to match impedances at each end. The G-line never became very popular, but the launcher has some nice qualities at higher frequencies. It looks like a funnel and works on the same principle as coaxial cable.

The impedance of coax is found by the ratio of the center conductor diameter to the inside diameter of the shield, using the following formula that disregards the dielectric:

$$Z = 138 \text{ Log } (D2/D1) \quad (1)$$

Where D2 is the inside diameter of the shield and D1 is the outside diameter of the center conductor.

By changing the ratio of D1 to D2 you change the impedance of the transmission line. If the transmission line impedance changes gradually, say over a quarter wavelength, the transition won't create a standing wave sufficient to cause appreciable loss. In short, you can match two impedances with minimum loss. This same concept is used in the G-line launcher.

The wavelength at 450 MHz is 66.66 cm, just 2/3 of a meter. A quarter wave length is only 16 cm. This short wavelength allows you to use the distributed compo-

nents of coax to make an impedance transformer that will serve for any frequency within that Amateur band.

For example, if you have a helix antenna and a length of 50-ohm coax cable, the input impedance of the helix is approximately 140 ohms. The mismatch that would accompany a direct connection would cancel out the antenna's gain. If you choose to use a quarter-wavelength coaxial transformer for matching, it would need a characteristic impedance of:

$$\begin{aligned} Z &= \sqrt{(Z1 \times Z2)} \\ &= \sqrt{(50 \times 140)} \\ &= 83.66 \text{ ohms} \end{aligned}$$

which is not a standard value. By using a launcher, you can effect a more efficient match between the cable and the helix.

The launcher dimensions include the input diameter, output diameter, and length. The length is not critical — but it should be longer than a quarter wavelength at the lowest frequency of operation. The two diameters are a function of the impedances.

The input diameter, for a 50-ohm cable is found as follows:

$$Z_{in} = 138 \text{ Log } (D2/D1)$$

$$\text{Let } D1 = 1$$

$$\text{Then } 50 = 138 \text{ Log } D2$$

$$2.303 = D2$$

The narrow end of the cone is 2-1/3 times larger than the wire of the helix antenna or the center conductor of the cable.

The output diameter of the cone for a 140-ohm antenna is as follows:

$$Z_{out} = 138 \text{ Log } (D3/D1)$$

$$\text{Let } D1 = 1$$

$$\text{Then } 140 = 138 \text{ Log } D3$$

$$10.33 = D3$$

The wide end of the cone is 10-1/3 times the wire of the helix antenna or the center conductor of the cable.

Use the information above to construct the launcher. First draw a template as shown in fig. 1. I used No. 12 AWG wire (diameter = 0.08081 inches) for D1. Cut along the curved lines and roll it onto itself to form the cone. If you have a compass with a 9-inch span, scribe

FIGURE 1

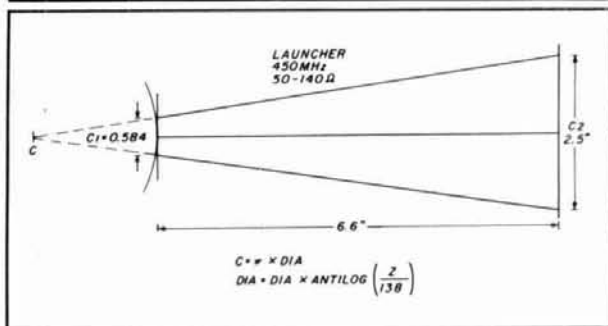

450-MHz roll-your-own launcher template.

FIGURE 2

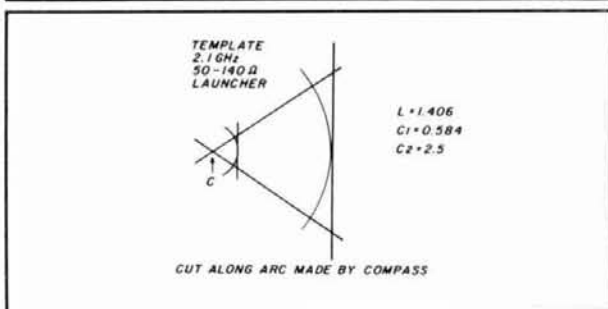

Template for 2.1 GHz 50-140 launcher. Cut along arc made by compass.

FIGURE 3

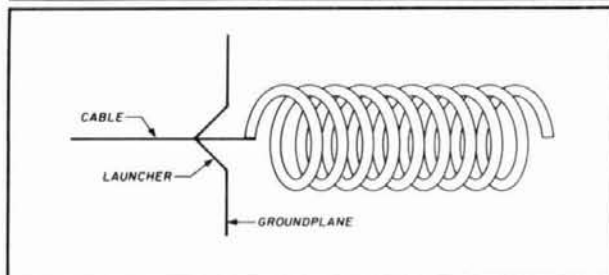

Helix antenna with launcher.

both ends as I did in the 2.1-GHz version in **fig. 2**. It will give the cone sides of equal length.

Purists will argue that the cone should be logarithmic like an old automobile horn. But you're working at the narrow end of the horn, and at that point the lines are almost straight.

One additional thing: if you're building a helix, the launcher diameter must be smaller than the helix diameter or the ground plane will fail. **Figure 3** shows the helix with launcher attached to the ground plane.

To test the idea, I built a helix antenna for 2.1 GHz and attached the launcher at the feedpoint. Return loss measurements of 18 dB indicate the antenna system works well.

Article F

HAM RADIO

RELY ON JAN FOR 3-WAY HELP:

1. **TECHNICALLY CORRECT CRYSTALS TO YOUR SPECS.**
2. **QUICK TURNAROUND WITH HUGE INVENTORY, PROMPT SERVICE, AND OUR EMERGENCY ORDER PLAN.**
3. **LOW PRICES.** ✓ 139

QUARTZ CRYSTALS FOR
TWO-WAY — INDUSTRY
MARINE — AMATEURS
SCANNERS — CBs
MICROPROCESSORS



FOR FREE CATALOG,
CALL OR WRITE:
JAN CRYSTALS
P.O. BOX 06017
FORT MYERS, FL 33906
(813) 936-2397

SINCE 1965

VISA

MasterCard

TOLL-FREE: 1-800-237-3063

IN FLORIDA: 1-800-226-XTAL
FAX ORDERS: 1-813-936-3750

NOVEX Speaker Mics

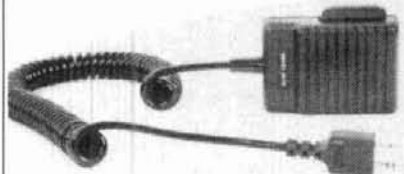

High quality audio • Privacy earphone jack
Rotatable lapel clip • Hi-Lo volume switch

ICOM DMC 537I
Kenwood DMC 537K
Yaesu DMC 537Y

SUPER VALUE
only \$19.95

✶ shipping & handling

NOVEX Handsets



PTT handset • backlit DTMF • Private listening
Wired for most current ICOM, Kenwood, Yaesu
& others (on special request)

ICOM HCS701I, Kenwood HCS701K, Yaesu HCS701Y
Available for many other radios at slightly higher prices.

Introductory price \$79.95

✓ 140

✶ shipping & handling



Orders: 800-368-3270 Local & tech info: 703-458-3550
Electronic Equipment Bank
516H Mill St. NE, Vienna, VA 22180
(just minutes from Washington, DC)

MOVING?

KEEP HAM RADIO COMING...

If possible let us know four to six weeks before you move and we will make sure your HAM RADIO Magazine arrives on schedule. Just remove the mailing label from this magazine and affix below. Then complete your new address (or any other corrections) in the space provided and we'll take care of the rest.

ham radio Magazine

Allow 4-6 weeks for correction.

Greenville, NH 03048

Thanks for helping us to serve you better.

Here's my new address:

Call _____

Name _____

Address _____

City _____ State _____ Zip _____

AFFIX LABEL HERE

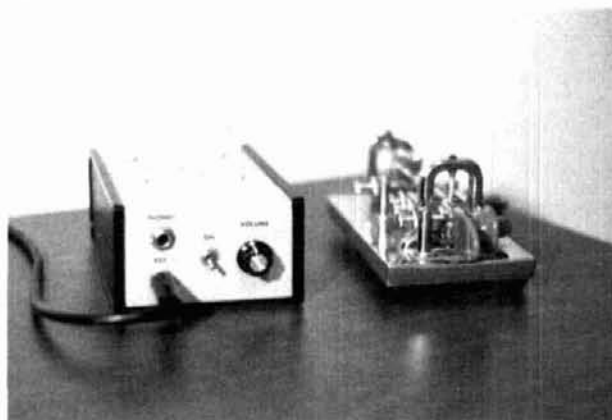

A code practice oscillator.

Parts List

Resistors (1/4 watt)

1	22k
1	1k
1	1M
2	220
1	470k
1	4k
1	39
1	10
1	270
2	15k

Potentiometers

1	10k audio taper
---	-----------------

ICs

1	LM386 (Radio Shack no. 276-1731)
1	MC3340A/ECG1829
1	LM741 (Radio Shack no. 276-1601)

Miscellaneous

2	9v Battery
2	Phone jack
2	Battery connector
1	DPST switch
1	3" speaker
1	Enclosure (Ten Tec JG-4) 4" x 2-1/4" x 6"
3 (optional)	8 pin DIP socket
	Perf board (Radio Shack)
	Fuse clip (Radio Shack)

Capacitors

4	400 μ F (electrolytic)
1	10 μ F (tantalum)
2	01 μ F (disc)
1	1 μ F (disc)
1	2 μ F (disc)
1	002 μ F (disc)

resistance. The voltage divider consists of the 220-ohm feedback resistor (R1) and lamp. It feeds back a higher proportion of the signal to the inverting input decreasing the closed loop gain. The amplitude decreases and is regulated. In normal operation the lamp's light will be invisible. Active devices in the op-amp are operated in the linear region yielding a single-tone sine wave.

Other audio amplifier circuits drive into saturation to regulate the amplitude. This causes the sine wave to be "squared off", generating distortion. Circuits using the 555 timer IC produce true square waves and have particularly raspy tones.

Oscillation frequency is controlled by the dual RC network in the noninverting feedback loop. Two 15k resistors and capacitors (C1), made up of three 4700 pF and one 680 pF disc ceramic capacitor, set an 800-Hz tone. These values can be changed to suit your preference. The resistors and capacitor don't have to be matched.

Keying the circuit in fig. 1 through the power leads is *not* recommended. A chirp would be produced as the lamp comes up to temperature. Let the oscillator run continuously and key its output signal with the electronic attenuator, IC2 (Motorola part MC3340P — also available as ECG829), in fig. 2. A key in the gain control input does a nice job. Shaping is controlled by the 4k and 0.2 μ F RC time constant; during key up



A CODE PRACTICE OSCILLATOR

Many code practice circuits have been published. Most will do an acceptable job, but tend to have a very rough "buzz saw" tone. They don't sound anything like a CW signal received off the air. This code practice oscillator has a pure sine wave 800-Hz note. It's a joy to use.

Circuit details

To obtain a pure tone, I used an audio oscillator that generates a sine wave with low distortion. In the circuit in fig. 1, an incandescent lamp-type 327, 28 volts at 40mA controls the feedback to the inverting input of a 741 operational amplifier. It regulates the signal amplitude to 5 volts peak-to-peak. The lamp glows brighter if the amplitude rises, increasing its

FIGURE 1

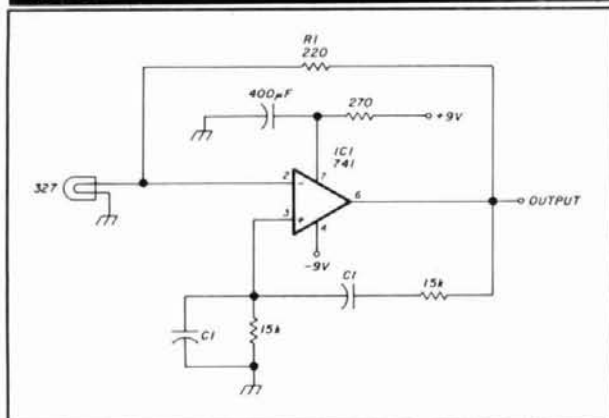

Oscillator circuit.

By John Pivnichny, N2DCH, 3824 Pembroke Lane, Vestal, New York 13850

FIGURE 2

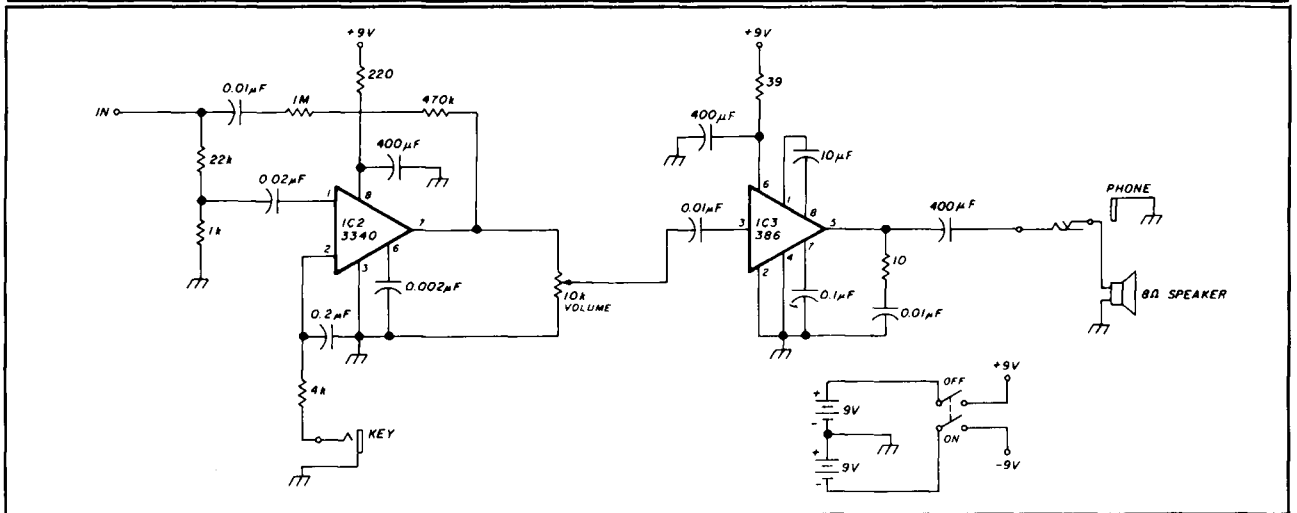

Keying circuit and power amplifier.

FIGURE 3

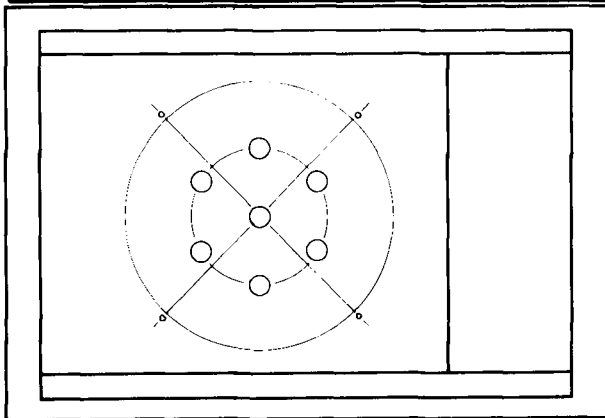

Top cover.

this part provides 60-80 dB attenuation. This may not be enough to completely eliminate a backwave signal. A feed-forward path using a 0.01 µF capacitor, 1 meg resistor, and a 470k resistor in series cancels any residual backwave signal. Note that the signal going through IC2 is inverted while the feed-forward signal is not; the two cancel out during key up. During key down IC2 provides 13-dB gain and can accept a maximum of 0.5 volt peak-to-peak signal at its input (pin 1). The resistive voltage divider at its input decreases the oscillator amplitude to an acceptable level.

Power amplifier IC3 is a conventional 386 circuit.^{2,3} There is enough power gain to drive headphones or a small speaker. Figure 2 shows the keyer and audio amplifier circuits. Two 9-volt transistor radio batteries supply power. The positive supply is decoupled at each IC. (This may be unnecessary as all circuits are very stable.)

Construction

All components are mounted on a 1-3/4" × 3" piece of perfboard. The lamp is mounted with a single fuse clip connecting it to the outside of the base, and a No. 30 gauge wire is soldered to the base center contact. The two batteries are held in place with spring clips fastened to the bottom of the enclosure with 4-40 × 1/4" machine screws. All other components are attached to the circuit board by their leads. I used insulated No. 30 gauge wire for the interconnections.

The box is 4" × 2-1/4" × 6" with a gray finish and black plastic side panels. A 3" diameter speaker is fastened to the top cover. Seven 1/4" holes, drilled as shown in fig. 3, form a speaker grill. There are also four 1/16" holes for speaker mounting machine screws. The front panel holds two 1/4" phone jacks for the key and earphone plugs, a DPST power switch, and the volume control. Dry transfer lettering with a protective coat of clear shellac completes the job. See the photograph for details.

Operation

Keying is done with a hand key, keyer, or semi-automatic bug. The built-in speaker and batteries make this oscillator compact, easy to use, and portable. Why not build one up for your next project?

References

1. Tom Schultz, "Audio Oscillator," *QST*, "Hints and Kinks," November 1974, page 43.
2. Rick Littlefield, K1BQT, "Construct an Audio Amplifier...", *QST*, April 1983, pages 28-31.
3. J. Rusgrove, "A General Purpose Audio Amplifier," *QST*, November 1976, page 32.



ALINCO ELECTRONICS INC.

20705 South Western Ave., Suite 104 Torrance, CA 90501 • (213)618-8616

Tiny, Tough & Terrific

The **NEW** Generation of T.T.& T. Hand Held Transceivers From Alinco Are Just Around the Corner!

Introducing The DJ-100T 2 Meter Hand Held Transceiver

- **Tiny** = 1-3/16" D x 2-3/8" W x 6-5/8" H
- **Tough** = 6.5 Watts (With Optional EBP-8NAZ Nicd Battery Pack)
- **Terrific** = Features and Benefits

AVAILABLE NOW

Suggested List Price \$299.00

- LCD with Switchable Backlighting
- 10 Memories
- BNC Antenna Connection
- 16 Button DTMF Pad
- Easily Accessible Dip Switches For Encoding Sub Audible Tones
- Battery Save Draws 15mA For Extended Battery Life
- .20uV Sensitivity
- 144.00 MHz to 147.995 MHz
- CAP and MARS Modifiable - Simplex only
- Standard Battery, EBP-9NAZ Has DC/DC Converter Built In
- Stores Standard Repeater Offsets In Memory
- Full Range of Accessories
- 220 MHz and 440 MHz To Follow Shortly

142



(Optional EBP-2NAZ Ni-Cd battery)

Alinco's products are carried by these fine dealers

A-Tech - Burbank, CA
 Amateur & Advance Comm. - Wilmington, DE
 Amateur Comm. ETC. - San Antonio, TX
 AES - Milwaukee, WI
 AES - Orlando, FL
 AES - Clearwater, FL
 AES - Las Vegas, NV
 Austin Amateur Radio Supply - Austin, TX
 Barry Electronics - New York, NY
 Burghardt Amateur Center - Watertown, SD
 Colorado Comm Center - Denver, CO
 Delaware Amateur Supply - New Castle, DE
 Doc's Communications - Rossville, GA
 El Original Electronics - Brownsville, TX
 EEB - Vienna, VA
 EGE, INC. - Woodbridge, VA

EGE, INC. - Salem, NH
 Erickson Communications - Chicago, IL
 F&M Electronics - Greensboro, NC
 Floyd Electronics - Collinsville, IL
 The Ham Station - Evansville, IN
 The Ham Hut - Amarillo, TX
 Hairy Radio - Hartford, CT
 Henry Radio - Los Angeles, CA
 Hirsch Sales Co. - Williamsville, NY
 HR Electronics - Muskegon, MI
 HRO - Anaheim, CA
 HRO - Atlanta, GA
 HRO - Burlingame, CA
 HRO - Oakland, CA
 HRO - Phoenix, AZ
 HRO - San Diego, CA
 HRO - Van Nuys, CA

HSC - Santa Clara, CA
 HSC - Sacramento, CA
 HSC - Sunnyvale, CA
 International Radio Systems - Miami, FL
 Jun's Electronics - Culver City, CA
 Kennedy Associates - San Antonio, TX
 KJI Electronics - Houston, TX
 Madison Electronics - Houston, TX
 Maryland Radio Center - Laurel, MD
 Memphis Amateur Electronics - Memphis, TN
 Michigan Radio - Mt. Clemens, MI
 Mission Consulting - Houston, TX
 Missouri Radio Center - Kansas City, MO
 N&G Electronics - Miami, FL
 Omni Electronics - Laredo, TX
 Quement Electronics - San Jose, CA
 RF Enterprises - Merrifield, MN

R&L Electronics - Hamilton, OH
 Reno Radio, Reno, NV
 Rivendell Associates - Derry, NH
 Rogus Electronics - Southington, CT
 Rosen's Electronics - Williamson, WV
 Ross Distributing Co. - Preston, ID
 Satellite City - Minneapolis, MN
 Tel-Com Electronic Comm. - Littleton, MA
 Texas Comm. Center - Houston, TX
 Texas Towers - Plano, TX
 VHF Communications - Jamestown, NY
 Williams Radio Sales, Colfax, NC

CANADA:
 Canadian Distributor
 Texpro Sales Inc. - Burlington, Ontario
 (416) 332-5944

here is the next generation Repeater
2 meters - 220 - 440

MARK 4CR

No other repeaters or controllers match Mark 4 in capability and features. That's why Mark 4 is the performance leader at amateur and commercial repeater sites around the world. Only Mark 4 gives you Message Master™ real speech • voice readout of received signal strength, deviation, and frequency error • 4-channel receiver voting • clock time announcements and function control • 7-helical filter receiver • extensive phone patch functions. Unlike others, Mark 4 even includes power supply and a handsome cabinet.

Call or write for specifications on the repeater, controller, and receiver winners.

The **only** repeaters and controllers with REAL SPEECH!

Create messages just by talking. Speak any phrases or words in any languages or dialect and *your own voice* is stored instantly in solid-state memory. Perfect for emergency warnings, club news bulletins, and DX alerts. Create unique ID and tail messages, and the ultimate in a real speech user mailbox — only with a Mark 4.



MICRO CONTROL SPECIALTIES

Division of Kendecom Inc.

23 Elm Park, Groveland, MA 01834 (508) 372-3442

TELEX 4932256 Kendecom

FAX 508-373-7304

WACOM DUPLEXERS

Our Exclusive Bandpass-Reject Duplexers
With Our Patented

B_p B_r CIRCUIT® FILTERS

provide superior performance... especially at close frequency separation.

Models available for all commercial and ham bands within the frequency range of 30 to 960 MHz.



CALL
817/848-4435



WACOM
PRODUCTS, INC.

P.O. BOX 21145

WACO, TEXAS 76702 • 817/848-4435

THE LAST AMPLIFIER YOU WILL EVER NEED! 7MHz - 1300 MHz



ONE AMPLIFIER MANY APPLICATIONS:

- Receiving-Ultra high dynamic range-Low noise.
- Transmitting-Driver or final...1 watt linear output.

Gain 15 dB ± 1 dB
IP3 + 44 dBm
IP2 + 73 dBm
N.F HF-UHF 4.5 dB (typ)
1dB Comp + 30 dBm
Connectors BNC

PRICE \$199
Add \$4.00 ship USA
CA Res. add 8%

✓ 145

**ADVANCED MILLIWAVE
LABORATORIES, INC.**
820 HAMPSHIRE RD., A3
WESTLAKE VILLAGE, CALIFORNIA 91361
TEL. (805) 495-7858

The entire back issue file of **Ham Radio Magazine** and **Ham Radio Horizons** is now available on easy to read, microfiche. The entire set (March 1968 thru December 1987, and March 1977 thru December 1980, respectively), is now available in one, easy to use format! Everything from front to back cover (ads too). Annual updates will be offered for \$10.

Ham Radio - \$150.00
HR Horizons - \$35.00
(\$5 shipping per order, USA)

Your satisfaction guaranteed, or money back.

Send or call order to:

Buckmaster Publishing
Post Office Box Ten
Mineral, Virginia 23117
(800) 282-5628
(703) 894-5777

VISA/MC accepted

313-469-4656
28360 South River Rd.
Mt. Clemens, MI 48045

Michigan Radio

SALES SERVICE



WE NOW HAVE



ALL PRICES SUBJECT TO CHANGE

ICOM	LIST	OURS!
IC-7B1	NEW super deluxe general cvg MOST ADVANCED BIG OUT!!!	5995.00 5899.95
IC-761	Delux gnt cvg acvrt/air excellent gnt cvg rig	2699.00 2314.95
IC-751A	Gnt cvg acvrt/air excellent rig Dk/operation Proven!!!	1699.00 1454.95
IC-735	Gnt cvg acvrt/air compact	1099.00 944.95
	Big performance/small size!	
R-71A	Big performance receiver The DXers Choice!!!	999.00 859.95
R-7000	25-2000 mHz scanning rcvr The Super Scanner!!!	1199.00 1029.95
IC-27A	25w 2m mobile cvr/DTMF mic	429.00 369.95
IC-27H	45w version of above	459.00 389.95
IC-37A	25w 220 mobile with DTMF mic	499.00 424.95
IC-47A	25w 440 mobile with DTMF mic	549.00 469.95
IC-28A	Compact 25w 2m mobile/DTMF mic	469.00 404.95
	ex-l-r-n-d-e-r rx coverage!	
IC-28H	45w version of above	499.00 429.95
IC-38A	Compact 25w 220 mobile/DTMF	499.00 414.95
IC-48A	Compact 25w 440 mobile/DTMF	509.00 439.95
	all of these ICOM VHF/UHF rigs	
	INCLUDE THE CTCSS (PL)!!!	
IC-471A	All mode 70cm cvr	1049.00 809.95
	PRICED TO CLEAR THEM OUT!	
IC-275A	Deluxe all mode 2m/ps/25w ICOM 5 latest all mode!!!	1299.00 1114.95
IC-275H	NEW 100w 2m all mode w/ps The Grid Square Center	1399.00 1199.95
IC-375	NEW 220 all mode/25w/ps Another first from ICOM!	1399.00 1199.95
IC-425A	NEW 70cm all mode/25w/ps	1399.00 1199.95
IC-475H	NEW 100w 70cm all mode/ps The biggest gun for UHF!	1599.00 1374.95
IC-900	NEW remote control multi-band FM cvr NEAT!!!	639.00 549.95
IC-2AT	1.5w 2m synthesized HT	319.00 274.95
	The IC-2AT has been in production longer than any other HT produced for the Ham market. Time tested, tried and true!!!	
IC-3AT	220 version of IC-2AT	349.00 299.95
IC-4AT	440 version of IC-2AT	349.00 299.95
IC-02AT	2m HT/10 memos/ctcss/DTMF	409.00 349.95
IC-02AT	5 watt version w/HPF	449.00 389.95
IC-02AT	2.5w 220 HT/ctcss/DTMF Great for novices!!!	449.00 389.00
IC-04AT	3w 440HT/ctcss/DTMF	449.00 389.00
	Get away from the crowd—go 440!	
IC-u2AT	Micro 2m HT/ctcss/DTMF/mems	329.00 289.95
IC-u4AT	Mini 440 HT/ctcss/DTMF/mems	369.00 319.95
	Looking for a small HT with big features? Check out the ICOM MICRO line hrs.	

WE STOCK A FULL LINE OF ACCESSORIES FOR THE ICOM LINES. CALL FOR INFORMATION, RECOMMENDATIONS AND OUR DISCOUNTED PRICES! (313) 469-4656

KENWOOD	LIST	OURS!
TS-940S	Super gnt cvg acvrt. The Ultimate Weapon! w/air without at	2449.95 2074.95
TS-930S	Gnt cvg acvrt/ps/hotch w/air DXcellence!	2219.95 1879.95
TS-440S	Compact acvrt/ps/mems	1199.95 1014.95
	102db dynamic range! w/air without at	1379.95 1168.95
TS-140S	Compact gnt cvg acvrt	1179.95 998.95
	DXciting price!!!!	929.95 787.95



TS-560S	LIST	OURS!
Compact gnt cvg acvrt WITH SIX METER COVERAGE!!!	999.95	929.95
R-5000 102 dB range SW receiver 100 Memory Channels!!!	999.95	815.95
R-2000 General coverage receiver 100 memories/2 clocks	749.95	610.00
TM-2630 25w 2m mobile/DTMF	479.95	405.95
TM-2550 45w 2m mobile/DTMF	499.95	419.95
TM-2570 70w 2m mobile/DTMF	599.95	505.95

POCKET HANDHELS

TUE WEDS 10-6
 THU FRI 10-9
 SAT 10-4

146

KENWOOD	LIST	OURS!
TM-3500	25w 220 mobile/DTMF	499.95 419.95
TW-4100	Kenwood's 25/35 series radios are DCS/OCL compatible.	599.95 514.95
TH-3100	2m/440 dual band mobile	299.95 254.95
TH-3101A	2m/440 deluxe dual band	699.95 589.95
TH-3102	220 version 21BT	299.95 234.95
TH-25AT	NEW MINI 2M SYNTHESIZED HT!!!	349.95 294.95
TH-205AT	2m 3w HT/10 memos/ctcss	299.95 249.95
TH-215AT	2m 3w HT/10 memos/ctcss	379.95 319.95
TH-310AR	220 3w HT/10 memos/ctcss	399.95 334.95
TH-415AT	2.5w 440 HT/10 memos/ctcss	399.95 334.95
TM-221A	45w mobile w/DTMF mic	439.95 369.95
TM-321A	220 version of 221	449.95 379.95
TM-421A	35w mobile 440 w/DTMF mic	449.95 379.95
TR-751A	2m all mode mobile	649.95 549.95
TS-711A	Deluxe 2m all mode w/ps	1029.95 869.95
TS-811A	Deluxe 70cm all mode w/ps	1229.95 1039.95

GO SATELLITE IN A BIG WAY - USE THE KENWOOD TWINS - 711/811!
 WE STOCK A COMPLETE LINE OF KENWOOD ACCESSORIES. RECOMMENDATIONS AND OUR LOW PRICES 469-4656

TEN TEC	LIST	OURS!
S85 PARAGON Super HF transceiver THE transceiver	2245.00	1924.95
S61 CORSAIR II HF transceiver	1445.00	1239.95
S250 ARGOSY II Economy HF transceiver	745.00	639.95
RX-325 Compact gnt cvg rcvr	699.00	574.95
2510 Satellite station	549.00	474.95

WE STOCK THE FULL LINE OF TEN TEC ACCESSORIES - CALL US FOR INFORMATION, RECOMMENDATIONS AND OUR DISCOUNT PRICES!!!

YAESU	LIST	OURS!
FT-767 Super acvrt/ps/mems accepts modules for VHF/UHF	1929.95	1664.95
FT-757II New improved version 757	1129.95	974.95
FT-747XR NEW! Economy HF XCVR	889.95	754.95
FT-736R NEW! multi-mode VHF/UHF	1749.95	1499.95
FRG-8000 Gnt cvg w/10 memos/key entry	759.95	624.95
FRG-9600 Scanning VHF/UHF receiver	699.95	494.95
FT-727RH 2m/440 HT NEW CPU! The first dual band HT!!!	439.95	358.95
FT-109RH 2m HT/5w scanning/memories	399.95	329.95
FT-109RH 440 HT/5w scanning/memories	389.95	329.95
FT-709RH 440 HT/5w scanning/memories	334.95	289.95
FT-738R Mini 2m HT/DTMF	389.95	329.95
FT-738R Mini 440 HT/DTMF	349.95	319.95
FT-211RH 2m 45w autobreak mobile	449.95	399.95
FT-311RH 220 25w version FT-211RH	439.95	384.95
FT-711RH 440 35w FM autotuner mobile	479.95	414.95

Limited number w/ autodial microphone
 Please note the 211 series no longer comes from Yaesu with the autodial microphone. We have a limited number of them in stock with the autodial mic.
 FT-212RH High Tech 45w 2m mobile 459.95 399.95
 FT-712RH High Tech 35w 70cm mobile 499.95 434.95

WE STOCK A COMPLETE LINE OF YAESU ACCESSORIES! CALL US FOR INFORMATION, RECOMMENDATIONS AND OUR LOW PRICES!!! (313) 469-4656

WORLD'S SMALLEST WEATHER STATION

THE TW-2 MICRO WEATHER STATION INCLUDES A COMPUTER MODULE, THE AN-2 ANEMOMETER, AND 40' OF LEAD IN CABLE. FOR ONLY \$159.95.

WIND SPEED AUTO SCAN
 WIND DIRECTION METRIC / STANDARD
 WIND CHILL FOUR WAY POWER
 WIND GUST RECORD N/CAD READY
 TEMPERATURE MOUNTING OPTIONS
 HI/LOW TEMP RECORD ONE YEAR WARRANTY

**** SATISFACTION GUARANTEED ****

MAGNAPHASE INDUSTRIES, INC.
 1502 PIKE STREET N.W.
 AUBURN, WA 98001 M/C & VISA
 ORDERS ONLY: 800-322-1502
 INFORMATION: 206-735-0374 FAX: 206-735-9044

NEW SUPER LONG PLAY TAPE RECORDERS

12 Hour Model — \$105.00*

Modified Panasonic Slimline, high quality, AC-DC Recorders provide 6 continuous hours of quality recording & playback on each side of cassette for a total of 12 hours.

Built-in features include:
 • Voice level control • Digital counter, etc. TDK DC 120 Cassette Furnished.

PHONE RECORDING ADAPTER
 Records calls automatically. All Solid state connects to your telephone jack and tape recorder. Starts recording when phone is lifted. Stops when you hang up. \$24.50*

VOX VOICE ACTIVATED CONTROL SWITCH
 Solid state. Self contained. Adjustable sensitivity. Voices or other sounds automatically activate and control recorder. Uses either recorder or remote mike. \$24.95*

*Add for ship & hdg. Phone Adapter & Vox \$1.50 ea. Recorders \$4.00 ea. Cal. Res. add tax. Mail order, VISA, M/C, COD's OK. Money Back Guarantee. Qty. disc. avail... Dealer inquiries invited. Free data.

AMC SALES INC. Dept# 9335 Lubec St., Box 928, Downey, CA 90241 Phone (213) 869-8519

CIE Cleveland Institute of Electronics

1776 East 17th St., Cleveland, Ohio 44114

Accredited Member National Home Study Council

CIE is the world's largest independent study electronics school. We offer ten courses covering basic electronics to advanced digital and microprocessor technology. An Associate in Applied Science in Electronics Engineering Technology is also offered.

Study at home — no classes. Programs accredited and eligible for VA benefits.

CIE Cleveland Institute of Electronics
 1776 East 17th St., Cleveland, Ohio 44114
 YES! I want to get started. Send me my CIE school catalog including details about the Associate Degree program.

Print Name _____
 Address _____ Apt. _____
 City _____ State _____ Zip _____
 Age _____ Area Code/Phone No. _____
 Check box for G.I. Bulletin on Educational Benefits
 Veteran Active Duty MAIL TODAY!
 149 AHR-06

R9100 SUPER ROTATOR

The Advanced Radio Devices (ARD) R9100 is the heavy duty antenna rotator designed for the big gun with antenna loads to one ton. All components are designed and selected for durability and long life, a quality often overlooked.

The control system provides both analog and digital readout of direction to within ± 1 degree. Provisions for external computer control which allows rotor positioning by the mere keyboard entry of a target country's prefix. Software is provided for use with most popular computers.

This quality rotor is the most capable and powerful unit designed for the amateur market today. You can pay more and get less.

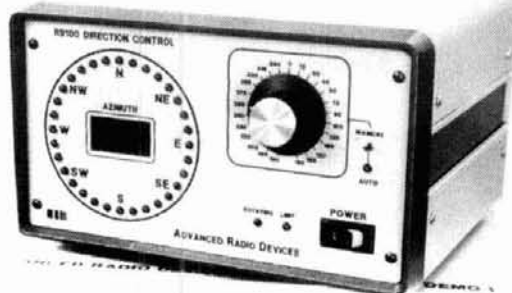
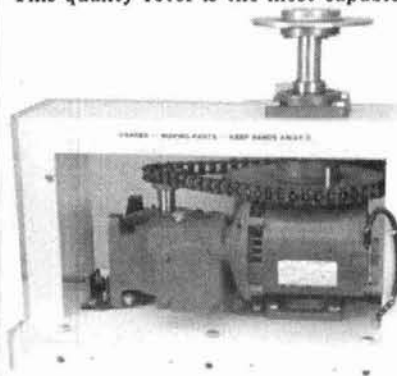

SPECIFICATIONS

Rotating torque: 10,000 inch lbs.
Braking torque: 24,000 inch lbs.
Vertical load: 2000 lbs.
Mast sizes: 2.0 to 3.5 inch O.D.
Motor: 1/3 HP
Rotation speed: 1 RPM
Weight: 230 lbs.
Size: 14.9x25x15.1 inches (w/h)

Write for complete specs and installation information

Distributed Exclusively by EEB



Orders: 800-368-3270

Local & tech info
703-938-3350

Electronic Equipment Bank

516H Mill St. NE, Vienna, VA 22180

(just minutes from Washington, DC)

✓ 150

NEMAL ELECTRONICS

*Complete Cable Assembly facilities MIL-STD-45208
*Commercial Accounts welcome- Quantity pricing * Same day shipping most orders
*Factory authorized distributor for Alpha, Amphenol, Belden, Kings, Times Fiber

Call NEMAL for computer cable, CATV cable, Flat cable, semi-rigid cable, telephone cable, crimping tools, D-sub connectors, heat shrink, cable ties, high voltage connectors.

HARDLINE 50 OHM

FXA12 1/2" Aluminum Black Jacket.....	.89/ft
FLC12 1/2" Cablewave corr. copper blk jkt	1.69/ft
FLC78 7/8" Cablewave corr.copper blk jkt	3.92/ft
NM12CC N conn 1/2" corr copper m/f	25.00
NM78CC N conn 7/8" corr copper m/f	54.00

COAXIAL CABLES (per ft)

1180 BELDEN 9913 very low loss52
1102 RG8/U 95% shield low loss foam 11ga.....	.36
1110 RG8X 95% shield (mini B)17
1130 RG213/U 95% shield mil spec NCV jkt.....	.39
1140 RG214/U dbl silver shld mil spec.....	1.85
1705 RG142B/U dbl silver shld, teflon ins	1.50
1310 RG217/U 50 ohm 5000 watt dbl shld98
1450 RG174/U 50 ohm .100" od mil spec14

ROTOR CABLE-8 CONDUCTOR

8C1822 2-18ga and 6-22ga21
8C1820 2-18ga and 6-20ga39

CONNECTORS-MADE IN USA

NE720 Type N plug for Belden 9913	\$3.95
NE723 Type N jack for Belden 9913.....	4.95
PL259 standard UHF plug for RG8,213.....	.85
PL259AM Amphenol PL25989
PL259TS PL259 teflon ins/silver plated	1.59
PL259AM Amphenol female-female (barrel).....	1.65
UG175/UG176 reducer for RG58/59 (specify).....	.22
UG21DS N plug for RG8,213,214 Silver	3.35
UG838 N jack to PL259 adapter, teflon	6.50
UG146A SO239 to N plug adapter, teflon	6.50
UG255 SO239 to BNC plug adapter, Amphenol.....	3.29
SO239AM UHF chassis mt receptacle,Amphenol.....	.89

GROUND STRAP-GROUND WIRE (per ft.)

GS38 3/8" tinned copper braid40
GS12 1/2" tinned copper braid50
GS200 1-1/2" heavy tinned copper braid	2.00
HW08 8ga insulated stranded wire35
AW14 14ga stranded Antenna wire CCS14

Prices do not include shipping, \$3 minimum, Visa/Mastercard \$30 min, COD add \$3.00

Call or write for complete price list. NEMAL's new 36 page CABLE AND CONNECTOR SELECTION GUIDE is available at no charge with orders of \$50 or more, or at a cost of \$4 with credit against next qualifying order.

NEMAL ELECTRONICS, INC. 12240 NE 14th Ave. N. Miami, FL 33161
(305) 893-3924 Telex 6975377 24hr FAX (305)895-8178

THE MULTIPLE RECEIVER SOLUTION

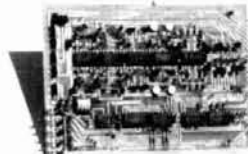

4 Channel Signal-to-Noise Voter

- Expandable to 32 Channel by Just Adding Cards
- Continuous Voting
- LED Indicators of COR and Voted Signals
- Built-in Calibrator
- Remote Voted Indicators Pinned Out
- 4 1/2 x 6 Double Sided Gold Plated 44 Pin Card
- Remote Disable Inputs
- MORE

Built, tested and calibrated with manual

\$350.00

Telephone interface now available
For more information call or write:

DOUG HALL ELECTRONICS
Voter Department
815 E. Hudson Street
Columbus, Ohio 43211
(614) 261-8871

✓ 151

VHF/UHF WORLD

Joe Reisert, W1JR

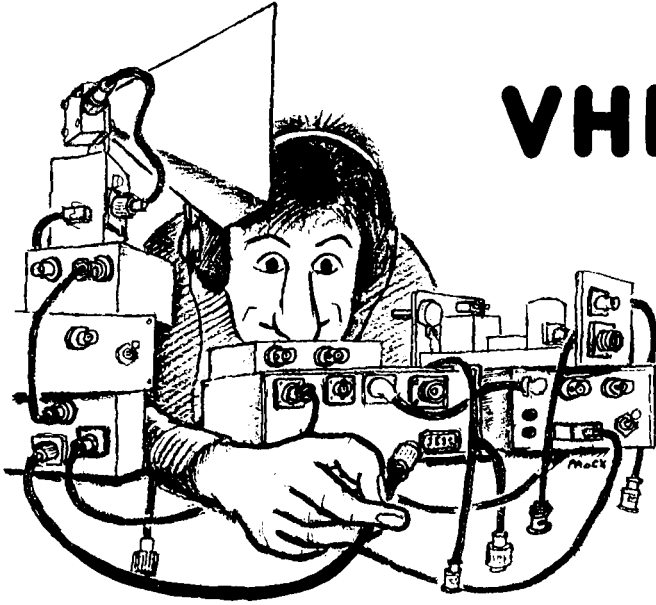

IMD and splatter

Interference has always been one of the greatest impediments to communications, regardless of frequency. If an Amateur with a strong signal transmits right on a frequency where a weak signal is present, there is virtually no way you can copy the weaker signal unless the stronger station stops transmitting.

But, interference isn't confined to the simple case described above. Often there are other circumstances like IMD (intermodulation distortion) — often referred to as splatter on SSB. The latter may be transmitted, or locally generated in the receiver.

This month I'll review the subject of IMD/splatter, answer some of the most often asked questions, and discuss some recommendations and test methods.

CW transmission

Using CW provides a partial solution to the interference problem. Even if two signals are on exactly the same frequency, you can achieve partial copy of the weak signal when the strong signal is "key up." Also, if a weak signal is on a slightly different frequency from a strong one (perhaps as little as 1.0 kHz away), and the strong signal is not blocking your receiver, you may be able to separate

the signals if you have a good narrow-band i-f filter (typically 500-Hz bandwidth) in your receiver.

There is a very basic reason why CW signals can be so easily separated. A good clean CW signal occupies very little bandwidth — less than 500 Hz, as shown in **fig. 1A**. This is only true if the oscillator in the transmitter is very stable and doesn't have any "phase noise."

Phase noise is a form of frequency modulation that is often superimposed on the carrier frequency. As a result, a transmitted signal is broadened or spread out in frequency (see **fig. 1B**). This phenomenon is particularly evident in the modern-day synthesized transceivers. I often refer to phase noise as the "aurora" affect. If you tune a few kilohertz off the carrier of a CW signal with phase noise, it sounds like keyed white noise which is similar to the signal returning from the auroral reflection.

Further complicating this phenomenon is that the local oscillator in your receiver may also have phase noise, exacerbating the problem. It will be difficult, if not impossible, to determine whether the transmitter or the receiver, or both, are the culprits! For those who want more information on this communications bugaboo, I'd recommend reading reference 1.

SSB transmission

As if the problems of CW transmission weren't bad enough, enter an SSB transmitter and you have a whole new ballgame. By nature an SSB signal has a broad bandwidth, typically 2-3 kHz at the half-power point, when carrying voice intelligence.

In the good old days, SSB signals were generated by the phasing method because it was low cost and had good fidelity. Phasing exciters characteristically have wider bandwidth because the filtering and phasing required is more complex.

Most modern exciters generate SSB by the rf-filtering method which employs well-controlled crystal band-pass filters. However, even these filters are seldom specified over more than a 40-dB range.

The local VHF/UHFers can tell when I alternate between my phasing and filter SSB exciters. The phasing exciter has good audio fidelity, but the IMD outside the passband is at a higher level. The filter exciter has poorer audio fidelity, but outside the passband IMD drops off at a faster rate.

What most Amateurs tend to forget is that SSB signals, by their very nature, have "controlled" IMD. Amateur SSB exciters and power amplifiers are often specified to have a typical IMD specification — 26-30 dB at a specific PEP output level. This means that the third order IMD products (the ones generated closest to the desired signal but outside the 2.5-3 kHz passband), are only 26-30 dB below the peak power level specified. Higher order sidebands are also present, but usually at a lower level.

Figure 1C puts all this in perspec-

FIGURE 1

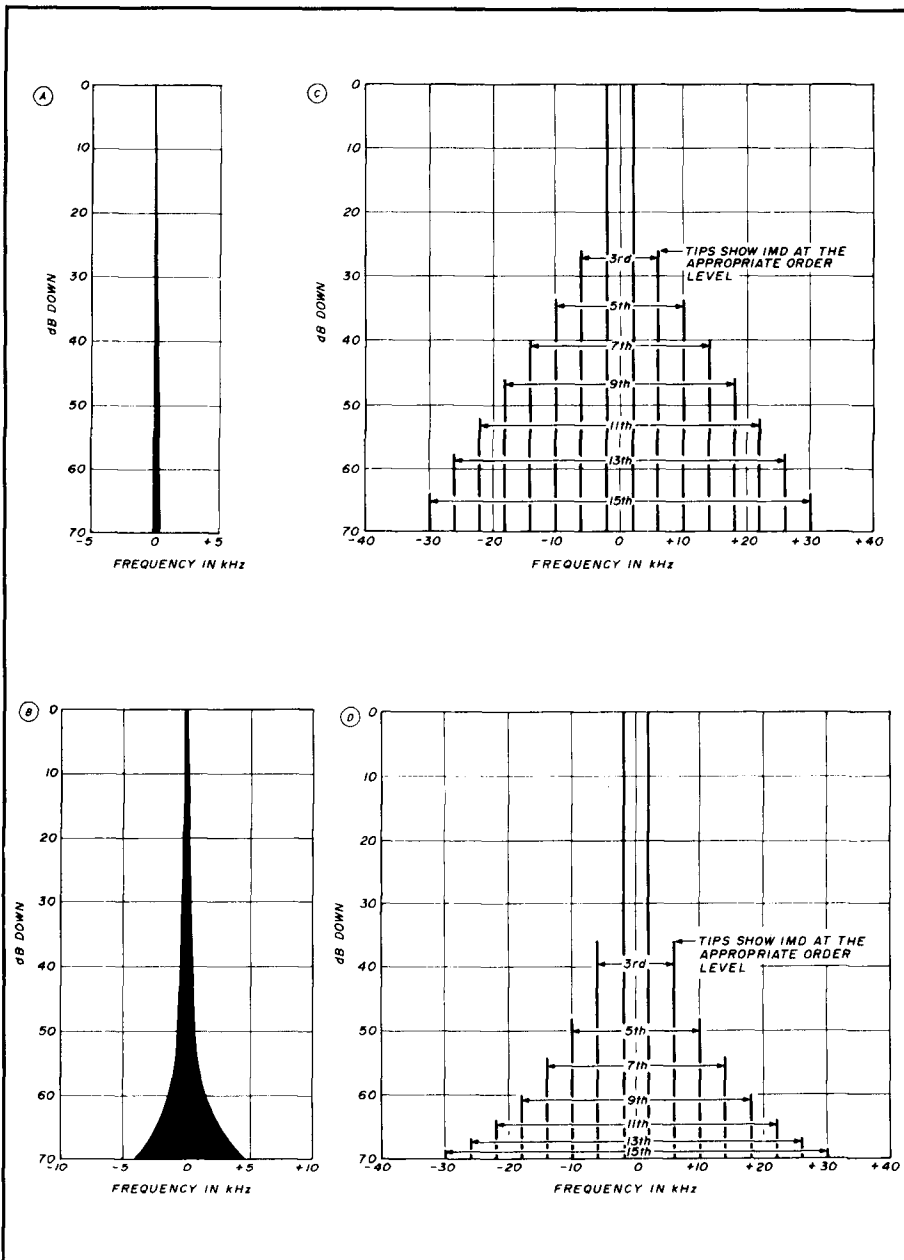

(A) The output spectrum of a pure CW signal.
 (B) The output spectrum of a typical CW signal with phase noise.
 (C) The output spectrum of a clean SSB signal from a commercial amplifier.
 (D) A typical Amateur SSB transmitter.

tive. It shows the typical output spectrum from a "commercial quality" filter-type SSB transmitter when modulated by two identical level audio tones, one near 500 and the other near 2500 Hz (adapted from reference 2). Remember that this spectrum display is typically 6-10 dB better than the average Amateur transmitter.

Referring to fig. 1C, note the high

level of rf at the 3rd order level — typically 36-dB down. Consequently, there will be rf energy outside the normal 2-3 kHz passband that will be only 36-dB below the carrier peaks, or about one four-thousandth of the peak power. Not bad if the station is only 25-30 dB out of the noise, but very objectionable if it's 40-60 dB out of the noise.

What about the higher order sidebands? The 5th, 7th, and 9th order IMD products are still only down 48-60 dB. They will be very noticeable on a strong local station which is typically 60-80 dB out of the noise!

To the average HFer, these problems may be an annoyance. With heavy interference, local noise, and intermittent operation (like a "DX pileup") you can learn to "live with it." However, to the VHF/UHFer who often listens on a relatively quiet band over a limited frequency range, IMD can be difficult to tolerate.

SSB splatter

So far I've been talking about the idealized transmitter case. What's it like when the IMD levels of an SSB transmitter are at Amateur specifications? Worse yet, what happens when an Amateur is trying to "eek out" the last bit of transmitted power by shouting into the microphone or turning the gain control up too high?

Figure 1D shows one possible spectrum display. This is a typical Amateur transmitter output spectrum at rated power output. Note that the 3rd order IMD products are only 26-dB below the peak power level. Furthermore, the 9th order products are 46-dB down, 14-dB worse than the commercial transmitter! Remember that if the transmitter is driven above these levels, the IMD will increase dramatically.

Why is this true? The linearity of a transmitter is limited by the ability of each stage to accurately reproduce and amplify the input signal. Each stage, usually a vacuum tube or solid state device, has a finite output power level beyond which it will generate distortion. Exceeding this level results in high levels of IMD and splatter.

Transmitting devices

Let's compare some typical transmitting devices. Vacuum tubes have been around a long time and maintain a good reputation when used as rf power amplifiers. RF transistors are in wide use, although they are often

TABLE 1

This table shows some of the most popular VHF/UHF high power transmitting tubes used by Amateurs. The ratings are extracted from manufacturers' data sheets. See text for further explanation.

Tube type	Dissipation in watts	Peak envelope power output	IMD specs	Remarks
Triodes				
3CX400A7/8874	400	590	35	
3-400Z/8163	400	590	28	
3CX800A7	800	750	36	
3-1000Z/8164	1000	1080	29	
3CX1500A7/8877	1500	2000	38	
8938	1500	2000	44	
Tetrodes				
4CX250R/7580W	250	470	23	
8930	350	350	27	Formerly DX393
7650	600	680	31	
4-1000/8166	1000	1540	NA	IMD Estimate 25 dB
4CX1000A/8168	1000	1400	23	
7213	1500	1000	NA	IMD Estimate 25 dB
4CX1500B/8660	1500	1500	43	
NA: Not available				

unfairly targeted as "splatter generators." More on this shortly.

Operating each stage of a transmitter in class "A" would be ideal for linear operation, but the power consumption would increase. The power dissipation of each stage would also be high, making the cost of the appropriate high power amplifier devices prohibitive. On the other hand, operating each transmitting stage in class "C" would raise efficiency, but distortion would be prohibitive.

As a result, most vacuum tube amplifiers are operated in class "AB" with moderate idling current. Vacuum tubes are usually large and, if they can't dissipate heat easily by themselves, heat dissipation can be assisted by a fan or blower.

Cooling solid-state devices with their very small geometry is still a problem, but one that is improving. Large heat sinks and special compounds are used to thermally bond the devices to the heat sink. Also most solid-state devices are operated in class "B." However, they are more prone to distortion.

Another reason vacuum tubes are so linear is that they operate with high voltages on the anode. Consequently,

there is a large voltage difference between the typical operating voltage on the anode and the minimum voltage across the anode when saturation occurs. If you go back to old vacuum tube literature you'll find lots of discussion about "load lines." In the typical vacuum tube application the load line operates over a very wide voltage swing before saturation and distortion occurs. Furthermore, vacuum tubes usually operate with output impedance levels of 1-5,000 ohms. This is a moderately easy impedance to match to 50 ohms; it's often done with a pi-network. As a result, impedance matching losses are usually low and efficiency is high.

Contrast this with the typical solid-state power amplifier used by Amateurs. It most often uses transistors specified for 12-14 volt operation because this is the voltage usually used in mobile operation, and therefore in Amateur shacks. These devices typically saturate at 1-2 volts, so the load line operates over a very narrow voltage range.

The operating impedance levels of the typical rf solid-state transistor are low, usually 1-10 ohms! This makes the matching networks more complex

and lossy. At UHF frequencies the parasitics of the components themselves become a major problem.

The use of higher voltage transistors like the 28-volt types will improve linearity, but require higher supply voltages at lower current. The development of MOS (metal oxide semiconductors) power FETs is a promising field. These devices usually require a 25-60 volt supply, although some lower-power types operate at 12-14 supply voltages.

Proper amplifier operating parameters

Now let's look specifically at power amplifiers. It should be obvious why just about all Amateur amplifiers, especially the commercial types, operate in linear service. Linear amplifiers are less likely to abruptly change power and can be used on any emission type: CW, FM, SSB, or ATV.

Vacuum tubes are still the favorite source of linear power, especially when good IMD and power levels over 100-200 watts are desired. But, the fact that an amplifier uses a vacuum tube is no guarantee that it will be linear. Certain operating parameters must be met. Many of them are described in references 3 and 4. Furthermore, what is often ignored is that for good IMD performance, the type of tube selected is often more important than the operating parameters. If the tube you choose isn't specifically designed for linear service, you probably won't obtain good linear output characteristics — regardless of the operating parameters and circuitry employed.

Generally speaking, at VHF/UHF frequencies, tetrodes have the highest power gain and are usually operated in the grounded-cathode configuration. However, the newer high-mu triodes driven in the ground-grid configuration, while having less gain, will generally deliver the best IMD performance.

Table 1 shows the expected linear performance from some of the most popular tubes Amateurs use. Data has been gleaned from manufacturers data sheets and literature.^{5,6}

mation on older tubes (prior to 1970) is almost nonexistent. From the table, it is obvious that the newer high-Mu triodes generally have better IMD performance. Additional parameter information is available in reference 3.

One further caution. The IMD shown in table 1 is an optimized target figure and will vary somewhat with different tubes. These numbers were probably derived under tight laboratory conditions with good instrumentation.

Table 1 is by no means complete. Always get the exact parameters directly from the manufacturers data sheets, not "Joe Ham" down the street. Deviating from the specific operating voltages shown on these data sheets will probably degrade the IMD.

If a tube is driven to higher power levels than shown, the IMD will drop accordingly. As a rough rule of thumb, every time the power output is doubled, the IMD will degrade by at least 6 dB. Going above the output power shown on table 1 is strongly discouraged, unless you want to severely

shorten the life of your tubes. Furthermore, you'll gain the ire of every VHF/UHFer in your area who'll be telling you how badly you're splattering.

Solid-state power amplifiers are popular, especially those delivering 10-160 watts. They are generally small in size and only require a single power supply voltage. Reference 7 describes them in detail, along with recommended circuitry. As stated above, the 12-14 volt transistor types are the most common. Some precautions are advised. The power supply should be fairly well regulated and, preferably, adjustable.

Most solid-state amplifiers are specified to operate at approximately 13.5 volts. Dropping the power supply voltage to 12 volts will usually drop the output power by 10-20 percent! Likewise, the IMD will severely degrade.

Pay special attention when wiring the power supply to a solid-state power amplifier. Large diameter wire, no. 14 or larger AWG, is recommended since these amplifiers draw from 5-20A. Small diameter wire will

cause a large voltage drop on the power supply lines, with a commensurate decrease in output power and IMD as described above.

As mentioned earlier, solid-state power amplifiers have developed a bad reputation with regards to splatter. There are many reasons for this. As I noted above, the power supply and supply voltage are sometimes to blame. But, the biggest offender is probably the user and his or her interpretation of the manufacturers' specification.

For example, a typical amplifier specification may say "100 watts output with 10 watts of drive." This implies that the amplifier has a true gain of 10 dB.

In reality, the 100 watts of output power may be the maximum output power possible from the amplifier, not the maximum linear output power. Also, the gain may be much higher at the lower output power. Lastly, you may be overdriving the amplifier.

Testing and evaluating power amplifiers

Up to now I've been describing operating parameters. Now let's dig in and see how to test, evaluate, and operate a linear power amplifier. Then you'll be able to better apply this information to your own station.

To better illustrate the point of linearity and specifications, I've plotted on fig. 2 the true output versus input power on a typical Amateur commercial 100-watt VHF solid-state power amplifier. Figure 2 shows that an input power of 1.0 watt yields an output power of approximately 23 watts — a gain of 23 or 13.6 dB. At 3.5 watts input, the output power is approximately 64 watts, a gain of 18.3 or 12.6 dB. Finally, at 10 watts input, the output power is approximately 100 watts; the gain is 10 dB.

Note that the gain isn't constant. What went wrong? The answer is nothing. This output versus input characteristic is typical of the solid-state power amplifiers used by Amateurs. They are linear, but only up to a point.

FIGURE 2

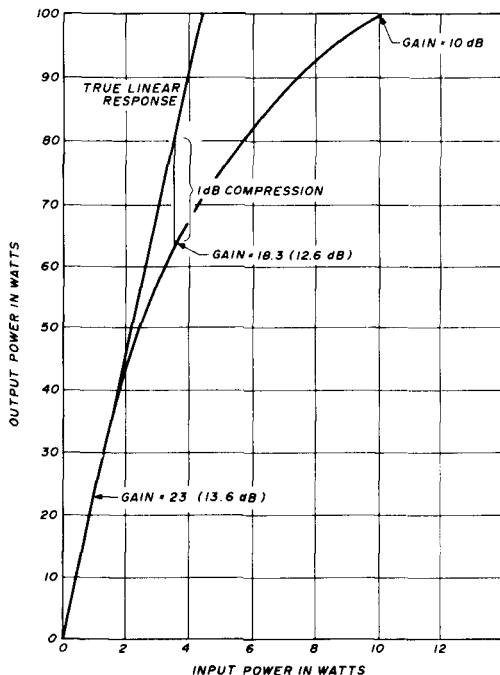

The graph shows the input versus output power from a typical VHF Amateur commercial amplifier. See text for further information on how to interpret the results and perform your own tests.



Food for thought.

Our new Universal Tone Encoder lends its versatility to all tastes. The menu includes all CTCSS, as well as Burst Tones, Touch Tones, and Test Tones. No counter or test equipment required to set frequency—just dial it in. While traveling, use it on your Amateur transceiver to access tone operated systems, or in your service van to check out your customers' repeaters; also, as a piece of test equipment to modulate your Service Monitor or signal generator. It can even operate off an internal nine volt battery, and is available for one day delivery, backed by our one year warranty.

- All tones in Group A and Group B are included.
- Output level flat to within 1.5db over entire range selected.
- Separate level adjust pots and output connections for each tone Group.
- Immune to RF
- Powered by 6-30vdc, unregulated at 8 ma.
- Low impedance, low distortion, adjustable sinewave output, 5v peak-to-peak
- Instant start-up.
- Off position for no tone output.
- Reverse polarity protection built-in.

Group A

67.0 XZ	91.5 ZZ	118.8 2B	156.7 5A
71.9 XA	94.8 ZA	123.0 3Z	162.2 5B
74.4 WA	97.4 ZB	127.3 3A	167.9 6Z
77.0 XB	100.0 1Z	131.8 3B	173.8 6A
79.7 SP	103.5 1A	136.5 4Z	179.9 6B
82.5 YZ	107.2 1B	141.3 4A	186.2 7Z
85.4 YA	110.9 2Z	146.2 4B	192.8 7A
88.5 YB	114.8 2A	151.4 5Z	203.5 M1

- Frequency accuracy, $\pm .1$ Hz maximum - 40°C to + 85°C
- Frequencies to 250 Hz available on special order
- Continuous tone

Group B

TEST-TONES:	TOUCH-TONES:	BURST TONES:			
600	697 1209	1600	1850	2150	2400
1000	770 1336	1650	1900	2200	2450
1500	852 1477	1700	1950	2250	2500
2175	941 1633	1750	2000	2300	2550
2805		1800	2100	2350	

- Frequency accuracy, ± 1 Hz maximum - 40°C to + 85°C
- Tone length approximately 300 ms. May be lengthened, shortened or eliminated by changing value of resistor

Model TE-64 \$79.95

COMMUNICATIONS SPECIALISTS

426 West Taft Avenue, Orange, California 92667
(800) 854-0547/ California: (714) 998-3021



HAM RADIO MAGAZINE

The Perfect Holiday Gift!

Every issue is chock-full of the kind of articles Hams are looking for. Each month there'll be at least two Weekenders — the kind of projects you really want to build. Extra emphasis is also given to excellent short technical pieces. In addition, HAM RADIO will continue to carry high quality technical articles.

HAM RADIO Magazine has monthly columns from some of the best authors in the radio field: Bill Orr, W6SAI, on antennas and general radio subjects; Joe Reiser, W1JR, spotlighting VHF/UHF technology; Garth Stonehocker, K0RYW's monthly propagation forecasts; Joe Carr, K4IPV, concentrating on equipment repair and Tom McMullen, W1SL, covering basic operating procedures and theory.

You also get four, highly regarded, very special issues. January brings the Annual Construction issue — put together to exemplify Ham Radio's new emphasis on building. In May, there's our annual Antenna Special—antenna designs and ideas from some of the world's best antenna experts. July means VHF and UHF with the latest in state-of-the-art. And in November, you'll receive the annual Receiver issue, full of high performance designs and technology. They all come absolutely FREE as part of your subscription.

HAM RADIO Magazine also has new graphics, design and layout that enhance HR's readability and give it a pizzazz not found elsewhere in the Amateur Radio field.

There's no time like now to give a HAM RADIO Magazine subscription as a present for that hard-to-buy-for Ham friend. While you're at it — why not renew your own subscription and take advantage of the special low one year rate.

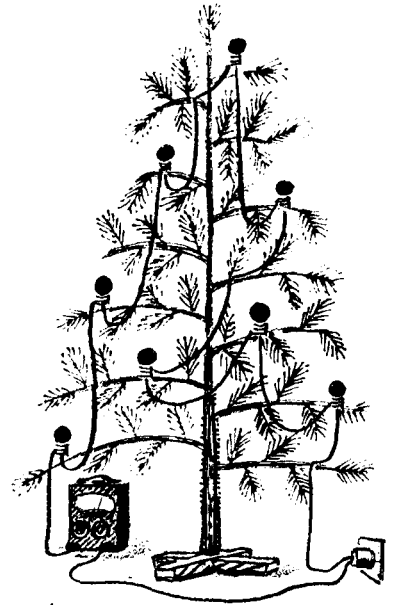
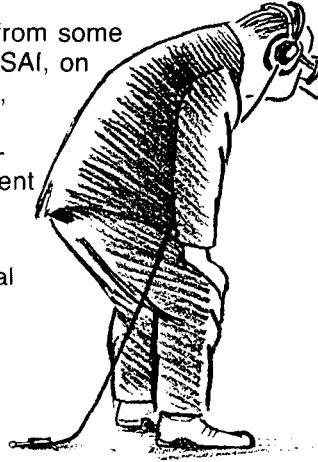

What Good PAO CX

**An attractive gift card will be sent
if your order is received before December 16, 1988**

Please enter my one year gift/renewal subscription(s) to HAM RADIO Magazine as follows:

First gift renewal \$19.95 SAVE \$3
Two or more \$15.95 SAVE \$7

**FIRST
SAVE \$3**

Name _____ Call _____
Address _____
City _____ State _____ Zip _____

**SECOND
SAVE \$7**

Name _____ Call _____
Address _____
City _____ State _____ Zip _____
 NEW RENEWAL

**THIRD
SAVE \$7**

Name _____ Call _____
Address _____
City _____ State _____ Zip _____
 NEW RENEWAL

Start Renew my Subscription to HR

Enclosed is a check or money order

Charge: Mastercard VISA

Card # _____ Expires _____

My Name _____

Address _____

City _____ State _____ Zip _____

**HAM
RADIO
MAGAZINE**
GREENVILLE, NH 03048

CALL TOLL FREE

800-341-1522

M-F: 8-9 EST. • Sat: 9-5

DATATEL 800

ORDERS ONLY

FOR EXTRA FAST SERVICE, CALL TOLL FREE
TO ORDER YOUR GIFT SUBSCRIPTIONS OR BOOKS

Prices U.S. only. Foreign prices upon request.

MAGAZINE EVALUATION & SWEEPS ENTRY CARD

Here's YOUR chance to comment on this issue of HR and enter our monthly radio drawing. Carefully read all the articles in this issue. Then, rate each article in this issue. Also let us know what you think of our changes to the magazine. Each article is marked with a letter on the last page.

YOU COULD WIN...

a hand-held radio.
Here's how.

Please fill out the Magazine evaluation card and mail it to us. We'll tabulate all the responses to see what you do and do not like.

There will be a drawing of evaluation cards. The person whose card is picked will win a hand-held. Help us make the best Amateur magazine even better. You could WIN a radio for your efforts!

Also, each month the author of the most popular WEEKENDER will be given a hand-held radio.

HAM RADIO

Article	A	B	C	D	E	F	G	H	I	J	K	L	M	N	O	P	Q	R	S	T	
I LIKE IT																					
OK																					
SORRY, NO.																					

MAGAZINE OVERALL GOOD _____ OK _____ NOT SO GOOD _____

NAME _____

ADDRESS _____

CITY _____ STATE _____ ZIP _____

Please run more: _____

Please run less: _____

OCT. 88



- One year 12 issues \$22.95
- Two years 24 issues \$38.95
- Three years 36 issues \$49.95

Subscribe to HAM RADIO today. Tap into Amateur Radio's #1 technical and building journal. You'll also save \$7.05 off the newsstand price (\$30 per year)! Fill out this card and mail it in.

For even more prompt service, call TOLL FREE (800) 341-1522, MasterCard, VISA and Bill Me orders accepted. Phone lines open Monday thru Friday 8 a.m. to 9 p.m. Please, *orders only.*

- Bill me Payment enclosed

Name _____

Address _____

City _____ State _____

- Check if this is a renewal OCT. 88

Please allow 4-6 weeks for delivery of first issue.

FOREIGN RATES: Europe via Air Forwarding Service \$40 per year. All other countries \$31.00 per year.

HAM RADIO Reader Service

For FREE literature or more information, first locate the company number at the bottom of the ad. Circle the appropriate number on this card, affix postage and drop into the mail. We'll hustle your request off to the companies you are interested in!

101 113 125 137 149 161 173 185 197 209 221 233 245 257 269 281 293 305 317 329 341
 102 114 126 138 150 162 174 186 198 210 222 234 246 258 270 282 294 306 318 330 342
 103 115 127 139 151 163 175 187 199 211 223 235 247 259 271 283 295 307 319 331 343
 104 116 128 140 152 164 176 188 200 212 224 236 248 260 272 284 296 308 320 332 344
 105 117 129 141 153 165 177 189 201 213 225 237 249 261 273 285 297 309 321 333 345
 106 118 130 142 154 166 178 190 202 214 226 238 250 262 274 286 298 310 322 334 346
 107 119 131 143 155 167 179 191 203 215 227 239 251 263 275 287 299 311 323 335 347
 108 120 132 144 156 168 180 192 204 216 228 240 252 264 276 288 300 312 324 336 348
 109 121 133 145 157 169 181 193 205 217 229 241 253 265 277 289 301 313 325 337 349
 110 122 134 146 158 170 182 194 206 218 230 242 254 266 278 290 302 314 326 338 350
 111 123 135 147 159 171 183 195 207 219 231 243 255 267 279 291 303 315 327 339
 112 124 136 148 160 172 184 196 208 220 232 244 256 268 280 292 304 316 328 340

Limit 15 inquiries per request.

NAME _____ CALL _____

ADDRESS _____

CITY _____ STATE _____ ZIP _____

PLEASE USE BEFORE DECEMBER 31, 1988

OCTOBER 1988

AFFIX POSTAGE
OR
POST OFFICE
WILL NOT
DELIVER

HAM RADIO

MAIN STREET
GREENVILLE, N.H. 03048

*Please
enter my
subscription*



NO POSTAGE
NECESSARY
IF MAILED
IN THE
UNITED STATES

BUSINESS REPLY CARD
First Class Permit No. 1 Greenville, NH

Postage Will Be Paid By Addressee



HAM RADIO

Greenville, NH 03048

AFFIX POSTAGE
OR
POST OFFICE
WILL NOT
DELIVER

HAM RADIO

READER SERVICE CENTER
P.O. BOX 2558
WOBURN, MASS. 01888

ATTN: Reader Service Dept.

In a true linear amplifier, a 1-dB input power increase would yield a 1-dB output power increase. In the case of solid-state power amplifiers, linear operation is generally acceptable up to the "1-dB compression point" — the output power level where the gain of the amplifier drops 1.0-dB below the low-power gain.

Said another way, the 1-dB compression point is the output power level where the amplifier output increases only 9 db for a 10 dB input power increase. Above this power level distortion and IMD increase rapidly.

Fine you say, but how do I test compression? The easiest way is to use two power meters, one at the input and one at the output of your amplifier (see fig. 3). Measure the output power at 5-10 different power levels. The greater the number of data points taken, the

the peak power to register, if in fact it ever does. This means that on SSB, the peak power you are running should never show on the meter. If it is, you're driving the rig too hard!

When using a typical power meter, you should be averaging about 25-30 percent of full linear power (1-dB compression point) capability. Never exceed 50 percent (see reference 7). Test your linearity, then advance the microphone gain on your exciter and observe the output power. If you ever reach a point where output power no longer increases with increasing microphone gain, back it down!

Say you have an amplifier that puts out 100 watts of linear power, after measuring it according to the methods described above. Set your gain control on the rig so that on average voice it is indicating 25-30 watts, as shown in fig. 4. This goes a long way towards

insuring that you are not splattering excessively and will still be transmitting full power on peaks!

If your power amplifier has too much gain (the most typical case) you'll have to be careful to keep the microphone gain turned down, or place an attenuator between the exciter and amplifier, or both. You can use a piece of RG-58 cable as an inexpensive moderate-power attenuator.⁸ At about 4-5 dB per 100 feet at 2-meters, you may only require 25-75 feet.

If you have ALC capability, use it! It's a great way to control the tendency to overdrive a rig, especially if the amplifier has too much gain.

Other tips

Never use an amplifier unless it's necessary. Remember the FCC regulation that Amateurs should use the minimum power required to maintain communications.

If you overdrive your rig, your signal may still sound great to the station listening to you! Try an A/B test. Switch your amplifier in and out, and have a local station observe the change in signal strength to verify that your gain increases by the number of dB expected from the power amplifier. Then have them tune off 5-10 kHz and repeat the A/B test to see if the IMD degrades with the power amplifier in line.

Remember that all IMD power is wasted and serves no purpose other than to cause interference to adjacent channels!⁵ Excessive power and overdrive, especially on solid state amps, can also cause premature death to the output devices.

Despite stories to the contrary, the gain of vacuum tube VHF/UHF amplifiers is finite, typically 10-17 dB. Don't expect a 10-watt exciter to drive a 1000-watt amplifier to full output power. You may still need a driver amplifier ahead of the final.

Test all new gear with a local. Problems such as misalignment and breakage can occur during shipment. Carrier suppression is sometimes a problem, but can usually be re-

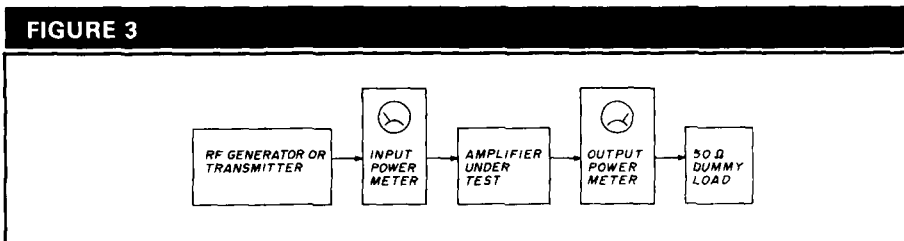

This diagram shows a recommended test set up to measure the linearity of a power amplifier as described in the text.

greater the accuracy. Plot the results as shown in fig. 2.

Next, draw the "true linear response line" from the origin as shown on fig. 2. The 1-dB compression point is the measured output power level which is 80-percent (-1 db) below the expected output power (64 versus 80 watts in fig. 2).

Power meters

There are several other things to remember when operating a linear. You must have a power meter; an external one is preferable. Without a calibrated power meter you'll never be able to determine if your equipment is operating properly.

There are several caveats when using a power meter. First, they all have a time constant. It takes time for

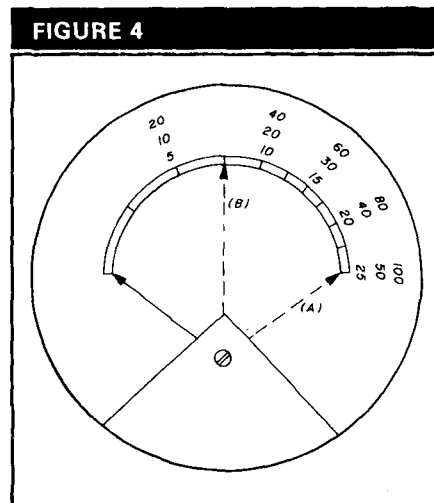

This diagram shows the face plate of a typical RF power meter. A is the key-down needle position for maximum linear power. B is the recommended needle position when operating SSB for same as described in text.

tweaked. In rare cases, power amplifiers may have to be re-peaked.

RF actuated power amplifiers can often cause a problem at lower power levels because they may not turn on properly. If possible, try to hard wire the switching on these amplifiers to the station or exciter T/R line.

RF compression is another topic that is really beyond the scope of this month's column. Suffice it to say that if you have it, try it, but only when necessary on weak signal paths. Adjust it carefully and don't use any more compression than necessary! Remember that rf compression significantly increases dissipation in the power amplifier, which could destroy or shorten device life.

Finally, for many years Vhf/UHFers have been gathering at conferences to shoot the bull, measure noise figures, and antenna gains. Maybe it's time we add a new wrinkle to these conferences by setting up workshops to test amplifier power and linearity.

Receiver considerations

So far I've concentrated mostly on the transmitter IMD. I feel that it's most often the culprit and is the easiest problem to deal with. This, of course, isn't always true.

Many of the transceivers used on VHF/UHF, and to a lesser degree those used on hf, have very poor dynamic range. This is especially true of those that were designed before 1985. Furthermore, transceivers and transverters often have poor sensitivity. The latter is not a problem on hf where noise levels are high. But, the typical 6-8 dB noise figures on 2-meters and above often require an external low-noise preamplifier. When such a preamplifier is added, the dynamic range of the receiver drops dramatically.

Low noise preamps don't usually suffer from IMD. However, they usually overdrive the rx following it. The rx has insufficient dynamic range and crashes. If you use an external preamplifier, configure it so that it can be easily bypassed especially if you suspect IMD.

Receiver IMD can usually be tested simply. If you place an attenuator ahead

of a receiver, the signal should decrease by the same amount of dBs as the attenuator. However, if the receiver IMD drops by a greater amount, some or all of the IMD is generated by the receiver.

As a rule of thumb, IMD that is generated in a receiver decreases 3 dB for every 1-dB decrease in signal level. A 3-10 dB 50-ohm attenuator pad is a nifty test device. If you suspect a station is causing IMD, note the signal strength and IMD level on the signal strength meter.

Next insert a 3-10 dB attenuator ahead of your receiver/preamplifier. The signal level should drop by the amount of attenuation introduced. If the IMD also drops the same amount, the transmitted signal is probably at fault. If the IMD level drops more than the amount of the attenuator, your receiver is partially at fault. If the receiver IMD drops 3 times the attenuator value, the IMD is probably all generated within your receiver.

You can try one final, simple test. By carefully watching a station on the signal strength meter, you can often see overdrive by observing how much the meter wiggles. A station that's clean will generally cause a typical S meter to move rapidly. A station hitting their transmitter too hard will cause the S meter to sort of hang near the same level because they are in compression.

Summary

This month's column was primarily devoted to improving linearity and decreasing IMD/splatter. Try never to run more power than required. Remember that a true linear doesn't exist. Sooner or later it will run out of gas as the power output is increased. Test your transmitted and received linearity as detailed above and, if you like, try some of the other suggestions I've made.

Note:

In reference 9, I described circuitry to obtain 28 volts from a 12-volt power supply, primarily for operating relays on portable operation. I've been informed that there is a commercial device already available — a Radio Shack Voltage Inverter, catalog number 22-129B.

Although it's shown as a 6-12 volt inverter, the instruction sheets clearly show how to use it for a negative ground 12-28 volt inverter. Many thanks to Bill Murray, K2GQI, for bringing this to my attention.

Important VHF/UHF events

- | | |
|----------------|---|
| October 1-2 | <i>International Region
1 UHF Contest
(70-cm and up)</i> |
| October 1-2 | <i>Mid-Atlantic States VHF
Conference, Warminster,
Pennsylvania (contact
WB2NPE/WC2K)</i> |
| October 9 | <i>Predicted peak of the
Draconids meteor
shower at 0900 UTC</i> |
| October 10 | <i>New moon</i> |
| October 20 | <i>Predicted peak of the
Orionids meteor shower
at 1400 UTC</i> |
| October 23 | <i>EME perigee</i> |
| October 22-23 | <i>ARRL International EME
contest, first weekend</i> |
| November 3 | <i>Predicted peak of the
Cassiopeids meteor
shower at 0245 UTC</i> |
| November 3 | <i>Predicted peak of the
Taurids meteor shower at
0300 UTC</i> |
| November 9 | <i>New moon</i> |
| November 16 | <i>Predicted peak of the
Leonids meteor shower
at 2000 UTC</i> |
| November 20 | <i>EME perigee</i> |
| November 26-27 | <i>ARRL International EME
contest, second week-
end.</i> |

References

1. John Grebenkemper, K16WX, "Phase Noise and its Effects on Amateur Communications," *QST*, March 1988, page 14.
2. E.W. Pappenfus, et al., "Single Sideband Principles and Circuits," McGraw Hill Book Company, 1964.
3. Joe Reisert, W1JR, "VHF/UHF World-VHF/UHF High Power Amplifiers: Part 1," *ham radio*, January 1985, page 97.
4. Joe Reisert, W1JR, "VHF/UHF World-VHF/UHF High Power Amplifiers: Part 2," *ham radio*, February 1985, page 38.
5. Bob Sutherland, W6PO, "Care and Feeding of Power Grid Tubes," Varian Eimac, 1982.
6. *Eimac Power Grid Tubes Quick Reference Catalog 284*, Varian Eimac.
7. Joe Reisert, W1JR, "VHF/UHF World-Medium Power Amplifiers," *ham radio*, August 1985, page 39.
8. Joe Reisert, W1JR, "VHF/UHF World-Transmission Lines," *ham radio*, October 1985, page 83.
9. Joe Reisert, W1JR, "VHF/UHF World-Microwave Portable Operation," *ham radio*, October 1987, page 75.

Article H

HAM RADIO

Hi Pro Repeaters ELCO

MAGGIORE ELECTRONIC LAB.

Manufacturers of Quality Communications Equipment

- Repeaters
- Links
- Remote Base
- VHF, UHF
- Receivers
- Transmitters
- Antennas



- Standard and Computerized Controllers
- Standard and Computerized Auto Patches
- Duplexers

Hi Pro 'E'

EXPANDABLE REPEATER SYSTEM

- A NEW CONCEPT IN REPEATER DESIGN, THE Hi Pro "E" IS AN EXPANDABLE REPEATER WITH THE FOLLOWING FEATURES: A BASIC REPEATER WHICH WOULD INCLUDE A COMPLETE RECEIVER, TRANSMITTER, COF, FRONT PANEL CONTROLS AND INDICATORS, LOCAL SPEAKER AND MIC JACK AND CAPABLE OF FUTURE EXPANSION. ALL HOUSED IN AN EXTREMELY RUGGED, ENCLOSED, 19-INCH RACK MOUNTABLE CABINET.
 - THIS SYSTEM CAN BE EXPANDED AT TIME OF PURCHASE OR CAN BE AN AFTER-PURCHASE ADD ON. THE ADD ONS ARE—HIGHER POWER, 110/220 VAC POWER SUPPLY, IDENTIFIER, AUTO PATCH, OR COMPUTER CONTROLLERS. IN ADDITION TO THESE ADD ONS AN ADDITIONAL RECEIVER AND TRANSMITTER CAN BE MOUNTED INTERNALLY FOR USE AS CONTROL LINKS, REMOTE BASE OR DUAL BAND OPERATION, ETC.
- AN EXTENSION PANEL IS AVAILABLE FOR LOCAL MONITORING OF THE REPEATER AND CONTAINS ALL NECESSARY METERING, STATUS LIGHTS AND INDICATORS. ALL ADD ONS ARE AVAILABLE FROM THE COMPANY AND ARE COMPLETE INCLUDING INSTRUCTIONS.

Hi PRO

VHF-UHF REPEATERS

SUPERIOR RECEIVER AND TRANSMITTER SPECIFICALLY DESIGNED FOR REPEATER SERVICE.

ADJUSTABLE TRANSMITTER POWER, FROM 1 TO 25 WATTS MINIMUM OUTPUT WITH EXTREMELY COOL OPERATION.—
AUTOMATIC BATTERY BACK UP SYSTEM CAPABILITY WITH BATTERY CHARGING AND REVERSE POLARITY PROTECTION.—
NOW WITH A FULL COMPLIMENT OF INDICATORS AND STATUS LIGHTS.—100% DUTY CYCLE—ADVANCED REPEATER SQUELCH
NO CHOPPING, POPPING, OR ANNOYING REPEATER KEY UPS DURING LIGHTNING STORMS.—DIE CAST ALUMINUM R.F.
ENCLOSURES —SMALL SIZE 5¼ x 19 x 13"—HIGH QUALITY LONG LIFE DESIGN.

AMATEUR DISCOUNTS AVAILABLE

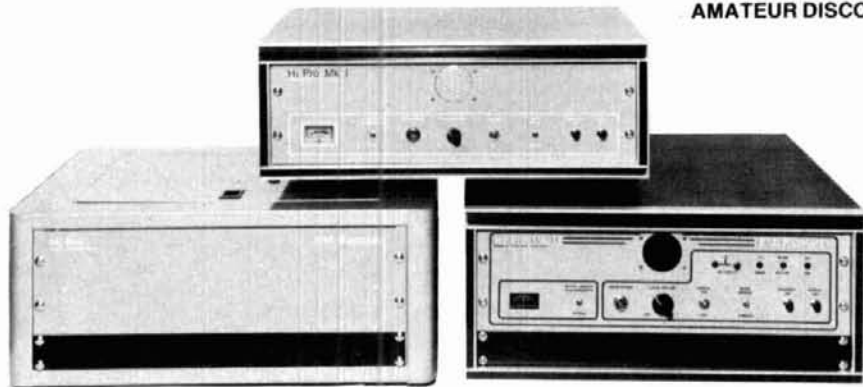

Hi Pro

TRANSMITTER AND RECEIVER

USED IN ALL HI PRO REPEATERS

ASSEMBLED
SMALL SIZE
3½ x 6¼"



HI PRO TRANSMITTER
DESIGNED FOR REPEATER
SERVICE WITH EXCELLENT
AUDIO, STABILITY,
HARMONIC REJECTION
AND LOW NOISE

ADJUSTABLE
POWER
OUTPUT
UP TO 5 WATTS
FROM THE
EXCITER BOARD
COOL OPERATION

HI PRO RECEIVER
THIS RECEIVER IS THE
HEART OF THE REPEATER
AND BOASTS SUPERIOR
SQUELCH ACTION NEEDED
FOR THIS TYPE OF
SERVICE EXCELLENT
SENSITIVITY, STABILITY
AND SELECTIVITY

USE THIS RECEIVER
TO REPLACE THAT
TROUBLESOME RECEIVER
IN YOUR PRESENT
REPEATER



ASSEMBLED
SMALL SIZE
3½ x 6¼"

ASK ABOUT OUR COMPUTER CONTROL SYSTEM, AND MICROCONTROL AUTO PATCH, AND REPEATER KITS.

Maggiore Electronic Laboratory

600 WESTTOWN RD., WEST CHESTER, PA 19382
PHONE: 215-436-6051 TELEX: 499-0741-MELCO FAX: 215-436-6268

WRITE OR CALL FOR OUR COMPLETE CATALOG



THE HAM NOTEBOOK

Using macros with packet

Computers are supposed to reduce the drudgery of repetitive tasks. When operating packet, I get tired of using the keyboard to enter the same commands over and over. Such tasks can be automated and then invoked when needed by means of a computer programming technique called a "macro". According to the Lotus Development Corporation *Lotus 1-2-3 Reference Manual*:

"A macro performs a task automatically. To create a macro, you create a set of entries that describes a particular task keystroke by keystroke, and then name...[it]. To use a macro, you invoke it by pressing...the name of the macro."

If you'd like to tell your computer to send any of the following sample packet commands by using only two or three keys:

```
CONNECT W1JLI
CONNECT W1JLI-1
CONNECT W1KRU
CONNECT WB1GMA
BE 90
BT HELLO PACKET.. TOM, AD1B
CONVERS
```

A macro can handle any of these tasks easily. Even better, macros can be designed for your particular needs and utilized in many terminal programs.

I'm using an IBM PC for my packet

operations and have chosen the ProComm communications program for terminal emulation. ProComm lets you define up to ten different macros that can be invoked by holding down the ALT key and then pressing any number between 0 and 9. The command line that you have stored is typed on the screen; when you hit the RETURN key, the command is executed. Alternatively, you can include an "embedded" character in the macro so that a carriage return is sent when the macro is invoked.

Consider acquiring ProComm if you're using an IBM or compatible computer for packet or telecommunications. This "shareware" product is distributed by many clubs, bulletin boards, and software vendors at nominal cost. The only charge is a duplication fee which shouldn't exceed \$6. If you like the program and use it, you are asked to register your copy with the developers and pay the licensing fee (\$25) to: Datastorm Technologies, Inc., P.O. Box 1471, Columbia, Missouri 65205.

There are any number of commercial, shareware, and public domain programs that can be used to store combinations of keystrokes for later use. ProComm comes with an option to store up to ten different macros in the program itself. To access this option, you need only call the macro menu.

You can create and edit macros by holding down the ALT key and striking the "M" key (ALT-M). When you do this, a small menu appears that allows the definition of the ten available macro strings used as command lines.

Each macro is a string of up to 36 characters in length; it may contain embedded control codes (such as the CONTROL character) and carriage returns. You don't need to hit the RETURN key if you choose to use an embedded carriage return; it is sent automatically when you use the macro.

Figure 1 gives an example of the macro screen that is used to define or change a macro. It also contains samples of typical macros. The steps are simple:

- Call the macro menu with the ALT-M option.
- Type "R" to revise a macro.
- Strike a number (from 0 to 9) to select or name a macro.
- Enter the text string that you want to use.
- Respond with the letter "Y" to save the new macro.
- Revise another macro or hit the "ESCAPE" key to exit.

FIGURE 1

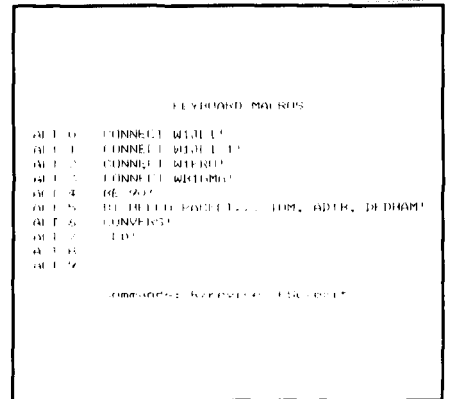

Macro screen.

Notice that all my macros end with an exclamation point. ProComm has a feature called Output String Translation — the program treats predefined characters in a special manner. The exclamation point is interpreted as a

carriage return; a caret ("^") is interpreted as the "control" character. If you want to send Control-C, include the "^C" string in your macro. Notice that macro number 7 in fig. 1 is the command "^CD!". This provides a Control-C (to call the command line on my terminal unit) and a D (for disconnect) followed by a carriage return. Macro number 7 is designed to disconnect and return to the command line.

Once the program is set up, you can use macros to speed up the entry of your ten most common terminal commands and execute them with only two keystrokes. If you forget the definition of any particular macro key, simply use the ALT-M combination to see the macro menu. I like macros; they provide an effortless way to get around that keyboard.

Thomas M. Hart, AD1B

Article 1 HAM RADIO

SEND FOR FREE 1988 CATALOG. 56 PAGES

★ QUALITY PARTS ★ DISCOUNT PRICES ★ FAST SHIPPING

ALL ELECTRONICS CORP.

WE STOCK OVER 4,000 ITEMS... CALL OR WRITE FOR OUR FREE CATALOG OF PARTS!

RESISTORS • CAPACITORS • DIODES • CABLES • BRIDGE RECTIFIERS • CHOKE COILS • CRYSTALS • CRIMP CONNECTORS • LAMP'S • HEAT SINKS • MOTORS • SUB MINIATURE D CONNECTORS • TRANSISTORS • I.C.'S • PHOTO BOARDS • POTENTIOMETERS • POWER SUPPLIES • JACKS • PLUGS • SWITCHES • PCB BOARDS • FANS • FUSES • SHRINK TUBING • TIE WRAPS • TOOLS • KEYPADS • VIDEO ACCESSORIES • RELAYS • S.C.R.'S • TRANSFORMERS • TELEPHONE ACCESSORIES • RIBBON CABLE • CIRCUIT BREAKERS • VOLTAGE REGULATORS • AND MANY OTHER ITEMS.

<p>TRANSISTORS</p> <table border="1"> <tr><th>PART</th><th>TYPE</th><th>PRICE</th></tr> <tr><td>2N2222</td><td>NPN</td><td>10-42 5 for 75</td></tr> <tr><td>2N2904</td><td>PNP</td><td>10-5 3 for \$1.00</td></tr> <tr><td>2N2906</td><td>PNP</td><td>10-18 3 for \$1.00</td></tr> <tr><td>2N2907</td><td>PNP</td><td>10-42 5 for 75</td></tr> <tr><td>2N2908</td><td>PNP</td><td>10-42 5 for 75</td></tr> <tr><td>2N2909</td><td>PNP</td><td>10-42 5 for 75</td></tr> <tr><td>2N2910</td><td>PNP</td><td>10-42 5 for 75</td></tr> <tr><td>2N2911</td><td>PNP</td><td>10-42 5 for 75</td></tr> <tr><td>2N2912</td><td>PNP</td><td>10-42 5 for 75</td></tr> <tr><td>2N2913</td><td>PNP</td><td>10-42 5 for 75</td></tr> <tr><td>2N2914</td><td>PNP</td><td>10-42 5 for 75</td></tr> <tr><td>2N2915</td><td>PNP</td><td>10-42 5 for 75</td></tr> <tr><td>2N2916</td><td>PNP</td><td>10-42 5 for 75</td></tr> <tr><td>2N2917</td><td>PNP</td><td>10-42 5 for 75</td></tr> <tr><td>2N2918</td><td>PNP</td><td>10-42 5 for 75</td></tr> <tr><td>2N2919</td><td>PNP</td><td>10-42 5 for 75</td></tr> <tr><td>2N2920</td><td>PNP</td><td>10-42 5 for 75</td></tr> <tr><td>2N2921</td><td>PNP</td><td>10-42 5 for 75</td></tr> <tr><td>2N2922</td><td>PNP</td><td>10-42 5 for 75</td></tr> <tr><td>2N2923</td><td>PNP</td><td>10-42 5 for 75</td></tr> <tr><td>2N2924</td><td>PNP</td><td>10-42 5 for 75</td></tr> <tr><td>2N2925</td><td>PNP</td><td>10-42 5 for 75</td></tr> <tr><td>2N2926</td><td>PNP</td><td>10-42 5 for 75</td></tr> <tr><td>2N2927</td><td>PNP</td><td>10-42 5 for 75</td></tr> <tr><td>2N2928</td><td>PNP</td><td>10-42 5 for 75</td></tr> <tr><td>2N2929</td><td>PNP</td><td>10-42 5 for 75</td></tr> <tr><td>2N2930</td><td>PNP</td><td>10-42 5 for 75</td></tr> <tr><td>2N2931</td><td>PNP</td><td>10-42 5 for 75</td></tr> <tr><td>2N2932</td><td>PNP</td><td>10-42 5 for 75</td></tr> <tr><td>2N2933</td><td>PNP</td><td>10-42 5 for 75</td></tr> <tr><td>2N2934</td><td>PNP</td><td>10-42 5 for 75</td></tr> <tr><td>2N2935</td><td>PNP</td><td>10-42 5 for 75</td></tr> <tr><td>2N2936</td><td>PNP</td><td>10-42 5 for 75</td></tr> <tr><td>2N2937</td><td>PNP</td><td>10-42 5 for 75</td></tr> <tr><td>2N2938</td><td>PNP</td><td>10-42 5 for 75</td></tr> <tr><td>2N2939</td><td>PNP</td><td>10-42 5 for 75</td></tr> <tr><td>2N2940</td><td>PNP</td><td>10-42 5 for 75</td></tr> </table>	PART	TYPE	PRICE	2N2222	NPN	10-42 5 for 75	2N2904	PNP	10-5 3 for \$1.00	2N2906	PNP	10-18 3 for \$1.00	2N2907	PNP	10-42 5 for 75	2N2908	PNP	10-42 5 for 75	2N2909	PNP	10-42 5 for 75	2N2910	PNP	10-42 5 for 75	2N2911	PNP	10-42 5 for 75	2N2912	PNP	10-42 5 for 75	2N2913	PNP	10-42 5 for 75	2N2914	PNP	10-42 5 for 75	2N2915	PNP	10-42 5 for 75	2N2916	PNP	10-42 5 for 75	2N2917	PNP	10-42 5 for 75	2N2918	PNP	10-42 5 for 75	2N2919	PNP	10-42 5 for 75	2N2920	PNP	10-42 5 for 75	2N2921	PNP	10-42 5 for 75	2N2922	PNP	10-42 5 for 75	2N2923	PNP	10-42 5 for 75	2N2924	PNP	10-42 5 for 75	2N2925	PNP	10-42 5 for 75	2N2926	PNP	10-42 5 for 75	2N2927	PNP	10-42 5 for 75	2N2928	PNP	10-42 5 for 75	2N2929	PNP	10-42 5 for 75	2N2930	PNP	10-42 5 for 75	2N2931	PNP	10-42 5 for 75	2N2932	PNP	10-42 5 for 75	2N2933	PNP	10-42 5 for 75	2N2934	PNP	10-42 5 for 75	2N2935	PNP	10-42 5 for 75	2N2936	PNP	10-42 5 for 75	2N2937	PNP	10-42 5 for 75	2N2938	PNP	10-42 5 for 75	2N2939	PNP	10-42 5 for 75	2N2940	PNP	10-42 5 for 75	<p>10 AMP SOLID STATE RELAYS</p> <p>ELECTROLA S2181 CONTROL Rated 5.5 to 10 Vdc will operate on 3-32 Vdc LOAD 10 Amp @ 240 Vac 2 1/4" X 1 3/4" X 7/8" CAT# SSR1Y-10B \$9.50 each QUANTITY DISCOUNT 10 for \$85.00 25 for \$175.00 50 for \$300.00 100 for \$500.00</p>	<p>MINIATURE TOGGLE SWITCHES all rated 5 Amps</p> <p>S.P.D.T. (on-on) Solder lug terminals. CAT# MTS-4 \$1.00 each 10 for \$9.00</p> <p>S.P.D.T. (on-on) Non threaded bushing P.C. mount. CAT# MTS-40PC 75¢ each 10 for \$7.00</p> <p>D.P.D.T. (on-on) Solder lug terminals. CAT# MTS-8 \$2.00 each 10 for \$19.00</p>
PART	TYPE	PRICE																																																																																																																		
2N2222	NPN	10-42 5 for 75																																																																																																																		
2N2904	PNP	10-5 3 for \$1.00																																																																																																																		
2N2906	PNP	10-18 3 for \$1.00																																																																																																																		
2N2907	PNP	10-42 5 for 75																																																																																																																		
2N2908	PNP	10-42 5 for 75																																																																																																																		
2N2909	PNP	10-42 5 for 75																																																																																																																		
2N2910	PNP	10-42 5 for 75																																																																																																																		
2N2911	PNP	10-42 5 for 75																																																																																																																		
2N2912	PNP	10-42 5 for 75																																																																																																																		
2N2913	PNP	10-42 5 for 75																																																																																																																		
2N2914	PNP	10-42 5 for 75																																																																																																																		
2N2915	PNP	10-42 5 for 75																																																																																																																		
2N2916	PNP	10-42 5 for 75																																																																																																																		
2N2917	PNP	10-42 5 for 75																																																																																																																		
2N2918	PNP	10-42 5 for 75																																																																																																																		
2N2919	PNP	10-42 5 for 75																																																																																																																		
2N2920	PNP	10-42 5 for 75																																																																																																																		
2N2921	PNP	10-42 5 for 75																																																																																																																		
2N2922	PNP	10-42 5 for 75																																																																																																																		
2N2923	PNP	10-42 5 for 75																																																																																																																		
2N2924	PNP	10-42 5 for 75																																																																																																																		
2N2925	PNP	10-42 5 for 75																																																																																																																		
2N2926	PNP	10-42 5 for 75																																																																																																																		
2N2927	PNP	10-42 5 for 75																																																																																																																		
2N2928	PNP	10-42 5 for 75																																																																																																																		
2N2929	PNP	10-42 5 for 75																																																																																																																		
2N2930	PNP	10-42 5 for 75																																																																																																																		
2N2931	PNP	10-42 5 for 75																																																																																																																		
2N2932	PNP	10-42 5 for 75																																																																																																																		
2N2933	PNP	10-42 5 for 75																																																																																																																		
2N2934	PNP	10-42 5 for 75																																																																																																																		
2N2935	PNP	10-42 5 for 75																																																																																																																		
2N2936	PNP	10-42 5 for 75																																																																																																																		
2N2937	PNP	10-42 5 for 75																																																																																																																		
2N2938	PNP	10-42 5 for 75																																																																																																																		
2N2939	PNP	10-42 5 for 75																																																																																																																		
2N2940	PNP	10-42 5 for 75																																																																																																																		
<p>PIEZO WARNING DEVICE</p> <p>Murata Erie # PKB8-440 High pitched audible alarm Operates on 3 - 20 Vdc @ 20 ma. 1" high X 7/8" dia. P.C. board mount. CAT# PBZ-84 \$1.75 each</p>	<p>SOUND ACTIVATED BOARD</p> <p>Designed to react to high pitched sounds. Each board contains many useful parts including a condenser mike Operates on 6 Vdc. Instructions included. CAT# SAB \$2.50 each</p>	<p>24 VOLT D.C. SOLENOID</p> <p>Intermittent duty cycle. 240 ohm coil Mounting flange is 1 1/8" wide. Solenoid body 1 1/2" X 1/2" X 1/2" CAT# SOL-24 \$1.00 each - 10 for \$8.50 100 for \$75.00 Large Quantity Available</p>	<p>MINI PUSH BUTTON</p> <p>S.P.S.T. momentary. Push to make. 1/4" threaded bushing. Rad. button. CAT# MPB-1 35¢ each - 10 for \$3.25</p>																																																																																																																	
<p>XENON TUBE</p> <p>1" long fasttube prepped with 3 1/2" red and black leads. Ideal for electronic flash or strobe projects. CAT# FLT-7 2 for \$1.00</p>	<p>NEW! STROBE KIT</p> <p>Variable rate strobe kit. Flashes between 60 to 120 times per minute. Will operate on either 6 or 12 Vdc depending upon how you wire the circuit. Comes complete with P.C. board and instructions for easy assembly. CAT# STROBE-1 \$7.50 each</p>	<p>SOUND & VIDEO MODULATOR</p> <p>TM UM1381-1 Designed for use with T.I. computer. Can be used with video camera, games, or other audio video sources. Built in A/B switch enables user to switch from T.V. antenna without disconnection. Operates on channel 3 or 4. Requires 12 Vdc. Hook up diagram included. CAT# AVMOD \$5.00 each</p>	<p>GRAB BAGS \$1.00 EACH</p> <p>50 ASSORTED DISC CAPS. Cut leads. Many common values, some are 500 volts. CAT# GRABCC ASSORTED 1/4 WATT RESISTORS Approximately 200 pieces of assorted values, some cut leads. CAT# GRABR ASSORTED PARTS Strips of 100 assorted parts. Each strip contains an assortment of resistors, capacitors, diodes, coils, etc. 100 pieces. CAT# GRABTR 15 VALUES OF ELECTROLYTIC Assortment contains 15 values of 1 mfd and up. Some cut leads. CAT# GRABCP</p>																																																																																																																	
<p>NICKEL-CAD (RECHARGEABLE) BATTERIES</p> <p>SPECIAL AAA SIZE Panasonic # P-18AAA 1.2 volt @ 180 mA CAT# NCB-AAA \$1.50 each 10 for \$13.50 100 for \$125.00 LARGE QUANTITIES</p> <p>AA SIZE \$2.00 each 1.25 Volts 500 mAh CAT# NCB-AA</p> <p>AA SIZE \$2.20 each with GOLDER TABS CAT# NCB-SAA</p> <p>C SIZE \$4.25 each 1.2 Volts 1200 mAh CAT# NCB-C</p> <p>D SIZE \$4.50 each 1.2 Volts 1200 mAh CAT# NCB-D</p>	<p>WALL TRANSFORMERS</p> <p>ALL PLUG DIRECTLY INTO 120 VAC OUTLET</p> <p>6 Vdc @ 200 ma. \$2.25 CAT# DCTX-620</p> <p>6 Vdc @ 750 ma. \$3.50 CAT# DCTX-675</p> <p>9 Vdc @ 250 ma. \$2.50 CAT# DCTX-925</p> <p>12 Vdc @ 930 ma. \$3.50 CAT# ACTX-1293</p> <p>18 Vdc @ 1 Amp. \$3.50 CAT# ACTX-1885</p>	<p>PROTO BOARD</p> <p>Large enough to design most experimental circuits. This proto board measures 6 3/4" X 2 1/2". Contains main board and two power bus strips. CAT# PB-101 \$9.00 each</p>	<p>FLASHING L.E.D. KIT</p> <p>Two L.E.D.'s flash in unison when a 9 volt battery is attached. Requires easy assembly, you solder the parts to the circuit board. CAT# LEDKIT \$1.50 each</p>																																																																																																																	
<p>WATER TIGHT ENCLOSURE</p> <p>ROSE# 02081905 Molded fiberglass enclosure with neoprene gasket. 2" X 3" X 7 1/2". Light blue. CAT# WP-905 \$7.50 each</p>	<p>LIGHT EMITTING DIODES (L.E.D.)</p> <p>STANDARD JUMBO LED DIFFUSED T 1-3/4 size RED CAT# LED-1 100 for \$1.50 1000 for \$11.00</p> <p>FLASHING LED with built in flashing circuit operates on 5 volts. RED CAT# LED-4 10 for \$9.50</p> <p>LED HOLDER Two piece holder CAT# HLED 10 for 65¢</p> <p>CLIPLITE LED HOLDER Makes L.E.D. look like a fancy indicator Fits T 1-3/4 size LED CLEAR CAT# HLCL-C RED CAT# HLCL-R GREEN CAT# HLCL-G YELLOW CAT# HLCL-Y</p> <p>GREEN 10 for \$2.00 CAT# LED-2 100 for \$17.00 1000 for \$150.00</p> <p>YELLOW 10 for \$2.00 CAT# LED-3 100 for \$17.00 1000 for \$150.00</p> <p>BI-POLAR LED Lights RED one direction, GREEN the other. Two leads. CAT# LED-6 2 for \$1.70</p>	<p>FULL WAVE BRIDGE RECTIFIERS</p> <p>10 AMP 200 P.I.V. 5/8" SQUARE CAT# FWB-1020 \$1.00 each - 10 for \$9.00</p> <p>25 AMP RATING 1 1/8" SQUARE metal epoxy filled case 200 P.I.V. \$2.50 each CAT# FWB-252 400 P.I.V. \$3.00 each CAT# FWB-254 600 P.I.V. \$3.50 each CAT# FWB-256</p>	<p>HALL EFFECT SWITCH</p> <p>MICROSWITCH #48E3 Sintered keyboard switch with hall effect sensor. Snaps into 5/8" square chassis hole. Hall effect sensor slides easily from switch and can be used in other applications. CAT# HESW 4 for \$1.00 10 for \$2.00 100 for \$15.00</p>																																																																																																																	

Generate Your Own Electricity



Hundreds of satisfied owners are now using the WINDSTREAM® WIND GENERATOR to provide power for RVs, weekend cottages, boats, workshops, remote locations, emergency back up power and much more. Portable—weighs only 20 lbs—easily installed with our comprehensive installation manual—minimum maintenance—full warranty

Thermax Corporation H
P.O. Box 3128, Burlington, VT 05401-3128

VISA



MasterCard

VHF COMMUNICATIONS

INTRODUCING W2DRZ VHF/UHF MODULES. NOW AVAILABLE.

ICOM, AEA, LARSEN, VAN GORDEN, VIBROPLEX, NYE-VIKING, FALCON COMM, LEADING EDGE, ARRL PUBLICATIONS, KAGLO, HAMTRONICS, PROWRITER, ELEPHANT DISKS, DEBCO, TRIONYX

915 North Main Street
Jamestown, New York 14701

Western New York's finest... amateur radio dealer!
PH. (716) 664-6345

Monitor More With the New Universal M-7000!



If you are monitoring only voice shortwave stations, you are missing half the action! Thousands of shortwave stations transmit in non-voice modes such as Morse code, various forms of radioteletype (RTTY) and facsimile (FAX). The Universal M-7000 will permit you to easily intercept and decode these transmissions. Simple connections to your shortwave receiver and video monitor will enable you to monitor with the most sophisticated surveillance decoder available. No computer is required. See the world of shortwave excitement you have been missing. Requires 115 or 230 VAC. Six month limited warranty.

Partial List of Modes & Features

- ◆ Morse Code (CW)
- ◆ Regular Baudot RTTY
- ◆ Variable Speed Baudot
- ◆ Bit Inverted Baudot
- ◆ ASCII Low Speed
- ◆ ASCII High Speed
- ◆ ASCII Variable Speed
- ◆ Sitor Mode A (ARQ)
- ◆ Sitor Mode B (FEC)
- ◆ Autor
- ◆ ARQ 2&4 chan. (TDM)
- ◆ VFT Modes (FDM)
- ◆ Russian 3rd Shift Cyrillic
- ◆ Facsimile (FAX) AM
- ◆ Facsimile (FAX) FM
- ◆ Packet AX.25
- ◆ Literal Mode
- ◆ Databit Mode
- ◆ Diversity Reception
- ◆ Dual Metering
- ◆ Low Tone & High Tone
- ◆ Variable & Standard Shift
- ◆ Option: Real Time Clock
- ◆ Option: Video Display of Facsimile (FAX)
- ◆ Option: Rack Mounting Brackets (For 19")
- ◆ Speed Readout
- ◆ 4 TTY Alphabets
- ◆ Ten Memories
- ◆ Automatic Tuning
- ◆ Video Squelch
- ◆ Audio Squelch
- ◆ Split Screen ARQ
- ◆ Self Diagnostics
- ◆ Screen Print
- ◆ Screen Saver
- ◆ Input Gain Control
- ◆ MSI, UOS, ATC
- ◆ User Programmable Sel Cals
- ◆ Serial & Parallel Printer Ports
- ◆ Remote Terminal Operation
- ◆ Direct Entry of Baud & Shift
- ◆ Auto-Start

FULL CATALOG AVAILABLE

Universal offers a comprehensive shortwave catalog covering all types of shortwave monitoring equipment including receivers, antennas, RTTY and FAX equipment plus books and accessories. Send \$1 (refundable) to receive your copy today.

Universal M-7000 Introductory Pricing:

Standard M-7000	\$ 999.00
With Real Time Clock Option	\$1059.00
With Video FAX Option	\$1089.00
With Clock & Video FAX Option ..	\$1129.00
Shipping/Handling (USA)	\$ 11.00

UNIVERSAL... Serving Radio Enthusiasts Since 1942

Universal Radio

1280 Aida Dr. Dept. H
Reynoldsburg, OH 43068
Toll Free: 800 431-3939
In Ohio: 614 866-4267

THE 1988 ARRL HANDBOOK

FOR THE RADIO AMATEUR



NEW EDITION

The 1988 ARRL Handbook For The Radio Amateur carries on the tradition of the previous editions by presenting 1200 pages of comprehensive information for the radio amateur, engineer, technician and student. Clothbound only. \$21 in the U.S., \$23 in Canada and elsewhere.

THE AMERICAN RADIO RELAY LEAGUE
225 MAIN STREET
NEWINGTON, CT 06111



WEATHER SOFTWARE

ACCU-WEATHER FORECASTER is a menu driven program that allows the user to tap into Accu-Weather's extensive computerized database. In addition to Accu-

Weather's forecasts, you can get hourly updates from National Weather Service Offices nationwide.

Maps, graphs, pictures, charts, and narrative descriptions are just part of what can be downloaded to your MS-DOS computer. To save telephone and hook-up charges, tell your computer first exactly what information you want. Then call ACCU-WEATHER; the computer will download the files you want and save them to disk. Information can be obtained for the entire United States or a specific geographical region.

Several different services are available from ACCU-WEATHER. Price varies with the service and time of day that the computer is accessed. Add \$3.50 for shipping and handling.

- MC-IBM \$89.95
- MC-MAC \$89.95

Please add \$3.50 for shipping and handling

HAM RADIO BOOKSTORE

GREENVILLE, NH 03048

603-878-1441



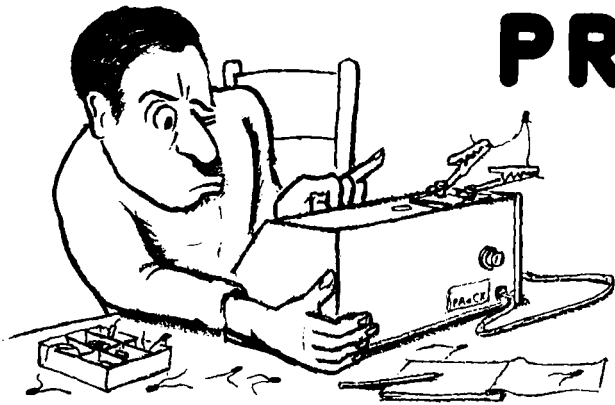

PRACTICALLY SPEAKING

Joe Carr, K4IPV

Standing waves: a review

Standing waves are always a consideration when dealing with antennas, transmission lines, and other rf source/load combinations. This month I'll take a brief look at standing waves, how they're calculated, how they're measured, and what they mean.

The reflection phenomenon was mentioned in last month's discussion of the step function or single-pulse response of a transmission line; the same phenomenon applies when the transmission line is excited with an ac signal. Let's review what happens in a transmission line system under ac excitation by using a little metaphorical device — the old rope trick. In **fig. 1** a taut rope is anchored at one end to an inflexible wall (**1A**). If a pulse is initiated by wiggling the free end of the rope (**1B**), the displacement wave will propagate down the rope (**1C**) until it hits the wall (**1D**). At this point the wave is reflected (**1E**) and repropagates back down the rope toward the source (**1F**). In this case, there is a 180-degree phase reversal, but that only happens in some transmission line situations (in other cases the reflected

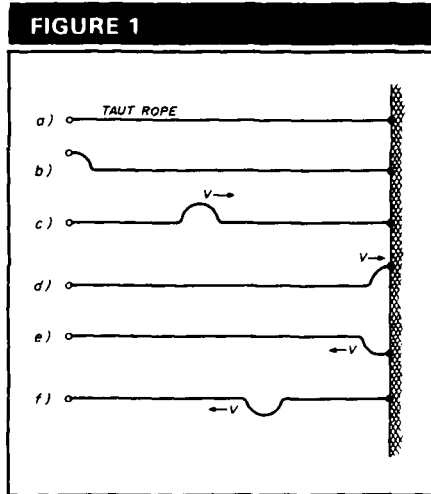

"Taut rope" metaphor for standing waves.

wave is in phase with the incident wave).

If the free end of the rope (our metaphorical "transmitter") is moved up and down, the rope oscillates and produces a series of waves. When an incident wave crosses a reflected wave the two will add algebraically as shown in **fig. 2A**. The amplitude at any given point is the sum of the two wave amplitudes; it may be either greater or less than the individual waves.

Figure 2B shows a situation in which the oscillations are recurrent in such a way that they produce standing waves on the rope. In this case, an

observer looking from the side would see what appears to be a single wave pattern standing in free space.

If a transmission line is perfectly matched to the load, no power is reflected back towards the source. This situation is analogous to a rope connected to a perfectly distensible foam rubber wall that absorbs all the mechanical energy of the rope wave. When a transmission line isn't matched to its load, some of the energy is absorbed by the load and some is reflected back down the line towards the source. This situation is

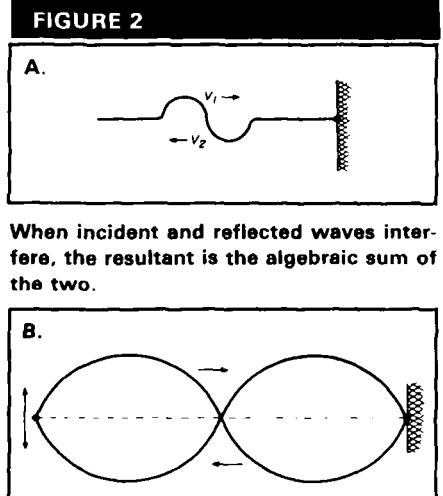

When incident and reflected waves interfere, the resultant is the algebraic sum of the two.

Oscillations on the input give rise to standing waves.

analogous to a rope connected to a somewhat distensible wall that absorbs some energy and reflects the rest. The interference of incident (forward) and reflected (reverse) waves creates standing waves on the transmission line.

The voltage or current measured along the line vary, depending on the load (see fig. 3). The voltage-vs.-length curve for a matched line is shown in fig. 3A, where $Z_L = Z_0$. The line is said to be "flat" because the voltage and current remain constant along the line. Figure 3B shows the voltage distribution over the length of the line when the load end of the line is shorted ($Z_L = 0$). At the load end the voltage is zero, a result of zero impedance. The same impedance and voltage situation is repeated every half wavelength down the line from the load end towards the generator. Voltage minima are called nodes, while voltage maxima are called antinodes.

The pattern in fig. 3C occurs when the line is not terminated (open); that is, Z_L is infinite. The pattern is the same shape as fig. 3B (shorted line), but phase shifted 90 degrees. In both cases the reflection is 100 percent, but the phase of the reflected wave is shifted 90 degrees.

Figure 3D shows the situation where Z_L is not equal to Z_0 ; it is neither zero nor infinite. In this case the nodes represent some finite voltage, V_{min} , rather than zero. The standing wave ratio (SWR) reveals the relationship between load and line.

If the current along the line is measured, the pattern will resemble the patterns of fig. 3. The SWR is then called ISWR, to indicate that it came from a current measurement. It is called VSWR if the SWR is derived from voltage measurements. VSWR is the term most commonly used, perhaps because voltage is easier to measure.

VSWR can be specified in any of several equivalent ways:

From incident voltage (V_i) and reflected voltage (V_r):

$$VSWR = \frac{V_i + V_r}{V_i - V_r} \quad (1)$$

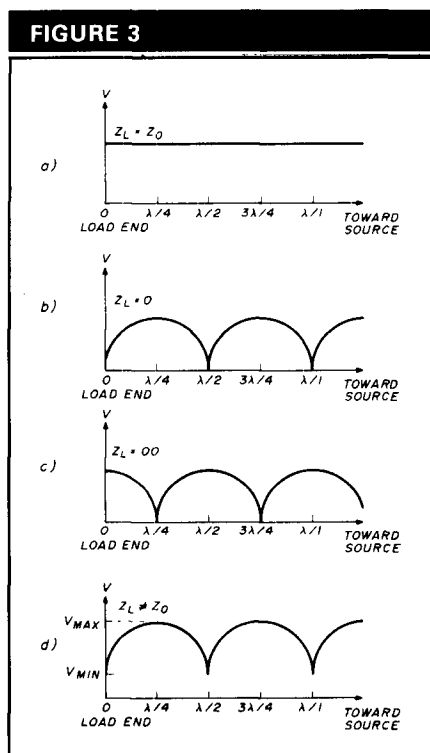

(A) Voltage vs. Length characteristic of transmission line: (a) flat line ($Z_L = Z_0$), (b) shorted line, (c) open line, (d) mismatched line.

From transmission line voltage measurements (fig. 3D):

$$VSWR = \frac{V_{max}}{V_{min}} \quad (2)$$

From load and line characteristic impedance:

$$(Z_L > Z_0) \quad VSWR = Z_L / Z_0 \quad (3)$$

$$(Z_L < Z_0) \quad VSWR = Z_0 / Z_L \quad (4)$$

From incident (P_i) and reflected (P_r) power:

$$VSWR = \frac{1 + [P_r/P_i]^{1/2}}{1 - [P_r/P_i]^{1/2}} \quad (5)$$

From reflection coefficient (p):

$$VSWR = \frac{1 + p}{1 - p} \quad (6)$$

It's also possible to determine the reflection coefficient (p) from knowledge of VSWR:

$$p = \frac{VSWR - 1}{VSWR + 1} \quad (7)$$

VSWR is usually expressed as a ratio. For example, when Z_L is 100

ohms and Z_0 is 50 ohms, the VSWR is $Z_L/Z_0 = 100 \text{ ohms}/50 \text{ ohms} = 2$, or VSWR = 2:1. VSWR can also be expressed in decibel form: $VSWR = 20 \log (VSWR)$

The SWR is important in systems for several reasons. At the root of it all is the fact that the reflected wave represents energy lost to the load. For example, in an antenna system less power is radiated if some of its input power is reflected back down the transmission line. This is because the antenna feedpoint impedance doesn't match the transmission line characteristic impedance. Now let's take a look at the problem of mismatch losses.

Mismatch (VSWR) losses

The power reflected from a mismatched load represents lost energy and, depending on the situation, will have implications that range from negligible to profound. A result might be anything from a slight loss of signal strength at a distant point from an antenna, to destruction of the output final amplifier device in a radio transmitter. The latter problem so plagued early solid-state transmitters that designers opted to include shutdown circuitry to sense high VSWR and limit output power proportionally.

VSWR on the transmission lines interconnecting devices under test, instruments, and signal sources can cause erroneous readings in radio system measurements, making them invalid. This problem is important, especially at VHF and with microwaves where transmission line lengths between signal sources, amplifiers, and indicating instruments are either an appreciable fraction of a wavelength or greater than a wavelength at those frequencies. For my MMIC column a few months back I built an amplifier that worked from near dc to 1 GHz or so. After making measurements above 400 MHz, I came up with a situation where there was more gain than the amplifier could offer. The "free" signal was actually wave combination in phase and *not* the gain of the MMIC amplifier.

ONLY
8 1/2 mi.
from the
SHERATON
to
TEL-COM



TEL-COM[★]

Electronic Communications

NEW ENGLAND'S FACTORY AUTHORIZED SALES & SERVICE FOR
KENWOOD & ICOM

We Invite ALL VISITORS to the
ARRL NEW ENGLAND CONVENTION
AT BOXBORO

To COME SHOP New England's REAL HAM STORE
STORE SHOW HOURS Saturday 9 to 5 - Sunday 9 to 3

Telephone 508/ 486-3400, 3040

675 Great Road, (Rte. 119) Littleton, MA 01460

1 3/4 miles from Rte. 495 (Exit 31) toward Groton, Mass.

Offering
Special
SHOW PRICES



NEW!
The classic "Antenna Bible"
now in a thoroughly-revised, much-enlarged
edition

ANTENNAS

2nd edition
by John Kraus, W8JK
Ohio State University

Covers both theory and its applications to practical systems. Over 1000 illustrations and nearly 600 worked examples and problems. Over 100 new topics. Complete with design formulas, tables and references

917 pages, hardcover. \$51.95

Add \$2.50 per book for shipping and handling U.S., \$5.00 elsewhere.

CYGNUS-QUASAR BOOKS
P.O. Box 85, Powell, Ohio 43065 ✓ 160
Tel. 614-548-7895

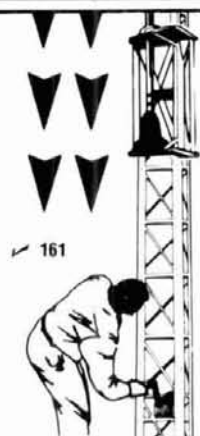

SAVE TIME and MONEY with THE HAZER

Bring things down for safety and convenience.

Never climb your tower again with this elevator system. Antennas and rotator mount on HAZER, complete system trans tower in vertical upright position. Safety lock system operates while raising or lowering. Never can fall.

Complete kit includes winch, 100 ft. of cable, hardware and instructions. For Rohm 20 and 25 G Towers.

Hazer 2-Heavy duty alum. 12 sq. ft. load **\$311.95 ppd.**
Hazer 3-Standard alum. 8 sq. ft. load **\$223.95 ppd.**
Hazer 4-Heavy galv. steel 16 sq. ft. load **\$291.95 ppd.**

NEW for ROHM 45 and 55 Towers

Hazer 8-Heavy duty galv. steel 16 sq. ft. load **CALL**
Ball Thrust Bearing TB-25 for any of above **Call for price**

Send for free details of aluminum towers specifically engineered for use with the Hazer. Two sizes; M-15 (13" wide) and M-18 (18" wide). All bolted construction, no welds. Easy to install hinge base, walk up erection. Complete tower UPS or air freight shippable. Pre-assembled or kit form.

Satisfaction guaranteed. Call today and charge to Visa, MasterCard or mail check or money order.

GLEN MARTIN ENGINEERING INC.

Rte 3, Box 322
Boonville, MO 65233
(816) 882-2734 FAX 816-882-7200

NOVEX

RF Signal Generator/Counter



- ✓ 1 - 150 MHz
- ✓ Harmonics to 450
- ✓ AM modulation
- ✓ XTAL. input/check
- ✓ Digital readout

NOVEX SG4162AD only **\$249.95 + \$4 S&H**

NOVEX SG4160A same as above except no digital readout/counter only \$149.95 + \$4 S&H

AF Audio Generator/Counter



- ✓ 10 Hz - 1 MHz
- ✓ Sine - sq wave
- ✓ Low distortion
- ✓ 8V RMS output
- ✓ Digital readout

NOVEX AG2603AD only **\$249.95 + \$4 S&H**

NOVEX AG2601A similar to above except no digital readout/counter only \$149.95 + \$4 S&H

Function Generator



- ✓ Sine, sq, triangle
- ✓ 5 Hz - 5 MHz
- ✓ DC offset
- ✓ 20 Vpp output
- ✓ 120 VAC power
- ✓ includes test leads

✓ External inputs can control AM (VCA) or FM (VCF) and produce AM, FM, sweep, ASK, or FSK signals

NOVEX FG2020A only **\$149.95 + 4 S&H**

Orders: 800-368-3270 Local & tech info 703-928-3350



Electronic Equipment Bank
516H Mill St. NE, Vienna, VA 22180
(Just minutes from Washington, DC)

✓ 162

October 1988 **HP** 87

CADDELL COIL CORP.

35 Main Street
Poultney, VT 05764
802-287-4055

BALUNS

Get POWER to your antenna! Our Baluns are already wound and ready for installation in your transmatch or you may enclose them in a weatherproof box and connect them directly at the antenna. They are designed for 3-30 MHz operation. (See ARRL Handbook pages 19-9 or 6-20 for construction details.)

100 Watt (4:1, 6:1, 9:1, or 1:1 impedance—select one)	\$10.50
Universal Transmatch 1 KW (4:1 impedance)	14.50
Universal Transmatch 2 KW (4:1 impedance)	17.00
Universal Transmatch 1 KW (6:1, 9:1, or 1:1—select one)	16.00
Universal Transmatch 2 KW (6:1, 9:1, or 1:1—select one)	18.50

Please send large SASE for info.

ENGINEERING CONSULTING *** SUPER COMSHACK 64 ***

Programmable Repeater Controller/HF & VHF Remotes/Autopatch/CW Practice Rotor Control/Voice Meters/Paging/User Logging/Unlimited Vocabulary/Package BBS

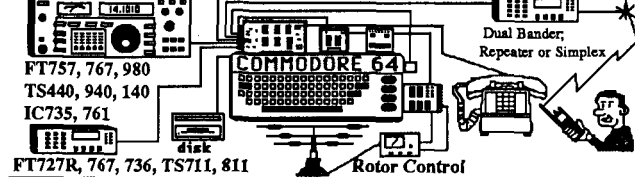

Set up your own personal or club repeater with any Dual band radio from your home or club site. Operate cross-band for instant full duplex. The CS64S now has the most advanced features available at any price!

REPEATER CONTROLLER
 Remote Change all variables
 Clear Synthesized voice
 Program mail box or select ID tail voice message or CW Alarm clock & auto execute Macro strings/user logging Individual user sys. codes CW Code practice & Voice Talking meters; hi/lo alarm H.F. REMOTE #1 20 Macro mem./mode sel. Scan up/down;set rate/step Voice ack. all commands Select any C.A.T. radio

AUTOPATCH REVERSE PATCH
 *1020 (18 digit) tel: #'s stored
 *300 users/CTCSS;2 tone page
 *50 enable/disable tel. #'s
 *Directed/general/ reverse page
 *Programmable answer message
 *Full or Half duplex (level cont.)
 *Secure mode/TT readback on/off
 *Reverse Patch active all modes
 *Call waiting/Quick dial/auto off
 *Control via Patch/mem redial
V.H.F. REMOTE #2
 *Dual VFO's/Rev/Split/COR
 *Set Scan inc. & offset/resume
 *Monitor mode & Link repeaters

Super Comshack 64
 Model CS64S \$349.95 + \$4.00 ship USA; incl. pre-wired, tested computer interface, disk, cables & manual (simplex version on request)

SYSTEM OPTIONS
 *External Relay Controls 3 DPDT relays: 5 Open col. out...CS-8 \$79.95
 *Rotor control; speaks bearing & rotates; 1 degree incre.....HM1 \$49.95
 *2 Voice Meter & Alarm inputs/8 On/off cont. Packet.BBS...PK8 \$149.95
 *EPROM Auto boot Cartridge custom with your system.....CART...\$99.95
 *Manual (Refunded).....MN1 \$15.00

MINI C.A.T. COMPUTER CONTROL FT-727R
 Programs and Scans Ham/General coverage. Converts HT into a powerful 100 ch. scanner & programs all in H.T. for field use! Digital "S" meter; comments; auto resume; delay; lockout
 *Loads & programs all FT-727R parameters in less than 15 secs.
 *Includes hardware & disk for C64 or IBM. Model 727 \$39.95



Decode-A-Pad
 12v. audio RS232C 123456 789ABC

Touchtone to RS232 (300 baud interface)
 Program your computer in basic to decode multidigit "strings" sound alarms, observe codes, includes basic program for 264 VIC20; 128; IBM. A must for repeaters."Decode-A-Pad" works on all computers Model DAP \$ 89.95

Audio Blaster IC02/04; 2AT; U16; FT 727R; 209; 23/73
 Module installs inside the radio in 15 Mtn. Boost audio to 1 watt! Low standby drain/Corrects low audio/1000's of happy users. Miniature audio amplifier Used by Police, fire, Emergency, adds 40 dB gain! for all H.T.'s when it needs to be LOUD!
 Model AB1S-\$ 22.95

ENGINEERING CONSULTING * 583 CANDLEWOOD ST.* BREA, CA. 92621
 MASTERCARD ** VISA ** CA. RES. ADD 6% ** TEL: 714-671-2009

ALL BAND TRAP VERTICAL ANTENNAS!

FULL 14th WAVE - All Band Automatic Selection with proven Hi-Q Traps, 5 Modes-ALL self supporting - Ground or roof mount. HI STRENGTH FIBERGLASS TUBING OVER - ALL NO WOBBLY, LUMPY TRAPS - NO UNSIGHTLY CLAMPS needed - Size 1 1/4" all the way up - Traps hidden inside. You can use it in a 1 ft. sq. Backyard FOR APARTMENTS, MOBILE HOMES - CONDOS etc. where minimum space and neat appearance is MANDATORY! Instant "Drive In" ground mount (included). Use with or without radials (included) (All angle roof mount - Extra) COMPLETELY PRE-TUNED - NO ADJUSTMENTS NEEDED EVER! NO TUNER NEEDED FOR MOST TRANSCIEVERS! Use - RGGU feedline, any length! 2000 Watt PEP, input power. Shipped - PREPAID IN USA, Assembles in 10 min. using only screwdriver. WEATHERPROOF!

No.-AVT80-10	5 Band	25'6"	\$199.95
No.-AVT40-10	4 Band	18'9"	\$139.95
No.-AVT20-10	3 Band	11'4"	\$109.95
No.-AVT80-10W	8 Band	22'	\$279.95
No.-AVT40-10W	7 Band	15'9"	\$199.95

SEND FULL PRICE FOR PP DEL IN USA (Canada is \$10.00 extra for postage, clerical, Customs) or order using VISA, MASTER CARD or AMER-EXP. Ph 1-308-236-5333 9AM-6PM weekdays. We ship in 2-3 days. All Antennas Guaranteed for 1 year - 10 day money back trial. Fr. In.

WESTERN ELECTRONICS
 Dept. AH Kearney Ne. 68647

12 volt C64 SWITCHER
 *Power C64 & 1541
 *70khz 75% efficient
 *Outputs 5v. @2A & 9 VAC @ 60Hz
 *Crystal time base
 *Plugs into C64
 MODEL DCPS.....\$119.95

Touchtone 4 Digit Decoder & Quad Relay Expansion
 *TSDQ Decoder ^QUAD Option
 *+8 to +20 V. supply; low power drain
 *Field prog. jumpers; 50,000 codes
 *Momentary & Latching; DPDT relays
 *Wrong digit reset; LED's digits+latch
 *24 Pin Conn. hook up & Expansion
 ^Quad (4) Relays; (2 Amp); Adds 4 individual 5 Digit on & off codes!
 ^Status outputs; wired & tested
 TSDQ \$79.95 QUAD \$99.95

QRZ CONTEST!

VHF Contest Software for PC Compatibles \$39.95 postage paid
 - Covers all VHF and UHF contests
 - Includes the 70 MHz European band
 - Menu driven and user friendly
 - Color and options user configured
 - Grids worked display on-line!
 - Full dupe checking
 - Complete log editor included
 - Handles 4000 contacts with 512K
 - Demo-version available \$5.00
 + HF Version to be available soon!

ATFAB Computers and Electronics
 P.O. Box 4766
 Maineville, OH 45039
 (513) 683-2042

BEVERAGE ANTENNA HANDBOOK

by Vic Misek, W1WCR New Edition

W1WCR has spent countless hours developing new antenna ideas and optimizing the SWA (Steerable wave antenna.) Misek delves deep into the secrets of the single wire Beverage with helpful hints and tips on how to maximize performance based upon wire size, height above ground, overall length and impedance matching. Also includes information on center fed Beverages constructed out of several wire types. **SMALL LOT OWNERS** - Beverage for you too! Called the Micro-SWA, it is just 60 ft long. You get excellent directivity and null steering capabilities. Transformer design information for both termination and feedline matching is completely revised. © 1987 80 pages

I VM-BAH Softbound \$14.95

THE BEVERAGE ANTENNA HANDBOOK
 SECOND EDITION

FULLY REVISED

Please enclose \$3.50 shipping & handling

HAM RADIO BOOKSTORE

GREENVILLE, NH 03048 603-878-1441

MISSION CONSULTING, INC. MISSION COMMUNICATIONS
 11903 Alief-Clodine Suite 500 HOUSTON, TEXAS 77082

WE HAVE EXPANDED AND NOW STOCK MANY NEW PRODUCTS. WE CARRY

AEA, ALINCO, AMECO, AMP SUPPLY, ALPHA DELTA, ANTECO, ARRL, B&B INSTRUMENTS, BARKER & WILLIAMSON, BENCH & BOYAR, BUTTECH, BEE, CHS, CHS BART, COMMUNICATION SPECIALISTS, CRR RESEARCH, DAHWA, DIAMOND, HENRY HUSTLER, HAM RADIO, INTL. CRYSTAL, INTL. WIRING & CABLE, KANTRONICS, KACHINA KENPRO, KOK-KIM, LITRACE, LUVA, LARSON, MOBILE MARK, MFJ, NEUTECH, NCE, NYE, PERIPHER, OSI, RF INDUSTRIES, RADIO PUBLICATIONS, RADIO AM, CALLBOOK, SAMSON, SPI-RO, SUTLEY ANTENNA, SANTEC, SYN, TEXTILES, 73 MAG, STANDARD, TAD, TEN-TEC, VALOR, VECTOR, GORDON WEST, WELZ, YAESU, AND ICOM.

In house service available.
 Just write, or (713) 879-7764
 give us a call! Telex 166872 MCON UT

You must take two VSWR situations into account when determining VSWR losses. Consider a transmission line of impedance Z_0 interconnecting a load impedance (Z_L) and a source with an output impedance (Z_s). There is a potential for impedance mismatch at both ends of the line.

Where one end of the line is matched (either $Z_s = Z_0$ or $Z_L = Z_0$), the mismatch loss due to SWR at the mismatched end is:

$$ML = -10 \log \left[1 - \left(\frac{SWR - 1}{SWR + 1} \right)^2 \right] \quad (8)$$

This can also be written as:
 $ML = -10 \log (1 - p^2)$

Example

A coaxial transmission line with a characteristic impedance of 50 ohms is connected to the 50-ohm output (Z_0) of a signal generator, and also to a 20-ohm load impedance (Z_L). Calculate the mismatch loss.

Solution:

First find the VSWR:

$$VSWR = Z_0/Z_L$$

$$VSWR = 50 \text{ ohms}/20 \text{ ohms} = 2.5:1$$

Mismatch loss:

$$ML = -10 \log \left[1 - \left(\frac{SWR - 1}{SWR + 1} \right)^2 \right] \quad (9)$$

$$ML = -10 \log \left[1 - \left(\frac{2.5 - 1}{2.5 + 1} \right)^2 \right]$$

$$ML = -10 \log \left[1 - \left(\frac{1.5}{3.5} \right)^2 \right]$$

$$ML = -10 \log [1 - (0.43)^2]$$

$$ML = -10 \log [1 - 0.185]$$

$$ML = -10 \log [0.815]$$

$$ML = (-10) (-0.089) = 0.89$$

When both ends of the line are mismatched a different equation is required:

$$ML = 20 \log [1 \pm (p_1 \times p_2)] \quad (10)$$

Where:

p_1 is the reflection coefficient at the source end of the line, $(VSWR_1 - 1)/(VSWR_1 + 1)$

p_2 is the reflection coefficient at the load end of the line, $(VSWR_2 - 1)/(VSWR_2 + 1)$

Note that the solution to eqn. 10 has two values: $[1 + (p_1 p_2)]$ and $[1 - (p_1 p_2)]$.

The preceding equations reflect the mismatch loss solution for low loss or "lossless" transmission lines. They are close approximations, but there are situations where they are insufficient — namely when the line is lossy. Though not very important at low frequencies, loss becomes significant at VHF through microwave frequencies. Interference between incident and reflected waves produces increased current at certain antinodes (which increases ohmic losses) and increased voltage at certain antinodes (which increases dielectric losses). The latter increases with frequency. Equation 11 relates reflection coefficient and line losses to determine total loss on a given line.

$$loss = 10 \log \left[\frac{n^2 - p^2}{n - np^2} \right] \quad (11)$$

Where:

loss is the total line loss in decibels

p is the reflection coefficient

n is the quantity $10^{(A/10)}$

A is the total attenuation in dBs presented by the line, when the line is properly matched ($Z_L = Z_0$)

Example

A 50-ohm transmission line is terminated in a 30-ohm resistive impedance. The line is rated at a loss of 3 dB/100 feet at 1 GHz. Calculate the loss in 5 feet of line, the reflection coefficient, and the total loss in a 5-foot line mismatched as above.

solution:

$$A = \frac{3dB}{100ft.} \times 5-ft = 0.15dB \quad (12)$$

$$p = \frac{Z_L - Z_0}{Z_L + Z_0} \quad (13)$$

$$p = \frac{50 - 30}{50 + 30}$$

$$p = 20/80 = 0.25$$

$$n = 10^{(A/10)}$$

$$n = 10^{(0.15/10)}$$

$$n = 10^{(0.015)} = 1.04$$

$$loss = 10 \log \left[\frac{n^2 - p^2}{n - np^2} \right] \quad (14)$$

$$loss = 10 \log \left[\frac{(1.04)^2 - (0.25)^2}{(1.04) - ((1.04)(0.25)^2)} \right]$$

$$loss = 10 \log \left[\frac{1.082 - 0.063}{(1.04) - ((1.04)(0.063))} \right]$$

$$loss = 10 \log \left[\frac{1.019}{1.04 - 0.066} \right]$$

$$loss = 10 \log \left[\frac{1.019}{0.974} \right]$$

$$loss = 10 \log (1.046)$$

$$loss = (10)(0.02) = 0.2dB$$

Compare the matched line loss ($A = 0.15$ dB) with the total loss ($loss = 0.2$ dB), which includes mismatch loss and line loss. The difference ($loss - A$) is only 0.05 dB. If the VSWR were considerably larger, the loss would rise. Work through some basic examples using VSWR values seen in Amateur Radio work; the answers may surprise you. Considering that an S unit is either 3 or 6 dB depending on which receiver you own, it isn't necessary to tweek out every little bit of VSWR. In fact, the only reasons to worry about it are that: the VSWR low point indicates resonance on the antenna, and solid-state final amplifiers are not too happy with VSWR.

Trimming the transmission line does not lower VSWR, despite what non-ideal instruments may lead you to believe. To reduce VSWR, you must either resonate the antenna or insert an impedance-matching device between the line and the antenna. The only time that transmission line can reduce VSWR is when it is used as a matching section, as discussed last month.

Editor's Note: This material was derived from Joe's forthcoming book, *Practical Antenna Handbook*. Joe Carr, K4IPV, can be reached at POB 1099, Falls Church, Virginia 22041; he'd like to have your comments and suggestions for this column.

Article J

HAM RADIO

HAM RADIO BOOKSTORE

FALL FLYER



BOOK PAGE



ARRL ANTENNA BOOK

by Jerry Hall, K1TD, NEW 15th Edition

The all new 15th edition of this antenna classic represents over two years of hard work by editor K1TD. It's doubled in size too -- from over 300 to over 700 pages big! 950 figures and charts cover just about every subject imaginable. Some of the highlights are: Chapters on Loop antennas, multi-band antennas, low frequency antennas, portable antennas, VHF and UHF systems, coupling the antenna to the transmitter and the antenna, plus o-l-e-n-t-y more. Like the 1988 HANDBOOK and new OPERATING MANUAL, the new ANTENNA BOOK is going to be a smash hit. Order yours today. 15th edition 900 + pages ©1988

AR-AM Softbound \$17.95

NOVICE ANTENNA NOTEBOOK

by Doug DeMaw W1FB

Novices have long wondered what is the best all around antenna for them to install. Up until now, this was a difficult question to answer. Aimed at the newly licensed Ham, DeMaw writes for the non-engineer in clear concise language with emphasis on easy-to-build antennas. Readers will learn how antennas operate and what governs performance. Also great reading for all levels of Amateur interest. 1st Edition ©1988.

AR-NAN Softbound \$7.95

1988-89 ARRL REPEATER DIRECTORY

Bigger and better than ever! Over 13,300 listings including 1400 repeaters--every Ham should have a copy of this book in their car or shack. Handy resource book has listings by frequency and location. Invaluable aid while travelling. ©1988

AR-R088 Softbound \$4.95
AR-2RD88 (Buy 2 & Save) \$7.95

ANTENNAS

by John Kraus, WB8JK, New 2nd Edition

Kraus's classic antenna book has been extensively revised and up-dated to reflect the latest state-of-the-art in antenna design and theory. Includes over 1,000 illustrations and nearly 600 worked examples and problem solutions. Chapters cover basic concepts, point sources and point source arrays, dipoles, helices, broadband and frequency independent antennas, special applications and tons more of information. Also includes 5 appendices: reference tables, computer programs, books and video tapes, answers to problems and a problem supplement. College level text for the Amateur. 2nd edition 917 pages ©1988

MH-35422 HARDBOUND \$59.95

1988 CALLBOOK SUPPLEMENT

The CALLBOOK SUPPLEMENT contains all of the new licenses, address and callsign changes from all the countries around the world. It also includes all of the new postal rate changes, current QSL bureaus, and many other helpful, handy features. A must for the active Ham -- it's the only way to have all the current addresses and callsigns. 320 pages ©1988

CB-S88 Softbound \$9.95

EASY-UP ANTENNAS for Radio Listeners

and Hams

by Ed Noll W3FQJ

Noll has long been known for easy-to-build antenna articles for all levels of Amateur operation. This book covers basic do-it-yourself antennas for SWLs, AM and FM BCB'ers, present and prospective Hams and scanner listeners. Includes dipoles, verticals, beams, long wires, and several special types and configurations. Also has time saving look-up dimension tables, constants and other helpful hints for antenna design. It's nice to have Noll back in print as his other two best selling antenna books have been out-of-print for years. 1st edition 164 pages ©1988

22495 Softbound \$16.95

THE 1989 ARRL HANDBOOK FOR THE

RADIO AMATEUR (Available late October 1988)

Revised and updated with the latest in Amateur technology, now is the time to order your very own copy of the world famous ARRL HANDBOOK. In addition to being the definitive reference volume for your Ham shack, there are plenty of projects for every interest in Amateur Radio -- from antennas for every application to the latest state-of-the-art projects -- you'll find it all in the 1989 HANDBOOK. Order now and we will ship as soon as the books arrive from the printer. They make perfect gifts for the holiday season for your hard-to-buy for Ham friends or for yourself. Over 1100 pages ©1988.

AR-HB89 Hardbound \$20.95

N6RJ's ELECTRONIC SECOND OP

for MS-DOS computers

by Jim Rafferty N6RJ

The world famous SECOND OP is now available in a state-of-the-art computerized data base. This program, written for MS-DOS computers, is a must for DX'ers, contesters and all Amateurs interested in reliable DX communication. Data can be displayed either in columnar format or in full screen displays. Unknown callsigns can be entered and compared to the ITU callsign allocation for easy identification. There's plenty more too such as: postal rates, beam headings and QSL bureaus to name just a few. Great program to have in your shack. Order yours today. ©1988 MS-DOS computers. 5/4 and 3/2 versions available. Please specify on your order.

CB-RJ (MS-DOS Computers) \$59.95

THE "GROUNDS" FOR LIGHTNING & EMP PROTECTION

by Roger Black, PolyPhaser Corporation

Here's a subject that has never really been fully covered in Amateur literature. This 116 page text contains a comprehensive analysis of proper grounding and protection against lightning and other EMP disasters. Includes information for all kinds of electronic gear: radios, telephones, computers, Ethernet, CATV, TVRO and security systems to name just a few. Of special interest to Hams are chapters on low inductance grounds and connections, guy anchor grounding, and how to ground inside the shack. Every Ham should have a copy. 1st edition 116 pages ©1987

PP-GLPE Hardbound \$19.95

GENIUS AT RIVERHEAD a profile of

H. H. Beverage

by Alberta Wallen

Born at the very beginning of the radio age, Harold Beverage is one of radio's pioneers. Most know him from his development of the Beverage or wave type receiving antenna. Learn about the career of this brilliant engineer in this easy-to-read biography. Starting with GE in 1917 and moving to RCA in 1920, Beverage was involved in some of the most exciting aspects of radio. Of particular interest is a reprint of the famous November 1922 QST article describing the wave antenna. Includes 35 photos. 130 pages ©1988

NH-BEV Hardbound \$15.95

SHORTWAVE DIRECTORY

by Bob Grove, 1988 Edition

Now includes both VLF and broadcasting information! This SWL's bible is crammed with all the latest up-to-date frequencies and callsign information. Covers 10 kHz to 30 MHz and has listings for just about every user possible from the US Government to as many clandestine stations as you can imagine. Most stations are cross-referenced by agency and frequency for rapid identification. Also contains a glossary of terms, acronyms and abbreviations commonly heard on-the-air. 4th edition 500 + pages ©1988

GE-SO Softbound \$17.95

1989 RADIO AMATEUR CALLBOOKS

(Available late November 1988)

NORTH AMERICAN EDITION

Fully updated and edited to include all the latest FCC and foreign government callsigns and addresses for Hams in North America. Includes plenty of handy operating aids such as time charts, QSL bureau addresses, census information and much more. Calls from Northern Canada to Tropical Panama. Now is the time to buy a new Callbook when you'll get the most use out of your investment. ©1988

CB-US89

Softbound \$25.95

INTERNATIONAL EDITION

QSL's are a very important part of our hobby. All sorts of awards, including the coveted DXCC, require confirmation of contact before the award can be issued. Of special interest, addresses are being added daily for Hams in the USSR and other countries. While in no means complete, it's a start and will be of tremendous help in getting QSLs. Handy operating aids round out this super book value. ©1988

CB-F89

Softbound \$28.95

BUY 'EM BOTH SPECIAL

Reg. \$54.90 Only \$49.95

SAVE \$4.95

MASTERING PACKET RADIO: the hands on guide

by Dave Ingram K4TWJ

Packet radio continues to grow at a rate that boggles the mind. This new book appeals to all levels of packet radio enthusiasts from novices to experts alike. Full of illustrations and written in a simple, easy-to-understand style. Topics covered include: a basic primer, home computers and data communications terminals, a survey of equipment available, how to set up a station plus much more. Great compliment to the other packet books available. 208 pages ©1988 1st edition

CB-22567

Softbound \$12.95

THE ARRL SATELLITE ANTHOLOGY

Taken from the pages of the "Amateur Satellite News" column in QST. Includes the latest information available on OCSARs 9 through 13 as well as the Russian RS satellites. Full coverage is given to Phase III, OSCAR 10 and 13, satellites. Also includes an unpublished article detailing UoSAT-OSCAR 11 operation. Digital modes, tracking, antennas, RUOAK, microcomputer processing of telemetry plus much more is contained in this valuable new volume. 112 pages ©1988

AR-SA

Softbound \$4.95

22nd CENTRAL STATES VHF SOCIETY CONFERENCE PAPERS

Papers in this book were submitted for the 1988 Central States VHF Society meeting. Includes: Microwave EME, predicting 144 MHz "Es" openings, matching versus noise figure trade-offs in pre-amps, 902 MHz transverter, power amplifier and antennas, how to measure your own K index plus much more. A must publication for the active VHF'er. ©1988

AR-22CS

Softbound \$11.95

PASSPORT TO WORLDBAND RADIO 1989 Edition

Brand new and fully revised, SWL's everywhere will want a copy for their library. Expanded to 416 pages, the book now includes a bigger and better buyer's guide, an interview with James Michener, an exciting real life drama of one SWL's escape from Iran plus much more. Also includes all the latest broadcast schedules from countries around the world. You're up-to-date if you have a copy of this new book by your radio. 416 pages 1989 Edition ©1988

IBS-RD89

Softbound \$14.95

CONFIDENTIAL FREQUENCY LIST

7th EDITION now includes RTTY stations

Compiled by Geoff Hulligeg

This new edition is jam-packed with all the latest frequencies, callsigns and other important information. Inside you'll find listings for aeronautical, military, embassy, VOLMET, INTERPOL, weather and RTTY stations. Also included is a thorough discussion on how to listen to RTTY stations, explanations of the abbreviations used by utility stations, the reasons behind international jamming and much, much more. Every radio enthusiast should have a copy in their shack. ©1988. 7th edition, 376 pages.

GL-CF

Softbound \$19.95

Please enclose \$3.50 shipping & handling.

HAM RADIO BOOKSTORE

GREENVILLE, N.H. 03048

(603) 878-1441

MORE FIXES FOR THE IC22S VHF RADIO

By Brian J. Henderson, VE6ZS, 23 Deermoss Place SE, Calgary, Alberta T2J 6P5 Canada

In its day, the Icom IC22S was one of the most popular radios sold. I still own two and have needed to repair them on a few occasions. One had a number of problems requiring major work. The radio's only shortcoming is that its manual gives little more than a circuit diagram; * I didn't find it particularly helpful. Some of the problems I've encountered and corrected are outlined here.

Theory and operation

A simplified block diagram is shown in fig. 1. A voltage-controlled oscillator (VCO) generates the frequencies required for the receiver and transmitter. The VCO operates at 135.3 MHz, the frequency required for receiver injection. The components used for phase detection and division won't operate at these high frequencies. The signal is mixed with a fixed frequency of 133.69 MHz generated by crystal X2 and Q7, which operate as a tripler. The difference between these two is 1.61 MHz. This signal is further divided by 2, by IC 6, and passed on to the programmable voltage divider, IC 1. The division of the signal by IC 1 is set by the diode matrix board and associated logic. The divided frequency is passed on to the phase comparator, IC 2. The frequency at this point should be about 7.5 kHz. Phase is compared with a reference 7.5-kHz signal produced by crystal X1 and fixed divider IC 3. The difference in phase and frequency between the fixed reference and the variable signal from the VCO is converted by IC 1 to a dc voltage (offset error voltage). The dc voltage is used to control the capacitance of D3 in the VCO. Changing the capacitance in the VCO will change its output frequency. The correction process continues until the VCO has the correct output frequency. This is achieved when the phase error between the reference and divided generated frequencies is reduced to zero. The PLL is then said to be "locked." When changing channels, or going from transmit to receive, repeat this process to give the required frequencies for the radio to operate.

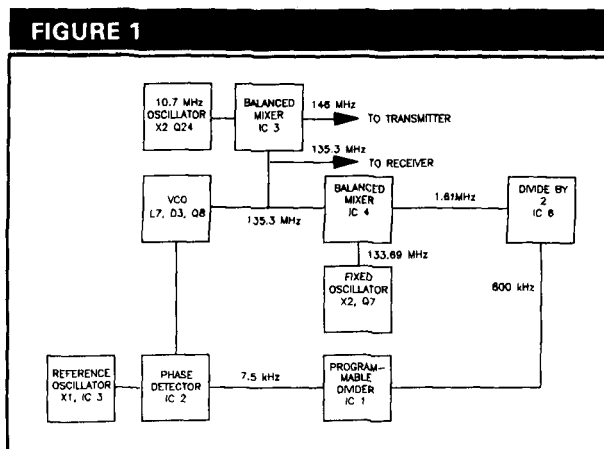

Block diagram of the PLL in the IC22S.

Frequency alignment

Make adjustments in the following order using a frequency counter, signal generator, and a plastic tuning tool.

• Reference Oscillator

Connect the counter to test point CP1 on the PLL board (located on the lower left corner of the PLL board). Adjust C2 for a frequency of 7.68 MHz (European version 10.24 MHz).

• Receive Frequency

Using a signal generator, inject a signal on a channel the radio can receive. The wire originally connected to pin 1 of the accessory socket is the discriminator output. Adjust C38 on the PLL board (lower left corner of board next to crystal X2) for zero discriminator current as measured between this point and chassis ground.

• Transmit Frequency

Most radios are usually on frequency and require no adjustment; should yours need it, transmit on a known frequency. If the radio is off frequency, as displayed on the counter, adjust L41 (located at the front, near the left corner of the main board) for the correct transmit frequency.

RAMSEY ELECTRONICS

Quality Test Gear & Electronic Kits for Professionals and Hobbyists



COM-3



\$2495.00

THE COMMUNICATIONS SERVICE MONITOR THAT WORKS HARDER FOR LESS.

Introducing COM-3... the new service monitor designed by service technicians for service technicians. It works harder for less... giving you advanced testing capabilities at a very affordable price.

FEATURES • Direct entry keyboard with programmable memory • Audio & transmitter frequency counter • LED bar graph frequency/error deviation display • 0.1-10,000 μ V output levels • High receive sensitivity, less than 5 μ V • 100 KHz to 999.9995 MHz Continuous frequency coverage • Transmitter protection, up to 100 watts • CTS tone encoder, 1 KHz and external modulation



\$499.95

wired includes AC adapter
PR-2 kit \$39.95

PR-2 COUNTER PREAMP

The PR-2 is ideal for measuring weak signals from 10 to 1000 MHz • flat 20 db gain • BNC connectors • great for sniffing RF • ideal receiver/TV preamp • 3 db NF



\$699.95

wired
PS-2 kit \$49.95

PS-2 AUDIO MULTIPLIER

The PS-2 is handy for high resolution audio resolution measurements, multiples 10x frequency • great for PL tone measurements • multiples by 10 or 100 • 0.01 Hz resolution & built-in signal preamp/conditioner



\$899.95

wired includes AC adapter

PS-10B 1.5 GHz PRESCALER

Extends the range of your present counter to 1.5 GHz • 2 stage preamp • divide by 1000 circuitry • super sensitive (50 mV typical) • BNC connectors • 1.5 GHz in, 1.5 MHz out • drives any counter.

ALL NEW KITS



Complete kit, SG-7
\$89.95

PERSONAL SPEED RADAR

New low cost microwave doppler radar kit "clocks" cars, planes, boats, horses, bikes, baseballs, models, runners or virtually anything that moves. Operates at 2.6 GHz with over 174 mile range. LED digital readout displays speeds in miles per hour, kilometers per hour or feet per second. Earphone output permits listening to actual doppler shift. Uses two 1 lb coffee cans for antenna (not included) and runs on 12 VDC. Easy to build—all microwave circuitry is PC stripboard. Kit includes deluxe ABS plastic case with speedy graphics for a professional look. A very useful and full-of fun kit!

RADIOS

40 & 80 METERS HAM RECEIVERS

Sensitive all mode, AM, CW, SSB receivers for 3.5-4.0 or 70-75 MHz. Direct conversion design using NE602 IC as featured in QST and ARRL handbooks. Less than 1 μ V sensitivity, varactor diode tuning, 50 mw audio output. Runs on 9VDC, has HF gain control. This kit is very easy to build, lots of fun and educational—ideal for the beginner or the old pro. The optional matching case kit features a rugged ABS plastic case with screened graphics. Included are machined aluminum knobs for a well-finished professional look.

40 Meter receiver kit, HR-4 **\$24.95** 80 Meter receiver kit, HR-8 **\$24.95** Receiver case kit, CHR **\$12.95**

QRP TRANSMITTER KITS, 40 & 80 METERS

Operate a mini ham shack. These little CW rigs are ideal mates to our 40 and 80 meter receivers. Features include smooth variable tuning, one watt output and excellent keying characteristics. Runs on 12 VDC and is VSWR protected. See how far you can stretch your signal with one of these mini rigs. Optional ABS cases are available.

40 meters QRP rig, QRP-40 **\$24.95** 80 meters QRP rig, QRP-80 **\$24.95** Case kit, CDRP **\$12.95**

AIRCRAFT RECEIVER KIT

Hear exciting aircraft communications—picks up planes up to 100 miles away. Receives 110-136 MHz AM air band, varactor tuned superhet design with AGC, ceramic filter and adjustable squelch. Runs on 9V battery, 50 mw audio output, 1 μ V sensitivity. Optional matching ABS plastic case lets you take it anywhere. Features screened graphics and machined aluminum knobs for a real professional look. Compact—great for airshows or for just plain hanging around the airport.

Complete kit, AR-1 **\$24.95** Receiver case kit, CAR-1 **\$12.95**



SHORTWAVE RECEIVER KIT

A fantastic receiver that captures the world with just a 12' antenna! Receives 4-11 MHz in 2 MHz bands, varactor tuned, superhet design with AGC, RF gain control and 50 mw audio output. Uses new Signetics mixer chip for less than a microvolt sensitivity, runs on 9V battery. This is a fascinating school, school or club project, and will provide hours of fun even to the most serious DX'er. Add the optional case kit and you have a real nice looking shortwave set.

Complete kit, SR-1 **\$24.95** Receiver case kit, CSR-1 **\$12.95**

PACKET RADIO

Commodore CB4128 packet radio interface. Uses famous German Digicom software. Features EXAR IC chip set for reliable operation—runs HF or VHF tones. Includes FREE disk software. PC board. All necessary parts and full documentation.

Complete kit, PC-1 **\$49.95**

FM COMMUNICATIONS/2 METER RECEIVER

Sensitive superhet FM receiver tunes any 5 MHz segment from 135-175 MHz. Listen to 2 mt ham operations, high band police calls, weather or mobile phone calls! Easy to build receiver features variable tuning, IC mixer stage, ceramic filter and dual conversion design with adjustable squelch. Less than 1 μ V sensitivity, runs on 9V battery, with 50 mw audio output. Optional ABS case with screened graphics and machined aluminum knobs provide a nice professional look.

Complete kit, FR-7 **\$29.95** Receiver case kit, CFR-7 **\$12.95**

NEW MINIKITS—NEW MINIKITS

BROADBAND PREAMP

A sensitive all purpose preamp, ideal for scanners, TV sets, VHF, UHF rigs, counters, etc. Features low noise, 4 db NF, 20 db gain, 100 KHz - 1 GHz operation. Runs on 9-12 VDC. 50 ohm input.

Complete kit, SA-7 **\$12.95**

LIGHT BEAM COMMUNICATORS

Transmits, modulated infrared light up to 30 feet without batteries, up to 1/4 mile using lenses. Uses 30 KHz carrier for hum-free operation. Transmits thru windows, etc. Ideal for "bugs" or listening to IR remote controls. Transmitter has sensitive mike input, receiver uses PM detector and drives speaker output. Units operate on 9-12 VDC.

Transmitter kit, LB-6 **\$8.95**
Receiver kit, LB-5 **\$9.95**

HIGH POWER FM WIRELESS MIKE

A high power unit that will transmit up to 1/2 mile to any FM broadcast radio. Sensitive input accepts any type of mike, will pick up normal voices 10 feet away using the available mini-electric microphone cartridge. Operates on 9-12 VDC.

FM-4 kit **\$9.95**
Sensitive microphone cartridge **\$2.95**

FREQUENCY COUNTERS

Ramsey Electronics has been manufacturing electronic test gear for over 10 years and is recognized for its lab quality products at breakthrough prices. All of our counters carry a full one year warranty on parts and labor. We take great pride in being the largest manufacturer of low cost counters in the entire USA. Compare specifications. Our counters are full featured, from audio to UHF, with FET high impedance input, proper wave shaping circuitry and durable high quality epoxy glass, plated-thru PCB board construction. All units are 100% manufactured in the USA.

ACCESSORIES FOR COUNTERS

- Telescopic whip antenna—BNC plug **\$ 8.95**
- High impedance probe, light loading **16.95**
- Low pass probe, audio use **16.95**
- Direct probe, general purpose use **13.95**
- Tilt pack for CT-70, 90 & 125 **3.95**
- Nicad pack for CT-70, 90 & 125 **8.95**

CT-70 7 DIGIT 525 MHz



\$139.95 WIRE INCLUDES AC ADAPTER

CT-90 9 DIGIT 600 MHz



\$169.95 WIRE INCLUDES AC ADAPTER

CT-50 8 DIGIT 600 MHz



\$189.95 WIRE INCLUDES AC ADAPTER

CT-125 9 DIGIT 1.2 GHz



\$189.95 WIRE INCLUDES AC ADAPTER

MODEL	FREQ RANGE	SENSITIVITY	ACCURACY	DIGITS	RESOLUTION	PRICE
CT-70	20 Hz-550 MHz	<50 mV to 150 MHz	1 PPM	7	1 Hz, 10Hz, 100Hz	139.95
CT-90	10 Hz-600 MHz	<10mV to 150 MHz <150mV to 600 MHz	1 PPM	9	0.1 Hz, 10Hz, 100 Hz	169.95
CT-50	5 Hz-600 MHz	LESS THAN 25 mV	1 PPM	8	1Hz, 10Hz	189.95
CT-125	10 Hz-1.25 GHz	<25mV @ 50 MHz <15mV @ 500 MHz <100mV @ 800 MHz	1 PPM	9	0.1Hz, 1Hz, 10Hz	189.95
CT-90 WITH DV-1 OPTION	10 Hz-600 MHz	<10mV to 150 MHz <150mV to 600 MHz	0.1 PPM	9	0.1 Hz, 1Hz, 10Hz	229.95

MINI KITS—EASY TO ASSEMBLE—FUN TO USE

TONE DECODER

A complete tone decoder on a single PC board. Features 400-5000 Hz adjustable range via 20 turn pot, voltage regulation, 567 IC. Useful for touch-tone burst detection, FSK, etc. Can also be used as a stable tone encoder. Runs on 5 to 12 volts.

Complete kit, TD-1 **\$5.95**

COLOR ORGAN

See music come alive! 3 different lights flicker with music. One light each for high, mid-range and lows. Each individually adjustable and drives up to 300 W, runs on 110VAC.

ML-1 kit, **\$8.95**

VIDEO MODULATOR

Converts any TV to video monitor. Super stable. Tunable over ch 4-6. Runs on 5-5V, accepts std. video signal. Best on the market! Complete kit, VD-1

\$7.95

LED Blinky KIT

Alternately flashes 2 jumbo LEDs. Use for name badges, buttons, warning panel lights. Runs on 3 to 15 volts.

BL-1 kit, **\$2.95**

MAD BLASTER

Produces LOUD ear shattering and attention getting siren like sound. Can supply up to 15 watts of obnoxious audio. Runs on 6-15 VDC.

MB-1 kit, **\$4.95**

FM WIRELESS MIKE

Transmits up to 300' to any FM broadcast radio. Uses any type of mike. Runs on 3 to 9V. Type FM-2 has added sensitive mike preamp stage.

FM-1 kit, **\$3.95**
FM-2 kit, **\$4.95**

40 WATT 2 mtr PWR AMP

Simple Class C power amp features 8 times power gain 1 W in for 80W, 2 W in for 15 out, 5 W in for 40 W out. Max output of 50 W, incredible value, complete with all parts, less case and T-R relay.

PA-1 40 W pwr amp kit **\$27.95**

TR-1 RF sensed T-R relay kit **6.95**

VOICE ACTIVATED SWITCH

Voice activated switch kit provides switched output with current capability up to 100 mA. Can drive relays, lights, LED or even a tape recorder motor. Runs on 9VDC.

VS-1 kit **\$6.95**

UNIVERSAL TIMER

Provides the basic parts and PCB board required to provide a source of precision timing and pulse generation. Uses 555 timer IC and provides a range of parts for most timing needs.

UT-5 kit, **\$5.95**

WHISPER LIGHT

An interesting kit, small mike picks up sounds and converts them to light. The louder the sound, the brighter the light. Includes: mike, controls up to 300 W, runs on 110 VAC.

WL-1 kit, **\$6.95**

SIREN

Produces upward and downward wail. 5 W peak audio output, runs on 3-15 volts, uses 3-45 ohm speaker.

Complete kit, SM-3 **\$2.95**

SUPER SLEUTH

A super sensitive amplifier which will pick up a pin drop at 50 feet! Great for monitoring baby's room or as general purpose amplifier. Full 2W rms output, runs on 6 to 15 volts, uses 8-45 ohm speaker.

BN-9 kit **\$5.95**

TELEPHONE TRANSMITTER

Low cost with professional performance. Features include: self phone line powered, tunable from 76 to 100 MHz, polarity antisensitive, compact size (1" x 1"), easily installs anywhere on the phone line or inside the instrument itself.

PB-1 kit **\$14.95**

FM RECEIVER

For built-in applications or hobby experimentation. Full fledged super-hetrodyne receiver, microvolt sensitivity 10 μ V MHz if; integrated circuit detector, 50 mw audio amplifier, 9V external power source, operation on standard FM broadcast band as well as large portions on each side, compact (6 square), for bug detection or reception.

FR-1 kit **\$14.95**

FM MINI MIKE

A super high performance FM wireless mike kit! Transmits a stable signal up to 300 yards with exceptional audio quality by means of its built-in electric mike. Kit includes case, mike, on-off switch, antenna, battery and super instructions. This is the finest unit available.

FM-3 kit **\$14.95**

MICROWAVE INTRUSION ALARM

A real microwave doppler sensor that will detect a human as far as 10 feet away. Operates on 1.3 GHz and is not affected by heat, light or vibrations. Drives up to 100 mA output, normally open or closed, runs on 12 VDC.

Complete kit, MD-3 **\$16.95**

SPEECH SCRAMBLER

Communicate in total privacy over your telephone or radio. This scrambler kit features full duplex operation using frequency inversion. Runs on a 9 volt battery. Both mike and line or speaker output/inputs. Easy to connect to any radio—telephone use requires no direct connection! Easy to build, uses IC DDM circuitry. Can also be used to descramble most com. scramblers.

Complete kit, SS-7 **\$29.95**
Case kit, CSS-7 **12.95**



TERMS: • satisfaction guaranteed • examine for 10 days; if not pleased, return in original form for refund • add 6% for shipping and insurance to a maximum of \$10.00 • foreign add 15% for surface mail • COD add \$2.50 (COD in USA only) • orders under \$15.00 add \$1.50 • NY residents add 7% sales tax • 90 day parts warranty on all kits • 1 year parts & labor warranty on all wired units.

PHONE ORDERS CALL 716-586-3950

RAMSEY ELECTRONICS, INC.
2575 Baird Rd.
Penfield, N.Y. 14256
TELEX 466735 RAMSEY CI
FAX 716-586-4754

VCO adjustment

I've had several problems with cold weather and PLL lockup. No specifications were given in the manual. Set the radio to 147 MHz (or the center of your desired operating range). Monitor the voltage between pin 1 of IC 2 and ground. Adjust L7 (inside the VCO can) for a voltage of 3.5 volts. This won't affect the frequency of operation if the radio has been adjusted according to the previous steps. Note that the radio's maximum operating bandwidth is approximately 2.5 MHz. Bear this in mind when choosing the center frequency.

PLL board jumpers

I traced a number of intermittent PLL lockup problems to the jumpers connecting the top and bottom of the PLL board. The original board didn't use plated-through holes, and these jumpers connected the top and bottom. Stainless steel wire was used originally; it doesn't solder well. Remove all these jumpers and replace them with tinned copper wiring. There are about 20 jumpers to replace.

PLL logic

The radio will work in simplex mode below 146 MHz if the VCO is adjusted as I explained above. However, the logic won't add the correct offset for the 600-kHz shift normally required if it's in the duplex mode. I added IC 11 (two gates) to correct this design problem. The gates can be installed by cutting traces, but I've had numerous problems with broken circuit traces on the PLL board. I removed all four existing ICs of the logic circuit (ICs 7, 8, 9, and 10) and built an entirely new logic board. I used wire-wrap techniques to construct the board and mounted it with L-brackets. The L-brackets attach to the sides of the chassis towards the rear, underneath the normal position of the speaker. Be sure to leave a 1-inch (2.5 cm) space between IC 7 and 8, and IC 9 and 10 for the speaker coil. I found that the wire-wrap pins were too long and interfered with the solder side of the main board when mounting this extra board. I cut off the excess pins so there was sufficient clearance for mounting.

Wire the extra board to the diode matrix board plug-in connection block on the PLL board. Resistors R36 and R37 are shown in fig. 2. These resistors are already installed in the radio. You don't have to add them if the input wiring to the logic board (D0-D7) is wired directly to the diode matrix board plug.

Wiring out of the logic board (D0-D2, P3-P7) connects to the input pins of the programmable divider (IC 1). These connections are shown on the original schematic. D0, D1, and D2 don't go through the logic board. They connect directly to pins 1, 2, and 3 of the programmable divider.

Common 4000 or 14000 series chips can be used as direct replacements for ICs 7, 8, 9, and 10 if removed or damaged. After installing this extra circuit board, I've had virtually no further intermittent problems with the PLL board.

Microphonics

One of the largest problems with frequency synthesizers is the mechanical vibration of the components in the synthesizer. This vibration can be heard as audio on an FM transmitter. It can also be heard in the speaker as an "echo" or hollow sound during receive. These vibrations are called "microphonics" and can result from speaker or microphone audio being coupled to the synthesizer. This means that everything inside the VCO must be "glued" together so it won't move mechanically.

There is a resin or hard material inside the VCO shielded box holding everything together so that it won't vibrate. If you remove it, you must replace it for the radio to operate without these microphonics. Beeswax is the easiest material to use. It's chemically inert and melts at

FIGURE 2

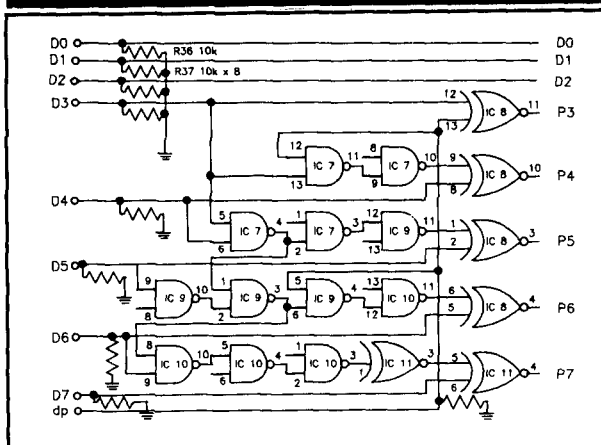

Schematic of the duplex offset logic board showing the addition of IC 11.

temperatures low enough that it will not damage components. You can find beeswax in sewing and fabric stores.

The beeswax can be melted in a small container, poured in, and allowed to set. Don't fill the VCO can completely — just enough to cover the components and keep them from vibrating. If it becomes necessary to remove the beeswax for further servicing, remove the VCO can and heat with a candle. The beeswax will melt and run out.

Component substitution

The original components can usually be replaced with substitutes from any cross-reference book. One com-

Make the most of your general coverage transceiver with *Monitoring Times!*

Every month *Monitoring Times* brings everything you need to make the most of your general coverage transceiver: the latest information on international broadcasting schedules, frequency listings, international DX reports, propagation charts, and tips on how to hear the rare stations. *Monitoring Times* also keeps you up to date on government, military, police and fire networks, as well as tips on monitoring everything from air-to-ground and ship-to-shore signals to radioteletype, facsimile and space communications.

ORDER YOUR SUBSCRIPTION TODAY before another issue goes by. In the U.S., 1 year, \$18; foreign and Canada, 1 year, \$26. For a sample issue, send \$2 (foreign, send 5 IRCs). For MC/VISA orders (\$15 minimum), call 1-704-837-9200.

MONITORING TIMES

*Your authoritative source,
every month.*

P.O. Box 98 A
Brasstown, N.C. 28902

✓ 167

W6SAI BOOKS

published by Bill Orr, W6SAI and Stu Cowan, W2LX

BEAM ANTENNA HANDBOOK

Completely revised and updated with the latest computer generated information on BEAM Antenna design. Covers HF and VHF Yagis and 10, 18 and 24 MHz WARC bands. Everything you need to know. 204 illustrations. 268 pages. ©1985. Revised 1st edition.

□RP-BA

Softbound \$11.95

SIMPLE LOW-COST WIRE ANTENNAS

Primer on how-to-build simple low cost wire antennas. Includes invisible designs for apartment dwellers. Full of diagrams and schematics. 192 pages. ©1972 2nd edition

□RP-WA

Softbound \$11.95

ALL ABOUT CUBICAL QUAD ANTENNAS

Simple to build, lightweight, and high performance make the Quad at DX'ers delight. Everything from the single element to a multi-element monster. A wealth of information on construction, feeding, tuning and installing the quad antenna. 112 pages. ©1982. 3rd edition.

□RP-CQ

Softbound \$9.95

THE RADIO AMATEUR ANTENNA HANDBOOK

A wealth of projects that covers verticals, long wires, beams as well as plenty of other interesting designs. It includes an honest judgement of gain figures, how to site your antenna for the best performance, a look at the Yagi-Quad controversy, baluns, slopers, and delta loops. Practical antenna projects that work! 190 pages. ©1978. 1st edition.

□RP-AH

Softbound \$11.95

Please enclose \$3.50 for shipping and handling.



**HAM
RADIO**

GREENVILLE, NH 03048

BOOKSTORE

(603) 878-1441

ponent I found particularly difficult to replace was the varactor diode in the PLL circuit. Cross-referencing the original part was next to impossible. By trial and error and some calculations, I determined that the diode I needed was a 1N5441A, MV 2101, or ECG610 varactor diode.

Circuit board cleaning

It appeared that the flux from component soldering was never removed when the board was manufactured. Flux is quite corrosive and will eventually eat its way through a circuit board. Remove as much of it as you can with flux remover, available at most electronics stores.

Nine-volt supplies

There are three 9-volt regulated power supplies in the radio: one common, one for transmit, and one for receive. Each 9-volt regulator transistor has a 15-ohm resistor in series with the collector. This resistor was originally installed with a power rating of 1/4 watt. I recommended that you change R141, R144, and R149 to a 1-watt rating, as the original components run too hot.

Transmitter tuning

Six trimmer capacitors are involved in aligning the transmitter. Set the radio to a frequency below the midpoint of the desired operating range — for example, 146.5 MHz if the center of the operating range is 147 MHz. Adjust C97, C100, C92, C91, C85, and C81 in that order for maximum power output into a matched load. Repeat these adjustments at least once.

Other adjustments

Here are some other common adjustments inside the radio:

- Deviation — R112 — located near the front center of the main board
- Low Power — R149 — located to the right of R112
- Mic Gain — R132 — located near the front of the main board near the right side
- Power Meter — R73 — located near the back of the radio in the shielded can
- S-meter — R23 — located near the front center of the main board

Conclusion

I've gained a lot of experience over the years from servicing a number of these radios. A service manual is unavailable, and the owner's manual contains little information pertaining to serviceability. These changes and notes should help you fix some of the minor problems which can occur in an older radio.

*Icom USA verifies that no service manuals were printed for the IC22S. Schematics can be provided by Icom upon request. Ed.

Article K

HAM RADIO

Uncle Bill's Commodore C-64 Computer Software

by Bill Clarke WA4BLC

CODE COURSE

This computer program is broken into three user friendly parts. Part one introduces to the beginner the different morse characters. The student simply presses a key and the character is sent and displayed on the screen. Part two generates the morse character and the student is required to press the correct key on the computer. If the student answers incorrectly, the character is automatically resent. Part three sends morse characters in random groups of five. The student can tailor what is sent to their particular needs; numbers only, letters only or a combination of both. Speeds are from 5 to 20 groups per minute. The computer can also be configured to send the Farnsworth method (high speed/low spacing code.) V 2.2

UB-CC (For C-64) \$9.95

KODE MASTER (for Novice, General or Extra Class students)

Prepare for your next code exam using computer generated QSOs. Each QSO contains call signs, names, QTH's equipment info plus many of the other exchanges commonly found in Ham QSO's. QSO's can be displayed on the screen by one character at a time, by each sentence or after the completion of the QSO for checking. With a printer you can print out a hard copy. Available in 5 wpm for Novices, 13 wpm for Generals and 20 wpm for Extra class students.

UB-KN Novice Class (for C-64) \$14.95
UB-KG (for C-64) \$14.95
UB-KE Extra Class (for C-64) \$14.95

ANTENNA SYSTEM

This nifty antenna modeling and development program will help you get the most from your antenna projects while eliminating much of the drudgery of antenna calculations. Part one covers standard design antennas—dipoles, verticals and Yagi designs. Part two designs shortened dipole antennas for space limited hams. Great for shortened 160/80 meter antennas. All dimensions are listed. At this price it's not an engineering program but a neat program to have around.

UB-AS (for C-64) \$9.95

RADIO AMATEUR CALLBOOK SUPPLEMENT

(both NA and International calls)

Invaluable operating aid to all classes of Radio Amateur. Includes all calls issued since publication of the 1988 edition of the North American and International editions. The ONLY way to be fully up-to-date is to have the Callbook supplement in your shack. 296 pages © 1988

CB-SUP 88 Softbound \$9.95

Please enclose \$3.50 shipping & handling

**HAM RADIO'S
BOOKSTORE**
Greenville, NH
03048

603-878-1441

WE SHIP WORLDWIDE Barry Electronics Corp. WORLD WIDE AMATEUR RADIO SINCE 1950 Your one source for all Radio Equipment!

For the best buys in town call:
212-925-7000
Los Precios Mas Bajos en
Nueva York...

KITTY SAYS: WE ARE NOW OPEN 7 DAYS A WEEK.
Saturday & Sunday 10 to 5 P.M.
Monday-Friday 9 to 6:30 PM Thurs. to 8 PM
Come to Barry's for the best buys in town.



May We Help You With the Best in Commercial and Amateur Radios? Lew W2BIE, Toni, Kitty WA2BAP, and Jan KB2RV.

KENWOOD



TS-440S1AT R-5000 R-2000 TS-840 S1AT
TM-221A/421A TM-2970A/SB0A/30A TR-751A
Kenwood Service Repair TM-721A TS-711B11A
TM-900A TH08GAT TH015A TM-621A TM-321A
TS-1400 TS6900

Budwig ANT. Products
NE-TECH Dlx-88 Digital Voice Key
FLUKE 77 Multimeter
Morse Monitor
Amateur Radio Course \$99.95

VoCom/Mirage/Alinco
Tokyo Hy-Power/TE SYSTEMS
Amplifiers &
5/8" HT Gain
Antennas IN STOCK



Soldering Station,
48 Watts, \$68
MICROLOG-ART 1, Air Disk,
SWL Morse Coach

KANTRONICS
UTU, KAM, UTU-XT,
KPC 2400, KPC IV

EIMAC
3-500Z
572B, 6JS6C
12B7A &
6146B

BIRD
Wattmeters &
Elements
In Stock

AEA 144 MHz
AEA 220 MHz
AEA 440 MHz
ANTENNAS



FT-76GX, FT-757GXII, FT-311 RM,
FRG-8800, FT-736, FRG-9600, FT-
711RH, FT-2700RH, FT 212/712RH.

YAESU
FT-23/73/727R
FT 211/709RH
FT-1900/1123
FT-2005/7005

ICOM
IC2AT/12AT
IC20AT/32AT
IC20GAT
IC-A2U16

Landmobile HTs
ICOM UT6, HT6, V100, U400
YAESU FT-2005/507
UNIDEN, REGENCY, KING, TAD
MARINE ICOM: MS, M55, M700
AVIATION ICOM: A20/H

AMERITRON AMPLIFIER AUTHORIZED DEALER



ALINCO ALD 24T
DJ-100T
YAESU FTR-2410, Wilson
ICOM IC-RP 3010 (440 MHz)
ICOM IC-RP 1210 (1.2 GHz)
ICOM IC-RP 2210 (220 MHz)

Complete Butternut Antenna
Inventory In Stock!

DIGITAL FREQUENCY COUNTERS
Optoelectronics model 1300H, 0-1300MHz
Trionyx, Model TR-1000, 0-600 MHz

METRON MA-1000 B STOCKED
Long-range Wireless
Telephone for export in stock

BENCHER PADDLES,
BALUNS, LOW PASS FILTERS
IN STOCK

MIRAGE AMPLIFIERS
ASTRON POWER SUPPLIES
Saxton Wire & Cable, Int'l Wire



IC-R71A, 751A, 781, 28AH, 38A, 48A, Micro24,
R-7000, IC-761, IC-375A, 275AH, 3210A, 475A/
H, 735, IC-900, IC-228H



SMART PATCH
CES Simplex Autopatch 510 5A With Patch FM
Transceiver To Your Telephone Great For
Telephone Calls From Mobile To Base. Simple
To Use. 510SA/510SAII



PRIVATE PATCH IV, Duplex 8000



NYE MBV-A 3 Kilowatt Tuner



MFJ-989B



Ten-Tec
Tuner 229B



HEIL EQUIPMENT
IN STOCK



SANGAN Portable Shortwave Radios

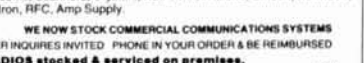

Hy-Gain Towers
& Antennas, and
Motors will be
shipped direct to you FREE of
shipping cost

MAIL ALL ORDERS TO: BARRY ELECTRONICS CORP., 512 BROADWAY, NEW YORK CITY, NY 10012 (FOUR BLOCKS NORTH OF CANAL ST.)

New York City's LARGEST STOCKING HAM DEALER COMPLETE REPAIR LAB ON PREMISES

"Aqui Se Habla Espanol"
BARRY INTERNATIONAL TELEX 12-7670
MERCHANDISE TAKEN ON CONSIGNMENT
FOR TOP PRICES
Monday-Friday 9 A.M. to 6:30 P.M. Thursday to 8 P.M.
Saturday & Sunday 10 A.M. to 5 P.M. (Free Parking)
AUTHORIZED DIST. MCKAY DYMEK FOR
SHORTWAVE ANTENNAS & RECEIVERS
"IRITEX" "Spring St. Station"
Subways: BMT "Prince St. Station"
IND "F" Train Bwy. Station"
Bus: Broadway #6 to Spring St.
Path—9th St. 4th Ave. Station.

We Stock: AEA, APRIL, Alpha, Ameco, Antenna Specialists, Astatic, Astron, B & K, B & W, Bencher, Bird, Butternut, CDE, CES, Communications Spec, Connectors, Cushcraft, Daiwa, Digimax, Drake, Eimac, Hell Sound, Henry, Hustler (Newtronics), Hy-Gain, Icom, KLM, Kantronics, Larsen, MJF, J.W. Miller, Mirage, Newtronics, Nye Viking, Palomar, RF Products, Radio Amateur Callbook, Saxton, Shure, Telex, Tempo, Ten-Tec, Tokyo Hi Power, Trionyx TUBES, W2AU, Waber, Wilson, Yaesu Ham and Commercial Radios, Vocom, Vibroplex, Curtis, Tri-Ex, Wacom Duplexers, Repeaters, Phelps Dodge, Fanon Intercoms, FSCanners, Crystals, Radio Publications, Uniden, Kenwood, Maxon, Metron, RFA, Amp Supply.

WE NOW STOCK COMMERCIAL COMMUNICATIONS SYSTEMS
HAM DEALER INQUIRES INVITED PHONE IN YOUR ORDER & BE REIMBURSED
COMMERCIAL RADIOS stocked & serviced on premises. ALL SALES FINAL
Amateur Radio Courses Given On Our Premises, Call
Export Orders Shipped Immediately. TELEX 12-7670

Sparky J Antennas

• Install Fast • Extend Range • Improve Reception •
The Sparky J-Antenna is a flexible half wave radiator fed by two wavelengths of low loss coax through an efficient linear matching transformer. Sparky J's beat duckies, 1/4 & 5/8 wave antennas, need no ground plane. Low flat SWR curve gives edge to edge band coverage. Great portable—rolls up to fit in pocket. Completely assembled with BNC connector.
• Easily hidden • Effective indoors or out. • Money-back guarantee •
Available for every band from 28 to 440 MHz
\$29.95 each Two for \$55.00 Add \$5 P & H
Instock \$1 by 1st class mail
Antennas West
Box 50062-H, Provo, UT 84605 (801) 373-8425

1988 CALL DIRECTORY

(on microfiche)
Call Directory \$8
Name Index \$8
Geographic Index \$8
All three — \$20 Shipping per order \$3
BUCKMASTER PUBLISHING
Mineral, Virginia 23117
703-894-5777
800-282-5626



DX FORECASTER

Garth Stonehocker, KØRYW

High sunspot propagation problems: part 2

Events that originate with solar flares cause propagation problems for Dxers and ragchewers alike. A sequence of events happens after a flare. Some (like sudden ionospheric disturbance, SID) occur shortly after the flare, some (like polar cap absorption, PCA) appear several hours later, and the final event (fade out) occurs from 1 to 3 days following the flare. The first two situations and remedies for them were discussed last month. These events will occur more frequently with the increased probability of large flares as the 11-year solar cycle reaches higher sunspot numbers and solar flux; be prepared with a remedy.

Fade out

Fade out is the most complicated and encompassing of all the ionospheric disturbances. It can affect propagation paths during the day or night, but the effect is worse at night. It lasts at least a day or two and is generally worldwide in extent, although the effects and severity differ with latitude and longitude. Fade out

is initially caused by the electrons that were ejected outward by the sun's flaring. These electrons are usually lower in energy than protons so they don't have the proton's speed, but they are more numerous. Being charged particles, the electrons are constrained to follow the solar magnetic field as they leave the sun. They travel with the solar wind, increasing its number density greatly and its speed a little. Those coming close enough to the earth's magnetic field veer into the polar regions along those magnetic field lines. Most of the electrons are high and weak enough to be fed into the geomagnetic field tail, captured, and then released at lower latitude into the ionospheric F region at night. It takes electrons some 1 to 3 days after the flare to affect the ionosphere due to their lower energy, the long solar path, and the delay caused by the earth's capturing some to release at night.

The latitude ion density distribution in the F region is normally at its highest in the equatorial latitudes from 30 degrees south to 30 degrees north. This is because the lower regions (D and E) are where the largest production of latitude ions from sunlight exists. When these ions drift to the F region up the field lines, the maximum density changes from its position along the geographic equator to one along the geomagnetic equator. The other ionospheric production region comes from the polar particles. Moving slightly toward the equator from the auroral zone (an area of no production) you'll find the F region trough, particularly on winter nights. However, when the electrons start coming

"hard" into the E region or "soft" from the tail into the F region, the trough widens and moves down even more toward the equator. How does this affect propagation and DX? The propagation paths at midlatitudes in east-west directions, like the United States to Europe or the Orient, go across higher latitudes. When the particles arrive, the auroral oval and trough come down right across your path, and the fade out has hit. Two things happen: the increase in the number of particles weakens the signal trying to get through, and the trough's lower density causes a decrease in maximum usable frequency (MUF). These decreases are not smooth, but variable (in seconds/minutes), and fluctuate over the 2 or 3 day period. The one difference between SID and fade out is that SID has a smoother decrease. The K figure broadcast at 18 minutes after the hour over radio station WWV is a measure of the geomagnetic-field ionosphere variations compared to the normal 3 hours of the day. It can be used to calibrate a path during non-disturbed periods which is used, in turn, to forecast how bad the propagation is when a fade out occurs. Fade outs from flares are more intense but of shorter duration than those from thin coronal solar wind increases.

The weak, variable signal strength and decreased MUF are hard to remedy. Ordinarily, the weak signal remedy for absorption is to increase the operating frequency as you would in the SID's remedy. But here MUF is decreasing on the propagation path, which calls for decreased operating

GMRT	0000	0100	0200	0300	0400	0500	0600	0700	0800	0900	1000	1100	1200	1300	1400	1500	1600	1700	1800	1900	2000	2100	2200	2300
------	------	------	------	------	------	------	------	------	------	------	------	------	------	------	------	------	------	------	------	------	------	------	------	------

OCTOBER

Region	WESTERN USA																							
	N	NE	E	SE	S	SW	W	NW	PDT	5:00	6:00	7:00	8:00	9:00	10:00	11:00	12:00	1:00	2:00	3:00	4:00	5:00		
ASIA FAR EAST	20	30	20	10	12*	12	10	15	20	20	30	40	40	30	40	40	30	30	40	40	30	40	40	20
EUROPE	30	40	20	15	15	12	15	20	30	30	40	40	30	40	40	30	30	40	40	30	40	40	30	40
S. AFRICA	20	40	20	15	15	12	15	20	30	30	40	40	30	40	40	30	30	40	40	30	40	40	30	40
S. AMERICA	20	40	20	15	15	12	15	20	30	30	40	40	30	40	40	30	30	40	40	30	40	40	30	40
ANTARCTICA	20	40	20	15	15	12	15	20	30	30	40	40	30	40	40	30	30	40	40	30	40	40	30	40
NEW ZEALAND	20	40	20	15	15	12	15	20	30	30	40	40	30	40	40	30	30	40	40	30	40	40	30	40
OCEANIA AUSTRALIA	20	40	20	15	15	12	15	20	30	30	40	40	30	40	40	30	30	40	40	30	40	40	30	40
JAPAN	20	40	20	15	15	12	15	20	30	30	40	40	30	40	40	30	30	40	40	30	40	40	30	40

Region	MID USA																							
	N	NE	E	SE	S	SW	W	NW	MIDT	6:00	7:00	8:00	9:00	10:00	11:00	12:00	1:00	2:00	3:00	4:00	5:00	6:00	7:00	
ASIA FAR EAST	20	30	20	12	12	10	10	20	30	30	40	40	30	40	40	30	30	40	40	30	40	40	30	40
EUROPE	30	40	20	15	15	12	15	20	30	30	40	40	30	40	40	30	30	40	40	30	40	40	30	40
S. AFRICA	20	40	20	15	15	12	15	20	30	30	40	40	30	40	40	30	30	40	40	30	40	40	30	40
S. AMERICA	20	40	20	15	15	12	15	20	30	30	40	40	30	40	40	30	30	40	40	30	40	40	30	40
ANTARCTICA	20	40	20	15	15	12	15	20	30	30	40	40	30	40	40	30	30	40	40	30	40	40	30	40
NEW ZEALAND	20	40	20	15	15	12	15	20	30	30	40	40	30	40	40	30	30	40	40	30	40	40	30	40
OCEANIA AUSTRALIA	20	40	20	15	15	12	15	20	30	30	40	40	30	40	40	30	30	40	40	30	40	40	30	40
JAPAN	20	40	20	15	15	12	15	20	30	30	40	40	30	40	40	30	30	40	40	30	40	40	30	40

Region	EASTERN USA																							
	N	NE	E	SE	S	SW	W	NW	EDT	8:00	9:00	10:00	11:00	12:00	1:00	2:00	3:00	4:00	5:00	6:00	7:00	8:00	9:00	
ASIA FAR EAST	30	40	20	12	12	12	12	20	30	30	40	40	30	40	40	30	30	40	40	30	40	40	30	40
EUROPE	30	40	20	15	15	15	15	20	30	30	40	40	30	40	40	30	30	40	40	30	40	40	30	40
S. AFRICA	20	40	20	15	15	12	15	20	30	30	40	40	30	40	40	30	30	40	40	30	40	40	30	40
CARIBBEAN S. AMERICA	20	40	20	15	15	12	15	20	30	30	40	40	30	40	40	30	30	40	40	30	40	40	30	40
ANTARCTICA	20	40	20	15	15	12	15	20	30	30	40	40	30	40	40	30	30	40	40	30	40	40	30	40
NEW ZEALAND	20	40	20	15	15	12	15	20	30	30	40	40	30	40	40	30	30	40	40	30	40	40	30	40
OCEANIA AUSTRALIA	20	40	20	15	15	12	15	20	30	30	40	40	30	40	40	30	30	40	40	30	40	40	30	40
JAPAN	20	40	20	15	15	12	15	20	30	30	40	40	30	40	40	30	30	40	40	30	40	40	30	40

The italicized numbers signify the bands to try during the transition and early morning hours, while the standard type provides MUF during "normal" hours.
 *Look at next higher band for possible openings.

2x4Z BASE REPEATER ANTENNA

THE HIGHEST GAIN
DUAL BAND
BASE/REPEATER ANTENNA

HIGH POWER 200 WATTS

CENTER FREQUENCY

146.500 MHz

446.500 MHz

GAIN:

VHF - 8.2dB

UHF - 11.5dB

VSWR - 1.-1.2 or less

CONNECTOR:

N TYPE FEMALE

LIGHTNING PROTECTION

GROUNDING DIRECT

LENGTH: 16 FT.

WEIGHT: 5 LBS. 3 OZ.

WIND LOAD: 90 MPH

MOUNTING: UP TO 2 IN.

MAST

CAN SIMULCAST ON

BOTH BANDS

WATERPROOF

CONNECTING

JOINTS

UPS SHIPPABLE

✓ 170

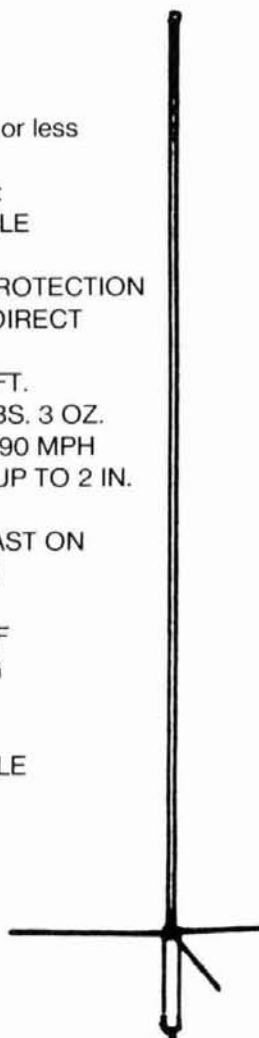

AMATEUR SPECIAL



1275 NORTH GROVE ST.
ANAHEIM, CALIF. 92806
(714) 630-4541

CABLE: NATCOLGLZ
FAX (714) 630-7024

NEW OSCAR

BRIDGES HAMISPHERE

- Coming soon to a shack near you.
- Signals from space.
- Catch some free.
- We know how.
- You can too!
- Join AMSAT
- Free brochure for SASE

AMSAT
PO BOX 27
WASHINGTON, DC 20044

✓ 171

IT'S BIGGER !! IT'S BETTER !!
AFTER 35 YEARS, NOW IT'S TWO DAYS, AND INDOORS!!

THE GEORGIALINA HAMFEST THE "OKTOBERFEST" OF HAM RADIO

THE GEORGIA NATIONAL GUARD ARMORY
AUGUSTA, GEORGIA

SATURDAY, OCTOBER 22 AND SUNDAY OCTOBER 23, 1988
9 AM 'TIL 5 PM 9 AM 'TIL 3 PM

FORUMS: Operation Skywarn by the National Weather Service.
Repeater Forum by the Georgia Repeater Coordinator.
DX forum. Plus More!



XYL EVENTS: Free Craft classes



VOLUNTEER EXAMS: Saturday, code at 9 AM; written at 10 AM
at hamfest site. Contact NA4I for info.

DELICIOUS HOMECOOKED BARBEQUE DINNERS ON PREMISES
Barbeque, Potato salad, Coleslaw, Roll, Tea

For more information contact Jim Abercrombie, P.O. Box 5943, Augusta, GA 30906
Phone 404-790-7802

frequency. You can try a combination of the two to determine which part of the problem is worse and go from there, or try VHF frequencies that may be getting through on auroral scatter. An alternate route south of the usual beam bearing (called side scatter at hf) may work, or long-path propagation may exist.

Last-minute forecast

The lower bands, 30 to 160 meters, are expected to be best the first and third weeks of October due to a dip in solar flux. Lower thunderstorm noise and summer absorption in the Northern Hemisphere will make a noticeable improvement in these bands. Expect some fade out to affect propagation during this equinox season around the 6th, 16th, 22nd, and 28th. The higher DX bands should improve the second week and be best the third week, as the result of a solar flux increase. Watch out for flare effects, SID, and PCAs during this activity. The Orionids meteor shower will be visible from the 15th to 24th of October, with a maximum rate of between 10 to 20 per hour on the 20th to 21st of the month. The moon is full on the 25th and perigee occurs on the 23rd.

Band-by-band summary

Ten, 12, 15, and 20 meters will provide many openings during the day. As you go up in frequency the openings will be shorter, centered around noon, and mainly towards the south. Twenty meters, the mainstay daytime band for northerly directions, will be useful towards the south in the evenings. Transequatorial openings might occur in the evening hours to southern locations if antenna radiation angles are down to 10 degrees.

Thirty, 40, 80, and 160 meters are all good for nighttime DX. Thirty and 40 meters are the night frequencies for the east, west, and northerly directions, and for distances of 1600 miles. Try 80 and 160 if disturbed conditions exist. These bands should be getting quiet, if fall weather frontal thunderstorms are absent.

Article L

HAM RADIO

DOWN EAST MICROWAVE

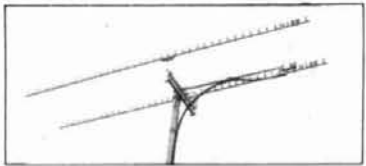

MICROWAVE ANTENNAS AND EQUIPMENT

- Loop Yagis • Power Dividers • Linear Amplifiers • Complete Arrays • Microwave Transverters • GaAs FET Preamps
- TROPO • EME • Weak Signal • OSCAR • 902 • 1269 • 1296 • 2304 • 2400 • 3456 MHz

2345 LY	45el	loop Yagi	1296 MHz	20dBi	\$97
1345 LY	45el	loop Yagi	2304 MHz	20dBi	\$84
3333 LY	33el	loop Yagi	902 MHz	18.5dBi	\$97

Above antennas assembled and tested. Kits available.
Add \$8 UPS S/H, \$11 West of the Mississippi

MICROWAVE LINEAR AMPLIFIERS SSB, ATV, REPEATER, OSCAR

2316 PA	1w in 18w out	1240-1300 MHz	13.8V	\$255
2335 PA	10w in 35w out	1240-1300 MHz	13.8V	\$305
3318 PA	1w in 20w out	900-930 MHz	13.8V	\$255
3335 PA	10w in 40w out	900-930 MHz	13.8V	\$305
23LNA	preamp 0.7dB N.F.	1296 MHz		\$ 80
33LNA	preamp 0.9dB N.F.	902 MHz		\$ 80

Add \$5 shipping UPS/48
LMW 1296 & 2304 MHz transverter kits in stock

Write for free catalog

DOWN EAST MICROWAVE
Bill Olson, W3HQT
Box 2310, RR 1, Troy, ME 04987
(207) 948-3741

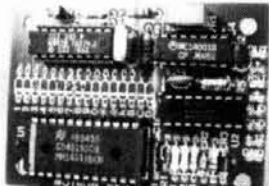

✓ 172

NET-KALL NK-1
DTMF ALERT DECODER



From
Only
\$34.95!

- Momentary or latched output
- Multiple Group-Call response
- High stability xtal controlled SSI-202
- Ideal for an economical alert system

	NK-1K (kit)	\$34.95
	NK-1W (Wired/Tested)	\$44.95

(Add \$2.00 Shipping/Handling in U.S.A.)

MoTron Electronics Call Toll-Free
695 W. 21st Ave. **1-800-338-9058**
Eugene, OR 97405 or (503) 687-2118

✓ 173

HI-PERFORMANCE DIPOLES



Antennas that work! Custom assembled to your center freq. ea. band - advise ht. of center and each end - hang as inverted "V" - horizontal, vert. dipole, sloping dipole - commercial quality - stainless hardware - legal power - no-trap, high-efficiency design. Personal check, MO or C.O.D. (B3)

MFD-5*	80-40-20-15-10M max-performance dipole 87' long	\$105ppd
MFD-2	80-40M max-performance dipole, 85' long 82'	95' 346 ppd
MPD-1*	160-80-40M hi-performance dipole 113' long	\$79 ppd
SSD-6*	160-80-40-20-15-10M space-saver dipole 71' long	\$125 ppd
SSD-5*	80-40-20-15-10M space-saver dipole-specify L, 42' \$105 52' \$108 ppd	
SSD-4*	80-40-20-15M space-saver dipole-specify L, 46'-593' 60'-5' 96 ppd	

*9-bands with wide-matching range tuner.

SASE for catalogue of 30 dipoles, slopers, and space-saving, unique antennas

WINN ANTENNAS
312-394-3414 BOX 393 MT. PROSPECT, IL 60056

✓ 174

800-882-1343





HF Equipment	IC-735	List	JUN's
ICOM			
IC-781	New Deluxe HF Rig	\$5995	Call \$
IC-761	Loaded with Extras	2699	Call \$
IC-735	Gen. Cvg Xcvr	1099	Call \$
IC-751A	Gen. Cvg Xcvr	1699	Call \$
Receivers			
IC-R7000	25-1300 ⁺ MHz Rcvr	1199	Call \$
IC-R71A	100 kHz-30 MHz Rcvr	999	Call \$
VHF			
IC-228A/H		509/539	Call \$
IC-28A/H	FM Mobile 25w/45w	469/499	Call \$
IC-02AT	FM HT	409.95	Call \$
IC-2GAT	2m 7w HT	429.95	Call \$
IC-900	Six Band Mobile	639	Call \$
UHF			
IC-48A	FM Mobile 25w	509	Call \$
IC-04AT	FM HT	449	Call \$
IC-4GAT	440MHz HT	429.95	Call \$
220 MHz			
IC-38A	25w FM Xcvr	489	Call \$
IC-32AT	2m/70cm HT	629.95	Call \$

KENWOOD

HF Equipment			
TS-940S/AT	Gen. Cvg Xcvr	2449.95	Call \$
TS-440S/AT	Gen. Cvg Xcvr	1379.95	Call \$
TS-140S	Compact Gen. Cvg Xcvr	929.95	Call \$
VHF			
TS-711A	All Mode Base 25w	1029.95	Call \$
TR-751A	All Mode Mobile 25w	649.95	Call \$
TM-221A	2m 45w	439.95	Call \$
TM-2550A	FM Mobile 45w	499.95	Call \$
TM-2570A	FM Mobile 70w	599.95	Call \$
TH-215A	2m HT Has It All	379.95	Call \$
TH-25AT	5w Pocket HT NEW	349.95	Call \$
TM-721A	2m/70cm FM Mobile	649.95	Call \$
UHF			
TM-421A	Compact FM 35w	449.95	Call \$
TH-45AT	5w Pocket HT NEW	369.95	Call \$
220 MHz			
TM-3530A	FM 220 MHz 25w	499.95	Call \$
TM-321A	Compact 25w Mobile	449.95	Call \$
TH-315A	Full Featured 2.5w HT	399.95	Call \$

YAESU

HF Equipment			
FT-767	GX Gen. Cvg Xcvr	1929.95	Call \$
FT-757	GX II Gen. Cvg Xcvr	1129.95	Call \$
FT-747	GX New Economical Performer	889.95	Call \$
FL-7000	15m-160m AMP	1995.00	Call \$
VHF			
FT-212RH	NEW 2m 45w	459.95	Call \$
FT-712RH	70cm 35W	499.95	Call \$
FT-290R	All Mode Portable	599.95	Call \$
FT-23	R/TT Mini HT	344.95	Call \$
FT-209RH	FM Handheld 5w	389.95	Call \$
VHF/UHF Full Duplex			
FT-736R	New All Mode 2m/70cm	1749.95	Call \$
Dual Bander			
FT-727R	2m/70cm HT	439.95	Call \$
FT-109RH	New HT	399.95	Call \$



**3919 Sepulveda Blvd.
Culver City, CA 90230
213-390-8003**

✓ 175



Ham Radio's guide to help you find your local

California

A-TECH ELECTRONICS

1033 HOLLYWOOD WAY
BURBANK, CA 91505
(818) 845-9203

New Ham Store and Ready to Make a Deal!

JUN'S ELECTRONICS

3919 SEPULVEDA BLVD.
CULVER CITY, CA 90230
213-390-8003
800-882-1343 Trades
Habla Espanol

Colorado

COLORADO COMM CENTER

525 EAST 70th AVE.
SUITE ONE WEST
DENVER, CO 80229
(303) 288-7373
(800) 227-7373
Stocking all major lines
Kenwood Yaesu, Encomm, ICOM

Connecticut

HATRY ELECTRONICS

500 LEDYARD ST. (SOUTH)
HARTFORD, CT 06114
203-527-1881

Call today. Friendly one-stop shopping at prices you can afford.

Delaware

AMATEUR & ADVANCED COMMUNICATIONS

3208 CONCORD PIKE
WILMINGTON, DE 19803
(302) 478-2757

Delaware's Friendliest Ham Store.

DELAWARE AMATEUR SUPPLY

71 MEADOW ROAD
NEW CASTLE, DE 19720
302-328-7728
800-441-7008

Icom, Ten-Tec, Microlog, Yaesu, Kenwood, Santec, KDK, and more. One mile off I-95, no sales tax.

Florida

AMATEUR ELECTRONIC SUPPLY

1898 DREW STREET
CLEARWATER, FL 33575
813-461-4267

Clearwater Branch

West Coast's only full service Amateur Radio Store.

Hours M-F 9-5:30, Sat. 9-3

AMATEUR ELECTRONIC SUPPLY

621 COMMONWEALTH AVE.
ORLANDO, FL 32803
305-894-3238
Fla. Wats: 1 (800) 432-9424
Outside Fla: 1 (800) 327-1917
Hours M-F 9-5:30, Sat. 9-3

Georgia

DOC'S COMMUNICATIONS

702 CHICKAMAUGA AVENUE
ROSSVILLE, GA 30741
(404) 866-2302 / 861-5610
ICOM, Yaesu, Kenwood, Bird...
9AM-5:30PM

We service what we sell.

Hawaii

HONOLULU ELECTRONICS

819 KEEAUMOKU STREET
HONOLULU, HI 96814
(808) 949-5564
Kenwood, ICOM, Yaesu, Hy-Gain, Cushcraft, AEA, KLM, Tri-Ex Towers, Fluke, Belden, Astron, etc.

Idaho

ROSS DISTRIBUTING COMPANY

78 SOUTH STATE STREET
P.O. BOX 234
PRESTON, ID 83263
(208) 852-0830
M 9-2; T-F 9-6; S 9-2
Stock All Major Brands
Over 7000 Ham Related Items on Hand

Illinois

ERICKSON COMMUNICATIONS, INC.

5456 N. MILWAUKEE AVE.
CHICAGO, IL 60630
312-631-5181
Hours: 9:30-5:30 Mon, Tu, Wed & Fri;
9:30-8:00 Thurs; 9:00-3:00 Sat.

Indiana

THE HAM STATION

220 N. FULTON AVE.
EVANSVILLE, IN 47710
(800) 523-7731
(812) 422-0231
ICOM, Yaesu, Ten-Tec, Cushcraft, Hy-Gain, AEA & others.

Maryland

MARYLAND RADIO CENTER

8576 LAURELDALE DRIVE
LAUREL, MD 20707
301-725-1212
Kenwood, Ten-Tec, Kantronics. Full service dealer.
M-F 10-7 SAT 9-5

Massachusetts

TEL-COM, INC.

675 GREAT ROAD, RTE. 119
LITTLETON, MA 01460
617-486-3400
617-486-3040
The Ham Store of New England
You Can Rely On.

Missouri

MISSOURI RADIO CENTER

102 NW BUSINESS PARK LANE
KANSAS CITY, MO 64150
(800) 821-7323
Missouri: (816) 741-8118
ICOM, Kenwood, Yaesu
Same day service, low prices.

Nevada

AMATEUR ELECTRONIC SUPPLY

1072 N. RANCHO DRIVE
LAS VEGAS, NV 89106
702-647-3114
Dale Porray "Squeak," AD7K
Outside Nev: 1 (800) 634-6227
Hours M-F 9-5:30, Sat. 9-3

New Hampshire

RIVENDALL ELECTRONICS

8 LONDONDERRY ROAD
DERRY, N. H. 03038
603-434-5371
Hours M-S 10-5; THURS 10-7
Closed Sun/Holidays

Dealers: *YOU SHOULD BE HERE TOO!*
Contact Ham Radio now for complete details.

New Jersey

ABARIS SYSTEMS

276 ORIENTAL PLACE
LYNDHURST, NJ 07071
201-939-0015
Don WB2GPU
ARRL, Astatic, Astron, B&W, Belden,
Bencher, Hustler, Kenwood, Larsen, RF
Concepts, Tonna and much, much more!
Tues-Fri 10 am-7:30 pm
Thurs 10 am-9:00 pm
Sat 10 am-4:00 pm
VISA/MC

KJI ELECTRONICS

66 SKYTOP ROAD
CEDAR GROVE, NJ 07009
(201) 239-4389
Gene K2KJI
Maryann K2RVH
Distributor of: KLM, Mirage, ICOM, Lar-
sen, Lunar, Astron. Wholesale - retail.

New York

BARRY ELECTRONICS

512 BROADWAY
NEW YORK, NY 10012
212-925-7000
New York City's Largest Full Service
Ham and Commercial Radio Store.

VHF COMMUNICATIONS

915 NORTH MAIN STREET
JAMESTOWN, NY 14701
716-664-6345
Call after 7 PM and save! Supplying all
of your Amateur needs. Featuring ICOM
"The World System." Western New
York's finest Amateur dealer.

Ohio

AMATEUR ELECTRONIC SUPPLY

28940 EUCLID AVE.
WICKLIFFE, OH 44092 (Cleveland Area)
216-585-7388
Ohio Wats: 1 (800) 362-0290
Outside Ohio: 1 (800) 321-3594
Hours M-F 9-5:30, Sat. 9-3

DEBCO ELECTRONICS, INC.

3931 EDWARDS RD.
CINCINNATI, OHIO 45209
(513) 531-4499
Mon-Sat 10AM-9PM
Sun 12-6PM
We buy and sell all types of electronic
parts.

UNIVERSAL AMATEUR RADIO, INC.
1280 AIDA DRIVE
REYNOLDSBURG (COLUMBUS), OH
43068

614-866-4267
Featuring Kenwood, Yaesu, Icom,
and other fine gear. Factory author-
ized sales and service. Shortwave
specialists. Near I-270 and airport.

Pennsylvania

HAMTRONICS,
DIV. OF TREVOSE ELECTRONICS
4033 BROWNSVILLE ROAD
TREVOSE, PA 19047
215-357-1400
Same Location for over 30 Years

Texas

MADISON ELECTRONICS SUPPLY
3621 FANNIN
HOUSTON, TX 77004
713-520-7300
Christmas?? Now??

K COMM dba THE HAM STORE

5707A MOBUD
SAN ANTONIO, TX 78238
512-680-6110
800-344-3144
Stocking all major lines. San Antonio's
Ham Store. Great Prices — Great
Service. Factory authorized sales and
service.
Hours: M-F 10-6; SAT 9-3

MISSION COMMUNICATIONS

11903 ALEIF CLODINE
SUITE 500 (CORNER HARWIN &
KIRKWOOD)
HOUSTON, TEXAS 77082
(713) 879-7764
Now in Southwest Houston—full line
of equipment. All the essentials and
extras for the "ham."

Wisconsin

AMATEUR ELECTRONIC SUPPLY
4828 W. FOND DU LAC AVE.
MILWAUKEE, WI 53216
414-442-4200
Wisc. Wats: 1 (800) 242-5195
Outside Wisc: 1 (800) 558-0411
M-F 9-5:30 Sat 9-3

QuicKit™ G5RV, Loop, & Dipole Kits

Fast & Easy to Build
• Everything included
• Failsafe visual instructions
• No measuring/cutting
• Finish antenna in minutes
Quality Components
• Presoldered Amphenol PL259
• Kinkproof Superflex wire
• Fully insulated, wx sealed,
no-corrode, low noise design
Fastest Antennas in the West
AntennasWest
(801) 373-8425 Box 50062-H. Provo, UT 84605

- Full Size G5RV dipole coverage 80-110 \$34.95
- Half Size G5RV dipole coverage 40-110 \$24.95
- Quarter Size G5RV dipole coverage 20-110 \$19.95
- Marconi Adapter kit \$ 4.95
- Antenna Launcher kit \$14.95
- 200' Dacron 250# line \$11.95
- Loops, dipoles, feedlines, etc.
- Add \$5 Shipping & Handling
- Catalog \$1 by 1st class mail

✓ 169



1-800-433-WIRE
FOR ALL AMATEUR WIRE & CABLE
Belden & Equivalent
(803) 895-4195 (SC & Ragchew)
CERTIFIED COMMUNICATIONS
PITTMAN ROAD, ROUTE 2, LANDRUM, SC 29356

✓ 176

Foreign Subscription Agents for Ham Radio Magazine

<p>Ham Radio Austria Karin Ueber Postfach 2454 D-7850 Loerrach West Germany</p>	<p>Canada Send orders to Ham Radio Magazine Greenville, NH 03048 USA Prices in Canadian funds 1 yr. \$41.85, 2 yrs. \$74.25 3 yrs. \$99.90</p>
<p>Ham Radio Belgium Stereohouse Brusselssteenvweg 416 B-9218 Gent Belgium</p>	<p>Ham Radio Italy Via Maniago 15 I-20134 Milano Italy</p>
<p>Ham Radio Holland Postbus 413 NL-7800 Ar Emmen Holland</p>	<p>Ham Radio Japan Katsumi Electronic Co., Ltd 27-5 Ikegami 4 Chome, Ota-Ku Tokyo 148, Japan Telephone (03) 753-2405</p>
<p>Ham Radio Europe Box 2084 S-194 02 Upplands Vasby Sweden</p>	<p>Ham Radio Switzerland Karin Ueber Postfach 2454 D-7850 Loerrach West Germany</p>
<p>Ham Radio France SM Electronic 20 bis, Ave des Clarions F-89000 Auxerre France</p>	<p>Ham Radio England c/o R S G B Lambda House Cranborne Road Potters Bar Herts EN8 3JW England</p>
<p>Ham Radio Germany Karin Ueber Postfach 2454 D-7850 Loerrach West Germany</p>	<p>Holland Radio 143 Greenway Greenside, Johannesburg Republic of South Africa</p>



(continued from page 42)



- Call channel function. A special memory channel for each band stores frequency, offset, reverse, and sub-tone of your favorite channel.
- Balance control and separate squelch controls for each band.
- Dual watch function allows 144 and 440 MHz receive simultaneously.
- Full duplex operation.
- CTCSS encode/decode selectable from front panel main knob or UP/DOWN keys on microphone. (Includes built-in, optional TSU-6 needed for decode.)
- Each function key has a unique tone for positive feedback.
- Handset/remote control option (RC-10).
- Dual antenna ports.
- Programmable memory and band scanning, with memory channel lock-out and priority watch function.
- Dimmer control.
- 16 key DTMF mic included.
- Supplied accessories: 16-key DTMF hand mic, memory channel, mounting bracket, DC cable.

The suggested retail price of the TM-621-A is \$699.95.

For information contact your nearest Authorized Kenwood Dealer or Kenwood USA Corporation, 2201 E. Dominguez Street, Long Beach, California 90810.

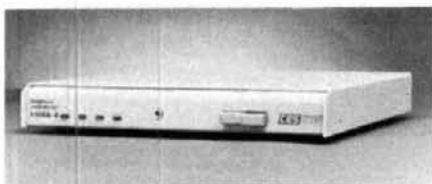

New CES autopatch with repeater controller

Communications Electronics Specialties, Inc. has a new model 510SA-II telephone autopatch for Amateur Radio fixed station and repeater applications. The 510SA-II is a full-featured microprocessor-controlled automatic telephone interconnect system that can be configured to operate in a simplex sampling mode for Amateur

VHF or UHF fixed stations. It can also be used at the repeater site in a half or full duplex mode for mobile initiated calls.

Other features include: multi-digit DTMF connect code, activity timers, time out timers, CW ID, toll restrict and disconnect override code — all programmable by use of any DTMF telephone with a special security access code. In addition, remote base station operation is enabled by special security code, repeater logic control is provided for making a repeater with autopatch capability out of two transceivers, and the unit is reverse-patch capable with automatic ringout upon receipt of an inbound call.

Additional information on the 510SA-II autopatch or other CES DTMF microphones, interconnects, and accessories is available by contacting CES, 931 S. Semoran Boulevard, Suite 218, Winter Park, Florida 32792.

Circle #305 on Reader Service Card.

Auto-kall—HF alert

The MoTron Auto-Kall HF-Alert is a selective calling or alerting system designed for use with HF SSB/CW Amateur Radio. It also works on VHF/UHF SSB/CW, CB, and marine HF/VHF.



The encoder sends two strings of "dits" at a precise, crystal-controlled speed. The decoder mutes the speaker until the correct calling sequence is received. This turns on the internal (or external) speaker for an adjustable time period, sets a red call LED, and enables an alarm output. There are 225 possible code combinations. The calling/decoding codes are set via rotary switches accessible through the front panel.

HF-Alert comes with mobile mounting bracket, 117-VAC power supply for base operation, and an audio patch cord. Use the built-in speaker or an external one. Send the calling signal by keying a CW transmitter or placing the microphone next to the speaker.

The HF-Alert is available from MoTron Electronics, 695 W. 21st Avenue, Eugene, Oregon 97405 for \$129.95.

Circle #306 on Reader Service Card.

New portable spectrum analyzer—PSA-37D

AVCOM introduces its PSA-3D Portable Spectrum Analyzer. Frequency coverage is from

less than 10 to over 1750 MHz, and from 3.7 to 4.2 GHz in 5 bands. Frequency readout is shown in MHz on a four-digit LCD front panel display.

The PSA-37D has a built in dc block with +18 Vdc for powering LNA's and BDC's, calibrated signal strength amplitude display, and internal battery with charger. Selectable vertical sensitivity of either 2 dB or 10 dB/DIV is standard. It is battery or line operated.

For more information write to AVCOM of Virginia Incorporated, 500 Southlake Blvd., Richmond, Virginia 23236

Circle #307 on Reader Service Card.

IMCT for XT/AT

AC3L Software announces its IMCT (international morse code trainer) for XT/AT compatible computers. The IMCT:

- Is menu driven with adjustable pitch and speeds of 1-20+ wpm.
- Has step-by-step beginner instructions — starting with sound recognition, it works through each code character.
- Allows keys to be typed and code heard; the keyboard can be used as a straight key. Computer tests are generated either by the computer (random) or from ASCII text files which can be read by IMCT and sent as entered or in random order.
- Has a built-in on-screen ham radio to tune around and practice copy.

The IMCT requires DOS 2.1 or later and at least 256 K of RAM and sells for \$39.95 (shipping included, US funds only) for a 5-1/4 or 3-1/2 inch diskette. Pennsylvania residents add 6 percent.

For more information contact AC3L Software, Box 7, New Derry, Pennsylvania 15671.

Circle #308 on Reader Service Card.

Voice box for dx'ers and contesters

QRZ Industries announces the Voice Box and the Mini Voice Box, two stand-alone operating accessories for DX'ers and contesters. The Voice Box digitizes and stores an operator's own natural voice. Once stored, a voice message can be instantly recalled to call CQ or repeat any other phrase.

You can record a total of 8 different phrases and operator voices for a total of 32 seconds. A voice message can be played back once at the touch of a button (or footswitch), or repeatedly with an adjustable pause between messages. If a response is received, the Voice Box aborts repeated playback until prompted to start again. When a voice message is deleted, the memory it used is freed up to record new phrases; all the other existing voice messages are preserved.

The Voice Box uses a 32-kHz sampling rate and several filters for high-quality audio. It automatically keys the PTT line to your transmitter or transceiver during playback, and also allows

(continued on page 105)

CELEBRATE

the 75th anniversary of ARRL with a new Handbook!

1989 marks the 75th anniversary of the founding of the League. There's no better way of celebrating this momentous occasion, than with the new *1989 ARRL Handbook for the Radio Amateur!*

The 1200-page sixty-sixth edition contains over 2100 tables, figures and charts. The new *Handbook* is better than ever with revised information on phase noise measurement, direct frequency synthesis and spread spectrum communication techniques. The section on repeaters has been updated including a new CW identifier circuit. You'll find new spectrum analyzer and oscilloscope material, as well as several new projects in the test equipment chapter.

As always, we've added a host of new construction projects to this new edition. Just some of the new projects include: A 500-MHz frequency counter, 160 through 10 meter legal limit amplifier, simple CMOS keyer project, digital audio memory keyer and a L/Q meter for measuring coil inductance.

But that's not all. You'll find many other popular construction projects that can be built in a weekend such as power supplies and VHF/UHF preamps. For the more ambitious builder there are projects like the 1.8 MHz QSK transverter (there are VHF/UHF transverter projects too) and there are many amplifier designs to suit your needs from HF through microwaves.

The Handbook has always been famous as a reference for component data and you will find an entire chapter devoted to everything from transmitting tube and transistor specifications to aluminum tubing sizes. Satellite enthusiasts will find that the digital TR sequencer will add operating convenience to your station. Of course, you'll find the most up-to-date information on digital techniques, and the *video communications chapter* is packed with information not only on SSTV, ATV and FAX but Weather FAX as well. QRP enthusiasts will find the famous "Cubic incher" transmitter; not much bigger are the QRP SWR indicator and QRP Transmatch. There is also a VXO-controlled 6-watt CW transmitter for your favorite band between 80 and 15 meters. There are a number of useful station accessories that you can build like DTMF encoders and decoders, PIN-diode TR switch, digital PEP wattmeter and SWR calculator, Transmatches and dummy loads.

For \$21, *The ARRL 1989 Handbook for the Radio Amateur*, remains an exceptional value for a hardcover technical publication. The price outside the US is \$23. For postage and handling, add \$2.00 (or \$3.50 for insured mail or UPS — please specify)



Here is a description of what is covered in the Handbook:

The first 5 chapters serve as an introduction and cover: basics of Amateur Radio, electrical fundamentals, radio design technique and language, and solid state fundamentals. Vacuum tube principles as they pertain primarily to high power amplifier design are also presented in these introductory chapters. There are 12 chapters devoted primarily to these radio principles: power supplies, audio and video, digital basics, modulation and demodulation RF transmitters, receivers, transceivers, repeaters, power amplifiers, transmission lines and antenna fundamentals. Another 4 chapters cover voice, digital, image and special modulation techniques. The RF spectrum, propagation and space communications are covered in 2 chapters. The construction and maintenance section has 12 chapters of useful projects ranging from power supplies and antennas through digital equipment. You'll find up-to-date component data that the Handbook is famous for. The final 5 chapters cover how to obtain your license, station design and operation, interference, monitoring and direction finding. An *abbreviations list*, *huge index* and *etching patterns* make up the balance of the book.

The American Radio Relay League, Inc., 225 Main St., Newington, CT 06111 USA

the HAM STATION



P.O. Box 6522
220 N. Fulton Ave.
Evansville, IN 47719-0522

Store Hours
MON-FRI: 9AM - 6PM
SAT: 9AM - 3PM
CENTRAL TIME

SEND A SELF ADDRESSED STAMPED ENVELOPE (SASE) FOR NEW AND USED EQUIPMENT SHEETS

WARRANTY SERVICE CENTER FOR:
ICOM, YAESU, TEN-TEC

FOR SERVICE INFORMATION CALL
(812) 422-0252
MONDAY - FRIDAY
9:00 AM - 12:00 NOON

YAESU



- FT-747GX**
- 100 Watts of Economical Performance
 - Dual VFO's, 20 Memories
 - Receives from 100 kHz-30 MHz
 - Built-in CW Filter + More



FT-212 RH

- 2 Meter Mobile
- Optional, Internal Digital Voice Recorder
- RX 138-174 MHz
- TX 144-148 MHz
- 45 Watts Output
- FT-712 RH Available for 70cm

ICOM

IC-32AT

- New Dual Band HT
- RX-138-174 MHz 440-450 MHz
- TX-140-150 MHz 440-450 MHz
- 5 Watts Output on Both Bands
- Full Duplex & 40 Memories



IC-228A

- 25 Watt, 2 Meter FM Mobile
- RCV 138-174 MHz
- TX 140-150 MHz
- 20 Memories

TEN-TEC



PARAGON

- Full Featured Synthesized HF Transceiver
- General Coverage Receiver
- 100w Output
- SSB, CW, FSK, Optional FM
- 62 Programmable Memories
- Made In USA

concept

VHF/UHF AMPS



- High VSWR and Overdrive Protection
- 5 Year Warranty, 6 Months on RF Transistors
- All Units have GaAsFET Receive Pre-amps

TERMS:

Prices Do Not Include Shipping.
Price and Availability Subject to
Change Without Notice

Most Orders Shipped The Same Day

COD's Welcome



Kantronics



KAM

- Packet, WEFAX, ASCII, AMTOR, RTTY, CW
- Simultaneous Operation on HF and VHF

ALINCO

ALD-24T

- Dual Band Mobile 140-149.995 MHz/ 440-450 MHz
- 21 Programmable Memories
- 25 Watts Output on Both Bands
- Loaded with Extra Features



MFJ

MFJ-986 3KW Roller Inductor Tuner



- Covers 1.8-30 MHz
- 2 Controls Makes Tuning Foolproof and Easy
- Peak Reading Cross Needle Meter

For Orders and Price Checks Call 800-523-7731

Indiana and Information
Call 1-812-422-0231

NUTS & VOLTS MAGAZINE

P.O. Box 1111-H
PLACENTIA, CA 92670
714-632-7721



- Ham Radio
- Computer Hardware
- Computer Software
- Plans-Kits
- Schematics
- Test Equipment
- CB Gear
- Satellite TV
- Video
- Components
- Antique Electronics
- Cable TV
- Publications
- Repairs-Services
- New Products
- Events Calendar

IF YOU ARE INTO ELECTRONICS AND SAVING MONEY IS IMPORTANT TO YOU, THEN YOU OWE IT TO YOURSELF TO TRY NUTS & VOLTS MAGAZINE. DISCOVER WHY THOUSANDS OF SMART PEOPLE NATIONWIDE TURN TO NUTS & VOLTS EACH MONTH TO MEET THEIR ELECTRONIC NEEDS. WHETHER YOU'RE BUYING, SELLING, OR JUST TRYING TO LOCATE THOSE UNIQUE OR HARD-TO-FIND ITEMS, FIND OUT HOW NUTS & VOLTS CAN HELP!

SUBSCRIBE TODAY!

CHECK MONEY ORDER VISA MC

Name _____

Address _____

City _____

State _____ Zip _____

Card No. _____ Exp. Date _____

CALL FOR ADVERTISING INFORMATION
DISTRIBUTOR INQUIRIES INVITED

Subscription Rates

U.S. FUNDS REQUIRED

3rd Class Mail - USA

- One Year \$12.00
- Two Years \$21.00
- Lifetime \$60.00

1st Class Mail

- One Year - USA . . . \$20.00
- Canada & Mexico . . \$22.00

Air Mail

- Foreign - 1 Year . . . \$55.00

Includes one FREE 40-word
Classified Ad

A National Publication For The Buying And Selling Of Electronic Equipment



(continued from page 102)

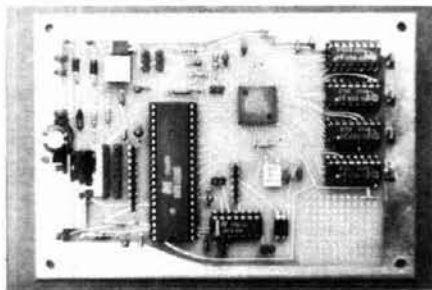

normal VOX operation. It has a switchable built-in microphone preamp to accommodate a wide variety of microphones and the audio output level to the transmitter is continuously adjustable. The Voice Box can be powered from a 10 to 16-Vdc source.

The Mini Voice Box has all the features of the regular Voice Box except that it has one voice message channel with up to 8 seconds of message time.

The Voice Box and the Mini Voice Box are shipped in kit form only. The kits consist of assembled, tested, working boards with complete instructions for installing the board in a suitable enclosure. Some standard offboard components (pushbuttons, toggle switches, microphone and power connectors, etc.) are required to complete the unit. They are available as an option.

Due to the current RAM shortage, Voice Box boards are being shipped without memory. Four plug-in 41256 (any speed) RAM chips are required to make the Voice Box operational. (The Mini Voice Box takes one.)

The introductory price of the Voice Box kit is \$95. The Mini Voice Box kit price is \$55. The off-board components option runs \$20 for the Voice Box and \$10 for the Mini Voice Box. To order send check, money order, or C.O.D. to QRZ Industries, P.O. Box 160, Piedmont, South Carolina 29673. Add \$10 for shipping and handling, and \$5 for C.O.D. orders. South Carolina residents add 5 percent sales tax. Please state name of publication where seen when placing order or requesting information.

Circle #313 on Reader Service Card.

Computerized DXing with software for IBM PC/XT/AT

The new MFJ-1286 Gray Line DX Advantage/Terminator is a computerized DXing tool

that predicts DX propagation by giving users instant access to Gray Line positions for any place in the world, at any time and date from 1980 to 1999.

You get a high resolution world map that displays the Gray Line as a moving area of day and night which changes with time. It shows you the moving Gray Line, UTC times, time zones, sun position over the earth, and latitude/longitude markers.

You can customize the MFJ-1286 Gray Line DX Advantage and display time and location for any QTH in the world. Run it by itself or as a memory resident program, in conjunction with your beam header or other software. It works with all graphics: Hercules, CGA, EGA and composite.

It comes with three maps: a default Land Mass Map, a map that shows the latitude/longitude markers, and a third map that displays the division of time zones throughout the world. CGA works with the Landmass Map and lets you send the display to your printer.

It also corrects for the north/south position of the sun and the curvature of the earth, making it perhaps the most accurate Gray Line predictor yet.

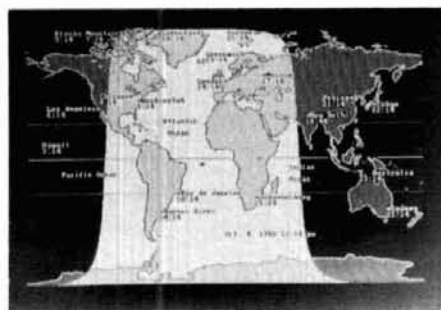

Pressing a function key switches the new MFJ-1286 Gray Line DX Advantage to a high speed display mode. This lets you watch solar and Gray line positions change in increments of 2 minutes, 6 minutes, 1 hour, 1 day, or 1 week. You can also pause the high speed display to study a position.

The MFJ-1286 retails for \$29.95 and is available from any MFJ dealer or direct from MFJ Enterprises Inc.

For more information contact MFJ Enterprises, Inc., P.O. Box 494, Mississippi State, Mississippi 39762.

Circle #314 on Reader Service Card.

Universal M-7000: new communications terminal

Universal Shortwave offers an exciting new product — the Universal M-7000 military-grade communications terminal. This self-contained device connects to the audio output of any quality communications receiver. Output is to a video

(continued on page 106)

When performance & price really count...

CRYSTEK CRYSTALS

The pulse of dependable communications



Reliability & Quality
From Start To Finished Product

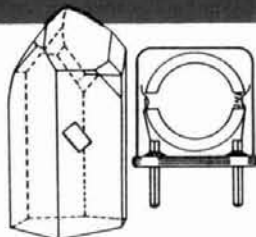

QUARTZ CRYSTALS/OSCILLATORS FOR ELECTRONIC — INDUSTRIAL

- Micro-Processor Control
- Computers/Modems
- Test/Measurement
- Medical

COMMUNICATIONS — REPLACEMENT

- Mobile/2-way/Channel Elements
- Pagers
- Marine
- Aircraft
- Telemetry
- Monitor/Scanners

AMATEURS

- CB
- Hobbyist
- Experimenter

COST EFFECTIVE
MODERATE PRICING
FAST DELIVERY



The Pulse of Dependable Communications

Crystek Crystals offers their new 16 page FREE catalog of crystals and oscillators. Offering state-of-the-art crystal components manufactured by the latest automated technology. Custom designed or "off the shelf," Crystek meets the need, worldwide. Write or call today!

CRYSTEK CORPORATION
DIVISION OF WHITEHALL CORPORATION

2351/2371 Crystal Dr. • Ft. Myers, FL 33907
P.O. Box 06135 • Ft. Myers, FL 33906-6135
TOLL FREE 1-800-237-3061
(813) 936-2109 — TWX 510-951-7448





(continued from page 105)

monitor (serial and parallel printer ports are also provided). The M-7000 decodes and displays all standard transmission modes: Morse code; Baudot, ASCII, Packet and Sitor A and B. Less common modes such as bit-inverted Baudot, high speed ASCII, ARQ-Moore (TDM), and Frequency Division Multiplex (FDM-VFT) are also supported. Other special display modes include Russian Third Shift Cyrillic, Literal, and Databit mode. The M-7000 also prints high quality facsimile (FAX) images to the parallel printer port.

Microprocessor controlled, switched capacitor filters comprise the prefilters, the channel filters, and the post detection low pass filter.

The M-7000 offers advanced monitoring features including: diversity inputs, split screen ARQ, remote terminal control, speed readout, screen saver, screen print, ten memories, Sel-Cals, auto-start, and screen print. Automatic filter tuning and auto-tune features provide semi-automated operation for maximum convenience.



The M-7000 is manufactured in Englewood, Florida by Digital Electronic Systems. Available factory installed options include a Real Time Clock and a Video FAX option. The M-7000 is available from stock at Universal and other selected dealers.

For additional information contact Universal Shortwave Radio, 1280 Aida Drive, Reynoldsburg, Ohio 43068.

Circle #315 on Reader Service Card.

New personal-scanning receiver offers 100 channels and all-band coverage

AOR, Ltd. has introduced of a new 100-channel hand-held receiver that offers complete public service band coverage.

The new radio measures 5-3/4" x 2-1/8" x 1-3/4". The receiver's frequency coverage is: 27-54 MHz, 108-174 MHz, 406-512 MHz, and 830-950 MHz. This allows coverage of all the police, fire and emergency bands, plus the new services now available above 800 MHz in 12.5, 25, and 30 kHz increments.



At 12 ounces total weight the model AR900 can be carried in a pocket, with the standard belt clip, or in an optional leather carry case.

Twenty-five front panel keys allow programming of five banks of 20 channels. Pairs of upper and lower limits for bands to be searched can be stored in 5 separate search memory locations. Information is stored in three permanent memories, which never lose program information should the batteries be disconnected. Extra features include first channel priority, keyboard lock-out, BNC antenna connector, and a blue-green display backlight for night use. The LCD display offers 22 separate prompting annunciators.

The suggested retail price is \$299. This includes a 450 MAH rechargeable battery, ac charger/adaptor, two antennas, and a stainless steel belt clip.

For further information contact ACE Communications, Monitor Division, 10707 East 106th Street, Indianapolis, Indiana 46256.

Circle #316 on Reader Service Card.

CS64W Connect-A-Call Telephone repeater

Engineering Consulting's "Connect-A-Call" (a telephone repeater) that is a cartridge for the Commodore (C-64, C-64C, C-128) computer. The cartridge works in three modes.

Mode #1 allows access to your Watts line from any phone — including cellular. It has multi-user options with multiple access codes and a logging option to provide usage time, and number dialed.

Mode #2 connects incoming calls to other telephone numbers if there is no answer after a preset number of rings. It can be remotely reprogrammed to change message, ring count, access codes, and delays.

Mode #3 re-directs incoming calls manually or automatically via access code, to as many as 1000 numbers.

The telephone repeater is dual amplified, and is powered by the computer. Connect-A-Call is available for \$399.95 from Engineering Consulting, 583 Candlewood St. Brea, CA 92621

New database provides high-speed device selection

Motorola has introduced the Motorola Data Disk: Discrete Semiconductor Version. This IBM PC-compatible (384K RAM required) high-performance database permits rapid automated search and selection of Motorola's entire discrete semiconductor portfolio. The high-density selector guide contains 58 product categories with technical information for over 7,200 devices, 20,000 cross references, over 200 standard package types, and 130,000 parameters. It supports both part number and parametric searches.

The Discrete Data Disk provides Sales Office and Distributor information for hundreds of Motorola worldwide locations, support for five languages, user color support (including monochrome), a printer utility, help screens, an information request form, and "smart" message lines. The disk also includes toggles allowing selection across surface mount devices only, military devices only, or surface mount military devices only. The message lines use the "progressive disclosure" technique eliminating the need for a user's manual.



Within the next year, the capabilities of the Data Disk will be expanded to include parametric information for all 30,000-plus Motorola Semiconductor products (ICs as well as Discretes), complete with cross references and prices.

Copies of the Motorola Discrete Semiconductor Data Disk are available for \$2.00 each by requesting DK101/D REV 1 from the Motorola Semiconductor Literature Distribution Center, P.O. Box 20912 Phoenix, Arizona 85036. The Data Disk is also available to Motorola customers through their local Motorola Semiconductor Sales Offices.

Circle #317 on Reader Service Card.

THE MOST AFFORDABLE REPEATER

ALSO HAS THE MOST IMPRESSIVE PERFORMANCE FEATURES
(AND GIVES THEM TO YOU AS STANDARD EQUIPMENT!)

KIT, ONLY \$675
WIRED \$975
VHF OR UHF



FEATURES:

- **SENSITIVITY SECOND TO NONE!** GaAsFET front end on vhf models gives 12dB SINAD of 0.12uV (vhf), 0.15uV (220). UHF model 0.25uV std, 0.1uV with optional helical resonator preamp.
- **SELECTIVITY THAT CAN'T BE BEAT!** Both 8-pole xtal filter & ceramic filter for > 100dB at only ±12kHz. Helical resonator front end to combat desense & intermod.
- **CLEAN, STABLE TRANSMITTER**, up to 18W output standard; 50W with accessory power amplifier.
- **FCC TYPE ACCEPTED** for commercial high band and uhf.
- **Courtesy beep**, field-programmable CWID, flutter-proof squelch, automatic frequency control to compensate for off-frequency transmitters (all standard features).
- **Full range of options** available, such as autopatch, phone line or radio remote control, sub-audible tones, duplexers.

HIGH PERFORMANCE TRANSMITTERS & RECEIVERS FOR REPEATERS AUDIO & DIGITAL LINKS, TELEMTRY, ETC.

FM EXCITERS:

- Kits \$99, w/t \$179. 2W continuous duty. TCXO & xtal oven options available.
- **TA51 for 10M, 6M, 2M, 150-174, 220 MHz.**
- **TA451 for uhf.**

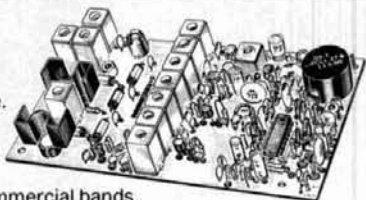

- FCC type accepted for commercial bands.
- Call for latest information on 900 MHz transmitters.
- **VHF & UHF AMPLIFIERS.** For FM, SSB, ATV. Output from 10 to 50 Watts. Several models, kits starting at \$79.

- **R144/R220 FM RECEIVERS** for 2M, 150-174, or 220 MHz. GaAs FET front end, 0.12uV sensitivity! Both crystal & ceramic filters plus helical resonator front end for exceptional selectivity: > 100dB at ±12kHz (best available anywhere!) Flutter-proof squelch. AFC tracks drifting transmitters. Kit \$149, w/t \$229.



- **R451 UHF FM RCVR.** Similar to above. Tuned line front end, 0.25uV sens. (0.1uV with optional hel. res. preamp). Kit \$149, w/t \$229.
- **R901 FM RCVR FOR 900 MHz.** Triple-conversion, GaAs FET front end, 0.2uV sens. Kit \$169, w/t \$259.
- **R76 ECONOMY VHF FM RCVR** for 10M, 6M, 2M, 220. Without hel res or afc. Kits only \$129.
- **Weather satellite & AM Aircraft receivers also avail.**

FCC TYPE-ACCEPTED TRANSMITTERS & RECEIVERS AVAILABLE FOR HIGH-BAND AND UHF. CALL FOR DETAILS.

- Send \$1 for 36 page catalog by return mail. (Send \$2.00 or 4 IRC's for overseas mailing)
- Order by phone or mail • Min \$3 S & H per order
- Use Visa, Mastercard, Check, or UPS COD.

GaAs FET PREAMPS at a fraction of the cost of comparable units!

LNG - (*)

GaAs FET PREAMP

ONLY \$59!
Wired/tested



FEATURES:

- **Very Low Noise:** 0.7dB VHF, 0.8dB UHF
- **High Gain:** 13-20dB, depending on frequency
- **Wide Dynamic Range:** to resist overload
- **Stable:** new-type dual-gate GaAs FET

* Specify tuning range desired: 26-30, 46-56, 137-150, 150-172, 210-230, 400-470, or 800-960 MHz.



LNW - (*)

MINIATURE GaAs FET PREAMP

ONLY \$24/kit,
\$39 Wired/tested

GaAs FET Preamp similar to LNG, except designed for **low cost & small size.** Only 5/8"W x 1-5/8"L x 3/4"H. Easily mounts in many radios.

* Specify tuning range desired: 25-35, 35-55, 55-90, 90-120, 120-150, 150-200, 200-270, or 400-500 MHz.

LNS - (*)

IN-LINE PREAMP

ONLY \$79/kit,
\$99 Wired/tested



GaAs FET Preamp with features similar to LNG series, except **automatically switches out of line during transmit.** Use with base or mobile transceivers up to 25W.

* Specify tuning range desired: 120-175, 200-240, or 400-500 MHz.

HELICAL RESONATOR PREAMPS

Low-noise preamps with helical resonators **reduce intermod & cross-band** interference in critical applications.

MODEL HRA - (*), \$49 vhf, \$84 uhf.

* Specify tuning range desired: 143-150, 150-158, 158-162, 162-174, 213-233, 420-450, 450-465, or 465-475 MHz.

NEW HIGH-SPEED DIGITAL RF LINKS

You've waited a long time for a simple, reliable, **low-cost 9600 baud PACKET NETWORKING system.** Now you've got it! Our new MO-96 MODEM and direct FSK Transmitters and Receivers for 220 or 440 MHz interface directly with most TNC's. Fast diode switched PA's output 15 or 50W. **Call for complete info on the right system for your application.**

ACCESSORIES



- **COR-3 Kit.** Control ckts and audio mixers needed to make a repeater. Tail & time-out timers, local spkr ampl, courtesy beep \$49
- **CWID Kit.** Field programmable, timers, the works \$59
- **TD-2 DTMF DECODER/CONTROLLER Kit.** Full 16 digits, switches 5 functions, toll call restrictor, programmable, much more. Great for selective calling too! \$79
- **AP-3 AUTOPATCH Kit.** Use with above for repeater autopatch. Reverse patch and phone line remote control std. \$79
- **AP-2 SIMPLEX AUTOPATCH TIMING BOARD Kit.** Use with above for simplex autopatch \$39
- **MO-202 FSK DATA MODULATOR Kit.** Run up to 1200 baud digital signals through any fm transmitter with full handshakes. Radio link computers, telemetry gear, etc. \$39
- **DE-202 FSK DATA DEMODULATOR Kit** for rcvr end of link \$39

RECEIVING CONVERTERS



	Antenna Input Range	Receiver Output
VHF MODELS	28-32	144-148
	50-52	28-30
	50-54	144-148
	136-138	28-30
	144-146	28-30
	145-147	28-30
Kit with Case	\$59	146-148 28-30
Kit less case	\$39	220-222 28-30
Wired w/case	\$89	220-224 50-54
		222-224 28-30
UHF MODELS	432-434	28-30
Kit with Case	\$69	435-437 28-30
Kit less Case	\$49	432-436 144-148
Wired w/case	\$99	439-25 50-54
		902-928 422-448
		902-922 430-450

See catalog for full line of 2w transmitting converters for vhf & uhf. Kits only \$79. Linear Amplifiers avail. up to 50 w.

Our 25th Anniversary
hamtronics, inc.
65-H MOUL ROAD • HILTON NY 14468-9535
Phone: 716-392-9430 Hamtronics® is a registered trademark

ASSOCIATED RADIO

8012 CONSER BOX 4327
OVERLAND PARK, KANSAS 66204

VISA-MC
AMEX-DISC.

EVERY DAY A HAMFEST

BUY — SELL — TRADE
ALL BRANDS NEW AND RECONDITIONED



**WE'LL BUY YOUR EXTRA RIG
STATIONS-ESTATES ETC.**

Call **913/381-5900**

FAX 913 648 3020

**SEND \$2 FOR CATALOG
AND WHOLESALE LIST**

Please send all reader inquiries directly.



**SPECIAL PURCHASE
FROM THE PUBLISHER
ALLOWS US TO
SLASH THE PRICES
ON THESE BOOKS**



**PROGRAMMING FOR THE TI-59 AND
HP-41 CALCULATORS**

by Paul Garrison

To take full advantage of your hand-held calculator's power, you need to learn how to program it. Clear easy-to-understand instructions make programming a snap! Over half the book has practical programming applications that will solve some very complex problems. © 1982, 294 pages.

T-1442 Was \$12.95 SAVE \$8 Softbound \$4.95

SOFTWARE FOR AMATEUR RADIO

by Joe Kasser, G3ZCZ

Packed with practical computer applications and tested and de-bugged programs that can be simply adapted to almost any microcomputer. Includes BASIC programming concepts as well as how to interface your computer to your radio, digital communications and more. © 1984, 284 pages.

T-1560 Was \$15.95 SAVE \$11.00 Softbound \$4.95

MICROCOMPUTERS IN AMATEUR RADIO

by Joe Kasser, G3ZCZ

Computers can be used in a number of different ways in your Ham shack. They can be used to control your rig, predict propagation, control antennas and hundreds of other applications. Kasser explores the possibilities in this book. Includes interface I/O devices, system categories, programming the micro-computer and much more. Great reading. © 1981, 307 pages.

T-1305 Was \$15.95 SAVE \$4.95 Softbound \$4.95

BUY ALL 3 SPECIAL

\$44.85 VALUE at retail

T-SPB **\$10.95**

SAVE \$33.90 WOW What a Deal!!!

Please enclose \$3.50 shipping and handling

**HAM RADIO'S
BOOKSTORE**

Greenville, NH
03048

603-878-1441



THROW AWAY YOUR FALCON CATALOGS

Falcon Communications,
THE source for quality,
American made, MOS-
FET and bipolar repeater,
base station and mobile
power amplifiers an-
nounces a major re-design
of our line.

Send for information on
our models 8151, 8152,
8153, 8162, 8163, 8171,
8172, 8181, 8182, 8183,
8184, 8251, 8252, 8253,
8261, 8262, 8271, 8272
and 8282.



FALCON
COMMUNICATIONS

P.O. Box 8979 • Newport Beach, CA 92658
(714) 760-3622

Please send all reader inquiries directly.

Short Broadband Dipoles & Slopers

Trapless 3-conductor legs
create short antenna with
broad 2- & 3-band resonance.

FB Dipoles
FB 80/40/15 62' \$79.95
*CW • Center
*LSSB • HSSB
FB 40/20 31' \$69.95
FB 20/10 16' \$59.95

**Trapless 2 & 3 band
FB HalfSlopers**

FB 160/80/30 CW 70' \$69.95
FB 160/75 SSB 62' \$69.95
*2KW
*Efficient
*Coax Fed
*Ready to Use
*No Caps or Coils
*Fully wx sealed & insulated

AntennasWest

(801) 373-8425

When ordering add \$5 P&H
Infopack \$1 by 1st class mail.
Box 50062-H, Provo, UT 84605

PI NETWORK CAPACITOR EQUATIONS

Mason A. Logan, K4MT, 1607 Monmouth Drive, Sun City Center, Florida 33570

Self-sufficient equations use no intermediate steps

The versatile Pi network couples transmitter output stages to antennas while acting not only as a transformer, but as a filter and antenna tuner. It is a "conjugate impedance" network.¹ The first step for determining the network frequency response and the limits of the antenna tuning range (for either analysis or design) requires equations for each of the reactive elements. There are many articles on Pi networks with various procedures for determining the required network reactances.²⁻⁷ Two new equations presented here for the shunt capacitors are self-sufficient and use no intermediate steps or square root factors.

Pi network circuit

Figure 1 is an apparatus diagram for a Pi network. It shows the terminations and reactive elements, with definitions for the resonant frequency impedances of each. Figure 2 shows these impedances in a circuit with a resistive match to the transmitter and load resistances. Definitions are included for capacitor element Q's and the "operating Q" to aid in circuit analysis.

There are three reactive elements, a series inductor and two shunt capacitors. As stated above, the circuit is a conjugate impedance network. At the resonant frequency, the resistive transmitter output stage and the equivalent parallel resistance of the antenna load are exactly matched by the network's terminal impedance, as shown in fig. 1.

The application of the conjugate impedance condition to the general circuit equations results in the development of a fourth factor, the operating Q. Choosing this

gives you a measure of control over the design. Q_{3dB} is always less than one-half of Q_0 . Equations relating the above four factors are the subject of this article. Their derivation is given in the appendix.

The three equations

There are three equations, two of them new. The known equation^{2,3} contains the dependency between Q_0 and the inductive reactance X_L . This third equation can be arranged as a solution for either Q_0 or X_L ; each depends on the other. Given Q_0 , there is only one inductive reactance X_L that goes with it, and vice versa. It should be obvious which of the two arrangements to use. The known equation plus the two others complete the set of equations to be calculated.

FIGURE 1

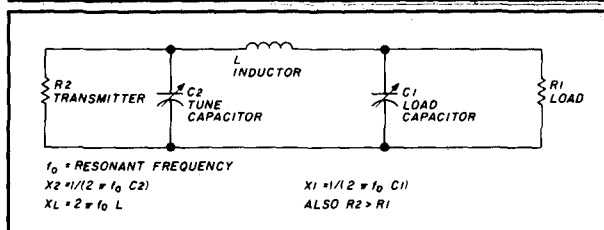

Pi-network apparatus diagram.

FIGURE 2

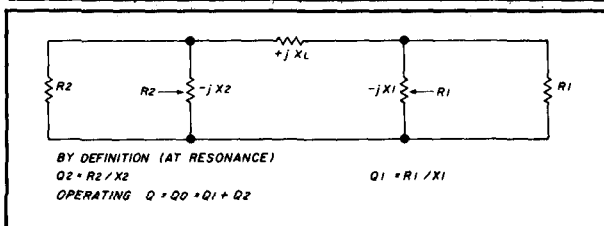

Pi-network circuit schematic.

First choose either Q_0 or X_L ; then calculate the other. If X_L is given:

$$Q_0 = \frac{(R_1 + R_2) + 2\sqrt{R_1 R_2 - X_L^2}}{X_L} \quad (1)$$

If Q_0 is given:

$$X_L = \frac{Q_0(R_1 + R_2) + 2\sqrt{R_1 R_2} \sqrt{Q_0^2 - (R_2 - R_1)^2}}{Q_0^2 + 4} \quad (2)$$

With Q_0 and X_L established, the two new symmetrical capacitor equations are:

Load:

$$X_1 = \frac{2R_1}{Q_0 - \frac{(R_2 - R_1)}{X_L}} \quad (3)$$

Tune:

$$X_2 = \frac{2R_2}{Q_0 + \frac{(R_2 - R_1)}{X_L}} \quad (4)$$

With nominal conditions, Q_0 would be chosen somewhere between 10 and 20. This calls for the use of eqn. 2 to determine the associated inductive reactance X_L . The load capacitor X_1 and the tune capacitor X_2 follow.

For another circuit (some other load condition, for instance) X_L is now fixed and you'll need to determine the changed Q_0 . Equation 1 is indicated in this situation.

For either circumstance, with a paired Q_0 and X_L defined, eqns. 3 and 4 directly determine X_1 and X_2 for the two capacitors.

For example, assume the transmitter R_2 is 5000 ohms, the antenna 50 ohms, and that a Q_0 of 15 has been chosen. Then:

$$\begin{aligned} Q_0 &= 15 \\ X_L &= 379.99 \text{ ohms} \\ X_1 &= 50.67 \text{ ohms} \\ X_2 &= 356.80 \text{ ohms} \end{aligned}$$

Suppose that the load R_1 is changed to 100 ohms with a SWR of 2, and that X_L just determined is fixed. Then:

$$\begin{aligned} X_L &= 379.99 \text{ ohms} \\ Q_0 &= 16.56 \\ X_1 &= 54.57 \text{ ohms} \\ X_2 &= 339.50 \text{ ohms} \end{aligned}$$

There is only about a 6-percent change in the calculated factors when the load is resistive; for reactive loads the change is greater.²

Appendix

Derivation of the new equations for the two capacitors in the Pi network begins with two known equations^{2,8}. These equations have the disadvantage of using square roots:

$$X_1 = \frac{R_1 X_L}{R_1 + \sqrt{R_1 R_2 - X_L^2}} \quad (5)$$

$$X_2 = \frac{R_2 X_L}{R_2 + \sqrt{R_1 R_2 - X_L^2}} \quad (6)$$

Divide both sides of eqn. 5 by R_1 and both sides of eqn. 6 by R_2 . Invert both and use the definition of Q_1 and Q_2 to obtain:

$$Q_1 = \frac{R_1 + \sqrt{R_1 R_2 - X_L^2}}{X_L} \quad (7)$$

$$Q_2 = \frac{R_2 + \sqrt{R_1 R_2 - X_L^2}}{X_L} \quad (8)$$

The sum of eqns. 7 and 8 is Q_0 , agreeing with eqn. 1 given earlier. The difference is the compact equation:

$$Q_2 - Q_1 = \frac{R_2 - R_1}{X_L} \quad (9)$$

Adding and subtracting this to the equation $Q_0 = Q_1 + Q_2$ gives:

$$Q_1 = \frac{1}{2} \left(Q_0 - \frac{R_2 - R_1}{X_L} \right) \quad (10)$$

$$Q_2 = \frac{1}{2} \left(Q_0 + \frac{R_2 - R_1}{X_L} \right) \quad (11)$$

Finally, inserting the definitions of Q_1 and Q_2 in terms of their impedances, the capacitive reactances at the resonant frequency are:

Load:

$$X_1 = \frac{2R_1}{Q_0 - \frac{R_2 - R_1}{X_L}} \quad (12)$$

Tune:

$$X_2 = \frac{2R_2}{Q_0 + \frac{R_2 - R_1}{X_L}} \quad (13)$$

completing the derivation of the new pair of equations.

references

1. Walt Maxwell, W2DU, "Technical Correspondence", *QST*, March 1985, page 45.
2. Earl W. Whyman, W2HB, "Pi Network Design and Analysis," *ham radio*, September 1977, page 30.
3. Elmer A. Wingfield, W5FD, "New and Improved Formulas for the Design of Pi and Pi-L Networks," *QST*, August 1983, page 23.
4. Chris Bowick, WD4C, "Impedance Matching-A Brief Review," *ham radio*, June 1984, page 48.
5. William Orr, W6SAI, *Radio Handbook*, 22nd edition, Howard W. Sams, 1981, page 11-33.
6. ARRL *Radio Amateur Handbook*, 1984, page 2-48 and 2-49.
7. *ITT Reference Data for Radio Engineers*, 5th edition, Howard W. Sams, 1974, page 11-5.
8. W. L. Everitt, *Communication Engineering*, 2nd edition, McGraw-Hill, 1937.

Article M

HAM RADIO



FLEA MARKET

RATES Noncommercial ads 10¢ per word; commercial ads 60¢ per word **both payable in advance**. No cash discounts or agency commissions allowed.

HAMFESTS Sponsored by non-profit organizations receive one free Flea Market ad (subject to our editing) on a space available basis only. Repeat insertions of hamfest ads pay the non-commercial rate.

COPY No special layout or arrangements available. Material should be typewritten or clearly printed (not all capitals) and must include full name and address. We reserve the right to reject unsuitable copy. **Ham Radio** cannot check each advertiser and thus cannot be held responsible for claims made. Liability for correctness of material limited to corrected ad in next available issue.

DEADLINE 15th of second preceding month.

SEND MATERIAL TO: Flea Market, Ham Radio, Greenville, N. H. 03048.

BEGINNER'S RADIO CLEARINGHOUSE. On a space available basis, we are going to offer you, OUR SUBSCRIBER, free of charge, a chance to find a home for your used equipment with a new Ham. Please send us a short description of what you want to sell along with price, name, address and phone number. We'll run it once in a special section of the classified ads under the heading of BEGINNER'S RADIO CLEARINGHOUSE. Please limit your ad to 20 words or less.

FOR SALE: Leader LIM 870A ant impedance mtr (89.95) Micronta 300000/v, mirror scale, shorting "beep" (49.95). Both new, \$25 each plus UPS. Josef Damento, W45XK, 11170 S. Tropical Trail, Merritt Island, FL 32952.

SELL Kenwood TS-780 2m/432 dual band base rig, manual, box, accessories except mic \$200. OBO. C. Fisher, WB4HXE, 2867 Rosemont Drive, Lawrenceville, GA 30244. (404) 242-1204.

SELL Hal Telesader CWR 670, mint, manuals. \$130. J. Mel, N1DPG, 28 Maywood Lane, Bristol, CT 06010. (203) 584-1600.

FOR SALE: Strip chart recorder-single channel, never used, mfd by Gulton and includes manual and paper. \$150. (313) 541-3370 evenings.

HEATHKIT SB300. Excellent condition with CW/SSB filters with manual and shipped continental US. \$145. Wayne Smith, CET/W4AWZP, 224 St. John Street, Arden, NC 28704. (704) 687-2410 weekends.

BELL COMPLETE STATION: TS-830S, VFO-230, SP-230, MC-50 \$775. SB-220 \$475 or trade all for TSJ-930S. Greg, KX4R. (404) 974-4816 evenings.

HAM RADIO, QST, CO and 73 Magazines. 35 cents each. Send SASE for list. W9GXr, 8915 Prairie Drive, Middleton, WI 53662.

RCA WT110A tube tester owners. I need card data for tubes in 500CX Swan. Will return data and pay reasonable price. Ernest Jenkinson, 102 Lesane Drive, Sumter, SC 29150.

FOR SALE: Kenwood TS-811 IC-10 computer controller installed/modified, full bandwidth. \$895.00 US. (416) 736-0717 days. (416) 253-0709 nights.

HARDLINE BARGAIN! Andrews 7/8" heliax, brand new 1000 + foot spool \$2.50/ft. Murray Lampert, VE3HI. (416) 661-0008. Nights (416) 225-5221.

PACKET TNC Heath HD-4040, with status indicator. Operates either VHF or HF via a switch, factory aligned \$125. AUTEK QF-1A audio filter \$50. Robert Dingle, KA4LAU, 657 Dell Ridge Drive, Dayton, OH 45429. (513) 299-7114.

ATLAS RADIO ten meter monoband mobile radio transceiver model AR2510. Up to 30 watts PEP USB/LSB and 30 watts CW. AM modes. Noise blanker, PA mode, digital multi function LCD display, VFO built-in, S/R/F/ MOD/SWR meter and channel switching microphone. Factory warranty for two full years service/full replacement no questions asked. Order direct from this ad. Price prepaid all fifty states \$219.95. Atlas Radio Company, Inc. PO Box 763, Lynbrook, New York USA 11562. Telephone 516-678-3904. Export inquiries invited. Call today.

FOR SALE: Drake Twins R4c w/Sherwood filter mods., T4Xc, power supply in MS-4 sprk cabinet. Astatic 10d mic, spare tubes and manuals \$400 plus shipping. Tom Crawford, W7KTI, 112 Bulb Farm Road, Elma, WA 98541. (206) 482-2766.

DIGITAL AUTOMATIC DISPLAYS. All Radios. GRAND SYSTEMS, POB 2171, Blaine, WA 98230.

SLEP SPECIALS: Jennings UC5L-1000 vacuum variable capacitors 10 thru 1000PF at 5000V with gear drive train and mounting bracket, ideal for that linear amplifier or tuner \$69.50, 2/6m amplifier using 4X150A, 4CX250B, 115VAC/1860VDC at 400MA, size 5-1/4L x 4-1/2W x 4-1/4H, for replacement or amplifier construction \$37.00, military late model USM-117C solid state small portable DC-5MHz oscilloscope, ideal for bench work or modulation/RTTY testing \$95.00, military USM-207 solid state portable 0 thru 500 MHz frequency counter lab quality, late model \$185.00, TS-510A/U signal generator, 10 MHz thru 420 MHz mil/spec version of HP608D \$195.00, satisfaction guaranteed, have quantity, VISA/MC or check, add shipping, phone Bill Slep (704) 524-7519, SLEP ELECTRONICS COMPANY, Highway 441, Otto, NC 28763.

MICROLOG AKB-1, AVR-2 keyboard and terminal for RTTY, CW, and ASCII. Inexpensive way to get into RTTY. With manuals, will ship. \$110.00. KE8JH (616) 327-2142.

TEST EQUIPMENT: General Radio 1001-A HF-VLF Signal Generator, 5 kHz-50 MHz, w/rare test loop antenna, \$175. GR-1115B Multi-frequency laboratory standard, \$225. GR-1811A capacitance bridge, \$160. HP-8601A AM/FM solid state signal/sweep generator, worth \$2500, sell \$550. HP-140T spectrum analyzer display, \$275. HP-741B 1000VDC calibrator, AC/DC Diff/Vol, \$275. HP-628A microwave generator 15-21 GHz, \$475. HP-1202A audio lab scope, 100uV sensitivity, \$175. Tektronix dual-sampling scope system, 4 to 6 GHz bandwidth, mint: 561A, 352, 372, 2-S2 heads, \$650. Tektronix 1A1 late model w/FET inputs, \$85. Type-M 4-trace, \$75. Type-82, 75 MHz, 580-series, \$75. Collectors/users: Simpson 479 RF/Gen, old, beautiful, \$75. Jerrold 802 sweep gen, 4-112 MHz, \$65. Tektronix manuals: new 475A, \$25. Set/5 rare sampling manuals, 661, 452A, 453, 6T1A, 5T3, \$50/all. Send SASE for list other equipment, manuals. FOB Joseph Cohen, 200 Woodside, Winthrop, MA 02152. (617) 846-6312.

DIGICOM 64: a software-based PACKET radio system for the Commodore 64 by W2UP, Aug 88 issue of 73 magazine, page 22. The software is public domain and requires a simple modern interface to the C64 which is provided by our kit. The board plugs directly into the cassette port or remote mounted via a cable. A watchdog timer, relay PTT and PTT inversion options are included. Circuit power is derived from the computer and uses 7910 chip so no alignment is required. A switch allows HF or VHF operation. Order KIT #154 for \$49.95 or Assembly #154 for \$79.95, both include FREE DISC. Add \$2.50 s/h. A & A ENGINEERING, 2521 W. LaPalma #K, Anaheim, CA 92801. (714) 952-2114. MC or VISA accepted.

AMERICAN FRIENDS- If you have any old British HAM equipment and would like the schematic circuit diagram manuals I may be able to help. I have collected a very large selection over the years covering Military and much other HAM equipment, etc. Drop me a line with IRC please and I'll try and help. Maurice Small, G0HJC, 8 Cherry Tree Road, Chinnor, Oxfordshire, OX9 4QY.

COMPUTER CODE COURSE: Apple II + /c/e/GS. C-64/128. 37 modes, graphics, 1-100 WPM, menus, proportional spacing, variable frequency, more (\$29.95). With word processor (\$39.95). Manual (\$10). Check/NO. LARESCO, POB 2081-HR, Calumet City, IL 60409. 1-312-891-3279.

QUALITY HAM SOFTWARE for the IBM-PC and compatibles. Many shareware and public domain disks for all aspects of ham radio. Business SASE for catalog. JK6S, Dept HA, POB 50521, Indianapolis, IN 46250-0521.

SELL: Heath VOM, MM-1 \$20.00. Coax relay \$20.00. Bowman power supply 12V, 3A, DC \$10.00. Add UPS. B. Nastoff, 320 W. 56th Place, Merrillville, IN 46410. (219) 884-5519.

WANTED: Old and unique bugs. Especially looking for Vibroplex Zephyr models and Dow keys from Canada. Smiley White, WB4EDB, POB 5150 Fredericksburg, VA 22403.

UHF PARTS. GaAs Fets, mmics, chip caps, feedthrus, teflon pcb, high Q trimmers. Moonbounce quality preamps. Electronic sequencer boards. Send SASE for complete list or call (313) 753-4681 evenings. MICROWAVE COMPONENTS, PO Box 1697, Taylor, MI 48180.

LOOKING FOR info on Jefferson Travis 350A-1, 1-12 MHz xcvr. Can anyone help? Chuck Banas, KA7WZM, 312 Filer Ave, Twin Falls, ID 83301. (208) 734-3144.

WANTED: HAM RADIO past copies, 1976 on. Prefer UK seller. Branson, 111, Park Road, Peterborough PE1 2TR. UK. (Tel 0733 67804).

GO MOBILE with tube type transceivers. Heath HP-10 transistorized power supply, \$39 delivered. W8QX, Box 452, Birmingham, MI 48012. (313) 644-5042.

SWAN 350, 80/40/20/15/10 SSB/CW transceiver, recently serviced by CUBIC, complete with external power supply, internal speaker, 100 kHz crystal calibrator and CW filter, desk mike, manual \$425. SWAN 350 80/40/20/15/10 SSB/CW transceiver, complete with external power supply/speaker, hand mike, manual \$200. Spare set of drivers and finals for one SWAN 350 \$25. SBE-34, 80/40/20/15 SSB only transceiver, with internal AC/DC power supply, both power cords, hand mike, manual \$125. For a Novice, I will even include a pair of headphones and a straight key (for the SWANs) and will pay shipping for all of the above! Myron Calhoun, W0PBV, 2001 Dunbar Road, Manhattan, KS 66502-3907.

RACAL RECEIVERS! RA-6790 forward/gm. \$3500.00. (416) 661-0008. Nights (416) 225-5221.

SWAN CYGNET TRANSCEIVER, mike, manuals, exc. condition, \$125. Heathkit HW-16 CW transceiver, good condition, \$50. Heathkit SB-500 2 meter transverter/power supply, \$75. Halcrafters HT-37 transmitter, \$95. K9ALD, Rt 5, Box 70, Mahomet, IL 61853. (217) 586-4958.

CUSTOM ENGRAVED EMBLEMS, & Enamelled Pins, your design, excellent quality, low prices, free booklet. A. T. PATCH CO, Box 882 Dept 19, Littleton, NH 03561. (603) 444-3423).

HAMLOG COMPUTER PROGRAMS. Full features, 17 modules, auto-logs, 7-band WAS/DXCC, Apple \$19.95, IBM or CP/M, KAYPRO, Tandy, C128 \$24.95. HR-KA1AWH, POB 2015, Peabody, MA 01960.

VHF-UHF-SHF. Lants SASE. West Coast VHFer, POB 685, Holbrook, AZ 86025.

COLLINS 30L-1, winged, extra 811A's \$595. 312 B-5 round \$195. (818) 349-2809.

CUSTOMIZED BROADCAST TV-FM STATION LISTS with distances, beam headings from your location. us tv, \$10. FM, \$5/state. Samples available. WEEDEN RADIO, 5833 Balsam Road, Madison WI 53711.

ICOM 761 HF Transceiver. Mint condition. \$1975.00. Phil (201) 460-1348.

CHASSIS & CABINET KITS. SASE. K3IWK, 5120 Harmony Grove Rd, Dover, PA 17315.

COMMODORE and AMIGA chips, parts, diagnostics, hard to find items. Low price on repairs. Heavy duty power supplies for the C64-\$28.00 plus UPS. Kasera Inc, 341 Route 306, Wesley Hills, NY 10952, 1-800-642-7634, 1-800-248-2983 (outside NY) or 914-362-3131.

HAMS-HELP. Handicapped Ham needs working HF rig with 10 meters, reasonably priced. Please help. Clem, KA3OUE. Call any time (412) 531-7443 EST.

CLOSED CIRCUIT TELEVISION EQUIPMENT. Discount pricing on cameras, monitors, sequential switches, pan tilt units, etc. Expert design assistance available. Dan Marshall, DETECTION DYNAMICS, 4700 Loyola Lane, #119, Austin, Texas 78723. (512) 345-8401.

WANTED: Collins KVM-2A, power supply, accessories, Heath Mohican, Apache, also Drake TR-4CW, E.F. Johnson Ranger II, Hammarlund SP-800. Very good to excellent shape only. Steve Struttman, KL7JT/1, (617) 494-9393, 27 Lillian, Sudbury, MA 01776.

CALL SIGN BADGES: Custom license plate holders, Personal, distinctive. Club discounts. SASE. WB3GND, Box 750, Clinton, MD 20735. (301) 248-7302.

ANALOG AND RF CONSULTING for the San Francisco Bay area. Commercial and military circuits and systems. James Long, Ph.D., N6VB (408) 733-8529.

RTTY JOURNAL—Now in our 36th year. Read about RTTY, AMTOR, PACKET, MOS'S, RTTY CONTESTING, RTTY DX and much more. Year's subscription to RTTY JOURNAL \$10.00, foreign slightly higher. Order from: RTTY JOURNAL, 9085 La Casita Ave., Fountain Valley, CA 92708.

CHRISTIAN AIRCRAFT MECHANIC wants family out of big city. Seeking farm, ranch, logging, other country opportunities. Call (512) 695-3006. N5MPW.

RUBBER STAMPS: 3 lines \$5.00 PPD. Send check or MO to G.L. Pierce, 5621 Birkdale Way, San Diego, CA 92117. SASE brings information.

PRESENTING

The K1FO 12 element 144 MHz YAGI

EME — TROPO — WEAK SIGNAL

MODEL FO-12-144



ELECTRICAL SPECIFICATIONS:

Gain	12.6 dBd
E-Plane beamwidth	2 X 17 deg
H-Plane beamwidth	2 X 18.5 deg
Siderobe attenuation	
1st E-Plane	-18 dB
1st H-Plane	-15 dB
FB ratio	22 dB
VSWR	1:1.1

MECHANICAL SPECIFICATIONS:

Length	17 ft 4 in
Wind survival	120+ MPH
Coax connector	N-type
Max. up to 2" diameter	
Element insulators	UV resistant black Delrin
Stainless steel hardware	(except U-bolts)
Elements	1/2" Aluminum rod

\$134.95

ALSO AVAILABLE

FO-16-220, FO-22-432, FO-25-432 and FO-33-432
STACKING FRAMES POWER DIVIDERS

We supply those hard to find parts for the home builder.
Delrin insulators \$12/100. Plated keepers \$4/100. Stainless \$10/100.
Add \$6 UPS. S&H for single or pair of Antennas.
58 West of Mississippi

PA residents add 6% state sales tax

RUTLAND ARRAYS

1703 Warren Street • New Cumberland, PA 17070
(717) 774-5298 7-10 P.M. EST

Dealer inquiries invited

VHF-UHF POWER DIVIDERS



RF power dividers provides the best way to feed in-phase 2 and 4 antenna arrays to maximize system gain and at the same time reduce losses to a minimum. Covering 144 thru 1296 MHz, this series of VHF/UHF power dividers are premier RF devices designed for a long service life with low SWR and broad operating bandwidth.

Extruded aluminum body with a durable enamel finish in addition to silicon sealing at connector flanges results in a ruggedized unit for all array installations. Available with N-type connectors only, these units are unconditionally guaranteed for 2 years.

MODEL	CONFIG.	PRICE
144-2P	(2 ports)	\$54.00
144-4P	(4 ports)	\$61.00
220-2P	(2 ports)	\$53.00
220-4P	(4 ports)	\$60.00
430-2P	(2 ports)	\$51.00
430-4P	(4 ports)	\$59.00
902-2P	(2 ports)	\$51.00
902-4P	(4 ports)	\$59.00
1296-2P	(2 ports)	\$52.00
1296-4P	(4 ports)	\$60.00

SHIPPING NOT INCLUDED

STRIDSBERG ENGINEERING, CO.

P.O. Box 7973 • Shreveport, LA 71107 • USA
Phone: (318) 865-0523

TEXPRO

snap-on-choke



ELIMINATES RF INTERFERENCE IN: TV sets, Radios, Hi-Fi, PA systems, Telephones, VCRs, Test equipment, Burglar and Fire alarms, Modems, Monitors, Computers, Radio and TV stations, etc.

EASY TO USE: fits over and snaps onto small, large and ribbon cables. No need to rewire connectors. Unique, split ferrite core design fits up to RG8U coax cables.

WORKS IN "COMMON MODE", filters current induced in the braid of shielded cables and ground wires!

Special ferrite material effective 0.5 - 200 MHz.

DOES NOT VOID EQUIPMENT WARRANTY

Available from your dealer or order direct from:

computeradio
Box 282, Pine Brook, NJ 07058
Tel: (201) 227-0712

Package of 4 chokes with inst. instructions
\$12.99
+ \$2.00 shipping

Send personal check with order, we ship same day First Class. 30-day money back warranty. Quantity discounts.

ELECTRON TUBES: Receiving, transmitting, microwave... all types available. Large stock. Next day delivery, most cases. DAILY ELECTRONICS, PO Box 5029, Compton, CA 90224. (213) 774-1255.

CUSTOM MADE EMBROIDERED PATCHES. Any size, shape, colors. Five patch minimum. Free sample, prices and ordering information. HEIN SPECIALTIES, Inc., Dept 301, 4202 N. Drake, Chicago, IL 60618.

RECONDITIONED TEST EQUIPMENT \$1.25 for catalog. Walter, 2697 Nickel, San Pablo, CA 94806.

COMING EVENTS

Activities — "Places to go . . ."

SPECIAL REQUEST TO ALL AMATEUR RADIO PUBLICITY COORDINATORS: PLEASE INDICATE IN YOUR ANNOUNCEMENTS WHETHER OR NOT YOUR HAMFEST LOCATION, CLASSES, EXAMS, MEETINGS, FLEA MARKETS, ETC. ARE WHEELCHAIR ACCESSIBLE. THIS INFORMATION WOULD BE GREATLY APPRECIATED BY OUR BROTHER/SISTER HAMS WITH LIMITED PHYSICAL ABILITY.

CONNECTICUT: November 13. Southcentral Conn. ARA's Hamfest, North Haven Park and Rec. Center, Linsley Street, North Haven. 9 AM to 3 PM. Talk in on 146.01/61. For information contact Brad Oestreicher, WA1TAS (203) 265-6478 from 7-10 PM. Wheelchair accessible.

TENNESSEE: October 29-30. The 10th annual Hamfest Chattanooga Amateur Radio and Computer Convention. South Hall of the Chattanooga-Hamilton County Convention and Trade Center. Free admission. All indoors. Convenient parking and lodging. Talk in on 146.19/79. For information write Hamfest Chattanooga, POB 3377, Chattanooga, TN 37404.

NEW HAMPSHIRE: October 8. The Hosstraders will hold their Fall Tailgate Swapfest at the fairgrounds on Route 125 in Kingston, NH. Admission \$5 per person, no extra charge for sellers or commercial types. Profits benefit Shriners' Hospitals. Our Spring 1988 donation was \$17,055.00! Questions SASE to Norm, WA1IVB, RFD Box 57, West Baldwin, ME 04091.

OPERATING EVENTS

"Things to do . . ."

OCTOBER 1: The Billy the Kid Chapter of Ten-Ten International will run a special event station, WM5Q, from the Whole Enchilada Fiesta in Las Cruces, NM. 1600 UTC to 2300 UTC. SSB, CW and Packet on VHF. Freq: 28.365 as well as other HF bands. For a certificate send \$1.00 and QSL to The Billy the Kid Chapter of Ten-Ten International, POB 274, Fairacres, NM 88033. For more information contact Gary Mayfield, KA0YOS at (505) 678-9623/days or (505) 523-8958/evenings or write QSL address.

OCTOBER 8-9: The Fort Smith (Arkansas) Area ARC will operate special event station W5ANR in conjunction with the 2nd annual Green Country Sorghum Festival to be held in Poteau, OK. 1400-2200Z Oct 9. Send QSL and SASE to FSAARC-W5ANR, Box 32, Fort Smith, AR 72902-0032.

OCTOBER 8-9: The Dalton ARC will operate a special event station from the Cotton Gin at the historic Praters Mill during the Fall Country Fair and Crafts Show. Contacts send SASE for a picture postcard of the Mill to DARCI, POB 143, Dalton, GA 30722-0143.

OCTOBER 16: The Chicago Amateur Radio Club, W9CAF, will hold "Old Timers Day" and Reunion of past members and friends, North Park Village, 5801 N. Pulaski, Chicago. 1 PM to 5 PM. For information call (312) 545-3622.

OCTOBER 15-16: The Raleigh ARS will operate W4DW from Mount Mitchell State Park, North Carolina, the highest point east of the Mississippi. 80-15 General phone bands and 10 Novice segment. For a special QSL, send QSL and SASE to W4DW Special Event, Raleigh ARS, Box 17124, Raleigh, NC 27609.

OCTOBER 21-23: The Quinipiac Council of the Boy Scouts will operate W1GB from 2359Z Oct 21 to 1800Z Oct 23 from the Battleship Massachusetts in Fall River, Mass. during the Jamboree-on-the-Air. Phone General portion 80-15m, Novice 10m, CW Mid 40 and 15m Novice bands. SASE for special QSL to Skip Paquette, KA1EAJ, 121 West Dayton Hill Rd, Wallingford, CT 06492.

October 30: Groves Mill, NJ. The GE Astro Space Division ARC will operate WB2JQR, 1400Z Oct 30 to 0200Z Oct 31, from the site of the first Martian landing to commemorate the 50th anniversary of Orson Wells' Mercury Theatre "War of the Worlds" radio broadcast depicting the invasion of Earth by spacecraft from the planet Mars. CW 3.535, 7.035, 7.135, 14.035, 21.135, 28.135 MHz. Phone 3.950, 7.235, 14.285, 21.355, 28.400 MHz. For QSL and certificate send QSL and 9x12 envelope to Alex Montare, KA2VLP, Astro Radio Club, MS 410-1B, GE Astro Space Division, POB 800, Princeton, NJ 08543-0800.

THE MIT UHF REPEATER ASSOCIATION and the MIT Radio Society offer monthly HAM EXAMS. All classes Novice to Extra. Wednesday, October 19, 7 PM, MIT Room 1-150, 77 Mass Avenue, Cambridge, MA. Reservations requested 2 days in advance. Contact Ron Hoffmann at (617) 484-2098. Exam fee \$4.50. Bring a copy of your current license (if any), two forms of picture ID, and a completed form 610 available from the FCC in Quincy, MA (617) 770-4023.

SYNTHESIZED SIGNAL GENERATOR



- Covers 100 MHz to 199.999 MHz in 1 kHz steps with thumbwheel dial
- Accuracy +/- 1 part per 10 million at all frequencies
- Internal FM adjustable from 0 to 100 kHz at a 1 kHz rate
- External FM input accepts tones or voice
- Spurs and noise at least 60 dB below carrier
- Output adjustable from 5-500 mV at 50 Ohms
- Operates on 12 Vdc @ 1/2 Amp
- Available for immediate delivery • \$429.95 delivered
- Add-on accessories available to extend freq range, add infinite resolution, AM, and a precision 120 dB attenuator
- Call or write for details • Phone in your order for fast COD shipment.

VANGUARD LABS

196-23 Jamaica Ave., Hollis, NY 11423
Phone: (718) 468-2720 Mon. thru Thu.

5-1000 MHZ PREAMPLIFIERS

	NF	G	P(1dB)	\$
WLA21m	3dB	13dB	8dBm	57
WLA22m	4	11	12	61
WLA23m	4	23	12	87
WLA24m	3	20	18	109

430/50MHZ CONVERTER

RCX431	.15µV	20dB	99
--------	-------	------	----



WILAM TECHNOLOGY, Div. of

WI-COMM ELECTRONICS INC.

P.O. Box 5174, MASSENA, N.Y. 13662
(315) 769-8334

AMATEUR RADIO MAIL LISTS

Self-stick 1x3 labels

- *** NEWLY LICENCED HAMS ***
- *** ALL NEW UPGRADES ***
- *** UPDATED EACH WEEK ***

Total List = 462,728 (ZIP sorted)
Price is 2.5 cents each (4-up Cheshire)

BUCKMASTER PUBLISHING

Mineral, Virginia 23117

703-894-5777

800-282-5628



ELMER'S NOTEBOOK

Tom McMullen, W1SL

Modems and RS-232

Let's take another look at modems and also at RS-232, which is associated with computers, modems, and packet radio.

What is a modem?

Modem is a contraction of the words MODulator/DEModulator, and it refers to a device that goes between a terminal (personal computer, keyboard, "dumb" terminal, etc.) and a radio transmitter/receiver. Before we get into the specifics of a modem's use with radios, let's look at another, earlier use of the device.

A simple communications circuit using data terminals and modems is shown in fig. 1. Modems are required because data pulses don't take kindly to cables that are longer than a few feet. The capacitance of such cables is placed effectively across the output of the terminals; this tends to distort the pulses and make them ineffective as signals between computers.

The modems overcome this limitation by translating the pulses into audio tones that aren't distorted by the long lines. Depending upon the transmission speed, the tone frequency changes according to the data pulse fed to the modem. When the pulse is at its low or zero state, the tone has

FIGURE 1

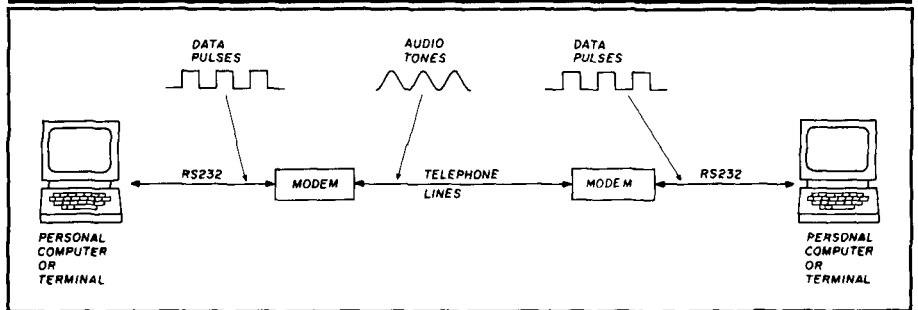

A data-communications circuit that uses modems and a telephone line. The modems create and decode tones that are within the normal voice band of frequencies acceptable by the telephone system.

one frequency; when the pulse changes to its high or 1 state, the frequency changes to something else. The difference between these two tones is called the "shift." There's nothing here that hasn't been done with RTTY, but computers do it faster.

This basic audio-frequency shift system is in common use at transmission rates up to perhaps 1200 bauds. At higher rates, another scheme called phase-shift keying is sometimes used. Here, the audio frequency does not shift, but the phase is shifted according to the state of the data pulse. Some advanced high-speed circuits use a mixture of both audio and phase-shift keying.

On a circuit that you might use to talk to another computer via your telephone lines, 300 or 1200 baud would be a common speed. Your terminal sends a stream of pulses to the

modem. The modem then translates them into a tone that changes frequency in step with the pulses and feeds them into the telephone system. The telephone network treats the tones as if they were a voice and sends them to the modem at the other end. The receiving modem performs a reverse translation, detecting the shift in the tone frequencies and turning it into pulses just like the ones your terminal generated. These pulses are sent to the other terminal and interpreted as letters, numbers, or commands.

There are a few simple "handshake" procedures in operation in a system like that in fig. 1. First, your terminal needs to know that the modem is at the other end of the line, and ready to operate. It does this by checking to see if there is continuity in a circuit that goes to the modem and back. In essence, it puts a dc voltage on a wire,

FIGURE 2

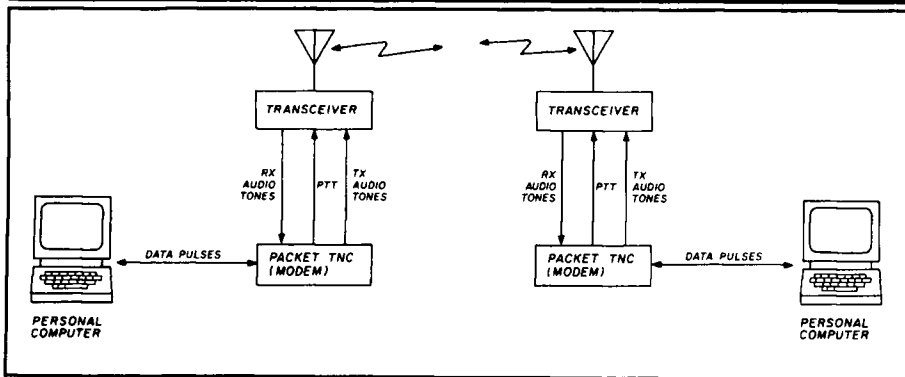

A packet-radio system. In addition to establishing rf communications between the two transceivers, the modems perform many encoding, decoding, and housekeeping chores.

telling the modem "I'm ready to send." This is known as a Data Terminal Ready (DTR) signal. The modem, in turn, places a voltage on a wire that says, "I'm ready to receive." In this case, it's a Data Set Ready (DSR) signal. Once this handshake has been accomplished, things are ready to go. But wait a minute! What if the telephone line isn't working? In another handshake procedure, the modem first looks for a carrier (audio tone of the correct frequency) from the modem at the other end of the line. If it's not there, it won't send the DSR signal back to the data terminal. If the tone is detected, the DSR signal is sent and you're ready to transmit data — assuming that the modem and terminal at the other end have completed their handshake and are ready too.

The "alphabet soup" here can get pretty thick: Data Terminal Equipment (DTE), Data Communications Equipment (DCE), Carrier Detect (CD), Ready To Send (RTS), Clear To Send (CTS), and on and on. You needn't know all these terms unless you want to get into data communications in a big way. Many of these signals and procedures are taken care of automatically by the equipment and programs, but knowledge of them is helpful if you're designing or troubleshooting a system.

The packet-radio modem

At first glance, it might seem that

you could simply remove the telephones and wire lines from the diagram in fig. 1, replace them with a transceiver and antennas, and have a packet-radio circuit as shown in fig. 2.

That's pretty close to the way it's done. The packet equipment, called a Terminal Node Controller (TNC), acts as a modem. It translates pulses into audio tones for transmitting, and does the reverse for receiving. However, the packet modem must have a lot more built-in "smarts". The modem does have some basic handshake systems, just like its land-line cousin, but the difference comes when you start using the packet rules called "protocols." For example, if you type the letter "H" on the keyboard in your land-line setup, it is translated into pulses (1's and 0's) by your terminal or computer. The modem then translates these pulses into tones and sends them out on the telephone line. At the other end, the modem translates the tones back to pulses; the terminal translates the pulses back to the letter H, and the letter appears on the screen. On a packet system, the TNC must first place the pulses that represent the letter H in a message form (the packet) that contains the correct address, along with information to check the accuracy of the message. The whole packet is then sent to the other station. The receiving station's TNC translates the tones into pulses and checks for errors. It then acknowledges receipt (if the message was received correctly), strips all

the address and sender's identification out of the packet, and sends the pulses on to the terminal, where a letter will be displayed on the screen. If the receiving station finds an error, it doesn't acknowledge receipt. The transmitting station tries until it either gets an answer or times out.

Your packet modem also includes software that lets you tell it what stations you do or don't want to communicate with, what to monitor or not to monitor, what speed (baud rate) to use, and which relay stations to use if needed. Some will let you switch bands and operating modes in response to a command from the keyboard. Most TNCs also have the ability to check their own health and calibration ability, letting you look at messages to find where an error occurs. Many TNCs can be configured to repeat packets between other stations by simply entering a command from your terminal.

Basically, a TNC is a microprocessor-controlled modem with a tremendous amount of built-in software, making operation easier and more enjoyable. This takes you far beyond just keying a transmitter and listening for a reply. You could use a less sophisticated modem by building most of these features into the data terminal or computer software; some packet equipment/software suppliers have done just that. The end result is the same and the way to go is a matter of choice.

What's RS-232?

First, let me point out that the plug or connector on the end of a cable or a piece of equipment isn't an RS-232 connector in the true sense of the word. The connectors most commonly called RS-232 are actually DB-25 connectors, although other types have also been misnamed.

RS-232 is a set of standards for data signal transmission. Since the latest version is "C," the standard is referred to as "RS-232C." Basically, the standard defines the voltage levels that must appear on certain lines, what those lines are called, what lines are

the 230A Linear Amplifier

Something new in a high power, high quality, HF linear amplifier

The Advanced Radio Devices (ARD) 230 series represents a new generation in high power linear amplifiers. Utilizing microprocessor control, the 230 provides full "HANDS OFF" automatic operation.

- » Full power is always available
- » Completely automatic
- » Microprocessor controlled tuning
- » No time limit for QRO
- » Full QSK
- » LCD metering
- » VSWR readout
- » Microprocessor controlled protection
- » Automatic tube monitoring
- » Easy modification for 10 meters
- » RS-232C output for external control
- » Modular construction
- » Export/commercial versions available
- » Remote antenna switching control
- » Remote control up to 250 feet away
- » UPS shippable (3 boxes)

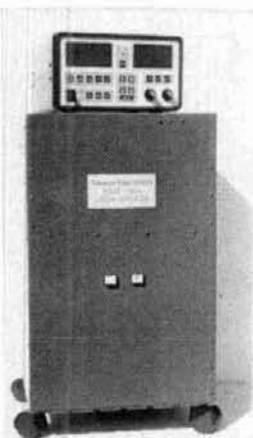

Frequency: all amateur (1.8 - 21 MHz)
Drive: 50 - 80 watts for full output
Output: 1500 watts PEP
Input Impedance: 50 ohms unbalanced
Input VSWR: 1.5:1 (higher on WARC)
Output Impedance: 50 ohms unbalanced
Harmonic Supp: greater than -45 dB
Intermod prods: more than -35 dB down
Duty: CCS (cont. commercial svc.)
Tubes: EIMAC 3CX800A7 (two)
ALC: 0 to -6 VDC
Output Configuration: Pi-L
AC Power: 230 VAC at 20A
Size (WHD in inches) & Weight
Microcontroller: 10x6x9 at 5 lbs
RF/AC unit: 14x22x13 at 86 lbs



Orders: 800-368-3270

Local & tech info
703-938-3350

Electronic Equipment Bank

516H Mill St. NE, Vienna, VA 22180

(just minutes from Washington, DC)

✓ 187

A RACE ON THE EDGE OF TIME

Radar — The Decisive Weapon of WW II

by David E. Fisher

A Race On The Edge Of Time reads like a thriller but is based upon painstaking and comprehensive research by the author. In fact, Fisher argues rather convincingly that radar was the crucial factor that allowed the allies to win the war and that radar has played the same important role in our current military and political environment. Filled with fascinating twists and turns of history that could have changed the war's outcome, anecdotes about the personalities involved in the development of radar and other military insights. Also includes radar development post WW II and how it will influence future battles. Illustrated with rare vintage photographs and diagrams.

☐ MH-21088

Hardbound \$19.95

Please enclose \$3.50 shipping and handling.

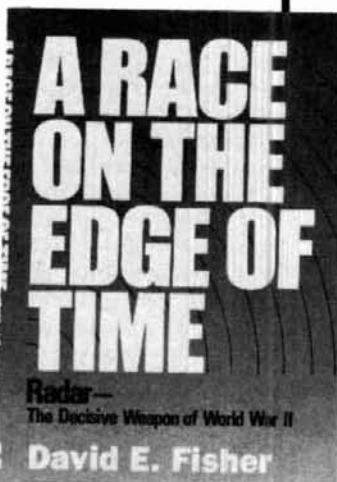

INTERNATIONAL MONTHLY MAGAZINE BY AND FOR ACTIVE RADIOAMATEURS

Radiosporting

THIS IS IT! - FOR BIG GUNS & LITTLE PISTOLS

A magazine dedicated to quality and sportsmanship in amateur radio operating. Fresh, timely, practical and down to earth reading for little pistols and big guns. Written by the world's best in their fields: ON4UN, SMØAGD, LZ2CJ, VE3BMV, KH6BZF, DJ9ZB, ZS6BRZ, W1WY, N2SS, K7GCO, K4ZN, W4GF, VE3JTG, WB4ZNH, WB9TBU, KQ2M, NS6X, W2XQ, W3FG, KA3B, K1PLR, N3IK, N7CKD, VE3XN, ABØX, JE1CKA and others.

Includes DX News, QSL Info, 160m, 80m, 10m, 6m columns, DXpeditioning, Propagation, Awards, Contest Rules and Results, Traffic - Emergency, FCC News, New Products, Antennas, Technical News and articles, Equipment Reviews and Modifications, Computer Programs, Radio Funnies, Club Life, SWL, RTTY, VHF/UHF, Mail Box, Classified Ads and much more in a magazine format with the speed of a bulletin. RADIOSPORTING sponsors DX Centurion Award, Contest Hall of Fame and World Radio Championship contest.

"Your publication is superb! Keep it up!" Joe Reisert, W1JR

"Your W2PV articles are priceless. Your magazine is super!"
Rush Drake, W7RM

"Let me congratulate you on a very impressive magazine. Just what I've been looking for as a DXer and Contester!" Dick Moen, N7RO

"RADIOSPORTING, once received, cannot be tossed aside until it is read from cover to cover. Then reviewed again and again."
Chas Browning, W4PKA

"I take every ham magazine and can say without reservation that RADIOSPORTING is the first one read each month."
Joe Rudi, NK7U, "Oakland A's"

Subscription rates: 1 year USA \$18, Canada CDN\$28, Overseas US\$25; 2 years \$33, \$50, \$44 respectively. Single issue \$2.

USA First Class Mail add \$10/year, DX Air Mail add \$20/year.

TRY US! SUBSCRIBE OR SEND \$1 FOR YOUR SAMPLE COPY. VISA, MASTERCARD accepted.

RADIOSPORTING Magazine

PO Box 282, Pine Brook, NJ 07058, USA Tel. (201) 227-0712

ham
radio magazine BOOKSTORE
GREENVILLE, NH 03048 VISA MC 603-878-1441

FIGURE 3

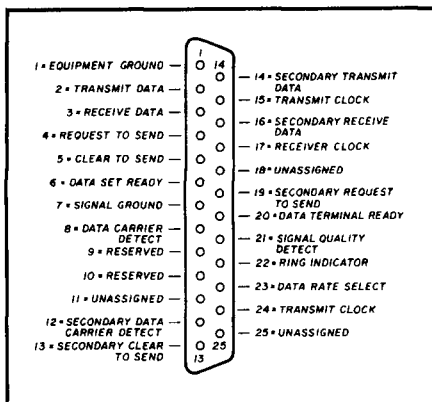

A common connector for communications equipment is a DB-25 type, shown here with pins and RS-232C signals identified.

necessary to provide data transfer and handshaking, and the amount of current the circuit can carry. In a circuit that meets these criteria, you can short any of the wires together and nothing will blow out or burn up — an important safety consideration. **Table 1** shows these signal names and values; **figure 3** shows a DB-25 connector with the signals and pins identified. It's important to note that not all manufacturers (and designers) have followed these standards to the letter. You may find some equipment that uses certain lines for purposes not covered in the standards, or that omits some signals or lines. The majority of computers and interfaces do, however, follow the standard well enough that most RS-232C devices will work with them.

Why is this important? Many TNCs available today use a cable (called an RS-232 cable) to connect between the computer and the TNC. If you have to troubleshoot the system, and suspect the cable, it's good to know what to look for. There are "breakout" boxes available that can be placed in series with cables such as these to see what's happening. They have several light-emitting diodes (LEDs) that are on or off, indicating the states of the circuits they are monitoring.

Some TNCs are designed to fit into a vacant slot in an IBM PC or compatible. These need no cable — they work from the interface bus in the computer. Their only connection to the

TABLE 1

The signals and voltage levels as described in the RS-232C standard. Not all of these are used in every piece of equipment.

Pin	RS-232C Name	Function and Description
1	AA	Protective ground or Equipment ground
2	BA	Transmitted Data: Mark = -3 to -25 volts; Space = +3 to +25 volts
3	BB	Received Data: Mark = -5 to -15 volts; Space = +5 to +15 volts
4	CA	Request To Send: Terminal asserts* this pin when it has data to transmit. It waits for Clear to Send before sending.
5	CB	Clear To Send: The Data Set asserts this in response to DTE if the set is ready.
6	CC	Data Set Ready: The modem (Data Set) asserts this line in response to DTR (pin 20) to show that it is on and operational.
7	AB	Signal Ground or Common Return. This can be connected to pin 1, but doing so may cause noise or ground-loop problems in some cases.
8	CF	Receive Signal Detector or Data Carrier Detect: The modem asserts this line when a correct carrier tone is detected.
9	Reserved	
10	Reserved	
11	Unassigned	
12	SCF	Secondary Receive Signal Detector: Same as pin 8, but not used with most common modems.
13	SCB	Secondary Clear to Send: Same as pin 5, but not used with most common modems.
14	SBA	Secondary Transmit Data: Same as pin 2, but not used with most common modems.
15	DB	Transmit Signal Clock: Used for timing signals between the modem and the terminal.
16	SBB	Secondary Receive Data: Same as pin 3, but not used with most common modems.
17	DD	Receiver Clock: Used for timing signals between the modem and the terminal.
18	Unassigned	
19	SCA	Secondary Request To Send: Same as pin 4, but not used with most common modems.
20	CD	Data Terminal Ready: Used by the terminal to indicate that it is on and ready to send or receive.
21	CG	Signal Quality Detector: The modem asserts this line when the received signal meets specified criteria for quality (strength, frequency, lack of noise, etc.).
22	CE	Ring Indicator: This line is asserted when the modem detects ringing voltage pulses on the telephone line.
23	CH(CI)	Data Signal Rate Selector: Used by the Terminal and/or the modem to select a baud rate and inform the other equipment of that rate.
24	DA	Transmitter Signal Element Timing: Similar to pin 15, but used when the timing comes from a source other than the main modem.
25	Unassigned	

*Asserts is a term meaning "makes active." A line can be asserted by placing a + or - voltage on it, or by pulling it from some voltage to zero, depending on the type of logic convention in use.

outside world is to the microphone, PTT, and receiver audio in your transceiver.

In summary, a modem is an interface between a computer or terminal and either the radio world or telephone systems. It provides both outgoing and

incoming translations to make data communications compatible with voice-type circuits. In addition, the packet-radio modem contains software that covers many operating procedures that Amateurs need for successful communications via

packet, ASCII, RTTY, or AMTOR over hf or VHF radio.

If you'd like to read more on this subject, try:

Get*****CONNECTED to Packet Radio**, by Jim Grubbs, K9EI. (An introduction to packet radio for the newcomer. Tells how and why, names some equipment and how to use it.)

Understanding Data Communications, by the Texas Instruments Learning Center and available from Radio Shack stores as part number 62-1839. (An excellent book on many phases of data communications. Technical enough for the experienced Amateur, but not so deep as to be impossible for the beginner.)



Article N

HAM RADIO

PACKET

YOUR GATEWAY TO PACKET RADIO

by Stan Horzepa, WA1LOU

Here is the complete beginner's guide to Packet Radio written by ARRL Packet expert, WA1LOU. Beginners will find the complete easy-to-understand explanations eliminate many of the frustrating aspects of packet operation. Full of helpful hints and tips that come from thousands of hours of on-the-air experience. Keep from re-inventing the wheel — learn from an expert. 208 pages © 1987.

□AR-PKT Softbound \$9.95

GET*CONNECTED TO PACKET RADIO**

by Jim Grubbs K9EI

This is your Packet Radio Handbook! Over 17 chapters cover every aspect of packet operation from: choosing a packet controller (TNC), an explanation of packet protocol, packet accessories and a primer on how to make your first packet contact to how packet bulletin boards (BBS) operate, plus more! Also has complete appendix with more information on: definitions, bibliography, frequencies, organizations, GLB/TAPR cross reference guide. Xerox 820 info, other publications, suppliers and WRLI commands. Written in an easy-to-read, informal manner, this handbook is must reading for all packet users. © 1986 208 pages — 1st edition.

□JG-PR Softbound \$12.95

ARRL COMPUTER NETWORKING CONFERENCES 1-4

Pioneer Papers on Packet Radio 1981-1985

These collections of Packet Radio papers should be in every Packet enthusiasts shack! Written during the formative years of Packet development, these papers (too numerous to mention them all) cover: theory, practical applications, protocols, software and hardware subjects. You also get a complete up-to-date collection of all published "Gateway", the ARRL Packet Radio newsletter. As big as the ARRL HANDBOOK. © 1985 over 1000 pages.

□AR-CNC Softbound \$17.95

5th COMPUTER NETWORKING CONFERENCE PAPERS ©1986

□AR-CNC5 Softbound \$9.95

6th ARRL COMPUTER NETWORKING CONFERENCE August 1987

Collection of papers given in August 1987 at Redondo Beach.

□AR-CNC6 Softbound \$9.95

THE PACKET RADIO HANDBOOK

by Jonathan Mayo, KR3T

Packet radio combines the power of today's microcomputer with worldwide digital communications. Newcomers will find this book to be full of helpful tips, tricks and information that will help get them on Packet as quickly as possible. Providing you first with packet basics, this book progresses through the inner workings and operational aspects of packet to a look at future technology still in developmental stages. Also includes: using bulletin boards, traffic handling on packet, modulation methods and networking principles, protocols (both AX.25 and VADCG) and a thorough discussion of the various TNCs and accessories available. © 1987 1st Edition 218 pages.

□T-2722 Softbound \$14.95

Please enclose \$3.50 shipping and handling.

**HAM RADIO'S BOOKSTORE
GREENVILLE, NH 03048
(603) 878-1441**

Receive Only	Freq. Range (MHz)	N.F. (dB)	Gain (dB)	1 dB Comp. (dBm)	Device Type	Price
P28VD	28-30	< 1.1	15	0	DGFET	\$29.95
P50VD	50-54	< 1.3	15	0	DGFET	\$29.95
P50VDG	50-54	< 0.5	24	+12	GaAsFET	\$79.95
P144VD	144-148	< 1.5	15	0	DGFET	\$29.95
P144VDA	144-148	< 1.0	15	0	DGFET	\$37.95
P144VDG	144-148	< 0.5	24	+12	GaAsFET	\$79.95
P220VD	220-225	< 1.8	15	0	DGFET	\$29.95
P220VDA	220-225	< 1.2	15	0	DGFET	\$37.95
P220VDG	220-225	< 0.5	20	+12	GaAsFET	\$79.95
P432VD	420-450	< 1.8	15	-20	Bipolar	\$32.95
P432VDA	420-450	< 1.1	17	-20	Bipolar	\$49.95
P432VDG	420-450	< 0.5	16	+12	GaAsFET	\$79.95

Inline (rf switched)

GP28VD	28-30	< 1.2	15	0	DGFET	\$59.95
SP50VD	50-54	< 1.4	15	0	DGFET	\$59.95
SP50VDG	50-54	< 0.55	24	+12	GaAsFET	\$109.95
SP144VD	144-148	< 1.6	15	0	DGFET	\$59.95
SP144VDA	144-148	< 1.1	15	0	DGFET	\$67.95
SP144VDG	144-148	< 0.55	24	+12	GaAsFET	\$109.95
SP220VD	220-225	< 1.9	15	0	DGFET	\$59.95
SP220VDA	220-225	< 1.3	15	0	DGFET	\$67.95
SP220VDG	220-225	< 0.55	20	+12	GaAsFET	\$109.95
SP432VD	420-450	< 1.9	15	-20	Bipolar	\$62.95
SP432VDA	420-450	< 1.2	17	-20	Bipolar	\$79.95
SP432VDG	420-450	< 0.55	16	+12	GaAsFET	\$109.95

Every preamplifier is precision aligned on ARR's Hewlett Packard HP8970A/HP346A state-of-the-art noise figure meter. RX only preamplifiers are for receive applications only. Inline preamplifiers are rf switched (for use with transceivers) and handle 25 watts transmitter power. Mount inline preamplifiers between transceiver and power amplifier for high power applications. Other amateur, commercial and special preamplifiers available in the 1-1000 MHz range. Please include \$2 shipping in U.S. and Canada. Connecticut residents add 7-1/2% sales tax. C.O.D. orders add \$2. Air mail to foreign countries add 10%. Order your ARR Rx only or inline preamplifier today and start hearing like never before!

Advanced Receiver Research

Box 1242 • Burlington, CT 06013 • 203 582-9409



BATTERIES

Nickel-Cadmium, Alkaline, Lithium, Etc. INDUSTRIAL QUALITY

YOU NEED BATTERIES? WE'VE GOT BATTERIES!

CALL US FOR FREE CATALOG

✓ 190



E.H.YOST & CO.
EVERETT H. YOST KB9X1
7344 TETIVA RD.
SAUK CITY, WI 53583
ASK FOR FREE CATALOG
(608) 643-3194

THE PSDTRON
COMPACT ANTENNAS FROM 160-10 METERS

NO TUNERS!
NO RADIALS!
NO RESISTORS!
NO COMPROMISE!
THREE EXCELLENT REVIEWS JUST DON'T HAPPEN BY CHANCE.
CALL US FOR A FREE CATALOGUE.

*See review in Oct 73, 1984
*Sept 73, 1985 *March 73, 1986

NEW LOCATION!
BILAL COMPANY
137 Manchester Dr.
Florissant, Colo. 80816
(719) 687-0650

✓ 191

1989 CALLBOOKS



THE QSL BOOK!

Continuing a 68 year tradition, we bring you three new Callbooks for 1989, bigger and better than ever!

The North American Callbook lists the calls, names, and address information for 495,000 licensed radio amateurs in all countries of North America, from Canada to Panama including Greenland, Bermuda, and the Caribbean Islands plus Hawaii and the U.S. possessions.

The International Callbook lists 500,000 licensed radio amateurs in countries outside North America. Its coverage includes South America, Europe, Africa, Asia, and the Pacific area (exclusive of Hawaii and the U.S. possessions).

The 1989 Callbook Supplement is a new idea in Callbook updates, listing the activity in both the North American and International Callbooks. Published June 1, 1989, this combined Supplement will include thousands of new licenses, address changes, and call sign changes for the preceding 6 months.

Every active amateur needs the Callbook! The 1989 Callbooks will be published December 1, 1988. Order early to avoid disappointment (last year's Callbooks sold out). See your dealer now or order directly from the publisher.

- North American Callbook
incl. shipping within USA \$29.00
incl. shipping to foreign countries 35.00
- International Callbook
incl. shipping within USA \$32.00
incl. shipping to foreign countries 38.00
- Callbook Supplement, published June 1st
incl. shipping within USA \$13.00
incl. shipping to foreign countries 14.00

SPECIAL OFFER

- Both N.A. & International Callbooks
incl. shipping within USA \$58.00
incl. shipping to foreign countries 68.00

Illinois residents please add 6 1/2% tax.
All payments must be in U.S. funds.

RADIO AMATEUR
callbook INC.

Dept. F
925 Sherwood Dr., Box 247
Lake Bluff, IL 60044, USA

Tel: (312) 222-6600



ADVERTISER'S INDEX AND READER SERVICE NUMBERS

Listed below are the page and reader service number for each advertiser in this issue. For more information on their products, select the appropriate reader service number make a check mark in the space provided. Mail this form to *ham radio* Reader Service, I.C.A., P.O. Box 2558, Woburn, MA 01801.

Name _____ Call _____

Address _____

City _____ State _____ Zip _____

*Please contact this advertiser directly.

Please use before November 30, 1988.

READER SERVICE #	PAGE #	READER SERVICE #	PAGE #
127 - Ace Communications, IN	46	153 - Maggiore Electronic Laboratory	81
145 - Advanced Millwave Laboratories, Inc.	68	147 - Magnaphase Industries, Inc.	69
189 - Advanced Receiver Research	117	161 - Glen Martin Engineering, Inc.	87
108 - AEA	51	113 - Master Publishing	22
142 - Alinco Electronics, Inc.	67	146 - Michigan Radio	69
154 - All Electronics Corp	83	103 - MFJ Enterprises	7
129 - Alpha Delta Communications, Inc.	48	143 - Micro Control Specialties	68
148 - AMC Sales, Inc.	69	165 - Mission Communications	88
171 - AMSAT	98	193 - Missouri Radio Center	119
169 - Antennas West	95, 101, 108	167 - Monitoring Times	94
114 - Antique Radio Classified	22	173 - Motron Electronics	99
158 - ARRL	84	170 - NCG	98
177 - ARRL	103	* Nema! Electronics	70
Associated Radio	108	178 - Nuts & Volts	104
118 - Astron Corp	28	112 - Wm. M. Nye Co. Inc	21
164 - ATFAB Computers and Electronics	88	194 - OPTOelectronics	120
* Barker & Williamson	12	138 - Pac-Comm Packet Radio Systems, Inc.	62
* Barry Electronics	95	105 - P.C. Electronics	12
191 - Bilal Company	117	192 - Radio Amateur Callbook	118
* Buckmaster Publishing	68	109 - Radio Shack	19
168 - Buckmaster Publishing	95	188 - Radiosporting	115
186 - Buckmaster Publishing	112	110 - The Radio Works	20
125 - Burghardt Amateur Center	46	166 - Ramsey Electronics, Inc.	92
* Butternut Electronics	25	111 - The RF Connection	20
119 - C&S Sales	32	133 - Robot Research Inc	54
* Caddell Coil Corp	87	181 - Rutland Arrays	112
176 - Certified Communications	101	182 - Stridsburg Engineering Co.	112
149 - CIE	69	132 - STV/OnSat	54
137 - Coaxial Dynamics, Inc	62	115 - Synthetic Textiles, Inc.	22
121 - Command Technologies, Inc.	33	159 - Tel-Com	87
130 - Communication Concepts, Inc	48	155 - Thermax Corporation	83
152 - Communications Specialists	75	* Tropical Hamboree	58
183 - Computradio	112	157 - Universal Radio	84
102 - Connect Systems Inc	1	184 - Vanguard Labs	112
179 - Crystek Crystals	105	106 - Varian EIMAC	13
160 - Cygnus-Quasar Books	87	156 - VHF Communications	83
122 - Datacom, International	37	174 - W9INN Antennas	99
128 - DMO Technology	33	163 - Western Electronics	88
151 - Doug Hall Electronics	70	144 - Wacom Products, Inc.	68
172 - Down East Microwave	99	185 - Wi-Comm Electronics Inc	112
134 - EDGE, Inc	59	135 - Yaesu USA	60, 61
117 - Electronic Equipment Bank	25	195 - Yaesu USA	CIII
126 - Electronic Equipment Bank	46	190 - E.H. Yost Co.	117
140 - Electronic Equipment Bank	64		
150 - Electronic Equipment Bank	70		
182 - Electronic Equipment Bank	87		
187 - Electronic Equipment Bank	115		
* Engineering Consulting	88		
* Falcon Communications	108		
* Geographical Hamfest	98		
124 - HAL Communications Corp.	45		
123 - Hal-Tronix	37		
131 - Ham Radio Outlet	52, 53		
* Ham Radio's Bookstore	48, 88, 90, 94, 95, 115		
* The Ham Station	104		
* Hamtronics, NY	107		
* Hamtronics, PA	20		
* Heath Company	16		
101 - ICOM America, Inc.	CII		
* International Crystal Mfg Co, Inc.	25		
139 - Jan Crystals	64		
104 - JDR Instruments	8		
175 - Jun's Electronics	99		
107 - Kantronics	14, 15		
116 - KComm, The Ham Store	22		
* Kenwood USA Corporation	2, 5, CIV		
136 - Madison Electronics Supply	62		

PRODUCT REVIEW/NEW PRODUCTS

308 - AC3L Software	102
316 - Ace Communications, Monitor Division	106
309 - Action Software	41
302 - Alinco Electronics, Inc.	42
307 - AVCOM of Virginia, Inc	102
305 - CES	102
* Engineering Consulting	41, 106
312 - Gilfer Shortwave	41
310 - Greenlight Software Development	41
* Hamtronics, NY	41
303 - ICOM America, Inc	42
301 - Kantronics	42
311 - Kantronics	41
* Kenwood USA Corporation	42, 102
304 - Metacom Software	42
314 - MFJ Enterprises	105
* Motorola Semiconductors Center	106
306 - MoTron Electronics	102
313 - ORZ Industries	102
315 - Universal Shortwave Radio	106

**ORDER
TOLL-FREE
-800-821-7323**

**Dependable Service
At The Right Price . . . Everytime**

MasterCard—VISA—Discover

Missouri Radio Center

KANTRONICS • KENWOOD • LARSEN • MFJ • MIRAGE/KLM • NYE VIKING • RF CONCEPTS • UNIDEN • YAESU

KENWOOD



TS-940 "DX-CELLENCE"

- All Band, All Mode Transceiver
- Direct Keyboard Entry
- Engineered for the DX-Minded and Contesting Ham
- Its Got It All!

YAESU



FT-767GX HF/VHF/UHF BASE STATION

- Add Optional 6m, 2m & 70cm Modules
- Dual VFO's
- Full CW Break-in
- Lots More Features

ICOM



IC-761 HF "PERFORMANCE" RIG

- 160-10M/General Coverage Receiver
- Built-in Power Supply and Automatic Antenna Tuner
- SSB, CW, FM, AM, RTTY
- QSK to 60 WPM

uniden



HR-2510

- Mobile 10 Meter Transceiver
 - SSB/AM/FM/CW
 - 25 Watts PEP
 - Computer Controlled Operation
- SALE PRICED**

KENWOOD



TS-140S AFFORDABLE DX-ing!

- HF Transceiver With General Coverage Receiver
- All HF Amateur Bands
- 100 W Output
- Compact, Lots of Features

YAESU



FT-736R VHF-UHF BASE STATION

- SSB, CW, FM on 2 Meters and 70 cm
- Optional 50 MHz, 220 MHz or 1.2 GHz
- 25 Watts Output on 2 Meters, 220 and 70 cm
- 10 Watts Output on 6 Meters and 1.2 GHz
- 100 Memories

ICOM



IC-781 NEWEST SUPER RIG

- 5 Function Display Screen
- Built-in Spectrum Scope
- 150 Watts Output
- Built-in PS and AT

rfconcepts

2m and 220 MHz Amplifiers
GaAsFET Receive Pre-Amps
and High SWR Shutdown
Protection

MODEL	144 MHz	220 MHz	SALE PRICE
2-23	2 in/30 out		
2-217	2 in/170 out		
2-117	10 in/170 out		
3-22	2 in/20 out		
2-211	2 in/110 out		
3-312	30 in/120 out		
		CALL	

KENWOOD



TM-721A DELUXE FM DUAL BANDER

- 2 Meters (138.000-173.995 MHz) 70 cm (438.000-449.995 MHz) Receiver Range
- 45 Watts on 2 Meters
- 35 Watts on 70 cm
- 30 Memory Channels

YAESU



FT-212RH

THE "ANSWERING MACHINE" MOBILE

- Rx: 138-174 MHz
- Tx: 144-148 MHz
- 45W Output
- Digital Voice Recorder
- FT-712 RH for 70cm

ICOM



IC-900 SIX BANDS IN ONE MOBILE

- Remote Controller, Interface A Unit, Interface B Unit, Speaker, Mic and Cables
 - Six Band Units to Choose
 - 10 Memories Per Band
 - Programmable Band Scan
 - Fiber Optic Technology
- SALE**

ASTRON



- RS7A . . . \$50
- RS12A . . . \$72
- RS20A . . . \$92
- RS20M . . \$109
- VS20M . . \$129
- RS35A . . \$139
- RS35M . . \$155
- VS35M . . \$175
- RS50A . . \$199
- RS50M . . \$225
- RM50M . . \$245
- VS50M . . \$239

KENWOOD

**TH-25AT
POCKET-SIZED
AND POWERFUL**



- Frequency Coverage: 141-163 MHz (Rx), 144-148 MHz (Tx)
- Front Panel DTMF Pad
- 5 Watts Output
- 14 Memories
- TH-45AT Available for 440 MHz

YAESU



FT23/73R

- Super "Mini" HT's
- Zinc-Aluminum Alloy Case
- 10 Memories
- 140-164 MHz, 440-450 MHz
- 2W Battery Pack or Optional 5W Pack

ICOM



**IC-μ2AT
IC-μ4AT**

MICRO HT'S
FOR 2M, 440

- Pocket Size HT Fun
- Ten Memories
- LCD Readout
- Wideband Coverage
- Up to 3 Watts Output
- 32 Built-in Subaudible Tones

Kantronics



KAM

- Packet, WEFAX, ASCII, AMTOR, RTTY, CW
 - Simultaneous Operation on HF and VHF
 - Personal Packet Mailbox™
- SALE PRICED**

102 N.W. Business Park Lane Kansas City, MO 64150
Call For Best Trade-In Deal

Call Toll Free—9am - 6pm Mon.-Fri. 9am - 2pm Sat.
In Missouri Call—816-741-8118

MOST ORDERS SHIPPED SAME DAY

• DAIWA • HUSTLER

HYGAIN • ICOM •

NEW

OPTOELECTRONICS INC.

FREQUENCY COUNTERS TO 2.4 GHz

POCKET SIZE

SIZE: 4" H x 3.5" W x 1" D
MADE IN USA

#TA-100S

8 LED DIGITS • 2 GATE TIMES
ALUMINUM CABINET
INTERNAL NI-CAD BATTERIES INCLUDED
AC ADAPTER/CHARGER INCLUDED

EXCELLENT SENSITIVITY
& ACCURACY

AC-DC • PORTABLE
OPERATION



Small enough to fit into a shirt pocket, our new 1.3 GHz and 2.4 GHz, 8 digit frequency counters are not toys! They can actually out perform units many times their size and price! Included are rechargeable Ni-Cad batteries installed inside the unit for hours of portable, cordless operation. The batteries are easily recharged using the AC adapter/charger supplied with the unit.

The excellent sensitivity of the 1300H/A makes it ideal for use with the telescoping RF pick-up antenna; accurately and easily measure transmit frequencies from handheld, fixed, or mobile radios such as: Police, firefighters, Ham, taxi, car telephone, aircraft, marine, etc. May be used for counter surveillance, locating hidden "bug" transmitters. Use with grid dip oscillator when designing and tuning antennas. May be used with a probe for measuring clock frequencies in computers, various digital circuitry or oscillators. Can be built into transmitters, signal generators and other devices to accurately monitor frequency.

The size, price and performance of these new instruments make them indispensable for technicians, engineers, schools, Hams, CBers, electronic hobbyists, short wave listeners, law enforcement personnel and many others.

STOCK NO:

- #1300H/A Model 1300H/A 1-1300 MHz counter with preamp, sensitivity, < 1mV, 27MHz to 450MHz includes Ni-Cad batteries and AC adapter \$169.95
- #2400H Model 2400H 10-2400 MHz microwave counter includes Ni-Cad batteries and AC adapter \$299.95
- #CCA Model CCA counter/counter, for debugging, ultra sensitive, < 50 micro volts at 150MHz! 1-600 MHz with adjustable threshold, RF indicator LED. Includes Ni-Cad batteries and AC adapter \$299.95

ACCESSORIES:

- #TA-100S Telescoping RF pick-up antenna with BNC connector \$12.00
- #P-100 Probe, direct connection 50 ohm, BNC connector \$20.00
- #CC-12 Carrying case, gray vinyl with zipper opening. Will hold a counter and #TA-1000S antenna. \$10.00

✓ 194



ORDER FACTORY DIRECT
FLA (305) 771-2050 **1-800-327-5912**



AVAILABLE NOW!

OPTOELECTRONICS INC.

5821 N.E. 14th Avenue
Ft. Lauderdale, Florida 33334

Orders to US and Canada add 5% of total (\$2 min, \$10 max)
Florida residents add 6% sales tax. COD fee \$2.
Foreign orders add 15%

Introducing the only mobiles that double as answering machines.

220 MHz
Model FT-312RM
Now Available

Now you can stay in touch—even when you're away from your radio.

With Yaesu's 2-meter FT-212RH and 70-cm FT-712RH, an optional, internal digital voice recorder serves as a convenient answering machine for you and your friends. And that's just the beginning!

High performance mobiles. The FT-212RH features wideband receive coverage of 140-174 MHz (144-148 MHz Tx), while the FT-712RH covers 430-450 MHz. An oversize amber display includes an innovative photo-sensor which increases the display brightness during the day. The function buttons are arranged in a chromatic musical scale—ideal for visually-impaired operators. You get 45 watts output on 2 meters, 35 watts on 70 cm.

An autodialer DTMF microphone with 10 memories, each ready to store telephone numbers up to 22 digits long.

And, like our FT-211RH Series mobiles, you'll enjoy simple controls, yet sophisticated microprocessor-based flexibility. Including 18 memories that store frequency, offset, PL tone, and PL mode (PL encoder built in, decoder optional). Band or memory scanning. Offset tuning from any memory channel. Memory channel lockout for scanning. High-low power switch.

All in an amazingly small package, shown actual size below.

Digital voice recorder option. Only Yaesu brings you the advanced technology found in our digital voice recorder option.

You can store messages or your call sign—in your own voice, not a synthesized replica—or give your friends a private code for leaving messages on your radio. All they need is a DTMF microphone! Then you can play back your messages either in-person, or remotely by using another radio with a DTMF microphone. And you've always got security because you can command your radio to respond only to in-person playback requests.

Visit your Yaesu dealer today. And test drive Yaesu's FT-212RH and FT-712RH mobiles. The only radios with the power to keep you in touch. Always.

YAESU

✓ 195



Yaesu USA 17210 Edwards Road, Cerritos, CA 90701 (213) 404-2700. Repair Service: (213) 404-4884. Parts: (213) 404-4847.

Prices and specifications subject to change without notice. PL is a registered trademark of Motorola, Inc.

KENWOOD

...pacesetter in Amateur Radio

**NOW
70 cm**

All Mode Mobility!

TR-751A/851A Compact all mode transceivers

It's the "New Sound" on the 2 meter band—Kenwood's TR-751A! Automatic mode selection, versatile scanning functions, illuminated multi-function LCD and status lights all contribute to the rig's ease-of-operation. All this and more in a compact package for VHF stations on-the-go!

Automatic mode selection, plus LSB
144.0 144.1 144.5 145.8 146.0 148.0 MHz

CW	USB	FM	USB	FM
----	-----	----	-----	----

- Optional front panel-selectable 38-tone CTCSS encoder
- Frequency range 142-149 MHz (modifiable to cover 141-151 MHz)
- High performance receiver with GaAs FET front end
- VS-1 voice synthesizer option

- 25 watts high/5 watts adjustable low
- Programmable scanning—memory, band, or mode scan with "COM" channel and priority alert
- 10 memory channels for frequency, mode, CTCSS tone, offset. Two channels for odd splits.
- All mode squelch, noise blanker, and RIT
- Easy-to-read analog S & RF meter

- Dual digital VFOs
- Semi break-in CW with side tone
- MC-48 16-key DTMF hand microphone and microphone hook included
- Frequency lock, offset, reverse switches
- Digital Channel Link (DCL) option

Optional accessories:

- CD-10 call sign display
- PS-430, PS-30 DC power supplies
- SW-100A/B SWR/power meter
- SW-200A/B SWR/power meter
- SWT-1 2 m antenna tuner
- SWT-2 70 cm antenna tuner
- TU-7 38-tone CTCSS encoder
- MU-1 modem unit for DCL system
- VS-1 voice synthesizer
- MB-10 extra mobile mount
- SP-40, SP-50B mobile speakers
- PG-2N extra DC cable
- PG-3B DC line noise filter
- MC-60A, MC-80, MC-85 deluxe base station mics.
- MC-43S UP/DOWN mic.
- MC-55 (8-pin) mobile mic.
- MA-4000 dual band antenna with duplexer



Actual size front panel

TR-851A

70 cm SSB/CW/FM transceiver

The same winning features are yours on 70 cm with the TR-851A!

- Covers 430-439.999 MHz
- 25 W high power/5 W adjustable low
- MC-43S UP/DWN mic, and mic. hook included



KENWOOD

KENWOOD U.S.A. CORPORATION
2201 E. Dominguez St., Long Beach, CA 90810
P.O. Box 22745, Long Beach, CA 90801-5745

Complete service manuals are available for all Kenwood transceivers and most accessories. Specifications and prices are subject to change without notice or obligation. Specifications guaranteed for the 144-148 MHz Amateur band only.