

ham *radio* magazine

**the HF/VHF
decade frequency marker**

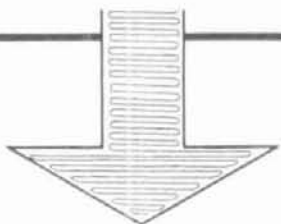

that does it all

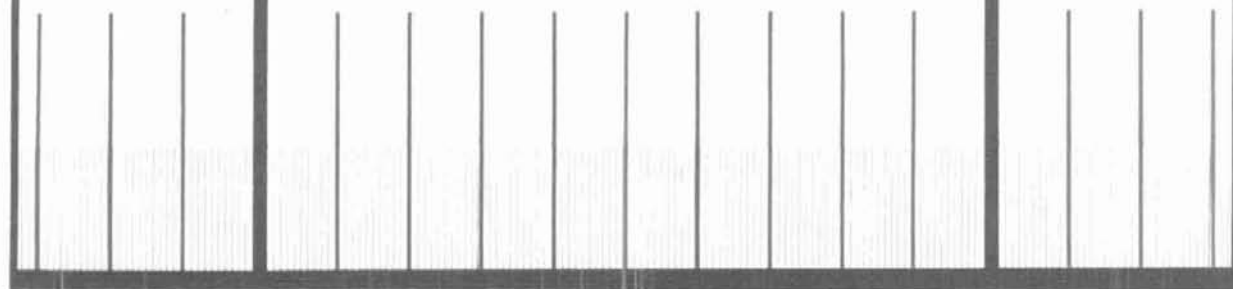

— f —>

ICOM HF Transceiver

IC-751



The Standard of Excellence in HF Base Stations

The IC-751 is the most advanced transceiver available today. It's a competition grade ham receiver, a 100KHz to 30MHz continuous tuning general coverage receiver AND a full-featured all mode solid-state ham band transmitter. The IC-751 also covers the new WARC bands, MARS frequencies, and is AMTOR compatible.

Important Standard Features. Compare these important standard features in this "top of the line" base station:

- 100KHz - 30MHz Receiver
- 105dB dynamic range
- QSK — full break-in CW (nominal speed 20WPM)

- FM Mode Standard
- High-grade FL-44A 455KHz SSB filter
- 32 tunable Memories with lithium battery backup
- 100% Duty Cycle Transmitter
- Passband Tuning
- 12V DC operation
- Adjustable AGC
- Adjustable Noise Blanker
- RIT/XIT with separate readout
- IC-HM12 Microphone with Up/Down Scan
- Continuously adjustable transmit power

Options. IC-EX310 speech synthesizer, internal IC-PS35 power supply, external IC-PS15 or IC-PS30 system supply, IC-SM8 two-cable desk mic,

IC-SM6 desk mic, RC-10 external controller, and a variety of filters.

FILTER SPECIFICATIONS

Filter	Model	Center Freq. [KHz]	-6dB Width
STANDARD FILTERS			
AM Ceramic	CFW 455 IT	455	6.0
SSB (PBT) XTAL	FL-30	9011.5	2.3
FM Filter	9M15A	9011.5	15 (-3dB)
SSB Narrow (Hygrade Crystal)	FL-44A	455	2.4
OPTIONAL FILTERS			
CW Narrow	FL-52A	455	0.500
CW Narrow	FL-53A	455	0.250
SSB Wide	FL-70	9011.5	2.8
CW Narrow	FL-32	9010.6	0.500
CW Narrow	FL-63	9010.6	0.250
AM	FL-33	9010.0	6.0

Operating From 12V, the IC-751 is also available with an optional internal AC power supply, the IC-PS35...for the winning edge in field day competition.



Shown with IC-PS35

The IC-751 provides superior performance for all amateur radio operators...from novice to extra class. See the IC-7 at your local ICOM dealer.

Now with a ONE YEAR Warranty!

ICOM

First in Communication

What To Look For In A Home Patch

The best way to decide what patch is right for you is to first decide what a patch should do. A patch should:

Give complete control to the mobile, allowing full break in operation.

Not interfere with the normal operation of your base station. It should not require you to connect and disconnect cables (or flip switches!) every time you wish to use your radio as a normal base station.

Not depend on volume or squelch settings of your radio. It should work the same regardless of what you do with these controls.

You should be able to hear your base station speaker with the patch installed. Remember, you have a base station because there are mobiles. **ONE OF THEM MIGHT NEED HELP.**

The patch should have standard features at no extra cost. These should include programmable toll restrict (dip switches), tone or rotary dialing, programmable patch and activity timers, and front panel indicators of channel and patch status.

ONLY SMART PATCH HAS ALL OF THE ABOVE.

How Mobile Operators Can Enjoy An Affordable Personal Phone Patch...

Without an expensive repeater.

Using any FM transceiver as a base station.

The secret is a SIMPLEX autopatch. The **SMART PATCH**.

SMART PATCH is Easy To Install

To install **SMART PATCH**, connect the multicolored computer style ribbon cable to mic audio, receiver discriminator, PTT, and power. A modular phone cord is provided for connection to your phone system. Sound simple? ... YES!

With SMART PATCH You are in CONTROL



With CES 510SA Simplex Autopatch, there's no waiting for VOX circuits to drop. Simply key your transmitter to take control.

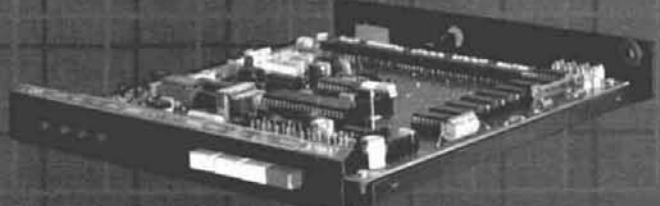

SMART PATCH is all you need to turn your base station into a personal autopatch. SMART PATCH uses the only operating system that gives the mobile complete control. Full break-in capability allows the mobile user to actually interrupt the telephone party. SMART PATCH does not interfere with the normal use of your base station. SMART PATCH works well with any FM transceiver and provides switch selectable tone or rotary dialing, toll restrict, programmable control codes, CW ID and much more.

**To Take CONTROL with Smart Patch
— Call 800-327-9956 Ext. 101 today.**

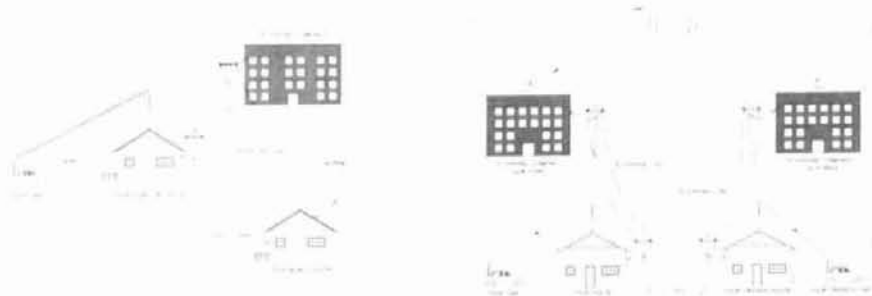

How To Use SMART PATCH

Placing a call is simple. Send your access code from your mobile (example: *73). This brings up the Patch and you will hear dial tone transmitted from your base station. Since **SMART PATCH** is checking about once per second to see if you want to dial, all you have to do is key your transmitter, then dial the phone number. You will now hear the phone ring and someone answer. Since the enhanced control system of **SMART PATCH** is constantly checking to see if you wish to talk, you need to simply key your transmitter and then talk. That's right, you simply key your transmitter to interrupt the phone line. The base station automatically stops transmitting after you key your mic. **SMART PATCH** does not require any special tone equipment to control your base station. It samples very high frequency noise present at your receiver's discriminator to determine if a mobile is present. No words or syllables are ever lost.

SMART PATCH Is All You Need To Automatically Patch Your Base Station To Your Phone Line.

Use **SMART PATCH** for:

- Mobile (or remote base) to phone line via Simplex base. (see fig. 1.)
- Mobile to Mobile via interconnected base stations for extended range. (see fig. 2.)
- Telephone line to mobile (or remote base).
- **SMART PATCH** uses **SIMPLEX BASE STATION EQUIPMENT**. Use your ordinary base station. **SMART PATCH** does this without interfering with the normal use of your radio.

WARRANTY?

YES, 180 days of warranty protection. You simply can't go wrong. An FCC type accepted coupler is available for **SMART PATCH**.



Communications Electronics Specialties, Inc.
P.O. Box 2930, Winter Park, Florida 32790
Telephone: (305) 645-0474 Or call toll-free (800)327-9956

KENWOOD

...pacesetter in Amateur radio

Accessories



TL-922A 160-15 m 2 kW PEP/1 kW DC Input Linear Amplifier. Pair of EIMAC 3-500Z tubes and excellent IMD characteristics. Perfect safety protection with blower turn-off delay circuit.



SM-220 Station monitor/10 MHz oscilloscope. Pan display capability with optional BS-8 (for TS-940S, TS-830S). Monitor transmitted waveforms and/or received signal waveforms. Built-in 2-tone generator.

Not Shown:

MC-50 Desk-top microphone. Hi/Lo Z. 4-pin connector.

MC-80 Desk-top microphone. 700 Ω unidirectional electret element with flexible boom. Built-in mic. pre-amp and UP/DOWN switch, with lock. (8-pin)

MC-48 Hand microphone with 16-key DTMF pad and UP/DOWN switches. (8-pin)

MC-46 As above, but with 6-pin connector.

MC-42S Hand microphone with UP/DOWN switches. (8-pin)

MC-35S Noise cancelling hand microphone. 50 k Ω (4-pin)

MC-30S As above, but 500 Ω .

PG-4A Microphone cable for MC-60A. Converts MC-60A to 4-pin connector.

PG-4B As above, but 6-pin.

PG-4C As above, but 8-pin, as supplied with MC-60A.

PG-4D Extra 4-pin cable for MC-85

PG-4E As above, but 6-pin.

PG-4F As above, but 8-pin.

HS-7 Micro-headphones.

KPS-7A 13.8 V DC, 7.5 A intermittent DC power supply.

RA-3 2 m, $\frac{1}{4}$ λ telescoping antenna with BNC connector.

RA-5 2 m $\frac{1}{4}$ λ / 70 cm $\frac{1}{4}$ λ telescoping antenna with BNC connector.

RA-8B 2 m StubbyDuk[®] with BNC connector

RA-9B As above, for 220 MHz

RA-10B As above, for 440 MHz

RD-20 Dummy load, 50 Ω DC: 500 MHz 20 W continuous, 50 W intermittent.

PG-3A DC line filter for mobile use.

Service manuals are available for all Kenwood transceivers and most accessories.



PC-1A Phone Patch (FCC Part 68 registered).

MA-5 80/40/20/15/10 meter mobile antenna. All resonators supplied. 200 W PEP max., VSWR 1.5:1 or less. Easily adjustable for center frequencies.

VP-1 Bumper mount for above.



VB-2530 25 W RF Power Amplifier (for TR-2600A). BNC-BNC cable, and mounting bracket supplied



HS-5 Deluxe headphones.

HS-6 Lightweight headphones.



LF-30A Low pass filter, 1 kW, 50 Ω . Insertion loss: less than 0.5dB at 30 MHz.

MA-4000 2 m/70 cm dual band mobile gain antenna. Duplexer supplied. Ideal for use with the TW-4000A "Dual Bander" and TM-211A/TM-411A. (Mount not supplied.)

AL-2 Lightning and static arrester. 1 kW, 50 Ω .



MC-85 (8-pin) Multi-function desk-top microphone (8-pin) 700 Ω unidirectional electret condenser mic. Built-in audio level compensation with output and tone control, meter, and UP/DOWN switch. Selector switch for up to three transceivers (Additional 4, 6, or 8-pin cables optional.)



MC-60A (8-pin) Deluxe desk-top microphone. Pre-amp built-in, PTT, LOCK and UP/DOWN switches. Hi/Lo Z selector switch.



SP-40 Compact mobile speaker

SP-50 Mobile speaker

Specifications and prices subject to change without notice or obligation

KENWOOD

TRIO-KENWOOD COMMUNICATIONS
1111 West Walnut Street
Compton, California 90220

ham radio

magazine

JANUARY 1986

volume 19, number 1

T. H. Tenney, Jr., W1NLB
publisher

Rich Rosen, K2RR
editor-in-chief
and associate publisher

Dorothy Rosa, KA1LBO
assistant editor

Joseph J. Schroeder, W9JUV
Alfred Wilson, W6NIF
associate editors
Susan Shorrock
editorial production

editorial review board

Peter Bertini, K1ZJH
Forrest Gehrke, K2BT
Michael Gruchalla, P. E.
Bob Lewis, W2EBS
Mason Logan, K4MT
Ed Wetherhold, W3NQN

publishing staff

J. Craig Clark, Jr., N1ACH
assistant publisher

Rally Dennis, KA1JWF
director of advertising sales

Dorothy Sargent, KA1ZK
advertising production manager

Susan Shorrock
circulation manager

Therese Bourgault
circulation

ham radio magazine is published monthly by
Communications Technology, Inc.
Greenville, New Hampshire 03048-0498
Telephone: 603-878-1441

subscription rates

United States:
one year, \$22.95; two years, \$38.95; three years, \$49.95
Canada and other countries (via surface mail):
one year, \$31.00; two years, \$55.00; three years, \$74.00
Europe, Japan, Africa (via Air Forwarding Service): one year, \$37.00
All subscription orders payable in U.S. funds, via international
postal money order or check drawn on U.S. bank

international subscription agents: page 120

Microfilm copies are available from
University Microfilms, International
Ann Arbor, Michigan 48106
Order publication number 3076

Cassette tapes of selected articles from *ham radio*
are available to the blind and physically handicapped
from Recorded Periodicals,
919 Walnut Street, Philadelphia, Pennsylvania 19107

Copyright 1985 by Communications Technology, Inc.
Title registered at U.S. Patent Office

Second-class postage paid
at Greenville, New Hampshire 03048-0498
and at additional mailing offices
ISSN 0148-5989

Send change of address to *ham radio*
Greenville, New Hampshire 03048-0498



contents

10 a frequency and level standard
Hans Evers, PA0CX

23 a calibrated S-meter
Robert J. Zavrel, Jr., W7SX

**29 passive audio filter design, part 3:
attenuation equalizers and driving,
terminating audio filters**
Stefan Niewiadomski

44 VHF/UHF world
Joe Reiser, W1JR

59 practically speaking
Joe Carr, K4IPV

67 ham radio techniques
Bill Orr, W6SAI

75 broadband RF transformers
Will Herzog, K2LB

84 optimizing a Yagi trigon reflector
Stanley Jaffin, WB3BGU

99 trapping stubborn harmonics
Robert M. Clarke, N1RC

**103 L-band ground wave propagation
program**
Lynn A. Gerig, WA9GFR

**107 designing Yagis with the
Commodore 64**
Fred A. Sontag, N0CAO

124 the Guerri report
Ernie, Guerri, W6MGI

126 advertisers index **122 ham mart**
and reader service **115 new products**
9 comments **6 presstop**
112 DX forecaster **4 reflections**
120 flea market **54,66 short circuits**

REFLECTIONS REFLECTIONS

before you panic, get the facts

Picture yourself in a quiet restaurant with your spouse or friend. Without warning, the peaceful atmosphere is disturbed by a loud discussion — its content quite private in nature — from across the room. It gets your attention and you find yourself listening. But suddenly you're jolted by an authoritative voice directed at *you*, informing you that you've just broken the law. Your offense: *listening to a private conversation*.

That scenario, half-jokingly told to me by Joe Schroeder, W9JUV (see *Presstop*), has a remnant of truth in an analogous situation. There are presently in the works two bills (HR-3378 in the House of Representatives and S-1667 in the Senate) that could make it a federal crime to listen in on certain conversations received over the airwaves.

Before you panic, listen to the following facts. Several voice and data-handling organizations — specifically the Cellular Telecommunications Industry Association (CTIA), the Electronic Mail Association, Teletocator, paging, and video conferencing industries — do not want their communications intercepted. Sounds reasonable enough. The problem, as I see it, is in their methods. These groups are lobbying (quite strongly, I might add) for Congress to pass what is now known as the Electronic Communications Privacy Act of 1985, which would prohibit anyone in the United States who has a general coverage receiver or similar type device from listening to transmissions at will. If, for example, you inadvertently tuned your receiver or scanner across a cellular phone conversation and *continued* to listen, you'd be breaking the law.

The problem is not the desire of these industries to protect their customers' privacy, but their assumption that the general public should be asked to forfeit its right to listen to radio transmissions without restriction.

What about us Radio Amateurs? Aren't we excluded from this situation? Yes and no. In preliminary hearings, six broad categories — including Amateur Radio — were considered. But when the subject of Amateur autopatches came up, an initial response from one of the subcommittee members was that since the telephone is involved, reception of these types of transmissions might not be part of the exclusion.

Keep in mind that both the House and Senate subcommittees drafting this act — which, incidentally, may turn out to be the single most important piece of legislation affecting us since the 1934 Geneva Radio Convention accords — are still in the preliminary phases of the project. *This* is the time to let your senators and representatives know that you're very interested in these bills even before they come out of the Senate and House subcommittees.* You want your representatives to acquire the facts and understand your concern about potential encroachment on and abridgement of your operating privileges. It might not hurt for you to remind them of the helpful services Radio Amateurs have provided and will continue to provide to the public in emergencies — without desire for or expectation of recompense. It would be nice to leave them with some positive suggestions that they could take to the subcommittees drafting the legislation.

The problem, as mentioned before, is one of fear: people in the commercial communications industries are concerned about possible interception of their signals. But as foolish and unworkable as it would be for the "authorities" to tell all the clients in the hypothetical restaurant scene to close their ears, so would it be for the government to tell radio owners what kinds of transmissions they should or should not listen to.

What would make more sense would be for the cellular and other voice and data-handling organizations to utilize some form of encryption — be it non-standard forms of modulation, tone insertion, inversion, or coding. The necessary technology exists, and one application of it is in daily use in police departments across the country. Otherwise, just imagine a scene in a penitentiary, wherein one pathetic soul is asked by his cellmate, a thrice-convicted murderer, what *his* crime was. . . and the poor soul replies, with great timidity, that he was caught listening to a radio transmission.

Rich Rosen, K2RR
Editor-in-Chief

*In the House of Representatives, the Subcommittee on Courts, Civil Liberties, and the Administration of Justice; in the Senate, the Subcommittee on Patents, Copyrights, and Trademarks.

KENWOOD

...pacesetter in Amateur radio

Incredible Flexibility!

TM211A/411A

The TM-211A 2 m and the TM-411A 70 cm transceivers combine ultra-compact size with an impressive array of features to give you maximum flexibility in mobile operations. The TM-211A and the TM-411A may be stacked for even more operating flexibility!

• External speaker.

A high-quality external communications speaker is provided for the best sound quality.

• 5-channel memory with multiple scanning functions.

The transceiver can scan the memory channels or can be programmed to scan all or a portion of the band.

• 25 watts high power.

5 (adjustable to approx. 15 watts) low.

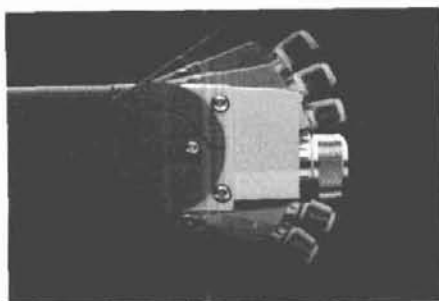

• 7-position, tilting control panel.

The unique control panel is designed to increase operating and installation ease. The panel may be moved to provide the best viewing angle and handiest access to controls.

• DCS—Digital Code Squelch.

Program your transceiver to respond only to a specific digital code—much more secure than CTCSS.

• Priority Watch.

The "Priority Watch" mode lets you keep an eye on an important channel when monitoring other frequencies.

• Extended frequency coverage on 2 m.

TM-211A covers 142-149 MHz—includes most MARS and CAP frequencies.

TM-411A covers 438-450 MHz

Optional accessories:

- CD-10 call sign display
- PS-430 DC power supply
- KPS-7A power supply
- MC-42S regular UP/DOWN hand microphone
- MC-55 (8-pin) mobile microphone with time-out timer
- MA-4000 dual band mobile antenna with duplexer
- SWT-1/2 2 m/70 cm 100 W antenna tuners
- SW-100A/B SWR/power meters
- PG-3A noise filter
- MB-201 extra mobile mount
- SP-40 compact mobile speaker



CD-10 DCS call sign display

CD-10 maximizes your use of Kenwood's new signalling concept, Digital Code Squelch. DCS uses a data string to open squelch on a receiver that has been programmed to accept the transmitted code. The transmitting station's call is programmed in ASCII. The CD-10 displays the station's call sign, and stores it in memory. Twenty calls may be stored. The CD-10 may be used with **any** receiver to display calls heard.



More product information is available from authorized Kenwood dealers.

KENWOOD

TRIO-KENWOOD COMMUNICATIONS
1111 West Walnut Street
Compton, California 90220

Complete service manuals are available for all Trio-Kenwood transceivers and most accessories. Specifications and prices are subject to change without notice or obligation.

A SERIOUS POTENTIAL THREAT TO ESTABLISHED AMATEUR RADIO PRACTICES may be developing as the "Electronic Communications Privacy Act of 1985" moves toward consideration by both the U.S. Senate and House of Representatives. The two bills, HR-3378 in the House and S-1667 in the Senate, were initially intended to simply make earlier Congressional action against wiretapping apply to radio-relayed data transfer. They provided an opportunity that was quickly seized by the cellular telephone industry, already deeply concerned about the security of its 800 MHz communications as scanners move into the microwave region.

Although Amateur Radio Is One Service Specifically Exempted, along with fire, police, and several others, from the bills' prohibitions against unauthorized "interception," its unrelenting "protectionist" character could drastically change, if not prohibit, some popular Amateur services. For example, the bills' drafters would apparently characterize any "interception" of a radio-relayed telephone conversation by anyone except those actually participating as a federal crime -- with possibly no exception for Amateur autopatches or phone patching! One subcommittee staff member has even been quoted as feeling that all Amateur interconnection with the telephone system is possibly illegal.

Though the Premise -- Privacy For Radio-Carried Personal Communications -- is a worthy one, the bills could, in effect, result in a case of classic overkill. In its present form, the proposed legislation could, for example, declare vast portions of the RF spectrum, including most of the short and long wave bands, illegal territory for the SWL or other radio hobbyist -- not to mention the tens of millions of scanner owners in the U.S. Thus far the League's position has been one of "wait and see," in apparent belief that Amateur Radio's "exemption" will be sufficient to stave off any negative effects. However, in the absence of strong Amateur representation in protection of current Amateur privileges and practices, the bills' impact on Amateur Radio could actually be quite severe.

Amateurs Should Contact Their Senators and Representatives and advise them of their deep concern for the potential effects of these bills on both Amateur Radio and other citizens' activities. Offers of technical expertise as to the legislation's effects might be welcomed by the legislators as well. Be sure to insist that they keep you advised as to progress and significant changes as the bills move toward passage.

RADIOLOCATION HAS BEEN ASSIGNED THE 1900-2000 KHZ BAND, the FCC announced in early November. Amateur Radio will, however, continue to share that portion of 160 meters on a Secondary basis. Impetus for the shift was WARC '79, which expanded the AM broadcast band upward into Radiolocation's former 1605-1705 kHz slot. Though a "Secondary" status means Amateur operators must take pains to avoid interfering with operations of the Primary users, the net effect on Amateurs should be negligible.

Users Of Wideband Radiolocation Systems Could Be Licensed on 160 as early as December, 1985, but no large-scale movement to their new band is expected until mid-1987 -- and even then usage is still likely to be light and mostly in limited geographical areas.

A CONFERENCE TO DISCUSS PROGRESS AND PROBLEMS OF THE VOLUNTEER EXAMINER PROGRAM is being planned during the Orlando Hamfest, March 7-9, 1986. Sponsored by CARE (Council for Amateur Radio Examining), the session will be open to all VECs, VEs, and other interested parties whether CARE members or not. Contact CARE for further details.

CARE Membership Rates Have Now Been Set, and all who've requested information on the new national VEC organization should have received membership information by now. Dues for a VEC organization are \$25 per year, while General members (VEs accredited by a member VEC) must pay \$10 annually. Dues for At-Large members (VEs with accreditation from a non-CARE member) and Associates (anyone else) are \$15.

CARE Now Has A Permanent Mailing Address: P.O. Box 866, Glenview, Illinois 60025.

AMATEURS WHO'VE LOST THEIR LICENSES MAY NOT USE ANOTHER AMATEUR'S STATION for any further Amateur operation, the Commissioners decided in a Report and Order on PR Docket 85-51. The question had arisen in the case of a former West Coast Amateur whose license had been revoked for various violations and who wanted to remain active using friends' stations. The ban pertains to any Amateur licensee whose license has been revoked or suspended for all or part of the license term, who has surrendered his license for cancellation in connection with an action against him, or who is subject to a "Cease and Desist" order that relates to his Amateur Radio activities.

EXTENSIVE RESTRUCTURING OF CANADA'S AMATEUR LICENSING has been proposed by Canada's Department of Communications. The new no-code entry-level license would provide full privileges above 30 MHz (250 watts maximum) using only commercial transmitting equipment; the exam would cover only station installation and operation, very basic theory, antennas, and rules. Moving to the second level would require only a 12-WPM code exam and would extend the same privileges below 30 MHz. Top level would require passing an exam on "advanced electronic theory," then permit using home-built equipment and up to a kilowatt.

KENWOOD

...pacesetter in Amateur radio

Handy Handful...

TR-2600A/3600A

Kenwood's TR-2600A and TR-3600A feature DCS (Digital Code Squelch), a new signalling concept developed by Kenwood. DCS allows each station to have its own "private call" code or to respond to a "group call" or "common call" code. There are 100,000 different DCS combinations possible.



- **Simple to operate**
Functional design is "user friendly." Built-in 16-key autopatch encoder, TX STOP switch, REVERSE switch, KEYBOARD LOCK switch, high efficiency speaker.
- **Large LCD**
Easy to read in direct sunlight or in the dark with convenient dial light that also illuminates the top panel S-meter.
- **Extended frequency coverage**
Allows operation on most MARS and CAP frequencies. Receive frequency range is 140-160 MHz. (TR-3600A covers 440-450 MHz.)
- **Programmable scan**
Channel scan or band scan, search for open or busy channels.
- **SLIDE-LOC battery case**
- **10 Channels**
10 memories, one for non-standard repeater offsets.
- **2.5 watts high power, 350 mW low**
TR-3600A has 1.5 watts high or 300 mW low.

The Kenwood TR-2600A and the TR-3600A pack "big rig" features into the palm of your hand. It's really a "handy handful"!

Optional accessories:

- TU-35B built-in programmable sub-tone encoder
- VB-2530 2-m 25 W RF power amp.
- ST-2 base stand/charger
- MS-1 mobile stand/charger
- PB-26 Ni-Cd battery
- DC-26 DC-DC converter
- HMC-1 headset with VOX
- SMC-30 speaker microphone
- LH-3 deluxe leather case
- SC-9 soft case with belt hook
- BT-3 AA manganese/alkaline battery case
- EB-3 external C manganese/alkaline battery case
- RA-3 2-m telescoping antenna
- RA-5 2-m/70-cm telescoping antenna
- AX-2 shoulder strap w/ant. base
- CD-10 call sign display
- BH-2A belt hook

More TR-2600A and TR-3600A information is available from authorized Kenwood dealers.

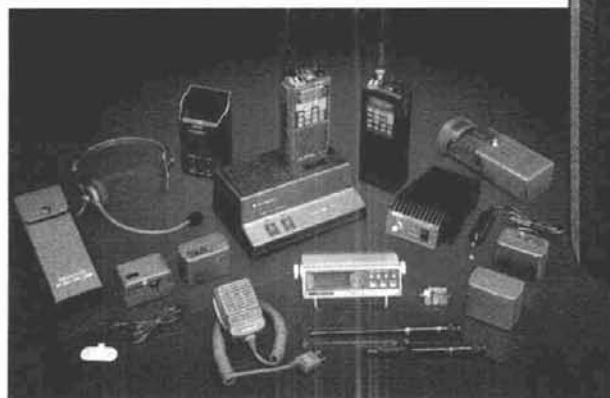

KENWOOD

TR-2600A shown. TR-3600A is available for 70 cm operation.
Complete service manuals are available for all Trio-Kenwood transceivers and most accessories.
Specifications and prices are subject to change without notice or obligation.

TRIO-KENWOOD COMMUNICATIONS
1111 West Walnut Street
Compton, California 90220

AFFORDABLE PACKET RADIO FROM MFJ

An identical TAPR TNC 2 clone with a new cabinet and added features ... for an incredible \$129.95.

MFJ-1270 **\$129.95**



Join the exciting packet radio revolution and enjoy error-free communications ... for an incredible \$129.95.

MFJ brings together efficient manufacturing and TAPR's (Tucson Amateur Packet Radio) leading edge technology to bring you affordable packet radio. You get a nearly identical clone of the widely acclaimed TAPR TNC 2 with identical software and hardware. It's in a new cabinet and includes a TTL serial port for extra versatility.

All you need is your rig, home computer with a RS-232 serial port and a terminal program. If you have a Commodore 64, 128 or VIC-20 you can use MFJ's optional Starter Pack to get on the air immediately. You get interfacing cable, terminal software on tape or disk and complete instructions ... everything you need to get on packet radio. Order MFJ-1282 (disk) or MFJ-1283 (tape), \$19.95 each.

Unlike machine specific TNCs, you never have to worry about your MFJ-1270 being obsolete because you change computers or because packet radio standards change. You can use any computer with an RS-232 serial port and an appropriate terminal program. If packet radio standards change, software updates will be made available as TAPR releases them. Also speeds in excess of 56K bauds are possible with a suitable external modem! Try that with a machine specific TNC or one without hardware HDLC as higher speeds come into widespread use. You can also use the MFJ-1270 as an inexpensive digipeater.

It features the latest AX.25 Version 2.0 software, hardware HDLC for full duplex, true Data Carrier Detect for HF, 16K RAM, simple operation plus more. Join the packet radio revolution now and help make history. Order the MFJ-1270 today.

Here are MFJ's latest and hottest products for improving your station's performance.

SUPER KEYBOARD

MFJ-496
\$169.95



Price slashed 50% to \$169.95! Get a full feature Super Keyboard that sends CW/RTTY/ASCII for the price of a good memory keyer.

You get the convenience of a dedicated keyboard—no program to load—no interface to connect—just turn it on and it's ready to use.

This 5 mode Super Keyboard lets you send CW, Baudot, ASCII, use it as a memory keyer and for Morse Code practice. You get text buffer, programmable and automatic message memories, error deletion, buffer preload, buffer hold.

TRIPLE OUTPUT LAB POWER SUPPLY

MFJ-4002 **\$149.95**



Lab quality power supply gives you plenty of voltage and current for all your analog and digital circuits. 3 completely isolated outputs: 2 variable 1.5-20 VDC at 0.5 amp and a fixed 5 VDC at 1 amp. Connect in series or parallel for higher voltage and current. It's short circuit protected, has excellent line (typ. 0.01%/V) and load regulation (typ. 0.1%). Lighted meters monitor volt./cur. 12x3x6 in. 110 VAC.

CROSS-NEEDLE SWR/WATT METER

MFJ-815 **\$59.95**

MFJ's cross-needle SWR/Wattmeter gives you SWR, forward and reflected power—all at a single glance! SWR is automatically computed

—no controls to adjust. Easy-to-use push buttons select three power ranges that give you QRP to full legal limit power readings. Reads 20/200/2000 W forward, 5/50/500 W reflected and 1:1 to 1:5 SWR on easy-to-read two color scale. Lighted meter. Needs 12 V. ±10% full scale accuracy. 6½ x 3¼ x 4½ inches.



2 KW COAX SWITCHES

Instantly select any antenna or rig by turning a knob. Organizes coax cables and eliminates plugging and unplugging. Unused terminals are grounded to protect your equipment for stray RF, static and lightning. 2 KW PEP, 1 KW CW. For 50 to 75 ohm. Negligible loss, SWR, and crosstalk gives high performance. SO-239s. Convenient desk or wall mounting.

MFJ-1702, \$19.95. 2 positions. Cast aluminum cavity construction gives excellent performance up to 500 MHz with better than 60 dB isolation at 450 MHz. Heavy duty, low loss switch has less than 20 milliohm contact resistance, less than 0.2 dB loss and SWR below 1:1.2. 2 x 2½ x 1 inches.

MFJ-1701, \$29.95. 6 positions. White markable surface for recording ant. positions. 8½ x 1½ x 3 in.

MFJ-1702
\$19.95



\$29.95 MFJ-1701



ANTENNA CURRENT PROBE

MFJ-206 **\$79.95**

This new breakthrough MFJ Antenna Current Probe lets you monitor RF antenna currents—no connections needed! Determine current distribution, RF radiation pattern and polarization of antennas, transmission lines, ground leads, building wiring, guy wires and enclosures.

- Indicate transmission line radiation due to high SWR, poor shielding or antenna unbalance.
- Detect re-radiation from rain gutters and guy wires that can distort antenna field patterns.
- Detect RF radiation from ground leads, power cords or building wiring that can cause RFI.
- Determine if ground system is effective.
- Pinpoint RF leakage in shielded enclosures.
- Locate the best place for your mobile antenna.
- Use as tuned field strength meter.

Monitors RF current by sensing magnetic field. Uses an electrostatically shielded ferrite core, FET RF amplifier, op-amp meter circuit for excellent sensitivity, selectivity. 1.8-30 MHz. Has sensitivity, bandwidth, tune controls, telescoping antenna for field strength meter. 4 x 2 x 2 inches.



MFJ's Best VERSA TUNER

MFJ-949C **\$149.95**



MFJ's best 300 watt tuner is now even better! The MFJ-949C all-in-one Deluxe Versa Tuner II gives you a tuner, cross-needle SWR/Wattmeter, dummy load, antenna switch and balun in a new compact cabinet. You get quality conveniences and a clutter-free shack at a super price.

A new cross-needle SWR/Wattmeter gives you SWR, forward and reflected power—all at a single glance. SWR is automatically computed with no controls to set. Has 30 and 300 watt scale.

Run up to 300 watts RF output—and match coax, balanced lines or random wires from 1.8 thru 30 MHz. Tune out SWR on dipoles, vees, long wires, verticals, whips, beams/quads. 10x3x7 in.

DIGITAL SWR/WATTMETER

MFJ-818
\$89.95



Fully automatic Digital SWR/Wattmeter reads SWR 1:1 to 1:9.9 directly and instantaneously—no SWR knob to set. Huge 0.6 inch bright orange digits make across-the-room reading easy. 12 segment LED bar graph wattmeter gives instantaneous PEP readings up to 200 watt RF output.

Good, bad, mismatch tri-color LEDs indicate SWR conditions. Small size (5½ x 4¼ x 1 in.) and easy-to-read digital display makes it ideal for mobile use. For 50 ohm systems. 1.8-30 MHz. 12 VDC or 110 VAC with MFJ-1312. \$9.95.

MOBILE ANTENNA MATCHER

MFJ-910 **\$19.95**

Lower your SWR and Get more power into your mobile whip for solid signals and more QSOs. Your solid state rig puts out more power and generates less heat. For 10-80 meter whips. Easy plug-in installation. Complete instructions. Fits anywhere. 2½x2½ in.



ORDER ANY PRODUCT FROM MFJ AND TRY IT-NO OBLIGATION. IF NOT SATISFIED RETURN WITHIN 30 DAYS FOR PROMPT REFUND (less shipping).
• One year unconditional guarantee • Add \$5.00 each shipping/handling • Call or write for free catalog, over 100 products.

MFJ

MFJ ENTERPRISES, INC.
Box 494, Mississippi State, MS 39762

TO ORDER OR FOR YOUR NEAREST DEALER, CALL TOLL-FREE

800-647-1800

Call 601-323-5869 in Miss. and outside continental USA Telex 53-4590 MFJ STKV





comments

Novice Privileges

Dear HR:

With reference to T. Dillingham's (KA0DOE) comments concerning Novice privileges, ("Comments," September, 1985, page 15), it seems KA0DOE wants a "reward" for being a Novice for six years. This is itself a reward, as originally the license was a one-year, non-renewable affair, and before that, of course, did not exist at all.

I can't believe that anyone who aspires to increased operating privileges can't master the skills necessary to pursue their interests in a six-year period.

The tone of this letter suggests that, for some at least, adding any additional benefits would only make them more complacent, thus defeating the purpose.

Ray Cunningham, W3YBF
Ambler, Pennsylvania

Dear HR:

We are in sorry shape, I fear. A casual chat with our Section Manager revealed that many Amateurs in Nebraska are against the ARRL's enhanced Novice Privileges Proposal

— some adamantly so. If this is true throughout the United States, I think we have big problems in that I believe this is just the attitude that will be the death of our hobby. Look at the numbers on page 9 of the August, 1985, issue of *QST*. The numbers are *still* not in our favor.

One of the favorite arguments seems to be that the bands are crowded enough already. Oh, really? Has anyone tried operating the HF bands on a weekday mid-morning? People who work nights should be made a target of our efforts if there is a general feeling that the bands are too crowded. The bands certainly are not overpopulated most weekdays.

Some repeater operators are concerned about losing 220 MHz to Novices because they may have to find new territory for their control links. Yes, there are lots of repeaters...probably more than we need in many areas, although not in Nebraska. But if they could take away band privileges by state they could easily revoke 220 here since the control links wouldn't even occupy a space of several kHz, let alone 5 MHz. We are not going to keep the band if we just use it for control links. We must get more people on the band one way or another. A space can be reserved for the control links by band plan as is done now. Novices can respect band plans, too: they must on the HF bands, and do.

As one who acquired Novice privileges when phone operation was permitted on 2 meters, I see no problem in once again permitting Novices to operate phone. This, as has been stated in League literature on the subject, is even less of a problem now since the Novice license is renewable. During my term as a Novice, the phone privileges were taken away. I have often wondered whether this was a contributing factor to the seemingly low numbers of hams my own age (32) and other hams licensed about that time (1966) on-the-air.

It's time to wake up, folks. There will still be plenty of room for those of us who like to tinker and prefer CW and SSB ragchews. But we have a dual problem: lack of population on the ham frequencies will lead to their loss, and ultimately to the loss of the hobby; the lack of population will become worse if would-be newcomers are not interested in joining our ranks. This is the only real stab at a solution yet proposed and it appears to be one which has been given much forethought. Hams spoke out against no-code. Here is a compromise. Let's put away petty differences and get behind it for the continuance of our hobby.

Michael S. Lennen, KD0EV
Omaha, Nebraska

to key or not to key?

Dear HR:

Print this if you like. It's just for fun.

To Key or Not To Key

*To key or not to key
— that is the question.
Should we drop the code exam?
Dismiss the simple switch
Or retain the day when ability
was reckoned by the fist?*

*To master the key
is to be
a radioman.
To scorn the key
is not
to be.*

*2001 — a CW odyssey.
What a sci-fi mode!
For each Jedi knight,
a practice oscillator
was dutifully stowed.
Even on the Enterprise
Uhura copied code.
Does the future hold
digital radio?
Eighty-meter beams on
a chip?
Or will we turn 'round
to see
Digital radio
to be
the key?*

Bob Zavrel, W7SX
Sunnyvale, California

a frequency and level standard

A little black box
and some digital pulse magic
produce a frequency-stable,
high-level generator

A good RF signal generator needs an effective electrical shield around its generating circuit. Without such a shield, it would not be possible to guarantee an accurately determined output level over a wide range of frequencies. In other words, the output attenuator would lose its credibility.*

Shielding an RF circuit requires more than just placing the components behind a metal wall. Leakage and radiation will occur from almost anything electrical that happens to protrude from the circuit enclosure. Sometimes a rather sophisticated filter system is required for stopping the interference that would otherwise spoil the output-level calibration, particularly at low levels and at high frequencies.

This shielding requirement is only one reason a good RF signal generator is usually an expensive piece of test equipment, and difficult to build yourself. For me, it was *the* reason behind the rather unusual design of the *frequency and level standard*, which, of course, is just another name for a signal generator.

design concept

In principle, the idea is simple. A circuit contained in a hermetically sealed box can't have any filter problems if there's nothing to filter in the first place. That's why I thought of designing a signal source without external controls, power cable, tuning, or level meter — just a box with an output connector. Everything except the output is kept inside.

*That is to say, RF from a poorly shielded generator could combine with a highly attenuated signal and provide erroneous results — Ed.

Thinking a bit further, putting such a drastic principle into practice was not as easy as it sounds, and a few concessions were unavoidable here and there. For example, it's difficult to tune an oscillator and to have its frequency displayed through a solid shield. Consequently, I had to restrict the output signal to cover only a certain number of predetermined frequencies.

The simplest way to obtain many fixed frequencies simultaneously is by adopting the frequency-marker principle; that is, by deriving harmonics from a crystal oscillator. This also guarantees good frequency stability. To keep the many signals separate from each other they must be labelled; I gave them, therefore, different amplitudes, making them clearly distinguishable. This was done with the help of a very elementary digital processing circuit.

A simple action — such as flipping a switch — could pose a problem if it had to be done through a metal shield. But this is also no problem: mercury switches mounted inside the circuit can be actuated simply by turning the box to a different position.

The part that needs most switching, the variable output attenuator, is kept outside the shielded enclosure. This allows the signal generator to produce a uniform, but accurate, signal level over a wide frequency range. In fact, it turns out that it's not only the generator itself, but also the variable attenuator that determines the eventual level accuracy at higher frequencies. And the outboard attenuator can be easily replaced by an improved version at a later date.

The cost of the active components (six ICs, including the voltage regulator) should come to not much more than \$3.00. To sum it up, at least for many applications, the box-with-plug idea works the way I hoped it would: as a good signal generator that is neither expensive nor difficult to build.

synthesizer

Many people who've tried to calibrate a receiver frequency scale using a frequency marker have had the experience of being confused by the different, but

By Hans Evers, PA0CX, Am Stockberg 15,
D-5165, Hürtgenwald, West Germany

look-alike, signals. It is therefore an advantage to introduce signals that belong to a different order in the spectrum hierarchy. First the 1-MHz markers, for instance, then the 100-kHz markers, and so on. Usually this is done by turning a switch.

To avoid using such a switch, I tried a different method. The coarse markers were labelled by emphasizing their amplitudes (fig. 1). After frequency division of a 1-MHz crystal-oscillator signal, pulses of

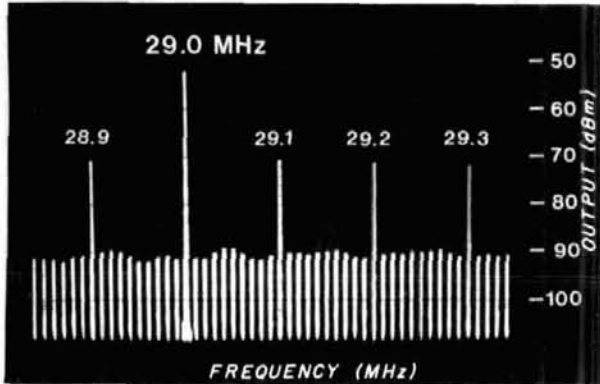

fig. 1. Typical output display spectrum as seen on a frequency-spectrum analyzer. Multiples of 100 kHz harmonics have signal strengths corresponding to the standard S9. The MHz markers are about 20 dB stronger; the 10-kHz markers are 20 dB weaker.

different lengths arrive at the NAND gates. The product is used to interrupt the stream of 1-MHz oscillator-output pulses at regular intervals by longer or shorter spaces (fig. 2).

The underlying mechanism that produces the different phenomena may be easier to understand when you realize what the pulse sequence would look like if the polarity had been reversed. Tuned circuits in a receiver recognize certain patterns in the stream passing by and therefore respond to certain rhythms. Thus, for example, the one-pulse space in the otherwise steady flow of 1- μ s (1-MHz) pulses represents, in fact, a pulse of relatively longer duration. If such an event occurs regularly every 10 μ s, it is capable of causing a response in a circuit tuned to a multiple of 100 kHz (being the repetition rate of the space).

The reason amplitudes of the 1-MHz markers stand out from the rest is not difficult to see. The train of 1- μ s pulses with each 10th pulse removed produces more energy in a circuit tuned to a 1-MHz multiple than to one tuned to a 0.1-MHz multiple (where, at the same time, the circuit has to manage with only one out of ten pulses).

The two-pulse spaces responsible for the 10-kHz markers (occurring every 100 μ s) produce energy that must be shared over 100 times as many signals in the frequency spectrum. This explains why the 10-kHz markers are so much weaker than the others. Of

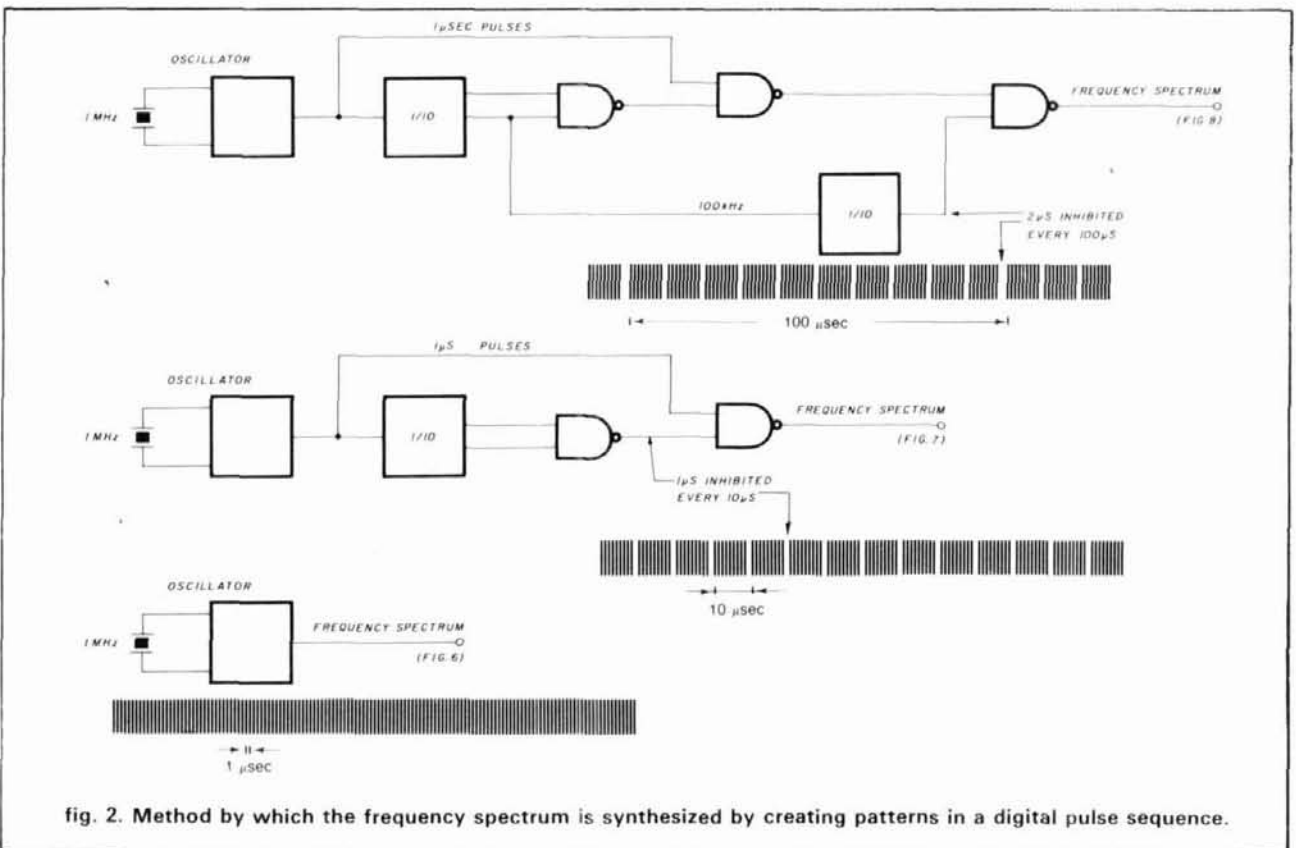

fig. 2. Method by which the frequency spectrum is synthesized by creating patterns in a digital pulse sequence.

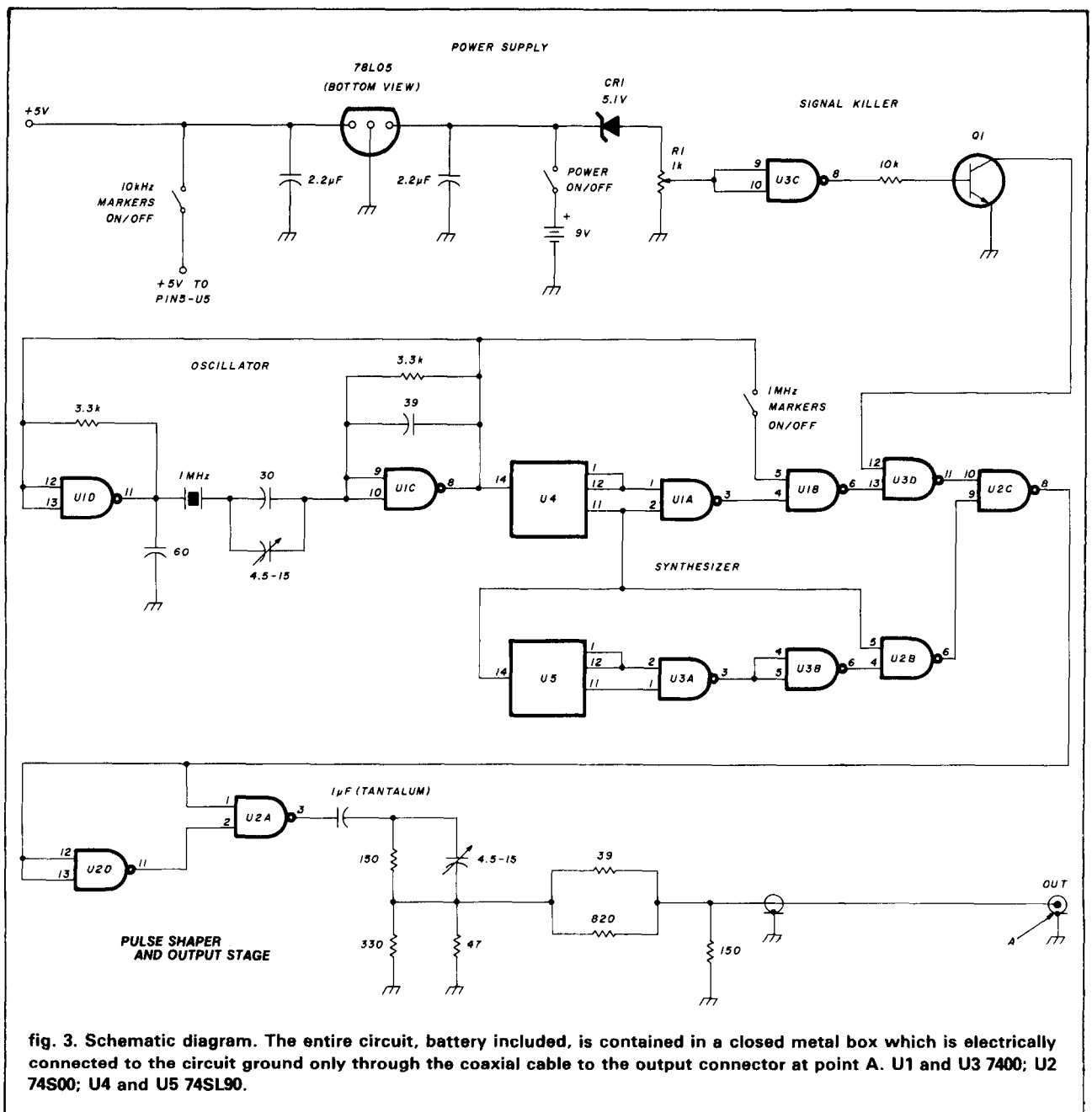

fig. 3. Schematic diagram. The entire circuit, battery included, is contained in a closed metal box which is electrically connected to the circuit ground only through the coaxial cable to the output connector at point A. U1 and U3 7400; U2 74S00; U4 and U5 74SL90.

course, all this tampering with pulses makes the total architecture rather complex. It is, therefore, not surprising to find that there's a practical limit to where the results remain acceptable, and where further refinements would create a less orderly spectrum. What happens is that if the mixture of pulses and spaces in between gets too complex, less-wanted patterns become recognizable. This results in poorly determined amplitudes. Therefore only the 100 kHz position (only multiples, all with identical amplitudes) should be used as a level standard. The spectrum-analyzer pictures show how the amplitudes tend to become irregular as the frequency spectrum becomes more complex.

Thus the imperfection is not so much the result of what a typical analog thinker (as many Radio Amateurs appear to be) might suspect: the wiring. Digital circuits are remarkably tolerant of construction-related problems such as breakthrough or crosstalk — and, for that matter, of poor layout, messy wiring, and horrible-looking breadboard creations. What is also appreciable is that from the synthesizer output onward, only the absolute amplitude may change. The amplitude ratios between the different orders of frequency, once they have been encoded into a digital pattern, are not likely to be changed by following wave-shapers, amplifiers, or other analog circuits.

Figure 3 shows the circuit as it was eventually

Take it with you.

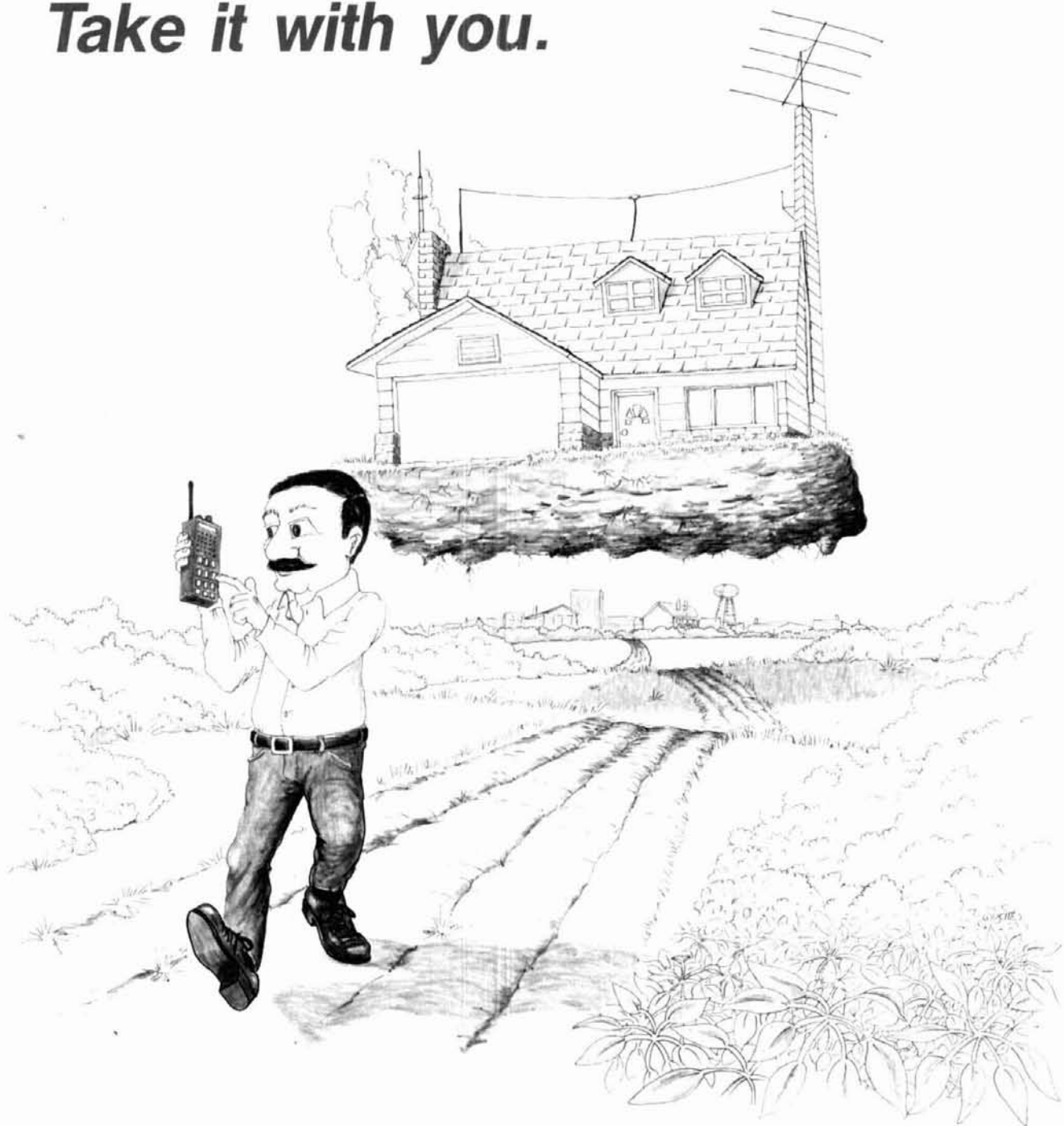

ShackMaster™ puts your home station in the palm of your hand. Whether portable, mobile, around the yard or around town you'll be linked through your handheld to your high performance equipment at home. Even call home from any Touch-Tone phone and operate.

Scan the bands, change modes, select antennas, turn gear on and off – all from your Touch-Tone keypad. Check into nets, work skeds, ragchew and DX without being tied down to the shack.

Exchange electronic mailbox messages with your family – like "I'll be late", or "All is OK". Or talk with your family directly through *ShackPatch™*, with you in remote control of your home station. Report traffic accidents or disabled motorists through your home phone while mobile or portable with *PersonalPatch™*.

All the power of your home station (and more) really can follow you anywhere... to find out more about ShackMaster™ just write, send us your QSL, or call and talk with us at 408-749-8330.

acc advanced
computer
controls, inc.

10816 Northridge Square • Cupertino, CA 95014

(408) 749-8330

adopted; **fig. 4** shows the socket connections of the ICs. Note that an electrolytic capacitor is provided at each individual IC for additional voltage protection.

Figure 5 shows an oscilloscope display of a detail from the synthesizer output pattern showing some 1-pulse spaces (indicated by A) responsible for the 100-kHz signals, as well as the 2-pulse spacing (B) that produces the 10-kHz markers. **Figures 6, 7, and 8** show the different frequency spectra that are created by the pulse patterns given in **fig. 2**.

output stage

The output stage consists mainly of a pulse shaper, or "harmonic producer," based on the fact that the shorter the pulse duration, the more frequencies are produced, and consequently the frequency spectrum will be wider and the harmonic amplitudes more uniform, though lower.

How short should the pulse duration be for obtaining a reasonable compromise between frequency range and output level? For lack of more specific information in the otherwise plentiful literature on frequency markers, I investigated a few circuits I found in Amateur Radio publications.

The output of a 7400-type NAND gate turns out to have an impedance of about a few hundred ohms and could, if necessary, be safely connected to a 50-ohm load. (The IC would even survive a full DC short from its output terminal to ground, if it ever came to that.) However, to permit a proper match into a 50-ohm device, such as an attenuator, a small network is inserted. This also permits an increase in frequency response at the high-frequency end of the spectrum.

Figure 9 illustrates some of the networks that I tried. Note the important improvement by the one shot in **fig. 9B**. This simple circuit turns out very short pulses indeed. In this circuit, the last NAND gate receives the pulse directly at its top input. The pulse is inverted at

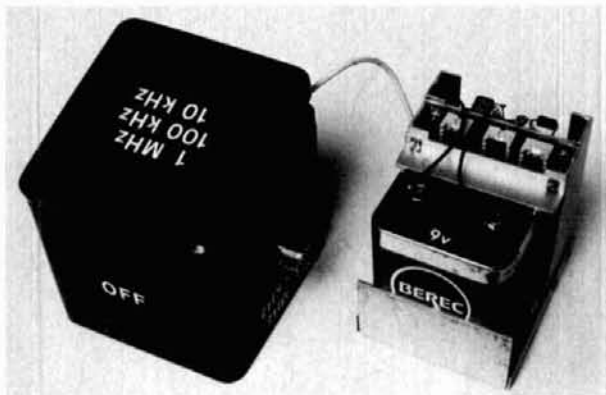

The frequency and level standard outside its enclosure. Normally the entire circuit, power supply, and all control elements are inside the black metal box; thus all RF leakage is eliminated without the need for any filtering.

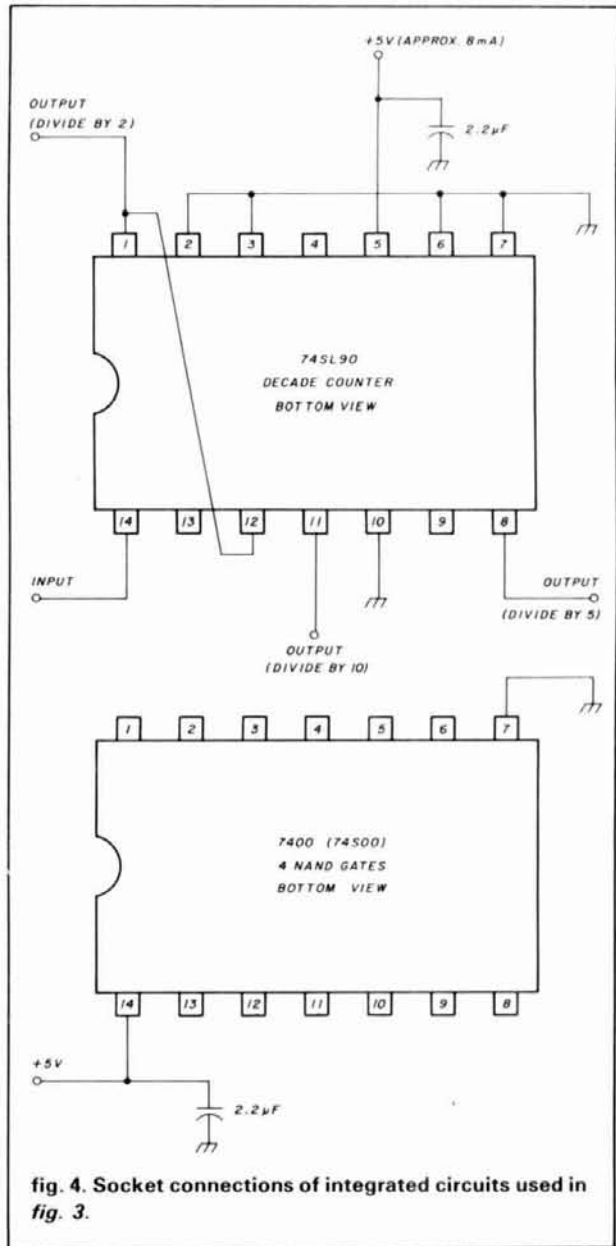

fig. 4. Socket connections of integrated circuits used in **fig. 3**.

the bottom input, and is delayed only by another NAND which acts as the inverter. As the output of a NAND gate is low only if both inputs are high, the total effect could perhaps be compared with letting a signal rush through the circuit, and immediately slam the gate shut behind it, chopping its tail. Thus, using an ordinary 7400, all output pulses have a duration that can't be longer than about 10 nanoseconds, the delay time of the inverter. The circuit produces adequately short pulses for creating a reasonably flat frequency response that covers all HF bands, requiring only a slight correction.

The 7400 also exists in a more than three-times-as-fast Schottky version, the 74S00. This device produces even shorter pulses and makes it possible, at least with

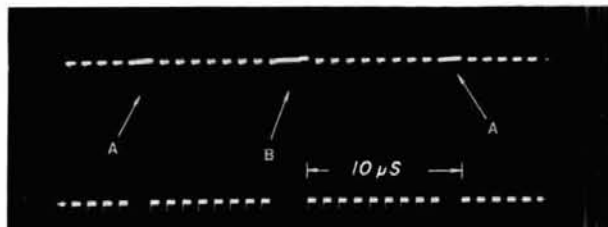

fig. 5. Synthesizer output signal as displayed on oscilloscope. At *A* one pulse is inhibited, repetition rate 10 μ s. At *B* two successive pulses are inhibited, repetition rate 100 μ s.

some correction again, to create a flat response that comfortably includes the 2-meter band. At the time the spectrum (which starts to roll off at 160 MHz) reaches 400 MHz, the amplitudes have dropped by about 15 dB. This would still make a good frequency marker for the 70-cm band.

In the final circuit (fig. 3) an extra 50-ohm, 6-dB attenuator is inserted. This puts the output level at -73 dBm and provides isolation between the frequency-correcting network and a possible capacitive load at the output connector.

The -73 dBm level was chosen for a good reason. It allows sufficient compensation of the frequency response for including the 2-meter band. It also corresponds with the IARU-recommended S9 level at HF bands. By leaving the output unterminated, the open-circuit output voltage produced by every multiple of 100 kHz (100 kHz position) is 100 μ V, or S9 at the high-impedance input terminal of an HF receiver. Terminated into a 50-ohm receiver antenna input, the voltage drops to the IARU-recommended 50 μ V.

Once the receiver S-meter has been calibrated for this level, the other S-points are easy to determine by halving the voltage for each lower S-point on the scale. To put it more practically, each S-point change in level corresponds to 6 dB. Just a few examples: S8 = -79 dBm, S3 = -109 dBm.

Somewhere in the last NAND lies the borderline between the digital and analog sections of the circuit. From this point onward, carefree wiring concepts are better abandoned. The resistor network between the NAND and output connector requires careful layout consistent with good VHF practice. The resistors are best mounted free from each other and from other components, and with their wires as short as possible. Printed-circuit technique is not recommended here.

The shield box is electrically insulated from the circuit ground except at the output connector, through the coaxial cable.

oscillator

Experimenting with ICs of the 7400 series, one may find that the different blocks, with their low input and

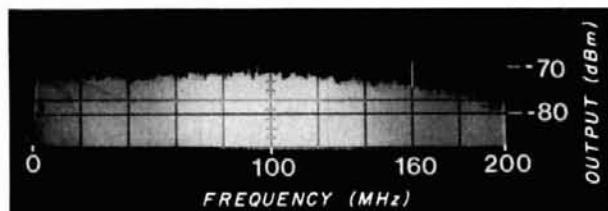
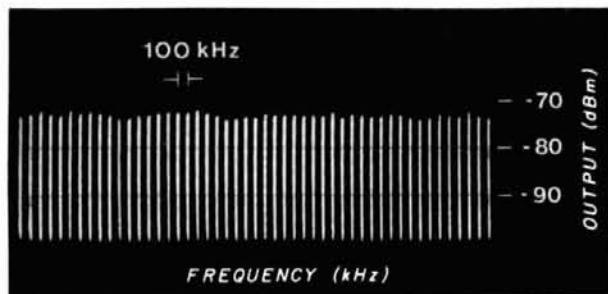

fig. 6. 100 kHz position. Top: typical segment of output frequency spectrum as displayed on spectrum analyzer. Each signal frequency is a multiple of 100 kHz and has a level of -73 dBm \pm 1.5 dB, up to at least 30 MHz. Bottom: spectrum displayed over full usable frequency range. Although signals are no longer individually distinguishable, the display shows signal levels within \pm 2 dB up to 160 MHz.

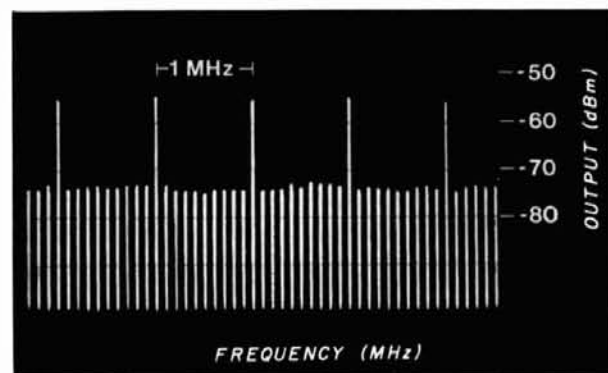
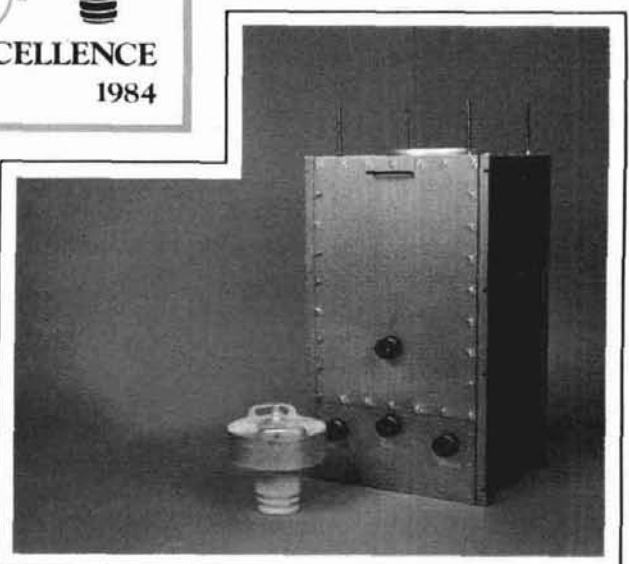
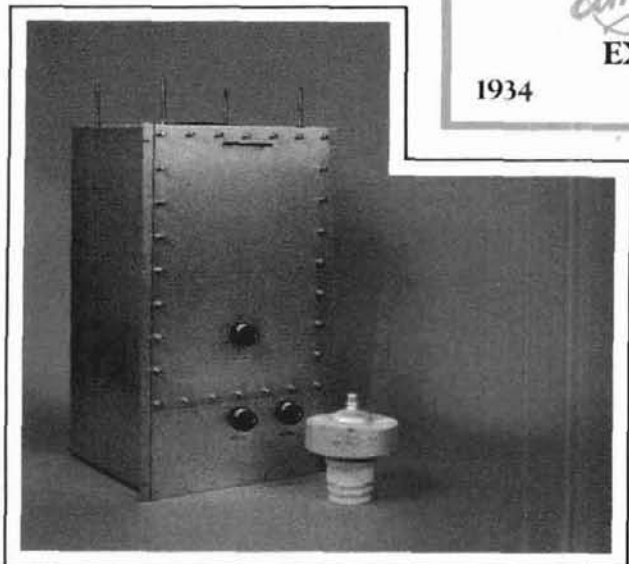
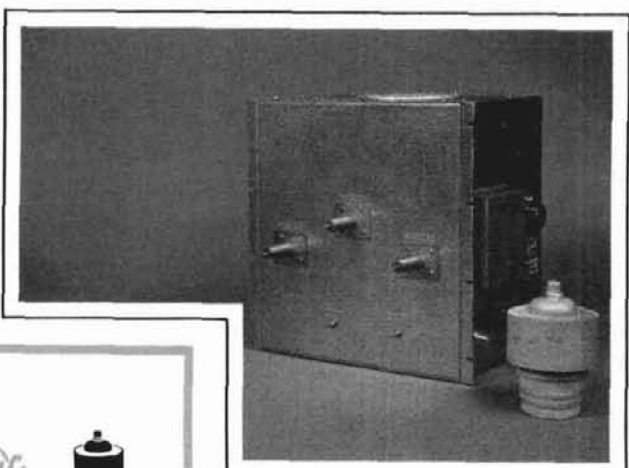
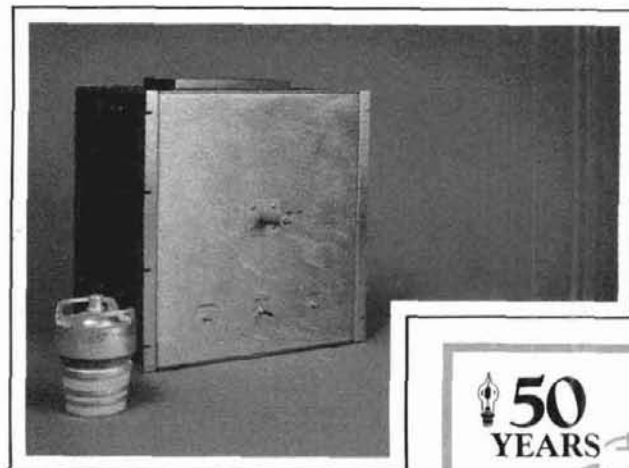

fig. 7. Position: 1 MHz + 100 kHz. Spectrum of 100-kHz marker signals, with 1-MHz marker amplitudes emphasized by approximately 20 dB.

output impedances, aren't the ideal elements for building a crystal oscillator. If the crystal isn't very active, the oscillator won't work. Nevertheless, the reason for using this circuit is that the NANDs — four of them combined in one IC — happened to be available, and they draw supply current whether they are used or not.

If the circuit doesn't work, it may well be possible to wake up a lethargic crystal by using different values for the resistors and capacitors in the oscillator circuit. However, it's also possible to overdo it, causing the oscillator to produce parasitics. In case of persistent recalcitrance, any other oscillator using one or two discrete transistors may do the job just as well, consuming only a few milliamperes of extra current.



EIMAC celebrates its 50th Anniversary with an extensive line of FM Broadcast Cavity Amplifiers.

Varian EIMAC celebrates 50 years of service to the broadcast industry with a spectrum of FM from a powerful 60 kW to a mini power 150 W solid state IPA.

For more information call or write Varian EIMAC or contact any Varian Electron Device Group sales office worldwide.

Varian EIMAC
301 Industrial Way
San Carlos, California 94070
Telephone: 415-592-1221

Varian AG
Steinhauserstrasse
CH-6300 Zug, Switzerland
Telephone: 042-23 25 75

The cost-effective path to a modern FM transmitter.

No one knows more about broadcast tubes and cavities than EIMAC. Our strong cavity development capability reduces RF engineering problems. EIMAC cavities are inexpensive and simple to use.

EIMAC FM BROADCAST CAVITY PRODUCT LINE

POWER	CAVITY	EIMAC TUBE
60 kW	CV-2230	4CX30,000G
30 kW	CV-2202	4CX20,000C
25 kW	CV-2200	4CX20,000A
15 kW	CV-2210	4CX12,000A
10 kW	CV-2228	4CX7500A
5 kW	CV-2225	4CX3500A
1.5 kW	CV-2220	3CX1500A7
150 W	AM-2215A	Solid State



varian

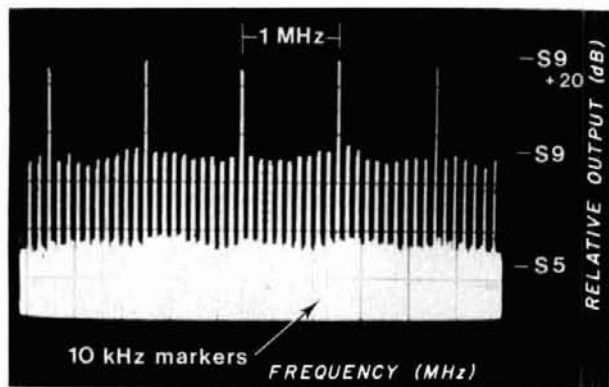

fig. 8. Position: 1 MHz + 100 kHz + 10 kHz. Spectrum is shown with all markers in operation.

power supply

One disadvantage of the closed-box technique may be that it doesn't leave much opportunity for monitoring the battery-supply voltage. That's why a voltage regulator, supplied by a battery that has some voltage to spare, is incorporated. The 9-volt battery can be drained to the point at which its actual voltage drops to 6.4 volts before the regulator gets in trouble trying to keep up its 5-volt output (that is to say, this is what I found; the 78L05 specifications state a minimum input voltage of 7 volts). As soon as the regulator output becomes affected, the RF output level of the total circuit becomes unreliable. Responsibility for this is mainly the last NAND in the output stage, producing pulses with lower amplitude and consequently less energy.

The problem of the aging battery is solved by applying a form of euthanasia. The "signal killer" circuit is based on the principle that it is better to have no signal at all than one on which you cannot rely. As soon as the battery drops below 6.4 volts, the RF output signal is cut off abruptly (fig. 10), before it can cause incorrect test results. This is done by blocking a NAND in the main signal path through a NAND inverter and a transistor.

When the appropriate moment arrives, the act is performed swiftly, even in case of a very slowly deteriorating battery voltage. The threshold is set by potentiometer R1 (fig. 3) to make the RF output signal disappear just before a reduction in amplitude occurs.

Because an output signal that suddenly disappears can be disconcerting, I found it useful to provide a means of alerting the user to the imminent demise of the battery. If the box fails to deliver its output signal, just turn it to the position 1 MHz + 100 kHz + 10 kHz. If only the 10-kHz markers are still present, this is a sign that the malfunction of the generator is the result of too-low battery voltage, and that there's no reason to expect anything worse than having to replace the battery.

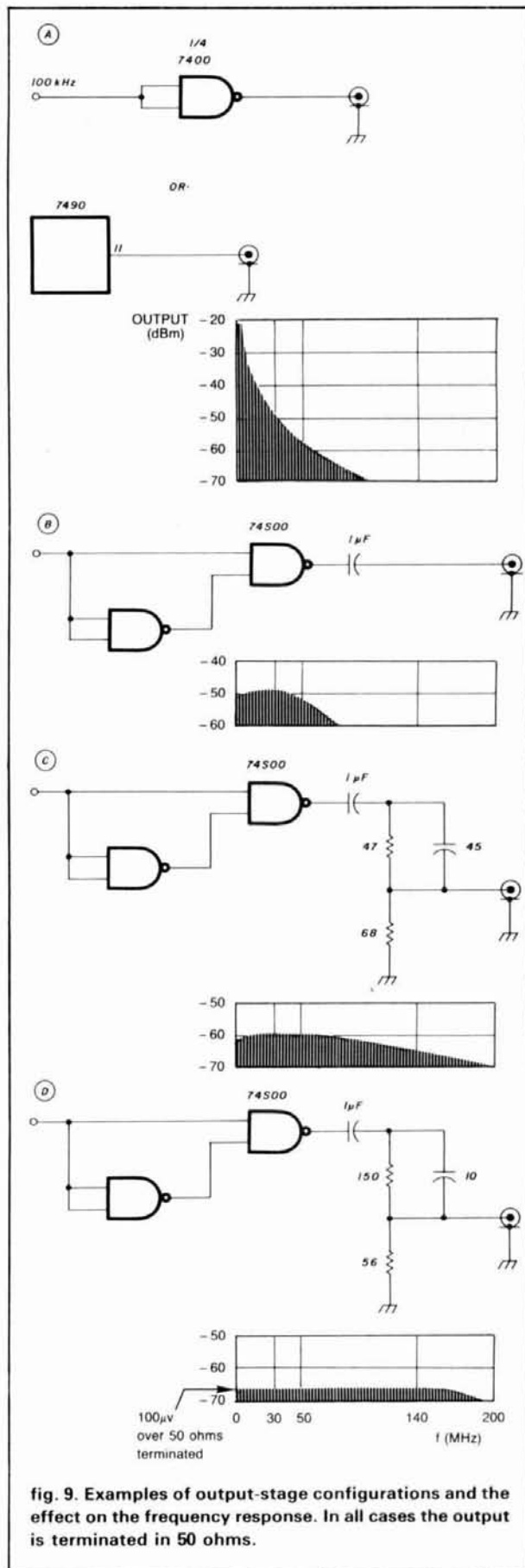

fig. 9. Examples of output-stage configurations and the effect on the frequency response. In all cases the output is terminated in 50 ohms.

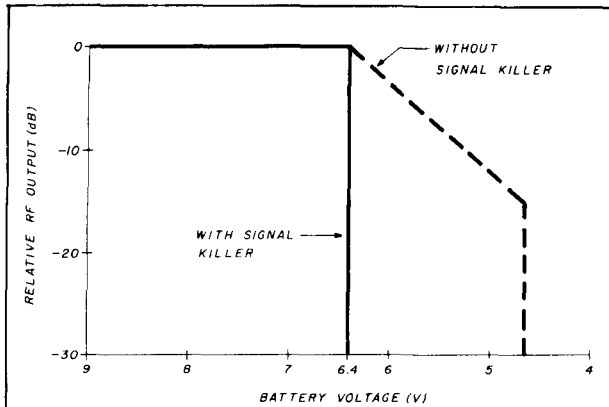

fig. 10. RF output as a function of battery voltage. An unnoticed drop in RF output level, resulting from an exhausted battery, is made impossible by the action of a "signal killer."

The battery is normally switched on and off by a mercury switch, a miniature glass bulb in which a droplet of mercury makes contact between two wires, depending on the position of the device. With some three-dimensional imagination, it's not difficult to see how, using a switch, a circuit can stay switched on at a maximum of three different positions of the box. This is done by mounting the switch in the circuit wiring at an oblique angle with respect to the three axes of the box. Similar switches are used for switching the 1-MHz and 10-kHz markers.

If mercury switches are difficult to obtain, it shouldn't be difficult to think of something else, such as one or more reed switches and a movable magnet, for example. Another method would be to use a steel ball (a ball bearing, for example) that can roll around inside a little plastic box with contact wires, or in a little box made of printed-circuit board (fig. 11).

The total battery consumption at 9 volts is about 43 mA with all markers operational, or about 36 mA in the 100 kHz position.

attenuator

The type of outboard step attenuator shown in the photograph has been described already in many Amateur publications. In this case, miniature toggle switches and 1/4-watt carbon resistors are used. The resistors are mounted on the solder lugs of the switches, with their leads kept as short as possible. For the rest of the wiring, copper braid (taken from thin coaxial cable) is used, soldered over the full length of the solder lugs. Braid is not essential insofar that it doesn't seem to extend the flat portion of the frequency response; however, I found that it can give a considerably smoother result at VHF.

Production tolerances in the resistor-manufacturing industry appear to have greatly improved over the last

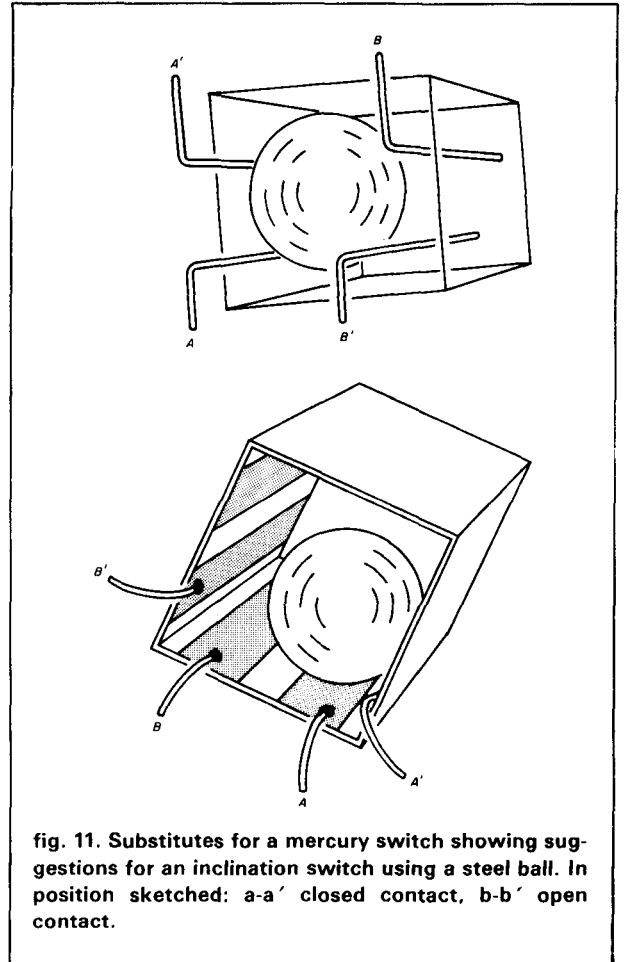

fig. 11. Substitutes for a mercury switch showing suggestions for an inclination switch using a steel ball. In position sketched: a-a' closed contact, b-b' open contact.

decade. At one time, a 10-percent resistor was almost bound to show a tolerance between 5 and 10 percent.

Today it's not unusual to find that ordinary 10-percent resistors are in fact not much more than 2 percent off the mark. And as more accurate ohmmeters become available to Radio Amateurs, it's no longer difficult to obtain reasonably precise resistors.

The required values for the attenuator are obtained by parallel combinations. In each combination it is mainly the lower-value resistor that is critical and which should preferably be within 1 to 2 percent. (Tolerances of resistors are like those of voltages, and the same rule-of-thumb applies: for small variations, each percent corresponds to 0.1 dB.) Alternatively, each combination should be brought as close as possible to the ideal value by selection and trial and error, using an accurate (digital) ohmmeter (fig. 12).

Most descriptions of this type of step attenuator remain rather vague about the performance, particularly at higher frequencies. Therefore, fig. 13 may be of interest, because it shows the test results of this home made attenuator, built with no particular care other than ordinary construction techniques. The device is accurate within 1/10 of a dB or thereabouts,

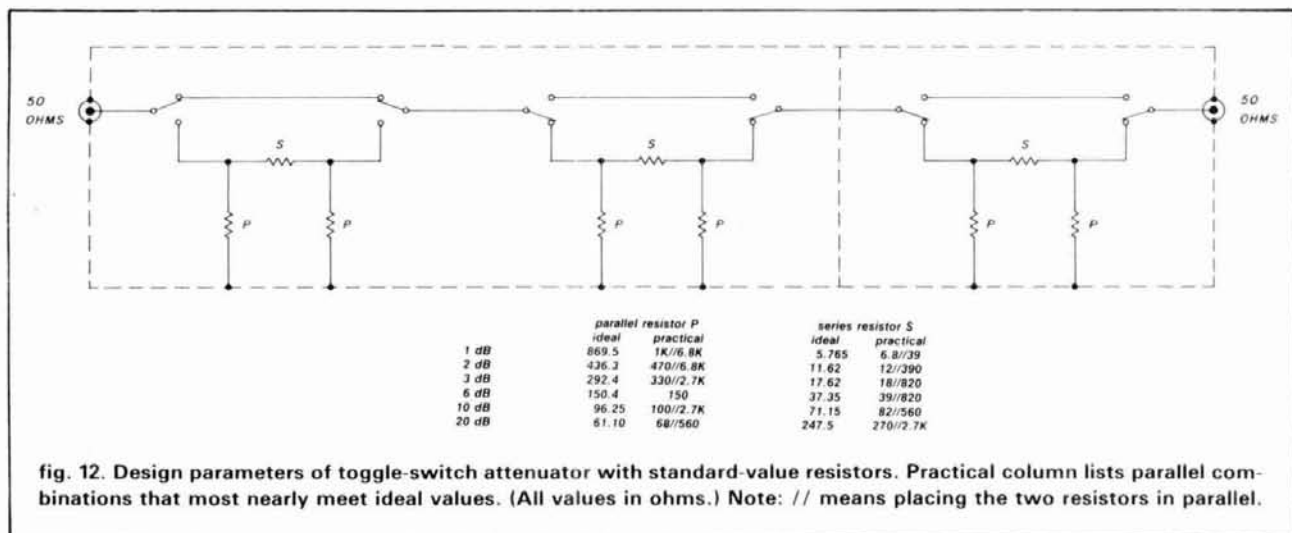

fig. 12. Design parameters of toggle-switch attenuator with standard-value resistors. Practical column lists parallel combinations that most nearly meet ideal values. (All values in ohms.) Note: // means placing the two resistors in parallel.

up to 65 MHz; that is, as accurate as the resistors could be selected with the available DC ohmmeter.

Figure 13 also shows the reason for the apparent reluctance to publish test results: at VHF precision tends to become questionable. Nevertheless, the general performance is still within the tolerance of the signal generator, about ± 1 dB uncertainty at 144 MHz.

That the discrepancies are mainly the result of the many twists and turns in the signal path through the switches is also clearly demonstrated. Even with all attenuators in the *OUT* position (0 dB), the wavy character of the curve remains. This gives hope; it's not impossible that (cheaper) slide switches and N-type coaxial connectors would make an improvement on VHF.

calibration

The accuracy of the frequency can be checked and corrected by adjusting the oscillator trimmer while comparing a signal with one of the short-wave standard signals such as WWV in the USA, or GDF in Europe. Because the circuit doesn't contain any variables in the form of tuned circuits, the output level of -73 dBm should be fairly easily reproducible for HF by using the components as described. Up to, say 30 or 40 MHz, the frequency response should remain flat within reasonable limits, even if the output trimmer is simply replaced by a 10 pF fixed capacitor.

In the multitude of standard-size 100-kHz harmonics there appear to be two exceptions where the amplitude seems to behave a bit freakishly: at 100 kHz itself and at 1MHz. I found relative levels of -4 dB and -10 dB, respectively. As yet I have no fully satisfactory explanation to offer for the phenomenon; it's difficult to speculate to what extent these findings may be typical for the circuit.

The output can be calibrated by comparing the level

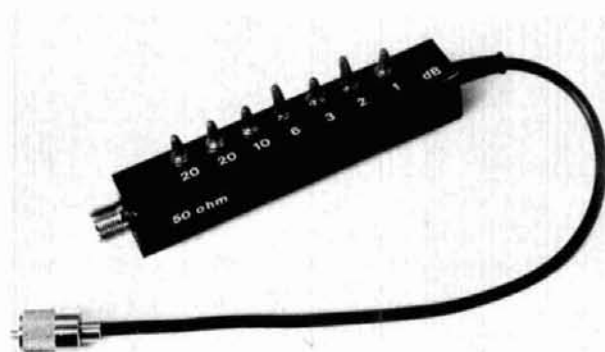

Toggle-switch attenuator.

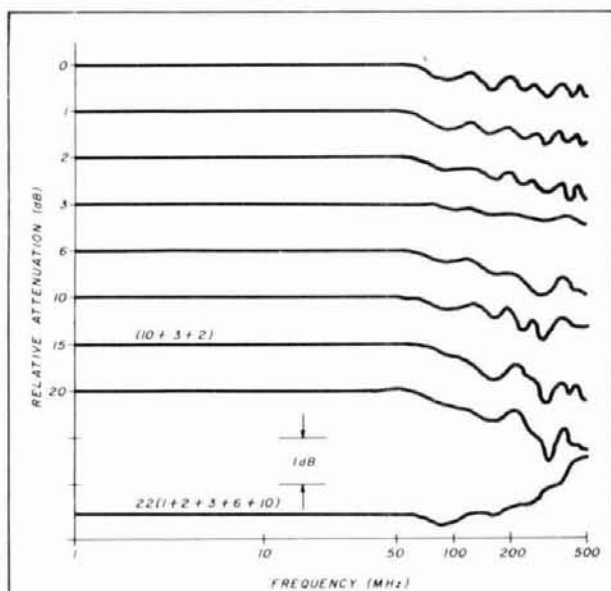
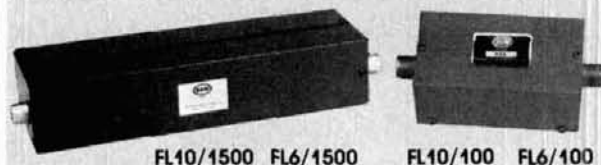

fig. 13. Test results of home made attenuator. Frequency response is shown at each setting, as well as at some combinations. Note absence of any appreciable discrepancies up to 65 MHz.

T.V.I. problems?

Low pass T.V.I. filters from Barker & Williamson



Model	Power (Watts)	Cut Off Frequency	Frequency of Maximum Attenuation	Minimum Attenuation	Frequency Range	Price
FL10/1500	1000	34 MHz	52 MHz	70 db	1.8 - 30 MHz	\$29.50*
FL10/100	100	44 MHz	57 MHz	60 db	1.8 - 30 MHz	\$22.50*
FL6/1500	1000	55 MHz	63 MHz	70 db	6 meter	\$36.00*
FL6/100	100	55 MHz	63 MHz	50 db	6 meter	\$25.00*

All above to match 50 ohm transmitters and antennas.

*Add \$2 shipping and handling

ALL OUR PRODUCTS MADE IN USA



BARKER & WILLIAMSON

Quality Communication Products Since 1932

At your Distributors write or call
10 Canal Street, Bristol PA 19007

(215) 788-5581



of one of the 100-kHz harmonics (except at 100 kHz and at 1 MHz) with that of a signal from an RF generator with a reliable output attenuator, using a radio receiver as a frequency-selective balance detector. A signal-strength meter is not absolutely essential. By comparing two beat tones, one immediately after the other, providing that they both have the same pitch, one should be able to match levels well within 1 dB.

However, a professional RF signal generator could be difficult to procure, and for the average Radio Amateur a more common audio generator might be more easily available. Audio levels are more accurately determined using an audio voltmeter or an oscilloscope. Most audio generators cover 200 kHz, and a level comparison could be made on a long-wave radio receiver, using an audio meter or the human ear. After all, the 200-kHz harmonic is just as strong as any other harmonic in the entire HF spectrum of the generator and, even if it sits at an extreme end of the range, it provides a perfectly typical specimen upon which to base the level calibration.

In case level corrections appear to be necessary, the resistors in the attenuator between output trimmer and coaxial cable can be replaced to change the 6-dB attenuation into a different value. Figure 13 supplies the data.

ham radio

Turn Your Antenna Into Several Antennas!

With the "Old Reliable" W2VS antenna traps

Traps Needed for a Multi-band:

A pair for every band — except lowest frequency.

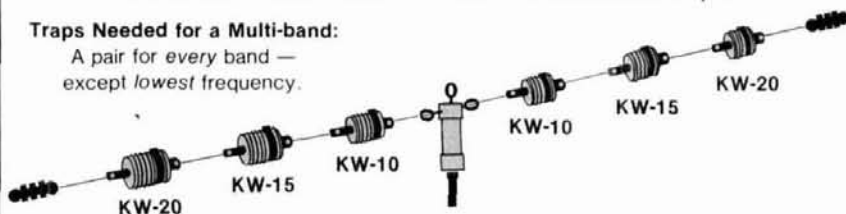

Special wire length data is shipped with your trap order. Get rid of the "antenna farm" and put all your favorite bands on one antenna.



Exclusive! Straps for user fine tuning

Model	Resonant Meters	at MHz
KW-10	10	28.675
KW-12 NEW	12	24.950
KW-15	15	21.275
KW-20	20	14.175
KW-30 NEW	30	10.125
KW-40	40	7.250
KW-80CW	80CW	3.625
KW-80F	80F	3.875

Need customized traps for a special frequency? Now you can get them! Add 30% to standard price.

FREE catalog PC/84 describes a complete line of baluns, remote antenna relays, and antenna traps in the 10-60 meter band.



"One River"

At your local dealer If not order direct

Only \$36.00/pair, \$18.00 each

Tax & UPS Shipping Included

How many? (1 = a trap, 2 = a pair, etc.)

__KW-10 __KW-12 __KW-15 __KW-20

__KW-30 __KW-40 __KW-80CW __KW-80F

Order Total \$ _____

Send free catalog PC/84

Name _____

Address _____

City _____ State _____ Zip _____

Phone () _____

AmEx VISA Mastercard

Card # _____

Valid (AmEx) _____ Expires _____

Check Money Order

To ORDER or request free full line catalog of baluns, antenna relays and antenna traps, call

1-800-523-0027

24 HOURS—7 DAYS A WEEK!

NY/HI/AK/CAN residents please use coupon or call collect 315-437-3953, 8-5 EST

1 week delivery for credit card
2 weeks for personal check.

60 DAY MONEY BACK GUARANTEE

Unadilla/Reyco/InLine

Division of Microwave Filter Company, Inc.

6743 Kinne Street, East Syracuse, NY 13057

HR

PC/XT™ COMPATIBLE COMPUTER

ARE YOU LOOKING FOR AN IBM COMPATIBLE COMPUTER? DO YOU KNOW WHAT COMPATIBLE WILL MEET YOUR NEEDS NOW AND IN THE FUTURE? ARE YOU CONFUSED? THE FIRST THING TO CLEAR UP IS THE QUESTION OF WHAT COMPATIBILITY REALLY IS. YOU PROBABLY THINK THAT ALL COMPATIBLES ARE THE SAME. WELL LET ME TELL YOU THAT THEY ARE NOT. SOME OF OUR COMPETITORS HAVE THEIR OWN DEFINITION OF COMPATIBILITY. SOME MACHINES ARE HARDWARE COMPATIBLE AND SOME ARE SOFTWARE COMPATIBLE. VERY FEW ARE BOTH, OUR UNIT WAS DESIGNED TO MEET IBM SPECIFICATIONS SUCH AS 8088 CPU 135W POWER SUPPLY, 8 EXPANSION SLOTS, 256K RAM, OPTIONAL 8087 CO-PROCESSOR 10 OR 20 MEGABYTE HARD DRIVE ENHANCED VIDEO FOR HIGH RESOLUTION GRAPHICS. STOP IN FOR A FREE TEST DRIVE AND BRING ANY SOFTWARE OR HARDWARE YOU MAY HAVE TO TEST OUR SYSTEM.

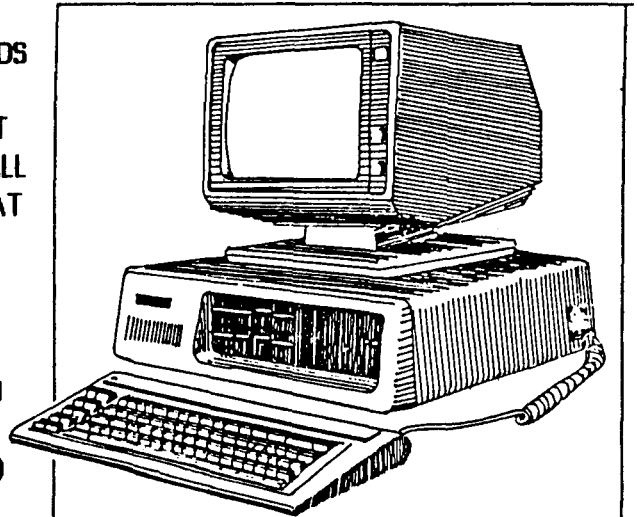

\$699.00

- * 2 DS/DD FLOPPY DISKS
- * 256K RAM
- * COLOR GRAPHICS CARD
- * 8K BIOS 8 SLOT MB
- * 135W POWER SUPPLY
- * IBM STYLE CASE
- * 108 KEY KEYBOARD
- * 90 DAY WARRANTY

FEATURES

PROCESSORS	INTEL 8088 16 BIT 4.77MHZ PROCESSOR OPTIONAL 8087 MATH CO-PROCESSOR
MEMORY	256K EXPANDABLE TO 640K
DISK STORAGE	MAXIMUM 4 360K FLOPPY DRIVES
DISPLAY	640 X 200 BLACK & WHITE GRAPHICS 320 X 200 COLOR GRAPICS
KEYBOARD	IBM STYLE 108 KEYS LED INDICATORS
OPERATING SYS	IBM PC-DOS CP/M-86 VENIX MS-DOS COMPAQUE-DOS COLUMBIA-DOS ETC.
SOFTWARE	RUNS FLIGHT SIMULATOR DBASE III FRAMEWORK SYMPHONY LOTUS 123 IBM DIAGNOSTICS GW BASIC WORDSTAR
OPTIONAL	10 OR 20 MEGABYTE HARD DRIVE

IBM PC IBM XT AND IBM AT ARE REGISTERED TRADEMARKS OF INTERNATIONAL BUSINESS MACHINES

AVAILABLE AT:

**AZOTIC INDUSTRIES
2026 W BELMONT
CHICAGO ILL 60618
312-975-1288**

PACKET RADIO . . .

. . . THE FASTEST GROWING PART OF AMATEUR RADIO TODAY

is already providing high speed, error free, communications on many amateur bands for qso's, data transmission, emergency traffic, dx'ing, traffic nets, mailboxes, endless experimentation, and soon... satellite operation.

networks continue to grow, as does the number of hams who enjoy this new and exciting mode. The increasingly popular **PACKETERM IPT** is contributing to phenomenal growth in amateur packet radio by providing a full function packet terminal in a compact, portable unit...



ALL YOU NEED FOR PACKET OPERATION IS A **PACKETERMtm IPT AND YOUR RIG !**

Designed for true portability, the IPT is equally at home in your ham shack or (with its optional carrying case) trekking in the country for battery powered hilltopping!

A single cable connects to your transceiver....thats all there is to it!
Use it with your base station, mobile, or with your HT on that hilltop!!!

- FEATURES:**
- * * 9 inch portable terminal and full function tnc combined
 - * * 66 commands available - the most widely used, field proven programming .
 - * * Built-in LSI modem ; 300 or 1200 baud, 200 or 1 kHz audio shift
 - * * stores setup parameters with power off - uses lithium battery
 - * * custom "beacon" text -- your call, qth, etc. in permanent memory
 - * * 74 key, full travel keyboard with 14 function keys for commands, calls, etc.
 - * * printer port - RS232C serial
 - * * optional printer, carrying case, and dc adaptor (13.8 VDC)

 **Packeterm**

Box 835, Amherst, NH 03031
(603)-673-6630

PRICES:	IPT COMPLETE	\$995
	PRINTER	\$349
	DC ADAPTOR	\$125
	TNC (BOARD ONLY)	\$275

a calibrated S-meter

Meaningful signal
reports are possible
— here's how

Long ago a wonderful idea emerged that would make signal reporting, gain measurements, antenna comparisons, and propagation studies as easy as reading, reporting, and comparing meter values. This idea came to be known as the S-unit system of signal reporting. Sometime later an S-unit "standard" was set, in which each S-unit change represented a level change of 6dB and S9 was referenced to 50 microvolts rms in a 50 ohm system. This standard was straightforward and simple. S1 was 48 dB below 50 microvolts, near the practical lower limit of receiver sensitivity and noise floor. This standard offered the Amateur community a method of quantifying signal reporting and other useful measurements. **Tables 1 and 2** are included to illustrate the nearly 180 dB of dynamic range common in Amateur Radio equipment and show where the S-unit scale fits in at the threshold of receiver sensitivity.*

Nearly half a century has passed with very little conformation to this or any other level standard. For practical purposes, the RST system as practiced today is a farce — yet it's the most common exchange between stations. Consequently, meaningless guesstimates echo endlessly through the ether, apparently for lack of something more meaningful to say. This ironic state of affairs is especially troublesome in light of the advantages standardization and conformation could afford.

By nature, Amateur Radio is a quantitative hobby embracing the technology and science of multiple disciplines. Why, then, is the basic RST number abused?

* From minimum discernible signal at the receiver to maximum legal output from a linear — Ed.

The more cynical among us might suggest that we're simply locked into a bad habit, or that you must give S9 signal reports to get rare QSL cards. There's probably some truth to the first notion; the second, even if true, is a poor reason for general abuse. After careful investigation, however, more subtle reasons emerge. The basic problem is simply that modern receivers generally do not have calibrated S-meters. Standards differ drastically from one manufacturer to another and from one unit to another. Most Amateurs know their S-meters are probably not calibrated and consequently give politely inflated signal reports.

Receiver manufacturers will respond only to customer demand; this is reflected by the multitude of "bells and whistles," compact size, and sleek styling found in modern Amateur equipment. Because Amateurs appear not to care, important specs have actually declined over the past several years. Dynamic range, on the other hand, has been improved because it has received much attention in the literature. Amateurs have become aware of this important phenomenon and now often ask equipment dealers embarrassing questions. I hope this signals a trend toward increased consumer demand for improved radio performance rather than for superficial enhancements that may have little or no effect on actual performance.

To be fair, lack of concern from the Amateur community is not the only reason that receiver manufacturers have not offered calibrated S-meters. There are real technical problems inherent in doing so. Providing consistent front end mixer gain over many frequency bands, for example, is a major problem. All amplifiers and attenuators ahead of the S-meter circuit must have identical gain on all bands and frequencies within these bands to assure consistent readings. Furthermore, most S-meter voltage sources are derived from the AGC circuit, and the response of these circuits varies widely — not only among receiver model types, but among individual units of similar types as

By Robert J. Zavrel, Jr., W7SX, P.O. Box 24845, San Jose, California 95154

well. **Table 3** shows the extent of this deviation among popular receiver types.^{1,2,3} This unpredictable deviation from receiver to receiver of the AGC voltage versus received signal strength represents the most difficult obstacle to setting an S-meter standard. The first problem can now be solved by broadbanding front ends, using flat response mixers, and employing modern RF components and layout techniques. The second problem has been alleviated with the introduction of the Signetics NE604, an FM RF integrated circuit designed primarily for the cellular radio market (fig. 1 and 2).

Receivers for cellular radio systems require a received signal strength indicator (RSSI) function. The response of this required logarithmic measurement must conform to 3 dB accuracy over an 80 dB dynamic range. This function represents an ideal signal source for S-meters and other RF measurement equipment

table 1. Power and voltage levels common to Amateur equipment.

dBm	power (watts)	volts (50 ohms)
+70	10 kW	707.0 V
+60	1 kW	223.0 V
+50	100 W	70.7 V
+40	10 W	22.3 V
+30	1 W	7.07 V
+20	100 mW	2.23 V
+10	10 mW	707.0 mV
0	1 mW	223.0 mV
-10	100 μ W	70.7 mV
-20	10 μ W	22.3 mV
-30	1 μ W	7.07 mV
-40	100 nW	2.23 mV
-50	10 nW	707.0 μ V
-60	1 nW	223.0 μ V
-70	100 pW	70.7 μ V
-80	10 pW	22.3 μ V
-90	1 pW	7.07 μ V
-100	100 fW	2.23 μ V
-110	10 fW	707.0 nV
-120	1 fW	223.0 nV

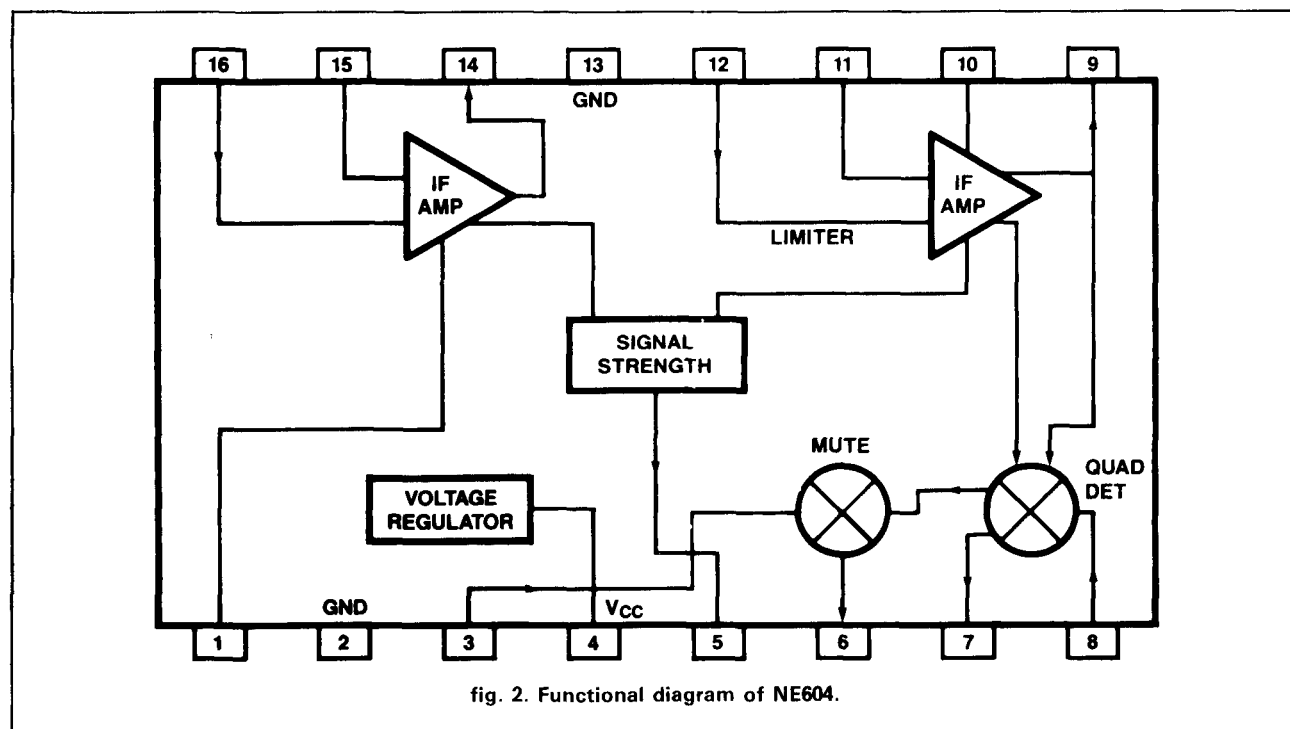
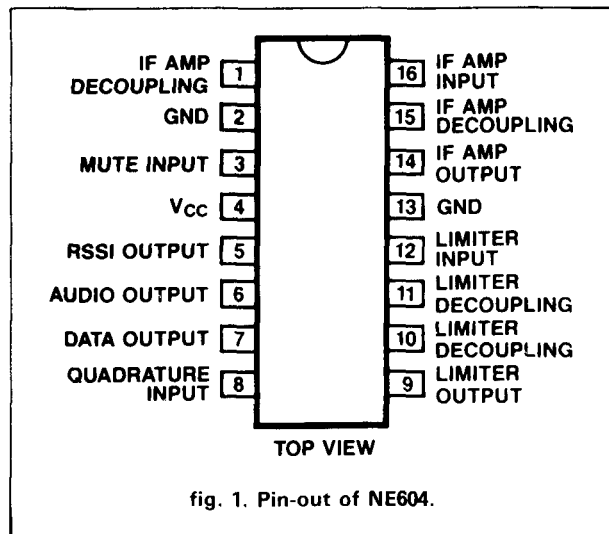

table 2. Power and voltage levels for the nine S-units.

S-unit	dBm	volts (50 ohms)
S9	-73	50.0 μ V
S8	-79	25.0 μ V
S7	-85	12.6 μ V
S6	-91	6.3 μ V
S5	-97	3.2 μ V
S4	-103	1.6 μ V
S3	-109	792.0 nV
S2	-115	397.0 nV
S1	-121	199.0 nV

such as field strength meters. The NE604 performs this function by providing a current source which is typically sunk through a 100 kilohm resistor (fig. 3). The high impedance voltage produced at pin 5 is then buffered by an op amp (NE532) to drive a linear analog voltmeter or other suitable display. The DC voltage output is plotted against RF level input in fig. 4. Responses for unattenuated and attenuated inputs are given.

The RF input to the NE604 can be taken off an IF amplifier stage operating up to 15 MHz. The higher RF levels associated with the later IF stages make them more attractive as drivers for the 604. Very light coupling can be employed (3 pF) with these stages to prevent any undesirable loading to the receiver IF amplifier. Figure 4 shows that the unattenuated amplitude input range for the 604 is about -90 to -10 dBm. The effect of the fig. 3 input isolation circuit is to move the effective range up about 20 dB. Because the RSSI function is mode independent, the S-meter will function for CW, AM, SSB, or FM.

A simple LC filter should be placed between the IF and limiter stages (pins 12 and 14) to reduce broadband noise. Optimum performance of the 604 occurs with a 6-volt power supply, but will work over a 4 to 8 volt range. Supply current is only about 2.5 mA suggesting battery powered operation for both Amateur receivers and accurate field strength meters.

building an S-meter circuit

As stated earlier, each S-unit represents a 6 dB change in RF signal strength. For each 10 dB change in RF input, the 604 circuit output will change about 1/2 volt. If S1 is referenced to the lower limit of the 604's dynamic range (about 0.3 volts output), then S9 will be 48 dB higher (about 2.7 volts output.) Each S-unit will represent 0.3 volt of output meter calibration. A standard linear 0-5 volt meter can be calibrated for S-units and "dB over S9." With an 80 dB dynamic range and 48 dB difference between S1 and S9, 32 dB remains for the "dB over S9" calibration. Furthermore, the S-meter can also be calibrated in dBm and/or RF

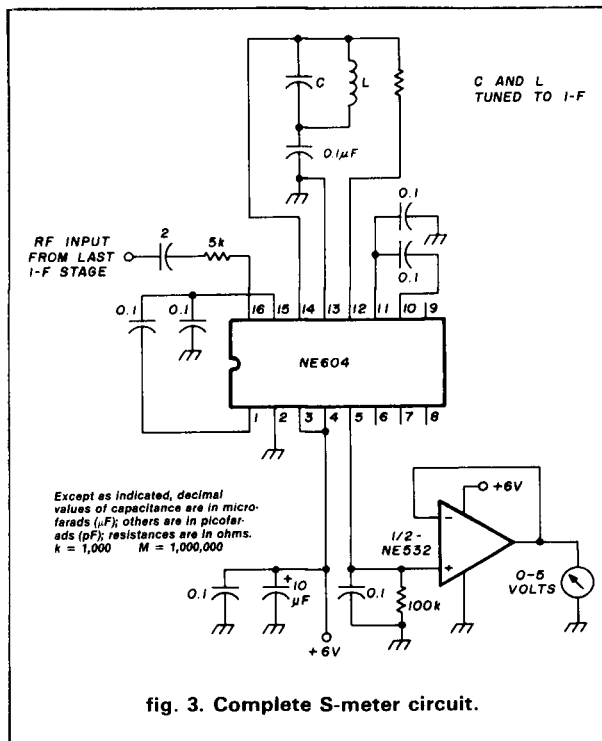

fig. 3. Complete S-meter circuit.

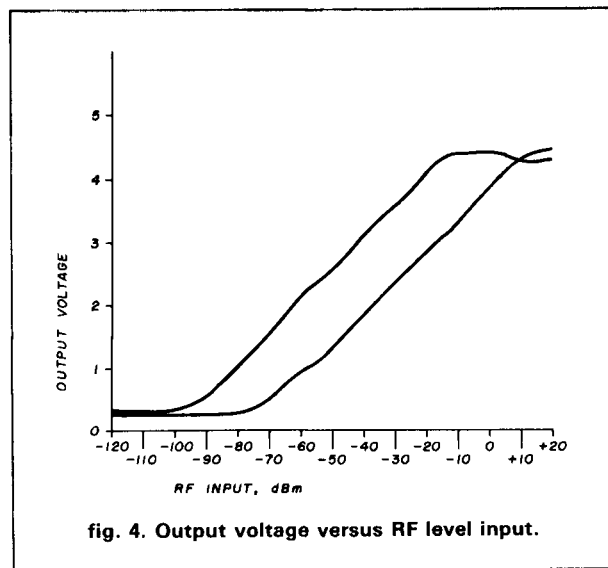

fig. 4. Output voltage versus RF level input.

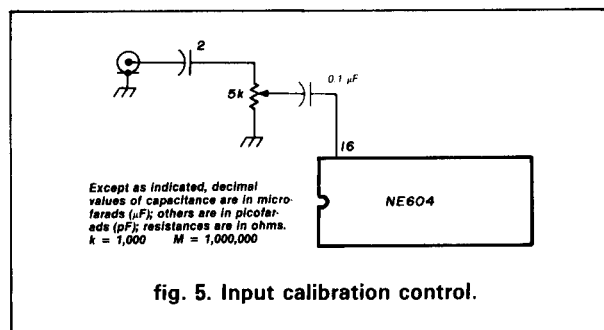

fig. 5. Input calibration control.

GREAT GEAR, AWESOME ANTENNAS, POWERFUL PACKET.

New rigs and old favorites, plus the best essential accessories for the amateur.

3621 FANNIN ST
HOUSTON, TX 77004-3913

CALL FOR ORDERS
1-713-520-7300 OR
1-713-520-0550

ALL ITEMS ARE GUARANTEED OR SALES PRICE REFUNDED

EQUIPMENT

Kenwood	Call for prices on all Kenwood
New Kantronics UTU-XT	319 00
Kenwood TS940S, contesters delight	Call
Icom R7000 25-2000Mhz	799 00
Alpha (ETO)	List-15%
Icom 271A, 27A	Call
Icom IC3200	489 95
Santec ST20T Handi Talkie	299 00
Regency UC 102 VHF 2 Channel Handi Talkie	150 00
Icom IC735	749 00

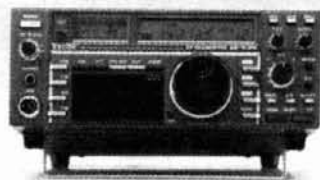

ACCESSORIES

B&W Viewstar Antenna Tuner	69 00
Heil HC3/HC4/HC5	Stock
Heil BM10 Boom Mike headset	53 95
CSI Private Patch III	469 95
FLUKE 77 auto-ranging digital multimeter	125 00
Bird 43 Wattmeter	Call
Bird Elements, H/59 00, A-E/48 00,	In Stock
Daiwa CN620B, 20-200, 2000W	109 95
Daiwa CN630 140-450, 20 200W	129 00

KEYS

Benchner & Vibroplex	Less 10%
Benchner is now improved Screws & springs, all stainless steel	
Extra hand polishing	
Vibroplex Carrying Case	\$20.00 w/purchase
MFJ Super keyboard #496	169 00

TUBES

Collins&Drake Replacement Tubes	stock
GE 6146B	11 95
Eimac 3-500Z	109 95
GE Industrial Tubes	Call
GE 12BY7A	6 00
GE 6JS6C	11 95

BOOKS

We stock SAMS, TAB, ARRL, RSGB, Ameco Radio Pubs Call
Some of the best buys are the RSGB books

CALRAD 65-287 SWR, Relative Power Meter 3-150Mhz, KW +	32 95
--	-------

PACKET POWER

AEA PK64, does RTTY, ASCII, AMTOR also	199 00
AEA PK80	soon
KANTRONICS PACKET	199 00
Icom 271A Great packet radio	Call

SERVICES

Alignment, any late model rig	50 00
Flat fee Collins rebuild	Call

QUANTITY DISCOUNTS

Want a good discount? Get three of your friends and order Madison's special four lot prices. For example: ICOM IC3200 \$1820.00

Call for four lot prices on other rigs.



ANTENNAS

ARX2B, V2S, 2MCV-5, ISOPOLE	44 95
A4	289 95
402CD	279 95
New Cushcraft LAC-3 Lightning Arrester	7 95
215WB New, 15EL, 2MBeam	79 95
AOP-1, Complete Oscar Antenna	149 95
Butternut HF6V, 80-10 Vertical	125 00
HF2V, 80 & 40 Vertical	125 00
HF4B	189 00
Hustler G7-144	119 95
Ham4 Rotator, T2X, CD45-2	Call
KLM HF World Class Series Antennas	Call Don

OTHER ANTENNAS

Larsen Kuldack	17 00
Avanti AP151 3G on Glass Antenna	33 00
Anteco 2M, 5/8, Mag. Mount, Comp	25 00
Avanti APR450-5G on glass	30 00
Philly Siran	Call

SURPLUS

Collins parts 75S/32S/KWM2/75A4/KWS-1 Specity Part No	
Model 33/35 Teletype	100 00/Each
Local Pickup Only	
24 Pin Solderdale dip sockets	25/Each
Signal Batteries Exact Replacement	
Yaesu 208/207	25 00/Each
Solid State 866A Replacements	15 00/Each
Scream'n' Demon Radar Detector	29 95
150MFD/400V DC	1 95
1 5Amp 400V full wave bridge rectifier	1 95
2.5A/1000PIV Epoxy diode	29c/Each or 19.00/100
0015-10KV	1 95
3N201	95
4 Inch ferrite rod	1 95
365pF cap	1 95
Sanyo AAA, AA Nicads w/tabs	2.50/ea
2, 4, 5, 6, 8 pin mic plugs	4 00
Close out on rigs & accessories All the time	Call
We may have what you're looking for	

BELDEN

9913 low loss, solid center, foil/braid shield	45c/ft
8214 RG8Foam	43c/ft
8237 RG8	37c/ft
8267 RG213	52c/ft
8000 14Ga stranded copper ant. wire	13c/ft
8448 8 conductor rotor cable	31c/ft
9405 Heavy duty, 2-16 Ga. 6-18 Ga.	52c/ft
9258 RG8x	19c/ft
8403 Mic Cable, 3 condctr & shield	80c/ft
100 Feet 8214 w/ends installed	45 00
8669 7 1/8" tinned copper braid	1.10/ft
International Wire RG214, non-mil, good cable	.70/ft

AMPHENOL

831SP-PL259 Silverplate	1 25
UG176 reducer RG8x	30
831J Double Female UHF	2 00
82-61 N Male	3 00
82-97 N Female Bulkhead	3 00
82-63 Inline Female N	4 00
82-98 N elbow	9 00
New 82-202-1006 N-Male fits 9913	5 00
1/4" E H S. Guy cable, Rohm US,	
1000 ft	250 00
3/16" E H S cable	210 00
1/4" Guy Cable, 6100 #7 x 7 strand, import	15c/ft
3/16" Guy Cable, 3700 #7 x 7 strand, import	12c/ft
3/8 x 6 E&J Turnbuckle	7 95
3/16" Wire Rope Clips	40
1/4" wire clips	50
Porcelain 500D Guy Insulator (3/16)	1 69
Porcelain 502 Guy Insulators (1/4)	2 99

COMPUTER STUFF

Kantronics UTU-XT	319 00
Fits any computer (even yours!) Software Available	19 00
Morse University (Great CW program for C-64)	39 00
AEA New VHF 1200	Coming

USED EQUIPMENT

All equipment, used, clean, with 90 day warranty and 30 day trial. Six months full trade against new equipment. Sales price refunded if not satisfied.

POLICIES

Minimum order \$10.00. Mastercharge, VISA, or C.O.D. All prices FOB Houston, except as noted. Prices subject to change without notice. Items subject to prior sale. Call anytime to check the status of your order. Texas residents add sales tax. Dats all, folks.



MADISON

Electronics Supply

3621 FANNIN
HOUSTON, TEXAS 77004

1-713-520-7300 OR 1-713-520-0550

volts. The receiver has now evolved into a valuable RF test instrument.

Because it might overshoot the actual peaks of signal intensity, an underdamped meter is not recommended for S-meters; critically or slightly overdamped meter movement is preferred instead. An LED or LCD bar graph would also make a suitable display. Digital readout displays are not recommended for S-meters because of their inferior peak reading response.

The RF input impedance at pin 16 is about 1500 ohms. Other capacitor and resistor values can be set for a given IF signal level range, including a potentiometer for a calibration adjustment (fig. 5). Calibration consists of placing a 50 microvolt signal at the antenna terminal, peaking the response by fine tuning the VFO, and adjusting the pot for S9. Correct meter tracking will now be automatic.

This circuit will provide an accurate S-meter reading if certain precautions are taken. Most S-meters use the AGC voltage as the control voltage. Although the RSSI generated voltage would also be ideal for the AGC voltage source, the S-meter linearity would require the AGC function to be disabled. Alternatively, the meter can be calibrated with the AGC "on". Either way, the NE604 will also allow you to know exactly the

table 3. Tested S9 μV sensitivity for some popular rigs.

radio	S9 (μV)	radio	S9 (μV)
FT901	50	Omni D	36
TS-820	200	Triton IV	20
SB104	265	Atlas 350 XL	150
FT301	95	FT901	8
TS-520	110	Argonaut	10
FT7	180	TS-820	110
TS-120V	180	FT301S	30
TR7	20	SB303	70
75S3B	250	KWM2	60
IC701	20	FT101E	10

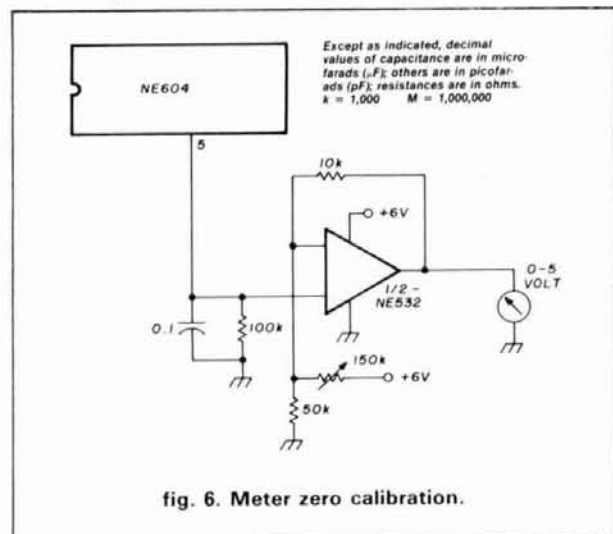

fig. 6. Meter zero calibration.

amount of gain limiting present at any time by comparing the S-meter readings with and without AGC. When not using the AGC, any RF or IF gain controls must have a "calibrated" position. Furthermore, if gain varies with frequency, as in older receiver designs, any array of trim pots controlled by the bandswitch could be the answer.

An important feature of this circuit is that relative dB measurements will be very accurate even if the absolute reading is not calibrated. This is a useful practical on-the-air feature for accurate antenna gain comparisons.

Figure 4 shows that the output voltage never goes to zero. A meter zeroing control should be easy to build with the addition of a few more op amps and standard DC offset techniques (fig. 6).

This is a simple project that can transform your receiver into a field strength and RF voltmeter. More importantly, it can transform meaningless numbers into valuable measurements.

references

1. *CQDL*, December, 1980, pages 550-555.
2. Sidney Kaiser, WB6CTW, "Measuring Receiver Dynamic Range," *ham radio*, November, 1979, page 56.
3. Doug DeMaw, W1FB, and Wes Hayward, W7ZOI, "Modern Receivers and Transceivers: What Ails Them?" *QST*, January, 1983, page 11.

ham radio

AMATEUR TELEVISION

NEW 70 CM ATV TRANSCEIVER

ALL YOU NEED IN ONE BOX



\$299 delivered
TC70-1

- **FULL COLOR, SOUND, & LIVE ACTION** just like broadcast TV. Get on this exciting amateur video mode at our affordable ready to go price.
- **WHAT IS REQUIRED FOR A COMPLETE OPERATING SYSTEM?** The TC70-1s downconverter outputs to any TV on ch 3 for receiving. Connect a good 70 cm antenna and low loss coax. Plug in any composite video source you want to transmit: Camera, VCR, computer, etc. Plug in any low Z dynamic mic or use color camera mic for Standard 4.5 MHz TV sound. Connect to 13.8 vdc for base, mobile, or portable. See chapt. 20 1985 ARRL Handbook. That's it!
- **WHAT CAN YOU DO WITH THE TC70-1 ATV TRANCEIVER?** Show the shack, projects, computer program listings, home video tapes, repeat Space Shuttle audio and video if you have a TVRO, repeat SSTV or RTTY, Weather Radar, do public service events such as parades, marathons, races, CAP searches and rescues... the list goes on. DX depends on antennas and terrain, typically 1 to 40 miles. We have video compensated RF linear amps for 20 (\$119) or 50 (\$189) watts pep for greater DX.
- **FEATURES:** Small 7x7x2.5". Push to Look (PTL) T/R switching. GaAsfet downconverter tunes whole 420-450 MHz band. Two switch selected video & audio inputs... RCA phone jacks and 10 pin color camera jack. Xmit video monitor output. Over 1 watt pep RF output on one or two (add \$15) selected crystal controlled frequencies. 439.25, 434.0, or 426.25 MHz.

CALL OR WRITE FOR OUR CATALOG for more info or who is on in your area. We stock antennas, modules, and everything you need on ATV.

TERMS: Visa, MC, or cash only UPS CODs by phone or mail. Checks must clear bank before shipment. Price includes UPS surface shipping in cont. USA, others add 3%. Transmitting equipment sold only to licensed Tech class or higher amateurs, verifiable in 1985 call book or copy of new license.

(818) 447-4565 m-f 8am-6pm pst.

P.C. ELECTRONICS
Tom W6ORG Maryann WB6YSS

2522 Paxson Lane
Arcadia CA 91006

**Come Join Us at the
Largest and Most Spectacular
Satellite TVRO Show in the World!
SPACE/STTI LAS VEGAS SHOW '86!**

**Las Vegas Convention Center,
Las Vegas, Nevada**

February 19-20-21, 1986

- 850 Booths Previewing All the Latest Equipment for '86!
 - 400 Operating Satellite TV Antennas!
 - Intensive Seminar Programming!
 - Plus Fun and Entertainment!
- This One is a Must . . . Don't Miss It!**

**FOR DETAILS: Call STTI at 1-800-654-9276 or 702-367-1471
or Write STTI, 4970 S. Arville, Suite 108, Las Vegas, Nevada 89111**

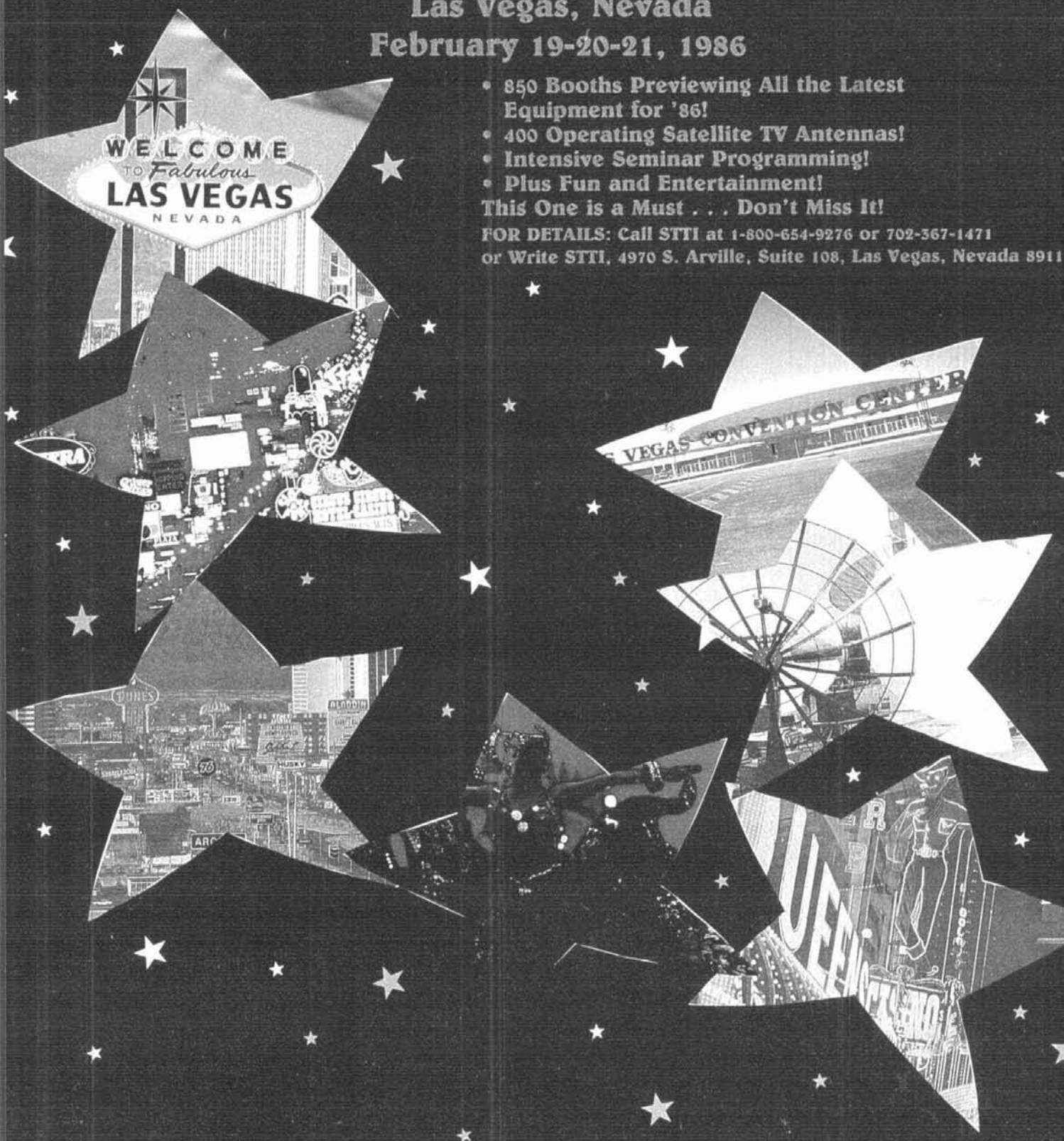

passive audio filter design

part 3: attenuation equalizers and driving, terminating audio filters

Improving the response of filters constructed with low- Q inductors

In parts 1 and 2^{1,2} of this series, it was shown that two effects of using low- Q inductors in a filter are a general decrease of the passband response as frequency increases and a roundoff near the theoretical cutoff frequency. These effects are most noticeable with the responses of sharp cutoff filters, such as the elliptic low-pass filters described earlier. To a certain extent, these effects can be reduced by adding a high-pass filter in series with the low-pass, giving a band-pass response.

The classical method of correcting this roundoff of the amplitude response (other than by using higher- Q inductors) is by using an attenuation equalizer. Do not be put off by the name; equalizers are very simple and can produce a dramatic improvement in filters with low- Q inductors. I will now outline the design of these equalizers and show the effect they can produce on some of the filters already described.

low-pass attenuation equalizers

The schematic of an ideal low-pass attenuation equalizer is shown in fig. 1(A), along with equations

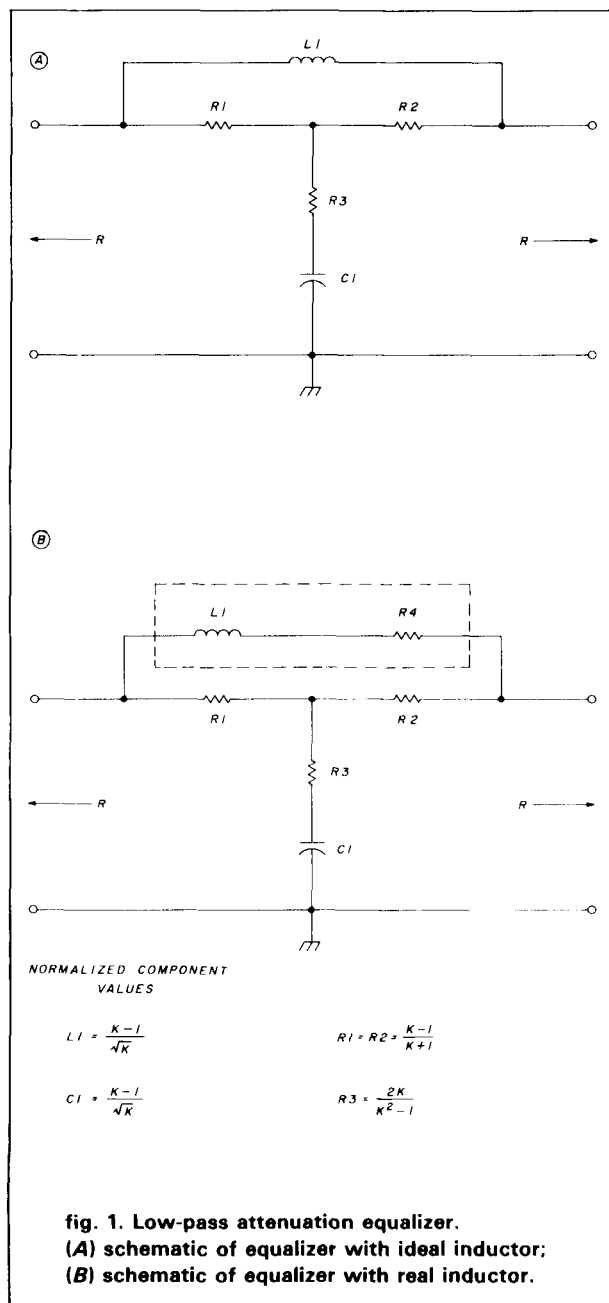

By Stefan Niewiadomski, 29 Mackinley Avenue, Stapleford, Nottingham, NG9 8HU, England

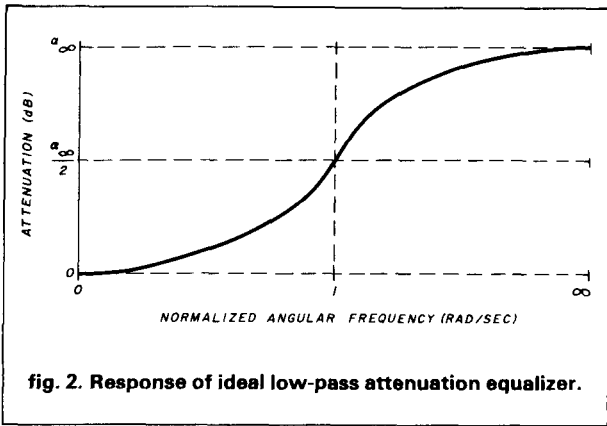

that define the normalized (1-ohm, 1-rad/sec) component values in terms of a constant, K .³ **Figure 1(B)** shows the equalizer with a resistor, R_4 , added in series with L_1 to simulate the low Q of the inductor used in the actual equalizer. The theoretical response of the ideal network is shown in **fig. 2**.

At zero frequency, the equalizer has no loss. As frequency increases, the attenuation increases, asymptotically approaching a finite value of α_∞ dB at infinite frequency. The value of α_∞ is given by:

$$\alpha_\infty = 20 \log K$$

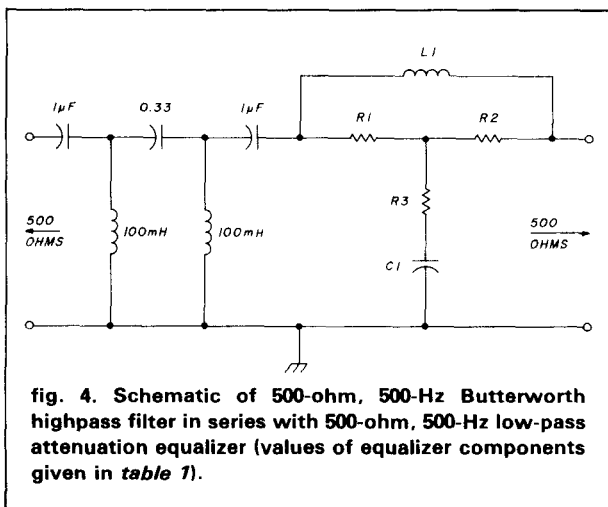
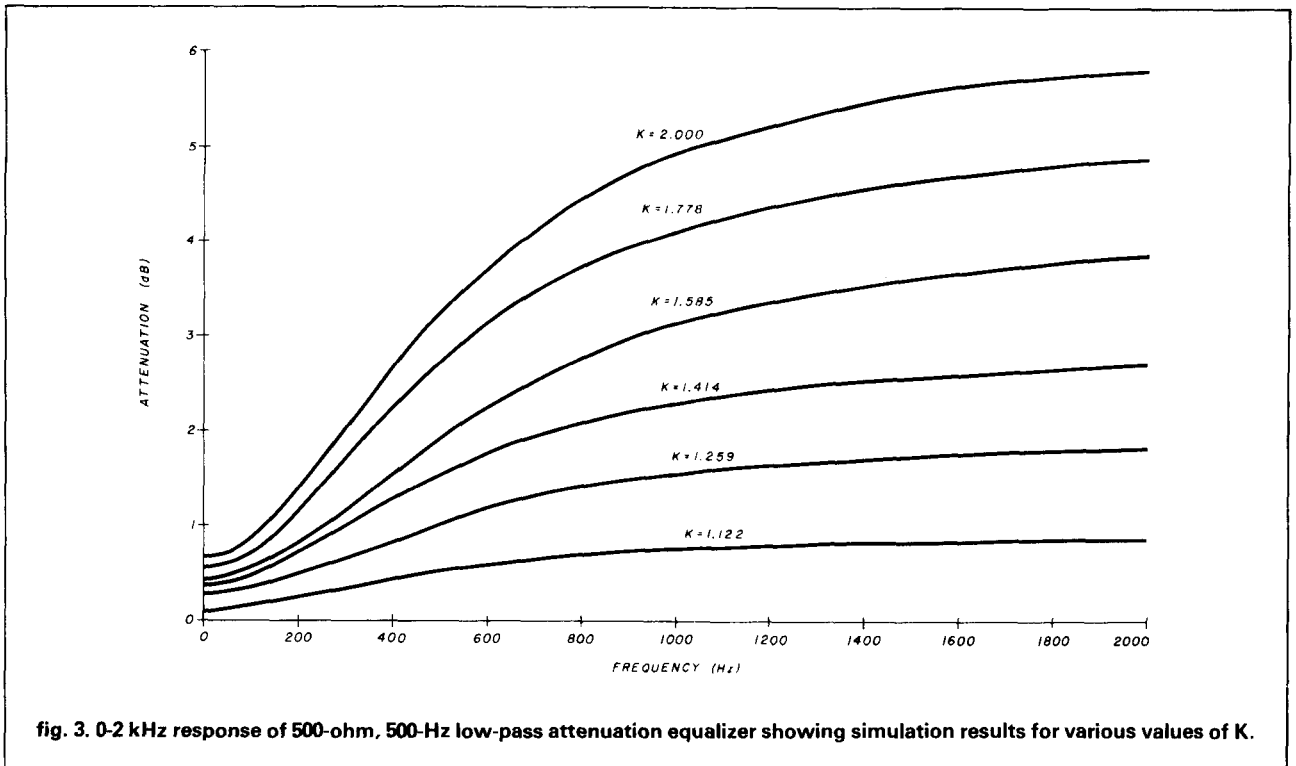

where K is the constant used to calculate the component values. At the normalized angular frequency of 1 rad/sec, the attenuation is $\alpha_\infty/2$.

A low-pass equalizer is intended for use with a high-pass filter, constructed with low- Q inductors, to correct its response near its cutoff frequency. I will use the Butterworth 500-ohm, 500-Hz highpass filter described previously to illustrate the effects of a low-pass equalizer. The normalized equalizer component values must therefore be scaled to 500 ohms to match the highpass filter. The scaled equalizer will then present an impedance at its terminals which is purely resistive and equal to 500 ohms at all frequencies. The half-attenuation frequency of the equalizer does not necessarily have to be equal to the filter cutoff frequency, but this represents a good starting point. The final,

You may not be able to solve the world's problems. But at least you can listen.



The Panasonic Command Series™. With double superheterodyne tuning, you'll hear the world loud and clear.

Now it's easy to listen in on the world's hot spots. With the Panasonic RF-B600 Command Series FM/LW/MW/SW receiver.

Its advanced microcomputer-controlled tuner lets you preset up to nine different frequencies. And reach them at the touch of a button. Or, press the appropriate buttons and tune in any desired frequency with direct-access digital tuning. It'll lock right in to every signal with a PLL quartz-synthesized tuner. Once tuned in, the Panasonic double superheterodyne system helps deliver a clean, consistent signal.

There's even built-in auto-tuning to let you scan the shortwave band automatically, as well as manually. All this means you can tune in Berlin, pick up Paris, or locate London in an instant. Without dialing all over the band.

Both the RF-B600 and the RF-B300 are packed with features and built to go anywhere.

The Panasonic Command Series offers something for everyone. With equipment sophisticated enough to impress the most avid enthusiast, and automatic features that get you where you want to be. Fast.

There's a whole world out there that's waiting to be heard. Tune in to it with the Panasonic Command Series.



Batteries not included.

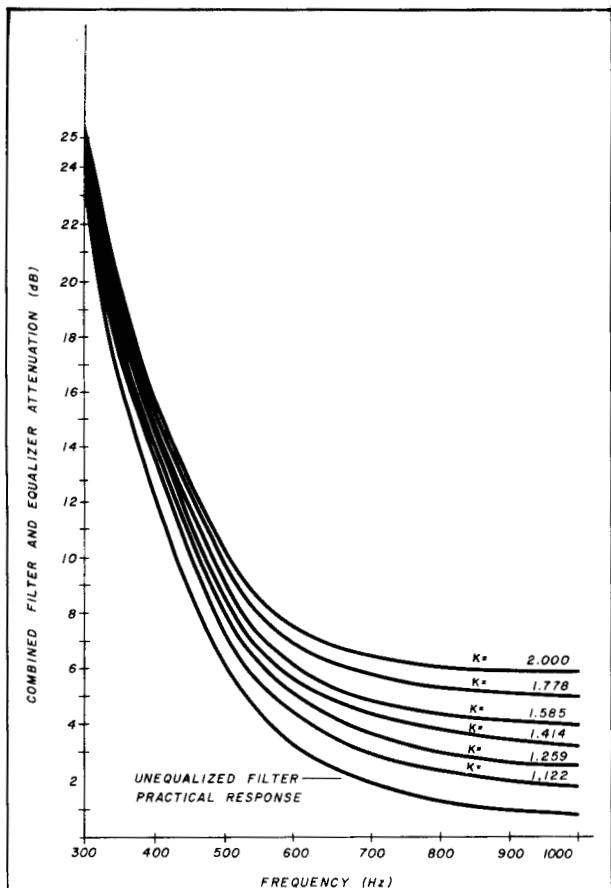

fig. 5. 300-1000 Hz response of 500-Hz Butterworth highpass filter with 500-ohm, 500-Hz lowpass equalizer for various values of K, showing simulation and practical results (original highpass filter practical response also shown for comparison).

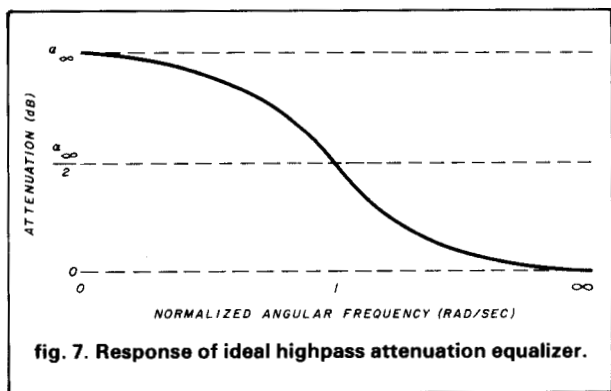

fig. 7. Response of ideal highpass attenuation equalizer.

scaled values of the equalizer are therefore set for 500 ohms and 500 Hz.

Table 1 shows, for six values of K, the 1-ohm, 1-rad/sec component values; the exact 500-ohm, 500-Hz values assuming an ideal inductor; and rounded values with a value entered for R4 to model the real inductor, L1. These six K's give values of α_{∞} of 1, 2,

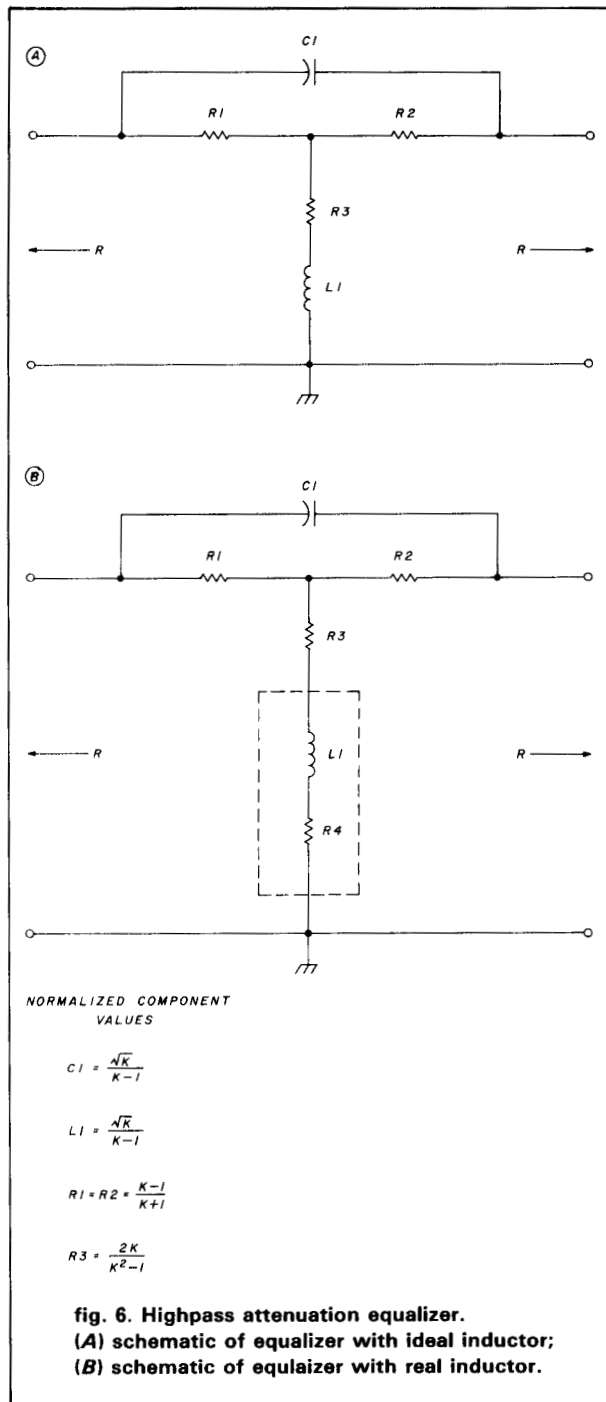

fig. 6. Highpass attenuation equalizer. (A) schematic of equalizer with ideal inductor; (B) schematic of equalizer with real inductor.

3, 4, 5, and 6 dB, respectively, and attenuations at 500 Hz (for the scaled values) of 0.5, 1, 1.5, 2, 2.5, and 3 dB. Component values for the scaled impedance and half-attenuation frequency are obtained in the same way as for filters,* so the normalized values in table 1 can be used to obtain practical values for any impedance and half-attenuation frequency.

Figure 3 shows the simulated response of the

*See part 1, September, 1985, page 30.

500-ohm, 500-Hz equalizer with the rounded values and real inductor. Curves are plotted for the six values of K tabulated in table 1. For K = 1.122, 1.259, 1.414, and 1.585, good agreement with theory was found, the half-attenuation values being 0.5, 1, 1.55, and 1.95 dB, respectively. At the maximum frequency plotted,

2 kHz, the responses flatten out and approach the maximum attenuation of 1, 2, 3, and 4 dB. The curves for K = 1.778 and 2.000 show more deviation from the theoretical responses, having half-attenuation values of 2.7 and 3.25 dB. However, at 2 kHz the maximum attenuations of 5 and 6 dB are approached.

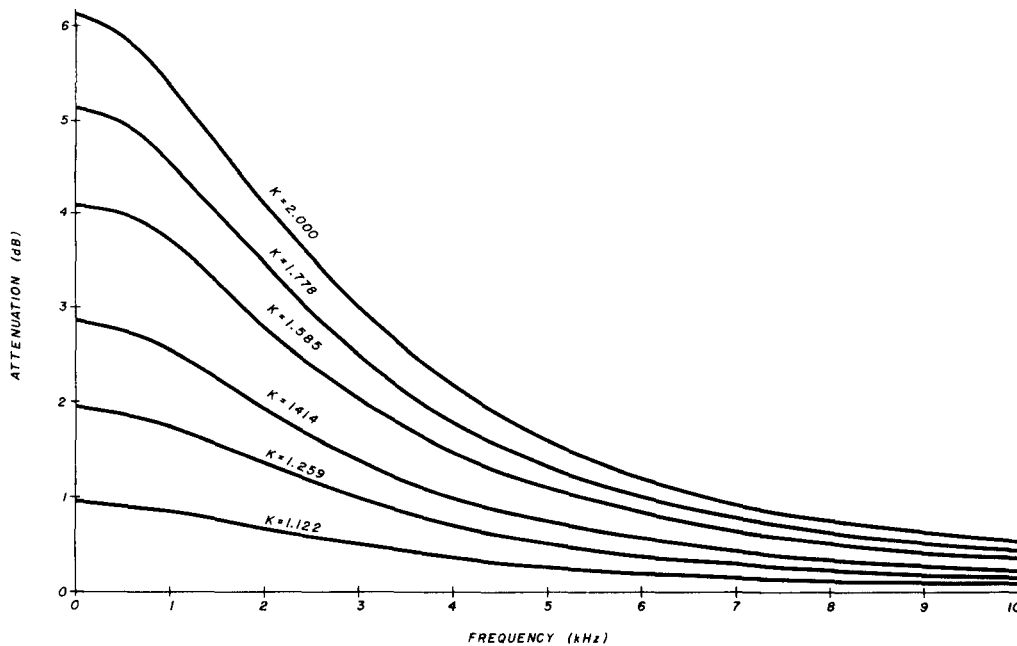

fig. 8. 0-10 kHz response of 500-ohm, 3-kHz highpass attenuation equalizer showing simulation results for various values of K.

table 1. Low-pass attenuation equalizer component values.

component	1 ohm, 1 rad/sec value	500 ohm, 3 kHz theoretical value ideal inductor	500 ohm, 3 kHz rounded value real inductor	1 ohm, 1 rad/sec value	500 ohm, 3 kHz theoretical value ideal inductor	500 ohm, 3 kHz rounded value real inductor
K = 1.122						
C1	0.1152 F	0.0733	0.068	0.2308 F	0.1469	0.15
L1	0.1152 H	18.33 mH	18 mH	0.2308 H	36.73 mH	39 mH
R1,R2	0.0575	28.75	27	0.1147	57.35	56
R3	8.668	4334	4700	4.304	2152	2200
R4	—	0	17	—	0	45
K = 1.259						
C1	0.3482 F	0.2217	0.22	0.4647 F	0.2958	0.27
L1	0.3482 H	55.42 mH	56 mH	0.4647 H	73.96 mH	68 mH
R1,R2	0.1715	85.75	82	0.2263	113.15	120
R3	2.830	1415	1500	2.0962	1048	1000
R4	—	0	58	—	0	66
K = 1.414						
C1	0.5835 F	0.3715	0.39	0.7071 F	0.4502	0.47
L1	0.5835 H	92.87 mH	100 mH	0.7071 H	112.54 mH	120 mH
R1,R2	0.2801	140.1	150	0.3333	166.67	180
R3	1.6453	822.7	820	1.3333	666.67	680
R4	—	0	82	—	0	97
K = 1.585						
C1	0.5835 F	0.3715	0.39	0.7071 F	0.4502	0.47
L1	0.5835 H	92.87 mH	100 mH	0.7071 H	112.54 mH	120 mH
R1,R2	0.2801	140.1	150	0.3333	166.67	180
R3	1.6453	822.7	820	1.3333	666.67	680
R4	—	0	82	—	0	97
K = 1.778						
C1	0.5835 F	0.3715	0.39	0.7071 F	0.4502	0.47
L1	0.5835 H	92.87 mH	100 mH	0.7071 H	112.54 mH	120 mH
R1,R2	0.2801	140.1	150	0.3333	166.67	180
R3	1.6453	822.7	820	1.3333	666.67	680
R4	—	0	82	—	0	97
K = 2.000						
C1	0.5835 F	0.3715	0.39	0.7071 F	0.4502	0.47
L1	0.5835 H	92.87 mH	100 mH	0.7071 H	112.54 mH	120 mH
R1,R2	0.2801	140.1	150	0.3333	166.67	180
R3	1.6453	822.7	820	1.3333	666.67	680
R4	—	0	82	—	0	97

Having shown by simulation that low-pass equalizers can be built with practical, preferred-value components, the effect on the Butterworth 500-ohm, 500 Hz filter will now be shown.

The schematic of the Butterworth filter combined with the low-pass equalizer is shown in **fig. 4**. **Figure 5** shows the simulated response of the Butterworth highpass filter in series with the 500-ohm, 500 Hz equalizer. Again, the responses for six values of K are shown, as well as the practical response of the original filter. How much improvement in the response has occurred?

If we take the difference in attenuation between 1 kHz and 500 Hz (which should, in theory, be very close to 3 dB) as a measure of quality, the improvement can be assessed. For the unequalized filter, this figure is about 5.5 dB; for the filter with the equalizer of $K = 1.122$ it is about 5.7 dB; with $K = 1.414$, it is about 5.3 dB; and with $K = 2.000$, it is about 4.3 dB. There has been a gradual improvement in the response as K increases, but of course the price to be paid is a corresponding increase in the 1-kHz (and beyond) insertion loss. This loss can be compensated by increasing the gain of the active devices in the audio path. With this particular example, however, it is doubtful whether the fairly marginal improvement in response is worth the extra components required and the extra insertion loss suffered.

highpass attenuation equalizers

The schematic of an ideal highpass attenuation equalizer is shown in **fig. 6A** with equations for the

normalized component values. This equalizer has been obtained by an identical transformation to that applied to a lowpass filter to transform it into a highpass filter.

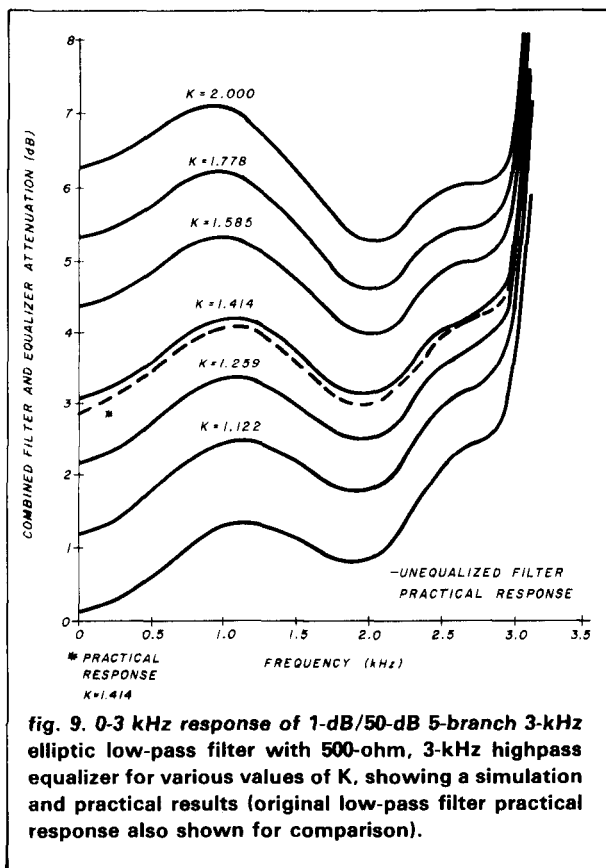

fig. 9. 0-3 kHz response of 1-dB/50-dB 5-branch 3-kHz elliptic low-pass filter with 500-ohm, 3-kHz highpass equalizer for various values of K, showing a simulation and practical results (original low-pass filter practical response also shown for comparison).

table 2. Highpass attenuation equalizer component values.

component	1 ohm, 1 rad/sec value	500 ohm, 3 kHz theoretical value ideal inductor	500 ohm, 3 kHz rounded value real inductor	1 ohm, 1 rad/sec value	500 ohm, 3 kHz theoretical value ideal inductor	500 ohm, 3 kHz rounded value real inductor
K = 1.122						
C1	8.681 F	0.921	1 μ F	4.333 F	0.460	0.47
L1	8.681 H	220.3 mH	220 mH	4.333 H	114.95 mH	120 mH
R1,R2	0.0575	28.75	27	0.1147	57.35	56
R3	8.668	4334	4700	4.304	2152	2200
R4	—	0	95	—	0	97
K = 1.414						
C1	2.872 F	0.3047	0.33	2.152 F	0.2283	0.22
L1	2.872 H	76.19	82 mH	2.152 H	57.09 mH	56
R1,R2	0.1715	85.75	82	0.2263	113.15	120
R3	2.830	1415	1500	2.0962	1048	1000
R4	—	0	71	—	0	58
K = 1.778						
C1	1.714 F	0.1819	0.18	1.4142 F	0.1500	0.15
L1	1.714 H	45.47 mH	47 mH	1.4142 H	37.52 mH	39 mH
R1,R2	0.2801	140.1	150	0.3333	166.67	180
R3	1.6453	822.7	820	1.3333	666.67	680
R4	—	0	52	—	0	45
K = 2.000						

SAVE \$7.05* with home delivery

SAVE \$7.05* with home delivery

*One year newsstand cost \$30.00

Here's my address label, enter my subscription. Payment enclosed
 Bill me later

- 1 Year 12 issues \$22.95 U. S. prices only
- 2 Years 24 issues \$38.95
- 3 Years 36 issues \$49.95

Name _____ Zip _____

State _____

Address _____ (attach label)

City _____

Check here if this is your renewal (attach label)

Subscribe to **ham radio** magazine

Please allow 4-6 weeks for delivery of first issues.

Foreign rates: Europe, Japan and Africa, \$37.00 for one year by air forwarding service. All other countries \$31.00 for one year by surface mail.

Please
enter my
subscription

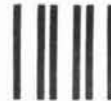

NO POSTAGE
NECESSARY
IF MAILED
IN THE
UNITED STATES

BUSINESS REPLY CARD

First Class Permit No. 1 Greenville, NH

Postage Will Be Paid By Addressee

**ham
radio**

Greenville, NH 03048



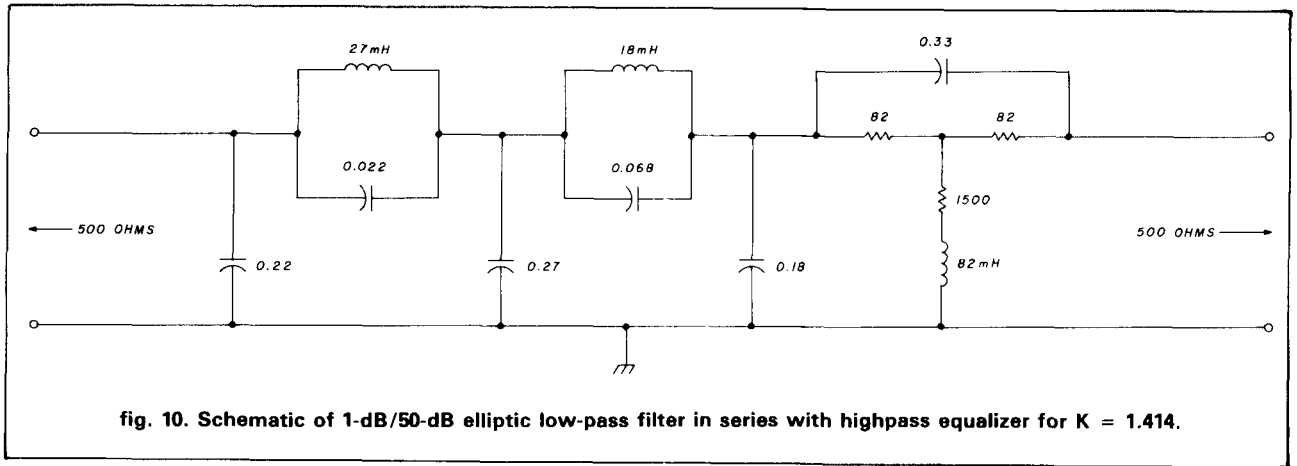

fig. 10. Schematic of 1-dB/50-dB elliptic low-pass filter in series with highpass equalizer for $K = 1.414$.

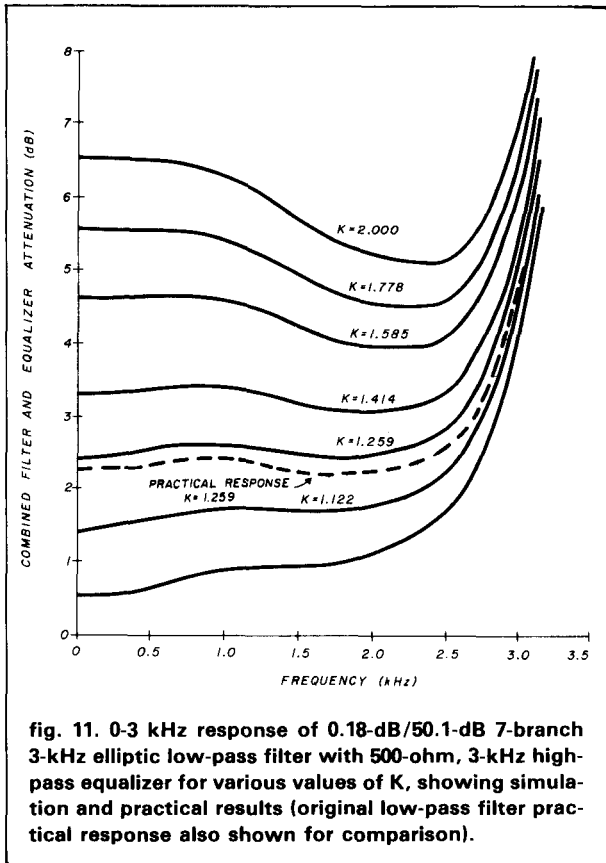

fig. 11. 0-3 kHz response of 0.18-dB/50.1-dB 7-branch 3-kHz elliptic low-pass filter with 500-ohm, 3-kHz high-pass equalizer for various values of K , showing simulation and practical results (original low-pass filter practical response also shown for comparison).

That is, the inductor has been transformed into a capacitor, the capacitor into an inductor, and their values are the inverse of the original values. **Figure 6B** shows resistor $R4$ added in series with $L1$, as before. The theoretical response of the ideal network is shown in **fig. 7**. This response is the inverse of that of the low-pass equalizer.

The method of calculating α_∞ is identical to the low-pass case, and again the half-attenuation angular frequency is 1 rad/sec.

Table 2 shows the component values obtained for the same six values of K as before. This time, however, the values have been scaled to 500 ohms, 3 kHz to make the equalizers compatible with the 1-dB/50-dB and 0.18-dB/50.1-dB low-pass elliptic filters described previously.

Figure 8 shows the simulated response of the 500-ohm, 3-kHz equalizer with the rounded values and real inductor. Curves for the six values of K are plotted. The simulations show good agreement with theory, having half-attenuation values close to the theoretical values at 3 kHz. For $K = 1.122, 1.259,$ and 1.414 , the curves approach 1, 2, and 3 dB respectively, as expected. However, for $K = 1.585, 1.778,$ and 2.000 , the asymptotic values are a little above those expected.

Figure 9 shows the simulated response of the 1-dB/50-dB elliptic low-pass filter in series with the highpass equalizers of **table 2** for the six values of K . For these simulations, the equalizer was inserted after the filter, but which comes first is not important. The practical response of the filter with no equalization is also shown, and the progressive effect of increasing the value of K for the equalizer can be seen. Only the responses up to 3100 Hz are shown, because above this frequency they are almost indistinguishable. The difference in minimum stopband attenuation between the unequalized filter and the filter with the $K = 2.000$ equalizer is only about 1 dB.

As shown in **figure 9**, the smoothest passband response is obtained for $K = 1.414$. The passband ripple up to 260 Hz now meets the design specification of 1 dB, with approximately 1.5 dB more loss before the design cutoff frequency of 3 kHz is reached. The total attenuation difference between 100 Hz and 3 kHz is therefore approximately 2.5 dB, compared with approximately 3.6 dB for the unequalized filter. The penalty paid is a decrease in the differential between the minimum passband and minimum stopband attenuations from approximately 53 dB to approximately 50 dB.

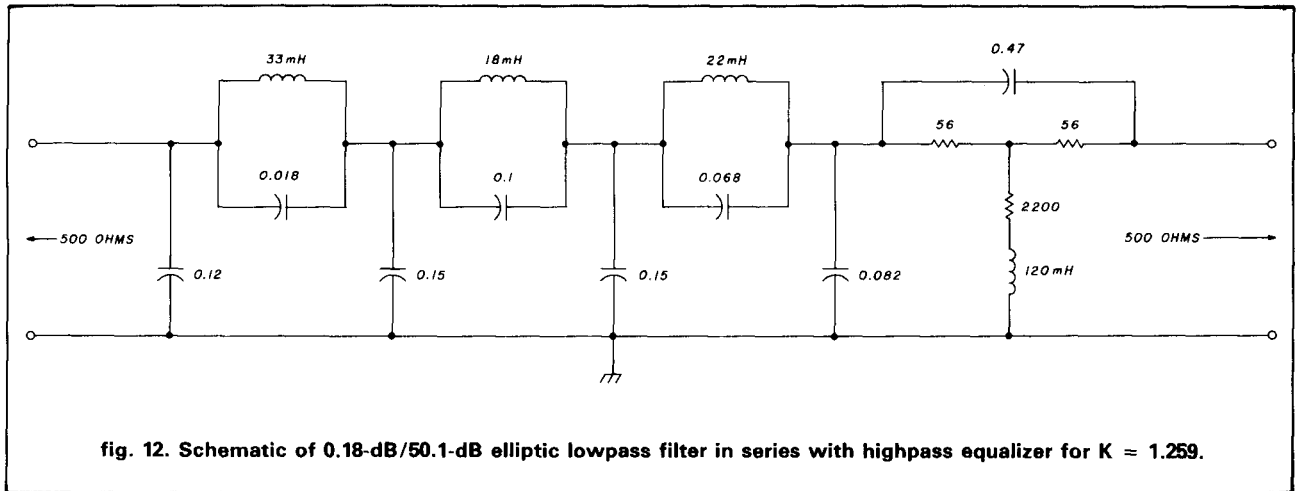

To verify the simulation results, the equalizer with $K = 1.414$ was built and connected to the output of the practical 1-dB/50-dB filter. The schematic of the combined network is shown in fig. 10. The results are plotted in fig. 9 for comparison with the simulated response. Very close agreement with the simulated response was obtained. In practice, slightly less insertion loss is seen at all frequencies than in the simulated response.

The way in which the highpass equalizer modifies the 0.18-dB/50.1-dB elliptic low-pass filter is shown in fig. 11. The equalizer component values are those shown in table 2. A flattening of the passband response can be seen, particularly for $K = 1.259$. The equalizer for this value of K was built, placed in series with the 0.18-dB/50.1-dB filter and the combined response measured. The schematic of the combined networks is shown in fig. 12, and the practical results are plotted in fig. 11 for comparison with the simulated response. Again, good agreement with the simulated response was found. The real insertion loss is slightly less than expected at all frequencies.

Ripple in the practical response for the combination with $K = 1.259$ is now less than 0.4 dB up to 2.5 kHz. Although this is still more than the theoretical maximum for the ideal low-pass filter, it is a considerable improvement on the unequalized response (approximately 1.5 dB).

driving and terminating audio filters

Whether passive audio filters are incorporated into existing equipment or included in new designs, correct source and termination impedances must be used if predictable results are to be obtained. Figure 13 shows some methods commonly used to interface these filters.

Figure 13A shows a common emitter amplifier that uses Q1, which can be almost any commonly available

transistor. The output impedance of this amplifier is equal to the collector resistor, R_S , so this should be chosen to be the same as the source impedance of the filter. The base and emitter resistors should be chosen to set the DC voltage at the collector of Q1 at a value that allows an AC swing compatible with the signal level being handled. The output buffer amplifier, Q2, is an emitter follower. The input impedance of the transistor in this configuration is very high, so the termination seen by the filter is the parallel combination of R1 and R2. R1 and R2 should therefore be chosen to terminate the filter correctly and set the DC operating conditions of Q2. If a DC path exists from the input of the filter to ground or to the output, then the input DC blocking capacitor, C_1 , will be required. If a DC path exists from the output of the filter to ground, then C_O will be required. The RC network in the supply line prevents any signal coupling from input to output through the buss, which would degrade filter performance.

Transistor Q2 can be replaced by an FET stage. The termination impedance for the filter will then be provided by a resistor from the gate of the FET to ground.

Figure 13B shows an operational amplifier circuit. Because the output impedance of an operational amplifier with feedback is very low, the source impedance for the filter has to be provided by resistor R_S . The termination for the filter is provided by R_T . The feedback resistors for the operational amplifiers can be chosen to provide any reasonable value of gain for these stages. Of course, the techniques of figs. 13A and 13B can be combined, and the final configuration can be chosen to make the best use of available components.

You may have noticed that the source and termination impedances for all the filters previously described is 500 ohms, which, of course, is a non-preferred value. The importance of providing the correct impedances is often stressed, so how critical is

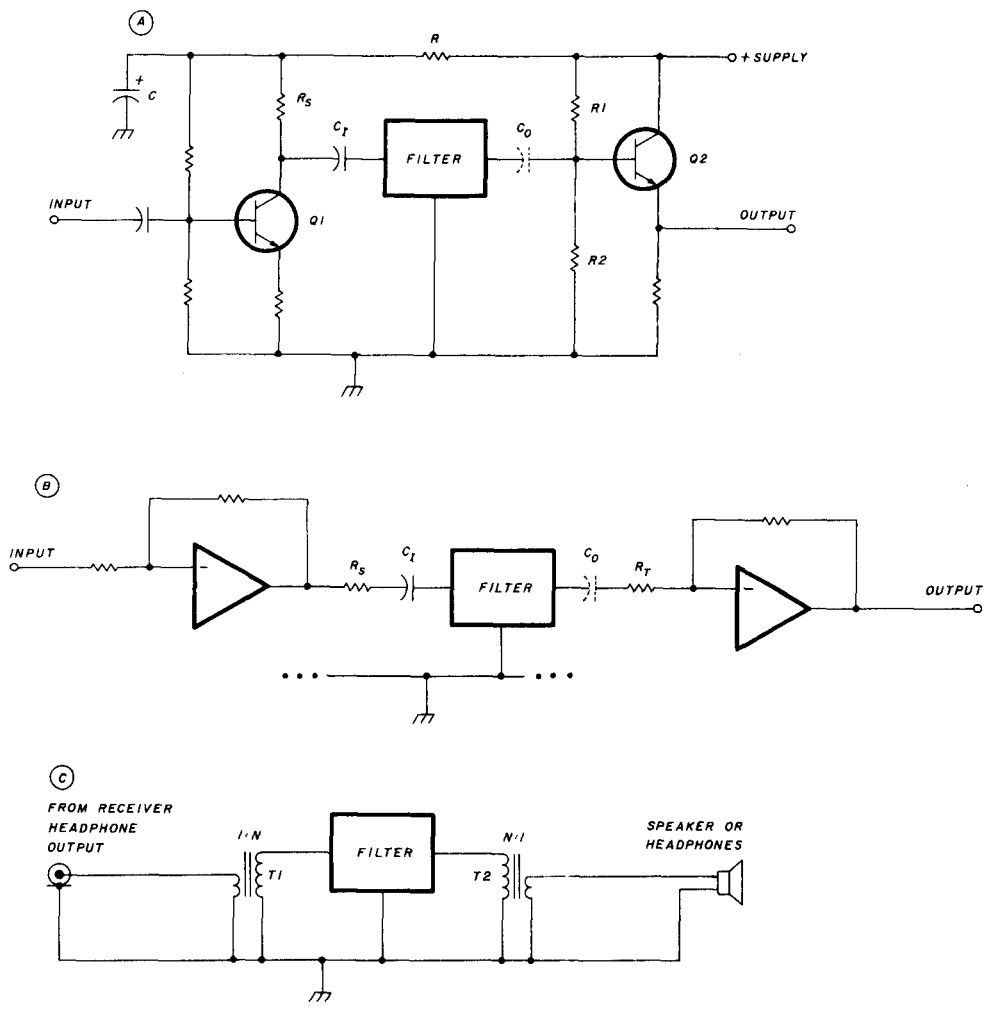

fig. 13. Various methods of connecting an audio filter into the audio path: (A) transistor circuit; (B) op-amp circuit; and (C) transformer-coupled circuit.

this matching? My own experiments have shown that the E12 values* of 470 and 560 will give slightly increased passband ripple, but not enough to be noticeable in practice. One interesting point is that an increase in passband ripple, even if it is caused by mismatching a filter, tends to give an increase in stopband attenuation (though this is not recommended as a method of obtaining better stopband performance.)

Often the simplest way of adding an audio filter is in the low-impedance headphone output of a receiver. A method used to couple the comparatively high-impedance filter (typically 500 ohms) to the much lower impedance audio output is shown in fig. 13C. Transformers T1 and T2 have a turns ratio equal to the square root of the ratio of the filter and speaker or phone impedances. One low-power transformer

suitable for matching an 8-ohm phone output to 500-ohm filters is the Mouser Electronics No. 42TU400, (8/500 ohm c-t) transformer with PC leads (\$1.67 each).

mismatched sources

Though transformer coupling is the easiest method of incorporating an audio filter into an existing design, it is also the most likely to result in filter mismatches. One source of mismatch is that the headphone output of a receiver may come directly from the audio power amplifier, which will have a very low output impedance — typically less than 1 ohm. The filter input is therefore most likely to be driven by a too low source impedance. This can be alleviated to a certain extent by inserting a low value resistor in series with the connection to the low-impedance winding of T1. A loss in signal will result, but it can be compensated for by

*See Niewiadomski, part 1, September, 1985, page 17.

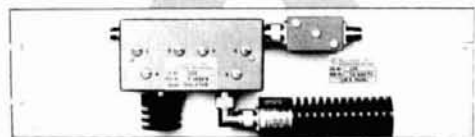

IM Suppression Panels



R.F. Power Monitoring

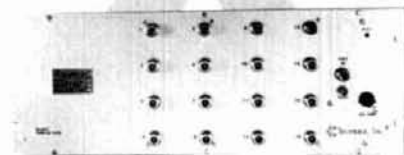

Receiver Multicoupling

The Problem Solvers



Duplexers & Preselectors

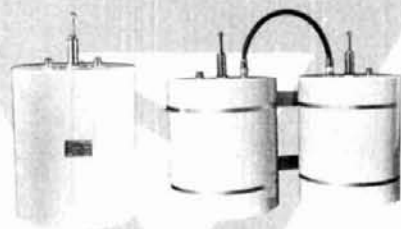

**Bandpass, Pass-Reject
and Notch Cavity Filters**

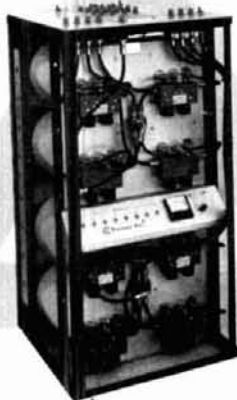

**Transmitter Combining
150 - 900 MHz**

COMPLETE SYSTEM ENGINEERING ASSISTANCE



TELEWAVE, INC.

1155 TERRA BELLA, MOUNTAIN VIEW, CA 94043
(415) 968-4400 • TWX 910-379-5055

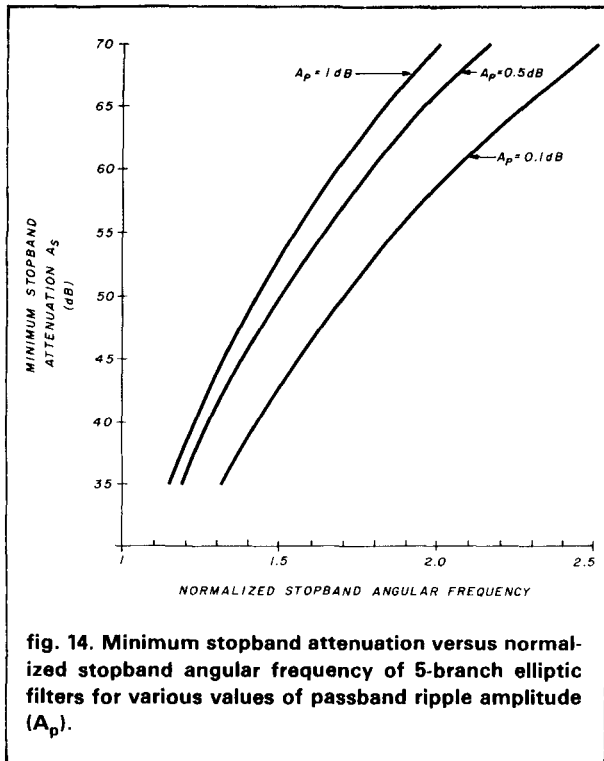

increasing the volume level of the receiver. Another source of mismatch is the speaker or headphones themselves, which can often have an impedance which varies with frequency, thereby mismatching the output of the filter. Additional losses and mismatches can occur in the transformers. Despite these problems, a filter connected into the output of the average receiver will result in a considerable reduction in hiss and hum as well as unwanted shifted frequency SSB signals, thereby providing a corresponding increase in intelligibility.

significance of passband ripple

One notable effect on the performance of a filter using rounded component values and low- Q inductors is an increase in passband ripple. The question that has to be asked, therefore, is whether this is a significant effect in practice for a filter used in a radio receiver? I will try to answer this question by looking for other sources of audio ripple in a receiver and assessing what amplitude this ripple might typically be.

The first element which may introduce any significant ripple is the IF SSB filter. Although these filters are usually of very high quality (and expensive), they typically have a passband ripple of 1-3 dB. This ripple value may effectively be doubled if you are communicating with someone using the same model of transceiver as yours, since the peaks in ripple produced in the other station's transmit IF filter will tend to be at the same frequencies as in your receive IF filter, and vice versa.

Probably the biggest source of ripple in a receiver is the loudspeaker, which inherently has a nonlinear electrical power input to sound pressure output characteristic. Typically, a 4-inch loudspeaker in free air exhibits a 9-dB ripple from 1 kHz to 3 kHz in its sound pressure output.⁴ When mounted in a metal case, with many cavities formed by metal dividers and printed circuit boards behind it, even more ripple may be produced.

Another source of ripple is the response of the human ear. Experiments performed to measure the thresholds of audibility for pure tones⁵ indicate that the ear exhibits approximately 8 dB variation in the range 1 kHz to 3 kHz, being more sensitive at high frequencies.

A similar effect to that caused by the loudspeaker response will also be caused by the microphone at the transmitting end. I do not have any typical figures for this ripple, but it could be similar to the loudspeaker value.

These factors tend to negate attempts to minimize the passband ripple of an audio filter in a receiver. In this context, I believe that the passband ripple found in the filters described here is insignificant for most practical applications. Since in many cases increased passband ripple can be traded for rapid rolloff and/or greater stopband attenuation, advantage should be taken of the relative insignificance of passband ripple. This trade-off can be seen from fig. 14, in which curves of minimum stopband attenuation (A_S) are plotted against normalized ripple cutoff frequency for 5-branch elliptic filters of 0.1, 0.5, and 1-dB passband ripple.³ It can be seen that for a normalized start of stopband angular frequency of 1.5 rad/sec, an extra 10 dB of stopband attenuation can be obtained by using the 1-dB rather than the 0.1-dB filter. Alternatively, the 50-dB stopband attenuation figure can be achieved at 1.42 rad/sec rather than at 1.7 rad/sec by using the 1-dB rather than the 0.1-dB filter. Another approach is to use a lower-order filter with a higher amplitude of ripple for a given application to achieve an attenuation comparable to a higher-order filter with a lower amplitude of ripple, thereby saving components and cost.

Considerable opportunity for experimentation remains on this question of passband ripple amplitude, specifically in regard to the point at which the ripple amplitude becomes both noticeable and objectionable, as well as values produced by modern receivers and transceivers.

summary

In this series of three articles, it has been shown, using simulation results, that rounding each component of an audio filter to the nearest preferred value does not result in a drastic change in performance.

Though the results obtained are not as good as with the exact component values, they would be indistinguishable for most practical purposes. This result in itself can considerably simplify the construction of filters using high- Q inductors, as exact values of capacitors and inductors do not have to be obtained or selected.

When low- Q inductors are used in filter designs, further degradation in performance takes place, but again acceptable results are obtained. Toko 10RB inductors were used in the experiments described here. Very small and inexpensive, they allow complex filters to be built compactly and inexpensively.

Several designs of elliptic low-pass filters and one Butterworth highpass filter have been described. All have been tested and shown to be thoroughly practical. Construction details have also been provided. The results obtained suggest that tables of normalized filter designs (which have for many years been used only by professionals) can now be used by Amateurs with the confidence that near-to-theoretical responses can be obtained. It has also been shown that these passive filters can be cascaded to form bandpass filters; construction details have been provided.

Attenuation equalizers have been shown to be a practical method of improving the response of filters constructed of low- Q inductors. These fairly simple networks, whose design procedure has been described, can be cascaded with the filters described here. Simulation and practical results have been presented to show the improvements obtained.

Computer simulation of filters and other networks has been shown to be a powerful design aid. As well as showing the effects of varying component values, simulation also shows that calculations such as scaling to the final cutoff frequency and impedance values can be confirmed before any components are bought.

Some methods of driving and terminating audio filters have been described, ensuring that the correct

source and termination impedances for the filter are provided.

Finally, some of the factors that affect the ripple amplitude in the audio passband of a receiver were discussed. This indicated that efforts to minimize the passband ripple of an audio filter can be negated by other factors. Therefore, it can be more advantageous to trade increased passband ripple for better stopband performance at the design stage to obtain improved overall performance.

The experiments have been carried out entirely with Toko 10RB inductors, which are very compact and inexpensive. Other inductors, such as those manufactured by Dale or Miller, may also be suitable for audio filter applications.

I hope this series of articles has convinced experimenters and builders that audio filters can be constructed easily, either by using the designs presented here or by selecting other designs from tables of normalized component values. With passive designs, performance far superior to that obtainable from active designs can be obtained; perhaps passive designs will become popular again in Amateur equipment.

references

1. Stefan Niewiadomski, "Passive Audio Filter Design, part 1: Development and Analysis," *ham radio*, September, 1985, page 30.
2. Stefan Niewiadomski, "Passive Audio Filter Design, part 2: Highpass and Bandpass Filters," *ham radio*, October, 1985, page 41.
3. Philip R. Geffe, "Simplified Modern Filter Design," John F. Rider publisher, New York, 1963, page 58.
4. *Mullard Technical Handbook*, Book 3, Part 5, AD4090/X Series Loudspeakers, August, 1978.
5. D.L. Richards, *Telecommunications by Speech*, Butterworths, 1973, page 83.

bibliography

- Daniels, Richard W., *Approximation Methods for Electronic Filter Design*, McGraw-Hill, 1974.
- Hansell, G.E., *Filter Design and Evaluation*, Van Nostrand Reinhold Company, 1969.
- Zverev, A.I., *Handbook of Filter Synthesis*, John Wiley and Sons, 1967.

ham radio

AR-200 XL
MEDIUM DUTY ANTENNA ROTOR

Select a Heading - Antenna Turns and Stops Automatically



\$99.95

SIDEBAND SQUELCH

- Fits inside most HF-SSB transceivers
- Requires human voice to activate
- ignores static, noise and heterodynes
- On/off switch only—no adjustments!
- Connects to audio leads and 9-12 VDC
- Fully assembled and tested \$99.95
- Complete with comprehensive manual
- Used worldwide in commercial and military transceivers



CMC COMMUNICATIONS
5479 Jetport, Tampa, FL 33614 (813) 885-3996

VHF POWER AMP
AM-6154/GRT (ITT 3211)

116-149.95 MHz RF amp, 50 watt output from 4-10 W input using Amperex DX393 or Eimac X651Z/8930; has silver-plated cavity in removable drawer. PA tube checked prior to shipment, but not guaranteed for use in modified amps. Requires 115/230 VAC & 20 VDC; 7x19.5x17, 75 lbs sh (UPS in 2 pkgs.). Used, not tested—good condition **\$209.50**

CU-872 HF ANTENNA COUPLER for upto eight 2-32 MHz receivers; 70 ohm output, N connections, test meter, and 20/6922 tubes. 7x9x16.5, 40 lbs sh. Used, **\$49.50**

Prices F.O.B. Lima, O. • VISA, MASTERCARD Accepted.
Allow for Shipping • Send for New FREE CATALOG
Address Dept. HR • Phone: 419/227-6573

FAIR RADIO SALES
1016 E. EUREKA • Box 1105 • LIMA, OHIO • 45802

CADDELL COIL CORP.

35 Main Street
Poultney, VT 05764
802-287-4055

BALUNS
Get POWER to your antenna! Our Baluns are already wound and ready for installation in your transmatch or you may enclose them in a weatherproof box and connect them directly at the antenna. They are designed for 3-30 MHz operation. (See ARRL Handbook pages 19-9 or 6-20 for construction details.)

100 Watt (4:1, 6:1, 9:1, or 1:1 Impedance — Select one)	\$ 9.50
Universal Transmatch 1 KW (4:1 Impedance)	13.50
Universal Transmatch 2 KW (4:1 Impedance)	16.00
Universal Transmatch 1 KW (6:1, 9:1 or 1:1 — select one)	15.00
Universal Transmatch 2 KW (6:1, 9:1 or 1:1 — select one)	17.50

Please send large SASE for info.

PACKET RADIO GOES PORTABLE

GLB ELECTRONICS

presents



Model PK1-L

- LOW 25 mA Current drain.
- Designed for portable or solar-powered stations.
- Miniature size—Lightweight
- Rugged all metal, shielded enclosure.
- On-board Lithium Battery RAM backup.
- On-board watchdog for reliability.
- Standard DB-25 Connectors.
- Output signal indicates "Connected" Status.
- Does not require squelched audio.
- Comes with 8K of RAM.
- Remote Command Mode for Unattended operation.
- Hardware command lockout for security.
- Commands compatible with our Model PK1.
- Retains all other features of the Model PK1.
- Extra I/O lines for special applications.

Power requirement:

9 to 15 Volts DC @ 25 mA typical

Dimensions:

4.6 X 5.90 X 1.0 inches

Total Weight:

12 ozs.

PK1L—Wired and Tested

List— \$239.95

Amateur net— \$209.95

GLB MODEL TNC-2A KIT

Just when you thought TAPR TNC-2 Kits were a thing of the past, GLB — the first commercial producer of Packet Controllers — Joins the "TAPR Revolution" at last!

Hardware
Software
Documentation

by TAPR

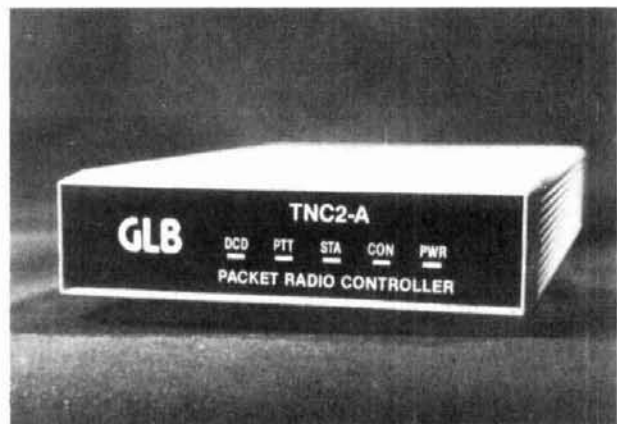

GLB Model TNC-2A Kit

COMPLETE KIT ONLY

\$169.95

+ shipping

Contact GLB for information on our full line of Packet Controllers



✓ 140

GLB ELECTRONICS, INC.

151 Commerce Pkwy.,
Buffalo, NY 14224
716-675-6740 9 to 4

Amateur microwave bands

My dictionary defines microwaves as the frequency range between 1 millimeter and 1 meter, the region between infrared and short-wave radio frequencies. Most Amateurs, however, consider the microwave bands those Amateur frequencies allocations above 450 MHz.

In the United States, we are presently allocated over 23,000 MHz — not counting all the frequencies above 1 mm (300 GHz). This is a huge resource. Compare this with less than 50 MHz below the microwave frequencies, of which 10 MHz are currently under attack (420-430 MHz), where greater than 99 percent of all Amateur operation takes place. For comparison, I've listed the Amateur frequency allocations above 450 MHz in the microwave bands in **table 1**.

As stated in last month's column, I haven't written much about the microwave bands because I felt I had to first establish a solid base at the VHF/UHF frequencies.¹ With the past 24 columns in this series behind us, that base is now in place. With this in mind, I hope now to devote some of my columns specifically to the microwave frequencies. Therefore, this month's column will serve as sort of an introduction to the microwave bands, frequencies in use, and activities thereon.

a look back

First, let's take a glance at the past. Amateurs have really only operated on the microwave frequencies since World War II.² Most microwave operation in North America has been conducted on the 23 cm (1215-1300 MHz), 13 cm (2300-2450 MHz), and 3 cm (10-10.5 GHz) bands with a little

table 1. Major worldwide Amateur microwave frequency allocations. Many countries share the same frequency bands, although the frequencies may be shifted slightly.

band	frequency	notes
33 cm	902-928 MHz	Available in USA since Sep. 28 1985. Canada has same but on A3/F3 only.
23 cm	1215-1300 MHz	1215-1240 still available in Canada, but recently withdrawn in USA. Some countries in Region 1 do not have the full assignment. Others have power or EIRP restrictions.
13 cm	2300-2450 MHz	2310-2390 was removed from USA use on November 6, 1984. Many Europeans cannot operate below 2320. Japan has only 2400-2450.
9 cm	3300-3500 MHz	Some area restrictions apply. UK and West Germany have 3400-3475.
6 cm	5650-5925 MHz	Some area restrictions apply. UK and West Germany have 5650-5850.
3 cm	10.0-10.5 GHz	
12 mm	24-24.25 GHz	24-24.05 in West Germany
6 mm	47-50 GHz	47-47.2 in West Germany, 48-50 in USA.
4 mm	71-76 GHz	75.5-76 in West Germany
2 mm	142-170 GHz	165-170 GHz in USA, 142-144 GHz in West Germany.
1.2 mm	240-250 GHz	248-250 in West Germany
1 mm	300 GHz and above	No restrictions in USA.

activity on 9 cm (3300-3500 MHz), 6 cm (5650-5925 MHz), 12 mm (24-25.25 GHz) and 6 mm (47-50 GHz) thrown in. In fact, the only reported North American Amateur contacts above 50 GHz are in the optical frequency bands, those frequencies above 300 GHz!³ I've updated the DX record table and the latest records (as of this date) are shown in **tables 2, 3 and 4**.

During World War II, the military classified frequencies by assigning let-

ter designations to the various bands. Some of those designations are still in use today, especially in reference to older surplus gear. **Table 5** shows these designations. However, tri-Service designations have now changed to a more orderly list; the more recent band designators are shown in **table 6**.

Until recently, most Amateur gear used on the microwave bands was commercial or surplus equipment that

table 2. Worldwide claimed microwave terrestrial DX records.

frequency	record holder	date of QSO	prop mode	dx miles (km)
1296 MHz	KH6HME-N6CA	6/24/84	Tropoducting	2472 (3977)
2.3 GHz	VK5QR-VK6WG	2/17/78	Tropoducting	1170 (1883)
3.3 GHz	G3LQR-SM6HYG	7/11/83	Ducting	576 (927)
5.7 GHz	G3ZEZ-SM6HYG	7/12/83	Ducting	610 (981)
10 GHz	I0SNY/EA9- I0YLI/IE9	7/08/83	Ducting	1032 (1660)
24 GHz	I3SOY/3, IW3EHQ/3- I4BER/6, I4CHY/6	4/25/84	LOS	180 (289)
47 GHz	HB9AMH/P-HB9 MIN/P	6/11/84	LOS	33 (53)
474 GHz	K6MEP-WA6EJO	6/09/79	LOS	15 (24)

table 3. North American claimed microwave DX records by propagation modes. The records are listed alphabetically by mode. Ducting is suspected where the paths are mostly over water. No efforts are made to separate ducting on overland paths, so they're grouped under "tropo".

frequency	record holder	date	prop mode	dx miles (km)
1296 MHz	KH6HME-N6CA	6/24/84	Ducting	2472 (3977)
	K2UYH-VK5MC	12/06/81	EME	10,562 (16995)
	W4WSR-WA5TKU	6/03/85	Tropo	1112 (1790)
2.3 GHz	PA0SSB-W6YFK	4/5/81	EME	5491 (8836)
	W4HHK-W8YIO	7/28/83	Tropo	583 (938)
3.3 GHz	K6HIJ/6-W6IFE/6	6/18/70	LOS	214 (344)
5.6 GHz	K5FUD-K5PJR	9/20/77	Tropo	267 (430)
10 GHz	WA4GHK/4- WD4NGG	8/07/84	Ducting	297 (478)
	W7JIP/7- W7LHL/7	7/31/60	LOS	265 (426)
24 GHz	KX00/0, W0MXY/0- NK0P/0, WA0VSL/0	8/24/85	LOS	74 (119)
48 GHz	W2SZ/1- WA2AAU/1	9/08/84	LOS	0.3 (.5)
71-250 GHz	None reported			
Above 300 GHz	K6MEP-WA6EJO	6/09/79	LOS	15 (24)

table 4. Worldwide claimed EME Microwave DX records.

frequency	record holder	date of QSO	prop mode	dx miles (km)
1296 MHz	PA0SSB-ZL3AAD	6/13/83	EME	11595 (18657)
2304 MHz	PA0SSB-W6YFK	4/05/85	EME	5491 (8836)
3300 MHz and above:	None reported.			

was often borrowed or modified by Amateurs for their use. The primary modes of communication were often wideband FM and pulse.²

The San Bernadino Microwave Society (SBMS) was an early supporter of the microwave bands with their "polaplexers."⁴ This scheme uses

only one oscillator at each end of the path that is modulated for transmitting and provides the LO for receiving. This LO was often a klystron; in more recent designs, it's often a Gunn diode oscillator.

Polaplexers were primarily used to set DX records between mountain tops using portable gear — with "portable" meaning gear that could be carried by two men and a boy! Indeed, the SBMS 9 cm record for North America still stands (table 3). The polaplexer's days seem to be numbered, and the gunplexer is rapidly replacing it on the 3 cm and 12 mm bands.⁵

looking forward

Before 1970, many of the microwave records were held by North Americans. Then the British and Germans started to take on the challenge. Before long, many of the European countries were there in great numbers. When you look at the worldwide DX records in table 2 and compare these with the North American records in table 3, you must conclude that there's plenty of room for challenging DX records. Furthermore, I'm not aware of any successful Amateur EME activity above the 13 cm band (table 4).

At the present time, narrow-band modes such as CW and SSB are starting to take hold even on 3 cm, a hotbed of activity in the UK. The state of the art advances rapidly. Needless to say, the Europeans have a good track record. So let's get in on the ground floor and see what we in North America can do!

Unless you're a radio astronomer, it's no fun to listen to white noise. Activity on the microwave bands, especially above 13 cm, will be successful only if individuals band together and concentrate their efforts. We have the technology — all we need to do is spend the time and make the effort.

The FCC has finally allocated the 33 cm or 902-928 MHz band to radio Amateurs in the USA on a secondary basis. Canadian Amateurs already

Introducing the BUTTERFLY™ Beam from Butternut!

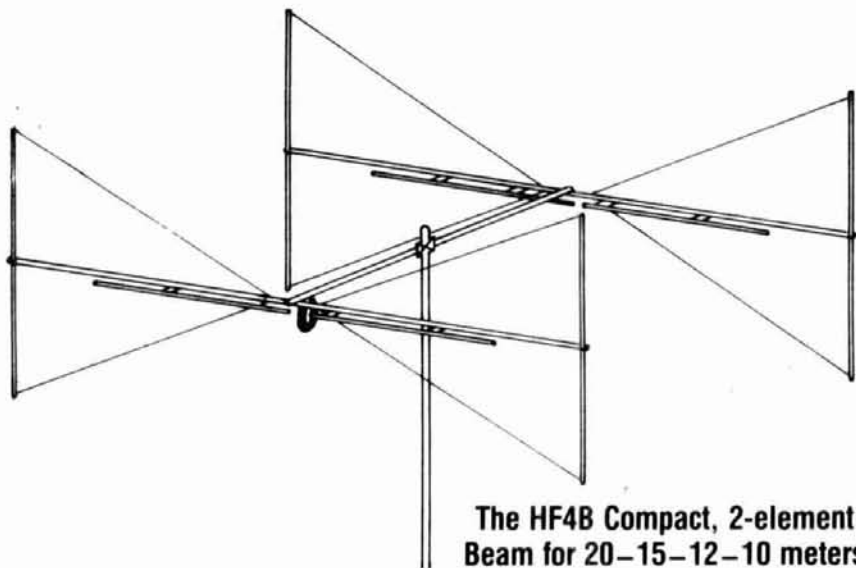

The HF4B Compact, 2-element
Beam for 20-15-12-10 meters

Compact Size

The HF4B's 12½-foot elements and 6-foot boom are ideal for home-station use and for weekend retreats, condos, apartments and other places where oversized beams are prohibited. Its light weight (17 pounds) means it can be turned with a tv rotator, yet it is robustly constructed in the best tradition of our world-famous Butternut verticals.

See your authorized
Butternut dealer

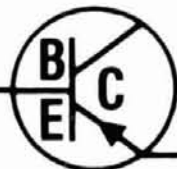

BUTTERNUT ELECTRONICS CO.

405 East Market Street
Lockhart, Texas 78644

Please send all reader inquiries direct.

Performance

The HF4B BUTTERFLY™ has not sacrificed performance for compactness. Its unique design with fanned elements and L-C circuits avoids use of power-robbing traps yet provided high-efficiency operating on all bands. The BUTTERFLY™ outperforms anything in its class.

The HF4B offers an SWR of 1.5:1 or less at resonance. Its 2:1 bandwidth is 200 kHz on 20 meters, 450 kHz on 15, 1.7 MHz on 10, and across the entire 12 meter band. And it will handle the legal power limits both CW & SSB. Gain is at least 3 dB on 20, 4.5 dB on 15 and 5 dB on 10 & 12 meters. Front-to-back is up to 18 dB on 10, 12 and 20m, and up to 15 dB on 15m.

Turn a few hours work into years of fun with Amateur Television.

Convert any TV receiver to a fast scan ATV monitor with the Communication Concepts ATV-2 converter. It allows you to monitor 430MHz ATV signals using channel 2, 3, or 4 on a standard TV set, without modification to the set. The circuit uses durable microstrip design for stability and simplicity. The combination of a dual RF stage, the microstrip design, and the hot-carrier diode double-balanced mixer reduces UHF TV intermod problems. An additional feature not found on other ATV downconverters

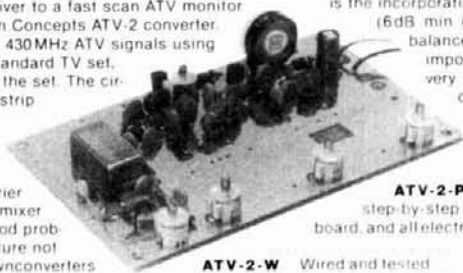

is the incorporation of a *post amplifier* stage (6dB min gain) following the double-balanced mixer. This is especially important and most noticeable on very weak signal reception. The converter requires an external 12 volt DC regulated power supply at 50 milliamps

ATV-2-PK Kit includes detailed step-by-step instructions, printed circuit board, and all electronics components as shown
\$44.95
\$59.95

ATV-2-W Wired and tested



CCI Communication Concepts Inc.

2648 North Aragon Ave. • Dayton, Ohio 45420 • (513) 296-1411



"ABSOLUTELY FREE!"



HAMFEST® GAME \$9.95 VALUE

We will ship you our unique version **HAMFEST®** 1986 board game, designed especially for Amateur Radio operators and their families "absolutely free" with your one-year "trial" subscription to the **USATVS Journal!** This unique "collectors item" includes dice, special event cards, player tokens, play money and comes with complete instructions. It even has its own protective mailing tube container!

Please add \$1.50 to offset mailing costs. Foreign orders add \$5.00 (sent surface).

THE SPEC-COM JOURNAL™ is a "monthly" publication (10 times per year) devoted to Amateur Radio "specialized modes". Whether your interests are in FSTV, SSTV, FAX, TVRO, OSCAR, EME, RTTY, PACKET, MICROWAVE, LASER, or COMPUTERS, the Journal covers it all! Now in our 19th year (formerly A5ATV Magazine), our "Membership Services" department offers back issue and article reprints, a vast technical book library, educational video tapes and a large computer software program collection for your home computer! Why not give us a try?

USA/CANADA/MEXICO \$20.00 yr.
Foreign subscriptions \$30.00 (surface)



"TUNE IN
THE WORLD
OF SPECIALIZED
COMMUNICATIONS!"

With a subscription to:

SPEC-COM™
Amateur Radio Specialized
Communication Journal
P.O. Box HR
Lowden, Iowa 52255



4% Added To All
Charge Card Orders

(319) 944-7669
(Membership Services)

have the band, but only for A3J emission. What a great challenge this band offers! Gear for this band is easier to design and more readily available than gear for the upper microwave bands.

microwave frequencies and modes

Most of the North American activity below 9 cm is now on CW and SSB. Many years ago weak signal operators used multipliers from 144 MHz to go to the 70 cm and higher bands. As a result, the weak signal frequencies of 432.0 MHz (144 X 3), 1296 MHz (144 X 9), 2304 MHz (144 X 16), 3456 MHz (144 X 24), 5760 MHz (144 X 40), and 10368 MHz (144 X 72) became established and are still recognized worldwide.

Because CW and especially SSB will probably become widely used, the transmitters and receivers presently employed must be upgraded. Some Gunnplexer operation on 3 cm and 12 mm will undoubtedly continue. But these units will probably be upgraded with frequency/phase locking, improving frequency stability and hence weak signal operation.

The prime weak signal calling frequencies on the lower microwave bands have mostly shifted to 1296.1 and 2304.1 MHz to allow EME exclusively between 1296.0-1296.05 and 2304.0-2304.05 MHz. EME on the 13 cm band will be somewhat fragmented since many European Amateurs can no longer operate below 2320 MHz, and the FCC has removed 2310-2390 MHz in the USA. Therefore, cross-band operation (2304.0 to 2320.15 MHz) is now in use. The ARRL VUAC has recommended 903.1 MHz as the weak signal calling frequency on 33 cm, with EME between 903.0 and 903.05 MHz.

propagation

Radio propagation on the microwave bands is somewhat different than on the VHF/UHF bands. Aurora, while theoretically possible, has yet to be reported. Meteor scatter, sporadic E, F2, and FAI are theoretically impossible on these frequencies.

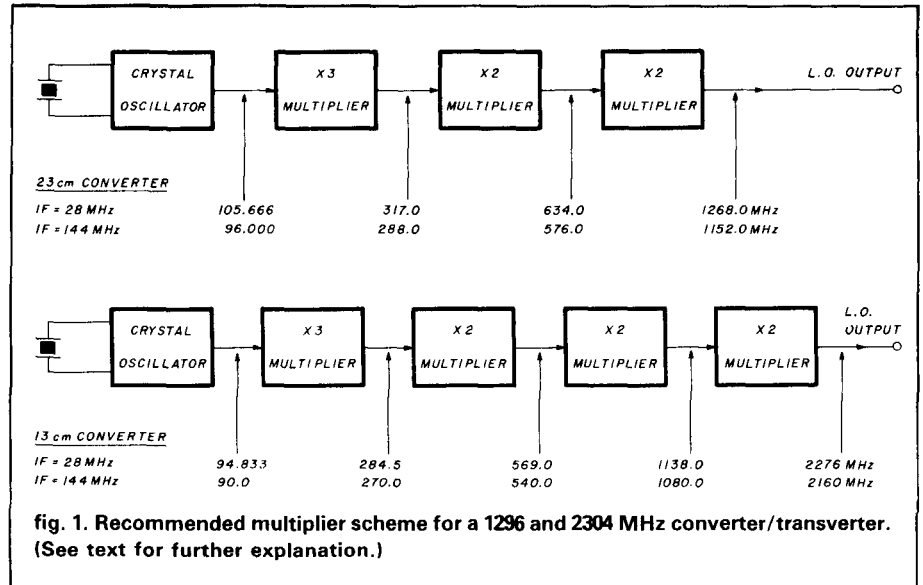

The most common modes of microwave propagation will probably be line-of-sight (LOS), tropospheric bending, tropospheric ducting, scatter, and EME. Scatter will undoubtedly become more popular for DX since it's very prevalent at microwave frequencies. Large stationary objects (buildings, hills, mountains, and such) as well as aircraft and lightning make excellent scattering media.³ Scatter is often overlooked, but even local operation may be enhanced between stations that have obstructed paths if each station aims at some large hill, building, TV tower, or other structure that they can both "see."

The biggest impediments to DX on microwaves will be foliage/evergreen attenuation, feedline losses, low transmitter power, and narrow antenna beamwidths. The latter problems can all be improved with continued development in state-of-the-art equipment (see below).

Therefore, with the exception of EME, the DX records on the microwave bands will probably be shorter than the VHF/UHF records until better equipment becomes available and activity increases. For more information on the subject of propagation, refer to references 3 and 6.

receiving equipment

Almost all microwave weak signal

operation now uses crystal controlled converters, with 28 and 144 MHz IFs most popular. This permits most of the weak signal types of emissions to be used.

Adequate RF filtering, especially at the image frequency, is required for low-noise operation. Allowing other RF frequencies outside the band of interest to enter the receiver lowers performance, especially if the signals are strong. If a 28 MHz IF is used, filtering is more critical.

However, simple filter designs such as the interdigital type are now available to Amateurs.^{7,8} These filters are particularly easy to design using computer programs that can change the mechanical and electrical specifications at will. Construction is not beyond the hand tool level.

The present state-of-the-art permits noise figures below 3 dB up to 25 GHz. Only a few years ago this would have been unheard of except with the use of parametric amplifiers and masers, both out of the reach of most Radio Amateurs.

Microwave bipolar transistors are now inexpensive and can deliver 1 to 3 dB noise figures through 4 GHz. Affordable (less than \$25) GaAs FETs can now provide less than 2 dB noise figures through 3 cm.⁹ The lower noise figure high mobility electron transistors (HMETs) are coming.¹⁰ Although they

presently cost around \$150.00 (if they can be obtained at all), they reportedly will eventually be less expensive than GaAsFETs since they're easier to manufacture.

The local oscillator (LO) of a microwave converter is very important. As I've stated in previous columns, the basic oscillator for VHF/UHF and above should be an overtone crystal type in the 90-120 MHz region.^{11,12} Not only will this reduce phase noise, but it will improve stability, generate fewer spurs, and require less multiplication.¹³ As a result, there will be fewer birdies and fewer LO products to be filtered out.

Multipliers should also be clean. I recommend that doublers be used if possible since they're more easily filtered and more efficient. If triplers are used, they should be limited to about 400 MHz on the output. Some recommended combinations for 1296 and 2304 MHz are shown in **fig. 1**. Many types of mixers have been used over the years. The through-line single-diode type was commonly used on microwave frequencies in the early days.² More recently, interdigital mixers and the anti-parallel harmonically pumped mixers have been used, since they require a lower frequency LO at a sub-harmonic of the desired frequency.^{14,15,16}

However, I prefer the balanced mixer types.^{11,12} They're usually broadband and represent 50 ohms at all three ports (LO, RF, and IF). Hence they're easy to work with, especially in a modular converter. The double-balanced (DBM) type with four diodes is preferred, and are becoming quite easy to obtain and are reasonable priced (usually \$10-40 for 1-4.5 GHz), with the MDS and TVRO market paving the way for the 2-5 GHz spectrum. The DBM usually requires about 5 milliwatts of LO power.

Finally, the post amplifier (the one following the mixer) should have a low (1 to 2 dB) noise figure to lessen the preamplifier gain requirements. A suitably low noise figure bipolar preamplifier that will cover any IF from 14-150 MHz is described in references 12 and

17. Other low noise circuits are also acceptable, especially those with good input VSWR.

transmitters

Multipliers are fine for the microwave bands. As mentioned before, 144 MHz transmitters used to be multiplied all the way up to the desired microwave band. However, their frequency stability left something to be desired.

If you decide to use a multiplier scheme, there's a preferred method that has been used by many microwave and contest stations.^{18,19} Basically, it uses a 96 MHz oscillator which is multiplied up to 1152 MHz. This is a convenient frequency since its second, third, fifth, and ninth harmonics allow operation on 2304, 3456, 5760, and 10368 MHz respectively, as shown in **fig. 2**. Coincidentally, 1152 mixed with 144 MHz yields 1296 MHz as a bonus!

However, the transverter is rapidly becoming the most popular scheme for getting on the microwave bands. Since only one LO is required per band, it significantly lowers the cost and reduces complexity, not to mention construction time. Properly built, it will have excellent frequency stability. In addition, a transverter allows CW as well as SSB operation at the flip of a switch on the exciter.

The only problem with a transverter is that a separate oscillator is required for each microwave band, unlike the 1152 MHz transmitter scheme just mentioned. Many simple two- or three-band schemes have been proposed to lower the number of required oscillators.

Recently a more or less universal microwave scheme was proposed using a single oscillator.²⁰ Although it may at first seem complicated, it would make a dandy add-on type of building block, since once the first block is in place, bands can be readily added. The disadvantage of the scheme is that a separate converter is required at 288 MHz. However, that frequency is a snap to work with and will be high enough to make image

table 5. Major microwave band designations used during and after World War II. Note that there are some overlaps to add to the confusion.

frequency (GHz)	designation
0.10 - 0.225	G
0.225 - 0.390	P
0.390 - 1.55	L
1.55 - 5.2	S
3.9 - 6.2	C
5.2 - 10.9	X
10.9 - 36	K
12.9 - 18	Ku
26.5 - 40	Ka
36 - 46	Q
46 - 56	V

table 6. Modern Tri-Service microwave band designations in present use.

frequency (GHz)	designation
0 - 0.25	A
0.25 - 0.5	B
0.5 - 1	C
1 - 2	D
2 - 3	E
3 - 4	F
4 - 6	G
6 - 8	H
8 - 10	I
10 - 20	J
20 - 40	K
40 - 60	L
60 - 100	M

rejection a trivial problem. The basic scheme is shown in **fig. 3**.

obtaining power

Power amplifiers aren't always required on the microwave bands. If solid-state multipliers are used, up to several watts can be generated on the lower microwave bands.

Solid-state bipolar transistors can generate several watts of power up through 6 GHz. Power MOSFETs that generate several watts at 1 GHz have been demonstrated. Power GaAs FETS that can deliver 5 to 10 watts of output through 10 GHz are also available.

Until recently, the 2C39/7289 has been the king of transmitting tubes on the lower microwave bands. Single, two, four, six and even eight-tube

KENWOOD

...pacesetter in Amateur radio

“Dual-Band” Leader!

TW-4000A

2-m/70-cm FM transceiver.

The first is still the best! The original FM “Dual Bander” TW-4000A delivers 25 watts output on both VHF and UHF in a single compact package.

transmit frequencies independently for odd repeater offsets, or cross-band (2 m/70 cm) operation.

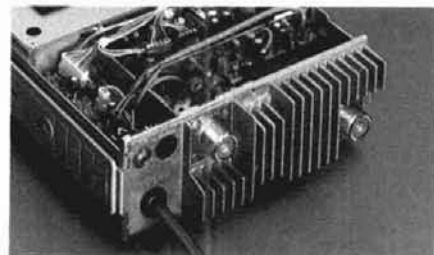

- **Rugged die-cast chassis.**
- **Two separate antenna ports.** Use of separate antennas is recommended. This simplifies antenna matching and minimizes loss. However, mobile installations may require a single antenna. The optional MA-4000 dual band mobile antenna comes with an external duplexer.
- **Programmable memory scan with channel lock-out.** Programmable to scan all memories, or only 2 m or 70 cm memories. Also may be programmed to skip channels.
- **Band scan in selected 1-MHz segments.** Scans within the chosen 1-MHz segment (i.e., 144,000-144,995 or 440,000-440,995, etc.). The scanning direction

may be reversed by pressing either the “UP” or “DOWN” buttons on the microphone.

- **Priority watch function.** Unit switches to memory 1 for 1 second every 10 seconds, to monitor the activity on the priority channel.
- **Common channel scan.** Memories 8 and 9 are alternately scanned every 5 seconds. Either channel may be recalled instantly.
- **High performance receiver/transmitter.** GaAs FET RF amplifiers on both 2 m and 70 cm, high performance monolithic crystal filters in the 1st IF section, provide high receive sensitivity and excellent dynamic range. The high reliability RF power modules assure clean and dependable transmissions on either band.
- **Optional “voice synthesizer unit!”** Installs inside the TW-4000A. Voice announces frequency, band, VFO A or B, repeater offset, and memory channel number.
- **Repeater reverse switch.**

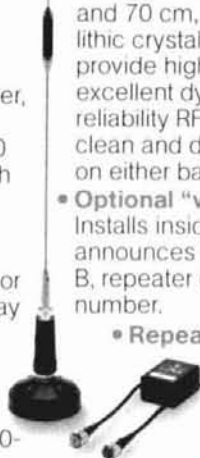

More TW-4000A information is available from authorized Kenwood dealers.



Optional accessories:

- VS-1 voice synthesizer
- TU-4C two-frequency CTCSS tone encoder
- PS-430 DC power supply
- KPS-7A fixed station power supply
- MA-4000 dual band mobile antenna with duplexer
- SP-40 compact mobile speaker
- SP-50 mobile speaker
- MC-42 UP/DOWN microphone
- MC-55 8-pin mobile mic. with time-out timer
- SW-100B SWR/power meter
- SW-200B SWR/power meter
- SWT-1/SWT-2 2 m/70 cm antenna tuners
- PG-3A noise filter
- MB-4000 extra mounting bracket

Complete service manuals are available for all Trio-Kenwood transceivers and most accessories. Specifications and prices are subject to change without notice or obligation. Antenna mag mount is not Kenwood supplied.

KENWOOD

TRIO-KENWOOD COMMUNICATIONS
1111 West Walnut Street
Compton, California 90220

Message Master™



Real-voice message system For any repeater or base

Now you can communicate vital information even when the station you are calling is not on the air — with Message Master. Message Master is a solid state voice recording system which can record messages just by listening to you speak, store messages in memory, and deliver messages on demand. If you can't be there to deliver your messages let Message Master deliver them for you - any messages in any language and in your own voice!

Message Master connects easily to any radio system for remote access: repeaters, base stations, even transceivers. It can even be connected to an autopatch device to exchange messages between your radio system and the telephone network.

Message Master is a multi-user system with mailbox style personalized message service for a hundred users. With 8 minutes of message storage it can store hundreds of messages simultaneously making it ideal for large, active repeater groups.

Would you like your callsign identifications, tail messages, and bulletin messages sent in real-voice? Message Master can send them too. Record several identification messages and it will even send a different ID each time. Almost like magic, Message Master knows when to send identifications and tail messages so it needs no special control signals from your base or repeater.

Call or write for further information before you make another wasted call.

Commercial users: Ask for a brochure on the Message Master Electronic Dispatcher with group and all call messaging.

- **Create messages just by talking.** Message Master's 'real-voice' technique saves YOUR VOICE in digital memory to deliver messages in your own voice, language and dialect.
- **Mailbox-style operation** gives individual message delivery service to 100 system users.
- **Easily added to any repeater or base station** for remote operation with only four connections.
- **Special features include** callsign identifications, tail messages, and bulletin messages.
- **Digital message storage** provides instant playback of stored messages.
- **Modular memory** meets your exact needs from 2 to 8 minutes of total message storage.

Serving all your repeater needs

- *Mark 4 Repeaters and Repeater Controllers are THE PERFORMANCE LEADERS with real voice, more autodial numbers, more synthesized voice and more features.*
- *Mark 3 Repeaters offer the winning combination of high performance and high value.*
- *LR-1 Repeaters boast superb RF circuitry at an economical price.*
- *MR-4 Receivers with 7 helical resonators are the only receivers to choose in harsh RF environments.*
- *PA-100 Amplifiers with rugged TMOS power FETs give you a continuous duty high power signal.*



COMING SOON: A 4-channel receiver voting system which operates on true signal-to-noise ratio to extend your coverage by linking to remote receivers.

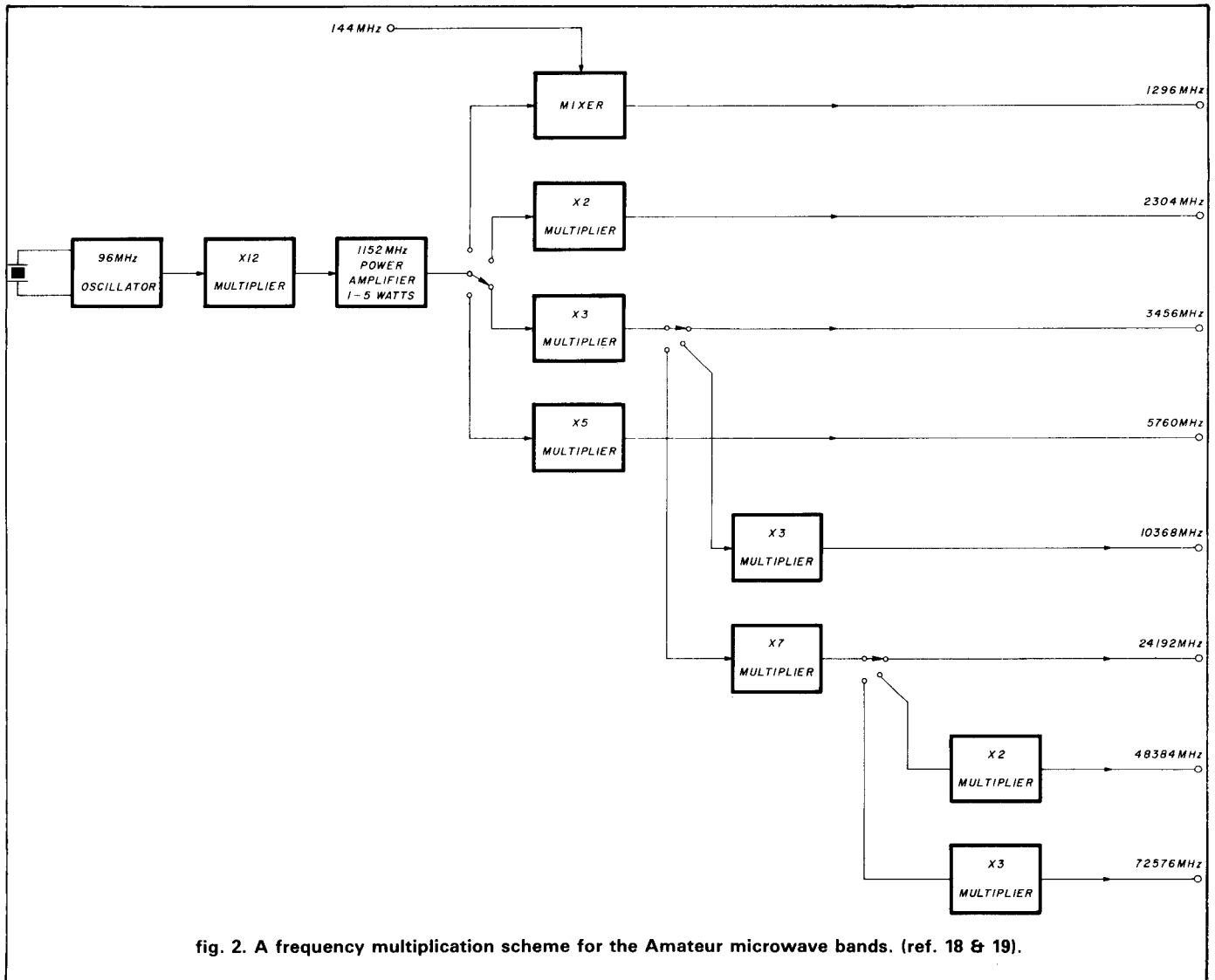

amplifiers have been used through 2304 MHz.²¹⁻²⁵ The eight-tube amplifier design described in reference 24, however, is not recommended, because this design offers very low efficiency (30-40 percent).

Recently a new single-tube 23-cm amplifier design using a UHF TV tube was introduced. It will reportedly deliver over 400 watts with a 10 dB gain.²⁶ Other tubes and designs are available. Traveling wave tubes (TWT) will deliver up to 100 watts at microwave frequencies, although those above 10 watts are rare in Amateur circles. The outstanding properties of the TWT are that it is broadband (typically one octave), has good linearity, and 25 to 35 dB of gain is typical!

Amateurs are also using high-power klystrons, but they're difficult to obtain and quite high in price. Like TWTs, they frequently have gains of over 30 dB. Magnetrons are another possibility. If someone can find out how to use the type presently so common in microwave ovens, we could have a readily available, low-cost high power amplifier source for 13 cm!

antennas

The principal types of antennas used on the microwave bands are the Yagi, loop Yagi, horn, and the parabolic dish. Because of the critical dimensional requirements, the Yagi will probably not be widely used except below 1300 MHz. But the loop Yagi, with its

unique mounting and matching methods, should be a good performer where 19 to 21 dBi of gain is required with low wind resistance up through at least 3500 MHz.^{27, 28} The microwave horn has only moderate gain (10 to 20 dBi), but is widely used on 3-cm gunplexers and as a feed system for parabolic dishes where low gain or controlled beamwidth is required. The parabolic dish, with its high gain, will probably remain the standard antenna for the microwave bands because it's easily designed, has predictable gain, and is easy to feed.²⁹

feedlines

The microwave bands are a transitional region for feedlines.³⁰ Coaxial

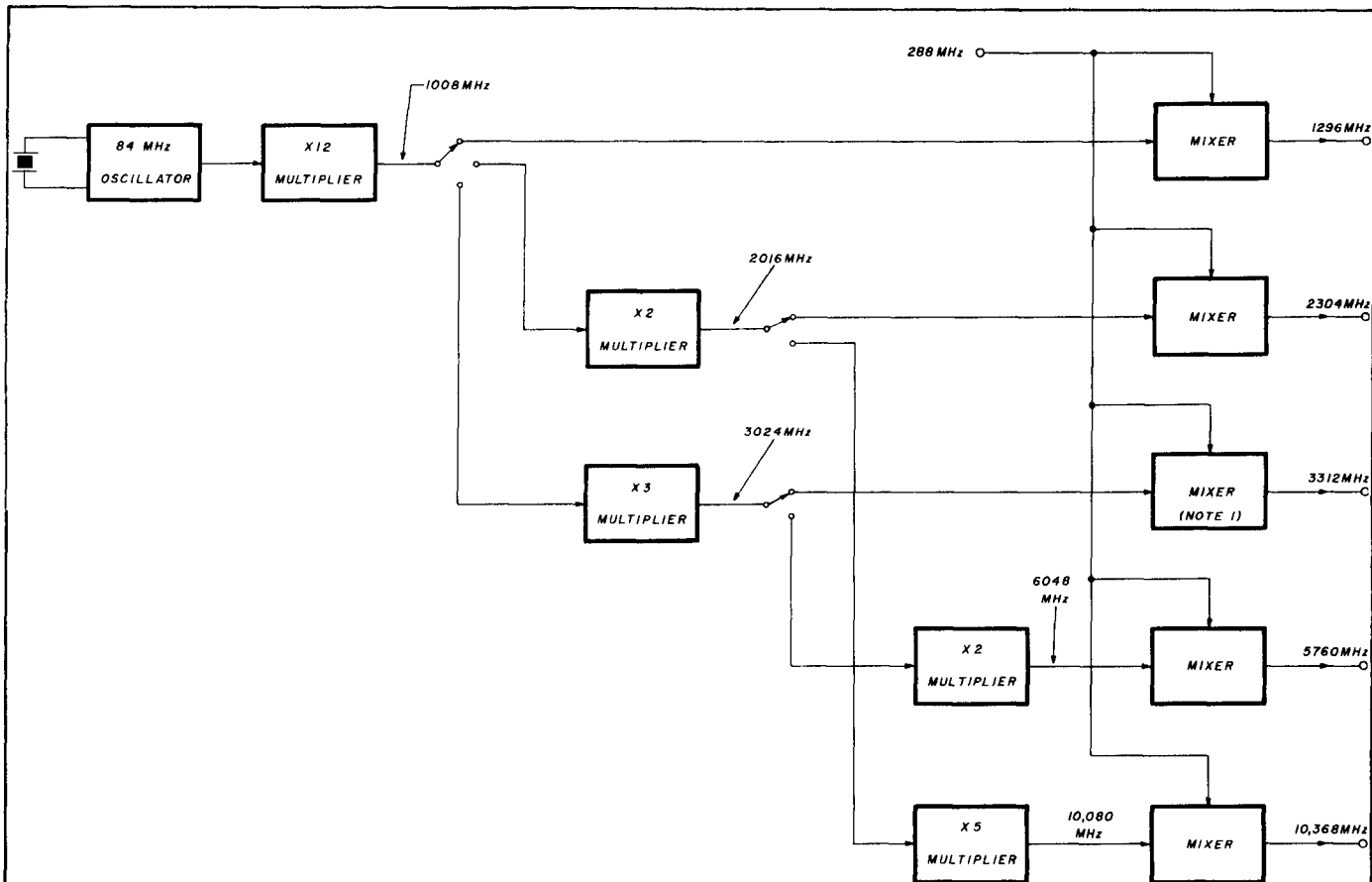

fig. 3. A universal frequency conversion scheme for many of the lower Amateur microwave bands. (ref. 20). Note 1: If 432 MHz is injected instead of 288 MHz, the output will be on 3456 MHz, the standard weak signal frequency.

cable is improving all the time; it's easy to work with, especially where bends or flexibility are required. It will probably remain the most popular line at the lower microwave frequencies and slowly move up in frequency as the state-of-the-art improves. In this regard, the air dielectric types of coax such as Heliac™ are preferred.

Waveguide will probably remain the most common type of transmission line on the microwave bands above 10 GHz. It's readily available as surplus and has very low insertion loss. Don't overlook the possibilities of "G-line," which has the potential for low loss at a very moderate cost — and you can "roll your own."³⁰

commercial gear

Those who know me well are aware that I prefer to build my own gear from scratch because it allows me flexibil-

ity in choosing features as well as the ability to make modifications and improvements without the fear of lowering resale value. It also yields a great sense of accomplishment when everything works!

However, there's now a fair amount of microwave gear available not only from Amateur suppliers, but from commercial suppliers, too. Furthermore, because the state-of-the-art in commercial equipment is moving ahead so rapidly, there's a lot of surplus equipment available to the Amateur. Check the Amateur magazines for further information. The microwave bands are no longer the exclusive territory of the homebrewer!

reference material

There's plenty of material about the microwave bands available if you know where to look.³¹ Of particular note are

the RSGB's *VHF/UHF Manual*, *The Microwave Newsletter Technical Collection*, *The Gunnplexer Cookbook*, *VHF Communications*, *DUBUS*, *IEEE Microwave Theory Transactions*, and *The UHF Compendium*, for example. (For information on how to obtain any of these, see reference 31.) Bibliographies are also available.^{32, 33, 34}

Finally, numerous trade magazines are available for those engaged in the electronics field.³¹ The material is available, but you'll have to take the initiative!

summary

In this month's column, I've tried to provide an introduction to the microwave bands. Because complete examination of the topic would obviously be beyond the scope of this column, I strongly advise you to refer to the references cited.

TAPR TNC-2 IS NOW PAC-COMM TNC-200

- Official TAPR TNC-2 design
- World - standard AX.25 Version 2 protocol
- Top quality components throughout
- Full duplex hardware HDLC
- Wired & tested, full kit, semi-kit, bare board
- Five terminal data rates up to 9600 baud
- Real time clock for date-time stamps
- Expanded to 16K RAM, 32K ROM
- Latest multiconnect software
- Five LED status indicators
- Level 3 networking compatibility
- Low-power CMOS draws 100ma typical

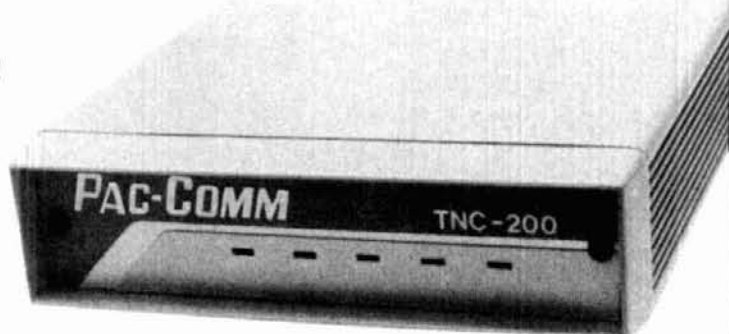

Discount 10% for orders of five or more TNC-200s

	CMOS	NMOS
Assembled/Tested	\$219.95	199.95
Full Kit	169.95	154.95
Full Kit Less Cabinet	144.95	129.95
Partial Kit	84.95	79.95

Bare Board 39.95
Cabinet & End Plates 29.95



Macintosh Owners: MACPACKET/TNC200term gives pull-down menus, split screens, file transfers, automatic routing and more!! \$69.95 (39.95 through January 31st)

ORDER TOLL FREE 800-835-2246 ext. 115 (Kansas 800-362-2421 ext. 115)
(No COD) **Information 813-689-3523** Florida addresses add 5%

PAC-COMM PACKET RADIO SYSTEMS, INC.

✓ 201

4040 W. Kennedy Blvd, Tampa, FL 33609 Intl TELEX 6502881526 WUI

THEY'RE ALL NEW FOR 1986!

Significant changes for 1986 mandate that all hams get both the North American and International Callbooks. ***DX'ers and Contester's note*** — Having both books is the only way you'll have all Foreign Amateur listings.

AVAILABLE NOW

NORTH AMERICAN CALLBOOK

The old US Callbook has been expanded and now contains the listings of all hams in North America plus Hawaii and US Possessions. This improved operating aid has all the latest calls and QTH information available at press time and will be an invaluable reference guide. With calls from Panama to Greenland, every ham should have a copy of this new book in their shack.

© 1985.

CB-US86 Softbound \$21.95

INTERNATIONAL CALLBOOK

The Foreign Callbook is no more! In its place, the new International Callbook includes all Amateurs outside of the North American continent. All the latest callsigns and QTH's are listed to help ensure you get that prized QSL card. Universally recognized as the source of information. Order your's today. © 1985.

CB-F86 Softbound \$20.95



Order Both and SAVE.
Reg. Price \$42.90

SPECIAL PRICE
SAVE \$2.95

\$39.95

CB-USF

Please enclose \$3.50 to cover postage and handling.

Order NOW.

ham
radio
magazine

BOOKSTORE
GREENVILLE, NH 03048





SERVICE CENTER
for
ICOM, KENWOOD
and **YAESU**

HAS YOUR WARRANTY GONE SOUTH?

When you're in need of service, you can rely on our factory trained experience in Amateur, Marine and Land Mobile.

"Write or phone, you'll be pleasantly surprised by our professional approach to your service needs".

Bob, KG7D

FCC NABER Lic

Mon-Fri 10:00-4:00 pm

(206) 776-8993

PACIFIC RIM COMMUNICATIONS

23332 58th Ave. West

Mountlake Terrace, Wa 98043



& C.O.D.S Welcome ✓ 170

Rush me my copy of the Dick Smith Catalog, I enclose \$1 to cover shipping

Name

Address

City

Zip

DICK SMITH ELECTRONICS INC.
P.O. Box 2249 Redwood City CA 94063



The Amateur microwave bands are an exciting area for exploration and challenge. Surely they'll be the resource of the future — not just for casual chit-chat, but as *the* place for improving the state-of-the-art in communications and equipment design.

references

1. Joe Reiser, W1JR, "VHF/UHF World: Old Wives' Tales and Trivia," *ham radio*, December, 1985, page 85.
2. Ed Tilton, *The ARRL VHF Manual*, ARRL, Newington, Connecticut (out of print).
3. Joe Reiser, W1JR, "VHF/UHF World: Propagation Update," *ham radio*, July 1985, page 86.
4. George Tillison, K6MBL, "The Polarization Diplexer—A Polaplexer," *ham radio*, March 1977, page 40.
5. Joe Reiser, W1JR, "VHF/UHF World: VHF/UHF Exciters," *ham radio*, April, 1984, page 84.
6. Joe Reiser, W1JR, "VHF/UHF World: A VHF/UHF Primer — An Introduction to Propagation," *ham radio*, July, 1984, page 14.
7. Joe Reiser, W1JR, "VHF/UHF World: The VHF/UHF Primer — An Introduction to Filters," *ham radio*, August, 1984, page 12.
8. Jerry Hinshaw, N6JH, and Sharokh Monemzadeh, "Computer-Aided Interdigital Bandpass Filter Design," *ham radio*, January, 1985, page 12.
9. Joe Reiser, W1JR, "VHF/UHF World: Low Noise GaAsFET Technology," *ham radio*, December, 1984, page 99.
10. Jack Browne, "Looking Forward to the Promise of the HMET," *Microwaves and RF*, March, 1985, page 17.
11. Joe Reiser, W1JR, "VHF/UHF World: VHF/UHF Receivers," *ham radio*, March, 1984, page 42.
12. Joe Reiser, W1JR, "VHF/UHF World: High-Dynamic Range," *ham radio*, November, 1984, Page 97.
13. Joe Reiser, W1JR, "High Dynamic Range," Dayton Hamvention, April 27, 1985. (Copies are available from WA8OGS for a nominal fee.)
14. R.E. Fisher, W2CQH, "Interdigital Converters for 1296 and 2304 MHz," *QST*, January, 1974, page 11.
15. M.V. Schneider and W.W. Snell, Jr., "Stripline Downconverter with Subharmonic Pump," *Bell System Technical Journal*, July-August, 1974, page 1179.
16. Jim Dietrich, WAORDX, "Twin-Diode Mixer — A New Microwave Mixer," *ham radio*, October, 1978, page 84.
17. Joe Reiser, W1JR, "VHF/UHF World: High Dynamic Range," *ham radio*, November 1985, page 54.
18. Dain Evans, G3RPE, "Microwaves—1000 MHz and Up," *Radio Communication*, January, 1973, page 31.
19. Geoffrey H. Krauss, WA2GFP, "First Building Blocks for Microwave Systems," *ham radio*, December 1980.
20. Charles Suckling, G3WDG, "Microwaves—Universal Frequency Conversion Scheme for Microwave Amateur Bands," *Radio Communication*, July, 1982, page 597.
21. R.E. Fisher, W2CQH, "A Power Amplifier for 1296 MHz," *ham radio*, March, 1970, page 43.
22. E.R. "Chip" Angle, N6CA, "A Quarter-Kilowatt 23-cm Amplifier—Part 1," *QST*, March, 1985, page 14; "A Quarter-Kilowatt 23-cm Amplifier—Part 2," *QST*, April, 1985, page 32.
23. Crawford Hill VHF Club, W2NFA, "A Water Cooled Power Amplifier for 1296 mc/s," *Technical Note No. 6*. (Copies available from W2IMU.)

24. Peter Laakman, WB6IOM, "A High-Power Linear for 1296 MHz," *ham radio*, August, 1968, page 8.
25. Norman J. Foot, WA9HUV, "2304-MHz Power Amplifier," *ham radio*, February, 1975, page 8.
26. Buzz Miklos, WA4GPM, "Coaxial Cavity Amplifiers," *Proceedings of the 1985 Central States VHF Society*. (Copies available for \$7.50 from W0RRY.)
27. Joe Reiser, W1JR, "VHF/UHF World: Designing and Building Loop Yagis," *ham radio*, September, 1985, page 56.
28. Joe Reiser, W1JR, "Designing Loop Yagis for 13 and 23 cm," *Proceedings of the First Annual 1296/2304 MHz Conference*, Estes Park, Colorado, September 25, 1985. (Copies from W0PW.)
29. Joe Reiser, W1JR, "Getting Started on 13 and 23 cm," *Proceedings of the First Annual 1296/2304 MHz Conference*, Estes Park, Colorado, September 25, 1985. (Copies from W0PW.)
30. Joe Reiser, W1JR, "VHF/UHF World: Transmission Lines," *ham radio*, October, 1985, page 83.
31. Joe Reiser, W1JR, "VHF/UHF World: Keeping VHF/UHFers Up to Date," *ham radio*, March, 1985,, page 126.
32. Cliff Buttschardt, W6HDO, "Microwave Bibliography," *ham radio*, January, 1978, page 68.
33. Bob Atkins, KA1GT, "The New Frontier — 1296-MHz Bibliography," *QST*, August, 1985, page 68.
34. Rich Rosen, K2RR, "From Beverages Through OSCAR — A Bibliography," Volumes 1 and 2 (over 2000 references on VHF/UHF, microwaves.)

important VHF/UHF events:

- January 3: *Peak of Quadrantids Meteor Shower predicted at 2300 UTC*
- January 8: *EME perigee*
- January 11-12: *ARRL VHF Sweepstakes Contest*
- February 4: *EME perigee*

ham radio

short circuit

VHF/UHF world

In the September, 1985 column, "VHF/UHF World" (page 45), the 2 7/8-inch dimension shown in fig. 2C should be changed to $\pm 2 1/2$ inches. This is the height of the loop (from top to bottom), not the diameter, and will cause the loop to appear somewhat oval rather than round.

During final adjustment, the loop Yagi should be tested for minimum VSWR. If it is not below 1.2:1 (after adjusting the spacings between the first director and the reflector, as explained in the text) adjust the loop height carefully to obtain the best match. After adjustment, the junction point where the driven element connects to the brass bolt and the transmission line should be thoroughly soldered together.

\$5 each — 5 for \$19.95 — 10 for \$39.95 — 20 for \$69.95

1984

December 1984

FEATURING: Solar powered ham station, Packet Radio, Quasi-bilateral IF, microstrip impedance program, transistor biasing, tuneup hints, cumulative index.

November 1984

FEATURING: Annual receiver issue, preamp, pulsewidth noise discriminator, IMD of cascaded stages, double conversion portable SW receiver, modular 2m receiver, receiving signals from outer space, receiver alignment system.

October 84

FEATURING: Adjustable power supply, low cost UHF tower, trap antenna design, the "smart" frequency counter, top loaded vertical, power dividers, compact keyer, Part 6 VHF Yagi design.

September 1984

FEATURING: History of SSB, audio AGC, MLA-2500 modifications, software packet radio approach, SEED antenna, EMI and digital radio, RFI solutions, OSCAR on your HT, Part 5 VHF Yagi design.

August 1984

FEATURING: 3CX800A7 linear amplifier, How to Buy and recycle surplus parts, ALC circuits, Part 2 cooling semiconductors, grayline fundamentals, computer DX'ing, Part 4 VHF Yagi design.

July 1984

FEATURING: Intro to VHF/UHF propagation, Part 1 cooling semiconductors, wideband VCO design, ground rod resistance, Part 3 VHF Yagi design.

June 1984

FEATURING: Tower issue, proper tower design, installation and maintenance, impedance matching, lowpass filters, Part 2 VHF Yagi design.

May 1984

FEATURING: Annual Antenna issue, Part 1 Yagi antenna design, capacitively loaded dipole, remote controlled low band vertical, Part 6 phased vertical arrays, easy antenna matching, end fed 8JK, Part 2 branch-line hybrids, simple wire plow.

April 1984

FEATURING: Resonant circuits, graphic filter design, high voltage switching power supply, portable SW receiver, HP-IL serial loop, mastering the CW keyboard, programmable PL tone generator.

March 1984

FEATURING: Audio to microwave amplifier, ICs and static electricity, computerized moon tracking, key to 3 element Yagi design, noise cancellation circuit, speech synthesis for repeaters, hazards of electric shock.

February 1984

FEATURING: VXO frequency synthesis, elliptic lowpass audio filter design, HF receiver performance, transmitter tuning aid, better sounding SSB, VHF meteor scatter communications, Part 2 EMI/RFI shielding.

January 1984

FEATURING: VHF power FETs, measuring noise figure, verticals over real ground, GOES reception, wide range ohmmeter, 2 meter V-antenna, Part 1 EMI/RFI shielding.

1983

January 1983

FEATURING: WARC band propagation, LF converter, Propagation, Remote site receivers and Repeater Operation, Simplex autopatch, Logic mate.

February 1983

FEATURING: 2304 MHz preamp, CB -10 FM, receiver, Cylinder and disk tuned VFO, Bobtail curtain antenna part 1.

March 1983

FEATURING: 15 meter SSB Transceiver, Bobtail Curtain part II, Dual Voltage Power Supply, GaAs FET Performance, Modern Noise Bridge, Capacitively Coupled Hybrids, CW Zero Beat Indicator.

April 1983

FEATURING: Inexpensive Video Monitor, Morse Time Synthesis, State-of-the-Art Touchtone R decoder, Remote Control HF operation, Microprocessor Repeater Controller, 6 meter amp.

May 1983

FEATURING: Vertical Phased Arrays part I, Stagger Tuned Dipoles, 20 meter Mobile Vertical, Short Verticals for Low Bands Part I, Inexpensive Hardline Connectors, Log Yagi Simplified Grounded Monopole with Elevated Feed.

June 1983

FEATURING: Measurement of PEP output Power, Short Vertical Antenna Design Part II, Vertical Phased Arrays Part II, Smart Squelch, 10 GHz Ultra Stable Oscillation, Color TRS-80 RTTY, Digital CW.

July 1983

FEATURING: Amateur Packet Radio Part I, Vertical Phased Arrays Part II, RTTY and Atari Modular Two Band Receiver.

August 1983

FEATURING: RF Synthesizers Part I, Amateur Packet Radio Part II, Testing Baluns, Hybrid Ring, Digital Audio Filter, Antenna Hinge.

September 1983

FEATURING: Linear Translators, Fail Safe Power Supply, RF Synthesizers Part II, 10 GHz Weather Radar, Installing Effective Grounds, Locating Orbiting Satellites.

October 1983

FEATURING: Electrical Calibration Standards, RF Synthesizers Part III, Vertical Phased Arrays Part IV, 2 meter Amplifier, Vacuum Tube substitution, 1750 meter transmitter, HF Hybrids.

November 1983

FEATURING: Compact SSB Receiver, Designing a Modern Receiver, Time and Frequency Standards, Time Domain Reflectometer, Optical FM Receiver, EMI/RFI Test Receivers, Shortwave Broadcast Receiver.

December 1983

FEATURING: Digital Ionosondes, State-of-the-Art Autodialer, Time and Frequency Standards Part II, PCB Dangers, Vertical Phased Arrays Part V, Lightning and Electrical Transient Protection.

1982

January 1982

FEATURING: Wilkinson hybrids, Blanking the Woodpecker: part one, 2-meter transverter, A neglected antenna for 40 and 80 meters, phantom-coil VXO.

February 1982

FEATURING: Response of pi-L and tandem quarter-wave-line matching networks, Blanking the Woodpecker: part two, Improved power supply for the Drake R-4C, Systematic design of crystal ladder filters.

March 1982

FEATURING: Microprocessor-based repeater controller, Blanking the Woodpecker: part three, Performance capability of active mixers, Simple tests for TTL ICs, Equations for determining antenna parameters, Easy matching sections.

April 1982

FEATURING: Stripline kilowatt amplifier for 220 MHz, 2716 Eprom programmer, Performance capability of active mixers, Readout for the deluxe memory keyer, Inductance meter.

May 1982

FEATURING: A quad owner switches, Dipole antenna over sloping ground, Inductance-tuned lowpass antenna matching unit, The half-delta loop, antenna geometry for optimum performance.

June 1982

FEATURING: Recommendations for 70-cm EME, Applying microcomputers to SSTV, The radiation of radio signals, Two-tone generator, The hybrid coupler, The big-amplifier power-supply.

July 1982

FEATURING: Versatile communications receiver, Design of the digital components of VHF and UHF synthesizers, Tandem pi networks.

ORDER FORM

Please send me the following back issues (use separate sheet of paper if necessary):

1. _____
2. _____
3. _____
4. _____
5. _____

1 for \$5.00

5 for \$19.95

10 for \$39.95

20 for \$69.95

Payment enclosed

Charge VISA Mastercard

Number _____ Expires _____

Name _____

Address _____

City _____

State _____ Zip _____

- ★ TECHNICAL FORUMS
- ★ ARRL AND FCC FORUMS
- ★ GIANT 3-DAY FLEA MARKET
Starting Noon Friday
All Day Saturday and Sunday
- ★ LICENSE EXAMINATIONS
- ★ NEW PRODUCTS AND EXHIBITS
- ★ GRAND BANQUET
- ★ ALTERNATIVE ACTIVITIES
- ★ SPECIAL GROUP MEETINGS
- ★ YL FORUM
- ★ PERSONAL COMPUTER FORUM
- ★ CW PROFICIENCY AWARDS
- ★ AMATEUR OF YEAR AWARD
- ★ SPECIAL ACHIEVEMENT AWARDS

DAYTON Hamvention®

April 25, 26, 27, 1986

Hara Arena and Exhibition Center — Dayton, Ohio

Meet your amateur radio friends from all over the world at the internationally famous Dayton HAMVENTION.

Seating will be limited for Grand Banquet and Entertainment on Saturday evening so please make reservations early.

If you have registered within the last 3 years you will receive a brochure in January. If not, write Box 44, Dayton, OH 45401.

Nominations are requested for Radio Amateur of the Year and Special Achievement Awards. Nomination forms are available from Awards Chairman, Box 44, Dayton, OH 45401.

For motel rates and reservations write to Hamvention Housing, 1980 Kettering Tower, Dayton, OH 45423-1980. Housing information phone, (513) 223-2612.

NO RESERVATIONS WILL BE ACCEPTED BY TELEPHONE.

All other inquiries write Box 44, Dayton, OH 45401 or phone (513) 433-7720.

ALL Flea Market spaces will be sold in advance ONLY. NO spaces sold at gate. Entrance for set-up available starting Wednesday. Special Flea Market telephone (513) 223-0923.

Bring your family and enjoy a great weekend in Dayton.

Sponsored by the Dayton Amateur Radio Association, Inc.

ADMISSION

\$8 in advance, \$10 at door.
(Valid for all 3 days)

BANQUET

\$14 in advance, \$16 at door.

FLEA MARKET SPACE

\$20 in advance.
(Valid for all 3 days)

Checks for advance registration to
Dayton HAMVENTION
Box 2205, Dayton, OH 45401

**Registration processing
starts Jan. 1, 1986.**

(Admission tickets must be ordered
with Flea Market spaces.)

Iron Powder and Ferrite

TOROIDAL CORES

Shielding Beads, Shielded Coil Forms
Ferrite Rods, Pot Cores, Baluns, Etc.

Small Orders Welcome
Free 'Tech-Data' Flyer

AMIDON
Associates

Since 1963

12033 Otsego Street, North Hollywood, Calif. 91607

In Germany: Elektronikiaden, Wilhelm — Meilies Str. 88, 4930 Detmold 18, West Germany
In Japan: Toyomura Electronics Company, Ltd., 7-9, 2-Chome Sota-Kanda, Chiyoda-Ku, Tokyo, Japan



✓ 112

AMATEUR RADIO MAIL LISTS

Self-stick 1x3 labels

- *** NEWLY LICENCED HAMS ***
- *** ALL NEW UPGRADES ***
- *** UPDATED EACH WEEK ***

Total List = 462,728 (ZIP sorted)
Price is 2.5 cents each (4-up Cheshire)

BUCKMASTER PUBLISHING
Mineral, Virginia 23117
703:894-5777

✓ 117

ALL BAND TRAP "SLOPER" ANTENNAS!

FULL COVERAGE! ALL BANDS! AUTOMATIC SELECTION with PROVEN Weatherproof sealed Traps - 18 Ga. Copperweld Wire! GROUND MOUNT SLOPERS - No Radials needed! Ground lg. rod or house water faucet! Connect Top to Trees, Buildings, Poles, etc at ANY angle from Straightup to 60 degrees for excellent "SLOPER" DX Antenna Gain or bend it anywhere you need to! 2000 Watt PEP input, max. Permanent or portable Use installs in 10 minutes. SMALL - NEAT - ALMOST INVISIBLE - No one will know you have a Hi-Power DX Antenna. Ideal For COND'Os APARTMENTS - RESTRICTED AREAS - Pre-tuned for 2-1 or less SWR over ALL bands (except 80-160-300ks). No adjustments needed - EVER. COMPLETELY ASSEMBLED, with 50 ft RG-58U Coax feedline and PL259 connector. Built in lightning arrester - ready to hookup! FULL INSTRUCTIONS!

No. 1080S - 80-40-20-15-10 - 1 trap	49 ft. - \$49.95
No. 1040S - 40-20-15-10 - 1 trap	26 ft. - \$48.95
No. 1020S - 20-15-10 - 1 trap	13 ft. - \$47.95
No. 1016S - 160-80-40-20-15-10 - 2 traps	83 ft. - \$79.95

SEND FULL PRICE FOR PP DEL IN USA (Canada is \$5.00 extra for postage etc.) or order using VISA, MASTERCARD - AMER EXP. Give Number Ex Date. Ph 1-308-236-5333 weekdays. We ship in 2-3 days (Per Cks 14 days) Guaranteed 1 yr - 10 day money back trial.

WESTERN ELECTRONICS ✓ 198
Dept. AR Kearney, Nebraska 68847

Electronic Repair Center

Servicing

Amateur

Commercial Radio

The most complete repair facility on the East Coast.

Large parts inventory and factory authorized warranty service for Kenwood, Icom and Yaesu.

SEND US YOUR PROBLEMS

Servicing "Hams" for 30 years, no rig too old or new for us.

HAMTRONICS, INC.

4033 Brownsville Road
Trevose, Pa. 19047
215-357-1400



THE STANDARDS OF EXCELLENCE

SUPERIOR WEAK SIGNAL PERFORMANCE COMMERCIAL MODEM

COMPARE with ANY unit at ANY Price

Now Available With
PACKET RADIO

**THE WORLD OF VHF/HF PACKET*,
CW, RTTY, ASCII AND NEW DUAL
AMTOR** IS AS CLOSE AS YOUR
FINGERTIPS WITH THE BRILLIANTLY
INNOVATIVE STATE-OF-THE-ART
MICRO-COMPUTER CONTROLLED
EXL-5000E.**

HOLIDAY SALE

\$649

With Packet Radio — \$795



SHOWN WITH OPTIONAL PACKET TNC

Everything built in — nothing else to buy!

- AUTOMATIC SEND/RECEIVE—ANY SPEED ANY SHIFT • BUILT IN COMPUTER GRADE 5" MONITOR • EXTERNAL MONITOR JACK • TIME CLOCK ON SCREEN • TIMED TRANSMISSION AND RECEIVING • SELCAL • CRYSTAL CONTROLLED AFSK MODULATOR • PHOTOCOUPLER CW, FSK KEYS • ASCII KEY ARRANGEMENT • 15 CHANNEL BATTERY BACK-UP MEMORY • 1,280 CHARACTER DISPLAY MEMORY • SPLIT SCREEN TYPE-AHEAD BUFFER • FUNCTION SCREEN DISPLAY • PARALLEL PRINTER INTERFACE • SPEEDS: CW 5-100 WPM (AUTOTRACK), 12-300 BAUD (ASCII AND BAUDOT); 12-600 BAUD TTL; 100 BAUD ARQ/FEC AMTOR • ATC • RUB-OUT FUNCTION • AUTOMATIC CR/LF • WORD MODE • LINE MODE • WORD WRAP AROUND • ECHO • TEXT CURSOR CONTROL • USOS • DIDDLE • TEST MESSAGES (RY AND QBF) • MARK AND BREAK (SPACE AND BREAK) SYSTEM • VARIABLE CW WEIGHTS • AUDIO MONITOR CIRCUIT BUILT IN • CW PRACTICE FUNCTION • CW RANDOM GENERATOR • BARGRAPH LED METER FOR TUNING • OSCILLOSCOPE OUTPUTS • BUILT IN 100-120 / 220-240 VAC 50/60HZ AND 13.8VDC POWER SUPPLIES • AND MUCH, MUCH MORE • SIZE: 14W x 14D x 5H • 1 YEAR LIMITED WARRANTY •



**Theta-777 THE MOST ADVANCED COMPUTER INTERFACE
EVER DESIGNED FOR COMMERCIAL AND AMATEUR USE.**

RTTY, BIT INVERSION (RTTY), ASCII, AMTOR (MODE A (ARQ), MODE B (FEC AND SEL-FEC), MODE L), CW, ANY SPEED ANY SHIFT (ASCII AND BAUDOT)*

HOLIDAY SALE \$249

- **AUTO DECODING:** Automatically decodes signal and displays mode, speed and polarity on the CRT — **COMPARE!**
- **28 BAR-LED'S** and **LED'S** plus a Bar-Graph Tuning Indicator indicate function, mode, and status — **COMPARE!**
- *The awesome power of the Theta-777 is limited only by the imagination of the user and the terminal program of the computer.*
- Use with **Any** computer that has RS232 or TTL I/O, IBM, Apple, Commodore, TRS80, etc.

Everything Built In - Including Software — Nothing Else To Buy!

- *SPEEDS: CW 5-100 WPM (AUTOTRACK), 12-200 BAUD (ASCII AND BAUDOT); 12-600 BAUD TTL, AND RS232 OR TTL LEVEL DATA CONNECTION - 100-2400 BAUD (ASCII) OR 45.5-200 BAUD (BAUDOT) • SELCAL • MEMORY: 15 CHANNELS • 768 CHARACTER INPUT BUFFER • AUTO PTT • CW ID • DIDDLE • USOS • ECHO • AUTO CR/LF • ATC • RUB-OUT • CW PRACTICE GENERATOR • VARIABLE CW WEIGHTS • TEST MESSAGE (RY AND QBF) • FULL CRT FUNCTION DISPLAY • MARK - AND - BREAK (SPACE - AND - BREAK) SYSTEM • XTAL AFSK • AUDIO MONITOR • OSCILLOSCOPE OUTPUTS • AND MUCH, MUCH MORE • POWER SUPPLY REQUIREMENTS: 13.8 V DC, 700MA • SIZE: 9W x 10D x 2 1/2H • 1 YEAR LIMITED WARRANTY •

EXCLUSIVE DISTRIBUTOR: **DEALER INQUIRIES INVITED** FOR YOUR NEAREST DEALER OR TO ORDER:
AMATEUR-WHOLESALE ELECTRONICS **TOLL FREE...800-327-3102**
8817 S.W. 129th Terrace, Miami, Florida 33176 Telephone (305) 233-3631 Telex: 80-3356

MANUFACTURER:
TONO CORPORATION
98 Motosoja Machi, Maebashi-Shi, 371, Japan

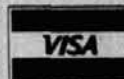

*PLEASE CALL FOR DETAILS

**Dual Amtor: Commercial quality, the EXL-5000E incorporates two completely separate modems to fully support the amateur Amtor codes and all of the CCIR recommendations 476-2 for commercial requirements.

Specifications Subject to Change.

Don't buy from Hamtronics . . .

Unless you want the best possible equipment
at the lowest possible price! ! !

The "wheeler-dealer" is back and he's beating everyone else's "deals."

We all know there's no such thing as a free lunch . . . so How Can We Do This?

- **We don't** run alot of ads featuring sale items
- **We don't** spend alot of money on full page ads
- **We don't** have sales on just the fastest selling products
- **We don't** short cut you on service. We are a factory warranty repair facility for everything we sell!
- **We don't** mail out free catalogs
- **We don't** have a free WATS number.

You and every other Ham customer is paying for all these do-dads and sales gimicks.

Hamtronics puts the savings into your pocket.

Hamtronics guarantees to meet or beat any advertised price on every item we sell.

Hamtronics Has It All!

Let **Hamtronics** be your Ham Radio equipment dealer. We're celebrating our 35th year in the Ham business at the same location.

ICOM DAY JANUARY 25, 1986

HAMTRONICS, INC.

A DIVISION OF TREVOSE ELECTRONICS
4033 BROWNSVILLE RD., TREVOSE, PA 19047
(215) 357-1400



✓ 145

GUS BROWNING, W4BPD's DX'ERS MAGAZINE

For over 17 years, Gus's DX'ERS MAGAZINE has brought thousands of DX'ERS worldwide, timely, pertinent information on when and where to find those elusive DX stations.

Gus's personable, chatty writing style and his years of DX operating experience makes the DX'ERS MAGAZINE a unique publication. One year \$14.00 USA, Canada & Mexico.

Gus also prints high quality QSLs and other related items.

✓ 136 Write today for a free sample of his QSLs and DX'ERS MAGAZINE.

Gus Browning, W4BPD • PO Drawer 405 • Cordova, SC 29039

SYNTHESIZED SIGNAL GENERATOR

MADE IN
USA



MODEL
SG-100F
\$429.95
delivered

- Covers 100 MHz to 199.999 MHz in 1 kHz steps with thumbwheel dial
- Accuracy +/- 1 part per 10 million at all frequencies
- Internal FM adjustable from 0 to 100 kHz at a 1 kHz rate
- External FM input accepts tones or voice
- Spurs and noise at least 60 dB below carrier
- Output adjustable from 5-500 mV at 50 Ohms
- Operates on 12 Vdc @ 1/2 Amp
- Available for immediate delivery • \$429.95 delivered
- Add-on accessories available to extend freq range, add infinite resolution, AM, and a precision 120 dB attenuator
- Call or write for details • Phone in your order for fast COD shipment.

✓ 195

VANGUARD LABS

196-23 Jamaica Ave., Hollis, NY 11423
Phone: (718) 468-2720 Mon. thru Thu.

LEARN ALL ABOUT TROUBLESHOOTING MICROPROCESSOR-BASED EQUIPMENT AND DIGITAL DEVICES

Attend this 4-day seminar and master the essentials of microprocessor maintenance. Gain a firm understanding of microprocessor fundamentals and learn specialized troubleshooting techniques. Fee is \$695.00.

CURRENT SCHEDULE

- Los Angeles, CA — Jan 14-17
- Sacramento, CA — Jan 21-24
- Dallas, TX — Feb 18-21
- Albuquerque, NM — Feb 25-28
- Atlanta, GA — Mar 18-21
- Tampa, FL — Mar 25-28

MICRO SYSTEMS INSTITUTE

Garnett, Kansas 66032
(913) 898-4695

✓ 160

STATION MANAGER/ADVANCED A General Purpose Logging Program

Designed for the IBM® PC,™ XT,™ enhanced PC jr,™ Menu driven; prompts for easy use; full color displays; multiple logs (each up to 1,000 entries with user editing), several reporting methods including one by partial callsign.

\$59.00 includes: 90 pg. User's Guide & Diskette (source code included)

\$20.00 — User's Guide only (may be applied to full purchase price)

Ohio residents include sales tax

WATCH FOR STATION MANAGER/CodeTutor
To be released soon

OMEGA CONCEPTS

Professional software for the Radio Amateur™

P.O. Box 615
Troy, OH 45373



T.L. Jones (KB80A)
Author

✓ 167

IBM is a registered trademark of International Business Machine Corp

PRACTICALLY SPEAKING ...

*JOE Carr
K4IPL*

troubleshooting I: signal tracing/injection

SCENE: It's one of those evenings when you can't determine whether the band has just died a little earlier in the evening than usual or somebody's stuck a pin through your antenna coax. Wise Old Elmer (WOE) is leisurely tuning across 15 meters when the doorbell rings. He opens the door. Standing there, looking more than a

little crestfallen, is Young Squirt (YS), a novice who has only recently upgraded to General Class.

"Hiya, Young Squirt — what's the matter, a truck run into your tower?" Young Squirt replies, "Almost. My \$800 Super Band-Buster Single Sideband (SBBSSB) transceiver died on receive — think ya' can help?"

Now, WOE is one of those old-fashioned people who believes that if you give someone a fish then they eat for today, but if you teach them how to fish, then you feed them for a lifetime. "Well, Squirt, I reckon I could fix it —

after all, you bought the shop manual and I got a workshop full of test equipment. But what good does it do if I fix it?"

WOE pauses, knowing YS's objection because he remembers a scene like that, oh, so many years ago, back when he thought the QCWA met in the local nursing home.

"Well, answers YS, ...it'd get me back on the air."

"Young Squirt," says WOE, assuming a fatherly tone, "you just passed a community college course in radio and nearly aced the General class

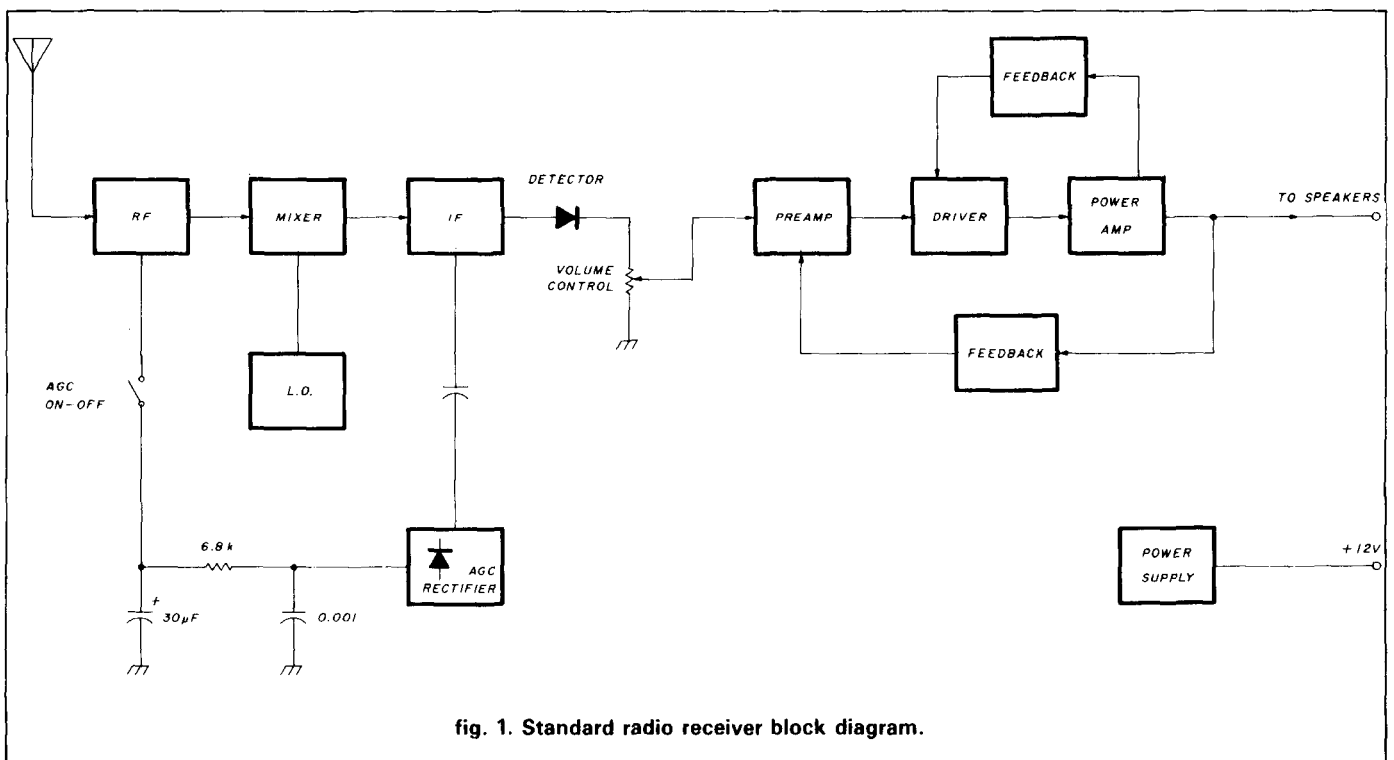

fig. 1. Standard radio receiver block diagram.

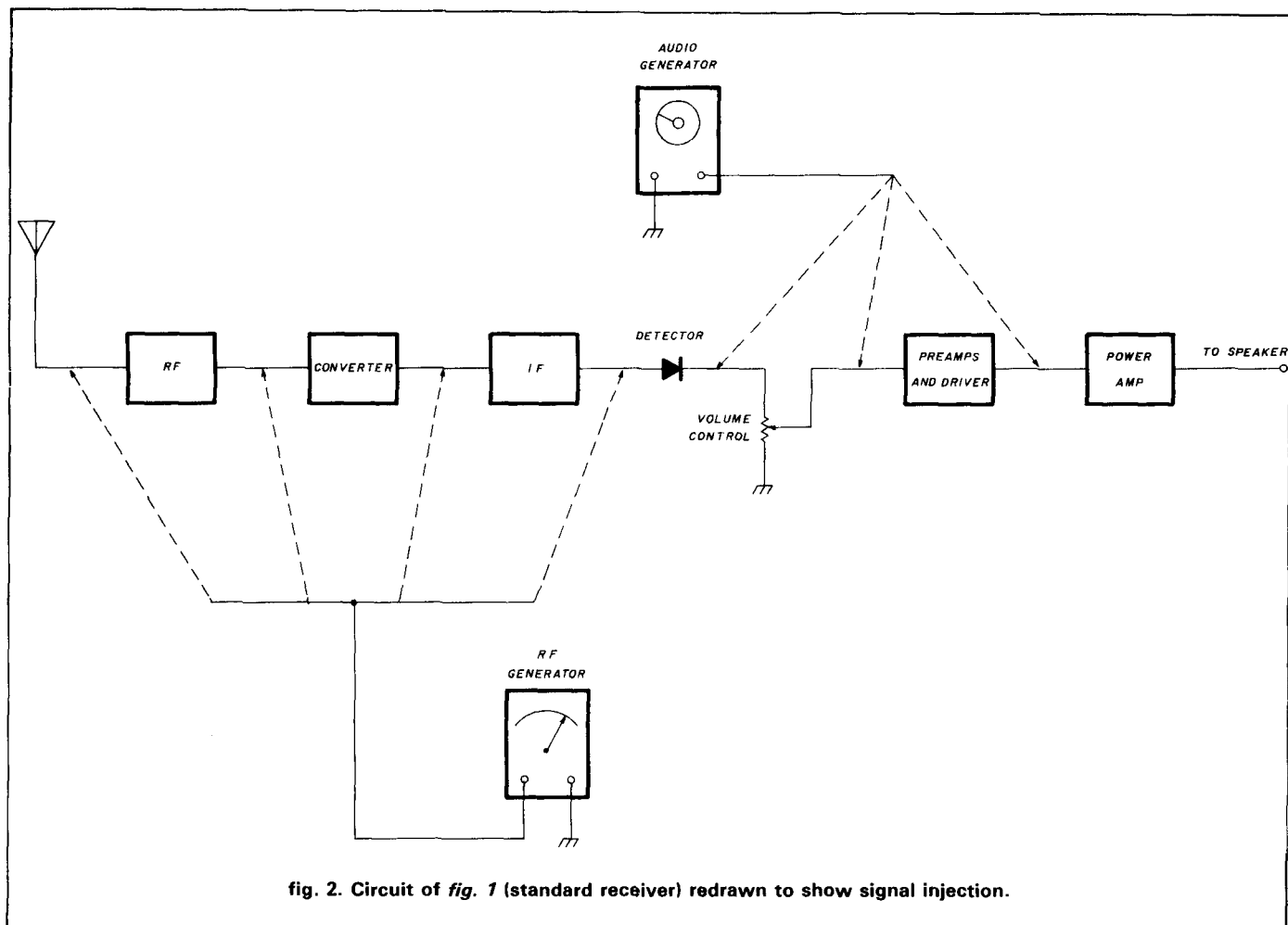

fig. 2. Circuit of fig. 1 (standard receiver) redrawn to show signal injection.

license exam. Why don't I show you how to troubleshoot that rig of yours, and see if you can learn a thing or two?"

YS is startled at the suggestion. Elated, but still questioning his own ability, he admits that WOE knows a lot more than he does, so puts his anxiety on hold. But when WOE heads over to the workbench — muttering something about getting out his fishing pole — the anxiety returns.

With the transceiver on the workbench, WOE directs YS to remove the top and bottom covers according to instructions in the service manual. Taking out a piece of paper and a stubby No. 2 pencil, he draws a block diagram of a standard radio receiver (fig. 1).

"Take a look at this picture, Squirt. Note the various stages. We have an RF amplifier tuned to the incoming sig-

nal, a converter or mixer/local-oscillator stage that converts the RF signal to the IF frequency, an IF amplifier where most of the gain and selectivity are placed, a detector — let me draw a simple AM envelope detector, just for the sake of argument — and an audio amplifier chain. There might be various feedback loops in the audio, but we can leave them out for now. There might also be an automatic gain control (AGC) circuit. This circuit is simple compared with the SBBSSB receiver section, but it serves to show you how to bait your hook."

"Huh? Bait my hook?"

WOE smirks. "Let's talk a little about troubleshooting philosophy, YS," he says. "It'll help us think this process through. *The vast majority of electronic troubleshooting problems involve either losing a desired path for current or gaining an undesired path*

for current." That certainly sounds simple, so Squirt figures WOE just might know a thing or two. "Furthermore," WOE continues, "there is, in each stage, an AC path for current and a DC path for current. Although there are cases in which examining the DC path in each stage will allow us to isolate the defective section of the receiver, it's more often the case that the signal path — an AC path — is the best way to attack the problem."

"DC path, AC path?" YS asks, "that sounds familiar. I talked to Sally Solderburn last week, and she told me about using those ideas to troubleshoot solid-state circuits." (Sally only recently obtained an Amateur license, but had been the Chief Engineer of the local National Public Radio FM station in their town for several years. She'd also spent several years repairing CB and taxicab two-way radios.)

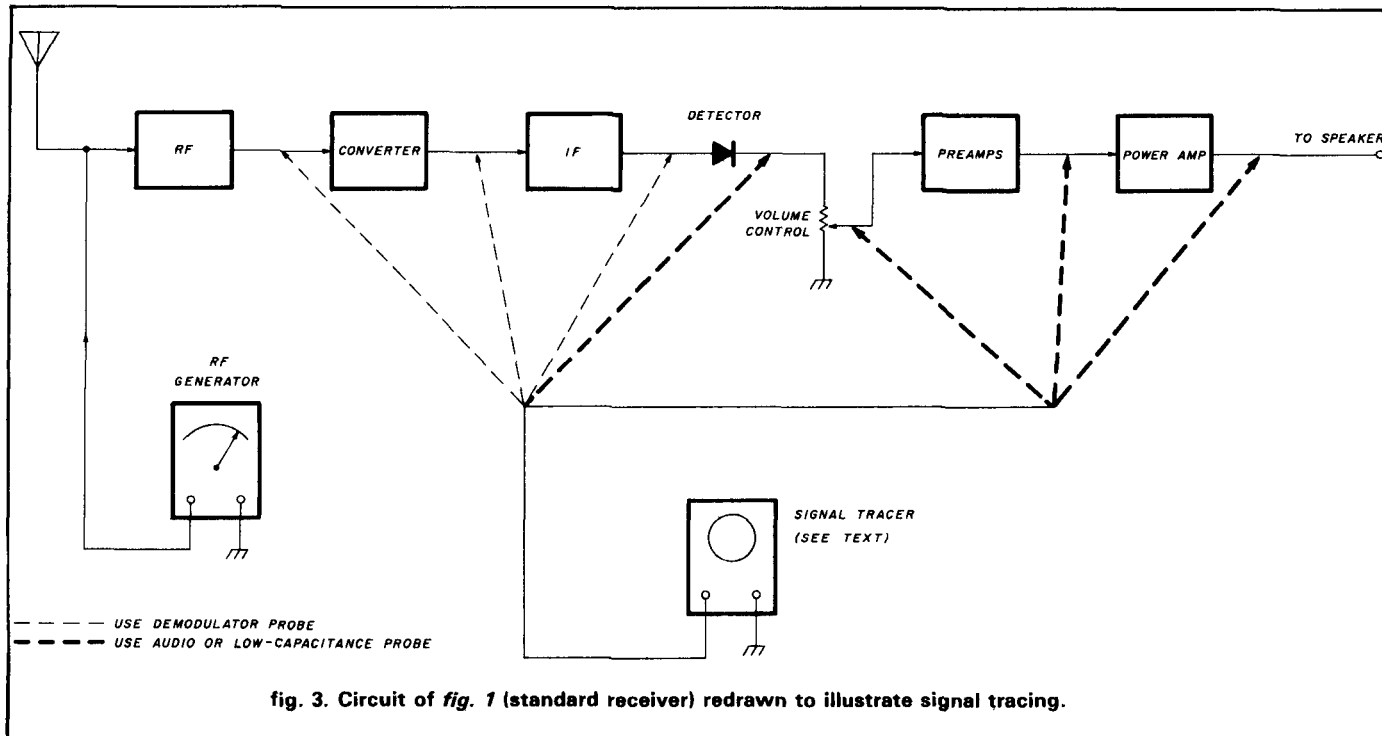

"Yeah, Sally showed me a thing or two about troubleshooting solid-state circuits," replies WOE, "but let's get to that in a moment. The first job is to isolate the dead stage. There are two methods we can use: signal tracing or signal injection."

Taking out another sheet of paper, WOE redraws the circuit of fig. 1 in the form of fig. 2. "In signal injection we use a signal generator to insert a signal into the various stages of the receiver, while monitoring the output signal on the speaker or a pair of headphones."

"In the textbook case — I use that term because, practically speaking, there are telling indications that allow us to cut the process short — we'll first use an audio generator at the input of the audio output stage. If this signal creates an appropriate response in the output — that is, a tone in the speaker — then we move the signal generator back to the input of the AF preamps or the volume control. If the audio stages prove out OK, then we have to switch to an RF signal generator. At first, set the RF sig gen to the IF frequency. Inject the signal into the input of each IF stage (there are three

stages, you know) and the output of the converter (or mixer, if that system is used). Finally, if all these stages prove out, as indicated by the signal getting all the way through to the output, switch the sig gen frequency to the RF frequency. This step's a little tricky, in some cases, because the receiver and sig gen aren't tuned to the same frequency; the dials are way off from each other. Rock either the receiver or signal generator dial back and forth to find the signal. The last stage is the RF amplifier."

YS marvels at the simple logic of stage isolation, but now wonders what "signal tracing" is: "Tell me, Wise Old Elmer," he asks, "you mentioned signal tracing a couple minutes ago — what's that?" WOE reaches for his old Heathkit signal tracer and shows it to YS. "Well, Squirt," he begins, "the signal tracer is merely a high gain audio amplifier with a loudspeaker output. The input is a switchable probe. In one switch position the probe acts like a simple low-capacitance probe, while in the other it's a demodulator probe. This latter position will demodulate an AM signal." Turning the now well-used piece of paper over, WOE again

draws the simplified block diagram of a radio receiver (fig.3) and shows Squirt how to signal trace.

"Remember how in signal injection we started at the audio output stage and worked backward toward the RF amplifier?" he asks. "In signal tracing, we work in the *opposite* direction — from the RF amplifier toward the AF stages. It's important to have the receiver tuned to some reasonably strong signal that will stay on the air for a little while. On some Amateur bands there are enough signals so that this is not a problem — 75 meters after 6 PM for example — but in other cases, we'll have to supply a signal. In our area, WWV on 10 MHz is usually strong, so we can use the WWV mode of the receiver. Otherwise, simply connect a signal generator to the antenna terminals. Set the output frequency to the same frequency as the receiver dial.

"Use the signal tracer in the 'demodulator' mode (also called the 'RF' mode on some instruments). Look for the signal first at the output of the RF stage, then at the converter (or mixer), at each IF stage in succession, and finally at the input of the

detector. If the bad stage is not found, then switch to the AF mode on the signal tracer, and continue to the detector and each of the audio stages in succession."

"The process of stage isolation," WOE continues, "is used to limit the problem area to a single bad stage. Once we determine which stage is dead, then we can use other methods to figure out which component is defective."

YS is impressed. "Darn!" he exclaims, "that's simple, WOE. Why didn't I think of that?"

"Hmmm..." thinks WOE, "that's a good question."

"WOE," asks YS, "you mentioned some shortcuts...what were you talking about?"

"Well, I don't mean to imply that the process isn't valid, because it works in almost all cases — in fact, it's never failed for me. But a little experience shows us that some indications allow

us to eliminate certain stages. You know, professional technicians often make more money from merely observing sets than from testing them. People like your friend Sally make their living by fixing as many sets per working hour as possible, so they're deeper in the bucks if an educated guess shortens the process."

Squirt is now almost breathless — but whether from a desire to impress Sally or from the technical wisdom he's gaining isn't clear. "What kind of shortcuts are there?" he asks.

"Well, let's take a quick look at your rig and see." WOE makes sure the rig is turned off and in the receive mode. He plugs in the AC power cord and turns on the power switch. "Run the AF gain control up and down through its range several times, YS," he directs. "Hear that scratching? Very few volume controls are perfectly clean potentiometers. Almost all of 'em have enough scratching to let you know whether or not the AF stages are working."

YS turns the control several more times, and sure enough, the speaker emits a rough scratching sound as the control is adjusted.

"That scratching tells us that the AF amplifiers are probably OK," WOE explains. "Now set the AF gain at or near maximum and turn the RF gain control all the way up. Notice that the set is all but dead — there's only a small hissing sound. That tells us that the problem is probably in the detector, IF, or mixer/oscillator (or converter) stages. If the mixer/oscillator and all following stages are working, and the problem is in the RF amplifier, then we'd hear a loud hiss amplified by the high gain IF amplifier. This hiss is a combination of thermal noise in the stages plus a certain amount of noise created by the heterodyning process. Listening to the receiver with the antenna disconnected is nearly the same sound."

WOE takes out another sheet of paper, brushes away some instant coffee crystals, and makes a list for his young friend. He titles it "common faults and their indications, especially

for AM/SSB radios" and begins to write

1. With all gain controls turned up, a loud hiss indicates a lot of gain is present, so the problem is closer to the front-end.

2. Picking up only a few stations in a normally crowded band (not 15 meters at 10 PM) could indicate a sensitivity problem. If there's not a lot of hiss, then look in the IF amplifiers (especially the early stages). The fact that the signals are there, in the right place, exonerates the mixer/oscillator.

3. A lot of signals, but with low volume, usually indicates that one of the latter IF stages, the detector, or one of the AF stages is faulty. If the volume control scratch is normal, then the AF stages are probably OK.

4. Tune the radio across a busy band while watching the S-meter. If there are periodic deflections — indicating that the receiver tuned across a signal — but there's still no output signal, then the dead stage is between the S-metered stage and the output.

5. A constant — or nearly constant — indication on the S-meter might indicate an oscillating IF amplifier or other stage.

"Well, there you have it, Squirt. Think you can show me which stage is bad?"

YS, who by now has had both his consciousness and confidence raised, mutters, "I expect so."

next month

This month we used a little "Elmer Scenario" to illustrate a little lesson in troubleshooting. Next month we'll return to our usual format and tell you what Sally Solderburn taught YS about troubleshooting.

have a question for Joe Carr?

Send your question to Joe Carr, *ham radio*, Greenville, New Hampshire 03048. While not every letter can be answered personally, he will try to answer as many as possible in this column.

—Ed.



STILL LOOKING FOR QUALITY WIRE & CABLE AT THE RIGHT PRICE?

RG-213 MIL SPEC. 97% SHIELD	28 5¢/ft
RG-214 MIL SPEC. DBL SILVER SHIELD	\$1.50/ft
RG-174 MIL SPEC. 97% SHIELD	10¢/ft
RG-8X (MINI 8) FOAM 95% SHIELD	12 5¢/ft
RG-8U FOAM 95% SHIELD	24 5¢/ft
RG-58A/U MIL SPEC. 97% SHIELD	12¢/ft
RG-11A/U MIL SPEC. 97% SHIELD	28¢/ft
RG-59U MIL SPEC. 97% SHIELD	12¢/ft
300 OHM KW TWIN LEAD	16¢/ft
450 OHM HD LADDER LINE. POLY INS	10¢/ft
450 OHM HD LADDER LINE. BARE. 100 FT ROLL	\$13.00
4 CONDUCTOR ROTOR CABLE	8¢/ft
6 CONDUCTOR ROTOR CABLE	14¢/ft
8 CONDUCTOR ROTOR CABLE (2#18/6#22)	16 5¢/ft
8 CONDUCTOR ROTOR CABLE HD (2#16/6#18)	34¢/ft
14 GA STRANDED COPPERWELD, 70 FT ROLL	\$5.50
14 GA STRANDED COPPERWELD, 140 FT ROLL	\$12.00
14 GA HD STRANDED COPPER	8¢/ft
12 GA HD SOLID COPPERWELD	10¢/ft
14 GA HD SOLID COPPERWELD	8¢/ft
18 GA HD SOLID COPPERWELD	4¢/ft

*SOLD IN CONTINUOUS LENGTHS TO 5000 FT. IN 50 FT. MULTIPLES ONLY

LA CUE, INC.
132 Village Street
Johnstown, PA 15902
orders only
1-800-637-3300

ham radio

Kantronics UTU-XT

NOW — for ANY computer, the intelligent terminal unit that can change its spots.

Can you imagine a terminal unit (TU) that has user programmable parameters? Would you like to be able to vary the MARK and SPACE tones you use by computer control, save these parameters for next time, and be able to change the center frequency and bandwidth of the CW detector? All this can be done with the **Universal Terminal Unit-XT by Kantronics.**

Imagine a **CW/RTTY/ASCII/AMTOR** machine that operates with a TNC-like command structure, including **54 commands.** The UTU-XT does just that with a 6303 microcomputer, 2K of RAM, NOVRAM, and 128K of EPROM embedded inside.



UTU-XT is also compatible to any computer with an RS232 or TTL (C-64) serial port — the circuit is built in. This allows you the flexibility to change computers at any time.

UTU-XT operates CW from 6-99 WPM, RTTY from 45 to 300 baud. ASCII from 110 to 300 baud, and AMTOR modes A, B, and L. Selective RTTY and SELFEC are included.

Suggested retail \$359.95

Kantronics

1202 E. 23rd Street 19131 842 7745
Lawrence, Kansas 66046

✓ 153

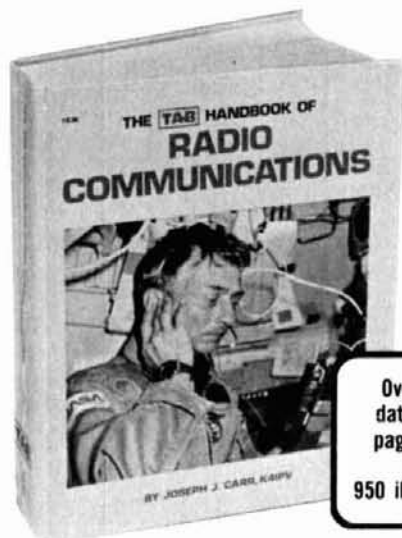

Over 1,000
data-packed
pages, more
than
950 illustrations!

Yours . . . for Only \$1.99 when you join



ELECTRONICS BOOK CLUB

The Most Complete Ham Information Source Available.
Regularly Sells for \$45!

From the *Only* Book Club that Delivers

- * Hundreds of top-quality books to select from!
- * Unmatched savings on every selection!
- * Exclusive access to all the books you want and need most!

more good reasons to join

- **Big Savings.** Save 20% to 75% on books sure to increase your radio and electronics know-how
- **NO-RISK GUARANTEE.** ALL BOOKS RETURNABLE WITHIN 10 DAYS WITHOUT OBLIGATION
- **Club News Bulletins.** All about current selections—mains, alternates, extras—plus bonus offers. Comes 13 times a year with hundreds of up-to-the-minute titles to pick from
- **Automatic Order.** Do nothing, and the Main selection will be shipped automatically! But . . . if you want an Alternate selection—or no books at all—we'll follow your instructions.
- **Bonus Books.** Immediately get Dividend Certificates with every book purchased good for discounts of 60% to 80%.
- **Exceptional Quality.** All books are first-rate publisher's editions, carefully selected by our Editorial Board.



ELECTRONICS BOOK CLUB

P.O. Box 10, Blue Ridge Summit, PA 17214

Please accept my membership in the Electronics Book Club and send my copy of *The TAB Handbook of Radio Communications* (Book No. 1636H) billing me only \$1.99 plus shipping and handling charges. If not satisfied, I may return the book within ten days without obligation and have my membership canceled. I agree to purchase 3 or more books at regular Club Prices (plus shipping/handling) during the next 12 months, and may resign any time thereafter.

Name _____

Address _____

City _____

State _____ Zip _____ Phone _____

Valid for new members only. Foreign applicants will receive ordering instructions. Canada must remit in U.S. currency. This order subject to acceptance by the Electronics Book Club.

HR-186

✓ 138

THOUSANDS OF SATISFIED
CUSTOMERS WORLDWIDE



HAM RADIO OUTLET

ALL MAJOR BRANDS IN STOCK

KENWOOD HAND-HELDS



TR-2600A Deserves its well-earned reputation as the leading HT

TH-21AT/41AT
COMPACT!
Only 2.4"W. 4.72"H. 1.1"D
Outstanding performers
in an ideal package size



CALL FOR PRICE

TOLL-FREE PHONE

INCLUDING ALASKA AND HAWAII



MA-40 40' TUBULAR H.D. MAST

Regular \$745

SALE \$549

MA-550 55' TUBULAR H.D. MAST

Regular \$1245

SALE \$899

Why You Should Buy-

1. Will handle 10 Sq. Ft. 50 mph
2. Pleases neighbors with tubular streamlined look
3. In stock for quick delivery
4. Other models at great prices



FREE SHIPMENT

MOST ITEMS. U.P.S. SURFACE.



SIMPLEX-REPEATER-SATELLITE



IC-271H
2 METERS • 100 WATTS
• ALL-MODE

IC-471H

430-450MHz • 75 WATTS
• ALL-MODE



CALL FOR YOUR SPECIAL PRICE



SUPER-COMPACT
2 METER MOBILE



ALSO IC-27H HIGH POWER VERSION
AND IC-37A, 220MHz
IC-47A, 70CM **SAVE!**

CALL FOR LOW, LOW PRICE



TOWER
SALE

W-51 \$899
51' CRANK-UP 9 SQ. FT.
WINDLOADING



ELH-230 D
2 MTR 3 IN/30 OUT

CALL FOR PRICE

6 STORE BUYING POWER!



FT-209RH



FT-2700H

NEW!
2M/70CM
TRANSCEIVER

FT-757GX



FT-726R



CALL FOR GREAT PRICES

KENWOOD TS-940S

TOP-OF-THE-LINE HF TRANSCEIVER

PAY REGULAR PRICE ~~\$1799.95~~



CALL FOR
YOUR LOW,
LOW PRICE

Free UPS Surface



HAM RADIO OUTLET

ALL MAJOR BRANDS IN STOCK



ICOM IC-R71A

SUPERIOR GRADE
GENERAL COVERAGE
RECEIVER



Regular \$799

SALE! ~~\$629.95~~
\$599.95

TOLL-FREE PHONE

INCLUDING ALASKA AND HAWAII



ICOM

HAND-HELDS



IC-02AT IC-2AT IC-3AT
IC-04AT IC-4AT

AT GREAT LOW
LOW PRICES

FREE SHIPMENT
MOST ITEMS. U.P.S. SURFACE.



ICOM IC-735

THE LATEST IN ICOM'S LONG LINE
OF HF TRANCEIVERS



CALL FOR LOW, LOW PRICE



ICOM IC-37A



220 MHz's BEST BUY!

REGULAR \$449

SALE!

LIMITED QUANTITIES
THIS PRICE.



**ICOM LATEST
EDITION**

IC-3200A DUAL BANDER

COVERS BOTH 2 METERS
and 70CM



CALL FOR
LOW,
LOW
PRICE

6 STORE BUYING POWER!



PERSONALIZED SERVICE

BOB FERRERO W6RU
President
JIM RAFFERTY N6RL
VP So. Calif. Div. Anaheim
Managers
GEORGE WOODS V Burlington
DON, N6IPE Oakland
BOB, K7RHD Phoenix
GLENN, N6NA San Diego
AL, K0YSA Van Nuys
and other active amateurs to serve you.

800-854-6046

TOLL FREE PHONE INCLUDING ALASKA AND HAWAII
CALIF. AND ARIZONA CUSTOMERS CALL OR VISIT NEAREST STORE
PHONE HOURS: 9:30 AM TO 5:30 PM PACIFIC TIME.
STORE HOURS: 10 AM to 5:30 PM Mon. through Sat.

FREE SHIPMENT
MOST ITEMS U.P.S. SURFACE



ANAHEIM, CA 92801
2620 W. La Palma,
(714) 761-3033, (213) 860-2040,
Between Disneyland & Knott's Berry Farm.

BURLINGAME, CA 94010
990 Howard Ave.,
(415) 342-5757,

5 miles south on 101 from San Fran. Airport. ✓ 144

OAKLAND, CA 94609
2811 Telegraph Ave.,
(415) 451-5757,
Highway 24 Downtown. Left 27th off-ramp.

PHOENIX, AZ 85015
1702 W. Camelback Road,
(602) 242-3515,
East of Highway 17

SAN DIEGO, CA 92123
5375 Kearny Villa Road,
(619) 560-4900,
Highway 163 and Clairemont Mesa Blvd.

VAN NUYS, CA 91401
6265 Sepulveda Blvd.,
(818) 988-2212
San Diego Freeway at Victory Boulevard

AA - ALLIANCE - ALPHA - AMECO - B & W CALIBROOK - CENTURION - COLLINS - JSC - J. W. MILLER - KANTRONICS - SIGNAL ONE - STORER - TEMPO - TEN TEC
AMPHEAD - ANITEK MARK - ANTYANA - COLUMBIA - CURTIS - CUSHCRAFT - KENWOOD - KLM - LARSEN - LUNAR - METZ - TRISTAR - TRIE - VAN LONDON - VICOOM
SPECIALISTS - ARRL - ASTRO - BASH - DAIWA - DRAKE - DR. EDGE - EIMAC - MF - MICRO LOG - MINI PRODUCTS - VIBRIPLEX - WEST - YAESU and more
BLIDER - BUCHER - BIRD - BUTTERFLY - GILFER - HAL - HUSTLER - HYUN - ICOM - MIRAGE - NYE - PALOMAR - ROHN - SHURE

Prices, specifications, descriptions subject to change without notice. Calif. and Arizona residents please add sales tax.

Measure Up With Coaxial Dynamics Model 83500 Digital Wattmeter

The "Generation Gap" is filled with the "new" EXPEDITOR, the microprocessor based R.F. AnaDigit System. The EXPEDITOR power computer...you make the demands, it fills the requirements.

- Programmable forward AND reflected power ranges.
- Can be used with the elements you now have.
- Compatible with all Coaxial Dynamics line sizes and power ranges.
- 18 scales from 100 mW to 50 kW.

Contact us for your nearest authorized Coaxial Dynamics representative or distributor in our world-wide sales network.



**COAXIAL
DYNAMICS, INC.**

15210 Industrial Parkway
Cleveland, Ohio 44135
216-267-2233 1-800-COAXIAL
Telex: 98-0630

Service and Dependability...A Part of Every Product



✓ 124

short circuit K1BQT transceiver

The following corrections should be made to K1BQT's November article, "A Compact 75-meter Monoband Transceiver":

AUDIO AMPLIFIER/AGC MODULE: Schematic omitted 1N914 in line from audio output to gate of Q1. Also, AGC delay may be too long with 2.5 μ F on gate of Q1. If so, substitute 1 or 1.5 μ F.

DRIVER/BPF MODULE: Q3 gate No. 1, resistor value should be 10k. Schematic omitted 0.01 between L4 and gate No. 1. L4 is direct coupled — *not link coupled* — to Q3. Also, schematic omitted RFC1 on Q4.

EXCITER MODULE: Schematic omitted 0.1 bypass on U5 pin 3. Delete 1k resistor shown between mic gain and U6 pin 1.

RECEIVER MODULE: Schematic omitted 0.1 bypass capacitors on U1 pin 7, +R, and U3 pin 7. On PCB, move 0.1 bypass from ALC input to U2 pin 5.

Finally, use silver mica capacitors in the transmitter BPF. Parasitic oscillation of the driver was traced to inferior quality ceramic capacitors in the two units.

Inter-Ear-Communication-System

A space age system that allows you to send and receive your message through your ear and leave your hands free.



n-ear-talk

- Replace your HT's awkward speaker-microphone with an n-ear-microphone.
- Discrete HT communications leaves you with both hands free.
- Allows voice communications in noisy environments.
- Our n-ear-talk interfaces with almost all HT's, which have external speaker microphone output jacks.
- Custom hybrid circuit.
- Low power consumption. Transmits at 5mA and less than 10uA when receiving.
- One year warranty.

Dealer inquiries are invited.

IECS-200

\$99.95 includes IECS-200 control unit, Ear transducer, 9V battery, 6-pin output connector and Instruction sheet. (Add 6% sales tax for California residents.)

Custom made interface cable for TEMPO 15' all ICOM HTs are available at \$19.95

FOR ALL PREPAID ORDERS, SHIPPING AND HANDLING CHARGE WILL BE PAID BY N-EAR-TALK.



ACE communications, inc.

22511 Aspan Street • Lake Forest • Calif. 92630-6321
(714) 581-4900 Telex 29-7385 ACE UR Fax (714) 768-4410

SWLS - HAMS
CALL TODAY FOR ALL
YOUR SWL & HAM NEEDS

*RECEIVERS *ANTENNAS
*TRANSCEIVERS *RTTY
*PUBLICATIONS *SWL

YAESU *KENWOOD *ICOM

HARDIN ELECTRONICS
5635 EAST ROSEDALE
FORT WORTH, TEXAS 76112
1-800-433-3203
IN TEXAS 817-429-9761

ham radio TECHNIQUES

Bill Over
W6SA1

let's hear it for the good guys

I have noticed a slight tendency, on the part of some high-tech people, to look down on hams and ham activity — as if such a hobby somehow lessened the professionalism of those whose livelihood is RF engineering. I challenge that notion. Quite to the contrary, experience as a practical operator cannot but deepen one's understanding of electromagnetic wave generation and propagation. In fact, if there are any computer kids among our readers who are not hams, we urge you to give it a try. It will give you much of the education, in this strange "new" field, that you're looking for.

These interesting and encouraging words appeared in an editorial by Keith Aldrich, publisher of *rf design* (August, 1985).*

Other Radio Amateurs in the technical fields have noticed the professional "snub" on occasions, but this is far outweighed by the great number of professionals that *are* hams. All one has to do is attend the Radio Amateur dinner and reception at the National Association of Broadcasters Convention, or the Amateur luncheon held at the annual gathering of the Armed Forces Communications and Electronics Association. You'll find an eye-popping number of top-notch professionals — who are also enthusiastic Radio Amateurs — at these meetings! So, let's hear it for the good guys and for Keith Aldrich, who I hope will become a ham himself one of these days!

the phasing SSB system — born again!

Old-timers will recall the phasing

system of SSB. Remember the Central Electronics 10A exciter? This thought should bring tears to the eyes of any sidebander who was active in the early 1950s. The phasing system died a quick death with the advent of the latest edition of the *ARRL Handbook*. (A friend of mine chided me for including a short section on the phasing SSB system in the latest edition of *Radio Handbook*. My reply to him was that it is still a valid system of generating a sideband signal and possesses some virtues that the filter system does not have. His only reply to me was a look of pity.)

But now it looks as if the phasing system has finally come into its own, especially in the field of VHF/UHF operation.

A major disadvantage of SSB is that it requires relatively inefficient linear amplifiers to reach high power levels. Unfortunately, reasonable efficiencies at VHF and higher are obtainable only with class C amplification, which precludes the use of a low level SSB driving signal. If the modulation takes place in the high level RF amplifier, however, linearity is not a problem. High audio power is required for high level modulation, but today's digital techniques make possible pulse-width modulated audio systems having a 90 per cent, or better efficiency level.

Finally, in some UHF frequency control systems a subaudible tone must be transmitted to phase-lock the product detector of the receiver. A typical SSB crystal or mechanical filter does not pass frequencies closer to the carrier than 250 to 300 Hz without sacrificing sideband rejection. But with a phasing transmitter, there's no such problem, because there's no low frequency limitation to the audio signal transmitted. The system can handle modulation down to the DC level.

The modern UHF SSB transmitter

makes use of high-power FETs because of their high class C efficiency. A block diagram of part of the audio phase shift and modulation system is shown in **fig. 1**. The audio signal is amplified and compressed and run through a bandpass filter. In the following buffer stage, the pilot or control tones are added to the audio signal. It then passes through a conventional audio phase shift network which provides two ports, separated by 90 degrees in phase. A differential amplifier follows the network. The amplifier is temperature compensated by mounting the two units on a common thermal link so that stable and equal gain are achieved in the two chains.

The audio signals are fed to a voltage-controlled astable multivibrator which has a resting frequency of 100 kHz with a 50 percent duty cycle. This stage drives a monostable multivibrator with a 10 microsecond reset time. With no modulation, these devices produce a square wave of 100 kHz with a 50 percent duty cycle. Any change in the frequency of the voltage controlled multivibrator will result in the change in the duty cycle of the following stage.

The multivibrators drive switching transistors (Q1, Q2) that reproduce the driving signal at the appropriate power level. The output passes through an integrator (L,C) which provides an exact reproduction of the input audio signal applied to the system. A protective diode (CR1) suppresses switching spikes that might damage the switching transistors.

The push-pull audio signals are fed to high level balanced modulators whose carriers are shifted 90 degrees in phase. The result represents cancellation of one sideband and reinforcement of the other. Upper or lower sideband can be chosen by reversing the audio phasing.

*Cardiff Publishing Co., Inc., 6530 S. Yosemite Street, Englewood, Colorado 80111.

ASTRON — SALE!

RS-7A	45.99	RS-35A	123.75
RS-12A	62.75	RS-35M	138.95
RS-12M	78.95	VS-35M	156.95
RS-20A	79.95	RS-50A	179.95
RS-20M	96.45	RS-50M	203.25
VS-20M	114.95	VS-50M	223.95

KLM

2M16LBX, 220-22LBX, 432-30LBX-90	50	
2M-14C-85	2M-22C-108	50
435-18C-110	435-40CX-144	50

KENPRO ROTORS

KR400/KR500	125.99/154.95
KR-5400/KR-5600	247.99/309.95

HENRY AMPS

2 KD CLASSIC	965.00
2002A/2004A Less Relay	1250/1350
3002A/3004A Less Relay	2100/2100

AMP SUPPLY

LK-500ZB	1,097.95
LK-800A	2,045.00

MIRAGE-FREE UPS BROWN ON ALL MIRAGE

A1015 - 235.90	C-22A - 85.95
B23A - 83.95	C-106 - 169.95
B215 - 245.90	C-1012 - 246.95
B108 - 149.95	D-24N - 177.50
B1016 - 235.90	D-1010N - 279.50
B3016 - 199.90	D-3010N - 251.00
MP-1 - 99.95	MP-2 - 99.95

TONNA 9FT ANTENNAS ARE BACK! WE ARE THE EXCLUSIVE U.S. DISTRIBUTOR INTRODUCTORY SPECIAL:
1269/1296 QUAD ARRAY COMPLETE WITH 4-23el YAGIS, 'H' FRAME, POWER DIVIDER, PHASING LINES, CONNECTORS. GREAT FOR OSCAR MODE 'L' OR TERRESTRIAL APPLICATIONS. REGULARLY 339.95 SALE PRICE 215.95

OTHER GREAT, HIGH PERFORMANCE ANTENNAS BY TONNA (CALL FOR SPEC. SHEET!!)

5 EL. 6 METER YAGI	69.95	13 EL. 2MTR YAGI	59.95	TONNA (CALL FOR SPEC. SHEET!!)	
21 EL. 70cm YAGI	56.95	23 EL. 1296/69 YAGI	46.95	19 EL. 70cm YAGI	44.95
(ATV MODELS IN STOCK)		17 EL. 2MTR SUPER YAGI	88.00	2MTR OSCARTWIST	65.95
70cm OSCARTWIST	68.95	55 EL. 1296 SUPER YAGI	68.95	2 x 9 EL. (18el)	
2 x 19 EL. (38el.)		9 ± 19 el OSCAR ANTENNA 2M & 70cm ON A COMMONBOOM-GREAT FOR STACKING	75.95		

WATCH OUR AD FOR NEW LINES!!

FOR THE BEST DEAL IN TOWN CALL THE BEST NUMBER AROUND 1-800-HAM-7373

CUSHCRAFT AOP-1 OSCAR PAK-133.95 RINGO RANGER II (2-220-440)-33.95
KENWOOD TS-940S/AT - CALL US! YAESU FT-757GX - CALL US!
KENWOOD TR2600A H.T. - CALL US! YAESU FT-726R - CALL US!

KENWOOD
FACTORY AUTHORIZED DEALER
CALL US FOR AMERICA'S LOWEST PRICE ON ALL YOUR KENWOOD NEEDS (FREE UPS BROWN ON KENWOOD GEAR)

CUSHCRAFT

215WB - 73.00	A-3	200.45
4218XL - 91.00	A-4	267.45
R-3 - 250.95	40-2CD	267.45

OTHER MODELS IN STOCK — CALL

CUE DEE THE SWEDISH BOOMER
USED BY MANY TOP '10' CONTESTERS
144-15AN 2MTR15EL. 75.95

PARABOLIC

1296-28 IW TRANSVERTER	339.95
1269-144 3W UP CONV.	319.95
1296 DUAL TUBE AMP CAVITY	439.95
2PORT POWER DIVIDERS (2-220-432)	50.95
4PORT POWER DIVIDERS (2-220-432)	55.95
1296 2PORT DIVIDER	57.95
1296 4PORT DIVIDER	62.95
1269/96 DISH FEEDS	89.95
2304 DISH FEEDS	89.95
1296 SLUG TUNERS	65.95

YAESU — FACTORY AUTHORIZED DEALER CALL FOR THE BEST DEAL AROUND ON 'THE RADIO' FULL LINE (FREE UPS BROWN ON YAESU GEAR)

MUTEK LTD.
DO YOU OWN AN ICOM VHF XCVR?
DO YOU WANT TO IMPROVE THE RECEIVER - TRY OUR MUTEK FRONT END BOARD - YOU'LL BE GLAD YOU DID!

RPCB211/251 RD FRONT END	143.95
FOR ICOM 211 OR 251	
RPCB271 FRONT END FOR ICOM 271A OR 271H	168.95
RPCB225 FRONT END FOR YAESU 221/225	
SLNA 50S 6MTR PREAMP	84.95
SLNA-144S 2MTR PREAMP	84.95
100WRF SWITCHED, N.F. < 1db, GAIN 15db.	
SBLA144E 2MTR MAST MOUNT R.F. SWITCHED PREAMP, 250W THRU POWER, N.F. < 1db, 15dbG	169.95
GLNA 433E 70CM MAST MOUNT R.F. SWITCHED PREAMP, 50W THRU N.F. < 1db G = 15db	172.95
GFBA-144E 2MTR MAST MT. PREAMP, 1KW THRU POWER G = 15db N.F. < 8db WITH AMP SEQUENCER	289.95
GLNA-432E 70cm MAST MT PREAMP, 500W THRU, G = 15db N.F. < 1db. WITH AMP SEQUENCER	299.95
HIGH D.R. DBM XVRTRS FOR ± 2MTRS COMING SOON!	

SSB ELECTRONIC

K6001 6 To 10 DBM RCY CONV.	115.95
K2001 2 To 10 DBM RCY CONV.	115.95
K7001 70cm To 10 DBM RCY CONV.	115.95
K2301G 23cm To 10 or 2 RCY CONV G.F. FRONT END AND DBM	159.95
TV-144-28-10 10W 2MTX XVRTR	209.95
TV-432-28-10 10W 70cm XVRTR	299.95
TV-220-28-10 10W 1 1/4M XVRTR Coming Soon	
DX-144 PREAMP N.F. < 4db	130.95
DX-220 PREAMP N.F. < 5db Coming Soon	
DX-432 PREAMP N.F. < 5db	130.95
(WON DAYTON 1985 N.F. CONTEST)	
DX-1296S PREAMP N.F. 5db	156.95
DX-2320 PREAMP N.F. < 8db	166.95
PA-2310 1269/1296 10W LINEAR AMP.	275.95
LT-23S 1296 10W LINEAR TRANSVERTER	275.95
2M F	610.95
LSM-24 1269-2 OSCAR MODEL XMIT CONV. 1W	
OUTPUT, 2M.F.	299.95
MICROLINE 13 1/2W 2.3GHZ XVRTR SYSTEM 2M.F.	410.95
MICROLINE 13 3W 2.3GHZ XVRTR SYSTEM, 2M.F.	675.95
SLA-13 2304 3W AMP	285.95

MAST MOUNTED PREAMPS:

MV144V 250W R.F. SWITCH WITH 12V SUPPLY INTERFACE	175.95
MV432V 150W R.F. SWITCH WITH INTERFACE	185.95
MV-144S-01 1KW THRU PWR WITH SEQUENCER	309.95
MV-432S-01 500W THRU PWR WITH SEQUENCER	319.95
MV-1296S 100W THRU PWR WITH SEQUENCER	349.95

OTHER HIGH QUALITY PRODUCTS IN STOCK-CALL FOR CATALOGUE

GREAT FOR OSCAR MODE 'L' OR TERRESTRIAL APPLICATIONS. REGULARLY 339.95 SALE PRICE 215.95

TERMS: Prices do not include shipping except where indicated and are subject to change without notice. At our discretion some COD's may require a deposit. Returns are subject to a 15% restocking charge. *Continental USA only

16 S. Mountain Blvd — Rt. 309 HOURS: Monday thru Friday 9 a.m. - 3:30 p.m. "24 HOUR PHONE SERVICE MC/VISA/C.O.D.
Mountaintop Pa. 18707 Saturdays 10 a.m. - 12 p.m. FOR YOUR CONVENIENCE!"

✓ 190

40m Phased Array — the Easy Way!

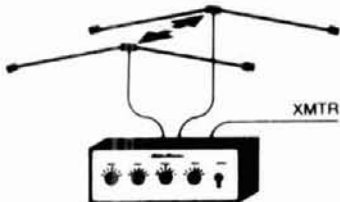

OPTI-PHASOR™ by BaileyTech

- Change direction instantly
- High F/B, adjustable phasing
- Low SWR over entire 40m band
- Just 2 dipoles gives 4 db gain

\$119.95 Also available with matched dipoles and feed lines

Check, MO, VISA, M/C
Call or Write for Complete Catalog.
TET Antennas, Larsen, Hy-Gain, Alpha Delta, etc.

SULTRONICS

1587 U.S. 68 N Xenia, OH 45385
(513) 376-2700

✓ 185

COMPUTER PROGRAMS FOR THE RADIO AMATEUR by Wayne Overbeck, N6NB, and Jim Steffen, KC6A

Here's the first source book of computer programs for the Radio Amateur. Besides covering computer basics, this book gives you programs that will help you log, determine sunrise/sunset times, track the Moon's path across the sky, use Greyligne propagation and set up record systems for WAS, DXCC and VUCC, or any other award. You can either buy the book alone or you can buy the book with the programs already on disk. Take full advantage of your computer with this well written source book. ©1984, 1st edition, 327 pages.

- HA-0657 Softbound \$16.95
- HA-0657 with program \$29.95 (specify computer (see list below))
- Program disk alone \$19.95

Programs available for: Apple II (DOS and CP/M), IBM (DOS), TRS-80 Model I and Model III and Commodore C-64. Please mark your order with the program disk you want.

Please include \$3.00 shipping and handling.

Ham Radio's Bookstore
Greenville, NH 03048



SAVE YOUR EARS WITH THIS HANDY SIGNAL ENHANCER

\$74.95 LESS power supply
\$84.90 with power supply postpaid

SEE ARTICLE in Sept. 85 Ham Radio, page 113

Hildreth Engineering

936 Azalea Drive Sunnyvale, CA 94086

✓ 147

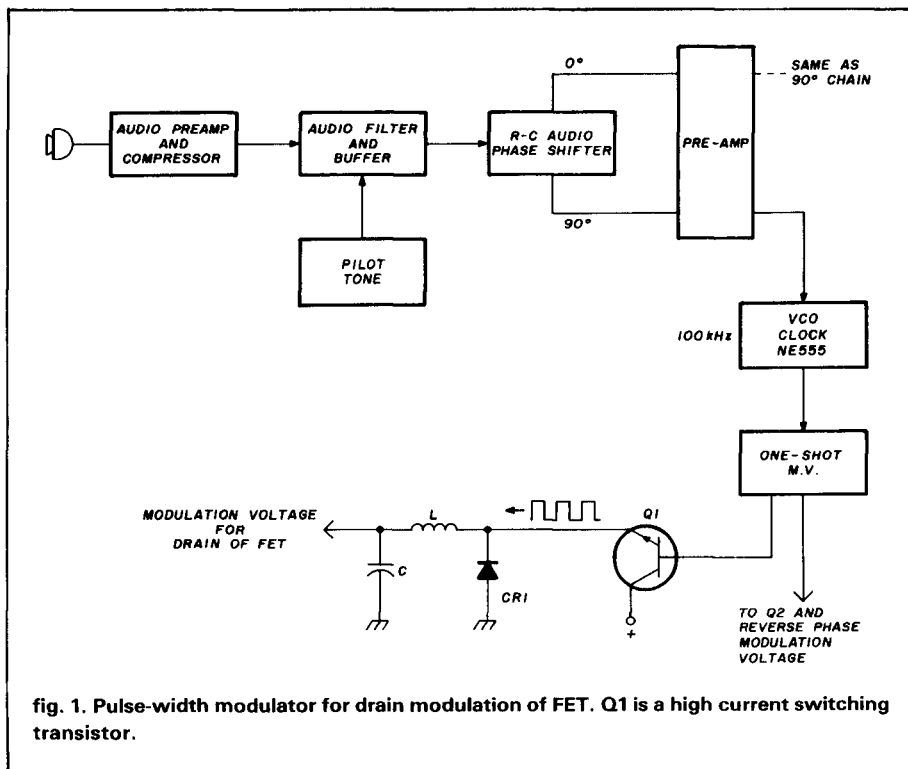

fig. 1. Pulse-width modulator for drain modulation of FET. Q1 is a high current switching transistor.

For high frequency operation, the RF phase splitter employs conventional coil and capacitor circuits. However, in the UHF region, these are replaced by a stripline hybrid circuit for stability and simplicity.

So the phasing system rises from the ashes to take part in today's exploration and utilization of the UHF frontier. Amateurs will soon rediscover this old technique and put it to new uses. †

the compact dipole: the general case

In previous articles I've discussed coil-loaded, compact dipoles of interest to the Amateur who wants to operate on the HF bands but has limited antenna space. The designs shown, which placed the loading coil in the middle of the dipole leg, represent specific instances of the general case, where the loading coil (L) may be placed at any point in the dipole leg (fig. 2).

There are good reasons why the loading coil is centrally located in a dipole element. If the coil is placed near the feedpoint, less inductance is required, but current in the coil is higher and losses are higher. If the coil

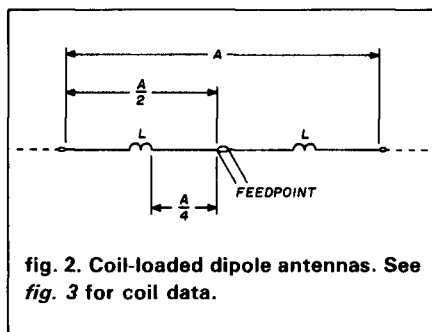

fig. 2. Coil-loaded dipole antennas. See fig. 3 for coil data.

is located near the dipole end, less current flows in the coil, but more turns are required, increasing coil loss. Theoretically, if the coil were to be placed at the end of the dipole, the number of turns required would be infinite. (Efficiency aside, valid reasons may exist for placing the loading coil at some point in the dipole other than the center of the leg. It has been proven that feedpoint loading works well, even though loading coil efficiency

† This material prepared and abstracted from "Technology Rejuvenates the Phasing SSB System," by Eric P. Nichols, in the August, 1985, issue of *Microwaves & RF* magazine, a Hayden Publishing Company monthly publication. (Hayden Publishing Company, Inc., 10 Mulholland Drive, Hasbrouck Heights, New Jersey 07604).

may not be the highest — but that's another story.)

A good summary of dipole loading is contained in *The ARRL Antenna Book*,¹ in which a chart provides general design information for dipoles of various length and loading.

For the case of the center-loaded leg, the ARRL chart may be simplified as shown in fig. 3 to indicate the reactance (X_L) required in a loading coil for antenna sizes ranging from 10 to 80 percent of normal. The graph is quite linear in the center portion but departs from linearity at both extremities.

As an example, assume a dipole only 100 feet long is needed for 3.8 MHz operation. A normal-sized dipole (made of wire) at this frequency would be 123.16 feet (37.53 meters) long. The required dipole, then, would be $100/123.16 = 0.81$, or 81 percent the length of the regular dipole. This point falls just outside the right-hand edge of the graph, but the required loading coil reactance can be estimated as about 305 ohms.

The inductance required is found by the formula:

$$L = \frac{X_L}{6.28 \cdot f}$$

where f is the frequency in MHz and L is the inductance in microhenries.

A second example: assume a dipole is needed for 1.8 MHz operation, but can be only 40 percent the length of a full-size dipole, which would be 260 feet. The compact dipole length would be $260 \times 0.4 = 104$ feet (31.69 meters) long. Finding 40 percent on the x-axis and tracing the point up to the curve and over to the y-axis indicates that the loading coil for this antenna should have a reactance of 1,300 ohms. The formula given above will convert this value into microhenries.

Enterprising Amateurs have taken this whole concept and computerized it into a simple program so that once the antenna size is established in relation to a full-size dipole, the inductance of the coil, the number of turns, and coil diameter can be quickly determined for a center loaded element. How about that, computer fans?

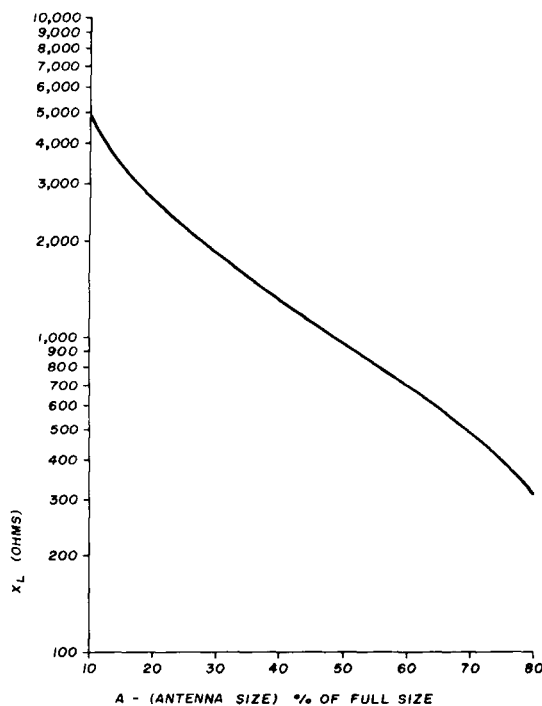

fig. 3. Loading reactance as a function of antenna length (A).

and now the bad news

Every HF operator is thoroughly familiar with the "Russian Woodpecker," the high power OTHB (over-the-horizon, backscatter) radars run by the Soviet Union. Repeated complaints about this obnoxious QRM generator have gone unheeded over the years. And now, I understand, the United States will soon have one running. But tests conducted with an experimental American OTHB radar revealed that the final version will not be a QRM-blast as the Russian one has proven to be.

The American OTHB was discussed in some detail by O.G. Villard, Jr., W6QYT, writing in *QST*.² And the April, 1985, issue of *Amateur Radio*, the publication of the Wireless Institute of Australia, revealed that the prototype of an Australian OTHB radar was built and tested in 1978. The radar is located in the general area of Alice Springs, with the actual transmitter some 60 miles to the northeast. It is reported that the installation has successfully tracked commercial aircraft

flying along the air route from Singapore to Australia. The radar receiving antenna array, which includes 468 pairs of broadband monopole antennas with each pair phased and sitting atop a very large ground mat, stretches over a distance of 1.7 miles (2.8 km). (*That should be very effective in a DX contest.*)

The power output of the transmitter is not disclosed, but it is reported to be over 400 kW. An array of vertically polarized log periodic antennas are used, with the beam steerable in azimuth.

Received echo signals, which are very weak, are analyzed in a computer. Frequency shifts on the returned signals caused by moving targets are analyzed to give an indication of the target speed. Thus the return signal from an aircraft is easily distinguished from a return signal from a small ship or other surface vehicle.

A frequency surveillance system prevents transmitted signal from operating on any occupied channel. The author of the article, Ian Hunt, of the

Australian Department of Defense, writes that he "can state with certainty that the HF Amateur Radio bands are thoroughly protected in this manner. This fact...should make it obvious that statements (claiming) that OTHR signals emanating from the Jindalee system are observed in the Amateur bands would be ill advised, alarmist, and irresponsible in nature."

The OTHR system can track commercial aircraft for safety, keep track of military flights, detect unauthorized flights (such as used in drug smuggling), and watch wave systems on the ocean to advise shipping of possible hazards. It can also be used for increasing the knowledge of the ionosphere and the study of long-haul propagation.

how does the OTHR affect ham radio?

The Australian OTHR appears to be a well-run project that promises to produce little interference to the various high frequency services, including Amateur Radio. It's comforting to know that this radar is programmed to avoid the Amateur bands. Good thinking!

Pandora's box?

The photographs of the Australian installations reveal the immense size of the project. Yet dollar-wise, it seems to be quite modest. It seems to me that Australia, unintentionally, may be pointing the way toward the day when any country with a few bucks and lots of open space can set up its own "do-it-yourself" backscatter radar system. The newcomers to the game may not be so charitably inclined as our Australian friends, and in a few years we could all be plagued by many worldwide backscatter radars, situated all over the globe and making HF communications a thing of the past.

references

1. *The ARRL Antenna Book*, 14th edition, American Radio Relay League, Newington, Connecticut 06111, page 10-5, (figs. 9 and 10).
2. O.G. Villard, Jr., W6QYT, "Over-the-Horizon or Ionospheric Radar," *QST*, April, 1980, page 39.

ham radio



Presenting two small cases for a lot of mobile power.

You won't find a 45-watt, 2-meter FM mobile rig that's built smaller than the Yaesu FT-270RH.

Nor will you find a dual-band FM mobile that offers the crossband full-duplex capability found in the 25-watt Yaesu FT-2700RH.

It shouldn't be surprising. We've been coming up with a lot of innovative concepts lately.

The FT-270RH measures just 2 x 6 x 7 inches. Conveniently fitting its high-power punch into many small spaces of your car. Places where other 45-watt mobiles just won't fit.

The FT-2700RH is small too. Smaller than other dual-banders. But with one big difference: a "DUP" button. Push it, and you're operating full duplex, 2 meters on one VFO, 440 MHz on the other. Each at 25 watts. So you can simultaneously

transmit and receive in true telephone style.

Once installed, you'll find the FT-270RH and the FT-2700RH equally simple to operate. Just turn the rig on, dial up a frequency, select offset or duplex split, and you're on the air.

Each rig gives you 10 memories for storing your favorite frequencies. Dual VFO capability. A clean, uncluttered LCD display for easy readout. Push-button jumps through the band in 1 MHz steps. Band scanning with programmable upper and lower limits. And priority channel operation.

You don't even have to take your eyes off the road to determine your operating frequency and memory channel. An optional voice synthesizer announces them both at the push of a button on the microphone. The FT-2700RH announces both your

2-meter and 440 MHz operating frequencies.

Also, tone encode and encode/decode capability is programmable from the front panel, using an optional plug-in board.

So when you need a lot of power in a compact mobile radio, discover Yaesu's FT-270RH and FT-2700RH. There's nothing else like them on the road.

YAESU

Yaesu Electronics Corporation
6851 Walthall Way, Paramount, CA 90723
(213) 633-4007

Yaesu Cincinnati Service Center
9070 Gold Park Drive, Hamilton, OH 45011
(513) 874-3100

Prices and specifications subject to change without notice.



HIGH PERFORMANCE PRESELECTOR-PREAMP

The solution to most interference, intermod, and desense problems in **AMATEUR** and **COMMERCIAL** systems.



- 40 to 1000 Mhz - tuned to your frequency
- 5 large helical resonators
- Low noise - High overload resistance
- 8 dB gain - ultimate rejection > 80 dB
- 10 to 15 volts DC operation
- Size - 1.6 x 2.6 x 4.75" exc. connectors
- **FANTASTIC REJECTION!**

Typical rejection:

±600 KHz@144 Mhz: -28dB
±1.6 Mhz@220 Mhz: -40dB
±5 Mhz@450 Mhz: -50dB

Price - **\$89.95** bipolar w/RCA jacks
Connector options: BNC \$5, UHF \$6,
N \$10

SUPER HOT! GaAs Fet option \$20

AUTOMATIC IDENTIFIERS

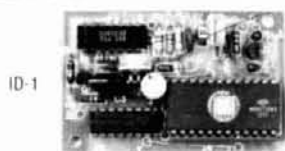

ID-1



ID-2

- For transceivers and repeaters - **AMATEUR** and **COMMERCIAL**
- Automatic operation - adjustable speed and amplitude
- Small size - easy installation - 7 to 15 volts DC
- 8 selectable, reprogrammable messages - each up to 2 min. long
- Wired, tested, and programmed with your message(s)
- Model ID-1 - \$49.95 Model ID-2 w/2 to 10 minute timer - \$69.95

We offer a complete line of transmitter and receiver strips and synthesizers for amateur and commercial use.

Request our free catalog. Allow \$2 for UPS shipping. Mastercard and VISA welcome

GLB ELECTRONICS, INC.

Dept H, 151 Commerce Pkwy., Buffalo, NY 14224
716-675-6740 9 to 4



INTERNATIONAL MONTHLY MAGAZINE BY AND FOR ACTIVE RADIOAMATEURS

RADIOSPORTING

Dedicated to quality and sportsmanship in amateur radio operating. Fresh, timely, practical and down to earth reading for little pistols and big guns written by world's best in their fields.

DX news, DXpeditioning, propagation, contest rules and results, emergency - traffic, FCC news, new products, antenna and technical articles, equipment reviews and modifications, computer programs, YL, RTTY, VHF, UHF, ATV, SSTV, AMTOR, classified ads and much more.

"Your publication is superb! Keep it up!"

Joe Reisert, W1JR

"Your W2PV articles are priceless. Your magazine is super!"

Rush Drake, W7RM

"Let me congratulate you on a very impressive magazine. Just what I've been looking for as a DXer and Contester!"

Dick Moen, N7RO

"RADIOSPORTING, once received, cannot be tossed aside until it is read from cover to cover. Then reviewed again and again."

Chas Browning, W4PKA

Subscription rates: 1 year USA \$ 16, Canada \$ 22, Overseas US\$ 19

Membership in International Radio Sport Assn \$ 4/yr

TRY US! PHONE OR SEND YOUR QSL CARD FOR SAMPLE COPY

RADIOSPORTING Tel. (416) 438-6313
Box 65, Don Mills, ON, M3C 2R6, Canada

176

CTM

The monthly magazine with a natural blending of two popular hobbies — Ham Radio and Computers

- ★ Articles on Ham Radio & Most Personal Computers
- ★ Hardware & Software Reviews
- ★ Various Computer Languages
- ★ Construction Articles
- ★ Much Much More...

"...received my moneys worth with just one issue..."

—J. Trenbick

"...always stop to read CTM, even though most other magazines I receive (and write for) only get cursory examination..."

—Fred Blechman, K6UGT

U.S.A. \$15.00 for 1 year
Mexico, Canada \$25.00
Foreign \$35.00(land) - \$55.00(air)
(U.S. funds only)
Permanent (U.S. Subscription) \$100.00
Sample Copy \$3.50



Circulation Manager

1704 Sam Drive

Birmingham, Alabama 35235

Phone 205/854-0271

Name _____

Call Sign _____

Address _____

City _____ State _____

Zip _____ Phone _____

Date _____

Signature _____

130

**ICOM****KENWOOD YAESU**

Regular SALE
 IC-735 New, compact HF Transceiver Call
 IC-751 9-band Xcvt./1-30 MHz Rcvr \$1399.00 Call
 IC-745 9-band Xcvt./1-30 MHz Rcvr \$ 999.00 Call



IC-271 H 100w 2m FM/SSB/CW Xcvt. ... \$899 Call
 IC-271 A 25w 2m FM/SSB/CW Xcvt. \$699.00 Call
 IC-471 A 10w 430-450 SSB/CW/FM Xcvt. \$799.00 Call



IC-02AT Call
 IC-04AT Call
 IC-2AT Call
 IC-3AT Call
 IC-4AT Call

**IC-R71A
GENERAL
COVER RCVR**

Regular SALE
 TS-940S/AT \$1995.00 Call
 TS-930S/AT \$1799.00 Call
 TS-930A \$1599.00 Call



TS-711A TS-811A Call



TR-2600A Call
 TH-21A Call
 TH-21AT Call
 TH-41A Call
 TH-41AT Call

**R-2000
GENERAL
COVER**

Regular SALE
 FT-980 \$1659.00 Call
 FT-09G Call



FT-726R \$ 899.00 Call



FT-209RH Call
 FT-709RH Call
 FT-203RH Call
 FT-103R Call
 FT-703R Call

**FRG-8800
GENERAL
COVER RCVR****SALE!!
NEW RTTY/CW
COMPUTER
INTERFACES****BIRD****MIRAGE
AMPLIFIER
SALE!****AMERITRON
AL-80**

JUN'S **ELECTRONICS**
 Calif. Call Collect for Order
 800-882-1343
 INCLUDES ALASKA HAWAII

- AMATEUR ● TWO WAY ● MARINE
- CELLULAR MOBILE PHONE ● SCANNER
- ★ Free U.P.S. Cash Order (Most Item, Most Place)
- ★ Shoppers, call us last, save \$\$
- ★ SE HABLA ESPANOL

(213)390-8003 3919 Sepulveda Blvd. Culver City, CA 90230

HF ANTENNAS — The Easy Way

by John Haerle, WB5IIR

This book has been published as a memorial to WB5IIR's work as an Amateur Radio teacher. Originally given as a series of speeches or papers, this tutorial is an excellent source book on antenna theory and applications. Examples of areas covered are: *Fundamentals*, antenna and feedline

terminology, baluns, ground systems, lightning protection, *The Basic Antenna*, the dipole, the zepp, G5RV, Windom, *Special Antennas*, the sloper, DDDR, Beverage, folded unipole, *Beams*, WBJK, Yagi, two element quad, and the *160 meter band story*. John's writing is in an easy-to-understand conversational style and is full of examples and handy tips and hints. There are no drawings or illustrations but John's prose paints pictures for clear and complete understanding of the information being presented. ©1984 1st Edition.

JH-AT

Softbound \$11.95

Please add \$3.50 for shipping and handling.

ham radio magazine
 GREENVILLE, NH 03048

BOOKSTORE
 (603) 878-1441

New

New

THE STANDARD OF EXCELLENCE

Definitely Superior!

AZDEN PCS-5000

COMMERCIAL — GRADE



UNPRECEDENTED WIDE FREQUENCY RANGE: Covers 140,000-153,000 MHz in steps that can be set to any multiple of 5 kHz up to 50 kHz.

CAP/MARS/NAVY MARS, BUILT IN: The wide frequency range facilitates use of CAP and ALL MARS FREQUENCIES including NAVY MARS. **COMPARE!**

TINY SIZE: Only 2 inches high, 5½ inches wide and 7¼ inches deep!

MICROCOMPUTER CONTROL: Gives you the most advanced operating features available.

UP TO 11 NONSTANDARD SPLITS: **COMPARE** this with other units!

20 CHANNELS OF MEMORY IN TWO SEPARATE BANKS: Retains frequency, offset information, PL tone frequency.

DUAL MEMORY SCAN: Scan memory banks separately or together. **ALL** memory channels are tunable independently. **COMPARE!**

MEMORY SCAN LOCKOUT: Allows you to skip over channels you don't want to scan.

TWO RANGES OF PROGRAMMABLE BAND SCANNING: Limits are quickly reset. Scan ranges separately or together with independently selective steps in each range. **COMPARE!**

BUSY SCAN AND DELAY SCAN: Busy scan stops on an occupied channel. Delay scan provides automatic auto-resume.

DISCRIMINATOR CENTERING (AZDEN EXCLUSIVE PATENT): Always stops on frequency desired when scanning.

PRIORITY MEMORY AND ALERT: Unit constantly monitors one memory channel for signals, alerting you when channel is occupied.

LITHIUM BATTERY BACKUP: Memory information can be stored for up to 5 years even if power is removed.

FREQUENCY REVERSE: Allows you to listen to repeater input frequency.

ILLUMINATED KEYBOARD WITH ACQUISITION TONE: Keys are easily seen in the dark, and actuation is positively verified audibly.

CRISP, BACKLIGHTED LCD DISPLAY: Easily read no matter what the lighting conditions!

DIGITAL S/R/F METER: Shows incoming signal strength and relative transmitter power.

MULTI-FUNCTION INDICATOR: Shows a variety of operating parameters on the display.

FULL 16-KEY TOUCHTONE PAD: Keyboard functions as autopatch when transmitting.

MICROPHONE CONTROLS: Up/down frequency control and priority channel recall.

PL TONE GENERATOR BUILT IN: Instantly program any of the standard PL frequencies into the microcomputer. **COMPARE!**

TRUE FM, NOT PHASE MODULATION: Unsurpassed intelligibility and audio fidelity. **COMPARE!**

HIGH/LOW POWER: Select 25 watts or 5 watts output — fully adjustable.

SUPERIOR RECEIVER: Sensitivity is better than 0.15 microvolt for 20-db quieting. Commercial-grade design assures optimum dynamic range and noise suppression. **COMPARE!**

DIRECT FREQUENCY ENTRY: Streamlines channel selection and programming.

OTHER FEATURES: Rugged dynamic microphone, built-in speaker, mobile mounting bracket, remote speaker jack, and all cords, plugs, fuses and hardware are included.

EXCLUSIVE DISTRIBUTOR DEALER INQUIRIES INVITED FOR YOUR NEAREST DEALER OR TO ORDER:

AMATEUR-WHOLESALE ELECTRONICS TOLL FREE...800-327-3102

8817 S.W. 129th Terrace, Miami, Florida 33176 Telephone (305) 233-3631 Telex: 80-3356

MANUFACTURER:

JAPAN PIEZO CO., LTD.

1-12-17 Kamirenjaku, Mitaka, Tokyo, 181 Japan

Telex: 781-2822452



broadband RF transformers

Add fractional turns ratio techniques to your impedance matching arsenal

Despite conventional wisdom, which holds that a transmission line transformer can be built only with integral turns ratios, it's entirely possible to build a practical 2:1 impedance change transformer — that is, a 1.5:1 turns ratio transformer. Many other fractions are also possible. But first let's review the evolution of RF transformers, keeping an eye out for some of the possible pitfalls along the way.

basic transformer

Consider a basic autotransformer, which has one winding, with a tap. If there are five turns from start to tap, and two more from tap to finish, then the input impedance from start to finish, assuming 25 ohms between start and tap, is $(25 \times 7 \times 7)/(5 \times 5)$, or 49 ohms. This is within 2 percent of 50 ohms, so it could serve as a 2:1 transformer.

leakage inductance

Leakage inductance occurs when the flux from any part of a turn doesn't cut all of another turn. Leakage inductance is always present — it's just a question of *how much*. One might think that any flux that cuts the cores couldn't possibly contribute to leakage inductance, because it would then couple to the other turns. Thus many early transformer designs stressed placing the windings close to the cores. Note that by definition, both the primary and secondary have separate, and therefore probably unequal, leakage inductances. These leakage inductances limit the high frequency response because they are very real inductors in series with the transformer's leads.

twisted and braided windings

One might think that lowest leakage inductance is achieved when all the wires are wound tightly together. Imagine a rope consisting of five parallel strands of insulated wire twisted together. This rope is wound through a core for five turns only. Then a group of three of the strands are unwound one turn and then cut off, leaving two strands with five turns and three strands with four turns. The three four-turn strands are then connected in parallel to one another.

These are in turn connected in series, aiding with both of the remaining five-turn windings. To summarize: from the bottom up, there are five turns in series with five turns to the tap, and then four turns to the top-end, producing a 14:10 ratio.

Another idea is to use seven strands twisted together as a rope with only one turn of this rope around the core. Connect five of these turns in series out to a tap, then add the remaining two in series. In theory this method might offer the lowest leakage inductance of any construction, but I can't handle the rat-nest of splices and still keep the leads short! And both of these techniques ignore capacitive effects that limit high frequency response.

transmission line

As the primary and secondary wires are brought closer to each other, rather than closer to the core, their mutual inductance and capacitance increases. It then becomes easier to envision the pair of wires as a transmission line. At first one might think the extra capacitance would limit the high frequency response, but it doesn't. The capacitance and leakage inductance combine to make a transmission line. The closer the wires are, the lower the transmission line's impedance. Considering the windings as transmission lines is a useful conceptual aid. It is now the standard method for making RF transformers, because it leads to wider-bandwidth performance. The high frequency end is helped without affecting the low frequencies.

bandwidth limitations

A transformer's low frequency response is a function of the type of core, its cross-sectional area, and the number of turns. The high frequency response depends on the inductance and the turn-to-turn capacitance as well as the length of the winding. The limiting length occurs when the induced voltage of a single turn adds to the next turns' (voltage) at a significantly *later* angle. This equates to a transmission line whose delay angle is determined by its length and velocity of propagation. The phase delay of the transformer limits its high frequency usefulness.

balanced transmission lines

Consider a pair of parallel conductors arranged so closely that when the current in one conductor flows in one direction, the current in the other flows in the

By Will Herzog, K2LB, 406 Yarmouth Road, Rochester, New York 14610

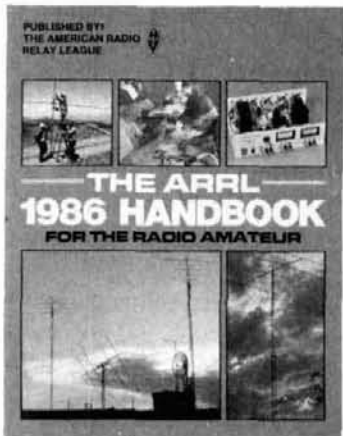

STATE OF THE ART

The ARRL 1986 Handbook For The Radio Amateur carries on the tradition of the previous editions by presenting 1192 pages of comprehensive information for the radio amateur, engineer, technician and student. Paper edition: **\$18** in the U.S., **\$19** in Canada, and elsewhere. Clothbound **\$27** in the U.S., **\$29** in Canada and elsewhere.

THE AMERICAN RADIO RELAY LEAGUE
225 MAIN ST.
NEWINGTON, CT 06111



NOW **Sinad** CAN BE MEASURED WITH YOUR VOM

- Quickly tune Receivers, Cavities, Preamps, etc.
- Works with your VOM or AC VTVM that has 2.5V full scale sensitivity or better.
- Fast accurate measurements.
- Sinad measurement displayed on meter in "dB" scale.
- Self contained, pocket size, go anywhere instrument.
- Powered by standard 9V battery or optional AC adaptor.

SINADAPTOR SAI-01

\$79.95

Please add \$3.50 shipping & handling

NY res. add 7% sales tax

J.S. Technology, Inc.

39 Main Street
Scottsville, NY 14546
(716) 889-3048 ✓ 149

ORLANDO HAMCATION
AND
COMPUTER SHOW
MARCH 7, 8, 9, 1986
FLORIDA STATE
ARRL CONVENTION



REGISTRATION

\$5.00 ADVANCE • \$7.00 AT DOOR

FOR INFORMATION

PLEASE SEND

SELF ADDRESSED STAMPED

ENVELOPE TO:

HAMCATION CHAIRMAN
P.O. BOX 15142
ORLANDO, FL 32858
(305) 422-ARRL

FREE PARKING AVAILABLE

114



YOUR RADIO CAN RELAY THE
DISTRESS CALL OF OIL SPILL VICTIMS

NAME _____
ADDRESS _____
PHONE _____
CALL _____
EQUIPMENT AVAILABLE _____



World Society for the Protection of Animals

When **DISASTER** Strikes YOU May be the Animals' Only Hope

The World Society for the Protection of Animals (WSPA), a nonprofit organization with offices around the globe, takes action to help animals in crisis, responding in times of fire, flood, earthquake, volcanic eruption, oil spills, and civil unrest.

To assure the quickest response to these disasters, WSPA needs the help of ham radio operators in the United States and abroad who can relay critical information to and from international trouble spots.

WSPA is the only organization officially recognized by the United Nations as a consultant on animal disaster issues. We urgently need you and your radio. To register as an animal-emergency operator, simply fill out the coupon and mail it to WSPA, Western Hemisphere Regional Office, 29 Perkins St., POB 190, Boston, MA 02130. We'll be depending on you when animals are in jeopardy.

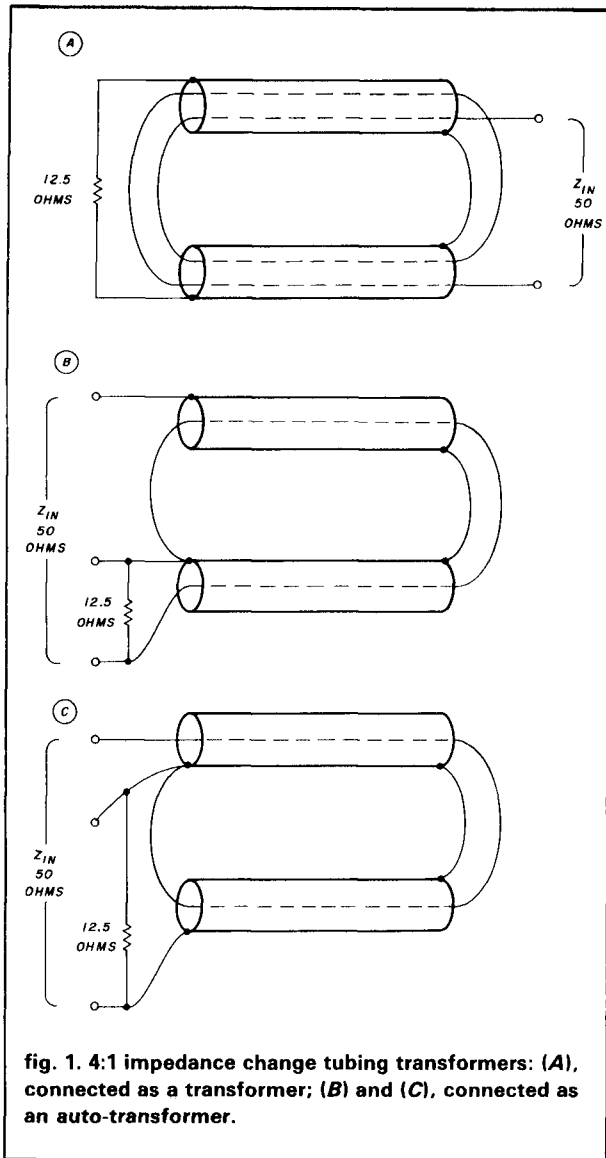

fig. 1. 4:1 impedance change tubing transformers: (A), connected as a transformer; (B) and (C), connected as an auto-transformer.

opposite direction. (Both are equal in magnitude.) This allows their magnetic fields to cancel out as soon as one is outside the space between the wires. As long as the currents are equal, the magnetic field does not need to intercept the cores. The inter-wire space also has an electric field due to the potential difference between the wires. The electric field diminishes as soon as one is away from the wires several times their spacing, especially if a material with a high dielectric constant is between the wires. Consequently, electromagnetic field propagates between the wires and transmission line theory applies. The uncoupled magnetic lines result in a leakage inductance, analogous to a transmission line unbalance which results in line radiation.

transmission line impedance

The impedance of a transmission line is sometimes

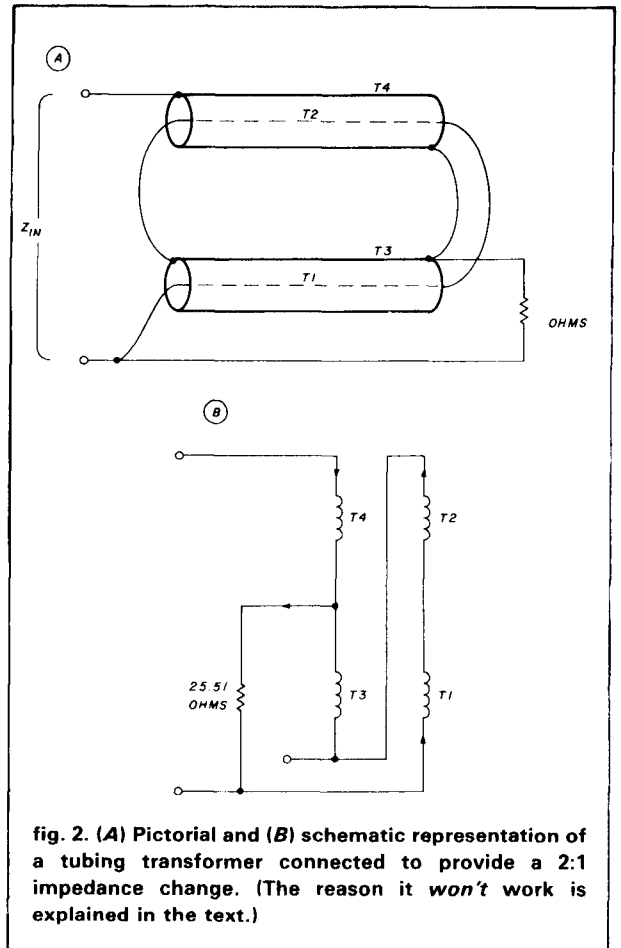
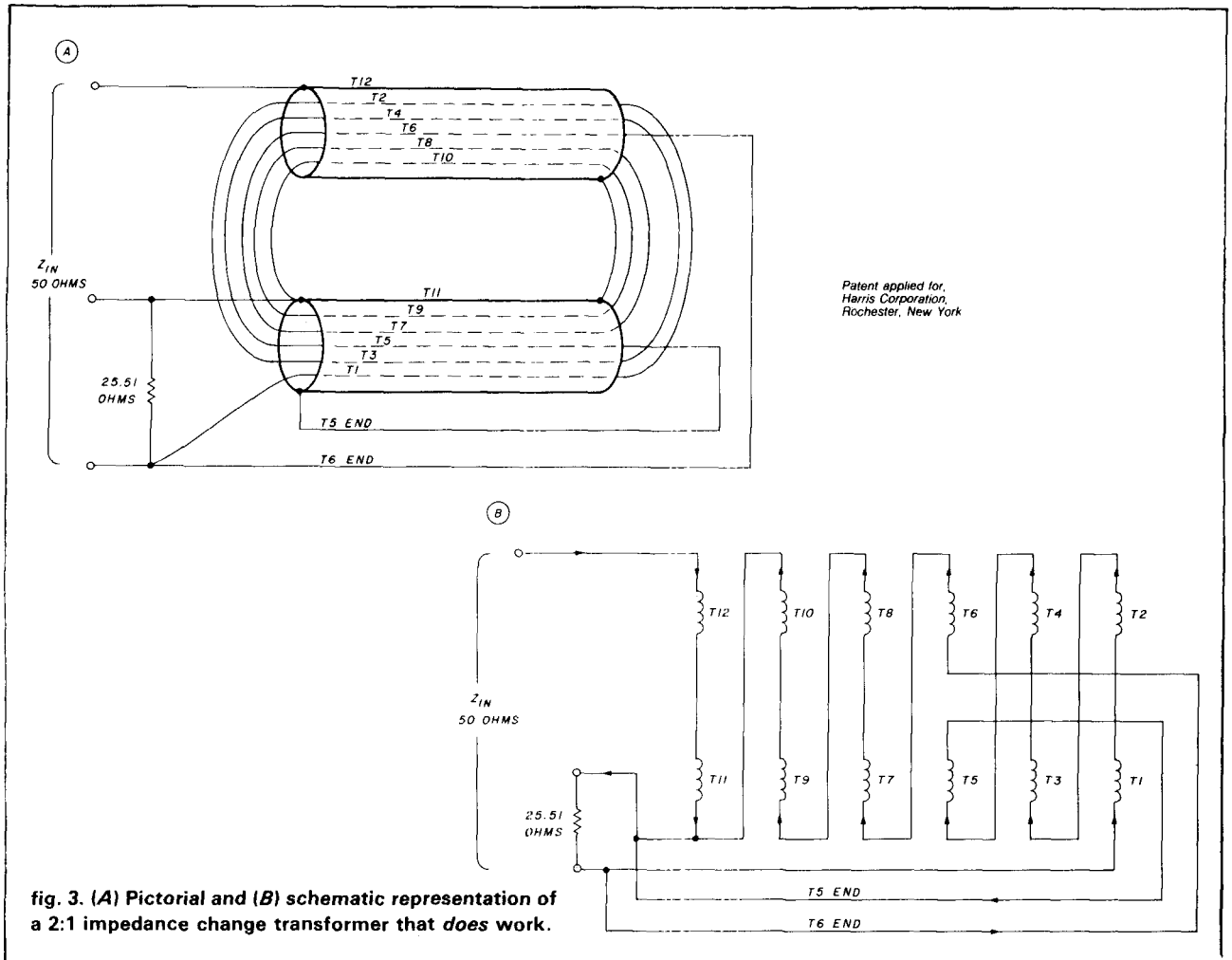

fig. 2. (A) Pictorial and (B) schematic representation of a tubing transformer connected to provide a 2:1 impedance change. (The reason it *won't* work is explained in the text.)

defined as the square root of the ratio of inductance per unit length divided by the capacitance per unit length. If one has inductance and capacitance meters, this can be measured easily by shorting the output end of the transmission line and measuring the inductance at the other end. Capacitance is measured directly after the short is removed. Measurements are taken at a frequency in which the line length is less than 1/10 of a wavelength. Divide the Henries by the Farads and take the square-root of this ratio to get the impedance of the transmission line in ohms. A vector impedance meter can be used to measure the line impedance by varying the frequency at about the 1/8 wavelength point until the magnitude of impedance stays the same as the other end of the line is alternately shorted and left open. The phase swings from inductive to capacitive; its amount is ignored. The surge impedance can be read directly.

We must be able to identify every conductor with a mate carrying current in the opposite direction, resulting in the absence of an external magnetic field and consequently small leakage inductance. However, even this procedure is difficult, since the capacity of each wire is not only to every adjacent wire(s), but also to ground; and the currents in parallel conductors still



must be kept equal and opposite for each sub-grouping of closely spaced conductors.

This means that every wire can have several individual characteristic impedances, each of which should be constructed to provide the same impedance as obtained by dividing voltage by current, or Z_f . Z_f is determined by wire size, spacing, insulation, and number of conductors. The ultimate limit in high frequency response is the physical length of all the turns, considered as a percentage of its electrical wave length. There's another paradox here: if one looks at it as a conventional transformer, the induced voltage of each turn must be the same because the flux is changing at the same time in each turn. However, with transmission line analysis, there isn't any external field, so it's much easier to see that it's the total length that counts.

tubing transformers

Tubing transformers, now very popular in transistor transmitters, use two parallel sections of metal tubing electrically connected at one end. The free ends of the tubing have terminals. The tubing itself can then

be used as part or all of one of the windings, or the tubing may simply be grounded to serve as an electrostatic shield for the cores. Cores of ferrite or powdered iron are threaded onto the exterior of the tubes to increase the low frequency inductance. Wire is then run through the interior of the tubing to make the other winding(s). The wires can come out at either the terminal ends of the tubing or at the common connected end; it makes no difference. The wires must make a complete turn, so the turns ratio is again always an integer. **Figure 1A** shows a 12.5 to 50-ohm transformer. **Figures 1B** and **1C** show a similar construction, connected as an autotransformer to transform 12.5 to 50 ohms.

If a transformer similar to the one shown in **fig. 1C** were used to transform a 25-ohm resistor to 50 ohms by tapping up on the winding or tubing to get a fractional turn, the results would be poor (see **fig. 2A**.) In **fig. 2B** arrows indicate the direction of the currents. Note that T2's and T4's currents are in opposite directions canceling the magnetic fields. But T1's and T3's currents are in the same direction! This means that the fields can't cancel, so instead of a transmission

PACKET EVOLUTION

From
\$219.95
Suggested amateur net price.

ANOTHER BREAKTHROUGH FROM AEA

Packet + RTTY= Pakratt™ PK-64.

If you've read about packet, or are already into it, you know how exciting it is. With the hot new Pakratt PK-64 we've just brought a new dimension to packet. The Pakratt PK-64 is a complete, fully assembled and tested packet radio controller which, together with a Commodore 64 or 128 computer, can convert your shack into a packet operations center.

And we've included a new version of our advanced MBA-TOR™ software to make it the first packet controller with AMTOR, Baudot, ASCII and Morse. But an even more exciting part of the Pakratt controller is its great price.

Incredibly Simple To Set Up

Just plug the Pakratt controller into the C-64's game cartridge slot, add a mic connector for connecting to your particular

transceiver, and you're set.

If you're anxious to try it out, our new "quickstart" manual section can get you on the air in under ½ hour.

Simply Powerful

The versatile Pakratt controller shows messages and connect status simultaneously on your Commodore with a unique split-screen display. And it lets you



PK-64 shown with HF modem option. Computer not included.

send letter-perfect text from the text editor software while monitoring incoming messages. The 20K byte QSO buffer stores more than 20 video screens of text! Disk commands let you save

specific operating parameters for quick set-up for emergency services, clubs, and multiple frequency use. And the Pakratt controller's standard, TAPR style modem gives you 300 and 1200 baud operation with great HF/VHF performance.

We can't possibly list all of the important features of Pakratt here. But the absolutely best part of the Pakratt PK-64 is that it's at your dealer now. So stop reading, run down to your local dealer, and check Pakratt out. Because the real challenge will be to find one after the other hams see it.

Pakratt PK-64. Packet Power from AEA. At amateur radio dealers everywhere.



Advanced Electronic Applications, Inc.
P.O. Box C-2160
Lynnwood, WA 98036-0918
(206) 775-7373
Telex: 6972496 AEA INTL UW

CALL TOLL FREE FOR QUOTES

TNT

RADIO SALES INC.

1-800-328-0250

1-612-535-5050

(IN MINNESOTA - COLLECT)

EXPLOSION OF VALUES!

ICOM KENWOOD
 KANTRONICS
 MIRAGE
 AEA
 SANTEC
 KDK
 NYE VIKING
 WELZ
 LARSEN BUTTERNUT
 TELEX HY-GAIN
 HUSTLER
 KLM
 ROHN
 MFJ
 AMERITRON
 BENCHER

CALL NOW!
1-800-328-0250
 FOR ABSOLUTE
LOWEST PRICE BUSTERS!

INVENTORY REDUCTION PRICED TO GO!

We must make room for your trade-ins. Check now for lowest prices on previously owned bench-tested equipment!

NEW! ICOM R7000 RCVR

Covers continuous 25 mhz to 2 ghz!
 99 memories—scans—etc., etc.
 Loaded with features. Available November, 1985.

VISA/MASTER CARD
 FREE SHIPPING
 ON MOST RIGS FOR CASH!



S.A.S.E. FOR OUR
 "BENCH-TESTED"
 USED EQUIPMENT LISTING

MON-FRI 9 AM - 6 PM CENTRAL TIME
 SATURDAY 9 AM - 5 PM

4124 West Broadway, Robbinsdale, MN 55422 (Mpls./St. Paul)

191

TUBES and IC's

FAST DELIVERY

LOWEST PRICES

call Toll Free (800) 221-5802

In-depth Inventory - Industrial & Receiving Tubes

Here are 2 dozen examples

8908	\$15.00	8122	110.00
3-400Z	\$85.00	MRF450	\$12.95
3-500Z	85.00	MRF454	18.95
572B	61.50	MRF455	14.95
811A	12.00	MRF492	19.95
6146B	8.75	6LF6	\$8.26
M2057	15.00	6JS6C	7.46
8950	12.50	6KD6	8.26
807	5.75	6MJ6	8.38
6550A	7.75	8417	8.38
4CX250B	60.00	7360	13.95
6DJ8	2.75	6CA7	5.55
6883B	9.50		

Major Manufacturers Factory Boxed and Full line of Sylvania ECG Replacement Semiconductors



Minimum order \$25.00 Allow \$3 UPS charge

TRANSLERONIC INC.



Box H, 1365 39th ST., BROOKLYN, NY 11218
 Tel. 718-633-2800/Watts Line 800-221-5802
 FAX # (718) 633-4375

Introducing...

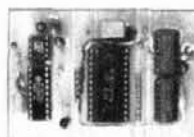

NAVAX

ON CALL

It's on duty when you're not.

OC-1 ONLY \$59.95 Complete with Shipping/Handling USA

ON CALL is a complete selective call system so you don't have to monitor the frequency, or it can be used as a decoder for controlling equipment at the repeater site and at home.

- Compare these features:
- 4 digit 16 tone sequential decoder programmable. 43,680 different codes. DTMF Format with Auto reset
- 1 AMP SPST relay output. momentary or latched for external paging device, such as Auto horn, tape recorder, speaker Audio etc.
- Flashing LED call indicator. (Energizes when your code has been accessed).
- easy connection to any radio
- 12-16 volt DC operation
- size 3.1 x 2.15 x .5 in.
- can be used for clubs or emergency groups for help situations

To Order Send Check or Money Order To: CURRENT DEVELOPMENT CORPORATION
 E. Carter Rd PO Box 384 Westmoreland, NY 13490
 MC/VISA Accepted NYS Residents Add Sales Tax
 Reg. Trade Mark of ATT
 or Phone 315-733-3719

131

VOLUNTEER EXAMINATION BOOKS & TAPES



- Novice Class Q&A Test Guide Package \$ 9.95
- Technician Class Q&A Test Guide 19.95
- Advanced Class Q&A Test Guide 19.95
- Extra Class Q&A Test Guide 19.95
- 5 wpm Novice QSO Test Preparation Tape 9.95
- 5-7 wpm Speed Builder 9.95
- 7-10 wpm Speed Builder 9.95
- 10 wpm Plateau Breaker QSOs 9.95
- 10-12 wpm Speed Builder 9.95
- 12-15 wpm Calls & Numbers Speed Builder 9.95
- 13-15 wpm Random Code Practice 9.95
- 13 wpm General Class QSO Test Prep Tape 9.95
- 13-15 wpm Speed Builder 9.95
- 15-17 wpm Speed Builder 9.95
- 17-19 wpm Speed Builder 9.95
- 20-22 wpm Random Code Practice 9.95
- 20 wpm Extra Class QSO Test Prep Tape 9.95
- Test Guides Updated to New '85 Questions and Answers
- Slow Code Tapes Use 13 wpm Character Speed
- We Ship First Class Mail, Same Day
- Add \$3.00 postage & handling for Test Guides. 50¢ P&H for each tape.
- 100% SATISFACTION OR MONEY BACK ✓ 175

GORDON WEST RADIO SCHOOL
 2414 COLLEGE DR., COSTA MESA, CA 92626

Mon.-Fri. 10-4pm (714) 549-5000

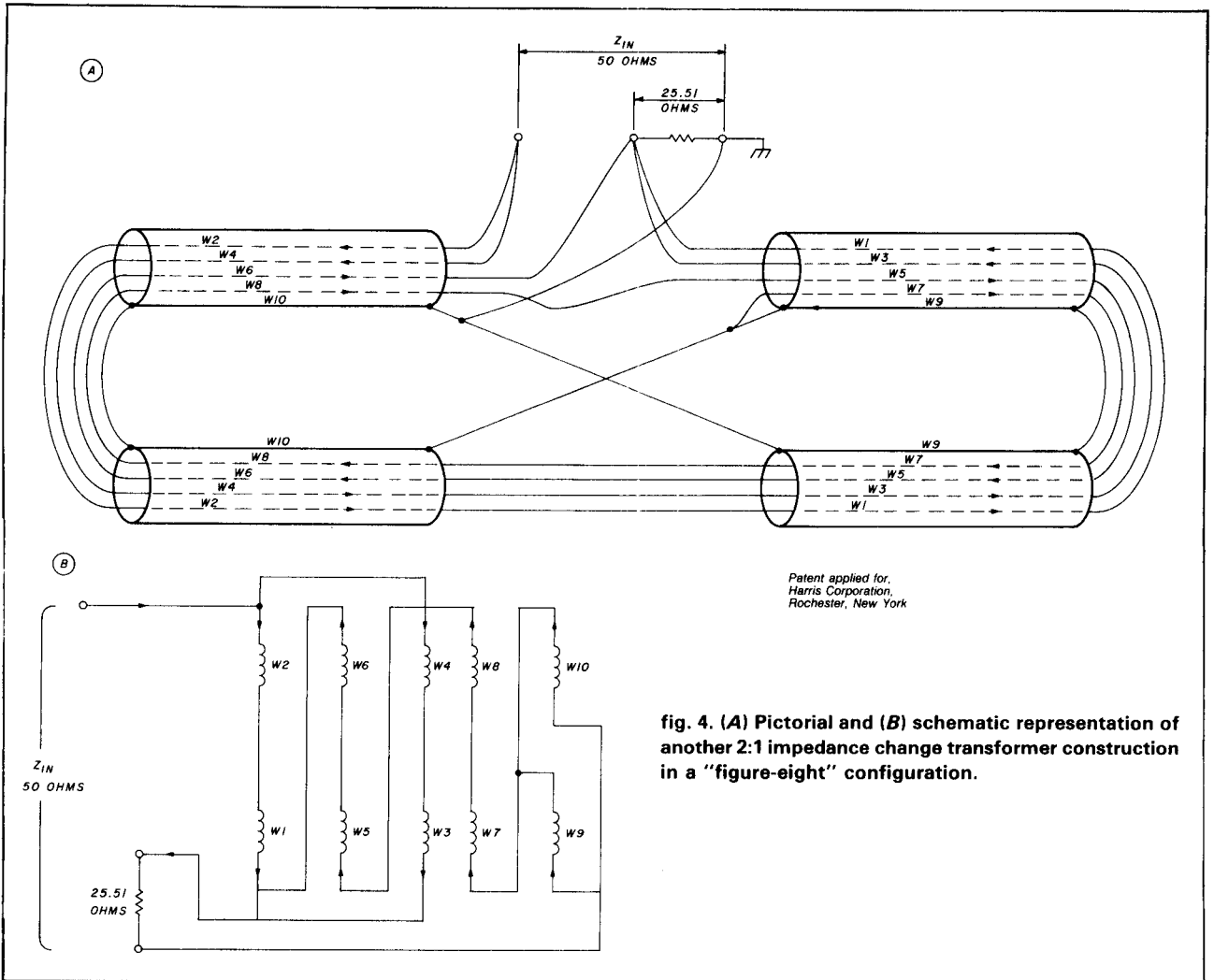

fig. 4. (A) Pictorial and (B) schematic representation of another 2:1 impedance change transformer construction in a "figure-eight" configuration.

line, we have a very good inductor — just what we *don't* need because it limits the high frequency response.

split the winding

Yes — you can use fractional turns and still have a transmission-line type device. The key is to add an extra winding that's mostly in parallel with the first so that two separate windings exist. The first winding has an extra half turn; the second winding skips that half turn and picks up the remaining half turn. Then the pair will function just like a single winding with a half-turn, but without a flux or current unbalance! Each of the two windings carries half as much current as the single winding did before it was split into two windings, so they can be made of smaller wire. (See figs. 3A and 3B.)

The fractional turn transformer in fig. 3 has a turns ratio of 7:5, which gives an impedance ratio of 49:25. The secondary has two windings in parallel: T1 through T5, in five sections; and T6 through T10, also in five sections. The primary has seven sections

because it adds T11 and T12 to the secondary's five sections. Thus if one counts the complete turns, it's a three-and-a-half-turn to two-and-a-half-turn transformer! Note that the T5 end and T6 end are longer leads, but that their currents flow in opposite directions, and the voltage between them is the secondary voltage; thus they can be envisioned as a transmission line. The fields are balanced in one direction because the currents are equal/and opposite, so the net ampere-turns is zero. It works well.

ampere-turn and Z_0 analysis

To see this balancing action more clearly, consider that for the amp-turns to be zero, the current total of T2, T4, T6, T8, and T10 must equal T12's. Let's assume 25 volts across the secondary load resistor, so the output current is then 1 ampere. The power out is $(25 \times 25) / 25.51 = 24.5$ watts. From symmetry, the voltage across each of the "T" sections must be equal to each other, and since there are five in series across the secondary, each section has 5 volts. The total voltage input across the seven sections is

K.V.G. CRYSTAL PRODUCTS



9 MHz CRYSTAL FILTERS

MODEL	Appli- cation	Band- width	Poles	Price
XF-9A	SSB	2.4 kHz	5	\$53.15
XF-9B	SSB	2.4 kHz	8	72.05
XF-9B-01	LSB	2.4 kHz	8	95.90
XF-9B-02	USB	2.4 kHz	8	95.90
XF-9B-10	SSB	2.4 kHz	10	125.65
XF-9C	AM	3.75 kHz	8	77.40
XF-9D	AM	5.0 kHz	8	77.40
XF-9E	FM	12.0 kHz	8	77.40
XF-9M	CW	500 Hz	4	54.10
XF-9NB	CW	500 Hz	8	95.90
XF-9P	CW	250 Hz	8	131.20
XF-910	IF noise	15 kHz	2	17.15

10.7 MHz CRYSTAL FILTERS

WRITE FOR FULL DETAILS OF CRYSTALS AND FILTERS
Export inquiries invited. Shipping \$3.50

MICROWAVE MODULES EQUIPMENTS

Use your existing HF or 2M rig on other VHF or UHF bands.

RECEIVE CONVERTERS

MMk1691-137	\$259.95
MMk1296-144G	159.95
MMc439-ATV	94.95
MMc432-28(s)	79.95
MMc144-28(HP)	84.95
MMc144-28	64.95

LINEAR TRANSVERTERS

MMi1296-144G	\$329.95
MMx1268-144	259.95
MMi435-28(S)	299.95
MMi432-28(S)	279.95
MMi144-28(R)	319.95
MMi144-28	189.95

LINEAR POWER AMPLIFIERS

2M:		70cm:	
MML144-30-LS	\$109.95	MML432-30-L	\$219.95
MML144-50-S	149.95	MML432-50	199.95
MML144-100-S	209.95	MML432-100	379.95
MML144-100-LS	249.95		
MML144-200-S	399.95		

ANTENNAS

2M:			
10XY-2M	\$69.95		
70cm:		LOOP YAGIS	
70/MBM28	\$39.95	1268-LY	\$49.95
70/MBM48	64.95	1296-LY	49.95
70/MBM88	94.95	1691-LY	59.95
		order loop yagi connector extra	



Send 66¢ (3 stamps) for full details of all our VHF & UHF equipments and KVG crystal products.

Shipping: FOB Concord, Mass.



si

(617) 263-2145
SPECTRUM
INTERNATIONAL, INC.
Post Office Box 1084
Concord, MA 01742, U.S.A.

BASEBALL CAP

How about an attractive **BASEBALL** style cap that has name and call on it. It gives a jaunty air when worn at Hamfests and it is a great help for friends who have never met to spot names and calls for easy recognition. Great for birthdays, anniversaries, special days, whatever occasion. Hats come in the following colors:

GOLD, BLUE, RED, KELLY GREEN.

Please send call and name (maximum 6 letters per line).

UFBC-81

\$6.00

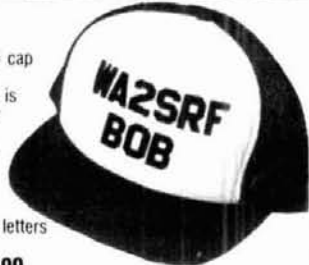

WA2SRF

I.D. BADGES

No ham should be without an I.D. badge. It's just the thing for club meetings, conventions, and get-togethers, and you have a wide choice of colors. Have your name and call engraved in either standard or script type on one of these plastic laminated I.D. badges. Available in the following color combinations (badge/lettering): white/red, woodgrain/white, blue/white, white/black, yellow/blue, red/white, green/white, metallic gold/black, metallic silver/black.

UID Engraved I.D. Badge

\$2.50

Ham Radio's Bookstore

Greenville, NH 03048

Please Enclose \$2.00
to cover shipping and handling

then 35 volts. If we assume a lossless transformer, there must be 24.5 watts input. The input impedance is, then, equal to $(35)(35)/24.51 = 50$ ohms. The input current in T12 and T11 must therefore, from Ohms law, equal $(35 \text{ volts})/(50 \text{ ohms}) = 0.7$ amperes. Likewise, the current out of the transformer is $(25 \text{ volts})/(25.51 \text{ ohms}) = 0.98$ amperes. Since T5 and T6 are in parallel and symmetrical, the current flowing through each of them is equal and is: $I = (I_{\text{out}} - I_{\text{in}})/2$ or $(0.98 - 0.7) = 0.14$ amperes.

Because we know all the currents, we can now calculate the amp-turn balance. Again, refer to the direction of the arrows in **fig. 3B**, noting that T2 plus T4, plus T6, plus T8 plus T10's currents must equal T12's. Five times the 0.14 ampere = 0.7 ampere, which was T12's current, verifying that the net external flux is zero.

The impedance of the T5-T6 lead transmission line should be 25 volts divided by 0.14 ampere or 178.6 ohms. Spacing the leads in the air can achieve this.

heat problems

Note that the tubing, which is the largest conductor, is used for the section of the transformer that carries the most current. This is good news. The bad news is that if high power operation is required, one finds that the hot spot is the ferrite cores, not the windings, which heat because of dielectric loss in the cores. The electric field is high on the cores because the tubing is at the highest RF voltage and the transformer is mounted near a chassis ground. Thus another novel technique, resulting in longer life at high power, evolved.

A tubular transformer, shaped as a figure-eight, was developed. This transformer allowed placing the leads closer together, eliminating the external line section, and permitting the tubing to work both as a better electrostatic shield and as the half-turn winding, thereby allowing the tubing to be placed near the chassis ground potential. The highest potential between the tubing and the cores is only a half-turn's worth, because it is now also used as the split turn. Note that in **fig. 4**, two labels are provided on each wire. These two quarter-turns are hereafter referred to as one half-turn. The turns of the secondary are W9 in parallel with W10, which serve as the half-turn, plus W7 and W8, W5 and W6. This makes a two-and-a-half-turn secondary. The primary totals three-and-a-half-turns because it adds to the secondary W3 plus W4 in parallel with W1 plus W2. The top primary turns are split into two paralleled sections because it carries the most current, and because physically W1-W2 and W5-W6 can be close-spaced to make one transmission line, and W3-W4 and W7-W8 are close-spaced to make a second transmission line.

ham radio

THE MOST AFFORDABLE REPEATER

ALSO HAS THE MOST IMPRESSIVE PERFORMANCE FEATURES

(AND GIVES THEM TO YOU AS STANDARD EQUIPMENT!)

Band	Kit	Wired
10M,6M, 2M,220	\$680	\$880
440	\$780	\$980



FEATURES:

- SENSITIVITY SECOND TO NONE; 0.15 uV (VHF), 0.2 uV (UHF) TYP.
- SELECTIVITY THAT CAN'T BE BEAT! BOTH 8 POLE XTAL FILTER & CERAMIC FILTER FOR > 100 dB AT ± 12 KHZ. HELICAL RESONATOR FRONT ENDS TO FIGHT DESENSE & INTERMOD.
- OTHER GREAT RECEIVER FEATURES: FLUTTER-PROOF SQUELCH, AFC TO COMPENSATE FOR OFF-FREQ TRANSMITTERS, SEPARATE LOCAL SPEAKER AMPLIFIER & CONTROL.
- CLEAN, EASY TUNE TRANSMITTER; UP TO 20 WATTS OUT (UP TO 50W WITH OPTIONAL PA).

HIGH QUALITY XMTR & RCVR MODULES FOR REPEATERS, LINKS, TELEMETRY, ETC.

- **R144/R220 FM RCVRs** for 2M or 220 MHz. 0.15uV sens., 8 pole xtal filter & ceramic filter in i-f, helical resonator front end for exceptional selectivity, > 100dB at ± 12kHz, best available today. Flutter-proof squelch. AFC tracks drifting xmtrs. Xtal oven avail. Kit only \$138.
- **R451 FM RCVR** Same but for uhf. Tuned line front end, 0.3 uV sens. Kit only \$138.
- **R76 FM RCVR** for 10M, 6M, 2M, or 220. As above, but w/o AFC or hel. res. Kits only \$118. Also avail w/4 pole filter, only \$98/kit.
- **R110 VHF AM RECEIVER** kit for VHF aircraft or ham bands or Space Shuttle. Only \$98.
- **T51 VHF FM EXCITER** for 10M, 6M, 2M, or 220 MHz. 2 Watts continuous, up to 3W intermittent. \$68/kit.
- **T451 UHF FM EXCITER** 2 to 3 Watts. Kit only \$78. Xtal oven avail.
- **VHF & UHF LINEAR AMPLIFIERS.** For either FM or SSB. Power levels from 10 to 45 Watts to go with exciters & xmtg converters. Several models. Kits from \$78.

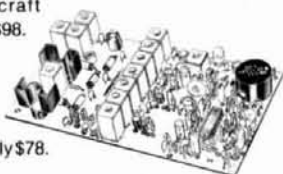

NOW—FCC TYPE-ACCEPTED TRANSMITTERS & RECEIVERS AVAILABLE FOR HIGH-BAND & UHF. CALL FOR DETAILS.

RECEIVING CONVERTERS

Models to cover every practical rf & if range to listen to SSB, FM, ATV, etc. NF = 2dB or less.



VHF MODELS

Kit with Case	\$49
Less Case	\$39
Wired	\$69

UHF MODELS

Kit with Case	\$59
Less Case	\$49
Wired	\$75

Antenna Input Range	Receiver Output
28-32	144-148
50-52	28-30
50-54	144-148
144-146	28-30
145-147	28-30
144-144.4	27-27.4
146-148	28-30
144-148	50-54
220-222	28-30
220-224	144-148
222-226	144-148
220-224	50-54
222-224	28-30
432-434	28-30
435-437	28-30
432-436	144-148
432-436	50-54
439.25	61.25

LOW-NOISE PREAMPS



Hamtronics Breaks the Price Barrier!



No Need to Pay \$80 to \$125 for a GaAs FET Preamp.

FEATURES:

- Very Low Noise: 0.7dB VHF, 0.8dB UHF
- High Gain: 13 to 20dB, Depending on Freq.
- Wide Dynamic Range for Overload Resistance
- Latest Dual-gate GaAsFET, Very Stable

MODEL	TUNES RANGE	PRICE
LNG-28	26-30 MHz	\$49
LNG-50	46-56 MHz	\$49
LNG-144	137-150 MHz	\$49
LNG-160	150-172 MHz	\$49
LNG-220	210-230 MHz	\$49
LNG-432	400-470 MHz	\$49
LNG-800	800-960 MHz	\$49

TRANSMIT CONVERTERS

For SSB, CW, ATV, FM, etc. Why pay big bucks for a multi mode rig for each band? Can be linked with receive converters for transceive. 2 Watts output vhf, 1 Watt uhf.

For VHF,
Model XV2
Kit \$79
Wired \$149
(Specify band)

For UHF,
Model XV4
Kit \$99
Wired \$169

Exciter Input Range	Antenna Output
28-30	144-146
28-29	145-146
28-30	50-52
27-27.4	144-144.4
28-30	220-222*
50-54	220-224
144-146	50-52
50-54	144-148
144-146	28-30
28-30	432-434
28-30	435-437
50-54	432-436
61.25	439.25
144-148	432-436*

*Add \$20 for 2M input

VHF & UHF LINEAR AMPLIFIERS. Use with above. Power levels from 10 to 45 Watts. Several models, kits from \$78.

HELICAL RESONATOR PREAMPS

Low-noise preamps with helical resonators reduce intermod and cross-band interference in critical applications. 12 dB gain.

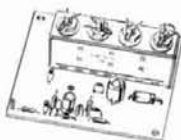

Model	Tuning Range	Price
HRA-144	143-150 MHz	\$49
HRA-220	213-233 MHz	\$49
HRA-432	420-450 MHz	\$59
HRA-()	150-174 MHz	\$54
HRA-()	450-470 MHz	\$64

MINIATURE PREAMPS

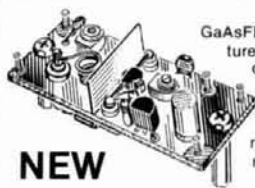

GaAsFET Preamps with features similar to LNG, except designed for LOW COST and SMALL SIZE: only 5/8" W x 1-5/8" L x 3/4" H. Easily mounts inside many radios.

NEW

MODEL	TUNES RANGE	KIT	WIRED
LNW-144	120-150 MHz	\$19	\$34
LNW-160	150-200 MHz	\$19	\$34
LNW-220	200-270 MHz	\$19	\$34
LNW-432	400-500 MHz	\$19	\$34

IN-LINE PREAMPS

NEW

GaAsFET Preamp with features like LNG. Automatically switches out of line during transmit. Use with base or mobile transceivers up to 25W. Tower mtg hdwr incl.



MODEL	TUNES RANGE	KIT	WIRED
LNS-144	120-150 MHz	\$68	\$98
LNS-160	150-180 MHz	\$68	\$98
LNS-220	200-240 MHz	\$68	\$98
LNS-432	400-500 MHz	\$68	\$98

ACCESSORIES

- **MO-202 FSK DATA MODULATOR.** Run up to 1200 baud digital or packet radio signals through any FM transmitter.
- **DE-202 FSK DATA DEMODULATOR**
- **COR-2 KIT** With audio mixer, local speaker amplifier, tail & time-out timers.
- **COR-3 KIT** with "courtesy" beep".
- **DTMF DECODER/CONTROLLER KITS**
- **AUTOPATCH KITS.** Provide repeater autopatch, reverse patch, phone line remote control of repeater, secondary control.
- **CWID KITS**
- **SIMPLEX AUTOPATCH**

- Send \$1 for Complete Catalog (Send \$2.00 or 4 IRC's for overseas mailing)
- Order by phone or mail • Add \$3 S & H per order (Electronic answering service evenings & weekends)
- Use VISA, MASTERCARD, Check, or UPS COD.

hamtronics, inc.

65-E MOUL ROAD • HILTON NY 14468

Phone: 716-392-9430

Hamtronics® is a registered trademark

NBS trigon
is improved
by increasing
element lengths

optimizing a Yagi trigon reflector

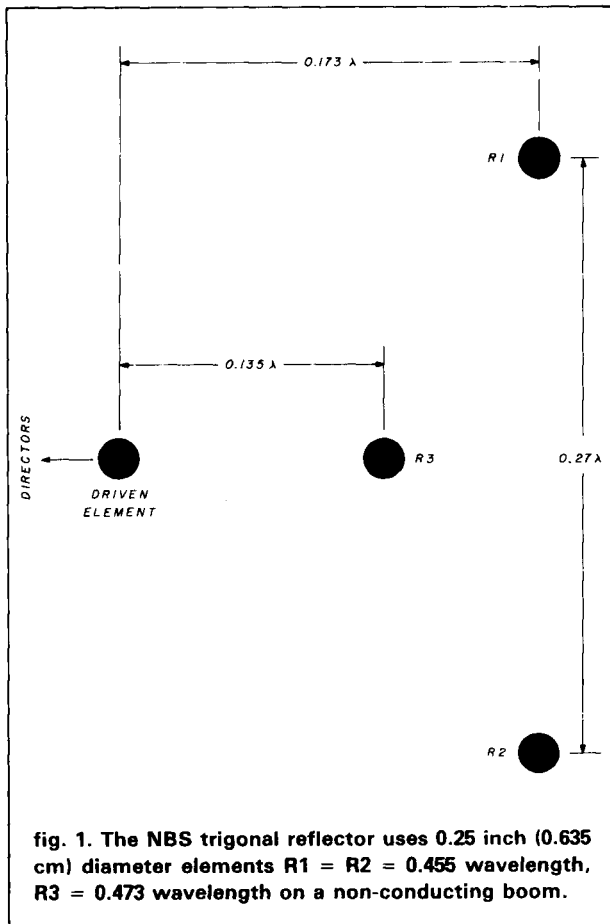

One of the most valuable sources of Yagi antenna designs is *NBS Technical Note 688*.¹ In addition to the seven measured and patterned Yagis fully discussed, it also includes suggestions for further enhancing Yagi designs.

One of the suggestions presented is the use of a three-element (trigon) reflector to increase the gain of the 4.2 wavelength Yagi. The trigon provided a stated 0.75 dB gain increase for this Yagi, representing the maximum increase obtainable by using more than one reflector. The 4.2 wavelength Yagi was the only Yagi with which this type of experiment was performed.²

Because the possibility of obtaining more gain from the six shorter Yagis was intriguing, it was pursued with the same Yagi computer model I described in several previous *ham radio* articles.³ But analyzing the use of parasitic elements not in the same plane with other Yagi elements would have required extensive modification to the model's code; to avoid that chore, I chose to use other software capable of modeling elements in multiple planes.

At the 1983 and 1984 Dayton Hamventions, Dr. James Breakall, WA3FET/6, described his use of the Numerical Electromagnetics Code (NEC) as the basis for his presentations on Yagis, dipoles, and vertical antennas. A complex FORTRAN software system, NEC requires a mainframe for execution. A shorter version, MININEC, is written in BASIC and is designed specifically for execution on microcomputers.* For those familiar with MININEC, the entire NBS series of Yagis was modeled using both eight and 18 segments per element. However, to speed the modeling process, trigon Yagis were stated in terms of eight segments per element.

*An Apple-readable version of the MININEC code can be obtained by sending a blank floppy disk to: Dr. Edmund K. Miller, L-153, Lawrence Livermore National Laboratories, P.O. Box 5504, Livermore, California 94550.

By Stanley Jaffin, WB3BGU, 800 Stonington Road, Silver Spring, Maryland 20902

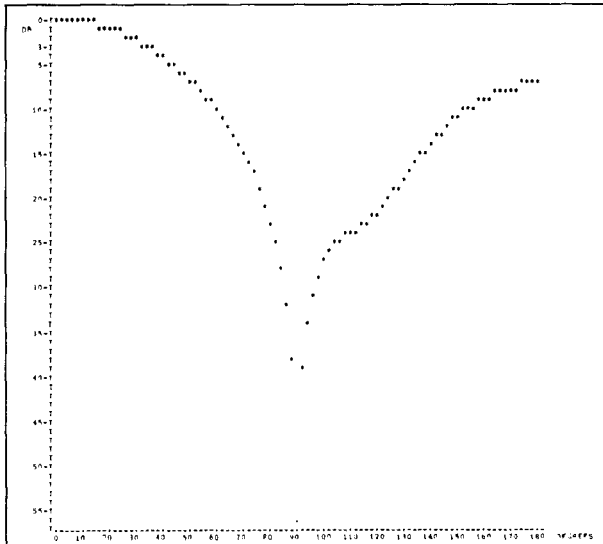

fig. 2. E-plane plot of NBS 0.2 wavelength, 2-element Yagi measured at 400 MHz. Notice in this and in figs. 3 through 75 the pattern amplitudes are normalized. Maximum response occurs at boresight (0 degrees) and is labeled 0 dB.

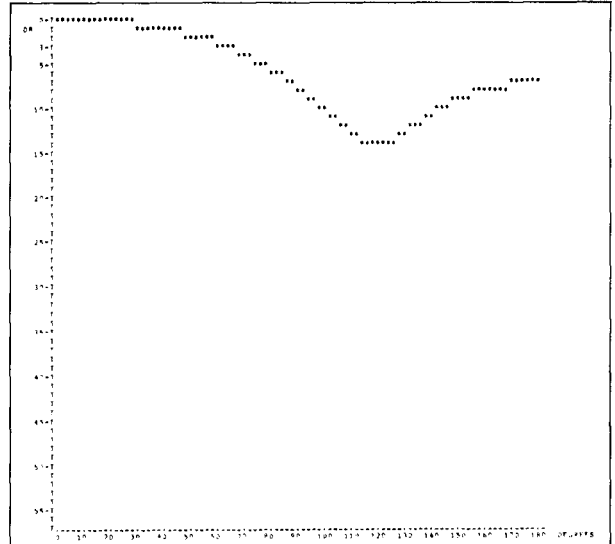

fig. 3. H-plane plot of NBS 0.2 wavelength, 2-element Yagi measured at 400 MHz. This Yagi shows a calculated gain of 6.62 dBi and a F/B of 7.28 dB.

Table 1 contains a summarized comparison of the published NBS findings, the WB3BGU model, MININEC, and pattern integration based on the radiation patterns in reference 1.⁴ The differences in gain figures are due to the different pattern integration code executed in each of the two models. Even slight variations in the overall pattern can affect how a single lobe (the main lobe) is defined in terms of the overall pattern. An examination of the seven E-plane and seven H-plane patterns resulting from each method of analysis (not shown) indicates a high degree of qualitative agreement. In many instances the MININEC patterns were more indicative of nuances in the NBS plots than the WB3BGU model. Reference 1 states that the original gain figures are accurate to within 0.5 dB, meaning that the NBS baseline is not exact. This is in part due to the fact that the NBS Yagis were measured for gain on one range but patterned on another.⁵ The lack of pattern symmetry indicates that the range

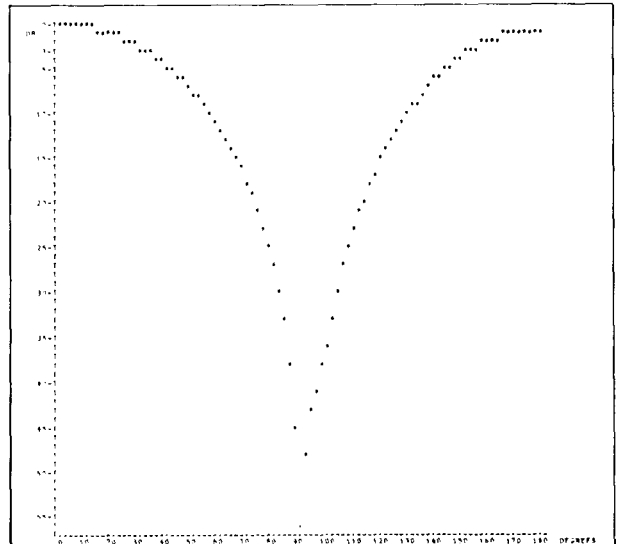

fig. 4. E-plane plot of baseline (stock) trigon reflector and driven element Yagi measured at 400 MHz.

table 1. Comparative gain and F/B figures for the NBS Yagi family. Note: NBS Technical Note 688 did not specify exact F/B measurements. The NBS F/B figures are taken from the cartesian plots provided for each Yagi.

NBS Yagi antenna		NBS		WB3BGU		MININEC-8		MININEC-18		pattern integration
boom in wavelengths	number of elements	gain (dBi)	F/B (dB)	gain (dBi)	F/B (dB)	gain (dBi)	F/B (dB)	gain (dBi)	F/B (dB)	gain (dBi)
0.2	2	6.71	6	6.70	6.71	6.62	7.28	6.58	7.90	6.71
0.4	3	9.15	8	9.15	12.07	9.27	11.82	9.47	11.97	9.62
0.8	5	11.35	15	10.71	22.71	10.69	24.53	10.93	20.76	11.41
1.2	6	12.35	19	11.75	19.05	11.67	19.11	11.97	27.88	12.64
2.2	12	14.40	23	14.00	30.47	13.75	22.68	13.99	36.43	14.28
3.2	17	15.55	24	15.22	24.06	14.99	22.55	15.20	27.82	15.47
4.2	15	16.35	22	15.70	19.26	15.38	21.21	15.72	21.93	16.22

used for patterning may not have been totally free of reflecting surfaces. Nevertheless, MININEC's calculated gain, F/B, and patterns can be considered to be very good replications of the NBS findings.

the NBS trigon reflector

Reference 1 provides a list of the multiple reflector arrangements NBS examined during the trigon evaluation. Maximum gain, the sole criterion in selecting the trigon configuration, is used as the main criterion in

evaluating the modeled trigons. As is the case for all other NBS parameters, an element diameter of 0.25 inches, a design frequency of 400.0 MHz, and a non-conducting boom apply. The stock NBS trigon is shown in **fig. 1**.

The 4.2 wavelength Yagi was modeled with the stock trigon. A significant reduction in both gain and F/B resulted. The first experiment involved varying the trigon element lengths (spacing was held constant) in order to achieve maximum gain. All three trigon elements were iterated over a range of plus and minus 0.015 wavelengths, in increments of 0.001 wavelengths. Increased gain correlated with increased trigon element length, reaching a calculated maximum with simultaneous extensions of 0.009 wavelengths. These iterations were repeated for each of the remaining six Yagis. **Table 2** contains the results of replacing the 0.2 wavelength Yagi's single 0.482 wavelength reflector with the stock (0.000 increment) trigon and successively incremented trigons. For this Yagi only, the 0.007 increment produces the maximum calculated gain. **Figures 2 and 3** contain the E- and H-plane plots for the original single reflector 0.2 wavelength Yagi. **Figures 4 and 5** contain these same plots using the stock trigon, and **figs. 6 and 7** present these same plots for the gain maximizing 0.007 increment trigon. For comparison, **figs. 8 and 9** do likewise for the 0.008 increment trigon, resulting in a minimal reduction in calculated gain but an increase of 0.77 dB in F/B ratio.

Either of the two incremented 0.2 wavelength Yagi versions would be useful as a single HF (7 MHz in particular) array or as a building block in a VHF/UHF col-

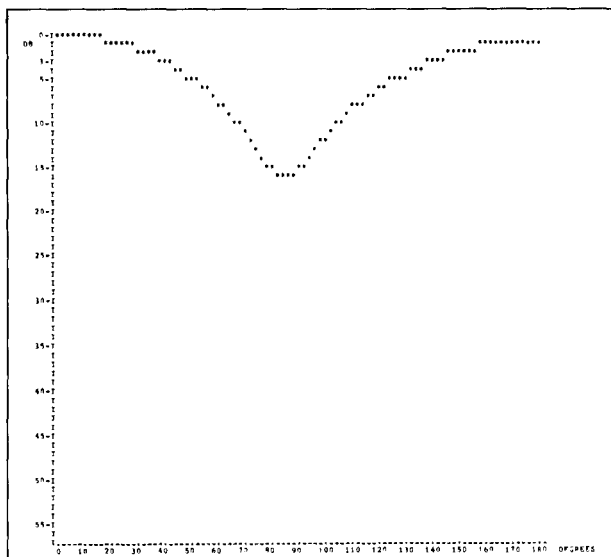

fig. 5. H-plane plot of baseline trigon reflector and driven element Yagi measured at 400 MHz. Gain is calculated at 6.42 dBi. F/B equals 0.76 dB.

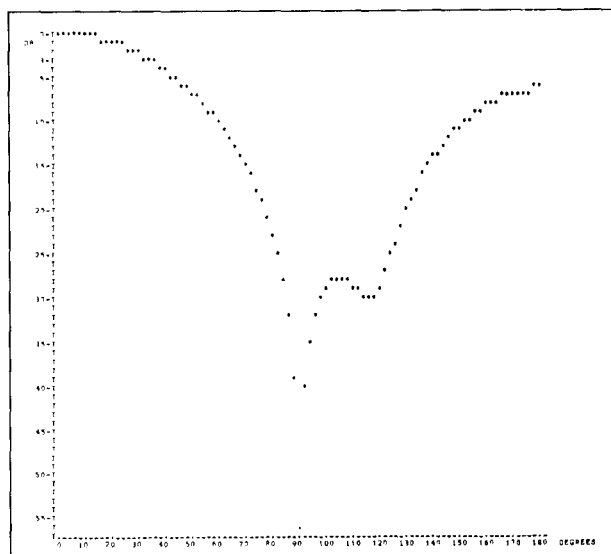

fig. 6. E-plane plot of 0.007 wavelength extended length trigon reflector and driven element Yagi measured at 400 MHz.

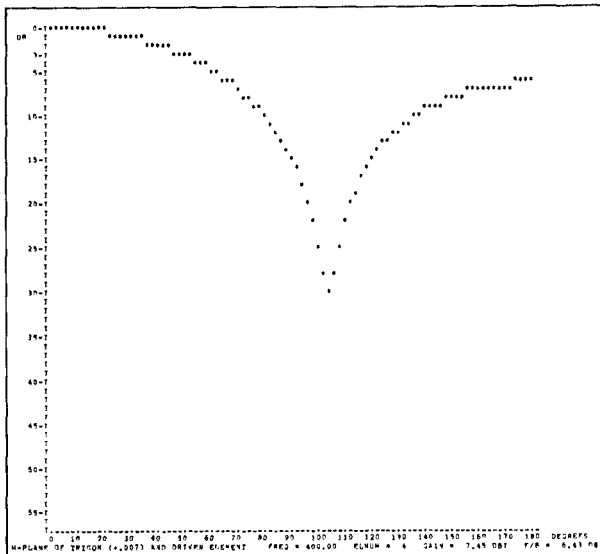

fig. 7. H-plane plot of 0.007 wavelength extended length trigon reflector and driven element Yagi measured at 400 MHz. Calculated gain equals 7.45 dBi and F/B equals 6.43 dB.

ASTRON POWER SUPPLIES

• HEAVY DUTY • HIGH QUALITY • RUGGED • RELIABLE •

RS and VS SERIES

SPECIAL FEATURES

- SOLID STATE ELECTRONICALLY REGULATED
- FOLD-BACK CURRENT LIMITING Protects Power Supply from excessive current & continuous shorted output.
- CROWBAR OVER VOLTAGE PROTECTION on all Models except RS-4A.
- MAINTAIN REGULATION & LOW RIPPLE at low line input Voltage.
- HEAVY DUTY HEAT SINK • CHASSIS MOUNT FUSE
- THREE CONDUCTOR POWER CORD
- ONE YEAR WARRANTY • MADE IN U.S.A.

PERFORMANCE SPECIFICATIONS

- INPUT VOLTAGE: 105 - 125 VAC
- OUTPUT VOLTAGE: 13.8 VDC \pm 0.05 volts (Internally Adjustable: 11-15 VDC)
- RIPPLE: Less than 5mv peak to peak (full load & low line)

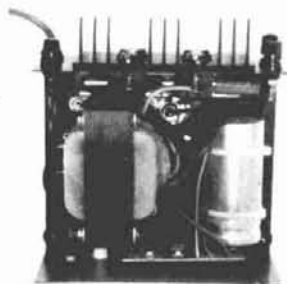

INSIDE VIEW - RS-12A



MODEL RS-50A



MODEL RS-50M



MODEL VS-50M

RM-A Series



MODEL RM-35A

19" X 5 1/4" RACK MOUNT POWER SUPPLIES

Model	Continuous Duty (AMPS)	ICS* (AMPS)	Size (IN) H X W X D	Shipping Wt. (lbs.)
RM-35A	25	35	5 1/4 x 19 x 12 1/2	38
RM-50A	37	50	5 1/4 x 19 x 12 1/2	50
• Separate Volt and Amp Meters				
RM-35M	25	35	5 1/4 x 19 x 12 1/2	38
RM-50M	37	50	5 1/4 x 19 x 12 1/2	50

RS-A SERIES



MODEL RS-7A

MODEL	Continuous Duty (Amps)	ICS* (Amps)	Size (IN) H x W x D	Shipping Wt (lbs)
RS-4A	3	4	3 3/4 x 6 1/2 x 9	5
RS-7A	5	7	3 3/4 x 6 1/2 x 9	9
RS-7B	5	7	4 x 7 1/2 x 10 3/4	10
RS-10A	7.5	10	4 x 7 1/2 x 10 3/4	11
RS-12A	9	12	4 1/2 x 8 x 9	13
RS-20A	16	20	5 x 9 x 10 1/2	18
RS-35A	25	35	5 x 11 x 11	27
RS-50A	37	50	6 x 13 3/4 x 11	46

RS-M SERIES



MODEL RS-35M

- Switchable volt and Amp meter

MODEL	Continuous Duty (Amps)	ICS* (Amps)	Size (IN) H x W x D	Shipping Wt (lbs)
RS-12M	9	12	4 1/2 x 8 x 9	13
RS-20M	16	20	5 x 9 x 10 1/2	18
RS-35M	25	35	5 x 11 x 11	27
RS-50M	37	50	6 x 13 3/4 x 11	46

VS-M SERIES



MODEL VS-20M

- Separate Volt and Amp Meters
- Output Voltage adjustable from 2-15 volts
- Current limit adjustable from 1.5 amps to Full Load

MODEL	Continuous Duty (Amps) @13.8VDC@10VDC@5VDC	ICS* (Amps) @13.8V	Size (IN) H x W x D	Shipping Wt (lbs)
VS-20M	16 9 4	20	5 x 9 x 10 1/2	20
VS-35M	25 15 7	35	5 x 11 x 11	29
VS-50M	37 22 10	50	6 x 13 3/4 x 11	46

RS-S SERIES



MODEL RS-12S

- Built in speaker

MODEL	Continuous Duty (Amps)	ICS* Amps	Size (IN) H x W x D	Shipping Wt (lbs)
RS-7S	5	7	4 x 7 1/2 x 10 3/4	10
RS-10S	7.5	10	4 x 7 1/2 x 10 3/4	12
RS-10L(For LTR)	7.5	10	4 x 9 x 13	13
RS-12S	9	12	4 1/2 x 8 x 9	13
RS-20S	16	20	5 x 9 x 10 1/2	18

Talk to the World With Your Computer!

Revolutionary NEW RTTY/CW Interface and Program Cartridge for

the VIC-20, Commodore-64 and C-128!

As reviewed by Lew McCoy, W1ICP for CQ Magazine! (Nov. 85)

Check these EXCLUSIVE features not found in any other T/U!

- Automatic RTTY scanning: Baudot 60-66-75-100-132 ASCII 110-300 plus Invert & repeat!
- Tape all incoming or outgoing data "on the fly" WHILE OPERATING!
- Tape or load at 16K/min rate! (Almost as fast as a disk.) Tape starts/stops automatically.
- Tape search! (Monitor displays only what you are searching for on tape.)
- Self Test! (No test equipment required for T/U check out.)



The Merlin Line

OTHER FEATURES

- Completely crystal controlled on transmit • Complete KYBD control, no switches • Screen display of operating modes and memory size • Automatic CW tracking 5-127 wpm • MSO (RBBS) program • Logging program • KYBD selectable HI/Low tone pairs to take advantage of filters in your receiver • Will operate CW, MCW, Break CW • CW speed lock • On-screen tuning indicator • Split screen • On-screen clock • Logging scratch pad • RTTY sync • Edit mode • 26 instant call-up message buffers plus memory filing system • In MSO (RBBS), user may assign read, write, list & delete codes • Extra memory may be added for larger MSO, etc. • Memory can be scrolled, edited, re-transmitted, taped, etc. • Will also transmit number of bytes remaining in memory and time that is displayed on the screen.

Designed by amateurs for amateurs. Routines in this program were originally developed in 1974 by Charles "Merlin" Myer (W8VCF) and recently updated to state of the art. There are over 100 functions in this program (too many to list here). A professional glass epoxy circuit board, plates through holes, and gold tabs. One-year warranty. If you don't think this is the finest RTTY/CW/T/U Interface and program on the market, return it within 30 days for full refund (less shipping), no questions asked! T/U plugs into user port, program cartridge plugs into expansion port. No hidden extras to buy. The only thing you need to supply is a microphone and audio connector to match your rig! Compare our price and specifications to units costing over \$500.00!

Newsome Electronics

19677 Allen Rd. • Trenton, Michigan 48183

(313) 479-2100

Dealer Inquiries Invited

ORDER: CM-20 (for Vic-20) \$124.95

CM-64 (for C-64) \$124.95

CM-128/64 (for C-128) \$124.95

(add \$3.75 for shipping & handling
in the Continental U.S. \$7.00 for Overseas)
Mich. residents add 4% sales tax

**AVAILABLE
NOW**

THE 1986 ARRL HANDBOOK FOR THE RADIO AMATEUR

Great gift idea for a ham friend or for yourself!

The new 1986 ARRL HANDBOOK is chockfull of projects, ideas, hints and kinks, theory and thousands of other handy things for your hamshack. New items include: switching power supplies, data and telemetry transmission, a section on conjugate matching by Walt Maxwell, data interface and Packet Radio, and remote control aircraft to name just a few examples. New projects include: 30 amp power supply, ATV monitoring instruments, digital frequency synthesizer, 1500 watt output 160 meter amplifier, state-of-the-art preamps for all Amateur VHF/UHF frequencies and much, much more. A grand total of 244 new pages! This is the reference book to have. Order your's today. ©1985. Over 1100 pages.

AR-HB86
AR-BB86

Softbound \$17.95
Hardbound \$26.95



Please enclose \$3.50 to cover shipping and handling



**ham
radio** magazine **BOOKSTORE**
GREENVILLE, NH 03048

ORR BOOKS



BEAM ANTENNA HANDBOOK

by Bill Orr, W6SAI and Stu Cowan, W2LX

The Beam Antenna Handbook, first published in 1955, has been completely revised and updated with the latest information on Beam Antenna design. Computer designed Yagis give maximum gain in minimum space. New info on Yagi HF and VHF beams and dimensions on beams for 10, 18 and 24 MHz WARC bands. Everything you need to know about beam design, construction and operation. 204 illustrations. 268 pages. 1st edition. ©1985.

RP-BA Softbound \$9.95

SIMPLE LOW-COST WIRE ANTENNAS

by Bill Orr, W6SAI

Learn how to build simple, economical wire antennas. Apartment dwellers take note! Fool your landlord and your neighbors with some of the "invisible" antennas found here. Well diagrammed. 192 pages. ©1972. 2nd edition.

RP-WA Softbound \$7.95

THE RADIO AMATEUR ANTENNA HANDBOOK

by William I. Orr, W6SAI and Stuart Cowan, W2LX

Contains lots of well illustrated construction projects for vertical, long wire, and HF/VHF beam antennas. There is an honest judgment of antenna gain figures, information on the best and worst antenna locations and heights, a long look at the quad vs. the yagi antenna, information on baluns and how to use them, and new information on the popular Sloper and Delta Loop antennas. The text is based on proven data plus practical, on-the-air experience. 190 pages. ©1978. 1st edition.

RP-AH Softbound \$7.95

ALL ABOUT CUBICAL QUAD ANTENNAS

by Bill Orr, W6SAI — New 3rd Edition

Includes NEW data for WARC bands

The cubical quad antenna is considered by many to be the best DX antenna because of its simple, lightweight design and high performance. You'll find quad designs for everything from the single element to the multi-element monster quad. There's a wealth of data on construction, feeding, tuning, and mounting quad antennas. 112 pages. ©1982. 3rd edition.

RP-CQ Softbound \$6.95

Please add \$1.50 for one book, \$2.50 for two or more books to cover shipping and handling

Ham Radio's Bookstore Greenville, NH 03048

table 2. Gain and F/B calculations resulting from iterating the trigon reflector on the 0.2 wavelength NBS Yagi.

increment in wavelengths	gain (dBi)	F/B (dB)
0.000	6.42	0.76
0.001	6.54	0.99
0.002	6.69	1.33
0.003	6.87	1.85
0.004	7.07	2.64
0.005	7.26	3.75
0.006	7.40	5.10
0.007	7.45	6.43
0.008	7.44	7.34
0.009	7.40	7.66
0.010	7.34	7.58
0.011	7.29	7.32
0.012	7.25	7.03
0.013	7.22	6.79
0.014	7.20	6.59
0.015	7.18	6.45

linear array. At 7 MHz a relatively short 25-foot boom would yield a high gain Yagi with good sidelobe structure. At VHF/UHF this same array serves as a relatively high performance building block for collinear arrays. In **table 3** the seven NBS Yagis are compared in terms of their respective single reflector versions and three trigon variations: stock, gain maximized, and F/B maximized. With the exception of the 0.2 wavelength Yagi, maximum gain occurs when each trigon element is extended 0.009 wavelengths from its stock length. With the exception of the 0.4 wavelength Yagi, calculated F/B maximas occur at even longer extensions. The 0.4 wavelength Yagi achieved both calculated maximas with the 0.009 extensions, and had the only single frequency F/B maxima.

table 3. Comparative performance calculations for the NBS Yagis with three specified sets of trigon reflectors. Note: Column 2 includes two additional elements in the trigon reflector. Column 1 shows the original Yagi length.

NBS Yagi antenna		Basic Yagi		stock trigon		gain maximum trigon		F/B maximum trigon		F/B maximum trigon increment
boom in wavelengths	number of elements	gain (dBi)	F/B (dB)	gain (dBi)	F/B (dB)	gain (dBi)	F/B (dB)	gain (dBi)	F/B (dB)	(dBi)
0.2	4	6.62	7.28	6.42	0.76	7.45	6.43	7.39	7.66	0.009
0.4	5	9.27	12.07	6.57	4.17	9.28	30.91	9.28	30.91	0.009
0.8	7	10.69	24.53	8.79	7.15	10.82	17.01	10.62	25.53	0.014
1.2	8	11.67	19.11	10.18	6.03	11.92	12.39	11.73	14.73	0.015
2.2	14	13.75	22.68	12.05	8.55	13.90	16.34	13.81	18.91	0.013
3.2	19	14.99	22.55	13.44	9.69	15.16	18.23	15.10	19.70	0.013
4.2	17	15.38	21.21	13.86	9.27	15.67	18.53	15.63	19.44	0.011

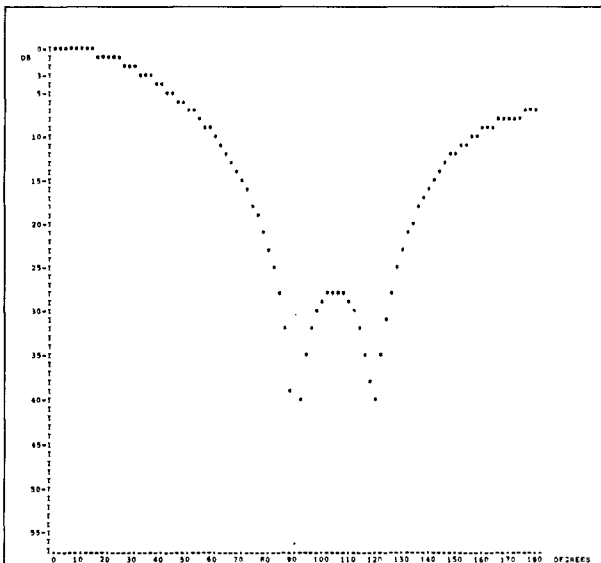

fig. 8. E-plane plot of 0.008 wavelength extended length trigon reflector and driven element Yagi measured at 400 MHz.

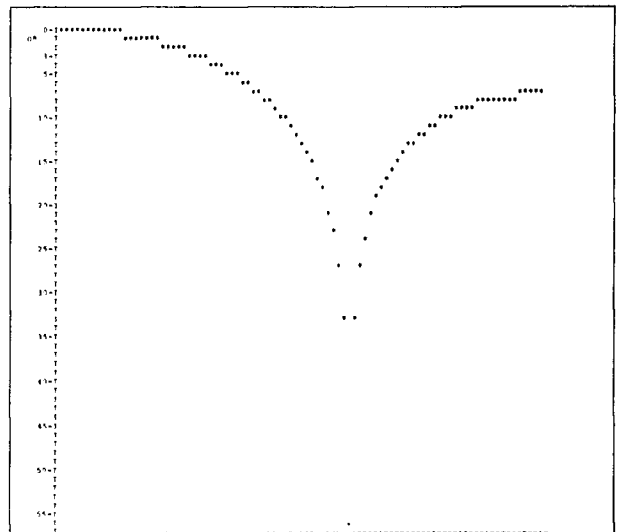

fig. 9. H-plane plot of 0.008 wavelength extended length trigon reflector and driven element Yagi measured at 400 MHz. Calculated gain equals 7.44 dBi and F/B equals 7.34 dB.

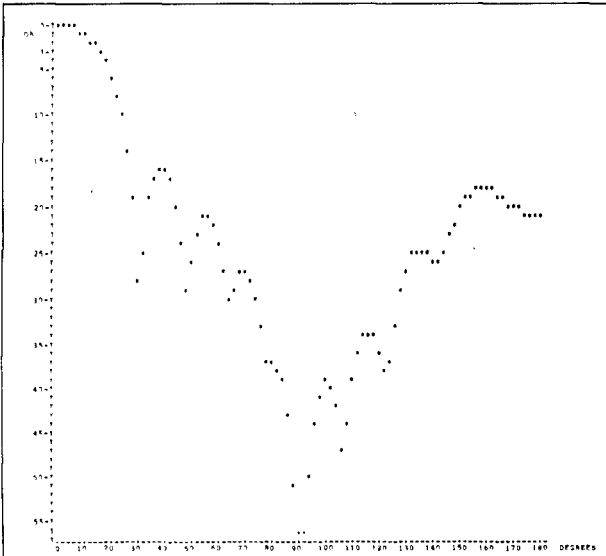

fig. 10. E-plane plot of 4.2 wavelength, 15-element Yagi that uses a single reflector.

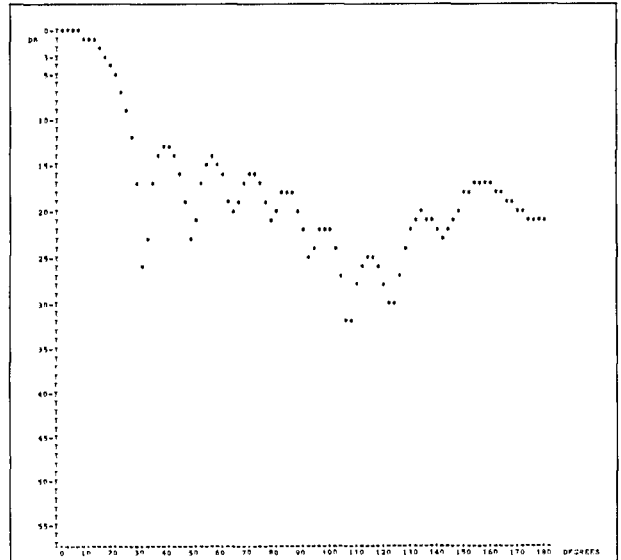

fig. 11. H-plane plot of 4.2 wavelength, 15-element Yagi that uses a single reflector. Calculated gain equals 15.38 dBi and F/B equals 21.21 dB.

Figures 10 and 11 illustrate E- and H-plane plots for the single reflector 4.2 wavelength Yagi. In figs. 12 and 13 a stock trigon reflector is used. In figs. 14 and 15 the 0.009-wavelength extended reflector length gain optimized version is plotted. For the first 80 degrees in the E-plane plot, the stock trigon actually improves the suppression of the minor lobes. This is also true for the first 55 degrees of the H-plane plot, but at the expense of gain, F/B, and other minor lobe levels in both planes. The gain maximizing 0.009 wavelength extensions provide the clean pattern normally associated with this Yagi, and additional 0.34 dB in gain, and further (1-2 dB) reduction of the first few minor lobes in both the E- and H-plane plots. While calculated F/B is reduced, the resulting first minor lobe permits an increased stacking distance and hence more incremental gain from a stack. As reference 1 did not report any patterns from the trigon experiment, it is not known whether NBS noted these other improvements along with increased forward gain.

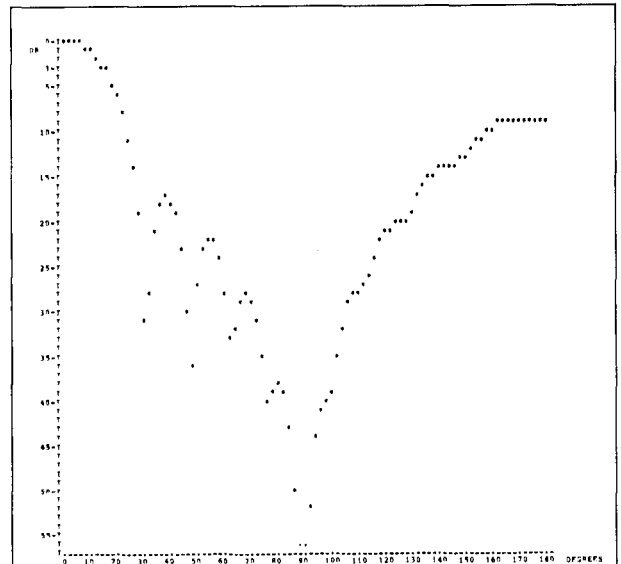

fig. 12. E-plane plot of 4.2 wavelength, 15-element Yagi that uses a stock trigon reflector.

validating the calculated trigon findings

Several questions about the validity of these calculated findings versus the published NBS findings arise. There is a measurable difference between the 4.2 wavelength trigon Yagi's calculated performance and what is given in reference 1. As NBS did not provide plots for this Yagi, even qualitative comparisons cannot be directly made. There is still the issue of the trigon's dimensions. Use of the stock element lengths

results in degrading the 4.2 wavelength Yagi's performance as well as that of the six others.

Before these iterations were begun, Joe Reisert, W1JR, had performed extensive analyses based on the use of a trigon reflector of the 2.2 and 3.2 wavelength NBS Yagis on an antenna range.⁶ He found that for these two Yagis the stock trigon reflector reduced the measured gain by just over 1.6 dB, and that a nominal gain increase of nearly 0.2 dB over the single reflector Yagi could be obtained by lengthening all three

TO
PHONE
LINE

COM-SHACK-64

SIMPLEX AUTO-PATCH & REMOTE H.F. BASE

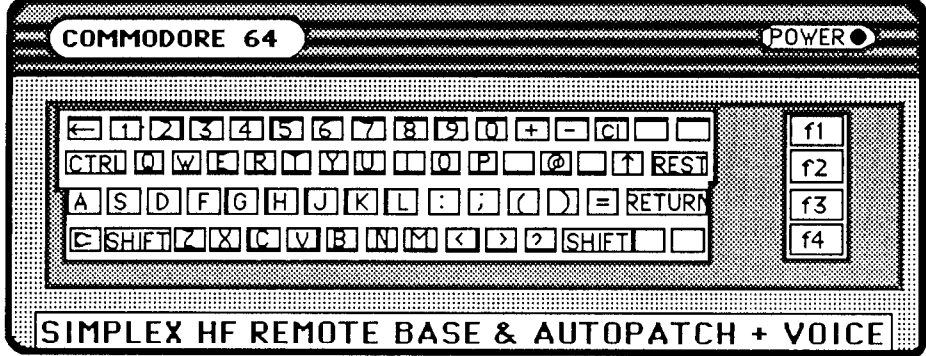
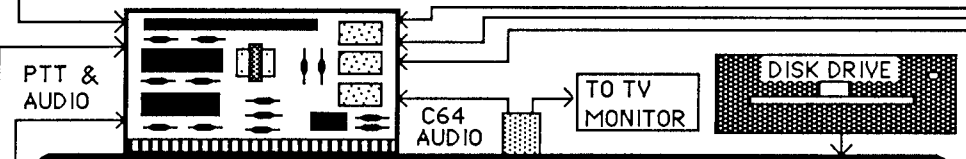

SIMPLEX HF REMOTE BASE & AUTOPATCH + VOICE

YOUR COMPUTER CONTROLS THE SHACK FROM YOUR HT

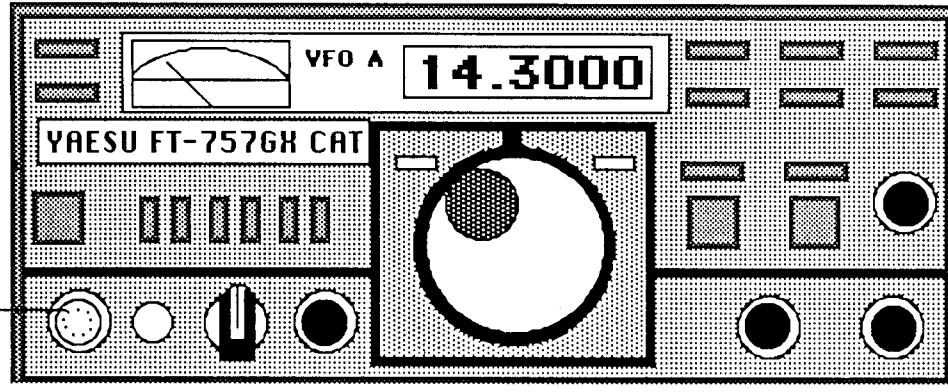

CO DX CO DX
20 METERS

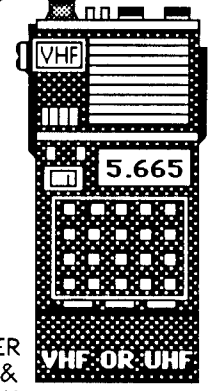

SPEAKER
AUDIO &
SQUELCH

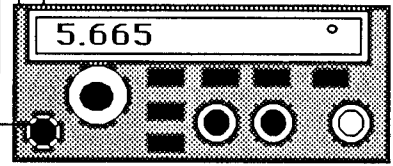

LET YOUR COMMODORE COMPUTER
CONTROL YOUR SHACK. WITH THE
CS-64 YOU TAKE IT ALL WITH YOU!
SATISFACTION GUARENTEED !

- *SIMPLEX AUTOPATCH AND H.F. REMOTE BASE WITH CLEAR VOICE MESSAGES
- *CONTROL YOUR YAESU FT 757 TRANSCEIVER WITH YOUR VHF/UHF PORTABLE.
- *SWITCH BETWEEN THE H.F. REMOTE AND THE AUTOPATCH WITH DTMF TONES
- *VOICE ID & ALL CONTROL FUNCTIONS & H.F. FREQUENCY VOICE ANNOUNCED WITH YOUR PROGRAMABLE ACCESS CODES
- *AUTOPATCH WORKS ON ANY TELEPHONE LINE - TONE OR DIAL PULSE
- *CALL WAITING COMPATABILITY - AFTER BEEP ANSWER SECOND INCOMING CALL WHILE ON THE PATCH !
- *RING DETECT & AUTOMATIC VOICE ALERT OF INCOMING TELEPHONE CALL
- *INACTIVITY TIMER TURNS OFF SYSTEM (USER PROGRAMABLE)
- *STORE 8 H.F. MEMORY FREQUENCIES + SHIFT VFO'S & CHANGE BANDS
- *FAST SCAN & SLOW SCAN + DIAL UP ANY FREQUENCY WITH DTMF TONES ALL FROM YOUR HANDHELD VHF/UHF PORTABLE OR MOBILE
- *USE THE AUTOPATCH OR THE REMOTE BASE BOTH FOR THE PRICE OF ONE!
- *USER DEFINED TIMING WINDOW, ACCESS CODES, CALL SIGN
- *SIMPLE TO INSTALL; HOOK MIC INPUT, PTT, SPKR OUTPUTS & FM SQUELCH CONNECTION 3 PIN H.F. DATA CABLE AND YOU ARE IN CONTROL
- *YOU SUPPLY COMMODORE 64 OR 128 & 1 DISK DRIVE + BASE RIG
- *NO ADDITIONAL POWER SUPPLY REQUIRED
- *WITH HUMAN VOICE SYNTHESIZED BY COVOX™
- *USER FRIENDLY MENUS, SIMPLE TO USE PROGRAM, AUTO LOAD
- *YOU CAN'T BUY A MORE FEATURE PACKED SIMPLEX PATCH !

ENGINEERING CONSULTING INTRODUCES COM-SHACK-64

MODEL CS-64 \$229.95

INC: DISK, CABLES, 757 MIC PLUG, USER I/O INTERFACE CARD WIRED & TESTED

SHIPPING U.S.A. INCLUDED CA. ADDRESS ADD 6%

MASTERCARD/VISA CHECK OR MONEY ORDER

ENGINEERING CONSULTING
583 CANDLEWOOD ST
BREAR, CA. 92621

FOR YOUR PERSONAL USE ** STATE OF THE ART DESIGN TEL: 714-671-2009

reflector elements by approximately 0.008 wavelengths. Trigon element spacing remained constant. These empirical findings are in very good agreement with the MININEC calculations in **table 1**. Günter Hoch, DL6WU, has reported similar gain findings for a broad range of multiple element reflector arrangements.⁷ While there is no reason to doubt that Peter Viezbicke, W0NXB, the author and principal investigator for the experiments reported in reference 1, actually measured what was reported, it is unfortunate

that neither subsequent empirical experiments nor mathematical modeling can exactly reproduce these well known findings.

conclusions

The trigon reflector can provide increases in (calculated) gain for all seven NBS Yagis. For the 0.2 wavelength Yagi this increase is at its maximum value. For the 0.4 through 3.2 wavelength Yagis, this increase is mostly nominal. For the 4.2 wavelength Yagi used to develop the trigonal reflector, the increase is more pronounced, but less than initially reported. For all NBS Yagis it is necessary to use reflector element lengths (with spacing held constant) longer than the stock lengths reported in reference 1. The stock lengths severely reduce the performance level of any NBS Yagi on which they are used.

Reference 1 presents a series of design curves in its table 21 for converting director and reflector elements to other diameter-to-wavelength ratios. Mathematical analysis indicated that reflector curves for trigon elements that were drawn parallel to the curves for single reflectors would result in accurate conversions. As is the case with the other curves, these trigon curves had to be drawn through the point of intersection between 0.0085 wavelengths in diameter (X axis) and the trigon element's optimal length on the Y axis. This was confirmed by reference 6. A more recent and easier to read version of these curves had been found, and with the trigon curves is presented as **fig. 16**.⁸ These curves can now be used exactly in the same fashion as the other design curves.

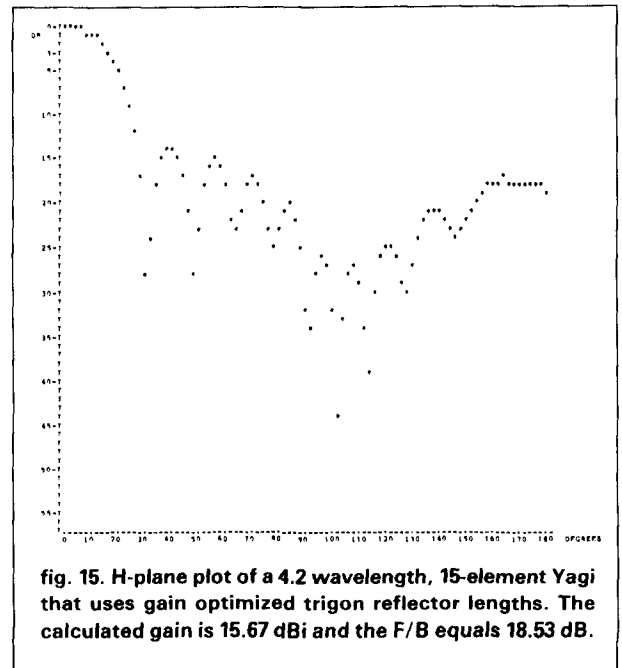
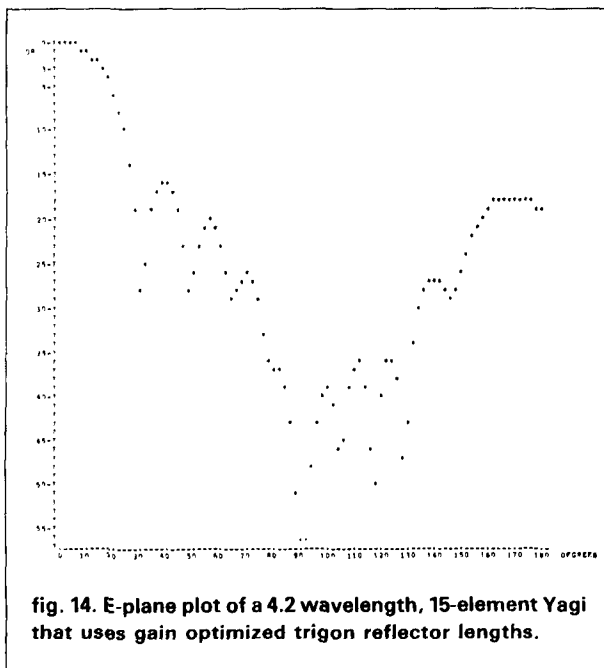
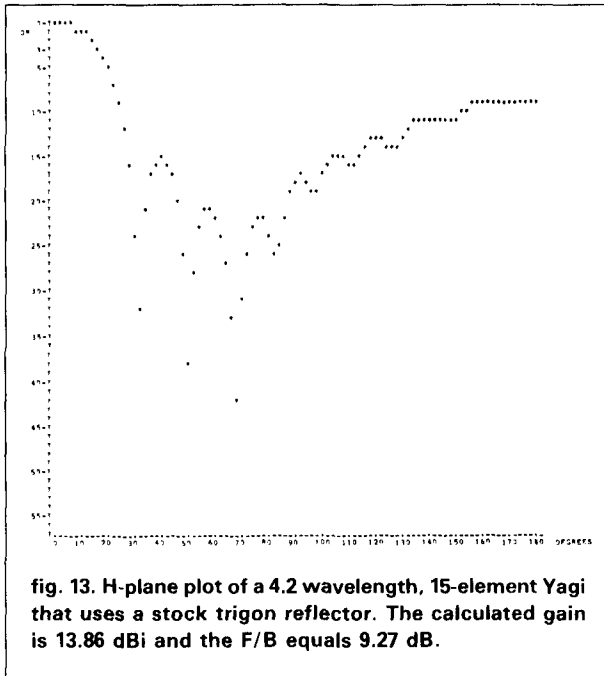

ham radio

Reader Service

For literature or more information, locate the Reader Service number at the bottom of the ad, circle the appropriate number on this card, affix postage and send to us. We'll hustle your name and address to the companies you're interested in.

101 113 125 137 149 161 173 185 197 209 221 233 245 257 269 281 293 305 317 329 341
102 114 126 138 150 162 174 186 198 210 222 234 246 258 270 282 294 306 318 330 342
103 115 127 139 151 163 175 187 199 211 223 235 247 259 271 283 295 307 319 331 343
104 116 128 140 152 164 176 188 200 212 224 236 248 260 272 284 296 308 320 332 344
105 117 129 141 153 165 177 189 201 213 225 237 249 261 273 285 297 309 321 333 345
106 118 130 142 154 166 178 190 202 214 226 238 250 262 274 286 298 310 322 334 346
107 119 131 143 155 167 179 191 203 215 227 239 251 263 275 287 299 311 323 335 347
108 120 132 144 156 168 180 192 204 216 228 240 252 264 276 288 300 312 324 336 348
109 121 133 145 157 169 181 193 205 217 229 241 253 265 277 289 301 313 325 337 349
110 122 134 146 158 170 182 194 206 218 230 242 254 266 278 290 302 314 326 338 350
111 123 135 147 159 171 183 195 207 219 231 243 255 267 279 291 303 315 327 339
112 124 136 148 160 172 184 196 208 220 232 244 256 268 280 292 304 316 328 340

Limit 15 inquiries per request.

NAME _____ CALL _____

ADDRESS _____

CITY _____ STATE _____ ZIP _____

Please use before February 28, 1986

January 1986

AFFIX POSTAGE
OR
POST OFFICE
WILL NOT
DELIVER

ham
radio
magazine

READER SERVICE CENTER
P.O. BOX 2558
WOBURN, MA 01888

ATTN: Reader Service Dept.

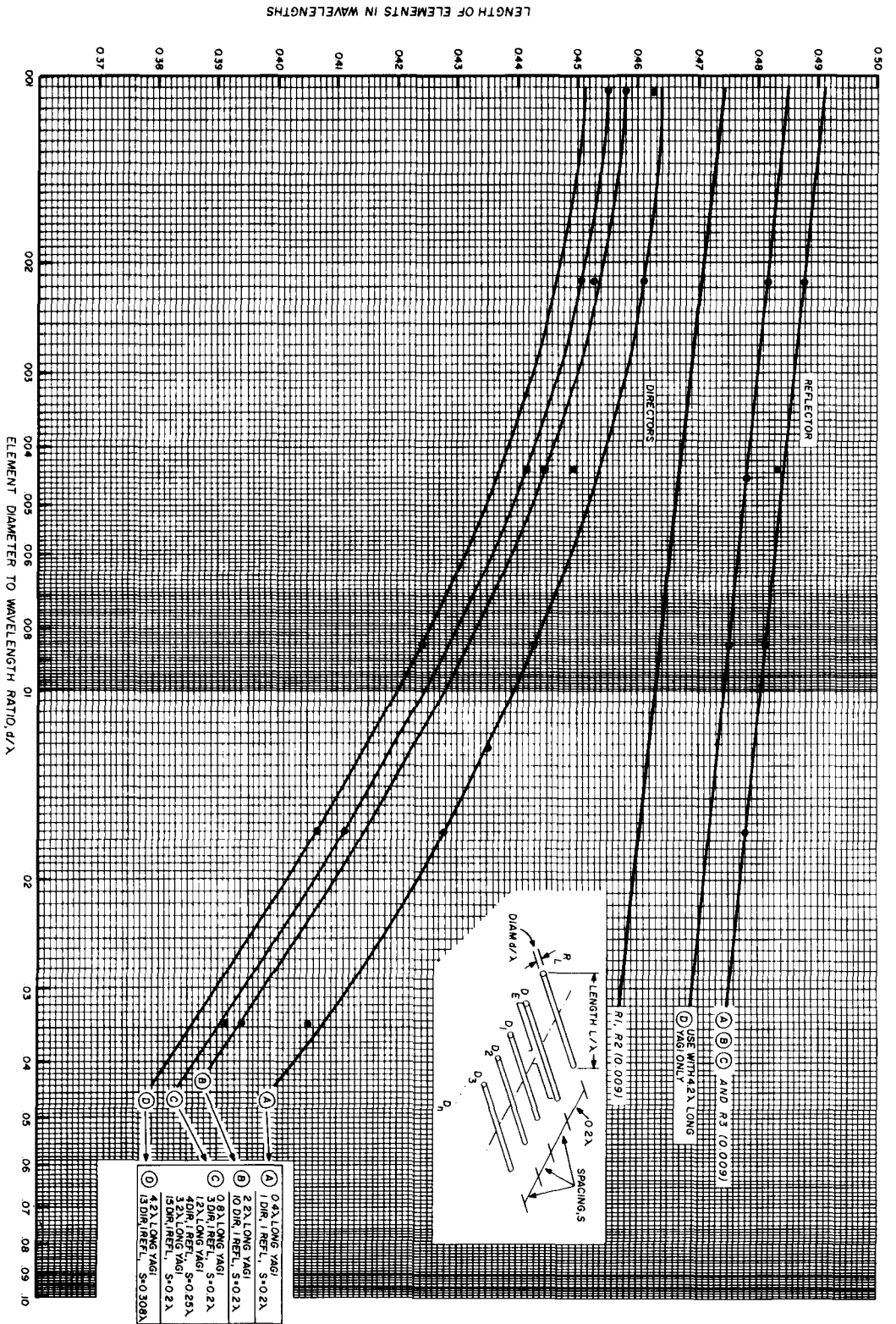

fig. 16. Yagi antenna design nomograph shows the relationship between element diameter and wavelength ratio (d/λ), and element length for different antennas.

Your Ham Tube Headquarters!

TUBES BOUGHT, SOLD AND TRADED
SAVE \$\$\$—HIGH \$\$\$ FOR YOUR TUBES

Call Toll Free 800-221-0860

Tubes

3-400Z.....\$85.00	7360.....\$13.75
3-500Z.....85.00	6550A.....7.50
4-400A.....80.00	8072.....125.00
4CX250B.....59.00	8156.....12.50
572B.....57.00	8643.....82.50
811A.....12.00	8844.....26.50
813.....30.00	8873.....195.00
6146B.....8.50	8874.....225.00
6360.....4.25	8877.....595.00
6883B.....8.00	8908.....14.50

MAJOR BRANDS ON RECEIVER TUBES

75% off list

Semiconductors

MRF 245/SD1416..\$30.00	SD1088.....19.95
MRF 454.....14.95	2N3055.....75¢
MRF 455.....10.95	2N6084.....12.50

RF Connectors

PL259.....10/\$4.95	M358.....2.50 ea.
PL258.....10/8.95	M359.....1.75 ea.
UG 175/176.....10/1.60	Type "N" Twist on
UG255/u.....2.50 ea.	(RG8/u).....\$4.75 ea.
UG273/u.....2.25 ea.	Minimum Order \$25.00

Allow \$3.00 min. for UPS charges ✓ 119

COMMUNICATIONS, Inc.

2115 Avenue X Brooklyn, NY 11235

SERVING THE INDUSTRY SINCE 1922

Phone (212) 646-6300

Call CECo For Your CCTV Security And Color Production Requirements

The procedure for compensating for the diameter of a conducting boom is the same as for other NBS Yagi elements.

A great deal of experimentation can still be performed on the NBS Yagi antenna. Whether performed on an antenna range or by computer iteration, the results should be presented so that all Radio Amateurs can benefit from these experiments.

references

1. Peter Viezbicke, "Yagi Antenna Design," *NBS Technical Note 688*, Department of Commerce, Washington, D.C., 1976.
2. Peter Viezbicke, W0NXB, personal communication.
3. Stanley Jaffin, WB3BGU, "Applied Yagi Antenna Design, Part 6: The Model and a Special Teaching Tool," *ham radio*, October, 1984, page 89.
4. James Lawson, W2PV, "Yagi Antenna Design: Experiments Confirm Computer Analysis," *ham radio*, February, 1980, page 24.
5. Dr. Karl G. Kessler, Director of the NBS Center for Basic Standards, personal communication.
6. Joseph Reiser, W1JR, personal communication.
7. Günter Hoch, DL6WU, "Extremely Long Yagi Antennas," *VHF Communications*, March, 1982, pages 135-136.
8. Joseph Reiser, W1JR, "How to Design Yagi Antennas," *ham radio*, August, 1977, page 25.

ham radio

26th Annual

TROPICAL HAMBOREE

FEBRUARY 8-9, 1986

EDWARDS BUILDING, ARNOLD BUILDING AND COLISEUM

DADE COUNTY YOUTH FAIR GROUNDS

TAMIAMI PARK, MIAMI, FLORIDA

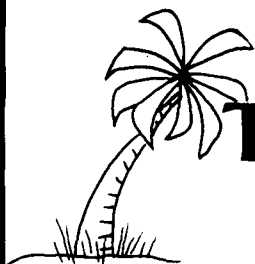

- FREE PARKING 15,000 VEHICLES
- 1000 INDOOR SWAP TABLES W/POWER
- AMATEUR RADIO & ARRL PROGRAMS
- LICENSE EXAMS
- QCWA HOSPITALITY CORNER
- CONSUMER ELECTRONIC DISPLAYS
- SATELLITE DISH GARDEN
- HAMBOREE DEALER SPECIALS
- 300 RV SPACES WITH FULL HOOKUPS
- 200 COMMERCIAL EXHIBIT BOOTHS
- DX FORUM & DINNER
- PACKET RADIO DEMONSTRATION
- RCA FL. SECTION LUNCHEON
- COMPUTERS AND SOFTWARE
- 2 DAYS OF PROGRAMS FOR NON-HAMS
- TRAFFIC HANDLERS BREAKFAST

Registration: \$5.00 Advance . . . \$6.00 Door (Valid Both Days)
Swap Tables, 2 Days: \$16.00 Each, Includes Power, Plus Registration Ticket
RV Parking: \$10.00 Per Day, Includes Water, Power, & Sanitary Hook-ups
Hotel Reservation Cards for Special Rates Available - Dec. 1st
(Advance Price Deadline on Registration Tickets, January 20th)

MAKE CHECKS PAYABLE TO: DADE RADIO CLUB, INC., P.O. BOX 350045, MIAMI, FL 33135

4 PAGE BROCHURE AVAILABLE — DEC. 1st.

Exhibit Booth Information: Evelyn D. Gauzens, W4WYR, Chairman
2780 N.W. 3 Street, Miami, FL 33125

Telephone:
305-642-4139

**SIMPLEX / DUPLEX
AUTOPATCH**

NOVAX I \$89.95



NOVAX II \$189.95

**IT'S NOT JUST ANOTHER
AUTOPATCH**

NOVAX
MOBILE CONNECTION

YOUR OWN PRIVATE AUTOPATCH

NOVAX interfaces your standard 3 meter 220, 450, etc. base station and telephone, using a high speed scan switching technique so that you can make and receive calls automatically from your automobile or with your HT. Easy installation. Use it as half duplex, using two transceivers, interface HF or other audio sources, remote switch, emergency alert etc., etc.

FEATURES	NOVAX I	NOVAX II
• 3 sec. Call duration timer	YES	YES
• Up to 40 sec. activity timer	YES	YES
• Single digit Access Control	YES	NO
• DTMF (Touch Tone)* phone connection	YES	YES
• 4 digit Access Control (Programmable)	NO	YES
• Toll Restraint	NO	YES
• LED Digital Displays	NO	YES
• 1/2" covered alarm speaker	5" x 6" x 2"	10" x 8" x 1 1/2"
• Direct* Interface with Repeater	NO	YES
• Battery Chut System (with radial features)	NO	YES "Optional" \$39.95
• Ring Back (reverse autopatch)	YES	YES

* U.S. Res. add approx. Sales Tax. * Transformers ATT

ORDER, SEND CHECK MONEY ORDER TO: NOVAX I CORP. 100 VIA ACC 27181

CURRENT DEVELOPMENT CORPORATION

E. Carter Rd. P.O. Box 284 Westwoodland, N.Y. 13490 or Phone 315-733-3719

132



CURLY CODE

- Exciting NEW learning experience lets the code RHYTHM build "unforgettable" shapes in your mind's eye. Sounds. ADD to the shape you already SEE: so never change your mind about them! Shapes ARE the characters: write them!
 - BEGINNERS: no "study" because: Only EIGHT shapes give you HALF of EVERYTHING and nearly ALL the LETTERS. Know EVERYTHING: only 2 more endings each!
 - EXPERTS: break your "learning plateau" by letting shapes form at "any" speed.
 - CLUBS: 20% discount on 10 or more sets.
 - PRICE: Complete set (Manual, Wall chart, Pocket card, Beginner's chart): \$11.50 Manual alone (no discount): \$6.50
- Hinds eye Publications, Dept. H10 P.O. Box 131C, McLean, VA 22101

162

**"HAM HOTLINE"
THE PROVEN MONEYMAKER**

The "Ham Hotline" is a complete mailing list of novice amateur radio operators and current hams who have renewed, upgraded or modified their FCC licenses. These ham enthusiasts have proven to be excellent prospects for radio equipment, accessories and publications. The Hotline is **UPDATED EVERY TWO WEEKS** with an average of 8,000 names and addresses each month. And, because we know the Hotline is the most up-to-date amateur radio listing available, we'll guarantee 98% deliverability. Target your sales efforts to your most likely buyers. Call DCC Data Service today and begin your subscription to the "Ham Hotline" . . . the proven moneymaker.

133

DCC Data Service
1990 M Street, N.W. Suite 610
Washington, D.C. 20036
Toll-free 1-800-431-2577
In DC & AK 202-452-1419

**Gunnplexers
& accessories 10 & 24 GHz**



A. Microwave Associates 10 GHz Gunnplexer. Two of these transceivers can form the heart of a 10 GHz communication system for voice, mcw, video or data transmission, not to mention mountaintop DXing! MA87141-1 (pair of 10 mW transceivers) \$251.95. Higher power units (up to 200 mW) available. B. Microwave Associates 24 GHz Gunnplexer. Similar characteristics to 10 GHz unit. MA87820-4 (pair of 20 mW transceivers) \$739.20. C. This support module is designed for use with the MA87141 and MA87820 and provides all of the circuitry for a full duplex audio transceiver system. The board contains a low-noise, 30-MHz fm receiver, modulators for voice and mcw operation, Gunn diode regulator and varactor supply. Meter outputs are provided for monitoring received signal levels, discriminator output and varactor tuning voltage. RXMR30VD assembled and tested \$119.95. D. Complete, ready to use communication system for voice or mcw operation. Ideal for repeater linking. A power supply capable of delivering 13 volts dc at 250 mA (for a 10 mW version), microphone, and headphone and/or loudspeaker are the only additional items needed for operation. The Gunnplexer can be removed for remote mounting to a tower or 2 or 4 foot parabolic antenna. TR10GA (10 GHz, 10 mW) \$399.95. Higher power units available. TR24GA (24 GHz, 20 mW) \$639.95. Also available: horn, 2 and 4 foot parabolic antennas, Gunn, varactor and detector diodes, search and lock systems, oscillator modules, waveguide, flanges, etc. Call or write for additional information. Let ARR take you higher with quality 10 and 24 GHz equipment!

**Advanced
Receiver
Research**

Box 1242 • Burlington CT 06013 • 203 582-9409



105

**Have a name — but need the Call Sign?
Traveling — and want to meet local Hams?**

1985-1986 Amateur Radio

NAME INDEX

By Name and Call. 583 pages



1985-1986 Amateur Radio

GEOGRAPHICAL INDEX

By State, City, Street No. and Call. 653 pages

No frills directories of over 462,000 U.S. Radio Amateurs. 8 1/2 x 11, easy to read format.

- NAME INDEX—\$25.00
- GEOGRAPHICAL INDEX—\$25.00



Add \$3.50 shipping to all orders.



**ham
radio** magazine **BOOKSTORE**

GREENVILLE, NH 03048



HF Equipment		Regular	SALE
IC-735 HF transceiver/SW rcvr/mic		849.00	729.95
PS-55 External power supply		160.00	144.95
AT-150 Automatic antenna tuner		349.00	314.95
FL-32 500 Hz CW filter		59.50	
EX-243 Electronic keyer unit		50.00	
IC-745 9-band xcvr w/1-30 MHz rcvr		999.00	769.95
PS-35 Internal power supply		160.00	144.95
EX-241 Marker unit		20.00	
EX-242 FM unit		39.00	
EX-243 Electronic keyer unit		50.00	
FL-45 500 Hz CW filter (1st IF)		59.50	
FL-54 270 Hz CW filter (1st IF)		47.50	
FL-52A 500 Hz CW filter (2nd IF)		96.50	89.95
FL-53A 250 Hz CW filter (2nd IF)		96.50	89.95
FL-44A SSB filter (2nd IF)		159.00	144.95
HM-10 Scanning mobile microphone		39.50	
SM-6 Desk microphone		39.00	
HM-12 Extra hand microphone		39.50	
MB-12 Mobile mount		19.50	



IC-751 9-band xcvr/1-30 MHz rcvr	1399.00	1089.95
PS-35 Internal power supply	160.00	144.95
FL-32 500 Hz CW filter (1st IF)	59.50	
FL-63 250 Hz CW filter (1st IF)	48.50	
FL-52A 500 Hz CW filter (2nd IF)	96.50	89.95
FL-53A 250 Hz CW filter (2nd IF)	96.50	89.95
FL-33 AM filter	31.50	
FL-70 2.8 kHz wide SSB filter	46.50	
HM-12 Extra hand microphone	39.50	
SM-6 Desk microphone	39.00	
RC-10 External frequency controller	35.00	
MB-18 Mobile mount	19.50	

IC-720A 9-band xcvr • (CLOSEOUT) •	1349.00	699.95
PS-15 20A external power supply	149.00	134.95
FL-32 500 Hz CW filter	59.50	
FL-34 5.2 kHz AM filter	49.50	
BC-10A Memory back-up	8.50	
SM-5 8-pin electret desk mic	39.00	
MB-5 Mobile mount	19.50	

Other Accessories:		Regular	SALE
PS-15 20A external power supply		149.00	134.95
CF-1 Cooling fan for PS-15		45.00	
EX-144 Adaptor for CF-1/PS-15		6.50	
PS-30 Systems p/s w/cord, 6-pin plug		259.95	234.95
OPC Opt. cord, specify 2, 4 or 6 pin		5.50	
SP-3 External base station speaker		49.50	
SP-5 Remote speaker for mobiles		25.00	
CR-64 High stab. ref. xtal (745/751)		56.00	
PP-1 Speaker/patch (specify radio)		139.00	129.95
SM-8 Desk mic - two cables, Scan		69.95	
AT-100 100W 8 band auto. antenna tuner		349.00	314.95
AT-500 500W 9 band auto. antenna tuner		449.00	399.95
AH-1 5-band mobile antenna w/tuner		289.00	259.95
GC-4 World clock • (CLOSEOUT) •		99.95	79.95



HF linear amplifier		Regular	SALE
IC-2KL 160-15m solid state amp w/ps		1795.00	1299.95
6-meter VHF Portable		Regular	SALE
IC-505 3/10W 6m SSB/CW portable		449.00	399.95
BP-10 Internal Nicad battery pack		79.50	
BP-15 AC charger		12.50	
EX-248 FM unit		49.50	
LC-10 Leather case		34.95	

VHF/UHF base multi-modes		Regular	SALE
IC-551D 80W 6-meter SSB/CW		699.00	599.95
EX-106 FM option		125.00	112.95
BC-10A Memory back-up		8.50	
SM-2 Electret desk microphone		39.00	
IC-271A 25W 2m FM/SSB/CW		699.00	569.95
AG-20 Internal preamplifier*		56.95	
IC-271H 100W 2m FM/SSB/CW		899.00	759.95
AG-25 Mast mounted preamplifier*		84.95	
IC-471A 25W 430-450 SSB/CW/FM xcvr		799.00	699.95
AG-1 Mast mounted preamplifier*		89.00	
IC-471H 75W 430-450 SSB/CW/FM		1099.00	969.95
AG-35 Mast mounted preamplifier*		84.95	

For a Limited time!
 With the purchase of an IC-271A/H or IC-471A/H get the matching PREAMP* for only • \$1.00 Extra.

Accessories common to 271A/H and 471A/H			
PS-25 Internal power supply for (A)		99.00	89.95
PS-35 Internal power supply for (H)		160.00	144.95
PS-15 External power supply		149.00	134.95
SM-6 Desk microphone		39.00	
EX-310 Voice synthesizer		39.95	
TS-32 CommSpec encode/decoder		59.95	
UT-15 Encoder/decoder interface		12.50	
UT-15S UT-15S w/TS-32 installed		79.95	

VHF/UHF mobile multi-modes		Regular	SALE
IC-290H 25W 2m SSB/FM, TTP mic		549.00	479.95
IC-490A 10W 430-440 SSB/FM/CW		649.00	579.95

VHF/UHF 1.2 GHz FM		Regular	SALE
IC-27A Compact 25W 2m FM w/TTP mic		369.00	299.95
IC-27H Compact 45W 2m FM w/TTP mic		409.00	359.95
IC-37A Compact 25W 220 FM, TTP mic		449.00	329.95
IC-47A Compact 25W 440 FM, TTP mic		469.00	399.95
PS-45 Compact 8A power supply		112.95	99.95
UT-16/EX-388 Voice synthesizer		29.95	
SP-10 Sim-line external speaker		29.95	
IC-3200A 25W 2m/440 FM w/TTP		549.00	489.95
UT-23 Voice synthesizer		29.95	
AH-32 2m/440 Dual Band antenna		32.95	
Larsen PO-K Roof mount		20.00	
Larsen PO-TLM Trunk-lip mount		20.18	
Larsen PO-MM Magnetic mount		19.63	
IC-1271A 10W 1.2 GHz SSB/CW Base		999.00	889.95
ATV-1200 ATV interface unit		TBA	
PS-25 Internal power supply		99.00	89.95
EX-310 Voice synthesizer		39.95	
UT-15S CTCSS encoder/decoder		79.95	
IC-120 1W 1.2 GHz FM Mobile		499.00	449.95
ML-12 1.2 GHz 10W amplifier		339.00	299.95

Repeaters		Regular	SALE
RP-3010 440 MHz, 10W FM, xtal cont.		999.00	899.95
RP-1210 1.2 GHz, 10W FM, 99 ch synth		1199.00	1089.95
Duplexer 1210 1.2 GHz duplexer		1199.00	1089.95
Cabinet for RP-1210		249.00	



Order Toll Free
Use your Credit Card!

Hand-held Transceivers		Regular	SALE
Deluxe models			
IC-02AT for 2m		349.00	289.95
IC-04AT for 440 MHz		379.00	319.95
Standard models		Regular	SALE
IC-2A for 2m		239.50	189.95
IC-2AT with TTP		269.50	199.95
IC-3AT 220 MHz, TTP		299.95	239.95
IC-4AT 440 MHz, TTP		299.95	239.95

Accessories for Deluxe models		Regular	
BP-7 425mah/13.2V Nicad Pak - use BC-35		67.50	
BP-8 800mah/8.4V Nicad Pak - use BC-35		62.50	
BC-35 Drop in desk charger for all batteries		69.00	
BC-60 6-position gang charger, all batts		SALE 359.95	
BC-16U Wall charger for BP7/BP8		10.00	
LC-11 Vinyl case		17.95	
LC-14 Vinyl case for Dix using BP-7/8		17.95	
LC-02AT Leather case for Dix models w/BP-7/8		39.95	

Accessories for both models		Regular	
BP-2 425mah/7.2V Nicad Pak - use BC35		39.50	
BP-3 Extra Std. 250 mah/8.4V Nicad Pak		29.50	
BP-4 Alkaline battery case		12.50	
BP-5 425mah/10.8V Nicad Pak - use BC35		49.50	
CA-2 Telescoping 2m antenna		10.00	
CA-5 5/8-wave telescoping 2m antenna		18.95	
FA-2 Extra 2m flexible antenna		10.00	
CP-1 Cig. lighter plug/cord for BP3 or Dix		9.50	
DC-1 DC operation pak for standard models		17.50	
LC-2AT Leather case for standard models		34.95	
RB-1 Vinyl waterproof radio bag		30.00	
HH-SS Handheld shoulder strap		14.95	
HM-9 Speaker microphone		34.50	
HS10 Boom microphone/headset		19.50	
HS-10SA Vox unit for HS-10 & Deluxe only		19.50	
HS-10SB PTT unit for HS-10		19.50	
ML-1 2m 2.3w in/10w out amplifier		SALE 79.95	
SS-32M Commspec 32-tone encoder		29.95	

Receivers		Regular	SALE
R-7000 25-2000 MHz, 117V AC		899.00	789.95
RC-12 Infrared remote controller		TBA	
R-71A 100 kHz-30 MHz, 117V AC		\$799.00	649.95
RC-11 Infrared remote controller		59.95	49.95
FL-32 500 Hz CW filter		59.50	
FL-63 250 Hz CW filter (1st IF)		48.50	
FL-44A SSB filter (2nd IF)		159.00	144.95
EX-257 FM unit		38.00	
EX-310 Voice synthesizer		39.95	
CR-64 High stability oscillator xtal		56.00	
SP-3 External speaker		49.50	
CK-70 (EX-299) 12V DC option		9.95	
MB-12 Mobile mount		19.50	



HOURS • Mon. thru Fri. 9-5:30; Sat. 9-3
 Milwaukee WATS line: 1-800-558-0411 answered evenings until 8:00 pm Monday thru Thursday.
Please use WATS lines for Ordering
 use Regular lines for other Info and Service dept.

Order Toll Free: 1-800-558-0411 In Wisconsin (outside Milwaukee Metro Area) 1-800-242-5195

AMATEUR ELECTRONIC SUPPLY[®] Inc.

4828 W. Fond du Lac Avenue; Milwaukee, WI 53216 - Phone (414) 442-4200

AES BRANCH STORES

WICKLIFFE, Ohio 44092
 28940 Euclid Avenue
 Phone (216) 585-7388
 Ohio WATS 1-800-362-0290

ORLANDO, Fla. 32803
 621 Commonwealth Ave.
 Phone (305) 894-3238
 Fla. WATS 1-800-432-9424

CLEARWATER, Fla. 33575
 1898 Drew Street
 Phone (813) 461-4267
 No In-State WATS

LAS VEGAS, Nev. 89106
 1072 N. Rancho Drive
 Phone (702) 647-3114
 No In-State WATS

CHICAGO, Illinois 60630
 ERICKSON COMMUNICATIONS
 5456 N. Milwaukee Avenue
 Phone (312) 631-5181

Outside Ohio 1-800-321-3594

Outside Florida 1-800-327-1917

No Nationwide WATS

Outside Nevada 1-800-634-6227

Outside Illinois 1-800-621-5802

Easy-to-build coax-stub filters help reduce both harmonics and intra-station interference

trapping stubborn harmonics

When you're trying to eliminate interference caused by harmonics, you have to stop the offending signals at the transmitter before they're radiated. In such multi-transmitter situations as Field Day and contests, harmonic interference can mean the difference between an interference-free operation and endless arguments over doing who's doing what to whom. By placing a coax stub filter at your transmitter's output, you can reduce harmonics at the source. What's more, coax-stub filters can also help reduce harmonic-induced TVI.

a simple solution

What makes coax-stub filters an easy solution to the problem is their simplicity; all you need is some coax and a few connectors. And stub filters don't have any coils to wind or capacitors to tweak. They don't require a sweep generator or network analyzer to tune. Just trim the stubs to length with the aid of a noise bridge.

Table 1 lists the HF Amateur bands and the filter combinations you can use to eliminate harmonics and, in the case of 20 meters and 15 meters, intra-band interference and front-end overload in your receiver. Each filter consists of one or two stubs.

how they work

A half-wave, single-stub filter acts as a subharmonic filter by introducing a short circuit into the transmission line at the frequency it's an open-circuited quarter-wave for. At the frequency for which the stub is a half wave, it looks like an open circuit and passes the desired signal.

A quarter-wave, single-stub filter acts as an even-harmonic filter by introducing a short circuit into the

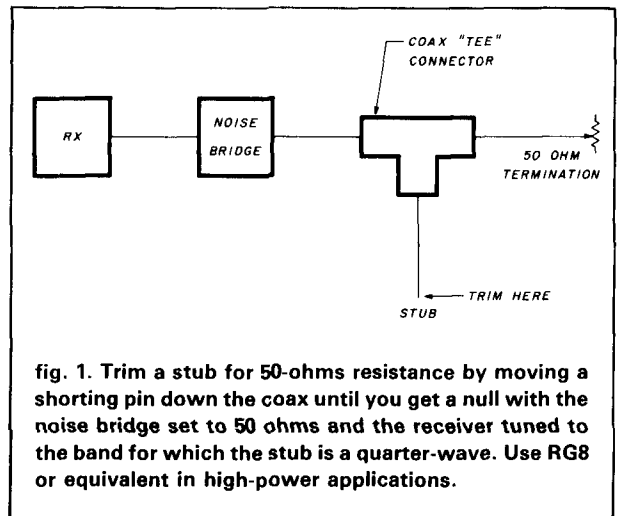

transmission line at the frequency it's a half-wave-length for. At the frequency for which the stub is a quarter wave, it looks like an open circuit and passes the desired signal. Because a shorted quarter-wave stub traps even harmonics, the 160-meter and 80-meter bands need just one filter each to trap all harmonics that fall in the Amateur bands below 30 MHz.

Some of the stubs introduce reactance on the line. In these cases, a second compensating stub tunes out the reactance by introducing an equal and opposite reactance. (The net effect is analogous to a parallel-resonant LC circuit; at resonance, the inductive and

By Robert M. Clarke, N1RC, 150 Stimson Street, West Roxbury, Massachusetts 02132

table 1. HF Amateur bands and filter combinations used to eliminate harmonics.

stub filter ¹ needed to prevent interference to						
band	160	80	40	20	15	10
160	x	$\frac{\lambda}{4}$ S	$\frac{\lambda}{4}$ S	$\frac{\lambda}{4}$ S	$\frac{\lambda}{4}$ S	$\frac{\lambda}{4}$ S
80	x	x	$\frac{\lambda}{4}$ S	$\frac{\lambda}{4}$ S	$\frac{\lambda}{4}$ S	$\frac{\lambda}{4}$ S
40	x	x	x	$\frac{\lambda}{4}$ S	$\frac{\lambda}{12}$ O ²	$\frac{\lambda}{4}$ S
					$\frac{\lambda}{6}$ O ⁴	
20	x	x	x	x	$\frac{\lambda}{6}$ O ²	$\frac{\lambda}{4}$ S
					$\frac{\lambda}{12}$ S ⁴	
15	x	x	x	$\frac{\lambda}{8}$ O ³	x	x
				$\frac{3\lambda}{8}$ O ³		
10	x	x	x	x	x	x

S = short-circuited stub O = open-circuited stub

Notes:

1. Electrical wavelength (feet) = $984 \frac{V}{f}$ = $\frac{300 V}{f}$ = (meters)
where V = velocity factor
f = frequency in MHz
2. This stub is a quarter-wavelength on 15 meters.
3. This stub is a quarter-wavelength on 20 meters.
4. Compensating stub.
5. TVI prevention.

capacitive reactances cancel.) In general, what you do to tune a filter is adjust the half- or quarter-wave stub by itself and then add and trim the compensating stub.

trimming to length

Figure 1 shows the test setup used to trim the stub filters. To make a filter, cut the stubs to the lengths listed in table 1 and add 10 percent to allow for variation in the velocity factor of the coax. Put a connector on one end and open or short-circuit the free end as required by table 1.

In adjusting the stubs, you have two cases to deal with: open-circuited half-wave stubs and short-circuited quarter-wave stubs. Trim the open-circuited stub, at the center frequency of the band for which it is a half-wavelength, until the noise bridge reads 50-ohms resistance with zero reactance.

For case of the shorted stub, trim it in the same way on the center frequency of the band on which it is a quarter wave. This trimming may simply involve moving a shorting pin down the cable until you reach the 50-ohm point. Remember that what you're really doing in this exercise is establishing an integral number of quarter-wavelengths of coax — by short- or open-circuiting a stub, you can treat it as a half- or quarter-wave on a convenient frequency — to arrive at the right length.

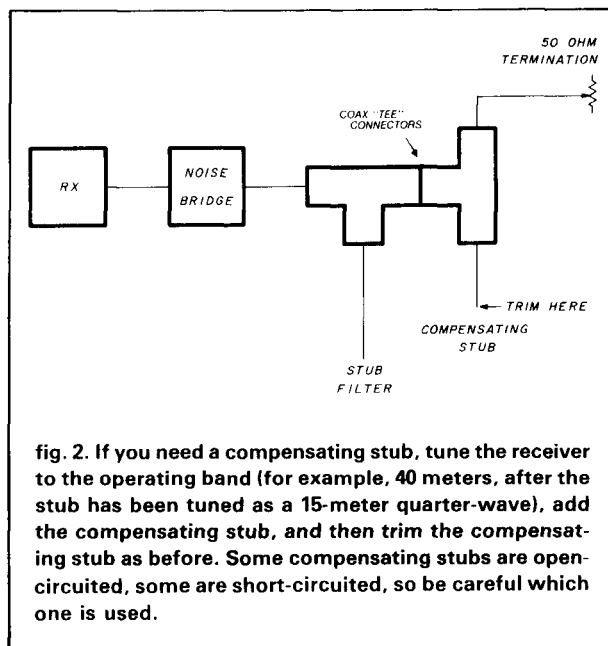

fig. 2. If you need a compensating stub, tune the receiver to the operating band (for example, 40 meters, after the stub has been tuned as a 15-meter quarter-wave), add the compensating stub, and then trim the compensating stub as before. Some compensating stubs are open-circuited, some are short-circuited, so be careful which one is used.

When you add a compensating stub (see fig. 2), trim its length to bring the noise bridge reading to 50-ohms resistance. This trimming adjusts the compensating stub's reactance to cancel out the filter stub's reactance.

velocity factor varies

Electromagnetic energy travels more slowly in a dielectric than it does in free space. The velocity factor is a constant that scales wavelength to reflect the media in which the energy is traveling. Because air is essentially free space, open-wire line with its air-dielectric has a velocity factor of 0.97.

Foam-dielectric coax is mostly air, so its velocity factor is about 0.8. In contrast, solid-dielectric coax, containing practically no air, has a velocity factor of 0.66. One word of caution: although foam-dielectric coax has less loss than solid-dielectric coax, its velocity factor varies with the amount of air in the foam. Consequently, the velocity factor can vary from roll to roll or from section to section of coax within the same roll. Don't assume the velocity factor for any two pieces of foam coax is the same. Always allow extra length in a stub before trimming it to size.

bibliography

- Jordan, Edward C. and Balmain, Keith G., *Electromagnetic Waves and Radiating Systems*, 2nd Edition, Prentice-Hall Inc., Englewood Cliffs, New Jersey, 1968, Chapter 7.
The Radio Amateur's Handbook, 49th Edition, American Radio Relay League, Newington, Connecticut, 1972, Table 20-1, page 569.

ham radio

★ QUALITY PARTS ★ DISCOUNT PRICES ★ FAST SHIPPING!

ALL ELECTRONICS CORP.

SEND FOR
FREE
FALL 1985 CATALOG...
48 PAGES!

EDGE CONNECTORS
ALL ARE 1.56" SPACING.

- 22/44 EDGE CONNECTOR
PC style \$2.00 each
10 for \$18.00
- 22/44 EDGE CONNECTOR
solder lug style \$2.50 each
- 28/56 EDGE CONNECTOR
PC style \$2.50 each
10 for \$22.00
- 36/72 EDGE CONNECTOR
PC style \$3.00 each
- 43/86 EDGE CONNECTOR
PC style \$4.50 each

TRANSISTORS

- 2N706 4 for \$1.00
- 2N2222A 3 for \$1.00
- PN2222A 4 for \$1.00
- 2N2904 3 for \$1.00
- 2N2904 3 for \$1.00
- MJ2955 \$1.50
- 2N3055 \$1.00
- PMD 10K40 \$1.00
- TIP 121 75¢
- TIP 125 75¢

***SPECIAL PRICE* TRANSISTOR**

PN3569 TO-92 N.P.N.
plastic transistor
100 for \$8.00
1000 for \$60.00
LARGE QUANTITIES AVAILABLE

TRANSFORMERS

- 120 volt primaries
- 5.6 volts @ 750 ma. \$3.00
- 6 volts @ 150 ma. \$1.25
- 20 v.c.t. @ 200 ma. \$2.00
- 18 volts @ 500 ma. \$3.50
- 24 v.c.t. @ 1 amp \$4.50
- 24 v.c.t. @ 200 ma. \$2.50
- 24 v.c.t. @ 400 ma. \$3.00
- 28 v.c.t. @ 15 amps \$20.00
- 30 v.c.t. @ 2 amps \$5.00

WALL TRANSFORMERS

- all plug directly into 120 vac outlet
- 4 VDC @ 70 ma. \$2.00
- 6 VAC @ 500 ma. \$3.50
- 6 VDC @ 750 ma. \$6.50
- 9 VDC @ 500 ma. \$5.00
- 12.5 VAC @ 265 ma. \$3.00
- 24 VAC @ 250 ma. \$3.00
- MULTI-VOLTAGE @ 500 ma \$7.50
- 3.4, 6.7, 9, or 12 VDC

MINI-BOX

Pomona #2104
Heavy-duty black phenolic project box with cover and screws 2 1/2" x 1 1/2" x 1 1/2" \$1.00 EACH

SOUND AND VIDEO MODULATOR FOR T.I. COMPUTER

T.I. # UM1381-1 Designed for use with T.I. computers. Can be used with video sources. Built-in A/B switch. Channel 3 or 4 selection switch. Operate on 12 vdc. Hook-up diagram included.
\$10.00 EACH

SLIM LINE COOLING FAN

Etrr # 99XMT182 low noise fan Measures 2 3/4" square x 1" deep 21 cfm, 23 db, 1700 rpm
SPECIAL PRICE... \$12.50 each

2K 10 TURN MULTI-TURN POT
SPECTROL #MOD 534-7161
\$5.00 EACH

SOLID STATE BUZZER
Star #SMB-06L
6 vdc
TTL compatible
\$1.00 each
10 for \$9.00

± 12 Vdc or 24Vdc POWER SUPPLY

DELTRON MODEL QD12/15-1.7 Dual plus and minus 12Vdc open frame power supply. Can be used as 24Vdc @ 1.5 amp. INPUT: either 115 Vac or 230 Vac Fully regulated computer grade supply. 7" x 4 3/4" x 2 3/8"
\$12.50 each 10 for \$110.00

DECEMBER* SPECIALS

ALL 1/4 WATT RESISTORS
1000 pcs of one value \$7.50

ALL 1/2 WATT RESISTORS
1000 pcs of one value \$9.50

1 AMP 50 VOLT DIODES
(N400) TAPE AND REEL
100 for \$4.50
1000 for \$30.00

D STYLE CONNECTORS
DB25 PLUS 10 for \$11.00
100 for \$100.00
DB25 SOCKET 10 for \$12.50
100 for \$110.00

SOLDER TAIL I.C. SOCKETS
24 PIN 10 for \$2.50
100 for \$22.00
1000 for \$200.00

8" P.A. SPEAKER

C T S Model 8B3079 8 ohms coil \$5.00 each
3.0 oz ferrite magnet
Typical response range 100 - 10,000 hz.
Power rating 15 watts max.
Drilled to mount line matching transformers.
CASE OF 8 SPEAKERS \$32.00

LINE CORDS

- TWO WIRE**
 - 6 1/8" 2 SPT-1 flat 3 for \$1.00
 - 6 1/8" 2 SPT-2 flat
 - 6 1/8" 2 SJT round \$1.25 each
- THREE WIRE**
 - 6 1/8" 3 flat \$1.50 each
 - 6 1/8" 3 round \$2.00 each
 - 6 1/8" 3 round \$4.00 each

RELAYS

10 AMP SOLID STATE
CONTROL: 3 - 32 vdc
LOAD: 140 vac 10 amp
SIZE: 2 1/2" x 3/4" x 7/8"
\$9.50 EACH 10 FOR \$90.00

ULTRA-MINIATURE 5 VDC RELAY
Fujitsu # FBR211NE005M20
High sensitivity
COIL: 120 ohms
CONTACTS: 1 amp
Mounts in 14 pin DIP socket
\$1.25 each 10 for \$10.00

MINIATURE 6 VDC RELAY
Aromat #RSD-6V
Super Smart
S.P.D.T. relay
Gold contact
Contact rated
1 amp @ 30 vdc. Highly sensitive.
TTL direct drive possible. 120 ohm coil.
Operate from 4 - 6 vdc
COIL: 120 ohms \$1.50 each
1 1/2" x 1 1/2" x 7/8" 10 for \$13.50

***SPECIAL PRICE* DUAL L.E.D. DISPLAYS**

560 high, 7 segment L.E.D. read-outs. Mount in 24 pin DIP sockets...
MAN-6640 orange, c.c. 75¢ each
FND-5148 red, c.c. 75¢ each
DL-527 red, c.a. 75¢ each

CASSETTE MECHANISM

New stereo cassette mechanism includes record/playback and erase heads. 2-12VDC motors drive belts, pulleys. 3-12VDC solenoids, pinch wheels, and other mechanical parts. These parts used on other current model decks would cost several times our selling price if purchased separately. Build your own audio or data recorder or use for spare parts.
\$75.00 EACH 2 FOR \$125.00

3 1/2" SPEAKER

8 ohm impedance. Full range speaker
8 oz magnet
4" diagonal mounting centers
\$2.50 each 10 for \$20.00

SPRING LEVER TERMINALS

Two color coded terminals on a sturdy 2 1/2" x 3/4" bakelite plate. Great for speaker enclosures or power supplies.
75¢ EACH 10 FOR \$7.00

CASSETTE MIKE

Dynamic cassette mike with 3.5mm plug and on/off switch.
\$1.50 EACH 10 FOR \$13.50

COMPUTER GRADE CAPACITORS

- 2,000 mfd. 200 VDC 1 1/4" DIA. x 5" HIGH \$2.00
- 3,600 mfd. 40 VDC 1 1/4" DIA. x 3 3/4" HIGH \$1.00
- 6,400 mfd. 60 VDC 1 1/4" DIA. x 4 1/4" HIGH \$2.50
- 9,700 mfd. 50 VDC 1 1/4" DIA. x 4 1/2" HIGH \$3.00
- 31,000 mfd. 15 VDC 1 3/4" DIA. x 4" HIGH \$2.50
- 72,000 mfd. 15 VDC 2" DIA. x 4 1/4" HIGH \$3.50
- 185,000 mfd. 6 VDC 2 1/2" DIA. x 4 1/2" HIGH \$1.50

MINIATURE TOGGLE SWITCHES
ALL ARE RATED 5 AMPS @ 125 VAC

- S.P.D.T. (on-on)**
PC style non-threaded bushing
75¢ each 10 for \$7.00
- S.P.D.T. (on-off-on)**
Solder lug terminals
\$1.00 each 10 for \$9.00
100 for \$80.00
- S.P.D.T. (on-off-on)**
PC style non-threaded bushing
75¢ each 10 for \$7.00
- S.P.D.T. (on-on)**
PC lugs threaded bushing
\$1.00 each 10 for \$9.00
100 for \$80.00
- D.P.D.T. (on-on)**
Solder lug terminals
\$2.00 each 10 for \$19.00
100 for \$180.00

TWIST-LOCK CONNECTOR

Same as Switchcraft #12CL5M 5 conductor in-line plug and chassis mount jack. Twist-lock style
\$2.50/SET

TI SWITCHING POWER SUPPLY

Compact, well-regulated switching power supply designed to power Texas Instruments computer equipment.
INPUT: 14 - 25 vac @ 1 amp
OUTPUT: - 12 vdc @ 350 ma.
5 vdc @ 1.2 amp
- 5 vdc @ 200 ma
SIZE: 4 3/4" x 4 1/4" x 1 1/4" high \$5.00 each

13.8 VDC REGULATED POWER SUPPLY

These are solid state, fully regulated 13.8 vdc power supplies. Both feature 100% solid state construction, fuse protection, and L.E.D. power indicator. U.L. listed.
2 amp constant, 4 amp surge \$18.00 each
3 amp constant, 5 amp surge \$25.00 each

D.C. CONVERTER

Designed to provide a steady - 5 vdc @ 240 ma. from a battery supply of 3.5 to 6.25 volts.
2 1/16" x 1 1/16" x 1 1/16" \$1.50 each

7 CONDUCTOR RIBBON CABLE

Spectra-strip red marker strip. 28 ga. stranded wire
\$5.00 per 100 roll

13 VDC RELAY

CONTACTS: S.P.N.C. 10 amp @ 120 vac
Energize coil to open contact.
COIL: 13 vdc 650 ohms
SPECIAL PRICE \$1.00 each

4PDT RELAY

14 pin KH style... 3 amp contacts... USED but fully tested. \$1.70 each
Specify coil voltage desired
Either 24 vdc or 120 vac
LARGE QUANTITIES AVAILABLE
SOCKETS FOR KH RELAY 75¢ each

ROTARY ACTION MICRO

OMRON #C-9G3 C41
Clockwise action micro used in coin operated mechanisms and low torque operations.
RATED 5 amps @ 125 Vac.
\$1.25 each 10 for \$11.00
LARGE QUANTITIES AVAILABLE.

SNAP ACTION SWITCH

Cherry elect. #E-21 N.O. or N.C. 0.1A contacts. Suitable for alarms and other low energy circuits.
1 1/2" lever
45¢ EACH 10 FOR \$4.20

STANDARD JUMBO DIFFUSED T 1/2

- RED 10 for \$13.00
100 for \$110.00
- GREEN 10 for \$2.00
100 for \$17.00
- YELLOW 10 for \$2.00
100 for \$17.00

FLASHER LED

5 volt operation red jumbo T 1 1/4 size \$1.00 each

BI-POLAR

jumbo T 1 1/4 size 2 for \$1.70

LED HOLDERS

Two piece holder for jumbo LED 10 for 65¢ 100 for \$5.00

CLEAR CLIPLETE LED HOLDER

Make LED a fancy indicator. Clear. 4 for \$1.00

D.P.S.T. LIGHTED ROCKER SWITCH

115 vac lighted rocker, snap mounts in 1/2" x 1 1/4" hole. Orange lens. 16 amp contact \$1.50

MINI-PUSH BUTTON

S.P.S.T. momentary normally open 1/4" bushing. Red button 35¢ each 10 for \$3.00

KEY ASSEMBLY

5 KEY \$1.00 each normally open switches. Measures 3/8" long

6 KEY

\$1.25 each contains 6 single-pole normally open switches. Measures 4 1/4" long

METAL OXIDE VARISTOR

Popular GE # 130L A10A varistor 1/2" diameter. \$1.25 each

ALL ELECTRONICS CORP.
LOS ANGELES, CA STORE
905 S. Vermont Ave.
213 380-8000
VAN NUYS, CA STORE
6228 Sepulveda Blvd.
818 997-1806

MAIL ORDERS TO:
P.O. BOX 20406
Los Angeles, CA 90006
TWX - 5101010163 ALL ELECTRONIC
EASYLINK MBX - 62887748

TOLL FREE ORDERS ONLY
1-800-826-5432
(ORDER ONLY)
(IN CALIFORNIA) 1-800-258-6666
ALASKA, HAWAII, OR INFORMATION
(213) 380-8000 NO C.O.D.!

QUANTITIES LIMITED
MINIMUM ORDER \$10.00
USA: \$3.00 SHIPPING
FOREIGN ORDERS:
INCLUDING SUFFICIENT SHIPPING
CALIF. RES. ADD 6 1/2%



the HAM STATION

P.O. Box 4405
220 N. Fulton Ave.
Evansville, IN 47710

Stores Hours
MON-FRI 9AM-6PM
SAT 9AM-3PM

WARRANTY SERVICE CENTER FOR:
ICOM, YAESU, TEN-TEC

TERMS:

Prices Do Not Include Shipping.
Price and Availability Subject to
Change Without Notice
UPS COD \$2.50 Per Package

USED EQUIPMENT

AZDEN	
PCS-300 2M H.T.	\$174.95
PCS-3000 w/Remote Cable	199.95
PCS-4000	199.95
DENTRON	
GLT 1000C Tuner	\$139.95
80-10 At Tuner	29.95
DRAKE	
UV-3 (2M & 440) TT MIC, PS-4	\$429.00
1.5 KHZ Filter	25.00

ENCOMM

ST 144 2M H.T.	\$185.00
HT 1200 2M H.T.	139.50
ST-440 440 MHZ H.T.	179.95
ST-77 440 MHZ H.T.	109.95
HL-32V 2/30 Amp	59.95
ST-8BC Base Chgr	19.00

HAL

MPT-3100 (NO MONITOR)	\$1775.00
CT2200/KB2100	525.00
CRI-200 Interface	199.95
HEATHKIT	
SB-200 Amp	\$329.95
HR-1680 RCVR	79.95
HM-102 WATT MTR	40.00
VL 1180 10/80W 2M Amp	89.95
IM-4190 VHF-UHF MTR	89.95

ICOM

745/PS	\$715.00
720A/CW	599.95
740/PS	639.95
740 XCVR	549.95
730, PBT, CW	509.95
730 XCVR	459.95
260A 2M All Mode	269.95
255A 2M	185.00
3AT 220 MHZ	189.95
PS 15 Power Supply	99.95
Phone Patch 720, 730, 740	99.95
2AT-2M H.T.	159.50

KANTRONICS

Interface II	\$179.95
Varifilter	49.95
Miniterminal	109.95
Amtor Soft (VIC 20)	29.29

KENWOOD

TS820S	\$459.95
TS120S	369.95
TS520, CW	419.95
TS520SE	429.95
TS520	389.95
TR2600 2M H.T.	229.95
TR2400 2M H.T.	169.95
TR8400 440 MHZ	229.95

KENWOOD

RM-76 MicroProcessor	45.00
BS-5 Pan Kit	49.00
DC Module (520 or 820)	55.00
PC-1 Phone Patch	49.00
ST-1 Basechgr-2400	39.00
SPKR/MIC-2400	25.00
SPKR/MIC-2500	25.00

TEN-TEC

Titan Amp	\$1850.00
OMNI-C	599.95
OMNI A/B	299.95
Century 22	289.00
Century 21	209.00
214 Electret MIC	35.00
2591 2M H.T.	189.95

YAESU

FT980	1150.00
FT901DM, CW, Fan	579.95
FT901DM, Fan, CW, SSB Filters	599.95
FV-901DM Remote VFO	169.00
FT101ZD, CW, Fan	549.95
FT101ZD MKII, Fan	549.95
FT101ZD MKIII	549.95
FT101Z, CW, Fan	459.95
FV101Z Remote VFO	105.00
FT101E	449.00
FT101B	369.50
FT107M/DMS/FP107E PS	569.00
FL101/FR101S	350.00
YC-601 Dig. Readout	175.00
FT221 2 MTR All Mode	269.95
207R 2M H.T.	139.50
FBA-2 Sleeve	3.75
FL-110 Amp	149.95
YD 148 Desk Mic	29.00
FP-757 HD	140.00

MISC

Cubic Astro 150	\$329.95
Collins 75S-3/CW Narrow	249.95
Collins 32S-3 XMTR/516F-2	399.95
Microlog Air-1 w/Amtor 64	189.00
55 FT. Crank up (* SQ FT.)	399.95
Hygain CD-45 Rotator	109.95

MISC

Vic 20 Computer	55.00
KDK-2016/TT MIC	169.95
Shure 444 MIC	29.00
Weiz SP-600 MTR	89.95

DEMONSTRATORS

AEA		\$ 45.00
MBA-20 Text		
AMERITRON		\$1225.00
AL-1200 Amp		
ENCOMM		
ST200 ET 2M H.T.	\$ 159.95	
ST-442 440 MHZ H.T.	249.95	
HT-7 440 MHZ H.T.	79.95	
ST-4QC 4-8 HR Base Chgr	54.95	
HAL		
CRI-200 Computer Interface	\$225.00	
CRI-100 Computer Interface	199.95	
ICOM		
751/PS	\$1089.95	
NYE		
MB-V Tuner	\$399.00	
VOCOMM		
25/100W 2M Amp	\$109.95	
YAESU		
270RH/Voice	\$350.00	
SP980 Spkr/Filters	42.50	
NC-8 Base Chgr	79.95	

CLOSE-OUT

AEA		\$279.95
AMT-1 Interface		
KT-3 Keyer/Trainer	109.95	
Woodpecker Blanker	109.95	
DRAKE		
7000-E CW, Rtty, Ascil	\$299.95	
ENCOMM		
ST-442 440MHZ H.T.	\$259.95	
ST-222 220MHZ H.T.	259.95	
ICOM		
PS 20 PS/Spkr	\$149.95	
7070 Interface	89.95	
KANTRONICS		
Radio-Tap SWL Interface	\$129.95	

For Orders and Price Checks Call 800-523-7731

Indiana call 1-812-422-0231
Service Dept. 1-812-422-0252

TOWERS

by ALUMA

HIGHEST QUALITY ALUMINUM

- TELESCOPING (CRANK-UP)
- GUYED (STACK-UP)
- TILT-OVER MODELS

Easy to install. Low Prices.
Crank-ups to 100 ft.

EXCELLENT FOR AMATEUR COMMUNICATIONS



Mobile Trailer Type



Mobile Truck Type

Over 36 types aluminum and steel towers made—specials designed and made—write for details

SPECIAL Four Section 50 Ft. Van Mounted Crank-Up Aluma Tower



ALUMA TOWER CO.
BOX 2806HR
VERO BEACH, FLA. 32960-2806
(305) 567-3423 TELEX 80-3405

POPULAR PA 19 Wideband Preamp

- Over 8,000 sold
- 0.5 - 200 MHz
- 19 dB gain
- 50 Ω in/output
- For receivers, counters, transmitter amp stages
- Built, tested & ready-to-go

ONLY \$9.95 + \$1 shipping

NEW POCKET SIZED 500 MHz Freq. Counter

- Fits in your shirt pocket
- Uses 1 9-volt battery
- 4 digit LED readout, 6 digit resolution
- 1 MHz - 500 MHz
- Great addition to shack and toolbox

ONLY \$49.95 + \$2 shipping



DIGITREX
1005 BLOOMER
ROCHESTER, MI 48063
WEST COAST DISTRIBUTOR
R. LUKASZEWICZ
20610 ALAMINOS DRIVE SAUGUS, CA 91350
(805) 252-6021

This publication is available in microform from University Microfilms International.



Please send information about these titles:

Name _____

Company/Institution _____

Address _____

City _____

State _____ Zip _____

Phone (____) _____

Call toll-free 800-521-3044. In Michigan, Alaska and Hawaii call collect 313-761-4700. Or mail inquiry to: University Microfilms International, 300 North Zeeb Road, Ann Arbor, MI 48106.

L-band ground wave propagation program

Update your VHF/UHF propagation program to include three additional ham bands

The increasing popularity of VHF/UHF communications has prompted us to expand our computer programs, described previously in *ham radio*, to include three additional ham bands.¹ If you have a working copy of the VHF propagation prediction program listed in our earlier article, you can easily update it to include the 1215-1300, 2300-2450, and 3300-3500 MHz ham bands by using the modifications described below.

L-band propagation data

The data for propagation predictions we used is taken from the ESSA Technical Report.² The curves from which we derived the L-band data are for 1.6 GHz (1600 MHz), but the program scales any input frequency from 1.0 to 3.5 GHz by a $20 \log (f/f_{REF})$ factor to accommodate all three ham bands within this frequency range. Although the original program included ground-to-air and air-to-air data, we have included only ground-to-ground data here, since most of you will not be working these bands aeronautical mobile.

entering the program

It's not necessary to type the entire new program into your computer.

If you have a Commodore 64 or 128PC, you can easily add the new data to your old program. First load your old program, then type the new lines listed in fig. 1, hitting <RETURN> at the end of each new line

typed. The BASIC editor will automatically replace the old line numbers in the program with the new ones, and the new data lines (4000-4610) will be automatically added to the end of the program. Now save the new program to either tape or disk (using a new program name such as "Propagation V2.0"), and you have a propagation program covering 100 MHz through 3.5 GHz.

Changes to the TI-99/4A program are similar, but because of the limited RAM in this computer, you'll need a separate program for each band (see previous article). Load your VHF program and then do the following:

- Delete the VHF data (lines 2005-2610)
- In lines 14, 38, and 430, change "VHF" to "L-BAND"
- In lines 38 and 426, change "100" to "1000"
- In lines 40 and 428, change "175" to "3500"
- In line 70, change "GOSUB 2005" to "GOSUB 4005"
- In line 258, change "100-175" to "1000-3500"
- In line 424, change "125" to "1600"

Now add the L-band data statements (lines 4005-4610) from the Commodore program listing in fig. 1 and save your new program.

If you've entered our previous program into another brand of computer, make the appropriate changes for your computer.

using the programs

Use of the new version is no different than use of the previous VHF/UHF programs, except that only ground-to-ground data has been included.¹ (When the program is running and you're asked to select your antenna height from the menu, select only heights of 25, 50, 100, or 500 feet.)

By Lynn A. Gerig, WA9GFR, R.R. #1, Monroeville, Indiana 46773, and Joseph R. Hennel, 4316 Winston Drive, Ft. Wayne, Indiana 46806

```

10 PRINTCL#:PRINT" VHF/UHF/L-BAND PROPAGATION PROGRAM
14 PRINT:PRINT" V2.0 C 1985 BY
50 PRINTCL#:PRINT"THIS PROGRAM CALCULATES EXPECTED RANGES
52 PRINT"FOR VHF (100-175 MHZ) UHF (225-400 MHZ)
54 PRINT"AND L-BAND (1-3.5 GHZ). APPROXIMATE
100 PRINTCL#"PRESS <V> FOR VHF, <U> FOR UHF, OR <L> FOR L-BAND":PRINT
108 IFF#="L"THENPRINT"ENTERING L-BAND DATA":GOSUB4000:GOTO200
110 GOTO102
300 PRINTCL#;:IFF#<>"L"THEN PRINTF#"HF PROPAGATION: FREQ ="F"MHZ
301 IFF#="L"THEN PRINT"L-BAND PROPAGATION: FREQ ="F"MHZ
4000 F1=1600:FL=1000:FU=3500:REM L-BAND DATA
4005 H*( 1, 1)="140010175024190050200088224208
4010 H*( 1, 2)="140012175028190057200092225212
4015 H*( 1, 3)="140014175032190060200098225218
4020 H*( 1, 4)="140030175045190070200106225225
4080 H*( 2, 2)="130009175030190060200095230240
4085 H*( 2, 3)="130010175035190065200100230245
4090 H*( 2, 4)="135027175052190078200110230258
4150 H*( 3, 3)="130015175040190065200105230250
4155 H*( 3, 4)="135035175055190078200120230260
4215 H*( 4, 4)="135040136050175067195100235300
4610 RETURN

```

fig. 1. BASIC LIST of Commodore 64 program changes.

If you don't want to make these changes yourself, or if you want a verified copy of the entire program (including the ground-to-air and air-to-air data), send a blank tape or formatted disk (tape only for the TI version) with a stamped, self-addressed return mailer and a check or money order for \$5.00. If you want a full program listing, send an SASE (with 2 first-class units of postage) and \$1.00. Send all Commodore requests to Lynn A. Gerig, and all TI requests to Joseph R. Hennel, at the addresses listed at the beginning of this article.

references

1. Lynn A. Gerig, WA9GFR, and Joseph R. Hennel, "Trade off Power for Antenna Gain at VHF?," *ham radio*, July, 1985, page 32.
2. *ESSA Technical Report ERL 111-ITS 79, Transmission Loss Atlas for Select Service Bands from 0.125 to 15.5 GHz*, Institute for Telecommunication Sciences, Boulder, Colorado, May, 1969. (Available for \$1.25 from Superintendent of Documents, United States Government Printing Office, Washington, D.C. 20402.)

ham radio

MAKE CIRCUIT BOARDS THE NEW, EASY WAY



WITH TEC-200 FILM

JUST 3 EASY STEPS:

- Copy circuit on TEC-200 film using any plain paper copier
- Iron film on to copper clad board
- Peel off film and etch

SATISFACTION GUARANTEED
convenient 8½ x 11 size

5-Sheet Starter Pack \$3.95

10 sheets only \$5.95

add \$1.00 postage — NY res. add sales tax

The MEADOWLAKE Corp.

Dept. R, P.O. Box 497
Northport, New York 11768

AUTHORIZED KENWOOD I-COM RADIO DEALER



H. L. HEASTER, INC., 203 Buckhannon Pike, Clarksburg, W. Va. 26301 Clarksburg Phone (304) 624-5485 or W. Va. Toll-Free 1-800-352-3177

HAROLD HEASTER, KA8OHX, 91 Ridgfield Place, Ormond Beach, Fl. 32074 Florida Phone (904) 673-4066

NEW NATION-WIDE TOLL-FREE TELEPHONE 1-800-84-RADIO
1-800-84-72346

Call us for a quotation, WE WILL SAVE YOU MONEY!

THE COMMODORE COMBINATION!



COMMAND
POST

As featured on Radio Sweden,
Radio Netherlands and the
WSYI Report.

The Commodore Ham's Companion: A 160 page paperback guide to using your Commodore computer in the ham shack. Good solid information on where to find software and hardware to use for CW, RTTY, AMTOR, SSTV, packet propagation prediction, antenna modeling, satellite tracking and much more. Includes a list of over 80 sources of Commodore amateur radio software and hardware and a bibliography of over 60 magazine articles and reviews about using Commodore machines in the ham shack.

"Command Post" A 32 page reprint of the popular Command Post column that includes basic language program listings you can type in for CW and RTTY send and receive, dupe checking, program exchange and more. It also serves as a tutorial on the basics of interfacing Commodore machines for control operations.

Commodore Ham's Companion \$15⁹⁵

Command Post \$9⁹⁵

SPECIAL \$19⁹⁵ for both books when ordered together

\$2.50 First Class shipping and handling applies on all U.S. orders

Mastercard and Visa accepted.



P.O. Box 3042
Springfield, IL
62708



\$30.00 OFF

Save \$30 on the RAMSEY 20MHz Dual Trace Oscilloscope

Unsurpassed quality at an unbeatable price, the Ramsey oscilloscope compares to others costing hundreds more. Features include a component testing circuit for resistor,

capacitor, digital circuit and diode testing • TV video sync filter • wide bandwidth & high sensitivity • internal graticule • front panel trace rotator • Z axis • high sensitivity x-y mode • regulated power supply • built-in calibrator • rock solid triggering

Was \$399.95 NOW ONLY **\$369.95** high quality hook on probes included



NEW RAMSEY 1200 VOM MULTITESTER

Check transistors, diodes and LEDs with this professional quality meter. Other features include: decibel scale • 20k volt metering system • 3 1/2" mirrored scale • polarity switch • 20 measuring ranges • safety probes • high impact plastic case

\$19.95 test leads and battery included



NEW RAMSEY D-4100 COMPACT DIGITAL MULTITESTER

Compact sized reliability and accuracy. This LCD digital multimeter easily fits in your pocket, you can take it anywhere. It features full overload protection • 3 1/2 digit LCD readout • recessed input jacks • safety probes • diode check function • 2000 hours battery life

\$22.95 test leads and battery included

NEW 35 MHz DUAL TRACE OSCILLOSCOPE



A heavy duty and accurate scope for service as well as production use. Features include • wide frequency bandwidth • optimal sensitivity • extremely bright display • delayed triggering sweep • hold off • ALT trigger • single sweep • TV sync • 5X magnification • XY or XYZ operation • HF/LF noise reduction

3500 Dual Trace Oscilloscope

\$499.95 includes 2 high quality probes

ALL OSCILLOSCOPES INCLUDE 2 PROBES

NEW 15 MHz DUAL TRACE PORTABLE OSCILLOSCOPE



Ideal for field/bench applications, this scope can display up to 15 MHz signals. Internal battery pack allows up to 2 hours operation on a single charge. Features include • built-in battery charger • 5X horizontal magnification • high brightness CRT • front panel trace rotator • internal rechargeable battery pack

2500 Portable Oscilloscope

\$449.95 includes 2 high quality probes

MINI KITS—EASY TO ASSEMBLE, FUN TO USE BEGINNERS & PROS WILL HAVE A GREAT TIME WITH THESE KITS

FM MINI MIKE



A super high performance FM wireless mike kit! Transmits a stable signal up to 300 yards with exceptional audio quality by means of its built-in electret mike. Kit includes case, mike, on-off switch, antenna, battery and super instructions. This is the finest unit available!

FM-3 Kit **\$14.95**
FM-3 Wired and tested **19.95**

Color Organ

See music come alive! 3 different lights flicker with music. One light each for high, mid-range and lows. Each individually adjustable and drives up to 300 W runs on 110VAC

Complete kit, ML-1 **\$8.95**

Video Modulator Kit
Converts any TV to video monitor. Super stable. Tunable over ch. 4-6. Runs on 5-10V. accepts slit video signal. Best unit on the market! Complete kit VSD-1 **\$7.95**



Led Blinky Kit
A great attention getter which alternately flashes 2 jumbo LEDs. Use for name badges, buttons, warning panel lights, anything! Runs on 3 to 15 volts. Complete kit, BL-1 **\$2.95**

Super Sleuth
A super sensitive amplifier which will pick up a pin drop at 15 feet! Great for monitoring baby's room or as general purpose amplifier. Full 2W rms output, runs on 6 to 15 volts, uses 6-45 ohm speaker. Complete kit, BN-9 **\$5.95**

CPO-1
Runs on 3-12 Vdc 1 watt out. 1 KHz good for CPO Alarm. Audio Oscillator. Complete kit **\$2.95**

FM Wireless Mike Kit



Transmits up to 300 to any FM broadcast radio, uses any type of mike. Runs on 3 to 9V. Type FM-2 has added sensitive mike preamp stage.

FM-1 Kit **\$3.95** FM-2 Kit **\$4.95**

Whisper Light Kit

An interesting kit, small mike picks up sounds and converts them to light. The louder the sound, the brighter the light! Includes mike, controls up to 300 W runs on 110 VAC. Complete kit, WL-1 **\$6.95**

Tone Decoder

A complete tone decoder on a single PC board. Features 400-5000 Hz adjustable range via 20 turn pot, voltage regulation, 567 IC. Useful for touch-tone burst detection, FSK, etc. Can also be used as a stable tone encoder. Runs on 5 to 12 volts. Complete kit, TD-1 **\$5.95**

Universal Timer Kit

Provides the basic parts and PC board required to provide a source of precision timing and pulse generation. Uses 555 timer IC and includes a range of parts for most timing needs.

UT-5 Kit **\$5.95**

Mad Blaster Kit

Produces LOUD ear shattering and attention getting siren like sound. Can supply up to 15 watts of obnoxious audio. Runs on 6-15 VDC. Complete kit, MB-1 Kit **\$4.95**

Siren Kit

Produces upward and downward wail characteristic of a police siren. 5 W peak audio output, runs on 3-15 volts, uses 3-45 ohm speaker. Complete kit, SM-3 **\$2.95**

30 Watt 2 mtr PWR AMP

Simple Glass C power amp features 8 times power gain. 1 W in for 8 out, 2 W in for 15 out, 4 W in for 30 out. Max output of 35 W, incredible value, complete with all parts, less case and T-R relay.

PA-1, 30 W pwr amp kit **\$2295**

TR-1, RF sensed T-R relay kit **695**

Power Supply Kit

Complete triple regulated power supply provides variable 6 to 18 volts at 200 ma and +5 at 1 Amp. Excellent load regulation, good filtering and small size. Less transformers, requires 6 3/4" (x 1 A and 24 VCT. Complete kit, PS-3LT **\$6.95**

CT-70 7 DIGIT 525 MHz COUNTER

Lab quality at a breakthrough price. Features • 3 frequency ranges each with pre amp • dual selectable gate times • gate activity indicator • 50mV @ 150 MHz typical sensitivity • wide frequency range • 1 ppm accuracy

\$119.95 wired includes AC adapter

CT-70 kit **\$99.95**

BP-4 nicad pack **8.95**

CT-90 9 DIGIT 600 MHz COUNTER

The most versatile for less than \$300. Features 3 selectable gate times • 9 digits • gate indicator • display holds • 25mV @ 150 MHz typical sensitivity • 10 MHz timebase for WWV calibration • 1 ppm accuracy

\$149.95 wired includes AC adapter

CT-90 kit **\$129.95**

OV-1 0.1 PPM oven timebase **\$9.95**

BP-4 nicad pack **8.95**

CT-50 8 DIGIT 600 MHz COUNTER

\$169.95 wired

CT-50 kit **\$139.95**

RA-1 receiver adapter kit **14.95**

CT-125 9 DIGIT 1.2 GHz COUNTER

\$169.95 wired includes AC adapter

BP-4 nicad **\$8.95**

DM-700 DIGITAL MULTIMETER

Professional quality at a hobbyist price. Features include 26 different ranges and 5 functions • 3 1/2 digit, 1/2 inch LED display • automatic decimal placement • automatic polarity

\$119.95 wired includes AC adapter

DM-700 kit **\$99.95**

MP-1 probe set **4.95**

PR-2 COUNTER PREAMP

The PR-2 is ideal for measuring weak signals from 10 to 1,000 MHz • flat 25 db gain • BNC connectors • great for shifting RF • ideal receiver-TV preamp

\$449.95 wired includes AC adapter

PR-2 kit **\$34.95**

PS-2 AUDIO MULTIPLIER

The PS-2 is handy for high resolution audio resolution measurements, multiplies up in frequency • great for PL tone measurements • multiplies by 10 or 100 • 0.01 Hz resolution • built-in signal preamp/conditioner

\$49.95 wired

PS-2 kit **\$39.95**

PS-10B 1 GHz PRESCALER

Extends the range of your present counter to 1 GHz • 2 stage preamp • divide by 1000 circuitry • super sensitive (50 mV typical) • BNC connectors • 1 GHz in, 1 MHz out • drives any counter

\$79.95 wired includes AC adapter

PS 10-B Prescaler **\$79.95**

ACCESSORIES FOR RAMSEY COUNTERS

- Telescopic whip antenna—BNC plug **\$ 8.95**
- High impedance probe, light loading **16.95**
- Low pass probe, audio use **16.95**
- Direct probe, general purpose use **13.95**
- Tilt bail, for CT-70, 90, 125 **3.95**



PHONE ORDERS CALL **716-586-3950**

TELEX 466735 RAMSEY CI



RAMSEY ELECTRONICS, INC.
2575 Baird Rd.
Penfield, N.Y. 14626

QUALITY ETCHED PC BOARDS IN LESS THAN 5 MINUTES.

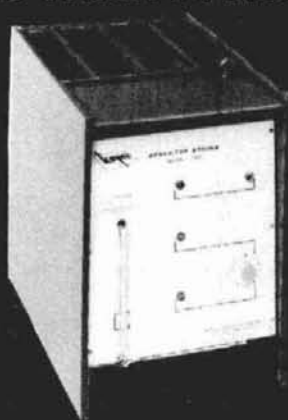

Convenient economical, high quality production of 12" x 12" panels is obtained using Kepro's Bench-Top Spray Etcher, only \$765. Kepro-the one stop source for all your Prototype and Short Run PCB needs.

kepro



Kepro Circuit Systems, Inc

Write for full line catalog or call
1-800-325-3878 • 1-314-343-1630 (Missouri)

630 Axminster Drive • Fenton, MO 63026-2992

✓ 155

DOCKING BOOSTER

Converts Your HT to a Powerful Mobile Unit

30 or 50 watts output
16 DB GaAs FET pre-amp
Fits on most car doors
Mic hang-up clip
Icom, Yaesu, Kenwood
2 Meters & 70 cm

\$149⁹⁵



CMC COMMUNICATIONS, INC.
5479 Jetport Industrial Blvd. • Tampa, FL 33614
Phone: 813-885-3996

✓ 121

DO YOU KNOW WHERE TO FIND REAL BARGAINS



on NEW and USED ELECTRONIC Equipment?

**You'll Find Them
in the Nation's No. 1
Electronic Shopper Magazine**

NUTS & VOLTS

Now in Our 5th Year

Nuts & Volts is published MONTHLY and features:
**NEW STATE-OF-THE-ART PRODUCTS •
SURPLUS EQUIPMENT • USED BARGAINS
• LOW COST AD RATES • PRIVATE AND
COMMERCIAL CLASSIFIEDS • NATIONAL
CIRCULATION • NEW PRODUCT NEWS
SECTION • AND A FREE CLASSIFIED AD
WITH YOUR SUBSCRIPTION**

SUBSCRIPTION RATES

- One Year - 3rd Class Mail \$10.00
- One Year - 1st Class Mail \$15.00
- One Year - Canada & Mexico (in U.S. Funds) .. \$18.00
- Lifetime - 3rd Class Mail (U.S. Only) \$35.00

ORDER NOW!

SEND: CHECK MONEY ORDER
 VISA MASTERCARD

TO: **NUTS & VOLTS MAGAZINE**
P.O. BOX 1111-H
PLACENTIA, CALIFORNIA 92670
(714) 632-7721

Name _____
Address _____
City _____
State _____ Zip _____
Card No. _____
Exp. Date _____

**IF YOU'RE INTO ELECTRONICS,
THIS MAGAZINE WILL SAVE YOU MONEY!**

Dealer Inquiries Invited

✓ 166

designing Yagis with the Commodore 64

Add screen enhancements to original WA3EKL program

Last summer, *ham radio* published WA3EKL's article, "Designing Yagis with the Commodore 64" (June, 1985, page 59). While running this technically excellent program, it occurred to me that certain features could be added to the program to enhance the quality of the visual display.

As is, the program may be confusing — for example, when the primary input of the frequency is suggested, input appears at the lower boundary of the screen and breaks into the next line, while the upper part of the screen continues to display the unnecessary data.

table 1. Summary of Commodore graphics commands. When you see bracketed commands [] in the instructions, press the keys as indicated. Do not type in brackets!

[CLR]	Press SHIFT & CLR HOME
[5 SPC]	Press SPACE BAR five times, or as many times as indicated by the number
[RVS ON]	Press CTRL & 9
[RVS OFF]	Press CTRL & 0
[4 DOWN]	Press CRSR DOWN four times, or as many times as indicated by the number shown.

Figure 1 lists WA3EKL's program, with the general sections rewritten to provide highlighted information and clear data input screens. Table 1 provides a summary of Commodore graphics commands, to simplify recall of specific symbols.

Just follow the instructions step by step and you'll enjoy an "easy on the eyes" computer program that will allow you to ignore the program and concentrate instead on the dimensions of your next antenna project.

instructions

Load your previously typed WA3EKL program from disk or cassette, but *do not run* the program. Then type in the enhancement program.

Note that the numbered lines of the enhancement program will automatically replace the existing lines of the WA3EKL program memory. Some new lines have also been added.

Spacing is important. Type each line *exactly* as shown. You'll notice that some words are run together; this is intentional — doing so places them in the proper location on the screen.

You'll have to use the symbol ? instead of typing **PRINT** for some lines to get the computer to accept the long line. (See your copy of *The Commodore User's Guide*.)

Line 80 changes the screen/border/letter colors. If you like the standard blue, omit all the **POKE** statements, and type in only **PRINT "[CLR]"**.

When you've finished typing, save the enhanced program under a new name of your choice.

By Fred A. Sontag, N0CAO, Lake Farm, Rt. 1, Box 47, Tebbetts, Missouri 65080

We Give You VHF Without VHC*

(* - Very High Cost)

Presenting Microwave Modules, the low-cost way to full-featured multi-mode operation on 50 Mhz, 144 Mhz, and 432 Mhz.

Expand your HF transceiver's capabilities for less than the cost of a VHF multimode radio.

All models feature:

- 25 Watts RF output
- Low Noise GaAsFET front end
- Built-in ALC circuit
- HF sensed VOX TR switching
- All mode operation—SSB, CW, FM, AM
- Easy hook-up to your present HF transceiver



New MMT 1442BR GaAsFET
144 Mhz Transverter
List Price \$325.00
(Other Models Available)

AVAILABLE FROM:

THE "PX" SHACK

VHF/UHF
EQUIPMENT

Ivars Lauzums KC2PX
52 Stonewyck Drive
Belle Mead, New Jersey 08502
(201) 874-6013



50Mhz
432 Mhz
1296 Mhz

Hours: 11am - 3pm
6pm - 10pm



MICROWAVE
MODULES LTD

✓ 189

One source for amateur radio books, tapes and computer programs.

PROPAGATION PUBLISHING

Over 125 books, tapes and computer programs to keep you up to date in the ham world, or to help you upgrade for that new ticket. ■ Send your name and address for a FREE copy of the new Propagation Publishing catalog

SPECIAL!

"Flying Horse"
1986 Callbooks

The new ones with the biggest change in callbook history! Now all of North America, with US possessions, in one book.

- North American Callbook
Postpaid in USA \$21.95
- International Callbook
Postpaid in USA \$20.95

Please send check or money order. Illinois residents please add 6% sales tax.

We are looking for authors!

We want authors with new ideas for books in the amateur radio field. If you have a book in work or just thinking about one, send an outline and sample chapter to us for review. We can give your book the national exposure needed to make it a success.

PROPAGATION PUBLISHING
P.O. Box 5255, Marton, Illinois 61550

✓ 172

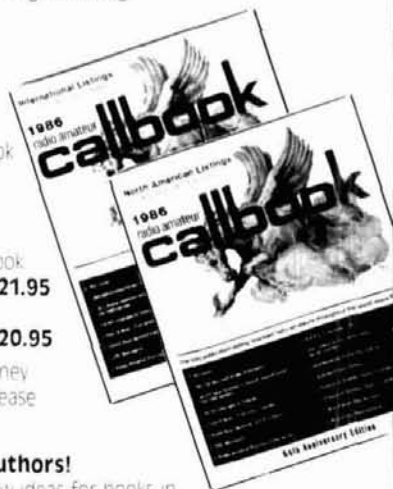

Join AMSAT...Today

Amateur Radio Satellite OSCAR 10 provides:

- A New Worldwide DX Ham Band open 10 hours a day.
- Rag Chew With Rare DX Stations in an uncrowded, gentlemanly fashion.
- Popular Modes In Use: SSB, CW, RTTY, SSTV, Packet
- Full Operating Privileges open to Technician Class licensee or higher.

Other AMSAT Membership Benefits:

ORBIT Magazine Subscription:
Dependable technical articles, satellite news, orbital elements, product reviews, DX news, and more.

Satellite Tracking Software
Available for most popular PCs.

QSL Bureau, AMSAT Nets, Area Coordinator Support, Forum Talks

Construction of Future Satellites For Your Enjoyment!

AMSAT Membership is \$24 a year, \$26 outside North America. VISA and MC accepted.

AMSAT
P.O. Box 27
Washington, DC 20044
301 589-6062

✓ 113

```

80 POKES3280,13:POKES3281,11:POKE646,7:PRINT"[CLR]"
100 PRINT"***** MONOBAND ANTENNA DESIGN *****":PRINT
106 IFCS="N"THEN311
108 PRINT:PRINT"[CLR]"
110 PRINT"THIS PROGRAM WAS WRITTEN USING THE
111 PRINT"FORMULAS PUBLISHED IN 1980 HAM RADIO
112 PRINT"MAGAZINE AND WRITTEN BY W2PU WHO PROVED MATHEMATICALLY AND EXPERIMENTA
LLY
114 PRINT"THAT ANTENNA ELEMENT RESONATE FREQUENCY LENGTH IS NO SIMPLE CALCULATIO
N"
116 PRINT"ESPECIALLY WHEN TAPERED ELEMENTS ARE[4 SPC]INVOLVED."
130 PRINT"***** MECHANICAL RECOMMENDATIONS *****":PRINT
140 PRINT"20 METER BOOM SHOULD BE 3 OR 4 INCH"
141 PRINT"DIAMETER ALUMINUM IRRIGATION PIPE"
150 PRINT"DEPENDING ON LENGTH."
160 PRINT"ELEMENTS SHOULD BE TAPERED SEGMENTS FROM 1 1/4 INCH TO 1/2 INCH"
184 PRINT"[DOWN]"
185 PRINT:PRINT"TO CONTINUE INSTRUCTION PRESS [RVS ON]RETURN[RVS OFF]";:INPUTIS
186 PRINT"[CLR]"
190 PRINT:PRINT"10-15 METER BOOMS SHOULD BE MADE OF[5 SPC]2 INCH ALUMINUM IRRIGA
TION PIPE.
200 PRINT"ELEMENTS SHOULD BE TAPERED FROM 7/8 INCH TO 5/8 INCH DIAMETERS OF"
215 PRINT"FOR MAXIMUM FRONT TO BACK RATIO USE 1/4 WAVELENGTH BOOM ON A 3 ELEMENT
"
220 PRINT"BEAM AND 3/4 WAVELENGTH BOOM ON A 4,[5]3 SPC]OR 6 ELEMENT BEAM."
225 PRINT"EQUALLY SPACE ALL ELEMENTS ALONG THE[4 SPC]BOOM REGARDLESS OF LENGTH."
230 PRINT"FOR A GOOD 2 ELEMENT BEAM USE A BOOM[4 SPC]LENGTH OF .150 WAVELENGTH."
240 PRINT"FOR A GOOD 3 ELEMENT BEAM USE A BOOM[4 SPC]LENGTH OF .300 WAVELENGTH."
244 PRINT"[4 DOWN]"
245 PRINT:PRINT"TO CONTINUE INSTRUCTION PRESS [RVS ON]RETURN[RVS OFF]";:INPUTIS:
PRINT"[CLR]"
250 PRINT:PRINT"IMPORTANT ALL TOTAL LENGTH DIMENSIONS[3 SPC]WILL BE ELEMENT HALF
LENGTH,"
255 PRINT"MEANING THE LENGTH OF THE ELEMENT[7 SPC]MEASURED FROM THE BOOM OUT TO
THE"
260 PRINT"TIP OF THE ELEMENT. ENTER ELEMENT SEGMENT LENGTHS AND DIAMETERS JUST"
270 PRINT"(WHICH CROSSES OVER THE BOOM) TO THE[5 SPC]SMALLEST DIAMETER SEGMENT AT
THE"
275 PRINT"ELEMENT TIP. THE OBJECT IS TO ADJUST THE ORIGINAL SEGMENT LENGTHS SO"
280 PRINT"THAT THE TOTAL EQUIVALENT LENGTH IS[5 SPC]EQUAL TO OR VERY CLOSE TO TH
E"
285 PRINT"NORMALIZED LENGTH FOR THE PARTICULAR[4 SPC]ELEMENT YOU ARE WORKING ON.
"
289 PRINT"[3 DOWN]"
290 PRINT:PRINT"TO CONTINUE INSTRUCTION PRESS [RVS ON]RETURN[RVS OFF]";:INPUTIS
291 PRINT"[CLR]"
295 PRINT"WHEN THE COMPUTER ASKS FOR INFORMATION[2 SPC][DOWN][RVS ON]-ENTER IN T
HE INFORMATION-[RVS OFF]"
296 PRINT
300 PRINT"THEN PRESS [RVS ON]RETURN[RVS OFF] - NOTHING WILL HAPPEN [DOWN]UNTIL[2
SPC]YOU PRESS [RVS ON]RETURN[RVS OFF]"
301 PRINT
305 PRINT"IF NOTHING HAPPENS IMMEDIATELY, WAIT --- [DOWN][RVS ON] THE COMPUTER MA
Y BE THINKING![RVS OFF]"
309 PRINT"[9 DOWN]"
310 PRINT:PRINT"TO START CALCULATIONS PRESS [RVS ON]RETURN[RVS OFF]";:INPUTIS
311 PRINT"[CLR]"
450 PRINT:PRINT"ENTER CENTRAL DESIGN FREQUENCY IN MHZ";:PRINT"[DOWN]":INPUTCDF
470 PRINT"ENTER NUMBER OF ANTENNA ELEMENTS 2,3,4,5 OR 6";:PRINT"[DOWN]":INPUTP
490 PRINT"ENTER BOOM DIAMETER";:PRINT"[DOWN]":INPUTBD
500 PRINT"ENTER NUMBER OF ANTENNA SEGMENTS";:PRINT"[DOWN]":INPUTN
550 PRINT:PRINT"ENTER (IN INCHES) LENGTH OF SEGMENT";:PRINT"[DOWN]":INPUTA
570 PRINT"ENTER (IN INCHES) DIAMETER OF SEGMENT";:PRINT"[DOWN]":INPUTB
970 PRINT:PRINT"INCHES-TOTAL EQUIV. LENGTH
972 PRINT:PRINT"HARDCOPY (Y/N)";:PRINT"[DOWN]"
980 PRINT"WANT TO CHANGE A SEGMENT LENGTH(Y/N)";:PRINT"[DOWN]":INPUTBS
1001 PRINT"[DOWN]"
1130 PRINT"ENTER NEW SEGMENT LENGTH (IN INCHES)";:PRINT"[DOWN]":INPUTU
3030 PRINTR;"INCHES-NORMALIZED REFLECTOR[20 SPC]1/2 LENGTH"
3040 PRINTDE;"INCHES-NORMALIZED DRIVEN EL.[19 SPC]1/2 LENGTH"
3050 PRINTDR;"INCHES-NORMALIZED DIRECTORS[20 SPC]1/2 LENGTH"
4000 PRINT:PRINT"[RVS ON]PLEASE WAIT ..... I'M THINKING[RVS OFF]"

```

READY.

fig. 1. Yagi design screen enhancement program listing.

**Micro Miniature/Lo Power FM
IF-DET-SQ
circuit**

\$34.50 ea!!

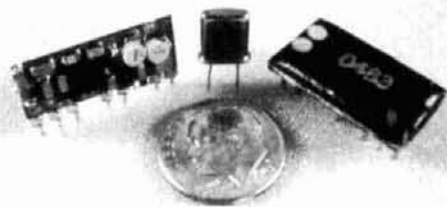

DUAL IN-LINE OR SINGLE IN-LINE
HYBRID PACKAGE

COMPLETE 10.7 MHz narrow band IF system
IF amp, 2nd LO, mixer, limiter, PLL detector, squelch
Adjustable VCO and SQUELCH controls
Squelch output for COS or scanner circuits
Reliable HYBRID construction

Great for all "home-brew" projects

TINY SIZE: only 1/2" x 1" x 1/4"

HI PERFORMANCE: 2.5 uv for 12db sinad

LO CURRENT DRAIN: 3ma typical - @ 7 vdc

AUDIO: 100 Hz to 3.5KHz

Shipped with applications, circuit data & 2nd LO xtal
specify SIP or DIP package

\$34.50 each plus \$2.00 shipping and handling

Send check or money order to:
UHC Electronics, P.O. Box 2062, San Rafael, CA 94912

193

**You read about it first
in the New Products
section of ham radio:**

"Many methods have been offered for learning Morse Code, some good and some not so good. **This is a good one.**"

- ➔ Have you plateaued at 10-13 WPM? **MASTER** the code in 40% less time.
- ➔ The method based on the scientific principles of Skill Acquisition and Perceptual Learning

**Adopted by the U.S. MILITARY
as the new training standard**

Four cassettes teach the entire alphabet in 25 trials at 20 WPM!

Includes numbers, punctuation, special characters, and an all new intro tape.

Send ck./M.O. in U.S. \$
We pay postage

Send _____ set(s) @ \$19.95 each
IL res. add \$1 sales tax (5%)

Name _____

Call _____ Class _____

Address _____

City _____ State _____ Zip _____

Mail to: TSG; PO Box 3897; Carbondale, IL 62902

Allow 4 wks delivery
Dealer inq. welcome
H-2

186

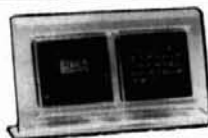

RECEIVE
THIS LCD
CALENDAR/
CLOCK FREE
WITH YOUR
SUBSCRIPTION

**WHAT'S REALLY
HAPPENING
IN HOME
SATELLITE
TV?**

STV THE HOME
SATELLITE
TELEVISION
MAGAZINE™

A monthly of 100-plus pages—has everything you need to know about where to find equipment, how to install it, system performance, legal viewpoints, and industry insights! With your subscription to STV® you will receive a FREE LCD Calendar/Clock.

- Only \$19.95 per year (12 monthly issues)
- \$1.00 for sample copy

**IF YOU HAVE
A SATELLITE
SYSTEM, THEN
YOU REALLY
NEED ...**



OnSat

The best in satellite programming! Featuring: ★All Scheduled Channels ★Weekly Updated Listings ★Magazine Format ★Complete Movie Listing ★All Sports Specials ★Prime Time Highlights ★Specials Listing and ★Programming Updates!

- Only \$45.00 per year (52 weekly issues)
- 2 Years \$79.00 (104 weekly issues)
- \$1.00 for sample copy

Visa® and MasterCard® accepted (subscription orders only). All prices in US funds. Write for foreign rates.

Send this ad along with your order to:

STV®/OnSat®

P.O. Box 2384—Dept. HR • Shelby, NC 28151-2384

SUBSCRIPTION CALLS ONLY

TOLL FREE 1-800-438-2020

1986 CALLBOOKS

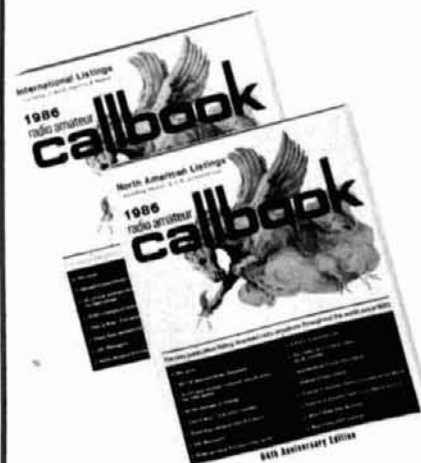

The "Flying Horse" has a great new look!

It's the biggest change in Callbook history!
Now there are 3 new Callbooks for 1986.

The North American Callbook lists the amateurs in all countries in North America plus those in Hawaii and the U.S. possessions.

The International Callbook lists the calls, names, and address information for licensed amateurs in all countries outside North America. Coverage includes Europe, Asia, Africa, South America, and the Pacific area (exclusive of Hawaii and the U.S. possessions).

The Callbook Supplement is a whole new idea in Callbook updates. Published June 1, 1986, this Supplement will include all the activity for both the North American and International Callbooks for the preceding 6 months.

Publication date for the 1986 Callbooks is December 1, 1985. See your dealer or order now directly from the publisher.

- North American Callbook
incl. shipping within USA \$25.00
incl. shipping to foreign countries 27.60
- International Callbook
incl. shipping within USA \$24.00
incl. shipping to foreign countries 26.60
- Callbook Supplement, published June 1st
incl. shipping within USA \$13.00
incl. shipping to foreign countries 14.00

SPECIAL OFFER

- Both N.A. & International Callbooks
incl. shipping within USA \$45.00
incl. shipping to foreign countries 53.50

Illinois residents please add 6 3/4% sales tax.
All payments must be in U.S. funds.

RADIO AMATEUR
callbook INC.

Dept. F
925 Sherwood Dr., Box 247
Lake Bluff, IL 60044, USA

Tel: (312) 234-6600  

REPEATER VOTER

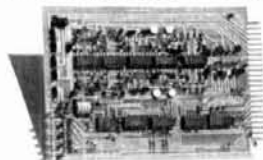

4RV Four Channel Repeater Voter

- Signal to Noise Type
 - Expandable to 32 Channel by Just Adding Cards
 - Designed for Commercial and Amateur Service
 - Continuous Instant Voting
 - Dual or Single 12 Volt Supply
 - LED Indicators of COR and Voted Signals
 - Front Mounted Level Pots
 - Built in Calibrator
 - Remote Voted Indicators Pinned Out
 - 4 1/2" x 6" Double Sided Gold Plated 44 Pin Card
 - Unsquenced Audio Input
 - On Board Audio Switching and Mixing
 - Audio Mixer Input Available for External Input
 - Open Collector or Relay Contact Input
 - Open Collector NPN Output
 - Remote Disable Inputs
 - More
- 4RV Kit including board and parts with 20 page manual \$200.00
Built, tested, and calibrated with manual \$350.00

For more information call or write:

VOTER Hall Electronics (614)
815 E. Hudson Street 261-8871
Columbus, Ohio 43211

✓ 143

CASE HISTORY!

For 2AT/3AT/4AT w/standard batt.



from **delta zulu**

\$24.95

free U.S. shipping
made in U.S.A.
90 day limited warranty



C.O.D. \$2

See through keypad window and instant access to all switches front, top, back plus unique zippered battery door. Fits with or w/o ICOM clip. Looks, feels and fits great. Black or burgundy tailored vinyl. Call (617) 599-3090.

Crowley Mfg. Co. 95 Federal St. Lynn MA 01905

✓ 129

DRAKE R-4/T-4X OWNERS AVOID OBSCOLESCENCE

PLUG-IN SOLID STATE TUBES!
Get state-of-the-art performance.
Most types available

INSTALL KITS TO UPGRADE
PERFORMANCE!

- BASIC Improvement
- Audio Bandpass Filter
- Audio IC Amplifier

TUBES \$23 PPD KITS \$25 PPD

OVERSEAS AIR \$7

SARTORI ASSOCIATES, W5DA
BOX 832085
RICHARDSON, TX 75083
214-494-3093

✓ 181

MISSOURI RADIO CENTER

ANTENNA SALE

HYGAIN TOWERS

HG37SS	C
HG52SS	A
HG54HD	L
HG70HD	L

CUSHCRAFT

A3	205.00
A4	275.00
R3	255.00
40-CD2	275.00
AV5	96.00
32-19	89.00
215WB	75.00
ARX2B	35.00
A144-11	46.00
A144-20T	69.00
424B	75.00
AOP-1	137.00

KLM

KT34A	329.00
KT34XA	475.00
432-20LBX	64.00
432-30LBX	90.00
435-18C	109.00
435-40C	149.00
2M-13LBA	77.00
2M-14C	85.00
2M-16LBX	89.00
2M-22C	115.00

HYGAIN

TH3JR	
TH7	
EX 14	C
14AVQ	A
18AVT	L
V2	L
V3	
V4	

HUSTLER

25% OFF ALL MOBILE	
6BTV	125.00

AEA

144SR	42.00
-------------	-------

BUTTERNUT

HF6V	110.00
HF2V	110.00

RG213U	\$26/foot
--------------	-----------

ROTATORS

CD45	C
HAM IV	A
T2X	L
	L

AVANTI 2M	29.95
HI-Q BALUN	9.95

KENPRO

KR400	119.00
KR500	149.00
KR600	199.00
KR5400	249.00

102 NW BUSINESS PARK LANE
KANSAS CITY, MISSOURI 64150
816-741-8118

CALL TOLL FREE
1-800-821-7323

MASTERCARD VISA & C.O.D. WELCOME

✓ 163

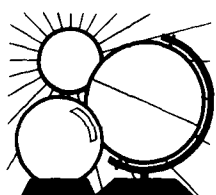

DX FORECASTER

Garth Stonehocker, KØRYW

MUF patterns and trends

For years computer programs have been used to provide the engineering (design) and operating maximum usable frequencies (MUF) necessary for a radio link between communications stations. These calculations define the equipment design and operation based on the minimum and maximum of sunspot cycle (years), season (months), and night and day (hours) for the transmission distance involved. The calculated hourly MUF is statistically based on the middle value (median) available during the month. There are variations from this median value throughout the month. The 10 and 90 decile values of the distribution are 15 percent under and over the median value for 27 days (90 percent) of a 30-day month. The 90 percent reliability figure is achieved by using a frequency 15 percent below the median value. Radio Amateurs can use the 15 percent *above* MUF median value, which should be reliable 10 percent of the time or three days a month.

A study has been done on the ratios (10 and 90 percentiles) to the median MUF. The largest variations in these distributions are diurnal and seasonal. **Table 1** summarizes some of the results in terms of percent below (- %) and above (+ %) for day and night deviations for three seasons (Winter, Equinox, and Summer) at propagation control point latitudes.

Interestingly, the daily MUF or foF2 making up the distribution in a monthly median is precisely the daily or next-day value forecasters are trying to determine. Some patterns and trends are worth noting. Nighttime variations from the median MUF are greater than daytime variations. The midlatitudes

table 1: Variations in the 10 percent, 90 percent ratio from median MUF values.

latitude	season	ratio interval			
		- %	day + %	- %	night + %
70	Winter	27	29	26	34
	Equinox	25	27	30	35
	Summer	19	18	22	20
50	Winter	16	13	19	23
	Equinox	24	21	24	21
	Summer	22	19	19	17
30	Winter	13	15	22	27
	Equinox	17	14	21	22
	Summer	20	23	21	20
20	Winter	16	19	25	33
	Equinox	14	14	24	31
	Summer	19	19	24	26
10	Winter	12	15	23	27
	Equinox	13	15	24	25
	Summer	16	21	24	27

show lower variations and these variations rise as one approaches the equator because of the geomagnetic equator. The variations increase toward high latitudes (because of the geomagnetic pole-auroral oval) during the night. The equatorial effect is more noticeable in winter and equinox than summer. This helps explain and confirm observed transequatorial DX openings to the southern hemisphere. However, in the daytime when ion production is more stable the MUF dispersion decreases from high latitudes (70 degrees) all the way to the low latitudes (10 degrees).

At the high latitudes the increased MUF dispersion reflects the influence of solar wind particles coming into the ionosphere at the auroral oval around the geomagnetic poles. This is the region where short time variations occur (QSB), and low signal strengths associated with geomagnetic storms are received. Propagation on east-west paths to Europe and Japan are those mostly affected. However, this ionospheric movement also causes unusual propagation openings to occur. This high-latitude MUF increased distribution dispersion should be sunspot number-sensitive and next month's column will look at that.

last-minute forecast

The higher frequency bands (10-30 meters) are expected to be very good during the first and last weeks of the

month. Don't look for too much in this winter season because the 27-day solar cycle isn't a big increase even though the ionosphere has increased sensitivity, as discussed last month. Little enhancement from geomagnetic field disturbances of transequatorial propagation (openings) is expected, since January is one of the most geomagnetically stable months of the year. The lower frequency bands will be best during the middle of the month. Low noise and signal absorption work together to make excellent signals, even out of the weak DX. However, abnormally weak signals (the winter anomaly) might be received for a few days this month on high midlatitude east-west and north directed paths.

Lunar perigee occurs on the 8th, with a full moon on the 26th this month. An intense but short-duration meteor shower, the Quadrantids, will occur between January 2nd and 4th and last a few hours.

band-by band summary

Ten, twelve, fifteen, and twenty meters will be open from morning to early evening almost every day, and to most areas of the world. The openings on the higher of these bands will be shorter and will occur closer to local noon. Transequatorial propagation on these bands will more likely occur toward evening during conditions of highest solar flux and a disturbed geomagnetic field.

WESTERN USA

QMT	PST	Directional Indicators							
		N	NE	E	SE	S	SW	W	NW
0000	4:00	40	40	20	10	10	10	10	20
0100	5:00	30	40	20	12	10	10	10	20
0200	6:00	30	40	20	20	12	10	10	20
0300	7:00	30	40	20	20	15	12	12	20
0400	8:00	30	40	20	20	15	20	20	30
0500	9:00	40	40	20	20	20	20	20	30
0600	10:00	40	40	30	20	20	20	20	30
0700	11:00	40	40	30	20	20	20	20	30
0800	12:00	40	40	30	20	20	20	20	40
0900	1:00	40	40	30	30	20	20	30	40
1000	2:00	40	40	30	30	30	30	30	40
1100	3:00	40	40	30	30	30	30	30	40
1200	4:00	40	40	30	30	30	30	30	40
1300	5:00	40	40	20	20	30	30	30	40
1400	6:00	40	30	20	12	15	30	30	40
1500	7:00	40	20	12	12	15	20	30	40
1600	8:00	40	20	10	10	15	20	40	40
1700	9:00	40	20	10	10	12	20	80*	40
1800	10:00	40	30	10	10	12	15	20	80
1900	11:00	40	30	10	10	12	20	80	80
2000	12:00	40	40	15	10	12	15	30	80
2100	1:00	80	40	15	10	12	15	20	80
2200	2:00	80	40	20	10	12	12	20	80
2300	3:00	80	40	20	10	10	12*	20	80

MID USA

MST	Directional Indicators							
	N	NE	E	SE	S	SW	W	NW
5:00	40	40	20	12	10	10	15	20
6:00	40	40	20	15	15	10	12	30
7:00	40	40	20	20	15	12	20	30
8:00	30	40	20	20	20	20	20	30
9:00	30	40	20	20	20	20	20	40
10:00	30	40	20	20	20	20	20	40
11:00	40	40	30	20	20	20	20	40
12:00	40	40	30	20	20	20	20	40
1:00	40	40	30	30	30	30	30	40
2:00	40	40	30	30	30	30	30	40
3:00	40	40	30	30	30	30	30	40
4:00	40	40	30	30	30	30	30	40
5:00	40	30	20	30	30	30	30	40
6:00	40	20	15	20	30	30	30	40
7:00	40	20	12	12	20	30	30	40
8:00	40	20	10	12	20	20	40	40
9:00	40	20	10	10	20	20	40	40
10:00	40	20	10	10	20	20	80	40
11:00	40	30	10	10	12	15	20	80
12:00	40	30	10	10	12	12	20	80
1:00	80	40	15	10	12	12	15	30
2:00	80	40	15	10	12	10	12	20
3:00	80	40	20	10	12	10	12	20
4:00	80	40	20	10	12	10	12	20

EASTERN USA

EST	Directional Indicators							
	N	NE	E	SE	S	SW	W	NW
7:00	40	40	20	15	15	20	12	30
8:00	40	40	20	20	20	20	20	30
9:00	40	40	20	20	20	20	20	40*
10:00	40	40	20	20	20	20	20	40
11:00	40	40	20	20	20	20	20	40
12:00	40	40	20	20	20	20	20	40
1:00	40	40	30	20	20	20	30	40
2:00	40	40	30	20	20	30	30	40
3:00	40	40	30	20	20	30	30	40
4:00	40	40	30	30	30	30	30	40
5:00	40	30	15	30	30	30	30	40
6:00	40	20	12	20	30	30	30	40
7:00	30	20	10	15	20	30	30	40
8:00	40*	20	10	12	20	20	20	40
9:00	40	20	10	12	15	20	20	40
10:00	40	20	10	10	15	20	20	40
11:00	40	20	10	10	12	20	20	40
12:00	40	20	10	10	12	15	20	40
1:00	40	20	10	10	12	15	20	80
2:00	80	30	10	10	12	12	15	80
3:00	80	40	15	10	12	10	12	80
4:00	80	40	15	10	12	10	12	80
5:00	80	40	20	10	12	10	12	80
6:00	80	40	20	12	12	10	12	80

The italicized numbers signify the bands to try during the transition and early morning hours, while the standard type provides MUF during "normal" hours.
 *Look at next higher band for possible openings.

ENGINEERING PROGRAMS FOR THE IBM-PC

RF-CAD ELECTRONICS DESIGN PROGRAM — Version 3.51



by Joe Reiser, W1JR and Gary Field, WA1GRC

For IBM PC and compatible computers

This software package has been written by electronic engineers and contains nearly 40 tested and proven programs that will help the Radio Amateur or engineer design many common types of radio circuitry. Emphasis has been placed upon ease of use. Wherever possible, menus of choices with examples are displayed. Should the user be computer literate, the programs are not copy protected so they can be modified to meet your specific requirements. (Full documentation is also provided.) Programs include: Filters, LC, active- LP, HP, BP; Inductor design, toroid, solenoid, straight wire, Matching networks; Crystal oscillators; Microstrip; Transmission lines; Antennas, Yagi-Uda, helix, dish, horn, element scaling; Pi and T attenuators. Also included: Radio Path Calculations; FM modulation analysis, Miscellaneous conversions; Geostationary satellite pointing; Moon tracking aids; Receiver noise figure calculations and Spurious receiver response prediction. Requires IBM-PC with at least one floppy drive and 128k of RAM.

© 1985

RF-CAD

RF NOTES — IBM-PC

by John Simmons, W6MDI

Here's an easy way to get answers for often asked electronics questions. Both volumes contain programs written by RF consulting engineers that answer a number of very important questions often asked by Hams. Monochrome and color versions available. Written in Basic A and fully menu driven. Graphics card and 128K memory required.

Volume I

Contains: *dB conversions*, to convert voltage, current or power levels to dB; *dBm conversions*, converts voltages or power levels to dBm and dBm to voltage or power; *VSWR calculations*, calculates VSWR and return loss when both reflected and incident powers are known; *Filter design*, 14 different filter configurations including schematics (6 low pass, 4 high pass, 2 band pass and 2 band elimination circuits; *Basic Microstrip and strip line design*, *Resonant Circuits*, design parallel and series resonant circuits, pi, capacitive and inductive impedance divider circuits.

□E-RF1 (Monochrome) IBM-PC

\$59.95

□E-RF1C (Color)

\$59.95

Volume II

This program covers: *Attenuator pads*, calculates constants for eleven different pad configurations (all with circuit diagrams.) Inductors, inductance in a single length of wire, single layer coils, both close and wide space wound and Toroidal coil design that gives automatic selection of wire size and toroidal form. Capacitors, calculates self resonant frequencies, determines optimum bypass values and decoupling applications. Impedance Matching Networks, including, L, pi, T and series LC configurations.

□E-RF2 (Monochrome) IBM-PC

\$59.95

□E-RF2C (Color)

\$59.95

\$39.95



Please enclose \$3.50 to cover shipping, handling.

ham radio magazine

BOOKSTORE

Greenville, NH 03048

Thirty and forty meters will be useful almost 24 hours a day. Daytime conditions will resemble those on 20 meters. Skip distances and signal strength may decrease during midday on days that coincide with the higher solar flux values. Nighttime DX will be good except after days of high MUF conditions and during geomagnetic disturbances. Look for DX from unusual places on east, north, and west paths during this time. The usable distance is expected to be somewhat less than 20 in daytime and greater than on 80 at night.

Eighty and one-sixty meters will exhibit short-skip propagation during daylight hours and lengthen for DX at dusk. These bands follow the darkness regions opening to the east just before your sunset, swinging more to the south near midnight, and ending up in the Pacific areas during the hour or so before dawn on the path of your interest. The 160 meter band opens later and ends earlier than 80.

ham radio

FLASH NEWS BULLETIN *we'll treat you*

For more than 40 years we have been serving the amateur community with QUALITY PRODUCTS and DEPENDABLE "S-E-R-V-I-C-E" and, we fully intend to carry on this proud tradition with even MORE new product lines plus the same "fair" treatment you've come to rely on. Our reconditioned equipment is of the finest quality with 30, 60 and even 90-day parts and labor warranties on selected pieces. And, remember...

— WE SERVICE WHAT WE SELL —

- | | | |
|-------------|---------------|------------------|
| AEA | DRAKE | MOSELEY |
| AMECO | ENCOMM | NYE |
| AMERITRON | HUSTLER | PALOMAR |
| ANTEK | ICOM | RADIO CALLBOOK |
| ARRL | JANEL | ROBOT |
| ASTRON | KANTRONICS | ROHN |
| ANTENNA | KDK | TELEX / HYGAIN |
| SPECIALISTS | KLM | TEN-TEC |
| B & W | LARSEN | TRIO-KENWOOD |
| BENCHER | MFJ | UNADILLA / REYCO |
| BUTTERNUT | MINI-PRODUCTS | YAESU |
| CUSHCRAFT | MIRAGE | |
| DIAWA | | |

Write today for our latest Bulletin/Used Equipment List.

SELECTION SERVICE and SATISFACTION!

STORE HOURS:
9-5 P.M. (CST)
MONDAY thru FRIDAY
OPEN SATURDAYS
from 9-1 P.M. (CST)
CLOSED
SUNDAYS/HOLIDAYS

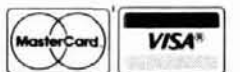

P.O. Box 73
208 East Kemp
Watertown, SD 57201

Burghardt INC.
AMATEUR CENTER
"AMERICA'S MOST RELIABLE AMATEUR RADIO DEALER"
SELL-TRADE
New & Reconditioned
HAM EQUIPMENT
Call or Write Us Today For a Quote!
You'll Find Us to be Courteous, Knowledgeable and Honest
PHONE (605) 886-7314



**AEA AMT-1. REGULARLY \$479.95
NOW ONLY \$299.95**
THE AMTOR TERMINAL UNIT!!! Works with any ASCII terminal or personal computer with a terminal program. Also works RTTY, CW, ASCII.
ORDER YOURS TODAY! Limited quantities.



Complete Novice

"The Complete Novice" is a new package from Gordon West that contains everything the beginner needs to pass the Novice test.

Packaged in a large transparent vinyl hang-bag, "The Complete Novice" contains the following study materials: four stereo code learning tapes, two stereo Novice class theory cassettes, a copy of ARRL's Novice theory book, the ARRL FCC Rule Book, a brass telegraph key, a solid-state code practice oscillator, including battery and hook-up wires, instructions for proper code sending, a list of the 200 FCC Novice test questions, a copy of FCC Form 610 plus VEC Examiner lists, a confidential written exam and ten 5-WPM tests for the examiner, and complete test instructions to the Volunteer Examiner.

The Complete Novice is available from Ham Radio's Bookstore or from Radio School, Inc., 2414 College Drive, Costa Mesa, California 92626. The price is \$49.95 plus \$5.00 for shipping and handling.

Circle #312 on Reader Service Card.

newest accessories for Kenwood HT

An extra-life battery pack and an AC operated quick-charger for the Kenwood TH-Series pocket transceivers are now available.

The PB-21H is an extra-life 500 mAh NiCad battery pack measuring just half an inch more than the standard PB-21 battery pack, and weighs only 6.5 ounces. (The standard PB-21 NiCad pack is rated at 180 mAh.)

The new BC-6 is an AC-operated, two-pack quick-charger that doubles as a DC power source for the TH-Series radios. The BC-6 can fully charge either the standard PB-21 or the new extra-life PB-21H in just one hour. The two-pack quick-charger comes complete with an adapter cable so you can operate your HT while the battery packs are charging.

For further information, contact Trio Kenwood Communications, 1111 West Walnut Street, Compton, California 90220.

MFJ Enterprises, Inc.

The new MFJ-818 automatic digital SWR/Wattmeter from MFJ Enterprises, Inc., is unique in several ways. First, it's digital, with easy-to-read, 1/2 inch bright-orange digits on the SWR display. But more importantly, MFJ-818 is automatic. It eliminates three steps in reading SWR: switching to set, setting the meter needle for full-scale deflection, and switching back to SWR 1:1 to 9.9:1 directly and instantaneously. There's no need to adjust the SWR set knob!

The MFJ-818 reads up to 200 watts RF output on its LED bar graph display. The 12-bar LED display indicates the "On Air" power level ins-

tantly and correctly to read instantaneous peak power. The unit features a tri-color indicator that lights up to show the antenna matching condition: green for good, yellow for "not very good," and red for a mismatched condition.

Despite all the features packed into this model, it measures only 5-1/2 x 4-1/4 x 1 inches and retails for only \$89.95 each. Like all MFJ products, the MFJ-818 carries a one-year unconditional warranty. In addition, if you order directly from MFJ, you get a 30-day money back guarantee: if you're not completely delighted, just send the SWR/wattmeter back within 30 days for a full refund (less shipping). For information, contact MFJ Enterprises, Inc. P.O. Box 494, Mississippi State, Mississippi 39762

Circle #310 on Reader Service Card.

ICOM IC-1271A 1.2 GHz transceiver

ICOM has announced the IC-1271A full-featured base station transceiver. With coverage from 1240 to 1300 MHz, the IC-1271A features 10 watts of RF output power, 32 memories, scanning and multi-mode operation including ATV (Amateur TV).



Additional features include front-end GaAs FETs for exceptional receiver sensitivity; CW/FM/upper and lower SSB; scanning (memory, program or mode scan); and 12 VDC or 117/240 VAC operation (optional). The suggested retail price is \$999.00.

Options include the TV-1200 ATV interface unit, IC-EX310 voice synthesizer, UT-15S CTCSS encoder/decoder and IC-PS25 13.8 VDC internal power supply.

For further information, contact ICOM America, Inc., 2380 116th Avenue, N.E., Bellevue, Washington 98009-9029.

Circle #311 on Reader Service Card.

new Jensen catalog

A new 160-page catalog of hard-to-find tools, service kits, and test equipment is offered free by Jensen Tools Inc. Illustrated in full color, this catalog contains more than 1000 items, including an expanded line of circuit board equipment.

To obtain a free copy, contact Jensen Tools Inc., 7815 South 46th Street, Phoenix, Arizona 85044.

Circle #309 on Reader Service Card.



REDIPART

SURPLUS TUBE LIST

P.O. BOX 10293
DALLAS, TEXAS 75207
214/747-7346

DESCRIPTION	PRICE	DESCRIPTION	PRICE
OA2	1.35	6GK6	2.00
2E26	3.75	6HS6	2.50
3B28	6.25	6J6	2.25
4CX150A	25.00	6SH7	2.25
50C5	1.70	6TF4	22.00
5663	4.00	6W6	2.00
5749	2.00	6087	3.15
5847	6.80	6201	1.90
6AC7	2.50	6360	4.00
6AG7	2.05	6662	1.15
6AL5	2.22	6676	1.00
6AN4	2.50	12AU7	.80
6AQ6	1.45	6907	35.00
6AS5	4.50	7A8	3.75
6AU6A	2.95	7C7	3.75
6AX4GTB	5.65	7054	2.10
6BC4	3.15	7058	1.50
6BH8	2.18	7061	2.20
6BL8	1.70	7167	1.95
6BW4	2.75	7360	6.50
6C4	2.30	7716	2.25
6CB6	2.23	7868	1.95
6CH8	2.44	866A	4.75
6CM6	2.00	8102	1.75
6CX8	2.44	8348	1.25
6DJ8	1.25	8595	15.00
6DZ4	1.60	12AB5	1.60
6DT8	1.60	12AT6	1.60
6D10	1.90	12AU7	1.85
6EU7	2.10	12BE6	1.80
6EW6	5.15	12B4A	6.60
6GE5	3.00	8624	65.00
6GW8	7.00	2D21W	1.75
6J4	2.25	3B25	8.00
6L6GL	3.25	4L25	40.00
6T8	1.41	5AQ5	6.00
6V4	6.00	5651	1.75
6X8	2.50	5686	3.50
6155	42.50	5814	1.90
6265	4.00	6AB4	2.25
6660	1.00	6AG5	1.90
6664	1.00	6AK6	.90
6678	1.00	6AM8A	2.65
6897	65.00	6AN8	3.60
7A7	3.75	6AR5	9.00
7B7	3.75	6AU5	2.25
7Y7	3.00	6AW8	2.85
7056	1.50	6BA8A	2.05
7060	2.50	6BE6	5.50
7094	60.00	6BD6	1.65
7271	60.00	6BS8	1.60
7701	3.75	6C10	1.75
7724	1.75	6CB5	2.15
829B	18.00	6CG7	1.90
8077	2.00	6CL8	3.42
8167	120.00	6CS7	1.90
8505A	43.00	6C30	11.00
9002	3.25	6GHABAG	1.65
12AO5	1.75	6EA8	2.70
12AV7	2.04	6EA8	5.85
12BH7	6.00	6EB8	2.50
12BY7	5.10	6EV7	1.85
12X4	1.00	6FV8	2.00
2D21	1.12	6GN8	2.80
2050A	2.25	6HS8	2.50
35W4	5.00	6KE8	8.60
100TH	62.50	6SK7	3.00
5R4G	1.75	6U8	3.00
5678	4.50	6X4	1.75
5751	2.00	6B6	1.75
5963	1.90	6252	45.00
6AF4	2.20	6397	7.50
6AK5	1.55	6663	1.00
6AM4	2.24	6677	1.00
6AN5	2.40	6688	4.50
6AG7	2.52	7A6	3.75
6AS6	2.50	7B5	3.75
6AU8	2.76	7H7	3.75
6BA6	1.70	7055	2.25
6CE5	1.20	7059	1.95
6BJ6	2.70	7077	46.00
6BN6	1.80	7258	2.20
6BZ6	2.75	7377	2.00
6CA4	3.00	7717	2.25
6CE5	1.69	816	7.50
6CL6	3.95	8058	12.00
6CM8	1.80	8136	1.25
6CY5	2.45	8458	15.00
6DS4	4.80	8683	45.00
6DT6	1.70	12AL5	2.25
6DV4	3.65	12AT7	3.21
6EM5	2.15	12BA7	1.50
6EU8	1.80	12BR7	2.50
6FG5	2.50	12DW7	2.50

REDIPART

- Tubes are from surplus stock.
- Do not carry a warranty.
- Send check or money order.
- American Express, MasterCard or VISA

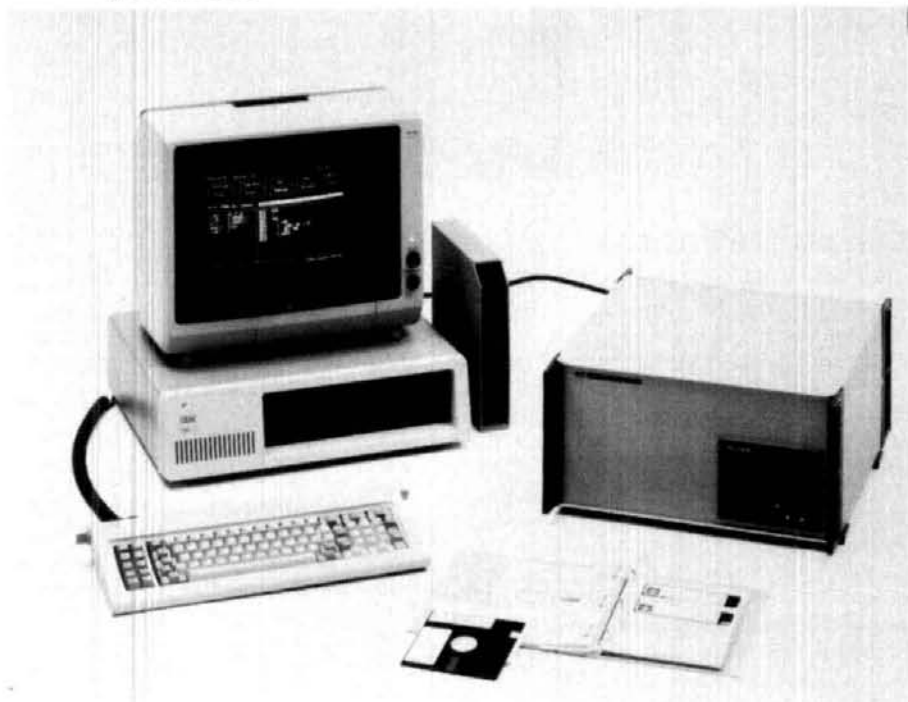

new software from Fluke

John Fluke Mfg. Co., Inc. has announced a new software package that links an IBM PC, XT or AT with the Fluke 2400B Intelligent Computer Front End. ProLink PC™ Program Development Package simplifies creation of data acquisition and control applications that, once developed, are executed on the 2400B, freeing the host PC for other tasks.

The package's main benefit is the ability to turn an IBM PC to that one task. ProLink allows the PC to download its application program to the 2400B. The Fluke 2400B in turn handles all A/D conversions, linearizations, limit checking and data buffering.

The friendly programming environment provides a set of menu choices that allows the operator to create and edit 2400B measurement and control programs using menu selection. Menu choices allow programs to be downloaded to and retrieved from the 2400B. Additional menu choices allow the user to check programs for errors and execute these programs while monitoring 2400B variables and data on the PC's screen. Up to 100 channel systems can be supported by this system. The user can also select the desired IBM serial port, set the port characteristics, or exit to PC-DOS.

ProLink PC contains everything needed to get an IBM-PC and 2400B working together. Included is a floppy diskette, manual, and RS-232-C cable. ProLink PC can be ordered immediately,

with a normal delivery time of six weeks. The price of the ProLink PC package is \$450.

For additional information, contact John Fluke Mfg. Co., Inc., at P.O. Box C9090, Everett, Washington 98206.

Circle 308 on Reader Service Card.

new phone patch

A unique phone patch has been introduced by the Heath Company, one of the world's largest manufacturers of high technology kit products. The HD-1515 Phone Patch kit employs a unique design and special speech transmission circuits to transfer audio signals between a telephone line and two-way radio equipment.

New active circuitry uses automatic gain control to help compensate for the varying attenuation introduced by different line lengths or loop distance on the external phone circuit. The integrated active speech and transmission circuit also allows the Phone Patch to be directly connected to the phone line, thereby eliminating

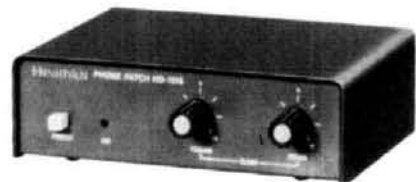

conventional hybrid transformers that convert 4-wires to 2-wires.

A high degree of electrical isolation from the radio equipment makes the Heathkit Phone Patch ideal for voice-operated installations. In addition, the transmission can be monitored on the phone line. An 8-pole filter in the input circuit makes the Patch compatible with all subscriber loop-frequency voice standards as prescribed by the FCC.

For information contact Heath Company, Dept. 150-575, Benton Harbor, Michigan 49022. Circle #301 on Reader Service Card.

film simplifies making PCBs at home

Anyone who's ever made a PCB at home knows that applying the etch resist takes patience, skill, and experience.

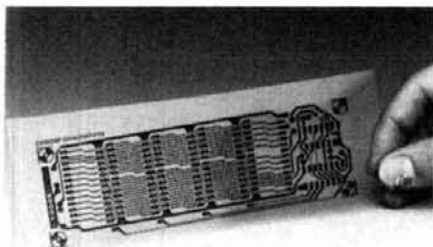

But TEC-200™ Image Film, a special plastic film available from Meadowlake, simplifies the process to three easy steps: first, the desired circuit pattern is photocopied directly from any magazine or book, using a sheet of TEC-200 film in the paper tray of any standard "plain paper" copier that uses toner. The high heat resistance of TEC-200 and the quality of modern photocopiers result in excellent reproduction with minimal pattern distortion.

Next, the photocopied circuit pattern is transferred to a piece of copper-clad board using a hot iron. The toner deposited on the photocopy melts and forms a varnish-like, acid-proof, etch-resist coating. Just remove the film from the board, and the board is ready for etching.

For information about TEC-200 Image Film, contact The Meadowlake Corporation, 25 Blanchard Drive, Northport, New York 11768.

Circle #302 on Reader Service Card.

curlycode™

Minds Eye Publications has announced a new publication: Curlycode™, a new way to learn Morse code.

Not "just another code course" but instead a new learning experience, it lets you become familiar with all the characters in one quick reading of the manual. It shows you how to let the rhythm of the code build shapes that you see in your mind's eye. Each sound adds to the

shape you already "see," so you never have to change your mind about the shape. Each shape is the character, so you can write it down instantly.

The beginner will remember most of the shapes without any study because only eight basic shapes are needed to know half of everything and nearly all the letters! Remember two additional endings for each shape and you'll know all 61 characters.

If you're already an expert, you'll find Curlycode an exciting new way to increase receiving speed. With a little practice, you may soon find the Curlycode shapes forming automatically in your mind's eye at practically any speed.

The price of the full set (including manual, wall chart, pocket card, and beginner's chart) is \$11.50. The manual alone (without the separate charts) is available for \$6.50. You or your club can save money by buying ten or more complete sets and deducting 20 per cent. All prices include postage and handling.

For further information, contact Minds Eye Publications, Dept. PH1, Box 1310, McLean, VA 22101.

Circle #303 on Reader Service Card.

antenna phasing unit

BaileyTech has introduced a new type of antenna product — the Opti-Phasor, an in-the-shack 40-meter phasing unit designed to drive a pair of dipoles or inverted vees to obtain a directional pattern and 4 dB gain. Either of two directions may be selected by merely throwing a switch. Variable reactance phasing allows the currents to be precisely balanced in the two dipoles so that deep nulls off the back and optimum gain can be achieved.

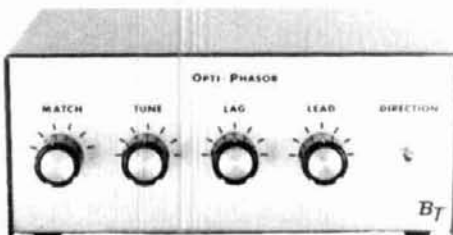

A front-to-back ratio of 20 dB or more is typical and the null is steerable. The five controls are "lead," "lag," "match," "tune," and the "direction" switch. Standard female UHF connectors are provided on the back of the phasor for the transmitter and two feedlines. A separate 52-ohm coax feedline is needed to drive each dipole. The Opti-Phasor will match a 52-ohm transmitter at full legal power. An SWR indicator or reflected power meter is needed to adjust the match. The user-supplied dipoles are hung parallel about 25 feet apart. Size is 7 1/2 x 3 3/8 x 6 1/8 inches; color is beige with black. The list price is \$120.

For details, contact BaileyTech, 304 West S. College Street, Yellow Springs, Ohio 45387.

Circle #304 on Reader Service Card.

RF TRANSISTORS

FRESH STOCK - NOT SURPLUS
TESTED — FULLY GUARANTEED

P/N	2-30 MHz 12V (* = 28V)		Match Pr
	Rating	Each	
MRF406	20W	\$14.50	\$32.00
MRF412/A	80W	18.00	45.00
MRF421	100W	25.00	56.00
MRF421C	110W	—	60.00
MRF422*	150W	38.00	82.00
MRF426/A*	25W	18.00	42.00
MRF428**	150W	55.00	125.00
MRF433	12.5W	12.00	30.00
MRF435*	150W	42.00	90.00
MRF449/A	30W	12.50	30.00
MRF450/A	50W	14.00	31.00
MRF453/A	60W	15.00	35.00
MRF454/A	80W	16.00	36.00
MRF455/A	60W	12.00	28.00
MRF458	80W	20.00	46.00
MRF460	60W	18.00	42.00
MRF464*	80W	25.00	60.00
MRF466*	40W	18.75	48.00
MRF475	12W	3.00	9.00
MRF476	3W	2.75	8.00
MRF477	40W	11.00	25.00
MRF479	15W	10.00	23.00
MRF485*	15W	6.00	15.00
MRF492	90W	18.00	40.00
SRF2072	75W	15.00	33.00
SRF3662	110W	28.00	60.00
SRF3775	75W	15.50	34.00
SRF3795	85W	16.50	37.00
CD2545	50W	23.00	52.00
SD1076	70W	17.00	40.00
SD1451	50W	15.00	36.00

Selected High Gain Matched Quads Available

VHF/UHF TRANSISTORS

Rating	MHz	Net Ea.	Match Pr
MRF212	10W	136-174	\$16.00
MRF221	15W	136-174	10.00
MRF222	25W	136-174	14.00
MRF224	40W	136-174	13.50
MRF231	3.5W	66-88	10.00
MRF234	25W	66-88	15.00
MRF237	4W	136-174	3.00
MRF238	30W	136-174	12.00
MRF239	30W	136-174	15.00
MRF240	40W	136-174	18.00
MRF245	80W	136-174	28.00
MRF247	75W	136-174	27.00
MRF250	50W	27-174	20.00
MRF260	5W	136-174	7.00
MRF261	10W	136-174	9.00
MRF262	15W	136-174	9.00
MRF264	30W	136-174	13.00
MRF607	1.75W	136-174	3.00
MRF641	15W	407-512	22.00
MRF644	25W	407-512	24.00
MRF646	40W	407-512	26.50
MRF648	60W	407-512	33.00
2N3866*	1W	30-200	1.25
2N4427	1W	136-174	1.25
2N5591	25W	136-174	13.50
2N5642*	20W	30-200	13.75
2N5945	4W	407-512	10.00
2N5946	10W	407-512	12.00
2N6080	4W	136-174	6.25
2N6081	15W	136-174	7.50
2N6082	25W	136-174	8.90
2N6083	30W	136-174	9.30
2N6084	40W	136-174	11.75

TMOS FET

MRF134*	5W	2-200	\$10.50
MRF137*	30W	2-200	22.50
MRF138**	30W	1.5-150	35.00
MRF150**	150W	1.5-150	80.00
MRF172*	80	2-200	65.00

Selected, matched finals for Kenwood, Yaesu, Icom, Atlas, etc. Technical assistance and cross-reference information on CD, PT, RF, SRF, SD P/Ns.

QUANTITY DISCOUNTS AVAILABLE
WE SHIP SAME DAY C.O.D./VISA/MC
INFORMATION AND CALIF. ORDERS: (619) 744-0728
OUTSIDE CALIF. ORDER DESK: 800-854-1927



RF PARTS

1320-16 Grand Ave., San Marcos
California 92069 (619) 744-0728

NEMAL ELECTRONICS INTL., INC.

NOW AUTHORIZED BELDEN DISTRIBUTOR

your one stop coax supplier!



Exclusive

SATELLITE CONTROL CABLE

5 TYPES AVAILABLE!

NEW!!! Lowest Loss

AVAILABLE IN
250-500-1000
FT. ROLLS
OR BY
THE FOOT

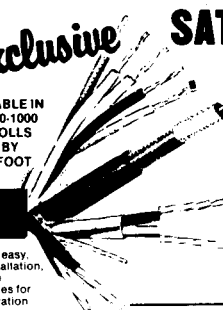

TYPE 1 (General Purpose)	TYPE 2 (M/I)	TYPE 3 (Interstat)	TYPE 4	TYPE 5
1 - RG59/U 96% Copper Braid	1 - RG59/U 96% Copper Braid	2 - RG59/U 96% Copper Braid	1 - RG6/U 18 Gauge 96% Copper Shield	2 - RG6/U 18 Gauge 96% Copper Shield
2 - 16 Gauge	2 - 12 Gauge	2 - 12 Gauge	2 - 12 Gauge	2 - 12 Gauge
3 - 20 Gauge	3 - 18 Gauge	3 - 18 Gauge	3 - 20 Gauge	3 - 18 Gauge
4 - 20 Gauge Shielded plus Tinned Copper Drain Wire	3 - 20 Gauge Shielded plus Tinned Copper Drain Wire	3 - 20 Gauge Shielded plus Tinned Copper Drain Wire	3 - 20 Gauge Shielded plus Tinned Copper Drain Wire	3 - 20 Gauge Shielded plus Tinned Copper Drain Wire
5 - 20 Gauge Shielded plus Tinned Copper Drain Wire	3 - 20 Gauge Shielded plus Tinned Copper Drain Wire	3 - 20 Gauge Shielded plus Tinned Copper Drain Wire	3 - 22 Gauge Shielded plus Tinned Copper Drain Wire	3 - 22 Gauge Shielded plus Tinned Copper Drain Wire

55¢ FT 75¢ FT 95¢ FT 79¢ FT 89¢ FT
Call for 1000 FT pricing

Designed for easy, one-step installation, providing the required cables for most earth station equipment in a direct burial jacket.

Only Nemal offers the quality construction RG59/U copper shielding made to mil spec JAN C 17, 12-gauge conductors, tinned copper drain wires, and a true direct burial polyethylene jacket



beam antenna handbook by Bill Orr, W6SAI and Stu Cowan, W2LX

Completely revised and updated, the *Beam Antenna Handbook* includes the latest state-of-the-art antenna design. Computer generated beam dimensions for the 40, 30, 20, 17, 15, 12, 10, and VHF bands are included, eliminating the need for time-consuming math calculations. Also covered are: beam height and optimum angle of radiation, how element types and hardware effect performance, effect of nearby objects on radiation patterns, feedlines, baluns, and matching systems and much more. *ham radio* VHF columnist Joe Reiser, W1JR, and noted European VHF'er DL6WU's VHF antenna designs are covered extensively as well as NBS VHF long Yagis. 286 clearly written pages — 204 easy-to-understand illustrations make this the book to buy for beam construction. The price is \$9.95 softbound.

For more information, contact Ham Radio's Bookstore, Greenville, New Hampshire 03048.

HARDLINE

- Two styles, two sizes for all installation needs
- Aluminum Outer Conductor with Polyethylene Jacket**
 - 1/2 inch loss .48 dB/100 ft. @ 30 MHz
 - 3.68 dB/100 ft. @ 1000 MHz\$1.25/ft.
 - 7/8 inch loss .28 dB/100 ft. @ 30 MHz
 - 2.54 dB/100 ft. @ 1000 MHz\$3.25/ft.
 - Corrugated Copper Outer Conductor with Polyethylene Jacket**
 - 1/2 inch loss .38 dB/100 ft. @ 30 MHz (FLC12-50J) 2.78 dB/100 ft. @ 1000 MHz\$1.59/ft.
 - 7/8 inch loss .13 dB/100 ft. @ 30 MHz (FLC12-78J) 1.3 dB/100 ft. @ 1000 MHz\$3.92/ft.
- COMPARE RG 213 1.25 dB/100 @ 30 MHz
8.5 dB/100 @ 1000 MHz !

HARDLINE CONNECTORS

- 1/2 inch aluminum UHF M/F \$19.00 Type N M/F \$22.00
- 7/8 inch aluminum UHF M/F \$49.00 Type N M/F \$49.00
- 1/2 inch copper UHF M/F \$22.00 Type N M/F \$22.00
- 7/8 inch copper UHF M/F \$49.00 Type N M/F \$49.00

shipping
Cable — \$6.00 per 100 ft.
Connectors — \$3.00 per order.
Orders under \$20 add \$2 additional plus shipping.
Charge card — orders over \$30 only.
COD add \$2.00. Florida Residents add 5%.

FACTORY AUTHORIZED DISTRIBUTOR
AMPHENOL, CABLEWAVE, COLUMBIA, KINGS
BLONDER-TONGUE, TYTON, B&K

- COAXIAL CABLE
- MULTICONDUCTOR CABLE
- CONNECTORS-ADAPTERS
- HARDLINE
- CABLE TIES
- SMATV PRODUCTS
- COAX-SEAL
- COMPUTER CABLE
- CRIMP TOOLS
- FIELD STRENGTH METER

COAXIAL CABLE SALE POLYETHYLENE DIELECTRIC

- RG-8/U 96% shield Mil Spec.....(\$29.00/100) or 31¢/ft.
- RG11U 96% shield 75 ohm mil spec.....25¢/ft.
- RG-55B/U double shield (RG-58 size) 50 ohm.....45¢/ft.
- RG58U mil spec 96% shield.....(\$10.00/100) or 11¢/ft.
- RG62A/U 96% shield mil spec 93 ohm.....12¢/ft.
- RG174/U min. 50 Ω mil spec.....10¢/ft.
- RG213 noncontaminating 96% shield mil spec.....36¢/ft.
- RG214/U double silver shield 50 ohm.....\$1.65/ft.
- RG214/U tinned copper.....65¢/ft.
- RG217/U double shield 50Ω 58" 00.....85¢/ft.

LOW LOSS FOAM DIELECTRIC

- RG-8X (Mini 8) 95% shield.....(\$15.00/100) or 17¢/ft.
 - RG8U 80% shield.....(\$19.00/100) or 22¢/ft.
 - RG-8/U 97% shield 11 gu. (eq. Belden 8214).....31¢/ft.
 - RG58U 80% shield.....07¢/ft.
 - RG58U 95% shield.....10¢/ft.
 - RG59/U 100% foil shield TV type.....10¢/ft.
 - RG59/U 70% copper shield.....09¢/ft.
 - HEAVY DUTY ROTOR CABLE 2-16 ga 6-20 ga.....36¢/ft.
 - Rotor cable 2-18 ga 6-22 ga Poly burial Jkt.....19¢/ft.
- Complete line of multiconductor cables available

CONNECTORS MADE IN USA

- Amphenol PL 259.....89¢
- PL-259 and/or SO-239.....65¢ ea. or 10/\$5.99
- Double Male Connector.....\$1.79
- PL-258 Double Female Connector.....98¢
- PL-259 Silver-Teflon Kings.....\$1.59 ea.
- Reducer UG-175 or 176.....22¢ or 10/\$2.00
- UG-255 (PL-259 to BNC).....\$2.95
- Elbow (M359) UHF Elbow.....\$1.79
- F59A (TV type).....24¢ or 10/\$2.00
- UG 21 D/U Type N Male for RG8, Amphenol.....\$3.00
- UG-88C/U BNC Male for RG-58, Amphenol.....\$1.25
- UG 273 BNC-PL259 Amphenol.....\$3.00
- 3/16 inch Mike Plug for Collins etc. (cutoff).....\$1.25

shipping
Cable — \$3.00 per 100 ft.
Connectors — add 10%. \$3.00 minimum.
Orders under \$20 add \$2 additional plus shipping.
Charge card — orders over \$30 only.
COD add \$2.00. Florida Residents add 5%.



12240 N.E. 14th Ave.
No. Miami, FL 33161
Telephone: (305) 893-3924

IN STOCK
— OVER 500 ITEMS —
COMPLETE LINES

164

MULTI-BAND SLOPERS

ALSO: DIPOLES & LIMITED-SPACE ANTENNAS

Outstanding performance of WSJNN antennas is well known! Now enjoy multi-band BIG-SIGNAL reports! Automatic bandswitching - Very low SWR - Coax lead - 3kw power - Compact - FULLY ASSEMBLED to your specified center frequency each band - Easy to install - Very low profile - Complete instructions - Your personal check accepted

4 BAND SLOPER - 160, 80, 40, 30, or 20M	60 ft. long	\$ 48 ppd
1 - 160, 80, 40M	80 ft. "	53 "
2 - 80, 40M	40 ft. "	35 "
3 - NO-TRAP DIPOLE - 160, 80, 40M	113 ft. long	71 "
2 - 80, 40M	85 ft. "	55 "

9 BAND SPACE-SAVER DIPOLE - 160 thru 10M* \$48.00 long
* Requires wide-range tuner (80, 40, 20, 15M without tuner) \$ 85 ppd

SEND SASE for complete details of these and other unique antennas

WSJNN ANTENNAS 312-394-3414
BOX 3933-M MT. PROSPECT, IL 60056

197

NEW 20-PAGE CATALOG FREE

7 MILLION TUBES

Includes all current, obsolete, antique, hard-to-find receiving, transmitting, industrial, radio/TV types. **LOWEST PRICES.** Major brands in stock.

Unity Electronics Dept.
P.O. Box 213, Elizabeth, N.J. 07206

194

Jim also lists sources of software for SSTV, satellite tracking, and other specialized applications, as well as over 80 sources of hardware and software for more general Amateur Radio applications.

The Commodore Ham's Companion is a 160-page paperback retailing for \$15.95, plus shipping and handling, (\$2.50 if ordered directly from the publisher, \$3.00 if ordered from *Ham Radio's Bookstore*).

For information, contact QSKY Publishing, P.O. Box 3042, Springfield, Illinois 62708.

Circle #305 on Reader Service Card.

WE SHIP WORLDWIDE
Barry Electronics Corp.
 WORLD WIDE AMATEUR RADIO SINCE 1950
 Your one source for all Radio Equipment!

For the best buys in town call:
 212-925-7000
 Los Precios Mas Bajos en
 Nueva York

12-meter antenna coil

KW-12 antenna coils allow trapped dipole coverage of the new 12-meter band (24.89-24.99 MHz). Resonant frequency is designed to provide a perfect half-wave dipole. The power handling capability is 1500 watts PEP maximum. The pair is installed 9 feet, 5 inches from the balun.



Hi-Q characteristics are obtained by optimum form factor on polystyrene. Coil dimensions are 5 1/2 inches by 1/8 inch diameter; the unit weighs 6 ounces, with tensile strength rated at 800 pounds. An acrylic lacquer waterproof coating and all-aluminum hardware help provide resistance to corrosion. A specification sheet and installation instructions are supplied.

For information, contact Microwave Filter Company, 6743 Kinne Street, East Syracuse, New York 13057.

Circle #306 on Reader Service Card.

SSTV transceiver

Davtrend has introduced two new products: the DRAE SSTV Transceiver and — for those who already have the receiver — a Transmit Module that upgrades the DRAE receiver to transceiver status.



The system specification is the standard 8.5 second SSTV format of 16 grey shades with a 128 x 128 pixel picture. Further specification details are available.

For further information, contact Davtrend Limited, Sanderson Centre, Lees Lane, Gosport, Hampshire PO12 3UL England.

Circle #307 on Reader Service Card.

KITTY SAYS: WE ARE NOW OPEN 7 DAYS A WEEK.
Saturday & Sunday 10 to 5 P.M.
 Monday-Friday 9 to 6:30 PM Thurs. to 8 PM
 Come to Barry's for the best buys in town.

ONV Safety belts in stock



ICOM

IC-R71A, 751, 745, 27A/H, 37A, 47A, R-7000, 127A, 271A/H, 3200A, 471A/H, 735

Ring in the New Year
 With the best of Barry's New Gear

KENWOOD

Antennas
 A-5 Cushcraft
 Hustler KLM
 MCTZ
 Mini-Products
 Mosley

R-600, R-1000, R-2000, TS-940/SAT
 TS-430S, TR-3600A, TR-7050,
 TW-4000A, Kenwood Service/Repair:
 TH2131/41AT, TM-211A/
 411A & TS-711A/811A

COMPU-FIRE EXTINGUISHERS
 EXL-5000E RTTY/MOTOR TERMINAL

VoCom/Mirage/Daiwa
 Tokyo Hy-Power
 Amplifiers &
 5/8" HT Gain
 Antennas IN STOCK



Soldering Station,
 48 Watts, \$68
 JBC soldering iron in stock
 MICROLOG-AIR I, Air Disk,

KANTRONICS
 UTU, Interface II,
 Challenger, Packet Comm.
 EIMAC
 3-500Z
 572B, 6JS6C
 12BY7A &
 4-400A

AEA 144 MHz
 AEA 220 MHz
 AEA 440 MHz
 ANTENNAS

BIRD
 Wattmeters &
 Elements
 In Stock

AMERITRON AMPLIFIER AUTHORIZED DEALER

Yaesu FTR-2410, Wilson
 ICOM IC-RP 3010 (440 MHz)
 ICOM IC-RP 1210 (1.2 GHz)

Computer Interfaces
 stocked: MFJ-1224
 AEA CP-1, PKT-1, DR-DX
 CP-100, PK-64, Dr. QSO,
 Morse University

ALPHA AMPLIFIERS
 Complete Butternut Antenna
 Inventory In Stock!

DIGITAL FREQUENCY COUNTERS
 Triang. Phil. Coll. Engineering
 Model: F1-100, B-100, 1200Hz
 0-400 MHz, B-110, 1200Hz

Long range Wireless
 Telephone for export in stock

BENCHER PADDLES,
 BALUNS, AUDIO FILTERS,
 IN STOCK

MIRAGE AMPLIFIERS
 ASTRON POWER SUPPLIES
 Saxton Wire & Cable

MAIL ALL ORDERS TO BARRY ELECTRONICS CORP., 512 BROADWAY, NEW YORK CITY, N.Y. 10012.

New York City's LARGEST STOCKING HAM DEALER COMPLETE REPAIR LAB ON PREMISES

"Aqui Se Habla Espanol!"
 BARRY INTERNATIONAL TELEX 12-7670
 MERCHANDISE TAKEN ON CONSIGNMENT
 FOR TOP PRICES

Monday-Friday 9 A.M. to 6:30 P.M. Thursday to 8 P.M.
 Saturday & Sunday 10 A.M. to 5 P.M. (Free Parking)
 AUTHORIZED DIST. MCKAY DYMEK FOR
 SHORTWAVE ANTENNAS & RECEIVERS

Subways: IRT/LEX "Spring St. Station"
 BMT "Prince St. Station"
 IND "F" Train Bwy Station

Bus: Broadway #6 to Spring St.
 Path - 9th St./Rth Ave. Station.

Commercial Equipment
 Stocked: ICOM, MAXON,
 Midland, Standard, Wil-
 son, Yaesu. We serve
 municipalities, busi-
 nesses, Civil Defense,
 etc. Portables, mobiles,
 bases, repeaters.

Local Ham Club
 Speeches
 Given

We Stock: AEA, ARRL, Alpha, Ameco, Antenna Specialists, Astatic,
 Astron, B & K, B & W, Bash, Bencher, Bird, Butternut, COE, CES, Collins,
 Communications Spec, Connectors, Covercraft, Cushcraft,
 Daiwa, Dentron, Digimar, Drake, ETO (Alpha), Eimac, Encomm, Heil
 Sound, Henry, Hustler (Newtronics), Hy Gain, Icom, KLM, Kantronics,
 Larsen, MCM (Daiwa), MFJ, J.W. Miller, Mini-Products, Mirage,
 Newtronics, Nye Viking, Palomar, RF Products, Radio Amateur Callbook,
 Robot, Rockwell Collins, Saxton, Shure, Telex, Tempo, Ten-Tec,
 Tokyo Hi Power, Trionyx TUBES, W2AU, Waber, Wilson, Yaesu Ham and
 Commercial Radios, Vocom, Vibroplex, Curtis, Tri-Ex, Wacom Duplexers,
 Repeater, Phelps Dodge, Fabon Intercoms, Scanners, Crystals, Radio
 Publications.

WE NOW STOCK COMMERCIAL COMMUNICATIONS SYSTEMS
 DEALER INQUIRIES INVITED. PHONE IN YOUR ORDER & BE REIMBURSED

COMMERCIAL RADIOS stocked & serviced on premises.

Amateur Radio Courses Given On Our Premises, Call
 Export Orders Shipped Immediately. TELEX 12-7670

COMPACT 75 M SSB TRANSCEIVER



Dimensions 2" x 6" x 6"

RECEIVER:

Frequency 3.8-4.0 MHz
 Sensitivity 0.5 µV for 10 dB S/N
 Selectivity -6 dB @ 2.4 KHz
 AGC Range +60 dB in = +3 dB out
 Audio Output >350 mW into 8 ohms

TRANSMITTER:

Frequency 3.8-4.0 MHz
 Output 30 watts into 50 ohms
 IMD -30 dB
 Harmonics 2nd -47 dB, 3rd -55 dB
 SWR Immunity 30:1 @ all phase angles
 ALC Amplified, fast response rate (quasi-processing)

Complete Kit
\$199.95

plus \$3.00
 shipping and
 handling

POWER REQUIREMENTS:

Voltage 28 Vdc regulated
 Current 2A transmit, 65 mA receive

1985-86
 CATALOG
 50¢



RADIO KIT
 BOX 411H
 Greenville, NH
 03048
 (603) 878-1033
 telex 887697

flea market



RATES Noncommercial ads 10¢ per word; commercial ads 60¢ per word **both payable in advance.** No cash discounts or agency commissions allowed.

HAMFESTS Sponsored by non-profit organizations receive one free Flea Market ad (subject to our editing) on a space available basis only. Repeat insertions of hamfest ads pay the non-commercial rate.

COPY No special layout or arrangements available. Material should be typewritten or clearly printed (not all capitals) and must include full name and address. We reserve the right to reject unsuitable copy. **Ham Radio** cannot check each advertiser and thus cannot be held responsible for claims made. Liability for correctness of material limited to corrected ad in next available issue.

DEADLINE 15th of second preceding month.

SEND MATERIAL TO: Flea Market, Ham Radio, Greenville, N. H. 03048.

WANTED: Regency XL2000 transceiver or new 10 channel 148-162 MHz or Wilson WH2510. PO Box 929, Blacksburg, VA 24060-0929. (703) 382-4458.

SCHEMATIC: Radio receivers 1920's/60's. Send brand name, model No., SASE. Scaramella, PO Box 1, Woonsocket, RI 02895-0001.

THE GOOD SAM HAMS invite RV operators to check in the Good Sam Ham net 14.240 ± Sundays 1900Z also 3.880 ± Tuesdays at 2359Z. Net control N5BDN, Clarksville, IN

OLD RADIO transcription discs wanted. Any size, speed. W7FIZ, Box 724 HR, Redmond, WA 98073-0724.

RTTY-EXCLUSIVELY for the Amateur Teleprinter. One year \$10.00. Beginners RTTY Handbook \$8.00. PO Box RY, Cardiff, CA 92007.

TR-7 USERS: NB-7 Noise blanker (new) \$65.00 ppd. HS-75 headset (padded) new \$14.00 ppd. SL-300, SL-500 CW filter \$55.00 ea. ppd. K3UKV, Tony Musero (215) 271-8898.

UHF PARTS. We stock GaAs Fets, Trimmers, and many of those impossible to find parts for the UHF builder. For example: MGF 1202 at \$10.00, Finger Stock at \$7.50 per 16" strip. SASE brings list. Microwave Components, 11216 Cape Cod, Taylor, MI 48180.

IMRA. International Mission Radio Association helps missionaries. Equipment loaned. Weekday net, 14.280 MHz, 2-3 PM Eastern. Eight hundred Amateurs in 40 countries. Brother Frey, 1 Pryer Manor Road, Larchmont, New York 10538.

RUBBER STAMPS: 3 lines \$4.50 PPD. Send check or MO to G.L. Pierce, 5521 Birkdale Way, San Diego, CA 92117. SASE brings information.

ELECTRON TUBES: Receiving, transmitting, microwave... all types available. Large stock. Next day delivery, most cases. Daily Electronics, PO Box 5029, Compton, CA 92224. (213) 774-1255.

CUSTOM MADE EMBROIDERED PATCHES. Any size, shape, colors. Five patch minimum. Free sample, prices and ordering information. Hein Specialties, Inc., Dept 301, 4202 N. Drake, Chicago, IL 60618.

P.C. BOARDS for all Amateur Radio magazine projects, current or past issues. Guaranteed lower than list prices. Any quantity available. Send specifications (magazine name, issue and page numbers). T.O.R.C.C.C. Electronics, Box # 47148, Chicago, Illinois 60647. (312) 342-9171.

NEW PACKET RADIO PROGRAM for IBM PC's. A telecom program for interfacing your PC with your packet controller. Special functions for GLB's. 5 page scrolling screen with cursor control. Two types Binary File Transfers. 300-9600 bps. Keyboard Macros. 50 page manual. Split screens. Windows! Much more. **NON COPY PROTECTED.** \$49.95 + \$3.00 shipping and handling. Kalt & Associates, Suite #138, 2440 E. Tudor Rd., Anchorage, AK 99507. (907) 248-0133. Write for more info.

BUILD a Computer-Aided-Designed 6dB gain stacked vertical omnidirectional 2 meter antenna for less than \$50.00 using hardware store materials. Send \$5.00 for detailed plans and parts list. WD40QC, John De Armond, PO Box 3657, Cleveland, TN 37311.

RECONDITIONED TEST EQUIPMENT \$1.25 for catalog. Walter, 2697 Nickel, San Pablo, CA 94806.

PRINTED CIRCUIT BOARDS and kits for QST articles. Call or write for information. A&A Engineering, 7970 Orchid Drive, Buena Park, CA 90620. (714) 521-4160.

TOWER FOR SALE Beautiful 70 foot fold over tower complete with Hy-Gain rotor system and much more. You ship and I will sacrifice for \$500. Worth over \$3000. Call late evenings at (319) 362-4606.

R-390A RECEIVER. 5-30 MHz all modes, 4 mechanical filters, meters sealed (Government removed, operation unaffected): complete/checked \$195, complete/repairable \$115, spare parts unit (80% complete) \$65. CPRC-26 Manpack Radio (described in March 1985 Ham Radio), transceives 46.54 MHz FM, with battery box, antenna, crystal, handset: \$22.50 apiece, \$42.50/pair. Info SASE. CPRC-26 add \$4/unit shipping. R-390A shipping charges collect. Baytronic, Dept. HR, Box 591, Sandusky, OH 44870. (419) 627-0460 evenings.

WANTED set of good working director and driven element traps for Hy-Gain beam. TH2MK2, TH3MK2, TH6DXX, TH5MK2, TH7DXX acceptable. David, W0PCW, POB 26, Halstead, Kansas 67056.

PACKET/ASCII/BAUDOT/CW for IBM-PC. SASE to: Emile Aline, 773 Rosa, Metairie, LA 70005.

PRINTED CIRCUIT BOARDS TORCCC Electronics will print any schematic, 6"x9" maximum, on a circuit board for \$1.50 (larger schematics—add \$1.25 per additional 50 square inches). Send check and schematic to: TORCCC Electronics, 2161 North California, Chicago, Illinois 60647.

SELL: TUBES 4032 one just \$35.00 each. Inquire on others. Wanted Conset aircraft monitor receiver reasonable. Levy, 101 East Driftwood#26, Fredericksburg, TX 78624. Tel 512-997-2534.

WANTED NC400 receiver. Any condition. W2PUA, 112 Tifford Road, Somerdale, NJ 07083. (609) 783-4175.

WANTED: Hy-Gain vertical antenna, converters for National receiver, old Hallicrafters receiver. K6KZT, 2255 Alexander, Los Osos, CA 93402.

DRAKE! DRAKE! DRAKE! Complete station with late model TR7A/DR7 transceiver and R7A receiver, speech processor, speaker, power supply, fans, cross-connect cables, manual. Asking \$1550. Guaranteed excellent condition or I pay for repair. Gary Jordan, WA6TKT, 1012 Olmo Court, San Jose, CA 95129 (408) 257-2222.

WANTED: Motorola HT220's and HT100's, VHF or UHF, PO Box 4344, Chatsworth, CA 91313.

CABLE TV CONVERTERS/DESCRAMBLERS. Guaranteed lowest prices in US. Jerrold, Hamlin, Zenith—Many others. Lowest dealer prices! Orders shipped within 24 hours! Complete illustrated catalog, \$2.00. Pacific Cable Co., Inc., 7325-1/2 Reseda Blvd, #1008, Reseda, CA 91335. (818) 716-5914.

IC-25A FOR SALE: \$225 or best offer. Good condition, used only as a mobile radio. Call Craig (603) 878-1441, 9-5 EST, M-F only.

2 METER AMP KITS: 8877 legal limit kit \$395. 3CX800A7 900W kit \$325. Also HV power supplies, CX600N relays, parts and EME newsletter. SASE for catalog. 2 Meter EME Bulletin, 417 Staudaher St., Bozeman, MT 59715

ELECTRON TUBES — Radio & TV types 75% off list price — huge inventory! Also industrial types. Send for Free Catalog today or call Toll Free (800) 221-5802. Box HC, Trans-Ieronics, Inc., 1365 — 39th Street, Brooklyn, NY 11218. See our display ad this issue.

DIGITAL AUTOMATIC DISPLAYS. All transceivers. Six 1/2" digits, 5" wide by 1-1/4" by 9" cabinet! Send \$1.00 for information. Be specific. Grand Systems, POB 2171, Blaine, Washington 98230.

CB to 10M CONVERSIONS. FM kits, frequency modification hardware, books, plans, high-performance CB accessories. Free catalog. CBCI, Box 31500HR, Phoenix, AZ 85046. (602) 996-8700.

CABLE TV CONVERTERS & EQUIPMENT: Plans and parts. Build or buy. FREE information. C & D Electronics, PO Box 1402, Dept. HR, Hope, AR 71801.

CIRCUIT BOARDS: Guaranteed lowest quotes and FREE twelve hour prototypes. Single and double sided boards. Small through large production quantities. Send specifications. T.O.R.C.C.C. Electronics, Box 47148, Chicago, Illinois 60647. (312) 342-9171.

WANTED: E.H. Scott Radios and McMurdo Silver Radios i.e. Scott Radio Labs "Scott Special" etc. McMurdo Silver "Single Signal Super 5A" or "Radio Professional Model 50" etc. Literature. Also Zenith Stratosphere Radio. I will arrange all shipping. Call collect after 5:00 CST. (414) 965-3641. Denis Yanko, 410 N. Summit, Oconomowoc, WI 53066.

HOME and excellent ARS QTH for sale. 3 bedroom, 1-1/2 baths, 1200 sq. ft., plus 700 sq. ft. shop and shack in separate, insulated, heated and A/C bldg. on 2 acres of land in rural Georgia on paved road 25 minutes from Macon. \$44,900 (firm). Write to WATG, PO Box F, Gray, GA 31032.

IBM-PC RTTY/CW. CompRtty II is the complete RTTY/CW program for the IBM-PC and compatibles. Virtually any speed ASCII, BAUDOT, CW. Text entry via built-in editor! 10,000 character transmit/receive buffers. Adjustable split screen display. Instant mode/speed change. Hardcopy, diskcopy, break-in buffer, select calling, text file transfer, customizable full screen logging, 24 programmable 1000 character messages. Now with WRU (simple mailbox). Ideal for MARS and traffic handling. Requires 128K PC, XT, AT, Pcr, PC-DOS, serial port, RS-232C TU \$65. Send call letters (including MARS) with order. Mention Ham Radio Magazine and take \$10 off. David A. Rice, KC2HO, 7373 Jessica Drive, North Syracuse, NY 13212.

RESISTORS any value/quantity, 1/4 watt @ \$.01, 1/2 watt @ \$.015 (\$1.00 minimum). Quantity discounts, 1,000 +. Send wattage(s), value(s), quantity(s), and remittance. T.O.R.C.C.C. Electronics, Box 47148, Chicago, Illinois 60647. (312) 342-9171.

COLLECTION of 40 Antique Radios and 22 Ham and drum Speakers. Many other items and parts all working. Blair Daley, K800H, Elsie, MI 48831. (517) 862-5228.

COMING EVENTS

Activities — "Places to go . . ."

CALIFORNIA: FCC exams, Novice-Extra. Sunnysvale VEC ARC. (408) 256-9000 24 hour. 73, Gordon, W6NLG, VEC.

MICHIGAN: The Southfield High School Amateur Radio Club is sponsoring their 20th annual Swap & Shop, January 26, Southfield High School, 24675 Lahser, Southfield. Doors open 6 AM for exhibitors. Public 8 AM to 3 PM. Admission \$2.50. Reserved tables \$20.00 (paid in advance) for two 8 ft. tables. Additional reserved tables \$10.00 each. Tables also available at door. For information and reservations: Robert Younker, Southfield High School, 24675 Lahser, Southfield, MI 48034.

NEW YORK: Yonkers Amateur Radio Club's Electronics Auction, Sunday, January 26, Lemko Hall, 556 Yonkers Avenue, Yonkers. Inspection 9 AM to 10 AM. Auction starts promptly at 10 AM. Admission \$3.00. Children under 8 free. Plenty of seats and parking. Unlimited free coffee all day. Club commission on successful sales only. 10% on first \$100, 5% on remainder.

SOUTH BEND, INDIANA: Hamfest Swap & Shop, January 5 (first Sunday after New Year's Day) Century Center downtown on US 33 one way North between St. Joseph Bank Building and river. Industrial history museum in same building. Carpeted half acre room. Open tables \$1 per ft. Four lane highways to door from all directions. Talk in freq: 52-52, 99-39, 93-33, 69-09, 145-29.

MASSACHUSETTS: The MIT UHF Repeater Association and the MIT Radio Society offer monthly Ham Exams. All classes Novice to Extra. Wednesday January 22, 1986, 7 PM, MIT Room 1-134, 77 Mass Ave, Cambridge, MA. Reservations requested 2 days in advance. Contact Ron Hoffmann (617) 253-5820/646-1641 or Craige Rodgers at 225-6616. Exam fee \$4.00. Bring copy of current license, 2 forms of picture ID and completed form 610 (available from FCC in Boston: 223-6609).

WISCONSIN: The Wild Rivers Amateur Radio Club will hold their mid-winter swapfest, Sunday, February 16, 10 AM to 3 PM. Spooner Experimental Farm east of Spooner on highway 70. VE exams by advance registration only. Tables available. Talk in on 147.81/21. For information: Tom Young, KD9FC, Route 5, Box 5239, Hayward, WI 54843.

OHIO: The Mansfield Mid-Winter Hamfest/Auction, Sunday, February 16, Richland County Fairgrounds, Mansfield. Doors open to public 7 AM. Tickets \$3.00 advance and \$4.00 at door. Tables \$5.00 advance and \$6.00 at door. Talk in on 146.34/94, W8WE. For information/tickets/tables SASE to Dean Wrasse, K8BMG, 1094 Beal Road, Mansfield, Ohio 44905 or phone (419) 589-2415 after 3 PM EST.

MASSACHUSETTS: The Algonquin ARC will hold its annual Hamfest/Swapfest Electronic Flea Market, Sunday, February 16, Marlboro Junior High School, Marlboro. Doors open 8:30

Foreign Subscription Agents for Ham Radio Magazine

Ham Radio Austria Karin Ueber Postfach 2454 D-7850 Loerach West Germany	Canada Send orders to Ham Radio Magazine Greenville, NH 03048 USA Prices in Canadian funds 1 yr \$29.95, 2 yrs \$53.30 3 yrs \$75.40
Ham Radio Belgium Stereohouse Brusselsesteenweg 416 B-9218 Gent Belgium	Ham Radio Italy Via Podonone 17 I-20132 Milano Italy
Ham Radio Holland Postbus 413 NL-7800 Ar Emmen Holland	Ham Radio Switzerland Karin Ueber Postfach 2454 D-7850 Loerach West Germany
Ham Radio Europe Box 2084 S-194 02 Upplands Vasby Sweden	Ham Radio England c/o R S G B Alma House Cranborne Road Potters Bar Herts EN6 3JW England
Ham Radio France SM Electronic 20 bis, Ave des Clairons F-89000 Auxerre France	
Ham Radio Germany Karin Ueber Postfach 2454 D-7850 Loerach West Germany	

AM for sellers, 10 AM for buyers. Admission \$1.00. Tables \$7.50 advance (by February 9) or \$10.00 at the door. Food available. For information/table reservations: AARC, PO Box 258, Marlboro, MA 01752 or call (617) 393-9920.

PENNSYLVANIA: Amateur Radio Social. The Chaverm of Delaware Valley will hold their 6th annual mid-winter social in downtown Philadelphia on Sunday, January 12, at 10 AM. Traditional buffet brunch, installation of new officers, entertainment and lots of eye-balling. Everyone invited. Reservations a must. Contact Bill Sobie, W3QXT (215) 676-6769 or write to 9357 Hoff Street, Philadelphia, PA 19115 for full details.

OHIO: Dayton Hamvention, April 25, 26, 27, Hara Arena and Exhibition Center. For more information write or phone Box 44, Dayton, OH 45401 (513) 433-7720. See display at this issue.

FLORIDA: Citrus County Ham Flea Market. February 8, 9 AM to 4 PM, County Fairgrounds, US 41 south, Inverness. License exams. For information: SHARC Hamfest, PO Box 572, Lecanto, FL 32661 or call Bob Gordon, W1KUL (904) 628-5045.

OPERATING EVENTS

"Things to do . . ."

1986 CLASSIC RADIO EXCHANGE 2100 UTC January 26 to 0400 UTC January 27. Object - restore, operate and enjoy old radio equipment with like-minded hams. A classic radio is any equipment built since 1945 and at least 10 years old. Exchange name, RST, state/province/country, receiver and transmitter type and other interesting information. CW call "CQ CX", phone call "CQ Exchange". Send logs, comments, etc to Stu Stephens, K8SJ, 1407 Hollywood Road, Sandusky, OH 44870. Include SASE for Classic Radio Newsletter printed January and September. 1986 Fall Classic Exchange is September 28-29.

1986 NEW HAMPSHIRE QSO PARTY sponsored by the NH Amateur Radio Association. 1900Z February 1 to 0700Z February 2 and 1400Z February 2 to 0200Z February 3. Exchange signal report and NH county or ARRL section/DXCC country. Stations may make contact on more than one band or mode. Logs must be submitted by March 25, 1986. Include large SASE for results. Send logs and comments to Mount Moriah Repeater Association c/o Bud Valcourt, N1BYQ, 19 Teague Drive, Salem, NH 03079.

MICHIGAN YL QSO PARTY sponsored by the TASYL's from 1800Z January 25 to 1800Z January 26, phone and CW. No crossband, net or repeater QSO's. Work stations once. Exchange call, signal report, QTH and TASYL # if working a member. Send logs to TASYL President, Verline Ferris, K1BV, 308 E. Harry, Hazel Park, Michigan 48030. Entries must be received by February 28, 1986.

CELEBRATE KANSAS' 125th Birthday Special Event Station KD0ZK will operate all General and Novice bands during January 1986. An 8-1/2 x 11 certificate is available for contact. Send QSL and large SASE to KD0ZK, Barry Horowitz, 715 West 5th Street, Junction City, Kansas 66441.

YORK RADIO CLUB will celebrate its 50th anniversary with several special programs in 1986. Starting January 1 through December 31, 1986, members of the YRC will work all HF bands at all class levels. Members will use their own call signs and add York Radio Club to all CO's and contacts. Submit proof of contact, SASE and one dollar for a certificate. Send to York Radio Club, 861 Fairfield, Elmhurst, IL 60126. Include time, date, condx and member's call letters.

YL-OM CONTEST All licensed men and women operators throughout the world are invited to participate. OMs call "CQ YL" and YLs call "CQ OM". All bands may be used. No cross-band operation, nets or repeater operation will count. Exchange station worked, QSO number, RS(T), ARRL section or country. Log entries must show time, band, date and transmitter power. Send logs to Mary Lou Brown, NM7N, Vice President, 504 Channel View Drive, Anacortes, WA 98221. Logs must be postmarked by March 10 and received no later than March 31, 1986.

CHARGE YOUR CLASSIFIED ADS

to your MC or VISA write or call

HAM RADIO MAGAZINE

Greenville, NH 03048

(603) 878-1441

ICOM R71-751-R7000* COMPUTER INTERFACE



MEC 71α



MICROCOMPUTER ELECTRONICS CORPORATION NOW OFFERS THE M.E.C. 71α COMPUTER CONTROL INTERFACE THAT WILL CONTROL AND EXPAND THE CAPABILITY OF THE ICOM R71A.



MAIN MENU Control center for entire system. Showing: 24HR UTC time; radio freq. & mode; memory CH, freq, mode plus ID functions for your selection.

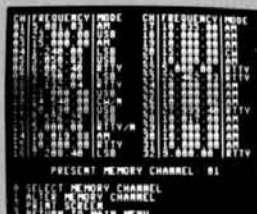

32 CH RADIO MEMORY Showing freq to 10 Hz, mode, filter w/n. Load/change any memory, mode, filter direct from keyboard and print command.

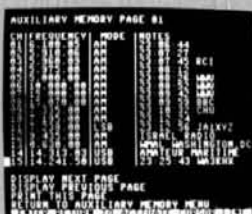

AUXILIARY MEMORY Showing page 1 of 47 pages each having 15 memories. Freq, mode, UTC time and room for your notes. Auto log feature allows instant logging of receiver freq, mode, time.

INTRODUCTORY PRICE \$199.95 + \$4 UPS

- **Easy to use.** No computer knowledge needed, automatic program loading. No disk or tape required (except for aux memory storage).
- **Menu driven** to aid user at each step.
- **No radio modification necessary** (ICOM EX309 — not supplied — required).
- **AUTO LOG** Allows logging of radio freq, mode and time by press of a key.
- **UNLIMITED STORAGE** via computer disk or tape (store 705 CH per disk side). Let your imagination run wild.
- **Software update.** As new software is developed MEC will make it available to owner subscribers.

- **HARD COPY** via computer printer of all memory channels.
- **KEYBOARD** memory loading.

Price to be announced - CALL. Available Fall 85. Dealer inquiries invited.

EEB is the exclusive distributor for Microcomputer Electronics Corp.'s product worldwide. Address all inquiries to EEB.

EEB is an authorized ICOM dealer and service center. Buy with confidence.

GET ALL THE DETAILS. WRITE OR CALL EEB TODAY



- Prices & specs subject to change
- Shipping charges not included
- Returns subject to 20% restock charge
- Free catalog in USA; all others 3 IRC's

ORDER TOLL FREE 800-368-3270
Tech Info — VA orders 703-938-3350

ELECTRONIC EQUIPMENT BANK
516 Mill Street NE
Vienna, VA 22180 USA

✓ 137

DIRECTION FINDING?

- ★ Interference Location
- ★ Stuck Microphones
- ★ Cable TV Leaks
- ★ Security Monitoring



- ★ VHF and UHF Coverage
- ★ Computer Interface
- ★ Speech Synthesizer
- ★ 12 VDC Operation

New Technology (patent pending) converts any VHF or UHF FM receiver into an advanced Doppler shift radio direction finder. Simply plug into receiver's antenna and external speaker jacks. Uses four omnidirectional antennas. Low noise, high sensitivity for weak signal detection. Call or write for full details and prices.

DOPPLER SYSTEMS, INC. 5540 E. Charter Oak, Scottsdale, AZ 85254 (602) 998-1151

✓ 135

HAM MART

Ham Radio's guide to help you find your local

California

C & A ROBERTS, INC.
18511 HAWTHORN BLVD.
TORRANCE, CA 90504
213-370-7451
24 Hour: 800-421-2258
Not The Biggest, But The Best —
Since 1962.

FONTANA ELECTRONICS
8628 SIERRA AVENUE
FONTANA, CA 92335
714-822-7710
714-822-7725
The Largest Electronics Dealer in San
Bernardino County.

JUN'S ELECTRONICS
3919 SEPULVEDA BLVD.
CULVER CITY, CA 90230
213-390-8003
800-882-1343 Trades
Habla Espanol

Connecticut

HATRY ELECTRONICS
500 LEDYARD ST. (SOUTH)
HARTFORD, CT 06114
203-527-1881
Call today. Friendly one-stop shopping
at prices you can afford.

Delaware

**AMATEUR & ADVANCED COMMUNI-
CATIONS**
3208 CONCORD PIKE
WILMINGTON, DE 19803
(302) 478-2757
Delaware's Friendliest Ham Store.

DELAWARE AMATEUR SUPPLY
71 MEADOW ROAD
NEW CASTLE, DE 19720
302-328-7728
800-441-7008
Icom, Ten-Tec, Microlog, Yaesu,
Kenwood, Santec, KDK, and more.
One mile off I-95, no sales tax.

Florida

AMATEUR ELECTRONIC SUPPLY
1898 DREW STREET
CLEARWATER, FL 33575
813-461-4267
Clearwater Branch
West Coast's only full service
Amateur Radio Store.
Hours M-F 9-5:30, Sat. 9-3

AMATEUR ELECTRONIC SUPPLY
621 COMMONWEALTH AVE.
ORLAND, FL 32803
305-894-3238
Fla. Wats: 1 (800) 432-9424
Outside Fla: 1 (800) 327-1917
Hours M-F 9-5:30, Sat. 9-3

Georgia

DOC'S COMMUNICATIONS
702 CHICKAMAUGA AVENUE
ROSSVILLE, GA 30741
(404) 866-2302
ICOM, Yaesu, Kenwood, KDK, Bird...
9AM-5:30PM
We service what we sell.

Hawaii

HONOLULU ELECTRONICS
819 KEEAUMOKU STREET
HONOLULU, HI 96814
(808) 949-5564
Serving Hawaii & Pacific area for 53
years.

Illinois

ERICKSON COMMUNICATIONS, INC.
5456 N. MILWAUKEE AVE.
CHICAGO, IL 60630
312-631-5181
Hours: 9:30-5:30 Mon, Tu, Wed & Fri;
9:30-8:00 Thurs; 9:00-3:00 Sat.

Indiana

THE HAM STATION
220 N. FULTON AVE.
EVANSVILLE, IN 47710
812-422-0231
Discount prices on Ten-Tec, Cubic,
Hy-Gain, MFJ, Azden, Kantronics,
Santec and others.

Massachusetts

James Millen Components by
ANTENNAS ETC.
16 HANSOM ROAD
ANDOVER, MA 01810
617-475-7831
Bezels, binding posts, capacitors, con-
densers, chokes, coils, ceramics, H.V.
connectors, plate caps, hardware
knobs, dials, scopes and grid dippers.
Inquire SASE or visit.

TEL-COM, INC.
675 GREAT ROAD, RTE. 119
LITTLETON, MA 01460
617-486-3400
617-486-3040
The Ham Store of New England
You Can Rely On.

Michigan

ENCON PHOTOVOLTAICS
Complete Photovoltaic Systems
27600 Schoolcraft Rd.
Livonia, Michigan 48150
313-523-1850
Amateur Radio, Repeaters, Satellite,
Computer applications.
Call Paul WD8AHO

Minnesota

TNT RADIO SALES
4124 WEST BROADWAY
ROBBINSDALE, MN 55422 (MPLS/ST.
PAUL)
TOLL FREE: (800) 328-0250
In Minn: (612) 535-5050
M-F 9 AM-6 PM
Sat 9 AM-5 PM
Ameritron, Bencher, Butternut, Icom,
Kenwood

Missouri

MISSOURI RADIO CENTER
102 NW BUSINESS PARK LANE
KANSAS CITY, MO 64150
(800) 821-7323
Missouri: (816) 741-8118
ICOM, Kenwood, Yaesu
Same day service, low prices.

Nevada

AMATEUR ELECTRONIC SUPPLY
1072 N. RANCHO DRIVE
LAS VEGAS, NV 89106
702-647-3114
Dale Porray "Squeak," AD7K
Outside Nev: 1 (800) 634-6227
Hours M-F 9-5:30, Sat. 9-3

New Jersey

KJI ELECTRONICS
66 SKYTOP ROAD
CEDAR GROVE, NJ 07009
(301) 239-4389
Gene K2KJI
Maryann K2RVH
Distributor of: KLM, Mirage, ICOM, Lar-
sen, Lunar, Astron. Wholesale - retail.

Dealers: *YOU SHOULD BE HERE TOO!*
Contact Ham Radio now for complete details.

Amateur Radio Dealer

New York

BARRY ELECTRONICS

512 BROADWAY
NEW YORK, NY 10012
212-925-7000
New York City's Largest Full Service
Ham and Commercial Radio Store.

VHF COMMUNICATIONS

915 NORTH MAIN STREET
JAMESTOWN, NY 14701
716-664-6345

Call after 7 PM and save! Supplying all
of your Amateur needs. Featuring ICOM
"The World System." Western New
York's finest Amateur dealer.

North Carolina

F & M ELECTRONICS

3520 Rockingham Road
Greensboro, NC 27407
1-919-299-3437
9AM to 7PM Closed Monday
ICOM our specialty — Sales & Service

Ohio

AMATEUR ELECTRONIC SUPPLY

28940 EUCLID AVE.
WICKLIFFE, OH 44092 (Cleveland Area)
216-585-7388
Ohio Wats: 1 (800) 362-0290
Outside Ohio: 1 (800) 321-3594
Hours M-F 9-5:30, Sat. 9-3

DEBCO ELECTRONICS, INC.

3931 EDWARDS RD.
CINCINNATI, OHIO 45209
(513) 531-4499
Mon-Sat 10AM-9PM
Sun 12-6PM
We buy and sell all types of electronic
parts.

UNIVERSAL AMATEUR RADIO, INC.

1280 AIDA DRIVE
REYNOLDSBURG (COLUMBUS), OH
43068
614-866-4267
Featuring Kenwood, Yaesu, Icom,
and other fine gear. Factory author-
ized sales and service. Shortwave
specialists. Near I-270 and airport.

Pennsylvania

HAMTRONICS, DIV. OF TREVOSSE ELECTRONICS

4033 BROWNSVILLE ROAD
TREVOSSE, PA 19047
215-357-1400
Same Location for over 30 Years.

LaRUE ELECTRONICS

1112 GRANDVIEW STREET
SCRANTON, PENNSYLVANIA 18509
717-343-2124
ICOM, Bird, Cushcraft, Beckman,
Larsen, Amphenol, Astron, Belden,
Antenna Specialists, W2AU/W2VS,
Tokyo Hy-Power Labs, WELZ, Daiwa,
Sony, Saxton, Vibroplex, Weller.

THE VHF SHOP

16 S. MOUNTAIN BLVD., RTE. 309
MOUNTAINTOP, PA 18707
717-474-9399
Lunar, Microwave Modules, ARCOS,
Astron, KLM, Tama, Tonna-F9FT,
UHF Units/Parabolic, Santec, Tokyo
Hy-Power, Dentrone, Mirage,
Amphenol, Belden

Texas

MADISON ELECTRONICS SUPPLY

3621 FANNIN
HOUSTON, TX 77004
713-520-7300
Christmas?? Now??

Wisconsin

AMATEUR ELECTRONIC SUPPLY

4828 W. FOND DU LAC AVE.
MILWAUKEE, WI 53216
414-442-4200
Wisc. Wats: 1 (800) 242-5195
Outside Wisc: 1 (800) 558-0411
M-F 9-5:30 Sat 9-3

SAVE SAVE
SAVE SAVE

1983-84
ARRL
AMATEUR RADIO
CALL DIRECTORY

WAS \$15.75
NOW \$4.95

SAVE \$10.80



Please add \$3.50 to cover
shipping and handling



Ham Radio's Bookstore
GREENVILLE, NH 03048

FREE CATALOG!

Features Hard-to-Find Tools
and Test Equipment



Jensen's new catalog features hard-to-
find precision tools, tool kits, tool cases
and test equipment used by ham radio
operators, hobbyists, scientists, en-
gineers, laboratories and government
agencies. Call or write for your free copy
today.

JENSEN
TOOLS INC.

Dept. HR
7815 S. 46th Street
Phoenix, AZ 85044
(602) 968-6241

✓ 150

WALL CLOCK



CAT. NO. C-101
Select pine
Natural wax finish

\$21.95 pp. (U.S.A.)

Quartz movement
One Year Warranty
Operate for full year on one AA Battery
(not included.)

Call or write:

HANCOCK TOY SHOP
P.O. Box 125
Hancock, NH 03449
(603) 525-4033

MC-VISA-AMEX-Personal Checks
Dealer inquiries invited.

✓ 146

DX EDGE

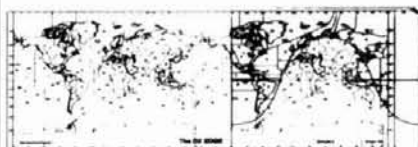

\$16.95

GRAYLINE AND LONG PATH
PREDICTOR

Great Circle Overlays

20°, 30°, & 40° Latitude (NSS)

\$5 each

\$3 When purchased with slide rule DX Edge
Please enclose \$3.50 shipping and handling

Ham Radio's Bookstore
Greenville, NH 03048

John J. Meshna Jr., Inc.

P. O. Box 62 19 Allerton St. E. Lynn, Ma. 01904 Tel: (617) 595-2275

COMPUTER TERMINAL BUILDING BLOCK \$50.00

This is a great beginning for a computer terminal. It is a brand new, Panasonic, 9" TTL input monitor complete with its own self-contained, switching power supply, and a removable (four screws) triple output power supply. The whole assembly runs on 115/230 V, 50/60 Hz. Now for some specifics: 9" green phosphor, TTL input monitor, attached regulated 12 VDC, 1.5 A power supply used exclusively to run the monitor and an attached triple output switching power supply with outputs of 5 VDC @ 3.5 A, +12 VDC @ 500 ma, and -12 VDC @ 500 ma. The assembly has mounting feet and should be a snap to make a case for. Comes with hook up data. New, factory boxed. We are offering this to you 4 ways:

- COMPLETE SET-UP AS SHOWN, including monitor, low voltage supply and triple output supply. SPL-116-38, 14 Lbs., \$50.00, 5/\$225.00
- TRIPLE OUTPUT SUPPLY ONLY, SPL-117-38, 3 Lbs. \$15.00
- 9" MONITOR ONLY, (you supply low voltage input) SPL-114-38, 10 Lbs. \$25.00
- 9" MONITOR W/LOW VOLTAGE SUPPLY ONLY, SPL-115-38, 12 Lbs. \$40.00

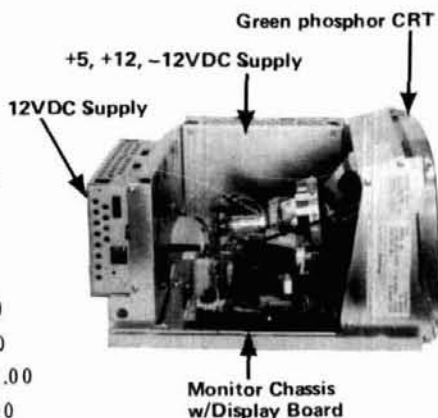

We are now selling guaranteed working, starlight scopes which allow sight in almost total darkness. They are so named because they incorporate a light amplification tube which uses the available star or moon light to allow you to see - without being seen. The scope has a spectral response of 4,500 to 8,000 angstroms, resolution of 50 lines/mm, viewing area of 25mm, standard 50mm F1.4 lens, optional telephoto 135mm F2.8 lens, cross hair reticle and optional carrying case. A great tool for security and naturalist applications. Runs on 9VDC transistor radio battery. Due to the nature of this device and people only having a one time use for it, we cannot accept returns for refund, credit or exchange on this item. To our knowledge, this is the least expensive starlight scope on the market. Includes 90 day warranty.

STARLIGHT SCOPE SPL-130A-39 \$1,200.00
 Optional Telephoto Lens, 135mm F2.8 SPL-131A-39 \$85.00
 Optional Fitted Carrying Case SPL-132A-39 \$65.00

ATTENTION:

**SECURITY PERSONNEL
 NATURALISTS
 HOBBYISTS**

NEW SEE-IN-THE-DARK EQUIPMENT!



5 1/4" HARD DRIVE CONTROLLER CARD

Finally, affordable, intelligent disc drive controllers are available at low, low surplus prices. The OMTI 20C controller boards we offer are unused, late style, surplus from a now defunct system house. OMTI is a division of Scientific Micro Systems. These boards will handle up to (2) 5 1/4 inch Winchester type hard drives that utilize a standard 34 pin SASI interface. Perfect for using with the above Seagate ST 506 drive, or other hard drives from 5 megabytes of storage on up. The controllers have buffered slew/seek modes, overlapped seeks, auto seek & verify, extensive fault detection, auto head & cylinder switching, full sector buffering, 256/512 bytes/sector, 33 or 18 sectors/track (jumper selectable), programmable disc parameters and much more. The board runs on +5 vdc & +12 vdc. We supply users manual & pinout data. Guaranteed O. K. Shpg. wt. 3 lb. OMTI 20 C \$150.00 each 2/\$275.00 Qty. pricing available.



HIGH POWER SURVEILLANCE IR SCOPE

This Infra-Red scope was designed specifically for long range surveillance use. The built-in, totally invisible, 50 watt halogen lamp IR source is coupled with a premium grade type 6032 image converter tube, 265 mm f4.2 lens, and 16 power military spec., color corrected eyepiece make this an ideal unit for viewing of clandestine activities or animals. The scope is capable of detection at more than 300 feet, recognition at 300 feet and positive facial identification at 150 feet. It runs on 12 VDC which makes it ideal for mobile use. It comes with a removable hand grip which allows for tripod mounting, 2 power cords for cigarette lighter or battery terminals, instructions and a 90 day warranty. Listed below are accessories which make this a very versatile instrument. The scope and accessories are new and guaranteed functional. Net wt. 5-1/4 Lbs.

IR Scope part no. ELD Shpg. Wt. 7 Lbs. \$735.00 ea.

ACCESSORIES:

12 VDC GELL BATTERY for above. Shpg. Wt. 6 Lbs. \$35.00
 BIOCLAR EYEPIECE which can be used in place of the standard eyepiece. This allows the scene being produced by the IR viewer to be seen by the operator up to 4 ft. away. 2 Lbs. \$89.95

MALE "T" f1.6 CAMERA DAPTER for SLR cameras Shpg. Wt. 1 Lb. \$129.00
 MALE "C" to FEMALE "T" ADAPTER for CCTV, requires use of above male "T" f1.6 adapter. Shpg. Wt. 1 Lb. \$29.95

Free 72 page catalogue available or send \$1.00 for 1st class service to P. O. Box 62 E. Lynn, Ma. 01904. Phone (617) 595-2275 to place your order by phone. MC, VISA, or American Express charge cards accepted.



THE GUERRI REPORT

by Ernie Guerri, W6MGI

computer graphics become more powerful

Next to word processing and accounting functions, graphics applications are rapidly becoming one of the most widely used functions of microcomputers. Unfortunately, small computers of the Apple/IBM PC class have relatively modest memory and data rate capabilities, and sophisticated graphics applications require enormous processing ability. For example, the IBM PC, using one of its most advanced graphics adapter boards, is capable of producing a picture consisting of 600 horizontal x 400 vertical picture elements (pixels) with 16 shades of gray (or 16 colors). This requires about 200,000 eight-bit bytes of memory, and can produce one full screen of picture each $\frac{1}{3}$ second. To produce just one second of television-grade picture would require *ten* times the computer power of the PC, and to add the full 64 shades of gray that the average eye can discern would double that requirement again!

But this is only the beginning. Advanced graphics applications such as computer aided engineering (CAE) require displays with 1200 x 1000 pixels and as many as 256 different colors. This requires memories capable of storing several hundred million bytes, computers operating at 5-10 million operations/second, and CRT data rates of up to 125 MHz. Typical of the computers in this class are the DEC VAX and the Gould 32/67 — half a million dollars without the chrome and tailfins.

To produce full-color moving pictures of entertainment quality requires displays capable of 4000 x 4000 pixels with 1000 colors. The memory requirements may be in the trillions of bytes, and the computers must be capable of

nearly a billion operations/second. The CRAY supercomputer is one of the few in this class — and is priced at about \$10 million! LucasFilm has reportedly invested in several CRAY's for the purpose of making movies that are 100 percent computer generated. Take heart, ATVers — these goodies should be available surplus in about 50 years!

super broadband amplifiers on the horizon

We've become accustomed to the notion that "broadband" generally means that a circuit or amplifier can cover all of a given band of interest with the same characteristics that we would expect of a circuit optimized for a specific frequency. Recent advances in hybrid microwave IC's, however, are redefining the concept of "broadband." Design groups at Philips Research in England have developed hybrid ICs using MESFETs that have measured bandwidths of nearly 12 GHz with about 7 dB of gain, and a noise figure of less than 8 dB. Moreover, the unit is capable of over $\frac{1}{4}$ watt of output over the entire band! Meanwhile, researchers at Hughes aircraft report an amplifier which is flat over the range from 2-40 GHz, giving 8 dB of gain. Scientists at several other organizations are reporting similar results which would indicate great progress in the development of devices and circuit concepts. HEMT GaAs FETs promise very low noise and high gain at these frequencies, and new computer aided modeling techniques will be required to optimize the circuit layouts and structures required to yield these bandwidths. Silicon bipolar transistors still seem to have plenty of life left for these applications. The AT200 series from Avantek, used in oscillators at 20 GHz, demonstrates better stabil-

ity and lower noise than GaAs designs, when followed by GaAs distributed amplifiers. Not surprisingly, the geometry and dimensions of the silicon devices is similar to the GaAs counterpart. Applications will initially be in highly sophisticated areas like electronic warfare and in the terminal ends of optical signal processors, but within a few years we should see this capability forming the basis for a whole new generation of lab and test equipment. Within a decade we could see low power transceivers that cover all the Amateur bands in a single unit.

vacuum tube ICs make debut

For the past several years investigators have contemplated the notion of using techniques that implement the microgeometries of transistors in order to make vacuum tubes with correspondingly small dimensions. The advantages would include the characteristics that make tubes attractive — high-temperature operation, radiation resistance, and substantial forgiveness of voltage surges.

Designers at Los Alamos National Laboratory have fabricated a vacuum tube "IC" that contains about 200 triodes and measures 40 mils on a side. It's expected that in about two years, devices that contain four to five times as many "tubes" and require only one-fourth as much space will be possible.

Because of the inherent high-temperature capability of these devices, the thermal consequences of increasing active device density may not be as serious as with semiconductors. It isn't yet clear that the small geometries associated with the "microtubes" translate to correspondingly improved high-frequency performance.

ham radio

ADVERTISER'S INDEX AND READER SERVICE NUMBERS

Listed below are the page number and reader service number for each company advertising in this issue. To get more information on their advertised products, use the bind-in card found elsewhere in this issue, select the correct reader service number from either the ad or this listing, check off the numbers, fill in your name and address, affix a postage stamp and return to us. We will promptly forward your request to the advertiser and your requested information should arrive shortly. If the card is missing, send all the pertinent information on a separate sheet of paper to: *ham radio magazine*, Attn: Reader Service, Greenville, NH 03048.

UNIVERSAL PACKET CONTROLLER model PK-80



\$219⁹⁵ Suggested
Amateur Net Price

The AEA model PK-80 is a wired, tested, and calibrated version of the famous TAPR TNC-2 and comes with a one-year conditional AEA warranty.

You can interface the PK-80 with any ASCII terminal or a personal computer and standard terminal software. The PK-80 is loaded with all the latest AX.25 version 2.0 software and advanced packet hardware circuitry that makes the TNC-2 the newest benchmark for comparison.

Compare the following as representative of the advanced new features relative to the competition.

- Hardware HDLC for full duplex
- True Data Carrier Detect (DCD) for HF operation
- Operates with 300, 1200, 2400, 4800, and 9600 baud terminals
- Five front-panel status indicators
- Multiple connect
- Connect check (poll final bit) fully implemented
- Connect AUTO response message
- Only three commands necessary for making standard contacts
- 82 software commands possible for the most demanding requirements

Prices and Specifications Subject to Change Without Notice or Obligation.

ADVANCED ELECTRONICS APPLICATIONS, INC.
P.O. Box C-2160, Lynnwood, WA 98036-0918
TELEX: 6972496 AEA INTL UW
(206) 775-7373

READER SERVICE #	PAGE #	READER SERVICE #	PAGE #
103 - Ace Communications	66	156 - LaCue Communications	62
104 - Advanced Computer Controls, Inc.	13	157 - Madison Electronics Supply	26
105 - Advanced Receiver Research	97	158 - Meadowlake Corp.	104
106 - AEA	79	151 - John J. Meshna, Jr. Co.	124
107 - AEA	126	159 - MFJ Enterprises	8
108 - All Electronics Corp.	101	160 - Micro Systems Institute	58
109 - Aluma Tower Co.	102	161 - Microwave Filter, Inc.	20
* Amateur Electronic Supply	98	162 - Minds Eye Publications	97
110 - Amateur Wholesale Electronics	57	163 - Missouri Radio Center	111
111 - Amateur Wholesale Electronics	74	164 - Nema Electronics	118
112 - Amidon Associates	56	* Newsome Electronics	88
113 - AMSAT	108	166 - Nuts & Volts	106
114 - ARRL	76	167 - Omega Concepts	58
115 - Astron Corp.	87	* Orlando Hamcation	76
116 - Azotic Industries	21	169 - P.C. Electronics	27
* Barker & Williamson	20	201 - Pac Comm Packet Radio Systems, Inc.	53
* Barry Electronics	119	170 - Pacific Rim Communications	54
117 - Buckmaster Publishing	56	* Packetem	22
118 - Burghardt Amateur Center	114	171 - Panasonic	31
* Butternut Electronics	46	172 - Propagation Publishing	108
* Caddell Coil Corp.	42	189 - The PX Shack	108
119 - CoCo Communications	96	173 - OSKY Publishing	104
120 - CES	1	174 - Radio Amateur Callbook	111
122 - CMC Communications	42	175 - Radio School	80
121 - CMC Communications, Inc.	106	177 - RadioKit	119
124 - Coaxial Dynamics, Inc.	66	176 - Radiosporting	72
126 - Communications Concepts, Inc.	46	178 - Ramsey Electronics, Inc.	105
127 - Communications Specialists	127	125 - Redipart	116
128 - Connect Systems, Inc.	128	179 - RF Parts/Westcom Eng.	117
129 - Crowley Mfg. Co.	111	181 - Sartori Associates	111
130 - CTM	72	182 - Spec Com	46
132 - Current Development Corp.	97	183 - Spectrum International, Inc.	82
131 - Current Development Corp.	80	* STTI	28
* Dayton Hamvention	56	184 - STV/OnSat Magazine	110
133 - DCC Data Service, Inc.	97	185 - Sulltronics	68
* Dick Smith Electronics	54	188 - Telewave, Inc.	40
134 - Digtrex	102	191 - TNT Radio Sales, Inc.	80
135 - Doppler Systems	121	192 - Transleteronic, Inc.	80
136 - DX'er's Magazine, Gus Browning, W4BPD	58	* Tropical Hamboree	96
137 - EEB	121	186 - TSG, Technical Systems Group	110
138 - Electronics Book Club	63	193 - UHC Electronics	110
* Engineering Consulting	91	194 - Unity Electronics	118
139 - Fair Radio Sales	42	* University Microfilms Int.	102
140 - GLB Electronics	43	195 - Vanguard Labs	58
141 - GLB Electronics	72	196 - Varian EIMAC	16
142 - H.L. Heaster, Inc.	104	190 - The VHF Shop	68
143 - Hall Electronics	111	197 - W9INN Antennas	118
144 - Ham Radio Outlet	64, 65	198 - Western Electronics	56
* Ham Radio's Bookstore	53, 55, 73, 82, 88, 97, 114, 123	* WSPA	76
* The Ham Station	102	199 - Yaesu Electronics Corp.	71
* Hamtronics, Inc.	83	200 - Yaesu Electronics Corp.	Cover III
145 - Hamtronics, Inc. PA	58		
* Hamtronics, PA	56		
146 - Hancock Toy Shop	123		
* Hardin Electronics	66		
147 - Hildreth Engineering	68		
148 - ICOM America, Inc.	Cover II		
149 - J.S. Technology, Inc.	76		
150 - Jensen Tools, Inc.	123		
152 - Jun's Electronics	73		
153 - Kantronics	63		
154 - Kendecom/MCS	50		
* Trio Kenwood Communications	2, 5, 7, 49, Cover IV		
155 - Kepro Circuit Systems	106		

PRODUCT REVIEW/NEW PRODUCT

304 - Bailey Tech	117
307 - Davtrend Ltd.	119
308 - John Fluke Mfg Co., Inc.	116
301 - Heath Company	116
311 - ICOM America, Inc.	115
309 - Jensen Tools, Inc.	115
* Trio Kenwood Communications	115
313 - Meadowlake Corp.	117
310 - MFJ Enterprises	115
306 - Microwave Filter, Inc.	119
303 - Minds Eye Publications	117
305 - OSKY Publications	118
312 - Radio School	115

* Please contact this advertiser directly.

Limit 15 inquiries per request.

Please use before February 28, 1986.

AEA BRINGS YOU THE
BREAKTHROUGH



Eureka!

We just struck gold with a miniature, high quality and very reliable DTMF decoder at a rock bottom price of \$59.95. Our DTD-1 will decode 5040, 4 digit codes with the security of wrong digit reset. It contains a crystal controlled, single chip DTMF decoder that works great in bad signal to noise environments and provides latched and momentary outputs. Why carry that heavy gear when its size is only 1.25 x 2.0 x .4 inches and it comes with our etched in stone, legendary, one year warranty.

Instead of sifting through the field...searching, use our super quick one day delivery and cash in on a rare find.

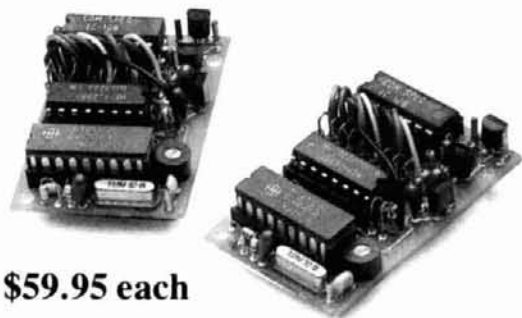

\$59.95 each

**COMMUNICATIONS
SPECIALISTS**

426 W. Taft Ave., Orange, CA 92665-4296
Local (714) 998-3021 • FAX (714) 974-3420
Entire U.S.A. 1-800-854-0547



THINGS TO LOOK FOR (AND LOOK OUT FOR) IN A PHONE PATCH

- One year warranty.
- A patch should work with any radio. AM, FM, ACSB, relay switched or synthesized.
- Patch performance should not be dependent on the T/R speed of your radio.
- Your patch should sound just like your home phone.
- There should not be any sampling noises to distract you and rob important syllables. The best phone patches do not use the cheap sampling method. (Did you know that the competition uses VOX rather than sampling in their \$1000 commercial model?)
- A patch should disconnect automatically if the number dialed is busy.
- A patch should be flexible. You should be able to use it simplex, repeater aided simplex, or semi-duplex.
- A patch should allow you to manually connect any mobile or HT on your local repeater to the phone system for a fully automatic conversation. Someone may need to report an emergency!
- A patch should not become erratic when the mobile is noisy.
- You should be able to use a power amplifier on your base to extend range.
- You should be able to connect a patch to the MIC and EXT. speaker jack of your radio for a quick and effortless interface.
- You should be able to connect a patch to three points inside your radio (VOL high side, PTT, MIC) so that the patch does not interfere with the use of the radio and the VOL. and SQ. settings do not affect the patch.
- A patch should have MOV lightning protectors.
- Your patch should be made in the USA where consultation and factory service are immediately available. (Beware of an inferior offshore copy of our former PRIVATE PATCH II.)

**ONLY
PRIVATE PATCH III
GIVES YOU ALL
OF THE ABOVE**

**N
E
W**

PRIVATE PATCH III

SIMPLEX SEMI-DUPLEX INTERCONNECT

**N
E
W**

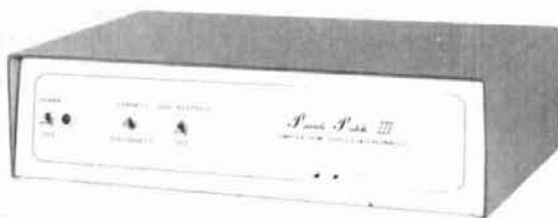

With an amazingly low price, the all new PRIVATE PATCH III is the most powerful personal phone patch system available. You can use it simplex, repeater aided simplex (from your base) or semi-duplex (at the repeater). That's right, you will never have to buy another patch. PRIVATE PATCH III does it all! There are many new and important features which were formerly only available in our top commercial models.

With a flick of the new connect switch you can patch your friends on the repeater into the phone system. One of them may need to report an emergency!

No hassles with busy signals! If you call a number that is busy, just put your MIC down and relax. PRIVATE PATCH III will disconnect automatically.

The new CW ID keeps you completely informed as to patch status. ID occurs when you access and again when you disconnect. ID is also sent after toll call attempts, all automatic disconnects, manual disconnect and when timeout is imminent. And of course your CW ID chip is free.

PRIVATE PATCH III does not interfere with the normal use of your base radio. A new audio pre-amp permits audio take off before the VOL. control. As a result, the VOL. and squelch settings do not affect patch operation. Of course you can also connect PRIVATE PATCH III to the MIC and EXT speaker jacks as before.

A new digit counting system makes the toll restrict positive even in areas where you do not have to dial "1" first. A secret five digit code disables the toll restrict for one toll call. Re-arm is automatic.

Additional new features: MOV lightning protection — Three digit access code (eg. *93) — Spare relay position on board — Plus former features: 3/6 minute timeout timer — Digital fast VOX (pat. pend.) — 115 VAC supply — Modular Jack and cord plus much more!

Why settle for a starter set? PRIVATE PATCH III provides you with commercial quality uninterrupted (cellular like) mobile telephone communications 24 hours a day. Send for our four page brochure today for complete details.

Options:
FCC approved coupler
12 VDC or 230 VAC power

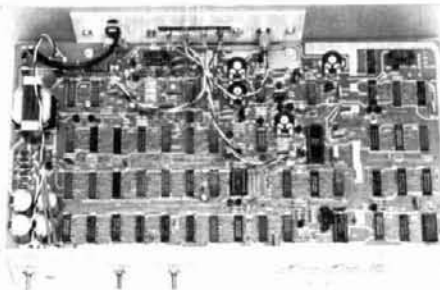

DEALERS

- | | |
|---|---|
| AMATEUR ELECTRONIC SUPPLY
Milwaukee WI, Wickliffe Oh,
Orlando FL, Clearwater FL,
Las Vegas NV | MADISON ELECTRONICS SUPPLY
Houston, TX |
| BARRY ELECTRONICS CORP.
New York, NY | MIAMI RADIO CENTER CORP.
Miami FL |
| COLES COMMUNICATIONS
San Antonio TX | MIKES ELECTRONICS
Ft. Lauderdale, Miami FL |
| EGE, INC.
Woodbridge, VA | N&G DISTRIBUTING CORP.
Miami FL |
| ERICKSON COMMUNICATIONS
Chicago IL | PACE ENGINEERING
Tucson AZ |
| HAM RADIO OUTLET
Anaheim CA, Burlingame CA,
Oakland CA, Phoenix AZ,
San Diego CA, Van Nuys CA | THE HAM STATION
Evansville IN |
| HENRY RADIO
Los Angeles CA | TEXAS TOWERS
Plano, TX |
| INTERNATIONAL RADIO SYSTEMS
Miami, FL | TNT RADIO SALES
Robbinsdale, MN |
| JUNS ELECTRONICS
Culver City CA | WESTCOM
San Marcos, CA |
| | CANADA:
DOLLARD ELECTRONICS
Vancouver, BC |

**CONNECT
SYSTEMS
INCORPORATED**

(213) 373-6803

23731 Madison St., Torrance, CA 90505



Celebrate your buying decision with the money you've saved.

When it comes to getting maximum HF performance for your dollar, the choice is clear. Yaesu's FT-757GX.

Nowhere else will you find so many HF features packed into one compact, mobile-ready package. At a price that's got the competition baffled.

For starters, each 757 includes an electronic keyer, 600-Hz CW filter, AM and FM modes, AF speech processor. And a 25-kHz marker generator. All at no extra charge.

And working the DX has never been easier with dual VFOs, single-button VFO/memory swap for split-frequency operation, eight

memories, and push-button quick memory and band scan.

The 757 also lets you listen from 500 kHz to 30 MHz with its high-performance general coverage receiver. The transmitter covers 160 through 10 meters, including the new WARC bands, with 100 watts output on sideband, FM and CW.

CW buffs will enjoy the delights of full QSK operation. Plus the massive heatsink and duct-flow cooling system allow continuous RITTY operation for up to 30 minutes. Use the FP-757HD heavy-duty power supply option for continuous-duty applications.

And of course, there's the 757's highly attractive price. It's the

perfect way to get all the HF performance you desire, with money left over to apply toward other ham gear. Perhaps a power supply for base station use. An antenna or antenna tuner. Or whatever else makes your operation complete.

So ask your dealer today about Yaesu's FT-757GX. The most celebrated HF price/performer on the air.

YAESU

Yaesu Electronics Corporation
6851 Wallball Way, Paramount
CA 90723 (213) 633-4007

Yaesu Cincinnati Service Center
9070 Gold Park Drive, Hamilton
OH 45011 (513) 874-3100

KENWOOD

...pacesetter in Amateur radio

NEW!

“DX-cellence!”

TS-940S

The new TS-940S is a serious radio for the serious operator. Superb interference reduction circuits and high dynamic range receiver combine with superior transmitter design to give you no-nonsense, no compromise performance that gets your signals through! The exclusive multi-function LCD sub-display panel graphically illustrates VBT, SSB slope, and other features.

- 100% duty cycle transmitter. Super efficient cooling system using special air ducting works with the internal heavy-duty power supply to allow continuous transmission at full power output for periods exceeding one hour.
- Programmable scanning.
- Semi or full break-in (QSK) CW.

- Low distortion transmitter. Kenwood's unique transmitter design delivers top "quality Kenwood" sound.
- Keyboard entry frequency selection. Operating frequencies may be directly entered into the TS-940S without using the VFO knob.
- Graphic display of operating features. Exclusive multi-function LCD sub-display panel shows CW VBT, SSB slope tuning, as well as frequency, time, and AT-940 antenna tuner status.
- QRM-fighting features. Remove "rotten QRM" with the SSB slope tuning, CW VBT, notch filter, AF tune, and CW pitch controls.
- Built-in FM, plus SSB, CW, AM, FSK.

Optional accessories:

- AT-940 full range (160-10 m) automatic antenna tuner
- SP-940 external speaker with audio filtering
- YG-455C-1 (500 Hz), YG-455CN-1 (250 Hz), YK-88C-1 (500 Hz) CW filters;
- YK-88A-1 (6 kHz) AM filter
- VS-1 voice synthesizer
- SO-1 temperature compensated crystal oscillator
- MC-42S UP/DOWN hand mic.
- MC-60A, MC-80, MC-85 deluxe base station mics.
- PC-1A phone patch
- TL-922A linear amplifier
- SM-220 station monitor
- BS-8 pan display
- SW-200A and SW-2000 SWR and power meters.

9:40
on 21:00 off 0:00

SLOPE 1

V-B 21.250.00 US
V-A 14.200.01 US

ANTENNA TUNER
AUTO TUNE READY



- High stability, dual digital VFOs. An optical encoder and the flywheel VFO knob give the TS-940S a positive tuning "feel".
- 40 memory channels. Mode and frequency may be stored in 4 groups of 10 channels each.
- General coverage receiver. Tunes from 150 kHz to 30 MHz.
- 1 yr. limited warranty. Another Kenwood First.



More TS-940S information is available from authorized Kenwood dealers.

KENWOOD

TRIO-KENWOOD COMMUNICATIONS
1111 West Walnut Street
Compton, California 90220

Complete service manuals are available for all Trio-Kenwood transceivers and most accessories. Specifications and prices are subject to change without notice or obligation.