

DECEMBER 1985 / \$2.50

Season's Greetings from . . .

ham radio magazine

DIGITAL
COMMUNICATIONS



hr
focus
on
communications
technology

spread spectrum • a packet radio primer • AMTOR, AX.25,
and HERMES • a packet radio frequency and deviation
tester • W1JR, K4IPV, W6SAI, K0RYW • plus ham radio's
five-year cumulative index

ICOM HF Transceiver

IC-745



High Performance Maximum Flexibility

The IC-745 is a full featured, high performance HF base station transceiver with a 100dB dynamic range receiver. PLUS features usually found only in more expensive units.

Compare these exceptional Standard Features:

- 100KHz - 30MHz Receiver
- 100 Watt RF output / 100% Duty Cycle
- Passband Tuning AND IF Shift
- Adjustable Noise Blanker (width and level)
- Adjustable AGC
- Receiver Preamp
- 16 tunable Memories with lithium battery backup



- Wide selection of filters and filter combinations (opt.)
- Continuously adjustable transmit power
- 10Hz/50Hz/1KHz Tuning rates with 1MHz band steps
- IC-HM12 Microphone with Up/Down Scan

Other Standard Features. Included as standard are many of the features most asked for by experienced ham radio operators: dual VFO's, RF speech compressor, tunable notch filter, program band scan, memory scan, all-mode squelch and VOX.

Options. Internal IC-PS35 power supply, external IC-PS15 or IC-PS30 system supply, IC-SM8 two-cable desk mic, EX241 marker, EX242 FM module, EX243 electronic keyer, IC-SM6 desk mic, and a variety of filters.

Filter	-6dB Width	Center Freq. MHz
FL45	500 Hz	9.000
FL54	270 Hz	9.000
FL44A	2.1 KHz	0.455
FL52A	500 Hz	0.455
FL53A	250 Hz	0.455

The IC-745 is the only transceiver today that has so much flexibility at a surprisingly low price...see it at your local ICOM dealer.

ICOM
First in Communication.

What To Look For In A Phone Patch

The best way to decide what patch is right for you is to first decide what a patch should do. A patch should:

- Give complete control to the mobile, allowing full break in operation.
- Not interfere with the normal operation of your base station. It should not require you to connect and disconnect cables (or flip switches!) every time you wish to use your radio as a normal base station.
- Not depend on volume or squelch settings of your radio. It should work the same regardless of what you do with these controls.
- You should be able to hear your base station speaker with the patch installed. Remember, you have a base station because there are mobiles. **ONE OF THEM MIGHT NEED HELP.**
- The patch should have standard features at no extra cost. These should include programmable toll restrict (dip switches), tone or rotary dialing, programmable patch and activity timers, and front panel indicators of channel and patch status.

ONLY SMART PATCH HAS ALL OF THE ABOVE.

Now Mobile Operators Can Enjoy An Affordable Personal Phone Patch...

- Without an expensive repeater.
- Using any FM transceiver as a base station.
- The secret is a **SIMPLEX** autopatch, The **SMART PATCH**.

SMART PATCH is Easy To Install

To install **SMART PATCH**, connect the multicolored computer style ribbon cable to mic audio, receiver discriminator, PTT, and power. A modular phone cord is provided for connection to your phone system. Sound simple? ... IT IS!

With SMART PATCH You are in CONTROL



With CES 510SA Simplex Autopatch, there's no waiting for VOX circuits to drop. Simply key your transmitter to take control.

SMART PATCH is all you need to turn your base station into a personal autopatch. **SMART PATCH** uses the only operating system that gives the mobile complete control. Full break-in capability allows the mobile user to actually interrupt the telephone party. **SMART PATCH** does not interfere with the normal use of your base station. **SMART PATCH** works well with any FM transceiver and provides switch selectable tone or rotary dialing, toll restrict, programmable control codes, CW ID and much more.

To Take CONTROL with Smart Patch - Call 800-327-9956 Ext. 101 today.

How To Use SMART PATCH

Placing a call is simple. Send your access code from your mobile (example: *73). This brings up the Patch and you will hear dial tone transmitted from your base station. Since **SMART PATCH** is checking about once per second to see if you want to dial, all you have to do is key your transmitter, then dial the phone number. You will now hear the phone ring and someone answer. Since the enhanced control system of **SMART PATCH** is constantly checking to see if you wish to talk, you need to simply key your transmitter and then talk. That's right, you simply key your transmitter to interrupt the phone line. The base station automatically stops transmitting after you key your mic. **SMART PATCH** does not require any special tone equipment to control your base station. It samples very high frequency noise present at your receivers discriminator to determine if a mobile is present. No words or syllables are ever lost.

SMART PATCH Is All You Need To Automatically Patch Your Base Station To Your Phone Line.

Use **SMART PATCH** for:

- Mobile (or remote base) to phone line via Simplex base. (see fig 1.)
- Mobile to Mobile via interconnected base stations for extended range. (see fig. 2.)
- Telephone line to mobile (or remote base).
- **SMART PATCH** uses **SIMPLEX BASE STATION EQUIPMENT**. Use your ordinary base station. **SMART PATCH** does this without interfering with the normal use of your radio.

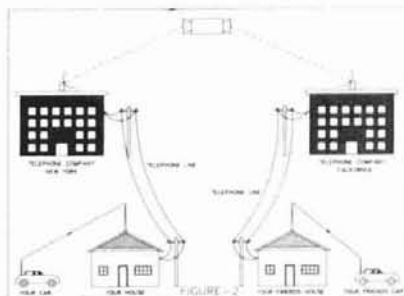
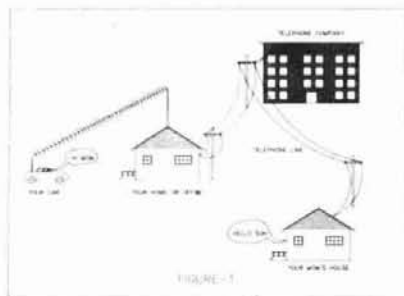

Communications Electronics Specialties, Inc.
P.O. Box 2930, Winter Park, Florida 32790
Telephone: (305) 645-0474 Or call toll-free (800)327-9956

WARRANTY?

YES. 180 days of warranty protection. You simply can't go wrong. An FCC type accepted coupler is available for **SMART PATCH**.

KENWOOD

...pacesetter in Amateur radio

The Smallest HT!

TH-21AT/31AT/41AT

Kenwood's advanced technology brings you a new standard in pocket/handheld transceivers!

- High or low power. Choose 1 watt high—enough to "hit" most local repeaters; or a battery-saving 150 mW low.
- Pocket portability! Kenwood's TH-series HTs pack convenient, reliable performance in a package so small, it slips into your shirt pocket! It measures only 57 (2.24) W x 120 (4.72) H x 28 (1.1) D mm (inch) and weighs 260 g (.57 lb) with PB-21.
- Expanded frequency coverage (TH-21AT/A). Covers 141.000-150.995 MHz in 5 kHz steps, includes certain MARS and CAP frequencies.
TH-31AT/A: 220.000-224.995 MHz in 5 kHz steps.
TH-41AT/A: 440.000-449.995 MHz in 5 kHz steps.



- Easy-to-operate, functional design. Three digit thumbwheel frequency selection and handy top-mounted controls increase operating ease.

- Repeater offset switch.
TH-21AT/A: ± 600 kHz, simplex.
TH-31AT/A: -1.6 MHz, reverse, simplex.
TH-41AT/A: ± 5 MHz, simplex.
- Standard accessories: Rubber flex antenna, earphone, wall charger, 180 mAH NiCd battery pack, wrist strap.
- Quick change, locking battery case. The rechargeable battery case snaps securely into place. Optional battery cases and adapters are available.
- Rugged, high impact molded case. The high impact case is scuff resistant, to retain its attractive styling, even with hard use. See your authorized Kenwood dealer and take home a pocketful of performance today!

NOW!
Extended-life
battery
pack



NEW BC-6 Charger!
Charges in just 1 hr.

Optional accessories:

- HMC-1 headset with VOX
- SMC-30 speaker microphone
- PB-21 NiCd 180 mAH battery
- PB-21H NiCd 500 mAH battery
- DC-21 DC-DC converter for mobile use
- BT-2 manganese/alkaline battery case
- EB-2 external C manganese/alkaline battery case
- SC-8/8T soft cases
- TU-6 programmable sub-tone unit
- AJ-3 thread-loc to BNC female adapter
- BC-6 2-pack quick charger
- BC-2 wall charger for PB-21H
- RA-8A/9A/10A StubbyDuk antenna
- BH-3 belt hook

KENWOOD

TRIO-KENWOOD COMMUNICATIONS
1111 West Walnut Street
Compton, California 90220

TH-series transceivers shown with optional StubbyDuk antenna. TH-31AT shown with PB-21H. Specifications and prices are subject to change without notice or obligation. Complete service manuals are available for all Trio-Kenwood transceivers and most accessories.

ham radio

magazine

DECEMBER 1985

volume 18, number 12

T. H. Tenney, Jr., W1NLB
publisher

Rich Rosen, K2RR
editor-in-chief
and associate publisher

Dorothy Rosa, KA1LBO
assistant editor

Joseph J. Schroeder, W9JUV
Alfred Wilson, W6NIF
associate editors
Susan Shorrock
editorial production

editorial review board

Peter Bertini, K1ZJH
Forrest Gehrke, K2BT
Michael Gruchalla, P.E.
Bob Lewis, W2EBS
Mason Logan, K4MT
Ed Wetherhold, W3NQN

publishing staff

J. Craig Clark, Jr., N1ACH
assistant publisher

Rally Dennis, KA1JWF
director of advertising sales

Dorothy Sargent, KA1ZK
advertising production manager

Susan Shorrock
circulation manager
Therese Bourgault
circulation

cover art:
Hans Evers, PA0CX

ham radio magazine is published monthly by
Communications Technology, Inc.
Greenville, New Hampshire 03048-0498
Telephone: 603-878-1441

subscription rates

United States:
one year, \$19.95; two years, \$32.95; three years, \$44.95
Canada and other countries (via surface mail):
one year, \$22.95; two years, \$41.00; three years, \$58.00
Europe, Japan, Africa (via Air Forwarding Service): one year, \$28.00
All subscription orders payable in U.S. funds, via international
postal money order or check drawn on U.S. bank

international subscription agents: page 132

Microfilm copies are available from
University Microfilms, International
Ann Arbor, Michigan 48106
Order publication number 3076

Cassette tapes of selected articles from ham radio
are available to the blind and physically handicapped
from Recorded Periodicals,
919 Walnut Street, Philadelphia, Pennsylvania 19107

Copyright 1985 by Communications Technology, Inc.
Title registered at U.S. Patent Office

Second-class postage paid
at Greenville, New Hampshire 03048-0498
and at additional mailing offices
ISSN 0148-5989

Send change of address to ham radio
Greenville, New Hampshire 03048-0498



contents

**13 spread spectrum and digital
communication techniques: a primer**

Ted S. Rappaport, N9NB

30 a packet radio primer

David McLanahan, WA1FHB

**41 automatic frequency and deviation
tester for packet radio**

John W. Langner, WB2OSZ

55 ham radio techniques

Bill Orr, W6SAI

**63 AMTOR, AX.25, and HERMES:
a performance analysis of
three systems**

Jerome T. Dijk, W9JD

79 practically speaking

Joe Carr, K4IPV

85 VHF/UHF world

Joe Reisert, W1JR

**104 annual cumulative index
(1981-1985)**

*W6MGI's column, "The Guerri Report," will return
next month.*

134 advertisers index and reader service	128 ham mart
8 comments	121 new products
98 DX forecaster	6 presstop
132 flea market	5 reflections
	8 short circuit

KENWOOD

...pacesetter in Amateur radio

Incredible Flexibility!

TM211A/411A

The TM-211A 2 m and the TM-411A 70 cm transceivers combine ultra-compact size with an impressive array of features to give you maximum flexibility in mobile operations. The TM-211A and the TM-411A may be stacked for even more operating flexibility!

- **External speaker.**
A high-quality external communications speaker is provided for the best sound quality.
- **5-channel memory with multiple scanning functions.**
The transceiver can scan the memory channels or can be programmed to scan all or a portion of the band.
- **25 watts high power.**
5 (adjustable to approx. 15 watts) low.

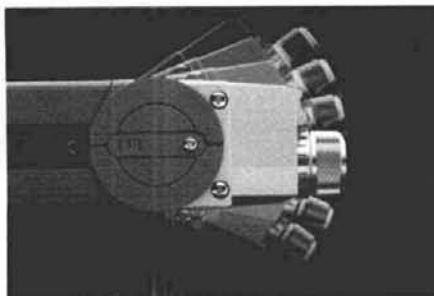

- **7-position, tilting control panel.**
The unique control panel is designed to increase operating and installation ease. The panel may be moved to provide the best viewing angle and handiest access to controls.
- **DCS—Digital Code Squelch.**
Program your transceiver to respond only to a specific digital code—much more secure than CTCSS.

- **Priority Watch.**
The "Priority Watch" mode lets you keep an eye on an important channel when monitoring other frequencies.
- **Extended frequency coverage on 2 m.**
TM-211A covers 142-149 MHz—includes most MARS and CAP frequencies.
TM-411A covers 438-450 MHz

Optional accessories:

- CD-10 call sign display • PS-430 DC power supply • KPS-7A power supply
- MC-42S regular UP/DOWN hand microphone • MC-55 (8-pin) mobile microphone with time-out timer
- MA-4000 dual band mobile antenna with duplexer • SWT-1/2 2 m/70 cm 100 W antenna tuners • SW-100A/B SWR/power meters • PG-3A noise filter • MB-201 extra mobile mount
- SP-403 compact mobile speaker



CD-10 DCS call sign display

CD-10 maximizes your use of Kenwood's new signalling concept, Digital Code Squelch. DCS uses a data string to open squelch on a receiver that has been programmed to accept the transmitted code. The transmitting station's call is programmed in ASCII. The CD-10 displays the station's call sign, and stores it in memory. Twenty calls may be stored. The CD-10 may be used with **any** receiver to display calls heard.



More product information is available from authorized Kenwood dealers.

KENWOOD

TRIO-KENWOOD COMMUNICATIONS
1111 West Walnut Street
Compton, California 90220

Complete service manuals are available for all Trio-Kenwood transceivers and most accessories. Specifications and prices are subject to change without notice or obligation.

REFLECTIONS REFLECTIONS

another revolution

We are in the midst of another revolution, albeit a peaceful one. Packet Radio and other forms of digital communications have arrived. Previously staunch users of the various forms of AM and FM have found themselves drawn into the world of zeros and ones and are talking to each other with ever-increasing speeds, efficiencies, and applications. For example, on 220 MHz and higher, up to 5600 characters per second transmission link speeds are both theoretically and legally possible. Passing the same amount of data on CW would require a sending speed of approximately 60,000 wpm — almost a thousand times faster than Ted McElroy's long-standing Morse code record.

Of course the proliferation of personal computers has had an important influence on this process, but I still attribute the rapid growth of this field to the inquisitive, intelligent, and practical mind of the Radio Amateur. For as soon as the first generation of Terminal Node Controllers (the interface between the terminal and the radio) became available, user groups formed and began developing applications ranging from direct message-passing to Packet Bulletin Board Systems (PBBSs).

Though most Packet activity occurs on VHF (in large measure on 145.010 MHz), this does not restrict transmissions to short distances. In fact, as of this date, a large section of each coast is inter-linked by a series of digital repeaters, or as they're better known, "digipeaters."

The startling growth rate of this mode became quite obvious as we prepared David McLanahan's article, "A Packet Radio Primer," for publication. Space was allocated for the April 10 version of the East Coast packet map shown on page 33. By September 10, activity increased dramatically and the size of the map *doubled*. This represents an increase of approximately 100 percent in the number of digipeaters, PBBSs, and home stations used predominantly for digipeating.

It seems particularly appropriate to consider this subject this month. December is, after all, a time of hope and renewal. In the past we've seen exciting developments — such as SSB, FM, and computers — make their mark on Amateur Radio. Will digital communications be the next logical step in this evolutionary process?

Turn the pages of this month's *ham radio* and see when and why the different forms of Packet Radio are appropriately used. And while you're on the subject, see how and why some hams have been experimenting with spread spectrum transmissions, once the exclusive domain of the military.

To paraphrase a well known soft drink manufacturer's slogan, "We're the Packet generation." Read on and see where you might fit in.

Rich Rosen, K2RR
Editor-in-Chief

THE AVERAGE U.S. AMATEUR IS JUST OVER 46 YEARS OLD, FCC's analysis of last April's Form 610s indicates. A detailed study of all that month's 9632 applications (all new licenses, renewals, and modifications) shows Novices to be the youngest, with an average age of 38.5. Techs average 45.1; Extras, 47.3; Generals, 50; Advanced, 51.8. By call areas, 9th district Novices were the youngest, at 35.6, and 0 district Advanced the oldest, at 55.

The U.S. Amateur Population Increased 0.65% During FCC's Fiscal 1985 (ending October 1), though the number of new Amateurs actually decreased by 7.6%. 17,373 newcomers joined Amateur ranks last year, while 14,709 dropouts left the year's end total 412,587. Largest percentage increase by license class was in Extras, up 2,344 to almost 38,000.

SOME MEANS SHOULD BE ESTABLISHED FOR "CERTIFYING" FREQUENCY COORDINATORS on a state or regional basis, as there's apparently no interest in establishing a "National Coordinator," FCC Safety and Special Services Chief Ray Kowalski suggested in his comments during the FM forum at the ARRL National Convention in Louisville. "Certified" coordinators would be those established and generally recognized for a given area; an eight-point plan is to be developed for determining appropriate qualifications and the method of formalizing such certification. Though the plan is to be published in the ARRL's Repeater Coordinators' Newsletter when completed, the League is specifically NOT participating in developing the plan.

Texas's Recoordination To 20 kHz Spacing On 2 Meters Has Been Completed, with the actual shift throughout the state expected to be complete by the end of November.

ARRL'S PROPOSAL TO PERMIT NOVICES PHONE PRIVILEGES probably won't be worked on at the FCC until early 1986, meaning that an NPRM won't be out until late spring at the earliest. So far there seems to be considerable division in the Amateur ranks on the issue, but the age figures in our lead item certainly indicate some change is needed.

Japanese CBers Have Invaded The Lower End Of 10 Meters, P29JS reports in a letter to the Southern California DX Bulletin. He's been hearing Japanese chatter all the way up to 28585 kHz, but without any indication of any "JA" call signs.

METROPLEX HAS BEEN NAMED THE FOURTH NATIONAL VEC effective September 19, the FCC has announced. Metroplex, one of the very first regional VECs, is now actively seeking VEs in other call areas. Call Alex Magocsi, WB2MGB, at (201) 592-6243 for information.

18 Regional And Three National VECs Have Expressed Interest In Joining CARE (Council of Amateur Radio Examining), which is now well along the road toward becoming a viable organization and expects to be incorporated as a not-for-profit corporation under Illinois law before the end of the year. Jim Georgias, W9JUG, can provide further information.

AFTERSHOCKS FROM NEWS MEDIA EXPLOITATION OF AMATEUR FREQUENCIES during the Mexico City earthquake disaster are still going on, with both the FCC and some of the offending news organizations on the receiving end of complaints by concerned Amateurs. Even some media people have themselves admitted feeling that the situation went far beyond reason, though most did not want to be quoted on the issue. Preliminary discussions between the FCC and both the Radio and TV News Directors Association and the National Association of Broadcasters have reportedly taken place, with hope that acceptable guidelines for Amateur Radio/media cooperation can be set up before the next crisis occurs. The FCC had thought it had defined the limitations in its Report and Order on BC Docket 79-47, but a widely distributed industry interpretation of the FCC's action left many in the industry with the impression that Amateur Radio was for their use pretty much as desired!

The FCC Is Interested In Reports Of Specific Media Incursions during the Mexico City crisis; they must be first-person and specific enough to be related to a specific news organization. Send them to Raymond Kowalski, Chief, Safety and Special Services, FCC, 1919 M St., NE, Washington D.C. 20554; tapes of abuses would be particularly welcome.

The Issue Of "Non-Amateur" Use Of Amateur Frequencies is an on-going issue that can't be ignored; the recent petition by a low-power TV broadcaster to use frequencies on the 70-cm Amateur band for TV remotes, and the establishment of a "protection zone" along the Canadian border for Canadian 420-430 MHz commercial users, are cases in point.

STILL MORE "HAM IN SPACE" OPERATIONS FROM SPACE SHUTTLES are shaping up for next year. AMSAT member Dr. Ron Parise, WA4SIR, has been selected to fly on Mission 61E in March, while Dr. Owen Garriott, W5LFL, is scheduled for mission 61K, now set for next September.

GEOSYNCHRONOUS AMATEUR SATELLITES ARE STARTING TO LOOK like real possibilities, according to AMSAT. Earlier, NASA had said it might provide Amateur Radio capability on one of its Advanced Communications Technology Satellites (ACTS), and now it appears an AMSAT transponder ("Phase 4") may find a spot on the same bird. In addition, Arianespace may also be able to provide a piggy-back launch opportunity for an Amateur transponder into geosynchronous orbit. AMSAT officials are now reviewing the possibilities, with particular interest in incorporating new approaches and capabilities in an Amateur proposal.

You may not be able to solve the world's problems. But at least you can listen.



The Panasonic Command Series™ With double superheterodyne tuning, you'll hear the world loud and clear.

Now it's easy to listen in on the world's hot spots. With the Panasonic RF-B600 Command Series FM/LW/MW/SW receiver.

Its advanced microcomputer-controlled tuner lets you preset up to nine different frequencies. And reach them at the touch of a button. Or, press the appropriate buttons and tune in any desired frequency with direct-access digital tuning. It'll lock right in to every signal with a PLL quartz-synthesized tuner. Once tuned in, the Panasonic double superheterodyne system helps deliver a clean, consistent signal.

There's even built-in auto-tuning to let you scan the shortwave band automatically, as well as manually. All this means you can tune in Berlin, pick up Paris, or locate London in an instant. Without dialing all over the band.

Both the RF-B600 and the RF-B300 are packed with features and built to go anywhere.

The Panasonic Command Series offers something for everyone. With equipment sophisticated enough to impress the most avid enthusiast, and automatic features that get you where you want to be. Fast.

There's a whole world out there that's waiting to be heard. Tune in to it with the Panasonic Command Series.



Batteries not included.

AEAEAEAEAEAEAEAEAEAEAEAE
 AEAEAEAEAEAEAEAEAEAEAEAE
 AEAEAEAEAEAEAEAEAEAEAEAE
 AEAEAEAEAEAEAEAEAEAEAEAE
 AEAEAEAEAEAEAEAEAEAEAEAE
DOCTOR
QSO T.M.

Relieves All Symptoms Of
 Morse Code Phobia!



\$79.95 AM NET

A Realistic Simulation of On-the-Air, Two-Way Morse Code 'Ragchew' Contacts (QSOs).

- Makes Upgrading of Morse Skills Easy and Fun
- Does Away With Drudgery
- Skilled Operators Enjoy the Realism
- Operate Anytime—Requires Only a Commodore C-64 (or C-128) and A TV Set
- Removes the "Mystery" of what to Say in On-the-Air Contacts
- Excellent Practice for Beginners and Old "Pro's"
- Standard Format and Common Abbreviations Used for All Exchanges
- Send Morse with your keyboard
- Select Appropriate QRM and QRN Levels
- Select the Portion of the 'Band'—Novice or Low End

Prices and Specifications Subject to Change Without Notice or Obligation

ADVANCED ELECTRONICS APPLICATIONS, INC.
 P.O. Box C-2160, Lynnwood, WA 98036

TELEX: 6972496
 AEA INTL UW
 (206) 775-7373

AEA BRINGS YOU THE BREAKTHROUGH



comments

Dear HR:

In response to KA0DOE's letter in the September, 1985, issue of *ham radio* (Comments, page 15) I have only one comment. The total function of the Novice Amateur Radio license is to introduce the public to Amateur Radio Service by giving them simple privileges on a few selected portions of the Amateur Radio bands and a very simple but effective mode of transmission called CW or Radiotelegraphy. Then it's up to the individual to make that commitment to upgrade to the higher grade license and more privileges.

Bill Eaton, WB1CXI
 Channelview, Texas

something for nothing

Dear HR:

Unlike KA0DOE, I read July's "Presstop" (page 6) with horror and disgust. The present-day attitude of rewarding hams for doing absolutely nothing will be the biggest reason for the ultimate death of the hobby.

Why are unearned extensions of band privileges the only thing that can help encourage these operators? Aren't there myriad challenges available to try the patience and ingenuity of any class of Amateur today? Will more "entertaining" modes give us any "more to encourage us to seek out our full potential as operators?"

At the beginning of World War II, Amateur Radio operators provided a highly proficient cadre of electronics technicians and skilled instructors to the United States. Let me propose a calamity today. What functions could a group of Amateurs provide whose

only claim to technical skill is the ability to box up their equipment and get it to the United Parcel Service?

I was granted a Class B license in 1947 and, one year later, passed the Class A examination. Can I now cry out that I have been a good and faithful ham for 38 years, so I deserve an Extra Class license? Hell, no! I must get my old brain in gear and hit the books and suffer my way back to 20 words per minute. That is one of the basic challenges of Amateur Radio. The frightening thing about "glorified CB operators" is not only the terrible operating practices that a lot of them demonstrate, but the "something for nothing" syndrome that fosters these practices.

If a soldier received the Purple Heart for falling off the back of a 6x6 when he was drunk, it would degrade the sacrifice of all the others who proudly wear that decoration. The time and effort spent to upgrade a license is vital to the spirit of Amateur Radio. With it comes the understanding of the privilege granted us to use certain parts of the radio spectrum. And with that understanding comes the resolve to operate legally and properly.

I raised my children to realize that they were due only what they were willing to expend their time and effort to gain. There is, and certainly should be, no free lunch. In like manner, I do not condone any unearned privileges for any Amateur Radio operator.

Joe Weite, KH6GDR
 Makakilo, Hawaii

short circuit
75-meter transceiver

The PC board art shown in K1BQT's article, "A Compact 75-meter Monoband Transceiver" (November, 1985, page 13) is incorrectly sized. For a complete, corrected set of board art suitable for reproduction, send a stamped, self-addressed No. 10 (business-sized) envelope to *ham radio*, Greenville, New Hampshire 03048.

NEW FROM MFJ

MFJ'S BEST 300 WATT TUNER NOW GIVES YOU A CROSS-NEEDLE METER THAT READS SWR, FORWARD AND REFLECTED POWER — ALL AT A GLANCE.



MFJ-949C
\$149.95

MFJ's best 300 watt tuner is now even better! The MFJ-949C all-in-one Deluxe Versa Tuner II gives you a tuner, cross-needle SWR/Wattmeter, dummy load, antenna switch and balun in a new compact cabinet.

You get quality conveniences and a clutter-free shack at a super price.

A new cross-needle SWR/Wattmeter gives you SWR, forward and reflected power—all at a single glance. SWR is automatically computed with no controls to set. Has 30 and 300 watt scale on easy-to-read 2 color lighted meter (needs 12 V).

A handsome new black brushed aluminum cabinet matches all the new rigs. Its compact size (10 x 3 x 7 inches) takes only a little room.

You can run full transceiver power output—up to 300 watts RF output—and match coax, balanced lines or random wires from 1.8 thru 30 MHz. Use it to tune out SWR on dipoles, vees, long wires, verticals, whips, beams and quads.

A 300 watt 50 ohm dummy load gives you quick tune ups and a versatile six position antenna switch lets you select 2 coax lines (direct or thru tuner), random wire or balanced line and dummy load.

A large efficient airwound inductor—3 inches in diameter—gives you plenty of matching range and less losses for more watts out. 1000 volt tuning capacitors and heavy duty switches gives you safe arc-free operation. A 4:1 balun is built-in to match balanced lines.

Order your convenience package now and enjoy.

SUPER KEYBOARD

MFJ-496
\$169.95



Price slashed 50% to \$169.95! Get a full feature Super Keyboard that sends CW/RTTY/ASCII for the price of a good memory keyer.

You get the convenience of a dedicated keyboard—no program to load—no interface to connect—just turn it on and it's ready to use.

This 5 mode Super Keyboard lets you send CW, Baudot, ASCII, use it as a memory keyer and for Morse Code practice. You get text buffer, programmable and automatic message memories, error deletion, buffer preload, buffer hold.

A 256 character keyboard buffer gives you perfect CW even if you "hunt and peck". A meter reads CW speed and buffer remaining. 4 message memories lets you store up to 256 characters. 4 preprogrammed messages lets you send CQ CQ DE, CQ TEST DE, DE, QRZ. Has speed weight, tone and volume pots that remembers their settings even after power is turned off. Send 60 WPM Baudot and 100 baud ASCII.

You can use it as a deluxe full feature memory keyer that has automatic and programmable memories, iambic operation, dot-dash memories. Has random and pseudo random code generator.

Automatic serial numbering, message repeating, tune switch, shielded for RFI. 12 VDC or 110 VAC with MFJ-1312, \$9.95. 12 x 7 x 3 1/2 inches.

CROSS-NEEDLE SWR/WATT METER

MFJ-815 \$59.95

MFJ's cross-needle SWR/Wattmeter gives you SWR, forward and reflected power

—all at a single glance! SWR is automatically computed

—no controls to adjust. Easy-to-use push buttons select three power ranges that give you QRP to full legal limit power readings. Reads 20/200/2000 W forward, 5/50/500 W reflected and 1:1 to 1:5 SWR on easy-to-read two color scale. Lighted meter. Needs 12 V. ±10% full scale accuracy. 6 1/2 x 3 1/4 x 4 1/2 inches.



2 KW COAX SWITCHES

Instantly select any antenna or rig by turning a knob. Organizes coax cables and eliminates plugging and unplugging. Unused terminals are grounded to protect

your equipment for stray RF, static and lightning. 2 KW PEP, 1 KW CW. For 50 to 75 ohm. Negligible loss, SWR, and crosstalk gives high performance. SO-239s. Convenient desk or wall mounting.

MFJ-1702, \$19.95. 2 positions. Cast aluminum cavity construction gives excellent performance up to 500 MHz with better than 60 dB isolation at 450 MHz. Heavy duty, low loss switch has less than 20 milliohm contact resistance, less than 0.2 dB loss and SWR below 1:1.2. 2 x 2 1/2 x 1 inches.

MFJ-1701, \$29.95. 6 positions. White markable surface for recording ant. positions. 8 1/2 x 1 1/2 x 3 in.

MFJ-1702
\$19.95

\$29.95 MFJ-1701



ANTENNA CURRENT PROBE

MFJ-206 \$79.95

This new breakthrough MFJ Antenna Current Probe lets you monitor RF antenna currents—no connections needed! Determine current distribution, RF radiation pattern and polarization of antennas, transmission lines, ground leads, building wiring, guy wires and enclosures.

- Indicate transmission line radiation due to high SWR, poor shielding or antenna unbalance.
- Detect re-radiation from rain gutters and guy wires that can distort antenna field patterns.
- Detect RF radiation from ground leads, power cords or building wiring that can cause RFI.
- Determine if ground system is effective.
- Pinpoint RF leakage in shielded enclosures.
- Locate the best place for your mobile antenna.
- Use as tuned field strength meter.

Monitors RF current by sensing magnetic field. Uses an electrostatically shielded ferrite core, FET RF amplifier, op-amp meter circuit for excellent sensitivity, selectivity. 1.8-30 MHz. Has sensitivity, bandswitch, tune controls, telescoping antenna for field strength meter. 4 x 2 x 2 inches.



DIGITAL SWR/WATTMETER

MFJ-818
\$89.95

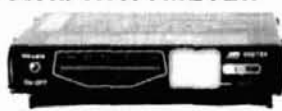

Fully automatic Digital SWR/Wattmeter reads SWR 1:1 to 1:9.9 directly and instantaneously—no SWR knob to set. Huge 0.6 inch bright orange digits make across-the-room reading easy. 12 segment LED bar graph wattmeter gives instantaneous PEP readings up to 200 watt RF output.

Good, bad, mismatch tri-color LEDs indicate SWR conditions. Small size (5 1/2 x 4 1/4 x 1 in.) and easy-to-read digital display makes it ideal for mobile use. For 50 ohm systems. 1.8-30 MHz. 12 VDC or 110 VAC with MFJ-1312, \$9.95.

MOBILE ANTENNA MATCHER

MFJ-910 \$19.95

Lower your SWR and get more power into your mobile whip for solid signals and more QSOs.

Your solid state rig puts out more power and generates less heat. For 10-80 meter whips. Easy plug-in installation. Complete instructions on how best to lower SWR. Fits anywhere, 2 1/2 x 2 1/2 inches.



TRIPLE OUTPUT LAB POWER SUPPLY

MFJ-4002 \$149.95



Triple output lab quality power supply gives you plenty of voltage and current for all your analog and digital circuits. You get 3 completely isolated outputs: 2 variable 1.5-20 VDC at 0.5 amp and a fixed 5 VDC at 1 amp. Connect in series or parallel for higher voltage and current. It's short circuit protected, has excellent line (typically 0.01% /V) and load regulation (typically 0.1%). **Lighted 3 inch precision meters** monitor voltage and current simultaneously. It's ruggedly built so you'll get many years of trouble free service. 12 x 3 x 6 inches. 110 VAC with safety ground.

ORDER ANY PRODUCT FROM MFJ AND TRY IT-NO OBLIGATION. IF NOT SATISFIED, RETURN WITHIN 30 DAYS FOR PROMPT REFUND (less shipping).

- One year unconditional guarantee • Made in USA
- Add \$5.00 each shipping/handling • Call or write for free catalog, over 100 products.

MFJ

MFJ ENTERPRISES, INC.
Box 494, Mississippi State, MS 39762

TO ORDER OR FOR YOUR NEAREST DEALER, CALL TOLL-FREE

800-647-1800

Call 601-323-5869 in Miss. and outside continental USA Telex 53-4590 MFJ STKV



THOUSANDS OF SATISFIED
CUSTOMERS WORLDWIDE



HAM RADIO OUTLET

ALL MAJOR BRANDS IN STOCK

KENWOOD HAND-HELDS



TR-2600A Deserves its well-earned reputation as the leading HT

TH-21AT/41AT
COMPACT!
Only 2.4"W, 4.72"H, 1.1"D
Outstanding performers in an ideal package size



CALL FOR PRICE

TOLL-FREE PHONE

INCLUDING ALASKA AND HAWAII



MA-40 40' TUBULAR H.D. MAST

Regular \$745
SALE \$549

MA-550 55' TUBULAR H.D. MAST

Regular \$1245
SALE \$899

•Why You Should Buy•

1. Will handle 10 Sq. Ft. 50 mph
2. Pleases neighbors with tubular streamlined look
3. In stock for quick delivery
4. Other models at great prices

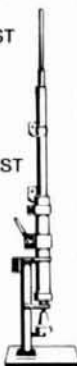

FREE SHIPMENT

MOST ITEMS. U.P.S. SURFACE.



SIMPLEX-REPEATER-SATELLITE



IC-271H
2 METERS • 100 WATTS
• ALL-MODE

IC-471H

430-450MHz • 75 WATTS
• ALL-MODE



CALL FOR YOUR SPECIAL PRICE



ICOM IC-27A

SUPER-COMPACT
2 METER MOBILE



ALSO *IC-27H HIGH POWER VERSION
AND IC-37A, 220MHz
IC-47A, 70CM

SAVE!

CALL FOR LOW, LOW PRICE



TOWER
SALE

W-51 \$899
51' CRANK-UP 9 SQ'



ELH 23D 2 MTR
30 W

CALL FOR PRICE

THE VERY BEST DEAL ON EVERY COUNT!



YAESU

FT-757GX



FT-2700H
NEW!
2M/70CM
TRANSCIVER



FT-726R

FT-209RH

CALL FOR GREAT PRICES

KENWOOD TS-940S

TOP-OF-THE-LINE HF TRANSCEIVER

PAY REGULAR PRICE ~~\$1799.95~~



CALL FOR
YOUR LOW,
LOW PRICE

Free UPS Surface



HAM RADIO OUTLET

ALL MAJOR BRANDS IN STOCK



ICOM IC-R71A

**SUPERIOR GRADE
GENERAL COVERAGE
RECEIVER**



Regular \$799

SALE! \$629.95
\$599.95



ICOM IC-37A



220 MHz's BEST BUY!
REGULAR \$449

SALE! \$299.95
LIMITED QUANTITIES
THIS PRICE.

TOLL-FREE PHONE

INCLUDING ALASKA AND HAWAII



ICOM

HAND-HELDS



IC-02AT IC-2AT IC-3AT
IC-04AT IC-4AT

**AT GREAT LOW
LOW PRICES**

FREE SHIPMENT
MOST ITEMS. U.P.S. SURFACE.



ICOM IC-735

THE LATEST IN ICOM'S LONG LINE
OF HF TRANCEIVERS



CALL FOR LOW, LOW PRICE



**ICOM LATEST
EDITION**

IC-3200A DUAL BANDER
COVERS BOTH 2 METERS
and 70CM



CALL FOR
LOW,
LOW
PRICE

6 STORE BUYING POWER!



PERSONALIZED SERVICE
BOB FERRERO W6RU
President
JIM RAFFERTY N6RL
VP So. Calif. Div. Anaheim
Managers
GEORGE W6RDSV Burlingame
DON W6PFE Oakland
BOB K7RCH Phoenix
GLENN K8NA San Diego
AL W6YVA Van Nuys
and other active amateurs to serve you

800-854-6046

TOLL FREE PHONE INCLUDING ALASKA AND HAWAII
CALIF. AND ARIZONA CUSTOMERS CALL OR VISIT NEAREST STORE
PHONE HOURS: 9:30 AM TO 5:30 PM PACIFIC TIME.
STORE HOURS: 10 AM to 5:30 PM Mon. through Sat.

FREE SHIPMENT
MOST ITEMS U.P.S. SURFACE



ANAHEIM, CA 92801
2620 W. La Palma,
(714) 761-3033, (213) 860-2040,
Between Disneyland & Knotts Berry Farm.

BURLINGAME, CA 94010
990 Howard Ave.,
(415) 342-5757,
5 miles south on 101 from San Fran. Airport.

OAKLAND, CA 94609
2811 Telegraph Ave.,
(415) 451-5757,
Highway 24 Downtown. Left 27th off-ramp.

PHOENIX, AZ 85015
1702 W. Camelback Road,
(602) 242-3515,
East of Highway 17.

SAN DIEGO, CA 92123
5375 Kearny Villa Road,
(619) 560-4900,
Highway 163 and Clairemont Mesa Blvd.

VAN NUYS, CA 91401
6265 Sepulveda Blvd.,
(818) 988-2212
San Diego Freeway at Victory Boulevard

AEA • ALLIANCE • ALPHA • AMECO • AMPHENOL • ANIKER MARK • ANTENNA SPECIALISTS • ARRL • ASTRON • BASH • BELDEN • BENCHER • BIRD • BUTTERNUT • B & W • CALBOOK • CENTURIAN • COLLINS • COLUMBIA • CURTIS • CUSHCRAFT • DAIWA • DRAKE • DX EDGE • EIMAC • GILFER • HAL • HUSTLER • HY GAIN • ICOM • JSC • J. W. MILLER • KANTRONICS • KENWOOD • KLM • ARSEN • LUNAR • METZ • MFJ • MICRO LOG • MINI PRODUCTS • MIRAGE • NYE • PALOMAR • ROHN • SHURE • SIGNAL ONE • STONER • TEMPO • TEN-TEC • TRISTAR • TRI EX • VAN GORDON • VOCCM • VIBROPLEX • WEST • YAESU and more

Kantronics out "SMARTS" the competition

Presenting three intelligent, versatile, compatible terminal units.

"SMART" means an internal microprocessor is used to improve performance and add versatility. The "Smart" Kantronics TU's can transmit and receive CW/RTTY/ASCII/AMTOR or Packet when combined with your computer and transceiver.

Any computer with a serial RS232 or TTL port can connect directly to a Kantronics TU. A simple terminal program, like one used with a telephone modem, is the only additional program required. Kantronics currently offers Packet and UTU Terminal Programs for IBM, Kaypro, Commodore 64, VIC 20, and TRS-80 Models III, IV, and IVP. Disk version \$19.95. Cartridge \$24.95.

UTU The Universal Terminal unit (UTU) is the original "Smart" amateur TU. CW, RTTY, ASCII, and AMTOR can all be worked with this single unit. Switched capacitance filters and LED display tuning make using the UTU easy for even the Novice. 12 Vdc 300mv power supply required. Suggested retail \$199.95.

UTU-XT The UTU-XT is an enhanced version of the UTU. Programmable baud rates, tone frequencies, and tone shifts give special versatility. Automatic Gain Control and Threshold Correction circuits greatly enhance sensitivity and selectivity. A RTTY signal detect circuit mutes copy with no carrier, and the CW filter center frequency and bandwidth are programmable. Power supply is provided. Suggested retail \$359.95.



Packet Communicator Kantronics joined the Packet Radio revolution with the Packet Communicator. The unit is an AX.25/Vancouver compatible TNC with features not found in other units, including Direct TTL connection for easy hookup to the VIC-20 and Commodore 64. With our onboard modem you can select either Bell 202 or 103 tones for VHF/UHF or HF work. Power supply is provided. Suggested retail \$219.00.

For more information contact your local
Kantronics dealer or write:

Kantronics

1202 E 23rd Street (913) 842-7745
Lawrence, Kansas 66046

spread spectrum and digital communication techniques: a primer

Not quite sure
how speech can be
transformed into a
digital signal?
Read on.

Ever since the inception of Amateur Radio, hams have kept abreast of the latest and most innovative methods of communication. From the advent of spark-gap radiotelegraphy, to the early FM transmitters, through the 2nd World War — when hams played an important part in concocting the first reliable pulse radar systems — to RTTY, SSTV, SSB, satellite communications, and packet radio, Amateurs have been ardent users of new and fascinating modulation methods.

In recent years there has been interest in a relatively new type of communication technique. While the foundation for this communication method was laid with the advent of ranging radar, it has only been in the past 10 to 15 years that it has received so much attention from both the military and the private sector. This technique, known as *spread spectrum* (SS) is unlike any communication method previously tried by Amateurs. However, judging by our track record, it would seem that it's only a matter of time before we familiarize ourselves with it.

The purpose of this article is to provide an overview of spread spectrum communications for those not familiar with it. While the topic is much too broad to be fully discussed here, the major concepts will be highlighted in a manner that can, I hope, be understood by those with little math background. As well

as the concepts governing spread spectrum and digital communications, typical station hardware requirements will also be addressed.

why spread spectrum?

One might wonder how and why spread spectrum evolved, and how it could be applicable to the Amateur Radio bands. To address the first query, it is necessary to consider the problems associated with military communications during World War II. At the time, jamming and antijamming techniques were the order of the day. By 1945 every Allied Bomber plane was equipped with two jamming transmitters, while it is estimated that as many as 90 percent of all electrical engineers in Germany were involved in an antijamming program of gargantuan proportion.¹

To combat the effects of jamming, spread spectrum was used to spread the signal out, thereby rendering narrow band jammers virtually ineffective. In addition, the fact that spread spectrum could be used with a *low probability of intercept* (LPI) made this an ideal method of communicating while appearing "radio silent" to conventional receivers.

Today the quest for a signal that cannot be jammed continues in military circles; commercial applications, such as banking and private mail systems, require security. As jamming and intercept capabilities become more sophisticated, methods of communicating become increasingly complex. Spread spectrum continues to evolve into a highly complicated mode of communication. Those fascinated with the history of radio would find the accounts of the development of spread spectrum to be very exciting reading. Several excellent accounts are listed in the references.^{1,2,3}

The above-mentioned attributes hardly seem appropriate for Amateur Radio! The FCC rules prohibit any kind of coded or secure communications, and intentional jamming is a problem we would ideally never

By Ted S. Rappaport, N9NB, Box 283, Electrical Engineering, Purdue University, West Lafayette, Indiana 47907

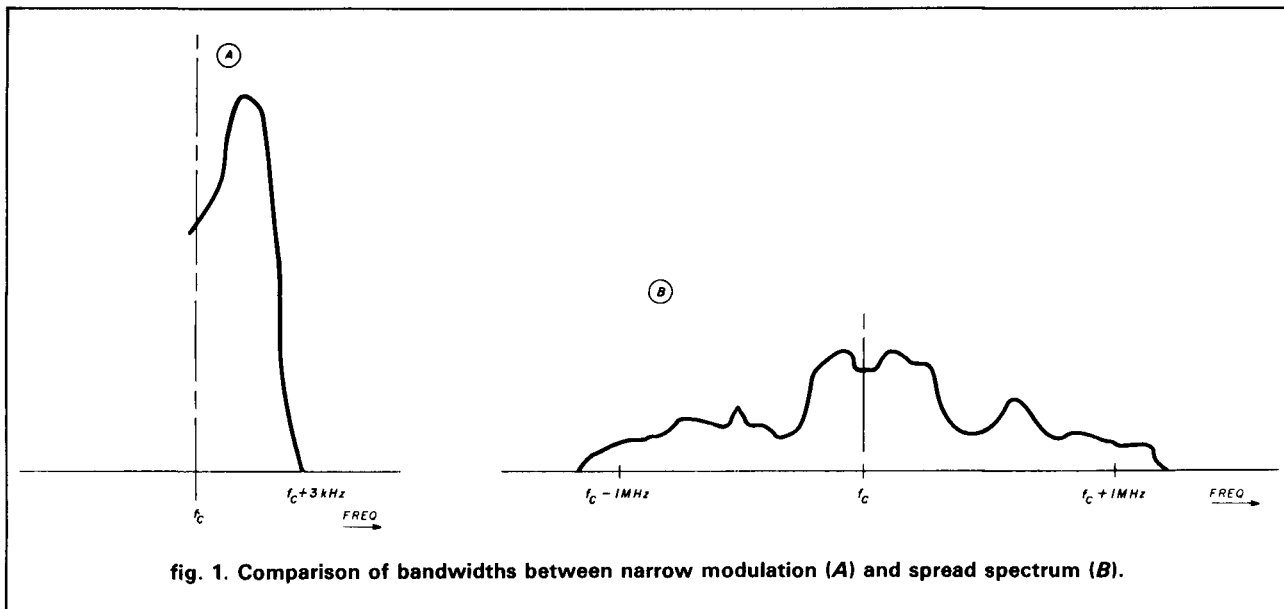

fig. 1. Comparison of bandwidths between narrow modulation (A) and spread spectrum (B).

have to deal with. There are several other benefits, however, that might be of use to us in the future as the Amateur Radio spectrum becomes saturated with users. In fact, a look at why mobile telephone companies are considering SS sheds some light on some of the possible rewards.

In metropolitan areas, where there are many mobile telephone users in a small area, cellular radio has been introduced to alleviate the congestion in the mobile telephone spectrum. In a cellular radio system, as the term suggests, the city is broken into "cells," with each cell having its own multichannel repeater capable of handling a limited number of users within the cell.⁴ As the user travels into an adjacent cell, the adjacent repeater takes over the communication. The cellular technique has been used to increase the maximum number of mobile telephone and commercial radio users from several hundred to several thousand in many cities across the country. Of special interest to the industry is the fact that compared to conventional narrow band modulation techniques, SS has the capability of supporting a larger number of users for a given cell size!⁵

Other advantages that SS offers to both the military and the mobile communication industry include selective addressing capability, code division multiplexing, and interference and multi-path rejection. With SS, it is possible for a transmitter to selectively communicate to one or several receivers while remaining oblivious to other users. Also, several stations may use the same band of frequencies simultaneously without interfering with one another. Since SS signals have very wide bandwidths, conventional narrow band users may also use the same spectrum without adversely

affecting the SS communication. Conversely, the average power of a SS signal in any narrow band region is small, so the narrow band modulation is not severely QRM'ed, either.

As will be demonstrated shortly, SS requires more complex hardware than does conventional narrow band equipment; as the spectrum stands today, its use in Amateur Radio is probably not currently warranted. However, with increased HF and VHF/UHF activity, it is conceivable that we may eventually need a drastically different approach to communications. Progress has recently been made by hams in such areas as coherent CW and packet communications.^{6,7,8,9} The inevitable thrust toward digital communications makes SS appear to be a likely modulation method in the future.

overview of spread spectrum

Figure 1 illustrates the bandwidth of an SSB speech signal compared to a typical spread spectrum signal. As its name implies, spread spectrum is a modulation method whereby the energy of the transmitted signal is spread out over a very wide bandwidth. This is quite unlike SSB or narrow band FM (NBFM), where the transmitter output has a bandwidth on the order of that of the modulating signal (the usable audio bandwidth for speech is about 3 kHz). However, wide band FM (WBFM) transmitters have bandwidths that are many times greater than that of the modulation. Clearly, though, WBFM is not spread spectrum! This is where the second important distinction between spread spectrum and conventional modulation methods must be made.

A spread spectrum communication system uses a

special generated wide band signal that is independent of the message modulation. At the transmitter end, the message modulation (a voice signal) may be multiplied by this independently generated signal, and the resulting mix then transmitted on a carrier. This is known as *Direct Sequence Spread Spectrum (DS)*. Another type of SS, known as *Frequency Hopping Spread Spectrum (FH)*, can be generated by using the independently generated signal to cause the carrier signal to frequency hop in a prescribed manner.

It is the independent signal that determines the amount of bandwidth spreading at the transmitter output. It also determines the immunity the SS signal has to narrow band interference. This independent signal is always digital, and is generated by digital logic devices (such as TTL). The term *pseudo noise code (PN)* is used to describe this independent signal since to an uninformed observer the PN code looks like a random jumble of 1s and 0s. Actually, though, the PN code is a periodic sequence that can be easily gener-

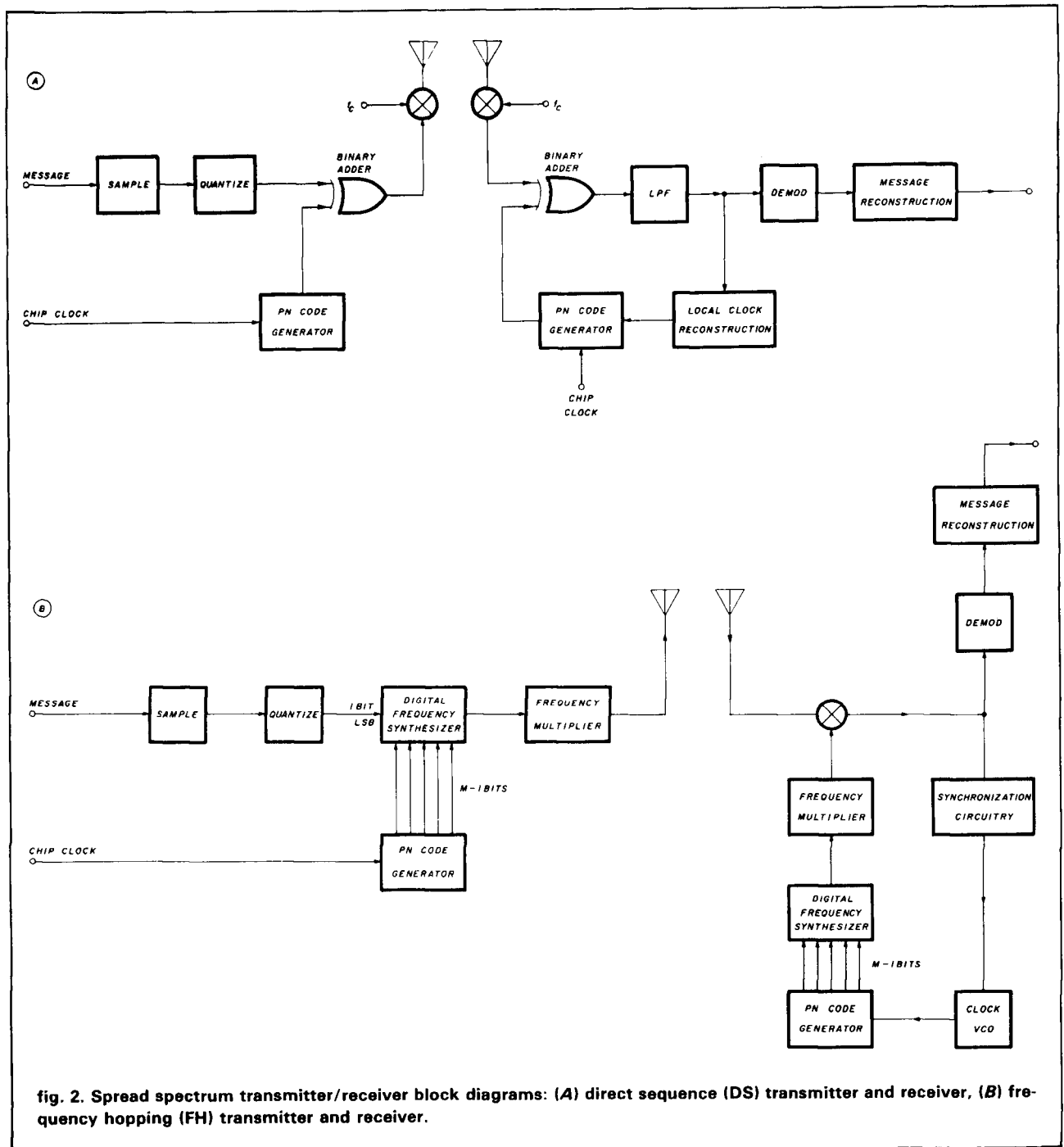
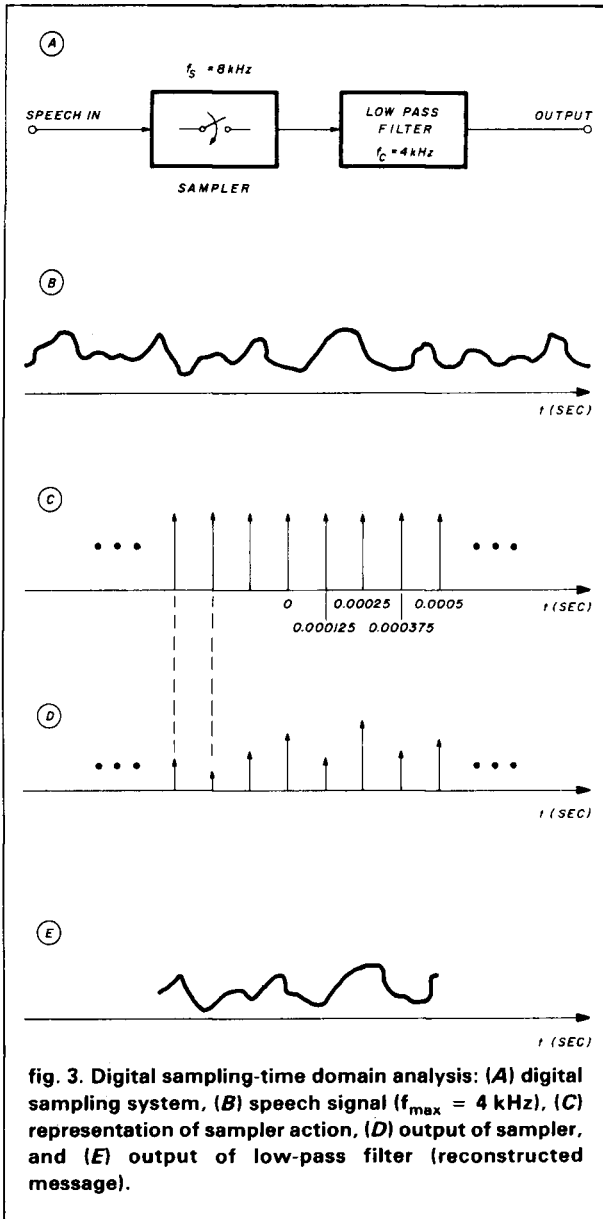

fig. 2. Spread spectrum transmitter/receiver block diagrams: (A) direct sequence (DS) transmitter and receiver, (B) frequency hopping (FH) transmitter and receiver.



ated by a sequence of shift registers. In order to recover the original message, the receiver must be able to reconstruct the same PN code used by the transmitter. When the transmitter and receiving encoding signals are identical, and when they are synchronized in time, then the message is detected. **Figure 2** illustrates block diagrams of spread spectrum transmitter and receiver pairs for both the DS and FH case. A more detailed look at the generation of the PN code is considered subsequently. However, before delving into the details of SS, it is first necessary to become familiar with some basic concepts of digital communications.

digital communication concepts

Because the encoding signal is digital, spread spec-

trum can be considered to be a special form of digital communications. Unlike SSB, AM and FM, which are analog, continuous time communication methods, digital communication systems work on the principle of the sampling theorem.

The sampling theorem, developed by Nyquist in 1924,¹⁰ states that a continuous time signal may be represented by a sequence of discrete time snapshots, or samples, without any loss of information in the signal, provided that the samples are taken at a rate which is at least twice as great as the highest frequency component of the original continuous time signal. A basic relationship which relates the sampling frequency (f_s) to the time duration between successive samples (T_s) is

$$f_s = \frac{1}{T_s} \quad (1)$$

Figure 3A shows the components of a typical sampling system. **Figure 3B** illustrates a typical speech signal that has been band limited to have a peak frequency component of 4 kHz. The action of the sampler is shown in **fig. 3C**. **Figure 3D** illustrates the output of a sampler that is taking samples at a rate of 8000 samples per second (twice the rate of the highest message component). **Figure 3E** shows the recreated message waveform after the samples are placed through a low-pass filter having a cutoff of 4 kHz.

In order to lay a foundation for the analysis and understanding of SS, it is instructive to look at the sampling theorem from a different point of view. In the early 1800's, Fourier, a famous mathematician, observed that most functions could be represented by a summation of sinusoids having different amplitudes and periods. In short, he laid the groundwork for the development of the celebrated Fourier transform. This transformation allows one to analyze a signal in the frequency domain rather than in the time domain.

Frequency domain analysis can directly give information pertaining to the bandwidth of a signal. Tables such as **table 1** have been compiled which lists the Fourier transforms of many common signal shapes.^{11,12,13} By analyzing the sampling circuit of **fig. 3A** in the frequency domain, we can better explain how and why the sampling theorem holds.

From **table 1**, the Fourier transform of an impulse sampler is an impulse train in the frequency domain. Note that in the time domain (**fig. 3C**), the sampling action is effectively multiplying the input signal by a "1" at each sampling instant, and multiplying by "0" in the interval between samples. Just as time signals have Fourier transforms, so do time operations such as addition and multiplication. The Fourier transform of a time multiplication is known as *frequency convolution*. Convolution is a fundamental concept in control

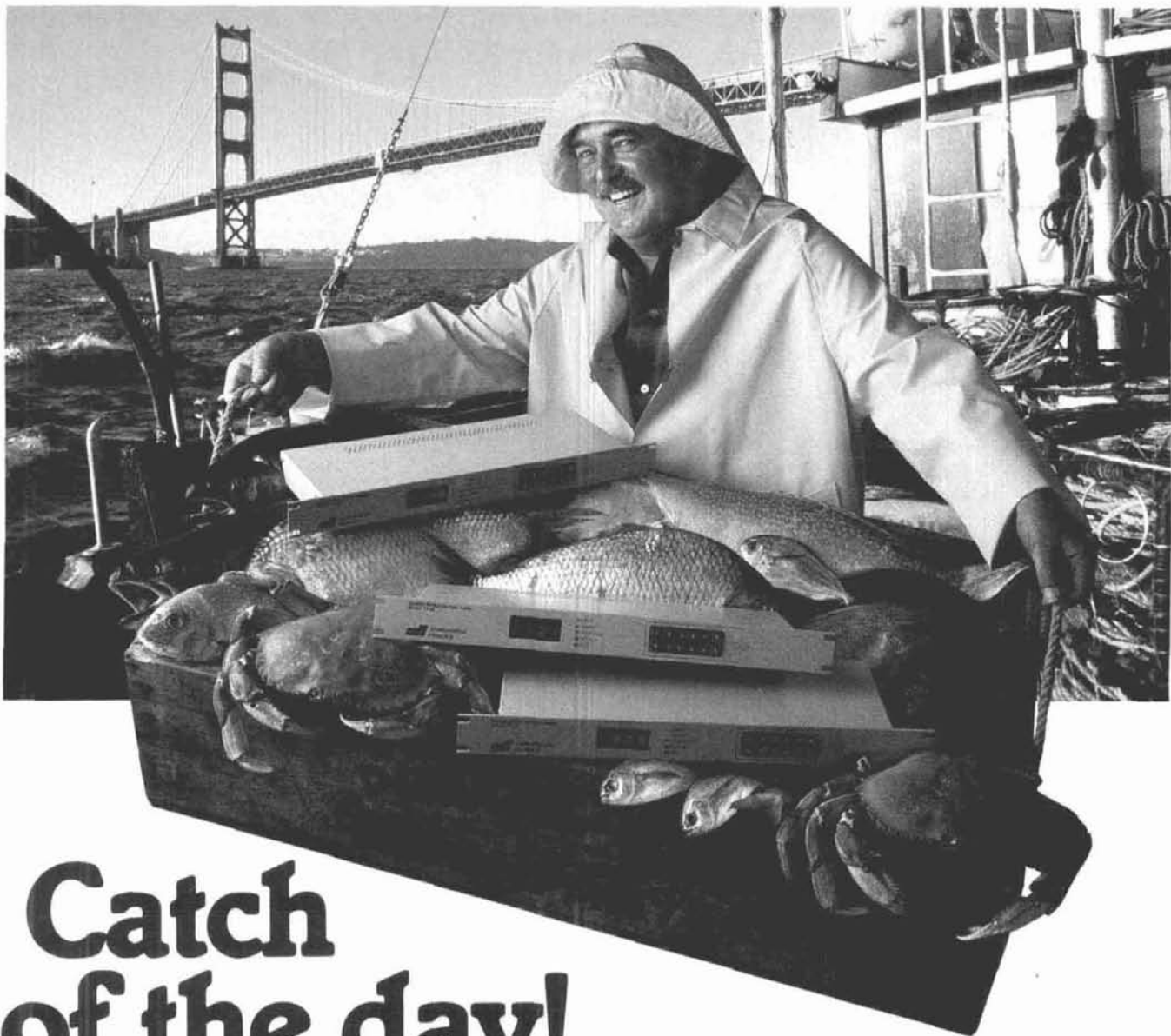

Catch of the day!

Have you been trawling the bounding main for a new product? We have just netted it—the TP-38 microprocessor controlled community repeater panel which provides the complete interface between the repeater receiver and transmitter. Scuttle individual tone cards, all 38 EIA standard CTCSS tones are included as well as time and hit accumulators, programmable timers, tone translation, and AC power supply at one low price of \$595.00. The TP-38 is packed like a can of sardines with features, as a matter of fact the only additional option is a DTMF module for \$59.95. This module allows complete offsite remote control of all TP-38 functions, including adding new customers or deleting poor paying ones, over the repeater receiver channel.

Other features include CMOS circuitry for low power consumption, non-volatile memory to retain programming if power loss occurs, immunity to falsing, programmable security code and much more. The TP-38 is backed by our legendary 1 year warranty and is shipped fresh daily. Why not set passage for the abundant waters of Communications Specialists and cast your nets for a TP-38 or other fine catch.

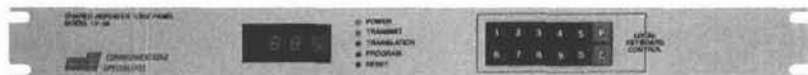

\$595.00 each
\$59.95 DTMF module

PICK A COMPUTER INTERFACE TO MATCH YOUR NEEDS

COMPUTER PATCH™
MODEL CP-1



MICROPATCH™ MODEL MP-1



COMPUTER PATCH MODEL CP-100

COMPUTER PATCH™ MODEL CP-1

The AEA Model CP-1 Computer Patch has earned a solid reputation for being the best overall interface value on the market today. We at AEA have now reaffirmed what our competitors already know; for the money, the CP-1 cannot be beat! That is why we have chosen to leave the popular CP-1 in our product line and to introduce new computer interface/terminal units with differing features and performance at different prices.

MICROPATCH™ MODEL MP-1

The new AEA model MP-1 Micropatch represents the best features and performance available for under \$140.00. Featuring true dual-channel filtering of Mark and Space tones with an AM detector and Automatic Threshold Correction (ATC) circuit, the MP-1 is in a totally different performance class than competitive units that often have only a single channel filter or no filtering at all.

The MP-1 also offers a high performance CW capability. With respect to the CP-1, overall performance is nearly as good; but the CP-1 offers a few more advanced features such as variable shift tuning, RS-232 option, and a more advanced tuning indicator.

COMPUTER PATCH MODEL CP-100

The new CP-100 Computer Patch offers all the following exciting features in addition to the CP-1 features:

- 170, 425, 850 Hz Calibrated Shifts for Transmit and Receive
- 75 to 1000 Hz Variable Receive Shift Range
- Normal and Reverse FSK Outputs
- Input AGC
- Direct Coupled Automatic Threshold Control
- Front Panel Squelch
- Discriminator Style Tuning Indicator
- Current Loop Option
- Built-in Monitor Speaker
- Baud Rate Switch
- Improved AM Detector

VHF
COMMUNICATIONS

915 North Main Street
Jamestown, New York 14701 (716)664-6345



**Brings you the
Breakthrough!**

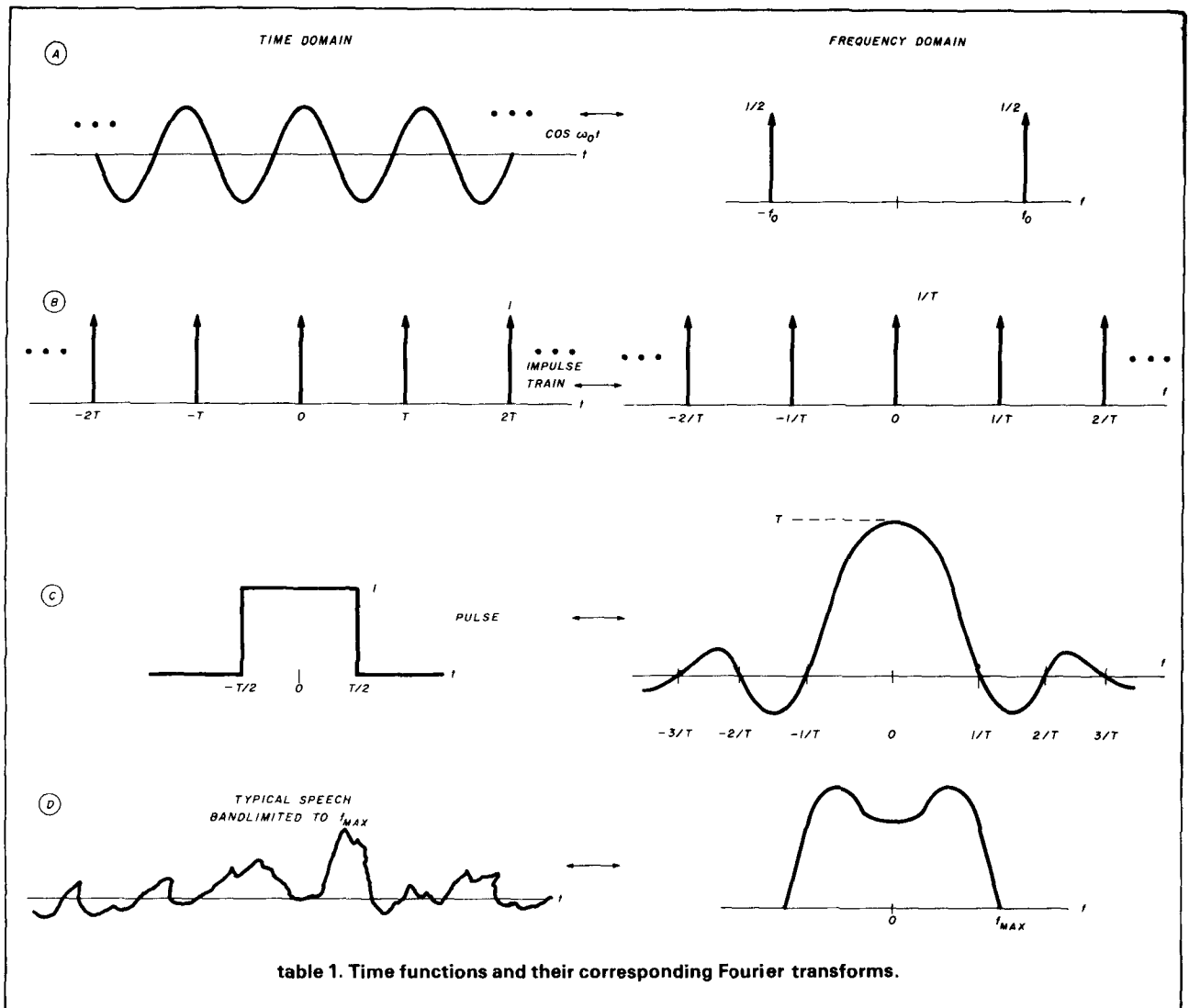

and communication theory, and is used to express the output of a system or filter in terms of the input signal and the system impulse response, (i.e., the response of the system to a sudden input signal). For this discussion, it is necessary to know only that the convolution of a band-limited spectrum (fig. 4A) with a frequency pulse train (fig. 4B) yields the original message spectrum replicated at each of the pulse train harmonics. Hence, by frequency domain techniques, we find that the output of an ideal sampler is the original message spectrum replicated throughout the entire frequency domain and separated by integer multiples of the sampling frequency (fig. 4C). By low-pass filtering the sampler output, we can recreate the original message exactly (fig. 4D). By the same token, we could bandpass filter the output of the sampler and also recreate the message, although this is not usually done.

If the highest frequency of the input message exceeds one half of the the sampling rate, then an

undesirable effect known as *aliasing* occurs. As can be seen in fig. 4E, each adjacent message spectrum overlaps so that the LPF output is not the original message, but rather a distorted signal. With frequency domain analysis, it becomes clear why the sampling frequency must be at least twice that of the peak frequency component of the input.

Before moving on, it should be noted that this quick look at the sampling theorem assumes an "ideal" sampler — one for which the sample durations are infinitely small. In reality, the sample durations are small, but finite. Taking this into account yields similar, but slightly more complicated, results. Figure 5 illustrates the spectrum of the output of a typical "real world" sampler. As the sample widths become wider, there is less energy at the higher frequencies. This is why the sampler is followed by a low-pass filter rather than a band pass filter. Also neglected here are some amplitude scaling factors that are involved in transforming between the time domain and frequency domain.

These subtleties are required in exact problem solving, but are not important in gaining a good understanding of the sampling theorem. Those interested in the finer details of the sampling theorem and Fourier transform techniques might find the references helpful.^{11,12,13,14,15}

data communication

Certain digital communication systems such as RTTY and packet radio, where the message text is originated by a keyboard rather than continuous-time speech, are known as data communication. In this case the sampling theorem does not apply, since there is no continuous time signal to sample. However, the data rate (the rate at which information can be sent) is a function of the number of bits used to represent each character, and is also a function of the time duration of each bit.

For example, the American Standard Code for Information Interchange (ASCII) prescribes that each keyboard character be represented by a unique 7-bit data word. The letter i, for example, is represented by the binary word 1101001. If each bit has a time duration of 1 millisecond, then any character may be sent down a channel in a time of 7ms. If a start bit, a stop bit, and a parity bit are sent along with the data, then one character can be sent every 10 ms. The data rate for this set-up would be 1000 bits per second (bps), or 100 characters per second.* Data communications of this type are termed "asynchronous" since the receiver never knows when the sender will depress the keyboard. The start bit and stop bit are the necessary overhead to identify each of the keyboard entries. The parity bit is used to validate the received data. **Figure 6** illustrates a complete asynchronous character word for the letter i.

There is a trade-off between bit rate and occupied bandwidth of a digital signal. A good rough estimate is that the required bandwidth of a digital signal is equal to the reciprocal of the bit duration. For the previous example, the required bandwidth would be on the order of

$$BW = \frac{1}{t_{bit}} = \frac{1}{0.001 \text{ s}} = 1000 \text{ Hz}$$

For a faster data rate, more bandwidth is required. In a band-limited channel, such as a commercial telephone line, there is an upper limit on the bit rate. This is why home computer modems seldom exceed a data rate of 1200 bps.¹⁶ While spread spectrum is well suited for either voice or data messages, the remainder of this article will consider only a voice message. Once the voice is "digitized," it is sent through the channel in the same manner as data.

*In digital communications the bit rate is the same as the baud rate, so for this example the data rate is equivalently 1000 baud.

quantization

From the sampling theorem, we know that it is necessary to send only the voltage values of the samples rather than the continuous time signal. If the sample values could be represented in a digital fashion, then we could take advantage of schemes that have been developed expressly for digital communication. In short, digital communications systems are able to outperform analog methods because signal reception is based on distinguishing whether a "0" or a "1" was sent, rather than trying to recreate a random continuous time waveform directly. Schemes such as *error correction coding* and *minimum probability of error receivers* can be used to provide far superior performance when compared to analog communication techniques.

To represent the height of a sample value digitally, it is necessary to quantize the sample. For binary data (standard digital logic), the quantizing action truncates the actual sample value so that each sample is represented by a fixed number of bits (i.e., every sample is expressed by N bits) in the time between successive samples. Since it is conceivable that the samples can take on a continuum of values, there is some error introduced by the quantizer. However, if a limiter is used (to contain the voice signal voltage within the limits of the quantizer) and if there is a sufficient number of levels in the quantizer, then this error, known as *quantization noise*, is quite small.

The quantizer is an important concept in digital communications. The resolution, or the accuracy in which a sample can be represented, is directly related to the N, the number of bits used to represent each sample. For N bits, there are 2^N quantizer levels (sometimes called *bins*).

An example is useful to clarify how speech can be quantized and sent down a channel as a digital bit stream. **Figure 7** demonstrates how the sample values are assigned data words in a three-bit quantizer (N=3). As indicated in **fig. 7**, there is some error introduced because of the fact that each sample is represented by only a three-bit word. By using more bits, each sample can be more accurately represented. Surprisingly, though, even with only three bits of quantization, intelligible speech can be transmitted.¹⁷ Once assigned a quantization data word, the truncated sample is converted into 1s and 0s and sent down the channel. The output of the quantizer is known as *pulse code modulation*, since the message has been coded into a train of digital pulses. Since N bits must be sent in the time between adjacent samples, the bit duration of the quantized data is

$$T_{bit} = \frac{T_s}{N} \quad (2A)$$

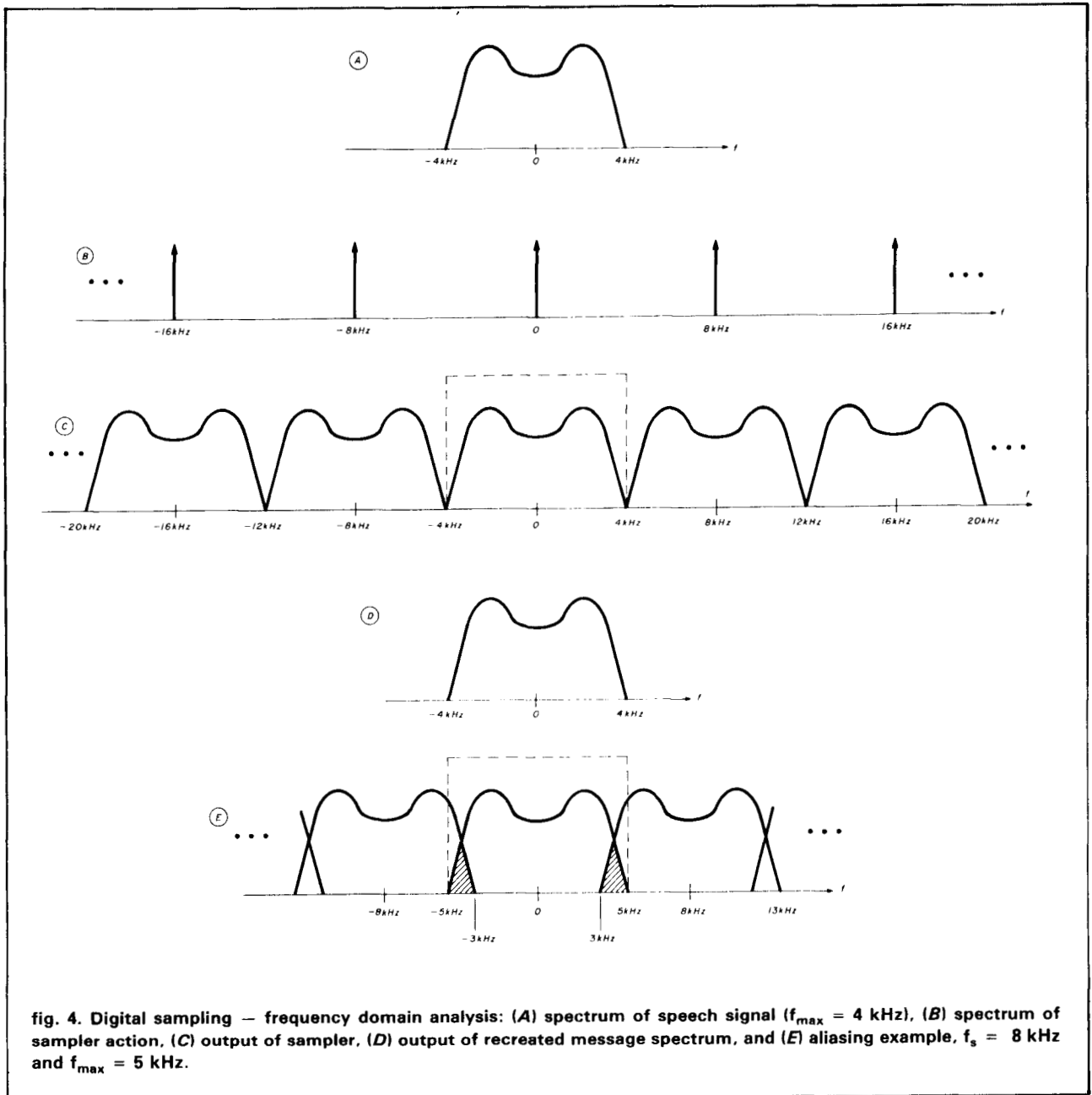

fig. 4. Digital sampling — frequency domain analysis: (A) spectrum of speech signal ($f_{\max} = 4$ kHz), (B) spectrum of sampler action, (C) output of sampler, (D) output of recreated message spectrum, and (E) aliasing example, $f_s = 8$ kHz and $f_{\max} = 5$ kHz.

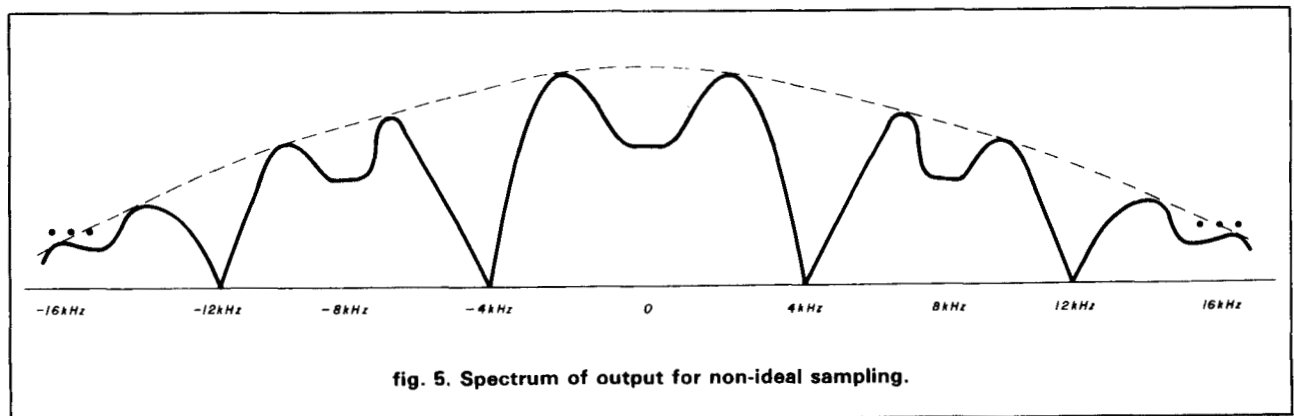

fig. 5. Spectrum of output for non-ideal sampling.

where T_s is the time between adjacent samples. Since

$$T_s = \frac{1}{f_s} \quad (2B)$$

each quantizer bit duration is given by

$$T_{bit} = \frac{1}{Nf_s} \quad (2C)$$

Hence, the bandwidth is given by

$$BW = Nf_s \quad (2D)$$

A practical method of sampling and quantizing is to use a *sample and hold* circuit followed by an *analog-to-digital* (A/D) converter. The sample and hold is similar to the ideal sampler, except the sample height is held for the entire time duration between samples, and is updated at each new sampling instant. While the sample value is held at a constant level, it is converted into a digital signal by the A/D converter. The end result is identical to that of **fig. 7**.

To recreate the message, the digital bit stream is clocked into a *digital-to-analog* (D/A) converter. This undoes the effect of quantizing which the A/D had

upon the original message samples. The D/A output is then low-pass filtered to transform the reconstructed samples into the original message.

spread spectrum systems

There are many types of spread spectrum systems. These include direct sequence (DS), frequency hopping (FH), time hopping (TH), chirp, and hybrid systems which combine several techniques at once. Only DS and FH are considered here, since these seem to be most easily implemented. Common to both of these types of SS systems is the need to generate and reconstruct a PN (pseudonoise) code.

To produce the DS spread spectrum signal, a PN code signal must be produced that has a bit rate (bandwidth) much greater than that of the quantized message. For FH spread spectrum, it is not so much the bit rate that matters as does the number of bits used in a complete cycle of the PN code.

The PN code can be generated by a feedback arrangement of flip-flop stages. A flip-flop is a digital device which can store a binary value (either a 0 or a 1). Flip-flops can be connected in series to form shift registers. As the term implies, shift registers store several binary digits and shift them to the left or right each time an external clock pulse is received.

The simplest PN codes (there are several types) are known as *maximal linear codes*, or *m-sequences*. These are produced by m-stage shift registers which use feedback to produce periodic codes that have N bits before recycling. For an m-stage shift register, there are $N = 2^m - 1$ bits in each period. **Figure 8** illustrates a three-stage shift register. All three flip-flops of the shift register are clocked to the right simultaneously, and each time a clock pulse appears, a new binary digit appears at the output. **Table 2** indicates the value held by each flip-flop for a given time inter-

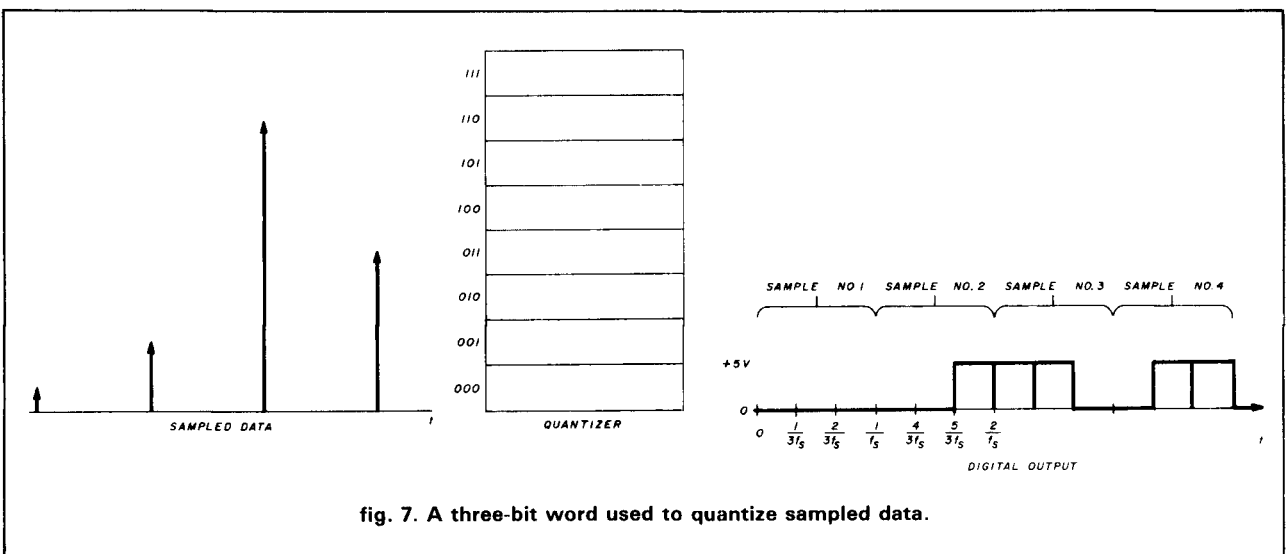
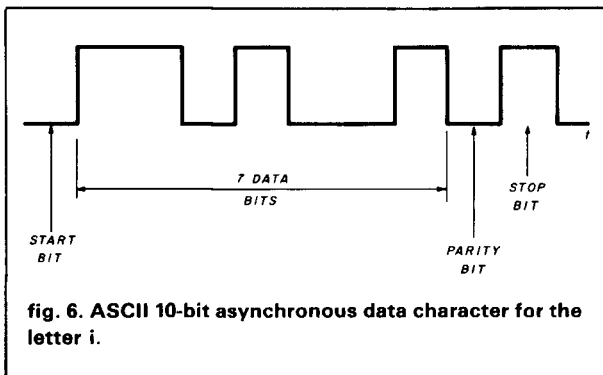

PACKET RADIO GOES PORTABLE

GLB ELECTRONICS

presents



Model PK1-L

- LOW 25 mA Current drain.
- Designed for portable or solar-powered stations.
- Miniature size—Lightweight
- Rugged all metal, shielded enclosure.
- On-board Lithium Battery RAM backup.
- On-board watchdog for reliability.
- Standard DB-25 Connectors.
- Output signal indicates "Connected" Status.
- Does not require squelched audio.
- Comes with 8K of RAM.
- Remote Command Mode for Unattended operation.
- Hardware command lockout for security.
- Commands compatible with our Model PK1.
- Retains all other features of the Model PK1.
- Extra I/O lines for special applications.

Power requirement:

9 to 15 Volts DC @ 25 mA typical

Dimensions:

4.6 X 5.90 X 1.0 inches

Total Weight:

12 ozs.

PK1L—Wired and Tested

List— \$239.95
Amateur net— \$209.95

GLB MODEL TNC-2A KIT

Just when you thought TAPR TNC-2 Kits were a thing of the past, GLB — the first commercial producer of Packet Controllers — Joins the "TAPR Revolution" at last!

GLB is now the exclusive supplier of TNC-2 Kits.

Hardware
Software
Documentation

by TAPR

GLB Model TNC-2A Kit

COMPLETE KIT ONLY

\$169.95

+ shipping

Contact GLB for information on our full line of Packet Controllers



GLB ELECTRONICS, INC.

151 Commerce Pkwy.,
Buffalo, NY 14224
716-675-6740 9 to 4

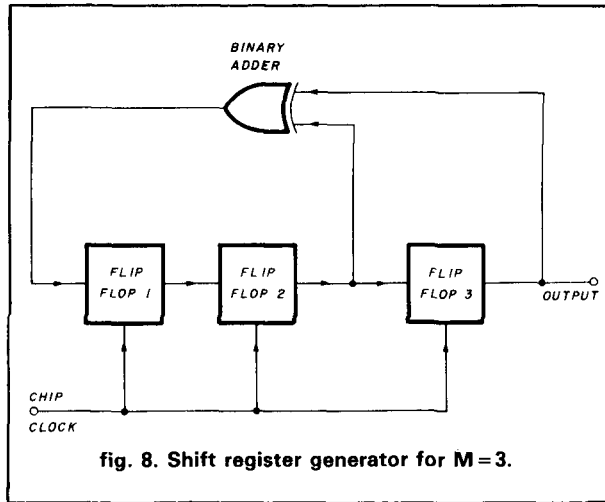

fig. 8. Shift register generator for $M=3$.

val. **Figure 9** shows the digital signal that would be produced by a standard TTL circuit.

To avoid confusion between the PN code and the actual message bit stream, the term chip is used to describe each bit of a PN code. For a chip duration of t_1 seconds, the periodic PN sequence repeats itself every Nt_1 seconds. For the example shown in **fig. 9**, the same chip value would be seen every $7t_1$ seconds apart.

By changing shift register feedback paths, it is possible to generate many unique m -sequence codes, each having a period of N chips. The number of possible codes is important since it defines the maximum number of users that can be uniquely addressed, assuming that each user has the same length shift register. The exact number of unique codes is dependent upon the number of shift register stages and the possible feedback paths. In general, the longer the shift register, the more unique codes exist. However, as can be noted in **table 3**, when the shift registers consist of a prime number of stages, there is a maximum of codes for a minimum of hardware.

Modular Shift Register Generators (MSRGs) such as the MC8504 are available for easy PN code generation. The MC8504 is a 16-pin chip that features four stages of an expandable shift register. They may be cascaded, and additional flip-flops (such as a 7474) may be added to implement an arbitrarily long m -sequence. A nine-stage MSRG capable of producing 48 selectable 511 chip codes is shown in **fig. 10**.

Direct sequence (DS) spread spectrum. As shown in **fig. 2A**, the PN code is added with the digitized message (usually PCM) to produce a digital signal that can be readily modulated. If one of the adding signals is wide band, then the resulting adder output signal is also wide band. Since the PCM has a bandwidth on the order of the original message, it is necessary to use a PN code which has a bandwidth several orders of magnitude larger than the message band-

table 2. Contents of Shift Register Stages for $m = 3$.

	stage 1	stage 2	stage 3
initial contents	1	1	1
clock pulse 1	0	1	1
clock pulse 2	0	0	1
clock pulse 3	1	0	0
clock pulse 4	0	1	0
clock pulse 5	1	0	1
clock pulse 6	1	1	0
clock pulse 7	1	1	1

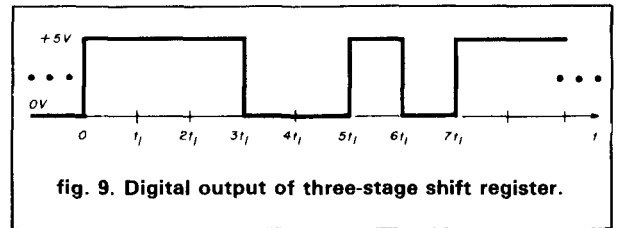

fig. 9. Digital output of three-stage shift register.

width in order to obtain large bandwidth spreading. For this reason, the chip rate is typically run at speeds of several Megachips per second (Mcps).

The output of the binary adder is fed into a balanced modulator. This modulator produces a particular carrier phase for a logic "1" and a 180-degree shifted carrier for a logic "0." Hot-carrier diodes are used in conjunction with wide band transformers to produce the final RF signal. **Figure 11** illustrates a double-balanced mixer, which is the most commonly used type of balanced modulator. The balanced modulator input and output signals are shown in **fig. 12**. While the output waveform appears simple in the time domain, frequency domain analysis reveals that there is a wide band of frequency components centered around the nominal carrier frequency.

In a DS-SS receiver, just as with any RF receiver, it is first necessary to bring the modulation down to baseband. This is accomplished by mixing the received signal with a local oscillator that is adjusted to the transmitter's frequency. Then, the coded signal must be matched with an internally generated PN code. This is accomplished by binary addition. If the internal PN code generator is not correlated with the incoming signal, the resulting adder output is called *code noise*. However, when the internal code is synchronized with the incoming signal, the output of the binary adder collapses to the original digital message bit stream. A manual tuning dial can be used to adjust the phase of the code generator until synchronization is obtained. Better yet, a microprocessor can be used to automatically adjust the receiver PN code phase. Once synchronized, the demodulation may be accomplished by using a D/A converter followed by a low pass filter.

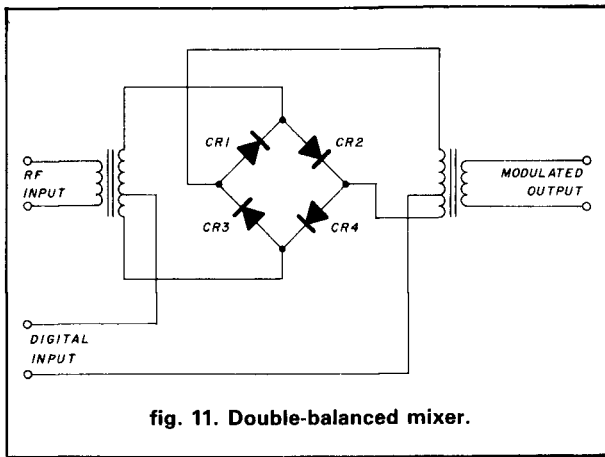
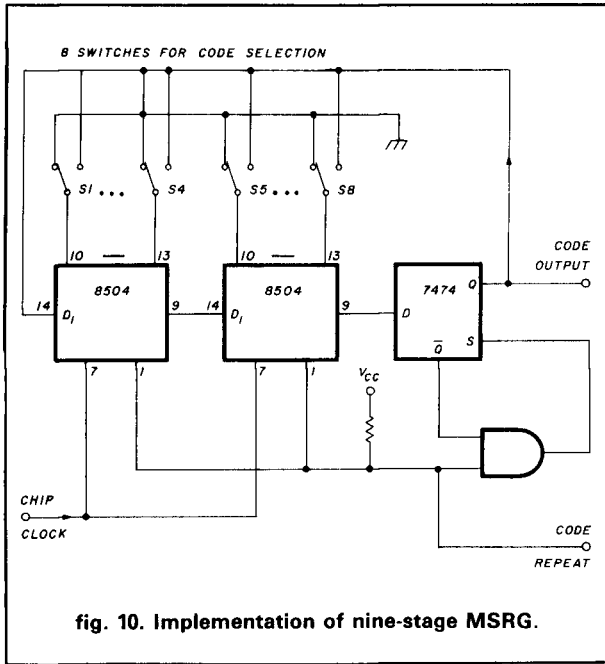

table 3. Characteristics of M-sequences of various length.

M stages	maximum number of unique codes	number of chips per period
3	2	7
4	4	15
5	6	31
6	4	63
7	18	127
8	16	255
9	48	511
10	60	1023
11	176	2047
13	630	8191
20	19,200	1,048,575
30	11,880,000	1,073,741,823
61	3.1×10^{16}	2.3×10^{18}

Since the receiver uses an internal clock signal for code reconstruction, the low pass filter could be of the switched capacitor variety.

It is important to note several points of practical interest. Obviously, the receiver must tune to the sender's transmitting frequency in order to establish the possibility of communication. This suggests that calling frequencies would be advisable for the first Amateur attempts at DS-SS communication. Furthermore, a standard shift register length (or a few agreed upon lengths) seems mandatory, since the senders and receivers must be able to match each other's PN code. A fixed chip duration is necessary, too, so that all stations would be ensured that they could synchronize with the other users.

Before leaving DS-SS, a word should be said about PN code length. In military applications, where security is an important consideration, it is not uncommon to find PN coding schemes which use shift register stages of length 40 or greater. If each chip duration is 1 microsecond, then one cycle of an $m = 40$ PN code is completed in a time of

$$(2^{40} - 1) \text{ chips} \times \frac{10^{-6} \text{ sec}}{\text{chip}}$$

$$= 1.1 \times 10^6 \text{ sec} = 12.7 \text{ days}$$

Even if an interceptor listened in on this signal for several hours, it would appear to be a random jumble of binary digits. For long codes such as this, it takes a very long time to synchronize the receiver. On the other hand, if a shorter PN code is used (say, $m = 13$), then the entire code sequence is repeated every 8.3 milliseconds! A code having such a short period can be synchronized quite quickly at the receiver end.

Frequency hopping (FH) spread spectrum. In a FH-SS system (fig. 2B) there is a narrow band transmission occurring at any given time instant. However, there is a wide range of frequencies from which the transmitter may select. The particular frequency selected for use at any given moment is determined jointly by the digitized message bit stream and the PN code generator.

The message bit stream is used as the least significant bit (LSB) of an M bit data word. The PN code generator supplies the other M-1 bits. The data word is then used to determine the additive offset required to generate the proper frequency. Frequency hopping takes place over $N = 2^M$ frequencies separated by integer multiples of f_1 , where f_1 is the gap between adjacent hop frequencies. The repetition rate of the frequency hopping sequence is determined by the number of stages in the PN code generator and by the speed of the chip clock. Since the generator supplies M-1 chips for each hop, the frequency hop sequence repeats every

$$\frac{(2^m \text{ stages} - 1)}{(M-1)} \text{ hops}$$

table 4. Indirect frequency synthesizer ICs and their characteristics.

part number	number of frequencies	reference frequency	maximum divider input frequency	control
Hughes HCTR0347	45	50 Hz-500 kHz	10 MHz	8 bits parallel
Nitron 6410	100	4.00 MHz	1.6 MHz	8 bits parallel
Motorola 145104	256	10.24 MHz	4.0 MHz	8 bits parallel
National DS8906	16384	10.24 MHz	120 MHz	20 bits parallel
National MM55110	1024	10.24 MHz	3.0 MHz	10 bits parallel
Fairchild 11C84	128	10.24 MHz	20 MHz	7 bits parallel
AD-TECH FS-2574	1000	10.00 MHz	258 MHz	10 bits parallel

Figure 13 illustrates a typical FH transmission for the case of $M = 3$ and a nine-stage m-code generator using a 1-kHz chip clock.

Typical values for a suitable FH system might be $f_1 = 500$ kHz and $M = 3$ bits. For this example, the total RF bandwidth of the system would be

$$2^3 \text{ frequencies} \times \frac{500 \text{ kHz separation}}{\text{frequency}} = 4.0 \text{ MHz}$$

If the lowest frequency of the transmitter were 420 MHz, the highest frequency used by this system would be 424.0 MHz.

The frequency synthesizer is the key to an FH-SS system. Its operating characteristics (such as frequency range, switching speed, and hop duration) determine a system's capability. There are two major classes of synthesizers, the direct type and the indirect type. The direct frequency synthesizer uses filters and mixers and is seldom found in current Amateur gear. The indirect type uses phase-lock-loops (PLLs) to generate the desired frequency set. As a rule, indirect synthesizers are not as quick to switch frequencies, but are easier to implement.

Figure 14 shows a block diagram of an indirect frequency synthesizer. Those familiar with PLLs will immediately recognize the structure. The reference frequency, f_1 , is related to the output frequency, f_j , by

$$f_j = n_j \times f_1$$

since the VCO and the feedback loop forces f_j/n_j to equal f_1 . As can be seen in table 4, indirect frequency synthesizers, manufactured by several IC companies, can produce output frequencies above 100 MHz. To achieve greater frequencies, multiplier stages must be added.

The duration of a single frequency hop (t_h) may be longer or shorter than the duration of a message bit. If the message bit duration is longer than t_h , then the system is called a *fast hop FH* system since the hop rate is greater than the message bit rate. Otherwise, the system is termed *slow hop FH*. The advantage of a fast hop system is that if there is interference on one of the hop frequencies, the garbled message bit may

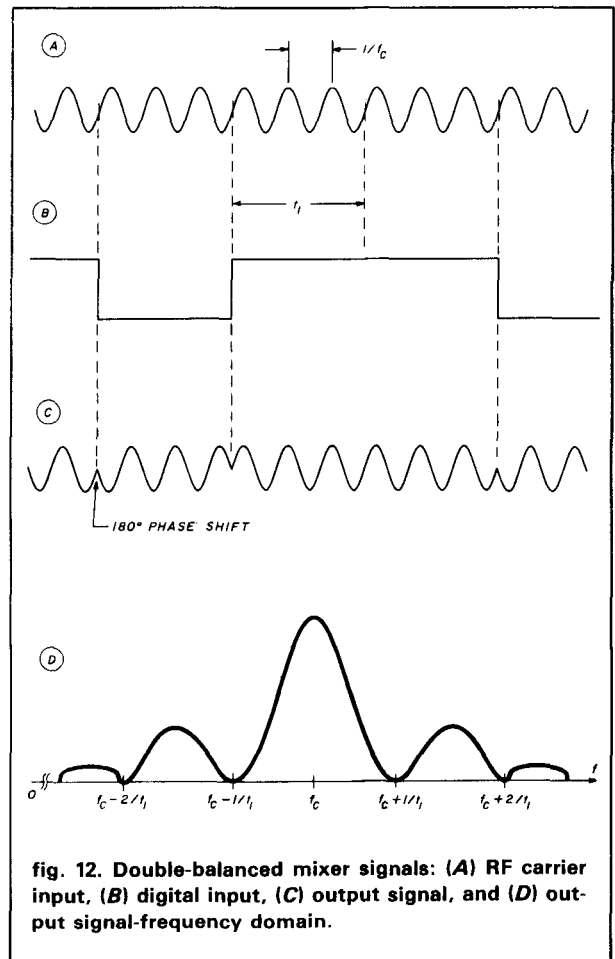

fig. 12. Double-balanced mixer signals: (A) RF carrier input, (B) digital input, (C) output signal, and (D) output signal-frequency domain.

still be present at the next hop frequency. For slow hop systems, error correction coding is needed since QRM on a given hop frequency could obliterate several message bits.

Reception of an FH-SS signal is achieved by synchronizing the receiver frequency with that of the transmitter's. Once synchronization occurs, the receiver output is identical to FSK, with the mark and space separated by f_1 Hz. The demodulator can consist of band pass filters which are compared to determine the value of the message bit. The actual message

Introducing the T.I. Detective.

The breakthrough you've been waiting for.

Phantom Engineering, the leader in T.I. technology, introduces the T.I. Detective™. An affordable field spectrum analyzer designed for precise T.I. analysis, filter tuning, and overall system tune-up.

The versatility of the T.I. Detective is unlike any other:

- Preliminary site surveys and field analysis of terrestrial interference.
- Fine tuning dish location.
- Proper filter selection.
- "Tweaking" dishes and aligning polar mounts.
- Tuning IF and RF notch filters.
- Diagnosis of receiver, downconverter, LNA and LNB problems.
- Checking cable loss and/or tilt in block systems.
- Pinpointing bad cable sections, splitters and amplifiers.
- Tuning receivers and programming actuators.
- Determining optimum placement of T.I. screens and fencing.

The T.I. Detective is compact in size and light weight with a rechargeable battery pack for complete portability. Easy to use and built durable with shockproof display and rugged construction to protect from bumps and shakes.

The T.I. Detective is a major breakthrough in test equipment for the TVRO industry. But the biggest breakthrough of all is the price. **Under \$500.**

For more information about Phantom's complete line of filters and test equipment, contact your distributor or:



16840 Joleen Way E3
Morgan Hill, CA 95037
(408) 779-1616

"The Breakthrough Specialists"

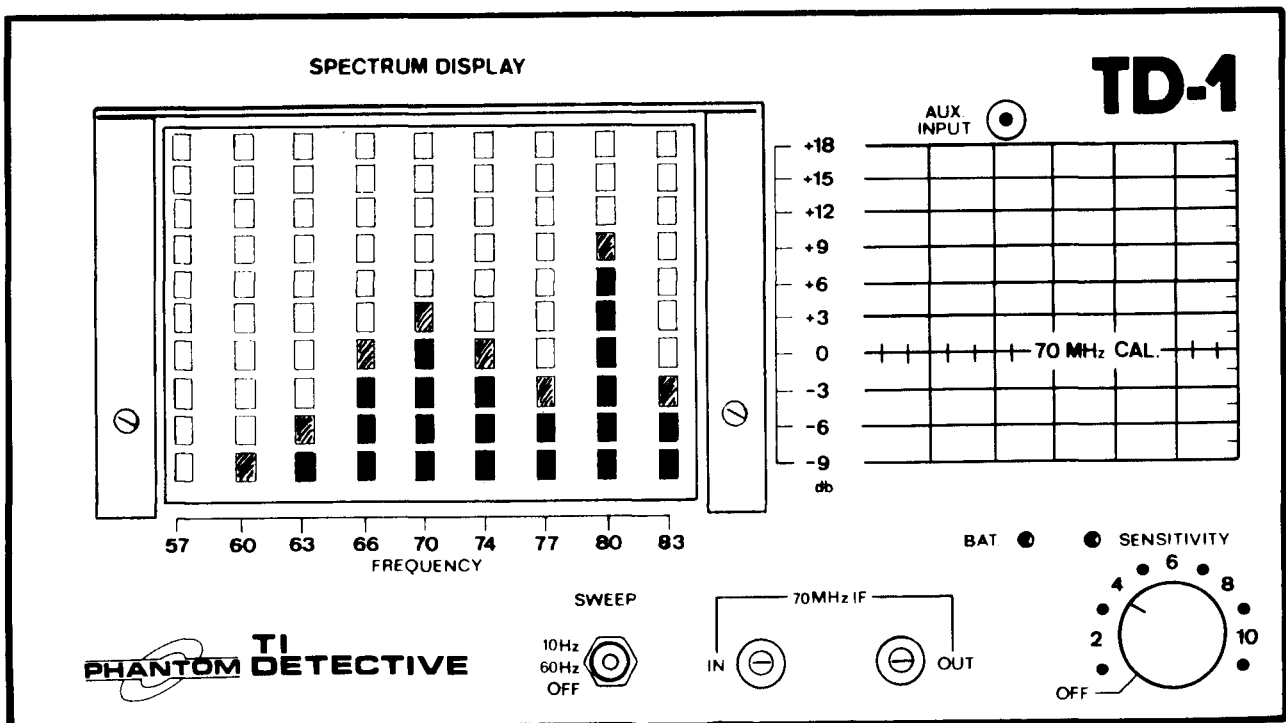

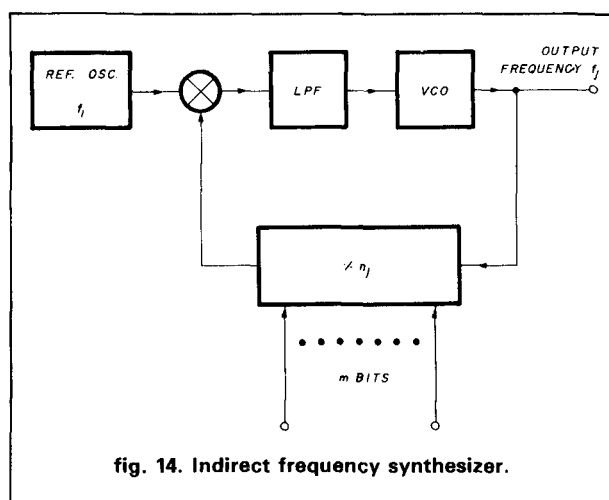
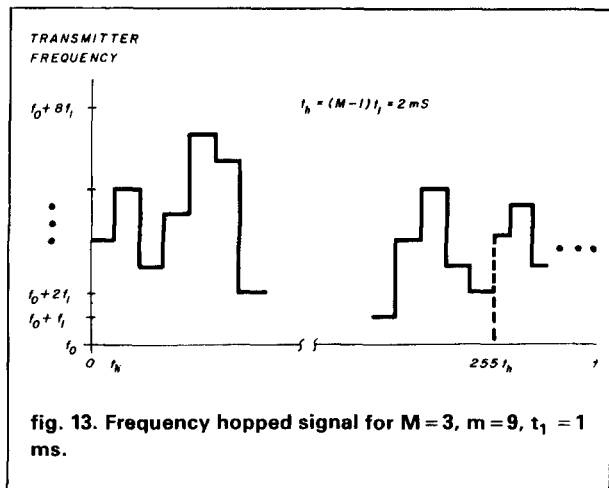

is then reconstructed by using a D/A and a low-pass filter.

Synchronization must be acquired in roughly the same manner as in the DS case. A computer shifts the $M-1$ bit PN code until the receiver tracks the transmitter through each hop. As cited in the DS case, a shorter PN code period ensures quicker acquisition of the transmitted signal.

With indirect synthesizer chips and MSRG chips readily available, it appears that FH systems could be constructed with slight modification to existing VHF/UHF gear. Certain standards such as hop duration, frequency band allocation, and the number of hop frequencies need to be developed, however.

future of spread spectrum

In late May, 1985, the FCC approved docket 81414, which allows the use of spread spectrum on all ham frequencies above 420 MHz as of May, 1986. Temporary authorizations are now being given to those Amateurs interested in experimentation.

In less than six months from now, we'll have a new

mode of communication unlike any other we've ever tried. With this new mode, our hobby may take a big step toward reaching state-of-the-art digital communication techniques. There's a lot of work to be done, though; defining protocols for Amateur SS will not be simple.

conclusion

The world of digital communications is a new, exciting technological field, and the future is being shaped daily by advances in this area. As Amateur operators, part of our charter is to increase the reservoir of electronics experts. While we don't have to be experts on digital communications, it's probably good for us to know the how's and why's of what is going on around us. Perhaps this article has shed some light on a subject that, as timely as it is, has not been widely discussed in the Amateur Radio literature.

For those interested in learning more about spread spectrum systems, the definitive reference is *Spread Spectrum Systems*, by Robert C. Dixon.¹⁷ Dixon's book was the first on the topic, and has recently been revised to include discussions about practical hardware considerations. Also good is a book just released: *Modern Communications and Spread Spectrum* by C.D. McGillem and G.R. Cooper.¹³ This book treats practically every type of modulation method and highlights some of the more important concepts of SS communication.

references

1. Robert A. Scholtz, "The Origins of Spread-Spectrum Communications," *IEEE Transactions on Communications*, May, 1982, pages 822-854.
2. David Kahn, "Cryptology and the Origins of Spread Spectrum," *IEEE Spectrum*, September, 1984, pages 72-80.
3. F.E. Terman, "Administrative History of the Radio Research Laboratory," *Radio Research Lab., Harvard University*, Cambridge, Massachusetts Rep. 411-299, March 21, 1946.
4. G.R. Cooper and R.W. Nettleton, "Cellular Mobile Technology: The Great Multiplier," *IEEE Spectrum*, June 1983, pages 30-37.
5. W.F. Utlaug, "Spread-Spectrum: Principles and Possible Application to Spectrum Utilization and Allocation," *IEEE Communications Magazine*, September, 1978, pages 21-30.
6. Bill de Carle, VE3OBE, "Technical Correspondence," *QST*, June, 1985, page 41.
7. C. Woodson, W6NEY, "Coherent CW," *QST*, May-June, 1981.
8. *AMSAT Packet Conference*, October 8-10, 1982.
9. *Packet Radio Terminal Node Controller (TNC) System Manual*, Tucson Amateur Packet Radio Corporation.
10. H. Nyquist, "Certain Factors Affecting Telegraph Speed," *Bell System Technical Journal*, Volume 3, No. 2, 1924, pages 324-346.
11. G.R. Cooper and C.D. McGillem, *Continuous and Discrete Signal and System Analysis*, Holt, Rinehart and Winston, Inc., 1974, page 365.
12. F.G. Stremmler, *Introduction to Communication Systems*, 2nd edition, Addison-Wesley Publishing Co., 1974, page 88.
13. C.D. McGillem and G.R. Cooper, *Modern Communications and Spread Spectrum*, McGraw-Hill Publishing Co., 1986.
14. K. Shanmugam, *Digital and Analog Communication Systems*, John Wiley and Sons, 1979.
15. L.W. Couch II, *Digital and Analog Communication Systems*, MacMillan Publishing Co., Inc., 1983.
16. Herb Friedman, "Modems," *Radio Electronics*, April, 1983, pages 85-89.
17. R.C. Dixon, *Spread Spectrum Systems*, John Wiley and Sons, 1984, page 143.

ham radio

When we set out to make the best amateur radio equipment in the world, we had some pretty tough standards to live up to ...



... yours

... and ours.

So we designed the **RC-850 Repeater Controller**, the industry's top of the line repeater control system. Now in it's "third wave" of innovation, thanks to its designed for the future architecture and new software releases. The '850 defines the industry standard in repeater control systems.

- Fully remotely programmable with Touch-Tone commands or computer terminal
- Front panel LED display, or terminal based display
- Over 300 word customized male and female speech synthesis vocabulary
- Time/day of week Scheduler with 10 set-up states, 30 changeovers and events, over 100 scheduled items for hands off operation and automatic reminders.
- Full or half duplex autopatch, autodial (200 numbers), emergency autodial, reverse autopatch, autodialer, toll restrict including telephone exchange tables, supports remote and multiple phone lines
- Informative remotely programmable ID's (17), tail messages (13), bulletin boards (5)
- 16 channel voice response analog metering, automatic storage of min/max values on each channel, values may be read back on command or may be included in any programmable messages
- Supports synthesized remote base transceivers and full duplex links
- Individual user access codes to selectable features
- Mailbox for user-to-user, and system-to-user messages
- Paging - two-tone, 5/6 tone, DTMF, CTCSS, HSC display, GSC digital display, user commandable and may be included in programmable messages (i.e. alarms)
- Logical to physical I/O mapping and internal "toolbox" for easy customizing of the controller to meet your needs and minimize external wiring
- Easy hookup to any repeater

Our new **Digital Voice Recorder** lets you remotely record ID's, tail messages, and various other response messages for automatic playback through your repeater. Audio is stored digitally with no-compromise reproduction quality in up to eight megabits of memory. The DVR can support up to three independent repeaters for a low per-channel cost. Its Touch-Tone activated voice mailbox lets your users easily record messages for other users when they aren't around.

QST: Attention All Hams

If you own a shack, you should know about ShackMaster™

ShackMaster lets you carry your home station with you in the palm of your hand. It acts as your gateway to the world, linking your handheld transceiver to your high performance HF station. Now, instead of your valuable home equipment being available to you 1% of the time, it's available 99% of the time! Whether around the house, in the yard, or across town, ShackMaster lets you take it with you.

But that's just part of ShackMaster's story. It lets you communicate with the family by handling third party traffic - its electronic mailbox and intercom let you keep in touch. And a simplex patch lets you place important calls directly through your home phone.

- Crossband linking - VHF/UHF to HF
- Telephone access to your home station
- BSR Home Control interface
- Electronic Mailbox
- ShackPatch™ intercom into the shack
- PersonalPatch™ simplex autopatch

If your repeater budget can't afford the '850, we offer the **RC-85 Repeater Controller**, which we like to call the "second best repeater controller in the world". It's a scaled down, simplified version of our '850, but overall, it offers more capability and higher quality than anyone elses control equipment at any price.

- Remotely programmable with Touch-Tone commands
- Over 175 word customized male speech synthesis vocabulary
- Selectable "Macro sets" for easy control operator selection
- Autopatch, autodial (200) numbers, emergency autodial, reverse patch
- Remotely programmable informative ID's (7), tail messages (3), bulletin board (2)
- Supports synthesized remote base transceiver, control receiver, alarm
- Selectable, informative courtesy tones
- Talking S-meter, Two-tone paging
- Easy hookup to any repeater

For those who like to "roll their own", we can get you off to a rolling start with our **ITC-32 Intelligent Touch-Tone Control Board**. Much more than just a decoder, it's a mini-control system of its own, with the basic repeater and remote base functions built-in. And it can be tailored by you with its Personality Prom.

- 28 remotely controllable latched or pulsed logic outputs
- 4 alarm or remote sensed logic inputs
- Response messages to confirm command entry
- Repeater functions including COR, IDer, timers, courtesy tone, etc.
- Remote base functions including control of synthesized transceiver

- Remotely recordable, variable length audio tracks, accessed from controller messages
- Top quality, no compromise audio reproduction
- Supports up to three repeaters for cost effective installation
- Expandable to roughly 6 minutes of speech in 8 megabits of memory
- Easy interface to RC-850, RC-85 controllers, or to any stand-alone repeater

All our products are designed and manufactured with industrial grade reliability. Little things that many people don't notice, like machine contact IC sockets for all ICs, gold on gold signal connectors, high performance CMOS for minimum power drain, and transient suppression. And the products are documented with high quality, easy to read manuals. Our goal is to advance the state of the repeater art. But most of all, our products put the FUN back into the FUN MODE!



To order one of these advanced control products, call 408-749-8330 and speak with Tim or Catherine. Visa and Mastercard accepted. Technical manuals are available for purchase and the amount paid is applied as a deposit on the equipment. For specifications and a copy of our ACC Notes newsletter, just write or send in your QSL card to:

acc advanced
computer
controls, inc.

10816 Northridge Square • Cupertino, CA 95014

(408) 749-8330

a packet radio primer

General information to get you started

Packet is the most exciting thing to hit ham radio since voice communication. It far overshadows SSB in importance, and it will, I believe, have even more impact on Amateur Radio than the proliferation of repeaters in the early 1970s.

At its simplest, packet radio resembles radio teletype. But there are differences between the two. First, a packet message is not transmitted as it is being typed. Instead, the characters are stored in a buffer and then sent in a block at the transmission speed of the link — up to 5,600 characters per second (cps) at 220 MHz and higher frequencies, 1960 cps for 6 and 2 meters, 120 cps on 10 meters, and 30 cps for the low bands. Thus, even in a hot-and-heavy QSO, transmit duty cycle and channel utilization are low.

Second, each packet station "knows" its own call and recognizes the messages addressed to it. A number of QSOs can occur on one channel simultaneously, yet each station in the connected mode* will have a screen clear of all messages other than its own contact.

Third, because of computerized error checking, you'll see only perfect, noise-and-garble-free transmissions (note that I didn't say "error-free"; I have a problem with my typing) unless you disable the error-checking function. And that's just for starters!

digital repeaters

Packets can be repeated. If you don't value the friendship of your fellow repeater users, packets can be put through your local 34-94 machine, but the raucous buzz will drive the control operator, and anyone else monitoring, mad. The better method is to use a digital repeater or "digipeater." This is a very simple device — just a regular packet station. The scheme is quite different from a voice repeater. The digipeater receives the packet signal, stores it in digital form and checks it for errors. If there are no errors, the digipeater retransmits it.

All operation is on one frequency — no duplexers are required, receiver desensitization by the accom-

panying transmitter cannot occur, and each packet is checked for errors at each digipeater. Unlike voice transmissions via repeaters, packet messages can be sent long distances on the VHF/UHF bands by naming a number of sequential digipeaters to form a path to the destination.

Although, at this moment, most packet activity takes place on 2 meters, there are a number of stations on both coasts operating "gateways," low band packet stations designed for long haul message passing with collection and distribution at either end via VHF or UHF.

packet applications

The four main uses for packet radio at the moment appear to be the following:

- **normal, rag-chew type QSOs.** This of course, includes the exchange of any type of traffic between two stations;
- **direct message passing** (if the destination station is running, I can leave a message on it, without the help or intervention of the operator);
- **Packet Bulletin Board Systems (PBBSs)** similar to the telephone-accessed bulletin board/program exchanges used by computer hobbyists, and **packet mail boxes**, which are usually operated in conjunction with a PBBS. In these, a message can be left for a specific ham by call, for a group such as GLBers, or for everybody (in this case, the call entered as "ALL"). Stations operating mail boxes usually transmit the calls for which they hold traffic. Thus it is not necessary to "check into" the PBBS to know if you have mail.

computer bulletin boards

It's not necessary for your QSO to be with a real, live human. Back in the middle 1970s, several computer operators in the Chicago area set up Remote CP/M (RCP/M) computers with personal message services, bulletin boards, and facilities to exchange computer programs, accessible to anyone with a telephone modem and a teletype or other computer terminal.

These "tele-computing" facilities have proliferated, and it's a poor town, indeed, that doesn't have at least two or three telephone-accessed, computerized bulletin board program exchanges devoted to some com-

By **David McLanahan, WA1FHB**, Box 17, Marlow, New Hampshire 03456

*"Packetese" for being in QSO —Ed.

puter-related or other special interest. (The problem with these marvelous facilities is that if you really get into them, your telephone bill approaches infinity asymptotically.)

This type of activity is a natural for packet radio, and packet bulletin board systems (PBBSs), usually running CP/M, are now springing up nearly everywhere. Many of these stations, based on surplus Xerox 820 computer boards, use software donated to the public domain by Hank Oredson, WØRLI, and distributed by ARRL and through the Newington, Connecticut, FIDO-Net bulletin board (203 665-1114). These bulletin boards offer the advantages of their telephone counterparts without running up your phone bill, and offer an additional convenience: most have a "beacon," a short automated transmission announcing their presence at regular intervals.

These PBBS beacons often include all ham calls for whom the board presently holds messages. Thus, unlike the telephone-accessed boards, you need not "log on" to know if you have mail; just monitor the channel and watch the beacon. In this application, the old ham expression of "reading the mail" takes on a new significance.

for the future

There are two precursors of things to come. The first is the concept of a "local user." This means that a ham tells area PBBS operators which PBBS he considers "home." Messages left for him on other boards are then forwarded to his "home" board. This is now handled manually, but automatic forwarding is only a computer program away.

Second, it's now necessary for a packeteer to determine the digipeater string and enter the calls manually. To assist with this, many PBBSs carry area system maps showing digipeater calls and station locations (an abbreviated map is shown in **fig. 1**). However, as I write, a number of hams are working on computer programs that monitor digipeater traffic, picking up routes and maintaining a dynamic area map in real time.

It doesn't take a great leap of imagination to see where all this is leading: automatic path selection and dynamic call forwarding, both "transparent to the user"; all you do is type the call and the computer and packet board does the rest (with a name/call file for your friends, all you'd need to type would be the name). We're rapidly approaching the point reached years ago by television's Napoleon Solo, who, when stranded on a remote Pacific isle, simply whispered "Open channel D," into his fountain pen. Our main unresolved technical challenge will be to place a workable (and comfortable) keyboard on the side of the pen!

There is one thorn in this rosy future: channel space. I've said that packet transmission is error-free, but I carefully avoided any reference to transmission times. At the moment, channels are relatively quiet, and over short paths things can happen quickly. For example, working through two 2-meter digipeaters handling little or no other traffic, packet delivery times run on the order of 4 to 5 seconds each. This is quite reasonable. But, add a few more QSOs, a longer path (several digipeaters), or someone using a PBBS (which shovels out long program or message packets as fast as it can), and things bog down quickly.

While we're on the subject of transmission speeds, two additional notes are necessary. First, the speeds given at the beginning of the article are FCC-permitted *maxima*. While 300 Baud (30 cps), the legal maximum, is used on the low bands, on 2 meters the universally used speed is presently 1200 Baud (120 cps) rather than the allowed 19.6 kilo-Baud, purely because the 1200 will go through a normal voice channel while the higher data rates (which require greater bandwidths) will quickly run aground in the intermediate frequency amplifier and audio circuitry of a normal voice rig.

Second, 1200 Baud sounds like a nice, snappy exchange rate, particularly if you're accustomed to a 300 Baud terminal. Sorry about that; the 1200 Baud is the character transmission rate. When it comes to actual message or data exchanges, the through-put (useful traffic passed) will be at a much lower effective speed, especially if noise or a busy channel forces repeats of transmissions. This is due to overhead within the packet (message header and such) and the necessity of getting acknowledgement for each packet.

Of course, packet activity has no way to go but up as more people get involved. Again, we have technical solutions that will (we hope) be here before the problems are — inexpensive "ham type" digipeaters up at UHF and microwave where transmission speeds can be increased dramatically. This doesn't mean you'll have to put a 1296 MHz rig in your car; local traffic can still be handled on 2 meters, but the heavy and long-distance communications can go on the microwave links.

equipment

You need only three pieces of equipment to operate on packet radio: a 2-meter transceiver (nothing special, that old rock-bound clunker in the basement will probably do, with some tuning); a Terminal Node Controller (TNC — the actual "packet board"); and a computer or computer terminal with which to communicate with the TNC.

Of course, there are always other ways. If you want to save time and reduce aggravation, there's the Pack-

Our Very-Hard to Find Components List

Semiconductors

MRF-208	\$12.00	MRF-901	\$ 1.75	MPSH-81	\$.50	1N6263	\$ 75
MRF-240	18.40	MHW-710-1	61.00	MV2205	.58	2N2907	60
MRF-247	34.80	2N5944	10.35	LM380N	1.90	2N4401	75
MRF-309	33.81	MC1330P	1.60	LM565CN	1.85	2N5190	1.50
MRF-421	37.00	MC1350P	1.20	LM741CN	.85	2N5192	1.50
MRF-422	41.40	MC1358P	1.25	1N756A	.55	2N5194	1.50
MRF-429	46.00	MC1458P	.65	1N4001	.25	2N5989	2.80
MRF-454	20.00	MC1723G	2.80	1N4148	.30	2N5990	2.80
MRF-644	27.60	MC3405	2.50	1N4997	1.50	2N5991	3.00
MRF-646	29.90	MC78L08CP	.50	1N5400	.35	2N6486	1.25
MRF-648	33.50	MPS-2222	.35	1N5363A	2.00		

Kemet Chip Capacitors

NPO C1210 Size - .50 ea		NPO C1210C Size - .75 ea		NPO C1813 Size - \$1.00 ea		BX C2225 Size	
10 pf	75 pf	4.7 pf		3300 pf	5600 pf	6800 pf	33 μf \$1.90
39 pf	82 pf			.1 μf BX			68 μf \$3.90
51 pf	100 pf						
56 pf	390 pf						
							✓ 124

We also carry a line of VHF, UHF amplifiers and ATV equipment. Call or write for our free catalog.



CCI Communication Concepts Inc.

2648 North Aragon Ave • Dayton, Ohio 45420 • (513) 296-1411



The Written Word Via Radio

Why spend money on phoneline rental and modems when you can install an AEA, PKT-1 PACKET RADIO CONTROLLER and send any alphanumeric information via (your existing) radio?

- Send any text, data, or program file, error free, to a remote screen, disk or printer.
- Data rates to 4800 Baud, dependent on FCC-allowed bandwidth.
- RS-232 connection to any terminal/computer configured as DTE.
- PTT, audio in and audio out are the only connections to any (FM, SSB, PSK, etc.) transceiver.
- 12 VDC operation allows portable/mobile operation.
- Extend range and/or avoid line-of-sight obstacles or multipath problems by using other packet stations as store-and-forward Digipeaters.
- Low cost: Typical total system costs are \$500-\$1000.

Connect your warehouse and office personal computers and send customer orders... Connect your Emergency Service or Search and Rescue base to field locations and send "equipment needed" lists... Send written dispatches to your fire, police, aid car, water department locations... Send avalanche sensor information automatically from remote highway sites... Control your irrigation equipment or your readerboard signs remotely... Receive security system messages from a break-and-enter site... Share bulletin board files at radio-remote sites... Send patient info to the receiving hospital from the triage hospital... Communicate using battery power when phone lines are down.

Your imagination is the only limit. Call John Gates, circle reader service number, or send coupon for fast response. Dealer inquiries invited.



Advanced Electronic Applications Inc.
Box C-2160
Lynnwood, WA 98036
(206) 775-7373

AEA, Inc., Box C-2160, Lynnwood, WA 98036
Send PKT-1 information to:

Name _____
Address _____
City/State _____
Zip _____ Call me at _____

fig. 1. At right is a graphic representation of Packet Radio links believed to exist on 145.010 MHz on the East coast of North America. The area covers part of Canada and extends to North Carolina. Another file, called SOUTMAP.NNN, covers the area from Virginia south to Florida.

Included in these maps are digipeaters, Packet Bulletin Board Stations (PBBS), and home stations usually left on for digipeating. Updated maps covering this and other areas are available from stations running WØRLI-compatible software for PBBSs, mailboxes and/or gateways; these stations are indicated by the use of the "@" character preceding the call sign.

The primary routes used for mail forwarding in EASTNET are marked with asterisks (****), while other links are shown by either | \ or / as connecting characters. All "*****" routes are presently on 145.010. In the Baltimore/Washington area .050 is heavily used for local traffic. Links on 145.050 MHz in Maryland, West Virginia, and Pennsylvania are connected on this map by dots. 220 MHz trunk links will parallel 145.010 in the future.

To improve readability of this linking you might want to use felt tipped pens to outline the various linking paths. Links marked with a question mark indicate a link of unknown reliability. If any links shown on this map prove to be unreliable or nonexistent, please drop me a note. Send the info to me, K1HTV @ W3IWI, via one of the many auto-forwarding PBBSs or via the U.S. mail (see Callbook for address).

Thanks to Rick Zwerko, K1HTV, one of 10 acting directors of the Mid-Atlantic Packet Radio Council (MAPRC). Formerly Vice-President for Operations, AMSAT, Rick also served as a member of the AMSAT Board of Directors and was past president of the Northeast VHF Association.

— WA1FHB

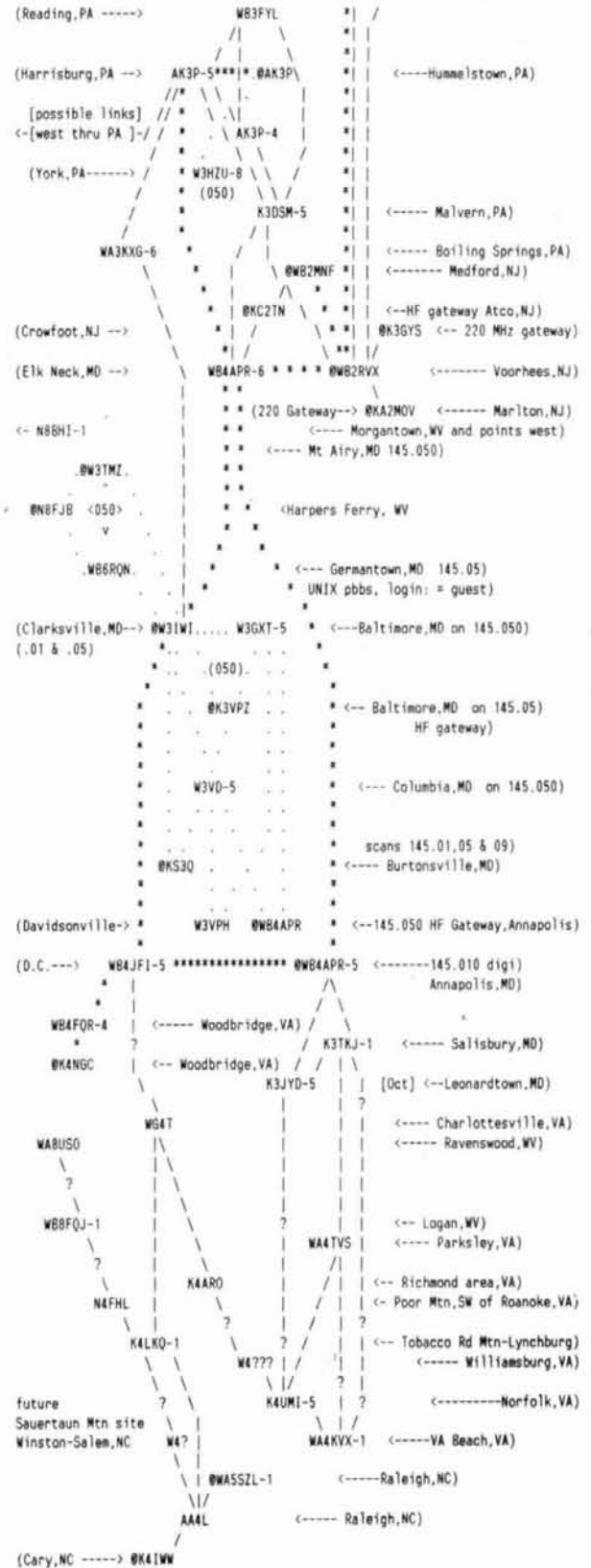
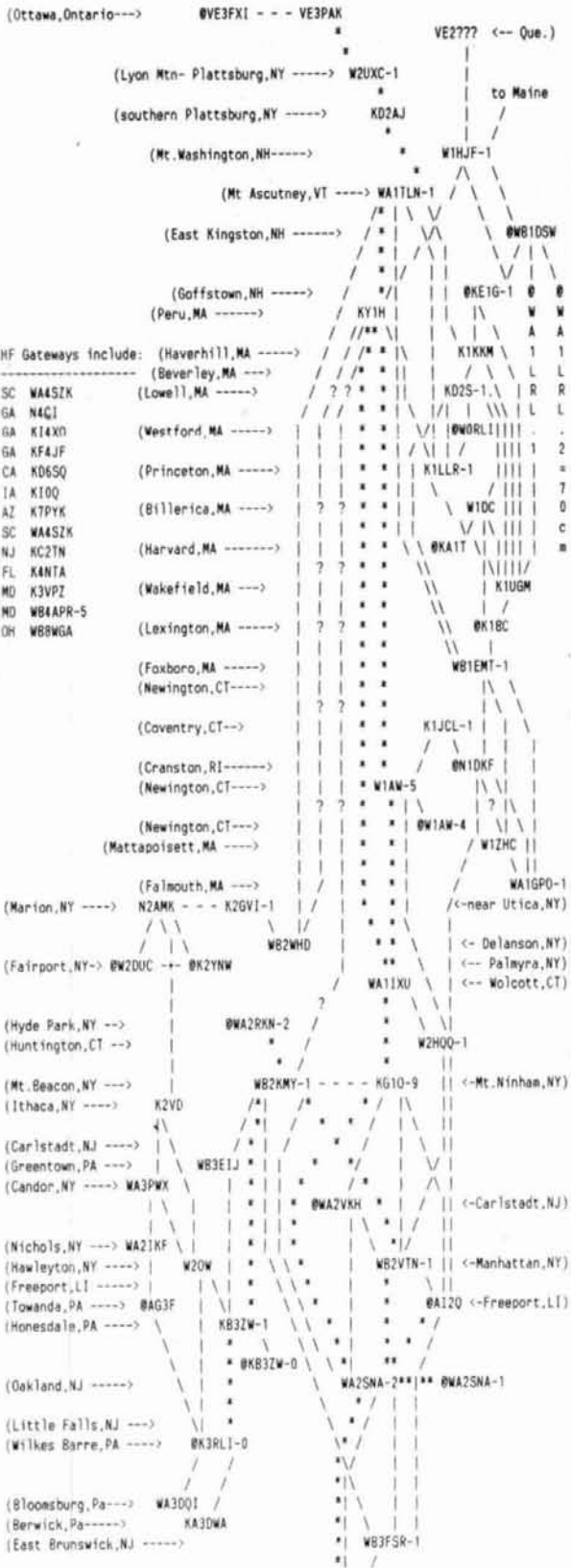

eterm, a portable unit (\$995) that combines a TNC and a computer terminal in one sleek-looking designer case (see photo). If you go that route, you can disregard the rest of this article and be on the air half an hour after unpacking the box . . .

I claim no special expertise in the area of 2-meter transceivers. I'm using an Azden PCS4000 because I happen to have it, and it's working fine. The only caveat is that most 2-meter packet activity is below 146 MHz and some of the older narrow-band equipment needs a tweak to get down there.

I'm using a GLB PK-1 Terminal Node Controller. I chose it because it appears to be the least expensive one available (\$165). At 4-1/2 x 9-1/2 inches (11.4 x 24 cm) it's also the smallest one I've seen. It also requires only a single-voltage power supply (+12 VDC at 170 mA) and it doesn't mind "mobile-type" voltage excursions; I've used it from 14-1/2 to 9 volts without a hiccup. And, like other TNCs on the market, the Z-80-based GLB features "dynamic programming"; the manufacturer frequently releases a new ROM offering enhanced and improved features.

Other TNCs are available from Vancouver Amateur Digital Communications Group, Tucson Amateur Packet Radio, Heath, AEA, Kantronics, Ashby, and Packeterm, to name a few (fig. 2). Richardson software converts a TRS-80 Model 1, 3, 4, or 4P into a computer/TNC*.

The last necessity, the terminal, offers the most opportunity for self-expression. It can be anything from a Model 15 Teletype to a microcomputer such as a Sinclair ZX-81 or a Commodore 64. The microcomputer route is the most popular. Of course the micro must have a serial port (or an adapter to provide one) as well as a modem program. (The Model 15 Teletype was preprogrammed at the factory.)

getting started

As with everything else, the most difficult part is getting started, especially if you don't have a packet Elmer around. You'll need either a reasonably local packet station that will give you a strong signal or two set-ups that you can work back-to-back. An independent monitor receiver is a big help.

There's nothing special about the monitor receiver. It can be any kind of tunable or fixed-frequency rig capable of receiving your area's packet channel(s). Be aware that some of the programmable (no-crystal) scanners won't tune lower than 146 MHz without special measures. For example, on my 16-channel Regency "Touch," Model ACT-T-16K, I must press, in order, MA, 9, CL, PR, then key in the frequency I want, and hit PR again.

*Synchronous Packet Radio Using the Software Approach — AX.25, by R.M. Richardson, W4UCH, available from Ham Radio's Bookstore, Greenville, NH 03048 (\$21.95 plus \$3.50 postage & handling)

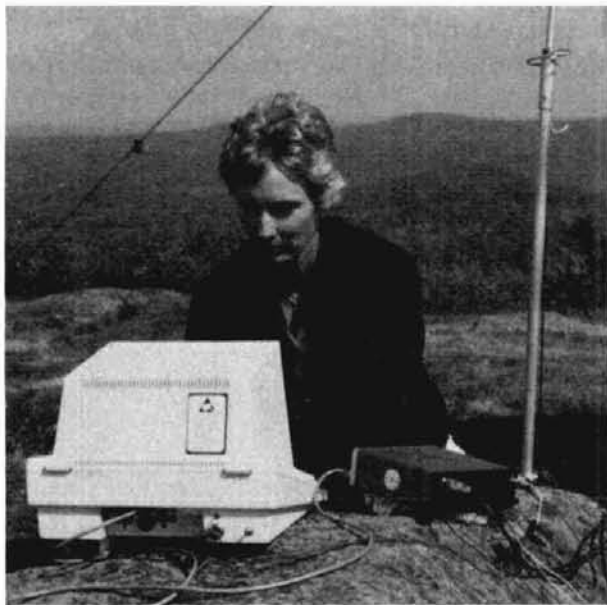

fig. 2A. Cynthia "Sam" Hensley, KY1D, operates Packeterm™ IPT, a portable terminal and TNC combined in one unit, from summit of Pitcher Mountain in Stoddard, New Hampshire.

This receiver is then set up on its own 1/4-wave whip near your packet station. Because a TNC requires a better signal to noise ratio than voice, if another station sounds reasonable on the quarter-wave whip, it will probably be fine for packet, assuming that you are using an outdoor gain antenna for the packet transceiver.

The monitor is used, first, to compare your station's deviation with others in the neighborhood, and, second, to keep track of when (and how) your station is transmitting. After your packet set-up is thoroughly established and proven, you may wish to return this radio to its prior service monitoring the local police, but till then it'll be invaluable in getting you started.

To begin with, you have to get your computer or terminal working with your TNC. This requires, first, an RS-232 interface from the computer or terminal to be connected with the RS-232 interface on the TNC, and, second, if you're using a computer, driver software (usually a "Modem" or "Terminal Emulator" program) to access the RS-232 port. Because the programming depends on the brand and type of computer used, I'll leave that part to you and your software dealer or local computer guru.

I can, however, provide some advice on using the RS-232.

the RS-232

First, the actual RS-232 specification doesn't define a physical connector, although a DB-25 is usually used. Second, RS-232 defines interfaces for modems and for terminals, but not for computers. Third, two

**Please enter my gift subscriptions
to HAM RADIO Magazine as follows:**

FIRST SUBSCRIPTION \$19.95

**TWO OR MORE SUBSCRIPTIONS \$16.95 EA. SAVE \$3.00
(you can also renew your own subscription at this low rate)**

FIRST	Name _____ Call _____
	Address _____
	City _____ State _____ Zip _____
	<input type="checkbox"/> new <input type="checkbox"/> renewal

SECOND	Name _____ Call _____
	Address _____
	City _____ State _____ Zip _____
	<input type="checkbox"/> new <input type="checkbox"/> renewal

THIRD	Name _____ Call _____
	Address _____
	City _____ State _____ Zip _____
	<input type="checkbox"/> new <input type="checkbox"/> renewal

- Start or Renew my own HR subscription.
- Enclosed is a check or money order for \$ _____ for _____ subscriptions. (use separate envelope)
- VISA MasterCard Bill me later
- Acct. # _____
- Expires _____ MC Bank # _____
- My Name _____ Call _____
- Address _____
- City _____ State _____ Zip _____

Prices U.S. only. Inquire about foreign rates.

Please
enter my
subscription



NO POSTAGE
NECESSARY
IF MAILED
IN THE
UNITED STATES

BUSINESS REPLY CARD

First Class Permit No. 1 Greenville, NH

Postage Will Be Paid By Addressee

**ham
radio**

Greenville, NH 03048

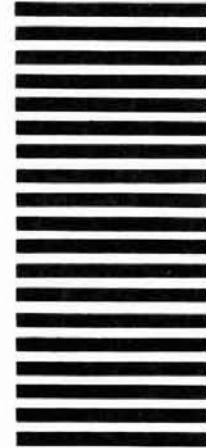

'Tis best to give as well as receive.

(especially before our January price increase!)

One Year/12 issues

\$ 19⁹⁵
SAVE*
OVER 10%

First Gift
OR

\$ 16⁹⁵ SAVE*
25%

**FOR TWO OR MORE SUBSCRIPTIONS OR EXTENSIONS
INCLUDING YOUR OWN**

*One-year subscriptions will be \$22.95 after January 1, 1986.

A gift card will be sent if your order is received before December 13, 1985.

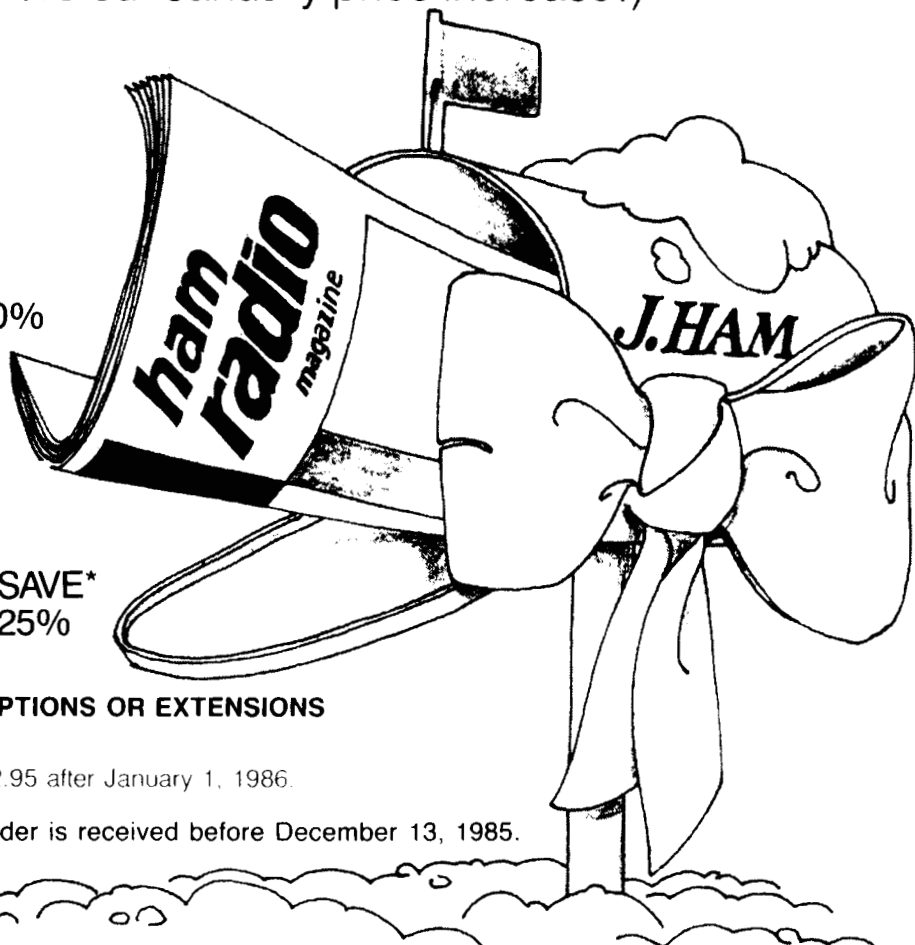

Giving Ham Radio is both fun and thoughtful.

And at the receiving end of a Ham Radio gift subscription, it's remembered all year long as a token of your friendship.

We have a super busy year planned for 1986, just take a look at a sampling of what your special Amateur friends(s) will see in their 12 big gift issues next year: The very latest in state-of-the-art projects and technical discussions, our Annual Antenna issue

in May and our Receiver issue in November, computers, monthly columns by Orr, Stonehocker, Reisert, and Guerri plus much, much more.

There's no time like the present to give the gift of HAM RADIO Magazine to that "hard to buy for" ham friend. While you're at it, why not treat yourself to another year of HR and save \$3 off our regular rate and \$6 off our new rate.

Please use handy
bind-in card.

**ham
radio**
magazine

Greenville, NH 03048

Prices US only

December 1985 **hr** 37

identical RS-232 interfaces (two modem interfaced or two terminal interfaces) won't work together because both will be transmitting data on one line and both will be "listening" on another line. Therefore, before you actually hook things together, compare the instructions for your computer and your TNC.

Normally, the computer will talk (transmit data, data out, or TxD) on pin 2 of the DB-25 and the TNC will listen (receive data, data in, or RxD) on the same pin number. If your literature shows that your two devices work this way, use a pin-for-pin cable. If, on the other hand, both units are talking on the same line, you'll have to swap pins 2 and 3 at just one end of the cable. (If you make the swap at both ends, you're back where you started!) Along with that swap, go swaps on several of the control lines, although ground *always* remains on pins 1 and/or 7. Check your literature.

If you find that you do require some line swaps, but

all you have is a pin-for-pin cable, check its connector type. There are three types of DB-25 connectors in common use commercially: insulation displacement connector (IDC), crimped onto ribbon cable; solder cup connector with wire leads soldered in as required; and crimp-type, where the pins are crimped onto the wires and then popped into the connector shell.

If you have only a ribbon cable, you're stuck. With the solder cup connector, changing conductors around is relatively simple, assuming that you have both patience and a small soldering pencil. Changing the pins around on the crimp-type connector is even easier than resoldering if you can get the little plastic insertion and extraction tools. Both tools (which slip together for storage) are slotted lengthwise for slipping over the wire. The tool is then slid down the wire so that its point enters the back of the connector block around the connector pin. Gently pulling the wire slides the pin out of the block. Reinsertion is just the reverse. Place the tool on the wire up against the pin and use the tool to seat the pin in the block.

Although these tools are inexpensive, they may be difficult to find. Made of plastic, they will break in time. You might try purchasing several from an industrial distributor who stocks the connectors.

listening to the data

If you're sure the wiring is under control but the interface still doesn't work, check to make certain that both units are really transmitting data when they should. Look at the TxD line from the computer. (An oscilloscope is ideal for this but you can use the audio channel of your video monitor, if it has one, or another audio amplifier and speaker.

Remove the plug cover from the cable connector at either end. Make sure that the audio channel ground is connected to the computer system ground. With the volume of the audio channel set low (to avoid ear-shattering surprises) check the audio by touching the exposed audio connection with your finger while the rest of your body is ungrounded. You should get a loud AC hum. Then, using a small-gauge conductor wedged into the back of the DB-25, make contact between either pin 2 or pin 3 and the audio input.

Now try a command to the TNC. With the GLB PK-1, the first thing it wants to see is a carriage return <cr> to establish the baud rate, which should be 9600 Baud or slower. (The baud rate between TNC and "terminal" has nothing to do with the "on the air" data rate of 1200 Baud.) When the GLB receives its carriage return, it responds with a dozen-character sign-on. If serial data is present on the line you've chosen, you'll get a raucous buzz (or a short burp) for a single character like the <cr>. Try this a couple of times. If the power doesn't come on cleanly (i.e., bounce in the power switch) it can discombobulate



fig. 2B. Packet terminal units from (A) AEA, (B) Heathkit, and (C) Kantronics.

the GLB's initialization routine. Hit GLB reset and try <cr> again.

If you still don't get the buzz, the most likely cause is that a required RS-232 control signal is not being handled properly. Of course, this requires a check of the RS-232 specifications as interpreted by the two particular devices that are giving you grief. For example, with the GLB PK-1, check to see that the computer or terminal is putting a high (>3VDC) on RTS (Ready To Send) (DB-25 pin 4 on the GLB), and that the computer doesn't need more control signals than the high that the GLB puts on its CTS (Clear To Send) (DB-25 pin 5) line.

If either the computer or the TNC is not getting the control signal(s) it requires, you won't hear data on either line from the end(s) with the problem. Check your control lines with a VOM.

Once the terminal-TNC interface is working, you are ready to hook the TNC to your transceiver, following the TNC manufacturer's guidelines.

Now see if you can receive. Connect all the equipment up and turn it on, instructing your packet board to display everything without checking the packets for transmission errors ("Garbage mode" on the GLB, **SG-E**). Wait for activity on the channel (as indicated by your transceiver's S-meter or the monitor radio) and see if it prints. (Very short transmissions may be connect requests or acknowledgements that will not yield a printable message.) If that works, try transmitting. Send anything and compare the sound of your transmitter through the monitor radio with the sound of another packet station. *If your signal doesn't sound raspy and disagreeable, your audio is set too low.*

talking to yourself — by radio

If the audio sounds okay, try talking to yourself through the other station. Program your call as the destination as well as the originator, making sure that the SSID numbers (usually zero) are the same. Then type in the call of the other packet station or digipeater, again watching the SSID. Many digipeaters use an SSID of one, with zero used by the trustee's home station. W1AW has several packet stations with SSIDs running up to 5! With the GLB your destination is set with **SD** and your digipeater(s) with **SV** (send via).

Now issue the command to connect (**AC** on the GLB). Your transmitter should come on for a short period (less than a second) followed almost instantly by a similar-length transmission by the other station. Your terminal should then "ring its bell" and display **-Connected to <your call>**. Now type a short message and hit your "dispatch" character (on the GLB this defaults to a line feed). The message should be duplicated almost immediately on your screen, then be followed in a second or two by another bell and an **-Ack**.

The **-Ack** means that the "receiving-you" has acknowledged the message back to the "sending-you." If the **-Ack** is not received by the TNC, the message will be held in the TNC's buffer and the transmission repeated. With the GLB, to disconnect, type **Control-C**. When disconnect is complete, the screen will show **#1**.

If all that worked, you're ready for a real, live QSO or a longer path test. On multi-hop self-connects, you must provide the *entire* round trip in the digipeater string. (Like any other computer, the TNC is wonderfully fast but very stupid.) Thus to self-connect through W1AA-1, W2BB-0, and W3CC-1, for example, your string must read W1AA 1, W2BB 0, W3CC 1, W2BB 0, W1AA 1.

If all this works, you're home free. If questions or problems arise, you can connect with another packeteer in your area and ask for help. You can also access your local PBBSs. Start with the one that's on the shortest, quietest, most reliable path until you get the hang of it. (The wee, small hours of the morning are the best time for this experimenting.) All you have to do is connect with the PBBS station, then be patient while it announces itself and gives you its prompt line ending with CP/M's >. It will then be looking for a letter command followed by a carriage return (and on the GLB, a line feed to send the packet). For starters, try an "H" (for Help). It should reward you with a list of its commands and explanations. If you have a printer, turn it on so you'll have a hard copy for future reference.

Of course, there's a great deal more to packet radio than I've mentioned here, and the field is changing rapidly, but, as the Chinese say, "The longest journey begins with but a single step." As with any Amateur Radio activity, the biggest and most important step is just getting on the air so you can contact fellow hams. I trust that you'll enjoy the rest of this unending journey.

ham radio

for further reading...

A special package of four back issues of *ham radio*, featuring the following Packet Radio articles, is available from Ham Radio's Bookstore:

"*Amateur Packet Radio, Part 1*," by Margaret Morrison, KV7D and Dan Morrison, KV7B, July, 1983; part 2, August, 1983.

"*Packet Radio — the Software Approach*," by Robert M. Richardson, W4UCH, September, 1984.

"*The New Industrial Revolution: Packet Radio and Local Area Networking*," Cornell Drentea, WB3JZO, December, 1984.

The special price for the four-issue package is \$14.95; single issues are priced at \$5.00 each (postpaid).

Ham Radio's Bookstore • Greenville, NH 03458

PACKET RADIO . . .

. . . THE FASTEST GROWING PART OF AMATEUR RADIO TODAY

is already providing high speed, error free, communications on many amateur bands for qso's, data transmission, emergency traffic, dx'ing, traffic nets, mailboxes, endless experimentation, and soon... satellite operation.

networks continue to grow, as does the number of hams who enjoy this new and exciting mode. The increasingly popular **PACKETERM IPT** is contributing to phenomenal growth in amateur packet radio by providing a full function packet terminal in a compact, portable unit...

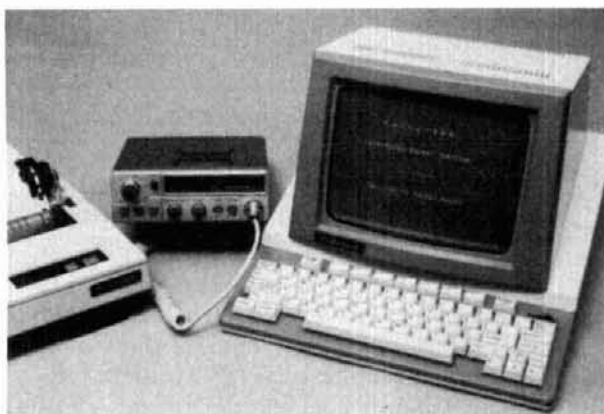

ALL YOU NEED FOR PACKET OPERATION IS A **PACKETERMtm IPT AND YOUR RIG !**

Designed for true portability, the IPT is equally at home in your ham shack or (with its optional carrying case) trekking in the country for battery powered hilltopping!

A single cable connects to your transceiver....that's all there is to it!
Use it with your base station, mobile, or with your HT on that hilltop!!!

- FEATURES:**
- * * 9 inch portable terminal and full function tnc combined
 - * * 66 commands available - the most widely used, field proven programming .
 - * * Built-in LSI modem ; 300 or 1200 baud, 200 or 1 kHz audio shift
 - * * stores setup parameters with power off - uses lithium battery
 - * * custom "beacon" text -- your call, qth, etc. in permanent memory
 - * * 74 key, full travel keyboard with 14 function keys for commands, calls, etc.
 - * * printer port - RS232C serial
 - * * optional printer, carrying case, and dc adaptor (13.8 VDC)

 **Packeterm**

Box 835, Amherst, NH 03031
(603)-673-6630

PRICES:	IPT COMPLETE	\$995
	PRINTER	\$349
	DC ADAPTOR	\$125
	TNC (BOARD ONLY)	\$275

automatic frequency and deviation tester for packet radio

Measure your
packet signals
from the comfort
of your home

Recent observations of packet radio signals revealed some startling facts. Several stations intending to be on 145.01 MHz were found as much as 3 or 4 kHz off frequency. Deviation levels also varied quite a bit.

Off-frequency operation and overdeviation cause distortion of the audio signal. Too little deviation results in a poor signal to noise ratio. In all these cases, the result is the same: a modem is less likely to demodulate the signal properly. Packets are retransmitted an excessive number of times and the channel gets clogged up.

The New England Packet Radio Association tried to improve the situation by having a calibration session at one of the regular meetings. A frequency counter, deviation meter, and qualified engineers were present to make sure everybody's equipment was properly adjusted. There was plenty of advance publicity, but no more than a few people bothered to bring their equipment.

Several months later a new beacon appeared on the air, transmitting "WB2OSZ>BEACON: frequency/deviation tester available." During the first few days of operation, many stations connected and received the following message:

"Welcome to the WB2OSZ automatic frequency/deviation tester. Instructions:

- 1. Send several non-blank lines.*
- 2. Wait for reply after each.*
- 3. Ignore any occasional erratic values.*
- 4. Disconnect when done.*

Recommended deviation is no more than 3 kHz. Anyone who disagrees with the results is invited to supply a reference more accurate than my 2AT. John"

Each time a packet was sent to the automated station, a reply was sent back in the form, "Your frequency is about 1.8 kHz too high. Deviation is about 2.6 kHz."

circuit description

The voltage from the detector of an FM receiver is proportional to the frequency of the incoming radio signal. Extracting the DC component of this will provide a measure of the carrier frequency. The peak amplitude of the AC component is proportional to the deviation. **Figure 1** shows a block diagram of a system designed to extract these parameters.

The first step is to obtain a DC-coupled signal from the demodulator of your FM receiver. The entire signal flow from receiver to computer is shown in **fig. 2A** and the individual circuits detailed in the **figs. 2B** through **2E**. **Figure 2B** contains a circuit used with an old VHF Engineering transceiver; it should work with anything else using an LM 3065, an MC 1358, or a CA 3065 quadrature detector. (This part will have to be customized for your particular rig.) It produces a zero volt output for a carrier on the desired frequency and changes by a half volt for each kHz change.

The next step is to extract DC and AC components of the signal with low- and high-pass filters (**fig. 2C**). U2 and associated components form a low-pass filter. Their output is proportional to the amount the incoming signal is off frequency. For example, -1.5 volts means the signal is 3 kHz too low.

The AC component, of course, is the audio. It is extracted by a high-pass filter composed of C3 and R12. This is fed through a full wave rectifier, peak detector, and another low-pass filter. R14 limits the peak current out of U4. (Without it, nasty spikes appeared on the power supply output). R18 boosts the gain slightly above unity to compensate for a small loss in the high-pass filter and peak detector. The result

By John W. Langner, WB2OSZ, 115 Stedman Street, Chelmsford, Massachusetts 01824

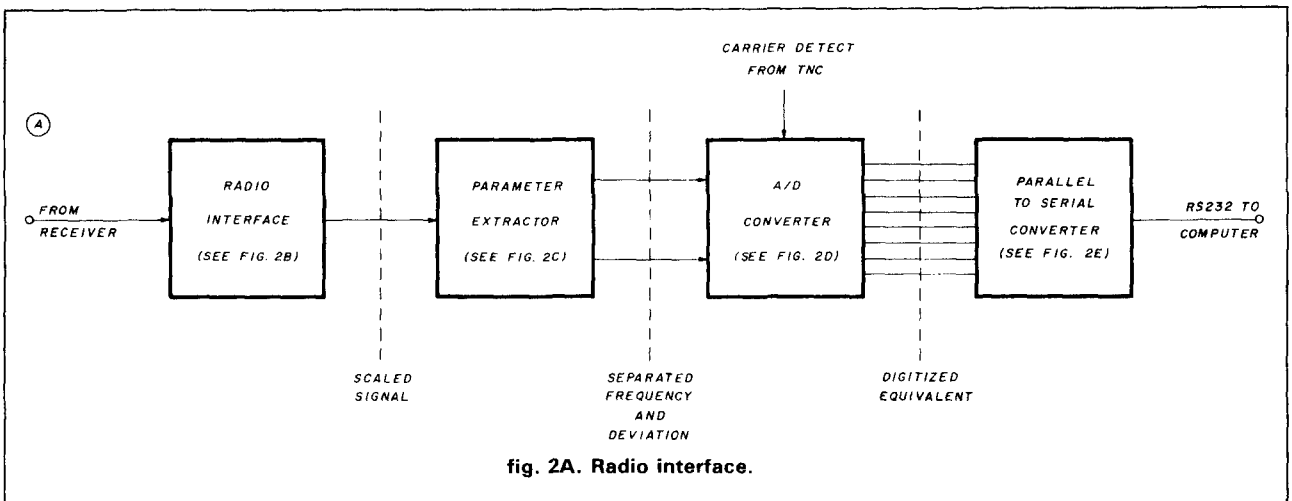
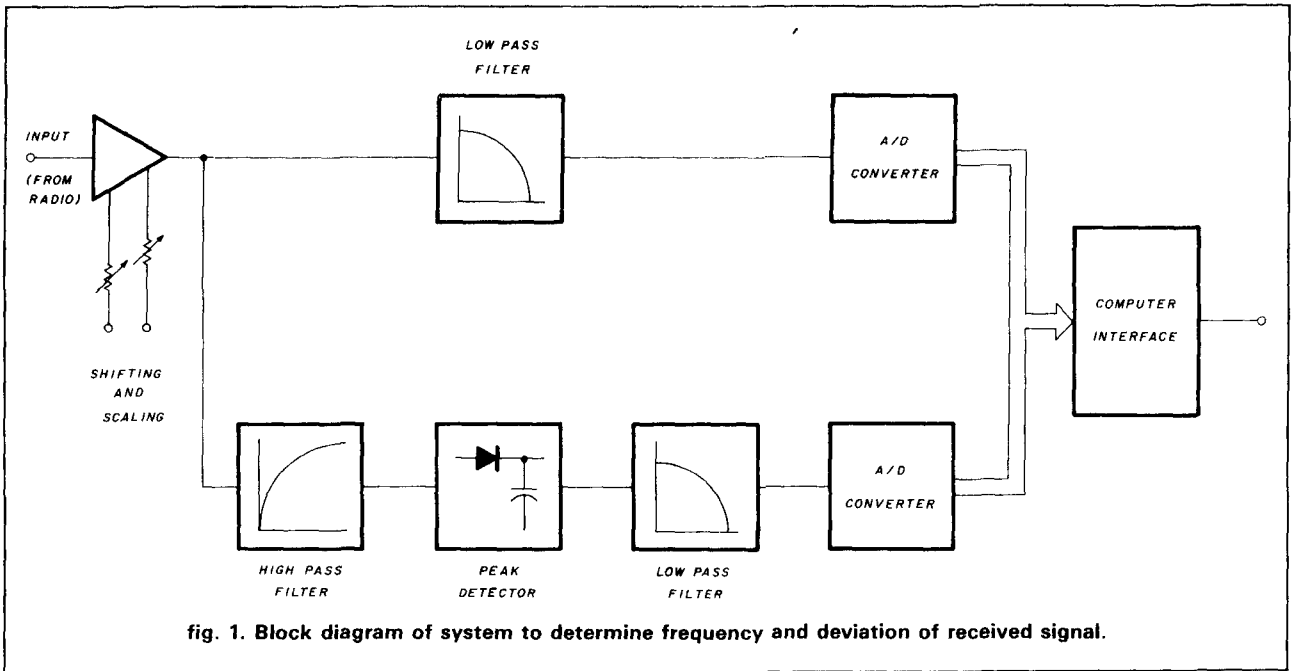

table 1. Integrated circuit pin designations for the supply lines.

	ground	+5 volts	-12 volts	+12 volts
555	1	8		
741			4	7
ADC 0804	10	20		
1458			4	8
74121	7	14		
AY-5-1013	3	1	2	

is a voltage proportional to the peak deviation, again 0.5 volt/kHz.

To build a useful piece of test equipment, connect these voltages to a pair of meters. You can also inte-

grate your system with a computer to open up many possibilities for automated operation. If you have a computer with joy stick input, you already have a pair of analog-to-digital converters and don't have to build the rest of the circuit. For those with computers not intended for playing games, additional external circuitry is required.

The analog voltages must be converted to digital signals the computer can understand. This is accomplished by the ADC0804 A/D converters in fig. 2D, which convert a voltage in the range of 0 to 5 volts into a corresponding number in the range of 0 to 255 in less than 20 microseconds. U7 and U8 determine when to start the conversion. CR3 through CR6 protect the inputs of U5 and U6 from voltages that could

damage them. CR3 through CR6 should not conduct during normal operation.

A purist may wish to connect a precision 2.5 volt reference to the V_{REF} pins. In its absence, internal voltage dividers use one half of the 5-volt supply.

When should the A/D converters be commanded

to start the conversion? You wouldn't want to do it when an audio carrier is first detected because the low-pass filters wouldn't have had time to settle down. And you can't do it after the computer has received the packet contents from the TNC (terminal node controller) because the audio signal is long gone. I decided

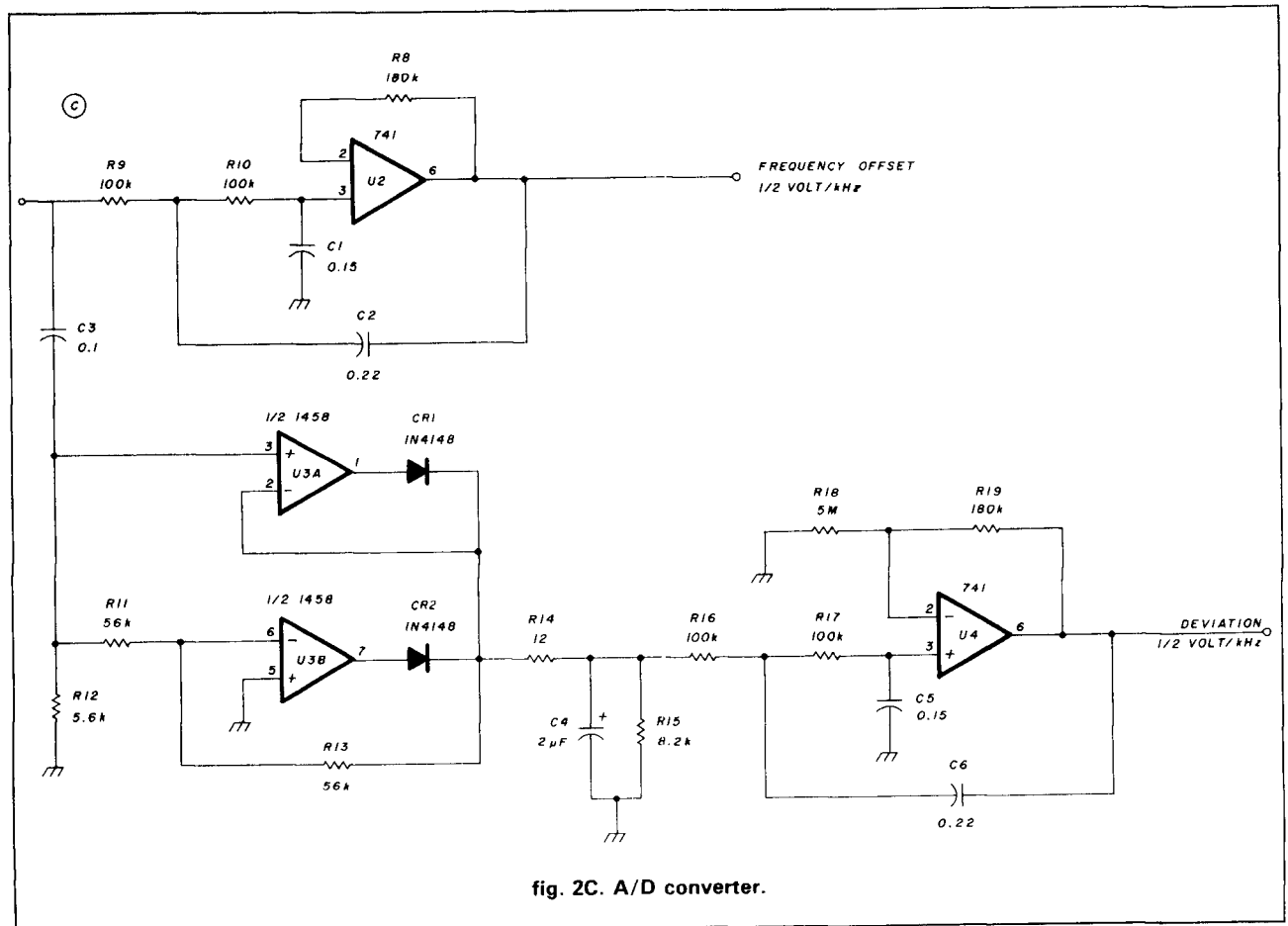
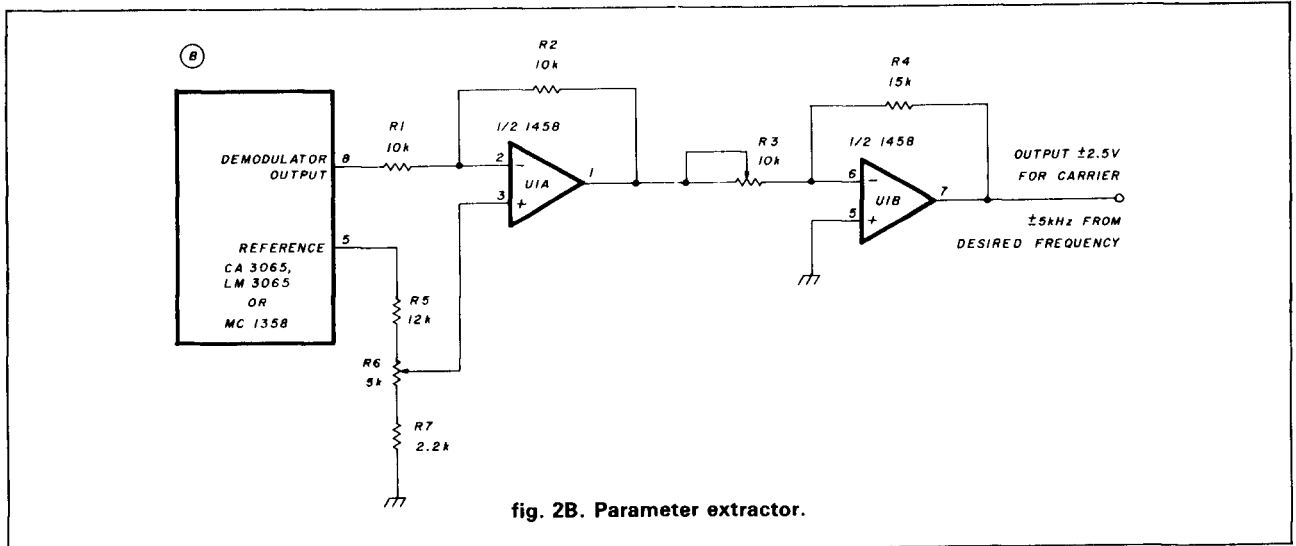

CONTINUOUS COVERAGE FOLDED DIPOLE ANTENNA

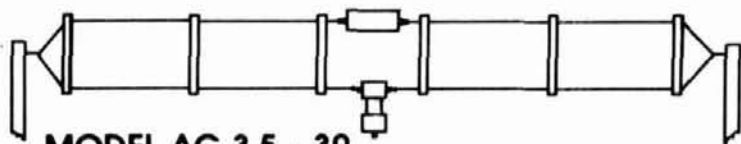

MODEL AC 3.5 - 30
(formerly Model 370-15)

- Fully Assembled • 52 OHM • Only 90 feet long
- SWR less than 2:1 from 3.5 thru 30 MHz. Average SWR 1.4:1
- Will handle 1 KW power (2 KW PEP)
- Can be installed as flat top, sloper, or inverted "V"
- Used the world over in government & commercial communication installations
- Ideal for all operations - amateur, commercial, MARS - any frequency from 3.5 - 30 MHz

PRICE \$159⁵⁰

PLUS \$3.00 Shipping and Handling

PATENTED

ALL OUR PRODUCTS MADE IN USA



BARKER & WILLIAMSON

Quality Communication Products Since 1932
At your Distributors. Write or call.
10 Canal Street, Bristol PA 19007
(215) 788-5581



1986 CALLBOOKS



The "Flying Horse"
has a great new look!

It's the biggest change in Callbook history!
Now there are 3 new Callbooks for 1986.

The North American Callbook lists the amateurs in all countries in North America plus those in Hawaii and the U.S. possessions.

The International Callbook lists the calls, names, and address information for licensed amateurs in all countries outside North America. Coverage includes Europe, Asia, Africa, South America, and the Pacific area (exclusive of Hawaii and the U.S. possessions).

The Callbook Supplement is a whole new idea in Callbook updates. Published June 1, 1986, this Supplement will include all the activity for both the North American and International Callbooks for the preceding 6 months.

Publication date for the 1986 Callbooks is December 1, 1985. See your dealer or order now directly from the publisher.

- | | |
|---|---------|
| <input type="checkbox"/> North American Callbook
incl. shipping within USA | \$25.00 |
| incl. shipping to foreign countries | 27.60 |
| <input type="checkbox"/> International Callbook
incl. shipping within USA | \$24.00 |
| incl. shipping to foreign countries | 26.60 |
| <input type="checkbox"/> Callbook Supplement, published June 1st
incl. shipping within USA | \$13.00 |
| incl. shipping to foreign countries | 14.00 |

SPECIAL OFFER

- | | |
|---|---------|
| <input type="checkbox"/> Both N.A. & International Callbooks
incl. shipping within USA | \$45.00 |
| incl. shipping to foreign countries | 53.50 |

Illinois residents please add 6 1/4% sales tax.
All payments must be in U.S. funds.

RADIO AMATEUR
callbook INC.



Dept. F
925 Sherwood Dr., Box 247
Lake Bluff, IL 60044, USA

Tel: (312) 234-6600



RELIABILITY & ACCURACY.

Precision Quartz Crystals 70 KHz to 200 MHz. International is a major supplier to the commercial, industrial, and amateur crystal market.



For complete information contact our sales department

INTERNATIONAL CRYSTAL MFG. CO., INC.

P.O. Box 26330, 701 West Sheridan, Oklahoma City, OK 73126-0330 (405) 236-3741 Telex 747-147

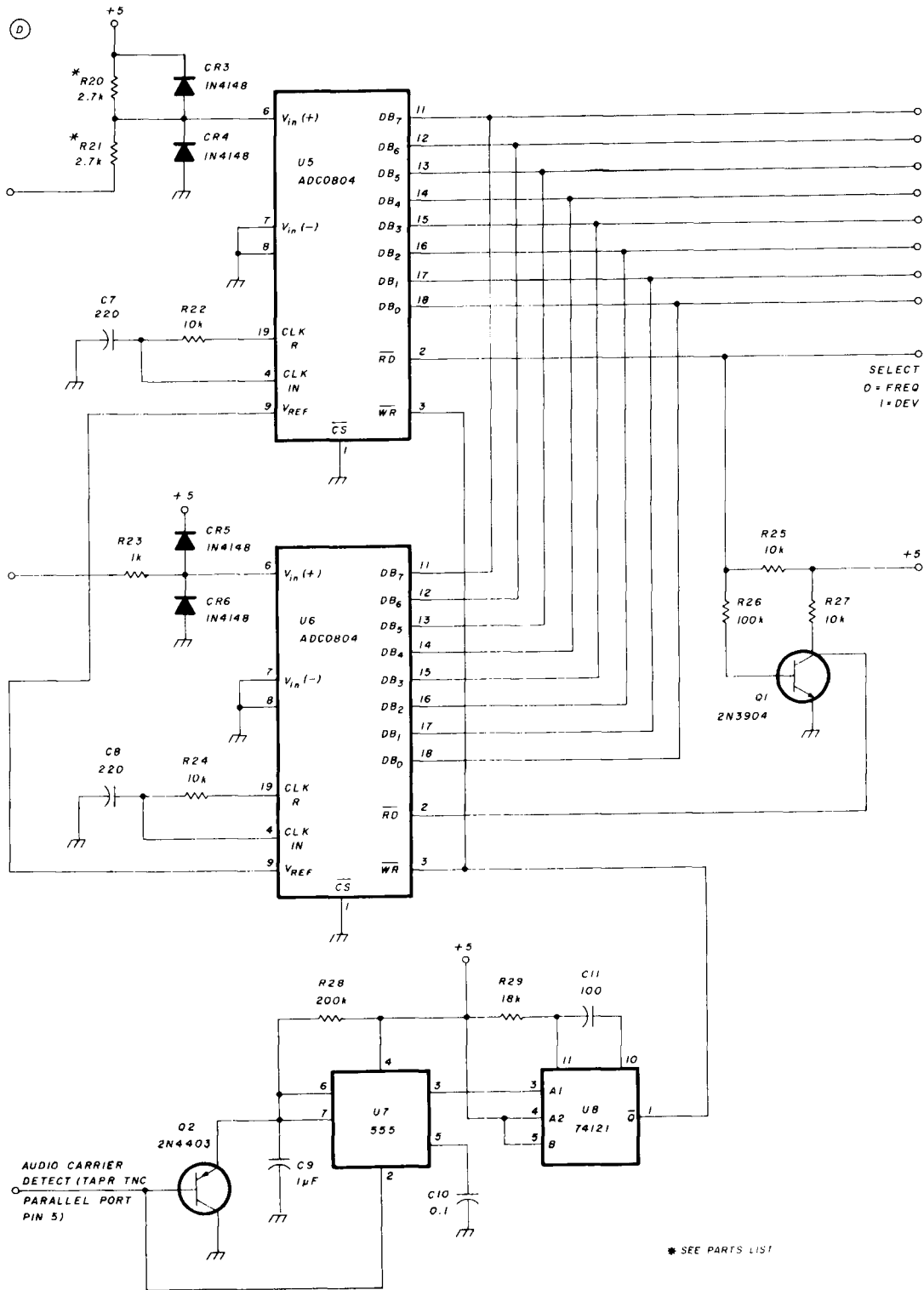

* SEE PARTS LIST

fig. 2D. Parallel to serial converter.

★ QUALITY PARTS ★ DISCOUNT PRICES ★ FAST SHIPPING!

SEND FOR
FREE
FALL 1985 CATALOG...
48 PAGES!

ALL ELECTRONICS CORP.

EDGE CONNECTORS

ALL ARE 1.56" SPACING.



- 22/44 EDGE CONNECTOR
PC style \$2.00 each
10 for \$18.00
- 22/44 EDGE CONNECTOR
solder lug style \$2.50 each
- 28/56 EDGE CONNECTOR
PC style \$2.50 each
10 for \$22.00
- 36/72 EDGE CONNECTOR
PC style \$3.00 each
- 43/86 EDGE CONNECTOR
PC style \$4.50 each

TRANSISTORS

- 2N706 4 for \$1.00
- 2N2222A 3 for \$1.00
- PN2222A 4 for \$1.00
- 2N2904 3 for \$1.00
- 2N2904 3 for \$1.00
- 2N2905 3 for \$1.00
- MJ2955 \$1.50
- 2N3055 \$1.00
- PMD 10K40 \$1.00
- TIP 121 75¢
- TIP 125 75¢

SPECIAL PRICE TRANSISTOR

PN3569 TO-92 N P N
plastic transistor
100 for \$8.00
1000 for \$60.00
LARGE QUANTITIES
AVAILABLE

TRANSFORMERS

- 120 volt primaries
- 5.6 volts @ 750 ma. \$3.00
- 6 volts @ 150 ma. \$1.25
- 12 v.c.t. @ 200 ma. \$2.00
- 18 volts @ 650 ma. \$3.50
- 18 volts @ 1 amp \$4.50
- 24 v.c.t. @ 200 ma. \$2.50
- 24 v.c.t. @ 400 ma. \$3.00
- 28 v.c.t. @ 15 amps \$20.00
- 30 v.c.t. @ 2 amps \$5.00

WALL TRANSFORMERS

- all plug directly into 120 vac outlet
- 4 VDC @ 70 ma. \$2.00
- 6 VAC @ 500 ma. \$3.50
- 6 VDC @ 750 ma. \$6.50
- 9 VDC @ 500 ma. \$5.00
- 12.5 VAC @ 265 ma. \$3.00
- 24 VAC @ 250 ma. \$3.00
- MULTI-VOLTAGE @ 500 ma. \$7.50
- 3, 4, 5, 6, 7, 9 or 12 VDC

MINI-BOX

Pomona #2104
Heavy-duty black phenolic project box with cover and screws 2 1/4" X 1 1/2" X 1 1/2"
\$1.00 EACH

SOUND AND VIDEO MODULATOR FOR T.I. COMPUTER

T.I. # UM1381-1 Designed for use with T.I. computers. Can be used with video sources. Built-in A/B switch. Channel 3 or 4 selection switch. Operate on 12 vdc Hook-up diagram included.
\$10.00 EACH

DECEMBER SPECIALS*

ALL 1/4 WATT RESISTORS
1000 pcs of one value \$7.50

ALL 1/2 WATT RESISTORS
1000 pcs of one value \$9.50

1 AMP 50 VOLT DIODES
IN4001 TAPE AND REEL
100 for \$4.50
1000 for \$30.00

D STYLE CONNECTORS
DB25 PLUG 10 for \$11.00
100 for \$100.00

DB25 SOCKET 10 for \$12.50
100 for \$110.00

SOLDER TAIL I.C. SOCKETS
24 PIN 10 for \$2.50
100 for \$22.00
1000 for \$200.00

CASSETTE MIKE

Dynamic cassette mike with 3.5mm plug and on/off switch.
\$1.50 EACH 10 FOR \$13.50

TWIST-LOCK CONNECTOR

Same as Switchcraft #12CL5M.
5 conductor in-line plug and chassis mount jack. Twist-lock style.
\$2.50/SET

TI SWITCHING POWER SUPPLY

Compact, well-regulated switching power supply designed to power Texas Instruments computer equipment.
INPUT: 14 - 25 vac @ 1 amp
OUTPUT: 12 vdc @ 350 ma
5 vdc @ 1.2 amp
5 vdc @ 200 ma
\$5.00 each

13.8 VDC REGULATED POWER SUPPLY

These are solid state, fully regulated 13.8 vdc power supplies. Both feature 100% solid state construction, fuse protection, and L.E.D. power indicator. U.L. listed
2 amp constant, 4 amp surge \$18.00 each
3 amp constant, 5 amp surge \$25.00 each

D.C. CONVERTER

Designed to provide a steady 5 vdc @ 240 ma. from a battery supply of 3.5 to 6.25 volts
2 1/2" x 1 1/2" x 1 1/2"
\$1.50 each

8" P.A. SPEAKER

C.T.S. Model 8B3079
8 ohms coil
3 0 oz ferrite magnet
Typical response range
100 - 10,000 hz
Power rating 15 watts max
Drilled to mount line matching transformers.
\$5.00 each
CASE OF 8 SPEAKERS \$32.00

LINE CORDS

- TWO WIRE
- 6 18/2 SPT-1 flat 3 for \$1.00
- 6 18/2 SPT-2 flat
- 6 16/2 SJT round \$1.25 each
- THREE WIRE
- 6 18/3 flat \$1.50 each
- 6 18/3 round \$2.00 each
- 6 16/3 round \$4.00 each

COMPUTER GRADE CAPACITORS

- 2,000 mfd. 200 VDC
1 1/2" DIA. x 5" HIGH \$2.00
- 3,600 mfd. 40 VDC
1 1/2" DIA. x 3 1/2" HIGH \$1.00
- 6,400 mfd. 60 VDC
1 1/2" DIA. x 4 1/2" HIGH \$2.50
- 9,700 mfd. 50 VDC
1 1/2" DIA. x 4 1/2" HIGH \$3.00
- 31,000 mfd. 15 VDC
1 1/2" DIA. x 4" HIGH \$2.50
- 72,000 mfd. 15 VDC
2" DIA. x 4 1/2" HIGH \$3.50
- 185,000 mfd. 6 VDC
2 1/2" DIA. x 4 1/2" HIGH \$1.50

4PDT RELAY

14 pin KH style
3 amp contacts
USED but fully tested - \$1.70 each
Specify coil voltage desired
Either 24 vdc or 120 vac
LARGE QUANTITIES AVAILABLE
SOCKETS FOR KH RELAY 75¢ each

ROTARY ACTION MICRO

OMRON #C-5G3 D41
Clockwise action micro used in cam operated mechanisms and low torque operations.
RATED 5 amps @ 125 Vac.
\$1.25 each 10 for \$11.00
LARGE QUANTITIES AVAILABLE

7 CONDUCTOR RIBBON CABLE

Spectra-strip red marker strip.
28 ga stranded wire
\$5.00 per 100 roll

SLIM LINE COOLING FAN

Etr # \$99M182 low noise fan. Measures 3 3/4" square x 1" deep
21 cfm, 23 db, 1700 rpm
SPECIAL PRICE \$12.50 each

2K 10 TURN MULTI-TURN POT

SPECTROL #MOD 534-7161
\$5.00 EACH

SOLID STATE BUZZER

Star #SMB-06L
6 vdc
TTL compatible
\$1.00 each
10 for \$9.00

± 12 Vdc or 24Vdc POWER SUPPLY

DELTRON MODEL QD12/15-1.7
Dual plus and minus 12Vdc open frame power supply. Can be used as 24Vdc @ 1.5 amp. INPUT: either 115 Vac or 230 Vac.
Fully regulated computer grade supply.
7" x 4 3/4" x 2 3/4"
\$12.50 each 10 for \$110.00

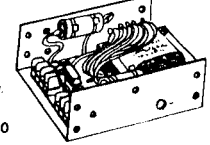

SPECIAL PRICE DUAL L.E.D. DISPLAYS

560 high, 7 segment L.E.D. read-outs. Mount in 24 pin DIP sockets
MAN-6640 orange. c.c. 75¢ each
FND-5148 red. c.c. 75¢ each
DL-527 red. c.a. 75¢ each

CASSETTE MECHANISM

New stereo cassette mechanism includes record/playback and erase heads. 2-12VDC motors drive belts, pulleys, 3-12VDC solenoids, pinchwheels and other mechanical parts. These parts used on other current model decks would cost several times our selling price if purchased separately. Build your own audio or data recorder or use for spare parts.
\$7.50 EACH 2 FOR \$12.50

3 1/2" SPEAKER

8 ohm impedance, Full range speaker
8 oz magnet
4" diagonal mounting centers
\$2.50 each 10 for \$20.00

SPRING LEVER TERMINALS

Two color coded terminals on a sturdy 2 3/4" x 3 3/4" bakelite plate.
Great for speaker enclosures or power supplies
75¢ EACH 10 FOR \$7.00

MINIATURE TOGGLE SWITCHES ALL ARE RATED 5 AMPS @ 125 VAC

- S.P.D.T. (on-on) PC style non-threaded bushing 75¢ each 10 for \$7.00
- S.P.D.T. (on-on) Solder lug terminals \$1.00 each 10 for \$9.00 100 for \$80.00
- S.P.D.T. (on-off-on) Solder lug terminals \$1.00 each 10 for \$9.00 100 for \$80.00
- S.P.D.T. (on-off-on) PC style non-threaded bushing 75¢ each 10 for \$7.00
- S.P.D.T. (on-on) PC lugs threaded bushing \$1.00 each 10 for \$9.00 100 for \$80.00
- D.P.D.T. (on-on) Solder lug terminals \$2.00 each 10 for \$19.00 100 for \$180.00

STANDARD JUMBO DIFFUSED T 1/2

- RED 10 for \$1.50 100 for \$13.00
- GREEN 10 for \$2.00 100 for \$17.00
- YELLOW 10 for \$2.00 100 for \$17.00

D.P.S.T. LIGHTED ROCKER SWITCH

115 vac lighted rocker. snap mounts in 1/2" x 1 1/8" hole
Orange lens 16 amp contact
\$1.50

FLASHER LED

5 volt operation red jumbo T 1 1/2 size \$1.00 each

MINI-PUSH BUTTON

S.P.S.T. momentary normally open 1/2" bushing Red button.
35¢ each 10 for \$3.00

BI-POLAR JUMBO T 1 1/2 size 2 for \$1.70

LED HOLDERS
Two piece holder for jumbo LED
10 for 65¢ 100 for \$5.00

KEY ASSEMBLY

5 KEY \$1.00 each
contains 5 single-pole normally open switches. Measures 3/4" long.

CLEAR CLIPLITE LED HOLDER

Make LED a fancy indicator. Clear
4 for \$1.00

6 KEY

\$1.25 each
contains 6 single-pole normally open switches. Measures 4 1/4" long.

METAL OXIDE VARISTOR

Popular GE # 130LA10A varistor. 1/2" diameter
\$1.25 each

ALL ELECTRONICS CORP.
LOS ANGELES, CA STORE
905 S. Vermont Ave.
213 380-8000
VAN NUYS, CA STORE
6228 Sepulveda Blvd.
818 997-1806

MAIL ORDERS TO:
P.O. BOX 20406
Los Angeles, CA 90006
TWX - 5101010163 ALL ELECTRONIC
EASYLINK MBX - 62887748



TOLL FREE ORDERS ONLY
1-800-826-5432
(ORDER ONLY)
(IN CALIFORNIA: 1-800-258-6666)
ALASKA, HAWAII,
OR INFORMATION
(213) 380-8000 NO C.O.D.!

QUANTITIES LIMITED
MINIMUM ORDER \$10.00
USA: \$3.00 SHIPPING
FOREIGN ORDERS:
INCLUDING SUFFICIENT
SHIPPING
CALIF. RES. ADD 6 1/2%

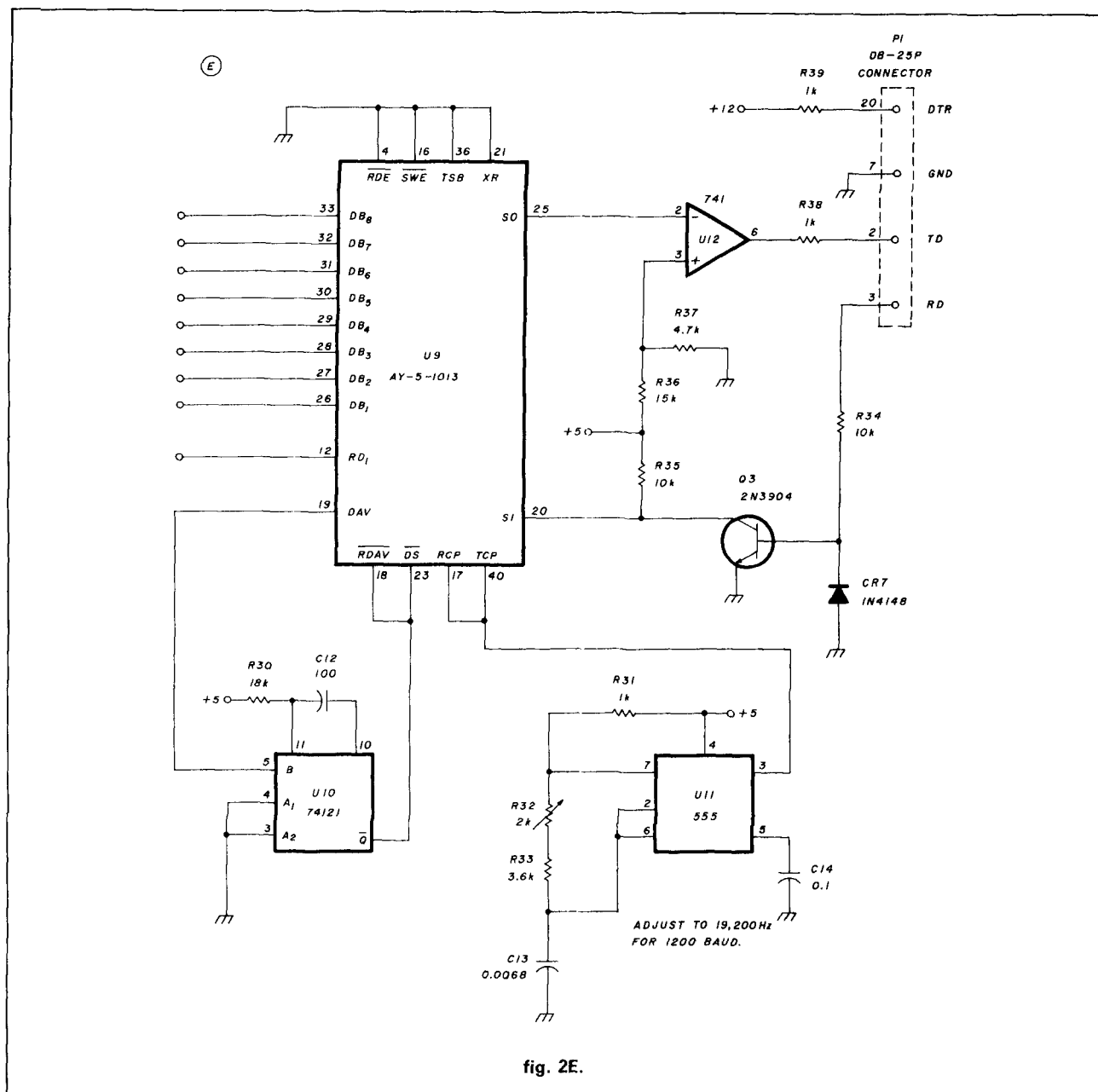

fig. 2E.

to sample the analog signals after the audio carrier had been present for approximately 200 milliseconds. This provides sufficient time for the analog components to settle down but is before the end of the shortest packet. A carrier detect signal is available at pin 5 of the parallel connector on the back of a TAPR TNC.* AEA and Heathkit units, similar to TAPR's, are probably the same.

The computer I'm using doesn't have any parallel input, but does have a spare serial (RS-232) port. The remainder of the circuit converts the parallel data into serial form for communication with the computer as shown in fig. 2E.

When the computer wants to obtain the most recent measurements, it sends a character to the circuit. The UART (U9) converts the serial character to parallel form and causes U10 to generate a pulse. The least significant bit of the character comes out of pin 12 and selects one of the A/D converters. The pulse from U10 causes the UART to begin conversion of the data from parallel to serial form.

The connections shown for P1 assume a computer port expecting a terminal. If using a modem port, use a DB-25S connector instead and swap the connections to pin 2 and 3.

U11 determines the speed for communications. R32 is adjusted for a frequency 16 times the desired baud rate, for instance 19200 Hz for 1200 baud. The com-

*Tucson Amateur Packet Radio.

item	description	quantity	approximate cost
C1,C5	0.15 μ F mylar (could use 0.1 + 0.047)	2	0.48
C2,C6	0.22 μ F mylar	2	0.33
C3,C10,C14	0.1 μ F disc ceramic	3	0.15
C4	2 μ F electrolytic (could use two 1 μ F)		0.34
C7,C8	220 pF mica	2	0.42
C9	1 μ F electrolytic		0.17
C11,C12	100 pF mica	2	0.35
C13	0.0068 mylar (could use 0.0047 + 0.0022)		0.24
CR1-CR7	1N4148 or similar	7	0.10
P1	DB-25P connector		2.39
Q1,Q3	2N3904 or similar NPN	2	0.25
Q2	2N4403 or similar PNP		0.25
R1,R2,R22,R24, R25,R27,R34,R35	10 kilohm		0.29
R3	10 kilohm, trim pot		
R4,R36	15 kilohm		
R5	12 kilohm		
R6	5 kilohm, 15 turn trim pot		1.19
R7	2.2 kilohm		
R8,R9	180 kilohm		
R9,R10,R16, R17,R26	100 kilohm		
R11,R13	57 kilohm		
R12	5.6 kilohm		
R14	12 ohms		
R15	8.2 kilohms		
R18	6 Megohms		
R20,R21	2.7 kilohms, *closely matched		
R23,R31,R38,R39	1 kilohm		
R28	200 kilohms		
R29,R30	18 kilohms		
R32	2 kilohms, 15 turn trim pot		1.19
R33	3.6 kilohms		
R37	4.7 kilohms		
	fixed 1/4 watt resistors	34	0.06
U1,U3	1458, dual op amp	2	0.59
U2,U4,U12	741, op amp	3	0.35
U5,U6	ADC 0804, analog to digital converter	2	3.49
U7,U11	555, timer	2	0.39
U8,U10	74121, monostable multivibrator	2	0.39
U9	AY-5-1013A, UART		3.95
Approximate total			\$28.00

*not in the catalog; possible substitutions are indicated.

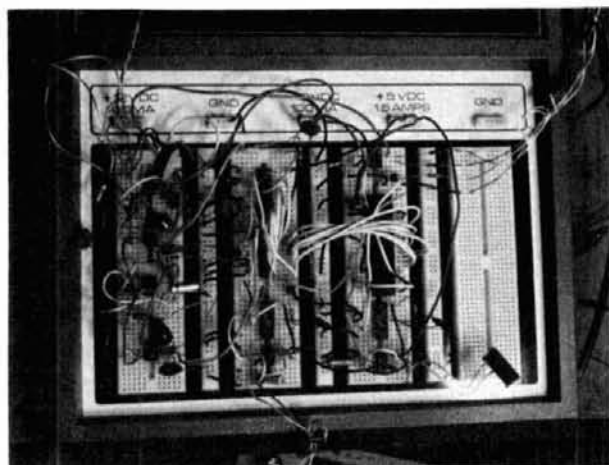

fig. 3. Point-to-point wired circuits.

pleted point-to-point wired circuits are shown in fig. 3. Pin designations for the six integrated circuit supply lines are provided in table 1.

software description

In the automatic answer mode, the station "advertises" the service available by beaconing and waiting

```

/* Snatch values from A/D */
/* converters before they */
/* have more of a chance to */
/* change. */

n_freq = adc_sample(0);
n_dev = adc_sample(1);

/* Any processing of */
/* received record is now */
/* done. */
/* This could include placing */
/* on screen, printing, */
/* saving in a disk file, */
/* etc. */

:
:

/* Process calibration data. */
/* First scale and convert */
/* to decimal digits. */

/* Ignore blank lines. */

if (Rrec_len > 0)
{
/* Approximate conversions: */
/* (Extreme values won't get */
/* thru most receivers.) */
/*
/* freq      raw      final      text */
/* offset    data    number    result */
/* (kHz)
/* -----
/* -10       0       -100     "-10.0"
/* -5        64      -50      "-5.0"
/* 0         128     0        ".0"
/* +5        192     50       "5.0"
/* +10       255     100      "10.0"
/*
/* deviation
/* -----
/* 0         0       0        ".0"
/* 5         128     50       "5.0"
/* 10        255     100      "10.0"

n_freq=((n_freq-128)*100)/128;
n_dev = (n_dev * 100) / 256;

for_mat(n_freq, s_freq);
for_mat(n_dev, s_dev);

/* Package compactly for */
/* screen or log file. */

if (n_freq > 0)
strcpy(s_compact, "[ +");
else
strcpy(s_compact, "[ ");

```

fig. 4. Segment of a routine executed when connection is first established.

```

norm_str("Welcome to the WB2OSZ
        automatic frequency/
        deviation tester.");
norm_str(" ");
norm_str("Instructions:");
norm_str(" 1. Send several
        non-blank lines.");
norm_str(" 2. Wait for reply
        after each.");
norm_str(" 3. Ignore any
        occasional erratic
        values.");
norm_str(" 4. Disconnect when
        done.");
norm_str(" ");
norm_str("Recommended deviation
        is no more than 3 kHz.");
norm_str("Anyone who disagrees
        with the results is
        invited");
norm_str("to supply a reference
        more accurate than my
        2AT.");
norm_str(" ");
norm_str("                                John");

/* Open the log file. */
/* Use the radio call with */
/* ".CAL" for file type. */

strcpy(temp,call);
strcat(temp, ".CAL");

Fp_cal_log = fopen(temp,"a");

now = time(0);
my_time(&now,date_and_time);

fprintf(Fp_cal_log,
        "%s %s, %s\n", f_name,
        l_name, date_and_time);

/* Find out if direct */
/* connection or via */
/* digipeater(s). */

function_key (F_TNC_COMMAND);
hang_around (1);
function_key (F_CONNECT);
normal_key (CR);
hang_around (1);
function_key (F_CONVERS);

/* Another routine, that */
/* determines types of */
/* messages from TNC, stashes */
/* away the connection path. */
/* The closest digipeater, if */
/* any, is put in */
/* Digi_nearest and used in */

```

```

strcat(s_compact, s_freq);
strcat(s_compact, ", ");
strcat(s_compact, s_dev);
strcat(s_compact, "]\n");

fprintf (Fp_cal_log,"%s\n",
        s_compact);

/* Construct more self- */
/* explanatory form for */
/* report to user. */
/* Instead of signed number */
/* for offset, give absolute */
/* value and "too low" or */
/* "too high." */

if (n_freq < 0)
{
    strcpy(too, "low");
    for_mat(-n_freq, s_freq);
}
else
    strcpy(too, "high");

/* See if direct connection. */
/* If one or more digipeaters */
/* used, put call of closest */
/* one in the message. */

if (Digi_nearest[0] == NUL)
    strcpy(who, "Your");
else
{
    strcpy (who, Digi_nearest);
    strcat (who, "'s");
}

sprintf(message, "%s frequency
        is about %s kHz too %s.
        Deviation is about %s
        kHz.", who, s_freq, too,
        s_dev);

norm_str(message);
}

```

fig. 5. Segment of a routine executed when a record is received from the station being tested.

for someone to connect. The user of the system is greeted with an explanation and a log file is opened (a program fragment is shown in fig. 4). For each record received, the A/D converters are sampled. The numbers are scaled to appropriate units, formatted into a message and sent back (a program fragment is shown in fig. 5). The user, date, time, and measurements are saved in a file for later analysis.

The method is certainly not foolproof. There is a chance that another packet's characteristics were sampled in the time that it took for the line of text to be

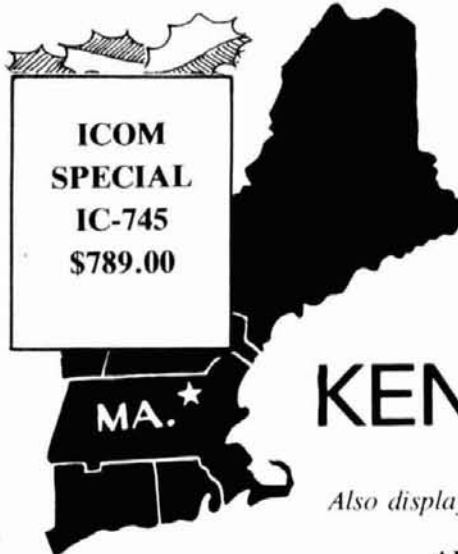

**ICOM
SPECIAL
IC-745
\$789.00**

TEL-COM★ *Electronic Communications*

Authorized Dealers For

KENWOOD &  ICOM

Also displaying the popular accessories needed to complete a HAM STATION . . .

- ARRL PUBLICATIONS • AEA PRODUCTS • AMPHENOL
- ALPHA DELTA • ASTRON • AUSTIN ANTENNAS • AVANTI
- BELDEN • BENCHER • B & W • DAIWA • HAM-KEY
- HUSTLER • KLM • LARSEN • MIRAGE • ROHN
- TELEX/HY-GAIN • VIBROPLEX • WELZ • ETC.

OPEN SIX DAYS A WEEK

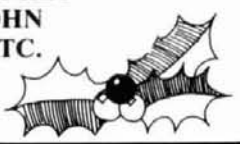

**KENWOOD
SPECIAL
NEW
TS-940S**
with automatic
tuner
\$1765.00

Telephone 617/486-3400, 3040
675 Great Rd., (Rte. 119) Littleton, MA 01460
1/4 miles from Rte. 495 (Exit 31) toward Groton, Mass.

OUT NOW!

FREE

DICK SMITH ELECTRONICS CATALOG 1986

THE DICK SMITH ELECTRONIC ENTHUSIAST'S CATALOG

132 PAGES CRAMMED WITH KITS • BOOKS • COMPONENTS • DATA • HAM GEAR AND MORE PLUS BONUS COUPONS WORTH \$2 REDEEMABLE OFF YOUR 1st ORDER

Rush me my copy of the Dick Smith Catalog, I enclose \$1 to cover shipping

Name

Address

City

Zip

DICK SMITH ELECTRONICS INC.
P.O. Box 2249 Redwood City CA 94063



HOT ROD ANTENNA

Achieve 1 or 2 db gain over ANY 1/2 wave two meter telescopic antenna. The AEA model HR-1 Hot Rod™ antenna was designed by Dr. D.K. Reynolds (designer of the IsoPole) to deliver maximum performance for any hand-held transceiver with a BNC fitting.

The factory-tuned HR-1 is 20% shorter, lighter and places far less stress on your hand-held connector and case. It will easily handle over 25 watts of power, making it an excellent emergency base or mobile antenna. In the collapsed position, the Hot Rod antenna will perform like a helical quarter wave.

The Hot Rod antennas can be expected to make the same improvement to hand-held communications that the IsoPole brand antennas have made to base station operations. Why pay more when the best costs less?

Prices and Specifications subject to change without notice or obligation.

ADVANCED ELECTRONIC APPLICATIONS, INC.
P.O. Box C-2160,
Lynnwood, WA 98036
(206) 775-7373
Telex: 152571 AEA INTL

AEA Brings you the Breakthrough!

THE CHAMP



BIRD MODEL 4304

NO ELEMENTS
25-1000 MHZ
RF SAMPLING PORT

AUTHORIZED  DISTRIBUTOR

Webster

WEBSTER COMMUNICATIONS INC.
115 BELLARMINE
ROCHESTER, MI 48063
313-375-0420

CALL TOLL FREE
800-521-2333
800-482-3610

table 2. Newsletters dedicated to digital communications via Amateur Radio.

American Radio Relay League
225 Main Street
Newington, Connecticut 06111
*Gateway: The ARRL Packet
Radio Newsletter*

British Amateur Radio
Teleprinter Group
7 Daubeny Close
Harlington,
Dunstable, Beds, LU5 6NF
DATACOM

Chicago Area Packet
Radio Association
21W464 Army Trail Rd.
Addison, Illinois 60101
CAPRA Beacon

Florida Amateur Digital
Communications Association
812 Childers Loop
Brandon, Florida 33511
FADCA > Beacon

Georgia Radio Amateur
Packet Enthusiast Society
P.O. Box 1354
Conyers, Georgia 30207
Grapevine

New England Packet
Radio Association
P.O. Box 15
Bedford, Massachusetts 01730
NEPRA PacketEar

Northwest Amateur Packet
Radio Association
13304 131st street KPN
Gig Harbor, Washington 98335
Zero Retries

Softnet User Group
Department of EE
Linköping University
S-581 83 Linköping, Sweden
Softnet News

Sydney Amateur Digital
Communications Group
P.O. Box 231
French's Forest, NSW
Australia 2086
The Australian Packeteer

Tucson Amateur Packet
Radio Corporation
P.O. Box 22888
Tucson, Arizona 85734
Packet Status Resister

Utah Packet Radio Association
4382 Cherryview Drive
West Valley City, Utah 84120
UPRA Connect

Vancouver Amateur Digital
Communications Group
9531 Odlin Road
Richmond, British Columbia,
Canada V6X 1E1
The Packet

transferred from the TNC to the computer. This is why instructions say to ignore any occasional erratic values.

One puzzled ham connected and got all kinds of random frequency reports, even though he hadn't sent anything. It turns out that a playful Amateur continually attempted to connect to my station while tuning his frequency back and forth. The solution was to recognize and ignore the "**** Connect request ..." message from the TNC.

There's also a manual mode that allows the system operator to perform measurements on another station by digipeating back to himself via the other station or just watching everything go by. The reporting and logging of measurements are naturally different, but the calculations are the same.

You don't need a high-powered computer for this application — something like a VIC-20 and a little BASIC program will be fine. It is important to get the line of text from the TNC quickly (at least 1200 baud) and sample the A/D converters before another packet comes along. After the data has been collected, there's plenty of time to do the calculations and prepare a response.

calibration

Proper adjustment is important to avoid giving incorrect reports. The procedure is simple. All you need is an accurate RF signal generator and voltmeter. I used the popular ICOM model 2AT synthesized RF signal generator as my source.

First set the signal generator (and receiver of course) to your local packet radio frequency. 145.01 MHz seems to be the most popular frequency in most parts of the country. Adjust R6 for zero volts at pin 7 of U1. Set the signal generator frequency 5 kHz higher and adjust R3 for 2.5 volts at the same place. Finally, set the frequency 10 kHz lower (i.e., 5 lower than original) and observe the voltage. It should be close to -2.5 volts.

If the negative voltage is much different than -2.5, you have a linearity problem as I did. In this case, alter the setting of R3 until you set a DIFFERENCE of 5 volts between + and - 5 kHz input. At least this will give a fairly accurate deviation for signals on frequency.

improvements

The output from my receiver is not very linear. For instance, a station 2 kHz too high might be given a report that it's 2.5 kHz too high, while a station 2 kHz too low might be told he's 1.5 kHz off frequency. (Note: a person on frequency is told he is on frequency. The problem is non-linearity, not an offset of 0.5 kHz.) Possible solutions are compensation in software, repair of the radio — or purchase of a new radio.

The modems commonly used for packet require the two tones to be fairly close in amplitude. Hank, WØRLI, suggested measuring the amplitudes of the

AMATEUR TELEVISION



KPA5 1 WATT 70 CM ATV TRANSMITTER BOARD

- **APPLICATIONS:** Cordless portable TV camera for races & other public service events, remote VCR, etc. Remote control of R/C airplanes or robots. Show home video tapes, computer programs, repeat SSTV to local ATVers. DX depends on antennas and terrain typ. 1 to 40 miles.
- **FULL COLOR VIDEO & SOUND** on one small 3.25x4" board.
- **RUNS ON EXTERNAL 13.8 VDC** at 300 ma supply or battery.
- **TUNED WITH ONE CRYSTAL** on 426.25, 434.0, or 439.25 mHz.
- **2 AUDIO INPUTS** for a low Z dynamic and line level audio input found in most portable color cameras, VCRs, or home computers.
- **APPLICATION NOTES & schematic** supplied for typical external connections, packaging, and system operation.
- **PRICE ONLY \$159** delivered via UPS surface in the USA. Technician class amateur license or higher required for purchase and operation.

WHAT IS REQUIRED FOR A COMPLETE OPERATING SYSTEM? A TV set with a TVC-2 or TVC-4 420-450 mHz to channel 3 downconverter, 70 cm antenna, and coax cable to receive. Package up the KPA5, add 12 to 14 vdc. antenna, and any TV camera, VCR, or computer with a composite video output. Simple, eh?

CALL OR WRITE FOR OUR COMPLETE CATALOG & more info on atv downconverters, antennas, cameras, etc., or who is on in your area.

TERMS: Visa, Mastercard, or cash only UPS COD by telephone or mail. Telephone orders & postal MO usually shipped within 2 days, all other checks must clear before shipment. *Transmitting equipment sold only to licensed amateurs verified in 1984 Callbook. Calif. include sales tax.*

(818) 447-4565 m-f 8am-6pm pst.

P.C. ELECTRONICS

Tom W6ORG Maryann WB6YSS



2522 Paxson Lane
Arcadia CA 91006

✓ 162

HOW DO RECEIVERS REALLY PERFORM? READ THIS BOOK.

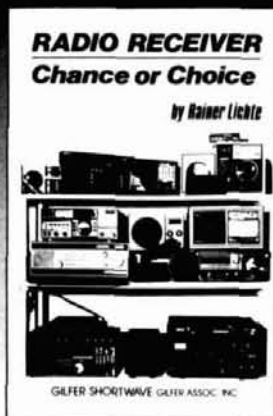

\$18.50
+ \$1.50 shipping
Available Sept.
Visa/Mastercards
accepted

You owe it to yourself to be informed. This comprehensive new book explores the receiver world through real-life tests conducted by internationally renowned radio engineer, Rainer Lichte. Read scores of no-axe-to-grind reviews about such famous brands as Panasonic, Sony, Yaesu, Kenwood, Drake, Eska, Hitachi, Grundig, Phillips, JVC, Zenith, Dymek, ITT, Bearcat - both old and new models, including ICOM R71A, Sony 2010, and Yaesu 8800. Explains the mysteries of technical specs, too. A must book.

GILFER SHORTWAVE

52 PARK AVE. • PARK RIDGE, NJ 07656 • Ph 201/391-7887

✓ 135

tones separately. This would require two band-pass filters (for 1200 and 2200 Hz) instead of the high-pass filter made up of C3 and R12. An additional peak detector, low-pass filter, and A/D converter would also be required. The deviation measurement would be based on the larger value. The difference in amplitude could be reported something like, "Amplitude of 2200 Hz tone is 89 percent of other tone."

conclusion

Asking people to drag their equipment to a meeting for adjustment was not successful; the automated approach has produced much better results. During the first few days of operation about 20 stations tried out the system. (This might not sound like many but I'm running only 1-1/4 watts in a valley.) During later measurements, most stations that were substantially off had made correcting adjustments.

For readers who wish to become better informed about packet radio, a list of organizations with newsletters oriented toward digital communications via Amateur Radio is shown in table 2.

acknowledgements

Thanks to Gary, WA1GRC, for the idea and for nagging us at every NEPRA meeting until someone actually designed and built the unit.

bibliography

- Borden, David W., K8MMO, "Applications of Packet Radio - Part I: Direction Finding Network," *QEX*, January, 1984, page 6.
- Borden, David W., and Rinaldo, Paul L., "The Making of an Amateur Packet-Radio Network," *QST*, October, 1981, page 28.
- Drentea, Cornell, WB3JZO, "The New Industrial Revolution: Packet Radio and Local Area Networking," *ham radio*, December, 1984, page 34.
- Goode, Steve, "BER Performance of TAPR TNC Modem," *QEX*, August, 1983, page 3.
- Johnson, Lyle, WA7GXD, "Join the Packet-Radio Revolution," *73*, September, 1983, page 19.
- Johnson, Lyle, WA7GXD, "Join the Packet-Radio Revolution, Part II," *73*, October, 1983, page 20.
- Johnson, Lyle, WA7GXD, "Join the Packet-Radio Revolution, Part III," *73*, January, 1984, page 36.
- Markoff, John, "Bulletin Boards in Space," *BYTE*, May, 1984, page 88.
- Moore, Jeffrey, KQ1E, "'Packet' Meteor Scatter Communications," *QEX*, December, 1983, page 3.
- Morrison, Margaret and Dan, "Amateur Packet Radio: Part 1," *ham radio*, July, 1983, page 14.
- Morrison, Margaret and Dan, "Amateur Packet Radio: Part 2," *ham radio*, August, 1983, page 18.
- Richardson, Robert M., W4UCH, "Packet Radio: The Software Approach," *ham radio*, September, 1984, page 63.
- ARRL, *The ARRL 1985 Handbook for the Radio Amateur*, American Radio Relay League, Newington, Connecticut, 1985.
- ARRL, *First ARRL Amateur Radio Computer Networking Conference, October, 1981*, American Radio Relay League, Newington, Connecticut, 1981, (\$8.00).
- ARRL, *Second ARRL Amateur Radio Computer Networking Conference, March, 1983*, American Radio Relay League, Newington, Connecticut, 1983, (\$9.00).
- ARRL, *Third ARRL Amateur Radio Computer Networking Conference, April, 1984*, American Radio Relay League, Newington, Connecticut, 1984 (\$10.00).
- ARRL, *Fourth ARRL Amateur Radio Computer Networking Conference, March, 1985*, American Radio Relay League, Newington, Connecticut, 1985, (\$10.00).

ham radio

PACKET EVOLUTION

From
\$219.95
Suggested amateur net price.

ANOTHER BREAKTHROUGH FROM AEA

Packet + RTTY= Pakratt™ PK-64.

If you've read about packet, or are already into it, you know how exciting it is. With the hot new Pakratt PK-64 we've just brought a new dimension to packet. The Pakratt PK-64 is a complete, fully assembled and tested packet radio controller which, together with a Commodore 64 or 128 computer, can convert your shack into a packet operations center.

And we've included a new version of our advanced MBA-TOR™ software to make it the first packet controller with AMTOR, Baudot, ASCII and Morse. But an even more exciting part of the Pakratt controller is its great price.

Incredibly Simple To Set Up

Just plug the Pakratt controller into the C-64's game cartridge slot, add a mic connector for connecting to your particular

transceiver, and you're set. If you're anxious to try it out, our new "quickstart" manual section can get you on the air in under ½ hour.

Simply Powerful

The versatile Pakratt controller shows messages and connect status simultaneously on your Commodore with a unique split-screen display. And it lets you



PK-64 shown with HF modem option. Computer not included.

send letter-perfect text from the text editor software while monitoring incoming messages. The 20K byte QSO buffer stores more than 20 video screens of text! Disk commands let you save

specific operating parameters for quick set-up for emergency services, clubs, and multiple frequency use. And the Pakratt controller's standard, TAPR style modem gives you 300 and 1200 baud operation with great HF/VHF performance.

We can't possibly list all of the important features of Pakratt here. But the absolutely best part of the Pakratt PK-64 is that it's at your dealer now. So stop reading, run down to your local dealer, and check Pakratt out. Because the real challenge will be to find one after the other hams see it.

Pakratt PK-64. Packet Power from AEA. At amateur radio dealers everywhere.



Advanced Electronic Applications, Inc.
P.O. Box C-2160
Lynnwood, WA 98036-0918
(206) 775-7373
Telex: 6972496 AEA INTL UW

NEWS we'll treat you

BULLETIN

For more than 40 years we have been serving the amateur community with QUALITY PRODUCTS and DEPENDABLE "S-E-R-V-I-C-E" and, we fully intend to carry on this proud tradition with even MORE new product lines plus the same "fair" treatment you've come to rely on. Our reconditioned equipment is of the finest quality with 30, 60 and even 90-day parts and labor warranties on selected pieces. And, remember...

— WE SERVICE WHAT WE SELL —

AEA	DRAKE	MOSELEY
AMECO	ENCOMM	NYE
AMERITRON	HUSTLER	PALOMAR
ANTEK	ICOM	RADIO CALLBOOK
ARRL	JANEL	ROBOT
ASTRON	KANTRONICS	ROHN
ANTENNA	KDK	TELEX / HYGAIN
SPECIALISTS	KLM	TEN-TEC
B & W	LARSEN	TRIO-KENWOOD
BENCHER	MFJ	UNADILLA / REYCO
BUTTERNUT	MINI-PRODUCTS	YAESU
CUSHCRAFT	MIRAGE	
DIAWA		

Write today for our latest

Bulletin/Used Equipment List.

SELECTION
SERVICE
and
SATISFACTION!

STORE HOURS:
9-5 P.M. (CST)
MONDAY thru FRIDAY
OPEN SATURDAYS
from 9-1 P.M. (CST)
CLOSED
SUNDAYS/HOLIDAYS



P.O. Box 73
208 East Kemp
Watertown, SD 57201

Burghardt INC.

AMATEUR CENTER

"AMERICA'S MOST RELIABLE AMATEUR RADIO DEALER"

SELL-TRADE

New & Reconditioned HAM EQUIPMENT

Call or Write Us Today For a Quote!
You'll Find Us to be Courteous, Knowledgeable and Honest

PHONE (605) 886-7314



AEA AMT-1. REGULARLY \$479.95
NOW ONLY \$299.95

THE AMTOR TERMINAL UNIT!!! Works with any ASCII terminal or personal computer with a terminal program. Also works RTTY, CW, ASCII.
ORDER YOURS TODAY! Limited quantities.

191

You read about it first in the New Products section of ham radio:

"Many methods have been offered for learning Morse Code, some good and some not so good. This is a good one."

- ➔ Have you plateaued at 10-13 WPM? MASTER the code in 40% less time.
- ➔ The method based on the scientific principles of Skill Acquisition and Perceptual Learning

Adopted by the U.S. MILITARY as the new training standard

Four cassettes teach the entire alphabet in 25 trials at 20 WPM!
Includes numbers, punctuation, special characters, and an all new intro tape.

205

Send ck./M.O. in U.S. \$\$ We pay postage

Send _____ set(s) @ \$19.95 each
IL res. add \$1 sales tax (5%)

Name _____

Call _____ Class _____

Address _____

City _____ State _____ Zip _____

Mail to: TSG; PO Box 3897; Carbondale, IL 62902

Allow 4 wks delivery Dealer inq. welcome

ORR BOOKS



BEAM ANTENNA HANDBOOK
by Bill Orr, W6SAI and Stu Cowan, W2LX
The Beam Antenna Handbook, first published in 1955, has been completely revised and updated with the latest information on Beam Antenna design. Computer designed Yagis give maximum gain in minimum space. New info on Yagi HF and VHF beams and dimensions on beams for 10, 18 and 24 MHz WARC bands. Everything you need to know about beam design, construction and operation. 204 illustrations. 268 pages. 1st edition. ©1985.

RP-BA Softbound \$9.95

SIMPLE LOW-COST WIRE ANTENNAS
by Bill Orr, W6SAI
Learn how to build simple, economical wire antennas. Apartment dwellers take note! Fool your landlord and your neighbors with some of the "invisible" antennas found here. Well diagrammed. 192 pages. ©1972. 2nd edition.

RP-WA Softbound \$7.95

THE RADIO AMATEUR ANTENNA HANDBOOK
by William I. Orr, W6SAI and Stuart Cowan, W2LX
Contains lots of well illustrated construction projects for vertical, long wire, and HF/VHF beam antennas. There is an honest judgment of antenna gain figures, information on the best and worst antenna locations and heights, a long look at the quad vs. the yagi antenna, information on baluns and how to use them, and new information on the popular Sloper and Delta Loop antennas. The text is based on proven data plus practical, on-the-air experience. 190 pages. ©1978. 1st edition.

RP-AH Softbound \$7.95

ALL ABOUT CUBICAL QUAD ANTENNAS
by Bill Orr, W6SAI — New 3rd Edition
Includes NEW data for WARC bands
The cubical quad antenna is considered by many to be the best DX antenna because of its simple, lightweight design and high performance. You'll find quad designs for everything from the single element to the multi-element monster quad. There's a wealth of data on construction, feeding, tuning, and mounting quad antennas. 112 pages. ©1982. 3rd edition.

RP-CQ Softbound \$6.95

Please add \$1.50 for one book, \$2.50 for two or more books to cover shipping and handling.

Ham Radio's Bookstore Greenville, NH 03048

ham radio TECHNIQUES

Bill W6SAI

low frequency DX

*No more about Ye DX bands
Do Wilde Men push and pulle,
Or talk about TA's, UJ's,
Or toss about Ye Bulle.
Ye Sunspot Cycle hath gummed Ye
Game,
Ye bands are dry as Snuffe.
And many Hardy Souls, no doubt,
Will find it hard to do Without,
Excepting Thee and Me, Old Friend,
Who Never Worked Ye Stuffe.*

This touching ode to DX, written by By Goodman, W1DX, in the late 1940s, certainly applies to DX today, as far as I'm concerned.

But while HF DXers may be moaning and groaning over the mediocre conditions, low frequency DXers are having a fine time. Eighty and 160 meters are *jumping* these days!

A note from Bob Eldridge, VE7BS, tells of some of the DX worked in the Pacific Northwest:

The Australian CW signals can be anywhere, usually below 1825 kHz. The VK SSB rag-chewing groups on daily are most often about 1832 kHz and 1825 kHz, with a few around 1815 kHz. They are most consistent this time of year (early summer) when they can be worked virtually every morning (their evening). I hear them from about half an hour before sunrise to about half an hour after. At about the time they come up in strength here they are dropping out at W0ZV (Colorado), and

he drops out to me at about the same time. He also hears them before and after his sunrise, so the VK opening to North America on 160 meters is quite long.

But although the Spring equinox is the most reliable time for Pacific contacts, I notice looking back through the log that I had good DX contacts in January and February and some DX in every month of the year. This week (week of July 24th) everyone is on the lookout for T31AT (Kiribati) and A35PP (Tonga).

VE7BS uses an inverted-V antenna with the apex at 105 feet and the ends about 60 feet (fig. 1). This is his "comparison antenna" for the others that he has experimented with from time to time. Bob says it is broadside to Australia and Europe, but works reasonably well in all directions. Three parallel wires are used in each leg and the coax feedline is wound into an RF choke just below the feedpoint of the antenna.

Another 160-meter antenna that VE7BS has used with success is the so-called "Lazy-U," shown in fig. 2. The vertical portion can be from 50 to 100 feet long, with the horizontal portions bringing the system to resonance without contributing much horizontally polarized radiation. The VE7BS "Lazy-U" worked better than the inverted-V in some directions and this was the antenna he used to land 5N8ARY (Nigeria).

An interesting adaptation of this ver-

tical antenna that some 160-meter DXers use is the so-called "G8ON" antenna, named after the Amateur who popularized it on the band (fig. 3). The antenna is a half-wavelength long, with the high current portion in the vertical plane. The wire is end-fed from the top end.

In closing, Bob has some interesting remarks about radial systems, as applied to 160-meter antennas. He advised the 160-meter operator not to worry too much about extensive radial systems. He says:

I managed WAC on 160 meters with a vertical without any radials and K7VIC has one of the most potent signals on the band using a vertical top-loaded monopole without radials, so I wouldn't get depressed if I had no room for radials. For transmitting, I see nothing wrong with a 45-foot tower, top-loaded with a Yagi, working against a few properly disposed 8-foot ground rods near the base and a cluster of short radials or chicken wire mesh under the tower. As far as I can see, the main disadvantage of a relatively short, loaded vertical is the narrow bandwidth achieved without retuning.

For those west coast DXers interested in 160 meters, Bob recommends (and I concur) the *160 meter West Coast Bulletin*, published by Dennis Peterson, N7CKD, 4248 A Street SE, Space 609, Auburn, Washington 98002. An SASE might bring you details from N7CKD.

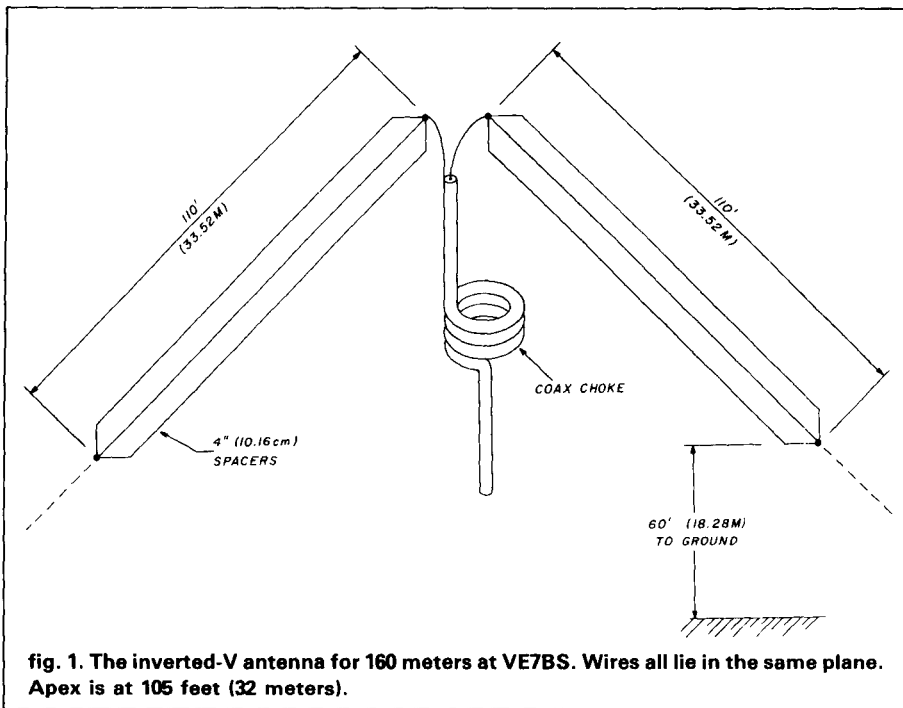

fig. 1. The inverted-V antenna for 160 meters at VE7BS. Wires all lie in the same plane. Apex is at 105 feet (32 meters).

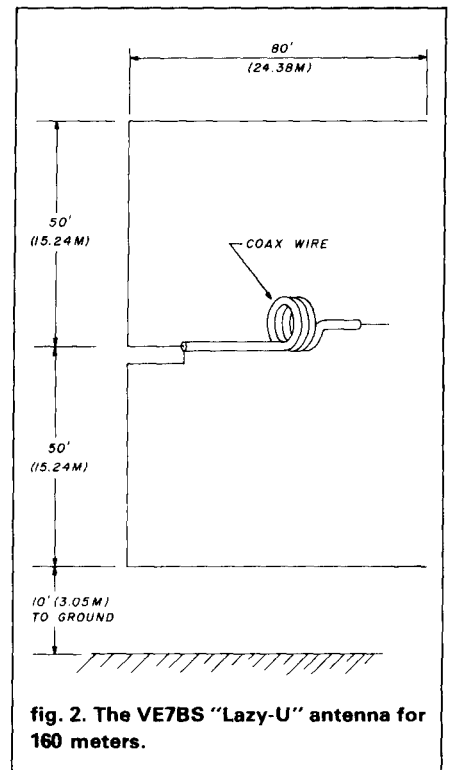

fig. 2. The VE7BS "Lazy-U" antenna for 160 meters.

the effects of trees and vegetation on your signal

From time to time I've received inquiries from Amateurs asking what effect upon their signals a nearby tree, or group of trees, might have. Since I didn't know, I could only reply with an evasive, ambiguous answer. My good friend Marv, W6FR, who was "bugged" by a tall tree into which his 20-meter beam fired on the European path, was convinced that during the months the tree was in bloom with heavy foliage, his signal suffered. When pressed for specifics, however, he admitted under pressure that his often-stated conclusion was a hunch. The upshot of this was that his local DX competitors felt they had a psychological edge on Marv during the spring months when the tree was in its full glory!

The June/July issue of *Broadcasters ID* (published by Information Dissemination, 2501 Hilldale Boulevard, Arlington, Texas 76016) has some interesting information on this subject. In an article by E.J. Pryor, Jr., of Broadcast Technologies, Inc., the subject of foliage and vegetation is

discussed, with respect to AM and FM broadcasting. The article says, in part:

Almost any engineer at an AM directional station could tell you that his array shifts each year due to the many factors which are related to seasons.

In most cases, some of the changes can be traced to ground conductivity which varies due to the moisture, water table variance, and the temperature factor in the area. Foliage growth has a direct effect on the radiation performance of your transmitting antenna....

The vegetation surrounding your transmitter plant absorbs and reradiates some of the energy radiated by your antenna. At AM frequencies, the vertical field can be reduced significantly by high grass and green trees near the antenna farm. At FM frequencies, this signal loss can be approximately 2.5 dB. Above 1000 MHz, the losses due to ground scatter, signal absorption, Fresnel zone losses and terrain can drastically change with the green season. Losses can be as much as 10 dB, or more.

You can control the foliage on your property where your transmitter and tower are located. Regardless of your frequency, the area around your trans-

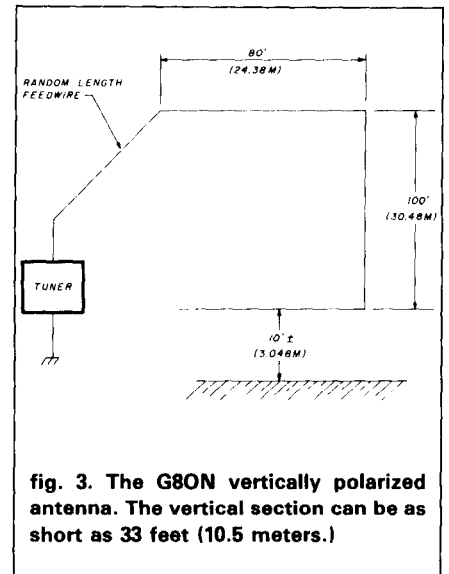

fig. 3. The G80N vertically polarized antenna. The vertical section can be as short as 33 feet (10.5 meters.)

mitter plant should be mowed regularly and kept free of trees. Trees have the greatest effect on your signal.... Tall grass, especially when green or freshly wet, can detune a directional array, upset drive point impedance, mutual coupling factors and significantly degrade the station's performance.

While these remarks are aimed at

vertical AM broadcast antennas and FM arrays, the ideas could apply to Amateur antennas. Most Amateur HF antennas are horizontally polarized, and my personal opinion (apologies to W6FR) is that nearby trees and foliage have relatively little effect on antenna performance in the HF region. In the case of vertical antennas, however, Mr. Pryor's remarks may be interpreted to mean that foliage and tall grass can affect the operation of the vertical antenna in the HF/VHF spectrum as well as in the broadcast band.

I would appreciate hearing from readers who may have experience in this area to find out what effect, if any, nearby trees and bushes have on the operation of both horizontally and vertically polarized Amateur antennas in the HF and VHF regions.

the W0SVM "shorty-forty" dipole

A good idea and a catchy name! Jack, W0SVM, has spent considerable time and effort designing a compact, practical dipole antenna for city dwellers who don't have the space to put up a full-size 40-meter antenna and for various reasons don't want to use a vertical antenna.

Jack wanted to build a simple, rugged antenna that would not have loading coils flopping around out in the elements. He felt that a center loading coil could do the job, if the coil was made properly. After several months of experimentation, he came up with the antenna shown in **fig. 4**. Briefly, it's a center-loaded dipole about half the size of the full dipole. The feedline is tapped on the loading coil in such a manner as to provide a good match to a 50-ohm line. The line is cut to an electrical half or full-wavelength and can be run directly to the transmitter or to a transmatch for maximum frequency flexibility. When used with a simple transmatch, the antenna has a 500-kHz passband between the 1.5:1 SWR points.

The resonant frequency of the antenna is determined by the wire sections. The difference in tip lengths be-

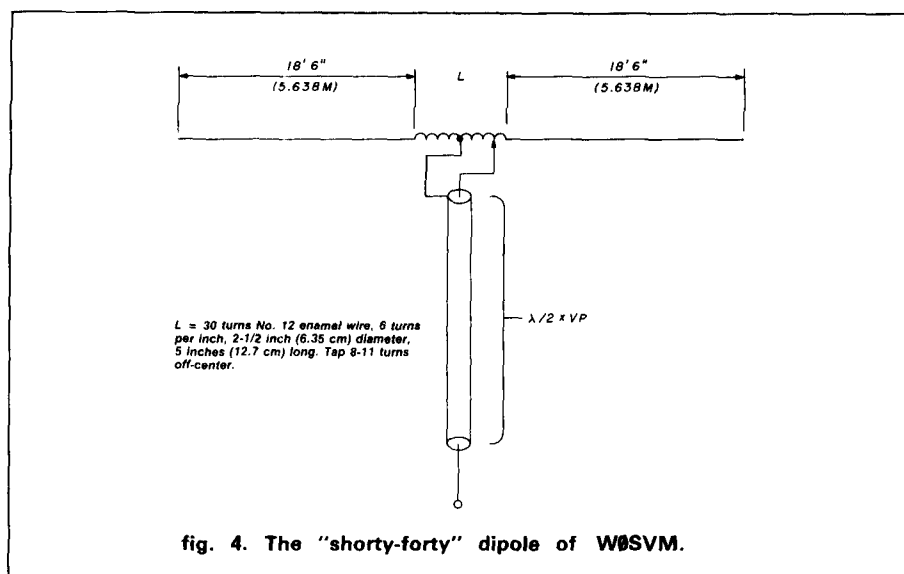

fig. 4. The "shorty-forty" dipole of W0SVM.

tween 7.0 and 7.3 MHz is 10 inches. It's best, therefore, to cut the antenna to that portion of the band in which most of the operating is to be done. Without the transmatch, bandwidth of the antenna is about 150 kHz between the 1.5:1 SWR points.

The shield of the coax line is tapped to the center point of the coil and the center conductor is tapped off-center. Using the 18-foot, 6-inch (5.638 meters) flat-top dimensions, the coil is tapped 11 turns off-center for operation at the low end of the band and at nine turns off-center for operation at the high end of the band.

Exact antenna resonance and the minimum value of SWR can be achieved at any point in the band by changing the tip length of the wires and the feedpoint on the coil. If operation is mainly confined to the high frequency end of the band, the wire sections can be reduced in length to 17 feet 8 inches (5.384 meters). All in all, the design is quite flexible and the resonant frequency and impedance match can be varied at will to suit any spot in the band, and also to match a 75-ohm transmission line, if desired.

The antenna can be erected in the conventional fashion or made into an inverted-V, with the end tips close to ground level. For best results, the center of the antenna should be from

30 to 50 feet (9 to 15 meters) in the air, and relatively clear of nearby objects.

While W0SVM doesn't mention it, I've found it helpful in some cases to wind the feedline into a choke coil directly below the antenna feedpoint. This reduces the RF field on the outside of the coax line and can reduce TVI in some instances. Of course, if the feedline is run parallel to the antenna after the choke is installed, all bets are off because the antenna will be coupled to the feedline by mere proximity. It's best to bring the feedline down vertically below the center of the antenna to ground level, or to the level of the station, if it's located on a higher floor. Running the feedline parallel to the antenna element(s) is bad practice, regardless of the type of antenna used.

do you have an unusual antenna?

Do you have an unusual antenna installation that would be of interest to readers? If so, I'd like to see it. Just send a clear pencil sketch of the antenna, including dimensions and the electrical characteristics, such as the SWR or operating bandwidth. A good black-and-white photograph is always appreciated, if the antenna can be photographed! (It's very difficult to take a decent picture of a wire antenna — although I have a friend who got

Introducing the BUTTERFLY™ Beam from Butternut!

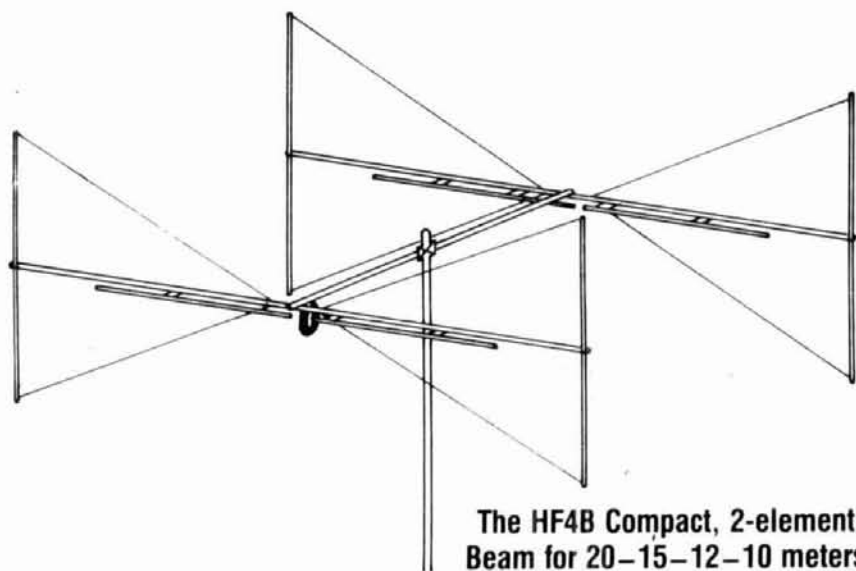

The HF4B Compact, 2-element
Beam for 20-15-12-10 meters

Compact Size

The HF4B's 12½-foot elements and 6-foot boom are ideal for home-station use and for weekend retreats, condos, apartments and other places where oversized beams are prohibited. Its light weight (17 pounds) means it can be turned with a tv rotator, yet it is robustly constructed in the best tradition of our world-famous Butternut verticals.

See your authorized
Butternut dealer

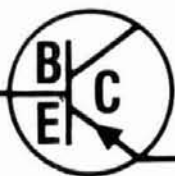

BUTTERNUT ELECTRONICS CO.

405 East Market Street
Lockhart, Texas 78644

Please send all reader inquiries direct.

Performance

The HF4B BUTTERFLY™ has not sacrificed performance for compactness. Its unique design with fanned elements and L-C circuits avoids use of power-robbing traps yet provided high-efficiency operating on all bands. The BUTTERFLY™ outperforms anything in its class.

The HF4B offers an SWR of 1.5:1 or less at resonance. Its 2:1 bandwidth is 200 kHz on 20 meters, 450 kHz on 15, 1.7 MHz on 10, and across the entire 12 meter band. And it will handle the legal power limits both CW & SSB. Gain is at least 3 dB on 20, 4.5 dB on 15 and 5 dB on 10 & 12 meters. Front-to-back is up to 18 dB on 10, 12 and 20m, and up to 15 dB on 15m.

good pictures of a wire antenna by taking the picture at night, using a camera with a flash attachment.)

Antennas featured in this column will win their owners an autographed copy of my *Beam Antenna Handbook*. * For those who don't have an inspirational antenna to talk about, the handbook is available from Ham Radio's Bookstore.

MXHNY

In closing this December column, I wish my readers a Merry Christmas and a Happy New Year. And may DX be good to you in 1986!

* Available from Ham Radio Bookstore, Greenville, New Hampshire 03048, \$9.95 plus \$3.50 shipping and handling.

ham radio

SATELLITE TV

buy from a HAM and SAVE

ZTE Communications

Pocatello, Idaho

Complete SYSTEM PACKAGES are available at reduced prices. Call for quotes before you buy.

Here are a few sample prices

- RECEIVERS — we pay UPS Shipping
- Chaparral SIERRA 85° polaramp, arm -----\$1350
- Luxor 9570/9534-02, 85° LNB, arm -----\$968
- Drake 324S with Down converter -----\$290
- Drake 424S with Down converter -----\$418
- Uniden UST 2000 with down converter -----\$235
- Uniden UST 7000 with BDC and 18 inch arm -----\$1008
- JANIEL BCR-2000 with Block down converter ---\$313
- ANTENNAS — ANTENNAS — you pay shipping
- Raydx 8.5 foot--\$563 Raydx 10.5 foot--\$632
- Luxor 10.5 foot--\$575 CALL

ZTE sells, Chaparral, Drake, Luxor, M/A Com, STS Panasonic, Houston tracker, Uniden, Toki, Hytec, Cal amp, MTI, PenTec, Sat-Tec, and others!

ZTE Communications is owned and operated by John Wilson, WA0DYU, I am the only employee, I work out of my house, which means lower prices for you!

Availability and prices are subject to change. Call John AFTER 5 PM mountain time. Telephone 1-208-237-1237 after 5 pm, no collect calls

✓ 185

GUS BROWNING, W4BPD's DX'ERS MAGAZINE

For over 17 years, Gus's DX'ERS MAGAZINE has brought thousands of DX'ERS worldwide, timely, pertinent information on when and where to find those elusive DX stations.

Gus's personable, chatty writing style and his years of DX operating experience makes the DX'ERS MAGAZINE a unique publication. One year \$14.00 USA, Canada & Mexico.

Gus also prints high quality QSLs and other related items.

Write today for a free sample of his QSLs and DX'ERS MAGAZINE.

Gus Browning, W4BPD • PO Drawer 405 • Cordova, SC 29039



✓ 138

GROTH-Type

COUNTS & DISPLAYS YOUR TURNS

- 99.99 Turns
- One Hole Panel Mount
- Handy Logging Area
- Spinner Handle Available

Case: 2x4"; shaft ¼"x3"

TC2 \$12.50

TC3 \$13.50

Spinner Handle Add \$1.50

Prices include UPS or Parcel Post in US

Model TC2: Skirt 2-1/8"; Knob 1-5/8"

Model TC3: Skirt 3"; Knob 2-3/8"

R. H. BAUMAN SALES

P.O. Box 122, Itasca, Ill. 60143

PERFORMANCE THAT IS OUT OF THIS WORLD...



\$389⁰⁰

**MODEL 2000 20MHz
DUAL TRACE**

\$549⁰⁰

**MODEL 3500 35MHz
DUAL TRACE DELAYED SWEEP**

...AT A DOWN TO EARTH PRICE

At last! Truly affordable test equipment with no compromise in design, and features you would expect to find only on oscilloscopes costing hundreds of dollars more! JDR Instruments presents two, new, high-performance models backed by a two year warranty and technical support which is only a phone call away. Perfect for the technician or advanced hobbyist, both models feature Dual Trace capability and a variety of operating and triggering modes, including CH-B Subtract and X-Y operation.

MODEL 2000 has a 20 MHz bandwidth and 20 calibrated sweeps ranging from .2s to .2 μ s. A convenient built-in component tester provides additional diagnostic power.



INCLUDES TWO HIGH QUALITY
1x, 10x TEST PROBES

MODEL 3500 features a 35 MHz bandwidth and exceptional 1mV/DIV sensitivity. Delayed sweep and variable holdoff allow stable viewing of complex waveforms.

ORDER TOLL FREE
800-538-5000
800-662-6279 (CA)



JDR INSTRUMENTS
1224 South Bascom Avenue
San Jose, California 95128 (408) 995-5430

The Problem Solver...

The RF Wattmeter Model 81000-A from Coaxial Dynamics, Inc. does more than provide accurate rf measurements. Testing of transmission lines, antennas, connectors, filters and related components can reveal unknown problems and assure optimum equipment performance.

The 81000-AK Wattkit features this easy-to-read RF Wattmeter (pictured here), with its optional carrying case and an array of elements and accessories. Coaxial Dynamics elements can be purchased separately for use in other manufacturer's Wattmeters. For more information on the 81000-A Wattmeter or any of the complete line of Coaxial Dynamics RF products and OEM components please contact Coaxial Dynamics, Inc.

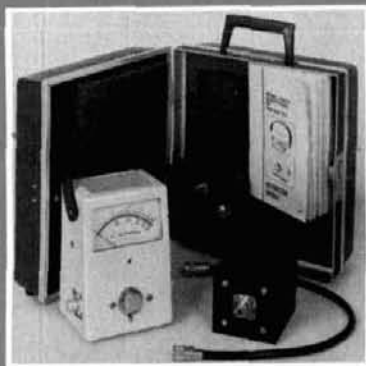

COAXIAL DYNAMICS, INC.

15210 Industrial Parkway, Cleveland, OH 44135 • (216) 267-2233
Outside Ohio, WATS: (800) Coaxial, Telex: 980-630

123



**WSPA CAN RESCUE FLOOD VICTIMS
FASTER WITH YOUR HELP**

NAME _____
ADDRESS _____
PHONE _____
CALL _____
EQUIPMENT AVAILABLE _____



World Society for the Protection of Animals

When DISASTER Strikes YOU May be the Animals' Only Hope

The World Society for the Protection of Animals (WSPA), a nonprofit organization with offices around the globe, takes action to help animals in crisis, responding in times of fire, flood, earthquake, volcanic eruption, oil spills, and civil unrest.

To assure the quickest response to these disasters, WSPA needs the help of ham radio operators in the United States and abroad who can relay critical information to and from international trouble spots.

WSPA is the only organization officially recognized by the United Nations as a consultant on animal disaster issues. We urgently need you and your radio. To register as an animal-emergency operator, simply fill out the coupon and mail it to WSPA, Western Hemisphere Regional Office, 29 Perkins St., POB 190, Boston, MA 02130. We'll be depending on you when animals are in jeopardy.

TNT RADIO SALES INC.

Call Now For Super
CHRISTMAS STOCKING STUFFERS
TOLL FREE
1-800-328-0250



- KENWOOD
- ICOM
- MIRAGE
- AEA
- KANTRONICS

- SANTEC
- KDK
- AZDEN
- NYE VIKING
- MFJ

- TELEX HY-GAIN
- HUSTLER
- KLM
- ROHN
- HEIL

- AMERITRON
- WELZ
- LARSEN
- BUTTERNUT
- BENCHER

- AVANTI
- CALLBOOK
- ARRL BOOKS
- CABLE
- CONNECTORS

VISA/MASTER CARD
 FREE SHIPPING
 ON MOST RIGS FOR CASH!



S.A.S.E. FOR OUR
 "BENCH-TESTED"
 USED EQUIPMENT LISTING

MON-FRI 9 AM - 6 PM CENTRAL TIME
 SATURDAY 9 AM - 5 PM

4124 West Broadway,
 Robbinsdale, MN 55422 (Mpls./St. Paul)

1-612-535-5050
 (IN MINNESOTA CALL
 TNT COLLECT)

1-800-328-0250
 TOLL FREE QUOTES

Kantronics Interface II We Met the Demands of the Serious Amateur



Suggested Retail \$269.95

INTERFACE II

- Dual Tone Detection copies Mark & Space.
- AM/FM operation for tuning versatility.
- Stable Quartz Generated Tones give clean AFSK Output on all shifts.
- Six Pole Switched Capacitance Filters
- Unique Tuning System displays both Mark and Space Tones, shows Signal Fading. Scope Outputs available.
- RS232 or TTL level compatible.
- Two Channel Operation for simultaneous connection of HF and VHF transceivers.
- Guaranteed compatible with six computers when used with Kantronics Software.

For more information contact your Kantronics dealer or write:
KANTRONICS, 1202 E. 23 St.
LAWRENCE, KS 66046

✓ 189



CADDELL COIL CORP.

35 Main Street
Poultney, VT 05764
802-287-4055

BALUNS

Get POWER to your antenna! Our Baluns are already wound and ready for installation in your transmatch or you may enclose them in a weatherproof box and connect them directly at the antenna. They are designed for 3-30 MHz operation. (See ARRL Handbook pages 19-9 or 6-20 for construction details.)

100 Watt (4:1, 6:1, 9:1, or 1:1 Impedance — select one) \$ 9.50
Universal Transmatch 1 KW (4:1 Impedance) 13.50
Universal Transmatch 2 KW (4:1 Impedance) 16.00
Universal Transmatch 1 KW (6:1, 9:1 or 1:1 — select one) 15.00
Universal Transmatch 2 KW (6:1, 9:1 or 1:1 — select one) 17.50

Please send large SASE for info.



AR-200 XL MEDIUM DUTY ANTENNA ROTATOR

Select a Heading - Antenna
Turns and Stops Automatically.

\$99.95

SIDE BAND SQUELCH

- Fits inside most HF SSB transceivers
- Requires human voice to activate
- Ignores static, noise and heterodynes
- On/off switch only—no adjustments!
- Connects to audio leads and 9-12 VDC
- Fully assembled and tested \$99.95
- Complete with comprehensive manual
- Used worldwide in commercial and military transceivers



CMC COMMUNICATIONS
5479 Jetport, Tampa, FL 33614 (813) 885-3996

✓ 122



NOW Sinad CAN BE MEASURED WITH YOUR VOM

- Quickly tune Receivers, Cavities, Preamps, etc.
- Works with your VOM or AC VTVM that has 2.5V full scale sensitivity or better.
- Fast accurate measurements.
- Sinad measurement displayed on meter in "dB" scale.
- Self contained, pocket size, go anywhere instrument.
- Powered by standard 9V battery or optional AC adaptor.

SINADAPTOR SAI-01

\$79.95

Please add \$3.50
shipping & handling



NY res. add 7% sales tax

J.S. Technology, Inc.

39 Main Street
Scottsville, NY 14546
(716) 889-3048 ✓ 148

RF Porta-Tenna

VHF/UHF Telescopic 1/4 & 5/8
Wavelength Antennas for
Hand-Held Transceivers &
Test Equipment

1/4 WAVELENGTH

Model No.	Freq. MHz	Description	Price
196-200	144-148	5/16-32 stud w/spring	\$5.95
196-204	"	BNC connector w/spring	7.95
196-214	"	BNC connector	6.95
196-224	144-UP	BNC conn. adj. angle	7.95
196-814	220-225	BNC connector	6.95

5/8 WAVELENGTH

191-210	"	5/16-32 for old TEMPO	22.95
191-214	"	BNC connector	19.95
191-219	"	PL-259 w/M-359 adpt.	22.95
191-810	220-225	5/16-32 for old TEMPO	22.95
191-814	"	BNC connector	19.95
191-940	440-450	5/16-32 for HT-220	22.95
191-941	"	1/4-32 stud	22.95
191-944	"	BNC connector	19.95

Largest Selection of Telescopic Antennas. Write for info. Prices are postpaid via UPS to 48 States. For air delivery via UPS Blue add \$2.25. Florida add 5% sales tax. Payment by M.O. or Cashiers Check only. ✓ 169

RF PRODUCTS

P.O. Box 33, Rockledge, FL 32955, U.S.A.
(305) 631-0775

Determining the next step
in flexible, robust
digital communications

AMTOR, AX.25, and HERMES: a performance analysis of three systems

AMTOR and the AX.25 packet protocol are currently being heralded as the state-of-the-art in Amateur digital communications. This article reports the results of an objective performance analysis of these two systems, and compares each to HERMES, a third, newly proposed system. Four performance measures are described and applied to each system.

applications

In order to choose reasonable conditions under which to evaluate the performance of competing communications systems, it is first necessary to look at the ways Amateurs actually use digital communications.

If you listen to normal RTTY traffic on the HF bands, you'll find that most Amateurs are engaged in casual conversation. These QSOs are almost exclusively conducted at a 45 baud (60 WPM Baudot) channel rate, with throughput usually limited by the speed at which the respective operators can type. While some of us can type fast enough to keep a 45 baud system running fairly continuously, most cannot.

Other users — though fewer in number — are involved in RTTY traffic nets, using computers or RTTY equipment to relay third-party message traffic. Although surprisingly little RTTY traffic handling actually occurs (compared to the amount handled by CW or SSB) at this time, the availability of improved digital communications schemes may help to encourage the growth of this type of activity.

Some users employ computer data transfer for traffic handling. It is primarily this application for which the AX.25 "packet" systems are designed. And on VHF, packet radio activity is growing rapidly. AX.25 has the capability of supporting conversation just like

RTTY, as well as direct computer-to-computer data file transfer.

I believe we should push for a single digital communications scheme that can adequately support all types of users at both HF and VHF, including satellite links. Such a system is not currently in use, nor has one yet been proposed.

Two of the three classes of users described above are dealing exclusively with plain language text, using the Baudot alphabet (or the AMTOR variation of the Baudot alphabet). Computer hobbyists are using ASCII, sending it in an eight-bit format so that arbitrary computer data (as well as text) can be transmitted within that scheme as well. Whatever digital scheme we agree to accept as standard, it should support both types of alphabet.

Those using digital communications for casual conversations are probably not too worried about a few errors now and then in the received text, but would like to see the channel processing their data fast enough (100 bps is probably sufficient). On the other hand, the other two user classes have no tolerance for any hits, and are willing to sacrifice some channel throughput to attain the required reliability. It would be best to have a system that could be conveniently optimized by the operator for each of these different applications.

comparing systems

The following four criteria are useful in comparing the various systems available:

- **Throughput under ideal channel conditions.** An "ideal" channel introduces no errors, thereby allow-

By Jerome T. Dijak, W9JD/4, 2736 Gwynnbrook Road, Montgomery, Alabama 36116

ing the communications system to run at its highest possible rate. (This is expressed in characters per second (cps).)

- **Robustness.** This is the probability, expressed as a percentage, that the system will falsely accept random noise or badly corrupted characters as valid. Any system must reject (or correct) all corrupted data received under these conditions with high reliability — i.e., have a very low probability of falsely accepting corrupted data characters as valid. (The mathematics used to compute this probability for each of these two systems evaluated is presented in the appendix.)

- **Bit Error Rate (BER) required to stop progress (expressed as a percentage).** It is assumed that random bit errors are occurring at a certain rate. How high must this error rate be to prevent the system from occasionally transferring data successfully? Under these circumstances, the throughput of the communications system is sharply reduced since there are many repeats. But we want the system to make *some* progress — occasionally, data should be correctly transferred and acknowledged by the receiving end. Other things being equal, it is desirable for a system to be able to tolerate as high a random BER as possible before forward progress is stopped.

- **Minimum Required Error Free Seconds (MREFS) to maintain progress in forward data transfer.** Here a channel generating "burst" errors is assumed. The channel makes no errors for a certain length of time, and then becomes unusable for a certain length of time (an error burst). An interesting parameter of a communications system is how short the "good" period of the channel may be while still allowing successful and correct data transfer to occur occasionally. Other things being equal, a system should have a low MREFS requirement.

To make reasonable comparisons, we will assume that each of the packet protocol systems is being operated with the same type of channel, arbitrarily a 100 bps synchronous channel such as that specified for AMTOR, with a 20 millisecond allowance for radio turn-around from transmit to receive and vice-versa. For consistency, it is assumed that a 5-bit symbol alphabet (Baudot) is being used when specifying throughput performance, even though any of the systems can transfer Baudot, ASCII (7-bit), or arbitrary computer data (8-bit) by employing appropriate alphabet conversion subroutines.

Figure 1 illustrates AMTOR in operation.^{1,2} In the ARQ mode, AMTOR sends three 7-bit characters and then pauses for an acknowledgement signal (one 7-bit character) from the receiving station before proceeding with the next three-character group. If no acknowledgement character is received, the last three-character group is repeated.

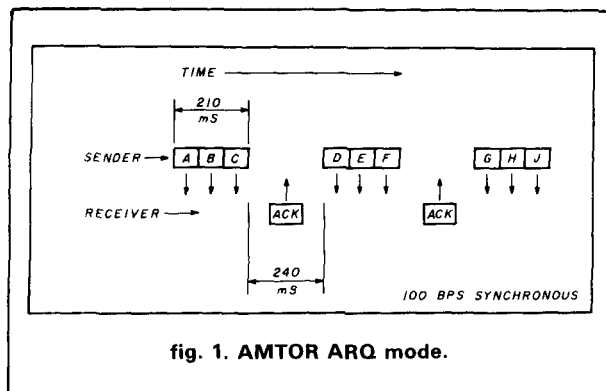

fig. 1. AMTOR ARQ mode.

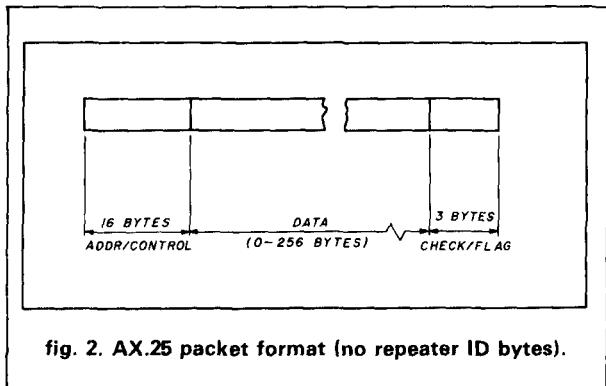

fig. 2. AX.25 packet format (no repeater ID bytes).

Time relationships are quite specific. AMTOR spends 210 milliseconds sending each group, and 240 milliseconds waiting for the acknowledgement before sending the next group.

Like Baudot, AMTOR uses a 32-character alphabet, but uses 7-bit symbols instead of the Baudot's 5-bit symbols. Each AMTOR symbol is composed of three 0 bits and four 1's, allowing it to detect errors in its received data (sometimes). To do this, AMTOR uses a simple parity check. Each received character must have four 1 bits and three 0 bits; if it doesn't, an error is flagged, and the entire group is discarded and must be repeated.

If the channel makes one bit error per character (or any *odd* number of bit errors per character) this simple parity check successfully detects the error. But if the channel reverses two (or any *even* number) of the character's bits, its 4/3 parity ratio will be preserved even though it has now been transformed into a different character of the alphabet. Under these conditions, the AMTOR code will fail to detect the error.

With the channel producing few errors, it is likely that no more than 1 bit error per character will be experienced. When the channel is very poor, however, and is making many bit errors, one has about an equal chance of experiencing an odd or even number of errors. Consequently, there is a 50 percent chance of an incorrect character unintentionally satisfying the parity check.

packet system design

Good references for a detailed description of the AX.25 or "packet protocol" are available.^{2,3} AX.25 is an adaptation of the 15-year-old data communications protocol pioneered by the Defense Advanced Research Projects Agency in the 1960s for error-free communications within telephone computer networks. This protocol assumes a telephone channel, or a channel of similar quality (in terms of signal-to-noise ratio, bandwidth, and lack of interference) in its design.

Figure 2 shows the current AX.25 packet makeup: 16 bytes or more of synchronizing and header information at the beginning of each packet, followed by up to 256 bytes of information, with the packet finished out with three final bytes for error checking and flagging the end of the frame. If the packet has been processed by one or more repeaters, seven additional address bytes are added to the packet to identify each repeater, up to a maximum of 9. For purposes of this discussion, use of a simplex channel only, with its requirement for only 19 overhead bytes in an AX.25 frame, is assumed.

Although AX.25 includes a significant amount of overhead in each packet, it is a very good system in light of the environment for which it was originally designed. It is not, however, ideal for use on a channel that doesn't look much like a telephone channel — a narrowband HF channel with fading, noise, and a high error rate, for instance.

Because this system was designed for transmitting computer data, it contains a robust error detecting scheme that provides a good probability of detecting a garbled block regardless of the source or severity of the errors.

Figure 3 shows the flow of activity on a packet channel. Since just one block at a time is sent, and each block must be acknowledged by the receiving station before the next block is sent, a certain amount of channel time is inevitably spent waiting. For our analysis, delays similar to those used with AMTOR are assumed.

The packet protocol is somewhat adaptive. Depending upon channel conditions, the operators can adjust the length of each packet by controlling the number of data characters sent (up to 256) in each block. Thus, when conditions are good and the channel is rarely making errors, a full-size block may be used, with a correspondingly small proportion of the channel time wasted in packet addressing overhead and waiting for acknowledgements. On the other hand, when the channel is very bad, the character count can be greatly reduced to shorten the packets, thus improving the chance of their being received error-free. Very short packets are quite inefficient, however, because of the addressing bytes that must always be included.

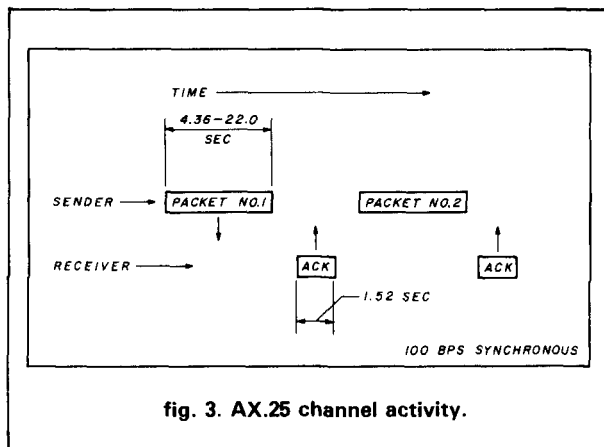

fig. 3. AX.25 channel activity.

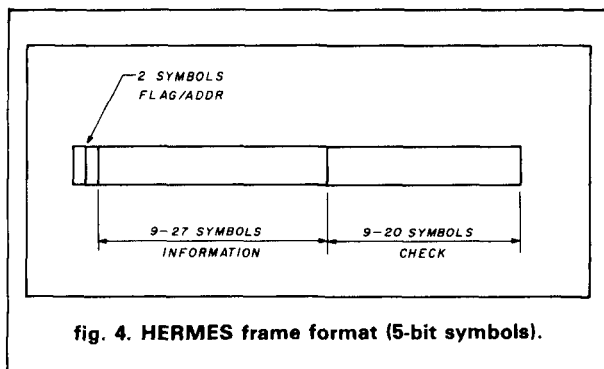

fig. 4. HERMES frame format (5-bit symbols).

For our purposes, then, we will examine the packet systems running with both maximum length packets (even though, in practice, hams rarely use more than about 80 data characters per packet) and extremely short packets (only 16 data characters) as well.

HERMES system design summary

HERMES was designed to be superior to both AMTOR and AX.25 in the Amateur narrowband HF environment. The latest version of a system described in reference 4, HERMES has been used experimentally for the past several years.

The key to HERMES is the use of a Reed-Solomon forward error-correcting code. The chosen code uses a 5-bit symbol alphabet and 31 symbols per block; a typical frame is diagrammed in fig. 4. The coder and decoder are adaptive — i.e. the ratio of data symbols to check symbols in each block is controllable by the operators to allow optimization to channel conditions. The check symbols add redundancy to the data in a special way that allows the system to mathematically correct some symbols in each frame that have been altered or destroyed by the channel. (Reference 4 also provides additional details on how forward error correcting systems work.)

This feature allows HERMES to perform efficiently when channel conditions are favorable, as well as

when the channel conditions are poor (in this case data transfer efficiency is traded off in favor of gaining additional error correcting capability).

HERMES uses a protocol that assumes a single link (i.e., a pair of stations in contact), but is also designed to accommodate net type operations. Unlike AX.25, it is not configured to allow several simultaneous and independent QSOs on a single channel, thus greatly reducing the number of overhead bytes that must be transmitted in each block.

The system is designed to handle Baudot characters, and conversions of 7-bit ASCII characters and arbitrary 8-bit bytes directly, so that all types of data can be handled with the same efficiency.

The operator can choose any of 48 different configurations that have been implemented; these support 16 different modes in each of the Baudot, ASCII, and byte communications modes. Data transfer efficiency of the system ranges from 93.5 down to 32.3 percent, depending on the degree of error correcting capability chosen. The probabilities of falsely accepting corrupted data as valid vary from 2.6 to 0.0000009 percent; error correcting capabilities vary from 0 (error detection only) to 11 symbol errors per block (35 percent correction capability).

The system can function in an **ARQ** mode or in a broadcast mode in which no acknowledgements are sent. In the **ARQ** mode, HERMES sends from nine to 27 data blocks per transmission (depending upon system configuration), after which the link is turned around, and the receiving station sends one "acknowledge" frame to identify all the blocks that were received correctly or were correctable. This pattern is illustrated in **fig. 5**. Since the ratio of data frames to acknowledge frames is quite high, there are relatively few link turn arounds and little wasted link time spent waiting for radios to switch. In the broadcast mode, HERMES sends the data frames using the same code configurations, but does not wait for acknowledgements.

AMTOR (ARQ) analysis

AMTOR sends three characters (requiring 210 milliseconds), then pauses for 240 milliseconds to allow the acknowledge signal to be received. Therefore 3 characters require 450 milliseconds to send under ideal conditions, resulting in a 6.67 cps throughput.

Under conditions of no signal (random noise input only), AMTOR will recognize a "block" only if it sees three valid characters. Since there are 34 legal characters out of the 128 possible 7-bit characters, the probability of any single character looking valid, with random input, is $34/128 = 0.266$. The probability that three such characters in a row are received with only noise input is the third power of this number, or about 1.9 percent.

Under very noisy signal conditions, in which we assume that many bit errors are being experienced, and we assume that a valid signal is being received in addition to the noise, we have a 50 percent chance of experiencing an even number of bit reversals in the received characters. If the odds of receiving an incorrect, but valid-looking, character are 50 percent, then the probability of receiving three of these is the third power of 0.50, or 12.5 percent. This second case is really more relevant to our discussion, and it is this number that we'll use for our robustness figure for AMTOR.

Just one bit error during each 450 millisecond is enough to stop data transfer progress with this system. This bit error would either corrupt the data transmission or the acknowledge signal, and the corruption of either is sufficient to force a repeat. Once we continually force repeats, the forward transfer of data has stopped. One bit in 450 milliseconds at a 100-bps data rate corresponds to a 2.22 percent BER.

To get data through once in a while, AMTOR needs to occasionally obtain a 450 millisecond window of error-free transmission by the channel. Therefore, for this system, $MREFS = 0.45$.

maximal frame packet analysis

A maximal length frame (256 data bytes) is used to configure the packet system for performance under ideal conditions. Without the repeater addressing bytes, the standard AX.25 packet requires 19 bytes of overhead for addressing and error checking, so the complete frame is 275 bytes long.

The AX.25 acknowledge frame would consist of just the 19 overhead bytes. With 22.0 seconds required to send the 275 byte information packet at 100 bps and 1.52 seconds required to send the acknowledge packet (plus two 20 millisecond intervals assumed for radio switching), the system requires 23.56 seconds to transfer one frame under ideal conditions. This corresponds to 10.86 cps for 8-bit characters, or 17.36 cps for equivalent 5-bit characters (409 5-bit characters can be loaded into the 256 byte data frame).

By the nature of the 16-bit CRC (Cyclic Redundancy Check) code used for error detection in the AX.25 format, the probability of a corrupted block being falsely accepted as valid is $1.53E-5$ (0.00153 percent), regardless of whether we are talking about random noise or a noisy signal input to the system. The CRC is a much more sophisticated algorithm than the simple parity check used in AMTOR, and is much more robust in the presence of massive channel errors.

Since AX.25 is only an error detection scheme, one bit error occurring during every 23.56 seconds would destroy the correctness of either the data frame or the ACK frame, and in either case the data frame would need to be repeated. Therefore, a random BER of

Everything from Superman III to Super Bowl XX.

Movies. Sports. News. Entertainment specials.
Music videos.

Everything you always wanted to see on
television but were afraid you'd never get.

Over one hundred channels of spectacular
entertainment. Of crystal clear reception.
Throughout the house. 24 hours a day.
With no monthly fees. No cable TV.

Come see the entire line of Uniden
Satellite Television Systems. It's legal.
It's affordable. And it's a whole new
world of television. Right in your own
backyard.

uniden[®]
Satellite Television Systems

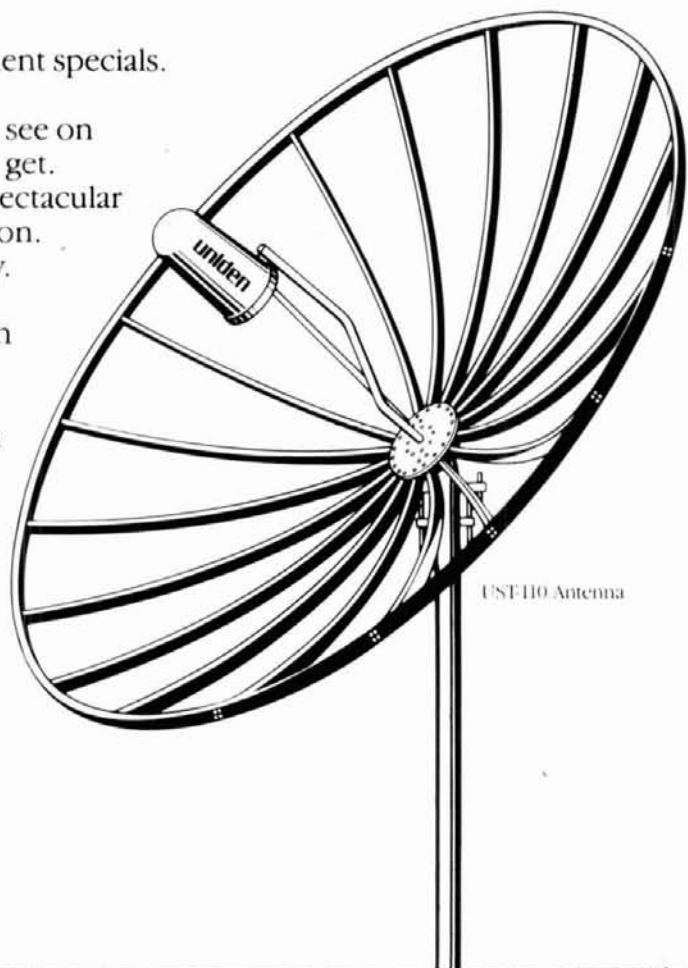

© Uniden Corporation of America 1985

2410 Ridge Road West
Rochester, New York 14626
716-225-6130
1-800-824-5014
Sales



VIDCOM
Satellite
Comm.

17 Industrial Street
Rochester, New York 14614
716-454-3630
1-800-824-5014
Service

NATIONAL: 1-800-732-TVRO

ICOM 440MHz



For a Total UHF System, Choose ICOM

ICOM offers a variety of UHF gear to meet your operating requirements... the IC-471H base station transceiver, IC-47A compact mobile, IC-04AT or IC-4AT handheld transceivers, and the RP-3010 crystal controlled repeater.

The IC-471H all mode 430-450MHz base station transceiver provides 10 to 75 watts of adjustable power. With 32 full-function memories, 32 PL tones, memory scan, mode scan and programmable band scan, the IC-471H provides maximum UHF base station performance. The IC-471A 25 watt version is also available.

The IC-47A 25 watt 440-449.995MHz ultra-compact FM mobile provides superb performance in the mobile environment. Measuring only 5½" wide by 1½" high by 9" deep, the IC-47A also features nine full-function memories, 32 built-in PL tones and a complete scanning system. Each unit comes standard with an HM-23 mic with up/down scan and a mobile mounting bracket.

Optional AG-35 Mast Mounted GaAsFET Pre-amplifier for IC-471H



The IC-04AT top-of-the-line UHF handheld features DTMF direct keyboard entry, LCD readout, 32 PL tones, 3 watts standard (5 watts optional) and 10 memories which store duplex offset and PL tone.

The IC-4AT handheld features 440-449.995MHz coverage, a DTMF pad, 1.5 watts output and thumbwheel frequency selection.

The IC-04AT and IC-4AT come standard with an IC-BP3 NiCd battery pack, flexible antenna, AC wall charger, belt clip, wrist strap and ear plug. PLUS a wide variety of slide-on battery packs and accessories are available.



The RP-3010 crystal controlled UHF repeater covers from 430-450MHz and includes CTCSS, 3 digit DTMF decoder and CW ID'er.

See ICOM's full line of UHF gear at your local ICOM dealer.

 **ICOM**

First in Communications

ICOM 144, 220 and 440MHz

MOBILES



The World's Most Compact Mobiles

ICOM's three ultra compact mobiles...the IC-27A 2-meter, the IC-37A 220MHz and the IC-47A 440MHz... are the smallest mobiles available.

Even in such a small package the 25 watt mobiles contain an internal speaker which makes them fully self-contained and easy to mount.

Size. The ICOM compacts measure only 5½"W x 1½"H x 7"D (IC-47A is 9" deep)... which allows them to be mounted in various "compact" locations. Yet the compacts have large operating knobs which are easy to use in the mobile environment.

More Features. Other IC-27A/37A/47A standard features include a mobile mount, IC-HM23 DTMF mic with up/down scan and memory scan, and internally adjustable transmit power. An optional IC-PS45 slim-line external power supply and IC-SP10 external speaker are also available.



Internal Speaker

32 PL Frequencies. The IC-27A/37A/47A come complete with 32 PL frequencies.

9 Memories. The compact mobiles have 9 memories which will store the receive frequency, transmit offset, offset direction and PL tone. All memories are backed up with a lithium battery.

Speech Synthesizer. To verbally announce the receive frequency, an optional UT-16 voice synthesizer is available.

Scanning. The ICOM compacts have four scanning systems...memory scan, band scan, program scan and priority scan. Priority may be a memory or a VFO channel...and the scanning speed is adjustable.

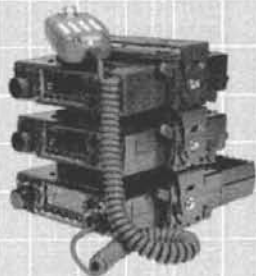

Stacking Mobile Mounts. The IC-27A/37A/47A can be stacked to provide a three band mobile station. Each band is full featured and will operate even when another band is in use.

The IC-27A/37A/47A provide superb performance in the mobile radio environment. See them at your local ICOM dealer.



ICOM

First in Communications

Message Master™

Real-voice message system For any repeater or base

Now you can communicate vital information even when the station you are calling is not on the air — with Message Master. Message Master is a solid state voice recording system which can record messages just by listening to you speak, store messages in memory, and deliver messages on demand. If you can't be there to deliver your messages let Message Master deliver them for you - any messages in any language and in your own voice!

Message Master connects easily to any radio system for remote access: repeaters, base stations, even transceivers. It can even be connected to an autopatch device to exchange messages between your radio system and the telephone network.

Message Master is a multi-user system with mailbox style personalized message service for a hundred users. With 8 minutes of message storage it can store hundreds of messages simultaneously making it ideal for large, active repeater groups.

Would you like your callsign identifications, tail messages, and bulletin messages sent in real-voice? Message Master can send them too. Record several identification messages and it will even send a different ID each time. Almost like magic, Message Master knows when to send identifications and tail messages so it needs no special control signals from your base or repeater.

Call or write for further information before you make another wasted call.

Commercial users: Ask for a brochure on the Message Master Electronic Dispatcher with group and all call messaging.



- **Create messages just by talking.** Message Master's 'real-voice' technique saves YOUR VOICE in digital memory to deliver messages in your own voice, language and dialect.
- **Mailbox-style operation gives individual message delivery service to 100 system users.**
- **Easily added to any repeater or base station for remote operation with only four connections.**
- **Special features include callsign identifications, tail messages, and bulletin messages.**
- **Digital message storage provides instant playback of stored messages.**
- **Modular memory meets your exact needs from 2 to 8 minutes of total message storage.**

Serving all your repeater needs

- *Mark 4 Repeaters and Repeater Controllers are THE PERFORMANCE LEADERS with real voice, more autodial numbers, more synthesized voice and more features.*
- *Mark 3 Repeaters offer the winning combination of high performance and high value.*
- *LR-1 Repeaters boast superb RF circuitry at an economical price.*
- *MR-4 Receivers with 7 helical resonators are the only receivers to choose in harsh RF environments.*
- *PA-100 Amplifiers with rugged TMOS power FETs give you a continuous duty high power signal.*



COMING SOON: A 4-channel receiver voting system which operates on true signal-to-noise ratio to extend your coverage by linking to remote receivers.



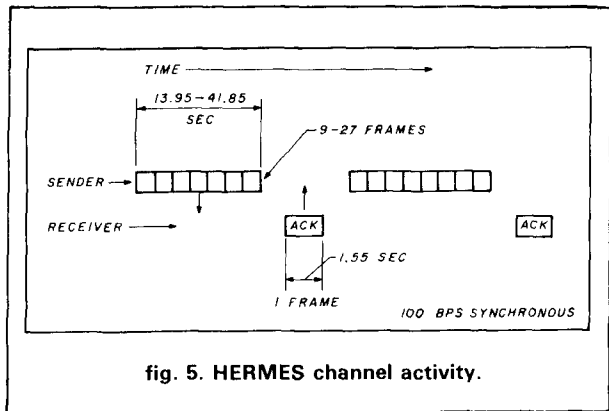

fig. 5. HERMES channel activity.

1/2356 or 0.042 percent would stop all progress for AX.25 in this configuration.

By the same token, to get data through once in a while, the channel must occasionally be good for at least 23.56 seconds at a time. So MREFS = 23.56.

minimal frame packet analysis

When channel conditions are very poor, we would want to operate the packet system with a very short frame — let's say just 16 data bytes, in addition to the 19 overhead bytes always required.

With this frame length, we need only 2.8 seconds to send the data frame, and a total of 4.36 seconds to complete a data transfer, including the ACK frame. This corresponds to 3.67 cps for 8-bit data and 5.87 cps for 5-bit characters.

The probability of a corrupted block being falsely accepted as valid is the same as with the maximal frame configuration, 0.0015 percent since this characteristic depends only upon the number of check bits used and the error detection algorithm.

The BER required to stop the system is now 1 bit in 4.36 seconds, or 0.23 percent. MREFS for this configuration is 4.36.

HERMES analysis

Case 1. For the first HERMES configuration we assume a good quality channel and choose a mode appropriate for maximum data throughput and adequate error probability for conversational use. We use a configuration with 29 data symbols and just 2 check symbols per block and operate the decoder in an error-detecting mode only.

For the throughput calculation, we assume the transmission of 27 data frames containing 27 information characters each, followed by 1 acknowledge frame from the receiving station. After allowing for two 20 millisecond switching intervals for the radios, the total time required for the exchange is 43.44 seconds. Since 729 characters are transferred, throughput is 16.78 cps (5-bit characters).

With two 5-bit check symbols and an error detect-

ing mode only, the probability of falsely accepting a bad block is 0.098 percent, regardless of whether we are talking about random noise or a noisy signal being fed in to the system.

To stop forward data transfer, we must have 1 or more bad bits in each frame sent by the sending station, which corresponds to one bit error out of 155, or a 0.65 percent BER. We can make some progress as long as at least one frame can get through once in a while, which requires 1.55 seconds, so MREFS = 1.55.

Case 2. For our second example we choose a HERMES configuration with 17 data symbols and 14 check symbols in each frame, with the decoder running in a six-error correcting mode (6 symbols out of each 31 symbol frame can be corrected).

In this configuration, the system will send up to 15 data frames before waiting for an acknowledge frame from the receiving station. This works out to 24.84 seconds to transmit the 15 frames and receive the acknowledgement. 225 characters would be transmitted during this time, for a throughput under ideal conditions of 9.06 cps.

In this mode, the decoder's probability of falsely accepting a bad block as valid is 0.000059 percent.

Since six symbol errors can be made in each frame with the decoder still being able to correct the block, this corresponds to one symbol in every five being in error. In order to stop forward progress, then, we must have one character in every 4 be in error. This corresponds to a random bit error rate of 1 in 20, or 5 percent.

On a bursty channel, we must be able to receive at least 25 symbols of a block without error in order to be able to correct it completely. This corresponds to MREFS = 1.25 seconds.

Case 3. For this example we assume a very poor channel, and are willing to sacrifice additional throughput to enhance the forward error-correcting power of the code. Here we use a configuration with 11 data symbols and 20 check symbols per block, and we allow the decoder to correct up to 10 errors per frame.

In this configuration, HERMES will send 9 data frames at a time before waiting for an acknowledgement, and spend 15.54 seconds doing it. In these 15.54 seconds, 81 characters will be transferred, for a throughput of 5.21 cps.

In this configuration, the probability of the decoder falsely accepting an invalid block is 0.0000029 percent.

Since the decoder can correct 10 symbols out of a 31 symbol frame, a channel making random bit errors can destroy every third symbol, and the decoder will still be able to fully correct the frame. Therefore, to stop the system, the channel must corrupt one symbol out of every two, for a random bit-error rate of 10 percent.

table 1. Performance summary.

system/statistic	throughput (cps)	robustness (percent error)	BER required to stop (percent)	MREFS (seconds)
AMTOR ARQ	6.67	12.5	2.220	0.45
AX.25 (Max)	17.36	0.0015	0.042	23.56
AX.25 (Min)	5.87	0.0015	0.230	4.36
HERMES/1	16.78	0.098	0.650	1.55
HERMES/2	9.06	0.000059	5.000	1.25
HERMES/3	5.21	0.0000029	10.000	1.05

On a bursty channel, we need to get 21 symbols out of every frame transmitted without error, so MREFS = 1.05.

performance summary

Table 1 summarizes the performance figures we have developed for each of the competing schemes. Once again, the ideal system would have a high throughput, a very low robustness percentage, a very low BER required to stop, and a very low MREFS.

AMTOR can absorb up to a 2.22 percent random channel BER before being stopped, and needs only 0.45 seconds to make progress, which is good, but the fact that it has a 12.5 percent chance of falsely accepting invalid data as valid is disqualifying. We can, and should, do much better than that.

The two AX.25 packet configurations evaluated, which fully bracket the usual operating configurations, represent the extremes of performance available with the AX.25 protocol. First, we see that packet's probability of falsely accepting invalid data is fairly low, which is good. 0.0015 percent is low enough for most purposes, and might need augmentation only when very large files are transferred at high data rates at UHF and beyond. (This figure equates to the acceptance of one bad frame in about 67,000.)

The maximal packet configuration produces a good throughput figure of 17.36 cps, but at the expense of allowing only a 0.042 percent random BER before being stopped and requiring 23.56 seconds to get a packet through. As we said before, if you have a good enough channel, this will work nicely. Good channels are pretty easy to get at VHF, but HF is another story.

The minimal packet configuration allows the channel BER to increase by a factor of 5, up to 0.23 percent and reduces the minimum required error-free seconds to 4.36, which is more realistic for an HF channel. The throughput, however, has now dropped to 5.87 cps.

HERMES configuration 1 was chosen to obtain the highest possible throughput while maintaining a robustness adequate for conversational communications. It achieves a 16.78 cps throughput, which is very nearly as good as the AX.25 protocol under the best

of conditions, and it does this while allowing a 0.65 percent BER before being stopped (this is 15 times more tolerant than the maximal length packet scheme), and an MREFS figure of just 1.55 seconds (1/15th the minimum required time for maximal length packet). Robustness in this configuration, 0.098 percent, is not as good as the AX.25 figure, but is more than adequate for the intended application, casual conversation.

Comparing the performance of HERMES case 1 to the minimal length packet case, we see that the packet scheme runs at about one-third the throughput and is still about three times less tolerant in both BER and MREFS.

HERMES configuration 2 was chosen for use on a moderately degraded channel, and in an application where high accuracy was required. Its 9.06 cps throughput falls midway between the extremes of the AX.25 configurations and its robustness is several orders of magnitude better than AX.25. Interestingly enough, it does this while being even more tolerant of channel errors, now allowing a 5 percent random BER before being stopped, and requiring 1.25 error-free seconds to transfer data. Comparing these figures to those for the minimal length packet scheme, HERMES is providing 54 percent more throughput while allowing a 27 times greater random BER in the channel, and requiring "good channel" bursts only one-third as long as AX.25. All these factors translate to superior performance by HERMES.

Even though the performance of AMTOR is disqualifying, due to its poor robustness, it is interesting to note that in this case, HERMES provides 36 percent more throughput. And while AMTOR does excel in the MREFS department, requiring only 0.45 seconds compared to 1.25 for HERMES, HERMES will allow more than twice as high a random BER before being stopped (5 percent versus 2.2 percent, overall), therefore, HERMES wins the comparison here, too.

Chosen for use on a very bad channel, HERMES case 3 allows a throughput of 5.21 cps, slightly worse than the minimal length packet case. But it has a phenomenally low probability of falsely accepting invalid data (0.0000029 percent), and can withstand a



R.F. Power Monitoring

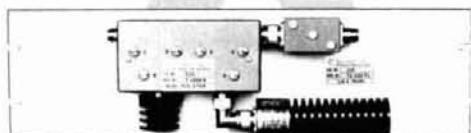

IM Suppression Panels

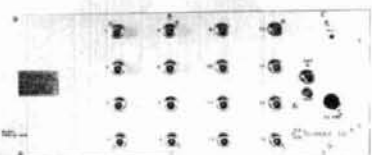

Receiver Multicoupling

The Problem Solvers



Duplexers & Preselectors

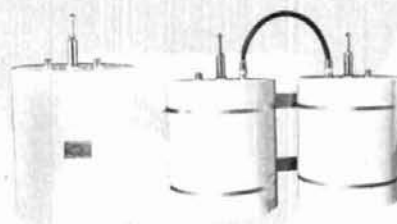

Bandpass, Pass-Reject
and Notch Cavity Filters

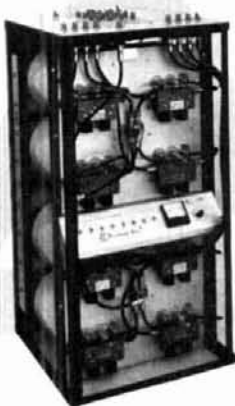

Transmitter Combining
150 - 900 MHz

COMPLETE SYSTEM ENGINEERING ASSISTANCE



TELEWAVE, INC.

1155 TERRA BELLA, MOUNTAIN VIEW, CA 94043
(415) 968-4400 • TWX 910-379-5055

State
of the art



by
K.V.G.

9 MHz CRYSTAL FILTERS

MODEL	Appli- cation	Band- width	Poles	Price
XF-9A	SSB	2.4 kHz	5	\$53.15
XF-9B	SSB	2.4 kHz	8	72.05
XF-9B-01	LSB	2.4 kHz	8	95.90
XF-9B-02	USB	2.4 kHz	8	95.90
XF-9B-10	SSB	2.4 kHz	10	125.65
XF-9C	AM	3.75 kHz	8	77.40
XF-9D	AM	5.0 kHz	8	77.40
XF-9E	FM	12.0 kHz	8	77.40
XF-9M	CW	500 Hz	4	54.10
XF-9NB	CW	500 Hz	8	95.90
XF-9P	CW	250 Hz	8	131.20
XF910	IF noise	15 kHz	2	17.15

10.7 MHz CRYSTAL FILTERS

XF107-A	NBFM	12 kHz	8	\$67.30
XF107-B	NBFM	15 kHz	8	67.30
XF107-C	WBFM	30 kHz	8	67.30
XF107-D	WBFM	36 kHz	8	67.30
XF107-E	Pix/Data	40 kHz	8	67.30
XM107-SO4	FM	14 kHz	4	30.15

Export Inquiries Invited.

Shipping \$3.75

MICROWAVE MODULES VHF & UHF EQUIPMENTS

Use your existing HF or 2M rig on other VHF or UHF bands.

LOW NOISE RECEIVE CONVERTERS

1691 MHz	MMk1691-137	\$249.95
1296 MHz GaAsFET	MMk1296-144G	149.95
432/435	MMc432-28(S)	74.95
439-ATV	MMc439-Ch x	89.95
220 MHz	MMc220-28	74.95
144 MHz	MMc144-28	59.95

Options: Low NF (2.0 dB max., 1.25 dB max.), other bands & IF's available

LINEAR TRANSVERTERS

1296 MHz	1.8 W output, 2M in	MMi1296-144-G	\$299.95
432/435	10 W output, 10M in	MMi432-28(S)	269.95
144 MHz	10 W output, 10M in	MMi144-28	179.95

Other bands & IFs available.

LINEAR POWER AMPLIFIERS

1296 MHz	20 W output	UP1296-20-L	439.95
432/435	100 W output	MML432-100	369.95
	50 W output	MML432-50	199.95
	30 W output	MML432-30-LS	209.95
144 MHz	200 W output	MML144-200-S	374.95
	100 W output	MML144-100-LS	239.95
	50 W output	MML144-50-S	149.95
	30 W output	MML144-30-LS	109.95

All models include VOX T/R switching.
"L" models 1 or 3W drive, others 10W drive.

Shipping: FOB Concord, Mass.

ANTENNAS

420-450 MHz MULTIBEAMS

28 Element	70/MBM28 12 dBd	\$79.95	\$39.95
48 Element	70/MBM48 15.7 dBd	75.75	59.95
88 Element	70/MBM88 18.5 dBd	105.50	89.95

144-148 MHz J-SLOTS

10 + 10 Twist	10XY/2M 11.3 dBd		69.95
---------------	------------------	--	-------

UHF LOOP YAGIS

1250-1350 MHz 29 loops	1296-LY 20 dB	\$49.95
1650-1750 MHz 29 loops	1691-LY 20 dB	59.95

Order Loop-Yagi connector extra.

Type N \$14.95, SMA \$5.95

Send 44¢ (2 stamps) for full details of all your VHF & UHF equipment and KVG crystal product requirements.



si

(617) 263-2145
**SPECTRUM
INTERNATIONAL, INC.**
Post Office Box 1084
Concord, MA 01742, U.S.A.

10 percent random BER, 50 times that tolerated by the AX.25 scheme even with minimal length packets.

conclusions

Although AMTOR has excellent burst error performance, its probability of falsely accepting invalid data under poor conditions (at 12.5 percent) makes it a non-competitor when systems like AX.25 and HERMES are considered.

Under good channel conditions the AX.25 packet scheme does very nicely, with good throughput and adequate robustness, but it bogs down rather rapidly once channel conditions start to degrade, since it has no capability for forward error correction.

HERMES combines, in one adaptive system, the capability to achieve very nearly the same throughput as AX.25 under ideal conditions, as well as very nearly the burst error performance of AMTOR. It allows convenient optimization and is able to tolerate a much higher rate of random channel errors than is either AMTOR or AX.25 due to HERMES's use of powerful Reed-Solomon forward error correcting codes. It represents the next step in flexible and robust digital communications.

Appendix

The probability of falsely accepting a corrupted data block (an "Undetected Bad Block") will be denoted as P_{UBB} . It can be computed as follows for an error-correcting or error-detecting algebraic block code (such as the CRC or Reed-Solomon codes.)

For an error-correcting code:

$$P_{UBB} = \frac{\binom{A-1}{E} \cdot (A-1)^E}{A^C}$$

where: A = 2^m (the code alphabet size)
 m = the number of bits per codeword symbol
($m = 8$ for AX.25 CRC, $m = 5$ for HERMES)
 $A - 1 = 2^m - 1$
 E = the number of errors being corrected by the decoder
 C = the number of check symbols in each codeword

$$\binom{A-1}{E} = \frac{(A-1)!}{E! (A-1-E)!}$$

For an error-detecting code:

$$P_{UBB} = 1/A^C$$

where: A and C are defined as above for error-correcting codes.

references

- J. P. Martinez, "AMTOR, An Improved Error-Free RTTY System," *QST*, June, 1981, page 25.
- The ARRL 1985 Handbook For The Radio Amateur, American Radio Relay League, Newington, Connecticut, 1985, Chapter 19.
- Lyle Johnson, "Join The Packet Radio Revolution," *73*, September, 1983, page 19.
- Jerome T. Dijk, W9JD, "Save Your Signal With Forward Error Correction," *73*, August, 1983, page 44.

ham radio

ROHN®

brings the top to you

ROHN brings the top to you with its patented design. For the ultimate "on the ground" service and antenna installation, a ROHN "Fold-Over" Tower is your best buy. Your safety comes first with "Fold-Over." For complete details write:

ROHN®

"FOLD-OVER" TOWERS

P.O. BOX 2000, PEORIA, IL 61656 U.S.A.
TWX: 910-652-0646 FAX: 309-697-5612

AN AMERICAN OWNED COMPANY

The Professional Meter for Amateur Radio.



The standard of the electronics industry is setting a new standard for amateur radio use as well.

The Fluke 77 multimeter is ideal for testing and repairing any amateur radio gear. It's inexpensive, easy to use, and filled with professional features. Plus a full line of accessories let you measure high frequency, high voltage and current, and temperature. Made in the U.S.A. and backed by a 3-year warranty, the new Fluke 77 is the world's first handheld meter to combine analog and digital displays.

For a free brochure or the distributor nearest you, call toll-free 1-800-227-3800, ext. 229. Or write John Fluke Mfg. Co., Inc., P.O. Box C9090, Everett, WA 98206. Distributor programs available.

FROM THE WORLD LEADER IN DIGITAL MULTIMETERS.

FLUKE 73	FLUKE 75	FLUKE 77
\$79†	\$99†	\$139†
Analog/digital display	Analog/digital display	Analog/digital display
Volts, ohms, 10A, diode test	Volts, ohms, 10A, mA, diode test	Volts, ohms, 10A, mA, diode test
Autorange	Audible continuity	Audible continuity
0.7% basic dc accuracy	Autorange/range hold	Touch-Hold™
2000+ hour battery life	0.5% basic dc accuracy	Autorange/range hold
3-year warranty	2000+ hour battery life	0.3% basic dc accuracy
	3-year warranty	2000+ hour battery life
		3-year warranty
		Multipurpose holster

† Suggested U.S. list price, effective November 1, 1985.

FLUKE®

© 1985 Fluke

199



"TUNE IN" THE WORLD OF SPECIALIZED COMMUNICATIONS!

Thousands of "Ham Radio" operators across the country are enjoying "Specialized Communications" modes. Whether it's FSTV, SSTV, FAX, OSCAR, EME, RTTY, PACKET or COMPUTERS, today's Radio Amateur is a highly skilled Communications Specialist!

Providing full, in-depth coverage of these modes is our business and we've been doing it now for over 19 years! And now we're expanding!

Iowa Residents Must Add 4% Sales Tax
4% Added To All Charge Card Orders



Now published "monthly" 10 times per year, **SPEC-COM™** readers are kept up-to-date in a world of fast moving modern technology.

Why not give us a try? Back issue samples are available for just \$2.00 ppd. (Master Article Indexes add \$1.00).

Special Six Month Trial Subscription -\$10.00. U.S./Canada/Mexico Annual Subscription \$20.00. (Foreign Subscriptions slightly higher).

SPEC-COM™

Amateur Radio Specialized Communication Journal

P.O. Box H
Lowden, Iowa 52255
(319) 944-7669 (Membership Services)

174

More Details? CHECK—OFF Page 134



FALCON
COMMUNICATIONS



Falcon Communications, Well Known For MOSFET Repeater Power Amplifiers, Also Makes A Hard Working Line Of Bipolar Power Amplifiers For Mobile/Base Use. Our 2 Meter Amplifiers Include:

Model 5121	2 Watts in = 150 out 1 Watt in = 90 out	List \$285
Model 5122	10 Watts in = 150 out 2 Watts in = 50 out	List \$275
Model 5123	30 Watts in = 150 out 10 Watts in = 90 out	List \$235

A FEW FEATURES:

- | | |
|------------------------------------|-----------------------------------|
| 1) Made in the USA | 4) Automatic COR or remote keying |
| 2) All mode (FM, SSB, CW) | 5) Built in thermal protection |
| 3) Optional plug-in receive preamp | 6) Full 1 Year warranty |

For Information On Our Complete Line See Your Local Dealer Or Call Factory Direct

P.O. Box 8979 • Newport Beach, CA 92658
(714) 760-3622

NEW Alpha Delta Model DX-A 160-80-40 METER QUARTER WAVE TWIN SLOPER ANTENNA

The Model DX-A combines the tremendous firepower of the quarter wave sloper with the wide bandwidth of a half wave dipole. Simple to install, quick to tune. Proven longhaul DX performance.

- Installs like an inverted-V dipole. One leg for 80 meters (67') and the other leg for 160/40 meters (55'). Fed with a single 50 ohm coax. SO-239 connector provided on mounting bracket.
- Configuration provides wide bandwidth on all three bands. Typically 70 kHz on 160 meters, 200 kHz on 80 meters and full band on 40 meters. Much wider than most other loaded slopers, dipoles or verticals. Tuner usually not required.
- Model DX-A also operates on 30-17-12 meters. VSWR of less than 2.5:1. Easily matched with a tuner.
- High-power operation. Rated at 1500 watts P.E.P. output. No traps to break

down. A single "ISO-RES" isolator-resonator is used in the 160/40 meter leg.

- Current lobe up high for maximum radiation and excellent DX performance. Can be installed from 25 to 40' high.
- The Model DX-A Antenna is fully assembled, uses all stainless steel hardware, a UV-protected "ISO-RES" coil, #12 copper wire and is rated for severe environments. Specially coated wire disappears from your neighbors' view.

\$49⁹⁵

Available from your local Alpha Delta Dealer or add \$4.00 shipping and handling (USA only).

ALPHA DELTA COMMUNICATIONS, INC.

P.O. Box 571 Centerville, OH 45459
(513) 435-4772 Orders • (513) 376-4180 Antenna Tech Info



current solutions to current problems

DRAKE R-4/T-4X OWNERS AVOID OBSOLESCENCE

PLUG-IN SOLID STATE TUBES!
Get state-of-the-art performance.
Most types available

**INSTALL KITS TO UPGRADE
PERFORMANCE!**

- BASIC Improvement
- Audio Bandpass Filter
- Audio IC Amplifier

TUBES \$23 PPD KITS \$25 PPD

OVERSEAS AIR \$7

SARTORI ASSOCIATES, W5DA
BOX 832085
RICHARDSON, TX 75083
214-494-3093

✓ 172

EXMET your source for Discounted Prime 6061-T6/6061-T6511 aluminum Tubing and Rod that is stronger than steel and 1/3 the weight.

TUBING		
O.D. and wall	Length	Price per Length
1/2" x .058	12 ft	\$ 12.50
7/8" x .058	12 ft	19.50
1" x .058	12 ft	21.75
1-1/4" x .058	12 ft	27.35
1-1/2" x .049	12 ft	28.80
1-1/2" x .058	12 ft	33.00
1-1/2" x .065	12 ft	38.40
1-1/2" x .083	12 ft	48.00
1-1/2" x .125	24 ft	86.40
1-1/2" x .250	24 ft	105.15
2" x .058	12 ft	42.25
2" x .065	12 ft	45.50
2" x .125	24 ft	110.40
2" x .250	24 ft	187.20
3" x .065	12 ft	81.50

ROD		
O.D.	Length	Price per Length
1/8"	12 ft	\$ 2.00
3/16"	12 ft	4.50

Volume discounts on orders over \$500.00. Other sizes of tubing and rod quoted upon request. Minimum order \$50.00 tubing, \$50.00 rod.

Policies: All prices FOB Twinsburg, Ohio. Payment is COD, or save COD charges by enclosing a check or money order with your order. Ohio residents add 5-1/2% sales tax.

Exmet, Inc. ✓ 134

2170 E. Aurora Rd., P.O. Box 117, Twinsburg, Ohio 44087
216-425-8455

Electronic Repair Center Servicing

Amateur Commercial Radio

The most complete repair facility on the East Coast.

Large parts inventory and factory authorized warranty service for Kenwood, Icom and Yaesu.

SEND US YOUR PROBLEMS

Servicing "Hams" for 30 years, no rig too old or new for us.

HAMTRONICS, INC.

4033 Brownsville Road

Treose, Pa. 19047
215-357-1400





ST-20T

a SMART Radio ... the INTELLIGENT Choice

Imagine yourself relaxing in your favorite easy chair. You have done your research, compared all the features of the new handhelds and now you have made the purchase for which you have been waiting so long. It feels good to relax knowing the decisions were made after considerable research through the magazines and data sheets for all the available models.

Comparing the ST-20T, it was obvious that the Santec simply works better... and the price was nice also. Which feature was it that really made you decide on the Santec ST-20T? Was it the two seven-digit number autodialer? Perhaps it was the ability to use all 10 memories with a different frequency, tone, and offset. Or could it have been the ease with which the ST-20T was programmed from the keyboard? Perhaps it was the honest values in construction and quality for your hard earned dollars? It could have been all of these things and more because the SANTEC ST-20T is the handheld truly worth holding.

- TWO SEVEN-DIGIT AUTO DIAL MEMORIES • ONE HAND, ONE FINGER SIMPLIFIED KEYBOARD ENTRY OF INFORMATION • 142-150.995 OPERATION FOR M.A.R.S. AND OR C.A.P. • TEN MEMORY CHANNELS FOR 10 DIFFERENT REPEATER OPERATIONS PLUS 'SCANLOCK' FOR LOCKOUT OF ANY ONE CHANNEL OR MULTIPLE CHANNELS WITHOUT REPROGRAMMING • SANTEC'S MULTIPLE MODES OF SCANNING • 3.5—5 WATTS OUTPUT • DIRECT 12 V.D.C. OPERATION • SUB-AUDIBLE TONE COMPUTER CONTROLLED • MICROPROCESSOR CONTROLLED ENCODE/DECODE OPTION AVAILABLE • TIME OF DAY QUARTZ CLOCK • ANALOG METER MOUNTED FOR BEST D.F. ING • AUTOMATIC ENTRY OF STANDARD OFFSET FOR BAND WITH EACH NEW ENTRY • ANY CTCSS TONE IN ANY MEMORY CHANNEL • SLIDE ON/OFF BATTERY PACK COMPATIBILITY
- SANTEC/ENCOMM, INC.'S TWO YEAR EXTENDED SERVICE PERIOD AT NO EXTRA COST •

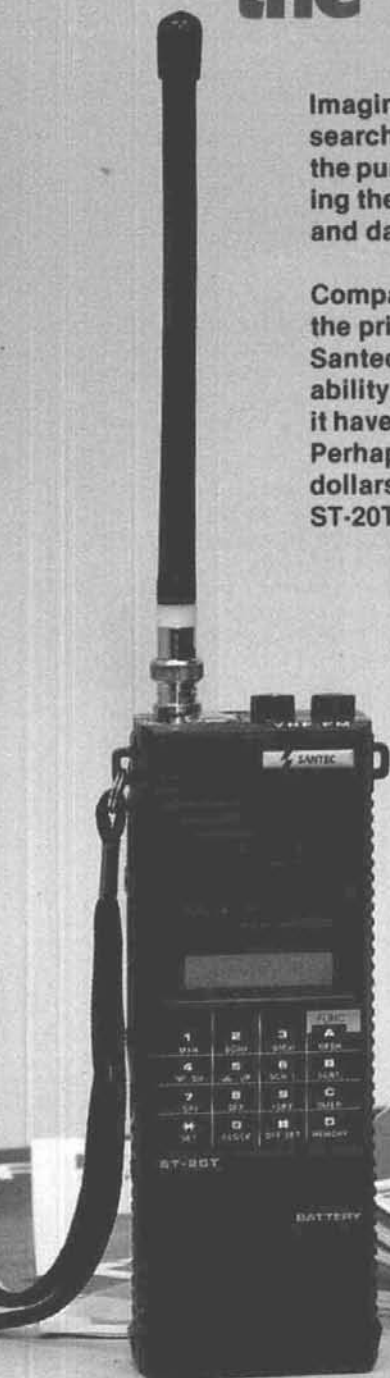

The **TITAN** final amplifier may be your final amplifier



Model 425 TITAN
Linear Power Amplifier

We have been accused of "over designing" the TITAN. And certainly, by cutting corners, it could be built at lower cost. But we think, in the long run, it will be an investment in reliability, flexibility, and the pure enjoyment of a permanent addition to your station — long after the price is forgotten.

Every component is chosen to work well below its rating. The power transformer is our own, using a Hypersil® tape wound core, generously designed for excellent regulation. Capacitors and inductors are also made in-house for close quality control.

The TITAN uses two 3CX800 tubes that will loaf along at 1,500 watts output. And, as they require lower plate voltage than older tubes, insulation breakdown is less likely.

We think we have included present and future needs. Things such as full break-in and operation on 160 meters and all authorized bands. A separate power supply makes

station layout easy for most convenient operating. And if you use AMTOR, SSTV or RTTY, there is no problem with continuous operation.

The TITAN could easily be your final FINAL AMPLIFIER.

See your dealer or write

TEN-TEC, INC.
SEVIERVILLE, TENNESSEE 37862

*Commercial version available

CASE HISTORY !

For 2AT/3AT/4AT w/standard batt.

from **delta zulu**

\$24.95

free U.S. shipping
made in U.S.A.
90 day limited warranty



C.O.D. \$2

See through keypad window and instant access to all switches front, top, back plus unique zippered battery door. Fits with or w/o ICOM clip. Looks, feels and fits great. Black or burgundy tailored vinyl. Call (617) 599-3090.

Crowley Mfg. Co. 95 Federal St. Lynn MA 01905

✓ 195

"HAM HOTLINE" THE PROVEN MONEYMAKER

The "Ham Hotline" is a complete mailing list of novice amateur radio operators and current hams who have renewed, upgraded or modified their FCC licenses. These ham enthusiasts have proven to be excellent prospects for radio equipment, accessories and publications.

The Hotline is **UPDATED EVERY TWO WEEKS** with an average of 8,000 names and addresses each month. And, because we know the Hotline is the most up-to-date amateur radio listing available, we'll guarantee 98% deliverability.

Target your sales efforts to your most likely buyers. Call DCC Data Service today and begin your subscription to the "Ham Hotline" . . . the proven moneymaker.

DCC Data Service ✓ 196

1990 M Street, N.W. Suite 610
Washington, D.C. 20036

Toll-free 1-800-431-2577

In DC & AK 202-452-1419

\$100 CASH BACK
WITH PURCHASE OF A
TITAN BEGINNING
NOVEMBER 1.

COMPACT 75 M SSB TRANSCEIVER



Dimensions 2" x 6" x 6"

RECEIVER:

Frequency 3.8-4.0 MHz
Sensitivity 0.5 µV for 10 dB S/N
Selectivity -6 dB @ 2.4 KHz
AGC Range +60 dB in = +3 dB out
Audio Output >350 mW into 8 ohms

TRANSMITTER:

Frequency 3.8-4.0 MHz
Output 30 watts into 50 ohms
IMD -30 dB
Harmonics 2nd -47 dB, 3rd -55 dB
SWR Immunity 30:1 @ all phase angles
ALC Amplified, fast response rate (quasi-processing)

Complete Kit

\$199.95

plus \$3.00
shipping and
handling

✓ 166

POWER REQUIREMENTS:

Voltage 28 Vdc regulated
Current 2A transmit, 65 mA receive

1985-86
CATALOG
50¢



RADIO KIT
BOX 411H
Greenville, NH
03048
(603) 878-1033
telex 887697

SPS
DIST.

'TI'
FINDER +



Complete Line of
Satellite Receiving Systems

SPS

San Pierre, IN

(219) 828-7255 — 828-3091 ✓ 171

tracking the hideous intermittent — part 2: thermal intermittents

In Part 1 of this two-part series we dealt with the problem of troubleshooting mechanical intermittents. In Part 2 we'll discuss thermal intermittents and their solution.

Both heat and cold can affect a piece of electronic equipment for the worse; in its most blatant form, the set refuses to operate properly under either hot or cold conditions. During the winter Amateur mobile equipment is subjected to the local overnight temperature, which may be as low as 40 degrees below zero in some areas. During the summer, on the other hand, mobile equipment will be subjected to temperatures considerably above local air temperatures. In 1963, when a major automobile electronics company began experiencing reliability problems with its new solid-state models, it asked employees to leave their cars unlocked so that the engineers could measure the cabin temperatures. After four hours in 90-degree sunlight, the interior temperatures were found to be 140 degrees at the front seat and up to 180 degrees behind the dashboard!

These extremes of temperature can result in some peculiar intermittents.

One familiar form is the set that won't work when you get into the car, but will work ten minutes after the heater or air conditioner has altered the cabin temperature.

Equipment used at the home or base station doesn't suffer the extremes of ambient temperature, but nonetheless may experience temperature-related intermittents. Typically, a set will either fail to work at all until it heats up, or will work nicely until it reaches a certain temperature and then fail. Even when an intermittent isn't specifically related to temperature, it's frequently true that changes in temperature will

aggravate the situation, thereby allowing you to find it more easily.

when the problem is heat

First, let's talk about how to heat up a set. Use a high-wattage lamp, sun lamp or hair dryer for general area heating to determine that the fault is temperature sensitive, rather than mechanical in origin. In a piece of equipment containing general power devices (or vacuum tubes), we can often heat up the circuits just by placing a box, towel, or blanket over the unit. This method is particularly useful for thermal faults that occur only in the cabinet. The thermal fault will continue for a few minutes after the box, towel, or blanket is removed, allowing time for troubleshooting.

Although area heating will give you the time needed to troubleshoot a fault, it won't help you find a specific thermally sensitive component. For this chore we must use local area heating. Several methods are available. A small high-intensity lamp, for example, will allow heating of a small area on a PCB. A soldering iron or gun will concentrate heat on an even smaller area almost to the exact component. (Be careful, — the hot tip of the soldering tool can damage some components, especially polyethylene capacitors.)

Another method used for heating individual components is shown in fig. 1. In this approach, the heat source is a 6 or 12-volt incandescent lamp. A No. 47 or No. 1891, for example. A small cylinder made of some material such as insulated sleeving ("spa-

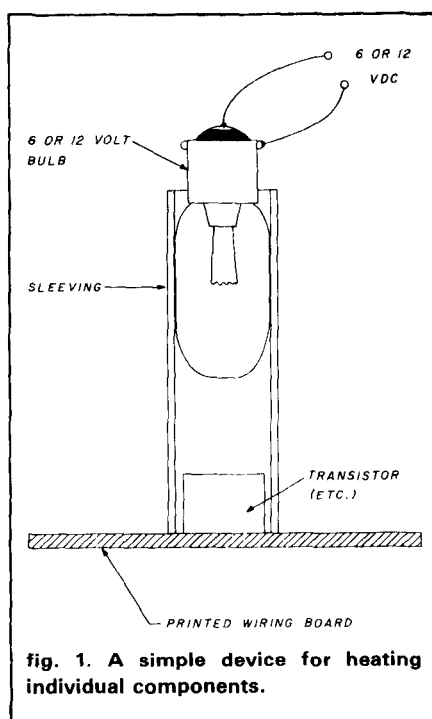

fig. 1. A simple device for heating individual components.

THE MOST AFFORDABLE REPEATER

ALSO HAS THE MOST IMPRESSIVE PERFORMANCE FEATURES

(AND GIVES THEM TO YOU AS STANDARD EQUIPMENT!)

Band	Kit	Wired
10M,6M, 2M,220	\$680	\$880
440	\$780	\$980



FEATURES:

- SENSITIVITY SECOND TO NONE; 0.15 uV (VHF), 0.2 uV (UHF) TYP.
- SELECTIVITY THAT CAN'T BE BEAT! BOTH 8 POLE XTAL FILTER & CERAMIC FILTER FOR > 100dB AT ± 12KHZ. HELICAL RESONATOR FRONT ENDS TO FIGHT DESENSE & INTERMOD.
- OTHER GREAT RECEIVER FEATURES: FLUTTER-PROOF SQUELCH, AFC TO COMPENSATE FOR OFF-FREQ TRANSMITTERS, SEPARATE LOCAL SPEAKER AMPLIFIER & CONTROL.
- CLEAN, EASY TUNE TRANSMITTER; UP TO 20 WATTS OUT (UP TO 50W WITH OPTIONAL PA).

HIGH QUALITY XMTR & RCVR MODULES FOR REPEATERS, LINKS, TELEMTRY, ETC.

- **R144/R220 FM RCVRs** for 2M or 220 MHz. 0.15uV sens., 8 pole xtal filter & ceramic filter in i-f, helical resonator front end for exceptional selectivity, > 100dB at ± 12kHz, best available today. Flutter-proof squelch. AFC tracks drifting xmtrs. Xtal oven avail. Kit only \$138.
- **R451 FM RCVR** Same but for uhf. Tuned line front end, 0.3 uV sens. Kit only \$138.
- **R76 FM RCVR** for 10M, 6M, 2M, or 220. As above, but w/o AFC or hel. res. Kits only \$118. Also avail w/4 pole filter, only \$98/kit.
- **R110 VHF AM RECEIVER** kit for VHF aircraft or ham bands or Space Shuttle. Only \$98.
- **T51 VHF FM EXCITER** for 10M, 6M, 2M, or 220 MHz. 2 Watts continuous, up to 3W intermittent. \$68/kit.
- **T451 UHF FM EXCITER** 2 to 3 Watts. Kit only \$78. Xtal oven avail.
- **VHF & UHF LINEAR AMPLIFIERS.** For either FM or SSB. Power levels from 10 to 45 Watts to go with exciters & xmtg converters. Several models. Kits from \$78.

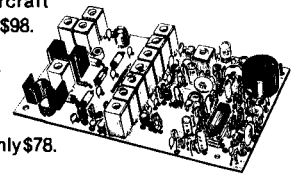
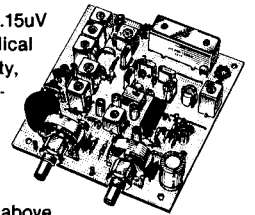

NOW—FCC TYPE-ACCEPTED TRANSMITTERS & RECEIVERS AVAILABLE FOR HIGH-BAND & UHF. CALL FOR DETAILS.

RECEIVING CONVERTERS

Models to cover every practical rf & if range to listen to SSB, FM, ATV, etc. NF = 2dB or less.

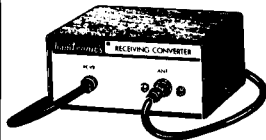

Antenna Input Range	Receiver Output
28-32	144-148
50-52	28-30
50-54	144-148
144-146	28-30
145-147	28-30
144-144.4	27-27.4
146-148	28-30
144-148	50-54
220-222	28-30
220-224	144-148
222-226	144-148
220-224	50-54
222-224	28-30

VHF MODELS

Kit with Case	\$49
Less Case	\$39
Wired	\$69

UHF MODELS

Kit with Case	\$59	432-434	28-30
Less Case	\$49	435-437	28-30
Wired	\$75	432-436	144-148
		432-436	50-54
		439.25	61.25

SCANNER CONVERTERS Copy 806MHz band on any scanner. Wired/tested ONLY \$88.

TRANSMIT CONVERTERS

For SSB, CW, ATV, FM, etc. Why pay big bucks for a multi mode rig for each band? Can be linked with receive converters for transceive. 2 Watts output vhf, 1 Watt uhf.

For VHF,
Model XV2
Kit \$79
Wired \$149
(Specify band)

Exciter Input Range	Antenna Output
28-30	144-146
28-29	145-146
28-30	50-52
27-27.4	144-144.4
28-30	220-222*
50-54	220-224
144-146	50-52
50-54	144-148
144-146	28-30

For UHF,
Model XV4
Kit \$99
Wired \$169

28-30	432-434
28-30	435-437
50-54	432-436
61.25	439.25
144-148	432-436*

*Add \$20 for 2M Input

VHF & UHF LINEAR AMPLIFIERS. Use with above. Power levels from 10 to 45 Watts. Several models, kits from \$78.

LOW-NOISE PREAMPS

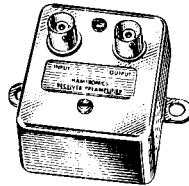

Hamtronics Breaks the Price Barrier!

*
No Need to Pay \$80 to \$125 for a GaAs FET Preamp.

FEATURES:

- Very Low Noise: 0.7 dB VHF, 0.8 dB UHF
- High Gain: 18 to 28 dB, Depending on Freq.
- Wide Dynamic Range for Overload Resistance
- Latest Dual-gate GaAs FET, Very Stable

MODEL	TUNES RANGE	PRICE
LNG-28	26-30 MHz	\$49
LNG-50	46-56 MHz	\$49
LNG-144	137-150 MHz	\$49
LNG-160	150-172 MHz	\$49
LNG-220	210-230 MHz	\$49
LNG-432	400-470 MHz	\$49
LNG-800	800-960 MHz	\$49

HELICAL RESONATOR PREAMPS

Low-noise preamps with helical resonators reduce intermod and cross-band interference in critical applications. 12 dB gain.

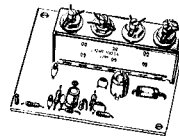

Model	Tuning Range	Price
HRA-144	143-150 MHz	\$49
HRA-220	213-233 MHz	\$49
HRA-432	420-450 MHz	\$59
HRA-()	150-174 MHz	\$54
HRA-()	450-470 MHz	\$64

ACCESSORIES

- **MO-202 FSK DATA MODULATOR.** Run up to 1200 baud digital or packet radio signals through any FM transmitter. Automatically keys transmitter and provides handshakes. 1200/2200 Hz tones. Kit only \$45.
- **DE-202 FSK DATA DEMODULATOR.** Use with any FM receiver to detect packet radio or other digital data in "202" modem format. Provides audio conditioning and handshakes. Kit only \$38.
- **COR-2 KIT** With audio mixer, local speaker amplifier, tail & time-out timers. Only \$38.
- **COR-3 KIT** as above, but with "courtesy beep". Only \$58.
- **CWID KITS** 158 bits, easily field programmable, clean audio. Kit only \$68.
- **A16 RF TIGHT BOX** Deep drawn alum. case with tight cover and no seams. 7 x 8 x 2 inches. Designed especially for repeaters. \$20.
- **DTMF DECODER/CONTROLLER KITS.** Control 2 separate on/off functions with touchtones®, e.g., repeater and autopatch. Use with main or aux. receiver or with Autopatch. Only \$90
- **AUTOPATCH KITS.** Provide repeater autopatch, reverse patch, phone line remote control of repeater, secondary control via repeater receiver. Many other features. Only \$90. Requires DTMF Module.
- **SIMPLEX AUTOPATCH.** Use with your FM transceiver. System includes DTMF & Autopatch modules above and new Timing module to provide simplex autopatch and reverse autopatch. Complete patch system only \$200/kit. Call or write for details.

• SEND \$1.00 for 40 page CATALOG

(Send \$2.00 or 4 IRC's for overseas mailing)

• Order by phone or mail • Add \$3 S & H per order

(Electronic answering service evenings & weekends)

• Use VISA, MASTERCARD, Check, or UPS COD.

hamtronics, inc.

65-E MOUL ROAD • HILTON NY 14468

Phone: 716-392-9430

Hamtronics® is a registered trademark

ghetti") is designed to fit over components such as transistors and some integrated circuits. The heat source is placed in the open end, thereby concentrating the heat only on the component under suspicion. The tale will be told in about 30 seconds.

The indication that the component being tested is bad will be obvious. There will be a sudden change of operation, or a sudden increase in the noise produced by the circuit — the change is only rarely subtle.

2-meter FM ham rigs, by the way). In most cases, 30 to 60 minutes in the refrigerator yields 5 to 10 minutes of troubleshooting time.

Local cooling is necessary for isolating components. Use a can of freon "freeze spray" as shown in **fig. 2**. (Electronic supply stores sell this product under several different brand names. The stores most likely to carry freeze spray are those whose clientele includes radio/TV/audio repair shops.)

Be careful not to spray too wide an

this case, however, we replace components on a "scattergun" basis. (*I can hear the howls from here! I admit it's not very elegant, and provides no balm at all to save the ego of the technical genius. After all, any dumb grunt can unsolder a half dozen components and replace them. . . .* But let's consider some *facts of life*.)

I once worked in a hospital electronics laboratory that repaired clinical equipment. The emphasis was on low-cost, rapid repairs. One famous brand-name patient monitor used vintage circuitry. The ECG preamplifier and the DC power supply regulator used literally dozens of 2N3393, 2N3906, and 2N3904 plastic small-signal transistors. These transistors were typically connected six to eight at a time in circuits with multiple feedback and signal paths, all direct coupled. (Troubleshooting in circuits like this is a *dog*.) At that time, those transistors cost us \$25 per hundred in bulk-packed bags. It takes 15 minutes to replace eight small transistors that cost \$2 *total*. A total of 30 minutes put the equipment back on line.

The situation is only a little different for you. The biggest difference is that *you* buy transistors in overpriced blister packs rather than lots of a hundred; that's the price paid for buying onesie-twosies. Nevertheless, when the troubleshooting problem seems intractable, shotgunning components is a practical alternative!

You can be almost as efficient by removing components one at a time and testing each one as you go. If you find the faulty components, then it's a reasonable bet that the job is done. Unfortunately, the nature of intermittents — and Murphy's law — means that this form of troubleshooting frequently fails.

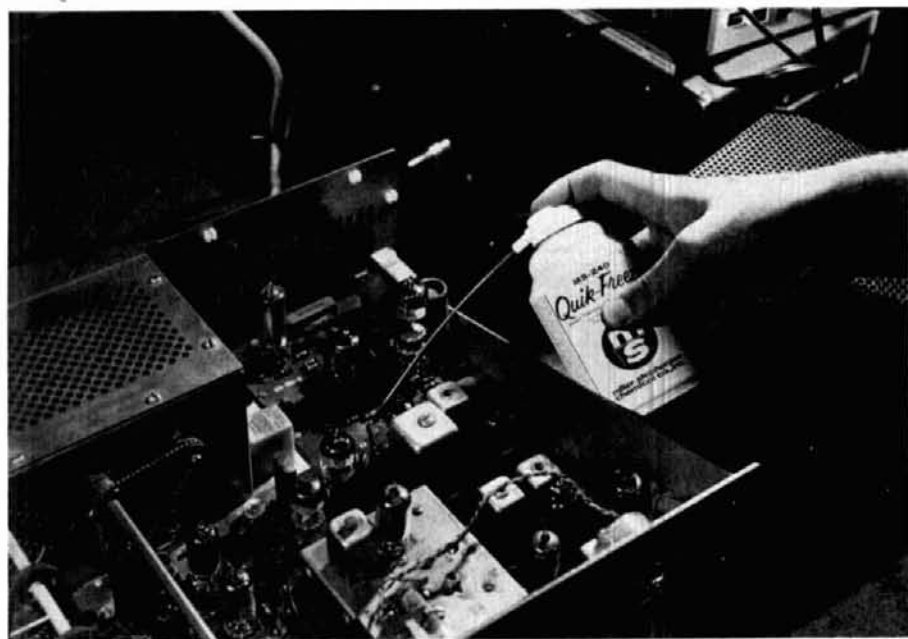

fig. 2. Freeze spray will cool off components.

when the problem is cold

"Cold" can mean anything from room temperature to arctic temperatures. When equipment fails to operate in this range, area cooling is in order.

Area cooling is more difficult, in some cases, than area heating. Try putting small devices (up to, say, the size of a mobile transceiver) in the refrigerator for about an hour. I still fondly recall the looks on the faces of shocked boat radio customers when I placed their "won't work on cold days" VHF-FM transceivers in the shop refrigerator. (Many of those rigs are merely overpriced variants of

area. Freeze spray is expensive and general area cooling won't help you find the bad components anyway. Use the spray only on individual components or small groups of components.

You can verify identification of the bad component by reheating it with soldering iron or the gizmo shown in **fig. 1**.

If the problem repeatedly appears and disappears on heating/cooling cycles, then you've found the source of the problem. Even if the problem isn't consistently repeatable, however, we can "work the odds" and replace the component "on speculation."

Our final method for fixing intermittents is another shotgun approach. In

have a question for Joe Carr?

Send your question to Joe Carr, *ham radio*, Greenville, New Hampshire 03048. While not every letter can be answered personally, he will try to answer as many as possible in this column. — Ed.

ham radio

26th Annual

TROPICAL HAMBOREE

FEBRUARY 8-9, 1986



EDWARDS BUILDING, ARNOLD BUILDING AND COLISEUM
DADE COUNTY YOUTH FAIR GROUNDS

TAMIAMI PARK, MIAMI, FLORIDA

- FREE PARKING 15,000 VEHICLES
- 1000 INDOOR SWAP TABLES W/POWER
- AMATEUR RADIO & ARRL PROGRAMS
- LICENSE EXAMS
- QCWA HOSPITALITY CORNER
- CONSUMER ELECTRONIC DISPLAYS
- SATELLITE DISH GARDEN
- HAMBOREE DEALER SPECIALS
- 300 RV SPACES WITH FULL HOOKUPS
- 200 COMMERCIAL EXHIBIT BOOTHS
- DX FORUM & DINNER
- PACKET RADIO DEMONSTRATION
- RCA FL. SECTION LUNCHEON
- COMPUTERS AND SOFTWARE
- 2 DAYS OF PROGRAMS FOR NON-HAMS
- TRAFFIC HANDLERS BREAKFAST

Registration: \$5.00 Advance . . . \$6.00 Door (Valid Both Days)
 Swap Tables, 2 Days: \$16.00 Each, Includes Power, Plus Registration Ticket
 RV Parking: \$10.00 Per Day, Includes Water, Power, & Sanitary Hook-ups
 Hotel Reservation Cards for Special Rates Available - Dec. 1st
 (Advance Price Deadline on Registration Tickets, January 20th)

MAKE CHECKS PAYABLE TO: DADE RADIO CLUB, INC., P.O. BOX 350045, MIAMI, FL 33135

4 PAGE BROCHURE AVAILABLE — DEC. 1st.

Exhibit Booth Information: Evelyn D. Gauzens, W4WYR, Chairman
2780 N.W. 3 Street, Miami, FL 33125

Telephone:
305-642-4139

Now You Can Receive The Weak Signals With The

ALL NEW PREAMPLIFIER



Model PT-2 is a continuous tuning 6-160 meter Pre-Amp and master power station control. It is specifically designed for use with a transceiver. The PT-2 contains new sophisticated control circuitry that permits it to be added to virtually any transceiver with No modification. No serious ham can be without one. Other features include: *Improves sensitivity and signal-to-noise ratio. *Boosts signal up to 26 db. *For AM or SSB. *Bypasses itself automatically when the transceiver is transmitting. *FET amplifier gives superior

cross modulation protection. *Advanced solidstate circuitry. *Simple to install. *Improves immunity to transceiver front-end overload by use of its built-in-attenuator. *Provides master power control for station equipment.

Model PT-2117 V. 60 Hz.\$94.95 ✓ 114
 Model PT-2E220-240 V., 50-60 Hz.\$99.95

AMECO EQUIPMENT CO.

220 East Jericho Turnpike, Mineola, New York 11501
516-741-5030

This publication is available in microform from University Microfilms International.



Please send information about these titles:

Name _____

Company/Institution _____

Address _____

City _____

State _____ Zip _____

Phone () _____

Call toll-free 800-521-3044. In Michigan,
 Alaska and Hawaii call collect 313-761-4700. Or
 mail inquiry to: University Microfilms International,
 300 North Zeeb Road, Ann Arbor, MI 48106.

New

New

THE STANDARD OF EXCELLENCE

Definitely Superior!

AZDEN PCS-5000

COMMERCIAL — GRADE



UNPRECEDENTED WIDE FREQUENCY RANGE: Covers 140,000-153,000 MHz in steps that can be set to any multiple of 5 kHz up to 50 kHz.

CAP/MARS/NAVY MARS, BUILT IN: The wide frequency range facilitates use of CAP and ALL MARS FREQUENCIES including NAVY MARS. **COMPARE!**

TINY SIZE: Only 2 inches high, 5 1/2 inches wide and 7 1/4 inches deep!

MICROCOMPUTER CONTROL: Gives you the most advanced-operating features available.

UP TO 11 NONSTANDARD SPLITS: **COMPARE** this with other units!

20 CHANNELS OF MEMORY IN TWO SEPARATE BANKS: Retains frequency, offset information, PL tone frequency.

DUAL MEMORY SCAN: Scan memory banks separately or together. **ALL** memory channels are tunable independently. **COMPARE!**

MEMORY SCAN LOCKOUT: Allows you to skip over channels you don't want to scan.

TWO RANGES OF PROGRAMMABLE BAND SCANNING: Limits are quickly reset. Scan ranges separately or together with independently selective steps in each range. **COMPARE!**

BUSY SCAN AND DELAY SCAN: Busy scan stops on an occupied channel. Delay scan provides automatic auto-resume.

DISCRIMINATOR CENTERING (AZDEN EXCLUSIVE PATENT): Always stops on frequency desired when scanning.

PRIORITY MEMORY AND ALERT: Unit constantly monitors one memory channel for signals, alerting you when channel is occupied.

LITHIUM BATTERY BACKUP: Memory information can be stored for up to 5 years even if power is removed.

FREQUENCY REVERSE: Allows you to listen to repeater input frequency.

ILLUMINATED KEYBOARD WITH ACQUISITION TONE: Keys are easily seen in the dark, and actuation is positively verified audibly. **CRISP, BACKLIGHTED LCD DISPLAY:** Easily read no matter what the lighting conditions!

DIGITAL S/R/METER: Shows incoming signal strength and relative transmitter power.

MULTI-FUNCTION INDICATOR: Shows a variety of operating parameters on the display.

FULL 16-KEY TOUCHTONE PAD: Keyboard functions as auto-patch when transmitting.

MICROPHONE CONTROLS: Up/down frequency control and priority channel recall.

PL TONE GENERATOR BUILT IN: Instantly program any of the standard PL frequencies into the microcomputer. **COMPARE!**

TRUE FM, NOT PHASE MODULATION: Unsurpassed intelligibility and audio fidelity. **COMPARE!**

HIGH/LOW POWER: Select 25 watts or 5 watts output — fully adjustable.

SUPERIOR RECEIVER: Sensitivity is better than 0.15 microvolt for 20-db quieting. Commercial-grade design assures optimum dynamic range and noise suppression. **COMPARE!**

DIRECT FREQUENCY ENTRY: Streamlines channel selection and programming.

OTHER FEATURES: Rugged dynamic microphone, built-in speaker, mobile mounting bracket, remote speaker jack, and all cords, plugs, fuses and hardware are included.

EXCLUSIVE DISTRIBUTOR: DEALER INQUIRIES INVITED FOR YOUR NEAREST DEALER OR TO ORDER

AMATEUR-WHOLESALE ELECTRONICS TOLL FREE...800-327-3102

8817 S.W. 129th Terrace, Miami, Florida 33176 Telephone (305) 233-3631 Telex: 80-3356

MANUFACTURER:

JAPAN PIEZO CO., LTD.

1-12-17 Kamirenjaku, Mitaka, Tokyo, 181 Japan



Telex: 781-2822452

✓ 113

ICOM R71-751-R7000* COMPUTER INTERFACE



MEC 71α



MICROCOMPUTER ELECTRONICS CORPORATION NOW OFFERS THE M.E.C. 71α COMPUTER CONTROL INTERFACE THAT WILL CONTROL AND EXPAND THE CAPABILITY OF THE ICOM R71A.



MAIN MENU Control center for entire system. Showing: 24HR UTC time; radio freq. & mode; memory CH, freq, mode plus ID functions for your selection.



32 CH RADIO MEMORY Showing freq to 10 Hz, mode, filter w/n. Load/change any memory, mode, filter direct from keyboard and print command.

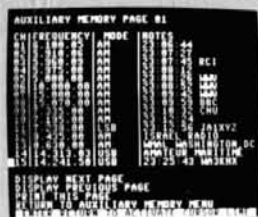

AUXILIARY MEMORY Showing page 1 of 47 pages each having 15 memories. Freq, mode, UTC time and room for your notes. Auto log feature allows instant logging of receiver freq, mode, time.

- **Easy to use.** No computer knowledge needed, automatic program loading. No disk or tape required (except for aux memory storage).
- **Menu driven** to aid user at each step.
- **No radio modification necessary** (ICOM EX309 — not supplied — required).
- **AUTO LOG** Allows logging of radio freq, mode and time by press of a key.
- **UNLIMITED STORAGE** via computer disk or tape (store 705 CH per disk side). Let your imagination run wild.
- **Software update.** As new software is developed MEC will make it available to owner subscribers.

- **HARD COPY** via computer printer of all memory channels.
- **KEYBOARD** memory loading.

Price to be announced - CALL. Available Fall 85. Dealer inquiries invited.

EEB is the exclusive distributor for Microcomputer Electronics Corp.'s product worldwide. Address all inquiries to EEB.

EEB is an authorized ICOM dealer and service center. Buy with confidence.

GET ALL THE DETAILS. WRITE OR CALL EEB TODAY



- Prices & specs subject to change
- Shipping charges not included
- Returns subject to 20% restock charge
- Free catalog in USA; all others 3 IRC's

ORDER TOLL FREE 800-368-3270
Tech Info — VA orders 703-938-3350

ELECTRONIC EQUIPMENT BANK
516 Mill Street NE
Vienna, VA 22180 USA



CURLYCODE

• **Exciting NEW learning experience** lets the code RHYTHM build "unforgettable" shapes in your mind's eye. Sounds ADD to the shape you already SEE; so never change your mind about them! Shapes ARE the characters; write them!

• **BEGINNERS:** no "study" because: Only EIGHT shapes give you HALF of EVERYTHING and nearly ALL the LETTERS. Know EVERYTHING: only 2 more endings each!

• **EXPERTS:** break your "learning plateau" by letting shapes form at "any" speed.

• **CLUBS:** 20% discount on 10 or more sets.

• **PRICE:** Complete set (Manual, Wall chart, Pocket card, Beginner's chart): \$11.50
Manual alone (no discount): \$6.50

MINDS
eye

Minds Eye Publications, Dept. H10
P.O. Box 1310, McLean, VA 22101

✓ 200

SAVE SAVE
SAVE SAVE

1983-84
ARRL

AMATEUR RADIO
CALL DIRECTORY

WAS \$15.75

NOW \$4.95

SAVE \$10.80



Please add \$3.50 to cover shipping and handling



Ham Radio's Bookstore
GREENVILLE, NH 03048

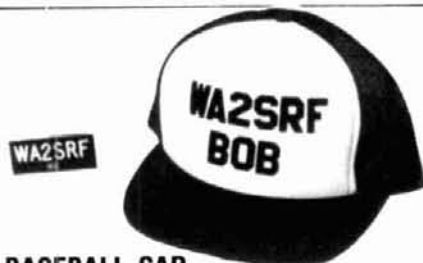

BASEBALL CAP

How about an attractive **BASEBALL** style cap that has name and call on it. It gives a jaunty air when worn at Hamfests and it is a great help for friends who have never met to spot names and calls for easy recognition. Great for birthdays, anniversaries, special days, whatever occasion. Hats come in the following colors: **GOLD, BLUE, RED, KELLY GREEN.** Please send call and name (maximum 6 letters per line).

☐ UFBC-81

\$6.00

I.D. BADGES

No ham should be without an I.D. badge. It's just the thing for club meetings, conventions, and get-togethers, and you have a wide choice of colors. Have your name and call engraved in either standard or script type on one of these plastic laminated I.D. badges. Available in the following color combinations (badge/lettering): white/red, woodgrain/white, blue/white, white/black, yellow/blue, red/white, green/white, metallic gold/black, metallic silver/black.

☐ UID Engraved I.D. Badge \$2.50

Please Enclose \$2.00 to cover shipping and handling

ham
radio

BOOKSTORE
GREENVILLE, NH 03048

SIMPLEX / DUPLEX AUTOPATCH

NOVAX I

PRICE \$59.95

NOVAX II

IT'S NOT JUST ANOTHER
AUTOPATCH

NOVAX
MOBILE CONNECTION

YOUR OWN PRIVATE AUTOPATCH

NOVAX interfaces your standard 2 meter, 220, 450, etc. base station and telephone, using a high speed scan switching technique so that you can make and receive calls automatically from your automobile or with your HT. Easy installation. Use it as half duplex, using two transceivers, interface HF or other audio sources, remote switch, emergency alert etc. etc.

FEATURES	NOVAX I	NOVAX II
• 3 min. Call duration timer	YES	YES
• Up to 45 sec. activity timer	YES	YES
• Single digit Access Control	YES	NO
• DTMF (Touch-Tone) phone connection	YES	YES
• 4 digit Access Control (programmable)	NO	YES
• Tilt Restraint	NO	YES
• LED Digital Display	NO	YES
• Vinyl operated alarm, auto scan	5" x 8" x 2"	10" x 8" x 1 1/2"
• Directly interfaces with Radios	NO	YES
• Rotary Dial System (with optional feature)	NO	YES (Optional - \$39.95)
• Ring Back (remote autopatch)	YES	YES
• Price	\$59.95 (incl. shipping and handling)	\$69.95 (incl. shipping and handling)

N.Y.S. Res. add approx. Sales Tax

To order, send check or money order to: NOVAX CORPORATION, P.O. Box 504, Westborough, N.Y. 13291, or phone 315-723-3716

VHF/UHF WORLD

Joe Reiser
W1JR

Old Wives' tales and trivia

It's hard to believe that two years have passed since my first column appeared in *ham radio*.

Before I accepted K2RR's invitation, I spent much time trying to determine what kind of information would be required and how it should be organized. I knew that the material would have to be interesting, informative, easily understood, technically correct, and presented in proper sequence.

The selection of general topics was easier. After all, I knew that antennas, receivers, transmitters, propagation, and test equipment were invariably favorite subjects of conversation whenever Amateurs got together. So I narrowed these general topics down to a list of specific technical subjects I thought most VHF/UHFers and HFers would find useful and then tried to arrange them — in building block fashion — in such a manner that all the basics would eventually fall into place. This may explain why I didn't jump into highly technical subjects — such as microwaves — right away.

Finally, I drew on my vast file of letters, both those answered and those I hadn't had time to answer. These clearly identified both the subjects of greatest interest and those subjects that Amateurs find most confusing. This immediately flagged specific items within the more general list of topics that needed special attention. Some letter writers, of course, asked for articles about microwaves. They had to wait, since microwaves wouldn't be easy to discuss without a base to draw on.

Finally, the list of actual column

topics and their tentative scheduling was complete. You've seen the result; in future columns, I'll try to cover new subjects, expand on subjects already covered, and explore further up into the microwave spectrum.

In the meantime, if you're following this series and can spare a few minutes, I need a favor: please drop me a note telling me what you liked and disliked about this column so far. Be frank. If I did a botch job on any subject, left you hanging on some item or left out a major point, let me know so I can try to correct the situation in a future column. I'll draw heavily on the letters for future topics.

Of course, as I've stated before, I can't possibly cover everything, nor can I answer all letters received. Just like you, I have only 24 hours in a day and a family that needs at least some of my time. After all, this is supposed to be a hobby!

So let's take a break from the usual format and see how sharp you are. *This will be your final exam on the first 23 installments and associated references listed therein.* With the help of some of my VHF/UHF friends and lots of letters to draw from, I've put together some trivia, some facts, some fallacies, and a few old wives tales. I hope they'll be fun to discuss and at the same time provide informative answers.

antennas

Let's start with everyone's favorite subject — antennas — and see what kind of old wives tales, etc., we hear. *Keep score, and no open books!*

1. "If your antenna stayed up last winter it wasn't big enough." This

is an original quote from one of the greatest VHF/UHFers ever, Sam Harris, ex W1FZJ, W1BU, KP4DJN, etc.

This statement is obviously not true. Maybe you live in Southern California. Or maybe you had a mild winter. Even better yet, maybe you built a big antenna but engineered the mechanics properly. It's nearly impossible to anticipate everything. How can any antenna survive a hurricane with winds exceeding 100 mph (161 kmph)? And how can you prevent your neighbor's tree from falling on and snapping your guy wires?

Tom, K8MMM, put it quite humorously in a recent letter: "If an outlandishly super-huge spectacle of an antenna doesn't stay up through *anything* nature has to afford for a particular area, it was too big, amateurishly conceived, and when down, due to all of the above — its owner is one of the least-heard-from and weakest things on the face of the earth!"

All things being equal, you can design a good antenna system with adequate gain if you follow the rules given in references 1, 2, and 3. Reference 4 discusses mechanical considerations and tubing strengths. *Do* build your antennas large enough, but not too large, and do so only with adequate mechanical strength!

2. "Always put your antenna as high as possible to get the best DX." This statement is basically true. However, there is a law of diminishing returns. First, if you're fortunate enough to be situated on a hilltop and have no obstructions, there's little to be gained by going up over 3 to 5 wavelengths. There's a problem if your

takeoff angle gets too low, especially when using F2, aurora, and sporadic-E propagation. At five wavelengths' height the takeoff angle will be about 3 degrees. Both EI2W and VE1ASJ found that often the optimum F2 signals come in with the antenna tilted upward several degrees! Ten wavelengths high is a real waste of time. If you do put up a large antenna on a high tower, it just may be large enough to meet the requirements spelled out by K8MMM.

Furthermore, especially on the UHF and microwave bands, the feedline loss can be horrendous.⁵ Depending on frequency, going up an additional 50 feet (15 meters) may increase the effective gain by 1 dB while incurring another 2 dB feedline loss, an overall net loss of 2dB in station performance.⁶ For VHF/UHF'ers I offer the following rule: *go high enough to clear local obstructions and STAY THERE. This is probably high enough!*

3. "Collinears are preferred over Yagis because they have broader bandwidth and larger capture area." This is truly a fallacy. While the bandwidth of a collinear antenna may be greater than a Yagi's, the matching method is often the limiting factor.¹ Also, what good is bandwidth when most VHF/UHFers never stray more than 50-100 kHz from the calling frequencies?⁶

As for capture area, this is a frequently misunderstood concept that was discussed in depth in reference 3. Capture area is directly related to gain regardless of the physical configuration of the antenna. Note that the capture area of a Yagi is usually much greater than its width and height, while with a parabolic dish it's the reverse, typically only 55 to 60 percent of the area of the dish.³

As discussed in reference 1, the choice of a collinear is primarily one of cost versus physical area. The collinear is usually a low-cost antenna, but takes up lots of area. The Yagi, while more critical to design, has less physical area and allows multiple antennas even on different bands on the same

mast. The bandwidth doesn't usually enter into the final decision at all.

4. "Always stack Yagis two-thirds of the boomlength apart." Under certain conditions, typically with intermediate (2 to 3 wavelengths) Yagis, this may be true. However, for the vast majority of designs in use, and particularly the long Yagis, this would be a gross error.

This two-thirds boomlength rule was a common misconception when the effects of capture area were poorly understood. Stacking antennas too closely results in low gain, while stacking too far apart (especially with Yagis), gives high sidelobes and a beamwidth so narrow as to make aiming the antenna³ properly very difficult. Check the beamwidth.² Then consult the charts in reference 3 and stack those antennas accordingly.

5. "The best Yagi designs are the ones produced by NBS." The NBS Yagis were a great stride forward. For once we had a cookbook with measured results. However, only six of the original NBS designs were provided in NBS Technical Note 688.⁷ That represents only a small percentage of Yagi designs available to date.

The noteworthy item about the NBS Yagi antennas is that if they are properly duplicated, they will work to specification. However, if one of the six designs doesn't fill your requirements, or if you need a longer boomlength, there are no other NBS designs available.

Today there are literally an infinite number of other designs that will fit any length of boom desired.^{8,9} Furthermore, using computer optimization techniques, up to 0.5 dB gain improvement is possible using existing Yagi designs such as the NBS 4.2 wavelength design.¹⁰ We've just begun to open up a whole new area for improved Yagi antennas.

6. "T matches should be used on high performance Yagi antennas since Gamma matches don't work very well." This fallacy has been around for some time. It was fueled

when all the new high-performance Yagi antennas, using balanced feeds and T matches, started springing up in the late 1970s. The Gamma match is capable of good performance. But it tends to inject a small imbalance into the design, which can cause a slight pattern skewing. The latter effect can be obviated by unbalancing the length of the driven element.¹¹

Establishing a good ground for the Gamma return path is difficult. Hence, at UHF frequencies, the transmission line often gets hot and the VSWR and radiation pattern of the antenna changes as the feedline is moved to different positions. Furthermore, the size of the gamma rod can get out of proportion at the higher frequencies.

Therefore, a good T match with a built-in balun is hard to beat, especially when antennas are to be stacked. It takes more hardware, however, than a Gamma match and can be lossy if the balun design is not properly handled.

7. "Every time the size of an antenna array is doubled, the gain increases by 3 dB." This is true only in theory. Most antennas don't have a perfectly rectangular capture area or a clean pattern free of sidelobes.³ As a result, antennas usually have to be stacked more closely than desired, with a resulting loss of gain.³

Stacking harness loss — which can approach 0.5 dB! — cannot be ignored. This is why the backplane feed system is recommended at the higher frequencies and where long transmission lines are used.⁴

Failure to provide sufficient mechanical strength not only in the individual antenna to be stacked but in the stacking frame can also cause gain to be lower than expected. Therefore, an array of long Yagis with a few feedlines is recommended over an array of smaller Yagis with more feedlines.¹ Plan on a 2.5 dB increase for each doubling of the array size.

8. "Sidelobes rob power and lower antenna gain." This is not necessarily true. The relationship of gain to sidelobe ratios was discussed in reference

2. It was shown in reference 3 that if the sidelobes are down 15 to 18 dB in the antenna to be stacked, the grating lobes in the final array should be down 13 dB for optimum gain. However, if the antennas to be stacked have sidelobes 13 or less dB down before stacking, they can't be optimally stacked. Each case must be studied separately, using references 2 and 3.

9. "A good antenna requires a balun." Not true. As stated above, a Gamma match can be effective. A well designed balun can do a great job of eliminating any radiation from a transmission line.¹² But an improperly designed balun, or one that uses a lossy transmission line, can actually *lower* the gain of the antenna! Proceed with caution and keep all balun losses as low as possible.

10. "Front-to-side and front-to-back ratios are important antenna design parameters." This statement is only partially true. The lobes at 90 degrees off boresight on a properly designed and built Yagi antenna are virtually at infinity in the E plane.²

A good front-to-back ratio may seem desirable for eliminating an interfering signal off the back of an antenna, but ratios exceeding 20 dB are not going to measurably improve gain or noise temperature. Furthermore, the angle subtended by the rear lobe is typically narrow so it is of dubious value. In a contest, it may be to your advantage to have some rear lobe radiation so you don't miss a new station or multiplier off the back of your antenna.

11. "The more elements in a Yagi antenna, the higher the gain." This is definitely false. Note that the NBS 4.2 wavelength Yagi has 15 elements, or two fewer elements than the 3.2 wavelength design. Yet it has more gain.⁷

What's more important in a Yagi antenna design is where the elements are placed with respect to each other (proper inter-element spacing) and the respective lengths of each director. There is a minimum number of ele-

ments to optimize the gain for each boom length. However, while extra elements may not be required, they can frequently be used to improve pattern and bandwidth of the design.^{8,9}

12. "Stacking improves gain and performance." Properly executed, the gain of an array is improved if it's properly stacked.³ Unfortunately, the operational performance may be degraded. For instance, if the beamwidth is too narrow in the horizontal plane, the array may not be optimum for meteor scatter operation, where the signals frequently arrive off the path.¹³ Also, auroral propagation may be degraded by vertical stacking. The proper stacking, be it vertical or horizontal, is a function of the type of propagation desired.⁶

operating

1. "The best place to operate is right on the calling frequencies since that's where the action is." Unfortunately, there's plenty of truth to this statement, especially when good propagation conditions are occurring, such as during meteor shower and sporadic-E openings. This has been a real problem ever since the concept of VHF/UHF "calling frequencies" was instituted in the U.S.A. in 1978.⁶ It's really sad, since it usually deprives all but the largest stations from sharing in the DX.

If the calling frequency concept is properly used, stations will call CQ or an appropriate station and *immediately* QSY to a different frequency so that others can then use the calling frequency. *Always remember to QSY at least 10 kHz away from the calling frequency.* QSYing only 5 kHz away very often causes QRM to other stations listening on the calling frequency, especially if adjacent stations are strong or if there is any splatter.

2. "146.52 MHz is a good frequency for VHF contest operation since there are so many stations that operate there." This frequency has been controversial for some time. In the early days of FM operation, most rigs were crystal-controlled and 146.52

MHz was often the only simplex crystal provided when the rigs were purchased. Hence it became a common meeting frequency for those who use simplex channelized FM. But as time went by, this frequency became very congested. What's more, it became a calling frequency for FM'ers as well as a frequency for passing emergency traffic. So it became a real sore point when contesting invaded 146.52 FM.

For the present, it's rather a moot question since contests — at least those run by ARRL — are no longer permitted on this frequency. Suffice it to say that this frequency should be used only as a calling frequency and for passing emergency traffic. Once contact is established, a quick QSY to one of the adjacent FM channels is suggested.

3. "Scheduling stations during a contest, especially those stations out of your area, helps to improve your score." This is probably not true unless you're a big contest station and desperately need every possible multiplier. Schedules do attempt to bring together people who normally may have difficulty casually running into each other. But schedules frequently take up valuable contest time. If too much time is used on schedules, there's a possibility that you may miss contacts by not working random stations that stay around for only a short time. Scoring must be carefully evaluated to see where your strengths and weaknesses lie.

4. "Everyone should develop his or her own style of operating procedures." This is an individual preference. It's always interesting when someone develops a new procedure that increases or improves communications. Such cases that quickly come to mind are meteor scatter and EME QSO procedures. But Amateurs who try to invent new procedures should be prepared to have lots of failures unless others know what they're up to! Confusion may follow when new routines or procedures are adapted. Signals on VHF/UHF are often weak, and any changes in operating procedures from

the HAM STATION



P.O. Box 4405
220 N. Fulton Ave.
Evansville, IN 47710

Stores Hours
MON-FRI 9AM-6PM
SAT 9AM-3PM

WARRANTY SERVICE CENTER FOR:
ICOM, YAESU, TEN-TEC

TERMS:

Prices Do Not Include Shipping.
Price and Availability Subject to
Change Without Notice
UPS COD \$2.50 Per Package

AEA	
ATU-1000-Superb Interface	\$1100.00
CP-100 Deluxe interface/MBA-TOR	CALL
CP-1 interface	189.95
MP-1 Micropatch	129.95
MBA-TOR Software	85.00
DR-DX/DR QSO	85.00/75.00
PKT-1 Packet Controller	459.95
PK-64 in Stock	CALL

ALINCO	
2 Mtr. & 440 MHz Amplifiers in Stock	CALL
ALPHA DELTA	
Transi-Trap And Powerstrips	CALL

AMERITRON	
Amplifiers And Remote Switches.	CALL

ANTENNA SPECIALISTS (AVANTI)	
AP153 3G 2M on Glass	\$34.00
AP200 3G 220 MHz on Glass	38.00
AP450 3G 450 MHz	34.00
AP450 5G 450 MHz	38.00

ARRL	
Books And Publications in Stock	CALL

ASTRON	
RS7A 5-7 Amp	\$ 49.00
RS10A 7.5-10 Amp	59.00
RS12A 9-12 Amp	69.00
RS20A 16-20 Amp	89.00
RS20M 16-20 Amp w/ meter	105.00
RS35A 25-35 Amp	135.00
RS35M 25-35 Amp w/ meter	149.00
RS50A 37-50 Amp	199.00
RS50M 37-50 Amp	225.00

BENCHER	
BY-1 Black/BY-2 Chrome	\$44.00/54.00
ZA-1A Balun	25.00

BUTTERNUT	
HF4B 20, 15, 12, 10 Mtr.	\$195.00
HF3B Butterfly Beam	179.95
12 Mtr. Kit	20.00
HF6V 80-10M Verticle	119.95
TBR-160S 160M Resonator	49.00
RMK-II Roof Mount Kit	49.00
STR-II Radial Kit	29.00
HF-2V 80 40M Vertical	115.00
2MVCV5 5-1/2 WAVE 2M Vertical	55.00
SC-3000 30-512 MHz Scanner Ant	55.00

B&W	
370-15 80-10M Folded Dipole	\$145.00
AT-110 5 Band Trap Dipole	76.00
AT-55 4 Band Trap Dipole	58.00
Coax Switches and Accessories in Stock	CALL

Merry Christmas from Dan, Sandi, Laura, Rick, Mark, Steve, Russ and the "Q"

COLLECTORS ITEMS	
1986 Ham Station Calendar	1.50
Baseball Cap With Ham Station Logo	4.99

CONNECT SYSTEMS	
Private Patch III	\$479.95
Private Patch II	329.95

CUSHCRAFT MULTI-BAND	
A3	\$215.00
A4	279.00
R3 Motor Tuned Vert.	279.00
215WB 2M Wide Band	79.00
230WB Stacked 215's	219.00
32-19 Boomer 19ELE 2M	95.00
A147-4	32.95
A449-6	34.00
A449-11	44.00
Ringo Ranger 2M, 6M, 220, 450	39.95
AOP-1 Package	149.00

DAIWA	
CN410M 3.5-150 MHz	\$ 65.00
CN520 1.8-60 MHz	63.00
CN540 50-148 MHz	72.00
CN550 144-250 MHz	81.00
CN620B 1.8-150 MHz	110.00
CN630 140-450 MHz	130.00
CN720B Same as CN620B, w/large Meter	CALL
CS401 4 Pos. Switch	62.00
CS201 2 Pos. Switch	23.00



FM-240

HAL	
Computer interfaces & Dedicated Terminals	CALL

HEIL	
Products in Stock	CALL

HUSTLER	
All Amateur Antennas in Stock	CALL

HY-GAIN	
TH7DXS 7EL Tribander	\$479.00
Explorer 14 3EL Tribander	329.00
18HTS 80-10M Vertical	439.00
18AVT/WBS 80-10M Vertical	109.00
14AVG/WBS 40-10M Vertical	75.00
2 Mtr. Beams in Stock	CALL
V2S, V3S, V4S Verticals in Stock	CALL



IC-735

751 Top of the Line	\$1179.00
745 Gen. Cov.	769.00
735 Fantastic New Xcvr	CALL
R71A World Class Receiver	CALL
R7000 Ultimate Scanner	CALL
1271A New 1.2 GHz Base Rig	CALL
471A/471H 430-450 MHz All Mode	699.95/949.95
271A/271H 2M Allmode	569.95/749.95
47A 440 MHz Mobile	399.95
37A 220 MHz Mobile	CALL

ICOM	
27A/27H 2M 25W & 45W Mobiles	CALL
3AT/4AT 220/440 H.T.'s	ea \$229.95
2AT 2M H.T.	199.95
02AT 2 Mtr. H.T.	289.95
04AT 440 MHz H.T.	289.95
3200 Dualband Mobile	CALL
Dual Band Antennas in Stock	CALL
Super Huge Inventory of Accessories & Radios	



PACKET COMMUNICATOR

Packet Communicator in Stock	CALL
UTU Universal Terminal Unit	\$179.95
UTU-SX Do-It-All Terminal Unit	CALL
Interface II Deluxe Interface	229.95
Large Inventory of Software & Pac-Term Programs in Stock	CALL

KLM	
2M-14C 2M Circular Ant	\$ 85.00
2M-22C 2M Circular Ant.	120.00
2M-16L BX 2M Ant.	105.00
435-18C w/CS-2	120.00
435-40CX Circular Ant	149.95
Many More Antennas in Stock	CALL

LARSEN	
NLA 150/220/450 MAG. Mnt.	ea \$ 42.95
NLA 2/70 Dual Band MAG. Mnt. Ant	59.95

MFJ	
1229 Interface/tree Software	\$159.95
1224 Interface/tree Software	85.00
1228 Interface/tree Software	59.95
989 3KW Roller Inductor tuner	289.95
949C 300W w/Tuner w/D Load	135.00
941D 300 w/full feature tuner	89.95
204 Antenna Bridge	71.95
422 Keyer Bencher Combo	99.95
108 Dual Clock 12/24 hr	19.95

MICROLOG	
Products in Stock	CALL

MIRAGE	
B1016 10/160W-Preamp	\$249.95
B3016 30/160W-Preamp	204.95
B23A 2/30W-Preamp	89.95
D1010N 10/100W 430-450 MHz	289.95

NYE	
MB-V-A The Ultimate Tuner	\$499.95

RADIO AMATEUR CALLBOOK	
1986 North American Call Book	21.95
1986 International Call Book	20.95

ROTATORS	
Alliance U-110	\$ 49.95
Alliance HD-73	109.95
Daiwa	Call for Price
HyGain CD-45	CALL
HyGain Ham 4	CALL
HyGain T2-X	CALL
HyGain HDR300	CALL
Ken-Pro KR500	155.00
Ken-Pro KR5400	255.00
Ken-Pro KR5400A	260.00
Ken-Pro KR5600A	324.00

SANTEC	
ST-20T New Superior Function H.T.	CALL

SHURE	
444D Hi-Lo Desk Mic	\$ 55.00

TEN-TEC	
New 561 Corsair II	CALL
Titan Your Last Amplifier	CALL
Century 22 CW Xcvr	\$349.95
525D Argosv	525.00



CORSAIR II

2510 Satellite Station	475.00
2591 2M H.T.	269.95
229 2KW Tuner	269.95
4229 2KW Tuner Kit	199.95
Large Stock of Ten Tec Products	CALL

TOKYO HY-POWER	
HL30V 3-30 W Amp w/Gaslet	\$ 62.95
HL35V 3-30 W/Amp	75.00
HL160V 3 10-160W Amp	295.95
HL160V25 25-160W Amp	259.95
HL-20U 430-449 MHz 3-20W Amp	105.95
HL 120U 430-449 MHz 10-100W Amp	329.95
HC-2000 2KW Tuner	295.95
HC 400L Tuner w/Dual Needle Mtr	175.95
HRA-2 2 Mtr. Mast Mount Gaslet Preamp	119.95
HRA 7 70 CM Mast Mount Gaslet Preamp	119.95

WELZ	
SP-220 1.8-220 MHz Peak Mtr	\$49.95
SP-230 1.8-150 MHz Watt Mtr.	46.95
SP-420 140-525 MHz Peak Mtr	63.95
Dual Band Base Antenna	CALL
CT15A Dummy Load DC-500 MHz	\$12.00
CT15N Same as above but w/N-Conn	21.00
DF72S Mobile Duplexer	29.95
DP-ED 770-E Dual Band Antenna	29.95
DP-5PM Mag. Mnt. for above Antenna	24.95
Large Stock of All SWR & Power Meters	CALL



FRG-9600

FRG9600 60-905MHz Scanner	CALL
FRG8800 HF Communications Rcvr	CALL
FT980 Deluxe Xcvr	1425.00
FT757GX Gen. Cov. Xcvr	CALL
FP757HD Heavy Duty Power Supply	175.00
FC757AT Auto Ant. Tuner	235.00
MMB-20 Mounting Bracket for 757GX	24.00
FT726R Tri Band Xcvr	CALL
FT26R Modules in Stock	CALL
MD 18B Desk Mic	69.00
FT209RH 2M H.T. 5W	299.95
FT270R 45W 2M Mobile Free FTS-8	CALL
FT2700 RH Dual Band Mobile Free FTS-8	CALL
Very Large Stock of Radios and Accessories Call for Discount	

Send SASE for our new & used equipment list.



AMEX, MC, VISA & C.O.D.s WELCOME - FREIGHT FOB EVANSVILLE

For Orders and Price Checks Call 800-523-7731

Indiana call 1-812-422-0231
Service Dept. 1-812-422-0252

those normally used could cause confusion and incomplete QSOs.

propagation

1. "Operation on EME requires an investment of thousands of dollars." This is no longer true, especially if you're resourceful and are willing to build much, or even all, of your own gear. The most costly items associated with EME operation are usually the antenna system and the power amplifier. There are now more than enough antenna designs available to enable you to "roll your own" EME antenna for any band where EME operation is presently conducted. Their performance can equal or exceed that of any commercially available antenna.

Likewise, there are plenty of designs available for power amplifiers.^{14,15} There's no need to run expensive tubes unless you want to go to the legal limit. Many active EME'ers (including yours truly) have never run over 750 watts of output power and have been quite successful. You can also purchase or trade amplifiers.

Full legal power can definitely increase success ratios. Power helps when conditions are poor or if one of the EME stations is only marginal. (For further information, see references 16 and 17. The bibliographies at the end of these references provide more than enough information to help you keep costs down.) *The best advice I can give on keeping costs low is to try tested and proven designs. Avoid inventing new designs that may be more costly — especially if they're not successful!*

2. "The Perseids meteor shower always peaks on the morning of August 11." This is a myth. There are times every few years when this meteor shower *does* peak on this date and time. But you have to remember that the showers occur at the same time each year unless they're deflected by a planetary encounter. Since our year is 365.25 days long (that's why we have a leap year every four years), the shower, in Earth time, will occur approximately 6 hours later each year!

Even though the shower may peak at a specific time, that may not be the best time for a schedule, since the radiant* of the shower may not be in the proper location for communication in the direction desired. For example, it won't be very productive to operate when the radiant of the shower is on the other side of the earth, even if it *is* during the peak of the shower! (See references 13 and 18 for further information on this and other questions about meteor scatter communications.) At the end of each month's VHF/UHF World column I list the latest updated information on the predicted peak of the major showers; please note that this information does not include the location of the radiant.)

3. "Circular polarization is the only way you can operate on OSCAR." This has been proven false many times by those who regularly operate the satellites. It's true that circular polarization can yield up to 3 dB improvement on transmitting and receiving the satellites.

However, due to the geometry involved, the "sense" of circular polarization may actually reverse. As a result, you'd be significantly weaker on circular polarization during these times than if you used linear polarization if the sense reverses.

The bottom line is that you can use linear polarization on OSCAR with the possibility of a greater fading rate. Circular polarized antenna systems are recommended, *but only if they provide the capability for switching sense from clockwise to counterclockwise as required.*

4. "Good openings always occur with a high barometer." This is particularly true for tropospheric propagation, but is not true for aurora, F2, sporadic E, etc. In North America, the best tropo openings seem to occur during the spring near the Gulf of Mexico, during the summer on the California-to-Hawaii path, and during the summer and fall in the more northern latitudes.^{6,19}

*Radiant — the point in the sky from which meteors appear to emanate.

Furthermore, the best tropo openings usually occur when a slow-moving high pressure (30.3 inches or 1025 millibars) area is present and mixed with warm moisture from the south. (For further information, see references 6 and 19.)

5. "The VHF/UHF bands are always open. It's just a case of no activity." This is a definite fallacy. I frequently hear this statement right after a VHF contest when the propagation conditions were good and there were lots of mountain-top stations. The dates of the ARRL June and September VHF QSO parties were purposely chosen to coincide with periods that have proven, over the years, to offer a high probability of extended openings. The August UHF and the spring Sprint contests are usually popular even though extended openings are few because of poorer propagation conditions at that time of year.

High locations do give some DX extension by virtue of the fact that they see a more distant horizon than a low-altitude station. Most mountain-toppers have shorter feedline and fewer obstructions to limit propagation. Although there are admittedly more mountain-top operations during the contests, there are fortunate persons who own mountain-top QTH's and are on the air year 'round. They can testify to the inaccuracy of the falsehood above.

Many good openings go undetected or are caught by only a few avid or lucky operators. Openings are missed mainly because of low, uncoordinated activity. We all know the frustration of calling a CQ with a highly directive antenna, only to find out later that a DX station was heard in our area, but that he had his antenna pointed in a different direction at the time of our CQ.

The best way to catch openings is to watch weather maps, be vigilant during the most likely seasons for openings^{6,19} monitor the calling frequencies, take advantage of propagation beacons, and adhere to nightly schedules as well as uniform activity nights and hours.⁶

6. "It takes a hurricane to get a good tropo opening." I have long observed that the good openings at higher latitudes often occur when hurricanes occur south of the path (references 6 and 9). But there are exceptions — for example, the Gulf of Mexico opening in the spring, and openings in the fall in the more northern latitudes.

What's required for an opening is explained in item 4 above. Yet the coincidence of longer DX openings occurring when hurricanes are present cannot be denied. Hurricanes cause low pressure areas to develop. These low-pressure areas affect high pressure areas, causing them to build up and move slowly — this slow movement, combined with the warm moisture drawn from the low pressure area, results in extended openings.⁶

receivers

1. "You need a GaAs FET preamp to work DX on the VHF/UHF bands." This is definitely false. How do you explain all the DX before solid-state devices were available in the 1960s? There are plenty of good JFETs, MOSFETs, and bipolars that yield low noise figures (1 to 2 dB), which is more than sufficient for non-EME modes where local noises are frequently the limiting factor in communications.

There's no denying that GaAs FETs are becoming very popular.²⁰ In many cases, they've improved receiver sensitivity. But the fallacy that they're the *only* devices that work well has probably been irrevocably spread since antenna-mounted preamplifiers are now quite popular and most use GaAs FETs.

2. "A low noise figure receiver will always outperform one with a high noise figure." You can't deny that receiver sensitivity is a great factor in communications. After all, "If you can't hear them, you can't work them." But noise figure is only one part of the equation. High dynamic range is also extremely important, especially if other strong stations are present. Low-noise preamplifiers often

have poor dynamic range.²⁰ High gain ahead of a mixer, especially a poor one, can cause blocking and IMD as well as other annoying phenomena.²¹

Many modern receivers, and in particular the synthesized HF transceivers, have very poor phase noise and are easily overloaded.²² Therefore, in order to hear the weak ones, attention must be paid to the dynamic range as well as the noise figure of the receiver.

3. "28 MHz is a good IF for a VHF/UHF converter." Generally speaking, this is true. Attention must be paid to dynamic range, as just discussed. However, when you go up into the UHF frequencies, image rejection becomes a real problem.²³ It's not a trivial problem to filter out an image only 56 MHz away from a 1296 MHz converter without incurring some undesirable filter loss.²⁴ Image rejection or image recovery mixers are recommended.²³ For simplicity, 2-meter (144-144.5 MHz) IFs are an acceptable alternative and are becoming very popular.

4. "A 1 MHz crystal calibrator makes an accurate VHF/UHF frequency calibrator." This is definitely false. Crystals below 3 MHz (because of their "cut") are usually much less stable than those between 3 and 10 MHz.²⁵ Furthermore, 3 and 4 MHz markers are very convenient because they can place loud, easy-to-find calibration points in most receivers on 144 MHz and above.

The calibrator discussed in reference 25 is highly recommended and should be an essential part of every well-equipped VHF/UHF station regardless of the equipment used. Your success rate drops dramatically when you don't know your frequency within at least 1 kHz, especially on EME and meteor scatter communications.^{13,16,17}

5. "You need a Hewlett Packard 8970A noise figure meter to accurately tweak a preamplifier to its lowest possible noise figure." This is definitely false. There were plenty of optimized low-noise preamplifiers long before the HP 8970A arrived on the

scene a few years ago. The older AIL models 74 and 75 as well as the HP 340 series gave good results.

The principal reason for the popularity of the HP 8970A is that it's quick and easy to use, measures both noise figure and gain simultaneously, and has a digital readout with 0.01 dB precision. It's been shown, however, even by the manufacturer, that the results are probably only accurate to ± 0.5 dB. It's also been shown more recently that preamplifiers with poor input VSWR (such as most GaAs FETs) can cause large measurement errors (up to 0.5 dB) if you don't use a noise tube with at least 10 dB of extra internal attenuation (such as the newer HP 346A type).²⁰

Don't be fooled by digital readouts and extravagant claims. What's really important is *whether your preamplifier is optimized to the minimum noise figure it can deliver* (this can be done with either the older or newer instruments) and *how it stacks up with other designs* (comparison at noise figure measurement parties).

6. "A 1N21 or back biased transistor makes a good noise figure generator." This is usually untrue. Many of the older 1N21 type of noise generators had terrible VSWR that caused the preamplifier under alignment to be optimized to the noise generator impedance rather than to 50 ohms. This can also be true with transistors. Always use at least 10 dB of attenuation, preferably an attenuator "pad" with low (1.2:1 maximum) VSWR, between your noise generator and the device-under-test. (See item 5 above.)

7. "A Dow-Key relay won't have sufficient isolation at VHF/UHF frequencies." This can be misleading unless the specific type of relay is stated. Some of the Dow-Key relays have an extra isolation feature. Other manufacturers also have isolation problems.

It has been pointed out that for safety's sake, the power entering a low-noise preamplifier should not exceed 10 milliwatts and 100 milliwatts at worst case.¹⁶ It was also shown in

Electronic Enclosures
Off Shelf O.E.M.

U.S. POWER CONVERTING CO./RELCO
Torrance, CA (213) 316-9984 * Canada (519) 696-2616

REGULATED POWER SUPPLIES

Magnetically Regulated Available from 5V to over 1000V with current range from 50 to over 100A. Designed to supply large peak current demands.

Electronically Regulated Voltage range is 0 to 50V with a current range of up to 20A. Ideal for critical laboratory or service applications requiring tight regulation with low hum and noise.



HF Equipment	Regular	SALE
IC-735 HF transceiver/SW rcvr/mic	849.00	749 ⁹⁵
PS-55 External power supply	160.00	144 ⁹⁵
AT-150 Automatic antenna tuner	349.00	314 ⁹⁵
FL-32 500 Hz CW filter	59.50	
EX-243 Electronic keyer unit	50.00	
IC-745 9-band xcvr w/1-30 MHz rcvr	999.00	779 ⁹⁵
PS-35 Internal power supply	160.00	144 ⁹⁵
EX-241 Marker unit	20.00	
EX-242 FM unit	39.00	
EX-243 Electronic keyer unit	50.00	
FL-45 500 Hz CW filter (1st IF)	59.50	
FL-54 270 Hz CW filter (1st IF)	47.50	
FL-52A 500 Hz CW filter (2nd IF)	96.50	89 ⁹⁵
FL-53A 250 Hz CW filter (2nd IF)	96.50	89 ⁹⁵
FL-44A SSB filter (2nd IF)	159.00	144 ⁹⁵
HM-10 Scanning mobile microphone	39.50	
SM-6 Desk microphone	39.00	
HM-12 Extra hand microphone	39.50	
MB-12 Mobile mount	19.50	



IC-751 9-band xcvr/1-30 MHz rcvr	1399.00	1199
PS-35 Internal power supply	160.00	144 ⁹⁵
FL-32 500 Hz CW filter (1st IF)	59.50	
FL-63 250 Hz CW filter (1st IF)	48.50	
FL-52A 500 Hz CW filter (2nd IF)	96.50	89 ⁹⁵
FL-53A 250 Hz CW filter (2nd IF)	96.50	89 ⁹⁵
FL-33 AM filter	31.50	
FL-70 2.8 kHz wide SSB filter	46.50	
HM-12 Extra hand microphone	39.50	
SM-6 Desk microphone	39.00	
RC-10 External frequency controller	35.00	
MB-18 Mobile mount	19.50	

IC-720A 9-band xcvr • (CLOSEOUT) •	1349.00	749 ⁹⁵
PS-15 20A external power supply	149.00	134 ⁹⁵
FL-32 500 Hz CW filter	59.50	
FL-34 5.2 kHz AM filter	49.50	
BC-10A Memory back-up	8.50	
SM-5 8-pin electret desk mic	39.00	
MB-5 Mobile mount	19.50	

Other Accessories:	Regular	SALE
PS-15 20A external power supply	149.00	134 ⁹⁵
CF-1 Cooling fan for PS-15	45.00	
EX-144 Adapter for CF-1/PS-15	6.50	
PS-30 Systems p/s w/cord, 6-pin plug	259.95	234 ⁹⁵
OPC Opt. cord, specify 2, 4 or 6-pin	5.50	
SP-3 External base station speaker	49.50	
SP-5 Remote speaker for mobiles	25.00	
CR-64 High stab. ref. xtal (745/751)	56.00	
PP-1 Speaker/patch (specify radio)	139.00	129 ⁹⁵
SM-8 Desk mic - two cables, Scan.	69.95	
AT-100 100W 8-band auto. antenna tuner	349.00	314 ⁹⁵
AT-500 500W 9-band auto. antenna tuner	449.00	399 ⁹⁵
AH-1 5-band mobile antenna w/tuner	289.00	259 ⁹⁵
GC-4 World clock • (CLOSEOUT) •	99.95	79 ⁹⁵



HF linear amplifier	Regular	SALE
IC-2KL 160-15m solid state amp w/ps	1795.00	1299
6-meter VHF Portable	Regular	SALE
IC-505 3/10W 6m SSB/CW portable	449.00	399 ⁹⁵
BP-10 Internal Nicad battery pack	79.50	
BP-15 AC charger	12.50	
EX-248 FM unit	49.50	
LC-10 Leather case	34.95	

VHF/UHF base multi-modes	Regular	SALE
IC-551D 80W 6-meter SSB/CW	699.00	599 ⁹⁵
EX-106 FM option	125.00	112 ⁹⁵
BC-10A Memory back-up	8.50	
SM-2 Electret desk microphone	39.00	
IC-271A 25W 2m FM/SSB/CW	699.00	569 ⁹⁵
AG-20 Internal preamplifier*	56.95	
IC-271H 100W 2m FM/SSB/CW	899.00	759 ⁹⁵
AG-25 Mast mounted preamplifier*	84.95	
IC-471A 25W 430-450 SSB/CW/FM xcvr	799.00	699 ⁹⁵
AG-1 Mast mounted preamplifier*	89.00	
IC-471H 75W 430-450 SSB/CW/FM	1099.00	969 ⁹⁵
AG-35 Mast mounted preamplifier*	84.95	

For a limited time!
 With the purchase of an IC-271A/H or IC-471A/H get the matching PREAMP* for only • \$1.00 Extra.

Accessories common to 271A/H and 471A/H	Regular	SALE
PS-25 Internal power supply for (A)	99.00	89 ⁹⁵
PS-35 Internal power supply for (H)	160.00	144 ⁹⁵
PS-15 External power supply	149.00	134 ⁹⁵
SM-6 Desk microphone	39.00	
EX-310 Voice synthesizer	39.95	
TS-32 CommSpec encode/decoder	59.95	
UT-15 Encoder/decoder interface	12.50	
UT-15S UT-15S w/TS-32 installed	79.95	

VHF/UHF mobile multi-modes	Regular	SALE
IC-290H 25W 2m SSB/FM, TTP mic	549.00	479 ⁹⁵
IC-490A 10W 430-440 SSB/FM/CW	649.00	579 ⁹⁵
VHF/UHF/1.2 GHz FM	Regular	SALE
IC-27A Compact 25W 2m FM w/TTP mic	369.00	299 ⁹⁵
IC-27H Compact 45W 2m FM w/TTP mic	409.00	359 ⁹⁵
IC-37A Compact 25W 220 FM, TTP mic	449.00	299 ⁹⁵
IC-47A Compact 25W 440 FM, TTP mic	469.00	399 ⁹⁵
PS-45 Compact 8A power supply	112.95	99 ⁹⁵
UT-16/EX-388 Voice synthesizer	29.95	
SP-10 Slim-line external speaker	29.95	
IC-3200A 25W 2m/440 FM w/TTP	549.00	489 ⁹⁵
UT-23 Voice synthesizer	29.95	
AH-32 2m/440 Dual Band antenna	32.95	
Larsen PO-K Roof mount	20.00	
Larsen PO-TLM Trunk-lip mount	20.18	
Larsen PO-MM Magnetic mount	19.63	

IC-1271A 10W 1.2 GHz SSB/CW Base	999.00	889 ⁹⁵
ATV-1200 ATV interface unit	TBA	
PS-25 Internal power supply	99.00	89 ⁹⁵
EX-310 Voice synthesizer	39.95	
UT-15S CTCSS encoder/decoder	79.95	
IC-120 1W 1.2 GHz FM Mobile	499.00	449 ⁹⁵
ML-12 1.2 GHz 10W amplifier	339.00	299 ⁹⁵

Repeaters	Regular	SALE
RP-3010 440 MHz, 10W FM, xtal cont.	999.00	899 ⁹⁵
RP-1210 1.2 GHz, 10W FM, 99 ch. synth	1199.00	1089
Duplexer 1210 1.2 GHz duplexer	1199.00	1089
Cabinet	249.00	



Order Toll Free
 Use your Credit Card!

Hand-held Transceivers	Regular	SALE
Deluxe models		
IC-02AT for 2m	349.00	289 ⁹⁵
IC-04AT for 440 MHz	379.00	289 ⁹⁵
Standard models	Regular	SALE
IC-2A for 2m	239.50	189 ⁹⁵
IC-2AT with TTP	269.50	199 ⁹⁵
IC-3AT 220 MHz, TTP	299.95	239 ⁹⁵
IC-4AT 440 MHz, TTP	299.95	239 ⁹⁵

Accessories for Deluxe models	Regular	SALE
BP-7 425mah/13.2V Nicad Pak - use BC-35	67.50	
BP-8 800mah/8.4V Nicad Pak - use BC-35	62.50	
BC-35 Drop in desk charger for all batteries	69.00	
BC-60 6-position gang charger, all batts	359.95	
BC-16U Wall charger for BP7/BP8	10.00	
LC-11 Vinyl case	17.95	
LC-14 Vinyl case for Dlx using BP-7/8	17.95	
LC-02AT Leather case for Dlx models w/BP-7/8	39.95	

Accessories for both models	Regular	SALE
BP-2 425mah/7.2V Nicad Pak - use BC35	39.50	
BP-3 Extra Std. 250 mah/8.4V Nicad Pak	29.50	
BP-4 Alkaline battery case	12.50	
BP-5 425mah/10.8V Nicad Pak - use BC35	49.50	
CA-2 Telescoping 2m antenna	10.00	
CA-5 5/8-wave telescoping 2m antenna	18.95	
FA-2 Extra 2m flexible antenna	10.00	
CP-1 Cig. lighter plug/cord for BP3 or Dlx	9.50	
DC-1 DC operation pak for standard models	17.50	
LC-2AT Leather case for standard models	34.95	
RB-1 Vinyl waterproof radio bag	30.00	
HH-SS Handheld shoulder strap	14.95	
HM-9 Speaker microphone	34.50	
HS10 Boom microphone/headset	19.50	
HS-10SA Vox unit for HS-10 & Deluxe only	19.50	
HS-10SB PTT unit for HS-10	19.50	
ML-1 2m 2.3w in/10w out amplifier	SALE 79.95	
SS-32M Commspec 32-tone encoder	29.95	

Receivers	Regular	SALE
R-7000 25-2000 MHz, 117V AC	899.00	789 ⁹⁵
RC-12 Infrared remote controller	TBA	
R-71A 100 kHz-30 MHz, 117V AC	\$799.00	659 ⁹⁵
RC-11 Infrared remote controller	59.95	49 ⁹⁵
FL-32 500 Hz CW filter	59.50	
FL-63 250 Hz CW filter (1st IF)	48.50	
FL-44A SSB filter (2nd IF)	159.00	144 ⁹⁵
EX-257 FM unit	38.00	
EX-310 Voice synthesizer	39.95	
CR-64 High stability oscillator xtal	56.00	
SP-3 External speaker	49.50	
CK-70 (EX-299) 12V DC option	9.95	
MB-12 Mobile mount	19.50	



HOURS • Mon. thru Fri. 9-5:30; Sat. 9-3
 Milwaukee WATS line: 1-800-558-0411 answered evenings until 8:00 pm Monday thru Thursday.
Please use WATS lines for Ordering
 use Regular lines for other Info and Service dept.

Order Toll Free: 1-800-558-0411

In Wisconsin (outside Milwaukee Metro Area)
 1-800-242-5195

AMATEUR ELECTRONIC SUPPLY[®] Inc.

4828 W. Fond du Lac Avenue; Milwaukee, WI 53216 - Phone (414) 442-4200

AES BRANCH STORES

Wickliffe, Ohio 44092	Orlando, Fla. 32803	Clearwater, Fla. 33575	Las Vegas, Nev. 89106	Chicago, Illinois 60630
28940 Euclid Avenue Phone (216) 585-7388 Ohio WATS 1-800-362-0290 Outside Ohio 1-800-321-3594	621 Commonwealth Ave. Phone (305) 894-3238 Fla. WATS 1-800-432-9424 Outside Florida 1-800-327-1917	1898 Drew Street Phone (813) 461-4267 No In-State WATS No Nationwide WATS	1072 N. Rancho Drive Phone (702) 647-3114 No In-State WATS Outside Nevada 1-800-634-6227	ERICKSON COMMUNICATIONS 5456 N. Milwaukee Avenue Phone (312) 631-5181 Outside Illinois 1-800-621-5802

reference 16 that for optimum results and safety, a two-relay system is recommended. The second relay should return the preamplifier to 50 ohms during transmit to prevent amplifier oscillation and possible destruction during transmission periods.

It was further pointed out in references 16 and 26 that the length of transmission line between the two relays is important if the increased isolation is to be obtained. Suffice it to say that much more attention should be paid to the relay types used and at least 50 dB of transmit-to-receive isolation is highly recommended, especially when high power is used.

8. "I built it just like the article and it didn't work." Oh, how often authors hear this statement! For this very reason I've often spent hours carefully writing and then *rewriting* my column to make sure that everything is perfectly clear. Proof copies are carefully scrutinized several times through the various stages of production. However, bugs do occasionally creep in!

Suffice it to say that all circuits should be duplicated *exactly* as shown (providing that an error hasn't crept into the schematic!) unless you have enough test equipment and experience to outwit the author. I must admit that I will sometimes not publish new designs for fear that they may be too complicated or will be likely to cause a rash of angry letters. *If you alter an author's circuit, however slightly, or substitute a different part than specified, don't blame the author or ask him for help if you experience a problem!*

transmission lines

1. "Open-wire transmission line has less loss than coax." This is probably true if the VSWR on the open wire line is low, or if there's no contamination or moisture on the insulators.⁴ However, open wire lines must be relatively straight and be kept away from other lines and antennas. As a result, coaxial cable, even though it may have slightly higher loss, may be more desirable, especially when multi-

ple antennas and feedlines are present on the same mast. (For further information on this subject, see references 4 and 5.)

2. "Always cut phasing lines in multiples of one-half wavelength."

This theory was debunked in reference 4, where it was pointed out that for proper power distribution, odd numbers of quarter-wavelength feedlines are preferred. (Refer to reference 4 and its references for further information on this subject.)

3. "The way to improve EME antennas is to replace all coax with open wire lines." This subject was discussed in detail in references 4 and 5. For many of the reasons mentioned above, coaxial cable, properly chosen and used, may be preferable to open wire line.

4. "You need a Bird wattmeter to accurately measure transmitter output power and VSWR." This is also not true. There are other suppliers of good accurate power/VSWR meters. Most power meters have their own limitations. For instance, the accuracy of the power indicated is usually only ± 5 percent of full scale. This means that a 5-watt error is possible on the 100-watt scale. This can really affect the power measurement at a 25-watt power level on the same scale!

VSWR measurement accuracy is affected by the directivity or ability of the instrument to be able to distinguish between a true and a poor VSWR. Typically 20 to 30 dB is the limit, meaning that VSWR readings below 1.2:1 may be inaccurate.

Accurate readings of VSWR can be accomplished at low levels using the techniques and inexpensive coupler or VSWR bridge described in reference 27. If you build a hybrid coupler similar to the one in reference 27, you can build your own power meter and calibrate it against a borrowed meter. Unless you're measuring power near the legal limit or are trying to measure the efficiency of a high-power amplifier, an expensive power/VSWR meter is not

required. But once you use one, you'll be hard pressed to do without it.

5. "A 1.5:1 VSWR is good enough."

This is true. But where is the VSWR measured, and how accurate is the VSWR meter? Reference 5 pointed out that the length and loss of the transmission line between the antenna under test is extremely important on VHF and higher frequencies. For instance, a line loss of 7 dB (not uncommon on some of the higher bands where long runs are needed) transforms an open or short circuit (infinite VSWR!) at the far end into 1.5:1 VSWR at the near end.²⁷

It can't be stressed enough that for optimum performance on the VHF and the higher bands, the quality of the VSWR meter as well as the feedline loss⁵ must be taken into account when testing for VSWR!

6. "RG-58 can be used on 432 MHz." True — but the results may be disastrous! This type of line normally has a loss of over 10 dB per 100 feet (30.5 meters) and can handle only about 75 watts safely at 432 MHz.⁵ So RG-58 coax cable should be used only sparingly in places where the line loss is not critical.

7. "PL259s are OK at 432 MHz."

True. But this is so only if the PL259 is properly integrated with the coaxial cable. It must be stressed that the PL259 is not watertight, doesn't have a guaranteed VSWR, and probably can't handle much power on the UHF frequencies. Therefore, it should be avoided if at all possible.

8. "Helix™ and hardline transmission lines are too expensive for Amateurs." This is a common misconception.⁵ The cost of generating high power at VHF/UHF frequencies and high transmission line losses are usually the limiting factors in successful communications. Placing preamplifiers at the top of a tower helps the receive path, but transmitters (especially the high power tube type) are not readily mounted at the top of a mast.

Good quality feedline such as Helix and hardline, with their low insertion

We Give You VHF Without VHC*

(* - Very High Cost)

Presenting Microwave Modules, the low-cost way to full featured multi-mode operation on 50 Mhz, 144 Mhz, and 432 Mhz

Expand your HF transceiver's capabilities for less than the cost of a VHF multimode radio

All models feature:

- 25 Watts RF output
- Low Noise GaAsFET front end
- Transmit ALC circuit
- RF sensed VOX TR switching
- All mode operation—SSB, CW, FM, AM
- Easy hook-up to your present HF transceiver



New MMT 144/28R GaAsFET
144 Mhz Transverter
List Price \$325.00
(Other Models Available)

50Mhz

432 Mhz

1296 Mhz

AVAILABLE FROM:

THE "PX" SHACK

VHF/UHF
EQUIPMENT

Ivars Lauzums KC2PX
52 Stonewyck Drive
Belle Mead, New Jersey 08502
(201) 874-6013



Hours: 11am - 3pm
6pm - 10pm



MICROWAVE
MODULES LTD

✓ 204

CTM

The monthly magazine with a natural blending of two popular hobbies — Ham Radio and Computers

- ★ Articles on Ham Radio & Most Personal Computers
- ★ Hardware & Software Reviews
- ★ Various Computer Languages
- ★ Construction Articles
- ★ Much Much More

"...received my moneys worth with just one issue..."

—J. Trenbick

"...always stop to read CTM, even though most other magazines I receive (and write for) only get cursory examination..."

—Fred Blechman, K6UGT

U.S.A.....	\$15.00 for 1 year
Mexico, Canada	\$25.00
Foreign	\$35.00(land) - \$55.00(air)
(U.S. funds only)	
Permanent (U.S. Subscription)	\$100.00
Sample Copy	\$3.50

CTM

Circulation Manager

1704 Sam Drive

Birmingham, Alabama 35235

Phone 205/854-0271

Name _____

Call Sign _____

Address _____

City _____ State _____

Zip _____ Phone _____

Date _____

Signature _____

✓ 127

DOCKING BOOSTER

Converts Your HT to a Powerful Mobile Unit



- 30 or 50 watts output
- 16 DB GaAs FET pre-amp
- Fits on most car doors
- Mic hang-up clip
- Icom, Yaesu, Kenwood
- 2 Meters & 70 cm

\$149⁹⁵

CMC COMMUNICATIONS, INC.

5479 Jetport Industrial Blvd. • Tampa, FL 33614

Phone: 813-885-3996

✓ 121

loss, will not only deliver the most "bang for the buck," but will also frequently outlast lower cost transmission lines by a 2 to 5:1 ratio. If remote relays are used, they can do double or even better duty by servicing multiple antennas. As a result, *the high initial cost is quickly amortized over the years and the performance is top notch to boot.* Couple this with the favorable prices often found at flea markets and you have a super bargain!

9. "The G-line is a nickname for the chorus line at a burlesque house."

I ask this question to see if you're still awake. "G-line" was mentioned in my October, 1985, VHF/UHF World Column.⁵ It's basically a single wire transmission line similar to a toy "string telephone." It has many exciting possibilities for low loss and inexpensive installations. See the October article for further information.

transmitters

1. "VHF/UHF amplifiers typically have 20 dB of gain." This theory, which has been around for some time now, invariably causes grief when someone discovers that you can't run 1500 watts of output with a 10-watt driver.¹⁴ Typically speaking, the gain of most VHF amplifiers is 15 to 20 dB and 10 to 16 dB at UHF. This is only if the amplifier is operated in linear service. Class C has lower gain and is not recommended for reasons mentioned in reference 14.

The more modern grounded grid triodes frequently have 3 dB lower gain than this although they are usually more stable than the older neutralized designs. When you buy or build an amplifier, check the specifications beforehand and see what the drive requirements will be. You may need an additional driver to get the output power expected from your amplifier.²⁸

2. "You can run a single 4CX250B at 500 to 600 watts output." True, *but your tube won't last very long!* Amateurs seem to have a thing about running devices past manufacturers' ratings! They frequently provide insufficient cooling to boot. Better read

references 14 and 15 and drop your power, too. Both you and the tube will be friends for a longer time!

3. "You can't operate 2-meter EME without an 8877 amplifier." If there ever was a misconception, this is it. *Hundreds of Amateurs operate EME without running the legal limit or using a high power tube like the 8877.*

Other tubes that will deliver the same power^{14,15} are available. Tubes can also be run in parallel. You can operate EME with as low as 500 watts of output power if you're patient, have sufficient antenna gain, and "have your act together."^{16,17}

4. "Speech processing extends your SSB transmitting range and prevents you from splattering."

This statement is true as long as you use the speech processing properly and don't overdrive your transmitter. All too often, Amateurs not only run their amplifiers in a highly non-linear fashion but also run improperly adjusted speech processors. If you run speech processing, the duty cycle on the power amplifier will increase. If you don't increase cooling to the final stage, you could experience premature failure.

5. "If your maximum output power level is 100 watts you should occasionally see that power level register on SSB peaks on your output power meter."

Boy, here's another big lie. Ever since reasonably priced power meters became available, they've been used to do the wrong things. For starters, most power meters have a highly damped meter movement. As a result, they respond slowly. The truth of the matter is that *under normal circumstances, the power meter should be indicating no more than about 25 to 30 percent of the actual power level of the amplifier in a key-down position.*²⁸ It's for this very reason that solid-state amplifier/drivers have gotten such a bad reputation.

6. "You can run a pair of 4CX250B's at 1 kW output on SSB." This is true. However, you won't have many

friends. The 4CX250B is rated on SSB operation at 500 watts input for 300 watts PEP output per tube with an IMD of only 25 dB.¹⁴ IMD of 30 dB is considered Amateur standard. So don't argue with fellow Amateurs when they say you're splattering and you are only running 600 watts PEP output from a pair of 4CX250Bs!

7. "IMD isn't a real problem on the VHF/UHF bands since there are so few stations and they're all geographically separated."

Amateurs on VHF/UHF used to say that they didn't have to worry about dirty signals on VHF/UHF since there were so few people and so much spectrum available. But that's all changing now, with many stations coming on and often operating in close proximity to the calling frequencies. Line of sight, higher gain antennas, and sensitive receivers that often lack high dynamic range are compounding the problem.^{21,22} Better start watching your signal quality as closely as you do on the DC bands.

summary

This month's column, sort of a mixed bag, was intended to put to rest several of the most popular old wives' tales. Most of the statements made were addressed in the past 23 columns and the other references cited. I hope you'll be sufficiently interested in the subjects discussed to research the referenced material independently. At the same time, I hope you've enjoyed this departure from my usual format and will continue to follow this column as faithfully as you have. Don't forget to drop me a line with any suggestions or advice.

acknowledgements

I'd like to thank all the unnamed Amateurs who brought the statements for this month's column to mind. Unfortunately, I can't name you all, but some of you would rather not be identified anyhow! I do want to extend special thanks to Lewis Collins, W1GXT, and Gary Madison, WA2NKL, for helping me assemble many of the statements used as the basis for this month's column.

MISSOURI RADIO CENTER

ANTENNA SALE

HYGAIN TOWERS

HG37SS		C
HG52SS		A
HG54HD		L
HG70HD		L

CUSHCRAFT

A3	205.00
A4	275.00
R3	255.00
40-CD2	275.00
AV5	96.00
32-19	89.00
215WB	75.00
ARX2B	35.00
A144-11	46.00
A144-20T	69.00
424B	75.00
AOP-1	137.00

KLM

KT34A	329.00
KT34XA	475.00
432-20LBX	64.00
432-30LBX	90.00
435-18C	109.00
435-40C	149.00
2M-13LBA	77.00
2M-14C	85.00
2M-16LBX	89.00
2M-22C	115.00

HYGAIN

TH3JR		C
TH7		A
EX 14		L
14AVQ		L
18AVT		L
V2		L
V3		L
V4		L

HUSTLER

25% OFF ALL MOBILE	
6BTV	125.00

AEA

144SR	42.00
-------------	-------

BUTTERNUT

HF6V	110.00
HF2V	110.00
RG213U	\$.26/foot

ROTATORS

CD45	139.00
HAM IV	228.00
T2X	275.00
AVANTI 2M	29.95
HI-Q BALUN	9.95

KENPRO

KR400	119.00
KR500	149.00
KR600	199.00
KR5400	249.00

102 NW BUSINESS PARK LANE
KANSAS CITY, MISSOURI 64150
816-741-8118

CALL TOLL FREE
1-800-821-7323

MASTERCARD VISA & C.O.D.'S WELCOME

references

1. Joe Reisert, W1JR, "VHF/UHF World: VHF/UHF Antennas and Antenna Systems," *ham radio*, February, 1984, page 46.
2. Joe Reisert, W1JR, "VHF/UHF World: Determining VHF/UHF Antenna Performance," *ham radio*, May, 1984, page 110.
3. Joe Reisert, W1JR, "VHF/UHF World: Stacking Antennas, Part 1," *ham radio*, April, 1985, page 129.
4. Joe Reisert, W1JR, "VHF/UHF World: Stacking Antennas, Part 2," *ham radio*, May, 1985, page 95.
5. Joe Reisert, W1JR, "VHF/UHF World: Transmission Lines," *ham radio*, October, 1985, page 83.
6. Joe Reisert, W1JR, "VHF/UHF World: The VHF/UHF Primer — an Introduction to Propagation," *ham radio*, July, 1984, page 14.
7. Joseph H. Reisert, Jr., W1JR, "How to Design Yagi Antennas," *ham radio*, 1977, page 22.
8. Günter Hoch, DL6WU, "Extremely Long Yagi Antennas," *VHF Communications*, 1982 Summer issue, page 130.
9. James Lawson, W2PV, "Antenna Gain and Directivity Over Ground," *ham radio*, August, 1979, page 12, and "Yagi Antenna Design," *ham radio*, January, 1980, page 22; February, 1980, page 19; May, 1980, page 18; June, 1980, page 32; July, 1980, page 18; September, 1980, page 37 (see page 67 of September issue for short circuit); October, 1980, page 29; November, 1980, page 22; and December, 1980, page 30.
10. Stanley Jaffin, WB3BGU, "Applied Yagi Antenna Design, Part 6: The Model and a Special Tool," *ham radio*, October, 1984, page 89.
11. Katashi Nose, KH6IJ, "Notes on Parasitic Beams," *QST*, March, 1960, page 43.
12. Joe Reisert, W1JR, "VHF/UHF Techniques: Feeding and Matching Techniques for VHF and UHF Antennas," *ham radio*, May, 1976, page 54.
13. Joe Reisert, W1JR, "VHF/UHF World: Improving Meteor Scatter Communications," *ham radio*, June, 1984, page 82.
14. Joe Reisert, W1JR, "VHF/UHF World: VHF/UHF High Power Amplifiers, Part 1," *ham radio*, January, 1985, page 97.
15. Joe Reisert, W1JR, "VHF/UHF World: VHF/UHF High Power Amplifiers, Part 2," *ham radio*, February, 1985, page 38.
16. Joe Reisert, W1JR, "Requirements and Recommendations for 70-cm EME," *ham radio*, June, 1982, page 12.
17. Joe Reisert, W1JR, "VHF/UHF World: 220-MHz EME Requirements," *ham radio*, September, 1984, page 45.

18. Walter Bain, W4LTU, "VHF Propagation by Meteor-Trail Ionization," *QST*, May, 1974, page 41.
19. Joe Reisert, W1JR, "VHF/UHF World-Propagation Update," *ham radio*, July, 1985, page 86.
20. Joe Reisert, W1JR, "VHF/UHF World: Low-Noise GaAs FET Technology," *ham radio*, July, 1985, page 99.
21. Joe Reisert, W1JR, "VHF/UHF World: High Dynamic Range Receivers," *ham radio*, November, 1984, page 97.
22. Joe Reisert, W1JR, "VHF/UHF World: High Dynamic Range on 2 Meters," November, 1985, page 54.
23. Joe Reisert, W1JR, "Getting Started on 13 and 23-cm," *Proceedings of the First Annual 1296/2304 MHz Conference*, Estes Park, Colorado, September, 1985 (copies of Proceedings available from W0PW).
24. Joe Reisert, W1JR, "VHF/UHF World: The VHF/UHF Primer — An Introduction to Filters," *ham radio*, August, 1984, page 112.
25. Joe Reisert, W1JR, "VHF/UHF World: VHF/UHF Frequency Calibration," *ham radio*, October, 1984, page 55.
26. Joe Reisert, W1JR, "VHF/UHF World: Protecting Equipment," *ham radio*, June, 1985, page 83.
27. Joe Reisert, W1JR, "VHF/UHF Techniques: Matching Techniques for VHF/UHF Antennas," *ham radio*, July, 1976, page 50.
28. Joe Reisert, W1JR, "VHF/UHF World: Medium Power Amplifiers," *ham radio*, August, 1985, page 39.

important VHF/UHF events

- December 2: 7 to 11 PM local SWOT
2-meter QSO party (information from K5IS)
- December 11: EME Perigee
- December 13: Peak of the Geminids Meteor Shower predicted at 0650 UTC
- December 21: Peak of the Ursids Meteor Shower predicted at 2200 UTC
- December 21: ± 1 month, winter peak of sporadic-E propagation
- January 3: Peak of the Quadrantids Meteor Shower predicted at 2300 UTC
- January 8: EME perigee
- January 11-12: ARRL VHF Sweepstakes contest

ham radio

Have a name — but need the Call Sign?
Traveling — and want to meet local Hams?



1985-1986 Amateur Radio

NAME INDEX

By Name and Call. 583 pages

1985-1986 Amateur Radio

GEOGRAPHICAL INDEX

By State, City, Street No. and Call. 653 pages

No frills directories of over 462,000 U.S. Radio Amateurs. 8½x11, easy to read format.

- NAME INDEX—\$25.00
- GEOGRAPHICAL INDEX—\$25.00

Add \$3.50 shipping to all orders.

ham
radio
BOOKSTORE
Greenville, NH 03048



RAMSEY

THE FIRST NAME IN ELECTRONIC TEST GEAR

PRICE CUT



20 MHz DUAL TRACE OSCILLOSCOPE

Unsurpassed quality at an unbeatable price, the Ramsey oscilloscope compares to others costing hundreds more. Features include a component testing circuit for resistor, capacitor, digital circuit and diode testing • TV video sync filter • wide bandwidth & high sensitivity • internal graticule • front panel trace rotator • 2 axis • high sensitivity x-y mode • regulated power supply • built-in calibrator • rock solid triggering. *USA — add \$10.00 per unit for postage, overseas orders add 15% of total order for insured surface mail.

~~\$399.95~~
\$369.95*

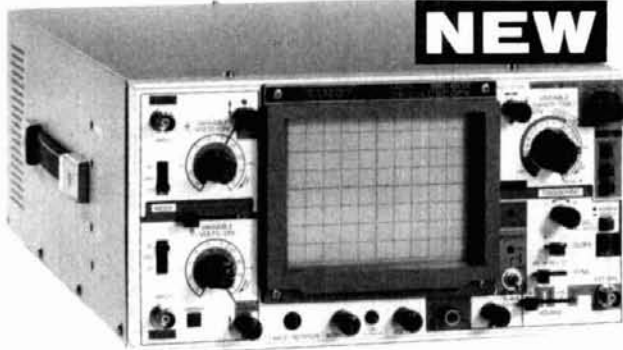

NEW

45 MHz DUAL SWEEP OSCILLOSCOPE

The Ramsey 625 is a dual time base, delayed sweep unit that includes a built-in signal delay line to permit clear viewing during very short rise times of high frequency waveforms. Other features include: variable trigger holdoff • 20 calibrated sweep time ranges from 0.5 ns/div to 0.2 s/div • fully adjustable sweep time • X5 sweep magnification • five trigger sources, CH1, CH2, LINE EXTERNAL and INTERNAL (V mode) • front panel x-y operation, 2 axis input • sum difference of CH1 and CH2 waveforms displayed as single trace • sweep gate and sweep output • auto focus • single sweep. *USA — add \$10.00 per unit for postage, overseas orders add 15% of total order for insured surface mail.

~~\$799.95~~
\$669.95*



RAMSEY D-1100 VOM MULTITESTER

Compact and reliable, designed to service a wide variety of equipment. Features include • mirror back scale • double-jeweled precision moving coil • double overload protection • an ideal low cost unit for the beginner or as a spare back-up unit.

~~\$19.95~~ test leads and battery included
12.95



NEW RAMSEY 1200 VOM MULTITESTER

Check transistors, diodes and LEDs with this professional quality meter. Other features include: decibel scale • 20K volt metering system • 3 1/2" mirrored scale • polarity switch • 20 measuring ranges • safety probes • high impact plastic case.

~~\$24.95~~ test leads and battery included
19.95



RAMSEY D-3100 DIGITAL MULTIMETER

Reliable, accurate digital measurements at an amazingly low cost • in-line color coded push buttons, speeds range selection • abs plastic tilt stand • recessed input jacks • overload protection on all ranges • 3 1/2 digit LCD display with auto zero, auto polarity & low BAT. indicator.

~~\$49.95~~ test leads and battery included



CT-70 7 DIGIT 525 MHz COUNTER

Lab quality at a breakthrough price. Features • 3 frequency ranges each with pre amp • dual selectable gate times • gate activity indicator • 50mV @ 150 MHz typical sensitivity • wide frequency range • 1 ppm accuracy.

~~\$119.95~~ wired includes AC adapter

CT-70 kit \$99.95
BP-4 nicad pack 8.95



CT-90 9 DIGIT 600 MHz COUNTER

The most versatile for less than \$300. Features 3 selectable gate times • 9 digits • gate indicator • display hold • 25mV @ 150 MHz typical sensitivity • 10 MHz timebase for WWV calibration • 1 ppm accuracy.

~~\$149.95~~ wired includes AC adapter

CT-90 kit \$129.95
OV-1 0.1 PPM oven timebase 59.95
BP-4 nicad pack 8.95



CT-125 9 DIGIT 1.2 GHz COUNTER

A 9 digit counter that will outperform units costing hundreds more. • gate indicator • 24mV @ 150 MHz typical sensitivity • 9 digit display • 1 ppm accuracy • display hold • dual inputs with preamps.

~~\$169.95~~ wired includes AC adapter

BP-4 nicad pack 8.95



CT-50 8 DIGIT 600 MHz COUNTER

A versatile lab bench counter with optional receive frequency adapter, which turns the CT-50 into a digital readout for most any receiver • 25 mV @ 150 MHz typical sensitivity • 8 digit display • 1 ppm accuracy.

~~\$169.95~~ wired

CT-50 kit \$139.95
RA-1 receiver adapter kit 14.95



DM-700 DIGITAL MULTIMETER

Professional quality at a hobbyist price. Features include 26 different ranges and 5 functions • 3 1/2 digit, 1/2 inch LED display • automatic decimal placement • automatic polarity.

~~\$119.95~~ wired includes AC adapter

DM-700 kit \$99.95
MP-1 probe set 4.95



PS-2 AUDIO MULTIPLIER

The PS-2 is handy for high resolution audio resolution measurements, multiplies UP in frequency • great for PL tone measurements • multiplies by 10 or 100 • 0.01 Hz resolution & built-in signal preamp/conditioner.

~~\$49.95~~ wired

PS-2 kit \$39.95



PR-2 COUNTER PREAMP

The PR-2 is ideal for measuring weak signals from 10 to 1,000 MHz • flat 25 db gain • BNC connectors • great for shifting RF • ideal receiver/TV preamp.

~~\$44.95~~ wired includes AC adapter

PR-2 kit \$34.95



PS-1B 600 MHz PRESCALER

Extends the range of your present counter to 600 MHz • 2 stage preamp • divide by 10 circuitry • sensitivity: 25mV @ 150 MHz • BNC connectors • drives any counter.

~~\$59.95~~ wired includes AC adapter

PS-1B kit \$49.95

ACCESSORIES FOR RAMSEY COUNTERS

- Telescopic whip antenna—BNC plug . . . \$ 8.95
- High impedance probe, light loading . . . 16.95
- Low pass probe, audio use 16.95
- Direct probe, general purpose use 13.95
- Tilt bail, for CT-70, 90, 125 3.95



PHONE ORDERS CALL
716-586-3950
TELEX 466735 RAMSEY CI

TERMS • satisfaction guaranteed • examine for 10 days, if not pleased, return in original form for refund • add 6% for shipping and insurance to a maximum of \$10.00 • overseas add 15% for surface mail • CDD add \$2.50 (CDD in USA only) • orders under \$15.00 add \$1.50 • NY residents add 7% sales tax • 90 day parts warranty on all kits • 1 year parts & labor warranty on all wired units.

RAMSEY

RAMSEY ELECTRONICS, INC.
2575 Baird Rd.
Penfield, N.Y. 14626

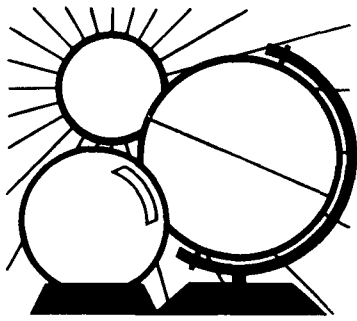

DX FORECASTER

Garth Stonehocker, KØRYW

MUF Forecasting

Recent studies of variations in maximum usable frequency (MUF) and its controlling factor, foF2 (the maximum ion density of the ionosphere), show how to do MUF forecasting (a day or two ahead) during the next year of DXing. In previous columns, methods for obtaining a mid-latitude noontime foF2 or MUF baseline (average) value using the average solar flux value for the same month were provided.¹

The daily percentage change in MUF can be obtained by using a factor related to the daily change in solar flux or geomagnetic A index. The factor given in 1984 was percentage change in MUF equals 30 per cent of the solar flux change (1 per cent for every 3 flux units). This was when the solar flux numbers were in the 150s, with large daily excursions of 10 to 20 units and a 2 to 3-day delay for the ionosphere's foF2 to catch up. This approach to forecasting really works!

Now that we're near minimum sunspot number, does the same factor still apply? No. Since the ionosphere is a geophysical system in equilibrium (i.e., balanced), expect compensating conditions to occur even though MUFs are lower. The large and fast variations no longer occur but are slower-changing — 10 to 20 units in value over a period of several days.

One study shows that the ionosphere is now more sensitive to solar flux changes. The new factor has each flux unit equal to 1.2 the percentage foF2 change. In addition, the 2 to 3-day delay is no longer experienced because solar flux variations occur slowly enough for the ionosphere to "keep in step."

The study also indicated that the

influence of geomagnetic field variations on the ionosphere is greater now than when solar flux levels were higher. For example, at higher fluxes, an A of 16 to 30 decreased the foF2 by approximately 4 to 7 per cent and an A of over 100 resulted in a 15 per cent decrease from the median value of the month. At the current flux level, an A of 11 to 70 causes an 8 to 25 per cent decrease in foF2. There appears to be quite a difference. However, the foF2 median value at the higher value of flux was 9 MHz; currently it is 5.5 MHz. Take 15 per cent of 9 MHz and 25 per cent of 5.5 MHz. Notice that these values are very close to 1.25 MHz — the actual foF2 reduction — in either case.

The ionosphere has a way of equalizing effects between sunspot extremes. These foF2, solar flux, and A index relationships were further confirmed by a study conducted at the Institute of Telecommunication Sciences (ITS) in Boulder, Colorado. The study examined the distribution of MUF values about the median (value) for the month over a 6-hour period during each day during the various seasons and over three sunspot number ranges. They found little difference (only 2 per cent) between mid-latitude MUF variation and sunspot levels. (More on this study next month).

In summary, the current solar flux increases, though small, cause the mid-latitude MUF to increase (1 per cent for each flux unit). During disturbed geomagnetic field conditions, the reduction in mid-latitude MUF (which occurs a few hours after the onset of a storm) can be found from this relationship: percentage change in MUF = $0.375A + 3.75$. Values of solar flux and geomagnetic field indices are

broadcast by WWV at 18 minutes after the hour. These new factors should help you more accurately forecast DX conditions during the next few years of low sunspot numbers.

last minute forecast

The higher HF bands (10 through 30 meters) are expected to be best during the first and second weeks of December as well as part of the last week of the month. A solar flux peak on December 5 and another on January 1 are expected to occur, enhancing DX conditions. Lower solar flux values will mean lower MUFs during the third and fourth weeks of December. However, lower flux means greater daytime signal strengths on the lower HF bands since there'll be less absorption during these times. Lower absorption normally occurs during the winter months as well as during the 27-day solar cycle minimums. The geomagnetic field will probably be disturbed during the third week of the month. These disturbances result in a reduced MUF on east-west and northern paths and an enhanced MUF on transequatorial paths.

The Geminids meteor shower, which will peak on December 13-14, will provide the richest and most reliable display of the year, with rates of 60 to 70 per hour. Because optical observations may be difficult or impossible during periods of poor weather in December, actual numbers must be determined by radio reception. A smaller version of the shower will be observed on December 22.

Lunar perigee and a full moon will occur on December 11 and 27, respectively. Winter solstice occurs on the 21st at 2208 UT.

WESTERN USA

GMT	PST										
	4:00	5:00	6:00	7:00	8:00	9:00	10:00	11:00	12:00	1:00	2:00
0000	40	30	30	30	30	30	30	30	30	40	40
0100	40	40	40	40	40	40	40	40	40	40	40
0200	40	40	40	40	40	40	40	40	40	40	40
0300	40	40	40	40	40	40	40	40	40	40	40
0400	40	40	40	40	40	40	40	40	40	40	40
0500	40	40	40	40	40	40	40	40	40	40	40
0600	40	40	40	40	40	40	40	40	40	40	40
0700	40	40	40	40	40	40	40	40	40	40	40
0800	40	40	40	40	40	40	40	40	40	40	40
0900	40	40	40	40	40	40	40	40	40	40	40
1000	40	40	40	40	40	40	40	40	40	40	40
1100	40	40	40	40	40	40	40	40	40	40	40
1200	40	40	40	40	40	40	40	40	40	40	40
1300	40	40	40	40	40	40	40	40	40	40	40
1400	40	40	40	40	40	40	40	40	40	40	40
1500	40	40	40	40	40	40	40	40	40	40	40
1600	40	40	40	40	40	40	40	40	40	40	40
1700	40	40	40	40	40	40	40	40	40	40	40
1800	40	40	40	40	40	40	40	40	40	40	40
1900	40	40	40	40	40	40	40	40	40	40	40
2000	40	40	40	40	40	40	40	40	40	40	40
2100	40	40	40	40	40	40	40	40	40	40	40
2200	40	40	40	40	40	40	40	40	40	40	40
2300	40	40	40	40	40	40	40	40	40	40	40

MID USA

GMT	MST										
	5:00	6:00	7:00	8:00	9:00	10:00	11:00	12:00	1:00	2:00	3:00
0000	40	40	40	40	40	40	40	40	40	40	40
0100	40	40	40	40	40	40	40	40	40	40	40
0200	40	40	40	40	40	40	40	40	40	40	40
0300	40	40	40	40	40	40	40	40	40	40	40
0400	40	40	40	40	40	40	40	40	40	40	40
0500	40	40	40	40	40	40	40	40	40	40	40
0600	40	40	40	40	40	40	40	40	40	40	40
0700	40	40	40	40	40	40	40	40	40	40	40
0800	40	40	40	40	40	40	40	40	40	40	40
0900	40	40	40	40	40	40	40	40	40	40	40
1000	40	40	40	40	40	40	40	40	40	40	40
1100	40	40	40	40	40	40	40	40	40	40	40
1200	40	40	40	40	40	40	40	40	40	40	40
1300	40	40	40	40	40	40	40	40	40	40	40
1400	40	40	40	40	40	40	40	40	40	40	40
1500	40	40	40	40	40	40	40	40	40	40	40
1600	40	40	40	40	40	40	40	40	40	40	40
1700	40	40	40	40	40	40	40	40	40	40	40
1800	40	40	40	40	40	40	40	40	40	40	40
1900	40	40	40	40	40	40	40	40	40	40	40
2000	40	40	40	40	40	40	40	40	40	40	40
2100	40	40	40	40	40	40	40	40	40	40	40
2200	40	40	40	40	40	40	40	40	40	40	40
2300	40	40	40	40	40	40	40	40	40	40	40

EASTERN USA

GMT	EST										
	7:00	8:00	9:00	10:00	11:00	12:00	1:00	2:00	3:00	4:00	5:00
0000	40	40	40	40	40	40	40	40	40	40	40
0100	40	40	40	40	40	40	40	40	40	40	40
0200	40	40	40	40	40	40	40	40	40	40	40
0300	40	40	40	40	40	40	40	40	40	40	40
0400	40	40	40	40	40	40	40	40	40	40	40
0500	40	40	40	40	40	40	40	40	40	40	40
0600	40	40	40	40	40	40	40	40	40	40	40
0700	40	40	40	40	40	40	40	40	40	40	40
0800	40	40	40	40	40	40	40	40	40	40	40
0900	40	40	40	40	40	40	40	40	40	40	40
1000	40	40	40	40	40	40	40	40	40	40	40
1100	40	40	40	40	40	40	40	40	40	40	40
1200	40	40	40	40	40	40	40	40	40	40	40
1300	40	40	40	40	40	40	40	40	40	40	40
1400	40	40	40	40	40	40	40	40	40	40	40
1500	40	40	40	40	40	40	40	40	40	40	40
1600	40	40	40	40	40	40	40	40	40	40	40
1700	40	40	40	40	40	40	40	40	40	40	40
1800	40	40	40	40	40	40	40	40	40	40	40
1900	40	40	40	40	40	40	40	40	40	40	40
2000	40	40	40	40	40	40	40	40	40	40	40
2100	40	40	40	40	40	40	40	40	40	40	40
2200	40	40	40	40	40	40	40	40	40	40	40
2300	40	40	40	40	40	40	40	40	40	40	40

The italicized numbers signify the bands to try during the transition and early morning hours, while the standard type provides the MUF during "normal" hours.
 *Look at next higher band for possible openings.

NEMAL ELECTRONICS INTL., INC.

NOW AUTHORIZED BELDEN DISTRIBUTOR

your one stop coax supplier!



Exclusive

SATELLITE CONTROL CABLE

5 TYPES AVAILABLE!

NEW!!! Lowest Loss

AVAILABLE IN
250-500-1000
FT ROLLS
OR BY
THE FOOT

TYPE 1 (General Purpose) RG59/U 96% Copper Braid	TYPE 2 (MII) RG59/U 96% Copper Braid	TYPE 3 (Interim) RG59/U 96% Copper Braid	TYPE 4 RG6/U 18 Gauge 96% Copper Shield	TYPE 5 RG6/U 18 Gauge 96% Copper Shield
2 @ 16 Gauge	2 @ 12 Gauge	2 @ 12 Gauge	2 @ 12 Gauge	2 @ 12 Gauge
3 @ 22 Gauge	3 @ 18 Gauge	3 @ 18 Gauge	3 @ 18 Gauge	3 @ 18 Gauge
3 @ 20 Gauge	3 @ 20 Gauge	3 @ 22 Gauge	3 @ 20 Gauge	3 @ 20 Gauge
Shielded plus Tinned Copper Drain Wire	Shielded plus Tinned Copper Drain Wire	Shielded plus Tinned Copper Drain Wire	Shielded plus Tinned Copper Drain Wire	Shielded plus Tinned Copper Drain Wire
55¢ FT	75¢ FT	95¢ FT	79¢ FT	89¢ FT

Designed for easy, one-step installation providing the required cables for most earth station equipment all in a direct burial jacket

Only Nermal offers the quality construction RG59/U copper shielding made to mil spec JAN C-17, 12-gauge conductors, tinned copper drain wires, and a true direct burial polyethylene jacket

Call for 1000 FT pricing

HARDLINE

Two styles, two sizes for all installation needs

- Aluminum Outer Conductor with Polyethylene Jacket**
 - 1/2 inch loss .48 dB/100 ft @ 30 MHz
 - 3.68 dB/100 ft @ 1000 MHz\$1.25/ft.
 - 7/8 inch loss .28 dB/100 ft @ 30 MHz
 - 2.54 dB/100 ft @ 1000 MHz\$3.25/ft.
 - Corrugated Copper Outer Conductor with Polyethylene Jacket**
 - 1/2 inch loss .38 dB/100 ft @ 30 MHz (FLC12-50) 2.78 dB/100 ft @ 1000 MHz\$1.59/ft.
 - 7/8 inch loss .13 dB/100 ft @ 30 MHz (FLC12-78) 1.3 dB/100 ft @ 1000 MHz\$3.92/ft.
- COMPARE RG 213 1.25 dB/100 @ 30 MHz
8.5 dB/100 @ 1000 MHz !

HARDLINE CONNECTORS

- 1/2 inch aluminum UHF M/F \$19.00 Type N M/F \$22.00
- 7/8 inch aluminum UHF M/F \$49.00 Type N M/F \$49.00
- 1/2 inch copper UHF M/F \$22.00 Type N M/F \$22.00
- 7/8 inch copper UHF M/F \$49.00 Type N M/F \$49.00

Shipping

Cable — \$6.00 per 100 ft.
Connectors — \$3.00 per order.
Orders under \$20 add \$2 additional plus shipping.
Charge card — orders over \$30 only.
COD add \$2.00. Florida Residents add 5%.

FACTORY AUTHORIZED DISTRIBUTOR
AMPHENOL, CABLEWAVE, COLUMBIA, KINGS
BLONDER-TONGUE, TYTON, B&K

- COAXIAL CABLE
- MULTICONDUCTOR CABLE
- CONNECTORS-ADAPTERS
- HARDLINE
- CABLE TIES
- SMATV PRODUCTS
- COAX-SEAL
- COMPUTER CABLE
- CRIMP TOOLS
- FIELD STRENGTH METER

COAXIAL CABLE SALE POLYETHYLENE DIELECTRIC

RG-8/U 96% shield Mil Spec. (\$29.00/100) or 31¢/ft.	
RG11U 96% shield 75 ohm mil spec. 25¢/ft.	
RG-55B/U double shield (RG-58 size) 50 ohm 45¢/ft.	
RG58U mil spec 96% shield (\$10.00/100) or 11¢/ft.	
RG62A/U 96% shield mil spec 93 ohm 12¢/ft.	
RG174/U min. 50 Ω mil spec 10¢/ft.	
RG213 noncontaminating 96% shield mil spec 36¢/ft.	
RG214/U double silver shield 50 ohm \$1.65/ft.	
RG214/U tinned copper 65¢/ft.	
RG217/U double shield 50Ω 5/8" OD. 85¢/ft.	

LOW LOSS FOAM DIELECTRIC

RG-8X (Mini 8) 95% shield (\$15.00/100) or 17¢/ft.	
RG8U 80% shield (\$19.00/100) or 22¢/ft.	
RG-8/U 97% shield 11 gu. (eq. Belden 8214) 31¢/ft.	
RG58U 80% shield 07¢/ft.	
RG58U 95% shield 10¢/ft.	
RG59/U 100% foil shield TV type 10¢/ft.	
RG59/U 70% copper shield 09¢/ft.	
HEAVY DUTY ROTOR CABLE 2-16 ga 6-20 ga 36¢/ft.	
Rotor cable 2-18 ga 6-22 ga Poly burial Jkt. 19¢/ft.	

Complete line of multiconductor cables; available

CONNECTORS MADE IN USA

Amphenol PL 259 89¢	
PL-259 and/or SO-239 65¢ ea. or 10/\$5.99	
Double Male Connector \$1.79	
PL-258 Double Female Connector 98¢	
PL-259 Silver-Teflon Kings \$1.59 ea.	
Reducer UG-175 or 176 22¢ or 10/\$2.00	
UG-255 (PL-259 to BNC) \$2.95	
Elbow (M359) UHF Elbow \$1.79	
F59A (TV type) 24¢ or 10/\$2.00	
UG 21 D/U Type N Male for RG8, Amphenol \$3.00	
UG-88C/U BNC Male for RG-58, Amphenol \$1.25	
UG 273 BNC-PL259 Amphenol \$3.00	
3/16 inch Mike Plug for Collins etc. (cutoff) \$1.25	

Shipping

Cable — \$3.00 per 100 ft.
Connectors — add 10%, \$3.00 minimum.
Orders under \$20 add \$2 additional plus shipping.
Charge card — orders over \$30 only.
COD add \$2.00. Florida Residents add 5%.

band-by-band summary

Ten and twelve meters, the highest day-only DX bands, are nearest the MUF for southern hemisphere paths. They will be open most days when the solar flux is above 75 during the 7 to 10-hour period centered on local noon. These bands open on paths toward the east and close toward the west. The paths are up to 4000 km (2400 miles) in single-hop length, and on occasion double that during evening trans-equatorial openings.

Fifteen meters, a day-only DX band open most of each day, has lower signal strengths and greater multipath variability than 10 and 12 meters. It will be best when the MUF is just resting above this band, until it drops below it — a transition period that occurs right after sunrise and just before sunset. Transequatorial openings will occur, with distances similar to 10 and 12 meters.

Twenty, thirty, and forty meters are both day and nighttime DX bands. Twenty is the maximum usable band for DX in the northern directions during daytime. In combination with 30 meters, it provides nighttime paths for the day-only bands. Forty meters becomes the main over-the-pole DX daytime band, with some hours covered by 30 meters. This path may be affected by anomalous absorption during a few days of the month.

Eighty and one sixty meters, the night-only DX bands, exhibit short-skip propagation during daylight hours, then lengthen at dusk. These bands follow the darkness path, opening to the east just before local sunset, swinging more to the north-south near midnight, and ending up in the Pacific areas for a few hours before dawn. On some nights, 80 meters, with its high signal strengths, will be the best band to use. One-sixty is also expected to provide good conditions. Please remember the DX windows of 3790 to 3800, 1825 to 1830, and 1850 to 1855 kHz.

references

- Garth Stonehocker, KØRYW, "DX Forecaster," *ham radio*, January, 1984, page 83, and February, 1984, page 79.

ham radio



12240 N.E. 14th Ave.

No. Miami, FL 33161

Telephone: (305) 893-3924

IN STOCK

— OVER 500 ITEMS —
COMPLETE LINES

✓ 159

ALL BAND TRAP "SLOPER" ANTENNAS!

FULL COVERAGE! ALL BANDS! AUTOMATIC SELECTION with PROVEN Weatherproof sealed Traps - 18 Ga Copperweld Wire! GROUND MOUNT SLOPERS - No Radials needed! Ground to rod or house water faucet! Connect Top to Trees, Buildings, Poles, etc at ANY angle from Straightup to 60 degrees for excellent "SLOPER" DX Antenna Gain or bend it anywhere you need to! 2000 Watt PEP Input, max. Permanent or portable Use. Installs in 10 minutes. SMALL - NEAT - ALMOST INVISIBLE. No one will know you have a Hi-Power DX Antenna. Ideal For COND'Os, APARTMENTS - RESTRICTED AREAS - Pre-tuned for 2-1 or less SWR over ALL bands (except 80-160-300Kc). No adjustments needed - EVER. COMPLETELY ASSEMBLED, with 50 ft RG-58U Coax feedline and PL-259 connector. Built in lightning arrester - ready to hookup! FULL INSTRUCTIONS!

No. 1080S - 80-40-20-15-10 - 1 trap 49 ft. — \$49.95
No. 1040S — 40-20-15-10 — 1 trap 26 ft. — \$49.95
No. 1020S — 20-15-10 — 1 trap 13 ft. — \$47.95
No. 1016S - 160-80-40-20-15-10 - 2 traps 83 ft. — \$79.95

SEND FULL PRICE FOR PPDEL IN USA (Canada is \$5.00 extra for postage etc) or order using VISA, MASCARD - AMER EXP. Give Number Ex. Date. Ph. 1-308-236-5333 weekdays. We ship in 2-3 days (Per Chk. 4 days) Guaranteed 1 yr - 10 day money back trial.

WESTERN ELECTRONICS
Dept. AR-12 Kearney, Nebraska 68847

DX EDGE

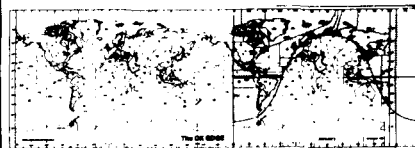

\$16.95

GRAYLINE AND LONG PATH
PREDICTOR

Great Circle Overlays

20°, 30°, & 40° Latitude (NSS)

\$5 each

\$3 When purchased with slide rule DX Edge

Please enclose \$3.50 shipping and handling

Ham Radio's Bookstore
Greenville, NH 03048

ham radio

Reader Service

For literature or more information, locate the Reader Service number at the bottom of the ad, circle the appropriate number on this card, affix postage and send to us. We'll hustle your name and address to the companies you're interested in.

101 113 125 137 149 161 173 185 197 209 221 233 245 257 269 281 293 305 317 329 341
102 114 126 138 150 162 174 186 198 210 222 234 246 258 270 282 294 306 318 330 342
103 115 127 139 151 163 175 187 199 211 223 235 247 259 271 283 295 307 319 331 343
104 116 128 140 152 164 176 188 200 212 224 236 248 260 272 284 296 308 320 332 344
105 117 129 141 153 165 177 189 201 213 225 237 249 261 273 285 297 309 321 333 345
106 118 130 142 154 166 178 190 202 214 226 238 250 262 274 286 298 310 322 334 346
107 119 131 143 155 167 179 191 203 215 227 239 251 263 275 287 299 311 323 335 347
108 120 132 144 156 168 180 192 204 216 228 240 252 264 276 288 300 312 324 336 348
109 121 133 145 157 169 181 193 205 217 229 241 253 265 277 289 301 313 325 337 349
110 122 134 146 158 170 182 194 206 218 230 242 254 266 278 290 302 314 326 338 350
111 123 135 147 159 171 183 195 207 219 231 243 255 267 279 291 303 315 327 339
112 124 136 148 160 172 184 196 208 220 232 244 256 268 280 292 304 316 328 340

Limit 15 inquiries per request.

NAME _____ CALL _____

ADDRESS _____

CITY _____ STATE _____ ZIP _____

Please use before January 31, 1986

December 1985

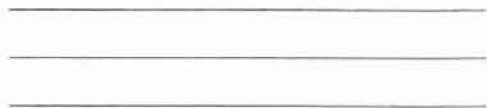

AFFIX POSTAGE
OR
POST OFFICE
WILL NOT
DELIVER

ham
radio
magazine

READER SERVICE CENTER
P.O. BOX 2558
WOBURN, MA 01888

ATTN: Reader Service Dept.

ASTRON POWER SUPPLIES

• HEAVY DUTY • HIGH QUALITY • RUGGED • RELIABLE •

RS and VS SERIES

SPECIAL FEATURES

- SOLID STATE ELECTRONICALLY REGULATED
- FOLD-BACK CURRENT LIMITING Protects Power Supply from excessive current & continuous shorted output.
- CROWBAR OVER VOLTAGE PROTECTION on all Models except RS-4A.
- MAINTAIN REGULATION & LOW RIPPLE at low line input Voltage.
- HEAVY DUTY HEAT SINK • CHASSIS MOUNT FUSE
- THREE CONDUCTOR POWER CORD
- ONE YEAR WARRANTY • MADE IN U.S.A.

PERFORMANCE SPECIFICATIONS

- INPUT VOLTAGE: 105 - 125 VAC
- OUTPUT VOLTAGE: 13.8 VDC \pm 0.05 volts (Internally Adjustable: 11-15 VDC)
- RIPPLE: Less than 5mv peak to peak (full load & low line)

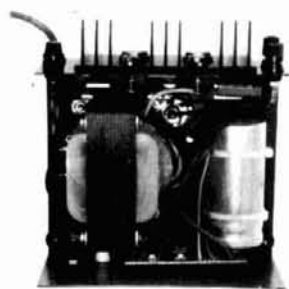

INSIDE VIEW - RS-12A



MODEL RS-50A



MODEL RS-50M



MODEL VS-50M

RM-A Series

19" X 5 1/4" RACK MOUNT POWER SUPPLIES



MODEL RM-35A

Model	Continuous Duty (AMPS)	ICS* (AMPS)	Size (IN) H X W X D	Shipping Wt. (lbs.)
RM-35A	25	35	5 1/4 x 19 x 12 1/2	38
RM-50A	37	50	5 1/4 x 19 x 12 1/2	50
• Separate Volt and Amp Meters RM-35M	25	35	5 1/4 x 19 x 12 1/2	38
RM-50M	37	50	5 1/4 x 19 x 12 1/2	50

RS-A SERIES



MODEL RS-7A

MODEL	Continuous Duty (Amps)	ICS* (Amps)	Size (IN) H x W x D	Shipping Wt (lbs)
RS-4A	3	4	3 3/4 x 6 1/2 x 9	5
RS-7A	5	7	3 3/4 x 6 1/2 x 9	9
RS-7B	5	7	4 x 7 1/2 x 10 3/4	10
RS-10A	7.5	10	4 x 7 1/2 x 10 3/4	11
RS-12A	9	12	4 1/2 x 8 x 9	13
RS-20A	16	20	5 x 9 x 10 1/2	18
RS-35A	25	35	5 x 11 x 11	27
RS-50A	37	50	6 x 13 3/4 x 11	46

RS-M SERIES



MODEL RS-35M

- Switchable volt and Amp meter

MODEL	Continuous Duty (Amps)	ICS* (Amps)	Size (IN) H x W x D	Shipping Wt (lbs)
RS-12M	9	12	4 1/2 x 8 x 9	13
RS-20M	16	20	5 x 9 x 10 1/2	18
RS-35M	25	35	5 x 11 x 11	27
RS-50M	37	50	6 x 13 3/4 x 11	46

VS-M SERIES



MODEL VS-20M

- Separate Volt and Amp Meters
- Output Voltage adjustable from 2-15 volts
- Current limit adjustable from 1.5 amps to Full Load

MODEL	Continuous Duty (Amps)			ICS* (Amps)	Size (IN) H x W x D	Shipping Wt (lbs)
	@ 13.8VDC	@ 10VDC	@ 5VDC			
VS-20M	16	9	4	20	5 x 9 x 10 1/2	20
VS-35M	25	15	7	35	5 x 11 x 11	29
VS-50M	37	22	10	50	6 x 13 3/4 x 11	46

RS-S SERIES



MODEL RS-12S

- Built in speaker

MODEL	Continuous Duty (Amps)	ICS* Amps	Size (IN) H x W x D	Shipping Wt (lbs)
RS-7S	5	7	4 x 7 1/2 x 10 3/4	10
RS-10S	7.5	10	4 x 7 1/2 x 10 3/4	12
RS-10L(For LTR)	7.5	10	4 x 9 x 13	13
RS-12S	9	12	4 1/2 x 8 x 9	13
RS-20S	16	20	5 x 9 x 10 1/2	18

ham radio cumulative index

1981-1985

antennas and transmission lines

general

- Antenna geometry for optimum performance
N4HI p. 60, May 82
- Antenna insulators, PTFE VHF
W5JTL p. 98, Oct 85
- Antenna parameters, equations for determining
KG6B p. 40, Mar 82
- Antenna restrictions (letter)
K3SRO p. 6, Nov 81
- Antenna support (HN)
W6XM p. 64, Jun 84
- Applied Yagi antenna design part 2:
220 MHz and the Greenblum design data
WB3BGU p. 33, Jun 84
- Bafun chop suey
K4KJ p. 113, May 85
- Beam antenna mast lock
W4KV p. 68, Jun 81
- Best way to get an antenna into a tree (HN)
WASVLX p. 84, Mar 81
- Bulkhead connector (HN)
K9CZB p. 78, Apr 85
Short Circuit p. 74, Jul 85
- Dipole antenna length reference chart (HN)
W6XM p. 75, Oct 81
- Direction-finding tool, the fox box
K1ZJH p. 25, Oct 85
- Ground rod resistance
K4MT p. 95, Jul 84
Comments p. 8, Sep 84
- Ground systems, installing effective
KR7L p. 67, Sep 83
- Ham radio techniques
W6SAI p. 75, Nov 84
- Ham radio techniques
W6SAI p. 67, Dec 84
- Leyden's magic jar: the derivation of
the Hertzian and Marconi antennas
KR6A p. 24, Oct 84
- Light-bulb dummy loads (HN)
W6HPH p. 74, Oct 81
- Neglected antenna for 40 and 80 meters
W0WL p. 44, Jan 82
Comments, W0WL p. 8, May 82
- Rain static resolved (Tech. forum)
W1FYX p. 83, Sep 83
- Static mystery (Tech. forum)
HB9FU p. 85, Jul 83
- The Zepp (letter)
W2RHQ p. 63, Aug 82
- Vertical antenna, folded umbrella, top-loaded
VE2CV p. 12, Sep 82
- Vertical- ν ee, converting (letter)
K5KWW p. 8, Sep 82
- VHF/UHF world
W1JR p. 110, May 84
- Wire plow, build a simple
W7IV p. 107, May 84
- Yagis, stacking is a science
K1FO p. 18, May 85
- Aligning Yagi beam elements (HN)
WA2SON p. 92, May 81
- Applied Yagi antenna design, part 6:
the model and a special teaching tool
WB3BGU p. 89, Oct 84
- Bobtail curtain and inverted ground plane: part 1
W6BCX p. 82, Feb 83
Short circuit p. 92, Nov 83
Comments, WA7BPO p. 12, Jul 83
Short circuit p. 92, Nov 83
- Bobtail curtain and inverted ground plane: part 2
W6BCX p. 28, Mar 83
Short circuit p. 16, May 83
Comments, WA7BPO p. 12, Jul 83
- Butterfly beam
W1XU p. 30, May 81
- Capacitively loaded dipole, high-performance
W6VX p. 33, May 84
- Debunking myths (letter)
WB9VWA p. 8, Mar 83
- Delta loop, the reduced-size, full-performance,
corner-fed
G3TKN p. 67, Jan 85
- Dipole antenna over sloping ground
N4HI p. 18, May 82
- Dipole antenna, trimming the (HN)
W5NPD p. 69, Jul 81
- End-fed 8JK: switchable vertical array
W1JF p. 53, May 85
- Four-vertical collinear element 20-meter array
WA8DXB p. 57, May 83
- Grounded monopole with elevated feed
VE2CV p. 87, May 83
- Half-delta loop
VE2CV p. 37, May 82
- Half-square antenna, the
N0AN p. 48, Dec 81
Short circuit p. 79, Oct 82
- Half-wave vertical
VE2CV p. 36, Sep 81
- Ham radio techniques
W6SAI p. 65, Jan 84
Comments, WA2DRL p. 8, Sep 84
- Ham radio techniques
W6SAI p. 63, Feb 84
Comments, K4KYV p. 12, May 84
Comments, WD6DUD p. 8, Sep 84
Comments, AD1G p. 8, Dec 84
- Ham radio techniques
W6SAI p. 53, Mar 84
- Ham radio techniques
W6SAI p. 76, Apr 84
- Ham radio techniques, fifty years ago
W6SAI p. 58, Jun 84
- Ham radio techniques, 160 redux
W6SAI p. 89, Jul 84
- Ham radio techniques
W6SAI p. 96, Aug 84
- Ham radio techniques
W6SAI p. 106, Oct 84
- Ham radio techniques
W6SAI p. 32, Sep 81
- Ham radio techniques
W6SAI p. 55, Dec 85
- HF antenna (HN)
W2GQK p. 22, Jul 83
- Inverted "L", limited space (HN)
W8FR p. 63, Jun 84
- JR vari-lobe antenna, control your take-off angle
W1JF p. 46, May 85
- Junk-box portable antenna
W3SMT p. 24, Oct 81
- K7CW quad
K7CW p. 36, Sep 82
- Log-Yagis simplified
W3EB p. 78, May 83
- Making verticals quieter (Tech forum)
W6BRYZ p. 98, Jun 83
- Matching dipoles (letter)
W5XW p. 8, Aug 85
- Mobile high-frequency antenna, refinements to
W3NZ p. 34, Jun 81
- Mobile vertical, 20-meter
K9CZB p. 26, May 83
- Modified Bobtail (HN)
W0MBP p. 87, Sep 84
- Multiband 8JK, an end-fed
G3SBA p. 81, May 84
- Phased arrays, feeding: an alternate method
K8BI p. 58, May 85
Short circuit p. 74, Jul 85
- Phased vertical arrays, pattern calculations for
WB5HGR p. 40, May 81
- Quad owner switches
N6NB, W6AQ p. 12, May 82
Comments, W6BOD p. 8, Dec 82
- Rhombics, controlled vertical radiation,
part 1: designing for high performance
N4UH p. 100, Mar 85
- Rhombics, controlled vertical radiation,
part 2: antenna erection and performance
N4UH p. 99, Apr 85
- SEED antenna: a short, efficient
end-fed dipole
W4JAZ p. 103, Sep 84
- Short antennas, efficiency of
W1GV/4 p. 18, Sep 82
- Short vertical antennas for low bands: part 1
W7DHD p. 36, May 83
- Short vertical antennas for low bands: part 2
W7DHD p. 17, Jun 83
- Six-element wide-beam for 10 (ham radio techniques)
W6SAI p. 30, Dec 81
- Stagger-tuned dipoles increase bandwidth
K4MT p. 22, May 83
- Suspended long Yagi (ham radio techniques)
W6SAI p. 34, Nov 81
- Tapered vertical, calculating the
input impedance of
K3OGF p. 24, Aug 85
Short circuit p. 78, Oct 85
- Terminated ν ee beam, sloping
Ross, Robert p. 71, May 85
- The K2GNC Giza beam
K2GNC p. 52, May 81
- Top-loaded vertical, a high-efficiency
W6US p. 65, Oct 84
- Transmission line antenna, 160-meter
N9NB p. 87, May 85
- Trap antenna, design your own
W4MB p. 37, Oct 84
- Trapped antenna, trapping the mysteries of
N3GO p. 10, Oct 81
Comments, K9CZB p. 8, Feb 82
- Triband Yagi beam (ham radio techniques)
W6SAI p. 68, Jan 81
- Two delta loops fed in phase
W8HXR p. 60, Aug 81
- Vertical phased arrays: part 1
K2BT p. 18, May 83
Comments, W9OAM p. 10, Mar 84
- Vertical phased arrays: part 2
K2BT p. 25, Jun 83
Comments, W9OAM p. 10, Mar 84
- Vertical phased arrays: part 3
K2BT p. 26, Jul 83
Short circuit p. 70, Oct 83
Comments, W9OAM p. 10, Mar 84

high-frequency antennas

- Active antenna, 0.5-30 MHz
K1ZJH p. 37, May 85
Comments, Hansen, R.C. p. 10, Jul 85

Vertical phased arrays: part 4	
K2BT	p. 34, Oct 83
Short circuit	p. 11, Dec 83
Comments, W9OAM	p. 10, Mar 84
Vertical phased arrays: part 5	
K2BT	p. 59, Dec 83
Comments, W9OAM	p. 10, Mar 84
Vertical phased arrays: part 6	
K2BT	p. 45, May 84
Verticals over REAL ground	
WB9VVA	p. 35, Jan 84
W8JK antenna, a new look at	
OD5CG	p. 60, Jul 81
Yagi beam elements, aligning (HN)	
WA2SON	p. 79, Jan 81
Yagis, designing with the Commodore 64	
WA3EKL	p. 59, Jun 83
Yagis, stacking is a science	
K1FO	p. 18, May 85
3-element Yagi design, key to	
K3OQF	p. 48, Mar 84
40, 80, and 160-meter vertical, remote controlled	
W7LR	p. 38, May 84
80-meter half-wave sloper uses reflector (HN)	
KO1F	p. 48, Oct 84
Short circuit	p. 8, Feb 85

vhf antennas

Antenna insulators, PTFE VHF	
W5JTL	p. 98, Oct 85
Applied Yagi antenna design part 1: a 2-meter classic revisited	
WB3BGU	p. 14, May 84
Applied Yagi antenna design part 2: 220 MHz and the Greenblum design data	
WB3BGU	p. 33, Jun 84
Applied Yagi antenna design part 3: 432 MHz with Knadle and Tilton	
WB3BGU	p. 73, Jul 84
Applied Yagi antenna design part 4: a 50-MHz Tilton/Greenblum design	
WB3BGU	p. 103, Aug 84
Applied Yagi antenna design part 5: additional optimization techniques	
WB3BGU	p. 93, Sep 84
Dual quad array for two meters	
W7SLO	p. 30, May 80
Efficient matching (Tech. forum)	
VE7BS	p. 83, Sep 83
Fastening Trigon reflectors to VHF antennas (HN)	
W5JTL	p. 88, Sep 84
Ham radio techniques	
W6SAI	p. 32, Sep 81
Handi-antennas	
AA6PZ	p. 42, May 83
Helical antenna matching (Tech. forum)	
Belliveau, John	p. 73, May 83
Inexpensive five-eighths wave groundplane (HN)	
W7CD	p. 84, Mar 81
Matching 432-MHz helical antenna (Tech. forum)	
W8NWU	p. 44, Mar 83
Microwave antenna, homebrew	
WB0VGI, Johnson	p. 68, Sep 82
Re-entrant cavity antenna for the VHF bands	
W4FXE	p. 12, May 81
Repeater antenna beam tilting	
K7NM	p. 29, May 83
Short circuit	p. 80, Jul 83
Using a 2-meter quarter-wave whip on 450 MHz (HN)	
K1ZJH	p. 92, May 81
VHF antenna null, achieving the perfect	
K3ED	p. 48, May 83
VHF/UHF World	
W1JR	p. 110, May 84
VHF/UHF World: stacking antennas, part 1	
W1JR	p. 129, Apr 85
VHF/UHF World: stacking antennas, part 2	
W1JR	p. 95, May 85
VHF/UHF world	
W1JR	p. 85, Dec 85
Yagis, stacking is a science	
K1FO	p. 18, May 85
2-meter J-pole antenna, all-metal	
KD8JB	p. 42, Jul 84
Comments, K2WWT, KD8JB	p. 8, Feb 85
Comments, DJ0TR/OE8AK	p. 8, Nov 85
2-meter V-antenna (Weekender)	
AD1B	p. 86, Jan 84

matching and tuning

A coreless balun	
WA2SON	p. 62, May 81
Antenna bridge calculations	
K6GK	p. 85, Mar 81
Short circuit	p. 84, Nov 81

Antenna match, quick and simple	
Anderson, Leonard H.	p. 58, Jan 81
Short circuit	p. 70, Feb 82
Antenna matching, easy	
WB4GCS	p. 67, May 84
Antenna tuner (HN)	
W6XM	p. 94, May 83
Antenna tuners (ham radio techniques)	
W6SAI	p. 30, Jul 81
Balun design, another	
W6HPH	p. 54, May 82
Capacitively coupled hybrids	
WA2EWT	p. 70, Mar 83
Efficient matching (Tech. forum)	
VE7BS	p. 83, Sep 83
Gamma matching, basic	
WB0KN	p. 29, Jan 85
Ham radio techniques	
W6SAI	p. 42, Oct 81
Ham radio techniques	
W6SAI	p. 65, Jan 84
Comments, WA2DRL	p. 8, Sep 84
Ham radio techniques	
W6SAI	p. 63, Feb 84
Comments, K4KYV	p. 12, May 84
Comments, WD6DUD	p. 8, Sep 84
Comments, AD1G	p. 8, Dec 84
Helical antenna matching (Tech. forum)	
Belliveau, John	p. 73, May 83
HF hybrid descriptions	
W5TRS	p. 80, Oct 83
High-frequency mobile antenna matcher, simple	
W6BCX	p. 28, Jun 81
Hybrid ring	
WA2EWT	p. 50, Aug 83
Impedance matching (Tech. forum)	
WB2NTQ	p. 85, Jul 83
Comment, K0CQ	p. 95, Nov 83
L-matching network, appreciating the	
WA2EWT	p. 27, Sep 80
Lowpass antenna matching unit, inductance-tuned	
W0YBF	p. 24, May 82
Low swr, how important?	
W1GV/4	p. 33, Aug 81
Comments K1KSY, W1GV/4	p. 6, Dec 81
Matching dipole antennas	
W1OLP	p. 129, May 84
Comments, W5XW	p. 12, Apr 85
Matching sections	
KL7HIT	p. 68, Mar 82
Matching 432-MHz helical antenna (Tech. forum)	
W8NWU	p. 44, Mar 83
Phased arrays, feeding: an alternative method	
KB8I	p. 58, May 85
Short circuit	p. 74, Jul 85
Swr meter, how accurate? (HN)	
WB9TQG	p. 78, Jan 81
Swr meter for the high-frequency bands	
WB6AFT	p. 62, Oct 81
Tandem pi networks	
W6MUR	p. 32, Jul 82
Testing baluns	
K4KJ	p. 30, Aug 83

towers and rotators

Antenna carriage and track pole mount	
KB3K	p. 46, Aug 83
Antenna hinge	
N4LI	p. 70, Aug 83
Antenna tower, fixed, tilt-over conversion	
PA0SE	p. 125, May 85
Armstrong beam rotator	
KP4DM	p. 68, Feb 82
CDE tailtwister rotor, pulse-position control of	
WB4EXW	p. 30, Jan 81
KLM antenna rotor, computer control for (HN)	
W8MQW	p. 66, Feb 81
Match your antenna to your tower	
WD0DGF	p. 14, Jun 84
Tower installation: make it sturdy, make it safe	
WB5IIR	p. 22, Jun 84
Keep your tower up	
KB9IW	p. 26, Jun 84
UHF antenna tower, low-cost	
KAG6VY	p. 30, Oct 84

transmission lines

Antiflex coaxial cable connection (HN)	
W4KV	p. 42, May 82
Bridge measurements, the half-wave transmission line in (HN)	
K4KI	p. 108, Nov 84
Cheapie coax (letter)	
WB4AHZ	p. 8, May 82

Coax, measuring with an RCL bridge (HN)	
WB9TQG	p. 78, Oct 82
Ham radio techniques, fifty years ago	
W6SAI	p. 58, Jun 84
Hardline connectors, inexpensive	
WB4GCS	p. 62, May 83
Comments, KM1H	p. 8, Nov 83
Hardline, matching 75 to 50-ohm	
W4VRV	p. 43, Oct 82
Hybrid coupler	
W1OOP	p. 36, Jun 82
Measuring coax cable loss with an swr meter	
WB9TQG	p. 35, May 81
Comments, WD4KMP, WB9TQG	p. 6, Sep 81
Comments, W4PPB	p. 8, Feb 82
Pi, pi-L, and tandem quarter-wave line matching networks, response of	
W6MUR	p. 12, Feb 82
Plumber's delight coax connector (weekender)	
N4LI	p. 50, May 81
PL-259 connectors, attaching to RG-58/U cable (HN)	
W5BVF	p. 81, Jan 82
Rf power divider (HN)	
W5TRS	p. 80, Feb 82
RF transmission cable, microwave applications	
K3HW	p. 106, May 85
T coupler, the (HN)	
K3NXU	p. 68, Nov 80
Time domain reflectometer	
VE3EFC	p. 49, Nov 83
Transmission-line design, Pt. 2: distributed resonant circuits in vhf/uhf lines	
W6GGV	p. 62, Jan 81
Transmission-line design, Pt. 3: distributed resonant circuits in vhf/uhf lines	
W6GGV	p. 56, Feb 81
Transmission-line design, Pt. 4: distributed resonant circuits in vhf/uhf lines	
W6GGV	p. 64, Mar 81
Transmission-line design, Pt. 5: 50 MHz and above	
W6GGV	p. 72, Apr 81
VHF/UHF World-transmission lines	
W1JR	p. 83, Oct 85
VHF/UHF World	
W1JR	p. 85, Dec 85

audio

Add-on selectivity for communications receivers	
G4GMO	p. 41, Nov 81
Audio filter building blocks	
KB0CY	p. 74, Jul 83
Audio Filter design, computer-aided	
KE2J	p. 15, Oct 85
Audio filter design, elliptic lowpass	
W3NGN	p. 20, Feb 84
Audio oscillator to pulse generator conversion (HN)	
W0DLQ	p. 50, Oct 84
Audio response, tailoring (HN)	
N1FB	p. 42, May 82
"Audio to microwave" amplifier, build your own	
Gruchalla, Michael	p. 12, Mar 84
Automatic gain control, an audio	
K7NM	p. 24, Sep 84
Better audio for mobile operation	
K6GCO	p. 48, Feb 81
CW acoustical filter (Tech. forum)	
W7BI	p. 22, Jan 83
CW and RTTY, digital audio filter for	
W1OER	p. 60, Aug 83
Short circuit	p. 199, Aug 84
Handheld transceiver, audio amplifier for	
N1IRM	p. 38, Jul 81
Heath HW-2036 mods (letter)	
Mosher, E.A.	p. 8, Jun 81
Passive audio filter design, part 2: highpass and bandpass filters	
Niewiadomski, S.	p. 41, Oct 85
Comments, W3NON	p. 8, Nov 85
Phone patches, building and using	
N6ARE	p. 34, Oct 85
Repeaters, speech synthesis for	
N9EE	p. 79, Mar 84
Simulated carbon microphones, using with	
Amateur transmitters	
W9MKV	p. 18, Oct 81
Telephone ring indicator, visual (HN)	
W2QLI	p. 62, Apr 84
TR-2400, external microphone for (HN)	
WB2IFV	p. 64, Mar 82
Understanding telephones	
N6ARE	p. 39, Sep 85

High Performance vhf/uhf preamps

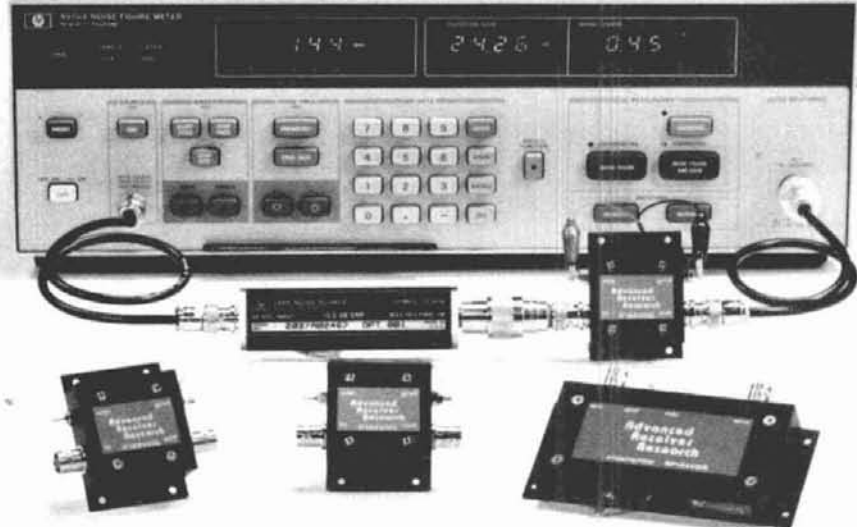

Receive Only	Freq. Range (MHz)	N.F. (dB)	Gain (dB)	1 dB Comp. (dBm)	Device Type	Price
P28VD	28-30	<1.1	15	0	DGFET	\$29.95
P50VD	50-54	<1.3	15	0	DGFET	\$29.95
P50VDG	50-54	<0.5	24	+12	GaAsFET	\$79.95
P144VD	144-148	<1.5	15	0	DGFET	\$29.95
P144VDA	144-148	<1.0	15	0	DGFET	\$37.95
P144VDG	144-148	<0.5	24	+12	GaAsFET	\$79.95
P220VD	220-225	<1.8	15	0	DGFET	\$29.95
P220VDA	220-225	<1.2	15	0	DGFET	\$37.95
P220VDG	220-225	<0.5	20	+12	GaAsFET	\$79.95
P432VD	420-450	<1.8	15	-20	Bipolar	\$32.95
P432VDA	420-450	<1.1	17	-20	Bipolar	\$49.95
P432VDG	420-450	<0.5	16	+12	GaAsFET	\$79.95
Inline (rf switched)						
SP28VD	28-30	<1.2	15	0	DGFET	\$59.95
SP50VD	50-54	<1.4	15	0	DGFET	\$59.95
SP50VDG	50-54	<0.55	24	+12	GaAsFET	\$109.95
SP144VD	144-148	<1.6	15	0	DGFET	\$59.95
SP144VDG	144-148	<1.1	15	0	DGFET	\$67.95
SP144VDA	144-148	<0.55	24	+12	GaAsFET	\$109.95
SP220VD	220-225	<1.9	15	0	DGFET	\$59.95
SP220VDA	220-225	<1.3	15	0	DGFET	\$67.95
SP220VDG	220-225	<0.55	20	+12	GaAsFET	\$109.95
SP432VD	420-450	<1.9	15	-20	Bipolar	\$62.95
SP432VDA	420-450	<1.2	17	-20	Bipolar	\$79.95
SP432VDG	420-450	<0.55	16	+12	GaAsFET	\$109.95

Every preamplifier is precision aligned on ARR's Hewlett Packard HP8970A/HP346A state-of-the-art noise figure meter. RX only preamplifiers are for receive applications only. Inline preamplifiers are rf switched (for use with transceivers) and handle 25 watts transmitter power. Mount inline preamplifiers between transceiver and power amplifier for high power applications. Other amateur, commercial and special preamplifiers available

in the 1-1000 MHz range. Please include \$2 shipping in U.S. and Canada. Connecticut residents add 7-1/2% sales tax. C.O.D. orders add \$2. Air mail to foreign countries add 10%. Order your ARR Rx only or Inline preamplifier today and start hearing like never before!

Advanced Receiver Research

Box 1242 • Burlington, CT 06013 • 203 582-9409



103

CUSTOM COMMUNICATION CONSOLES

Personal, Commercial, Industrial & Governmental Applications

Any shape & size to fill a corner or a room. Special design features & services are:

- Replaceable front panel, for equipment changes.
- Precisely cut front panel holes by computerized equipment.
- Computer aided design for: Floor plan lay-out, & console design.
- Design assistance, on-site analysis & installation are available.

Constructed from plastic laminated birch plywood & black anodized aluminum extrusions.

Contact: Larry Kushner, WA6BKC/4, President
BCS, Inc., 5817 SW 21 Street, Hollywood, FL 33023 (305) 989-2371

117

Introducing...

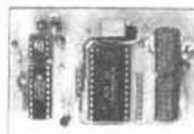

NoVax
ON CALL
It's on duty when you're not.

OC-1 ONLY \$59.95 Complete with Shipping/Handling USA

ON CALL is a complete selective call system so you don't have to monitor the frequency or it can be used as a decoder for controlling equipment at the repeater site and at home.

- Compare these features:
- 4 digit 16 tone sequential decoder programmable, 43,680 different codes, DTMF™ Format with Auto reset
 - 1 AMP SPST relay output, momentary or latched for external paging device, such as Auto horn, tape recorder, speaker Audio etc.
 - Flashing LED call indicator (Energizes when your code has been accessed).
 - easy connection to any radio
 - 12-16 volt DC operation
 - size 3 1/2 x 2 1/5 x 5 in.
 - can be used for clubs or emergency groups for help situations

*Reg. Trade Mark of ATT

To Order Send Check or Money Order To: **URGENT DEVELOPMENT CORPORATION**
MC-VISA Accepted NYS Residents Add Sales Tax
E Carter Rd PO Box 384 Westmoreland, NY 13490 or Phone 315-733-3719

188

STATION MANAGER/ADVANCED A General Purpose Logging Program

Designed for the IBM® PC, XT, enhanced PC jr.® Menu driven; prompts for easy use; full color displays; multiple logs (each up to 1,000 entries with user editing), several reporting methods including one by partial calling.

FALL SPECIAL

\$59.00 includes: 90 pg. User's Guide & Diskette (source code included)
\$20.00 — User's Guide only (may be applied to full purchase price)
Ohio residents include sales tax

WATCH FOR STATION MANAGER/CodeTutor To be released soon

OMEGA CONCEPTS

Professional software for the Radio Amateur™

P.O. Box 615 Troy, OH 45373



T.L. Jones (KB80A) Author

IBM is a registered trademark of International Business Machine Corp.

161

AUTHORIZED KENWOOD I-COM RADIO DEALER



139

H. L. HEASTER, INC., 203 Buckhannon Pike, Clarksburg, W. Va. 26301 Clarksburg Phone (304) 624-5485 or W. Va. Toll-Free 1-800-352-3177

HAROLD HEASTER, KA8OHX, 91 Ridgely Place, Ormond Beach, FL 32074 Florida Phone (904) 673-4066

NEW NATION-WIDE TOLL-FREE TELEPHONE 1-800-84-RADIO 1-800-84-72346

Call us for a quotation, WE WILL SAVE YOU MONEY!

commercial equipment

- Argonaut 509 conversion for 30 meters (HN)
AA4LL p. 49, Oct 84
- Atlas 210 transceiver, sidetone (HN)
ZL2RP p. 67, Mar 82
Short circuit p. 79, Oct 82
- Atlas 350 AGC circuit, modifications (HN)
KØRL p. 42, May 82
- CDE tailtwin rotor, pulse-position control of
WB4EXW p. 30, Jan 81
- Collins KWM-2 KWM-2A, owners' reports
WB1CHQ p. 22, Mar 81
- Collins S-line, owners' reports
WB1CHQ p. 12, Apr 81
- Collins 75S-3 alignment (HN)
N1FB p. 79, Jan 81
- Collins 516F-2 low-voltage and bias modification (HN)
N1FB p. 68, Jul 81
- Collins 516F-2 power supply, transient protection for
W6AD p. 31, Apr 81
- DerTron 160XV transverter, stabilizing the (weekender)
WB2QLL p. 46, Jun 81
- Drake R-4C receiver audio improvements (HN)
W3CVS p. 79, Jan 81
- Drake TR-7 transceiver, Woodpecker noise blanker for (HN)
K1KSY p. 67, Feb 81
- FT-101E, 10-meter preamp for
K1NYK p. 26, Jul 81
- Ham radio techniques
W6SAI p. 63, May 84
- Ham radio techniques, fifty years ago
W6SAI p. 58, Jun 84
- Heath Model 10-4530 oscilloscope, modifications
Bailey p. 20, Aug 82
- Heath HW-8, improved keying for (HN)
W3HVK p. 60, Aug 82
- Heath HX1681 (Tech. forum)
W2UWO p. 83, Sep 83
- Heath SB-400/SB-401, simple speech amplifier for (HN)
W8LMB p. 72, Jun 81
- Heathkit SB-104A, improved receiver performance for
N2EO p. 78, Apr 81
- Heath's new all-band transceiver, the SS-9000
W5JUV p. 12, Nov 82
- ICOM IC-2A(T), odd splits
N7AAD p. 65, Jul 82
- ICOM 701 owners' report
WB1CHQ p. 56, Oct 81
- IC2AT, carrying case for (HN)
W6XM p. 62, Aug 83
- Kenwood TR-7400A, scanner for (the Kenscan 74)
WB7QYB p. 50, Jan 81
- Kenwood TS-520-SE transceiver, counter mixer for
W5NPD p. 60, Sep 80
- KLM antenna rotor, computer control for (HN)
W8MQW p. 66, Feb 81
- KWM2, RIT for the (HN)
KH6JF p. 109, Jul 84
- Owners' survey, TR7
WB1CHQ p. 66, Nov 81
- Owners' survey: 2-meter handhelds
KA1ZM p. 35, Jul 82
- Practically speaking: now that the warranty has expired
K4IPV p. 67, Sep 85
Comments, W5QJM p. 8, Nov 85
- R-1000 mod (HN)
W6XM p. 60, Aug 82
- S-line, QSK noise (HN)
N1FB p. 66, Mar 82
- SB-303 receiver, noise reduction (HN)
Suzuki p. 70, Jun 82
- Sony ICF-2001, eight-channel memory scanner for
W3CSW p. 54, Aug 82
- Ten-Tec Corsair modification (HN)
N3BEK p. 62, Apr 84
- Triton IV, 30-meter operation (HN)
AA4LL p. 68, Jun 83
- TR-2500/2600 2-channel programming (HN)
K9MLD p. 128, Oct 85
- TS-430S IF filter mod (HN)
KBØCY p. 125, May 84
- TS-930S headset audio, increased undistorted (HN)
W6FR p. 128, Oct 85
- 3-500Z tube failure (HN)
AG6K p. 78, Oct 82
- 5CX1500A power pentode (HN)
K9XI p. 77, Oct 82

computer-aided design

- Bandpass filter design, interdigital, computer-aided
N6JH, Monemzadeh p. 12, Jan 85
Short circuit p. 117, Jun 85
- Yagis, designing with the Commodore 64
WA3EKL p. 59, Jun 85

construction techniques

- Air-wound coils, constructing
W7BKE p. 37, Aug 84
- Antenna carriage and track pole mount
KB3K p. 46, Aug 83
- Antenna hinge
N4LI p. 70, Aug 83
- AN/UPX-6 cavities, converting surplus
W6NBI p. 12, Mar 81
- Audio filter building blocks
KBØCY p. 74, Jul 83
Short circuit p. 92, Nov 83
- Battery charger, NiCad, constant current, a pulsed
K2MWU p. 67, Aug 85
- Build a better box
Gruchalla, Michael p. 45, Aug 84
- Bulkhead connector (HN)
K9CZB p. 78, Apr 85
Short circuit p. 74, Jul 85
- Cheap dots (HN)
W6XM p. 77, Sep 82
- Cooling semiconductors part 1: designing and using heatsinks
Martin, Vaughn D. p. 33, Jul 84
- Cooling semiconductors part 2: blowers and fans
Martin, Vaughn D. p. 52, Aug 84
- Custom resistors, nomogram design
WA5EKA p. 68, Jun 83
- Dummy load, DC (weekender)
W4MLE p. 91, Apr 85
- Dust buildup, decreasing (HN)
K4KI p. 77, Sep 82
- Elevation indicator, inexpensive (weekender)
W5JTL p. 67, Jun 85
- Fan, speed control (HN)
K4KI p. 77, Sep 82
- G.O.E.S. reception: a simple approach
WA4WDL p. 46, Jan 84
- Heatsink cooling fan (HN)
W6XM p. 22, Jul 83
Comments, W2GH p. 8, Oct 83
Comments, DJ4BZ p. 12, May 84
- High-frequency dummy load (HN)
W1KWE p. 64, Jun 84
- IC2AT, carrying case for (HN)
W6XM p. 62, Aug 83
- Inductance equation, a different approach (HN)
K4KU p. 116, Dec 84
- Junk-box ingenuity: how to buy, use, and recycle surplus electronic parts
WB4EHS p. 32, Aug 84
- Metal cleaning with dip-type cleaners (HN)
W5XW p. 82, Jan 82
Comment, K6YPD p. 8, Jun 82
- Microstrip impedance program
K8UR p. 84, Dec 84
- Passive audio filter design, part 1: development and analysis
Niewiadomski, S. p. 17, Sep 85
- Polymer film transforms mechanical energy to electrical energy
WA4KFZ p. 55, Dec 84
- Power FETs: trend for VHF amplifiers
Peters, Daniel and W7PUA p. 12, Jan 84
- Printed circuit layout and drilling template
WA4WDL p. 73, Jul 82
- Quick fix for soldering irons (HN)
W2YW p. 62, Apr 84
- Reflected power limiter (Weekender)
K4KI p. 63, Jul 84
- Set screws, taming (HN)
W5PGG p. 64, Mar 82
- Silk screen techniques, make your own board using
W3QOM p. 83, Nov 84
- Silverplating, safe, sensible
K9EYY p. 29, Feb 85
- Solar power for your ham station
NH6N p. 14, Dec 84

- Superhet coilset, design with a microcomputer
Stierenburg, F.A.S. p. 113, Nov 84
- Turns per inch from wire size (HN)
K8UR p. 97, Dec 83

digital techniques

- AMTOR, AX.25, and HERMES: a performance analysis of three systems
W9JD p. 63, Dec 85
- Applied Yagi antenna design part 1: a 2-meter classic revisited
WB3BGU p. 14, May 84
- Applied Yagi antenna design part 6: the model and a special teaching tool
WB3BGU p. 89, Oct 84
- Audio filter design, computer-aided
KE2J p. 15, Oct 85
- Commodore 64, \$100 printer (HN)
W2QLI p. 86, Aug 85
- Digital clock, build a fail-safe
K1MC p. 54, Oct 85
- Digital-circuit problems, avoiding built-in, part one
W1BG p. 43, Sep 81
Comments VE2QO p. 6, Dec 81
- Digital-circuit problems, avoiding built-in, part two
W1BG p. 50, Oct 81
Comments VE2QO p. 6, Dec 81
- Digital frequency readout using the Commodore 64
W3NNL p. 83, Nov 85
- Digital HF radio: a sampling of techniques
KA2WEU, DJ2LR p. 19, Apr 85
Short circuit p. 121, May 85
- Digital techniques: inside a phase-frequency detector
Anderson, Leonard H. p. 28, Sep 82
- Digital techniques: shocking truths about semiconductors
Anderson, Leonard H. p. 36, Oct 82
- DTMF controller for repeaters
WB4FXD p. 47, Sep 85
- HP-IL serial loop
Martin, Vaughn D. p. 101, Apr 84
- Making waves
W6HDM p. 44, Mar 82
- Packet radio: part 1
KV7D, KV7B p. 14, Jul 83
- Packet radio: part 2
KV7D, KV7B, WA7GXD p. 18, Aug 83
- Packet radio and area networking
WB3JZO p. 38, Dec 84
- Packet radio, automatic frequency and deviation tester
WB20SZ p. 41, Dec 85
- Packet radio primer
WA1FHB p. 30, Dec 85
- Packet radio: the software approach
W4UCH p. 63, Sep 84
- PL tone generator, a programmable
WBØVSZ p. 51, Apr 84
Short circuit p. 125, May 84
- RTTY reader, interrupt-driven
KN4L p. 72, Sep 84
- Run RTTY on your Timex
NU4V p. 110, Apr 85
- Run RTTY on your VIC-20
W5TRS p. 120, Apr 85
- Satellite tracker, digitally-controlled
K8OBL p. 102, Sep 85
- Smith Chart impedance matching on your Commodore 64
WA9GFR p. 120, Oct 84
- Software piracy (letter)
Forsyth, Mike p. 8, Sep 84
- Spread spectrum and digital communication techniques: a primer
N9NB p. 13, Dec 85
- Synthesizers, VHF and UHF, design of digital components
G4CLF p. 26, Jul 82
- The Guerri report — computer technology
W6MGI p. 54, Nov 84
Short circuit p. 8, Dec 84
- The Guerri report: signal processing
W6MGI p. 156, Dec 84
- VIC-20 printer (HN)
W2QLI p. 88, Sep 84

features and fiction

DXer's Diary W9KNI	p. 18, Mar 81
DXer's Diary W9KNI Comments	p. 26, Apr 81 p. 6, Sep 81
DXer's Diary W9KNI	p. 22, Jun 81
DXer's Diary W9KNI	p. 60, Aug 81
DXer's Diary W9KNI	p. 70, Dec 81
Electromagnetic jargon generator, state-of-the-art N6TX	p. 75, Apr 85
From Amateur to professional K1ZU	p. 54, Aug 81
Ham radio techniques: tri-band Yagi beam and 10 meters W6SAI	p. 68, Jan 81 p. 84, Nov 81
Ham radio techniques: earth-moon-earth W6SAI	p. 40, Feb 81
Ham radio techniques: more about moonbounce W6SAI	p. 34, Mar 81
Ham radio techniques: ten-meter band W6SAI	p. 38, Apr 81
Ham radio techniques: 160-meter band W6SAI	p. 46, May 81
Ham radio techniques: amateur radio, 1933 W6SAI	p. 41, Jun 81
Ham radio techniques: antenna tuners W6SAI	p. 30, Jul 81
Ham radio techniques: amateur radio 1941 W6SAI	p. 30, Aug 81
Ham radio techniques W6SAI	p. 32, Sep 81
Ham radio techniques W6SAI	p. 42, Oct 81
Ham radio techniques: radio-frequency interference W6SAI	p. 34, Nov 81
Ham radio techniques: radio-frequency interference W6SAI	p. 30, Dec 81
Ham radio techniques W6SAI	p. 66, Jan 83
Ham radio techniques W6SAI	p. 77, Feb 83
Ham radio techniques W6SAI	p. 47, Mar 83
Ham radio techniques W6SAI Comments, W6DKZ	p. 52, Apr 83 p. 8, Dec 83
Ham radio techniques W6SAI	p. 52, May 83
Ham radio techniques W6SAI	p. 46, Jun 83
Ham radio techniques W6SAI	p. 42, Jul 83
Ham radio techniques W6SAI	p. 40, Aug 83
Ham radio techniques W6SAI	p. 41, Sep 83
Ham radio techniques W6SAI	p. 64, Oct 83
Interview with Dr. Kenneth Davies K2RR	p. 28, Jan 83
Jim, a tug at your memory W4VT	p. 28, May 81
Observation and opinion W9KNI	p. 6, Jul 81
Q signals (letter) W4MB	p. 8, Feb 83
Reinartz, John L., father of shortwave radio WA6CBQ	p. 10, Aug 81
Shopping for parts by mail W8FX Comments K1THP	p. 16, Jul 81 p. 6, Dec 81
Tune in on the world WA4PYQ	p. 12, Jun 81

fm and repeaters

Add fm to your receiver (weekender) K3NXU	p. 74, Mar 81
Autopatch, simplex WB6GTM	p. 42, Jan 83
DTMF controller for repeaters WB4FXD	p. 47, Sep 85
FM advantage WA9GDZ6	p. 38, Sep 84
FM repeater separation — 20 kHz, Yes, 15 kHz, No WD5BS, W0NK	p. 12, Aug 85
Forgot memory, Ni-Cd discussion K0OV	p. 62, Jan 83

IC-255A switching circuit (HN) WB6IQV Comments, WA4MZZ	p. 70, Jan 83 p. 8, Jun 83
Linear translators WB6JNN	p. 14, Sep 83
Microprocessor based repeater controller K80CY	p. 12, Mar 82
Microprocessor repeater controller KB5F	p. 56, Apr 83
Repeater antenna beam tilting K7NM	p. 29, May 83
Short circuit Repeater etiquette (letter) W1OLP	p. 80, Jul 83 p. 8, Oct 83
Repeater, high-tech: designing and building an FM translator WA6CAY	p. 82, Feb 85
Repeaters, speech synthesis for N9EE	p. 79, Mar 84
Repeaters, three circuits for (HN) N9EE	p. 91, Jan 84
Speech processor for fm transmitters G4CLF, G3RZP	p. 76, Mar 82
Squelch, smart W6NRW	p. 37, Jun 83
State-of-the-art auto dialer K2MWU Short circuit Short circuit	p. 21, Dec 83 p. 10, Feb 84 p. 10, Mar 84
Tone decoder, ultimate WD9EIA Comments, WD9EIA	p. 33, Sep 82 p. 8, Feb 83
Touch-tone autodialer, portable K2MWU Comments, K2MWU	p. 12, Aug 82 p. 8, Feb 83
Touch-tone decoder K9C9	p. 27, Apr 83
Touch-tone decoder, third generation WA7DPX Short circuit	p. 36, Feb 80 p. 67, Sep 80

hazards

Electric shock, the effects and treatment of NY6U	p. 85, Mar 84
Lightning and electrical transient protection KR7L	p. 73, Dec 83
When hazardous waste comes home: PCBs in the ham shack Leads, Dorothy	p. 42, Dec 83

integrated circuits

Binary coded decimal addition (HN) WA9HUV Comment, Schiffler, Jeffrey L.	p. 66, Apr 82 p. 8, Dec 82
FSK tone generator using an IC tone dialer (HN) Nagel, David	p. 88, Apr 83
low-pass filter, integrated circuit WB2KTG	p. 59, Jan 85
Static electricity and modern integrated circuits K4KEF	p. 33, Mar 84
The Guerri Report: superchips come of age W6MGI	p. 126, Feb 85
TouchTone decoder, an improved N6JH	p. 24, Dec 82
TTL ICs, simple tests for W6ALF	p. 37, Mar 82
2716 EPROM programmer N3CA	p. 32, Apr 82

keying and control

Call sign identifier: programmable (weekender) WB3CEH	p. 33, Feb 85
Cathode key with the Heath HD-1410 (HN) K9XM, N9MX	p. 80, Jan 82
CW memory modification (HN) W0DLQ	p. 93, May 81
Ham radio techniques W6SAI	p. 106, Oct 84
Keyer, simple, compact QRP (weekender) W5FG	p. 82, Oct 84
Keyer, single-chip, for QRP (weekender) W3HVK	p. 70, Oct 82
Latching relay control (HN) K6HTM	p. 94, May 83
Low-power keyer and interface K1HOP Short circuit	p. 68, Feb 83 p. 97, Aug 83

Microcomputer-based contest keyer K9CW	p. 36, Jan 81
Microprocessor repeater controller KB5F	p. 56, Apr 83
Micros and VHF beacons Transmit messages automatically K9EI	p. 51, Jul 85
Morse Code tutor N3SE	p. 45, Jun 85
Morse keyboard, an easier approach to mastering the W1KZ	p. 80, Apr 84
Morse lime synthesis N3SE	p. 17, Apr 83
Remote control hf operation K5QY Short circuit	p. 32, Apr 83 p. 97, Aug 83
Sending CW K4AQVK	p. 75, Jun 83
Solid-state CW T-R system W4RNL	p. 62, Mar 83
Ten-Tec 645 ultramatic keyer mods (HN) K4JST	p. 70, Dec 82
Testing baluns K4KJ	p. 30, Aug 83
WPM readout for deluxe memory keyer (weekender) WA10EH	p. 50, Apr 82

measurements and test equipment

Battery charger sensor W3BYM	p. 54, Dec 82
BC221, unusual (Tech. forum) VK2ZH	p. 22, Jan 83
Bridge measurements, the half-wave transmission line in (HN) K4KI	p. 108, Nov 84 p. 89, Apr 83
Capacitive-reactance meter multiplier (HN) K4KI	p. 89, Apr 83
Continuity tester, simple (weekender) WD6GMB	p. 130, Sep 85
Detailed look at probes Martin, and Davis	p. 75, Sep 85
Detector, logarithmic, wideband PA0CX/DJ0SA	p. 75, Jul 85
Diode tester (HN) W2OLU	p. 90, Apr 83
Dip meters, a new look at W6GXN	p. 25, Aug 81
Dual wattmeter, 50-500 MHz (weekender) WB4EHS	p. 67, Jul 85
Electrical calibration standards Martin, Vaughn	p. 10, Oct 83
EME/RFI shielding: new techniques part 1 Martin, Vaughn D.	p. 72, Jan 84
EMI/RFI shielding: new techniques part 2 Martin, Vaughn D.	p. 85, Feb 84
Field-strength meter for the high-frequency Amateur bands WB6AFT	p. 42, Jul 81
Field strength meter, sensitive K4KI	p. 51, Jan 85
Filter tester, simple (HN) W6XM	p. 116, Dec 84
Frequency counter, "smart" WA5VQK Short circuit	p. 41, Oct 84 p. 126, Apr 85
Ground rod resistance K4MT Comments	p. 95, Jul 84 p. 8, Sep 84
High-frequency receiver performance G4OBU	p. 33, Feb 84
HP-1B greatly simplified Martin, Vaughn D.	p. 65, Mar 84
IF sweep generator, compact PA0CX/DJ0SA	p. 35, Jun 85
Impedance matching (Tech. forum) WB2NTQ	p. 85, Jul 83
Inductance meter, easy-to-build W6XM Comments, WB2LAO	p. 76, Apr 82 p. 8, Sep 82 p. 79, Oct 82
K4EEU frequency standard, battery backup for (HN) N4BA	p. 68, Jul 81
L and C measurements WB6ZLN	p. 117, Oct 84
Light-bulb dummy loads (HN) W6PHH	p. 74, Oct 81
Logic mate N9CZK	p. 57, Jan 83
Logic probe (HN) Rozenthal, J.	p. 91, Apr 83

Logic probe, digital N6UE	p. 38, Aug 80	Calculator or computer — which to buy? W4MB	p. 86, Nov 82	Ham radio techniques W6SAI	p. 90, Aug 85
Measuring inductances (Tech. forum) K6HIK	p. 85, Jul 83	Computer rfi (letter) KA5HJI	p. 8, Jun 81	Ham radio techniques: I have seen the future and it works W6SAI	p. 91, Sep 85
Measuring noise figure K2BLA	p. 26, Jan 84	Data retrieval program using the APPLE II computer (HN) WB6YHS	p. 75, Oct 81	Ham radio techniques W6SAI	p. 75, Oct 85
Measuring small values (Tech. forum) W6SDM	p. 74, Aug 83	Frequency counters, CMOS timing circuit for (HN) Bevel, David H.	p. 72, Jul 82	Ham radio techniques W6SAI	p. 67, Nov 85
Microphone calibration NY6U	p. 73, Jun 84	Ham gear controller: part 1 N3CA	p. 12, Oct 82	Harmonic product detector for QRP transceivers W5FG	p. 44, Jun 83
Noise bridge, precision K2BT	p. 51, Mar 83	Ham gear controller: part 2 N3CA	p. 25, Nov 82	Hyperbolic navigation (letter) Burhans, Ralph W.	p. 6, Feb 81
Comments	p. 8, Jun 83	Microcomputer-based contest keyer K9CW	p. 36, Jan 81	Impedance matching: a brief review WD4C	p. 49, Jun 84
Short circuit	p. 97, Aug 83	Microprocessor repeater controller KB5F	p. 56, Apr 83	Instant balun (letter) W8MQW	p. 6, Aug 81
Noise-figure meter, automatic, for preamplifiers and converters K9IMM	p. 12, Feb 81			KWM 380 external control circuit (HN) WA2RUD	p. 96, Dec 83
Ohmmeter, wide-range Bailey, John T.	p. 53, Jan 84			Linear amplifier, 3CX800A7 K8FA	p. 17, Aug 84
Panoramic adaptor/spectrum analyzer design notes WA6NCX/1	p. 12, Sep 83			Low cost linear design and construction W4MB	p. 12, Dec 82
Comments, K2C8Y	p. 12, Sep 83			Low-pass filter, integrated circuit WB2KTG	p. 59, Jan 85
Short circuit	p. 70, Oct 83			Multiplexing, the how and why of KH6N	p. 60, Sep 81
PEP output power measurement VK3AFQ	p. 10, Jun 83			Mysterious spur on 160 (Tech. forum) N3BEK	p. 73, May 83
Comments, K4KYV	p. 12, Sep 83			Comments, KØKL, N3BEJ	p. 95, Nov 83
Practically speaking K4JPV	p. 79, Dec 85			Neutralizing 572B final at 1500 watts output (HN) W2YW	p. 63, Jun 84
QRP wattmeter (HN) W6XM	p. 110, Jul 84			Noise cancellation circuit (weekender) K1RGO	p. 75, Mar 84
Receiver sweep alignment system WB6BIH	p. 124, Nov 84			Operation upgrade: part 1 W6B8B	p. 12, Sep 81
Reflected power limiter (weekender) K4KI	p. 63, Jul 84			Operation upgrade: part 2 W6B8B	p. 28, Oct 81
Required dynamic range and design guides for EMI/RFI test receivers DJ2LR	p. 70, Nov 83			Peaked fowpass: a look at the ultraspherical filter W7ZOI	p. 96, Jun 84
Rf power meter, part 1: instrument description and construction N6YC	p. 70, May 81			Phase modulator, PLL (HN) VE3FHM	p. 117, Jun 85
Rf power meter, part 2: measurements and measurement accessories N6YC	p. 55, Jun 81			Photovoltaic cells: a progress report WD8AHO	p. 52, Dec 83
Comments W3NQN	p. 6, Oct 81			Comments, K6KVX, Sample Martin, WD8AHO, WB4APT	p. 10, Feb 84
Solid-state replacements (Tech. forum) AK7N	p. 46, Apr 83			Polymer film transforms mechanical energy to electrical energy WA4KFZ	p. 55, Dec 84
Standing wave indicator (Tech. forum) GW8FKB	p. 97, Nov 83			Power FETs: trend for VHF amplifiers Peters, Daniel, and W7PUA	p. 12, Jan 84
Sweep generator, stable wideband W7BAR	p. 18, Jun 81			Practically speaking: repairing flood damage K4IPV	p. 95, Oct 85
Short circuit	p. 84, Nov 81			Practically speaking: intermittents, pt. 1 K4IPV	p. 75, Nov 85
Swr meter for the high-frequency bands WB6AFT	p. 62, Oct 81			Practically speaking: intermittents, pt. 2 K4IPV	p. 79, Dec 85
Comments, WA4UPN, WB6AFT	p. 36, Mar 82			Prerecorded messages help the hearing impaired (HN) W2QLJ	p. 87, Sep 84
The Guerri report: signal processing W6MGI	p. 156, Dec 84			Relay, inexpensive automatic send/receive WØPBV	p. 40, May 82
Time and frequency standards: part 1 Martin, Vaughn D.	p. 36, Nov 83			Resonant circuits WD4C	p. 12, Apr 84
Time and frequency standards: part 2 Martin, Vaughn D.	p. 31, Dec 83			Rf power distributor, the W3BYM	p. 46, Dec 81
Transmitter tuning aid: buffer your load with this resistive network (weekender) K4KI	p. 52, Feb 84			Rfi cures: avoiding side effects WB9TQG	p. 52, Sep 81
Tune-up method, low duty-cycle for transmitters (HN) K4KI	p. 62, Aug 83			Comments WB7SYB, WB9TQG, VE2QO	p. 6, Dec 81
Comments, W5XW	p. 11, Dec 83			RFI, solving the problems of W2YW	p. 124, Sep 84
Comments, K4KI	p. 11, Jan 84			Russian Woodpecker, the: a continuing nuisance KR7L	p. 37, Nov 84
Tuneup, safe, silent (weekender) K4KI	p. 123, Dec 84			Solar power for your ham station NH6N	p. 14, Dec 84
Two-tone generator N1RM	p. 32, Jun 82			Short circuit	p. 145, Mar 85
Two-tone signal generator (HN) K4KI	p. 77, Sep 82			Sorting and inventory of standard resistor values, computer program for WA6SWR	p. 66, Jun 81
Using the Astro 103 as a frequency counter (HN) W4ATE	p. 69, Jun 83			Super beep circuit for repeaters KP4AQI	p. 48, Jul 81
VHF/UHF world W1JR	p. 55, Oct 84			The Guerri report — computer technology W6MGI	p. 54, Nov 84
Video monitor, inexpensive K8CG	p. 12, Apr 83			Short circuit	p. 8, Dec 84
Comments, K9TA	p. 10, Aug 83			The Guerri report W6MGI	p. 124, Jan 85
Weather radar, 10-GHz K4TWJ	p. 61, Sep 83			The Guerri report: superchips come of age W6MGI	p. 126, Feb 85
Wide range inductance meter (Tech. forum) K9EBA	p. 52, Feb 83			The Guerri report W6MGI	p. 158, Mar 85
Wien Bridge oscillators, voltage-controlled Zener diode test circuit (Tech. forum) W3PHK	p. 52, Feb 83			The Guerri report W6MGI	p. 157, Apr 85
				The Guerri report: a busy signal from space W6MGI	p. 165, May 85
				The Guerri report — predicting equipment failure W6MGI	p. 125, Jun 85

miscellaneous technical

Ac-line switching precautions (HN) W5PGG	p. 69, Jul 81
ALC circuits, improving amplifier part 1 WA8AJN	p. 40, Aug 84
ALC circuits, improving amplifier: part 2 WA8AJN	p. 38, Sep 84
Amplifier for 220 MHz, stripline kilowatt W2GN	p. 12, Apr 82
Analog-to-digital display converter for the visually handicapped KB7JW	p. 44, Jan 81
"Audio to microwave" amplifier, build your own Gruchalla, Michael	p. 12, Mar 84
Bicycle-powered station W1BG	p. 25, Dec 84
Branch-line hybrid: part 1 WA2EWT	p. 107, Apr 84
Branch-line hybrid: part 2 WA2EWT	p. 93, May 84
CATV (letter) WB4NMA	p. 10, Aug 83
Computer for the blind (HN) W8MQW	p. 69, Jun 82
CW identifier, versatile, an improved memory for WB2BWJ	p. 24, Feb 82
CW station, updating (HN) KM5T	p. 77, Oct 82
Data bandwidths compared W9JD/2	p. 50, Dec 82
Comments, W6JTH	p. 8, Jun 83
Decibel, defining the Gruchalla, M.	p. 51, Feb 85
Electrolytic capacitors (letter) WB8MKU	p. 6, Jun 81
Electromagnetic interference and the digital era K3PUR	p. 114, Sep 84
EMI/RFI shielding: new techniques part 1 Martin, Vaughn D.	p. 72, Jan 84
EMI/RFI shielding: new techniques part 2 Martin, Vaughn D.	p. 84, Feb 84
Filters (letter) W6XM	p. 8, Feb 83
Comments, W3NOW	p. 8, Apr 83
Filters, bridged W6MUR	p. 51, Oct 82
Filter design, graphic W6NRW	p. 37, Apr 84
Short circuit	p. 13, Jul 84
Ham radio techniques: radio-frequency interference W6SAI	p. 34, Nov 81
Ham radio techniques: radio-frequency interference W6SAI	p. 30, Dec 81
Ham radio techniques W6SAI	p. 63, May 84
Ham radio techniques, fifty years ago W6SAI	p. 58, Jun 84
Ham radio techniques W6SAI	p. 106, Oct 84
Ham radio techniques W6SAI	p. 75, Jan 85
Ham radio techniques W6SAI	p. 59, Feb 85
Ham radio techniques W6SAI	p. 83, Mar 85
Ham radio techniques: electron-hole theory exposed as fraud W6SAI	p. 67, Apr 85
Ham radio techniques W6SAI	p. 66, May 85
Ham radio techniques W6SAI	p. 51, Jun 85
Ham radio techniques W6SAI	p. 59, Jul 85

microprocessors, computers and calculators

An RS-232 to TTL interface WD4KI	p. 70, Nov 82
-------------------------------------	---------------

GREAT GEAR, AWESOME ANTENNAS, POWERFUL PACKET.

New rigs and old favorites, plus the best essential accessories for the amateur.

3621 FANNIN ST.
HOUSTON, TX 77004-3913

CALL FOR ORDERS
1-713-520-7300 OR
1-713-520-0550

ALL ITEMS ARE GUARANTEED OR SALES PRICE REFUNDED

EQUIPMENT

Kenwood	Call for prices on all Kenwood
New Kantronics UTU-XT	319.00
Kenwood TS940S, contesters delight	Call
Icom R7000 25-2000Mhz	799.00
Alpha (ETO)	List-15%
Icom 271A, 27A	Call
Icom IC3200	489.95
Santec ST20T Handi Talkie	299.00
Regency UC102 VHF 2 Channel Handi Talkie	150.00
Icom IC735	749.00



ACCESSORIES

B&W Viewstar Antenna Tuner	69.00
Heil HC3/HC4/HCS	Stock
Heil BM10 Boom Mike headset	53.95
CSI Private Patch III	469.95
FLUKE 77 auto-ranging digital multimeter	125.00
Bird 43 Wattmeter	Call
Bird Elements, H/59.00, A-E/48.00,	In Stock
Daiwa CN620B, 20-200, 2000W	109.95
Daiwa CN630 140-450, 20.200W	129.00

KEYS

Benchler & Vibroplex	Less 10%
Benchler is now improved. Screws & springs, all stainless steel	
Extra hand polishing *	
Vibroplex Carrying Case	\$20.00 w/purchase
MFJ Super keyboard #496	169.00

TUBES

Collins & Drake Replacement Tubes	stock
GE 6146B	11.95
Ermac 3-500Z	109.95
GE Industrial Tubes	Call
GE 12BY7A	6.00
GE 6JS6C	11.95

BOOKS

We stock SAMS, TAB, ARRL, RSGB, Ameco Radio Pubs	Call
Some of the best buys are the RSGB books.	
CALRAD 65-287 SWR, Relative Power Meter 3-150Mhz. KW+	32.95

PACKET POWER

AEA PK64, does RTTY, ASCII, AMTOR also	199.00
AEA PK80	soon
KANTRONICS PACKET	199.00
ICOM 271A Great packet radio	Call

SERVICES

Alignment any late model rig	50.00
Flat fee Collins rebuild	Call

QUANTITY DISCOUNTS

Want a good discount? Get three of your friends and order Madison's special four lot prices. For example:
ICOM IC3200 \$1820.00
Call for four lot prices on other rigs.



ANTENNAS

ARX2B, V2S, 2MCV-5, ISOPOLE	44.95
A4	289.95
402CD	279.95
New Cushcraft LAC-3 Lightning Arrester	7.95
215WB New, 15EL, 2M Beam	79.95
AOP-1, Complete Oscar Antenna	149.95
Butternut HF6V, 80-10 Vertical	125.00
HF2V, 80 & 40 Vertical	125.00
HF4B	189.00
Hustler G7-144	119.95
Ham4 Rotator, T2X, CD45-2	Call
KLM HF World Class Series Antennas	Call Don

OTHER ANTENNAS

Larsen Kuldruk	17.00
Avanti AP151 3G on Glass Antenna	33.00
Anteco 2M, 5/8, Mag Mount, Comp	25.00
Avanti APR450-5G on glass	30.00
Philly Stran	Call

SURPLUS

Collins parts 75S/32S/KWM2/75A4/KWS-1 Specify Part No	
Model 33/35 Teletype	100.00/Each
Local Pickup Only	
24 Pin Solderable dip sockets	25/Each
Signal Batteries Exact Replacement Yaesu 208/207	25.00/Each
Solid State 866A Replacements	15.00/Each
Scream'n Demon Radar Detector	29.95
150MFD/400V DC	1.95
1.5Amp/400V full wave bridge rectifier	1.95
2.5A/1000PIV Epoxy diode	29c. Each or 19.00/100
0015/10KV	1.95
3N201	.95
4 inch ferrite rod	1.95
365pF cap	1.95
Sanyo AAA, AA Nicads w/tabs	2.50/ea
2, 4, 5, 6, 8 pin mic plugs	4.00
Close out on rigs & accessories. All the time	Call
We may have what you're looking for.	

BELDEN

9913 low loss, solid center, foil/braid shield	45c/ft.
8214 RG8Foam	43c/ft.
8237 RG8	37c/ft.
8267 RG213	52c/ft.
8000 14Ga stranded copper ant wire	13c/ft.
8448 B conductor rotor cable	31c/ft.
9405 Heavy duty, 2-16 Ga. 6-18 Ga.	52c/ft.
9258 RG8x	19c/ft.
8403 Mic Cable, 3 condctr & shield	80c/ft.
100 Feet 8214 w/ends installed	45.00
8669 7/16" tinned copper braid	1.10/ft.
International Wire RG214, non-mil, good cable	.70/ft.

AMPHENOL

831SP-PL259 Silverplate	1.25
UG176 reducer RG8X	.30
831J Double Female UHF	2.00
82-61 N Male	3.00
82-97 N Female Bulkhead	3.00
82-63 Inline Female N	4.00
82-98 N elbow	9.00
New 82-202-1006 N-Male fits 9913	5.00
1/4" E.H.S. Guy cable, Rohn US,	
1000 ft	250.00
3/16" E.H.S. cable	210.00
1/4" Guy Cable, 6100 #7 x 7 strand, import	15c/ft.
3/16" Guy Cable, 3700 #7 x 7 strand, import	12c/ft.
3/8 x 6 E&J Turnbuckle	7.95
3/16" Wire Rope Clips	.40
1/4" wire clips	.50
Porcelain 500D Guy Insulator (3/16)	1.69
Porcelain 502 Guy Insulators (1/4)	2.99

COMPUTER STUFF

Kantronics UTU-XT	319.00
Fits any computer (even yours!) Software Available	19.00
Morse University (Great CW program for C-64)	39.00
AEA New VHF 1200	Coming

USED EQUIPMENT

All equipment, used, clean, with 90 day warranty and 30 day trial. Six months full trade against new equipment. Sales price refunded if not satisfied.

POLICIES

Minimum order \$10.00. Mastercharge, VISA, or C.O.D. All prices FOB Houston, except as noted. Prices subject to change without notice. Items subject to prior sale. Call anytime to check the status of your order. Texas residents add sales tax. Dats all, folks.

DON'S CORNER

First of all: The winner of our first Proofreading Contest is Bob Reinhart, K1KK. Bob will be receiving our CALRAD SWR meter, prepaid and free. If you didn't win, look at this ad. This is an ongoing contest. Send us a card. First card with most correct errors noted wins.

If you're a collector of old equipment, call us on your money, and we'll tell you if the prices you're paying is fair. Best new electronic notation: a supposedly old-time ham who came into the store with his parts list. At the top of his list was a peek-a-ferret capacitor. We told him we didn't sell small animals—even surplus ones. Also—we've been having some problems with the new address and get mail addressed to Phantom Avenue. It's F-A-N-N-I-N.

Have a great Christmas from everyone at Madison. Hope that Santa brings you a real nice transceiver—and buys it from us.

73 & Good DX

DON

MADISON

Electronics Supply

3621 FANNIN
HOUSTON, TEXAS 77004

1-713-520-7300 OR 1-713-520-0550

The Guerri report	
W6MGI	p. 124, Jul 85
The Guerri report	
W6MGI	p. 124, Aug 85
The Guerri report: RF power supplies	
achieve high efficiency	
W6MGI	p. 157, Sep 85
The Guerri report: RF effects — the good and the bad	
W6MGI	p. 142, Oct 85
The Guerri report	
W6MGI	p. 140, Nov 85
Timer, electronic (HN)	
W9EBT	p. 65, Mar 82
Varactor tuning tips (HN)	
N3GN	p. 67, Feb 81
VHF/UHF world: the VHF/UHF primer	
an introduction to filters	
W1JR	p. 112, Aug 84
VMOS on 1750 meters	
K1RGO	p. 71, Oct 83
Wilkinson hybrids	
WA2EWT	p. 12, Jan 82

novice reading

Morse code computer tutor	
N3SE	p. 45, Jun 85
New band privileges for Novice operators	(letter)
KA0DOE	p. 15, Sep 85
Novice playground (letter)	
WA5MUF	p. 8, Jan 82
Novice privileges (letter)	
WB9IVR	p. 9, Oct 85
Novice roundup (letter)	
KA9AZY	p. 8, Jun 81
Operation upgrade: part 1	
W6BNB	p. 12, Sep 81
Operation upgrade: part 2	
W6BNB	p. 28, Oct 81
Practically speaking	
K4IPV	p. 79, Dec 85
Used equipment for new hams (letter)	
K8YUW	p. 15, Sep 85

operating

Amateur radio, 1933 (ham radio techniques)	
W6SAI	p. 41, Jun 81
Amateur radio, 1941 (ham radio techniques)	
W6SAI	p. 30, Aug 81
Battlefield, the (letter)	
W0WL	p. 8, Jun 83
Best best regards regards (letter)	
W6BQD	p. 8, Jan 82
Comments, N4AGS	p. 8, Apr 82
Comments, KA6NFD	p. 8, May 82
Comments, KA2AGZ	p. 8, Sep 82
Blind ham (letter)	
Gerrey, Bill	p. 8, Sep 82
Burglar alarm RFI (letter)	
WB2YVY	p. 8, Mar 82
Card from Frenchy (letter)	
W2LPV	p. 8, Apr 82
Carrier-operated CW reception limiter	
W6NRW	p. 113, Sep 85
CATV (letter)	
WB4NMA	p. 10, Aug 83
County awards (letter)	
KB7SB	p. 8, Jul 81
CW anyone?	
W7JWJ	p. 44, Mar 81
CW nets (letter)	
N4EVS	p. 8, Jun 82
CW zero-beat indicator for transceivers (weekender)	
W6KVD	p. 88, Mar 83
DX and QRP (letter)	
W6QJL	p. 8, Oct 82
DXer's diary	
W9KNI	p. 18, Mar 81
DXer's diary	
W9KNI	p. 26, Apr 81
Comments	p. 6, Sep 81
DXer's diary	
W9KNI	p. 22, Jun 81
DX Forecaster	
K0RYW	p. 76, Nov 81
DX Forecaster	
K0RYW	p. 78, Dec 81
EME, 70-CM, requirements and recommendations	
W1JR	p. 12, Jun 82
Short circuit	p. 79, Oct 82
Ham radio techniques	
W6SAI	p. 53, Jan 82

Ham radio techniques	
W6SAI	p. 60, Feb 82
Ham radio techniques	
W6SAI	p. 26, Mar 82
Ham radio techniques	
W6SAI	p. 26, Apr 82
Ham radio techniques: the crystal ball	
W6SAI	p. 68, May 82
Ham radio techniques	
W6SAI	p. 76, Jun 82
Ham radio techniques	
W6SAI	p. 42, Jul 82
Ham radio techniques	
W6SAI	p. 42, Aug 82
Ham radio techniques	
W6SAI	p. 40, Sep 82
Ham radio techniques	
W6SAI	p. 20, Oct 82
Ham radio techniques	
W6SAI	p. 46, Nov 82
Ham radio techniques	
W6SAI	p. 58, Dec 82
Ham radio techniques	
W6SAI	p. 66, Jan 83
Ham radio techniques	
W6SAI	p. 65, Nov 83
Ham radio techniques	
W6SAI	p. 81, Dec 83
Ham radio techniques	
W6SAI	p. 58, Sep 84
Hamvention slide show (letter)	
N8ADA	p. 8, Jan 82
Homebrew linears: treat or trap? (HN)	
VK4LR	p. 77, Nov 82
IC-255A switching circuit (HN)	
WB6IQV	p. 70, Jan 83
Comments, WA4MZZ	p. 8, Jun 83
Intruder watch (letter)	
ZL6IW/ZL1BAD	p. 6, Aug 81
Is it stolen?	
W8AP	p. 84, Dec 82
Lifeline SAR (letter)	
WB9PFZ	p. 8, Apr 82
Listening in on 10 fm	
W8FX	p. 62, Jan 82
Mysterious spur on 160 (Tech. forum)	
N3BEK	p. 73, May 83
No-code license (letters)	
WB4SKP, W9ZMR, W2LX,	
W2JTP, W1BL, K4JW	p. 8, Jan 83
No code (letter)	
W6SN	p. 10, Aug 83
On-air tune-up (letter)	
K3EQ	p. 36, Mar 82
Operating etiquette (letter)	
W9MKV	p. 12, Jul 84
Operation upgrade: part 3	
W6BNB	p. 30, Jan 82
Operation upgrade: part 4	
W6BNB	p. 32, Feb 82
Operation upgrade: part 5	
W6BNB	p. 56, Mar 82
Operation upgrade: part 6	
W6BNB	p. 56, Apr 82
Operation upgrade: part 7	
W6BNB	p. 54, Jun 82
Operation upgrade: part 8	
W6BNB	p. 56, Jul 82
Operation upgrade: part 9	
W6BNB	p. 58, Sep 82
Operation upgrade: part 10	
W6BNB	p. 60, Oct 82
Operation upgrade: part 11	
W6BNB	p. 58, Nov 82
Other guy (letter)	
KA2GXS	p. 8, May 82
Pacemakers and rfi (Tech. forum)	
K4CN	p. 98, Jun 83
Comments, K1RGO	p. 76, Oct 83
Comments, K4CN	p. 77, Oct 83
Pacemakers and RFI: safety first (Tech. forum)	
K3EAS, K3FOW	p. 76, Oct 83
Propagation of radio waves	
W1GV/4	p. 26, Aug 82
Protecting amateur radio (letter)	
K2JYJ	p. 8, Jul 81
QRP (letter)	
W5QJM	p. 8, Nov 82
Repeater etiquette (letter)	
W1QLP	p. 8, Oct 83
RST (letter)	
W0JCK	p. 6, Feb 81
Service — not hobby (letter)	
W5VSR	p. 8, Aug. 85
Ten-meter band (ham radio techniques)	
W6SAI	p. 38, Apr 81
Ten-meter beacon (Tech. forum)	
WA1IOB	p. 46, Apr 83

Ten-meter beacons (letter)	
KA1YE	p. 13, Sep 83
Comments, KA1YE	p. 11, Jan 84
Ten-second call swaps (letter)	
WB1FJE	p. 6, Aug 81
TOM remembered (letter)	
W1ESN	p. 11, Jan 84
Transceiver tuning (letter)	
N6TO	p. 8, Jun 82
Tune-up method, low duty-cycle for transmitters (HN)	
K4KI	p. 62, Aug 83
Comments, W5XW	p. 11, Dec 83
Comments, K4KI	p. 11, Jan 84
Volunteer examiners: keep standards high (letter)	
K6WX	p. 12, May 84
Wearing cans (letter)	
WB9FRV	p. 8, Jul 81
Who pays the jammer (letter)	
W3MEO	p. 8, Oct 82
Working W5LFL from space	
K6DUE	p. 81, Sep 83
2 meters outlawed (letter)	
AA6C	p. 8, Aug 82
160-meter band (ham radio techniques)	
W6SAI	p. 46, May 81

oscillators

Audio oscillator to pulse generator conversion (HN)	
W0DLQ	p. 50, Oct 84
Crystal oscillator, low-frequency (HN)	
W6XM	p. 66, Mar 82
Short circuit	p. 79, Oct 82
CW BFO crystal for the 75S-3 (HN)	
N1FB	p. 80, Feb 82
Frequency synthesis by VXO harmonic selection	
W3MT	p. 12, Feb 84
High-stability BFO for receiver applications	
K1ZJH	p. 28, Jun 85
Local oscillators, high stability for microwave receivers and other applications	
WB3JZO	p. 29, Nov 85
Oscillator, voltage controlled, uses ceramic resonators	
K2BLA	p. 18, Jun 85
Short Circuit	p. 27, Aug 85
Phantom-coil VXO	
W3MT	p. 66, Jan 82
Comments, W3MT	p. 8, Jul 82
PL tone generator, a programmable	
WB0VSZ	p. 51, Apr 84
Short circuit	p. 125, May 84
RF synthesizers for hf communications, part 1	
WA6OAA	p. 12, Aug 83
Short circuit	p. 125, May 84
RF synthesizers for hf communications, part 2	
WA6OAA	p. 48, Sep 83
Short circuit	p. 125, May 84
RF synthesizers for hf communications, part 3	
WA6OAA	p. 17, Oct 83
Short circuit	p. 125, May 84
VCO, 1800-2600 MHz	
W0DTV	p. 21, Jul 85
VFOs tuned by cylinder and disc	
W0YBF	p. 58, Feb 83
Wideband VCO design	
WA4MGX	p. 49, Jul 84
10 GHz oscillator, ultra stable	
K8UR	p. 57, Jun 83

power supplies

AC converter, DC to 400-Hz (HN)	
WB2YVY	p. 58, Mar 83
Battery charger, NiCad, constant current, a pulsed	
K2MWU	p. 67, Aug 85
Diesel generator repair (Tech. forum)	
Richardson, Wayne	p. 46, Apr 83
Drake R-4C receiver improved power supply	
W3RJ	p. 28, Feb 82
Dual voltage power supply	
WD4SKH	p. 32, Mar 83
Comments, WB2UAQ	p. 12, Jul 83
Short circuit	p. 80, Jul 83
Dual voltage surge-protection for high-voltage power supplies (weekender)	
K8VIR	p. 42, Aug 81
Electrolytic capacitors (letter)	
WB8MKU	p. 6, Jun 81
Forget memory (Ni-Cd discussion)	
K6OV	p. 62, Jan 83

Low-voltage power supplies, designing	
W4MLE	p. 46, Mar 85
Short Circuit	p. 121, May 85
Power supply, amplifier	
WA2GFP	p. 32, Sep 83
Power supply for the big amplifier	
W6YUY	p. 64, Jun 82
Power supply, six-output	
Martin, Vaughn D.	p. 12, Oct 84
Power supply, switching high-voltage	
W5FG	p. 48, Apr 84
Protection for your solid-state devices	
W1OOP	p. 52, Mar 81
Regulator problem solved (HN)	
W6XM	p. 97, Dec 83
Safe power for your low-noise GaAs FET amplifier	
WA9HUV	p. 18, Nov 82
Squirrel-cage motors make field-day power supplies (HN)	
K6DZY	p. 74, Aug 81
Temperature control, automatic	
WB5IRI	p. 75, Jun 85
The Guerri report: RF power supplies achieve high efficiency	
W6MGI	p. 157, Sep 85
Transformers, wind your own — inexpensively	
W4GDW	p. 96, Jun 85
Trans-global power supply (HN)	
W9CGI	p. 76, Nov 82
Two-way power for the IC2AT 2-meter handheld	
WB3JF	p. 57, Feb 82
Comments WB4MNV, WB3JF	p. 8, Jul 82
Vacuum tube substitution	
W2YE	p. 58, Oct 83

propagation

Digital Ionosondes	
K2RR	p. 14, Dec 83
DX forecaster	
KØRYW	p. 76, Jan 81
DX forecaster	
KØRYW	p. 92, Feb 81
DX forecaster	
KØRYW	p. 78, Mar 81
DX forecaster	
KØRYW	p. 52, Apr 81
DX forecaster	
KØRYW	p. 76, May 81
DX forecaster	
KØRYW	p. 52, Jun 81
DX forecaster	
KØRYW	p. 56, Jul 81
DX forecaster	
KØRYW	p. 46, Aug 81
DX forecaster	
KØRYW	p. 48, Sep 81
DX forecaster	
KØRYW	p. 46, Oct 81
DX forecaster	
KØRYW	p. 76, Nov 81
DX forecaster	
KØRYW	p. 78, Dec 81
DX forecaster	
KØRYW	p. 74, Jan 82
DX forecaster	
KØRYW	p. 74, Feb 82
DX forecaster	
KØRYW	p. 82, Mar 82
DX forecaster	
KØRYW	p. 70, Apr 82
DX forecaster	
KØRYW	p. 50, May 82
DX forecaster	
KØRYW	p. 42, Jun 82
DX forecaster	
KØRYW	p. 78, Jul 82
DX forecaster	
KØRYW	p. 80, Aug 82
DX forecaster	
KØRYW	p. 82, Sep 82
DX forecaster	
KØRYW	p. 82, Oct 82
DX forecaster	
KØRYW	p. 84, Nov 82
DX forecaster	
KØRYW	p. 80, Dec 82
DX forecaster	
KØRYW	p. 74, Jan 83
DX forecaster	
KØRYW	p. 56, Feb 83
DX forecaster	
KØRYW	p. 84, Mar 83
DX forecaster	
KØRYW	p. 94, Apr 83

DX forecaster	
KØRYW	p. 74, May 83
DX forecaster	
KØRYW	p. 65, Jun 83
DX forecaster	
KØRYW	p. 82, Jul 83
DX forecaster	
KØRYW	p. 66, Aug 83
DX forecaster	
KØRYW	p. 84, Sep 83
DX forecaster	
KØRYW	p. 87, Oct 83
DX forecaster	
KØRYW	p. 90, Nov 83
DX forecaster	
KØRYW	p. 92, Dec 83
DX forecaster	
KØRYW	p. 83, Jan 84
DX forecaster	
KØRYW	p. 79, Feb 84
DX forecaster	
KØRYW	p. 93, Mar 84
DX forecaster	
KØRYW	p. 93, Apr 84
DX forecaster	
KØRYW	p. 119, May 84
DX forecaster	
KØRYW	p. 109, Jun 84
DX forecaster	
KØRYW	p. 103, Jul 84
DX forecaster	
KØRYW	p. 63, Aug 84
DX forecaster	
KØRYW	p. 79, Sep 84
DX forecaster	
KØRYW	p. 100, Oct 84
DX forecaster	
KØRYW	p. 92, Nov 84
DX forecaster	
KØRYW	p. 63, Dec 84
DX forecaster	
KØRYW	p. 94, Jan 85
DX forecaster	
KØRYW	p. 75, Feb 85
Short circuit	p. 117, Jun 85
DX forecaster	
KØRYW	p. 120, Mar 85
DX forecaster	
KØRYW	p. 84, Apr 85
DX forecaster	
KØRYW	p. 79, May 85
DX forecaster	
KØRYW	p. 102, Jun 85
DX forecaster	
KØRYW	p. 100, Jul 85
DX forecaster	
KØRYW	p. 100, Aug 85
DX forecaster	
KØRYW	p. 122, Sep 85
DX forecaster	
KØRYW	p. 105, Oct 85
DX forecaster	
KØRYW	p. 92, Nov 85
Dxing by computer	
NS6N and Buchanan, Walter	p. 81, Aug 84
Grayline propagation, fundamentals of	
KR7L	p. 77, Aug 84
Moon coordinates, determining basic	
W2WD	p. 38, Jan 85
Moon-tracking by computer	
K6WX	p. 38, Mar 84
New band propagation	
KK2XJM (W4MB)	p. 12, Jan 83
Radio astronomy and the search for extra terrestrial intelligence	
WB3JZO	p. 10, Mar 85
Radio signals, radiation of	
W1GV/4	p. 26, Jun 82
Russian Woodpecker, the: a continuing nuisance	
KR7L	p. 37, Nov 84
Solar outages, predicting	
VE7ABK	p. 75, Mar 85
VHF meteor scatter communications	
A17J	p. 69, Feb 84
VHF/UHF world: improving meteor scatter communications	
W1JR	p. 82, Jun 84
VHF/UHF world: the VHF/UHF Primer, an introduction to propagation	
W1JR	p. 14, Jul 84
VHF/UHF world	
W1JR	p. 45, Sep 84
VHF/UHF World: propagation update	
W1JR	p. 86, Jul 85
VHF/UHF World	
W1JR	p. 85, Dec 85

receivers and converters

general

Active mixers, performance capability: part 1	
DJ2LR	p. 30, Mar 82
Active mixers, performance capability: part 2	
DJ2LR	p. 38, Apr 82
Automatic repeater/receiver sensitivity (HN)	
VE7ABK	p. 81, Jan 82
Bragg-cell receiver	
WB3JZO	p. 42, Feb 83
Cascaded stages, IMD and intercept points of	
W3IMG	p. 28, Nov 84
CB to 10-meter conversions, scanner	
W2FMY, KB2GA	p. 98, Nov 85
Communications receiver	
K2BLA	p. 12, Jul 82
Compact 75-meter monoband transceiver	
K1BQT	p. 13, Nov 85
Crystal ladder filters, systematic design of	
N7WD	p. 40, Feb 82
CW filter, high performance	
W3NQN	p. 18, Apr 81
Comments W3NQN	p. 6, Nov 81
Digital frequency readout using the Commodore 64	
W3NNL	p. 83, Nov 85
External product detector improves receiver performance	
W6GB	p. 107, Nov 85
High-stability BFO for receiver applications	
K1ZJH	p. 28, Jun 85
LF converter, fixed-tuned	
K1RGO	p. 19, Jan 83
Low-noise preamplifiers with good impedance match	
W1OOP	p. 36, Nov 82
Measuring receiver dynamic range: an addendum (HN)	
WB6CTW	p. 86, Apr 81
Mixer frequencies, graphical selection	
W2HVN	p. 41, Jun 85
Noise discriminator, a pulsewidth	
W6NRW	p. 23, Nov 84
Panoramic adaptor/spectrum analyzer design notes	
WA6NCX/1	p. 26, Feb 83
Comments, K2CBY	p. 12, Sep 83
Short circuit	p. 70, Oct 83
Preamp at work, Quiet!	
N6TX	p. 14, Nov 84
Receiver dynamic range	
W3JZO	p. 77, Dec 82
Receiver input temperature (letter)	
WA6JTD	p. 13, Apr 85
Receiver, 10 through 80-meter homebrew	
N1BFV	p. 40, Nov 85
Remote-site receivers and repeater operation	
K9EID	p. 36, Jan 83
Rotary dial and encoder for digital tuning	
N3CA	p. 30, Dec 82
Spectrum analyzer, a handheld optical	
WA4WDL	p. 23, Apr 84
TS-930S headset audio, increased undistorted (HN)	
W6FR	p. 128, Oct 85
VHF/UHF world — high dynamic range receivers	
W1JR	p. 97, Nov 84
Short circuit	p. 103, Jan 85

high-frequency receivers

Blanking the Woodpecker: part 1	
VK1DN	p. 20, Jan 82
Blanking the Woodpecker, part 2: a practical circuit	
VK1DN	p. 18, Feb 82
Comments, NP4B	p. 8, Jul 82
Blanking the Woodpecker, part 3: an audio blanker	
VK1DN	p. 22, Mar 82
CB to 10 fm transceiver conversion	
VE3FIT, VE3AQN	p. 16, Feb 83
Communications receivers for the year 2000, part 1:	
DJ2LR	p. 12, Nov 81
Communications receivers for the year 2000, part 2:	
DJ2LR	p. 36, Dec 81
Compact SSB receiver	
K1BQT	p. 10, Nov 83
Comments KAØGPE	p. 10, Mar 84
Designing a modern receiver	
WB3JZO	p. 23, Nov 83

Don't buy from Hamtronics . . .

Unless you want the best possible equipment at the lowest possible price! ! !

The "wheeler-dealer" is back and he's beating everyone else's "deals."

We all know there's no such thing as a free lunch . . . so How Can We Do This?

- **We don't** run alot of ads featuring sale items
- **We don't** spend alot of money on full page ads
- **We don't** have sales on just the fastest selling products
- **We don't** short cut you on service. We are a factory warranty repair facility for everything we sell!
- **We don't** mail out free catalogs
- **We don't** have a free WATS number.

You and every other Ham customer is paying for all these do-dads and sales gimicks.

Hamtronics puts the savings into your pocket.

Hamtronics guarantees to meet or beat any advertised price on every item we sell.

Hamtronics Has It All!

Let **Hamtronics** be your Ham Radio equipment dealer. We're celebrating our 35th year in the Ham business at the same location.

HAMTRONICS, INC.

A DIVISION OF TREVOSE ELECTRONICS
4033 BROWNSVILLE RD., TREVOSE, PA 19047
(215) 357-1400



✓ 142

SYNTHESIZED SIGNAL GENERATOR

MADE IN USA



MODEL SG-100F
\$429.95 delivered

- Covers 100 MHz to 199.999 MHz in 1 kHz steps with thumbwheel dial
- Accuracy +/- 1 part per 10 million at all frequencies
- Internal FM adjustable from 0 to 100 kHz at a 1 kHz rate
- External FM input accepts tones or voice
- Spurs and noise at least 60 dB below carrier
- Output adjustable from 5-500 mV at 50 Ohms
- Operates on 12 Vdc @ 1/2 Amp
- Available for immediate delivery • \$429.95 delivered
- Add-on accessories available to extend freq range, add infinite resolution, AM, and a precision 120 dB attenuator
- Call or write for details • Phone in your order for fast COD shipment.

✓ 180

VANGUARD LABS

196-23 Jamaica Ave., Hollis, NY 11423
Phone: (718) 468-2720 Mon. thru Thu.

THE COMMODORE COMBINATION!

THE COMMODORE HAM'S COMPANION



As featured on Radio Sweden, Radio Netherlands and the WSTI Report.

The Commodore Ham's Companion: A 160 page paperback guide to using your Commodore computer in the ham shack. Good solid information on where to find software and hardware to use for CW, RTTY, AMTOR, SSTV, packet, propagation prediction, antenna modeling, satellite tracking and much more. Includes a list of over 80 sources of Commodore amateur radio software and hardware and a bibliography of over 60 magazine articles and reviews about using Commodore machines in the ham shack.

Command Post: A 32 page reprint of the popular Command Post column that includes Basic language program listings you can type in for CW and RTTY send and receive, dupe checking, program exchange and more. It also serves as a tutorial on the basics of interfacing Commodore machines for control operations.

✓ 164

Commodore Ham's Companion \$15⁹⁵
Command Post \$9⁹⁵
SPECIAL \$19⁹⁵ for both books when ordered together.
\$2.50 First Class shipping and handling applies on all US orders.
Mastercard and Visa accepted.

QST PUBLISHING
P.O. Box 3042
Springfield, IL 62708

TWO NEW ONES FROM ARCSOFT

QUICK-N-EASY ELECTRONICS PROJECTS



by Bob Green

Here's a neat book to help while away a rainy afternoon. Contains 40 quick and easy to build projects using commonly found electronic components. Learn-by-doing format is a boon to beginners while advanced builders will enjoy the range of projects included. Projects include: CPO, high VSWR alarm, three battery charger, body bug and sun spotter to

name just a few. Also includes list of mail order and local parts supplier suggestions. 1st edition © 1985 96 pages.

AS-QN

Softbound \$7.95

EASY-TO-BUILD ELECTRONICS PROJECTS

by Bob Green

40 more electronics projects to work on! Complete plans and schematics and easy-to-locate parts means that you can usually complete these projects in an evening. Projects include: Ad silencer, Mugger bugger, radio-tester, fuse telltale plus 36 more. More practice for the beginner and more fun for the advanced builder. 1st edition © 1985 96 pages.

AS-ET



Softbound \$7.95

Please enclose \$3.50 to cover shipping and handling

ham radio
GREENVILLE, NH 03048

BOOKSTORE

(603) 878-1441

MAKE CIRCUIT BOARDS THE NEW, EASY WAY



WITH TEC-200 FILM

JUST 3 EASY STEPS:

- Copy circuit on TEC-200 film using any plain paper copier
- Iron film on to copper clad board
- Peel off film and etch

SATISFACTION GUARANTEED
convenient 8 1/2 x 11 size

5-Sheet Starter Pack \$3.95
10 sheets only \$5.95

add 50¢ postage NY res. add sales tax

The MEADOWLAKE Corp.

Dept. R, P.O. Box 497
Northport, New York 11768

✓ 156

Digital HF radio: a sampling of techniques
 KA2WEU/DJ2LR p. 19, Apr 85
 Short circuit p. 121, May 85

High-frequency receiver performance
 G4OBU p. 33, Feb 84

Improved stability and dial calibration
 for the Heathkit HW-8 (HN)
 W3HVK p. 103, Nov 83

Inexpensive CW filter (HN)
 WB1AFQ p. 80, Jan 82

Radio interference to shortwave receivers (HN)
 W6XM p. 68, Jul 81

Receiver sweep alignment system
 WB6BIH p. 124, Nov 84

Shortwave converter, portable
 PY2PE1C p. 64, Apr 81

Shortwave receiver, portable
 PY2PE1C p. 67, Apr 84

Simple shortwave broadcast receiver (weekender)
 W6XM p. 83, Nov 83

Superhet coilset, design with
 a microcomputer
 Sterrenburg, F.A.S. p. 113, Nov 84

SW receiver, a double conversion portable
 PY2PE1C p. 48, Nov 84

Transceivers, quasi-bilateral IF for
 K1ZJH p. 75, Dec 84

Two-band receiver, extending the modular
 WA3TFS p. 57, Nov 84

Two-band receiver, modular
 WA3TFS p. 53, Jul 83
 Comments WA3TFS p. 8, Sep 84

Understanding performance data of high-frequency
 receivers
 K6FM p. 30, Nov 81
 Comments KL7HT, K6FM p. 8, Aug 82

Up-conversion receiver for the high-frequency bands:
 part 1
 W2VJN p. 54, Nov 81

Up-conversion receiver for the high-frequency bands:
 part 2
 W2VJN p. 20, Dec 81

15-meter sideband transceiver
 WA4ZXF p. 12, Mar 83
 Short circuit p. 80, Jul 83

80-meter receiver for the experimenter
 W6XM p. 24, Feb 81
 Comments p. 6, Jun 81

SSB transmitters, FSK adapter for
 WA3PLC p. 12, Jul 81
 Comments N1AL, WA3PLC p. 8, Mar 82
 Comments WB5DPZ, N1AL p. 8, Oct 82

Timex/Sinclair newsletter (letter)
 AD1B p. 12, Jul 84

TRS-80 color computer for RTTY
 W1OER p. 62, Jun 83

VIC-20 printer (HN)
 W2QLI p. 88, Sep 84
 Short circuit p. 145, Mar 85

satellites

Demodulator, telemetry, PSK, for OSCAR 10
 G3RUH p. 50, Apr 85

Elevation indicator, inexpensive (weekender)
 W5JTL p. 67, Jun 85

First HT-to-HT QSO via OSCAR 10
 WA2LQQ p. 32, Sep 84

Geostationary satellite bearings with the TI-58/59
 programmable calculator (HN)
 WA6BKC p. 87, Apr 81

Geostationary satellites, locating
 W2TQK p. 66, Oct 81
 Comments W1DHX p. 8, Jan 82
 Comments W2TI p. 8, Feb 82
 Short circuits p. 89, Jan 82

G.O.E.S. reception: a simple approach
 WA4WDL p. 46, Jan 84

Graphic azimuth and elevation calculator
 W8VGI p. 25, Jan 83

Locate orbiting satellites
 W0ZWW p. 72, Sep 83

Moon-tracking by computer
 K6WX p. 38, Mar 84

Satellite tracker, digitally-controlled
 KA8OBL p. 102, Sep 85

Signals from space, receiving
 K8UR p. 67, Nov 84

Tracking satellites in elliptical orbits
 WA6VJR p. 46, Mar 81

Work OSCAR 10 with your HT
 WA2LQQ p. 29, Sep 84

semiconductors

Amplifiers, biasing Class-A bipolar transistor
 KQ7B p. 32, Aug 82

Cooling semiconductors part 1:
 designing and using heatsinks
 Martin, Vaughn D. p. 33, Jul 84

Cooling semiconductors part 2:
 blowers and fans
 Martin, Vaughn D. p. 52, Aug 84

GaAs FET performance and
 preamplifier application
 K8UR p. 38, Mar 83
 Comments, KC0W p. 12, Jul 83

Solid-state replacements (Tech. forum)
 AK7N p. 46, Apr 83

Transistor biasing, back to basics
 WD4C p. 91, Dec 84

single sideband

Adjusting SSB amplifiers
 AG6K p. 33, Sep 85

Better sounding SSB
 AG6K p. 58, Feb 84
 Comments W2OZH p. 13, Jun 84

Development of Amateur SSB:
 a brief history
 K4KJ p. 12, Sep 84
 Comments, AG4R p. 8, Dec 84

Early single-sideband transmitter (ham radio
 techniques)
 W6SAI p. 30, Dec 81

Ham radio techniques
 W6SAI p. 106, Oct 84

Linear amplifier, modular, for the high-frequency
 Amateur bands
 K8RA p. 12, Jan 81
 Comments K1THP p. 6, Mar 81

Linear amplifier, HF solid-state kilowatt, mobile
 WA7SPR p. 67, Feb 85

Weaver modulation, 2-meter transmitter
 N1COX p. 12, Jul 85

software

TI58/TI59 (HN)
 K3VGX p. 65, Mar 82

television

CRT character enhancer
 W9CGI p. 66, Aug 82

Medium-scan television
 W9NTP p. 54, Dec 81

SSTV, applying microcomputers to
 G3ZCZ/4X p. 20, Jun 82

transmitters and power amplifiers

general

Adjusting SSB amplifiers
 AG6K p. 33, Sep 85

Am/Im converter for facsimile transmission, an
 SM6FJB p. 12, Dec 81

Lowpass filters, elliptic, for transistor amplifiers
 W3NQN p. 20, Jan 81

MC1496, improved carrier suppression (HN)
 K1ZJH p. 78, Apr 85
 Short circuit p. 74, Jul 85

RF switching, high power with pin diodes
 KN8Z p. 82, Jan 85

Single-conversion transceivers, digital frequency
 display for
 K6YHK p. 28, Mar 81

VMOS on 1750 meters
 K1RGO p. 71, Oct 83

6-meter amplifier
 W2GN p. 72, Apr 83
 Short circuit p. 97, Aug 83

40-meter transmitter-receiver
 W6XM p. 43, Dec 82

5CX1500 screen protection (HN)
 VE3AIA p. 58, Mar 83

high-frequency transmitters

ALC circuits, an analysis of
 K4JW p. 19, Aug 81

Amplifier, 3CX1200A7 10 to 80 meter
 K8RA p. 75, Aug 85

CB to 10 fm transceiver conversion
 VE3FIT, VE3AQN p. 16, Feb 83

Compact 75-meter monoband transceiver
 K1BQT p. 13, Nov 85

Improved stability and dial calibration
 for the Heathkit HW-8 (HN)
 W3HVK p. 103, Nov 83

Linear amplifier, HF, solid-state kilowatt, mobile
 WA7SPR p. 67, Feb 85

Linear amplifier, modular, for the high-frequency
 Amateur bands
 K8RA p. 12, Jan 81
 Comments K1THP p. 6, Mar 81

Lowpass filters, elliptic, for transistor amplifiers
 W3NQN p. 20, Jan 81

Remote control hf operation
 K5QY p. 32, Apr 83
 Short circuit p. 97, Aug 83

Vacuum tube amplifier, design a
 toroidal tank circuit for
 W6YUY p. 29, Aug 85

15-meter sideband transceiver
 WA4ZXF p. 12, Mar 83
 Short circuit p. 80, Jul 83

vhf and uhf transmitters troubleshooting

GLA-1000 amplifier, stop blowing finals
 G4CFY, G3ROG p. 59, Aug 85

TVI problem, solving a difficult (HN)
 W2YW p. 152, Sep 85

vhf receivers and converters

Communications receivers for the year 2000: part 1
 DJ2LR p. 12, Nov 81

Communications receivers for the year 2000: part 2
 DJ2LR p. 36, Dec 81

Interesting preamplifier for 144 MHz (HN)
 WA2GFP p. 50, Nov 81

K9LHA 2-meter synthesizer, extending
 the range of (HN)
 K9LHA p. 52, Dec 81

Optical fm receiver
 Poon and Pieper p. 53, Nov 83
 Short circuit p. 85, Jan 84
 Comment, W6OAL p. 13, Jun 84

VHF/UHF world: VHF/UHF receivers
 W1JR p. 42, Mar 84

RTTY

Baudot, a vote for (letter)
 W6NRM p. 8, Mar 82

CW and RTTY digital audio filter
 W1OER p. 60, Aug 83

New MSO for RTTY (letter)
 N2EO p. 12, Jul 84

RTTY and Atari™ computer
 K5VUV p. 36, Jul 83
 Short circuit p. 10, Feb 84

RTTY oscilloscope input
 using line transformers (HN)
 W6XM p. 87, Sep 84

RTTY tuning indicator, a free (HN)
 N1AW p. 74, Oct 81

RTTY zero-beat indicator (HN)
 W2QLI p. 78, Oct 83

Run RTTY on your Timex
 NU4V p. 110, Apr 85

Run RTTY on your VIC-20
 W5TRS p. 120, Apr 85

Slow ASCII
 W3FVC p. 6, Jun 81

ASTRON — SALE!

RS-7A	45.00	RS-35A	123.75
RS-12A	62.75	RS-35M	138.95
RS-12M	78.95	VS-35M	156.95
RS-20A	79.95	RS-50A	179.95
RS-20M	96.45	RS-50M	203.25
VS-20M	114.95	VS-50M	223.95

KLM

2M16LBX, 220-22LBX, 432-30LBX-90.50	
2M-14C-85.50	2M-22C-108.50
435-18C-110.50	435-40CX-144.50

KENPRO ROTORS

KR400/KR500	125.99/154.95
KR-5400/KR-5600	247.50/309.95

HENRY AMPS

2 KD CLASSIC	965.00
2002A/2004A Less Relay	1250/1350
3002A/3004A Less Relay	2100/2100

AMP SUPPLY

LK-500ZB	1,097.95
LK-800A	2,045.00

MIRAGE-FREE UPS BROWN ON ALL MIRAGE

A1015 - 235.50	C-22A - 85.95
B23A - 83.95	C-106 - 169.95
B215 - 245.50	C-1012 - 246.95
B108 - 149.95	D-24N - 177.50
B1016 - 235.50	D-1010N - 279.50
B3016 - 199.50	D-3010N - 251.00
MP-1 - 99.95	MP-2 - 99.95

TONNA 9FT ANTENNAS ARE BACK! WE ARE THE EXCLUSIVE U.S. DISTRIBUTOR INTRODUCTORY SPECIAL:
1296/1296 QUAD ARRAY COMPLETE WITH 4-23el YAGIS; 'H' FRAME; POWER DIVIDER; PHASING LINES, CONNECTORS, TERRESTRIAL APPLICATIONS. REGULARLY 339.95 **SALE PRICE 215.95**

OTHER GREAT, HIGH PERFORMANCE ANTENNAS BY TONNA (CALL FOR SPEC. SHEET!!)

5 EL. 6 METER YAGI	69.95	13 EL. 2MTR YAGI	59.94	TONNA(CALL FOR SPEC. SHEET!!)	
21 EL. 70cm YAGI	56.95	23 EL. 1296/69 YAGI	46.95	19 EL. 70cm YAGI	44.95
(ATV MODELS IN STOCK)		17 EL. 2MTR SUPER YAGI	88.90	2MTR OSCARTWIST	65.95
70cm OSCARTWIST	68.95	55 EL. 1296 SUPER YAGI	68.95	2 x 9 EL. (18el.)	
2 x 19 EL. (38el.)		9 ± 19 EL OSCAR ANTENNA 2M & 70cm ON A COMMONBOOM-GREAT FOR STACKING	75.62		

WATCH OUR AD FOR NEW LINES!!
16 S Mountain Blvd — Rt 309 Mountaintop, Pa 18707

FOR THE BEST DEAL IN TOWN CALL THE BEST NUMBER AROUND 1-800-HAM-7373

CUSHCRAFT AOP-1 OSCAR PAK-133.95 RINGO RANGER II (2-220-440)-33.95
KENWOOD TS-940S/AT - CALL US! YAESU FT-757GX - CALL US!
KENWOOD TR2600A H.T. - CALL US! YAESU FT-726R - CALL US!

KENWOOD
FACTORY AUTHORIZED DEALER
CALL US FOR AMERICA'S LOWEST PRICE ON ALL YOUR KENWOOD NEEDS (FREE UPS BROWN ON YAESU GEAR)

CUSHCRAFT

215WB - 73.00	A-3	200.45
4218XL - 91.00	A-4	267.45
R-3 - 250.95	40-2CD	267.45

OTHER MODELS IN STOCK — CALL

CUE DEE THE SWEEDISH BOOMER
USED BY MANY TOP '10' CONTESTERS
144-15AN 2MTR15EL 75.95

PARABOLIC

1296-28 IW TRANSVERTER	339.95
1269-144 3W UP CONV.	319.95
1296 DUAL TUBE AMP CAVITY	439.95
2PORT POWER DIVIDERS (2-220-432)	50.95
4PORT POWER DIVIDERS (2-220-432)	55.95
1296 2PORT DIVIDER	57.95
1296 4PORT DIVIDER	62.95
1269/96 DISH FEEDS	89.95
2304 DISH FEEDS	89.95
1296 SLUG TUNERS	65.95

YAESU — FACTORY AUTHORIZED DEALER CALL FOR THE BEST DEAL AROUND ON 'THE RADIO' FULL LINE (FREE UPS BROWN ON YAESU GEAR)

MUTEK LTD.

DO YOU OWN AN ICOM VHF XCUR? DO YOU WANT TO IMPROVE THE RECEIVER - TRY OUR MUTEK FRONT END BOARD - YOU'LL BE GLAD YOU DID!

RPCB211/251 RD FRONT END	143.95
FOR ICOM 211 OR 251	
RPCB271 FRONT END FOR ICOM 271A OR 271H	168.95
RPCB225 FRONT END FOR YAESU 221/225	143.95
SLNA 50S 6MTR PREAMP	84.95
SLNA-144S 2MTR PREAMP	84.95
100WRF SWITCHED, N.F. < 1db GAIN	169.95
SBLA144E 2MTR MAST MOUNT R.F. SWITCHED PREAMP, 250W THRU POWER, N.F. < 1db 15dbG	172.95
GLNA 432 70CM MAST MOUNT R.F. SWITCHED PREAMP, 50W THRU N.F. < 1db G = 15db	289.95
GFBA-144E 2MTR MAST MT. PREAMP, 1KW THRU POWER G = 15db N.F. < 8db WITH AMP SEQUENCER	289.95
GLNA-432E 70cm MAST MT PREAMP, 500W THRU, G = 15db N.F. < 1db WITH AMP SEQUENCER	299.95
HIGH D.R. DBM XVRTRS FOR 6 ± 2MTRS COMING SOON!	

SSB ELECTRONIC

K6001 6 To 10 DBM RCV CONV.	115.95
K2001 2 To 10 DBM RCV CONV.	115.95
K7001 70cm To 10 DBM RCV CONV.	115.95
K2301G 23cm To 10 or 2 RCV CONV G.F. FRONT END AND DBM	159.95
TV-144-28-10 10W 2MTX XVRTR	209.95
TV-432-28-10 10W 70cm XVRTR	299.95
TV-220-28-10 10W 1 1/4 M XVRTR Coming Soon	
DX-144 PREAMP N.F. < 4db	130.95
DX-220 PREAMP N.F. < 5db Coming Soon	
DX-432 PREAMP N.F. < 5db	130.95
(WON DAYTON 1985 N.F. CONTEST)	
DX-1296S PREAMP N.F. 5db	156.95
DX-2320 PREAMP N.F. < 8db	166.95
PA-2310 1269/1296 10W LINEAR AMP	275.95
LT-23S 1296 10W LINEAR TRANSVERTER	610.95
2MIF	
LSM-24 1269-2 OSCAR MODE L XMIT CONV. 1W	299.95
OUTPUT, 2MIF	
MICROLINE 13 1/2 W 2.3GHZ XVRTR SYSTEM 2MIF	410.95
MICROLINE 13 3W 2.3GHZ XVRTR SYSTEM, 2MIF	675.95
SLA-13 2304 3W AMP	285.95

MAST MOUNTED PREAMPS:
MV144V 250W R.F. SWITCH WITH 12V SUPPLY INTERFACE 175.95
MV432V 150W R.F. SWITCH WITH INTERFACE 185.95
MV-144S-01 1KW THRU PWR WITH SEQUENCER 309.95
MV-432S-01 500W THRU PWR WITH SEQUENCER 319.95
MV-1296S 100WTHRU PWR WITH SEQUENCER 349.95
OTHER HIGH QUALITY PRODUCTS IN STOCK-CALL FOR CATALOGUE

GREAT FOR OSCAR MODE 'L' OR 215.95

TERMS: Prices do not include shipping except where indicated and are subject to change without notice. At our discretion some COD's may require a deposit. Returns are subject to a 15% restocking charge. *Continental USA only

16 S Mountain Blvd — Rt 309 Mountaintop, Pa 18707 HOURS: Monday thru Friday 9 a.m. - 3:30 p.m. Saturdays 10 a.m. - 12 p.m. "24 HOUR PHONE SERVICE FOR YOUR CONVENIENCE!" MC/VISA/C.O.D

One source for amateur radio books, tapes and computer programs. **PROPAGATION PUBLISHING**

Over 125 books, tapes and computer programs to keep you up to date in the ham world, or to help you upgrade that new ticket. Send your name and address for a FREE copy of the new Propagation Publishing catalog.

SPECIAL!
"Flying Horse" 1986 Callbooks
The new ones with the biggest change in callbook history! Now all of North America, with US possessions, in one book.
■ North American Callbook Postpaid in USA ... \$21.95
■ International Callbook Postpaid in USA ... \$20.95



Please send check or money order. Illinois residents please add 6% sales tax.

We are looking for authors!
We want authors with new ideas for books in the amateur radio field. If you have a book in work or just thinking about one, send an outline and sample chapter to us for review. We can give your book the national exposure needed to make it a success.

PROPAGATION PUBLISHING
PO. Box 5255, Morton, Illinois 61550

STATEMENT OF OWNERSHIP, MANAGEMENT AND CIRCULATION

1. TITLE OF PUBLICATION: Ham Radio Magazine

2. FREQUENCY OF ISSUE: monthly

3. COMPLETE MAILING ADDRESS OF KNOWN OFFICE OF PUBLICATION: Main Street, Greenville, NH 03048-0498

4. FULL NAMES AND COMPLETE MAILING ADDRESS OF PUBLISHER, EDITOR AND MANAGING EDITOR: T.H. Tenney, Jr., Main Street, Greenville, NH 03048-0498

5. FULL NAMES AND COMPLETE MAILING ADDRESS OF OWNERS: Richard Brown, Main Street, Greenville, NH 03048-0498

6. FULL NAMES AND COMPLETE MAILING ADDRESS OF STOCKHOLDERS: T.H. Tenney, Jr., Main Street, Greenville, NH 03048-0498

7. CIRCULATION DATA (1985):

TOTAL NO. COPIES (Net Press Run)	13,100	12,500
PAID AND UNPAID SUBSCRIPTIONS	2,700	2,600
SALES THROUGH DEALERS AND CARRIERS	38,000	38,200
FREE DISTRIBUTION BY MAIL, CARRIER OR OTHER MEANS	300	200
TOTAL DISTRIBUTION (Net of Paid and Free)	41,100	41,200
COPIES NOT DISTRIBUTED	1,800	1,200
TOTAL (Sum of 7, 8 and 9)	42,900	42,500

vhf and microwave

general

ATV power amplifier, fast-scan
WB0ZJP p. 67, Mar 85

"Audio to microwave" amplifier, build your own
Gruchalla, Michael p. 12, Mar 84

Bandpass filter design, interdigital, computer-aided
N6JH, Monemzadeh p. 12, Jan 85

Short circuit p. 117, Jun 85

Battery-voltage monitor for HTs (weekender)
K2MWU p. 78, Sep 82

Diplexer mods (HN)
K5PFE p. 89, Apr 83

Dual wattmeter, 50-500 Hz (weekender)
WB4EHS p. 67, Jul 85

Duplexer, six cavity, home-brewed
K9EYY p. 12, Feb 85

Earth-moon-earth (ham radio techniques)
W6SAI p. 40, Feb 81

Efficient matching (Tech. forum)
VE7BS p. 83, Sep 83

Elevation indicator, inexpensive (weekender)
W5JTL p. 67, Jun 85

Get on 6 meters — the inexpensive way
KB1KJ p. 91, Mar 85

G.O.E.S. reception: a simple approach
WA4WDL p. 46, Jan 84

Handheld transceiver mount (a 2-way ashtray for your car) (weekender)
KB2XM p. 64, Jul 81

Helical antenna matching (Tech. forum)
Belliveau, John p. 73, May 83

Instant balun (letter)
W8MQW p. 6, Aug 81

K9LHA 2-meter synthesizer, extending the range of (HN)
K9LHA p. 52, Dec 81

Local oscillators, high stability for microwave receivers and other applications
WB3JZO p. 29, Nov 85

Measuring noise figure
K2BLA p. 26, Jan 84

Micros and VHF beacons
transmit messages automatically
K9EI p. 51, Jul 85

Microstrip impedance program
K8UR p. 84, Dec 84

Microwave network for multimode communications
K4TWJ p. 36, Aug 82

Moon coordinates, determining basic
W2WD p. 38, Jan 85

Moon-tracking by computer
K6WX p. 38, Mar 84

More about moonbounce (ham radio techniques)
W6SAI p. 34, Mar 81

Multipurpose uhf oscillator, simplifying the
WA9HYV p. 26, Sep 81

Power dividers, extended/expanded
W5JTL p. 73, Oct 84

Power FETs: trend for VHF amplifiers
Peters, Daniel, W7PUA p. 12, Jan 84

Power supply, amplifier
WA2GFP p. 32, Sep 83

Preamp at work, Quiet!
N6TX p. 14, Nov 84

Radio telescope antenna requirement (Tech. forum)
Landecker, Tom p. 44, Mar 83

RF transmission cable, microwave applications
K3HW p. 106, May 85

Repeater security
WA5FRF p. 52, Feb 81

Silverplating, safe, sensible
K9EYY p. 29, Feb 85

Super beep circuit for repeaters
KF4AQI p. 48, Jul 81

Synthesized time identifier for your repeater
WA4GUA p. 42, Nov 82

The Guerri report: signal processing
W6MGI p. 156, Dec 84

Tone decoder, the ultimate
WD9EIA, WB9HGZ p. 33, Sep 82
Comment, WD9EIA p. 8, Feb 83

Touchtone auto-dialer, portable
K2MWU p. 12, Aug 82
Comments, K2MWU p. 8, Feb 83

Trade off power for antenna gain at VHF?
WA9GFR, Hennesl p. 32, Jul 85

UHF antenna tower, low-cost
KA6GVY p. 30, Oct 84

VHF amplifiers, carrier-operated relay
WB3JCC, KD8KZ p. 45, Apr 85

VHF meteor scatter communications
AI7J p. 69, Feb 84

VHF signal generation, harmonic mixer (weekender)
K1ZJH p. 40, Mar 85

Short circuit p. 121, May 85

VHF/UHF world: the VHF/UHF challenge
W1JR p. 42, Jan 84

VHF/UHF world: improving meteor scatter communications
W1JR p. 82, Jun 84

VHF/UHF world: the VHF/UHF primer, an introduction to propagation
W1JR p. 14, Jul 84

VHF/UHF world: the VHF/UHF Primer, an introduction to filters
W1JR p. 112, Aug 84

VHF/UHF world
W1JR p. 45, Sep 84

VHF/UHF world
W1JR p. 55, Oct 84

VHF/UHF world — low-noise GaAs FET technology
W1JR p. 99, Dec 84

VHF/UHF world: high power amplifiers: pt. 1
W1JR p. 97, Jan 85

VHF/UHF world: high power amplifiers: pt. 2
W1JR p. 38, Feb 85

VHF/UHF world: keeping VHF/UHFers up-to-date
W1JR p. 126, Mar 85

VHF/UHF world: protecting equipment
W1JR p. 83, Jun 85

VHF/UHF world: propagation update
W1JR p. 86, Jul 85

VHF/UHF world: designing and building loop Yagis
W1JR p. 56, Sep 85

VHF/UHF world — transmission lines
W1JR p. 83, Oct 85

VHF/UHF world
W1JR p. 54, Nov 85

VHF/UHF world
W1JR p. 85, Dec 85

Weather radar, 10-GHz
K4TWJ p. 61, Sep 83

Wireless 220-MHz to 2-meter converter (weekender)
W3RW p. 36, Jan 82

X-band calibrator
WA6EJO p. 44, Apr 81

X-band mixer, low noise (Tech. forum)
NSAX p. 22, Jan 83

10-GHz oscillator, ultra stable
K8UR p. 57, Jun 83

40-meter transmitter-receiver
W6XM p. 43, Dec 82

vhf and microwave antennas

Antenna insulators, PTFE VHF
W5JTL p. 98, Oct 85

Cylindrical feedhorns, second-generation
WA9HUV p. 31, May 82

Direction-finding tool, the fox box
K1ZJH p. 25, Oct 85

Fresnel-zone plate for 10.4 GHz
WB6YVK p. 44, May 82

Comments, KB9O, WB6YVK p. 8, Nov 82

Inexpensive five-eighth wave groundplane (HN)
W7CSD p. 84, Mar 81

Matching 432 MHz helical antennas (Tech. forum)
W8NWU p. 44, Mar 83

Re-entrant cavity antenna for the vhf bands
W4FXE p. 12, May 81

Using a 2-meter quarter-wave whip on 450 MHz (HN)
K1ZJH p. 92, May 81

VHF/UHF world: VHF/UHF antennas and antenna systems
W1JR p. 46, Feb 84

VHF/UHF world: stacking antennas, part 1
W1JR p. 129, Apr 85

VHF/UHF world: stacking antennas, part 2
W1JR p. 95, May 85

VHF/UHF world
W1JR p. 85, Dec 85

Weathering the elements at 10.4 GHz
WB6YVK p. 74, Aug 82

2-meter beam, portable
KB5QJ p. 113, Oct 85

vhf and microwave receivers and converters

Add fm to your receiver (weekender)
K3NXU p. 74, Mar 81

GaAs FET performance and preamplifier application
K8UR p. 38, Mar 83
Comments, KC0W p. 12, Jul 83

Kenscan 74
WB7QYB p. 50, Jan 81
Short circuit p. 89, Jan 82

Local oscillators, high stability for microwave receivers and other applications
WB3JZO p. 29, Nov 85

Modification of K9LHA 2-meter synthesizer for 144-148 MHz coverage (HN)
K9LHA p. 93, May 81

Preamplifier design, UHF, computer-aided
KB0O p. 28, Oct 82

Synthesizer, genesis of a
VE3FIT p. 38, Mar 81

TR-2500/2600 2-channel programming (HN)
K9MLD p. 128, Oct 85

VHF/UHF world: VHF/UHF receivers
W1JR p. 42, Mar 84

VHF/UHF world — low-noise GaAs FET technology
W1JR p. 99, Dec 84

VHF/UHF world
W1JR p. 54, Nov 85

Yaesu's latest VHF/UHF receiver, add general coverage
W6MGI p. 67, Oct 85

2-meter synthesizer, frequency modulator for
K9LHA p. 68, Apr 81

2-meter transverter
W6HPH p. 24, Jan 82

2-meter weather converter (weekender)
WA3EEC p. 87, Dec 83

10-60 MHz preamp, low-noise, low-cost
WA2GFP p. 65, May 81

2304-MHz preamplifier, low-noise
WA2GFP p. 12, Feb 83

vhf and microwave transmitters

Amplifier, 2 meter, 40 watt
WB4GCS p. 50, Oct 83

Amplifier, 432-MHz, 1500-watt
W2GN p. 40, Jul 85

AN/UPX-6 cavities, converting surplus
W6NBI p. 12, Mar 81

Modification of K9LHA 2-meter synthesizer for 144-148 MHz coverage (HN)
K9LHA p. 93, May 81

Solid-state power for 1296 MHz
N6JH p. 30, Feb 81

Synthesizer, genesis of a
VE3FIT p. 38, Mar 81

Temperature control, automatic
WBSIRI p. 75, Jun 85

TR-2500/2600 2-channel programming (HN)
K9MLD p. 128, Oct 85

VCO, 1800-2600 MHz
W0DTV p. 21, Jul 85

VHF/UHF world: medium power amplifiers
W1JR p. 39, Aug 85

VHF/UHF world: VHF/UHF exciters
W1JR p. 84, Apr 84
Short circuit p. 60, Oct 84

Weaver modulation, 2-meter transmitter
N1COX p. 12, Jul 85

2-meter synthesizer, frequency modulator for
K9LHA p. 68, Apr 81

6-meter amplifier
W2GN p. 72, Apr 83
Short circuit p. 97, Aug 83

HIGH PERFORMANCE PRESELECTOR-PREAMP

The solution to most interference, intermod, and desense problems in **AMATEUR** and **COMMERCIAL** systems.



- 40 to 1000 Mhz - tuned to your frequency
- 5 large helical resonators
- Low noise - High overload resistance
- 8 dB gain - ultimate rejection > 80 dB
- 10 to 15 volts DC operation
- Size - 1.6 x 2.6 x 4.75" exc. connectors
- **FANTASTIC REJECTION!**

Typical rejection:
± 600 Khz@144 Mhz: -28dB
± 1.6 Mhz@220 Mhz: -40dB
± 5 Mhz@450 Mhz: -50dB

Price - **\$89.95** bipolar w/RCA jacks
Connector options: BNC \$5, UHF \$6,
N \$10
SUPER HOT! GaAs Fet option \$20

AUTOMATIC IDENTIFIERS

ID-1

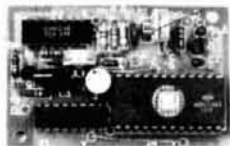

ID-2



- For transceivers and repeaters - **AMATEUR** and **COMMERCIAL**
- Automatic operation - adjustable speed and amplitude
- Small size - easy installation - 7 to 15 volts DC
- 8 selectable, reprogrammable messages - each up to 2 min. long
- Wired, tested, and programmed with your message(s)

✓ 137 Model ID-1 - \$49.95 Model ID-2 w/2 to 10 minute timer - \$69.95

We offer a complete line of transmitter and receiver strips and synthesizers for amateur and commercial use.

Request our free catalog. Allow \$2 for UPS shipping - Mastercard and VISA welcome

GLB ELECTRONICS, INC.

Dept H, 151 Commerce Pkwy., Buffalo, NY 14224
716-675-6740 9 to 4

AMATEUR TELEVISION

NEW 70 CM ATV TRANSCEIVER

ALL YOU NEED IN ONE BOX



\$299 delivered
TC70-1

- **FULL COLOR, SOUND, & LIVE ACTION** just like broadcast TV. Get on this exciting amateur video mode at our affordable ready to go price.
- **WHAT IS REQUIRED FOR A COMPLETE OPERATING SYSTEM?** The TC70-1s downconverter outputs to any TV on ch 3 for receiving. Connect a good 70 cm antenna and low loss coax. Plug in any composite video source you want to transmit: Camera, VCR, computer, etc. Plug in any low Z dynamic mic or use color camera mic for Standard 4.5 mHz TV sound. Connect to 13.8 vdc for base, mobile, or portable. See chapt. 20 1985 ARRL Handbook. That's it!
- **WHAT CAN YOU DO WITH THE TC70-1 ATV TRANSCEIVER?** Show the shack, projects, computer program listings, home video tapes, repeat Space Shuttle audio and video if you have a TVRO, repeat SSTV or RTTY, Weather Radar, do public service events such as parades, marathons, races, CAP searches and rescues... the list goes on. DX depends on antennas and terrain, typically 1 to 40 miles. We have video compensated RF linear amps for 20 (\$119) or 50 (\$189) watts pep for greater DX.
- **FEATURES:** Small 7x7x2.5". Push to Look (PTL) T/R switching. GaAsFet downconverter tunes whole 420-450 mHz band. Two switch selected video & audio inputs... RCA phone jacks and 10 pin color camera jack. Xmit video monitor output. Over 1 watt pep RF output on one or two (add \$15) selected crystal controlled frequencies. 439.25, 434.0, or 426.25 mHz.

CALL OR WRITE FOR OUR CATALOG for more info or who is on in your area. We stock antennas, modules, and everything you need on ATV.

TERMS: Visa, MC, or cash only UPS CODs by phone or mail. Checks must clear bank before shipment. Price includes UPS surface shipping in cont. USA, others add 3%. Transmitting equipment sold only to licensed Tech class or higher amateurs, verifiable in 1985 call book or copy of new license.

(818) 447-4565 m-f 8am-6pm pst.

P.C. ELECTRONICS

Tom W6ORG Maryann WB6YSS



2522 Paxson Lane
Arcadia CA 91006

Join AMSAT...Today

Amateur Radio Satellite OSCAR 10 provides:

- **A New Worldwide DX Ham Band** open 10 hours a day.
- **Rag Chew With Rare DX Stations** in an uncrowded, gentlemanly fashion.
- **Popular Modes In Use:** SSB, CW, RTTY, SSTV, Packet
- **Full Operating Privileges** open to Technician Class licensee or higher.

Other AMSAT Membership Benefits:

ORBIT Magazine Subscription:
Dependable technical articles, satellite news, orbital elements, product reviews, DX news, and more.

Satellite Tracking Software
Available for most popular PCs.

QSL Bureau, AMSAT Nets, Area Coordinator Support, Forum Talks

Construction of Future Satellites For Your Enjoyment!

AMSAT Membership is \$24 a year, \$26 outside North America. VISA and MC accepted.

AMSAT
P.O. Box 27
Washington, DC 20044

301 589-6062

✓ 115

John J. Meshna Jr., Inc.

P. O. Box 62 19 Allerton St. E. Lynn, Ma. 01904 Tel: (617) 595-2275

COMPUTER TERMINAL BUILDING BLOCK \$50.00

This is a great beginning for a computer terminal. It is a brand new, Panasonic, 9" TTL input monitor complete with its own self-contained, switching power supply, and a removable (four screws) triple output power supply. The whole assembly runs on 115/230 V, 50/60 Hz. Now for some specifics: 9" green phosphor, TTL input monitor, attached regulated 12 VDC, 1.5 A power supply used exclusively to run the monitor and an attached triple output switching power supply with outputs of 5 VDC @ 3.5 A, +12 VDC @ 500 ma, and -12 VDC @ 500 ma. The assembly has mounting feet and should be a snap to make a case for. Comes with hook up data. New, factory boxed. We are offering this to you 4 ways:

- COMPLETE SET-UP AS SHOWN, including monitor, low voltage supply and triple output supply. SPL-116-38, 14 Lbs., \$50.00, 5/\$225.00
- TRIPLE OUTPUT SUPPLY ONLY, SPL-117-38, 3 Lbs. \$15.00
- 9" MONITOR ONLY, (you supply low voltage input) SPL-114-38, 10 Lbs. \$25.00
- 9" MONITOR W/LOW VOLTAGE SUPPLY ONLY, SPL-115-38, 12 Lbs. \$40.00

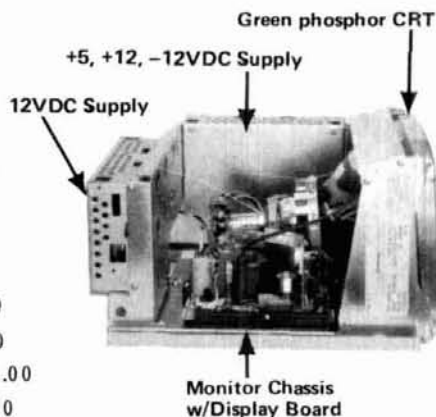

We are now selling guaranteed working, starlight scopes which allow sight in almost total darkness. They are so named because they incorporate a light amplification tube which uses the available star or moon light to allow you to see - without being seen. The scope has a spectral response of 4,500 to 8,000 angstroms, resolution of 50 lines/mm, viewing area of 25mm, standard 50mm F1.4 lens, optional telephoto 135mm F2.8 lens, cross hair reticle and optional carrying case. A great tool for security and naturalist applications. Runs on 9VDC transistor radio battery. Due to the nature of this device and people only having a one time use for it, we cannot accept returns for refund, credit or exchange on this item. To our knowledge, this is the least expensive starlight scope on the market. Includes 90 day warranty.

STARLIGHT SCOPE SPL-130A-39 \$1,200.00
 Optional Telephoto Lens, 135mm F2.8 SPL-131A-39 \$85.00
 Optional Fitted Carrying Case SPL-132A-39 \$65.00

ATTENTION:

SECURITY PERSONNEL
 NATURALISTS
 HOBBYISTS

NEW SEE-IN-THE-DARK EQUIPMENT!



5 1/4" HARD DRIVE CONTROLLER CARD

Finally, affordable, intelligent disc drive controllers are available at low, low surplus prices. The OMTI 20C controller boards we offer are unused, late style, surplus from a now defunct system house. OMTI is a division of Scientific Micro Systems. These boards will handle up to (2) 5 1/4 inch Winchester type hard drives that utilize a standard 34 pin SASI interface. Perfect for using with the above Seagate ST 506 drive, or other hard drives from 5 megabytes of storage on up. The controllers have buffered slow/seek modes, overlapped seeks, auto seek & verify, extensive fault detection, auto head & cylinder switching, full sector buffering, 256/512 bytes/sector, 33 or 18 sectors/track (jumper selectable), programmable disc parameters and much more. The board runs on +5 vdc & +12 vdc.. We supply users manual & pinout data. Guaranteed O. K. Shpg. wt. 3 lb. OMTI 20 C \$150.00 each 2/\$275.00 Qty. pricing available.

HIGH POWER SURVEILLANCE IR SCOPE

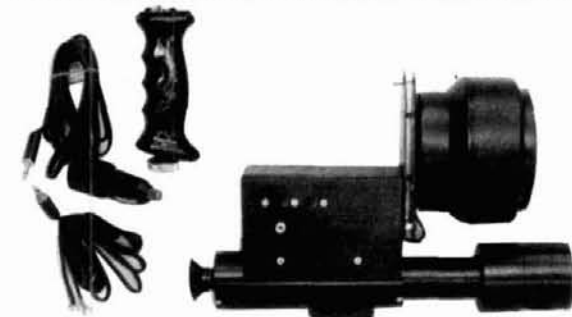

This Infra-Red scope was designed specifically for long range surveillance use. The built-in, totally invisible, 50 watt halogen lamp IR source is coupled with a premium grade type 6032 image converter tube, 265 mm f4.2 lens, and 16 power military spec., color corrected eyepiece make this an ideal unit for viewing of clandestine activities or animals. The scope is capable of detection at more than 300 feet, recognition at 300 feet and positive facial identification at 150 feet. It runs on 12 VDC which makes it ideal for mobile use. It comes with a removable hand grip which allows for tripod mounting, 2 power cords for cigarette lighter or battery terminals, instructions and a 90 day warranty. Listed below are accessories which make this a very versatile instrument. The scope and accessories are new and guaranteed functional. Net wt. 5-1/4 Lbs.
 IR Scope part no. ELD Shpg. Wt. 7 Lbs. \$735.00 ea.

ACCESSORIES:

12 VDC GELL BATTERY for above. Shpg. Wt. 6 Lbs. \$35.00
 BIOCULAR EYEPIECE which can be used in place of the standard eyepiece. This allows the scene being produced by the IR viewer to be seen by the operator up to 4 ft. away. 2 Lbs. \$89.95

MALE "T" f1.6 CAMERA DAPTER for SLR cameras Shpg. Wt. 1 Lb. \$129.00
 MALE "C" to FEMALE "T" ADAPTER for CCTV, requires use of above male "T" f1.6 adapter. Shpg. Wt. 1 Lb. \$29.95

Free 72 page catalogue available or send \$1.00 for 1st class service to P. O. Box 62 E. Lynn, Ma. 01904. Phone (617) 595-2275 to place your order by phone. MC, VISA, or American Express charge cards accepted.



Your Ham Tube Headquarters!

**TUBES BOUGHT, SOLD AND TRADED
SAVE \$\$\$—HIGH \$\$\$ FOR YOUR TUBES**

Call Toll Free 800-221-0860

Tubes			
3-400Z.....	\$85.00	7360.....	\$13.75
3-500Z.....	85.00	6550A.....	7.50
4-400A.....	80.00	8072.....	125.00
4CX250B.....	59.00	8156.....	12.50
572B.....	57.00	8643.....	82.50
811A.....	12.00	8844.....	26.50
813.....	30.00	8873.....	195.00
6146B.....	8.50	8874.....	225.00
6360.....	4.25	8877.....	595.00
6883B.....	8.00	8908.....	14.50

MAJOR BRANDS ON RECEIVER TUBES 75% off list

Semiconductors			
MRF 245/SD1416 ..	\$30.00	SD1088	19.95
MRF 454	14.95	2N3055.....	75¢
MRF 455	10.95	2N6084.....	12.50

RF Connectors			
PL259.....	10/\$4.95	M358.....	2.50 ea.
PL258.....	10/8.95	M359.....	1.75 ea.
UG 175/176.....	10/1.60	Type "N" Twist on	
UG255/u.....	2.50 ea.	(RG8/u).....	\$4.75 ea.
UG273/u.....	2.25 ea.	Minimum Order	\$25.00

Allow \$3.00 min. for UPS charges ✓ 119

CeCo

COMMUNICATIONS, Inc.
2115 Avenue X Brooklyn, NY 11235

Phone (212) 646-6300

Call CECo For Your CCTV Security And Color Production Requirements

SATELLITE TELEVISION RECEIVER SEMIKIT

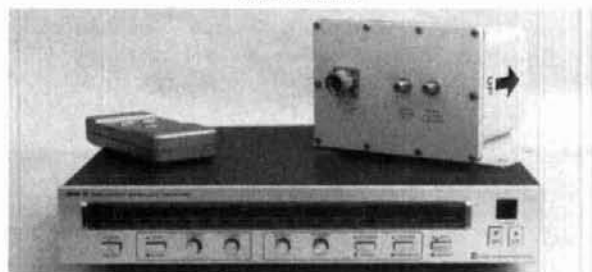

with dual conversion downconverter

FEATURES:

- Infrared remote control tuning
- AFC, SAW filter
- RF or video output
- Stereo output
- Polarator controls
- LED channel & tuning indicators

Install six factory assembled circuit boards to complete.

SEMIKIT	\$300.00
Completed downconverter add	100.00
Completed receiver and downconverter add	150.00

JAMES WALTER SATELLITE RECEIVER

2697 Nickel, San Pablo, CA 94806 ✓ 149 Tel. 415-724-0587

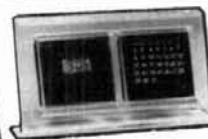

RECEIVE THIS LCD CALENDAR/CLOCK FREE WITH YOUR SUBSCRIPTION

WHAT'S REALLY HAPPENING IN HOME SATELLITE TV?

STV[®] THE HOME SATELLITE TELEVISION MAGAZINE[™]

A monthly of 100-plus pages—has everything you need to know about where to find equipment, how to install it, system performance, legal viewpoints, and industry insights! With your subscription to STV[®] you will receive a FREE LCD Calendar/Clock.

- Only \$19.95 per year (12 monthly issues)
- \$1.00 for sample copy

IF YOU HAVE A SATELLITE SYSTEM, THEN YOU REALLY NEED ...



OnSat[®]

The best in satellite programming! Featuring: ★All Scheduled Channels ★Weekly Updated Listings ★Magazine Format ★Complete Movie Listing ★All Sports Specials ★Prime Time Highlights ★Specials Listing and ★Programming Updates!

- Only \$45.00 per year (52 weekly issues)
- 2 Years \$79.00 (104 weekly issues)
- \$1.00 for sample copy

Visa[®] and MasterCard[®] accepted (subscription orders only). All prices in US funds. Write for foreign rates.

Send this ad along with your order to:

STV[®]/OnSat[®]

P.O. Box 2384—Dept. HR • Shelby, NC 28151-2384

SUBSCRIPTION CALLS ONLY

TOLL FREE 1-800-438-2020



product

REVIEW

Alpha Delta's multi-band twin sloper antenna

Sloper antennas have enjoyed considerable popularity over the past few years. Recently a number of different manufacturers have been producing several models of multi-band slopers that are fairly convenient to install and apply and give a pretty good accounting of themselves on the air.

The newest sloper is the DX-A from Alpha Delta, designed to cover 160, 80, and 40 meters. Alpha Delta is well known for its MACC power supply switch and transient protector and its Transi-trap antenna lightning protector. Don Tyrell, W8AD, president of Alpha Delta, was looking for a way to improve his low band signals and came upon the March, 1981, *QST* article by Doug DeMaw, W1FB, "More Thoughts on The Confounded Sloper." Don researched the sloper further and decided that the design could give him the kind of performance he was looking for.

Because he wanted a multi-band antenna, he had to make a few modifications. The first was to modify the basic design to configure it more like an inverted dipole rather than a single wire antenna (as described in the *QST* article and produced by other manufacturers.) This was done to broaden the bandwidth and improve the radiation efficiency of the antenna. As first designed, the antenna had one element that covered 160 and 80, while the other tuned 40 meters. However, after a number of these units were produced and out in the field, Don found that the antenna's performance could be improved if the 160-meter resonator was placed on the end of the 40-meter wire (see fig. 1).

Since I had the original DX-A antenna, I had to make a number of minor modifications before this review could begin.

Alpha Delta uses an aluminum tower bracket drilled to fit a Rohn tower bolt and has an SO-238, female UHF connector to simplify attaching the antenna feed line. The two antennas are fed from this common point and extend away from the tower just as a dipole would. If there's any question of a good ground connection, such as with a crank-up or older and possibly corroded tower, it will be necessary to run a grounding wire to ensure proper operation.

Alpha Delta recommends that the DX-A be placed between 25 and 40 feet up — 30 is suggested as optimum. The elements should be run as closely to 180 degrees apart as possible. (The test antenna was installed at 32 feet on a 56 foot

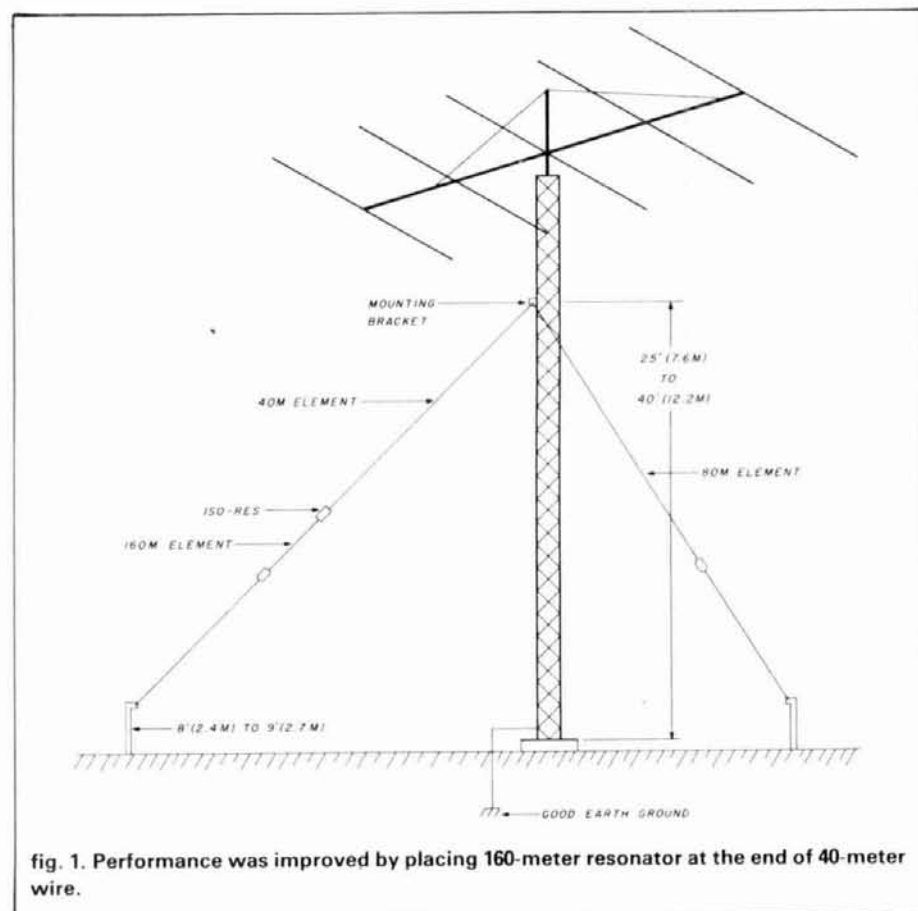

fig. 1. Performance was improved by placing 160-meter resonator at the end of 40-meter wire.

UNIVERSAL PACKET CONTROLLER model PK-80



\$219⁹⁵ Suggested Amateur Net Price

The AEA model PK-80 is a wired, tested, and calibrated version of the famous TAPR TNC-2 and comes with a one-year conditional AEA warranty.

You can interface the PK-80 with any ASCII terminal or a personal computer and standard terminal software. The PK-80 is loaded with all the latest AX.25 version 2.0 software and advanced packet hardware circuitry that makes the TNC-2 the newest benchmark for comparison.

Compare the following as representative of the advanced new features relative to the competition.

- Hardware HDLC for full duplex
- True Data Carrier Detect (DCD) for HF operation
- Operates with 300, 1200, 2400, 4800, and 9600 baud terminals
- Five front-panel status indicators
- Multiple connect
- Connect check (poll final bit) fully implemented
- Connect AUTO response message
- Only three commands necessary for making standard contacts
- 82 software commands possible for the most demanding requirements

Prices and Specifications Subject to Change Without Notice or Obligation.

ADVANCED ELECTRONICS APPLICATIONS, INC.
P.O. Box C-2160, Lynnwood, WA 98036-0918
TELEX: 6972496 AEA INTL UW
(206) 775-7373

AEA BRINGS YOU THE BREAKTHROUGH

Inter-Ear-Communication-System

A space age system that allows you to send and receive your message through your ear and leave your hands free.



- Replace your HT's awkward speaker-microphone with an n-ear-microphone.
- Discrete HT communications leaves you with both hands free.
- Allows voice communications in noisy environments.
- Our n-ear-talk interfaces with almost all HT's, which have external speaker microphone output jacks.
- Custom hybrid circuit.
- Low power consumption. Transmits at 5mA and less than 10uA when receiving.
- One year warranty.

IECS-200

Dealer inquiries are invited.

\$99.95 includes IECS-200 control unit, Ear transducer, 9V battery, 6-pin output connector and Instruction sheet. (Add 6% sales tax for California residents.)

Custom made interface cable for TEMPO S-15 and all ICOM HTs are available at \$19.95

FOR ALL PREPAID ORDERS, SHIPPING AND HANDLING CHARGE WILL BE PAID BY N-EAR-TALK.



ACE communications, inc.

22511 Aspan Street • Lake Forest • Calif. 92630-6321
(714) 581-4900 Telex 29-7385 ACE UR Fax (714) 768-4410

193

WARNING

SAVE YOUR LIFE OR AN INJURY

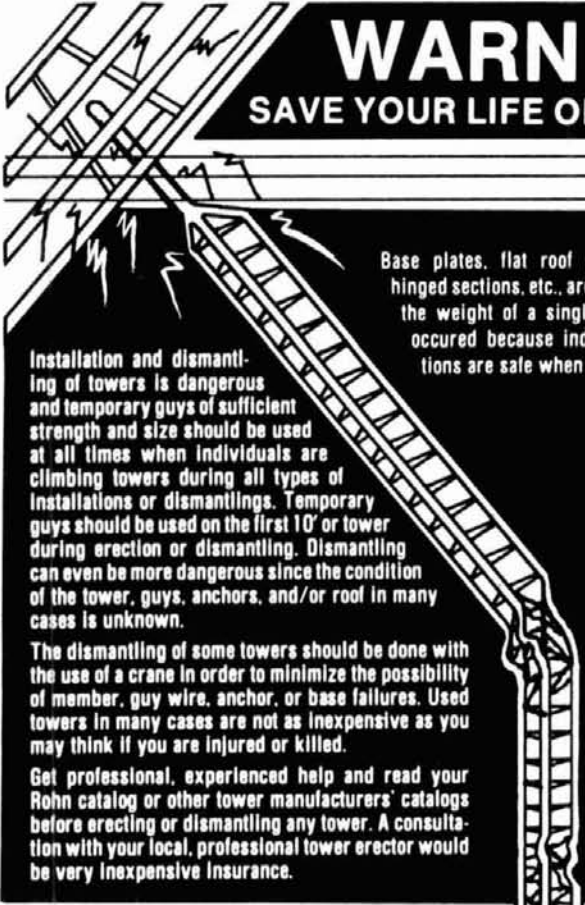

Base plates, flat roof mounts, hinged bases, hinged sections, etc., are not intended to support the weight of a single man. Accidents have occurred because individuals assume situations are safe when they are not.

Installation and dismantling of towers is dangerous and temporary guys of sufficient strength and size should be used at all times when individuals are climbing towers during all types of installations or dismantlings. Temporary guys should be used on the first 10' or tower during erection or dismantling. Dismantling can even be more dangerous since the condition of the tower, guys, anchors, and/or roof in many cases is unknown.

The dismantling of some towers should be done with the use of a crane in order to minimize the possibility of member, guy wire, anchor, or base failures. Used towers in many cases are not as inexpensive as you may think if you are injured or killed.

Get professional, experienced help and read your Rohn catalog or other tower manufacturers' catalogs before erecting or dismantling any tower. A consultation with your local, professional tower erector would be very inexpensive insurance.

Paid for
By the
Following:
ROHN®
P. O. Box 2000
Peoria, IL 61656
AN AMERICAN OWNED COMPANY

tower.) Other dimensions can be used without seriously degrading performance.

The antenna is a single-wire radiator for 80 meters and a loaded radiator on 40 and 160. It uses a low-Q "iso-resonator" instead of an L-C trap to eliminate the problems of capacitor breakdown under high RF loads. This coil is rated at 1500 watts PEP. Don's new dimensions for the antenna are:

80 meters	67-69 feet
40 meters	34 feet
160 meters	18 feet

Tuning 80, I found that I was able to get an acceptable match at 3.6 MHz without too much difficulty. However, finding that the suggested dimensions for 40 meters were a bit too long, I spent a considerable amount of time pruning the antenna in an attempt to get the antenna to resonate. I was finally able to get the unit to cover the whole band when the antenna was approximately 32 feet long. Luckily at this point, the antenna was just about resonant at where I wanted it for 160. One cut and it was at 1.84 MHz.

Should you have any problems during installation or tune up, you can call Alpha Delta's technical department at 513-376-4180. Their representatives will be able to provide you with sound advice.

Less than 2:1 SWR bandwidth for this installation is:

160 meters	50 kHz	1.815-1.865 MHz
80 meters	200 kHz	3.5-3.7 MHz
40 meters	300 kHz	7.1-7.3 MHz

This antenna can also be tuned with open wire feeders or coax and a transmatch for greater frequency excursions. As modified, the DX-A will also tune the 30 and 17-meter Amateur bands with a reasonable SWR.

It is far too soon to tell how well this antenna will perform on long-haul DX contacts. However, early results indicate that it will be pretty good on 80 and 40 with credible results on 160.

The multi-band sloper won't give you the performance of full-sized antennas. But, if your space is limited or if you need a single antenna to get on the air, the DX-A is a perfect candidate for you to consider.

For more information, stop by your local dealer or contact Alpha Delta, P.O. Box 571, Centerville, Ohio 45459.

Circle #301 on Reader Service Card. **N1ACH**



packet goes portable

GLB Electronics, Inc., has introduced the first packet radio controller designed for portable and solar powered stations.

(continued on page 124)

WE SHIP WORLDWIDE

Barry Electronics Corp.

WORLD WIDE AMATEUR RADIO SINCE 1950
Your one source for all Radio Equipment!

For the best buys in town call:
212-925-7000
Los Precios Mas Bajos en
Nueva York

KITTY SAYS: WE ARE NOW OPEN 7 DAYS A WEEK,
Saturday & Sunday 10 to 5 P.M.
Monday-Friday 9 to 6:30 PM Thurs. to 8 PM
Come to Barry's for the best buys in town.

ONV Safety
belts-in stock



IC—R71A, 751, 745, 27AH, 37A, 47A, R-7000,
127A, 271A/H, 3200A, 471A/H, 735

Santa Kitty says,
"Seasons Greetings to All!"



KENWOOD
R-600, R-1000, R-2000, TS-940 S/A/T
TS-430S, TR-3600A, TR 7950,
TW-4000A, Kenwood Service/Repair.
TH2131/41AT, TM-211A/
411A & TS-711A/811A

COMPU-FIRE EXTINGUISHERS
EXL-5000E RITTY/AMTOR TERMINAL

VoCom/Mirage/Daiwa
Tokyo Hy-Power
Amplifiers &
5/8" HT Gain
Antennas IN STOCK

Soldering
Station,
48 Watts, \$68

JRC soldering iron in stock
MICROLOG-AIR 1, Air Disk,
SWL, Morse Coach

KANTRONICS
UTU, Interface II,
Challenger, Packet Comm.

EIMAC
3-500Z
572B, 6JS6C
12BY7A &
4-400A

AEA 144 MHz
AEA 220 MHz
AEA 440 MHz
ANTENNAS

Antennas
A-5
Cushcraft
Hustler
KLM
METZ
Mini-Products
Mosley



YAESU
FT-ONE, FT-980, FT-757GX, FRG-8800
FT-726R, FRG-9600, FT-270RH, FT-2700RH

Yaesu ICOM Land Mobile HT
FT-10703R IC2AT Wilson Standard
FT-2709RH IC02AT Yaesu FT-C 2203, FT 4703
FT-C 1903 IC 04AT Icom IC M12 (Mairmai) M700
Tempo M-1

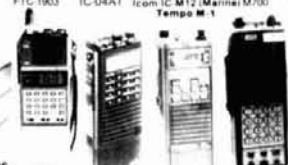

AMERITRON AMPLIFIER AUTHORIZED DEALER

Yaesu FTR-2410, Wilson
ICOM IC-RP 3010 (440 MHz)
ICOM IC-RP 1210 (1.2 GHz)



Computer Interfaces
stocked: MFJ-1224
AEA CP-1, PKT-1, DR-DX
CP-100, PK-64, Dr. QSO,

Morse University

ALPHA AMPLIFIERS
Complete Butternut Antenna
Inventory in Stock!

DIGITAL FREQUENCY COUNTERS
Fluke, Pro-Gem Engineering
Model TM-1000 0-1 GHz 1200Hz
0-800 MHz 0-1.3 GHz 1200Hz

Long range Wireless
Telephone for export in stock

BENCHER PADDLES,
BALUNS, AUDIO FILTERS,
IN STOCK

MIRAGE AMPLIFIERS
ASTRON POWER SUPPLIES
Saxton Wire & Cable



SMART PATCH
CES Computer Autopatch 9510 SA W/ Patch FM
Transceiver To Your Telephone Great For
Telephone Calls From Mobile To Base Simple
To Use \$119.95

PRIVATE PATCH III in stock
CELLULAR PHONES STOCKED
FLUKE 77 Multimeter



Nye MBVA 3 Kilowatt Tuner

SANTEC
ST-222UP
ST-20T
ST-442UP
HT-7

MFJ Models
422, 313, 1224 & 941D

MURCH
Model
2000 A,
A.L.S. B
in stock

HEIL
EQUIPMENT
IN STOCK

New TEN-TEC
2591HT, Corsair II, Argosy II, Century 22

RF TRANSISTORS

FRESH STOCK - NOT SURPLUS
TESTED - FULLY GUARANTEED

P/N	2-30 MHz 12V (* = 28V)		Match Pr.
	Rating	Each	
MRF406	20W	\$14.50	\$32.00
MRF412,IA	80W	18.00	45.00
MRF421	100W	25.00	56.00
MRF421C	110W	—	60.00
MRF422*	150W	38.00	82.00
MRF426,IA*	25W	18.00	42.00
MRF428**	150W	55.00	125.00
MRF433	12.5W	12.00	30.00
MRF435*	150W	42.00	90.00
MRF449,IA	30W	12.50	30.00
MRF450,IA	50W	14.00	31.00
MRF453,IA	60W	15.00	35.00
MRF454,IA	80W	16.00	36.00
MRF455,IA	60W	12.00	28.00
MRF458	80W	20.00	46.00
MRF460	60W	18.00	42.00
MRF464*	80W	25.00	60.00
MRF466*	40W	18.75	48.00
MRF475	12W	3.00	9.00
MRF476	3W	2.75	8.00
MRF477	40W	11.00	25.00
MRF479	15W	10.00	23.00
MRF485*	15W	6.00	15.00
MRF492	90W	18.00	40.00
SFR2072	75W	15.00	33.00
SFR3662	110W	28.00	60.00
SFR3775	75W	15.50	34.00
SFR3795	85W	16.50	37.00
CD2545	50W	23.00	52.00
SD1076	70W	17.00	40.00
SD1451	50W	15.00	36.00

Selected High Gain Matched Quads Available

VHF/UHF TRANSISTORS

Rating	MHz	Net Ea. Match Pr.		
		Rating	Match Pr.	
MRF212	10W	136-174	\$16.00	—
MRF221	15W	136-174	10.00	—
MRF222	25W	136-174	14.00	—
MRF224	40W	136-174	13.50	32.00
MRF231	3.5W	66-88	10.00	—
MRF234	25W	66-88	15.00	39.00
MRF237	4W	136-174	3.00	—
MRF238	30W	136-174	12.00	—
MRF239	30W	136-174	15.00	—
MRF240	40W	136-174	18.00	—
MRF245	80W	136-174	28.00	65.00
MRF247	75W	136-174	27.00	63.00
MRF250	50W	27-174	20.00	46.00
MRF260	5W	136-174	7.00	—
MRF261	10W	136-174	9.00	—
MRF262	15W	136-174	9.00	—
MRF264	30W	136-174	13.00	—
MRF607	1.75W	136-174	3.00	—
MRF641	15W	407-512	22.00	—
MRF644	25W	407-512	24.00	54.00
MRF646	40W	407-512	26.50	59.00
MRF648	60W	407-512	33.00	69.00
2N3866*	1W	30-200	1.25	—
2N4427	1W	136-174	1.25	—
2N5591	25W	136-174	13.50	34.00
2N5642*	20W	30-200	13.75	34.50
2N5945	4W	407-512	10.00	—
2N5946	10W	407-512	12.00	—
2N6080	4W	136-174	6.25	—
2N6081	15W	136-174	7.50	—
2N6082	25W	136-174	8.90	—
2N6083	30W	136-174	9.30	24.00
2N6084	40W	136-174	11.75	28.50

TMOS FET				
MRF134*	5W	2-200	\$10.50	—
MRF137*	30W	2-200	22.50	—
MRF138**	30W	1.5-150	35.00	—
MRF150**	150W	1.5-150	80.00	—
MRF172*	80	2-200	65.00	—

Selected, matched finals for Kenwood, Yaesu,
Icom, Atlas, etc. Technical assistance and cross-
reference information on CD, PT, RF, SRF, SD P/Ns.

QUANTITY DISCOUNTS AVAILABLE
WE SHIP SAME DAY C.O.D./VISA/MC
INFORMATION AND CALIF. ORDERS: (619) 744-0728
OUTSIDE CALIF. ORDER DESK: 800-854-1927



New York City's LARGEST STOCKING HAM DEALER
COMPLETE REPAIR LAB ON PREMISES

"Aquí Se Habla Español!"
BARRY INTERNATIONAL TELEX 12-7670
MERCHANDISE TAKEN ON CONSIGNMENT
FOR TOP PRICES

Monday-Friday 9 A.M. to 6:30 P.M. Thursday to 8 P.M.
Saturday & Sunday 10 A.M. to 5 P.M. (Free Parking)

AUTHORIZED DIST. MCKAY DYMEK FOR
SHORTWAVE ANTENNAS & RECEIVERS

Subways: IRT/LEX "Spring St. Station"
BMT "Prince St. Station"
IND-"F" Train B'way Station

Bus: Broadway #6 to Spring St.
Path - #9 St. Ave. Station

Local Ham Club
Speeches Green

We Stock: AEA, ARRL, Alpha, Ameco, Antenna Specialists, Astatic,
Astron, B & K, B & W, Bash, Bencher, Bird, Butternut, CDE, CES, Collins,
Communications Spec. Connectors, Covercraft, Cushcraft,
Daiwa, Dentron, Digimax, Drake, ETO (Alpha), Eimac, Encom, Heil-
Sound, Henry, Hustler (Newtronics), Hy-Gain, Icom, KLM, Kantronics,
Larsen, MCM (Daiwa), MFJ, J.W. Miller, Mini-Products, Mirage,
Newtronics, Nye Viking, Palomar, RF Products, Radio Amateur Callbook,
Robot, Rockwell Collins, Saxton, Shure, Telex, Tempo, Ten-Tec,
Tokyo Hi Power, Trionyx TUBES, WZAU, Waber, Wilson, Yaesu Ham and
Commercial Radios, Vocom, Vibroplex, Curtis, Tri-Ex, Wacom Duplexers,
Repeaters, Phelps Dodge, Fanon Intercoms, Scanners, Crystals, Radio
Publications.

WE NOW STOCK COMMERCIAL COMMUNICATIONS SYSTEMS
LEADER INQUIRIES INVITED. PHONE IN YOUR ORDER & BE REIMBURSED

COMMERCIAL RADIOS stocked & serviced on premises.
Amateur Radio Courses Given On Our Premises, Call
Export Orders Shipped Immediately. TELEX 12-7670

Invitation to Authors

ham radio welcomes manu-
scripts from readers. If you
have an idea for an article
you'd like to have consid-
ered for publication, send for
a free copy of the ham radio
Author's Guide. Address your
request to ham radio,
Greenville, New Hampshire
03048 (SASE appreciated).

MICROWAVE EQUIPMENT

RMLA - 2.3
Single Stage, Low Noise
Gas Fet Amplifier
\$60.00

Optimum Transistor Noise Figure less than .5 dB.
Associated Gain Greater Than 15dB at 2.3 GHz.
Source/Load must be 50 ± 10 ohm Non-Reactive.
SMA Connectors. Requires ± 5VDC Power with
- 5VDC present when + 5VDC applied. Power Sup-
ply and Sequencing is not supplied. Zener Protection.
Unenclosed on 2" x 2" PC Board.

Write for Price/Delivery for any frequency from 1 to 6
GHz. Also VCO's, Signal Generators, Detectors, At-
tenuators, Filters, Mixers, and Converters.

Price includes Shipping and Insurance when paid by
check or money order. Charge or C.O.D. orders,
F.O.B., Brookfield, MO

ROENSCH MICROWAVE
R.R. 1, Box 156B,
BROOKFIELD, MISSOURI 64628 ✓ 170

MULTI BAND TRAP ANTENNAS

TRAP DIPOLES:

Model	Bands	Traps	Length	Price
D-42	10/15/20/40	2	55	\$59.95
D-52	10/15/20/40/80	2	105	64.95
D-56	10/15/20/40/80	6	99	109.95

TRAP VERTICALS - "SLOPERS":*

VS 31	10/15/20	1	12	42.95
VS 41	10/15/20/40	1	27	44.95
VS 52	10/15/20/40/80	2	52	59.95
VS 53	10/15/20/40/80	3	49	69.95

*Can be used without radials.

**Feed line can be tuned if desired.

ALL ANTENNAS are Ready to use - Factory assembled - Commercial Quality - Handle full power - Comes complete with Deluxe Traps, Deluxe center connector, 14 ga Stranded Copper-Weld ant wire and End Insulators, Automatic Band Switching - Tuner usually never required - For all transmitters, Receivers & Transceivers - For all class amateurs - One feeding works all bands - Instructions included - 10 day trail!

COAX CABLE: (includes PL-259 connector on each end)

Type	Length	With antenna purchase	Separately
RG 58	50	\$8.00	\$11.95
RG 58	90	12.00	16.95

DELUXE CENTER CONNECTOR

- NO RUST Brass Terminals
- NO jumper wires used
- NO Soldering
- Built in Lightning Arrestor
- With SO 239 Receptacle
- Handles Full Power
- Completely sealed, weatherproof
- Easy element adjustments
- Commercial quality



CE 1
\$8.95

DELUXE ANTENNA TRAPS: Completely sealed & weatherproof - Solid brass terminals - Handles Full power - NO jumpers - NO Soldering - Instructions included
For 4 band Dipole Ant 40/20/15/10 \$36.00/pr
For 5 band Dipole Ant 80/40/20/15/10 \$38.00/pr

ORDER DIRECT FROM FACTORY. All orders shipped US Postpaid. VISA/MC give card # Exp. date, Signature.



SPI-RO MANUFACTURING, INC.
Room 103, P.O. Box 1538
Hendersonville, NC 28793



Dealer Inquiries Invited



Unique in terms of small size and low current drain, the PK1L is designed for portable use and for remote digipeater operation. At a current drain of only 25 mA, the PK1L can even be operated on a 9-volt transistor radio battery. PK1L also has self-contained "watchdog" and power-down sensing circuits with a lithium battery backup for memory. When power is disconnected all parameters and modes that have been set up are retained and become available again when power is restored. For remote digipeater operation in the event of malfunction due to nearby lightning strikes, etc. the watchdog automatically resets the CPU, ensuring continued operation for anything short of physical damage to the unit. The PK1L also provides a "connected" signal, plus two spare inputs and outputs that can be programmed for custom applications. A "remote command lockout" input can be used to prevent unauthorized stations from sending control commands.



The PK1L is housed in a rugged, all-metal, shielded enclosure measuring only 4.6 x 5.9 x 1.0 inches. The PK1L is entirely self-contained with an onboard CPU, 8K of memory, pre-programmed 32K ROM, RS-232 interface and packet MODEM weighing only 12 ounces. Both connectors are DR-25s, chosen for ready availability. Pinouts were chosen to preclude damage due to improper insertion. One connector is for transceiver and power supply and the other for a computer, a computer terminal, or a teletype machine, either ASCII or Baudot. The CPU is a CMOS Z80A microprocessor operating at 3.58 MHz.

For further information, contact GLB Electronics, Inc., 151 Commerce Parkway, Buffalo, New York 14224.

Circle #303 on Reader Service Card.

ICOM IC-R7000 receiver

A new continuous-coverage receiver from ICOM monitors all Amateur Radio frequencies, from 25 MHz through 2000 MHz in FM, AM, and SSB modes. (Specifications guarantee from 25 to 1300 MHz.) The unit also covers aircraft, marine, government, emergency services and television bands.

Nintey-nine memory channels are featured. Frequencies are accessed by either keyboard or tuning knob. Scanning speed is adjustable. Five

tuning speeds (0.1 kHz, 1.0 kHz, 5 kHz, 10 kHz, 12.5 kHz, and 25 kHz) are available. The fluorescent display includes a dimmer switch for comfortable viewing.

The compact unit measures 4 3/8 x 11 1/4 x 10 7/8 inches and is priced at \$899. Infrared remote controller and voice synthesizer are optional.

For details, contact ICOM America, Inc. 2380 116 Avenue N.E., Bellevue, Washington 98009-9029.

Circle #304 on Reader Service Card.

AZDEN 2-meter transceiver

Amateur-Wholesale Electronics has announced the new AZDEN PCS-5000 2-meter microcomputer FM transceiver.

The PCS-5000 has an unprecedented frequency range of 140.000-152.995 MHz, allowing the unit to be used for CAP and all MARS frequencies. Its small size — only 2 inches high by 5-1/2 inches wide by 7-1/4 inches deep — allows the radio to be placed almost anywhere.

The microcomputer facilitates features not previously available, including up to 11 nonstandard splits, 20 channels of memory in which offset and PL information can be stored, dual memory scan, scan lockout in memory mode, two ranges of programmable band scanning, with selectable scan increments, busy scan and delay scan in both the memory and band-scan modes, discriminator scan centering (AZDEN exclusive patent), priority memory with alert tone, state-of-the-art lithium battery for memory backup, repeater reverse, acquisition tone, programmable PL generator, and direct frequency entry.

The crisp, easy-to-view backlit liquid crystal display shows operating functions as well as frequency and S/Rf bar-graph meter. The keyboard is backlit for easy viewing even in total darkness.

Other features of the PCS-5000 include high/low power (25 watts and 5 watts, fully adjustable), a superior receiver with *unprecedented* sensitivity and dynamic range, true frequency modulation, 16-key touchtone pad, a rugged multi-function dynamic microphone, a built-in speaker, mobile mounting bracket, remote speaker jack, and all cords, plugs and fuses.

For further information, contact Amateur-Wholesale Electronics, Inc., 8817 S.W. 129 Terrace, Miami, Florida 33176.

Circle #305 on Reader Service Card.

new Heathkit catalog

More than 400 kit and assembled electronic products — including a new personal LORAN navigational computer suitable for boating or backpacking — are showcased in the latest Heathkit catalog.

Many new products are featured; for example, Heath's instrument line has been expanded to include the ID-4801 EPROM Programmer,

ORLANDO HAMCATION AND COMPUTER SHOW MARCH 7, 8, 9, 1986 FLORIDA STATE ARRL CONVENTION



REGISTRATION

\$5.00 ADVANCE • \$7.00 AT DOOR

FOR INFORMATION

PLEASE SEND

SELF ADDRESSED STAMPED
ENVELOPE TO:

HAMCATION CHAIRMAN
P.O. BOX 15142
ORLANDO, FL 32858
(305) 422-ARRL

FREE PARKING AVAILABLE

used to program, duplicate, verify, and simulate single-power supply 2500 and 2700-series EPROMS. A new version of the H/Z-100 Desktop Computer is also available, featuring 8MHz operation and equipped with a minimum of 256K bytes of RAM.

Of special interest to readers is an FCC-registered phone patch that employs a new design and special speech transmission circuits that allow the patch to be directly connected to the phone line, thereby eliminating conventional hybrid transformers used on four-wire to two-wire conversions.

For a free copy of Heathkit's new catalog, contact Heath Company, Dep't 150-585, Benton Harbor, Michigan 49022.

Circle #306 on Reader Service Card.

2-position coax switch

The new MFJ-1702 two-position coax switch features one pole, two output positions, and low insertion loss — less than 0.2 dB. Its maximum frequency range is 500 MHz, and it has less than 20 milliohms contact resistance SO-239 connectors.

The MFJ-1702 is designed for high-performance at a reasonable price. It has a VSWR of 1:1.2 and gets better than 60 dB isolation at 300 MHz and better than 50 dB at 450 MHz. The power rating is 2.5 kw PEP, 1 kw CW. Unused terminals are also automatically grounded for protection from static, lightning, and RF.

Hams will find that they can rely on this durable two-position coax switch because MFJ includes a one-year unconditional guarantee and an additional 30-day money-back guarantee if the product is purchased directly from MFJ Enterprises.

For more information, contact MFJ Enterprises, P.O. Box 494, Mississippi State, Mississippi 39762.

Circle #307 on Reader Service Card.

plug-in encoder-decoder

Communications Specialists has introduced another new direct plug-in encoder-decoder for three popular radios. Based on the proven TS-32 programmable encoder-decoder, the TS-32JRC plugs directly into the J.R.C. JHM-45S50, Sonar FM-2112/FM-2114, and Repco RSM. No modifications to the radio are necessary.

The TS-32JRC allows individual selection of all 32 standard EIA CTCSS tones on any of the radios' channels. The send and receive tones may be the same or different on each of the 16 channels. The TS-32JRC is available for immediate delivery from factory stock and sells for \$62.95. A catalog is available on request.

For further details, contact Communications Specialists, Inc., 426 West Taft Avenue, Orange, California 92665-4296.

Circle #308 on Reader Service Card.

PK-64 packet system

The PK-64 form AEA is the first Packet System with both hardware and software optimized for the Commodore-64 computer.

On the hardware side, the PK-64 includes Western Digital 1935 HDLC chip for full-duplex operation. The modem is based on the Exar 2206 and 2211 chip set including a 6-pole post detection filter for improved HF and VHF performance. The PK-64 is designed for small size and light weight, for convenient use. AEA designed the PK-64 to operate from 12 volts DC for maximum flexibility in powering the unit. An AC Adapter is available for those wishing to use a 115 volt AC power source. The PK-64 will work with virtually any voice transceiver.

The hardware is only half the story. No Packet Radio Controller is complete without appropriate communications software. Existing terminal emulation programs used with present Packet Controllers were not designed with Packet Radio Communication in mind and are not optimum. The PK-64 includes its own MBA-TOR™ style communications software which has been optimized for Packet Radio.

The PK-64 software allows Split Screen operation for more efficient Packet Radio communications. This is a valuable feature since it allows receiving and displaying packets while the operator is typing a message or response to be transmitted. There is a built-in word processor file text editor that allows disk or cassette files to be created, edited, or deleted. Commodore 64 text and executable files may be transferred error-free with the PK-64. Ten command and message buffers are available for traffic, bulletins, or often used connect paths, etc. A software clock is included which automatically logs the connect and disconnect times and dates. PK-64 commands are the same style as the TAPR family of commands.

The price is less than \$220.

For more information, contact Advanced Electronic Applications, Inc., PO Box C-2160, Lynnwood, Washington 98036.

Circle #302 on Reader Service Card.

**SAY
YOU SAW
IT IN**

**ham
radio** magazine



**STILL LOOKING FOR QUALITY
WIRE & CABLE
AT THE RIGHT PRICE?**

RG-213 MIL SPEC. 97% SHIELD	28 5¢/ft
RG-214 MIL SPEC. DBL SILVER SHIELD	\$1 50/ft
RG-174 MIL SPEC. 97% SHIELD	10¢/ft
RG-8X (MINI 8) FOAM. 95% SHIELD	12 5¢/ft
RG-8U FOAM. 95% SHIELD	24 5¢/ft
RG-58A/U MIL SPEC. 97% SHIELD	12¢/ft
RG-11A/U MIL SPEC. 97% SHIELD	28¢/ft
RG-59U MIL SPEC. 97% SHIELD	12¢/ft
300 OHM KW TWIN LEAD	16¢/ft
450 OHM HD LADDER LINE POLY INS	10¢/ft
450 OHM HD LADDER LINE BARE. 100 FT ROLL	\$13 00
4 CONDUCTOR ROTOR CABLE	8¢/ft
6 CONDUCTOR ROTOR CABLE	14¢/ft
8 CONDUCTOR ROTOR CABLE (2#18/6#22)	16 5¢/ft
8 CONDUCTOR ROTOR CABLE HD (2#16/6#18)	34¢/ft
14 GA STRANDED COPPERWELD. 70 FT ROLL	\$6 50
14 GA STRANDED COPPERWELD. 140 FT ROLL	\$12 00
14 GA HD STRANDED COPPER	8¢/ft
12 GA HD SOLID COPPERWELD	10¢/ft
14 GA HD SOLID COPPERWELD	8¢/ft
18 GA HD SOLID COPPERWELD	4¢/ft

*SOLD IN CONTINUOUS LENGTHS TO 5000 FT. IN 50 FT. MULTIPLES ONLY.

LA CUE, INC.
132 Village Street
Johnstown, PA 15902
orders only
1-800-637-3300

POPULAR PA 19 Wideband Preamp

- Over 8,000 sold
 - 0.5 - 200 MHz
 - 19 dB gain
 - 50 Ω in/output
 - For receivers, counters, transmitter amp stages
 - Built, tested & ready-to-go
- ONLY \$9.95 + \$1 shipping**

NEW POCKET SIZED 500 MHz Freq. Counter

- Fits in your shirt pocket
 - Uses 1 9-volt battery
 - 4 digit LED readout, 6 digit resolution
 - 1 MHz - 500 MHz
 - Great addition to shack and toolbox
- ONLY \$49.95 + \$2 shipping**



DIGITREX
1005 BLOOMER
ROCHESTER, MI 48063

WEST COAST DISTRIBUTOR
R. LUKASZEWICZ
20610 ALAMINOS DRIVE SAUGUS, CA 91350
(805) 252-6021

WOW! AT LAST!! A VERY AFFORDABLE COMPUTER
AT A VERY AFFORDABLE PRICE

POWERFUL FULLY PROGRAMMABLE WITH 2K OF MEMORY—PORTABLE—6.78" x 1.38 INCH MODULE SINGLE KEY ENTRY COMMANDS—DURABLE 40 KEY MEMBRANE TYPE KEYBOARD—280A BASED FOUR CHIP DESIGN—EDUCATIONAL—UNIQUE SYNTAX CHECK REPORT CODES FOR ERROR IDENTITY—GRAPH DRAWING AND ANIMATED DISPLAY—ACCURATE TO 9-12 DECIMAL PLACES FOR FULL RANGE MATH AND SCIENTIFIC FUNCTIONS—AT AN AFFORDABLE PRICE.

WE CANNOT TELL YOU THE MAKE OF THE COMPUTER BUT IT WAS MADE BY A FAMOUS WATCH COMPANY THEY USED TO SELL FOR \$99.95

WE BOUGHT OUT WHAT THE FACTORY HAD LEFT IN STOCK AND HAD TO REMOVE THE LABELS, THESE UNITS ARE UNPACKAGED LESS THE 9V WALL ADAPTER AND MANUAL BECAUSE THIS IS A DISCONTINUED ITEM THERE IS NO WARRANTY GET THEM WHILE THEY LAST

LIMITED SUPPLY

BUY THE UNIT FOR \$19.95 BUY THE UNIT FROM OPERATING FOR PARTS \$10.95 9V WALL ADAPTER \$4.95
BUY THE UNIT (NON OPERATING FOR PARTS) \$10.95 MANUAL (OVER 150 PAGES) \$2.95

See September 1984 issue of 73 for TIMEX/RTTY article

CHIP BONANZA (AT THESE PRICES THEY ARE A STEAL)

2708		\$1.00 EA OR 10 FOR \$ 9.00
2716		\$2.25 EA OR 10 FOR \$20.00
2732		\$3.25 EA OR 10 FOR \$30.00
2754		\$4.00 EA OR 10 FOR \$35.00
2713B		\$7.00 EA OR 10 FOR \$60.00
6602		\$4.95 EA OR 10 FOR \$45.00
6610	(REG \$3.95)	\$1.95 EA OR 10 FOR \$18.00
66A09	(REG \$19.95)	\$5.95 EA OR 10 FOR \$50.00
66A21	(REG \$9.95)	\$2.95 EA OR 10 FOR \$25.00
4115	(or equivalent)	8 FOR \$ 5.99
4134		9 FOR \$12.95
XR2211	(SPECIAL)	\$ 2.95
TMS 9900NL MICRO-P 64 PIN 8 BIT DIB - 16 BIT CPU		\$ 4.95
TMS 9901NL MICRO-P PSI		\$ 2.95
TMS 9904NL MICRO-P CLOCK GEN. AND DRIVER		\$ 5.95
TMS 9918ANL MICRO-P COLOR GRAPHICS AND DISPLAY		\$ 9.95
KEYBOARD (99A) 48 KEYS MEASURE 4 x 10 (H) TEK		\$ 9.95

APPLE II and APPLE III - COMPUTER MAINFRAMES (fully populated) \$150
Power supply, case and keyboard, separately available. Call or Write
Unit as described above, fully assembled and tested \$350 plus shipping
APPLE POWER SUPPLIES \$29.95

Cassette Software:

I have cassette software send for list (reg \$9.95-\$14.95) Hal's Special Price: 1 for \$3.95, 3 for \$10.95, 6 for \$19.50, 10 for \$29.50, 20 for \$50.00 or let Hal select 25 different cassettes (my choice) at 25 for \$50.00!!!

HAL'S COMPUTER GOODIES

Timex printer (reg. \$99.95 now \$59.95)
Coleco cassette player (battery op.) \$29.95
9V @ 850 Ma adapter (needed for 10K RAM packs) \$7.95
16K RAM pack module, new \$29.95, refurbished \$19.95
16K RAM pack module, refurbished \$19.95
RCA TV interface cable \$1.25
Dual jack cassette interface \$2.50
TV/Computer game switch \$3.95

SHIPPING INFORMATION: ORDERS OVER \$25 WILL BE SHIPPED POST-PAID EXCEPT ON ITEMS WHERE ADDITIONAL CHARGES ARE REQUESTED ON ORDERS LESS THAN \$25 PLEASE INCLUDE ADDITIONAL \$2.50 FOR HANDLING AND MAILING CHARGES MICHIGAN RESIDENTS ADD 4% SALES TAX SEND 20¢ STAMP OR SASE FOR FREE FLYER CANADIAN ORDERS ADD \$5.00 POSTAGE IN U.S. FUNDS

HAL-TRONIX, INC.
P.O. BOX 1101 - DEPT. HR
SOUTHGATE, MICH. 48195
PHONE (313) 285-1782



"HAL" HAROLD C. NOWLAND W8ZXH

VE Groups! Individual VEs! DeVERY Wants You!

Work with the VEC that was — and still is — one of the first (and best) in the VEC Program.

Upgrading? An SASE will bring you DeVERY exam dates and locations by return mail.

Call or write Jim Georgius, W9JUG, Director

DeVERY ARS VEC Program

DeVERY Institute of Technology
3300 North Campbell
Chicago, Ill 60618
(312) 929-8500

130

DO YOU KNOW WHERE TO FIND REAL BARGAINS

on NEW and USED
ELECTRONIC Equipment?

*You'll Find Them
in the Nation's No. 1
Electronic Shopper Magazine*

NUTS & VOLTS

Now in Our 5th Year

Nuts & Volts is published MONTHLY and features:
**NEW STATE-OF-THE-ART PRODUCTS •
SURPLUS EQUIPMENT • USED BARGAINS •
LOW COST AD RATES • PRIVATE AND
COMMERCIAL CLASSIFIEDS • NATIONAL
CIRCULATION • NEW PRODUCT NEWS
SECTION • AND A FREE CLASSIFIED AD
WITH YOUR SUBSCRIPTION**

SUBSCRIPTION RATES

- One Year - 3rd Class Mail \$10.00
- One Year - 1st Class Mail \$15.00
- One Year - Canada & Mexico (in U.S. Funds) .. \$18.00
- Lifetime - 3rd Class Mail (U.S. Only) \$35.00

ORDER NOW!

SEND: CHECK MONEY ORDER
 VISA MASTERCARD

TO: **NUTS & VOLTS MAGAZINE**
P.O. BOX 1111-H
PLACENTIA, CALIFORNIA 92670
(714) 632-7721

Name _____
Address _____
City _____
State _____ Zip _____
Card No. _____
Exp. Date _____

**IF YOU'RE INTO ELECTRONICS,
THIS MAGAZINE WILL SAVE YOU MONEY!**

Dealer Inquiries Invited

160

Uncle Ben says...

"I give you
much more than
just the lowest price..."

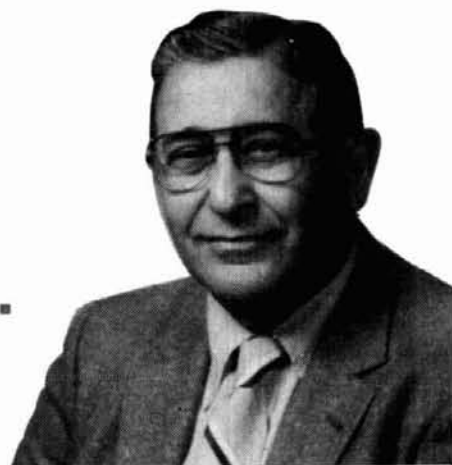

"Uncle Ben" Snyder, W2SOH
the head man of

HARRISON

"HAM HEADQUARTERS,
USA" ...Since 1925!

When you get that exciting new piece of equipment from me, you know you are going to be completely happy... I see to it, personally! I also give you earliest delivery, greatest trade-in allowances, my friendly assistance in every possible way.

Just ask any of the many thousands of hams all over the world who have been enjoying my friendly good service for over a half a century.

73, Uncle Ben, W2SOH

• **CALL ME...**

(516) 293-7995

HARRISON
HAS THEM ALL!
KENWOOD

• **WRITE ME...**

For my prompt,
personal reply.

• **SEE ME...**

At one of the world's largest
Ham Supply Centers!



Kenwood TH21AT, 31AT, 41AT



Kenwood TR-7950/7930



Kenwood TS-940S



Kenwood TS-430S



Kenwood TR-2600, TR-3600



Kenwood TS-711A (2m)
TS-811A (70 cm)

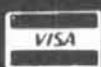

HARRISON RADIO

...Since 1925!

CHARGE IT!

"HAM HEADQUARTERS, USA"

2263 Route 110 (at Smith St.)
E. Farmingdale, NY 11735

1-(516) 293-7995

HAM MART

Ham Radio's guide to help you find your local

California

C & A ROBERTS, INC.
18511 HAWTHORN BLVD.
TORRANCE, CA 90504
213-370-7451
24 Hour: 800-421-2258
Not The Biggest, But The Best —
Since 1962.

FONTANA ELECTRONICS
8628 SIERRA AVENUE
FONTANA, CA 92335
714-822-7710
714-822-7725
The Largest Electronics Dealer in San
Bernardino County.

JUN'S ELECTRONICS
3919 SEPULVEDA BLVD.
CULVER CITY, CA 90230
213-390-8003
800-882-1343 Trades
Habla Espanol

Connecticut

HATRY ELECTRONICS
500 LEDYARD ST. (SOUTH)
HARTFORD, CT 06114
203-527-1881
Call today. Friendly one-stop shopping
at prices you can afford.

Delaware

**AMATEUR & ADVANCED COMMUNI-
CATIONS**
3208 CONCORD PIKE
WILMINGTON, DE 19803
(302) 478-2757
Delaware's Friendliest Ham Store.

DELAWARE AMATEUR SUPPLY
71 MEADOW ROAD
NEW CASTLE, DE 19720
302-328-7728
800-441-7008
Icom, Ten-Tec, Microlog, Yaesu,
Kenwood, Santec, KDK, and more.
One mile off I-95, no sales tax.

Florida

AMATEUR ELECTRONIC SUPPLY
1898 DREW STREET
CLEARWATER, FL 33575
813-461-4267
Clearwater Branch
West Coast's only full service
Amateur Radio Store.
Hours M-F 9-5:30, Sat. 9-3

AMATEUR ELECTRONIC SUPPLY
621 COMMONWEALTH AVE.
ORLANDO, FL 32803
305-894-3238
Fla. Wats: 1 (800) 432-9424
Outside Fla: 1 (800) 327-1917
Hours M-F 9-5:30, Sat. 9-3

Georgia

DOC'S COMMUNICATIONS
702 CHICKAMAUGA AVENUE
ROSSVILLE, GA 30741
(404) 866-2302
ICOM, Yaesu, Kenwood, KDK, Bird...
9AM-5:30PM
We service what we sell.

Hawaii

HONOLULU ELECTRONICS
819 KEEAUMOKU STREET
HONOLULU, HI 96814
(808) 949-5564
Serving Hawaii & Pacific area for 53
years.

Illinois

ERICKSON COMMUNICATIONS, INC.
5456 N. MILWAUKEE AVE.
CHICAGO, IL 60630
312-631-5181
Hours: 9:30-5:30 Mon, Tu, Wed & Fri;
9:30-8:00 Thurs; 9:00-3:00 Sat.

Indiana

THE HAM STATION
220 N. FULTON AVE.
EVANSVILLE, IN 47710
812-422-0231
Discount prices on Ten-Tec, Cubic,
Hy-Gain, MFJ, Azden, Kantronics,
Santec and others.

Massachusetts

James Millen Components by
ANTENNAS ETC.
16 HANSOM ROAD
ANDOVER, MA 01810
617-475-7831
Bezels, binding posts, capacitors, con-
densers, chokes, coils, ceramics, H.V.
connectors, plate caps, hardware
knobs, dials, scopes and grid dippers.
Inquire SASE or visit.

TEL-COM, INC.
675 GREAT ROAD, RTE. 119
LITTLETON, MA 01460
617-486-3400
617-486-3040
The Ham Store of New England
You Can Rely On.

Michigan

ENCON PHOTOVOLTAICS
Complete Photovoltaic Systems
27600 Schoolcraft Rd.
Livonia, Michigan 48150
313-523-1850
Amateur Radio, Repeaters, Satellite,
Computer applications.
Call Paul WD8AHO

Minnesota

TNT RADIO SALES
4124 WEST BROADWAY
ROBBINSDALE, MN 55422 (MPLS/ST.
PAUL)
TOLL FREE: (800) 328-0250
In Minn: (612) 535-5050
M-F 9 AM-6 PM
Sat 9 AM-5 PM
Ameritron, Bencher, Butternut, Icom,
Kenwood

Missouri

MISSOURI RADIO CENTER
102 NW BUSINESS PARK LANE
KANSAS CITY, MO 64150
(800) 821-7323
Missouri: (816) 741-8118
ICOM, Kenwood, Yaesu
Same day service, low prices.

Nevada

AMATEUR ELECTRONIC SUPPLY
1072 N. RANCHO DRIVE
LAS VEGAS, NV 89106
702-647-3114
Dale Porray "Squeak," AD7K
Outside Nev: 1 (800) 634-6227
Hours M-F 9-5:30, Sat. 9-3

New Jersey

KJI ELECTRONICS
66 SKYTOP ROAD
CEDAR GROVE, NJ 07009
(301) 239-4389
Gene K2KJL
Maryann K2RVH
Distributor of: KLM, Mirage, ICOM, Lar-
sen, Lunar, Astron. Wholesale - retail.

Dealers: *YOU SHOULD BE HERE TOO!*
Contact Ham Radio now for complete details.

Amateur Radio Dealer

New York

BARRY ELECTRONICS

512 BROADWAY
NEW YORK, NY 10012
212-925-7000

New York City's Largest Full Service
Ham and Commercial Radio Store.

VHF COMMUNICATIONS

915 NORTH MAIN STREET
JAMESTOWN, NY 14701
716-664-6345

Call after 7 PM and save! Supplying all
of your Amateur needs. Featuring ICOM
"The World System." Western New
York's finest Amateur dealer.

North Carolina

F & M ELECTRONICS

3520 Rockingham Road
Greensboro, NC 27407
1-919-299-3437

9AM to 7PM Closed Monday
ICOM our specialty — Sales & Service

Ohio

AMATEUR ELECTRONIC SUPPLY

28940 EUCLID AVE.
WICKLIFFE, OH 44092 (Cleveland Area)
216-585-7388

Ohio Wats: 1 (800) 362-0290
Outside Ohio: 1 (800) 321-3594
Hours M-F 9-5:30, Sat. 9-3

DEBCO ELECTRONICS, INC.

3931 EDWARDS RD.
CINCINNATI, OHIO 45209
(513) 531-4499

Mon-Sat 10AM-9PM
Sun 12-6PM

We buy and sell all types of electronic
parts.

UNIVERSAL AMATEUR RADIO, INC.

1280 AIDA DRIVE
REYNOLDSBURG (COLUMBUS), OH
43068

614-866-4267
Featuring Kenwood, Yaesu, Icom,
and other fine gear. Factory author-
ized sales and service. Shortwave
specialists. Near I-270 and airport.

Pennsylvania

HAMTRONICS, DIV. OF TREVISE ELECTRONICS

4033 BROWNSVILLE ROAD
TREVISE, PA 19047
215-357-1400

Same Location for over 30 Years.

LaRUE ELECTRONICS

1112 GRANDVIEW STREET
SCRANTON, PENNSYLVANIA 18509
717-343-2124

ICOM, Bird, Cushcraft, Beckman,
Larsen, Amphenol, Astron, Belden,
Antenna Specialists, W2AU/W2VS,
Tokyo Hy-Power Labs, WELZ, Daiwa,
Sony, Saxton, Vibroplex, Weller.

THE VHF SHOP

16 S. MOUNTAIN BLVD., RTE. 309
MOUNTAINTOP, PA 18707
717-474-9399

Lunar, Microwave Modules, ARCOS,
Astron, KLM, Tama, Tonna-F9FT,
UHF Units/Parabolic, Santec, Tokyo
Hy-Power, Dentron, Mirage,
Amphenol, Belden

Texas

MADISON ELECTRONICS SUPPLY

3621 FANNIN
HOUSTON, TX 77004
713-520-7300

Christmas?? Now??

Wisconsin

AMATEUR ELECTRONIC SUPPLY

4828 W. FOND DU LAC AVE.
MILWAUKEE, WI 53216
414-442-4200

Wisc. Wats: 1 (800) 242-5195
Outside Wisc: 1 (800) 558-0411
M-F 9-5:30 Sat 9-3

REPEATER VOTER

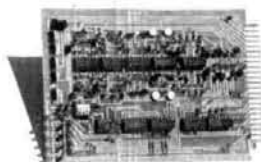

4RV Four Channel Repeater Voter

- Signal to Noise Type
 - Expandable to 32 Channel by Just Adding Cards
 - Designed for Commercial and Amateur Service
 - Continuous Instant Voting
 - Dual or Single 12 Volt Supply
 - LED Indicators of COR and Voted Signals
 - Front Mounted Level Pots
 - Built in Calibrator
 - Remote Voted Indicators Pinned Out
 - 4 1/2" x 6" Double Sided Gold Plated 44 Pin Card
 - Unswitched Audio Input
 - On Board Audio Switching and Mixing
 - Audio Mixer Input Available for External Input
 - Open Collector or Relay Contact Input
 - Open Collector NPN Output
 - Remote Disable Inputs
 - More
- 4RV Kit including board and parts with 20 page
manual \$200.00
Built, tested, and calibrated with manual \$350.00

For more information call or write:

VOTER Hall Electronics (614)
815 E. Hudson Street 261-8871
Columbus, Ohio 43211

CRYSTAL FILTER SALE

Top-quality 8-pole CW/SSB/AM FOX TANGO Filters

For most Models from:

KENWOOD · YAESU · HEATHKIT

Also DRAKE R-4C/7 Line, COLLINS 75S-3B/C,
and ICOM (FL44A Twin)

25% OFF LIST!!

Check your IF to find List Prices for the following Ranges:

IF Range: 3 to 11 MHz —

For all Yaesu, Kenwood, Heath \$ 60

IF Range: 444 to 446KHz — List prices as follows:

Yaesu . . . \$75, Kenwood . . . \$110, Icom . . . \$100
Collins 75S3-B/C (250Hz BW only) . . . \$125

Drake R-4C —

GUF1 (1st IF 8KHz BW) for SSB/CW . . . \$ 65

GUF2 (1st IF 800 BW) with PC Board for CW . . . \$100

2nd IF — Special 125Hz for contesters . . . \$ 75

All other bandwidths . . . \$ 65

Drake FR-7, R7, 250, 400, 1.8K, 2.1K BW . . . \$ 60

MATCHED-PAIR CW AND SSB FILTERS FOR TOP PERFORMANCE

TS830/930/940 —

CW 400Hz or SSB 2.1kHz Each Pair . . . \$170

CW 400Hz and SSB 2.1kHz (Both Pairs) . . . \$300

(Many find SSB's so improve VBT that CW's are not needed!)

FT-980 (SSB 2.1 kHz Pair) . . . \$150

FILTER CASCADING KITS FOR SUPER SELECTIVITY

For FT-101 or TS400S

(includes board and 2.1 Filter) . . . \$ 75

FILTER BANDWIDTHS AVAILABLE

(CW in Hz, Others in kHz)

CW: 125, 250, 400, 500 — SSB: 1.8, 2.1, 2.4 — AM: 6.0

- Not every bandwidth for every model, we send closest
- Since 1978, Fox Tango filters have been rated Best!
- Fox Tango stocks filters for both old and current rigs.
- Use FT's to fill optional CW/AM spots, or replace units
- Unlimited time guarantee to original filter purchasers.
- All filters finest 8-pole discrete-crystal construction.
- Most filters are designed for easy drop-in installation
- Complete instructions and free parts furnished for others.
- Limited supply of the most popular types - Order NOW!
- Sale ends December 31, 1985. Price rises likely in '86!

SPECIAL FILTERS

Send specifications for quotation on custom-built filters for special projects.
Attractive prices and samples for OEM or volume purchasers. Dollar-value
discount and trade restrictions probably make this your last chance to buy
top-quality Japanese-made filters at reduced prices.

ORDERING INSTRUCTIONS

SPECIFY: Make of Set, Model Number, Filter Bandwidth, IF

DEDUCT: 25% from above List Prices (Reg. \$60 - Sale \$45)

SHIPPING: \$3 US, \$5 Air (US & Canada), \$10 Elsewhere

ORDER: Mail or phone, VISA/MC Accepted, FL add 5% tax

GO FOX TANGO TO BE SURE!



FOX TANGO CORP.

P.O. Box 15944
W. Palm Beach, FL 33416
Telephone: (305) 683-9587

SWLS - HAMS

CALL TODAY FOR ALL
YOUR SWL & HAM NEEDS

*RECEIVERS *ANTENNAS

*TRANSCEIVERS *RTTY

*PUBLICATIONS *SWL

YAESU *KENWOOD *ICOM

HARDIN ELECTRONICS

5635 EAST ROSEDALE
FORT WORTH, TEXAS 76112
1-800-433-3203
IN TEXAS 817-429-9761

Ham Radio's Bookstore

ARRL Q&A LICENSE MANUALS ALL LICENSE CLASSES NOW AVAILABLE!

ARRL Q&A License Manuals are keyed to the latest FCC Exam syllabi now in use by the Volunteer Examiners. These books are written in an easy-to-read conversational style that enhances understanding without scaring the student away. All technical subject areas are explained in clear terminology and with plenty of illustrations, diagrams and schematics. Rules are also fully covered. Each book has the official ARRL multiple choice question Pool with answers and a key to the FCC Exam syllabus for reference to other study publications. These are *the* study guides to have. All books ©1985 1st Editions.

- AR-TG General **Softbound \$5.00**
- AR-AG Advanced **Softbound \$5.00**
- AR-EG Extra **Softbound \$5.00**

HR CODE TAPES

Formerly Kantronics Tapes

These code tapes have been designed by experts to help you learn code. Several different methods are available for all classes of license. Transcripts enclosed for checking copy.

Gradient Tapes. (Slowly increasing in speed)

- KT-NG Novice 4-9 WPM **\$6.95**
- KT-GG General 7-15 WPM **\$6.95**
- KT-EG Extra 13-23 WPM **\$6.95**

QSO Simulation Tapes

- KT-QS01 7.5, 10, 13 & 15 WPM 1 hour **\$5.95**
- KT-QS02 7.5, 10, 13 & 15 WPM 1 hour **\$5.95**
- KT-QS013 13 WPM 1 hour **\$5.95**

ANTENNA COMPENDIUM edited by ARRL Staff

This book has more than 20 antenna articles that have never been published before. Subjects covered include: Quads, Yagis, Phased Arrays, Log Periodics, Subsurface Antennas, "The Old Spruce Antenna", as well as discussions on Smith Charts, antenna design, the G5RV multi-band antenna and antenna polarization. Great summer reading and full of ideas for Fall '85 antenna projects. ©1985, 1st Edition.

- AR-AC **Softbound \$9.95**

AMECO STUDY GUIDES

Designed for VEC Exams

AMECOA Study Guides are taken from the FCC Amateur Exam syllabus, PR-1035 and have answers keyed to ARRL's recently released study material. These study guides are compatible with ARRL and all other VEC Exams. While nothing can guarantee that you will pass, AMECO Study Guides will make sure that you are fully prepared and ready to go when you sit down for the exam. Written in clear, concise, easy-to-read format, each question fully explained. Novice and General books cross referenced to AMECO's 102-01 for a more thorough explanation.

- 27-01 Novice Class **Softbound \$2.95**
- 12-01 General Class **Softbound \$4.95**
- 26-01 Advanced Class **Softbound \$4.95**
- 17-01 Extra Class **Softbound \$4.95**

THE AMATEUR RADIO VERTICAL HANDBOOK

by Cpt. Paul H. Lee, USN (Ret.), N6PL

This is the only book dedicated to the vertical antenna and will be of interest to all those using or looking to use the vertical design. Based upon the author's years of work with a number of different vertical antenna designs, you'll get plenty of theory and design information along with a number of practical construction ideas. Included are designs for simple 1/4 and 5/8-wave antennas as well as broadband and multi-element directional antennas. Paul Lee is an engineer and avid ham and is Amateur Radio's resident expert on the vertical antenna. ©1984, 2nd edition.

- CQ-VAH **Softbound \$9.95**

COMPUTER WIMP

BY John Bean

"166 things I wish I had known before I bought my first computer." Based upon ten years of often frustrating experience, this light-hearted, text is designed to help you learn about computers and to make intelligent decisions about their purchase. Author Bean first examines common pitfalls about purchasing a computer. He then examines warranties, how to deal rationally with malfunctions, how to buy by mail, how to talk "technobabble" or computerese, how to avoid computer phobia, games, software piracy and much more. 1st Edition 285 pages •1983

- TP-CW **Softbound \$9.95**

COMMUNICATIONS SATELLITES

by Larry Van Horn

Here's the most exhaustive text ever written about communications satellites! Easy-to-read text along with plenty of pictures and illustrations make this new book a veritable gold mine of information. Nine chapters include: OSCAR, weather, domestic and international communications satellites, DBS, space shuttle, U.S. Military and space surveillance systems and Soviet Space program. Also included are four appendices on satellite frequency cross references, satellite compendium, current geostationary satellites and a bibliography. Must reading for all satellite users. ©1985 1st edition 216 pages.

- GE-CS **Softbound \$12.95**

THE COMPLETE DX'ER

by Bob Locher, W9KNI

DX'ing can be as simple as turning the radio on and searching across a band, or it can be hours spent studying propagation reports, sunspot figures and the DX newsletters looking for tidbits of information. The first part of the book is designed to teach the reader DX'ing fundamentals. Part two is for the "over 200 countries worked" operator and has plenty of handy tips, aids and ideas. Part three is full of more esoteric hints for the "over 300 countries worked" operator. This book tells all and should be required reading before anyone starts their quest for DXCC. Even if you don't care about DXCC, Bob's easy-to-read style of writing is most enjoyable reading. ©1984, 1st edition.

- ID-DX **Softbound \$10.95**

UNDERSTANDING DATA COMMUNICATIONS

(Includes Packet Information)

By G. Friend, J.L. Fike, H.C. Baker and J.C. Bellamy

Covers basic concepts of data transmission and reception, asynchronous and synchronous protocols, error control and networking data communications systems. Data terminals are fully discussed as are message and transmission terminals, modems and interfaces, fiber optics and satellite communications systems. Packet Networks and standards are covered with information on X.25 switching architecture. ©1984 1st edition 272 pages.

- TI-UUC **Softbound \$14.95**

COMPUTER

COMPUTER PROGRAMS FOR THE RADIO AMATEUR

by Wayne Overbeck, N6NB, and Jim Steffen, KC6A

Here's the best source book of computer programs for the Radio Amateur. Besides covering computer basics, this book gives you programs that will help you log, determine sunrise/sunset times, track the Moon's path across the sky, use Greylines propagation and set up record systems for WAS, DXCC and VUCC, or any other award. You can either buy the book alone or you can buy the book with the programs already on disk. Take full advantage of your computer with this well written source book. ©1984, 1st edition, 327 pages.

Program Listing

- Data Base Mgmt.**
- Logs, Awards Data Base, Gridlocator
- Latitude/Longitude Programs**
- Data File, Beamheadings, DX Display, Sunrise Chart, Greylines, DX Checker
- Contest and Duping**
- Dupechecker, General Contest Logger, Field Day Logger, Sweepstakes Logger, Log Print
- Antenna Programs**
- Antenna Scaler, Matching Evaluator, Vertical Pattern Plotter
- EME**
- EME System Calculator, Sky Locator, Moontracker
- HA-0657 **Softbound \$17.95**
- HA-0657 book with program disk **\$29.95**
- specify computer (see list below)
- Program disk alone **\$19.95**
- specify computer (see list below)

Programs available for: Apple II (DOS 3.3), IBM PC-DOS, TRS-80 Model I and Model III and Commodore C-64. Please mark your order with the program disk you want.

**HAM
DATA**

By
**Chip Lohman
NN4U**

AMATEUR RADIO COMPUTER SOFTWARE

ANTENNA DESIGN

This self-prompting program covers dipoles, Yagis, long wires, rhombics, quads, loops, verticals and other antennas. You simply enter the frequency you are designing an antenna for, the antenna you want to make, and the computer will give you all the initial design specifications you need. The results can be stored on disk for permanent retention.

- HD-AD (For C-64) **\$9.95**

PROPAGATION CHART

Invaluable addition to any Hamshack. The Propagation Chart allows you to determine the maximum usable frequency (MUF) and the optimum frequency (FOT) between your QTH and any spot on the globe. You can get either a screen display, a printed tabular list over several days, or a printed graph of MUF and FOT. You also get automatic beam headings and distance to the DX station. Covers 160-10 meters and the new WARC bands.

- HD-PC (For C-64) **\$16.95**

SUPER LOG

Super log gives you all the advantages of a computerized data base without significantly changing the traditional log format. For contesters, Super Log can be configured to either manually or automatically enter contact number as well as time of contact. Make an error and you can easily

go back and edit the entry. Super Log also allows you to print out either selected contents or the whole log. Will print QSLs.

- HD-SL (For C-64) **\$19.95**

CONTEST LOG

This disk contains four different contest programs; ARRL Sweepstakes, Field Day, Universal WW Contest log, plus a dupe checking routine. Each program is designed for real time use. It automatically enters date, time, band and serial number for each contact. A 24-hour clock is displayed at the top of the VDT screen. When the contest is over, the program will print your results listing all duped and scored contacts in serial sequence with all the necessary information as well as completed score at the bottom of the page.

- HD-CL (For C-64) **\$24.95**

MASTER LOG

Over three years of development went into this program. It creates a file of 2100 individual records with up to 13 different entries per record. Master Log can do a search and select based upon time, frequency, mode or any of the other variable parameters. It keeps track of DXCC and WAS status, prints QSL labels and can search its whole file in less than 5 seconds! Complete documentation is included to help you learn and use this truly state-of-the-art logging program.

- HD-ML **\$28.95**

Ham Radio has many other books in stock not shown here.

Call or write today for your free catalog or to place an order. (603) 878-1441 8-4 EST

Please enclose \$3.50 with your order to cover postage and handling.



Holiday Special

Stocking Stuffers and Other Gift Ideas

BEAM ANTENNA HANDBOOK

by W6SAI and W2LX

Completely revised and updated the **Beam Antenna Handbook** includes the very latest state-of-the-art antenna design. Computer generated beam dimensions for the 40, 30, 20, 17, 15, 12, 10 and VHF bands are included eliminating the need for time consuming math calculations. Also covered are: Beam height and optimum apex of radiation, how element types and hardware effect performance, effect of nearby objects on radiation patterns, feedlines, baluns and matching systems and much more. Ham Radio VHF columnist W1JR, and noted European VHF'er DL6WO's VHF antenna designs are covered extensively as well as NBS VHF long Yagis. 268 clearly written pages — 204 easy-to-understand illustrations, make this the book to buy for beam construction. ©1985. 1st edition.

□RP-BA Softbound \$9.95

1985-86 ARRL REPEATER DIRECTORY

You could call this book the "repeater bible". Close to 8,000 listings include stations organized first by frequency then by state and region. All of the important details such as access tones, auto patch, etc. are also included. If you do any tracing and take a two-meter rig with you, this is the book to have! ©1984.

□AR-RD Softbound \$3.00

ARRL OPERATING MANUAL

Brand New 2nd edition. Just released and fully revised! This book tells you all about how to operate your station. Message handling, emergency traffic, tips for successful contesting and DX'ing are fully covered as well as new sections on digital communications and satellite operation. The reference section has been greatly expanded to include many new entries. ©1985 2nd Edition.

□AR-0G Softbound \$5.00

SOFTWARE

RTTY MAILBOX MSO

for Vic 20 and C-64 Computers

Turns your Commodore home computer into a powerful, easy-to-use message handling system. Messages can be stored, read or deleted by either incoming RTTY signals or by using the computer's keyboard. Each message is listed in a directory by file name, along with date and time of message initiation. The Basic/Assembly language software combines high speed with user friendly features and fully controls your transmitter and receiver with automatic identification, an optional special message and automatic transmission of date and time during MSO use. You can also use this program to operate direct RTTY and 60, 67, 75 or 100 wpm Baudot or 110 baud ASCII. Vic 20 needs 24k of memory to use this program.

VC-CP Use with AEA CP1 interface & equiv. \$79.95

VC-MF Use with MFJ interface & equiv. \$79.95

VC-KT Use with Kantronics interface & equiv. \$89.95

RF NOTES by John Simmons, W6MDI

Here's an easy way to get answers for often asked electronics questions. RF NOTES contains programs written by RF consulting engineers that answer: *dB conversion*, to convert voltage, current or power levels to dB; *dBm conversions*, converts voltages or power levels to dBm and dBm to voltage or power; *VSWR calculations*, calculates VSWR and return loss when both reflected and incident powers are known; *Filter design*, 14 different filter configurations including schematics (6 low pass, 4 high pass, 2 band pass and 2 band elimination circuits); *Basic Micro-strip and basic strip line design*; and *resonant circuits*, design parallel and series resonant circuits, PI, capacitive impedance divider and inductive impedance divider. This disk is an invaluable reference for all Radio Amateurs. Graphics cards required.

E-RF (IBM PC only) Monochrome Monitor \$59.95

E-RF (IBM PC only) Color Monitor \$59.95

CONTENDER II LOGGING DATABASE

(Commodore C-64)

This Commodore C-64 program will meet just about every logging need you can imagine. It can be used as a contest log, general log or dupe checker and can be used for all band WAS, WAZ or DXCC. The storage disk holds up to 2,000 exchanges and can be edited and updated simply and easily. Each entry contains callsign, signal reports, automatic or manually entered time and date, band and mode as well as name and QTH. Contender will also print QSL's, mail labels and contest dupe sheets. The Contender USA-CA (three disks) is a Worked All County data base that saves time and hassle and a tremendous amount of paperwork.

□CT-C Basic Contender (C-64) 1 disk \$34.95

□CT-CUSA Contender Plus USA-CA (C-64) 3 disks \$49.95

PACKET RADIO THRU SOFTWARE

AX.25 Protocol

You can get on Packet Radio two ways. One is with a sophisticated "black box." The other is by making your computer act like a "black box" by programming it in a high level machine language code. W4UCH has written a machine language program for the Radio Shack TRS-80 Models 1, 3 and 4 computer (Model 4 works with Model 3 disk while in Model 3 mode). This book has twelve chapters plus seven appendices that take you step by step through the process of setting your computer to first convert the digital information into a useable format and then to decode the information. ©1984, 3rd edition.

□RE-AX Softbound \$21.95

□RE-MI Model 1 Disk \$29.00

□RE-MIII Model III & 4 Disk \$29.00

□RE-BD special book and disk \$49.95

(Specify disk, Mod. I or Mod. III)

COMPUTERIZED DX EDGE.

Generate your own Greylines display.

Xantek has adapted their best selling DX Edge to the computer world and it comes at a very reasonable price. This computerized operating aid brings into your ham shack the ability to know and predict when and where DX is going to appear. When you are using the program, the computer will automatically update the information as the sun progresses across the face of the Earth. To make the computerized DX Edge even easier to use, the display is keyed to the DXCC list and the 40 CQ zones. Disk and documentation are just \$34.95. This is something you've Got to have! ©1985.

□XN-C64 (For Commodore C-64)

34.95

AEA MORSE UNIVERSITY

Contains C-64 code training cartridge software package (no disk or cassette necessary).

• ARRL's *Tune In The World With Ham Radio*
Great NEW way to study for your Novice License!

This brand new package contains all one needs to learn the code and theory for the Novice class Radio Amateur exam. Basic code is taught using a character by character teaching routine. Practice can be either with individual letters or in groups of up to nine characters. Proficiency is developed through practice sessions that can be: progressively speeded up during the session, either random characters or five letter groups, Farnsworth (high speed characters, slow spacing) or slow speed sending. AEA has incorporated a video game to make the code learning process even more fun. You can also enter text from the keyboard for "customized" practice sessions or as an example of how code should sound. An analysis routine is included so that the computer can check one's progress in learning the code. ARRL *Tune In The World* booklet will give you all you need to know to pass the Novice theory and regulations Exam. Great state-of-the-art teaching device. Sure to be a hit this fall. Get one now. It's a great holiday season gift!

□AEA-MU (For C-64)

\$39.95



flea market



RATES Noncommercial ads 10¢ per word; commercial ads 60¢ per word **both payable in advance.** No cash discounts or agency commissions allowed.

HAMFESTS Sponsored by non-profit organizations receive one free Flea Market ad (subject to our editing) on a space available basis only. Repeat insertions of hamfest ads pay the non-commercial rate.

COPY No special layout or arrangements available. Material should be typewritten or clearly printed (not all capitals) and must include full name and address. We reserve the right to reject unsuitable copy. **Ham Radio** cannot check each advertiser and thus cannot be held responsible for claims made. Liability for correctness of material limited to corrected ad in next available issue.

DEADLINE 15th of second preceding month.

SEND MATERIAL TO: Flea Market, Ham Radio, Greenville, N. H. 03048.

FREE 3 month subscription. Send call to Westlink Report-H12, 28221 Stanley Court, Canyon Country, CA 91351. New only!

THE GOOD SAM HAMS invite RV operators to check in the Good Sam Ham net 14.240 ± Sundays 1900Z also 3.880 ± Tuesdays at 2359Z. Net control N5BDN, Clarksville, IN.

SCHEMATIC: Radio receivers 1920's/60's. Send brand name, model No., SASE. Scaramella, PO Box 1, Woonsocket, RI 02895-0001.

BACK ISSUES QST, 73, Ham Radio. Stamp for list. Koepke, 6 Katherine Rd., Albany, NY 12205.

WANTED: Regency XL2000 transceiver or new 10 channel 148-162 MHz or Wilson WH2510. PO Box 929, Blacksburg, VA 24060-0929. (703) 382-4458.

CABLE TV CONVERTERS/DESCRAMBLERS. Guaranteed lowest prices in U.S. Jerrold, Hamlin, Zenith—many others. Lowest dealer prices. Orders shipped within 24 hours! Complete illustrated catalog \$2.00. Pacific Cable Co., Inc., 7325-1/2 Reseda Blvd., -1007, Reseda, CA 91335. (818) 716-5914.

NEW VLF 2 kHz-500 kHz products by K1RGO. L-1018 VLF converter, L-201 VLF broadband preamplifier, L-400 VLF active antenna and more. Write for free catalog. LF Engineering Co., 17 Jeffrey Road, East Haven, CT 06512.

TR-7 USERS: NB-7 Noise blander (new) \$65.00 ppd. HS 75 headset (padded) new \$14.00 ppd. SL-300, SL-500 CW filter \$55.00 ea. ppd. K3UKW, Tony Musero (215) 271 8898.

IMRA, International Mission Radio Association helps missionaries. Equipment loaned. Weekday net, 14 280 MHz, 2-3 PM Eastern. Eight hundred Amateurs in 40 countries. Brother Frey, 1 Pryer Manor Road, Larchmont, New York 10538.

ELECTRON TUBES: Receiving, transmitting, microwave... all types available. Large stock. Next day delivery, most cases. Daily Electronics, PO Box 5029, Compton, CA 09224 (213) 774-1255.

CUSTOM MADE embroidered patches. Any size, shape, colors. Five patch minimum. Free sample, prices and ordering information. Hein Specialties, Inc., Dept. 301, 4202 N. Drake, Chicago, IL 60618.

CX7 REPAIRS. 415-549-9210.

RTTY-EXCLUSIVELY for the Amateur Teleprinter. One year \$10.00. Beginners RTTY Handbook \$8.00. PO Box RV, Cardiff, CA 92007.

TRS-80 Model III/IV owners. HF antenna design program calculated dimensions for dipole, Yagi, and quad antennas. \$14.95 (cassette) + \$2.00 s&h to Cwynwyn, Dept. H, 4791 Broadway, Suite 2F, New York, NY 10034.

OLD RADIO transcription discs wanted. Any size, speed. W7FIZ, Box 724 HR, Redmond, WA 98073-0724.

RUBBER STAMPS: 3 lines \$4.50 PPD. Send check or MO to G.L. Pierce, 5521 Birkdale Way, San Diego, CA 92117. SASE brings information.

NEW PACKET RADIO PROGRAM for IBM PC's. A telecom program for interfacing your PC with your packet controller. Special functions for GLB's. 5 page scrolling screen with cursor control. Two types Binary File Transfers. 300-9600bps. Keyboard Macros. 50 page manual. Split screens. Windows! Much more. **NON COPY PROTECTED.** \$49.95 + \$3.00 shipping and handling. Kalt & Associates, Suite -138, 2440 E. Tudor Rd., Anchorage, AK 99507. (907) 248-0133. Write for more info.

PRINTED CIRCUIT BOARDS and kits for QST articles. Call or write for information. AGA Engineering, 7970 Orchid Drive, Buena Park, CA 90620. (714) 521-4160.

RECONDITIONED TEST EQUIPMENT \$1.25 for catalog. Walter, 2697 Nickel, San Pablo, CA 94806.

BUILD a Computer-Aided-Designed 6dB gain stacked vertical omnidirectional 2 meter antenna for less than \$50.00 using hardware store materials. Send \$5.00 for detailed plans and parts list. WD40QC, John De Armond, PO Box 3657, Cleveland, TN 37311.

FREE CUSTOM BUMPER STICKER when you buy three at \$2.50 each. (Different messages okay). Call, name, favorite frequency, rig, car, anything, 13 characters, 2 line max. Order now for Christmas! Alvin Koffman, 9334S 550W, Columbus, IN 47201. (812) 342-6740.

WANTED ANY CONDITION WWV/WWVB receivers made by Specific Products, kinematics or parts, manuals, etc. Gil Barber, POB 31654, Aurora, CO 80041.

ANYONE INTERESTED in starting a rag chew net on 6 meter FM simplex. 52.660 in San Diego County, San Diego North County and beyond! B. Kirschner, WB0YCO, 266 Carissa Drive, Oceanside, CA 92056.

COMING EVENTS

Activities — "Places to go . . ."

MASSACHUSETTS: The MIT UHF Repeater Association and the MIT Radio Society offer monthly Ham Exams. Novice through Extra. Wednesday, December 18, 7 PM, MIT room 1-134, 77 Mass. Ave, Cambridge, MA. Reservations requested 2 days in advance. Contact Ron Hoffmann at (617) 253-5820/646-1641. Exam fee \$4.00. Bring copy of current license, two forms of picture ID and completed form 610 available from FCC in Boston (223-6609).

VIRGINIA: The ninth annual Richmond Frostfest, sponsored by Richmond Amateur Telecommunications Society, Sunday, January 12, Virginia State Fairgrounds, 8:30 AM to 3:30 PM. General admission \$4.00. Flea market spaces \$4.00; with 8' table \$8.00. Dealer/exhibitors booths available. All indoors. No outside tailgating. Deadline for booths and reserved flea market spaces December 31. Buildings open Saturday for setup. VEC exam on Saturday. Write Richmond Frostfest, PO box 1070, Richmond, VA 23208 or call Bill Scruggs, N4DDM (804) 272-8206.

SOUTH BEND, INDIANA: Hamfest Swap & Shop, January 5 (first Sunday after New Year's Day) Century Center downtown on US 33 oneway North between St. Joseph Bank Building and river. Industrial history museum in same building. Carpeted half acre indoor. Open tables \$1 per ft. Four lane highways to door from all directions. Talk in freq: 52-52, 99-39, 93-33, 69-09, 145.29.

WISCONSIN: The annual Midwinter Swapfest, Saturday, January 11, at the Waukesha County Expo Center Forum at 8 AM. Admission \$2.00 advance; \$3.00 at door. 4' tables \$3.00 advance; \$4.00 at door. Dealers welcome. Sponsored by the West Allis Radio Amateur Club. For tickets or information write WARAC SWAPFEST, PO Box 1072, Milwaukee, WI 53201. Please SASE.

OPERATING EVENTS

"Things to do..."

21st annual Telephone Pioneer QSO Party The John D. Burle Chapter invites all Telephone Pioneer Amateur Radio Operators in the U.S. and Canada to participate in contacting as many members as possible in as many different chapters. (ITPA members are also invited to participate. 1900 UTC Saturday, December 7 to 0500 UTC, Monday, December 9. Exchange contact number and chapter number. (ITPA Club or Chapter name). Return log sheets via PAR Coordinator. Send logs no later than January 15, 1986 to Ted Phelps, WB7P, c/o John D. Burle Chapter 89, Telephone Pioneers of America, 6200 East Broad Street, Columbus, OH 43213.

THE CONCORD BRASSPONDERS will operate W10C to commemorate Christa McCauliffe's "First Teacher in Space" flight, 1300Z Saturday to 1259Z Sunday during the first weekend following the launch of the space shuttle with Christa aboard. Anticipated launch date January 22. For 8-1/2 x 11 certificate please SASE to W10C, PO Box 2214, Concord, NH 03301.

Farmington, Maine: The members of the Sandy River ARC will operate the Chester N. Greenwood memorial station to honor the inventor of the Earmuff, 1700Z December 20 to 2359Z December 22, 10 kHz up from lower edges of General bands 160-10 meters. QSL and large SASE to KA1CNG via Callbook.

AZORES RADIO AMATEURS call prefix with change from CT2 to CU effective on December 1, 1985.

CHARGE YOUR CLASSIFIED ADS

to your MC or VISA write or call

HAM RADIO MAGAZINE

Greenville, NH 03048

(603) 878-1441



EVERY COMMODORE HAM NEEDS A COMPANION!

From JIM GRUBBS, K9EI

the author of Command Post, Micro-Wave Radio and Gateway to the World, QSKY Publishing announces THE COMMODORE HAM'S COMPANION.

INCLUDES:

- Over 80 sources for Commodore amateur radio software and hardware
- A bibliography of over 60 magazine articles and reviews about using Commodore machines in the ham shack
- How to use your Commodore computer to join the packet radio revolution
- Where to find specialized programs for such things as slow scan television, satellite tracking and more
- How to realize a dramatic increase in speed without learning machine language programming
- Why the Commodore machines are the easiest to interface

14 chapters / 160-page paperback

Price: \$15.95 + \$3.50 shipping and handling

HAM RADIO'S BOOKSTORE
Greenville, NH 03048

Foreign Subscription Agents for Ham Radio Magazine

Ham Radio Austria
Karin Ueber
Postfach 2454
D-7850 Loerrach
West Germany

Ham Radio Belgium
Stereohouse
Brusselsesteenweg 146
B-9218 Gent
Belgium

Ham Radio Holland
Postbus 413
NL-7800 At Emmen
Holland

Ham Radio Europe
Box 2084
S-194 02 Uppdals Vasby
Sweden

Ham Radio France
SM Electronic
20 bis, Ave des Clairons
F-88000 Auxerre
France

Ham Radio Germany
Karin Ueber
Postfach 2454
D-7850 Loerrach
West Germany

Canada
Send orders to
Ham Radio Magazine
Greenville, NH 03048 USA
Prices in Canadian funds
1 yr. \$29.95, 2 yrs. \$53.30
3 yrs. \$75.40

Ham Radio Italy
Via Pordenone 17
I-20132 Milano
Italy

Ham Radio Switzerland
Karin Ueber
Postfach 2454
D-7850 Loerrach
West Germany

Ham Radio England
c/o R S G B
Alma House
Crabborne Road
Potters Bar
Herts EN6 3JW
England



ICOM

KENWOOD YAESU



IC-735 New, compact HF Transceiver Call
 IC-751 9-band Xcvr/ 1.30 MHz Rcvr \$1399.00 Call
 IC-745 9-band Xcvr/ 1.30 MHz Rcvr \$ 999.00 Call

Regular SALE



IC-271 H 100w 2m FM/SSB/CW Xcvr ... \$899 Call
 IC-271A 25w 2m FM/SSB/CW Xcvr. \$699.00 Call
 IC-471A 10w 430-450 SSB/CW/FM Xcvr \$799.00 Call



IC-02AT Call
 IC-04AT Call
 IC-2AT Call
 IC-3AT Call
 IC-4AT Call

**IC-R71A
GENERAL
COVER RCVR**



TS-940S/AT Regular SALE \$1995.00 Call
 TS-930S/AT \$1799.00 Call
 TS-930A \$1599.00 Call

Regular SALE



TS-711A TS-811A Call



TR-2600A Call
 TH-21A Call
 TH-21AT Call
 TH-41A Call
 TH-41AT Call

**R-2000
GENERAL
COVER**



FT-980 Regular SALE \$1659.00 Call
 FT-DNG Call

Regular SALE



FT-726R \$ 899.00 Call



FT-209RH Call
 FT-709RH Call
 FT-203RH Call
 FT-103R Call
 FT-703R Call

**FRG-8800
GENERAL
COVER RCVR**

EAID SALE!!
NEW RTTY/CW
COMPUTER
INTERFACES

BIRD



MIRAGE
AMPLIFIER
SALE!

AMERITRON
AL-80

JUN'S
ELECTRONICS
 800-882-1343
 INCLUDES ALASKA HAWAII

Calif. Call Collect for Order

- AMATEUR ● TWO WAY ● MARINE
- CELLULAR MOBILE PHONE ● SCANNER
- ★ Free U.P.S. Cash Order (Most Item, Most Place)
- ★ Shoppers, call us last, save \$\$
- ★ SE HABLA ESPANOL

(213)390-8003 3919 Sepulveda Blvd. Culver City, CA 90230

HF ANTENNAS — The Easy Way

by John Haerle, WB5IIR

This book has been published as a memorial to WB5IIR's work as an Amateur Radio teacher. Originally given as a series of speeches or papers, this tutorial is an excellent source book on antenna theory and applications. Examples of areas covered are: *Fundamentals*, antenna and feedline

terminology, baluns, ground systems, lightning protection, *The Basic Antenna*, the dipole, the zepp, G5RV, Windom, *Special Antennas*, the sloper, DDDR, Beverage, folded unipole, *Beams*, W8JK, Yagi, two element quad, and the *160 meter band story*. John's writing is in an easy-to-understand conversational style and is full of examples and handy tips and hints. There are no drawings or illustrations but John's prose paints pictures for clear and complete understanding of the information being presented. ©1984 1st Edition.

JH-AT Softbound \$11.95
 Please add \$3.50 for shipping and handling.

ham radio magazine **BOOKSTORE**
 GREENVILLE, NH 03048 (603) 878-1441

PUBLISHED BY:
THE AMERICAN RADIO
RELAY LEAGUE



THE ARRL 1986 HANDBOOK FOR THE RADIO AMATEUR

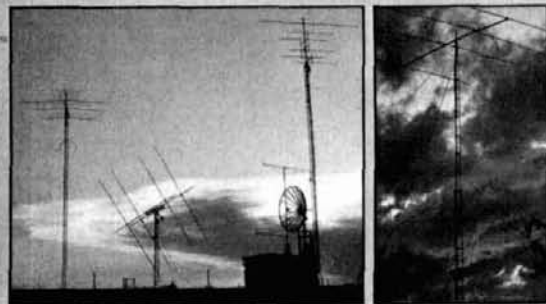

BIGGER AND BETTER THAN EVER!

The ARRL 1986 Handbook for the Radio Amateur takes over where the 1985 Edition left off. Each of the 40 chapters has had some revision, and there are more than 500 new or revised figures. The new edition will contain 1184 pages — way up from last year's count of 1024. Many key chapters with "hot" topics among today's radio amateurs have been completely revised and rewritten. In fact the new material represents 532 text pages.

An understanding of digital electronics is a must these days since such circuitry has so many practical applications in station control, frequency synthesis, telemetry, word processing and other information-handling systems. The Digital Basics chapter will help you to understand what is going on in everything from simple keyers to sophisticated microcomputers. Packet-radio enthusiasts will find the most up-to-date information available in the Digital Communications chapter. There are new sections on data interfacing and modems, 50 new and revised figures, plus an expanded bibliography and glossary.

The Special Modulation Techniques chapter has the latest on spread-spectrum. On the fun side, we've added a new section on remote control of model aircraft and vehicles.

On the practical side, you will find many of the 27 new projects described in October *QST*. There are new power amplifiers for 1.8, 50, 144 and 1296 MHz, plus preamplifiers and transverters for the VHF/UHF enthusiast. The new digital PEP Wattmeter - SWR Calculator will be one of the most popular projects.

We've only scratched the surface in describing what is the standard manual of RF communication. Over 5.7 million copies of *The Handbook* have been published in 63 editions since 1926. The new edition is must reading for today's radio amateur!

The *1986 Handbook* is available now. Paperbound prices are \$18.00 in the U.S., \$19.00 in Canada and elsewhere. Cloth prices are \$27.00 in the U.S. and \$29.00 elsewhere. Prices in U.S. funds. Foreign remittance should be in the form of an international money order or a check drawn on a bank account in the U.S.

THINGS TO LOOK FOR (AND LOOK OUT FOR) IN A PHONE PATCH

- One year warranty.
- A patch should work with any radio. AM, FM, ACSB, relay switched or synthesized.
- Patch performance should not be dependent on the T/R speed of your radio.
- Your patch should sound just like your home phone.
- There should not be any sampling noises to distract you and rob important syllables. The best phone patches do not use the cheap sampling method. (Did you know that the competition uses VOX rather than sampling in their \$1000 commercial model?)
- A patch should disconnect automatically if the number dialed is busy.
- A patch should be flexible. You should be able to use it simplex, repeater aided simplex, or semi-duplex.
- A patch should allow you to manually connect any mobile or HT on your local repeater to the phone system for a fully automatic conversation. Someone may need to report an emergency!
- A patch should not become erratic when the mobile is noisy.
- You should be able to use a power amplifier on your base to extend range.
- You should be able to connect a patch to the MIC and EXT. speaker jack of your radio for a quick and effortless interface.
- You should be able to connect a patch to three points inside your radio (VOL high side, PTT, MIC) so that the patch does not interfere with the use of the radio and the VOL. and SQ. settings do not affect the patch.
- A patch should have MOV lightning protectors.
- Your patch should be made in the USA where consultation and factory service are immediately available. (Beware of an inferior offshore copy of our former PRIVATE PATCH II.)

**ONLY
PRIVATE PATCH III
GIVES YOU ALL
OF THE ABOVE**

**N
E
W**

PRIVATE PATCH III

SIMPLEX SEMI-DUPLEX INTERCONNECT

**N
E
W**

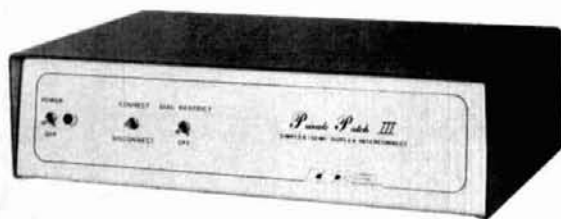

With an amazingly low price, the all new PRIVATE PATCH III is the most powerful personal phone patch system available. You can use it simplex, repeater aided simplex (from your base) or semi-duplex (at the repeater). That's right, you will never have to buy another patch. PRIVATE PATCH III does it all! There are many new and important features which were formerly only available in our top commercial models.

With a flick of the new connect switch you can patch your friends on the repeater into the phone system. One of them may need to report an emergency!

No hassles with busy signals! If you call a number that is busy, just put your MIC down and relax. PRIVATE PATCH III will disconnect automatically.

The new CW ID keeps you completely informed as to patch status. ID occurs when you access and again when you disconnect. ID is also sent after toll call attempts, all automatic disconnects, manual disconnect and when timeout is imminent. And of course your CW ID chip is free.

PRIVATE PATCH III does not interfere with the normal use of your base radio. A new audio pre-amp permits audio take off before the VOL. control. As a result, the VOL. and squelch settings do not affect patch operation. Of course you can also connect PRIVATE PATCH III to the MIC and EXT speaker jacks as before.

A new digit counting system makes the toll restrict positive even in areas where you do not have to dial "1" first. A secret five digit code disables the toll restrict for one toll call. Re-arm is automatic.

Additional new features: MOV lightning protection — Three digit access code (eg. *93) — Spare relay position on board — Plus former features: 3/6 minute timeout timer — Digital fast VOX (pat. pend.) — 115 VAC supply — Modular Jack and cord plus much more!

Why settle for a starter set? PRIVATE PATCH III provides you with commercial quality uninterrupted (cellular like) mobile telephone communications 24 hours a day. Send for our four page brochure today for complete details.

Options:
FCC approved coupler
12 VDC or 230 VAC power

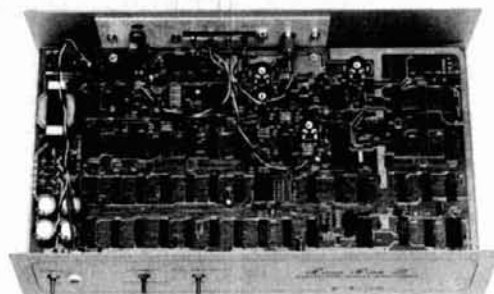

DEALERS

- | | |
|--|---|
| AMATEUR ELECTRONIC SUPPLY
Milwaukee WI, Wickliffe Oh,
Orlando FL, Clearwater FL,
Las Vegas NV | MADISON ELECTRONICS SUPPLY
Houston, TX |
| BARRY ELECTRONICS CORP.
New York, NY | MIAMI RADIO CENTER CORP.
Miami, FL |
| COLES COMMUNICATIONS
San Antonio TX | MIKES ELECTRONICS
Fl. Lauderdale, Miami FL |
| EGE, INC.
Woodbridge, VA | N&G DISTRIBUTING CORP.
Miami, FL |
| ERICKSON COMMUNICATIONS
Chicago IL | PACE ENGINEERING
Tucson AZ |
| HAM RADIO OUTLET
Anaheim CA, Burlingame CA,
Oakland CA, Phoenix AZ,
San Diego CA, Van Nuys CA | THE HAM STATION
Evansville IN |
| HENRY RADIO
Los Angeles CA | TEXAS TOWERS
Piano, TX |
| INTERNATIONAL RADIO
SYSTEMS
Miami, FL | TNT RADIO SALES
Robbinsdale, MN |
| JUNS ELECTRONICS
Culver City CA | WESTCOM
San Marcos, CA |
| | CANADA:
DOLLARD ELECTRONICS
Vancouver, BC |

CONNECT SYSTEMS (213) 373-6803
INCORPORATED 23731 Madison St., Torrance, CA 90505

More output for the money you put out.

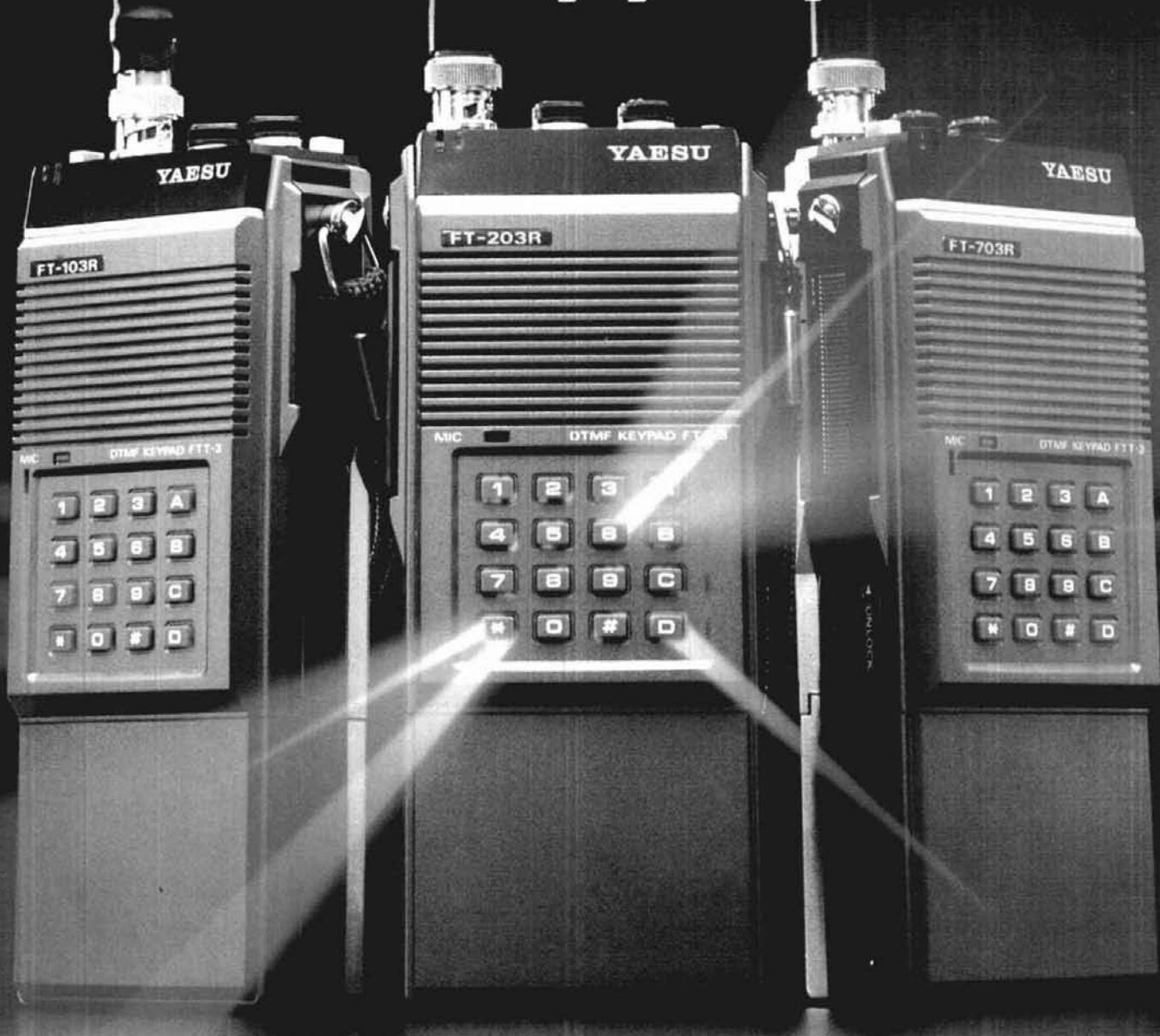

Why buy a low-power thumbwheel HT when Yaesu's high-power handhelds are available for virtually the same price?

Ours give you 2.5 watts RF output right off the shelf. Or 3.7 watts with the optional FNB-4 battery pack.

Ours come with a hi/low power switch. A relative signal strength/PO meter with nightlight. And built-in VOX capability. (Optional headset required.)

Plus ours offer options like a DTMF keypad. And a plug-in sub-audible tone board with both encode and decode capability.

And thanks to our unique robotic assembly of surface mount components, it's all enclosed in a lightweight and compact case, measuring just 2.6 x 1.4 x 6.1 inches.

Choose from three models: the FT-203R for 2 meters, the FT-703R for 440 MHz, and the FT-103R for 220 MHz.

As standard equipment you get a rechargeable battery, AC wall charger, rubber duck, earphone, belt clip and soft case.

Plus a wealth of optional accessories. Including a fast charger, VOX headset with boom mic. Mobile

radio hanger. Speaker/microphone. DC car adapter. And much more.

So don't settle for low power in a thumbwheel HT.

Go with Yaesu. The best way to get more power for your dollar.

YAESU

Yaesu Electronics Corporation
6851 Walthall Way, Paramount, CA 90723
(213) 633-4007

Yaesu Cincinnati Service Center
9070 Gold Park Drive, Hamilton, OH 45011
(513) 874-3100

Prices and specifications subject to change without notice.

KENWOOD

...pacesetter in Amateur radio

ALL NEW!

Power-Full...70 Watts!

TM-2570A/2550A/2530A

Sophisticated FM transceivers

Kenwood sets the pace again! The all-new "25-Series" brings the industry's first compact 70-watt 2-meter FM mobile transceiver. There is even an *auto dialer* which stores 15 telephone numbers! There are three power versions to choose from: The TM-2570A 70-watt model, the TM-2550A for 45-watts, and the 25-watt TM-2530A.

- **First** 70-watt FM mobile (TM-2570A)
- **First** mobile transceiver with telephone number memory and auto-dialer (up to 15 telephone numbers)
- Direct keyboard entry of frequency
- Automatic repeater offset selection according to the ARRL 2-meter band plan — a **Kenwood exclusive!**
- Extended frequency coverage for MARS and CAP (142-149 MHz; 141-151 MHz modifiable)
- 23 channel memory for offset, frequency and sub-tone
- Big multi-color LCD and back-lit controls for excellent visibility

- Front panel programmable 38-tone CTCSS encoder **includes 97.4 Hz** (optional)
- 16-key DTMF pad, with audible monitor
- Center-stop tuning — **another Kenwood exclusive!**
- Frequency lock switch
- **New** 5-way adjustable mounting system
- **Unique** offset microphone connector —relieves stress on microphone cord

- HI/LOW Power switch (adjustable LOW power)
- Compact DIN size

DCL Introducing... Digital Channel Link

Compatible with Kenwood's DCS (Digital Code Squelch), the DCL system enables your rig to **automatically** QSY to an open channel. Now you can automatically switch over to a simplex channel after repeater contact! Here's how it works:

The DCL system searches for an open channel, remembers it, returns to the original frequency and transmits control information to another DCL-equipped station that switches **both** radios to the open channel. Micro-processor control assures fast and reliable operation. The whole process happens in an instant!

Large heatsink with built-in cooling fan (TM-2570A)

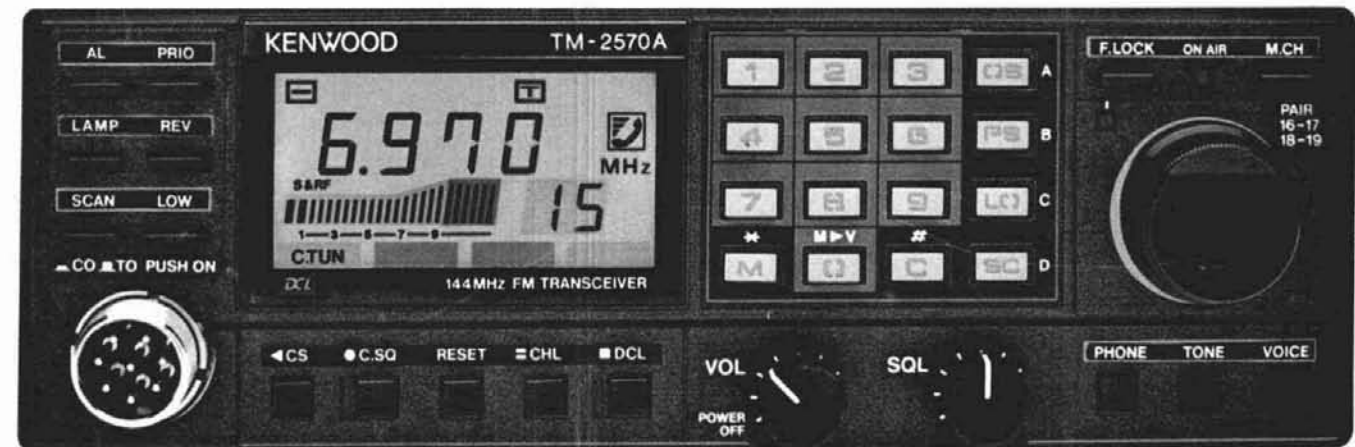
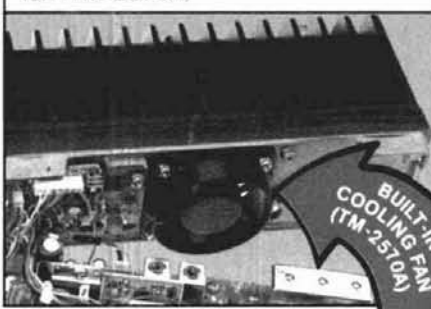

Optional Accessories

- **TU-7** 38-tone CTCSS encoder
- **MU-1** DCL modem unit
- **VS-1** voice synthesizer
- **PG-2K** extra DC cable
- **PG-3A** DC line noise filter
- **MB-10** extra mobile bracket
- **CD-10** call sign display
- **PS-430** DC power supply for TM-2550A/2530A
- **PS-50** DC power supply for TM-2570A
- **MC-60A/MC-80/MC-85** desk mics.
- **MC-48** extra DTMF mic. with UP/DWN switch
- **MC-42S** UP/DWN mic.
- **MC-55** (8-pin) mobile mic. with time-out timer
- **SP-40** compact mobile speaker
- **SP-50** mobile speaker
- **SW-200A/SW-200B** SWR/power meters
- **SW-100A/SW-100B** compact SWR/power meters
- **SWT-1** 2m antenna tuner

Actual size front panel

KENWOOD

TRIO-KENWOOD COMMUNICATIONS
1111 West Walnut Street
Compton, California 90220

Complete service manuals are available for all Trio-Kenwood transceivers and most accessories. Specifications and prices are subject to change without notice or obligation.