

# ham radio magazine

new column:  
**PRACTICALLY SPEAKING**  
by Joe Carr, K4IPV

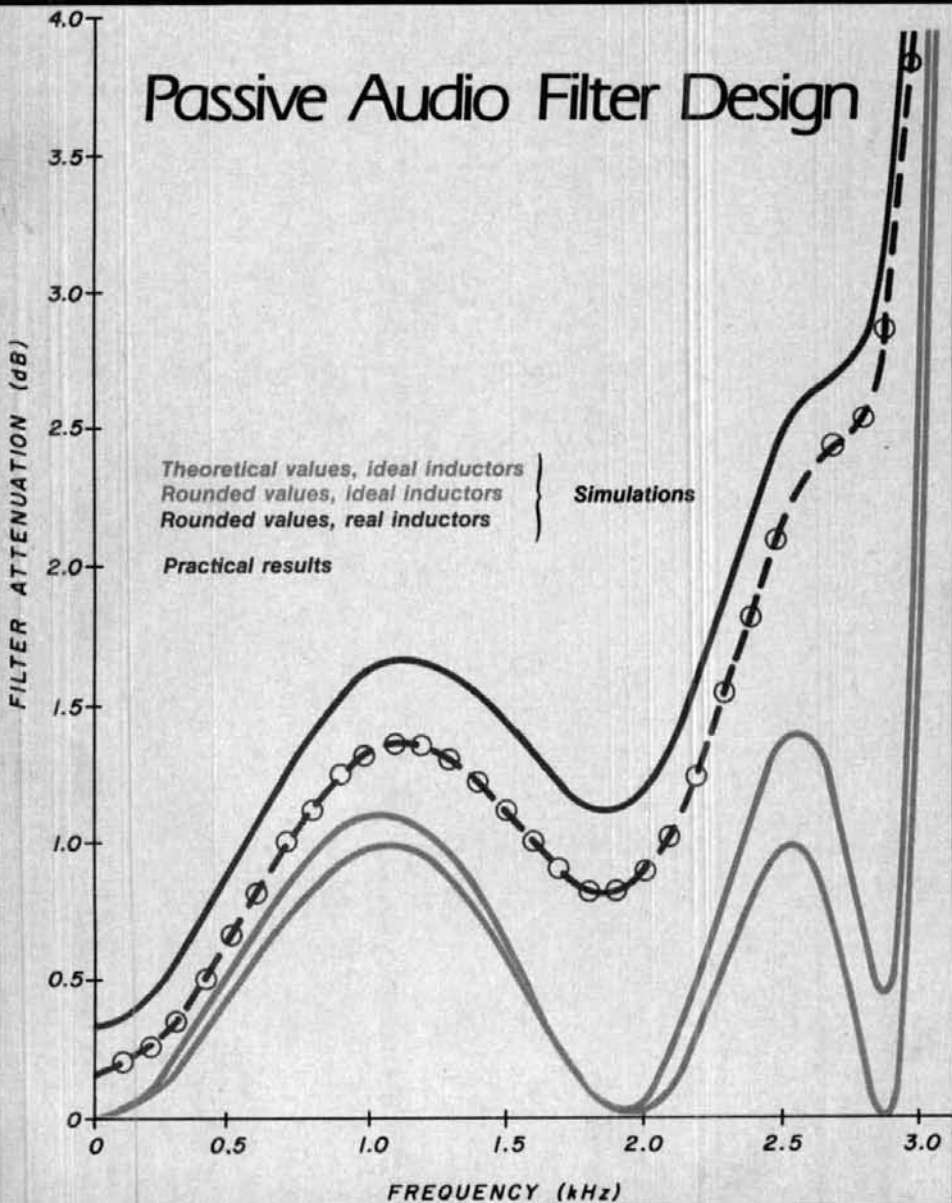

**hr**

focus  
on  
communications  
technology

- **adjusting SSB amplifiers**
- **understanding telephones**
- **a DTMF controller for repeaters**
- **a look at probes**
- **digital satellite tracker**
- **carrier-activated CW reception limiter**
- **simple continuity tester**
- **plus W9JUV, W6SAI, W1JR, W6MGI, K0RYW**

ICOM 1.2GHz Transceiver

# IC-1271A



## Explore the World of 1.2GHz!

Explore the world of 1.2GHz with ICOM's new IC-1271A base station transceiver. ICOM has a complete line of 1.2GHz gear to meet your operating requirements...the IC-1271A base station, IC-120 mobile and RP-1210 repeater.

IC-1271A. ICOM introduces the first full-featured 1240 to 1300MHz base station transceiver, the IC-1271A. With 10 watts of RF output power, 32 memories, scanning and multi-mode operation including ATV (amateur TV), the IC-1271A is a pioneer in 1.2GHz technology.

Whether your interest is in mobile, DX, repeater, satellite or moonbounce operation, the IC-1271A has exceptional receiver sensitivity because of front end GaAs FETS.

A variety of options are available for the IC-1271A including the IC-EX310 voice synthesizer, UT-155 CTCSS encoder/decoder, IC-PS25 internal AC power supply and the TV-1200 interface unit.

TV-1200. The interface unit allows amateur television (ATV) operation when used in conjunction with a video recorder or a video camera for transmission, and a television monitor for reception. Explore the new facet of amateur radio, "video hamming."



RP-1210. Complete your 1.2GHz system with the RP-1210 repeater. The RP-1210 features PLL frequency selection (198 channel, DIP switch), high stability PLL, repeater access to CTCSS, three digit DTMF decoder for control of special functions, 10 watts, selectable hang time and ID'er.

IC-120. The 1.2GHz mobile transceiver features six memory channels, scanning an HM-14 up/down scanner mic, RIT, LED readout and three tuning rates. Accessories include the ML-12 10 watt amplifier and the PS-45 slim line power supply.



See ICOM's full line of 1.2GHz gear at your local ICOM dealer.

 **ICOM**

First in Communication

## What To Look For In A Phone Patch

The best way to decide what patch is right for you is to first decide what a patch should do. A patch should:

- Give complete control to the mobile, allowing full break in operation.
- Not interfere with the normal operation of your base station. It should not require you to connect and disconnect cables (or flip switches!) every time you wish to use your radio as a normal base station.
- Not depend on volume or squelch settings of your radio. It should work the same regardless of what you do with these controls.
- You should be able to hear your base station speaker with the patch installed. Remember, you have a base station because there are mobiles. ONE OF THEM MIGHT NEED HELP.
- The patch should have standard features at no extra cost. These should include programmable toll restrict (dip switches), tone or rotary dialing, programmable patch and activity timers, and front panel indicators of channel and patch status.

**ONLY SMART PATCH HAS ALL OF THE ABOVE.**

## Now Mobile Operators Can Enjoy An Affordable Personal Phone Patch...

- Without an expensive repeater.
  - Using any FM transceiver as a base station.
- The secret is a SIMPLEX autopatch, The **SMART PATCH**.

## SMART PATCH is Easy To Install

To install **SMART PATCH**, connect the multicolored computer style ribbon cable to mic audio, receiver discriminator, PTT, and power. A modular phone cord is provided for connection to your phone system. Sound simple? ... YES!

# With SMART PATCH You are in CONTROL

With **CES 510SA Simplex Autopatch**, there's no waiting for VOX circuits to drop. Simply key your transmitter to take control.

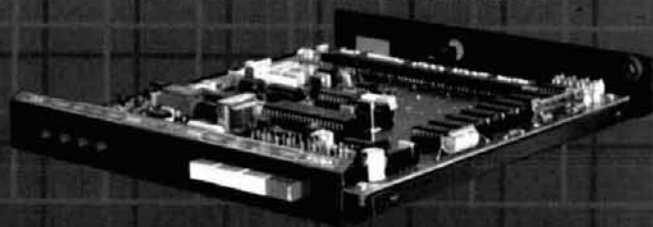

**SMART PATCH** is all you need to turn your base station into a personal autopatch. **SMART PATCH** uses the only operating system that gives the mobile complete control. Full break-in capability allows the mobile user to actually interrupt the telephone party. **SMART PATCH** does not interfere with the normal use of your base station. **SMART PATCH** works well with any FM transceiver and provides switch selectable tone or rotary dialing, toll restrict, programmable control codes, CW ID and much more.

**To Take CONTROL with Smart Patch - Call 800-327-9956 Ext. 101 today.**

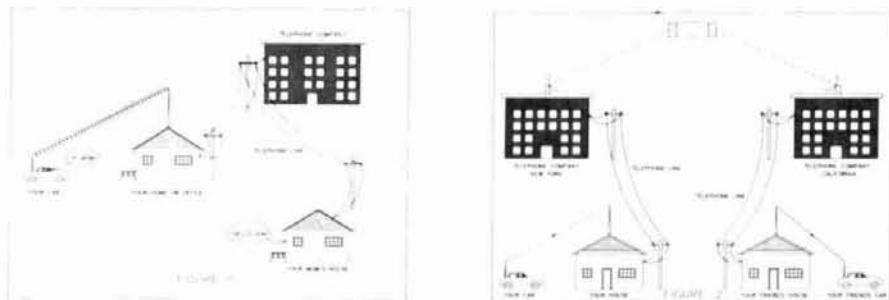

## How To Use SMART PATCH

Placing a call is simple. Send your access code from your mobile (example: \*73). This brings up the Patch and you will hear dial tone transmitted from your base station. Since **SMART PATCH** is checking about once per second to see if you want to dial, all you have to do is key your transmitter, then dial the phone number. You will now hear the phone ring and someone answer. Since the enhanced control system of **SMART PATCH** is constantly checking to see if you wish to talk, you need to simply key your transmitter and then talk. That's right, you simply key your transmitter to interrupt the phone line. The base station automatically stops transmitting after you key your mic. **SMART PATCH** does not require any special tone equipment to control your base station. It samples very high frequency noise present at your receiver's discriminator to determine if a mobile is present. No words or syllables are ever lost.

## SMART PATCH Is All You Need To Automatically Patch Your Base Station To Your Phone Line.

Use **SMART PATCH** for:

- Mobile (or remote base) to phone line via Simplex base. (see fig. 1.)
- Mobile to Mobile via interconnected base stations for extended range. (see fig. 2.)
- Telephone line to mobile (or remote base).
- **SMART PATCH** uses **SIMPLEX BASE STATION EQUIPMENT**. Use your ordinary base station. **SMART PATCH** does this without interfering with the normal use of your radio.

## WARRANTY?

YES, 180 days of warranty protection. You simply can't go wrong. An FCC type accepted coupler is available for **SMART PATCH**.



**Communications Electronics Specialties, Inc.**  
P.O. Box 2930, Winter Park, Florida 32790  
Telephone: (305) 645-0474 Or call toll-free (800)327-9956

# KENWOOD

...pacesetter in Amateur radio

**NEW!**  
1.2 GHz transceiver  
TR-50

## Reach Higher...

### TR-50

1.2 GHz FM transceiver.

As the Amateur bands become more and more crowded, hams seek higher and higher frequencies to "get away from it all." Here's a chance to experience "something different"—1200 MHz!

- LCD frequency readout with S/RF/battery check bar meter
- Battery set and charger
- External power cable for base or mobile operation
- 1 watt output
- 5 memory channels
- Odd-split operation on memory channel 5
- Programmable scanning
- 16-key DTMF hand microphone
- 1/4-wave sleeve antenna on an 8-position adjustable mount

- Offset reverse switch
- RIT
- Repeater offset switch (±20 MHz)

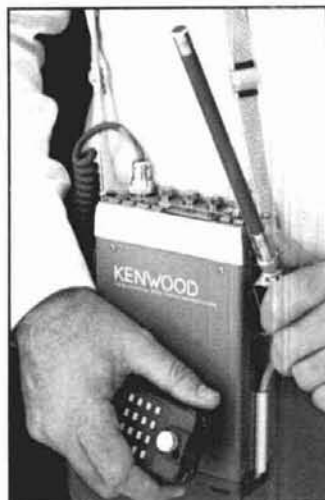

• The perfect portable for microwave mountain-topping!

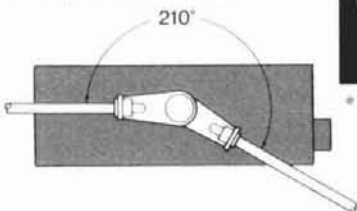

#### Optional accessories:

- VB-50 Power amplifier (10 watts)
- MB-3 Mobile mounting bracket
- PB-16 NiCd battery set
- TU-6 Sub-tone unit
- MC-55 (8-pin) Mobile microphone with time-out timer
- SWC-4 1.2 GHz directional coupler for SW-200A/200B and SW-2000 meters
- SC-10 soft case

Specifications and prices subject to change without notice or obligation. Complete service manuals are available for all Trio-Kenwood transceivers and most accessories.

## Ultra-Compact

### TM-201A

2-m FM transceiver.



The Kenwood TM-201A 2-meter transceiver is the smallest and lightest FM unit available!

- 25-watt output, with HI/LO power switch
- Dual digital VFOs
- 5 memories plus "COM" channel, with lithium battery back-up
- Memory scan/programmable band scan
- Priority alert scan
- Highly visible yellow LED frequency display
- High performance receiver/transmit
- External high quality speaker supplied
- 16-key autopatch UP/DOWN microphone
- Repeater offset (±600 kHz and simplex) and reverse switch

#### Optional accessories:

- TU-3 programmable CTCSS encoder
- KPS-7A fixed station power supply

- MC-55 (8-pin) mobile microphone with time-out timer
- SP-40 compact mobile speaker
- SW-100 A/B SWR/power meter
- SW-200 A/B SWR/power meter
- SWT-1 2-m antenna tuner
- FC-10 frequency controller

More information on the TR-50 and TM-201A is available from authorized Kenwood dealers.

#### Times Change - Quality Remains

##### 1970's:

**TR-7400A** Revolutionary new concept - the first 25 watt, 2 meter synthesized FM transceiver.

##### 1980's:

**TM-201A** Revolutionary re-defined. Dual digital VFO's, 25 watts, 5 memories, scanning, super-compact.



# KENWOOD

TRIO-KENWOOD COMMUNICATIONS  
1111 West Walnut Street  
Compton, California 90220

# ham radio

magazine

SEPTEMBER 1985

volume 18, number 3

T. H. Tenney, Jr., W1NLB  
publisher

Rich Rosen, K2RR  
editor-in-chief  
and associate publisher

Dorothy Rosa, KA1LBO  
assistant editor

Joseph J. Schroeder, W9JUV  
Alfred Wilson, W6NIF  
associate editors  
Susan Shorrock  
editorial production

#### editorial review board

Peter Bertini, K1ZJH  
Forrest Gehrke, K2BT  
Michael Gruchalla, P.E.  
Bob Lewis, W2EBS  
Mason Logan, K4MT  
Ed Wetherhold, W3NON

#### publishing staff

J. Craig Clark, Jr., N1ACH  
assistant publisher

Rally Dennis, KA1JWF  
director of advertising sales

Dorothy Sargent, KA1ZK  
advertising production manager

Susan Shorrock  
circulation manager

Therese Bourgault  
circulation

cover:  
Anne Fleming

ham radio magazine is published monthly by  
Communications Technology, Inc.  
Greenville, New Hampshire 03048-0498  
Telephone: 603-878-1441

#### subscription rates

United States:  
one year, \$19.95; two years, \$32.95; three years, \$44.95  
Canada and other countries (via surface mail):  
one year, \$22.95; two years, \$41.00; three years, \$58.00  
Europe, Japan, Africa (via Air Forwarding Service): one year, \$28.00  
All subscription orders payable in U.S. funds, via international  
postal money order or check drawn on U.S. bank

international subscription agents: page 150

Microfilm copies are available from  
University Microfilms, International  
Ann Arbor, Michigan 48106  
Order publication number 3076

Cassette tapes of selected articles from ham radio  
are available to the blind and physically handicapped  
from Recorded Periodicals,  
919 Walnut Street, Philadelphia, Pennsylvania 19107

Copyright 1985 by Communications Technology, Inc.  
Title registered at U.S. Patent Office

Second class postage paid  
at Greenville, New Hampshire 03048-0498  
and at additional mailing offices  
ISSN 0148-5989

Send change of address to ham radio  
Greenville, New Hampshire 03048-0498



## contents

17 passive audio filter design  
part 1: development and analysis  
Stefan Niewiadomski

33 adjusting SSB amplifiers  
Richard Measures, AG6K

38 understanding telephones  
Julian Macassey, N6ARE

47 a DTMF controller for repeaters  
Terry Simonds, WB4FXD

56 VHF/UHF world  
Joe Reisert, W1JR

67 NEW COLUMN:  
practically speaking  
Joe Carr, K4IPV

75 a detailed look at probes  
Vaughn D. Martin

91 ham radio techniques  
Bill Orr, W6SAI

102 a digitally-controlled  
satellite tracker  
Rudolf E. Six, KA8OBL

113 a carrier-activated  
CW reception limiter  
Don E. Hildreth, W6NRW

130 the weekender:  
a simple continuity tester  
Robert R. Frahm, WD6GMB

157 the Guerri report  
Ernie Guerri, W6MGI

158 advertisers index  
and reader service

15 comments  
122 DX forecaster  
150 flea market

140 ham mart  
152 ham notes

142 new products  
10 presstop  
4 reflections

# REFLECTIONS

## it can happen to anyone

One of the more pleasurable obligations of working in the Amateur Radio industry is keeping up-to-date on all the latest equipment, accessories, and doo-dads that come along.

One night not too long ago I took one of the newest radios home to do a little informal testing. Like most radios on the market today, this one is loaded with just about every feature you'd want to have. In fact, if it had legs, I guess it would walk the dog in the morning — if I remembered to set the timer the night before. After making up all the cables and installing the radio, I sit down to make its acquaintance. All goes well for the first few minutes . . . signals are strong and the radio operates flawlessly. Until, that is, I decide to QSY to the broadcast band to listen to the local news.

The radio goes dead.

My first reaction is to assume I'd either turned the wrong knob or pushed the wrong button, so I run through the standard drill of trouble-shooting: punch every knob and turn every button to see if *that* solves the problem. Five minutes of this pass, and the problem is still there . . . the radio is *dead*.

Now what? "Back to the manufacturer," I sigh, and off I go to bed. It's late, and I'm completely discouraged. "Why can't they build something that *works*?" I complain to my sleeping XYL. I am utterly discouraged.

After I turn out the light, and I'm lying there waiting to fall asleep, I ask myself, "Did I try the squelch?" I'm not sure, so I throw on a robe and head for the door. My wife stirs in her sleep, pulls the covers to *her* side, and murmurs something good-naturedly unintelligible. I run downstairs, turn on the radio, set it to the broadcast band, and wait for the problem to reappear. It does, I turn off the squelch.

BINGO.

The bottom line, I guess, is that problems like this can strike us all. From Novice to Extra, no one is immune. The increasing complexity of our world — and of Amateur Radio — makes it hard to be fully expert on the many different pieces of equipment and in the varied technologies we use. So when a problem occurs, all we can do is walk through a step-by-step check of each and every control to determine whether it's really an equipment problem or just another embarrassing incidence of "cockpit error." If the malfunction escapes this scrutiny, then we can consult the owner's manual to see if the problem is one that the manufacturer has already anticipated. If this step fails, we can check with the dealer to see what he has to say. (Most likely, he'll be thoroughly equipped to handle the problem.)

My point is that sending equipment back to the manufacturer is always the action of last resort. Yes, the manufacturer has a skilled service staff to troubleshoot and repair equipment. But as Joe Carr, K4IPV, points out in his new *ham radio* column (see page 67), as much as 40 percent of the equipment that lands on the benches of professional service technicians has absolutely nothing wrong with it! By not taking time to really check things out first, its owners are inconvenienced, off the air, and out the cost of packing and postage.

These newfangled radios sure are nice. But they're a whole different world from the Hammarlund HQ-129 and Johnson Ranger I started out with.

**Craig Clark, N1ACH**  
Assistant Publisher

# MFJ ACCESSORIES

**300 WATT ANTENNA TUNER HAS SWR/WATTMETER, ANTENNA SWITCH, BALUN. MATCHES VIRTUALLY EVERYTHING FROM 1.8 TO 30 MHz.**



**\$99.95** MFJ-941D

**NEW FEATURES**

MFJ's fastest selling tuner packs in plenty of new features!

- **New Styling!** Brushed aluminum front. All metal cabinet.
- **New SWR/Wattmeter!** More accurate. Switch selectable 300/30 watt ranges. Read forward/reflected power.
- **New Antenna Switch!** Front panel mounted. Select 2 coax lines, direct or through tuner, random wire/balanced line or tuner bypass for dummy load.
- **New airwound inductor!** Larger more efficient 12 position airwound inductor gives lower losses and more watts out. Run up to 300 watts RF power output. Matches everything from 1.8 to 30 MHz: dipoles, inverted vee, random wires, verticals, mobile whips, beams, balanced and coax lines. Built-in 4:1 balun for balanced lines. 1000V capacitor spacing. Black. 11x3x7 inches. Works with all solid state or tube rigs. Easy to use, anywhere.

## RTTY/ASCII/CW COMPUTER INTERFACE

MFJ-1224  
**\$99.95**



Free MFJ RTTY/ASCII/CW software on tape and cable for VIC-20 or C-64. Send and receive computerized RTTY/ASCII/CW with nearly any personal computer (VIC-20, Apple, TRS-80C, Atari, TI-99, Commodore 64, etc.). Use Kantronics or most other RTTY/CW software. Copies both mark and space, any shift (including 170, 425, 850 Hz) and any speed (5-100 WPM RTTY/CW, 300 baud ASCII). Sharp 8 pole active filter for CW and 170 Hz shift. Sends 170, 850 Hz shift. Normal/reverse switch eliminates retuning. Automatic noise limiter. Kantronics compatible socket plus exclusive general purpose socket. 8x1 1/4x6 in. 12-15 VDC or 110 VAC with adapter, MFJ-1312, \$9.95.

## RX NOISE BRIDGE

Maximize your antenna performance!



**\$59.95** MFJ-202B

Tells whether to shorten or lengthen antenna for minimum SWR. Measure resonant frequency, radiation resistance and reactance.

**New Features:** individually calibrated resistance scale, expanded capacitance range ( $\pm 150$  pf). Built-in range extender for measurements beyond scale readings. 1-100 MHz. Comprehensive manual. Use 9 V battery. 2x4x4 in.

## INDOOR TUNED ACTIVE ANTENNA

**NEW! IMPROVED!** ANTENNA with higher gain "World Grabber" rivals or exceeds reception

of outside long wires! Unique tuned Active Antenna minimizes intermode, improves selectivity, reduces noise outside tuned band, even functions as preselector with external antennas. Covers 0.3-30 MHz. Tele scoping antenna. Tune, Band, Gain, On-off bypass controls. 6x2x6 in. Uses 9V battery, 9-18 VDC or 110 VAC with adapter, MFJ-1312, \$9.95. **MFJ-1020A \$79.95**



## POLICE/FIRE/WEATHER 2 M HANDHELD CONVERTER

Turn your synthesized scanning 2 meter handheld into a hot Police/Fire/Weather band scanner!

144-148 MHz handhelds receive Police/Fire on 154-158 MHz with direct frequency readout. Hear NOAA maritime coastal plus more on 160-164 MHz. Converter mounts between handheld and rubber ducky. Feedthru allows simultaneous scanning of both 2 meters and Police/Fire bands. No missed calls. Crystal controlled. Bypass/Off switch allows transmitting (up to 5 watts). Use AAA battery. 2 1/4x1 1/2x1 1/2 in. BNC connectors. **\$39.95** MFJ-313



## MFJ/BENCHER KEYSER COMBO

MFJ-422  
**\$109.95**

The best of all CW worlds—a deluxe MFJ Keyer in a compact configuration that fits right on the Bencher iambic paddle! MFJ Keyer - small in size, big in features. Curtis 8044-B IC, adjustable weight and tone, front panel volume and speed controls (8-50 WPM). Built-in dot-dash memories. Speaker, sidetone, and push button selection of semi-automatic/tune or automatic modes. Solid state keying. Bencher paddle is fully adjustable; heavy steel base with non-skid feet. Uses 9 V battery or 110 VAC with optional adapter, MFJ-1305, \$9.95.



## VHF SWR/WATTMETER

Low cost VHF SWR/Wattmeter! Read SWR (14 to 170 MHz) and forward/reflected power

at 2 meters. Has 30 and 300 watts scales. Also read relative field strength. 4x2x3 in. **MFJ-812 \$29.95**



## 1 KW DUMMY LOAD

MFJ-250 **\$39.95**

Tune up fast, extend life of finals, reduce QRM! Rated 1KW CW or 2KW PEP for 10 minutes. Half rating for 20 minutes, continuous at 200 W CW, 400 W PEP. VSWR under 1.2 to 30 MHz, 1.5 to 300 MHz. Oil contains no PCB. 50 ohm non-inductive resistor. Safety vent. Carrying handle. 7 1/2x6 3/4 in.



## 24/12 HOUR CLOCK/ID TIMER

MFJ-106  
**\$19.95** NEW

Switch to 24 hour UTC or 12 hour format! Battery backup maintains time during power outage. ID timer alerts every 9 minutes after reset. Red LED .6 inch digits. Synchronizable with WWV. Alarm with snooze function. Minute set, hour set switches. Time set switch prevents mis-setting. Power out, alarm on indicators. Gray and black cabinet. 5x2x3 inches. 110 VAC, 60 Hz.



## DUAL TUNABLE SSB/CW/RTTY FILTER

MFJ-752B **\$99.95**



Dual filters give unmatched performance! The primary filter lets you peak, notch, low pass or high pass with extra steep skirts. Auxiliary filter gives 70 db notch, 40 Hz peak. Both filters tune from 300 to 3000 Hz with variable bandwidth from 40 Hz to nearly flat. Constant output as bandwidth is varied. Linear frequency control. Switchable noise limiter for impulse noise. Simulated stereo sound for CW lets ears and mind reject QRM. Mounts for 2 rigs. Plugs into phone jack. Two watts for speaker. Off bypasses filter. 9-18 VDC or 110 VAC with optional adapter. MFJ-1312, \$9.95.

**ORDER ANY PRODUCT FROM MFJ AND TRY IT-NO OBLIGATION. IF NOT DELIGHTED, RETURN WITHIN 30 DAYS FOR PROMPT REFUND (LESS SHIPPING).**

- One year unconditional guarantee • Made in USA.
- Add \$4.00 each shipping/handling • Call or write for free catalog, over 100 products.

# MFJ

MFJ ENTERPRISES, INC.  
Box 494, Mississippi State, MS 39762

TO ORDER OR FOR YOUR NEAREST DEALER, CALL TOLL-FREE  
**800-647-1800.** Call 601-323-5869 in Miss. and outside continental USA  
Telex 53-4590 MFJ STKV



"The Key to Worldwide



Communications"

# HAM RADIO OUTLET

THE COMPLETE RESOURCE FOR YOUR HAM RADIO NEEDS.

## KENWOOD HAND-HELDS



TR-2600A Deserves its well-earned reputation as the leading HT

TH-21AT/41AT  
COMPACT!  
Only 2.4"W. 4.72"H. 1.1"D  
Outstanding performers in an ideal package size.



CALL FOR PRICE

## TOLL-FREE PHONE

INCLUDING ALASKA AND HAWAII



MA-40 40' TUBULAR H.D. MAST

Regular \$745

SALE \$549

MA-550 55' TUBULAR H.D. MAST

Regular \$1245

SALE \$899

- Why You Should Buy-
  - Will handle 10 Sq. Ft. 50 mph
  - Pleases neighbors with tubular streamlined look
  - In stock for quick delivery
  - Other models at great prices

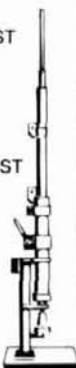

FREE SHIPMENT

MOST ITEMS. U.P.S. SURFACE.



SIMPLEX-REPEATER-SATELLITE



IC-271H  
2 METERS • 100 WATTS  
• ALL-MODE

IC-471H

430-450MHz • 75 WATTS  
• ALL-MODE



CALL FOR YOUR SPECIAL PRICE



ICOM IC-27A

SUPER-COMPACT  
2 METER MOBILE



ALSO \*IC-27H HIGH POWER VERSION  
AND IC-37A, 220MHz  
IC-47A, 70CM **SAVE!**

FALL SPECIAL - LOW, LOW PRICE



SALE!

W-51 SALE \$899

LM-354 SALE \$1599

IMMEDIATE DELIVERY

ONLY A LIMITED  
QUANTITY AT THIS PRICE.

THE VERY BEST DEAL ON EVERY COUNT!



FT-2700H  
NEW!  
2M/70CM  
TRANSCEIVER



FT-726R

FT-209RH CALL FOR GREAT PRICES

KENWOOD TS-940S

TOP-OF-THE-LINE HF TRANSCEIVER

PAY REGULAR PRICE \$1799.95



RECEIVE  
FREE

AT-940 \$199 Value  
ANTENNA TUNER  
MC-60A \$79.95 Value  
MICROPHONE

Free UPS Surface



"The Key to Worldwide

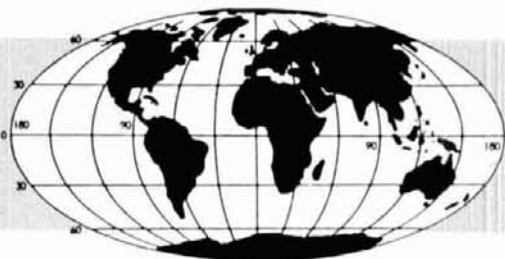

Communications"

# HAM RADIO OUTLET

THE COMPLETE RESOURCE FOR YOUR HAM RADIO NEEDS.

## ICOM IC-R71A

SUPERIOR GRADE  
GENERAL COVERAGE  
RECEIVER



Regular \$799  
**SALE! \$629.95**

## ICOM IC-37A



220 MHz's BEST BUY!  
REGULAR \$449

**SALE! \$299.95**  
LIMITED QUANTITIES  
THIS PRICE.

## TOLL-FREE PHONE

INCLUDING ALASKA AND HAWAII



## HAND-HELDS



IC-02AT IC-2AT IC-3AT  
IC-04AT IC-4AT

AT GREAT LOW  
SUMMER PRICES

FREE SHIPMENT  
MOST ITEMS. U.P.S. SURFACE.

## ICOM IC-735

THE LATEST IN ICOM'S LONG LINE  
OF HF TRANCEIVERS



CALL FOR LOW, LOW PRICE

## ICOM LATEST EDITION

IC-3200A DUAL BANDER  
COVERS BOTH 2 METERS  
and 70CM



CALL FOR  
LOW,  
LOW  
PRICE

# 6 STORE BUYING POWER!



PERSONALIZED SERVICE  
BOB FERRERO W8RJ  
President  
JIM RAFFERTY N8RJ  
VP/So. Calif. Div. Anaheim  
Managers  
GEORGE W6DSV Burlingame  
DON W6PFS Oakland  
BOB K7RQH Phoenix  
GLENN KBNA San Diego  
AL N8YRA Van Nuys  
and other active amateurs to serve you

ANAHEIM, CA 92801  
2620 W. La Palma,  
(714) 761-3033, (213) 860-2040,  
Between Disneyland & Knotts Berry Farm.

BURLINGAME, CA 94010  
990 Howard Ave.,  
(415) 342-5757,  
5 miles south on 101 from San Fran. Airport.

# 800-854-6046

THE TOLL FREE NUMBER IS NOT IN EFFECT IN THE STATES OF CALIF. AND ARIZONA  
CALIF. AND ARIZONA CUSTOMERS CALL OR VISIT NEAREST STORE  
PHONE HOURS: 9:30 AM TO 5:30 PM PACIFIC TIME.  
STORE HOURS: 10 AM TO 5:30 PM Mon. through Sat.

OAKLAND, CA 94609  
2811 Telegraph Ave.,  
(415) 451-5757,  
Highway 24 Downtown, Left 27th off-ramp.

PHOENIX, AZ 85015  
1702 W. Camelback Road,  
(602) 242-3515,  
East of Highway 17.

FREE SHIPMENT  
MOST ITEMS U.P.S. SURFACE



✓ 158

SAN DIEGO, CA 92123  
5375 Kearny Villa Road,  
(619) 560-4900,  
Highway 163 and Clairemont Mesa Blvd.

VAN NUYS, CA 91401  
6265 Sepulveda Blvd.,  
(818) 988-2212  
San Diego Freeway at Victory Boulevard

AEA • ALLIANCE • ALPHA • AMECO • AMPHENOL • ANKSTER MARK • ANTENNA SPECIALISTS • ARRI • ASTRON • BASH • BELDEN • BENCHER • BIRD • BUTTERNUT •

B & W • CALLBOOK • CENTURIAN • COLLINS • COLUMBIA • CURTIS • CUSHCRAFT • DAIWA • DHAKI • DA EDGE • EIMAC • GILFER • HAL • HUSTLER • HY GAIN • ICOM •

JSC • J. W. MILLER • KANTRONICS • KENWOOD • KLM • LARSEN • LUNAR • METZ • MFJ • MICRO LOG • MINI PRODUCTS • MIRAGE • NYE • PALOMAR • ROHN • SHURE •

SIGNAL ONE • STONER • TEMPO • TEN-TEC • TRISTAR • TRI-EK • VAN GORDEON • VOICOM • VIBROPLEX • WEST • YAESU and more

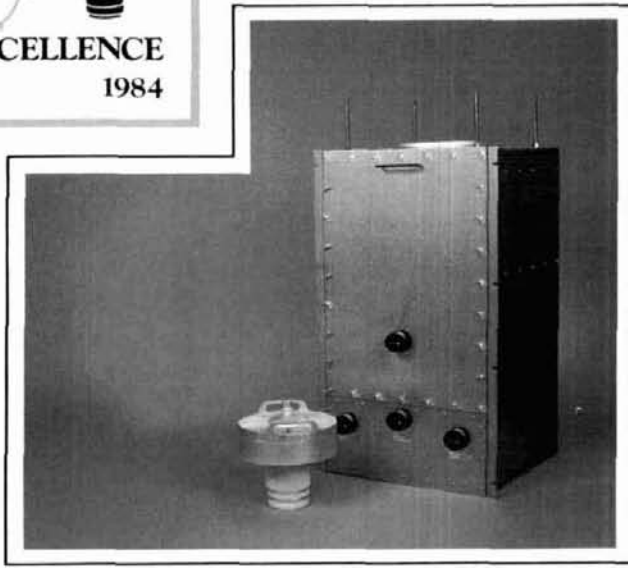
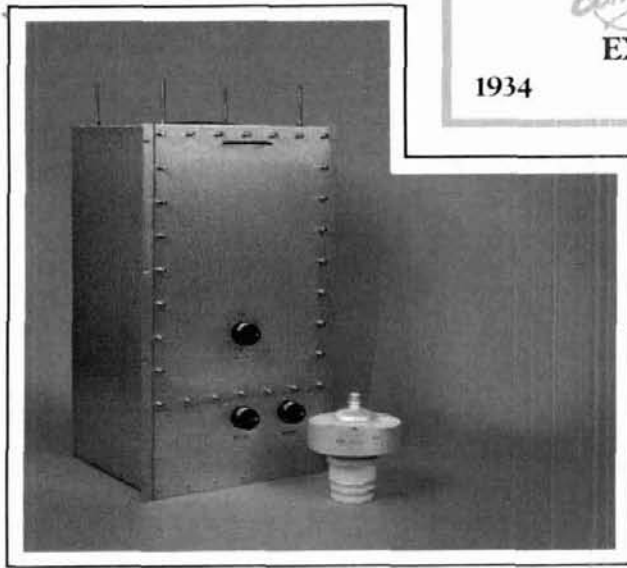
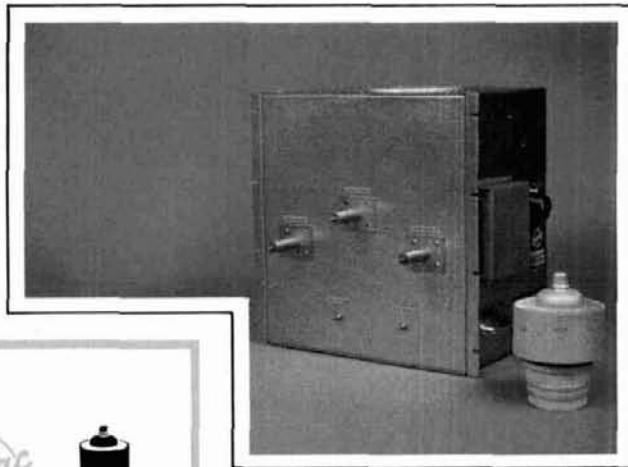
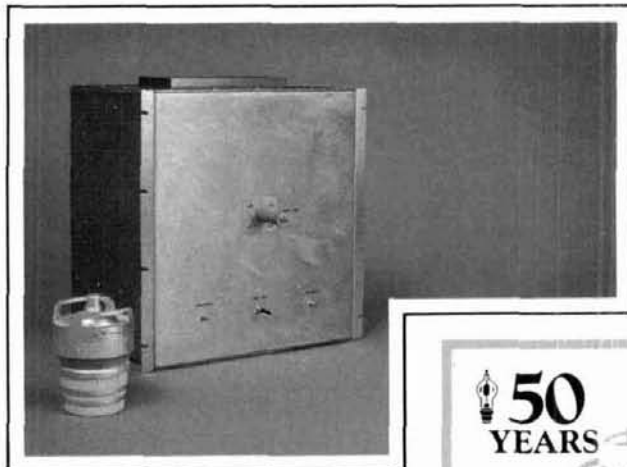

# EIMAC celebrates its 50th Anniversary with an extensive line of FM Broadcast Cavity Amplifiers.

Varian EIMAC celebrates 50 years of service to the broadcast industry with a spectrum of FM from a powerful 60 kW to a mini power 150 W solid state IPA.

For more information call or write Varian EIMAC or contact any Varian Electron Device Group sales office worldwide.

Varian EIMAC  
301 Industrial Way  
San Carlos, California 94070  
Telephone: 415-592-1221

Varian AG  
Steinhauserstrasse  
CH-6300 Zug, Switzerland  
Telephone: 042-23 25 75

**The cost-effective path to a modern FM transmitter.**

No one knows more about broadcast tubes and cavities than EIMAC. Our strong cavity development capability reduces RF engineering problems. EIMAC cavities are inexpensive and simple to use.

### EIMAC FM BROADCAST CAVITY PRODUCT LINE

POWER	CAVITY	EIMAC TUBE
60 kW	CV-2230	4CX30,000G
30 kW	CV-2202	4CX20,000C
25 kW	CV-2200	4CX20,000A
15 kW	CV-2210	4CX12,000A
10 kW	CV-2228	4CX7500A
5 kW	CV-2225	4CX3500A
1.5 kW	CV-2220	3CX1500A7
150 W	AM-2215A	Solid State



## Are you radioACTIVE?



Dean LeMon, KRØV sure is! Dean got active in Amateur Radio when he was 16 years old and earned his Extra Class license in less than four years! "It's a fascinating hobby and a great way to meet all kinds of new people from all over the world."

Dean has cerebral palsy and got started in Amateur Radio with help from the Courage HANDI-HAM System. The HANDI-HAM System is an international organization of able-bodied and disabled hams who help people with physical disabilities expand their world through Amateur Radio. The System matches students with one-to-one helpers, provides instruction material and support, and loans radio equipment.

Isn't it time you got radioACTIVE with the Courage HANDI-HAM System?

Call or write the Courage  
**HANDI-HAM System**  
WØZSW at Courage Center,  
3915 Golden Valley Road,  
Golden Valley, Minnesota  
55422, phone (612) 588-0811.



### Invitation to Authors

*ham radio* welcomes manuscripts from readers. If you have an idea for an article you'd like to have considered for publication, send for a free copy of the *ham radio* Author's Guide. Address your request to *ham radio*, Greenville, New Hampshire 03048 (SASE appreciated).

# NOT SO HOT.

At high power a hot antenna rod is a sure sign that power is going to waste. At lower power you're losing the same percentage of energy, but the dissipation is so rapid you can't feel the heat. That's why it's important to know the cold facts about Larsen antennas.

Our exclusive Kùlrod® whip minimizes RF loss regardless of the watts applied, so you can talk farther. It stays cool to the touch even at high power.

The stainless steel rod is first plated with nickel, then with copper for high

conductivity. Thin layers of nickel and chrome protect the copper from corrosion and provide a sleek finish, without hindering performance.

So whether you're calling for fun, or calling for help, you can depend on Larsen antennas and our no-nonsense warranty to deliver a strong, clear signal... instead of a lot of hot air.

*Shown in cutaway: Top plating of chrome. Inner platings of nickel, copper and nickel over stainless steel rod. (Layers not drawn to scale.)*



## Larsen Antennas The Amateur's Professional™

See your favorite amateur dealer or write for a free amateur catalog.

IN USA Larsen Electronics, Inc.  
11611 N.E. 50th Ave. PO Box 1799  
Vancouver, WA 98668  
206-573-2722

IN CANADA Canadian Larsen Electronics, Ltd.  
149 West 6th Avenue  
Vancouver, B.C. V5Y 1K3  
604-872-8517

LARSEN® KÙLROD® AND KÙLDUCKIE® ARE REGISTERED TRADEMARKS OF LARSEN ELECTRONICS, INC.

AMATEUR USE OF A GEOSTATIONARY SATELLITE has been proposed by NASA. One of NASA's Advanced Communications Technology Satellites (ACTS) is to be made available for use by experimenters for a two-year period starting in 1989; Amateur Radio is one of the groups that NASA expects to be interested in using it. Uplink band will be 27.5-30 GHz; downlink, 17.7-20.2 GHz. As these are outside the Amateur bands, it's likely either an STA or experimental license will be required for them. The satellite will use highly directive antennas aimed at some major population centers, but NASA even suggests Amateurs might use repeater techniques to permit others outside the bird's antenna "footprint" access to it. Interested Amateurs should request NASA's November 1984 "Notice of Intent" from Ron Schertler, ACTS Projects Experiment Manager, MS-54-6, NASA, 21000 Brookpark Road, Cleveland, Ohio 44135.

BROADCASTERS MAY DO ANYTHING THEY WISH WITH AMATEUR TRANSMISSIONS, but Amateurs are strictly forbidden to use Amateur Radio in any way that might be construed to benefit any "broadcaster." The FCC's Report and Order on BC Docket 79-47 now appears to almost forbid such well established Amateur Radio "public service" activities as, for example, any direct tie between an Amateur Radio weather net and the U.S. Weather Bureau, since Weather Bureau information is "broadcast" on NOAA's 162-MHz weather stations.

The Redefinition Of "Emergency" in Part 97 Is At The Heart of the problem. Verified emergency communications such as "The dam has broken" or "A tornado just crossed the river" would still be permitted, of course. What appears to be against the new rules is letting an Amateur station in a weather net tell the Weather Bureau "The dam looks shaky" or "The sky's getting very dark." Under the new rules, however, nothing would prevent the Weather Bureau, broadcasters, or anyone else from monitoring an Amateur Radio weather net and using the reports heard in any way they wished.

A Petition For Reconsideration Has Been Filed By ARRL, asking the Commission to go back to the former less stringent definition of "Emergency," or to temper the new one so it won't preclude public service ties between weather nets and the Weather Bureau.

AUXILIARY OPERATION ON ALL AMATEUR FREQUENCIES except 431-433 MHz and 435-438 MHz has been proposed by the Commission in PR Docket 85-215. The present rules restrict auxiliary operation (principally control links) to above 220.5 MHz. However, the FCC feels that there is no reason, given the present state of the art, that such auxiliary operation shouldn't be permitted on the other Amateur bands, as well.

Comments On PR Docket 85-215 Are Due At The Commission September 24, and Reply Comments by October 25.

NEVADA HAS JOINED THE SHIFT TO 20 KHZ 2-METER SPACING, except for the Las Vegas area, which has traditionally gone along with Southern California. Eastern Nevada will be coordinated by the Utah coordinator, and the western part by NARC's northern California coordinator. Iowa's council, however, has voted to remain at 15 kHz and the ARRL bandplan though with a voluntary state-wide tone access system. They also intend shifting the 145-MHz repeater subband to 15 kHz spacing in order to pick up additional channels.

800-MHZ SCANNERS WOULD BE OUTLAWED IN CALIFORNIA under a proposal, SB 1431, presently being considered in the state legislature. The proposal, apparently the result of phone company concern over the security of cellular communications, has California Amateurs worried over possible negative impact on Amateurs. Los Angeles attorney Joe Merdler, N6AHU, has been instrumental in delaying the bill's approval, though scanner manufacturers haven't seemed very concerned about it. If it becomes law a court challenge seems likely.

AN 800 NUMBER FOR QUESTIONS ABOUT ITS VEC PROGRAM, including its own or any other VEC's exam schedule, has been installed by DeVry. The number, which is presently accessible only in the greater Midwest area, is 1-800-327-2444; A DeVry WATS line covering the entire Continental U.S. will be announced in the near future.

"The Volunteer Examiner," A VE Newsletter created and edited by DeVry VE KI9R, is now being distributed by DeVry. An SASE to Jim Georgius, W9JUG, DeVry ARS, 3300 N. Campbell, Chicago, Illinois 60618 will bring a sample copy.

W9JUG's Sunday VE Net Now Meets On 7173 kHz, 1400Z, with a second session at 1800Z.

"12-12 WORLDWIDE" IS A NEWLY FORMED ORGANIZATION to promote activities on the new 24 MHz (12 meter) WARC band. For details send an SASE to Steve Walz, WA5UTO, Box 222, 318 S. Massachusetts Avenue, Cherokee, Oklahoma 73728, or call him at (405) 596-3487.

AN FCC CITATION FOR "BROADCASTING" HAS COST K6KPS \$2000. K6KPS, James Brantley, has been a problem to 20-meter phone band users for decades, calling CQ but ignoring responses and carrying on imaginary QSOs on top of various nets, DX pileups, phone patches, and ordinary rag chews with a big signal from the Los Angeles area. Though he's done this for years (K6KPS often broke up a 14295 "commuter's net"—in which Presstop editor W9JUV participated in the mid-60s) and has been the subject of previous FCC investigations, the fine was levied for his operating tactics observed during last December.

L U X O R 9 9 0 0

THE  
INTELLIGENT  
SATELLITE  
TELEVISION  
SYSTEM

# THE LUXOR 9900 KNOWS

## **Where all the satellites are**

Up to 36 satellite locations can be programmed for instant recall. The antenna controller is integrated into the satellite receiver. The hand-held remote control activates a 3-speed actuator action which precisely locates the satellite and fine tunes the antenna position for maximum signal reception.

## **Where all the channels are**

Every channel on every satellite is individually factory programmed prior to delivery. All audio and video information is ready for recall automatically. As new channels are added they can be added to the program. The 9900 is ready to receive individual channel selection information for up to 864 separate selections.

## **All about stereo Hi-Fi sound**

5 audio modes, factory programmed to individual transponders, deliver the right sound system automatically when a channel is selected. Dozens of audio subcarriers can be added to the program for audio only hi-fi enjoyment (including Dolby® Noise Reduction) in addition to television.



**ALL YOU NEED TO KNOW IS  
WHAT SHOW YOU WANT TO WATCH**

## NOW LUXOR HAS UNIFIED SATELLITE, VIDEO, AUDIO AND COMPUTER TECHNOLOGY IN A SINGLE INTEGRATED HOME SATELLITE TV SYSTEM

### So advanced it's as easy to operate as an ordinary TV



The front panel LED display tells you what satellite you're on, what channel you're watching, what sound system you're receiving and a signal bar graph indicates signal strength. All functions are controlled from the hand-held wireless remote.

### The sky is alive with the sound of music

Luxor loudspeakers bring new life to TV audio, mono or stereo, and much more. Satellite audio sub-carriers broadcast a wide range of music for audio only.

These optional high quality 6-speaker sets (3 per side) are available in passive or active models with sound power up to 40 W per channel. They are specially magnetic shielded for close location to your TV set.

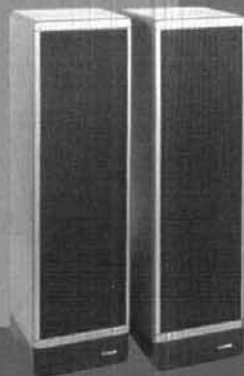

Here is the best of Scandinavian design and high technology. Because Luxor is a leading European manufacturer of satellite products, TV's, audio hi-fi systems, and computers, the company is able to combine these technologies in the advanced 9900 series. After all, Luxor has been a leader in radio, television and electronic technology since 1923.

### Simple, clear and color-coded

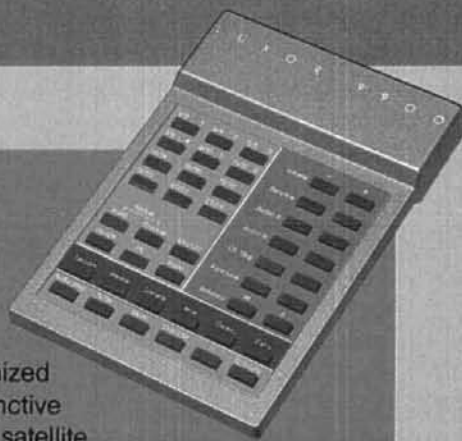

The Luxor hand-held remote is clearly organized to make life easy. Distinctive color sections present satellite and channel selection functions, tuning functions and switching functions. For most viewing however, video and audio delivery will be automatic. When a channel is selected, the exclusive Luxor Micro-Step™ Tuning System (LMS) automatically seeks out the right signal within that channel's frequency. The receiver automatically compensates for any form of frequency drift due to climate or transponder variances.

An internal TI filter can be assigned to individual channels to minimize terrestrial interference.

And a discrete parental lock-out can eliminate one or more individual channels on a single satellite, as desired.

That's it. Advanced Luxor technology has produced a system so simple to operate, yet complete enough to satisfy the most fanatic videophile and audiophile. For the technician, the Luxor 9900 even has its own diagnostic system built-in and ready at the touch of a button.

### The perfect companion



The Luxor Model 9995 Block Satellite Receiver is designed and built to function as an add-on receiver to Luxor 9900 multiple TV's installations. This low cost manually operated receiver offers independent channel selection for TV's located throughout the house. The 9995 can also be used as a stand-alone receiver for both C-Band and Ku-Band reception.

# LUXOR HAS ADVANCED THE STATE-OF-THE-ART TO THE POINT OF ELEGANT SIMPLICITY FOR THE CONSUMER AND THE TECHNICIAN

Each electronic innovation is incorporated to aid ease of operation, assure high performance reliability, and maintain outstanding quality of both picture and sound.



## 9900 Block Receiver

### Control Functions

- + Integrated satellite receiver and antenna controller.
- C-band (4 GHz) and Ku-band (12 GHz) capable. Remote control switchable.
- Satellite direct access.
- Transponder direct access.
- + Built-in A/B switch.
- + "Normal" button return to factory pre-set values.
- Built-in polarizer drive.
- Built-in RF modulator.
- Non-volatile memory unaffected by power outages.
- Remote sensor interface.

### Programs

- + Factory programmed for individual transponders on each satellite.
- + Automatic correct audio system factory programmed for each satellite and each transponder.
- + Program capacity up to 864 individual selections, audio video matched and fine tuned.
- + Self-diagnostic microprocessor.
- + LED display of satellite, channel, audio system and signal strength

### Video Functions

- + Luxor Micro-Step™ tuning system (LMS).
- Baseband audio and video output for VCR or monitor.
- Baseband input for other video sources.
- Built-in polarity control.
- + Built-in programmable TI filter.
- Raw video (unfiltered, unclamped) for descrambler connection.

### Audio Functions

- + Audio subcarrier frequency read-out.
- Wide/Narrow Bandwidth selection.
- + Remote audio volume control.
- + Remote stereo balance control.
- + Remote Dolby® on/off
- + 5 audio modes—2 mono, 2 matrix, and discrete stereo. Automatic multiplex selection.
- Built-in stereo processor.
- + Direct loudspeaker drive.



## 9902 Remote Sensor

- Controls satellite system from any room.
- Low-cost add-on for other TVs.
- Comes complete with hand-held IR remote control.

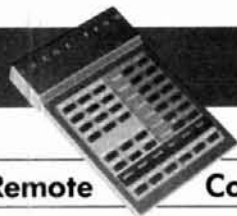

## 9901 Remote Control

- + Full-function, color-coded IR wireless remote control.
- + Remote ON/OFF
- + Discrete parental lock-out for individual channels.
- + Remote mute.
- + Volume control.
- + Stereo balance.
- Channel UP/Down.
- + Video fine tune.
- + Audio fine tune
- Antenna fine tune.
- Satellite selection.
- Channel selection.
- + Divided into 4 easy-to-read segments: Satellite selection, channel selection, tuning functions, switching functions.



## 9904 Actuator Interface

- + 36V power supply to antenna drive.
- + Surge protected.
- + Voltage spikes protected.
- + Design coordinated with 9900.
- + Can be wall-mounted out of sight.



## 9906/9907 Stereo Loudspeakers

- + Passive or active models.
- + Up to 40 W per channel.
- + 3 elements per side; tweeter, mid-range and woofer.
- + Magnetic shielded.
- + Automatic ON/OFF.
- + LED indicators; standby and active.
- + Complete with line cable feed.



## 9995 Block Satellite Receiver

- + Add-on "slave" to 9900 multiple TV's installations.
- + Can function as a stand-alone block receiver; C-band and Ku-band reception.
- + Manually operated channel selection.
- + Video fine tune. AFC defeat.
- + Built-in V/H switch.
- + Built-in antenna switch for satellite or local reception.
- + Preprogrammed audio frequencies 6.2 and 6.8 MHz.
- + Audio frequency selection 5.0 to 8.0 MHz.
- + Wide/narrow audio bandwidth selection.
- + Raw video output (unclamped, unfiltered) for descrambler connection.
- + External TI filter input.
- + Skew control.
- + Polarizer One control output.
- + Denotes new features available only on 9900 series products.



## Luxor High-Performance Microwave Block Downconverters

Designed and constructed for continuous reliable performance, each Luxor unit is individually inspected and tested against all specification requirements. The Block Downconverter (30 dB gain min.) is used in conjunction with an LNA. The LNB Block Downconverter (60 dB gain min.) is an LNA and a Block Downconverter in one compact package. Each unit is weather-tight, rust-proof and fully warranted.

Luxor Sales And Technical Services  
Throughout America

# 1-(800)245-9995

Canada: Evolution Technology (416) 335 4422  
Mexico: Klan SA 52 83 789 015

## LUXOR®

Luxor (North America) Corp.  
600 108th Ave. N.E., Bellevue, WA 98004



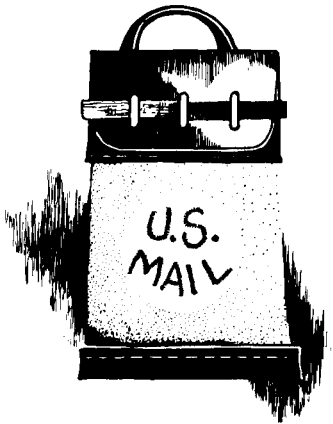

## comments

### new band privileges for Novice operators

Dear HR:

I was amazed and very pleased to see your July *Presstop* item about the proposed upgrading of Novice privileges. I have been a Novice ham operator since 1979 and am pleased to see the prospect of a reward in the form of more privileges being considered for the Novice class license.

I would like to encourage all Novice operators who read *ham radio* to speak out and let their feelings on this subject be known to the ARRL and the FCC. This may be our only chance to assist in changing the long-time rules and regulations regarding our hobby. It may very well be a turning point that will create the interest to save the hobby as we know it.

Allowing the Novice use of phone on 10 meters, 220 MHz, and 23 cm can only help to encourage us to strive for the privileges of the higher grade licenses. CW is an entertaining and rewarding mode of communication, but I believe the Novice license should give more to encourage us to seek out our full potential as operators. A simple pat-on-the-back in the form of a reward would be all it would take for many of us.

Technicians would, of course, benefit from these new privileges also by

allowing phone on 10 meters. I might go even a step further and suggest not only the use of SSB, but even FM for both license grades.

I do not believe for a minute that this rule change would degrade the bands with "glorified CB operators" because the license elements are still sufficiently difficult to discourage such abuse. Besides, that era was just a passing fancy for many.

With today's increasing use of digital communications, the new rules would also allow Novices to utilize the state-of-the-art computer systems to further their knowledge of present-day communications.

All in all, I think it would be foolish to not allow us the opportunity to take part in this ever growing advancement in technology.

**T. Dillingham, KA0DOE**  
Aspen, Colorado

### used equipment for new hams

Dear HR:

Much has been said recently about bringing new blood into the Amateur Radio hobby, and several articles have focused on the wonderful services being provided in the public interest, convenience, or necessity. All of these remarks are laudable, and the two situations can easily go hand-in-hand. Additionally, a few other problems we must each face someday can easily be solved now, while helping with the first two I mentioned: what will become of our equipment when we tire of it, or leave for the land of the silent key? And how can we find replacements for the tax loopholes about the run out of town on the Amtrak rails? (These remarks are addressed to dealers as well as the average ham.)

I suppose we have all seen on the "used" shelf at the few remaining Amateur Radio stores some piece of equipment that could be put to better use in a shack somewhere. Perhaps we have a piece or two in our attic or

garage that we haven't really been using in the recent past, but hesitate to just throw away. Maybe one of our senior citizens has some neat stuff that his or her surviving spouse will have some problem with disposing of in some coming period of distress. One cure would be to put that gear to good use now, getting the tax advantage now, providing a service now, and perhaps helping out some youngster getting started down that primrose path we have each delighted in following.

There are literally thousands of applications for used equipment in each of our hometown areas, and many of them are equally deserving of attention; there is simply no room here to list them all, but a few will get your minds moving in the right direction. Rigs and associated equipment of appurtenances are sorely needed by schools, camps, Courage Handi-hams, Civil Defense, FEMA, DSA, National Weather Service, Fire and Police Departments, and our many clubs with active Novice classes, among countless others. Perhaps your donation of usable and serviceable equipment now will be just what is needed to get new hams on line or to provide that equipment needed by present-day hams to provide that vital service to the public that will keep this hobby active and thriving.

Think about it now, while you can still do something about it, and before the spouse cleans house for you, or a good piece of equipment self-destructs on your shelf!

**Jerry Murphy, K8YUW**  
Lakewood, Ohio

### off and on

I recently saw a 12 VDC to 110 VAC power inverter that was switched on and off on demand by the load, without extra switches or wires.

Do any of your readers have information on how this is done?

**Sam Popkin, K2DNR/7**  
Mesa, Arizona

THE ULTIMATE CONTACT . . .  
MAKE IT WITH **ROBOT**<sup>TM</sup> COLOR SSTV

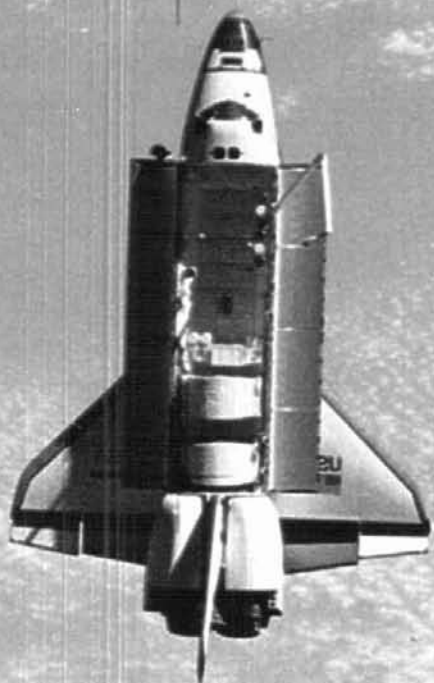

**ROBOT**

ROBOT RESEARCH, INC.  
7591 Convoy Court  
San Diego, California 92111  
Phone (619) 279-9430

Step aboard the Shuttle from your shack with the world's most advanced slow scan video system!

**YES!** Tell me about how I can participate in SSTV aboard the Space Shuttle.

NAME

CALL

ADDRESS

CITY/STATE

ZIP

# passive audio filter design

## part 1: development and analysis

Circuits using miniature preferred-value components are adaptable to printed-circuit boards

A recent article in *ham radio*<sup>1</sup> was the latest of a long series by W3NQN on the subject of elliptic lowpass audio filters suitable for Amateur constructors. It is mainly through the efforts of W3NQN that these filters have remained in the Amateur literature despite the proliferation of designs for active audio filters using operational amplifiers.<sup>2-5</sup>

It is surprising that active filters have become so popular considering the complexity required to equal the performance of passive designs and the disadvantages associated with active elements. They require power, produce noise, have a limited ability to handle large signals and have a limited upper operating frequency unless expensive, high-frequency devices are used. These disadvantages usually don't apply when using a passive circuit containing inductors.

Probably the main reasons for the decline of passive filters are the misunderstandings surrounding the selection of components for them. Some of these misunderstandings can be explained by:

- The lack of published designs using preferred-value inductors and capacitors.
- The belief that highly accurate inductance and capacitance values must be used to obtain acceptable results.
- The belief that only high- $Q$  inductors are suitable for use in filters.
- Ignorance of the fact that ready-wound, standard-value inductors are available easily and inexpensively.
- A general phobia of winding inductors, especially ones with several hundred turns of wire.

W3NQN has avoided these problems by using telephone-line loading coils in his designs. These loading coils are relatively high- $Q$  components. Specialized designs have been developed which make use of the inductance values included in these coils, or by slight modifications to the inductors by removing turns.<sup>6</sup>

In general, the capacitance values required in a passive filter are non-preferred and are obtained either by connecting several preferred value capacitors in parallel or by measuring capacitors and selecting the required value. Designs have been published in which some<sup>7,8</sup> or all<sup>9,10</sup> of the capacitors are preferred value, but these are intended for RF applications in which the non-preferred value inductors are not too difficult to wind and will have a relatively high  $Q$  value.

The question of what effect the inductor  $Q$  has on a filter response does not seem to have been addressed in the United States Amateur literature. Only two references that consider this question could be found,<sup>11,11A</sup> but non-preferred values of capacitance and inductance were used. The results from this investigation were encouraging, with only a slight degradation in the flatness of the passband and rounding in the cut off region of the Butterworth, Chebyshev, and Bessel filters considered.

### objectives

One aim of this series of articles is to describe my investigations into the use of miniature preferred value inductors and capacitors in several types of audio filter. My goal was to use a single, unselected, inexpensive component for each inductance and capacitance value so that passive filter construction (and design, if the reader so wishes) can be simple for even the most inexperienced Amateur. Filters using these components are extremely compact and suitable for construction on printed circuit boards in modern equipment — which, unfortunately, designs using the telephone line loading coils are not.

The investigations were carried out using computer

By Stefan Niewiadomski, 29 MacKinley Avenue, Stapleford, Nottingham, NG9 8HU, England

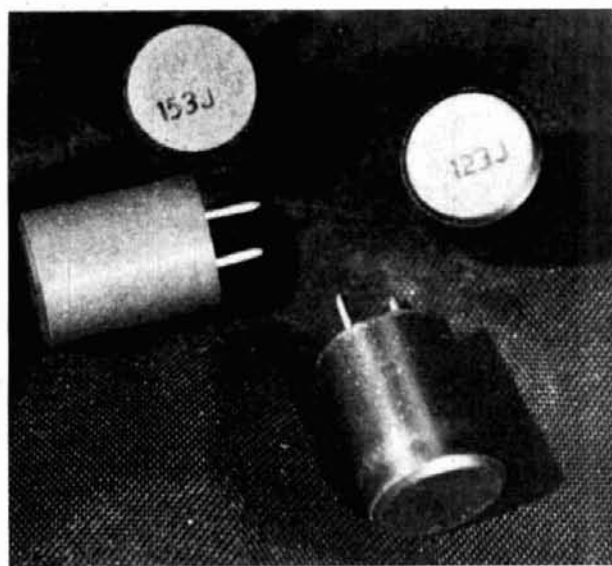

fig. 1. The Toko inductors used in the author's filter studies.

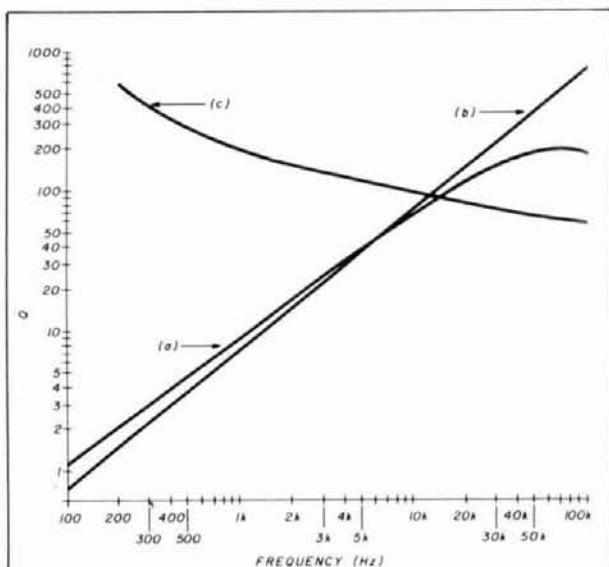

fig. 2. Plot of  $Q$  versus frequency for (a) 22-mH Toko 10RB inductor; (b) ideal 27-mH inductor and 22 ohm resistor; and (c) Siemens 0.22- $\mu$ F capacitor.

simulations and practical tests. The simulations were performed on an Apple II microcomputer, using a BASIC circuit analysis program.<sup>12</sup> Circuit simulation programs that run on several home computers are now available.\*

The major advantage of using circuit simulation in this field is that the effects of altering component values and using low- $Q$  inductors can be isolated from each other and investigated separately. This contrasts with an experimental approach, in which the combined

effects of non-exact component values and low- $Q$  inductors would have to be accepted unless a large number of inductors of various values and  $Q$ s could be wound — which is obviously impractical for the Amateur.

I will also discuss attenuation equalizers and show how these comparatively simple circuits can improve the responses of filters made from low- $Q$  inductors. I believe this is the first time these networks have been described in a practical way in the Amateur literature.

Also discussed in this series of articles are some methods of incorporating an audio filter into an audio path to ensure correct matching of the filter. Other topics tackled are the question of how much passband ripple is acceptable in an audio filter used in an Amateur receiver, and how passband ripple and stopband attenuation can be traded off to produce improved overall performance.

## components

The inductors used in this study are the Toko 10RB range, manufactured from 1 mH to 120 mH with 5 percent tolerance. Another range, the 10RBH, is available from 150 mH to 1500 mH with 10 percent tolerance.<sup>†</sup> These two inductor types have identical case styles. They are cylindrical with a diameter of 10.5 mm and a height of 14 mm (see fig. 1). Leads are radial with a 5-mm pitch, enabling an extremely compact PCB layout.

Examination of a 47-mH inductor after removing its outer ferrite casing revealed a wire size of approximately No. 40 AWG. For most of the 10RB range, the  $Q$  quoted<sup>13</sup> is a minimum of 100 at a test frequency of 50 kHz. The recommended operating frequency range for these coils is from 100 kHz to approximately 170 kHz<sup>14</sup> over which they have a sufficiently high  $Q$  to be considered as almost ideal inductances.

The  $Q$  at audio frequencies is much lower and was measured for a 27-mH coil from 100 Hz to over 100 kHz using a Hewlett Packard 4192A LF Impedance Analyzer. Figure 2 shows the results obtained. At 100 Hz, the  $Q$  is 1.1, rising to about 9 at 1 kHz, 24 at 3 kHz, and more than 50 at 7 kHz. At frequencies above 80 kHz, the  $Q$  begins to tail off, as the maximum operating frequency of the ferrite is approached and skin effects in the wire become appreciable.

Also shown in fig. 2 is a plot of the  $Q$  of an ideal inductor of 27 mH with a 22-ohm resistor in series, which is the quoted DC resistance of the 27-mH Toko inductor. This model seems to be accurate at about

\*One available in the UK is sold by Number One Systems, 9A Crown Street, St. Ives, Huntingdon, Cambs, England. Versions are available for the BBC model B and Sinclair Spectrum 48K computers.

†To order, contact Toko America, Inc., 1250 Feehanville Drive, Mt. Prospect, Illinois 60056 (312 297-0070).

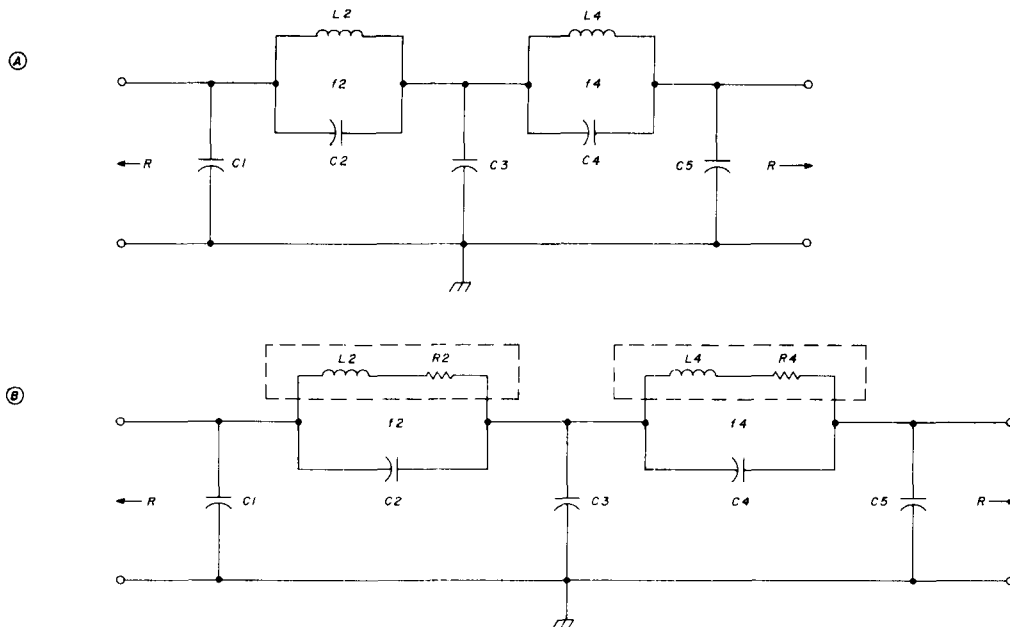

fig. 3. Elliptic 5-branch low-pass filter. (A) Schematic of filter with ideal inductors, and (B) schematic of filter with real inductors.

6 kHz, giving worse results below 6 kHz and better results above 6 kHz.

Ideally, to accurately model these inductors, a plot of  $Q$  versus frequency should be obtained for each value of inductor and the series resistance determined which most closely follows this plot. For the simulations presented here, the inductors were modeled with a series resistor equal to the manufacturer's quoted DC resistance, considering that this will give slightly worse results than in practice.

The DC current flowing through these coils, particularly in the 10RBH range, should be kept to a minimum to avoid heating and core saturation. In fact, to be completely safe, it is better to keep the DC current at zero. In most applications, this is achieved by inserting a DC blocking capacitor in series with the input of the filter in which the inductors are used when there is a direct DC path to a potential different from the input source. This also has the advantage of obviating the danger of interaction between the DC conditions of the driving and terminating circuits. In most applications a capacitor of 100  $\mu\text{F}$  will avoid modifying the response of a filter, but the value can be chosen to have beneficial effects, which will be discussed later.

There are many types of capacitors suitable for use in audio filters. The ones I prefer are the Siemens B32560/1/2 metalized polyester layer type, which are available in a wide range of values and are very compact for their capacitance\*. The variation of  $Q$  with

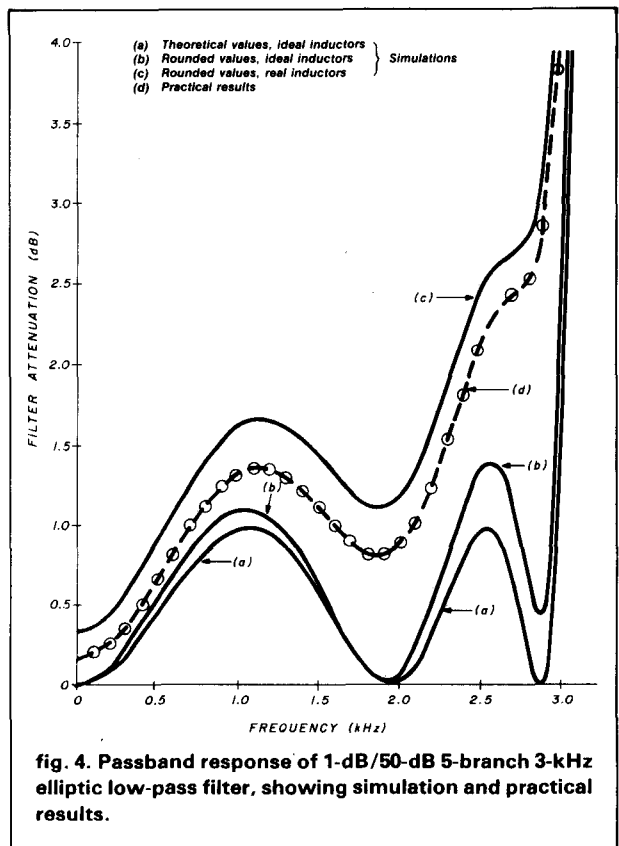

fig. 4. Passband response of 1-dB/50-dB 5-branch 3-kHz elliptic low-pass filter, showing simulation and practical results.

\*Panasonic capacitors, available from Digi-Key Corp., P.O. Box 677, Thief River Falls, Minnesota 56701, (1-800-344-4539) may be substituted. —Ed.

# TIME FOR AN AEA BREAKTHROUGH

The high quality of AEA products is appreciated long after the price paid is forgotten.

**No Antenna  
No Radio  
No TV!**



**DOCTOR DX™**

**\$99.95**

## THE FANTASTIC DOCTOR DX™ CW Band Simulation That Is So Real You Won't Believe It!

- Will improve the operating skills of ANY CW operator!
- More fun than ANY Morse Code trainer yet devised.
- Use with a C-64, TV set, and key (or keyer).
- Experience the thrill of a "DXpedition" to anywhere in the world.
- Operate anytime you want, ideal for travelers.
- Impressive award certificates available for verified performance.
- On-going contests: 8-hour sprint and 24-hour marathon.

## HOT ROD™

½ Wave Telescope Antenna **\$24.95\***

- Fewer telescopic sections than any ½ wave whips.
- Shorter and lighter than all ¼ wave whips
- Better performance than a ¼ wave whip when mounted on a handle talkie.
- Special matching network designed by Professor D.K. Reynolds (co-inventor of Isopole™ antenna).

- Most gain attainable for length of antenna—3 dBd (0 dBd for JR models).
- Best decoupling of any commercial VHF base station antenna available.
- More gain than many antennas claiming up to 7 dB gain—don't be fooled by misleading claims!
- Zero degree angle of radiation.
- Factory-tuned matching network.
- Greater bandwidth than any competitive product.
- DC grounded for static discharge protection.
- Documented cases of wind survival in 140+ mph hurricanes.
- Easier than any competitive antenna to assemble.

**Mast  
Not  
Included**

ISO = 144 or 220—\$49.95

ISO = 440—\$69.95

## ISOPOLE ANTENNA™



## CP-1 **\$239.95\*** Computer Patch™ Interface

- Better performance than any competitive product
- Dual channel filtering with auto threshold correction
- Variable shift
- 117 VAC power supply included



## DOCTOR QSO™ **\$79.95** Morse Code Trainer

- Makes Morse Training Fun, Fun, Fun!!!
- Plug-in Cartridge For C-64 Computer
- Simulates Real Morse Ragchews
- Can Operate With Only C-64 and TV Set



## PKT-1 Packet Controller **\$499.95**

- Multitasking - Can receive information from the keyboard and off the air at the same time.
- Uses TAPR circuitry and firmware.
- Senses squelch to detect busy channel.
- Send computer files error free.
- Data detect (DCD) for HF operation.
- Digital radio communications for computer to computer.
- Every PKT-1 is a digipeater
- Operates from 9-15 VDC

## GET YOUR FIRST HAM RADIO LICENSE, OR INCREASE YOUR CODE SPEED SO YOU MAY UPGRADE!



+



## AMATEUR RADIO STARTER KIT **\$39.95**

- Includes Morse University™, Morse code training software.
- Morse training routine teach you the Morse code a character at a time.
- Proficiency routine helps you increase code speed, and upgrade your license class.
- Receiving audio/video game gives you code practice under pressure.
- Sending analysis routine helps you improve your sending ability.

- Keyboard input allows you to compose your own code practice sessions.
- More complete than any Morse code trainer now available.
- Includes the ARRL book "Tune in the World" to help you get your first license.
- Club and license information for your area.
- Use with a C-64 (or C-128) & T.V. set.

## NEW! MP-1 MICROPATCH™ **\$159.95\***



- Morse/Baudot/ASCII/AMTOR
- Use any AEA software
- Compact and Economical
- Operates from 12-16 VDC.

## NEW! ATU-1000 ADVANCED TERMINAL UNIT



**\$1195**

- World's most advanced terminal unit/computer interface
- 32 poles, active filtering
- Set filters & AFSK tones to one Hertz
- TTL, RS-232, loop keyer incl

## NEW! CP-100 COMPUTER PATCH™ **\$369.95\***



- 170/425/850 or variable shift
- Front-panel squelch
- Built-in monitor speaker
- Discriminator-style tuning for AMTOR

## Unmatched Software For C-64 And VIC-20 Computers

**MBA-TOR™**—The most advanced software written for Morse-Baudot/ASCII/AMTOR including mail drop.  
**MARSTEXT™**—A special Morse-Baudot/ASCII package written especially for MARS and other traffic operators.  
**SWLTEXT™**—The most sophisticated software available for the shortwave listening enthusiast. Automatic data analysis. Morse, Baudot, ASCII, AMTOR, and SITOR.

**AEA also offers Morse, Baudot, and ASCII software for the following computers: Apple II, II+, IIe; IBM-PC.**

\*Retail Prices

## MIDWEST AMATEUR RADIO SUPPLY

3456 Fremont Avenue, North  
Minneapolis, MN 55412

Store Hours: Mon.-Fri. 9-6, Saturday 9-3

For service call: (612) 521-4662

For orders call: 1-800-328-6365

**AEA**

**Brings you the  
Breakthrough!**

frequency of a 0.22 $\mu$ F B32560 capacitor is also shown in **fig. 2**. This capacitor maintains a  $Q$  of more than 100 at frequencies up to 10 kHz and can be accurately modeled as a pure capacitance at audio frequencies. These capacitors can be obtained with a 5-percent tolerance and 7.5-mm lead pitch. These are used here.

### low-pass filters

The most popular filter for audio low-pass applications is the elliptic or Cauer filter, named for the German network theorist who developed the mathematics associated with its characteristics. An excellent introduction to elliptic filters is given in reference 15, but many of W3NQN's articles include descriptions of the terminology of these filters and their fundamental characteristics. A brief resume of these points is given in the **Appendix**.

The first design considered here is the five-branch low-pass whose circuit is shown in **fig. 3**. **Figure 3A** shows ideal inductors and **fig. 3B** shows a resistor in series with each inductor to simulate their losses. The specification for this filter is:

passband ripple ( $A_p$ )	1dB
stopband minimum attenuation ( $A_s$ )	50 dB
ripple cutoff frequency ( $f_{A_p}$ )	3000 Hz

start of stopband frequency ( $f_{A_s}$ )	4221 Hz
source impedance	500 ohms
load impedance	500 ohms

From now on, I will refer to this filter as the 1-dB/50-dB filter, indicating its passband ripple and minimum stopband attenuation; this terminology will also be used for the other low-pass filters described later.

**Table 1** shows the component values for the 1-ohm, 1-rad/sec prototype,<sup>16</sup> the exact values for the filter scaled to 500 ohms and 3 kHz, and the rounded values both with and without resistors to simulate the lossy real inductors. Each capacitor and inductor has simply been rounded to its nearest E12 series preferred value.\*

The simulation and practical results for this filter are shown in **figs. 4, 5, and 6**. Three sets of graphs have been plotted so that the axes for each set can be chosen to show the maximum detail in the passband,

\*Capacitors are commercially available in several series of preferred values, two of which have designations of E12 (with a 10 percent tolerance) and E24 (with a 5 percent tolerance), (16A). The reciprocal of the E-number is the power to which 10 is raised to give the step multiplier for that particular series. For example, for the E12 series, the step multiplier is  $10^{(1/12)}$  or  $10^{0.083333} = 1.2115$ . The sequence of the series is therefore 10,  $10 \cdot 1.2115 = 12$ ,  $12 \cdot 1.2115 = 15$ ,  $15 \cdot 1.2115 = 18$ ,  $18 \cdot 1.2115 = 22$ ,  $22 \cdot 1.2115 = 27$ , etc. — Ed.

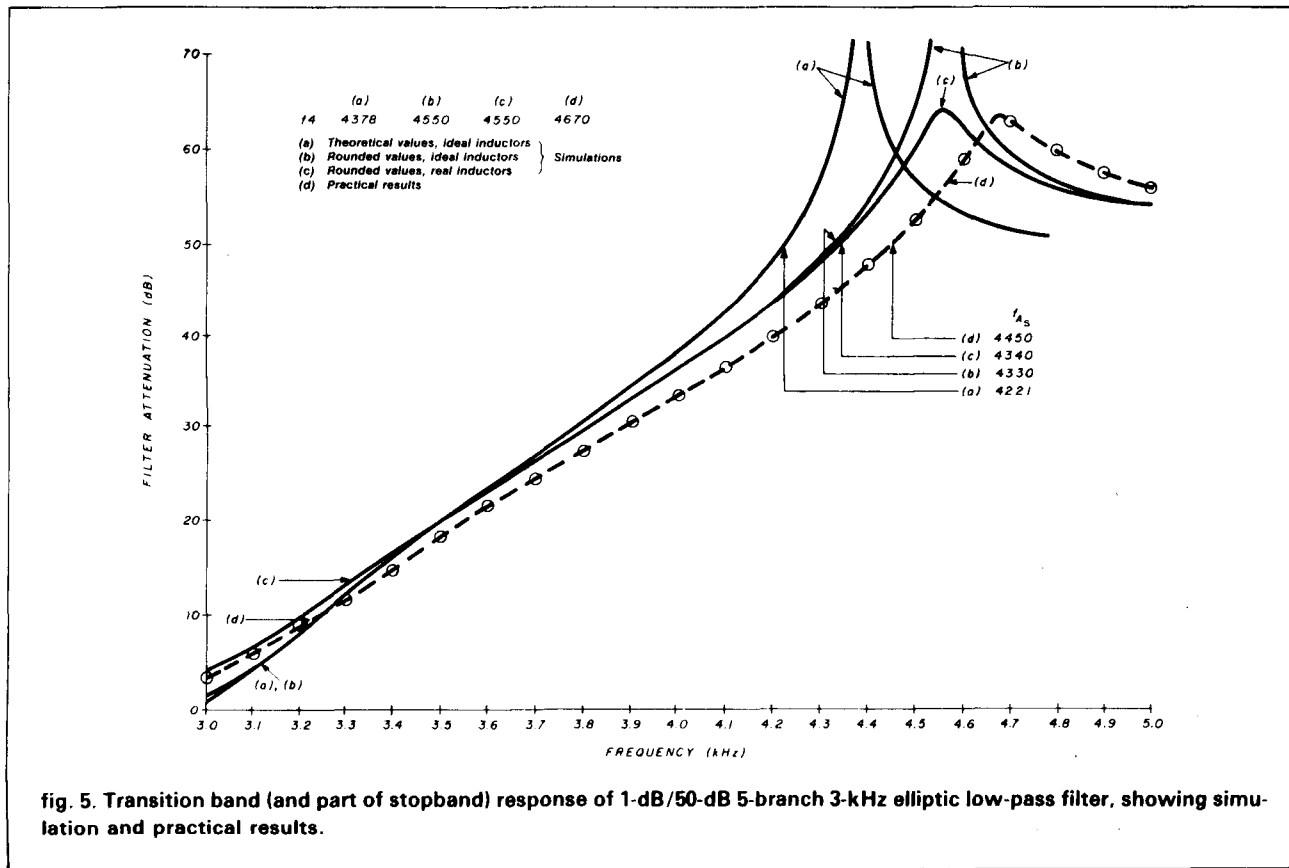

**fig. 5.** Transition band (and part of stopband) response of 1-dB/50-dB 5-branch 3-kHz elliptic low-pass filter, showing simulation and practical results.

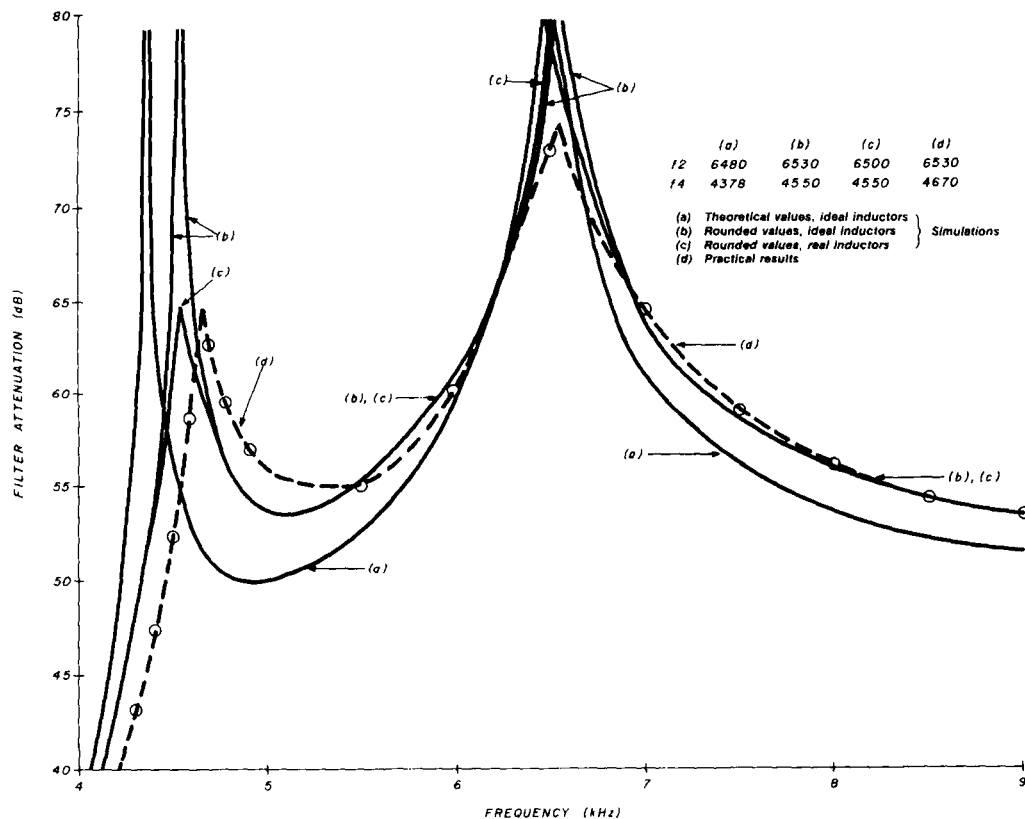

fig. 6. Stopband response of 1-dB/50-dB 5-branch 3-kHz elliptic low-pass filter, showing simulation and practical results.

transition band and stopband. I have used the term "transition band" to describe the response between the ripple cutoff frequency ( $f_{Ap}$ ) and the start of stopband frequency ( $f_{As}$ ). Many authors include this region in the stopband, but it was convenient for me to divide the total response into three regions, and the middle region seems most appropriately to be described as the transition band.

Curve *a* on figs. 4, 5, and 6 is the simulated response of the filter with theoretical values and ideal inductors (table 1, column 2). The response meets the 1-dB passband ripple ( $A_p$ ), 3-kHz ripple cutoff frequency ( $f_{As}$ ), 4221-Hz start of stopband frequency ( $f_{As}$ ) and 50-dB minimum stopband attenuation ( $A_s$ ) specifications. The calculations carried out to scale the 1-ohm, 1-rad/sec values (table 1, column 1) to 500 ohms, 3 kHz (table 1, column 2) are therefore correct. The frequencies of infinite attenuation in the stopband,  $f_2$  and  $f_4$ , are 6480 Hz and 4378 Hz. These are the resonant frequencies of the parallel tuned circuits L2/C2 and L4/C4 respectively.

Curve *b* in figs. 4, 5, and 6 is the simulated response of the filter with rounded values (table 1, column 3). The passband ripple has increased, but by less than

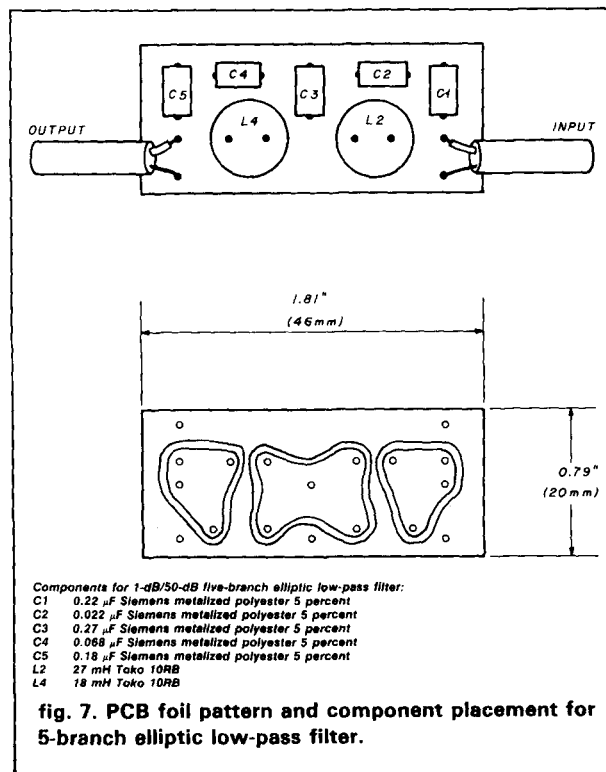



table 1. Component values of 1-dB/50-dB five-branch elliptic low-pass filter. 500 ohm, 3-kHz values obtained by multiplying 1 ohm, 1 rad/sec values by  $1.061 \times 10^{-7}$  for capacitors and  $2.653 \times 10^{-2}$  for inductors.

component	column 1 1 ohm, 1 rad/sec value	column 2 500 ohm, 3 kHz theoretical value, ideal inductors	column 3 500 ohm, 3 kHz rounded value, ideal inductors	column 4 500 ohm, 3 kHz rounded value, real inductors
C1	1.933 F	0.2051 $\mu$ F	0.22 $\mu$ F	0.22 $\mu$ F
C2	0.223 F	0.0237 $\mu$ F	0.022 $\mu$ F	0.022 $\mu$ F
C3	2.392 F	0.2538 $\mu$ F	0.27 $\mu$ F	0.27 $\mu$ F
C4	0.626 F	0.0664 $\mu$ F	0.068 $\mu$ F	0.068 $\mu$ F
C5	1.635 F	0.1735 $\mu$ F	0.18 $\mu$ F	0.18 $\mu$ F
L2	0.963 H	25.5 mH	27 mH	27 mH
L4	0.750 H	19.9 mH	18 mH	18 mH
R2	—	0 ohms	0 ohms	22 ohms
R4	—	0 ohms	0 ohms	17 ohms

0.5 dB; there has also been a slight decrease in the ripple cutoff frequency. In the transition band, close agreement with the unrounded value response is found. The frequency at which the stopband minimum attenuation is first achieved ( $f_{As}$ ) is now 4330 Hz rather than the original 4221 Hz. The frequencies of infinite attenuation are now 6530 Hz and 4550 Hz, reflecting the change in resonant frequencies of L2/C2 and L4/C4 because of their value changes. One interesting result of the component changes is that the minimum stopband attenuation is now approximately 53 dB, rather than 50 dB. Though not shown in fig. 6, this value is maintained beyond 10 kHz. This increase in stopband attenuation seems to be a result of the increase in passband ripple, since these two parameters can be traded off at the design stage.

Curve *c* in figs. 4, 5, and 6 is the simulated response of the filter with rounded values and real inductors (table 1, column 4). The filter now exhibits non-zero insertion-loss at all frequencies (having a value of about 0.3 dB at 100 Hz) and increased passband ripple. Other effects of the low-*Q* inductors are the smoothing of the final passband ripple and a gradual, rather than a sharp, transition from the passband into the transition band. The frequencies of high attenuation in the stopband are the same as those of the rounded values, ideal inductors' response (curve *b*), but the attenuations are no longer infinite. They are approximately 63 dB at 4550 Hz and 78 dB at 6530 Hz. The minimum stopband attenuation is similar to that shown by curve *b*, being approximately 53 dB.

Curve *d* in figs. 4, 5, and 6 shows the measured response obtained from the real filter constructed with the values of table 1, column 4. These results were obtained using a Hewlett Packard 3585A Spectrum Analyzer, which enables filter response measurements to be made very easily. Curve *d* shows close agreement with curve *c*, indicating that the simulation

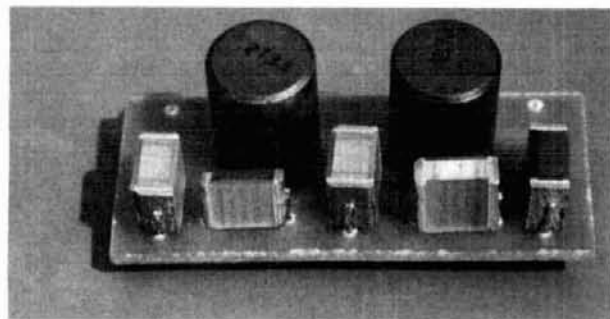

fig. 8. Experimental five-branch elliptic low-pass filter.

method was largely valid. The passband response is slightly better than simulations indicated, probably because the inductors have a higher *Q* than the simple simulation model produces. (Remember, this was seen from the measured *Q* values plotted in fig. 2.) Differences in the transition band and stopband response are probably because of the real components having values slightly different from their nominal values. The value of high attenuation attained by the practical filter at 4670 Hz is similar to that of the simulated filter (approximately 63 dB), but is approximately 5 dB less than the simulated filter at 6530 Hz. Minimum attenuation in the stopband is still a healthy 53 dB. This attenuation has been measured beyond 10 kHz, and remains at greater than 50 dB to more than 30 MHz.

Before I comment on the significance of the changes in performance between the theoretical and the final, practical filter, I would like to show the method used to construct this filter and the results obtained from a more complex low-pass design.

Figure 7 shows the PCB foil pattern and component layout used for this practical filter. The layout follows the schematic of the filter, with the output as far from the input as possible. A good ground plane

# GLB PACKET RADIO CONTROLLER

Now you can get in on the fun in packet radio! Digital communications is the wave of the future, for handling all kinds of data such as text, graphics, computer programs, data bases, telemetry and even voice or video.

"Packet" radio is a means of sending digital data via radio, and a packet network is operated by means of computers. A packet controller is a computer by itself, dedicated to the purpose of operating the packet station.

- \* Ready to operate - wired and tested - Low Cost.
- \* Operates with Voice Transceivers.
- \* Easy to learn, easy to operate.
- \* Built in Packet Modem and CW identification.
- \* Use with a computer, terminal or Teletype Machine
- \* Terminal Code is ASCII or BAUDOT.
- \* Terminal Speeds from 45 to 9600 Baud.
- \* Radio Link Speeds of 300, 600 or 1200 Baud.
- \* Automatically selects AX.25 or VADC protocol.
- \* Remote Command Lockout for repeater control.
- \* Full 8-digipeater operation in AX.25.
- \* Over 90 Commands.
- \* Stores received messages for delayed reading.
- \* Able to display other calls while connected.
- \* "Block" and "Transparent" modes for data files.
- \* Operates as an unattended digipeater.
- \* "Beacon" mode.
- \* Signals available for Teletype Motor Control.
- \* Standard memory is 4K, expandable to 14K.
- \* 48K RAM available on special order.
- \* Can be customized for LAN's.
- \* Squelch input for sharing of voice channels.
- \* Call sign, SSID, & VADC # programmed in ROM.



## SPECIAL PACKAGE DEAL!!!

Amateurs Only

Includes PK1 installed in cabinet w/cable set & pwr. supply

**\$229.95**

(if purchased separately \$241.85)

Simple to install, requiring only a 12V DC supply and connections to receiver audio, transmitter audio and transmitter keying. Connections to the host computer or terminal is via an RS232 cable. An adapter board is available to allow the use of a Teletype machine as the terminal, and includes signals for motor control.

Computer software can range from simple "dumb" terminal programs to sophisticated programs such as our "CPK" - a program that mediates automatic disk file transfers, off-line editing, printer controls and much more. "CPK" runs on virtually any CP/M-based computer system.

Power requirement: 12 Volts DC @ 200 ma.

Dimensions: 4.5 X 9.5 X 1.5 (inches) subassembly  
2.3 X 11 X 5 (inches) cabinet

PK1 - FCC CERTIFIED - wired and tested in cabinet	\$209.95
PK1S - Subassembly board (wired and tested)	\$164.95
PKM2K - 2K Additional memory, installed and tested	\$ 10.00/2k
PKDOC - Documentation only, refundable on first PK1 purchase	\$ 9.95
PKCBL - 4-ft. cable set (DB-25 - 10 pin; uncommitted - 10 pin)	\$ 21.95
PKCNT - 10 pin edge connector only (2 required)	\$ 2.95
PKPWR - Power supply (115V input)	\$ 9.95
PKCAB - Cabinet kit	\$ 39.95
PKTTY - Teletype adapter (Teletype machine as terminal)	\$ 17.95
PKWD1 - WATCHDOG assembly (for unattended repeater use)	\$ 17.95
PKLA1 - Level Converter (converts PK1 RS232 to +/- Voltages)	\$ 21.95
PKCPK - CPK Program (specify disk size, format, and computer)	\$ 34.95
PKSMX - Addl. RAM socket (specify 24 or 28 pin)	\$ 2.00
PK48 - Modification for 48K w/28 pin sockets (less RAM)	\$ 29.95

Please specify Call Sign, SSID Number, and Node Number when ordering.

MODEL  
PK1S

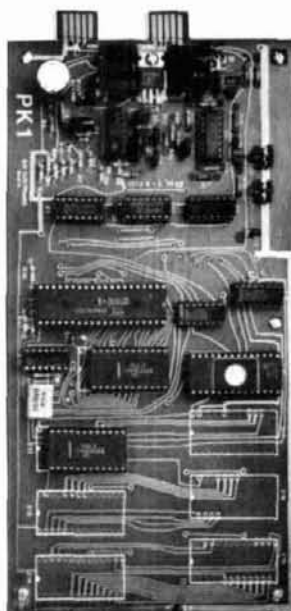

286

# GLB ELECTRONICS, INC.

151 Commerce Pkwy.,  
Buffalo, NY 14224  
716-675-6740 9 to 4

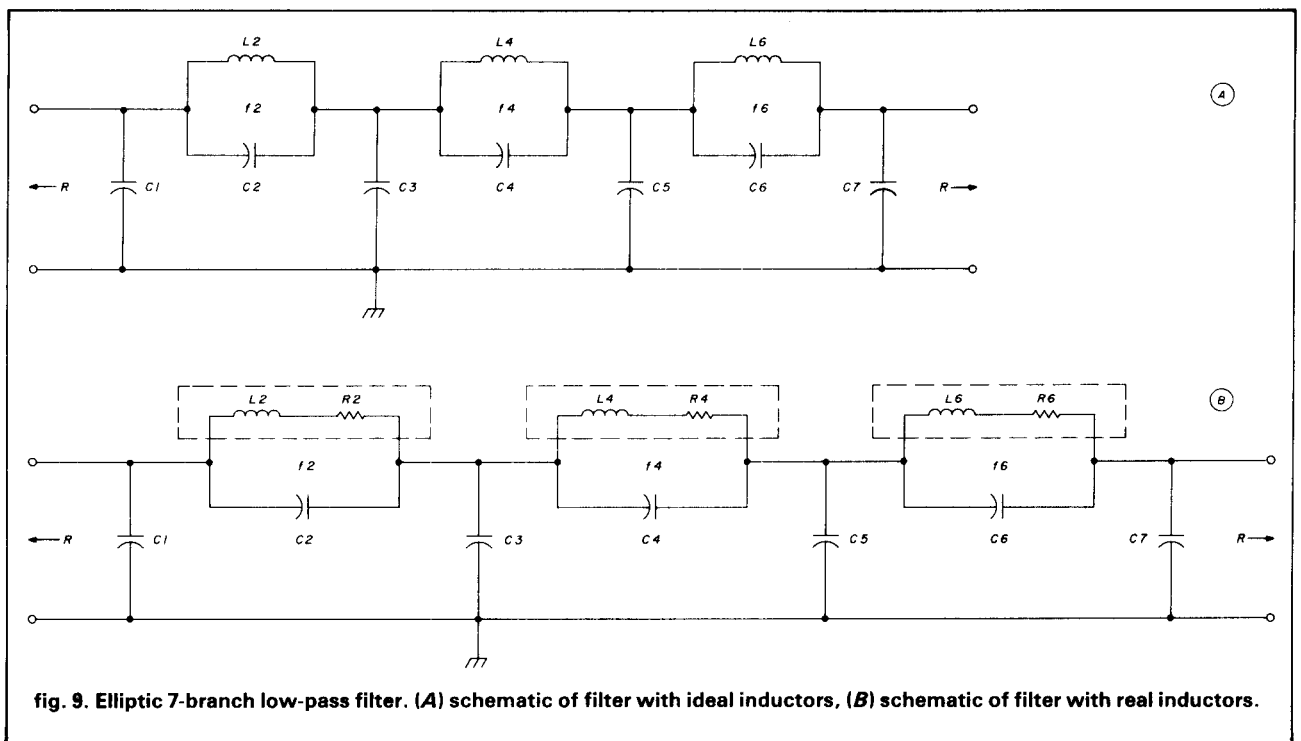

fig. 9. Elliptic 7-branch low-pass filter. (A) schematic of filter with ideal inductors, (B) schematic of filter with real inductors.

is maintained by etching away only the minimum amount of copper possible. The small amount of extra capacitance between each circuit node and ground is insignificant when compared with the capacitors. The ground plane gives low-impedance ground return paths and helps isolate the output from the input. If required, the filter can be made even more compact than my layout indicates. The ferrite caps over the Toko coils are such that they can be positioned very close to each other without any coupling effects. Stripboard can also be used for construction without any drastic effects on performance. Figure 8 shows a photograph of this filter.

Figure 9 shows the schematics for a seven-branch elliptic low-pass filter, with and without the resistors to simulate the real inductors. The specification for this filter is:

passband ripple ( $A_p$ )	0.18 dB
stopband minimum attenuation ( $A_s$ )	50.1 dB
ripple cutoff frequency ( $f_{Ap}$ )	3000 Hz
start of stopband frequency ( $f_{As}$ )	3500 Hz
source impedance	500 ohms
load impedance	500 ohms

Table 2 shows the component values for the 1-ohm, 1-rad/sec prototype;<sup>17</sup> the exact values scaled to 500 ohms, 3 kHz; and the rounded values both with and without resistors to simulate the lossy real inductors. Again, each component has been rounded to the nearest E12 preferred value. Note that in the case of C4 and L4, both have been rounded downward, so we

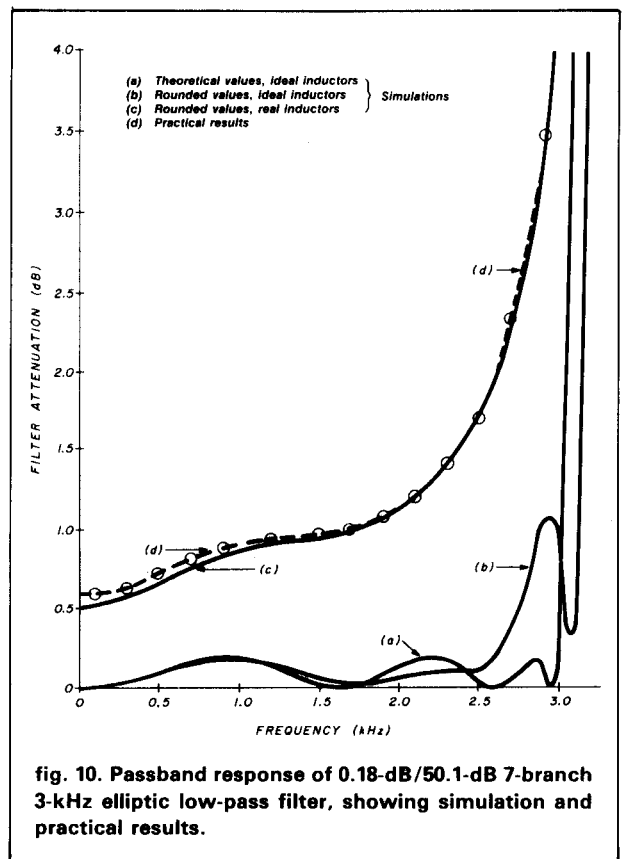

fig. 10. Passband response of 0.18-dB/50.1-dB 7-branch 3-kHz elliptic low-pass filter, showing simulation and practical results.

should expect a larger than average shift in the  $f_4$  frequency. If the peaks in stopband attenuation are being used in a particular application to obtain more than

the minimum stopband attenuation at particular frequencies, then it is best to round the tuned circuit elements in the filter in opposite directions. The frequencies of these peaks can be placed accurately by rounding only the inductor values and then selecting

or paralleling capacitors to obtain the desired resonances.

The simulation and practical results for this filter are shown in **figs. 10, 11, and 12**. I will not describe the responses in as much detail as for the 1-dB/50-dB low-

**table 2.** Component values of 0.18-dB/50.1-dB seven-branch elliptic low-pass filter. 500 ohm, 3-kHz values obtained by multiplying 1 ohm, 1 rad/sec values by  $1.061 \times 10^{-7}$  for capacitors and  $2.653 \times 10^{-2}$  for inductors.

component	column 1 1 ohm, 1 rad/sec value	column 2 500 ohm, 3 kHz theoretical value, ideal inductors	column 3 500 ohm, 3 kHz rounded value, ideal inductors	column 4 500 ohm, 3 kHz rounded value, real inductors
C1	1.183 F	0.1255 $\mu$ F	0.12 $\mu$ F	0.12 $\mu$ F
C2	0.1853 F	0.0197 $\mu$ F	0.018 $\mu$ F	0.018 $\mu$ F
C3	1.535 F	0.1629 $\mu$ F	0.15 $\mu$ F	0.15 $\mu$ F
C4	0.9576 F	0.1016 $\mu$ F	0.1 $\mu$ F	0.1 $\mu$ F
C5	1.307 F	0.1387 $\mu$ F	0.15 $\mu$ F	0.15 $\mu$ F
C6	0.6755 F	0.0717 $\mu$ F	0.068 $\mu$ F	0.068 $\mu$ F
C7	0.8543 F	0.0906 $\mu$ F	0.082 $\mu$ F	0.082 $\mu$ F
L2	1.203 H	31.92 mH	33 mH	33 mH
L4	0.7482 H	19.85 mH	18 mH	18 mH
L6	0.8217 H	21.80 mH	22 mH	22 mH
R2	—	0 ohms	0 ohms	26 ohms
R4	—	0 ohms	0 ohms	17 ohms
R6	—	0 ohms	0 ohms	19 ohms

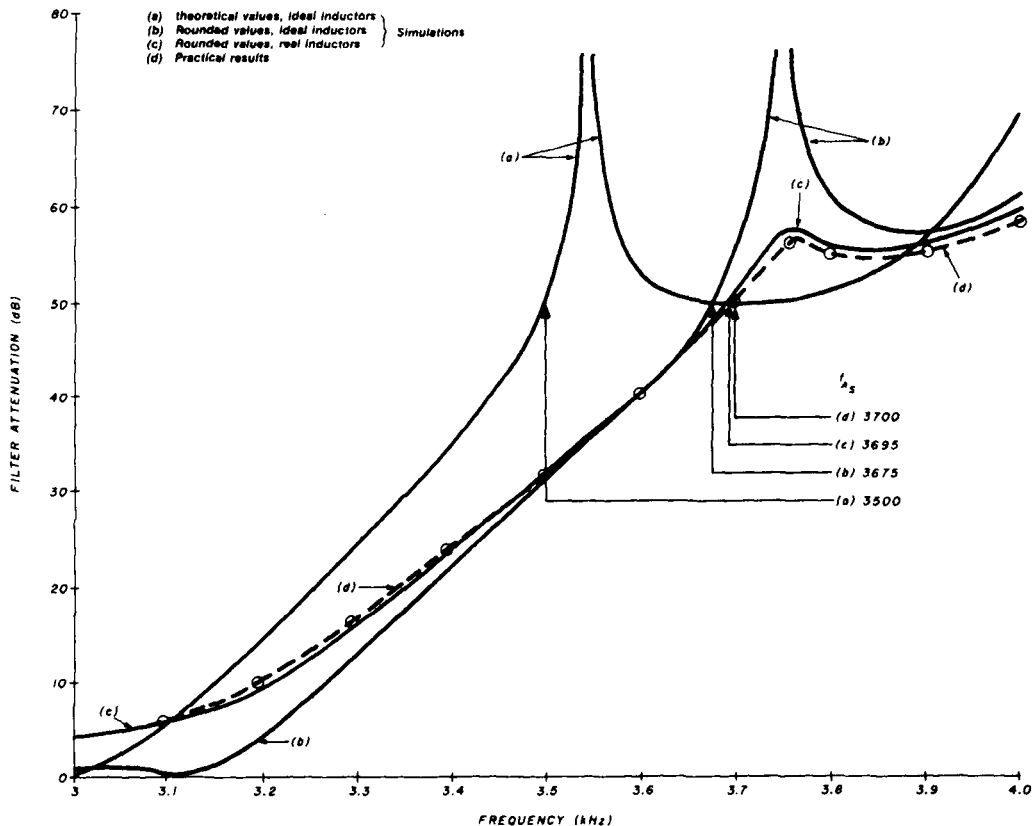

**fig. 11.** Transition band (and part of stopband) response of 0.18-dB/50.1-dB 7-branch 3-kHz elliptic low-pass filter, showing simulation and practical results.

pass filter; the graphs speak for themselves. The scaled, theoretical value response meets the filter specification exactly. As before, the rounded values, ideal inductor response is very similar to that of the theoretical values apart from an increase in pass-

band ripple (especially close to the cutoff frequency), a shift in the  $f_2$  frequency from 3500 Hz to 3751 Hz, and a corresponding shift in the initial 50.1-dB attenuation frequency ( $f_{A_5}$ ). The minimum stopband attenuation is approximately 52 dB.

table 3. Component values of 0.18-dB/81-dB seven-branch elliptic low-pass filter. 500-ohm, 3-kHz values obtained by multiplying 1 ohm, 1 rad/sec values by  $1.061 \times 10^{-7}$  for capacitors and  $2.653 \times 10^{-2}$  for inductors.

component	column 1 1 ohm 1 rad/sec value	column 2 500 ohm, 3 kHz theoretical value, ideal inductors	column 3 500 ohm, 3 kHz rounded value, real inductors
C1	1.280 F	0.1358 $\mu$ F	0.15 $\mu$ F
C2	0.065 F	0.0690 $\mu$ F	0.0068 $\mu$ F
C3	1.943 F	0.2062 $\mu$ F	0.22 $\mu$ F
C4	0.3079 F	0.0327 $\mu$ F	0.033 $\mu$ F
C5	1.837 F	0.1949 $\mu$ F	0.18 $\mu$ F
C6	0.2183 F	0.0232 $\mu$ F	0.022 $\mu$ F
C7	1.145 F	0.1215 $\mu$ F	0.12 $\mu$ F
L2	1.321 H	35.05 mH	33 mH
L4	1.183 H	31.38 mH	33 mH
L6	1.157 H	30.70 mH	33 mH
R2	—	0 ohms	26 ohms
R4	—	0 ohms	26 ohms
R6	—	0 ohms	26 ohms

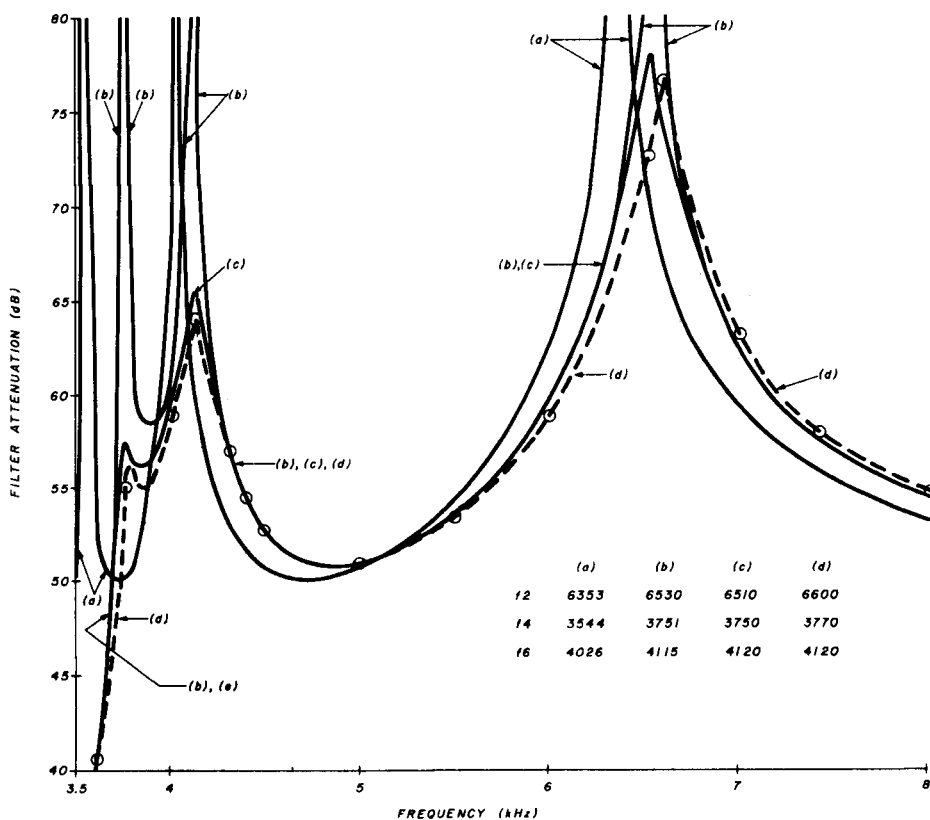

fig. 12. Stopband response of 0.18-dB/50.1-dB 7-branch 3-kHz elliptic low-pass filter, showing simulation and practical results.

# EXTRA TERRESTRIAL INVASION

---

NO, NOT BUG-EYED MONSTERS. NOT CUDDLY LITTLE EXTRA TERRESTRIAL CASTAWAYS, EITHER. WE MEAN EXTRA TERRESTRIAL RELAY TOWERS. LOTS OF EXTRA ONES. GOVERNMENT SOURCES PREDICT A 60-80% INCREASE IN LAND BASED USAGE OF THE 3.7 TO 4.2 GHz OVER THE NEXT TWO YEARS. JUST ONE NEW RELAY TOWER IN YOUR AREA CAN MEAN HUNDREDS OF CUSTOMERS WHOSE SYSTEMS ARE AFFECTED. WHO DO THEY TURN TO FOR HELP? YOU, THAT'S WHO. YOU CAN BE READY TO MEET (AND PROFIT FROM) THE CHALLENGE BY ARMING YOURSELF NOW WITH INFORMATION ON THE LATEST IN TEST EQUIPMENT AND FILTERING PRODUCTS FROM THE LEADERS IN THE BATTLE AGAINST T.I.

FOR INFORMATION, CONTACT YOUR DISTRIBUTOR OR:

The logo for Phantom, featuring the word "PHANTOM" in a bold, sans-serif font. The letters are contained within a thick horizontal bar. A stylized, swirling line graphic loops around the bar, starting from the left, passing behind the bar, and ending on the right side.

**PHANTOM**

16840 JOLEEN WAY, BLDG. E.  
MORGAN HILL, CA 95037  
(408) 779-1616

"THE BREAKTHROUGH SPECIALISTS"

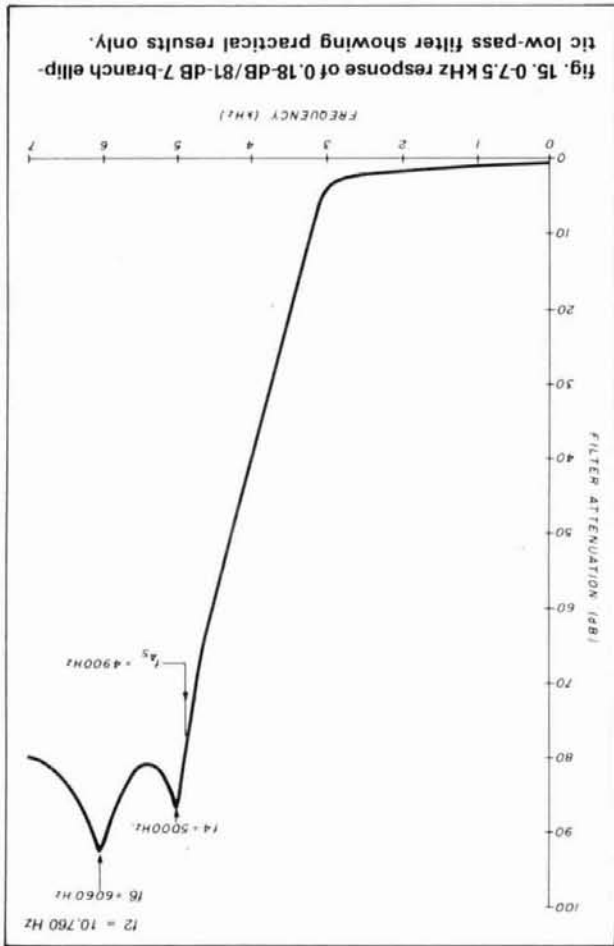

To answer this question, a 0.18-dB passband ripple, 81-dB minimum stopband attenuation seven-branch elliptic low-pass filter was selected<sup>18</sup> and scaled to 500 ohms, 3 kHz. Table 3 shows the component values for this filter. The expected start of stop-band frequency ( $f_{AS}$ ) is 4872 Hz, corresponding to a

tion peak is considered. Can, therefore, filters with high stopband attenuation be constructed with these inductors?

Fig. 14. Experimental seven-branch elliptic low-pass filter.

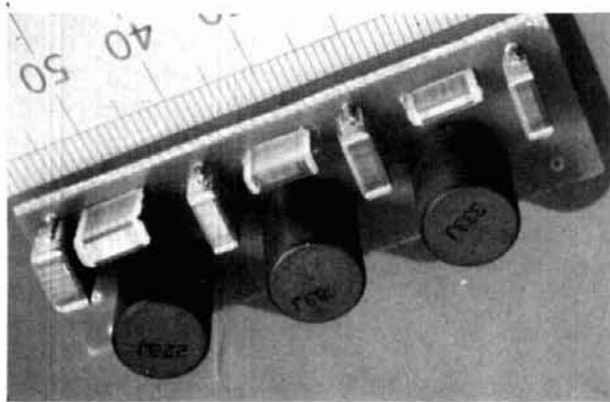

The two low-pass filters considered so far were specified to have a minimum stopband attenuation of 50 dB and achieved that figure. In theory, at the points of maximum attenuation in the stopband, these filters should have infinite attenuation, but the finite  $Q$  of the inductors causes this attenuation to be reduced to typically 55-75 dB, depending on which attenua-

### low-pass filters high stopband attenuation

filter can be made considerably smaller. photograph of my prototype. Again, if required, this next layout used for this filter, and fig. 14 is a Figure 13 shows the PCB foil pattern and component layout used for this filter, and fig. 14 is a photograph of my prototype. Again, if required, this filter can be made considerably smaller. The two low-pass filters considered so far were specified to have a minimum stopband attenuation of 50 dB and achieved that figure. In theory, at the points of maximum attenuation in the stopband, these filters should have infinite attenuation, but the finite  $Q$  of the inductors causes this attenuation to be reduced to typically 55-75 dB, depending on which attenua-

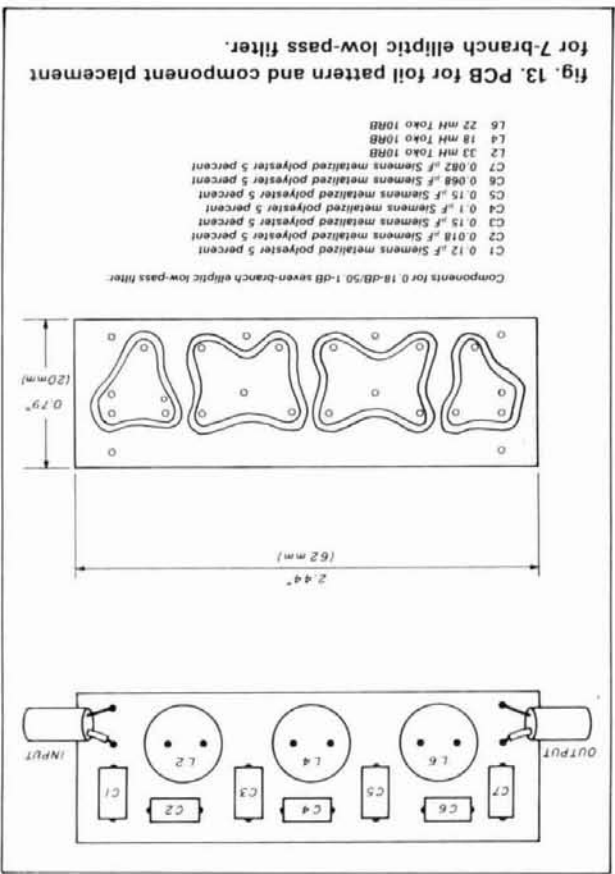

Fig. 14. Experimental seven-branch elliptic low-pass filter.

normalized start of stopband *angular* frequency of 1.624 radians/second.

Detailed simulation results for this filter are not given here and I have only shown the practical results when the layout of **fig. 13** was used. These results are shown in **fig. 15**.

As we expected, the actual passband response has greater ripple (exceeds the 0.18 dB theoretical value) and has rounded corners. The insertion loss at 100 Hz is approximately 0.4 dB. Stopband attenuation shows a minimum of approximately 80 dB above the measured ( $f_{A_s}$ ) of 4900 Hz. The two maxima of stopband attenuation below 10 kHz occur at approximately 5000 Hz and 6060 Hz, with values of 86 and 92 dB respectively. A further maximum of 93 dB occurs at 10,760 Hz.

This example shows that despite the use of low- $Q$  inductors, high stopband attenuation can still be obtained if required in a particular application.

### references

1. Ed Wetherhold, W3NQN, "Elliptic Lowpass Audio Filter Design," *ham radio*, February, 1984, page 20.
- 1A. Ed Wetherhold, W3NQN, "Simplified Elliptic Lowpass Filter Construction Using Surplus 88-mH Inductors," *Radio Communications*, April, 1983.
2. Bob Witte, KB0CY, "Audio Filter Building Blocks," *ham radio*, July, 1983, page 74.
3. "A Deluxe Audio Filter for Phone and CW," *1983 Radio Amateur's Handbook*, American Radio Relay League, Newington, Connecticut, page 8-53.
4. *Solid State Design for the Radio Amateur*, 1977, American Radio Relay League, Newington, Connecticut, page 82.
5. Don Lancaster, *Active-Filter Cookbook*, Howard W. Sams and Co., Indianapolis, Indiana, 1975.
6. "Passive CW Audio Filters," *The ARRL 1985 Handbook for the Radio Amateur*, American Radio Relay League, Newington, Connecticut, page 28-1.
7. Ed Wetherhold, W3NQN, "Table Picks Standard Capacitors for Low-Pass Elliptic Filters," *Electronics*, November, 1982, page 113.
8. Ed Wetherhold, W3NQN, "Table Picks Standard Capacitors for Highpass Elliptic Filters," *Electronics*, February, 1983, page 110.
9. William I. Orr, W6SAI, *Radio Handbook*, 22nd edition, page 3.36, Howard W. Sams & Co., Inc. Indianapolis, Indiana, 1981.
10. Ed Wetherhold, W3NQN, "Design 7-Element Low-pass Filters Using Standard Value Capacitors," *EDN*, January 7, 1981, page 187.
11. Marie L. Fuchs, "Shrink Passive Filter Size with Lower Q Inductors," *EDN*, May 5, 1979, page 119.
- 11A. S. Niewiadomski, "Elliptic Lowpass Audio Filter Design Using Miniature Preferred Value Components," *Radio Communications*, October, 1984, page 846.
12. Richard Steincross, "Basic Program Performs Circuit Analysis," *EDN*, September 1, 1982, page 260.
13. *Ambit Components Catalogue*, Summer, 1983.
14. *Toko 1984 General Catalogue*, page 8.
15. John Wilkinson, G4HGT, "An Introduction to Elliptic Filters for the Radio Amateur," *Radio Communication*, February, 1983, page 125.
16. Philip R. Geffe, *Simplified Modern Filter Design*, John F. Rider, Publisher, New York, 1963, page 146.
- 16A. *Reference Data for Radio Engineers*, Sixth edition, Table 2, page 5-3, Howard W. Sams & Co. Inc. Indianapolis, Indiana, 1981.
17. Philip R. Geffe, *Simplified Modern Filter Design*, John F. Rider, Publisher, New York, 1963, page 153.
18. Philip R. Geffe, *Simplified Modern Filter Design*, John F. Rider, Publisher, New York, 1963, page 152.

### appendix

#### elliptic low-pass filter terminology

The schematic of a five-branch elliptic low-pass filter is shown in **fig. A1(A)**. The ideal response of this filter is shown in **fig. A1(B)**.

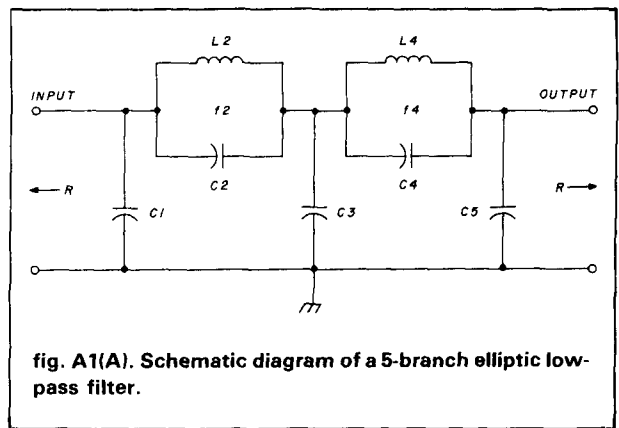

**fig. A1(A).** Schematic diagram of a 5-branch elliptic low-pass filter.

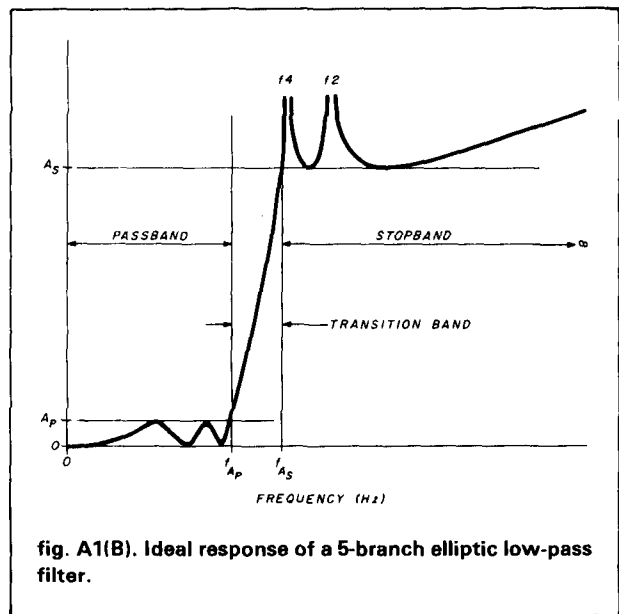

**fig. A1(B).** Ideal response of a 5-branch elliptic low-pass filter.

Some of the terms used in describing elliptic filters are explained below.

- **Passband ripple.** A variation in the passband attenuation between zero and some maximum value,  $A_p$ . The number of half cycles of ripple is equal to the number of branches of the filter.
- **Minimum stopband attenuation.** The value of stopband attenuation, designated  $A_s$ , below which the attenuation never falls having once achieved this value.
- **Maxima in stopband attenuation.** Frequencies within the stopband region, designated  $f_2$  and  $f_4$ , at which the attenuation is infinite due to the resonances of  $L_2/C_2$  and  $L_4/C_4$  respectively.
- **Ripple cutoff frequency.** The frequency, designated  $f_{A_p}$ , at which the attenuation first exceeds the  $A_p$  value.
- **Start of stopband frequency.** The frequency, designated  $f_{A_s}$ , at which the attenuation first exceeds the  $A_s$  value.

Tables of component values for filter designs usually give normalized values; that is, values which produce a filter with source and load impedance values of 1 ohm and a cutoff frequency (angular) of 1 rad/sec. To obtain practical component values for impedance of  $R$  ohms and a cutoff frequency of  $f$  Hz, multiply all inductor values by  $\frac{R}{2\pi f}$  and all capacitor values by  $\frac{1}{2\pi fR}$ .

**ham radio**



ICOM  
SPECIAL  
IC-745  
\$789.00

# TEL-COM<sup>★</sup>

*Electronic Communications*

Authorized Dealers For

**KENWOOD &  ICOM**

Also displaying the popular accessories needed to complete a HAM STATION . . .

- ARRL PUBLICATIONS • AEA PRODUCTS • AMPHENOL
- ALPHA DELTA • ASTRON • AUSTIN ANTENNAS • AVANTI
- BELDEN • BENCHER • B & W • DAIWA • HAM-KEY
- HUSTLER • KLM • LARSEN • MIRAGE • ROHN
- TELEX/HY-GAIN • VIBROPLEX • WELZ • ETC.

✓ 161

**KENWOOD  
SPECIAL  
NEW  
TS-940S**  
with automatic  
tuner  
**\$1765.00**

**OPEN SIX DAYS A WEEK**

**Telephone 617/486-3400, 3040**

675 Great Rd., (Rte. 119) Littleton, MA 01460  
1<sup>3</sup>/<sub>4</sub> miles from Rte. 495 (Exit 31) toward Groton, Mass.

## POPULAR PA 19 Wideband Preamp

- Over 8,000 sold
- 0.5 - 200 MHz
- 19 dB gain
- 50 Ω in/output
- For receivers, counters, transmitter amp stages
- Built, tested & ready-to-go

**ONLY \$9.95 + \$1 shipping**

## NEW POCKET SIZED 500 MHz Freq. Counter

- Fits in your shirt pocket
- Uses 1 9-volt battery
- 4 digit LED readout, 6 digit resolution
- 1 MHz - 500 MHz
- Great addition to shack and toolbox

✓ 140 **ONLY \$34.95 + \$2 shipping**

**DIGITREX**  
1005 BLOOMER  
ROCHESTER, MI 48063

# ROHN<sup>®</sup>

*brings the top to you*

ROHN brings the top to you with its patented design. For the ultimate "on the ground" service and antenna installation, a ROHN "Fold-Over" Tower is your best buy. Your safety comes first with "Fold-Over." For complete details write:

**ROHN<sup>®</sup>**  
**"FOLD-OVER"**  
**TOWERS**

P.O. BOX 2000, PEORIA, IL 61656 U.S.A.  
TWX: 910-652-0646 FAX: 309-697-5612

# John J. Meshna Jr., Inc.

P. O. Box 62 19 Allerton St. E. Lynn, Ma. 01904 Tel: (617) 595-2275

## COMPUTER TERMINAL BUILDING BLOCK \$50.00

This is a great beginning for a computer terminal. It is a brand new, Panasonic, 9" TTL input monitor complete with its own self-contained, switching power supply, and a removeable (four screws) triple output power supply. The whole assembly runs on 115/230 V, 50/60 Hz. Now for some specifics: 9" green phosphor, TTL input monitor, attached regulated 12 VDC, 1.5 A power supply used exclusively to run the monitor and an attached triple output switching power supply with outputs of 5 VDC @ 3.5 A, +12 VDC @ 500 ma, and -12 VDC @ 500 ma. The assembly has mounting feet and should be a snap to make a case for. Comes with hook up data. New, factory boxed. We are offering this to you 4 ways:

- COMPLETE SET-UP AS SHOWN, including monitor, low voltage supply and triple output supply. SPL-116-38, 14 Lbs., \$50.00, 5/\$225.00
- TRIPLE OUTPUT SUPPLY ONLY, SPL-117-38, 3 Lbs. \$15.00
- 9" MONITOR ONLY, (you supply low voltage input) SPL-114-38, 10 Lbs. \$25.00
- 9" MONITOR W/LOW VOLTAGE SUPPLY ONLY, SPL-115-38, 12 Lbs. \$40.00

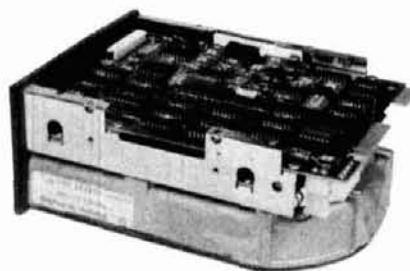
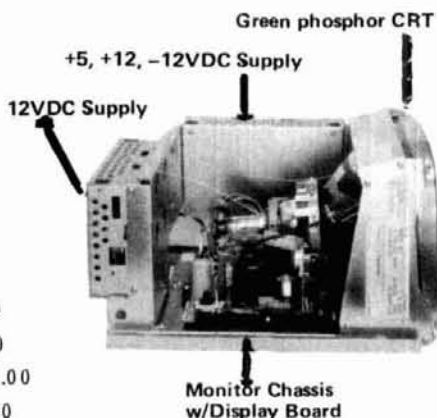

## SEAGATE TECHNOLOGY ST 506 5 1/4" HARD DRIVES

The Seagate Technology ST 506 hard disc drive utilizes proven Winchester technology for reliable storage of up to 5 megabytes of formatted data. Some features of this very popular drive are: 5 megabit/second data transfer rate, simple floppy like interface, high speed band actuator & stepper head positioning, requires only +5 & +12 vdc, and same physical size and mounting parameters as a mini floppy drive. This Shugart compatible drive is the same as used on many home personal computers. Each drive is checked out prior to shipment. Comes with data. Only a few on hand, so order early. Shpg. wt. 8 lb. ST-506 ~~\$205.00~~ REDUCED! now only \$175.00

**TI 99/4A Owners:** We are in the process of developing a Winchester Hard Drive subsystem for the Texas Instruments 99/4A. Please call or send SASE for further info.

## 1/2 Height 1 MEGabyte Disc Drives

Here we go with another blockbuster buy on disc drives which should make the competition's head spin! We are offering brand new, Mitsubishi no. 4853, 1/2 height, 1 megabyte, mini floppy disc drives. These drives are beautiful. They are fully Shugart 34 pin compatible. All are double side, double density, 80 tracks per side units. Each runs on +5 vdc, .5 A and +12 vdc, .7 A. Just the drives to use with your IBM, Sanyo or other computer. Each order will come with schematics and pin out data.

SPL-85C-35 \$175.00 each \$175.00 each, 2/\$325.00, 5/\$725.00

New, 75 watt power supply. +5vdc 5.5amps, +12vdc 4amps, -12vdc .3amps  
115/230 input. Made by GI, fully enclosed, with schematic.  
Shpg. wt. 4 lb. PS-10 \$50.00

- Use with:
- \* IBM
  - \* RADIO SHACK
  - \* HEATH
  - \* XEROX
  - \* SANYO

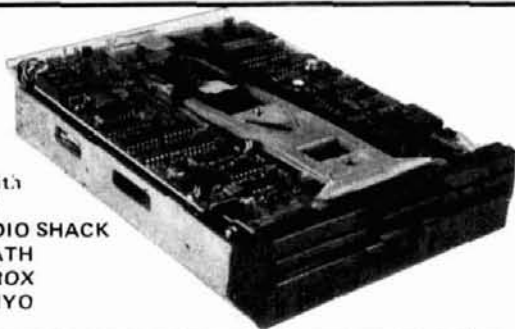

## HIGH POWER SURVEILLANCE IR SCOPE

This Infra-Red scope was designed specifically for long range surveillance use. The built-in, totally invisible, 50 watt halogen lamp IR source is coupled with a premium grade type 6032 image converter tube, 265 mm f4.2 lens, and 16 power military spec., color corrected eyepiece make this an ideal unit for viewing of clandestine activities or animals. The scope is capable of detection at more than 300 feet, recognition at 300 feet and positive facial identification at 150 feet. It runs on 12 VDC which makes it ideal for mobile use. It comes with a removeable hand grip which allows for tripod mounting, 2 power cords for cigarette lighter or battery terminals, instructions and a 90 day warranty. Listed below are accessories which make this a very versatile instrument. The scope and accessories are new and guaranteed functional. Net wt. 5-1/4 Lbs.

IR Scope part no. ELD Shpg. Wt. 7 Lbs. \$735.00 ea.

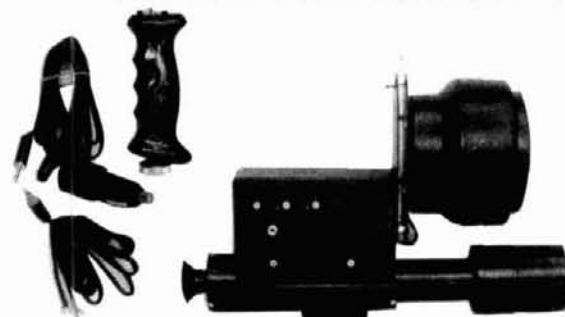

### ACCESSORIES:

12 VDC GELL BATTERY for above. Shpg. Wt. 6 Lbs. \$35.00

BIOCULAR EYEPIECE which can be used in place of the standard eyepiece. This allows the scene being produced by the IR viewer to be seen by the operator up to 4 ft. away. 2 Lbs. \$89.95

MALE "T" f1.6 CAMERA DAPTER for SLR cameras Shpg. Wt. 1 Lb. \$129.00

MALE "C" to FEMALE "T" ADAPTER for CCTV, requires use of above male "T" f1.6 adapter. Shpg. Wt. 1 Lb. \$29.95

Free 72 page catalogue available or send \$1.00 for 1st class service to P. O. Box 62 E. Lynn, Ma. 01904. Phone (617) 595-2275 to place your order by phone. MC, VISA, or American Express charge cards accepted.



# adjusting SSB amplifiers

Use a tuning pulser  
for added safety  
and linearity

**How many times have you** had your on-the-air conversations interrupted by someone who's more than 5 kHz from the frequency you're using? I can't remember how many times this has happened to me.

Splatter is rude and unnecessary. It *ought* to be against FCC rules — but it isn't. Part 97 of the Amateur Radio Rules states, in 97.73, (under "purity of emissions," paragraph *d*) that spurious radiation causing harmful interference to the reception of another radio station is against the rules, and that the licensee responsible for it may be required to eliminate the interference. At first this sounds good, but there's a note that explains that they're only talking about the garbage that slips outside of the Amateur band. In other words, if an operator on 14,275 kHz splatters  $\pm 50$  kHz, he's in compliance with Part 97 because his spurious emissions *inside* the Amateur Radio bands are specifically exempted by the note that follows paragraph *d*. If the same splattering station were to move up to 14,310 kHz, the splatter would extend beyond the Amateur band and a violation of the rules would occur.

It seems, then, that the only way to avoid stations who splatter would be to operate near the band edge with a clean signal. Dirty stations operating in this area are likely to spill over the band edge and receive FCC citations.

The most common cause of splatter is a mis-adjusted "linear" amplifier. Linear amplifiers are far from foolproof; in fact, they're easy to operate non-linearly.

There are many different settings of the tune and load controls, and only one combination will represent the best compromise between linearity and power output.

Without a doubt, the two-tone test, used in conjunction with an oscilloscope, is the best method of adjusting a linear amplifier. Unfortunately, the two-tone generator and a good oscilloscope cost more than many linear amplifiers.

A second method is the single-tone test. This involves inserting a single frequency — usually with the CW mode on the transmitter, or transceiver — at the maximum carrier level, and adjusting the linear amplifier for maximum power output by alternately adjusting the plate-tune and load controls. This method can be improved if the loading control is increased (for less capacitance) slightly beyond the point where the power peaks. At this point the linearity will be improved and the power output drops, just perceptibly. But this method places a terrible strain on the amplifier tubes and power supply. If the operator makes an error during this procedure, the tubes are likely to be damaged because the duty cycle is 100 percent.

Another problem with the single-tone test is that the average amplifier power supply is not designed to supply the 2500 watts of key-down power needed for the legal output of 1500 watts, assuming a typical efficiency of 60 percent. The average table-top 1500 watt output linear amplifier appears to have a 600 watt CCS plate transformer. This is completely satisfactory in SSB service, but it is not intended for full throttle single-tone tune-up.

Reducing the carrier level on tune-up would reduce the strain, but reduced carrier level results in reduced peak plate current in the amplifier tubes. Because peak plate current and peak AC plate voltage determine the plate load impedance, altering one would upset the

**By Richard Measures, AG6K, 6455 La Cumbre Road, Somis, California 93066**

★ **QUALITY PARTS**      ★ **DISCOUNT PRICES**      ★ **FAST SHIPPING!**

SEND FOR  
**FREE**  
FALL 1985 CATALOG...  
**48 PAGES!**

# ALL ELECTRONICS CORP.

**EDGE CONNECTORS**  
ALL ARE 1.56 SPACING.

22/44 EDGE CONNECTOR  
PC style \$2.00 each  
10 for \$18.00

22/44 EDGE CONNECTOR  
solder lug \$2.50 each  
style

28/56 EDGE CONNECTOR  
PC style \$2.50 each  
10 for \$22.00

36/72 EDGE CONNECTOR  
PC style \$3.00 each

43/86 EDGE CONNECTOR  
PC style \$4.50 each

**TRANSISTORS**

2N705	4 for \$1.00
2N2222A	3 for \$1.00
PN2222A	4 for \$1.00
2N2904	3 for \$1.00
2N2904	3 for \$1.00
2N2905	3 for \$1.00
MJ2955	\$1.50
2N3055	\$1.00
FND 10K40	\$1.00
TIP 121	75¢
TIP 125	75¢

**TRANSFORMERS**

120 volt primaries

5.6 volts @ 750 ma.	\$3.00
6 volts @ 150 ma.	\$1.25
12 v.c.t. @ 200 ma.	\$2.00
18 volts @ 850 ma.	\$3.50
18 volts @ 1 amp	\$4.50
24 v.c.t. @ 200 ma.	\$2.50
24 v.c.t. @ 400 ma.	\$3.50
28 v.c.t. @ 15 amps	\$20.00
30 v.c.t. @ 2 amps	\$5.00

**WALL TRANSFORMERS**

all plug directly into 120 vac outlet

4 VDC @ 70 ma.	\$2.00
6 VDC @ 500 ma.	\$3.50
6 VDC @ 750 ma.	\$6.50
9 VDC @ 500 ma.	\$5.00
12.5 VAC @ 265 ma.	\$3.00
24 VAC @ 250 ma.	\$3.00
MULTI-VOLTAGE @ 500 ma.	\$7.50

3.4, 6.7, 9 or 12 VDC

**MINI-BOX**

Pomona #2104

Heavy-duty black phenolic project box with cover and screws 2 1/2" X 1 1/2"

\$1.00 EACH

**SOUND AND VIDEO MODULATOR FOR T.I. COMPUTER**

T.I. # UM1381-1 Designed for use with T.I. computers. Can be used with video sources. Built-in A/B switch. Channel 3 or 4 selection switch. Operate on 12 vdc. Hook-up diagram included.

\$10.00 EACH

**SLIM LINE COOLING FAN**

Etr # 99XM182 low noise fan. Measures 3 1/4" square x 1" deep. 21 cfm. 23 db. 1700 rpm.

SPECIAL PRICE... \$12.50 each

**SUB-MINIATURE D TYPE CONNECTORS**

DB-15 PLUG	\$2.75
DB-15 SOCKET	\$4.00
DB-15 HOOD	\$1.50
DB-25 PLUG	\$2.75
DB-25 SOCKET	\$3.50
DB-25 HOOD	\$1.25

**8" PA. SPEAKER**

C.T.S. Model 8B3079

8 ohms coil

3.0 oz. ferrite magnet

Typical response range 100-10,000 Hz

Power rating 15 watts max

Drilled to mount line matching transformers.

\$5.00 each

CASE OF 8 SPEAKERS \$32.00

**RELAYS**

**5 AMP SOLID STATE**

Heinemann Electric #101-5A-140-5AMP CONTROL 3-32 vdc LOAD: 140 vac 5 amp SIZE 2 x 1 x 3/4" h

\$5.00 each      10 for \$45.00

**2K 10 TURN MULTI-TURN POT**

SPECTROL #MOD 534-7161

\$5.00 EACH

**SOLID STATE BUZZER**

Star #SMB-06L

6 vdc

TTL compatible

\$1.00 each

10 for \$9.00

**TV REMOTE CONVERTER**

Enhance the versatility of your video equipment. Converts cable TV stations to channel 2 or 3. Use with standard TV antenna to give your TV remote tuning capability. Converter operates on 115VAC 36 channel selector with fine tuning on 25 ft cord. **Not a decoder.**

• A \$75.00 VALUE •  
• ONLY \$27.50!

**CASSETTE MECHANISM**

New stereo cassette mechanism. Includes record/playback and erase heads. 2-12VDC motors, drive belts, pulleys, 3-12VDC solenoids, pinchwheels and other mechanical parts. These parts used on other current model decks would cost several times our selling price if purchased separately. Build your own audio or data recorder or use for spare parts. 5 1/4" X 3 1/2" X 3 1/4"

\$7.50 EACH      2 FOR \$12.50

**PARALLEL PRINTER CONNECTORS**

Solder style 36 pin used on parallel data cables.

MALE CONNECTOR \$5.50 each

FEMALE CONNECTOR \$5.50 each

**LINE CORDS**

**TWO WIRE**

6 18/2 SPT-1 flat	3 for \$1.00
6 18/2 SPT-2 flat	
6 16/2 SJT round	\$1.25 each

**THREE WIRE**

6 18/3 flat	\$1.50 each
8 18/3 round	\$2.00 each
8 16/3 round	\$4.00 each

**ULTRA-MINIATURE 5 VDC RELAY**

Fujitsu # FBR211NED005M20

High sensitivity COIL: 120 ohms

CONTACTS: 1 amp

Mounts in 14 pin DIP socket

\$1.25 each

10 for \$10.00

**"SPECIAL PRICE" DUAL L.E.D. DISPLAYS**

560 high, 7 segment L.E.D. readouts. Mount in 24 pin DIP sockets...

MAN-5640 orange. c.c. 75¢ each

FND-5148 red. c.c. 75¢ each

DL-527 red. c.a. 75¢ each

**3 1/2" SPEAKER**

8 ohm impedance, Full range speaker. 8 oz magnet 4" diagonal mounting centers

\$2.50 each 10 for \$20.00

**SPRING LEVER TERMINALS**

Two color coded terminals on a sturdy 2 3/4" x 3 3/4" bakelite plate

Great for speaker enclosures or power supplies.

\$1.00 each 10 for \$9.00

**I.D.C. CONNECTORS**

Will press fit on standard ribbon cable

DB-25 PLUG	\$6.25
DB-25 Socket	\$8.75
36 PIN MALE	\$5.50
36 PIN FEMALE	\$5.50

**COMPUTER GRADE CAPACITORS**

2,000 mfd. 200 VDC 1 1/4" DIA x 5" HIGH	\$2.00
3,600 mfd. 40 VDC 1 1/4" DIA x 3 3/4" HIGH	\$1.00
6,400 mfd. 60 VDC 1 1/4" DIA x 4 1/2" HIGH	\$2.50
9,700 mfd. 50 VDC 1 1/4" DIA x 4 1/2" HIGH	\$3.00
31,000 mfd. 15 VDC 1 1/4" DIA x 4" HIGH	\$2.50
72,000 mfd. 15 VDC 2" DIA x 4 1/2" HIGH	\$3.50
185,000 mfd. 6 VDC 2 1/2" DIA x 4 1/2" HIGH	\$1.50

**MINIATURE 6 VDC RELAY**

Aromat #RSD-6V

Super Small S P D T relay

Gold colloid contacts rated

1 amp @ 30 vdc. Highly sensitive.

TTL direct drive possible. 120 ohm coil.

Operate from 4.3 - 6 vdc.

COIL: 120 ohms

1 1/16" X 1/2" X 7/16"

\$1.50 each      10 for \$13.50

**MINIATURE TOGGLE SWITCHES**

ALL ARE RATED 5 AMPS @ 125 VAC

S.P.D.T. (on-on) PC style non-threaded bushing 75¢ each 10 for \$7.00	S.P.D.T. (on-on) Solder lug terminals \$1.00 each 10 for \$9.00	S.P.D.T. (on-off-on) Solder lug terminals \$1.00 each 10 for \$9.00
S.P.D.T. (on-off-on) PC style non-threaded bushing 75¢ each 10 for \$7.00	S.P.D.T. (on-on) PC lugs threaded bushing \$1.00 each 10 for \$9.00	D.P.D.T. (on-on) Solder lug terminals \$2.00 each 10 for \$18.00

**TWIST-LOCK CONNECTOR**

Same as Switchcraft #12CL5M

5 conductor in-line plug and chassis mount jack. Twist-Lock style.

\$2.50/SET

**TI SWITCHING POWER SUPPLY**

Compact, well-regulated switching power supply designed to power Texas Instruments computer equipment.

INPUT: 14 - 25 vac @ 1 amp

OUTPUT: 12 vdc @ 350 ma  
5 vdc @ 1.2 amp  
5 vdc @ 200 ma.

SIZE: 4 3/4" x 4 1/4" x 1 1/4" high

\$5.00 each

**13 VDC RELAY**

CONTACTS: S P N C

10 amp @ 120 vac

Energize coil to open contact

COIL: 13 vdc 650 ohms

SPECIAL PRICE \$1.00 each

**STANDARD JUMBO DIFFUSED T 1 1/2**

RED	10 for \$1.50 100 for \$13.00
GREEN	10 for \$2.00 100 for \$17.00
YELLOW	10 for \$2.00 100 for \$17.00

**FLASHER LED**

5 volt operation red jumbo T 1 1/4" size \$1.00 each

**BI-POLAR**

jumbo T 1 1/4" size

2 for \$1.70

**LED HOLDERS**

Two piece holder for jumbo LED

10 for 65¢      100 for \$5.00

**CLEAR CLIPLITE LED HOLDER**

Make LED a fancy indicator. Clear.

4 for \$1.00

**D.P.S.T. LIGHTED ROCKER SWITCH**

115 vac lighted rocker snap mounts in 7/8" x 1 1/4" hole. Orange lens. 16 amp contact.

\$1.50

**MINI-PUSH BUTTON**

S P S T momentary normally open 1/4" bushing. Red button. 35¢ each 10 for \$3.00

**KEY ASSEMBLY**

5 KEY \$1.00 each

contains 5 single-pole normally open switches. Measures 3/4" long

6 KEY \$1.25 each

contains 6 single-pole normally open switches. Measures 4/4" long

**13.8 VDC REGULATED POWER SUPPLY**

These are solid state, fully regulated 13.8 vdc power supplies. Both feature 100% solid state construction, fuse protection, and L.E.D. power indicator U.L. listed.

2 amp constant, 4 amp surge	\$18.00 each
3 amp constant, 5 amp surge	\$25.00 each

**4PDT RELAY**

14 pin KH style.

3 amp contacts

USED but fully tested \$1.70 each

Specify coil voltage desired

Either 24 vdc or 120 vac

LARGE QUANTITIES AVAILABLE

SOCKETS FOR KH RELAY 75¢ each

**SNAP ACTION SWITCH**

Cherry elect. #E-21. N.O. or N.C. 0.1A contacts. Suitable for alarms and other low energy circuits

1 1/2" lever

45¢ EACH      10 FOR \$4.20

**D.C. CONVERTER**

Designed to provide a steady .5 vdc @ 240 ma from a battery supply of 3.5 to 6.25 volts.

2 1/16" x 1 1/8" x 1 1/8"

\$1.50 each

**7 CONDUCTOR RIBBON CABLE**

Spectra-strip red marker strip 28 ga. stranded wire

\$5.00 per 100 roll

**ALL ELECTRONICS CORP.**

LOS ANGELES, CA STORE  
905 S. Vermont Ave  
213 380-8000

VAN NUYS, CA STORE  
6228 Sepulveda Blvd  
818 997-1806

MAIL ORDERS TO:  
PO BOX 20406  
Los Angeles, CA 90006

TWX - 5101010163 ALL ELECTRONIC

EASYLINK MBX - 6288/748

VISA

MasterCard

TOLL FREE ORDERS ONLY  
1-800-826-5432  
(ORDER ONLY)  
(IN CALIFORNIA: 1-800-258-6666)

ALASKA, HAWAII, OR INFORMATION  
(213) 380-8000

NO C.O.D!

QUANTITIES LIMITED  
MINIMUM ORDER \$10.00  
USA: \$3.00 SHIPPING

FOREIGN ORDERS:  
INCLUDING SUFFICIENT SHIPPING  
CALIF RES. ADD 6 1/2%

**METAL OXIDE VARISTOR**

Popular GE # 130LA10A varistor 5/8" diameter

\$1.25 each

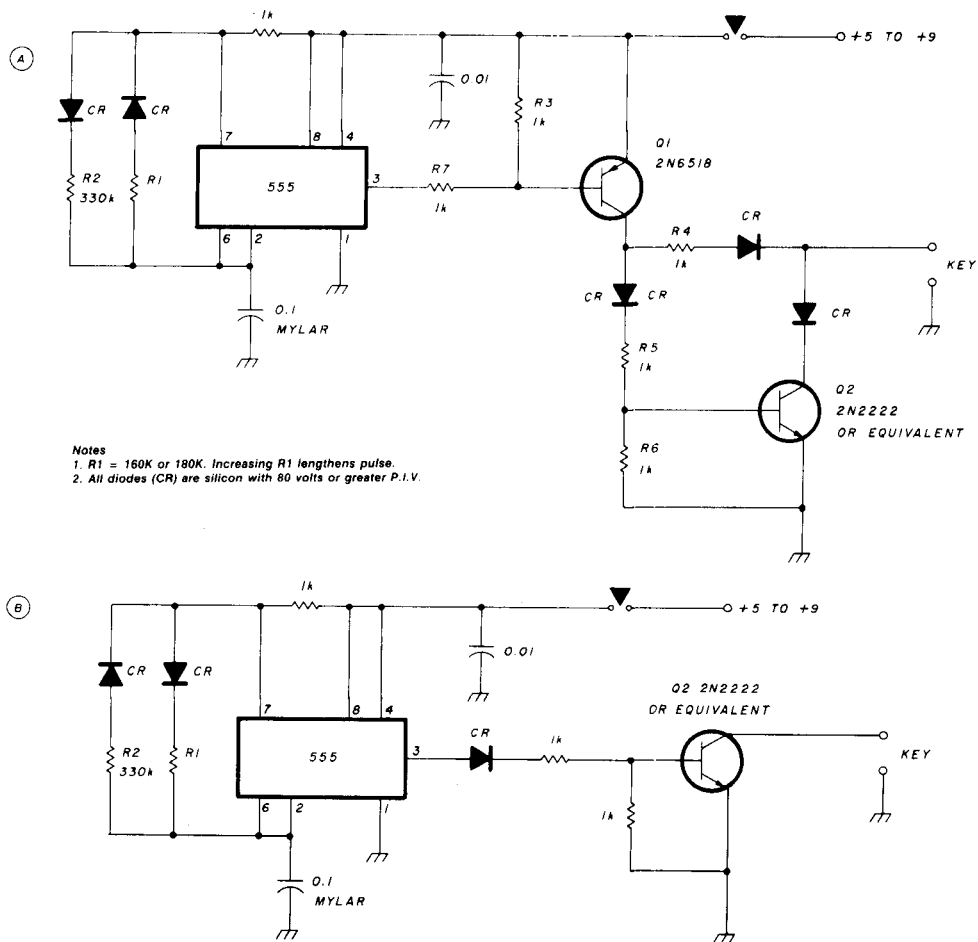

fig. 1. Schematic of a tuning pulser circuit. (A) for positive or negative keyed transmitters, and (B) for positive-keyed transmitters only.

adjustment, since the plate tune and load controls would be set to match a different plate load than will be encountered on voice peaks. This mis-adjustment method will make the amplifier splatter and beat up the grids of the common grounded-grid, class  $AB_2$  amplifier because of excessive grid current.

Yet another problem with the single tone, or A-zero (A0) tune-up is that it's not permitted, except for short periods below 51 MHz — but the chance of being cited for A0 emission is probably slim in comparison to the chance of experiencing a melt-down.

So the problem is how to tune-up a linear amplifier, linearly and safely, without spending a lot of money. The solution is obviously some device that will produce maximum peak plate current with a human voice duty-cycle, which is about 33 percent on the average. For ease of adjustment, the device must also produce steady meter indications.

The circuit shown in fig. 1A is a solution to the problem. It consists of a 555 timer and two transistor

switches, one for positive keyed transmitters and the other for negative keyed transmitters. The 555 timing resistors have steering diodes so that the charge and discharge times are different by the ratio of 2:1. This produces a duty cycle of 0.3333, or one-third. The output of the 555 is high for about 24 ms and low for about 12 ms. When the base of Q1 goes low, it is forward biased and conducts collector current through R5 and the base of Q2, whose collector is then switched on. During the 24 ms high interval, the base-to-emitter voltage of Q1 is zero, which turns Q1 off, which then turns Q2 off. This causes the amplifier to work hard for 12 ms, then rest for 24 ms, alternately working and resting until the tuning process is complete.

The circuit shown in fig. 1B, which will key positive voltages only, requires fewer parts than the previously described circuit. (Most transceivers built today are positive-keyed.)

The pulser should be enclosed in a metal box or open-button metal chassis. (I used a 3 × 5 × 1 inch/7

× 12 × 2.5 cm open bottom chassis.) The keying lead to the transceiver should be shielded. These precautions will help to keep RF, which would interfere with proper operation, out of the pulser.

A good method of powering the pulser is to use four AA penlight batteries. There's plenty of room in the box for a four-cell AA holder, and the added milli-ampere hour capacity advantage over a 9-volt battery makes the AA cells a good choice.

Either circuit can be built on a piece of perfboard in less than one hour, so it isn't worth the trouble of making a printed circuit board unless you're going to make several tuning pulsers for Christmas presents.

### using the tuning pulser

Set the transceiver to CW. Turn on the pulser and advance the carrier control until you have some ALC. If your exciter has an individual band tune feature, adjust it for maximum relative output.

Now turn on your amplifier and set the plate voltage to SSB. Key the pulser again and tune for maximum relative output on the plate tune and load controls. Sometimes a slight improvement in linearity can be had by loading the amplifier past the peak in output until the relative output drops about 2 percent.

Normal readings of plate current using the tuning pulser should be approximately one-third of what you would see with a steady carrier. Average-reading RF wattmeters are good for relative indications only, when tuning with the pulser. The indicated wattage cannot be simply multiplied by 3 to find the peak power because the time constant of the meter is unknown.

If you own a linear amplifier that uses sweep tubes, which are easily damaged by normal tune-up methods, a tuning pulser could provide increased tube life.

Another use for the tuning pulser is in locating loose hardware (such as clotheslines, rain gutters, or rusty guy-wires), that may be causing TVI by metal-oxide diode-rectification. Such problems usually occur only at or near the peak-power level. Running the typical amplifier key-down for the length of time needed to locate the fault is risky. With the tuning pulser, the amplifier can generate full peak power with little risk of damage, even for lengthy periods of time. A harmonic "sniffing" device is then used to determine the location of the fault. (Normal operating courtesies still apply; check the frequency first with your receiver, keep the tests short, and try to make your tests when the band is dead. — Ed)

ham radio

## Unadilla Amateur Antenna Baluns

For 20 years, preferred by Amateur, Commercial and Military Radio Operators



W2AU 1:1 & 4:1  
Only \$17.95, UPS  
shipping & tax included

### W2AU Broadband Ferrite Core Baluns

For medium power (1000 watts RF min.) and broadband operation 3-40 MHz.

#### W2AU 1:1

- \* 50 to 50 or 75 to 75 ohms
- \* For dipoles, V's, beams, quads

#### W2AU 4:1

- \* 200 to 50 or 300 to 75 ohms
- \* For high impedance antennas such as folded dipoles

Designer: Paul Wandelt, W2AU



W2DU-HF  
Only \$19.95, UPS  
shipping & tax included

### W2DU Non-Ferrite Very High Power Baluns

#### W2DU-HF (High Power)

- \* 1.8-30 MHz
- \* 3000-9000 watts with 1:1 antenna SWR
- \* 1500-5000 watts with 2:1 antenna SWR

#### W2DU-VHF (High Power & Extended Range)

- \* 30-300 MHz
- \* 2000-4000 watts with 1:1 antenna SWR
- \* 1200-2400 watts with 2:1 antenna SWR

Designer: Walt Maxwell, W2DU



W2DU-VHF  
Only \$19.95, UPS  
shipping & tax included

All our baluns are fully guaranteed.

### Unadilla baluns help you...

- \* Minimize coax TVI to neighbors
- \* Increase antenna power withstanding
- \* Protect your radio against lightning

### Features...

- \* Acts as strong center insulator (600# pull)
- \* Keeps ice off your high feedpoint
- \* First built-in lightning arrester
- \* Long life- all stainless steel hardware
- \* Wired pigtailed for positive dipole leg contact

### Easy ordering...

- \* Buy two or more and take a 10% discount
- \* Call for our free catalog of Baluns/Antenna Coils/Antenna Relays
- \* Bonus with any order- the "Dandy Dipole" book. Shows how to build and prune dipoles, includes wire length tables for over 150 multi-band combinations using coils.

To order or get your free catalog, call 24 hours a day, 7 days a week **1-800-523-0027**

NY/HI/AK/CAN call collect 315-437-3953  
VISA, MasterCard, AmEx, COD accepted  
Mail orders also accepted



Rob, WA3QLS



Katherine, KA31YO



Paul, WA3QPX

# Delaware Amateur Supply

71 Meadow Road, New Castle, Del. 19720 302-328-7728

*Factory Authorized Dealer! 9-5 Daily, 9-8 Friday, 9-3 Saturday*

**KENWOOD YAESU ICOM TENTEK  
MICROLOG KDK SANTEC KANTRONICS**

## 800-441-7008

*Order & Pricing  
New Equipment*

Large Inventory



Daily UPS Service



**All Other Calls  
302-328-7728**

**No Sales Tax  
in Delaware!  
One mile off I-95**

# understanding telephones

Everybody has one.  
But what makes it work?

**Although telephones and telephone company practices** may vary dramatically from one country to another, and even from one locality to another, the basic principles underlying the way they work remain unchanged.

Every telephone consists of three separate sub-assemblies, each capable of independent operation. These assemblies are the *speech network*, the *dialing mechanism*, and the *ringer or bell*. Together, these parts — as well as any additional devices such as modems, dialers, and answering machines — are attached to the *phone line*.

## the phone line

A telephone is usually connected to the telephone exchange by about three miles (4.83 km) of a twisted pair of No. 22 (AWG) or 0.5 mm copper wires, known by your phone company as "the loop." Although copper is a good conductor, it does have resistance. The resistance of No. 22 AWG wire is 16.46 ohms per thousand feet at 77 degrees F (25 degrees C). In the United States, wire resistance is measured in ohms per thousand feet; telephone companies describe loop length in kilofeet (thousands of feet). In other parts of the world, wire resistance is usually expressed as Ohms per kilometer.

Because telephone apparatus is generally considered to be current driven, all phone measurements refer to current *consumption*, not voltage. The length of the wire connecting the subscriber to the telephone

exchange affects the total amount of current that can be drawn by anything attached at the subscriber's end of the line.

In the United States, the voltage applied to the line to drive the telephone is 48 VDC; some countries use 50 VDC. Note that telephones are peculiar in that the signal line is also the power supply line. The voltage is supplied by lead acid cells, thus assuring a hum-free supply and complete independence from the electric company, which may be especially useful during power outages.

At the telephone exchange the DC voltage and audio signal are separated by directing the audio signal through 2  $\mu$ F capacitors and blocking the audio from the power supply with a 5-Henry choke in each line. Usually these two chokes are the coil windings of a relay that switches your phone line at the exchange; in the United States, this relay is known as the "A" relay (see fig. 1). The resistance of each of these chokes is 200 ohms.

We can find out how well a phone line is operating by using Ohm's law and an ammeter. The DC resistance of any device attached to the phone line is often quoted in telephone company specifications as either 600 or 900 ohms; this will vary from one country to another. But the resistance may, in fact, vary from 300 to 1,000 ohms.

Using these figures you can estimate the distance between your telephone and the telephone exchange. In the United States, the telephone company guarantees you no lower current than 20 mA — or what is known to your phone company as a "long loop." A "short loop" will draw 50 to 70 mA, and an average

**By Julian Macassey, N6ARE, 475 North Daisy Avenue, Pasadena, California 91107**



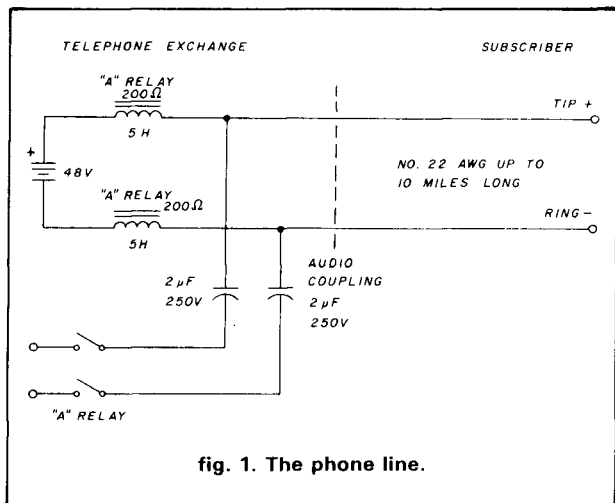

fig. 1. The phone line.

loop, about 35 mA. Some countries will consider their maximum loop as low as 12 mA. In practice, United States telephones are usually capable of working at currents as low as 14 mA. Some exchanges will consider your phone in use and feed dial tone down the line with currents as low as 8 mA, even though the telephone may not be able to operate.

Although the telephone company has supplied plenty of nice clean DC direct to your home, don't assume you have a free battery for your own circuits. The telephone company wants the DC resistance of your line to be about 10 Megohms when there's no apparatus in use ("on hook," in telephone company jargon); you can draw no more than 5 microamperes while the phone is in that state. When the phone is in use, or "off hook," you can draw current, but you'll need that current to power your phone. Any current you might draw for other purposes would tend to lower the signal level.

The phone line has an impedance composed of distributed resistance, capacitance, and inductance. The impedance will vary according to the length of the loop, the type of insulation of the wire, and whether the wire is aerial cable, buried cable, or bare parallel wires strung on telephone poles. For calculation and specification purposes, the impedance is normally assumed to be 600 or 900 ohms. If the instrument attached to the phone line should be of the wrong impedance, you'd get a mismatch, or what telephone company personnel refer to as "return loss." (Radio Amateurs will recognize return loss as SWR.) A mismatch on telephone lines results in echo and whistling, which the phone company calls "singing" and owners of very cheap telephones may have come to expect. A mismatched device can, by the way, be matched to the phone line by placing resistors in parallel or series with the line to bring the impedance of the device to within the desired limits. This will cause some

signal loss, of course, but will make the device usable.

A phone line is a balanced feed, with each side equally balanced to ground. Any imbalance will introduce hum and noise to the phone line and increase susceptibility to RFI.

The balance of the phone line is known to your telephone company as "longitudinal balance." If both impedance match and balance to ground are kept in mind, any device attached to the phone line will perform well, just as the correct matching of transmission lines and devices will ensure good performance in radio practice.

If you live in the United States, the two phone wires connected to your telephone should be red and green. (In other parts of the world they may be different colors.) The red wire is negative and the green wire is positive. Your telephone company calls the green wire "Tip" and the red wire "Ring." (In other parts of the world, these wires may be called "A" and "B".) Most installations have another pair of wires, yellow and black. These wires can be used for many different purposes, if they're used at all. Some party lines use the yellow wire as a ground; sometimes there's 6.8 VAC on this pair to light the dials of Princess® type phones. If you have two separate phone lines (not extensions) in your home, you'll find the yellow and black pair carrying a second telephone line. In this case, black is "Tip" and yellow is "Ring."

The above description applies to a standard line with a DC connection between your end of the line and the telephone exchange. Most phone lines in the world are of this type, known as a "metallic line." In a metallic line, there may or may not be inductance devices placed in the line to alter the frequency response of the line; the devices used to do this are called "loading coils." (Note: if they impair the operation of your modem, your telephone company can remove them.) Other types of lines are party lines, which may be metallic lines but require special telephones to allow the telephone company to differentiate between subscribers. Very long lines may have amplifiers, sometimes called "loop extenders" on them. Some telephone companies use a system called "subscriber carrier," which is basically an RF system in which your telephone signal is heterodyned up to around 100 kHz and then sent along another subscriber's "twisted pair."

If you have questions about your telephone line, you can call your telephone company; depending on the company and who you can reach, you may be able to obtain a wealth of information.

## the speech network

The speech network — also known as the "hybrid" or the "two wire/four wire network" — takes the incoming signal and feeds it to the earpiece and takes

## Introducing the BUTTERFLY™ Beam from Butternut!

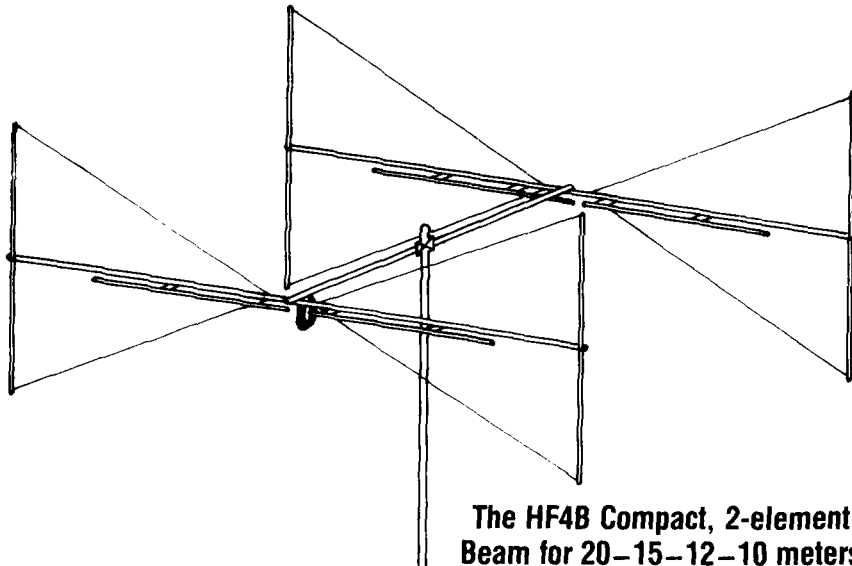

The HF4B Compact, 2-element  
Beam for 20-15-12-10 meters

### Compact Size

The HF4B's 12½-foot elements and 6-foot boom are ideal for home-station use and for weekend retreats, condos, apartments and other places where oversized beams are prohibited. Its light weight (17 pounds) means it can be turned with a tv rotator, yet it is robustly constructed in the best tradition of our world-famous Butternut verticals.

See your authorized  
Butternut dealer

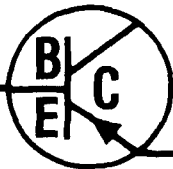

## BUTTERNUT ELECTRONICS CO.

405 East Market Street  
Lockhart, Texas 78644

Please send all reader inquiries direct.

### Performance

The HF4B BUTTERFLY™ has not sacrificed performance for compactness. Its unique design with fanned elements and L-C circuits avoids use of power-robbing traps yet provided high-efficiency operating on all bands. The BUTTERFLY™ outperforms anything in its class.

The HF4B offers an SWR of 1.5:1 or less at resonance. Its 2:1 bandwidth is 200 kHz on 20 meters, 450 kHz on 15, 1.7 MHz on 10, and across the entire 12 meter band. And it will handle the legal power limits both CW & SSB. Gain is at least 3 dB on 20, 4.5 dB on 15 and 5 dB on 10 & 12 meters. Front-to-back is up to 18 dB on 10, 12 and 20m, and up to 15 dB on 15m.

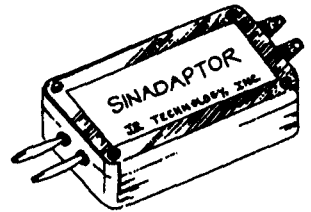

## NOW Sinad CAN BE MEASURED WITH YOUR VOM

- Quickly tune Receivers, Cavities, Preamps, etc.
- Works with your VOM or AC VTVM that has 2.5V full scale sensitivity or better.
- Fast accurate measurements.
- Sinad measurement displayed on meter in "dB" scale.
- Self contained, pocket size, go anywhere instrument.
- Powered by standard 9V battery or optional AC adaptor.

SINADAPTOR SAI-01

**\$79.95**



**J.S. Technology, Inc.**

39 Main Street  
Scottsville, NY 14546  
(716) 889-3048

✓ 168

**OUT NOW!**  
ONLY \$2.00 PLUS \$1 SHIPPING

**DICK SMITH  
ELECTRONIC ENTHUSIASTS  
CATALOG**  
132 PAGES CRAMMED WITH KITS • BOOKS • COMPONENTS • DATA • HAM GEAR AND MORE PLUS BONUS COUPONS WORTH \$2 REDEEMABLE OFF YOUR 1st ORDER

Rush me my copy of the Dick Smith Catalog, I enclose \$2 & \$1 shipping.

Name .....

Address .....

City .....

Zip .....

DICK SMITH ELECTRONICS INC.  
P.O. Box 2249, Redwood City, CA 94063  
Orders FREEFONE 1-800-332-5373



## CADDELL COIL CORP.

35 Main Street  
Poultney, VT 05764  
802-287-4055

### BALUNS

Get POWER to your antenna! Our Baluns are already wound and ready for installation in your transmatch or you may enclose them in a weatherproof box and connect them directly at the antenna. They are designed for 3-30 MHz operation. (See ARRL Handbook pages 19-9 or 6-20 for construction details.)

100 Watt (4:1, 6:1, 9:1, or 1:1 Impedance — Select one)	\$ 9.50
Universal Transmatch 1 KW (4:1 Impedance)	13.50
Universal Transmatch 2 KW (4:1 Impedance)	16.00
Universal Transmatch 1 KW (6:1, 9:1 or 1:1 — select one)	15.00
Universal Transmatch 2 KW (6:1, 9:1 or 1:1 — select one)	17.50

Please send large SASE for info.

## Fox Tango Filters

NEW FOR FT-757GX!

Improve selectivity by replacing your stock 2700 & 600 bandwidth filters with genuine Fox Tango 8-pole drop ins; 2100Hz for SSB, 500 or 250 for CW.

### INTRODUCTORY PRICES

Reg. \$60. Special \$55 ea., \$100 pr.

SHIPPING: \$3 US, \$5 Air (US & Canada),

\$10 Elsewhere • Order by mail or phone

VISA/MC or COD accepted

Ask About Our Filters For Many Other Rigs.

## FOX-TANGO Corp.

Box 15944, W. Palm Bch, FL 33416

Telephone: (305) 683-9587 ✓ 169

the microphone output and feeds it down the line. The standard network used all over the world is an LC device with a carbon microphone; some newer phones use discrete transistors or ICs.

One of the advantages of an LC network is that it has no semiconductors, is not voltage sensitive, and will work continuously as the voltage across the line is reduced. Many transistorized phones stop working as the voltage approaches 3 to 4 volts.

When a telephone is taken off the hook, the line voltage drops from 48 volts to between 9 and 3 volts, depending on the length of the loop. If another telephone in parallel is taken off the hook, the current consumption of the line will remain the same and the voltage across the terminals of both telephones will drop. Bell Telephone specifications state that three telephones should work in parallel on a 20 mA loop; transistorized phones tend not to pass this test, although some manufacturers use ICs that will pass. Although some European telephone companies claim that phones working in parallel is "technically impossible," and discourage attempts to make them work that way, some of their telephones *will* work in parallel.

While low levels of audio may be difficult to hear, overly loud audio can be painful. Consequently, a well designed telephone will automatically adjust its transmit and receive levels to allow for the attenuation — or lack of it — caused by the length of the loop. This adjustment is called "loop compensation." In the United States, telephone manufacturers achieve this compensation with silicon carbide varistors that consume any excess current from a short loop (see fig. 2). Although some telephones using ICs have built-in loop compensation, many do not; the latter have been designed to provide adequate volume on the average loop, which means that they provide low volume on long loops, and are too loud on short loops. Various countries have different specifications for transmit and receive levels; some European countries require a higher transmit level than is standard in the United States so a domestically-manufactured telephone may suffer from low transmit level if used on European lines without modification.

Because a telephone is a duplex device, both transmitting and receiving on the same pair of wires, the speech network must ensure that not too much of the caller's voice is fed back into his or her receiver. This function, called "sidetone," is achieved by phasing the signal so that some cancellation occurs in the speech network before the signal is fed to the receiver. Callers faced with no sidetone at all will consider the phone "dead." Too little sidetone will convince callers that they're not being heard and cause them to shout, "I can hear you. Can you hear *ME?*" Too much sidetone causes callers to lower their voices and not be heard well at the other end of the line.

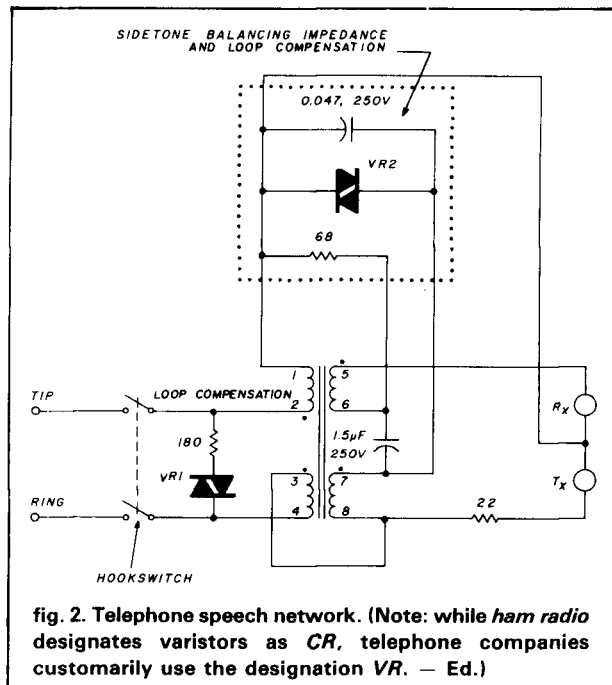

A telephone on a short loop with no loop compensation will appear to have too much sidetone, and callers will lower their voices. In this case, the percentage of sidetone is the same, but as the overall level is higher the sidetone level will also be higher.

## the dial

There are two types of dials in use around the world. The most common one is called pulse, loop disconnect, or rotary; the oldest form of dialing, it's been with us since the 1920's. The other dialing method, more modern and much loved by Radio Amateurs is called Touchtone Dual Tone Multi-Frequency (DTMF) or Multi-Frequency (MF):

Pulse dialing is traditionally accomplished with a rotary dial, which is a speed governed wheel with a cam that opens and closes a switch in series with your phone and the line. It works by actually disconnecting or "hanging up" the telephone at specific intervals. The United States standard is one disconnect per digit, so if you dial a "1," your telephone is "disconnected" once. Dial a seven and you'll be "disconnected" seven times; dial a zero, and you'll "hang up" ten times. Some countries invert the system so "1" causes ten "disconnects" and 0, one disconnect. Some add a digit so that dialing a 5 would cause six disconnects and 0, eleven disconnects. There are even some systems in which dialing 0 results in one disconnect, and all other digits are *plus one*, making a 5 cause six disconnects and 9, ten disconnects.

Although most exchanges are quite happy with rates of 6 to 15 Pulses Per Second (PPS), the phone company accepted standard is 8 to 10 PPS. Some

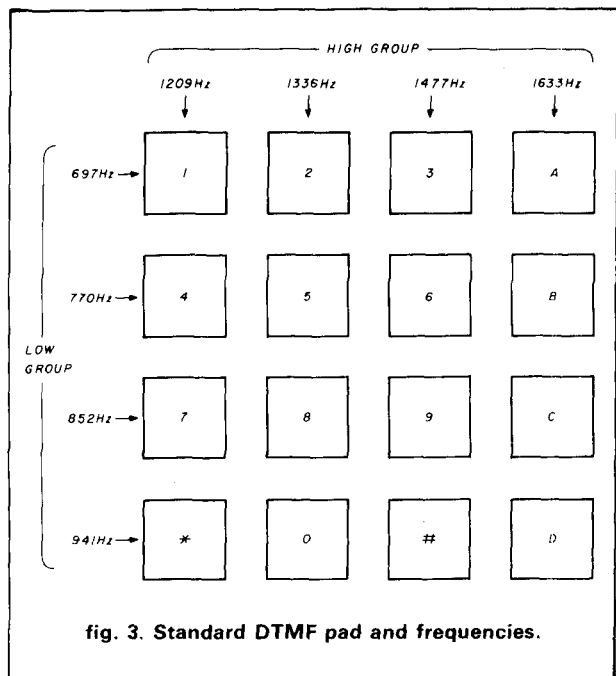

modern digital exchanges, free of the mechanical inertia problems of older systems, will accept a PPS rate as high as 20.

Besides the PPS rate, the dialing pulses have a make/break ratio, usually described as a percentage, but sometimes as a straight ratio. The North American standard is 60/40 percent; most of Europe accepts a standard of 63/37 percent. This is the pulse measured at the telephone, not at the exchange, where it's somewhat different, having travelled through the *phone line with its distributed resistance, capacitance, and inductance*. In practice, the make/break ratio does not seem to affect the performance of the dial when attached to a normal loop. Bear in mind that each pulse is a switch connect and disconnect across a complex impedance, so the switching transient often reaches 300 volts. Try not to have your fingers across the line when dialing.

Most pulse dialing phones produced today use a CMOS IC and a keyboard. Instead of pushing your finger round in circles, then removing your finger and waiting for the dial to return before dialing the next digit, you punch the button as fast as you want. The IC stores the number and pulses it out at the correct rate with the correct make/break ratio and the switching is done with a high-voltage switching transistor. Because the IC has already stored the dialed number in order to pulse it out at the correct rate, it's a simple matter for telephone designers to keep the memory "alive" and allow the telephone to store, recall, and redial the Last Number Dialed (LND). This feature enables you to redial by picking up the handset and pushing just one button.

Because pulse dialing entails rapid connection and disconnection of the phone line, you can "dial" a telephone that has lost its dial, by hitting the hook-switch rapidly. It requires some practice to do this with consistent success, but it can be done. A more sophisticated approach is to place a Morse key in series with the line, wire it as normally closed and send strings of dots corresponding to the digits you wish to dial.

Touchtone, the most modern form of dialing, is fast and less prone to error than pulse dialing. Compared to pulse, its major advantage is that its audio band signals can travel down phone lines further than pulse, which can travel only as far as your local exchange. Touchtone can therefore send signals around the world via the telephone lines, and can be used to control phone answering machines and computers. Pulse dialing is to touchtone as FSK or AFSK RTTY is to Switched Carrier RTTY, where mark and space are sent by the presence or absence of DC or unmodulated RF carrier. Most Radio Amateurs are familiar with DTMF for controlling repeaters and for accessing remote and auto phone patches.

Bell Labs developed DTMF in order to have a dialing system that could travel across microwave links and work rapidly with computer controlled exchanges. Each transmitted digit consists of two separate audio tones that are mixed together (see fig. 3). The four vertical columns on the keypad are known as the high group and the four horizontal rows as the low group; the digit 8 is composed of 1336 Hz and 852 Hz. The level of each tone is within 3 dB of the other, (the telephone company calls this "Twist"). A complete touchtone pad has 16 digits, as opposed to ten on a pulse dial. Besides the numerals 0 to 9, a DTMF "dial" has \*, #, A, B, C, and D. Although the letters are not normally found on consumer telephones, the IC in the phone is capable of generating them.

The \* sign is usually called "star" or "asterisk." The # sign, often referred to as the "pound sign," is actually called an *octothorpe*. Although many phone users have never used these digits — they're not, after all, ordinarily used in dialing phone numbers — they are used for control purposes, phone answering machines, bringing up remote bases, electronic banking, and repeater control. The one use of the octothorpe that may be familiar occurs in dialing international calls from phones in the United States. After dialing the complete number, dialing the octothorpe lets the exchange know you've finished dialing. It can now begin routing your call; without the octothorpe, it would wait and "time out" before switching your call.

When DTMF dials first came out they had complicated cams and switches for selecting the digits and used a transistor oscillator with an LC tuning network to generate the tones. Modern dials use a matrix switch and a CMOS IC that synthesizes the tones from

a 3.57 MHz (TV color burst) crystal. This oscillator runs only during dialing, so it doesn't normally produce QRM.

Standard DTMF dials will produce a tone as long as a key is depressed. No matter how long you press, the tone will be decoded as the appropriate digit. The shortest duration in which a digit can be sent and decoded is about 100 milliseconds (ms). It's pretty difficult to dial by hand at such a speed, but automatic dialers can do it. A twelve-digit long distance number can be dialed by an automatic dialer in a little more than a second — about as long as it takes a pulse dial to send a single 0 digit.

The output level of DTMF tones from your telephone should be between 0 and -12 dBm. In telephones, 0 dB is 1 milliwatt over 600 ohms. So 0 dB is 0.775 volts. Because your telephone is considered a 600 ohm load, placing a voltmeter across the line will enable you to measure the level of your tones.

## the ringer

Simply speaking this is a device that alerts you to an incoming call. It may be a bell, light, or warbling tone. The telephone company sends a ringing signal which is an AC waveform. Although the common frequency used in the United States is 20 Hz, it can be any frequency between 15 and 68 Hz. Most of the world uses frequencies between 20 and 40 Hz. The voltage at the subscriber's end depends upon loop length and number of ringers attached to the line; it could be between 40 and 150 volts. Note that ringing voltage can be hazardous; when you're working on a phone line, be sure at least one telephone on the line is off the hook (in use); if any are not, take high voltage precautions. The telephone company may or may not remove the 48 VDC during ringing; as far as you're concerned, this is not important. *Don't take chances.*

The ringing cadence — the timing of ringing to pause — varies from company to company. In the United States the cadence is normally 2 seconds of ringing to 4 seconds of pause. An unanswered phone in the United States will keep ringing until the caller hangs up. But in some countries, the ringing will "time out" if the call is not answered.

The most common ringing device is the gong ringer, a solenoid coil with a clapper that strikes either a single or double bell. A gong ringer is the loudest signaling device that is solely phone-line powered.

Modern telephones tend to use warbling ringers, which are usually ICs powered by the rectified ringing signal. The audio transducer is either a piezoceramic disk or a small loudspeaker via a transformer.

Ringers are isolated from the DC of the phone line by a capacitor. Gong ringers in the United States use a 0.47  $\mu$ F capacitor. Warbling ringers in the United

States generally use a 1.0  $\mu$ F capacitor. Telephone companies in other parts of the world use capacitors between 0.2 and 2.0  $\mu$ F. The paper capacitors of the past have been replaced almost exclusively with capacitors made of Mylar film. Their voltage rating is always 250 volts.

The capacitor and ringer coil, or Zeners in a warbling ringer, constitute a resonant circuit. When your phone is hung up ("on hook") the ringer is across the line; if you've turned off the ringer you've merely silenced the transducer, not removed the circuit from the line.

When the telephone company uses the ringer to test the line, it sends a low-voltage, low-frequency signal down the line (usually 2 volts at 10 Hz) to test for continuity. The company keeps records of the expected signals on your line. This is how it can tell if you've added equipment to your line. If your telephone has had its ringer disconnected, the telephone company cannot detect its presence on the line.

Because there is only a certain amount of current available to drive ringers, if you keep adding ringers to your phone line you'll reach a point at which either all ringers will cease to ring, some will cease to ring, or some ringers will ring weakly. In the United States the phone company will guarantee to ring five normal ringers. A normal ringer is defined as a standard gong ringer as supplied in a phone company standard desk telephone. The value given to this ringer is *Ringer Equivalence Number (REN) 1*. If you look at the FCC registration label of your telephone, modem, or other device to be connected to the phone line, you'll see the *REN* number. It can be as high as 3.2, which means that device consumes the equivalent power of 3.2 standard ringers, or 0.0, which means it consumes no current when subjected to a ringing signal. If you have problems with ringing, total up your RENs; if the total is greater than 5, disconnect ringers until your REN is at 5 or below.

Other countries have various ways of expressing REN, and some systems will handle no more than three of their standard ringers. But whatever the system, if you add extra equipment and the phones stop ringing, or the phone answering machine won't pick up calls, the solution is disconnect ringers until the problem is resolved. Warbling ringers tend to draw less current than gong ringers, so changing from gong ringers to warbling ringers may help you spread the sound better.

Frequency response is the second criterion by which a ringer is described. In the United States most gong ringers are electromechanically resonant. They are usually resonant at 20 and 30 Hz ( $\pm 3$  Hz). The FCC refers to this as *A* so a normal gong ringer is described as *REN 1.0A*. The other common frequency response is known as type B. Type B ringers will respond to signals between 15.3 and 68.0 Hz. Warbling ringers are

State  
of the art



by  
**K.V.G.**

### 9 MHz CRYSTAL FILTERS

MODEL	Appli- cation	Band- width	Poles	Price
XF-9A	SSB	2.4 kHz	5	\$53.15
XF-9B	SSB	2.4 kHz	8	72.05
XF-9B-01	LSB	2.4 kHz	8	95.90
XF-9B-02	USB	2.4 kHz	8	95.90
XF-9B-10	SSB	2.4 kHz	10	125.65
XF-9C	AM	3.75 kHz	8	77.40
XF-9D	AM	5.0 kHz	8	77.40
XF-9E	FM	12.0 kHz	8	77.40
XF-9M	CW	500 Hz	4	54.10
XF-9NB	CW	500 Hz	8	95.90
XF-9P	CW	250 Hz	8	131.20
XF910	IF noise	15 kHz	2	17.15

### 10.7 MHz CRYSTAL FILTERS

MODEL	Appli- cation	Band- width	Poles	Price
XF107-A	NBFM	12 kHz	8	\$67.30
XF107-B	NBFM	15 kHz	8	67.30
XF107-C	WBFM	30 kHz	8	67.30
XF107-D	WBFM	36 kHz	8	67.30
XF107-E	Pix/Data	40 kHz	8	67.30
XM107-SO4	FM	14 kHz	4	30.15

Export Inquiries Invited.

Shipping \$3.75

### MICROWAVE MODULES VHF & UHF EQUIPMENTS

Use your existing HF or 2M rig on other VHF or UHF bands.

### LOW NOISE RECEIVE CONVERTERS

1691 MHz	MMk1691-137	\$249.95
1296 MHz GaAsFET	MMk1296-144G	149.95
432/435	MMc432-28(S)	74.95
439-ATV	MMc439-Ch x	89.95
220 MHz	MMc220-28	74.95
144 MHz	MMc144-28	59.95

Options: Low NF (2.0 dB max., 1.25 dB max.), other bands & IF's available

### LINEAR TRANSVERTERS

1296 MHz	1.8 W output, 2M in	MM1296-144-G	\$299.95
432/435	10 W output, 10M in	MM1432-28(S)	269.95
144 MHz	10 W output, 10M in	MM1144-28	179.95

Other bands & IFs available.

### LINEAR POWER AMPLIFIERS

1296 MHz	20 W output	UP1296-20-L	439.95
432/435	100 W output	MML432-100	369.95
	50 W output	MML432-50	199.95
	30 W output	MML432-30-LS	209.95
144 MHz	200 W output	MML144-200-S	374.95
	100 W output	MML144-100-LS	239.95
	50 W output	MML144-50-S	149.95
	30 W output	MML144-30-LS	109.95

All models include VOX T/R switching.

"L" models 1 or 3W drive, others 10W drive.

Shipping: FOB Concord, Mass.

### ANTENNAS



#### 420-450 MHz MULTIBEAMS

28 Element	70/MBM28 12 dBd	<del>\$49.95</del>	\$39.95
48 Element	70/MBM48 15.7 dBd	<del>75.75</del>	59.95
88 Element	70/MBM88 18.5 dBd	<del>105.50</del>	89.95

#### 144-148 MHz J-SLOTS

10 + 10 Twist	10XY/2M	11.3 dBd	69.95
---------------	---------	----------	-------

#### UHF LOOP YAGIS

1250-1350 MHz 29 loops	1296-LY 20 dBi	\$49.95
1650-1750 MHz 29 loops	1691-LY 20 dBi	59.95
Order Loop-Yagi connector extra.		Type N \$14.95, SMA \$5.95

Send 44¢ (2 stamps) for full details of all your VHF & UHF equipment and KVG crystal product requirements.



**si**

(617) 263-2145  
SPECTRUM  
INTERNATIONAL, INC.  
Post Office Box 1084  
Concord, MA 01742, U.S.A.

all type B and some United States gong ringers are type B. Outside the United States, gong ringers appear to be non-frequency selective, or type B.

Because a ringer is supposed to respond to AC waveforms, it will tend to respond to transients (such as switching transients) when the phone is hung up, or when the rotary dial is used on an extension phone. This is called "bell tap" in the United States; in other countries, it's often called "bell tinkle." While European and Asian phones tend to bell tap, or tinkle, United States ringers that bell tap are considered defective. The bell tap is designed out of gong ringers and fine tuned with bias springs. Warbling ringers for use in the United States are designed not to respond to short transients; this is usually accomplished by rectifying the AC and filtering it before it powers the IC, then not switching on the output stage unless the voltage lasts long enough to charge a second capacitor.

### conclusion

This brief primer describing the working parts of a telephone is intended to provide a better understanding of phone equipment. Note that most telephone regulatory agencies, including the FCC, forbid modification of anything that has been previously approved or attached to phone lines.

ham radio

## 1985 A.R.R.L. National Convention Louisville, Kentucky

Sponsored by The Greater Louisville Hamfest Assn.

**October 4th, 5th and 6th**

From 1200 to 1800 Friday, 0800 to 1800 Saturday,  
0800 to 1600 EDT Sunday

At the Kentucky Fair and Exposition Center  
Take exit 12B off of I-264 in Louisville  
Over 250,000 sq. ft. of Floor Space  
Devoted to the Convention

Gigantic Exhibitors Area and Flea Market  
Technical Forums, A.R.R.L. Meeting,  
Fabulous Ladies Program

Camping Available on Grounds —  
Contact KFEC, P.O. Box 37130  
Louisville Ky. 40233 (502-366-9592)

Convention Motel — Executive West,  
Directly Across From Convention Site  
Contact (502-367-2251)

**For Information Contact**  
The Greater Louisville Hamfest Assn.  
P.O. Box 34444, Louisville, Ky. 40232  
or Phone (502) 368-6657

## ASTRON POWER SUPPLIES

• HEAVY DUTY • HIGH QUALITY • RUGGED • RELIABLE •

### RS and VS SERIES

#### SPECIAL FEATURES

- SOLID STATE ELECTRONICALLY REGULATED
- FOLD-BACK CURRENT LIMITING Protects Power Supply from excessive current & continuous shorted output.
- CROWBAR OVER VOLTAGE PROTECTION on all Models except RS-4A.
- MAINTAIN REGULATION & LOW RIPPLE at low line input Voltage.
- HEAVY DUTY HEAT SINK • CHASSIS MOUNT FUSE
- THREE CONDUCTOR POWER CORD
- ONE YEAR WARRANTY • MADE IN U.S.A.

#### PERFORMANCE SPECIFICATIONS

- INPUT VOLTAGE: 105 - 125 VAC
- OUTPUT VOLTAGE: 13.8 VDC  $\pm$  0.05 volts (Internally Adjustable: 11-15 VDC)
- RIPPLE: Less than 5mv peak to peak (full load & low line)

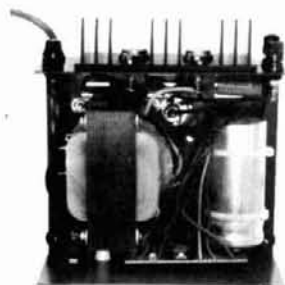

INSIDE VIEW - RS-12A



MODEL RS-50A



MODEL RS-50M



MODEL VS-50M

### RM-A Series



MODEL RM-35A

### 19" X 5 1/4" RACK MOUNT POWER SUPPLIES

• Separate Volt and Amp Meters

Model	Continuous Duty (AMPS)	ICS* (AMPS)	Size (IN) HxWxD	Shipping Wt. (lbs.)
RM-35A	25	35	5 1/4 x 19 x 12 1/2	38
RM-50A	37	50	5 1/4 x 19 x 12 1/2	50
RM-35M	25	35	5 1/4 x 19 x 12 1/2	38
RM-50M	37	50	5 1/4 x 19 x 12 1/2	50

### RS-A SERIES



MODEL RS-7A

MODEL	Continuous Duty (Amps)	ICS* (Amps)	Size (IN) H x W x D	Shipping Wt (lbs)
RS-4A	3	4	3 3/4 x 6 1/2 x 9	5
RS-7A	5	7	3 3/4 x 6 1/2 x 9	9
RS-7B	5	7	4 x 7 1/2 x 10 3/4	10
RS-10A	7.5	10	4 x 7 1/2 x 10 3/4	11
RS-12A	9	12	4 1/2 x 8 x 9	13
RS-20A	16	20	5 x 9 x 10 1/2	18
RS-35A	25	35	5 x 11 x 11	27
RS-50A	37	50	6 x 13 3/4 x 11	46

### RS-M SERIES



MODEL RS-35M

• Switchable volt and Amp meter

MODEL	Continuous Duty (Amps)	ICS* (Amps)	Size (IN) H x W x D	Shipping Wt (lbs)
RS-12M	9	12	4 1/2 x 8 x 9	13
RS-20M	16	20	5 x 9 x 10 1/2	18
RS-35M	25	35	5 x 11 x 11	27
RS-50M	37	50	6 x 13 3/4 x 11	46

### VS-M SERIES



MODEL VS-20M

- Separate Volt and Amp Meters
- Output Voltage adjustable from 2-15 volts
- Current limit adjustable from 1.5 amps to Full Load

MODEL	Continuous Duty (Amps) @ 13.8VDC @ 10VDC @ 5VDC	ICS* (Amps) @ 13.8V	Size (IN) H x W x D	Shipping Wt (lbs)
VS-20M	16 9 4	20	5 x 9 x 10 1/2	20
VS-35M	25 15 7	35	5 x 11 x 11	29
VS-50M	37 22 10	50	6 x 13 3/4 x 11	46

### RS-S SERIES



MODEL RS-12S

• Built in speaker

MODEL	Continuous Duty (Amps)	ICS* Amps	Size (IN) H x W x D	Shipping Wt (lbs)
RS-7S	5	7	4 x 7 1/2 x 10 3/4	10
RS-10S	7.5	10	4 x 7 1/2 x 10 3/4	12
RS-10L(For LTR)	7.5	10	4 x 9 x 13	13
RS-12S	9	12	4 1/2 x 8 x 9	13
RS-20S	16	20	5 x 9 x 10 1/2	18

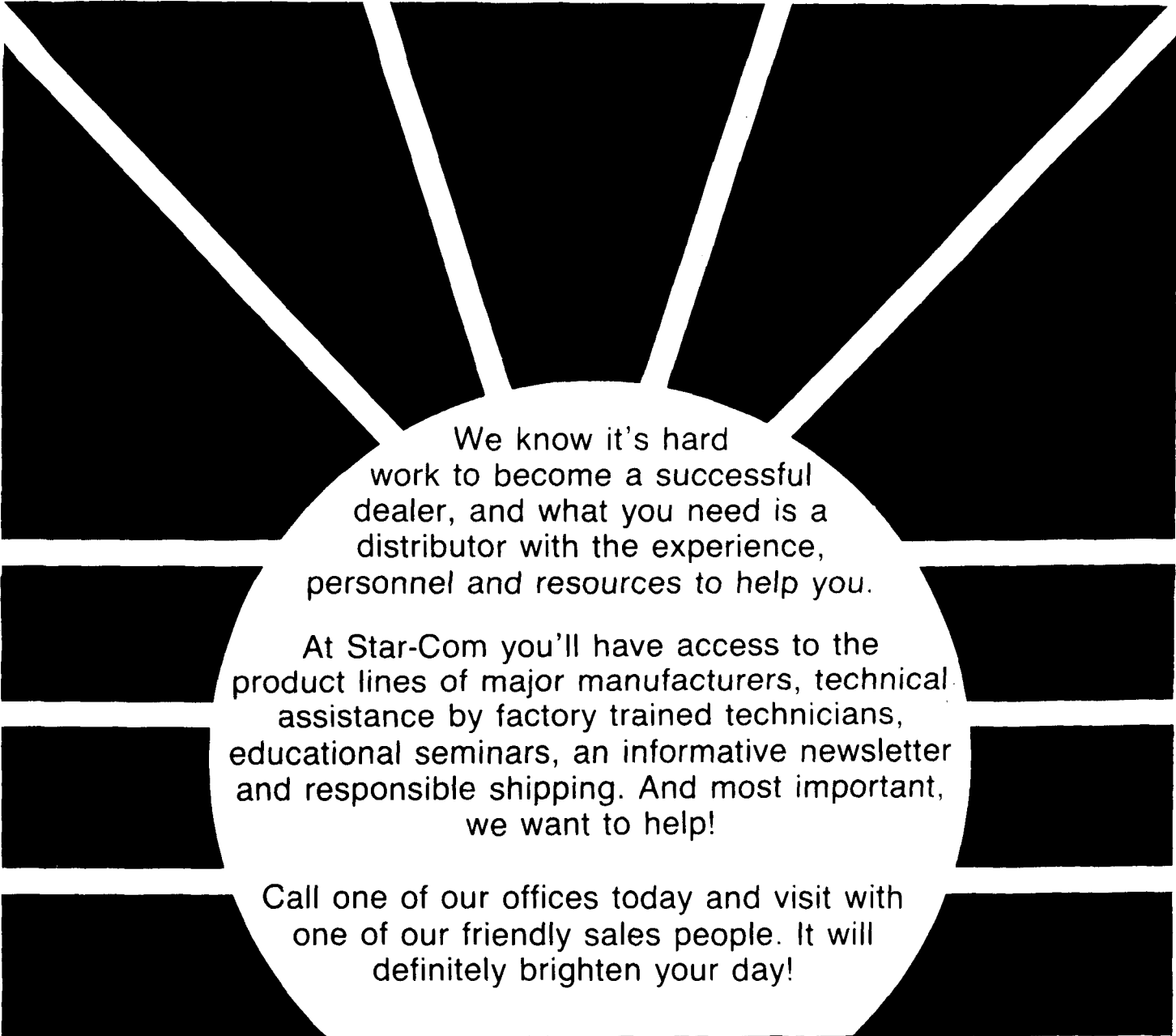

We know it's hard  
work to become a successful  
dealer, and what you need is a  
distributor with the experience,  
personnel and resources to help you.

At Star-Com you'll have access to the  
product lines of major manufacturers, technical  
assistance by factory trained technicians,  
educational seminars, an informative newsletter  
and responsible shipping. And most important,  
we want to help!

Call one of our offices today and visit with  
one of our friendly sales people. It will  
definitely brighten your day!

# STAR COM

## DISTRIBUTING

**Big Spring, TX**  
800-351-1426 National  
800-592-1476 Texas

**Arlington, TX**  
(817) 640-1121  
1-800-242-3662 Tx.

**Oklahoma City, OK**  
800-522-7052 OK Wats  
800-348-0008 Nat. Wats

**Houston, TX**  
1-800-833-5364 Texas Wats  
1-800-222-1384 Nat. Wats

**Jefferson City, MO**  
800-421-7242 National  
800-892-6080 Missouri

**San Antonio, TX**  
(512) 650-3291  
1-800-292-2116 Texas

**Mission, TX**  
512-581-2785

**Affiliate Distributor**  
**Tallahassee, FL**  
(904) 878-0816



# a DTMF controller for repeaters

This multifunctional, expandable decoder uses high quality components — but doesn't cost a fortune to build

**Remote control of the various functions** of a repeater is usually accomplished through the use of dual-tone multifrequency (DTMF) signals generated in a pushbutton touchtone pad. These signals can also be generated in computer-controlled synthesizers, but the end result is always the same — a series of tone-encoded signals that must be detected and decoded to perform the intended function. Over the years a number of articles have appeared in Amateur publications concerning the decoding of the DTMF signal, but what to do with the decoded signals has often remained in question. The circuit described in this article may help to answer that question and perhaps encourage repeater technical committees whose members are thinking about modernizing or expanding their control circuitry.

This multifunctional, expandable decoder features full DTMF decoding, multi-digit coding, latching output, multi-source reset and a separate auxiliary output, for use by system logic. It's DC coupled to greatly reduce falses from noise, and expandable. No adjustments are necessary; no tedious alignment or periodic

tweaking are required. Its circuits detect the sequence in which the decoded DTMF signals are received and, if the sequence is correct, provide a latched open-collector output that can be used to activate the intended function.

## circuit description

Two basic circuits comprise the DTMF controller: a DTMF decoder and a sequence detector (see **fig. 1**). For practical repeater control it may be preferable to locate these two circuits on separate PC boards. However, for purposes of explanation, consider them to be located on one subassembly.

The heart of the DTMF decoder is the SSI-201, manufactured by Silicon Systems, Inc. I won't go into details of the chip's operation, except to say that it represents a quantum leap beyond the traditional 567 decoder and exhibits central-office quality with respect to immunity to talk-off and noise falsing. This circuit was described in *ham radio* by KC9C<sup>1</sup> and is essentially lifted from the data sheet\* provided by the manufacturer.

One addition that I made was to add the low-pass filter consisting of R1, R2, C1, and C2 (see **fig. 2**), which significantly improved the chip's tolerance to different pads in the field. No problems were encountered when the DTMF tones were generated in a Western Electric Series 35 pad, or equivalent. However, the vagaries of synthesized DTMF generators found in a variety of HTs and DTMF microphones made the decoder a little fussy — some pads would work, while others would not. Since the addition of the LPF, none of the pads used to access the decoder has failed to produce the correct outputs.

When the correct tone pair is received at pin 12 of U1, a hexadecimal output is generated on pins 1, 20, 21, and 22. These four data lines are applied directly

\*Data sheet available from Silicon Systems, Inc., 14351 Myford Road, Tustin, California 92680.

By Terry Simonds, WB4FXD, PO Box 1558, Edgartown, Massachusetts 02539

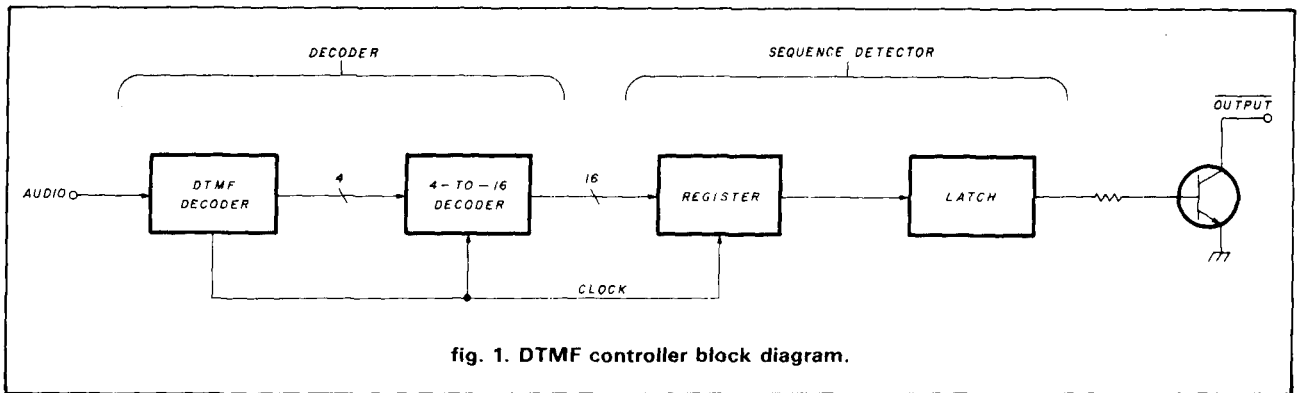

fig. 1. DTMF controller block diagram.

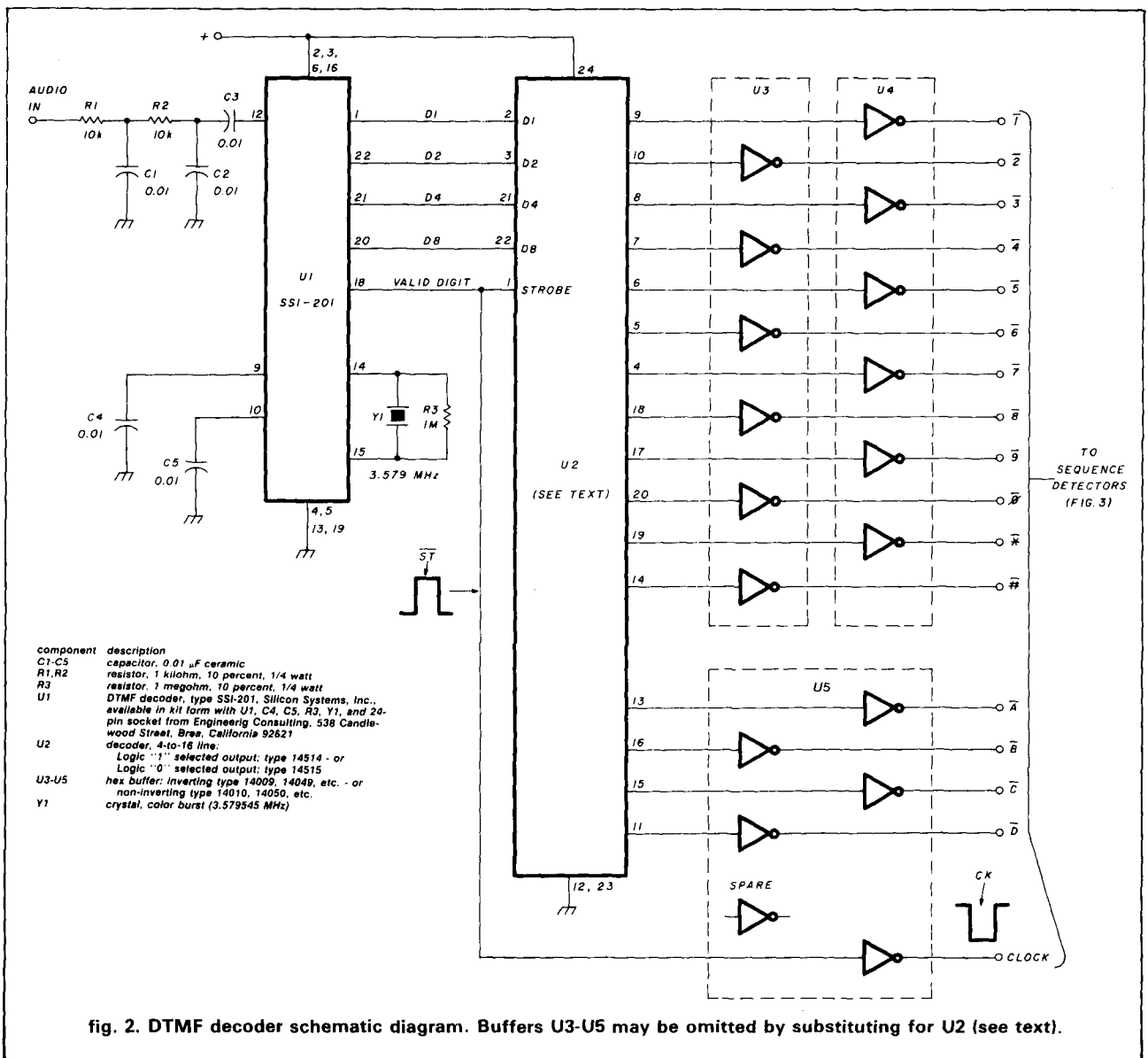

fig. 2. DTMF decoder schematic diagram. Buffers U3-U5 may be omitted by substituting for U2 (see text).

to U2, a 4- to 16-line decoder. Pin 18 of U1 produces a positive-going "valid-digit" pulse if both DTMF tones have been received and decoded. This pulse is applied

directly to U2 as a strobe for that chip's operation and is inverted and applied to the sequence detector as a clock.

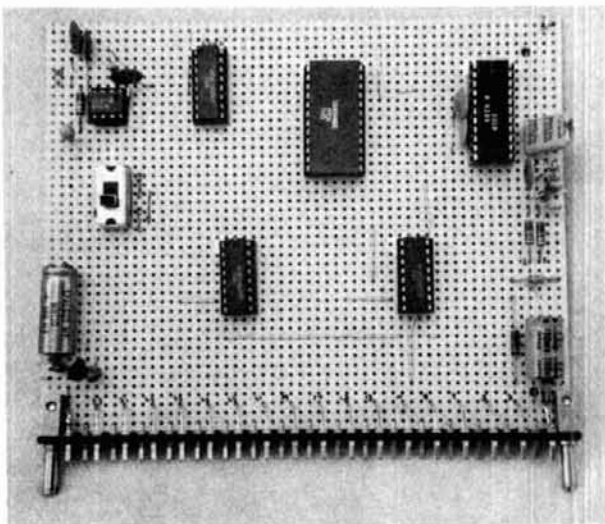

fig. 4. Decoder card. The heart of the decoder is the 24-pin chip — the SSI-201. Several components shown here are not required for basic decoder operation, but are used in other repeater-control functions.

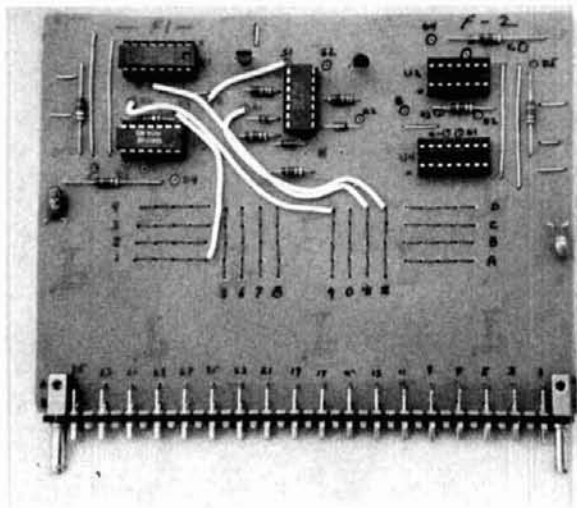

fig. 5. Sequence-detector card. The left half of the card has been programmed with the code \*97. The right half is un-coded at the present. The vertically oriented chip at the top center is the output latch shared by the two sequence detectors on the card.

The resulting output from U2 is logic 1 latched on one of its 16 output lines. By appropriately labeling these lines, one arrives at a unique output that corresponds to the button that was pressed on the pad.

Each output line from U2 is buffered and inverted in three hex inverter/buffers, U3-U5, for presentation to the sequence detector that follows. Note that these buffers are shown in the dashed box illustrated in fig. 2. When I was designing the control system for our repeater, I was unsure of the number of stages that would follow the decoder, for reasons that will become

apparent later. I therefore chose the 14514 decoder, which has a decoded "1" output and inverted this in the buffer. If it's known in advance what the load will be, it may be possible to substitute a 14515 for U2 and eliminate U3-U5 (the 14515 presents a decoded "0" on its output line).†

The purpose of the sequence detector is to produce a latched output if, and only if, the sequence of 0's received from the decoder coincides with a preprogrammed sequence of digits for the desired function. Figure 3 shows the schematic diagram of the sequence detector, which consists of a register and a latch. The register, made up of quad-D flip-flop U1 and quad-OR U2, has applied to its DIGIT-1 through DIGIT-5 inputs the desired decoded digit lines from the decoder in the sequence that corresponds to the desired code. Also applied to the register at U1-9 is the clock signal from the decoder.

As DTMF signals from the repeater receiver are decoded, 0's are momentarily placed on various of the 16 lines to the sequence detector. At the same time, a clock signal is generated for each decoded digit. The first digit line in the code is connected to DIGIT-1, the second to DIGIT-2, and so on. The first 0 received on DIGIT-1 is clocked through U1A to its Q output, where it is stored and presented to OR gate U2A. The second decoded digit, presented to the other input to U2A, produces a 0 at the output of U2A which, upon receiving the second clock pulse, is passed on the the Q output of U1B. The third 0 in the sequence is OR'ed in U2B to produce a 0 at U2-3. It can be seen that a logic 0 is then passed along from output to output of the register as the correct code is punched into the pad. Note that there are output lines from the register corresponding to codes of two, three, four, and five digits. Any of these outputs can be used, depending on the number of digits in the code. If an incorrect digit appears in the code, a 1 will be clocked into the register at that point because there would not be a "desired digit line" as an input. This will cause the corresponding OUT line to remain high. The valid sequence is thus lost, and must be entirely re-entered.

The 0 from the appropriate OUT line is applied to SET input of conventional R-S flip-flop U3, configured as a dual-output latch. The Q output (pin 3) saturates transistor Q1 through R7, thereby pulling its collector to ground to actuate the selected function. The Q-bar output from the latch (pin 4) can be used as an auxiliary output if desired. A typical application would be as an interlock signal for the repeater controller logic. If an auxiliary output is not wanted, omit diode CR3.

There are several ways that the latch can be reset and the function turned off; each requires that a logic 0 be placed on the latch RESET line.

†The nominal fan-out capability of a CMOS chip is 50.

# BUY DIRECT FROM A DISTRIBUTOR AND SAVE

- WA6YFU

## Little Wil

BY WILSON



The first small system that  
makes satellite TV simple

**AMATEUR SPECIAL!**

WILSON "LIL WIL" only \$899.<sup>00</sup>

With paid order shipping is included

Call Collect to Order  
(714) 659-3351

or Write

**Wolcott's  
Satellite Systems**

25880 Hwy. 243  
P.O. Box 482  
Idyllwild, CA 92349



✓ 171



# Your Ham Tube Headquarters!

TUBES BOUGHT, SOLD AND TRADED  
SAVE \$\$\$—HIGH \$\$\$ FOR YOUR TUBES

Call Toll Free 800-221-0860

Tubes			
3-400Z.....	\$85.00	7360.....	\$10.00
3-500Z.....	85.00	7735A.....	27.50
4-400A.....	80.00	8122.....	110.00
4CX250B.....	50.00	8156.....	12.50
572B.....	55.00	8643.....	82.50
811A.....	12.00	8844.....	26.50
813.....	30.00	8873.....	175.00
6146B.....	6.50	8874.....	195.00
6360.....	4.25	8877.....	500.00
6883B.....	6.75	8908.....	12.50

### MAJOR BRANDS ON RECEIVER TUBES

75% off list

Semiconductors			
MRF 245/SD1416	\$30.00	SD1088	19.95
MRF 454	14.95	2N3055	75¢
MRF 455	10.95	2N6084	12.50

RF Connectors			
PL259.....	10/\$4.95	M358.....	2.50 ea.
PL258.....	10/8.95	M359.....	1.75 ea.
UG 175/176.....	10/1.60	Type "N" Twist on	
UG255/u.....	2.50 ea.	(RG8/u).....	\$4.75 ea.
UG273/u.....	2.25 ea.	Minimum Order	\$25.00

Allow \$3.00 min. for UPS charges ✓ 129

**CeCo**

COMMUNICATIONS, Inc.

2115 Avenue X Brooklyn, NY 11235

SERVING THE INDUSTRY SINCE 1922

Phone (212) 646-6300

Call CECo For Your CCTV Security And Color Production Requirements

# ISOTRON ANTENNAS



A STEP FORWARD  
IN HF  
COMMUNICATIONS

NO TUNERS!

NO RADIALS!

NO COMPROMISE!

Models From  
160-10 Meters

"Comparing antennas, Frank mentioned to me that the Isotron was S9 + 10 dB, whereas the outside antenna was only S9 + 5 dB! Here, the Isotron actually put out a better signal than the regular antenna! Probably skip angle, ect., but who cares? The performance of the Isotron 40 is just plain phenomenal." See review in October 73, 1984.

Finally, a full size Antenna in a 3-dimensional package. Perfect for limited space, RV's, Marine and more

The Isotrons offer you excellent transmitting performance along with low noise reception and a sensitive receiving quality.

80-METER - \$63.95 plus \$4.75 Shipping  
40-METER - \$52.95 plus \$3.75 Shipping  
80-40 Combination - \$110.00 plus \$ 50 Shipping  
ASK FOR PRICES ON OTHER MODELS

BILAL COMPANY

S.R. 2, Box 62, Dept. 91  
Eucha, Ok. 74342 PH: 918-253-4094



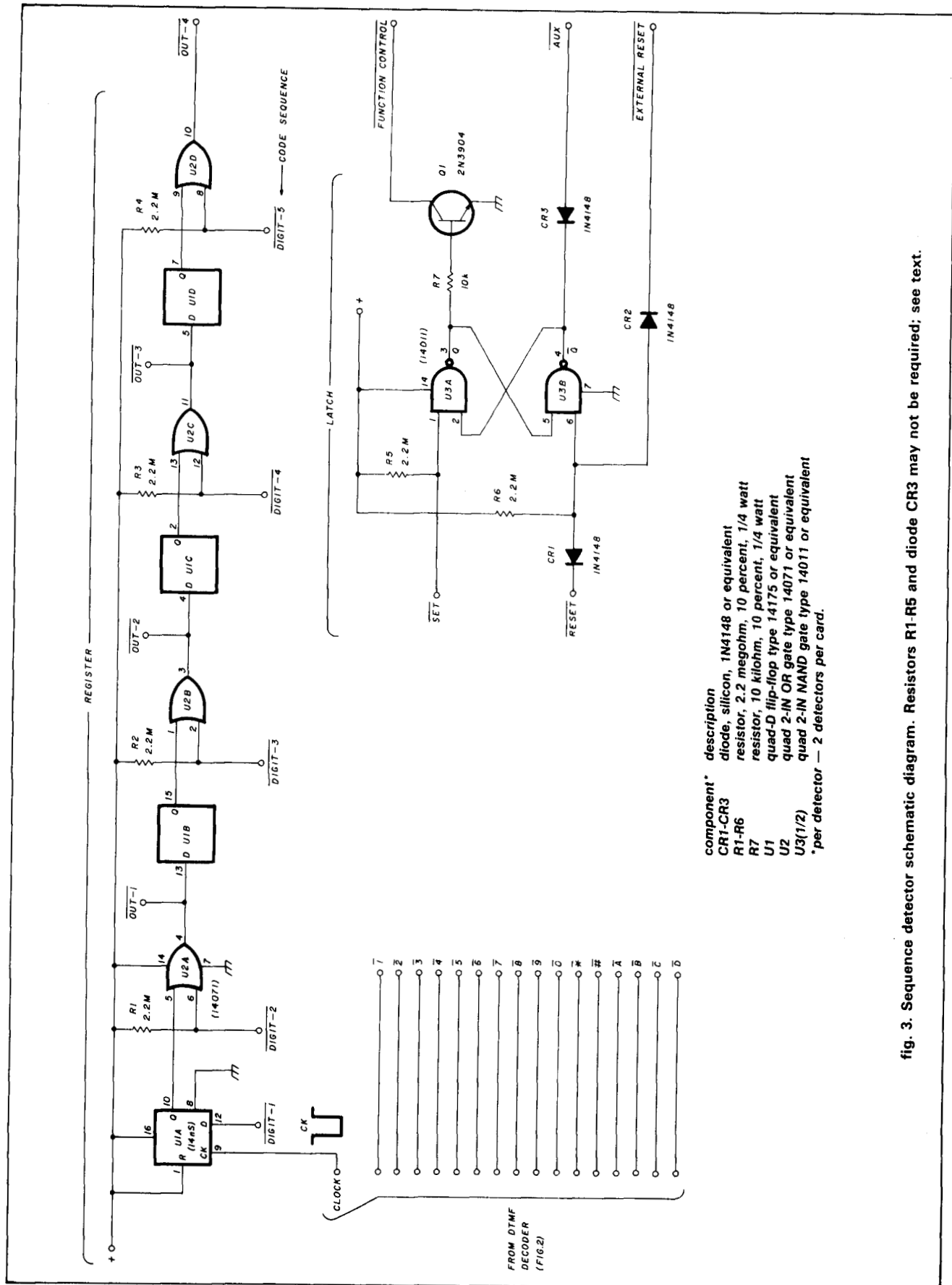

fig. 3. Sequence detector schematic diagram. Resistors R1-R5 and diode CR3 may not be required; see text.

# CB-10 FM SPECIAL



- Hy Gain 40-Channel Board
- 40-Channel Switch
- Volume & Squelch Control
- FM Detector Module
- Full Instructions Included

**\$14.95** Add \$2.00 shipping & handling BOARD ONLY \$6.95

**QRP TRANSCEIVER SET - \$34.95**

**VHF CONVERTER SET - \$24.95**

Add \$2.00 For Shipping & Handling - Send For FREE Brochure

SEND \$2.00 FOR FULL MANUAL WITH CIRCUIT DIAGRAMS

MANY OTHER MODULES AVAILABLE

**MORNING DISTRIBUTING CO.**

P.O. BOX 717, HIALEAH, FLA. 33011  
(305) 884-8686

# HOBBY KITS®

EXPERIMENT — LEARN ELECTRONICS  
BUILD AND DESIGN YOUR OWN AM, FM, CW,  
OR SSB RECEIVERS, TRANSMITTERS AND ETC.  
WITH OUR MINI-LINEAR CIRCUIT KITS  
All kits Come Complete With Etched and Drilled Circuit Boards  
and All Parts Needed To Function As Described

AFA-1 AUDIO AMP, LM 380 1-2 Watts 4-16 OHM Output	\$4.95
AFP-1 AUDIO PREAMP, Dual Audio Preamp — For Mike Etc	\$3.95
BMD-1 BAL. MIX, LM 1496 Mixer — S B Modulator Tuned Output	\$9.95
DET-1 AM DET, Am Envelope Detector With AGC Output	\$3.95
DET-2 FM DET, LM 3065 FM Detector (455 KHZ or 4-11 MHZ)	\$7.95
DET-3 SSB DET, LM 1496 SSB Detector (Needs OSC-1 or OSC-4)	\$9.95
DET-4 DETECTOR CW/SSB using a dual gate FET transistor	\$4.95
IFA-1 IF AMP, CA 3028 30 DB Gain, Optional AGC (455 KHZ or 9-11 MHZ)	\$6.95
FLS-9 SSB FILTER 9 MHZ/2 1 KHZ BW with USB XAL for OSC-1	\$49.95
IFA-2 IF AMP, CA 3028 30 DB Gain 1-100 MHZ Optional AGC	\$6.95
MBA-1 FREQ. MULT, Tuned Output Buffer-Mult. Amplifier To 250 MHZ	\$5.95
OSC-1 CRYSTAL OSC, 100 KHZ — 20 MHZ Not Tuned	\$3.95
OSC-2 CRYSTAL OSC, Ov. 18-200 MHZ Tuned Output	\$4.95
PSV-1 POWER SUPPLY LM 723 With Pass Transistor, 3 amps max	\$7.95
PLL-2 TONE DETECTOR LM567 PLL Tone Detector	\$5.95
RF/MIX-1 RF-AMP/MIXER CA 3028 — Tuned RF AMP/Mixer 1-100 MHZ	\$7.95
RF/MIX-2 RF-AMP/MIXER 3N204 Tuned RF AMP/Mixer 1 — 250 MHZ	\$7.95
VCO-3 VARIABLE HI STAB OSC, Varactor tuned, 400 to 600 KHz output	\$7.95
VCO-4 VARIABLE HI STAB OSC, Varactor tuned, 3 to 20 Mhz output	\$7.95

Add \$2.00 For Shipping & Handling - Send For FREE Brochure

SEND \$2.00 FOR FULL MANUAL WITH CIRCUIT DIAGRAMS AND

TYPICAL RECEIVER AND TRANSMITTER HOOK-UPS

MANY OTHER MODULES AVAILABLE

**MORNING DISTRIBUTING CO.**

P.O. BOX 717, HIALEAH, FLA. 33011

✓ 172

## RF Porta-Tenna

VHF/UHF Telescopic 1/4 & 5/8  
Wavelength Antennas for  
Hand-Held Transceivers &  
Test Equipment

### 1/4 WAVELENGTH

Model No.	Freq. MHz	Description	Price
196-200	144-148	5/16-32 stud w/spring	\$5.95
196-204	"	BNC connector w/spring	7.95
196-214	"	BNC connector	6.95
196-224	144-UP	BNC conn. adj. angle	7.95
196-814	220-225	BNC connector	6.95

### 5/8 WAVELENGTH

191-210	"	5/16-32 for old TEMPO	22.95
191-214	"	BNC connector	19.95
191-219	"	PL-259 w/M-359 adpt.	22.95
191-810	220-225	5/16-32 for old TEMPO	22.95
191-814	"	BNC connector	19.95
191-940	440-450	5/16-32 for HT-220	22.95
191-941	"	1/4-32 stud	22.95
191-944	"	BNC connector	19.95

Largest Selection of Telescopic Antennas. Write for Info. Prices are postpaid via UPS to 48 States. For air delivery via UPS Blue add \$2.25. Florida add 5% sales tax. Payment by M.O. or Cashiers Check only. ✓ 141

**RF PRODUCTS**

P.O. Box 33, Rockledge, FL 32955, U.S.A.  
(305) 631-0775

## MICROWAVE EQUIPMENT



**RMLA - 2.3**  
Single Stage, Low Noise  
Gas FET Amplifier  
\$60.00

Optimum Transistor Noise Figure less than 5 dB, Associated Gain Greater Than 15dB at 2.3 GHz. Source/Load must be 50 ± 10 ohm Non-Reactive. SMA Connectors. Requires ±5VDC Power with -5VDC present when +5VDC applied. Power Supply and Sequencing is not supplied. Zener Protection. Unenclosed on 2" x 2" PC Board.

Write for Price/Delivery for any frequency from 1 to 6 GHz. Also VCO's, Signal Generators, Detectors, Attenuators, Filters, Mixers, and Converters.

Price includes Shipping and Insurance when paid by check or money order. Charge or C.O.D. orders, F.O.B., Brookfield, MO

**ROENSCH MICROWAVE**

R.R. 1, Box 156B,  
BROOKFIELD, MISSOURI 64628 ✓ 236



NEW  
20-PAGE  
CATALOG FREE

### 7 MILLION TUBES

Includes all current, obsolete, antique, hard-to-find receiving, transmitting, industrial, radio/TV types. **LOWEST PRICES**, Major brands in stock. Unity Electronics Dept.

P.O. Box 213, Elizabeth, N.J. 07206



✓ 237

## MULTI-BAND SLOPERS

ALSO: DIPOLES & LIMITED-SPACE ANTENNAS  
Outstanding performance of WSPN antennas is well known. Now enjoy multi-band BIG-SIGNAL reports! Automatic bandswitching - Very low SWR - Coax feed - 3kw power - Compact - FULLY ASSEMBLED to your specified center frequency each band - EASY TO INSTALL - Very low profile - Complete instructions - Your personal check accepted

4 BAND SLOPER - 160, 80, 40, 30, or 20M	60 ft long	\$ 48 ppd	
1 "	160, 80, 40M	60 ft "	\$ 43 "
2 "	80, 40M	40 ft "	\$ 35 "
3 "	NO-TRAP DIPOLE - 160, 80, 40M	113 ft long	\$ 71 "
2 "	80, 40M	85 ft "	\$ 55 "
8 BAND SPACE SAVER DIPOLE - 160 thru 10M*	56 ft long	\$ 85 ppd	

\* Requires wide-range tuner (80, 40, 20, 15M without tuner)

SEND SASE for complete details of these and other unique antennas

WINN ANTENNAS 312 394 3414  
BOX 393-H MT. PROSPECT, IL 60056

✓ 145

# NEW

## ARRL TECH-GENERAL LICENSE MANUAL

Written in an easy to read and understand style, this is the guide you need for your Tech/General studying. FCC questions with complete answers ©1985. 1st edition.  
 AR-TG Softbound \$5.00  
Please add \$2.50 for shipping and handling

ham radio BOOKSTORE  
Greenville, NH 03048

**Single-digit reset.** If one of the digit lines from the decoder is connected to  $\overline{\text{RESET}}$ , the latch will be reset when that digit is received. The most common would be #.

**External reset.** A logic 0 applied through diode CR2 will reset the latch. For example, if the function selected were autopatch, a negative-going pulse from the autopatch time-out timer could be connected here to reset the latch so that the patch would not be immediately brought back up after time-out. If external reset is not needed, omit diode CR2.

**Multi-digit coded reset.** If it is desired to provide a coded reset function, such as enabling the repeater transmitter after it has been "put to sleep," then  $\overline{\text{SET}}$  is connected to an  $\overline{\text{OUT}}$  line higher in number than that used to enable the function. For example, suppose the code \*7539 were to be used to disable the transmitter. The five digit lines corresponding to that code would be connected to  $\overline{\text{DIGIT-1}}$  through  $\overline{\text{DIGIT-5}}$  in the code sequence and  $\overline{\text{OUT-4}}$  would be connected to the  $\overline{\text{SET}}$  line of the latch. The  $\overline{\text{OUT-2}}$  line from the register would be connected to the  $\overline{\text{RESET}}$  line of the latch. When the disable code \*7539 is received, the latch is set and the output 0 is used to disable the transmitter, for example, by holding the receiver COR line low. To enable the transmitter, the code \*75 would be used and the latch would be reset allowing the COR to operate the transmitter. This is not a particularly secure coding system, but it allows turning a function on and off with the same hardware and with a code that the average repeater user would not be able to "guess." Perhaps this is an acceptable tradeoff in component count and reliability.

Another very practical application of single- and multi-digit reset would be in the restriction of certain types of calls made on the repeater autopatch. For toll restriction, use the single-digit approach. Toll calls can only be made by dialing a 0 or a 1 after you have received dial tone. Assume a three-digit autopatch-access code. Connect the digit lines from the decoder in the correct sequence to the sequence detector  $\overline{\text{DIGIT}}$  inputs and connect the  $\overline{\text{OUT-2}}$  line to the  $\overline{\text{SET}}$  line of the latch. Then diode-OR digits 1 and 0 to  $\overline{\text{DIGIT-4}}$  and connect  $\overline{\text{OUT-3}}$  to  $\overline{\text{RESET}}$ . When you now try to dial 1 or 0 as the first digit after the patch has been brought up, it will be immediately disconnected. To restrict calls to certain central offices, diode-OR the first two digits of the prohibited offices to  $\overline{\text{DIGIT-4}}$  and  $\overline{\text{DIGIT-5}}$  and connect  $\overline{\text{OUT-4}}$  to  $\overline{\text{RESET}}$ . This latter method may be particularly attractive to repeater groups whose telephone billing is based on message unit systems.

Note resistors R1-R5. These are pull-ups to hold the

gate inputs high if there is not a digit line or output line connected. This is necessary to prevent possible instability due to floating gate input. R6 performs the same function in the latch. Since this gate input is diode-coupled, R6 must be installed at all times.

## construction details

The DTMF controller for our repeater was built as several subassemblies; the decoder and its associated circuits occupy one 4.5 × 6 inch (11 × 15 cm) perf-board, while two sequence detectors are located on each of several identically sized PC cards. **Figure 4** shows the decoder card. The 555 timer in the upper left corner is not required for decoder operation. Its function in the repeater controller is to mute the DTMF tones to the transmitter so that they are not retransmitted. This affords increased security of repeater codes, and somewhat calms the nerves of the control operators. The slide switch is used to select muting or non-muting of the tones and is also not required. The transistor, seen near the lower left corner, is not shown on the schematic. It functions as a power-up sequencer for the card, required because of different logic voltages used in the repeater controller logic system, but is not necessary for decoder operation.

**Figure 5** shows one of the sequence-detector cards used in the repeater controller. This card is shown with jumpers installed for control code \*91 and the diode installed for an auxiliary output for that function. When the photo was taken, the right half of the card was not required and was therefore left blank. Another function has since been added, jumpers have been appropriately arranged, and the necessary chips installed in their sockets.

## expansion and change

As every repeater operator knows, there's no such thing as a finished machine. There are always changes to be made, more functions to be added, and codes to change for one reason or another. With the controller described here, this becomes a relatively simple task.

For example, if an access code is to be changed, all that has to be done is to move a few jumpers around. If you want to add a new function and all the sequence-detector cards are in use, it's a simple matter to fabricate another one, code it, and install it in the controller card cage. If the digit and clock lines from the decoder are "daisy-chained" to a reasonably large number of "dedicated-spare" sockets, together with  $V_{DD}$ , ground, and reset, then backplane wiring in the card cage at the time of addition would be significantly reduced. All that would be required would be to connect a  $\overline{\text{FUNCTION ON}}$  line and the  $\overline{\text{AUX OUT}}$  line if desired.

Because, at the time of design, I did not know what

# AMATEUR TELEVISION

## NEW 70 CM ATV TRANSCEIVER

ALL YOU NEED IN ONE BOX



**\$299 delivered**  
**TC70-1**

- **FULL COLOR, SOUND, & LIVE ACTION** just like broadcast TV. Get on this exciting amateur video mode at our affordable ready to go price.
- **WHAT IS REQUIRED FOR A COMPLETE OPERATING SYSTEM?** The TC70-1s downconverter outputs to any TV on ch 3 for receiving. Connect a good 70 cm antenna and low loss coax. Plug in any composite video source you want to transmit: Camera, VCR, computer, etc. Plug in any low Z dynamic mic or use color camera mic for Standard 4.5 mHz TV sound. Connect to 13.8 vdc for base, mobile, or portable. See chapt. 20 1985 ARRL Handbook. That's it!
- **WHAT CAN YOU DO WITH THE TC70-1 ATV TRANSCEIVER?** Show the shack, projects, computer program listings, home video tapes, repeat Space Shuttle audio and video if you have a TVRO, repeat SSTV or RTTY, Weather Radar, do public service events such as parades, marathons, races, CAP searches and rescues... the list goes on. DX depends on antennas and terrain, typically 1 to 40 miles. We have video compensated RF linear amps for 20 (\$119) or 50 (\$189) watts pep for greater DX.
- **FEATURES:** Small 7x7x2.5". Push to Look (PTL) T/R switching. GaAsfet downconverter tunes whole 420-450 mHz band. Two switch selected video & audio inputs... RCA phone jacks and 10 pin color camera jack. Xmit video monitor output. Over 1 watt pep RF output on one or two (add \$15) selected crystal controlled frequencies. 439.25, 434.0, or 426.25 mHz.

**CALL OR WRITE FOR OUR CATALOG** for more info or who is on in your area. We stock antennas, modules, and everything you need on ATV.

**TERMS:** Visa, MC, or cash only UPS CODs by phone or mail. Checks must clear bank before shipment. Price includes UPS surface shipping in cont. USA, others add 3%. Transmitting equipment sold only to licensed Tech class or higher amateurs, verifiable in 1985 call book or copy of new license.

(818) 447-4565 m-f 8am-6pm pst.

**P.C. ELECTRONICS**  
Tom W6ORG Maryann WB6YSS

   
**2522 Paxson Lane**  
**Arcadia CA 91006**

functions were to be included in the final configuration of the repeater, I buffered the digit and clock lines from the decoder card. So configured, the DTMF decoder should be able to drive all the sequence detectors or other loads required by the wildest imagination of any repeater technical committee!

### conclusion

The simple circuit described here has been in operation for several months in the Vineyard Amateur Radio Association's 220-MHz machine on Martha's Vineyard. It has performed according to design in all respects and has afforded control of our machine's various functions without fail. Barring a near hit by lightning or a catastrophic failure in the power supply, it should remain operative for years. While not providing the flexibility over control functions that a micro-based system could, this control system comes close and is considerably simpler and less expensive to build.

### reference

1. Mark Forbes, KC9C, "A State-of-the-Art Touchtone Decoder," *ham radio*, April, 1983, page 27.

**ham radio**

✓ 132

# NCG Co. NEW-TECHNOLOGY HIGH-QUALITY

AFFORDABLE TRANSCEIVERS FOR ALL. WINNERS IN COMPARISON HANDS DOWN!

**10/160 M**  
**HF TRANSCEIVER**



**40-15-6 M NEW**  
**TRI-BANDER**



**15 M**  
**15 METER MOBILE**



JUST SLIGHTLY AHEAD! WITH THE QUALITY YOU HAVE ALWAYS LOOKED FOR!

4 MEMORIES - 3 WAY AUTO SCAN, DUAL VFO, IF SHIFT, CW-W, 400 Hz. CW-N 200 Hz. ALL 9 BANDS PLUS MARS. BUILT IN AC/DC POWER. SSB. CW OR RTTY. I.F. TUNE 3-STEP TUNING SPEED, 200 WATT PEP, MICROPHONE IMPEDANCE 600-50K OHM HAND MIC. INCLUDED.

40, 15 AND 6 METERS ARE YOUR BASE STATION OR MOBILE WITH AC/DC BUILT IN POWER SUPPLY CW-N 200 Hz OR USB, 2.S0239 ANTENNA CONNECTORS, HAND MIC. BUILT IN TVI FILTER LITTLE TO NO TV INTERFERENCE, 20 WATTS PEP, MARS ON 40 AND 6 METERS.

A GREAT QRP RIG WITH THE BIG RIG SIGNAL, 2 WATTS OR 10 WATTS OUT. BUILT IN CW SIDE TONE, DIGITAL DISPLAY, HAND MIC. TOP MOUNTED SPEAKER. MOBILE BRACKET. RIT OR FINE TUNE TX&RX.  $\pm 4$ KHz, 21 TO 21.450 MHz SIGNAL TO NOISE MORE THAN 10dB DOWN.



**SPECIAL**

**90 DAY WARRANTY ON ALL TRANSCEIVERS - DIRECT FROM NCG OR YOUR DEALER**

WE HAVE 1.2 GHz BASE/REPEATER & MOBILE ANTENNAS

1275 N. Grove Street, Anaheim, CA 92806 (714) 630-4541

✓ 117

**SPECIAL**

**SPECIAL**

**NOTE:** PRICES AND SPECIFICATIONS SUBJECT TO CHANGE WITHOUT NOTICE OR OBLIGATION



# THE MOST AFFORDABLE REPEATER

ALSO HAS THE MOST IMPRESSIVE PERFORMANCE FEATURES

(AND GIVES THEM TO YOU AS STANDARD EQUIPMENT!)

Band	Kit	Wired
10M,6M, 2M,220	\$680	\$880
440	\$780	\$980



## FEATURES:

- SENSITIVITY SECOND TO NONE; 0.15 uV (VHF), 0.2 uV (UHF) TYP.
- SELECTIVITY THAT CAN'T BE BEAT! BOTH 8 POLE XTAL FILTER & CERAMIC FILTER FOR > 100dB AT ± 12KHZ. HELICAL RESONATOR FRONT ENDS TO FIGHT DESENSE & INTERMOD.
- OTHER GREAT RECEIVER FEATURES: FLUTTER-PROOF SQUELCH, AFC TO COMPENSATE FOR OFF-FREQ TRANSMITTERS, SEPARATE LOCAL SPEAKER AMPLIFIER & CONTROL.
- CLEAN, EASY TUNE TRANSMITTER; UP TO 20 WATTS OUT (UP TO 50W WITH OPTIONAL PA).

## HIGH QUALITY XMTR & RCVR MODULES FOR REPEATERS, LINKS, TELEMTRY, ETC.

- **R144/R220 FM RCVRs** for 2M or 220 MHz. 0.15uV sens.; 8 pole xtal filter & ceramic filter in l-f, helical resonator front end for exceptional selectivity, > 100dB at ± 12kHz, best available today. Flutter-proof squelch. AFC tracks drifting xmtrs. Xtal oven avail. Kit only \$138.
- **R451 FM RCVR** Same but for uhf. Tuned line front end, 0.3uV sens. Kit only \$138.
- **R76 FM RCVR** for 10M, 6M, 2M, or 220. As above, but w/o AFC or hel. res. Kits only \$118. Also avail w/4 pole filter, only \$98/kit.
- **R110 VHF AM RECEIVER** kit for VHF aircraft or ham bands or Space Shuttle. Only \$98.
- **T51 VHF FM EXCITER** for 10M, 6M, 2M, or 220 MHz. 2 Watts continuous, up to 3W intermittent. \$68/kit.
- **T451 UHF FM EXCITER** 2 to 3 Watts. Kit only \$78. Xtal oven avail.
- **VHF & UHF LINEAR AMPLIFIERS.** For either FM or SSB. Power levels from 10 to 45 Watts to go with exciters & xmtrg converters. Several models. Kits from \$78.

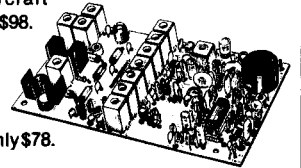
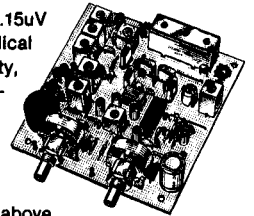

NOW—FCC TYPE-ACCEPTED TRANSMITTERS & RECEIVERS AVAILABLE FOR HIGH-BAND & UHF. CALL FOR DETAILS.

## RECEIVING CONVERTERS

Models to cover every practical rf & if range to listen to SSB, FM, ATV, etc. NF = 2 dB or less.



Antenna Input Range	Receiver Output
28-32	144-148
50-52	28-30
50-54	144-148
144-146	28-30
145-147	28-30
144-144.4	27-27.4
146-148	28-30
144-148	50-54
220-222	28-30
220-224	144-148
222-226	144-148
220-224	50-54
222-224	28-30

### VHF MODELS

Kit with Case	\$49
Less Case	\$39
Wired	\$89

### UHF MODELS

Kit with Case	\$59	432-434	28-30
Less Case	\$49	432-436	144-148
Wired	\$75	432-436	50-54
		439.25	61.25

SCANNER CONVERTERS Copy 806 MHz band on any scanner. Wired/tested ONLY \$88.

## TRANSMIT CONVERTERS

For SSB, CW, ATV, FM, etc. Why pay big bucks for a multi mode rig for each band? Can be linked with receive converters for transceive. 2 Watts output vhf, 1 Watt uhf.

For VHF,  
Model XV2  
Kit \$79  
Wired \$149  
(Specify band)

Exciter Input Range	Antenna Output
28-30	144-148
28-29	145-148
28-30	50-52
27-27.4	144-144.4
28-30	220-222*
50-54	220-224
144-146	50-52
50-54	144-148
144-146	28-30

For UHF,  
Model XV4  
Kit \$99  
Wired \$169

Exciter Input Range	Antenna Output
28-30	432-434
28-30	435-437
50-54	432-436
61.25	439.25
144-148	432-436*

\*Add \$20 for 2M input

VHF & UHF LINEAR AMPLIFIERS. Use with above. Power levels from 10 to 45 Watts. Several models, kits from \$78.

## LOW-NOISE PREAMPS

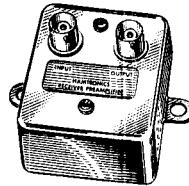

Hamtronics Breaks the Price Barrier!

\*  
No Need to Pay \$80 to \$125 for a GaAs FET Preamp.

### FEATURES:

- Very Low Noise: 0.7 dB VHF, 0.8 dB UHF
- High Gain: 18 to 28 dB, Depending on Freq.
- Wide Dynamic Range for Overload Resistance
- Latest Dual-gate GaAs FET, Very Stable

MODEL	TUNES RANGE	PRICE
LNG-28	26-30 MHz	\$49
LNG-50	46-56 MHz	\$49
LNG-144	137-150 MHz	\$49
LNG-160	150-172 MHz	\$49
LNG-220	210-230 MHz	\$49
LNG-432	400-470 MHz	\$49
LNG-800	800-960 MHz	\$49

## HELICAL RESONATOR PREAMPS

Low-noise preamps with helical resonators reduce intermod and cross-band interference in critical applications. 12 dB gain.

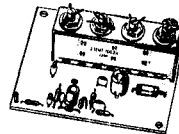

Model	Tuning Range	Price
HRA-144	143-150 MHz	\$49
HRA-220	213-233 MHz	\$49
HRA-432	420-450 MHz	\$59
HRA-( )	150-174 MHz	\$54
HRA-( )	450-470 MHz	\$64

## ACCESSORIES

- **MO-202 FSK DATA MODULATOR.** Run up to 1200 baud digital or packet radio signals through any FM transmitter. Automatically keys transmitter and provides handshakes. 1200/2200 Hz tones. Kit only \$45.
- **DE-202 FSK DATA DEMODULATOR.** Use with any FM receiver to detect packet radio or other digital data in "202" modem format. Provides audio conditioning and handshakes. Kit only \$38.
- **COR-2 KIT** With audio mixer, local speaker amplifier, tail & time-out timers. Only \$38.
- **COR-3 KIT** as above, but with "courtesy beep". Only \$58.
- **CWID KITS** 158 bits, easily field programmable, clean audio. Kit only \$68.
- **A16 RF TIGHT BOX** Deep drawn alum. case with tight cover and no seams. 7 x 8 x 2 inches. Designed especially for repeaters. \$20.
- **DTMF DECODER/CONTROLLER KITS.** Control 2 separate on/off functions with touchtones®, e.g., repeater and autopatch. Use with main or aux. receiver or with Autopatch. Only \$90
- **AUTOPATCH KITS.** Provide repeater autopatch, reverse patch, phone line remote control of repeater, secondary control via repeater receiver. Many other features. Only \$90. Requires DTMF Module.
- **SIMPLEX AUTOPATCH.** Use with your FM transceiver. System includes DTMF & Autopatch modules above and new Timing module to provide simplex autopatch and reverse autopatch. Complete patch system only \$200/kit. Call or write for details.

- SEND \$1.00 for 40 page CATALOG (Send \$2.00 or 4 IRC's for overseas mailing)
- Order by phone or mail • Add \$3 S & H per order (Electronic answering service evenings & weekends)
- Use VISA, MASTERCARD, Check, or UPS COD.

# hamtronics, inc.

65-E MOUL ROAD • HILTON NY 14468

Phone: 716-392-9430

Hamtronics' is a registered trademark

## designing and building loop Yagis

Antennas are always an exciting subject. Even more exciting is the introduction of a new type of design.

The loop Yagi is one new design that's become quite a performer, especially on 23 and 13 cm (1296 and 2304 MHz). However, its design parameters have not been widely available (especially in North America) and are often confusing.

Recently I had a call from Vern "Rip" Riportella, WA2LQQ, who wanted to know if the loop Yagi would work well on OSCAR 10, Mode "L." "Of course it will work," I told him, and pointed out that several stations were already using them. "But how do I build one?" he asked. Well, that got things rolling.

At Rip's suggestion, I moved this article a few months ahead on my planned schedule so that more stations could take advantage of the loop Yagi, especially on OSCAR 10. When you finish reading this month's column you should have all the material necessary on loop Yagis performance and know how to design and construct one of your own.

### development of the loop Yagi

The loop Yagi, as we know it, came into existence in the back yard of Mike Walters, G3JVL, in 1974. Mike was trying to obtain high gain at 23 cm on a single long boom instead of using a parabolic dish. He tried and discarded many combinations of wire loops similar to quad elements; tuning was always critical and the gain was far less than expected.

Then Mike tried using thin (0.028 inch or 0.7 mm) flat strips of aluminum 0.1875 inch (4.8 mm) wide mounted on a 1/2-inch (12.7 mm) diameter boom. Gain was almost immediately realized. Using the heuristic (cut-and-try!) approach and a large box of dif-

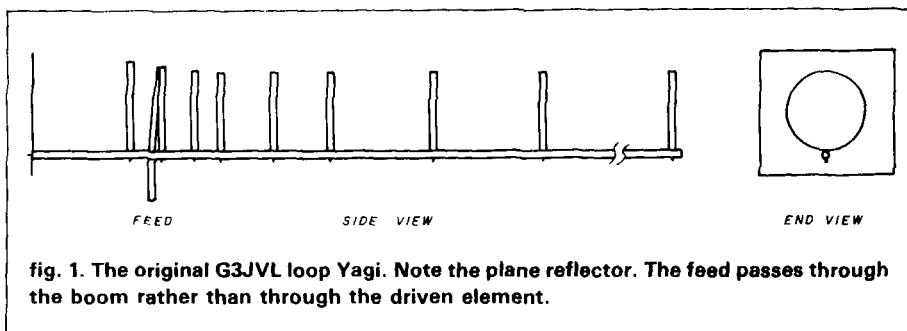

fig. 1. The original G3JVL loop Yagi. Note the plane reflector. The feed passes through the boom rather than through the driven element.

ferent length loops, he moved the elements around to various positions on a boom to optimize gain as indicated on a signal strength meter.

What finally evolved was a 24-director loop Yagi on an 81-inch (206-cm) boom with one driven element and two reflectors, as shown in fig. 1.<sup>1</sup> One reflector was a regular loop placed close behind the driven element. The second reflector consisted of a rectangular perforated aluminum sheet measuring 4-1/2 by 5-1/2 inches (11.5 × 14 cm) and mounted on the rear of the boom. The driven element is fed directly at the top with a short length of 0.141 inch (3 mm) diameter 50-ohm semi-rigid coax.

### Yagi versus loop Yagi

You may ask, "Why all the fuss about loop Yagis?" The answer lies mainly in their mechanical design. Really long Yagis (over 10 wavelengths long) with high gain (over 18 dBi) were not readily available until the 1980's.<sup>2</sup> Furthermore, long Yagi dimensions are very critical if optimum gain and low side lobes are desired. UHF and microwave designs are even more critical. For instance, at 23 cm the typical Yagi tolerance should be within  $\pm 0.003$  wavelengths, with 0.001 wavelength preferred.<sup>3</sup> This equates to a 23 cm tolerance of 0.027 and 0.009 inches (0.069 and 0.023 mm), respectively — and these tolerances are quite difficult to maintain.

Metallic boom Yagis also require a correction factor to be applied to each element. (This area is still quite controversial.) Add this to the problems of conductivity to the boom or the capacitive and inductive effects of through the boom mounting with insulated elements and you have a tall order to fill.

Don't overlook the feed system in a Yagi antenna. For a good match, you must have a good mechanical assembly that can tune out variations in the design, and the antenna should preferably be fed with a balanced feed system. This implies the use of a balun, another item requiring good tolerances and construction techniques.

Many of the previously mentioned items were designed out or improved in the G3JVL loop Yagi designs. Mechanical duplication is straightforward. For instance, elements are mounted on top of the boom and connected with just one screw. Various boom diameter corrections are quite well documented, as we shall shortly see. Similarly, the loop length, width and thickness have been carefully tabulated with correction factors for different sizes and frequencies. Finally, a unique driven element feed system with a built-in balun was developed. Thus the loop Yagi is relatively easy to duplicate.

By now you must be asking what the disadvantages must be. Well, the main problem is that there just aren't a lot of recipes. In fact, there have

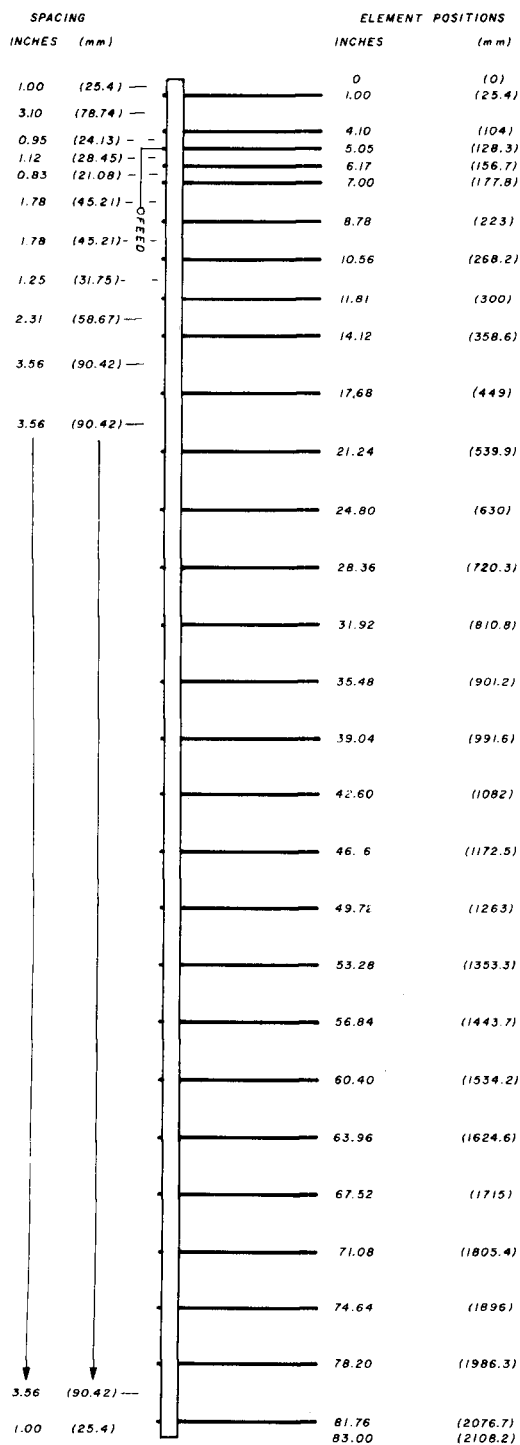

fig. 2A. The basic 28-element loop Yagi, with mechanical dimensions based on 1296 MHz. When constructing a 38 or 45-element loop Yagi, add additional loops as required, spacing them each 3.56 inches (90.42 mm) further down the boom as described in text.

been only three major designs published for 28, 38, and 45 elements.<sup>1,4,5</sup> Even these designs could probably use some improvements to reduce the first side lobe levels.

The loop Yagi also has a fair wind load. Several years ago Rick Commo, K1LOG, and I set out to build a 70 cm (432 MHz), 28-element loop Yagi. It looked truly inspiring and had very good gain when we measured it on my backyard antenna range. But plans to install it at K1LOG's QTH had to be abandoned halfway up the tower, because even in a 10 mph (16 km) wind, holding on to the antenna was like holding on to a large sail! So loop Yagis simply aren't practical below about 900 MHz.

Another loop Yagi headache is large birds since they can easily bend or flatten the loops if they decide to roost on them. G3JVL solved most of this problem by mounting his loop Yagi antennas upside down!

A third problem is deterioration of the joints after long exposure to the elements. This, however, is quite manageable, as we shall see.

### loop Yagi variations and improvements

Many of the disadvantages mentioned above have been solved or circumvented and the loop Yagi — still a high-performance antenna — is widely accepted on OSCAR 10 and the 23 and 13 cm bands. If you're looking for an antenna that's relatively easy to duplicate and provides high gain on 23 cm and up, this may be the one for you.

Soon after the original design was published, several persons built models and frequency-swept the response.<sup>1</sup> Some dips in gain were noted, especially below the frequency of interest. Although this isn't normally a problem, it can be if tolerances vary. The first improvement was the addition of another director between directors 4 and 5 of the original design.<sup>4</sup> This also broadened bandwidth and increased gain by about 0.5 dB.

Shortly after I built my first loop Yagi

in 1978, I became disillusioned with the plane reflector. It was difficult to fabricate and has a wind load that caused it to act like the tail end of a weather vane! But removing the plane reflector caused the gain to drop as much as 1 dB. I tried a variety of substitutes and finally settled for a second reflector loop, identical to the first one (just behind the driven element) but placed at the rear of the boom. It had far less wind load than the plane reflector and was easier to fabricate; the only perceptible change noted was perhaps a 0.1 dB drop in forward gain, a small penalty for the simplification it yielded.

Since the original design was conceived, the feed system has been improved. Originally the semirigid coax passed to the rear of the driven element and through the boom as shown in **fig. 1**. G3JVL found that if you pass the same coax directly through the lower portion of the driven element and correctly shape the element, a quarter-wave type of balun is formed.<sup>4</sup>

Other improvements made by G3JVL included higher gain for the original design, longer boom models, and correction factors for changing loop thickness and width as well as boom diameter. The latter makes frequency scaling the loop Yagi a breeze.<sup>5</sup>

## how to design a loop Yagi

Let's look at the designs available. The improved original design now uses 28 elements with two different director lengths as shown in **fig. 2** and **table 1**. All the loop lengths shown in **table 1** are based on the original design with a boom diameter of 1/2 inch (12.7 mm) and loops made from flat aluminum strips 3/16 inches (4.76 mm) wide and 0.028 inches (0.71 mm) thick. This will be the reference point for all other

designs. Also note that the length of the loops is equal to the distance between the mounting holes. An extra 0.25 inch (6 mm) should be added to each end.

I immediately found these sizes to be unacceptable. First, the elements were too narrow and would often break at the screw holes when they were tightened to the boom. This problem was overcome by using a wider (0.25 inch or 6.35 mm) strip. Also the 0.028 inch (0.71 mm) aluminum is not commonly available in the United States but 0.032 inch (0.81 mm) material is. Finally, the 1/2 inch (12.7 mm) diameter boom is too flimsy in areas where snow and ice are common. Adding extra support struts helps, but a larger diameter boom is still recommended.

Calculating these changes becomes very simple with the correction factors that G3JVL later derived.<sup>5</sup> This information is shown on individual graphs in **fig. 3** (the correction factor for boom diameter changes) and **figs. 4** and **5** (correction factors for different loop widths and thicknesses, respectively).

Let's work through an example. I prefer to use a 3/4 inch (19 mm) boom and loops that are 1/4 inch (6.35 mm) wide and 0.032 inch (0.81 mm) thick. Looking at **figs. 3, 4, and 5**, we see that corrections are +0.9, -0.3, and +0.04 percent, respectively. Adding these corrections together, we get a net change of +0.64 percent. This means that if we select new sizes of materials, all we have to do is increase the sizes of all directors and reflectors shown in **fig. 2** by 0.64 percent. Therefore, the scaled directors will now be 8.303 inches (211 mm) and 8.051 inches (205 mm), respectively.

The reflectors will measure 9.732 inches (247 mm).

## other designs

The compact 28-element has a gain equivalent to that of a 35-inch (90-cm) dish. But if you want a model with a higher gain, you may want to build a 38 or 45-element loop Yagi — roughly equivalent to a 39-inch (1 meter) and 43-inch (1.1-meter) dish, respectively — instead.

**Table 1** shows the lengths of the 38 and 45-element designs. Again, these are based on the original boom diameter and loops as noted above. Note

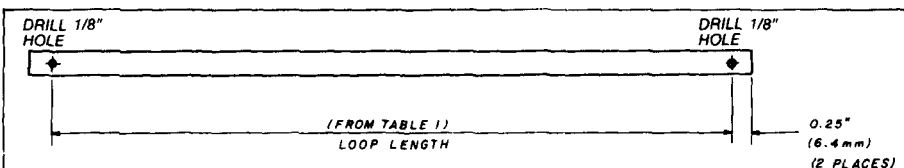

**fig. 2B.** Loop length is measured from hole to hole. Note that an extra 0.25 inch (6.4 mm) of aluminum strap should be provided at both ends of each loop for mechanical stability.

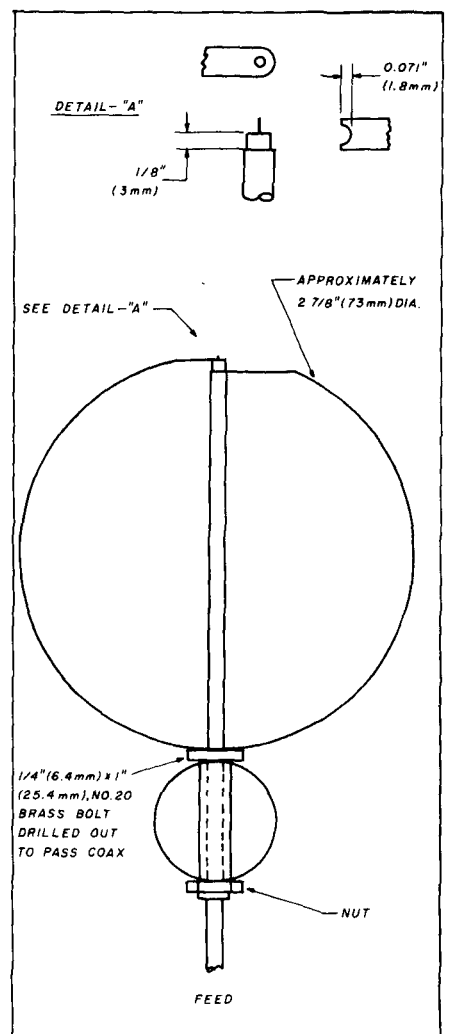

**fig. 2C.** The driven element is constructed as shown using a brass or copper strap 0.25 inch (6.35 mm) wide and 0.032 inch (0.81 mm) thick. The length is shown in **table 1** and is the distance between the center of the attachment holes. See text for final checkout.

table 1. 1296 MHz loop-Yagi element lengths.

design	28 elements		38 elements		45 elements	
	inches	mm	inches	mm	inches	mm
reflector 1 & 2	9.67 (9.732)	246 (247)	9.67 (9.732)	246 (247)	9.67 (9.732)	246 (247)
driven element	9.23 (9.292)	234 (236)	9.23 (9.292)	234 (236)	9.23 (9.292)	234 (236)
directors 1-11	8.25 (8.303)	209 (211)	8.25 (8.303)	209 (211)	8.25 (8.303)	209 (211)
directors 12-18	8.00 (8.051)	203 (205)	8.00 (8.051)	203 (205)	8.00 (8.051)	203 (205)
directors 19-23	8.00 (8.051)	203 (205)	7.70 (7.749)	196 (197)	7.75 (7.800)	197 (198)
directors 24-25	8.00 (8.051)	203 (205)	7.70 (7.749)	196 (197)	7.65 (7.699)	194 (196)
directors 26-35			7.70 (7.749)	196 (197)	7.65 (7.699)	194 (196)
directors 36-42					7.50 (7.548)	191 (192)

The numbers shown above are the reference element lengths for designing a loop Yagi at 1296 MHz. These dimensions are based on a 0.5 inch (12.7 mm) boom diameter with 3/16 inch (4.76 mm) wide by 0.028 inch (0.71 mm) thick loops. The lengths shown in parenthesis are for use of a 3/4-inch (19 mm) boom and loops that are 1/4 inch (6.35 mm) wide and 0.032 inch (0.81 mm) thick. Other size material can be used if scaled as discussed in the text.

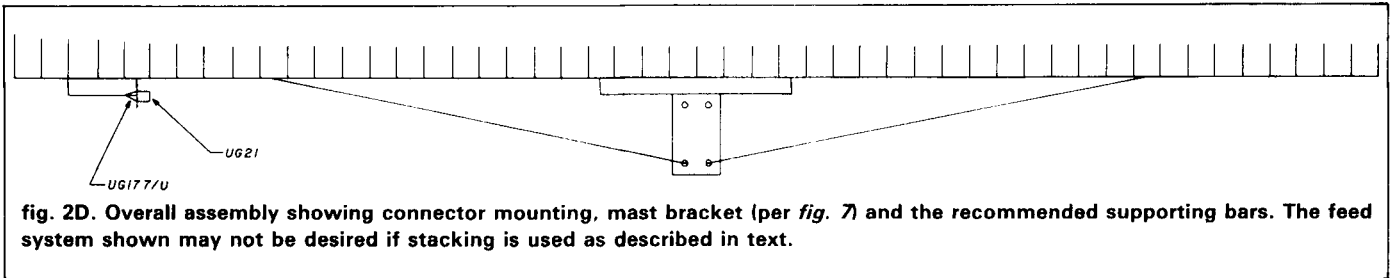

fig. 2D. Overall assembly showing connector mounting, mast bracket (per fig. 7) and the recommended supporting bars. The feed system shown may not be desired if stacking is used as described in text.

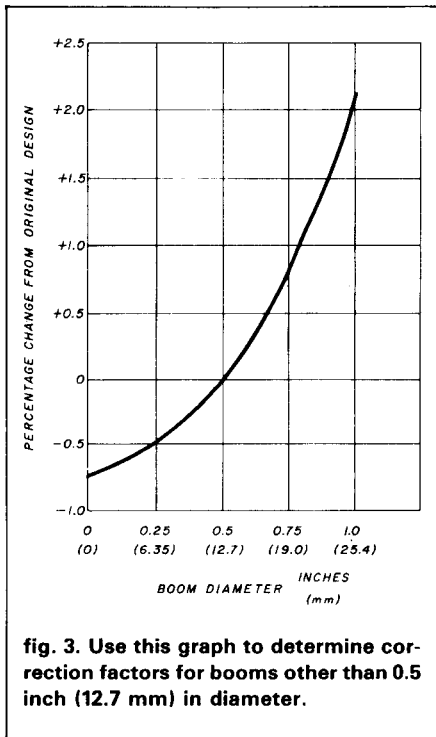

fig. 3. Use this graph to determine correction factors for booms other than 0.5 inch (12.7 mm) in diameter.

that all new directors on the longer boom designs are moved out an additional 3.56 inches (9.04 cm). However, the diameter of the loops varies with a slightly different tapering schedule.

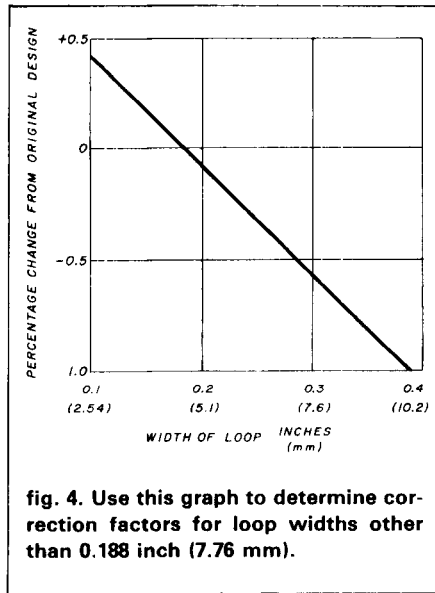

fig. 4. Use this graph to determine correction factors for loop widths other than 0.188 inch (7.76 mm).

For those who don't want to go through the scaling exercise, I've listed, in table 1 (in parentheses), the recommended sizes for the 28, 38, and 45-element designs using a 3/4 inch (19 mm) boom and loops that are 0.032 inch (0.81 mm) thick and 1/4 inch (6.35 mm) wide. Different sizes can also be used, but you'll have to work out the new values yourself!

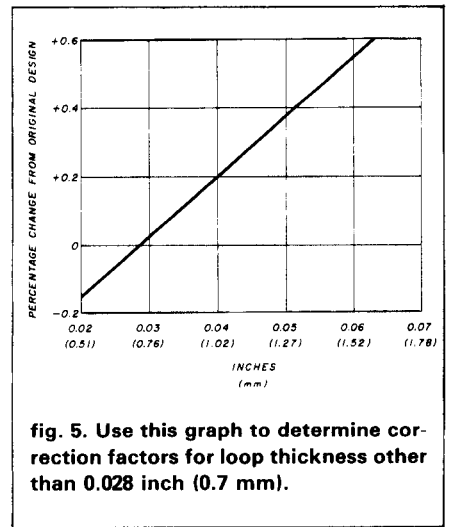

fig. 5. Use this graph to determine correction factors for loop thickness other than 0.028 inch (0.7 mm).

### frequency scaling

If you want to operate at a frequency other than 1296, how do you perform the scaling? It actually isn't that complicated. All it requires is a hand calculator, some scratch paper and some thought! All data can be found on the scaling charts.

For example, suppose you want to make an optimized OSCAR Mode L design. 1269 MHz is actually only

table 2. Specifications and stacking information for the 28, 38, and 45-element loop Yagi designs discussed in the text.

design	boom length (in $\lambda$ )	gain* (dBi)	equivalent dish size*		BW* (degrees)	stacking distance in $\lambda$	
			(inches)	(meters)		(E plane)	(H plane)
28-element	9.0	19.0	35	0.9	18.0	2.50	2.30
38-element	13.2	20.0	39	1.0	16.5	2.75	2.55
45-element	15.7	20.7	43	1.1	15.0	2.85	2.65

\*Approximate

about 2 percent lower in frequency than 1296 MHz. In reality, the models shown work quite well even though they're made for 1296 MHz, since the bandwidth of a typical Yagi type structure is usually good for at least  $-2$  to  $+1$  percent. But let's say you really want to optimize the design without compromise.

In order to exactly duplicate the performance, *all element dimensions and spacings must be increased by 2 percent (1296-1269/1296)*. The spacing is easy. Just make all spacings 2 percent or 1.02 times the values shown in the figures and the table.

Then scale the new boom diameter. Let's say you want to use a 3/4 inch (19 mm) boom at 1269 MHz. First you have to design the boom as if it were 2 percent smaller in diameter at 1296. For example, if we have a boom 0.735 inches (18.67 mm) in diameter at 1296, it will be equivalent to 0.750 inch (19 mm) in diameter at 1269 MHz. The correction factor for 0.735 inch (19 mm) at 1296 is approximately  $+0.8$  percent.

The elements are done in the same fashion; they're shortened by 2 percent at 1296 MHz and looked up in **figs. 4** and **5**. Then the changes are added to the boom correction for the final correction. If the frequency is above 1296, the boom correction and element parameters must be lengthened by the equivalent percentage at 1296. Proceed in the same way as already described.

## construction

The loop locations should be marked carefully on the boom as shown in **fig. 2**. *This is a very important procedure that should not be taken lightly*. Because spacings are

quite close for the first directors, a build-up tolerance could occur. I've therefore shown all dimensions referenced from the rear of the boom to prevent tolerance buildup.

For best symmetry, the boom should be drilled while supported in either a "V" block or a Porta Vise.<sup>TM</sup> After the first element hole is drilled, a dummy element should be fastened in place. This will provide a reference point for drilling successive holes so that they'll all be located in the same plane. Admittedly, this is less of a problem on a loop Yagi than a conventional Yagi since the elements can be leveled by pushing them sideways for alignment. Finally, drill out the larger hole for the driven element mounting screw.

Next, center-punch each loop for the proper length as shown in **fig. 2**, leaving about 0.25 inches (6.35 mm) of extra material on each end. Make sure the punch is centered on the loop width since any sideways skewing will weaken the joint. Also, use the smallest possible drill to just pass the screw shank.

The loops can be pre-formed by rolling them on a piece of tubing or dowel. Next insert the screw while drawing the two ends together, inserting the screw through the boom in the correct location and securing it with a lock washer and nut. *Do not overtighten; this will deform the loop material*.

Assembling the driven element is a little tricky. It must first be soldered together as a sub-assembly as shown in **fig. 2**. Then pass the mounting screw through the boom and secure it with the nut. (Suitable semi-rigid transmission line can be purchased from Microwave Components, WB8EUJ,

11216 Cape Cod, Taylor, Michigan 48180, for approximately \$2.00 per foot.)

Now add the connector. For maximum strength, rigidity, and reliability, it should be mounted on a small right angle plate attached to the boom. This simple, low-cost assembly with the shield, suggested to me by Bob Johnson, K9KFR, has worked well on the four loop Yagis I presently use.

Alternatively, a type OSN<sup>TM</sup>\* male "N" cable connector can be attached directly to the semi-rigid transmission line. This method offers an advantage if you're going to stack your antennas. You can use a transmission line the proper length required to reach the power splitter (more on this later).

## other variations

Other loop widths can be used on this design if they're properly scaled by the methods already discussed. For instance, if some of the elements are widened, it may be possible to use a uniform length loop on the shorter model.

As mentioned earlier, the simplicity of the element attachment to the boom is one of the selling points of this design. But the place at which the loop attaches to the boom is a high current point. Therefore, if the elements are not tightened properly, the joints can corrode, resulting in increased loss in the future.

Several methods have been used to circumvent this problem. One is to coat the joints with an epoxy or sealant type of material after assembly. A second, more complex mounting method is to rotate all the elements 90 degrees.

First, a single screw, washer, and

\*"OSN" is a trademark of Omni-Spectra, Inc.

nut hold the loop ends together. Then a second hole is drilled one-fourth the distance between the end mounting holes in each loop. Finally the loops are attached with another screw to the boom. This locates the point at which the loops are attached at a voltage node.

*Remember that all sizes given, including sizes on the scaling charts, are*

*based on mounting loops exactly as shown. Any deviations will upset the correction factors and possibly degrade performance. Several years ago, for example, a number of these loop Yagis were distributed in kit form by a midwest Amateur. Although the design was satisfactory, the instructions recommended, for mechanical reasons, that a lock washer be placed between the loop and the boom rather than between the boom and the nut. The effect of this instruction was subtle. Since the element was now further removed from the boom, the boom correction was diminished, and the elements therefore resonated at a slightly lower frequency. The net result was a 0.5 to 0.75 dB gain decrease and higher side lobes. Removing the washer, cleaning up the surfaces, and then placing the washer on the other side of the boom instantly restored the antenna's original design performance.*

### stacking loop Yagis

The designs given in this month's column will work fine by themselves. However, there's always somebody who wants more gain. Since loop Yagis have lower wind loss than dishes (one of the prime reasons for using this

design), they're often stacked to obtain higher gain.

Recommended stacking distances and configurations are discussed in references 6 and 7. Table 2 lists electrical parameters to follow for proper stacking on all three models just discussed. Generally speaking, the spacings shown may seem too close, but they were confirmed at my QTH by a series of tests using both a signal source and on-the-air test.

When stacking antennas at such high frequencies, phasing harness losses and phase lengths are very important. Four matched phasing lines can be brought to the mast where a power splitter is attached — or you can use an identical length of the same amount of semi-rigid coax as mentioned earlier. You can then use short phasing lines with the back plane feed method as discussed.

Any suitable two-way or four-way in-phase power divider can be used.<sup>7</sup> One simple and usually inexpensive power divider can be made for 23 cm operation by combining three UG 107A/U type N Tee adapters as shown in fig. 6.<sup>8</sup> The longer (and older) type UG 107A/U is recommended because it's closer to the desired phase length. However, the newer UG 107B/U will work with slightly higher VSWR. These coax adapters are readily available at flea markets.

Loop Yagis are usually mounted on brackets similar to the one shown in fig. 7. These brackets are then attached to a mast or a stacking frame. If two- or four-loop Yagis are stacked vertically, it's often more convenient to turn the lower ones upside down so that the mast doesn't have to pass through the boom or loops. In this case, remember to invert the feed on the upside down antennas so that they're not fed out of phase.<sup>7</sup>

You may ask whether the mast can be placed through a loop Yagi as is typically done on Yagi antennas. The answer is yes, but the diameter should be kept reasonable and the mast should preferably pass midway between two loops. Tests conducted by G3JVL showed a slight gain reduction

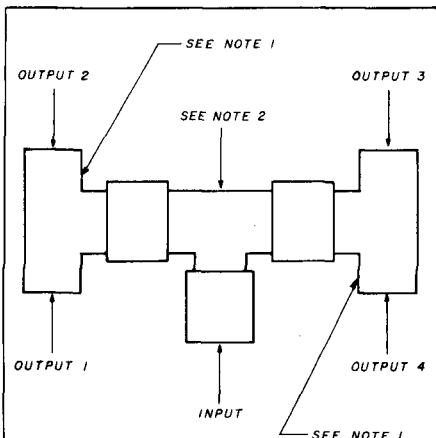

fig. 6. This is a simple power splitter using three type "N" coaxial Tee adapters. Note 1: Type UG 107A/U recommended but UG 107B/U is usable with slightly higher VSWR. Note 2: Either a UG 107B/U or UG 28A/U are usable.

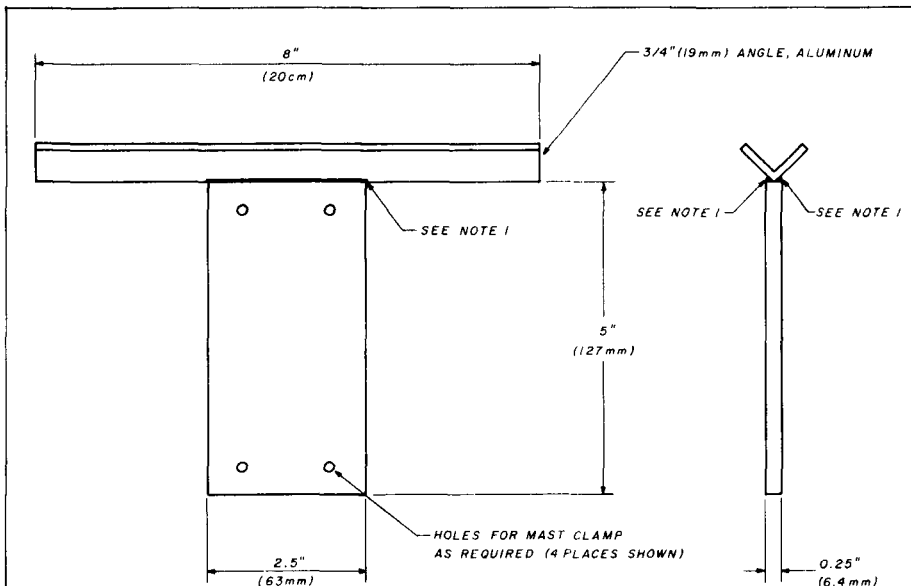

fig. 7. A recommended mast to boom mounting bracket. Material is aluminum. Note 1: Helic arc the angle aluminum and plate together at this point. Most local welding shops can provide this service.

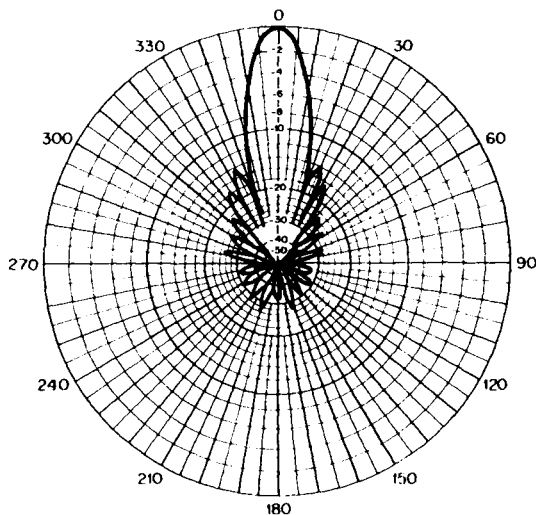

fig. 8. This is a polar plot of the typical "E" plane of a 45 element loop Yagi. Other designs will have similar patterns but with wider half-power beamwidth as shown in table 2.

(approximately 0.25 dB) when a large (2 inch or 51 mm) diameter boom was passed through the plane of a 23-cm loop Yagi.

Supports or trusses should be used to stabilize and strengthen the boom, especially where ice and snow are prevalent. This can easily be done by attaching a piece of tubing between a point about two thirds the distance out on the boom and the bottom corner of the mounting plate shown in fig. 7. This tubing can have the same or slightly smaller diameter as the boom.

### final performance evaluation

Once the loop Yagi is completely assembled, it should be mounted on a mast in a clear area and pointed away from any local objects. Then the VSWR should be measured. If it is not below 1.5:1, bend the first reflector or the first director closer or further away from the driven element for a better match. Sometimes even the second director can be bent slightly to enhance VSWR. If all else fails, shorten or lengthen the driven element slightly.

After the antenna is mounted in its final resting place, the pattern can be tested. The beamwidth is narrow as shown in table 2. The first side lobes

should be at least 10 dB and usually 13 or so dB below the main lobe. If not, you may have scaled your dimensions improperly.

For reference, see fig. 8, in which a pattern adapted from an equivalent 13 cm (2304 MHz) 45 element loop Yagi is shown. The initial data for this pattern was done on a professional antenna range and supplied to me by N3CX. The 2304 MHz loop Yagi will be covered in a paper I'll be presenting at the First Annual 1296/2304 MHz conference in Estes Park, Colorado from September 20 to 22 (see end of column). Note that the nulls between the main beam and the side lobes can be easily used to determine beamwidth, as described in reference 9.

### summary

The loop Yagi is an exciting and relatively new antenna design that has been well received as a true performer. In this month's column I've tried to provide some overall background information on its design along with procedures for modifying the design for other frequencies and material sizes to suit the builder.

This antenna isn't a panacea, nor does it necessarily offer any more gain than a well-designed Yagi. However,

it's easily reproduced and has much less wind load than an equivalent dish of the same gain. Models have been made to frequencies as high as 3 cm (10 GHz) with equivalent performance.

### acknowledgements

This design would not have been possible without the many hours of trials and testing by Mike Walters, G3JVL. I'd like to thank him for all the encouragement and information supplied to me over the years so that I too could obtain the gain claimed. Also, thanks to N3CX for providing the pattern data of the 45-element loop Yagi shown in fig. 8.

### references

1. Dain Evans, G3RPE, "Microwaves — A Long Quad-Yagi for 1296 MHz," *Radio Communications*, January, 1975, page 24.
2. Gunter Höch, DL6WU, "Extremely Long Yagi Antennas," *VHF Communications*, Issue No. 3, 1982.
3. Joseph H. Reiser, Jr., W1JR, "How to Design Yagi Antennas," *ham radio*, August, 1977, page 22.
4. Dain Evans, G3RPE, "Microwaves — The G3JVL Loop-Yagi," *Radio Communications*, July, 1976, page 525.
5. Charles Suckling, G3WGD, "Microwaves, the G3JVL Loop-Yagi Antenna," *Radio Communications*, September, 1978, page 782.
6. Joe Reiser, W1JR, "VHF/UHF World: Stacking Antennas — Part 1," *ham radio*, April, 1985, page 129.
7. Joe Reiser, W1JR, "VHF/UHF World: Stacking Antennas — Part 2," *ham radio*, May, 1985, page 95.
8. Reed Fisher, W2CQH, "A Successful 1296-MHz Yagi," *ham radio*, May, 1972, page 24.
9. Joe Reiser, W1JR, "VHF/UHF World: Determining VHF/UHF Antenna Performance," *ham radio*, May, 1984, page 110.

### important VHF/UHF events

- September 7-8: *International Region 1 VHF Contest*
- September 14-16: *ARRL VHF QSO Party*
- September 16: *EME Perigee*
- September 20-22: *First Annual 1296/2304 MHz Conference, Estes Park, Colorado (Contact W0PW)*
- October 5-6: *Mid-Atlantic States VHF Conference, Warminster, Pennsylvania (Contact WA2OMY)*
- October 5-6: *International Region 1 UHF/SHF Contest*
- October 9: *Peak of Draconids Meteor Shower predicted at 0300 UTC*
- October 15: *EME Perigee*
- October 20: *Peak of Orionids Meteor Shower predicted at 1100 UTC*

ham radio



# SAVE \$10.00\* with home delivery

Payment enclosed  
Bill me later

\*One year newsstand cost \$30.00

Here's my address label, enter my subscription.

1 Year . . . . . \$19.95

2 Years . . . . . \$32.95

3 Years . . . . . \$44.95 U. S. prices only

1 Year . . . . . 12 issues

2 Years . . . . . 24 issues

3 Years . . . . . 36 issues

Name \_\_\_\_\_

Zip \_\_\_\_\_

Address \_\_\_\_\_

State \_\_\_\_\_

City \_\_\_\_\_

Check here if this is your renewal (attach label)

Subscribe to **ham radio** magazine

Please allow 4-6 weeks for delivery of first issues.

**Foreign rates:** Europe, Japan and Africa, \$28.00 for one year by air forwarding service. All other countries \$22.95 for one year by surface mail.

Please  
enter my  
subscription



NO POSTAGE  
NECESSARY  
IF MAILED  
IN THE  
UNITED STATES

**BUSINESS REPLY CARD**

First Class    Permit No. 1    Greenville, NH

Postage Will Be Paid By Addressee

**ham  
radio**

Greenville, NH 03048



# PERFORMANCE

## THAT IS OUT OF THIS WORLD...



**\$389<sup>00</sup>**

**MODEL 2000 20MHz  
DUAL TRACE**

**\$549<sup>00</sup>**

**MODEL 3500 35MHz  
DUAL TRACE DELAYED SWEEP**

## ...AT A DOWN TO EARTH PRICE

At last! Truly affordable test equipment with no compromise in design, and features you would expect to find only on oscilloscopes costing hundreds of dollars more! JDR Instruments presents two, new, high-performance models backed by a two year warranty and technical support which is only a phone call away. Perfect for the technician or advanced hobbyist, both models feature Dual Trace capability and a variety of operating and triggering modes, including CH-B Subtract and X-Y operation.

MODEL 2000 has a 20 MHz bandwidth and 20 calibrated sweeps ranging from .2s to .2 $\mu$ s. A convenient built-in component tester provides additional diagnostic power.



INCLUDES TWO HIGH QUALITY  
1x, 10x TEST PROBES

MODEL 3500 features a 35 MHz bandwidth and exceptional 1mV/DIV sensitivity. Delayed sweep and variable holdoff allow stable viewing of complex waveforms.

**ORDER TOLL FREE**  
**800-538-5000**  
**800-662-6279 (CA)**

✓ 174



**JDR INSTRUMENTS**  
1224 South Bascom Avenue  
San Jose, California 95128 (408) 995-5430

# The best DMM in its class just got better.

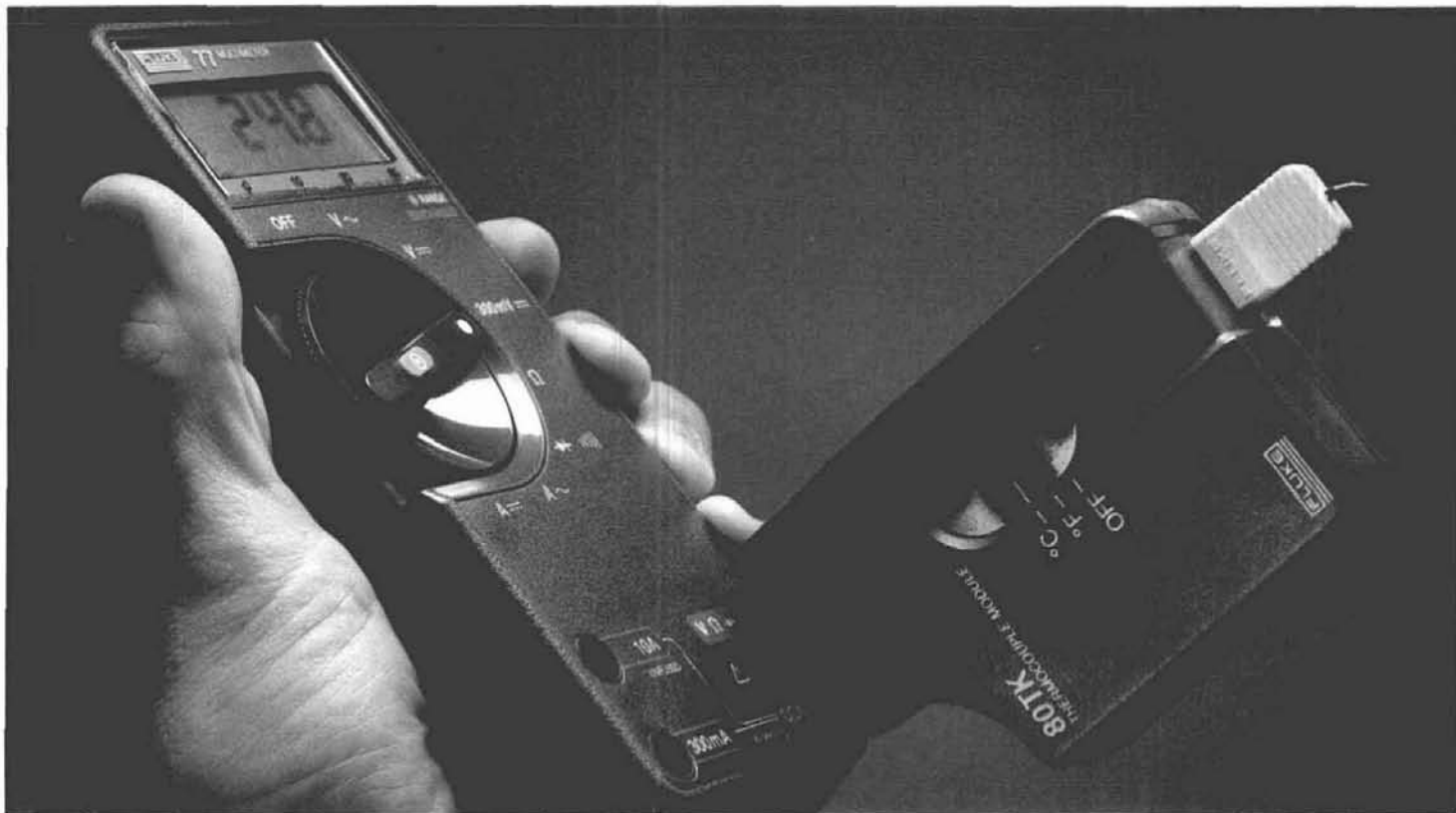

## The Fluke 80TK. One innovation leads to another.

First there was the 70 Series, which set a new standard for low-cost, high-performance, Fluke-quality multimeters.

And now, another first. The Fluke 80TK K-type Thermocouple Converter. A temperature measurement device that adds instant temperature measurement capabilities to the 70 Series DMMs.

Or any DMM, for that matter.

Feature for feature, the versatile 80TK is the most affordable unit of its kind. For quick comparison readings, it can measure °C or °F at the flick of a switch. It includes a built-in battery test. And the availability of 3 Fluke probes give you the flexibility to measure any

form of temperature, from freezer to furnace, with just one base unit.

No other thermocouple converter we know of offers DMM users so much for so little. Just \$59, including a general-purpose bead probe.

So even if you don't own a Fluke 70 Series multimeter, the 80TK will help the DMM you're now using measure up when things get hot. Or cold.

For your nearest distributor, call toll-free **1-800-227-3800, ext. 229, day or night.** Outside the U.S., call 1-402-496-1350, ext. 229.

FROM THE WORLD LEADER  
IN DIGITAL MULTIMETERS.



Surface, immersion and general-purpose probes with "mini" thermocouple connectors are available for the Fluke 80TK.

### 80TK SPECIFICATIONS

Temperature Measurement Range	_____
—50 to 1000°C	_____
—58 to 1832°F	_____
Battery Life: 1600 Hours (9V)	_____



# PRACTICALLY SPEAKING ...

by Joe Carr, K4IPV

## now that the warranty has expired. . .

**The big day has finally arrived.** After months — or years — of scrimping and saving, you've plunked down a kilobuck or so for a new transceiver. It's a gleaming engineering marvel with knobs, dials, and a luminous digital display. A firm squeeze on the Push-To-Talk button and your voice projects instantly and effortlessly around the world.

But sooner or later, long after the initial euphoria has worn off, you're going to have to consider what we all dread: repairing the rig. Repairing electronic equipment is like buying insurance; most of us never give it a moment's thought until something catastrophic happens. A little planning in this regard can make the difference between quick success or being off the air for weeks while the rig moves through the repair "pipeline."

The first time to think about repairs is while you're unpacking the new rig: should it have to be shipped back to the manufacturer's or importer's repair shop, that original packing carton is probably the best shipping container available. Unpack carefully, taking care not to destroy the carton in your eagerness to get to the goodies.

You think that's a bit extreme? After all, who has room to store that enormous cardboard shipping crate? I called the repair shop service manager for a major mail order seller of ham gear; he told me that all too often, improper packing results in shipping damage, often hidden, that must be repaired at the owner's expense *before* the warranty problem can be examined. Some-

times the shipping damage completely masks rightful warranty repairs — for example, a broken printed circuit board track.

*An old grocery carton and three inches of newspaper are not proper shipping materials!* Nor is it prudent to use a single wrap of masking tape to seal the carton; rigs have been "lost in the mail" because of inadequate sealing of perfectly adequate shipping containers. Use *two* runs of broad nylon filament tape, wrapped around the carton in both directions. Top this off with plastic film tape or paper packing tape (the kind you have to moisten). Tape a card with your name, callsign, address, and telephone number directly to the rig, just in case your rig becomes separated from its packaging.

It's not prudent to ship more than one item per container. My contact told me of one fellow who shipped an in-warranty Kenwood TS-120S in the same substandard carton as the 12-volt DC, 20-ampere AC power supply that powers the rig. That heavy power supply bounced around that newspaper-lined cardboard box like a cannonball and mashed the TS-120S to bits! Unfortunately, because the damage was caused by improper packing, neither the shipper nor the manufacturer could cover the damage.

In general, it's wise to not ship items such as external power supplies, microphones, telegraph keys, loudspeakers, headphones and other accessories unless told to do so by the repair shop. Twenty years of working in various repair shops left me with many memories of lost customer property. If your transceiver is bad, then ship *only* the

transceiver. Keep the other stuff at home. You can be certain that an authorized repair shop will have an adequate DC power supply, speaker or microphone on hand for testing the equipment.

## do you really have a problem?

In one shop where I worked, our service jobs ran about 40 percent "NFF" — No Fault Found — although some of the technicians had a more vulgar way of putting it. That means that the user diagnosed a fault when none existed, and the unit was out of service for no reason at all.

Eliminating the NFF takes a little common sense. If you suspect a malfunction, check all connections, accessories, and switch settings. Consult the troubleshooting chart in the owner's manual. I know it sounds dumb, but many a "probable blown fuse" complaint results from the AC power cord's being disconnected from the wall socket.

You'd be surprised to know how often a "won't transmit" complaint is traced to a broken PTT wire in the microphone connector. If your unit won't transmit, try several operating modes. If the rig won't "push to talk," but does work on CW mode, then it's a fair bet that the microphone is faulty. Similarly, if your rig will work on VOX but not on PTT, then the PTT wire is probably at fault. A little common sense goes a long way.

I prefer to keep certain accessories on hand to check my rig; for example, I normally have a spare microphone. Because I'm rarely fond of the standard handheld microphones that come

# HIGH PERFORMANCE PRESELECTOR-PREAMP

The solution to most interference, intermod, and desense problems in **AMATEUR** and **COMMERCIAL** systems.



- 40 to 1000 Mhz - tuned to your frequency
- 5 large helical resonators
- Low noise - High overload resistance
- 8 dB gain - ultimate rejection > 80 dB
- 10 to 15 volts DC operation
- Size - 1.6 x 2.6 x 4.75" exc. connectors
- **FANTASTIC REJECTION!**

Typical rejection:  
± 600 KHz@144 Mhz: -28dB  
± 1.6 Mhz@220 Mhz: -40dB  
± 5 - Mhz@450 Mhz: -50dB

Price - **\$89.95** bipolar w/RCA jacks  
Connector options: BNC \$5, UHF \$6,  
N \$10  
**SUPER HOT!** GaAs Fet option \$20

## AUTOMATIC IDENTIFIERS

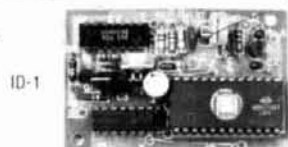

ID-1



ID-2

- For transceivers and repeaters - **AMATEUR** and **COMMERCIAL**
- Automatic operation - adjustable speed and amplitude
- Small size - easy installation - 7 to 15 volts DC
- 8 selectable, reprogrammable messages - each up to 2 min. long
- Wired, tested, and programmed with your message(s)

Model ID-1 - \$49.95 Model ID-2 w/2 to 10 minute timer - \$69.95

We offer a complete line of transmitter and receiver strips and synthesizers for amateur and commercial use.

Request our free catalog. Allow \$2 for UPS shipping - Mastercard and VISA welcome

## GLB ELECTRONICS, INC.

Dept H, 151 Commerce Pkwy., Buffalo, NY 14224  
716-675-6740 9 to 4

## SATELLITE TELEVISION RECEIVER SEMIKIT

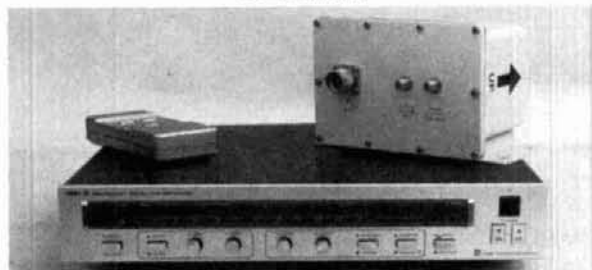

with dual conversion downconverter

### FEATURES:

- Infrared remote control tuning
- AFC, SAW filter
- RF or video output
- Stereo output
- Polarator controls
- LED channel & tuning indicators

Install six factory assembled circuit boards to complete.

<b>SEMIKIT</b>	<b>\$300.00</b>
Completed downconverter add	100.00
Completed receiver and downconverter add	150.00

### JAMES WALTER SATELLITE RECEIVER

2697 Nickel, San Pablo, CA 94806 ✓ 133 Tel. 415-724-0587



The monthly magazine with a natural blending of two popular hobbies — Ham Radio and Computers

- ★ Articles on Ham Radio & Most Personal Computers
- ★ Hardware & Software Reviews
- ★ Various Computer Languages
- ★ Construction Articles
- ★ Much Much More...

*"...received my moneys worth with just one issue..."*

—J. Trenbick

*"...always stop to read CTM, even though most other magazines I receive (and write for) only get cursory examination..."*

—Fred Blechman, K6UGT

U.S.A.....	\$15.00 for 1 year
Mexico, Canada .....	\$25.00
Foreign .....	\$35.00(land) - \$55.00(air)
(U.S. funds only)	
Permanent (U.S. Subscription) .....	\$100.00
Sample Copy .....	\$3.50



Circulation Manager

1704 Sam Drive

Birmingham, Alabama 35235

Phone 205/854-0271

Name \_\_\_\_\_

Call Sign \_\_\_\_\_

Address \_\_\_\_\_

City \_\_\_\_\_ State \_\_\_\_\_

Zip \_\_\_\_\_ Phone \_\_\_\_\_

Date \_\_\_\_\_

Signature \_\_\_\_\_

✓ 114

with new rigs, I buy another model — either a desk mike for the home rig or a touchtone mike for the 2-meter mobile rig. It's a simple matter to squirrel away the original mike, or I would buy a standby replacement mike, to use in troubleshooting problems later.

Other useful items to have on hand are a dummy load and RF wattmeter. Although I now use a Bird Model 43, a simple \$30 VSWR meter is also handy for troubleshooting. In the latter case, however, the reading is relative only, so it helps to make a record of readings and knob settings when the rig is known to be working properly. Take the readings with the rig driving a dummy load, and then record the readings and the knob settings that created them. A deflection of 50 to 80 percent of full scale is suitable.

### what to fix

Although some "old timers" like me, with 25 or more years in Amateur Radio behind us, loathe the idea of not being able to repair our own rigs, it's nonetheless necessary to recognize that some problems will inevitably be "Beyond Capability of Maintenance" (BCM). If the rig is BCM, then it needs to go the service shop.

You have to decide what repairs you're willing (and able) to undertake. Part of this decision will depend on the design of the rig, while part will be based on the capabilities of your workshop test equipment. Another factor is your personality: if you're fearful of breaking into your rig, then it's probably best to leave that job to others.

Of course, it's also possible to reduce the fear factor by working under the supervision of an "Elmer" who has repair savvy.

In general, the repair of purely mechanical problems with minor controls (for example, toggle switches or potentiometers), visible solder joint problems on printed circuit boards, and DC power supply problems should be well within the capability of most Amateurs. It's also possible to add digital displays to the list above. If the design of your transceiver is such that most assemblies are on removable

PCBs, then swapping boards is also on the list of "can do's."

Problems with electronic equipment tend to recur in individual sets within a model group. Because professionals see the same problems again and again, they soon develop a "sense" for the symptoms. During my college years, I worked part-time in an auto radio shop that supposedly didn't hire part-time help. I'd gone into the shop to talk to the owner, who tried to ignore me while he worked on a Delco radio. As we talked, I recognized the problem and told him — without touching the radio myself — to go get a 7281933 trimmer capacitor and replace the LO capacitor. My point in telling this story is to encourage you to call the repair technicians at the manufacturer's or importer's facility, describe the symptoms, and take their advice. Whatever your problem is, they've probably seen it before, and they'll most likely be willing to help you.

While you have a technician on the line, ask whether there are any updates, retrofits, or engineering changes that would normally be incorporated into your rig if it were on the bench right now. You'd probably be surprised to know how often manufacturers and importers will update equipment returned for repair at little or no cost to the owner. Such a courtesy can often eliminate future problems.

### tools and supplies

If you don't have a certain minimum assortment of tools, don't even think about attempting the repair of your radio. If you decide to proceed, perhaps the first thing you'll need will be the screwdrivers required for removing the covers. Be sure to have the correct size screwdrivers; improperly sized screwdrivers will tear up both the screw heads and the screwdriver — or pop out of the heads and scratch the cabinet's paint job.

Many rigs are made in Japan. Because the bevel angle of Phillips screws on many Japanese products differs from that of American-made

Phillips screws, American-made tools will turn improperly inside the screw slots and tear up the screws. This is one instance in which cheap two-for-a-buck imported "tool barrel" screwdrivers work better than classy \$3 models.

You'll also want to have a couple of soldering devices on hand. For small work (and PCB repairs), use a 25-watt to 75-watt pencil iron; for larger jobs (and wire antennas), use a 250-watt soldering gun. (My own *Weller D-440* has served for 20 years.)

The choice of solder and desoldering aids are as important as the soldering iron you select. The only type of solder to use is *resin core* solder marked for radio, TV, or electronic use. I know many experienced hands will smirk, claiming that this advice is a useless restatement of the obvious, but it's necessary nonetheless: every shop I know occasionally sees a set that is ruined from the use of the wrong solder. Don't use an acid core solder, "plumber's solder" or "industrial solder." All these products use an acid core that will corrode your equipment into the junkyard! Use only resin core solder marked for radio, TV, or electronic uses. (I prefer either *Kester* or *Ersin Multicore* brands in either 50/50 or 60/40 lead/tin mixtures.)

Solder size is also somewhat important. For light work on things like IC pins or other PCB points, I prefer a No. 22, No. 24, or even No. 26 solder. Larger work or wire antennas require a No. 14 to No. 20 size. I keep rolls of No. 14, No. 18, and No. 24 solder in my toolbox. Solder isn't cheap, by the way — so either learn to use it sparingly or get rich and foolish.

Desoldering is a workbench skill that is just as important as soldering, but is all too often ignored in Amateur circles. Several aids available for desoldering, especially on printed wiring boards: desoldering tips, solder suckers, and solder wick.

• **Desoldering tips** are special soldering iron (or gun) tips that are shaped like the pin pattern for the device being



## meet Joe Carr, K4IPV

**Licensed since 1959**, Joe Carr has written more than 221 magazine articles and 41 books on a wide variety of subjects including Amateur Radio, computers and computer programming, electronics, mathematics, and biomedical equipment repair.

Joe began his lengthy and diversified career as a technician, working in mobile and biomedical electronics, communications, and both radio and television broadcasting. He won IS CET certification in consumer and communications electronics in 1971 and 1973, respectively, and was co-recipient, in 1977, of that organization's Technician of the Year Award.

He holds an MSEE from George Washington University (1981) and is currently employed as an electronics engineer in avionics.

Joe's recent books include *Interfacing Your Microcomputer to Virtually Anything*, *Designing and Building Electronic Gadgets (with Projects)*, *104 Weekend Electronics Projects*, *CMOS/TTL: A User's Guide (with Projects)*, and *The Complete Handbook of Radio Transmitters*, as well as *The Complete Handbook of Radio Receivers*, all published by Tab Books, Inc. Other titles — published by Reston Publishing Company, a division of Prentice-Hall — include *Elements of Microcomputer Interfacing*, *Designing Microprocessor-Based Instrumentation*, and *Elements of Electronic Instrumentation and Measurement*.

Five additional books have been completed and are awaiting publication, and six more are "in the works." ham radio welcomes K4IPV aboard.

desoldered. For example, there are tips that fit over all 14 or 16 pins of a DIP integrated circuit. The tip is chucked up in a soldering gun so that all pins can be heated simultaneously.

- **Solder suckers** are vacuum tools that, when used in conjunction with a soldering iron, suck melted solder from a joint. Really fancy (high dollar) systems are available; these use a vacuum pump and a pneumatic plumbing system that's an integral part of the soldering iron. Such tools are suitable for commercial shops or industrial users. Amateurs and most other users can get away with less elaborate solder suckers.

There are at least two types of solder suckers that are practical for Amateur applications. One type is a rubber squeeze ball (something like those little ear irrigating syringes you can buy at the drug store) with a nylon or teflon desoldering nozzle. The other type of solder sucker is a spring-powered piston device. The operator cocks it by engaging the spring, then places the tip against the molten joint and presses the spring release trigger. The solder zips up into the tool, leaving a clean joint. If you buy one of these devices, be sure to also buy a spare tip. Worn out tips tend to splash solder around the PCB a little bit. A small file or penknife does wonders in repairing worn-out tips, but a spare tip is nice to have on hand.

A small collection of other hand tools is also necessary. You should have a small pair of diagonal sidecutters, small longnose pliers, mid-size longnose pliers, wire strippers, several sizes of nutdrivers, and some alignment tools suitable for the type of radio set that you own. With this last comment I feel compelled to issue a stern warning: ALIGNMENT ADJUSTMENTS ARE NEVER USED IN TROUBLESHOOTING! The mark of a neophyte servicer is the use of the "diddle stick" in troubleshooting. So-called alignment problems do not occur suddenly, but typically occur over a very long period. When alignment shifts suddenly, it isn't an "alignment

problem" at all, but rather a component failure. Alignment causes a certain amount of wear and tear trauma, so constant tweeking is likely to add more faults than it may correct.

You might also want to keep a small supply of certain service chemicals on hand. Repair and maintenance jobs sometimes require cleaning of switches and potentiometers, so a spray can of cleaner (*Blue Stuff*, for example) is handy. You'll also need a small tube of either silicone grease or white grease (*Lubriplate* is a popular brand), some heat transfer grease for power transistors, and a freeze spray for locating intermittents. For that really professional touch on equipment with PCBs, buy a bottle of PCB cleaner designed to remove solder resins. Cleaning cabinets can be done with special cleaners, but they're expensive, so I always use modest amounts of soapy water on soft sponges or cloths.

I also recommend that you order the shop manual for your rig. Most rigs come with a manual that's fine for operating (it may even contain a schematic diagram), but not much good for troubleshooting. The shop manual must be purchased separately. Some rigs include a postcard or order form with the rig's documentation to make ordering a shop manual easier. In other cases, you'll have to write to the manufacturer or importer and ask about the availability of the manual. You should also consider buying service aids such as PCB card extenders, which allow you to operate PCBs out of the rig for troubleshooting, as well as patch cords and other items the company offers to professional servicers.

## conclusion

Repairing commercially made electronic equipment is not always a difficult matter better left to professional repair services. The Amateur with enough knowledge to pass a General or Advanced class license examination should be able to learn the job of trouble-shooting and repair — even if under a friendly "Elmer" the first time.

**ham radio**



**NEW!**  
ICOM HF Transceiver

# IC-735



## Ultra Compact

The new ICOM IC-735 is what you've been asking for...the most compact and advanced full-featured HF transceiver with general coverage receiver on the market. Measuring only 3.7 inches high by 9.5 inches wide by 9 inches deep, the IC-735 is well suited for mobile, marine or base station operation.

## More Standard Features

Dollar-for-dollar the IC-735 includes more standard features...FM built-in, an HM-12 scanning mic, FM, CW, LSB, USB, AM transmit and receive, 12 tunable memories and lithium memory backup, program scan, memory scan, switchable AGC, automatic SSB selection by band, RF speech processor, 12V operation, continuously adjustable output power up to 100 watts, 100% duty cycle and a deep tunable notch.

## Superior Performance

It's a high performer on all the ham bands, and as a general coverage receiver, the IC-735 is exceptional. The IC-735 has a built-in receiver attenuator, preamp and noise blanker to enhance receiver performance. PLUS it has a 105dB dynamic range and a new low-noise phase locked loop for extremely quiet rock-solid reception.

## Simplified Front Panel

The large LCD readout and conveniently located controls enable easy operation, even in the mobile environment. Controls which require rare adjustment are placed behind a hatch cover on the front panel of the radio. VOX controls, mic gain and other seldom used controls are kept out of sight, but are immediately accessible.



Options. A new line of accessories is available, including the AT-150 electronic, automatic antenna tuner and the switching PS-55 power supply. The IC-735 is also compatible with most of ICOM's existing line of HF accessories.

See the IC-735 at your authorized ICOM dealer. For superior performance and innovative features at the right price, look at the ultra compact IC-735.

113



**First in Communications**



# ALINCO ELECTRONICS

The new name to look for in Amateur gear and the name to watch for innovation.



## RF Power Amplifiers

\* GaAsFet RX Preamp



## Power Supplies



ELH-730D  
List \$156.95

ELH-230D  
List \$89.95

EP-3030 List \$208.00

EP-660 List \$69.00

Model	ELH-230D	ELH-260D	ELH-730D
Frequency Range	144-148MHz	144-148MHz	440-450MHz
Modes	All Mode (FM SSB CW)	All Mode (FM SSB CW)	All Mode (FM SSB CW)
Input Power	1W-3W	1W-3W	3W
Output Power	30W	50W	30W
Power Source	DC13.8V/45A	DC13.8V/10A	DC13.8V/7A
RX-PRE-AMP (About)	10dB	10dB	15dB
Input & Output Impedance	50Ω	50Ω	50Ω
Dimension (m/m) (W x H x D)	3.6" x 1.6" x 6.5"	3.6" x 1.6" x 8.5"	3.6" x 1.6" x 7.75"
N/W (About g)	18 oz.	24 oz.	23.5 oz.

Model	EP-3030 (With Two Meters)	EP-660 (With Dual Meter)	EP-5500 (With Two Meters)
Output Voltage	About 10V-15V D.C. (With Voltage Adjuster on rear side)	About 10V-15V D.C. (With Voltage Adjuster on rear side)	About 10V-15V D.C. (With Voltage Adjuster on rear side)
Output Current	25A D.C. (Continuous) 30A D.C. (Max.) (50% Duty Cycle)	5.5A D.C. (Continuous) 6.5A D.C. (Max.)	50A D.C. (Continuous) 55A D.C. (Max.)
Ripple Voltage	Under 30mV (P-P) (Rated)	Under 30mV (P-P) (Rated)	Under 30mV (P-P) (Rated)
Power Consumption	770VA (Rated)	180VA (Rated)	1,300VA (Rated)
Circuit Protection System	Automatic Current Limiting System shuts down in excess of 30 amps	Automatic Current Limiting System shuts down in excess of 6 amps	Automatic Current Limiting System shuts down in excess of 55 amps
Dimension (L x W x H)	13" x 9 1/2" x 6"	9" x 4 1/2" x 4"	18 1/2" x 12 1/2" x 7 8"
Weight	19 lbs.	8 1/2 lbs.	44 lbs.

many others from 6-55 amps

Watch for the introduction of our new 2 meter hand held available soon! Contact Alinco for your nearest dealer

Alinco Electronics Corp. P.O. Box 7007 Reno, NV 89570 (702) 359-1414

✓ 175

## TUBES and IC's

### FAST DELIVERY

### LOWEST PRICES

call Toll Free (800) 221-5802

In-depth Inventory - Industrial & Receiving Tubes  
Here are 2 dozen examples

3-400Z	\$85.00	8122	110.00
3-500Z	85.00	MRF450	\$12.95
572B	55.00	MRF454	18.95
811A	12.00	MRF455	14.95
6146B	8.75	MRF492	19.95
M2057	15.00	6LF6	\$8.26
8950	11.50	6JS6C	7.46
807	5.75	6KD6	8.26
6550A	7.75	6MJ6	8.38
4CX250B	60.00	8417	8.38
6DJ8	2.75	7360	13.95
6883B	8.25	6CA7	5.55

Major Manufacturers Factory Boxed and Full line of Sylvania ECG Replacement Semiconductors

Minimum order \$25.00 Allow \$3 UPS charge

## TRANSLETERONIC INC.

Box H, 1365 39th ST., BROOKLYN, NY 11218  
Tel. 718-633-2800/Watts Line 800-221-5802  
FAX # (718) 633-4375

## VHF COMMUNICATIONS

Contact us for all of your amateur radio needs. FEATURING:

ICOM, AEA, LARSEN, VAN GORDEN, VIBROPLEX, NYE-VIKING, FALCON COMM, LEADING EDGE, ARRL PUBLICATIONS, KAGLO, HAMTRONICS, PROWRITER, ELEPHANT DISKS, DEBCO, TRIONYX

915 North Main Street  
Jamestown, New York 14701

Weston New York's finest... amateur radio dealer!  
PH. (716) 664-6345

✓ 177

## GUS BROWNING, W4BPD's DX'ERS MAGAZINE

For over 17 years, Gus's DX'ERS MAGAZINE has brought thousands of DX'ERS worldwide, timely, pertinent information on when and where to find those elusive DX stations.

Gus's personable, chatty writing style and his years of DX operating experience makes the DX'ERS MAGAZINE a unique publication. One year \$14.00 USA, Canada & Mexico.

Gus also prints high quality QSLs and other related items.

Write today for a free sample of his QSLs and DX'ERS MAGAZINE.

Gus Browning, W4BPD • PO Drawer 405 • Cordova, SC 29039

✓ 136

# ENGINEERING MAKES THE DIFFERENCE



## Production Expertise And Service Integrity Form The Foundation For Your Long-Term Satisfaction

The fact that the Computer Patch Interface unit by Advanced Electronic Applications, Inc. is known as the best value on the market is no accident. The CP-1 was designed by Al Chandler, K6RFK (PHD-E.E.), an active RTTY user since 1963.

Given a cost per unit budget for the CP-1, Al designed as much performance as possible into the Computer Patch, including a unique new tuning indicator, referred to by one of our customers as the "Dead Eye Dick" tuning indicator. This indicator is ideal for RTTY and CW, in that it is both fast to tune and (within 10 Hz) as accurate as scope tuning. It also performs under poor signal to noise conditions in which other indicators provide no useful data.

Al's variable shift tuning was designed to move the space filter center frequency from 2225 Hz to 3125 Hz without changing the bandwidth (by varying the Q of the filter). All this is accomplished using a precision ganged potentiometer to assure proper tracking of the multiple filter stages. We could have used a pot costing a tenth as much by simply using a two-pole filter design, but we feel the advantage of a sharper filter reduces the noise bandwidth significantly and allows the variable shift control to be used like passband tuning for extra elimination of adjacent channel interference.

Some manufacturers are concerned that amateurs might try calibrating their own equipment and, therefore, have used non-adjustable components, which results in sub-optimal performance. Although more costly, trimpots used in AEA equipment allow factory adjustment for performance to design specifications. Competently designed active filter circuits need not be adjusted after leaving the factory; however, for specialized use the owner can easily change filter parameters.

Mindful of the fact that many of our customers are new to RTTY, Al made the CP-1 tuning as forgiving as possible, while providing the most critical operator a piece of equipment in which he could be proud. Even old "pro's" are surprised at the poor signal conditions under which the CP-1 will still provide good copy.

You can now experience the BEST RTTY, CW, and AMTOR offered. Couple the CP-1 with our new AEASOFT™ software packages designed for the MARS, SWL, or amateur radio operator, and you will feel a pride reminiscent of what "made in U.S.A." brought in years gone by. Please do not hold the low price of the CP-1 against us. This is one case where you get much more than you pay for relative to any of the competitive units. For more information send for our FREE catalog. Better yet, see your favorite dealer.

 **VHF**  
**COMMUNICATIONS**

915 North Main Street  
Jamestown, New York 14701 (716)664-6345

✓ 178



New

New

# THE STANDARD OF EXCELLENCE

## Definitely Superior!

# AZDEN PCS-5000

COMMERCIAL — GRADE



**UNPRECEDENTED WIDE FREQUENCY RANGE:** Covers 140,000-153,000 MHz in steps that can be set to any multiple of 5 kHz up to 50 kHz.

**CAP/MARS/NAVY MARS, BUILT IN:** The wide frequency range facilitates use of CAP and ALL MARS FREQUENCIES including NAVY MARS. **COMPARE!**

**TINY SIZE:** Only 2 inches high, 5 1/2 inches wide and 7/8 inches deep!

**MICROCOMPUTER CONTROL:** Gives you the most advanced operating features available.

**UP TO 11 NONSTANDARD SPLITS:** **COMPARE** this with other units!

**20 CHANNELS OF MEMORY IN TWO SEPARATE BANKS:** Retains frequency, offset information, PL tone frequency.

**DUAL MEMORY SCAN:** Scan memory banks separately or together. **ALL** memory channels are tunable independently. **COMPARE!**

**MEMORY SCAN LOCKOUT:** Allows you to skip over channels you don't want to scan.

**TWO RANGES OF PROGRAMMABLE BAND SCANNING:** Limits are quickly reset. Scan ranges separately or together with independently selective steps in each range. **COMPARE!**

**BUSY SCAN AND DELAY SCAN:** Busy scan stops on an occupied channel. Delay scan provides automatic auto-resume.

**DISCRIMINATOR CENTERING (AZDEN EXCLUSIVE PATENT):** Always stops on frequency desired when scanning.

**PRIORITY MEMORY AND ALERT:** Unit constantly monitors one memory channel for signals, alerting you when channel is occupied.

**LITHIUM BATTERY BACKUP:** Memory information can be stored for up to 5 years even if power is removed.

**FREQUENCY REVERSE:** Allows you to listen to repeater input frequency.

**ILLUMINATED KEYBOARD WITH ACQUISITION TONE:** Keys are easily seen in the dark, and actuation is positively verified audibly.

**CRISP, BACKLIGHTED LCD DISPLAY:** Easily read no matter what the lighting conditions!

**DIGITAL S/R F METER:** Shows incoming signal strength and relative transmitter power.

**MULTI-FUNCTION INDICATOR:** Shows a variety of operating parameters on the display.

**FULL 16-KEY TOUCHTONE PAD:** Keyboard functions as auto-patch when transmitting.

**MICROPHONE CONTROLS:** Up/down frequency control and priority channel recall.

**PL TONE GENERATOR BUILT IN:** Instantly program any of the standard PL frequencies into the microcomputer. **COMPARE!**

**TRUE FM, NOT PHASE MODULATION:** Unsurpassed intelligibility and audio fidelity. **COMPARE!**

**HIGH/LOW POWER:** Select 25 watts or 5 watts output — fully adjustable.

**SUPERIOR RECEIVER:** Sensitivity is better than 0.15 microvolt for 20-db quieting. Commercial-grade design assures optimum dynamic range and noise suppression. **COMPARE!**

**DIRECT FREQUENCY ENTRY:** Streamlines channel selection and programming.

**OTHER FEATURES:** Rugged dynamic microphone, built-in speaker, mobile mounting bracket, remote speaker jack, and all cords, plugs, fuses and hardware are included.

EXCLUSIVE DISTRIBUTOR: DEALER INQUIRIES INVITED FOR YOUR NEAREST DEALER OR TO ORDER:  
**AMATEUR-WHOLESALE ELECTRONICS TOLL FREE...800-327-3102**  
 8817 S.W. 129th Terrace, Miami, Florida 33176 Telephone (305) 233-3631 Telex: 80-3356



MANUFACTURER:

**JAPAN PIEZO CO., LTD.**

1-12-17 Kamirenjaku, Mitaka, Tokyo, 181 Japan

Telex: 781-2822452

235

# a detailed look at probes

From simple to exotic,  
these devices  
invariably affect circuits

Although it's admittedly difficult to get excited about probes, this article may offer insight into, and perhaps even respect for, these devices. Despite their uncomplicated appearance, they're really much more than "just a piece of wire with a handle."

## probes load down circuits

Most low- to medium-frequency oscilloscopes have a 1-Megohm impedance shunted by 8 to 50 pF of capacitance. Some scopes above 200 MHz have a 50-ohm or both a 1 Megohm and 50-ohm input impedance that is switch-selectable. In either case, when a scope's probe is attached to the circuit under test, this impedance loads the circuit and may alter its proper operation or even cause it not to work.

Figure 1 shows an attenuator probe and scope input. An attenuator probe contains a built-in voltage divider. Most typical values of these types of probes are 10:1 and sometimes even 100:1.

How does the probe affect the input signal? First, consider what happens to square wave and sinewave inputs. (With sinewave inputs we're especially concerned with amplitude and phase distortion.) Referring again to fig. 1, note that the probe and scope in-

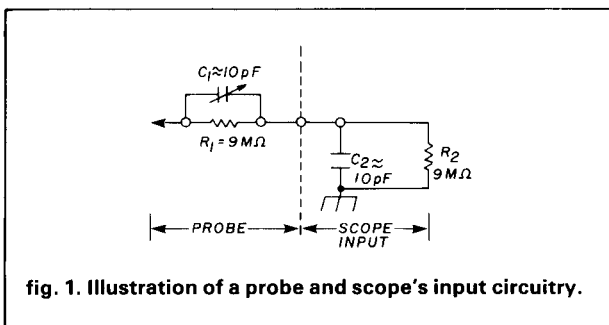

fig. 1. Illustration of a probe and scope's input circuitry.

Note: All figures courtesy Tektronix, Inc., unless otherwise noted.

put essentially form an RC divider. Since  $R_1C_1$  must equal  $R_2C_2$  for equal attenuation at all frequencies, as  $R_1$  increases  $C_1$  must decrease. The capacitance at the probe tip can be reduced by going to higher values of attenuation.

## measuring pulsed signals

Referring to fig. 2A, note that if  $R_s = 200$  ohms and if  $C_s = 20$  pF, then  $t_{r1}$  would be limited by the integration network of  $R_sC_s$  and would be equal to  $2.2 R_s \cdot C_s$  or 8.8 nanoseconds in this case. Using a typical passive probe such as the P6053B (fig. 3) with a 9.5 pF and 10 Megohm impedance then results in the circuit shown in fig. 2B. ( $R_p$  has been disregarded because it is much greater than  $R_s$ .) Looking at the risetime as  $2.2 R_s (C_s + C_p)$  we obtain 13 nanoseconds. Mathematically

$$\frac{t_{r2} - t_{r1}}{t_{r1}} \times 100 = \frac{13 \text{ ns} - 8.8 \text{ ns}}{8.8 \text{ ns}}$$

$$\text{and } \frac{C_p}{C_s} \times 100 = \frac{9.5 \text{ pF}}{20 \text{ pF}} = 48 \text{ percent}$$

Next, let's look at what happens when we use a P6048 probe (fig. 4) with its 1 pF, 10 kilohm characteristic. Referring to fig. 2C, note that by using Thévenin's theorem that  $t_{r3} = 2.2 R_2 (C_s + C_p) = 7.7$  nanoseconds now. This percentage change is dramatically less than that caused by the P6053B. Mathematically,

$$\frac{7.7 \text{ ns} - 8.8 \text{ ns}}{8.8 \text{ ns}} \times 100 = 12 \text{ percent change}$$

Interestingly, though, by not degrading the signal by slowing its risetime, the probe actually modified the source resistance to decrease the risetime, making it faster than it should be. This, however, was at the expense of output amplitude, which decreased to 83.3 percent. Recall that in the first example there was no change in signal source amplitude when the probe was applied.

By Vaughn D. Martin, 114 Lost Meadows, Cibolo, Texas 78108 and Billy W. Davis, 8914 Rich Quail, San Antonio, Texas 78251

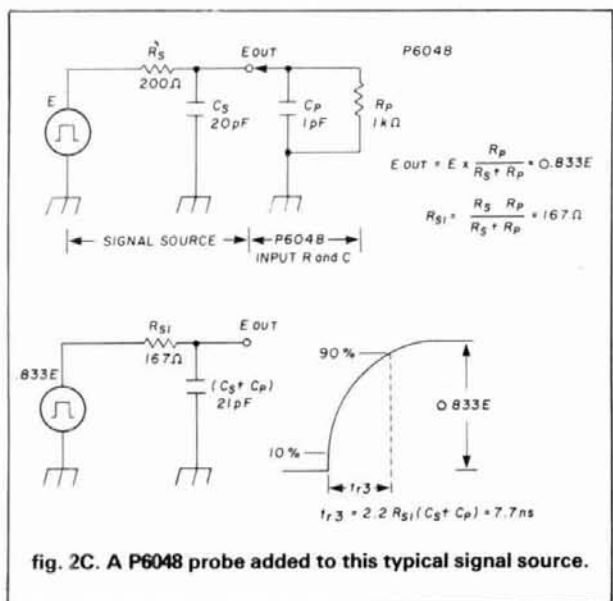
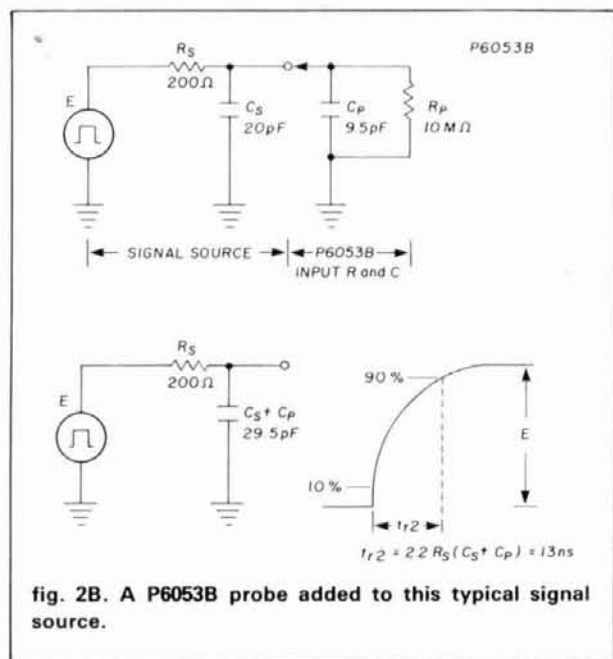
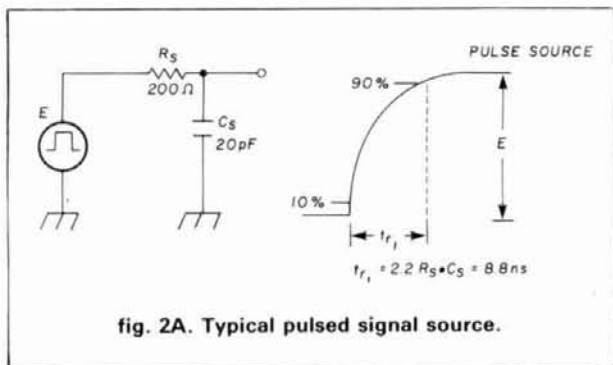

These two examples demonstrate that when measuring pulsed or square wave signals, low capacitance is desired when measuring risetime, but *high resistance* is more important when measuring amplitude. Also, selecting a low impedance test point in a circuit is best when measuring both risetime and amplitude.

Using the same probes and the same circuit, let's see how amplitude and phase relationships are affected when the signal source is a sinewave oscillator. Refer to **fig. 5** and note that we now have a 10 MHz source; at these higher frequencies, the  $X_p$  and  $R_p$  of the P6053B probe change (see **fig. 6**). Applying the P6053B probe to the source, the output voltage drops to 94 percent of the generator voltage. This represents a 3 percent drop from the 97 percent output voltage normally obtained from the source.

Applying a P6048 probe to the same circuit causes an output voltage of 81 percent of the generator's open circuit voltage and 16 percent from the unloaded voltage condition (**fig. 7**).

Because all probes contain a capacitive element, phase relationships or shifts will naturally occur. Refer to **fig. 8** and consider an amplifier driven from a 10 MHz, 50 ohm source and having an output impedance



**fig. 3. P6053B high-impedance probe.**



fig. 4. P6048 low-capacitance probe.

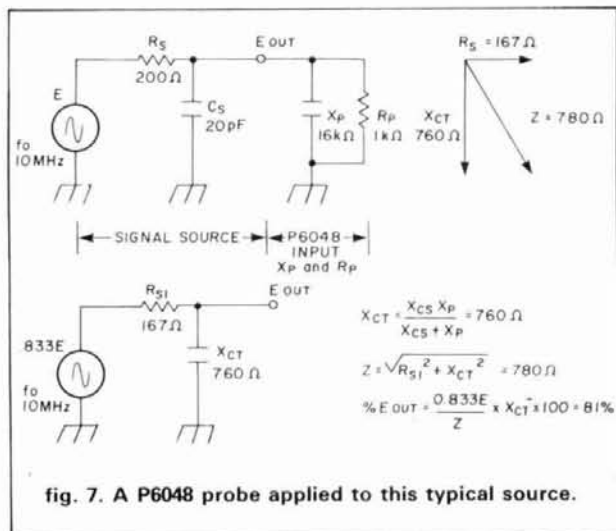

fig. 7. A P6048 probe applied to this typical source.

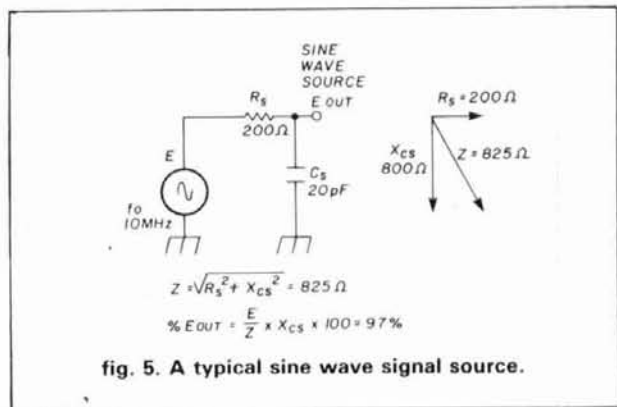

fig. 5. A typical sine wave signal source.

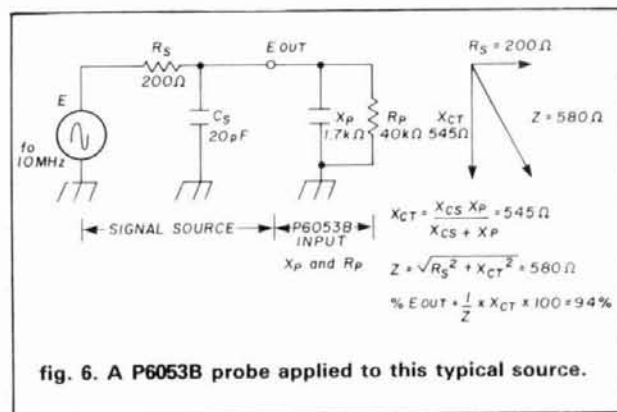

fig. 6. A P6053B probe applied to this typical source.

of 2 kilohms. Examining the input and output using two 10 Megohm 10 pF probes graphically shows a 49

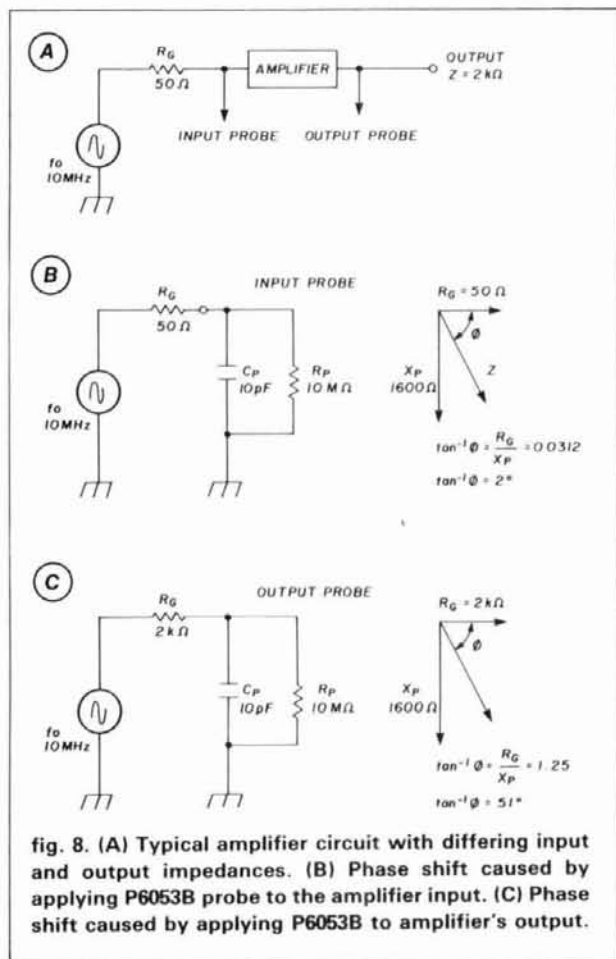

fig. 8. (A) Typical amplifier circuit with differing input and output impedances. (B) Phase shift caused by applying P6053B probe to the amplifier input. (C) Phase shift caused by applying P6053B to amplifier's output.

degree phase shift difference in the points in the circuit being examined.

Next, refer to fig. 9. Note that with 1 kilohm, 1 pF probes the phase difference is now only 2 percent. But the price paid for this is an attenuation in signal — it's only 67 percent of the original amplitude.

## application determines probe needed

Here are some general guidelines to follow when making measurements with a passive scope probe.

- Always check the probe compensation on the oscilloscope being used to make the measurement.
- Choose the lowest *impedance* test point possible to view the signal.
- When making risetime measurements:

Choose a probe with R and C values as low as possible.

Scope and probe risetime should be short relative to the signal risetime.

- Observed risetime is approximately equal to the square root of the sum of the squares of all risetimes in the system. These risetimes include that contributed by the signal source, the probe and the scope.

- When making amplitude measurements:

For sine wave measurements, choose a probe that has the highest input impedance at the frequency of interest. Remember, loading error changes with frequency.

For pulse measurements, choose a probe that has a large input resistance relative to the source impedance. Input C is of no concern if pulse duration is about five times longer than the input RC.

## active probes

Two prime advantages of active probes include the following: isolation (provided between the measurement point and the probe cable and scope, allowing high input resistance and low capacitance to be achieved) and full bandwidth (obtainable without input signal attenuation).

Most active probes are compatible with either 1 Megohm or 50 ohm scope inputs without using external adapters. When working in the 50 ohm mode, a 50 ohm cable can be used to extend the probe length without increasing capacitive loading. However, longer cables will slow the risetime.

A typical active probe such as the Tektronix P6201 in **fig. 10** has a probe bandwidth of from DC to 900 MHz with a risetime of 0.4 nanosecond.

To show how much better an active probe is than a passive probe, let's go back to the same circuits we've been comparing and see what happens to the circuit once the active probe is connected to it (see **fig. 11**). Realizing that the P6201 has a 1.5 pF capacitance, its loading effect is only 8 percent, increasing the pulse risetime from 8.8 ns to 9.5 ns or mathematically:

$$\frac{t_{r3} - t_{r1}}{t_{r1}} \times 100 = \frac{9.5 - 8.8}{8.8} = 8 \text{ percent}$$

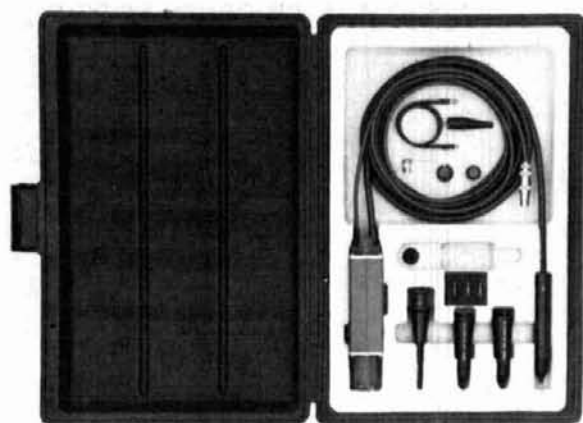
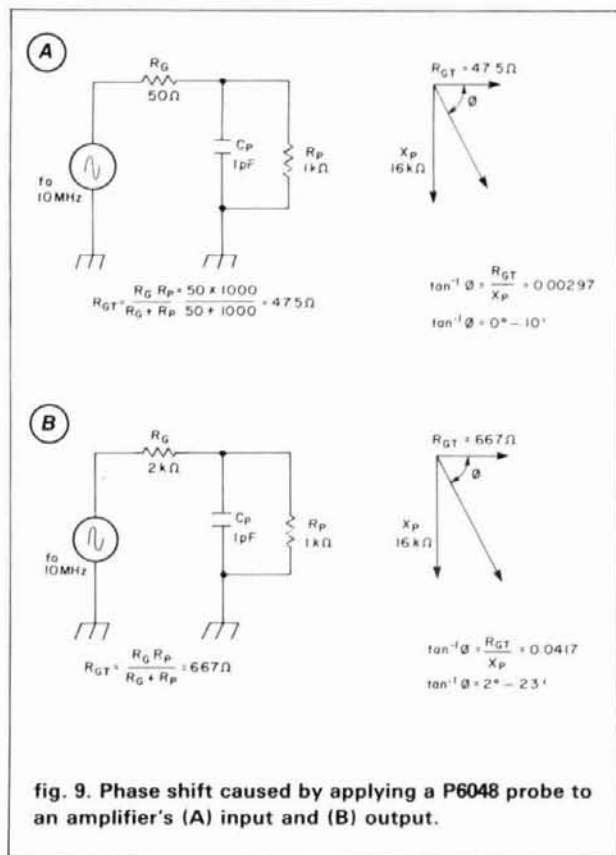

**fig. 10. A typical active probe, the Tektronix P6201.**

This 8 percent value is a marked improvement over the 48 percent increase in risetime caused by a 10x high impedance *passive* probe like the P6048.

## measuring low-level signals

One prime advantage of an active probe is full bandwidth at 1x attenuation with minimum circuit loading. **Figure 12** shows that the active probe increased the risetime from 8.8 ns to 10 ns for a 14 percent change. Although somewhat greater than the 8 percent change



# PICK A COMPUTER INTERFACE TO MATCH YOUR NEEDS

**COMPUTER PATCH™  
MODEL CP-1**



**MICROPATCH™ MODEL MP-1**



**COMPUTER PATCH MODEL CP-100**

## **COMPUTER PATCH™ MODEL CP-1**

The AEA Model CP-1 Computer Patch has earned a solid reputation for being the best overall interface value on the market today. We at AEA have now reaffirmed what our competitors already know; for the money, the CP-1 cannot be beat! That is why we have chosen to leave the popular CP-1 in our product line and to introduce new computer interface/terminal units with differing features and performance at different prices.

## **MICROPATCH™ MODEL MP-1**

The new AEA model MP-1 Micropatch represents the best features and performance available for under \$140.00. Featuring true dual-channel filtering of Mark and Space tones with an AM detector and Automatic Threshold Correction (ATC) circuit, the MP-1 is in a totally different performance class than competitive units that often have only a single channel filter or no filtering at all.

The MP-1 also offers a high performance CW capability. With respect to the CP-1, overall performance is nearly as good; but the CP-1 offers a few more advanced features such as variable shift tuning, RS-232 option, and a more advanced tuning indicator.

## **COMPUTER PATCH MODEL CP-100**

The new CP-100 Computer Patch offers all the following exciting features in addition to the CP-1 features:

- 170, 425, 850 Hz Calibrated Shifts for Transmit and Receive
- 75 to 1000 Hz Variable Receive Shift Range
- Normal and Reverse FSK Outputs
- Input AGC
- Direct Coupled Automatic Threshold Control
- Front Panel Squelch
- Discriminator Style Tuning Indicator
- Current Loop Option
- Built-in Monitor Speaker
- Baud Rate Switch
- Improved AM Detector

**Advanced Electronic Applications, Inc.**  
P.O. BOX C-2160 • LYNNWOOD, WA 98036  
(206) 775-7373 • TELEX: 152571 AEA INTL



**Brings you the  
Breakthrough!**



# Around the corner. Yaesu's VHF/UHF

Whether it's for working your favorite repeater or working an exotic land, Yaesu's got the choice in VHF

and UHF radios that you need.

In fact, you'll discover that our VHF/UHF line is as diverse as your operating needs.

So when you want to make your VHF/UHF operation complete, just look to Yaesu for the solution.

**For your hand.** We're constantly raising the standards in handheld radio technology. And our 5-watt, 2-meter FT-209RH and

our 4-watt 440-MHz FT-709R are no exceptions.

In fact, you won't find a more flexible, easy to use HT design anywhere.



handheld alternative, we've got your bases covered too.

We give you a choice of three bands of operation: the FT-203R for 2 meters, the FT-103R for 220 MHz, and the FT-703R for 440 MHz.

Each of these lightweight rigs features 2.5 watts of power and an optional DTMF keyboard.

**Over land.** Our two mobiles give you a lot of power in very small packages.

The FT-270RH is a 2-meter, 45-watt rig that conveniently packs its 45-watt punch into just about any small space in your car.

The FT-2700RH is a 25-watt FM dual-bander that lets you operate on 2 meters or 440 MHz. Or combine the two for cross-band, full-duplex, telephone-style operation.

Either way, both rigs are simple to operate. You get ten memory channels. Flexible band-scanning functions. Dual VFO capability.

Each rig gives you a battery saver that really helps conserve your battery power.

Two microprocessors make for a wider range of scanning functions. And complete storage capability in each of the ten memory channels.

Even an optional plug-in tone encode/decode module is available.

And best yet, these two high-powered HTs fit very comfortably in your hand, thanks to an ultra-slim and lightweight design.

However, if you're looking for a more basic and inexpensive





# Around the world. line gets you there.

With a clean, uncluttered LCD display for easy readout.

You don't even have to take your eyes off the road to determine your operating frequency and memory channel. An optional voice synthesizer announces them both at the push of a button on the microphone.

Also, an optional plug-in tone encode/decode board is available.



**Across the world.** We've got the world's most popular link to OSCAR 10, the tri-band FT-726R.

And talk about DX. You'll be making worldwide contacts in true 20-meter style. With excellent signal quality too.

And better, you can work the world from just about anywhere. Including apartments and antenna

restricted neighborhoods.

The FT-726R is a 2-meter, 10-watt rig with cross-band capability. To assemble the core of your earth station, simply plug in two optional modules, one for 435-MHz operation, another for cross-band duplex.

You get eleven memories, dual VFO registers, highly versatile scanning functions, and a whole lot

more to make the FT-726R a highly worthwhile investment.

**Tie it all together.** Finally, if you're looking for a repeater system, we've got just the repeater and intelligent controller that you need.

We'll help fine-tune your system to fit your individual requirements. No matter what they



may be. Just write us with your system specifications, and we'll recommend the required hardware.

What's more, you can rest assured that our repeater system is proven and reliable. In fact, it's been used extensively in both amateur and commercial applications.

**Yaesu gets you there.**

So when you're ready to get out on VHF/UHF, go with

Yaesu. You'll discover a new world of innovation.

## YAESU

**Yaesu Electronics Corporation**  
6851 Waltham Way, Paramount, CA 90723  
(213) 633-4007

**Yaesu Cincinnati Service Center**  
9070 Gold Park Drive, Hamilton, OH 45011  
(513) 874-3100

CALL TOLL FREE FOR QUOTES

**1-800-328-0250**

1-612-535-5050

(IN MINNESOTA—COLLECT)

# TNT RADIO SALES INC.

**YOU GET MORE "BANG FOR YOUR BUCK"  
AT TNT RADIO SALES!**

- |              |                |               |             |
|--------------|----------------|---------------|-------------|
| ■ Kenwood    | ■ Mirage       | ■ MFJ         | ■ Welz      |
| ■ Icom       | ■ KLM          | ■ Astron      | ■ Azden     |
| ■ Bencher    | ■ Telex Hygain | ■ Alpha/Delta | ■ Santec    |
| ■ AEA        | ■ Nye Viking   | ■ Bearcat     | ■ KDK       |
| ■ Kantronics | ■ Larsen       | ■ Regency     | ■ Ameritron |

**SALES AND SERVICE AT PRICES YOU CAN AFFORD!  
CALL OUR WATS LINE FOR LOW LOW PRICES!**

**SPECIAL OF THE MONTH: LARSEN MAG MOUNT 2M 1/2 PKG—\$36.95**

VISA/MASTER CARD  
FREE SHIPPING  
ON MOST RIGS FOR CASH!



S.A.S.E. FOR OUR  
"BENCH-TESTED"  
USED EQUIPMENT LISTING

MON-FRI 9 AM - 6 PM CENTRAL TIME  
SATURDAY 9 AM - 5 PM

4124 West Broadway, Robbinsdale, MN 55422 (Mpls./St. Paul)

182

## Iron Powder and Ferrite TOROIDAL CORES

Shielding Beads, Shielded Coil Forms  
Ferrite Rods, Pot Cores, Baluns, Etc.

Small Orders Welcome  
Free 'Tech-Data' Flyer

**AMIDON** Associates Since 1963

12033 Otsego Street, North Hollywood, Calif. 91607



In Germany: Elektronkladen, Wilhelm — Mellies Str. 88, 4930 Detmold 18, West Germany  
In Japan: Toyomura Electronics Company, Ltd., 7-9, 2-Chome Sota-Kanda, Chiyoda-Ku, Tokyo, Japan

136

## CALL LONG DISTANCE ON 2 METERS

Only 10 watts drive will deliver 75 watts of RF power on 2M SSB, FM, or CW. It is biased Class AB for linear operation. The current drain is 8-9 amps at 13.6 Vdc. It comes in a well constructed, rugged case with an oversized heat sink to keep it cool. It has a sensitive C.O.R. circuitry, reliable SO-239 RF connectors, and an amplifier IN/OUT switch. The maximum power input is 15 watts.



Our products are backed by prompt factory service and technical assistance. To become familiar with our other fine products in the amateur radio market, call or write for our free product and small parts catalog.

Model 875  
Kit \$109.95  
Wired & Tested \$129.95



**CCI** Communication Concepts Inc.  
2648 North Aragon Ave. • Dayton, Ohio 45420 • (513) 296-1411



137

This publication is available in microform from University Microfilms International.



Please send information about these titles:

\_\_\_\_\_

\_\_\_\_\_

Name \_\_\_\_\_

Company/Institution \_\_\_\_\_

\_\_\_\_\_

Address \_\_\_\_\_

City \_\_\_\_\_

State \_\_\_\_\_ Zip \_\_\_\_\_

Phone ( ) \_\_\_\_\_

Call toll-free 800-521-3044. In Michigan, Alaska and Hawaii call collect 313-761-4700. Or mail inquiry to: University Microfilms International, 300 North Zeeb Road, Ann Arbor, MI 48106.

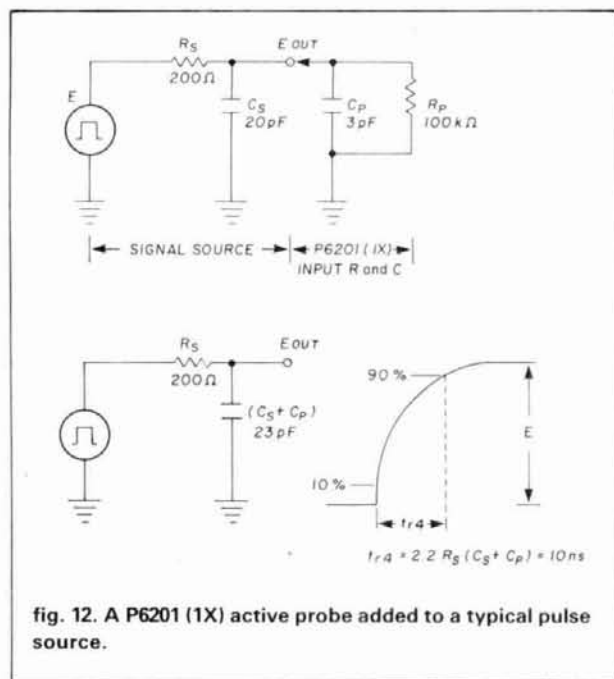
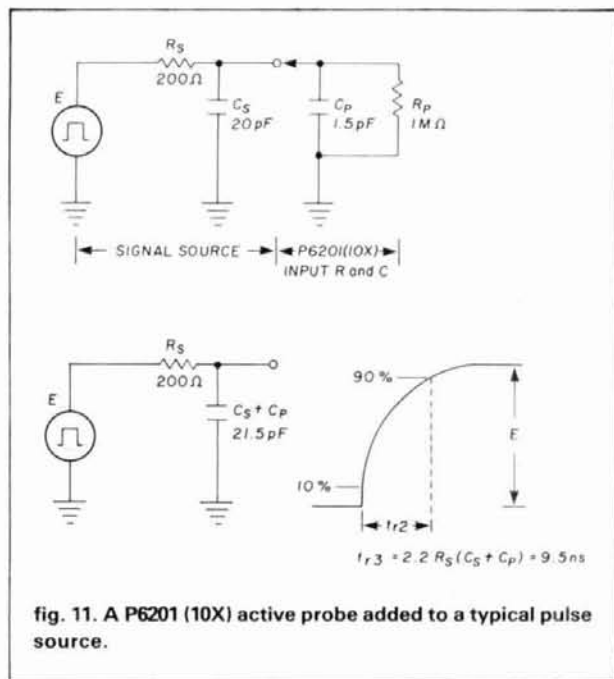

of the P6201 (10x), it virtually had no effect at all on the signal amplitude. But in fairness to the passive probes, it must be noted that at lower values of source impedance or with slower risetimes the small difference in measurement error may not justify the difference in cost between the active and passive probes. But in the final selection process it might be advisable to observe the following general guidelines:

- Full bandwidth is provided with no signal attenuation using the 1X configuration.
- The active nature of the probe provides the high input impedance characteristics of most passive probes and the low input capacitance of passive probes designed to work into 50 ohm inputs. These features yield the best features of both — minimum risetime and minimum pulse-amplitude error.
- Impedance selection to permit use with either 50 ohm or 1 Megohm inputs is usually provided.
- Probe length can be extended through the use of a 50 ohm cable without increasing probe loading.
- Over-voltage capability is typically provided. However, to minimize the likelihood of over-voltage, the highest attenuation configuration should always be used when probing unknown voltages.
- Dynamic signal range of the active probe is not as great as that of a passive probe. For example, the P6201 (1X) can handle signals up to  $\pm 600$  mV. This can be extended to  $\pm 60$  volts using the 100X attenuator. DC offset provides a measurement window of  $\pm 5.6$  volts using the probe alone, with the range extended to  $\pm 200$  volts using the 100X attenuator.



**fig. 12A. The P6042 current probe and accessories.**

## the current probe

Now let's turn our attention to a measurement tool often overlooked — the current probe. Current probe measurements are particularly applicable for high impedance measurement points where the voltage probe would significantly alter the circuit characteristics.

The current probe offers the lowest circuit-loading of any available probe. There is, however, an insertion impedance reflected into the circuit under test, which consists of a series resistance shunted by a small

# BARKER & WILLIAMSON OFFERS

★ **ONCE IN A LIFETIME DEAL** ★

## MODEL VS-300A ANTENNA TUNER



**GUARANTEED THE BEST VALUE YOU'LL EVER FIND!  
REGULARLY \$100.00**

**NOW ONLY \$69.95 WHILE SUPPLIES LAST**

- FULL COVERAGE - 1.8-30MHz
- HANDLES UP TO 300 WATTS
- MATCHES VIRTUALLY ALL ANTENNAS:  
DIPOLE BEAM  
INVERTED VEE RANDOM WIRE  
VERTICAL MOBILE WHIP
- ACCEPTS COAX, BALANCED LINE OR  
SINGLE WIRE FEEDLINE
- BUILT-IN ANTENNA SWITCH.
- BUILT-IN WATTMETER WITH FORWARD  
AND REFLECTED POWER FOR SWR  
MEASUREMENTS.
- WATTMETER ACTIVE EVEN WITH TUNER  
IN BYPASS POSITION.
- ATTRACTIVE CHARCOAL GRAY FINISH  
- AT HOME IN ANY HAM SHACK.
- RUGGED 4:1 BALUN FOR BALANCED  
FEEDLINE.

AVAILABLE AT PARTICIPATING DEALERS



**BARKER & WILLIAMSON**

Quality Communication Products Since 1932

WRITE OR CALL:

10 CANAL STREET, BRISTOL, PA 19007  
215-788-5581



## MULTI BAND TRAP ANTENNAS



### TRAP DIPOLES:

Model	Bands	Traps	Length	Price
D-42	10/15/20/40	2	55	\$59.95
D-52	10/15/20/40/80	2	105	64.95

### TRAP VERTICALS - "SLOPERS":

Model	Bands	Traps	Length	Price
VS-31	10/15/20	1	12	42.95
VS-41	10/15/20/40	1	27	44.95
VS-52	10/15/20/40/80	2	52	59.95

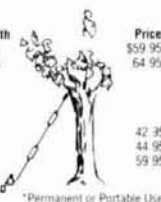

\*Can be used without radials  
\*Feed line can be buried if desired

\*Permanent or Portable Use

ALL ANTENNAS are Ready to use - Factory assembled - Commercial Quality - Handle full power - Comes complete with Deluxe Traps, Deluxe center connector, 14 ga Stranded Copper Weld ant. wire and End Insulators Automatic Band Switching - Tuner usually never required - For all transmitters, Receivers & Transceivers - For all class amateurs - One feedline works all bands - Instructions included - 10 day trial!

### COAX CABLE: (includes PL-259 connector on each end)

Type	Length	With antenna purchase	Separately
RG-58	50	\$8.00	\$11.95
RG-58	90	12.00	16.95

### DELUXE CENTER CONNECTOR

- NO RUST Brass Terminals
- NO jumper wires used
- NO Soldering
- Built in Lightning Arrestor
- With SO 239 Receptacle
- Handles Full Power
- Completely sealed, weatherproof
- Easy element adjustments
- Commercial quality



**DELUXE ANTENNA TRAPS:** Completely sealed & weatherproof - Solid brass terminals - Handles Full power - NO jumpers - NO Soldering - Instructions included  
For 4 band Dipole Ant 40/20/15/10 \$36.00/pr  
For 5 band Dipole Ant 80/40/20/15/10 \$38.00/pr

ORDER DIRECT FROM FACTORY. All orders shipped US Postpaid  
VISA/MC - give card #, Exp. date, Signature



**SPI-RO MANUFACTURING, INC.**  
Room 103, P.O. Box 1538  
Hendersonville, NC 28793



Dealer Inquiries Invited

139

## DESIGN EVOLUTION IN RF P.A.'s

Now with  
**GaAs FET  
Preamp**



- Linear (all mode) RF power amp with automatic T/R switching (adjustable delay). Amplifier useable with drive powers as low as 1/2 watt.
- Receive preamp option, featuring GaAs FETs (lowest noise figure, better IMD). Device NF typically .5 dB.
- Thermal shutdown protection incorporated
- Remote control capability built-in
- Rugged components and construction provide for superior product quality and performance
- All models include a complete operating/service manual and carry a factory warranty on all components
- Designed to ICAS ratings, meets FCC part 97 regulations
- Approximate size is 2.8 x 5.8 x 10.5" and weight is 5 lbs.

Specifications/price subject to change

MODEL	FREQUENCY 2 (MHz)	OUTPUT POWER (W)	INPUT POWER (W)	NF	PRE-AMP GAIN
0508	50-54	170	1	-	-
0508G	50-54	170	1	.6	15
0510	50-54	170	10	-	-
0510G	50-54	170	10	.6	15
1410	144-148	160	10	-	-
1410G	144-148	160	10	.6	15
1412	144-148	160	30	-	-
1412G	144-148	160	30	.6	15
2210	220-225	130	10	-	-
2210G	220-225	130	10	.7	12
2212	220-225	130	30	-	-
2212G	220-225	130	30	.7	12
4410	420-450	100	10	-	-
4410G	420-450	100	10	1.1	12
4412	420-450	100	30	-	-
4412G	420-450	100	30	1.1	12

1. Models with G suffix have GaAs FET preamps. Non-G suffix units have no preamp.
2. Covers full amateur band. Specify 10 MHz Bandwidth for 420-450 MHz Amplifier.

★SEND FOR FURTHER INFORMATION★

**TE  
SYSTEMS**

**TE SYSTEMS**  
P.O. Box 25845  
Los Angeles, CA 90025  
(213) 478-0591

NEW!

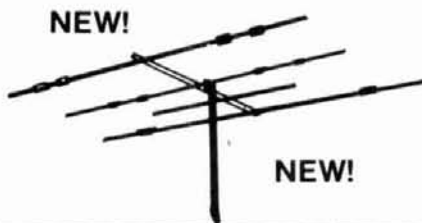

NEW!

## THE ARRL ANTENNA COMPENDIUM

Because of space limitations in *QST*, we don't have room to run all of the good antenna articles that are submitted. The solution to this problem? **THE ARRL ANTENNA COMPENDIUM!** You'll find 178 pages packed with new material on quads, loops, log periodic arrays, other beam antennas, multiband antennas, verticals, reduced size antennas, plus such interesting topics as: Mr. Smith's "Other" Chart and Broadband Rigs; Available Power, SWR and Loading; Baluns; What They Do and How They Do It; The Horizontal Dipole Over Lossy Ground; and Antenna Polarization. Copyright 1985. Paperbound: \$10.00 in the U.S., \$11.00 elsewhere.

✓ 185

THE AMERICAN RADIO RELAY LEAGUE  
225 MAIN ST.  
NEWINGTON, CT 06111

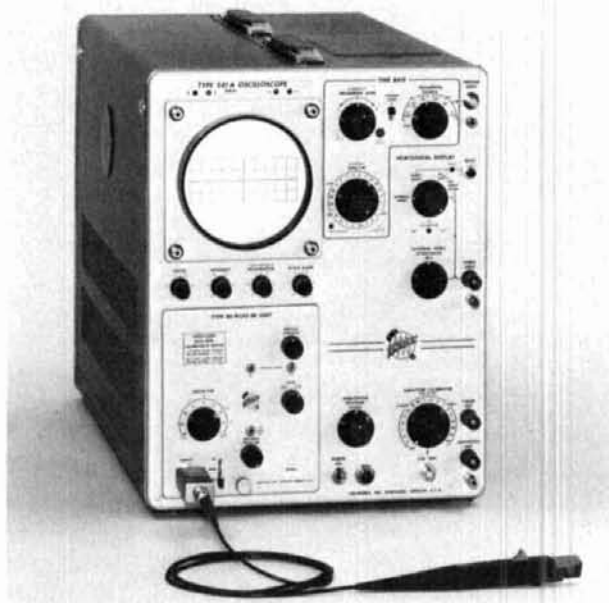

fig. 13A. Examples of closed-core head current probes.

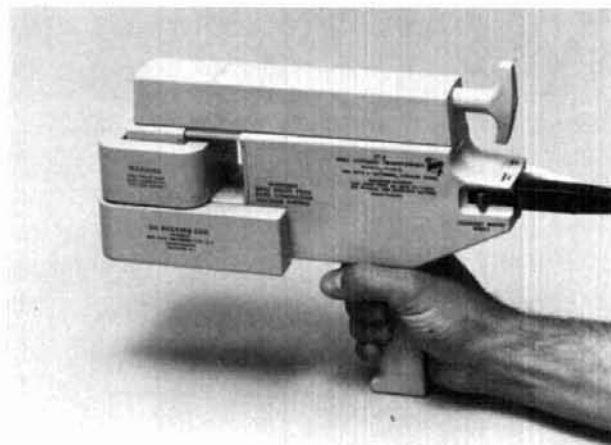

fig. 13B. Examples of split-core head current probes.

inductance which is associated with the inserted impedance of the current-sensing unit in the probe head. The P6042 current sensing probe is a DC to 50 MHz device with insertion impedance of 0.1 ohms at 5 MHz, (fig. 12A). Therefore, to realize an amplitude measurement error of no greater than 2 percent the signal source impedance should be 50 times the insertion impedance or 5 ohms in this case. But let's take a closer look at this head. It uses a Hall Effect\* device to yield tilt-free display of the current waveform. This also supplies the DC and low frequency information to the

\*The Hall Effect describes the phenomenon of what happens when a conductor through which a current is flowing is placed in a magnetic field: a difference in potential (the Hall voltage) is generated between the two opposite edges of the conductor in the direction perpendicular to both the field and the current.

P6042 amplifier. In this amplifier, this low frequency information is combined with the high frequency component of the signal to yield the output.

Another consideration in using current probes is the capacitive loading from the probe to the circuit. The coupling — the only shunt loading placed on the circuit by the probe — will vary according to the size and type of wire or current conductor. For example, while a No. 20 AWG wire will show approximately 0.6 pF, a No. 14 wire will have approximately 1.5 pF. The majority of capacitance occurs between the shielding and the current sensing unit. This can be minimized by using the probe ground lead when working with large voltage swings of high-frequency signals.

There are two types of current probes (figs. 13A and 13B): the *closed-core unit*, in which the wire is

threaded through the head and the *split-core unit*, which provides for a portion of the core to slide back, allowing the current-carrying lead to be inserted without breaking the circuit.

A different set of terms is used to describe the operational characteristics of a current probe than is used with a voltage probe. The most important parameter is the Amp-Second Product, which is directly related to the flux saturation of the transformer core. Effectively, the Coulomb\* charge (one volt is the potential difference between two points in an electric circuit when the energy involved in moving one coulomb of electric charge from one point to the other is one joule) under one pulse is integrated to determine whether it will place the current transformer into saturation.

The following are general considerations related to current probe use:

- The current probe can be considered complementary to the voltage probe in that while the voltage probe requires low impedance points for accurate measurements, the current probe requires higher impedance points.
- The current probe exhibits lower loading than any voltage probe. This generally implies minimum signal amplitude attenuation and minimum risetime inaccuracies.
- Where information on current supply requirements is needed, primarily current into capacitive elements, the current probe is almost a necessity.

### a more exotic probe

The last type of probe to be considered is the sophisticated, cleverly designed HP5363B time interval probe (fig. 14).

An electronic counter works on a simple principle in the time interval mode. First, any frequency counter has a main gate that when opened, allows pulses from an extremely accurate quartz crystal oscillator to be counted and accumulated in a counting register. The main gate remains open and the register keeps counting the crystal's frequency as long as a measurement is being made. In the time interval mode, there is a finite elapsed time between two events. These two events, the START and STOP events, take the form of the two independent inputs on a frequency counter. The problem arises when the two channels (the START and STOP inputs) have unequal delays through their probes, cabling, and input circuitry. Also, a counter's input circuitry has been designed for optimum performance at detecting zero crossings. This makes the measurement of risetimes, propagation delays and slow rates very difficult because its limited

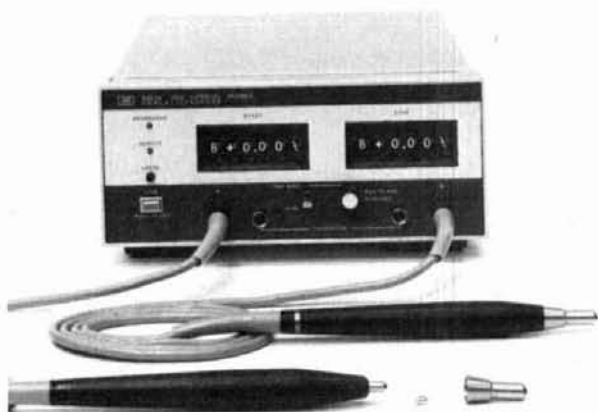

fig. 14. The HP5363B time-interval probe. (Photo courtesy Hewlett-Packard.)

trigger range is typically  $\pm 1$  volt or less. A slight uncertainty or ambiguity in the exact triggering point results.

The HP5363B time interval probe can be very useful in this situation. The user goes through a procedure that basically involves grounding the probe to be calibrated and pressing a front panel switch. This action causes the reference voltage,  $V_r$ , to move up or down in a stair-step fashion in very precise 1 mV steps until the device triggers. Knowing the exact value of  $V_r$  helps and the dynamic range of this probe is +9.99 volts to -9.99 volts and is presettable in 1 mV steps by the thumbwheel switches on the front panel. This probe eliminates the need for attenuators and allows more accurate measurements nearer the top and bottom of waveforms than would be possible without this device. The probe also has a pullable engaging type switch that adds 10 nanoseconds to the measurement to compensate for less than ideally matched input channels. Naturally, though, this 10 nanoseconds has to be added to the final reading if you engage this feature on the time interval probe.

### conclusion

The judicious selection of a probe results in more accurately derived readings, and this enhanced accuracy will be evident in both more precise amplitude and phase measurements with a passive scope probe and more accurate current measurements with an active current probe. And if you have to make very precise time interval measurements (stop-to-start intervals, for example,) between events using a frequency counter, you now know of an accessory for the frequency counter's probes that minimizes and nulls out the differences in each channel's probe and its input circuitry.

\* A Coulomb is mathematically equal to  $\frac{W}{V}$  or one joule divided by one volt.



# PACKET RADIO . . .

## . . . THE FASTEST GROWING PART OF AMATEUR RADIO TODAY

is already providing high speed, error free, communications on many amateur bands for qso's, data transmission, emergency traffic, dx'ing, traffic nets, mailboxes, endless experimentation, and soon... satellite operation.

networks continue to grow, as does the number of hams who enjoy this new and exciting mode. The increasingly popular **PACKETERM IPT** is contributing to phenomenal growth in amateur packet radio by providing a full function packet terminal in a compact, portable unit...



## ALL YOU NEED FOR PACKET OPERATION IS A PACKETERM™ IPT AND YOUR RIG !

Designed for true portability, the IPT is equally at home in your ham shack or (with its optional carrying case) trekking in the country for battery powered hilltopping!

A single cable connects to your transceiver....that's all there is to it!  
Use it with your base station, mobile, or with your HT on that hilltop!!!

- FEATURES:**
- \* \* 9 inch portable terminal and full function tnc combined .
  - \* \* 66 commands available - the most widely used, field proven programming .
  - \* \* Built-in LSI modem ; 300 or 1200 baud, 200 or 1 kHz audio shift
  - \* \* stores setup parameters with power off - uses lithium battery
  - \* \* custom "beacon" text -- your call, qth, etc. in permanent memory
  - \* \* 74 key, full travel keyboard with 14 function keys for commands, calls, etc.
  - \* \* printer port - RS232C serial
  - \* \* optional printer, carrying case, and dc adaptor (13.8 VDC)

 **Packeterm**

Box 835, Amherst, NH 03031  
(603)-673-6630

PRICES:	IPT COMPLETE	\$995
	PRINTER	\$349
	DC ADAPTOR	\$125
	TNC (BOARD ONLY)	\$294



# JPC/AZDEN®

## 4000 SERIES FM TRANSCEIVERS

10 METERS & DOWN

**\$239**  
**SPECIAL PRICE**  
90 DAY WARRANTY



PCS-4000  
2-m FM Transceiver

COMMERCIAL-GRADE  
QUALITY AT AMATEUR PRICES

**EXCLUSIVE 1 YEAR LIMITED WARRANTY! COMPARE!**

### THE 4000 SERIES



PCS-4300 70-cm FM Transceiver



PCS-4500 6-m FM Transceiver



PCS-4800 10-m FM Transceiver

- **WIDE FREQUENCY COVERAGE:** PCS-4000 covers 142,000-149,995 MHz in selectable steps of 5 or 10 kHz. PCS-4200 covers 220,000-224,995 MHz in selectable steps of 5 or 20 kHz. PCS-4300 covers 440,000-449,995 MHz in selectable steps of 5 or 25 kHz. PCS-4500 covers 50,000-53,995 MHz in selectable steps of 5 or 10 kHz. PCS-4800 covers 28,000-29,990 MHz in selectable steps of 10 or 20 kHz.
- **CAP/MARS BUILT IN:** PCS-4000 includes coverage of CAP and MARS frequencies.
- **TINY SIZE:** Only 2" H x 5.5" W x 6.8" D. COMPARE!
- **MICROCOMPUTER CONTROL:** At the forefront of technology!
- **UP TO 8 NONSTANDARD SPLITS:** Ultimate versatility. COMPARE!
- **16-CHANNEL MEMORY IN TWO 8-CHANNEL BANKS:** Retains frequency and standard simplex or plus/minus offsets. Standard offsets are 600 kHz for PCS-4000, 1.6 MHz for PCS-4200, 5 MHz for PCS-4300, 1 MHz for PCS-4500, and 100 kHz for PCS-4800.
- **DUAL MEMORY SCAN:** Scan memory banks either separately or together. COMPARE!
- **TWO RANGES OF PROGRAMMABLE BAND SCANNING:** Limits are quickly reset. Scan the two segments either separately or together. COMPARE!
- **FREE AND VACANT SCAN MODES:** Free scanning stops 5 seconds on a busy channel; auto-resume can be overridden if desired. Vacant scanning stops on unoccupied frequencies.
- **DISCRIMINATOR SCAN CENTERING (AZDEN EXCLUSIVE PATENT):** Always stops on frequency.
- **TWO PRIORITY MEMORIES:** Either may be instantly recalled at any time. COMPARE!
- **NICAD MEMORY BACKUP:** Never lose the programmed channels!
- **FREQUENCY REVERSE:** The touch of a single button inverts the transmit and receive frequencies,

no matter what the offset.

- **ILLUMINATED KEYBOARD WITH ACQUISITION TONE:** Unparalleled ease of operation.
- **BRIGHT GREEN LED FREQUENCY DISPLAY:** Easily visible, even in direct sunlight.
- **DIGITAL S/R/F METER:** Shows incoming signal strength and relative power output.
- **BUSY-CHANNEL AND TRANSMIT INDICATORS:** Bright LEDs show when a channel is busy and when you are transmitting.
- **FULL 16-KEY TOUCHTONE® PAD:** Keyboard functions as autopatch when transmitting (except in PCS-4800).
- **PL TONE:** Optional PL tone unit allows access to private-line repeaters. Deviation and tone frequency are fully adjustable.
- **TRUE FM:** Not phase modulation. Unsurpassed intelligibility and audio fidelity.
- **HIGH/LOW POWER OUTPUT:** 25 or 5 watts selectable in PCS-4000; 10 or 1 watt selectable in PCS-4200, PCS-4300, PCS-4500, and PCS-4800. Transmitter power is fully adjustable.
- **SUPERIOR RECEIVER:** Sensitivity is 0.2 uV or better for 20-dB quieting. Circuits are designed and manufactured to rigorous specifications for exceptional performance, second to none. COMPARE!
- **REMOTE-CONTROL MICROPHONE:** Memory A-1 call, up/down manual scan, and memory address functions may be performed without touching the front panel! COMPARE!
- **OTHER FEATURES:** Dynamic microphone, rugged built-in speaker, mobile mounting bracket, remote speaker jack, and all cords, plugs, fuses, and hardware are included.
- **ACCESSORIES:** CS-7R 7-amp ac power supply, CS-4.5R 4.5-amp ac power supply, CS-AS remote speaker, and Communications Specialists SS-32 PL tone module.
- **ONE YEAR LIMITED WARRANTY!**

186

EXCLUSIVE DISTRIBUTOR

DEALER INQUIRIES INVITED

**AMATEUR-WHOLESALE ELECTRONICS**

**TOLL FREE... 800-327-3102**

8817 S.W. 129th Terrace, Miami, Florida 33176

Telephone (305) 233-3631

Telex: 80-3356

MANUFACTURER:

**JPC/AZDEN**

**JAPAN PIEZO CO., LTD.**

1-12-17 Kamirenjaku, Mitaka, Tokyo, 181 Japan

Telex: 781-2822452



## THINGS TO LOOK FOR (AND LOOK OUT FOR) IN A PHONE PATCH

- A patch should work with any radio. AM, FM, ACSB, relay switched or synthesized.
- Patch performance should not be dependent on the T/R speed of your radio.
- Your patch should sound just like your home phone.
- There should not be any sampling noises to distract you and rob important syllables. The best phone patches do not use the cheap sampling method. (Did you know that the competition uses VOX rather than sampling in their \$1000 commercial model?)
- A patch should disconnect automatically if the number dialed is busy.
- A patch should be flexible. You should be able to use it simplex, repeater aided simplex, or semi-duplex.
- A patch should allow you to manually connect any mobile or HT on your local repeater to the phone system for a fully automatic conversation. Someone may need to report an emergency!
- A patch should not become erratic when the mobile is noisy.
- You should be able to use a power amplifier on your base to extend range.
- You should be able to connect a patch to the MIC and EXT. speaker jack of your radio for a quick and effortless interface.
- You should be able to connect a patch to three points inside your radio (VOL high side, PTT, MIC) so that the patch does not interfere with the use of the radio and the VOL. and SQ. settings do not affect the patch.
- A patch should have MOV lightning protectors.
- Your patch should be made in the USA where consultation and factory service are immediately available.

**ONLY  
PRIVATE PATCH III  
GIVES YOU ALL  
OF THE ABOVE  
BEWARE OF INFERIOR  
IMITATIONS**

**N  
E  
W**

# PRIVATE PATCH III

## SIMPLEX SEMI-DUPLEX INTERCONNECT

**N  
E  
W**

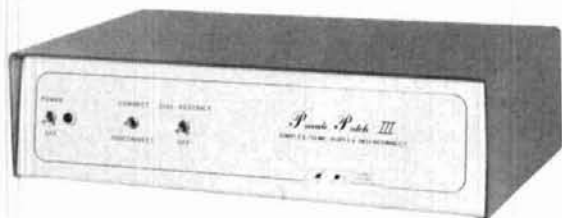

With an amazingly low price, the all new PRIVATE PATCH III is the most powerful personal phone patch system available. You can use it simplex, repeater aided simplex (from your base) or semi-duplex (at the repeater). That's right, you will never have to buy another patch. PRIVATE PATCH III does it all! There are many new and important features which were formerly only available in our top commercial models.

With a flick of the new connect switch you can patch your friends on the repeater into the phone system. One of them may need to report an emergency!

No hassles with busy signals! If you call a number that is busy, just put your MIC down and relax. PRIVATE PATCH III will disconnect automatically.

The new CW ID keeps you completely informed as to patch status. ID occurs when you access and again when you disconnect. ID is also sent after toll call attempts, all automatic disconnects, manual disconnect and when timeout is imminent. And of course your CW ID chip is free.

PRIVATE PATCH III does not interfere with the normal use of your base radio. A new audio pre-amp permits audio take off before the VOL. control. As a result, the VOL. and squelch settings do not affect patch operation. Of course you can also connect PRIVATE PATCH III to the MIC and EXT speaker jacks as before.

A new digit counting system makes the toll restrict positive even in areas where you do not have to dial "1" first. A secret five digit code disables the toll restrict for one toll call. Re-arm is automatic.

Additional new features: MOV lightning protection — Three digit access code (eg. \*93) — Spare relay position on board — Plus former features: 3/6 minute timeout timer — Digital fast VOX (pat. pend.) — 115 VAC supply — Modular Jack and cord plus much more!

Please write or call for our four page brochure to get the complete story.

Options:  
FCC approved coupler  
12 VDC or 230 VAC power

Warranty? Yes, one full year!

### DEALERS

- |   |   |
|---|---|
| <b>AMATEUR ELECTRONIC SUPPLY</b><br>Milwaukee WI, Wickliffe Oh,<br>Orlando FL, Clearwater FL,<br>Las Vegas NV | <b>JUNS ELECTRONICS</b><br>Culver City CA, Reno NV            |
| <b>COLES COMMUNICATIONS</b><br>San Antonio TX   | <b>MIAMI RADIO CENTER CORP.</b><br>Miami FL                   |
| <b>ERICKSON COMMUNICATIONS</b><br>Chicago IL  | <b>MIKES ELECTRONICS</b><br>Ft. Lauderdale, Miami FL          |
| <b>HAM RADIO OUTLET</b><br>Anaheim CA, Burlingame CA,<br>Oakland CA, Phoenix AZ,<br>San Diego CA, Van Nuys CA | <b>N&amp;G DISTRIBUTING CORP.</b><br>Miami FL                 |
| <b>HENRY RADIO</b><br>Los Angeles CA, Anaheim CA,<br>Butler MO  | <b>PACE ENGINEERING</b><br>Tucson AZ                          |
|   | <b>THE HAM STATION</b><br>Evansville IN                       |
|   | <b>CANADA:</b><br><b>DOLLARD ELECTRONICS</b><br>Vancouver, BC |

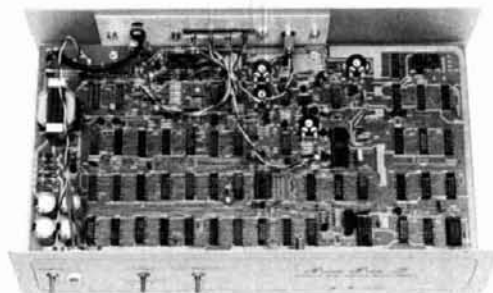

**CONNECT SYSTEMS INCORPORATED** (213) 373-6833 102  
23731 Madison St., Torrance, CA 90505

# ***The Right Source***

PRODUCT IN STOCK

FROM OVER 100 MANUFACTURERS

- \*SATELLITE RECEIVING SYSTEMS
- \*VHF & UHF COMMERCIAL 2-WAY
- \*TV'S \* VCR'S \* AUDIO SYSTEMS
- \*SMALL PARTS \* ACCESSORIES \* CABLE

INTRODUCING THE NEW MAXON RD-1 STATE  
OF THE ART RADAR DETECTOR. ONLY \$99.00



- \*COMPETITIVE PRICING
- \*DEALER TRAINING
- \*IN HOUSE SERVICE
- \*TECHNICAL ASSISTANCE

LEWIS ELECTRONICS

P.O. BOX 100 WEST ELM ST.

HUMBOLDT, TN 38343

(901) 784-2191

# ham radio TECHNIQUES

Bill W6SAI

**"I have seen the future  
— and it works"\***

It may be that Amateur Radio is undergoing a technical revolution as great as those revolutions brought about by the switch to single sideband and to VHF repeaters. Both developments changed the face of Amateur Radio within a few short years. Amateurs of the 1940s would be astounded if they were magically transported through time to visit a modern Amateur Radio station.

The microcomputer is leaving its mark on Amateur Radio today. Last winter, for example, the first 20-meter SSB computer controlled contacts were made via a VHF/UHF repeater and remote link (fig. 1). The heart of this unique communication circuit was the newly-developed Shackmaster® station control unit (fig. 2) developed by Ed Ingber, WA6AXX, and his associates at Advanced Computer Controls, Inc., of Cupertino, California.

The Shackmaster is a station accessory that permits remote control of a home station via digital command given over the air or via a telephone line. In the case I'm talking about, N6IPE (Don Melchoir), controlled his 14 MHz SSB station via a remote VHF radio link. And this is *complete* — receiver and transmitter band scanning, mode changing, band changing and on/off control — just as if the operator were sitting at the station console!

## crossband linking

Imagine yourself driving along the highway. Your vehicle is equipped with two FM transceivers, one on the 440-MHz band and the other on the

1296-MHz band. At the moment you're listening on 443.875 MHz, which is the output frequency of the hill-mounted repeater. The down-link is 443.875 MHz, and an FM receiver at the 20-meter home station is listening to

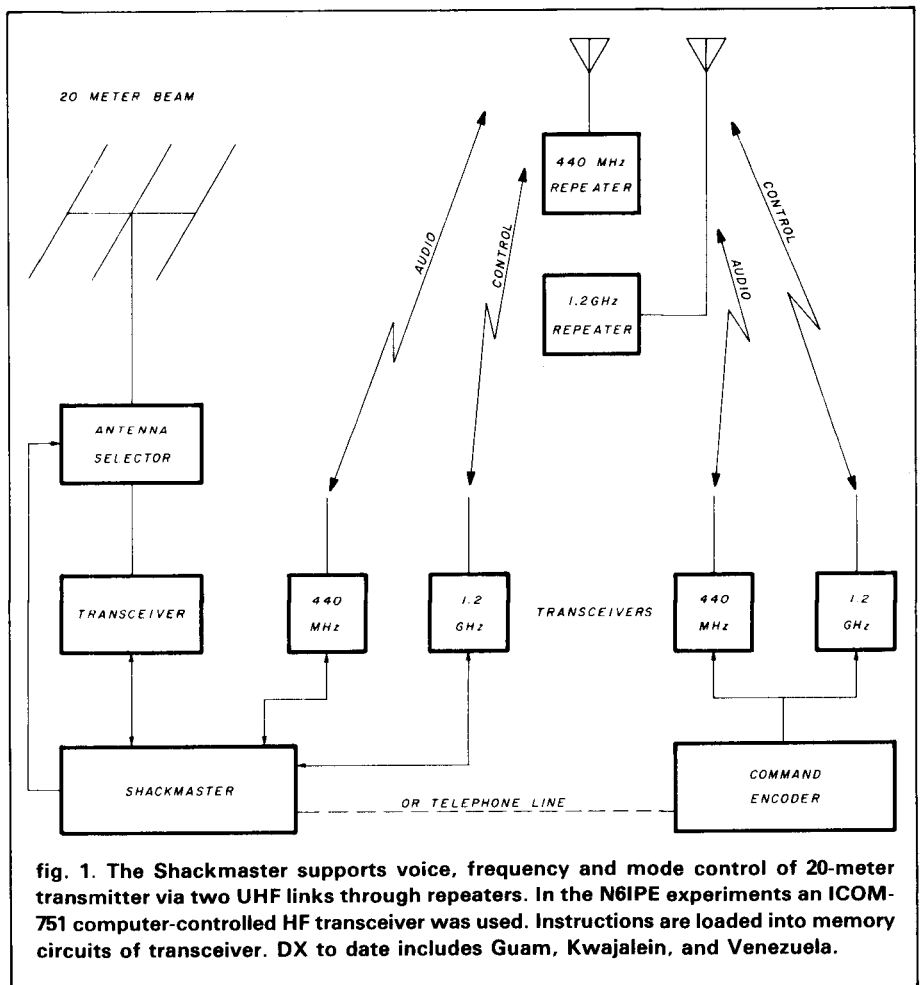

fig. 1. The Shackmaster supports voice, frequency and mode control of 20-meter transmitter via two UHF links through repeaters. In the N6IPE experiments an ICOM-751 computer-controlled HF transceiver was used. Instructions are loaded into memory circuits of transceiver. DX to date includes Guam, Kwajalein, and Venezuela.

\*John M. Reed, 1920.



fig. 2(A). Shackmaster 100 Station Controller<sup>®</sup> allows operator to control home station over the air or over the phone lines. Unit ties together home equipment and allows deposit of electronic messages in its "mailbox."

this channel. This link provides the two-way voice channel. The 1296-MHz channel is provided for frequency control of the home station and for transmit-receive control. Everything's ready for operation.

Via the 1296-MHz link, you key the command "HF LISTEN" by sending your individual code number plus 74. You now key in 3 and the "SCAN UP SLOW" command starts the transceiver to slowly tune up the band. To "STOP SCAN," you key in 2 and to scan down, you key in 7. Other commands allow fast scan up or down, and frequency jumps of 20, 100, and 500 Hz. The keyed command 5 allows you to shift to the auxiliary VFO, which can be programmed separately.

Now you've tuned in the signal you wish to call. As soon as the opportunity presents itself, you pick up the 440 MHz mic, key in \*75 and call. To return to listen, you key in 5.

When the contact is finished, you

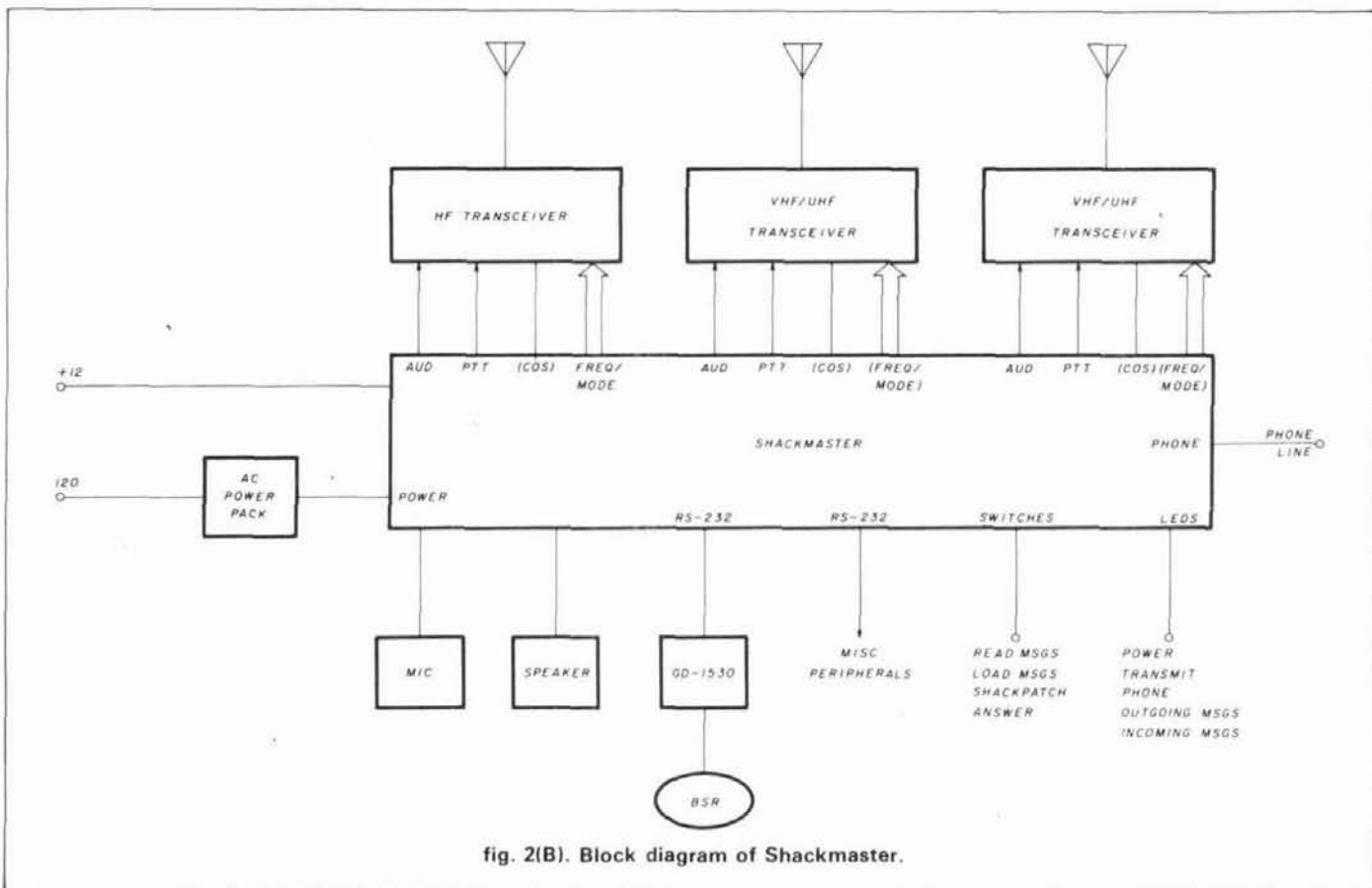
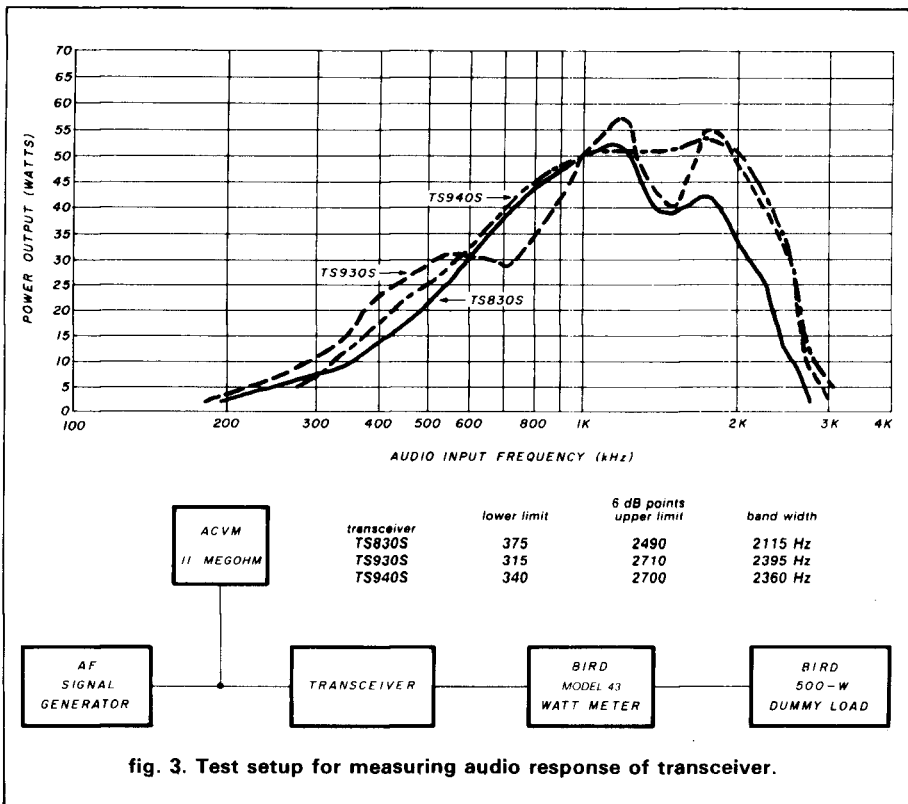

fig. 2(B). Block diagram of Shackmaster.



decide you want to see what's coming in from the west. A beam heading of 270 degrees will do the job. You key in \*4 to actuate the rotator, followed by 270. Your antenna is now aimed west.

All this may sound very complex and confusing at first, but it quickly becomes second nature and provides an enormous amount of control capability with a touchtone pad.

The home station makes use of a computer-controlled transceiver, broadband linear amplifier and computer-controlled antenna tuner. In the case of N6IPE, the transceiver was an ICOM-751, the linear amplifier was an ICOM 2KL solid state, broadband device, and the antenna tuner was an ICOM-AT500. The IC-751 was run in the memory mode and the various commands were loaded into the memory.

As you become experienced with the system, you can query the Digital Voice Synthesizer, which will tell you the frequency the 20-meter equipment is tuned to. The capabilities are infinite. Too much QRM on 20 meters? Key

72400 on the touchtone pad and you've instantly QSY'd to 7.240 MHz.

And finally, when you get to your destination and leave your mobile rig, you can still activate your home station via the telephone line!

Well, it all sounds like lots of fun. No doubt you'll be hearing more and more remote-controlled, computer operated stations on the HF and VHF bands during the coming months. The day when two computers talk to each other is not far away in the amazing world of Amateur Radio.

### audio response revisited

In my April column I discussed some of the variations in the audio response curve of some representative SSB transceivers. The conclusion was that the passband of some of them left much to be desired. Recently Tiff, W6GNX, had the opportunity to run an audio passband check on three more HF transceivers: the Kenwood TS-830S, the TS-930S, and the new TS-940S. The test was accomplished by injecting an audio tone into the "phone patch" port and measuring the power

# RF TRANSISTORS

FRESH STOCK - NOT SURPLUS  
TESTED - FULLY GUARANTEED

P/N	Rating	Each	Match Pr.
MRF406	20W	\$14.50	\$32.00
MRF412,1A	80W	18.00	45.00
MRF421	100W	25.00	56.00
MRF421C	110W	—	60.00
MRF422*	150W	38.00	82.00
MRF426,1A*	25W	18.00	42.00
MRF428**	150W	55.00	125.00
MRF433	12.5W	12.00	30.00
MRF435*	150W	42.00	90.00
MRF449,1A	30W	12.50	30.00
MRF450,1A	50W	14.00	31.00
MRF453,1A	60W	15.00	35.00
MRF454,1A	80W	16.00	36.00
MRF455,1A	60W	12.00	28.00
MRF458	80W	20.00	46.00
MRF460	60W	18.00	42.00
MRF464*	80W	25.00	60.00
MRF466*	40W	18.75	48.00
MRF475	12W	3.00	9.00
MRF476	3W	2.75	8.00
MRF477	40W	11.00	25.00
MRF479	15W	10.00	23.00
MRF485*	15W	6.00	15.00
MRF492	90W	18.00	40.00
SRF2072	75W	15.00	33.00
SRF3682	110W	28.00	60.00
SRF3775	75W	15.50	34.00
SRF3795	85W	16.50	37.00
CD2545	50W	23.00	52.00
SD1076	70W	17.00	40.00
SD1451	50W	15.00	36.00

Selected High Gain Matched Quads Available

### VHF/UHF TRANSISTORS

Rating	MHz	Net Ea.	Match Pr.
MRF212	10W	136-174	\$16.00
MRF221	15W	136-174	10.00
MRF222	25W	136-174	14.00
MRF224	40W	136-174	13.50
MRF231	3.5W	66-88	10.00
MRF234	25W	66-88	15.00
MRF237	4W	136-174	3.00
MRF238	30W	136-174	12.00
MRF239	30W	136-174	15.00
MRF240	40W	136-174	18.00
MRF245	80W	136-174	28.00
MRF247	75W	136-174	27.00
MRF250	50W	27-174	20.00
MRF260	5W	136-174	7.00
MRF261	10W	136-174	9.00
MRF262	15W	136-174	9.00
MRF264	30W	136-174	13.00
MRF607	1.75W	136-174	3.00
MRF641	15W	407-512	22.00
MRF644	25W	407-512	24.00
MRF646	40W	407-512	26.50
MRF648	60W	407-512	33.00
2N3866*	1W	30-200	1.25
2N4427	1W	136-174	1.25
2N5591	25W	136-174	13.50
2N5642*	20W	30-200	13.75
2N5945	4W	407-512	10.00
2N5946	10W	407-512	12.00
2N6080	4W	136-174	6.25
2N6081	15W	136-174	7.50
2N6082	25W	136-174	8.90
2N6083	30W	136-174	9.30
2N6084	40W	136-174	11.75

### TMOS FET

MRF134*	5W	2-200	\$10.50
MRF137*	30W	2-200	22.50
MRF138**	30W	1.5-150	35.00
MRF150**	150W	1.5-150	80.00
MRF172*	80	2-200	85.00

Selected, matched finals for Kenwood, Yaesu, Icom, Atlas, etc. Technical assistance and cross-reference information on CD, PT, RF, SRF, SD P/Ns.

**QUANTITY DISCOUNTS AVAILABLE**  
**WE SHIP SAME DAY C.O.D./VISA/MC**  
INFORMATION AND CALIF. ORDERS: (619) 744-0728  
OUTSIDE CALIF. ORDER DESK: 800-854-1927



## RF PARTS

1320-16 Grand Ave., San Marcos  
California 92069 (619) 744-0728

# MISSOURI RADIO CENTER

## ANTENNA SALE

### HYGAIN TOWERS

HG37SS	799.00
HG52SS	1195.00
HG54HD	1799.00
HG70HD	2799.00

### CUSHCRAFT

A3	199.00
A4	275.00
R3	255.00
40-CD2	275.00
AV5	96.00
32-19	89.00
215WB	75.00
ARX2B	35.00
A144-11	46.00
A144-20T	69.00
424B	75.00
AOP-1	137.00

### KLM

KT34A	329.00
KT34XA	475.00
432-20LBX	64.00
432-30LBX	90.00
435-18C	109.00
435-40C	149.00
2M-13LBA	77.00
2M-14C	85.00
2M-16LBX	89.00
2M-22C	115.00

### HYGAIN

TH3JR	185.00
TH7	459.00
EX 14	289.00
14AVQ	69.00
18AVT	102.00
V2	44.00
V3	44.00
V4	55.00

### HUSTLER

25% OFF ALL MOBILE

6BTU	125.00
------	--------

### AEA

144SR	42.00
-------	-------

### BUTTERNUT

HF6V	110.00
HF2V	110.00

RG213U	\$.26/foot
--------	------------

### ROTATORS

CD45	139.00
HAM IV	228.00
T2X	275.00
AVANTI 2M	29.95
HI-Q BALUN	9.95

### KENPRO

KR400	119.00
KR500	149.00
KR600	199.00
KR5400	249.00

2900 N.W. VIVION ROAD  
KANSAS CITY, MISSOURI 64150  
816-741-8118

CALL TOLL FREE  
1-800-821-7323

MASTERCARD, VISA & DISCOVER WELCOME

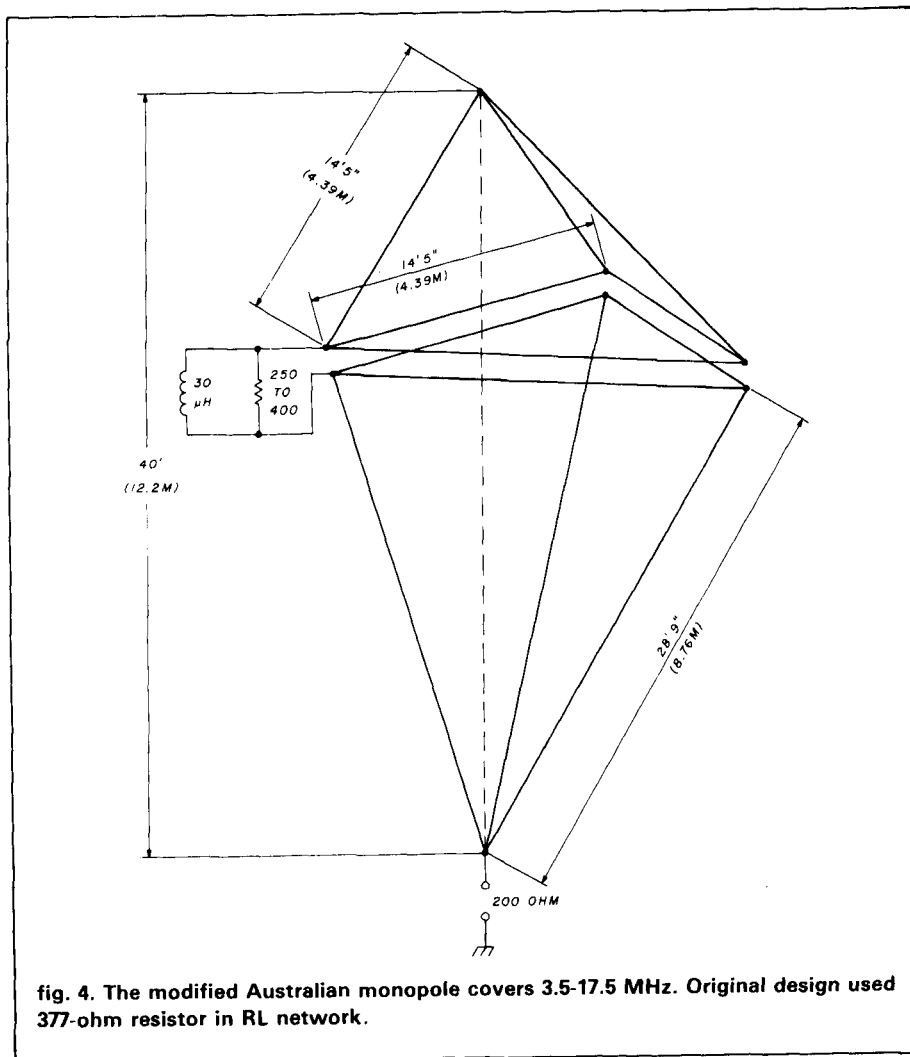

fig. 4. The modified Australian monopole covers 3.5-17.5 MHz. Original design used 377-ohm resistor in RL network.

output of the transceiver as the tone was swept across the audio passband. Sufficient instrumentation was used so that the tone level was constant and the transceiver always operated in the linear mode. The results are shown in fig. 3.

The TS-830S and TS-930S both exhibit the characteristic "bumpy" audio response common to that derived from a multi-pole filter that controls the passband. (Compare the curves with that run on the FT-980, as shown in the April column).

Now observe the passband curve of the TS-940S; it's nearly devoid of the filter "humps" and shows a nearly flat frequency response from about 700 Hz to 2300 Hz (less than 1 dB variation). Of interest, too, is the enhanced high-frequency response of both the TS-

930S and TS-940S, as compared to the TS-830S.

On-the-air tests of all three transceivers over a period of time showed that it was easy to distinguish the TS-830S from the other two transceivers. It just didn't sound as clear and penetrating, even though the same microphone was used for all tests.

It was even more difficult to differentiate the TS-930S from the TS-940S. I could do it because I knew what Tiff's voice sounded like in person. But the on-the-air difference was marginal.

In any event, the audio passband of the TS-940S is a step in the right direction. As AG6K said, "Perhaps we can now stop sounding like Donald Duck on the air!"



# in stock now

## LUXOR 9550

A high performance 4 GHz, 70 MHz input receiver featuring programmable video and audio, hand held remote, four different audio systems, switchable audio bandwidths, built-in RF modulator, two speed scanning modes and built-in stereo processor.



## Mark 2™

Offers independent channel selection for multiple TV sets from a single antenna, with a selection of up to 24 individual channels from a single satellite. The Mark 2 also features individually programmed audio, automatic fine tuning control, fine tuning storage, special function switches and built-in stereo processor.

## SKANTIC

Offers versatility and quality performance including fine tuning and video, automatic audio and video digital memory, automatic polarization and four programmable audio modes.

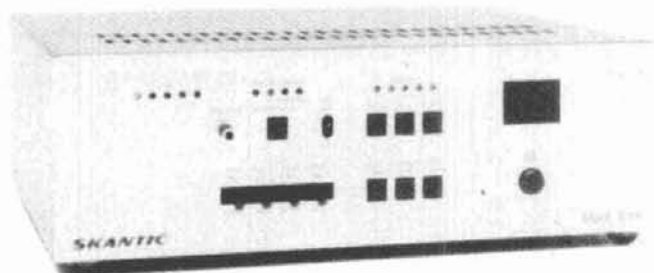

## The Northeast's Leading Distributor



Sales and Marketing Assistance  
Factory Authorized Service  
Professional Training Seminars  
Co-op Advertising Support  
Automated UPS Shipping

Satellite Video  
Services, Inc.  
RR #1, Box 85-S  
Catskill, NY 12414  
**518-678-9581**  
800-528-DISH - National  
800-831-DISH - NY Only

Satellite Video  
Services NH, Inc.  
RFD #2, Harriman Hill Rd.  
Raymond, NH 03077  
**603-895-3182**  
800-448-0012 - National

Satellite Video  
Services PA, Inc.  
317 E. Pleasant Valley Blvd.  
Altoona, PA 16602  
**814-942-5003**  
800-242-3860 - PA Only  
800-367-8899 - National

Satellite Video  
Services WNY, Inc.  
East Avenue Extension  
Hornell NY 14843  
**607-324-3435**  
800-641-0018 - NY Only  
800-831-1134 - National

Uniden M/A Com Norsat Gensat Houston Tracker Winegard Conifer Laux Orbitron Kaul-Tronics



# ICOM

# KENWOOD YAESU



**Regular SALE**  
 IC-735 New, compact HF Transceiver ..... Call  
 IC-751 9-band Xcvr/1-30 MHz Rcvr ..... \$1399.00 Call  
 IC-745 9-band Xcvr/1-30 MHz Rcvr ..... \$ 999.00 Call



IC-271 H 100w 2m FM/SSB/CW Xcvr .. \$899 Call  
 IC-271 A 25w 2m FM/SSB/CW Xcvr. \$699.00 Call  
 IC-471 A 10w 430-450 SSB/CW/FM Xcvr \$799.00 Call



IC-02AT Call  
 IC-04AT Call  
 IC-2AT Call  
 IC-3AT Call  
 IC-4AT Call

**IC-R71A  
GENERAL  
COVER RCVR**



**Regular SALE**  
 TS-940S/AT ..... \$1995.00 Call  
 TS-930S/AT ..... \$1799.00 Call  
 TS-930A ..... \$1599.00 Call



TS-711A TS-811A ..... Call



TR-2600A Call  
 TH-21A Call  
 TH-21AT Call  
 TH-41A Call  
 TH-41AT Call

**R-2000  
GENERAL  
COVER**



**Regular SALE**  
 FT-980 ..... \$1659.00 Call  
 FT-09G ..... Call



FT-726R ..... \$ 899.00 Call



FT-209RH Call  
 FT-709RH Call  
 FT-203RH Call  
 FT-103R Call  
 FT-703R Call

**FRG-8800  
GENERAL  
COVER RCVR**



**SALE!!  
NEW RTTY/CW  
COMPUTER  
INTERFACES**



**BIRD**



**THIS MONTH'S  
SPECIAL**

**FREE PB-26**  
with the purchase of a TR-2600A

**FREE PB-21**  
with the purchase of a TH-21AT

IC-04AT Yaesu FT-709R  
Call for special price

**MIRAGE  
AMPLIFIER  
SALE!**



**AMERITRON  
AL-80**



# JUN'S ELECTRONICS

Calif. Call  
Collect  
for Order

**800-882-1343**  
INCLUDES ALASKA  
HAWAII

● AMATEUR ● TWO WAY ● MARINE  
● CELLULAR MOBILE PHONE ● SCANNER

- ★ Free U.P.S. Cash Order (Most Item, Most Place)
- ★ Shoppers, call us last, save \$\$
- ★ SE HABLA ESPANOL

**(213)390-8003**

**3919 Sepulveda Blvd.  
Culver City, CA 90230**

189

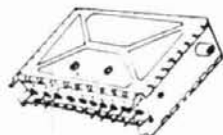

AMNEC EPU 202  
 UHF VARACTOR TUNER  
 REC. CHANNELS: 14 - 83  
 ANTENNA INPUT: 75 Ohm  
 \$12.95 EACH  
 \$11.50 EACH  
 100 & OVER



24 DB GAIN UHF/VHF/FM  
 ANTENNA/LINE AMPLIFIER  
 AUV-724  
 75 Ohm in and out  
 \$19.50 EACH  
 3/\$17.50 EACH

**Accessory  
Specialties**

P.O. BOX 486 HAWTHORNE, CA 90250  
 TELEPHONE (213) 324-1973  
 WE ACCEPT MONEY ORDER, VISA, MASTERCARD  
 PERSONAL CHECK ORDERS HELD 20 DAYS. NO COD  
 ADD \$3.50 for Shipping & Handling. CA Residents ADD 6% TAX

SHIPPED UPS



**PROGRAM  
DISK  
NOW  
AVAILABLE**



Please add \$3.50  
for shipping

## PACKET RADIO THRU SOFTWARE

AX.25 Protocol By Bob Richardson, W4UCH

You can get on Packet Radio two ways. One is with a sophisticated "black box". The other is by making your computer act like a "black box" by programming it in a high level machine language code. W4UCH has written a machine language program for the Radio Shack TRS-80 Models 1, 3 and 4 computer. (Model 4 works with Model 3 disk while in Model 3 mode). This book has twelve chapters plus seven appendices that take you step by step through the process of setting your computer to first convert the digital information into a usable format and then to decode the information.  
 1984 3rd edition

- RE-AX Softbound \$21.95
  - RE-MI Model 1 Disk \$29.00
  - RE-MIII Model III & 4 Disk \$29.00
  - RE-BD SPECIAL BOOK AND DISK \$49.95
- (Specify disc, Mod. I or Mod. III) **SAVE \$2**

**ham  
radio**  
magazine  
GREENVILLE, NH 03048

**BOOKSTORE**  
(603) 878-1441

# ham radio

## Reader Service

For literature or more information, locate the Reader Service number at the bottom of the ad, circle the appropriate number on this card, affix postage and send to us. We'll hustle your name and address to the companies you're interested in.

101 113 125 137 149 161 173 185 197 209 221 233 245 257 269 281 293 305 317 329 341  
102 114 126 138 150 162 174 186 198 210 222 234 246 258 270 282 294 306 318 330 342  
103 115 127 139 151 163 175 187 199 211 223 235 247 259 271 283 295 307 319 331 343  
104 116 128 140 152 164 176 188 200 212 224 236 248 260 272 284 296 308 320 332 344  
105 117 129 141 153 165 177 189 201 213 225 237 249 261 273 285 297 309 321 333 345  
106 118 130 142 154 166 178 190 202 214 226 238 250 262 274 286 298 310 322 334 346  
107 119 131 143 155 167 179 191 203 215 227 239 251 263 275 287 299 311 323 335 347  
108 120 132 144 156 168 180 192 204 216 228 240 252 264 276 288 300 312 324 336 348  
109 121 133 145 157 169 181 193 205 217 229 241 253 265 277 289 301 313 325 337 349  
110 122 134 146 158 170 182 194 206 218 230 242 254 266 278 290 302 314 326 338 350  
111 123 135 147 159 171 183 195 207 219 231 243 255 267 279 291 303 315 327 339  
112 124 136 148 160 172 184 196 208 220 232 244 256 268 280 292 304 316 328 340

*Limit 15 inquiries per request.*

NAME \_\_\_\_\_ CALL \_\_\_\_\_

ADDRESS \_\_\_\_\_

CITY \_\_\_\_\_ STATE \_\_\_\_\_ ZIP \_\_\_\_\_

Please use before November 30, 1985

**September 1985**

---

---

---

---

AFFIX POSTAGE  
OR  
POST OFFICE  
WILL NOT  
DELIVER

**ham**  
**radio**  
*magazine*

READER SERVICE CENTER  
P.O. BOX 2558  
WOBURN, MA 01888

ATTN: Reader Service Dept.

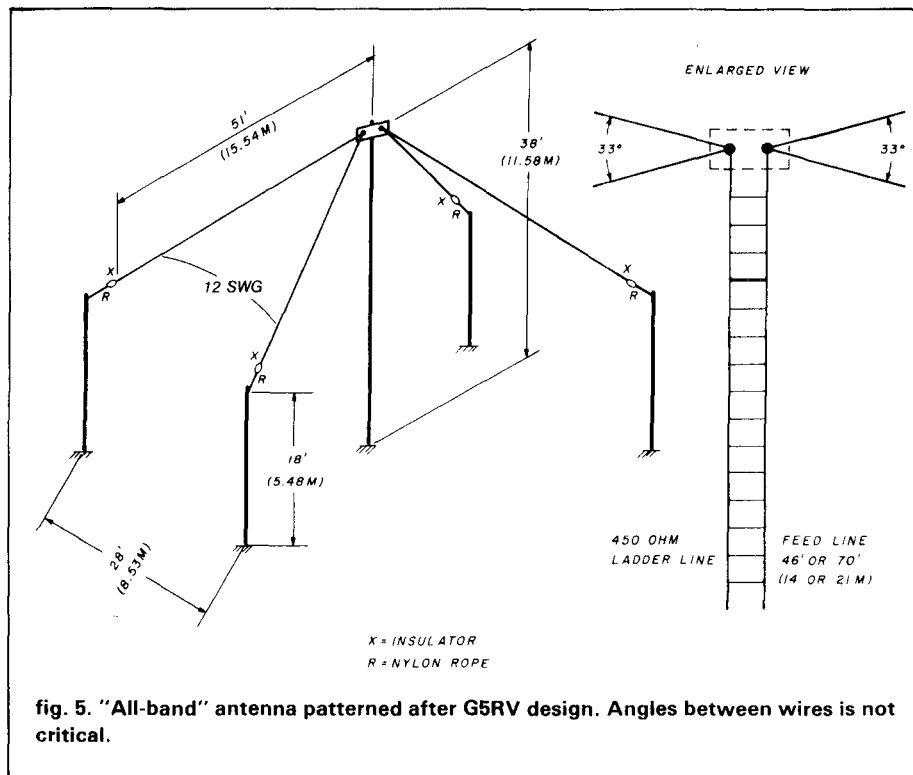

fig. 5. "All-band" antenna patterned after G5RV design. Angles between wires is not critical.

## the "Australian monopole"

In my April, 1984, column I described a wideband monopole antenna. Recently I received a letter from Tom, KA2APX, who has built and used it. He says, "I've had several hundred hours operating time on the antenna and am very pleased with the results. I've seen a received signal increase between 12 to 15 dB, as measured on an SP-600 S-meter as compared to an inverted-V at resonance. Incoming signal strength has been good overall, with VK and ZL signals running reasonably well above the noise floor on 75 and 160 meter SSB."

Tom is using a 100-watt, 250-ohm resistor in the antenna network and a 60 inch diameter cage instead of a 72 inch one. He concludes, "Many stations, whom I regularly contact, have indicated an interest in the antenna because of its compact length, radiation efficiency, and bandswitching ease."

Recently *Amateur Radio*, the publication of the *Wireless Institute of Australia* described a new version of this interesting wideband antenna. The description was written by Ron,

VK3AFW; the general layout of the antenna is shown in fig. 4. It's a kite-shaped, three-dimensional affair, about 40-feet high, that could be suspended from a single pole with crossarms to support the widest part of the structure.

The upper and lower portions of the antenna are connected with a simple R-L network. Experience has shown that the resistor should be noninductive and have a power rating equal to about 10 percent of the power output of the transmitter.

The feed point resistance of the antenna is about 200 ohms, so a 4:1 balun is used to match a 50-ohm transmission line. The frequency range of the antenna is 5:1, so this design should presumably cover the range of 3.5 MHz to 17.5 MHz. Ron has found that bumps in the SWR response curve can be moved about or eliminated by varying the value of the shunt resistor in the antenna network.

As with any vertical antenna, a good ground system is required, although VK3AFW reports good results when using only a single 6-foot ground rod.

The whole family of so-called "Aus-

tralian" antennas (dipole and monopoles) was covered in a technical paper, "Low Profile Radiator for HF Surface and Skywaves," by R.R. Treharne, published in the *IRRECON Digest* (Melbourne, Australia, August, 1981).

It would seem to me that an antenna of this type — one that could be packaged like an umbrella, capable of being opened and erected by one person — would make an excellent portable antenna for military or commercial use, and represent an interesting challenge in experimental design for Radio Amateurs.

## a simple "all-band" antenna

In my February column I discussed the so-called G5RV multiband antenna, which is very popular in Europe but not as well-known in the States. In brief, it's a 102-foot (31.09 meter) wire, center-fed with tuned feeders and a Transmatch,<sup>®</sup> or other form of antenna tuner.

I understand many of the dedicated QRP stations use this antenna and the design has recently resurfaced in the fine QRP Column hosted by George Dobbs, G3RJV, in *Radio Communication*, the flagship publication of the *Radio Society of Great Britain*. The basic design is shown in fig. 5. It consists of two G5RV antennas, 33 degrees apart, fed in parallel by an open-wire transmission line. It's an ideal antenna to mount above a single-family residence, with the apex supported on a pole strapped to the chimney.

Both 300-ohm ribbon line and 240-ohm oval line have been used with this interesting antenna (taking into account the propagation factor of the line). A center height of 38 to 45 feet (11.58 to 13.71 meters) is recommended and end heights of 14 to 18 feet (4.26 to 5.48 meters) are satisfactory. And, as G3RJV says, "The antenna is cheap, simple and can, because of its inverted-V nature, fit into a surprisingly small space." That's not bad for an antenna that covers 3.5 to 28 MHz and exhibits some power gain on the higher frequency bands.

**ham radio**





## WE'VE GOT EM!

### 5-1/4" HALF SIZE DRIVES!

For IBM PC, TI PC,  
XEROX 820

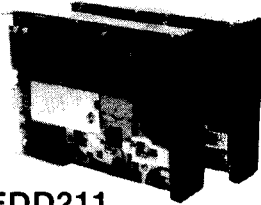

#### Canon FDD211

\*Two of These Half Size Drives will  
Fit in the Same Space as 1 Full Size Drive!

**\$69.95 2/\$129.95**

ADD \$3.00 UPS PER DRIVE

- 40 Track per side  
48 TPI
- Double-sided,  
double density
- Same as SA455
- Latest head &  
drive technology
- Fast access time

#### Canon FDD221

\*Two of These Half Size Drives will  
Fit in the Same Space as 1 Full Size Drive!

**\$99.95**

ADD \$3.00 UPS PER DRIVE

MANUAL FOR EITHER DRIVE \$12.50

- 80 Track per side  
96 TPI
- Double-sided,  
quad density
- Same as SA465
- Latest head &  
drive technology
- Fast access time

## 400/800 CASSETTES

### REQUIRES ATARI RECORDER

We bought 5 skids of these cassettes. Titles include: *Touch Typing, Invitation to Programming I & II, Hangman, Introduction to Sound, Blackjack, Juggles House, Juggles Rainbow, Introduction to Graphics, States and Capitals, European Countries and Capitals, Scram and Writing Programs Two*. These are a very high quality recording tape and may be recorded over for excellent reproduction. Most come in cassette holders. Sorry, no choice on titles. Super good assortment (some duplications when necessary). Most C-60. May be last chance to obtain these.

12/\$15.00 or 24/\$25.00

## SERIAL ASCII KEYBOARD

**\$14<sup>95</sup>**  
Each



**4**  
for  
**\$49<sup>95</sup>**

*This is no misprint!*

Maxi Switch 67 Key (includes 10 function keys) QWERTY serial keyboard. Number KYBD2185010 keyboard which uses a CMOS 8048 single chip microprocessor for super low power consumption. Very high quality with an exceptionally smooth feel. Originally designed for use in a portable computer. Simple serial interface — complete documentation included — Size: 12" x 5 1/2"

These won't last long at this price!!!!

## ATARI 5200 GAME BOARD

This is the second generation video game board that replaced the Atari 2600. We are offering the complete board assembly with all components and I.C.'s, but less the plastic outer case. Includes 8 - 16K RAM chips and 5 L.S.I. chips all socketed. The Atari part numbers for the L.S.I. chips are CO14806-03, CO19156-05, CO12294B-01, CO12296D-22 and CO14805-22. These chips are the GTIA, ANTIC, CPU, POKEY and ROM. These are complete units that we are selling as is — no warranty — primarily for spare parts. Units may or may not work. We have no data or schematics.

**\$14.95 3/\$40.00**

Include \$2.00 each for shipping

## COMPUTER POWER SUPPLY BOARDS FOR THE ATARI 400 or ATARI 800

Contains various power supply components such as voltage regulators, filter cap, etc. Also includes a high quality R.F. video modulator. Compare video modulator alone at up to \$9.95. Brand New.

**\$5.95 each 2/\$10.00**

Add \$1.50 each for shipping

## ATARI MODEM BOARD

Apparently manufactured for Atari by Raycal-Vadic. P.C Board #81219-903 Rev. D. These are complete factory finished modem boards with all parts except the 8048 (8748) C.P.U. chip, for which there is a socket. Includes the popular T.I. TMS99532 modem chip which is socketed. This T.I. chip alone lists for as much as \$29.95 at some of our competitors. These are factory new boards with all connectors, switches, relay, etc., but are sold as is — no warranty or data. Super limited quantity

**\$9.95 3/\$25.00**

Add \$1.50 each for shipping

## ATARI VCS CARTRIDGE ADAPTOR

This unit was designed to allow playing the original Atari 2600 cartridges on the newer Atari 5200 game system. Unit contains, in sockets, 1-6507, 1-6532 and 1 - OKI MSM 3980 (CO10444-22), plus other assorted parts. These are factory new units, but we must sell them as is, without any warranty or documentation, since we don't have facilities to test them. Remember these are complete units and are a bargain if used just for replacement parts. Very limited stock. We reserve the right to limit quantities.

**\$12.95 3/\$29.95**

Add \$1.50 each for shipping

## REPEAT OF SELL OUT! ATARI HEX KEYBOARD

**\$7<sup>95</sup>**

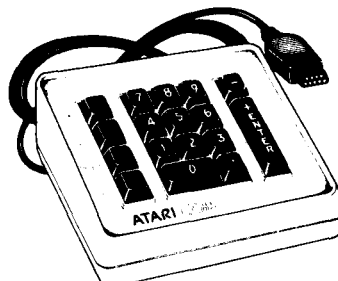

**3 for \$20<sup>00</sup>**

Add \$1.00 per unit  
for postage.

Originally designed for use with an Atari Home Computer. Brand new in box. Encoded using the popular National Semi 74C923. Full schematic included. Originally sold for many times our price. Many applications besides computer use.

TERMS: (Unless specified elsewhere) Add \$1.50 postage, we pay balance. Orders over \$50.00 add 85¢ for insurance. No C.O.D. Texas Res. add 6-1/8% Tax. 90 Day Money Back Guarantee on all items. All items subject to prior sale. Prices subject to change without notice. Foreign order - US funds only. We cannot ship to Mexico. Countries other than Canada, add \$3.50 shipping and handling.

This unit features azimuth and elevation memory storage, manual or clock control, digital readout and a 24-hour clock

## a digitally-controlled satellite tracker

For satellite tracking *two* rotators are required for pointing the antennas in both azimuth and elevation. But constant adjustment as the satellite moves across the sky — which can be especially troublesome when you're trying to track the fast-moving, low orbit, Russian satellites — is, in fact, not necessary at all.

This system provides 1-degree tracking resolution. The unit (**Photo A**) includes a 24-hour clock and a memory for azimuth, elevation and time data. A small keyboard loads data for storage so that hands-off tracking can be accomplished by loading data before starting operations. Manual control is provided for positioning the antennas for start-up or manual tracking if desired.

### the rotator

The most common rotator available is the U-100 TV rotator from Alliance. It has a double-field coil for forward and reverse, coupled through gears to the mast shaft. Every ten cycles of the 60-Hz power line turns the mast shaft 1 degree. A disc in the gear train mechanically closes a set of contacts every 10 degrees of rotation; this signal steps the control box. While 10-degree increments are a bit coarse for satellite tracking, the unit is inexpensive and readily available. A minor modification must be made to the rotator gear train, as explained later.

To get the rotators to turn with 1-degree resolution I use a counter clocked by the 60-Hz power line, which counts up or down as the rotator turns. Due to start up drag and antenna load, parity between mechanical position and readout cannot be maintained, and the 10-degree rotator signal is used to update the counter. Therefore, should the counter count ahead or behind, it is mechanically corrected by presetting the units



Photo A. Controller mounted in a BUD cabinet. The RUN-PROGRAM/MANUAL toggle switch shown here has since been changed to a 3-position rotary switch.

counter to 5. For instance, when the counter has reached 14, mechanically the rotator is at 15 degrees. The rotator signal presets the counter to 15. Continuing on, the correction occurs again at 25 degrees, or every 10 degrees.

### operating controls

The keyboard is used to load the memory with azimuth, elevation, and time data. The button in the lower right corner of the keyboard is the ENTER key and enters the data into memory. The memory program counter, clock and antenna aiming data are displayed. Azimuth is expressed in degrees from north; elevation in degrees from horizontal. Each seven-segment readout has an extra LED, which is normally used for the decimal point.

Some of these LEDs show internal functions. The A = B LED indicates that the data entered from the keyboard has successfully entered the memory. The START LED indicates the starting position for loading keyboard data.

Data is entered into the PROGRAM mode as follows: Depress the PROGRAM START pushbutton; the START LED lights momentarily. The first keyboard entry will load into the ten's hour bit of the clock. The next key will load into the unit's hour bit and so on across the program counter, AZ display and EL display. When all the data has been loaded, press the ENTER key to load data into memory. The A = B LEDs light to show successful memory loading. Press PROGRAM START again and we can load the next

By Rudolf E. Six, KA8OBL, 30725 Tennessee, Roseville, Michigan 48066



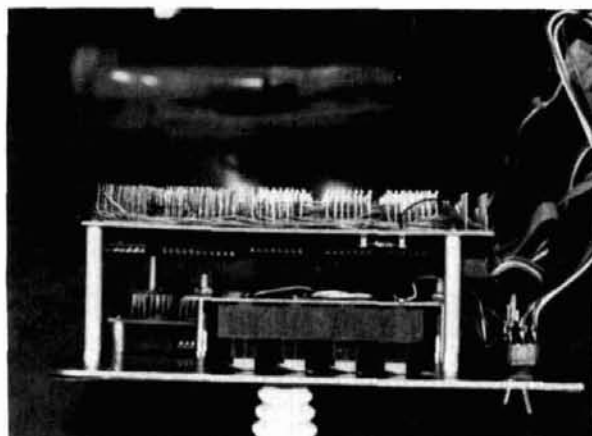
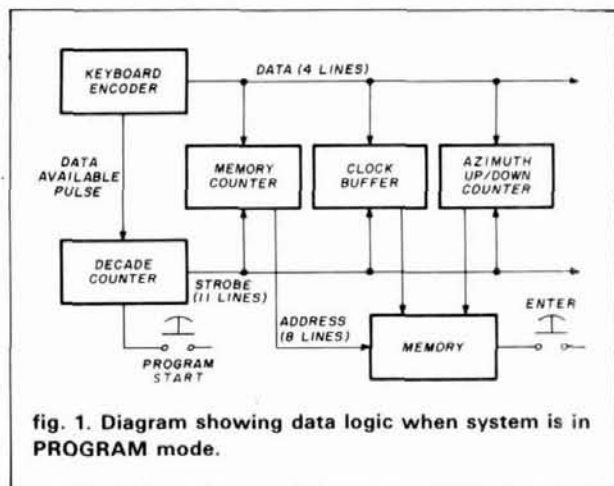

Side view of front panel showing keypad mounting.

table 1. Typical data loading schedule for OSCAR 10 satellite. (December 21, 1984.)

universal time	azimuth	elevation
1747	267	10
1754	264	18
1800	261	26
1810	258	34
1823	252	43
1843	245	51
1944	230	57
2203	230	47
2316	235	38
0028	238	28
0141	238	19
0253	232	08

Programming the satellite tracker with antennas parked at 260-degrees azimuth and 80 degrees elevation:

	time	memory	azimuth	elevation	
PROGRAM	1747	01	260	80	ENTER
Program Start	1754	02	267	10	ENTER
Program Start	1800	03	264	18	ENTER
Program Start	1810	04	261	26	ENTER
Program Start	1823	05	258	34	ENTER
Program Start	1843	06	252	43	ENTER
Program Start	1944	07	245	51	ENTER
Program Start	2203	08	230	57	ENTER
Program Start	2316	09	230	47	ENTER
Program Start	0028	10	235	38	ENTER
Program Start	0141	11	238	28	ENTER
Program Start	0253	12	238	19	ENTER
Program Start	2600	13	232	08	ENTER
Program Start	0000	00	000	00	ENTER
RUN					

Note: The time value of 2600 at step 13 prevents turning by the rotators at the end of a run.

batch of data. Start with 01 in the memory counter and increment by 1 for a possible 99 steps.

Table 1 shows a typical loading schedule for OSCAR 10. The ROTOR LEDs show the closing of the cam switch in the rotator heads for every 10 degrees

of rotation. They can be monitored for possible rotor jamming. In the RUN mode, time in memory is compared with the clock. When equal the program counter is incremented, and the rotators move to the new azimuth and elevation data. In MANUAL mode the

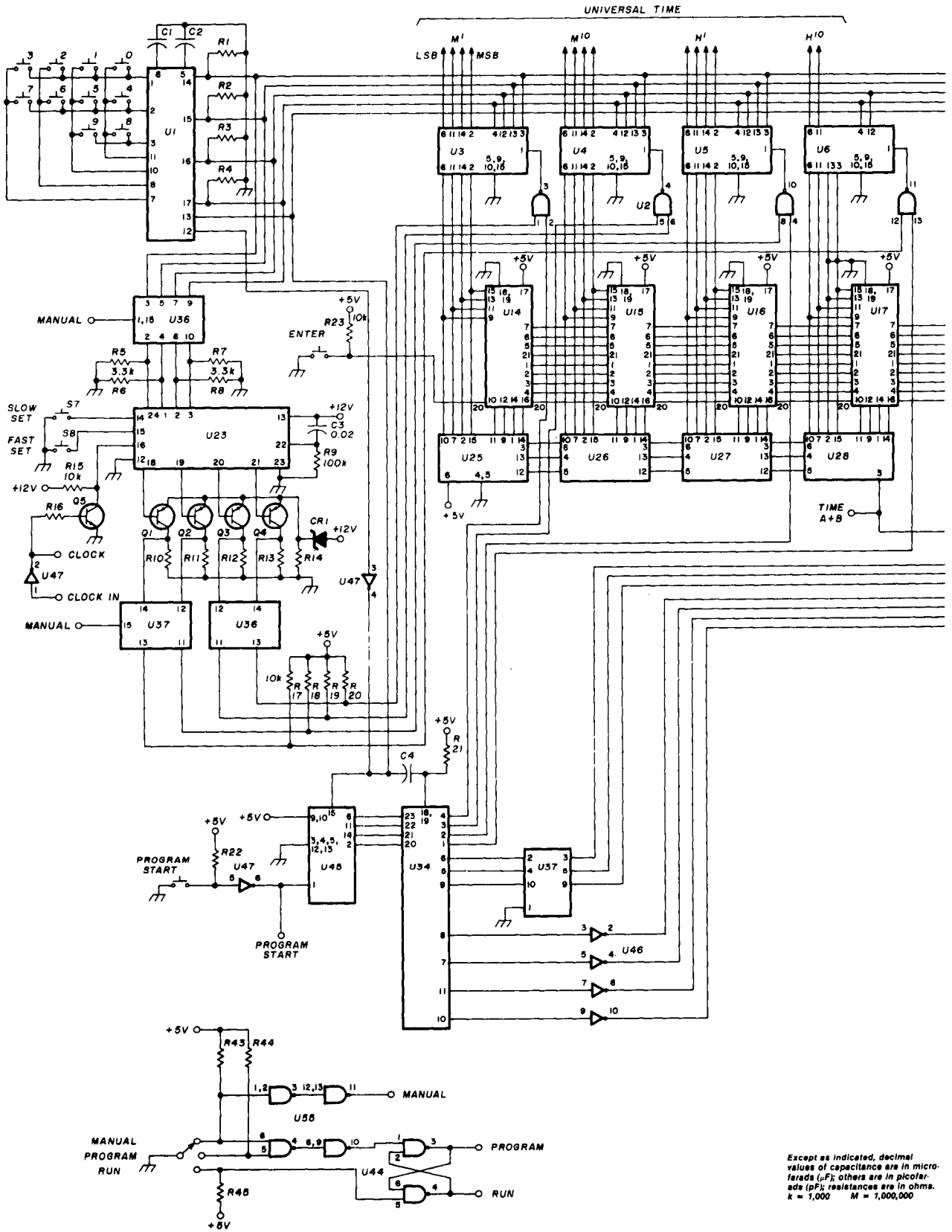
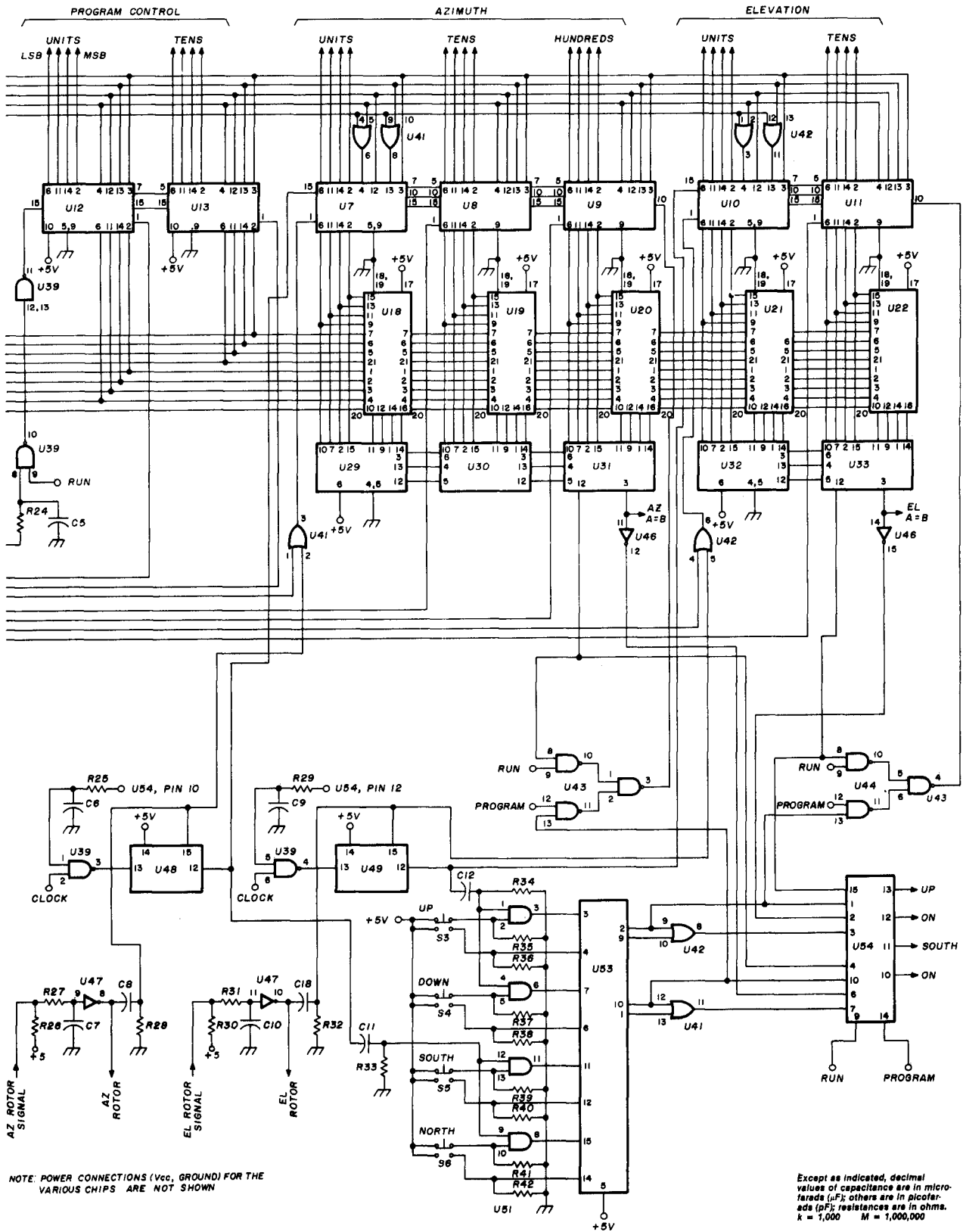

fig. 2 (part 1). Satellite tracker schematic diagram shows keyboard encoder, universal timer,



NOTE: POWER CONNECTIONS (Vcc, GROUND) FOR THE VARIOUS CHIPS ARE NOT SHOWN

Except as indicated, decimal values of capacitance are in microfarads ( $\mu$ F); others are in picofarads (pF); resistances are in ohms.  $k = 1,000$   $M = 1,000,000$

program counter, and azimuth/elevation counters.

# RAMSEY

# THE FIRST NAME IN ELECTRONIC TEST GEAR



## 20 MHz DUAL TRACE OSCILLOSCOPE

Unsurpassed quality at an unbeatable price, the Ramsey oscilloscope compares to others costing hundreds more. Features include a component testing circuit for resistor, capacitor, digital circuit and diode testing • TV video sync filter • wide bandwidth & high sensitivity • internal graticule • front panel trace rotator • Z axis • high sensitivity x-y mode • regulated power supply • built-in calibrator • rock solid triggering. \*USA — add \$10.00 per unit for postage, overseas orders add 15% of total order for insured surface mail.

**\$39995\***

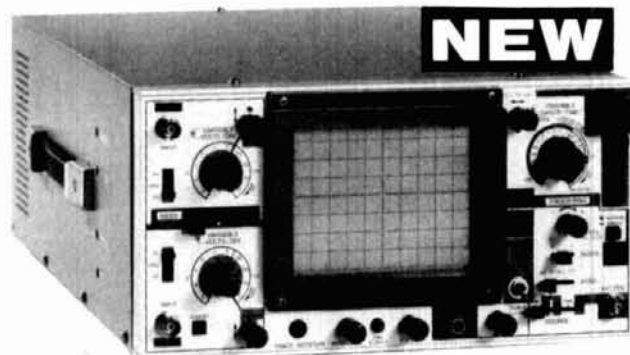

## 45 MHz DUAL SWEEP OSCILLOSCOPE

The Ramsey 625 is a dual time base, delayed sweep unit that includes a built-in signal delay line to permit clear viewing during very short rise times of high frequency waveforms. Other features include: variable trigger holdoff • 20 calibrated sweep time ranges from 0.5 ns/div to 0.2 μs/div • fully adjustable sweep time • X5 sweep magnification • five trigger sources, CH1, CH2, LINE, EXTERNAL and INTERNAL (V mode) • front panel x-y operation, Z axis input • sum difference of CH1 and CH2 waveforms displayed as single trace • sweep gate and sweep output • auto focus • single sweep. \*USA — add \$10.00 per unit for postage, overseas orders add 15% of total order for insured surface mail.

**\$79995\***



### RAMSEY D-1100 VOM MULTITESTER

Compact and reliable, designed to service a wide variety of equipment. Features include • mirror back scale • double-jeweled precision moving coil • double overload protection • an ideal low cost unit for the beginner or as a spare back-up unit.

**\$1995** test leads and battery included



### NEW RAMSEY 1200 VOM MULTITESTER

Check transistors, diodes and LEDs with this professional quality meter. Other features include: decibel scale • 20K volt metering system • 3 1/2" mirrored scale • polarity switch • 20 measuring ranges • safety probes • high impact plastic case.

**\$2495** test leads and battery included



### RAMSEY D-3100 DIGITAL MULTIMETER

Reliable, accurate digital measurements at an amazingly low cost • in-line color coded push buttons, speeds range selection • abs plastic tilt stand • recessed input jacks • overload protection on all ranges • 3 1/2 digit LCD display with auto zero, auto polarity & low BAT indicator.

**\$4995** test leads and battery included



### CT-70 7 DIGIT 525 MHz COUNTER

Lab quality at a breakthrough price. Features • 3 frequency ranges each with pre amp • dual selectable gate times • gate activity indicator • 50mV @ 150 MHz typical sensitivity • wide frequency range • 1 ppm accuracy.

**\$11995** wired includes AC adapter

CT-70 kit ..... \$99.95  
BP-4 nicad pack ..... 8.95



### CT-90 9 DIGIT 600 MHz COUNTER

The most versatile for less than \$300. Features 3 selectable gate times • 9 digits • gate indicator • display hold • 25mV @ 150 MHz typical sensitivity • 10 MHz timebase for WWV calibration • 1 ppm accuracy.

**\$14995** wired includes AC adapter

CT-90 kit ..... \$129.95  
OV-1 0.1 PPM oven timebase ..... 59.95  
BP-4 nicad pack ..... 8.95



### CT-125 9 DIGIT 1.2 GHz COUNTER

A 9 digit counter that will outperform units costing hundreds more. • gate indicator • 24mV @ 150 MHz typical sensitivity • 9 digit display • 1 ppm accuracy • display hold • dual inputs with preamps.

**\$16995** wired includes AC adapter

BP-4 nicad pack ..... 8.95

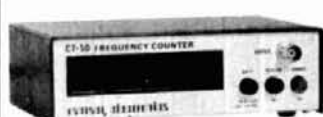

### CT-50 8 DIGIT 600 MHz COUNTER

A versatile lab bench counter with optional receive frequency adapter, which turns the CT-50 into a digital readout for most any receiver • 25 mV @ 150 MHz typical sensitivity • 8 digit display • 1 ppm accuracy.

**\$16995** wired

CT-50 kit ..... \$139.95  
RA-1 receiver adapter kit ..... 14.95



### DM-700 DIGITAL MULTIMETER

Professional quality at a hobbyist price. Features include 26 different ranges and 5 functions • 3 1/2 digit, 1/2 inch LED display • automatic decimal placement • automatic polarity.

**\$11995** wired includes AC adapter

DM-700 kit ..... \$99.95  
MP-1 probe set ..... 4.95



### PS-2 AUDIO MULTIPLIER

The PS-2 is handy for high resolution audio resolution measurements, multiplies UP in frequency • great for PL tone measurements • multiplies by 10 or 100 • 0.01 Hz resolution & built-in signal preamp/conditioner.

**\$4995** wired

PS-2 kit ..... \$39.95



### PR-2 COUNTER PREAMP

The PR-2 is ideal for measuring weak signals from 10 to 1,000 MHz • flat 25 db gain • BNC connectors • great for shifting RF • ideal receiver/TV preamp.

**\$4495** wired includes AC adapter

PR-2 kit ..... \$34.95



### PS-1B 600 MHz PRESCALER

Extends the range of your present counter to 600 MHz • 2 stage preamp • divide by 10 circuitry • sensitivity: 25mV @ 150 MHz • BNC connectors • drives any counter.

**\$5995** wired includes AC adapter

PS-1B kit ..... \$48.95

### ACCESSORIES FOR RAMSEY COUNTERS

Telescopic whip antenna—BNC plug ..... \$ 8.95  
High impedance probe, light loading ..... 16.95  
Low pass probe, audio use ..... 16.95  
Direct probe, general purpose use ..... 13.95  
Tilt ball, for CT-70, 90, 125 ..... 3.95



PHONE ORDERS CALL  
**716-586-3950**

TELEX 466735 RAMSEY CI

TERMS: • satisfaction guaranteed • examine for 10 days, if not pleased, return in original form for refund • add 6% for shipping and insurance to a maximum of \$10.00 • overseas add 15% for surface mail • COD add \$2.50 (COD in USA only) • orders under \$15.00 add \$1.50 • NY residents add 7% sales tax • 90 day parts warranty on all kits • 1 year parts & labor warranty on all wired units.

# RAMSEY

RAMSEY ELECTRONICS, INC.  
2575 Baird Rd.  
Penfield, N.Y. 14626

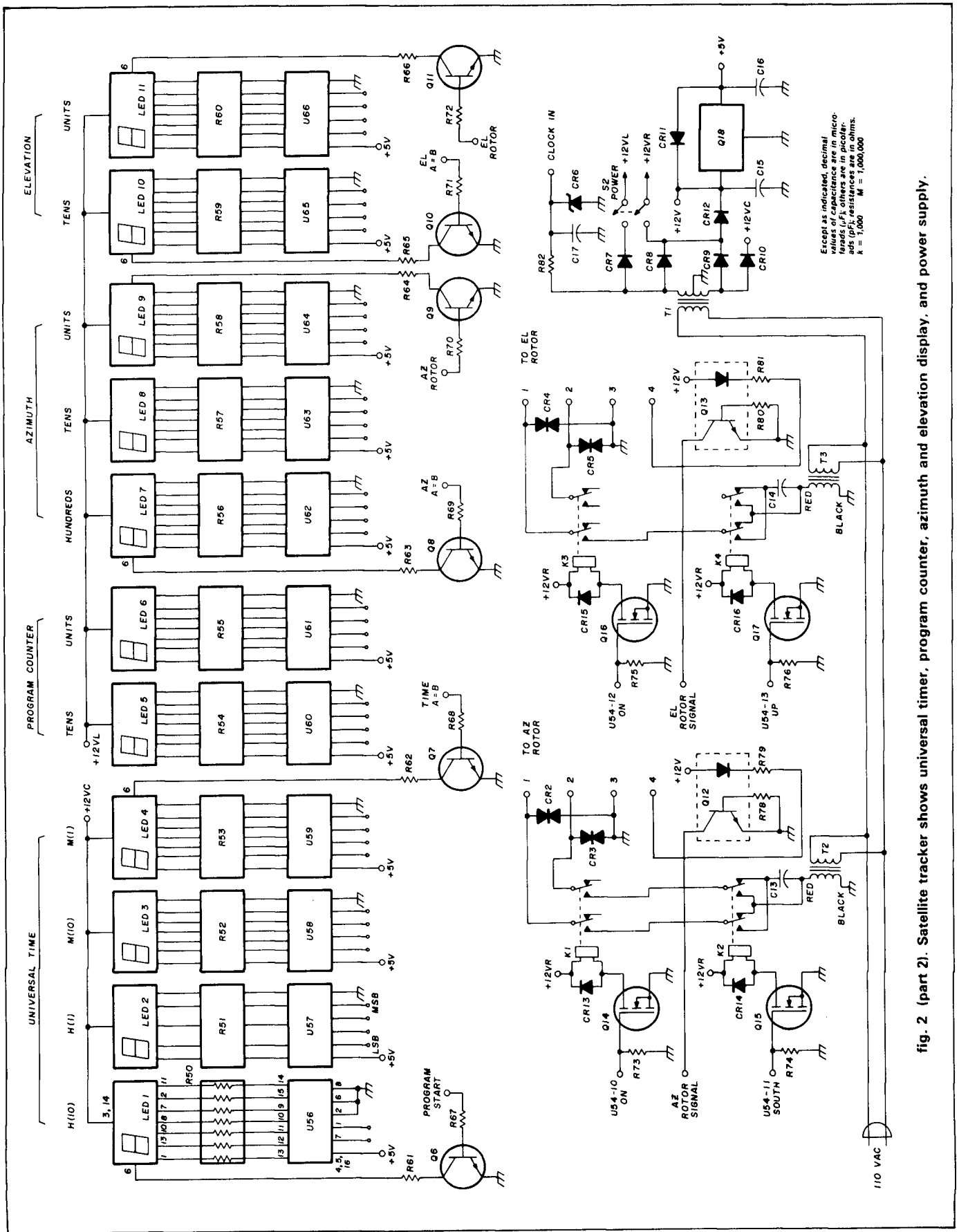

fig. 2 (part 2). Satellite tracker shows universal timer, program counter, azimuth and elevation display, and power supply.

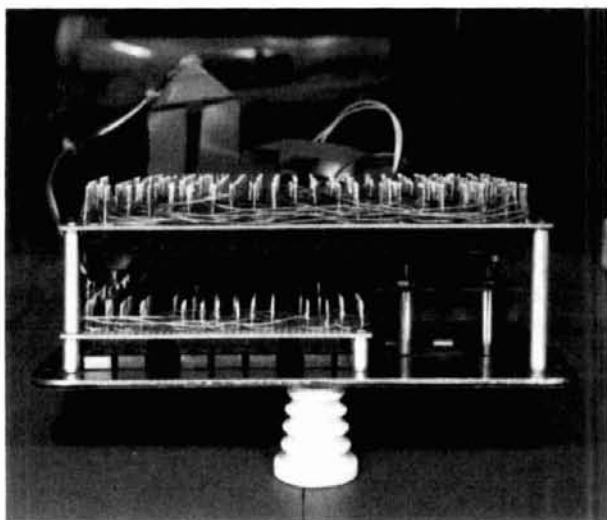
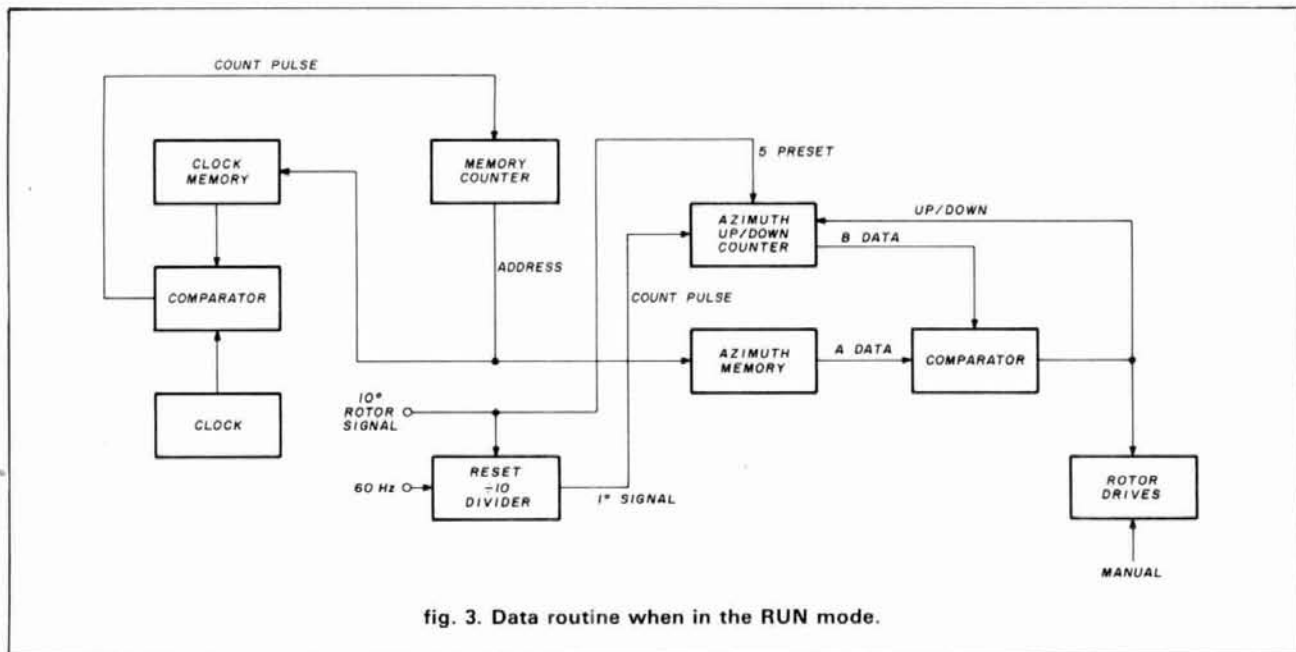

Photo B. Top view of front panel. Note keypad mounted on spacers.

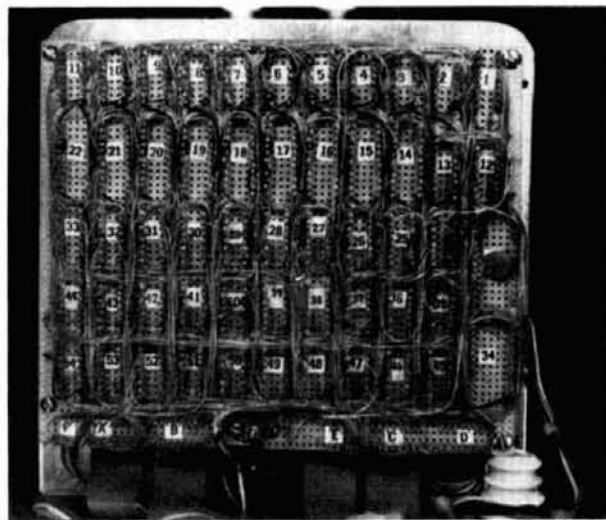

Photo C. Main circuit board showing wire-wrap. The numbers indicate ICs. Parts are mounted on DIP headers. Letters indicate sockets for interconnecting cables.

manual pushbuttons are available for positioning the rotors. A FAST and SLOW pushbutton is available to set the clock to universal (or Greenwich Mean Time) in the MANUAL mode.

### basic operation

For simplicity the elevation circuitry will not be included. It is exactly the same as the azimuth circuitry.

- **Loading data from the keyboard (PROGRAM MODE), (fig. 1).** The key encoder (U1) encodes a keyboard array and outputs the binary value on four data lines (see fig. 2). This data presets the clock,

AZ-EL and memory counters (U3 through U11). The key encoder also outputs a data-available pulse each time a keyboard entry is made. This pulse steps decade counter U45, U34. The output of the decade counter strobes each data counter sequentially until the data is loaded. We are now ready to store the information. The output from the memory address counter becomes the address for the memories (U14 through U22). The clock and AZ-EL counters provide the data input for the memories. Data is stored when the ENTER key is depressed.

- **Tracking the satellite automatically (RUN**

**mode, fig. 3).** During RUN mode the program counter is stepped by the output of the clock comparator (U25 through U28). When real time from the clock equals the time stored in memory the program counter increments to the next address. New AZ-EL data from memory (U18 through U22) is compared with the data in the AZ-EL counters (U7 through U11). Three signals are available from the AZ comparator (U29 through U31). If Data A = Data B, the data in both memory and counter is the same and the rotator will not move. If Data A is smaller than Data B, the rotator is turned on in reverse and the UP/DOWN counter is placed in the down mode.

A 1-degree pulse steps the counter until A = B and the rotator stops. If Data A is larger than Data B then the rotator is turned on forward, the UP/DOWN counter is placed in the up mode and again the 1-degree pulse steps the counter until A = B. The 1-degree signal comes from a decade divider (U48) which is clocked from the 60-Hz power line.

When the rotators are turning the counters are corrected every 10 degrees by a rotator strobe, which forces U7 to a count of 5 through OR gate U41 (pin 3). The decade divider is also reset by the rotator strobe from the Schmitt trigger U47 (pin 8).

- **Manual Mode.** In MANUAL mode the rotators are directly energized. The memory and comparator are not used. The manual pushbuttons each set a flip-flop (U53). Reset of each latch is synchronous with the zero count of the decade divider. This ensures manual operation in 1-degree steps. The select gate (U54) either routes MANUAL or RUN commands to the rotators. During the MANUAL mode the clock is also operational.

## construction

A complete parts list is provided in **table 2**. All control circuitry was wirewrapped on the two boards. The board behind the front panel has the LED displays and drivers U56 through U66. The dropping resistors are DIP with seven resistors. The keyboard, purchased from Jameco, came mounted on a PC board, which was removed and the assembly remounted on a blank circuit board (**photo B**). The unit was then rewired to conform to the U1 keyboard decoder. Because the right row of switches is not used, the pushbuttons should be removed. (I have since used another keyboard sold by Herbach and Rademan, Inc. This keyboard doesn't have to be modified.)

The main circuit board contains all logic circuits in wirewrap sockets (**photo C**). Both boards are mounted to the front panel of a BUD cabinet with spacers. All interconnections were made with flat ribbon cable DIP plugs (**photos B, D**). Some care must be exercised in wiring the V+ and ground to the chips.

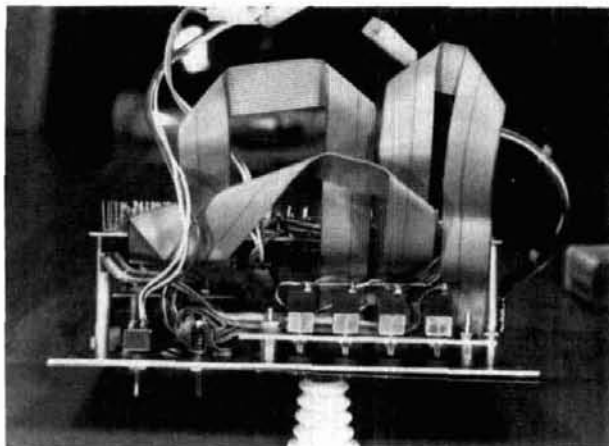

Photo D. Bottom view of front panel. Pushbuttons are mounted on a spacer. Note flat ribbon interconnect cables.

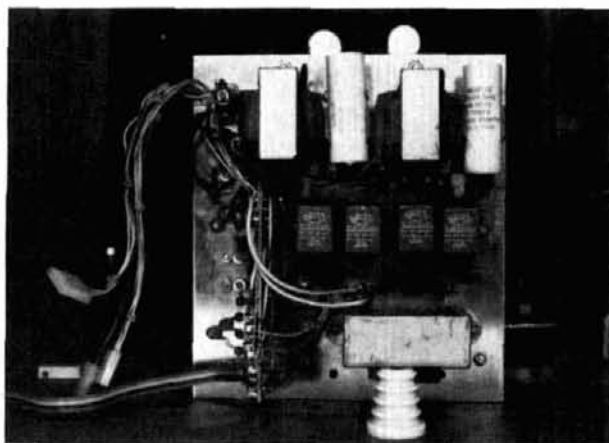

Photo E. Power supply chassis mounted in rear of BUD cabinet. Top transformers and capacitors are from original rotator drive. Small board to the left contains relay drivers, optical couplers and power supply. The +5 volt regulator is mounted on the chassis for cooling.

Each row was daisy-chained, and each chain was provided with a 0.01  $\mu\text{F}$  bypass capacitor; all were then run to a common connection on the board. Two No. 18 wires with Molex plugs connect to the power supply. The power supply, rotator transformer, and control relay circuitry were mounted on the chassis back plate.

The rotators are very noisy when starting and stopping. Each output has a varistor (CR2 through CR5), which takes care of some of the noise, but good ground housekeeping is a must. Lead dress is especially important.

Coupling between rotators and circuitry is kept to a minimum by using relays and VMOS drivers for isolation (**photo E**). Optical couplers Q12 and Q13 are used for the rotator signal, and the 60-Hz clock signal is filtered through R82, C17 at the power transformer.

**table 2. Parts list for the digital satellite tracker.**

item	description
C1	10 $\mu$ F 10 volt tantalum
C2,7,10	0.1 $\mu$ F 5 volt disc
C3	0.02 $\mu$ F 5 volt disc
C4,6,8,9,11,12,18	0.01 $\mu$ F disc
C5	1 $\mu$ F 10 volt tantalum
C13,14	see text
C15	1000 $\mu$ F 24 volt electrolytic
C16	50 $\mu$ F 10 volt electrolytic
C17	0.2 $\mu$ F 5 volt disc ceramic
CR1	3.3 volt zener
CR2 thru CR5	24 volt varistor GE V47ZA1
CR6	5 volt zener
CR7 thru CR16	1N4002
K1 thru K4	DPDT 12 volt coil
Q1 thru Q4	2N3905
Q5 thru Q11	2N3904
Q12,13	MCT-2 (4N25, LIT-1)
Q14 thru Q17	VN10KM (Radio Shack 276-2070)
All resistors are 10 kilohm, 1/4 watt except the following:	
R5,6,7,8	3.3 kilohm
R9	100 kilohm
R10,11,12,13,14	4.7 kilohm
R26,30	1 kilohm
R50 thru R60	470 DIP
R61 thru R66	470
R73 thru R76,78,80	68 kilohm
R79,81	620
R82	22 kilohm
S1	SP3T rotary miniature
S2	2PST toggle
S3 thru S6	SP2T momentary
S7,8,9*	SPST momentary N.O.
T1	24 VCT 2A (Stancor P-6377)
T2,3	see text
U1	74C922
U2,43,44,55	CD4011
U3 thru U13,45	CD4029
U14 thru U22	5101 RAM
U23	MM5312
U25 thru U33	74C85
U34	74C154
U36,37	74LS368
U39	CD4093
U41,42	74C32
U46	CD4049
U47	74C14
U48,49	CD4017
U51	74C08
U53	CD4043
U54	CD4019
U56 thru U66	74LS247
keyboard	Jameco K-19 TM23K222 (Herback & Rademan, Inc., 401 E. Erie Ave., Philadelphia, PA 19134)
displays	common anode, RHDP, LHDP (Hewlett-Packard HDSP-4030 or equivalent)

\*"Slow-set" clock, "fast-set" clock, "program start."

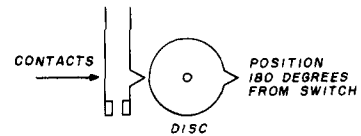

**fig. 4. Repositioning the switch contact disc for 5-degree set in the Alliance rotator controller.**

I have not experienced any problems with everything mounted in one unit, but keep in mind that CMOS is high impedance and will react to low-frequency noise.

Three separate pairs of wires supply +5 volts to the circuit boards. One pair is for the main logic card, one pair for the front panel LED circuitry and a final pair for the manual pushbuttons, mode switch and ENTER buttons. All three pairs originate at the regulator chip Q18. Since continuous power is needed for the clock, no switch is provided for it in the power supply. The +12 volts is turned off to most of the display (except the clock) and power to the relays is turned off for safety. The +5 volts remains on. Transformers T2 and T3 and capacitors C13 and C14 were removed from the Alliance rotator controllers.

### mods to rotators

One small modification must be made to the rotators. Before removing the transformers and capacitors, connect the rotators to the Alliance control box and check to make sure they work properly. Turn the knob counter-clockwise until the rotator runs into the stops. Now open the rotator housing, but try not to disturb the gears. Tabs on the main shaft move a T-slug stop. Make sure the rotator has gone into the stop at full counter-clockwise rotation. Note the disc which activates the switch contacts; this produces the 10-degree signal. Carefully remove the snap ring, lift the gear, and position the disc as shown in fig. 4. Replace the snap ring and reassemble the body.

It probably would be a good idea to clean the contacts and lubricate the gears at this time. This disc is now at the 0-degree point and will produce a signal at every 5-degree set. I used a cable with 3 pairs of wires in aluminum foil wrap to connect the digital controller to the rotators. The two ground wires were used for AC return. Both rotator signals were brought down in one pair with the bare wire grounded at the controller.

A simplified version (manual operation, AZ-EL read-out only) of the KA8OBL satellite tracker is available from the author. Send SASE to Rudolph Six, KA8OBL, 30725 Tennessee, Roseville, Michigan 48066

**ham radio**



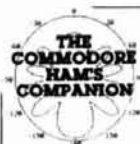

**EVERY  
COMMODORE HAM  
NEEDS A COMPANION!**

From **JIM GRUBBS, K9EI**

the author of *Command Post*, *Micro-Wave Radio and Gateway to the World*, **QSKY Publishing** announces **THE COMMODORE HAM'S COMPANION**.

**INCLUDES:**

- Over 80 sources for Commodore amateur radio software and hardware
- A bibliography of over 60 magazine articles and reviews about using Commodore machines in the ham shack
- How to use your Commodore computer to join the packet radio revolution
- Where to find specialized programs for such things as slow scan television, satellite tracking and more
- How to realize a dramatic increase in speed without learning machine language programming
- Why the Commodore machines are the easiest to interface

14 chapters / 160-page paperback

Price: \$15.95 + \$2.50 First Class shipping and handling. Mastercard and Visa accepted.



✓ 192

P.O. Box 3042 • Springfield, IL 62708

# RADIO WAREHOUSE

Division of HARDIN Electronics

**NO FRILLS—JUST LOW PRICES  
CALL FOR SPECIAL PRICES ON—**

**KENWOOD**

**YAESU**

**ICOM**

**TEN-TEC**

**DAIWA METERS—KEYERS—AUDIO FILTERS  
CUSHCRAFT LINE OF ANTENNAS**

CALL TOLL FREE

**1-800-433-3203**



IN TEXAS CALL 817-496-9000

5635 EAST ROSEDALE

FT. WORTH, TEXAS 76112

**SPS  
DIST.**

**'TI'  
FINDER +**



Complete Line of  
Satellite Receiving Systems

**SPS  
San Pierre, IN**

(219) 828-7255 — 828-3091 ✓ 193

**Electronic Repair Center  
Servicing**

**Amateur Commercial Radio**

The most complete repair facility on  
the East Coast.

Large parts inventory and factory  
authorized warranty service for  
Kenwood, Icom and Yaesu.

**SEND US YOUR PROBLEMS**

Servicing "Hams" for 30 years, no rig  
too old or new for us.

**HAMTRONICS, INC.**

4033 Brownsville Road

Treose, Pa. 19047

**215-357-1400**



**Gunnplexers  
& accessories 10 & 24 GHz**

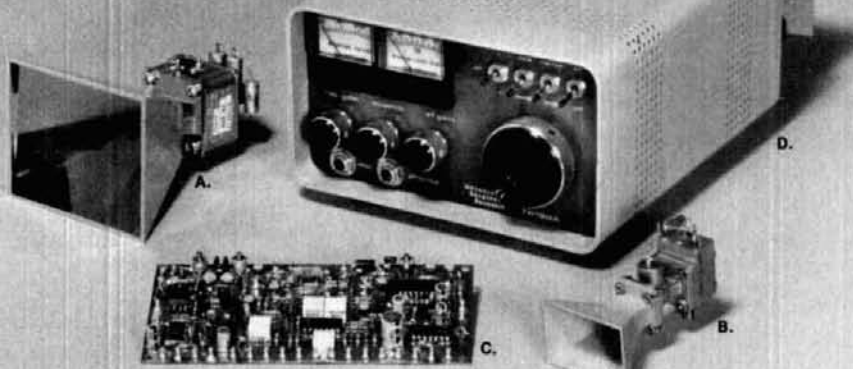

A. Microwave Associates 10 GHz Gunnplexer. Two of these transceivers can form the heart of a 10 GHz communication system for voice, mcw, video or data transmission, not to mention mountaintop DXing! MA87141-1 (pair of 10 mW transceivers) \$251.95. Higher power units (up to 200 mW) available. B. Microwave Associates 24 GHz Gunnplexer. Similar characteristics to 10 GHz unit. MA87820-4 (pair of 20 mW transceivers) \$739.20. C. This support module is designed for use with the MA87141 and MA87820 and provides all of the circuitry for a full duplex audio transceiver system. The board contains a low-noise, 30-MHz fm receiver, modulators for voice and mcw operation, Gunn diode regulator and varactor supply. Meter outputs are provided for monitoring received signal levels, discriminator output and varactor tuning voltage. RXMR30VD assembled and tested \$119.95. D. Complete, ready to use communication system for voice or mcw operation. Ideal for repeater linking. A power supply capable of delivering 13 volts dc at 250 mA (for a 10 mW version), microphone, and headphone and/or loudspeaker are the only additional items needed for operation. The Gunnplexer can be removed for remote mounting to a tower or 2 or 4 foot parabolic antenna. TR10GA (10 GHz, 10 mW) \$399.95. Higher power units available. TR24GA (24 GHz, 20 mW) \$639.95. Also available: horn, 2 and 4 foot parabolic antennas, Gunn, varactor and detector diodes, search and lock systems, oscillator modules, waveguide, flanges, etc. Call or write for additional information. Let ARR take you higher with quality 10 and 24 GHz equipment!

**Advanced  
Receiver  
Research**

Box 1242 • Burlington CT 06013 • 203 582-9409





## a carrier-activated CW reception limiter

Save your ears  
with this handy  
signal enhancer

Cut those big signals down to the same size as the small ones, the ad said, "use a limiter on your CW receiver." I did a double-take. Of course it's possible to do this — but only in the very special case where there's no more than one signal going through the limiter at any given time.

In the reality of our ham bands, this isn't always the case. CW bands usually present an irregular variation of anything from zero to several signals at any given moment in a typical audio passband. When two sine-wave signals are stuffed through a limiter, the stronger signal will suppress the weaker so that the difference between the two is nominally 6 dB greater at the limiter's output than at its input.<sup>1</sup> For example, if a pair of signals, one at 40 volts and the other at 2 volts, are fed to a 1-volt amplitude limiter, the 40-volt signal will be limited to 1 volt and the 2-volt signal will be reduced to 1/20 volt — 6dB, or 1/40th of a volt. Signals passed through an amplitude limiter are like Mother Nature's offspring — only the fittest survive.

Figure 1 shows what happens if, for example, random 4-volt and 2-volt CW signals are fed to a 1-volt limiter. For clarity, a filter that passes signal B and re-

jects the frequency of signal A is assumed. The unfiltered output of the limiter contains signals A and B plus harmonics and cross-products — a real mess.

Despite the poor quality of signal B at the limiter/filter output, experienced "brass pounders" can often get solid copy because of our fantastic ear-brain coordination capabilities. But comprehension is made more difficult, not easier, by the limiter's action. Moreover, if signal A is initially three or four times the amplitude of signal B, then copying B becomes very unlikely. Finally, even copying one signal can become a problem if heavy limiting is used. In this case, noise would come up to fill the spaces between code elements.

In addition to the suppression factor, if one or more signals above the limit threshold are fed to a limiter,



By Don E. Hildreth, W6NRW, 936 Azalea Drive,  
Sunnyvale, California 94086

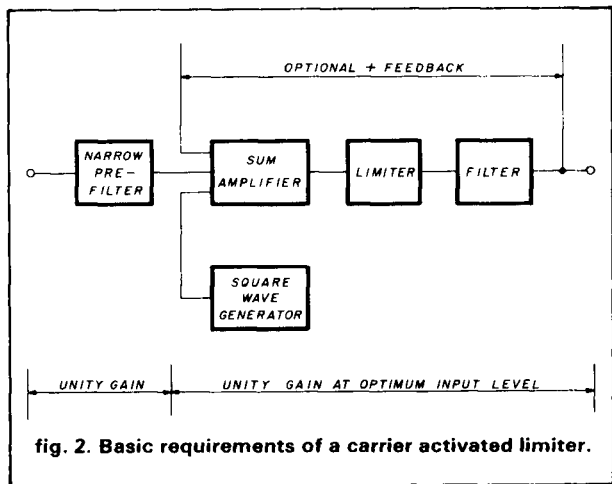
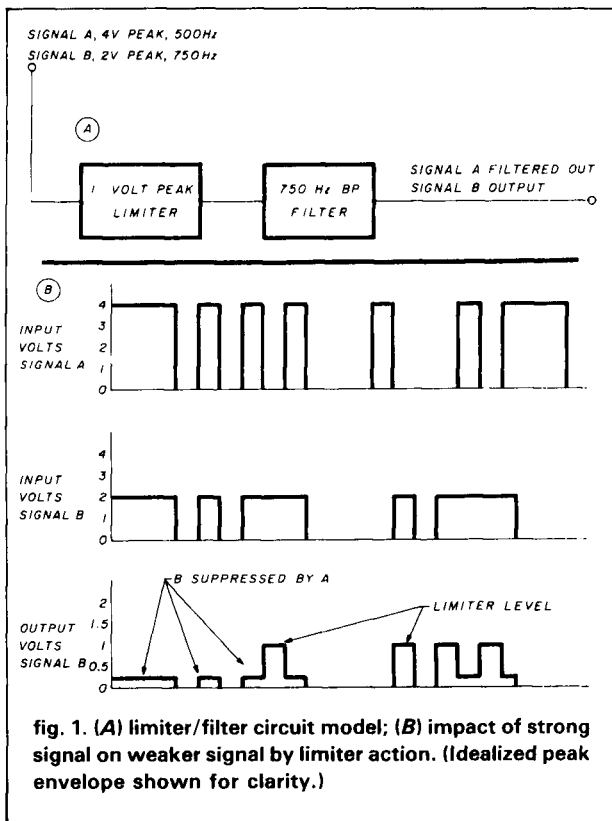

a squared-off waveshape, which contains a considerable amount of harmonic energy, is produced. In a recent article, a limiter was shown in front of a narrow-band CW filter.<sup>2</sup> The article stated that locating the limiter in front prevents harmonics generated by the limiter action from reaching the power amplifier, prevents overload of the following power amplifier by strong signals, and makes up for AGC problems with CW. This is true as far as it goes, but it does nothing

for the suppression problems illustrated above. In addition, it doesn't prevent sub-harmonics of the filter frequency from entering the limiter which, in turn, creates harmonics that appear as false signals in the filter passband.

To eliminate the problem with sub-harmonics and mitigate the suppression effect, a narrow filter must be added in front of the limiter. This practice prevents lower frequency signals that are sub-harmonically related to the output filter frequency from getting to the limiter and reduces the number of signals with which the limiter is likely to be confronted. But even with the addition of filters surrounding the amplitude limiter, because of the isochronal\* nature of CW, the signal-to-noise ratio is worse when using a limiter than for the linear case. The S/N for the limiter case can, however, approach linear performance if a received signal can be adjusted to an amplitude level where limiting is just about to begin. (In this case, S/N refers to the ratio of the coded signals; ON response to the noise response during the coded signals' OFF state.) If the input level is made high enough so that receiver noise is at or above the limit level, then the effective S/N for any received CW signal will be 0 dB — usually an undesirable condition.

At this point one may wonder whether or not a limiter is worth the bother. Not only is the system no longer simple, but the input signal amplitude adjustment is very fussy, even if you're trying to get an S/N only nearly as good as would exist in the linear case — where the limiter could just be thrown out altogether. Fortunately something can be done — with just a little more hardware — that will tilt the S/N ratio more than 14 dB in favor of the limiter case.

### the super-CW model 10: a carrier-activated limiter

Figure 2 shows a block diagram of what must be added to the basic Filter-Limiter-Filter combination in order to obtain the S/N enhancement. The basic concept recognizes that the noise floor, which is present between the coded elements, must be treated as a particular case. To accomplish control of this noise, a nominal 10-kHz squarewave carrier is linearly summed with the output from the pre-filter and fed to a low level limiter. The amplitude level of this carrier is made large enough to fully capture the basic limiter under no-signal conditions.

For a simplified explanation of operation, when a receiver's input to the system is set at a level where the noise floor output from the pre-filter is below the voltage amplitude of the carrier, the noise is suppressed by the carrier — remember, survival of the fittest. Then when a signal voltage appears that is above

\*isochronal — occurring at equal intervals of time

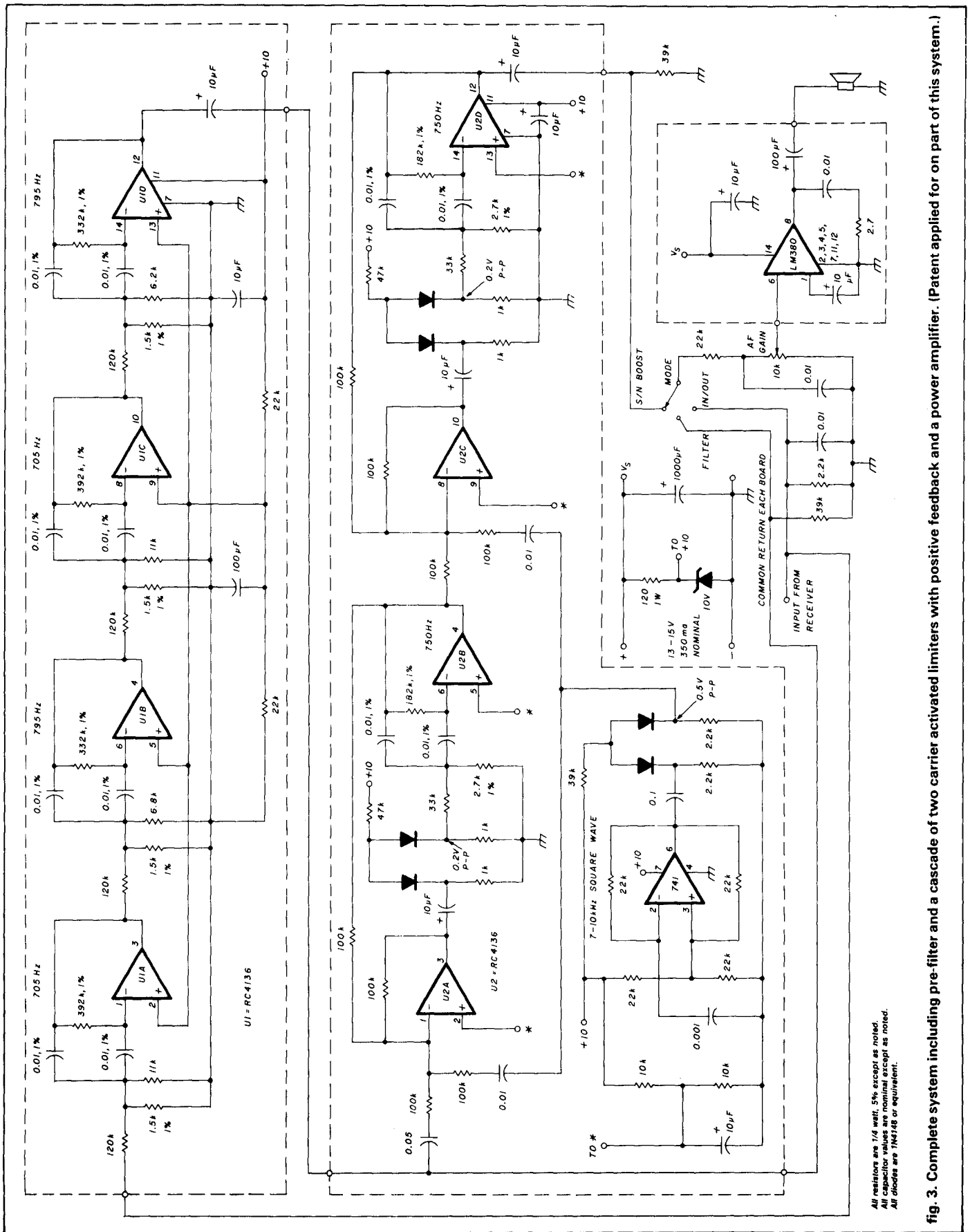

All resistors are 1/4 watt, 5% except as noted. All capacitor values are nominal except as noted. All diodes are 1N4148 or equivalent.

fig. 3. Complete system including pre-filter and a cascade of two carrier activated limiters with positive feedback and a power amplifier. (Patent applied for on part of this system.)



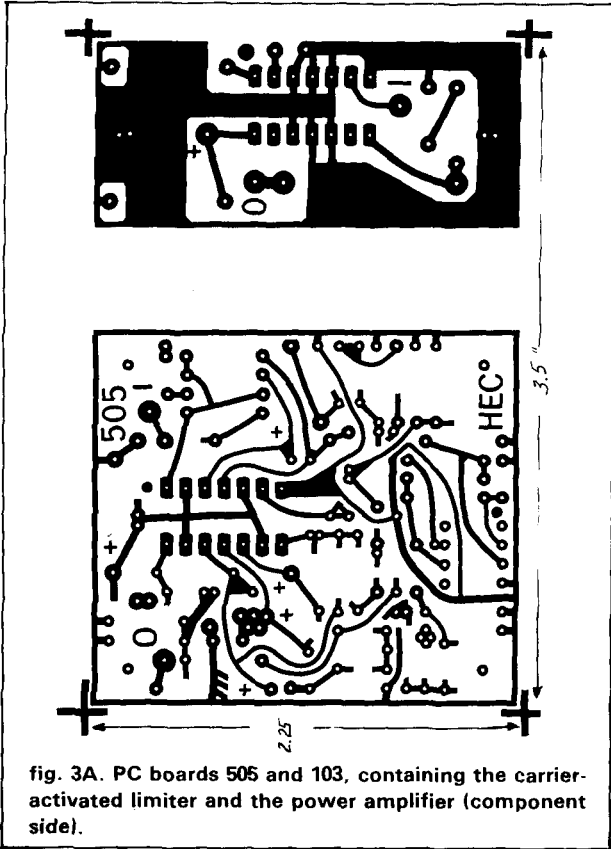

the carrier amplitude, the signal suppresses the carrier. Moreover, the instantaneous signal and carrier voltages add to suppress coincident noise. The filter following the limiter removes harmonics created by the limiter as well as the 10-kHz squarewave carrier.

By designing the op-amp summer, limiter and op-amp active filter so that the gain is unity from input to output for the desired signal, identical stages may be cascaded for a multiplied S/N enhancement in a manner similar to that of a quality FM communication system. A complete system, including a narrow pre-filter and two stages of carrier activated limiters, which seems to provide just about the right amount of S/N enhancement for excellent operating "feel," is shown in fig. 3.

The input filter is an 8th-order Butterworth two-pole cascade with a 100-Hz bandwidth centered at 750 Hz. This design provides minimal ringing and much better skirt rejection than can be obtained from synchronously tuned filters or others of the Gaussian class. The summing amplifiers are designed to linearly add three inputs: the signal, the carrier, and a resistive controlled positive feedback, which assists the S/N enhancement of each stage. Circuit constants of the in-line limiters provide limiting levels of 0.2 volts peak-

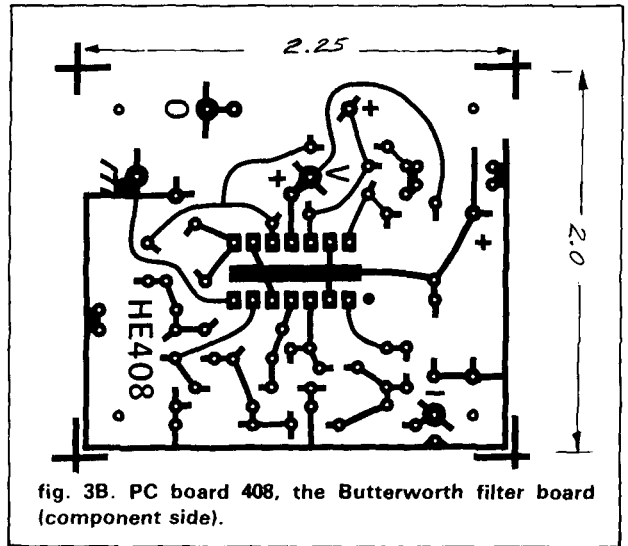

to-peak. The same limiter design is used to control output from the 10-kHz carrier, but in this case components are selected to make a 0.5 volt peak-to-peak limiter. Because of the light loading presented by the op-amp summer design, only one 10-kHz carrier generator/limiter combination is required to drive both carrier activated limiter stages. Identical 2nd order filters with a nominal 175-Hz bandwidth centered at 750 Hz are used following each carrier activated limiter. Output from the last filter is fed through an L network and volume control to drive an LM380 power amplifier. A mode control switch is included to enable selecting the input from a receiver, output from the linear pre-filter, or output from the complete carrier activated limiter system for input to the power amplifier.

### system performance

With this system, S/N enhancement has essentially reached its maximum of a little over 14 dB when the S/N out from the pre-filter is +10 dB and enhancement declines smoothly toward zero as the S/N from the pre-filter approaches zero dB. As a relative comparison, this means that a received signal at about 4.5 dB below the noise in a typical 3 kHz bandwidth would yield a +10 dB S/N from the pre-filter and a +24 dB S/N from the carrier activated limiter system. Figures 4A and B illustrate generalized performance.

In addition to reducing the noise by 14 dB, the system can also suppress the ringing residues from the pre-filter by the same amount. Since the ringing residue amplitudes from a Butterworth filter are more than 10 dB below the ON elements of a CW signal that triggers them, the final effect is reduction of ringing residues to more than 24 dB below the desired signal.

# HOW DO RECEIVERS REALLY PERFORM? READ THIS BOOK.

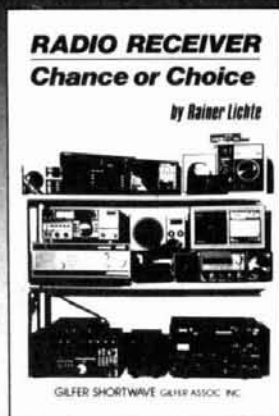

**\$18.50**  
+ \$1.50 shipping  
Available Sept.  
Visa/Mastercards  
accepted

You owe it to yourself to be informed. This comprehensive new book explores the receiver world through real-life tests conducted by internationally renowned radio engineer, Rainer Lichte. Read scores of no-axe-to-grind reviews about such famous brands as Panasonic, Sony, Yaesu, Kenwood, Drake, Eska, Hitachi, Grundig, Phillips, JVC, Zenith, Dymek, ITT, Bearcat - both old and new models, including ICOM R71A, Sony 2010, and Yaesu 8800. Explains the mysteries of technical specs, too. A must book.

## GILFER SHORTWAVE

52 PARK AVE. • PARK RIDGE, NJ 07656 • Ph 201/391-7887

✓ 194

## Join AMSAT...Today

*Amateur Radio Satellite OSCAR 10 provides:*

- A New Worldwide DX Ham Band open 10 hours a day.
- Rag Chew With Rare DX Stations in an uncrowded, gentlemanly fashion.
- Popular Modes In Use: SSB, CW, RTTY, SSTV, Packet
- Full Operating Privileges open to Technician Class licensee or higher.

*Other AMSAT Membership Benefits:*

**ORBIT Magazine Subscription:**  
Dependable technical articles, satellite news, orbital elements, product reviews, DX news, and more.

**Satellite Tracking Software**  
Available for most popular PCs.

QSL Bureau, AMSAT Nets, Area Coordinator Support, Forum Talks

Construction of Future Satellites For Your Enjoyment!

AMSAT Membership is \$24 a year, \$26 outside North America. VISA and MC accepted.

**AMSAT**  
P.O. Box 27  
Washington, DC 20044

**301 589-6062**

✓ 121

## DOCKING BOOSTER

Converts Your HT to a Powerful  
Mobile Unit

30 or 50 watts output  
16 DB GaAs FET pre-amp  
Fits on most car doors  
Mic hang-up clip  
Icom, Yaesu, Kenwood  
2 Meters & 70 cm

**\$149<sup>95</sup>**



CMC COMMUNICATIONS, INC.  
5479 Jetport Industrial Blvd. • Tampa, FL 33614  
Phone: 813-885-3996



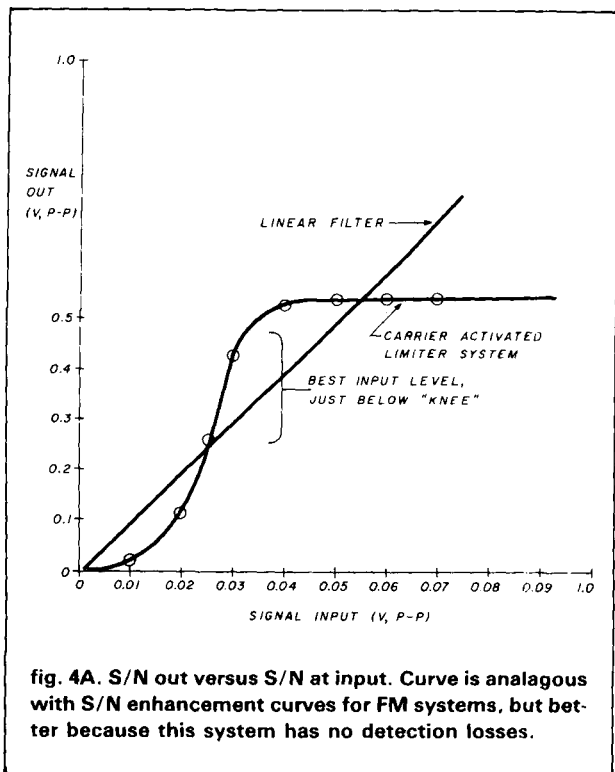

fig. 4A. S/N out versus S/N at input. Curve is analogous with S/N enhancement curves for FM systems, but better because this system has no detection losses.

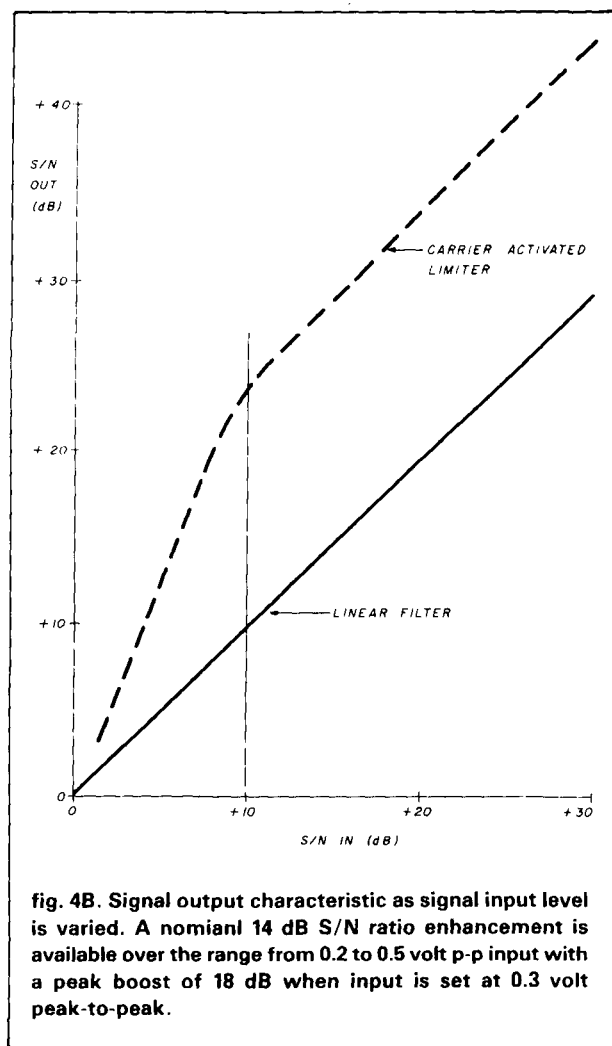

fig. 4B. Signal output characteristic as signal input level is varied. A nominal 14 dB S/N ratio enhancement is available over the range from 0.2 to 0.5 volt p-p input with a peak boost of 18 dB when input is set at 0.3 volt peak-to-peak.

Also, because filter ringing increases in duration rather than amplitude as bandwidth decreases, this makes possible the use of sharper filters — down to 25 Hz or so for a CW signal at 20 WPM.<sup>3</sup> And this can be done without the need for a complicated synchronous detection system. However, to make use of this very narrow bandwidth and assure comfortable operation, many existing receivers would need better bandwidth tuning control than they now have. Even the 100-Hz bandwidth used in this system requires relatively stable oscillators on the part of a received signal and the receiver as well as very careful tuning.

Since the limiter/filter system effectively holds the signal output level constant, the sound pressure listening level cannot exceed that selected by the AF gain control. This feature, present for any signal or noise pulse received, guards against damage to the listener's hearing. This protection is lost, however, when switching to the IN/OUT or Filter positions.

Other methods of S/N enhancement include those techniques that develop a voltage from a received signal to operate an electronic switch to turn an audio oscillator on and off, or to drive a digital system. In general, these methods are fine when a CW signal has a good S/N, but they usually don't perform well with threshold signals. However, the electronic switch method, where it must be used, can be improved by driving it from the carrier activated limiter system.

Finally, the system is designed to operate from a low input level to avoid the requirement of moderate to high receiver gain when listening to weak signals. This reduces the possibility of receiver saturation — unplanned limiting with all of its ramifications as shown in the beginning — by strong signals that may exist in a receiver outside of the pre-filter bandpass.

### operating with the model 10

The nominal signal input voltage requirement is from 0.25 to 0.5 volt peak-to-peak at 700 to 800 Hz. Input termination is resistive at 2.2 kilohms, which enables the unit to be driven from either a receiver's speaker or phones output, or an op-amp. Output from the power amplifier is low impedance to enable driving a speaker of from 4 to 8 ohms. If headsets are used, connection to the output should be made through a nominal 100 ohms to avoid possible damage to ears or headset.

**DO YOU  
KNOW  
WHERE  
TO FIND  
REAL  
BARGAINS**



**on NEW and USED  
ELECTRONIC Equipment?**

**You'll Find Them  
in the Nation's No. 1  
Electronic Shopper Magazine**

# NUTS & VOLTS

**Now in Our 5th Year**

Nuts & Volts is published MONTHLY and features:  
**NEW STATE-OF-THE-ART PRODUCTS •  
 SURPLUS EQUIPMENT • USED BARGAINS  
 • LOW COST AD RATES • PRIVATE AND  
 COMMERCIAL CLASSIFIEDS • NATIONAL  
 CIRCULATION • NEW PRODUCT NEWS  
 SECTION • AND A FREE CLASSIFIED AD  
 WITH YOUR SUBSCRIPTION**

### SUBSCRIPTION RATES

- One Year - 3rd Class Mail ..... \$10.00
- One Year - 1st Class Mail ..... \$15.00
- One Year - Canada & Mexico (in U.S. Funds) .. \$18.00
- Lifetime - 3rd Class Mail (U.S. Only) ..... \$35.00

### ORDER NOW!

SEND:     CHECK     MONEY ORDER  
            VISA         MASTERCARD

TO:        **NUTS & VOLTS MAGAZINE**  
               **P.O. BOX 1111-H**  
               **PLACENTIA, CALIFORNIA 92670**  
               **(714) 632-7721**

Name \_\_\_\_\_  
 Address \_\_\_\_\_  
 City \_\_\_\_\_  
 State \_\_\_\_\_ Zip \_\_\_\_\_  
 Card No. \_\_\_\_\_  
 Exp. Date \_\_\_\_\_

**IF YOU'RE INTO ELECTRONICS,  
THIS MAGAZINE WILL SAVE YOU MONEY!**

Dealer Inquiries Invited

✓ 120

The MODE control has three positions. In the IN/OUT position, no filtering takes place, but the variable gain from the AF GAIN control is in effect. In the FILTER position, the 8th order Butterworth pair cascade is inserted between the input and the power amplifier. In the S/N BOOST position, the cascade of carrier operated limiters is connected between the FILTER output and the power amplifier.

To make the best marriage with a receiver, disable the AGC, use a low RF/IF gain, and set the audio level from moderately high to maximum. In a receiver that does not have an AGC ON/OFF capability, AGC action is effectively defeated by a reduced RF/IF gain setting. A little experience with the system will make this clear.

With the preliminaries completed, listen to the system with your receiver set at a point on its dial where no signal is present and with Model 10's AF GAIN set at mid scale. Then, switching through the three positions, you should hear broadband noise in the IN/OUT position, reduced noise in the FILTER position and still further reduced noise in the S/N BOOST position. As a quick reference, you can put Model 10 in its S/N BOOST position, then adjust your receiver's RF/IF gain control to obtain a weak noise background. Tune in a moderate-to-weak signal. Now, when adjusting your receiver's gain up and down, you'll notice a "knee" (see fig. 4B) where the signal remains constant in level for increased input and where the signal falls off very sharply as gain is reduced. In the region of the knee, your receiver's gain control is adjusted for optimum S/N ratio enhancement. At this point, switching the MODE control to any of its three positions will result in about the same signal output level — which confirms an optimum receiver input level.

In the S/N BOOST position, tuning is even sharper than in the FILTER position. The BOOST position suppresses skirt responses and residual ringing in the same manner as it reduces the noise floor, which enables clean high speed copy with a narrow filter.

In normal operation you simply adjust receiver gain for input level and Model 10's AF GAIN for desired sound pressure level.

*Don't want to build it yourself?* The super-CW Model 10 is available preassembled. Contact the author at Hildreth Engineering, P. O. Box 60003 Sunnyvale, California 94088, for details.

### references

1. Elie J. Baghdady, Sc. D., *Lectures on Communication System Theory*, McGraw-Hill, New York, 1961, page 494-498.
2. Doug DeMaw, "A Second Look at Magnetic Cores," *QST*, June, 1984, page 19.
3. Don E. Hildreth, W6NRW, "Graphic Filter Design," *ham radio*, April, 1984, page 38.

**ham radio**

# ALL MODE MOBILE TELEPHONE INTERFACE

## Automatic Vox Phone Patch System

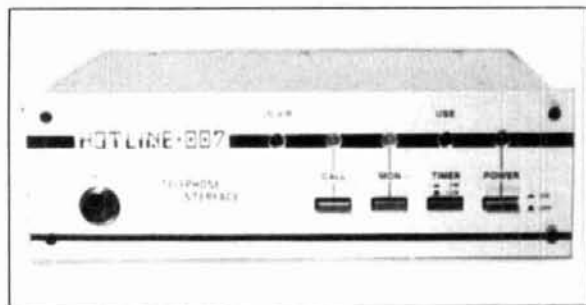

**OPTIONAL:**  
DTMF TELEPHONE  
TYPE SPEAKER/  
MICROPHONE

**HOTLINE-007** is a fully automatic simplex telephone interconnect. Operates through any base transceiver with FM-AM-Squelched SideBand mode. No modifications to the transceiver, just connect to the external speaker, microphone and phone line. VOX operation both transmit and receive. Selectable tone or rotary dialing. Repeater pickup operational also.

- \* Programmable access code
- \* Adjustable VOX both transceiver and phone line.
- \* Will not transmit when frequency is busy, 7 second clear time

- \* Programmable CW ID
- \* Adjustable microphone and line gain
- \* Microphone jack for base operation

- \* 3 or 12 minute timer
- \* Dial restrict switch
- \* Ringback (reverse patch)
- \* Accepts speed dialing
- \* Operates on 115/220 VAC, 12 VDC

NO EXTRAS TO PURCHASE FOR OPERATION, TRANSCIVER AND PHONE LINE CONNECT TIME 30 MINUTES.

N.C.G. CO.



**EXCLUSIVE IMPORT DISTRIBUTOR**

1275 N. Grove Street  
Anaheim, California 92806

118

NOTE: Prices and specifications subject to change without notice or obligation

**TOUCHTONE™ DECODER KIT**

**MODEL TTK - \$22.95**

- SSI 201 DTMF Receiver
- Receive all 16 DTMF digits
- No additional filtering
- Output BCD or hex format
- Open collector output
- Low power (29ma @ 12V)
- Kit includes 3.58Mhz crystal 22 pin IC socket, resistor, capacitors, data sheet and schematics

**4 DIGIT SEQUENCE DECODER**

**MODEL TSD - \$59.95**

- Completely wired & tested
- User programmable
- LED status indicator
- Open collector output
- Control relays, mute audio
- Control link on/off
- Custom IC insures high reliability & small size!
- Fits inside most rigs - runs on 12 VDC (35ma)
- Over 1500 different codes!

- Makes excellent private call on busy repeaters!
- Use it to turn on audio or sound an alarm
- Momentary and latching outputs

MasterCard and Visa accepted, or send check/M.O. Cal. address add 6%, price includes shipping USA. Send to:

**ENGINEERING CONSULTING**  
583 CANDLEWOOD ST., BREA, CA 92621  
TEL: 714-671-2009

**ENGINEERING CONSULTING INTRODUCES**

**TOUCHTONE™ DTMF to RS-232-C 300 BAUD INTERFACE**

- **Use your computer to decode DTMF touchtones.**
- Receive all 16 digits as fast as they can be transmitted
- Easily program your computer in BASIC to decode multi-digit "strings", display digits, sound alarms, observe secret codes, control relays, remote base
- Simple to use: just provide +12 VDC and audio, hook two wires to the RS-232-C serial input on your computer, enter a simple BASIC program and begin to decode
- Sample BASIC program and instructions included
- LED Indicator

**"Decode-A-Pad" Model DAP-1**  
Wired and Tested **\$89.95**

Includes shipping USA. Cal. addresses add 6%. VISA and MasterCard accepted, or send check/M.O. to:

**ENGINEERING CONSULTING**  
583 CANDLEWOOD ST., BREA, CA 92621  
714/671-2009

**ENGINEERING CONSULTING INTRODUCES**

**'REMOTE A PAD'™ MODEL RAP-1**

2 FOUR DIGIT DTMF DECODERS PLUS 16 DIGIT KEYPAD CONTROL

**TUNE THE WORLD FROM YOUR HANDHELD VHF/UHF RADIO**

- Audio tones from any source are converted to solid state switches which control any 16 digit keypad of a radio or other device
- Some examples you can control include the Pro Search™ Hamax (rotatable beam remote), ICOM IC 701 or ICOM IC 211 when using the RM 2 controller, ICOM H500 & 701, Aztec PCS-4000 handhelds such as Vaux F1-200, ST 700, ICOM IC 202A1, and many more.
- Anything you can do manually with your 16 digit keypad the RAP-1 will do, remotely using audio tones from any source.
- Two four digit programmable access codes, and used to operate relays or other on/off functions.

**Model RAP-1 \$149.95**

**'Remote A Pad'**

Remote control interface board and DTMF decoder

- 16 LED decoder status indicators and momentary plus steady state decoder outputs are provided
- 25 gold pin card edge connector, 16 pin D-sub socket and ribbon cable are supplied
- All CMOS low power drain (30ma), 5 Vdc 201 Decoder
- Nine eight wires (4 rows and 4 columns) in parallel with the existing keypad of the radio you wish to control remotely. Connect 1 decoder from any source 12 volts D.C. and **YOU ARE IN CONTROL!**
- The dual 8 digit decoders will turn your radio on and off using your programmable access code
- Detailed wiring diagrams and instructions included with purchase. Interface cable for Pro Search™ \$9.95 (price in stock)

**ICOM IC-202T USER'S "AUDIO BLASTER"™ MODULE**

**Now Available for IC-2AT**

- Module installs inside the radio in 10 minutes.
- Boosts audio to nearly 1 watt!
- Low power drain (1ma stand by)
- Complete step by step instructions included
- Corrects the 1.0V audio problem
- Drive external speakers or full volume even against high level deviation!

**Model AB-1 \$19.95**

Price includes postage and handling. U.S.A. CA res. add 6%

Send check or money order to:

**ENGINEERING CONSULTING**  
583 CANDLEWOOD ST., BREA, CA 92621  
(714) 671-2009



NOW INCLUDES ANSWERS TO FCC/VEC EXAM QUESTIONS

### ARRL LICENSE MANUAL

Here's the latest up-to-date licensing guide from the ARRL. Plenty of theory and detailed explanations take most of the pain out of studying to upgrade your license.

1984 80th edition 216 pages

AR-LG

Softbound \$4.00

Please add \$3.50 shipping & handling

**HAM RADIO'S BOOKSTORE**  
Greenville, NH 03048

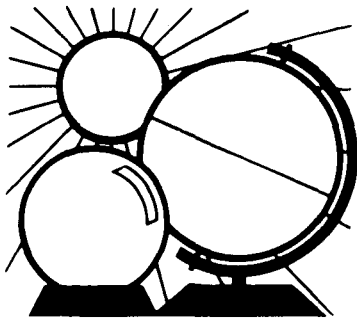

# DX FORECASTER

Garth Stonehocker, KØRYW

## equinoctial DX propagation brings change, excitement

This season's propagation is characterized by change and excitement resulting from the fewer number of daylight hours as winter approaches. In addition the MUF diurnal curve will no longer exhibit summer's typical low, flat response but will instead show a pronounced peak in the afternoon and a downward dip in the pre-dawn hours. Short-skip sporadic E openings will become scarce, giving way to long skip, including many long one-hop transequatorial openings, particularly towards the south in the evening. Shortwave broadcasters must anticipate these changes by planning for frequency changes after each of the two-month periods, (March/April and September/October). The change is slower during the other two periods, which comprise four-month intervals (May through August and November through February).

During the equinoctial period the geomagnetic field exhibits the greatest variability. The magnetosphere (geomagnetic field) acts as a source of high latitude electrons and accounts for ionospheric movement. During equinox — when the earth's equatorial plane intersects the sun — solar wind particles feed down through the magnetosphere into both polar regions of the ionosphere. The variability, both in speed and density, of the solar wind stream is transferred to the geomagnetic field and ionosphere. Geomagnetic field control of the ionosphere is

strong at this time; consequently we can look to it as a measure of what the ionosphere's reaction will be. Recall the large geomagnetic disturbances of last spring's equinox in April; the A index, which was 77 on April 21, was again up to 40 the following week, on April 28. Remember what propagation conditions were like then?

But what is meant by geomagnetic data? The A index is a measure of the amount of change, with time (minutes to hours), of the geomagnetic field from a normally (average) quiet day at that station. The larger the A index (one number per day) or K index (every three hours or 8 per day), the more the ionosphere is moving around. The eight K numbers are summed and multiplied by a factor that converts it into the daily single A index. (The number is further manipulated to calibrate the data from each measuring station.) Large changes in the ionospheric layers take place with K's above 6, especially for paths along or across the auroral zone (65 to 75 degrees north latitude). A K of 4 to 5 indicates moderate movement with its accompanying signal strength variation, QSB.

When listening on the bands during various degrees of geomagnetic disturbance, you'll notice something like this: with K's of 0 to 2 the band will be full of signals from just about every direction; with K's of 3 to 5, the accompanying absorption and some QSB will cut out some of the stations you hear. When the K's are 6 and 7, signals you hear will be coming from unusual, less frequently heard direc-

tions. For even higher K's, all signals are lost in the absorption and QSB. Don't despair — when the K drops slightly from the previous high, we're back in the "unusual direction" K category.

## last-minute forecast

The third week of September is expected to be the best for working DX on the 10 through 30 meter HF bands, coincident with a higher solar flux. To confirm that this situation is occurring, monitor radio station WWV on 2.5, 5, 10, 15, and 20 MHz at 18 minutes after each hour. If the flux is up, expect transequatorial openings to occur to South Africa, South America, and especially Australia. These will be enhanced openings during a geomagnetic-ionospheric disturbance indicated by an A index of 20 to 40, which is likely at this equinoctial season of the year. The lower bands should greatly improve through the month with lower atmospheric noise levels and higher signal strengths. The MUF will be lower on east-west paths during disturbed conditions, with QSB noticed on the signals. Under these same circumstances, expect to hear DX from some unusual locations.

A full moon will occur on September 29th and its perigee on the 16th. The autumnal equinox will be on the 23rd at 0207 UTC. No significant meteor showers are expected this month to enhance meteor burst DXing.

## band-by-band summary

*Six meters* may have a few sporadic E openings around local noon, but don't count on them. This month should be the last chance for E<sub>s</sub> until next summer's season begins.

*Ten, twelve, and fifteen meters* should provide a few short-skip E<sub>s</sub> openings and many long-skip openings during any solar flux peaks to most southern areas of the world during daylight. Some of these openings will result from transequatorial propagation, especially during the disturbed conditions.

GMT	0000	0100	0200	0300	0400	0500	0600	0700	0800	0900	1000	1100	1200	1300	1400	1500	1600	1700	1800	1900	2000	2100	2200	2300	
<b>WESTERN USA</b>	20	20	20	20	20	20	20	30	40	40	40	40	40	40	40	40	40	40	40	40	40	40	40	40	20
ASIA FAR EAST	20	20	20	20	20	20	20	30	40	40	40	40	40	40	40	40	40	40	40	40	40	40	40	40	20
EUROPE	40	40	40	40	40	40	40	40	40	40	40	40	40	40	40	40	40	40	40	40	40	40	40	40	30
S. AFRICA	20	20	20	20	20	20	20	20	20	20	20	20	20	20	20	20	20	20	20	20	20	20	20	20	20
S. AMERICA	10	12	15	15	15	15	15	20	20	20	20	20	20	20	20	20	20	20	20	20	20	20	20	20	10
ANTARCTICA	12	15	15	15	15	15	20	30	30	30	30	30	30	30	30	30	30	30	30	30	30	30	30	30	12
NEW ZEALAND	10	10	10	10	10	10	10	15	15	15	15	15	15	15	15	15	15	15	15	15	15	15	15	15	10
OCEANIA AUSTRALIA	10	10	10	10	10	10	10	15	15	15	15	15	15	15	15	15	15	15	15	15	15	15	15	15	10
JAPAN	15	15	15	15	15	15	20	30	30	30	30	30	30	30	30	30	30	30	30	30	30	30	30	30	15
<b>MID USA</b>	20	30	30	30	30	30	30	40	40	40	40	40	40	40	40	40	40	40	40	40	40	40	40	40	30
ASIA FAR EAST	20	30	30	30	30	30	30	40	40	40	40	40	40	40	40	40	40	40	40	40	40	40	40	40	30
EUROPE	40	40	40	40	40	40	40	40	40	40	40	40	40	40	40	40	40	40	40	40	40	40	40	40	30
S. AFRICA	20	20	20	20	20	20	20	20	20	20	20	20	20	20	20	20	20	20	20	20	20	20	20	20	20
S. AMERICA	10	12	15	15	15	15	15	20	20	20	20	20	20	20	20	20	20	20	20	20	20	20	20	20	10
ANTARCTICA	15	15	15	15	15	15	20	30	30	30	30	30	30	30	30	30	30	30	30	30	30	30	30	30	15
NEW ZEALAND	10	10	10	10	10	10	10	15	15	15	15	15	15	15	15	15	15	15	15	15	15	15	15	15	10
OCEANIA AUSTRALIA	10	10	10	10	10	10	10	15	15	15	15	15	15	15	15	15	15	15	15	15	15	15	15	15	10
JAPAN	20	20	20	20	20	20	20	30	30	30	30	30	30	30	30	30	30	30	30	30	30	30	30	30	20
<b>EASTERN USA</b>	20	30	30	30	30	30	30	40	40	40	40	40	40	40	40	40	40	40	40	40	40	40	40	40	30
ASIA FAR EAST	20	30	30	30	30	30	30	40	40	40	40	40	40	40	40	40	40	40	40	40	40	40	40	40	30
EUROPE	40	40	40	40	40	40	40	40	40	40	40	40	40	40	40	40	40	40	40	40	40	40	40	40	40*
S. AFRICA	20	20	20	20	20	20	20	20	20	20	20	20	20	20	20	20	20	20	20	20	20	20	20	20	20
CARIBBEAN S. AMERICA	10	12	15	15	15	15	15	20	20	20	20	20	20	20	20	20	20	20	20	20	20	20	20	20	10
ANTARCTICA	15	15	15	15	15	15	20	30	30	30	30	30	30	30	30	30	30	30	30	30	30	30	30	30	15
NEW ZEALAND	10	10	10	10	10	10	10	15	15	15	15	15	15	15	15	15	15	15	15	15	15	15	15	15	10
OCEANIA AUSTRALIA	10	10	10	10	10	10	10	15	15	15	15	15	15	15	15	15	15	15	15	15	15	15	15	15	10
JAPAN	20	20	20	20	20	20	20	30	30	30	30	30	30	30	30	30	30	30	30	30	30	30	30	30	20

The italicized numbers signify the bands to try during the transition and early morning hours, while the standard type provides the MUF during "normal" hours.

\*Look at next higher band for possible openings.

## DIRECTION FINDING?

- ★ Interference Location
- ★ Stuck Microphones
- ★ Cable TV Leaks
- ★ Security Monitoring



- ★ VHF and UHF Coverage
- ★ Computer Interface
- ★ Speech Synthesizer
- ★ 12 VDC Operation

**New Technology** (patent pending) converts any VHF or UHF FM receiver into an advanced Doppler shift radio direction finder. Simply plug into receiver's antenna and external speaker jacks. Uses four omnidirectional antennas. Low noise, high sensitivity for weak signal detection. Call or write for full details and prices.

**DOPPLER SYSTEMS, INC.** 5540 E. Charter Oak, (602) 998-1151  
Scottsdale, AZ 85254

# COMPUTER SMYTH

Now there's a hardware magazine that's all about computers for people who like to build their own. *Computer Smyth's* premiere issue is now published, providing all the pleasure, economy and satisfaction of build-it-yourself projects that Hams know so well.

Our authors take you inside the chips, talk about what they do and how they're controlled, and explain command options you may never have heard of before. *Computer Smyth's* first quarterly issue begins a series on a complete Z80 based computer on three 4 x 6 1/2" boards, which lets you interface 3 1/4", 5 1/4" and 8" floppy disks in *all* densities and track configurations. John Adams' series will include a switching power supply, a PROM burner and software options for this rack-mount system.

The first issue also features an X/Y plotter you can build, an in-

expensive motorized wire-wrap tool and an RGB color to composite adapter.

During its premiere year, *Computer Smyth* will survey the more than two dozen computer kits now available in the US. Kit builders will report on many of them. A major series on building a 32-bit 68000 micro begins in issue two.

*Computer Smyth* is published by Audio Amateur Publications, publishers of *Audio Amateur* and *Speaker Builder* magazines. All three are reader-centered, hardware-intensive publications whose editors believe that a magazine's primary job is satisfying the reader not consumer marketing. Our magazines are run by tech enthusiasts not MBAs looking for profits.

We guarantee that if you are unhappy with *Computer Smyth* for any reason, your money will be refunded upon request.

Yes, enter my subscription to *Computer Smyth* for one year at \$15.

Check enclosed.

Make that two years at \$25. H-75

Charge to credit card.

Charge card orders: (603) 924-9464

Name \_\_\_\_\_

Street & No. \_\_\_\_\_

Town \_\_\_\_\_

State \_\_\_\_\_

Zip \_\_\_\_\_

MC/VISA Card # \_\_\_\_\_

Expire \_\_\_\_\_ Signature \_\_\_\_\_

**Computer Smyth Magazine**  
PO Box 176, Peterborough, NH 03458

Twenty, thirty, and forty meters will support propagation from most areas of the world during the daytime and into the evening hours almost every day, either long-skip to 2500 miles (4000 km) or some short-skip E<sub>s</sub> to 1250 miles (2000 km) per hop.

Thirty, forty, eighty, and one-sixty meters are all good for nighttime DX. The bands will be open in the east soon after sundown, swing toward the south about midnight, and end in the Pacific areas during the hour or so before dawn. On some nights these bands will be as good as the winter DX season. Some nights, noise (QRN) from thunderstorms (airmass and fronts of fall weather storms) will be a problem. However, high signal levels that occur during short-skip E<sub>s</sub> propagation conditions may overcome the static.

ham radio

**EXMET** your source for **Discounted Prime** 6061-T6/6061-T6511 aluminum TUBING and ROD.

O.D. and wall	TUBING	
	Length	Price per Length
1/2" x .058	12 ft	\$ 12.50
7/8" x .058	12 ft	19.50
1" x .058	12 ft	21.75
1-1/4" x .058	12 ft	27.35
1-1/2" x .049	12 ft	28.80
1-1/2" x .058	12 ft	33.00
1-1/2" x .065	12 ft	38.40
1-1/2" x .083	12 ft	48.00
1-1/2" x .125	24 ft	86.40
1-1/2" x .250	24 ft	105.15
2" x .058	12 ft	42.25
2" x .065	12 ft	45.50
2" x .125	24 ft	110.40
2" x .250	24 ft	187.20
3" x .065	12 ft	81.50

O.D.	ROD	
	Length	Price per Length
1/8"	12 ft	\$ 2.00
3/16"	12 ft	4.50

Volume discounts on orders over \$500.00. Other sizes of tubing and rod quoted upon request. Minimum order \$50.00 tubing, \$50.00 rod.

**Policies:** All prices FOB Twinsburg, Ohio. Payment is COD, or save COD charges by enclosing a check or money order with your order. Ohio residents add 5-1/2% sales tax.

**Exmet, Inc.**  
2170 E. Aurora Rd., P.O. Box 117, Twinsburg, Ohio 44087  
216-425-8455

213

**SAY YOU SAW IT  
IN  
HAM RADIO**

116

# WARC for FT-101/901

## WELCOME TO 12 METERS!

Add all three WARC Bands to your FT-101

- Increases Resale Value of your Rig.
- Installs easily; detailed instructions.
- Includes all crystals, relays, wire, etc.
- Tested, fool-proof design for all but 'ZD

FT-101 3-band WARC Kit .....\$25  
 FT-901 30M Only WARC Kit .....\$10

Shipping: \$3, Air \$5 (US & Canada), \$10 Elsewhere  
 Order by mail or phone. VISA/MC or COD Accepted

GO FOX TANGO - TO BE SURE!

## FOX TANGO CORPORATION

Box 15944 H, W. Palm Beach, FL 33416  
 (305) 683-9587

**\$69.95**  
**NEW LOW PRICE!**  
 Plus \$3.00 Shipping & Handling

Fully Assembled and Tested



MODEL VS 300A ANTENNA TUNER \$69.95

### MATCH MOST ANTENNA-FEEDLINE COMBINATIONS TO YOUR RIG

**MATCHES:** dipoles, inverted vees, beams, quads, verticals, mobile whips, random wire, etc. that are fed by coax, balanced line or single wire  
**MAXIMUM POWER:** 300 watts RF  
**INPUTS** (selectable from front panel):  
 3-coax: 1-direct, 2-direct or thru tuner  
 1-balanced line (4:1 balun inc.) or single wire  
**IN-LINE CALIBRATED WATTMETER INCLUDED**

1985-86  
**CATALOG**  
 50¢



**RADIOKIT**  
 Box 411H  
 Greenville, NH 03048  
 (603) 878-1033  
 telex 887697

# SPECTRUM ANALYZER

TS-1010/UPM 84 Analyzer for 10 Mhz to 44 GHz in 8 bands; 20 KHz resolution @ 3 db points. Dispersion: 0.5-25 Mhz above 55 MHz; 0-60 db IF attenuation in 6 db steps. With 5ADP7 CRT: requires 115/230 VAC. 17.3x19.5x26, 180 lbs sh.

Used-repairable .....\$425- \$265  
**ACCESSORY KIT** including filters, attenuators, and adapters .....w/set purchase \$85  
**TRANSIT CASE** \$15 **MANUAL**, partial repro .....\$15  
**R-1420 UHF RECEIVER**, 30-300 MHz AM-FM-CW in two bands; selectable 20 or 300 KHz bandwidth. Same as CEI 905A. 3.5x19x15, 25 lbs sh.  
 Used-repairable w/repro book .....\$495- \$395

Prices F.O.B. Lima, O - VISA, MASTERCARD Accepted.  
 Allow for Shipping - Send for '85 Catalog Suppl.  
 Address Dept. HR - Phone: 419/227-6573

**FAIR RADIO SALES**  
 1016 E. EUREKA - Box 1105 - LIMA, OHIO 45802

# TOWERS by ALUMA

**HIGHEST QUALITY ALUMINUM** 40' Alum. Crank-Up Model T-140  
 60 Ft. Alum. Crank-Up Model T-60-H  
 • TELESCOPING (CRANK-UP)  
 • GUYED (STACK-UP)  
 • TILT-OVER MODELS  
**Easy to install. Low Prices. Crank-ups to 100 ft.**

**EXCELLENT FOR AMATEUR COMMUNICATIONS**

**MICROLOG-AIR I**, Air Disk, SWL, Morse Coach  
**KANTRONICS**  
 UTU, Interface II, Challenger  
**EIMAC**  
 3-500Z  
 572B, 6JS6C  
 12BY7A & 4-400A

**AEA 144 MHz**  
**AEA 220 MHz**  
**AEA 440 MHz**  
**ANTENNAS**  
**BIRD** Wattmeters & Elements in Stock

Over 36 types aluminum and steel towers made—specials designed and made—write for details

**SPECIAL Four Section 50 Ft. Van Mounted Crank-Up Aluma Tower**

**ALUMA TOWER CO.**  
 BOX 2806HR  
 VERO BEACH, FLA. 32960-2806  
 (305) 567-3423 TELEX 80-3405

# Barry Electronics Corp.

WE SHIP WORLDWIDE  
 WORLD WIDE AMATEUR RADIO SINCE 1950  
 Your one source for all Radio Equipment!

**Kenwood**  
 R-600, R-1000, R-2000, TS-940/SIAT  
 TS-430S, TR-3600A, TR 7950,  
 TW-4000A. Kenwood Service/Repair.  
 TH21/31/41AT, TM-211A/  
 411A & TS-711A/811A

**COMPU-FIRE EXTINGUISHERS**  
 EXL-5000E RTTY/AMTOR TERMINAL

VoCom/Mirage/Daiwa Tokyo Hy-Power Amplifiers & 5/8" HT Gain Antennas IN STOCK

**KITTY SAYS: WE ARE NOW OPEN 7 DAYS A WEEK. Saturday & Sunday 10 to 5 P.M. Monday-Friday 9 to 6:30 PM. Thurs. to 8 PM. Come to Barry's for the best buys in town.**

**ONV Safety belts-in stock**

**ICOM**  
 IC-R71A, IC-751, IC-745, IC-27A/H, IC-37A, IC-47A, IC-1271A, IC-271A/H, IC-3200A, IC-471 A/H, IC-735

**YAESU**  
 FT-ONE, FT-980, FT-75/GX, FRG-8800  
 FT-276R, FRG-9600, FT-270RH, FT-2700RH  
 YAESU ICOM  
 FT-107/53H IC2AT  
 FT-2709RH IC02AT  
 FT-1003 IC-04AT  
 Land Mobile HT Midland/Standard Wilson Maxon  
 Yaesu F7C 2203, FT 4703  
 Icom IC M12 Marine M700

For the best buys in town call:  
**212-925-7000**  
 Los Precios Mas Bajos en Nueva York

**SMART PATCH**  
 LED Simplex Autopatch 510 2A VFO Plate FM Transceiver To Your Telephone. Great For Single-Line Calls From Mobile To Base. Single To Base. \$39.95

**CELLULAR PHONES STOCKED**

**WELZ**  
 FLUKE 77 Multimeter  
 Nye MBV-A 3 Kilowatt Tuner

**AMERICAN AMPLIFIER AUTHORIZED DEALER**

Yaesu FTR-2410, Wilson ICOM IC-RP 3010 (440 MHz) ICOM IC-RP 1210 (1.2 GHz)

**Computer Interfaces**  
 stocked: MFJ-1224  
 AEA CP-1, PKT-1, DR DX CP-100, ATU, Dr. QSO, Morse University

**ALPHA AMPLIFIERS**  
**Complete Butternut Antenna Inventory In Stock!**

**DIGITAL FREQUENCY COUNTERS**  
 Long range Wireless Telephone for export in stock

**BENCHER PADDLES, BALUNS, AUDIO FILTERS, IN STOCK**

**MIRAGE AMPLIFIERS**  
**ASTRON POWER SUPPLIES**  
 Alnico/Falcon Amps

**HEIL EQUIPMENT IN STOCK**

**DIGITAL FREQUENCY COUNTERS**  
 Long range Wireless Telephone for export in stock

**SANTEC**  
 ST-222A/JP  
 ST-142/JP  
 ST-442/JP  
 HT-7

**MFJ Models**  
 422, 313, 1224 & 941D  
**HAM MasterTapes** - Beta or VHS Tapes

**MURCH** Model 2000 A, ALS, B in stock  
**HAM MasterTapes** - Beta or VHS Tapes

MAIL ALL ORDERS TO BARRY ELECTRONICS CORP., 512 BROADWAY, NEW YORK CITY, NY 10012.

**New York City's LARGEST STOCKING HAM DEALER COMPLETE REPAIR LAB ON PREMISES**

"Aqui Se Habla Espanol!"  
 BARRY INTERNATIONAL TELEX 12-7670  
 MERCHANDISE TAKEN ON CONSIGNMENT FOR TOP PRICES  
 Monday-Friday 9 A.M. to 6:30 P.M. Thursday to 8 P.M.  
 Saturday & Sunday 10 A.M. to 5 P.M. (Free Parking)  
 AUTHORIZED DIST. MGRY DYMEK FOR SHORTWAVE ANTENNAS & RECEIVERS  
 IRITEX® Spring St. Station  
 Subways: BMT - "Prince St. Station"  
 IND - "F Train Bay Station"  
 Bus: Broadway #6 to Spring St.  
 Path - 9th St 66th Ave. Station

We Stock: AEA, ARRL, Alpha, Ameco, Antenna Specialists, Astatic, Astron, B & K, B & W, Bash, Bencher, Bird, Butternut, COE, CES, Collins, Communications Spec, Connectors, Covercraft, Cushcraft, Daiwa, Dentron, Digimax, Drake, ETO (Alpha), Eimac, Encom, Heil Sound, Henry, Hustler (Newtronics), Hy-Gain, Icom, KLM, Kantronics, Larsen, MCM (Daiwa), MFJ, J.W. Miller, Mini-Products, Mirage, Newtronics, Nye Viking, Palomar, RF Products, Radio Amateur Callbook, Robot, Rockwell Collins, Saxton, Shure, Telex, Tempo, Ten Tec, Tokyo Hi Power, Trioxys TUBES, W2AU, Waber, Wilson, Yaesu Ham and Repeaters, Phelps Dodge, Fanon Intercoms, Scanners, Crystals, Radio Publications.

**WE NOW STOCK COMMERCIAL COMMUNICATIONS SYSTEMS**  
 DEALER INQUIRIES INVITED, PHONE IN YOUR ORDER IS BE REIMBURSED

**COMMERCIAL RADIOS STOCKED & serviced on premises.**  
 Amateur Radio Courses Given On Our Premises. Call  
**Export Orders Shipped Immediately. TELEX 12-7670**

GLB products include high quality components and prewound coils. Circuit boards are made from G-10 epoxy and are silk-screened and solder-masked for easy construction.

High performance and affordability are featured throughout the GLB product line. All products carry a 90-day warranty.

Our design capabilities offer cost-effective solutions for special applications from HF to microwave, with production support for large quantities.

Contact us with your requirements—amateur, commercial, and military.

## GLB PRESELECTOR - PREAMP

THE SOLUTION TO MOST INTERFERENCE, INTERMOD & DESENSE PROBLEMS.



### FANTASTIC REJECTION!

Typical rejection:

$\pm 600$  KHz @ 144 Mhz: - 28dB

$\pm 1.6$  Mhz @ 220 Mhz: - 40dB

$\pm 5$  Mhz @ 450 Mhz: - 50db

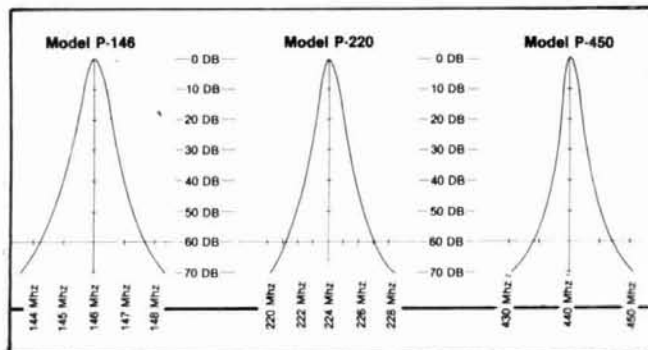

### Typical Selectivity Curves

Bipolar w/RCA jacks \$89.95, Commercial \$109.95  
GaAs fet option (200 Mhz & up) \$20.00

Connector options:

N \$10.00, UHF \$6.00, BNC \$5.00

Custom tuning is available when maximum selectivity is required. Gain is then controlled to 2-3 db.

Special order— \$10.00

- LOW COST
- 40 - 1000 Mhz - tuned to your frequency
- 5 Large Helical Resonators
- LOW noise - HIGH overload resistance
- 8 db Gain - Ultimate Rejection 80 db
- 10 to 15 Volts DC Operation
- 5-10 ma Current Drain
- Cast Aluminum Enclosure
- Small size - 1.6 x 2.6 x 4.75" exc. connectors

### DESIGN OBJECTIVES

The function of a preselector is to provide additional filtering against undesired signals. The design objective in this product line is to achieve the highest possible selectivity with carefully controlled gain. Very sharp selectivity is produced through five helical resonators which can benefit receivers in many instances where intermod and cross-band interferences occur. The "nose" of the selectivity curve is extremely sharp, so the unit must be tuned to the exact frequency used.

Easy installation of our "add on" preselector can be the low-cost cure for problems which until now could only be accomplished by improving the dynamic range of the receiver itself.

Custom units are available on special order. Write or call for quotations.

### GALLIUM ARSENIDE VERSION

Better performance is obtained with GaAs transistors. The higher gain these transistors provide is traded off for still better selectivity. GaAs transistors also offer greater resistance to overload and improved noise figure.



# TOP QUALITY MODULES

## HIGH PERFORMANCE HELICAL FRONT END

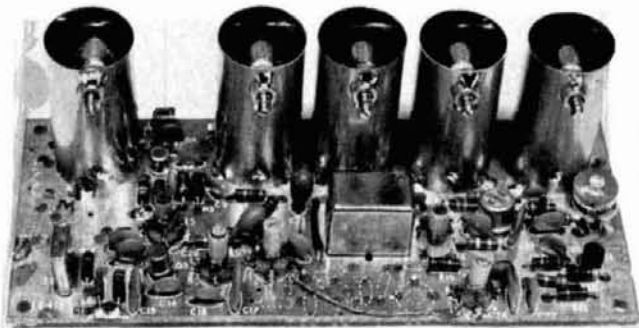

- Designed for any application requiring state-of-the-art performance
- Five large helical resonators
- 8-pole Crystal Filter
- On-board crystal oscillator
- Typical sensitivity: .29 @ 20 db
- Over 100 db adjacent channel rejection
- Image rejection well over 80 db
- Over 105 db dynamic range (no desense below 100,000 uv)
- Front end bandwidth less than 1 Mhz (wider bandwidths available on special order)
- Dimensions - 5.25 x 2.25 x 1.75 inches
- 12V DC operation

Model 415 - 144 to 148 Mhz (pictured) \$139.95  
 Model 415 A - 220 to 225 Mhz \$149.95  
 Model 415 C - Commercial Hi-Band \$179.95  
 \* Now Available - 420 to 1000 Mhz w/GaAs Fet - Call

## UHF TRANSMITTER

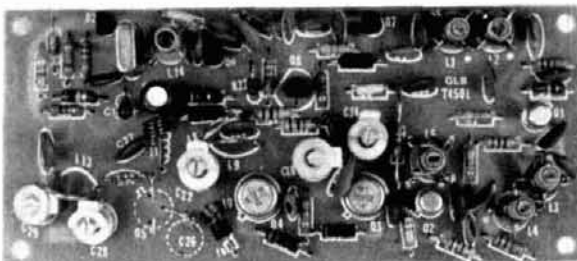
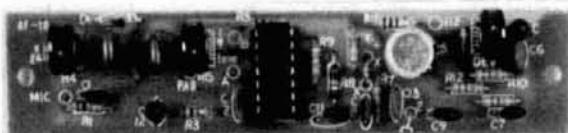

- Direct FM capability or AM for ATV
- On-board crystal oscillator
- Typical output - 2 Watts
- Spurious down 55 db
- 12V DC operation
- On-board keying circuit for push-to-talk
- Includes AF-10 audio processor (see description above)
- Dimensions - 2 x 4.5 x 0.8 inches  
 AF-10 - 1 x 4.5 x 0.8 inches

Model T450L Kit \$59.95  
 Wired/Tested \$99.95  
 Add \$10.00 out of ham band

✓ 285

## 10.7 FM IF/AF



- Fantastic squelch - can be set to open on signals you can't even hear! "Chop" resistant and there is no "pop" when it opens or closes!
- Temperature stable squelch & audio levels
- Hard FM limiting
- 2 Watts of audio output power
- Fully compatible with GLB front ends (or yours)
- 12V DC operation
- Dimensions - 2 x 4.5 x 0.8 inches

Model R107 Kit \$39.95  
 Wired/Tested \$64.95

## AUTOMATIC CW IDENTIFIERS

The alternative to troublesome diode programming  
 Model ID-2 w/2-10 min. interval timer.

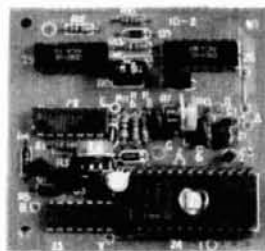
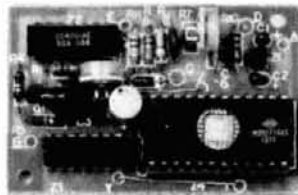

- Enormous capacity - Up to 8 reprogrammable, 2,000 bit messages. (Approx. 2.5 minutes each at 20 WPM!)
- Size: ID-1 2.5 x 1.7 x 0.7" ID-2 2.5 x 2.75 x 0.7"
- Adjustable audio, speed, and interval timer (ID-2). (30 sec. to 1 hr. intervals spec. order)
- Simple installation - +7 to +15 volts, DC
- Automatic operation. Mode 1 - trigger input starts message cycle - terminates at end of message. A "hold" signal is provided to maintain transmission until cycle is completed. Mode 2 - message starts when power is applied - cycles continuously until power goes off. (repeats about every 2.5 min. @ 20 WPM).
- Message switching w/jumper wires. A multi-tap switch or logic gates can be used.

INCLUDE message(s). Print or type with exact spacing, punctuation, etc., clearly.

Model ID-1 \$49.95  
 Model ID-2 \$69.95  
 Wired, tested and programmed

Use Your Wireless Control  
**FROM ANY ROOM!**  
Works with most infrared  
remote control receivers or VCR's.

**XTRA-LINK™**



**SWITCH COMPONENTS  
REMOTELY**

FOR YOUR  
**MRTV™**  
MULTI-ROOM TELEVISION  
SYSTEM



Wholesale and Retail Sales

**800-545-3522**

In Wisconsin 800-362-7212  
(Authorized Video Link™ Distributor)

MERRIMAC

SPACE

VISA

MasterCard

**SATELLITE**

327 Palisade St. Merrimac WI 53561 ✓ 131

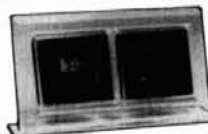

RECEIVE  
THIS LCD  
CALENDAR/  
CLOCK FREE  
WITH YOUR  
SUBSCRIPTION

**WHAT'S REALLY  
HAPPENING  
IN HOME  
SATELLITE  
TV?**

**STV™** THE HOME  
SATELLITE  
TELEVISION  
MAGAZINE™

A monthly of 100-plus pages—has everything you need to know about where to find equipment, how to install it, system performance, legal viewpoints, and industry insights! With your subscription to **STV** you will receive a **FREE LCD Calendar/Clock**.

- Only \$19.95 per year (12 monthly issues)
- \$1.00 for sample copy

**BRAND  
NEW**

**BEAM ANTENNA  
HANDBOOK**

by Bill Orr, W6SAI  
and Stu Cowan, W2LX

Bill Orr and Stu Cowan have completely revised and updated the **Beam Antenna Handbook** to include the very latest information on state-of-the-art antenna design. Accurate, computer generated beam dimensions for the 40, 30, 20, 17, 15, 12, 10 and 6 meter bands and VHF bands are included eliminating the need for time consuming math calculations. Also covered are: Beam height and optimum apex of radiation, how element types and hardware effect perfor-

mance, effect of nearby objects on radiation patterns, feedlines, baluns and matching systems and much more. Ham Radio VHF columnist, W1JR, and noted European VHF'er DL6WO's VHF antenna designs are covered extensively as well as NBS VHF long Yagis. 268 clearly written pages — 204 easy-to-understand illustrations make this the book to buy for beam construction. ©1985, 1st edition.

RP-BA

Softbound \$9.95

Please enclose \$3.50 for shipping and handling.

**ham  
radio** magazine  
GREENVILLE, NH 03048

**BOOKSTORE**

(603) 878-1441

**IF YOU HAVE  
A SATELLITE  
SYSTEM, THEN  
YOU REALLY  
NEED ...**

**OnSat**

The best in satellite programming! Featuring: ★All Scheduled Channels ★Weekly Updated Listings ★Magazine Format ★Complete Movie Listing ★All Sports Specials ★Prime Time Highlights ★Specials Listing and ★Programming Updates!

- Only \$39.00 per year (52 weekly issues)
- 2 Years \$69.00 (104 weekly issues)
- \$1.00 for sample copy

Visa® and MasterCard® accepted (subscription orders only). All prices in US funds. Write for foreign rates.

Send this ad along with your order to:

**STV®/OnSat®**

P.O. Box 2384—Dept. HR • Shelby, NC 28151-2384

**SUBSCRIPTION CALLS ONLY**

**TOLL FREE 1-800-438-2020**



# the weekender



## a simple continuity tester

A United States Navy training manual once described a circuit — affectionately known as the “octopus” — for examining semiconductor junctions, capacitors, and comparing printed circuit boards similar to the circuit shown in **fig. 1**. Through the years, I have run across several other versions of the octopus differing only in the methods of attaching the many wires connecting the instrument to the oscilloscope, power source, and device under test. The octopus is useful in pointing out problem nodes and providing fast go/no-go tests on a variety of components. Oscilloscope patterns obtainable are combinations of those depicted in **fig. 2**.

While ferreting out the cables and cords necessary to hook up a particularly elaborate octopus, it occurred to me that I would not be wasting time looking for a power cord if the octopus were battery powered. After locating the power cable, I determined that elimination of the required oscilloscope would also be necessary because every available oscilloscope was hopelessly buried under other people’s ongoing calibration setups.

### circuit description

As a result of my decision to eliminate both the power cord and the oscilloscope, the circuit shown in **fig. 3** was developed. The circuit illustrates a 555 timer operating as a minimum-parts astable oscillator. The ceramic sounder provides an aural indication of resistance. The diode bridge steers current through the ceramic sounder with the correct polarity, and the dual color LED (light emitting diode) provides a visual indication of current flow and polarity information. The tapped power source provides a node that is negative when the 555 timer is conducting and positive when the timer is not conducting. Current through the LED and the device under test is limited to a nondestructive

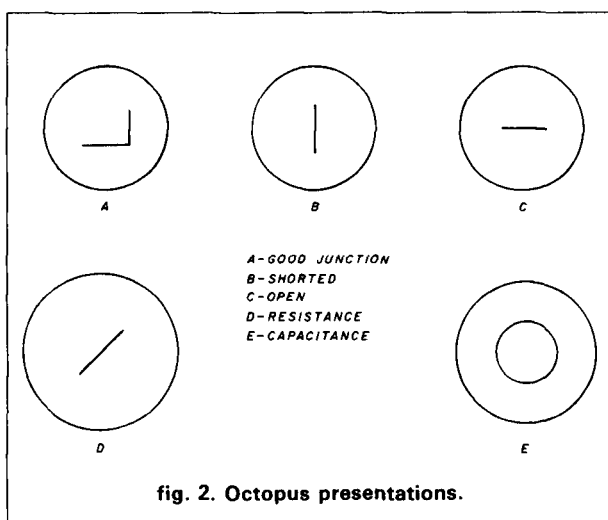
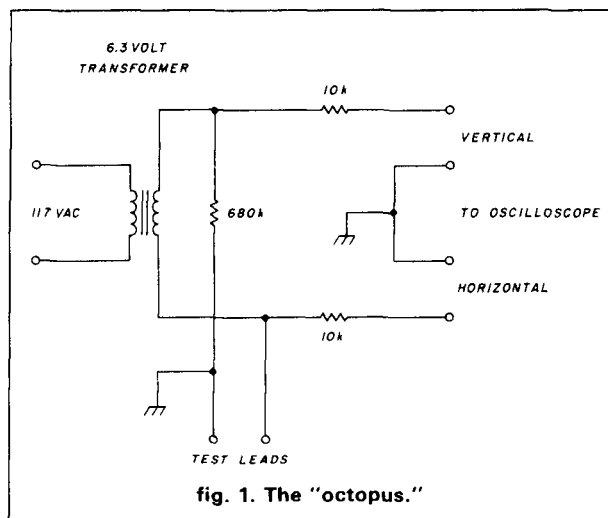

tive value by the internal resistance of the ceramic sounder.

### directions for use

With the junction tester turned on, a *shorted* condition is indicated by a steady tone and by the alternately blinking red and green LED. This condition can be observed by holding the test probes together. The tone should be steady — i.e., there should be no change in volume.

An *open* condition is indicated by silence and the absence of color in the LED. A clicking noise may be heard if the test probes are held close together due to capacitance between the probes.

A good junction is indicated by a beeping sound and either a blinking red or blinking green LED when the test probes are placed across the junction. If the test probes are reversed, the same sound will be heard, but the LED will blink in the opposite color! For ex-

By Robert R. Frahm, WD6GMB, Box E, American Embassy, APO Miami 34002

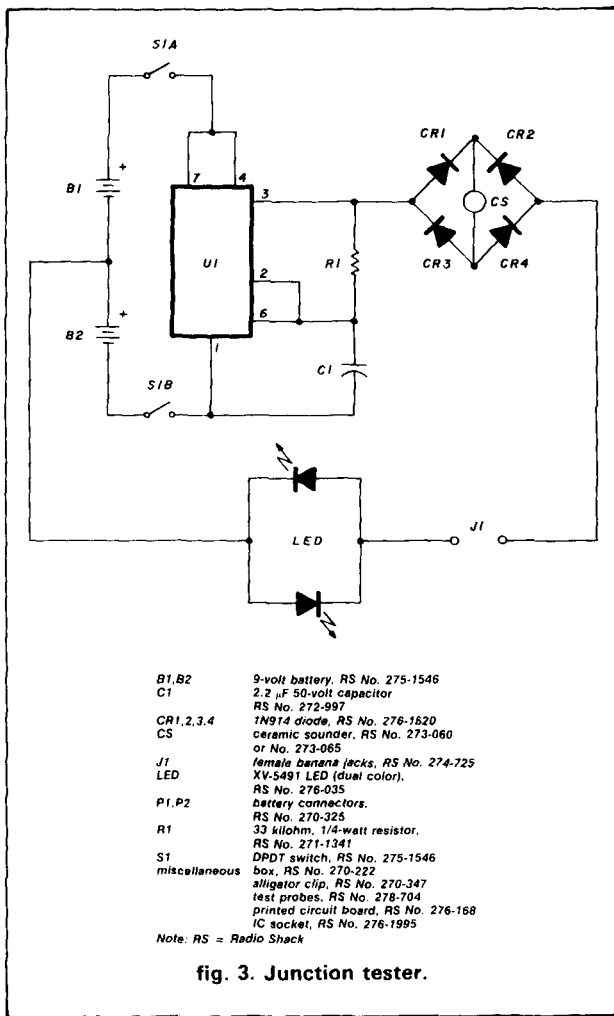

ample, if a beeping sound and blinking red LED indicate a good junction, then a beeping sound and blinking green LED indicate that the test probes are reversed. Take note of this relationship, since it helps to determine the polarity of the junction.

The junction tester may be used both in and out of the circuit (with the power off), but parallel resistances may complicate interpretation of the results. Comparing the results of testing printed circuit boards known to be good can facilitate interpretation of the results of testing boards of unknown status.

Low current pulses (10 Hz at 18 volts peak-to-peak) are available at the test probe tips. These signals are useful when implementing signal or pulse injection techniques.

A slight change in volume while the test probes are shorted may indicate that the batteries are "out-of-balance." This condition may be corrected by interchanging or replacing the batteries. Since the junction tester draws current from the batteries whenever it is turned on, be sure to turn it off after use.

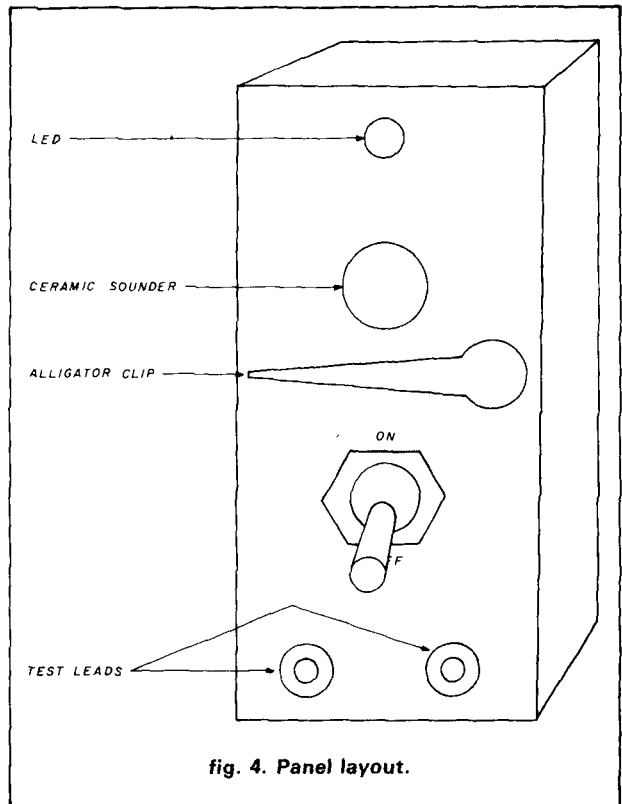

### construction details

Circuit layout is not critical. A socket is recommended for the 555 timer to simplify replacement. The low current (CMOS) 555 timer version is unforgiving of inductive loads and not recommended, particularly on modified junction testers that may include a switch to bypass the ceramic sounder and LED. A suggested panel layout is presented in **fig. 4**. The total cost of parts is about \$20.00 if they're purchased new.

### conclusion

An alligator clip secured to the panel holds a loose transistor, sparing me the bother of chasing the transistor around the bench with the test probes. (Since building the junction tester, I still find myself searching for it because other technicians are always carrying it away.)

I've often found faulty parts while demonstrating the junction tester. Once I used it to "wring out" a problem extender board that had been tested with an ohmmeter, but showed no apparent defects. Using the tester, I found a staked terminal where oxidation had developed between it and the printed circuit, turning the mechanical connection into a diode!

**ham radio**

## MEMO

from the desk of  
THE PUBLISHER

Skip Tenney, W1NLB

The Ham Radio Publishing Group

## IS YOUR HAMSHACK COMPUTERIZED?

The modern home computer, with some priced at less than \$100, is certainly one of the most exciting and challenging new items to be offered to the Radio Amateur in many years. These machines are such a logical extension of our Amateur activities, that it's a wonder that it has taken some of us as long as it has to get involved.

Thousands of hams are using these new machines to do everything from handling their logging and QSLing and as CW, RTTY and ASCII terminals to doing many of their routine station calculations in areas such as antenna and circuit design. Others are now able to do their own propagation forecasting with MUF and greyline programs. It's all mindboggling. We have just begun to see the tip of what is yet to come in the months and years ahead.

Whether you are merely contemplating the purchase of your first computer or you are an experienced user, Ham Radio's Bookstore wants to help you in this important new area. We have selected a number of the more interesting new programs which have been written for Amateur use, along with some excellent books to help you learn more.

Sincerely,

Skip Tenney, W1NLB

ham  
radio magazine

BOOKSTORE

Computer Programs  
for the Amateur RadioNOW WITH  
COMPUTER DISKSCOMPUTER PROGRAMS FOR  
THE RADIO AMATEURby Wayne Overbeck, N6NB, and  
Jim Steffen, KC6A

Here's the first source book of computer programs for the Radio Amateur. Besides covering computer basics, this book gives you programs that will help you log, determine sunrise/sunset times, track the Moon's path across the sky, use Greyline propagation and set up record systems for WAS, DXCC and VUCC, or any other award. You can either buy the book alone or you can buy the book with the programs already on disk. Take full advantage of your computer with this well written source book. ©1984, 1st edition, 327 pages.

## Program Listing

- Data Base Mgmt.**  
Logs, Awards Data Base, Gridlocator
- Latitude/Longitude Programs**  
Data File, Beamheadings, DX Display, Sunrise Chart  
Greyline, DX Checker
- Contest and Duping**  
Dupechecker, General Contest Logger,  
Field Day Logger, Sweepstakes Logger, Log Print
- Antenna Programs**  
Antenna Scaler, Matching Evaluator, Vertical Pattern  
Plotter
- EME**  
EME System Calculator, Sky Locator, Moontracker
- HA-0657 **Softbound \$16.95**
- HA-0657 with program disk **\$29.95**  
specify computer (see list below)
- Program disk alone **\$19.95**

Programs available for: Apple II (DOS and CP/M), IBM (DOS), TRS-80 Model I and Model III and Commodore C-64. Please mark your order with the program disk you want.

By  
Chip Lohman  
NN4U

AMATEUR RADIO COMPUTER SOFTWARE

## ANTENNA DESIGN

This self-prompting program covers dipoles, Yagis, long wires, rhombics, quads, loops, verticals and other antennas. You simply enter the frequency you are designing an antenna for, the antenna you want to make, and the computer will give you all the initial design specifications you need. The results can be stored on disk for permanent retention.

HD-AD (For C-64) **\$39.95**

## CONTEST LOG

This disk contains four different contest programs: ARRL Sweepstakes, Field Day, Universal WW Contest log, plus a dupe checking routine. Each program is designed for real time use. It automatically enters date, time, band and serial number for each contact. A 24-hour clock is displayed at the top of the VDT screen. When the contest is over, the program will print your results listing all duped and scored contacts in serial sequence with all the necessary information as well as completed score at the bottom of the page.

HD-CL (For C-64) **\$24.95**

## SUPER LOG

Super log gives you all the advantages of a computerized data base without significantly changing the traditional log format. For contesters, Super Log can be configured to either manually or automatically enter serial number as well as time of contact. Make an error and you can easily go back and edit the entry. Super Log also allows you to print out either selected contents or the whole log. Will print QSLs. Easy to modify.

HD-SL (For C-64) **\$19.95**

## PROPAGATION CHART

Invaluable addition to any Hamshack. The Propagation Chart allows you to determine the maximum usable frequency (MUF) and the optimum frequency (FOT) between your QTH and any spot on the globe. You can get either a screen display, a printed tabular list over several days, or a printed graph of MUF and FOT. You also get automatic beam headings and distance to the DX station. Covers 160-10 meters and the new WARC bands.

HD-PC (For C-64) **\$16.95**

STAR 1.0  
DESIGN PROGRAM  
by Randall RheaCOMPUTER  
SOFTWARE

STAR, S-parameter Two part Analysis Routine, is a professional engineering program designed to help analyze elec-

tronic circuits. It is particularly helpful in frequency domain analysis of RF and microwave circuits. To use STAR, you input circuit information by component; inductors, resistors, capacitors, transformers, transmission lines, two port data and several two port manipulations. STAR will then give you S-parameter data for each requested frequency in tabular or plot form. You can also use STAR to optimize component values for maximum circuit performance. This program is definitely not for electronic beginners. Engineers and serious hams, however, will find STAR to be an invaluable design tool.

- RR-IBM program for IBM **\$99**
- RR-C-64 program for Commodore C-64 **\$99**
- RR-AP program for Apple II **\$89**
- RR-KP program for KayPro **\$89**

## COMPUTERIZED DX EDGE

Generate your own Greyline display.

NEW  
FASTER  
VERSION

Xantek has adapted their best selling DX Edge to the computer world and it comes at a very reasonable price. This computerized operating aid brings into your ham shack the ability to know and predict when and where DX is going to appear. When you are using the program, the computer will automatically update the information as the sun progresses across the face of the Earth. To make the computerized DX Edge even easier to use, the display is keyed to the DXCC list and the 40 CQ zones. Disk and documentation are just \$34.95. This is something you've GOT to have! ©1985.

XN-C64 (For Commodore C-64) **\$34.95**



## RF NOTES

by John Simmons, W6MDI

Here's an easy way to get answers for often asked electronics questions. RF NOTES contains programs written by broadcast engineers that answer: dB conversion, to convert voltage, current or power levels to dB, dBm conversions, converts voltages or power levels to dBm and dBm to voltage or power; VSWR calculations, calculates VSWR and return loss when both reflected and incident powers are known; Filter design, 14 different filter configurations including schematics (6 low pass, 4 high pass, 2 band pass and 2 band elimination circuits); Basic Microstrip and basic strip line design; and resonant circuits, design parallel and series resonant circuits, PI, capacitive impedance divider and inductive impedance divider. This disk is an invaluable reference for all Radio Amateurs.

**E-RF (IBM PC only) \$59.95**

CONTENDER II LOGGING DATABASE  
(Commodore C-64)

This Commodore C-64 program will meet just about every logging need you can imagine. It can be used as a contest log, general log or dupe checker and can be used for all band WAS, WAZ or DXCC. The storage disk holds up to 2,000 exchanges and can be edited and updated simply and easily. Each entry contains callsign, signal reports,

automatic or manually entered time and date, band and mode as well as name and QTH. Contender will also print QSL's, mail labels and contest dupe sheets. The Contender USA-CA (three disks) is a Worked All County data base that saves time and hassle and a tremendous amount of paperwork.

**CT-C \$34.!**

Basic Contender (C-64) 1 disk

**CT-CUSA \$49.!**

Contender Plus USA-CA (C-64) 3 disks

## RTTY MAILBOX MSO

for Vic 20 and C-64 Computers

Here's a super user friendly software package that turns Commodore home computer into a powerful, easy-to-use message handling system. Messages can be stored, read or deleted by either incoming RTTY signals or by using the computer's keyboard. Each message is listed in a directory by file name, along with date and time of message initiation. The Basic/Assembly language software combines high speed with user friendly features and fully controls your transmitter and receiver with automatic identification, an optional special message and automatic transmission of date and time during MSO use. You can also use this program to operate direct RTTY and 60, 67, 75 or 100 wpm Baudot or 110 baud ASCII. Vic 20 needs 24k of memory use this program.

**VC-CP Use with AEA CP1 interface & equiv. \$79.**

**VC-MF Use with MFJ interface & equiv. \$79.**

**VC-KT Use with Kantronics interface & equiv. \$89.**

AMPRO SOFTWARE  
FOR THE IBM PC

Edited by E.B. Rough, KB3GX

Programming by Ron Nord, N3AKP

These four programs have been written with the Active Amateur in mind and are designed to greatly simplify record keeping chores. You simply enter basic QSO data, call, prefix, country, state, or zone, date, RST and mode. The program then adds the contact to the disk data base. You can review your current status of stations worked, confirmed or verified at a glance. You can also print up "wish list" to give to your friends who are helping you find those missing stations. The DXCC and 5 band DXCC lists are current through January 1, 1985 and can be updated should any new countries be added. These programs are a great value at a good price and represent a major time saver.

**AMP-DXCC (IBM PC only) \$29.**

**AMP-5CC (IBM PC only) \$29.**

**AMP-WAZ (IBM PC only) \$29.**

**AMP-WAS (IBM PC only) \$29.**

**ARRL Worked All States**

# NOW HAS COMPUTER BOOKS AND SOFTWARE

## COMMODORE 64 USER'S GUIDE by Commodore Engineers

This beginner's book gives you hands-on instructions on how to set up and use your brand new C-64 computer. Learn how to do color animation, generate music or specialized sound effects and interface the computer with peripheral equipment. Just about every question a beginner could ask is answered in this useful text. ©1982, 166 pages.  
 122010 **Softbound \$12.95**

## COMMODORE 64 PROGRAMMER'S REFERENCE GUIDE

This programmer's guide will give you all the handy hints and tips that will let you get full value from your C-64. For the beginner, complicated topics are taken step-by-step, with plenty of sample programs and complete detailed explanations. Advanced users will find plenty of pretested and debugged programs. 1st edition, 486 pages.  
 122056 **Softbound \$19.95**

## COMMODORE C-64 STARTER BOOK by Jan and Christopher Titus and David Larsen

This book is designed to get the new C-64 owner up and running with the minimum of fuss and hassle. Each chapter is packed with experiments and exercises designed to build competence in the user. Full of simple to load and use programs written with the beginner's need in mind. ©1984, 384 pages.  
 122293 **Softbound \$17.95**

## REPAIR AND TROUBLESHOOTING GUIDES C-64, IBM-PC AND APPLE II by Robert C. Brenner

If you've been taking care of your ham gear, there's certainly no reason why you can't do much of your own microcomputer servicing. These handy guides give you a real headstart in taking on your "micro" when problems arise. Troubleshooting is clearly illustrated by simple flow charts that are designed to pinpoint failures and correct them. There is also an Advanced Troubleshooting chapter for more complicated systems failures. Clear easy-to-read text and plenty of illustrations.  
 122363 Commodore C-64 ©1985 **\$18.95**  
 122353 Apple II Plus/IIe ©1984 **\$19.95**  
 122358 IBM-PC ©1985 **\$18.95**

## CIRCUIT DESIGN PROGRAMS FOR THE APPLE II by Howard Berlin, W3HB

Use your Apple to help design electronic circuits. This book is a series of engineering programs written in Applesoft that give you various "what happens if" and "what's needed when" as they apply to a number of engineering questions. By using the computer you can change various circuit components and tell exactly how the circuit will perform without going through extensive manual calculations. ©1982, 132 pages.  
 121863 **Softbound \$15.95**

## APPLE IIe PROGRAMMER'S GUIDE by David Heigerman

This book zeros in on how to program the popular Apple IIe home computer in both BASIC and assembly language. Chock full of helpful facts, applications, ideas, suggestions and technical information in one simple easy-to-use reference manual. You also get a number of short application and demonstration programs in BASIC and assembly language. ©1984, 416 pages.  
 122299 **Softbound \$19.95**

## APPLE PROGRAMMER'S HANDBOOK by Paul Irwin

Get the most of your Apple computer by learning assembly language programming. Assembly language programs run *much faster* than basic programs and can be designed for maximum effectiveness with minimum compromise. Plenty of stock routines are included, organized by topic and detailed memory map. This 408-page book will answer just about all your questions on assembly language programming. ©1984, 480 pages.  
 122175 **Softbound \$22.95**

**SPECIAL PRICE**  
**COMPUTER DICTIONARY AND HANDBOOK**  
 by Sippl

More than 22,000 definitions, acronyms, and abbreviations as well as 14 information packed appendixes make this an invaluable reference book for all levels of computer users. Operational control, storage devices, and time sharing are just a few of the subjects extensively covered in this important volume. ©1980, 928 pages.  
 21632 **SAVE \$5 Softbound \$29.95**

## VIC 20 PROGRAMMER'S REFERENCE GUIDE

To get the Vic to perform for you, you have to know how to program. The book is divided into four sections: BASIC Programming, Machine Language Programming, Input/Output Interfacing and Programming Graphics and Sound. Each chapter is fully illustrated with sample programs and has plenty of "how to" explanations. 1st edition, ©1982, 289 pages.  
 21948 **Softbound \$16.95**

## THE 68000 PRINCIPLES AND PROGRAMMING by Leo Scanlon

Motorola's 68000 is the first 16 bit  $\mu$ p to have a 32 bit internal architecture. This book covers CPU information that is needed for all microcomputer professionals and hobbyists alike. Also includes information on Motorola's cross-macro assembler, a 68000 instruction set, printouts and interfacing. ©1981, 240 pages.  
 121853 **Softbound \$15.95**

## Z-80 MICROPROCESSOR PROGRAMMING AND INTERFACING by Nichols and Rony

This is the easy way for novices and experts to learn how to write and design programs for the popular Z-80 microprocessor. This book focuses on fundamentals and use of the Z-80. ©1979.  
 121609 **Softbound \$12.95**

## MICRO COOKBOOK Vol. 1 and 2 by Don Lancaster

Learning to use a PC can be a real challenge. However, Don Lancaster has tried to filter out all the gobbledygook and make it as easy as can be. Volume 1 features down-to-earth coverage of fundamentals, number systems, hardware and software logic, mainstream codes and standards, electronic memory and memory devices and other applications. Volume 2 covers address space, addressing, system architecture, machine code programming, I/O and helpful suggestions to common problems.  
 21828 Volume 1 ©1982 **\$15.95**  
 21829 Volume 2 ©1983 **\$15.95**  
 Buy BOTH Special **\$26.95**  
**SAVE \$4.95**

## ORDER FORM

Name \_\_\_\_\_  
 Address \_\_\_\_\_  
 City \_\_\_\_\_ State \_\_\_\_\_ Zip \_\_\_\_\_  
 Check or Money Order Enclosed  
 VISA  MasterCard  
 Card # \_\_\_\_\_ Expires \_\_\_\_\_

Catalog #	Title	QTY.	Price	Total

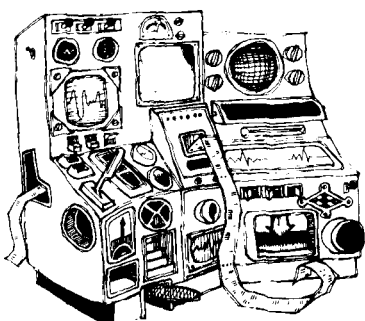

Subtotal	
Shipping	\$350
<b>TOTAL</b>	

# TUBES

TYPE	PRICE	TYPE	PRICE	TYPE	PRICE
2C39/7289	\$ 34.00	1182/4600A	\$500.00	ML7815AL	\$ 60.00
2E26	7.95	4600A	500.00	7843	107.00
2K28	200.00	4624	310.00	7854	130.00
3-500Z	102.00	4657	84.00	ML7855KAL	125.00
3-1000Z/8164	400.00	4662	100.00	7984	14.95
3B28/866A	9.50	4665	500.00	8072	84.00
3CX400U7/8961	255.00	4687	P.O.R.	8106	5.00
3CX1000A7/8283	526.00	5675	42.00	8117A	225.00
3CX3000F1/8239	567.00	5721	250.00	8121	110.00
3CW30000H7	1700.00	5768	125.00	8122	110.00
3X2500A3	473.00	5819	119.00	8134	470.00
3X3000F1	567.00	5836	232.50	8156	12.00
4-65A/8165	69.00	5837	232.50	8233	60.00
4-125A/4D21	79.00	5861	140.00	8236	35.00
4-250A/5D22	98.00	5867A	185.00	8295/PL172	500.00
4-400A/8438	98.00	5868/AX9902	270.00	8458	35.00
4-400B/7527	110.00	5876/A	42.00	8462	130.00
4-400C/6775	110.00	5881/6L6	8.00	8505A	95.00
4-1000A/8166	444.00	5893	60.00	8533W	136.00
4CX250B/7203	54.00	5894/A	54.00	8560/A	75.00
4CX250FG/8621	75.00	5894B/8737	54.00	8560AS	100.00
4CX250K/8245	125.00	5946	395.00	8608	38.00
4CX250R/7580W	90.00	6083/AZ9909	95.00	8624	100.00
4CX300A/8167	170.00	6146/6146A	8.50	8637	70.00
4CX350A/8321	110.00	6146B/8298	10.50	8643	83.00
4CX350F/8322	115.00	6146W/7212	17.95	8647	168.00
4CX350FJ/8904	140.00	6156	110.00	8683	95.00
4CX600J/8809	835.00	6159	13.85	8877	465.00
4CX1000A/8168	242.50*	6159B	23.50	8908	13.00
4CX1000A/8168	485.00	6161	325.00	8950	13.00
4CX1500B/8660	555.00	6280	42.50	8930	137.00
4CX5000A/8170	1100.00	6291	180.00	6L6 Metal	25.00
4CX10000D/8171	1255.00	6293	24.00	6L6GC	5.03
4CX15000A/8281	1500.00	6326	P.O.R.	6CA7/EL34	5.38
4CW800F	710.00	6360/A	5.75	6CL6	3.50
4D32	240.00	6399	540.00	6DJ8	2.50
4E27A/5-125B	240.00	6550A	10.00	6DQ5	6.58
4PR60A	200.00	6883B/8032A/8552	10.00	6GF5	5.85
4PR60B	345.00	6897	160.00	6GJ5A	6.20
4PR65A/8187	175.00	6907	79.00	6GK6	6.00
4PR1000A/8189	590.00	6922/6DJ8	5.00	6HB5	6.00
4X150A/7034	60.00	6939	22.00	6HF5	8.73
4X150D/7609	95.00	7094	250.00	6JG6A	6.28
4X250B	45.00	7117	38.50	6JM6	6.00
4X250F	45.00	7203	P.O.R.	6JN6	6.00
4X500A	412.00	7211	100.00	6JS6C	7.25
5CX1500A	660.00	7213	300.00*	6KN6	5.05
KT88	27.50	7214	300.00*	6KD6	8.25
416B	45.00	7271	135.00	6LF6	7.00
416C	62.50	7289/2C39	34.00	6LQ6 G.E.	7.00
572B/T160L	49.95	7325	P.O.R.	6LQ6/6MJ6 Sylvania	9.00
592/3-200A3	211.00	7360	13.50	6ME6	8.90
807	8.50	7377	85.00	12AT7	3.50
811A	15.00	7408	2.50	12AX7	3.00
812A	29.00	7609	95.00	12BY7	5.00
813	50.00	7735	36.00	12JB6A	6.50

NOTE \* = USED TUBE

NOTE P.O.R. = PRICE ON REQUEST

"ALL PARTS MAY BE NEW, USED, OR SURPLUS. PARTS MAY BE SUBSTITUTED WITH COMPARABLE PARTS IF WE ARE OUT OF STOCK OF AN ITEM.

NOTICE: ALL PRICES ARE SUBJECT TO CHANGE WITHOUT NOTICE.

For information call: 602-265-0731

**Toll Free Number**  
**800-528-0180**  
**(For orders only)**

"All parts may be new or surplus, and parts may be substituted with comparable parts if we are out of stock of an item."

## MHz electronics

3802 North 27th Ave., Phoenix, AZ 85017

PRICES SUBJECT TO CHANGE WITHOUT NOTICE



# "FILTERS"

## COLLINS Mechanical Filter #526-9724-010 MODEL F455Z32F

455KHZ at 3.2KHz wide. May be other models but equivalent. May be used or new, \$15.99

## ATLAS Crystal Filters

5.595-2.7/8/LSB, 5.595-2.7/USB	
8 pole 2.7KHz wide Upper sideband. Impedance 800ohms 15pf In/800ohms 0pf out.	19.99
5.595-2.7/8/U, 5.595-2.7/USB	
8 pole 2.7KHz wide Upper sideband. Impedance 800ohms 15pf In/800ohms 0pf out.	19.99
5.595-.500/4, 5.595-.500/4/CW	
4 pole 500 cycles wide CW. Impedance 800ohms 15pf In/800ohms 0pf out.	19.99
9.0USB/CW	
6 pole 2.7KHz wide at 6dB. Impedance 680ohms 7pf In/300ohms 8pf out. CW-1599Hz	19.99

## KOKUSAI ELECTRIC CO. Mechanical Filter #MF-455-ZL/ZU-21H

455KHz at Center Frequency of 453.5KC. Carrier Frequency of 455KHz 2.36KC Bandwidth.  
 Upper sideband. (ZU) 19.99  
 Lower sideband. (ZL) 19.99

## CRYSTAL FILTERS

NIKKO	FX-07800C	7.8MHz	\$10.00
TEW	FEC-103-2	10.6935MHz	10.00
SDK	SCH-113A	11.2735MHz	10.00
TAMA	TF-31H250	CF 3179.3KHz	19.99
TYCO/CD	001019880	10.7MHz 2pole 15KHz bandwidth	5.00
MOTOROLA	4884863B01	11.7MHz 2pole 15KHz bandwidth	5.00
PTI	5350C	12MHz 2pole 15KHz bandwidth	5.00
PTI	5426C	21.4MHz 2pole 15KHz bandwidth	5.00
PTI	1479	10.7MHz 8pole bandwidth 7.5KHz at 3dB, 5KHz at 6dB	20.00
COMTECH	A10300	45MHz 2pole 15KHz bandwidth	6.00
FRC	ERXF-15700	20.6MHz 36KHz wide	10.00
FILTECH	2131	CF 7.825MHz	10.00

## CERAMIC FILTERS

AXEL	4F449	12.6KC Bandpass Filter 3dB bandwidth 1.6KHz from 11.8-13.4KHz	10.00
CLEVITE	TO-01A	455KHz+2KHz bandwidth 4-7% at 3dB	5.00
	TCF4-12D36A	455KHz+1KHz bandwidth 6dB min 12KHz, 60dB max 36KHz	10.00
MURATA	BFB455B	455KHz	2.50
	BFB455L	455KHz	3.50
	CFM455E	455KHz +-5.5KHz at 3dB, +-8KHz at 6dB, +-16KHz at 50dB	6.65
	CFM455D	455KHz +-7KHz at 3dB, +-10KHz at 6dB, +-20KHz at 50dB	6.65
	CFR455E	455KHz +-5.5KHz at 3dB, +-8KHz at 6dB, +-16KHz at 60dB	8.00
	CFU455B	455KHz +-2KHz bandwidth +-15KHz at 6dB, +-30KHz at 40dB	2.90
	CFU455C	455KHz +-2KHz bandwidth +-12.5KHz at 6dB, +-24KHz at 40dB	2.90
	CFU455G	455KHz +-1KHz bandwidth +-4.5KHz at 6dB, +-10KHz at 40dB	2.90
	CFU455H	455KHz +-1KHz bandwidth +-3KHz at 6dB, +-9KHz at 40dB	2.90
	CFU455I	455KHz +-1KHz bandwidth +-2KHz at 6dB, +-6KHz at 40dB	2.90
	CFW455D	455KHz +-10KHz at 6dB, +-20KHz at 40dB	2.90
	CFW455H	455KHz +-3KHz at 6dB, +-9KHz at 40dB	2.90
	SFB455D	455KHz	2.50
	SFD455D	455KHz +-2KHz, 3dB bandwidth 4.5KHz +-1KHz	5.00
	SFE10.7MA	10.7MHz 280KHz +-50KHz at 3dB, 650KHz at 20dB	2.50
	SFE10.7MS	10.7MHz 230KHz +-50KHz at 3dB, 570KHz at 20dB	2.50
	SFG10.7MA	10.7MHz	10.00
NIPPON	LF-B4/CFU455I	455KHz +-1KHz	2.90
	LF-B6/CFU455H	455KHz +-1KHz	2.90
	LF-B8	455KHz	2.90
	LF-C18	455KHz	10.00
TOKIN	CF455A/BFU455K	455KHz +-2KHz	5.00
MATSUSHIRA	EFC-L455K	455KHz	7.00

## SPECTRA PHYSICS INC. Model 088 HeNe LASER TUBES

POWER OUTPUT 1.6MW, BEAM DIA. .75MM, BEAM DIR. 2.7MR, 8KV STARTING VOLTAGE DC  
 68K OHM 1WATT BALLAST, 1000VDC +-100VDC, At 3.7MA, \$59.99

## ROTRON MUFFIN FANS Model MARK4/MU2A1

115 VAC 14WATTS 50/60CPS IMPEDENCE PROTECTED-F 88CFM at 50CPS \$ 7.99  
 105CFM at 60CPS THESE ARE NEW

# MHz electronics

**Toll Free Number**  
**800-528-0180**  
**(For orders only)**

"All parts may be new or surplus, and parts may be substituted with comparable parts if we are out of stock of an item."

3802 North 27th Ave., Phoenix, AZ 85017

PRICES SUBJECT TO CHANGE WITHOUT NOTICE For information call: 602-265-0731

# RF TRANSISTORS

TYPE	PRICE	TYPE	PRICE	TYPE	PRICE	TYPE	PRICE
2N1561	\$25.00	2N5920	\$ 70.00	40608 RCA	\$ 2.48	BFY90	\$ 1.50
2N1562	25.00	2N5921	80.00	40673 RCA	2.50	BLW60C5	15.00
2N1692	25.00	2N5922	10.00	40894 RCA	1.00	BLX67	12.25
2N2857	1.55	2N5923	25.00	60247 RCA	25.00	BLX67C3	12.25
2N2857JAN	4.10	2N5941	23.00	61206 RCA	100.00	BLX93C3	22.21
2N2857JANTX	4.50	2N5942	40.00	62800A RCA	60.00	BLY87A	7.50
2N2876	13.50	2N5944	10.35	62803 RCA	100.00	BLY88C3	13.08
2N2947	18.35	2N5945	10.00	430414/3990RCA	50.00	BLY89C	13.00
2N2948	13.00	2N5946	12.00	3457159 RCA	20.00	BLY90	45.00
2N2949	15.50	2N5947	9.20	3729685-2 RCA	75.00	BLY92	13.30
2N3118	5.00	2N6080	6.00	3729701-2 RCA	50.00	BLY94C	45.00
2N3119	4.00	2N6081	7.00	3753883 RCA	50.00	BLY351	10.00
2N3134	1.15	2N6082	9.00	615467-902	25.00	BLY568C/CF	30.00
2N3287	4.90	2N6083	9.50	615467-903	40.00	C2M70-28R	92.70
2N3288	4.40	2N6084	12.00	2SC568	2.50	C25-28	57.00
2N3309	4.85	2N6094	11.00	2SC703	36.00	C4005	2.50
2N3375	17.10	2N6095	12.00	2SC756A	7.50	CD1659	20.00
2N3478	2.13	2N6096	16.10	2SC781	2.80	CD1899	20.00
2N3553	1.55	2N6097	20.70	2SC1018	1.00	CD1920	10.00
2N3553JAN	2.90	2N6105	21.00	2SC1042	24.00	CD2188	18.00
2N3632	15.50	2N6136	21.85	2SC1070	2.50	CD2545	24.00
2N3733	11.00	2N6166	40.24	2SC1216	2.50	CD2664A	16.00
2N3818	5.00	2N6267	142.00	2SC1239	2.50	CD3167	92.70
2N3866	1.30	2N6304	1.50	2SC1251	24.00	CD3353	95.00
2N3866JAN	2.20	2N6368	30.00	2SC1306	2.90	CD3435	26.30
2N3866JANTX	3.80	2N6439	55.31	2SC1307	5.50	CD3900	152.95
2N3866JANTXV	4.70	2N6459	18.00	2SC1424	2.80	CM25-12	20.00
2N3866AJANTXV	5.30	2N6567	10.06	2SC1600	5.00	CM40-12	27.90
2N3924	3.35	2N6603	13.50	2SC1678	2.00	CM40-28	56.90
2N3926	16.10	2N6604	13.50	2SC1729	32.40	CME50-12	30.00
2N3927	17.25	2N6679	44.00	2SC1760	1.50	CTC2001	42.00
2N3948	1.75	2N6680	80.00	2SC1909	4.00	CTC2005	55.00
2N3950	25.00	021-1	15.00	2SC1945	10.00	CTC3005	70.00
2N3959	3.85	01-80703T4	65.00	2SC1946	40.00	CTC3460	20.00
2N4012	11.00	35C05	15.00	2SC1947	10.00	DV2820S	25.00
2N4037	2.00	102-1	28.00	2SC1970	2.50	DXL1003P70	22.00
2N4041	14.00	103-1	28.00	2SC1974	4.00	DXL2001P70	19.00
2N4072	1.80	103-2	28.00	2SC2166	5.50	DXL2002P70	14.00
2N4080	4.53	104P1	18.00	2SC2237	32.00	DXL3501AP100F	47.00
2N4127	21.00	163P1	10.00	2SC2695	47.00	EFJ4015	12.00
2N4416	2.25	181-3	15.00	A2X1698	POR	EFJ4017	24.00
2N4427	1.25	210-2	10.00	A3-12	14.45	EFJ4021	24.00
2N4428	1.85	269-1	18.00	A50-12	24.00	EFJ4026	35.00
2N4430	11.80	281-1	15.00	A209	10.00	EN15745	20.00
2N4927	3.90	282-1	30.00	A283	6.00	FJ9540	16.00
2N4957	3.45	482	7.50	A283B	6.00	FSX52WF	58.00
2N4959	2.30	564-1	25.00	A1610	19.00	G65739	25.00
2N5016	18.40	698-3	15.00	AF102	2.50	G65386	25.00
2N5026	15.00	703-1	15.00	AFY12	2.50	GMO290A	2.50
2N5070	18.40	704	4.00	AR7115	20.00	HEP76	4.95
2N5090	13.80	709-2	11.00	AT41435-5	6.35	HEPS3002	11.40
2N5108	3.45	711	4.00	B2-8Z	10.70	HEPS3003	30.00
2N5109	1.70	733-2	15.00	B3-12	10.85	HEPS3005	10.00
2N5160	3.45	798-2	25.00	B12-12	15.70	HEPS3006	19.90
2N5177	21.62	3421	28.00	BAL0204125	152.95	HEPS3007	25.00
2N5179	1.04	3683P1	15.00	BF25-35	56.25	HEPS3010	11.34
2N5216	56.00	3992	25.00	B40-12	19.25	HP8003	10.00
2N5470	75.00	4164P1	15.00	B70-12	55.00	HFET2204	112.00
2N5583	3.45	4243P1	28.00	BF272A	2.50	HP35821	38.00
2N5589	9.77	4340P3	18.00	BFQ85	2.50	HP35826B	32.00
2N5590	10.92	4387P1	27.50	BFR21	2.50	HP35826E	32.00
2N5591	13.80	7104-1	28.00	BFR90	1.00	HP35831E	30.00
2N5596	99.00	7249-2	10.50	BFR91	1.65	HP35832E	50.00
2N5636	12.00	7283-1	37.50	BFR99	2.50	HP35833E	50.00
2N5637	15.50	7536-1	30.00	BFT12	2.50	HP35859E	75.00
2N5641	12.42	7794-1	10.50	BFW16A	2.50	HP35866E	44.00
2N5642	14.03	7795	15.00	BFW17	2.50	HXTR2101	44.00
2N5643	25.50	7795-1	15.00	BFW92	1.50	HXTR3101	7.00
2N5645	13.80	7796-1	24.00	BFX44	2.50	HXTR5101	31.00
2N5646	20.70	7797-1	36.00	BFX48	2.50	HXTR6104	68.00
2N5651	11.05	40081 RCA	5.00	BFX65	2.50	HXTR6105	31.00
2N5691	18.00	40279 RCA	10.00	BFX84	2.50	HXTR6106	33.00
2N5764	27.00	40280 RCA	4.62	BFX85	2.50	J310	1.00
2N5836	3.45	40281 RCA	10.00	BFX86	2.50	JO2000	10.00
2N5842	8.45	40282 RCA	20.00	BFX89	1.00	JO2001	25.00
2N5847	19.90	40290 RCA	2.80	BFY11	2.50	JO4045	24.00
2N5849	20.00	40292 RCA	13.05	BFY18	2.50	KD5522	25.00
2N5913	3.25	40294 RCA	2.50	BFY19	2.50	KJ5522	25.00
2N5916	36.00	40341 RCA	21.00	BFY39	2.50	M1106	13.75

**Toll Free Number**  
**800-528-0180**  
**(For orders only)**

"All parts may be new or surplus, and parts may be substituted with comparable parts if we are out of stock of an item."  
For information call: 602-265-0731

PRICES SUBJECT TO CHANGE WITHOUT NOTICE

**MHz electronics**

3802 North 27th Ave., Phoenix, AZ 85017

## RF TRANSISTORS (CONTINUED)

M1107	\$16.75	MRF458	\$20.70	NEO2160ER	\$100.00	SD1009	\$15.00
M1131	5.15	MRF464	25.30	NEO21350	5.30	SD1009-2	15.00
M1132	7.25	MRF466	18.97	NE13783	61.00	SD1012	10.00
M1134	13.40	MRF472	1.50	NE21889	43.00	SD1012-3	10.00
M9116	29.10	MRF475	3.10	NE57835	5.70	SD1012-5	10.00
M9579	6.00	MRF476	3.16	NE64360ER-A	100.00	SD1013	10.00
M9580	7.95	MRF477	20.00	NE64480 (B)	94.00	SD1013-3	10.00
M9587	7.00	MRF479	8.05	NE73436	2.50	SD1013-7	10.00
M9588	5.20	MRF492	23.00	NE77362ER	100.00	SD1016	15.00
M9622	5.95	MRF502	1.04	NE98260ER	100.00	SD1016-5	15.00
M9623	7.95	MRF503	6.00	PRT8637	25.00	SD1018-4	13.00
M9624	9.95	MRF504	7.00	PT3127A	5.00	SD1018-6	13.00
M9625	15.95	MRF509	5.00	PT3127B	5.00	SD1018-7	13.00
M9630	14.00	MRF511	10.69	PT3127C	20.00	SD1018-15	13.00
M9740	27.90	MRF515	2.00	PT3127D	20.00	SD1020-5	10.00
M9741	27.90	MRF517	2.00	PT3127E	20.00	SD1028	15.00
M9755	16.00	MRF525	3.45	PT3190	20.00	SD1030	12.00
M9780	5.50	MRF559	1.76	PT3194	20.00	SD1030-2	12.00
M9827	11.00	MRF587	11.00	PT3195	20.00	SD1040	5.00
M9848	35.00	MRF605	20.00	PT3537	7.80	SD1040-2	20.00
M9850	13.50	MRF618	25.00	PT4166E	20.00	SD1040-4	10.00
M9851	20.00	MRF626	12.00	PT4176D	25.00	SD1040-6	5.00
M9860	8.25	MRF628	8.65	PT4186B	5.00	SD1043	12.00
M9887	2.80	MRF629	3.45	PT4209	25.00	SD1043-1	10.00
M9908	6.95	MRF641	25.30	PT4209C/5645	25.00	SD1045	3.75
M9965	12.00	MRF644	27.60	PT4556	24.60	SD1049-1	2.00
MM1500	25.00	MRF646	29.90	PT4570	7.50	SD1053	4.00
MM1550	10.00	MRF648	33.35	PT4577	20.00	SD1057	10.00
MM1552	50.00	MRF816	15.00	PT4590	5.00	SD1065	4.75
MM1553	50.00	MRF823	20.00	PT4612	20.00	SD1068	15.00
MM1607	8.45	MRF846	44.85	PT4628	20.00	SD1074-2	18.00
MM1614	10.00	MRF892	35.50	PT4640	20.00	SD1074-4	28.00
MM1810	15.00	MRF894	46.00	PT4642	20.00	SD1074-5	28.00
MM1810	15.00	MRF901 3 Lead	1.00	PT5632	4.70	SD1076	18.50
MM1943	1.80	MRF901 4 Lead	2.00	PT5749	25.00	SD1077	4.00
MM2608	5.00	MRF902/2N6603JAN	15.00	PT6612	25.00	SD1077-4	4.00
MM3375A	17.10	MRF902B	18.40	PT6619	20.00	SD1077-6	4.00
MM4429	10.00	MRF904	2.30	PT6708	25.00	SD1078-6	24.00
MM8000	1.15	MRF905	2.55	PT6709	25.00	SD1080-7	7.50
MM8006	2.30	MRF911	2.50	PT6720	25.00	SD1080-8	6.00
MM8011	25.00	MRF965	2.55	PT8510	15.00	SD1080-9	3.00
MPSU31	1.01	MRF966	3.55	PT8524	25.00	SD1084	8.00
MRA2023-1.5	42.50	MRF1000MA	32.77	PT8609	25.00	SD1087	15.00
MRF134	10.50	MRF1004M	31.05	PT8633	25.00	SD1088	22.00
MRF136	16.00	MRF2001	41.74	PT8639	25.00	SD1088-8	22.00
MRF171	35.00	MRF2005	54.97	PT8659	25.00	SD1089-5	15.00
MRF208	11.50	MRF5176	24.00	PT8679	25.00	SD1090	15.00
MRF212	16.10	MRF8004	2.10	PT8708	20.00	SD1094	15.00
MRF221	10.00	MSC1720-12	225.00	PT8709	20.00	SD1095	15.00
MRF223	13.00	MSC1821-3	125.00	PT8727	29.00	SD1098-1	30.00
MRF224	13.50	MSC1821-10	225.00	PT8731	25.00	SD1100	5.00
MRF227	3.45	MSC2001	30.00	PT8742	19.10	SD1109	18.00
MRF230	2.00	MSC2010	93.00	PT8787	25.00	SD1115-2	7.50
MRF231	10.00	MSC2223-10	245.00	PT8828	25.00	SD1115-3	7.50
MRF232	12.07	MSC2302	POR	PT9700	25.00	SD1115-7	2.10
MRF237	3.15	MSC3000	35.00	PT9702	25.00	SD1116	5.00
MRF238	13.80	MSC3001	38.00	PT9783	16.50	SD1118	22.00
MRF239	17.25	MSC72002	POR	PT9784	32.70	SD1119	5.00
MRF245	35.65	MSC73001	POR	PT9790	56.00	SD1124	50.00
MRF247	31.00	MSC80064	35.00	PT31083	20.00	SD1132-1	15.00
MRF304	36.00	MSC80091	10.00	PT31962	20.00	SD1132-4	12.00
MRF306	50.00	MSC80099	3.00	PTX6680	20.00	SD1133	9.50
MRF313	11.15	MSC80593	POR	RE3754	25.00	SD1133-1	10.00
MRF314	29.21	MSC80758	POR	RE3789	25.00	SD1134-1	2.50
MRF315	28.86	MSC82001	33.00	RF35	16.00	SD1134-4	12.00
MRF316	55.43	MSC82014	33.00	RF85	17.50	SD1134-17	12.00
MRF317	63.94	MSC82020M	130.00	RF110	21.00	SD1135	10.25
MRF412	18.00	MSC82030	33.00	S50-12	23.80	SD1135-3	12.00
MRF420	20.12	MSC83001	40.00	S3006	15.00	SD1136	12.50
MRF421	25.00	MSC83003	82.00	S3007	10.00	SD1136-2	12.50
MRF422	38.00	MSC83005	70.00	S3031	22.00	SD1143-1	10.00
MRF427	17.25	MSC83026	POR	SCA3522	5.00	SD1143-3	17.00
MRF428	63.00	MSC83303	POR	SCA3523	5.00	SD1144	4.00
MRF433	12.07	MSC84900	60.00	SD345	5.00	SD1145-5	15.00
MRF449/A	12.65	MT4150	14.40	SD445	5.00	SD1146	15.00
MRF450/A	14.37	MT5126	25.00	SD1004	15.00	SD1147	15.00
MRF452/A	17.00	MT5596 (2N)	99.00	SD1007	15.00	SD1188	10.00
MRF453/A	18.40	MT5768 (2N)	95.00	SD1007-2	15.00	SD1189	24.00
MRF454/A	20.12	MT8762	25.00	SD1007-4	15.00	SD1200	1.50
MRF455/A	16.00	NEO2136	2.00	SD1007-5	15.00	SD1201-2	15.00

**Toll Free Number**  
**800-528-0180**  
**(For orders only)**

"All parts may be new or surplus, and parts may be substituted with comparable parts if we are out of stock of an item."

For information call: 602-265-0731

# MHz electronics

3802 North 27th Ave., Phoenix, AZ 85017

PRICES SUBJECT TO CHANGE WITHOUT NOTICE

## E.F. JOHNSON ROLLER INDUCTORS

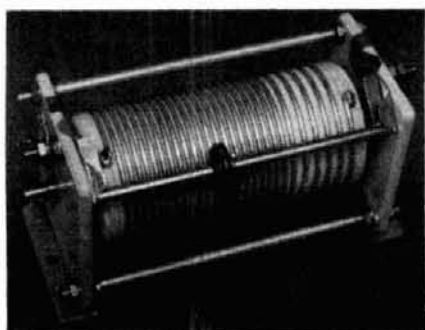
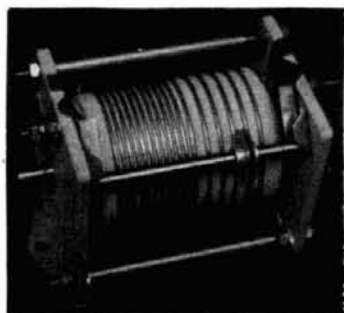

MODEL 229-0201-01  
10UH at 3AMPS MAX.

\$36.99

MODEL 229-0202-01  
18UH at 5AMPS MAX.

\$44.99

## NI-CAD BATTERY CHARGERS



UNIVERSAL CHARGER

\$19.99

### UNELCO, SEMCO, ARCO METAL CLAD MICA CAPACITORS

#### Standard Size

3.9	14	33	62	175
4.7	15	34	68	180
5	18	36	75	200
5.1	20	38	80	220
6.8	22	39	82	240
7	24	40	100	250
8.2	25	43	110	300
9.1	27	44	120	360
10	27.5	47	123	470
11	28	50	125	500
12	30	51	140	820
13	32	56	150	1000

#### Micro Size

5	25
6	27
7	33
8	36
9	51
12	62
15	
16	
18	
20	
22	
24	

\*\*\*\*\*NOTE ALL VALUES LISTED IN PICO FARAD\*\*\*\*\*

#### PRICE INFORMATION

1 to 10 \$.90ea. 11 to 51 \$.80ea. 52 to 102 \$.70ea.  
103 and up call



MALLORY CHARGER

\$23.99

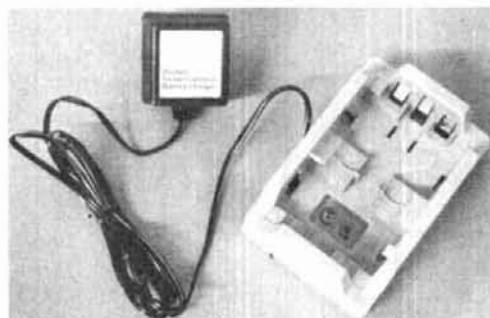

EVEREADY CHARGER

\$9.99



### GOULD NI-CAD BATTERIES

AA size 1.25v at 500mah	new	a	\$ 1.99
D size 1.25v at 4 AMPHR	new	h	7.49

### GENERAL ELECTRIC NI-CAD BATTERIES

AA size 1.25v at 500mah	new	a	2.99
195194 3.75v at 100mah	new		1.99
AA size 3.75v at 100mah	new	a	2.99
AA size pack of 10 12.5v at 450mah	used	a	5.99
Sub C Pack of 10 12.5v at 2.5Amphr	new	c	9.99

### UNION CARBIDE NI-CAD BATTERIES

193817 3.75v at 225mah	new	a	2.99
------------------------	-----	---	------

### GLOBE GEL-CELL BATTERIES

2v at 8AMPHR GC280	new	g	5.99
12v at 20AMPHR GC12200	new	g	49.99
12v at 23AMPHR GC12300	new	g	54.99

### EAGLE PICHER GEL-CELL BATTERIES

12v at 1.5AMPHR CF12V1.5	new	d	11.99
--------------------------	-----	---	-------

### GATES SEALED RECHARGEABLE LEAD ACID BATTERIES AND PACKS

2v at 2.5AMPHR D Cell	new	b	5.99
8v at 5AMPHR 4 X Cell	used	f	14.99
12v at 2.5AMPHR 6 D Cells	new	e	24.99
18v at 2.5AMPHR 9 D Cells	new	e	29.99

### GENERAL ELECTRIC SEALED RECHARGEABLE LEAD ACID BATTERIES AND PACKS

6v at 2.5AMPHR 3 D Cells	used	e	10.00
12v at 2.5AMPHR 6 D Cells	used	e	19.99
12v at 5AMPHR 6 X Cells	used	e	24.99

**Toll Free Number**  
**800-528-0180**  
**(For orders only)**

"All parts may be new or surplus, and parts may be substituted with comparable parts if we are out of stock of an item."

For information call: 602-265-0731

# MHz electronics

3802 North 27th Ave., Phoenix, AZ 85017

PRICES SUBJECT TO CHANGE WITHOUT NOTICE

MHz electronics

3802 North 27th Ave., Phoenix, AZ 85017

All parts may be new or surplus, and parts may be substituted with comparable parts if we are out of stock of an item.

Toll Free Number 800-528-0180 (For orders only) For information call: 602-265-0731



ORDER FORMS: New order forms are included with each order for your convenience. Additional order forms are available on request.
INSURANCE: Please include \$25 for each additional \$100 over \$100.00 UPS only. All insured packages are shipped thru UPS and U.S. Mail. U.S. Mail insurance is calculated at the time of shipment. In the United States insured packages are shipped only by UPS.
HOURS: Monday thru Friday 8:30 a.m. to 5:00 p.m., Saturdays 9:30 a.m. to 4:00 p.m.
FOREIGN ORDERS: All foreign orders must be prepaid with Cashier's check, Money Order, or bank wire made out in U.S. Funds only. We are sorry but C.O.D.'s are not available to foreign countries and letters of credit are unacceptable forms of payment.
DELIVERY: Orders are usually shipped the same day they are placed or the next business day, unless we are out of stock on an item. The customer will be notified by post card if we are going to backorder the item. Our normal shipping method is UPS or U.S. Mail depending on size or weight of the package. "Fast Equip." items are shipped only by air and is freight collect, unless prior arrangements have been made and approved.
DEFECTIVE MATERIALS: All claims for defective materials must be made within 30 days after receipt of the part. All claims must include the defective material for testing purposes, a copy of our invoice, and a return authorization number. The return authorization number can be obtained by calling (602) 265-0731 or sending us a postcard. This must be obtained before shipping the merchandise back to us otherwise the return will be considered complete. Due to manufacturer's warranties we are unable to replace or issue credit on items which have been soldered to or have been altered in any way. All return items must be packed properly, and insured if this is not done so it will void all warranties. We do not assume any responsibility for shipping charges incurred.
DATA SHEETS: When we have data sheets in stock on devices we will supply them with the order.
CREDIT CARDS: We are now accepting MASTERCARD, VISA, AND AMERICAN EXPRESS.
CONFIRMING ORDERS: We would prefer that confirming orders not be sent after a telephone order has been placed. If the company policy requires a confirming order, please mark "CONFIRMING ORDER" boldly on the order. If problems or duplicate shipments occur due to an order which is not properly marked, the customer will be held responsible for any charges incurred, plus a 15% restocking fee on the returned parts.
C.O.D.: We cannot accept personal checks for C.O.D.'s. C.O.D.'s are shipped by air only and thru United Parcel Service. C.O.D.: Payment from customer will be by CASH ONLY. We are sorry but FOREIGN Prepaid only, U.S. Funds, Money Order, or Cashier's Check Only.
TERMS: DOMESTIC: Prepaid, C.O.D. or Credit Card
POSTAGE: Minimum shipping and handling in the U.S., Canada, and Mexico is \$3.00 for ground shipments. Foreign countries is \$5.00 or 25% of order whichever is greater. Air rates are available at the time of your order. C.O.D.'s are shipped AIR ONLY.
PREPAID ORDERS: Orders must be accompanied by check, bankcard number, or money order.
PURCHASE ORDERS: We accept purchase orders accompanied by a check. All others must have prior approval by management.
RESTOCK CHARGES: If parts are returned to MHz Electronics, Inc. due to customer error, the customer will be held responsible for all fees incurred and will be charged a 15% restocking fee with the remainder in CREDIT ONLY. Return authorization must be obtained within 5 working days of receipt of the parcel, otherwise the order will be considered complete. The following must accompany any return: a copy of our invoice, return authorization number which must be obtained prior to shipping merchandise back and must appear on the outside of the package. Return authorizations can be obtained by calling (602) 265-0731. Return authorizations will not be given out on the 800 number. All items must be properly packed and insured. We will not give any credit on items which are damaged due to improper packing.
SALES TAX: ARIZONA residents must add 6% sales tax, unless signed ARIZONA resale tax card is currently subject to the 6% sales tax.
SHORTAGE ON DAMAGED MERCHANDISE: All claims for shortages or damages must be made within 5 days of receipt of parcel. Claims must include a copy of our invoice, along with a return authorization number (602) 265-0731 or sending us a postcard. Authorizations cannot be given on our 800 number. All items must be properly packed and insured. We are not responsible for shipping charges which may occur in shipment back to us. We do not assume any responsibility for shipping charges incurred if you have received a damaged package please make sure to contact the carrier so that they can come out and inspect the package before it is shipped back to us. All damaged packages must be returned to us with its original shipping material and contents. Customers which do not notify us within this time period will be held responsible for the entire order as will consider the order complete.
OUR 800 NUMBER IS STRICTLY FOR ORDERS ONLY (800) 528-0180. INFORMATION CALLS ARE TAKEN ON (602) 265-0731

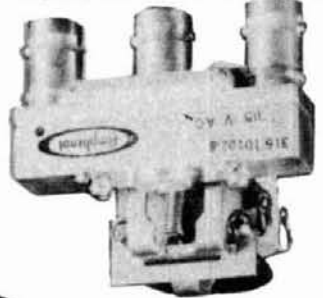

Part # 316-10102-8 Amphenol 115Vac Type BNC DC to 4 GHz.



BNC to Banana Plug Coax Cable RG-58 36 Inch., or BNC to N Coax Cable RG-58 36 Inch., \$7.99 or 2 For \$13.99 or 10 For \$50.00



Part # 300-11173 FXR 120Vac Type BNC Same as P5N 5985-543-1850 \$39.99

COAXIAL RELAY SWITCHES SPDT

Relays

Table listing various relay models and their prices, including part numbers like 50124-1, 50120-8, 50110-2, etc., and prices ranging from \$5.00 to \$10.00.

RF Transistors (continued)



*Ham Radio's guide to help you find your local*

## California

**C & A ROBERTS, INC.**  
18511 HAWTHORN BLVD.  
TORRANCE, CA 90504  
213-370-7451  
24 Hour: 800-421-2258  
Not The Biggest, But The Best —  
Since 1962.

**FONTANA ELECTRONICS**  
8628 SIERRA AVENUE  
FONTANA, CA 92335  
714-822-7710  
714-822-7725  
The Largest Electronics Dealer in San Bernardino County.

**JUN'S ELECTRONICS**  
3919 SEPULVEDA BLVD.  
CULVER CITY, CA 90230  
213-390-8003  
800-882-1343 Trades  
Habla Espanol

## Connecticut

**HATRY ELECTRONICS**  
500 LEDYARD ST. (SOUTH)  
HARTFORD, CT 06114  
203-527-1881  
Call today. Friendly one-stop shopping  
at prices you can afford.

## Delaware

**AMATEUR & ADVANCED COMMUNICATIONS**  
3208 CONCORD PIKE  
WILMINGTON, DE 19803  
(302) 478-2757  
Delaware's Friendliest Ham Store.

**DELAWARE AMATEUR SUPPLY**  
71 MEADOW ROAD  
NEW CASTLE, DE 19720  
302-328-7728  
800-441-7008  
Icom, Ten-Tec, Microlog, Yaesu,  
Kenwood, Santec, KDK, and more.  
One mile off I-95, no sales tax.

## Florida

**AMATEUR ELECTRONIC SUPPLY**  
1898 DREW STREET  
CLEARWATER, FL 33575  
813-461-4267  
Clearwater Branch  
West Coast's only full service  
Amateur Radio Store.  
Hours M-F 9-5:30, Sat. 9-3

**AMATEUR ELECTRONIC SUPPLY**  
621 COMMONWEALTH AVE.  
ORLANDO, FL 32803  
305-894-3238  
Fla. Wats: 1 (800) 432-9424  
Outside Fla: 1 (800) 327-1917  
Hours M-F 9-5:30, Sat. 9-3

**AMATEUR RADIO CENTER, INC.**  
2805 N. E. 2ND AVENUE  
MIAMI, FL 33137  
305-573-8383  
The place for great dependable  
names in Ham Radio.

## Hawaii

**HONOLULU ELECTRONICS**  
819 KEEAUMOKU STREET  
HONOLULU, HI 96814  
(808) 949-5564  
Serving Hawaii & Pacific area for 51  
years. Complete lines of Amateur equip-  
ment, accessories and parts.

## Illinois

**ERICKSON COMMUNICATIONS, INC.**  
5456 N. MILWAUKEE AVE.  
CHICAGO, IL 60630  
312-631-5181  
Hours: 9:30-5:30 Mon, Tu, Wed & Fri;  
9:30-8:00 Thurs; 9:00-3:00 Sat.

## Indiana

**THE HAM STATION**  
808 NORTH MAIN STREET  
EVANSVILLE, IN 47710  
812-422-0231  
Discount prices on Ten-Tec, Cubic,  
Hy-Gain, MFJ, Azden, Kantronics,  
Santec and others.

## Massachusetts

James Millen Components by  
**ANTENNAS ETC.**  
16 HANSOM ROAD  
ANDOVER, MA 01810  
617-475-7831  
Bezels, binding posts, capacitors, con-  
densers, chokes, coils, ceramics, H.V.  
connectors, plate caps, hardware  
knobs, dials, scopes and grid dippers.  
Inquire SASE or visit.

**TEL-COM, INC.**  
675 GREAT ROAD, RTE. 119  
LITTLETON, MA 01460  
617-486-3400  
617-486-3040  
The Ham Store of New England  
You Can Rely On.

## Michigan

**ENCON PHOTOVOLTAICS**  
Complete Photovoltaic Systems  
27600 Schoolcraft Rd.  
Livonia, Michigan 48150  
313-523-1850  
Amateur Radio, Repeaters, Satellite,  
Computer applications.  
Call Paul WDBAHO

## Nevada

**AMATEUR ELECTRONIC SUPPLY**  
1072 N. RANCHO DRIVE  
LAS VEGAS, NV 89106  
702-647-3114  
Dale Porray "Squeak," AD7K  
Outside Nev: 1 (800) 634-6227  
Hours M-F 9-5:30, Sat. 9-3

**JUN'S ELECTRONICS**  
460 E. PLUMB LANE — 107  
RENO, NV 89502  
702-827-5732  
Outside Nev: 1 (800) 648-3962  
Icom — Yaesu Dealer

## NEW YORK

**ADIRONDACK ELECTRONICS, INC.**  
1991 CENTRAL AVENUE  
ALBANY, NY 12205  
518-456-0203  
Amateur Radio for the Northeast since  
1943.

**BARRY ELECTRONICS**  
512 BROADWAY  
NEW YORK, NY 10012  
212-925-7000  
New York City's Largest Full Service  
Ham and Commercial Radio Store.

**VHF COMMUNICATIONS**  
915 NORTH MAIN STREET  
JAMESTOWN, NY 14701  
716-664-6345  
Call after 7 PM and save! Supplying all  
of your Amateur needs. Featuring ICOM  
"The World System." Western New  
York's finest Amateur dealer.

**Dealers:** *YOU SHOULD BE HERE TOO!*  
*Contact Ham Radio now for complete details.*

# NEMAL ELECTRONICS INTL., INC.

SEE US AT DAYTON BOOTH #104

your one stop coax supplier!

Amateur Radio Dealer

## Ohio

**AMATEUR ELECTRONIC SUPPLY**  
28940 EUCLID AVE.  
WICKLIFFE, OH (CLEVELAND AREA)

44092  
216-586-7388  
Ohio Wats: 1 (800) 362-0290  
Outside Ohio: 1 (800) 321-3594  
Hours M-F 9-5:30, Sat. 9-3

**UNIVERSAL AMATEUR RADIO, INC.**  
1280 AIDA DRIVE  
REYNOLDSBURG (COLUMBUS), OH  
43068

614-866-4267  
Featuring Kenwood, Yaesu, Icom,  
and other fine gear. Factory author-  
ized sales and service. Shortwave  
specialists. Near I-270 and airport.

## Pennsylvania

**HAMTRONICS,**  
DIV. OF TREVOSE ELECTRONICS  
4033 BROWNSVILLE ROAD  
TREVOSE, PA 19047  
215-357-1400  
Same Location for 30 Years.

**LaRUE ELECTRONICS**  
1112 GRANDVIEW STREET  
SCRANTON, PENNSYLVANIA 18509  
717-343-2124  
Icom, Bird, Cushcraft, Beckman,  
Larsen, Hustler, Astron, Belden,  
Antenna Specialists, W2AU/W2VS,  
AEA, B&W, Amphenol, Saxton, J.W.  
Miller/Daiwa, Vibroplex.

**THE VHF SHOP**  
16 S. MOUNTAIN BLVD., RTE. 309  
MOUNTAINTOP, PA 18707  
717-474-9399  
Lunar, Microwave Modules, ARCOS,  
Astron, KLM, Tama, Tonna-F9FT,  
UHF Units/Parabolic, Santec, Tokyo  
Hy-Power, Dentron, Mirage,  
Amphenol, Belden

## Texas

**MADISON ELECTRONICS SUPPLY**  
3621 FANNIN  
HOUSTON, TEXAS 77004  
713-520-7300  
1 (800) 231-3057  
Christmas?? Now??

## Wisconsin

**AMATEUR ELECTRONIC SUPPLY**  
4828 W. FOND DU LAC AVE.  
MILWAUKEE, WI 53216  
414-442-4200  
Wisc. Wats: 1 (800) 242-5195  
Outside Wisc: 1 (800) 558-0411  
M-F 9-5:30  
Sat 9-3



## Exclusive SATELLITE CONTROL CABLE

5 TYPES AVAILABLE!

NEW!!! Lowest Loss

AVAILABLE IN  
250-500-1000  
FT. ROLLS  
OR BY  
THE FOOT

Designed for easy,  
one-step installation,  
providing the best  
equipment  
all in a direct  
burial jacket.



TYPE 1 (General Purpose)	TYPE 2 (MT)	TYPE 3 (Interstat)	TYPE 4	TYPE 5
1 - RG59/U 96% Copper Braid	1 - RG59/U 96% Copper Braid	2 - RG59/U 96% Copper Braid	1 - RG6/U 18 Gauge 96% Copper Shield	2 - RG6/U 18 Gauge 96% Copper Shield
2 @ 16 Gauge	2 @ 12 Gauge	2 @ 12 Gauge	2 @ 12 Gauge	2 @ 12 Gauge
5 @ 22 Gauge	3 @ 18 Gauge	2 @ 18 Gauge	3 @ 18 Gauge	3 @ 18 Gauge
3 @ 20 Gauge	3 @ 20 Gauge	3 @ 22 Gauge	3 @ 20 Gauge	3 @ 20 Gauge
Shielded plus Tinned Copper Drain Wire	Shielded plus Tinned Copper Drain Wire	Shielded plus Tinned Copper Drain Wire	Shielded plus Tinned Copper Drain Wire	Shielded plus Tinned Copper Drain Wire
	3 @ 22 Gauge Shielded plus Tinned Copper Drain Wire		3 @ 22 Gauge Shielded plus Tinned Copper Drain Wire	3 @ 22 Gauge Shielded plus Tinned Copper Drain Wire

55¢  
FT

75¢  
FT

95¢  
FT

79¢  
FT

89¢  
FT

Call for 1000 FT pricing

Only Nemal offers the quality construction RG59/U copper shielding made to mil spec JAN C-17  
12-gauge conductors, tinned copper drain wires, and a true direct burial polyethylene jacket

## HARDLINE

Two styles, two sizes for all installation needs

- Aluminum Outer Conductor with Polyethylene Jacket
  - 1/2 inch loss .48 dB/100 ft. @ 30 MHz
  - 3.68 dB/100 ft. @ 1000 MHz .....\$1.25/ft.
  - 7/8 inch loss .28 dB/100 ft. @ 30 MHz
  - 2.54 dB/100 ft. @ 1000 MHz .....\$3.25/ft.

- Corrugated Copper Outer Conductor with Polyethylene Jacket
  - 1/2 inch loss .38 dB/100 ft. @ 30 MHz  
(FLC12-50U) 2.78 dB/100 ft. @ 1000 MHz .....\$1.59/ft.
  - 7/8 inch loss .13 dB/100 ft. @ 30 MHz  
(FLC12-78U) 1.3 dB/100 ft. @ 1000 MHz .....\$3.92/ft.

COMPARE RG 213 1.25 dB/100 @ 30 MHz  
8.5 dB/100 @ 1000 MHz !

## HARDLINE CONNECTORS

- 1/2 inch aluminum UHF M/F \$19.00 Type N M/F \$22.00
- 7/8 inch aluminum UHF M/F \$49.00 Type N M/F \$49.00
- 1/2 inch copper UHF M/F \$22.00 Type N M/F \$22.00
- 7/8 inch copper UHF M/F \$49.00 Type N M/F \$49.00

shipping  
Cable \$6.00 per 100 ft.  
Connectors — \$3.00 per order.  
Orders under \$20 add \$2 additional plus shipping.  
Charge card — orders over \$30 only.  
COD add \$2.00. Florida Residents add 5%.

FACTORY AUTHORIZED DISTRIBUTOR  
AMPHENOL, CABLEWAVE, COLUMBIA, KINGS  
BLONDER-TONGUE, TYTON, B&K

- COAXIAL CABLE
- MULTICONDUCTOR CABLE
- CONNECTORS-ADAPTERS
- HARDLINE
- CABLE TIES
- SMATV PRODUCTS
- COAX-SEAL
- COMPUTER CABLE
- CRIMP TOOLS
- FIELD STRENGTH METER



12240 N.E. 14th Ave.  
No. Miami, FL 33161

Telephone: (305) 893-3924

IN STOCK  
— OVER 500 ITEMS —  
COMPLETE LINES

✓ 119

## ALL BAND TRAP "SLOPER" ANTENNAS!



FULL COVERAGE! ALL BANDS! AUTOMAT-  
IC SELECTION with PROVEN Weatherproof  
Traps - 18 Ga. Copperweld Wire!  
GROUND MOUNT SLOPERS - No Radials  
needed! Ground to rod or house water faucet!  
Connect Top to Trees, Buildings, Poles, etc at  
ANY angle from Straightup to 60 degrees for  
excellent "SLOPER" DX. Antenna Gain or  
bend it anywhere you need to! 2000 Watt  
PEP Input, max. Permanent or portable Use  
Installs in 10 minutes. SMALL - NEAT -  
ALMOST INVISIBLE - No one will know you  
have a Hi-Power DX Antenna. Ideal For COND'Os APART-  
MENTS - RESTRICTED AREAS - Pre-tuned for 2-1 or less  
SWR over ALL bands (except 80-160-300kHz) No adjust-  
ments needed - EVER. COMPLETELY ASSEMBLED. With  
50 ft RG-58U Coax feedline and PL259 connector - Built  
in lightning arrester - ready to hookup! FULL INSTRU-  
CTIONS!

No. 10B0S - 80-40-20-15-10 - 1 trap 49 ft. — \$49.95  
No. 10A0S — 40-20-15-10 — 1 trap 28 ft. — \$49.95  
No. 10Z0S — 20-15-10 — 1 trap 13 ft. — \$47.95  
No. 1018S-180-90-40-20-15-10 - 2 traps 83 ft. — \$79.95  
SEND FULL PRICE FOR PPDEL IN USA (Canada) \$5.00  
extra for postage etc) or order using VISA, MASCARD -  
AMER EXP. Give Number Ex Date. Ph 1-308-238-5333  
weekdays. We ship in 2-3 days (Per Cks 14 days) Guaranteed  
1 yr - 10 day money back trial.  
WESTERN ELECTRONICS  
Dept. AH Kearney, Nebraska 68847

✓ 200

## Crystal Filters

TS430S KIT IMPROVED!

Superior tail-end cascading kit includes genuine 8-pole Fox Tango filter on tuned IF board, Mil-spec silver braided teflon coax, complete instructions. Improves selectivity, Shift operation; reduced IF noise.

Reg. \$85. Now only \$75 w/1.2KHz filter.  
Also 250, 400, 1800, 6000 Bandwidths - \$60 ea.  
DISCOUNT: 10% off on any 2 or more of above.  
SHIPPING: \$3 US, \$5 Air (US & Canada),  
\$10 Elsewhere • Order by mail or phone  
VISA/MC or COD accepted  
Ask About Our Filters For Many Other Rigs.

**FOX-TANGO Corp.**  
Box 15944, W. Palm Bch, FL 33416  
Telephone: (305) 683-9587

✓ 201



product

# REVIEWS

## world time clock

Azimuth Clock has just released its new World Time/Dual Zone clock. Using a large 1-7/16 x 2-1/2-inch LCD display, it's easy to read. And with large pushbuttons on the side, it's also easy to set. There's no need to fumble with a pen or pencil on tiny buttons recessed into the clock's mechanism.

To ensure accuracy, these clocks use a quartz crystal time base oscillator. The local time display shows time in the standard AM/PM format. The Universal Time clock display is in 24 hour/Zulu/military notation for instant logging accuracy. Both displays can be set to also flash the date, if desired. Both the UTC and local time clocks have been programmed to automatically determine the number of days per month and will require resetting only during leap years, or should the battery fail.

These clocks are set in a durable piece of extruded aluminum that has been beautifully silk screened. Azimuth also offers a 14-day satisfaction-guaranteed or your money-back offer: if you're not delighted with your Azimuth clock, simply return it within 14 days of purchase. The World Time dual zone clock retails for \$29.95 but is currently specially priced at \$24.95, plus \$1.95 shipping and handling.

Toll-free numbers are available for ordering by credit card; call (800) 821-6842; in California, (800) 421-1061. Further information is available from Azimuth, 11030 Santa Monica Blvd., Suite 200, Los Angeles, California 90025.

Circle #307 Reader Service Card.

N1ACH

## CMC's docking booster

Here's a really neat product for owners of handheld radios. The Docking Booster is a compact, self-contained power supply, a 16-dB gain GaAsMESFET receiver pre-amp, and a 30-watt RF amplifier (a 50-watt unit will be available soon), all in one package. Designed to integrate your portable radio into your car without sacrificing either portability or versatility, the Docking Booster is currently available for the IC-2AT, IC-02AT and Yaesu, Kenwood, and Standard radios.

When I unpacked the box, I was surprised that the unit is really quite small. Installation is quite simple. You just connect the unit to the car battery either directly or through the fuse block, slide the radio in, attach the external antenna and you're on the air!

The Docking Booster comes with a U-shaped bracket that can be attached to the door of most



cars. (Unfortunately, our Dodge station wagon door is too deep, and the unit wouldn't fit there. I also found that both the power cord and antenna feedline tend to get in the way if you install the radio on the driver's door.) But I did find the perfect place to install the unit — right in the ashtray (I don't smoke). The U-clamp which fit perfectly, provides a stable, easy-to-reach mounting platform.

Now, trying to shout into the ashtray while you're driving down the road is bound to attract attention, if not cause an accident. So you'll want to add the optional ICOM handheld speaker mike.

The Docking Booster is simple to use, with only a high and low power switch for the 30-watt RF amplifier. There are no other switches, knobs, or dials to turn or set.

Here in Southern New Hampshire, I found the extra 30 watts to be helpful in accessing repeaters. The 16-dB pre-amp helped tremendously in hearing distant repeaters and weak mobile stations on simplex frequencies.

I did find one problem with the unit. You have to avoid long-winded transmissions because there's no heatsink for the RF amplifier. I don't yet have enough experience with the unit to tell whether this is going to be a problem or not, but in normal use, the Docking Booster did get warm to the touch. (The 50-watt unit does have a heat sink.)

The Docking Booster uses the latest Japanese power transistors in a stripline circuit for high, stable power output. Using a 1.5-dB NF GaAs

FET device, the 16-dB receiver provides excellent weak signal reception over the full 2-meter band. Designed to run on 13.8 volts DC, the unit requires 4 amps maximum on transmit and supplies a stable 10 volt power source for the radio.

For more information on the Docking Booster, contact CMC Communications, 5479 Jetport, Tampa, Florida 33614.

N1ACH

Circle #305 on Reader Service Card.



## integrated packet terminal

Packeterm, a company specializing in packet radio technology, has announced release of the PACKETERM IPT. The IPT is a complete packet node controller and terminal in one compact unit. The IPT will interface with any popular FM or SSB rig, for use on both HF and VHF channels. The IPT can operate at 300 or 1200 baud. All that's required for operation is to connect the IPT to a transceiver and tune to one of the local packet frequencies.

The IPT uses Tuscon Amateur Packet Radio



firmware for complete compatibility with existing packet networks. A built-in modem allows much greater tolerance for receiver audio level than previous available designs.

The IPT will also function as a general-purpose ASCII terminal. It features data rates from 110 to 19,200 baud, 7 function keys, 40 or 80 column display, and will drive an optional printer. Power required is 120 VAC at 1/2 ampere. For portable operation, a DC converter that uses a 13.8 VDC power source is available.

For further information, contact Packeterm, P.O. Box 835, Amherst, New Hampshire 03031.

Circle #303 on Reader Service Card.

## ICOM IC-A2 air band handheld transceiver

ICOM has announced the IC-A2 5-watt PEP output aircraft handheld transceiver. Utilizing over 20 years of experience in synthesized communications equipment, the ICOM IC-A2 in-



cludes outstanding new features not available in other handhelds.

Standard features include all 720 COM and 200 NAV channels plus 720 additional COM channels and 200 NAV channels. Five watts PEP power output — an ICOM exclusive — and 1.5 watts operation capability for battery-saving low power operation are standard.

The unit features ten owner-programmable memory channels, with internal lithium cell memory backup.

The ICOM IC-A2 comes standard with an IC-CM7 rechargeable Nicad battery pack, charger, LC-14 soft leather case, and earphone. A wide selection of options and accessories are available, including the ICOM HS-10 headset and HS-10SA VOX unit or HS-10SB PTT switchbox.

The ICOM IC-A2 may be purchased only through authorized ICOM avionics dealers/distributors or FBO shops.

For further information, contact ICOM, 2380 116th Avenue N.E., Bellevue, Washington 98004.

Circle #306 on Reader Service Card.

## packet radio relay power amplifier

With linking of packet radio stations on 220 MHz becoming popular, Hamtronics has announced a new version of their widely-used power amplifiers designed just for this service. Called the PPA-220, the new PA is similar to the Hamtronics LPA 2-40, except that it has increased gain (up to 50 watts out with 2 watts drive) and built-in PIN diode antenna switching to allow T/R transition in only a few milliseconds. The new PA can be used with the Hamtronics T51 or any other 2 watt, 220 MHz exciter. With the ultra-fast T/R switching, the PPA-220 is an ideal component for packet relay stations being constructed for inter-area ties at 9600 baud. The cost of the kit is \$138.00.

For more information on this and other products, such as transmitters, receivers, repeaters, and "202" type modulators and demodulators, contact Hamtronics, Inc., 65 Moul Road, Hilton, New York 14468-9535.

## multi-tap V/H switch

The MTS-1200 is the first in Gensat's series of MICROSTAR® integrated block downconversion accessories. Incorporating all the circuitry required to independently operate up to four receivers from one dish, the MTS-1200 offers the easiest solution to most MTVRO system requirements.

The MTS-1200 is designed to operate with most block downconversion receivers operating at 950 to 1450 MHz. Each receiver can independently select the vertical or horizontal line from the block downconverters. No signal loss is introduced by the accessory.

The switching circuitry is driven from the polarizer output of the receiver. In order to ensure proper isolation between the horizontal and



vertical signal, the polarizer interface must be compatible with either a ferrite or pin diode polarizer.

Packaged in Gensat's standard weather-proof housing, this MICROSTAR® product can be mounted either indoors or outdoors.

For further information, contact Gensat, 951 Alness Street, Downsview, Ontario, Canada M3J 2J1.

Circle #308 on Reader Service Card.

## DATA ACQUISITION



\*\*\* RS 232C VOLTMETER FOR YOUR PC \*\*\*  
8 channel, 4 1/2 digit AC/DC voltmeter & controller  
SENSATROL talks your computer's language! Sensors hook up easily to differential inputs providing 15 bits of 100uV. Special tri-state serial output allows networking. Includes seven binary control outputs. Uses simple PRINT and INPUT with BASIC. Detailed manual starts amateurs in sensor hookup & applications. \$385 COMPLETE!

DEALER INQUIRIES WELCOME.  
603-588-3746

BOX 33, FRANCESTOWN, NH 03043

## DATA WORLD PRODUCTS

203

## LEARN ALL ABOUT TROUBLESHOOTING MICROPROCESSOR-BASED EQUIPMENT AND DIGITAL DEVICES

Attend this 4-day seminar and master the essentials of microprocessor maintenance. Gain a firm understanding of microprocessor fundamentals and learn specialized troubleshooting techniques. Fee is \$695.00.

### CURRENT SCHEDULE

- Atlanta, GA — September 17-20
- Greensboro, NC — September 23-26
- Chicago, IL — October 1-4
- Indianapolis, IN — November 12-15
- Oklahoma City, OK — December 3-6
- San Antonio, TX — December 10-13

### MICRO SYSTEMS INSTITUTE

Garnett, Kansas 66032  
(913) 898-4695

204

## COMPUTER PROGRAMS FOR THE RADIO AMATEUR

by Wayne Overbeck, N6NB,  
and Jim Steffen, KC6A

Here's the first source book of computer programs for the Radio Amateur. Besides covering computer basics, this book gives you programs that will help you log, determine sunrise/sunset times, track the Moon's path across the sky, use Greylane propagation and set up record systems for WAS, DXCC and VUCC, or any other award. You can either buy the book alone or you can buy the book with the programs already on disk. Take full advantage of your computer with this well written source book. ©1984, 1st edition, 327 pages.

- HA-0657 Softbound \$16.95
- HA-0657 with program \$29.95  
specify computer (see list below)
- Program disk alone \$19.95

Programs available for: Apple II (DOS and CP/M), IBM (DOS), TRS-80 Model I and Model III and Commodore C-64. Please mark your order with the program disk you want.

Please include \$3.00 shipping and handling.

**Ham Radio's Bookstore**  
Greenville, NH 03048

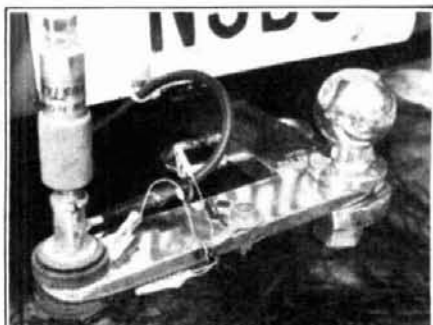

## TENNA HITCH by DC SALES

For Class #1 & #2 hitches  
Adapts your existing car trailer hitch for any  
HF Antenna No holes in your car

Complete \$29.95

Plus \$5 postage & handling

Contact your favorite dealer or:



**DC SALES**

1602 Chestnut Ridge Rd.

Kingwood, TX 77339

(713) 358-0051

Dealer inquiries invited

✓ 148

## AUTHORIZED KENWOOD I-COM RADIO DEALER



✓ 149

H. L. HEASTER, INC., 203 Buckhannon Pike, Clarksburg, W. Va. 26301  
Clarksburg Phone (304) 624-5485 or W. Va. Toll Free 1-800-352-3177

Harold Heaster, K4B0HX, 350 Hickory Hill Place, Ormond Beach, FL 32074  
Florida Phone (904) 673-4066

We sell all brands of amateur radios, amplifiers, antennas, towers, etc.  
Call us for a quotation for your needs. **we guarantee to save your money!**  
Nation wide toll free (answers 24 hrs.) 1-800-624-7888, operator 885 when  
using the nation-wide toll free telephone you must leave a message for a  
call back from me. Please allow 3-5 days for a return call. Thank you!

## HAZER YOUR ROHN 25 G Tower

- Antenna and rotator mount on HAZER, complete system trans tower in vehicle upright position
- Safety lock system on HAZER operates while raising-lowering & normal position. Never can fall
- Weight transferred directly to tower. Winch cable used only for raising & lowering. Easy to install and use
- Will support most antenna arrays.
- High quality materials & workmanship
- Safety - speed - convenience - smooth travel
- Complete kit for 50' or less tower includes winch, cable, hardware and instructions

Hazer 2 Heavy duty alum. 12 sq ft load \$297.00 ppd  
Hazer 3 Standard alum. 8 sq ft load 213.00 ppd  
Hazer 4 Heavy galv. steel 16 sq ft load 278.00 ppd  
Ball thrust bearing TB 25 for any of above 42.50 ppd

As an alternative, purchase a Martin M-13 or M-18 aluminum tower engineered specifically for the HAZER system.



GLEN MARTIN ENGINEERING INC.  
P.O. Box H 253 Boonville, Mo. 65233  
816-882-2734

✓ 151



## digital level meter

North American SOAR Corporation has announced the release of its Model 1700 digital level meter, which represents an entirely new concept in surface level measurements. Model 1700 was designed to assist the professional engineer or craftsman in making finite level or angular measurements quickly and accurately. Small and compact, the unit is sized 6-1/4 x 3-3/4 x 1-1/4 inches for portability. The Model 1700 has two 3-1/2 digit LCD readouts with annunciators, enabling the operator to observe the slope angle in degrees, the slope direction, and slope height in meters per meter from either the side or top. A buzzer can be activated to give an audible tone alarm when 0 degree (level) is attained. It contains a switchable LCD light for reading in dim light. Powered by two 1.5 volt "AA" batteries, the Model 1700 can be continuously operated for 500-800 hours. The measuring method employs an encoder and micro-computer, giving it a dynamic range of ±120 degrees with an accuracy of 1.0 degree and resolution to 0.5 degree. The Model 1700 is priced at \$99.95 in small quantities.

For more information, contact North American SOAR Corporation, 1126 Cornell Avenue, Cherry Hill, New Jersey 08002.

Circle #310 on Reader Service Card.

## transmitter kit

RF Kit Co. has developed a compact Amateur Radio transmitter kit that can be assembled in one evening and provide a solid 5-watt CW output on the 7, 10.1, and 14 MHz Amateur bands. This unit is crystal controlled and one crystal is included in the \$39.95 price. Stock crystals available include: 7.035, 7.125, 10.108, 10.125, and 14.035 MHz.



This unit is suitable for home use with a simple dipole antenna or for portable and emergency power communications.

The electronic design is straightforward and

may be easily modified for any Amateur band from 160 to 10 meters. The 3.5 x 2 x 1 inch size will allow the builder to custom-fit this transmitter into many surplus enclosures.

For further information, contact RF Kit Company, P.O. Box 27127, Seattle, Washington 98125.

Circle #302 on Reader Service Card.

## weather boots

Kilo-Tec has announced a new custom weather boot for use with RG-58, RG-59, and RG-8X. Simply slip the weather boot over the

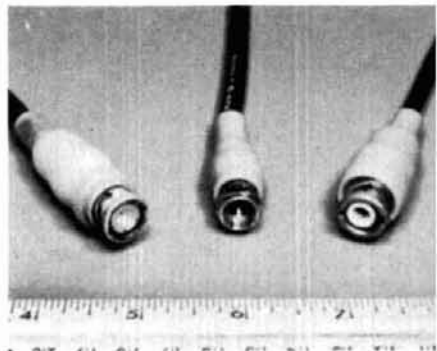

coaxial cable before soldering on the connector, then slide the boot over the connector for a good weather-tight seal — without the use of tape or rubber compounds.

The boots are manufactured with a flexible vinyl material that resists moisture and breakdown from the sun's rays.

Three new boots are available: Model KTBNC-59 for (F) BNC/RG-59 and RG-8X; Model KTBNC-58 for (F) BNC/RG-58; and Model KTBNC-59 for (M) Type F/RG-59 and RG-8X. We also offer various models for PL-259 and type N. Boots for TNC are available on special order.

For more information, contact Kilo-Tec, P.O. Box 1001, Oak View, California 93022.

Circle #313 on Reader Service Card.

## RF circuit design program

STAR 1.0 is a low-cost program written for circuit design using personal computers. It analyzes and optimizes electronic circuits including amplifiers, oscillators, filters, matching networks, hybrids, couplers and others. STAR 1.0 features include frequency domain analysis of circuits, optimization of any component values in circuit, file storage of circuits for easy recall or modification, and screen, printer, and plot outputs. The program disk includes 30 application examples. The program is available for IBM, PC/XT/JR, APPLE II+IIc/IIe, Kaypro 2/2X/4/10 CP/M and the Commodore C-64.

For additional information, write Circuit Busters, P. O. Box 256, Lilburn, Georgia 30247.

Also available from Ham Radio's Bookstore — IBM and C64, \$99; Apple and Kaypro, \$89. Add \$3.50 for shipping and handling.

Circle #309 on Reader Service Card.

## new antennas

NCG Company has announced its new line of Amateur antennas. The line includes a 1.2 GHz antenna for base/repeater use (with a 12.5 dB gain) and a new mobile with a 7.5 dB gain.

Also available are the new 2-meter 70-cm antenna duplexer and 6-meter/2-meter antenna duplexer combinations. A quad band vertical for HF + VHF 40, 15, 10, and 6 meters is ideal for the limited roof areas.

Another new antenna is the new ground-plane vertical Tribander for the new 10, 12, and 18-MHz band.

For further information, contact NCG Company, 1275 North Grove Street, Anaheim, California 92806.

Circle #312 on Reader Service Card.

## CoCo MORSE

The latest release from dataLOG Software allows you to send morse code from your Radio Shack Color Computer. "CoCo MORSE" requires 32K of RAM and a disk drive. It features a 320-character input buffer for type ahead that will keep up with the fastest typist. (The operator is usually not aware of the buffer limit because the buffer works in a circular fashion, allowing wrap-around when the 320 character limit is reached.) A split screen display shows input buffer and transmitted characters.

The program will allow operation from 5 to 80 words per minute and speed changes may be made during transmission. Up to five predefined message buffers can be created and saved to disk for increased efficiency during contests or for that "brag" tape. The messages may be dumped into the transmit buffer, up to the buffer's limit, without effecting transmission speed or quality.

Included in the purchase price is an RS232 interface to connect the computer to the transmitter. The interface also provides the necessary isolation between the transmitter and computer. CoCo MORSE is written in machine language and is relocatable. Its documentation includes information for modifying the weight and duration of the transmitted code. A future release of the "dataLOG Logbook" program will allow combined operation of the morse program AND the log program for the dedicated CW operator. CoCo MORSE, including the interface sells for \$39.00 plus \$2.50 for shipping and handling.

For additional information, contact dataLOG Software, P.O. Box 10531, Jacksonville, Florida 32247.

Circle #311 on Reader Service Card.

## antique radios

*Antique Radio Classified*, a national publication for buyers and sellers of old radios and related items, is entering its second year of publication. The largest publication of its type, it caters to collectors interested in collecting radios

# THE CHOICE IS YOURS



Available: August (?)

- Unassembled Kit
- No Warranty
- Service Assistance (?)



Available: April, 1985  
Dayton

Price: **NOW** \$219.00

- Fully Assembled Unit
- Full One-Year Warranty
- Complete Service Facility & Staff

## BUT LOOK BEFORE YOU LEAP

Both units are Packet Radio Terminal Node controllers with AX.25 protocol, a standard RS-232 compatible port, and command format software. But many differences exist too.

**B**uying the Kantronics Packet Communicator makes sense. You know our reputation for quality products and after-sales-support. You know the Kantronics tradition of making computer interfaces and software that work. So take your pick, the unassembled kit with no warranty, or the guaranteed Kantronics Packet Communicator, ready to work in your shack.

With a price of \$219 we think the  
Kantronics Packet Communicator is more than a bargain,  
it's the smartest buy you'll make this year.

 **Kantronics**

1202 E. 23rd Street (913) 842-7745  
Lawrence, Kansas 66046



# ASK ANY HAM... THEN ASK FOR HUSTLER.

STILL THE  
STANDARD OF PERFORMANCE

## HUSTLER

3275 North Avenue B  
Kissimmee, Florida 32758  
(305) 933-0500

An AMATEUR Company

## AMATEUR ANTENNA PRODUCTS

built between 1905 and the 1940's. Although the emphasis is on "Wanted" and "For Sale" ads, many articles related to the hobby are included in each issue. Every subscriber is entitled to a free classified ad in each issue.

*Antique Radio Classified* is published 12 times a year in an attractive 5-1/2 x 8 inch size format.

For further information, contact Gary B. Schneider, publisher, *Antique Radio Classified*, 9951 Sunrise Blvd., Suite R-9, Cleveland, Ohio 44133. (Enclose SASE.)

Circle #315 on Reader Service Card.

### 'tenna hitch

Mounting mobile antennas on cars has always been a problem. Most people are reluctant to drill holes into the car body, and now that many bumpers are made of plastic, that relatively easy way out is no longer usable, either. However, DC Sales has come up with an idea that makes mounting antennas on cars equipped with trailer hitches as easy as 1, 2, 3!

The 'Tenna Hitch is designed to fit underneath the trailer hitch ball and is equipped with the standard 3/8-inch insulated mount. The 'Tenna Hitch is made from high strength, chrome plated steel and is designed to give years of trouble-free service. It will mount all currently available commercial mobile antennas.

For more information, contact DC Sales, 1602 Chestnut Ridge Road, Kingwood, Texas 77339. Circle #314 on Reader Service Card.

### 2-meter RF amplifier

Hustler has announced the availability of its new model HVA-225 Class C Amplifier for 144-149 MHz 2-meter FM Amateur mobile use. Utilizing state-of-the-art broadband microstrip design, the amplifier exhibits components and manufacturing techniques found only in higher priced commercial units for superior performance and reliability.

The HVA-225 is conservatively rated at 25 watts with only 2 watts of drive while requiring only 4 amperes at 13.8 VDC for full output. Separate power and RF indicators, on-off switch, SO-239 connectors, reverse polarity protection plus extra capacity heat sink for high temperature reliability and efficiency. The amplifier is housed in a black matte finish aluminum housing complete with gimble bracket and thumb screws for underdash mounting.

For more information on the HVA-225 amplifier, write Hustler, Inc., 3275 North "B" Avenue Kissimmee, Florida 32758.

Circle #317 on Reader Service Card.

206

Custom Mailing Lists on Labels!

### Amateur Radio Operator NAMES

Custom lists compiled to your specifications  
• Geographic by ZIP and/or State  
• By License Issue or Expiration Date  
Self stick 1x3 labels

Total List 453,000 Price: \$25/Thousand

Buckmaster Publishing 143

Whitehall

Mineral, VA 23117 USA (703) 894-5777



### Quality Microwave TV Antennas

Multi-Channel 1.9 to 2.7 GHz  
40dB Gain True Parabolic 20 Inch Dish  
Complete System \$84.95 (Shipping incl.)  
Dealerships, Qty. Pricing, Replacement Parts  
**Phillips-Tech Electronics**  
P.O. Box 34772 • Phoenix, AZ 85067  
(802) 947-7700 (\$3.00 Credit all phone orders!)  
MasterCard • Visa • C.O.D.s

144

## THE VHF SHOP ORDERS QUOTES 1-800-HAM-7373

ASTRON	RS7A	45.00	RS35M	138.95
RS12A	62.75	VS35M	156.95	
RS20A	79.95	RS50A	179.95	
RS20M	96.45	RS50M	203.25	
VS20M	114.95	VS50M	223.95	
RS35A	123.75	RMS0A	206.95	

MIRAGE	A1015 6Mtr 150w Amp/Pa	333.95
B23A 2 Mtr HT Amp/Pa	478.95	
B1018 2 Mtr 160w Amp/Pa	90.95	
B3016 2Mtr 30 In / 160 c-w	86.50/113.95	
C1012 1.3Mtr 120w Amp/Pa	112.95	
D1010N 430-450MHz 100w N's		

KLM	KT34A 4el. Tribander	333.95
KT34XA 6el. Tribander	478.95	
2M16LX/220-222LBX/432-30LBX	90.95	
2M14C/2M-22C	86.50/113.95	
435-18C	112.95	

KENPRO	KR500 Elevation Rotor	169.95
--------	-----------------------	--------

**FLASH:**  
The Tonna F9FT's are back. CALL FOR QUOTE

HENRY RADIO	2KD-Classic 2 KW Amp.	965.00
2002/2004A KW's	1250.00/1350.00	

MICROWAVE MODULES	MMT144-26 2Mtr X-verter	199.95
MMT220-26 220MHz X-verter	260.00	
MMT432/435-28a 10w X-verter	279.95	
MMT1206-144G 2w X-verter	349.95	
MMC144-26 2Mtr converter	59.00	
MMC432/435-26 converter	69.00	

FOR THE BEST DEAL IN TOWN  
CALL THE BEST NUMBER AROUND 1-800-HAM-7373  
SPECIALS: Astron Power Supply Sale (see prices at left); Yaesu FT-980 \$1,330, FT-757GX \$745.95; Kenwood TS-430S - Call!, TS-711A - CALL!

YAESU	FT203R NEW 2Mtr HT	109.95
FT-209RH	FT706R 440MHz HT	149.95
FT77 Great Mobile Rig	FT757GX HF XCVR - A Winner!	279.95
FT960 CAT System Special	FT726R with 2Mtr Module	432.435 Module - 726R
SU726 Sat. Duplex Module	50 MHz Module - 726R	FT726 10 - 12 - 15Mtr Module

SSB ELECTRONICS	High Performance - Low Noise DBM converters for 50MHz, 144MHz, or 432MHz	109.95
SSB1296-28/144 GaAsFet converter	149.95	
SSB144-28 10w Transverter Kit with Double Balanced Mixer on Tx/Rx	199.95	
SSB432/435-28 10w Transverter Kit with GaAsFet front-end, DBM's on Tx/Rx	Call!	
LT23a 1296 MHz 10w X-verter, NF 1.8dB	650.00	
GaAsFet front-end, Dual Channel	399.95	
Microline13 2.3GHz Linear X-verter	279.95	
LSM24 OSCAR MODE L up-converter	124.95	
DX144 GaAsFet Preamp NF 4dB	124.95	
DX432 GaAsFet Preamp NF 5dB	124.95	
DX1206 GaAsFet Preamp NF 8dB	124.95	
SSB MAST-MOUNTED GaAsFet Preamps: MV144S-01 NF 6dB 1Kw PEP Max.	275.95	
MV432S-01 NF 7dB 1Kw PEP Max.	275.95	

MUTEK LTD.	Low Noise - High dynamic range front-end boards with: Low loss relay, RF Amp, DBM, 6-pole Xtal filter, and IF Amplifier.	
ICOM IC211 / 251 Board	135.95	
ICOM IC271A Board	149.95	
GLNA432E mast mount GaAsFet preamp and sequencer	269.95	
SLN144E RF Switched Preamp, 100w max. Input, NF 1dB Gain 15dB typ.	74.95	
SLNA50s Same as above for 50MHz	74.95	
SBLA144e Mast-Mounted RF Switched preamp, 250w. max input NF 1dB	159.95	
GFBA144e Mast-Mounted GaAsFet preamp, 1 Kw PEP Max. includes Lin. amplifier sequencer, Interfaces to all rigs!	249.95	
CUE DEE - The Swedish Boomer "SALE!" 144-15AM 15el 144MHz Yagi w/N conn.	79.95	

PARABOLIC - UHF UNITS - LABE	1296/228 dual conversion xverter	385.00
1296/1296 single tube amp (50w)	279.95	
1269/1296 dual tube amp (120w)	389.95	
1 meter dish kit	95.95	
Dish feeds 1296 or 2304	85.95	
2 way ant. combiners 144/432	51.95/49.95	
4 way ant. combiners 144/432	59.95/56.95	

Information & Pa. Residents  
Call (717) 474-9399

FLASH! NOW UNDER NEW MANAGEMENT!

16 S. Mountain Blvd. - Rt. 309  
Mountain Top, Pa. 18707

MC/VISA HOURS: Monday & Friday 9:00am - 8:00pm  
Tues. Wed. Thurs. Sat. - 9:00am - 5:00pm

207

## 1000-call paging encoder

Communications Specialists has just announced the availability of its new PE-1000 desk-top paging encoder. The PE-1000 is capable of 100 or 1000 call paging capacity for two-tone sequential signaling. Five-tone sequential and REACH formats are also available. All features are included in every unit and fully field programmable through the front panel keyboard. A non-volatile memory retains the programming if a power loss occurs.



The PE-1000 includes all standard tone groups from 250.0 Hz to 4000.0 Hz and uses state-of-the-art microprocessor technology for high accuracy and stability of paging tones. The unit provides outputs for recording a hard copy print-out of all paging activity and an automatic self test is run each time the PE-1000 is powered up. The PE-1000 is protected by a full one-year warranty and is available for immediate shipment from factory stock. The price is \$224.95.

For information, contact Communications Specialists, Inc., 426 West Taft Avenue, Orange, California 92665.

Circle #316 on Reader Service Card.

## communications satellites

by Larry Van Horn

The first comprehensive directory of communication satellites and their radio frequencies is now available from Grove Enterprises.

Chapters cover spy and surveillance satellites, U.S. and Russian manned space missions, military tactical and scientific satellites, oceanographic and water satellites, navigational and communication satellites, and private and direct broadcast satellites.

This directory of space communications includes chapters on channelization band plans, transponder identification, international satellites, and a history of earth satellite development. An exhaustive frequency cross-reference allows quick identification of the source of unknown transmissions from space!

Illustrations and tables are included for better understanding of this space technology. Special chapters provide insight into satellite operation, much of which has never been revealed to the public.

The price is \$12.95. Book-rate shipping by mail is free. (For shipping by UPS, add \$1.50.)

To order, contact Grove Enterprises, P.O. Box 98, Brasstown, North Carolina 28902.

Also available through Ham Radio's Bookstore, \$12.95 plus \$3.50 shipping and handling.

Circle #301 on Reader Service Card.

# FREE high tech catalog



New Heathkit terminal node controller combines computer technology with amateur radio.



Build one of the finest multi-purpose ham rigs available and save.



"Universal" terminal interfaces computer, ham station for RTTY.

Crossfire Visual Tuning Indicator tunes RTTY transmissions fast.

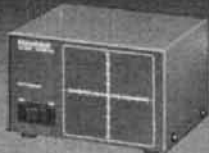

World's only automatic antenna tuner with 18 presets.



Microelectronics make the new HW-9 QRP CW transceiver small and light.



General coverage receiver has exceptional selectivity and sensitivity.



Triple-trace oscilloscope speeds troubleshooting.

*More than just a catalog, a trustworthy guide to what's new in electronics and computers*

News about important product innovations is packed into every page of the quarterly, full-color Heathkit catalog. For many years, the illustrated Heathkit Catalog has been a guide to new and exciting kit products for people like you to build. To enjoy and learn from them, while saving money in the process. What sets the Heathkit catalog apart is its range of high quality products and accurate information to help make your buying decisions easy.

*All you have to do is fill out the coupon to get your copy.*



**Heathkit**  
Heath  
Company

Mail to: Heath Company, Dept. 122-332  
Benton Harbor, Michigan 49022

YES! Please send me a copy of the all-new  
**FREE** Heathkit Catalog.

Name \_\_\_\_\_

Address \_\_\_\_\_

City \_\_\_\_\_ State \_\_\_\_\_

AM 446D Zip \_\_\_\_\_



EVERYONE'S  
GOING TO

LAS VEGAS

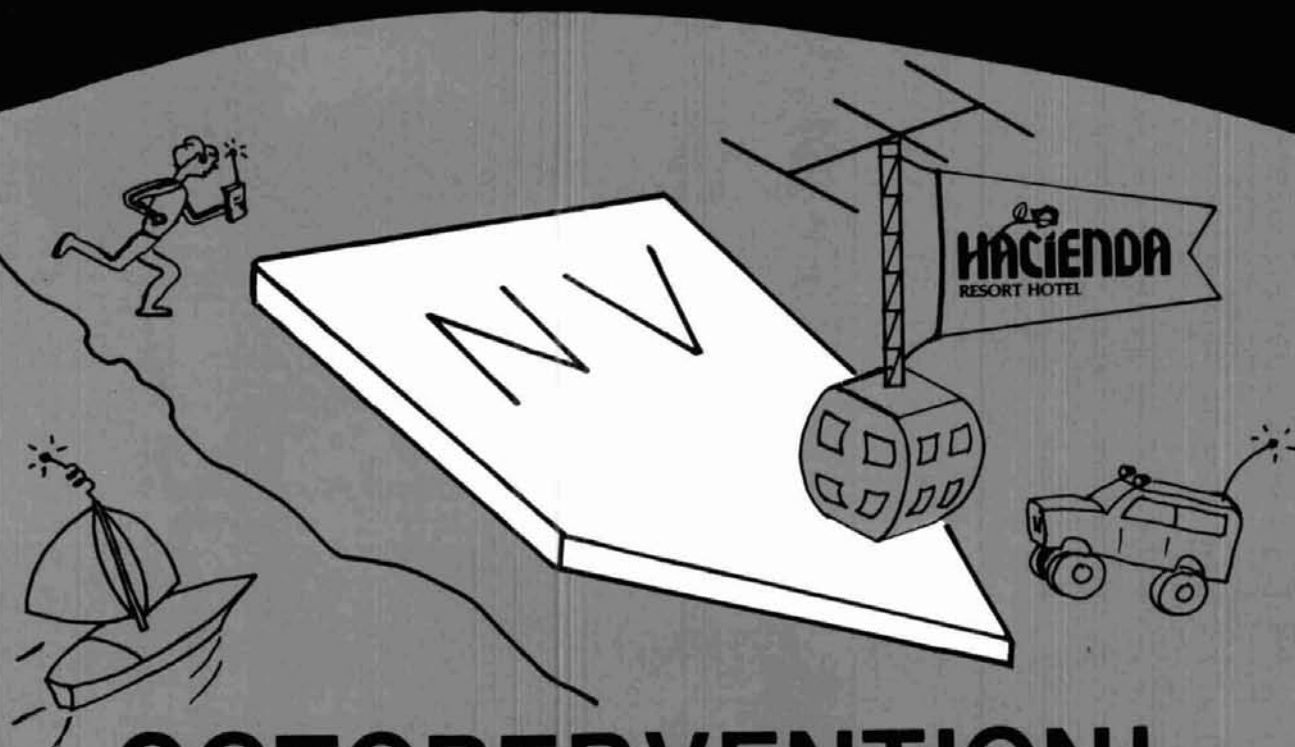

# OCTOBERVENTION!

We're launching Amateur Radio into the future with how-to-do-it forums on Packet Radio, Satellites, and Amateur TV. Plus FCC exams, ARRL, MARS, QCWA, manufacturer's exhibits and acres of flea market! Also enjoy a deluxe banquet and awards program, or alternate activities, including tours and shows.



*Pacific  
Division  
Convention  
Oct. 31 - Nov. 3*

We just can't get it all in this space, so rush an SASE for the complete brochure to:

OCTOBERVENTION  
Dept. 400  
P.O. BOX 19675  
Las Vegas, NV 89132



## DeVry to coordinate nationwide VE program

The DeVry Technical Institute of Technology is planning to expand its VEC coverage from the 9th call district to all 13 districts according to Jim Georgias, W9JUG, DeVry VE Coordinator. DeVry is looking for groups of three Extra Class Amateurs to set up "core groups" that will function as DeVry representatives in their local areas. DeVry will provide core group members with three written exams per license class and a computer generated tape for code tests. The core groups will then be responsible for setting up, administering, and correcting of exams. DeVry requires that core groups comply with FCC Part 17, Subpart I rules and regulations.

Initially DeVry representatives will schedule exams at least every other month, though a once-monthly schedule is preferred.

If your club or group is interested in working with the DeVry Institute of Technology, call Jim Georgias at (312) 929-8500 between 9:00 A.M. and 4:00 P.M. (CDST) or write to him at DeVry Institute of Technology, 3300 N. Campbell Avenue, Chicago, Illinois 60618.

Circle #318 on Reader Service Card.

## Advanced terminal unit

Said to be the most advanced HF RTTY modulator-demodulator available, the ATU-1000 from AEA is designed for interconnecting a communications transceiver with a computer (or mechanical communications device) using appropriate computer communications software. Operation on Morse, Baudot, ASCII, Packet and AMTOR teletype is provided.

The heart of the demodulator system of the ATU-1000 is a pair of identical eight pole (0.5 dB ripple) Chebyshev filters. Twin oscillator-modulators mix the input tones to the filter's center frequency.

Both mark and space tones may be adjusted independently from 1000 to 3000 Hz, providing compatibility with all commercial and Amateur one pairs. Adjustment of the tone frequencies is accomplished with ten turn potentiometers and the tone frequencies are indicated with a built in frequency counter. Adjustment of the filters is accurate to 1 Hz. For fixed tone pair operation, an optional eight-pole bandpass pre-

filter is selectable from the front panel. Selection of the normal channel bandwidth of 180 Hz or a narrow 100 Hz bandwidth is provided for optimizing the channel filters for the mode of operation.

The filter system is followed by twin full-wave detectors and twin four-pole low-pass filters with selectable cutoff frequencies corresponding to 50, 110, and 300 baud data rates. This is followed by a DC coupled threshold correction system that provides superior performance during selective fades and low signal conditions. In total, 32 poles of receive filter are provided in this system.

Operation using both normal mark-space comparison and mark only or space only is selectable during interference on one of the information channels.

Tuning is indicated with a discriminator style LED bar graph with selectable mark only, space only and summed mark and space operation. In addition, the tuning rate is selectable for quick initial tuning and precise final tuning.

For further information, contact Advanced Electronic Applications Inc., P.O. Box C-2160, Lynnwood, Washington 98036.

Circle #304 on Reader Service Card.

## Heath TNC

The state-of-the-art HD-4040 Terminal Node Controller (TNC) from Heath is said to be the only RFI approved TNC on the market.

A version of the popular Tucson Amateur Packet Radio (TAPR) TNC, the Heath TNC allows communication using terminal or computer control of any Amateur Radio system. Packet radio insures error-free communication and greatly increases communication speed. The HD-4040 has a built-in 1200 baud modem, although Baud rates up to 9600 are possible with an external modem. Both AX.25 and VADCG protocols are used.

Three modes of operation are provided: a conversation mode that allows conversation with another operator, a command mode that allows configuration of the TNC and use of variety of operating commands, and a transparent mode that's used in transferring files from one computer to another. A 6809 processor and a 32K ROM and 8K RAM are featured. Both ROM and RAM can be expanded by adding up to 16K.

A built-in automatic beacon can be set to transmit a message at designated intervals determined by the operator. Any station can act as a digital repeater and up to eight such "linking" stations are allowed which greatly expands the operator's range.

For complete information and a free catalog of Heath products, write Heath Company, Dept. 150-525, Benton Harbor, Michigan 49022. (In Canada write Heath Company, 1020 Islington Avenue, Suite 3100, Toronto, Ontario, M8Z 5Z3.)

Circle #319 on Reader Service Card.

**AZOTIC INDUSTRIES**  
2026 W. BELMONT  
CHICAGO, IL 60618  
312-975-1290

### ELECTRONIC COMPONENTS & SUPPLIES

- RF CONNECTORS
- UG CONNECTORS
- AUDIO CONNECTORS
- LINEAR IC'S
- DIGITAL IC'S
- TRANSFORMERS
- METERS
- COMPUTER CABLES
- DISKETTES
- IDC CONNECTORS
- D-SUBMINIATURE
- TEST EQUIP
- TRANSISTORS
- DIODES
- TRIM CAPS
- RELAYS
- SWITCHES
- TOOLS

WRITE FOR FREE CATALOG  
VISIT OUR RETAIL STORE  
HRS. MON-FRI 10-5 SAT 10-2  
PHONE ORDERS WELCOMED  
312-975-1290

✓ 209

## FREE CATALOG!

Features Hard-to-Find Tools  
and Test Equipment



Jensen's new catalog features hard-to-find precision tools, tool kits, tool cases and test equipment used by ham radio operators, hobbyists, scientists, engineers, laboratories and government agencies. Call or write for your free copy today.

**JENSEN TOOLS INC.** 7815 S. 46th Street  
Phoenix, AZ 85040  
(602) 968-6231

✓ 150

## STATION MANAGER/ADVANCED

A General Purpose Logging Program

Designed for the IBM® PC,® XT,® enhanced PC jr.® Menu driven; prompts for easy use; full color displays; multiple logs (each up to 1,000 entries with user editing), several reporting methods including one by partial calling.

**\$79.00** includes: 90 pg. User's Guide & Diskette (source code included)

**\$20.00** — User's Guide only (may be applied to full purchase price)

Ohio residents include sales tax

## OMEGA CONCEPTS

Professional software for the Radio Amateur™

P.O. Box 615  
Troy, OH 45373



T.L. Jones (KB80A)  
Author

✓ 152

IBM is a registered trademark of International Business Machine Corp.



# flea market

**RATES** Noncommercial ads 10¢ per word; commercial ads 60¢ per word **both payable in advance.** No cash discounts or agency commissions allowed.

**HAMFESTS** Sponsored by non-profit organizations receive one free Flea Market ad (subject to our editing) on a space available basis only. Repeat insertions of hamfest ads pay the non-commercial rate.

**COPY** No special layout or arrangements available. Material should be typewritten or clearly printed (**not** all capitals) and must include full name and address. We reserve the right to reject unsuitable copy. **Ham Radio** cannot check each advertiser and thus cannot be held responsible for claims made. Liability for correctness of material limited to corrected ad in next available issue.

**DEADLINE** 15th of second preceding month.

**SEND MATERIAL TO:** Flea Market, Ham Radio, Greenville, N. H. 03048.

**CX7 REPAIRS.** 415-549-9210.

**LETTERING** and text for QSL pasteup and label usage. Stamp brings circular. Labelcraft, PO Box 412, W. Sand Lake, NY 12196.

**HOUSE READY FOR HAM.** Beautiful mountain top all brick 4 bedroom, 3 full bath home and radio site on one acre landscaped, private, with huge inground pool. Located 55 miles from Washington, DC and 60 miles from Baltimore, easy commute by Amtrack or van pools. Extremely energy efficient brick home, full basement and other extra rooms, radio room. All cable, poles, antennas, fire alarm system and intercom system stay. Must see to fully appreciate. Call or write to receive free written details of all features, \$250,000. (301) 371-7521. John Murray. Box 290, Jefferson, Maryland 21755.

**ELECTRON TUBES** — Radio & TV types 75% off list price. Huge inventory. Also industrial types. Send for free catalog today or call Toll Free (800) 221-5802. Box HC, Translateronice, Inc., 1365 - 39th Street, Brooklyn, NY 11218. See our display ad in this issue.

**CUSTOM MADE** embroidered patches. Any size, shape, colors. Five patch minimum. Free sample, prices and ordering information. Hein Specialties, Inc., Dept. 301, 4202 N. Drake, Chicago, IL 60618.

## Foreign Subscription Agents for Ham Radio Magazine

Ham Radio Austria  
Karin Ueber  
Postfach 2454  
D-7850 Loerrach  
West Germany

Ham Radio Belgium  
Streekluis  
Brusselsesteenweg 416  
B-9218 Gent  
Belgium

Ham Radio Holland  
Postbus 413  
NL-7800 Ar Emmen  
Holland

Ham Radio Europe  
Box 2084  
S-194 02 Uplands Vastby  
Sweden

Ham Radio France  
SM Electronic  
20 bis. Ave des Clairons  
F-89000 Auxerre  
France

Ham Radio Germany  
Karin Ueber  
Postfach 2454  
D-7850 Loerrach  
West Germany

Canada  
Send orders to  
Ham Radio Magazine  
Greenville, NH 03048 USA  
Prices in Canadian funds  
1 yr. \$29.95, 2 yrs. \$53.30  
3 yrs. \$75.40

Ham Radio Italy  
Via Pordenone 17  
I-20132 Milano  
Italy

Ham Radio Switzerland  
Karin Ueber  
Postfach 2454  
D-7850 Loerrach  
West Germany

Ham Radio England  
c/o R. S. G. B.  
Alma House  
Cranborne Road  
Potters Bar  
Herts EN8 3JW  
England

Holland Radio  
143 Greenway  
Greenside, Johannesburg  
Republic of South Africa

**RECLAIM SILVER** from electronics scrap! Write RALTEC, 25884F Highland, Cleveland, OH 44143.

**WANTED:** Manual and schematics for military V.L.F. receiver R-1134/WR-3. Tom Adams, K9TA, PO Box 5541, Madison, WI 53705.

**NEW CW** Word Copying Course. Easy to learn. Complete. QSO-Trainer™ Course. Send \$16.95 (Indiana add 85¢). Money-back satisfaction guarantee (less \$2.00 shipping and handling). Business-size SASE gets free information. AVC Innovations, Inc., Department HC, PO Box 20491, Indianapolis, IN 46220

**COMPUTERIZE** Your IC-720 or R-70 Keyboard frequency entry, 64 memories, scanning (frequency, Memory, and mode) Many more features. Requires no interface, just cable, directions included. For Commodore 64. Cassette \$14.75, disk \$16.75, pdd. Cables also available. David Oliver, W9ODK, Rt. 2, Box 246, Shevlin, MN 56676

**WINDMILL & TOWER:** 1978 Dunite 2000 watt windmill, 110' Rohn 45G tower with new concrete anchors, 110V - 220 amp battery bank, converter, loading switch. Complete system only. \$4,995.00. (518) 623-9951 Box 196, HCR-01, Warrensburg, NY 12885

**TRS-80 Model I/III/IV** owners. HF antenna design program calculated dimensions for dipole, Yagi, and quad antennas. \$14.95 (cassette) + \$2.00 s&h to Cynwyn, Dept. H, 4791 Broadway, Suite 2F, New York, NH 10034.

**MILITARY RADIOS:** CPRC-26 Manpack Radio (described in March 1985 Ham Radio). Transceives 46.54 MHz, with battery box, antenna, crystal, handset. \$22.50 apiece, \$42.50 pair, good condition. R-390A Receiver, 5-32 MHz all modes, 4 mechanical filters, meters sealed (government removed, operation unaffected): \$175 complete/checked; spare parts unit (80% complete, missing PTO/F): \$65. Info SASE. CPRC-26 add \$4/unit shipping. R-390A shipping charges collect. Baytronics, Dept. HR, Box 591, Sandusky, Ohio 44870. 419-627-0460 evenings

**CLIMBING BELTS.** OSHA certified nylon web belt with adjustable lanyard. \$54.95 plus \$3 UPS. John Limbach, K8NN, 7397 S. Platte Canyon Drive, Littleton, CO 80123.

**MINT ROBOT 400.** First sync modification. Instruction book and original box. 1 ship. \$275 firm. Jim Valentino, KW2W, PO Box 438, Mastic Beach, NY 11951.

**RUBBER STAMPS:** 3 lines \$4.50 PPD. Send check or MO to G.L. Pierce, 5521 Birkdale Way, San Diego, CA 92117. SASE brings information.

**CHASSIS** and cabinet kits. SASE K3IWK.

**IMRA**, International Mission Radio Association, helps missionaries. Equipment loaned. Weekday net, 14,280 MHz, 2-3 PM Eastern. Eight hundred amateurs in 40 countries. Brother Frey, 1 Fryer Manor Road, Larchmont, NY 10538.

**ELECTRON TUBES:** Receiving, transmitting, microwave... all types available. Large stock. Next day delivery, most cases. Daily Electronics, PO Box 5029, Compton, CA 90224 (213) 774-1255

**RTTY-EXCLUSIVELY** for the Amateur Teleprinter. One year \$7.00. Beginners RTTY Handbook \$8.00 includes journal index. P.O. Box RTY, Cardiff, CA 92007.

**OLD RADIO** transcription discs wanted. Any size, speed. W7FIZ, Box 724 HR, Redmond, WA 98073-0724.

## Coming Events ACTIVITIES "Places to go..."

**OHIO:** 43rd annual Findlay Hamfest sponsored by the Findlay Radio Club at the Hancock County Fairgrounds. Sunday, September 8, 6:30 AM to 5 PM. Advance tickets \$3.00 by September 1. At the door \$4.00. Tables \$6.00 each. Outdoor flea market spaces \$3.00 each. Talk in on 147.75/15. For more information write Findlay Radio Club, PO Box 587, Findlay, Ohio 45839.

**CALIFORNIA:** The Sonoma County Radio Amateurs' third annual Ham Radio flea market Saturday, September 21, 8 AM to 2 PM, Sebastopol Community Center, 390 Morris St., Sebastopol. Admission and parking free. Tables \$6/door, \$5/advance. Vendor setup 7 AM. Radio clinic, exhibits, refreshments. Noon auction. Talk in on 146.13/73. For tickets and information: SCRA, Box 116, Santa Rosa, CA 95402.

**WYOMING:** (Laramie-Cheyenne) The 6th annual High Plains Ham Roundup, September 6, 7, 8, Medicine Bow National Forest, Yellow Pine Campground, 14 miles east of Laramie on I-80. Sponsored by the Shy-Wy ARC, University of Wyoming ARC and Northern Colorado ARC. Saturday potluck supper — bring your favorite dishes. Swapfest, packet radio, musical entertainment and campfire sing-a-long. All hams and families welcome. No registration fees. Small forest service charge for campers. Talk in on 22/82 and 25/85. For information: K0HRS, 2204 Vassar Ave., Fort Collins, CO 80525

**PENNSYLVANIA:** York Hamfest, September 21 and 22, York Fairgrounds, Rt. 74. Seminars, tailgating, displays, banquet and FCC exams on Saturday. Tailgating and displays on Sunday. Registration \$2/Saturday and \$4/Sunday. \$5/both days. XYL's and Jr. ops under 12 free. Saturday evening banquet \$10.00 advance only. Tailgating \$4 per day, \$6 both days. Indoor tables \$5 and up per day. Vendors setup 6 AM. Registration 8 AM both days. Ladies' activities. Special motel rates and overnight camping on grounds. Write York Hamfest, Box W, Dover, PA 17315.

**TEXAS:** Houston Con-Vention '85, September 20-22, Stouffer Greenway Plaza Hotel, SW freeway and Edloe St., 5 miles SW of downtown Houston. Friday night registration 5:00 PM, hospitality suites and HARC auction. Saturday 8 AM to 5 PM. Sunday 9 AM to 3 PM. Indoor flea market, exhibits, ladies' luncheon and forums, free parking. Saturday night Texas BBQ dinner. For information (713) 333-1466.

**NEW YORK:** Hall of Science Amateur Radio Club Hamfest, Hall of Science parking lot, Flushing Meadow Park, 47-01 111th Street, Corona, Queens, Sunday, September 8. Rain-date September 15. 9 AM to 4 PM. Donation: buyers \$3.00, sellers \$5.00 per space. Talk in on 144.250 simplex link, 223.6000 repeat, 445.225 repeat. For information: John Powers, KA2AHJ, (718) 847-8007. Arnie Schiffman, WB2YXB, (718) 343-0172.

**NEW YORK:** Long Island Hamfair, Sunday, September 22, New York Institute of Technology, Rt. 25A, Northern Blvd., Old Westbury. General admission \$3. Spouse, children, sweethearts free. Exhibitors \$5 per car space. No reservations. Talk in on 146.85. Hank Wener, WB2ALW (516) 484-4322 or Bob Reed, WB2DIN (516) 221-8116 evenings.

**OHIO:** Lima Hamfest, October 13, Allen County Fairgrounds, Rts. 309 and 117. Advance tickets \$3.00. Door \$3.50. Tables \$6.00; half tables \$3.50. For reservations SASE and check to NOARC. PO Box 211, Lima, OH 45801. Amateur exams, Novice through Extra. Send completed FCC 610 with check for \$4.00 payable to ARRL/VEC and photocopy of current license by September 13 to Amateur Exams, NC8F, PO Box 211, Lima, Ohio 45802. SASE required.

**NEW YORK:** The 1985 Ham-O-Rama, September 14, Niagara Falls International Convention Center, Niagara Falls. General admission \$3.50/advance before August 24, \$5.00/gate. Canadian money accepted at par for advance general admission tickets. Computer and equipment displays, tech programs, indoor/outdoor flea market, FCC exams Novice through Extra. Outside flea market \$5.00, inside \$15.00. Talk in on 146.31/91 and 146.52 simplex. For information: Nelson Oldfield, 126 Greenaway Blvd., Cheektowaga, NY 14225.

**1985 BLOSSOMLAND BLAST**, Sunday, October 6, 1985, Write "BLAST", PO Box 175, St. Joseph, MI 49085.

**KENTUCKY:** The 1985 ARRL National Convention, October 4, 5 and 6, Kentucky Fair and Exposition Center, Louisville. Exhibitors and flea market all air conditioned. ARRL forum, packet radio, AMSAT, FCC National weather service, ladies' programs and much more. Admission \$5.00 advance; \$6.00 at door. 12 and under free. For information contact The Greater Louisville Hamfest Assn., PO Box 34444, Louisville, KY 40232. (502) 368-6657.

**OHIO:** The annual Cincinnati Hamfest, Sunday, September 15, Stricker's Grove, Rt 126, one mile west of Venice (Ross). Exhibits, food and refreshments, flea market, music, hidden transmitter hunt, awards and sensational air show. Admission and registration \$5.00. For information: Lillian Abbott, K8CKI, 317 Greenwell Road, Cincinnati, OH 45238.

**MICHIGAN:** The L'Anse Creuse ARC presents the 13th annual Swap and Shop, September 15, L'Anse Creuse High School, Mt. Clemens. 0800-1500. Plenty of food and parking. Trunk sales \$4.00 per space. Inside tables \$8.00 each. Tickets \$2.00 at door, \$1.00 advance. Talk in on 147.69/.09 and 146.52. For tickets and table reservations: Maurice Schietcatte, NBCEO, 15835 Touraine Ct., Mt. Clemens, MI 48044. (313) 286-1843.

**VIRGINIA:** ARRL Virginia State Convention and 10th annual Amateur Radio-Computer Fair, Saturday and Sunday, September 21 and 22, rain or shine, Virginia Beach Pavilion, 9 AM to 5 PM. Advance tickets both days \$5.00. \$6.00/door. Flea market tables \$5.00 one day, \$8.00 both days. Displays, forums, computer equipment, ARRL license upgrading exams. For information and tickets: Jim Harrison, N4NV, 123 Little Bay Avenue, Norfolk, VA 23503. (804) 587-1695.



**MICHIGAN:** The Central Michigan ARC and Lansing Civil Defense Repeater Association are sponsoring Ham Fair '85 at the National Guard Armory, 2500 S. Washington Avenue, Lansing, Sunday, October 13, 8 AM to 3 PM. Admission \$3.00. Tables 75¢ per foot by reservation only. FCC exams at 1 PM registration by September 13. For information and reservations: Rowena Elrod, KA8OBS, 111 Lancelot Place, Lansing, MI 48906. (517) 482-9650.

**NEW HAMPSHIRE:** The Connecticut Valley FM Association's 9th annual Hamfest and Flea Market, September 29, 9 AM to 5 PM rain or shine, King Ridge Ski Area, Sutton. General admission \$2.00. Dealers and flea market set up \$3.00. Food available. Overnight camping for SC units (no hookups). Talk in on 146.76 or 146.52 simplex.

**CONNECTICUT:** The Candlewood Amateur Radio Association (CARA) annual Flea Market, Sunday, September 15, Edmond Town Hall, Main St., Newtown, 10 AM to 4 PM, Dealers 9 AM. Admission \$2. Tables \$7. Tailgating \$5. Talk in on 147.72/12 or 52 simplex. For table reservations send check or MO to CARA, PO Box 143, Bethel, CT 06801. For information: Gene Marino, W1IDH, Valley View Rd., Newtown, CT 06470. (203) 426-8852.

**ILLINOIS:** The 10th annual New Berlin Hamfest sponsored by the Sangamon County Fair Association, Sunday, September 22, rain or shine, Sangamon County Fairgrounds, 7 AM to 3 PM. Admission and flea market setup free. Food and drink available. Talk in on 146.52 and 146.88. For information: Al Sweetman, K9QFR, Box 2, Pleasant Plains, IL 62677 (217) 626-1634.

**OHIO:** Cleveland Hamfest & Computer Show, Sunday, September 22, Cuyahoga County Fairgrounds, Berea. General admission 8 AM to 5 PM, \$3.50 at gate, \$3.00 advance. Under 12 free. Special NASA displays, vendors, speakers, Packet Radio, FCC and more. Non-ham and ladies' activities. For tickets or information: Cleveland Hamfest Assn., PO Box 93077, Cleveland, OH 44101. Walk-in Amateur Radio license exams starting 9 AM. Bring original and copy of current license. Check for \$4 payable to ARRL/VEC. For information: Dave Willemis, A18M, 331 Courtland, Elyria, OH 44035. Ph: 324-4574. Saturday night Hamfest banquet. For reservations: Barbara Ernest, N8DAD, 327-3914.

**CONNECTICUT:** Annual Natchaug Amateur Radio Association Flea Market, Sunday, September 22, 9 AM to 4 PM, Elk's Home, 198 Pleasant Street, Willimantic. Advance reserved tables inside/outside \$5.00 ea. At door \$7.00 ea. Admission \$2.00. Under 16 free. Free parking. Talk in on 52 direct or 147.30/90. For information: Ed Sadeski, 49 Circle Drive, Willimantic, CT 06226. (203) 456-7029 after 4 PM.

**GEORGIA:** DXPO 1985, September 27, 28 and 29. Lanier Plaza Hotel, I-85 and Monroe Drive NE, Atlanta. Reservations: Grover Meinert, KC8BX, 720 Starlight Lane NE, Atlanta, GA 30342. Registration \$49.50.

**PENNSYLVANIA:** Pack Rats (Mt. Airy VHF ARC) 9th annual Mid-Atlantic VHF Conference, Saturday, October 5, Warrington Motor Lodge, Rt. 611, Warrington, 14th annual Hamarama, Sunday, October 6, Bucks County Drive-In Theatre, Rt. 611, Warrington. Flea market admission \$5.00. Selling spaces \$8.00 each. Gates open 6 AM, rain or shine. Bring own tables. Advance registration for Conference \$4.00. Send to Hamarama '85, PO Box 311, Southampton, PA 18966 or Lee A. Cohen, K3MXX (215) 634-4942.

**NORTH CAROLINA:** 1985 National QCWA Convention, September 26, 27 and 28, Hyatt Winston-Salem. Meetings, forums and interesting local tours.

**OREGON:** The Walla Walla Valley Radio Amateur Clubs' 39th annual Hamfest, September 21 and 22, Community Building, Milton-Freewater. Free registration. For flyers write Pat Stewart, W7GVC, 1404 Ruth Street, Walla Walla, WA 99362.

**GEORGIA:** The 12th annual Lanierland ARC Hamfest, September 22, 9 AM Gainesville Holiday Inn. Free tables and inside display area for dealers with advance registration. Large parking lot for flea market. Doors open 8 AM for dealer set up. Talk in Novice through Extra exams starting 9 AM. Talk in on 146.07/67. For information/reservations: Paul Walkins, W4FDK, Route 11, Box 536, Gainesville, GA 30501 (404) 536-8280.

**NEW YORK:** The Elmira Amateur Radio Association's 10th annual International Hamfest, September 28, Chemung County Fairgrounds. Outdoor flea market, dealer display, breakfast and lunch available on premises. Gates open 6 AM to 5 PM. Tickets at gate or advance from Steve Zolksky, 118 East 8th Street, Elmira Heights, NY 14903.

**NEW MEXICO:** Northern New Mexico ARC's annual Hamfest, September 28 and 29, Camp Stony, 8 miles east of Santa Fe. Saturday AM — ARRL/VEC exams. Free overnight camping, no hookups. Sunday, 8 AM to 3 PM, tailgate flea market, dealers, programs. Admission \$3.75 adults; \$1.75 kids includes lunch. Talk in on 52 and local repeaters. For information: SASE to NNMARC, Rt. 3, Box 95-15, Santa Fe, NM 87501.

**ILLINOIS:** Peoria Area Amateur Radio Club's Superfest '85, September 21 and 22, Exposition Gardens, W. Northmoor Rd., Peoria. Admission \$3.00 advance, \$4.00 gate. Children under 12 free. Amateur radio and computer displays, huge flea market, FCC exams Saturday. Free bus to Northwoods Mall on Sunday. Full camping facilities on grounds. Saturday night get-together at Heritage House Smorgasboard, 8209 N. Mt. Hawley Rd., Peoria. For information: SASE to Superfest '85, PO Box 3461, Peoria, IL 61614.

**MARYLAND:** The Columbia Amateur Radio Association's 9th annual Hamfest, Sunday, October 6, 8 AM to 3:30 PM, Howard County Fairgrounds, 15 miles west of Baltimore. Admission \$3.00. Spouse and kids free. Outdoor tailgating \$5.00. Tables \$6.00. Indoor tailgating (payments by Sept. 30) \$6.00. Food available. Talk in on 147.735/147.135, 146.52/146.52. For reservations and information: Mike Vore, W3CCV, 9098 Lampskin Lane, Columbia, MD 21045. (301) 992-4953.

**NEW YORK:** Yonkers Electronics Fair and Giant Flea Market, Sunday, October 6, 9 AM to 4 PM, Yonkers Municipal Parking Garage, Nepperhan Avenue & New Main Street. Rain or shine. Refreshments, free parking, unlimited free coffee all day. Giant auction 2 PM. Admission \$3.00. Children under 12 free. Sellers \$7.00 per parking space, admits one. Bring tables. For further information: (914) 969-1053.

**CONNECTICUT:** CQ Radio Club of Torrington will hold its annual Flea Market, Saturday, October 5, 9 AM to 3 PM, East Albert Street Recreation Building. Dealers \$7.00 per table. Tailgaters \$5.00. Admission \$1.00. Talk in on 146.955. For information: Donald D. Taylor, KA1GKJ, PO Box 455, Watertown, CT 06795.

**NEW JERSEY:** The South Jersey Radio Association, the oldest radio club in continuous operation in the US (1916) will hold its 37th annual Hamfest, Sunday, September 15, Pennsauken High School, Hylton Road, Pennsauken. Table and tailgating sales in parking lot. Refreshments and food available. Gates open 8 AM. Tickets \$2.50 advance, \$3.00 at door. Tailgating \$5.00 per space plus admission ticket. Talk in 145.29/144.69. Contact Fred Haller, W2EKB, 348 Bortons Mill Rd., Cherry Hill, NJ 08034. (609) 795-0577.

**NEW HAMPSHIRE:** Hosstraders annual Fall tailgate swapfest, Saturday, October 5, Deerfield Fairgrounds. Donation \$2 per person sellers included. Profits benefit Shriners' Boston Burns Center. Our May Swapfest gave \$6,960. Friday night camping at Nominal fee after 4 PM. Talk in 52 and 146.40-147.00. For information SASE to Norm, WA1IVB, RFD Box 57, West Baldwin, ME 04091.

**NEW YORK:** The Radio Amateurs of Greater Syracuse 30th RAGS Hamfest, Saturday, October 5, New York State Fairgrounds off Rt. 690, 9 AM to 6 PM. Flea market setup 7:30 AM. Flea market tables \$6. Outdoor tailgating \$3. Exhibitors and dealers. VE exams by pre-registration. Speakers, ARRL forum, free parking. Admission \$3. Talk in on 31/91 and 90/30. For information: Viv Douglas, WA2PUU or Ed Swiatowski, WA2URK, PO Box 88, Liverpool, NY 13088.

**RHODE ISLAND:** The RI Amateur FM Repeater Service will hold its annual Fall Flea Market and Auction, Saturday, September 22, American Legion Fairmont Post 85, 870 River St., Woonsocket. Starts 9 AM. Spaces \$5.00 each. Some other spaces available under pavilion. Auction noon to 5 PM. Admission free. Food and beverages available. Talk in on 34/94 and 52 simplex. For information: Richard Fairweather, K1KY1, 127 Sherman Farm Rd., Harrisville, RI 02830. (401) 568-3468.

**MASSACHUSETTS:** The Hampden County Radio Association will be giving exams for all classes of Amateur Radio licenses, Saturday, October 18, Hampden-Wilbraham Reg. High School, 621 Main Street, Wilbraham at 9 AM. Get Form 610 by writing to the club. For upgrading, bring original and copy of current license, check for \$4 payable to ARRL/VEC. Send completed applications to Yorke Phillips, 235 Ames Rd., Wilbraham, MA 01036 or sign up that day. Sign up time 8:30 AM. Amateur radio classes will be held in the Fall. Send post card with name, address and phone number to Hampden County Radio Association, PO Box 482, West Springfield, MA 01090.

## OPERATING EVENTS

"Things to do..."

**Riding Radio Operators** — Amateur Radio Motorcycle Club Net meets every Thursday night at 0300 UTC at 3888 kHz standard time and 7237.5 kHz daylight saving time. An eastern USA group meets one hour earlier at 3888 kHz year-round. Send business SASE to AG0N, Gary McDuffie, Rt. 1, Box 464, Bayard, NE 69334 and ask for net information.

**September 21:** Celebrate Connecticut's 350th anniversary with Connecticut DX Association and the Newtoning Amateur Radio League. Listen for KW1V operating from the grounds of the State Capitol in Hartford. For a special QSL card and official Connecticut Tourism map send business SASE with

39¢ to Dave Rose, KW1V, 13 Long Crossing Road, East Hampton, CT 06423.

**September 18:** The Little Brown Jug special event held by the Delaware Amateur Radio Association, W8QLS, at the Delaware County Fair. For a Delara QSL card SASE to W8QLS, Staff Stafford, 5987 Dublin Road, Delaware, OH 43015.

**September 14:** Members of the Utica-Shelby Emergency Communications Association (USECA) Utica, Michigan, will operate KA8KTV to celebrate the first air-to-ground public telephone service inaugurated between Chicago and Detroit 1957. For a certificate send large SASE to USECA, PO Box 291, Utica, MI 48087.

**September 13:** The Michigan Technological University ARC will operate special event station W8YY to celebrate the University's Centennial and the Club's Golden Anniversary. Help support young Amateur Radio students. For a commemorative certificate send QSL and large SASE to Debbie Parmer, c/o W8YY, W. Wadsworth Hall, MTU, Houghton, MI 49931.

**September 10-14:** The Southern Counties ARA will operate K2BR during the Miss America Pageant, Atlantic City, NJ. SASE via SCARA, Box 121, Linwood, NJ 08221.

**September 29:** Fall Classic Radio Exchange, 2000 UTC, Sunday to 0300 UTC, Monday. Object to restore, operate and enjoy older equipment with like-minded hams. Exchange name, RST, QTH, receiver and transmitter type. Same station may be worked with different equipment combinations, each band, each mode. CW call "CQ CX", phone "CQ Exchange". Send logs and SASE to Stu Stephens, K8SJ, 1407 Hollywood Road, Sandusky, OH 44870.

**September 14:** The West Alabama Amateur Radio Society (WAARS) will operate special event station WD4DAT from the campus of the University of Alabama to commemorate the "Greatest College Football Coach in History" Paul 'Bear' Bryant. 1300Z to 2400Z. For a handsome commemorative certificate of the event send \$1 and large SASE to WAARS, PO Box 1741, Tuscaloosa, AL 35403.

**September 17:** The Eagle Rock ARC of Idaho Falls will commemorate the 198th anniversary of the adoption of the Constitution of the United States with special event stations KX7C and N07B. For a special commemorative QSL SASE to Eagle Rock ARC.

**September 21:** The Paul Bunyan Wireless Association will operate a special event station from the site of the Paul Bunyan Festival near Brainerd, MN. For a commemorative QSL SASE to Paul Bunyan Wireless Assoc., PO Box 354, Pequot Lakes, MN 56472.

**September 21:** Minnesota QSO Party sponsored by the Paul Bunyan Wireless Association, 1700Z Saturday to 1700Z Sunday. Special awards for most contacts on phone, CW, mixed and QRP. Send logs to George Carleton, AD0S, PO Box 43, Merrifield, MN 56465.

**September 12:** The Columbiana County ARC will operate N8DKX to commemorate the annual Johnny Appleseed Festival. For a certificate send large SASE and QSL to N8DKX, 6008 Camp Blvd., Lisbon, OH 44432.

# SAY YOU SAW IT IN

**ham  
radio** magazine

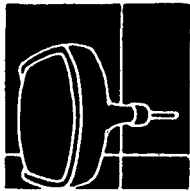

## "TUNE IN" THE WORLD OF SPECIALIZED COMMUNICATIONS!

Thousands of "Ham Radio" operators across the country are enjoying "Specialized Communications" modes. Whether it's FSTV, SSTV, FAX, OSCAR, EME, RTTY, PACKET or COMPUTERS, today's Radio Amateur is a highly skilled Communications Specialist!

Providing full, in-depth coverage of these modes is our business and we've been doing it now for over 19 years! And now we're expanding!

Iowa Residents Must Add 4% Sales Tax.  
4% Added To All Charge Card Orders.



Now published "monthly" 10 times per year, **SPEC-COM™** readers are kept up-to-date in a world of fast moving modern technology.

Why not give us a try? Back issue samples are available for just \$2.00 ppd. (Master Article Indexes add \$1.00).

Special Six Month Trial Subscription -\$10.00. U.S./Canada/Mexico Annual Subscription \$20.00. (Foreign Subscriptions slightly higher).

### SPEC-COM™

Amateur Radio Specialized Communication Journal

P.O. Box H

Lowden, Iowa 52255

(319) 944-7669 (Membership Services)

125

## the ham notebook

### solving a difficult TVI problem

Just when I thought I had the neighborhood TVI-proofed a new neighbor called to tell me my station was causing TVI to his cable service.

After many fruitless attempts to help him solve the problem, I told him that his situation was, in my opinion, due to the shoddy, run-of-the-mill converter that the cable company had provided. He didn't believe me and continued to write letters of complaint to the FCC.

In due time two FCC field engineers from the New York City office came to my place, dragged a truckload of instruments into the house, made a number of tests, gave my station a clean bill of health, and told the neighbor the TVI problem was *his* baby. Again I told the neighbor to get a better converter.

When the cable company did nothing about the problem, the neighbor bought a completely shielded state-of-the-art, crystal-controlled converter that cleared up most of the TVI.

We concluded that the residual interference may have been caused by reradiation from the neighbor's "Genie" automatic door units.

A call to the manufacturer was met not only with a sympathetic reception but also with quick action. The manufacturer's representative was familiar with the problem, which originated in the sequencer boards in the units. She said that even though the old units were out of warranty, the company would send new replacement boards at no charge provided the old boards were sent back. Installing the new boards (Alliance, Inc. Part No. 21277R) removed the last trace of TVI.

John Labaj, W2YW

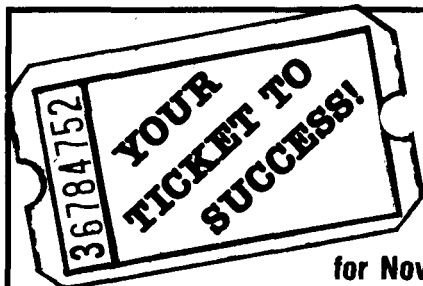

## AMECO STUDY GUIDES

for Novice, General, Advanced and Extra

AMECO study guides are taken from the FCC Amateur Exam syllabus, PR 1035A and have answers keyed to the ARRL's recently released study material. These study guides are compatible with ARRL and all other VEC exams. While nothing can guarantee that you will pass, AMECO study guides will make sure that you are fully prepared and ready-to-go when you sit for the exam.

Each study guide has been written in a clear, precise easy-to-read format. Each question is fully explained. For subjects that need a more complete explanation, AMECO has cross referenced the Novice and General Class study guides with AMECO's AMATEUR RADIO THEORY COURSE, 102-01.

27-01 Novice Class	Softbound \$2.25
12-01 General Class	Softbound \$4.95
26-01 Advanced Class	Softbound \$4.95
17-01 Extra Class	Softbound \$4.95
23-01 Novice Class Theory Course	Softbound \$3.75
102-01 Amateur Radio Theory Course	Softbound \$6.95

Order today! Get yourself ready to upgrade with AMECO Study guides.

Please enclose \$3.50 per order for shipping and handling.

**ham radio** magazine **BOOKSTORE**  
GREENVILLE, NH 03048 (603) 878-1441



# Eureka!

We just struck gold with a miniature, high quality and very reliable DTMF decoder at a rock bottom price of \$59.95. Our DTD-1 will decode 5040, 4 digit codes with the security of wrong digit reset. It contains a crystal controlled, single chip DTMF decoder that works great in bad signal to noise environments and provides latched and momentary outputs. Why carry that heavy gear when its size is only 1.25 x 2.0 x .4 inches and it comes with our etched in stone, legendary, one year warranty.

Instead of sifting through the field...searching, use our super quick one day delivery and cash in on a rare find.

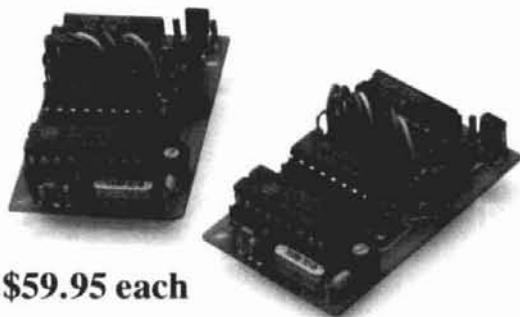

**\$59.95 each**

**COMMUNICATIONS  
SPECIALISTS**

426 W. Taft Ave., Orange, CA 92665-4296  
Local (714) 998-3021 • FAX (714) 974-3420  
Entire U.S.A. 1-800-854-0547



# The Problem Solver...

The RF Wattmeter Model 81000-A from Coaxial Dynamics, Inc. does more than provide accurate rf measurements. Testing of transmission lines, antennas, connectors, filters and related components can reveal unknown problems and assure optimum equipment performance.

The 81000-AK Wattkit features this easy-to-read RF Wattmeter (pictured here), with its optional carrying case and an array of elements and accessories. Coaxial Dynamics elements can be purchased separately for use in other manufacturer's Wattmeters. For more information on the 81000-A Wattmeter or any of the complete line of Coaxial Dynamics RF products and OEM components please contact Coaxial Dynamics, Inc.



**COAXIAL DYNAMICS, INC.**

15210 Industrial Parkway, Cleveland, OH 44135 • (216) 267-2233  
Outside Ohio, WATS: (800) Coaxial, Telex: 980-530

QUADS — TOWERS — QUADS — TOWERS — QUADS

## UNDER NEW MANAGEMENT DO YOU WANT THE STRAIGHT INFO ON QUADS?

Info on verticals, dipoles, mini-quads, Yagis, including comparative performances?

**Without pulling any punches.**

Our references are ANY AMATEUR WHO USES A SKYLANE QUAD.

Our prices are lower than any comparable Quad or tower

Info on quads **half a buck**, and info on BOTH towers and quads for a **buck**. Charge due to increased cost of postage and printing.

### SKYLANE PRODUCTS

359 Glenwood Avenue  
Satellite Beach, FL 32937  
(305) 773-1342

QUADS — TOWERS — QUADS — TOWERS — QUADS

QUADS — TOWERS — QUADS — TOWERS — QUADS

QUADS — TOWERS — QUADS — TOWERS — QUADS

**AR-200 XL**  
MEDIUM DUTY ANTENNA ROTOR  
Select a Heading - Antenna Turns and Stops Automatically

**\$99.95**

**SIDE BAND SQUELCH**

- Fits inside most HF-SSB transceivers
- Requires human voice to activate
- Ignores static, noise and heterodynes
- On/off switch only—no adjustments!
- Connects to audio leads and 9-12 VDC
- Fully assembled and tested \$99.95
- Complete with comprehensive manual
- Used worldwide in commercial and military transceivers

CMC COMMUNICATIONS  
5479 Jetport, Tampa, FL 33614 (813) 885-3996

# WARNING

## SAVE YOUR LIFE OR AN INJURY

Base plates, flat roof mounts, hinged bases, hinged sections, etc., are not intended to support the weight of a single man. Accidents have occurred because individuals assume situations are safe when they are not.

Installation and dismantling of towers is dangerous and temporary guys of sufficient strength and size should be used at all times when individuals are climbing towers during all types of installations or dismantlings. Temporary guys should be used on the first 10' or tower during erection or dismantling. Dismantling can even be more dangerous since the condition of the tower, guys, anchors, and/or roof in many cases is unknown.

The dismantling of some towers should be done with the use of a crane in order to minimize the possibility of member, guy wire, anchor, or base failures. Used towers in many cases are not as inexpensive as you may think if you are injured or killed.

Get professional, experienced help and read your Rohn catalog or other tower manufacturers' catalogs before erecting or dismantling any tower. A consultation with your local, professional tower erector would be very inexpensive insurance.

Paid for  
By the  
Following:  
**ROHN**  
P.O. Box 2000  
Peoria, IL 61656

115

142

Uncle Ben says...

**"I give you  
much more than  
just the lowest price..."**

When you get that exciting new piece of equipment *from me*, you know you are going to be completely happy...

I see to it, personally! I also give you earliest delivery, greatest trade-in allowances, my friendly assistance in every possible way.

Just ask any of the many thousands of hams all over the world who have been enjoying my friendly good service for over a half a century.

73, Uncle Ben, W2SOH



"Uncle Ben" Snyder, W2SOH  
the head man of

**HARRISON**

"HAM HEADQUARTERS,  
USA®" ...Since 1925!

• **CALL ME...**

(516) 293-7995

• **WRITE ME...**

For my prompt,  
personal reply.

• **SEE ME...**

At one of the world's largest  
Ham Supply Centers!

**HARRISON**  
**HAS THEM ALL!**  
**KENWOOD**



Kenwood TH21AT, 31AT, 41AT



Kenwood TR-7950/7930



Kenwood TS-940S



Kenwood TS-430S



Kenwood TR-2600, TR-3600



Kenwood TS-711A (2m)  
TS-811A (70 cm)



**HARRISON** RADIO

...Since 1925!

**CHARGE IT!**

"HAM HEADQUARTERS, USA"

2263 Route 110 (at Smith St.)  
E. Farmingdale, NY 11735

1-(516) 293-7995

# Take it with you.

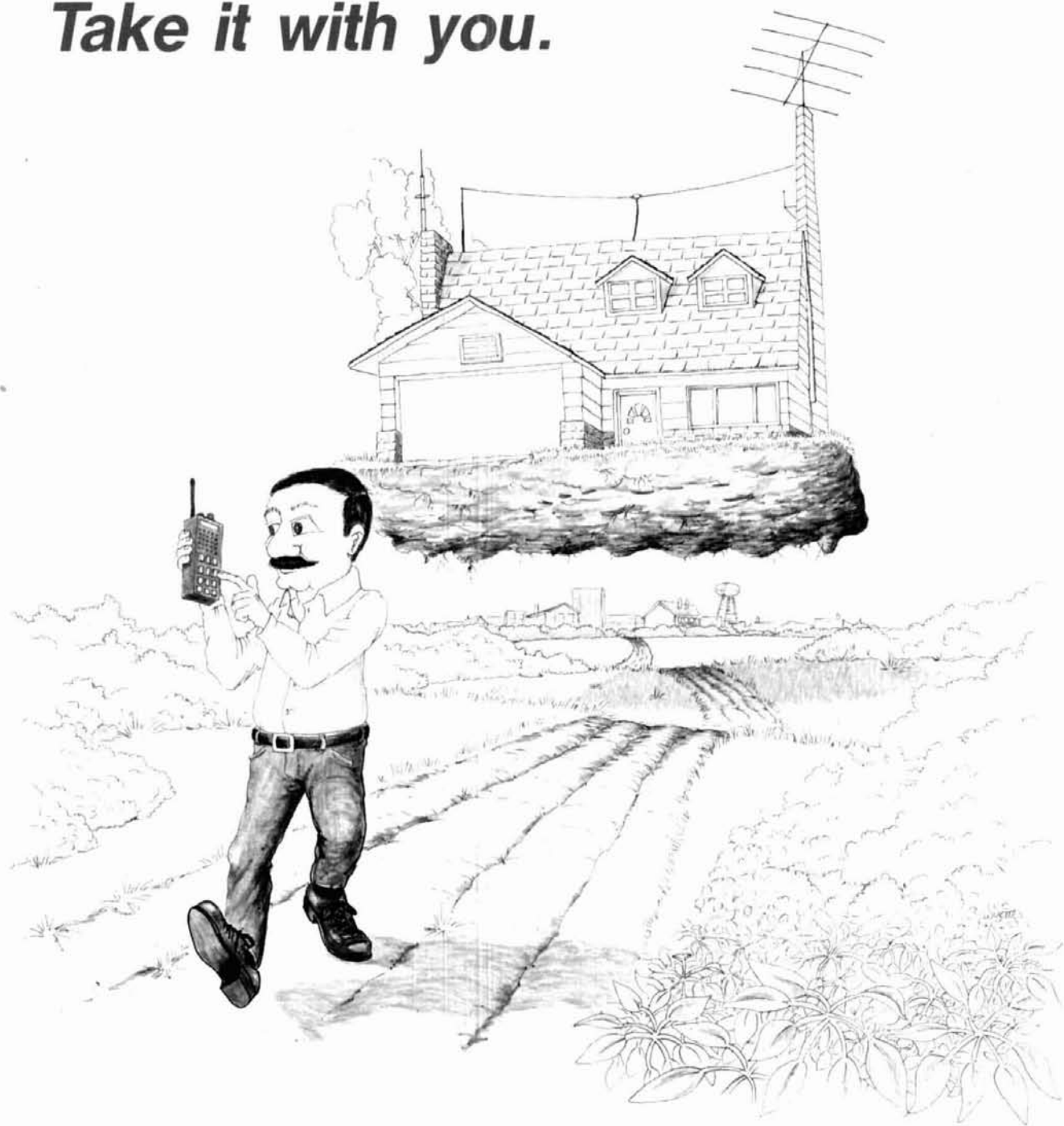

ShackMaster™ puts your home station in the palm of your hand. Whether portable, mobile, around the yard or around town you'll be linked through your handheld to your high performance equipment at home. Even call home from any Touch-Tone phone and operate.

Scan the bands, change modes, select antennas, turn gear on and off – all from your Touch-Tone keypad. Check into nets, work skeds, ragchew and DX without being tied down to the shack.

Exchange electronic mailbox messages with your family – like "I'll be late", or "All is OK". Or talk with your family directly through *ShackPatch™*, with you in remote control of your home station. Report traffic accidents or disabled motorists through your home phone while mobile or portable with *PersonalPatch™*.

All the power of your home station (and more) really can follow you anywhere... to find out more about ShackMaster™ just write, send us your QSL, or call and talk with us at 408-749-8330.

**acc**

advanced  
computer  
controls, inc.

10816 Northridge Square • Cupertino, CA 95014

(408) 749-8330

# THE GUERRI REPORT

Ernie *Guerrì*  
W6 MGI

## RF power supplies achieve high efficiency

We have long come to expect the power supply to be the one part of any system that is heavy and hot. Typical linear power supplies have power densities of about 0.25 watt/inch<sup>3</sup>, and are about 35 percent efficient at converting AC line power to usable DC. In recent years, however, switching supplies have improved the situation by converting the AC line to square waves at about 20 kHz. This higher frequency permits switching schemes using pulse width modulation as a regulation mechanism, which in turn keeps the input-output differential across the regulator quite small. The resulting supplies have power densities of about 1 watt/inch<sup>3</sup>, and efficiencies of more than 60 percent. But this improvement is not without a price. Switching supplies generate considerable noise, and consequently require more extensive filtering and shielding than linear supplies. Even so, their efficiency is excellent, and switching supplies are now the prevalent type in most Amateur equipment.

Recently, National Semiconductor has made a significant advance in switching technology by developing a power module (No. HS9151) that operates at 1 MHz. This integrated package operates directly from the 120 volt AC line and can deliver 5 volts at 5 amperes with almost 80 percent efficiency. Its small size gives it a power density of over 5 watts/inch<sup>3</sup>. As would be expected, appropriate filter-

ing is mandatory if you don't want to hear 1 MHz all over the spectrum. However, the high switching frequency makes filtering/shielding very manageable. This development surely signals the beginning of the end for bulky power supply components and frees valuable space in the new equipment designs for increased functionality.

## receiver technology makes new strides

No matter what band we favor, part of our success or failure depends on the quality of the receiver we have working for us. Modern technology gives us the option to have nearly perfect receiving capability — if we choose. Sadly, much of today's excellent technology is not implemented in the latest production receivers.

It's nearly impossible to find a "professional" grade communications receiver whose front-end doesn't fall apart at the seams with input signals of only -10 dBm, and many do much worse. Yet we've had balanced JFET front-end designs with 3rd order intercepts of over +20 dBm for nearly 20 years! The incremental cost for incorporating these front-ends would be a few dollars in production. On the plus side, nearly all new VHF/UHF receivers incorporate GaAs FET input stages, which give good noise figures and can handle large, complex input signals.

Intermediate frequency and detector sections suffer similarly. The availability of monolithic crystal and ceramic

filters has resulted in uniformly good performance at IF frequencies up to 45 MHz. However, few receivers offer multiple filters and all-mode detectors, even as options. Most of the necessary features are available in one or two ICs that could be added by the user if appropriate provisions were made during manufacture. Perhaps receiver designers could take a lesson from the computer people who leave empty card slots for expansion, or unpopulated sockets for memory expansion.

Thanks to the TV industry, frequency synthesis up to about 1 GHz is now relatively easy to achieve at modest cost. The Yaesu FRG-9600 is the first general coverage VHF/UHF receiver to use these low cost component assemblies in a versatile, reasonably priced package. These same techniques could be used to make high quality up-conversion (1st IF above the highest tuned frequency) receivers that would be image-free up through 450-500 MHz.

Just as ideas have been borrowed from the TV industry, we should soon see broader incorporation of computer technology into key receiver functions. The fact that most current equipment is microprocessor controlled makes the inclusion of an RS-232 port fairly easy, for example. Some manufacturers offer this feature now — but it (or something like it) will become almost a necessity as time goes by. Many of the advances now taking shape in the field of telecommunications are keyed to equipment that is computer controlled and highly adaptive.

ham radio

## SYNTHESIZED SIGNAL GENERATOR

MADE IN  
USA



MODEL  
SG-100F  
\$429.95  
delivered

- Covers 100 MHz to 199.999 MHz in 1 kHz steps with thumbwheel dial
- Accuracy +/- 1 part per 10 million at all frequencies
- Internal FM adjustable from 0 to 100 kHz at a 1 kHz rate
- External FM input accepts tones or voice
- Spurs and noise at least 60 dB below carrier
- Output adjustable from 5-500 mV at 50 Ohms
- Operates on 12 Vdc @ 1/2 Amp
- Available for immediate delivery • \$429.95 delivered • Add-on accessories available to extend freq range, add infinite resolution, AM, and a precision 120 dB attenuator
- Call or write for details • Phone in your order for fast COD shipment.

### VANGUARD LABS ✓ 155

196-23 Jamaica Ave., Hollis, NY 11423  
Phone: (718) 468-2720 Mon. thru Thu.

### "HAM HOTLINE" THE PROVEN MONEYSMAKER

The "Ham Hotline" is a complete mailing list of novice amateur radio operators and current hams who have renewed, upgraded or modified their FCC licenses. These ham enthusiasts have proven to be excellent prospects for radio equipment, accessories and publications.

The Hotline is **UPDATED EVERY TWO WEEKS** with an average of 8,000 names and addresses each month. And, because we know the Hotline is the most up-to-date amateur radio listing available, we'll guarantee 98% deliverability.

Target your sales efforts to your most likely buyers. Call DCC Data Service today and begin your subscription to the "Ham Hotline" . . . the proven moneysmaker.

**DCC Data Service, Inc.**  
**1990 M Street, N.W. Suite 610**  
**Washington, D.C. 20036**  
**(202) 452-1419** ✓ 147

### DRAKE R-4/T-4X OWNERS AVOID OBSELESCENCE

**PLUG-IN SOLID STATE TUBES!**  
Get state-of-the-art performance.  
Most types available

**INSTALL KITS TO UPGRADE  
PERFORMANCE!**

- BASIC Improvement
- Audio Bandpass Filter
- Audio IC Amplifier

TUBES \$23 PPD KITS \$25 PPD

OVERSEAS AIR \$7

**SARTORI ASSOCIATES, W5DA**  
BOX 832085  
RICHARDSON, TX 75083  
214-494-3093 ✓ 154

## ADVERTISER'S INDEX AND READER SERVICE NUMBERS

Listed below are the page number and reader service number for each company advertising in this issue. To get more information on their advertised products, use the bind-in card found elsewhere in this issue, select the correct reader service number from either the ad or this listing, check off the numbers, fill in your name and address, affix a postage stamp and return to us. We will promptly forward your request to the advertiser and your requested information should arrive shortly. If the card is missing, send all the pertinent information on a separate sheet of paper to: *ham radio magazine*, Attn: Reader Service, Greenville, NH 03048.

READER SERVICE #	PAGE #	157 - MFJ Enterprises	5
146 - Accessory Specialties	96	106 - MHz Electronics	134-139
110 - Advanced Computer Controls	156	204 - Micro Systems Institute	143
126 - Advanced Receiver Research	111	166 - Microwave Filter, Inc.	36
112 - AEA	79	111 - Midwest Amateur Radio Supply	20
175 - Alinco Electronics	72	188 - Missouri Radio Center	94
165 - All Electronics Corp.	34	172 - Morning Distributing	52
134 - Alum Tower Co.	125	118 - NCG Co.	121
* - Amateur Electronic Supply	116	117 - NCG Co.	54
186 - Amateur Wholesale Electronics	88	119 - Nomal Electronics	141
211 - Amateur Wholesale Electronics	159	120 - Nuts & Volts	120
235 - Amateur Wholesale Electronics	74	* - Octobvention	148
135 - Amidon Associates	82	152 - Omega Concepts	149
121 - AMSAT	118	132 - P. C. Electronics	54
185 - ARRL	84	183 - Packeterm	87
* - ARRL Nat'l Conv. Louisville, KY	44	163 - Phantom Engineering	28
170 - Astron Corporation	45	144 - Phillips-Tech Electronics	146
209 - Azotic Industries	149	192 - QSKY Publishing	111
190 - B.G. Micro	100, 101	* - Radio Warehouse	111
* - Barker & Williamson	84	195 - Radiokit	125
* - Barry Electronics	125	108 - Ramsey Electronics, Inc.	106
128 - Bilal Company	50	127 - RF Parts	93
136 - Gus Browning, W4BPD's DX'ers Magazines	72	141 - RF Products	52
143 - Buckmaster Publishing	146	105 - Robot Research, Inc.	16
* - Butternut Electronics	40	236 - Roensch Microwave	52
* - Caddell Coil Corp.	40	193 - San Pierre Satellite	111
129 - CeCo Communications	50	154 - Sartori Associates	158
101 - CES	1	104 - Satellite Video Services	95
142 - CMC Communications	154	153 - Skylane Products	154
191 - CMC Communications	118	125 - Spec-Corn	152
115 - Coaxial Dynamics, Inc.	154	122 - Spectrum International, Inc.	44
137 - Communications Concepts, Inc.	82	139 - Spi-Ro Manufacturing, Inc.	84
103 - Communications Specialists	153	179 - Starcom Distributing	46
116 - Computer Smyth Magazine	124	123 - STV/OnSat Magazine	128
102 - Connect Systems, Inc.	89	184 - TE Systems	84
114 - CTM	68	161 - Tel-Corn	13
203 - Data World	143	182 - TNT Radio Sales, Inc.	82
148 - DC Sales	144	176 - Translatelectronic, Inc.	72
147 - DCC Data Service, Inc.	158	237 - Unity Electronics	52
167 - Delaware Amateur Supply	37	* - University Microfilms Int.	82
* - Dick Smith Electronics	40	* - UNR-Rohn	31
199 - Digiteq Corp.	129	155 - Vanguard Labs	158
140 - Digitrex	31	109 - Varian, Eimac	8
138 - Doppler Systems	124	177 - VHF Communications	72
* - Engineering Consulting	121	178 - VHF Communications	73
213 - EXMET	124	207 - The VHF Shop	146
197 - Fair Radio Sales	125	145 - W9INN Antennas	52
173 - John Fluke Manufacturing Co., Inc.	66	133 - James Walter Satellite Receiver	68
169 - Fox Tango Corp.	40	127 - Westcom Engineering/RF Parts	93
194 - Gifler Shortwave	118	200 - Western Electronics	141
130 - GLB Electronics	68	171 - Wolcott's Satellite Systems	50
285 - GLB Electronics	126, 127	212 - Yaesu Electronics Corp.	Cover III
286 - GLB Electronics	24	180 - Yaesu Electronics Corp.	80, 81
151 - Glen Martin Engineering	144		
149 - H.L. Heaster, Inc.	144		
158 - Ham Radio Outlet	6, 7		
* - The Ham Station	112		
* - Hamtronics, Inc.	55		
* - Hamtronics, Inc. PA	111		
210 - Harrison Radio	155		
208 - Heath Company	147		
206 - Hustler, Inc.	146		
113 - ICOM America, Inc.	71		
156 - ICOM America, Inc.	Cover II		
168 - J.S. Technology, Inc.	40		
174 - JDR Microdevices	65		
150 - Jensen Tools, Inc.	149		
189 - Jun's Electronics	96		
205 - Kantronics	145		
107 - Kendeecom/MCS	160		
* - Trio-Kenwood Communications	2, Cover IV		
159 - Larsen Antennas	9		
162 - Lewis Electronics	90		
160 - LUXOR (North America) Corp.	11, 12, 13, 14		
131 - Merrimac Satellite	128		
164 - John J. Meshna, Jr. Co., Inc.	32		

\*Please contact this advertiser directly.

Limit 15 inquiries per request.



# THE STANDARD OF EXCELLENCE

*The world of CW, RTTY, and new DUAL AMTOR\* is as close as your fingertips with the new brilliantly innovative state-of-the-art microcomputer controlled EXL-5000E.*

**Automatic Sender/Receiver:** Due to the most up to date computer technology, just a console and keyboard can accomplish complete automatic send/receive of Morse Code (CW), Baudot Code (RTTY), ASCII Code (RTTY) and new ARQ/FEC (AMTOR).

**Code:** Morse (CW includes Kana), Baudot (RTTY), ASCII (RTTY), JIS (RTTY), ARQ/FEC (AMTOR).

**Characters:** Alphabet, Figures, Symbols, Special Characters, Kana.  
**Built-in-Monitor:** 5" high resolution, delayed persistence green monitor — provides sharp clear image with no jiggle or jitter even under fluorescent lighting. Also has a provision for composite video signal output.

**Time Clock:** Displays Month, Date, Hour and Minute on the screen.

**Time/Transmission/Receiving Feature:** The built-in timer enables completely automatic TX/RX without operator's attendance.

**Selcal (Selective Calling) System:** With this feature, the unit only receives messages following a preset code. Built-in Demodulator for High Performance: Newly designed high speed RTTY demodulator has receiving capability of as fast as 300 Baud. Three-step shifts select either 170Hz, 425Hz or 850Hz shift with manual fine tune control of space channel for odd shifts. HIGH (Mark Frequency 2125Hz)/LOW (Mark Frequency 1275Hz) tone pair select, Mark only or Space only copy capability for selective fading. ARQ/FEC features incorporated.

**Crystal Controlled AFSK Modulator:** A transmitter without FSK function can transmit in RTTY mode by utilizing the high stability crystal-controlled modulator controlled by the computer.

**Photocoupler CW, FSK Keyer built-in:** Very high voltage, high current photocoupler keyer is provided for CW, FSK keying.

**Convenient ASCII Key Arrangement:** The keyboard layout is ASCII arrangement with function keys. Automatic insertion of LTR/FIG code makes operation a breeze.

**Battery Back-up Memory:** Data in the battery back-up memory, covering 72 characters  $\times$  7 channels and 24 characters  $\times$  8 channels, is retained even when the external power source is removed. Messages can be recalled from a keyboard instruction and some particular channels can be read out continuously. You can write messages into any channel while receiving.

**Large Capacity Display Memory:** Covers up to 1,280 characters.

Screen Format contains 40 characters  $\times$  16 lines  $\times$  2 pages.

**Screen Display Type-Ahead Buffer**

**Memory:** A 160-character buffer memory is displayed on the lower part of the screen. The characters move to the left erasing one by one as soon as they are transmitted. Messages can be written during the receiving state for transmission with battery back-up memory or SEND function.

**Function Display System:** Each function (mode, channel number, speed, etc.) is displayed on the screen.

**Printer Interface:** Centronics Para Compatible interface enables easy connection of a low-cost dot printer for hard copy.

**Wide Range of Transmitting and Receiving:** Morse Code transmitting speed can be set from the keyboard at any rate between 5-100 WPM (every word per minute). AUTOTRACK on receive. For communication in Baudot and ASCII Codes, rate is variable by a keyboard instruction between 12-300 Baud when using RTTY Modem and between 12-600 Baud when using TTL level. The variable speed feature makes the unit ideal for amateur, business and commercial use.

**Pre-load Function:** The buffer memory can store the messages written from the keyboard instead of sending them immediately. The stored messages can be sent with a keyboard command.

**"RUB-OUT" Function:** You can correct mistakes while writing messages in the buffer memory. Misspellings can also be erased while the information is still in the buffer memory.

**Automatic CR/LF:** While transmitting, CR/LF automatically sent every 64, 72 or 80 characters.

**WORD MODE operation:** Characters can be transmitted by word groupings, not every character, from the buffer memory with keyboard instruction.

**LINE MODE operation:** Characters can be transmitted by line groupings from the buffer memory.

**WORD-WRAP-AROUND operation:** In receive mode, WORD-WRAP-AROUND prevents the last word of the line from splitting in two and makes the screen easily read.

**"ECHO" Function:** With a keyboard instruction, received data can be read and sent out at the same time. This function enables a cassette tape recorder to be used as a back-up memory, and a system can be created just like telex which uses paper tape.

**Cursor Control Function:** Full cursor control (up/down, left/right) is available from the keyboard. Test Message Function: "RY" and "QB" test messages can be repeated with this function.

**MARK-AND-BREAK (SPACE-AND-BREAK) System:** Either mark or space tone can be used to copy RTTY.

**Variable CW weights:** For CW transmission, weights (ratio of dot to dash) can be changed within the limits of 1:3-1:6.

**Audio Monitor Circuit:** A built-in audio monitor circuit with an automatic transmit/receive switch enables checking of the transmitting and receiving state. In receive mode, it is possible to check the output of the mark filter, the space filter and AGC amplifier prior to the filters.

**CW Practice Function:** The unit reads data from the hand key and displays the characters on the screen. CW keying output circuit works according to the key operation.

**CW Random Generator:** Output of CW random signal can be used as CW reading practice. **Bargraph LED Meter for Tuning:** Tuning of CW and RTTY is very easy with the bargraph LED meter. In addition, provision has been made for attachment of an oscilloscope to aid tuning.

**Built-in AC/DC:** Power supply is switchable as required; 100-120 VAC; 220-240 VAC/50/60Hz + 13:8VDC.

**Color:** Light grey with dark grey trim — matches most current transceivers.

**Dimensions:** 363(W)  $\times$  121(H)  $\times$  351(D) mm; Terminal Unit.

**Warranty:** One Year Limited

Specifications Subject to Change



*Everything built in — nothing else to buy!*

EXCLUSIVE DISTRIBUTOR: DEALER INQUIRIES INVITED  
**AMATEUR-WHOLESALE ELECTRONICS**  
8817 S.W. 129th Terrace, Miami, Florida 33176

FOR YOUR NEAREST DEALER OR TO ORDER:  
**TOLL FREE . . . 800-327-3102**  
Telephone (305) 233-3631 Telex: 80-3356



MANUFACTURER:

**TONO CORPORATION**

98 Motosoja Machi, Maebashi-Shi, 371, Japan

\*Dual Amtor: Commercial quality, the EXL-5000E incorporates two completely separate modems to fully support the amateur Amtor codes and all of the CCIR recommendations 476-2 for commercial requirements.

# Message Master™

**Real-voice message system  
For any repeater or base**

Now you can communicate vital information even when the station you are calling is not on the air — with Message Master. Message Master is a solid state voice recording system which can record messages just by listening to you speak, store messages in memory, and deliver messages on demand. If you can't be there to deliver your messages let Message Master deliver them for you - any messages in any language and in your own voice!

Message Master connects easily to any radio system for remote access: repeaters, base stations, even transceivers. It can even be connected to an autopatch device to exchange messages between your radio system and the telephone network.

Message Master is a multi-user system with mailbox style personalized message service for a hundred users. With 8 minutes of message storage it can store hundreds of messages simultaneously making it ideal for large, active repeater groups.

Would you like your callsign identifications, tail messages, and bulletin messages sent in real-voice? Message Master can send them too. Record several identification messages and it will even send a different ID each time. Almost like magic, Message Master knows when to send identifications and tail messages so it needs no special control signals from your base or repeater.

Call or write for further information before you make another wasted call.

Commercial users: Ask for a brochure on the Message Master Electronic Dispatcher with group and all call messaging.



- **Create messages just by talking. Message Master's 'real-voice' technique saves YOUR VOICE in digital memory to deliver messages in your own voice, language and dialect.**
- **Mailbox-style operation gives individual message delivery service to 100 system users.**
- **Easily added to any repeater or base station for remote operation with only four connections.**
- **Special features include callsign identifications, tail messages, and bulletin messages.**
- **Digital message storage provides instant playback of stored messages.**
- **Modular memory meets your exact needs from 2 to minutes of total message storage.**

## **Serving all your repeater needs**

- *Mark 4 Repeaters and Repeater Controllers are THE PERFORMANCE LEADERS with real voice, more autodial numbers, more synthesized voice and more features.*
- *Mark 3 Repeaters offer the winning combination of high performance and high value.*
- *LR-1 Repeaters boast superb RF circuitry at an economical price.*
- *MR-4 Receivers with 7 helical resonators are the only receiver to choose in harsh RF environments.*
- *PA-100 Amplifiers with rugged TMOS power FETs give you continuous duty high power signal.*



**COMING SOON: A 4-channel receiver voting system which operates on true signal-to-noise ratio extend your coverage by linking remote receivers.**

✓ 107



**KENDECOM INC.  
MICRO CONTROL SPECIALTIES**

23 Elm Park  
Groveland, MA 01834  
(617) 372-3442



# Celebrate your buying decision with the money you've saved.

When it comes to getting maximum HF performance for your dollar, the choice is clear. Yaesu's FT-757GX.

Nowhere else will you find so many HF features packed into one compact, mobile-ready package. At a price that's got the competition baffled.

For starters, each 757 includes an electronic keyer. 600-Hz CW filter. AM and FM modes. AF speech processor. And a 25-kHz marker generator. All at no extra charge.

And working the DX has never been easier with dual VFOs, single-button VFO/memory swap for split-frequency operation, eight

memories, and push-button quick memory and band scan.

The 757 also lets you listen from 500 kHz to 30 MHz with its high-performance general coverage receiver. The transmitter covers 160 through 10 meters, including the new WARC bands, with 100 watts output on sideband, FM and CW.

CW buffs will enjoy the delights of full QSK operation. Plus the massive heatsink and duct-flow cooling system allow continuous RTTY operation for up to 30 minutes. Use the FP-757HD heavy-duty power supply option for continuous-duty applications.

And of course, there's the 757's highly attractive price. It's the

perfect way to get all the HF performance you desire, with money left over to apply toward other ham gear. Perhaps a power supply for base station use. An antenna or antenna tuner. Or whatever else makes your operation complete.

So ask your dealer today about Yaesu's FT-757GX. The most celebrated HF price/performer on the air.

## YAESU

*Yaesu Electronics Corporation  
6851 Walthall Way, Paramount  
CA 90723 (213) 633-4007*

*Yaesu Cincinnati Service Center  
9070 Gold Park Drive, Hamilton  
OH 45011 (513) 874-3100*

# KENWOOD

...pacesetter in Amateur radio

## “Digital DX-terity!”



## TS-430S

**Digital DX-terity—that outstanding attribute built into every Kenwood TS-430S lets you QSY from band to band, frequency to frequency and mode to mode with the speed and ease that will help you earn that dominant DX position from the shack or from the mobile!**



- **Covers all Amateur bands** 160 through 10 meters, as well as the new 30, 17, and 12 meter WARC bands. High dynamic range, general coverage receiver tunes from 150 kHz to 30 MHz. Easily modified for HF MARS operation.
- **Superb interference reduction** Eliminate QRM with the IF shift and tuneable notch filter. A noise blanker suppresses ignition noise. Squelch, RF attenuator, and RIT are also provided. Optional IF filters may be added for optimum interference reduction.

- **Reliable, all solid state design.** Solid state design permits input power of 250 watts PEP on SSB, 200 watts DC on CW, 120 watts on FM (optional), or 60 watts on AM. Final amplifier protection circuits and a cooling fan are built-in.
- **Memory channels.** Eight memory channels store frequency, mode and band data. Channel 8 may be programmed for split-frequency operation. A front panel switch allows each memory channel to operate as an independent VFO or as a fixed frequency. A lithium battery backs up stored information.
- **Programmable, multi-function scan.**
- **Speech processor built-in.**
- **Dual digital VFOs.**
- **VOX circuit, plus semi break-in with sidetone.**

### Optional accessories:

- PS-430 compact AC power supply
- SP-430 external speaker
- MB-430 mobile mounting bracket
- AT-130 compact antenna tuner covers 80-10 meters, incl. WARC bands
- AT-250 automatic antenna tuner covers 160-10 meters, incl. WARC bands
- TL-922A 2 kW PEP linear amplifier
- FM-430 FM unit
- YK-88C (500 Hz) or YK-88CN (270 Hz) CW filters
- YK-88SN (1.8 kHz) narrow SSB filter
- YK-88A (6 kHz) AM filter
- MC-42S UP/DOWN hand mic.
- MC-60A/80/85 deluxe desk mics.
- SW-2000/200A SWR/power meters
- SW-100A SWR/power/volt meter
- PC-1A phone patch
- HS-4, HS-5, HS-6, HS-7 headphones



# KENWOOD

TRIO-KENWOOD COMMUNICATIONS  
1111 West Walnut Street  
Compton, California 90220

Complete service manuals are available for all Trio-Kenwood transceivers and most accessories. Specifications and prices are subject to change without notice or obligation.