

JULY 1984 / \$2.50

ham **radio** *magazine*

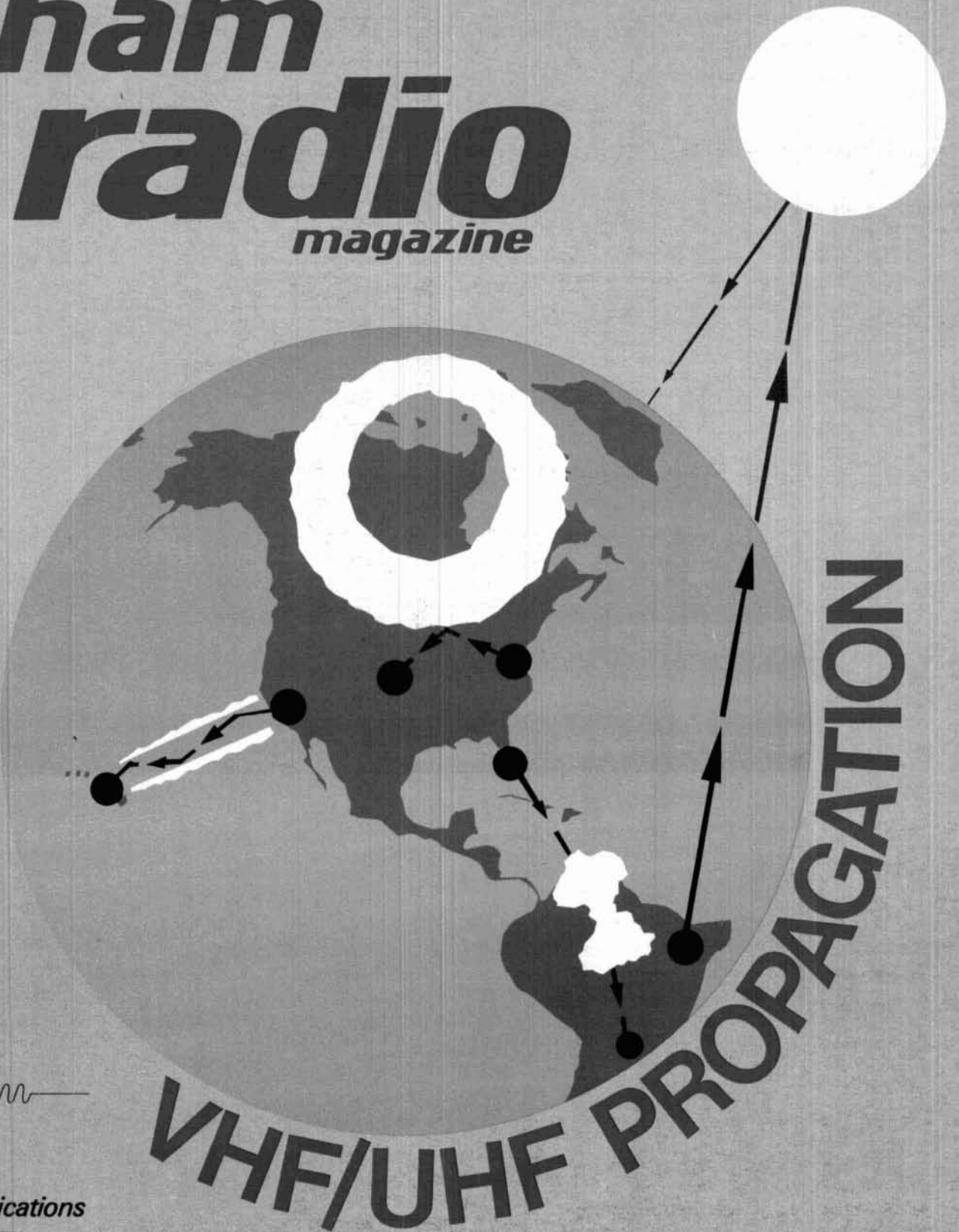
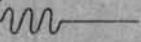

hr 
focus
on
communications
technology

IC-271H

Now a 100 Watt, 2 Meter Base!



For the ultimate in two-meter communications, ICOM presents the IC-271H transceiver with a high dynamic range receiver and a 100 watt transmitter. Operating from the IC-PS30, IC-PS15, or the internal IC-PS35 (optional), the IC-271H brings all the advanced functions of the latest CPU controlled radios to your shack.

100 Watts. Now a two-meter base station with 100 watts of internal power! The IC-271H provides all the power required for operation from remote places to repeaters, or for simplex.

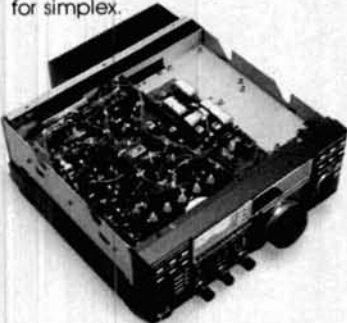

IC-PS30
Power Supply

Subaudible Tones.

Included as a standard feature are 32 built-in subaudible tones which are easily selected by rotating the main tuning knob. PL tones may be stored into memory.

32 Full-Function Memories.

Each tunable memory holds frequency, offset, offset direction, mode and subaudible tone. Each parameter is selected by rotating the main tuning knob in conjunction with the switches on the front panel.

PLL Locked at 10Hz.

An extremely low-noise, professional receiver and a good signal-to-noise ratio PLL allows the IC-271H's synthesizer to lock to 10Hz providing receiver performance unparalleled by any other VHF receiver.

Fluorescent Display. ICOM's high-visibility, multicolor display gives easy-to-read display of all information necessary for logging a contact. Frequency, mode, duplex, offset direction, RIT frequency, memory channel and PL tone can be displayed.

Scanning. The IC-271H can scan memories and programmed sections of the band or modes. Mode-S scan can be used to scan only memories with a particular mode or lock out frequencies continuously busy so the receiver will not stop at that memory channel while scanning.

Other Standard Features.

To facilitate the operation of the IC-271H, ICOM has incorporated a duplex check switch, all-mode squelch, receive audio tone control, S-meter, center meter, seven-year lithium battery memory backup, accessory connector and microphone.

Optional Features. IC-271H options are: switchable preamplifier, CTCSS encoder/decoder (encoder is standard), computer interface and voice synthesizer.

Size. Only 11¼ inches wide by 4¾ inches high, the IC-271H is styled to look good and engineered for ease of operation.



IC-271H
Shown with internal
power supply, IC-PS35

The IC-271A. The IC-271A with 25 watt output is available and has the same features as the IC-271H, plus an optional IC-PS25 internal power supply to make it a compact, go-anywhere two-meter base station. See the IC-271A(H) and other fine ICOM equipment at your ICOM dealer today.



ICOM

The World System

CLEAR CHOICE



For a crystal clear picture, choose a Lowrance System 70 Satellite Receiver

Lowrance System 70 receivers truly have no equal for picture quality. Colors are true and vibrant — not that washed-out look so common in other receivers. Lines are clear and distinct — not fuzzy. Low threshold makes 1000-foot runs a snap. And the audio is crystal clear. No wonder that Lowrance, one of the world's finest electronics companies, is proud to put its name on the new System 70 models.

Look over the multitude of easy-use features. With detent tuning, you click right to the channel you want — no fishing around. A polarity push-button with separate skew adjustment makes polarization changes easy and works with the Polarotor 1, Omni polarizer, or a Ferite device. Fixed and variable audio tuning with wide or narrow filter selection makes audio tuning extremely versatile. The System 70 models are equipped with scan tuning, 125 feet of pre-made cables, built-in modulator, AFC defeat and signal strength meter, so installation and antenna positioning are a breeze.

Two Models to Choose From

The System 70^s has all the remarkable features of the standard 70^s, plus superb stereo reception with *discreet and matrix capability*. The stereo reproduction will please the most discriminating listener, and it's easy to tune with independent subcarrier A and B tuning capabilities.

For System 70 dealers, we provide outstanding support with product brochures, posters, the popular customer question-and-answer brochures AND the best warranty service in the industry.

Lowrance System 70^s and 70^s. They're the clear choice in satellite receivers and downconverters.

Please send me more information about Lowrance System 70^s and 70^s.

NAME _____

ADDRESS _____

CITY _____ STATE _____ ZIP _____

Mail to Dept.

LOWRANCE ELECTRONICS, INC.
12000 E. SKELLY DR., TULSA, OK 74128

KENWOOD

pacesetter in amateur radio

TS-830S

TS-830S... a "top notch" field proven performer.

The TS-830S is the HF transceiver that delivers the performance the others can only talk about.

Kenwood's TS-830S offers you every conceivable operating feature built-in for 160-10 meters, including the WARC bands. Key operating features

such as wide receiver dynamic range, variable band width tuning, notch filter, adjustable noise-blanker, IF shift (pass-band tuning), and receive capability of WWV on 10 MHz, have established the TS-830S as the first choice of the serious Amateur.

Two 6146B's in the final assure you of rugged, reliable service. The fluorescent tube digital display, RF speech

processor, narrow/wide filter selection on CW/SSB monitor circuit and receiver (RIT) and transmitter (XIT) incremental tuning, add to the operating ease and enjoyment of the TS-830S.

Yes, all these features along with unprecedented reliability have made the field-proven TS-830S truly "top notch".

Optional accessories:

- SP-230 external speaker.

- VFO-230 remote digital VFO with five memories, digital display.
- VFO-240 remote analog VFO.
- AT-230 antenna tuner.
- YG-455C (500 Hz) or YG-455CN (250 Hz) CW filter for 455 kHz IF.
- YK-88C (500 Hz) or YK-88CN (270 Hz) CW filter for 8.83 MHz IF.
- KB-1 deluxe heavyweight knob.



TS-530SP

TS-530SP... "Cents-ational" in performance and value.

No other HF transceiver gives you all these features at such an affordable price.

The TS-530SP covers 160-10 meters, LSB, USB, CW, including WARC bands and it also receives WWV on 10 MHz.

When you turn on your TS-530SP, the IF shift tunes

out interfering signals, and the tunable audio notch filter also helps eliminate QRM. Your frequency is displayed in six digits by the fluorescent tube display, with an analog dial for added convenience. Other key features include wide receiver dynamic range, narrow/wide filter selection for CW and/or SSB, built-in speech processor for extra talk power, adjustable noise-blanker and RIT/XIT to allow independent fine-tuning

of receive or transmit frequencies. All this along with two 6146B's in the final to allow for lasting, dependable operation.

The TS-530SP, solid dependability at a price everyone can afford!

Optional accessories:

- SP-230 external speaker with selectable audio filters.
- VFO-240 remote analog VFO.
- VFO-230 remote digital VFO.
- MC-50 desk microphone.

- AT-230 antenna tuner/SWR/power meter.
- KB-1 deluxe VFO knob.
- YK-88C (500 Hz) or TK-88CN (270 Hz) CW filter.
- YK-88SN (1.8 kHz) narrow SSB filter.

More information on the TS-830S and TS-530SP is available from authorized dealers of Trio-Kenwood Communications, 1111 West Walnut Street, Compton, California 90220.

Specifications and prices are subject to change without notice or obligation.



SAVE \$10.00* with home delivery

*(One year newsstand cost \$30.00)

Payment enclosed

Bill me later

U. S. prices only

- Here's my address label, enter my subscription.
- 1 Year 12 issues \$19.95
 - 2 Years 24 issues \$32.95
 - 3 Years 36 issues \$44.95

Name _____ Zip _____

Address _____ State _____

City _____

Check here if this is your renewal (attach label)

Subscribe to **ham** **radio** magazine

Please allow 4-6 weeks for delivery of first issues.
Foreign rates: Europe, Japan and Africa, \$28.00 for one year by air forwarding service. All other countries \$22.95 for one year by surface mail.

Please
enter my
subscription

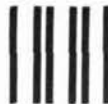

NO POSTAGE
NECESSARY
IF MAILED
IN THE
UNITED STATES

BUSINESS REPLY CARD

First Class Permit No. 1 Greenville, NH

Postage Will Be Paid By Addressee

**ham
radio**

Greenville, NH 03048



ham radio

magazine

JULY 1984

volume 17, number 7

T. H. Tenney, Jr., W1NLB
publisher

Rich Rosen, K2RR
editor-in-chief
and associate publisher

Dorothy Rosa, KA1LBO
assistant editor

Joseph J. Schroeder, W9JUV
associate editor

Susan Shorrock
editorial production

editorial review board

Forrest Gehrke, K2BT
Bob Lewis, W2EBS
Mason Logan, K4MT
Ed Wetherhold, W3NON

publishing staff

J. Craig Clark, Jr., N1ACH
assistant publisher

Rally Dennis, KA1JWF
director of advertising sales

Dorothy Sargent, KA1ZK
advertising production manager

Susan Shorrock
circulation manager

Therese Bourgault
circulation

Wayne Pierce, K3SUK
cover art

ham radio magazine is published by
Communications Technology, Inc.
Greenville, New Hampshire 03048-0498
Telephone: 603-878-1441

subscription rates

United States:

one year, \$19.95; two years, \$32.95; three years, \$44.95

Canada and other countries (via surface mail):

one year, \$22.95; two years, \$41.00; three years, \$58.00

Europe, Japan, Africa (via Air Forwarding Service) one year, \$28.00

All subscription orders payable in U.S. funds via international
postal money order or check drawn on U.S. bank

international subscription agents: page 130

Microfilm copies are available from
University Microfilms, International
Ann Arbor, Michigan 48106
Order publication number 3076

Cassette tapes of selected articles from ham radio
are available to the blind and physically handicapped
from Recorded Periodicals,
919 Walnut Street, Philadelphia, Pennsylvania 19107

Copyright 1984 by Communications Technology, Inc.
Title registered at U.S. Patent Office

Second-class postage paid
at Greenville, New Hampshire 03048-0498
and at additional mailing offices
ISSN 0148-5989

Postmaster send form 3579 to ham radio
Greenville, New Hampshire 03048-0498



contents

**14 the VHF/UHF primer:
an introduction to propagation**
Joe Reisert, W1JR

**33 cooling semiconductors
part 1: designing and using heatsinks**
Vaughn D. Martin

42 all-metal, 2-meter J-pole antenna
Michael Hood, KD8JB

49 wideband VCO design
Alan Victor, WA4MGX

**63 the weekender:
reflected power limiter**
William Vissers, K4KI

**73 applied Yagi antenna design
part 3: 432 MHz with Knadle and Tilton**
Stanley Jaffin, WB3BGU

88 ham radio techniques
Bill Orr, W6SAI

95 ground rod resistance
Mason A. Logan, K4MT

**132 advertisers index
and reader service**

**114 book and
product reviews**

12 comments

103 DX forecaster

130 flea market

128 ham mart

109 ham notebook

115 new products

11 presstop

6 reflections

THE NUMBER 1 QUESTION

I've recently discovered that if I connect two framastans in parallel, water-cool them, operate them in Class E, and drive them with my 2N5109 solid-state QRP transmitter, I can achieve the legal output power level and cover 160 meters through 40,000 GHz without retuning. Would you be interested in seeing a manuscript on this subject?

Every time I read a question like this from a prospective author my interest is definitely aroused. Editors constantly receive telephone and mail inquiries about possible articles covering a wide range of subjects. We at *ham radio* are no exception, because every day we receive proposals for manuscripts ranging in size from quarter-page ham notes through six-part series of epic proportions. In order to encourage you to contribute your wisdom and experience to the pages of *ham radio*, I'd like to tell you what I'd like to see coming through the transom.

If you'll look at a magazine — any magazine — you'll notice that there are a number of realities associated with it. One is the number of pages allocated to editorial content. Ah, but what's editorial content? you ask. Basically, "editorial" content is anything that isn't advertising — technical articles, ham notes, columns, letters, *Presstop*, new product announcements, and even the front cover, as well as (ahem) this editorial. If you were to view each page as if it were a parcel of extremely valuable land, you'd understand the dilemma (and the joy) an editor faces when reviewing manuscripts. So many good ideas . . . and so little space!

We have a mandate from our readers, consistent with our charter and clearly reaffirmed by the Reader Survey of September, 1983, that directs us to provide high quality *technical* material. For my part, I'm more than willing to meet this demand. For those of you who are thinking of proposing an idea for an article, please keep the following guidelines in mind:

Length. Don't worry about it. With very few exceptions (and this editorial may be one of them), the subject will dictate the length of the article. It's difficult to write more than a paragraph or two about how to insert 6146s into sockets (with a hammer, of course), so if you're going to write on a small, limited topic, keep your article short. But if you're going to deal with a larger topic in a more comprehensive way, then give your subject the room it needs; consider, for example, K2BT's series on vertical phased arrays, which ran in six installments spread over a year's time.

Style. Yours is *fine*. Just keep it simple; the point is, after all, to convey information. Don't worry about grammar; we'll worry about that. It may help to remember this rule of thumb: *write to inform, not impress*.

Accuracy. Here's where we all get into trouble now and then. "In conclusion, my superduper loudenboomer metal noodle, described herein, works on the principle of thermoquality of non-homogeneous turf." It very well might. But please prove it. If you've discovered some fabulous new technique that promises to revolutionize the world's understanding of antennas, propagation, or anything else, we want to hear about it . . . but please present your idea in a logical sequence of facts and build your case. If you decide to compare your method to a standard, make sure your setup is carefully designed and that it generates reproducible results.

Subject. This I leave to you. However, you might want to ask yourself one question before taking pen in hand. How many readers will be interested? Three, three thousand, or thirty thousand? This is especially true in regard to conversions. Not too many readers are interested in converting a BC610 to 11 meters. However, a simple circuit that adds the three WARC bands to an older transceiver will generate substantial interest. How about a short article on receivers, or on some particularly exciting aspect of future technology? I'll be glad to consider your idea. Just pick up the phone or send a one-page outline of your proposed manuscript. (I can't, by the way, consider simultaneous submissions.)

A final word. Please double space your manuscript. Don't hide or crowd your words . . . let them sing out and tell your story. For this — and more — I thank you.

Rich Rosen, K2RR
Editor-in-Chief

FREE MFJ SOFTWARE

Free MFJ RTTY/ASCII/CW software for VIC-20 or C-64 with purchase of MFJ-1224, MFJ-1225 or MFJ-1228 from MFJ. Send/receive Baudot, ASCII, CW. Type ahead buffer. 24 hour clock. Supports VIC printer. Menu Driven. MFJ-1224/1225 cable. On tape. Available separately for \$29.95.

RTTY/ASCII/ AMTOR/CW INTERFACE CARTRIDGE

FOR
VIC-20/C-64 MFJ-1228 \$ 69⁹⁵



FREE MFJ RTTY/ASCII/CW Software
INCLUDES MFJ-1228, SOFTWARE ON TAPE. ADD
VIC-20 OR C-64 AND RIG TO ENJOY COMPUTER-
IZED RTTY/ASCII/CW. ORDER MFJ-1228/MFJ-
1264 FOR VIC-20, MFJ-1228/MFJ-1265 FOR C-64.

Most versatile RTTY/ASCII/AMTOR/CW interface cartridge available for VIC-20 and Commodore 64. Gives you more features, more performance, more value for your money than any other interface cartridge available.

Same interface cartridge works for both VIC-20 and Commodore 64. Plugs into user's port.

Choose from wide variety of RTTY/ASCII/CW, even AMTOR software. Not married to one on-board software package. Use MFJ, Kantronics, AEA plus other software cartridge, tape or disk.

850 Hz and 170 Hz shifts on receive and transmit. Has mark and space outputs for scope tuning.

Normal/Reverse switch eliminates retuning. True dual channel mark and space active filters and automatic threshold correction gives good copy when one tone is obliterated by QRM or selective fading.

Easy, positive tuning with twin LED indicators.

Narrow 800 Hz active CW filter. Automatic PTT.

Exar 2206 sine generator for AFSK output.

Shielded XCVR AFSK/PTT interface cable provided. Plus or minus CW keyed output. FSK out.

Powered by computer (few ma.), no power adapter to buy or extra wire to dangle or pick up/radiate RFI.

Glass epoxy PCB. Aluminum enclosure. 4 1/2 x 4 1/2 x 1 1/2".

UNIVERSAL SWL RECEIVE ONLY COMPUTER INTERFACE FOR RTTY/ASCII/AMTOR/CW

MFJ-1225
\$ 69⁹⁵



FREE MFJ RTTY/ASCII/CW Software
TAPE AND CABLE FOR VIC-20 OR C-64. ORDER MFJ-1225/
MFJ-1264 FOR VIC-20 OR MFJ-1225/MFJ-1265 FOR C-64.

Use your personal computer and communications receiver to receive commercial, military and amateur RTTY/ASCII/AMTOR/CW traffic.

Plugs between receiver and VIC-20, Apple, TRS-80C, Atari, TI-99, Commodore 64 and most other personal computers. Requires appropriate software.

Use MFJ, Kantronics, AEA and other RTTY/ASCII/AMTOR/CW software.

Copies all shifts and all speeds. Twin LED indicators makes tuning easy, positive. Normal/Reverse switch eliminates tuning for inverted RTTY. Speaker out jack. Includes cable to interface MFJ-1224 to VIC-20

UNIVERSAL RTTY/ASCII/AMTOR/ CW COMPUTER INTERFACE

Lets you send and receive computerized RTTY/ASCII/AMTOR/CW. Copies all shifts and all speeds. Copies on both mark and space. Sharp 8 pole active filter for 170 Hz shift and CW. Plugs between your rig and VIC-20, Apple, TRS-80C, Atari, TI-99, Commodore 64 or other personal computers. Uses MFJ, Kantronics, AEA software and other RTTY/CW software.

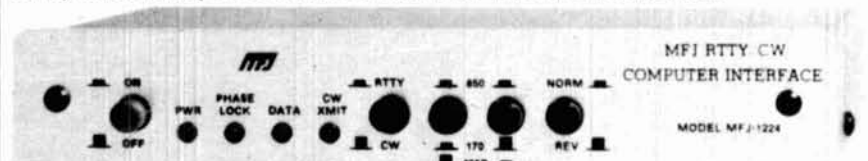

FREE MFJ RTTY/ASCII/CW Software
COMPLETE PACKAGE INCLUDES MFJ-1224, SOFTWARE ON TAPE,
CABLES. YOU NEED ONLY VIC-20 OR C-64 AND RIG TO ENJOY COM-
PUTERIZED RTTY/ASCII/CW. ORDER MFJ-1224/MFJ-1264 FOR VIC-20,
MFJ-1224/MFJ-1265 FOR C-64.

MFJ-1224
\$ 99⁹⁵

New MFJ-1224 RTTY/ASCII/AMTOR/CW Computer Interface lets you use your personal computer as a computerized full featured RTTY/ASCII/AMTOR/CW station for sending and receiving. Plugs between rig and VIC-20, Apple, TRS-80C, Atari, TI-99, Commodore 64 and most others.

Use MFJ software for VIC-20, Commodore 64 and Kantronics for Apple, TRS-80C, Atari, TI-99 and most other software for RTTY/ASCII/AMTOR/CW.

Easy, positive tuning with twin LED indicators. Copy any shift (170, 425, 850 Hz and all other shifts) and any speed (5-100 WPM RTTY/CW and up to 300 baud ASCII).

Copies on both mark and space, not mark only or space only, to improve copy under adverse conditions.

Sharp 8 pole 170 Hz shift/CW active filter gives good copy under crowded, fading and weak signal conditions. Automatic noise limiter suppresses static crashes for better copy.

Normal/Reverse switch eliminates retuning. +250 VDC loop output drives RTTY machine. Speaker jack.

Automatic tracking copies drifting signal. Exar 2206 sine generator gives phase continuous AFSK tones. Standard 2125 Hz mark and 2295/2975 Hz space. Microphone line: AFSK out, AFSK ground, PTT out and PTT ground.

FSK keying output. Plus and minus CW keying. CW transmit LED. External CW key jack.

Kantronics compatible socket.

Exclusive general purpose socket allows interfacing to nearly any personal computer with most appropriate software. Available TTL lines: RTTY demod out, CW demod out, CW-ID input, +5 VDC, ground. All signal lines are buffered and can be inverted using an internal DIP switch.

Use Galfo software with Apple, RAK with VIC-20, Kantronics with TRS-80C, TI-99, N4EU with TRS-80 III, IV. Some computers with some software may require some external components.

Metal cabinet. Brushed alum. front. 8x1 1/4x6 in. 12-15 VDC or 110 VAC with adapter, MFJ-1312, \$9.95. MFJ-1223, \$29.95, RS-232 adapter for MFJ-1224.

SUPER RTTY FILTER

MFJ-725
\$ 39⁹⁵



Super RTTY filter greatly improves copy under

crowded, fading and weak signal conditions. Improves any RTTY receiving system. 8 pole bandpass active filter for 170 Hz shift (2125/2295 Hz mark/space). 200 or 400 Hz bandwidths. Automatic noise limiter. Audio in, speaker out jacks. On/off/bypass switch. "ON" LED. 12 VDC or 110 VAC with optional AC adapter, MFJ-1312, \$9.95. 3x4x1 inch aluminum cabinet.

or Commodore 64. 4 1/2 x 1 1/4 x 1/4 inches. 12-15 VDC or 110 VAC with optional adapter, MFJ-1312, \$9.95.

CW INTERFACE CARTRIDGE FOR VIC-20/C-64

High performance CW interface cartridge. Gives excellent performance under weak, crowded, noisy conditions. Works for both VIC-20 and Commodore 64. Plugs into user's port.

4 pole 100 Hz bandwidth active filter. 800 Hz center frequency. 3 pole active lowpass post detection filter. Exclusive automatic tracking comparator.

Plus and minus CW keying. Audio in, speaker out jacks. Powered by computer.

Includes Basic listing of CW transmit/receive program. Available on cassette tape, MFJ-1252 (VIC-20) or MFJ-1253 (C-64), \$4.95 and on software cartridge, MFJ-1254 (VIC-20) or MFJ-1255 (C-64), \$19.95.

You can also use Kantronics, AEA other software. Also copy RTTY with single tone detection.

ORDER ANY PRODUCT FROM MFJ AND TRY IT-NO OBLIGATION. IF NOT DELIGHTED, RETURN WITHIN 30 DAYS FOR PROMPT REFUND (LESS SHIPPING).
• One year unconditional guarantee • Made in USA.
• Add \$4.00 each shipping/handling • Call or write for free catalog, over 100 products.

MFJ

MFJ ENTERPRISES, INC.
Box 494, Mississippi State, MS 39762

TO ORDER OR FOR YOUR NEAREST DEALER, CALL TOLL-FREE
800-647-1800. Call 601-323-5869 in Miss. and outside continental USA
Telex 53-4590 MFJ STKV



Kantronics Interface II

The Interface For
*Apple, Atari, TI-99/4A, TRS-80C,
VIC-20, and Commodore 64
Computers*



Suggested Retail Price 269.95

Interface II is the new Kantronics transceiver-to-computer interface. Interface II features a highly sensitive front end with mark and space filtering. Even the most discerning operator will be surprised with the Interface II's ability to dig out signals in poor band conditions. Our unique tuning system even displays signal fading.

X-Y scope outputs and dual interface outputs for VHF and HF connections make Interface II compatible with almost any shack. All three standard shifts are selectable, and Interface II is AMTOR compatible. Interface II is designed for use with Kantronics software.

Kantronics Software — The Industry Standard

Hamsoft

Our original program for reception and transmission of CW/RTTY/ASCII. Features include Split Screen Display, Message Ports, Type-ahead buffer, and printer compatibility. Apple Diskette \$29.95, VIC-20 cartridge \$49.95, Atari board \$49.95, TRS-80C board \$59.95, TI-99/4A cartridge \$99.95.

Hamtext

All the features of Hamsoft with the following additional capabilities: text editing, received message storage, variable buffer sizes, diddle, word wraparound, time transmission, and text transmission from tape or disc. The program is available on cartridge for the VIC-20 or Commodore 64, and diskette for the Apple. Suggested Retail \$99.95.

Hamsoft/Amtor

This program has Hamsoft features with the added ability of communicating in the newest coded amateur format-AMTOR. AMTOR offers error free low power communication. Hamsoft Amtor is available for the Atari, TRS-80C, VIC-20, and Commodore 64 computers. Suggested Retail \$79.95.

Amtorsoft

For the serious AMTOR operator using a VIC-20, Commodore 64, or Apple computer. This program is similar to Hamtext in capabilities, but can only be used for AMTOR. The Apple version includes both Hamtext and Amtorsoft on one diskette (\$139.95), while the Vic-20 and Commodore 64 cartridge is just Amtorsoft (\$89.95).

Kantronics UTU

The Universal Terminal Unit For Everyone Else



Suggested Retail Price 199.95

KANTRONICS SETS A NEW STANDARD WITH THE KANTRONICS UNIVERSAL TERMINAL UNIT.

UTU allows any computer with an RS232 port and a terminal program to interface with any transceiver. Additional software isn't necessary with UTU, as an internal microcomputer gives the unit data processing capabilities to send and receive in four coded amateur formats; Morse code, Radioteletype, ASCII, and AMTOR.

Sample terminal programs for IBM, TRS-80 Model III and IV, Kaypro, and other computers are included in the manual. Enhanced features can be user defined by altering the terminal program, giving you

flexibility to program for your specific needs.

The Kantronics Universal Terminal Unit can send and receive CW at 6-99 WPM; RTTY 60, 67, 75, 100, and 132 WPM; ASCII 110, 150, 200, and 300 baud; and AMTOR. Dual tone detection and our unique bargraph tuning system make tuning fast and easy. Additional LEDs indicate Lock and Valid status during AMTOR operation. The RS232 port is TTL or RS232 level compatible.

If you've been waiting for a Kantronics system for your computer, the wait is over.

For more information contact an **Authorized Kantronics Dealer,**

or write: **Kantronics**

1202 E. 23rd Street
Lawrence, Kansas 66044

OWN THE WORLD WITH THE R3 NO RADIAL VERTICAL 10, 15, 20 METERS

The R3 half wavelength design eliminates the ground radial system required by other verticals. Optimum current distribution gives more efficiency and low angle radiation for DX communications.

R3 brings high performance antenna features to those living in apartments, condominiums or on small city lots. Even if you have plenty of space, R3's combination of neat appearance and DX capability make it ideal for your station. The R3 includes an integral tuner to give a perfect match across 10, 15, and 20 meters. The remote tuning feature allows easy fingertip control as you operate your station.

R3 is a complete antenna system ready to install in virtually any location from ground level to roof top.

FEATURES

3 dB Gain, ref $\frac{1}{4}\lambda$ whip
No Radials
360° Coverage
Integral Tuner with
Remote Control Console and Indicator
24 Volts To Tuner
110 or 220 Volt Operation
75 ft (22.9m) Control Cable Included
Only 22ft (6.7m) High
1 sq ft (.09 sq m) Space
Self Supporting
Stainless Steel Hardware
Mount: Sleeve Type Fits Pipe Up To
1 3/4 in (4.5cm) dia
Can Be Easily Stored and Set Up For
Portable or Temporary Operation

Add up the features—you'll find that you can have ALL OF THIS PERFORMANCE without the need to buy tower, rotator and associated hardware. *R3 IS ANOTHER PRODUCT CREATED FOR THE ENJOYMENT OF YOUR HOBBY BY THE WORLD RENOWNED CUSHCRAFT ENGINEERING DESIGN TEAM.*

R3



cushcraft
CORPORATION

THE ANTENNA COMPANY

48 Perimeter Road, P.O. Box 4680
Manchester, NH 03108 USA
TELEPHONE 603-627-7877
TELEX 953-050 CUSHSIG MAN

AVAILABLE THROUGH DEALERS WORLDWIDE

OSCAR 11 IS BACK ON THE AIR AFTER 10 WEEKS OF FRUSTRATING SILENCE. UOSAT OSCAR 11, the University of Surrey's scientific satellite, finally responded to signals from its parent command station May 14 and is now being tested to uncover its post-launch problem.

Launched March 1 From Vandenberg AFB in California, the English Amateur satellite had gone off the air after only three orbits and then staunchly resisted all attempts to bring it back to life. The key to its resuscitation was provided by a crew in Greenland, who used a 100-foot dish to hear signals leaking from its 1.2 GHz command receiver that both confirmed its actual orbital position and provided clues to unlocking the command hangup!

OSCAR 11's Three Beacons Can Now Be Heard Again on 145.825, 435.025, and 2304.5 MHz.

Another Sophisticated Amateur Satellite Could Be In The Offing, with a projected early 1986 launch date. This possible launch opportunity would permit a large payload, at least as heavy as OSCAR 10, opening the door for still another multi-function Amateur bird.

A World-Spanning Set Of Geostationary Amateur Satellites is also currently under consideration by AMSAT. Operating in the 1.3 or 2.3 GHz bands and stationed at suitable intervals around the equator, these satellites could provide a round-the-clock worldwide communications capability far beyond that of present orbiting Amateur satellites. Such a project would be expensive, however, so before proceeding too far with it AMSAT would like to hear expressions of interest and support. Write AMSAT, Box 27, Washington, D.C. 20044.

VOLUNTEER EXAMINER COORDINATORS ARE NOW IN PLACE IN 10 of the 13 areas designated by the FCC. The sixth district now has a VEC, the Greater Los Angeles Amateur Radio Group (GLAARG), a grouping of area clubs; the San Diego Amateur Radio Council (SANDARC), should also have FCC acceptance before this sees print. Two additional VECs are on board in the fourth district, VE-administered exams have already been given in Alaska and the second, eighth and ninth call areas as this went to press, and GLAARG was hoping to start giving exams in the LA area in conjunction with Field Day. This leaves only the first and zero call areas, and the Pacific, without at least one acceptable VEC, though Wayne Green, W2NSD, has told Westlink that he intends to apply for first district VEC through the radio club at his recently established Wayne Green University.

The Proposal To Permit Exam Expense Reimbursement will probably be considered by the Commissioners by mid-July, and if there's no hitch, exam fees could be in place before Labor Day. If so, expect the ARRL to submit its long-awaited VEC proposal very quickly. Just how soon a League-sanctioned program could get under way is questionable, however. The experience of those VECs already up and running is that both the necessary paperwork and the exam process itself are sufficiently complicated to require some formal VE training. Dayton, for example, gives its VEs two three-hour training sessions. The League, however, expects to prepare its VE corps by simply distributing a "training manual!" Another factor to be resolved is whether the League can build an adequate "Chinese Wall" between its VEC role and its Amateur training and training publications activities, a problem that will also be a potential obstacle to any proposal from a Wayne Green enterprise.

THE 1984 SUMMER OLYMPIC TORCH RUN KICKED OFF MAY 8 in New York City and passed through Chicago two weeks later. The torch bearers each run a four-mile segment, with their efforts coordinated by teams of 16 Amateur volunteers from AT&T's Telephone Pioneers of America. Two meters is used for the bulk of their communications, using both simplex and area repeaters when available. By the time the run ends in Los Angeles in late July, the runners (and their Amateur Radio support teams) will have covered over 9000 miles.

ADDITIONAL EXPANSION OF PHONE BANDS COULD BE DECIDED before the end of July. Unlike the earlier FCC action on phone band expansion, which concerned only 20 meters, this time all other bands in the NPRM—75, 40, 15, and 10 meters—will be considered. However, just which phone bands will be changed and by how much is still an open question. Canada's Department of Communications has proposed doing away with mandated subbands in its Amateur service!

Amateur Access To The New 902 MHz Amateur Allocation may also be relatively imminent. IRAC (the Interdepartmental Radio Advisory Committee) seems to have no objection to giving Amateurs the band on a secondary basis, though RCA is protesting that its video disc players are susceptible to 902 MHz RFI. In the HF spectrum, 24 MHz may also see Amateur occupancy soon as well, but problems with existing users make access to 18 MHz a more distant hope.

Getting New Bands From WARC Has A Negative Aspect, as well. Along with the gains come losses, the first of which will be a severe cut in the 1215-1300 MHz band. Amateurs along the Canadian border will also lose access to 420-430 MHz, and eventually (when AM broadcast expands upward) radiolocation will again lay claim to 1900-2000 MHz.

FURTHER EXPANSION OF 20-KHZ CHANNELIZATION TO TWO METER'S TOP HALF will be a major topic at the Texas VHF-FM Society's August 11 meeting in Austin. Heading up the forum on this controversial change is Joe Jarrett, K5FOG, who seeks inputs from concerned Amateurs across the country. Papers (from those unable to attend in person) and outlines of oral presentations on the subject should go to Joe at 8501 Spring Valley Drive, Austin, Texas 78736.

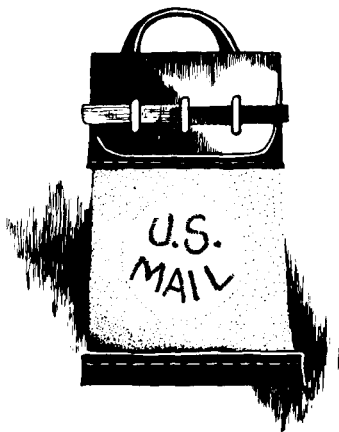

comments

on the VHF/UHF challenge

Dear HR:

I am especially pleased to see Joe Reisert's VHF/UHF column and have written a personal note of thanks to him. I've been an avid V/UHF'er for over 20 years and try to communicate the excitement and challenge of operating on the VHF/UHF bands to other hams whenever I can. That's why I'm glad to see you giving someone of Joe's stature and expertise a chance to reach a large "lay" audience on a monthly basis!

Jack C. Parker, KC0W
Bismarck, North Dakota

Dear HR:

The January, 1984, issue came today, and I'm very pleased to be able to look forward to Joe Reisert's "VHF/UHF World" every month.

I'm one of a handful of Amateurs in Montgomery who operate 2-meter SSB and plan to be on 432 soon. I am NCS of the Central Alabama 2-meter SSB net each Wednesday night at 0200 (Thursday) UTC on 144.250 MHz.

I also really liked the January "Ham Notebook." There have been many repeater controllers published in various publications, but this is the first time I have seen a repeater-to-phone schematic. This is a circuit I have been looking for — thanks.

Alton L. Erdman, W4CNO
Montgomery, Alabama

Timex/Sinclair newsletter

Dear HR:

A specialized newsletter is available for Amateurs with Timex-Sinclair computers. *QZX* is a monthly publication that includes programs and news features pertaining to Sinclair computers. At \$12 per year, I think it's a great resource for Sinclair computer owners; one recent issue, for example, was dedicated to RTTY applications.

For more information, contact *QZX* at 2025 O'Donnell Drive, Las Cruces, New Mexico 88001.

Tom Hart, AD1B
Westwood, Massachusetts

new MSO for RTTY

Dear HR:

A new MSO (Message Storage Operation) system has been established in the New York metropolitan area by N2CKA. The frequency of operation is 145.680 MHz-FM, using 100 WPM (74 baud) Baudot Code.

All Amateurs in the New York-New Jersey-Connecticut area (for that matter, anyone who can "hit" the MSO from elsewhere) are encouraged to leave items of interest, bulletins, or just "mail."

The MSO uses standard DS 3100 type format. The access code, "MSOCKA.HELP" will bring a list of commands to assist the new user. "EXIT" is used to "close" or deactivate the system.

N2CKA or I will be glad to help users unfamiliar with MSO operation to get off on the right foot.

Rich Tashner, N2EO
Whitestone, New York

can you help?

Dear HR:

I am in possession of a 6-channel HF-SSB marine transceiver made by Maritek — Model No. SB6-80, approximate date of manufacture, 1973.

I have been able to trace the company to the following address: 1819 South Central, Kent, Washington, 98031, but letters have been stamped "Not known" and returned. No phone number is listed.

I would like very much to have a copy of the workshop service handbook and/or circuit details, a copy of the operations handbook, and any other information — but specifically that which applies to the settings of the taps of the output stage.

I can arrange to have these photocopied in either the U.S. or Canada, or here in the U.K., and the original returned. I am willing to reimburse any expenses incurred.

Kris Partridge, G8AUU
6 Blagdon Walk,
Teddington, TW11 9LN,
United Kingdom

While the HI MANUALS catalog doesn't list the Maritek SB6-80, it's often a helpful source of hard-to-find manuals and schematics. For a copy, write to HI MANUALS, P.O. Box 802HR, Council Bluffs, Iowa 51502; enclose \$1.00.

Editor

operating etiquette

Dear HR:

I'm delighted when editors speak out about the selfish operating practices prevalent on the HF bands (Reflections, *ham radio*, February, 1984). On the accidental occasions when I work DX, I want to get to know the other guy and find out interesting things about his country. I would never insult a foreign ham by implying that I am interested in him only for his QSL. If I naively try to converse for more than a couple of minutes, however, the vultures pounce.

I'm also dismayed by hams who hog frequencies, claiming they are participating in phantom "nets" or handling nonexistent "overseas phone-patch traffic." I've heard better operating

practices on the frequencies between 10 and 11 meters! CB isn't to blame; some of the most rules-conscious hams I know are ex-CB'ers who hoped to find something better in Amateur Radio.

These things, plus the obnoxious proliferation of contests, cause me to confine most of my activity to experimental modes of communication where contacts are rare but always stimulating.

There are two kinds of hams — operators and experimenters. Both are necessary, but the operators vastly outnumber the experimenters. Bravo for *ham radio* for supporting us underdogs!

Frank Reid, W9MKV
Bloomington, Indiana

short circuit filter design

In fig. 6 of W6NRW's article, "Graphic Filter Design," (April, 1984, page 37), the resistor labeled 528.2 should be labeled 582.2. This nominal 7 percent error in value results in some peaking and a general tilt to the filter's passband.



Building a current *ham radio* project? Call the Short Circuit Hotline any time between 9 AM and Noon, or 1 to 3 PM — Eastern time — *before* you begin construction. We'll let you know of any changes or corrections that should be made to the article describing your project.

(See "Publisher's Log," April, 1984, page 6, for details.)



Hal's Most Popular

RTTY, AMTOR and CW EQUIPMENT BY HAL COMMUNICATIONS



The Professional's Choice

Henry Radio stocks and displays the most complete line of RTTY, AMTOR, printers and peripherals, all available for "hands on viewing". Veterans in RTTY, George Sanso (AB6A) and Boyd Crawford (K6RD) have set up a comprehensive display of RTTY AND AMTOR sending and receiving units that are actually "on the air". Stop by if you're in the area or call or write for literature and information. Henry Radio is a specialist in all types of teletype equipment, including commercial applications.



Henry Radio

2050 S. BUNDY DRIVE
LOS ANGELES, CA 90025
(213) 820-1234

TOLL FREE OUTSIDE CALIF. (800) 421-6631

931 N. Euclid, Anaheim, CA 92801 (714) 772-9200 • Butler, MO 64730 (816) 679-3127

143

DX'ERS SPECIAL

DX EDGE \$16.95
GRAYLINE AND LONG PATH PREDICTOR

2nd OP \$6.95

PREFIX CALLS
TIME ZONES
BEAM HEADINGS

REGULAR \$23.90 PLUS SHIPPING

JUST \$19.95 plus \$2.50 S&H

HAM RADIO'S BOOKSTORE
GREENVILLE NH 03048

the VHF/UHF primer: an introduction to propagation

To really work DX,
try a new mode

One of the most interesting aspects of the world above 10 meters is radio wave propagation. Sure, we've all heard about F2, tropo, meteor scatter, ducting, EME, and perhaps auroral propagation. But are these the prime or only ways of working DX on VHF/UHF? No way!

In preparing my monthly column for *ham radio*, I've noticed that I'll occasionally identify a propagation mode without providing any explanation about how that mode works. Sometimes it's difficult to readily identify a particular mode of propagation on the VHF/UHF frequencies because not all modes are well understood. And different propagation modes are frequently combined, making identification difficult at best.

Over the years, the many articles written about VHF/UHF propagation have only rarely covered more than a few modes at a time. Lesser known modes have been hidden away and almost forgotten. In this article, I'll identify and explain the most common modes of radio propagation, discuss some newly discovered, less common ones, and try to provide some insight into how you can exploit them and perhaps discover some new modes yourself. Wherever possible, references will be listed for those interested in pursuing the individual subjects further.

Before we proceed, remember that communications on any frequency is limited not only by the propagation mode and path length, but by several other factors such as transmitter power, receiver sensitivity, and antenna gain, among others. A full discussion of the latter parameters would fill an entire article, if not a book; hence, I'll limit this discussion to a basic introduction and a review of most of the identified

VHF/UHF propagation modes, as well as the operating techniques that make use of these modes. I'll begin with the propagation modes on the lowest VHF frequencies and move on upward through SHF, adding some of my own observations and suggestions about how to use each mode to its best advantage.

line-of-sight

Line-of-sight, surely the most common form of VHF/UHF propagation; is easily understood.^{1,2} At one time it was thought to be the *only* reason to use VHF/UHF; even now, the idea of QRM-free local communications is appealing.

Light and radio signals usually travel in relatively straight lines. If the antenna height is known, a simple formula can be used to determine the distance to the horizon:

$$D \text{ (miles)} = \sqrt{1.5H} \quad (1)$$

where H is in feet,

$$D' \text{ (km)} = \sqrt{12.75H'} \quad (2)$$

where H' is in meters.

Because of changes in air pressure, temperature, and humidity along the path, the refractive index of the atmosphere may change and bend or refract signals over a greater distance than the normal line-of-sight. Generally speaking, this refractive index averages 1.33, meaning that we can normally communicate over a distance 33 percent further than the normal line-of-sight. To account for this we can modify eqs. 1 and 2 as follows:

$$D \text{ (miles)} = \sqrt{2H} \quad (3)$$

or
$$D' \text{ (km)} = \sqrt{17H'} \quad (4)$$

For example, station "A" has a 50-foot (15.24 meter) tower. It has a horizon of approximately 8.66 miles (13.94 km) and a radio horizon of 10 miles (16.09 km).

By Joe Reisert, W1JR, 17 Mansfield Drive,
Chelmsford, Massachusetts 01824

table 1. Claimed 2-meter (and up) terrestrial DX records.

frequency band	record holder	date	mode	DX	
				miles	km
144-148 MHz	I4EAT-ZS3B	30 March 1979	Trans. Eq.	4840	7788
220-225 MHz	KP4EOR-LU7DJZ	9 March 1983	Trans. Eq.	3670	5906
420-450 MHz	KD6R-KH6IAA	28 July 1980	Tropo. duct.	2550	4103
1240-1300 MHz	VK5MC-VK7KZ/P	23 Jan. 1980	Tropo. duct.	1422	2290
2300-2450 MHz	VK5QR-VK6WG/P	27 Jan. 1978	Tropo. duct.	1190	1883
3300-3500 MHz	G3LQR-SM6HYG	11 July 1983	Tropo.	576	927
5650-5925 MHz	G3ZEZ-SM6HYG	12 July 1983	Tropo.	610	981
10-10.5 GHz	I0SNY/EA9-I0YLI/IT9	18 July 1983	Tropo. duct.	1034	1663
24-24.5 GHz	DJ2UH/P-DJ4YJ/P	21 Feb. 1982	Tropo.	152	244
48 GHz and up:	none reported				

Note: EME hasn't been included since it would distort the records significantly. EME DX of over 11,000 miles (17,699 km) has been accomplished on 2 meters, 70 cm and 23 cm. 220 MHz is only limited by the lack of frequency allocations worldwide. 13 cm is the highest band where Amateur EME QSOs have been claimed.

Station "B" has a 100-foot (30.48 meter) tower. It has a horizon of approximately 12.25 miles (19.71 km) and a radio horizon of 14.14 miles (22.76 km). If stations "A" and "B" are on opposite ends of a straight line between the same point on the horizon, the distances can be added to find the maximum path length. In this example the line-of-sight distance would be 20.91 miles (33.65 km) and the radio horizon would be 24.14 miles (38.85 km). If two stations are attempting to communicate, any obstructions or trees at the common point on their respective horizons may attenuate signals!

path loss attenuation

Space does not permit me to discuss path loss attenuation at length; see reference 2 for a detailed summary of this phenomenon. In brief, it may be useful to know that typical line-of-sight attenuations for a 10-mile (16 km) unobstructed radio path are 90.5 dB at 50 MHz, 109.3 dB at 432 MHz, 123.8 dB at 2304 MHz and 136.6 dB at 10 GHz. Due to the inverse square law, attenuation increases or decreases by 6 dB every time you either double or half the path length or frequency, respectively. Hence, if you try to double the path length (providing you have line-of-sight), the path loss will be 6 dB greater.

F2 propagation

The supreme propagation mode for DX and the workhorse of the HF bands is F2 propagation. Once it was thought that ultraviolet radiation from the sun would never be sufficient to ionize the ionosphere sufficiently to support communications on 50 MHz via the F2 layer (approximately 150 to 250 miles or 250 to 400 km above the earth), but the experts were proven wrong when W1HDQ contacted G6DH crossband (6 to 10 meters) via this mode on November 26, 1946. Only hours later a transcontinental 6-meter two-way

QSO using the same mode between W4GJO in Florida and W6QG in California occurred. Six-meter F2 was not too common during solar cycle 18, and the sun "cooled down" by November, 1947.

The International Geophysical Year (1957-1958) helped numerous stations obtain 6-meter permits where operation was normally forbidden. In October 1957 W4UMF worked SM5CHH, signaling what may have been the start of the greatest F2 openings ever recorded on 6 meters. Later that year K6GDI submitted the QSLs to qualify for the first WAC above 10 meters, showing the worldwide participation. In 1957, solar cycle 19 hit a tremendous peak, the highest recorded in history, when on December 24 to 25, the sunspot count reached 355 and worldwide propagation, even via the long path, became commonplace on 6 meters. But by early 1960, this cycle was on the decline, and unfortunately, solar cycle 20 displayed a more normal solar activity peak level with some 6-meter F2 contacts reported between November, 1967, and February, 1970. Most were single-hop contacts. It began to look as if we'd never see F2 on 6 meters again in our lifetime.

However, in the fall of 1978, during cycle 21, solar activity increased dramatically and F2 propagation began anew on 6 meters. The mean sunspot count in December, 1979, was 164.5, the highest for cycle 21. Unfortunately, many countries no longer permitted Amateur operation on 6 meters because of TV and other frequency allocations. As a result, many VHFers outside the United States had to be satisfied with SWLing or 6 to 10 meter crossband QSOs. 1980 saw a big F2 dip in the United States, but surprisingly, propagation returned for a strong second session in November, 1981, slowly diminishing in late 1982. (As I wrote this column, in March of 1984, F2 returned, with some USA areas working VK's and ZL's. No guess on how long it will last, but enjoy!)

F2 propagation requires a very high sunspot count, typically greater than 125, which is roughly equivalent to a 2800 MHz solar flux of 175 (as broadcast at 18 minutes after each hour on radio station WWV). Generally speaking, in the continental United States, openings start first at the southern latitudes, slowly working up to the northern latitudes over a period of days to weeks as the ionosphere gets "pumped up." Hence the solar activity has to be sustained for at least several days in a row. In the continental USA, openings usually occur between late October and March, favoring southern latitude stations.

At the first appearance of F2, single hop distances are right at the MUF and very long (typically 2500 miles or 4000 km), getting shorter as the ionization builds for several days. As the ionization increases, the MUF slowly rises, permitting operation above 52 MHz. Six-meter communications with low power (10 watts or less) become possible even with dipole antennas. If conditions remain favorable, multiple hops become possible.

The best propagation between two points usually occurs when the sun is about halfway between the stations and almost always requires that the entire path be in sunlight. At times the path can be rather selective, especially on multiple hops; this means that stations as few as 10 miles (16 km) apart may not be able to hear the same distant station. F2 can also link up with sporadic E (more on this later) and extend the path. When solar disturbances occur, the north-south paths show little or no change and often become enhanced soon after the storm subsides. However, the east-west paths drop off quickly and are usually good only during undisturbed solar periods.

Although several crossband 50-70 MHz QSOs were reported during cycle 21 between VE1ASJ and the United Kingdom, the 70 MHz signals were almost certainly not propagated by F2 but rather by sporadic E, since sporadic E propagation was in evidence on 6 meters during these openings.

Much of the success during cycle 21 can be attributed to improved gear, propagation beacons, monitoring of commercial paging and television stations (such as the BBC on 48.25 MHz), and the various liaison nets, especially those on 28.885 MHz (this frequency is still used whenever 10 meters is open). Most of the 6 to 10 meter crossband operation takes place near this frequency. Solar bulletins on radio station WWV at 18 minutes after each hour are also helpful because they report solar flux, an indication of sunspot count, and disturbance warnings via the "A" and "K" indices. Much more information on F2 can be found in "The World Above 50 MHz" column in *QST* during the appropriate years. It's doubtful that any widespread F2 propagation will occur on 6 meters again until about the year 2000, but it sure was great while it lasted!

backscatter

This mode of propagation, a form of radar, often precedes sporadic E and F2 openings. It is most prevalent on 10, 15, and 20 meters and sometimes occurs even on 40 meters. Its presence indicates that the MUF is very high. In backscatter operation, what happens is that an area of the ionosphere is so highly charged that signals traversing the E or F2 layer path strike the earth at some distant point and are scattered. If two stations running reasonable power and antenna gain aim at this common scattering point, communication is made possible by reflection. Because signals arrive from several different directions at the same time (multipath), they are usually weak and distorted. A good time to look for 6-meter backscatter is when propagation is good on 10 meters; even then, it may be difficult to spot unless there is lots of activity. This mode is primarily limited to 6 through 40 meters and can be used for DX even up to 3000 miles (4825 km).

midlatitude intense sporadic E

This is truly the workhorse mode for DX on 6 meters. Propagation is typically from ionized clouds located in the E layer and usually approximately 60 miles (100 km) above the earth in the midlatitudes (25 to 55 degrees north latitude). There is also equatorial and polar sporadic E, but they are slightly different in nature and of little value for continental USA stations since they are too far south or north to be of any use.

In the continental USA, sporadic E propagation usually peaks near the summer solstice (June 21). Typical limits are from May to early August but can occur any time of year. Typical DX limits are about 300 to 1300 miles (485 to 2100 km) per hop but two and even three hops are not uncommon on 6 meters. A lesser peak occurs approximately within plus or minus one month of the winter solstice (December 21) but this peak is considerably shorter, weaker and usually limited to single hop. It is worthwhile noting that the peaks also occur in the southern hemisphere in reverse order. Although sporadic E propagation can start at any time of the day, it is most prevalent in the late morning, the late afternoon and into the early evening. There is some speculation that sporadic E occurrences are more common and stronger when sunspot activity is low. Hence propagation via this mode may improve in the next few years.

The exact mechanism that triggers sporadic E is still not known. Some people attribute it to weather-related phenomenon, especially wind shear and lightning storms. The late Mel Wilson, W1DEI/W2BOC, devoted much of his Amateur career to the study of sporadic E and wrote several very interesting articles on the subject.^{3,4} He pointed out that the clouds that produce the propagation originate at a location he

called the "birthplace" and usually travel in relatively straight lines at approximately 180 miles (290 km) per hour from southeast to northwest (fig. 1). For best propagation, he said, the cloud should be on or nearly on a line drawn between the two stations at the half-way point. Clouds ± 5 degrees off the path can be used and up to ± 10 degrees at the extreme. A single cloud will be usable for up to 5 minutes. The size of the cloud has been estimated to be in the order of tens to hundreds of feet (5 to 100 meters) vertically. Multiple clouds are often being formed in the same birthplace so they will pass by as they are generated. The best sporadic E propagation seems to occur when no major high pressure areas are present. (Mel's work will be carried on by his son Steve, W2CAP/1.)

Midlatitude sporadic E is also usable on 2 meters with the first reported contacts made between northern Texas and southern California on July 10, 1951, for a distance of approximately 1300 miles (2090 km). At first, other 2-meter openings were rare, probably due to lack of activity, and weren't recorded again until July, 1956 and June, 1959. Nowadays 2-meter con-

tacts are usually reported yearly and tend to occur between late June and early August, but can occur on the winter peak as described above. Strong lightning activity, especially the type that occurs above 60,000 feet (18,288 meters), is often present near the midpath of big 2-meter openings.⁵ Tornadoes and hail storms are often present at the mid-point of the path during 2-meter openings. Typical 2-meter QSOs using sporadic E are shown in fig. 2 from data given to me by the late Mel Wilson. Although we have had some very long DX (over 1600 miles or 2575 km) 2-meter openings in the United States, I have never heard of a documented double-hop QSO over 2000 miles (3218 km) such as has been recorded in Europe. The greater number of reported 2-meter openings "caught" in recent years is probably due to better monitoring and improved equipment as well as the new common 2-meter calling frequency, 144.2 MHz. The frequency limits for sporadic E are believed to extend above 220 MHz and W1JR and W0VB have both been heard on this frequency by other stations but in each case equipment problems at one end of the path prevented

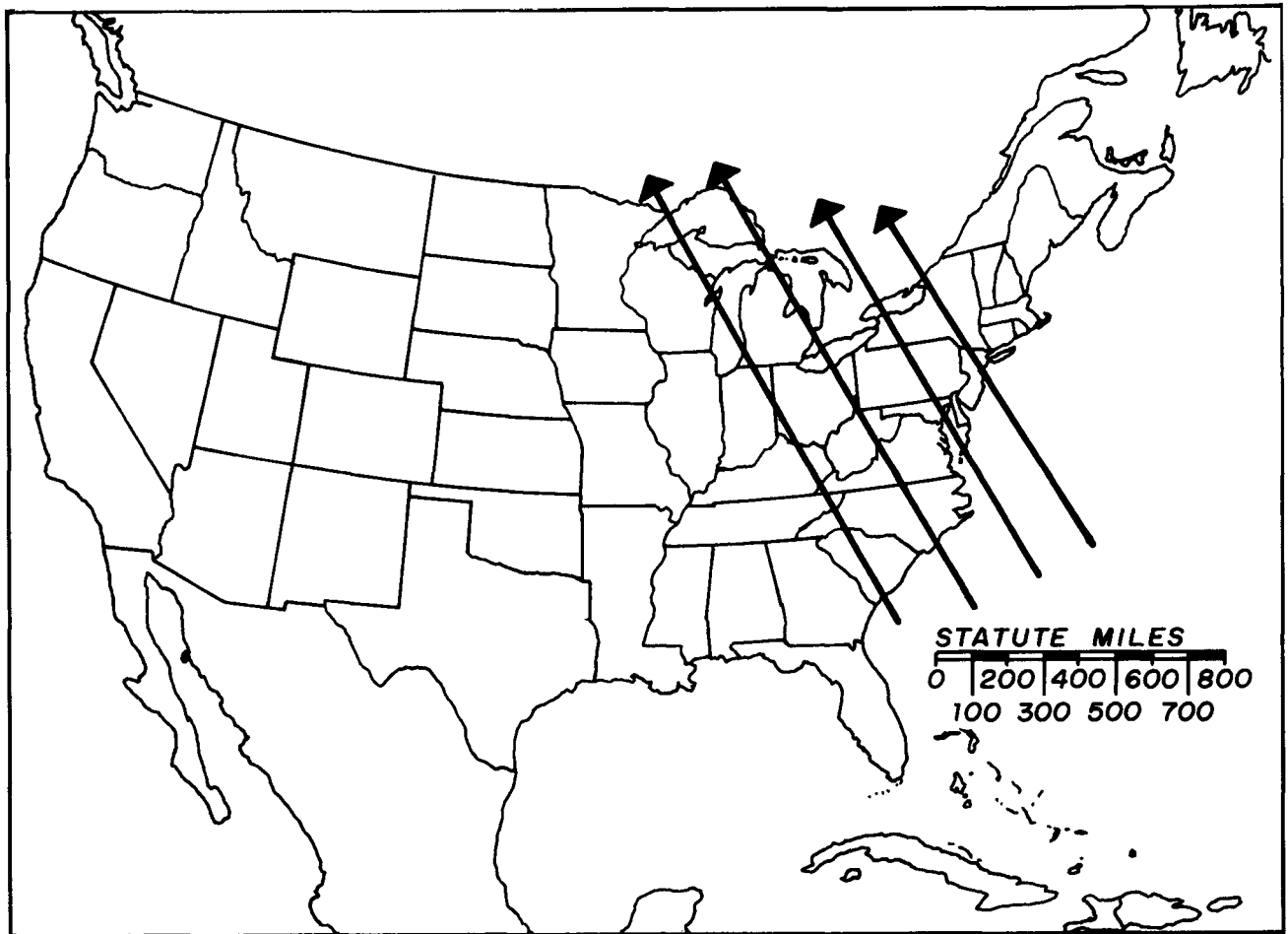

fig. 1. Clouds producing sporadic-E propagation generally travel from southeast to northwest at approximately 180 miles (290 km) per hour, moving in a relatively straight line.

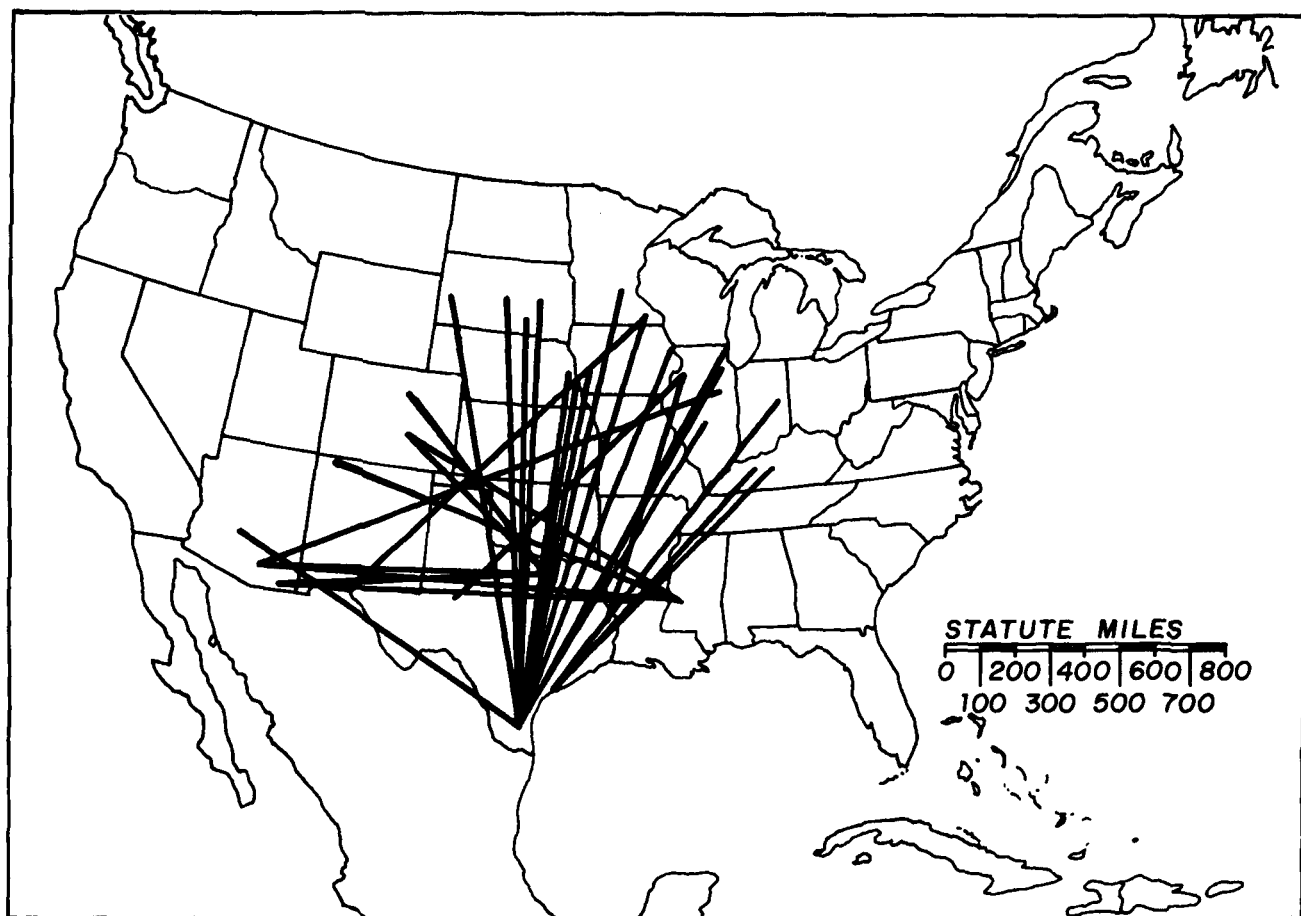

fig. 2. A typical 2-meter sporadic-E opening shows paths between stations in QSO on February 3, 1977, on 144 MHz (0000-0229 UTC).

completed QSOs! (I've noticed, by the way, that all the good east-to-west 2-meter sporadic E openings I've heard from the New England area in the past eight years have occurred within two weeks on either side of July 20th. Any comments?)

The best way to "catch" sporadic E openings is to listen on 10 meters for short skip conditions. When the 10-meter path gets down to 300 to 500 miles (483 to 805 km), the 6-meter band is probably ready to pop or is already open. Similarly, when the path on 6 meters gets very short (perhaps 400 to 500 miles or 645 to 805 km) and intense, try putting out a call on the 2-meter calling frequency. Remember that the reflection from the cloud will usually be different on 2 meters than on 6 meters. The distance will generally be much longer on the higher frequency, so judge accordingly if you're making schedules. Backscatter, especially from a local, is an indication that there are lots of clouds and a big opening is about to begin. You can't have a QSO without making some noise to alert others of an opening. W4WD has noticed that whenever WWV forecasts a "strat-warm," a sporadic E opening usually occurs within the following 12 to 24 hours.

TE (transequatorial) scatter

This was truly an Amateur Radio first when long-distance (5000 miles or 8000 km) propagation was established across the equator on 6 meters in August, 1947. It is significant that tests have verified that the signals first enter a bell-shaped ionized area midway between the station and the geomagnetic equator and then are ducted to the opposite ionized area without intermediate reflection from the earth.⁶

For best results, stations should be located about 1500 to 2500 miles (2400 to 4000 km) north and south of the geomagnetic equator and signals should cross the geomagnetic equator at close to right angles. However, deviations of up to ± 20 degrees have been known to occur. It is also significant that propagation may not necessarily be present at the same time at lower frequencies. These contacts usually improve during the equinoctial periods, especially when solar activity is high, as occurs near the peaks of the solar cycles. Openings may start in the late afternoon with clear sounding signals but early evening (at the midpoint on the path) signals often have a flutter with up to a 15 Hz rate. Signals may last until midnight, long

Stainless Steel... IS Forever!



Quality, Strength,
Durability & Smoothness

The NOVA SS 112
"compatible at 2° spacing"
Also the NOVA SS 90
And the Amazing
NOVA SS 66



- Low noise deep dish design. Superior hydroforming process.
- High Gain one-piece design.
- Excellent durability and low maintenance.
- One piece for easy installation.
- All electronics enclosed in protective housing.
- Plated bolts, nuts and washers.
- Complete heavy duty packaging of entire system for safe shipment.
- Polarizer & LNA Bracket included.
- **BEST OF ALL: A 10 Year Limited Warranty.**



Our NEW Full Color Catalogs Are Now Available!

Featuring a complete assortment of NOVA Equipment and accessories. Send name & address and \$1 for postage.

NOVA SS 112 ANTENNA DATA

Antenna Construction: Hydroformed, one piece, stainless steel

Antenna Type	Prime Focus	Frequency	3.70 - 4.20 GHz
Finish	Dull, satin	Gain	39.5 dB at 3.95 GHz - 40.0 dB at 4.20 GHz
Thickness	16 ga.	Efficiency	64%
Quality	304 Stainless Steel	Beamwidth	B = 1.7°
Weight	183 lbs.		3db
Depth	22 3/4"		B = 3.0°
Focal Length	33-5/8"		10db
f/D	3	Feed	Single linear or dual orthogonal linear polarization, rotatable 360°
Wind operational	40-50 mph steady load	Warranty	10 years
Survival	125 mph steady load		
Temperature Range	- 50° to 130°		

... Manufacturer of home and commercial TVRO systems. Stainless steel and fiberglass antenna plus wide variety of receivers and other electronics and accessories.



KAUL-TRONICS, INC.™

Route 2 • Box 637 • Richland Center, WI 53581 • For Service Phone 608/647-8902
Phone for Ordering: WI (800) 826-NOVA • USA (800) 826-KAUL

150

after F2 has disappeared. The frequency usable is typically 1.5 times the MUF maximum that occurred earlier in the same day.

Unfortunately for stations in the continental United States, the geomagnetic equator runs about 15 degrees south of the true equator in this hemisphere. Consequently only stations in very southerly latitudes of the continental United States are optimally located. Stations in South Africa to the Mediterranean as well as Japan to Australia are in more favorable locations for this mode of radio propagation.

equatorial FAI (field aligned irregularities)

There was always the hope that someday there would be propagation as high as 2 meters across the equator. Then on October 29, 1977, it happened, when YV5ZZ/6 in Venezuela made a 2-meter contact with LU1DAU (in Argentina) at a distance of about 3135 miles (5045 km).⁷ After this initial success, openings kept occurring and distances kept improving, and by February, 1979, contacts were established between Puerto Rico and Southern Argentina, Australia and Japan as well as between Rhodesia and Greece.

Often the signals had an auroral sound (more on this later). Stations with elevation control noticed that signals were optimized at 5 to 8 degrees elevation. And while 70 cm (432 MHz) signals could be heard no QSOs were made on that frequency. Finally, in 1983, a successful 220 MHz QSO was completed between KP4OER and LU7DJZ (see **table 1**). Some Amateurs speculated on the existence of a new propagation mode,⁷ possibly one using a scatter mechanism and FAI from ionized bubbles. Others suggested ducts. At this time no one agrees except to say that more time and study is required.

We now know that propagation between stations equally spaced north and south of the geomagnetic equator can occur up to 70 cm. The best times and seasons for these contacts seem to be those most frequently observed for TE, as explained above. There is much more to be done in this important area — another Amateur Radio *first*.

ionospheric scatter

This mode of propagation,⁹ a form of forward scatter, is believed to be due to scattering in the lower D region (30 to 55 miles or 50 to 90 km) of the ionosphere. Typical distances are 800 to 1300 miles (1300 to 2100 km). Signals are usually continuous, but weak and wavy with a broad peak around midday at the midpath and during the summer months. Signal attenuations are approximately 90 dB greater than free-space loss at 6 meters and 115 dB at 2 meters. Hence this mode of propagation is definitely within the capability of two well equipped stations with 2-meter EME capability and deserves more attention.

aurora

Aurora, caused by magnetic disturbances on the sun,¹⁰ is called *aurora borealis* (or "northern lights") in the northern hemisphere and *aurora australis* in the southern hemisphere. Aurora borealis are most common around the equinoxes in March and September and usually begin in the late afternoon or early evening, though they can occur at any time of the year and are sometimes active in the early afternoon as well as all through the night and even into morning! The number of auroral occurrences tends to peak at the beginning and at the end of a solar cycle peak (e.g. 1978-79 and 1982-83) and decrease significantly when sunspot activity is low. They usually occur 24 to 48 hours after a major solar flare. A WWV "A" index of 30 or greater or a "K" index of 4 or more is a good warning of impending aurora. Weak or "watery" sounding HF signals are an excellent indicator of aurora presence although their presence does not guarantee that the openings will extend to VHF/UHF.

Typical auroral propagation occurs in a region between 47 to 84 miles (75 to 135 km) above the earth. If you were to look down on the earth from directly over the magnetic pole, an aurora would appear to be shaped like a halo or doughnut. (See satellite photograph shown in reference 11.) From a vantage point on the earth, auroras appear to be thin sheets or columns of light that are not quite vertical but tipped at the local dip angle of the magnetic field. Those in the far north are usually green, while those that extend further south may be red. The further south the aurora extends, the greater the DX possibilities; they are, after all, a superb reflector of radio waves.

The auroral reflection occurs when the angle of incidence equals the angle of reflection, but incidence and reflection paths need not lie in the same plane. Propagation via auroral reflection has been verified up to about 3000 MHz, but no known Amateur contacts have been reported above 70 cm (432 MHz). The best reported DX is about 1336 miles (2150 km). High power (several hundred watts or greater) is beneficial, but even 10-watt stations have had confirmed 70 cm QSOs. Occasionally the aurora extends far enough south so that even stations in Florida, Texas, New Mexico, and Arizona can establish auroral contacts.

For communications via auroral propagation, both stations should aim their antennas at the same "hot" spot. The cross-section of reflection decreases with increasing frequency. The angle of perpendicularity with respect to the earth's magnetic field also decreases with frequency. Typical accuracies required are ± 12 degrees at 220 MHz, ± 9.5 degrees at 432 MHz and ± 6 degrees at 780 MHz.¹² Since typical antenna installations have beamwidths that usually decrease in both the horizontal and vertical planes with

increasing frequency, the path becomes more difficult and would definitely be improved above 220 MHz if both stations could also change antenna elevation. This is particularly true when trying to contact a station that is either several degrees of latitude north or south of you. Hence, higher power is definitely preferable to increased antenna gain.

Auroral signals usually sound like a "buzz" or white noise because of the Doppler spreading caused by the rapidly changing ionization. CW is preferred, but SSB is usable, though hard to understand and lacking high pitched sounds, if you are operating on the lower VHF bands and the aurora is strong. I've noticed that if a CW signal is narrow (1 to 2 kHz) on 2 meters, there is usually sufficient ionization to permit 220 MHz and maybe even 70 cm contacts. I've also noticed that the MUF usually peaks shortly after the onset of the aurora, perhaps in 15 to 30 minutes, and then slowly decreases as time passes. *Hence it is advisable to take advantage of the higher VHF/UHF bands as soon as the aurora gets going rather than discover later that the MUF has dropped.*

"Watery" or wavy sounding signals on HF (10 to 160 meters) are an excellent indication that aurora is present and can be a tip-off to look for VHF/UHF auroral propagation. Auroras can be easily detected using a TV video carrier monitor on channel 12 (205.25 MHz) or 13 (211.25 MHz), similar to the one I described in last month's column.¹³ Just point your beam north and listen for the "buzz" on the carriers. This is also a good system for finding where the aurora is peaking and whether the MUF is high. I've noticed that the "hot" spot may be in a slightly different place at 220 MHz than on 6 or 2 meters (perhaps due to antenna patterns or other variables). This is invaluable information when trying to find 220 MHz and 70 cm signals.

Another observation I've made is that the Doppler shift may vary when you swing your beam back and forth while listening to an auroral signal. I've measured up to ± 1 kHz shift on 2 meters on locals and considerably more on 220 MHz and 70 cm. Consequently it's advisable to tune \pm several kHz when listening for answers to a CQ. If you're using a modern transceiver, tune with your RIT so you don't transmit back on a new frequency! Lately I've noticed this happening more often — but doing so can be disastrous on aurora, since you may land on top of another signal and be completely unreadable in the QRM, causing confusion to the operator you've answered, who is no doubt wondering where you went! Likewise, be careful where you zero-beat your own signal if you want an answer.

Finally, look for activity on or near the VHF/UHF calling frequencies. During auroras, this is usually 50.100, 144.100, 220.100 and 432.100 MHz on CW and with 50.110 and 144.2 on SSB. By all means, call CQ.

When you hear a reply, try to peak your beam quickly in order to optimize the path, since each station will come in at a slightly different direction depending on latitude and longitude.

artificial auroras

Attempts have been made to generate artificial auroras by using rockets to inject barium clouds into the ionosphere; in recent years, scientists in both the United States and the Soviet Union have created yet another form of artificial radio aurora.¹⁴ This propagation mode is similar to the natural auroras described except in that it is generated by radiating very high amounts (typically 40 Megawatts of ERP) of HF (typically 3 to 10 MHz) CW power vertically into the ionosphere. The scattering center is directly above the transmitter. The principal tests have been conducted in Platteville, Colorado, with a 1-Megawatt transmitter and a large antenna array, and at Arecibo, Puerto Rico, with 100 kilowatts, using the 1000 foot (305 meter) spherical dish. Operations have been successful as high as 430 MHz, and the signals are usually narrower than those generated by natural aurora.

auroral "E_s"

This is a much sought after mode of propagation on 6 meters. According to WAØIQN,¹⁵ ionospheric sounders have verified that sporadic E may be present just below an aurora, but the reasons for this are not known. When particle precipitation becomes strong enough, sufficient electrons collect at the bottom of the field line and form a "puddle" which can spread horizontally. It may then appear like sporadic E after the effects of the aurora wear off and thus yield DX in the northern regions of the United States and Canada. This may explain why some 6 meter auroras sound almost like sporadic E propagation. Auroral E_s usually occur within a few hours after an aurora fades out.

meteor scatter

Meteor scatter is one of the prime modes for DXing on VHF/UHF. Every day 50 to 100 million particles randomly enter the earth's atmosphere, where they burn up in the E region (50 to 150 km high) and leave ionized trails capable of reflecting radio signals. Due to the orbital characteristics of the earth, these random particles tend to increase slowly after midnight, reaching a broad peak at 6 AM and slowly decrease as the morning wears on, reaching a minimum at about 6 PM local time. The best months for random meteors in the continental United States are between June and August, with a minimum occurrence in February.

Even more important to the VHF/UHF DXer are meteor showers. They can occur at any hour of the day, and while they may be short in duration (any-

where from a few hours to a day or two long), they do occur on predictable dates. The better known showers are the Perseids (approximately August 11) and the Geminids (approximately December 11). DX, typically 500 to 1400 miles (805 to 2250 km) is accomplished by reflecting signals off these meteor trails.¹⁶

Most meteor scatter operation is on 6 and 2 meters, but 220 MHz and occasionally 70 cm (although there have been only about a half dozen reported contacts on this frequency to date) can be used in the higher speed showers. A recent article¹³ described how to optimize the use of this mode; readers who wish to know more should refer to that article.

FAI

The authors of reference 7 speculated that FAI similar in nature to that which produces the great TE FAI may be present in the midlatitude regions, and that signals in this mode would probably have an auroral quality. At the same time this article was published, K4GFG was conducting a nightly over-water tropo schedule in an attempt to QSO KP4EOR, who was also involved in the TE FAI experiment. What transpired was a QSO, not by tropo propagation, but by FAI with weak and "watery" signals peaking about 10 to 20 degrees north of the great circle path.¹⁷

During the following summer (1979), signals appeared over the United States and FAI-type QSOs were made from Florida to Texas and Alabama again, with auroral-type signals peaking north of the great circle path. Occurrences seem to be in the late evening, following sporadic E openings. Typical path loss is in the area of 218 to 230 dB at 2 meters and 248 dB at 220 MHz, meaning that fairly large setups (kW and modest gain antennas) are required to take advantage of this mode. Reference 17 provides charts for pointing antennas and speculates that this mode may be possible as high as 70 cm, although no known QSOs have taken place above 2 meters as of this writing. It is a fascinating possibility for VHFers and a nice way to work real DX when the band would otherwise be quiet!

EME

Earth-Moon-Earth, or "moonbounce" is one of my favorite subjects because it's *the* ultimate DX for the Radio Amateur. When you bounce your signal off the moon and listen for the returning signal, the path is up to 500,000 miles (804,500 km) in length and it takes the signal over 2.5 seconds to traverse the distance! Hence EME allows you to monitor your own signal after it is sent — and if you hear your own echoes, you know that your signal got where it was supposed to go, not like the dead-band syndrome on HF. You also know your equipment is operating successfully; by listening to the strength of the echo you can also

tell how well it's working and whether your most recent improvement actually works.

While EME is not for the faint-hearted, it can be achieved by the typical VHF/UHFer. The first EME stations were highly experimental and results were marginal at best. However, with the advances in the state-of-the-art (such as good low-noise transistors and GaAs FETs, high performance Yagis and parabolic dishes as well as efficient amplifiers), EME really took off in the late 1960s. Nowadays, when conditions are good on 2 meters, you have the capability of hearing your own echoes; WAS as well as WAC are possible with 500 watts of output power and four 3.2 wavelength NBS-type Yagis. Even a single-Yagi station with a good low-noise antenna-mounted preamplifier can hear the larger EME 2-meter and 70 cm stations off the moon when conditions are good. Over 50 DXCC countries are now or have been active on EME in the last few years and EME expeditions are no longer uncommon.

Typical path losses for EME range from 251 dB on 2 meters to 276 dB on 13 cm (2300 MHz), the highest frequency band on which Amateur contacts have been claimed.¹⁸ A few EME QSOs have been made on 6 meters, but the antenna systems were *very* large, and noise was a limiting factor. EME is now commonplace on 2 meters, 220 MHz, 70 cm, and 23 cm, where contacts are made almost daily and even SSB QSOs are not uncommon. Typical EME operating and calling frequencies are listed in **table 2**.

table 2. Typical EME operating and calling frequencies.

band	frequencies used	calling frequencies
2 meters	144.000-144.110	144.003-144.010
220 MHz	220.0-220.080	220.020
70 cm	432.000-432.070	432.010
23 cm	1296.000-1296.060	1296.010
13 cm	2304-2304.1 and 2320-2320.2	2304.050 and 2320.150*

*Most Europeans can no longer operate below 2320 MHz in the 13 cm band. The USA Amateurs may soon lose the frequencies between 2310-2390 MHz. Therefore, cross band operation may be required.

13 cm is now being tried, and DFØEME has reported several QSOs using a 9-meter dish. The interesting thing about 23 and 13 cm is that the power levels and antenna systems are small in comparison to 2 meters and 220 MHz. For example, some stations on 23 cm have been making QSOs rather routinely with dishes as small as 8 to 13 feet (2.5 to 4 meters) in diameter and with power as low as 100 watts at the feed. They're making good use of the new low-noise GaAs FET preamplifiers mounted right at the feed and of the

AEA Brings You The RTTY Breakthrough

NEW MBATEXT™ \$109.95 List/CALL FOR PRICE VIC-20 MBATEXT or C-64 MBATEXT



MBATEXT™ is the most advanced MBA (Morse, Baudot, ASCII) software plug-in cartridge available for the VIC-20 or Commodore 64 computer. Compare our outstanding features and price to the competition.

- KEYBOARD OVERLAY instructions to avoid constant referral to the manual
- RTTY and ASCII SPEED ESTIMATE MODE
- BREAK-IN CW MODE
- QSO BUFFER RECORD TOGGLE
- WORD PROCESSOR style insertion, deletion, and correction in TEXT EDIT MODE
- CW AUTO SPEED TRACKING plus SPEED LOCK
- BREAK-IN BUFFER that is easy to use
- Low speed FARNSWORTH CW TRANSMISSION (between 5 and 14 WPM)
- RE-TRANSMIT RECEIVED TEXT DIRECTLY without need of disk or cassette
- DISK, CASSETTE, OR PRINTER storage of message and QSO buffers
- RECEIVE AND TRANSMIT 5-99 WPM MORSE
- 10 SOFT-PARTITIONED™ MESSAGE (OR TEST) BUFFERS
- WORD WRAP
- TIME OF DAY CLOCK
- PRECOMPOSE SPLIT SCREEN OPERATION
- STATUS INDICATORS on screen
- EASY START-UP by simply typing SYS 44444 or SYS 33333
- DEDICATED FUNCTION KEYS for quick operation
- Ability to IMBED CONTROL FUNCTIONS in type-ahead buffer
- WORD OR CHARACTER mode
- SELECTABLE BAUDOT UNSHIFT ON SPACE (USOS)
- SEND/RECEIVE 60, 67, 75, 100, 132 WPM BAUDOT PLUS 100, 300 BAUD ASCII
- RTTY BLANK-FILL and MORSE BT option for idle transmit periods
- AUTOMATIC PTT
- computer control of TONE REVERSE
- MASTER MENU, COMMAND MENU, and OPTIONS MENU makes MBATEXT™ easy to use with no prior experience
- INCLUDES CABLE TO INTERFACE WITH AEA model CP-1 COMPUTER PATCH™
- POWERED BY HOST COMPUTER.

NEW MICROPATCH™

MICROPATCH™ IS A NEW LOW-COST, HIGH-PERFORMANCE Morse, Baudot and ASCII SOFTWARE/HARDWARE computer interface package. The MICROPATCH™ model MP-20 or MP-64 incorporates the complete MBATEXT software ROM (described above) for either the VIC-20 or Commodore 64 computers. All circuitry and software is incorporated on a single, plug-in cartridge module featuring the following:

- TRUE DUAL CHANNEL MARK AND SPACE MULTI-STAGE 4 POLE, CHEBYSHEV ACTIVE FILTERS
- AUTOMATIC THRESHOLD CORRECTION for good copy when one tone is obliterated by QRM or SELECTIVE FADING
- EASY, POSITIVE TUNING with TRIPLE LED INDICATOR
- NOT a low-cost, low-performance phase-locked loop detector!!!
- SWITCH SELECTED 170 Hz or WIDE SHIFT on receive
- 800 Hz multi-stage active CW FILTER
- AUTOMATIC PTT
- RTTY ANTI-SPACE
- demodulator circuitry powered by external 12VDC (not supplied) to AVOID OVERLOADING HOST COMPUTER and for maximum EMI ISOLATION
- EXAR 2206 SINE GENERATOR for AFSK output
- SHIELDED TRANSCIVER AFSK/PTT INTERFACE CABLE PROVIDED
- PLUS or MINUS CW KEYED OUTPUT
- FSK keyed output.



The Micropatch is structured for easy upgrading to the AEA Computer Patch™ advanced interface unit without having to buy a different software package! Simply unplug the external computer interface cable (supplied with the Micropatch) from the Micropatch and plug it into the Computer Patch.

\$149.95 List CALL FOR PRICE MP-20 or MP-64

COMPUTER PATCH™



COMPUTER PATCH™ is the name of our most advanced computer interface equipment for Morse, Baudot, ASCII, or AMTOR operation. The CP-1 will allow you to patch most of the popular personal computers to your transceiver when used with the appropriate AEASOFT™ TU software such as AEA MBATEXT, AMTOR TEXT™, or the MBATEXT RESIDENT ON THE MICROPATCH units. AEA also offers a full feature software package for the Apple II, II plus and IIE; TRS-80 Models I, III and IV; and the IBM-PC. The CP-1 will also work with certain other computers using commonly available software packages.

The CP-1 offers the following advanced and high quality features:

- HANDSOME ALL METAL ENCLOSURE FOR MAXIMUM RF IMMUNITY
- DUAL CHANNEL, MULTI-STAGE ACTIVE MARK AND SPACE FILTERS
- AUTOMATIC THRESHOLD CORRECTION
- RECEIVE 170 HZ FIXED OR 100-1000 HZ VARIABLE SHIFT
- 800 HZ multi-stage CW FILTER
- PRE-LIMITER AND POST-LIMITER FILTERS
- SERIAL RS-232 FIELD INSTALLABLE OPTION
- 117 VAC WALL ADAPTOR SUPPLIED
- PLUS (+) and MINUS (-) CW OUTPUT JACKS
- MAGIC EYE STYLE BAR GRAPH TUNING INDICATOR
- SCOPE OUTPUT JACKS
- NORMAL/REVERSE front panel switch
- MANUAL (override) PTT switch
- VARIABLE THRESHOLD for CW
- ANTI-SPACE RTTY
- KEY INPUT JACK for narrow shift CW ID on RTTY, CW practice, or keyboard bypass.

The CP-1 is made in the U.S. with high quality components including double-sided glass epoxy through-hole plated boards, complete with solder mask and silk screened parts designators.

\$239.95 List CALL FOR PRICE CP-1

PACKAGE SPECIALS

\$239.95*

Combine the VIC-20 or COMM-64 MBATEXT™ software with the CP-1 at time of purchase and you receive a SPECIAL PACKAGE PRICE. NOW the best RTTY COMPUTER INTERFACE SYSTEM is available at prices comparable only to vastly inferior systems.

CP-1/20 (CP-1 with VIC 20 MBATEXT) CP-1/64 (CP-1 with C-64 MBATEXT)

*SUGGESTED AMATEUR DISCOUNT PRICE THROUGH PARTICIPATING DEALERS ONLY

C & A ROBERTS, INC.

18511 Hawthorne Blvd., Torrance, CA 90504
213-370-7451 800-421-2258

AEA Brings you the Breakthrough!



P.O. Box 620625 Woodside, CA 94062 (415) 851-8779

**The only manufacturer offering Amateurs
the advantages of MOSFET RF Power Amps**

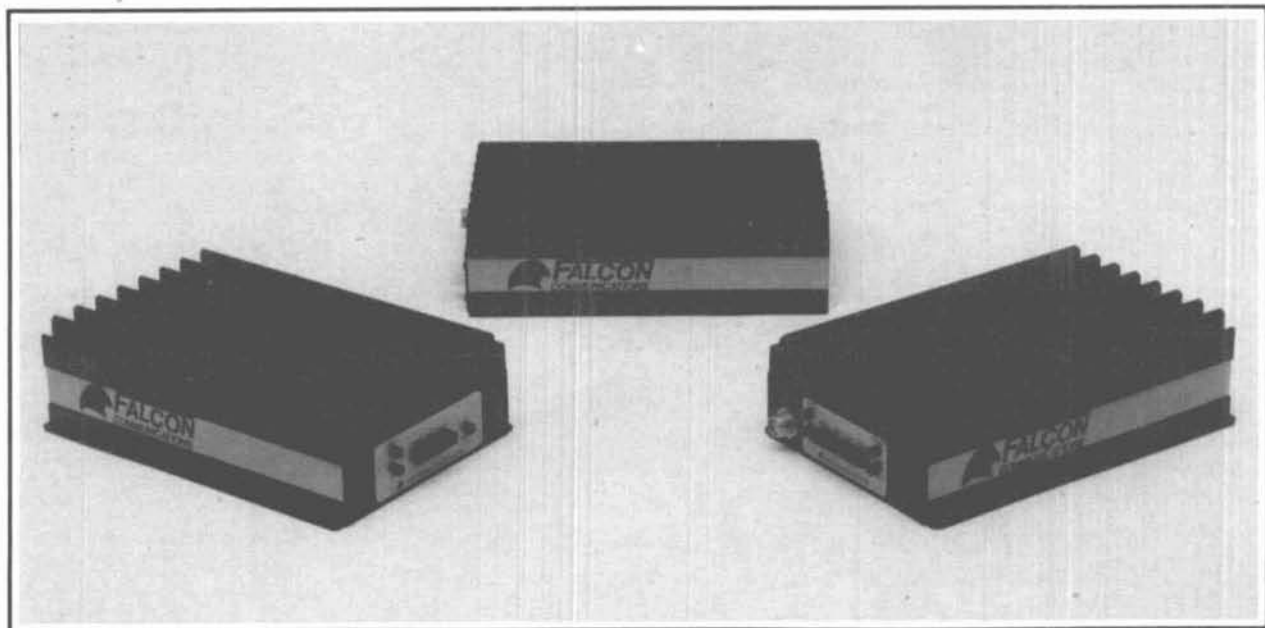

MOSFET Mobile Power Amplifiers

4101 Complete 2 Meter Handie Talkie Accessory - All mode RF power amp., 2 Watts in = 25 Watts out, 50 Watt max.. Regulated power supply, with adjustable current limit, for HT power or battery charge. 4 Watt speaker amplifier. Optional plug-in receive preamp. You must fabricate a cable to connect to HT; plug supplied. **\$215**

4102 Complete 2 Meter Handie Talkie Accessory - All mode RF power amp., 2 Watts in = 100 Watts out. Regulated power supply, with adjustable current limit, for HT power or battery charge. 4 Watt speaker amplifier. Optional plug-in receive preamp. You must fabricate a cable to connect to HT; plug supplied. **\$325**

4103 All Mode 100 Watt 2 Meter Amplifier - 10 Watts in = 90 Watts out, 2 Watts in = 30 Watts out. No harm with 25 Watt transceivers. Optional plug-in receive preamp. Optional #4106 remote control. **\$245**

4104 All mode 100 Watt 220 MHz amplifier - 10 Watts in = 70 Watts out, 2 Watts in = 25 Watts out. No harm with 25 Watt transceivers. Optional plug-in receive preamp. Optional #4106 remote control. **\$245**

4105 All mode 100 Watt 2 Meter amplifier - 2 Watts in = 100 Watts out. Optional plug-in receive preamp. **\$295**

**Also come to FALCON for your
MOSFET Repeater Amplifiers**

very low sky noise above 400 MHz. All things being equal, path loss and antenna gain increase directly with frequency. However, since the antenna gain is added twice (once on receive, and once on transmit), the overall signal-to-noise ratio increases with increasing frequency. Another advantage of EME is that you don't have to wait for a band opening!

The EIMAC EME notes¹⁹ are a great help for the newcomer to EME. Reference 20 describes the requirements for 70 cm EME as well as helpful hints to improve your station and equipment both on EME and terrestrial. (A later column will describe 220 MHz requirements. See you off the moon!)

tropospheric scatter

This mode of propagation uses the reflections off dust particles, clouds and the refractive index variations that occur in the troposphere (1000-50,000 ft. or 305-15,250 meters above sea level) to provide reliable VHF/UHF propagation up to 1000 miles (1609 km) between well equipped stations.^{21,22} For several years starting in 1953 Chisolm et al²² conducted interesting tropo scatter tests over 98-830 mile (158-1335 Km) paths from Massachusetts to North Carolina. They proved that with adequate equipment, 70 cm signals could always get through with path loss varying from 190 dB at 98 miles (158 km) to 258 dB at 618 miles (994 km) and 300 dB at 830 miles 1335 km).

Both stations should aim their antennas at each other on the great circle path and their signals will scatter from the common volume of the atmosphere somewhere near the mid point in the path. For best long haul DX, a low angle of radiation is essential making it desirable to have your antenna fairly high (10 wavelengths minimum but greater than 20 wavelengths is unnecessary), in the clear, and a good low-angle horizon. Antenna gain is not fully realized since the power is not from a point source but from a volume in the atmosphere.

Typical path attenuations for the long DX (greater than 300 miles or 483 Km) are such that an EME type setup is desirable. However, many EME stations are now using their EME arrays with mast mounted pre-amplifiers so DX is no longer a problem on the VHF/UHF frequencies. Recent work in the U.K. on 3 cm (10 GHz) shows that troposcatter is a very reliable mode.²¹ They predict that a 440 Km range is possible using 1 watt and 4 foot (1.22 meter) dishes by each station. This propagation mode deserves more attention especially on 70 cm and above!

tropospheric bending

Tropospheric communication utilizes weather-related changes in the atmosphere to propagate VHF/UHF signals over much greater than line-of-sight distances. Under normal weather conditions, the tem-

perature of the atmosphere decreases in a more or less linear fashion with increasing altitude. However, if the temperature should abruptly increase with increasing altitude, the conditions are right for long haul DX. This usually happens between 3000 and 6000 feet (915 to 1930 meters) above local terrain and causes the refractive index to significantly increase beyond 1.33 as started earlier in the line-of-sight discussion. If you are at an elevated QTH, you could get above the temperature inversion and be unable to propagate through this layer!

Best tips are to look for increased cloudiness following a period of fair and calm weather. Best periods occur after a long (two or more days) high steady barometer (greater than 30.3 inches or 1025 millibars) starts to drop due to the approach of a slow moving low pressure area from a few hundred miles away, especially when moist air masses are approaching such as from the Gulf of Mexico. Signals are usually strongest in the late evening and especially in the early morning around sunrise. For advanced warning watch weather maps especially on TV. Remember that weather maps in the newspapers may be 24-48 hours old and hence may be after the fact! The late Ross Hull wrote several interesting articles on this subject.²³

I have also noticed that the really good overland tropospheric bending generally occurs in the winter months in the states bordering or near the Gulf of Mexico and between mid-August and late November in the central, northern and northeastern continental USA. Openings are also prevalent when there are large inversion layers with uncomfortably high humidity. The eastern USA should look for enhanced north to south DX when a weather condition called a "Bermuda High" is present. The best DX, especially east to west, seems to occur when a hurricane is bearing down on the area. Fortunately or unfortunately, the hurricanes that used to come roaring across the eastern half of the USA have been few in numbers since the early 1970s.

tropo ducting

This form of propagation is quite similar to the tropospheric bending just discussed but is more prevalent on the over water paths. In contrast to the normal tropospheric bending caused by an abrupt temperature change with increasing altitude, this form of propagation usually has two abrupt changes, one very low (maybe only a few meters above the surface) and the other one above it by perhaps 1000 feet (300 meters) or so. The net result is that a sort of waveguide is formed, the thickness of which determines the best frequencies of radio propagation. If you are in the duct, signals will propagate almost unattenuated until the duct deforms. If you are outside, take up another pastime!

Those who have studied ducting of radio signals tell me that at the onset of the duct, the optimum frequency is often quite high, typically 1500 MHz, and may slowly decrease as the duct stabilizes often going up again as the duct starts to disappear. During the great tropospheric ducting conditions between Hawaii and California in July, 1973, the openings were first heard on 70 cm and then slowly shifted to 2 meters. Two days later even 6-meter signals (viz. KH6IJ) were making the grade. It is noteworthy that this duct took place while two tropical (hurricane type) storms were traversing the path between Baja, California, and Hawaii just to the south of the path.

There are other peculiarities about tropo ducting. If you are above or below the duct (as in tropospheric bending), you will not be able to couple sufficiently into the duct to take advantage of it. Seldom does an over-water duct extend very far inland. Instead, the duct may abruptly become elevated as it passes over land. Hence, if you are over 10 to 40 miles (16 to 64 km) inland, the only effective way to use the duct will be if you are elevated or have a reflection assist (more on this later).

Let me elaborate on the later point. Researchers in the United States Navy and others have studied the California to Hawaii ducting with aircraft and often found that the duct was elevated 1 to 2 miles (1.6 to 3.2 km) as it approached Hawaii. The Amateurs active in Hawaii frequently drove up and down the side on Mauna Loa to optimize this path. After several years of observing this path, they installed the 24-hour-a-day warning beacons well up the side of Mauna Loa to take advantage of this phenomenon. Unfortunately, if an opening takes place (as seen by monitoring the beacon from California), there has to be an able body to drive up to the sight as soon as possible to catch the opening, and this hasn't always been possible!

The farthest inland ducting I know of is the KD6R to KH6IAA QSO. Ironically, both stations were elevated. KD6R was about 38 miles (61 km) inland, but at an elevation of almost 6000 feet (1828 meters) on the side of Mount Palomar. Likewise, the Bermuda-to-USA path where coastal stations can often access the duct but inland stations can't except K2RIW who is about 10 miles (16 km) inland but elevated on one of the highest spots (400 feet or 121 meters) on Long Island. K1PXE, at sea level in Connecticut, has never heard Bermuda, perhaps because the signals have to first traverse Long Island and are thereby elevated beyond reasonable altitudes.

The best ducts observed and used for long DX are the "Great Australian Bight" off southern Australia, the Gulf of Mexico, the Mediterranean Sea, the North Sea, Bermuda to the United States, the Atlantic Ocean between the United Kingdom and the Canary

Islands, and of course the California-to-Hawaii path. In fact, rumor has it that a 5 GHz microwave signal from the Philippines was intercepted in Southern California in the mid 1970s but that the news was suppressed because no one would believe the story! There is still much to be learned about tropospheric ducting and perhaps someday the United States-to-Europe path will finally be conquered using this mode.

super refraction

With a few exceptions, this mode is really an extension of tropospheric ducting. These ducts are usually very intense, over warm water, close to the surface and probably not as thick as the usual tropospheric ducts. Hence they are primarily good at 23 cm and above. The British were the first ones I know to really exploit this mode. In their somewhat casual manner (as we see it!) they would go to the beach for a Sunday outing with a pair of "GunnPlexers" or similar 3 cm gear. During the day they would occasionally go down to the beach and try to communicate with a station on another beach over an all-water path. By trial and error they would often find an optimum height and time for a QSO.

Another interesting story I've heard also comes from the UK. The English Channel is an ideal spot to try UHF between England and the European continent. As the story goes, an English station was in 3 cm communications across the channel with a French station, when communications abruptly ceased and then returned just as quickly a few moments later. Upon observation of the path with binoculars, it was discovered that a larger ship had apparently passed between the stations and momentarily broken up the duct!

Not to be outdone, the Italians and Yugoslavians used the Adriatic and Mediterranean Seas. They had many successes, the greatest DX being the 3 cm QSO between I0SNY/EA9 and I0YLI/IT9 (see table 1). This was an incredible DX record of 1034 miles (1663 km), using only 50 milliwatts of power and 1 meter dishes.²⁴ Once again, there is much to be learned about super refraction, but what is clear is that UHF/SHF ducts do appear on over-water paths during warm weather, especially during the summer months.

lightning scatter

The first known QSO via this mode took place on 70 cm between W0DRL (KS) and W5RCI (MS) on September 16, 1968, over a 449 mile (722 km) path. They noticed that signals peaked 15 to 18 degrees off the great circle path at an area which turned out to be a storm cell over Texas. Enhancements were up to 40 dB, some with durations of 25 seconds, with extremely rapid QSB and lots of Doppler shift. Since then, other observers have noticed the same phenomenon. This is a mode worth looking into, especially

when severe lightning storms are in progress. I have observed this same type of propagation on 70 cm on somewhat shorter paths between New Jersey and Massachusetts when severe lightning was over the central Connecticut area. Since most VHFers tend to shut off their rigs during stormy weather, it may be well to rethink our operating habits — but only if the storm *isn't* nearby!

aircraft scatter

Few VHF/UHFers give this mode a thought or even are aware of its capabilities. While in California, I discovered (undoubtedly as others did), that aircraft make fine reflectors for radio signals, especially on 70 cm and above. Since commercial aircraft often fly as high as 40,000 feet (12,192 meters), they can be used for propagation via line-of-sight out to 500 miles (805 km) reflections on a regular basis. The best paths are over the central USA, since many aircraft are available and usually fly at high altitudes. Coastal QTHs are not as favored because these aircraft usually fly low or are in takeoff or landing patterns. But don't rule them out; the California coast and the eastern seaboard of the United States have lots of traffic though these areas aren't quite as good for the long DX via aircraft scatter.

All you have to do to work via aircraft scatter is to be alert, know when the flights are in between and set up a schedule! Don't use long transmissions: at the longer DX, the mutual location for best scatter may last only a minute or less! Beware also of the Doppler shift which can be as much as 100-300 Hz on 70 cm and up to 1.5 kHz on 2304. When I QSO'd Harley, WA6HXW, on 2304 MHz from W6FZJ, a path of 310 miles (500 km), I copied Harley on two different frequencies separated by almost 1.5 kHz, one via tropo and the other via aircraft. At times the aircraft-reflected signal was up to 5 degrees off the great circle path!

table 3. Typical selected aircraft reflection sizes and figures of merit (original source of data is unknown but was sent to me via K9MHR and WB0YSG). Intermediate sized aircraft can be easily estimated.

type of aircraft	reflecting area (square meters)	relative reflection (dB)
Cessna 336 Skymaster	1.3	1
Lear Jet	2.0	3
McDonald Douglas DC 9	8-10	9-10
Douglas DC 3	12.6	11
Boeing 707	16.0	12
McDonald Douglas DC 8	20.0	13
Boeing 747	63.0	18

Some relative data on aircraft sizes and figures of merit are listed in table 3. This data, which may be

of use to those who want to make radar path loss calculations, show why larger aircraft are preferred. I have also noticed that aircraft scatter can often assist with another mode for a sort of link-up. For instance, on both the Bermuda to USA and the California to Hawaii paths, my 70 cm signals have been coupled into the duct and copied, probably via aircraft scatter at my end, but I was unable to complete the QSO due to insufficient access time before signals disappeared. This is an entertaining mode that deserves more attention since it is available 365 days a year as long as you have a reasonably good station. The possibilities for long DX on 3 cm and above are fascinating.

knife-edge diffraction

This mode of propagation, used for many years for Gigahertz microwave communications by commercial stations, is well documented. It is based on the theory that if a sharp peak or hill lies between two stations, signals can be diffracted over them. Losses of only 10 to 20 dB over the typical free space path loss are possible.² The sharper the peak, the better. Lack of foliage or reflecting objects is preferred at the peak; 3 cm signals do not go through tree leaves! Although this is a specialized propagation mode and is primarily for moderate DX, it is nevertheless interesting, especially to the UHFer who is in a low lying area or surrounded by hills or mountains.

rain scatter

This mode of propagation was discovered in 1978 by G3JVL and G3YGF/A when operating on the 3 cm band over a 110 km path during a rain squall.²⁵ They found that if two stations both aimed their antennas at the storm center, they could communicate at distances greater than 100 km. They were unable to reproduce this mode at lower Amateur frequencies. The signals are highly distorted and have an auroral quality with some noticeable Doppler. Signals tend to peak very broadly in-azimuth and elevating the antenna can improve signals if the storm is nearby. 10-20 dB enhancements are typical. Other British Amateurs also participated and verified this phenomenon, even with low power stations. This mode is especially interesting when one or both of the stations have obstructed views or a poor VHF/UHF QTH since the scattering center may be well above the horizon at one or both ends of the path. Hopefully this mode will soon be more fully utilized here in the USA.

conclusion

VHF/UHF radio propagation is a fascinating subject to which every Amateur can contribute. All it takes is time, patience, good notes, and of course some reasonably good equipment. The records listed in table 1 are good goals to pursue.

To review, VHF/UHF radio propagation is basically divided into four categories:

1. *Natural* (line-of-sight, tropo/ionospheric scatter),
2. *Weather-related* (tropospheric bending, ducting, sporadic E, precipitation scatter),
3. *Celestial* (EME, meteor scatter, F2, aurora), and
4. *Manmade* (satellite, aircraft scatter, artificial aurora).

A basic knowledge of all these types of radio propagation will show that the VHF/UHF bands are hardly a quiet and uninteresting place!

To predict radio propagation conditions we can use several sources of data such as: HF/VHF or satellite nets, propagation beacons, TV video carriers monitoring or the warning sounds on HF signals as well as alerts such as weather maps/reports and WWV forecasts at 18 minutes after each hour.

table 4. These are the typical United States VHF/UHF calling frequencies. It is common courtesy to QSY up or down after establishing contact to allow other stations to use the calling frequency.

band	frequency	mode
6 meters	50.110	SSB
2 meters	144.100	CW
2 meters	144.200	SSB
220 MHz	220.100	CW/SSB
70 cm	432.100	CW/SSB
23 cm	1296.100	CW/SSB
13 cm	2304.100	CW/SSB

Calling frequencies listed in **table 4** are also helpful. Sometimes there just aren't enough signals to go around and congregating on special frequencies can increase the probability of observing good conditions. However, you must put out an occasional call because silence doesn't convey much activity! Above all, when you do establish contact on a calling frequency, move off so that someone else can use it. Activity nights are also helpful. In the northeast, we concentrate 2 meter activity on Monday evenings, 220 MHz on Tuesdays, 70 cm on Wednesdays, and 23 cm on Thursdays.

acknowledgements

I want to thank all those who helped contribute information for this article, and in particular G3WDG, VE1YX, W4WD, WA4MVI, WB5LUA, W6ABN, and K6FV — it takes lots of cooperation to gather so much material. I hope that some of this information will be new or helpful to you and that you too will be able to help in the future.

references

1. Jack Friedigkeit, W6ZGN, "A Simple Computer Model for VHF/UHF Propagation," *QST*, July, 1983, page 32.
2. *Reference Data for Radio Engineers*, Howard W. Sams and Company, Indianapolis, Indiana.
3. Melvin S. Wilson, W1DEI/W2BOC, "Mid-latitude Intense Sporadic-E Propagation, Part 1," *QST*, December, 1970, page 52.
4. Melvin S. Wilson, W1DEI/W2BOC, "Mid-latitude Intense Sporadic-E Propagation, Part 2," *QST*, March, 1971, page 54.
5. Jim Stewart, WA4MVI, "Sporadic E on 144 MHz-1983," *QST*, February, 1984, page 23.
6. R.G. Cracknell, ZE2JV, "Transequatorial Propagation of VHF Signals," *QST*, December, 1959, page 11.
7. Joseph H. Reisert, W1JR, and Gene Pfeffer, K0JHH, "A Newly Discovered Mode of VHF Propagation," *QST*, October, 1978, page 11.
8. Ray Cracknell, ZE2JV, et. al., "The Euro-Asia to Africa Transequatorial Circuit During Solar Cycle 21," *QST*, December, 1981, page 23.
9. Joe Taylor, Jr., K2ITP, "Working Ionospheric Scatter at 50 Mc.," *QST*, December, 1958, page 28.
10. Don Lund, WA0IQN, "Auroral Notes," *QST*, May, 1968, page 36.
11. Tom Frenaye, K1KI, "Looking Down on the Aurora," *QST*, November, 1983, page 15.
12. Kenneth Davies, "Ionospheric Radio Propagation," *NBS Monograph 80*, April 1, 1965, page 381.
13. Joe Reisert, W1JR, "VHF/UHF World: Improving Meteor Scatter Communications," *ham radio*, June, 1984, page 110.
14. V.R. Frank, WB6KAP et. al., "Communicating at VHF via Artificial Radio Aurora," *QST*, November, 1974, page 27.
15. Bill Smith, K0CER/4, "The World Above 50 MC," *QST*, October, 1967, page 94.
16. Walter Bain, W4LTU, "VHF Propagation by Meteor-Trail Ionization," *QST*, May, 1974, page 78.
17. Thomas F. Kneisel, K4GFG, "Ionospheric Scatter By Field-Aligned Irregularities at 144 MHz," *QST*, January, 1982, page 30.
18. Joseph H. Reisert, Jr., W6FZJ/1, "EME Scheduling, When and Where," *QST*, January, 1974, page 25.
19. *Eimac EME Notes*, can be obtained by writing to William Orr, W6SAI, c/o Varian EIMAC, 301 Industrial Way, San Carlos, California 94070.
20. Joe Reisert, W1JR, "Requirements and Recommendations for 70-cm EME," *ham radio*, June, 1982, page 12.
21. J.N. Gannaway, G3YGF, "Tropospheric Scatter Propagation," *QST*, November, 1983, page 43.
22. J.H. Chisolm et. al., "Properties of 400 Mcps Long-Distance Tropospheric Circuits," *Proceedings of the IRE*, December, 1962, page 2464.
23. Ross A. Hull, "Notes on the Ultra-High-Frequency DX Work," *QST*, December, 1934, page 8, (additional *QST* references: June 1935, May 1937, and July 1937).
24. Bob Atkins, KA1GT, "The New Frontier, the World Above 1 Gig," *QST*, October, 1983, page 71.
25. Charles Suckling, G3WDG, "Microwaves," *Radio Communication*, (RSGB), January, 1979, page 48.

VHF/UHF coming events

July 3: EME perigee

July 20 (± 2 weeks): look for 2-meter E openings

July 27: (21:15 UTC) peak of Delta Aquarids Meteor Shower

July 27-29: Central States VHF Society Conference, Cedar Rapids, Iowa. (Contact W0OHU for further information.)

July 31: EME perigee

If you have any VHF/UHF events or contests planned, let me know at least 2 to 3 months in advance so I can let others know through this column. — W1JR

ham radio

The First Name In Satellite TV...

When you invest in a **DRAKE** Earth Station Receiver, you've chosen the very finest. Elegantly designed with the latest engineering concepts in solid-state techniques, every **DRAKE** is characterized by superb performance and versatility. **DRAKE**... world-class leader in satellite television reception.

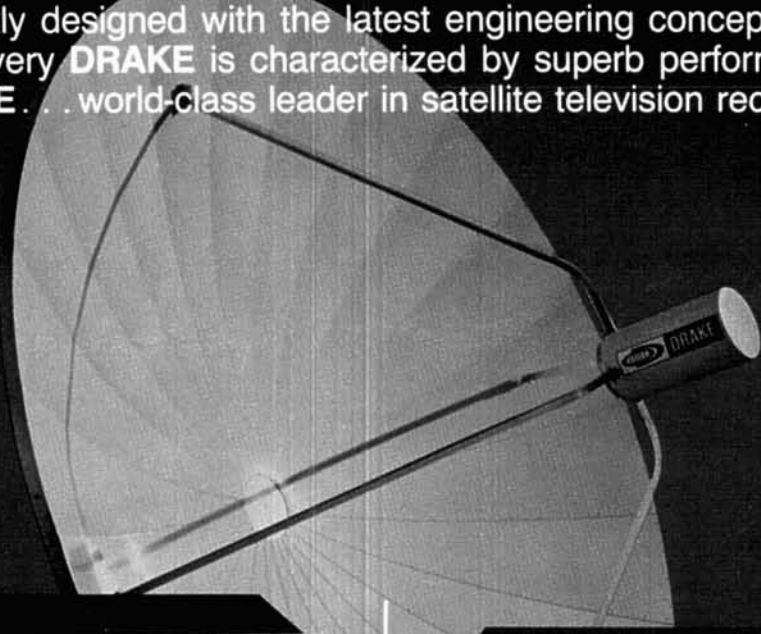

ESR240 EARTH STATION RECEIVER

- Infrared Remote Control
- Digital Channel Readout
- Preset 6.2/6.8 and Variable Audio Tuning



ESR324 EARTH STATION RECEIVER

- Digital Channel Readout
- Detent Channel Tuning
- Preset 6.8 and Variable Audio Tuning

...The Last Word In Performance!



R.L. Drake Company
540 Richard Street, Miamisburg, Ohio 45342, USA
Phone: (513) 866-2421
Telex: 288-017

PIONEER MEMBER OF
SPACE

RECEIVE WEATHER CHARTS IN YOUR HOME!



You can DX and receive weather charts from around the world.

Tune in on free, worldwide government weather services. Some transmitting sites even send weather satellite cloud cover pictures!

You've heard those curious facsimile sounds while tuning through the bands — now capture these signals on paper!

Assemble ALDEN's new radiofacsimile Weather Chart Recorder Kit, hook it up to a stable HF general-coverage receiver, and you're on your way to enjoying a new hobby activity with many practical applications. Amateurs, pilots, and educators can now receive the same graphic printouts of high-quality, detailed weather charts and oceanographic data used by commercial and government personnel.

Easy to assemble — Backed by the ALDEN name.

For over 40 years, ALDEN has led the way in the design and manufacture of the finest weather facsimile recording systems delivered to customers worldwide. This recorder kit includes pre-assembled and tested circuit boards and mechanical assemblies. All fit together in a durable, attractive case that adds the finishing professional touch.

Buy in kit form and save \$1,000!

You do the final assembly. You save \$1,000. Complete, easy-to-follow illustrated instructions for assembly, checkout, and operation. And ALDEN backs these kits with a one-year limited warranty on all parts.

Easy to order.

Only \$995 for the complete ALDEN Weather Chart Recorder Kit.

To order, fill out and mail the coupon below. For cash orders enclose a check or money order for \$995. Add \$5 for shipping and handling in the U.S. and Canada, plus applicable sales tax for CA, CO, CT, IA, MA, NY, WI. (Export price is \$1250 F.O.B. Westborough, MA. Specify 50 or 60 Hz.) To use your MasterCard or Visa by phone, call (617) 366-8851.

ALDEN ELECTRONICS

Washington Street, Westborough, MA 01581

NAME: _____

CALLSIGN: _____

ADDRESS: _____

CITY: _____ STATE: _____ ZIP: _____

I've enclosed a check or money order for \$995.00 and \$5.00 for shipping and handling, plus applicable sales tax.

Charge to: MasterCard  Visa 

ACCOUNT # (ALL DIGITS)

--	--	--	--	--	--	--	--	--	--	--	--	--	--	--	--	--	--	--	--	--

EXPIRATION DATE

--	--	--	--	--	--	--	--	--	--

SIGNATURE REQUIRED
IF USING CREDIT CARD _____

The Digital vs. Analog battle is over.

\$85* buys you the new champion. **The new Fluke 70 Series.**

They combine digital and analog displays for an unbeatable two-punch combination.

Now, digital users get the extra resolution of a 3200-count LCD display.

While analog users get an analog bar graph for quick visual checks of continuity, peaking, nulling and trends.

Plus unparalleled operating ease, instant autoranging, 2,000+ hour battery life and a 3-year warranty.

All in one meter.

Choose from three new models. The Fluke 73, the ultimate in simplicity. The feature-packed Fluke 75. Or the deluxe Fluke 77, with its own multipurpose protective holster and unique "Touch Hold" function (patent pending) that captures and holds readings, then beeps to alert you.

Each is Fluke-tough to take a beating. American-made, to boot. And priced to be, quite simply, a knockout.

For your nearest distributor or a free brochure, call toll-free anytime **1-800-227-3800, Ext. 229**. From outside U.S., call 1-402-496-1350, Ext. 229.

FROM THE WORLD LEADER IN DIGITAL MULTIMETERS.



Fluke 73

\$85*
Analog/digital display
Volts, ohms, 10A, diode test
Audible continuity
0.7% basic dc accuracy
2000+ hour battery life
3-year warranty



Fluke 75

\$99*
Analog/digital display
Volts, ohms, 10A, mA, diode test
Audible continuity
Autorange/range hold
0.5% basic dc accuracy
2000+ hour battery life
3-year warranty



Fluke 77

\$129*
Analog/digital display
Volts, ohms, 10A, mA, diode test
Audible continuity
"Touch Hold" function
Autorange/range hold
0.3% basic dc accuracy
2000+ hour battery life
3-year warranty
Multipurpose holster

* Suggested U.S. list price, effective October 1, 1983.

FLUKE®

Actual slow motion frames from Ham MasterTapes



1. Larry, N2NY, Lee, KA2RNV



2. Lee discharges cap

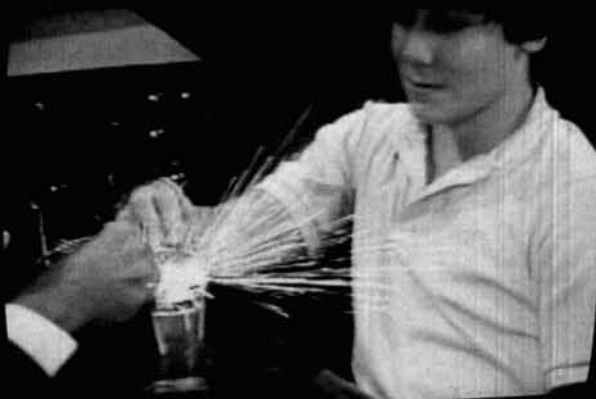

3. In slow motion it's dazzling



4. Wow. Can we see it again?

**You've never seen this, like this,
before this!**

**And you can see it—in color—again and again
when you own the N2NY Ham MasterTapes.**

Ever see a cap discharge in slow motion? You will on Ham MasterTapes. Ham MasterTapes can perform the dozens of complicated demonstrations necessary for a beginner's understanding of Ham Radio Theory.

Finally, a step-by-step course in Ham Radio Theory is available on color videotape. The Larry Horne N2NY Ham MasterTapes video course is a unique, effective teaching technique expertly produced by New York's leading professionals in studio and field videotape.

- Video Graphics highlight important details.
- Carefully worked-out demonstrations on video avoid the problem of getting complex gadgets to work on command in front of a class.
- Working examples of every ham radio component, device, or system covered in the FCC guide can be clearly understood.

The N2NY Ham MasterTapes give you a basic grasp of concepts that build theory background—not only for passing the FCC tests, but for understanding electronics.

The hobby has long needed better, clearer, high-tech teaching aids to help newcomers into our wonderful world of Ham Radio.

These six-hour tapes cover completely all the material needed to understand Novice and Tech/General Theory and operations, and include the new 200-question FCC syllabus used beginning September 1983.

Only \$199.95. Order direct and specify Beta or VHS format. Call or write: Larry Horne, N2NY

Ham MasterTapes™

THE N2NY HAM RADIO COURSE ON VIDEOTAPE

Ham MasterTapes
136 East 31st Street
New York, N.Y. 10016 212-673-0680.

© 1983 N2NY Productions, Inc.

cooling semiconductors part 1: designing and using heatsinks

Can't stand the heat?
dissipate it!

What effect does heat have on semiconductors?

How can that heat be dissipated? And what are the implications, for designers of electronic equipment, of the answers to these questions? Part one of this series will cover the design and use of heatsinks; part two will address other means, both novel and conventional, of monitoring and cooling semiconductors *without* the use of semiconductors — for example, by using a fan with flapping blades that operates on the piezoelectric crystal principle.

It is crucial for transistors, ICs, or thyristors (triacs and SCRs) to remain within their safe operating junction temperature ranges. Semiconductor junctions can withstand temperatures between 85 degrees C and 200 degrees C. Germanium withstands from 85 degrees C to 100 degrees C maximum temperature, while silicon withstands from 150 degrees C to 200 degrees C maximum temperature. However, semiconductors operated at these high temperatures show reduced performance. For example, low-input bias op amps require twice as much bias current for every 10-degree C rise in junction temperatures. (Note the typical power derating curve in **fig. 1** for a power transistor.)

Both junctions in a transistor give off heat; however, since the collector-base junction is reverse biased, it has higher resistance and produces more heat. In fact, the collector-base junction produces so much more heat than the transistor's forward-biased emitter-base

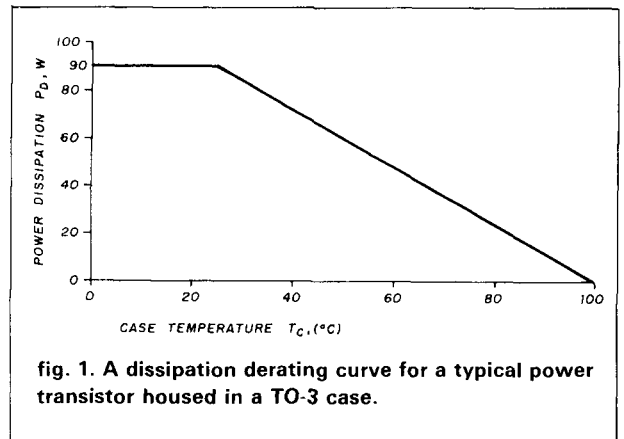

fig. 1. A dissipation derating curve for a typical power transistor housed in a TO-3 case.

junction that the heat generated by the later junction is usually ignored. As a result, the power dissipation equation is simplified and can be defined as follows:

$$P_D = I_C \times V_{CE} \quad (1)$$

where P_D = power dissipation
 I_C = collector current
 V_{CE} = voltage from collector to emitter

electrical-thermal analogies

Analogies can be helpful in visualizing abstract phenomena. For example, high school science teachers will often compare electricity to water flowing from a tower. In this comparison, voltage is defined as the "push" or potential (height) of the water within this tower. Current is equated with flow of water, and resistance is compared to the action of the tower's faucet, which impedes or constricts flow.

By Vaughn D. Martin, 114 Lost Meadows,
Cibolo, Texas 78108

Table 1. Unit symbols in electrical and thermal models.

electrical			heat		
quantity	unit	symbol	quantity	unit	symbol
voltage	V	V	temperature	°C	T
current	A	I	heat flow	W	P_D
resistance	Ω	R	thermal resistance	°C/W	θ

An analogy can also be drawn between heat transfer and electrical parameters (fig. 2). The flow (transfer of heat) corresponds to current. The heat differential between the hottest object (the transistor's junction) and the coolest object (the free-standing ambient air) is seen as voltage, and each thermal resistance — from the resistor's junction to its case, to the heatsink, and eventually to the free-standing ambient air — is compared to electrical resistances in series. Therefore, thermal resistances are added together to determine the total thermal resistance.

In fig. 2, the dual subscript on a thermal resistance, such as θ_{SA} , means resistance of the sink (S)-to-ambient air (A). Table 1 illustrates the unit symbols in both the electrical and thermal models.

The basic thermal relationship is:

$$T = P_D \theta \quad (2)$$

where T = temperature rise
 P_D = power dissipation
 θ = thermal resistance

It becomes obvious from this equation that thermal resistance θ must be minimized. This is what a heat-sink does.

how heatsinks work

Power transistors and voltage regulators with 1A or greater ratings are usually installed in large metal cases so that they can radiate more heat. Because the case size may still be inadequate for the amount of power to be dissipated, a heatsink or similar metal fitting is added to the case to increase thermal mass, lower thermal resistance, and provide additional surface area to allow heat to radiate from the surface more effectively.

The purpose of a heatsink is to transfer heat away from the semiconductor, causing it to flow from one medium to another by means of one or more of the three heat transfer methods: conduction, convection, and radiation.

Conduction is the most effective means of moving heat from the semiconductor junction to the case and from the case to the heatsink. *Convection* — which is merely surface conduction from a surface to a fluid or to air — is the most effective means of moving heat

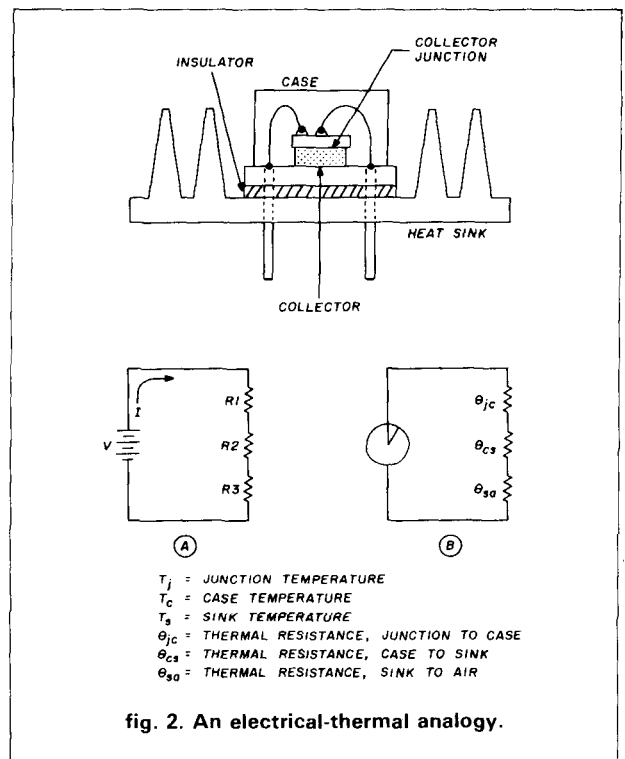

fig. 2. An electrical-thermal analogy.

from case or heatsink to ambient air. *Radiation*, the most effective means of transferring heat from radiating heatsink fins, depends on the existence of a difference in temperature between radiating and adjacent objects or space. *Emissivity* is a term used to describe this effect; table 2 illustrates some typical emissivities of various common surfaces. (The greater the emissivity, the better the ability to radiate heat.) Note that black oil-painted heatsinks radiate most effectively; this is why commercially available heatsinks (fig. 3) are almost always painted black.

heatsink materials

The two most common materials for heatsinks are copper and aluminum. Copper has a thermal conductivity four times that of aluminum, but is much more expensive. Aluminum, therefore, is the most commonly used heatsink material. In applications in which weight is a concern, magnesium can be used. If insulation is necessary, beryllium oxide (BeO), an excellent electrical insulator, can be used.

Very often, power transistors such as the ones packaged in TO-3 or TO-66 cases ("TO" stands for "transistor outline"; the number identifies the shape and size of the case) have their collectors soldered directly to the cases. Unless the collector is to be electrically grounded, the case must be isolated from the chassis.

Three other materials (used in electrical insulating washers) are also effective heat conductors: mica,

anodized aluminum, and beryllium oxide. Mica is the most common. Although anodized aluminum is fairly widely used, an electrical short will result if its surface is scratched. Beryllium oxide performs better than mica or anodized aluminum, but both its powdered form and its fumes are toxic.

custom made heatsinks

For the homebrew enthusiast in electronics who wants to make his or her own heatsinks, the nomographs of metal types and shapes and fin effectiveness, shown in **figs. 4** and **5**, will aid in the selection of appropriate materials and forms. Perhaps you have access to some surplus extruded copper or aluminum, or just want to attach a single flat square or rectangular piece of metal to a voltage regulator or power transistor and wonder whether it will do the job. A good question!

Before making any calculations, identify the semiconductor's case. If its case is a TO-220 to TO-202 metal tab, look at the accompanying data sheet to see whether the metal tab is the collector on a transistor or the output pin on a voltage regulator, or if it is the emitter (which might be grounded) or the ground pin on a voltage regulator. If the metal surface of the semiconductor's case had *any* voltage indicated on it, paint the heatsink — or chunk of metal you are about to fashion into a heatsink — so that it will be electrically insulated. A mica insulating wafer or washer may also be used, but will add a small thermal resistance.

Will a heatsink be necessary? Is the one you have in mind adequate? Use this typical heatsink calculation to be sure. A generalized equation of temperature differential (rise), power dissipation, and thermal resistance is:

$$P_{D(MAX)} = \frac{T_{J(MAX)} - T_{A(MAX)}}{\theta_{JA}} \quad (3)$$

where $T_{J(MAX)}$ = maximum junction temperature in degrees centigrade
 $T_{A(MAX)}$ = maximum ambient air temperature in degrees centigrade
 θ_{JA} = junction-to-air thermal resistance

This equation states that the maximum power dissipated is equal to the maximum junction temperature of the transistor or regulator minus the maximum ambient or outside free-standing air temperature divided by the thermal resistances from the junction (*J*) to the ambient air (*A*). These thermal resistances, analogous to electrical resistances in series, are added together. Stated mathematically, $\theta_{JA} = \theta_{JC} + \theta_{CS} + \theta_{SA}$; the thermal resistance from junction to air (θ_{JA}) equals the sum of the thermal resistances:

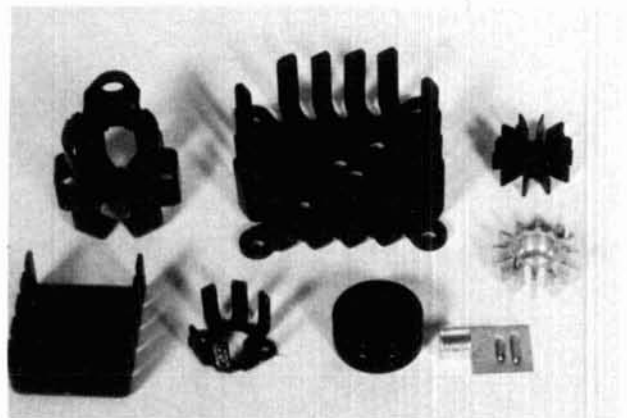

fig. 3. Commercially-available heatsinks vary in form, but are almost always painted black.

junction-to-case (*JC*), case-to-heatsink (*CS*) and heatsink-to-air (*SA*). Quite simply, if the $P_{D(MAX)}$ of the preceding equation is exceeded, then a heatsink is required. Typically, a TO-3 case will withstand 2.8 watts, and a TO-220 power tab with a flat rectangular body and three parallel leads coming out of the end, separated by 0.1 inch each, will withstand 1.8 watts, while the very small TO-39 and TO-92 packages will handle only about 0.66 watts.

Assume the following in our heatsink calculations:
 maximum ambient temperature: 60 degrees C
 maximum junction temperature: 125 degrees C
 maximum output current: 800 mA
 maximum input-output differential: 10 volts

If we use a 7800 series voltage regulator with a TO-220 case, $\theta_{JC} = 5^{\circ}\text{C}/\text{W}$ (this is obtained from the data sheet). The θ_{CS} and θ_{SA} must be solved for by:

$$\begin{aligned} \theta_{JA} = \theta_{JC} + \theta_{CS} + \theta_{SA} &= \frac{T_J - T_A}{P_D} \\ &= \frac{125^{\circ}\text{C} - 60^{\circ}\text{C}}{0.8 \text{ A} \times 10 \text{ V}} = \frac{65^{\circ}\text{C}}{8 \text{ watts}} = 8.13^{\circ}\text{C}/\text{W} \end{aligned} \quad (4)$$

where θ_{JC} = junction-to-case thermal resistance

θ_{CS} = case-to-heatsink thermal resistance

θ_{SA} = heatsink-to-air thermal resistance

T_J = junction temperature

T_A = ambient air temperature

Let us solve the far right side of the equation first, $T_J - T_A = 65^{\circ}\text{C}$. The denominator is the 800 mA output current times 10 volts, the input-output voltage differential. The three thermal resistances, then, sum to $8.13^{\circ}\text{C}/\text{W}$. From the data sheet we already know that the junction-to-case thermal resistance is $5^{\circ}\text{C}/\text{W}$, so the other two remaining resistances must add up to $3.13^{\circ}\text{C}/\text{W}$. With the use of silicon thermal grease (**table 4**), we can approximate with some assurance from **table 1** that the case-to-sink resistance is

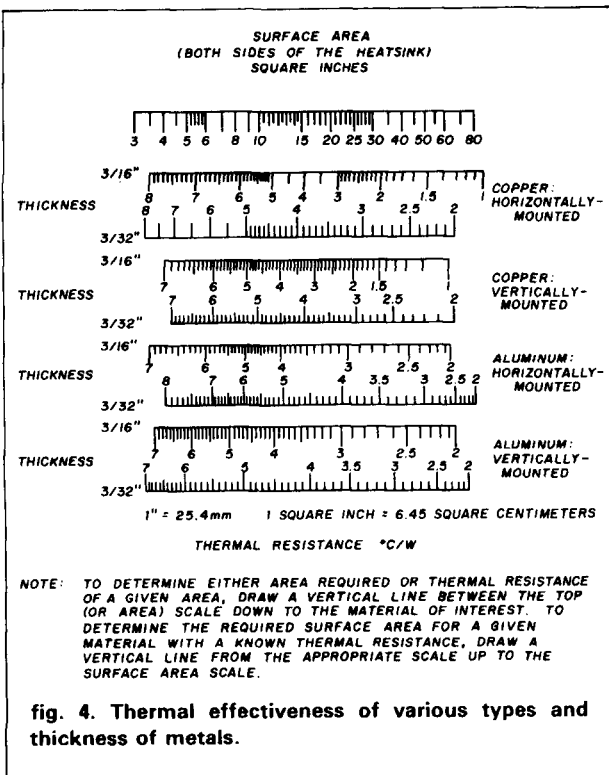

fig. 4. Thermal effectiveness of various types and thickness of metals.

Table 2. Emissivity of selected common heatsink surfaces.

Surface	emissivity (E)
polished aluminum	0.05
polished copper	0.07
rolled sheet steel	0.66
oxidized copper	0.70
black anodized aluminum	0.7-0.9
black air drying enamel	0.85-0.91
dark varnish	0.89-0.9
black oil paint	0.92-0.96

0.13°C/W, so this leaves the $\theta_{SA} = 3^\circ\text{C/W}$. Refer again to fig. 4 and note that a 22 square-inch piece of aluminum 3/16-inch thick with vertically bent ends will meet this requirement. The note at the bottom of the figure explains how to use the nomograph.

Calculating the effectiveness of a heatsink with fins is much more involved than calculating the effectiveness of a heatsink of square or rectangular metal as was just done. The heatsink-to-ambient air thermal resistance is expressed as:

$$\theta_{SA} = \frac{1}{2H^2\eta(h_c + h_r)} \text{ } ^\circ\text{C/W} \quad (5)$$

- where H = vertical height of fins in inches
- η = fin effectiveness factor
- h_c = convection heat transfer coefficient
- h_r = radiation heat transfer coefficient

$$h_c = 2.21 \times 10^{-3} \left(\frac{T_S - T_A}{H} \right)^{1/4} \text{ W/in}^2\text{ } ^\circ\text{C} \quad (6)$$

$$h_r = 1.47 \times 10^{-10} E \left(\frac{T_S + T_A}{2} + 273 \right)^3 \text{ W/in}^2\text{ } ^\circ\text{C} \quad (7)$$

where T_S = temperature (°C) of heatsink at regulator mounting

T_A = temperature (°C) of ambient air

E = surface emissivity (refer to table 2)

H = vertical height of fins in inches

do it yourself

Using fig. 5 and the formulas shown, let's design a finned heatsink for a 5-volt regulator. Assume that we are using a 1/16-inch thick piece of black anodized aluminum and want to have symmetrical square heat-sink fins. Our desired heatsink will have a thermal resistance of 4°C/W. An LM340T-5 is used under the following realistic conditions:

$$\begin{aligned} T_J &= 125^\circ\text{C} & V_{OUT} &= 5\text{V} \\ T_A &= 60^\circ\text{C} & I_{OUT} &= 800\text{mA} \\ V_{IN} &= 15\text{V} \end{aligned}$$

We find T_S by $I \cdot V \cdot \theta_{JS} = T_J - T_S$. V equals $V_{IN} - V_{OUT}$ or $(15\text{V} - 5\text{V}) \cdot 800\text{mA} \cdot 4^\circ\text{C/W} = 125^\circ\text{C} - T_S$. Solving for T_S we obtain T_S equals 93°C. Next h_c is solved for using a 4-1/4 inch high fin.

$$h_c = 2.21 \times 10^{-3} \left(\frac{93^\circ\text{C} - 60^\circ\text{C}}{4.25\text{in}} \right)^{1/4} = 3.7 \times 10^{-3}$$

and h_r is solved for with $E = 0.9$, which is found in table 2.

$$\begin{aligned} h_r &= 1.47 \times 10^{-10} \times 0.9 \left(\frac{93^\circ\text{C} + 60^\circ\text{C}}{2} + 273 \right)^3 \\ &= 5.6 \times 10^{-3} \end{aligned}$$

Next, add h_c to get $h = 9.3 \times 10^{-3}$. Now we find η from fig. 5. Draw the first line on the nomograph in fig. 5 from h through the fin thickness (remember, we are using 0.0625-inch (1/16-inch) aluminum to find

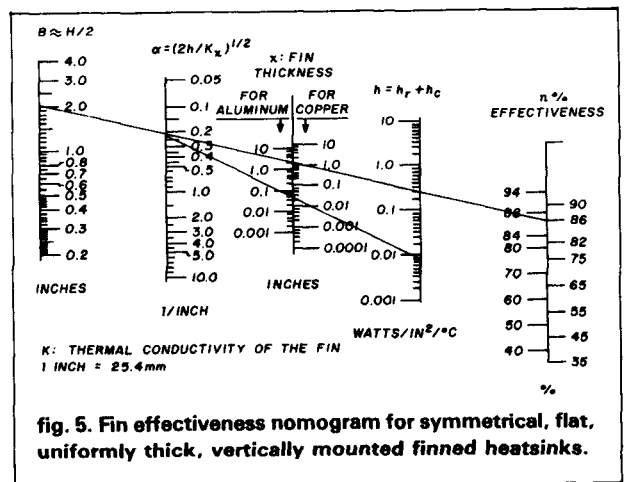

fig. 5. Fin effectiveness nomogram for symmetrical, flat, uniformly thick, vertically mounted finned heatsinks.

THE STANDARD OF EXCELLENCE

The world of CW, RTTY, and new DUAL AMTOR* is as close as your fingertips with the new brilliantly innovative state-of-the-art microcomputer controlled EXL-5000E.

Automatic Sender/Receiver: Due to the most up to date computer technology, just a console and keyboard can accomplish complete automatic send/receive of Morse Code (CW), Baudot Code (RTTY), ASCII Code (RTTY) and new ARQ/FEC (AMTOR).

Code: Morse (CW includes Kana), Baudot (RTTY), ASCII (RTTY), JIS (RTTY), ARQ/FEC (AMTOR).

Characters: Alphabet, Figures, Symbols, Special Characters, Kana.

Built-in Monitor: 5" high resolution, delayed persistence green monitor — provides sharp clear image with no jiggle or jitter even under fluorescent lighting. Also has a provision for composite video signal output.

Time Clock: Displays Month, Date, Hour and Minute on the screen.

Time/Transmission/Receiving Feature: The built-in timer enables completely automatic TX/RX without operator's attendance.

Selcal (Selective Calling) System: With this feature, the unit only receives messages following a preset code. Built-in Demodulator for High Performance: Newly designed high speed RTTY demodulator has receiving capability of as fast as 300 Baud. Three-step shifts select either 170Hz, 425Hz or 850Hz shift with manual fine tune control of space channel for odd shifts. HIGH (Mark Frequency 2125Hz)/LOW (Mark Frequency 1275Hz) tone pair select. Mark only or Space only copy capability for selective fading. ARQ/FEC features incorporated.

Crystal Controlled AFSK Modulator: A transceiver without FSK function can transmit in RTTY mode by utilizing the high stability crystal-controlled modulator controlled by the computer.

Photocoupler CW, FSK Keyer built-in: Very high voltage, high current photocoupler keyer is provided for CW, FSK keying.

Convenient ASCII Key Arrangement: The keyboard layout is ASCII arrangement with function keys. Automatic insertion of LTR/FIG code makes operation a breeze.

Battery Back-up Memory: Data in the battery back-up memory, covering 72 characters x 7 channels and 24 characters x 8 channels, is retained even when the external power source is removed. Messages can be recalled from a keyboard instruction and some particular channels can be read out continuously. You can write messages into any channel while receiving.

Large Capacity Display Memory: Covers up to 1,280 characters. Screen Format contains 40 characters x 16 lines x 2 pages.

Screen Display Type-Ahead

Buffer Memory: A 160-character buffer memory is displayed on the lower part of the screen.

The characters move to the left erasing one by one as soon as they are transmitted. Messages can be written during the receiving state for transmission with battery back-up memory or SEND function.

Function Display System: Each function (mode, channel number, speed, etc.) is displayed on the screen.

Printer Interface: Centronics Para Compatible interface enables easy connection of a low-cost dot printer for hard copy.

Wide Range of Transmitting and Receiving: Morse Code transmitting speed can be set from

the keyboard at any rate between 5-100 WPM (every word per minute). AUTOTRACK on receive. For communication in Baudot and ASCII Codes, rate is variable by a keyboard instruction between 12-300 Baud when using RTTY Modem and between 12-600 Baud when using TTL level. The variable speed feature makes the unit ideal for amateur, business and commercial use.

Pre-load Function: The buffer memory can store the messages written from the keyboard instead of sending them immediately. The stored messages can be sent with a keyboard command.

"RUB-OUT" Function: You can correct mistakes while writing messages in the buffer memory. Misspellings can also be erased while the information is still in the buffer memory.

Automatic CR/LF: While transmitting, CR/LF automatically sent every 64, 72 or 80 characters.

WORD MODE operation: Characters can be transmitted by word groupings, not every character, from the buffer memory with keyboard instruction.

LINE MODE operation: Characters can be transmitted by line groupings from the buffer memory.

WORD-WRAP-AROUND operation: In receive mode, WORD-WRAP-AROUND prevents the last word of the line from splitting in two and makes the screen easily read.

"ECHO" Function: With a keyboard instruction, received data can be read and sent out at the same time. This function enables a cassette tape recorder to be used as a back-up memory, and a system can be created just like telex which uses paper tape.

Cursor Control Function: Full cursor control (up/down, left/right) is available from the keyboard. Test Message Function: "RY" and "QBF" test messages can be repeated with this function.

MARK-AND-BREAK (SPACE-AND-BREAK) System: Either mark or space tone can be used to copy RTTY.

Variable CW weights: For CW transmission, weights (ratio of dot to dash) can be changed within the limits of 1:3-1:6.

Audio Monitor Circuit: A built-in audio monitor circuit with an automatic transmit/receive switch enables checking of the transmitting and receiving state. In receive mode, it is possible to check the output of the mark filter, the space filter and AGC amplifier prior to the filters.

CW Practice Function: The unit reads data from the hand key and displays the characters on the screen. CW keying output circuit works according to the key operation.

CW Random Generator: Output of CW random signal can be used as CW reading practice.

Bargraph LED Meter for Tuning: Tuning of CW and RTTY is very easy with the bargraph LED meter. In addition, provision has been made for attachment of an oscilloscope to aid tuning.

Built-in AC/DC: Power supply is switchable as required; 100-120 VAC; 220-240 VAC/50/60Hz + 13.8VDC.

Color: Light grey with dark grey trim — matches most current transceivers. **Dimensions:** 363(W) x 121(H) x 351(D) mm: Terminal Unit.

Warranty: One Year Limited

Specifications Subject to Change



Everything built in — nothing else to buy!

EXCLUSIVE DISTRIBUTOR:

AMATEUR-WHOLESALE ELECTRONICS

8817 S.W. 129th Terrace, Miami, Florida 33176

DEALER INQUIRIES INVITED

FOR YOUR NEAREST DEALER OR TO ORDER:

TOLL FREE ... 800-327-3102

Telephone (305) 233-3631

Telex: 80-3356

MANUFACTURER:

TONO CORPORATION

98 Motosoja Machi, Maebashi-Shi, 371, Japan

*Dual Amtor: Commercial quality, the EXL-5000E incorporates two completely separate modems to fully support the amateur Amtor codes and all of the CCIR recommendations 476-2 for commercial requirements.



SWL HEADQUARTERS

NATIONS LEADING SHORTWAVE EQUIPMENT SUPPLIER

Designed for Serious DXing

ICOM R71

THE ULTIMATE RECEIVER

ICOM DID IT AGAIN

Sale Price

\$699

NEW



- 100KHz-30MHz
- Keyboard entry
- 32 memories
- Remote control (optional)
- Scanning
- Pass band & notch tuning
- Memory back-up
- Wide dynamic range
- Voice synthesizer (optional)
- See ICOM's ad in this issue for more details.

→ BUY FROM EEB WITH CONFIDENCE ←

- We are ICOM's #1 Receiver Dealer
- Our factory authorized service center and modification department know ICOM receiver in depth.
- You get (at no charge) our double extended warranty covering your receiver parts and labor for 6 months.

EEB Options Installed —

1. Mechanical filter (Replaces SSB ceramic filter) \$95.00
2. FL44A 8 pole crystal filter replaces SSB ceramic filter \$159. Installed \$179
3. FM (Detection) 10 meter band \$39.50. Installed \$49.50
4. 12V DC Kit \$9.95. Installed \$15.00

• UNIDEN CR 2021



NEW

* Uniden's Worldwide Radio is among the finest multi-purpose available anywhere. It features a triple conversion receiver that precisely locates weak, distant signals automatically. It locks the precise stations in for perfect reception.

- 12 Channel Programmable Memory
- Dual Power AC or DC
- Micro-processor
- Triple Conversion Receiver
- Keyboard Channel Selector
- LCD Readout
- Preset Channels

Sale \$189

List \$229.00

• KENWOOD R-2000



Sale \$499

List \$599.95 (\$6.00 UPS)

- 100 KHz to 30 MHz
- All mode AM-CW-SSB-FM
- 10 memories (memorizes mode)
- Memory backup
- Memory scan
- Programmable band scan
- 24-hour clock-timer
- VC-10 VHF converter 118-174 MHz \$139

R-2000 \$599.95 SALE \$499
R-1000 \$499.95 SALE \$429
R-600 \$399.95 SALE \$329
ADD \$6.50 UPS

• SONY ICF-2002



Introductory Special \$229

List \$249.95

Features: Ten memory channels • 12/24 hour quartz clock/PLL tuning for drift-free performance • Dual conversion Super-heterodyne for high sensitivity • SSB/CW

ICR-4800 \$99.95 SALE \$69.95
ICF-6500W \$199.95 SALE \$99.95
ICF-6800W \$699.95 SALE \$549
ICF-7600A \$189.95 SALE \$139
AN-1 \$79.95 (AC Adapt \$9.95)
ADD \$4.00 UPS



ICF-6500W

Sale \$99.95

List \$199.95

ICF-6500W AM/FM WORLD BAND RADIO

- 3 SW/MW/FM high performance, easy-to-use world band receiver
- LCD frequency readout for all bands
- Dual conversion circuitry for increased sensitivity and reduced interference on SW
- BFO for SSB/CW reception
- Slow/fast tuning dial for quick tuning

• YAESU FRG-7700

Sale \$399



- 150 KHz-30MHz
- All mode AM-CW-SSB-FM
- Digital frequency and clock

Options:

- FRA-7700 active antenna \$59
- MU-7700 12 channel memory \$135
- FRT-7700 antenna tuner \$59
- FF-5 VLF low pass filter \$20
- DC-7700 12 VDC kit \$8
- FRV-7700 VHF converter \$135
- ADD \$6.50 UPS

SPECIAL PACKAGE DEAL 7700-MU7700 FRA-7700 \$499

• PANASONIC RF-B600



Sale \$429

List \$595 (\$6.00 UPS)

- 1.6 to 30 MHz, FM/LW/MW/SW
- Micro computer multi-tuning system
- 9 memory stations, scan
- Slow/Fast rotary tuning
- 10 key direct access tuning
- Universal voltage

RF-9 \$99.95 SALE \$89.00
RF-B50 159.95 SALE \$129.00
RF-085 CLOSE OUT \$49.95
RF-B300 \$249.95 SALE \$209
RF-3100 \$379 SALE \$279
ADD \$4.00 UPS

FREE CATALOG



- We ship worldwide
- Shipping charges not included
- Prices & specifications subject to change without notice
- Canadian Orders: VISA, MC or POSTAL MAIL ORDERS ONLY!



10 Miles West of Washington, D.C.
Sorry—No COD's
10-5 Tues., Wed., Fri.
10-9 Thursday
10-4 Saturday
Closed Sunday and Monday

Electronic Equipment Bank

516 Mill Street, N.E.
Vienna, Virginia 22180

Order Toll Free 800-368-3270

Virginia 703-938-3350



LARSEN HELPS THE UNDERGROUND.



When you're in a tight spot, dependable communications is crucial. Like repairing a split cable or a broken waterline underground. If you lose touch with the outside world, it's a long climb back to the top.

That's why underground crews use a Larsen Antenna and Magnetic Mount topside, attached to a handheld below. Because Larsen Antennas keep high performance standards, even with the underground.

Külrod® plating, a Larsen exclusive, gives your antenna high conductivity to assure that maximum power goes into communicating—not heat. And the precision tapered stainless steel whip provides flexibility while mini-

mizing radiation pattern distortion, giving you a consistent signal.

Whether your communications take you down under, or just downtown, Larsen Antennas will keep you on top of the situation with dependable performance.

That full measure of performance goes into our product integrity too. With a no nonsense warranty that won't let you down.

For more range with your handheld, or your mobile, you'll find Larsen's performance is tops. Ask your favorite Amateur dealer to demonstrate how you can hear the difference with Larsen Antennas.



Larsen Antennas

IN USA: Larsen Electronics, Inc.

P.O. Box 1799 11611 N.E. 50th Avenue Vancouver, WA 98668 Phone 206-573-2722

IN CANADA: Canadian Larsen Electronics, Ltd.

283 E. 11th Avenue, Unit 101
Vancouver, B.C. V5T 2C4 Phone 604-872-8517



Table 4. Use of silicon grease or adhesive decreases thermal resistance.

insulator	thermal resistance, °C/W	
	dry	silicon grease
none	0.20	0.10
Teflon	1.45	0.80
mica	0.80	0.40
anodized aluminum	0.40	0.35

With the values used thus far, η has been graphically determined to be 0.86. Substituting our numbers in eq. 5 we obtain the following:

$$\theta_{SA} = \frac{10^3}{2 \times 18 \times 0.86 \times 9.3} = 3.47^\circ\text{C/W}$$

Incidentally, the 10^{-3} was changed to 10^3 by moving it to the numerator and changing the sign of the exponent. The value of 3.47°C/W is not exactly the desired 4.00°C/W we initially sought, but gives a margin of safety. Remember, when doing it yourself, these formulas apply to both round and square symmetrical fins. Rectangular 2:1 aspect ratio (length-to-height) fins may also be used with the appropriate deratings used. Table 3 shows some typical θ_{SA} values per case size in commercially available heat-sinks; by following figs. 4 and 5 you can build your own, and know it will do the job!

guidelines for use

Avoid placing voltage regulators next to heat-generating components like power resistors. When using smaller package regulators like the TO-5, TO-39, or TO-92 cases, keep the lead lengths to a minimum and use the largest possible printed circuit board copper connector runs to provide a heat dissipation path for the regulator. Make sure that the heatsink-to-case surfaces mate. With larger heatsinks, this is more difficult, so for good thermal conduction, use a thin layer of silicon thermal grease such as Dow Corning 340, General Electric 662, or Thermalloy's "Thermacote" or a thermal adhesive. Metallic-oxide-filled silicon grease placed between two surfaces eliminates air gaps and fills in scratches on the two metal surfaces. (A typical transistor mounted dry with a 0.2°C/W resistance will exhibit half this resistance after a layer of thermal grease or adhesive is applied.)

Negative voltage regulators, in particular, require that the heatsink and metal voltage regulator case be electrically insulated from each other. To accomplish this, use either a fiberglass or mica 0.003 to 0.005-inch thick insulating washer. While the presence of the washer will naturally increase thermal resistance, this effect can be partially offset by applying thermal grease

to each side of the washer. When mounting a regulator on a heatsink with fins, orient the fins in the vertical plane. And be *very* careful when bending the regulator's leads, should such action ever be necessary.

bibliography

- Carbonell, Nelson P. and Nevela, David J., "Forced Air Cooling," *Electronic Products*, April, 1979, page 59.
- Chardon, Carlos C., "Design Equipment to Run Silent, Run Cool," *Electronic Design*, June 21, 1980, page 119.
- Martin, Vaughn D., "LCD Primer," *CQ*, April, 1983, page 45.
- Newberry, Deb, "Heat Pipes," *Circuits Manufacturing*, June, 1983, page 54.
- Rodriguez, Edward T., "Model Semiconductor Thermal Designs Even with Scanty Vendor Data," *Electronic Design*, February 15, 1979, page 102.
- Sass, Forrest, "Keep Cool and Live Longer," *Electronic Products*, May 1980, page 55.
- Siegel, Bernard S., "Measuring Thermal Resistance is the Key to a Cool Semiconductor," *Electronics*, July 6, 1978, page 121.

This article has been adapted, with permission, from *IC Voltage Regulator Sourcebook with Experiments*, by Vaughn D. Martin, published by TAB Books, Inc., and available from Ham Radio's Bookstore, Greenville, NH 03048 (\$14 postpaid).

ham radio



FILTERS — BLANKERS AND CONVERTERS FOR THE SERIOUS AMATEUR

DISTRIBUTED EXCLUSIVELY BY

ALL COMM
5717 N.E. 56 ST.
SEATTLE, WASH. 98105

✓ 102

all-metal 2-meter J-pole antenna

5/8 wave vertical
survives any weather

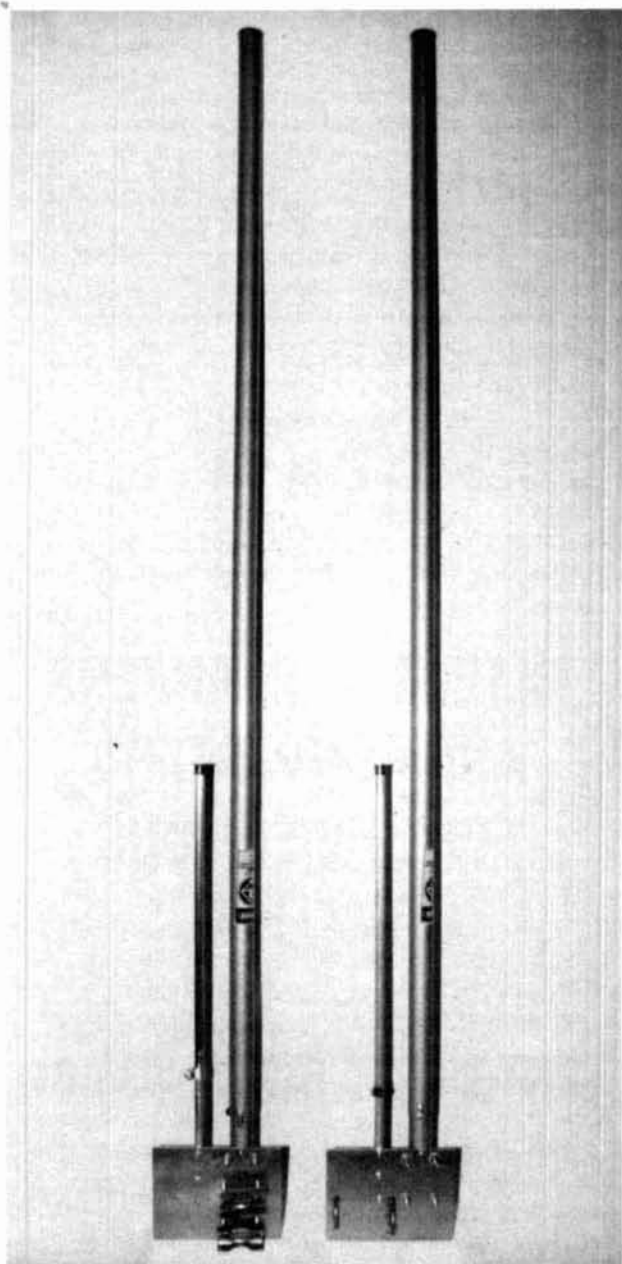

fig. 1. J-pole antenna: for upright mast mounting (left) and mounting to horizontal boom on tower (right).

While the J-pole antenna shown in fig. 1 is by no means a new design,¹ it doesn't seem to be used often. Basically it's a 5/8-wave radiator with a 1/4-wave matching section. The matching section is positioned 1-1/4 inch from and parallel to the 5/8-wave element.

I've built two of these antennas; one is for mounting to a conventional upright mast, as shown by the unit on the left in fig. 1; the other is for mounting to a horizontal boom on a tower. No significant problems were experienced in either installation.

The advantages of the J-pole design are its omnidirectional radiation pattern, characteristic of vertical antennas, and its small-diameter installation area. It lacks the radials common to ground plane antennas, and does not require driven elements to be cut in order to tune for best match.

Advantages less readily apparent, but equally important, are the elimination of the need to insulate the radiating element from the ground system, making possible an all-metal unit of rigid construction. With the whole antenna effectively grounded and installed atop a tower or mast which is grounded at the base, there is very little static noise buildup. The additional gain possible over the quarter wave ground plane because of the increased length is considered yet another advantage.

construction

A list of materials is provided in table 1; dimensional information is shown in fig. 2. The mounting plate is shown in fig. 3. The extra set of four holes in the plate allows the J-pole to be mounted in either of two different planes, depending on the location of the final installation.

The total length of the longest piece of tubing is 57 inches (144.8 cm) from the tip to the mounting plate. This piece can be made from a 5-foot (152-cm) section of lightweight (20 gauge) mast available from Radio Shack. There is no reason to spend more for the heavier gauge mast because it doesn't support anything other than its own weight. (If you really want to spend more money on this antenna, put the money to good use and buy better coax, or stainless steel assembly hardware, or both.)

By Michael Hood, KD8JB, 849 Dickinson S.E.,
Grand Rapids, Michigan 49507

hexnuts (see **fig. 5**). Inserting the dowel permits the 6-32 hardware to be tightened without unduly distorting the tubing, which would allow hairline cracks to form and cause premature element failure.

The clamp used to attach the coax center conductor (**fig. 4**) is an aircraft-type Adel clamp with the rubber sleeve removed. This clamp was originally intended for 5/16-inch (0.79 cm) tubing, but with the rubber removed and the clamp installed as shown, a tight fit is maintained around the matching section. Any such device can be used as long as a good mechanical connection is maintained.

As shown in **fig. 4**, the shield of the cable is attached to the larger diameter element at a point 1-1/2 inches (3.8 cm) away from the mounting plate. Two different methods of attaching the shield to the 5/8-wave section were used; both are satisfactory, though I feel more confident about the No. 10 through-bolt in the 5/8ths section than I do about the No. 6 sheet-metal screw and lockwasher. This is a matter of personal preference. A No. 14 AWG terminal lug was used to terminate the shield as shown, but both lug ends were replaced with a solderable lug and then silver soldered on the completed installation.

If a certain amount of hardware "overkill" seems apparent in this project, it's because in the case of antennas, too much is usually better than too little, particularly where weather conditions are severe. It's a good idea to invest in stainless steel hardware and to protect the mounting plate assembly with a polyurethane coating or spray varnish, following the directions and precautions on the spray can. Do this *after* tuning the matching section.

tuning

To tune the matching section, start at a point about 2 inches (5 cm) from the mounting plate and apply RF at the frequency most likely to be used, for example, 146.52 MHz. Note the SWR at that frequency and adjust the clamp, sliding it as necessary to produce minimum SWR. The antennas in the photographs tuned at approximately 2-1/2 to 4 inches (6.4 to 10 cm) from the mounting plate. They did not tune to identical points on the respective matching sections. In both cases, the antennas tuned to an indicated SWR of 1.2:1 at 146.52 MHz. If you've worked with antennas before, you probably know that any SWR reading depends on so many factors that tuning for minimum SWR is, more often than not, sufficient for most purposes.

installation

Figure 6 shows the antenna mounted to a horizontal boom off the side of a mast. Convention dictates that the antenna point upward when installed, but there is no reason that it cannot be pointed downward.

If high winds are a problem, or if the clamps used to attach the assembly to the boom are not of the gripper variety, pointing the antenna downward can help maintain its vertical position. As long as the antenna is mounted one or more wavelengths away from any large reflective or RF absorbent surface, fear of upside-down mounting is completely unfounded.

Conventional mounting to a vertical mast is accom-

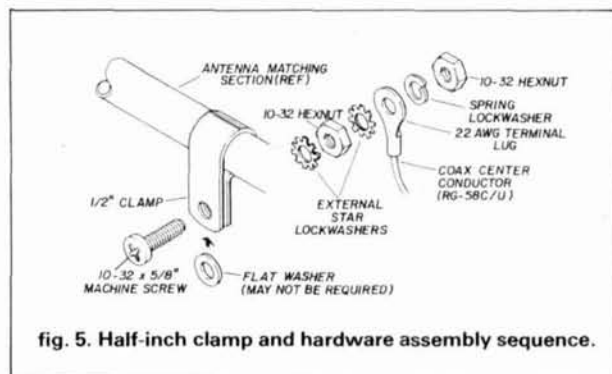

fig. 5. Half-inch clamp and hardware assembly sequence.

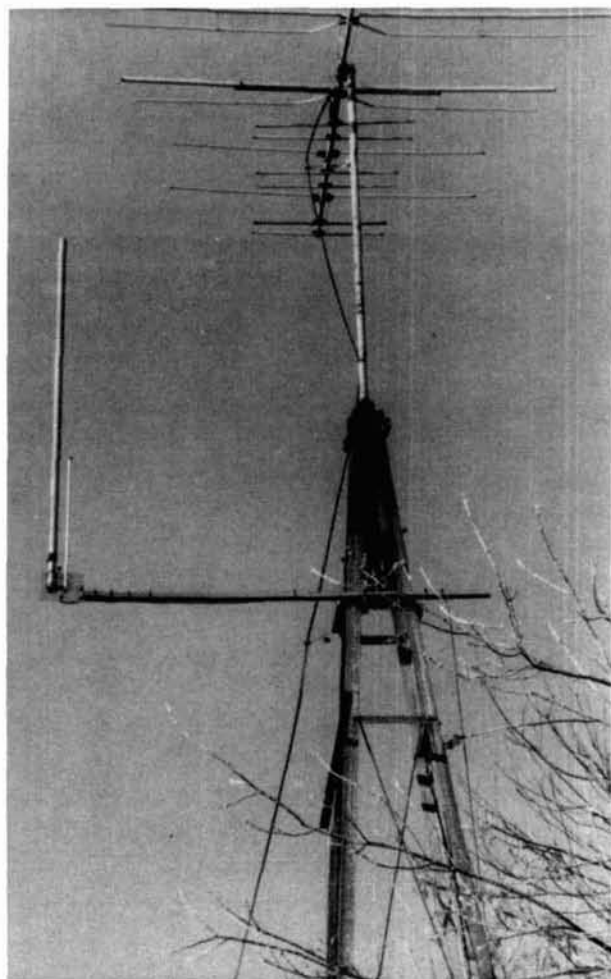
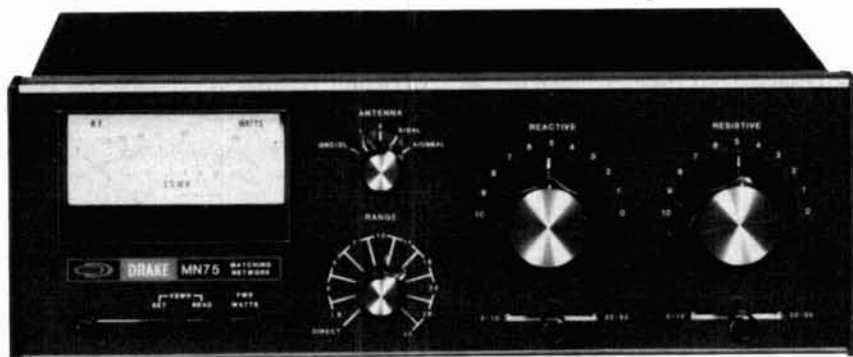

fig. 6. Horizontal mounting on a windmill tower.

COMPLETE YOUR STATION!



DRAKE MN75 ANTENNA TUNER

The Drake MN75 matching network will optimize your system performance with a surprising range of features and flexibility. From 1.8 to 30MHz., the MN75 matches balanced lines, coaxial lines, or random wires. (Optional B-1000 balun required for balanced lines.) RF output and VSWR readings are available at the push of a button. The rugged MN75 is rated at 200 watts continuous duty and features antenna switching as well as bypass capability. Get maximum power to your antenna system with the Drake MN75.



DRAKE SP75 SPEECH PROCESSOR

The Drake SP75 Speech Processor packs the punch it takes to be heard! The SP75 is an RF type speech processor designed to give your signal that needed boost when the going gets tough. Connect the SP75 between your microphone and your Drake TR7 or TR5 — that's all! Front panel switching gives you a bypass option as well as phone patch or tape player input. Special muting circuitry even allows you to operate VOX while using the SP75. The clipping level is adjustable and the LED indicator shows the proper audio input level.



DRAKE CW75 ELECTRONIC KEYS

A no-nonsense keyer for the '80's: the Drake CW75. Smooth iambic keying (grid block or direct) is at your fingertips with either a squeeze key, semi-automatic "bug", or straight key. 5 to 50 WPM capability with front panel speed control. Built-in side tone monitor with volume control. Operates from an external 7 to 14 volt supply or a nine volt optional internal battery.



DRAKE P75 PHONE PATCH

Use your station to its fullest! The Drake P75 Phone Patch puts you on the front lines of amateur radio public service. With the P75, your station can be that vital link between the remote location and the folks back home. The P75 is a hybrid patch for use with the Drake 7-line or other transmitter/receiver combinations. Features such as in/out switching and adjustable RX/TX level controls make the P75 Phone Patch the choice you can count on.



R.L. Drake Company • 540 Richard Street • Miamisburg, Ohio 45342 • USA • Phone (513) 866-2421 • Telex: 288-017

© COPYRIGHT 1984 R.L. DRAKE COMPANY

State
of the art



by

K.V.G.

9 MHz CRYSTAL FILTERS

MODEL	Appli- cation	Band- width	Poles	Price
XF-9A	SSB	2.4 kHz	5	\$53.15
XF-9B	SSB	2.4 kHz	8	72.05
XF-9B-01	LSB	2.4 kHz	8	95.90
XF-9B-02	USB	2.4 kHz	8	95.90
XF-9B-10	SSB	2.4 kHz	10	125.65
XF-9C	AM	3.75 kHz	8	77.40
XF-9D	AM	5.0 kHz	8	77.40
XF-9E	FM	12.0 kHz	8	77.40
XF-9M	CW	500 Hz	4	54.10
XF-9NB	CW	500 Hz	8	95.90
XF-9P	CW	250 Hz	8	131.20
XF910	IF noise	15 kHz	2	17.15

10.7 MHz CRYSTAL FILTERS

XF107-A	NBFM	12 kHz	8	\$67.30
XF107-B	NBFM	15 kHz	8	67.30
XF107-C	WBFM	30 kHz	8	67.30
XF107-D	WBFM	36 kHz	8	67.30
XF107-E	Pix/Data	40 kHz	8	67.30
XM107-SO4	FM	14 kHz	4	30.15

Export Inquiries Invited.

Shipping \$3.50

MICROWAVE MODULES VHF & UHF EQUIPMENTS

Use your existing HF or 2M rig on other VHF or UHF bands.

LOW NOISE RECEIVE CONVERTERS

1691 MHz	MMk1691-137	\$249.95
1296 MHz GaAsFET	MMk1296-144G	149.95
432/435	MMc432-28(S)	74.95
439-ATV	MMc439-Ch x	84.95
220 MHz	MMc220-28	69.95
144 MHz	MMc144-28	54.95

Options: Low NF (2.0 dB max., 1.25 dB max.), other bands & IF's available

LINEAR TRANSVERTERS

1296 MHz	1.3 W output, 2M in	MMt1296-144-G	\$339.95
432/435	10 W output, 10M in	MMt432-28(S)	259.95
144 MHz	10 W output, 10M in	MMt144-28	169.95

Other bands & IFs available.

LINEAR POWER AMPLIFIERS

1296 MHz	20 W output	UT1296BL	ASK
432/435	100 W output	MML432-100	379.95
	50 W output	MML432-50-S	199.95
	30 W output	MML432-30-LS	179.95
144 MHz	100 W output	MML144-100-LS	249.95
	50 W output	MML144-50-S	199.95
	30 W output	MML144-30-LS	109.95
	25 W output	MML144-25	99.95

All models include VOX T/R switching.

"L" models 1 or 3W drive, others 10W drive.

Shipping: FOB Concord, Mass.

ANTENNAS



420-450 MHz MULTIBEAMS

48 Element	70/MBM48 15.7 dBd	\$75-75	\$59.95
88 Element	70/MBM88 18.5 dBd	105-50	89.95

144-148 MHz J-SLOTS

8 over 8 Hor. pol	D8/2M	12.3 dBd	\$63.40
8 by 8 Vert. pol	D8/2M-vert	12.3 dBd	ASK
10 + 10 Twist	10XY/2M	11.3 dBd	79.95

UHF LOOP YAGIS

1250-1350 MHz	29 loops	1296-LY 20 dBi	\$44.95
1650-1750 MHz	29 loops	1691-LY 20 dBi	55.95

Order Loop-Yagi connector extra:

Type N \$14.95, SMA \$5.95

Send 40¢ (2 stamps) for full details of all your VHF & UHF equipment and KVG crystal product requirements.



si

(617) 263-2145
SPECTRUM
INTERNATIONAL, INC.
Post Office Box 1084
Concord, MA 01742, U.S.A.

plished by using the other set of mounting holes in the antenna mounting plate. No special problems were noted with this arrangement.

variations

As with any project, several additional ideas came to mind after the antennas were completed. For instance, the coaxial shield attachment to the 5/8th's element could certainly be made to be adjustable. Doing this might result in a better SWR reading, or perhaps allow the coax terminations to be physically matched more evenly at the antenna. If I were to build another, I would try this approach. Should you decide to make both connections adjustable, remember to remove the paint from the portion of the mast the clamp will rest against when tuned.

It may also be possible to make the 5/8th's element diameter smaller. The 1-1/4 inch tubing is convenient because it can be purchased at the proper length, but if you have stock left over from other antenna projects, it would be less expensive to use what you have. If you do, remember that antennas built from different stock may tune at positions other than those indicated in this article. I'd be delighted to hear from anyone who attempts this alternative approach.

reference

1. *FM and Repeaters for the Radio Amateur*, American Radio Relay League, Newington, Connecticut, 1978, page 70.

bibliography

Aurick, L., "A J-Fed Vertical for 2 Meters," *ARRL Antenna Book*, 14th Edition, 1983, American Radio Relay League, Newington, Connecticut, pages 11-24.

Barvicks, Alex, WB4RVH, Editor, *VHF Antenna Handbook*, 73 Publications, Peterborough, New Hampshire, 1975, reprinted 1980, pages 14-17.

ham radio

Great Novice Gift Idea

HOW TO TROUBLESHOOT & REPAIR AMATEUR RADIO EQUIPMENT

by Joseph J. Carr, K4IPV

Not everyone is lucky enough to have someone to teach them the basics of troubleshooting. For many of us the only way to learn was by trial and error. Joe Carr has put in one comprehensive guide, a complete step-by-step program on how to troubleshoot electronic equipment. Chapters include how to use simple test equipment like the voltmeter and ammeter and the more complex kinds of equipment like the oscilloscope. You also get plenty of helpful hints, the kind you can only get from someone who knows how to repair broken gear. Fully illustrated to help insure that you understand what you are doing. ©1980.

☐ T-1194

Softbound \$9.95

Please add \$1.00 for shipping and handling.

Ham Radio's Bookstore
Greenville, NH 03048

ENGINEERING MAKES THE DIFFERENCE



Production Expertise And Service Integrity Form The Foundation For Your Long-Term Satisfaction

The fact that the Computer Patch Interface unit by Advanced Electronic Applications, Inc. is known as the best value on the market is no accident. The CP-1 was designed by Al Chandler, K6RFK (PHD-E.E.), an active RTTY user since 1963.

Given a cost per unit budget for the CP-1, Al designed as much performance as possible into the Computer Patch, including a unique new tuning indicator, referred to by one of our customers as the "Dead Eye Dick" tuning indicator. This indicator is ideal for RTTY and CW, in that it is both fast to tune and (within 10 Hz) as accurate as scope tuning. It also performs under poor signal to noise conditions in which other indicators provide no useful data.

Al's variable shift tuning was designed to move the space filter center frequency from 2225 Hz to 3125 Hz without changing the bandwidth (by varying the Q of the filter). All this is accomplished using a precision ganged potentiometer to assure proper tracking of the multiple filter stages. We could have used a pot costing a tenth as much by simply using a two-pole filter design, but we feel the advantage of a sharper filter reduces the noise bandwidth significantly and allows the variable shift control to be used like passband tuning for extra elimination of adjacent channel interference.

Some manufacturers are concerned that amateurs might try calibrating their own equipment and, therefore, have used non-adjustable components, which results in sub-optimal performance. Although more costly, trimpots used in AEA equipment allow factory adjustment for performance to design specifications. Competently designed active filter circuits need not be adjusted after leaving the factory; however, for specialized use the owner can easily change filter parameters.

Mindful of the fact that many of our customers are new to RTTY, Al made the CP-1 tuning as forgiving as possible, while providing the most critical operator a piece of equipment in which he could be proud. Even old "pro's" are surprised at the poor signal conditions under which the CP-1 will still provide good copy.

You can now experience the BEST RTTY, CW, and AMTOR offered. Couple the CP-1 with our new AEASOFT™ software packages designed for the MARS, SWL, or amateur radio operator, and you will feel a pride reminiscent of what "made in U.S.A." brought in years gone by. Please do not hold the low price of the CP-1 against us. This is one case where you get much more than you pay for relative to any of the competitive units. For more information send for our FREE catalog. Better yet, see your favorite dealer.

AEA Brings you the
Breakthrough!

MIDWEST AMATEUR RADIO SUPPLY

3454 Fremont Avenue, North
Minneapolis, MN 55412

Store Hours: Mon.-Fri. 9-6, Saturday 9-3
(612) 521-4662

✓ 160

★ ★ **VECTOR** **VT-3 / VT-4** ★ ★
MOBILE / HOME
REMOTE CONTROLLED ANTENNA TUNERS



- ★ VT-4 INSTALLS DIRECTLY AT THE ANTENNA FEEDPOINT WHERE YOU CAN REALLY "TUNE" THE ANTENNA.
- ★ DESIGNED FOR HALF WAVE DIPOLES, INVERTED V's, AND QUARTER WAVE VERTICALS USING 50 OHM COAX FEED-LINES.
- ★ OPERATES WITH SINGLE BAND OR MULTIBAND ANTENNAS, TRAP TYPE OR PARALLEL ELEMENT TYPES.
- ★ WORKS ALL BANDS FROM 10 THROUGH 160 METERS.
- ★ FULL BAND COVERAGE WITH MAXIMUM EFFICIENCY AND VERY LOW VSWR, TYPICALLY LESS THAN 1.2 TO 1.
- ★ FINGER TIP CONTROL FROM THE HAM SHACK FOR EXACT RESONANCE AND IMPEDANCE MATCH.
- ★ FOR MOBILE OPERATORS THE VECTOR VT-3 INSTALLS IN THE TRUNK AND TUNES STANDARD TYPE MOBILE ANTENNAS FOR FULL BAND COVERAGE, (All of 75M phone band), WITH TYPICAL VSWR LESS THAN 1.2 TO 1.

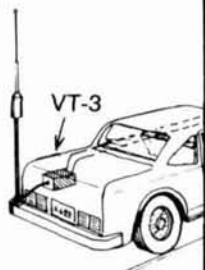

VT-4

WRITE FOR INFORMATION.

191

VECTOR RADIO CO., P.O. BOX 1166, CARDIFF, CA 92007

**1984
CALLBOOKS**

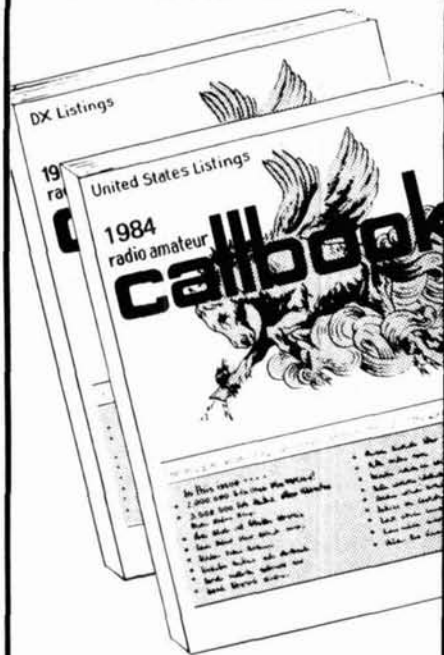

**Order today!
1984**

RADIO AMATEUR CALLBOOKS

Known throughout the world for accuracy, the 1984 Callbooks are a better value than ever before. The U.S. Callbook contains over 433,000 listings; the Foreign Callbook has over 413,000. More than 100,000 changes have been made in each edition since last year. Special features include call changes, Silent Keys, census of amateur licenses, world-wide QSL bureaus, international postal rates, prefixes of the world, and much more. You can't beat this value! Order your 1984 Callbooks now.

	Each	Shipping	Total
□ U.S. Callbook	\$19.95	\$3.05	\$23.00
□ Foreign Callbook	18.95	3.05	22.00

Order both books at the same time for \$41.95 including shipping within the USA.

Order from your dealer or directly from the publisher. Foreign residents add \$4.55 for shipping. Illinois residents add 5% sales tax.

Keep your 1984 Callbooks up to date.

The U.S. and Foreign Supplements contain all activity for the previous three months including new licenses. Available from the publisher in sets of three (March 1, June 1, and September 1) for only \$12.00 per set including shipping. Specify U.S. or Foreign Supplements when ordering. Illinois residents add 5% sales tax. Offer void after November 1, 1984.

RADIO AMATEUR callbook INC.
Dept. F
925 Sherwood Dr., Box 247
Lake Bluff, IL 60044, USA

Tel: (312) 234-6600



**GEM-QUAD FIBRE-GLASS
ANTENNA FOR 10, 15, and 20 METERS**

Two Elements \$235.00
Extra Elements \$164.00
Price is F.O.B. Transcona
**INCLUDES U.S. Customs
Duty**

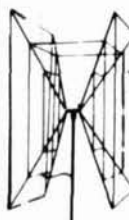

KIT COMPLETE WITH
*SPIDER
*ARMS
*WIRE
*BALUN KIT
*BOOM WHERE
NEEDED

**WINNER OF MANITOBA
DESIGN INSTITUTE
AWARD OF EXCELLENCE**

Buy two elements now — a third and fourth may be added later with little effort.

Enjoy up to 8 db forward gain on DX, with a 25 db back to front ratio and excellent side discrimination.

Ask for our new 2m Quad Kit when you order your Gem Quad. It's FREE for the asking!

Get maximum structural strength with low weight, using our "Tridetic" arms. Please inquire directly to:

GEM QUAD PRODUCTS LTD.
Box 53
Transcona Manitoba
Canada R2C 2Z5
Tel. (204) 866-3338

**ELECTRONIC
COMPONENTS**



FREE CATALOG

**MANUFACTURERS OF QUALITY
ELECTRONIC COMPONENTS**

- BATTERY CLIPS & HOLDERS
- CABLE SETS • CONNECTORS • CAPACITORS
- DISPLAYS • LED's • FUSES • JACKS & PLUGS
- KNOBS • LAMPS • POTENTIOMETERS
- RF COILS • RELAYS • RESISTORS
- SWITCHES • SEMICONDUCTORS • SPEAKERS
- TEST EQUIPMENT • TRANSFORMERS • TOOLS
- WIRE & CABLE

OVER 15,000 DIFFERENT ITEMS IN STOCK!

- Sales and Order Desk Open from 6:00a.m. (PST)
- TERMS C.O.D. Visa, MasterCard (Open Accounts Available)
- Phone and Mail Orders Welcome
- Catalogs Mailed Outside USA Send \$2.00 ✓ 164

MOUSER ELECTRONICS
11433 WOODSIDE AVE SANTEE CA 92071
PHONE (619) 449-2222 TWX 910 331-1175

wideband VCO design

Use this low-noise near-octave source in your HF receiver or VHF/UHF exciter

This article discusses the design and construction of a wideband voltage controlled oscillator (VCO). It can be used as an LO in a broadband receiver or spectrum analyzer, as a low-noise phase locked source in a VHF or UHF exciter, or alone as a basic signal generator.

This particular design is used in an HF communications receiver. When phase locked to a low-noise reference, it demonstrates excellent signal-to-noise performance — greater than 130 dBc/Hz at 20 kHz offset from the carrier. As mentioned in previous articles^{1,2,3} this noise performance, or spectral purity of the oscillator, is quite important if the receiver is to perform well in the presence of strong adjacent channel signals.

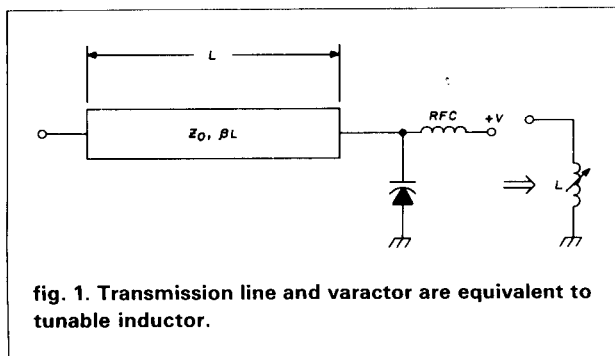

design concept

The oscillator design uses a resonator or tank circuit which consists of a transmission line terminated by a voltage variable capacitor or varactor. A transmission line of correct length looks like a variable inductance as the varactor voltage is varied (fig. 1). The oscillator uses the Colpitts configuration, and takes advantage of the feedback capacitor voltage divider plus any parasitic capacitance present. If the Colpitts configuration is operated with a fairly high C to L ratio, then this condition tends to improve the oscillator operating Q and consequently the oscillator signal-to-noise ratio. To assist in the design of the VCO a BASIC computer program routine has been included. Some examples, as well as actual designs and performance data, are also provided. Finally some interesting applications are highlighted.

equations developed

The input impedance of a lossless transmission line, Z_s , is equal to:

$$Z_s = \frac{Z_\ell \cos \beta L + j Z_0 \sin \beta L}{\cos \beta L + j (Z_\ell / Z_0) \sin \beta L} \quad (1)$$

If Z_ℓ is zero (the line is shorted at the end) from the preceding equation, $Z_s = j Z_0 \tan \beta L$ and the line has an inductive reactance of Z_0 ohms times the electrical length of the line. This is true provided the value of βL ($\beta = 2\pi/\lambda$) is less than 90 degrees or the line is less than a quarter wavelength long. If the line is precisely a quarter wave long (electrically), then from eq. 1 we have:

$$Z_s = Z_0^2 / Z_\ell \quad (2)$$

By Alan Victor, WA4MGX, 8758 SW 51st Place, Cooper City, Florida 33328

In this case, if Z_ℓ were a capacitive reactance of $-jX_{C_v}$ then

$$Z_s = jZ_0^2/X_{C_v} \quad (3)$$

and the capacitive reactance of the termination is reflected to the input of the line as an inductive reactance of $j/X_{C_v} = Z_s/Z_0^2$ and an inductance of

$$L = C_v Z_0^2 \quad (4)$$

For example, an oscillator that tunes 135 MHz to 145 MHz requires the electrical length to remain a quarter wavelength or less at the maximum frequency of 145 MHz. If a 50-ohm transmission line is used, then the physical length of a quarter wave is calculated using:

$$\text{length (feet)} \approx 246/f_0(\text{MHz}) \sqrt{\epsilon_r} \quad (5)$$

where ϵ_r is the relative dielectric constant of the line. The ϵ_r for a 50-ohm line using a Teflon[®] dielectric is 2.2; therefore, the physical line length is 13.7 inches. If our oscillator includes device shunt capacitance,

feedback capacitance, and parasitics totaling 20 pF, then the required inductance to achieve resonance is 60 nH at 145 MHz and 70 nH at 135 MHz. Consequently, the required variation in the varactor capacity is calculated from eq. 4 as 24 pF to 28 pF or 4 pF. If a lower Z_0 line were chosen, and the total capacitance remained the same, an increase in the varactor capacitance change would be required.

The equations developed so far allow us to choose a value for the transmission line impedance Z_0 and obtain a value of inductance L for a given varactor capacity, C_v . This equivalent inductance then becomes part of our oscillator tank. Since a transmission line and capacitor are readily controlled, it becomes very attractive to construct VHF and UHF oscillators in this manner since small fixed inductances are difficult to control. Furthermore, the resonator or tank is a shielded structure and therefore quite immune to outside disturbances, such as, microphonics, which can lead to hum and modulation effects.

three parameters affect frequency

Now consider what happens if the transmission line length, impedance, or the oscillator shunt capacitance is varied. Under these conditions, any value of inductance necessary to resonate the oscillator tank can be developed. Given these three variables, an oscillator frequency change of 50 percent can be achieved for a given value of transmission line length and impedance Z_0 . With careful design, even an octave is possible. The necessary design equations are presented in the **appendix**, and a BASIC program is included to solve for the transmission line impedance, Z_0 , electrical length, and required varactor capacitance change. Finally, the transmission line *physical* length is calculated, with the dimensions given in both inches and metric units. Because the program is in-

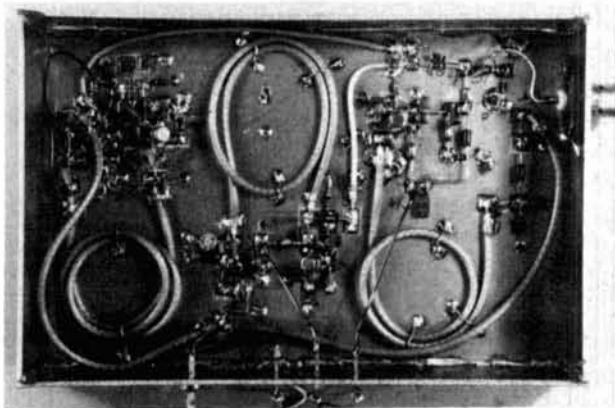

Switched transmission line injection oscillators as shown in fig. 2.

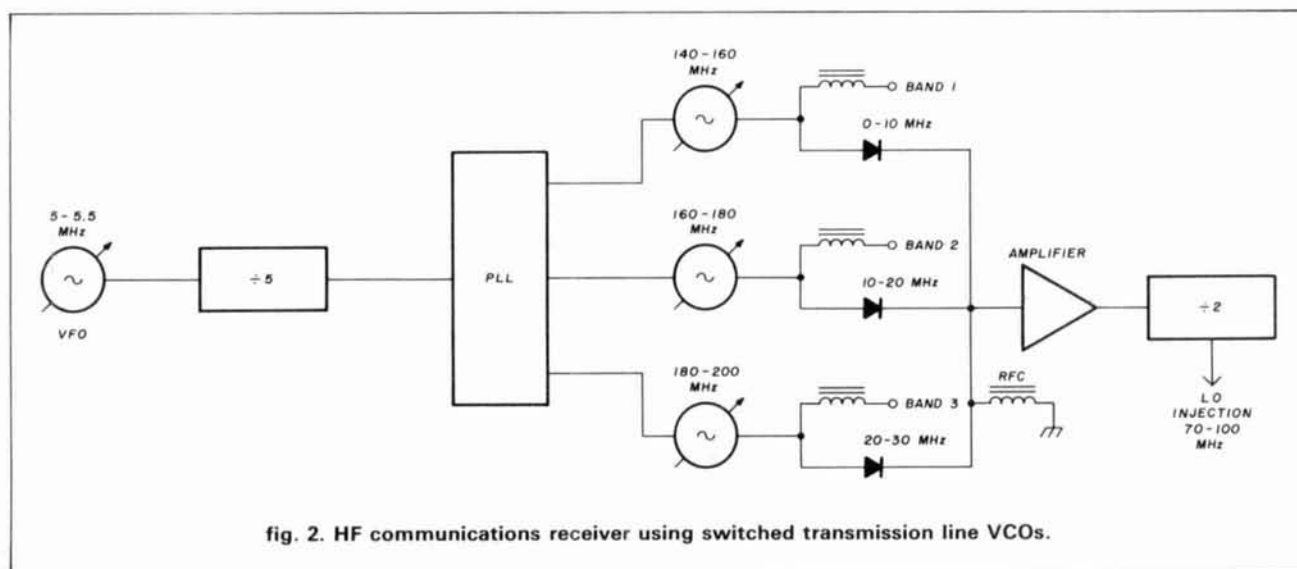

fig. 2. HF communications receiver using switched transmission line VCOs.

Program 1. Varactor oscillator design program listing.

JLIST

```

10 HOME: REM CLEARS THE SCREEN
20 PRINT " VARACTOR TUNED WIDEBAND"
30 PRINT " OSCILLATOR DESIGN"
40 PRINT " A.M.VICTOR"
50 PRINT " 1.1 9/9/84"
60 PRINT: PRINT: PRINT
70 PI = 3.1415926
80 PRINT "WHAT IS THE MIN AND MAX TUNE": PRINT "RANGE IN MHZ ";; INPUT
  F1,F2
90 W2 = 2 * PI * F2 * 1E6
100 W1 = 2 * PI * F1 * 1E6
110 PRINT: PRINT "ENTER TRANSMISSION LINE ZO,": PRINT "AND STARTING LI
  NE LENGTH": PRINT "IN DEGRESS";: INPUT ZO,ITHETA
120 STHETA = ITHETA
130 PRINT: PRINT "ENTER LINE LENGTH INCREMENT";: INPUT DL
140 PRINT: PRINT "ENTER THE DEVICE CAPACITANCE": PRINT "PLUS ANY PARAS
  ITICS IN PF";: INPUT CIN
150 HOME: REM BEGIN CALCULATIONS
160 XIN = 1 / (W1 * CIN * 1E - 12)
170 X2IN = 1 / (W2 * CIN * 1E - 12)
180 PRINT: PRINT "DELTA XCV "; TAB( 12);"LENGTH"; TAB( 20);"CVMIN"; TAB(
  30);"CVMAX"
190 FOR THETA = ITHETA TO 180 STEP DL
200 RTHETA = THETA / 57.29578
210 A = (ZO * TAN ((W2 / W1) * RTHETA)) - (W1 / W2) * XIN
220 B = 1 + (XIN * TAN (RTHETA) / ZO)
230 C = 1 + ((W1 / W2) * (XIN / ZO) * TAN ((W2 / W1) * RTHETA))
240 D = ZO * TAN (RTHETA) - XIN
250 XQUOT = (A * B) / (C * D)
260 XCVW1 = (ZO * TAN (RTHETA) - XIN) / (1 + (XIN / ZO) * TAN (RTHETA)
  )
270 Y2CVW2 = ((ZO * TAN ((W2 / W1) * RTHETA) - X2IN)) / (1 + (X2IN / ZO
  ) * TAN ((W2 / W1) * RTHETA))
280 CMAX = 1 / (2 * PI * F1 * XCVW1 * 1E6)
290 CMAX = CMAX * 1E12
300 X = CMAX
310 GOSUB 450
320 CMAX = H
330 YCMIN = 1 / (2 * PI * F2 * Y2CVW2 * 1E6)
340 YCMIN = YCMIN * 1E12
350 X = YCMIN
360 GOSUB 450
370 YCMIN = H
375 REM: NEXT 4 LINES CHECK FOR VALID TRANSMISSION LINE LENGTHS AND CAP
  ACITOR VALUES.
380 IF XQUOT < 0 THEN 430
390 IF YCMIN < 0 THEN 430
400 IF CMAX < 0 THEN 430
410 IF YCMIN > CMAX THEN 430
420 PRINT XQUOT; TAB( 13);THETA;"DEG"; TAB( 20);YCMIN;"PF"; TAB( 30);CM
  AX;"PF"
430 NEXT THETA
440 GOTO 530
450 G = INT (X)
460 H = G - X
470 H = ABS (H)
480 H = 100 * H

```

```

490 H = INT (H)
500 H = H / 100
510 H = H + G
520 RETURN
530 PRINT "ANOTHER RUN WITH NEW PARAMETERS Y/N ";: INPUT R$
540 IF R$ = "N" THEN 740
550 HOME : PRINT : PRINT "EDIT WHICH PARAMETERS?"
560 PRINT "FREQUENCY RANGE (1)?"
570 PRINT "TRANSMISSION LINE (2)?"
580 PRINT "DEVICE CAPACITANCE (3)?"
590 PRINT "OR DO TRANSMISSION LINE LENGTH CALCULATION (4)?"
600 PRINT "START NEW CALCULATION (5)"
610 PRINT "OR (6) TO END"
620 INPUT T
630 ON T GOTO 640,680,700,750,150,850
640 PRINT "ENTER TUNING RANGE MIN,MAX";: INPUT F1,F2
650 W1 = 2 * PI * F1 * 1E6
660 W2 = 2 * PI * F2 * 1E6
670 GOTO 550
680 PRINT "ENTER TRANSMISSION LINE Z0";: INPUT Z0
690 GOTO 550
700 PRINT "ENTER DEVICE CAPACITANCE PLUS ANY PARASITICS IN PF";: INPUT
    CIN
710 GOTO 550
720 HOME : ITHETA = STHETA
730 GOTO 160
740 HOME
750 PRINT "TRANSMISSION LINE LENGTH CALCULATION"
760 PRINT : PRINT "ENTER REL.DIELECTRIC CONSTANT OR": PRINT "VELOCITY F
    ACTOR, (E) OR (V) AND VALUE";: INPUT K$,ER
770 IF K$ = "V" THEN ER = 1 / ER ^ 2
780 PRINT "ENTER TRANSMISSION LINE": PRINT "LENGTH IN DEGREES";: INPUT
    FTHETA
790 LM = (FTHETA / 360) * (300 / F1) * (1 / SQR (ER))
800 IM = (LM * 100) / 2.54
810 PRINT "METRIC LENGTH"; TAB( 30);"INCHES"
820 PRINT LM; TAB( 30);IM
830 PRINT "ANOTHER RUN Y/N";: INPUT R$
840 IF R$ = "Y" THEN 550
850 END

```

teractive, you can try various combinations of line impedance, line length, and oscillator shunt output capacitance, which can be altered by shunting the oscillator device with an external capacitance. The program is arranged to automatically increment the transmission line length by a specified amount. During the program operation you'll notice that a particular line length exists which minimizes the required varactor capacitance change. Depending on the oscillator's tuning range and the line impedance, the required capacitance change of the varactor is affected and changes. For a large percentage tuning bandwidth, a high Z_0 is needed to keep the varactor capacitance change within practical limits.

VCO circuit

Several versions of the oscillator were tried. The

VCOs shown in **fig. 2** and in the photograph work well in an HF receiver using up-conversion. Each of the three VCOs covers 20 MHz in the 140-200 MHz range. The oscillators are phaselocked to a 1 MHz reference and their outputs are divided by 2. The final output is then tunable from 70 to 100 MHz in 500 kHz steps and provides injection for an up-conversion receiver with a 70 MHz first IF. U310 J-FETs and MV109 varactors are used. Trimmer capacitor values, varactor capacitance swing, and transmission line dimensions were determined by using the computer program. Each oscillator uses clamp bias to help regulate oscillator feedback as it is tuned and to prevent the FET gate-source junction from becoming forward-biased. This appears to help the oscillator noise performance as evidenced by measured values of better than 135 dBc/Hz, measured 25 kHz away from the car-

AEA Brings you the Breakthrough!

MBA-RC Code Converter

This full function decoder and display unit represents the latest in state-of-the-art decoders. Morse, Baudot, and ASCII. Will perform serial to parallel and parallel to serial code conversions as well as cross mode conversions. Two powerful μ PS, 43 ICs, make up one complete package. Compatible with HF, VHF and UHF bands and RTTY modes. Separate receive filters are ahead of and behind a special signal limited circuit.



CALL FOR YOUR PRICE



AEA Computer Patch CP-1

A Personal Computer + Your Transceiver + AEA's CP-1 = FUN! Get a professional quality RTTY/CW terminal on a beer budget price. Easy to hook up and use. The CP-1 demodulator provides greatly improved performance compared to popular single channel RTTY detectors. With appropriate software and your personal computer, you can have hours of fun.

CALL FOR YOUR PRICE

ISOPOLE™

Models available for: 144 MHz, 220 MHz and 440 MHz. Maximum gain, very low angle of radiation. Covers complete band with SWR less than 1.4-1.

CALL FOR YOUR PRICE

AEA Contester™ CK-2

Here's great gift idea for your favorite ham. Designed with the needs of the active contester in mind — at a price that is affordable. Has an 800 character message memory that can be soft partitioned into as many as 10 sections. Mistakes are easily corrected with unique edit mode. Also has automatic serial number generator.

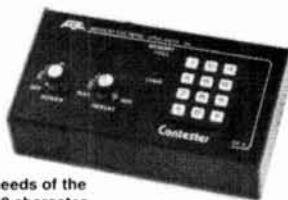

CALL FOR YOUR PRICE



AEA Moscow Muffler WB-1

Blank the woodpecker — once and for all. No modifications necessary to your equipment. Hooks up in your antenna so synchronous blanker works where most effective, in the RF stage. Will not overload from strong adjacent signals. Also has low noise, broadband 6 dB preamp. WB-1 will typically display 40-50 dB of attenuation. Two pulse rates blanking speeds available — 10 and 16 Hz.

CALL FOR YOUR PRICE

AEA Amtor Terminal Unit AMT-1

AMTOR is fast growing in popularity. Don't you want to join the fun? Computer based, self correcting mode of transmission virtually ensures error-free copy — even with strong interference or weak signals, AMTOR can get your message through. AMT-1 contains everything you need to get on AMTOR with the addition of your radio and personal computer. Will also work on standard RTTY and CW for additional flexibility. Great Christmas gift idea. State-of-the-art FUN.



CALL FOR YOUR PRICE

HAMTRONICS is your complete ham dealer. Looking for something and can't find it elsewhere? CALL HAMTRONICS TODAY



✓ 141

HAMTRONICS, INC.

4033 BROWNSVILLE ROAD, TREVOSE, PA. 19047

(215) 357-1400

WHAT IS THE MIN AND MAX TUNE
RANGE IN MHZ ?100,200

ENTER TRANSMISSION LINE ZO,
AND STARTING LINE LENGTH
IN DEGRESS?50,10

ENTER LINE LENGTH INCREMENT?5

ENTER THE DEVICE CAPACITANCE
PLUS ANY PARASITICS IN PF?40

DELTA XCV	LENGTH	CVMIN	CVMAX
62.3339054	40DEG	9.82PF	1225.29PF
22.0994892	45DEG	6.33PF	279.89PF
23.7659259	50DEG	3.29PF	156.62PF
114.03646	55DEG	.47PF	107.54PF

ANOTHER RUN WITH NEW PARAMETERS Y/N ?Y

EDIT WHICH PARAMETERS?
FREQUENCY RANGE (1)?
TRANSMISSION LINE (2)?
DEVICE CAPACITANCE (3)?
OR DO TRANSMISSION LINE LENGTH CALCULATION (4)?
START NEW CALCULATION (5)
OR (6) TO END

?2
ENTER TRANSMISSION LINE ZO?75

EDIT WHICH PARAMETERS?
FREQUENCY RANGE (1)?
TRANSMISSION LINE (2)?
DEVICE CAPACITANCE (3)?
OR DO TRANSMISSION LINE LENGTH CALCULATION (4)?
START NEW CALCULATION (5)
OR (6) TO END

DELTA XCV	LENGTH	CVMIN	CVMAX
28.0326343	30DEG	10.55PF	591.88PF
11.6044757	35DEG	7.38PF	171.5PF
10.1093855	40DEG	4.91PF	99.38PF
12.2899117	45DEG	2.81PF	69.17PF
29.0553268	50DEG	.9PF	52.38PF

rier frequency (see fig. 3). Each VCO output is combined through switched pin diodes and the VCO is enabled by switching DC power from a bandswitch control logic board. The tuning line voltage of each VCO is tied together through shielded coax and 400 nH RF chokes. A small series resistor is used in line with the chokes to provide for a lower choke Q . Note that a small resistor is used; large decoupling resistors

add excessive amounts of thermal noise and can ruin an otherwise low-noise design.

digital VFO applications

The octave-tuned oscillator presented in fig. 4 covers 100-200 MHz. The layout is more critical since any additional parasitic capacitance present tends to reduce the achievable tuning range. The circuit does

The Only
Factory
Authorized
**SALES &
SERVICE**
in
New England



TEL-COM★

Electronic Communications

Authorized Dealers For

KENWOOD & ICOM

Also displaying the popular accessories needed to complete a HAM STATION . . .

ARRL PUBLICATIONS • AEA • ALPHA DELTA • ASTRON •

AUSTIN • BENCHER • B&W • DAIWA • MIRAGE •

TELEX/HY-GAIN • VIBROPLEX • WELZ • ETC.

OPEN SIX DAYS A WEEK

✓ 186

**TRY US FOR YOUR
MAIL ORDER
PURCHASES**

VISA and
MASTER CARDS
Accepted

Telephone 617/486-3400, 3040
675 Great Rd., (Rte. 119) Littleton, MA 01460
1/4 miles from Rte. 495 (Exit 31) toward Groton, Mass.

AMATEUR TELEVISION

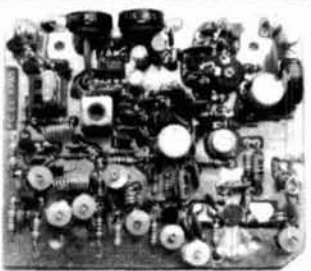

KPA5 1 WATT 70 CM ATV TRANSMITTER BOARD

- **APPLICATIONS:** Cordless portable TV camera for races & other public service events, remote VCR, etc. Remote control of R/C airplanes or robots. Show home video tapes, computer programs, repeat SSTV to local ATVers. DX depends on antennas and terrain typ. 1 to 40 miles.
- **FULL COLOR VIDEO & SOUND** on one small 3.25x4" board.
- **RUNS ON EXTERNAL 13.8 VDC** at 300 ma supply or battery.
- **TUNED WITH ONE CRYSTAL** on 426.25, 434.0, or 439.25 MHz.
- **2 AUDIO INPUTS** for a low Z dynamic and line level audio input found in most portable color cameras, VCRs, or home computers.
- **APPLICATION NOTES & schematic** supplied for typical external connections, packaging, and system operation.
- **PRICE ONLY \$159** delivered via UPS surface in the USA. Technician class amateur license or higher required for purchase and operation.

WHAT IS REQUIRED FOR A COMPLETE OPERATING SYSTEM? A TV set with a TVC-2 or TVC-4 420-450 MHz to channel 3 downconverter, 70 cm antenna, and coax cable to receive. Package up the KPA5, add 12 to 14 vdc, antenna, and any TV camera, VCR, or computer with a composite video output. Simple, eh?

CALL OR WRITE FOR OUR COMPLETE CATALOG & more info on atv downconverters, antennas, cameras, etc., or who is on in your area.

TERMS: Visa, Mastercard, or cash only UPS COD by telephone or mail. Telephone orders & postal MO usually shipped within 2 days, all other checks must clear before shipment. Transmitting equipment sold only to licensed amateurs verified in 1984 Callbook. Calif. include sales tax.

(818) 447-4565 m-f 8am-6pm pst.

P.C. ELECTRONICS
Tom W60RG Maryann WB6YSS

2522 Paxson Lane
Arcadia CA 91006

Your Ham Tube Headquarters!

TUBES BOUGHT, SOLD AND TRADED
SAVE \$\$\$—HIGH \$\$\$ FOR YOUR TUBES

Call Toll Free 800-221-0860

Tubes	
3-400Z	\$85.00
3-500Z	85.00
4-400A	80.00
4CX250B	50.00
572B	48.50
811A	12.00
813	30.00
6146B	6.50
6360	4.25
6883B	6.75
7360	\$10.00
7735A	27.50
8122	105.00
8156	12.50
8643	82.50
8844	26.50
8873	175.00
8874	185.00
8877	500.00
8908	12.50

MAJOR BRANDS ON RECEIVER TUBES 75% off list

Semiconductors	
MRF 245/SD1416	\$30.00
MRF 454	14.95
MRF 455	10.95
MRF 644/SD1088	19.95
2N3055	75¢
2N6084	12.50

RF Connectors	
PL259	10/\$4.95
PL258	10/8.95
UG 175/176	10/1.60
UG255/u	2.50 ea.
UG273/u	2.25 ea.
M358	2.50 ea.
M359	1.75 ea.
Type "N" Twist on (RG8/u)	\$4.75 ea.
Minimum Order	\$25.00

Allow \$3.00 min. for UPS charges

CeCo COMMUNICATIONS, Inc.
2115 Avenue X Brooklyn, NY 11235
SERVING THE INDUSTRY SINCE 1922 Phone (212) 646-6300
Call CECo For Your CCTV Security And Color Production Requirements

provide octave coverage and requires a varactor voltage change from 1 to 20 volts. The noise performance was less impressive (115 to 120 dBc/Hz). However, if used in a low-noise phase lock loop and followed by frequency division, it provides the basis for a low noise synthesizer or digital VFO with 10 Hz resolution.

Another example of a digital VFO is shown in fig. 5. How about a continuous-tuning HF receiver with 1 kHz steps, using a single phase lock loop and the popular 9 MHz IF? The approach outlined uses a single 200 to 400 MHz VCO. Despite the coverage of the VCO, which is only an octave, appropriately dividing down the VCO frequency provides for frequency coverage in excess of an octave! If the first IF is 9 MHz, then an LO injection frequency from 10 to 40 MHz will provide reception from 1 to 31 MHz. Using the 200 to 400 MHz VCO with a divide by 10/20 circuit following it yields the needed coverage. The VCO is locked to a 10 kHz reference and programmed in 1 kHz steps.

Steps smaller than 1 kHz could be provided for by tuning or synthesizing the BFO.

A 200 to 400 MHz VCO was constructed and the measured noise performance varied from 110 dBc/Hz to 115 dBc/Hz at 25 kHz offset from the carrier. Division by 10 or 20 improves the noise by at least 20 dB or 130 dBc/Hz, which is quite adequate for most receiver applications. Signal generation is handled in a similar fashion, using a cascade of binary dividers. Our 200 to 400 MHz VCO, could provide the basis of an HF through UHF source by using successive division of the VCO and bandpass filtering. A number of commercially available signal sources use this approach.

summary

A design technique which allows the construction of wideband tunable oscillators with excellent noise performance is presented. The technique uses a trans-

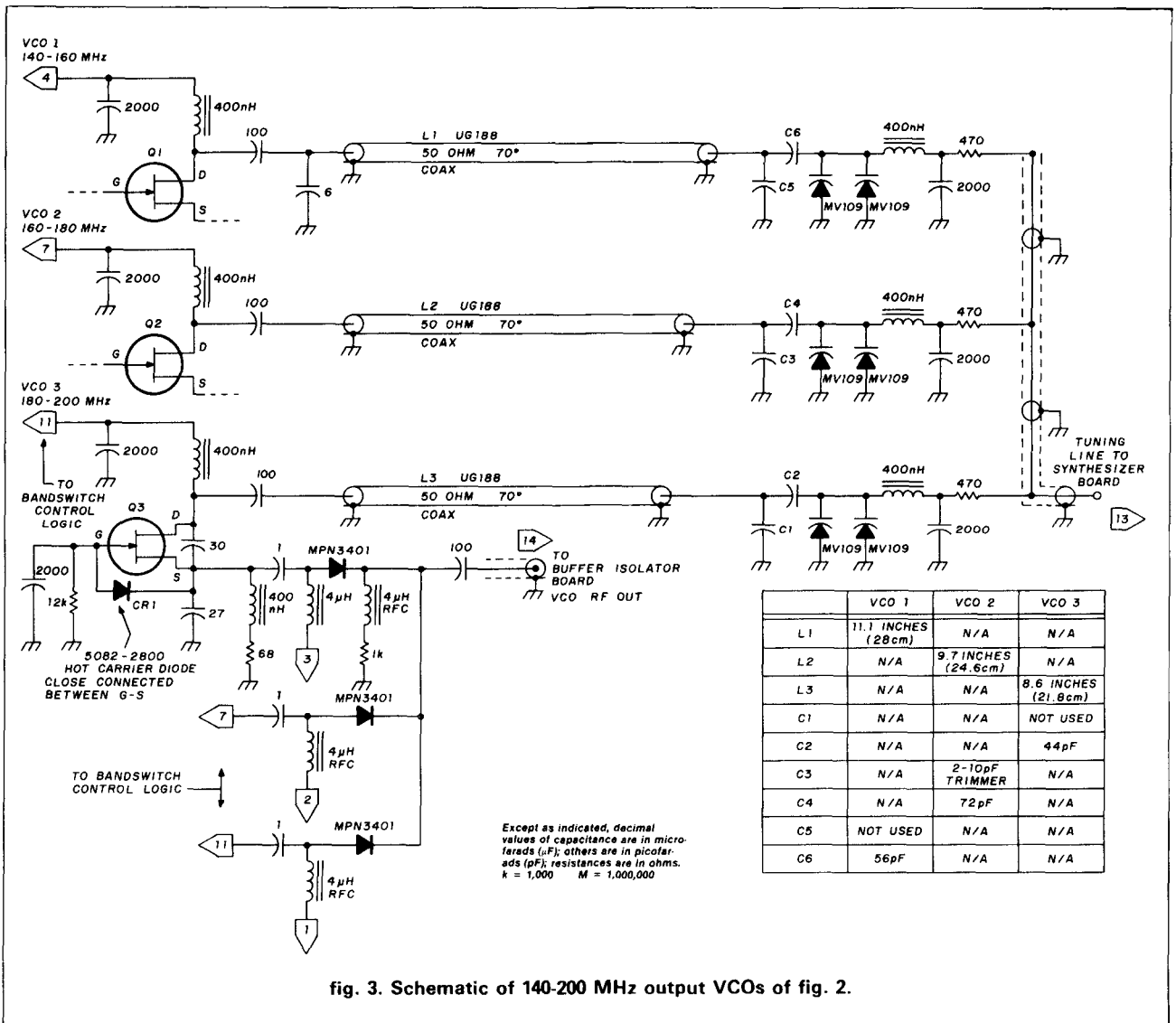

fig. 3. Schematic of 140-200 MHz output VCOs of fig. 2.

mission line and voltage variable capacitor that simulates an inductive change. A BASIC program which aids in the design of this configuration is included. Oscillators which exhibit broadband and low-noise performance have many applications. I would be very interested in hearing from readers who have similar applications.

references

1. Doug DeMaw and Wes Hayward, "Modern Receivers and Transceivers: What Ails them?" *QST*, January, 1982, pages 13-14.
2. William F. Egan, *Frequency Synthesis By Phaselock*, John Wiley and Sons, 1981, pages 196-201.
3. D.B. Leeson, "A Simple Model of Feedback Oscillator Noise Spectrum," *Proceedings of the IEEE*, February, 1966, page 329.
4. Ulrich L. Rohde, *Digital PLL Frequency Synthesizers*, Prentice-Hall, Inc., 1983.
5. W.H. Hayward, *Introduction to Radio Frequency Design*, Prentice-Hall, Inc., 1982.

appendix

determination of the transmission-line resonator parameters

The transmission line formula (eq. 1) can be rearranged to solve for Z_0 . Note that βL is not restricted to an electrical length of 90 degrees or a quarter wavelength.

$$Z_0 = \frac{jZ_0 \tan \beta L - Z_s}{j(Z_s/Z_0) \tan \beta L - 1} \quad (A1)$$

Now $Z_s = +jX_{in}$ and resonates with $-jX_{in}$ of the device at resonance. Therefore, substituting for Z_s in eq. A1 gives:

$$Z = \frac{-j(Z_0 \tan \beta L - X_{in})}{1 + \frac{X_{in} \tan \beta L}{Z_0}} \quad (A2)$$

and the reactance of our tuning varactor is:

$$X_{C_v} = \frac{Z_0 \tan \beta L - X_{in}}{1 + \frac{X_{in} \tan \beta L}{Z_0}} \quad (A3)$$

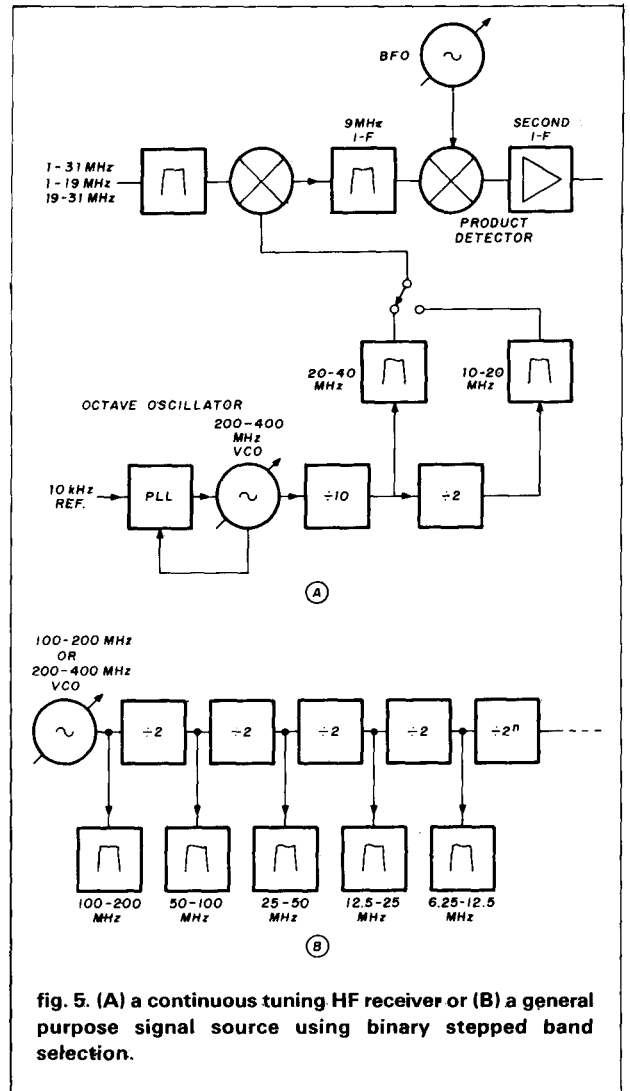
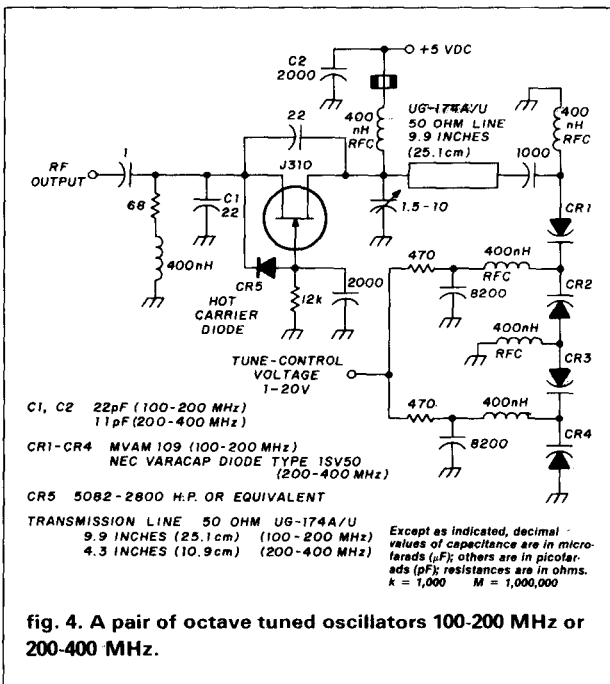

Simplify by setting $\beta L = X$ at frequency f_1 , and $\beta L = \frac{f_2}{f_1} X$ at frequency f_2 . Since the oscillator shunt capacitance remains constant, X_{in} at f_2 equals (f_1/f_2) times X_{in} at f_1 . This information is now used to obtain the following reactance change needed to tune the VCO from f_1 to f_2 . The following reactance expression can be solved using the BASIC computer program or even a hand-held calculator. The equation is:

$$\frac{X_{C_v}(f_2)}{X_{C_v}(f_1)} = \frac{\left[Z_0 \tan \left(\frac{f_2}{f_1} X \right) - \frac{f_1}{f_2} X_{in}(f_1) \right] \left[1 + \frac{X_{in}(f_1) \tan X}{Z_0} \right]}{\left[1 + \frac{f_1}{f_2} \frac{X_{in}(f_1)}{Z_0} \tan \left(\frac{f_2}{f_1} X \right) \right] \left[Z_0 \tan X - X_{in}(f_1) \right]} \quad (A4)$$

where $X_{in}(f_1)$ = oscillator total shunt reactance at frequency f_1
 $X_{in}(f_2)$ = oscillator total shunt reactance at frequency f_2
 $X_{C_v}(f_1)$ = varactor reactance at frequency f_1
 $X_{C_v}(f_2)$ = varactor reactance at frequency f_2

Using the BASIC program and eq. A4 values of X , Z_0 , X_{in} will yield the required tuning ratio.

B. G. MICRO

P. O. Box 280298 Dallas, Texas 75228
(214) 271-5546



115

74LS

LS00	.24	LS164	.60
LS01	.24	LS165	.90
LS02	.24	LS166	.99
LS03	.24	LS169	1.25
LS04	.24	LS174	.60
LS05	.24	LS175	.50
LS08	.24	LS181	1.99
LS10	.24	LS191	.90
LS11	.24	LS192	.80
LS12	.30	LS193	.80
LS13	.50	LS195	.65
LS14	.50	LS197	.85
LS20	.24	LS221	.80
LS21	.25	LS240	.95
LS27	.24	LS241	.80
LS30	.28	LS242	.90
LS32	.36	LS243	.90
LS42	.49	LS244	1.25
LS51	.24	LS245	1.50
LS74	.40	LS251	.50
LS85	.60	LS257	.55
LS86	.39	LS258	.55
LS90	.50	LS266	.50
LS93	.55	LS273	1.25
LS109	.39	LS279	.45
LS112	.39	LS283	.60
LS123	.75	LS290	.85
LS124	2.75	LS293	.85
LS125	.45	LS298	.89
LS132	.50	LS299	1.60
LS133	.49	LS366	.45
LS138	.60	LS367	.50
LS139	.60	LS368	.40
LS151	.50	LS373	1.25
LS153	.50	LS374	1.35
LS154	1.75	LS375	1.19
LS155	.50	LS377	1.49
LS156	.55	LS378	.85
LS157	.60	LS390	1.19
LS161	.60	LS393	1.19
LS162	.65	LS399	1.25
LS163	.50		

TTL

7400	.19	74125	.49
7402	.19	74151	.50
7404	.19	74154	1.19
7408	.24	74157	.50
7410	.19	74164	.75
7440	.19	74174	.85
7474	.35	74175	.79
7486	.29	74367	.59
74109	.45		

6500

6502	4.50	6545	10.00
6522	6.95	6551	10.00

6800

6800	2.50	6840	10.00
6802	5.00	6845P	10.00
6803	14.95	6850	2.60
6810	2.00	68A21	4.95
6820	3.25	68B45	17.50
6821	2.95		

EPROM

2708 1KX8 450 n.s.	2.20
27A08 1KX8 350 n.s.	3.95
2758 1KX8 +5V 450 n.s.	2.50
2716 2KX8	
450 n.s.	3.20
2716-1 2KX8 350 n.s.	5.50
2732 4KX8 450 n.s.	4.75
2532 4KX8 450 n.s.	5.50
2764-25 250 n.s.	7.50

EPROM SPECIAL

We bought a large quantity of 2708s from a computer manufacturer who redesigned their boards. We removed them from sockets, erased and verified them, and now we offer the savings to you. Complete satisfaction guaranteed.

2708

\$1.49 or 10/\$12.00

STATIC RAM

TMM2016-2KX8	
200 n.s.	8/39.95
2101-1 - 256X4	
500 n.s.	.75
21L02-1 350 n.s.	.65
2102AL-4 L.P. 450 n.s.	.49
2114L-3 1KX4 300 n.s.	
L. P.	2.75 8/16.00
TMS4044 (MCM6641 C-25)	
4KX1 250 n.s.	8/6.00
TMS4046 450 n.s.	.65
5101E-8 - 256X4 - CMOS	\$1.00
HM6116P-4-2KX8	
200 n.s. CMOS	8/39.95
6501-5 256X4 - CMOS - Data Retention 2 Volts - 22 Pin - 200 n.s. Typ. - 5V - Very Low Power	1.00
8108-5 1KX8 NMOS 500 NS	
22 Pin	2.00

4K STATIC RAMS

LESS THAN 50¢ EACH
MK4104J-4 - 250 N.S. 18 Pin
Ceramic Computer Mfg.
Surplus. PRIME. Fully Static.
Easy to Use. Has Same Pin Out as TMS4044, but slightly different timing. With Specs. (Mostek)
8 for 5.00 32 for 15.95
VERY LOW POWER!

DMA CONTROLLER

SPECIAL

9517A-4 (8237-4) 10.50

DYNAMIC RAM

5280N-5 (2107B-4 • TMS4060)	
4KX1	8/3.95
4027-4KX1-250 n.s.	1.00
4116-16KX1-250 n.s.	8/9.00
4116-16KX1-200 n.s.	8/11.50
4164- +5v 64K 200 n.s.	8/48.00

8000

Z8002	29.95	8085A	5.95
8035	4.50	8086-2	30.00
8039	5.00	8087-3	175.00
8080A	2.00	8088	20.00

8200

8202A	15.95	8253	4.95
8212	1.25	8253-5	5.95
8214	2.00	8255-5	5.50
8216	1.50	8257	6.00
8224	1.50	8259A	4.95
8228	3.00	8275	19.95
8237-4	10.50	8279-5	7.95
8250B	9.95	8287	5.75
8251	3.95	8288	24.95

DIP SWITCH

DT08 BY ALCO

8 POSITION DIP SWITCH

Super low profile -

Made for automatic insertion -
SPECIAL — .90 10/7.50

DT-10 1.00 10/8.50

Z80

Z80 2.5 MHZ CPU	3.50
Z80CTC	3.75
Z80DMA-DMA	9.95
Z80PIO	3.95
Z80SIO/O	16.95
Z80A-4MHZ CPU	4.95
Z80A DART	9.95
Z80A-PIO	5.95
Z80A SIO/O	19.95
Z80B 6 MHZ CPU	14.95

UART

1602 (COM 2017)	2.95
1863	3.95
IM6402-+5v High speed	
UART-AY5-1013 pin out	2.95
INS 8250B	9.95

2114 SPECIAL!

COMPUTER
MANUFACTURERS
EXCESS INVENTORY
SALE!

PRIME! 2114-300 n.s.
INCREDIBLE PRICE!
YOU SAVE!

8/\$9.00
GUARANTEED

SOCKETS

Low Profile SOLDER TAIL

6 Pin	14/1.00
8 Pin	13/1.00
14 Pin	10/1.00
16 Pin	8/1.00
18 Pin	8/1.00
20 Pin	7/1.00
24 Pin	6/1.00
28 Pin	6/1.00
40 Pin	5/1.00

BUY \$10

GET \$1.00

FREE CHOICE

F.D. CONTROLLERS

1771 Single Density	15.00
1791 Double Density	20.00
1793	22.00
1797	24.95
2793	35.95

CONTROLLER SET

THREE CHIP SET

1797, 2143-03, 1691 by W.D.

Compare at up to 86.85.

B.G. SPECIAL

All 3 for only \$29.95

CRYSTALS

32.768 Khz SPECIAL	.65
262.144	.75
300.000	1.00
307.200	1.25
1.5432 Mhz	.75
1.8432	2.49
2.000000	2.49
3.000	1.15
3.120	1.20
3.579545 - HC18	1.00
4.000	2.49
4.194304	1.50
4.433618	.75
4444.000	1.25
4.9152	2.49
4.916 Bd. Rate	1.25
5.000000	1.50
5.0688	3.75
5.616	1.59
8.000	1.99
9.90000	1.25
10.69425	3.75
10.8864	1.49
11.088	1.59
13.440	1.00
12.000	2.75
15.2	1.10
14.31818	2.49
16.00000	1.50
17.430	2.49
18.2259	1.00
20.000	3.75
21.87108	1.00
22.092	1.00
32.000	2.49
40.000	2.00
87.3333	1.00
91.000	1.00
104.8	1.00

TERMS: (Unless specified elsewhere) Add \$1.50 postage, we pay balance. Orders over \$50.00 add 85¢ for insurance. No C.O.D. Texas Res. add 6% Tax. 90 Day Money Back Guarantee on all items. All items subject to prior sale. Prices subject to change without notice. Foreign order - US funds only. We cannot ship to Mexico. Countries other than Canada, add \$3.50 shipping and handling.

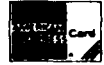

Big Computer Mfg. Makes \$900,000 Goof!!

COMPUTER/DISK DRIVE SWITCHING POWER SUPPLY

ORIGINALLY DESIGNED TO RUN A Z-80
BASED SINGLE BOARD COMPUTER
WITH TWO 5-1/4 IN. DISK DRIVES AND
CRT MONITOR.

ORIGINAL
OEM COST
\$72 EACH!

\$37⁵⁰ EA

3 FOR \$95⁰⁰

BRAND NEW: UNUSED!

ADD \$1.50 PER UNIT FOR UPS

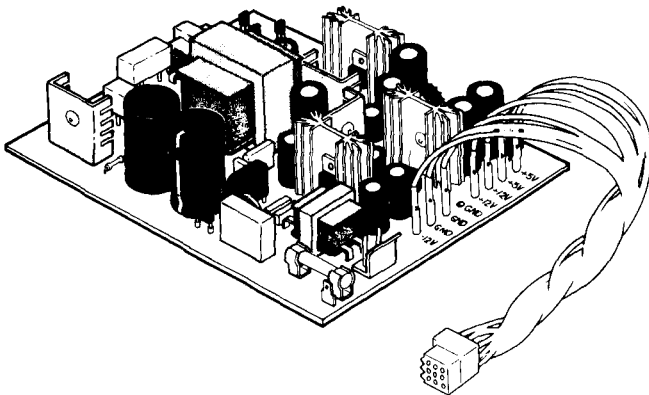

SPECS: + 5VDC 5 AMPS MAX
#1 + 12 VDC 2.8 AMPS MAX
#2 + 12 VDC 2.0 AMPS MAX
- 12 VDC .5 AMPS MAX

INPUT: 115 or 230 VAC 60Hz

SMALL SIZE: 6-1/8 x 7-3/8 In.
HIGH EFFICIENCY SWITCHER MFG.
BY CAL. DC IN USA!

The poor Purchasing Agent bought about 10 times as many of these DC switchers as his company would ever use! We were told that even in 10,000 piece lots they paid over \$72 each for these multi-output switchers. When this large computer manufacturer discontinued their Z-80 Computer, guess what the Big Boss found in the back warehouse; several truckloads of unused \$72.00 power supplies. Fortunately we heard about the deal and made the surplus buy of the decade. Even though we bought a huge quantity, please order early to avoid disappointment. Please do not confuse these high quality American made power supplies with the cheap import units sold by others.

✓ 116

TERMS: Orders over \$50 add 85¢ insurance. No COD. Tex. Res. Add 6% Sales Tax. Subject to prior sale. Foreign orders: US funds only. We cannot ship to Mexico. Foreign countries other than Canada add \$6 per board shipping.



Z80* SINGLE BOARD COMPUTER!

64K RAM — 80 x 24 VIDEO DISPLAY — FLOPPY DISK CONTROLLER
RUNS CP/M* 2.2!

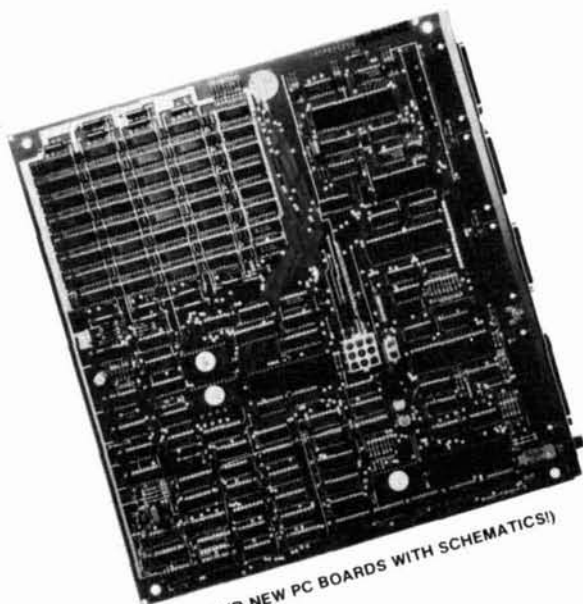

(BRAND NEW PC BOARDS WITH SCHEMATICS!)

\$29.95

(BLANK BOARD WITH
DATA AND ROM'S.)

NEW PRICE

**GROUP SPECIAL:
BUY 6 FOR \$165!**

**USES EASY
TO GET PARTS!**

**BOARD MEASURES
11½" x 12½"**

**ALL ORDERS WILL BE
PROCESSED ON A STRICT,
FIRST COME, FIRST SERVED
BASIS! ORDER EARLY!**

GIANT COMPUTER MANUFACTURER'S SURPLUS!

UNBELIEVABLE LOW PRICE!!!

Recently Xerox Corp. changed designs on their popular 820* computer. These prime, new, 820-1 PC boards were declared as surplus and sold. Their loss is your gain! These boards are 4 layers for lower noise, are solder masked, and have a silk screened component legend. They are absolutely some of the best quality PC boards we have seen, and all have passed final vendor QC. Please note, however, these surplus boards were sold by Xerox to us on an AS IS basis and they will not warranty nor support this part.

We provide complete schematics, ROM'S, and parts lists. If you are an *EXPERIENCED* computer hacker, this board is for you! Remember, these are prime, unused PC boards! But since we have no control over the quality of parts used to populate the blank board, we must sell these boards as is, without warranty. You will have to do any debugging, if necessary, yourself!

ADD \$2 PER PC BOARD FOR SHIPPING. (USA and Canada)

*CP/M TM OF DIGITAL RESEARCH INC. (CALIF.) 820 TM OF XEROX CORP. Z80 TM OF ZILOG

WE'VE GOT EM!

5-1/4" HALF SIZE DRIVES

- 40 Track per side
- Double-sided, double density
- Same as SA455
- Latest head & drive technology
- Fast access time

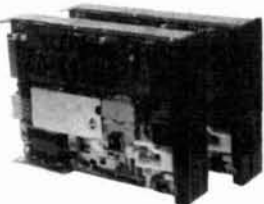

Two of These Half Size Drives will
Fit in the Same Space as 1 Full Size Drive!

\$179.00 per drive

Compare at up to \$349 ea.

ADD \$3.00 UPS PER DRIVE

TERMS: Orders over \$50 add 85¢ insurance. No COD. Tex. Res. Add 6% Sales Tax. Subject to prior sale. Foreign orders: US funds only. We cannot ship to Mexico. Foreign countries other than Canada add \$6 per board shipping.

NEW from BARKER & WILLIAMSON!

1.8 - 30 MHz. Continuous Coverage Antenna for Commercial and Amateur Service

Model AC 1.8 - 30

The AC 1.8 - 30 Antenna uses only 80 feet horizontally, and, when space is limited, can be shortened even further with only slight loss of radiation efficiency.

Patent Pending

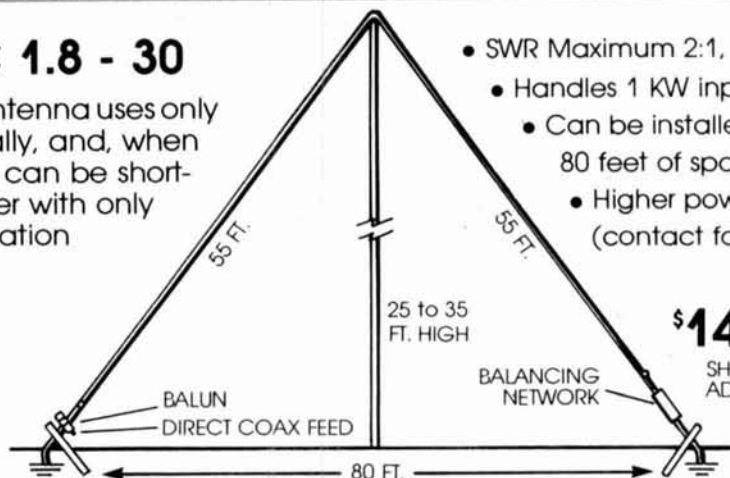

- SWR Maximum 2:1, 1.4:1 Average
- Handles 1 KW input ICAS
- Can be installed in approximately 80 feet of space
- Higher power models available (contact factory)

\$149.50

SHIPPING AND HANDLING ADD \$4.00



BARKER & WILLIAMSON

Quality Communication Products Since 1932
At your Distributors write or call, 10 Canal Street, Bristol PA 19007
(215) 788-5581

ALL OUR PRODUCTS MADE IN USA



HIGH PERFORMANCE PRESELECTOR-PREAMP

The solution to most interference, intermod, and desense problems in **AMATEUR** and **COMMERCIAL** systems.



- 40 to 1000 Mhz - tuned to your frequency
- 5 large helical resonators
- Low noise - High overload resistance
- 8 dB gain - ultimate rejection > 80 dB
- 10 to 15 volts DC operation
- Size - 1.6 x 2.6 x 4.75" exc. connectors
- **FANTASTIC REJECTION!**

Typical rejection:
± 600 KHz@144 Mhz: -28dB
± 1.6 Mhz@220 Mhz: -40dB
± 5 Mhz@450 Mhz: -50dB

Price - **\$89.95** bipolar w/RCA jacks
Connector options: BNC \$5, UHF \$6, N \$10
SUPER HOT! GaAs Fet option \$20

AUTOMATIC IDENTIFIERS

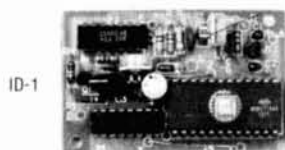

ID-1



ID-2

- For transceivers and repeaters - **AMATEUR** and **COMMERCIAL**
- Automatic operation - adjustable speed and amplitude
- Small size - easy installation - 7 to 15 volts DC
- 8 selectable, reprogrammable messages - each up to 2 min. long
- Wired, tested, and programmed with your message(s)
- Model ID-1 - \$49.95 Model ID-2 w/2 to 10 minute timer - \$69.95

We offer a complete line of transmitter and receiver strips and synthesizers for amateur and commercial use.

Request our free catalog. Allow \$2 for UPS shipping - Mastercard and VISA welcome

GLB ELECTRONICS

1952 Clinton St. Buffalo, NY 14206
716-824-7936, 9 to 4

STUMPED FOR A GIFT IDEA?

I.D. BADGES

No ham should be without an I.D. badge. It's just the thing for club meetings, conventions, and get-togethers, and you have a wide choice of colors. Have your name and call engraved in either standard or script type on one of these plastic laminated I.D. badges. Wear it with pride! Available in the following color combinations (badge/lettering): white/red, woodgrain/white, blue/white, white/black, yellow/blue, red/white, green/white, metallic gold/black, metallic silver/black.



UID Engraved I.D. Badge

\$2.50



HERE'S A GIFT IDEA!

How about an attractive **BASEBALL** style cap that has name and call on it. It's the perfect way to keep eyes shaded during Field Day, it gives a jaunty air when worn at Hamfests and it is a great help for friends who have never met to spot names and calls for easy recognition. Great for birthdays, anniversaries, special days, whatever occasion you want it to be. Hats come in the following colors: **GOLD, BLUE, RED, KELLY GREEN**. Please send call and name (maximum 6 letters per line).

UFBC-81

\$5.00

REGULAR PRICE HAT AND BADGE \$7.50 + SHIPPING

SPECIAL \$6.49
SAVE \$1.00

Please enclose \$1 to cover shipping and handling.

HAM RADIO'S BOOKSTORE
GREENVILLE, NH 03048
(603) 878-1441

✓ 139

the weekender

reflected power limiter



Most of the newer transistorized transceivers have circuits that limit output power if a high SWR or reflected power condition is encountered. But because many earlier rigs — and also linears — do not have such protection, the following unit was designed and built to automatically shut down equipment if a pre-set value of reflected power is exceeded. As some of us already know through sad experience, high reflected power, even if only for a few seconds, can be both damaging and costly.

operation

The idea is to sample a small amount of RF voltage from your SWR or reflected power meter, rectify it, and feed it through a sensitivity control to the base input of a Darlington transistor. At the proper triggering level, a relay in the collector circuit will close two of its contacts, locking itself in. At the same time another set of relay contacts will open the AC input power to your transceiver, shutting it off. The RF voltage selected by switch S2 is either REFLECTED or FORWARD, which makes it easy to initially set up the unit. A switch, S3, provides an override circuit which simplifies initial setup.

A Darlington transistor was chosen because it has a Beta (current gain) of more than 5000, which pro-

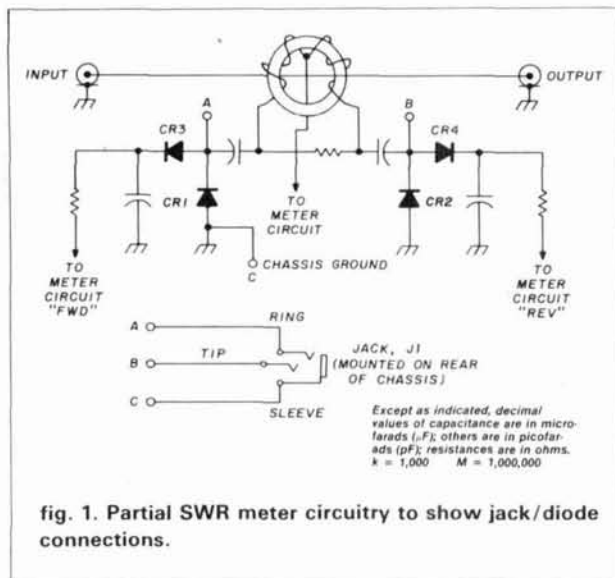

fig. 1. Partial SWR meter circuitry to show jack/diode connections.

vides more than sufficient sensitivity. The LED is useful in setting the bias control, and also indicates when the relay is locked in. During the breadboard development of the unit, some troublesome RF and 60 cycle pickup was encountered. This was readily cured by adding capacitors C1 and C2 as shown. They were incorporated into the final finished unit, as a precaution to eliminate such problems.

My own RF wattmeter is a SWAN WM-1500, and is generally representative of how SWR meters and wattmeters are constructed. The partial schematic is shown to indicate how the FORWARD and REFLECTED voltages are picked off and rectified by the added diodes CR1 and CR2. A stereo jack, J1, grounded to the meter chassis is a neat, easy way to transfer the voltages to the unit. Fig. 1 shows the schematic of the pick off voltages. At first glance it might seem that the DC voltage required for the unit could be picked off directly at the outputs of CR3 and CR4, thus eliminating the need for the added diodes CR1 and CR2. This worked well, except that under certain circumstances, a small amount of DC voltage from the unit would feed back into the wattmeter and cause the indicating meter of the wattmeter to read downscale by a few microamperes. The addition of the two diodes as shown eliminated that problem.

By William Vissers, K4KI, 1245 South Orlando Avenue, Cocoa Beach, Florida 32931

Without any RF voltage being fed into the unit, the bias control, if turned up sufficiently in the clockwise position, will turn on the transistor, locking in the relay. The bias control is a screwdriver adjustment on the rear of the unit. (It could also have been more conveniently mounted on the panel, using a conventional knob.) It is normally set somewhat below the turn-on point of the LED and relay lock in. The lower the bias control is set, the lower the standby current will be; I found that for normal operation, the standby current is less than a half a milliamper, which makes for long battery life. Switch S1 performs two functions, turning the power to the unit on, and when in the off position, isolating the unit from the wattmeter. Actually, the loading effect is so small as to be almost undetectable; the circuit was added more as a precaution than as a necessity.

The easiest way to set up the unit is to first determine the level of reflected power at which you want your transmitter to turn OFF. With the override switch, S3, on, and the bias properly set as just described, turn your sensitivity control counterclockwise. Set switch S2 in the FORWARD position. Then load up your transmitter until the forward power is the amount at which you want your reflected power level to trip the relay. Now turn the sensitivity control (clockwise) until the LED lights and the relay locks in. Throw S2 to the REFLECTED position, reset the relay by momentarily turning switch S1 OFF and then ON, and turn the override switch S3 OFF. The unit is now calibrated and ready to go. Now, if your reflected power in your system reaches the preselected level already set up, your LED will light up, your relay will lock in, and contacts DE of the relay will open, turning off your transmitter almost instantaneously and automatically protecting your equipment.

The required level of reflected power can be easily determined by knowing that if it is one tenth of the maximum forward power, then your SWR will be slightly below 2:1. Naturally, each operator may want to determine the maximum SWR at which the equipment will be shut off. When the unit is set up for its most sensitive condition, it actually will trip at about 3 to 4 watts of reflected power, which I have found is more sensitivity than you will normally need. Although the unit and the circuit shown in fig. 2 turn off my transceiver input power, the relay contacts could instead easily be used to reduce your drive, increase your bias, reduce your plate voltage, or any one of the many different ways to reduce power output. The unit shown was built for my Yaesu FT-101-B transceiver. Its relay contacts have a current capacity of 3 amperes. Some experimentation was also done using an NPN Darlington transistor TIP 120, (Radio Shack™ part number 276-2068), which has a power

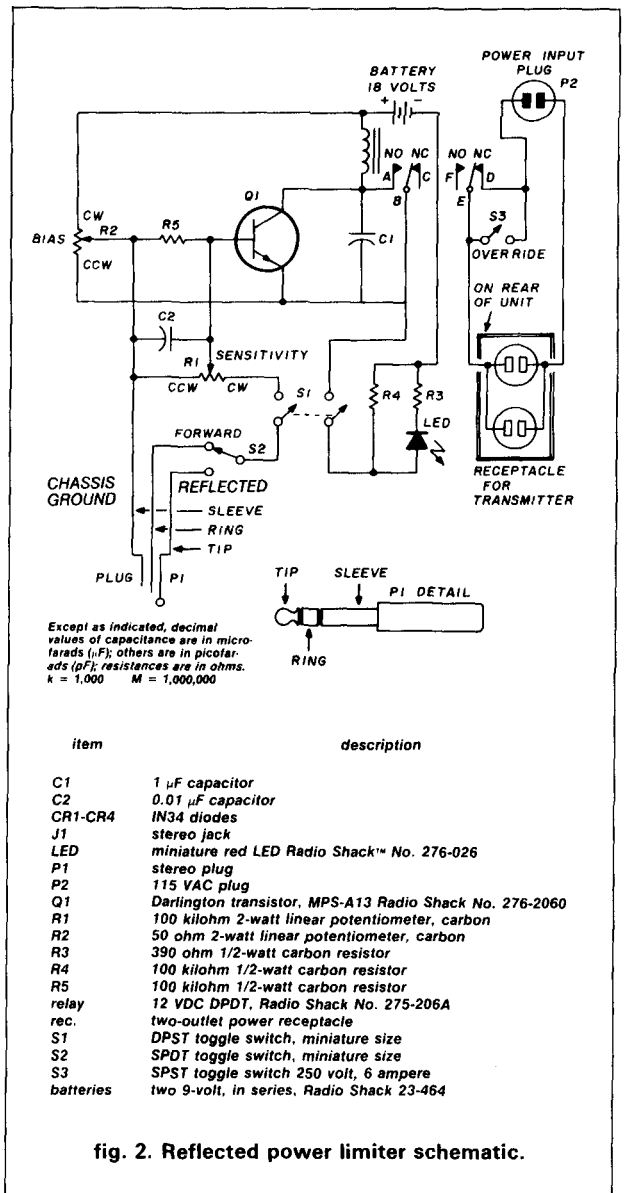

fig. 2. Reflected power limiter schematic.

dissipation of 65 watts, and would therefore be suitable for a high power linear control, in which a larger relay with heavier current contacts would be needed. It works in the circuit shown, but is slightly less sensitive. None of the parts listed were critical in any way; most of them came from my collection gathered over more than fifty years of hamming. The unit is housed in a metal box measuring 4 x 5 x 3 inches (10 x 12.7 x 7.6 cm). Any similar metal box will do.

I'd be interested in hearing from others who have built or experimented with a similar unit, and will be glad to answer any questions I can. Just include an SASE with your letter, addressed to me at the address provided.

ham radio

**If you thought you were
priced out of the satellite
television market,
Relax**

**We've got
your
System!**

World View Electronics has made owning a satellite television receiving system affordable with a choice of products manufactured by the most reputable names in the satellite TVRO industry.

Now you can choose the system that fits your needs and your pocketbook by ordering directly from World View Electronics.

For your convenience, we've packaged five systems together (Systems 1 through 5). Or if you wish, you can mix and match components to your own specifications.

Worried about installation? Relax. Installation is simple because each system we sell includes an installation guide that makes installing your system a breeze.

So call us today. With World View Electronics you don't have to give up quality for price.

**Nice Price & Good Advice
1-502-781-6715**

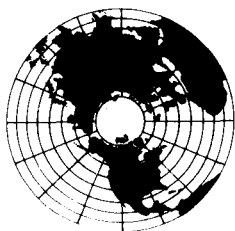

World View
Electronics

1527 US 31 West Bypass, Bowling Green, K.Y. 42101

With SMART PATCH You are in CONTROL

With CES 510SA Simplex Autopatch, there's no waiting for VOX circuits to drop. Simply key your transmitter to take control.

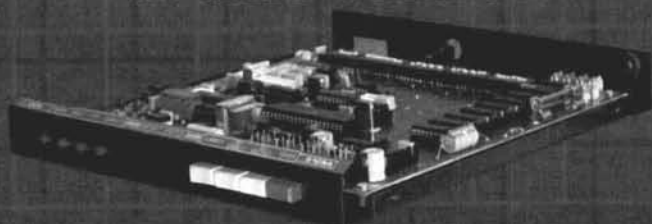

SMART PATCH is all you need to turn your base station into a personal autopatch. SMART PATCH uses the only operating system that gives the mobile complete control. Full break-in capability allows the mobile user to actually interrupt the telephone party. SMART PATCH does not interfere with the normal use of your base station. SMART PATCH works well with any FM transceiver and provides switch selectable tone or rotary dialing, toll restrict, programmable control codes, CW ID and much more.

**To Take CONTROL with Smart Patch
— Call 800-327-9956 Ext. 101 today.**



COMMUNICATIONS ELECTRONIC SPECIALTIES, INC.
P.O. Box 2930 • Winter Park, Florida 32790
Phone (305) 645-0474 • Order Only (800) 327-9956

✓ 124

Iron Powder and Ferrite TOROIDAL CORES

Shielding Beads, Shielded Coil Forms
Ferrite Rods, Pot Cores, Baluns, Etc.

Small Orders Welcome
Free 'Tech-Data' Flyer

AMIDON
Associates

Since 1963

12033 Otsego Street, North Hollywood, Calif. 91607

In Germany: Elektronikiaden, Wilhelm — Mellies Str 88, 4930 Detmold 18, West Germany
In Japan: Toyomura Electronics Company, Ltd., 7-9 2-Chome Sota-Kanda, Chiyoda-Ku, Tokyo, Japan



✓ 109

AUSTIN. When only the best will do!

Taking the leading role in custom antenna design comes easily to Austin. With over 25 years of engineering and consulting experience, how could we offer you less than the best?

And our high performance solutions go beyond our popular MULTIBAND antennas.

There's THE OMNI sidebander with horizontal and vertical polarization. Or the ALL BAND SCANNER with high gain that outperforms the competition. And THE STICK, a broad band design for operation from Amateur to Marine frequencies. Just a sampling of the choices available.

Whatever your antenna needs, the winner is Austin.

Call or write for product information.
Dealer inquiries invited.



**AUSTIN
CUSTOM
ANTENNA**

P.O. Box 357
Sandown, NH 03873
(603) 887-2926 ✓ 114

NEW FROM

NEMAL

your one stop coax supplier!

HARDLINE

Two styles, two sizes for all installation needs

- Aluminum Outer Conductor with Polyethylene Jacket

1/2 inch loss	48 dB/100 ft @ 30 MHz\$1 25/ft.
	3.68 dB/100 ft @ 1000 MHz	
7/8 inch loss	28 dB/100 ft @ 30 MHz\$3 25/ft.
	2.54 dB/100 ft @ 1000 MHz	
 - Corrugated Copper Outer Conductor with Polyethylene Jacket

1/2 inch loss	38 dB/100 ft @ 30 MHz\$1 59/ft.
(FLC12-50J)	2.78 dB/100 ft @ 1000 MHz	
7/8 inch loss	13 dB/100 ft @ 30 MHz\$3 92/ft.
(FLC12-78J)	1.3 dB/100 ft @ 1000 MHz	
- COMPARE RG 213 1.25 dB/100 @ 30 MHz
> 8.5 dB/100 @ 1000 MHz !

HARDLINE CONNECTORS

- | | | | |
|---------------------------|---------|------------|---------|
| 1/2 inch aluminum UHF M/F | \$19.00 | Type N M/F | \$22.00 |
| 7/8 inch aluminum UHF M/F | \$49.00 | Type N M/F | \$49.00 |
| 1/2 inch copper UHF M/F | \$22.00 | Type N M/F | \$22.00 |
| 7/8 inch copper UHF M/F | \$49.00 | Type N M/F | \$49.00 |

Call or write for Free Catalog

shipping
Cable — \$6.00 per 100 ft.
Connectors — \$3.00 per order.
Orders under \$20 add \$2 additional plus shipping.
COD add \$2.00. Florida Residents add 5%.

NEMAL ELECTRONICS

Dept. H, 12240 N.E. 14th Ave., N. Miami, FL 33161
Telephone: (305) 893-3924



✓ 168

Tell 'em you saw it in HAM RADIO!

SANTEC presents the smarter handhelds

FOR 144 VHF, 220 VHF & 440 UHF



SANTEC Handhelds just got a little smarter, with new computer-control software designed by U.S. Hams who are also professional programmers. Now SANTEC Handhelds, which were the first to offer you varactor diode tuning in a handheld, first to offer you thick-film technology, first to provide 3.5W as a selectable handheld option and first to give you the time of day on a handheld read-out, have made another user-friendly leap forward in the logical progression of computer-controlled handhelds.

Now three SANTEC Handhelds can lock out selected memory channels from the memory scan, allowing you to check your favorite frequencies much faster, without interruption from less commonly used ones or from unprogrammed memory channels. SANTEC Handheld's new operating programs now allow you to store variable offset values in all 10 user-written memory channels; and, as always with SANTEC Handhelds, your stored offset automatically comes back when you select a channel through the memory mode, and the plus or minus indication shows on the LCD display.

Other new features are the provision in Memory 9 for split memory offset operation, for those really unusual offset situations, and the capacity for hardware storage of a special PL tone for each memory channel (requires an optional encoder, available December, 1983). The new SANTEC Handhelds will also accept the keyboard input of all frequencies as either short, fast 4-digit numbers or the familiar 6-digit versions: your SANTEC Handheld is smart enough to know what you want, either way.

The handhelds with the most now have more for you. Don't you dare settle for anything less: get your hands on a SANTEC Handheld today!

Shown above is just one of the three new smarter handhelds from SANTEC: the **ST-142** VHF, the **ST-442** UHF and the **ST-222** VHF. Owners of earlier SANTEC models **ST-144**, **ST-440** and **ST-220**, please write for information on how your SANTEC Handhelds can be upgraded to the new state of the art in handheld transceivers.



©1983, Encomm, Inc.
2000 Avenue G, Suite 800, Plano, Texas 75074
Phone (214) 423-0024 • TLX 79-4783 ENCOMM DAL

Repairs, Parts & Services Available... 

✓ 132 Export orders invited.

All stated specifications are subject to change without notice or obligation.



The Smarter Handhelds, clockwise from upper left: **ST-142** VHF Transceiver; **ST-442** UHF Transceiver; **ST-222** VHF Transceiver, operating from the **ST-4QC** Quick-Charge Battery Charger & Power Supply; **ST-LC** Leather Case and Strap; **ST-MC** Mobile Charger; **MS-50S** Remote Speaker; **ST-500B3** Rechargeable 500 mAh NiCd Battery Pack; **ST-EC** External Charge Adapter; **SM-3** Speaker Mic; **ST-HA-1/HBM-1** Head Set Boom Mic & Adapter.

ANTENNA/TOWER SALE!

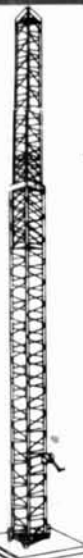

hy-gain CRANKUP SALE!

All Models Shipped Factory Direct— Freight Paid*!

- Check these features:
- All steel construction
 - Hot dip galvanized after fabrication
 - Complete with base and rotor plate
 - Totally self-supporting—no guys needed

Model	Height	Load	Sale Price
HG375S	37 ft.	9 sq. ft.	\$ 967
HG525S	52 ft.	9 sq. ft.	\$ 959
HG54HD	54 ft.	16 sq. ft.	\$1499
HG70HD	70 ft.	16 sq. ft.	\$2399

Masts—Thrust Bearings— Other Accessories Available
—Call! Prices Shown Are Your Total Delivered Price In Continental U.S.A.!

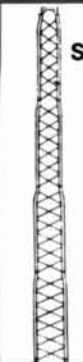

ROHN Self Supporting Towers On SALE!

FREIGHT PREPAID

- All Steel Construction—Rugged
- Galvanized Finish—Long Life
- Totally Free Standing—No Guy Wires
- America's Best Tower Buy—Compare Save \$
- Complete With Base and Rotor Plate
- In Stock Now—Fast Delivery

Model	Height	Ant. Load*	Weight	Delivered Price*
HBX40	40 ft	10 sq ft	164	\$319
HBX48	48 ft	10 sq ft	303	\$399
HBX56	56 ft	10 sq ft	385	\$489
HDBX40	40 ft	18 sq ft	281	\$379
HDBX48	48 ft	18 sq ft	363	\$469

*Your Total Delivered Price Anywhere in Continental 48 States. Antenna Load Based on 70 MPH Wind.



Tri-Ex®

These rugged crankup towers now available from Texas Towers! All models available On Sale for tremendous savings to you!

To save on freight costs, all towers are shipped directly from the Tri-Ex factory to you!

- Check these features:
- All steel construction
 - Hot dip galvanized after fabrication
 - Complete with base and rotor plate
 - Totally self-supporting—no guys needed

Model	Height Up	Down	Wind Load	List	Sale
W36	36.0 ft	20.5 ft	9.0 sq ft	\$694	\$579
WT51	51.0 ft	20.5 ft	9.0 sq ft	\$1154	\$999
LM354	54.0 ft	21.0 ft	16 sq ft	\$2010	\$1599
LM470D	70.0 ft	22.0 ft	16 sq ft	\$4195	\$2999
(Motorized) DX85	86.0 ft	23.0 ft	25 sq ft	\$7200	Call
(Motorized)					



BUTTERNUT ELECTRONICS CO.

- Designed to operate on all Amateur Bands at "FULL" Legal Power Input.
- Automatic Band Switching (80/10 meters).
- Automatic Band Switching (160/10 meters) with optional model TBR-160 HD.
- IN STOCK for IMMEDIATE DELIVERY & LOOK at very SPECIAL PRICES . . .
- New Model HF6V \$129.00
- New Model TBR-160HD (High Power 160 meter Base Resonator) \$49.00.
- Model RMK-11 (roof mount kit with multiband radial kit) \$39.00.
- Model STR-2 (Stub Tuned Radial Kit) \$29.00.

Delivery Anywhere In The Continental USA At No Additional Cost. (Free Shipping On Butternut Accessories Also When Purchased With Antenna.)

RG-213U \$.29/ft \$279/1000 ft Up to 600 ft via UPS

- RG-213/U—95% Bare Copper Shield
- Mil-Spec Non-contaminating Jacket for longer life than RG8 cables.
- Our RG-213/U uses virgin materials.
- Guaranteed Highest Quality!

RG-8X \$.19/ft \$179/1000 ft

- RG8X—95% Bare Copper Shield • Low Loss
- Non-contaminating Vinyl Jacket • Foam Dielectric

Coaxial Cable Loss Characteristics (DB/100 ft)

Cable Type/Imped	10MHz	30MHz	150MHz	450MHz
RG-213/U 50	.6	.9	2.3	5.2
RG8X 52	.8	1.2	3.5	6.8
RG-58/U 52	1.4	1.9	6.0	12.5
1/2" Alum 50	.3	.5	1.2	2.2
1/2" Heliax 50	.2	.4	.9	1.6
1/4" Heliax 50	.1	.2	.5	.9

HARDLINE/HELIAX™ Lowest Loss for VHF/UHF!

- 1/2" Alum. w/poly Jacket . . . \$.79/ft
 - 1/2" LDF4-50 Andrew Heliax™ . . . \$1.69/ft
 - 1/4" LDF5-50 Andrew Heliax™ . . . \$3.99/ft
- select connectors below.

HARDLINE & HELIAX™ CONNECTORS

Cable Type	UHF FML	UHF MALE	N FML	N MALE
1/2" Alum	\$19	\$19	\$19	\$25
1/2" Heliax™	\$22	\$22	\$22	\$25
1/4" Heliax™	\$49	\$49	\$49	\$49

AMPHENOL CONNECTORS

Silver PL259	\$1.25	UG230 N Female	\$2.95
UG218 N Male	\$2.95		

ANTENNA WIRE & ACCESSORIES

- 12 Ga Copperweld \$12/ft 14 Ga Copperweld \$10/ft
- 14 Ga Stranded \$10/ft 18 Ga Copperweld 1/4 mi \$30
- 450 Ohm H.D. Line \$16/ft H.D. End Insulators \$2/ea
- Van Gorden 1:1 Balun \$11
- Van Gorden Center Insulator \$6

HUSTLER

- 6BTV 80-10 mtr Vert \$129
- 4BTV 40-10 mtr Vert \$89 5BTV 80-10 mtr Vert \$109
- G6-144B 2-mtr Base \$89 G7-144 2-mtr Base \$119

Mobile Resonators

Mobile Resonators	10m	15m	20m	40m	75m
400W Standard	\$12	\$12	\$15	\$18	\$22
2KW Super	\$18	\$20	\$22	\$26	\$36

Bumper Mounts - Springs - Folding Masts in Stock!

CUSHCRAFT MULTI-BAND HF ANTENNAS

- A3 3-el Tribander \$219 A4 4-el Tribander \$285
- R3 20/15/10mtr Vert \$279 A743/A744 40mtr Kit \$75

HF MONO-BAND ANTENNAS

10-3CD	\$ 95	10-4CD	\$109
15-3CD	\$119	15-4CD	\$129
20-3CD	\$199	20-4CD	\$279
40-2CD	\$289	D40	\$149

VHF/UHF BEAMS

A50-5	\$ 79	617B	\$199
214B	\$ 79	3219	\$ 95
220B	\$ 95	424B	\$ 79

OSCAR/TWIST ANTENNAS

A144-10T	\$ 52	A144-20T	\$ 75
A147-20T	\$ 63	416TB	\$ 59
A14TB	\$ 29	PS4	\$ 69

VHF/UHF FM ANTENNAS

A147-4	\$ 29	A147-11	\$ 49
214FB	\$ 79	228FB	\$219
A449-6	\$ 29	ARX2B	\$ 39

HY-GAIN Explorer-14, In Stock—\$289

- OK710 30/40 mtr. Add-On-Kit \$79.00
- V2S 2-mtr Base Vertical \$39
- TH5MK2S Broad Band 5-el Triband Beam \$389
- TH7DXS 7-el Triband Beam \$439
- TH3JRS 3-el Triband Beam \$179
- TH2MK3S 2-el Triband Beam \$159
- HY-QUAD 2-el Triband Quad \$299
- 402BAS 2-el 40-mtr Beam \$219
- 205BAS 5-el 20-mtr Beam \$329
- 155BAS 5-el 15-mtr Beam \$189
- 105BAS 5-el 10-mtr Beam \$129
- 204BAS 4-el 20-mtr Beam \$249
- 203BAS 3-el 20-mtr Beam \$149
- 153BAS 3-el 15-mtr Beam \$89
- 103BAS 3-el 10-mtr Beam \$69
- DB105BAS 3-el 10/15 mtr Beam \$179
- 648S 4-el 6-mtr Beam \$59
- 668S 6-el 6-mtr Beam \$119
- 18HTS 80-10 mtr Hy-Tower Vertical \$429
- LC-160 160-mtr Coil Kit for 18HTS \$39
- 214 114-el 2-mtr Beam \$39
- 28DQ 80/40 mtr Trap Dipole \$59
- 58DQ 80-10 mtr Trap Dipole \$119
- BN86 80-10 mtr KW Balun W/Coax Seal \$19

MOSLEY

- CL-333-el Triband Beam \$279
- TA-333-el Triband Beam \$249
- TA-33JR 3-el Triband Beam \$189
- TA40KR 40mtr KR for TA33 \$119



MINI-PRODUCTS HQ-1 LIST \$182.50 SALE \$159

- Wing Span - 11 ft • Wind Area - 1.5 sq ft
- Boom - 54 in. long • 1200W P.E.P. Input

ALPHA DELTA COMMUNICATIONS

- Transi-Trap™ Surge Protectors—In Stock Now!
- Model LT 200W UHF Type . . . \$19
- Model HT 2KW UHF Type . . . \$29
- Model LT/N 200W N Type . . . \$39
- Model HT/N 2KW N Type . . . \$44
- Model R-T 200W Deluxe . . . \$29
- Model HV 2KW Deluxe . . . \$32



KLM

- KT34A 4-el Broad Band Triband Beam \$339
- KT34XA 6-el Broad Band Triband Beam \$489
- 80m-1 80-mtr Rotatable Dipole \$469
- 40m-1 40-mtr Rotatable Dipole \$179
- 40m-2 2-el 40-mtr Beam \$309
- 40m-3 3-el 40-mtr Beam \$439
- 40m-4 4-el 40-mtr Beam \$649
- 20m-6 6-el 20-mtr Beam \$689
- 15m-6 6-el 15-mtr Beam \$439
- 10m-6 6-el 10-mtr Beam \$259
- 10-30-7LPA Log Periodic Beam \$639
- 2m-13LBA 13-el 2-mtr Beam \$79
- 2m-14C 14-el 2-mtr Satellite Antenna \$89
- 435-18C 435 MHz Satellite Antenna \$65
- 432-16L B 16-el 432 MHz Beam \$69

ROTORS & CABLES

- Alliance HD73 (10.7 sq ft rating) . . . \$109
- Alliance U100 (for small beams & elevation) \$49
- Telex HAM 4 (15 sq ft rating) . . . \$199
- Telex Tailtwister (20 sq ft rating) . . . \$249
- Telex HDR300 Heavy Duty (25 sq ft rating) \$479
- Kenpro KR-500 Heavy duty elevation rotor \$189.00
- Standard 8 cond cable \$19/ft (vinyl jacket 2-#18 & 6-#22 ga)
- Heavy Duty 8 Cond cable \$36/ft (vinyl jacket 2-#18 & 6-#18 ga)

SOUTH RIVER ROOF TRIPODS

- HDT-3 3 ft Tripod . . . \$19
 - HDT-5 5 ft Tripod . . . \$29
 - HDT-10 10 ft Tripod . . . \$49
 - HDT-15 15 ft Tripod . . . \$69
- Heavy Duty Tripods include mtg hdw—UPS Shippable

ROHN GUYED TOWERS

- 10 ft Stack Sections
- 20G \$37.50 25G \$46.50
- 45G \$107.50 55G \$127.50

All 20G, 25G, 45G and 55G Accessories In Stock at Discount Prices - CALL!

Foldover Towers	Model	Height	Ant Load*	Price
	FK2548	48 ft	15.4 sq ft	\$ 829
	FK2558	58 ft	13.3 sq ft	\$ 899
	FK2568	68 ft	11.7 sq ft	\$ 959
	FK4544	44 ft	34.8 sq ft	\$1159
	FK4554	54 ft	29.1 sq ft	\$1259
	FK4564	64 ft	28.4 sq ft	\$1359

25G Foldover Double Guy Kit . . . \$199
45G Foldover Double Guy Kit . . . \$229

*Above antenna loads for 70 MPH winds and Guys at Hinge & Apex.

TOWER/GUY HARDWARE

- 3/16" EHS Guywire (3990 lb rating) . . . \$13/ft
- 1/4" EHS Guywire (6000 lb rating) . . . \$16/ft
- 5/32" 7 x 7 Aircraft Cable (2700 lb rating) \$12/ft
- 3/16" CCM Cable Clamp (3/16" or 5/32" Cable) \$35
- 1/4" CCM Cable Clamp (1/4" Cable) \$45
- 1/4" TH Thimble (fits all sizes) \$30
- 3/8" EJ (3/8" Eye & Jaw Turnbuckle) \$5.95
- 3/8" EJ (3/8" Eye & Jaw Turnbuckle) \$6.95
- 1/2" EE (1/2" Eye & Jaw Turnbuckle) \$8.95
- 1/2" EJ (1/2" Eye & Jaw Turnbuckle) \$9.95
- 3/16" Preformed Guy Grip \$1.99
- 1/4" Preformed Guy Grip \$2.49
- 6" Diam - 4 ft Long Earth Screw Anchor \$12.95
- 500D Guy Insulator (5/32" or 3/16" Cable) \$1.39
- 502 Guy Insulator (1/4" Cable) \$2.49
- 5/8" Diam - 8 ft Copper Clad Ground Rod \$12.95

PHILLYSTRAN GUY CABLE

- HPTG2100 Guy Cable (2100 lb rating) . . . \$29/ft
- HPTG4000 Guy Cable (4000 lb rating) . . . \$43/ft
- HPTG6700 Guy Cable (6700 lb rating) . . . \$69/ft
- 9901LD Cable End (for 2100/4000 cable) . . . \$6.95
- 9902LD Cable End (for 6700 cable) . . . \$7.95
- Socketfast Potting Compound (does 6-8 ends) \$12.95

GALVANIZED STEEL MASTS

Heavy Duty Steel Masts 2 in OD - Galvanized Finish

Length	5 FT	10 FT	15 FT	20 FT
.12 in Wall	\$25	\$39	\$59	\$79
.18 in Wall	\$39	\$69	\$99	\$109
.25 in Wall	\$69	\$129	\$189	\$249

TEXAS TOWERS

Div. of Texas RF Distributors Inc.
1108 Summit Ave., Suite 4 • Plano, Texas 75074

Telephone
(214) 422-7306

Store Hours: Mon-Fri: 9am - 5pm
Sat: 9am - 1pm



COMMUNICATIONS EQUIPMENT SALE!

ICOM



ICOM IC-751A LIST PRICE \$1399
CALL FOR SPECIAL SALE PRICE!



ICOM IC-745 LIST PRICE \$999
CALL FOR SPECIAL SALE PRICE!

**IC-02AT
NEW 2 METER
TOP OF THE LINE HT**
 • Digital LCD Readout
 • Scanning
 • Programmable PL Tones
 • Optional 5W Battery
 • S-meter Function
 • 10 Memories
 • Offset Storage
 • Lithium Memory Backup
 • 13.8VDC Operation!
 • Sealed Case
**SUGGESTED LIST PRICE \$349
CALL FOR SALE PRICES!**



KENWOOD



TS-930S LIST PRICE \$1799
CALL FOR SPECIAL SALE PRICE!



TS-430S LIST PRICE \$899.95
CALL FOR SPECIAL SALE PRICE!



**TR-2500 2.5W/300 mW
(Switchable) 2 Meter
Handheld Transceiver
Small Size— Small Price—
Big Performance!**
 • LCD Readout
 • Ten Memories
 • w/Lithium Backup
 • Band and Memory Scan
 • Built-In Sub-tone Encoder
 • Built-In 16 Key
 • Autopatch Encoder
 • Slide Lock Battery Pack
**TR-2500 List Price \$329.95
CALL FOR SPECIAL SALE PRICES**



FT-757GX LIST PRICE \$829
CALL FOR SPECIAL SALE PRICE!



FT-726R LIST PRICE \$829
CALL FOR SPECIAL SALE PRICE!

**FT-208R 2M HT
List \$319**
**FT-708R 440 MHz HT
List \$319**
 • LCD Display
 • 10 Memories



**CALL FOR
SPECIAL PRICES!**

SANTAC

**NEW ST142µP
2M HT**

- 3.5W/1W/0.1W
- 142-149.995 MHz
- LCD Display
- Programmable PL Option

**List 339.95
SALE \$299.95!**

ST144µP \$259.95
ST222µP CALL!
ST442µP CALL!

SANTAC Accessories

- SM3 Speaker Mic. \$34.95
- ST-LC Leather Case. \$34.95
- ST-50 NiCad Battery. . \$29.95
- ST-4QC Base Charger. . \$69.95



FACTORY AUTHORIZED DEALER FOR ALL MAJOR AMATEUR LINES

ETD ALPHA SALE!



76PA \$1899!

Model	List	Sale*
76A	\$1985	CALL
76PA	\$2395	CALL
76CA	\$2695	CALL
374A	\$2595	CALL
78	\$3495	CALL

*Sale Prices Too Low To Print—
CALL & SAVE \$\$!

**TEN-TEC
SALE!**



**CORSAIR List \$1169
Deluxe AC Supply List \$199
Both Items—Yours for \$1169!
All Ten-Tec Accessories in Stock
for Fast Shipment!**



**TEN-TEC
New 2M HT
Full Featured!
List \$319
Sale \$279.95!**

4229 2KW Tuner Kit \$189.95!

**HAL SALE!
NEW RTTY/CW COMPUTER
INTERFACES**



CRI-100 List \$249 SALE \$229.95!
CRI-200 List \$299 SALE \$269.95!

**CWR6850
RTTY/CW
TERMINAL**



List \$999 SALE \$749.95!

Other HAL Products On Sale
 CWR6700 \$439.95 DS3100ASR \$1699.95
 CWR6750 \$629.95 MP13100 \$2199.95
 CT2100/KB2100 \$749.95 RS2100 \$289.95
 CT2200/KB2100 \$949.95 ST5000 \$219.95
 DSK3100 \$1049.95 ST6000 \$649.95
 ARQ1000 \$649.95 KG-12 \$169.95

**TOKYO
HY-POWER LABS**



**HL-30V Reg. \$69.95
SALE \$59.95**

HL-82V \$139.95 HL-90U \$329.95
HL-160V \$289.95 HC-200 \$89.95
HL-20U \$99.95 HC-2000 \$289.95

**KDK FM2033
List \$339.95 Sale \$299.95**



Kantronics

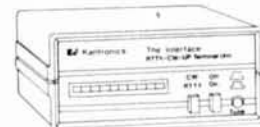

**The Interface Reg. \$169.95 Sale \$129.95
The Interface II Reg. \$269.95 Sale \$239.95**

Apple Amtor
 Soft/Hamtext...\$139 VIC-20 Hamsoft49
 VIC-20 Amtor Soft...89 Hamtext VIC-2099
 Model 64 Hamtext Model-64...99
 Amtor Soft89 Atari Hamsoft49
 Apple Hamsoft29 TRS-80C Hamsoft...59

**MIRAGE AMPLIFIER
SALE!**



**B1016
\$249**

Model	Band	Pre-amp	Input	Output	DC Pwr	Sale Price
A1015	6M	Yes	10W	150W	20A	\$249
B23	2M	No	2W	30W	5A	\$ 79
B215	2M	Yes	2W	150W	22A	\$259
B108	2M	Yes	10W	80W	10A	\$159
B1016	2M	Yes	10W	160W	20A	\$249
B3016	2M	Yes	30W	160W	17A	\$199
C22	220	No	2W	20W	5A	\$ 79
C106	220	Yes	10W	60W	10A	\$179
C1012	220	Yes	10W	120W	20A	\$259
D24	440	No	2W	40W	8A	\$179
D1010N	440	No	10W	100W	20A	\$289

RC-1 Remote Control for Mirage Amplifiers \$24
MP-1 and MP-2 Peak-Reading Wattmeter \$99

ASTRON POWER SUPPLIES
Heavy Duty · High Quality · Rugged · Reliable

- Input Voltage: 105-125 VAC Output: 13.8 VDC ± .05V
- Fully Electronically Regulated—5mV Maximum Ripple
- Current Limiting & Crowbar Protection Circuits
- M-Series With Meter—A-Series Without Meter

Model	Cont. Amps	ICS Amps	Price
RS4A	3	4	\$ 39
RS7A	5	7	49
RS12A	9	12	69
RS20A	16	20	89
RS20M	16	20	109
RS35A	25	35	135
RS35M	25	35	149
RS50A	37	50	199
RS50M	37	50	229



MODEL RS-50A



**CP-1 COMPUTER PATCH
List \$239.95 SALE \$189.95!**
 CP1-20\$219 CP1-64\$219
 MP-20\$129 MP-64\$129
 VIC-20 MBA Text \$79 C-64 MBA Text...\$79

**All AEA Keyers, Antennas & Accessories
In Stock!**



MFJ 1224 COMPUTER INTERFACE \$89.95

202B Noise Bridge\$59.95
250 2KW Oil Load\$35.95
422 Keyer/Paddle\$89.95
901 300W Tuner\$59.95
941C 300 W Tuner\$89.95
989 Deluxe 2KW\$299.95



**METRON
MA1000B
AMPLIFIER**
 Solid State
1KW Amplifier
 • No Tuning • 13.8 VDC Operation
 • Remote Bandswitching • Compact
 • Heavy-Duty Construction
List Price \$995 SALE PRICE \$895.95



TEXAS TOWERS

Div. of Texas RF Distributors Inc. 1108 Summit Ave., Suite 4 • Plano, Texas 75074

Monday-Friday 9 AM - 5 PM Saturday 9 AM - 1 PM

**Telephone
(214) 422-7306**

ANTENNA SALE

HY-GAIN

TH3RJS	\$169
TH5MK2S	\$355
TH7BX3S	\$410
EXPLORER 14	\$269
14AVQB	\$59
18AVT/WBS	\$95
V2S	\$37
V3	\$40
V4	\$49
66BS	\$109
CD45 II	\$125
HAM IV	\$199
T2X	\$245
ALLIANCE HD73	\$99

HY-GAIN TOWERS

HG37SS	\$629
HG5OMT2	\$739
HG52SS	\$899
HG54HD	\$1449
HG70HD	\$2269

KLM

KT34A	\$329
KT34XA	\$479
40M-2	\$290
2M-13LBA	\$77
2M-14C	\$85
435-18C	\$59
432-16LB	\$65

CUSHCRAFT

A-3	\$209
A-4	\$279
40-2CD	\$279
R-3	\$265
AV5	\$98
32-19	\$91
214B-FB	\$77
ARX-2B	\$37
A144-11	\$46

LARSEN CALL **NEW**

HUSTLER CALL

BEARCAT SPECIAL SALE

BC 350	\$375.00
BC 300	\$339.00
BC 20/20	\$279.00
BC 210XL	\$219.00
BC 200	\$169.00
BC 180	\$159.00
BC 260	\$249.00
BC 100	\$279.00
BC WA	\$34.95
*CP2100	\$279.00
ALL SOFTWARE	\$39.95

BUTTERNUT

HF6V \$109

AEA

CALL

Call "TOLL FREE" For All Antennas & Accessories



2900 N.W. VIVION RD. / KANSAS CITY, MISSOURI 64150 / 816-741-8118

ADM-10'

When cost is a factor, don't sacrifice performance.

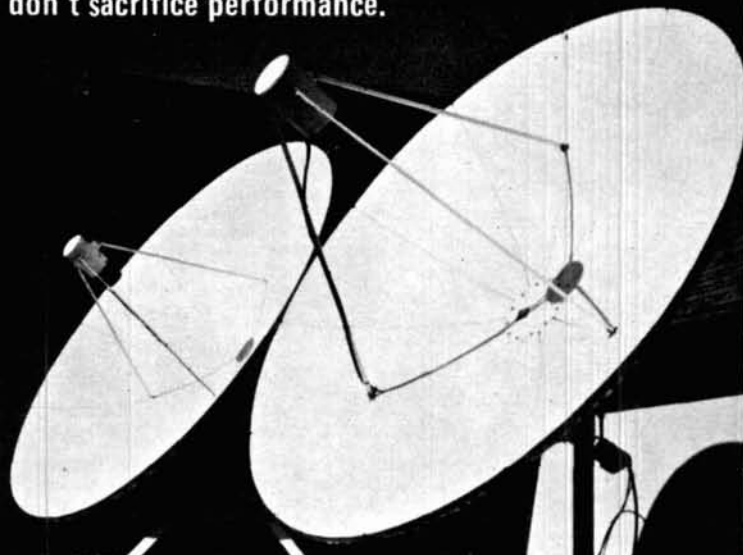

The ADM-10' satellite antenna system gives you the most for your investment. At the cost of an 8' dish, the ADM-10' provides performance margins to account for loss of signal due to satellite aging. Constructed of rugged steel or aluminum with fully adjustable polar mount. ADM-10'—the competitive edge in the private TVRO market.

For the competitive edge, call—

ANTENNA DEVELOPMENT & MANUFACTURING, INC.

P.O. BOX 1178 • POPLAR BLUFF, MO 63901 • (314) 785-5988

R.F. DESIGNERS

COME TO WORK WITH US NOT FOR US!

We have an immediate need for an **ENGINEER** with a minimum of 2 years of hands-on experience in RF communications design and implementation in the 30-500 MHz range. You should be able to take total responsibility for RF circuit design and make significant contribution to our design effort.

We also have an immediate opening for an **RF TECHNICIAN** with similar background.

ChipCom Corporation is an early stage company specializing in state-of-the-art data communication equipment. We offer a challenging environment, professional growth potential and an attractive compensation package including an equity position.

Please send your resume, in confidence, to Joseph L. Linde, Vice President of Engineering.



TECHNOLOGY FOR COMMUNICATIONS

CHIPCOM CORPORATION

19 BROOK ROAD

NEEDHAM, MA 02194

JPC/AZDEN®

4000 SERIES

FM TRANSCEIVERS

10 METERS & DOWN

COMMERCIAL-GRADE
QUALITY AT AMATEUR PRICES

EXCLUSIVE 1 YEAR LIMITED WARRANTY! COMPARE!



THE 4000 SERIES



PCS-4300 70-cm FM Transceiver



PCS-4500 6-m FM Transceiver



PCS-4800 10-m FM Transceiver

SALE

**PLEASE CALL FOR
SPECIAL PRICE**

PCS-300
2m Handheld
FM Transceiver
142-149.995 MHz

✓ 107

- **WIDE FREQUENCY COVERAGE:** PCS-4000 covers 142.000-149.995 MHz in selectable steps of 5 or 10 kHz. PCS-4200 covers 220.000-224.995 MHz in selectable steps of 5 or 20 kHz. PCS-4300 covers 440.000-449.995 MHz in selectable steps of 5 or 25 kHz. PCS-4500 covers 50.000-53.995 MHz in selectable steps of 5 or 10 kHz. PCS-4800 covers 28.000-29.990 MHz in selectable steps of 10 or 20 kHz.
- **CAP/MARS BUILT IN:** PCS-4000 includes coverage of CAP and MARS frequencies.
- **TINY SIZE:** Only 2"H x 5.5"W x 6.8"D. COMPARE!
- **MICROCOMPUTER CONTROL:** At the forefront of technology!
- **UP TO 8 NONSTANDARD SPLITS:** Ultimate versatility. COMPARE!
- **16-CHANNEL MEMORY IN TWO 8-CHANNEL BANKS:** Retains frequency and standard simplex or plus/minus offsets. Standard offsets are 600 kHz for PCS-4000, 1.6 MHz for PCS-4200, 5 MHz for PCS-4300, 1 MHz for PCS-4500, and 100 kHz for PCS-4800.
- **DUAL MEMORY SCAN:** Scan memory banks either separately or together. COMPARE!
- **TWO RANGES OF PROGRAMMABLE BAND SCANNING:** Limits are quickly reset. Scan the two segments either separately or together. COMPARE!
- **FREE AND VACANT SCAN MODES:** Free scanning stops 5 seconds on a busy channel; auto-resume can be overridden if desired. Vacant scanning stops on unoccupied frequencies.
- **DISCRIMINATOR SCAN CENTERING (AZDEN EXCLUSIVE PATENT):** Always stops on frequency.
- **TWO PRIORITY MEMORIES:** Either may be instantly recalled at any time. COMPARE!
- **NICAD MEMORY BACKUP:** Never lose the programmed channels!
- **FREQUENCY REVERSE:** The touch of a single button inverts the transmit and receive frequencies,

no matter what the offset.

- **ILLUMINATED KEYBOARD WITH ACQUISITION TONE:** Unparalleled ease of operation.
- **BRIGHT GREEN LED FREQUENCY DISPLAY:** Easily visible, even in direct sunlight.
- **DIGITAL S/R/F METER:** Shows incoming signal strength and relative power output.
- **BUSY-CHANNEL AND TRANSMIT INDICATORS:** Bright LEDs show when a channel is busy and when you are transmitting.
- **FULL 16-KEY TOUCHTONE® PAD:** Keyboard functions as autopatch when transmitting (except in PCS-4800).
- **PL TONE:** Optional PL tone unit allows access to private-line repeaters. Deviation and tone frequency are fully adjustable.
- **TRUE FM:** Not phase modulation. Unsurpassed intelligibility and audio fidelity.
- **HIGH/LOW POWER OUTPUT:** 25 or 5 watts selectable in PCS-4000; 10 or 1 watt selectable in PCS-4200, PCS-4300, PCS-4500, and PCS-4800. Transmitter power is fully adjustable.
- **SUPERIOR RECEIVER:** Sensitivity is 0.2 uV or better for 20-dB quieting. Circuits are designed and manufactured to rigorous specifications for exceptional performance, second to none. COMPARE!
- **REMOTE-CONTROL MICROPHONE:** Memory A-1 call, up/down manual scan, and memory address functions may be performed without touching the front panel! COMPARE!
- **OTHER FEATURES:** Dynamic microphone, rugged built-in speaker, mobile mounting bracket, remote speaker jack, and all cords, plugs, fuses, and hardware are included.
- **ACCESSORIES:** CS-7R 7-amp ac power supply, CS-4.5R 4.5-amp ac power supply, CS-AS remote speaker, and Communications Specialists SS-32 PL tone module.
- **ONE YEAR LIMITED WARRANTY!**

EXCLUSIVE DISTRIBUTOR:

AMATEUR-WHOLESALE ELECTRONICS

8817 S.W. 129th Terrace, Miami, Florida 33176

DEALER INQUIRIES INVITED

TOLL FREE... 800-327-3102

Telephone (305) 233-3631

Telex: 80-3356

MANUFACTURER:

JPC/AZDEN

JAPAN PIEZO CO., LTD.

1-12-17 Kamirenjaku, Mitaka, Tokyo, 181 Japan.

Telex: 781-2822452



ICOM IC-27H

Ultra Compact 45 Watt, 2-Meter Mobile!

Now ICOM offers the best choices in compact 2-meter FM mobiles...the IC-27H 45-watt compact (1 1/2" H x 5 1/2" W x 9 3/4" D) and the IC-27A 25-watt super compact mobile. These units are the smallest full-featured 2-meter mobile transceivers available, and they feature an internal speaker for easy installation.



Internal Speaker

45 Watts. The IC-27H provides 45 watts of output power, while the IC-27A provides 25 watts of output power. Even though both units are the smallest available 2-meter mobile units, they have not sacrificed features found in fully featured VHF models.



32 PL Frequencies. The IC-27A and IC-27H come complete with 32 PL frequencies ready to go and are controlled from the front panel knob. Each PL frequency may be selected by the main tuning knob and stored into memory for easy access along with frequency and offset.

9 Memories. The IC-27A and IC-27H have nine memories avail-

able to store receive frequency, transmit offset, offset direction, and PL tone. Memories are backed up by a lithium backup battery, which will store memories for up to seven years.

Speech Synthesizer. As an added plus, the IC-27A/H features an optional speech synthesizer to verbally announce the receiver frequency of the transceiver through the simple touch of a button.

Scanning. Included with the IC-27A/H is a scanning system which allows scanning of the entire band.

Priority Scan. Priority may be selected to be either a memory channel or a VFO channel. By using sampling techniques, the operator can determine if a frequency of interest is free or busy.

See the IC-27A/H compact mobile transceivers at your local ICOM dealer. For superb performance, reliability, and the ultimate in a VHF mobile radio, your only choice is an ICOM.



The IC-25A 2-meter 25-watt mobile and its 45-watt companion, the IC-25H, are also available.



IC-HM23

IC-27H



IC-27A

ICOM
The World System

applied Yagi antenna design

part 3:

432 MHz with Knadle and Tilton

Computer model
analyzes, optimizes
Knadle, Tilton/Greenblum
antenna designs

From the viewpoint of the antenna experimenter, the 432-MHz band is one of Amateur Radio's more intriguing frequency assignments. A Yagi with a boomlength of many wavelengths can be easily constructed, and stacking distances allow almost any operator to build arrays with formidable levels of performance. But with these advantages come several possible pitfalls: feedline losses can be a considerable factor in how well an array performs, and even the best of coaxial cables are noticeably lossy at 432 MHz. The matching system is very critical, and great care must be taken to avoid power losses between the driven element and the feedline.

While greater precision is required in cutting the parasitic elements for a 432 MHz Yagi than for a 144 MHz Yagi, precise element lengths are not as critical as is commonly believed. As is obvious from even a cursory examination of the tables of antenna iterations presented in this article, considerable latitude in the precise lengths of a series of parasitic elements is possible before the operator at either end of the signal path would notice any difference in signal strength.

Finally, even at today's inflated prices, a single pound of welding rod would yield the elements for many long Yagis at 432 MHz.

432 MHz computer iterations

Two different Yagi design approaches — based on the Knadle and Tilton/Greenblum design data — are discussed in this article. Both are familiar to VHF/UHF Amateurs; both enjoy good reputations for excellent performance and reproducibility; and both resulted from long hours of effort on the parts of well known, experienced Amateurs. The design frequency is 432.0 MHz. Previous articles used 144.5 MHz and 220.5 MHz for those respective VHF bands.^{1,2} This was a function of the stated design frequencies used in the development of the Yagis being iterated, or of the specific usage patterns of a particular band's frequency assignments. As is true of these two bands, the majority of weak-signal activity on 432 MHz is very close to 432.0 MHz. In addition, even long Yagis are comparatively broadbanded in frequency response on 432 MHz, making the use of 432.1 or 432.5 MHz as a design frequency of little practical purpose. An 8 MHz bandwidth, 428-436 MHz, is used to provide frequency response parameters. Because 0.0625 inch is probably the smallest measurement to which most Amateurs can accurately cut, it is used as the iteration increment.

the K2RIW Yagi antenna

Richard Knadle, K2RIW, is one of the most prolific contributors to Amateur VHF/UHF practice; his anten-

By Stanley Jaffin, WB3BGU, 800 Stonington Road, Silver Spring, Maryland 20902

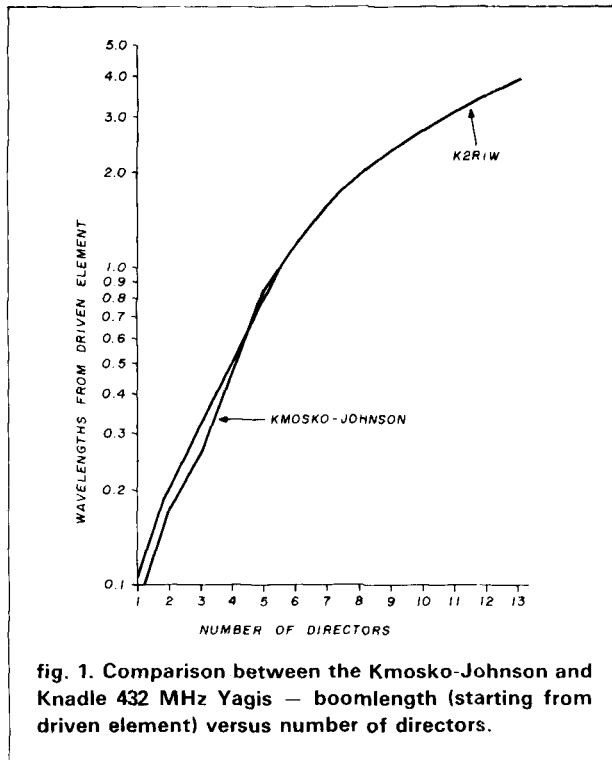

fig. 1. Comparison between the Kmosko-Johnson and Knadle 432 MHz Yagis — boomlength (starting from driven element) versus number of directors.

na and EME work is in addition to the transmitters, amplifiers, and receiver pre-amplifiers whose designs he has published in Amateur Radio journals. His original Yagi antenna design has been modified for introduction as a commercial product.³ Yet another modification of his original design is the subject of this article's computer iterations.

For a while it seemed that locating a copy of the Knadle Yagi antenna design was akin to trying to locate a schematic of the fabled Black Widow VHF/UHF transceiver. However, a full set of specifications was finally found in a rather obvious place,⁴ and the optimization process was begun.

The possible origin of the K2RIW Yagi may be apparent from table 1 and fig. 1. While its similarity to the Kmosko-Johnson design is apparent, the basic Knadle antenna has slightly more forward gain than the basic Kmosko-Johnson antenna (15.657 dBi versus 15.601 dBi). These basic antennas have thirteen elements and a zero director taper. What is perhaps the most interesting result of baselining the original K2RIW Yagi was finding the peak performance to be calculated to occur at the exact parasitic element lengths Knadle specified. Such close agreement between the empirical findings of a prominent practitioner and the iterations of a mathematical model is always a source of joy to the model's developers and users.

Before presenting the results of the computer iterations, it is worth noting that Knadle's exact matching method should be used on K2RIW Yagis. Other

table 1. A comparison of the interelement spacings of the Knadle and Kmosko-Johnson thirteen-element Yagis.

element number	name	spacing in wavelengths from previous element	
		Knadle	Kmosko-Johnson
1	reflector	0.0000	0.0000
2	driven	0.2289	0.2449
3	director 1	0.1098	0.0857
4	director 2	0.0984	0.0918
5	director 3	0.1235	0.0918
6	director 4	0.2013	0.1959
7	director 5	0.2745	0.3918
8	director 6	0.4323	0.3918
9	director 7	0.3889	0.3918
10	director 8	0.3889	0.3918
11	director 9	0.3889	0.3918
12	director 10	0.3889	0.3918
13	director 11	0.3889	0.3918

table 2. Baselined K2RIW Yagi at 432.0 MHz with fixed parasitic element spacings and parasitic element lengths supplied during each iteration.

element number	name	length (inches)	element spacing (λ)	cumulative length (λ)
1	reflector	—	0.000000	0.000000
2	driven	12.991445	0.228755	0.228755
3	director 1	—	0.109802	0.338557
4	director 2	—	0.098364	0.436922
5	director 3	—	0.123527	0.560450
6	director 4	—	0.201304	0.761755
7	director 5	—	0.274506	1.036261
8	director 6	—	0.432347	1.468609
9	director 7	—	0.388884	1.857493
10	director 8	—	0.388884	2.246378
11	director 9	—	0.388884	2.635262
12	director 10	—	0.388884	3.024146
13	director 11	—	0.388884	3.413030
14	director 12	—	0.388884	3.801914
15	director 13	—	0.388884	4.191789
16	director 14	—	0.388884	4.579683

methods are probably equally efficient,⁵ but by following the designer's instruction for at least the first antenna, the builder is able to establish a baseline for later comparisons.

iterating the K2RIW antenna

The original thirteen-element K2RIW Yagi was just over 3.4 wavelengths long, and was probably designed for use in multi-Yagi arrays; this would explain the relatively short boomlength. Extending this design to sixteen elements results in a Yagi still readily stacked, but with even more impressive results for the single antenna. Baselined in table 2, this antenna is just over 4.5 wavelengths long and fits easily on a 10-foot boom. All elements are 0.125 inch in diameter, and the design frequency is 432.0 MHz. As is necessary for successful

table 3. A comparison of optimized 432 MHz K2RIW Yagis for each of six different director tapering approaches.

taper	optimized performance parameter	parasitic element lengths (inches)		gain (dBi)	F/B (dB)
		reflector	director 1		
0.000000	gain	13.3125	11.5000	16.741	17.253
	F/B	13.4375	11.2500	16.372	32.666
0.015625	gain	13.3125	11.6250	16.737	17.535
	F/B	13.5000	11.3750	16.380	27.966
0.031250	gain	13.3125	11.7500	16.713	17.447
	F/B	13.5000	11.5000	16.400	25.026
0.046875	gain	13.3125	11.8750	16.696	16.971
	F/B	13.5000	11.6250	16.406	22.900
0.062500	gain	13.2500	11.9375	16.638	18.085
	F/B	13.6250	11.6875	16.211	21.372
0.078125	gain	13.1875	12.0625	16.595	17.428
	F/B	13.6250	11.8125	16.202	20.153

computer iterations, the driven element is specified at its $R + j0$ physical length.

Table 3 summarizes the results of six different pairs of K2RIW Yagi design iterations. As even the slightest element taper (increments of 0.015625 inch) results in degraded performance, full details are provided for only the zero taper antenna. Interestingly enough, Knadle specified a zero taper in the original design. Parasitic element lengths for optimizing a sixteen-element antenna differ from those that optimize a thirteen-element antenna. (More information on this phenomenon is contained in a later article in this series that addresses other Yagi optimization techniques.)

Table 4 presents the gain optimizing iteration that produced 16.741 dBi, and table 5 presents the F/B optimizing iteration that produced 32.666 dB. Tables

6 and 7 present these antennas' respective performance over the 8-MHz bandwidth. The gain optimized Yagi effectively illustrates the relatively broadband response of even long Yagis at 432 MHz. The F/B optimized antenna provides an excellent F/B across this same bandwidth. This optimized F/B is not a single frequency F/B resulting from sharp vectorial cancellation, but is the high level of F/B that comes naturally with long Yagis that are well designed. Figures 2 and 3 present these antennas' respective E-plane plots. The gain optimized antenna has the sharper main lobe, but the F/B optimized antenna has a deeper first null. Knadle seems to have preferred a gain optimized antenna, but depending on the chosen antenna's designated use, either of these optimized K2RIW designs result in first-rate antennas. His original thir-

table 4. Optimized gain iteration for the zero taper K2RIW antenna with a reflector length of 13.3125 inches.

director 1 (inches)	gain (dBi)	F/B (dB)
11.0000	15.754	20.051
11.0625	15.918	21.305
11.1250	16.081	23.071
11.1875	16.241	25.658
11.2500	16.394	29.312
11.3125	16.533	30.406
11.3750	16.648	25.467
11.4375	16.724	20.842
11.5000	16.741	17.253
11.5625	16.676	14.346
11.6250	16.504	11.908
11.6875	16.214	9.836
11.7500	16.004	8.469
11.8125	15.336	6.733
11.8750	14.848	5.873
11.9375	14.075	8.464
12.0000	13.632	8.218

table 5. Optimized F/B iteration for the zero taper K2RIW antenna with a reflector length of 13.4375 inches.

director 1 (inches)	gain (dBi)	F/B (dB)
11.0000	15.727	21.757
11.0625	15.811	22.437
11.1250	16.058	25.663
11.1875	16.219	29.167
11.2500	16.372	32.666
11.3125	16.510	28.755
11.3750	16.621	23.484
11.4375	16.690	19.491
11.5000	16.696	16.335
11.5625	16.614	13.713
11.6250	16.424	11.474
11.6875	16.116	9.549
11.7500	15.704	7.929
11.8125	15.232	6.664
11.8750	14.766	5.902
11.9375	14.339	6.060
12.0000	13.616	8.739

The small dish that captures all the entertainment.

**WILSON
MICROWAVE
SYSTEMS, INC**



Only Wilson Microwave Systems can give you the versatility of hand-held control of the total satellite television spectrum at such a remarkably low price.

Total System Design.

From the solid steel antenna to the state-of-the-art electronic receiver and hand-held control unit, Wilson gives you the most complete, integrated system you can own.

At Wilson Microwave Systems, we put the world of entertainment in the palm of your hand.



BUILT BY YAESU

**1 year warranty on receivers
4 year limited warranty on dish**

NOW ONLY

\$1695.00 F.O.B. Nampa, ID

Includes: 110° LNA - Polarizer I - 100' Cable
Wilson MD9 Dish - YM1000 Receiver

**Dealerships
Available**

Antenna is shown with optional LNA cover.

Distributed by

NAMPA SATELLITE SYSTEMS

312 12th Avenue South • Nampa, Idaho 83651

(208) 466-6727

In State Wats 1-800-654-1319 • Out of State Wats 1-800-654-0795

teen-element Yagi provided a single frequency type of F/B when optimized for F/B.

the Tilton/Greenblum Yagi

The evolution of the Greenblum and Tilton/Greenblum designs was discussed in a previous article.² Tilton's 432 MHz Yagi was originally published as an eleven-element design.⁶ For purposes of computer iteration and comparison with the Knadle design, a sixteen-element Yagi is presented. The additional five directors are spaced equally apart in accordance with

table 6. Frequency response parameters for the gain optimized zero taper K2RIW antenna.

frequency (MHz)	gain (dBi)	F/B (dB)
428.0	16.630	25.127
429.0	16.683	23.056
430.0	16.721	20.926
431.0	16.736	18.982
432.0	16.741	17.253
433.0	16.717	15.716
434.0	16.667	14.340
435.0	16.589	13.097
436.0	16.480	11.969

table 7. Frequency response parameters for the F/B optimized zero taper K2RIW antenna.

frequency (MHz)	gain (dBi)	F/B (dB)
428.0	16.122	23.635
429.0	16.191	25.519
430.0	16.256	27.874
431.0	16.316	30.675
432.0	16.372	32.666
433.0	16.422	31.198
434.0	16.466	27.976
435.0	16.501	25.028
436.0	16.526	22.584

table 8. Baselined Tilton/Greenblum Yagi at 432.0 MHz with fixed parasitic element spacings and parasitic element lengths supplied during each iteration.

element number	element name	length (inches)	spacing (λ)	element cumulative length (λ)
1	reflector	—	0.000000	0.000000
2	driven element	13.032811	0.137253	0.137253
3	director 1	—	0.137253	0.274506
4	director 2	—	0.173854	0.448361
5	director 3	—	0.237906	0.686266
6	director 4	—	0.265356	0.951622
7	director 5	—	0.274506	1.226129
8	director 6	—	0.347708	1.573837
9	director 7	—	0.347708	1.921545
10	director 8	—	0.347708	2.269254
11	director 9	—	0.347708	2.616962
12	director 10	—	0.347708	2.964670
13	director 11	—	0.347708	3.312378
14	director 12	—	0.347708	3.660086
15	director 13	—	0.347708	4.007795
16	director 14	—	0.347708	4.355503

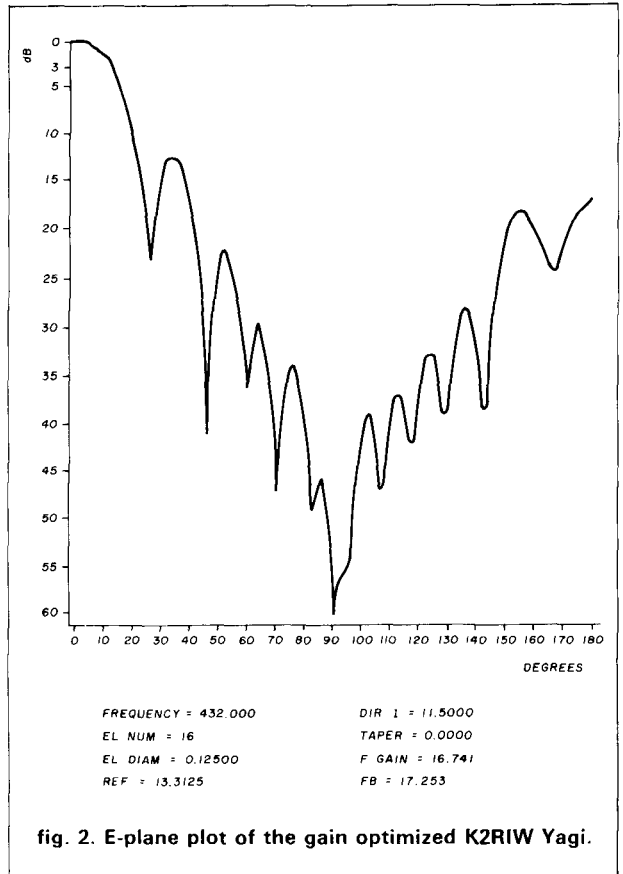

fig. 2. E-plane plot of the gain optimized K2RIW Yagi.

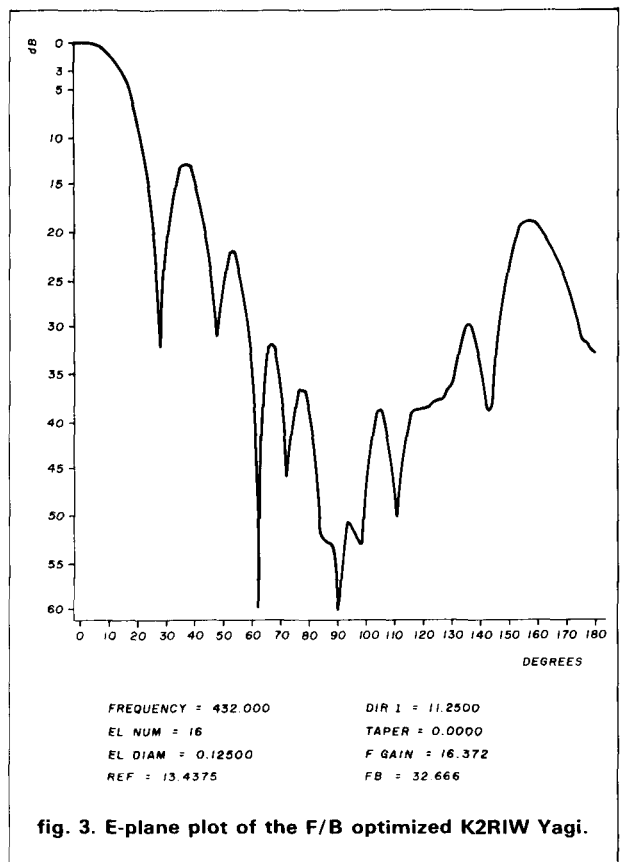

fig. 3. E-plane plot of the F/B optimized K2RIW Yagi.

table 9. A comparison of the optimized Tilton/Greenblum 432 MHz Yagis for each of thirteen director tapering approaches.

taper	optimized performance parameter	parasitic element lengths (inches)		gain (dBi)	F/B (dB)
		reflector	director 1		
0.000000	gain	13.5000	11.6875	15.942	12.794
	F/B	13.1875	12.0625	14.303	38.225
0.015625	gain	13.5625	11.8750	16.103	14.277
	F/B	13.1875	12.1875	14.473	37.976
0.031250	gain	13.6250	12.0000	16.259	15.754
	F/B	13.2500	12.3125	14.753	35.519
0.046875	gain	13.6250	12.1250	16.390	17.088
	F/B	13.2500	12.3750	15.299	30.234
0.062500	gain	13.6250	12.1875	16.498	18.106
	F/B	13.2500	12.5000	15.187	42.848
0.078125	gain	13.6250	12.3125	16.574	20.076
	F/B	13.3125	12.5625	15.619	39.416
0.093750	gain	13.6875	12.3125	16.657	22.212
	F/B	13.3750	12.6250	15.907	37.921
0.109375	gain	13.6875	12.4375	16.634	24.416
	F/B	13.4375	12.6875	16.067	39.146
0.125000	gain	13.5625	12.5000	16.651	24.325
	F/B	13.4375	12.7500	16.099	42.827
0.140625	gain	13.5625	12.5625	16.583	25.312
	F/B	13.5625	12.7500	16.319	48.957
0.156250	gain	13.6250	12.6250	16.529	29.287
	F/B	13.7500	12.6875	16.457	46.691
0.171875	gain	13.6250	12.6875	16.448	30.353
	F/B	13.7500	12.6875	16.421	35.637
0.187500	gain	13.6250	12.6875	16.364	28.608
	F/B	13.8125	12.6875	16.319	31.650

table 10. Optimized gain iteration for a taper of 0.0625 with a reflector length of 26.375 inches.

director 1 (inches)	gain (dBi)	F/B (dB)
11.7500	15.903	17.498
11.8125	16.028	17.296
11.8750	16.143	17.153
11.9375	16.247	17.087
12.0000	16.337	17.122
12.0625	16.413	17.285
12.1250	16.469	17.605
12.1875	16.498	18.106
12.2500	16.485	18.778
12.3125	16.408	19.504
12.3750	16.235	19.941
12.4375	15.931	19.609
12.5000	15.484	18.497
12.5625	14.930	17.179
12.6250	14.359	15.962
12.6875	13.839	14.147
12.7500	13.355	11.391

table 11. Optimized F/B iteration for a taper of 0.0625 with a reflector length of 13.25 inches.

director 1 (inches)	gain (dBi)	F/B (dB)
11.7500	15.821	13.870
11.8125	15.936	13.701
11.8750	16.036	13.568
11.9375	16.119	13.495
12.0000	16.180	13.513
12.0625	16.215	13.660
12.1250	16.220	13.992
12.1875	13.665	22.300
12.2500	16.113	15.587
12.3125	15.986	17.210
12.3750	15.796	19.961
12.4375	15.535	25.365
12.5000	15.187	42.848
12.5625	14.753	24.093
12.6250	14.231	17.825
12.6875	13.664	13.723
12.7500	13.251	10.706

the Greenblum design data and Tilton's adaptation. This Yagi is constructed on a non-conductive boom and is baselined in table 8. Parasitic element diameter is 0.09375 inch, and the design frequency is 432.0 MHz. Tilton did not specify his own exact design frequency, but a careful reading of his article gives the

impression that a slightly higher frequency was used. This would follow from the general band usage patterns of that era. As the matching of the transmission line and driven element is very critical on 432 MHz, Tilton's driven element assembly should be duplicated exactly. Any desired changes should be made in a sec-

table 12. Frequency response parameters for the gain optimized antenna with a 0.0625 taper.

frequency (MHz)	gain (dBi)	F/B (dB)
428.0	16.419	16.157
429.0	16.446	16.589
430.0	16.469	17.061
431.0	16.487	17.570
432.0	16.498	18.106
433.0	16.492	18.641
434.0	16.487	19.127
435.0	16.460	19.485
436.0	16.411	19.622

table 13. Frequency response parameters for the F/B optimized antenna with a 0.0625 taper.

frequency (MHz)	gain (dBi)	F/B (dB)
428.0	15.201	18.096
429.0	15.244	20.376
430.0	15.263	23.657
431.0	15.173	27.940
432.0	15.187	42.848
433.0	15.073	30.226
434.0	14.908	24.244
435.0	14.700	20.882
436.0	14.469	18.625

ond Yagi so as to allow comparisons with an established standard.

Table 9 summarizes the results of iterating thirteen pairs of Tilton/Greenblum 432 MHz Yagis. Performance trends are easily noted and there is no real need for additional iterations. As it is highly unlikely that many VHF/UHF operators could reliably measure or build to tolerances of 0.015625 inch, the Yagis of real interest are those at intervals of 0.0625 inch. These four Yagis also represent peaks or near-peaks in either gain or F/B. This same interval is also used for parasitic element lengths. Furthermore, the zero taper Yagis can be readily seen to be the poorest performers of these four pairs of antennas. As such they are excluded from the detailed examinations that follow for the tapering approaches of 0.0625, 0.125, and 0.1875 inch. The tables that follow refer to these Yagis.

taper = 0.0625

This is the only Tilton/Greenblum 432 MHz Yagi that was actually presented by Tilton. The two Yagis that follow (0.125 and 0.1875 taper) are the products of computer iteration. **Table 10** presents the gain optimizing iteration that resulted in 16.498 dBi of gain, and **table 11** presents the F/B optimizing iteration and its calculated result of 42.848 dB. Nearly 1.3 dB of gain and over 24 dB of F/B separate these two 0.0625 taper Yagis. **Tables 12** and **13** present these antennas' respective calculated performance over the specified

bandwidth. Both antennas show peaks in their calculated performance parameters at 432.0 MHz. The F/B optimized value is clearly the result of single frequency vectorial cancellation. When coupled with a weak signal bandwidth that is relatively narrow in terms of the design frequency's wavelength, this F/B value will not deteriorate as rapidly as it would at a lower frequency. Extensive QSYs will probably result in noticeable decreases in rearward attenuation. **Figures 4** and **5** present E-plane plots of these antennas. The gain optimized antenna has a significantly sharper and deeper main lobe as well as a measurably higher degree of unwanted signal attenuation between 100 and 160 degrees. The F/B optimized antenna provides the expected outstanding level of unwanted signal attenuation from 160 to 180 degrees.

table 14. Optimized gain iteration for a taper of 0.125 with a reflector length of 13.5625 inches.

director 1 (inches)	gain (dBi)	F/B (dB)
12.0000	15.826	20.040
12.0625	15.968	20.006
12.1250	16.103	20.023
12.1875	16.229	20.117
12.2500	16.345	20.324
12.3125	16.433	20.524
12.3750	16.532	21.296
12.4375	16.592	22.247
12.5000	16.651	24.325
12.5625	16.601	26.163
12.6250	16.519	30.366
12.6875	16.359	35.590
12.7500	16.119	29.599
12.8125	15.825	24.253
12.8750	15.543	20.913
12.9375	15.355	18.600
13.0000	15.271	16.726

table 15. Optimized F/B iteration for a taper of 0.125 with a reflector length of 13.4375 inches.

director 1 (inches)	gain (dBi)	F/B (dB)
12.0000	15.826	18.494
12.0625	15.962	18.442
12.1250	16.090	18.422
12.1875	16.210	18.456
12.2500	16.318	18.573
12.3125	16.411	18.812
12.3750	16.486	19.229
12.4375	16.538	19.905
12.5000	16.558	20.971
12.5625	16.537	22.664
12.6250	16.460	25.498
12.6875	16.315	31.062
12.7500	16.099	42.827
12.8125	15.832	28.671
12.8750	15.567	22.795
12.9375	15.373	19.036
13.0000	15.262	16.159

10 REASONS WHY KNOWLEDGEABLE AMATEUR RADIO OPERATORS CHOOSE

flexible,
electrically
transparent
Phillystran®



guys

1. non-absorption and no re-radiation of radio signals.
2. no need to compute non-resonant lengths.
3. complete elimination of RFI associated with steel guys.
4. substantial reduction in guy-installation time.
5. no more cutting of steel cable to install insulators and cable clamps.
6. no more handling of steel cable; and no "fish hook" frayed ends to snag your hands.
7. non-corroding and maintenance-free.
8. high strength combined with lightweight, non-stretch and inherent flexibility.
9. a neater, more aesthetically pleasing tower appearance.
10. substantial reduction in ice loading.

FIELD PROVEN: More than 450 commercial radio & TV towers have been guyed with Phillystran. Pourable resin provides convenient, highly efficient terminations.

TECHNICAL LITERATURE AVAILABLE. Call/write

Philadelphia Resins Corporation

P.O. Box 454 • 20 Commerce Drive,
Montgomeryville, PA 18936
Telephone: (215) 855-8450
Telex 84-6342 Cable: Philres MMLL



DISTRIBUTORSHIPS AVAILABLE to qualified suppliers of amateur-radio equipment

★ ENGINEERING CONSULTING INTRODUCES ★

"REMOTE A PAD"® MODEL RAP-1

• 2 FOUR DIGIT DTMF DECODERS, PLUS 16 DIGIT KEYPAD CONTROL •

TUNE THE WORLD FROM YOUR HANDHELD VHF/UHF RADIO

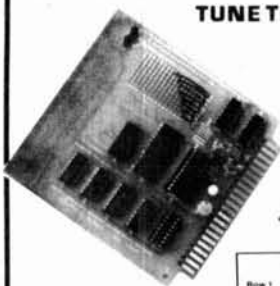

Model RAP-1
\$149.95
"Remote A Pad"®
DTMF and tone-pad controller.

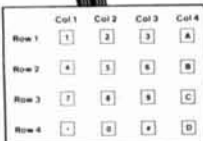

- Audio tones from any source, are converted to solid state switches which control any 16 digit keypad of a radio or other device.
- Some examples you can control include the Pro-Search Rotator (rotate beam remotely); ICOM IC-701 or ICOM IC-211 when using the RM-2 controller; ICOM 7950; Azden PCS-4000; handhelds such as Yaesu FT-20B, FT-70B; ICOM IC2-DAT; and many more...
- Anything you can do manually with your 16 digit keypad, the RAP-1 will do remotely using audio touch tones from any source.
- Two (four digit) programmable access codes are used to operate relays or other on/off functions.
- LED decoder status indicators and momentary plus steady state decoder outputs are provided.
- 22 gold pin card edge connector, 16 pin dip socket and ribbon cable are supplied.
- All CMOS low power drain (30ma); State of the art LSI IC's.
- Hook eight wires (4 rows and 4 columns) in parallel with the existing keypad of the radio you wish to control remotely. Connect audio from any source. 12 volts D.C and you are in control.
- The dual 4 digit decoders will turn your links on and off using your programmable access code.
- Detailed interface diagrams and instructions included with purchase.

ATTENTION ICOM IC2-OAT OWNERS...

ICOM IC2-OAT USER'S

"AUDIO BLASTER"® MODULE



- Module installs inside the radio in 10 minutes.
- Boosts audio to nearly 1 watt!
- Low power drain (4ma stand-by)
- Complete step by step instructions included.
- Corrects the LOW audio problem!
- Drive external speakers to full volume, even signals with low deviation!

MODEL AB-1 \$19.95

"Audio Blaster"® Module for the ICOM IC2-OAT/IC4-OAT. Ask for info for use with other hand held transceivers.



Price includes postage and handling, U.S.A. Calif. residents add 6%. Send check or money order to:

ENGINEERING CONSULTING
583 CANDLEWOOD ST., BREA, CA 92621, (714) 671-2009

✓ 133

TOWERS by ALUMA

HIGHEST QUALITY ALUMINUM

- TELESCOPING (CRANK-UP)
- GUYED (STACK-UP)
- TILT-OVER MODELS

Easy to install. Low Prices. Crank-ups to 100 ft.

EXCELLENT FOR AMATEUR COMMUNICATIONS



Mobile Trailer Type



Mobile Truck Type

Over 36 types aluminum and steel towers made—specials designed and made—write for details

SPECIAL Four Section 50 Ft. Van Mounted Crank-Up Alumina Tower

ALUMA TOWER CO.

BOX 2806HR
VERO BEACH, FLA. 32960-2806
(305) 567-3423 TELEX 80-3405



July 28 thru Aug. 10, 1984

Our 25th year

TAKE A VACATION WITH A PURPOSE THIS YEAR

Join students from around the world at OAK HILL's

SILVER ANNIVERSARY Session

Over 25 years of successful teaching experience means upgrading is as easy as 1-2-3.

Your vacation is spent in the beautiful Blue Ridge Mountains of Virginia with expert instructors in friendly surroundings and with excellent accommodations.

Oak Hill also has a ham lab set up for all to use.

Courses offered are:

- Novice to General
- General or Tech to Advanced
- Advanced to Extra

Learn — don't just memorize the answers to the exam questions.

C. L. PETERS, K4DNJ, Director
Oak Hill Academy Amateur Radio Session
Box 43
Mouth of Wilson, VA 24363

Name _____ Call _____

Address _____

City/State/Zip _____

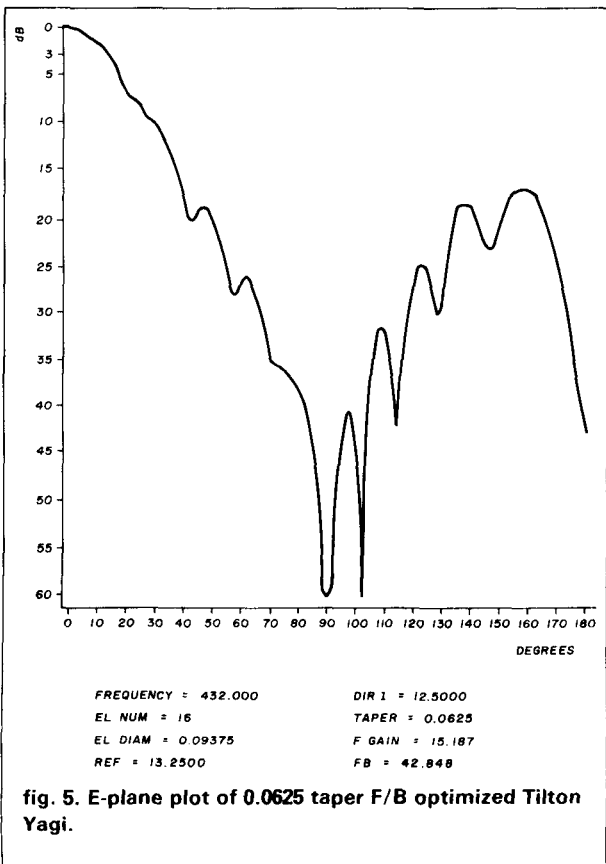
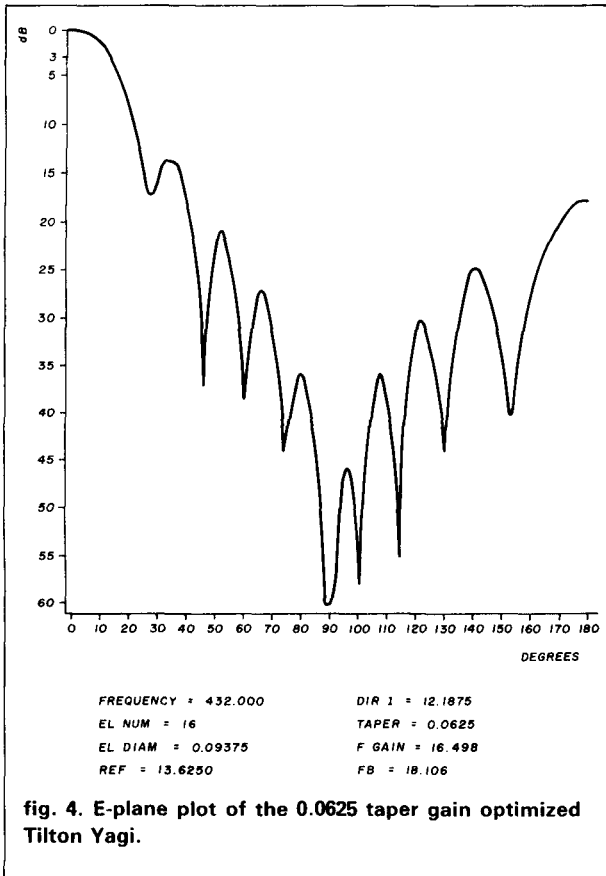

taper = 0.125

This antenna exists solely as a product of computer iterations. In comparison with the 0.0625 tapered antenna design presented by Tilton and optimized through computer iteration, the optimized antennas with a 0.0125 taper require shorter reflectors and longer directors. **Table 14** presents the gain optimizing iteration that resulted in 16.651 dBi of gain, and **table 15** presents the F/B optimizing run with a calculated F/B of 42.825 dB. Over 0.5 dB of gain and 18 dB of F/B

table 16. Frequency response parameters for the gain optimized antenna with a 0.125 taper.

frequency (MHz)	gain (dBi)	F/B (dB)
428.0	16.498	19.253
429.0	16.542	20.106
430.0	16.578	21.101
431.0	16.604	22.290
432.0	16.651	24.325
433.0	16.622	25.548
434.0	16.608	27.807
435.0	16.575	30.379
436.0	16.520	31.856

table 17. Frequency response parameters for the F/B optimized antenna with a 0.125 taper.

frequency (MHz)	gain (dBi)	F/B (dB)
428.0	16.249	21.400
429.0	16.253	23.727
430.0	16.231	27.083
431.0	16.180	32.775
432.0	16.099	42.827
433.0	15.990	32.371
434.0	15.861	26.835
435.0	15.722	23.582
436.0	15.587	21.398

table 18. Optimized gain iteration for a taper of 0.1875 with a reflector length of 13.625 inches.

director 1 (inches)	gain (dBi)	F/B (dB)
12.2500	15.690	23.557
12.3125	15.830	23.848
12.3750	15.962	24.218
12.4375	16.083	24.698
12.5000	16.190	25.333
12.5625	16.277	26.172
12.6250	16.337	27.266
12.6875	16.364	28.608
12.7500	16.348	29.937
12.8125	16.281	30.455
12.8750	16.167	29.535
12.9375	16.023	27.980
13.0000	15.897	26.706
13.0625	15.845	25.256
13.1250	15.855	21.841
13.1875	15.733	17.729

separate these two antennas. **Tables 16 and 17** present these antennas' respective calculated performance over the relevant bandwidth. Both antennas' optimized parameters show peak values at 432.0 MHz. The F/B optimized antenna's F/B value is clearly a single frequency peak. However, as is true of the 0.0625 tapered F/B optimized antenna, the relative broad frequency responses of Yagis at 432 MHz is coupled with a relatively small bandwidth for the weak signal area. Consequently it is very likely that high F/B values, though not the calculated peak values, will be recognized in practice. **Figures 6 and 7** present these antennas' respective E-plane plots. The gain optimized antenna has the more sharply defined main lobe and generally deeper nulls throughout the pattern. Signal attenuation between 150 and 170 degrees is also greater than for the F/B optimized antenna. It is in the last 10 degrees that the F/B antenna provides a noticeable difference in performance. To some degree this F/B antenna typifies some of the exceptions to the use of F/B as an antenna performance parameter that were detailed by Lawson.⁷

taper = 0.1875

As is the case for the 0.125 tapered antennas, this pair of Yagis exists solely as the result of computer iterations. Compared to the 0.125 tapered antennas, longer reflectors and longer directors are used. **Table 18** presents the gain optimizing iteration that resulted in 16.364 dBi of gain, and **table 19** presents the F/B optimizing iteration with a calculated F/B of 31.650 dB. Less than 0.5 dB of gain and just over 3 dB of F/B separate these antennas. **Tables 20 and 21** present these antennas' respective calculated performance over the relevant bandwidth. Both antennas show peaks at 432 MHz for their respectively optimized parameters. The F/B values shown in **table 21** are not the single frequency F/B ratios of the two prior F/B optimized antennas. This F/B comes naturally from the antenna's design and is available over a 3 MHz bandwidth. **Figures 8 and 9** present these antennas' nearly identical E-plane plots, respectively. There are no distinguishing differences of any major consequence.

comparative results of computer iteration

These iterated comparisons between the single Knadle and multiple Tilton designs indicate there are no really significant differences in calculated forward gain. Any choice between these two design approaches, or from within the Tilton design approach would have to be based on a given antenna's calculated radiation pattern.

With the exception of the 0.1875 tapered Yagi, the F/B optimized antenna in each Tilton pair has the less clearly defined main lobe. The opposite was true of

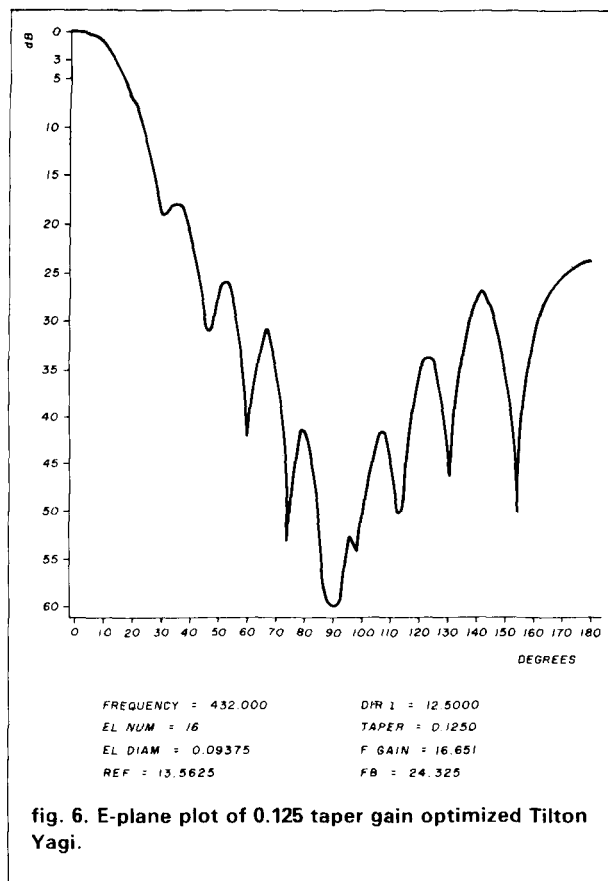

fig. 6. E-plane plot of 0.125 taper gain optimized Tilton Yagi.

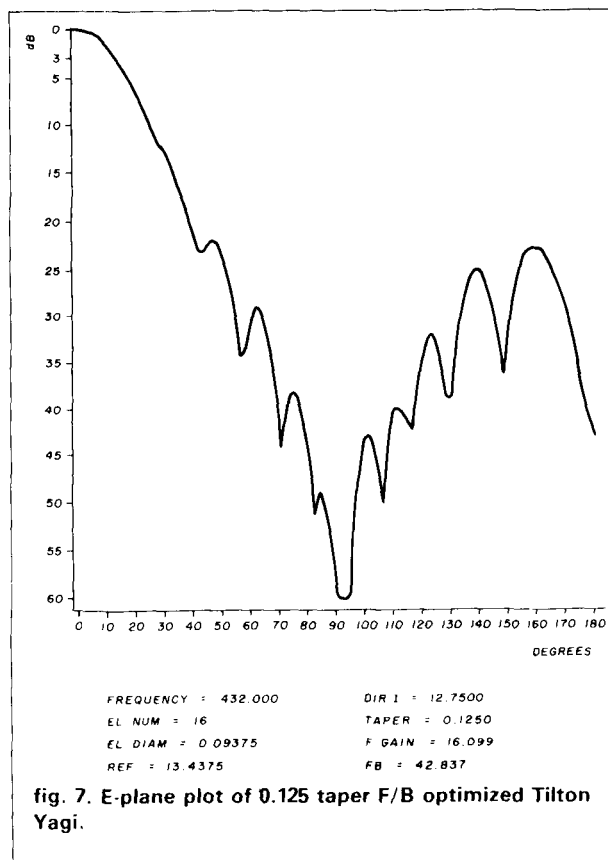
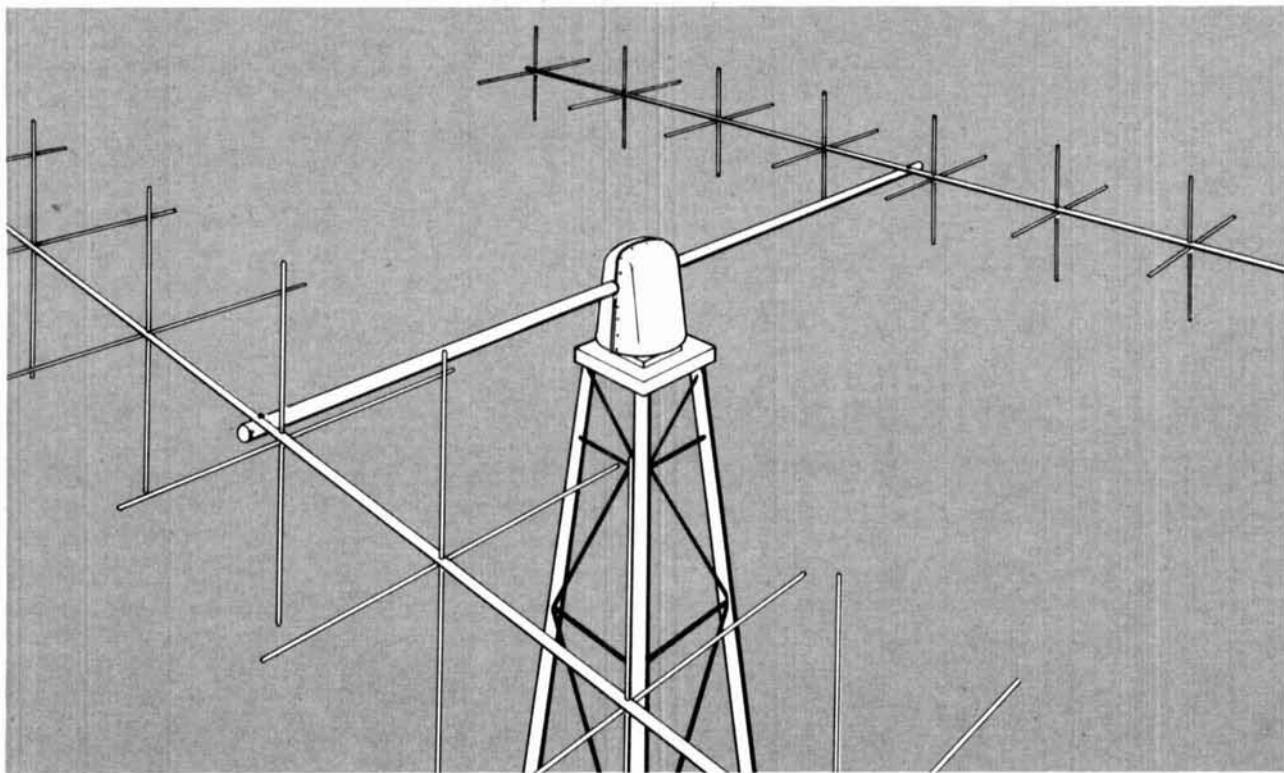

fig. 7. E-plane plot of 0.125 taper F/B optimized Tilton Yagi.

NEW!

OSCAR 10 Dual Axis Rotor



As a leading manufacturer of precision motor drive systems, we believe the newly developed DR10 is the finest dual drive system for satellite antennas. To provide you the highest level of performance and convenience, the DR10 Dual Axis Rotor features:

- **COMPACT CONTROL UNIT WITH SELF CONTAINED AC POWER SUPPLY**
 - **SINGLE DUAL SCALE METER (AZIMUTH/ELEVATION)**
 - **SINGLE 8 WIRE CONTROL CABLE (BELDEN TYPE)**
 - **STANDARD TOWER TOP MOUNTING**
 - **ACCEPTS 1½ INCH ANTENNA BOOM**
 - **SERVICEABLE WITHOUT ANTENNA REMOVAL**
 - **DYNETIC SYSTEMS' HIGH TORQUE, PRECISION GEARMOTORS**
-
- **LIST PRICE LESS THAN TWO CONVENTIONAL ROTORS**
 - **AVAILABLE FOR AUGUST DELIVERY**

Our DR10 will out-perform any combination of conventional rotors popularly used, and is supplied ready to mount, including the rotor, control unit, and all stainless steel mounting hardware. (less cable)



For immediate ordering information,
individuals and dealers call or write

612-441-4303

DYNETIC SYSTEMS

19128 INDUSTRIAL BOULEVARD
ELK RIVER, MN 55330

RADIO WAREHOUSE

Division of HARDIN Electronics

**NO FRILLS—JUST LOW PRICES
CALL FOR SPECIAL PRICES ON—**

KENWOOD YAESU

ICOM TEN-TEC

**DAIWA METERS—KEYERS—AUDIO FILTERS
CUSHCRAFT LINE OF ANTENNAS**

CALL TOLL FREE

1-800-433-3203



**IN TEXAS CALL 817-496-9000
5635 EAST ROSEDALE
FT. WORTH, TEXAS 76112**

RF Porta-Tenna

**VHF/UHF Telescopic 1/4 & 5/8
Wavelength Antennas for
Hand-Held Transceivers &
Test Equipment**

1/4 WAVELENGTH

Model No.	Freq. MHz	Description	Price
196-200	144-148	5/16-32 stud w/spring	\$5.9
196-204	"	BNC connector w/spring	7.9
196-214	"	BNC connector	6.9
196-224	144-UP	BNC conn. adj. angle	7.9
196-814	220-225	BNC connector	6.9

5/8 WAVELENGTH

191-210	"	5/16-32 for old TEMPO	22.5
191-214	"	BNC connector	19.5
191-219	"	PL-259 w/M-359 adpt.	22.5
191-810	220-225	5/16-32 for old TEMPO	22.5
191-814	"	BNC connector	19.5
191-940	440-450	5/16-32 for HT-220	22.5
191-941	"	1/4-32 stud	22.5
191-944	"	BNC connector	19.5

**Largest Selection of Telescopic
Antennas. Write for info. Price are
postpaid via UPS to 48 States. For air
delivery via UPS Blue add \$1.50.
Florida add 5% sales tax. Payment by
M.O. or Cashiers Check only. ✓ 175**

RF PRODUCTS

P.O. Box 33, Rockledge, FL 32955, U.S.A.
(305) 631-0775

SEMICONDUCTORS:

MRF-208.....	12.00	MHW-252.....	53.00
MRF-240.....	18.40	MHW-710-1.....	61.00
MRF-247.....	34.80	MPSH-81.....	50
MRF-309.....	33.80	MV2205.....	58
MRF-422.....	41.40	78L08CP.....	50
MRF-454.....	20.00	2N4401.....	75
MRF-901.....	1.75	2N5190.....	1.50
SBL-1 Double-Balance Mixer.....	6.50		

P.C. BOARDS FOR MOTOROLA BULLETINS

AN-762.....	14.00	AN-791.....	10.00
EB-27A.....	14.00	EB-67.....	14.00
EB-63.....	14.00		
KEMET CHIP CAPACITORS: 56 pf, 82 pf, 100 pf, 390 pf, 470 pf.....			
680 pf, 1000 pf.....			
5600 pf, 6800 pf, .1 µf.....			
.33 µf.....			
1.90 ea. .68 µf.....			
3.90 ea.			

CAMBION RF CHOKES: .15 µh, .22 µh, .33 µh, 4.7 µh, 10 µh.....1.20 ea.

BROADBAND TRANSFORMERS PER MOTOROLA BULLETINS: AN-762, EB-27A, EB-63

UNDERWOOD/SEMCO METAL-CLAD MICA CAPACITORS: 5pf, 10pf, 15pf, 25pf, 30pf,
40pf, 56pf, 60pf, 68pf, 80pf, 91pf, 100pf, 200pf, 250pf, 390pf, 470pf, 1000pf

We also carry a line of VHF, UHF amplifiers and ATV equipment. ✓ 123

Call or write for our free catalog.



CCI Communication
Concepts Inc.



2648 North Aragon Ave. • Dayton, Ohio 45420 • (513) 296-1411

R-390A HF RECEIVER



Famous military receiver covers 0.5-32 Mhz AM-CW in 31 one Mhz bands using mechanical digital tuning. 455 KHz IF; has four Collins mechanical filters for selectable 2-4-

8-16 KHz bandwidth. 100 KHz calibrator; BFO. No covers. 115/230 VAC 60 Hz; 10 1/2 x 19 x 16 3/4", 95 lbs. sh. (UPS in 2 pks.). Used-reparable \$215. Checked \$335. Manual, partial repro \$15.

CV-1982/TSC-26 SSB CONVERTER, compatible with R-390A and other rec. Used-reparable. \$155.

RYCOM R-2174/URR, selective voltmeter used by military as 1.0-420 KHz AM-LSB-USB receiver; 0.1-3-10 KHz selectable bandwidth. Built-in speaker. 9x19x7", 25 lbs. sh. Used-reparable \$125. Checked \$195.

Prices F.O.B. Lima, O. • VISA, MASTERCARD Accepted. Allow for Shipping • Send for New FREE CATALOG '84 Address Dept. HR • Phone: 419/227-6573

FAIR RADIO SALES

1016 E EUREKA • Box 1105 • LIMA, OHIO • 45802

TELEX/HY-GAIN ANNOUNCES HOT LINE

MINNEAPOLIS — Telex/Hy-Gain has installed a toll-free customer service hot line for its Amateur Radio products division (only). The number is (800) 328-5652. In Minnesota, the number is (612) 887-5528. Calls will be accepted Monday through Friday, 8:00 AM to 5:00 PM central time. The purpose of the service is to assist Amateurs with product selections and to help answer questions about applications and installations.

**This Publication
is available in
Microform.**



University Microfilms
International

Please send additional information

for _____
Name _____
Institution _____
Street _____
City _____
State _____ Zip _____

300 North Zeeb Road
Dept. PR
Ann Arbor, MI 48106

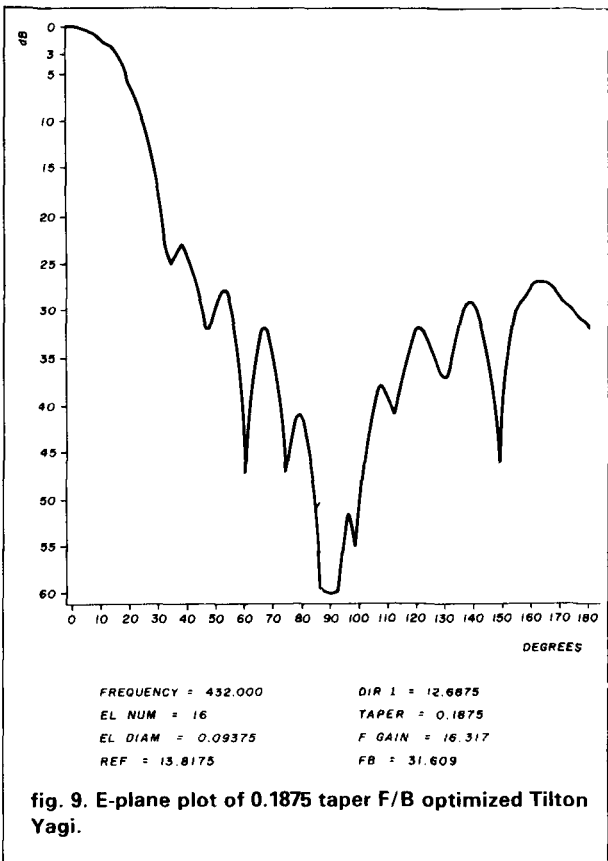
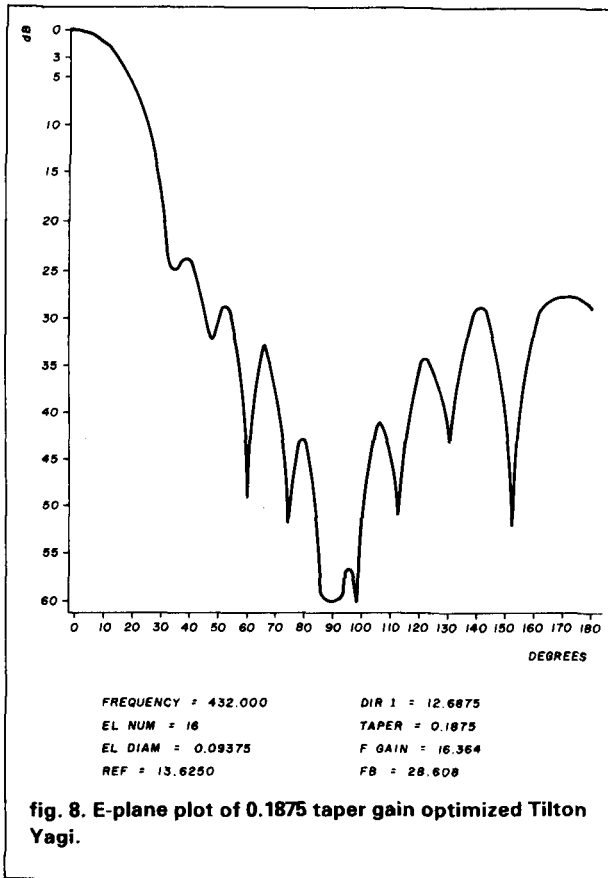

the single Knadle Yagi. However, the first minor lobe on the Knadle Yagis tended to be of greater amplitude than the same lobe on comparable Tilton Yagis.

The need for an exceptionally high F/B on 432 MHz is open to question. F/B is a moot point for EME, and for terrestrial paths there simply is not the level of QRM comparable to 40 meters. Given that the pattern-wide attenuation of unwanted signals calculated for the Tilton 0.0625 and 0.125 gain optimized Yagis exceeds that of the F/B optimized Yagi in these pairs, these

table 19. Optimized F/B iteration for a taper of 0.1875 with a reflector length of 13.8125 inches.

director 1 (inches)	gain (dBi)	F/B (dB)
12.2500	15.627	25.171
12.3125	15.774	25.658
12.3750	15.912	26.283
12.4375	16.040	27.094
12.5000	16.151	28.143
12.5625	16.239	29.453
12.6250	16.299	30.867
12.6875	16.319	31.650
12.7500	16.291	30.726
12.8125	16.211	28.534
12.8750	16.083	26.331
12.9375	15.936	24.760
13.0005	15.823	24.066
13.0625	15.796	23.808
13.1250	15.782	21.524
13.1875	15.506	17.627
13.2500	14.849	15.885

table 20. Frequency response parameters for the gain optimized antenna with a 0.1875 taper.

frequency (MHz)	gain (dBi)	F/B (dB)
428.0	16.248	23.482
429.0	16.311	24.298
430.0	16.340	25.563
431.0	16.358	27.004
432.0	16.364	28.608
433.0	16.357	30.223
434.0	16.335	31.363
435.0	16.299	31.314
436.0	16.406	25.784

table 21. Frequency response parameters for the F/B optimized antenna with a 0.1875 taper.

frequency (MHz)	gain (dBi)	F/B (dB)
428.0	16.290	27.628
429.0	16.312	28.969
430.0	16.326	30.323
431.0	16.328	31.389
432.0	16.319	31.650
433.0	16.297	30.838
434.0	16.260	29.321
435.0	16.210	27.614
436.0	16.146	25.995

Free Antenna Accessories Catalog



◀ Coaxial Antenna Relays

Remotely select up to 9 antennas from your transmitter, using only *one* coaxial cable. Environmentalized, high power and low loss.

W2AU and W2DU Baluns▶

Our baluns, center insulators and insulators have been preferred for 20 years by Hams, industry, and the armed forces. Protect against TVI and lightning 1.8-200 MHz.



◀ W2VS Antenna Traps

Add these traps to your dipole and get low SWR on 2 to 6 bands, depending on how many you add. Antenna wire and custom kits also available.

Send For Yours Today▶

Don't delay. Call or write today, and we will send you free literature which fully describes our Ham antenna accessory product line.

Dealer inquiries also welcome.



UNADILLA/REYCO/INLINE
A Division of Microwave Filter Co., Inc.

6743 Kinne St., East Syracuse, NY 13057
Toll Free 1-800-448-1666 TWX 710-541-0493
NY/HI/AK/Canada (Collect) 315-437-3953

✓ 159

CB-10 FM SPECIAL



- Hy Gain 40-Channel Board
- 40-Channel Switch
- Volume & Squelch Control
- FM Detector Module
- Full Instructions Included

\$14.95 Add \$2.00 shipping & handling BOARD ONLY \$6.95

QRP TRANSCEIVER SET - \$34.95

VHF CONVERTER SET - \$24.95

Add \$2.00 For Shipping & Handling - Send For FREE Brochure

SEND \$2.00 FOR FULL MANUAL WITH CIRCUIT DIAGRAMS
MANY OTHER MODULES AVAILABLE

MORNING DISTRIBUTING CO.

P.O. BOX 717, HIALEAH, FLA. 33011
(305) 884-8686

✓ 162

gain optimized Yagis seem to be preferable. To a much lesser degree this is also true for the 0.1875 Tilton Yagi pair. In effect the real choice of antennas is narrowed to any of the gain optimized Tilton Yagis and either of the Knadle Yagis.

The minor lobe structure of the 0.125 and 0.1875 gain optimized Tilton Yagis is measurably sharper than either of the Knadle antennas. If a final choice of antennas were to be made, either of these Tilton designs would be appropriate, with the 0.125 design preferable. The selection of one antenna design from these many fine designs depends more on the station operator than any of the calculated differences in the stated selection criteria. Excellent results can be expected from either of the two preferable Tilton designs or from either of the Knadle Yagis. The differences in forward gain are more a function of the Knadle Yagi's longer boomlength than any verifiable design superiority. In fact, the additional 0.22 wavelength advantage should have given the Knadle Yagi a larger margin by at least another 0.1 dB.

Comparisons among these Tilton and Knadle Yagis and the NBS 4.2 wavelength Yagi are also interesting. Though the former Yagis are only marginally longer, they provide higher calculated forward gains. The NBS Yagi has a calculated forward gain of 15.71 dBi. The 0.0625, 0.125, and 0.1875 Tilton gain optimized Yagis were calculated to have 16.498, 16.651, and 16.364 dBi of gain, respectively. The gain and F/B optimized Knadle Yagis had calculated gain figures of 16.741 and 16.372 dBi, respectively. The additional gain calculated for any of these five Yagis is in excess of what the comparative differences in boomlength would explain. An additional director and the use of varying parasitic element spacing are the main reasons for these differences. The NBS antenna's first minor lobe is of greater amplitude than these 0.0625 and 0.125 Tilton Yagis. The NBS antenna also has slightly less F/B than these 0.125 and 0.1875 Tilton Yagis.

Next month's article will present a single pair of 50 MHz Yagis with highly desirable performance parameters. They represent an interesting exception to a very popular design approach.

references

1. Stanley Jaffin, WB3BGU, "Applied Yagi Antenna Design, Part 1: A 2-meter Classic Revisited," *ham radio*, May, 1984, page 14.
2. Stanley Jaffin, WB3BGU, "Applied Yagi Antenna Design, Part 2: 220 MHz and the Greenblum Design Data," *ham radio*, June, 1984, page 33.
3. William A. Tynan, W3XO, "The World Above 50 MHz," *QST*, June, 1981, page 68.
4. *The ARRL Antenna Book*, American Radio Relay League, Newington, Connecticut, 1974, pages 243-244.
5. Joseph Reiser, W1JR, "VHF/UHF Techniques," *ham radio*, May, 1976, page 54.
6. Edward Tilton, W1HDQ, "Yagi Arrays for 432 Mc," *QST*, April, 1966, page 19.
7. James Lawson, W2PV, "Yagi Antenna Design: Part 1," *ham radio*, January, 1980, page 23.

ham radio

AMAZING SCIENTIFIC and ELECTRONIC DEVICES

LASER DEVICES

- LC5 BURNING CUTTING CO2 LASER.....\$15.00
- RUB3 RUBY LASER RAY PISTOL.....15.00
- LR63 IR LASER RIFLE/PISTOL.....10.00
- LGU3 VISIBLE RED LASER RIFLE.....10.00
- LHP/LLD LASER LIGHT XMTR/RCVR SYS.....10.00
- LHC2 BEGINNER simulated VISIBLE LASER.....5.00

SCIENTIFIC & ELECT

- TCL3 SOLID STATE TESLA COIL 35KV.....6.00
- BTC3 25C THOUSAND VOLT TESLA COIL.....9.00
- BTC5 1.5 MILLION VOLT TESLA COIL.....15.00
- HVM3 125 THOUSAND VOLT DC SUPPLY.....8.00
- IOG3 ION RAY FORCE FIELD GUN.....8.00
- HEG1 MILLION WATT 500 JOULE SOURCE.....10.00

ULTRASONIC ACOUSTICAL

- PPF1 PHASOR PAIN FIELD GENERATOR.....15.00
- PSP3 PHASOR SHOCK WAVE PISTOL.....7.00
- IPG5 POCKET PAIN FIELD GENERATOR.....7.00
- RAT2 RAT AND PEST ELIMINATOR.....6.00
- HT9 HIGH FREQ. LISTENING DEVICE.....8.00

SECURITY & PROTECTION

- DEVI DEVASTATING DEVICES.....10.00
- PPG1 PHASOR PROPERTY GUARD.....15.00
- MFT1 MINI VOICE XMTR 2-3 MILE.....7.00
- INF1 INFINITY TRANSMITTER.....15.00
- PSW3 PHASOR BURNING STUN WAND.....8.00
- PG1 PARALYZING WAND.....10.00

WE STOCK ALL PARTS NECESSARY FOR CONSTRUCTION OF THE ABOVE PROJECTS

• CATALOG CONTAINING HUNDREDS MORE OF ALL NEW AMAZING and FASCINATING PLANS. EASY TO BUILD KITS AND ASSEMBLED ITEMS \$1.00. CATALOG INCLUDED FREE WITH ANY OF THE ABOVE PROJECT PLANS. SEND CASH, CHECK, MO, VISA, MC TO:

INFORMATION UNLIMITED

P.O. BOX 716, DEPT. HR AMHERST, NH 03031

✓ 146

SATELLITE HANDBOOKS

INTRODUCTION TO SATELLITE TV

by Chris Bowick, WD4C and
Tim Kearney, N24Q

Forty years ago, the most sophisticated piece of electronics in the average home was an AM radio. Today, many homes are set up with state-of-the-art receivers designed to pluck signals from satellites orbiting 23,000 miles in space. Instead of getting into a nuts and bolts approach to TVRO, this book gives you a broad overview of TVRO, in general with emphasis on home use. Chapter 1 covers TVRO background and gives a generalized explanation of what TVRO is all about. Chapters 2-4 give you a broad overview of the equipment used to transmit and receive TVRO signals. Three appendices also cover DBS, locating satellites and a glossary of TVRO terms. 1st edition. ©1983 142 pages.

□ 21978 Softbound \$9.95

THE SATELLITE TV HANDBOOK

by Anthony T. Easton

Answers virtually any question you might have on satellite TV. This new book gives you a complete overview of the satellite service, how satellites work, what programming is available, who operates the various satellites, networks and stations, how to engineer and install a system, and the legal background of TVRO. For the "homebrewer", there is a section on building your own TV dish and receiver for around \$600. You also get a section about the non-television services from satellites — radio feeds, teletext, newswire and information on DXing international satellites. ©1983 439 pages First edition

□ 22055 Softbound \$16.95

Please include \$2.50 shipping and handling.
Foreign orders shipped FOB Greenville.

HAM RADIO'S BOOKSTORE
Greenville, NH 03048

Barry Electronics Corp.

WE SHIP WORLDWIDE
WORLD WIDE AMATEUR RADIO SINCE 1950
Your one source for all Radio Equipment!

KITTY SAYS: WE ARE NOW OPEN 7 DAYS A WEEK.
Saturday & Sunday 9 to 6 PM
Monday-Friday 9 to 6:30 PM Thurs. to 8 PM
Come to Barry's for the best buys in town.
For Orders Only Please Call: 800-221-2683

For the best buys in town call:
212-925-7000
Los Precios Mas Bajos en Nueva York...



We are your FLAGSHIP STORE for the 1984 ARRL National Convention. Join Us. July 20th through 22nd.

KENWOOD

R-600, R-1000, R-2000, TS-930S/AT, TS 430S, TR 2500/3500, TR-9130, TR 7950, TW-4000A.
Kenwood Service/Repair.

ROCKWELL/COLLINS

KWM-380
VoCom/Mirage/Daiwa Large inventory of Tokyo Hy-Power Saxton Wire & Cable Amplifiers & S/B HT Gain Antennas IN STOCK



MICROLOG-AIR I in stock

KANTRONICS interface II, software
EIMAC 3-500Z 572B, 6JS6C 12BY7A & 4-400A

BIRD Wattmeters & Elements In Stock



FT-ONE FT-980, FT-230R FT-757GX FT-726R, FT-77, FRG-7700, FT-203R

Land Mobile HT Midland Wilson Mini-Com II Yaesu FT-209, FT-4703 Icom IC M12 (Marine) Tempo M-1



Computer Interfaces stocked: MFJ-1224 AEA CP-1, Kantronics Big Ham Clock/Ham Tags

Repeaters in Stock: Yaesu FTR-2410, Wilson ICOM IC-RP 3010 (440 MHz) ICOM IC-RP 1210 (1.2 GHz) Spectrum

Complete Butternut Antenna Inventory in Stock!

ROBOT 450C-800C-1200C Color Mod Kits
Long range Wireless Telephone for export in stock

BENCHER PADDLES & Vibroplex Keys in Stock!!
Fox-Tango Filters

DENTRON IS BACK IN STOCK! 2591 HT, Corsair in Stock to you FREE of shipping cost

YAESU



IC-R7A, IC-751A, IC-745, IC-27A/H, IC-37A IC-47A, IC-271A/H, IC-2KL, IC-471A, IC-290H.



SMART PATCH CES Simplex Autopatch 510 SA Will Patch FM Transceiver To Your Telephone. Great For Telephone Calls From Mobile To Base Simplex To Use \$319.95

DRAKE TR-7A, L-7 Earth Satellite Receiver ESR-24, THETA 9000E & 500, EARTH SATELLITE STATION ESS-2250



Nye-MB5 3 Kilowatt Tuner

SAITEC ST-222/UP ST-142/UP ST-442/UP HT-7

DIGITAL FREQUENCY COUNTER MFJ Models 900, 840B, 841C, & 851D

HAM MasterTapes—Beta or VHS Tapes
Trionyx Model TR 1000 to 600 MHz
Digimax Model D 510 50 Hz 10Hz

MURCH Model UT2000B

ONV Safety belts-in stock

Tri-Ex Towers & Rotors

New TEN TEC will be shipped direct to you FREE of shipping cost

MAIL ALL ORDERS TO BARRY ELECTRONICS CORP., 512 BROADWAY, NEW YORK CITY, NY 10012.

New York City's LARGEST STOCKING HAM DEALER COMPLETE REPAIR LAB ON PREMISES

"Aqui Se Habla Espanol"

BARRY INTERNATIONAL TELEX 12-7670
TOP TRADES GIVEN ON USED EQUIPMENT
Monday-Friday 9 A.M. to 6:30 P.M.
Thursday to 8 P.M.
Saturday & Sunday 9 A.M. to 6 P.M. (Free parking)
Paid parking lot across the street anytime.

AUTHORIZED DIST. MCKAY DYMEK FOR SHORTWAVE ANTENNAS & RECEIVERS.
IRTLX™ Spring St. Station

Subways: BMT—Prince St. Station
IND—"F" Train-Buy. Station

Bus: Broadway #6 to Spring St.
Path—9th St. 8th Ave. Station.

ORDER LINE
CALL
800-221-2683

We Stock: AEA, ARRL, Alpha, Ameco, Antenna Specialists, Astatic, Astron, B & K, B & W, Bush, Bencher, Bird, Butternut, CDE, CES, Collins, Communications Spec, Conners, Covercraft, Cubic (Swan), Cushcraft, Daiwa, Dentron, Digimax, Drake, ETO (Alpha), Eimac, Encorn, Heil-Sound, Henry, Hustler (Newtronics), Hy-Gain, Icom, KLM, Kantronics, Larsen, MCM (Daiwa), MFJ, J.W. Miller, Mini-Products, Mirage, Newtronics, Nye Viking, Palomar, RF Products, Radio Amateur Callbook, Robot, Rockwell Collins, Saxton, Shure, Swan, Telex, Tempo, Ten-Tec, Tokyo Hi Power, Trionyx TUBES, W2AU, Waber, Wilson, Yaesu Ham and Commercial Radios, Vocom, Vibroplex, Curtis, Tri-Ex, Wacon Duplexers, Repeater, Phelps Dodge, Fanon Intercoms, Scanners, Crystals, Radio Publications.

WE NOW STOCK COMMERCIAL COMMUNICATIONS SYSTEMS
DEALER INQUIRIES INVITED. PHONE IN YOUR ORDER & BE REIMBURSED
COMMERCIAL RADIOS stocked & serviced on premises.

Amateur Radio & Computer Courses Given On Our Premises, Call
Export Orders Shipped Immediately. TELEX 12-7670

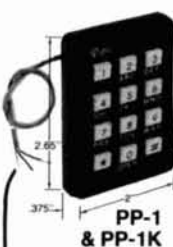

PP-1 & PP-1K

THE Pipo TOUCH TONE ENCODER

An ultra high quality encoder for absolute reliability and function. Positive touch key action with non-malfunction gold contacts, totally serviceable and self-contained. Easy level control, no frequency drift, operates in temperatures from -15°F to 160°F. Supplied with instructions, schematic, template and hardware. Call or write for free catalog, dealer's list and information guide.

PP-1 \$55./PP-1K, S.P.S.T. Adj. Relay \$62.

PP-2, \$59./PP-2K S.P.S.T. Adj. Relay \$66.

M Series = Detached frame for irreg. install.

P-3, 12 or 16 Key, for custom installation, flush mount, 3 different circuits available—request P-3 info.



PP-2 & PP-2K

PATENTED
* ATAT

Mail Order To: **Pipo Communications**® P.O. Box 3435 Hollywood, California 90028 (213) 852-1515
Emphasis is on Quality & Reliability

ham radio TECHNIQUES

Bill W6SAI

160 redux

Fifty years ago 160 meters was the beginner's phone band. Use of the 80- and 20-meter phone bands was restricted to the Class A (Advanced) licensee, 15 meters was not an Amateur band, 10 meters was sparsely occupied by experimenters and the 40-meter phone band did not exist.

During weekdays, until about 5 PM local time, 160 phone was a cross-section of juvenile America. High school lads, with plenty of enthusiasm

and little money, were on the air with 20 or 30-watt phone rigs. In the evening hours, they were obliterated by older, more affluent Amateurs who boasted powerful rigs of 50 to 150 watts. All in all, it was a lot of fun.

There was plenty of DX excitement for the young operators. Many a tired teen-ager stumbled into class in the morning after an all-night DX session. On the east coast, the mark of a true DXer was that he had been able to hear W6JYH in Los Angeles on phone. (*Working him was out of the question!*) On the west coast, the test was to hear W1DJL in Massachusetts. And every-

body envied the booming 160 phone signal of W4CPG in New Port Richey, Florida.

With the advent of World War II and the invasion of LORAN, the old 160-meter band remained practically deserted except for a few die-hards — until recently. Now, with the band appearing on the bandswitch of most new excitors, and LORAN banished to the low frequencies, interest in "top band" has exploded.

I listened in during the spring CW contest. The band was jumping with CW signals from all over the United States and Canada, crowding the

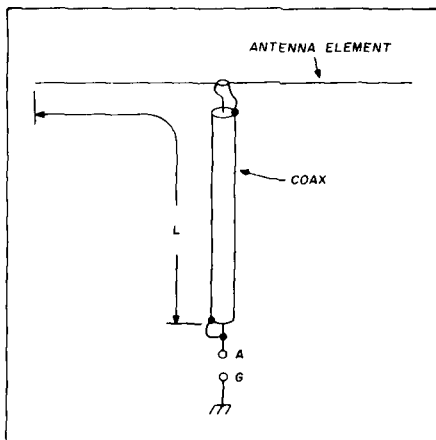

fig. 1. The active element of an HF antenna plus the feedline can be used as a T-Marcconi antenna on 160 meters. One-half the element length plus the feedline length (L) is the length of the 160-meter antenna. Note that the coax conductors are jumpered at the feedpoint (A-G).

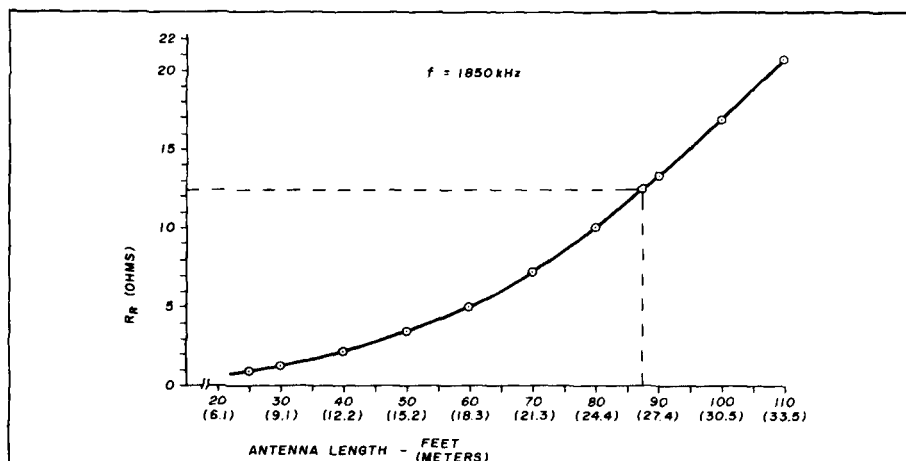

fig. 2. Approximation of feedpoint resistance (R_R) for a short 160-meter Marconi antenna.*

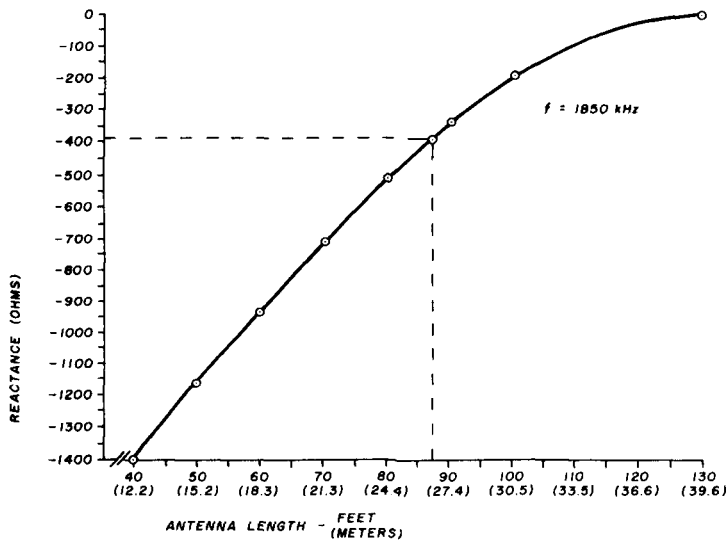

fig. 3. Approximation of the feedpoint reactance for a short 160-meter Marconi antenna.*

band from 1800 to about 1850 kHz. And there was plenty of SSB activity from 1850 to 1950 kHz, with some contented AM operation at the top end of the band.

Yes, 160 had come back to life and I had to get on. All I needed was an antenna.

let's get on 160 meters

One possible choice is to use the high frequency antenna (dipole, Yagi, Quad, or groundplane) as a T-type Marconi antenna, working the antenna-plus-feedline against ground (fig. 1).

This can be accomplished by shorting the inner and outer conductors on the coaxial line at the station and using a good earth ground connection as the return. If half of your driven element plus the feedline length approaches a quarter wave (about 126 feet) on the top band, you're in good shape; a simple antenna tuner will get you on 160 meters quickly. Just make sure your coaxial line is clear of the ground and not bundled up with rotator cables and such as it functions on 160 meters as part of the radiating system.

If your regular antenna tuner covers

*Derived from data presented in reference 1.

160 meters, it may work with overall antenna lengths between 115 and 150 feet. But what do you do if your antenna-plus-feedline length is shorter than this? A different approach to the problem is required.

very short antennas for 160 meters

I measured my feedline length, plus half the driven element length of my tribander and the total length came out to be only 87 feet 6 inches. Could I work this shortened antenna system on 160 meters?

First, I had to determine if the physical length (L) was the same, or close to, the electrical length. I connected the T-antenna to my ground connection via a small 4-turn coil and used a dip oscillator to determine the natural quarter-wave resonance of the system. It was 2.73 MHz. That agreed closely with the theoretical resonance value, which is:

$$f(\text{MHz}) = \frac{234}{\text{length (feet)}} = \frac{234}{87.5} = 2.67 \text{ MHz}$$

Now that I knew the electrical and physical length of my proposed 160-meter antenna were very close, I could determine the radiation (feedpoint) resistance of the antenna, assuming I had a perfect ground.

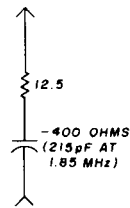

fig. 4. Equivalent circuit of my 160-meter Marconi antenna.

Figure 2 shows that value to be close to 12.5 ohms. (See note, fig. 2)¹

For my ground I ran a short, heavy conductor to the copper plumbing system of the house and grounded the pipes via two eight-foot long ground rods driven into the soil at each end of the house. (Unfortunately, the lawn sprinkling system buried in the front yard was constructed of PVC plastic pipe, otherwise it would have been added to the ground system too.)

I decided to use a simple L-matching network between my transceiver and the 160 meter T-antenna and concluded it would be best to design this for the lowest estimated feedpoint resistance of my antenna because it's much easier for the network to match a load higher in resistance than the design value than lower in value. Accordingly the worst-case feedpoint resistance was chosen to be 10 ohms. Because I didn't know the ground resistance, and didn't have the time or inclination to measure it, I ignored it for the time being.

antenna reactance

I wasn't out of the woods yet. An antenna shorter than an electrical quarter wavelength exhibits negative (capacitive) reactance at the feedpoint, with the exact value depending upon the antenna length and the length/diameter ratio of the conductor. For a thin wire, the chart in fig. 3 provides an approximation. (See fig. 3 footnote.)¹

My particular antenna would have a negative reactance of about -400 ohms. A schematic representation of what the antenna is, as far as the transceiver and matching network is shown

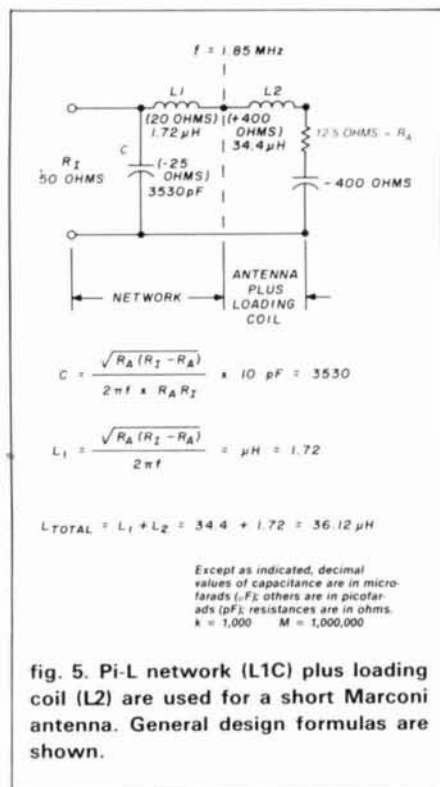

fig. 5. Pi-L network (L1C) plus loading coil (L2) are used for a short Marconi antenna. General design formulas are shown.

in fig. 4. Expressed as a complex number, the load to be matched is about $12.5-j400$. The resistive portion of the load can be estimated more accurately than the reactive portion, which varies widely with antenna capacitance to ground and nearby objects.

In any event, the requirement is a 4:1 impedance transformation to 50 ohms plus cancellation of the -400 ohms of capacitive reactance. The cancellation can be accomplished by adding $+400$ ohms of inductive reactance between the antenna and the matching device. The required reactance is termed a *loading coil*.

the matching network

The equivalent antenna circuit shown in fig. 4 has to be accurately matched to 50 ohms in order for modern transceivers to work properly on the top band. Because of limited adjustment range, most transceivers are not very "forgiving" with regard to a mismatched antenna load, particularly on the 160 meter range.

A matching network to transform approximately 12 ohms to 50 ohms and cancel out the negative reactance

exhibited by the antenna is shown in fig. 5. The circuit is an L-network, with extra series inductance added to cancel the capacitive effect of the short antenna. In practical terms it boils down to lots of shunt capacitance (C) plus a modest amount of series inductance (L1) in the network, plus the large extra loading inductance (L2) required as a loading coil. The two coils can be combined into one, as shown in the assembly of fig. 6.

Surplus mica capacitors are used, plus a large variable capacitor. A multi-gang "broadcast" capacitor with the sections tied in parallel can be substituted for the single section capacitor used in this unit.

it works — almost

In real life, the required inductance turned out to be less than the calculated amount, indicating that the antenna had less capacitive reactance than determined by the design chart. The antenna was measured to actually be 11.8 ohms in series with -211 ohms (407 pF).

After all was tuned up and the SWR reading between the tuner and the transceiver was unity, the last step was to decouple the house wiring from the antenna system. As soon as I got on the air, the lights in the family room blinked on and off in step with my keying.

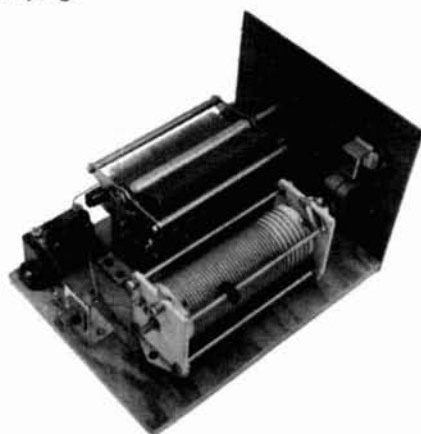

fig. 6. The 160-meter antenna tuner is built up on a plywood base and Masonite panel. The variable capacitor is a surplus Cardwell 2000 pF unit — probably unobtainable! Connected in parallel with the variable capacitor is a $0.002 \mu\text{F}$ transmitting-type mica capacitor and across it, a 250 pF mica unit.

It seemed as if a goodly proportion of my radiated power was being absorbed by the nearby house wiring. Since I couldn't move the antenna, or the house, the only thing left to do was to decouple the wiring from the RF field as much as possible. This was accomplished by taking a few AC plugs and mounting $0.01 \mu\text{F}$, 1.6 kV ceramic capacitors across the pins.* The plugs were then inserted into wall outlets around the house at random until no lights came on when I was on the air and turning lights off and on did not affect the SWR reading. No kidding, when the house wiring was "hot," switching lights on and off *did* change the 160-meter antenna tuning and the SWR on the transmission line! (Live and learn.)

This all came about because the exposed house wiring was in close proximity to the antenna. It can happen on other bands, too. The best situation is to live in a home where the wiring is fed through metal conduit.

the results

After all of this horsing around (which took only about a day of spare time) I settled down to see what I could work with this puny antenna. While I was not the biggest kid on the block, I could do well within 500 miles and could get reasonable reports out to the Midwest. I capped my DX activities one weekend by working two stations in New England! Granted, I got only a 339 report from each of them, but the contacts were genuine.

a 160-meter harmonic filter

Part 97.73 of the FCC rules specifies that spurious signals generated by the transmitter must be attenuated 40 dB below the output power level at frequencies between 1 and 5 MHz. Most Amateur excitors can meet this require-

*The "garden variety" $0.01 \mu\text{F}$, 600-volt disc ceramic capacitor is not rated for operation at 115 VAC. Various manufacturers market special capacitors for this purpose that are rated for continuous operation at 125 VAC and 1400 VDC. (The high DC rating is required because of high-voltage transients that often appear on the power line.) Three well-known brands of capacitors are Aerovox type AC-7, Centralab type CI-103, and Sprague type 125L-S10.

ment with room to spare, but this doesn't help the nearby Amateur working DX on 80 meters when he or she picks up your weak second harmonic atop the weaker, more desirable signal. A few extra dB of harmonic attenuation will solve this problem.

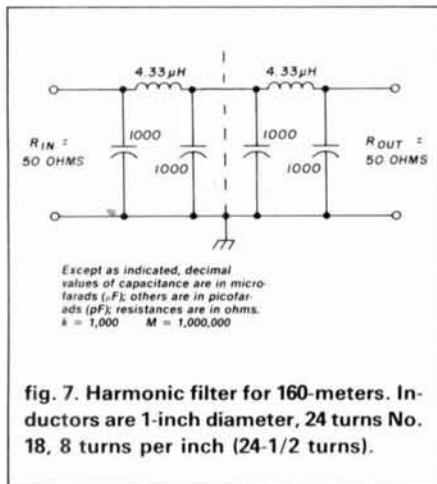

fig. 7. Harmonic filter for 160-meters. Inductors are 1-inch diameter, 24 turns No. 18, 8 turns per inch (24-1/2 turns).

Shown in fig. 7 is a simple 5-element Chebyshev lowpass filter that will attenuate the second and higher harmonics of a 160-meter signal about 24 dB, provided the SWR on the transmission line is near unity. The filter is placed immediately after the transceiver and the SWR meter and before the tuner.

Construction of the filter is simple. A two-compartment box is soldered up out of circuit board and a filter section is placed in each compartment. The size of the box depends upon the size of the components. For powers below 150 watts, postage-stamp size mica capacitors can be used, together with miniature air-wound coils. Matching coaxial receptacles are placed on the ends of the box.

The cutoff frequency of this filter is just above the top edge of the 160-meter band, so be sure to remove it from your antenna circuit when you operate on the higher bands, or you'll have fireworks.

in summary, then . . .

In order to use your HF beam, dipole, or whatever, with your feedline as a Marconi antenna, you'll have to determine the electrical length of the

installation for 160-meter operation. This measurement is from one tip of the antenna element to the station. You can readily see that the coaxial line comprises the greater portion of the antenna. If the line runs close to the ground, performance on the top band won't be very good, because your makeshift antenna will be low. If the line runs 10 to 20 feet above the ground, you are in luck. Don't worry about twists or turns in the line; the antenna tuner will take care of that.

Watch out for coupling between your antenna and the house wiring or other nearby antennas. Some time ago, during an earlier attempt to get on 160 meters, I loaded up a random, 100-foot wire I'd used for general reception with my vintage National HRO receiver. During the tuning process I noticed smoke coming out from underneath by beloved receiver. I turned everything off quickly and soon discovered that the 15-foot long lead-in to the HRO antenna post was draped near the wire serving as part of the 160-meter antenna. Enough RF pickup existed to fry the receiver antenna coil to a crisp, even though no physical connection existed between the transceiver and the receiver.

The point is that a large portion of the 160-meter antenna was *in* the house, or near to it, and a strong RF field existed where one had never existed before, because the usual high-frequency antenna is not in close proximity to the house. Any unbalanced Marconi-type antenna working against ground is capable of pumping large portions of RF into the house wiring, if you don't take precautions to prevent it!

So there you have it. 160-meter operation is possible even with a small antenna *if* you have a reasonably good ground connection and the right antenna tuner. Keep clear of your house wiring, get on the band, and I'll see you on the low end!

reference

1. Henry Jasik, *Antenna Engineering Handbook*, McGraw-Hill Book Company, New York.

ham radio

TOUCH TONE™ CONTROL

OUR NEW CS-16 DUAL PASSWORD DECODER BOARD IS THE FINAL SOLUTION TO REPEATER CONTROL SECURITY

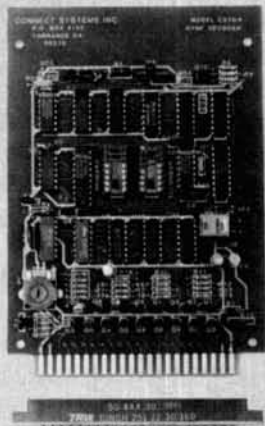

- 16 latched on/off functions
- Open collector (can drive relays directly) and logic outputs for each function.
- Two separately programmable three digit passwords allow hierarchy control
- Primary password can access all 16 functions
- Secondary password can access 8 functions
- A primary password command can enable/disable secondary password control
- Can be strapped to operate without passwords
- Adjustable pre-amp accommodates 10MV-2V input
- Retransmission of control tones can be eliminated by use of either open collector or data strobe logic outputs
- Power up reset
- XTAL controlled tone decoder
- Operates from 10 VDC to 25VDC. Reverse polarity protected
- Standard 4 1/2" x 6 1/2" glass board with 44 pin gold plated edge connector. Holes permit hard mounting
- Comes complete with manual and mating connector
- 30 day return privilege
- Limited six month warranty

CALL OR WRITE FOR BROCHURE



\$149



ANOTHER QUALITY PRODUCT FROM



23731 Madison Street
Torrance, CA 90505
Phone (213) 373-6803

RAMSEY

THE FIRST NAME IN ELECTRONIC TEST GEAR

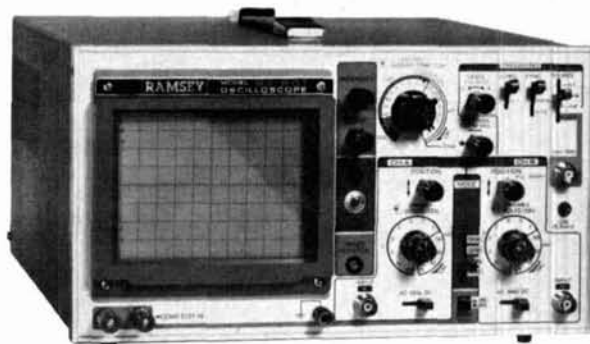

NEW FROM RAMSEY—20 MHz DUAL TRACE OSCILLOSCOPE

Unsurpassed quality at an unbeatable price, the Ramsey oscilloscope compares to others costing hundreds more. Features include a component testing circuit that will allow you to easily test resistors, capacitors, digital circuits and diodes • TV video sync filter • wide bandwidth & high sensitivity • internal graticule • high quality rectangular CRT • front panel trace rotator • Z axis • high sensitivity x-y mode • very low power consumption • regulated power supply • built-in calibrator • rock solid triggering • high quality hook-on probes

\$399.95 high quality hook-on probes included



RAMSEY D-1100 VOM-MULTITESTER

Compact and reliable, designed to service a wide variety of equipment. Features include • mirror back scale • double-jeweled precision moving coil • double overload protection • an ideal low cost unit for the beginner or as a spare back-up unit.

\$19.95

test leads and battery included



RAMSEY D-2100 DIGITAL MULTITESTER

A compact easy to use unit designed to operate like a pro. Featuring • 3 1/2 digit LCD • low BAT. indicator • all range overload protection • overrange indication • auto-polarity • Transistor tester • dual-slope integration • vinyl carrying case

\$54.95

test leads, battery & vinyl carrying case included

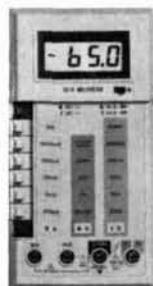

RAMSEY D-3100 DIGITAL MULTIMETER

Reliable, accurate digital measurements at an amazingly low cost • in-line color coded push buttons, speeds range selection • abs plastic tilt stand • recessed input jacks • overload protection on all ranges • 3 1/2 digit LCD display with auto zero, auto polarity & low BAT. indicator

\$59.95

test leads and battery included



CT-70 7 DIGIT 525 MHz COUNTER

Lab quality at a breakthrough price. Features • 3 frequency ranges each with pre amp • dual selectable gate times • gate activity indicator • 50mV @ 150 MHz typical sensitivity • wide frequency range • 1 ppm accuracy

\$119.95

wired includes AC adapter

CT-70 kit \$99.95
BP-4 nicad pack 8.95



CT-90 9 DIGIT 600 MHz COUNTER

The most versatile for less than \$300. Features 3 selectable gate times • 9 digits • gate indicator • display hold • 25mV @ 150 MHz typical sensitivity • 10 MHz timebase for WWV calibration • 1 ppm accuracy

\$149.95

wired includes AC adapter

CT-90 kit \$129.95
OV-1 0.1 PPM oven timebase 59.95
BP-4 nicad pack 8.95



CT-125 9 DIGIT 1.2 GHz COUNTER

A 9 digit counter that will outperform units costing hundreds more. • gate indicator • 24mV @ 150 MHz typical sensitivity • 9 digit display • 1 ppm accuracy • display hold • dual inputs with preamps

\$169.95

wired includes AC adapter

BP-4 nicad pack 8.95



CT-50 8 DIGIT 600 MHz COUNTER

A versatile lab bench counter with optional receive frequency adapter, which turns the CT-50 into a digital readout for most any receiver • 25 mV @ 150 MHz typical sensitivity • 8 digit display • 1 ppm accuracy

\$169.95

wired

CT-50 kit \$139.95
RA-1 receiver adapter kit 14.95



DM-700 DIGITAL MULTIMETER

Professional quality at a hobbyist price. Features include 26 different ranges and 5 functions • 3 1/2 digit, 1/2 inch LED display • automatic decimal placement • automatic polarity

\$119.95

wired includes AC adapter

DM-700 kit \$99.95
MP-1 probe set 4.95



PS-2 AUDIO MULTIPLIER

The PS-2 is handy for high resolution audio resolution measurements, multiplies UP in frequency • great for PL tone measurements • multiplies by 10 or 100 • 0.01Hz resolution & built-in signal preamp/conditioner

\$49.95

wired

PS-2 kit \$39.95

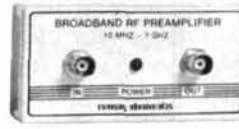

PR-2 COUNTER PREAMP

The PR-2 is ideal for measuring weak signals from 10 to 1,000 MHz • flat 25 db gain • BNC connectors • great for sniffing RF • ideal receiver/TV preamp

\$44.95

wired includes AC adapter

PR-2 kit \$34.95



PS-1B 600 MHz PRESCALER

Extends the range of your present counter to 600 MHz • 2 stage preamp • divide by 10 circuitry • sensitivity 25mV @ 150 MHz • BNC connectors • drives any counter

\$59.95

wired includes AC adapter

PS-1B kit \$49.95

ACCESSORIES FOR RAMSEY COUNTERS

Telescopic whip antenna—BNC plug \$ 8.95
High impedance probe, light loading 16.95
Low pass probe, audio use 16.95
Direct probe, general purpose use 13.95
Tilt bail, for CT-70, 90, 125 3.95



PHONE ORDERS CALL
716-586-3950

TELEX 466735 RAMSEY CI

TERMS • satisfaction guaranteed • examine for 10 days; if not pleased, return in original form for refund • add 6% for shipping and insurance to a maximum of \$10.00 • overseas add 15% for surface mail • COD add \$2.50 (COD in USA only) • orders under \$15.00 add \$1.50 • NY residents add 7% sales tax • 90 day parts warranty on all kits • 1 year parts & labor warranty on all wired units.



RAMSEY ELECTRONICS, INC.
2575 Baird Rd.
Penfield, N.Y. 14626

We now have available a bunch of goodies too good to bypass. Items are limited so order today

716-586-3950

Call your Phone Order in Today. TERMS: Satisfaction guaranteed or money refunded. C.O.D. add \$2.50. Minimum order \$6.00. Orders under \$10.00 add \$1.50. Add 6% for postage, insurance, handling. Overseas add 15%. N.Y. residents add 7% tax.

**MINI KITS - YOU HAVE SEEN THESE BEFORE NOW
HERE ARE OLD FAVORITE AND NEW ONES TOO.
GREAT FOR THAT AFTERNOON HOBBY.**

**FM
MINI
MIKE**

A super high performance FM wireless mike kit! Transmits a stable signal up to 300 yards with exceptional audio quality by means of its built-in electret mike. Kit includes case, mike, on-off switch, antenna battery and super instructions. This is the finest unit available.

FM-3 Kit **\$14.95**
FM-3 Wired and Tested **\$22.95**

Color Organ

See music come alive! 3 different lights flicker with music. One light each for high, mid-range and lows. Each individually adjustable and drives up to 300 W runs on 110 VAC.

Complete kit, ML-1 **\$8.95**

Video Modulator Kit
Converts any TV to video monitor. Super stable, tunable over ch. 4-6. Runs on 5-15V, accepts std video signal. Best unit on the market! Complete kit VD-1 **\$8.95**

Led Blinky Kit
A great attention getter which alternately flashes 2 jumbo LEDs. Use for name badges, buttons, warning panel lights, anything! Runs on 3 to 15 volts. Complete kit, BL-1 **\$2.95**

Super Sleuth
A super sensitive amplifier which will pick up a pin drop at 15 feet! Great for monitoring baby's room or as general purpose amplifier. Full 2 W rms output, runs on 6 to 15 volts, uses 8-45 ohm speaker. Complete kit, BN-9 **\$5.95**

CPO-1
Runs on 3-12 Vdc. Good for CPO. Alarm, Audio O. Complete kit **\$2.95**

FM Wireless Mike Kit

Transmits up to 300' to any FM broadcast radio, uses any type of mike. Runs on 3 to 9V. Type FM-2 has added sensitive mike preamp stage.

FM-1 kit **\$3.95** FM-2 kit **\$4.95**

Whisper Light Kit

An interesting kit, small mike picks up sounds and converts them to light. The louder the sound, the brighter the light. Includes mike, controls up to 300 W, runs on 110 VAC. Complete kit, WL-1 **\$6.95**

Tone Decoder

A complete tone decoder on a single PC board. Features 400-5000 Hz adjustable range via 20 turn pot, voltage regulation, 567 IC. Useful for touch-tone burst detection, FSK, etc. Can also be used as a stable tone encoder. Runs on 5 to 12 volts. Complete kit, TD-1 **\$5.95**

Mad Blaster Kit

Produces LOUD ear shattering and attention getting siren like sound. Can supply up to 15 watts of obnoxious audio. Runs on 6-15 VDC. Complete kit, MB-1 **\$4.95**

Siren Kit

Produces upward and downward wail characteristic of a police siren. 5 W peak audio output, runs on 3-15 volts, uses 3-45 ohm speaker. Complete kit, SM-3 **\$2.95**

Universal Timer Kit

Provides the basic parts and PC board required to provide a source of precision timing and pulse generation. Uses 555 timer IC and includes a range of parts for most timing needs. Complete kit, UT-5 **\$5.95**

CLOCK KITS

Your old favorites are here again. Over 7,000 Sold to Date. Be one of the gang and order yours today!



Try your hand at building the finest looking clock on the market. Its satin finish anodized aluminum case looks great anywhere, while six 4" LED digits provide a highly readable display. This is a complete kit, no extras needed, and it only takes 1-2 hours to assemble. Your choice of case colors: silver, gold, black (specify).
Clock kit, 12/24 hour, DC-5 **\$24.95**
Clock with 10 min. ID timer, 12/24 hour, DC-10 **\$29.95**

For wired and tested clocks add \$10.00 to kit price. SPECIFY 12 OR 24 HOUR FORMAT

SATELLITE TV KIT



image rejection, fully tunable audio to recover 'hidden' subcarriers, divide by two PLL demodulator for excellent threshold performance, light tracking AFC to assure drift free reception, and of course, full 24 channel tunable coverage.

Build your satellite TV system around the R2B, close to ten thousand others already have and now it's available in kit form at a new low price. Order yours today.

THE POPULAR SAT-TEC RECEIVER IN KIT FORM!

NEW, LOWER PRICES!

Featured in a Radio Electronics magazine cover story (May 82), the reliable R2B Satellite TV receiver is now operating in thousands of locations. The R2B is easy to build, pre-checked printed boards with screened component layout assures accurate component placement and the critical IF section is fully tested. Kits are pre-assembled at our factory. Kits are included for the R2B, an RF case, power supply, descriptive operating manual as well as complete assembly instructions. Features of the receiver include: dual conversion design for best

A complete Satellite TV System requires:
1. Aerial Antenna, LNA (low noise amplifier), Receiver and Modulator **\$295.00**
2. Receiver Kit **\$395.00**
3. R2B Receiver, Wired and Tested **\$395.00**
4. 120" K LNA **\$295.00**
5. RM3RF Modulator **\$49.95**
Prices include domestic UPS shipping and insurance.

PARTS PARADE

IC SPECIALS

LINEAR	TTL
301 \$.35	74S00 \$.40
324 \$1.50	7447 \$.65
380 \$1.50	7475 \$.50
555 \$.45	7490 \$.50
556 \$1.00	74196 \$1.35

SPECIAL
567 \$1.25
741 \$10.00
1458 \$.50
3900 \$.50
8038 \$2.95

CMOS	FERRITE BEADS
4011 \$.50	With info and specs \$15.00
4013 \$.50	6 Hole Balun Beads \$5.00
4046 \$1.85	
4049 \$.50	
4059 \$9.00	
4511 \$2.00	
4518 \$1.35	
5639 \$1.75	

READOUTS	Sockets
FND 359 4" C C \$1.00	8 Pin \$10.00
FND 507/510 5" C A 1.00	14 Pin \$10.00
MAN 72/HP7730 33" C A 1.00	16 Pin \$10.00
HP 7851 43" C A 2.00	24 Pin \$4.00
	28 Pin \$4.00
	40 Pin \$3.00

TRANSISTORS	Diodes	25 AMP	Mini-Bridge 50V
2N3904 NPN C-F \$15.00	5.1 V Zener \$20.00	1N914 Type \$50.00	1 AMP
2N3906 PNP C-F \$15.00	1KV 2Amp \$1.00	1KV 1Amp \$1.00	2 for \$1.00
2N4403 PNP C-F \$15.00	100V 1Amp \$1.00		
2N4410 NPN C-F \$15.00			
2N4916 FET C-F \$4.00			
2N5401 PNP C-F \$5.00			
2N6028 C-F \$4.00			
2N3771 NPN Silicon \$1.50			
2N5179 UHF NPN \$3.00			
Power Tab NPN 40W \$3.00			
Power Tab PNP 40W \$3.00			
MPP 102/2N5484 \$3.00			
NPN 3904 Type T-R \$0.82.50			
PNP 3906 Type T-R \$0.82.50			
2N3055 \$3.00			
2N2846 UJT \$3.00			

Resistor Ass't	Crystals
Assortment of Popular values - 1/2 watt. Cut lead for PC mounting. 50% center. 100 leads, bag of 300 or more. \$2.00	3579545 MHZ \$1.50
	10 000000 MHZ \$5.00
	5 2488000 MHZ \$5.00

Switches	Earphones	AC Adapters
Mini toggle SPDT \$1.00	Good for clocks, record chargers, all 110 VAC plug one end.	8.5 vdc @ 20 mA \$1.00
Red Pushbuttons N O 3/\$1.00	3" leads, 8 ohm, good for small tone speakers, alarm clocks, etc. 5 for \$1.00	16 vdc @ 160mA \$2.50
		12 vdc @ 250mA \$3.00

Mini 8 ohm Speaker	Solid State Buzzers	AC Outlet
Approx 2" diam Round type for radios, mike etc. 3 for \$2.00	small buzzer 450 Hz 86 dB sound output on 5-12 vdc at 10-30 mA. TTL compatible. \$1.50	Panel Mount with Leads 4/\$1.00

Slugs Tuned Coils	AC Outlet
Small 3/16" Hex Slugs turned coil 3 turns 10 for \$1.00	Panel Mount with Leads 4/\$1.00

CAPACITORS	DC-DC Converter	Ceramic IF Filter
TANTALUM Dipped Electrolytic	+5 vdc input prod. +9 vdc @ 30ma	Mini C-F SOLD OUT
1.5 uF 25V 3/\$1.00	+9 vdc produces -15 vdc @ 35ma \$1.25	BW \$1.50 ea.
1.8 uF 25V 3/\$1.00		
22 uF 25V 3/\$1.00		
1000 uF 16V Radial \$50		
500 uF 20V Axial \$50		
150 uF 16V Axial \$31.00		
10 uF 15V Radial 10/\$1.00		
01 16V disk 20/\$1.00		
1 16V 15/\$1.00		
100 pf 20/\$1.00		
047 16V 20/\$1.00		

Crystal Microphone	9 Volt Battery Clips
Small 1" diameter 1/4" thick crystal mike cartridge \$75	Nice quality clips 5 for \$1.00
	1/4" Rubber Grommets 10 for \$1.00

Coax Connector	Parts Bag	Connectors
Chassis mount BNC type \$1.00	Ass't of chokes, disc, caps, tantal resistors, transistors, diodes, MIC A caps etc. sm bag (100 pc) \$1.00 lg bag (300 pc) \$2.50	6 pin type gold contacts for MA-1003 car clock module price .75 ea.

Leds	Varactors
your choice, please specify Mini Red, Jumbo Red, High intensity Red, Illuminator Red 8/\$1 Mini Yellow, Jumbo Yellow, Jumbo Green 8/\$1	Motorola MV 2209 30 PF Nominal cap 20-80 PF - Tunable range - \$6 each or 3/\$1.00

Audio Prescaler
Make high resolution audio measurements, great for musical instrument tuning, PL tones, etc. Multiplies audio UP in frequency, selectable x10 or x100, gives 01 HZ resolution with 1 sec gate time! High sensitivity of 25 mv, 1 meg input z and built-in filtering gives great performance. Runs on 9V battery, all CMOS. PS-2 kit \$39.95 PS-2 wired \$49.95

30 Watt 2 mtr PWR AMP
Simple Class C power amp features 8 times power gain. 1 W in for 8 out, 2 W in for 15 out, 4 W in for 30 out. Max output of 35 W, incredible value, complete with all parts, less case and T-R relay. PA-1, 30 W pwr amp kit \$24.95 TR-1, RF sensed T-R relay kit \$6.95

MRF-238 transistor	Power Supply Kit
as used in PA-1 8-10db gain 150 mhz \$15.95	Complete triple regulated power supply provides variable 6 to 18 volts at 200 ma and +5 at 1 Amp. Excellent load regulation, good filtering and small size. Less transformers, requires 6.3 V +1 A and 24 VCT. Complete kit, PS-3LT \$6.95

RF actuated relay	OP-AMP Special
senses RF (1W) and closes DPDT relay. For RF sensed T-R relay TR-1 Kit \$6.95	BI-FET LF 13741 - Direct pin for pin 741. Input z, super low 50 pa input current, power drain 50 for \$9.00 10 for \$2.00

SOLD OUT	Regulators
723 \$3.00	7812 \$1.00
309K \$1.15	7815 \$1.00
7805 \$1.00	7905 \$1.25
	7912 \$1.25
	7915 \$1.25

Shrink Tubing Nubs	Mini TO-92 Heat Sinks
Nice precut pcs of shrink size 1" x 1/4" shrink to 1/4". Great for splices 50/\$1.00	Thermalloy Brand 5 for \$1.00
	To-220 Heat Sinks 3 for \$1.00

Opto Isolators	Opto Reflectors
- 4N28 type \$1.00 ea.	Photo diode + LED \$1.00 ea.

Molex Pins	CDS Photo Cells
already precut in length of 7. Perfect for 14 pin sockets. 20 strips for \$1.00	Resistance varies with light. 250 ohms to over 3 meg 3 for \$1.00

10GHz GUNNPLEXER transceiver



TR10GA

- Complete ready to use 10 GHz fm voice/cw transceiver • 10 mW power output
- Typical frequency coverage 10.235-10.295 GHz • Full duplex operation
- Internal Gunnplexer for portable operation • Gunnplexer removable for tower mounting in fixed location service — three shielded cables required for interconnection
- Powered by 13 volts dc nominal at 250 mA • 30 MHz i-f • 10-turn potentiometer controlled VCO tuning • 220 kHz ceramic i-f filter • Extra diode switched filter position for optional filter
- Dual polarity afc • Rugged two-tone grey enclosure • Full one year warranty • \$389.95 with 10 mW Gunnplexer • \$269.95 without Gunnplexer

Advanced Receiver Research

Box 1242 • Burlington CT 06013 • 203 582-9409

Postpaid for U.S. and Canada. CT Residents add 7-1/2% sales tax. C.O.D. orders add \$2.00. Air mail to foreign countries add 10%



FREE CATALOG!

Features Hard-to-Find Tools and Test Equipment



Jensen's new catalog features hard-to-find precision tools, tool kits, tool cases and test equipment used by ham radio operators, hobbyists, scientists, engineers, laboratories and government agencies. Call or write for your free copy today.

JENSEN TOOLS INC. | 7815 S. 46th Street
Phoenix, AZ 85040
(602) 968-6231

✓ 147

dy Jan Dysan CORPORATION

5 1/4" SSDD

\$33 Box of 10
(10 or more \$31/Box)

FREE SUPPLIES CATALOG
Write Today

Payment: Mastercard/Visa (include Number and expiration date), Money Order, Cashier's Check, Personal Checks (allow 10 days to clear). Shipping 3%, \$3 minimum, by UPS mainland USA. Sorry no APO/FPO/COD's. New Jersey add 6%. Prices and availability subject to change without notice.

OUTPRINT

COMPUTER AND WORD PROCESSING SUPPLIES

✓ 170 44 FORREST ROAD
RANDOLPH, NEW JERSEY 07869

WARNING SAVE YOUR LIFE OR AN INJURY

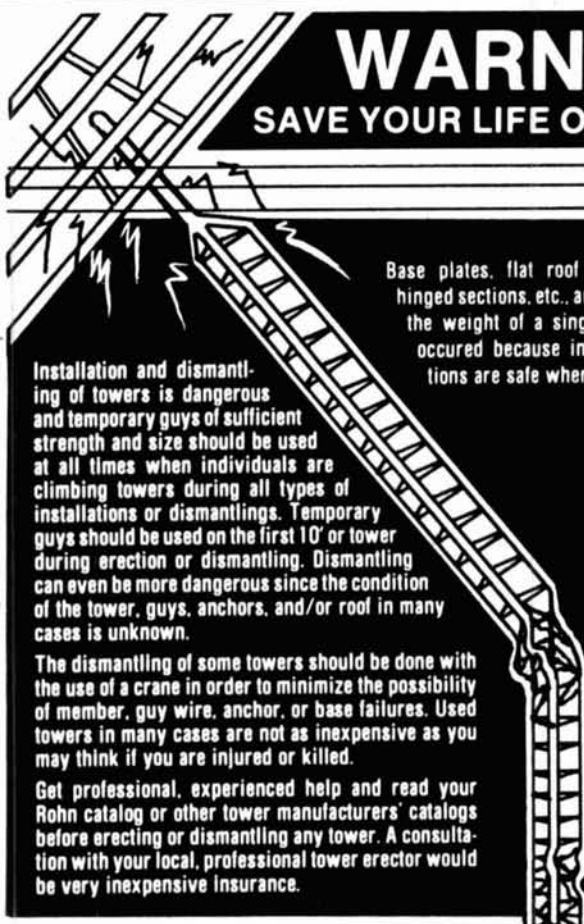

Base plates, flat roof mounts, hinged bases, hinged sections, etc., are not intended to support the weight of a single man. Accidents have occurred because individuals assume situations are safe when they are not.

Installation and dismantling of towers is dangerous and temporary guys of sufficient strength and size should be used at all times when individuals are climbing towers during all types of installations or dismantlings. Temporary guys should be used on the first 10' or tower during erection or dismantling. Dismantling can even be more dangerous since the condition of the tower, guys, anchors, and/or roof in many cases is unknown.

The dismantling of some towers should be done with the use of a crane in order to minimize the possibility of member, guy wire, anchor, or base failures. Used towers in many cases are not as inexpensive as you may think if you are injured or killed.

Get professional, experienced help and read your Rohn catalog or other tower manufacturers' catalogs before erecting or dismantling any tower. A consultation with your local, professional tower erector would be very inexpensive insurance.

Paid for
By the
Following:
ROHN®
P.O. Box 2000
Peoria, IL 61656

✓ 101

TUNE IN THE WORLD OF HAM-TV!

Amateur Radio operators in the 1980's are discovering the fascinating "World of Amateur Television". Be it Fast Scan TV (FSTV), Slow Scan TV (SSTV), Facsimile (FAX) or somewhere in between. Video communications modes are growing at an exciting pace!

New advancements are taking place in High-Resolution/Color SSTV and the use of personal computers for ATV graphics. SSTV-FAX-RTTY communications. Interest is even growing in MICROWAVE and TVRO applications.

A5 ATV MAGAZINE™ has supported these modes of Amateur Specialized Communications since 1967 — over 17 years! And now, under guidance of the UNITED STATES ATV SOCIETY, HAM-TV will continue to grow rapidly. Interested?

Send SASE for "free" information brochures today!

Special six month TRIAL subscription only \$10.00

One year subscription (12 issues) of the "USATVS Journal" \$20.00

Sample issue available for \$2.50 ppd

A5 ATV MAGAZINE™

P.O. BOX H
LOWDEN, IOWA 52255

A DIVISION OF QCD PUBLICATIONS, INC.

✓ 113



ground rod resistance

Exploring ground, ground rod, and antenna relationships

An approximate equation has been derived for determining the resistance of a ground rod under a quarter wave vertical antenna. The physical factors involved are the antenna height and ground rod length and diameter, combined with the resistive and dielectric properties of the ground under the antenna. The derivation is based on choosing earth current paths which are both realistic and expressible with simple equations. With the equation it can then be demonstrated that in the regions where the current path is less certain, the power loss and hence the resistance contributions are minor.

The electrical characteristics of the ground are that of a "quasi-conductor" because of its dielectric property.¹ At 160 meters, it behaves more nearly as a resistive body, but at 10 meters, the dielectric currents become predominant. The effect is to markedly reduce the "ground resistance" at the higher frequencies.

The "constriction resistance" to the radial current as it leaves the ground rod can be calculated. As an example, at 80 meters, over one-third of the ground rod resistance is located within 6 inches (12.7 cm) of a 1-inch (2.54 cm) diameter ground rod. It confirms that the injection of salt brine into this very small region is of great benefit in reducing the effective ground resistance.²

The equation will answer such questions as what would be the effect of changes to the ground system. Such changes might be the use of longer or greater diameter ground rods, or the addition of more, well separated ground rods.

A ground rod can be considered as an inverted antenna in a lossy dielectric. At 10, 15, and even 20 meters, adverse resonances can occur, adding to the ground resistance. The approximate equation derived in this article does not include this effect, although the conditions for its presence are discussed in an appendix.

approximate equivalent circuit for ground currents

When a vertical quarter wave antenna is used with a ground rod, the current which enters the ground rod leaves it along its length, just as the antenna current leaves along its length. Figure 1 shows the antenna system considered here, sketching the vertical plane through the antenna. Dimensions h , g , and d indicate antenna height, ground rod length, and ground rod diameter, respectively, and will appear in the ground rod resistance equation. The assumed current paths are discussed later.

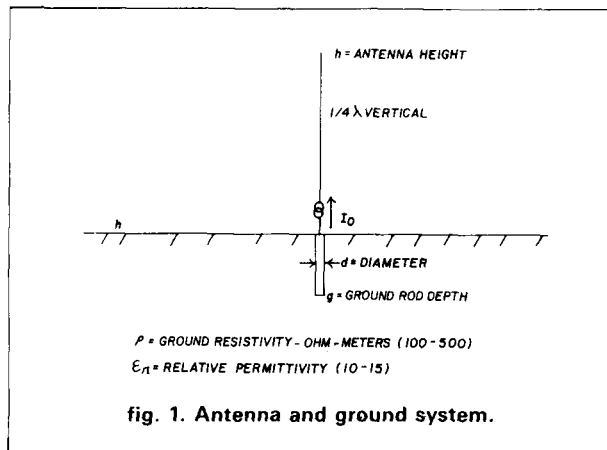

Evaluation of the ground currents which flow from the ground rod requires a knowledge of the electrical characteristics of the ground. Ground has both resistive and dielectric properties.^{1,3} Resistivity is the reciprocal of conductivity, the latter being the characteristic usually tabulated. In this article, resistivity will be used in the ground rod equation. However, conductance may be used in the discussion, when appropriate.

The normal ranges for resistivity and relative permittivity are given in fig. 1. The resistivity shows such great variability that at a particular site it probably should be measured. This can be done simply and accurately with a four-point probe.⁴

Fortunately the relative dielectric constant seems to be less subject to variation. A major contributor is the

By Mason A. Logan, K4MT, 1607 Monmouth Drive, Sun City Center, Florida 33570

moisture content. A choice of 12 to 14 could suffice, and is adequate for the present article.

These two fundamental constants will now be related to approximate discrete equivalent circuit elements. A cubic meter of ground is shown in **fig. 2**. Two one-meter square conducting plates are placed on opposite sides. Such a meter cube has the property that when using MKS (meter-kilogram-second system of units — metric) units, the resistance between the two plates is numerically equal to the resistivity. Thus from a measurement or by estimation the parallel resistance can be determined for the approximate equivalent circuit shown below the cube in **fig. 2**.

A representative relative dielectric constant, $\epsilon_r = 13$, will usually be used for discussion, and preparation of figures in this article. The capacitance for this value is 115 pF.

The formula for the capacitance between two parallel plates is from reference 5. Because the cube obviously conducts DC, the approximate equivalent network capacitance must appear in parallel.

When RF current flows through the ground, both equivalent parallel elements conduct. At very low frequencies, almost all goes through the resistor. As the frequency increases, an increasing part passes through the lossless dielectric. Only current through the resistor causes power loss. As shown in **fig. 2**, the magnitude of the resistive part of the current is:

$$I_R = \frac{I}{\sqrt{1 + Q^2}}$$

where Q from **fig. 2** introduces the current division effect. The sum of all the power losses, P , determines the ground rod resistance through the relation:

$$R_g = \frac{P}{I^2} \quad (1)$$

The ground behaves as an inductive impedance, rather than simply as a resistance.⁶ (This is discussed in **appendix B**.) The inductive effect is caused by the lower velocity of wave transmission through the dielectric, compared to that through the resistance, acting like current lagging a voltage. *This inductive effect contributes to a vertical antenna being shorter than the length called for by the formula; the negative phase angle of the antenna is used to neutralize the positive phase angle of the ground.*

ground resistance equation

The approximate equation for the ground rod resistance is:

$$R_g = \frac{\rho}{(1 + Q^2)} \cdot \frac{1}{2\pi g} \left[\left(\log_e \frac{2h}{d} \right) - 1 \right] \text{ ohms} \quad (2)$$

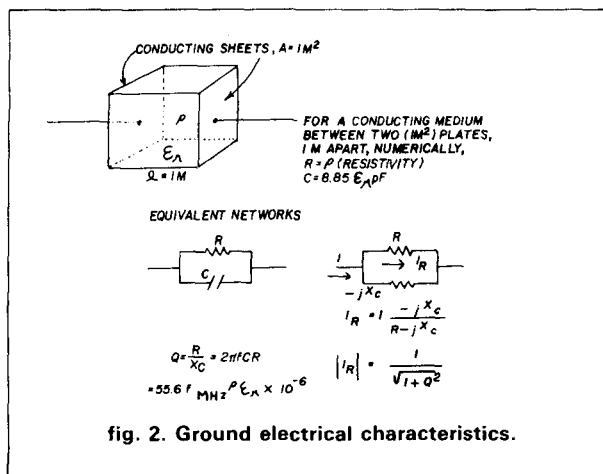

fig. 2. Ground electrical characteristics.

- where h = antenna height, meters
- g = ground rod length, meters
- d = ground rod diameter, meters
- ρ = ground resistivity, ohm-meters
- $Q = 55.6 f_{\text{MHz}} \rho \epsilon_r \times 10^{-6}$, from **fig. 2**.

The derivation of this equation is given in **appendix A**.

As an example, take a 20-meter high, quarter wave vertical for 80 meters, with an 8-foot ground rod 1 inch in diameter, and a ground resistivity of 200 ohm-meters. Using the equations in **fig. 2**, $Q = 0.5$. Then:

$$R_g = \frac{200}{(1 + 0.5^2)} \cdot \frac{1}{2\pi \cdot 2.44} \left[\left(\log_e \frac{2 \times 20}{0.025} \right) - 1 \right]$$

$$= 66.5 \text{ ohms}$$

(equal to about that for eight radials.⁹)

If the ground rod diameter were increased to 12 inches, the ground resistance would be 40.5 ohms, about 40 percent reduction. Thus, as mentioned earlier, over one-third of the ground loss occurs within 6 inches of a 1-inch rod. One half is inside the 1-foot radius.

It is convenient to consider this equation as the product of two factors, which have been plotted as curves in **figs. 3** and **4**. **Figure 3** represents how the ground resistivity, with its relative dielectric constant and the frequency, enter into the equation. **Figure 4** represents how the one-quarter wavelength vertical antenna height and the relatively shorter ground rod dimensions enter. The product of the two factors determined by these curves is the ground rod resistance in ohms.

equivalent series resistivity

The curves of **fig. 3**, one for each frequency band, are directly proportional to the antenna's ground resistance. The ground resistivity usually is reported as being in the range from 100 to 500 ohm-meters.³

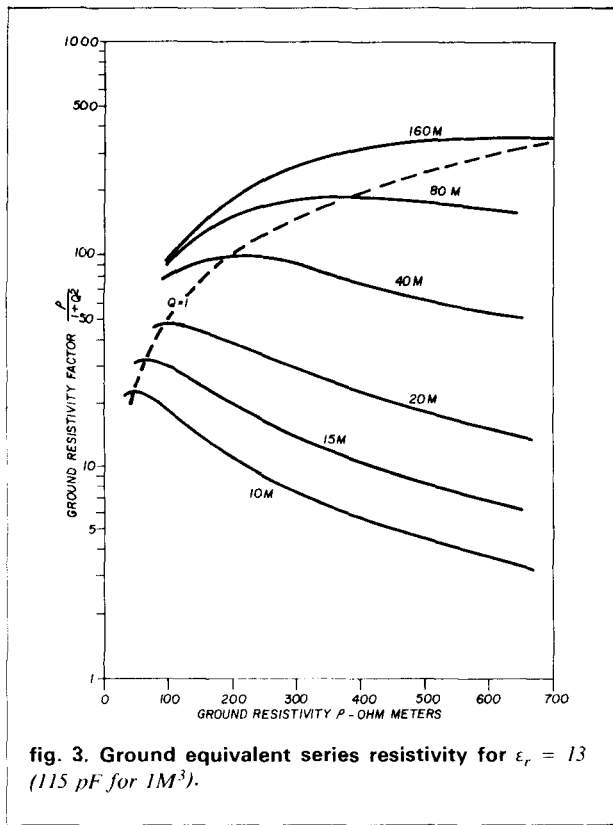

fig. 3. Ground equivalent series resistivity for $\epsilon_r = 13$ (115 pF for 1M³).

These curves can be considered as plots of the equivalent series resistance determined by a fixed capacitor shunted by a range of resistances. For each curve, the plot is for a shunting resistor increasing from less than the reactance of the capacitor, up to 700 ohms. Such a network has the property that the maximum equivalent series resistance occurs when the parallel resistance is numerically equal to the reactance, and for that condition, that is $Q = 1$, the series resistance maximum is exactly equal to half the parallel resistance.

The curves for 40 and 80 meters surprisingly show that because the maximum is centrally located, the series resistance changes less than 2 to 1 over the normal ground conductivity range.

The reactance of the parallel capacitor decreases inversely with increasing frequency. Thus the corresponding equivalent series resistivity peak decreases, with each curve becoming much lower overall. Two advantageous effects appear here. Not only is the peak less, but because it moves outside the parallel resistivity range normally encountered, the working equivalent series resistivity range is much lower than the peak. For example, at 10 meters, the effective resistivity is decreasing to below 10 ohm-meters, less than 1/20th of that for 80 meters. This is because an increasing portion of the ground current has become lossless dielectric current.

antenna system dimensions

The curves of fig. 4 are drawn using the ratio of the one-quarter wavelength high antenna to the ground rod diameter as the x-axis. The height of the antenna is taken as representing the radius on the ground beyond which practically no ground currents flow. The curves are for different ground rod lengths. A possible adverse resonant effect not included in the approximate equation and which may be important at 10 and 15 meters, is considered in appendix B.

The chart is entered through the x-axis. The ground rod length is found next. From there across to the y-axis determines the dimension factor.

Repeating the 80-meter example calculated earlier, from fig. 3, the ground resistivity factor is 150. From fig. 4, for $g = 2.4$ meters, the dimension factor is about 0.42. The product is 63 ohms, duplicating the earlier result.

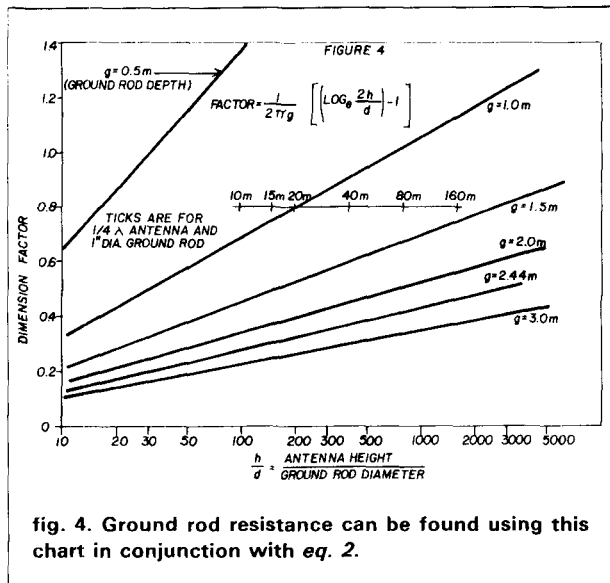

fig. 4. Ground rod resistance can be found using this chart in conjunction with eq. 2.

For convenience, a bar is drawn with ticks shown for each Amateur HF band, locating the h/d for 1-inch diameter ground rods and quarter-wave verticals. For other diameters, start with a tick for 1 inch, then move right or left inversely as the ratio of the 1-inch diameter to the diameter wanted. For instance, for a 1/2-inch diameter ground rod, move right to twice the 1-inch h/d value. Thus at 20 meters, move from a scale of 200 to 400. Then locate g to find the dimension factor.

The curves clearly show that there is a large decrease in effective ground resistance as the frequency increases. The dimension factor from fig. 4 is also lower for the higher frequencies. Approximate ground resistance measurements at 10, 15, and 20 meters to support the results of these calculations will be given later.

WE HAVE QUALITY PARTS, DISCOUNT PRICES AND FAST SHIPPING!

TRANSFORMERS

120 volt primaries



5 6 VOLTS @ 750 MA \$3.00
 6 VOLTS @ 150 MA \$1.25
 12 VCT @ 200 MA \$2.00
 16.5 V @ 3 AMPS \$6.50
 18 V @ 650 MA \$3.50
 18 VOLTS @ 1 AMP \$4.50
 24 VOLTS @ 250 MA \$2.50
 24 VCT @ 1 AMP \$4.50
 42 VCT @ 1.2 AMP \$4.50

WALL TRANSFORMER

ALL ARE 115 VAC PLUG IN



4 VDC @ 70 MA \$2.00
 6 VDC @ 100 MA \$2.50
 6 VDC @ 500 MA \$5.00
 9 VDC @ 225 MA \$3.00
 14 VDC @ 300 MA \$3.50
 15 VAC @ 300 MA \$3.00
 16.5 VAC @ 10 VA \$3.50
 17 VAC @ 500 MA \$4.00

SPRING LEVER TERMINALS

TWO COLOR CODED TERMINALS ON A STURDY 2 1/4" x 3 3/4" BAKELITE PLATE GREAT FOR SPEAKER ENCLOSURES OR POWER SUPPLIES



\$1.00 EACH 10 FOR \$9.00

2 CHANNEL LIGHT ORGAN

EASILY HOOKS INTO STEREO SPEAKERS AND ALLOWS 110 VAC LIGHTS TO DANCE WITH MUSIC. TWO SEPARATE 110 VAC OUTPUTS FOR HIGH AND LOW FREQUENCY AUDIO SIGNALS. USE TWO ORGANS FOR STEREO

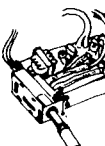

\$6.50 PER UNIT
 COLOR LIGHT STRING AVAILABLE \$1.75 EA

HELPING HAND

WILL HOLD P.C. BOARD OR OTHER SMALL ITEMS AND ALLOW BOTH YOUR HANDS FREEDOM TO WORK

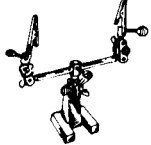

\$6.50 EACH

MIKE CONNECTOR

5 CONDUCTOR IN-LINE PLUG AND CHASSIS MOUNT JACK TWIST LOCK STYLE. SAME AS SWITCHCRAFT 12CL5M \$2.50 PER SET



METER

0 - 15 V.D.C. THIS 2-1/4" SQUARE METER MEASURES 0-15 VDC \$4.50 EACH



SUB-MINIATURE D TYPE CONNECTOR

SOLDER TYPE SUB-MINIATURE CONNECTORS USED FOR COMPUTER HOOK UPS

DB-15 PLUG \$2.75
 DB-15 SOCKET \$4.00
 DB-5 HOOD \$1.50
 DB-25 PLUG \$2.75
 DB-25 SOCKET \$3.50
 DB-25 HOOD \$1.25



"PARALLEL" PRINTER CONNECTOR

SOLDER STYLE 36 PIN MALE USE D 10N "PARALLEL" DATA CABLES \$5.50 EACH



LIGHTS

GRAIN OF WHEAT T1 SIZE

125" DIA (3 15mm)

3 to 6 VOLTS 3 for \$1.00
 Rated 55ma @ 5 VOLTS

6 to 12 VOLTS 3 for \$1.00
 Rated 55ma @ 8 VOLTS

T1 SIZE WITH WIRE LEADS

3 to 6 VOLTS 2 for \$1.00
 Rated 55ma @ 5 VOLTS

6 to 12 VOLTS 2 for \$1.00
 Rated 55ma @ 8 VOLTS

12 to 24 VOLTS 2 for \$1.00
 Rated 45ma @ 14 VOLTS

T1 - 3/4 SIZE WITH WIRE LEADS

163" DIA (4 14mm)

3 to 6 VOLTS 2 for \$1.00
 Rated 45ma @ 6 VOLTS

6 to 12 VOLTS 2 for \$1.00
 Rated 55ma @ 8 VOLTS

12 to 24 VOLTS 2 for \$1.00
 Rated 45ma @ 14 VOLTS

NEON W/ RESISTOR

DIRECT OPERATION

7 for \$1.00 FROM 120 VOLT

120V INDICATOR

NEON INDICATOR RATED 120 V 1/3 W MOUNTS IN 5/16" HOLE RED LENS 75¢ EACH 10 FOR \$7.00 100 FOR \$65.00



8 TRACK RECORD/PLAY TAPE DECK

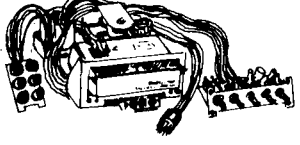

MORSE MODEL 74 A

8 TRACK RECORD WITH AUTO STOP. NOT FULLY FUNCTIONAL. REMOVED FROM ASSEMBLY LINE FOR MINOR PROBLEMS. IDEAL FOR PARTS. EACH UNIT CONTAINS SWITCHES, LIGHTS, TAPE MOTOR, BELT, WHEELS, PULLEYS, PRE AMPS, TAPE HEADS, ETC.

SPECIAL PRICE \$4.00 EACH 10 FOR \$35.00

2K 10 TURN MULTI-TURN POT

SPECTROL #MOD 534-7161 \$5.00 EACH



EDGE CONNECTORS

ALL ARE 156" SPACING

18/36 GOLD SOLDER EYELET \$2.00 EACH

22/44 TIN

P.C. STYLE. NO MOUNTING EARS \$1.50 EACH 10 FOR \$14.00

22/44 GOLD

P.C. STYLE. \$2.00 EACH 10 FOR \$18.00

28/56 GOLD

28-56 D PLATED CONTACTS. 156 CONTACT SPACING. \$2.50 EACH 10 FOR \$22.00

50/100 GOLD

STANDARD 50/100 CONNECTOR. 125 SPACING. GOLD PLATED P.C. MOUNT. \$3.75 EACH 10 FOR \$35.00

SWITCHES

MINI-PUSH BUTTON

S.P.S.T. MOMENTARY NORMALLY OPEN 1/4" BUSHING

35¢ EACH
 10 FOR \$3.25
 100 FOR \$30.00

SPECIFY COLOR: RED, BLACK, WHITE, GREEN, YELLOW



KEY SWITCH

S.P.S.T. 4 AMPS @ 125 VAC. KEY REMOVES BOTH POSITIONS \$3.50 EA



LIGHTED PUSH BUTTON

RED LIGHTED 120 VAC 10 AMP S.P.S.T.

"POWER" PRINTED ON FACE. MOUNTS IN 7/8" SQUARE HOLE \$1.50 EA 10 FOR \$13.50



FREE! FREE! FREE! SEND FOR NEW LARGER! 48 PAGE CATALOG FREE! FREE! FREE!

LINE CORDS

TWO WIRE 6' 18ga TWO WIRE 3 FOR \$1.00

THREE WIRE 18 INCH 18ga THREE WIRE 2 for \$1.00

8 FOOT 18ga THREE WIRE \$2.00 EACH

SOLDERING IRON STAND

SPRING STEEL IRON HOLDER ON WEIGHTED BASE

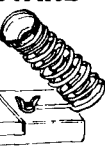

\$5.00 EACH

TRANSISTORS

2N706 5 for \$1.00
 2N2222A 4 for \$1.00
 PN2222 4 for \$1.00
 2N2904 4 for \$1.00
 2N2905 4 for \$1.00

POWER SUPPLY W/ PRE-AMP

THIS SUPPLY WAS USED TO POWER AN 8 TRACK/CASSETTE UNIT. IT WILL SUPPLY APPROX 18 VDC AND INCLUDES A SMALL PRE-AMP TO BOOST SIGNAL LEVEL. RCA PLUGS FOR LINE IN/OUT

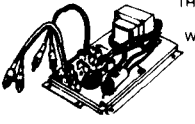

\$4.50 EACH

KEY ASSEMBLY

5 KEY \$1.00 EACH

CONTAINS 5 SINGLE-POLE NORMALLY OPEN SWITCHES. MEASURES 3 3/4" LONG

6 KEY \$1.25 EACH

CONTAINS 6 SINGLE-POLE NORMALLY OPEN SWITCHES. MEASURES 4 1/4" LONG



BATTERY OPERATED SMOKE DETECTOR

BRK MODEL #79R UL APPROVED 9 VOLT BATTERY OPERATION FOR CEILING OR WALL MOUNT



\$8.00 EACH 2 FOR \$15.00

ROTARY SWITCH

1 POLE 6 POSITION 1 1/2" DIA x 1 1/2" HIGH 75¢ EACH 10 for \$6.00



RELAYS

MINIATURE 6 VDC RELAY SUPER SMALL SPOT RELAY. GOLD COBALT CONTACTS

RATED 1 AMP AT 30 VDC. HIGHLY SENSITIVE. TTL DIRECT DRIVE POSSIBLE. OPERATES FROM 4.3 TO 6 V. COIL RES 220 OHM

1 3/16" x 13/32" x 7/16" AROMAT # RSD-6V \$1.50 EACH 10 FOR \$13.50



13 VDC RELAY

CONTACT SPNC 10 AMP @ 120 VAC ENERGIZE COIL TO OPEN CONTACT COIL 13 VDC 650 OHMS SPECIAL PRICE \$1.00 EACH



4 PDT RELAY

14 pin style
 3 amp contacts
 24 volt d.c. coil
 120 volt a.c. coil
 Used but fully tested \$1.70 EACH
 specify coil voltage
 LARGE QUANTITIES AVAILABLE
 SOCKETS FOR RELAY 50¢ each



COMPUTER GRADE CAPACITORS

2,000 mfd. 200 VDC 13/4 DIA - 5" HIGH \$2.00
 3,600 mfd. 40 VDC 13/8 DIA - 3 3/4" HIGH \$1.00
 6,400 mfd. 60 VDC 13/8 DIA - 4 1/4" HIGH \$2.50
 21,000 mfd. 50 VDC 2 1/2 DIA - 5" HIGH \$4.00
 22,000 mfd. 40 VDC 2" DIA - 6" HIGH \$3.00
 31,000 mfd. 15 VDC 1 3/4 DIA - 4" HIGH \$2.50
 44,000 mfd. 35 VDC 2" DIA - 5" HIGH \$4.00
 72,000 mfd. 15 VDC 2" DIA - 4 3/8" HIGH \$3.50
 185,000 mfd. 6 VDC 2 1/2 DIA - 4 1/2" HIGH \$1.50

CLAM'S TO FIT CAPACITORS 50¢ ea

MINIATURE TOGGLE SWITCHES

ALL ARE RATED 5 AMPS @ 125 VAC

S.P.D.T. (on-on) P.C. STYLE. NON-THREADED BUSHING 75¢ EACH 10 FOR \$7.00

S.P.D.T. (on-on) SOLDER LUG TERMINALS \$1.00 EACH 10 FOR \$9.00 100 FOR \$80.00

S.P.D.T. (on-off-on) P.C. STYLE. NON-THREADED BUSHING 75¢ EACH 10 FOR \$7.00

S.P.D.T. (on-on) P.C. LUGS. THREADED BUSHING \$1.00 EACH 10 FOR \$9.00 100 FOR \$80.00

S.P.D.T. (on-off-on) SOLDER LUG TERMINALS \$2.00 EACH 10 FOR \$19.00 100 FOR \$180.00

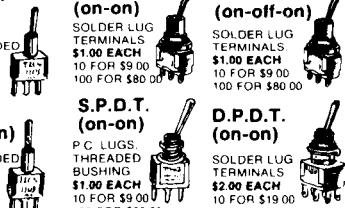

SLIDE POTS

100K linear tape 2" LONG 1 5/8" TRAVEL 75¢ EACH 500K linear taper 2 7/8" LONG 1 3/4" TRAVEL 75¢ EACH DUAL 100K audio taper 3 1/2" LONG 2 1/2" TRAVEL \$1.50 EACH

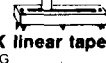

CRYSTALS

CASE STYLE HC33/U 2 MHZ \$3.50 EACH COLORBURST 3579 545 KC \$1.00 EACH

METAL OXIDE VARISTOR

G.E. # V82ZA12 50 VOLTS. NOMINAL D.C. VOLTAGE 5/8" DIAMETER 2 FOR \$1.50



L.E.D.'S

STANDARD JUMBO DIFFUSED RED 10 FOR \$1.50 GREEN 10 FOR \$2.00 YELLOW 10 FOR \$2.00

FLASHER LED 5 VOLT OPERATION RED JUMBO SIZE \$1.00 EACH

BI-POLAR LED 2 FOR \$1.70

SUB MINI LED 079" - 098" RED 10 FOR \$1.00 200 FOR \$18.00 GREEN 10 FOR \$1.50

LED HOLDERS TWO PIECE HOLDER FOR JUMBO LED 10 FOR 65¢ 200 FOR \$10.00





PHOTO-FLASH CAPACITORS

35 MFD 330 VOLT 1" - 5/8" DIA 45¢ EACH... 10 FOR \$4.00

170 MFD 330 VOLT 1 1/8" x 7/8" 2 FOR \$1.50 10 FOR \$7.00

750 MFD 330 VOLT 2" HIGH x 1 1/4" DIA \$1.25 EACH 10 FOR \$11.00



TOLL FREE ORDERS ONLY 1-800-826-5432 (ORDER ONLY) (IN CALIFORNIA: 1-800-258-6666) ALASKA, HAWAII, OR INFORMATION (213) 380-8000

ALL ELECTRONICS CORP.
ALL ELECTRONICS CORP.
 905 S. Vermont Ave. P.O. BOX 20406 Los Angeles, Calif. 90006

QUANTITIES LIMITED MINIMUM ORDER \$10.00 USA: \$2.50 SHIPPING FOREIGN ORDERS INCLUDE SUFFICIENT SHIPPING CALIF. RES. ADD 6 1/2% NO C.O.D.



parallel ground rods

The parallel resistance of two ground rods may be estimated through a study of the current flow paths. When there are two ground rods, each receiving half of the total current, each acts as an "image" for the other. This effect causes the resistance of the two in parallel to be higher than just half of either alone.

The image repels any current flow across a perpendicular plane which bisects the line joining the two rods. The bisector thus acts as a virtual insulator. Visualization of the current flow paths from the two rods is helped by field maps shown in many texts.⁸ They usually are drawn for static charges, but the field lines are like current flow lines in sheets.

Near each rod and inside a radius of about half the distance to the bisector, the effect of the other rod, while increasing, is small. Inside this region then, almost the full advantage of separate rods is realized. A resistance factor of 1/2 will be used.

For the next region, to a radius of the distance to the bisector, all currents including those which started out toward the bisector have completed most of their change in direction. The advantage of separate ground rods thus decreases in this region. A resistance factor of three quarters will be used.

Beyond this second region there is very little gain. To apply the above discussion an estimation involves first calculating the external resistance for circles centered around a single ground rod. This is done for diameters of 2 feet, 3 feet, and so on, using the formula. Such calculations for 80 meters are shown in **fig. 5**. Two cases have been chosen as examples, applying to 4-foot and 6-foot spacings.

For **Case 1**, the estimate of the resistance using two ground rods spaced 4-feet apart is shown as 48 ohms or a reduction compared to a single rod of 27 percent. For comparison, about 14 radials have a resistance of 48 ohms.⁹ The calculation for the first foot assumed a 0.5 factor as complete independence, as discussed

earlier. The second foot used a 0.75 factor for an intermediate effect, while outside that, negligible reduction compared to a single ground rod was used.

A very large number of rods in the circle could only approach 26 ohms. Thus two rods accomplish almost half of the possible reduction.

Case 2 is for rods spaced 6 feet apart. Calculating in the same manner there is a reduction to about 45 ohms, or a 31 percent decrease. The increased spacing from 4 to 6 feet thus gained another 2.3 ohms.

20 meter measurements

The striking information of **fig. 3** and **4** is the exhibition of the beneficial effect of the ground's dielectric property in reducing the effective ground resistance. With increasing frequency, the increasing Q rapidly reduces the resistance.

Elementary but restricted resistance measurements were made with a double-pointer SWR bridge. The restriction with this method is that the resistance can be determined only at a frequency where the SWR is a minimum.

Starting with a vertical wire having a 16 foot 9 inch formula length, the wire was shortened until the minimum was within the band (final length was 15 feet, 10 inches). Using two rods four feet long and four feet apart, measurements and calculations were as follows:

rods	SWR	R_g ohms	R_g (calc.)
1" D	1.43*	34.5	27
3/4" D	1.33	28.0	30
parallel	1.18*	19.0	20 (est.)

The addition of a shunt resistor* has reduced the SWR in the measurements printed in bold type, establishing that the load was greater than 50 ohms. The formula for such a minimum SWR, is:

$$R_g = [(50 \times SWR) - 37.5] \text{ ohms} \quad (3)$$

These results agree to within a few ohms of the resistances calculated using the formula. The measurement formula for R_g may be optimistic in that the radiation resistance of the antenna probably decreases from 37.5 ohms as the wire is shortened for system resonance.

10 and 15 meter measurements

There was further confirmation at 10 and 15 meters when measuring with a shorter 2 foot, 3/4-inch diameter round rod:

band (meters)	formula height	tuned height	min. SWR	R_g ohms	calc. R_g ohms
15	11' 0"	9' 9"	1.49	37	33
10	8' 4"	7' 7"	1.14	19	17

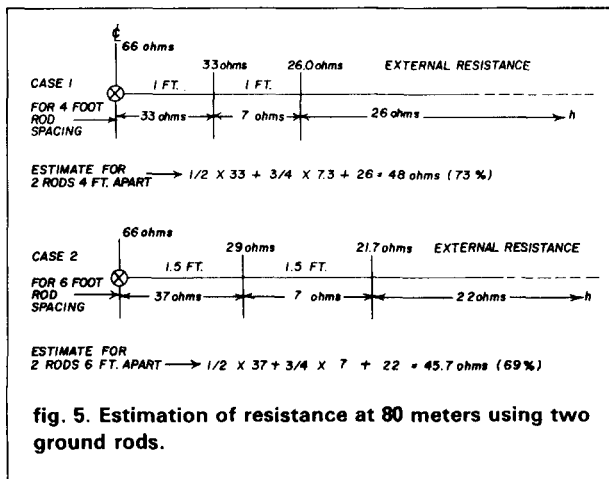

Even with a 2 foot ground rod, at 10 meters (10 meter band) the resistance was about half that at 20 meters with a 4 foot ground rod.

However, a problem was found when trying to measure using the 4-foot ground rod. As the antenna height was reduced, the SWR curve kept the same slope across the band, reached a lowest curve, and then increased again. There was no minimum in the band. Thus the SWR bridge method could not be used. The lowest SWR, at the band edge for both bands, was higher than the minimum found for 20 meters.

The lower end of the SWR curve was on the high frequency edge for 15 meters and on the low frequency edge for 10 meters. It may be that a resonance in the 4-foot ground rod, acting as an inverted antenna in a lossy dielectric prevents the lowest SWR curves having a minimum in the band. (Further discussion is in **appendix B**.) At 10 and 15 meters, for the local conductivity condition, one-quarter wavelengths are 2-1/2 and 3 feet respectively. Thus the 4-foot ground rods were above their series resonance. It may be that an odd number of underground quarter wave lengths is best.

conclusion

An approximate equation for the resistance of a ground rod has been derived when using a quarter wave vertical antenna. It relates the elements which affect the ground rod resistance and provides a means for estimating the result of changes in the ground system. Measurements confirm the importance of the relative dielectric constant of ground in reducing the effective ground resistance as the frequency increases.

How well the formula applies to trap verticals has not been established. Knowing the trap antenna resistance for the subtraction is another problem.

With the use of ground rods only there always is some power loss penalty. However, sometimes pavements, sidewalks, buildings, or someone else's property precludes other approaches. Even with such a restriction, it appears that a system equivalent in power loss to quite a few radials can be realized — but it is unlikely that the radiation angle will be as low.

appendix A

derivation of the approximate ground resistance equation

This equation applies to the antenna and ground rod system shown earlier in **fig. 1**. That figure, and **fig. 2**, defined the physical characteristics included in the ground resistance formula.

Figure 6 shows in more detail the underground geometry and the current flow paths assumed. The ground current I_0 entering the ground rod is assumed to leave the rod uniformly along its length. This is represented by the equation:

$$I = I_0 \left[1 - \frac{z}{g} \right]$$

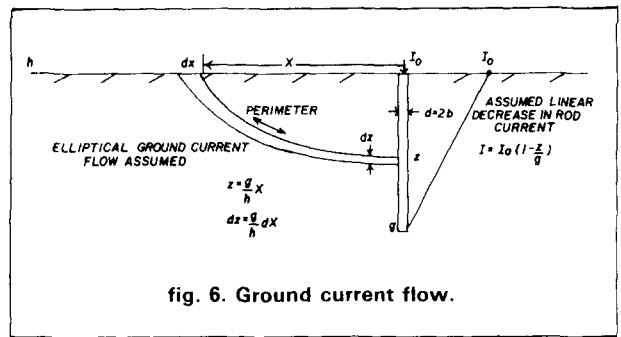

fig. 6. Ground current flow.

where z is the variable depth from the ground surface and g is the length of the ground rod.

An elliptical path is shown leaving the ground rod. An ellipse terminates at right angles to both the ground and ground rod. The path shown leaves the ground rod at z , and ends at x on the ground surface. This sheet, which starts with thickness dz , and is flattened out in **fig. 7**, carries the current dI . All such circuits are in parallel and account for the total current. For any sheet like the one shown, the current entering is:

$$dI = -\frac{I_0}{g} dz$$

As discussed earlier, the resistive current portion is:

$$dI_R = \frac{-I_0}{g\sqrt{1+Q^2}} dz$$

The resistance to radial current flow through the parallel resistive part of the differential ring shown in **fig. 7**, is:

$$dR = \rho \cdot \frac{\text{length}}{\text{area}} = \frac{\rho dr}{2\pi r dz}$$

At this point, two simplifying assumptions will be made: first, the outer radius is just x rather than $1.1x$, applicable to the elliptical perimeter, and second, that the thickness of the sheet remains a constant dz instead of increasing. These are reasonable because they introduce opposite resistance changes having a cancelling effect, and because their effect is in the far region where only a small part of the total resistance is involved. By integration, the sheet resistance to a radial current leaving the ground is:

$$dR = \frac{\rho}{dz} \int_b^x \frac{dr}{2\pi r} = \frac{\rho}{2\pi dz} \log_e \frac{x}{b}$$

There is an equal differential current in each sheet. Squaring the current which flows through the resistance and multiplying by the sheet resistance just arrived at, determines the sheet power:

$$dP = \left(\frac{I_0}{g\sqrt{1+Q^2}} dz \right)^2 \frac{\rho}{2\pi dz} \log_e \frac{x}{b}$$

Substituting

$$dz = \frac{g}{h} dx$$

$$P = \frac{I_0^2}{gh} \frac{\rho}{2\pi(1+Q^2)} \int_b^h \log_e \frac{x}{b} dx$$

where the quarter wave antenna height is used as a measure of the end of the outer region.

Finally, dropping the very small lower limit factor for simplicity, the approximate ground rod resistance formula is:

$$\frac{P}{I_0^2} = R_g = \frac{\rho}{(1+Q^2)} \frac{1}{2\pi g} \left[\left(\log_e \frac{2h}{d} \right) - 1 \right]$$

- where ρ = ground resistivity
- h = quarter wave antenna height
- d = ground rod diameter
- g = ground rod depth
- $Q = 55.6 f_{MHz} \rho \epsilon_r \times 10^{-6}$

appendix B ground electromagnetic wavelength

For the Amateur HF bands, the ground is described as a quasi-conductor because of its relative dielectric constant, greater than unity.¹ In such a medium, the velocity of an electromagnetic wave is reduced, compared to the velocity of an electromagnetic wave in a vacuum. The physical characteristics which apply to a conducting medium are:

- ϵ_r = relative permittivity (12 to 14 estimated locally)
- ϵ_0 = vacuum permittivity = 8.85×10^{-12} farads/meter
- $\epsilon = \epsilon_0 \epsilon_r$ = actual permittivity
- μ_0 = vacuum permeability = $4\pi \times 10^{-7}$ henrys/meter
- σ = conductivity - siemens/meter
(7×10^{-3} measured locally)
- $\rho = 1/\sigma$ = resistivity ohm-meters
- $\omega = 2\pi \times \text{frequency} - \text{radians/second}$

The equation¹⁰ for a wave travelling in a positive x direction is:

$$E_y = E_0 e^{-\gamma x}$$

where γ is the propagation constant and x is the distance. The constant is:

$$\gamma^2 = j\omega\mu\sigma - \omega^2\mu\epsilon$$

It is convenient in the last term to substitute:

$$a = \epsilon\omega/\sigma$$

Then $\gamma^2 = \omega\mu\sigma (j - a)$

$$\text{But } \sqrt{j-a} = \sqrt[4]{1+a^2} (\cos \theta + j \sin \theta)$$

where $\theta = (90^\circ + \tan^{-1}a)/2$

$$\text{Finally: } \gamma = \sqrt{\omega\mu\sigma} \sqrt[4]{1+a^2} (\cos \theta + j \sin \theta)$$

Thus γ has a real and imaginary part. The real part is associated with attenuation and the imaginary part with phase. Equating the phase part to 2π , determines the x which is equal to one wavelength. Thus the equation for one wavelength is:

$$\lambda = \frac{2\pi}{\sqrt{\omega\mu\sigma}} \cdot \frac{1}{\sqrt[4]{1+a^2} \cdot \sin[(90^\circ + \tan^{-1}a)/2]}$$

This equation has been plotted in **fig. 8**. The reciprocal of "a" is the x -axis. The label for each curve uses the variable part from the left of the fraction above. The left vertical axis is the result and gives the wavelength inside the conducting ground. It always is less than the wavelength in free space.

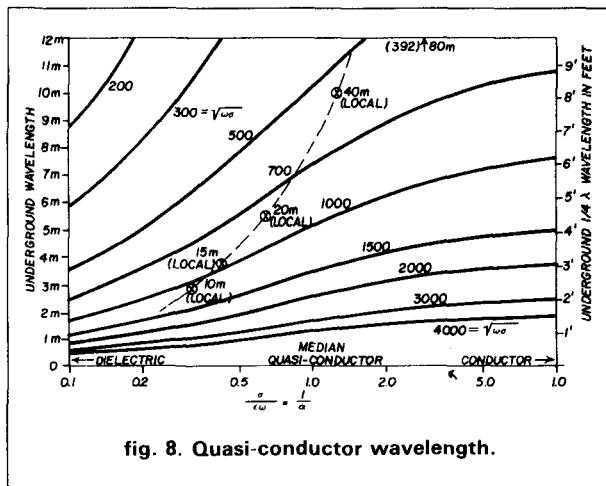
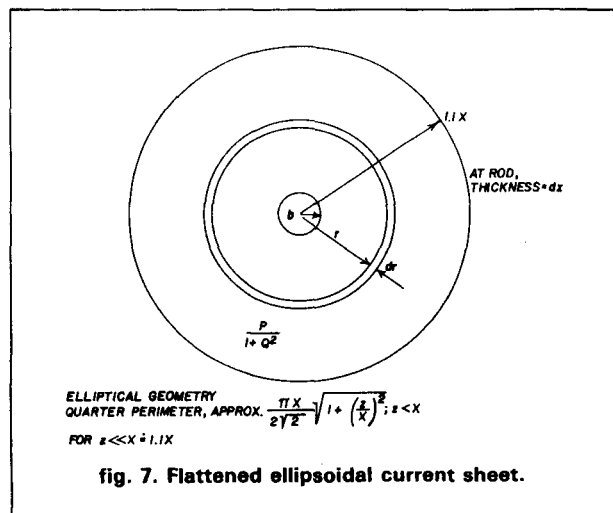

fig. 8. Quasi-conductor wavelength.

The right vertical shows the quarter wavelength in feet, which is significant for a ground rod.

On the chart in **fig. 8**, the circled crosses marked 10, 15, and so on represent the local conditions. Four-foot ground rods were used, and are very close to a quarter wavelength at 20 meters. At 10 and 15 meters they are much longer. For these, a 2-foot rod was also used.

A ground rod can be considered to be an inverted antenna in its own medium, and as an antenna, could have resonant effects. These were not included in the elementary derivation of the approximate ground resistance equation which has been presented.

Aside from any resonant effect, there is another viewpoint. The impedance of the ground rod acts as if it were inductive. The wave through the earth may be considered as made up of two parts, one through the resistive medium and the other through the dielectric medium. The latter travels at a lower velocity than the velocity through the former. The total wave is the vector sum of the two, a complex quantity which thus lags in time phase. This is analogous to the situation in a circuit having resistance and inductance in series, where the current lags the applied voltage. Therefore, the conducting medium behaves like an inductive impedance.

The existence of such an inductive impedance is supported by the frequent comment that a quarter wave antenna is much shorter than called for by the formula. A shorter antenna develops a negative reactance which neutralizes the positive ground rod reactance.

references

1. John D. Kraus, *Electro-Magnetics*, McGraw-Hill, 1953, Chapter 10, pages 392 and 393.
2. *The ARRL Antenna Book* Eighth Edition, American Radio Relay League, Newington, Connecticut, 1956, page 189.
3. *Reference Data for Radio Engineers*, Fifth Edition, 1974, ITT/Howard W. Sams, Inc., Indianapolis, Indiana, page 26-3.
4. Jerry Sevicik, "4-Point Probe Measurements," *QST*, March, 1981, page 38. (Caution: use an isolating transformer in the extension cord to prevent any current to the lightning ground rod near the power meter.)
5. John D. Kraus, *Electro-Magnetics*, McGraw-Hill, 1953, Chapter 2, page 61.
6. John D. Kraus, *Electro-Magnetics*, McGraw-Hill, 1953, Chapter 10, page 401.
7. Forrest Gehrke, K2BT, "Vertical Phased Arrays, Part 2," *ham radio*, June, 1983, page 26.
8. John D. Kraus, *Electro-Magnetics*, McGraw-Hill, 1953, Chapter 2, page 71, figure 2-17.
9. Forrest Gehrke, K2BT, "Vertical Phased Arrays, Part 6," *ham radio*, May, 1984, page 45.
10. John D. Kraus, *Electro-Magnetics*, McGraw-Hill, 1953, Chapter 10, equation 10-14.

ham radio

NCG CO.

Just Slightly Ahead

10/160M

THE 10/160M GIVES YOU THAT EXTRA BIT OF QUALITY THAT REALLY GETS YOU THROUGH TO THAT SPECIAL DX STATION, OR JUST ENJOYING A FULLY RELAXED QSO WITH ANOTHER AMATEUR THE OTHER SIDE OF THE COUNTRY. YOUR 10/160M GIVES YOU THE EASE OF OPERATION THAT YOU WANT WITH 4 MEMORIES OR THE 3 WAY AUTO SCAN, DUAL VFO, IF SHIFT, CW-W CW-N, HAND MIC AND BUILT IN AC/DC POWER. ALL BANDS ARE FULLY OPERATIONAL INCLUDING THE NEW WARC BANDS. YOUR CHOICE OF EASY OPERATING USB, LSB, CW OR RTTY IS AT YOUR FINGER TIPS. WITH A FULL 200 WATTS PEP OUTPUT YOUR FINALS ARE PROTECTED FROM HIGH SWR.

YOUR 10/160M IS ALL SOLID STATE WITH MODULAR BOARDS THAT ARE EASY ACCESSIBLE. A BRIGHT BLUE FLUORESCENT DIGITAL DISPLAY IS EASY TO READ AT ALL TIMES.

BEST OF ALL THERE ARE NO EXTRA OPTIONS TO BUY TO GET YOU ON THE AIR, ITS ALL THERE. JUST TAKE YOUR 10/160M HOME AND 1. CONNECT A ANTENNA. 2. PLUG INTO 120V AC OUTLET. 3. TURN THE SWITCH ON. 4. SELECT THE BAND AND FREQUENCY AND YOU'RE ON THE AIR. YOUR RECEIVING AUDIO IS CRISP AND CLEAR, YOUR TRANSMITTED SIGNAL WILL GET YOU A PRAISE FROM EACH CONTACT. THE 10/160M GIVES YOU A SUPERIOR TRANSCEIVER THAT IS UNCOMPARABLE.

MORE INFORMATION IS AVAILABLE FROM YOUR LOCAL DEALER, OR NCG CO.
1275 N. Grove St., Anaheim, CA 92806

15M

15M-MOBILE IS YOURS TO CONTINUE YOUR QSO WITH THAT SPECIAL FRIEND WHEN YOU GO ON A VACATION OR JUST GOING TO OFF FROM WORK. A TRULY QRP RIG WITH THE BIG RIG SIGNAL EITHER CW OR USB. THE DIGITAL FREQUENCY DISPLAY IS EASY TO READ AND YOUR 10 WATTS OR 2 WATTS ON USB OR CW WITH A BUILT IN SIDE TONE, HIGHLY EFFECTIVE NOISE BLANKER, AUDIO ALC GIVES DISTORTION FREE TRANSMISSION. THE VFO BALANCE WITH GEARS ALLOWS HIGH-PRECISION TUNING. DIGITAL DISPLAY OFFSET WHEN RTTY IS IN OPERATION (A MODIFICATION THAT TAKES 5 MINUTES CHANGES THE RTT TO A FINE TUNE CONTROL). A LARGE S/RF METER IN THE CENTER AND A TOP 8 OHM .5W SPEAKER, YOUR RECEIVE AUDIO IS DIRECTED UP.

EXTERNAL SPEAKER AND CW JACKS, MOBILE MOUNTING BRACKET AND A 400 OHM PT DYNAMIC MICROPHONE. FULL 15 METER BAND OPERATION FROM 21 TO 21.450 MHZ, YOUR OFFSET FREQUENCY RANGE OR FINE TUNE IS ± 4 KHZ. THE SIGNAL TO NOISE SENSITIVITY IS MORE THAN 10DB DOWN AT -6DB INPUT POWER SOURCE IS 13.8V DC, 3 AMPS. THE SMALL SIZE WILL ALLOW MOBILE OPERATION FROM EVEN THE SMALL CARS, ITS ONLY 9"H x 2.5"W x 9.5"D, THE LIGHT WEIGHT OF ONLY 5.7 LBS. MAKES THE 15M A POSSIBLE BACKPACKERS DREAM.

WITH YOUR 15M YOU WILL NOT HAVE A BIG EXPENSIVE PIECE OF EQUIPMENT SETTING IN YOUR VEHICLE, IT CAN BE UNDER THE DASH OUT OF SIGHT.



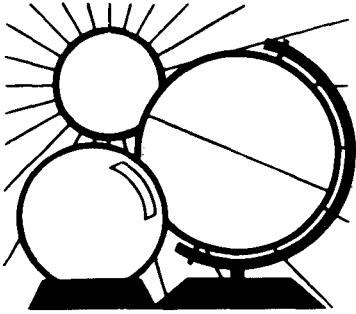

DX FORECASTER

Garth Stonehocker, KØRYW

summer DX

Every season of the year offers advantages and disadvantages for DX operation. The winter and summer solstices (days of shortest and longest daylight) and the equinoxes (days of equal light and darkness) produce distinct propagation characteristics that require specialized operating procedures.

Summertime DX offers longer high frequency (10-30 meter) operating time. Higher MUFs occur earlier in the day and end later than they did in previous seasons. In the higher latitudes (i.e., in the northern hemisphere), MUFs for east-west and transpolar paths are highest at this time of year.

But summer is not without its operating disadvantages: signal strengths are generally lower, as are midday MUFs; hop lengths are shorter; and there's little one-long-hop transequatorial propagation. Amateurs in the northern hemisphere can expect increased noise QRN as well.

Some of these negative characteristics of summertime operation can be turned into advantages. Others can be overcome. In this column and the next, I'll discuss these characteristics and offer some suggestions for improving your summertime DX operating.

last-minute forecast

The higher frequency bands (6-30

meters) are expected to be best during the first ten days of July. During this time, both long and short skip openings should be plentiful except on 6 meters, where only short skip openings by sporadic E are possible. During the latter two weeks of the month sporadic-E short skip will provide the best openings. The lower bands (30-160 meters) are expected to be of limited use during the month because of summer thunderstorm QRN; the first of the month may have the better nighttime openings, and the last two weeks the better daytime openings if the solar radio flux is 80 or less, as expected.

A full moon will occur on the 13th; perigee (closest approach) is on the 2nd and 30th. The Aquarid meteor shower starts on July 18, peaks on the 28th, and lasts until August 7 (all dates approximate, but close). The radio-echo rate at maximum is about 34 per hour.

band-by-band summary

Six meter paths will exist during several days around local noon by means of sporadic-E short skip propagation.

Ten and fifteen meters will provide long-skip conditions in the afternoon during the peak times of the 27-day solar maximum. Otherwise, look to sporadic-E short-skip and multihop

openings around local noon for DX on these bands. Transequatorial evening openings do not usually occur in the summertime.

Twenty and thirty meters will be open all day and much of the night. If twenty does not stay open through the night, thirty probably will. Sporadic-E short-skip is also often effective on these bands throughout the day. Propagation paths to most areas of the world are possible in a sequence that follows the sun's journey across the sky: east in the morning, south during midday, and west during the evening.

Thirty and forty meters will be the main nighttime DX bands this time of year, although long-skip distances will be shorter. Sporadic-E openings are possible during most of the day into pre-sunrise and after sunset. With thunderstorm-induced static levels high in the evening, look to pre-dawn periods for best results.

Eighty and one-sixty meters are difficult DX bands during this time of year. Short nights and high noise levels hamper DX operation, although eighty offers slightly lower noise levels. Most useful openings may occur during the pre-dawn hours. Sporadic-E propagation signal strengths may exceed the static level near sunrise and sunset.

ham radio

WESTERN USA

GMT	PDT								
		N	NE	E	SE	S	SW	W	NW
0000	5:00	20	20	15	10	20	10	10	20
0100	6:00	20	20	20*	10	20	10	10	20*
0200	7:00	20	20	20	10	20	10	10	15
0300	8:00	20	20	20	10	20	10	10	15
0400	9:00	20	20	20	10	20	15	10	15
0500	10:00	20	20	20	10	20	15	15	15
0600	11:00	20	30*	20	15	30	15	15	15
0700	12:00	20*	30*	20	15	30	15	15	15
0800	1:00	20*	30*	20	15	30	20	15	20
0900	2:00	20*	30*	20	20	30	20	20*	20
1000	3:00	20	30*	20	20	30	20	20	20
1100	4:00	20	20	20	20	30	20	20	20
1200	5:00	20	20	15	20	30	20	20	20
1300	6:00	20	20	15	20	30	20	20	20
1400	7:00	20	20	15	20	30	20	20	20
1500	8:00	20	20	15	20	30	20	20	20
1600	9:00	20	20	15	20	20	15	20	20
1700	10:00	20	20	10	20	20	15	20	20
1800	11:00	20	20	10	20	20	15	20*	20
1900	12:00	20	20	10	15	20	15	15	20
2000	1:00	20	20	10	15	20	15*	15	20
2100	2:00	20	20	10	15	20	10	15	20
2200	3:00	20	20	15	15	20	10	15	20
2300	4:00	20	20	15	15	20	10	15	20

JULY

MID USA

MDT								
	N	NE	E	SE	S	SW	W	NW
6:00	20	20	15	15	20	10	10	20
7:00	20	20	20*	20	20	10	10	20
8:00	20	20	20	20	20	10	10	20
9:00	20	20	20	20	20	10	10	20*
10:00	20	20	20	20	30	15	15	20*
11:00	20	20	20	20	30	15	15	20
12:00	20	30*	20	20	30	20	15	20
1:00	20	30*	20	20	30	20	15	20
2:00	20	30*	20	20	30	20	20*	20
3:00	20	30*	20	20	30	20	20	20
4:00	20	30*	20	20	30	20	20	20
5:00	20	20	15	15	30	20	20	20
6:00	20	20	15	15	30	20	20	20
7:00	20	20	15	15	30	20	20	20
8:00	20	20	15	15	30	20	20	20
9:00	20	20	15	15	30	20	20	20
10:00	20	20	10	10	20	15	20	20
11:00	20	20	10	10	20	15	20	20
12:00	20	20	10	10	20	15	20	20
1:00	20	20	10	10	20	15	20	20
2:00	20	20	10	10	20	15	20	20
3:00	20	20	10	10	20	15	20	20
4:00	20	20	15	15	20	15	20	20
5:00	20	20	15	15	20	15	20	20

EASTERN USA

EDT								
	N	NE	E	SE	S	SW	W	NW
8:00	20	20	15	15	20	10	10	20
9:00	20	20	20*	20	20	10	10	20
10:00	20	20	20	20	20	10	10	20
11:00	20	20	20	20	20	10	10	20*
12:00	20	20	20	20	30	15	15	20*
1:00	20	20	20	20	30	15	15	20*
2:00	20	20	20	20	30	15	15	20
3:00	20	30*	20	20	30	20*	15	20
4:00	20	30*	20	20	30	20	20*	20
5:00	20	30*	20	20	30	20	20	20
6:00	20	30*	20	20	30	20	20	20
7:00	20	30*	15	15	30	20	20	20
8:00	20	20	15	15	30	20	20	20
9:00	20	20	15	15	30	20	20	20
10:00	20	20	15	15	30	20	20	20
11:00	20	20	15	15	30	20	20	20
12:00	20	20	10	10	20	15	20	20
1:00	20	20	10	10	20	15	20	20
2:00	20	20	10	10	20	15	20	20
3:00	20	20	10	10	20	15	20	20
4:00	20	20	10	10	20	15*	15	20
5:00	20	20	10	10	20	10	15	20
6:00	20	20	15	15	20	10	15	20
7:00	20	20	15	15	20	10	15	20

The italicized numbers signify the bands to try during the transition and early morning hours, while the standard type provides the MUF during "normal" hours.
 *Look at next higher band for possible openings.

CALL TOLL FREE FOR QUOTES

TNT RADIO SALES INC.

1-800-328-0250

1-612-535-5050

(IN MINNESOTA - COLLECT)

Get More Bang for the Buck!

ICOM 745 NOW ONLY \$779⁰⁰ A SUPER VALUE

and Get a SM-6 DESK MIKE FREE (Reg. \$39.00 Value)



SPECIAL SALE ON ICOM ACCESSORIES

PS-35 Int. Pwr. Supply	\$144.95
PS-15 Ext. 20 Amp. Pwr. Supply	\$134.95
AT-100 (100w) Automatic Ant. Tuner	\$299.95
AT-500 (500w) Automatic Ant. Tuner	\$389.95
EX-243 Int. Electronic Keyer	\$ 44.95

- KENWOOD
- ICOM
- MIRAGE
- AEA
- KANTRONICS
- SANTEC
- KDK
- AZDEN
- NYE VIKING
- MFJ
- TELEX HY-GAIN
- HUSTLER
- KLM
- CUSHCRAFT
- ROHN
- LARSEN
- BUTTERNUT

SPECIAL OF THE MONTH: LARSEN MAG MOUNT 2M 5/8 PKG—\$36.95

VISA/MASTER CARD
FREE SHIPPING
ON MOST RIGS FOR CASH!



S.A.S.E. FOR OUR
"BENCH-TESTED"
USED EQUIPMENT LISTING

MONDAY - SATURDAY
9 AM to 6 PM CENTRAL TIME

4124 West Broadway, Robbinsdale, MN 55422 (Mpls./St. Paul)

APPLIED INVENTION

THE SOURCE FOR SOLID STATE / STATE-OF-THE-ART

GaAs FETS by MITSUBISHI

144 MHz — 12 GHz lowest noise and best price available

MGF1100—Dual Gate	MGF1202
MGF1203	MGF1402
MGF1203	MGF1404
MGF1412	MGF1801

Full Data and Pricing in Current Catalog

MITSUBISHI X BAND MITSUBISHI GaAs FET DR0 Modules — Gold

FO-1010X 10.4 GHz, 15mw out, UER100 Flange	\$39.37
FO-1210Y 11.5 or 12.0 GHz, UER120 Flange	\$39.37
FO-UP11KF Complete Heterodyne Rx, 10.468 GHz LO	\$36.22

Can be used for 12.5 GHz terrestrial and DBS

FO-OP13KF "DPLEXER" Transceiver Module	\$43.05
X-Band 15 dBG die cast horn antenna (UER100)	\$17.85

At THE SOURCE for RETICON Universal Audio Active Filters

R5620 digitally programmed switched capacitor audio filter	\$ 7.85
R5621 dual section resistor programmed SCF	\$ 6.51
R5622 quad section resistor programmed SCF	\$11.07
Out performs National MF-10! Application notes	\$ 2.00

OPTOELECTRONICS — MITSUBISHI Lasers and Avalanche PD's

High Output IREDS, PIN Photodiodes, IR Phosphor Screens

MITSUBISHI BIPOLAR POWER TRANSISTORS FOR 900/1296

MBF 901 Substrate 25C2876, Ft=7GHz, 2.2dBm @ 1GHz	\$ 1.50
MEC 64535 direct replacement: Siemens BFG 74	\$ 9.66

UHF and Microwave Low Loss Capacitors

Small signal and transmitting type chips
Leadless discs, Feedthroughs

STRIPLINE SHUTTLE TRIMMERS (VOLTRONICS) 0.1-2.5, 0.5-9.0pF	\$ 3.34
W-D SEALED CERAMIC PISTON TRIMMERS (VOLTRONICS) 0.6-9.0pF	\$ 3.58
SAPPHIRE TRIMMERS Johnson 0.4-2.5pF	\$ 9.47
For WA2GFP preamp Sprague 0.6-4.5pF	\$ 9.47

Thermo Electric Heat Pumps & Sub-Minature Cryogenic Refrigerators

3M GX250 glass/ite PC board 0.031 and 0.062
E.F. Johnson SMA Connectors

WA2GFP 2304 and WGP0 1296 Preamp Kits

PROMPT SERVICE. SEND FOR CATALOG. MINIMUM ORDER \$5.00
VISA/MASTERCARD Accepted. CASH prepay take 5% discount.
S&H * ITEMS (UPS) \$3.75. ALL OTHER ITEMS \$2.50 (1st CLASS)
NY STATE RESIDENTS ADD 7% SALES TAX.

R.D.2 ROUTE 21 HILLSDALE, NY 12529
518-325-3911

112

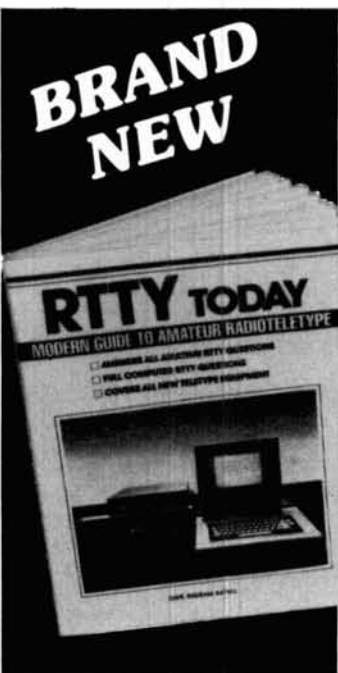

RTTY TODAY

MODERN GUIDE TO AMATEUR RADIOTELETYPE

by Dave Ingram, K4TWJ

This brand new book is the only RTTY handbook available that covers all facets of RTTY operation from the "green key" generation to personal computers. Author Dave Ingram, K4TWJ, noted RTTY enthusiast, writes in a personable, easy-to-understand style that will appeal to all levels of RTTY interest. **RTTY TODAY** is fully illustrated with photos, diagrams, RTTY station set ups and equipment to help ensure full understanding of the material. 11 chapters cover: an overview of RTTY operation, operating parameters, home computers, equipment you can build, dedicated systems and complete chapters on RTTY SWLING with frequencies, codes and other helpful hints and tips. Old time RTTY users and novices alike will find this book extremely useful. ©1984, 95 illustrations. 1st edition. 8 1/2 x 11.

Order yours today **\$895** plus \$1.75 shipping

UNIVERSAL ELECTRONICS

4555 Groves Rd. • Suite 3 • Columbus, OH 43232

(614) 866-4605

Dealer Inquiries Invited

189

P.C. BOARDS AND ART SERVICES

FACE PLATES

ENCLOSURES

WRITE OR CALL
For Literature or Quotes

Let us quote you on any stage of your product from proto types to production.

FABTRON DIV.
P.O. Box 925
Columbia, TN 38401
(615) 381-1143

134

Amateur Radio Operator NAMES

Custom lists compiled to your specifications

- Geographic by ZIP and/or State
- By License Issue or Expiration Date
- On Labels of Your Choice

Total List: 435,000 Price: \$25/Thousand

Buckmaster Publishing

Whitehall
Mineral, VA 23117 U.S.A. (703) 894-5777

119

OUTSTANDING PERFORMANCE with MOSLEY ANTENNAS

NEW!

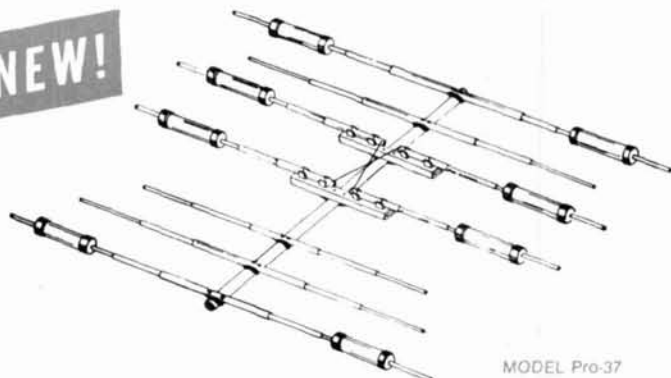

MODEL Pro-37



TA-33 Jr.
Three element
rotary beam
aerial.
10-15-20M.
Rated to 300W.

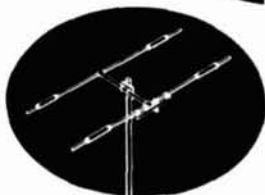

Two element
rotary beam
aerial.
10-15-20M.
Rated to 300W.
MODEL TA-32 Jr.

The Pro-37 follows in the Mosley tradition of high performance, dependability, and quality construction. The Pro-37 is pre-drilled for easy assembly. No adjustments or measuring. Average assembly is about 1½ to 2 hours. As with all the Mosley antennas we use stainless steel hardware throughout. Rugged construction makes our antenna the cleanest, strongest of its class, no cluttered elements or boom to cause electrical and mechanical problems down the road. Put it up and leave it up. In performance it has no peers...It is as broadbanded or broaderbanded than any antenna made. Its gain and front to back is as good or better than other antennas in its class, even those with longer booms. Mechanically we feel it's the best built.

The Pro-37 has 7 elements on a 24 foot boom which needs no boom support. It has 3 wide spaced elements on 20 and 15 not counting the extra driven element. 10 meters has 4 wide spaced elements not counting the extra driven element. The Pro-37 uses a unique direct feed system which enables the driven elements to contribute gain to the antenna, while giving it the broadest possible frequency spectrum. Clean design makes the antenna easy to assemble and erect and solves maintenance problems. No clutter on the elements or boom. The Pro-37 uses the proven Mosley traps which on the Pro-37 will handle 2.5 KWDC out on C.W. and 5 KWPEP on SSB. We're quite excited about the Pro-37 and we know you will be too!

Want 40 Meter DX?
Then Try...



S-401

BROADBAND SINGLE ELEMENT
Can be made into 2 element or 3 element later.



S-402

**FULL SIZE PERFORMANCE WITH 44' ELEMENT
AND A 20' BOOM**
Excellent Gain and Front to Back.
Strongest Built 2 Element on 40 Meters
Good Bandwidth. Can be made to 3 element later.

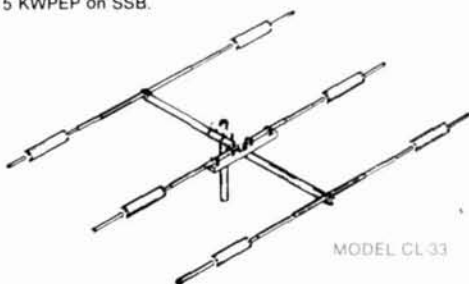

MODEL CL-33

**WANT A HIGH PERFORMANCE TRI-BANDER
BUT SMALLER?
THEN THE CL-33 IS FOR YOU!**

- * 3 elements on an 18' boom
- * Wide spaced for gain higher than normal size TRI-Banders
- * Uses our Classic feed system
- * Rated at 1KW CW and 2KW on SSB



new!

Vertical Aerial, 10 thru 40 no band-switching is necessary. Very portable and no pipe mount needed
MODEL V-4-6

V-4-6

new! 7-Band SWL/DX Dipole Kit
for 11-13-16-19-25-31-49 meters

Here's a low cost 7-band receiving dipole aerial kit that will pick up those hard-to-get DX stations. Everything included...just attach the wires and you're on the air! Weatherproof traps enclosed in Poly-Chem for stable all-weather performance.
MODEL SWL-7

Complete with
8 Trap Assemblies
Transmission Line Connector
Insulators
45 ft. No. 16 Tinned Copper Wire
100 ft. of 75 ohm twin lead

Mosley Electronics Inc.

1344 Baur Boulevard St. Louis, Mo. 63132 1-314-994-7872 1-800-325-4016

NOW ALL THESE ANTENNAS ARE UPS SHIPPABLE!

NOW THREE MODELS OF OUR DIGITAL ANTENNA CONTROL

Your Choice Of Center, North Or South



GOOD
PSE-1A, 3A

The "CONTESTER" provides the least expensive DIGITAL CONTROL UNIT WITH COMPLETE COMPUTERIZED CONTROL, BUT WITH LESS FEATURES, than the "DX'ER" and "DELUX". This unit gives you the current position of your antenna digitally in 5° steps. It has 2 memories and the command mode, plus single button operation. The PSE-1A, "CONTESTER" comes with a 10 amp continuous duty motor supply. PSE-3A has a 12 amp power pack. It is not capable of being modified to talk or accept the computer interface or remote interface. It is completely shielded and made of the same quality components as the other models. The warranty on our unit is one year on materials and labor, and ninety days on parts. This unit is a very inexpensive way to have the best of both worlds. A real time saver during contests. Hands off operation will save many hours of hanging on the rotor. Just a few dollars more than the manual control box, but worlds apart in state-of-the-art and operation. Price \$229.95*

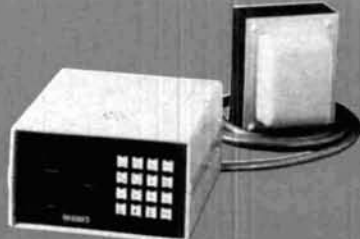

BETTER
PSE-1, PSE-3

The "DX'ER" is the top of the line of the non-voice synthesized units, and is for the ham who is in need of more features on their controller. It has "2" digital readouts, one to show the antenna's current position, plus a storage readout which holds a heading or digitally displays your last position. This is valuable for switching between long path or short path, or checking front to back, or working between two different stations, a real time saver and a nice convenience. The "DX'ER" also has "5" scan functions: 0-90, 90-180, 180-270, 270-360, and 0-360. This is a real aid in looking for that doppleg opening or peaking a weak signal. The "DX'ER" has 2 memories for storing headings, it can be expanded to talk, and does have the hardware necessary to use with the computer interface. It can be remotely keyed, where verbal confirmation isn't required. Price \$362.95*

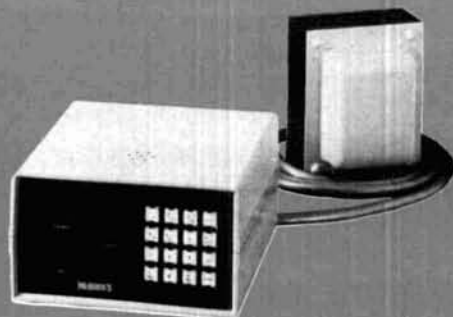

BEST
PSE-2, PSE-4

This is the ultimate in rotor controls. Nothing tops this one. It has all the features of the other models, plus it talks...Yes, it talks. The "DELUX" has a voice synthesizer which confirms your entries, plus tells you your heading as you enter it and when your antenna arrives. All commands are spoken, plus as your antenna turns you hear a 400HZ tone going in one direction and a 80HZ tone in the other. This gives you positive verification of movement. This unit, as the others, will combine with the HAM IV, T2X, and HDR-300, giving you the best antenna rotor combination you could ever want at any price. Price \$469.00*

INTRODUCING THE ULTIMATE PACKAGE...FROM PRO-SEARCH™ NINE COMBINATIONS OF OUR CONTROL UNIT AND THE TELEX/HYGAIN* ROTOR MOTORS... FOR JUST A FEW DOLLARS MORE YOU CAN HAVE THE CONTROLLER OF THE FUTURE TODAY!

Package #1 PSE-1A

The "Contester" Package...try one of these TELEX/HY-GAIN rotors with our PSE-1A/3A. A system which is low in cost, high in performance.

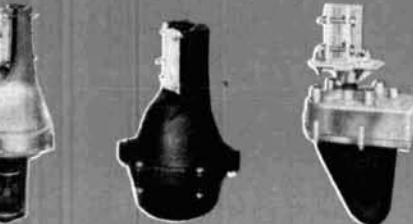

HAM IV* T2X* HDR-300*

PSE-1A will save you lots of time in your favorite contests. No more hanging on the rotor control...Gives you positive control with DIGITAL readout plus 2 memories, command positioning, and single button manual movement.

Package Special

- PSE-1A + HAM IV \$369.95
- PSE-1A + T2X 415.95
- PSE-3A + HDR-300 544.95

* Printed with permission of TELEX/HYGAIN Telex Communications, Inc.

Package #2 PSE-1/PSE-3

The "DX'ER" Package...Couple this unit with a rotor and you have the best non talking control we make. Expandable, plus has 5 scan functions, 2 DIGITAL displays and REC/LAST to check long path or short path. Has all internal hardware to plug into our computer interface. Can be remotely controlled from accessory jack. Try this with any of the TELEX/HY-GAIN* Rotors! This will give you the broadest of functions with a mid-range price.

Package Special

- PSE-1 + HAM IV \$502.95
- PSE-1 + T2X 548.95
- PSE-3 + HDR-300 677.95

Package #3 PSE-2/PSE-4

The "Delux" is the most sophisticated antenna control unit ever made. With the "Delux" you have all the functions of our other units, plus it talks...Yes it talks. Not only do you have your headings digitally displayed, but is also said as your antenna stops...All commands are spoken, plus as your antenna turns you hear a 400Hz tone in one direction and an 80Hz in the other, giving you positive verification of movement. This unit, when combined with the HAM IV, T2X or HDR-300 gives you the best buy anywhere at any price...

Package Special

- PSE-2 + HAM IV \$608.95
- PSE-2 + T2X 655.00
- PSE-4 + HDR-300 784.00

Controllers also available for other rotors. Prices and specifications subject to change without notice or obligation. U.S. and Foreign Patents

* For PSE, 3A, 3, 4 add \$24.50 for 12 amp power pack.



© Copyright 1983

Write or Call for our Catalog • Pro Search Electronics Co. 1344 Bauer Boulevard St. Louis, Missouri 63132 • 1-314-994-7872 (Missouri) 1-800-325-4016

DALBANI CORPORATION

Japanese Components

CALL FOR PRICE SHEETS

- AN SERIES**
- AN-124Q
 - AN-203C
 - AN-210
 - AN-214P
 - AN-214Q
 - AN-225
 - AN-228W
 - AN-234
 - AN-236
 - AN-239Q
 - AN-240P
 - AN-241P
 - AN-245
 - AN-246
 - AN-247
 - AN-252
 - AN-253
 - AN-259
 - AN-262
 - AN-264
 - AN-271
 - AN-274
 - AN-277
 - AN-295
 - AN-303
 - AN-305
 - AN-313
 - AN-315
 - AN-316
 - AN-318
 - AN-328
 - AN-331U
 - AN-360
 - AN-362
 - AN-366P
 - AN-610
 - AN-5111
 - AN-5132
 - AN-5250
 - AN-5310
 - AN-5320
 - AN-5411
 - AN-5510
 - AN-5710
 - AN-5712
 - AN-5720
 - AN-5722
 - AN-5730
 - AN-5732
 - AN-5753
 - AN-5763
 - AN-6100
 - AN-6120
 - AN-6344
 - AN-7110
 - AN-7114E
 - AN-7115E
 - AN-7120
 - AN-7130
 - AN-7145M
 - AN-7146M
 - AN-7150
 - AN-7151
 - AN-7154
 - AN-7158N
 - AN-7254
 - AN-7311
 - AN-7363
- BA SERIES**
- BA-301
 - BA-308
 - BA-311
 - BA-313
 - BA-311A
 - BA-514
 - BA-521
 - BA-524
 - BA-528
- BU SERIES**
- BU-205A
 - BU-208A
- CX SERIES**
- CX-130
 - CX-143A
 - CX-186
 - CX-187
- HA SERIES**
- HA-1125
 - HA-1137W
 - HA-1156
 - HA-1197
 - HA-1199
 - HA-1203
 - HA-1306W
 - HA-1319
 - HA-1322
 - HA-1339
 - HA-1339A
 - HA-1342A
 - HA-1366W
 - HA-1366WR
 - HA-1368
 - HA-1368R
 - HA-1371
 - HA-1377
 - HA-1377A
 - HA-1389
 - HA-1389R
 - HA-1392
 - HA-1394
 - HA-1397
 - HA-1398
 - HA-11211
 - HA-11215
 - HA-11221
 - HA-11223
 - HA-11225
 - HA-11226
 - HA-11227
 - HA-11229
 - HA-11235
 - HA-11247
 - HA-11251
 - HA-12402
 - HA-11401
- LA SERIES**
- LA-1111P
 - LA-1130
 - LA-1150
 - LA-1201
 - LA-1210
 - LA-1222
 - LA-1230
 - LA-1231N
 - LA-1240
 - LA-1245
 - LA-1320
 - LA-1352
 - LA-1354
 - LA-1357
 - LA-1363
 - LA-1364
 - LA-1365
 - LA-1367
 - LA-1368
 - LA-1369
 - LA-1385
 - LA-1387
- LC SERIES**
- LC-7120
 - LC-7130
- MB SERIES**
- MB-3705
 - MB-3712
 - MB-3712M
 - MB-3715A
 - MB-3730M
 - MB-3731M
 - MB-3756
 - MB-8719
- SKT SERIES**
- SKT-0025
 - SKT-0029
 - SKT-0030
 - SKT-0039
 - SKT-0040
 - SKT-0049
 - SKT-0050
 - SKT-0059
 - SKT-0060
 - SKT-0080
 - SKT-011
 - SKT-013
 - SKT-014
- TA SERIES**
- TA-7054P
 - TA-7061AP
 - TA-7063
 - TA-7066P
 - TA-7070
 - TA-7072
 - TA-7073A
 - TA-7074P
 - TA-7108P
 - TA-7109A
 - TA-7119P
 - TA-7120P
 - TA-7129AP
 - TA-7130P
 - TA-7133
 - TA-7137
 - TA-7139P
- UPC SERIES**
- UPC-576H
 - UPC-577C
 - UPC-580C
 - UPC-592C
 - UPC-595C
 - UPC-596
 - UPC-1001H
 - UPC-1020
 - UPC-1021C
 - UPC-1023
 - UPC-1025H
 - UPC-1026C
 - UPC-1028H
 - UPC-1031H
 - UPC-1032
 - UPC-1155
 - UPC-1156H
 - UPC-1181H
 - UPC-1182H
 - UPC-1185
 - UPC-1230H
 - UPC-1277
 - UPC-1350
 - UPC-1363C
 - UPC-1384
 - UPC-1447H
 - UPC-1458C
 - UPC-2002
- UPD SERIES**
- UPD-416D
 - UPD-2716D
 - UPD-2764
- 2SA SERIES**
- 2SA-562
 - 2SA-564
 - 2SA-634
 - 2SA-683
 - 2SA-684
 - 2SA-699
 - 2SA-712
 - 2SA-715
 - 2SA-720
 - 2SA-733
 - 2SA-771
 - 2SA-773
 - 2SA-777
 - 2SA-844
 - 2SA-899
 - 2SA-899B
 - 2SA-913
 - 2SA-916
 - 2SA-940
 - 2SA-950
 - 2SA-953
 - 2SA-984
 - 2SA-992
 - 2SA-1015
 - 2SA-1048
 - 2SA-1075
- 2SB SERIES**
- 2SB-22
 - 2SB-324
 - 2SB-337
 - 2SB-389
 - 2SB-411
 - 2SB-507
 - 2SB-536
 - 2SB-539
 - 2SB-554
 - 2SB-557
 - 2SB-560
 - 2SB-563
 - 2SB-595
 - 2SB-596
 - 2SB-616
 - 2SB-618A
 - 2SB-624
 - 2SB-628
 - 2SB-630
 - 2SB-633
 - 2SB-636
 - 2SB-681
 - 2SB-686
 - 2SB-754
 - 2SB-755
 - 2SB-844
 - 2SB-861
- 2SC SERIES**
- 2SC-373
 - 2SC-398
 - 2SC-400
 - 2SC-460
 - 2SC-461
 - 2SC-495
 - 2SC-606
 - 2SC-645
 - 2SC-710
 - 2SC-730
 - 2SC-792
 - 2SC-828
 - 2SC-829
 - 2SC-839
 - 2SC-867A
 - 2SC-940
 - 2SC-945
 - 2SC-959
 - 2SC-980
 - 2SC-998
 - 2SC-1025
 - 2SC-1034
 - 2SC-1047
 - 2SC-1060
 - 2SC-1061
 - 2SC-1074
 - 2SC-1096
 - 2SC-1098
 - 2SC-1114
 - 2SC-1115
 - 2SC-1124
 - 2SC-1162
 - 2SC-1165
 - 2SC-1172
 - 2SC-1172B
 - 2SC-1177
 - 2SC-1226A
 - 2SC-1306
 - 2SC-1307
 - 2SC-1308K
 - 2SC-1313
 - 2SC-1316
 - 2SC-1317
 - 2SC-1318
 - 2SC-1325
 - 2SC-1342
 - 2SC-1345
 - 2SC-1358
 - 2SC-1364
 - 2SC-1383
 - 2SC-1384
 - 2SC-1413
 - 2SC-1449
 - 2SC-1501
 - 2SC-1507
 - 2SC-1589
 - 2SC-1675
 - 2SC-1678
 - 2SC-1730
 - 2SC-1815GR
 - 2SC-1826
 - 2SC-1881
 - 2SC-1909
 - 2SC-1913
 - 2SC-1941
 - 2SC-1946
 - 2SC-1947
 - 2SC-1956
 - 2SC-1960
 - 2SC-1966
 - 2SC-1968
 - 2SC-1972
 - 2SC-1975
 - 2SC-2026
 - 2SC-2028
 - 2SC-2029
 - 2SC-2073
 - 2SC-2075
- 2SD SERIES**
- 2SD-24Y
 - 2SD-188
 - 2SD-198R
 - 2SD-287
 - 2SD-313
 - 2SD-315
 - 2SD-325
 - 2SD-348
 - 2SD-350
 - 2SD-371
 - 2SD-387AE
 - 2SD-388
 - 2SD-389
 - 2SD-401A
 - 2SD-415
 - 2SD-424
 - 2SD-425
 - 2SD-427
 - 2SD-470
 - 2SD-471
 - 2SD-478
 - 2SD-495
 - 2SD-525
 - 2SD-526
 - 2SD-587
 - 2SD-588
 - 2SD-612
 - 2SD-613
 - 2SD-636
 - 2SD-638
 - 2SD-685
 - 2SD-687
 - 2SD-688
 - 2SD-689
 - 2SD-684
 - 2SD-712
 - 2SD-718
 - 2SD-733
 - 2SD-746
 - 2SD-824
 - 2SD-844
 - 2SD-870
- 2SK SERIES**
- 2SK-19
 - 2SK-48
 - 2SK-49
 - 2SK-117
 - 2SK-168
 - 2SK-241Y

CALL FOR PRICE SHEETS

- TC SERIES**
- TC-5081AP
 - TC-9106BP
 - TC-9108BP
 - TC-9125BP
- 2SA SERIES**
- 2SA-562
 - 2SA-564
 - 2SA-634
 - 2SA-683
 - 2SA-684
 - 2SA-699
 - 2SA-712
 - 2SA-715
 - 2SA-720
 - 2SA-733
 - 2SA-771
 - 2SA-773
 - 2SA-777
 - 2SA-844
 - 2SA-899
 - 2SA-899B
 - 2SA-913
 - 2SA-916
 - 2SA-940
 - 2SA-950
 - 2SA-953
 - 2SA-984
 - 2SA-992
 - 2SA-1015
 - 2SA-1048
 - 2SA-1075
- TBA SERIES**
- TBA-800
 - TBA-810SH
 - TBA-820M
- UPC SERIES**
- UPC-16C
 - UPC-20C
 - UPC-354C
 - UPC-555H
 - UPC-566H
 - UPC-571H
 - UPC-574
 - UPC-575C
- 2SC SERIES**
- 2SC-373
 - 2SC-398
 - 2SC-400
 - 2SC-460
 - 2SC-461
 - 2SC-495
 - 2SC-606
 - 2SC-645
 - 2SC-710
 - 2SC-730
 - 2SC-792
 - 2SC-828
 - 2SC-829
 - 2SC-839
 - 2SC-867A
 - 2SC-940
 - 2SC-945
 - 2SC-959
 - 2SC-980
 - 2SC-998
 - 2SC-1025
 - 2SC-1034
 - 2SC-1047
 - 2SC-1060
 - 2SC-1061
 - 2SC-1074
 - 2SC-1096
 - 2SC-1098
 - 2SC-1114
 - 2SC-1115
 - 2SC-1124
 - 2SC-1162
 - 2SC-1165
 - 2SC-1172
 - 2SC-1172B
 - 2SC-1177
 - 2SC-1226A
 - 2SC-1306
 - 2SC-1307
 - 2SC-1308K
 - 2SC-1313
 - 2SC-1316
 - 2SC-1317
 - 2SC-1318
 - 2SC-1325
 - 2SC-1342
 - 2SC-1345
 - 2SC-1358
 - 2SC-1364
 - 2SC-1383
 - 2SC-1384
 - 2SC-1413
 - 2SC-1449
 - 2SC-1501
 - 2SC-1507
 - 2SC-1589
 - 2SC-1675
 - 2SC-1678
 - 2SC-1730
 - 2SC-1815GR
 - 2SC-1826
 - 2SC-1881
 - 2SC-1909
 - 2SC-1913
 - 2SC-1941
 - 2SC-1946
 - 2SC-1947
 - 2SC-1956
 - 2SC-1960
 - 2SC-1966
 - 2SC-1968
 - 2SC-1972
 - 2SC-1975
 - 2SC-2026
 - 2SC-2028
 - 2SC-2029
 - 2SC-2073
 - 2SC-2075
- 2SD SERIES**
- 2SD-24Y
 - 2SD-188
 - 2SD-198R
 - 2SD-287
 - 2SD-313
 - 2SD-315
 - 2SD-325
 - 2SD-348
 - 2SD-350
 - 2SD-371
 - 2SD-387AE
 - 2SD-388
 - 2SD-389
 - 2SD-401A
 - 2SD-415
 - 2SD-424
 - 2SD-425
 - 2SD-427
 - 2SD-470
 - 2SD-471
 - 2SD-478
 - 2SD-495
 - 2SD-525
 - 2SD-526
 - 2SD-587
 - 2SD-588
 - 2SD-612
 - 2SD-613
 - 2SD-636
 - 2SD-638
 - 2SD-685
 - 2SD-687
 - 2SD-688
 - 2SD-689
 - 2SD-684
 - 2SD-712
 - 2SD-718
 - 2SD-733
 - 2SD-746
 - 2SD-824
 - 2SD-844
 - 2SD-870
- 2SK SERIES**
- 2SK-19
 - 2SK-48
 - 2SK-49
 - 2SK-117
 - 2SK-168
 - 2SK-241Y

CALL TOLL FREE
IN U.S.A.

1-800-DALBANI

ADDITIONAL ITEMS*

We also carry micro motors, telescopic antennas, AC/DC adaptors, transformers, splitters, magnetic tape heads, cartridges, car antennas, car equalizers, car stereos, speakers, and other items that are added daily.

*We can handle any order from Japan direct to you, with competitive prices.

TERMS

1. Payment in U.S. dollars only.
2. Payment by check or money order payable to Dalbani Corporation.
3. Payment by VISA or MasterCard.
4. Payment by credit card (MasterCard, Visa, American Express, Discover, etc.)
5. Payment by bank transfer (T/T) or wire transfer.
6. Payment by bank draft (D/P) or bank order (B/O).

★ SANYO UHF VARACTOR TUNER ★

For channels 14-83 • Tuning voltage: 0-1 to 28VDC • Input impedance: 250 Ω • IF band width: 7.0MHz • Size: 20 x 11 x 10 mm • Supply voltage: 5VDC
PN 151B-401A for 40.0MHz
PN 151B-401A for 60.0MHz



\$12.95 ea.

DALBANI CORPORATION

785 EAST 14TH STREET • LOS ANGELES, CALIFORNIA 90021 • U.S.A. • TELEPHONE: (213) 747-6830 747-6856 TELEX: 194654 DALBANI USA

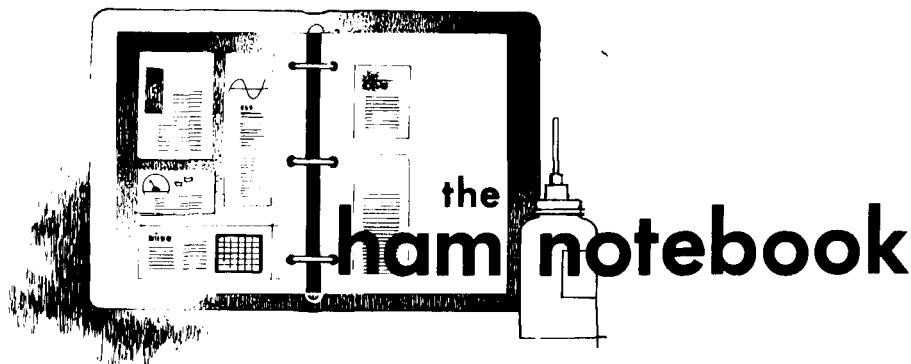

RIT for the KWM2

Tired of playing leapfrog when working stations on CW that have rigs like yours, but lack any clarifier provision in the receive mode? And are you tired of working in nets where 20 percent of the operators aren't exactly on frequency, and you have to keep leaving the NCS (Net Control Station) frequency in order to read them clearly? Well, I was — so I decided to add a clarifier module to my KWM2A (fig. 1).

Most of the necessary parts, with the exception of a varactor diode, are probably already in your junk box; the diodes are quite plentiful and reasonably priced.

design approach

No kinks were found in this unit; it works like a charm, providing about 2 kHz or better frequency swing on receive.

You can make the swing as much as you desire by using different types of varactor diodes or by varying the size of C7 (see fig. 1), which is effectively in series with the varactor diode. The diode I used has a capacitance variation of 4.5 to 22 pF when the bias is varied from 0 to 10 volts. Many varactor sizes are available from 5 to 10 pF up to hundreds of pF in value. Choose whatever you need; any of those in the parts list should suffice.

For the Collins modification I decided the best place for the power supply section was in the external power supply speaker unit. I had never used the built-in speaker, so I just removed it and used the space to house a board with the voltage doubler circuit shown, using the 6.3 VAC filament supply as a source.

I found one lead in the power cable

from the AC power supply to the KWM2 that terminated in an unused pin (power supply end). This is pin 6, which actually has switched 110 VAC coming from the transceiver end. I

disconnected the 110 VAC from this lead and used it to carry the 15 VDC from the AC power supply into the transceiver. I also disconnected this lead from the T/R relay, K4, in the KWM2, in which it formerly appeared on relay contact No. 13, and ran it via shielded wire up through a hole in the chassis near the VFO unit. This becomes the 15 VDC supply to power the RIT board and regulator circuit. This leaves a relay arm and two contacts (No. 12 and 11) unused in T/R relay K4. I put the arm (No. 12) to use as a disable circuit so that during transmit the clarifier is automatically out of the circuit, regardless of whether it is left switched on from the front panel switch or not. When receiving, this relay arm furnishes a ground and in turn activates the RIT control relay. When transmitting, however, this arm closes to contact No. 13; this prevents the confusion that would result from transmitting with the clarifier inadvertently left on and thereby operating on an undesired frequency. I made the entire regulator and RIT circuitry on one small perforated hole board and mounted it on the two screws on the back of the Collins PTO. This puts it as close to the VFO tube (6AU6) as possible and permits running a short lead from the varactor diode blocking capacitor, C7, to the cathode lead of the 6AU6 VFO tube. It isn't necessary to enter the PTO box at all. Just wrap a small solid wire a turn or two around the cathode pin of the 6AU6 tube and solder it. Be careful; too much heat for too long a time will cause the glass on the tube to crack. Be sure the potentiometers used are the linear taper type in order to obtain a smooth frequency swing from stop to stop; one is used for adjusting the transmit frequency and should be set somewhere near mid-range. The other potentiometer is switched in only when the RIT switch is on. This potentiometer has a shaft brought out to the front panel right over the top of the PTO chassis. This is your receiving RIT control. If you're squeamish about drilling holes in the front panel, knocking out the "Collins" name decal will leave a hole in the

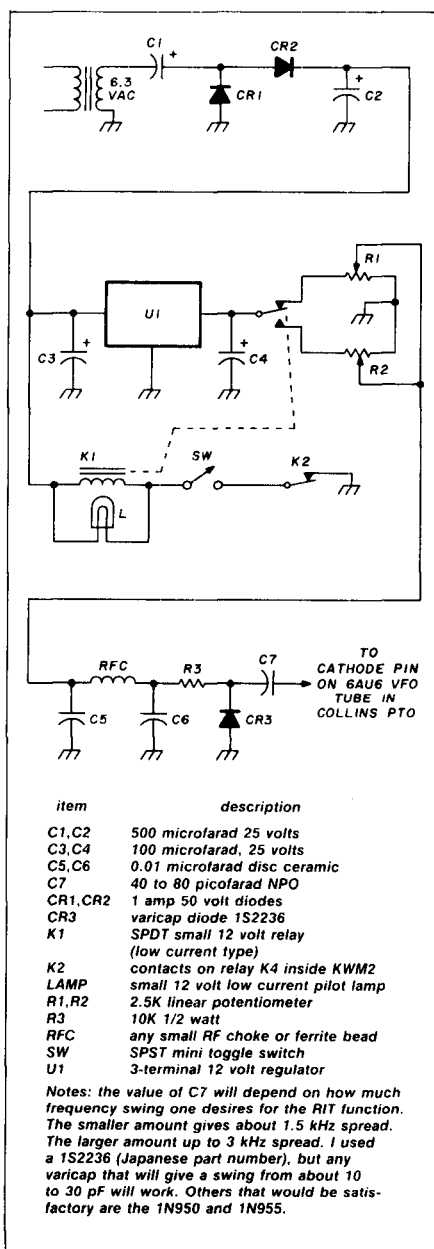

RF TRANSISTORS

FRESH STOCK - NOT SURPLUS
TESTED - FULLY GUARANTEED

2-30MHz 12V (*=28V)

P/N	Rating	Ea	Match Pr
MRF406	20W	\$14.50	\$32.00
MRF412	80W	18.00	40.00
MRF412A	80W	18.00	40.00
MRF421	100W	25.00	54.00
MRF421C	110W	27.00	58.00
MRF422*	150W	38.00	82.00
MRF426*	25W	17.00	40.00
MRF426A*	25W	17.00	40.00
MRF433	13W	14.50	32.00
MRF435*	150W	42.00	90.00
MRF449	30W	12.00	27.00
MRF449A	30W	11.00	25.00
MRF450	50W	12.00	27.00
MRF450A	50W	12.00	27.00
MRF453	60W	15.00	33.00
MRF453A	60W	15.00	33.00
MRF454	80W	16.00	35.00
MRF454A	80W	16.00	35.00
MRF455	60W	12.00	27.00
MRF455A	60W	12.00	27.00
MRF458	80W	18.00	40.00
MRF460	60W	16.50	36.00
MRF475	12W	3.00	9.00
MRF476	3W	2.50	8.00
MRF477	40W	13.00	29.00
MRF479	15W	10.00	23.00
MRF485*	15W	6.00	15.00
MRF492	90W	18.00	39.00
SRF2072	75W	15.00	33.00
CD2545	50W	24.00	55.00

Selected High Gain Matched Quads Available

VHF TRANSISTORS

Type	Rating	Ea	Match/Pr
MRF221	15W	\$10.00	—
MRF222	12W	12.00	—
MRF224	40W	13.50	\$32.00
MRF231	3.5W	10.00	—
MRF234	25W	15.00	39.00
MRF237	1W	2.50	—
MRF238	30W	12.00	—
MRF239	30W	15.00	—
MRF240	40W	16.00	—
MRF245	80W	25.00	59.00
MRF247	80W	25.00	59.00
MRF260	5W	6.00	—
MRF264	30W	13.00	—
MRF492	70W	18.00	39.00
MRF607	1.8W	2.60	—
MRF627	0.5W	9.00	—
MRF641	15W	18.00	—
MRF644	25W	23.00	—
MRF646	40W	24.00	59.00
MRF648	60W	29.50	69.00
SD1416	80W	29.50	—
SD1477	125W	37.00	—
2N4427	1W	1.25	—
2N5945	4W	10.00	—
2N5946	10W	12.00	—
2N6080	4W	6.00	—
2N6081	15W	7.00	—
2N6082	25W	9.00	—
2N6083	30W	9.50	—
2N6084	40W	12.00	29.00
TMOS FET			
MRF137	30W	\$22.50	—
MRF138	30W	35.00	—
MRF140	150W	92.00	—
MRF150	150W	80.00	—
MRF172	80W	65.00	—
MRF174	125W	88.00	—

Technical Assistance & cross-reference information on CD, PT, RF, SRF, SD P/NS Call Engineering Dept. (619) 744-0728

RF Parts Catalog Available ✓ 193
OEM & Quantity Discounts

Minimum Order \$20 Add \$3.50 Shipping
WE SHIP SAME DAY C.O.D./VISA/MC

ORDERS ONLY: 800-854-1927



WESTCOM

1320 Grand Ave. San Marcos
California 92069 (619) 744-0728

panel through which the control shaft may be passed.

I put the on/off switch and an optional warning light (to let me know when the clarifier is operating while in receive mode) below the PTO dial area near the bottom of the front panel near the center. You can use the new mini-toggles or a push-on/push-off mini-switch and one of the smaller types of pilot lights. Make sure the relay, K1, and the pilot lamp are both low-current consumption devices. If these two items pull too much current from the unregulated 15 VDC source, degradation of the voltage regulator's operation could result.

My relay is very small and has the required SPST configuration. The relay and the pilot lamp pull only about 50 mA of current. I would say that up to 100 mA could be handled without any loading down of the 15 VDC supply. The operation of the clarifier is straightforward, and has no adverse effect on the stability of the VFO; whatever stability existed before will remain even with the clarifier in use.

I happened to use a 12-volt three-terminal regulator because that was what I found in my junk box, but you could use a 9-volt unit as well, except for its slightly narrower frequency range on the RIT. Also, when reconfiguring the power lead pins, I found that C108 and R101, which were formerly across the K4 relay contacts, were no longer needed, so I clipped them out. (Tracing these two components in the KWM2 is easy as they are right behind the K4 contacts in question. Note also that the K4 contact numbering is different in the older KWM2 than in the later KWM2A series. On the former, the contacts were numbered 9, 10, and 11, instead of 11, 12, and 13.)

not limited to Collins transceivers

This modification can be used in most transceivers that do not have RIT, such as the Drake TR4, Heath SB104, etc., by connecting a lead from the varactor blocking capacitor C7 to the proper point in your VFO tuned cir-

cuit. This additional capacitance helps tune the VFO. This in turn will require you to estimate the amount of capacitance your varactor diode will need in order to cause your VFO frequency to swing the desired number of kHz.

After adding this modification to the KWM2, your VFO (Collins PTO) will read a little off frequency one way or the other. Just take a turn or two on the coil slug, which is on top of the PTO box and just to the right of the 6AU6 VFO tube. This adjustment corrects the readout for all bands. The amount you have to adjust this slug is small and will depend somewhat on the particular varactor diode you select.

Joe Fenn, KH6JF

QRP wattmeter

Prowling around radio swap meets or surplus stores, one sometimes finds a Weston Thermo Galvanometer. Because no one seems to know how they can be used, they just stay in the junk pile.

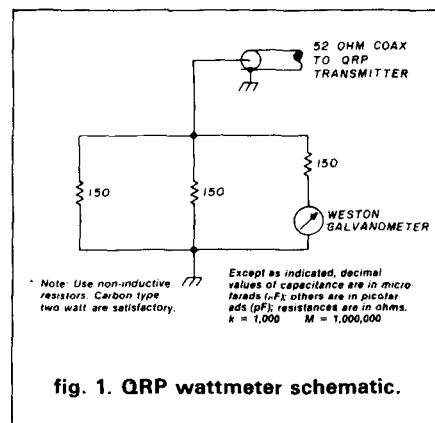

fig. 1. QRP wattmeter schematic.

A 0-100 mA RF current indicated galvanometer makes an excellent direct-reading 0-5 watt power meter that can be used with QRP rigs. The internal resistance is 5.2 ohms for 100 mA full scale reading.

Using three 150-ohm 2-watt resistors in parallel, and putting the galvanometer in the leg of one of them makes an excellent wattmeter (fig. 1) with an accuracy of 2 percent up to 65 MHz.

Ed Marriner, W6XM

John J. Meshna Jr., Inc.

19 Allerton Street • Lynn, MA 01904 • Tel: (617) 595-2275

DUAL FLOPPY DISC DRIVES

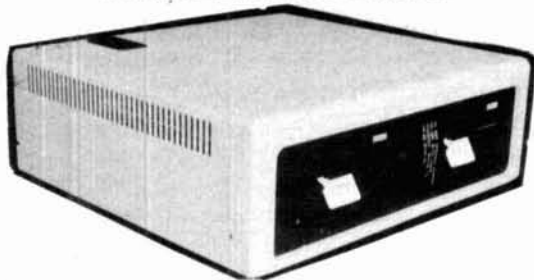

BRAND NEW, dual floppy disc drives made for Digital Equipment Corp. (DEC model no. RX 180 AB). This beautiful piece of computer hardware consists of 2 Shugart compatible TEAC 40 track, double density, 5¼" mini-floppy disc drives brand new in the case with their own regulated, switching power supply, cooling fan & on/off switch. Each unit also comes with a line cord & documentation. These were made for DEC, but are also compatible with other personal computers such as IBM, TRS 80 models I, II, III, & the Color Computer, and other Shugart compatible interfaces. Naturally you supply the cables and disc controller card to suit your particular system. The RX 180 AB runs off of 115 /230 VAC 50/60 Hz. w/out any modifications to the drives. Each system comes in the original factory box and are guaranteed functional. A blockbuster of a buy !! Shpg. wt. 20 lb. Stock no. RX 180 AB \$250.00

Modified to run with TI99-4A \$285.00

HIGH SPEED KSR PRINTER TERMINAL



World famous, high speed G. E. Terminet 1200 RS 232 KSR printer terminals are now in stock ready for shipment to you. This has to be one of the finest letter quality printers ever offered at a bargain price. These terminals can be used as an RS 232 asynchronous communications terminal or used in the local mode as a typewriter. The terminals were removed from service for upgrading. Highlights of these machines are: Standard RS 232, full duplex, asynchronous data comm., fully formed upper and lower case letters, 128 character ASCII set, selectable baud rates of 110, 300, or 1200 BPS, 80 columns on pin feed paper, and less weight & size than an ASR 35 teletype with far less racket. They are virtually electronically foolproof as every pc board is Pico fuse protected. Should your machine not work, just check the on board fuses & 9 out of 10 times that is where the problem lies. Schematics are provided w/ each machine sold. Current price of this machine new is over \$2000.00 ! Our meager price for this fantastic printer is only 10% of this: \$200.00 each!!! Visually inspected prior to shipment to insure completeness. Shpd. truck freight collect. \$200.00

5 MEGABYTE SEAGATE ST 506 5¼" MICROWINCHESTER HARD DISC DRIVES

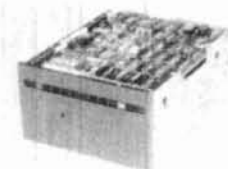

The Seagate Technology ST 506 MicroWinchester hard disc drives are identical in size and mounting configuration to the industry standard 5¼" mini-floppy disc drives. These drives utilize 2 5¼" fixed platters as storage media. Each surface employs 1 read/write head to service 153 tracks. The storage capacity is 5 megabytes formatted ! The voltage requirements are only 5vdc 700ma & 12vdc 1.6 amps. hardly more than a regular mini-floppy drive. The drives we have are in beautiful condition and look to be unused. Each one comes with factory literature which includes the pinouts. The ST 506's will run with computer systems from Kaypro, IBM, Xerox, and other Shugart compatible interfaces when used with the proper controller card (not provided). Only 10 pieces in stock, so order early. Seagate ST 506 Shpg. wt. 9 lb. \$300.00 2/\$575.00

IBM model no. 745

NEW IBM SELECTRIC BASED TYPEWRITER PRINTERS



Send for free data sheet.

These rugged, handsome printers were made for one of the giants of the computer industry. They can be used as a standard typewriter or as a printer in a word processing system for true letter quality printing. Solenoids were added to the selectric mechanism which disabled the manual repeat function but still allows electronic repeat functions. It uses standard IBM typing balls. The voltage requirements are standard 115 vac, 5 vdc @ 100 ma, & 24 vdc @ 4 amps. All are new in factory boxes, but may require adjustments. We provide literature and schematics with 1 ribbon & cleaning tools. With the addition of our Centronics to Selectric I/O adapter, you could easily interface this printer to almost any micro computer system.

Typewriter Printer stock no. RE 1000A \$375.00 shpg wt. approx. 80 lb. shpd. by truck collect. Centronics to Selectric adapter. Fully tested & operational \$245.00 Shpd. UPS 15 lb.

SHUGART 901 8" FDD

We just got in a small lot of nice clean world reknown Shugart 8" disc drives. Single side, single density units. Each drive will come with data on using the 901's in 801 compatible systems which should make them very versatile. Schematics are also provided. Used, good condition. Shpg. wt. 15 lb. \$75.00



BA 279 BATTERIES

Unused surplus from Uncle Sam. Output is 135v, 67½ v, 6v, & 1½v. Socket is made to fit plug from PRC 8,9,& 10. May fit other rigs as well. Current list price is \$42.25. Our price is only \$15.00 Shpg. wt. 9 lb.

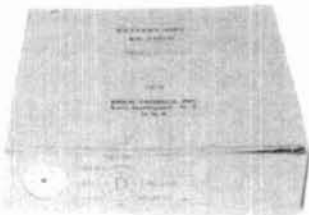

Phone Orders accepted on MC, VISA, or AMEX Surplus Electronic Material
No COD's. Tel. 1-617-595-2275

Send for our free 72 page catalogue jam packed with goodies.

THE MOST AFFORDABLE REPEATER

ALSO HAS THE MOST IMPRESSIVE PERFORMANCE FEATURES

(AND GIVES THEM TO YOU AS STANDARD EQUIPMENT!)



JUST LOOK AT THESE PRICES!

Band	Kit	Wired/Tested
10M, 6M, 2M, 220	\$680	\$880
440	\$780	\$980

Both kit and wired units are complete with all parts, modules, hardware, and crystals.

CALL OR WRITE FOR COMPLETE DETAILS.

Also available for remote site linking, crossband, and remote base.

FEATURES:

- SENSITIVITY SECOND TO NONE; TYPICALLY 0.15 μ V ON VHF, 0.3 μ V ON UHF.
- SELECTIVITY THAT CAN'T BE BEAT! BOTH 8 POLE CRYSTAL FILTER & CERAMIC FILTER FOR GREATER THAN 100 dB AT \pm 12KHZ. HELICAL RESONATOR FRONT ENDS. SEE R144, R220, AND R451 SPECS IN RECEIVER AD BELOW.
- OTHER GREAT RECEIVER FEATURES: FLUTTER-PROOF SQUELCH, AFC TO COMPENSATE FOR OFF-FREQ TRANSMITTERS, SEPARATE LOCAL SPEAKER AMPLIFIER & CONTROL.
- CLEAN, EASY TUNE TRANSMITTER; UP TO 20 WATTS OUT (UP TO 50W WITH OPTIONAL PA).

HIGH QUALITY MODULES FOR REPEATERS, LINKS, TELEMETRY, ETC.

HIGH-PERFORMANCE RECEIVER MODULES

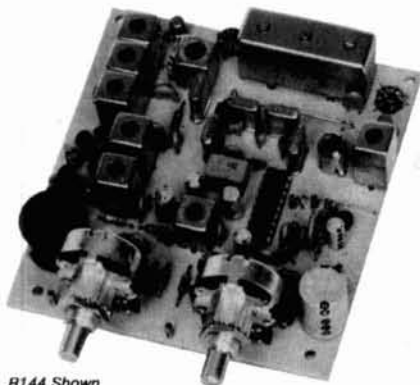

R144 Shown

- **R144/R220 FM RCVRs** for 2M or 220 MHz. 0.15 μ V sens.; 8 pole xtal filter & ceramic filter in i-f, helical resonator front end for exceptional selectivity, more than -100 dB at \pm 12 kHz, best available today. Flutter-proof squelch. AFC tracks drifting xmtrs. Xtal oven avail. Kit only \$138.
- **R451 FM RCVR** Same but for uhf. Tuned line front end, 0.3 μ V sens. Kit only \$138.
- **R76 FM RCVR** for 10M, 6M, 2M, 220, or commercial bands. As above, but w/o AFC or hel. res. Kits only \$118. Also avail w/4 pole filter, only \$98/kit.
- **R110 VHF AM RECEIVER** kit for VHF aircraft band or ham bands. Only \$98.
- **R110-259 SPACE SHUTTLE RECEIVER**, kit only \$98.

TRANSMITTERS

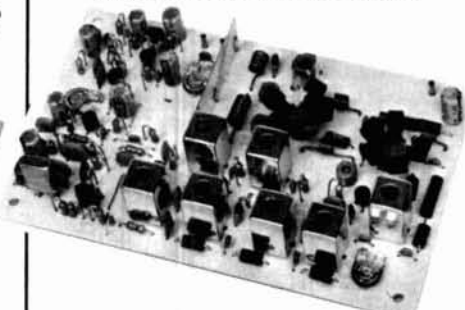

- **T51 VHF FM EXCITER** for 10M, 6M, 2M, 220 MHz or adjacent bands. 2 Watts continuous, up to 2 1/2 W intermittent. \$68/kit.



- **T451 UHF FM EXCITER** 2 to 3 Watts on 450 ham band or adjacent freq. Kit only \$78.
- **VHF & UHF LINEAR AMPLIFIERS.** Use on either FM or SSB. Power levels from 10 to 45 Watts to go with exciters & xmtg converters. Several models. Kits from \$78.
- **A16 RF TIGHT BOX** Deep drawn alum. case with tight cover and no seams. 7 x 8 x 2 inches. Designed especially for repeaters. \$20.

ACCESSORIES



- **COR KITS** With Audio mixer, speaker amplifier, tail & time out timers. Kit only \$38.
- **CWID KITS** 158 bits, field programmable, clean audio, rugged TTL logic. Kit only \$68.
- **DTMF DECODER/CONTROLLER KITS.** Control 2 separate on/off functions with touchtones[®], e.g., repeater and autopatch. Use with main or aux. receiver or with Auto-patch. Only \$90
- **AUTOPATCH KITS.** Provide repeater autopatch, reverse patch, phone line remote control of repeater, secondary control via repeater receiver. Many other features. Only \$90. Requires DTMF Module.

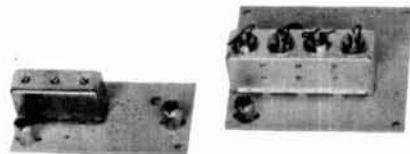

- **HELICAL RESONATOR FILTERS** available separately on pcb w/connectors.
 - HRF-144 for 143-150 MHz \$38
 - HRF-220 for 213-233 MHz \$38
 - HRF-432 for 420-450 MHz \$48

hamtronics[®]

NEW LOW-NOISE PREAMPS



Hamtronics Breaks the Price Barrier!



No Need to Pay \$80 to \$125 for a GaAs FET Preamp.

FEATURES:

- Very Low Noise: 0.7 dB VHF, 0.8 dB UHF
- High Gain: 18 to 28 dB, Depending on Freq.
- Wide Dynamic Range for Overload Resistance
- Latest Dual-gate GaAs FET, Stable Over Wide Range of Conditions
- Rugged, Diode-protected Transistors
- Easy to Tune
- Operates on Standard 12 to 14 Vdc Supply
- Can be Tower Mounted

MODEL	TUNES RANGE	PRICE
LNG-28	26-30 MHz	\$49
LNG-50	46-56 MHz	\$49
LNG-144	137-150 MHz	\$49
LNG-220	210-230 MHz	\$49
LNG-432	400-470 MHz	\$49
LNG-40	30-46 MHz	\$64
LNG-160	150-172 MHz	\$64

ECONOMY PREAMPS

Our traditional preamps, proven in years of service. Over 20,000 in use throughout the world. Tuneable over narrow range. Specify exact freq. band needed. Gain 16-20 dB. NF = 2 dB or less. VHF units available 27 to 300 MHz. UHF units available 300 to 650 MHz.

- P30K, VHF Kit less case \$18
- P30W, VHF Wired/Tested \$33
- P432K, UHF Kit less case \$21
- P432W, UHF Wired/Tested \$36

HELICAL RESONATOR PREAMPS

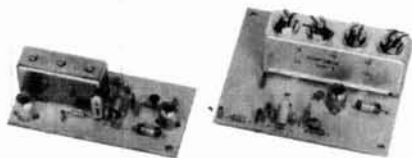

Our lab has developed a new line of low-noise receiver preamps with helical resonator filters built in. The combination of a low noise amplifier and the sharp selectivity of a 3 or 4 section helical resonator provides increased sensitivity while reducing intermod and cross-band interference in critical applications. See selectivity curves at right. Gain = approx. 12 dB.

Model	Tuning Range	Price
HRA-144	143-150 MHz	\$49
HRA-220	213-233 MHz	\$49
HRA-432	420-450 MHz	\$59
HRA-()	150-174 MHz	\$69
HRA-()	450-470 MHz	\$79

RECEIVING CONVERTERS



Models to cover every practical rf & if range to listen to SSB, FM, ATV, etc. NF = 2 dB or less.

VHF MODELS	Antenna Input Range	Receiver Output
Kit with Case \$49	28-32	144-148
Less Case \$39	50-52	28-30
Wired \$69	50-54	144-148
	144-146	28-30
	145-147	28-30
	144-144.4	27-27.4
	146-148	28-30
	144-148	50-54
	220-222	28-30
	220-224	144-148
	222-226	144-148
	220-224	50-54
	222-224	28-30

UHF MODELS	Antenna Input Range	Receiver Output
Kit with Case \$59	432-434	28-30
Less Case \$49	435-437	28-30
Wired \$75	432-436	144-148
	432-436	50-54
	439.25	61.25

SCANNER CONVERTERS Copy 72-76, 135-144, 240-270, 400-420, or 806-894 MHz bands on any scanner. Wired/tested Only \$88.

SAVE A BUNDLE ON VHF FM TRANSCEIVERS!

FM-5 PC Board Kit - **ONLY \$178** complete with controls, heatsink, etc. 10 Watts, 5 Channels, for 2M or 220 MHz.



Cabinet Kit, complete with speaker, knobs, connectors, hardware. Only \$60.

REPEAT OF A SELLOUT!

While supply lasts, get \$60 cabinet kit free when you buy an FM-5 Transceiver kit. Where else can you get a complete transceiver for only \$178

For SSB, CW, ATV, FM, etc. Why pay big bucks for a multi mode rig for each band? Can be linked with receive converters for transceive. 2 Watts output vhf, 1 Watt uhf.

	Exciter Input Range	Antenna Output
For VHF, Model XV2 Kit \$79	28-30	144-146
	28-29	145-146
	28-30	50-52
	27-27.4	144-144.4
	28-30	220-222*
Wired \$149 (Specify band)	50-54	220-224
	144-146	50-52
	50-54	144-148
	144-146	28-30
	144-148	28-30

	Exciter Input Range	Antenna Output
For UHF, Model XV4 Kit \$99	28-30	432-434
	28-30	435-437
	50-54	432-436
	61.25	439.25
Wired \$169	144-148	432-436*

*Add \$20 for 2M input

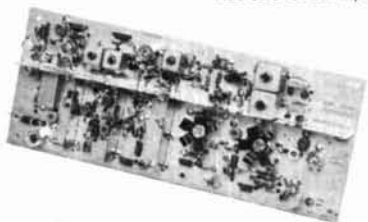

VHF & UHF LINEAR AMPLIFIERS. Use with above. Power levels from 10 to 45 Watts. Several models, kits from \$78.

LOOK AT THESE ATTRACTIVE CURVES!

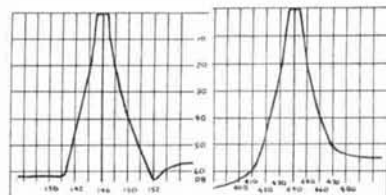

Typical Selectivity Curves of Receivers and Helical Resonators.

IMPORTANT REASONS WHY YOU SHOULD BUY FROM THE VALUE LEADER:

1. Largest selection of vhf and uhf kits in the world.
2. Exceptional quality and low prices due to large volume.
3. Fast delivery, most kits shipped same day.
4. Complete, professional instruction manuals.
5. Prompt factory service available and free phone consultation.
6. In business 21 years.
7. Sell more repeater modules than all other mfrs. and have for years. Can give quality features for much lower cost.

- Call or Write for **FREE CATALOG**
- (Send \$1.00 or 4 IRC's for overseas mailing)
- Order by phone or mail • Add \$3 S & H per order (Electronic answering service evenings & weekends) Use VISA, MASTERCARD, Check, or UPS COD.

hamtronics, inc.

65-E MOUL RD. • HILTON NY 14468
Phone: 716-392-9430

Hamtronics® is a registered trademark



book and product

REVIEWS

Palomar Engineers P-308 preamplifier

Not everyone needs a preamplifier these days because most of the newest generation of receivers and transceivers have more than sufficient sensitivity. Some, like the ICOM 751, Yaesu FT102 and TenTec Corsair, to name a few, have switchable RF amplifiers already installed. However, for older solid-state units and for tube-type radios, preamplifiers can make the difference between being able to hear the weak station or missing it altogether.



Another situation that will often require the use of preamplifiers is when you're using specially designed receiving antennas such as beverages and loops. These antennas aren't "gain" devices and are, in fact, 10-20 dB down from full-sized dipoles or other types of antennas. They're used because they're less susceptible to noise and because they exhibit directivity.

In my installation, the beverages are several hundred feet away from the station, so in addition to the low signal input, I also have several hundred feet of coax to get a signal through. As you VHF/UHFers know, this is a major problem. On 160 meters, coax loss isn't nearly as bad as at VHF/UHF, but a dB here, a dB there, all add up.

I looked through my 160-meter file to see what I had in the way of information on preamps and found several interesting circuits and specs for commercially manufactured gear. I realized I wouldn't have enough time to collect all the parts I needed to complete the project before the upcoming 160 meter CQ CW test. So I decided that this would be a good opportunity to try out a commercially manufactured preamp, and I gave Palomar Engineers a call.

Within a few days I had a P-308 preamplifier in hand to try out.

the unit

The P-308 is one of four dual-gate FET amplifiers available from Palomar. The P-308 is designed to be used with receivers and runs off

110 VAC (the P-305 is the same unit, but it runs off a 9-volt battery). The P-310X and P-312X are designed to be used with transceivers and have a built-in carrier operated relay (COR) that automatically switch the preamp circuit in and out.

All Palomar preamps use a tuned RF circuit and cover 1.8-54 MHz in four continuous bands: 1.8-4 MHz, 4-10 MHz, 10-23 MHz, and 23-54 MHz. The preamp uses a dual-gate FET and has a variable gain of up to 20 dB controlled by a front-panel control. The unit also has a 20-dB pad included for situations in which you might have too much gain in crowded band conditions, where cross mod or overloading the receiver could be a problem.

One tricky feature about the unit is making absolutely sure that it is properly tuned when in use. Failure to properly tune the preamp can result in images or spurs being amplified at the same time as the weak signal. The RF tuner stage uses a tapped coil that is switch-selectable by band and a 150-pF variable capacitor. Careful adjustment of the capacitor will eliminate this potential problem.

use

I've used this unit during the last two 160-meter contests and found it to be quite helpful in bringing those very weak DX signals up to an audible level. (That doesn't mean I actually *worked* them — but at least I could hear them!) During the contests, careful adjustment of the capacitor and gain reduction reduced or eliminated cross mod and overloading, due to the extremely crowded band conditions. (Last night I tried to get through the "wall of 4s" to work YV0AA. The YV0 was uncopiable without the preamp being on.)

I haven't spent much time with the P-308 on 15 or 10 meters. I would expect that it would be useful at that end of the ham spectrum, because that's the region where many ham receivers and transceivers need extra "oomph."

conclusion

If you're looking to pep up an old tube-type receiver, one of the Palomar preamplifiers may be just right for you. The attractive silver-gray front panel and black chassis will fit quite nicely into any ham shack. The unit weighs approximately 3 pounds and measures 8 x 5 x 3 inches.

For the name of your local dealer, contact Palomar Engineers, Box 455, Escondido, California 92025.

Circle 1315 on Reader Service Card.

N1ACH

"The Complete DX'er" by Bob Locher, W9KNI

Over the years there have been some pretty good DX books, and a few that have been sim-

ply terrible. What there hasn't been is a really great DX book — until now, that is. Drawing on the skill and knowledge that earned him one of the first CW DXCCs in 1975 and has kept him at the top of that mode's DXCC Honor Roll ever since, W9KNI has created a first-class treatise on the art of DXing that's every bit as entertaining as it is educational.

Of course this should be no surprise to readers of *ham radio* or *Ham Radio Horizons*. Bob's very popular articles on DXing and DX adventures in the two magazines were avidly read by all kinds of people, even non-hams, because they were well written and entertaining. Hams read them eagerly because each one of those articles included priceless "tricks of the trade" known but to consummate DXers. No one, whether newly-licensed Novice or grizzled DXCC Honor Roll member will fail to find something useful in Bob's latest dissertation on DXing. (Even though Bob's credentials are for CW, what he has to say applies equally well to other modes as well. That's why this is a unique DX book.)

The book is divided into two sections, the first primarily directed to the beginning DXer and the second for the advanced (200+ countries) DX chaser. The experienced DXer might be tempted to skim or even skip the first. *Don't*. It's not only very entertaining reading, but every page is laced with those little morsels of DX wisdom that always spice Bob's writing. Oh yes, there are chapters on the basics of listening, operating, and equipment, but even in those mundane subjects Bob has sewn some pearls that almost any DXer, regardless of experience, will find profitable.

The fun continues in the second half. After a very practical discussion of the art of QSL-chasing, Bob launches into "Graduate Hunting" and later on "Hunting — Again." Here the reader learns that a first class station and operating skills are not always sufficient in themselves. The top DXer must also bring to the chase the deductive ability of a Sherlock Holmes, the results of which Bob demonstrates with some fascinating anecdotes. Finally, after a much-needed chapter on the ethics of DXing and discussions on various special tools for the DXer, Bob sends the reader back to the shack to resume the search for that ever-elusive new one. He'll find him, too, now that he's been helped along by one of the true masters of the art.

Those who buy this book looking for beam heading charts, prefix lists and postal rates are going to be disappointed — there are no charts or tables. What it does contain is the wit and wisdom of DX chasing, written by an acknowledged expert. This book could be the best investment a DXer could make; I can think of no higher recommendation!

The Complete DX'er is available from Ham Radio's Bookstore, Greenville, NH 03048, for \$10.95 plus \$2.50 shipping and handling.

W9JUV



ICOM mobile transceiver

ICOM has announced the release of the new IC-37A 220 MHz ultra-compact mobile transceiver. The IC-37A features: 25 watts/5 watts low; and measures only 5-1/2" wide x 1-1/2" high x 7" deep, offering the same compact design as the IC-27A. 32 PL frequencies are stan-



dard and built-in; nine memories with offset and PL storage are included. Dial steps are in increments of 10 kHz/5 kHz. Scanning features include memory scan, band scan, and priority scan. Dual VFOs and HM-23 Touchtone® and scanning mic are standard. A speech synthesizer option is available.

For additional information, contact ICOM America, Inc., 2112 116th Avenue, N.E., Bellevue, Washington 98004.

Circle #317 on Reader Service Card.

H/T amplifiers

Mirage Communications has added two new low-profile H/T amplifiers to its expanding line of American made communications equipment.



The B23A (144-148 MHz) and C22A (220-225 MHz) incorporate features that are typically available only on larger, more expensive amplifiers. Both feature a built-in receive preamp that delivers a 1.5-2.0 dB noise figure, all-mode operation (CW, FM, or SSB), and automatic antenna changeover.

Their RF power input range is from 100 mW to 5 watts; high RF power output (B23A, 2W in, 20W out/C22A, 2W in, 30W out) makes them ideal for use with virtually all low-power transmitters.

They're each backed by a five-year factory warranty (1 year on RF power transistors) and a worldwide sales network, and priced at \$89.95.

For more information, contact Mirage Communications, P.O. Box 1000, Morgan Hill, California 95037.

Circle #313 on Reader Service Card.



Fox Tango Filters

Your rig — old or new — is no better than its i.f. filter.

TOP PERFORMANCE

Fox Tango Filters contain eight specially treated discrete quartz crystals, unlike miniature ceramic or monolithic corner-cutting designs. Give your set *new life* with a Fox Tango implant or transplant. It's a lot cheaper than buying a new rig with features you don't need and probably won't use!

VARIETY

Fox Tango stocks superior CW, SSB, and AM filters for practically all Yaesu, Kenwood, and Heath models. Also for Drake R-4C, 7-line; Collins 75S3-B/C, and some ICOM's. More than 80% of our filters sell for \$60. Most are designed for easy *drop-in* installation. For the others, complete instructions and all needed parts are included in the price.

INFORMATION

Tell us the make and model of your set. You'll get the complete information on FT filters to fill optional spots, replace your present tired or inferior stock units or supplement them with Fox Tango Filter-Cascading kits. If you phone you can order at the same time; we accept VISA/MC or ship C.O.D. Order direct or from your favorite dealer.

GO FOX-TANGO — to be SURE!

Ask the ham who has one.

FOX TANGO CORPORATION

Box 15944, Dept. H
West Palm Beach, FL 33416
Telephone: (305) 683-9587

Dealer inquiries invited.

✓ 136

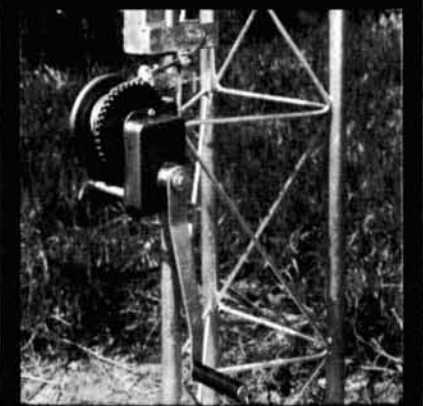

ROHN® "FOLD-OVER" TOWERS

■ EASE OF INSTALLATION

ROHN "Fold-Over" Towers are quickly and easily installed. The "Fold-Over" is safe and easy to service.

■ ADAPTABILITY

ROHN has several sizes to fit your applications or you can purchase the "Fold-Over" components to convert your ROHN tower into a "Fold-Over".

■ HOT DIP GALVANIZED

All ROHN towers are hot dip galvanized after fabrication.

■ REPUTATION

ROHN is one of the leading tower manufacturers, with over 25 years of experience.

Write today for complete details.

QUALITY STEEL PRODUCTS BY

ROHN

Box 2000 · Peoria, Illinois 61656
U.S.A.

ALL BAND TRAP ANTENNAS!



PRETUNED—ASSEMBLED ONLY ONE NEAT SMALL ANTENNA FOR ALL BANDS! EXCELLENT FOR APARTMENTS! IMPROVED DESIGN!

FOR ALL MAKES AMATEUR TRANSCEIVERS! GUARANTEED FOR 2000 WATTS SSB INPUT FOR NOVICE AND ALL CLASS AMATEURS!

COMPLETE with 90 ft. RG58U-52 ohm feedline, and PL259 connector, insulators, 30 ft. 300 lb. test dacron end supports, center connector with built in lightning arrester and static discharge. Low SWR over all bands. Tuners usually NOT NEEDED! Can be used as inverted V's - slopers - in attics, on building tops or narrow lots. The ONLY ANTENNA YOU WILL EVER NEED FOR ALL BANDS! NO BALUNS NEEDED!

80-40-20-15-10 -- 2 trap - 104 ft. - Model 998BUC . . \$99.95
40-20-15-10 -- 2 trap -- 54 ft. - Model 1001BUC . . \$98.95
20-15-10 meter- 2 trap - 26ft. - Model 1007BUC . . \$97.95

SEND FULL PRICE FOR POSTPAID INSURED. DEL. IN USA. (Canada is \$5.00 extra for postage - clerical - customs etc.) or order using VISA - MASTER CARD - AMER. EXPRESS. Give number and ex. date. Ph 1-308-236-5333 9AM - 6PM week days. We ship in 2-3 days. ALL PRICES MAY INCREASE SAVE - ORDER NOW! All antennas guaranteed for 1 year, 10 day money back trial if returned in new condition! Made in USA. FREE INFO. AVAILABLE ONLY FROM

WESTERN ELECTRONICS

Dept. AR-7 ✓ 194 Kearney, Nebraska, 68847

NEW products

robot color SSTV converter

Robot Research has introduced a new black and white-compatible single-frame slow scan TV color converter. Designated Model No. 450C, it incorporates the latest in microcircuit technology and represents a significant breakthrough in the application of microprocessor-based systems to Amateur SSTV.

Model 450C features touch-sensitive front panel switches for full station control and several automatic functions for easy use. Fine tuning, speed switching and color or black and white detection are automatically accomplished without operator intervention.

Three selectable 4-bit memory planes combine to form 4,096 color combinations in a 128 pixel by 120 line full screen display. Eight different black and white and color transmission formats are available with automatic selection on receive. The unit accepts color or black and white composite video from standard TV cameras and has RGB, composite or RF modulated video output.



A unique feature of the 450C is the 8-bit parallel I/O ports for computer interface and hard copy picture printing. This analog provides total access to each individual pixel by a host computer for image processing, transformation, storage and recall, and graphics. In addition, the unit has provisions to connect to the new robot model 800C super terminal for color graphics, SSTV graphics composition, graphics overlays, and special test patterns.

For further information, contact Robot Research, Inc. 7591 Convoy Court, San Diego, California 92111.

Circle #312 on Reader Service Card.

Model 230 decoder

SYT Corporation has announced the Model 230 DTMF mobile decoder for autopatch and selective call systems.

The 230 DTMF decoder is housed in a compact metal housing for RFI protection. It features a high-speed precision decoder with wrong-digit lockout to prevent falsing. It is field programmable for DTMF code lengths from 1 to 8 digits. Call alert outputs are provided for horn, external speaker control, and internal call lamp. An optional internal alert buzzer is available.

For more information, contact Larry Francis at SYT Corporation, 1220 Barranca, El Paso, Texas 79935.

Circle #311 on Reader Service Card.

pen-type DMM

North American Soar Corporation has released the new Model 3100 Pen Type DMM, offering 25 percent greater range capability and a 3 1/2 digit LCD readout with annunciators that are said to be 50 percent larger than similar units presently available.



Model 3100 is fully autoranging and can measure DC volts from 0.1 mV through 500 volts on five ranges, AC volts from 1 mV through 500 volts on four ranges and resistance from 0.1 ohm through 20 Megohms on six auto-ranges. This dynamic range capability is made possible by use of Soar's custom 80-pin flat pack chip. Use of this state-of-the-art circuit allows fast, stable readings to be obtained. The Model 3100 has an audible continuity check feature that indicates a circuit is continuously conductive by beeping; the beeper reaction time is 0.4 seconds or less. A "Data Hold" switch is provided for freezing a reading even though the test probe is removed from the test point.

The unit is supplied with two interchangeable test points, one uninsulated 1/2 inch and one 2 3/4 inch insulated extension tip, safety type ground probe with slip-on insulated alligator clip, and two batteries. The Model 3100 is priced at \$49.99.

For further information, contact North American Soar Corporation, 1126 Cornell Avenue, Cherry Hill, New Jersey 08002.

Circle #310 on Reader Service Card.

Transi-Trap™

The new Alpha Delta Model ACTT AC Transi-Trap™ is a direct plug-in-the-wall AC surge protector providing two 120 VAC sockets, status light, circuit breaker, and a three-stage automatic surge protection circuit. The Model ACTT provides both transverse and common mode protection with a hot-to-neutral, neutral-to-ground and hot-to-ground 6000 volt, 2000 ampere surge discharge self-restoring high speed circuit. The configuration of the Model ACTT also protects equipment plugged into any other common branch AC wall outlet down line from the ACTT. The unit is UL listed and is priced at \$29.95.



For further information, contact Alpha Delta Communications, P.O. Box 571, Centerville, Ohio 45459.

Circle #307 on Reader Service Card.

computer prototyping board

The "eZ BOARD" is a solderless system for building experimental add-ons to interface with personal computers. Its features include a glass epoxy printed-circuit board mounted with a set of solderless breadboarding units. Four separate distribution buses with fifty tie-points each can be used for power, ground, clock lines, reset commands, and other purposes. A four-position DIP switch is mounted on the board. Each switch position connects to a set of the tie-point block sockets on either side. A flat ribbon cable connects the board to the computer's bus expansion slot.

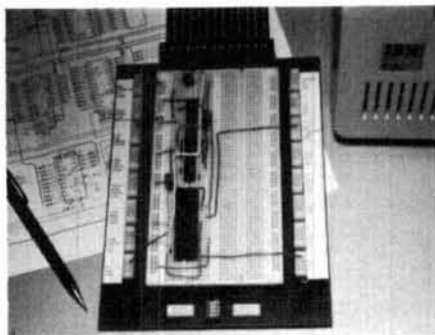

The breadboarding area consists of 1460 tie-points with a capacity of sixteen 14-pin DIPs. Components with lead diameters up to 0.032 can be plugged in with ordinary solid hook-up wire.

Models IPC, APC, and CPC are available for IBM-PC, APPLE and Commodore, respectively, and all other hardware-compatible computers of similar types. Models for other computers will be introduced during 1984. The retail price for the entire system, including cable and connectors, is \$174.95 plus \$5.00 shipping.

For further information, contact Sabadia Export Corporation, P.O. Box 1132, Yorba Linda, California 92686.

Circle #308 on Reader Service Card.

VHF/UHF diplexer

If you operate VHF and UHF, you know that long coaxial cable runs will reduce your power to the antenna significantly. You also know that low-loss coaxial cable is quite expensive. So what do you do if you want to operate both VHF and UHF without using a lot of expensive coax to feed your antennas? Microwave Filter has come up with an answer: the Model 4525 diplexer.

But what's a diplexer? A diplexer either combines or splits RF signals; for example, you could use one diplexer in the shack to combine RF from your 144 MHz and your 420 MHz radios. These

combined signals would then be fed through just one coaxial cable to the top of the tower, where a second diplexer would be located. This diplexer would again split the signals and route one to the 144 MHz antenna and the other to the 420 MHz antenna.

The Model 4525 diplexer, priced at \$104.50, is designed for the 144 and 420 MHz bands. With insertion loss less than 0.4 dB, it's designed to handle up to 200 watts of RF.

For more information, contact Microwave Filter Company, 6743 Kinne Street, East Syracuse, New York 13057.

Circle #309 on Reader Service Card.

Design Kit™ Series

Communications Consulting Corp. has announced the availability of its General Purpose Design Kit™ series. The series currently consists of an RF design kit, communications design kit, and a PLL design kit.

Most software packages available for desktop computers are concentrated in the area of computer aided analysis. The important area of circuit *synthesis* is frequently overlooked. In introducing the Design Kit™ Series, Communications Consulting Corp. has made these very powerful tools available for the HP series 9845B/C, the HP 9000, series 200 and series 500 (Model 9020). They all consist of a universal mathematical function plot and a frequency selection for minimum IMD products in mixers and relevant programs.

The RF Design Kit™ includes software for a universal mathematical function plot; frequency selection for minimum IMD products in mixers; optimization of noise figure or intercept point of cascaded amplifiers, mixers, and filters; determination of noise figure from S/N ratio; compensated wideband transformer; equalizers; quarter and half wavelength UHF oscillators; and design of microwave striplines.

The Communications Design Kit™ contains software for a universal mathematical function plot; frequency selection for minimum IMD products in mixers; dual loop AGC with group delay correction; digital filter design program; complex impedance of electrical short antennas; antenna array pattern with all driven elements; and quarter and half wavelength UHF oscillators.

The PLL Design Kit™ includes software for a universal mathematical function plot; frequency selection for minimum IMD products in mixers; optimization of type 2, second order loops; optimization of type 2, third order loops; optimization of type 2, fifth order loops (these programs include BODE plot, lock-up calculations, and component selection); general analysis of PLL circuits; and quarter and half wavelength UHF oscillators.

For further information, contact Communications Consulting Corp., 52 Hillcrest Drive, Upper Saddle River, New Jersey 07458.

Circle #306 on Reader Service Card.

Design Kit™ is a registered trademark of Communications Consulting Corp.

ANTENNAS & TOWERS

THIS MONTH'S FEATURES:

HY-GAIN EXPLORER-14 — \$264.95 **HY-GAIN TH7DXS — \$399.95**
CUSHCRAFT A3 — \$202.00 **CUSHCRAFT R3 — \$254.95**
BUTTERNUT HF6V — \$106.00

(Accessories in stock)

NEW Hy Gain's 40 Mtr. Beam
Write For Details/Prices

cushcraft

A3	\$202.00	A50-5	\$74.95	ARX-2B	\$34.95
A4	264.95	617-B	189.95	A147-11	44.95
A743	67.95	32-19	88.00	A147-22	119.95
A744	67.95	214B	73.00	416TB	54.95
R3	254.95	220B	88.00	A144-20T	64.95
AV3	49.95	410B	54.95	A144-10T	46.00
AV4	87.95	424B	74.95	A14T-MB	26.00
AV5	95.00				
40-2CD	269.95				

Stacking & Quad Kits!

hy-gain

TH7DXS	\$399.95	18AVT/WB-S	\$89.95	ROTORS:	
TH5Mk2S	349.95	14AVQ/WB-S	61.95	AR-40	\$87.95
Explorer-14	264.95	12AVQ-S	44.95	CD-45II	119.95
QK-710 add-on	74.95	14RMQ	34.95	HAM-IV	192.50
392S Conv. Kit	129.95	18HTS	395.00	T2X	239.00
204BAS	224.95	V2S	36.95	HDR-300	450.00
205BAS	299.95				

WIRE & CABLE

(Coax quality guaranteed. 95%+plus shielding)

RG-213/U	\$0.29/ft.	Rotor cable-standard (6-22, 2-18)	0.18/ft.	450 ohm line	\$0.09/ft.
RG-8/U	0.28/ft.	Rotor cable-hvy. duty (6-18, 2-16)	0.32/ft.	14 ga. copperweld (solid)	0.10/ft.
RG-8/U foam	0.27/ft.			12 ga. copperweld (solid)	0.12/ft.
RG-8X	0.15/ft.				

Unarco-Rohn

We stock 25G, 45G, HBX, & HDBX towers.

All accessories available. FOLD-OVER towers shipped freight pre-paid to your QTH!

25G	\$46/sect.	HBX48	\$250.00
45G	109/sect.	HBX56	320.00
FOLD-OVERS:		HDBX40	230.00
Get our quote & save!		HDBX48	315.00

rf enterprises

Route No. 7
St. Cloud, Minnesota 56301
(612) 255-0855



Let us bid the self-supporting crank-up tower of your choice with the accessories you select.

HG-37SS	\$625.00
HG-52SS	900.00
HG-54HD	1459.00
HG-70HD	2300.00

Shipped freight paid. Order tower with Hy-Gain antenna, rotor & other accessories. Receive free shipping on all.

Prices subject to change without notice or obligation. Minnesota residents add 6% tax. Shipping not included except as indicated.

✓ 174



Homebrew Headquarters

SPLIT-BAND SPEECH PROCESSOR KIT \$69.95

hr 8/79



plus \$3.00 shipping & handling

PUNCH THRU THE PILEUPS WITH 10X MORE TALK POWER

Increased talk power: Up to 15 dB, adjustable (10 dB recommended under most operating conditions)

Frequency response: 350 Hz — 2.4 kHz at 3 dB down (200 Hz — 3 kHz at 12 dB down)

Harmonic Distortion: Less than 12% at 1 kHz with 10 dB clipping
Requires 12 Vdc at 200 mA

ALSO IN STOCK:

Kits for HF, VHF & UHF
Test Equipment Kits
Toroids, Rods & Beads
Resistors & Capacitors
Antenna Components

See Catalog

1984-85 CATALOG 50¢

RADIOKIT

Box 411H, Greenville, NH 03048
(603) 878-1033

BEST BUY!

EASY-TO-ASSEMBLE KIT

only **\$660⁰⁰**

freight prepaid
in 48 states

40 ft. M-13 aluminum tower and FB-13
fixed concrete base (beautiful!)

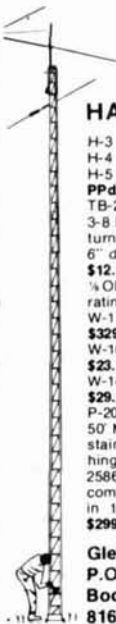

Othersizes at comparablesavings.
HAZER - Tower Tram System
Lowers antenna with winch. Complete
system comes to ground
level in upright position.

HAZER your Rohn 20-25G

H-3 — 8 sq. ft. ant. **\$213.00 PPd.**
H-4 — 16 sq. ft. ant. **\$278.00 PPd.**
H-5 — 12 sq. ft. ant. (for M-13 above) **\$302.00
PPd.** All Hazers include winch, cable & hdw.
TB-25 — Thrust bearing **\$42.50**
3-B EE — 1/2" x 6 forged steel eye and eye
lumbuckle **\$10.75**
6" diam. — 4 ft. long earth screw anchor
\$12.75
1/4 OD — 7x7 Aircraft cable guy wire 1700 lb.
rating, **12 ft.**
W-115 — 115 VAC winch - 1000 lb. load
\$329.95
W-1000 — Manual winch 1000 lb. capacity
\$23.95
W-1400 — Manual winch 1400 lb. capacity
\$29.95
P-2068 — Pulley block for 3/16 cable **\$5.65**
50' M-18S — 18 inch face aluminum tower,
stainless bolts HAZER, TB-25 bearing and
hinged base system **\$1523.00 freight prepaid**
25860 — Martin Super Tower (nothing else
compares) 60' galv. steel, totally freestanding
in 100 MPH wind with 30 sq. ft. antenna
\$2992.00

Glen Martin Engr.
P.O. Box H-253
Boonville, Mo. 65233
816-882-2734



156

GLEN MARTIN ENGR



7-21-50 radio

The new 7-21-50 from NCG is an all solid-state radio that covers the complete 40 and 15-meter bands and from 50 to 50.5 MHz on the 6-meter band. All bands operate in either the SSB or CW mode; PLL circuitry in the VFO ensures drift-free operation. The transmitter runs 26 watts PEP and utilizes balanced modulation for clear, crisp SSB audio.

Designed with extensive TVI suppression to minimize TVI problems while operating on a well matched 6-meter antenna, the 7-21-50 is small enough to be used mobile or portable, and offers additional features for use as a base station radio,



too. No external power supply is required. Technician class hams will find the 7-21-50 to be well suited to 6 meter SSB and 40 and 15 meter CW.

The 7-21-50 comes complete with an internal AC/DC power supply.

For additional information, contact NCG, 1275 N. Grove Steet, Anaheim, California 92806.

Circle #316 on Reader Service Card.

computer-controlled scanner

Electra Company has announced that the Bearcat® CP-2100, said to be the first scanner radio designed as a peripheral for today's popular personal computers, is now available in versions compatible with the IBM Personal Computer, Atari 800, Apple II and IIe, Osborne and Commodore 64 personal computers.

The CP-2100 can monitor live police and fire calls, emergency and Amateur Radio transmissions, Coast Guard rescues, and aircraft communications.

Each of its 200 channels can be programmed to display the source and location of a transmission, 10-codes, phone numbers and more. Whenever a broadcast is monitored, the information programmed into the channel will automatically appear on the screen. For scanner enthusiasts, the Bearcat CP-2100 can eliminate pages of cumbersome frequency lists. In the newsroom, it can help news crews be dispatched to the scene of a story with less confusion.

Its 200-channel capacity is three times that of the most sophisticated programmable scanners.



The Bearcat CP-2100 is also the first scanner to feature multiple priority levels. Users can select up to three different priority frequencies so most important calls will be heard first. During a priority transmission, the video monitor will flash to alert the listener. "Search/Store/Count" lets users search frequency ranges of their choice for active channels. The scanner will automatically find all active frequencies and store them in separate memory without the need for the operator to be present. The count register shows how many transmissions were noted on each active frequency. In addition, every channel includes four auxiliary settings which can be programmed to activate tape recorders, alarms and other optional equipment whenever a call is received on the programmed channel.

Other features include patented "selective scan delay," "automatic lockout," "automatic and manual search," and patented "track tuning." Frequency coverage includes 10, 6, and 2-meters, and 70-centimeter Amateur; VHF Low and High; VHF Aircraft; UHF and UHF-"T"; and Military Land Mobile bands.

The Bearcat CP-2100's basic package includes the radio, AC adapter, plus a special telescoping whip antenna with 20 foot coaxial cable and mating BNC connectors. A custom 5-1/4 inch program diskette, custom interface cable, and manual are packaged separately for compatibility with different models of computers. The software can be user-modified to suit individual needs.

The suggested retail price of the Bearcat CP-2100, including both hardware and software packages, is \$499.95. For additional information, write Electra Company, 300 East County Line Road, Cumberland, Indiana 46229.

Circle #304 on Reader Service Card.

VIC-20 programs

Three new HAMWARE programs developed by John Vesty Company are said to extend the utility of VIC-20 computers to logging and QSO operations.

Ham List serves as a memory jogger during a QSO, quickly searching for a call and displaying data on file. The program provides for the convenient addition, revision, or deletion of entries, and a screen-review of the list.

1984 THE RADIO AMATEUR'S HANDBOOK



STATE OF THE ART

The 1984 Edition of *The Radio Amateur's Handbook* carries on the tradition of the previous editions by presenting 640 pages of comprehensive information for the radio amateur, engineer, technician and student. Paper edition: **\$12** in the U.S., **\$13** in Canada, **\$14.50** elsewhere. Cloth: **\$17.75** in the U.S., **\$20** elsewhere. In U.S. funds.

THE AMERICAN RADIO RELAY LEAGUE
225 MAIN ST.
NEWINGTON, CT 06111

Quick Log provides automatic logging of data and time, and search by call or QTH. The list can be printed, saved to tape, or screen-reviewed as desired. Time is displayed on the menu page.

QSO Manager combines a ten-minute identification timer and a 24-hour clock, with a screen-based notepad for use during a phone or CW QSO. The notepad incorporates a word-wrap routine to eliminate broken words at the end of a line. The timer can be set, reset, or cancelled at any time.

The three programs are available on tapes, and are designed for use with both unexpanded and expanded VIC-20 computers. The capacity of the logging programs ranges from 100 to 700 entries maximum, depending on the memory expansion used and the length of individual entries.

For further information, contact John Vestly Company, 415 Elm Street, Fayetteville, New York 13066.

Circle #303 on Reader Service Card.

support system

"Lightfoot," a new antenna support system that evenly distributes loads to rooftop structures, features a pedestal that holds a tower/elevator suspended above the roof with three extended legs secured to the roof structure on mounting pads at the outer ends.



This design is said to reduce roof load by as much as 65 percent over conventional rooftop systems.

Once in place, an elevator track allows the array or rotator to be lowered to comfortable working height by one person in minutes. The height is 23 feet, pedestal radius is 13 feet. The aluminum unit weight is 640 pounds; the steel unit, 1400 pounds.

Designated RM-20, the system is available in either steel or aluminum. Additionally, the RM-20 is available in combination with antenna arrays and rotators, as well as a power winch system for raising and lowering.

For further information, contact Sabre Communications Corp., 117 Main Street, Sioux City, Iowa 51102.

Circle #302 on Reader Service Card.

VIC 20 & C64 USERS A Powerful MSO!

Now you can own your own MSO! Your computer and any interface plus our menu driven, machine language Radio Bulletin Board Service software will give you and your MSO users a powerful mailbox with the following features:

- Read, write & delete messages
- List a directory of all messages
- Scan directory of messages
- User selectable baud rates
- Automatic date and time keeping
- Automatic time out feature
- Automatic ID of your call
- Automatic indication of memory used
- 3 modes - MSO, SYSOP & Direct RTTY
- Works with or without disk drive
- Specifically for VIC 20 (8 k min) or C64

Software package includes — manual, program diskette or cassette and interface cable

\$49.95 plus \$1.90 postage
(Kantronics interfaces add \$5.00)
Ph. (818) 957-7550

Vid-Com Communication ✓ 192
3131 Foothill Blvd., #H • La Crescenta, CA 91214

the smarter SANTEC

ST-142 289⁰⁰

For 2 Meters

Free \$9.95 Mob. Quick Charge Cable
We Stock ALL Santec Accessories!

ST-222...\$299 ST-442...\$319

KDK FM-2033

25 Watt 2-Meter FM

289⁰⁰

with Touchtone Mike and Mobile Bracket

KDK 220, 440, 6M-Call-Availability!

FREE UPS Brown Shipping-Add \$1.65 for COD
N.C. Res. Add 4 1/2% Sales Tax. Sorry No Cards.

WELZ SWR&POWER METER

TOKYO HY-POWER AMPLIFIERS

The Nation's Largest Mail Order Santec Dealer

WILLIAMS RADIO SALES

600 LAKEDALE ROAD, DEPT. H
COLFAX, N.C. 27235 ✓ 196
(919) 993-5881 Noon to 10 P.M. EST

Our 5th Year

**BUY • SELL
TRADE
ELECTRONICS**

IN

NUTS & VOLTS

**The Nation's #1 Electronic
Shopper Magazine**

PO BOX 1111-H • PLACENTIA, CA 92670
(714) 632-7721 ✓ 169

Join 1000's of Readers Nationwide
Each Month

U.S.A. SUBSCRIPTIONS

\$ 7.00 - 1 YEAR 3RD CLASS MAIL
\$12.50 - 1 YEAR 1ST CLASS MAIL
\$25.00 - LIFETIME - 3RD CLASS MAIL

With Free Classified Ad

NUTS & VOLTS

HAM GEAR
COMPUTERS
SOFTWARE
SCANNERS • OPTICS
TEST EQUIPMENT
MICROWAVE
SATELLITE
AUDIO VISUAL
NEW PRODUCTS
COMPONENTS • KITS
ANTIQUE ELECT.
PUBLICATIONS
PLANS • SERVICES

TUBES, SEMICONDUCTORS, IC'S DIODES AT SUPER LOW PRICES IN DEPTH INVENTORY EIMAC, SYLVANIA, GE, CETRON

OA2.....	\$2.75
3CX800A7.....	242.00
3-400Z.....	115.00
3-500Z.....	90.00
4CX250B/7203.....	58.00
4CX1000A/8168.....	430.00
4PR60C/8252W.....	295.00
4X150A/7034.....	45.00
5AR4.....	6.24
5C22.....	165.00
5R4GB.....	3.85
6AK5.....	4.91
6AL5.....	3.86
6AO5.....	3.77
6CA7.....	7.41
6DJ8.....	2.75
6JG6A.....	7.53
6JS6C.....	8.00
6KD6.....	8.85
6KV6A.....	6.92
6L6GC.....	6.83
6LF6.....	8.85
6LQ6.....	8.85
6MJ6.....	8.99
12AT7.....	3.87
12AU7.....	3.47
12AX7A.....	3.48
572B/T160L.....	49.50
705A.....	10.00
811A.....	13.50
813.....	40.00
829B.....	40.00
832A.....	38.00
833A.....	145.00
866A.....	9.50
872A.....	24.00
M-2057.....	15.00
5670.....	4.40
5684.....	33.00
5687.....	4.00
5751.....	4.00
5814A.....	3.70
5879.....	5.75
5894.....	65.00
6005.....	5.25
6146B.....	8.75
6360.....	6.50
6528A.....	75.00
6550A.....	7.50
6883B.....	10.00
7360.....	12.25
7558.....	7.00
7591A.....	6.20
7868.....	6.68
8072.....	95.00
8417.....	8.99
8874.....	210.00
8875.....	220.00
8877/3CX1500A7.....	475.00
8908.....	12.95
8950.....	11.50
MRF-453.....	19.95
MRF-454/A.....	19.95
MRF-455/A.....	19.95
2N6084.....	15.00

SYLVANIA

RCA

RAYTHEON

NATIONAL

RAYTHEON

RCA

NATIONAL

SYLVANIA

✓ 188

Full line of Sylvania ECG Replacement Semiconductors Always in Stock. All Major Manufacturers Factory Boxed, Hard To Get Receiving Tubes At Discount Prices.

Minimum Order \$25.00. Allow \$3.00 For UPS Charges. Out of Town, Please Call Toll Free: 800-221-5802 and Ask For "ABE".

TRANSLERONIC INC.

1365 39th STREET, BROOKLYN, N. Y. 11218H
Tel. 212-633-2800/Wats Line 800-221-5802
TWX 710-584-2460 ALPHA NYK.

Clean up the radio/computer clutter.

For less than \$250 you can make your investment in yourself pay off!

Chances are you have spent a couple thousand dollars on setting up a computer system that gets a lot of your work done. But sometimes it gets to be work to work at it.

I know that when I have to move two program manuals and a pencil holder to boot up the disk drive, it is work. When there is an unlabeled floppy (that I am going to identify some day) on top of the monitor and the business check-book is on top of the printer . . . and I will remember (I hope) before the next "report" comes through . . . that is work.

I found the annoyance of my own "computer clutter" was even worse than the extra work the disorder created. And that is when I started looking for some practical furniture for my computer set up. Since I had already spent a lot of money on the system itself, I was really dismayed when I found out how much it would cost to get a decent-looking desk or even a data table for my equipment. \$400 . . . \$500 . . . even more for a sleazy unit that looked like junk! In fact, it was junk! And it took a long time for me to find something that was really worth the money . . . and more.

A lot of my working day is spent with my computer, and I will bet a lot of your time is too. So I figure a "home" for my system—a housing that is good looking as well as efficient to work at—will pay off two ways:

1. Less work: an efficient and orderly layout will save me time and energy.
2. Personal satisfaction: good quality furnishings look better; they just plain feel better to work at too.

So imagine how good I felt to find the "Micro-Office" Work Center! These are fine pieces of computer system furniture that make my office-at-home as pleasant a place to work as it ought to be. And the



MICRO-OFFICE WORK CENTER

biggest and best surprise is the low, low price for such good quality.

Here is what you get—all for only \$249.50 plus shipping.

- Mar-resistant work surface. Your choice of oak or walnut grained. Work surface height is adjustable to your keyboard, your chair, your height.
- Two shelves plus work surface extender. Both shelves tilt to lock in position so that monitor faces you—in a position that does away with screen glare squinting and neck craning forever. Retainer bar keeps equipment from sliding off shelf. Snap-in bookends hold reference manuals and programs.
- Strong, sturdy and steady. All-steel welded frame construction is concealed by top-quality wood grain surfaces with finished trim. Adjustable floor levelers included. The work center is really a piece of fine furniture.
- There is no risk in buying from us either. We will make a full refund of purchase

price plus shipping charges if you return the workcenter within 30 days for any reason whatsoever. In addition, the product is warranted for any defects in materials or construction for a full year from date of purchase. This is a no-risk investment in your own productivity and work efficiency that will pay off for years to come—even if you do not yet have a microcomputer of your own.

- Take your choice for your own work center decor:

Order 48-inch unit in walnut, #2KPO-945, or in oak, #2KPO-947. Only \$249.50 for each unit plus \$20.00 shipping charge. On orders for two or more units at the same time, shipping charge applies to only the first unit ordered. Shipment made UPS, so we cannot ship to post office box. Illinois residents please add \$15 per unit sales tax. Please allow 10 extra days for personal checks to clear. Sorry—at these special offer prices we cannot ship c.o.d. or bill direct.

CALL TOLL FREE TODAY WHILE SUPPLIES LAST: 1-800/323-8064.
In Illinois call 1-312/251-5699. Or mail check with order to:

Micro-Mart Distributors

Dept. HR • 1131 Central Street • Wilmette, IL 60091

NEW products

Ten-Tec Century 22

Ten-Tec has just released its newest radio, the Century 22. The Century 22, an update of the popular Century 21, features the latest in solid-state RF technology. The design concept is a low power, gimmick-free, CW only radio. Ideal for beginners on a budget — as well as for established hams as either a second set or mobile radio — this new unit offers full QSK, 50 watts of RF input power, a six-pole audio filter, linear crystal mixed VFO and covers the standard five bands 80-10 meters plus the WARC 30-meter band.



The Century 22 also features receiver sensitivity of 0.5 μ V, offset receiver tuning, automatic gain and level control, adjustable side tone, CW and SSB or receive, and SWR and forward power metering. The unit weighs just 6 pounds (2.7 kg) and measures 4 x 10 x 10.5 inches (10.2 x 25.4 x 26.67 cm). It has a rigid metal chassis with molded front panel and aluminum back, top and bottom. It includes 28 transistors, 24 diodes, and 7 ICs. Frequency tolerance is ± 5 KC of dial reading, (± 2 KC when using the optional calibrator). The Century 22 is priced to fit the beginner's budget at \$389. The optional 110 VAC to 12 VDC, 5-amp power supply is \$89 additional.

For more information, contact Ten-Tec, Inc. Sevierville, Tennessee 37862.

increased weather protection

The improved NMO series of antenna hardware from Larsen Electronics features an extra lip around the bottom of the coil, providing a place for an "O" ring. The ring surrounds the threads that tighten to the vehicle surface, eliminating the chance that water may be drawn through the threads, decreasing performance and corroding mounting hardware. This improvement is said to make a difference in areas where antennas are constantly exposed to heavy rain, and to offer additional protection under less severe conditions as well. All NMO-series VHF and UHF products now incorporate this change; LM and NLA series are also equipped with a neoprene gasket around mounting hardware for a weather-tight seal.

For details, contact Larsen Electronics, P.O. Box 1799, Vancouver, Washington 98668.

Circle #314 on Reader Service Card.

satellite antenna

Cushcraft has introduced a new Amateur satellite antenna system featuring two high gain circularly polarized Yagi antennas. The 70 cm, 16-element uplink and 2-meter, 20-element downlink antennas are fixed to a common mounting boom. The entire array is lightweight with reasonable dimensions for quick installation.

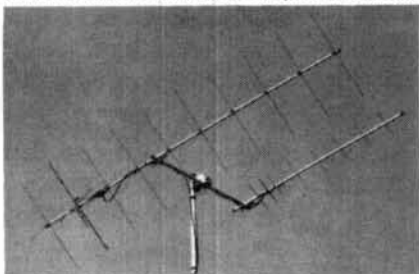

For more information, contact Cushcraft Corporation, P.O. Box 4680, Manchester, New Hampshire 03108.

Circle #301 on Reader Service Card.

HF antenna design program

HF Antenna Design is the latest offering in Cynwyn's line of software for Amateur Radio operators. The program makes the necessary calculations for building three popular types of antennas — dipole, Yagi, and quad — for frequencies of 1.8 - 30 MHz and displays them in an easy-to-read tabular format. The dimensions for the Yagi and quad are optimized for maximum gain.

HF Antenna Design required a TRS-80C Color Computer™ with 16K RAM and Extended Color Basic or MC-10 with 4K RAM. The program is available from Cynwyn — 4791 Broadway, Suite 2F, New York, New York 10034 — on cassette for \$10 plus \$2 shipping and handling.

Circle #305 on Reader Service Card.

repeater amplifier

Falcon Communications has announced its new Model 4114 2-meter repeater amplifier, a basic amplifier that supplies a full 100-watt output when driven with 2 watts. Features include carrier operated relay or external keying; operation on 13.8 volts DC, from either a battery or power supply; regulated bias supply (adjustable for limited power output adjustment); and a thermostat designed to prevent any damage in the event of overheating. No damage results from high VSWR.



Other units in this series supply maximum power outputs of from 50 to 100 watts and accept drive levels up to 25 watts. A 220 MHz unit is also available.

For further information, contact Falcon Communications, P.O. Box 620625, Woodside, California 94062.

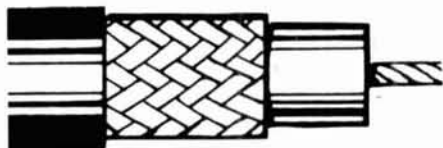

THE WIREMAN

FOR ALL AMATEUR WIRE & CABLE

Direct Pricing Fast Service

1-800-433-WIRE

CB to 10 LARSEN ANTENNAS UNADILLA

VISA MASTERCARD COD CASH

1-800-433-9473

616 924 4561 (Mich & Ragchew) 122

CERTIFIED COMMUNICATIONS
4138 SOUTH FERRIS, FREMONT, MICHIGAN 49412

1296 & PHASE III
MAKI UTV 1200 - \$499⁹⁵
MAKI 20W AMP - \$430⁰⁰

KT 200 ET

0-10 TRACKING PROG.
TIMEX/ZX - 16K
Vic-Basic \$12.95
Also Avail. w/RS & STS

SASE for full details on the
Timex/ZX AUTOTRAK ROTOR
CONTROLLER

SPECTRUM WEST
5717 NE 56th, SEATTLE, WA 98105
206-641-7461 183

QUADS — TOWERS — QUADS — TOWERS — QUADS

UNDER NEW MANAGEMENT
DO YOU WANT THE STRAIGHT
INFO ON QUADS?

Info on verticals, dipoles, mini-quads, Yagis, including comparative performances? **Without pulling any punches.**

Our references are ANY AMATEUR WHO USES A SKYLANE QUAD.

Our prices are lower than any comparable Quad or tower

Info on quads **half a buck**, and info on BOTH towers and quads for a **buck**. Charge due to increased cost of postage and printing.

SKYLANE PRODUCTS

359 Glenwood Avenue
Satellite Beach, FL 32937
(305) 773-1342

QUADS — TOWERS — QUADS — TOWERS — QUADS

181

RF TRANSISTORS, MICROWAVE DIODES

TYPE	PRICE	TYPE	PRICE	TYPE	PRICE	TYPE	PRICE
2N1561	\$ 25.00	2SC1678	\$ 2.00	M1134	\$ 16.90	MSC1821-3	\$125.00
2N1562	25.00	2SC1729	20.00	M9579	7.95	MSC1821-10	225.00
2N1692	25.00	2SC1760	1.50	M9588	7.50	MSC2001	40.00
2N2957	1.55	2SC1909	4.00	M9622	7.95	MSC2223-10	200.00
2N2857JANIX	4.10	2SC1946	36.00	M9623	9.95	MSC3000	50.00
2N2857JANITXV	4.10	2SC1946A	40.00	M9624	11.95	MSC3001	50.00
2N2876	13.50	2SC1970	2.50	M9625	17.95	MSC73001	50.00
2N2947	18.35	2SC1974	4.00	M9630	18.00	MSC82001	40.00
2N2948	13.00	2SC2166	5.50	M9740	29.90	MSC82014	40.00
2N2949	15.50	2SC2237	32.00	M9741	29.90	MSC82020	40.00
2N3375	17.10	2SC2695	47.00	M9755	19.50	MSC82030	40.00
2N3553	1.55	A50-12	25.00	M9848	37.00	MSC83001	50.00
2N3632	15.50	A209	10.00	M9850	16.90	MSC83005	100.00
2N3733	11.00	A283	5.00	M9851	20.00	MT4150	14.40
2N3818	5.00	A283B	6.00	M9887	5.25	MT5126	POR
2N3866	1.30	AF102	2.50	MEL80091	25.00	MT5596/2N5596	99.00
2N3866JAN	2.20	AFY12	2.50	MM1550	10.00	MT5768/2N5768	95.00
2N3924	3.35	BF272A	2.50	MM1552	50.00	MT8762	POR
2N3927	17.25	BFR21	2.50	MM1553	50.00	NBD2136	2.50
2N3950	25.00	BFR90	1.00	MM1614	10.00	NE13783	POR
2N4012	11.00	BFR91	1.65	MM1943/2N4072	1.80	NE21889	POR
2N4041	14.00	BFR99	2.50	MM2608	5.00	NE57835	5.70
2N4072	1.80	BFT12	2.50	MM3375A	17.10	NE73436	2.50
2N4080	4.53	BFW16A	2.50	MM4429	10.00	TRW	
2N4127	21.00	BFW17	2.50	MM8000	1.15	PRT8637	POR
2N4427	1.30	BFW92	1.50	MM8006	2.30	PT3190	POR
2N4428	1.85	BFX44	2.50	MM8011	25.00	PT3194	POR
2N4430	11.80	BFX48	2.50	MPF102	.45	PT3195	POR
2N4957	3.45	BFX65	2.50	MPSU31	1.01	PT3537	7.80
2N4959	2.30	BFX84	2.50	MRA2023-1.5	42.50	PT4166E	POR
2N5090	13.80	BFX85	2.50	MRP208	16.10	PT4176D	POR
2N5108	3.45	BFX86	2.50	MRP212	16.10	PT4186B	POR
2N5109	1.70	BFX89	1.00	MRP223	13.25	PT4209	POR
2N5160	3.45	BFY11	2.50	MRP224	15.50	PT4209C/5645	POR
2N5177	21.62	BFY18	2.50	MRP231	10.92	PT4556	24.60
2N5179	1.04	BFY19	2.50	MRP232	12.07	PT4570	7.50
2N5216	56.00	BFY39	2.50	MRP233	12.65	PT4577	POR
2N5583	3.45	BFY90	1.00	MRP237	3.15	PT4590	POR
2N5589	9.77	BLX67	15.24	MRP238	13.80	PT4612	POR
2N5590	10.92	BLX68C3	15.24	MRP239	17.25	PT4628	POR
2N5591	13.80	BLX93C3	22.21	MRP245	35.65	PT4640	POR
2N5637	15.50	BLY87A	8.94	MRP247	35.65	PT4642	POR
2N5641	12.42	BLY88C3	13.08	MRP304	43.45	PT5632	4.70
2N5642	14.03	BLY94C	21.30	MRP309	33.81	PT5749	POR
2N5643	15.50	BLY351	10.00	MRP314	28.52	PT6629	POR
2N5645	13.80	BLY568C/CF	30.00	MRP315	28.86	PT6709	POR
2N5646	20.70	C458-617	25.00	MRP316	POR	PT6720	POR
2N5651	11.05	C4005	20.00	MRP317	63.94	PT8510	POR
2N5691	18.00	CD1869	20.00	MRP420	20.00	PT8524	POR
2N5764	27.00	CD2188	18.00	MRP421	36.80	PT8609	POR
2N5836	3.45	CD2545	25.00	MRP422A	41.40	PT8633	POR
2N5842/MM1607	8.45	CTC3005	100.00	MRP427	17.25	PT8639	POR
2N5849	20.00	Dexcel GaAs FET		MRP428	46.00	PT8659	POR
2N5913	3.25	DXL3501A-P100F	49.30	MRP433	12.07	PT8679	POR
2N5916	36.00	Fujitsu GaAs FET		MRP449/A	12.65	PT8708	POR
2N5922	10.00	FSX52WF	58.00	MRP450/A	14.37	PT8709	POR
2N5923	25.00	GMO290A	2.50	MRP453/A	18.40	PT8727	29.00
2N5941	23.00	HEP76	4.95	MRP454/A	20.12	PT8731	POR
2N5942	40.00	HEPS3002	11.40	MRP455/A	16.00	PT8742	19.10
2N5944	10.35	HEPS3003	30.00	MRP458	20.70	PT8787	POR
2N5945	11.50	HEPS3005	10.00	MRP463	25.00	PT9783	16.50
2N5946	14.40	HEPS3006	19.90	MRP472	1.00	PT9784	32.70
2N6080	10.35	HEPS3007	25.00	MRP475	3.10	PT9790	56.00
2N6081	12.07	HEPS3010	11.34	MRP476	2.00	PT31962	POR
2N6082	12.65	Hewlett Packard		MRP477	14.95	PT31963	POR
2N6083	13.25	HFET2204	112.00	MRP492	23.00	PT31083	POR
2N6084	15.00	35821E	38.00	MRP502	1.04	PTX6680	POR
2N6094	11.00	35826B	32.00	MRP503	6.00	RCA	
2N6095	12.00	35826E	32.00	MRP504	7.00	40081	5.00
2N6096	16.10	35831E-H31	30.00	MRP509	5.00	40279	10.00
2N6097	20.70	35831E	30.00	MRP511	10.69	40280	4.62
2N6105	21.00	35832E	50.00	MRP515	2.00	40281	10.00
2N6136	21.85	35833E	50.00	MRP517	2.00	40282	20.00
2N6166	40.24	35835E	71.50	MRP559	2.05	40290	2.80
2N6201	50.00	35854E	75.00	MRP605	20.00	40292	13.05
2N6304	1.50	35866E	44.00	MRP618	25.00	40294	2.50
2N6459	18.00	HXT1C1101	7.00	MRP628	8.65	40341	21.00
2N6567	10.06	HXT1C1102	8.75	MRP629	3.45	40608	2.48
2N6680	80.00	HXT1C1104	30.00	MRP644	27.60	40894	1.00
2SC703	3.00	HXT1C1104	68.00	MRP646	29.90	40977	10.00
2SC756A	7.50	HXT1C1105	31.00	MRP616	15.00	62800A	60.00
2SC781	2.80	HXT1C1106	33.00	MRP823	20.00	RE3754	25.00
2SC1018	1.00	J310	.70	MRP901 (3) Lead	1.00	RE3789	25.00
2SC1042	12.00	TRW		MRP901 (4) Lead	2.00	RF110	25.00
2SC1070	2.50	JO2000	10.00	MRP904	2.30	S50-12	25.00
2SC1239	2.50	JO2001	25.00	MRP911	3.00	S3006	5.00
2SC1251	12.00	JO4045	25.00	MRP961	2.30	S3031	5.00
2SC1306	2.90	Motorola Comm.		MRP8004	2.10	SCA3522	5.00
2SC1307	5.50	ML131	8.50	MS261F	POR	SCA3523	5.00
2SC1424	2.80	M1132	11.95	MSC1720-12	225.00	PRICE ON REQUEST = POR	

Toll Free Number
800-528-0180
(For orders only)

"All parts may be new or surplus, and parts may be substituted with comparable parts if we are out of stock of an item."

For information call: (602) 242-3037

PRICES SUBJECT TO CHANGE WITHOUT NOTICE

MHz electronics

GaAs, TUNNEL DIODES, ETC.

* R F TRANSISTORS *

TYPE	PRICE	TYPE	PRICE	TYPE	PRICE	TYPE	PRICE
THOMSON CSF							
SD345	\$ 5.00	SD1119	\$ 5.00	SD1278-5	\$18.00	SD1453-1	\$18.00
SD445	5.00	SD1124	50.00	SD1281-2	8.00	SD1451-1	48.00
SD1004	15.00	SD1127	3.50	SD1283	10.00	SD1477	48.00
SD1009	15.00	SD1133	14.00	SD1289-1	15.00	SD1478	21.00
SD1009-2	15.00	SD1133-1	14.00	SD1290-4	15.00	SD1480	60.00
SD1012	9.90	SD1134-1	3.00	SD1290-7	15.00	SD1484	1.50
SD1012-3	9.90	SD1135	8.00	SD1300	3.00	SD1484-5	1.50
SD1012-5	9.90	SD1136	15.00	SD1301-7	3.60	SD1484-6	1.50
SD1013-3	13.50	SD1136-2	15.00	SD1305	3.00	SD1484-7	1.50
SD1013-7	13.50	SD1143-1	12.00	SD1307	3.00	SD1488	39.00
SD1014	11.00	SD1143-3	17.00	SD1308	3.00	SD1488-1	28.00
SD1014-6	11.00	SD1144-1	3.00	SD1311	1.00	SD1488-7	27.00
SD1016	15.00	SD1146	15.00	SD1317	10.00	SD1488-8	28.00
SD1016-5	13.00	SD1147	15.00	SD1335	3.00	SD1499-1	39.00
SD1018-4	15.00	SD1188	10.00	SD1345-6	5.00	SD1520-2	18.00
SD1018-6	15.00	SD1189	24.00	SD1365-1	2.50	SD1522-4	33.00
SD1018-7	15.00	SD1200	1.50	SD1365-5	2.50	SD1528-1	24.00
SD1018-15	15.00	SD1201-2	10.00	SD1375	7.50	SD1528-3	34.00
SD1020-5	19.00	SD1202	10.00	SD1375-6	7.50	SD1530-2	38.00
SD1028	15.00	SD1212-11	4.00	SD1379	15.00	SD1536-1	41.00
SD1030-2	12.00	SD1212-12	4.00	SD1380-1	1.00	SD1545	34.00
SD1043	12.00	SD1212-16	4.00	SD1380-3	1.00	SD1561	79.00
SD1043-1	10.00	SD1214-7	5.00	SD1380-7	1.00	SF4557 Mot.	25.00
SD1045	3.75	SD1214-11	5.00	SD1405	40.00	SK3048 RCA	5.00
SD1049-1	2.00	SD1216	12.00	SD1409	18.00	SK3177 RCA	15.00
SD1053	4.00	SD1219-4	15.00	SD1410	22.00	SMS7714 Mot.	2.50
SD1065	4.75	SD1219-5	15.00	SD1410-3	21.00	SFR750 Mot.	36.00
SD1068	15.00	SD1219-8	15.00	SD1413-1	18.00	SFR1018 Mot.	5.00
SD1074-2	18.00	SD1220	8.00	SD1416	50.00	SFR2147 Mot.	22.00
SD1074-4	28.00	SD1220-9	8.00	SD1422-2	24.00	SFR2356 Mot.	38.00
SD1074-5	28.00	SD1222-8	16.00	SD1428	33.00	SFR2378 Mot.	16.00
SD1076	20.00	SD1222-11	7.50	SD1429-2	15.00	SFR2584 Mot.	40.00
SD1077-4	4.00	SD1224-10	18.00	SD1429-3	15.00	SFR2821 Mot.	25.00
SD1077-6	4.00	SD1225	18.00	SD1429-5	15.00	SFR2857 Mot.	20.00
SD1078-6	24.00	SD1228-8	POR	SD1430	12.00	TA8894 RCA	15.00
SD1080-8	6.00	SD1229-7	13.00	SD1430-2	18.00	TA1889/MRF966	3.55
SD1080-9	3.00	SD1229-16	13.00	SD1434-5	30.00	TP312	2.50
SD1084	8.00	SD1232	4.00	SD1434-9	30.00	TP1014 TRW	5.00
SD1087	15.00	SD1240-8	15.00	SD1438	26.00	TP1028 TRW	15.00
SD1089-5	15.00	SD1244-1	14.00	SD1441	91.00	01-80703T04/	
SD1095	15.00	SD1262	12.00	SD1442	15.00	458-949 Mot. Comm.	65.00
SD1100	5.00	SD1263	15.00	SD1444	6.00	TXVF2201 H.P.	450.00
SD1109	18.00	SD1263-1	15.00	SD1444-8	6.00	62803 RCA	100.00
SD1115-2	8.00	SD1272	13.00	SD1450-1	28.00	TA7205/2N5921	80.00
SD1115-3	8.00	SD1272-2	15.00	SD1451	18.00	TA7487/2N5920	75.00
SD1115-7	2.50	SD1278	20.00	SD1451-2	18.00	TA7995/2N6267	150.00
SD1116	5.00	SD1278-1	18.00	SD1452	20.00	SFR2092 Mot.	18.00
SD1118	22.00			SD1452-2	20.00	MRF479	8.05

We Can Cross Reference Most RF Transistors, Diodes, Hybrid Modules And Any Other Type Of Semiconductor.

* DIODES (HOT CARRIER, MICROWAVE, PIN, SCHOTTKY, TUNNEL, VAJACTOR, GUNN) *

1N21	\$ 3.40	1N21B	\$ 3.40	1N21BR	\$ 3.40	1N21C	\$ 3.40
1N21D	4.00	1N21DR	4.00	1N21FR	6.00	1N21RF	5.00
1N21WE	5.80	1N21WG	5.80	1N22	5.00	1N23A	10.00
1N23B	3.40	1N23C	3.40	1N23CR	3.40	1N23D	4.95
1N23DR	4.00	1N23WE	5.00	1N25	7.50	1N25AR	18.00
1N28WE	10.00	1N29	10.00	1N32	20.00	1N53A	55.50
1N76	26.00	1N76R	28.00	1N78	26.00	1N78A	20.00
1N78B	26.00	1N78D	28.00	1N78DR	28.00	1N78R	28.00
1N149	6.00	1N150MR	18.00	1N415	4.00	1N415C	4.00
1N415G	15.00	1N416D	5.00	1N416E	6.00	1N446	10.00
1N831	10.00	1N833	10.00	1N950	4.00	1N1084	2.00
1N2930	15.00	1N2932	15.00	1N3540	15.00	1N3712	11.00
1N3713	18.00	1N3714	11.00	1N3715	16.00	1N3716	10.00
1N3717	14.00	1N3718	10.00	1N3721	14.00	1N3733	10.00
1N3747	21.00	1N4386	20.00	1N4396	15.00	1N4785	11.00
1N4812B	9.00	1N5139A/B	4.25	1N5140A/B	4.25	1N5141A/B	4.25
1N5142A/B	4.25	1N5143A/B	4.25	1N5144A/B	4.25	1N5145A/B	4.25
1N5146A/B	4.25	1N5147A/B	4.25	1N5148A/B	4.25	1N5167	5.50
1N5453	3.75	1N5465	7.65	1N5711	1.00	1N5711 JAN	2.00
1N5713	5.00	1N5767	2.00	1N6263	1.00	1S2199	15.00
1S2200	15.00	1S2208/9	1.00	8B1087/48R869558	65.00	8D3020	65.00
AZK116M Aertech	50.00	BB105B	1.00	BB105G	1.00	BD4/4JFEM G.E.	15.00
BL161 Bornec	5.00	CM0514AB C.M.	POR	D4060 Alpha	POR	D4159 Alpha	POR
D4233B Alpha	POR	D4900 Alpha	POR	D4959 Alpha	POR	D4987M Alpha	POR
D5047C Alpha	POR	D5147D Alpha	POR	D5503 Alpha	POR	D5506 Alpha	POR
DGB6158-98 Alpha	POR	DMD6022 Alpha	POR	DMD6460A Alpha	POR	DP20054 Crown	POR
GC1691-89 GHZ	31.35	GC1602-89 GHZ	31.35	GC1607-40 GHZ	31.35	GC2531-88 GHZ	37.40
GC2542-46 GHZ	37.40	GC3208-40 GHZ	37.40	GC17044 GHZ	50.00	HP33644A-H01	125.00
HP5082-0112	14.20	HP5082-0241	75.60	HP5082-0253	105.00	HP5082-0320	58.00
HP5082-0375	POR	HP5082-0386	POR	HP5082-0401	POR	HP5082-0438	POR
HP5082-1028	POR	HP5082-1332	POR	HP5082-2254	POR	HP5082-2302	10.70
HP5082-2303	5.20	HP5082-2696	POR	HP5082-2711	23.15	HP5082-2727	POR
HP5082-2800	1.00	HP5082-2805	4.45	HP5082-2835	1.00	HP5082-2884	POR
HP5082-3039	6.70	HP5082-3040	36.00	HP5082-3080	2.00	HP5082-3188	1.00
HP5082-3379	1.50	HP5082-6459	POR	HP5082-6462	POR	HP5082-6888	POR
HP5082-8016	POR	HP5082-8323	POR	K3A Kemitron	7.00	MA450A	POR
MA475	POR	MA40008	POR	MA41487	POR	MA41765	POR
MA41766	POR	MA43004	46.00	MA43589	POR	MA43622	POR
MA43636	POR	MA45104	27.00	MA47044	POR	MA47051	25.50
MA47100	3.05	MA47202	30.80	MA47771	POR	MA47838*	POR
MA47852	POR	MA49106	37.95	MA49558	POR	MA96731	125.00

* OUR STOCK CHANGES DAILY SO CALL IF THE PART YOU NEED IS NOT LISTED *

For information call: (602) 242-3037

Toll Free Number
800-528-0180
(For orders only)

"All parts may be new or surplus, and parts may be substituted with comparable parts if we are out of stock of an item."

MHz electronics

PRICES SUBJECT TO CHANGE WITHOUT NOTICE

COAXIAL RELAY SWITCHES SPDT

Electronic Specialty Co./Raven Electronics FSN 5985-556-9683 \$49.00
 Part # 25N28 Part # SU-01
 26Vdc Type N Connector, DC to 1 GHz.

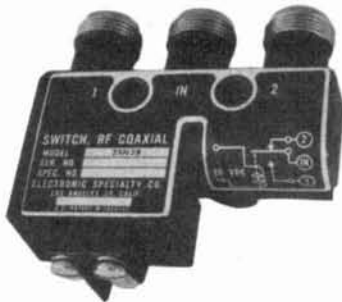

Amphenol
 Part # 316-10102-8
 115Vac Type BNC DC to 3 GHz.

\$29.99

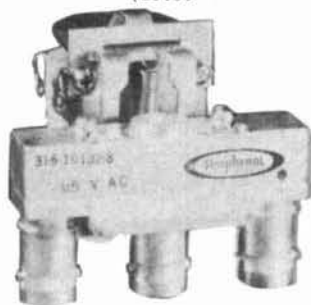

FXR
 Part # 300-11182
 120Vac Type BNC DC to 4 GHz.
 FSN 5985-543-1225

\$39.99

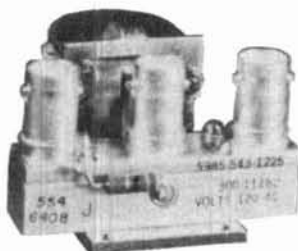

FXR
 Part # 300-11173
 120Vac Type BNC Same
 FSN 5985-543-1850

\$39.99

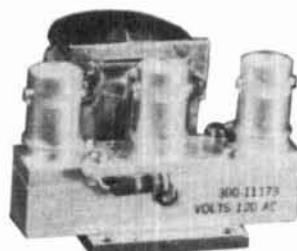

BNC To Banana Plug Coax Cable RG-58 36 inch or BNC to N Coax Cable RG-58 36 inch.

\$7.99 or 2 For \$13.99 or 10 For \$50.00

\$8.99 or 2 For \$15.99 or 10 For \$60.00



SOLID STATE RELAYS

P&B Model ECT1DB72 5vdc turn on
 PRICE EACH \$5.00

Disisig, Inc. Model ECS-215 5vdc turn on
 PRICE EACH \$7.50

Grigsby/Barton Model GB7400 5vdc turn on
 PRICE EACH \$7.50

120vac contact at 7amps or 20amps on a 10"x 10"x .124 aluminum. Heatsink with silicon grease.

240vac contact 14amps or 40amps on a 10"x 10"x .124 aluminum. Heatsink with silicon grease.

240vac contact at 15amps or 40amps on a 10"x 10"x .124 aluminum. Heatsink with silicon grease.

NOTE: *** Items may be substituted with other brands or equivalent model numbers. ***

For information call: (602) 242-3037

MHz electronics

"All parts may be new or surplus, and parts may be substituted with comparable parts if we are out of stock of an item."

Toll Free Number
 800-528-0180
 (For orders only)

PRICES SUBJECT TO CHANGE WITHOUT NOTICE

TUBES

TYPE	PRICE	TYPE	PRICE	TYPE	PRICE
2C39/7289	\$ 34.00	1182/4600A	\$500.00	ML7815AL	\$ 60.00
2E26	7.95	4600A	500.00	7843	107.00
2K28	200.00	4624	310.00	7854	130.00
3-500Z	102.00	4657	84.00	ML7855KAL	125.00
3-1000Z/8164	400.00	4662	100.00	7984	14.95
3B28/866A	9.50	4665	500.00	8072	84.00
3CX400U7/8961	255.00	4687	P.O.R.	8106	5.00
3CX1000A7/8283	526.00	5675	42.00	8117A	225.00
3CX3000F1/8239	567.00	5721	250.00	8121	110.00
3CW30000H7	1700.00	5768	125.00	8122	110.00
3X2500A3	473.00	5819	119.00	8134	470.00
3X3000F1	567.00	5836	232.50	8156	12.00
4-65A/8165	69.00	5837	232.50	8233	60.00
4-125A/4D21	79.00	5861	140.00	8236	35.00
4-250A/5D22	98.00	5867A	185.00	8295/PL172	500.00
4-400A/8438	98.00	5868/AX9902	270.00	8458	35.00
4-400B/7527	110.00	5876/A	42.00	8462	130.00
4-400C/6775	110.00	5881/6L6	8.00	8505A	95.00
4-1000A/8166	444.00	5893	60.00	8533W	136.00
4CX250B/7203	54.00	5894/A	54.00	8560/A	75.00
4CX250FG/8621	75.00	5894B/8737	54.00	8560AS	100.00
4CX250K/8245	125.00	5946	395.00	8608	38.00
4CX250R/7580W	90.00	6083/AZ9909	95.00	8624	100.00
4CX300A/8167	170.00	6146/6146A	8.50	8637	70.00
4CX350A/8321	110.00	6146B/8298	10.50	8643	83.00
4CX350F/8322	115.00	6146W/7212	17.95	8647	168.00
4CX350FJ/8904	140.00	6156	110.00	8683	95.00
4CX600J/8809	835.00	6159	13.85	8877	465.00
4CX1000A/8168	242.50*	6159B	23.50	8908	13.00
4CX1000A/8168	485.00	6161	325.00	8950	13.00
4CX1500B/8660	555.00	6280	42.50	8930	137.00
4CX5000A/8170	1100.00	6291	180.00	6L6 Meta1	25.00
4CX10000D/8171	1255.00	6293	24.00	6L6GC	5.03
4CX15000A/8281	1500.00	6326	P.O.R.	6CA7/EL34	5.38
4CW800F	710.00	6360/A	5.75	6CL6	3.50
4D32	240.00	6399	540.00	6DJ8	2.50
4E27A/5-125B	240.00	6550A	10.00	6DQ5	6.58
4PR60A	200.00	6883B/8032A/8552	10.00	6GF5	5.85
4PR60B	345.00	6897	160.00	6GJ5A	6.20
4PR65A/8187	175.00	6907	79.00	6GK6	6.00
4PR1000A/8189	590.00	6922/6DJ8	5.00	6HB5	6.00
4X150A/7034	60.00	6939	22.00	6HF5	8.73
4X150D/7609	95.00	7094	250.00	6JG6A	6.28
4X250B	45.00	7117	38.50	6JM6	6.00
4X250F	45.00	7203	P.O.R.	6JN6	6.00
4X500A	412.00	7211	100.00	6JS6C	7.25
5CX1500A	660.00	7213	300.00*	6KN6	5.05
KT88	27.50	7214	300.00*	6KD6	8.25
416B	45.00	7271	135.00	6LF6	7.00
416C	62.50	7289/2C39	34.00	6LQ6 G.E.	7.00
572B/T160L	49.95	7325	P.O.R.	6LQ6/6MJ6 Sylvania	9.00
592/3-200A3	211.00	7360	13.50	6ME6	8.90
807	8.50	7377	85.00	12AT7	3.50
811A	15.00	7408	2.50	12AX7	3.00
812A	29.00	7609	95.00	12BY7	5.00
813	50.00	7735	36.00	12JB6A	6.50

NOTE * = USED TUBE

NOTE P.O.R. = PRICE ON REQUEST

"ALL PARTS MAY BE NEW, USED, OR SURPLUS. PARTS MAY BE SUBSTITUTED WITH COMPARABLE PARTS IF WE ARE OUT OF STOCK OF AN ITEM.

NOTICE: ALL PRICES ARE SUBJECT TO CHANGE WITHOUT NOTICE.

For information call: (602) 242-3037

Toll Free Number
800-528-0180
(For orders only)

"All parts may be new or surplus, and parts may be substituted with comparable parts if we are out of stock of an item."

MHz electronics

PRICES SUBJECT TO CHANGE WITHOUT NOTICE

HEWLETT PACKARD SIGNAL GENERATORS

606A	50KHz to 65MHz in 6 bands $\pm 1\%$ Output level adjustable 0.1uV to 3V into 50 ohms. Built-in crystal calibrator. 400 - 1000Hz modulation.	\$ 650.00	616B	Same as above but later model.	\$ 600.00
606B	Same as above but has frequency control feature to allow operation with HP 8708A Synchronizer.	\$1100.00	618B	3.8 to 7.6GHz range, with calibrated output and selection of pulse-FM or square wave modulation.	\$ 600.00
608C	10MHz to 480MHz, 0.1uV-1V into 50 ohms, AM, CW, or pulse modulation, calibrated attenuator.	\$ 500.00	618C	Same as above but later model.	\$2200.00
608D/TS510	10MHz to 420MHz, 0.1uV-0.5V into 50 ohms, $\pm 0.5\%$ accuracy, built-in crystal calibrator, AM-CW or pulse output.	\$ 375.00	620A	7 to 11GHz range, with calibrated output and selection of pulse-FM or square wave modulation.	\$ 750.00
608E	Improved version of popular 608C. Up to 1V output. Improved stability, low residual FM.	\$1450.00	620B	Same as above but later model.	\$2200.00
608F	10MHz to 455MHz in 5 bands $\pm 1\%$ frequency accuracy with built-in crystal calibrator. Can be used with HP 8708A Synchronizer. Output continuously adjustable from .1uV to .5V into 50 ohms.	\$1100.00	626A	10 to 15GHz, 10mW output power with calibrated output and pulse-square wave or FM modulation.	\$4200.00
612A	450-1230MHz, 0.1uV-0.5V into 50 ohms, calibrated output.	\$ 750.00	8708A	Synchronizer used with 606B, 608F. The synchronizer is a phase-lock frequency stabilizer which provides crystal oscillator frequency stability to 430MHz in the 608F signal generator. Phase locking eliminates microphonics and drift resulting in excellent frequency stability. The 8708A includes a vernier which can tune the reference oscillator over a range of $\pm 0.25\%$ permitting frequency settable to 2 parts in 10 to the seventh. Provides a very stable signal that satisfies many critical applications.	(With HP 606B or 608F) \$ 350.00 (Without) \$ 450.00
614A	900-2100MHz with many features including calibrated output and all modulation characteristics.	\$ 500.00	EMC-10	ELECTROMETRICS EMC-10 RFI/EMI RECEIVER Low frequency analyzer covering 20Hz to 50KHz frequency range. Extendable to 500 KHz in wideband mode.	\$2500.00
616A/TS403	Direct reading and direct control from 1.8 to 4.2GHz. The H.P. 616A features ± 1.5 dB calibrated output accuracy from -31.27dBm to -dBm. The output is directly calibrated in microvolts and dBm with continuous monitoring. Simple operation frequency dial accuracy is $\pm 1\%$ and stability exceeds 0.005% / C change in ambient temperature. Calibrated attenuator is within ± 1.5 dB over entire output band. 50 ohm impedance unit has internal pulse modulation with rep rate variable from 40 Hz to 4KHz, variable pulsewidth (1 to 10usec) and variable pulse delay (3 to 300usec). External modulating inputs increase versatility.	\$ 375.00	NF-105F	Empire Devices Field Intensity Meter. Has NF-105/TA, NF-105/TX, NF-105/T1, NF-105/T2, NF-105/T3. Covers 14KHz to 1000MHz.	\$2100.00

ALL EQUIPMENT CARRY A 30 DAY GUARANTEE.

EQUIPMENT IS NOT CALIBRATED.

TERMS: DOMESTIC: Prepaid, C.O.D. or Credit Card
FOREIGN: Prepaid only, U.S. Funds, Money Order, or Cashier's Check Only.

C.O.D.: Acceptable by telephone or mail. Payment from customer will be by Cash, Money Order, or Cashier's Check. We are sorry but we cannot accept personal checks for C.O.D.'s. C.O.D.'s are shipped by air only and thru United Parcel Service.

CONFIRMING ORDERS: We would prefer that confirming orders not be sent after a telephone order has been placed. If company policy necessitates a confirming order, please mark "CONFIRMING" boldly on the order. If problems or duplicate shipments occur due to an order which is not properly marked, the customer will be held responsible for any charges incurred, plus a 15% restock charge on the returned parts.

CREDIT CARDS: We are now accepting MASTERCARD, VISA, AND AMERICAN EXPRESS

DATA SHEETS: When we have data sheets in stock on devices we will supply them with the order.

DEFECTIVE MATERIALS: All claims for defective materials must be made within 30 DAYS after receipt of the parcel. All claims must include the defective material for testing purposes, a copy of our invoice, and a return authorization number which must be obtained prior to shipping the merchandise back to us. This can be obtained by calling (602) 242-8916 or sending us a postcard. Due to Manufacturer warranties we are unable to replace or issue credit on items which have been soldered to or have been altered in any way. All return items must be packed properly or it will void all warranties. We do not assume responsibility for shipping and handling charges incurred.

DELIVERY: Orders are usually shipped the same day they are placed or the next business day, unless we are out of stock on an item. The customer will be notified by post card if we are going to backorder the item. Our normal shipping method is UPS or U.S. Mail depending on size or the weight of the package. Test Equipment is shipped only by air and is freight collect, unless prior arrangements have been made and approved.

FOREIGN ORDERS: All foreign orders must be prepaid with a Cashier's Check, or Money Order made out in U.S. FUNDS ONLY. We are sorry but C.O.D. is not available to foreign countries and letters of credit are unacceptable as a form of payment. Further information is available on request.

HOURS: Monday thru Friday 8:30 a.m. to 5:00 p.m. Saturdays 8:30 a.m. to 4:00 p.m.

INSURANCE: Please include 25¢ for each additional \$100.00 over \$100.00. UPS ONLY. All insured packages are shipped thru UPS only. If you wish to have it shipped through the post office there is a \$5.00 fee which is additional to the shipping, handling and insurance.

OPEN ACCOUNTS: We regret that we do not issue open accounts.

ORDER FORMS: New order forms are included with each order for your convenience. Additional order forms are available on request.

PARTS: We reserve the right to substitute or replace any item with a part of equal or comparable specification.

POSTAGE: Minimum shipping and handling in the U.S., Canada, and Mexico is \$3.00 for ground shipments, all other countries is \$5.50. Air rates are available at the time of your order. All foreign orders please include 25% of the ordered amount for shipping and handling. C.O.D.'s are shipped AIR ONLY.

PREPAID ORDERS: Orders must be accompanied by a check.

PRICES: Prices are subject to change without notice.

PURCHASE ORDERS: We accept purchase orders only when they are accompanied by a check.

RESTOCK CHARGES: If parts are returned to MHZ ELECTRONICS, INC. due to customer error, the customer will be held responsible for all fees incurred and will be charged a 15% RESTOCK CHARGE with the remainder in CREDIT ONLY. The following must accompany any return: A copy of our invoice, return authorization number which must be obtained prior to shipping the merchandise back. Returns must be done within 10 DAYS of receipt of parcel. Return authorization numbers can be obtained by calling (602) 242-8916 or notifying us by post card. Return authorizations will not be given out on our 800 number.

SALES TAX: ARIZONA residents must add 6% sales tax, unless a signed ARIZONA resale tax card is currently on file with us. All orders placed by persons outside of ARIZONA, but delivered to persons in ARIZONA are subject to the 6% sales tax.

SHORTAGE OR DAMAGE: All claims for shortages or damages must be made within 5 DAYS of receipt of parcel. Claims must include a copy of our invoice, along with a return authorization number which can be obtained by contacting us at (602) 242-8916 or sending a post card. Authorizations cannot be on our 800 number. All items must be properly packed. If items are not properly packed make sure to contact the carrier so that they can come out and inspect the package before it is returned to us. Customers which do not notify us within this time period will be held responsible for the entire order as we will consider the order complete.

OUR 800 NUMBER IS STRICTLY FOR ORDERS ONLY (800) 528-0180. INFORMATION CALLS ARE TAKEN ON (602) 242-8916 or (602) 242-3037.



Toll Free Number
800-528-0180
(For orders only)

For information call: (602) 242-3037

PRICES SUBJECT TO CHANGE WITHOUT NOTICE.

UNEX LABORATORIES THS-2 FLEXICOM HEADSET.

these headsets come with data to hook up to a ICOM radios and many other equipment.

Perfect for Airplanes, Helicopters, Mobile Radios, or Just the Telephone.

These Are Factory New In Sealed Boxes. Limited Supply Only \$69.95



\$69.95

MHz electronics

2111 W. CAMELBACK ROAD
PHOENIX, ARIZONA 85015

"All parts may be new or surplus, and parts may be substituted with comparable parts if we are out of stock of an item."

Get Your Best Deal . . .
Then CALL US . . . TOLL FREE!

1-800-238-6168 (In Tennessee, call 901-683-9125)

KENWOOD  **ICOM**

AUTHORIZED DEALER FOR: Kenwood, ICOM, Drake, Ten-Tec, Santec, MFJ, Astron, AEA, Mirage, B&W, Hustler, Cushcraft, Larsen, Hy-Gain, and others. . . . **PLUS CURRENT USED GEAR**

When you call, talk to a Qualified Ham Operator! Ask for MARSHALL, KU4O, or BILL, W4TNP

WE TRADE!

Call us for a free appraisal!

After the sale, it's the service that counts!

Memphis Amateur Electronics, Inc.

1465 Wells Station Rd., Memphis, TN 38108

Store Hours:
Monday-Friday, 9 to 5,
Saturday 9 to 12
(Central Time)



157

ORR BOOKS

BEAM ANTENNA HANDBOOK

by Bill Orr, W6SAI

Recommended reading. Commonly asked questions like: What is the best element spacing? Can different yagi antennas be stacked without losing performance? Do monoband beams outperform tribanders? Lots of construction projects, diagrams, and photos. 198 pages. ©1977. 1st edition.

RP-BA Softbound \$7.95

SIMPLE LOW-COST WIRE ANTENNAS

by Bill Orr, W6SAI

Learn how to build simple, economical wire antennas. Apartment dwellers take note! Fool your landlord and your neighbors with some of the "invisible" antennas found here. Well diagramed. 192 pages. ©1972.

RP-WA Softbound \$7.95

THE RADIO AMATEUR ANTENNA HANDBOOK

by William I. Orr, W6SAI and Stuart Cowan, W2LX

Contains lots of well illustrated construction projects for vertical, long wire, and HF/VHF beam antennas. There is an honest judgment of antenna gain figures, information on the best and worst antenna locations and heights, a long look at the quad vs. the yagi antenna, information on baluns and how to use them, and new information on the popular Sloper and Delta Loop antennas. The text is based on proven data plus practical, on-the-air experience. **The Radio Amateur Antenna Handbook** will make a valuable and often consulted reference. 190 pages. ©1978.

RP-AH Softbound \$7.95

ALL ABOUT CUBICAL QUAD ANTENNAS

by Bill Orr, W6SAI

The cubical quad antenna is considered by many to be the best DX antenna because of its simple, lightweight design and high performance. You'll find quad designs for everything from the single element to the multi-element monster quad, plus a new, higher gain expanded quad (X-Q) design. There's a wealth of supplementary data on construction, feeding, tuning, and mounting quad antennas. 112 pages. ©1977.

RP-CQ Softbound \$6.95

Please add \$1.00 to cover shipping and handling.

HAM RADIO'S BOOKSTORE
GREENVILLE, NH 03048

More Details? CHECK — OFF Page 132

LATE NEWS..

Get the news
As it happens



Westlink Report is *your* source for information on all the late breaking stories in the exciting world of Amateur Radio. Westlink Report summarizes the news that will impact the future of Amateur Radio. Westlink digs into its stories and gives you the latest from Newington, summarizes the actions of the FCC, reports on the important international news, keeps you fully informed about space and AMSAT news and much, much more.

Subscribe to Westlink Report today. Be informed. Don't be surprised by the latest developments in this fast paced hobby.

26 issues just \$22.50 per year U.S., Canada, Mexico.
\$42.50 per year Air Mail.

THE WESTLINK REPORT
11119 Allegheny Street
Sun Valley, CA 91352

195

July 1984  127



Ham Radio's guide to help you find your loc

California

C & A ROBERTS, INC.
18511 HAWTHORN BLVD.
TORRANCE, CA 90504
213-370-7451
24 Hour: 800-421-2258
Not The Biggest. But The Best —
Since 1962.

FONTANA ELECTRONICS
8628 SIERRA AVENUE
FONTANA, CA 92335
714-822-7710
714-822-7725
The Largest Electronics Dealer in San Bernardino County.

JUN'S ELECTRONICS
3919 SEPULVEDA BLVD.
CULVER CITY, CA 90230
213-390-8003
619-463-1886 San Diego
800-882-1343 Trades
Habla Espanol

Connecticut

HATRY ELECTRONICS
500 LEDYARD ST. (SOUTH)
HARTFORD, CT 06114
203-527-1881
Call today. Friendly one-stop shopping
at prices you can afford.

Delaware

DELAWARE AMATEUR SUPPLY
71 MEADOW ROAD
NEW CASTLE, DE 19720
302-328-7728
800-441-7008
Icom, Ten-Tec, Microlog, Yaesu,
Kenwood, Santec, KDK, and more.
One mile off I-95, no sales tax.

Florida

AMATEUR ELECTRONIC SUPPLY
1898 DREW STREET
CLEARWATER, FL 33575
813-461-4267
Clearwater Branch
West Coast's only full service
Amateur Radio Store.
Hours M-F 9-5:30, Sat. 9-3

AMATEUR ELECTRONIC SUPPLY
621 COMMONWEALTH AVE.
ORLANDO, FL 32803
305-894-3238
Fla. Wats: 1 (800) 432-9424
Outside Fla: 1 (800) 327-1917
Hours M-F 9-5:30, Sat. 9-3

AMATEUR RADIO CENTER, INC.
2805 N. E. 2ND AVENUE
MIAMI, FL 33137
305-573-8383
The place for great dependable
names in Ham Radio.

Hawaii

HONOLULU ELECTRONICS
819 KEEAUMOKU STREET
HONOLULU, HI 96814
(808) 949-5564
Serving Hawaii & Pacific area for 51
years. Complete lines of Amateur equip-
ment, accessories and parts.

Illinois

ERICKSON COMMUNICATIONS, INC.
5456 N. MILWAUKEE AVE.
CHICAGO, IL 60630
312-631-5181
Hours: 9:30-5:30 Mon, Tu, Wed & Fri;
9:30-8:00 Thurs; 9:00-3:00 Sat.

Indiana

THE HAM SHACK
808 NORTH MAIN STREET
EVANSVILLE, IN 47710
812-422-0231
Discount prices on Ten-Tec, Cubic,
Hy-Gain, MFJ, Azden, Kantronics,
Santec and others.

Kansas

ASSOCIATED RADIO
8012 CONSER, P.O. BOX 4327
OVERLAND PARK, KS 66204
913-381-5900
America's No. 1 Real Amateur Radio
Store. Trade — Sell — Buy.

Kentucky

L & S RADIO
307 McLEAN AVENUE
HOPKINSVILLE, KY 42240
502-885-8071
Ten-Tec, Azden, Ameritron Sales and
Service.

Massachusetts

TEL-COM, INC.
675 GREAT ROAD, RTE. 119
LITTLETON, MA 01460
617-486-3040
617-486-3400 (this is new)
The Ham Store of New England
You Can Rely On.

Michigan

ENCON PHOTOVOLTAICS
Complete Photovoltaic Systems
27600 Schoolcraft Rd.
Livonia, Michigan 48150
313-523-1850
Amateur Radio, Repeaters, Satellite,
Computer applications.
Call Paul WD8AHO

Nevada

AMATEUR ELECTRONIC SUPPLY
1072 N. RANCHO DRIVE
LAS VEGAS, NV 89106
702-647-3114
Dale Porray "Squeak," AD7K
Outside Nev: 1 (800) 634-6227
Hours M-F 9-5:30, Sat. 9-3

JUN'S ELECTRONICS
460 E. PLUMB LANE — 107
RENO, NV 89502
702-827-5732
Outside Nev: 1 (800) 648-3962
Icom — Yaesu Dealer

New Hampshire

POLCARI'S ELECTRONICS CENTER
61 LOWELL ROAD
HUDSON, NH 03051
603-883-5005
Southern New Hampshire's only Ham
Store. Call today for quotes.

Dealers: *YOU SHOULD BE HERE TOO!*
Contact Ham Radio now for complete details.

nateur Radio Dealer

New Jersey

RADIOS UNLIMITED

P.O. BOX 347
1760 EASTON AVENUE
SOMERSET, NJ 08873
201-469-4599
800-526-0903

New Jersey's only factory authorized Yaesu and Icom distributor. New and used equipment. Full service shop.

ROUTE ELECTRONICS 17

777 ROUTE 17 SOUTH
PARAMUS, NJ 07625
201-444-8717

Drake, Cubic, DenTron, Hy-Gain, Cushcraft, Hustler, Larsen, MFJ, Butternut, Fluke & Beckman Instruments, etc.

New York

BARRY ELECTRONICS

512 BROADWAY
NEW YORK, NY 10012
212-925-7000

New York City's Largest Full Service Ham and Commercial Radio Store.

VHF COMMUNICATIONS

915 NORTH MAIN STREET
JAMESTOWN, NY 14701
716-664-6345

Call after 7 PM and save! Supplying all of your Amateur needs. Featuring ICOM "The World System." Western New York's finest Amateur dealer.

Ohio

AMATEUR ELECTRONIC SUPPLY

28940 EUCLID AVE.
WICKLIFFE, OH (CLEVELAND AREA)
44092

216-585-7388
Ohio Wats: 1 (800) 362-0290
Outside Ohio: 1 (800) 321-3594
Hours M-F 9-5:30, Sat. 9-3

UNIVERSAL AMATEUR RADIO, INC.

1280 AIDA DRIVE
REYNOLDSBURG (COLUMBUS), OH
43068

614-866-4267
Featuring Kenwood, Yaesu, Icom, and other fine gear. Factory authorized sales and service. Shortwave specialists. Near I-270 and airport.

Pennsylvania

HAMTRONICS, DIV. OF TREVOSE ELECTRONICS

4033 BROWNSVILLE ROAD
TREVOSE, PA 19047
215-357-1400

Same Location for 30 Years.

LaRUE ELECTRONICS

1112 GRANDVIEW STREET
SCRANTON, PENNSYLVANIA 18509
717-343-2124

Icom, Bird, Cushcraft, Beckman, Larsen, Hustler, Astron, Belden, Antenna Specialists, W2AU/W2VS, AEA, B&W, Amphenol, Saxton, J.W. Miller/Daiwa, Vibroplex.

THE VHF SHOP

BOX 349 RD 4
MOUNTAINTOP, PA 18707
717-868-6565

Lunar, Microwave Modules, ARCOS, Astron, KLM, Tama, Tonna-F9FT, UHF Units/Parabolic, Santec, Tokyo Hy-Power, Dentron, Mirage, Amphenol, Belden

Texas

MADISON ELECTRONICS SUPPLY

1508 MCKINNEY
HOUSTON, TX 77010
713-658-0268
Christmas?? Now??

Virginia

ELECTRONIC EQUIPMENT BANK

516 MILL STREET, N.E.
VIENNA, VA 22180
703-938-3350
Metropolitan D.C.'s One Stop Amateur Store. Largest Warehousing of Surplus Electronics.

Wisconsin

AMATEUR ELECTRONIC SUPPLY

4828 W. FOND DU LAC AVE.
MILWAUKEE, WI 53216
414-442-4200
Wisc. Wats: 1 (800) 242-5195
Outside Wisc: 1 (800) 558-0411
M-F 9-5:30
Sat 9-3

**SAY
YOU SAW
IT IN
ham radio!**

PRECISION PROCESSING



The E-CLIPS Model III
Provides total dynamic range control with very low distortion

- Selectable processing modes envelope compression or peak limiting
- Variable high and low frequency response equalization
- Five segment LED display
- Easy to install and use with any transmitter/transceiver

110

Introductory price—\$189.95 ppd.

For brochure with complete technical specifications contact

ANALOG TECHNOLOGY

P.O. Box 8964 • Fort Collins, CO 80525

NEW HAND MOLDABLE PLASTIC GOX™ SEAL
SEALS COAX FITTINGS FROM MOISTURE AND CORROSION

• Non-Conductive
• Permanent Long COAX Life
• Stays Flexible At Any Temperature
• Insures Low SWR
• Burns and Seals Over Odd Shapes and Difficult COAX Fittings
• Fast Easy Seal for All Antenna Connections
• Non-Contaminating

YES, WE HAVE IT!
TWO 5' x 1/2" ROLLS FOR \$5.95 ppd. **OR:**
FOUR 12' x 1/2" ROLLS FOR \$13.95 ppd.

Send payment with order **OR**, call for faster service (have charge card number ready).

BIRCH HILL SALES
P.O. Box 234
Peterborough, NH 03458
(603) 924-7959

118

GO MOBILE WITH YOUR H.T.!

Model I—Icom IC-2A/T, Etc.
Model K-1 for TR-2500
—slides on bottom of radio

Guaranteed!

Model K—TR-2400;
—powered thru battery plug
Model N—FT-208R
Model T—Simple mod for Tempo and all Santec

NOW FOR FT-208R & TR-2500

Model Y—FT-207R, Wilson
—fits into battery compartment

"A unique battery eliminator" HANDI-TEK Regulator allows constant hand-held operation from auto DC or base supply with no nicad drain and **WITHOUT RADIO MODIFICATION!** \$24.95 PPD in USA Calif. add \$1.50 Sales Tax.

142
HANDI-TEK
P.O. BOX 2205, LA PUENTE, CA 91746

flea market



RATES Noncommercial ads 10¢ per word; commercial ads 60¢ per word **both payable in advance.** No cash discounts or agency commissions allowed.

HAMFESTS Sponsored by non-profit organizations receive one free Flea Market ad (subject to our editing) on a space available basis only. Repeat insertions of hamfest ads pay the non-commercial rate.

COPY No special layout or arrangements available. Material should be typewritten or clearly printed (not all capitals) and must include full name and address. We reserve the right to reject unsuitable copy. **Ham Radio** cannot check each advertiser and thus cannot be held responsible for claims made. Liability for correctness of material limited to corrected ad in next available issue.

DEADLINE 15th of second preceding month.

SEND MATERIAL TO: Flea Market, Ham Radio, Greenville, N. H. 03048.

QSLs & RUBBER STAMPS — Top Quality! Card Samples and Stamp info — 50¢ — Ebbert Graphics 5R, Box 70, Westerville, Ohio 43081.

4D32 Transmitting tubes new at \$30.00 each. Limited supply. Collection of 30 years receiving tubes only one dollar each. Send list of needs for availability. Trade commercial test equipment for machinist tools from retired machinists. W5QJT, P.O. Box 13151, El Paso, TX 79913. (915) 581-2017.

WANTED: Old RCA, Western Electric, tubes, speakers, amps. (713) 728-4343, Corb, 11122 Atwell, Houston, Texas 77096.

NEED: Service manual/schematic for HQ-110. I'll copy and return or you send good copy. State price. N3ALA.

TRAVEL-PAK QSL KIT — Converts post cards, photos to QSLs. Stamp brings circular. Samco, Box 203-c, Wyncantskill, New York 12198.

WANTED: Operational Heath HW-8 transceiver. Dean Olson, Box 161, Box Elder, SD 57719

RADIO ITEMS before 1930 wanted. Buying battery operated radios, horn and cone speakers, radio tubes and parts, radio literature — books, catalogs, magazines, radio advertising signs, posters. Gary Schneider, 68428 Commonwealth Blvd., Parma Heights, Ohio 44130.

DIGITAL AUTOMATIC DISPLAYS for FT-101's TS-520's, and most others. Six 1/2" digits. Write for information. Grand Systems, P.O. Box 2171, Blaine, Washington 98230. (604) 530-4551.

ELECTRONIC CMOS Keyer kit pcb + parts only \$9.95 plus \$1.50 shipping. WI res. add 5% tax. Send for free information. BEL-TEK, PO Box 125H, Beloit, WI 53511.

COMPLETE DRAKE "C" LINE: R4-C, T4-C, AC-4, MS-4. Accessories incl. 1.5 kHz and .5 kHz filters, noise blander, 10 SW Xtals, cables and manuals. All excellent condx. \$700 Sony ICF 2001 digital AM/FM/SW portable rcvr. \$175. Mark. WB9AQI c/o Milwaukee Sound Studios, 610 N. Water, Ste. 240, Milwaukee, WI 53202. (414) 272-7085 (24 hrs).

RUBBER STAMPS: 3 lines \$4.50 PPD. Send check or MO to G.L. Pierce, 5521 Birkdale Way, San Diego, CA 92117 SASE brings information.

JOHNSON Matchbox \$25, Johnson 6&2 \$35, CRT test set \$10, Knight tube tester \$15, RCA mobile FM test set \$20. K6KZT, 2255 Alexander, Los Osos, CA 93402.

"THE SWAP LIST" has bargains galore. Subscribe now! 6 months for \$4.00; 1 year only \$6.50. The Swap List, Box 988-H, Evergreen, CO 80439.

ENGINEERING SOFTWARE — CP/M, MSDOS, TRSDOS, free flyer. PLOTPRO graph printing program. Linear/log/semilog, multiple plots, grid lines, labeling \$52.95. ACNAP -- analyzes active/passive electronic circuits. Monte-Carlo Worst Case, sensitivities \$52.95. SPP — Signal processing, FFT, linear/nonlinear, LaPlace, transient analysis, \$62.95. BV Engineering, Box 3429, Riverside, CA 92519. (714) 781-0252.

HAM RADIO MAGAZINE Collection: Bound volumes 1969, 1970, 1971, 1972, 1973, 1974, 1975. In HR binders 1976, 1977, 1978, 1979. Loose copies 1980, 1981, 1982, 1983. Best offer for lot. W4UCH, P.O. Box 1065, Chautauqua, NY 14722. (716) 753-2654.

REPAIR, ALIGNMENT, calibration. Collins written estimates \$25; non Collins \$50. K1MAN. (207) 495-2215.

FOR SALE: Yaesu FT DX400 transceiver. Has no final tune-up. \$150.00 shipped. Phone (518) 883-5007.

CHASSIS and cabinet kits. SASE K3IWK.

ELECTRON TUBES: Receiving, transmitting, microwave ... all types available. Large stock. Next day delivery most cases. Daily Electronics, 14126 Willow Lane, Westminster, CA 92683. (714) 894-1368.

WANTED: Cash paid for used speed radar equipment. Write or call: Brian R. Esterman, PO Box 8141, Northfield, Illinois 60093. (312) 251-8901.

WANTED: Old microphones, remote mixers other mic related items. All pre-1935. Box Paquette, 107 E. National Avenue, Milwaukee, WI 53204.

STERLING SILVER call sign jewelry pin or tack; \$11.95, alligator tie clip; \$19.95, all ppd. Info-SASE. Tom's Silver, PO Box 3758, Manchester, NH 03105.

ROHN TOWERS — Wholesale direct to users. All products available. Write or call for price list. Also we are wholesale distributors for Antenna Specialists, Regency, and Hy-Gain. Hill Radio, P.O. Box 1405, 2503 G.E. Road, Bloomington, IL 61701-0887. (309) 663-2141.

RECONDITIONED TEST EQUIPMENT \$1.00 for catalog. Walter, 2697 Nickel, San Pablo, CA 94806.

NH ALL BAND QTH. South slope, Crotched Mountain, Greenfield. Lodge and guest house at 920' elevation. 1200' from highway and power mains. 59 wooded acres, elegant privacy, paved access \$95,000.00. Clarence ("CW") Farr, Broker (603) 547-2053.

FOX-TANGO Newsletters — Since 1972, the prime source of modifications, improvements, and repair of Yaesu gear, free to Club members. Calendar year dues still only \$8 U.S., \$9 Canada, \$12 elsewhere. Includes five year cumulative index by model numbers, or send \$1 for index and sample Newsletter. Fox Tango Club, Box 15944, W. Palm Beach, FL 33416.

RTTY-EXCLUSIVELY for the Amateur Teleprinter. One year \$7.00. Beginners RTTY Handbook \$8.00 includes journal index. P.O. Box RY, Cardiff, CA 92007.

IMRA International Mission Radio Assn. helps missionaries — equipment loaned; weekday net, 14.280 MHz, 2-3 PM Eastern. Br. Frey, 1 Fryer Manor Rd., Larchmont, NY 10538.

"HAMS FOR CHRIST." Reach other Hams with a gospel tract sure to please. Clyde Stanfield, WA6HEG, 1570 N. Albright, Upland, CA 91786.

TENNATEST — Antenna noise bridge — out-performs others, accurate, costs less, satisfaction guaranteed, \$41.00. Send stamp for details, W8URR, 1025 Wildwood Road, Quincy, MI 49082.

WANTED: Early Hallicrafter "Skyriders" and "Super Skyriders" with silver panels, also "Skyrider Commercial", early transmitters such as HT-1, HT-2, HT-8, and other Hallicrafter gear, parts, accessories, manuals. Chuck Dachis, WD5EOG, The Hallicrafter Collector, 4500 Russell Drive, Austin, Texas 78745.

HAVE A-M CAPABILITY? Join S.P.A.M. (Society for Promotion A-M). Membership is free. Write S.P.A.M. c/o F. Dunlap, 14113 Stoneshire, Houston, TX 77060.

VERY in-ter-est-ing! Next 4 issues \$2. Ham Trader "Yellow Sheets", POB356, Wheaton, IL 60189.

QUALITY COMPONENTS Transco #11300 UHF relays dual 28VDC coils milspec new \$80.00. FXR UHF relay 26VDC coil hermetic milspec new \$45.00. Collins filter F455FA15 \$85.00. High voltage diode stacks 15kV one ampere milspec new \$9.25. Power solenoids 3PST 120A new \$45.00; 50A new \$35.00 28VDC coils. Carborundum #887 100 ohm 50 watt noninductive resistors new \$9.75. Prices prepaid insured. W6FR (714) 871-3607.

NEW 1.2 GHz antennas from NCG. Base or repeater use: (in-cleuds mounting hardware) #1260 - 17 step, 1/2 wave collinear, 10.2 dBi gain, VSWR less than 1.5-1, 100 watts, 50 ohm coax. \$145.00. #1217 - 17 step, 1/2 wave collinear, 10.8 dBi gain VSWR less than 1.5-1, 30 watts, 50 ohm coax. \$85.00. Mobile antenna: #1270M - 10 step, 1/2 wave collinear, 8.5 dBi gain, VSWR less than 1.7-1, 20 watts, type "N" connector \$54.50. For more information contact: NCG, 1275 North Grove St., Anaheim, CA 92806.

ATTENTION KENWOOD and Icom owners. Informative separate newsletters. 5th year of publication. Back issues available. Add more selectivity to your 430, 830, and 930. Magicom RF clipper processor for TS-120, 130, 430, 520 and 820. Call for prices. IC-730 FM kit \$79.95. TS-830S FM kit \$94.95. Send SASE (37¢) for free brochure to International Radio, Inc., 364 Kilpatrick Ave., Port St. Lucie, FL 33452 (305) 335-5545. Master/Visa accepted.

LIKE TO BUY, sell or trade? For the best deals, subscribe to the Ham Boneyard. A complete stockyard of radio and/or related electronic equipment. Second year, published twice monthly, 24 issues annually. Send SASE for free issue. 364 Kilpatrick Ave., Port St. Lucie, FL 33452.

FOR RENT: "Ham-Home", Northern Virginia, 5 miles southwest of Pentagon, 3 bedrooms, family room, fifty foot telephone pole, tribander, 14 el. two-meter, 40/80 meter dipole, 1/2 acre, fenced yard. Available August '84. K1CTK/4. Use callbook address. Phone 703-379-7437 evenings.

MARCONI WIRELESS TELEGRAPH CO. OF AMERICA. We have a small quantity of ORIGINAL STOCK CERTIFICATES, signed by the Vice-President and Treasurer of the Company, sealed, issued, and cancelled. MARCONI first proved that messages actually could be sent by wireless, and sparked the imagination of those who became the first HAM RADIO OPERATORS. These certificates, dated in the 1910's, are colorful with an exceptionally nice VIGNETTE of Miss Liberty sitting between globes of the East and West hemispheres, with transmission towers on each side. Each comes beautifully framed and matted, including glass protection, ready to add to the decor of any room or shack. ORIGINAL MARCONI CERTIFICATES cost much less than limited edition art works, represent the beginning of our great hobby, may increase in value (Scrippophily, the collection of old stock and bond certificates, is in its infancy and becoming more popular), represents the beginning of a giant corporation (RCA was formed with the express purpose of buying out the Marconi Wireless Telegraph Co. of America), makes a unique addition to any home, and makes a great gift. Ten day unconditional money back guarantee. Price complete and delivered (we pay shipping charges): \$49.95 (Pa. residents must add \$3 for sales tax). Send check (personal checks — O.K. Place your call on your check and we will ship immediately without waiting for the check to clear your bank), Money Order, or Master Card/VISA information to: AUTHENTIC CERTIFICATES, RD 2073, Fleetwood, Pa. 19522. Phone: 215-944-0627. Checks received after the MARCONI Certificates are sold out will be returned uncashed.

Foreign Subscription Agents for Ham Radio Magazine

Ham Radio Austria
Karin Ueber
Postfach 2454
D-7850 Loerrach
West Germany

Ham Radio Belgium
Sterehouse
Brusselsesteenweg 416
B-9218 Gent
Belgium

Ham Radio Canada
Box 400, Goderich
Ontario, Canada N7A 4C7

Ham Radio Europe
Box 2084
S-194 02 Upplands Vasby
Sweden

Ham Radio France
SM Electronic
20 bis, Ave des Clarions
F-89000 Auxerre
France

Ham Radio Germany
Karin Ueber
Postfach 2454
D-7850 Loerrach
West Germany

Ham Radio Holland
Postbus 413
NL-7800 Ar Emmen
Holland

Ham Radio Italy
Via Pordenone 17
I-20132 Milano
Italy

Ham Radio Switzerland
Karin Ueber
Postfach 2454
D-7850 Loerrach
West Germany

Ham Radio UK
P O Box 63, Harrow
Middlesex HA3 6HS
England

Holland Radio
143 Greenway
Greenside, Johannesburg
Republic of South Africa

Coming Events ACTIVITIES

"Places to go..."

ILLINOIS: The Quad-Co. ARC will sponsor the 27th annual "Breakfast Club" Hamfest, July 21 and 22, Terry Park, Palmyra. All other groups are invited. Please give prior notice to Hamfest Committee. Dancing and movies Saturday night. Bring a basket lunch. Sandwiches and soft drinks available on grounds. Games, contests, golfing and fishing. Bring your swap gear. Camping facilities open from Friday afternoon to Monday morning. Talk in on 3973 kHz. Write: Hamfest, c/o Quad-Co. ARC, 602-D East Walnut, Chatham, IL 62629.

SOUTH CAROLINA: The Charleston Amateur Radio Society will host the annual Charleston Hamfest, July 14 and 15, Omar Shrine Temple. Commercial tables \$40.00 (over 2, \$20.00 each additional). Flea market tables \$5.00 each. Talk in on 146.19/79. For information/table reservations: Hamfest Committee, P.O. Box 70341, Charleston Heights, SC 29405.

TEXAS: The Austin ARC and the Austin Repeater Org. will sponsor Summerfest '84, August 10, 11 and 12, Austin Marriott Hotel, I-35 at Hwy. 290. Admission \$5 advance (deadline July 31). \$7.00 at the door. Indoor swapfest, dealers' showcase, transmitter hunt. Featured speakers: KG5U, president of the NASA/Johnson Space Center ARC, KQ5I of AMSAT, K5FOG and WA5MWD on packet radio. Ladies' programs. Reserved swapfest tables \$1.00 each, limit two. Talk in on 146.34/94. For more information: Austin Summerfest '84, P.O. Box 13473, Austin, TX 78711.

WEST VIRGINIA: The 6th annual TSRAC Hamfest, Sunday, July 22 at Wheeling Park. 9 AM to 4 PM. Admission \$3.00 by reservation. Dealers, exhibits all under roof. Refreshments, family park activities, flea market, auctions, free parking. All spaces free both dealers and flea market. For brochure, information and map contact: TSRAC, Box 240, RD 1, Adena, OH 43901. (614) 546-3930.

TENNESSEE: The Radio Amateur Transmitting Society is pleased to announce the 6th annual Nashville Ham and Computer Fest, July 29, at the Nashville Municipal Auditorium. No admission charge. Tables available for \$5.00. For further information: SASE to Willie Porter, KB4BLL, 4907 Idaho Avenue, Nashville, TN 37209.

NEW YORK: The Allied Armored Force Amateur Radio National Emergency Team, (AFAR NET) will hold an eyeball bivouac, July 28, Sheraton Inn in Canandaigua starting at 1 PM. All Amateur Radio operators who have been assigned or attached to an armored unit are invited to attend the get-together. For additional information: Harry B. Thomsen, W2PJH, 348 Jefferson Avenue, Apt. 15, Canandaigua, NY 14424 Please SASE.

NEW JERSEY: Sussex County ARC will sponsor "SCARC '84", Saturday, July 14, at the Sussex County Fairgrounds, Plains Rd., Augusta. Doors open at 8 AM. Admission \$2. Indoor tables \$5 advance, \$6 at door. Tailgate space \$4 advance, \$5 at gate. Food and refreshments. Free parking. Talk in on 90/30 and 52 simplex. For further information: Donald R. Stickle, K2OX, Weldon Rd., RD #4, Lake Hopatcong, NJ 07849. (201) 663-0677.

WISCONSIN: The Eau Claire Amateur Radio Club's annual Hamfest, Saturday, July 14, 4-H Buildings in Eau Claire. 8 AM to 4 PM. Tickets \$2.00 in advance, \$3.00 at door. Free tables and coffee. Talk in on 31/91 and 52 simplex. For information, tickets SASE to Gene Lieberg, KA9DWH, 2840 Saturn Avenue, Eau Claire, WI 54703.

FLORIDA: The 11th annual Greater Jacksonville Hamfest, August 4 and 5, Orange Park Kennel Club, US 17 south near I-295. 8 AM to 5 PM Saturday and 9 AM to 3 PM Sunday. Registration \$4.00. Swap tables \$9/one day, \$15/weekend. Exhibitors, large swap table area, forums and programs. Special discounts and promotions available to exhibitors contracting for space prior to July 15. Plenty of free parking. For information, swap tables, registration: Mike Parnin, N4EPD, 6716 Diane Rd., Jacksonville, FL 32211.

MICHIGAN: The Copper Country Radio Amateur Association is hosting the 1984 Upper Peninsula Hamfest, July 28, Memorial Union Cafeteria, Michigan Technological University campus, Houghton. For further information contact: Howard Junkin, N8FHF, Co-chairman UP Hamfest, 106 West South St., Houghton, MI 49931. (906) 482-4630.

MONTANA: The Great Falls Area ARC's 50th annual Glacier-Waierton International Hamfest, July 20, 21 and 22 at Three Forks Campground on the southern edge of Glacier National Park. QCWA meeting and contests, 2m transmitter hunts. Pre-registration is \$8.50 and includes Saturday night dinner (bring

your own meat and utensils) and Sunday morning breakfast. Talk in on 52 and 34/94. For more information SASE to Shirley Smith, KC7OA, 1822 - 14th Avenue South, Great Falls, MT 59405.

MARYLAND: The Baltimore Radio Amateur Television Society again presents the BRATS Hamfest and Computerfest, Sunday, July 29, Howard County Fairgrounds, Route 144 at Route 32, West Friendship. Indoor tables with A/C \$20.00 each. Indoor tables no A/C \$10.00 each. Outdoor tailgating. RV hook-ups available. For table reservations and information: BRATS, P.O. Box 5915, Baltimore, MD 21208 or call Mayer Zimmerman, W3GXK (301) 655-7812. Talk in on 146.76 (-600), 147.03 (+600) or 52 simplex.

WEST VIRGINIA: Wheeling Hamfest, Sunday, July 22, Wheeling Park. Flea market, auction, dealers welcome. Under roof tables available. Admission \$3.00. For information/reservations: TSRAC, Box 240, RD 1, Adena, OH 43901. (614) 546-3930.

INDIANA: The combined LaPorte-Michigan City Amateur Radio Clubs will sponsor their Summer Hamfest, Sunday, July 15, LaPorte County Fairgrounds, State Road 2, LaPorte. 8 AM to 2 PM. Donation \$3.00. Indoor tables by reservation, 40¢/ft. P.O. Box 30, LaPorte, IN 46350.

KENTUCKY: The Central Kentucky ARRL Hamfest, sponsored by the Bluegrass Amateur Radio Society, Sunday, August 12, 8 AM to 5 PM, Scott County High School, Longlick Road and US 25, Georgetown. Tech forums, awards, exhibits. AC facilities. Free outside flea market space. Tickets \$3.50 advance and \$4.00 at gate. For information or tickets: Edward B. Bono, WA4ONE, P.O. Box 4411, Lexington, KY 40504.

NORTH CAROLINA: The WCARS annual Hamfest, July 28 and 29, Firemen's Training Center, Asheville. Admission \$4.00. Preregistration \$3.50 before July 15. Talk in 31/91, 16/76 and 52 simplex. For information: Nelda Williams, KA4WPM, P.O. Box 1488, Asheville, NC 28802.

PENNSYLVANIA: The Mid-Atlantic ARC announces its annual Hamfest, Sunday, August 12, 9 AM to 4 PM, rain or shine, Route 309 Drive-In Theater, Montgomeryville. Admission \$3.00 plus \$2.00 additional for each tailgate space. Bring your own table. Plenty of parking and refreshments. Talk in on WB3JQER, 144.66/06 or 146.52. For information: MARC, P.O. Box 352, Villanova, PA 19085 or call Bob Josuweit, WA3PZO (215) 449-9727

OKLAHOMA: The Central Oklahoma Radio Amateurs will host "Ham Holiday" and State ARRL Convention, July 21 and 22, Lincoln Plaza Inn & Conference Center, 4445 Lincoln Blvd., Oklahoma City, DX, Packet Radio, satellites, computers with RTTY and a host of special interest events. Unlimited free parking for cars and self-contained RV's. Dealers Saturday and Sunday. Flea Market Saturday only. Pre-registration by July 6, \$8.00; \$10.00 at the door. Saturday evening banquet \$14.00. Sunday QCWA breakfast \$7.20. Reserved flea market table \$5.00; \$8.00 at door (if available). Mail reservations to CORA, P.O. Box 44091, Oklahoma City, OK 73144.

MICHIGAN: ARRL State Convention, sponsored by the Livonia ARC with the help of nine other Radio Clubs. Friday, June 29 and Saturday, June 30, Schoolcraft College campus, 18600 Haggerty Road, Livonia. Friday evening "Eye-Ball Social", 7:30 PM at the Plymouth Hilton with a Wouff Hong initiation at Midnight. Convention opens Saturday, 8 AM to 5 PM. Exhibits, forums, seminars, YL activities, operating demos, state nets and more. Convention banquet Saturday evening, 7:30 PM at the Plymouth Hilton. Admission \$3.00 at the door; \$2.50 advance. Swap tables \$1.00/ft. and trunk sales \$5.00 space. Talk in on LARC Repeater 145.35 (-600) or the 146.52 simplex. For tables, trunk sales, tickets or information: Neil Coffin, W8GWL, Livonia ARC, P.O. Box 2111, Livonia, MI 48151.

NEW HAMPSHIRE: Fly-in to the 2nd largest Amateur Radio/electronic flea market in the state, Saturday, July 14, Manchester Municipal Airport. Sponsored by the New Hampshire FM Association. Starting time 9 AM. General admission \$1.00. Sellers \$5.00 with own table. Refreshments available. For information: Dick DesRosiers, W1KGZ (603) 668-8880 or Doug Aiken, K1WPM, 30 Meadowglen Dr., Manchester, NH 03103 (603) 622-0831.

OHIO: The Northern Ohio Amateur Radio Society's 7th annual ARRL approved NOARSFEST, July 21, Lorain County Fairgrounds, Wellington. 8 AM to 4 PM. Huge black-topped flea market area \$1.00 per car space. Setup 6 to 8 AM. Free overnight camping Friday night, no hookups. Dealers indoor 8' tables \$8.00 each. Donation \$3.00 advance, \$3.50 gate. Children under 12 free. Talk in on 144.55 - 145.15. Mobile checkin 146.52. For advance registration mail check to John Paul Jones, WA8CAE, 4612 Timberview Drive, Lorain, OH 44052 (216) 282-4256.

NORTH CAROLINA: The Cary ARC's 12th annual Mid-Summer Swapfest, Saturday, July 21, 9 AM to 3 PM, Lion's

Club Shelter, Cary (near Cary High School). Open auction starting at 1:00 PM. We sell anything! No commission. No admission. Talk in on 146.28/88; 147.75/15; 146.52/52. For information: Cary ARC, P.O. Box 53, Cary, NC 27511.

NEW JERSEY: The West Jersey Radio Amateurs' 6th annual Hamfest, July 15 (rain or shine) 9 AM to 3 PM, Super 130 Drive-in Theatre, Route 130, Edgewater Park. Registration \$3.00. Tailgating \$3.00 additional with own table. Vendors' only setup starting at 7 AM. For information or tickets SASE to: Mary Lou Shontz, N2CLX, 107 Spruce Lane, Route 16, Mount Holly, NJ 08060. (609) 267-3063.

MISSOURI: The 22nd annual Zero-Beaters ARC Hamfest, July 15, 9 AM to 3 PM, Washington, MO, Fairgrounds. Free admission. Free flea market area. Limited rental spaces under pavillion. Advance reservation advised. Cake walk, candy scramble, traders row, refreshments and food available. Talk in on 147.24-84, 146.52. For information: Zero-Beaters ARC, Box 24, Dutzow, MO 63342.

COLORADO: The Ski Country ARC's third annual Swapfest and CCARC meeting, July 28, 9 AM to 3:30 PM, CMC Building, 1402 Blake, Glenwood Springs. Tables \$5.00 each. Half table \$3.00. Speakers, demos. Talk in on 146.07/67. For information: Bob Ludtke, K9MWM, 1001 Grand Ave., Glenwood Springs, CO 81601. (303) 945-5966.

VERMONT: The annual ARRL International Hamfest, Saturday, August 11 and Sunday, August 12, Old Lantern Camp Grounds, Charlotte. Tickets \$4.00 for both days. Heterodynes under 12 free. Outdoor flea market space \$2.00; indoors \$5.00. Overnight camping available. Talk in on 34/94, 01/61, and 52 simplex. For information: Roger, WA10ZE, Burlington ARC President, P.O. Box 312, Burlington, VT 05402.

WASHINGTON: W7DK, the Radio Club of Tacoma, presents Hamfair '84, August 11 and 12, Olsen Auditorium, Pacific Lutheran University campus. Registration \$5.00. Trailer and dormitory space available on campus at reasonable rates. Saturday night banquet. Commercial space and flea market tables available by advance registration. Talk in on W7DK repeater, 147.88/28. For information or registration: Grace Teitzel, AD7S, 701 South 120th, Tacoma, WA 98444.

IOWA: The 18th annual Central States VHF Conference, July 27-29, Sheraton Inn, Cedar Rapids. Technical presentations, DXpedition reports and organizational meetings. Plan to attend and meet your friends. For more information: Barry Buelow, WA0RJT, 4110 Emerson Ave N.E., Cedar Rapids, IA 52402.

ILLINOIS: The DuPage Amateur Radio Club Hamfest/Computerfest will be held on Sunday, July 8, 1984, at the Downers Grove American Legion Post 80. Large outdoor flea market and swappers row. Indoor commercial exhibits available. General admission \$2.00, \$3.00 for swappers row sellers. Tickets available at the gate only. Plenty of free parking space. Food and drink available. Talk-in on 145.490 Rpt. or 223.74 Rpt. For more information, send SASE to W9DUP, P.O. Box 71, Clarendon Hills, IL 60514 or call 312-971-3298 between 8 A.M. and 9 P.M.

OPERATING EVENTS

"Things to do..."

JULY 21: The Tank-Automotive Command ARC will operate W8JPW from 1300 to 2000Z to commemorate the 43rd year of the Detroit Arsenal. Frequencies: Phone 7.274, 21.400 and 146.49 MHz. CW 7.055 from 1500-1700Z. Send 9 x 12 SASE with QSO number and frequency for certificate to W8JPW, U.S. Army Communications Command, Att: CCNC-TAC-M, 28251 Van Dyke, Warren, MI 48090.

SEPTEMBER 9-15: The Southern Counties Amateur Radio Association (SCARA) is planning to have a special events station during the Miss America Pageant. Check September Ham Radio for details.

AUGUST 4-5: The Wild Bunch 160 SSB Contest: 0000 GMT Aug. 4 to 2359 Aug. 5. Single operators only. Exchange: RST/State, Country or Province. 10 pts. per QSO. Multipliers: total number of states, countries. VES Plaque to winner. Deadline for logs September 6, 1984, to: KA1SR, R.J. Koziomkowski, 5 Watson Dr., Portsmouth, R.I. 02871.

JULY 14-15: The Eastern Michigan ARC (K8EPV) will commemorate the annual Port Huron to Mackinac Island Yacht Race. 1400Z to 0200Z both days. Frequencies: 3.910, 7.235, or 14.235. Phone 3.710, 7.110 or 21.110 CW. For a certificate send QSL with legal SASE to K8EPV (C.B.A.) or 654 Georgia, Marysville, MI 48040.

Advertisers check-off

... for literature, in a hurry — we'll rush your name to the companies whose names you "check-off"

Place your check mark in the space between name and number. Ex: Ham Radio 234

ARR	101	Madison	155
Alden	203	Martin Eng.	156
All Comm	102	Memphis Amateur	
All Elec.	103	Elec.	157
Alpha Delta	104, 307	Meshna	158
Aluma	105	Micro-Mart *	
Amateur-Wholesale		Microwave Filter	
.....	106, 107	159, 309
ARRL	108	Midwest Am.	160
Amidon	109	Mirage Comm.	313
Analog Tech.	110	Missouri Radio ..	161
ADM	111	Morning Dist.	162
Applied Inv.	112	Mosley	163
ATV Mag.	113	Mouser Elec.	164
Austin Antenna ...	114	NCG	165, 316
B & W *		W. H. Nail Co. ...	166
Barry *		Nampa	167
B.G. Micro		Nemal	168
.....	115, 116, 117	North American	
Birch Hill	118	Soar	310
Buckmaster	119	Nuts & Volts	169
Butternut *		Oak Hill Academy *	
C & A Roberts	120	Outprint	170
Ceco	121	P.C. Elec.	171
Certified Comm.	122	Palomar	315
Chipcom *		Philadelphia Resins	205
Comm. Concepts	123	Pipo Comm.	172
CES	124	Pro-Search	173
Comm. Consulting	306	RF Enterprises	174
Comm. Spec.	125	RF Products	175
Comp. Trader	126	Callbook	176
Connect Systems	127	Radiokit	177
Cushcraft	128, 301	Radio Warehouse *	
Cynwyn	305	Ramsey	178, 179
Dalbani	129	Robot Research	312
Drake *		SYT Corp.	311
Dynetic Systems	130	Sabadia Export	308
Electra	304	Sabre Comm.	302
EEB	131	Sartori	180
Encomm	132	Skylane Prod.	181
Eng. Cons.	133	Spectrum Int.	182
Fabtron	134	Spectrum West	183
Fair Radio	135	Spi-Ro Dist.	184
Falcon Comm. *		TNT Radio	185
Fluke *		Tel-Com	186
Fox Tango	136	Ten-Tec	
GLB Elec.	137	Texas Towers	187
Gem Quad *		Transleteronic	188
Ham MasterTapes	138	UNR-Rohn *	
HRB	139	Universal Elec.	189
Hamtronics, N.Y.	140	University Microfilms *	
Hamtronics, PA.	141	VHF Comm.	204
Handi-Tek	142	Vanguard	190
Henry Radio	143	Vector Radio	191
Icom	144, 145, 317	Vesty Co.	303
Info. Un	146	Vid-Com Comm.	192
Jensen	147	Westcom	193
Kantronics	148, 149	Western Elec.	194
Kaul-Tronics	150	Westlink	195
Kenwood *		Williams	196
Larsen Elec.	151, 314	World View Elec.	197
Lowrance	152	Yaesu	198
MFJ	153		
MHz Elec.	154		

*Please contact this advertiser directly.
Limit 15 inquiries per request.

July 1984

Please use before August 31, 1984

Tear off and mail to
HAM RADIO MAGAZINE — "check off"
Greenville, N. H. 03048-0498

NAME

CALL

STREET

CITY

STATE ZIP

MADISON

Electronics Supply

1508 McKinney
Houston, Texas 77010

Call for Quotes
713-658-0268

KDK FM2033	\$289.45
SANTEC ST142	299.95
ST440up (limited)	250.00
Accessories Available	
TOKYO HiPower	
HC2000 Tuner	289.95
HC400L	129.95
HC200	89.95
TOKYO HiPower Amps	LESS 15%
WELZ Meters	LESS 10%
TRIPLETT Model 50 VOM	59.00
FLUKE Model 77	
Digital Multimeter	115.00
COBRA, MAXON 49MHZ	
headset	39.95
FOXTANGO	LESS 10%
MIRAGE AMPS	LESS 12%
TS430S	RING US FOR A PRICE
FT757GX Mobile deluxe	749.95
GE 6146B	9.95
572B	65.00
VALOR mobile antennas	
75-10M	20.00 ea.
BOOKS-AMECO BOOKS & CODETAPES.	
ARRL, GILFER, SAMS, TAB, RIDER,	
UNIVERSAL, WRTVH, RADIO PUB.,	
CALLBOOKS	
ALPHA DELTA MACC-8	
Console	73.00
BENCHER, ST1, BY1,	42.95
ST2, BY2	54.95
VIBROPLEX, AMECO	
Preamps	Less 10%
EIMAC 3-500Z	99.95
ROHN 50' 25G Tower, 4 sections	
1 section 25AG-2 or	
25AG-3	269.00
BELDEN 9913 Solid Center Coax	
Foil — Braid Shield	45¢/ft.
8214 RG-8 Foam	43¢/ft.
100' 8214 — ends installed	45.00
BEARCAT DX1000	499.95
TRANSMITTING TUBES	CALL
SPECIAL!	
65-287 CALRAD SWR	
& POWER METER	\$29.95
<i>Measures output and reflected power at the same time. Easy to read, dual 100 microamp meter movements. Low insertion loss. May be left in line. Will handle up to 2000 watts. Good through 175 MHz. Size 4-3/4" long x 2-1/2" deep.</i>	
Ameco Code Records	2.50
Ameco General Book	
(pass it)	3.25
AEA Keyers	STOCK
FoxTango	10% OFF

1-800-231-3057

NIGHT NUMBERS
5-10 p.m. CST
Mon., Wed., Fri.
1-800-231-1064
INSIDE TEXAS
1-713-331-2235

Advertisers Index

Advanced Receiver Research	94
Alden Electronics	30
All Comm	41
All Electronics	98
Alpha Delta Communications	135
Aluma Tower Company	80
Amateur Wholesale Electronics	37, 71
American Radio Relay League	118
Amidon Associates	66
Analog Technology	129
Antenna Development & Manufacturing	70
Applied Invention	105
ATV Magazine	94
Austin Custom Antenna	66
Barker & Williamson	62
Barry Electronics	87
B.G. Micro	59, 60, 61
Birch Hill Sales	129
Buckmaster Publishing	105
Butternut Electronics	135
C & A Roberts, Inc.	23
Ceco	56
Certified Communications	121
Chipcom Corporation	70
Communications Concepts, Inc.	84
CES, Inc.	66
Communications Specialists	136
Computer Trader	135
Connect Systems	91
Cushcraft Corporation	10
Dalbani Corporation	108
R.L. Drake Company	29, 45
Dynetic Systems	83
Electronic Equipment Bank	38
Encomm, Inc.	67
Engineering Consulting	80
Fabtron Corporation	105
Fair Radio Sales	84
Falcon Communications	24
John Fluke Manufacturing Company	31
Fox Tango Corporation	115
GLB Electronics	62
Gem Quad Products	48
Ham MasterTapes	32
Ham Radio's Bookstore	30, 46, 62, 127
Hamtronics, N.Y.	112, 113
Hamtronics, PA.	53
Handi-Tek	129
Henry Radio	13
Icom America, Inc.	Cover II, 72
Information Unlimited	87
Jensen Tools	94
Kantronics, Inc.	8, 9
Kaul-Tronics	19
Trio-Kenwood Communications	2, Cover IV
Larsen Electronics	40
Lowrance Electronics	1
MFJ Enterprises	7
MHz Electronics	122, 123, 124, 125, 126
Madison Electronics Supply	132
Glen Martin Engineering	118
Memphis Amateur Electronics	127
John J. Meshna, Jr., Co., Inc.	111
Micro Mart Distributors	120
Microwave Filter, Inc.	86
Midwest Amateur Radio Supply	47
Missouri Radio Center	70
Morning Distributing	86
Mosley Electronics	106
Mouser Electronics	48
NCG	102
W.H. Nail Company	135
Nampa Satellite Systems	76
Nemal Electronics	66
Nuts & Volts	119
Oak Hill Academy ARS	80
Outprint	94
P.C. Electronics	56
Philadelphia Resins Corporation	80
Pipo Communications	87
Pro-Search Electronics	107
RF Enterprises	117
RF Products	84
Radio Amateur Callbook	48
Radiokit	117
Radio Warehouse	84
Ramsey Electronics	92, 93
Sartori Associates	135
Skylane Products	121
Spectrum International	46
Spectrum West	121
Spi-Ro Distributing	135
TNT Radio Sales, Inc.	105
Tel-Com	56
Texas Towers	68, 69
Transleteronic, Inc.	119
UNR-Rohn	94, 115
Universal Electronics	105
University Microfilms International	84
VHF Communications	13
Vanguard Labs	135
Vector Radio	48
Vid-Com Communications	119
Westcom Engineering	110
Western Electronics	115
Westlink Report	127
Williams Radio Sales	119
World View Electronics, Inc.	65
Yaesu Electronics	Cover III

ham radio

Reader Service

For literature or more information, locate the Reader Service number at the bottom of the ad, circle the appropriate number on this card, affix postage and send to us. We'll hustle your name and address to the companies you're interested in.

101 113 125 137 149 161 173 185 197 209 221 233 245 257 269 281 293 305 317 329 341
102 114 126 138 150 162 174 186 198 210 222 234 246 258 270 282 294 306 318 330 342
103 115 127 139 151 163 175 187 199 211 223 235 247 259 271 283 295 307 319 331 343
104 116 128 140 152 164 176 188 200 212 224 236 248 260 272 284 296 308 320 332 344
105 117 129 141 153 165 177 189 201 213 225 237 249 261 273 285 297 309 321 333 345
106 118 130 142 154 166 178 190 202 214 226 238 250 262 274 286 298 310 322 334 346
107 119 131 143 155 167 179 191 203 215 227 239 251 263 275 287 299 311 323 335 347
108 120 132 144 156 168 180 192 204 216 228 240 252 264 276 288 300 312 324 336 348
109 121 133 145 157 169 181 193 205 217 229 241 253 265 277 289 301 313 325 337 349
110 122 134 146 158 170 182 194 206 218 230 242 254 266 278 290 302 314 326 338 350
111 123 135 147 159 171 183 195 207 219 231 243 255 267 279 291 303 315 327 339
112 124 136 148 160 172 184 196 208 220 232 244 256 268 280 292 304 316 328 340

Limit 15 inquiries per request.

NAME _____ CALL _____

ADDRESS _____

CITY _____ STATE _____ ZIP _____

Please use before August 31, 1984

July 1984

AFFIX POSTAGE
OR
POST OFFICE
WILL NOT
DELIVER

ham
radio
magazine

READER SERVICE CENTER
P.O. BOX 358
ARLINGTON, MA 02174

ATTN: Reader Service Dept.

FCC LOWERS REQUIREMENTS — GET YOUR RADIO TELEPHONE LICENSE

FCC changes make obtaining a High-level Radio Telephone License much easier now. Eliminate unnecessary study with our short-cuts and easy to follow study material. Obtaining the General Radio Telephone License can be a snap! Sample exams, also section covering Radar Endorsement.

A small investment for a high-paying career in electronics.

\$19.95 ppd.

Satisfaction Guaranteed

SPI-RO DISTRIBUTING

P.O. Box 1538

Hendersonville, N. C. 28793

✓ 184



We now accept MC and VISA
Give card #, exp. date, and signature



DRAKE R-4/T-4X OWNERS AVOID OBSOLESCENCE

PLUG-IN SOLID STATE TUBES!

Get state-of-the-art performance.
Most types available

**INSTALL KITS TO UPGRADE
PERFORMANCE!**

- BASIC Improvement
- Audio Bandpass Filter
- Audio IC Amplifier

TUBES \$23 PPD KITS \$25 PPD

OVERSEAS AIR \$7

SARTORI ASSOCIATES, W5DA
BOX 832085
RICHARDSON, TX 75083
214-494-3093

✓ 180

SYNTHESIZED SIGNAL GENERATOR

MADE IN
USA



**MODEL
SG-100E**
\$399.95
plus shipping

• Covers 100 MHz to 185 MHz in 1 kHz steps with thumbwheel dial • Accuracy +/− 1 part per 10 million at all frequencies • Internal FM adjustable from 0 to 100 kHz at a 1 kHz rate • External FM input accepts tones or voice • Spurs and noise at least 60 dB below carrier • Output adjustable from 5-500 mV at 50 Ohms • Operates on 12 Vdc @ 1/2 Amp • Available for immediate delivery • \$399.95 plus shipping • Add-on accessories available to extend freq range, add infinite resolution, AM, and a precision 120 dB attenuator • Call or write for details • Phone in your order for fast COD shipment.

✓ 190

VANGUARD LABS

196-23 Jamaica Ave., Hollis, NY 11423
Phone: (212) 468-2720

BUTTERNUT ELECTRONICS COMPANY



Model 2MCV "Trombone"
Model HF6V
Model 2MCV-5 "Super Trombone"
THE WINNERS

Model HF6V—Completely automatic bandswitching 80 through 10 plus 30 meters. Outperforms all 4- and 5-band "trap" verticals of comparable size. Thousands in use worldwide since December 81! 160 meter option available now. retrofit kits for remaining WARC bands coming soon. Height: 26 ft/7.8 meters, guying not required in most installations.

Model 2MCV "Trombone"—omnidirectional collinear gain vertical for 2 meters having the same gain as "double- λ " types, but the patented "trombone" phasing section allows the radiator to remain unbroken by insulators for maximum strength in high winds. No coils "plumber's delight" construction and adjustable gamma match for complete D.C. grounding and lowest possible SWR. Height: 9.8 ft/2.98 meters.

NEW Model 2MCV-5 "Super-Trombone"—Same advanced features as the basic 2MCV but a full wavelength taller with additional "Trombone" phasing section for additional gain. Height: 15.75 ft/4.8 meters.

All BUTTERNUT ANTENNAS use stainless steel hardware and are guaranteed for a full year. For further information on these and other BUTTERNUT products write for our FREE CATALOG!

**BUTTERNUT
ELECTRONICS**
405 E. MARKET STREET
LOCKHART, TX 78644

EGBERT][+ RTTY - CW - XFER

for the Apple II, II+, IIe
Transmit & Receive with Software Only
NO TU REQUIRED

The Egbert][+ has RTTY/CW/XFER on the same disk! and features: split screen operation, type ahead buffer, selectable mark, space, shift and speed, change modes and speeds from menu, mailbox with selective call and save to disk. Provisions for up to 9 canned messages on each data disk, and much more.

FOR MORE INFO, OR ORDER, CALL OR WRITE:

W.H. NAIL COMPANY
275 Lodgeview Drive
Oroville, Ca. 95965

M/C

(916) 589-2043

VISA

Egbert][+ = 69.95 includes program, back up & documentation. USA Residents add \$2.50 for shipping. All others add \$6.00. Ca. Res. add 6% sales tax.

✓ 166

INCLUDE CALL SIGN WITH ORDER!

R-T HV Mark II



NEW, EASY-TO-USE DESIGN GET TRANSI-TRAP™ LIGHTNING PROTECTION

Protect your valuable equipment from antenna voltage surges caused by nearby lightning, high wind and static build-up. Keeps harmful ARC energy off equipment by safely shunting it to ground. Uses tested, field proven, and replaceable ARC-PLUG™ gas filled ceramic cartridge.

Model LT 200 watts @ 50Ω \$19.95
Model HT 2kw @ 50Ω \$24.95

Ruggedized Super Low Loss (.1dB @ 500 MHz)
Model R-T 200 watts @ 50Ω \$29.95
Model HV 2kw @ 50Ω \$32.95

See your local dealer or order direct. Pse. include \$2 for shipping and handling. MC and VISA accepted.

**ALPHA DELTA
COMMUNICATIONS**

P.O. Box 571, Centerville, Ohio 45459
(513) 435-4772

✓ 104

COMPUTER®

**TRADER
MAGAZINE**

★ ★ ★ LIMITED TIME OFFER ★ ★ ★
BAKER'S DOZEN SPECIAL!
\$12.00 for 13 Issues

Regular Subscription \$15.00 Year
Foreign Subscription: \$55.00 (air mail)
\$35.00 (surface)

Articles on MOST Home Computers, HAM Radio, hardware & software reviews, programs, computer languages and construction, plus much more!!!

Classified Ads for Computer & Ham Radio Equipment

FREE CLASSIFIED ADS
for subscribers

Excellent Display and Classified Ad Rates
Full National Coverage

CHET LAMBERT, W4WDR
1704 Sam Drive • Birmingham, AL 35235
(205) 854-0271
Sample Copy \$2.50

✓ 126

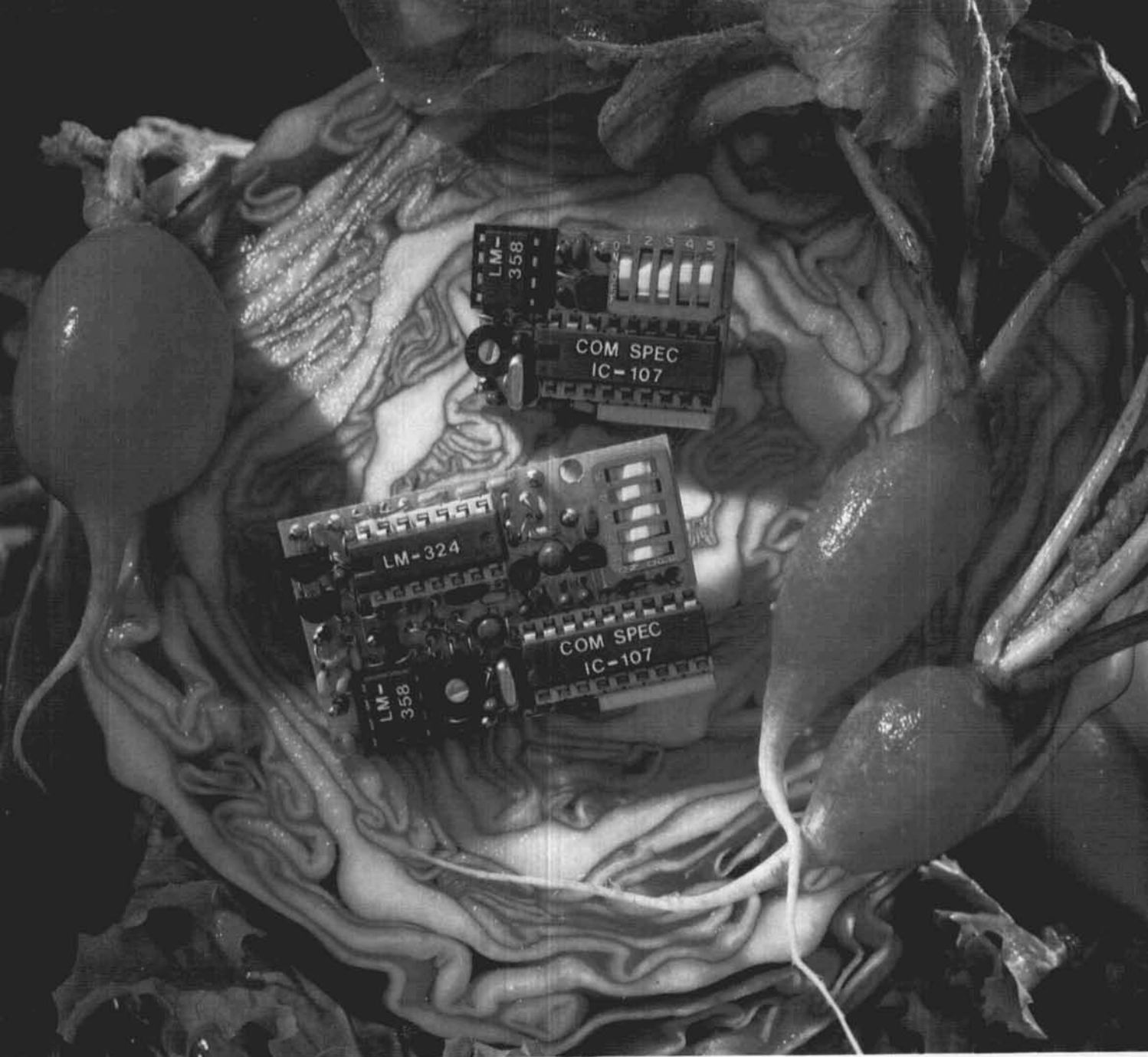

A fresh idea!

Our new crop of tone equipment is the freshest thing growing in the encoder/decoder field today. All tones are instantly programmable by setting a dip switch; no counter is required. Frequency accuracy is astonishing $\pm .1$ Hz over all temperature extremes. Multiple tone frequency operation is a snap since the dip switch may be removed. Our TS-32 encoder/decoder may be programmed for any of the 32 CTCSS tones. The SS-32 encode only model may be programmed for all 32 CTCSS tones plus 19 burst tones, 8 touch-tones, and 5 test tones. And, of course, there's no need to mention our one day delivery and one year warranty.

 **COMMUNICATIONS SPECIALISTS**

426 West Taft Avenue, Orange, California 92667
(800) 854-0547 / California: (714) 998-3021



✓ 125

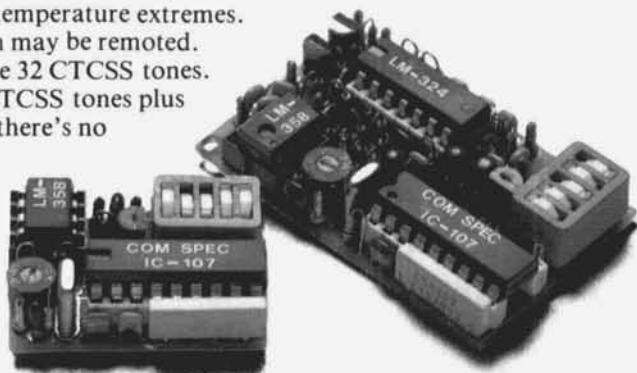

SS-32 \$29.95, TS-32 \$59.95

THE NEW LOOK AT YAESU



Tired of paying too much for your Ham gear? The new generation of Yaesu high-technology equipment is designed with you in mind! New advances in computer-aided design and robotics manufacture help you save money while being assured of the best... from Yaesu!!!

FT-757GX Line Affordable Excellence

GENERAL COVERAGE

Continuous coverage on RX from 500 kHz to 29.99 MHz in 10 Hz steps, with easy modification for MARS TX outside the Ham bands. WARC bands factory installed.

ACCESSORIES FACTORY PACKED

Electronic keyer, 600 Hz CW filter, speech processor, AM and FM units, all-mode squelch, Woodpecker noise blanker, and receiver preamp... all included in the base price, not expensive options!

FULL PERFORMANCE

Full CW QSK, full 100 watts output at 100% duty cycle (SSB/CW/FM), and full microprocessor control with dual VFOs, eight memories with bilateral memory/VFO swap, and personal computer (CAT System) compatibility make the FT-757GX a winner, at home or away.

FT-757GX ACCESSORIES

FP-757GX Switching Power Supply, FP-757HD Heavy Duty Power Supply (for 100% duty cycle operation), FC-757AT Automatic Antenna Tuner with Memory, FAS-1-4R Remote Antenna Selector, SP-102 Speaker with Audio Filters, MD-1B8 Desk Mic, MH-1B8 Hand Mic, FIF-232C Computer Interface Module.

FT-203R Line The Compact Companion

ULTRA-COMPACT DESIGN

Chip components installed by Yaesu's assembly robots significantly reduce circuit board size, resulting in a rugged, reliable transceiver with a weight of only 450g, including the standard FNB-3 battery.

HANDS-FREE VOX

A VOX (voice-actuated transmit) unit is built-in, allowing hands-free operation when the optional YH-2 Headset is used. Ideal for tower work, public safety, or other applications where manual PTT control is inadvisable. Level control provided.

FULL FLEXIBILITY

Built-in S-meter, thumbwheel frequency programming, HI/LOW power switch, busy channel and transmit indicators are standard. DTMF Encoder versions, as well as 220 MHz and 440 MHz lines, are coming soon!

FT-203R ACCESSORIES

FTS-7 CTCSS Module, FBA-5 AA Cell Case, YH-2 Headset, MH-12 Speaker/Mic, FNB-4 High-Capacity Battery, PA-3 Mobile Adapter, MMB-21 Mobile Hanger, NC-15 Quick Charger/AC Adapter, FTI-3 DTMF Keypad.

Next time you're in the market for a better rig, ask about Yaesu. Designed with care and built with pride, your Yaesu will get you through!

Prices and specifications subject to change without notice or obligation.



198
YAESU ELECTRONICS CORPORATION 6851 Walthall Way, Paramount, CA 90723 (213) 633-4007
YAESU CINCINNATI SERVICE CENTER 9070 Gold Park Drive, Hamilton, OH 45011 (513) 874-3100

KENWOOD

pacesetter in amateur radio

TS-930S "DX-traordinary" TS-930S

We call it "DX-traordinary" because the TS-930S has now become the favorite rig of the serious contesters! Its superior capability for full break-in split-frequency operation, the speed and convenience with which its eight memory channels can be accessed, its unsurpassed receiver dynamic range and its remarkable ability to select the desired signal during periods of heavy QRM, utilizing VBT, Slope tuning, IF Notch filtering, and tuneable audio filtering, have all combined to make this the rig that gives you the EXTRA EDGE!

The TS-930S is loaded with all the special features that you always wanted in an HF transceiver. Full coverage of the 160 through 10 meter bands, including the new WARC frequencies, (easily modified for HF MARS), plus a general coverage receiver that can tune any frequency from 150 kHz to 30 MHz. Operation in the SSB, CW, FSK, and AM modes, with selectable full or semi CW break-in. All solid-state, with 250 watts PEP input on SSB,

CW, FSK, and 80 watts input on AM. SWR/power meter. Triple final protection circuits plus two cooling fans built-in. 10-Hz step synthesized frequency control. Available with optional automatic antenna tuner built-in, another industry first! Dual digital VFO's. Eight memory channels that store both frequency and band information, with internal battery back-up, (batteries not supplied). Dual mode adjustable noise blankers, especially effective in eliminating "woodpecker" type interference. SSB IF slope tuning, for maximum rejection of interference. CW variable bandwidth, with pitch and side-tone control. IF notch filter. Tuneable audio peaking filter. Unique six digit white fluorescent tube digital display is easy-on-the-eyes during those long contests. RF speech processor, for higher average "talk-power." SSB monitor circuit. 4-step RF attenuator. VOX, 100-kHz marker. AC power supply built-in, 120, 220, or 240 VAC.

TS-930S Optional Accessories:

AT-930 automatic antenna tuner, SP-930 external speaker, with selectable audio filters, YG-455C-1 (500 Hz), YG-455CN-1 (250 Hz), YK-88C-1 (500 Hz) CW filter, YK-88A-1 (6 kHz) AM filter, all plug-in type. SO-1 commercial stability TCXO, MC-60A deluxe desk microphone, MC-80 and MC-85 communications microphones, MC-42S mobile hand microphone, TL-922A linear amplifier (not for CW QSK), SM-220 station monitor, PC-1A phone patch, SW-2000 SWR/power meter, 160-6 meter, SW100A SWR/power/volt meter 160-2m HS-4, HS-5, HS-6, and HS-7 headphones.

Isn't it about time you stepped into the winner's circle?

More information on the TS-930S is available from authorized dealers of Trio-Kenwood Communications, 1111 West Walnut Street, Compton, California 90220.



Specifications and prices are subject to change without notice or obligation.

