

# *ham radio* magazine

- amplifying your ht
- vacuum tube substitution
- 1750 meter operation
- rf synthesizers
- vertical phased arrays
- hybrid types explained

*BACK TO BASICS:  
DEFINING AMPS, VOLTS, AND OHMS*

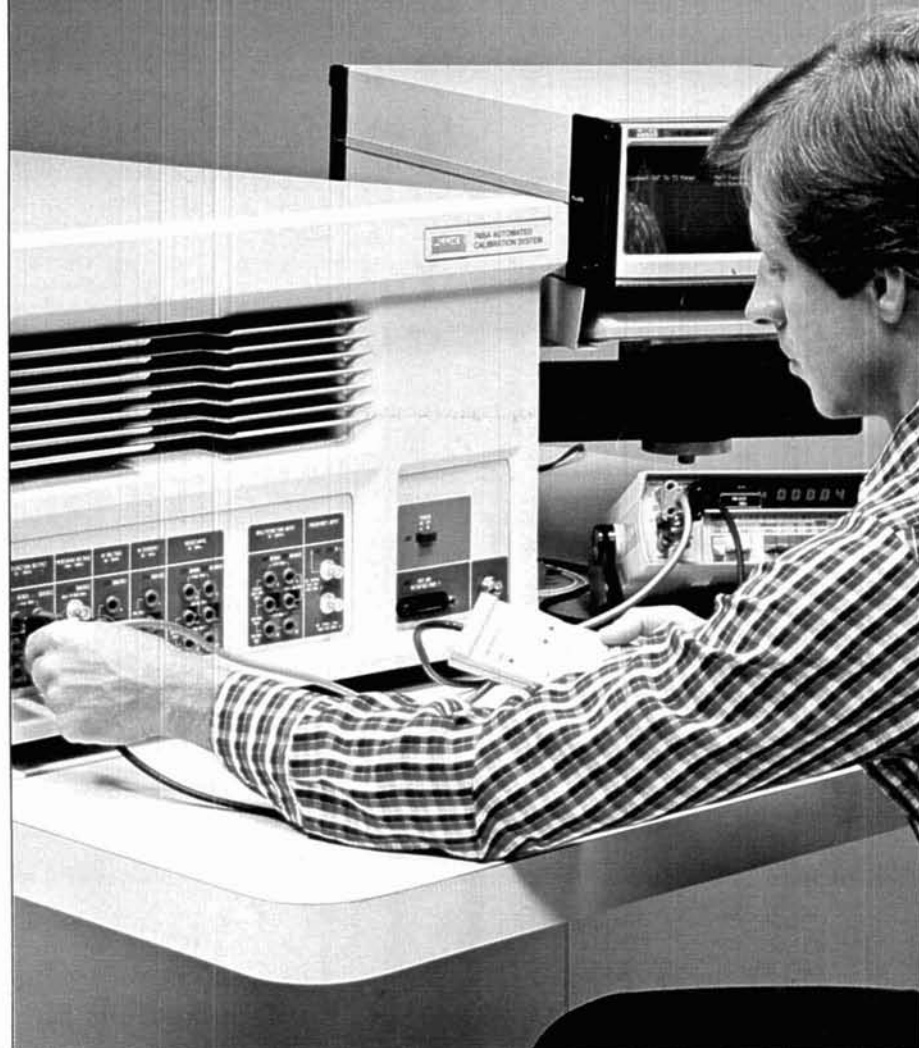

**hr**

focus  
on  
communications  
technology

# ICOM IC-45A

## Compact 440 — 449.995 MHz Mobile



**IC-45A**  
440-449.995 MHz Mobile  
10 Watts

**10 watts / 5 memories / 2 scanning systems in a 2"H x 5½"W x 7"D size / optional tone encoder / touchtone® microphone make the IC-45A the most popular 440-449.995 MHz mobile transceiver.**

**Dual VFO's.** Dual VFO's give an extra stored frequency for scanning (memory scan scans 5 memories plus 2 VFO's) and each VFO has a different tuning rate for easy QSY.

**Optional Encoder.** Plug-in to allow easy access. Field programmable.

**5 Memories.** Instant access to most used frequencies. VFO A information is transferred to the selected memory by pushing the W/CK button.

**Priority Channel.** Any memory channel may be monitored for activity on a sample basis, every 5 seconds, without disruption of a QSO conducted on a VFO frequency.

**LED Bar Meter.** Shows strength of received signal as well as relative transmitter

output from the fully protected final RF amplifier. APC (automatic power control) is used to detect SWR and adjust the power output to a safe level.

**Simplex/Duplex Operation.** Standard 600KHz offset initializes into radio at turn on. Offset may be changed by pressing the priority button while in VFO mode. Rotating the main tuning knob will now change the offset up or down and the offset will be displayed on the frequency readout.

**Adjustable Power Levels.** Pulling the squelch knob out places the unit into low power. Both the high and low power may be independently set to accommodate your simplex/repeater requirements or amplifier input characteristics.

**Nor/Rev Capability.** Use of the W/CK button in the duplex mode, allows one touch monitoring of the repeater input frequency. If simplex operation is possible you will know instantly.

**Scanning.** Pushing the S/S button initiates the scan

circuitry. With the mode switch in a memory position the unit will scan all 5 memories plus the 2 VFO frequencies.

With the mode switch in a VFO position, the unit will scan the band defined by memories 1 and 2. Full band scan or program band scan is selected internally.

The IC-45A has internally switched scanning choices of adjustable delay period after a carrier is received then resume scan, or resume on carrier drop.

**A Compact FM Mobile.** Fits in the smallest of places. Stacking, matching Mobile Mounts for UHF and VHF units make a complete mobile communications system for your car.

**Memory Backup.** When the optional IC-BU1 backup power unit is installed on the back of the IC-45A, memory will be maintained while transferring the unit from power source to power source. If the unit is not removed from power, it will maintain memory even when turned off with or without the IC-BU1.



**IC-RP3010**  
FM Repeater

Now a 10 watt 440Mhz FM repeater from the leader in VHF communications. The IC-RP3010 features high stability crystal controlled channels, CTCSS system, ID'er, remote control through a DTMF decoder and microprocessor controlled circuitry.



# ICOM

## The World System

# MFJ RTTY / ASCII / CW COMPUTER INTERFACE

Lets you send and receive computerized RTTY/ASCII/CW. Copies all shifts and all speeds. Copies on both mark and space. Sharp 8 Pole active filter for 170 Hz shift and CW. Plugs between your rig and VIC-20, Apple, TRS-80C, Atari, TI-99, Commodore 64 or most other personal computers. Uses Kantronics software and most other RTTY/CW software.

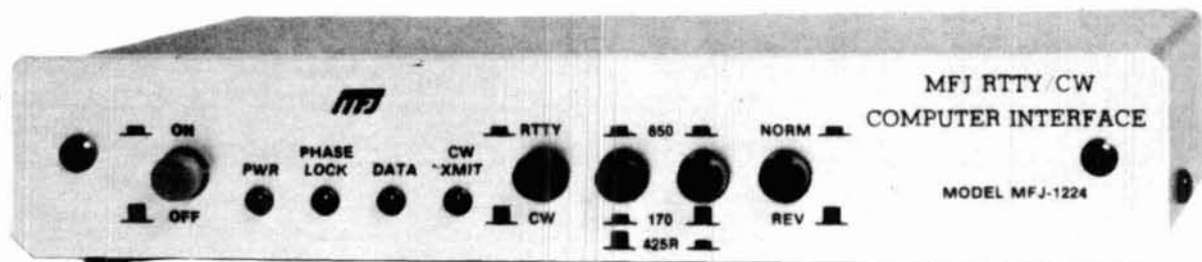

- Copies on both mark and space tones.
- Plugs between rig and VIC-20, Apple, TRS-80C, Atari, TI-99, Commodore 64 and most other personal computers.
- Uses Kantronics software and most other RTTY/CW software.

**\$ 99<sup>95</sup>**  
**MFJ-1224**

This new MFJ-1224 RTTY/ASCII/CW Computer Interface lets you use your personal computer as a computerized full featured RTTY/ASCII/CW station for sending and receiving.

It plugs between your rig and your VIC-20, Apple, TRS-80C, Atari, TI-99, Commodore 64, and most other personal computers.

It uses the Kantronics software which features split screen display, 1024 character type ahead buffer, 10 message ports (255 characters each), status display, CW-ID from keyboard, Centronic type printer compatibility, CW send/receive 5-99 WPM, RTTY send/receive 60, 67, 75, 100 WPM, ASCII send/receive 110, 300 baud plus more.

You can also use most other RTTY/CW software with nearly any personal computer.

A 2 LED tuning indicator system makes tuning fast, easy and positive. You can distinguish between RTTY/CW without even hearing it.

Once tuned in, the interface allows you to copy any shift (170, 425, 850 Hz and all shifts between and beyond) and any speed (5 to 100 WPM on RTTY/CW and up to 300 baud on ASCII).

Copies on both mark and space, not mark only or space only. If either the mark or space is lost the MFJ-1224 maintains copy on the remaining tone. This greatly improves copy under adverse conditions.

A sharp 8 pole active filter for 170 Hz shift and CW allows good copy under crowded, fading and weak signal conditions. Uses FET input op-amps.

An automatic noise limiter helps suppress static

crashes for better copy.

A Normal/Reverse switch eliminates retuning while stepping thru various RTTY speeds and shifts.

The demodulator will even maintain copy on a slightly drifting signal.

A +250 VDC loop output is available to drive your RTTY machine. Has convenient speaker output jack.

Phase continuous AFSK transmitter tones are generated by a clean, stable Exar 2206 function generator. Standard space tones of 2125 Hz and mark tones of 2295 and 2975 Hz are generated. A set of microphone lines is provided for AFSK out, AFSK ground, PTT out and PTT ground.

FSK keying is provided for transceivers with FSK.

High voltage grid block and direct outputs are provided for CW keying of your transmitter. A CW transmit LED provides visual indication of CW transmission. There is also an external hand key or electronic keyer input jack.

In addition to the Kantronics compatible socket, an exclusive general purpose socket allows interfacing to nearly any personal computer with most appropriate software. The following TTL compatible lines are available: RTTY demod out, CW demod out, CW-ID input, +5 VDC, ground. All signal lines are buffered and can be inverted using an internal DIP switch.

For example, you can use Galfo software with Apple computers, or RAK software with VIC-20's. Some computers with some software may require some external components.

DC voltages are IC regulated to provide stable

AFSK tones and RTTY/ASCII/CW reception.

Aluminum cabinet. Brushed aluminum front panel. 8x1 1/4x6 inches. Uses 12-15 VDC or 110 VAC with optional adapter, MFJ-1312, \$9.95.

## RTTY / ASCII / CW Receive Only SWL Computer Interface



**\$ 69<sup>95</sup>**  
**MFJ-1225**

Use your personal computer to receive commercial, military and amateur RTTY/ASCII/CW traffic.

The MFJ-1225 automatically copies all shifts (850, 425, 170 Hz shift and all others) and all speeds.

It plugs between your receiver and VIC-20, Apple, TRS-80C, Atari, TI-99, Commodore 64 and most other personal computers.

It uses Kantronics software which features CW receive 5-99 WPM, RTTY receive 60, 67, 75, 100 WPM, and ASCII receive 110, 300 baud, plus more.

An automatic noise limiter helps suppress static crashes for better copy, while a simple 2 LED tuning indicator system makes tuning fast, easy and positive.

In addition to the Kantronics compatible socket, a general purpose socket provides RTTY out, RTTY inverted out, CW out, CW inverted out, ground and +5VDC for interfacing to nearly any personal computer with most appropriate software.

Audio in, speaker out jacks. 4 1/2x1 1/4x4 1/4 in. 12-15 VDC or 110 VAC with adapter, MFJ-1312, \$9.95.

ORDER ANY PRODUCT FROM MFJ AND TRY IT-NO OBLIGATION. IF NOT DELIGHTED, RETURN WITHIN 30 DAYS FOR PROMPT REFUND (LESS SHIPPING).

- One year unconditional guarantee • Made in USA.
- Add \$4.00 each shipping/handling • Call or write for free catalog, over 100 products.

# MFJ

MFJ ENTERPRISES, INC.  
Box 494, Mississippi State, MS 39762

TO ORDER OR FOR YOUR NEAREST DEALER, CALL TOLL-FREE  
**800-647-1800**. Call 601-323-5869 in Mississippi and outside continental U.S.A. Telex 53-4590.





## TS-830S

"Top-notch"...VBT, notch, IF shift, wide dynamic range

The TS-830S has every conceivable operating feature built-in for 160-10 meters (including the three new bands). It combines a high dynamic range with variable bandwidth tuning (VBT), IF shift, and an IF notch filter, as well as very sharp filters in the 455-kHz second IF.

### TS-830S FEATURES:

- LSB, USB, and CW on 160-10 meters, including the new 10, 18, and 24-MHz bands. Receives WWV on 10 MHz.
- Wide receiver dynamic range. Junction FETs in the balanced mixer, MOSFET RF amplifier at low level, and dual resonator for each band.
- Variable bandwidth tuning (VBT). Varies IF filter passband width.
- Notch filter high-Q active circuit in 455-kHz second IF.
- IF shift (passband tuning).
- Noise-blanker threshold level control.
- Built-in digital display, (fluorescent tube), with analog dial.
- 6146B final with RF negative feedback. Runs 220 W PEP (SSB)/180 W DC (CW) input on all bands.
- Built-in RF speech processor.
- Narrow/wide filter selection on CW.
- SSB monitor circuit.
- RIT and XIT (transmitter incremental tuning).

### Optional accessories:

- SP-230 external speaker.
- VFO-230 external digital VFO with five memories, digital display.
- VFO-240 external analog VFO.
- AT-230 antenna tuner.
- YG-455C (500 Hz) or YG-455CN (250 Hz) CW filter for 455 kHz IF.
- YK-88C (500 Hz) or YK-88CN (270 Hz) CW filter for 8.83 MHz IF.
- KB-1 deluxe heavyweight knob.



## TS-530S

"Cents-ational"...IF shift, digital display, narrow-wide filter switch

The TS-530S SSB/CW transceiver covers 160-10 meters using the latest, most advanced circuit technology, yet at an affordable price.

### TS-530S FEATURES:

- 160-10 meters, LSB, USB, CW, all amateur frequencies, including new 10, 18, and 24 MHz bands. Receives WWV on 10 MHz.
- IF shift tunes out interfering signals.
- Built-in digital display (six digits, fluorescent tubes), with analog dial.
- Narrow/wide filter selector switch for CW and/or SSB.
- Built-in speech processor, for increased talk power.
- Wide receiver dynamic range, with greater immunity to overload.
- Two 6146B's in final, allows 220W PEP/180 W DC input on all bands.
- Advanced single-conversion PLL, for better stability, improved spurious characteristics.
- Adjustable noise-blanker, with front panel threshold control.
- RIT/XIT front panel control allows independent fine-tuning of receive or transmit frequencies.

### Optional accessories:

- SP-230 external speaker with selectable audio filters.
- VFO-240 remote analog VFO.
- VFO-230 remote digital VFO.
- AT-230 antenna tuner/SWR/power meter.
- MC-50 desk microphone
- KB-1 deluxe VFO knob.
- YK-88C (500 Hz) or YK-88CN (270 Hz) CW filter.
- YK-88SN (1.8 kHz) narrow SSB filter.



## TS-660

The TS-660 "QUAD BANDER" covers 6, 10, 12, 15 meters.

- FM, SSB (USB), CW, and AM
- Dual digital VFO's
- Digital display
- IF shift built-in
- 5 memories with memory scan
- UP/DOWN microphone
- All-mode squelch
- Noise blanker
- CW semi break-in/sidetone
- 10 W on SSB, CW, FM; 4 W on AM.

### Optional accessories:

- PS-20 power supply
- VOX-4 speech processor/VOX
- SP-120 External speaker
- MB-100 Mobile mount
- YK-88C, YK-88CN CW filters
- YK-88A AM filter.

# KENWOOD

TRIO-KENWOOD COMMUNICATIONS  
1111 West Walnut, Compton, California 90220

# ham radio

magazine

OCTOBER 1983

volume 16, number 10

**T. H. Tenney, Jr., W1NLB**  
publisher

**Rich Rosen, K2RR**  
editor-in-chief  
and associate publisher

**Dorothy Rosa Leeds**  
assistant editor

**editorial staff**

Alfred Wilson, W6NIF  
Joseph J. Schroeder, W9JUV  
Leonard H. Anderson  
associate editors  
Susan Shorrock  
editorial production  
Cover photo courtesy  
John Fluke Mfg. Co.

**publishing staff**

J. Craig Clark, Jr., N1ACH  
assistant publisher  
Rally Dennis, KA1JWF  
director of advertising sales  
Dorothy Sargent, KA1ZK  
advertising production manager  
Susan Shorrock  
circulation manager  
Therese Bourgault  
circulation

ham radio magazine  
is published monthly by  
Communications Technology, Inc  
Greenville, New Hampshire 03048-0498  
Telephone: 603-878-1441

**subscription rates**

United States: one year, \$19.50  
two years, \$32.50; three years, \$42.50  
Canada and other countries (via Surface Mail)  
one year, \$21.50; two years, \$40.00  
three years, \$57.00  
Europe, Japan, Africa (via Air  
Forwarding Service) one year, \$28.00  
All subscription orders payable in  
United States funds, please

**foreign subscription agents**

Foreign subscription agents are  
listed on page 102

Microfilm copies  
are available from  
University Microfilms, International  
Ann Arbor, Michigan 48106  
Order publication number 3076

Cassette tapes of selected articles  
from ham radio are available to the  
blind and physically handicapped  
from Recorded Periodicals  
919 Walnut Street, 8th Floor  
Philadelphia, Pennsylvania 19107

Copyright 1983 by  
Communications Technology, Inc  
Title registered at U.S. Patent Office

Second-class postage  
paid at Greenville, N.H. 03048-0498  
and at additional mailing offices  
ISSN 0148-5989

Postmaster send Form 3579 to ham radio  
Greenville, New Hampshire 03048-0498



## contents

**10 electrical calibration standards**  
Vaughn D. Martin

**17 rf synthesizers for hf communications:  
part 3**  
Craig Corsetto, WA6OAA

**34 vertical phased arrays: part 4**  
Forrest Gehrke, K2BT

**50 a one-weekend, 2-meter amplifier**  
James A. Sanford, WB4GCS

**58 vacuum tube substitution**  
Carleton F. Maylott, W2YE

**64 ham radio techniques**  
Bill Orr, W6SAI

**71 VMOS on 1750 meters**  
S.J. DeFrancesco, K1RGO

**80 hf hybrids: a second look**  
Henry S. Keen, W5TRS

<b>111 advertisers index and reader service</b>	<b>92 new products</b>
<b>8 comments</b>	<b>6 presstop</b>
<b>87 DX forecaster</b>	<b>90 product reviews</b>
<b>102 flea market</b>	<b>4 reflections</b>
<b>100 ham mart</b>	<b>76 technical forum</b>
<b>78 ham notes</b>	<b>70 short circuits</b>

# REFLECTIONS REFLECTIONS

## “The Old Man” lives

**I don't know how many of you remember “T.O.M.”** I'm not old enough myself to have read the column when it first came out (1916-1932?) but I sure became another avid fan of his while pouring through old volumes of *QST*. For those of you who have never had the pleasure, let me introduce you to one of the greatest cynical voices of Amateur Radio to have ever existed.

“T.O.M.” was a pseudonym assumed by an individual who was gutsy enough to call it as he saw it. He recognized situations for what they were and freely voiced his opinion. Usually the subjects were associated with either poor operating techniques or poorly functioning equipment. The comments in the form of a letter to the magazine would mysteriously appear on the editor's desk without any knowledge of who wrote it or where it had come from. There are those who believe it was written by Hiram Percy Maxim himself. In honor of the fine gentleman, whoever he may have been, I dedicate the following short piece and actively solicit comments.

**Rotten operating.** At the top of my list are *LISTS*. *Hate is a strong word, but it sure approaches how I feel about self-appointed “gods” who believe it is their inalienable right to “manage” a DX station's callers when they themselves have a hard time understanding the DX station because of low signal level at their location or a language “barrier.”* A case in point is a well known French-speaking DX station on 20 meters who puts an excellent signal into the East Coast at least. *One of the MC's in this case had a hard time hearing and understanding the station while others were copying him Q5. What sense does it make to take a list of 100 calls when the band is dropping out? What sense does it make to have two or three MC's trading off calls on the same frequency while the DX station just waits? I'm not talking just seconds — I'm talking many minutes — precious minutes as the vagaries of propagation does its thing.*

In defense of list operation there are those who say that the DX station requested help and couldn't handle the ensuing pile-up alone. I used to feel that way. But come on, folks! What is the real value of that contact if your call has been retransmitted by a more powerful station and perhaps even your signal report? *It cheapens the process and product. (Incidentally, what is the product? I won't get into that now. I'm not done with list operation yet.)*

**Dear “rare” DX station:** If you have a hard time sorting out the horde and want to use an MC, why don't you tell him to repeat the following: *“The DX station requests all callers to listen carefully, keep all calls short and only answer if your letters are acknowledged.”* Listen to Arild, 3X4EX, some day and see how he handles pile-ups — extremely effectively, I might add. If the DX station must have an MC, how about interspersing the list operation with “free” periods during which anyone NOT on the list may call in? The DX station just might be very surprised to see how many more stations he can work and also gain some confidence in the process. By the way, DX station, if there is some persistent Amateur calling out of turn and you just want to get him off your back, acknowledge him and just forget to log the contact, or more directly, *say so at the time.* (That'll either straighten everyone up or create pandemonium.)

I have to admit that on the lower bands there's more of a temptation to assist a friend or “twenty friends.” (I've done it myself and have been helped also.) But I've tried to do it right in as rapid fire a manner as possible, not retransmitting calls, and I have been extremely sensitive to even one dissenting voice on the frequency.

There, I've said it. There are many other areas of rotten operating that I can and will address as the need arises. Remember folks — this is our hobby — with a stress on the word *hobby*. Let's go back to basics, recalling that it's a privilege to use the frequencies and try to communicate a little more.

**Rich Rosen, K2RR**  
Editor-in-Chief

P.S. You still have an opportunity to express *your* opinions. Just grab your copy of the September issue, find the survey on the editorial page and go for it. Preliminary returns have been fantastic. I know it's impossible, and too much to wish for, but if everyone could just take the time to fill out the survey what a well-rounded poll that would make. It would help us provide to you the best ham radio magazine of the 80's.

# NEC

## Linear Power Bipolars

### NEL1300

- High linear power and gain

NEL1306  $P_{1dB} = 38 \text{ dBm typ.}$   
 $G_{1dB} = 7.5 \text{ dBm typ.}$

NEL1320  $P_{1dB} = 43 \text{ dBm typ.}$   
 $G_{1dB} = 6.0 \text{ dB typ.}$

- 13.5 volt operation
- Pt-Si/Ti/Pt/Au metallization system
- Emitter ballasting
- Silicon nitride passivation

From our latest line of NPN epitaxial power transistors, NEC now introduces the NEL1300 range of linear power bipolar devices. The series is available in a low cost metal-ceramic stripline package offering linear power output levels of 6 watts and 20 watts. Designed primarily for mobile and base station operation in the 1300 MHz band, the series is compatible with single sideband and other popular modulation modes requiring high linearity combined with high output power and gain.

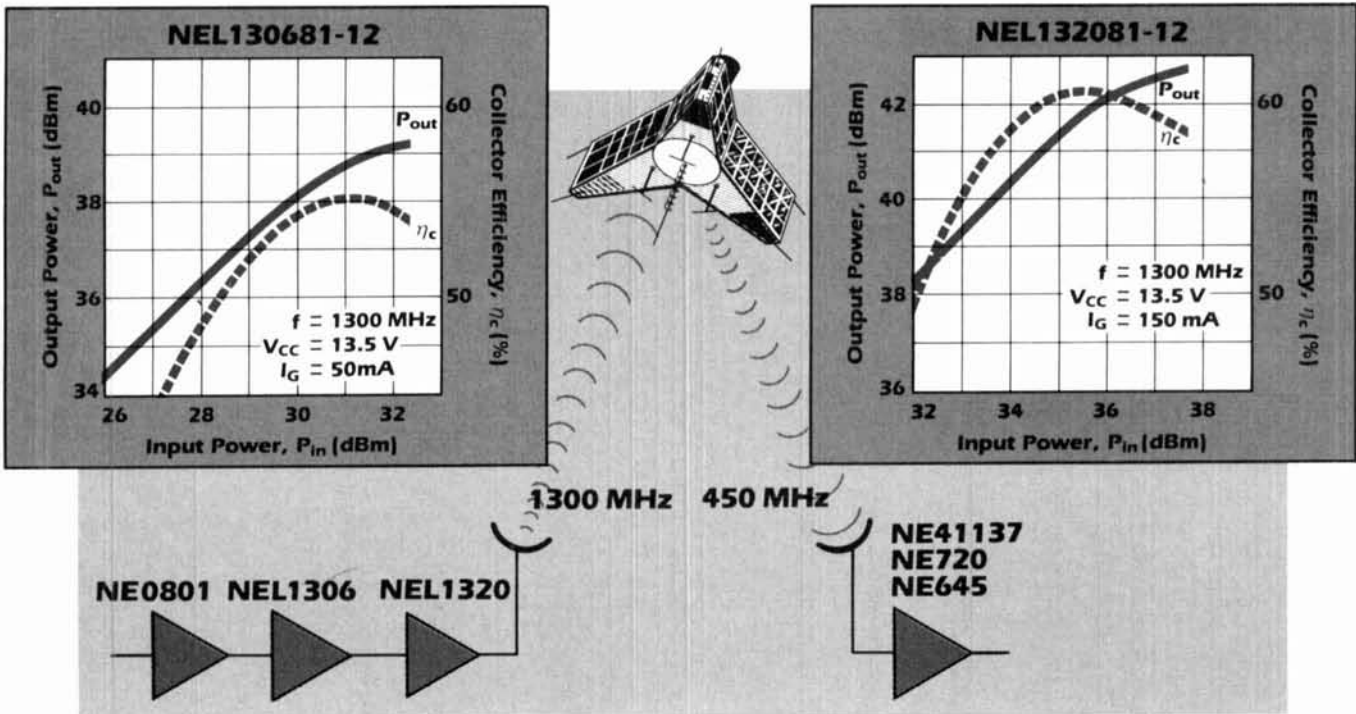

CALIFORNIA EASTERN LABORATORIES, INC.—U.S. and Canada  
Exclusive sales agents for NEC Corporation, Microwave Semiconductor Products.

Headquarters, Santa Clara, CA 95050 • 3005 Democracy Way • (408)988-3500 • Tlx. 34-6393 or 171197

In Europe Contact: NEC Electronics (Europe) GmbH • Oberrather Strasse 4 • 4000 Düsseldorf 30 • West Germany  
Tel 0211/650301 • Tlx. 841/8581353 or 8587419

AMATEUR RADIO-CABLE TV CONFRONTATION CONTINUES TO HEAT UP, with the ARRL filing a Motion for Expedited Action on its previous petition to have cable channels E (2 meters) and K (220 MHz) taken away from the cablecasters. That earlier petition, RM-4040, was filed in January, 1982, and cited numerous problems Amateurs throughout the country were having with cable system leakage. Attempts to resolve the problem through discussions with the National Cable TV Association have met with frustration, hence the latest League action to push the Commission toward a workable solution. The NCTA received an extension of time to file comments on the League's petition, so its response wasn't available at press time.

Excessive Leakage Will Cost A California CATV Firm a \$3000 fine, according to the FCC. Times-Mirror Cable Television was cited for leakage problems with its Encinitas (near San Diego) system, which was found to have high signal leakage on many frequencies including the Amateur bands. That system had been investigated previously by the FCC, but had claimed to have cleared up its leakage problems.

OCTOBER 28 IS THE NEW DATE FOR STS-9'S LAUNCH with W5LFL/Space/Mobile aboard, after delays in checking out some of the mission systems. W5LFL's hand-held is a custom-built Motorola, which passed NASA's rigorous compatibility checks after a minor interference problem with a telemetry system was found to be due to cable routing.

W5LFL's Primary Transmit Frequency Will Be 145.550 MHz, with 145.250, 145.530 and 145.570 as back-ups. He'll listen on 144.650, 144.700-144.850 (25-kHz channels), 144.910-145.090 (20-kHz channels), plus 145.350 and 145.450. The 25-kHz channel spacing is to conform with 2-meter usage in other parts of the world. In all cases he should specify the frequencies to which he'll be listening, as well as any special instructions such as call areas or states he's looking for, during his "even minute" transmit period.

EXTENSION OF AMATEUR LICENSE TERMS TO 10 YEARS should be the first Commission action for Amateur Radio following the August recess. Present licenses would not be extended, but all new licenses and renewals will be for the longer period. It's also expected that the present five-year grace period for renewal after expiration will be trimmed to two years.

Some Other Pending FCC Actions May Be Delayed, however, since the Commission has been reduced by law to five commissioners and only four are presently serving, following Anne Jones' departure. Few controversial issues are likely to be resolved until another Commissioner is on board, to avoid the possible stalemate of a two-two split.

OSCAR 10'S MODE B TRANSPONDER WORKS BEAUTIFULLY following turn on August 6. Users from all corners of the world appeared in the first few days, leading to comments that the downlink sounded more like 20 meters than 2—complete with pileups! Signals have improved steadily, and with the final position tweaking at the end of August, it's possible to work through OSCAR 10 well, with an ERP well under 100 watts.

Some Excessively Strong Signals Have Been Noted, as much as 20 to 30 dB above the beacon. Such signals cut down transponder gain, knocking weaker signals out completely. Users are asked to limit power so their downlink signals are no stronger than the beacon.

ARRL CW Bulletins Are Now Carried On OSCAR 10, 145.840 downlink. Both the AMSAT Tuesday night net and Westlink have also been relayed by the new bird.

Mode L Tests Are Set For Early September; listen for the 70 cm downlink signals Thursdays and Saturdays (GMT) + one hour from OSCAR 10's orbital apogee.

AMSAT's 1983 Annual Meeting Will Be November 12 near Laurel, Maryland. An excellent space symposium is planned; call AMSAT at (301) 589-6062 right away if you want to attend.

Two Russian Satellites, RS-4 and RS-5, are no longer being heard and appear dead.

ARRL WILL ADMINISTER "NO-CODE" LICENSE EXAMS if the FCC adopts no-code and the ARRL becomes the exam program administrator. Responding to questioners at the Pacific Division Convention, League President W4KFC also stated that membership status and privileges of no-code Amateurs would be decided by the League membership.

BEACON POWER HAS BEEN INCREASED TO 100 WATTS OUT in an addendum to the FCC's recent revision of the rules on Amateur power. Beacons had been limited to 100 watts input.

BELGIAN AMATEURS FACE LOSS OF MANY MICROWAVE BANDS if a bill proposed for the Belgian Parliament becomes law. According to G3WDG, 432-434 MHz plus the 23, 13, 9 and 6 cm bands are all involved. ON6AT/RTT solicits messages of support from other Amateurs.

LOG-KEEPING IS NO LONGER REQUIRED OF CANADIAN AMATEURS, after their Department of Communications deleted that part of its rules in a surprise move. However, a log showing CW activity will still be required in applying for some license endorsements.

NO MORE REPEATERS WILL BE COORDINATED ON TO 2 METERS in southern California. Following the lead of the Northern Amateur Relay Council, which recently ended its attempts to coordinate 2 meters due to overcrowding, the 2-Meter Area Spectrum Management Association (TASMA) agreed that the band could accommodate only a few limited coverage repeaters in remote areas. Any uncoordinated machines that appear could be subject to the sanctions against intentional interference cited by former FCC Private Bureau Chief Jim McKinney.





# HF, VHF, UHF, Across the spectrum. VARIAN EIMAC.

Ham operators know that EIMAC started in power tube development with the 150T in 1934. While the 150T is now a collector's item, EIMAC, a division of Varian, still holds leadership in power tube design with its 4CX250B, 8874, 3-500Z, 8877 and 3CX400U7; modern examples of EIMAC's continuing, innovative solutions to tough communication requirements.

EIMAC's proven power tubes are used in amateur service for heavy-duty, reliable performance in traffic; RTTY; SSTV; DX operation; VHF/UHF work; moonbounce, and exploration of the outer limits of communication techniques across the spectrum.

High quality and long life make EIMAC tubes the favorite choice of operator and equipment builder, amateur and professional alike.

For communication and research worldwide, choose EIMAC. For information on VARIAN EIMAC power tubes, call or write today. Or contact the nearest Varian Electron Device Group sales office.

VARIAN EIMAC  
301 Industrial Way  
San Carlos, California 94070  
415-592-1221

VARIAN EIMAC  
1678 S. Pioneer Road  
Salt Lake City, Utah 84104  
801-972-5000

VARIAN AG  
Grienbachstrasse 17  
Postfach  
CH-6300 Zug, Switzerland  
Tel: (042) 31 66 55  
Telex: 845-78789





## comments

### fan letter

Dear HR:

In regard to the heatsink cooling fan suggested by Ed Marriner, (*ham radio*, Ham Notes, July, 1983), perhaps a better scheme to minimize losses and unnecessary heating would be to substitute a 1- or 2- $\mu$ F capacitor for the dropping resistor.

This provides a use for the old "bathtub" capacitors (600V) which otherwise seem to end up in the trash barrel.

**Fred J. Norvik, W2GH**  
Albany, New York

### repeater etiquette

Dear HR:

The spectacular growth in the number of repeaters has resulted in operating practices we can all be proud of — as usual, the self-discipline of Amateur Radio operators has made itself evident. (A few minutes spent listening to the radio services that do not have stringent licensing standards will convince anyone that Amateurs are doing a good job.)

Some aspects of repeater use could use improvement; consider, for example, the following:

*Overuse and underuse of call signs.* Once every ten minutes and at the beginning and end of a QSO does the trick. Some Amateurs are beginning to use call abbreviations — typically, omitting the prefix and using only the body of their call. This is certainly unlawful and confusing to the listener.

*Non-substantial communications* — some repeaters are monopolized by Amateurs who talk by the hour and say very little. They usually break politely when asked to by a "call please" request but return to their meaningless gabbing as soon as the interruption has cleared. Another problem occurs when people continuously update each other on their whereabouts without apparent reason. In one case overheard recently, this type of never-ending QSO involved a man and wife who continually embellished their conversation with expressions of endearment.

The foregoing applies doubly to phone patch conversations. This is an important privilege; it should be guarded carefully.

It should be apparent that we are judged by what we say. I have two non-Amateur associates who ride to and from work with me. Their comments on conversations we overhear suggest what the public thinks. If we expect the public's support in matters of tv, rfi, and antenna erection, we must at least convince them that we use our privileges meaningfully. There are hundreds of acceptable subjects for discussion, both related to and not related to Amateur Radio; before you push the microphone button, ask yourself if you really have something to say!

*Inconsiderate operation* — how many times have you heard a station break into a QSO and take over, ignoring one or more of the original participants? I was testing an antenna not long ago with the help of another very cooperative station. Without any warning, a friend of the other operator broke in and interrupted the tests for several minutes. He signed off as if I were not even there. Eventually the tests were completed. Remember, when you are impolite, a lot of people are listening and forming their opinion of you (and Amateur Radio).

There are those who talk only to a fixed group and make the newcomer feel he did something wrong by just trying to say "hello." Single-purpose repeaters and nets and closed repeaters may have to be accepted. How-

ever, those who use repeater time and exclude others for no good reason ought to think twice: none of us has the exclusive right to any Amateur frequency.

On the whole, in my opinion, repeater operation deserves a very high mark. With a little more effort, it could get itself into the "straight A" class!

**George A. Wilson, Jr., W1OLP**  
Walpole, Massachusetts

### high spirits

Dear HR:

I don't know when I ever enjoyed *ham radio* as much as I did the May, 1983 issue on antennas. I'm in the process of mounting a vertical atop a 70-foot tower; I don't know how well it will work, but I'll try.

The article on "Log-Yagis Simplified" was really great; it was a big help to me. I just had to write and let you know about it.

Keep the good articles coming. I'll be looking for one soon on vertical antennas mounted above the beams on a tower.

**Fred Jones, WA4SWF**  
Louisa, Kentucky

### free QSL's

Dear HR:

Help! My poor secretary is being buried in a pile of coupons from *ham radio* readers who've requested the free QSL cards offered in our August advertisement.

We're making every effort to fill all requests as quickly as possible. But because of the tremendous response to our offer, some hams will have to wait.

If you've requested QSL cards but not yet received them, please be patient; we'll mail yours as soon as the next print order is received.

Thanks.

**Tom Bluesteen**  
Advertising Manager  
RCA Government  
Communications Systems  
Camden, New Jersey 08102

# NEW from BARKER & WILLIAMSON!

## 1.8 - 30 MHz. Continuous Coverage Antenna for Commercial and Amateur Service

### Model AC 1.8 - 30

The AC 1.8 - 30 Antenna uses only 80 feet horizontally, and, when space is limited, can be shortened even further with only slight loss of radiation efficiency.

Patent Pending

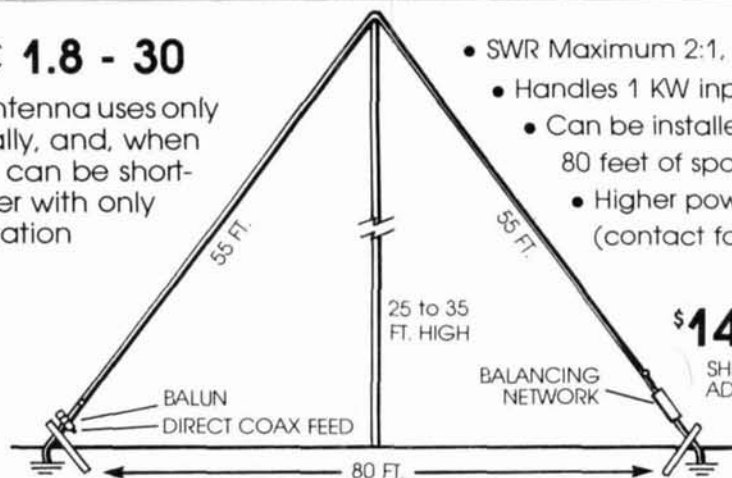

- SWR Maximum 2:1, 1.4:1 Average
- Handles 1 KW input ICAS
- Can be installed in approximately 80 feet of space
- Higher power models available (contact factory)

**\$149.50**

SHIPPING AND HANDLING ADD \$4.00



**BARKER & WILLIAMSON**

ALL OUR PRODUCTS MADE IN USA

Quality Communication Products Since 1932  
At your Distributors write or call, 10 Canal Street, Bristol PA 19007  
**(215) 788-5581**



✓ 115

## NCG WORLD BAND COMMUNICATIONS



### 15M

Tested and Proven 15 Meter Mobile Transceiver USB and CW  
Power-High 10 watts, Low 2 watts  
VFO Tuning, Noise Blanker  
Fine Tune  $\pm 1$  kHz  
Digital Frequency Counter  
13.8 VDC @ 3A Neg. Ground  
9.5" L x 9" W x 2.5" H  
All this PLUS the freedom of DXing

Regular Price: \$305.00

**SPECIAL PRICE: NOW \$279.00**

Just  
Slightly  
Ahead



### 160/10M

ALL NEW, with the features you have been waiting for  
HF 160-10 meters SOLID STATE Transceiver 200 watt PEP  
All 9 HF Bands ready to go  
AC/DC Power supply built in  
3-Step Tuning 1 kHz/100Hz/25Hz  
4 memories, Auto Scan  
Automatic Up/Down Tuning Advanced Systems  
Dual VFO, Solid State-Adjustment Free, IF Tuning, IF Offset  
Noise Blanker, Mic. Compressor  
VOX, CW Side tone, AC 120V DC 13.8 RTTY-Fax operation  
USB-LSB CW (Narrow CW filter optional).

Regular Price: \$1075.00

**SPECIAL PRICE: NOW \$949.50**



1275 North Grove Street  
Anaheim, CA 92806  
(714) 630-4541

Mail Order COD  
Visa Master Charge  
Cable: NAT COLGLZ

Prices and specifications subject to change without notice or obligation  
Calif. Res. add Sales Tax

✓ 166

Back to basics:  
the fundamentals  
of measurement

## electrical calibration standards

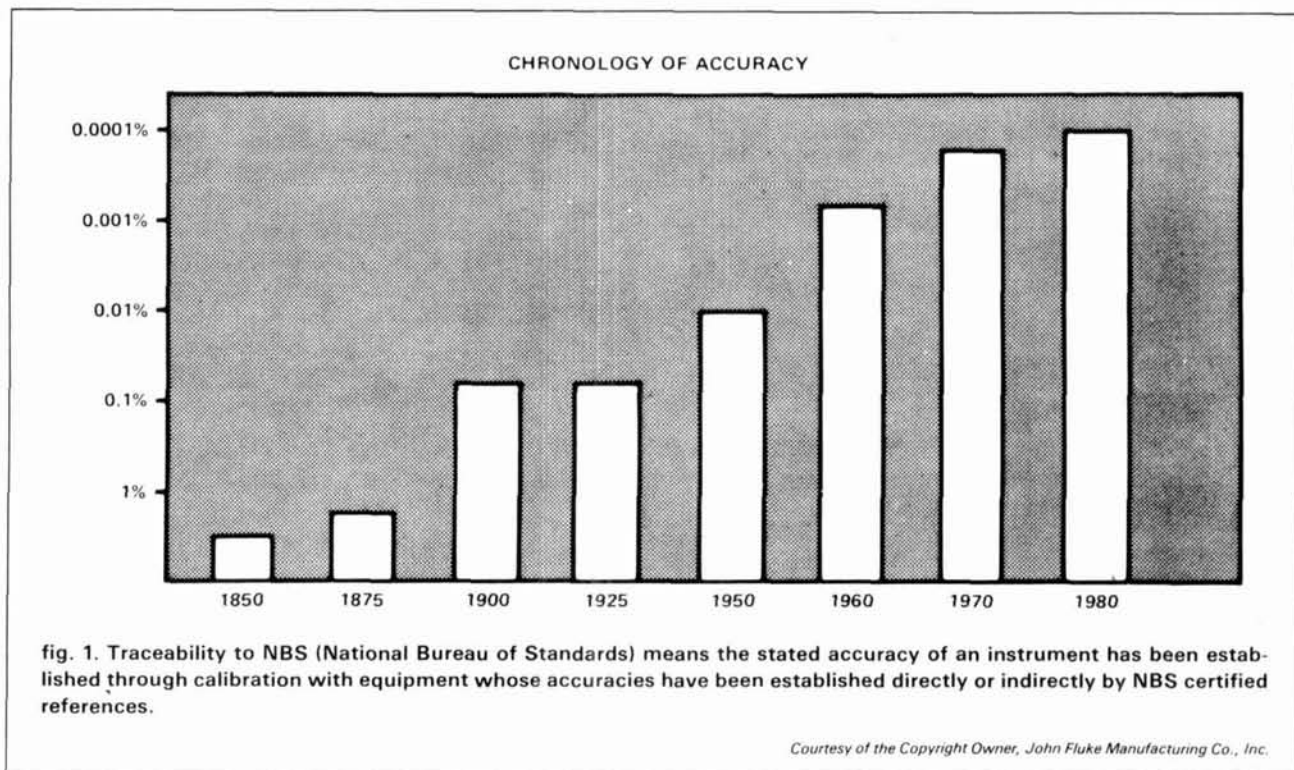

**Calibration** — whether it be checking the butcher's scales or fine tuning in a radio station — always involves certain principles and goals. These are to achieve accuracy and precision and to permit interchangeability in mass-produced items. Along with metrology, the science of measurement, calibration gives us confidence in the units of measure we use daily.

Before delving into the specifics of determining the five basic electrical quantities (the farad, ampere, volt, henry, and ohm), let's discuss and define some calibration philosophies. Calibration is the process of comparing the readings obtained on test and measurement instruments to those of carefully defined

references or standards of usually far greater accuracy in order to determine and then correct any deviations in the instrument. Two benefits result — uncertainty about the particular instrument under test is minimized and the instrument meets the requirements for traceability.

"Traceability" means that measurements can be traced back to the National Measurement System. (See **figs. 1** and **2**.) It exists on seven levels, all traceable to the NBS (National Bureau of Standards):

**By Vaughn D. Martin**, 114 Lost Meadows, Cibolo, Texas 78108

The *Tertiary Level* includes instruments used for production work, quality control, maintenance, and general measurement purposes.

*Local Secondary Standards* are used for calibration work and as references in certain production and engineering areas.

*Transfer and Inter-laboratory Standards* maintain or represent the basic electrical units locally and are sometimes referred to as Local Primary Standards.

*NBS Working Standards* are used to calibrate and certify local standards.

*NBS Secondary Standards* include Transfer, Check, and Scaling Standards. They are used to compare NBS Working Standards to the Legal Electrical Reference Units, the values of which are embodied in the NBS Primary Standards.

*NBS Primary Standards* are derived from the basic "SI" Units.

The *International System of Units (SI)* is the "glue" that holds the whole structure together.

### what is a standard?

It is possible to build a rugged platinum and iridium standard, but that standard would change, over time, as it became affected by its environment. While a standard could be arbitrarily defined without regard to the physical environment, such a standard would never be more than arbitrary. We could say that it was a standard derived or based upon a previous standard, or carefully examine the physical properties and elements of nature and advantageously base the standards on these properties. In actuality, the determination and derivation of each of the various standards employs some or all four of these techniques.

Consider this. The two most basic units of measurement, length and time, are derived as follows:

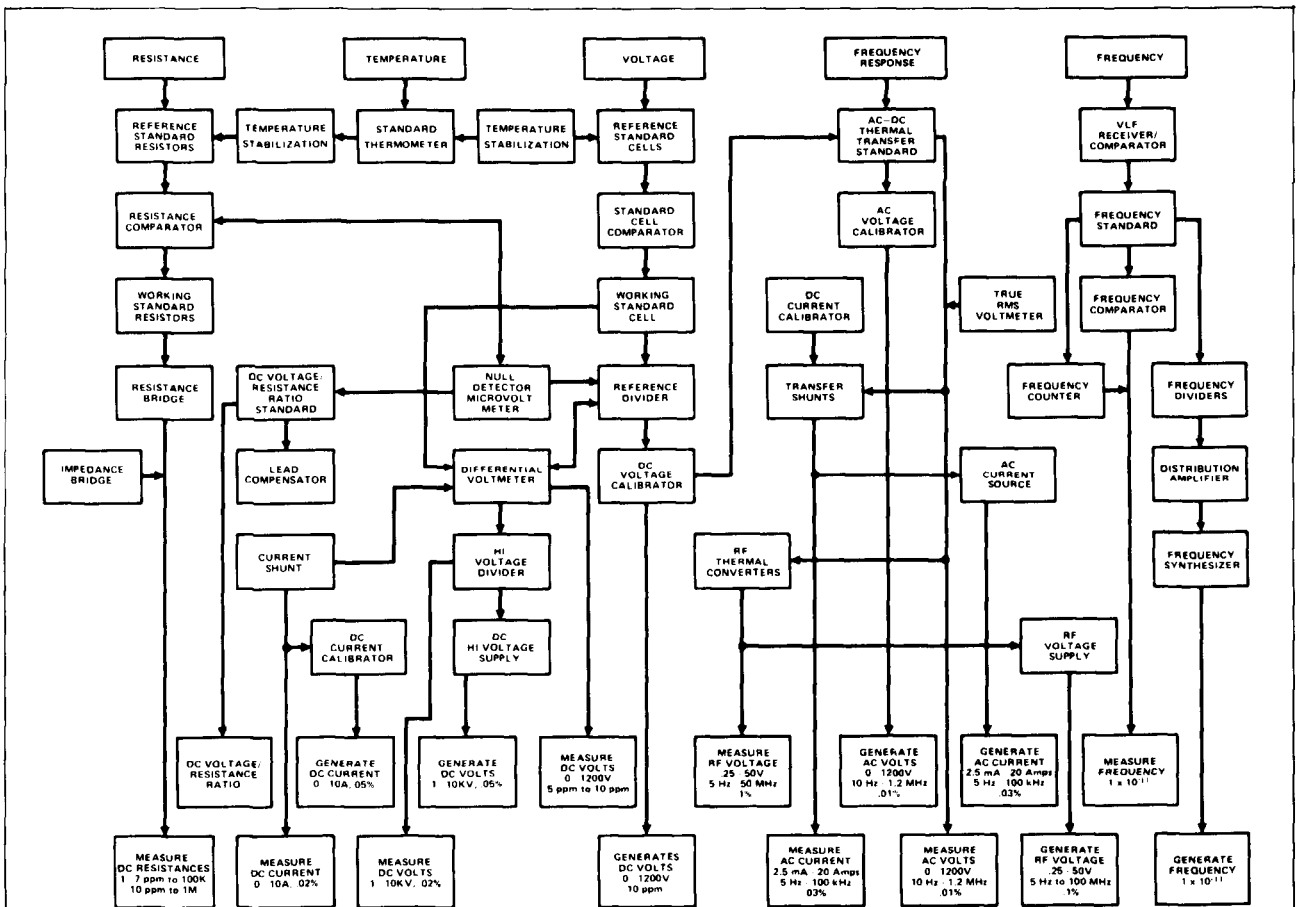

fig. 2. All measurements can be "traced" back to NBS National Measurement System.

Courtesy of the Copyright Owner, John Fluke Manufacturing Co., Inc.

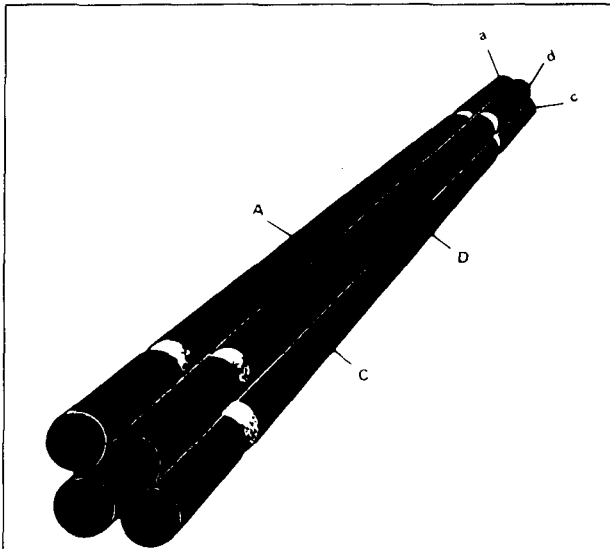

fig. 3. Basic structure of the first operating calculable capacitor, built at NBS in 1960. The calculated "cross capacitor" is the average of the capacitance (per meter of length) of the capacitor formed by rods A and C and that formed by B and D. When the "guard" sections a, are kept at the same voltage as A b, b at the same voltage as B, etc., then A, B, C, and D are very nearly as if parts of infinitely long rods.

Courtesy of the Copyright Owner, John Fluke Manufacturing Co., Inc.

length is based on the meter, which is a set number of wavelengths of radiation of the Krypton 86 atom. Measurement of time is based on the second, which is defined as a certain number of cycles of radiation of the Cesium 133 atom in the NBS atomic clock.

In electronic communications, one of the most vital concerns is with the propagation of electromagnetic waves, the maximum velocity of which is limited only by the speed of light. Now that we know the exact value of length and time, it is possible — through the use of Maxwell's equations in electrodynamics and electrostatics — to precisely realize the relationships existing between permeability and permittivity of free space.\* We can now derive one electrical standard from another (a technique mentioned earlier), and we do precisely this in the definition of the farad, the standard of electrical capacitance. Once we define the farad, all other electrical parameters fall into place.

### defining the farad

The farad was really not very precisely defined until 1956 when two Australian physicists, Thompson

\* $c$  (velocity of light) =  $\frac{1}{\mu_0 \epsilon_0}$  where  $\mu_0 \epsilon_0$  equals free space permeability and permittivity, respectively. Editor

and Lampard, contrived a technique of precisely measuring the lengths of two parallel metal rods in a special configuration, measuring the speed of light, and then calculating the value of the permittivity of free space. (See figs. 3 and 4.) Extensive work at the NBS followed, and these techniques were refined to the point where we now know the value of a farad to within  $\pm 2$  ppm (parts per million). Now that the farad, the unit of capacitance, is known, determination of all other electrical units can follow. Impedance to the flow of AC is based on capacitive reactance formulas, and other electrical parameters such as current can be defined from this.

It is known that a quadrature or four-element bridge is an electronic circuit that can be used to compare the impedance of capacitors, inductors, and resistors. (Refer to the lower left portion of fig. 5.) A stable source of known ac frequency is all that is left to power the bridge. Since frequency is the inverse of time and since time is quite well defined by the atomic clock in the NBS facility in Boulder, Colorado, we are home free. Realizing also that there is one frequency, called the resonant frequency, at which inductive and capacitive reactances cancel one another, we can now define the henry from the farad, since the farad is already known. In addition,

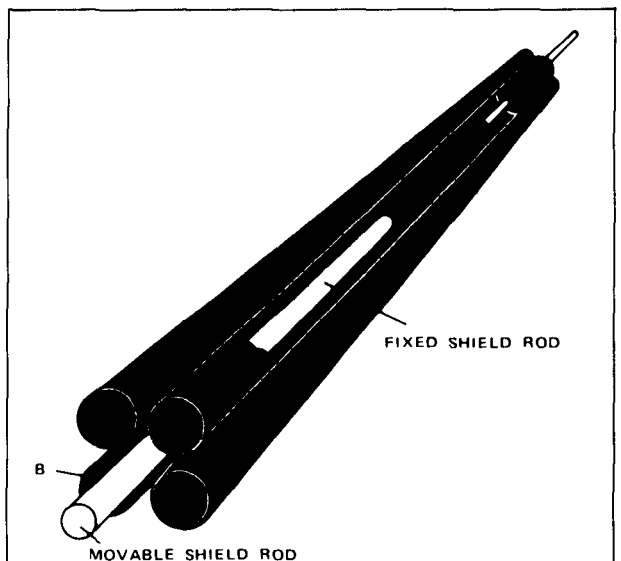
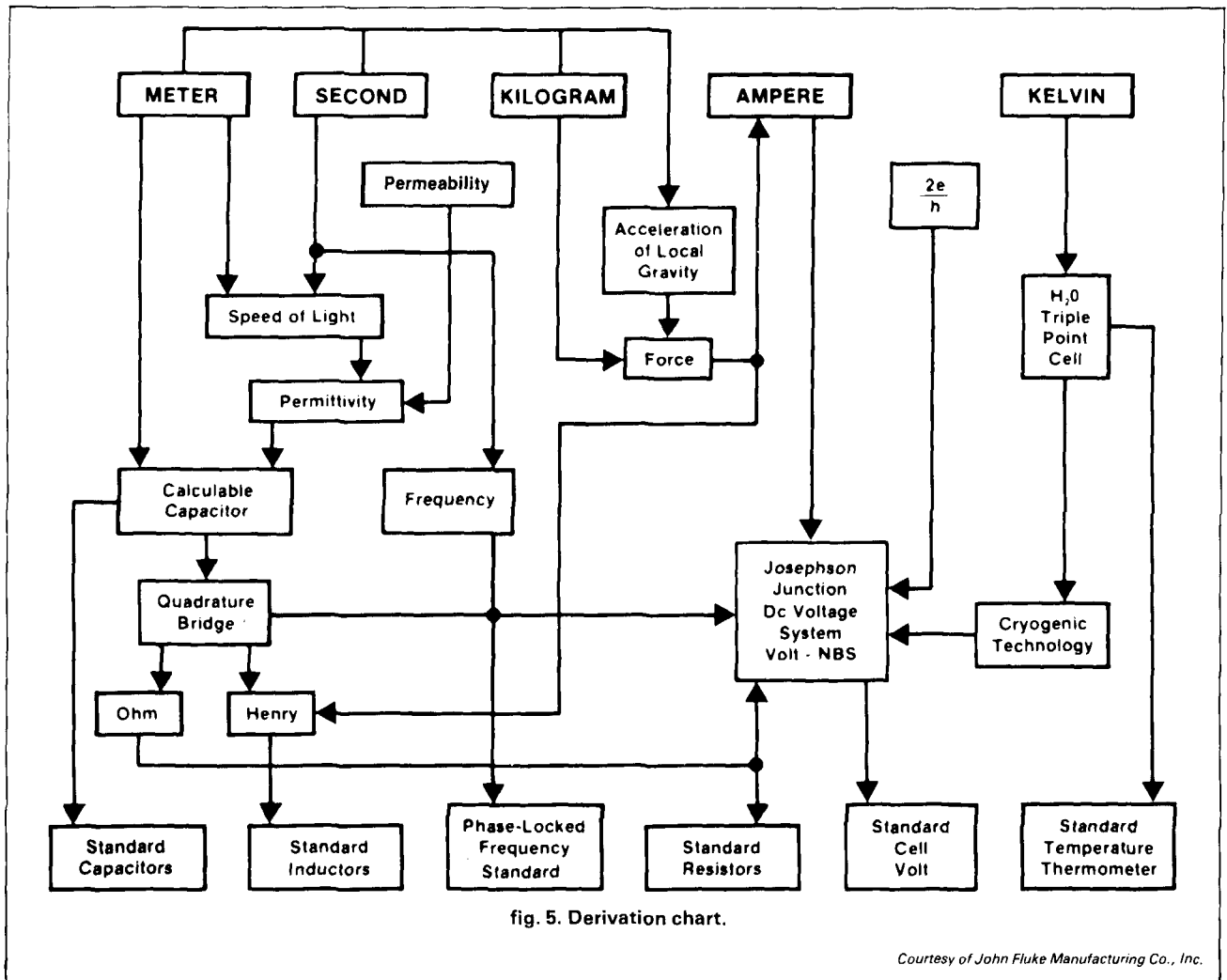

fig. 4. Basic structure of the variable cross capacitor used as standard of farad and ohm. The capacitance calculated is the change in cross capacitance when the movable shield rod is displaced through a measured distance along the axis. (Most of the rod D has been removed so the shield rod can be better seen. Note that the variable cross capacitor does not need guard sections. Omitted from this and the preceding figure is the metal shield that encloses the entire device.)

Courtesy of the Copyright Owner, John Fluke Manufacturing Co., Inc.



through an AC-DC transfer technique, the ohm has been defined to better than  $\pm 0.06$  ppm. In other words, the ohm was derived by calculating the inductance of a carefully designed coil, taking into account all physical dimensions and the number of turns and type of wire used.

An ac source was then applied to the coil, and by knowing its frequency and being able to calculate the coil's inductance, the third quantity in the formula for inductance reactance (the resistance in ohms) was then derived.

### the ampere

In Ampere's equation, current and its conductors are defined with respect to magnetic force. But first — in this hair-splitting business of defining absolute standards — *force itself* has to be very well defined. You will recall from physics that force is equivalent to *mass times acceleration*. The mass standard in the form of a kilogram bar of iridium and platinum al-

ready exists (in the BPIM, the French equivalent to our NBS). Next, we concern ourselves with acceleration — a special kind of acceleration, or the acceleration at local gravity at the site of the experiment. We derive acceleration by performing a drop test and measuring the distance traveled and the time elapsed.

Having now established force and inductance from previous work on the quadrature bridge arrangement as a result of first knowing capacitance and time, we can proceed in defining the ampere absolutely by placing one free coil inside a fixed coil and attaching the free coil to the arm of a balance. Current is run through the coils; this counterbalances the gravitational force, attracting a known mass which has been placed on the other arm of the balance. By opposing the downward force of local gravity on our known mass with magnetic fields resulting from the solenoid or magnetic "pulling" of our two coils and through Ampere's equation, an absolute determination of the unit of current, the ampere, is made.

## the volt

The last unit to determine in the set of electrical standards is the volt. This unit can be determined in one of two ways. First, a very precise one-ohm resistor could have one ampere of current passed through it; as a result of Ohm's law, a one-volt drop would exist across this one-ohm resistor (see fig. 6). This very precisely determined volt would then be compared to some standard saturated cells and the results of this comparison would then be the nominal mean value assigned to this reference group. By having a number of standard saturated cells, the drifting of one cell to a few millionths of a volt above an actual volt would be offset by another cell drifting a few millionths of a volt in the other direction and collectively averaging all readings, a mean or average would then be obtained. But there are two problems with this technique, which the NBS used until most recently. First, the cells drifted; and second, since the volt was defined as a result of first determining the ampere, the problem was compounded by the practice of precisely redetermining the ampere only once or twice per decade.

The second method of determining the volt was much better and resulted from the work of a British physicist, Brian Josephson. In 1962, he published a paper entitled "Possible New Effects in Superconductive Tunneling" and won a Nobel Prize for what was later to be known as the "AC (alternating current) Josephson Effect." This discovery offers the computer industry semiconductor switching speeds approaching the speed of light and probably more importantly, offers a means by which the absolute volt can be very accurately determined.

To understand this wonderful discovery, let's first examine what a Josephson junction is and how it is used. In its simplest terms, the Josephson junction is a frequency-to-voltage converter. The frequency/voltage ratio is precisely equal to two times the elementary electron charge divided by Planck's Constant. The NBS places a resonant thin-film tunnel junction in an environment approaching absolute zero (0 degrees Kelvin or -273.15 degrees C) (see fig. 7). The result is a superconductor. Next, they interface the Josephson junction to an external voltage comparator which is connected to a Reference Standard Cell and then apply a stable dc supply voltage to the junction. This junction is irradiated with microwave energy from a Klystron tube that is phase-locked or precisely tuned by being locked to WWVB, the radio station at the NBS in Boulder, Colorado, that broadcasts the atomic time signals. (The atomic clock's quartz crystal oscillator is extremely accurate, with a short-term frequency stability of 1

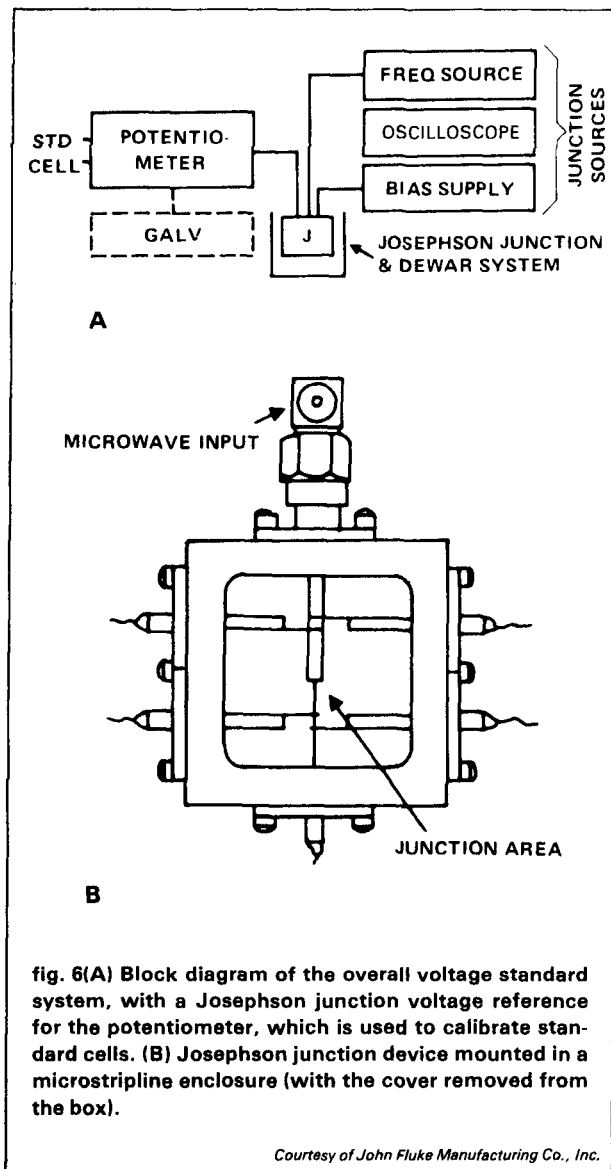

fig. 6(A) Block diagram of the overall voltage standard system, with a Josephson junction voltage reference for the potentiometer, which is used to calibrate standard cells. (B) Josephson junction device mounted in a microstripline enclosure (with the cover removed from the box).

Courtesy of John Fluke Manufacturing Co., Inc.

part per  $10^9$ .) The Josephson junction then generates a DC voltage between 1 and 10 millivolts, depending on the microwave frequency. The beauty of the system is that the resulting DC voltage has an accuracy approaching that of the Atomic Time Standard; furthermore, this can be reproduced anywhere in the world where WWVB or its equivalent can be received by radio and then processed for phase-lock control. The total system uncertainty in this voltage determining scheme is less than five parts per  $10^8$ .

The resulting junction voltage is transferred up to the 1-volt level and then used as a check standard on a reference group of saturated cells. This small group then serves as a check on the working standards used for the Bureau's voltage calibration services.

**ham radio**



# Morse Keyers & Trainers by AEA

AEA produces the finest Morse keyers and trainers in the world. All AEA keyers operate with any standard keyer paddle and offer selectable monitor tone, selectable dot and dash ratios, full weighting and selectable dot and/or dash memory. In addition, all our keyers offer full, semi-automatic or straight key modes. The keyers and trainers are keypad controlled which significantly reduces the complexity of operation for all the features offered. Each keyer has separate + and - keyed outputs for keying any modern transmitter. All keyers and trainers operate from 12 VDC (or 117 VAC with optional model AC-1 wall adaptor) which makes them ideal for portable operation. AEA microcomputer-based products are all subjected to a full burn-in and test prior to shipment, as well as being designed for maximum R.F. immunity.

## NEW BT-1



The **BT-1 Basic Trainer** is a hand-held computerized unit which teaches the code one character at a time at 18 or 20 words per minute. The BT-1 contains a self-paced training program that allows serious students the possibility of learning Morse to 20 wpm in as little as one month! Each character represents a separate practice session in which the character is first introduced by itself, and then presented 50% of the time along with all previously learned characters. There are no tapes to memorize, wear out, or break. No programming skills are necessary; the BT-1 is very easy to use. The tone oscillator can also be keyed for sending practice. An earphone jack is provided for private listening. The BT-1 will go as high as 99 WPM in 1 WPM increments. A battery operated version, the BT-1P, is available with wall charger and internal NICAD batteries.

The **KT-3 Keyer-Trainer** unit uses the teaching program used in the BT-1 trainer. In addition, the KT-3 features a full function Morse automatic keyer for keying any modern transceiver, or for sending practice. Speed range is 18-99 wpm for transmitting and 1-99 wpm for training.

The **KT-2 Keyer-Trainer** is a computerized keyer with all the features shown above, plus a Morse proficiency trainer. It is designed to increase your existing code as quickly as possible. The unit can be set for beginning practice speed, ending practice speed, and duration of practice. The microcomputer does all the rest by gradually increasing the speed during the practice time selected. You can even select between fast code (Farnsworth) or slow code methods. The characters are sent in 5 letter groups, or random word lengths. Two levels of difficulty can be selected; common Morse characters or all English Morse characters. A 24,000 character answer book is provided for the 10 separate starting positions. There is also random practice mode for which no answers are available.

## NEW KT-3



The **CK-2 Contester™ Keyer** is the lowest cost automatic keyer available featuring an automatic serial number generator for contesting. The CK-2 keyer features a large 500 character message memory that can be soft-partitioned into as many as 10 sections. An exclusive AEA edit mode makes it possible to correct mistakes made while entering messages or to insert words into previously established messages. Two different speeds can be set for fast recall in addition to a stepped variable speed control. The CK-2 features an automatic message repeat mode with variable delay-before-repeat for automatic CQ transmissions or TVI testing.

## CK-2 Contester™



## MM-2 MorseMatic™



The **MM-2 Morsematic Keyer** represents the most sophisticated paddle keyer ever designed and features two powerful microcomputers. The Morsematic incorporates virtually all the features (except the preset and stepped variable speeds) of both the CK-2 and KT-2 shown above. In addition, the MM-2 offers an exclusive automatic beacon mode which is invaluable for meteor scatter, moonbounce scheduling, or beacon operation.

**AEA** Brings you the Breakthrough!

**ADVANCED ELECTRONIC APPLICATIONS, INC.**

P.O. Box C-2160, Lynnwood, WA 98036  
206/775-7373 Telex: 152571 AEA INTL



# rf synthesizers for hf communications: part 3

## Design and build a 5 to 5.5 MHz synthesizer

The first two parts of this series discussed the basic PLL. This third section applies the developed theory to the design and construction of a 5.000 to 5.500 MHz synthesizer that steps in 1 kHz increments, demonstrates synthesizer design, and provides some solutions to problems that may occur in synthesizer design.

### synthesizer specifications

Loop performance specifications in a communications application such as an LO in a receiver or transmitter are phase noise, spurious content, and lock time. The best phase noise performance can be obtained with multi-PLL synthesizers<sup>1</sup> if space, complexity, and design time are not a problem. But because a simple single-loop synthesizer can be made more inexpensively and compactly than a multi-PLL synthesizer, design and construction of a simple single-loop synthesizer will be discussed here.

As a receiver LO, any spurs around the carrier can create spurious responses in the audio output. These spurs usually appear as reference feedthrough, power line (and harmonic) modulation of the VCO, and spurious oscillations in the VCO itself. Spurious oscillations in the VCO and power line modulation of the VCO are prevented by proper oscillator design, which includes good shielding and filtering. Reference feedthrough is largely a product of proper choice of loop parameters ( $f_n$ ,  $\xi$ , etc.) and type of phase detector.

In the design loop,  $-70$  dBc was chosen as a reasonable reference feedthrough limit, and  $-40$  dBc for any spurs created by power line 60 Hz (and harmonics). Since spurs at 60 Hz (and odd harmonics) originate largely from the power lines coupling into the VCO, shielding is an effective technique for reducing them. 120 Hz spurs are usually the result of

power supply ripple modulating the VCO and can be suppressed by filtering.

Lock time happens to be not only a function of loop bandwidth, but of frequency step size as well as the amount of frequency error, the designer considers acceptable for the "lock" state. Lock time for frequency synthesizers is usually specified as to within some  $\Delta f$  of the desired frequency before some specified time. Our loop must be within 1 Hz in less than 100 ms with a 1 kHz step in VCO frequency. A very rough equation for lock time for much less than 1 percent frequency error (relative to frequency step taken) is:

$$t_{LOCK} = 10/f_{\beta}$$

which is about 100 ms for a loop bandwidth of 100 Hz.

### the phase detector

The design loop with an  $f_{REF} = 1$  kHz requires a very narrow bandwidth to reduce reference feedthrough, while a wide loop bandwidth is required for a fast lock time. This design uses a relatively wide loop bandwidth ( $f_{\beta} = 100$  Hz) for rapid lock time. To achieve the  $-70$  dBc reference feedthrough requirement, a sample and hold (or an approximation of it) phase detector was used.

The phase detector is part of Motorola's MC145151 PLL IC. This phase/frequency detector goes tri-state (open circuit) with zero phase error at its inputs. As long as zero phase error is maintained, there will be no reference feedthrough. However, there is always a small amount of reference feedthrough, since zero phase error cannot be maintained indefinitely because of VCO drift, etc., which causes the phase detector to generate occasional corrective pulses (at an  $f_{REF}$  pulse rate).

### programmable divider

The MC145151 PLL IC contains a programmable divider usable to at least 15 MHz at a supply voltage of 5 volts and a signal voltage of 500 mV peak-to-peak. The maximum division ratio is 16,383. It uses a straight binary input (not BCD), which facilitates linking to a computer, though not thumbwheel switches.

By Craig Corsetto, WA6OAA, 4312 Marlowe Drive, San Jose, California 95124

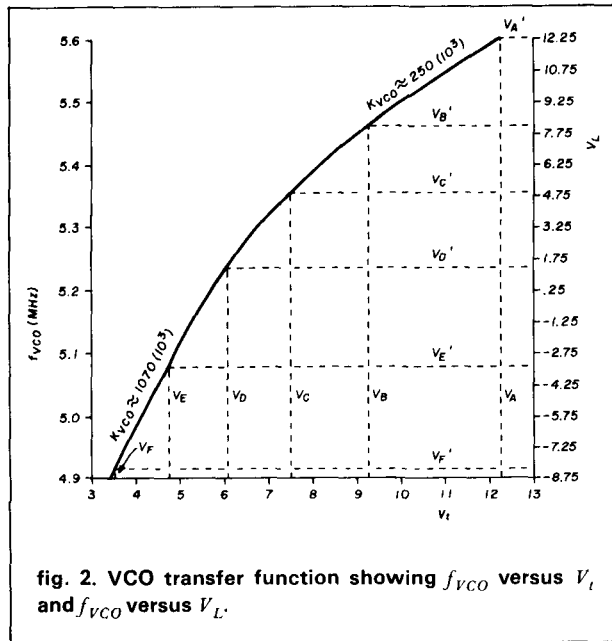
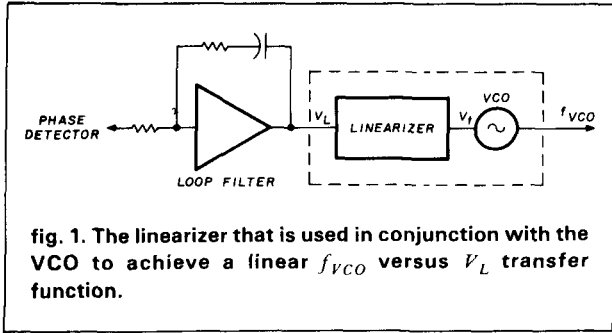

## the VCO

In this narrow-loop bandwidth synthesizer design low spurious content and good phase noise performance directly relate to the VCO physical and electrical design. In addition it is also important that the VCO has a low frequency drift rate (to reduce reference feed-through), linear transfer function (to keep loop bandwidth and damping reasonably constant), and be well filtered and shielded (to reduce modulation of the VCO by power supply ripple and induced 60 Hz from power wiring).

VCO frequency drift can increase reference feed-through by forcing the phase detector to generate correction pulses (which are not completely filtered by the loop filter) which in turn modulate the VCO. This is especially important when the reference frequency is close to the loop bandwidth, as is the case in this loop. Common contributors to frequency drift are the varactor diodes, toroidal core inductors in the resonator (if used), or excessive power in the resonator (unfortunately one of the requirements for a high signal-to-noise floor ratio for the oscillator).

Because a short lock time is required and  $f_{REF}$  is close to the loop bandwidth, then  $K_{VCO}$  must be fairly constant across the VCO frequency range in order to hold the loop bandwidth close to its designed value (and therefore reference feedthrough). Usually all that is required is to use the most linear section of the VCO tuning curve; its size dependent upon an acceptable value of nonlinearity. If the section of the VCO tuning curve used is small, this means a higher  $K_{VCO}$ , and the VCO will be more sensitive to unwanted signals on its tune line. The approach chosen here is to use a linearizer in combination with the VCO (fig. 1) to very closely approximate a linear VCO tuning curve (constant  $K_{VCO}$ ).

## the VCO linearizer

Fig. 2 shows the tuning curve for the VCO used in the design loop, with its 4.3:1 variation in  $K_{VCO}$ . Since this is significantly more than the 1.1:1 variation in  $K_N$ , (across the synthesizer frequency range) the effects of  $K_N$  on loop gain can be neglected in the following analysis.

With  $K_{VCO}$  the major cause of loop gain variations, its effects on  $f_n$  and  $\xi$  can be calculated:

$$\Delta_K = \sqrt{\frac{K_t(MAX)}{K_t(MIN)}} = \sqrt{4.3} = 2.07 \quad (1)$$

Assuming that the loop bandwidth is 100 Hz and the damping factor equals 2 when the loop gain is greatest (i.e.  $K_{VCO}$  is at its maximum), then the effect of the 4.3:1 variation of  $K_{VCO}$  can be calculated:

$$f_n = \frac{f_\beta}{\sqrt{2\xi^2 + 1 + \sqrt{(2\xi^2 + 1) + 1}}} = 100/4.25 = 23.53 \text{ Hz} \quad (2)$$

$$\text{And } f_n(MIN) = f_n(MAX)/\Delta_K = 23.53/2.07 = 11.37 \text{ Hz}$$

$$\xi(MIN) = \xi(MAX) / \Delta_K = 2/2.07 = 0.97$$

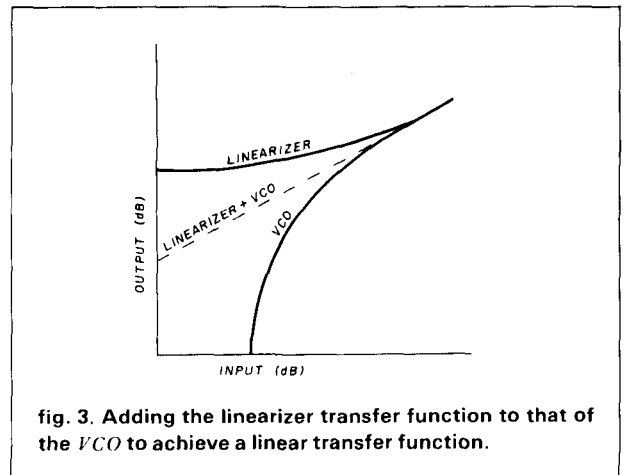

$$f_{\beta} = f_n \sqrt{2\xi^2 + 1 + \sqrt{(2\xi^2 + 1)^2 + 1}}$$

$$= 11.37 \text{ Hz} (2.44) = 27.74 \text{ Hz} \quad (3)$$

which results in a 100/27.74 (3.6:1) change in loop bandwidth with its resulting effect on lock time.

The linearizer is designed to have a response that is the inverse of the VCO (nonlinear) transfer function so that when the linearizer is added to the VCO it will have the effect of producing a linear VCO tuning curve with constant  $K_{VCO}$  (fig. 3).

The linearizer is implemented (fig. 4) using resistor/diode sections<sup>2</sup> and a voltage divider network in order to individually modify the slope of the linearizer transfer function as each resistor/diode section is forward biased. (As  $V_L$  decreases, successive diodes are turned on modifying the slope of the  $V_L$  versus  $V_t$  curve).

The method used to design the linearizer required the following steps:

1. plotting  $K_{VCO}$  versus  $V_t$  and then determining the VCO range to be linearized,
2. calculating the quantity of resistor/diode sections required for the maximum allowed variation in  $K_{VCO}$  (realizing that this is only a segmented approximation of the required transfer function to achieve a linear VCO tuning curve),
3. calculating the voltages for the voltage divider,
4. calculating the resistor values for the resistor/diode sections.

The VCO frequency range to be linearized is roughly 4.92-5.6 MHz which allows for some drift in frequency. The  $K_{VCO}$  at these two frequencies are  $1070 (10^3)$  and  $250 (10^3)$  rad/sec/volt. The number of resistor/diode sections needed for the linearizer are approximately:

$$n \approx \frac{\log \frac{K_{VCO} (MAX)}{K_{VCO} (MIN)}}{\log \Delta K_{VCO}} \quad (4)$$

where  $\Delta K_{VCO}$  is the allowed variation in  $K_{VCO}$  after it is linearized. For the design loop, it was decided that  $K_{VCO}$  will be allowed to change by only 30 percent so

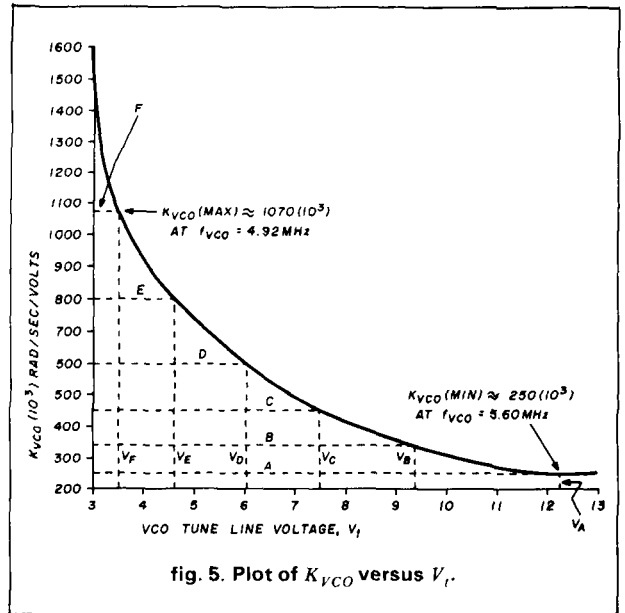
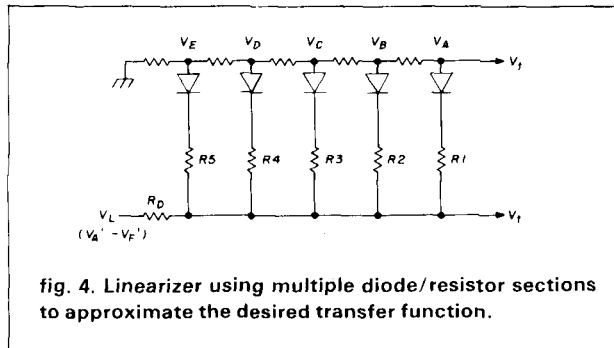

$\Delta K_{VCO} = 1.3$ . (Once again, neglecting  $K_N$ , if  $K_{VCO}$  is the only source of loop gain variation, it varies only by 30 percent, then  $f_n$  and  $\xi$  will vary only by the square root of this, or 14 percent. This is acceptable.)

Therefore the number of resistor diode pairs needed are:

$$n = \frac{\log \frac{1070 (10^3)}{250 (10^3)}}{\log 1.3} = 5.54$$

It is decided to use 5 resistor/diode pairs instead of 6 even though this means a slightly higher error. This error is approximately:

$$\Delta K_{VCO} = 10 \frac{\log \frac{K_{VCO} (MAX)}{K_{VCO} (MIN)}}{n}$$

$$= 10 \frac{\log 4.3}{5} = 1.337 \quad (5)$$

Knowing  $\Delta K_{VCO}$  the voltage divider voltages can be calculated. In fig. 5 a mark for every 33.7 percent increase in  $K_{VCO}$  (starting at the low end of the  $K_{VCO}$  plot, or  $250 (10^3)$  in the example) corresponds to a voltage on the VCO tune line,  $V_t$ . If all the calculations are computed correctly, then the last computed point should correspond to the maximum  $K_{VCO}$  of the range over which the linearizer was designed to work ( $1070 \cdot 10^3$ ).

$$K_{VCO} (B) = 1.337 K_{VCO} (A)$$

$$= 1.337 \cdot (250 \cdot 10^3) = 334.25 \cdot 10^3$$

$$K_{VCO} (C) = 1.337 K_{VCO} (B)$$

$$= 1.337 \cdot (334.25 \cdot 10^3) = 446.89 \cdot 10^3$$

$$K_{VCO} (D) = 1.337 K_{VCO} (C)$$

$$= 1.337 \cdot (446.89 \cdot 10^3) = 597.5 \cdot 10^3$$

$$K_{VCO}(E) = 1.337 K_{VCO}(D)$$

$$= 1.337 \cdot (597.5 \cdot 10^3) = 798.8 \cdot 10^3$$

and for a check

$$K_{VCO}(F) = 1.337 K_{VCO}(E)$$

$$= 1.337 \cdot (798.8 \cdot 10^3) = 1068 \cdot 10^3$$

which is very close to  $1070 \cdot 10^3 = K_{VCO}(MAX)$ .

The corresponding trip voltages (where the resistor/diode combination starts conducting) are:

$$V_A = 12.25 \text{ volts} \quad V_D = 6.05 \text{ volts}$$

$$V_B = 9.35 \text{ volts} \quad V_E = 4.60 \text{ volts}$$

$$V_C = 7.70 \text{ volts} \quad V_F = 3.50 \text{ volts}$$

The voltage divider component values are chosen such that the current through them is much higher than the maximum current through the diodes to keep the voltages  $V_A$  through  $V_E$  constant.

To calculate the resistor values  $R_1$  through  $R_5$  and  $R_D$ , the voltage  $V_L$  that corresponds to the voltage  $V_t$  (especially at the trip voltages  $V_A$  through  $V_E$ ) must be determined. This is done by letting  $V_A'$  equal  $V_A$  and then linearly scaling the voltages  $V_B'$  through  $V_F'$  such that these voltages are always less than their corresponding voltages  $V_B$  through  $V_F$  (fig. 2). This means that  $V_L$  will swing through a larger range of voltages ( $-9.25$  to  $12.25$ ) than  $V_t$ , ( $3.5$ - $12.25$ ) as detailed below:

$$V_{A'} = 12.25 \quad (V_{A'} = V_A)$$

$$V_{B'} = 8.2 \quad (V_{B'} < V_B)$$

$$V_{C'} = 4.9 \quad (V_{C'} < V_C)$$

$$V_{D'} = 1.4 \quad (V_{D'} < V_D)$$

$$V_{E'} = -3.25 \quad (V_{E'} < V_E)$$

$$V_{F'} = -9.2 \quad (V_{F'} < V_F)$$

By assuming perfect diodes (i.e., no forward voltage drop), resistors  $R_1$  through  $R_5$  can be determined. To keep the current through the diodes at a minimum  $R_D$  should be fairly high (46.4k chosen here). By knowing what voltage the linearizer requires at its input ( $V_L$ ) to generate a corresponding voltage at the output, ( $V_t$ ) (fig. 2) resistors  $R_1$  through  $R_5$  can be calculated (fig. 6).

Power supply ripple is kept off the VCO tune line by using a Darlington transistor with a large RC time constant in its base that buffers the voltage to the linearizer voltage divider.

Ideally, the linearizer provides a perfectly constant  $K_{VCO}$  across the VCO tuning range. Because the linearizer is synthesized using linear segments (and these linear segments are really nonlinear due to the imperfect diodes), there will still be a non-constant  $K_{VCO}$  (non-linear VCO tuning curve), though vastly improved. Fig. 7 shows the measured  $K_{VCO}$  versus  $V_L$  using the linearizer and is compared to fig. 5 to show the improvement. The error appears to be very close to the calculated value of 33.7 percent.

## loop filter

With  $K_{VCO}$  almost constant and  $K_\phi$  and  $K_N$  defined, the loop filter components can now be determined. Looking at fig. 7, the minimum and maximum values for  $K_{VCO}$  are:

$$K_{VCO}(MAX) = 250 \cdot 10^3$$

$$K_{VCO}(MIN) = 190 \cdot 10^3$$

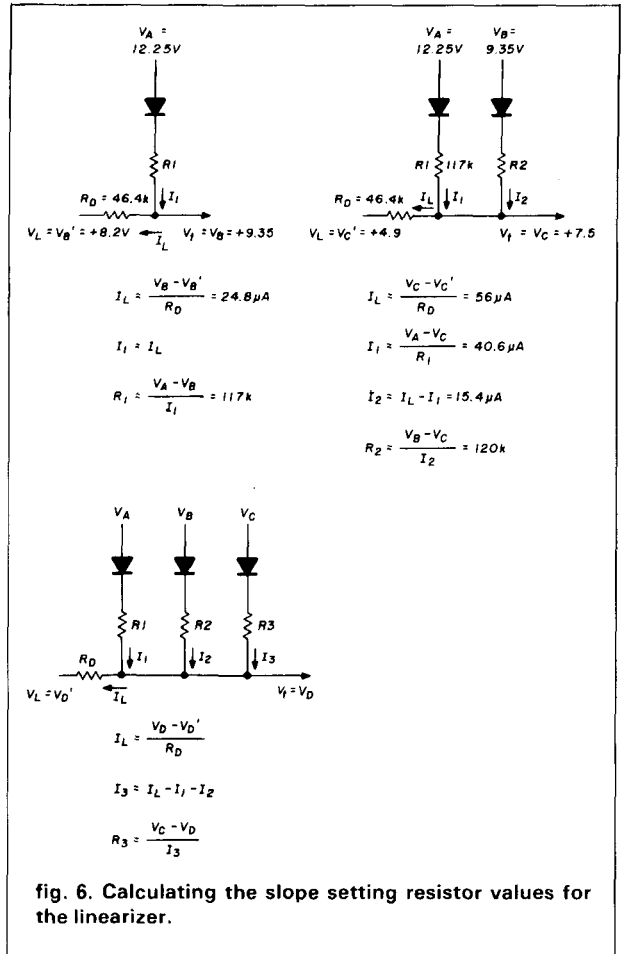

fig. 6. Calculating the slope setting resistor values for the linearizer.

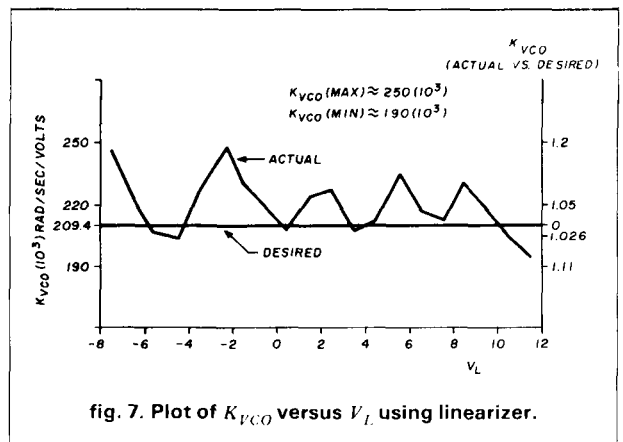

fig. 7. Plot of  $K_{VCO}$  versus  $V_L$  using linearizer.

# RTTY

**NEW**



## TU-470

- Full featured RTTY to 300 baud plus CW terminal unit.
  - 3 Shifts, active filters, remote control, xtal AFSK, FSK, plus much more.
- Suggested retail price..\$499.95



## TU-170A

- Single shift RTTY terminal unit.
- Xtal AFSK, FSK, active-filters and more.

Kit \$189.95  
wired \$289.95



## TU-170

- Single shift RTTY terminal unit.
- Low cost, AFSK, active-filters.

\$149.95  
(Kit only)



## TRS-80\* RTTY/CW

ROM-116 Interface for model I, III, IV (16K MIN). All standard Baudot & ASCII rates to 1200 baud. Text editing, auto CW/ID, split screen, RTTY art, & much more. Proven reliable & available on tape or disk. Disk MAILBOX software available too. Call or write for more details & special prices.

\*Trademark of TANDY CORP.

FOR MORE INFORMATION AND SALES ONLY PLEASE CALL

**1-800-HAM-RTTY**



Flesher Corporation  
P.O. BOX 976  
TOPEKA, KS. 66601

# The Circular Advantage



2M-14C

For OSCAR 10 and Russian Satellite Communications

KLM's Circular Polarized antennas have been specifically designed to optimize OSCAR 10 and Russian satellite operation. Quality workmanship and superior design, yield virtually perfect circular patterns over the satellite operational bandwidth. Enjoy less Multi-Path Distortion, less Flutter, Fade, and better S/N Ratios, with comparable performance on transmit.

Both the 2M-14C and 435-18C sport virtually unbreakable 3/16" rod parasitic elements anchored thru the boom, folded dipole driven elements produce excellent physical and electrical symmetry for years of constant performance.

## Specifications: (2M-14C)

BANDWIDTH: .. 144-150 MHz	BOOM LENGTH: ..... 12' 9"
GAIN: ..... 11 dBdc	VSWR: ..... 1.2:1
BEAMWIDTH: ..... 48°	WINDLOAD: ..... 1.25 sq. ft.
FEED IMP: ..... 50 ohm unbal.	WT. (LBS): ..... 7.5
BALUN: ..... 4:1,2KW	ELLIPTICITY: ..... 3 dB Max.
CIRCULARITY SWITCHER: .....	INCLUDED

The 435-18C is a star performer, an optional CS-2 circularity switcher puts left, and right-hand circular control in your shack, and doubles as a two port divider/impedance transformer for single feed line convenience.



435-18C

## Specifications: (435-18C)

BANDWIDTH: .. 420-450 MHz	GAIN: ..... 12 dBdc
BOOM LENGTH: ..... 7.3 ft.	VSWR: ..... 1.5:1
BEAMWIDTH: ..... 44°	FEED IMP: ..... 50 ohm unbal.
WT. (LBS): ..... 4.5	BALUN: ..... 2-4:1, 1KW
MAST DIA: ..... Cen-Rear/1/2"	ELLIPTICITY: ..... 3dB MAX.
CIRCULARITY SWITCHER .....	(CS-2) OPTIONAL

See your local KLM dealer or write for our complete catalog

**KLM** electronics Inc.

P.O. Box 816, Morgan Hill, CA 95037





The values for  $K_N(MAX)$  and  $K_N(MIN)$  were as stated before:

$$K_N(MAX) = 200 \cdot 10^{-6}$$

$$K_N(MIN) = 181.82 \cdot 10^{-6}$$

$$K_\phi = 0.398 \text{ volts/radian}$$

Assuming  $K_{VCO}(MAX)$  occurs at  $K_N(MAX)$  and  $K_{VCO}(MIN)$  at  $K_N(MIN)$  (for worse case open loop gain variation) then:

$$K_t(MAX) = 19.9$$

$$K_t(MIN) = 13.75$$

Variations in  $f_n$  and  $\xi$  are:

$$\Delta_K = \sqrt{\frac{19.9}{13.75}} = 1.2$$

It was decided to have a damping factor of approximately one, but since it will vary by  $\Delta_K = 1.2$  the lower value of  $\xi$  will be set at  $\xi = 0.95$  and the maximum value will then be  $\xi = 0.95 (1.2) = 1.14$ , which, as discussed before, corresponds to the maximum loop bandwidth of 100 Hz. Using this information both  $f_n(MAX)$  and  $f_n(MIN)$  can be calculated:

$$f_n(MAX) = \frac{f_\beta(MAX)}{\sqrt{2\xi^2 + 1} + \sqrt{(2\xi^2 + 1)^2 + 1}}$$

$$= 100/2.708 = 36.92 \text{ Hz}$$

and

$$f_n(MIN) = f_n(MAX)/\Delta_K = 36.92/1.2 = 30.77 \text{ Hz}$$

With maximum values of damping, loop natural frequency, and loop gain known, the two time constants for the loop filter can now be determined.

$$t_1 = \frac{K_t}{(\omega_n)^2}$$

$$t_2 = \frac{2\xi}{\omega_n}$$

At  $f_{VCO} = 5.00 \text{ MHz}$  the loop gain is at its maximum corresponding to maximum values for  $f_n$ ,  $f_\beta$ , and  $\xi$ . Using these maximum values the time constants are:

$$t_1 = \frac{19.9}{(2\pi 36.92)^2} = 369.8 \mu\text{s}$$

$$t_2 = \frac{2(1.14)}{2\pi 36.92} = 9.828 \text{ ms}$$

Using minimum values of  $K_t$ ,  $f_n$ , and  $\xi$  should produce the similar results:

$$t_1 = \frac{13.75}{(2\pi 30.77)^2} = 367.8 \mu\text{s}$$

$$t_2 = \frac{2(0.95)}{2\pi 30.77} = 9.83 \text{ ms}$$

Although the loop filter components could now be

calculated using  $t_1$  and  $t_2$ , there are two areas that will restrict the values of R1 and C1 and should be examined (fig. 8). These areas are leakage currents and phase detector output current.

With the loop in lock the phase detector is in an open-state mode and does not "source" or "sink" current to the integrator, thereby allowing the integrator to hold its charge. Therefore the voltage out of the loop filter is constant. However, leakage currents will either add or subtract charge from the integrator capacitor causing the loop filter output voltage to the VCO to vary, changing its frequency. The loop then corrects for this frequency shift during the next reference frequency clock cycle. This means that a signal, at a frequency equal to the reference frequency and of an amplitude dependent on the leakage current, will be on the VCO tune line and thus modulate it (reference feedthrough).

Given the equation for the integrator:  $\Delta V_{OUT} = I/C (\Delta t)$ , where I is the leakage current,  $\Delta t = 1/f$ , and C is the integrator capacitor (C1), C is really the only variable available to the designer. ( $f_{REF}$  is fixed, and I is the leakage current of both the phase detector in its open circuit mode and the bias currents of the (LF-356) op-amp used in the integrator. The leakage current for the phase detector is 1 nanoampere and for the op-amp is about 10 pico ampere. The phase detector leakage predominates and so the op-amp leakage can be neglected.)

With maximum acceptable spur level of  $-70 \text{ dBc}$ , and knowledge of  $K_{VCO}(MAX)$ , the maximum reference feedthrough voltage on the VCO tune line can be approximated, then the smallest value of C1 for that reference feedthrough voltage can be calculated (given the leakage current).

$$V_L (p-p) = \frac{P_{SSB}^{20}}{8\pi f_m 10^{20} K_{VCO}(MAX)}$$

$$= \frac{8\pi (1\text{kHz}) 10^{-70}}{250 \cdot 10^3}$$

$$= 31.8 \mu\text{V}(p-p) \approx 32 \mu\text{V}(p-p)$$

where  $V_L = (p-p)$  reference feedthrough signal voltage

$P_{SSB}$  = single sideband spur level in dBc

$f_m$  = reference feedthrough signal frequency

The minimum value of C1 is:

$$C1(MIN) = (I) \frac{\Delta t}{\Delta V} = (I) \frac{1/f_{REF}}{\Delta V_L}$$

$$= 1 \text{ nA} \left( \frac{1 \text{ ms}}{32 \mu\text{V}} \right) = 0.031 \mu\text{F}$$

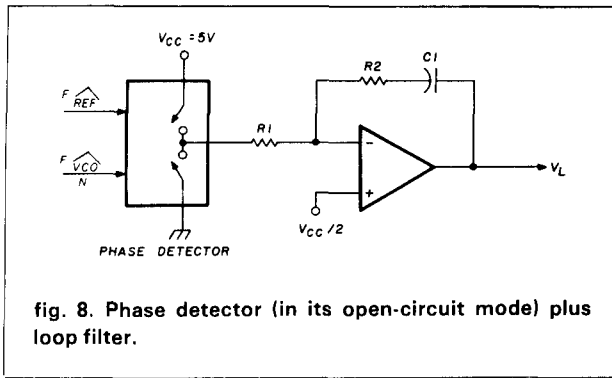

fig. 8. Phase detector (in its open-circuit mode) plus loop filter.

$$R1(MIN) = (5 - 2.5) / 500 \mu A = 5000 \text{ ohms}$$

The loop filter components can now be calculated by letting  $R1 = 5000$  and solving for  $C1$ :

$$C1 = t_1 / R1 = 367.8 \mu s / 5000 = 0.0736 \mu F$$

which fortunately happens to be greater than the minimum value for  $C1$  calculated before. Letting  $C1$  take on a more practical value,  $C1 = 0.068 \mu F$ ,  $R1$  can be recalculated:

$$R1 = 367.8 \mu s / 0.068 \mu F = 5410 \text{ ohms}$$

Calculating for  $R2$ :

$$R2 = t_2 / C1 = 9.83 \text{ ms} / 0.068 \mu F = 144.5K$$

or 147K, a common value in 1 percent resistors. Both  $R1$  and  $C1$  are within the desired limits.

For prefiltering ahead of the loop filter  $R1$  is split into two series resistors and a capacitor is tied between their common points and ground.

A unity gain inverter using a low noise op-amp follows the loop filter for required signal inversion

where  $I$  is the leakage current and  $V$  is the calculated reference feedthrough voltage for a  $-70$  dBc spur level.

The smallest value of  $R1$  is determined by the maximum current the phase detector can develop which, for the MC145151 is about  $500 \mu A$ . With the maximum phase detector voltage of approximately  $+5V$  and the other extreme at (a virtual)  $2.5V$  then:

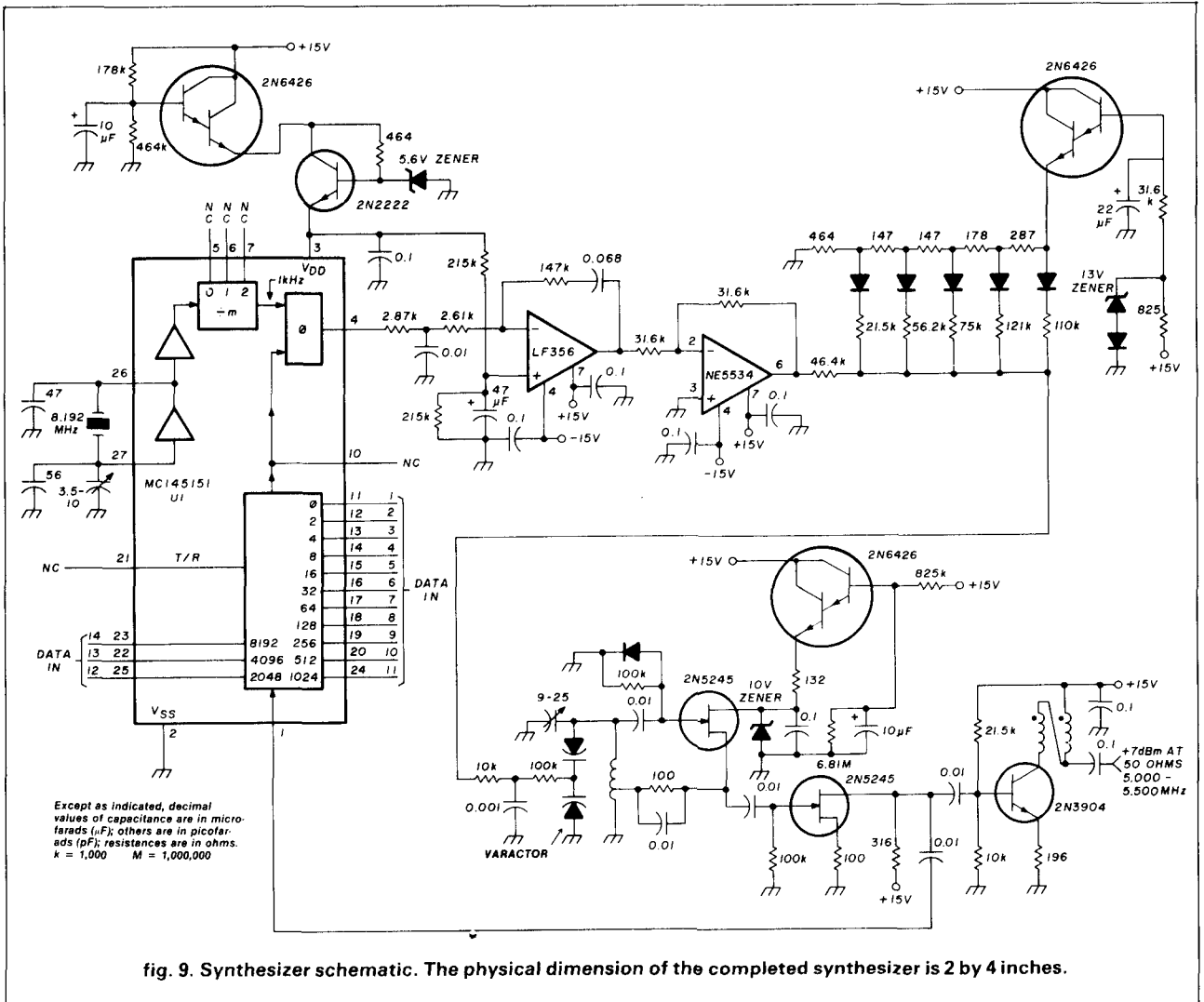

fig. 9. Synthesizer schematic. The physical dimension of the completed synthesizer is 2 by 4 inches.

for negative feedback in the phase-locked loop. Another filter pole is added to the loop by the addition of a 0.01  $\mu\text{F}$  capacitor across the inverters' feedback resistor. Like the pre-filter ahead of the loop filter, this pole is located at a frequency well outside the loop bandwidth.

### loop performance

This synthesizer (fig. 9) performed according to specifications immediately after completion. The only problem was excessive 60 Hz (and its odd harmonics) spurs which were solved with proper shielding. A Hewlett-Packard HP8568 spectrum analyzer was used to measure phase noise and spurious responses. Fig. 10 uses a wide-frequency sweep to show the general "cleanliness" of the synthesizer output for large frequency offsets from the carrier. The noise pedestal around the carrier is that generated by the spectrum analyzer.

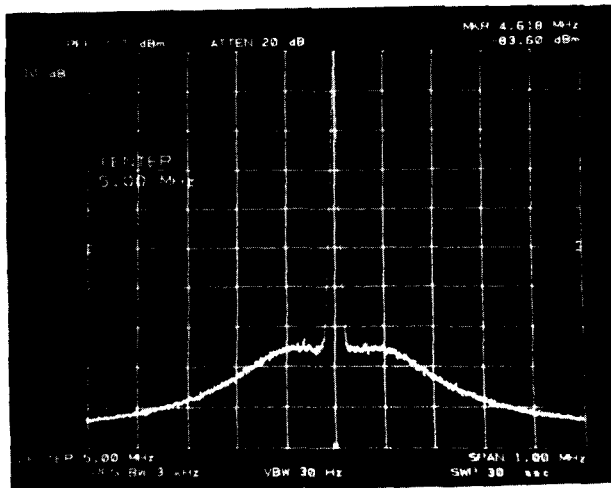

fig. 10. Phase and amplitude noise spectrum of the synthesizer for large offset frequencies ( $\pm 500$  kHz).

Fig. 11 is a SSB phase (and amplitude) noise plot of the synthesizer output using a 5-kHz linear sweep. The spurs are caused by the phase detector; examined closely, they can be seen to be two noise peaks centered around where the reference feed-through spur should be. Upon close examination the reference feed-through was greater than  $-70$  dBc, as designed. Unfortunately temperature effects on phase detector leakage current were not taken into account (as well as the variations in leakage current among MC145151's) and the  $-70$  dBc spur requirement is exceeded as the MC145151 heats.

Fig. 12 is a narrow spectrum view of the synthesizer using a 500 Hz sweep. This shows what reasonable shielding and filtering can do to minimize spurs. The 60 Hz spurs, originally only  $-30$  dBc,

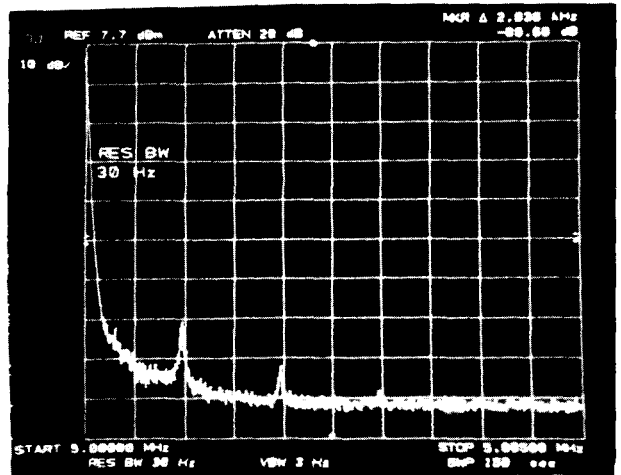

fig. 11. SSB phase and amplitude noise spectrum for up to 5 kHz offset. Spurs are actually two noise peaks centered around the reference feedthrough spur.

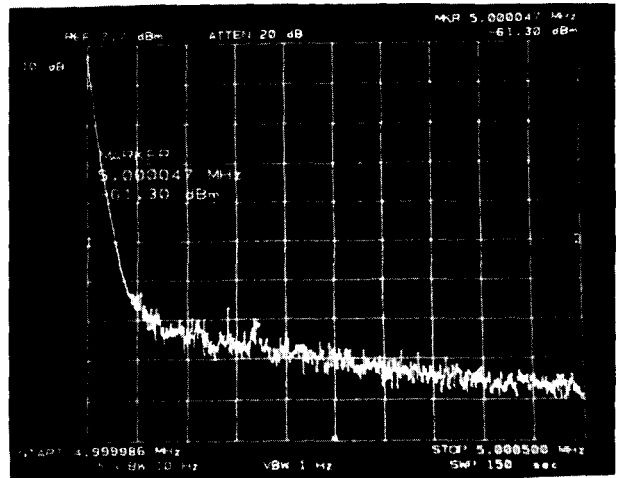
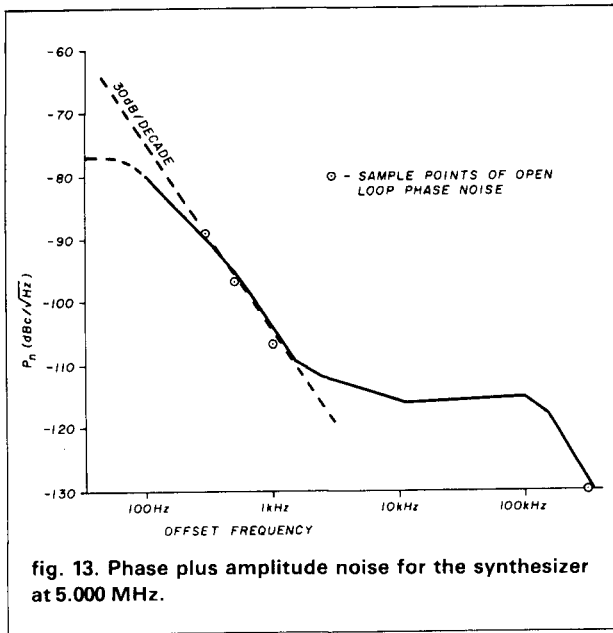

fig. 12. Close in phase and amplitude noise spectrum of synthesizer showing no perceptible 60 Hz or harmonic related spurs.

were reduced an additional 15 dB by optically shielding the varactor diodes, and by more than 30 dB through magnetic shielding of the synthesizer. The 120 Hz spurs were taken care of by using a Darlington transistor as an active filter for supply lines to sensitive parts of the synthesizer (i.e., VCO, linearizer, etc.).

Fig. 13 is a phase noise plot of the synthesizer at 5 MHz. Since the phase noise past the loop bandwidth (offset frequencies greater than  $f_{\beta} = 100$  Hz) is equivalent to that of the open loop VCO, while loop bandwidth and damping are held fairly constant, then the phase noise plot taken at any other frequency within the synthesizer range will be essentially identical.

The lock time was examined by changing the programmable divider by one ( $\Delta f_{VCO} = 1$  kHz) and measuring the voltage settling time at  $V_L$  for a



roughly 1 percent frequency error. This turned out to be about 30 ms, much less than the  $10/f_\beta$  calculated (which shows just how rough an estimate of  $10/f_\beta$  is).

### using the Bode plot

Another method used in designing the loop filter, as well as a check and debugging aid, is by using the Bode plot. This is done by plotting the transfer function of  $K_t = K_\phi K_{VCO} K_N$ , then plotting the desired transfer function of  $K_\phi K_F K_{VCO} K_N$ . Subtracting the two gives the required transfer function of the loop filter from which the time constants for it can be derived.

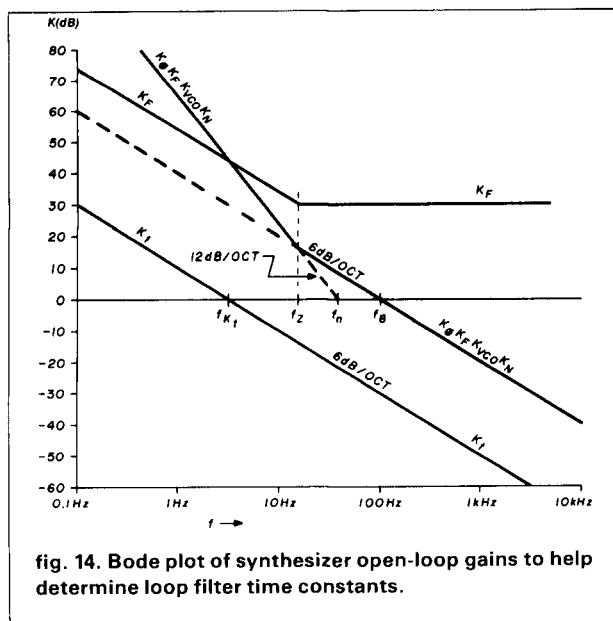

In the example loop,  $K_t = 19.9$  (at  $f_{VCO} = 5.0$  MHz). A plot of  $K_t$  would have a 6 dB/octave slope crossing zero at a frequency of:

$$f = K_t/2\pi = 19.9/2\pi = 3.2 \text{ Hz}$$

The desired open-loop response,  $K_\phi K_F K_{VCO} K_N$  (fig. 14) crosses the desired bandwidth  $f_\beta = 100$  Hz with a 6 dB/octave slope at unity gain, then intersects and assumes the 12 dB/octave slope of a line that crosses unity gain at:

$$f_n = \frac{f_\beta}{\sqrt{2\xi^2 + 1} + \sqrt{(2\xi^2 + 1)^2 + 1}} = 39.4 \text{ Hz}$$

where the desired value of damping is one.

Subtracting  $K_t$  from  $K_\phi K_F K_{VCO} K_N$  (the desired total open-loop response) gives  $K_F$  as shown in fig. 14. The 6 dB/octave slope of  $K_F$  levels off at  $f_z$  at  $A = 30$  dB. The resistor ratios for the loop filter (fig. 8) are:

$$R2/R1 = Y = 10^{A/20} = 10^{+30/20} = 31.62$$

The time constants are:

$$t_2 = 1/(2\pi f_z) = 1/(2\pi 15.5 \text{ Hz}) = 10.27 \text{ ms}$$

$$t_1 = t_2/Y = 10.27 \text{ ms}/31.67 = 324.2 \mu\text{s}$$

As expected, these are very close to the earlier designed values.

This plot could further include all poles and zeros in the loop to spot potential problems (i.e., too much phase shift where it may cause loop instability).

### conclusion

This synthesizer should work fairly well as an LO for a receiver or transmitter if a 1 kHz step is small enough. For a synthesizer requiring smaller frequency steps a different configuration may be used, in-loop mixing with a VXO being a good choice.

It is important to realize that this synthesizer wanted a fast lock time with low reference feed-through, and paid a rather high price — i.e., inclusion of the linearizer — for it. If a longer lock time is acceptable (lower  $f_\beta$  to accommodate variations in loop gain), the linearizer can be left out of the circuit, simplifying the design. However, in the application for which this synthesizer will be used (frequency scanning), a rapid lock time is desirable. It also must be mentioned that as  $f_\beta$  decreases, the loop will have increasing difficulty in tracking mechanical vibrations, and even its own VCO drift.

### references

1. Craig Corsetto, WA6OAA, "RF Synthesizers for HF Communications: part 2," *ham radio*, September, 1983, page 48.
2. William Egan, *Frequency Synthesis by Phase Lock*, pages 55-58, John Wiley and Sons, 1981.

# Star Performers!

## ICOM's VHF/UHF Pairs for Satellite Communications

Oscar 10...Are you ready?  
Join the future of amateur  
satellite communications with  
ICOM VHF and UHF transceivers.  
Read why ICOM is ...*Simply  
the Best* for satellite  
communications.

### IC-271A/471A Twins

This new series of VHF/UHF  
base stations offers a  
combination of features and  
flexibility found in no other  
transceivers anywhere. For  
receiving MODE J down-link, the  
IC-471A features a less than 0.5  
microvolt for 10dB quieting SSB  
receiver plus an optional mast  
mounted GaAs FET preamplifier  
with a 15dB gain.

Thirty-two tunable memories  
keep the IC-471A ready to go on  
frequency and to monitor the  
beacon frequencies. A good  
noise blanker plus all-mode  
squelch make listening a real  
pleasure. 10Hz variable speed  
tuning, which automatically  
shifts to 100Hz when needed,  
and a low-noise PLL that locks to  
10Hz makes the frequency  
resolution of the ICOM Twins



ICOM's  
Stackable  
Portable Twins  
IC-290H & IC-490A

second to none. For MODE B  
use, the IC-471A features a 10W  
SSB transmitter with variable  
power control.

The same basic features of  
the IC-471A apply to the IC-271A  
and an optional internal pre-  
amplifier with front panel switch  
is available. The IC-271A

transmitter features 25W of  
transmitter power.

The IC-471A and the IC-271A  
both have options for computer  
interfacing. The ICOM BUS is  
brought out through an optional  
interface to the back of the  
radio. From this point, it may be  
routed to the ICOM computer

interface terminal, mounted in a  
matching box, that will convert  
the ICOM BUS to RS232C  
standard. Allowing computer  
control of both transceiver units,  
this capability, plus the antenna  
tracking programs available for  
Oscar 10, will make the IC-271A  
and 471A Twins the ultimate for  
computer control of your satellite  
operations.

### IC-290H/IC-490A Twins

ICOM's IC-290H and IC-490A  
mount together as a stackable  
mountable pair that offers  
versatility, portability and satellite  
capability in an incredibly small  
size. These units are easily hung  
from your ham shack bench  
taken on portable operations or  
used mobile.

Each features multiple  
tuning rates, memories,  
FM/SSB/CW, programmable  
scan and priority function, and  
an all-mode squelch. The IC-  
290H has a 25W transmitter, the  
IC-490A, 10W. Both of these  
transceivers are high quality  
designs by ICOM and offer all  
the flexibility needed for satellite  
operations.



ICOM's  
2 Meter  
4 Meter

 **ICOM**  
The World System



# The Bearcat<sup>®</sup> DX1000 makes tuning in London as easy as dialing a phone.

Direct access keyboard tuning brings a new level of simplicity to shortwave radio. With the *Bearcat<sup>®</sup> DX 1000*, dialing in the BBC in London is as easy as dialing a telephone. And you can switch from the BBC to Peruvian Huayno music from Radio Andina instantly. Without bandswitching.

Featuring the innovative microprocessor digital technology made famous by *Bearcat* scanner radios, the *DX 1000* covers 10 kHz to 30 MHz continuously, with PLL synthesized accuracy. But as easy as it is to tune, it has all the features even the most sophisticated "DXer" could want. 10 memory channels let you store favorite stations for instant recall—or for faster "band-

scanning" during key openings.

The digital display measures frequencies to 1 kHz, or at the touch of a button, doubles as a two time zone, 24-hour digital quartz clock. A built-in timer wakes you to your favorite shortwave station. Or, it can be programmed to activate peripheral equipment like a tape recorder to record up to ten different broadcasts—any frequency, any mode—while you are asleep or at work.

The *DX 1000* also includes independent selectivity selection to help you separate high-powered stations on adjacent

frequencies. Plus a noise blanking system that stops Russian pulse radar interference.

There's never been an easier way to hear what the world has to say. With the *Bearcat DX 1000* shortwave radio, you have direct access to the world.

For the name of your nearest retailer dial toll-free... 1-800-SCANNER.

**Frequency Range:** 10 kHz to 30 MHz continuously. **Tuning:** Direct keyboard entry, selectable 3 or 24 kHz per revolution knob tuning, or manual step tuning in selectable 1-99 kHz steps. **Sensitivity:** 1.0  $\mu$ V AM, 0.5  $\mu$ V CW/SSB/FM, 1.6-30 MHz. **Image and IF Rejection:** 70 dB or more. **Memory:** 10 frequency capacity. **Frequency Stability:** Better than 100 Hz after warm-up. **Modes:** AM/LSB/USB/CW/FM. **AGC:** Selectable Fast/Slow release times. **Filter Bandwidths:** 2.7 kHz, 6 kHz and 12 kHz. **Filter Selection Independent of Mode.**

## Bearcat<sup>®</sup> DX 1000

shortwave radio.

Direct Access To The World.

134

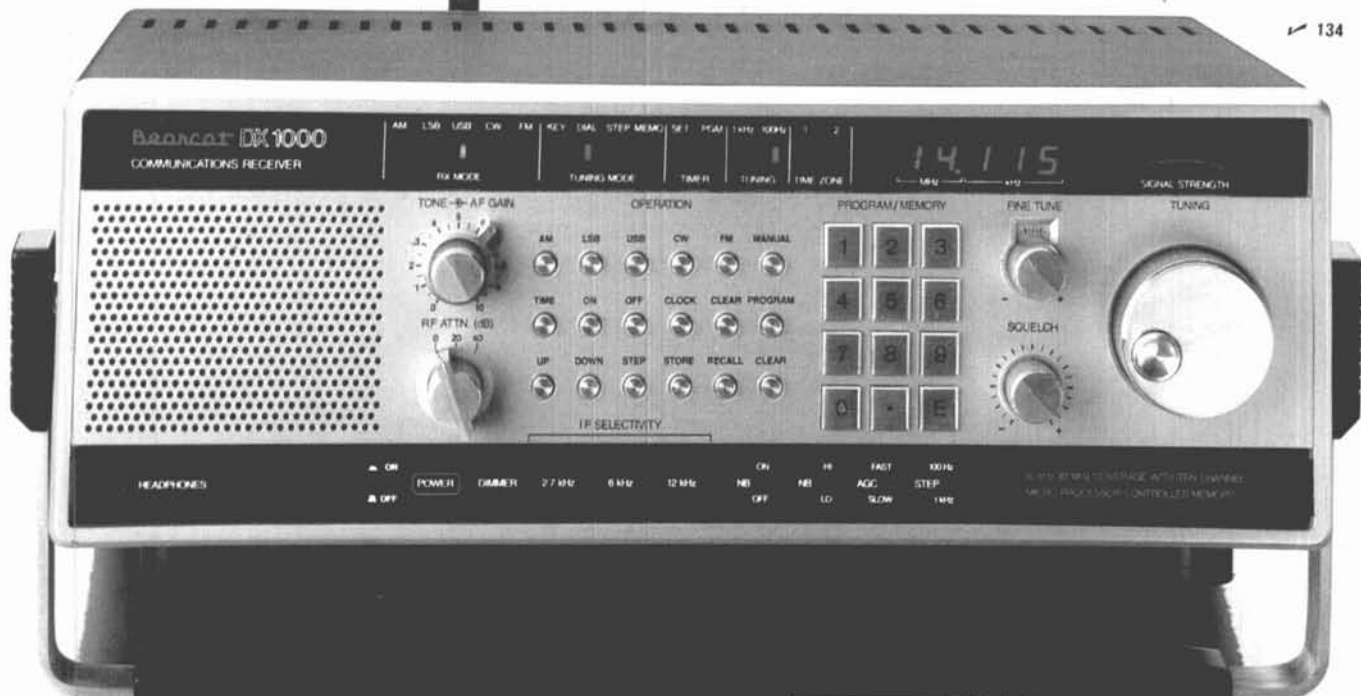

# Amazing new solid-state oscilloscope... fits in the palm of your hand

## CRT oscilloscopes just became obsolete!

The revolutionary new solid-state digital LED Pocket-O-Scope does it all, in a 4-ounce package you can put in your pocket.

**Easy to use.** Ideal for the hobbyist or the technician. The Pocket-O-Scope is 100% solid-state, focus and brightness on the 210 point, high-intensity illuminated screen are *electronically* self-controlled. The trace is *always* in sharp focus. Zero and sweep positions are maintained automatically. Zero-reference, or cross-over line is always centered for full trace minimum on the screen. Automatic internal circuitry always assures a properly positioned wave form. 4 solid-state controls do it all. The only knobs on the Pocket-O-Scope are for positive and negative sensitivity and for coarse and fine synchronization of the frequency of the incoming signal. The easiest to use, full capability scope available!

**Years in development.** The Pocket-O-Scope is the culmination of years of development in high technology, micro-electronic components and digital design.

**Features:** All solid-state, digital design • Hand-held or bench operation • High resolution 210 point, 1.5" square display • Battery or A/C operation with adapter • Factory calibrated – *never requires recalibration* • Full function, single trace capability plus 1/2 channel dual trace and signal inverter • Full



Patent Pending

overload protection to prevent damage to scope

- Automatic zero voltage centering
- Automatic free run or locked image
- Automatic full horizontal sweep circuit
- External input/output for add-on capability

### Specifications:

- 5 Megahertz bandwidth
- Sensitivity – vertical, 10MV
- Accuracy  $\pm 3\%$  on wave forms – sweep linearity  $\pm 5\%$
- Time base – .1 microseconds to .5 seconds

- Vertical gain – 0 to 120 volts
- Continuous free run to locked image response
- Power supply 9VDC – dual polarity
- Controls:** Single or dual trace • On-off, battery-A/C • Sensitivity; separate pos. & neg. controls • Sync C & Sync F controls

Limited, 90-day warranty

**No risk introductory offer.** The revolutionary Pocket-O-Scope is a development of Calvert Instruments, Inc., for 25 years a manufacturer of electrical equipment. As an introductory offer for a limited time only, you can buy the Pocket-O-Scope including a carrying case, A/C adapter, 3 standard "grabber" probes and 2 high voltage probes for only \$249.95, a \$321 value. If you act now, you will also receive FREE Calvert's 200-page Comprehensive Oscilloscope Training Manual, a \$15.95 value!

Put your Pocket-O-Scope to the test for two weeks. And if you decide, for *any* reason, that the Pocket-O-Scope is not for you, return it within the 14-day trial period for a prompt refund. The training manual will still be yours to keep.



Mail this coupon today, or call toll-free\* while the introductory offer is still in effect.

**Calvert Instruments, Inc.**

HR-1083

19851 Ingersoll Dr., Cleveland OH 44116 • 216-356-2155

### Please send me:

- Pocket-O-Scope(s), including carrying case, A/C adapter, standard and high voltage probes, and FREE training manual. (Batteries not included) all for \$249.95 plus \$5 for postage and insurance. Ohio residents add 6.5% sales tax.
- Pocket-O-Scope only with standard probes: \$179.95 plus \$5 postage. Ohio Residents add 6.5% sales tax.

- My check is enclosed.
- Please charge the credit card account checked below. (Fill in all account number digits of the *one* credit card you wish to use.)
- MasterCard  Visa

Expiration Date \_\_\_\_\_ Interbank No. \_\_\_\_\_ (Master Card only)

Full signature \_\_\_\_\_

Name \_\_\_\_\_ (please print)

Address \_\_\_\_\_ Apt. \_\_\_\_\_

City \_\_\_\_\_

State \_\_\_\_\_ Zip \_\_\_\_\_

\*CALL TOLL-FREE 800-835-2246 EXT. 118 to order by phone, request further information or to inquire about becoming a distributor. In Kansas, call 800-362-2421 Ext. 118. Allow 6-8 weeks for delivery.

# THE SANTEC TRIO

	144	440	220
FREQ. COVERAGE	142 — 149.95MHz	440 — 449.975MHz	220 — 224.995MHz
REPEATER OFFSETS	± 600kHz	± 5MHz	± 1.6MHz
POWER OUTPUT	3.5W High Option	3.0W High Option	2.5W High Option

**144, 440, and now 220 MHz!**

The Santec ST series of handheld transceivers is now complete! With the introduction of the new **ST-220/μP** which covers 220.000 — 224.995 MHz in 5 kHz steps, Santec brings its unparalleled technology and quality to a third complete band. Now you can get it right on three bands with Santec.

All of the little Santec ST radios are identical in form and features, varying only in power output and individual band characteristics. All share: 10 memories with stored offsets; priority memory scan; 24 hr. format clock; three output power levels; wide band operation; low "quiet time" standby drain; three modes of bandscan; and a full two year extended service plan. Now there are three great handhelds which get it right the Santec way!

Distributed by

**Encomm, Inc.**

2000 Avenue G, Suite 800, Plano, Texas 75074

Phone (214) 423-0024 TLX 79-4783 ENCOMM DAL

## YOU'LL NEVER GET A BETTER DEAL

### HUSTLER ANTENNAS

SF2 - "Buck Buster" 5/8" Wave  
2 Meter Antenna w/3/8 x 24"  
Threaded Base -  
3dB gain

**\$8<sup>95</sup>**

HOT - EASY ON/OFF  
TRUNK MOUNT  
with 3/8 x 24" Swivel Ball  
for CG144 & SF-2



**\$14<sup>95</sup>**

And many other Hustler Antennas & Mounts

BBL144 .....	25 <sup>95</sup>	MRK-1 .....	13 <sup>75</sup>
BBL144 .....	35 <sup>00</sup>	SFM .....	24 <sup>75</sup>
BBL440 .....	24 <sup>75</sup>	THF .....	13 <sup>95</sup>
HLM .....	13 <sup>95</sup>	UHT-1 .....	8 <sup>95</sup>

**CECO STOCKS THE ENTIRE HUSTLER  
VHF/UHF & COMMERCIAL LINE  
DEALER INQUIRIES INVITED**

**CeCo**  
COMMUNICATIONS, INC.

2115 AVENUE X  
BROOKLYN, N.Y. 11235  
(212) 646-6300  
(800) 221-0860  
TELEX: 235125

124

## TERMINALL

### RADIO MODEM



apple TRS-80 ATARI

### SEND & RECEIVE CW & RTTY

TERMINALL is a hardware and software system which converts your Personal Computer into a state of the art communications terminal.

- TERMINALL is easy to use. Plug into your receiver headphone jack and copy Morse code or radioteletype. Plug into your CW key jack and send Morse code. Attach a Microphone connector and send Baudot or ASCII RTTY using audio tones (AFSK). That's all there is to hooking it up.
- Fantastic Morse reception. No adjustments are necessary to receive Morse code. It's fully automatic! Six stage active filter demodulator and auto adaptive Morse algorithm copes the weak and sloppy ones.
- Separate RTTY and CW demodulators. Built in crystal controlled AFSK, CW and PTT keying. 60 mil loop interconnect, RS 232 IN and OUT, hand key input and side tone output.
- Built in parallel printer driver software allows hardcopy in all modes.
- Hardware clock maintains accurate time.

- Multiple user defined WRU functions. You select initiate sequence, terminate sequence, what to transmit back and whether to save on tape or disk.
- Word wrapping, word mode editing, doddle, ignore carriage returns, user programmable end of line sequence, adjustable carriage width, transmit delay (fixed, none or auto adaptive), excellent documentation, break mode and much more.
- TERMINALL has capabilities far surpassing dedicated terminal systems. And since it works on a general purpose computer, the majority of your investment (your computer) is spread out over many different applications. You get more for your money.
- Complete with software on cassette and diskette, assembled and tested hardware, and extensive instruction manual. Call or write for specifications on TERMINALL for TRS-80 Model I or Model III, Apple or ATARI 400/800 COMPUTERS. #489.
- 15 day money back trial period. One year parts and labor limited warranty on factory direct orders.

To Order

(209) 667-2888



**MACROTRONICS, Inc.**

1125 N. Golden State Blvd  
Turlock, CA 95380

C O D

\* Apple is a Registered Trademark of Apple Inc.  
\* TRS-80 is a Registered Trademark of Tandy Corp.  
\* Atari is a Registered Trademark of Atari Inc.  
Shipping U.P.S. Reg. Del. \$4.00 CA residents add 6% sales tax.



REG.  
\$19.50

Please enter my gift subscriptions  
to **HAM RADIO Magazine** as follows:

**EACH GIFT JUST \$14.50**

**SAVE OVER 25%**

Prices U.S. only

**SAVE 25% \$AVE 25% \$AVE 25%**

**FIRST**

Name \_\_\_\_\_ Call \_\_\_\_\_

Address \_\_\_\_\_

City \_\_\_\_\_ State \_\_\_\_\_ Zip \_\_\_\_\_

new  renewal

**SECOND**

Name \_\_\_\_\_ Call \_\_\_\_\_

Address \_\_\_\_\_

City \_\_\_\_\_ State \_\_\_\_\_ Zip \_\_\_\_\_

new  renewal

**THIRD**

Name \_\_\_\_\_ Call \_\_\_\_\_

Address \_\_\_\_\_

City \_\_\_\_\_ State \_\_\_\_\_ Zip \_\_\_\_\_

new  renewal

Start or  Renew my own HR subscription

Enclosed is a check or money order for \$\_\_\_\_\_ for  
\_\_\_\_\_ subscriptions (use separate envelope)

VISA  MasterCard  Bill me later

Acct # \_\_\_\_\_ Expires \_\_\_\_\_ MC Bank # \_\_\_\_\_

My Name \_\_\_\_\_ Call \_\_\_\_\_

Address \_\_\_\_\_

City \_\_\_\_\_ State \_\_\_\_\_ Zip \_\_\_\_\_

Prices U.S. only

Please  
enter my  
subscription



**BUSINESS REPLY CARD**

First Class    Permit No. 1    Greenville, NH

Postage Will Be Paid By Addressee

NO POSTAGE  
NECESSARY  
IF MAILED  
IN THE  
UNITED STATES



**ham  
radio**

Greenville, NH 03048

# SUPER GIFT IDEA GIVE HAM RADIO THIS YEAR!

*It's simple and easy and  
You save over 25%.*

That's right. You save over 25% off the regular one year rate of \$19.50. Just \$14.50 brings 12 big, fat, issues, jam-packed with all the latest from state-of-the-art electronics to easy-to-build projects. We will even send an attractive personalized gift card to the recipient(s) so they will know about your interest in their future as hams.

1984 is going to be an exciting year for Amateur Radio. The only way to stay on top of all of the late breaking developments is with a subscription to **ham radio** Magazine.

There has never been a better time than now to "gift" **ham radio** to that hard-to-buy-for friend . . . or yourself.

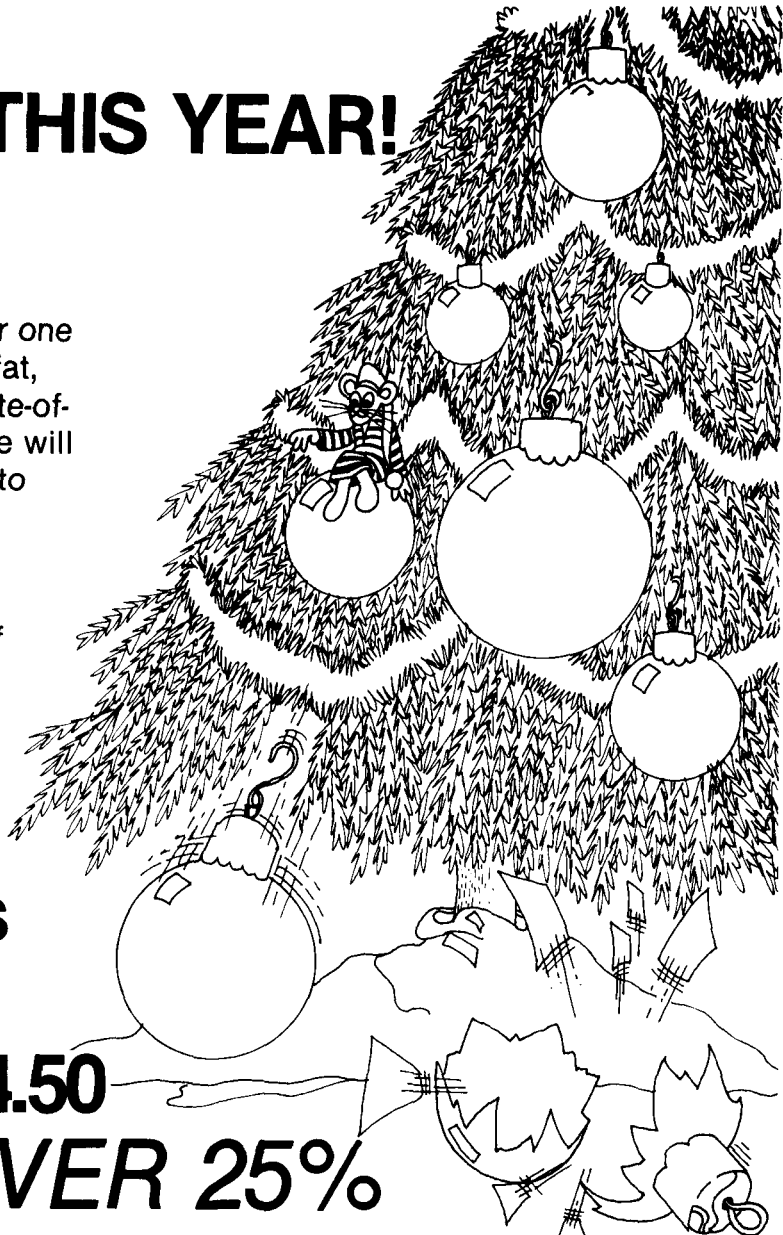

**One year, 12 issues  
Reg. \$19.50**

**SPECIAL PRICE \$14.50  
SAVE OVER 25%**

Please send my **hamradio** gift subscriptions as indicated. Also send a handsome gift acknowledgement card. (Gift card will be sent if your order is received before Dec. 16, 1983.)

From:  
Name \_\_\_\_\_  
Address \_\_\_\_\_  
City \_\_\_\_\_ State \_\_\_\_\_ Zip \_\_\_\_\_

Payment enclosed \$ \_\_\_\_\_  
(check or money order)

Mastercard     VISA/BAC  
Acct.# \_\_\_\_\_ Exp. \_\_\_\_\_ Bank# \_\_\_\_\_  
(MC only)

Bill me after Jan. 1, 1984.

**FILL OUT AND MAIL TO:  
HAM RADIO MAGAZINE  
Greenville, NH 03048  
(603) 878-1441**

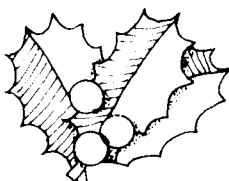

**\$14.50  
Save 25%**

SEND TO:  
Name \_\_\_\_\_  
Address \_\_\_\_\_  
City \_\_\_\_\_ State \_\_\_\_\_ Zip \_\_\_\_\_  
 New Subscription     Subscription Renewal

**\$14.50  
Save 25%**

SEND TO:  
Name \_\_\_\_\_  
Address \_\_\_\_\_  
City \_\_\_\_\_ State \_\_\_\_\_ Zip \_\_\_\_\_  
 New Subscription     Subscription Renewal

**\$14.50  
Save 25%**

SEND TO:  
Name \_\_\_\_\_  
Address \_\_\_\_\_  
City \_\_\_\_\_ State \_\_\_\_\_ Zip \_\_\_\_\_  
 New Subscription     Subscription Renewal

**PRICES U.S. Only. CANADA \$21.50 per year.  
Use Handy Bind-in Card or this Form.**

# vertical phased arrays: part 4

## Feed network design using L-match circuits, $\pi$ and tee coax-equivalent circuits

**Previous articles of this series** on vertical phased arrays<sup>1,2,3</sup> concentrated on the design of the physical aspects of arrays: element length, radius, spacing and ground planes. The latest article<sup>3</sup> dealt with electrical measurements of the arrays and calculation of driving-point impedances. Knowing the required drive current amplitude and phase for each element of the array pattern selected, and knowing the measured values of self- and mutual impedances, we can calculate the driving-point impedance of these elements. The importance of this cannot be over-emphasized; because of mutual impedance effects between elements, driving-point impedances of elements in an array are not fixed entities. Each element's driving-point impedance depends upon the amplitude and phase of the drive currents — not just upon its own drive current, but upon the amplitude and phase of the drive current of every element in this array. A change of the current amplitude or phase to any element results in a driving-point impedance change of every element together with a change in all current amplitudes and phases. Examination of the set of simultaneous equations defining these driving-point impedances illustrates this relationship:

$$\begin{aligned} Z_1 &= E_1/I_1 = Z_{11} + I_2Z_{12}/I_1 \\ &+ I_3Z_{13}/I_1 + \dots + I_nZ_{1n}/I_1 \quad (1) \\ Z_2 &= E_2/I_2 = I_1Z_{12}/I_2 + Z_{22} \\ &+ I_3Z_{23}/I_2 + \dots + I_nZ_{2n}/I_2 \end{aligned}$$

$$\begin{aligned} Z_n &= E_n/I_n = I_1Z_{1n}/I_n + I_2Z_{2n}/I_n \\ &+ I_3Z_{3n}/I_n + \dots + Z_{nn} \end{aligned}$$

where  $Z_1, Z_2, \dots, Z_n$  are element driving-point impedances

$E_1, E_2, \dots, E_n$  are element impressed voltages

$I_1, I_2, \dots, I_n$  are element drive currents

$Z_{11}, Z_{22}, \dots, Z_{nn}$  are element self impedances

$Z_{12}, Z_{13}, Z_{23}, \dots, Z_{1n}, Z_{2n}, Z_{3n}$  are mutual impedances between pairs of elements

(All terms can be complex.)

For example, suppose the drive current  $I_2$  to element 2 changes. Since  $I_2$  appears in the equation for every element, all driving-point impedances, currents and voltages are affected. The self and mutual impedances do *not* change, even though it is the mutual impedances that cause this interaction.

An array is a coupled system, automatically adjusting to any change with a new set of currents and phases, which again simultaneously satisfies all the equations. There is an infinite number of such solutions, but *only a few* result in useful array patterns. A feed network must be designed that when connected to the terminals of each element, applies the proper voltage amplitude and phase, causing the required drive currents to flow. If this condition is met, then all conditions are met. (It may now be clearer why I have been emphasizing the importance of physical and electrical symmetry of the elements.) As the array direction is switched, each port of the feed network continues to "see" the same driving-point impedance it was designed for, even though each port is now feeding a different element. Exact symmetry is probably the most difficult condition to meet in practice because it depends upon more than just simple duplication of physical elements; it also depends on duplication of the environment adjacent to each element: for example, ground planes or other nearby conductors that might act as antennas.

**By Forrest Gehrke, K2BT, 75 Crestview Road,  
Mountain Lakes, New Jersey 07046**

## feed networks

Just as there are an infinite number of solutions to the set of equations defining the driving-point impedances of an array, there are almost as many ways to design networks fitting the one solution required. Some designs are better than others, resulting in more bandwidth for usable F/B (front-to-back) ratio or low SWR. As a general rule, the simpler (that is, the fewer stages in the network), the better, but there are exceptions.

*For superior F/B performance, for all network designs, the designer must know the driving-point impedance of each element.* In this respect, vertical phased arrays are more critically affected by element variations than Yagis are by height variations. For multiple-element arrays, cookbook recipe duplication attempts are almost guaranteed to miss optimum current drive conditions by 10 percent. *This is enough to reduce the F/B performance by 50 percent or more.*

## basic design objectives

Some basic design decisions must first be made: what type of circuit elements should be used? Should the design have the objective of a 1:1 SWR match to the array feedline? Feed networks may be devised using coaxial cables as circuit elements. Although simple in construction, there may be technical and cost drawbacks. Series or stub coaxial cable sections, provided one has a wide enough selection of different characteristic impedances and lengths, could be used for a network that matches to the feedline. The cost would be high and bandwidth narrower than the array's intrinsic F/B capability.

As a special case, for arrays operating with 90-degree current phase multiples and equal current amplitude ratio element pairs,<sup>3</sup> an approach suggested by W7EL<sup>4</sup> makes use of the unique characteristic of a 1/4-wavelength line to produce a constant 90-degree phase displacement between input voltage and output current, independent of the load termination. If two such lines are connected to a common feedpoint, equal current will flow into the loads regardless of their termination impedances. The current phase displacement between the two loads is 0 degrees, but this may be changed to 180 degrees by insertion of a 1/2-wavelength line in series with one of the lines. (The phase displacement of a 1/2-wavelength line also is independent of the load impedance.) A 90-degree current phase displacement, as was pointed out earlier in this series,<sup>1</sup> cannot be obtained by insertion of a 1/4-wavelength line when the termination is reactive. Therefore, instead of inserting an additional 1/4-wavelength line, a lumped-constant phase correction circuit based upon the calculated driving-point impedances is inserted. It pro-

vides a drive current phase of 90 degrees and the correct amplitude at the element(s). The input voltage amplitude and phase to the correction circuit must be designed to be the same as that of the common connection point of the array. SWR of the array can be minimized by proper choice of the characteristic impedance of the coaxial cable feeder lines but cannot be designed for a 1:1 condition. This approach, based upon this unique characteristic of 1/4-wavelength lines, which are also the element feedlines, is limited to arrays where this length is able to physically reach the directional switch. If not possible, a further 1/2-wavelength line has to be added to each feedline to maintain the basis of the design concept.

*This article provides sufficient information to enable the reader to design a feed network for any conceivable array. There are no restrictions on array spacings, current amplitude ratios or phase displacements. The elements must be alike, but they need not be resonant. Conventional or not, if the array you've been able to fit onto your property has a useful pattern, a feed network can be designed to drive it at the needed conditions.* Such versatility requires complete design freedom — freedom to use any characteristic impedance, to transform to any input resistance, regardless of reactive load impedances. Coax is an excellent means for transmission of RF energy between physically separated points. If it also fills a role as a specific circuit element, so much the better. But as a circuit element where the physical spacing does not require it, coax is confining; with only two characteristic impedance choices commonly available (there are perhaps two more, but neither is easy to find), one is constantly making compromises and designing around this limitation. Furthermore, ease of circuit adjustment is not notable. On the other hand,  $\pi$  and tee coax-equivalent lumped-constant circuits may be designed for any exact characteristic impedance or any electrical length, whether lagging or leading phase, and are easily adjusted. And surprisingly, low impedance lumped constant circuits of the same levels as coaxial transmission lines display comparable characteristics, even when designed for fairly large single increments of phase displacement. **Table 1** compares coaxial cable with a 45-degree  $\pi$  circuit cascaded with a 45-degree tee circuit operated as a 1/4-wavelength transformer. Off-frequency phase variation and development of input reactance compares very favorably with coaxial transmission line.

Rounding out the list of network building blocks are the shunt and series input L-match transforming circuits. Included are the two special cases of this circuit, where the series or shunt branch is absent, which I will call a Parallel and a Series impedance circuit, respectively. **Figs. 1A** through **1F** are schematics of all of these circuits.

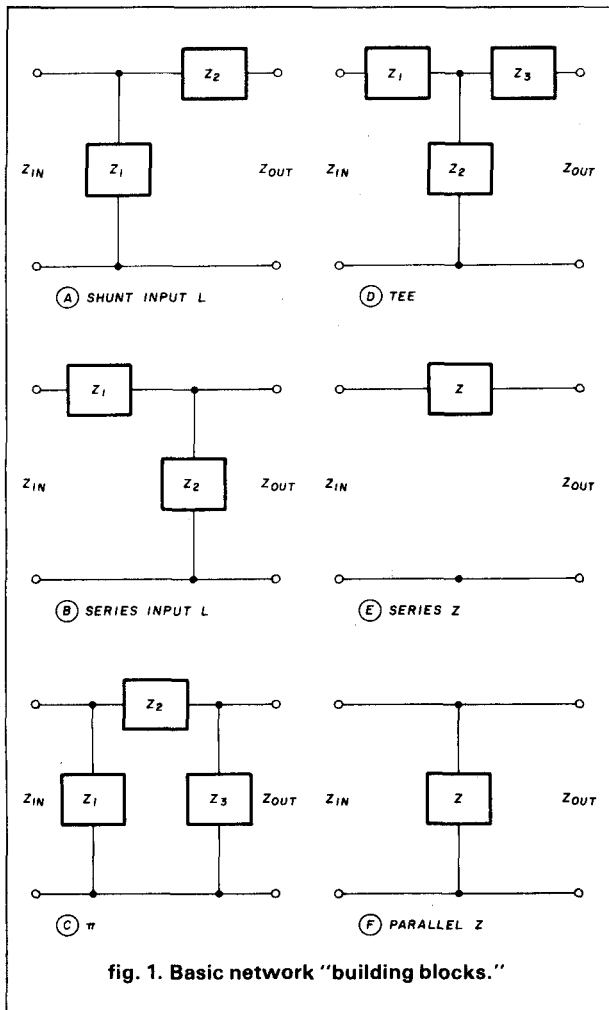

fig. 1. Basic network "building blocks."

## why a 1:1 SWR?

For multi-element arrays the objective of a 1:1 match to the array feedline does not stem from an obsession with SWR. *A low SWR provides no significant measure of an array's efficiency or usable F/B bandwidth.* Designing for an SWR of 1:1 simplifies network design calculations and electrical tests. However, the real value is the instant array condition conveyed every time an SWR measurement is made. A failing relay in a directional switch or a network malfunction is quickly detected, even if this circuit is to an element requiring very little power. Such a failure may raise the SWR from 1:1 to 1.1:1, for example, while the same failure in an array normally showing 2:1 will not be noticed. At "smoke" test time it removes uncertainty; a 1:1 SWR represents an unambiguous confirmation of the accuracy of array measurements, network design, and construction.

As an illustration of the step-by-step design procedure for an array feed network, I will use the popular 2-element array. The same array will be used to show the error that arises in many 2-element ver-

tical array feed arrangements. From Part 3 of this series,<sup>3</sup> the driving-point impedances of two 1/4-wavelength resonant elements spaced 1/4-wavelength apart with unity current ratio and 90 degree phase displacement, are:

Element 1	Element 2
$Z_1 = 21.4 - j15$	$Z_2 = 51.4 + j15$
$I_1 = 1 \angle 0^\circ$	$I_2 = 1 \angle -90^\circ$

Assuming 50 ohm 1/4-wavelength feedlines, using a Smith Chart or by calculation, the element driving-point impedances rotated to the input ends of the feeders are:

$$Z_1 = 78.3 + j54.91 \quad Z_2 = 44.82 - j13.08$$

At element drive conditions of 1 ampere with a phase displacement of  $-90$  degrees between elements, the voltages and currents that must be applied to the inputs of these feeders in polar form are:

$$I_1 = 0.52 \angle 55.0^\circ \quad I_2 = 1.07 \angle 16.3^\circ$$

$$E_1 = 50 \angle 90^\circ \quad E_2 = 50 \angle 0^\circ$$

Notice that the current phase change in the two equal 1/4-wavelength feeders are 55 degrees and 106.3 degrees (90 degrees + 16.3 degrees). Next a 1/4-wavelength 50-ohm delay line is added to the feedline from element 2. Rotating the impedance to the end of the delay line we find these conditions:

$$Z_2 = 51.4 + j15$$

$$I_2 = 1 \angle 90^\circ$$

$$E_2 = 53.54 \angle 106.3^\circ$$

These are the conditions that must exist at the input ends of the feeders from each element for the assumed drive conditions. The current phase delay through the delay line is less than 90 degrees, (90 degrees - 16.3 degrees, or 73.7 degrees, the difference between the input and output angle). Observe that the input voltage amplitudes and phases are not alike at the input ends of the coaxial lines from the two elements. But these two terminals are normally connected together; clearly two different voltages can't coexist here. Since the difference is fairly small, the actual drive conditions that result if connected anyway will be acceptable, though the F/B ratio will diminish. The choice of 1/4-wavelength element feeders just happened to provide this fair agreement. I estimate the actual phase displacement between elements to be about 115 degrees and the current amplitude ratio about 1.15. The 1/4-wavelength delay line didn't produce a 90-degree delay and the delays in the two equal length feeder lines were unequal; these are all quite different results from what is often assumed to occur.

Some writers have assured us we can use any

## Computer Program Books for Beginners

Everything you need to know to get started programming your own computer. These handy books of programs, each jam-packed with easy-to-understand info for beginners, are crammed with hundreds of tips, tricks, secrets, hints, shortcuts, techniques, plus hundreds of tested ready-to-run programs. For the TRS-80 Color Computer. For the TRS-80 Pocket Computer and Sharp PC-1211, PC-1500 pocket computers.

### Color Computer

- 401 Color Computer Programming Tips & Tricks.** learn-by-doing instructions, hints, secrets, shortcuts, techniques, insights, for TRS-80 Color Computer, 128 pages **\$7.95**
- 55 Color Computer Programs for Home, School & Office.** practical ready-to-run software with colorful graphics for TRS-80 Color Computer, 128 pages **\$9.95**
- 55 MORE Color Computer Programs for Home, School & Office.** sourcebook of useful type-in-and-run software with exciting graphics, for TRS-80 Color Computer, 112 pages **\$9.95**

### Pocket Computer

- Pocket Computer Programming Made Easy.** new fast 'n easy way to learn BASIC, make your computer work for you, for TRS-80, Sharp, Casio pocket computers, 128 pages **\$8.95**
- 101 Pocket Computer Programming Tips & Tricks.** secrets, hints, shortcuts, techniques from a master programmer, 128 pages **\$7.95**
- 50 Programs in BASIC for Home, School & Office.** sourcebook of tested ready-to-type-in-and-run software for TRS-80 and Sharp pocket computers, 96 pages **\$9.95**
- 50 MORE Programs in BASIC for Home, School & Office.** ideal source for lots more useful software for TRS-80 and Sharp pocket computers, 96 pages **\$9.95**

QTY.	Title	Price	Total

Allow 2-4 weeks for delivery.

SHIPPING **\$2.00**  
TOTAL

#### FROM:

Name \_\_\_\_\_ Call \_\_\_\_\_  
 Address \_\_\_\_\_  
 City \_\_\_\_\_ State \_\_\_\_\_ Zip \_\_\_\_\_  
 Check or Money Order Enclosed  
 VISA  MasterCard  
 Acct. # \_\_\_\_\_  
 Expires \_\_\_\_\_ MC Bank # \_\_\_\_\_

**SEND TO: HAM RADIO'S BOOKSTORE  
 GREENVILLE, NH 03048**

# GLB PACKET RADIO CONTROLLER

Now you can get in on the fun on packet radio!

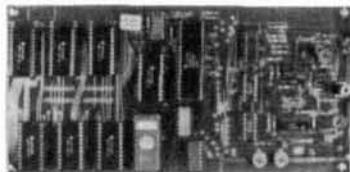

**MODEL PK1**  
(shown with 14K RAM and 8K ROM)

- Low cost!
- Adaptable to any transceiver
- Easy to learn, easy to use.
- Nearly 50 commands.
- Built-in packet Modem and CW identifier.
- Use with teletype machines, computers, terminals.
- RS232 serial interface—45 to 9600 baud!
- Uses both ASCII and Baudot.
- Vancouver protocol—AX.25 to be released soon.
- Optionally write your own protocol on host computer.
- Stores received messages until requested at a later time.
- Operates in "connected" and "general" modes.
- Activates teletype motor to print messages.
- Board accepts up to 14K of RAM.
- Model PK1 can be customized for Commercial Systems.

Protocol can be changed by swapping ROM chips. Board designed to accept 6264's for up to 56K of RAM with minor modification.

Dimensions: 4.5 x 8.5 inches; 1" vertical clearance.

Power requirement: +12 VDC, approx. 200 ma.

Standard equipment includes 4K of RAM (expandable to 14K).

Model PK1, wired & tested— **\$149.95**

additional memory, installed & tested (up to 12K) **\$10/2K**

RTTY adaptor board **\$9.95**

Connecting cables & enclosure—optional ✓ 141

We offer a complete line of transmitters and receivers, strips, preselector-preamps, CWID'ers & synthesizers for amateur & commercial use. Request our FREE catalog, MC & Visa welcome. Allow \$2 for UPS shipping.

## GLB ELECTRONICS

1952 Clinton St. Buffalo, NY 14206  
 716-824-7936, 9 to 4

Hi we're

## Hatry Electronics



AMPHENOL



DAIWA

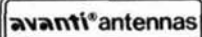

J. W. Miller



Bash Books



Used Equipment



## Hatry Electronics

The Elect in Electronics

500 LEDYARD STREET  
 HARTFORD, CONN. 06114  
 Phone 203-527-1881 ✓ 148



length feeders as long as lengths are kept equal. Let's see how we fare following this advice using 3/8-wavelength 50-ohm feeders for the same array:

Element 1	Element 2
$Z_1 = 21.4 - j15$	$Z_2 = 51.4 + j15$
$I_1 = 1 \angle 0^\circ$	$I_2 = 1 \angle -90^\circ$
$E_1 = 26.13 \angle -35.03^\circ$	$E_2 = 53.54 \angle -73.73^\circ$

135° Feeder	135° Feeder
$Z_1 = 63.58 - j53.98$	$Z_2 = 37.43 + j2.67$
$I_1 = 0.58 \angle 148.56^\circ$	$I_2 = 1.17 \angle 51.66^\circ$
$E_1 = 48.39 \angle 108.22^\circ$	$E_2 = 43.97 \angle 55.75^\circ$

1/4 wavelength delay line
$Z_2 = 66.46 - j4.75$
$I_2 = 0.88 \angle 145.75^\circ$
$E_2 = 58.60 \angle 141.66^\circ$

Note: all impedances, voltages, and currents are input conditions — that is, looking towards the load.

Using 3/8-wavelength feeders, the input voltages required to be applied to each chain are very different. If these terminals are tied together the drive conditions to the elements will be far from intended. Conclusion: element feeders are an integral part of the feed network for a phased array; their circuit characteristics must be taken into account.

### designing for optimum drive

While it is possible to solve for the undesirable drive conditions that would result from making this connection, why bother? It is better to start with the correct design. While doing so, suppose a 1:1 SWR match to a 50-ohm array feedline is included. This would require that the paralleled input impedances of the networks from each element be 50 ohms pure resistance. Assuming lossless conditions, we can go

back to the resistive components of the element driving-point impedances for this determination. These are 21.4 and 51.4 ohms, respectively. At 1 ampere to each element the total drive power is the sum of the  $I^2R$  inputs, or 72.8 watts. Using the relationship  $E^2/R = W$ , and substituting 50 ohms (the characteristic impedance of the array feed-line) for  $R$ :

$$E^2 = 50(72.8), \text{ or } E = \sqrt{3640} = 60.33 \text{ volts}$$

Having established the array feedline voltage amplitude for this drive power, we can calculate the required resistive inputs for each element's network. Rearranging,  $R = E^2/W$ :

$$R_1 = 3640/21.4 = 170.09 \text{ ohms}$$

for network, No. 1 input

$$R_2 = 3640/51.4 = 70.82 \text{ ohms}$$

for network, No. 2 input

As a check on calculations it is useful to do the parallel conductance calculation:

$$1/R_1 + 1/R_2 + \dots + 1/R_n = 1/Z_0 \quad (2)$$

Starting again at the end of the 3/8-wavelength feeder to element 1, one possibility is an L-match network, transforming directly to 170.09 ohms pure resistance. L-match circuit component calculations involve a square root extraction, guaranteeing at least two solutions. (Under certain circumstances, there may be four solutions.) While all solutions produce the intended transformation, they do so with differing phase displacements, with at least one of those displacements being a leading phase. Remembering that element 2 is starting 90 degrees behind the first, fewer stages in the network usually result if a leading phase L-match is chosen for element 1.

Shown in **table 2**, beginning with the driving-point impedances and working forward to the common

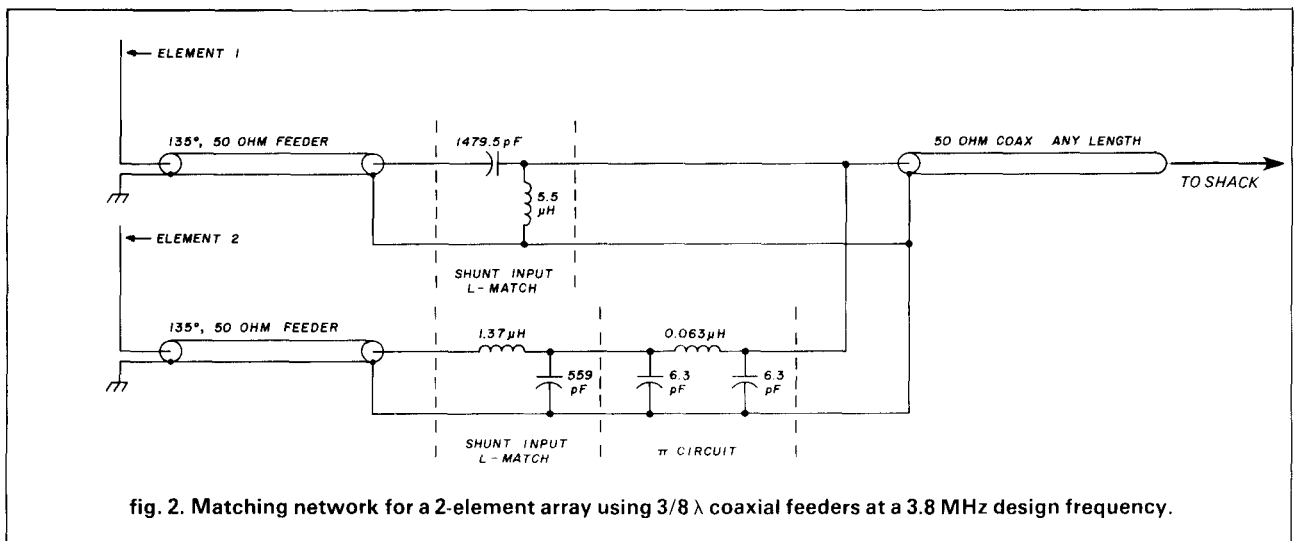

fig. 2. Matching network for a 2-element array using 3/8 λ coaxial feeders at a 3.8 MHz design frequency.



connection of the array, are the input parameters of each circuit. Fig. 2 shows the schematic and component values at the design frequency of 3.8 MHz.

At the inputs of each network chain,  $E_1$  and  $E_2$  are equal in amplitude and phase; the two inputs may be connected together without disturbing drive conditions. Their paralleled resistive inputs represent a 50-ohm resistive load, as designed. The  $\pi$  coaxial-equivalent network was added to the element 2 chain only to show how this type of network circuit is used to match the voltage phase at the common connection of the array network. In this example the agreement that happened to be achieved at the input to the 2 element shunt L-match is sufficient; the  $\pi$  network can be omitted.

**4-terminal networks.** The design procedure for producing exact matching at the required array conditions has been demonstrated. Before proceeding with other examples, the design equations for these circuits are presented. All network circuit components are reactances and assumed to be lossless. Subscript **a** denotes the series load termination components,  $R_a + jX_a$ , instead of the more commonly used  $R_L + jX_L$ , to avoid any confusion with  $jX_L$ , as an inductive reactance.

**L-match circuit.** This circuit can take two forms (see fig. 1A and 1B), termed *Shunt Input* and *Series Input* L-matches. Though this circuit consists of only two components, its analysis is relatively complex. The calculations for either form include a square root extraction, resulting in two possible sets of components for any desired impedance transformation. Either set works; one set often has a leading phase angle, while the other may lag. The absolute value of the angles are not necessarily equal nor always of opposite sign! The component set may have the same reactance sign; that is, both may be inductive (+) or both capacitive (-). The circuit is sometimes referred to as an L-C match, but it could also be an L-L or C-C match. A more apt description is L-match, taken from the similarity of its schematic representation to the letter "L".

**Shunt input L-match.** The series arm component  $X_2$ , must be calculated first, since its value is used in the calculation for the second component:

$$X_2 = -X_a \pm \sqrt{R_a(R_{in} - R_a)} \text{ ohms} \quad (3)$$

$$X_1 = - \left[ \frac{R_a^2 + (X_2 + X_a)^2}{X_2 + X_a} \right] \text{ ohms} \quad (4)$$

where  $R_a$  and  $X_a$  are the series equivalents of the load termination and  $R_{in}$  is the desired input (pure) resistance.

Close attention must be paid to signs. A positive result indicates an inductance, while a negative sign is a capacitance.

**Series input L-match.**  $X_2$  must be calculated first. Note that  $X_2$  is the shunt arm of this circuit, however.

$$X_2 = \frac{-R_{in}X_a \pm \sqrt{R_{in}R_a(R_a^2 + X_a^2 - R_{in}R_a)}}{R_{in} - R_a} \text{ ohms} \quad (5)$$

$$X_1 = \frac{-X_2[R_a^2 + X_a(X_2 + X_a)]}{R_a^2 + (X_2 + X_a)^2} \text{ ohms} \quad (6)$$

Which form should be used? Usually, the shunt input L-match is the only form possible if  $R_{in}$  is equal to or greater than  $R_a$ . Besides, the arithmetic is easier! The series input L-match is used when  $R_{in}$  is less than  $R_a$ . There is a set of circumstances, however, in which the series form can be used even if  $R_{in}$  is greater than  $R_a$ . Inspection of the equation for the series form calculation of  $X_2$  will show this case when  $R_{in}$  is greater than  $R_a$  and when  $(R_a^2 + X_a^2 - R_{in}R_a)$  is equal to or greater than zero. Four solutions, two series and two shunt L-matches, then result. These additional options, if available, are often useful, allowing a smaller phase displacement or more (physically) realizable set of components as a result.

**$\pi$  coaxial-equivalent circuit (fig. 1C).** The  $\pi$  circuit and the shunt input L-match will be found to be the most frequently used circuits for vertical phased array feed networks. The type used here is set up as a reversible network — that is, the input and output can be interchanged without affecting operation, just as with coaxial cable. Reactances  $X_1$  and  $X_3$  are always equal and if capacitive, then  $X_2$  is inductive. At the design frequency this particular configuration shows the same properties as coax. As the frequency is varied, the phase displacement starts differing from that obtained with coax, the difference being larger the greater the equivalent "length" of the circuit. If, instead, multiple sections, each an equal increment of the total phase displacement, are cascaded, the combined network approaches coaxial cable characteristics. This should be expected since the equivalent circuit of coax is a series of infinitesimally small  $\pi$  sections. The design equations are relatively simple:

$$X_2 = Z_0 \sin \theta \text{ ohms} \quad (7)$$

$$X_1 = X_3 = - \frac{Z_0 \sin \theta}{1 - \cos \theta} \text{ ohms} \quad (8)$$

where  $Z_0$  is the required characteristic impedance  
 $\theta$  is the electrical length in degrees

A positive sign indicates an inductance while a negative sign indicates capacitance.

If a *leading* phase, say 30 degrees, is desired, this would be equivalent to 330 degrees in electrical

length if coaxial cable were used. Substituting 330 degrees in these equations causes  $X_2$  to be negative and  $X_1$  and  $X_3$  to be positive; the appropriate capacitance and inductances can then be calculated from the relations:

$$C = 1/\omega X \text{ and } L = X/\omega \quad (9)$$

where  $\omega = 2\pi f$ ,  $f = \text{frequency in Hz}$

Half-wave section (180 degree electrical length)  $\pi$  circuits are taboo, since the calculated circuit values are physically unrealizable. At the least, two separate 90-degree sections are suggested to achieve this "electrical length."

**Tee coaxial-equivalent circuit (fig. 1D).** This circuit is used in the same applications as the  $\pi$  circuit. Alternated with  $\pi$  networks in equal increments of electrical length, network characteristics can be made to equal or exceed coax (assuming coax of the same characteristic impedance is available for comparison). For applications requiring a leading phase displacement only one inductance (for the shunt arm) is necessary, sometimes simplifying construction. The design equations are:

$$X_2 = -Z_0/\sin \theta \text{ ohms} \quad (10)$$

$$X_1 = X_3 = \frac{Z_0(1 - \cos \theta)}{\sin \theta} \text{ ohms} \quad (11)$$

where  $Z_0 = \text{required characteristic impedance}$   
 $\theta = \text{electrical length required in degrees}$

As with the  $\pi$  network, a positive sign indicates inductive reactance and a negative sign, capacitive reactance. Also, 180 degree sections cannot be physically realized and require at least a 2-section cascaded network to achieve that displacement.

**Series impedance circuit (fig. 1E).** This circuit is used when  $R_{in}$  is equal to  $R_a$  and the load has a reactance  $X_a$ . The series matching impedance is simply the reactance of the opposite sign.

$$X = -X_a \text{ ohms} \quad (12)$$

**Parallel impedance circuits (fig. 1F).**

$$X = - \left[ X_a + \frac{R_a^2}{X_a} \right] \text{ ohms} \quad (13)$$

The parallel matching reactance has the opposite sign of the parallel equivalent reactance of the load. The series and parallel circuits can be thought of as a shunt input L-match — with one of its circuit branches either equal to infinity or zero impedance, respectively.

These conditions occur when  $R_{in} = R_a$  or

$$X_a = \sqrt{R_a(R_{in} - R_a)}$$

Either circuit should be considered, particularly when the load has a relatively large reactance compared to its resistive component. The circuit is simple, and cascaded with a following L-match circuit, results in a broader bandwidth network.

## design limitation and other considerations

Some design hints may be helpful to understanding the use of these circuits:

1. The L-match circuits first require selection of the input resistance wanted, transforming from any output impedance. Phase displacement, however, cannot be pre-defined, though the direction, lead or lag, may be chosen.

2. Single L-match impedance transformation ratios exceeding 5-to-1 should be avoided. Above that ratio, expect to see increased frequency sensitivity and resultant reduction in bandwidth. For high ratios, consider transforming in step increments of resistance using several L-matches or combinations of L-match and  $\pi$  or tee circuits (the latter as 1/4-wavelength transformers).

3. In this particular application,  $\pi$  and tee circuits are always designed for pure resistance terminations. These circuits are designed to act as a 1/4-wavelength transformer, or as a specific coaxial-equivalent length, leading or lagging, of transmission line. Choose any characteristic impedance, but keep in mind that large (more than  $\pm 90$  degree) increments of angular displacement, especially at high impedances, reduce bandwidth.

4. Cascaded circuits may each have a capacitor at their common connection points, which are then in parallel. For example, see fig. 3 showing a 567 pF and 392 pF capacitor at a common connection point. The two values may be added and a single capacitor placed at that junction. However, until the network has been tested, it is useful to keep the circuits independent for separate adjustment.

## designing networks for multi-element arrays

Armed with the design equations for simple 4-terminal networks, we can now examine feed networks for arrays consisting of several elements. If the array is one requiring a phase angle multiple, for example, 0, 90, and 180 degrees, or 0, 100 and 200 degrees, and all feedlines are equal in length, the simplest network may result if the middle element is treated as if it were the reference element of the array. The respective networks for the array end elements are designed to lead and to lag the middle element. Then neither has to be designed to span a large angular displacement, and fewer stages result.

Actual slow motion frames from Ham MasterTapes



1. Larry, N2NY, Lee, KA2RNV, Virginia, N2EGJ



2. Lee discharges cap

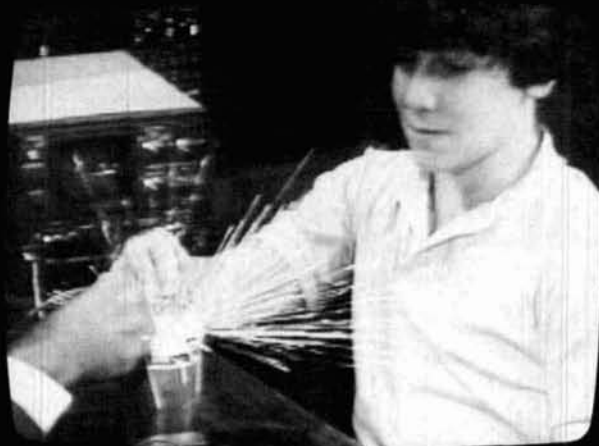

3. In slow motion it's dazzling



4. Wow. Can we see it again?

**You've never seen this, like this,  
before this!**

**And you can see it—in color—again and again  
when you own the N2NY Ham MasterTapes.**

Ever see a cap discharge in slow motion? You will on Ham MasterTapes. Ham MasterTapes can perform the dozens of complicated demonstrations necessary for a beginner's understanding of Ham Radio Theory.

Finally, a step-by-step course in Ham Radio Theory is available on color videotape. The Larry Horne N2NY Ham MasterTapes video course is a unique, effective teaching technique expertly produced by New York's leading professionals in studio and field videotape.

- Video Graphics highlight important details.
- Carefully worked-out demonstrations on video avoid the problem of getting complex gadgets to work on command in front of a class.
- Working examples of every ham radio component, device, or system covered in the FCC guide can be clearly understood.

The N2NY Ham MasterTapes give you a basic grasp of concepts that build theory background—not only for passing the FCC tests, but for understanding electronics.

The hobby has long needed better, clearer, high-tech teaching aids to help newcomers into our wonderful world of Ham Radio.

These six-hour tapes cover completely all the material needed to understand Novice and Tech/General Theory and operations, and include the new 200-question FCC syllabus used beginning September 1983.

Only \$199.95. Order direct and specify Beta or VHS format. Call or write: Larry Horne, N2NY or Virginia Hamilton, N2EGJ at Ham MasterTapes, 295 Park Avenue South, New York, N.Y. 10010 212-673-0680.

**Ham MasterTapes™**

THE N2NY HAM RADIO COURSE ON VIDEOTAPE

© 1983 N2NY Productions, Inc.

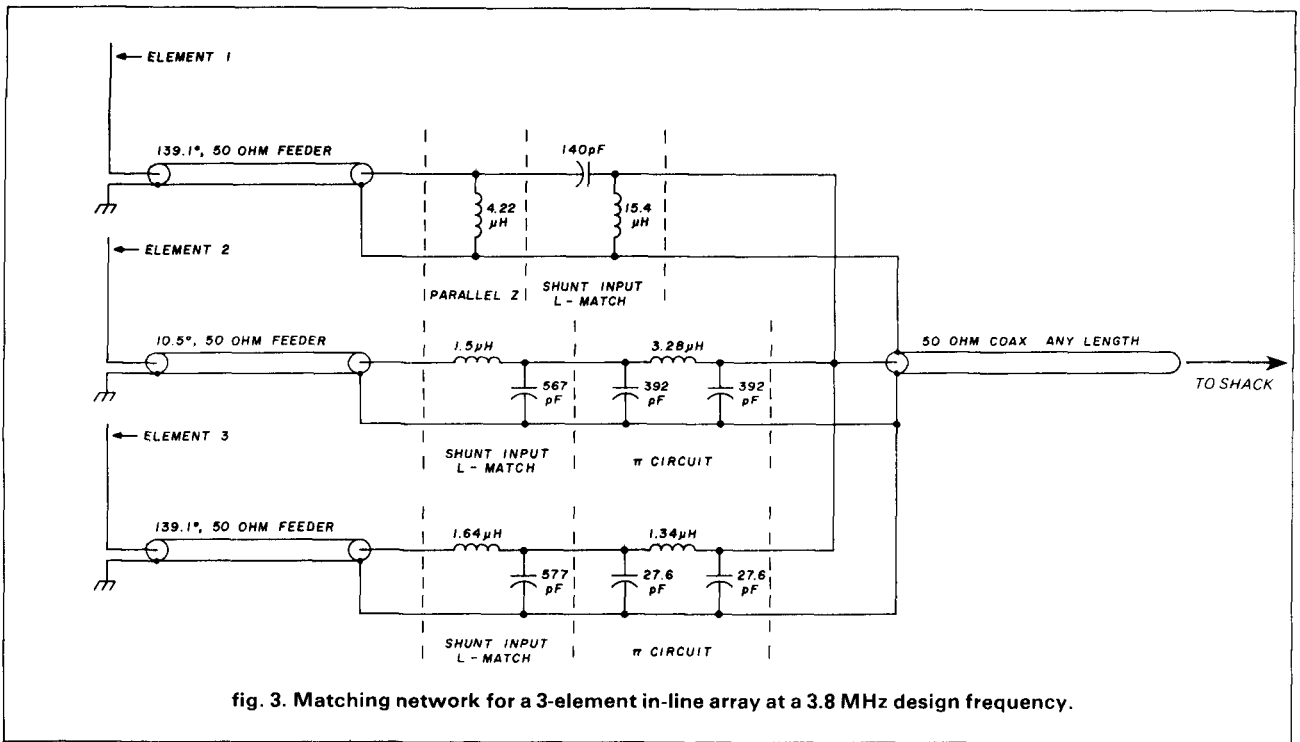

fig. 3. Matching network for a 3-element in-line array at a 3.8 MHz design frequency.

**3-element in-line array.** This array has a particularly deep F/B ratio extending over a wide azimuthal sector. We should be especially interested in taking advantage of this capability. Since the middle element has the same drive-point impedance regardless of array direction, there is no need to make its feeder equal in length to other feeders. Assuming the directional switch is located five feet from the middle element, equal length end element feeders are brought to the center area. At 3.8 MHz, using 0.66 velocity coax, these are 66 feet (139.1 degrees) and for the center element, 5 feet (10.5 degrees) with a  $Z_0$  of 50 ohms. Assuming an array of 3 resonant 1/4-wavelength elements, spaced a quarter-wavelength apart, with current amplitude ratios of 1,2,1 and phase relationships of 0, -90, and -180 degrees, respectively, the driving point impedances are  $Z_1 = 15.4 - j17$ ,  $Z_2 = 36.2 + j0$  and  $Z_3 = 75.4 + j43$ . (Part 3 showed these values incorrectly).<sup>5</sup> As was done with the 2-element array example, the feed network is matched to the 50-ohm array feedline. The sum of the  $I^2R$  input power terms, assuming 1 ampere to the first and third elements and 2 amperes to the middle element, is 235.6 watts. Using the  $E^2/R = W$  relationship, this establishes an amplitude of 108.54 volts at the array feedline connection. At that point the input impedances for each element's network are the pure resistances:

$$Z_1 = 764.94 + j0$$

$$Z_2 = 81.25 + j0$$

$$Z_3 = 156.23 + j0$$

The sequence of input parameters at each junction of the networks is shown in **table 3**.

The resulting network is shown in **fig. 3**. Illustrated in this example is the application of the parallel circuit and the use of leading and lagging phase L-match circuits. Here, element 1 is used as the reference element of the feed network. A parallel impedance circuit is used to transform the impedance seen at the input end of the feeder to a pure resistance. This is then transformed to the pure resistance required for the chain with a shunt input L-match chosen to produce a leading phase change. The resulting input voltage then becomes the objective for the other two network chains.

**Triangular array.** The triangular array feed network demonstrates still another technique for simplifying a feed network. Since elements 2 and 3 operate at identical conditions, the inputs of their transmission line feeders may be paralleled and fed from a common network. **Fig. 4** shows the two feeders connected to a shunt input L-match, and being transformed directly to a resistive input. This is then cascaded with a tee circuit having a sufficiently leading phase displacement to equal the voltage amplitude and phase of the element 1 network. The array termination is designed to match a 50-ohm transmission line. Part 3 incorrectly showed the driving-point impedance of element 1. The correct impedance is  $Z_1 = 20.4 - j10$ . **Table 4** shows the sequence of input parameters at each network junction.

**4-square array.** The 4-square array obviously requires a more complicated drive network. The look-



**table 1. Comparison of impedance, voltage and current phase, and SWR variations with frequency, of 90 degree length of coax and a cascaded 45 degree  $\pi$  circuit and 45 degree tee circuit, both acting as a 50-ohm characteristic impedance 1/4-wavelength transformer. Load termination is 75 ohms pure resistance; the center design frequency is 3.75 MHz.**

frequency MHz		coax	$\pi$ and tee
3.55	$Z_{in}$	33.46 - j2.33	33.45 - j1.86
	$I_o/I_i$	0.67 $\angle$ -86.8°	0.67 $\angle$ -86.33°
	$E_o/E_i$	1.49 $\angle$ -82.82°	1.50 $\angle$ -83.15°
	SWR	1.5	1.498
3.65	$Z_{in}$	33.37 - j1.16	33.36 - j0.91
	$I_o/I_i$	0.67 $\angle$ -88.4°	0.67 $\angle$ -88.15°
	$E_o/E_i$	1.5 $\angle$ -86.4°	1.5 $\angle$ -86.58°
	SWR	1.5	1.5
3.75	$Z_{in}$	33.33 + j0	33.33 + j0
	$I_o/I_i$	0.67 $\angle$ -90°	0.67 $\angle$ -90°
	$E_o/E_i$	1.5 $\angle$ -90°	1.5 $\angle$ -90°
	SWR	1.5	1.5
3.85	$Z_{in}$	33.37 + j1.16	33.36 + j0.88
	$I_o/I_i$	0.67 $\angle$ -91.6°	0.67 $\angle$ -91.88°
	$E_o/E_i$	1.5 $\angle$ -93.6°	1.5 $\angle$ -93.39°
	SWR	1.5	1.5
3.95	$Z_{in}$	33.46 + j2.33	33.45 + j1.72
	$I_o/I_i$	0.67 $\angle$ -93.2°	0.67 $\angle$ -93.79°
	$E_o/E_i$	1.49 $\angle$ -97.18°	1.5 $\angle$ -96.74°
	SWR	1.5	1.498

Note:  $I_i, E_i$  equal input current and voltage, respectively.  $I_o, E_o$  equal output current and voltage, respectively.

network can be designed to reduce this tendency is a question. Perhaps the best alternative is to set the design center frequency on the low end of the intended operating range, recognizing that the optimum F/B bandwidth is a narrow frequency band of about 2 to 3 percent.

Using the driving-point impedances from Part 3 for a 4-square consisting of 1/4-wavelength resonant elements, spaced a quarter-wavelength apart, and phased 0, -90, -90, -180 degrees with current amplitude ratios 1,1,1,1, respectively, input parameter sequences of a suggested drive network are

**table 5. Network input parameters for a 4-square array.**

element 1	element 2	element 3	element 4
$Z_1$ 3.4 - j12	$Z_2$ 39.4 - j17.5	$Z_3$ 39.4 - j17.5	$Z_4$ 63.4 + j47.5
$I_1$ 1 $\angle$ 0°	$I_2$ 1 $\angle$ -90°	$I_3$ 1 $\angle$ -90°	$I_4$ 1 $\angle$ -180°
$E_1$ 12.47 $\angle$ -74.18°	$E_2$ 43.11 $\angle$ -113.95°	$E_3$ 43.11 $\angle$ -113.95°	$E_4$ 79.22 $\angle$ -143.16°
<b>100° coax</b>	<b>100° coax</b>	<b>100° coax</b>	<b>100° coax</b>
$Z_1$ 403.97 + j387.1	$Z_2$ 62.39 + j22.57	$Z_3$ 62.39 + j22.57	$Z_4$ 22.73 - j11.37
$I_1$ 0.09 $\angle$ 46.88°	$I_2$ 0.79 $\angle$ -12.43°	$I_3$ 0.79 $\angle$ -12.43°	$I_4$ 1.67 $\angle$ -74.97°
$E_1$ 51.33 $\angle$ 90.66°	$E_2$ 52.73 $\angle$ 7.46°	$E_3$ 52.73 $\angle$ 7.46°	$E_4$ 42.44 $\angle$ -74.97°
<b>elements 2 &amp; 3 paralleled</b>			
<b>L-match</b>	<b>L-match</b>	<b>L-match</b>	<b>L-match</b>
$Z_1$ 2141 + j0	$Z_2, Z_3$ 92.39 + j0	$Z_4$ 114.83 + j0	
$I_1$ 0.04 $\angle$ -17.37°	$I_2, I_3$ 0.92 $\angle$ 42.04°	$I_4$ 0.74 $\angle$ 15.2°	
$E_1$ 85.32 $\angle$ -17.37°	$E_2, E_3$ 85.32 $\angle$ 42.04°	$E_4$ 85.32 $\angle$ 15.2°	
<b><math>\pi</math> circuit</b>		<b><math>\pi</math> circuit</b>	
$Z_1$ 2141 + j0		$Z_4$ 114.83 + j0	
$I_1$ 0.04 $\angle$ 42.04°		$I_4$ 0.74 $\angle$ 42.04°	
$E_1$ 85.32 $\angle$ 42.04°		$E_4$ 85.32 $\angle$ 42.04°	

**table 2. Network input parameters for a 2-element array.**

element 1	element 2
$Z_1$ 21.4 - j15	$Z_2$ 51.4 + j15
$I_1$ 1 /0°	$I_2$ 1 /-90°
$E_1$ 26.13 /-35.03°	$E_2$ 53.54 /-73.73°
<b>135° coax feeder</b>	<b>135° coax feeder</b>
$Z_1$ 63.58 - j53.98	$Z_2$ 37.43 + j2.67
$I_1$ 0.58 /148.56°	$I_2$ 1.77 /51.66°
$E_1$ 48.39 /108.22°	$E_2$ 43.97 /55.75°
<b>shunt input L-match</b>	<b>shunt input L-match</b>
$Z_1$ 170.09 + j0	$Z_2$ 70.82 + j0
$I_1$ 0.36 /96.25°	$I_2$ 0.85 /95.03°
$E_1$ 60.33 /96.25°	$E_2$ 60.33 /95.03°
	<b><math>\pi</math> circuit</b>
	$Z_2$ 70.82 + j0
	$I_2$ 0.85 /96.25°
	$E_2$ 60.33 /96.25°

**table 3. Network input parameters for a 3-element in-line array.**

element 1	element 2	element 3
$Z_1$ 15.4 - j17	$Z_2$ 36.2 + j0	$Z_3$ 75.4 + j43
$I_1$ 1 /0°	$I_2$ 2 /-90°	$I_3$ 1 /-180°
$E_1$ 22.94 /-47.83°	$E_2$ 72.4 /-90°	$E_3$ 86.80 /-150.3°
<b>139.1° Coax</b>	<b>10.5° Coax</b>	<b>139.1° Coax</b>
$Z_1$ 47.42 - j67.6	$Z_2$ 36.71 + j4.35	$Z_3$ 27.77 + j20.68
$I_1$ 0.57 /159.27°	$I_2$ 1.98 + /-82.33°	$I_3$ 1.65 /-36.83°
$E_1$ 47.06 /104.32°	$E_2$ 73.49 /-75.59°	$E_3$ 56.98 /-0.25°
<b>parallel Z</b>	<b>shunt input L</b>	<b>shunt input L</b>
$Z_1$ 143.19 + j0	$Z_2$ 81.35 + j0	$Z_3$ 156.23 + j0
$I_1$ 0.33 /104.32°	$I_2$ 1.33 /-34.59°	$I_3$ 0.69 /28.24°
$E_1$ 47.06 /104.32°	$E_2$ 108.54 /-34.59°	$E_3$ 108.54 /28.24°
<b>shunt input L</b>	<b><math>\pi</math> circuit</b>	<b><math>\pi</math> circuit</b>
$Z_1$ 764.94 + j0	$Z_2$ 81.35 - j0	$Z_3$ 156.23 + j0
$I_1$ 0.14 /40.01°	$I_2$ 1.33 /40.01°	$I_3$ 0.69 /40.01°
$E_1$ 108.54 /40.01°	$E_2$ 108.54 /40.01°	$E_3$ 108.54 /40.01°

given in table 5 with the schematics shown in fig. 5.

Reaching the center area of a 4-Square array whose elements are spaced 1/4 wavelength with 1/4 wavelength feeders is a problem. Coax with a velocity factor greater than 0.71 is required. Unfortunately, most foam dielectric cables have velocity factors around 0.71, allowing little or no slack for placement of and connections to a directional switch and the feed network. Since a lumped-constant network imposes no restriction on element feeder lengths, I have chosen 100° for these feeders (at 3.8 MHz, 47.45 feet), which is more than sufficient.

The input ends of the feeders to the two middle elements are paralleled and a shunt input L-match is used to transform this combined load directly to the desired pure resistance at the common connection to the array. The input voltage for this chain is the design objective for the networks feeding the remaining elements. Consequently, after transforming the other elements to their required pure resistances (equalling 50 ohms when all networks are paralleled), coax-equivalent  $\pi$  circuits are used to match the voltage phase required at the common connection of the array.

### coming soon

In a forthcoming article in this series I shall cover in detail a method of calculating simple 4-terminal networks based on matrix algebra. As with many mathematical procedures, application of the procedures to the solution of problems doesn't necessarily depend upon a complete understanding of the underlying theory. It is a tool simplifying what is otherwise a tedious process. The calculation procedures are struc-

**table 4. Network input parameters for a triangular array.**

element 1	element 2	element 3
$Z_1$ 20.4 - j10	$Z_2$ 78.4 + j4	$Z_3$ 78.4 + j4
$I_1$ 1 /0°	$I_2$ 0.5 /-90°	$I_3$ 0.5 /-90°
$E_1$ 22.72 /-26.11°	$E_2$ 39.25 /-87.08°	$E_3$ 39.25 /-87.08°
<b>90° Coax</b>	<b>90° Coax</b>	<b>90° Coax</b>
$Z_1$ 98.81 + j48.43	$Z_2$ 31.81 - j1.62	$Z_3$ 31.81 - j1.62
$I_1$ 0.45 /63.89°	$I_2$ 0.79 /2.92°	$I_3$ 0.79 /2.92°
$E_1$ 50 /90°	$E_2$ 25 /0°	$E_3$ 25 /0°
<b>shunt input L</b>	<b>elements 2 &amp; 3 paralleled shunt input L</b>	
$Z_1$ 146.08 + j0	$Z_2, Z_3$ 76.02 + j0	
$I_1$ 0.37 /29.22°	$I_2, I_3$ 0.72 /65.70°	
$E_1$ 54.59 /29.22°	$E_2, E_3$ 54.59 /65.70°	
	<b>tee circuit</b>	
	$Z_2, Z_3$ 76.02 + j0	
	$I_2, I_3$ 0.72 /29.22°	
	$E_2, E_3$ 54.59 /29.22°	

fering equations for matrix values), making it ideal for programmable calculators or small computers. For the same reason, the procedure easily lends itself to chained calculations, allowing fast analysis of a cascade of networks.

### reference

1. Forrest Gehrke, K2BT, "Vertical Phased Arrays, Part 1," *ham radio*, May, 1983, page 18.
2. Forrest Gehrke, K2BT, "Vertical Phased Arrays, Part 2," *ham radio*, June, 1983, page 24.
3. Forrest Gehrke, K2BT, "Vertical Phased Arrays, Part 3," *ham radio*, July, 1983, page 26.
4. Roy Lewallen, W7EL, private communication. Contact K2BT for further information.
5. See "Short Circuits," *ham radio*, October, 1983.

ham radio

**STOP PRESS**  
**AMTOR NOW OFFICIALLY**  
**APPROVED IN U.S.A.**

# AMT-1

## The Definitive AMTOR Terminal Unit

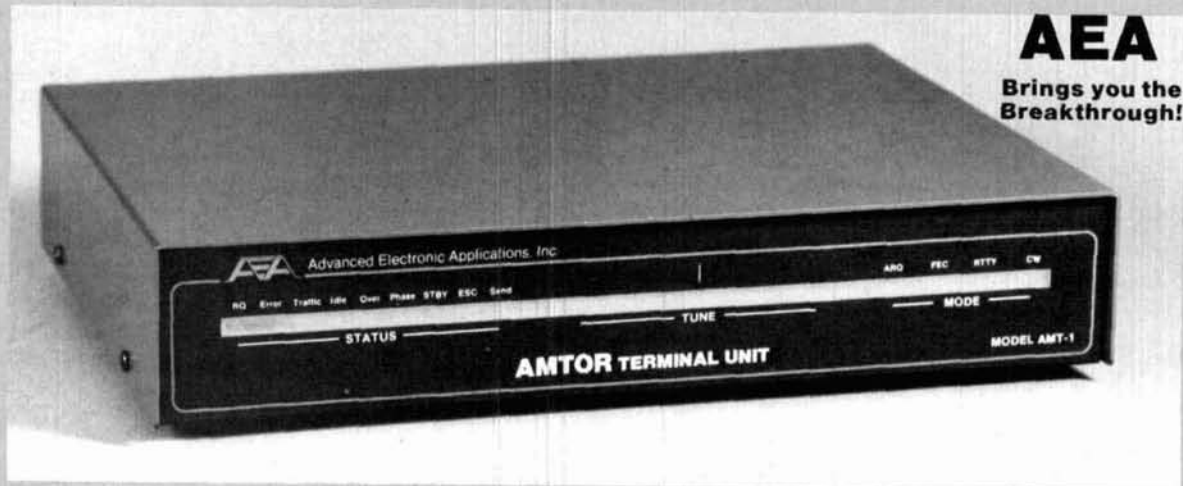

**\$499<sup>95</sup> Introductory Price**

AMTOR is the system of error correcting RTTY which has been rapidly overtaking conventional RTTY in Europe, just as its marine equivalent, SITOR, has been taking over in ship to shore communications.

It was originated by Peter Martinez, G3PLX (see June 1981 QST, p. 25). He first interpreted the international marine CCIR 476-1 specification for amateur use. Virtually all of the 400+ stations presently on AMTOR world wide are using software/hardware designs originated by Peter. The AMT-1 is a proven product which represents his latest and most highly refined design. It represents the culmination of over three years of development and on the air testing, and sets the standard against which all future AMTOR implementations will be judged.

Not only does it incorporate the latest AMTOR specification, but it gives superlative performance on normal RTTY, ASCII and CW (transmit only). As well as some fairly incredible real time microprocessor software, the AMT-1 boasts a four pole active receive filter, a discriminator type demodulator, a crystal controlled transmit tone generator, and a 16 LED frequency analyzer type tuning indicator, which is very easy to use.

Driven from a 12 volt supply, the AMT-1 connects to the speaker, microphone and PTT lines of an HF transceiver and to the RS-232 serial interface of a personal computer or ASCII terminal. All mode control is via ESCAPE and CONTROL codes from the keyboard (or computer program).

It used to be that C.W. was the ultimate mode for "getting through" when QRM and fading were at their worst. That's no longer true — AMTOR will get through with perfect error-free copy when all other conventional transmission modes become useless.

**Order Toll Free: 1-800-558-0411**

*In Wisconsin (outside Milwaukee Metro Area)*  
1-800-242-5195

# AMATEUR ELECTRONIC SUPPLY <sup>®</sup> Inc.

4828 W. Fond du Lac Avenue; Milwaukee, WI 53216 - Phone (414) 442-4200



# CHAMPAGNE RTTY/CW on a Beer Budget

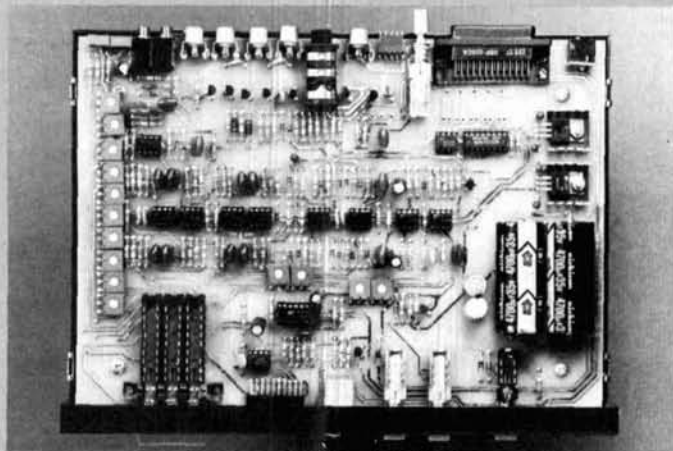

## AEA

Brings you the  
Breakthrough!

## CP-1 Computer Patch™ Interface

The AEA Model CP-1 Computer Patch™ interface will let you discover the fastest growing segment of Amateur Radio: computerized RTTY and CW operation.

When used with the appropriate software package (see your dealer), the CP-1 will patch most of the popular personal computers to your transceiver for a complete full-feature RTTY/CW station. No computer programming skills are necessary. The CP-1 was designed with the RTTY neophyte in mind, but its sophisticated circuitry and features will appeal to the most experienced RTTY operator.

The CP-1 offers variable shift capability in addition to fixed 170 Hz dual channel filtering. Auto threshold plus pre and post limiter filters allow for good copy under fading and weak signal conditions.

Transmitter AFSK tones are generated by a clean, stable function generator. Plus (+) and minus (-) output jacks are also provided for CW keying of your transmitter. An optional low cost RS-232 port is also available. The CP-1 is powered with 16 VAC which is supplied by a 117 VAC wall adaptor included with the CP-1.



# AMATEUR ELECTRONICS SUPPLY <sup>®</sup> Inc.

## BRANCH STORES

WICKLIFFE, Ohio 44092  
28940 Euclid Avenue  
Phone (216) 585-7388  
Ohio WATS 1-800-362-0290

ORLANDO, Fla. 32803  
621 Commonwealth Ave.  
Phone (305) 894-3238  
Fla. WATS 1-800-432-9424

CLEARWATER, Fla. 33515  
1898 Drew Street  
Phone (813) 461-4267  
No In-State WATS

LAS VEGAS, Nev. 89106  
1072 N. Rancho Drive  
Phone (702) 647-3114  
No In-State WATS

## Associate Store

CHICAGO, Illinois 60630  
ERICKSON COMMUNICATIONS  
5456 N. Milwaukee Avenue  
Phone (312) 631-5181

Outside Ohio 1-800-321-3594

Outside Florida 1-800-327-1917

No Nationwide WATS

Outside Nevada 1-800-634-6227

Outside Illinois 1-800-621-5802

State  
of the art



by  
**K.V.G.**

### 9 MHz CRYSTAL FILTERS

MODEL	Appli- cation	Band- width	Poles	Price
XF-9A	SSB	2.4 kHz	5	\$53.15
XF-9B	SSB	2.4 kHz	8	72.05
XF-9B-01	LSB	2.4 kHz	8	95.90
XF-9B-02	USB	2.4 kHz	8	95.90
XF-9B-10	SSB	2.4 kHz	10	125.65
XF-9C	AM	3.75 kHz	8	77.40
XF-9D	AM	5.0 kHz	8	77.40
XF-9E	FM	12.0 kHz	8	77.40
XF-9M	CW	500 Hz	4	54.10
XF-9NB	CW	500 Hz	8	95.90
XF-9P	CW	250 Hz	8	131.20
XF910	IF noise	15 kHz	2	17.15

### 10.7 MHz CRYSTAL FILTERS

XF107-A	NBFM	12 kHz	8	\$67.30
XF107-B	NBFM	15 kHz	8	67.30
XF107-C	WBFM	30 kHz	8	67.30
XF107-D	WBFM	36 kHz	8	67.30
XF107-E	Pix/Data	40 kHz	8	67.30
XM107-SO4	FM	14 kHz	4	30.15

Export Inquiries Invited.

Shipping \$3.50

### MICROWAVE MODULES VHF & UHF EQUIPMENTS

Use your existing HF or 2M rig on other VHF or UHF bands.

### LOW NOISE RECEIVE CONVERTERS

1691 MHz		MMk1691-137	\$224.95
1296 MHz		MMk1296-144	119.95
432/435		MMc432-28(S)	74.95
439-ATV		MMc439-Ch x	84.95
220 MHz		MMc220-28	69.95
144 MHz		MMc144-28	54.95

Options: Low NF (2.0 dB max., 1.25 dB max.), other bands & IF's available

### LINEAR TRANSVERTERS

1296 MHz	1.3 W output, 2M in	MMt1296-144	\$339.95
432/435	10 W output, 10M in	MMt432-28(S)	269.95
144 MHz	10 W output, 10M in	MMt144-28	179.95

Other bands & IFs available.

### LINEAR POWER AMPLIFIERS

1296 MHz	10 W output	MML1296-10-L	\$ ask
432/435	100 W output	MML432-100	399.95
	50 W output	MML432-50-S	214.95
	30 W output	MML432-30-LS	189.95
144 MHz	100 W output	MML144-100-LS	254.95
	50 W output	MML144-50-S	214.95
	30 W output	MML144-30-LS	109.95
	25 W output	MML144-25	99.95

All models include VOX T/R switching.

"L" models 1 or 3W drive, others 10W drive.

Shipping: FOB Concord, Mass.

### ANTENNAS



#### 420-450 MHz MULTIBEAMS

48 Element	70/MBM48	15.7 dBd	\$75.75
88 Element	70/MBM88	18.5 dBd	105.50

#### 144-148 MHz J-SLOTS

8 over 8 Hor. pol	D8/2M	12.3 dBd	\$63.40
8 by 8 Vert. pol	D8/2M-vert	12.3 dBd	76.95
8 + 8 Twist	8XY/2M	9.5 dBd	ask

#### UHF LOOP YAGIS

1250-1350 MHz	29 loops	1296-LY	20 dBi	\$44.95
1650-1750 MHz	29 loops	1691-LY	20 dBi	55.95

Order Loop-Yagi connector extra:

Type N \$14.95, SMA \$5.95

Send 40¢ (2 stamps) for full details of all your VHF & UHF equipment and KVG crystal product requirements.



177



**si**

(617) 263-2145  
**SPECTRUM**  
INTERNATIONAL, INC.  
Post Office Box 1084  
Concord, MA 01742, U.S.A.

**KENPRO**

WHEN ONLY THE BEST WILL DO . . .

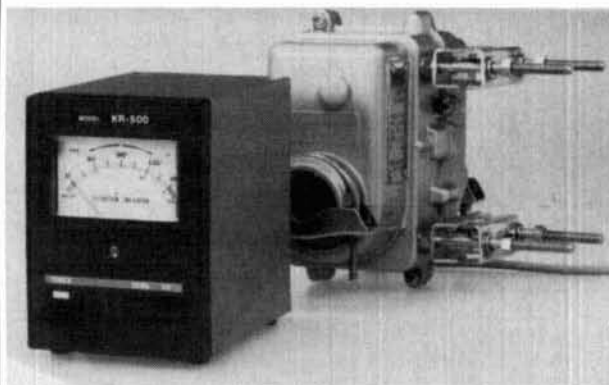

### KR 500 ELEVATION ROTOR

THE WORLD STANDARD

AVAILABLE ONLY THROUGH FULL-TIME AMATEUR DEALERS

DISTRIBUTED BY

**SPECTRUM WEST**

5717 N.E. 56th St. Phone 206/382-2132  
Seattle, Washington 98105 TLX DUFF INTL SEA

✓ 157

## ORR BOOKS

### BEAM ANTENNA HANDBOOK

by Bill Orr, W6SAI

Recommended reading. Commonly asked questions like: What is the best element spacing? Can different yagi antennas be stacked without losing performance? Do monoband beams outperform tribanders? Lots of construction projects, diagrams, and photos. 198 pages. ©1977; 1st edition.

RP-BA Softbound \$7.95

### SIMPLE LOW-COST WIRE ANTENNAS

by Bill Orr, W6SAI

Learn how to build simple, economical wire antennas. Apartment dwellers take note! Fool your landlord and your neighbors with some of the "invisible" antennas found here. Well diagrammed. 192 pages. ©1972.

RP-WA Softbound \$7.95

### THE RADIO AMATEUR ANTENNA HANDBOOK

by William I. Orr, W6SAI and Stuart Cowan, W2LX

Contains lots of well illustrated construction projects for vertical, long wire, and HF/VHF beam antennas. There is an honest judgment of antenna gain figures, information on the best and worst antenna locations and heights, a long look at the quad vs. the yagi antenna, information on baluns and how to use them, and new information on the popular Sloper and Delta Loop antennas. The text is based on proven data plus practical, on-the-air experience. The Radio Amateur Antenna Handbook will make a valuable and often consulted reference. 190 pages. ©1978.

RP-AH Softbound \$7.95

### ALL ABOUT CUBICAL QUAD ANTENNAS

by Bill Orr, W6SAI

The cubical quad antenna is considered by many to be the best DX antenna because of its simple, lightweight design and high performance. You'll find quad designs for everything from the single element to the multi-element monster quad, plus a new, higher gain expanded quad (X-Q) design. There's a wealth of supplementary data on construction, feeding, tuning, and mounting quad antennas. 112 pages. ©1977.

RP-CQ Softbound \$6.95

Please add \$1.00 to cover shipping and handling.

**HAM RADIO'S BOOKSTORE**  
GREENVILLE, NH 03048

# AMTOR RTTY

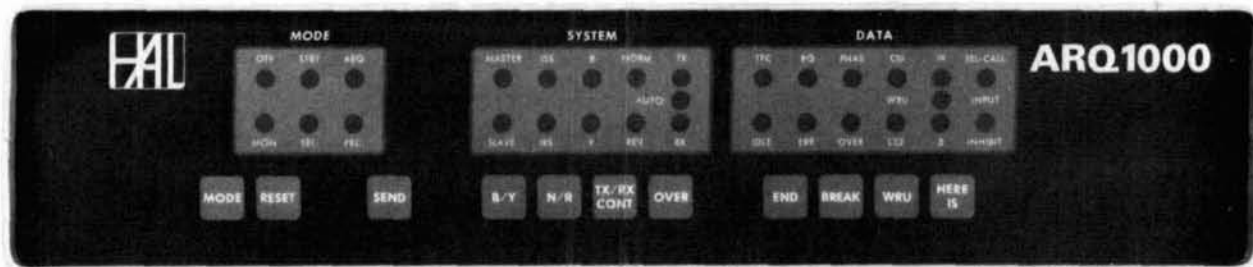

HAL is proud to announce the ARQ1000 code converter. This terminal not only supports the AMTOR amateur codes, but meets ALL of the commercial requirements of CCIR Recommendation 476-2. The ARQ1000 can be used with present and previous generation HAL RTTY products. In fact, any Baudot or ASCII full duplex terminal at data rates from 45 to 300 baud may be used with the ARQ1000. Some of the outstanding features of the ARQ1000 are:

- Send/receive error-free ARQ, FEC, and SEL-FEC modes
- Automatic listen mode for ARQ, FEC, and SEL-FEC
- Meets commercial requirements of CCIR 476-2
- By-pass mode for normal RTTY without changing cables
- Programmable ARQ access code, SEL-CAL code and WRU
- Programmable codes stored in non-volatile EEPROM
- Keyboard control of normal send/receive functions
- 30 Front panel indicators and 11 control switches
- Interfacing for loop, RS232, or TTL I/O
- "Handshaking" control for printer and keyboard or tape
- Self-contained with 120/240V, 50/60 Hz power supply
- Cabinet matches style and size of HAL CT2200
- Table or rack mounting
- Built-in M1700 modem option available
- Encryption option available for commercial users
- 3½" x 17" x 10½"

The ARQ1000 is commercial-quality equipment that will give you the outstanding performance you expect from a HAL product. Write for full details and specifications of the ARQ1000.

## BY POPULAR REQUEST



By popular request – the new CT2200. Our slogan is "When Our Customers Talk, We Listen" – and we have been listening. The CT2200 includes these often requested features:

- New AMTOR connections for use with ARQ1000
- Keyboard programming of all 8 "brag-tape" messages
- Programmable selective call code
- Expanded HERE IS storage for a total of 88 characters
- Non-volatile storage of HERE IS, "brag-tape," and SEL-CAL code
- 3½" x 17" x 10½"

All of the proven CT2100 features are retained. Some of these features are:

- Tuning scope outputs (a MUST for AMTOR)
- Built-in demodulator for high tones, low tones, "103", or "202" modem tones
- 36 or 72 character display lines
- 2 pages of 72 character lines or 4 pages of 36 character lines
- Split screen or full screen display
- Baudot or ASCII, 45 to 1200 baud
- Full or half duplex
- Morse code send/receive at 5 to 99 wpm
- Send/receive loop connection
- Automatic transmit/receive control (KOS)
- Audio, RS232C, or Loop I/O
- On-screen tuning and status indicators
- Clearly labeled front panel switches, not obscure keyboard key combinations
- Separate convenient lap-size keyboard
- Internal 120/240, 50/60 Hz power supply
- Attractive shielded metal cabinet

In addition, an update kit is available so that all CT2100 owners can update their CT2100's to include CT2200 features. The kit even includes a new CT2200 front panel! Rather than making a proven product obsolete, HAL put even more behind the buttons. Pick up a CT2200 at your favorite HAL dealer and join the RTTY fun. Write for our full RTTY catalog.



**HAL COMMUNICATIONS CORP.**

**Box 365**

**Urbana, IL 61801 (217) 367-7373 TWX 910-245-0784**

# a one-weekend, 2-meter amplifier

30 watts from  
an easy-to-build project  
using low-cost components

After years of operating on two-meter FM with a tube-type radio, I decided it was finally time to replace it with something less demanding on the car's electrical system. My purchase of a synthesized hand-held transceiver spurred me to develop an amplifier which would provide a mobile system with the same capabilities as the tube rig, but with lower power consumption. That amplifier is described here.

## evolution of the amplifier

I've never seen an amplifier design that is quite what I needed to meet these design requirements: 1-watt drive for full output (30 to 40 watts), low cost, ease of construction, and long-term reliability. I decided to build one based on a two-transistor circuit.

The 2N6080 and MRF238 transistors were readily available at low cost. This particular combination provided an excess of drive power between stages; however, this helps make the amplifier wideband, and ensures continued operation near rated output under low-battery conditions. The power consumption consequently is slightly higher than necessary, but still much less than that of an equivalent tube-type radio.

To make the amplifier easy to duplicate and tune, I decided to use printed-line inductors instead of discrete coils. The next step was to calculate the impedance-matching networks. Motorola's excellent application notes<sup>1</sup> were used to do this. Once calculated, the networks were verified using "The Electronic Breadboard."<sup>2</sup> Data for the inductors was obtained from references 3 and 4. Once built, the matching networks were modified empirically.

The resulting circuit is shown in fig. 1. The input-matching network consists of  $C_1, C_2, C_3, C_{13}$ , and  $L_1$ . The interstage network uses  $C_4, C_5$ , and  $L_2$ , and the

output network is made up of  $L_3, C_6, C_7, C_8$  and  $C_{14}$ . Power-supply decoupling is very important and is achieved by  $C_9-C_{12}$ , RFC2, RFC4, and feed-through capacitor  $C_{15}$ .

The 1N540 diode serves two functions. It protects the amplifier by clipping inductive spikes from things like starter motors. It also protects the amplifier against reverse polarity of the power supply, by causing the line fuse to blow.

Once the amplifier was constructed and working, some means of transmit/receive switching was needed. PIN diodes are state-of-the-art and small, but not readily available. The alternative was to modify an open-frame relay, as described in reference 5. The relay circuit is actuated by RF from the exciter. Its driver circuit is shown in fig. 2.

## construction

Once the design is completed, the circuit board must be constructed. I used a 9-1/4 × 2-3/4 inch (23.5 × 7 cm) piece of G-10 board with copper on both sides. Orr<sup>6</sup> highly recommends short, direct paths, and this philosophy was followed. The inductor and RF-transistor connecting pads must be laid out first. It is important to realize that these are printed inductors and not transmission lines; therefore, the copper material on the reverse side of the board must be removed under the inductors. If this is not done, the amplifier will not work.

Although straight-line inductances are shown in fig. 3, this is not mandatory. The important parameters are average path length and the path width. Next, lay out the power-supply line — remember it carries several amperes and must not have any appreciable resistance. Finally, allocate an area for the modified T/R relay and its driver circuit, and lay this out. The layout that I used is shown in fig. 3.

This layout is simple enough to reproduce directly on the board, using ordinary electrical tape and trimming it to size with a sharp blade. After the layout is completed and verified, etch the board using standard techniques. (I used ferric chloride.)

By James A. Sanford, WB4GCS, 509 Forest Drive, Casselberry, Florida 32707

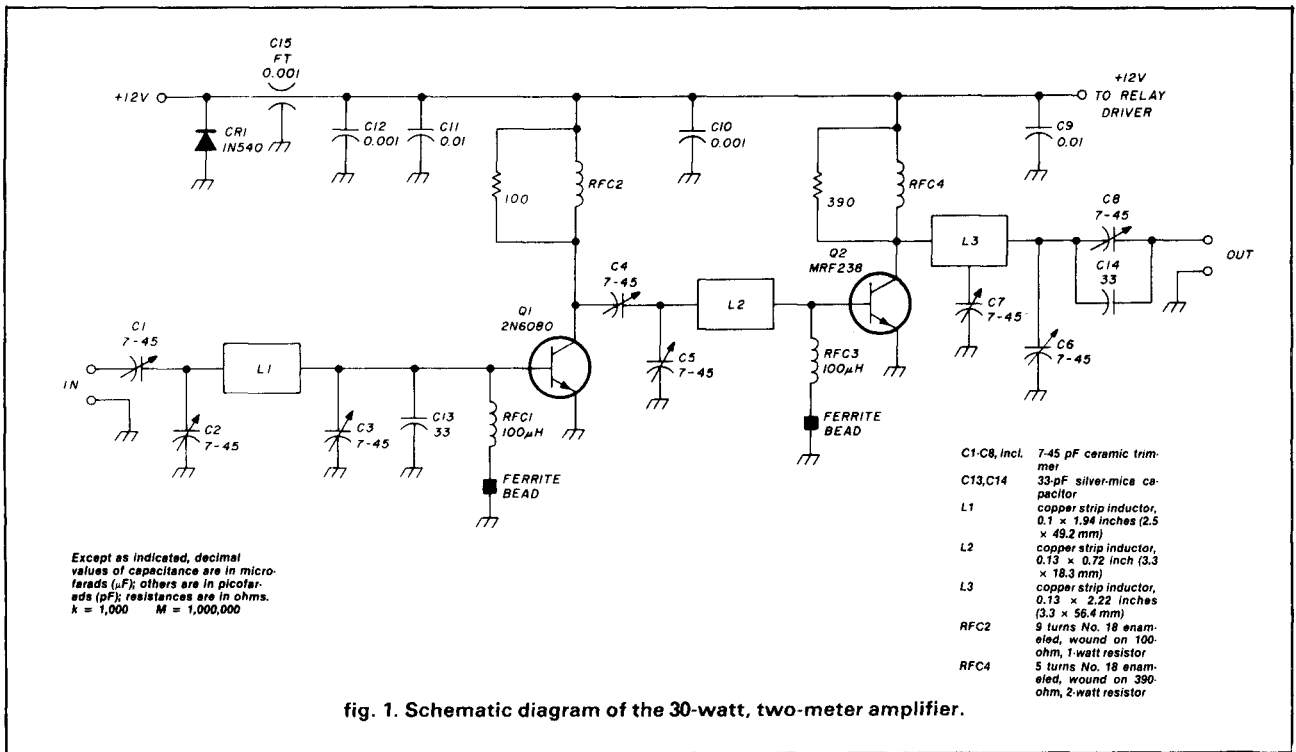

fig. 1. Schematic diagram of the 30-watt, two-meter amplifier.

After the board is made and drilled, mount it to the heatsink using 1/8 inch (0.32 cm) spacers 5/16 inch (0.79 cm) in diameter. Mount the RF transistors to the heatsink, using a thermal compound to ensure good heat transfer. If a torque wrench is available, torque the hardware to six inch pounds (0.68 Ntm). Otherwise, tighten it until a moderate resistance is felt, using a wrench no longer than three inches. Make sure you hold the stud to prevent it from moving. Avoid overtightening the stud on the transistors or they could be damaged. Also, be sure that the top and bottom ground planes are connected together in at least six places.

After the transistors are mounted to the heatsink, solder them to the PC board. The transistors are mounted before soldering to avoid excessive (damaging) stresses on the leads during mounting to the heatsink.

Next, mount the capacitors and chokes, keeping the lead lengths as short as possible. Follow the parts layout in fig. 4. Mount the relay, using either metal hardware or epoxy glue. Wire the input and output coax lines to the relay, and then install the relay-driver components. The input and output coax connectors can be mounted directly on the PC board, or made part of the cabinet and connected by short lengths of coax. This completes the actual construction.

Carefully check the wiring against the circuit diagram. Pay close attention to transistor orientation and placement of the variable capacitors. The amplifier is now ready for a "smoke test."

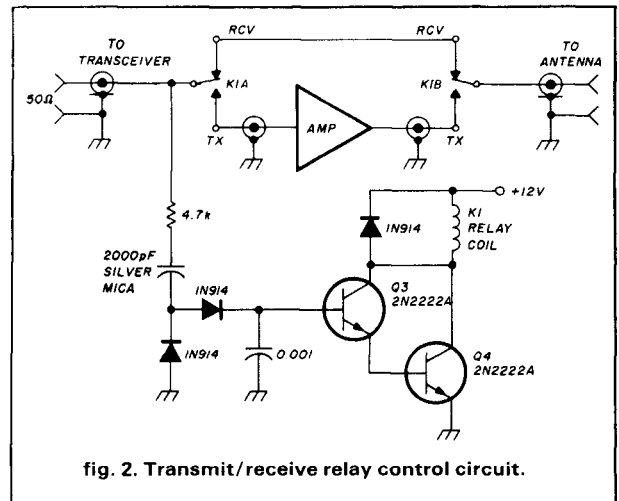

fig. 2. Transmit/receive relay control circuit.

## testing

Connect the amplifier to a 12-volt source through a fuse of 10 amperes, a 50-ohm load, and a driver. Apply power and monitor the idling current — it should be low (a few mA). With some means of measuring output to the load, apply drive to the amplifier. The relay should switch to the transmit position. If it doesn't, check the relay-control circuit and try again.

Once the relay transfers, you should see some RF output. If not, adjust the input tuning until you see some low value of output. Then peak the output network for maximum output. Next, peak the interstage and input networks for maximum output. Repeat the entire procedure until no further increase in output

This tower is ready for shipment to one of our customers, or is it? If we were an ordinary tower company, this tower would have already been sent.

We are not an ordinary tower company and that is why this tower did not go out.

We have the best quality control in the business and we are not afraid to say so. That is why when John Pasillas

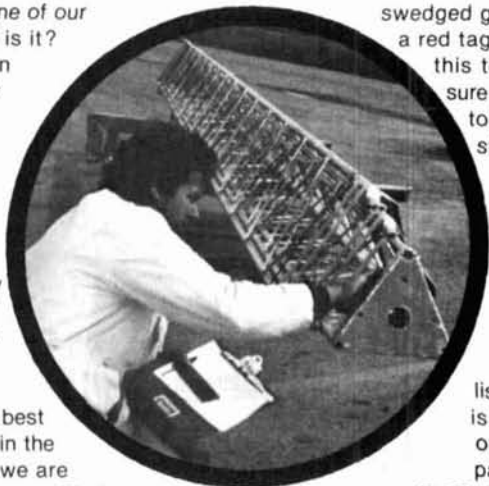

found a 1/8" clearance on the swedged guide, he placed a red tag of rejection on this tower and made sure it was corrected to 1/16" before he stamped his final approval for shipment.

Every employee at Tri-Ex knows that the reputation you establish in an industry is what will make or break his company. That is why Tri-Ex has been in business continually since 1955.

When you purchase your tower from Tri-Ex, you can be assured that all welds have been done by certified welders, all construction and galvanizing has met ASTM standards, all towers have been constructed in precision jigs, all steel has been tested for carbon content and tensile strength.

When it goes to shipping, John is ready.

When you decide on Tri-Ex you have many models to choose from.

#### STACKED:

Light, medium, heavy duty  
10 feet and up.

#### CRANK UPS:

Light, medium, heavy duty  
25 feet to 88 feet standard.

#### SPECIAL TOWERS:

Sky needle, Clementower  
37 feet to 180 feet & higher

Introducing Tri-Ex's new DX-86 — 86 feet tall, 25 square feet in a 50 mph wind.

Call your local dealer for details.

FOR ADDITIONAL INFORMATION WRITE TO:



**TOWER CORPORATION**

7182 Rasmussen Ave.  
Visalia, Calif. 93291

P.O. Box 5009

Visalia, California 93278

(209) 651-2171

✓ 184

## 1296 & PHASE III

MAKI UTV 1200 - \$499<sup>95</sup>  
2M or 6M I.F. / 3 WATTS

**MICROWAVE MODULES**  
**432 / PHASE III UNITS**  
**\$269.95**

**J-BEAM / LOOP YAGIS**  
**AND ACCESSORIES**

SEE US IN HOUSTON

**SPECTRUM WEST**

5717 NE 56th, SEATTLE, WA

206-382-2132 ✓ 178 98105



#### New CMOS DTMF Chip Kit

Telnet's TRK-957 Kit makes it easier and less expensive to breadboard a low-power, central office quality DTMF detection system. All you need is a power source from 5 to 12 VDC. The sensitivity, wide dynamic range, noise immunity, and low-power consumption make the TRK-957 ideal for telephone switching, computer, and remote control applications. The TRK-957 DTMF Kit is only \$24.75. To order call:

(800) 227-3800, ext. 1130.

In CA. (800) 792-0990, ext. 1130.

**TELNET**

✓ 181

Our 4th Year

**BUY • SELL**  
**TRADE**  
**ELECTRONICS**

IN

**NUTS & VOLTS**  
**The Nation's #1 Electronic**  
**Shopper Magazine**

PO BOX 1111-H • PLACENTIA, CA 92670  
(714) 632-7721

Join 1000's of Readers Nationwide  
Each Month

**U.S.A. SUBSCRIPTIONS**

\$ 7.00 - 1 YEAR 3RD CLASS MAIL

\$12.50 - 1 YEAR 1ST CLASS MAIL

\$25.00 - LIFETIME - 3RD CLASS MAIL

With Free Classified Ad

VISA

MasterCard

✓ 169

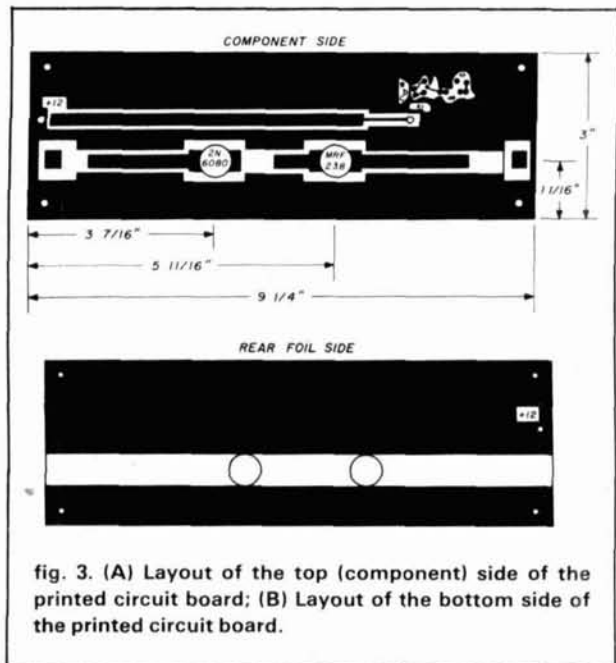

fig. 3. (A) Layout of the top (component) side of the printed circuit board; (B) Layout of the bottom side of the printed circuit board.

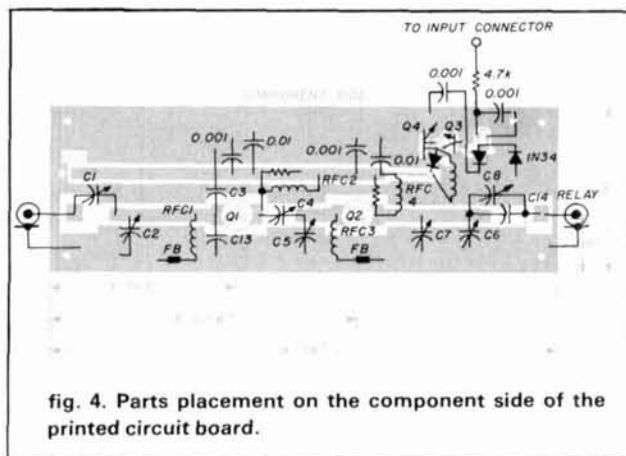

fig. 4. Parts placement on the component side of the printed circuit board.

can be seen. The output should be between 30 and 40 watts, depending on drive level and power-supply voltage. The input SWR should be very close to 1:1. Measure the power supply current, which should be between 4 and 6 amps. Keep in mind that the duty cycle should be kept low until the tuning has been completed. Pay close attention to transistor temperatures — they will get warm, and excessive temperature can result in catastrophic failure.

### final assembly

The enclosure is up to you. I soldered together double-sided circuit board to make a simple, cheap, and RF-tight enclosure. After the amplifier is placed in the enclosure, recheck the output — there should be little change.

Amateurs often ignore a basic fact of heat transfer and fluid flow: hot air rises. The heatsink needs to be mounted in such a way that the hot air can flow un-

impeded. This means that the fins must be vertical. I have seen far too many installations where heatsink fins are horizontal, reducing efficiency. The obvious benefit of doing this right is increased reliability and long life.

### results

I installed the amplifier in my car and it has been working well for several months. Output power and gain as a function of frequency are shown in fig. 5. Though not perfect, the bandwidth is certainly acceptable for use on the two-meter band. During several months of operation, no degradation in performance or change in tuning has been noted. This attests to the long-term stability and reliability of the amplifier.

One aspect all too often neglected by Amateurs is that of spurious outputs. This amplifier was checked on a spectrum analyzer with gratifying results. There were no measurable outputs other than the one desired. As close as could be measured, the output was a faithful reproduction of the input. When modulated with a single tone, the TR-2400-and-amplifier combination exhibited textbook response, clean and symmetrical, with no hint of instability or distortion. The insertion loss in the receive mode is negligible.

The total time needed to build and test this amplifier was less than one weekend, including fabricating the circuit board. The final product was a reliable 30-watt amplifier capable of being driven to full output by a 1-watt hand-held transceiver.

### parts

One of my pet peeves is people who describe equipment that is very nice to build, but uses hard-to-find, or outrageously expensive, custom-manufactured components. This amplifier uses readily available components, and I will cite my sources for non-

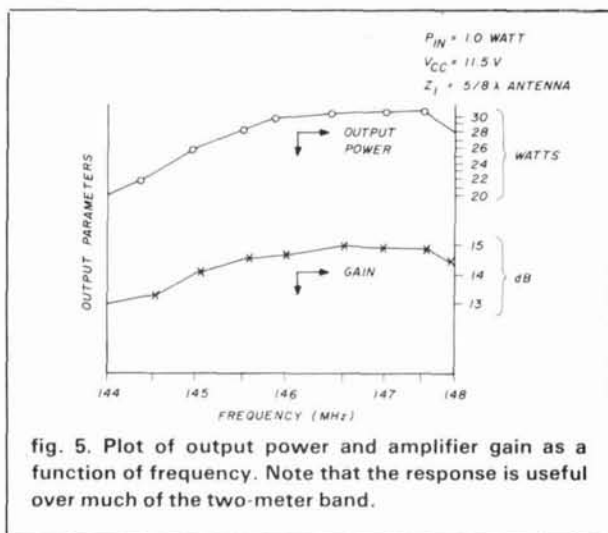

fig. 5. Plot of output power and amplifier gain as a function of frequency. Note that the response is useful over much of the two-meter band.

## TUCSON AMATEUR PACKET RADIO

- ERROR-FREE DIGITAL COMMUNICATIONS
- COMPLETE TERMINAL-RADIO INTERFACE SYSTEM
- CUSTOM TRANSFORMER AND POWER SUPPLY
- BUILT-IN MODEM (TU)
- 32K OF EPROM SOFTWARE INCLUDED
- FULL AX.25 AND VADCG PROTOCOLS
- NONVOLATILE STORAGE OF CALL SIGN AND OTHER ADJUSTABLE PARAMETERS
- DESIGN FIELD TESTED BY 200 AMATEURS WORLDWIDE
- KIT INCLUDES PC BOARD, COMPONENTS AND MANUAL

ONLY \$240 plus \$7 Shipping and Handling  
(5% Sales Tax for Arizona Residents)

FOR FURTHER INFORMATION WRITE:  
Tucson Amateur Packet Radio Corp.  
P.O. Box 22888 Tucson, AZ 85734  
(A Non-Profit Research and Development Group)

MANUAL AVAILABLE SEPARATELY for \$15 plus \$1.50 Shipping (Manual Price can be Credited toward Kit Purchase)

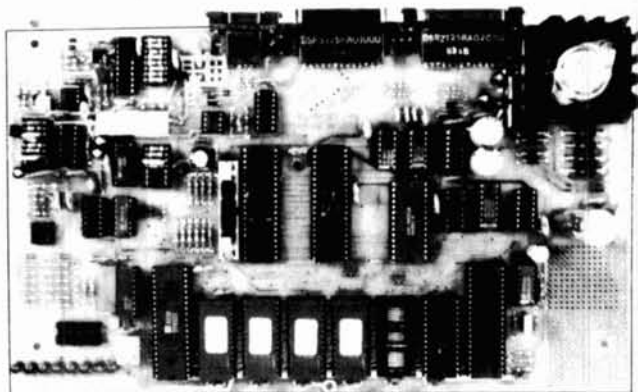

186

## STUMPED FOR A GIFT IDEA?

### I.D. BADGES

No ham should be without an I.D. badge. It's just the thing for club meetings, conventions, and get-togethers, and you have a wide choice of colors. Have your name and call engraved in either standard or script type on one of these plastic laminated I.D. badges. Wear it with pride! Available in the following color combinations (badge/lettering): white/red, woodgrain/white, blue/white, white/black, yellow/blue, red/white, green/white, metallic gold/black, metallic silver/black.

UID Engraved I.D. Badge

\$2.50



### HERE'S A GIFT IDEA!

How about an attractive BASE-BALL style cap that has name and call on it. It's the perfect way to keep eyes shaded during Field Day, it gives a jaunty air when worn at Hamfests and it is a great help for friends who have never met to spot names and calls for easy recognition. Great for birthdays, anniversaries, special

days, whatever occasion you want it to be. Hats come in the following colors: GOLD, BLUE, RED, KELLY GREEN. Please send call and name (maximum 6 letters per line).

UFBC-81

\$5.00

REGULAR PRICE HAT AND BADGE \$7.50 + SHIPPING

**SPECIAL \$6.49**

**SAVE \$1.00**

Please enclose \$1 to cover shipping and handling.

## HAM RADIO'S BOOKSTORE

GREENVILLE, NH 03048  
(603) 878-1441

junk-box parts. The transistors came from Semiconductor Surplus. I obtained the circuit board and ceramic trimmers from a local surplus outlet, but these are seen at every hamfest and in the advertising pages of *ham radio*. The chokes came from the junk box and are not critical. The ferrite beads are available from Amidon and others, and also at hamfests. I have modified several types of junk-box relays, and all worked well in this circuit.

You can make some substitutions. The chokes are not critical; just be sure to use ferrite beads to lower the *Q* and prevent low-frequency oscillations. I used ceramic trimmer capacitors, although compression or piston types would probably also work. Whatever type is used, it must be capable of withstanding the rf currents involved. This is especially important in the output circuitry. If you have access to a good capacitance meter, you can build the amplifier using various capacitors, and then substitute fixed-value chip capacitors, such as those made by Unelco. This will provide maximum reliability.

The most critical part is the heatsink — if it is not adequate, the transistors will not survive. I used one 6 × 3-3/4 inches (15.24 × 9.83 cm). If you have a bigger one, so much the better. The more area available for heat transfer, the cooler the transistors will run.

To ensure adequate cooling in the hot Florida sun, I placed a fan on the heatsink to help keep temperatures low. This may not be necessary, but is good insurance to help the amplifier last. To date there have been no thermal problems, even with temperatures inside the car higher than 100 degrees F.

### acknowledgements

Several people contributed in different ways to the success of this project. I am grateful for the assistance of W4MJJ, W4RJV, WA4HSY, and WD4LWL.

### conclusion

I would welcome any comments or suggestions. Please include an SASE if a reply is desired. Printed circuit boards may be available. Contact the author for details.

### references

1. *Application Note AN-721*, Motorola Semiconductor Products, Inc., 1974.
2. R. Nicol, "The Electronic Breadboard" computer program, Instant Software. Available for TRS-80 Model I/III Color Computer and Apple II.
3. H. Granberg, K7ES, "Printed Line Techniques Applied to VHF Amplifier Design," *QST*, September, 1979, pages 11-16.
4. Kochen, "Practical VHF and UHF Coil Winding Data," *ham radio*, April, 1971, pages 6-14.
5. *FM and Repeaters*, ARRL, 1st edition, page 63.
6. William I. Orr, W6SAI, *VHF Handbook*, Radio Publications, Inc., 1974.

ham radio



# YOU CAN'T BEAT THE SYSTEM

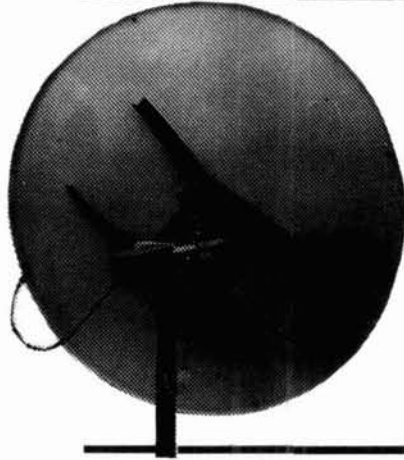

## 8' FIBERGLASS

- One piece construction
- Reflector weight 80 Lbs.
- Focal point of 27 $\frac{3}{4}$ "
- F/D of .275
- Gain of 37.8 dB
- Noise at 50° elevation 30°K
- Mount complete with 3 $\frac{1}{2}$ " pole
- Polorotor I standard

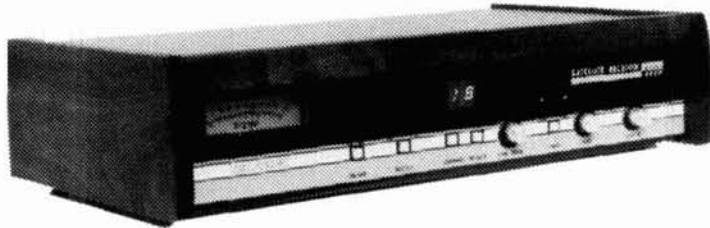

## GILLASPIE 9600

- Infra-red wireless remote control
- Digital tuning
- Polarity reverse (Satcom/Westar)
- On/off switch on remote
- Built in A/B switch
- Large signal strength meter
- Automatic polarity control
- Attractive wood cabinet
- Built in channel  $\frac{3}{4}$  modulator

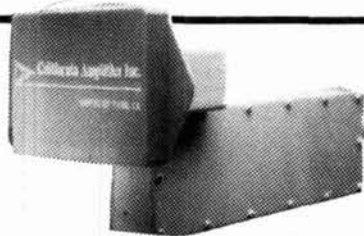

**CAL AMP LNA'S**  
120° 100° 85°



**SAT-PAK**  
LNA CABLES



**ECLIPSE I**  
PROGRAMABLE ACTUATORS

# YOU CAN'T BEAT THE PRICE

**ORDER NOW**



**(800) 221-6535**  
**(212) 345-8000**

**ATTENTION DEALERS:**

This is the system that you have been waiting for. An 8' Delta Gain antenna with low noise temperature at low angles, a wireless remote receiver that looks good and works great and has the features the others forgot. Quality LNA's, cables and accessories. This system is complete. You don't have to buy pipe, wire or connectors. It's light weight and can be installed by one man. **CALL FOR DEALER PRICES THAT CAN'T BE BEAT ... 800-221-6535.**

185

**RITON MARKETING corp.**  
79 Remsen Avenue  
Brooklyn, New York 11236

**WHOLESALE**  
**DISTRIBUTORS**

**(800) 221-6535**  
**(212) 345-8000**

# MORE FROM PRO-SEARCH™ ELECTRONICS

## NOW THREE MODELS OF OUR DIGITAL ANTENNA CONTROL Your Choice Of Center, North Or South

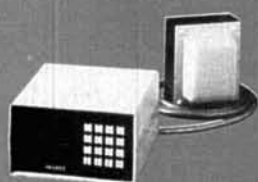

**GOOD**  
PSE-1A, 3A

The "CONTESTER" provides the least expensive DIGITAL CONTROL UNIT WITH COMPLETE COMPUTERIZED CONTROL, BUT WITH LESS FEATURES, than the "DX'ER" and "DELUX".

This unit gives you the current position of your antenna digitally in 5° steps. It has 2 memories and the command mode, plus single button operation. The PSE-1A, "CONTESTER" comes with a 7.0 amp continuous duty motor supply. PSE-3A has a 12 amp power pack.

It is not capable of being modified to talk or accept the computer interface or remote interface. It is completely shielded and made of the same quality components as the other models.

The warranty on our unit is one year on materials and labor, and ninety days on parts.

This unit is a very inexpensive way to have the best of both worlds. A real time saver during contests. Hands off operation will save many hours of hanging on the rotor. Just a few dollars more than the manual control box, but worlds apart in state-of-the-art and operation. Price \$229.95\*

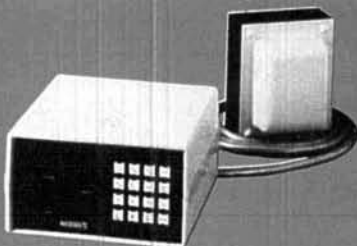

**BETTER**  
PSE-1, PSE-3

The "DX'ER" is the top of the line of the non-voice synthesized units, and is for the ham who is in need of more features on their controller. It has "2" digital readouts, one to show the antenna's current position, plus a storage readout which holds a heading or digitally displays your last position. This is valuable for switching between long path or short path, or checking front to back, or working between two different stations...a real time saver and just a nice convenience.

The "DX'ER" also has "5" scan functions: 0-90, 90-180, 180-270, 270-360, and 0-360. This is a real aid in looking for that dogleg opening or peaking a weak signal.

It can be expanded to talk, and does have the hardware necessary to use with the computer interface.

It can be remotely keyed, where verbal confirmation isn't required. Price \$362.95\*

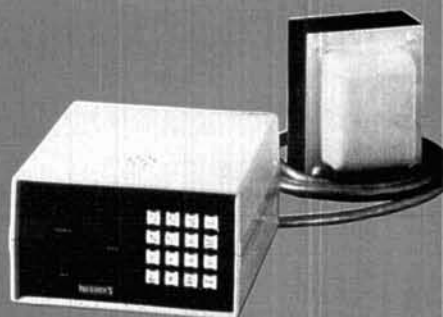

**BEST**  
PSE-2, PSE-4

This is the ultimate in rotor controls. Nothing tops this one.

It has all the features of the other models, plus it talks...Yes, it talks.

The "DELUX" has a voice synthesizer which confirms your entries, plus tells you your heading as you enter it and when your antenna arrives.

All commands are spoken, plus as your antenna turns you hear a 400Hz tone going in one direction and a 80Hz tone in the other. This gives you positive verification of movement.

This unit, as the others, will combine with the HAM IV, T2X, and HDR-300, giving you the best antenna rotor combination you could ever want at any Price \$469.00\*

## INTRODUCING THE ULTIMATE PACKAGE...FROM PRO-SEARCH™ NINE COMBINATIONS OF OUR CONTROL UNIT AND THE TELEX/HYGAIN\* ROTOR MOTORS... FOR JUST A FEW DOLLARS MORE YOU CAN HAVE THE CONTROLLER OF THE FUTURE TODAY!

#1 The "Contester" Package...try one of these TELEX/HY-GAIN rotors with our PSE-1A/3A. A system which is low in cost, high in performance.

The "DX'ER" Package...Couple this unit with a rotor and you have the best non talking control we make. Expandable, plus has 5 scan functions, 2 DIGITAL displays and REC/LAST to check long path or short path. Has all internal hardware to plug into our computer interface. Can be remotely controlled from accessory jack.

Try this with any of the TELEX/HY-GAIN\* Rotors! This will give you the broadest of functions with a mid-range price.

The "Delux" is the most sophisticated antenna control unit ever made. With the "Delux" you have all the functions of our other units, plus it talks...Yes it talks. Not only do you have your headings digitally displayed, but is also said as your antenna stops...All commands are spoken, plus as your antenna turns you hear a 400Hz tone in one direction and an 80Hz in the other, giving you positive verification of movement. This unit, when combined with the HAM IV, T2X or HDR-300 gives you the best buy anywhere at any price...



HAM IV\*

T2X\*

HDR-300\*

PSE-1A will save you lots of time in your favorite contests. No more hanging on the rotor control...Gives you positive control with DIGITAL readout plus 10 memories, command positioning, and single button manual movement.

### Package Special

PSE-1 + HAM IV	\$508.95
PSE-1 + T2X	548.95
PSE-3 + HDR-300	677.95

### Package Special

PSE-2 + HAM IV	\$608.95
PSE-2 + T2X	655.00
PSE-4 + HDR-300	784.00

PSE-1A + HAM IV	\$369.95
PSE-1A + T2X	415.95
PSE-3A + HDR-300	544.95

\* Printed with permission of TELEX/HYGAIN Telex Communications, Inc.

**PRO-SEARCH™**  
Reaching The World 

© Copyright 1983

Controllers also available for other rotors.

Prices and specifications subject to change without notice or obligation.

U.S. and Foreign Patents

\* For PSE, 3A, 3, 4 add \$24.50 for 12 amp power pack

# Mosley.....

A BETTER ANTENNA .....

## WHY SETTLE FOR LESS? LOOK WHAT THE MOSLEY TA-33 OFFERS

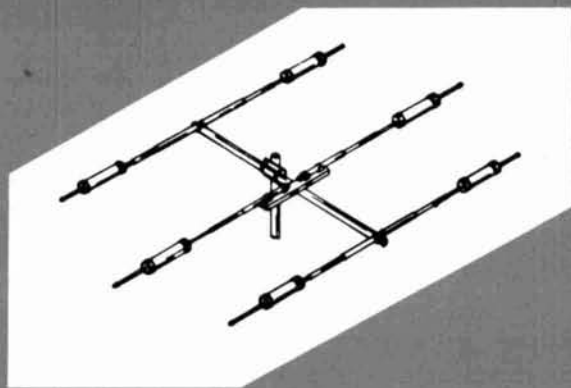

- 3 Element full power
- All stainless steel hardware
- Ease of assembly
- No balun required
- Now a 2 year limited warranty
- Now a standard 2" mast adapter
- Built to last

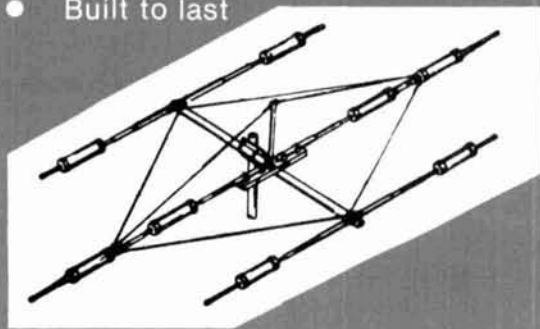

- Expandable to 30 or 40 meters
- Superb front to back ratio
- Excellent gain
- Outstanding SWR

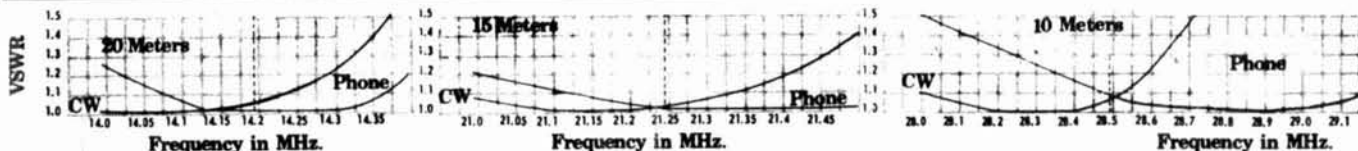

### SPECIFICATIONS:

Forward gain	
Front-to-Back Ratio	
Power rating	CW 1KW
	SSB 2KW P.E.P.
Feedpoint Impedance	52 ohm
VSWR HT Resonance	1.5 to 1 or better
Matching System	Mosley
Number of Elements	3
Longest Element	28'
Boom Length	14'
Mast Size	1 1/2" or 2"
Turning Radius	15'6"
Wind surface area (in. sq. ft.)	5.7
Wind load (EIA standard 80 mph)	114 lbs.
Assembled Wt.	39 lbs.
Shipping Wt.	44 lbs.

- Used around the world
- Work CW or phone without tuning or adjusting antenna
- A great antenna for the new solid state rigs

ALL MOSLEY ANTENNAS  
AND CATALOGS AVAILABLE  
AT QUALITY DEALERS  
OR CALL TOLL FREE

1-800-325-4016

ASK ABOUT OUR FALL SPECIAL

Prices and specifications  
subject to change  
without notice or  
obligation.

REMEMBER WHETHER YOU USE TRAPS OR LINEAR LOADING, 8db GAIN IS 8db GAIN  
YOUR RECEIVER CAN'T TELL THE DIFFERENCE ... MOSLEY ... TRAP MASTERS QUALITY STILL SETTING THE PACE ...

**Mosley Electronics**

A DIVISION OF WURDACK & ASSOCIATES INC. 1344 BAUR BOULEVARD ST. LOUIS, MO. 63132 1-314-994-7872

# vacuum tube substitution

## Using one tube in place of another saves time, trouble

**Radio Amateurs always keep** a supply of spare parts and vacuum tubes on hand, but when a vacuum tube fails and an exact replacement is unavailable, the Amateur has two choices: either to buy a new tube — which may be expensive or scarce — or find a substitute.

Because a substitute tube may be cheaper than the original, and perhaps easier to obtain, this article discusses tube substitution in general and rectifier tubes in particular.

Unfortunately, tube substitution handbooks aren't always very useful. This would not be so if most of the substitutes were listed, but this is seldom the case. For some tubes, no substitutes are listed; for others, suggested substitutes denoted by suffixes such as *G*, *GT*, and *GTA* may differ only slightly from the original and be as costly or as difficult to obtain. Sometimes substitutes may be as hard to find as the originals themselves. (Receiving tube manuals may be more helpful in that they list many tubes which have identical base diagrams and are thus interchangeable if they have similar or superior characteristics.)

Tubes with the same kind of base but with different terminal diagrams require only minor changes in socket wiring for substitution. Tubes with the same kind of base and known terminal diagrams, but different filament or heater voltage, may also be used; a higher voltage requires a different filament transformer or secondary winding, and a lower voltage requires a dropping resistor in series with either one of the two socket terminals. The resistance of the drop-

ping resistor is determined by Ohm's law: the drop in voltage is divided by the current in amperes. The power rating must exceed the product of these factors, or  $E \cdot I$  watts. Current differences are seldom important.

If a substitute tube has a different base than the original, it requires a very different socket unless a suitable adapter is available. It is both difficult and impractical to change bases on old tubes; the absence of separate bases permits only socket rewiring for substitution.

### tube-base history

Early vacuum tubes were often baseless or had only bases for filaments. Candelabra bases, Edison medium screw bases, and Edison bases were common. From 1915 to 1927 various 4-pin bases and sockets were tried, with varying success. In 1923 the famous UV199 and UV201A triodes were introduced. Their UV bases had solder-filled brass pins which made butt-end contacts with flat socket contacts. The solder tips often corroded badly, so some tips were gold-plated and later, in 1925, UV bases were superseded by UX bases with long pins for side-wiping contacts with ordinary metals.

In 1927 the 27-triode detector-amplifier was introduced to avoid hum in new AC receivers. It had a unipotential or heater-type cathode and required a 5-pin base. The then-new 24A screen-grid tube or tetrode, also of heater-type, needed a 5-pin base and a top cap for connection to the control grid. The advent of pentodes, beam power tubes, and multifunction tubes led to 6- and 7-pin bases and often top caps. The use of 4- to 7-pin bases practically ended in 1935 when octal-base tubes were introduced.

Most tubes required no more than seven active

By Carleton F. Maylott, W2YE, 279 Cadman Drive, Williamsville, New York 14221

pins, but the 6L7 pentagrid mixer required all eight pins plus a top cap, for a total of nine connections. Miniature baseless tubes, which began to replace octal tubes in about 1950, are usually 7-pin or 9-pin types. Some multi-unit tubes have ten or twelve pins.

The first vacuum tube rectifiers on the market were the half-wave UV216 in 1921, (replaced by the UX216B in 1925), and the full-wave UX213 in 1925, which was superseded by the UX280, (now simply 80), in 1927. These tubes, sold by RCA, were developed by GE and Westinghouse, respectively. Unlike other types, rectifier tubes largely survived the trend to more than 4-pin bases from 1927 to 1935. Octal-base rectifier tubes have endured over the years, as

demonstrated by the presence of approximately fifty rectifier tubes in the octal-base list (table 1). Notable exceptions to the 4-pin and 8-pin rectifier preference are the 5-pin 84/6Z4, which had a heater-type cathode, and the 6-pin 25Z5, which had a heater, two cathodes and two plates, and provided doubler operation. Half-wave rectifiers need only three connections, of which two are for filament and one is for plate — usually a top cap, so only two base pins are wired. Full-wave filament-type rectifiers need four pins — two for filament and two for plates.

### rectifier type substitution

There are several good reasons why rectifier tubes are usually the first tubes to fail or weaken. They sup-

table 1. Rectifier tube base diagrams. Commas signify common connections. Column K dashes signify filament/heater-only type tubes, with no cathode employed; column K numbers indicate cathode element pin connection(s). (M) signifies mercury vapor; TC, top cap plate connections (half-wave).

pins	diagram	tube type	F or H	K	P	
4	4AB	2X2A, 2Y2	1 + 4	—	TC	
	4AD	83V	1 + 4	4	2 + 3	
	4AT	872A/872 (M)	2 + 4	—	TC	
	4B	2Z2/G84, 866 Jr. (M)	1 + 4	—	2	
	4C	5X3, 5Z3, 80, 82 (M), 83 (M)	1 + 4	—	2 + 3	
	4G	6Z3	1 + 4	3	2	
	4P	3B28, 816, 836, 866A, AX, B(M)	1 + 4	—	TC	
	5	5D	84/6Z4	1 + 5	4	2 + 3
		6E	25Z5	1 + 6	3 + 4	2 + 5
	7 (none)					
8	3C	1G3GTA/1B3GT, 1K3A/1J3	2 + 7	—	TC	
	5DA	5AR4/GZ34, GZ32-34-37, R52, U54, U70	2 + 5	5	3 + 4	
	5DE	3DG4	1 + 3	—	5 + 7	
	5L	5AT4, 5V4GA, 5Z4, GZ32	2 + 8	8	4 + 6	
	5Q	5X4G, 5Y4G-GA-GT	7 + 8	—	3 + 5	
	5T	5AS4A, 5AW4GT, 5AZ4, 5R4GB, 5R4GY, 5T4, 5U4GB, 5V3A/5AU4, 5W4GT, 5Y3GT, 5Z10, GZ30-31, RJ2, U50-51-52, WTT102	2 + 8	—	4 + 6	
	6AD	35Z5GT, 45Z5GT	Midtap 3, 2 + 7	8	5	
	6S	6AX5GT, 6X5GT, 6ZY5G, EZ35	2 + 7	8	3 + 5	
	8EZ	3A3C, 3CZ3A	2 + 7	7	TC	
	8KS	5DJ4	1, 7 + 2, 8	—	3, 4 + 5, 6	
	8MK	3CU3A	2 + 7	—	TC	
	8MU	2CN3A, 3CN3B	2 + 7	7	TC	
	8MX	3DB3/3CY3, 3DJ3	2 + 7	1, 7	TC	
	8MY	3DA3/3DH3	3 + 5	8	TC	
	8MZ	3DC3	2	1, 3, 5, 7	TC	
	7 min.	5BQ	35W4	Midtap 6, 3 + 4	7	5
		5BS	6BX4, 6X4, 12X4, EZ90, EZ900, HZ90, U78, U707, VZM70, 6202	3 + 4	7	1 + 6
	9 min.	9BS	12DF5	4 + 5	3 + 8	1 + 6
		9CB	6AF3, 6AL3	4 + 5	TC	9
9DJ		6BW4	4 + 5	9	1 + 7	
9DT		3A2A	2, 5, 8	1, 4, 6, 9	TC	
9M		6CA4, EZ4, U709, UU12	4 + 5	3	1 + 7	
9NT		5BC3	1 + 3	—	5 + 9	
9QT		5BC3A	1 + 2, 3	—	5, 6 + 8, 9	
9U		1V2	4 + 5	—	1, 9	
9Y		1X2A, B, C	2, 5, 8	—	TC	

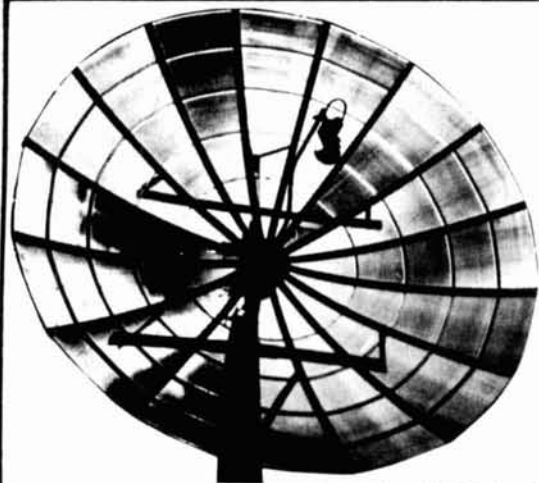

# CQ CQ HAMS

- SPECIAL OFFER TO LICENSED HAMS -

Do you think *Ham Radio* is the number 1 Amateur Publication?

Are you interested in Satellite Television?  
Then why not read *Satellite TV Magazine*?

Believe me - this is the number 1  
Satellite TV Publication!

Now ... as a special offer to licensed amateurs only - we will send you a sample copy of *Satellite TV Magazine* for only \$1.00\* (Reg. \$2.95) and offer you an annual subscription for only \$24.95\* (Reg. \$29.95).

If you're still not convinced - QSY the Satellite TV Net each Sunday at 2:00 pm Eastern Time on 14.310 MHz and hear what the other HAMS are saying about *Satellite TV Magazine*.

Chris J. Schultheiss VE-2FRJ  
Editor & Publisher

Just give us your name and QTH

Name \_\_\_\_\_ Call \_\_\_\_\_

Address \_\_\_\_\_

State \_\_\_\_\_ Zip \_\_\_\_\_

Please Enclose Check or Money Order or if you prefer we accept Visa® & Mastercard®.

Card Number \_\_\_\_\_ Exp. Date \_\_\_\_\_

\*All Prices in US Funds.



Satellite TV Magazine  
P.O. Box 2384  
Shelby, North Carolina 28150



Call Toll Free  
1-800-438-2020

## DIRECTION FINDING?

- ★ Doppler Direction Finding
- ★ No Receiver Mods
- ★ Mobile or Fixed
- ★ Kits or Assembled Units
- ★ 135-165 MHz Standard Range



- ★ Circular LED Display
- ★ Optional Digital Display
- ★ Optional Serial Interface
- ★ 12 VDC Operation
- ★ 90 Day Warranty

**New Technology** (patent pending) converts any VHF FM receiver into an advanced Doppler Direction Finder. Simply plug into receiver's antenna and external speaker jacks. Use any four omnidirectional antennas. Low noise, high sensitivity for weak signal detection. Kits from \$270. Assembled units and antennas also available. Call or write for full details and prices.

**DOPPLER SYSTEMS**, 5540 E. Charter Oak, (602) 998-1151  
Scottsdale, AZ 85254

✓ 132

## UP YOUR ERP



For HT owners operating inside a vehicle and wanting increased T/R range, RF PRODUCTS has the low cost solution.

Remove your BNC antenna from the HT and mount on the RF PRODUCTS BNC magnet mount, install the magnet mount on the roof top and connect the BNC co-ax connector.

The magnet mount (part no. 199-445) has 10 feet of small (5/32") co-ax with BNC connector attached and is priced at \$15.95 (including shipping by UPS to 48 states).

**TO ORDER - send \$15.95 money order or cashiers check only**  
Fla. residents add 5% tax, for air UPS add \$1.50

PART NO.	LOW COST ACCESSORY ANTENNAS DESCRIPTION	PRICE
194-214	2M helical full length BNC connector	\$7.95
194-254	2M helical stubby type BNC connector	8.95
194-814	1 1/4 M helical full length BNC connector	7.95
194-854	1 1/4 M helical stubby type BNC connector	8.95
194-944	3/4 M helical stubby type BNC connector	8.95
195-914	3/4 M flexible 1/4 wave BNC connector	7.95
196-214	2M telescopic 1/4 wave BNC connector	6.95
196-244	2M-3/4 M whip 1/4 wave BNC connector	7.95 ✓ 172

## RF PRODUCTS

P.O. Box 33, Rockledge, FL 32955, U.S.A. (305) 631-0775

# Barry Electronics

## Your One-Stop Electronic Supermarket

Barry is New York City's largest stocking Ham Dealer. From accessories to transceivers - Barry has it all. Barry also carries commercial and business band radio equipment and systems.

When in town, come on down. Barry is easy to get to by either subway or bus. Don't pay uptown prices!

Barry is also as close as your phone or telex machine. Contact us today for the *best buys* in Amateur Radio.

**BARRY ELECTRONICS CORP.**  
512 BROADWAY  
NEW YORK CITY, NY 10012.  
212-925-7000 TELEX 12-7670

OPEN 7 DAYS A WEEK.  
Monday-Friday 9 to 6:30 PM  
Saturday & Sunday 10 to 5 PM

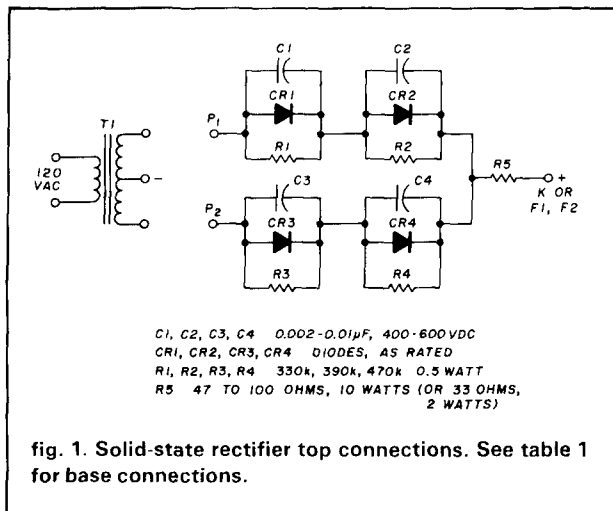

fig. 1. Solid-state rectifier top connections. See table 1 for base connections.

ply DC plate power for other tubes in radio receivers and for much electronic equipment. They also frequently sustain severe transients and momentary overloads. While many suitable substitutes are available, many of these require changes in socket wiring, as evident in **table 1**, which lists about fifty rectifier tubes among fifteen octal-base diagrams. **Table 1** includes both foreign and domestic half-wave and full-wave rectifier tubes. It will assist in substituting one tube for another as well as substituting solid-state equivalents for rectifier tubes.

### solid-state rectifier substitution

It is unnecessary to substitute tubes or to change socket wiring or sockets if solid-state parts are mounted in an old vacuum-tube base or a similar plug foundation. (The bases of defunct tubes are easily removed by hack-sawing them about midway or by crushing the glass in a vise. A cloth wrapper will help prevent the hazard of flying glass particles.)

Each leg of a full-wave rectifier circuit must withstand a peak inverse voltage of 1.4 times the RMS voltage to center-tap of the transformer secondary. This voltage usually exceeds the PIV rating of a single diode, so two or more diodes must be used in series. Each diode should be shunted by a small capacitor in order to minimize voltage spikes, and by a resistor to equalize PIV drops. Capacitors should be rated at 400 to 600 volts and 0.002 to 0.01  $\mu$ F capacitance. Resistors should be rated at one-half watt minimum and 500 to 1000 ohms per volt of PIV. Values of 330k, 390k, and 470k, are suitable at 200 to 400 volts per diode.

These parts should be chosen carefully and connected properly, according to the diagram of **fig. 1** and the pin numbers of **table 1**. The two anode or plate leads (P1 and P2) and one cathode or filament

lead (K or F) must be connected to three specific pins in the desired tube base. Solder in the base pins must be melted so as to pass the leads, which may be No. 18 solid copper wire; the pins must then be resoldered.

It is seldom necessary to use diodes in parallel because their current ratings usually exceed those of rectifier tubes. If two or more diodes must carry the load current, each diode should be in series with an equalizing resistor of about 33 to 47 ohms and 2 watts minimum rating. Without series resistors, one of several nonlinear devices in parallel may take most of the current and burn out.

A limiting resistor of at least 10 watts and 47 to 100 ohms rating may be connected in series with a rectifier output or a transformer center-tap connection. The resistor may burn out under overload conditions, but it will protect the diodes and cost less to replace. A well-chosen fuse may be used instead of, or in addition to, the resistor.

### rectifier design data

The following facts deserve consideration in rectifier design:

1. Half-secondaries of plate transformers usually have about 50- to 200-ohms resistance, and power-line inputs to transformerless rectifiers have negligible resistance.
2. Choke-input and resistive input filters usually have more than 100-ohms input resistance, and capacitor-input filters have negligible input resistance until the capacitors are charged.
3. Vacuum-tube diodes usually withstand high peak currents caused by short circuits and starting transients because their plate resistance exceeds 500 ohms and their plate current is limited by filament emission and space charge. Solid-state diodes, on the other hand, may fail because they usually have less than 100 ohms resistance and no current-limiting saturation phenomena.
4. Peak current in all rectifiers may be limited to safe values by adding series resistance of high enough value to make the total resistance adequate but low enough value to avoid an excessive voltage drop under normal load.
5. In order to avoid abnormally-high peak currents and peak inverse voltages, as well as poor ripple reduction, in choke-capacitor filters, the product of the choke inductance in henrys and the capacitor capacitance in microfarads must be greater than the resonant value of 7.08 for a half-wave filter (60 Hz ripple) and 1.77 for a full-wave filter (120 Hz ripple).

ham radio

# BUILD THIS SSB TRANSCEIVER FROM OUR MODULES

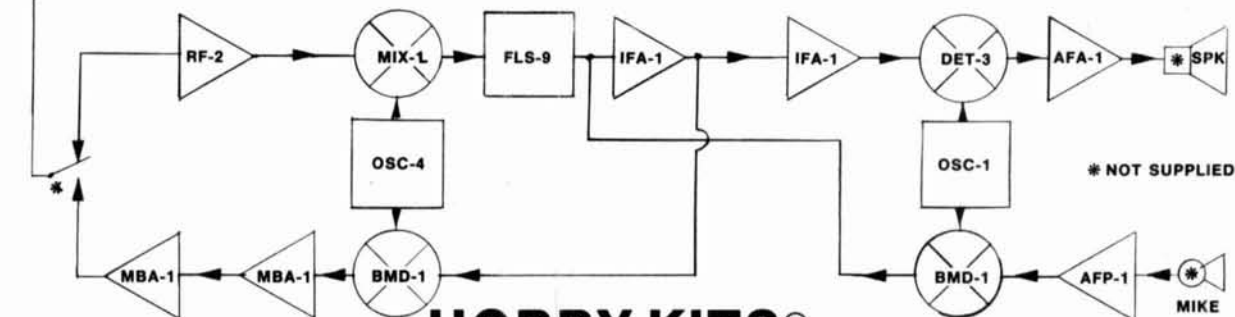

## HOBBY KITS®

EXPERIMENT — LEARN ELECTRONICS; BUILD AND DESIGN YOUR OWN AM, FM, CW, OR SSB RECEIVERS, TRANSMITTERS AND ETC. WITH OUR MINI-LINEAR CIRCUIT KITS

All kits Come Complete With Etched and Drilled Circuit Boards and All Parts Needed To Function As Described

AFA-1 AUDIO AMP, LM-380 1-2 Watts 4-16 OHM Output .....	\$4.95	MBA-1 FREQ. MULT. Tuned Output Buffer-Mult.-Amplifier To 250 MHz .....	\$5.95
AFP-1 AUDIO PREAMP, Dual Audio Preamp — For Mike Etc. ....	\$3.95	OSC-1 CRYSTAL OSC. 100 KHZ — 20 MHz Not Tuned .....	\$3.95
BMD-1 BAL. MIX, LM 1496 Mixer — S.B. Modulator Tuned Output .....	\$9.95	OSC-2 CRYSTAL OSC. Ov. 18-200 MHz Tuned Output .....	\$4.95
DET-1 AM DET. Am Envelope Detector With AGC Output .....	\$3.95	OSC-3 VARIABLE FREQ OSC Varactor Tuned 455KHZ .....	\$5.95
DET-2 FM DET. LM 3065 FM Detector (455 KHZ or 4-11 MHz) .....	\$7.95	OSC-4 VARIABLE FRF OSC Varactor Tuned 4-11 MHz .....	\$5.95
DET-3 SSB DET. LM 1496 SSB Detector (Needs OSC-1 or OSC-4) .....	\$9.95	PSV-1 POWER SUPPLY LM 723 With Pass Transistor, 3 amps max .....	\$7.95
IFA-1 IF AMP. CA 3028 30 DB Gain, Optional AGC (455 KHZ or 9-11 MHz) ..	\$6.95	PLL-2 TONE DETECTOR LM567 PLL Tone Detector .....	\$5.95
FLS-9 SSB FILTER 9 MHz/2.1 KHZ BW with USB XAL for OSC-1 .....	\$49.95	RF/MIX-1 RF-AMP/MIXER CA 3028 — Tuned RF AMP/Mixer 1-100 MHz ..	\$7.95
IFA-2 IF AMP. CA 3028 30 DB Gain 1-100 MHz Optional AGC .....	\$6.95	RF/MIX-2 RF-AMP/MIXER 3N204 Tuned RF AM/Mixer 1 — 250 MHz .....	\$7.95

MANY OTHER MODULES AVAILABLE

SEND \$2.00 FOR FULL CATALOG  
WITH CIRCUIT DIAGRAMS AND  
TYPICAL RECEIVER AND  
TRANSMITTER HOOK-UPS

ADD \$2.00 SHIPPING & HANDLING  
**MORNING DISTRIBUTING CO.**  
P.O. BOX 717, HIALEAH, FLA. 33011

COMPLETE SET OF MODULES TO BUILD A  
1-WATT SSB/CW MONO-BAND TRANSCEIVER  
LESS CASE, CONTROLS, PWR SUPPLY  
(12 VDC), SPK AND MIKE  
\$149.95 (Specify Band)

✓ 165

OVER 70 BRANDS IN STOCK

LAND-MOBILE RADIO

Full Service Shop • Spectrum Analysis • Antennas  
New and Used Equipment • CW-SSB-FM, Etc. • Towers  
FCC Study Guides • Code Tapes • Books • Accessories

**SPECTRONICS**

Specialists in Amateur Radio,  
Short-Wave Listening  
And Contemporary  
Electronic Gear.

HOURS  
MON, TUES, WED.: 9:30-6:00 PM  
THURS, FRI.: 9:30-8:00 PM  
SAT.: 9:30-3:00 PM

**SPECTRONICS INC.**  
1009 GARFIELD ST. OAK PARK, IL. 60304  
(312) 848-6777

MADE IN USA

### BASIC PROGRAM MANUAL FOR AMATEURS

Programs Design: Quads, beams, trap dipoles, antenna wind load, filters, pads, striplines, op amps, microwave, RF coils, calc. Ohms law, L. C. power, log OSO's, global distances and much more.

All FOR \$9.95 (INCLUDES SHIPPING AND HANDLING)

### ATTENTION YAESU FT-207R OWNERS AUTOMATIC SCAN MODULE

15 minutes to install; scan restarts when carrier drops off; busy switch controls automatic scan on-off; includes module and instructions.

Model AS-1 \$25.00  
BATTERY SAVER KIT  
Model BS-1 \$14.95

- No more dead batteries due to memory backup
- 30% less power drain when squelched
- Simple to install, step-by-step instructions and parts included
- 4 mA memory backup reduced to 500  $\mu$ A
- 45 mA receiver drain reduced to 30 mA
- Improved audio fidelity and loudness

ENGINEERING CONSULTING  
P.O. BOX 216 DEPT. H  
BREA, CALIFORNIA 92621

✓ 137

**GROTH-Type**  
COUNTS & DISPLAYS  
YOUR TURNS

• 99.99 Turns  
• One Hole Panel Mount  
• Handy Logging Area  
• Spinner Handle Available

Case: 2x4"; shaft 1/4"x3"

TC2 \$12.50	Model TC2: Skirt 2-1/8";
TC3 \$13.50	Knob 1-5/8"
Spinner Add \$1.50	Model TC3: Skirt 3";
	Knob 2-3/8"

Prices include UPS or Parcel Post in US

**R. H. BAUMAN SALES**  
P.O. Box 122, Itasca, Ill. 60143

✓ 116

SYNTHESIZED  
SIGNAL GENERATOR

MADE IN USA

MODEL SG1000  
\$349.95 plus shipping

• Covers 100 to 185 MHz in 1 kHz steps with thumb-wheel dial • Accuracy 1 part per 10 million at all frequencies • Internal FM adjustable from 0 to 100 kHz at a 1 kHz rate • Spurs and noise at least 60 dB below carrier • RF output adjustable from 5-500 mV at 50 ohms • Operates on 12 Vdc @ 1/2 Amp • Available for immediate delivery • \$349.95 plus shipping

• Add-on Accessories available to extend freq. range, add infinite resolution, voice and sub-audible tones, AM, precision 120 dB calibrated attenuator

• Call for details • Dealers wanted worldwide.

**VANGUARD LABS**  
196-23 Jamaica Ave., Hollis, NY 11423  
Phone: (212) 468-2720

✓ 190

**SAY YOU SAW IT  
IN  
HAM RADIO**



# KANTRONICS SOFTWARE

## Hamsoft,™ Hamtext,™ and Amtorsoft™

```

MORSE                                00:00:00
TRANSMIT SPEED  25
RECEIVE SPEED   28
  
```

```

-----
ENJOY YOUR MEAL AND
WE'LL TALK TO YOU
REAL SOON ... 73'S ...
WA5RGU
-----
WEATHER HERE IS WARM TODAY
WITH LOTS OF SUN. . .XYL SAYS
TIME FOR DINNER SO 73'S WØXI
  
```

Kantronics has led the amateur community in software and total computer communications systems with our original program, **HAMSOFT**. With five-computer compatibility and reasonable prices **HAMSOFT** has become the industry standard. **HAMSOFT** includes split screen display, type ahead buffer, message ports, and complete keyboard control for Morse Code, Radioteletype, and ASCII communications. With THE INTERFACE or INTERFACE II, **HAMSOFT** can make any of five computers a complete amateur communications terminal. All programs are on a ROM board, except the Apple diskette.

VIC-20 - \$49.95, ATARI - \$49.95, APPLE - \$29.95,  
 TRS-80C - \$59.95, TI-99/4A - \$99.95

**HAMTEXT** is our advanced CW/RTTY/ASCII program for the VIC-20, COMMODORE 64, and APPLE computers. **HAMTEXT** gives you the ability to store incoming messages in the computer's memory, transmit files directly from tape or disk, and use your computer to its fullest potential. Features like Diddle, Time Transmission, Text Transmission, Printer Outputs, and Word Wraparound, make **HAMTEXT** the program for the serious amateur. **HAMTEXT** was created with input from our users as guidelines, and with total use of the computer in mind.

**Suggested Retail** ..... \$99.95

00:00:00

- PROGRAM OPTIONS
- A. RETURN TO BASIC
  - B. EDIT MESSAGE PORTS
  - C. SAVE MESSAGE PORTS
  - D. LOAD MESSAGE PORTS
  - E. SET XMIT BUFF SIZE
  - F. EDIT HOLDING BUFFER
  - G. SAVE HOLDING BUFFER
  - H. LOAD HOLDING BUFFER
  - I. SET TIME

```

00:00:00
KANTRONICS AMTORSOFT
COPYRIGHT 29 JUNE 1983
  
```

- CHOOSE
- S (AMTOR SLAVE)
  - M (AMTOR MASTER)
  - L (AMTOR LISTENER)
  - P (PROGRAM OPTIONS)
  - T (T/R OPTIONS)

On January 27th, 1983, AMTOR, Amateur RadioTeletype Over Radio, became a legal mode for the amateur service. AMTOR is an essentially error-free radioteletype form of communication. **AMTORSOFT**, Kantronics' newest software package, gives your computer the ability to become an AMTOR communications terminal when used with The Interface or interface II. **AMTORSOFT** is currently available for the Apple, VIC-20, and COM-64 computers. **AMTORSOFT** brings you the newest in computer-amateur communications at an affordable price.

**Suggested Retail** ..... \$89.95

For more information see your Kantronics dealer, or contact:  
 Kantronics 1202 E. 23rd Street Lawrence, KS 66044

# ham radio TECHNIQUES

Bill Orr  
W6SAI

Today's popular all-solid-state transmitters's would make yesterday's old timers' eyes pop out. What fun to work a modern rig with all the bells and whistles!

Owners of today's transmitters, however, find that many of them require matching to an antenna with an SWR less than 2:1. This is no problem on the higher bands, since most antennas meet this requirement, but 80 meter operators discover that they cannot cover the whole band with a single simple antenna and are therefore restricted to operating within a small portion of the band.

Some heroic attempts have been made to solve this problem<sup>1,2,3</sup> but the "broadband" 80-meter antenna solution still seems in doubt — or has it already been solved?

## let's not reinvent the wheel

The basic 80 meter, center-fed dipole, mounted in close proximity to ground, has a feedpoint resistance in the neighborhood of 30 ohms. I say "in the neighborhood" advisedly, as the measured resistance varies with height above ground, the conductivity of the soil in the vicinity of the anten-

na and the degree of coupling between the antenna, the outer shield of the feedline and any other conductors (such as house wiring, telephone lines, etc.) in the vicinity of the antenna.

As a result of these variables, SWR measurements made on one 80-meter dipole may vary considerably from those made on an identical antenna at a different location.

Because of the antenna environment, some "lucky" 80-meter operators find their dipole has an extremely broad frequency response and they can operate their solid-state transmitter over nearly the whole band! But their buddy across town with the same antenna is limited in operation to a small segment of the band, since the SWR quickly departs from low values when he operates his antenna away from the design frequency.

Improving ground conductivity is a difficult task.<sup>2</sup> An extensive ground screen is called for in the case of vertical polarization and it is not known if such a ground installation would be cost-effective with horizontal polarization. I would doubt it, myself. [It would, at the minimum, better define the "array" (antenna plus image) elevation pattern. — Editor]

## decoupling the antenna from the environment

Meaningful SWR measurements are difficult to achieve when the transmitting antenna is coupled to nearby conducting objects. In my case, the SWR measurements on an 80-meter dipole changed radically when I turned on the ceiling light fixture in the living room. The dipole was parallel to the wires leading from the utility box at one end of the house to the light fixture. Placing a 0.01, 1.6-kV ceramic capacitor across the connections of the fixture seemed to detune the house wiring sufficiently so that meaningful SWR numbers could be obtained.

The first step was to determine if the dipole was coupled to the outside of the outer shield of the coaxial feedline. This was tested by adding an extra length of line at the station end and noting if the SWR reading changed from the original measurements at different frequencies.

Since I knew there was unwanted coupling, I was not surprised when I was able to plot a new SWR curve that had only a vague resemblance to the old one after my line-splicing experiment. It looked as if I could move

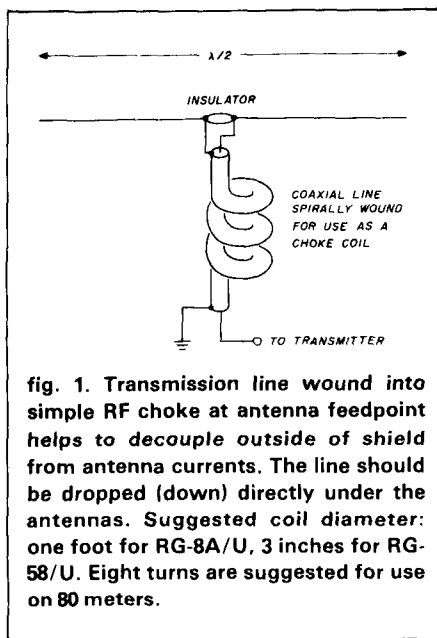

fig. 1. Transmission line wound into simple RF choke at antenna feedpoint helps to decouple outside of shield from antenna currents. The line should be dropped (down) directly under the antennas. Suggested coil diameter: one foot for RG-8A/U, 3 inches for RG-58/U. Eight turns are suggested for use on 80 meters.

the resonant frequency at will within the band by merely changing the length and position of the coaxial line with respect to the dipole!

The second step was to bring the coaxial line directly down to the surface of the ground under the center of the dipole and run it along the ground to the station. Before, it had looped through the air at about a 45 degree angle to the dipole.

Repeating the SWR measurements showed that by varying line length the SWR changed but not nearly as much as in the previous situation. It looked as if I were proceeding in the right direction.

The next step was to try to decouple the outer shield of the coax a bit more. I wound the line up into a choke coil just under the center of the antenna (fig. 1). This helped, but it seemed as if more isolation were required. Luckily, I had a 2.5 MHz to 15 MHz air-wound balun available (fig. 2). I placed this device at the dipole feedpoint and was successful in decoupling the coaxial shield from unwanted antenna-induced currents.

### a balun transformer for 80 and 160 meters

The balun design shown in fig. 2 is useful for both 80 and 160 meters.

Since it has an air core, it will not saturate at a high power level as the ferrite core design might do; and because the windings have more turns (inductance) than the more common design, this balun performs better at the lower frequencies.

The balun is wound on a plastic (PVC) form 3-1/2 inches (9.0 cm) in diameter. The design consists of 10 trifilar turns on No. 14 Formvar™ (or enamel) insulated wire. The ends are held in place by 4-40 hardware. The windings are interconnected by short lengths of wire run between the appropriate terminals. The common connection of two of the windings is used as the ground point at one end of the balun and is attached to the coaxial shield. When completed, a plastic bottle is cut to fit over the balun as a rain shield. The balun is attached directly to the center insulator of the dipole and the coaxial line dropped down directly beneath it.

Take care that the top end of the coaxial line is sealed from moisture. Water can seep into the line by capillary action of the shield but a good coat of sealant (RTV, for example) will waterproof the end of the line. (Make sure your sealant does not contain acetic acid, or it will corrode the copper wires of the coax. Read the label before you buy.)

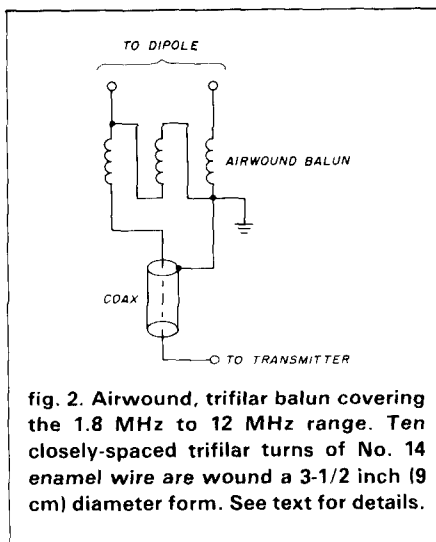

fig. 2. Airwound, trifilar balun covering the 1.8 MHz to 12 MHz range. Ten closely-spaced trifilar turns of No. 14 enamel wire are wound a 3-1/2 inch (9 cm) diameter form. See text for details.

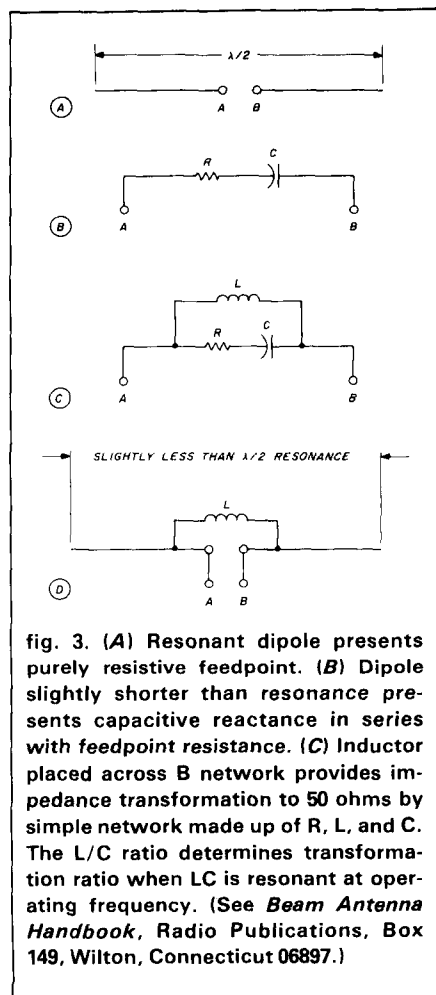

fig. 3. (A) Resonant dipole presents purely resistive feedpoint. (B) Dipole slightly shorter than resonance presents capacitive reactance in series with feedpoint resistance. (C) Inductor placed across B network provides impedance transformation to 50 ohms by simple network made up of R, L, and C. The L/C ratio determines transformation ratio when LC is resonant at operating frequency. (See *Beam Antenna Handbook*, Radio Publications, Box 149, Wilton, Connecticut 06897.)

### matching the antenna to the line

I was now in a position to make a meaningful SWR measurement of the antenna. As expected, a minimum of 1.56:1 occurred at resonance corresponding to an antenna impedance of 32 ohms. The easiest way to achieve a better match between antenna and line is to make the antenna form a portion of a network whose input impedance over a small range is 50 ohms (fig. 3). If the antenna is cut slightly shorter than its resonant length, its terminal impedance will have a capacitive reactance term. A compensating inductor placed across the antenna terminals would then provide a tuned network whose total impedance can be made to match the coaxial line impedance. For an antenna (radiation) resistance of 32 ohms,

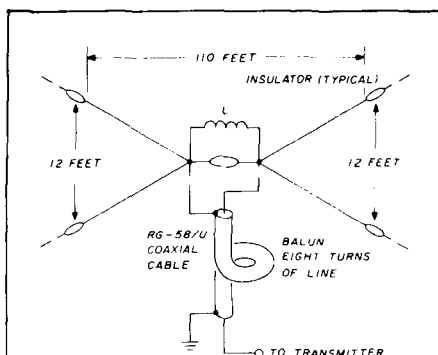

fig. 4. Broadband fan dipole for 80 meters. Wires may be either in horizontal or vertical plane. See fig. 3 for data on coil L.

points? Alas, the correctly-designed dipole still will not cover the whole 80-meter band, falling within the desired SWR ratio limits over only about 220 kHz. But this exercise provides a clue that may help solve the bandwidth problem.

### broadband dipoles

The previous discussion illustrates a method of feeding and matching a centered 80-meter antenna system. It applies equally well to a broadband antenna as to a conventional antenna.

The fan dipole shown in fig. 4 provides good bandwidth on 80 meters when properly matched to the transmission line. It is only 110 feet (33.53m) long at resonance (3.75 MHz). When the length of the arms and the center matching coil are properly adjusted, the antenna exhibits an SWR of less than 2:1 over the complete 80-meter band.

A second broadband antenna design similar to the fan dipole is shown in fig. 5. This scheme consists of two parallel-fed dipoles placed at right angles to each other. The dipoles are cut for opposite ends of the band. (I

haven't tried this idea, but I am waiting for a report from someone who has.<sup>3</sup>) The dipole's SWR follows a V curve with points of minimum SWR occurring near the band edges. The dipoles have to be physically separated by at least 60 degrees; otherwise, the broadband response is lessened.

Again, as in the case of the simple dipole, the input impedance of the antenna is quite low and a matching coil has to be placed across the feed-point to provide a step-up transformation to 50 ohms.

The idea looks like a good one and with sufficient separation between the dipoles, it should work.

### the W6TC two-frequency dipole

George, W6TC, wrestled with the problem of using a dipole across the 80-meter band and finally came up with a classic solution so simple that I wish I had thought of it myself!

George's idea is shown in fig. 6. This illustrates a dipole cut for 3800 kHz and used for SSB operation. To

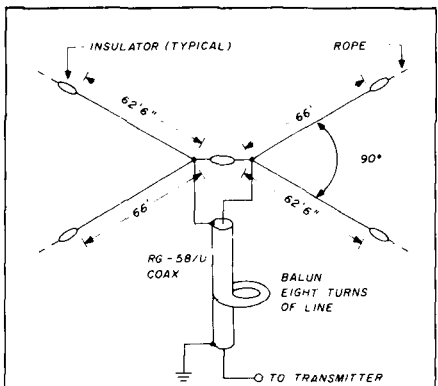

fig. 5. Parallel-fed dipoles placed at right angles to each other provide wideband response. Dipoles are cut for opposite ends of the 80-meter band. See fig. 6 for coaxial balun data. (Note: Dipoles are in horizontal plane.)

the shunt coil (L) should have a reactance of about 64 ohms. For the 80-meter band, this turns out to be about 2.7  $\mu$ H. A coil of 8-1/2 turns of No. 12 wire, 2 inches in diameter and 2 inches long will do the job. The antenna is trimmed six inches at a time until unity match is achieved at the desired operating frequency of the antenna.

### antenna bandwidth

After this task is completed, what will the operating bandwidth of the antenna be between the 2:1 SWR

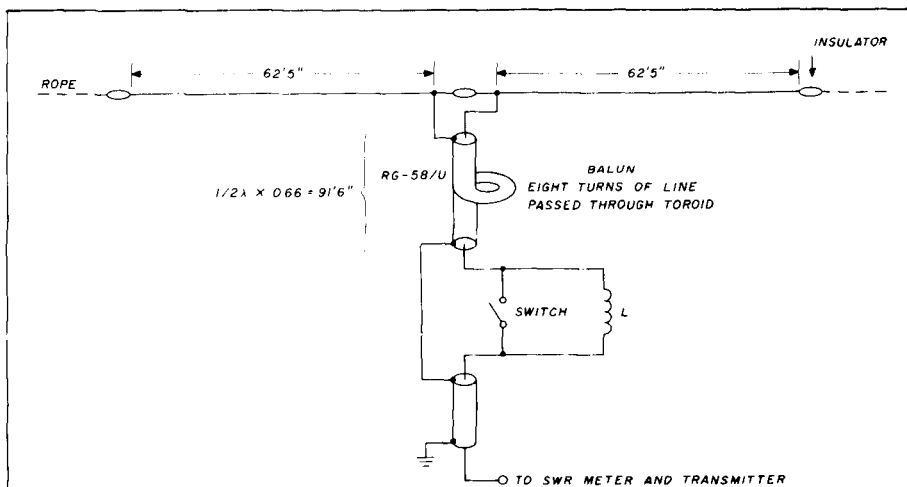

fig. 6. The W6TC two-frequency dipole for 80 meters. Antenna is cut for resonance at high frequency end of band. A single loading coil for operation at the low frequency end of the band is placed an electrical half-wavelength down the transmission line. The line is decoupled from the antenna by a simple balun placed directly at the antenna insulator. Toroid is powdered iron material T-200 (2" OD) (1.25" ID), 2-mix (red,  $\mu = 10$  (Amidon T-200-2), or equivalent.

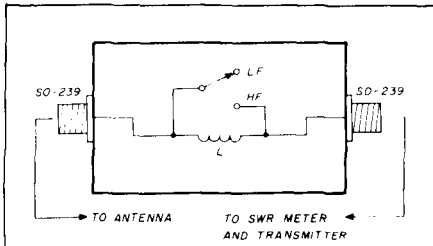

fig. 7. Remote loading inductor is placed in shielded box at operating position. Coil is approximately 11 turns No. 12 wire, 2" diameter and 2-1/4" long. (About 3.75  $\mu$ H). Switch is surplus ceramic unit.

operate at 3500 kHz, George first placed a single loading coil in series with one leg of the dipole. The unbalance caused by not splitting the coil and putting half of it in each leg was unnoticeable.

Now, the problem is that the dipole has to be raised and lowered to insert or remove the loading coil for a QSY from one end of the band to the other. George solved this problem by moving the coil a half-wavelength down the coaxial feedline, placing the loading coil right at the operation position.

Physically, the coil is placed in a box as shown in fig. 7. A ceramic switch is connected across the loading coil and instant QSY between the ends of the band is possible — right from the operating position. The two SWR curves for the antenna are shown in fig. 8.

### another easy way

In microwave antennas, a device known as a "double-stub tuner" can be used to reduce the SWR on a feed system. Simpler versions of this tuner have become known as "line flatteners" and one that will work on 80 meters is shown in fig. 9.

Using the line flattener, an 80-meter dipole cut for one portion of the band can be made to work anywhere in the band with near-unity SWR presented to the transmitter.

Under the worst of circumstances, the SWR on the line could go as high as 5:1 if a dipole cut for one end of the band were used at the opposite end of the band. Even so, the line flattener can readily take care of the problem. In most instances, the dipole is cut for some frequency within the band and maximum SWR excursions run closer to 3:1 at the band edges. No matter, the line flattener does the job.

The device is easy to adjust. The capacitors and inductors are adjusted until the SWR at the transmitter is unity. If you run out of capacitance range in one unit, a 1250 working volt mica capacitor placed in parallel with the fully meshed capacitor will help.

### any ideas from the field?

Well, I've heard of the scheme of making the 80-meter dipole out of steel wire to introduce a little loss and thereby lower the circuit Q and improve the bandwidth. And it might work, but I don't have feedback from anybody who has tried the idea.

But I would like to hear from those who have any original thoughts on an 80-meter broadband antenna system that will show a low value of SWR to the new solid-state rigs.

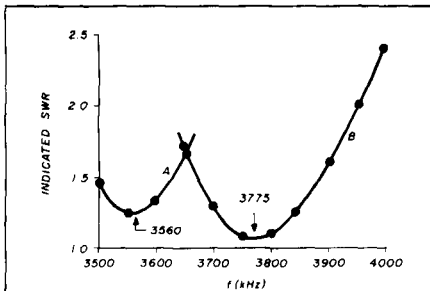

fig. 8. The W6TC two-frequency dipole. Curve A shows resonance at 3560 kHz with a remote loading inductor in the circuit. Curve B shows resonance at 3775 kHz with inductor shorted out. Resonance curve B can be shifted by changing length of antenna; curve A can be shifted by changing the value of the loading inductor.

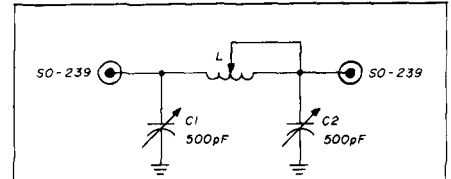

fig. 9. A coaxial "line flattener" for 80 and 160 meters. Capacitors may be shunted with 1250 volt mica units to increase range. (As much as 2000 pF may be required on 160 meters.) Inductor can be tapped or switched. No. 16 bare or tinned copper wire is recommended as a starter (12 turns per inch). Surplus rotary inductor would be useful.

### computermania!

In my April, 1983, column I discussed short, loaded dipole antennas and showed a simple computer program that would aid in the fast design of a short dipole for any Amateur band. Missing from the program was the section required to design the impedance matching coil. The program was modified by Dick, W6EDE, for a TRS-80 (II), and has been further refined by John McComic, K4KAJ (fig. 5). John's program covers the complete antenna design, plus matching coil, for any frequency. The result is a half-length dipole, perfect for cramped locations.

A copy of the missing section of the program is available directly from *ham radio*. Be sure to enclose a stamped (20¢) business-size envelope (9-1/2 x 4-1/8) with your request.

(My thanks to the following who also provided interesting and useful antenna programs: Lloyd Phillips, WB6WCA; Warner Thompson, N7WT; and I. L. McNally, K6WX.)

### references

1. William I. Orr, W6SAI, "Ham Radio Techniques," *ham radio*, August, 1982, page 42. (See Snyder 80-meter antenna product review in this issue. Editor)
2. Jerry Hall, K1TD, "The Search for a Simple Broadband 80-Meter Dipole," *QST*, April, 1983, page 22.
3. Mason A. Logan, K4MT, "Stagger-Tuned Dipoles Increase Bandwidth," *ham radio*, May, 1983, page 22.

ham radio

# NEW LOW-NOISE PREAMPS RECEIVING CONVERTERS TRANSMIT CONVERTERS

New low-noise microwave transistors make preamps in the 0.9 to 1.0 dB noise figure range possible without the fragility and power supply problems of gas-fet's. Units furnished wired and tuned to ham band. Can be easily retuned to nearby freq.



Models LNA( ), P30, and P432 shown

Model	Tunable		Noise Figure	Gain	Price
	Freq Range				
LNA 28	20-40		0.9 dB	20 dB	\$39.95
LNA 50	40-70		0.9 dB	20 dB	\$39.95
LNA 144	120-180		1.0 dB	18 dB	\$39.95
LNA 220	180-250		1.0 dB	17 dB	\$39.95
LNA 432	380-470		1.0 dB	18 dB	\$44.95

## ECONOMY PREAMPS

Our traditional preamps, proven in years of service. Over 20,000 in use throughout the world. Tuneable over narrow range. Specify exact freq. band needed. Gain 16-20 dB. NF = 2 dB or less. VHF units available 27 to 300 MHz. UHF units available 300 to 650 MHz.

- P30K, VHF Kit less case \$14.95
- P30C, VHF Kit with case \$20.95
- P30W, VHF Wired/Tested \$29.95
- P432K, UHF Kit less case \$18.95
- P432C, UHF Kit with case \$24.95
- P432W, UHF Wired/Tested \$33.95

P432 also available in broadband version to cover 20-650 MHz without tuning. Same price as P432; add "B" to model #.

## HELICAL RESONATOR PREAMPS

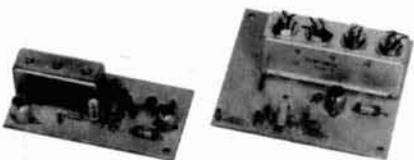

Our lab has developed a new line of low-noise receiver preamps with helical resonator filters built in. The combination of a low noise amplifier similar to the LNA series and the sharp selectivity of a 3 or 4 section helical resonator provides increased sensitivity while reducing intermod and cross-band interference in critical applications. See selectivity curves at right. Noise figure = 1 to 1.2 dB. Gain = 12 to 15 dB.

Model	Tuning Range	Price
HRA-144	143-150 MHz	\$49.95
HRA-220	213-233 MHz	\$49.95
HRA-432	420-450 MHz	\$59.95



Models to cover every practical rf & if range to listen to SSB, FM, ATV, etc. NF = 2 dB or less.

VHF MODELS	Antenna Input Range	Receiver Output
	28-32	144-148
50-52	28-30	
Kit \$44.95	50-54	144-148
Less Case \$39.95	144-146	28-30
Wired \$59.95	145-147	28-30
	144-144.4	27-27.4
	146-148	28-30
	144-148	50-54
	220-222	28-30
	220-224	144-148
	222-226	144-148
	220-224	50-54
	222-224	28-30

UHF MODELS	Antenna Input Range	Receiver Output
432-434	28-30	
435-437	28-30	
Kit \$54.95	432-436	144-148
Less Case \$49.95	432-436	50-54
Wired \$74.95	439.25	61.25

**SCANNER CONVERTERS** Copy 72-76, 135-144, 240-270, 400-420, or 806-894 MHz bands on any scanner. Wired/tested Only \$79.95.

**SPECIAL FREQUENCY CONVERTERS** made to custom order \$119.95. Call for details.

## SAVE A BUNDLE ON VHF FM TRANSCEIVERS!

FM-5 PC Board Kit - **ONLY \$159.95** complete with controls, heatsink, etc. 10 Watts, 5 Channels, for 6M, 2M, or 220



Cabinet Kit, complete with speaker, knobs, connectors, hardware. Only \$59.95

**REPEAT OF A SELLOUT!**

While supply lasts, get \$59.95 cabinet kit free when you buy an FM-5 Transceiver kit. Where else can you get a complete transceiver for only \$159.95?

For SSB, CW, ATV, FM, etc. Why pay big bucks for a multi mode rig for each band? Can be linked with receive converters for transceive. 2 watts output.

For VHF, Model XV2 Kit \$79.95 Wired \$119.95 (Specify band)	Exciter Input Range	Antenna Output
	28-30	144-146
28-29	145-146	
28-30	50-52	
27-27.4	144-144.4	
28-30	220-222*	
50-54	220-224	
144-146	50-52	
50-54	144-148	
144-146	28-30	

For UHF, Model XV4 Kit \$99.95 Wired \$149.95	Exciter Input Range	Antenna Output
	28-30	432-434
28-30	435-437	
50-54	432-436	
61.25	439.25	
144-148	432-436*	

\*Add \$20 for 2M input

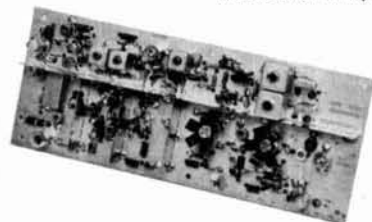

**VHF & UHF LINEAR AMPLIFIERS.** Use with above. Power levels from 10 to 45 Watts. Kits from \$69.95.

## LOOK AT THESE ATTRACTIVE CURVES!

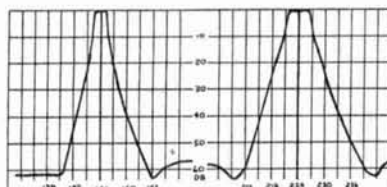

R144 & R220 Front Ends, HRA 144/220, & HRF-144/220

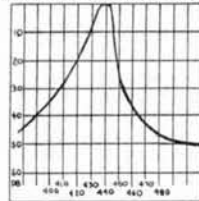

R451 Receiver Front End

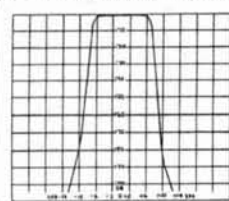

Rcvr I-F Selectivity

Typical Selectivity Curves of Receivers and Helical Resonators.

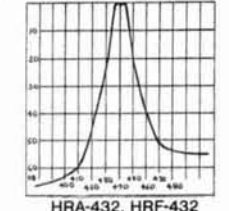

HRA-432, HRF-432

- Call or Write for **FREE CATALOG** (Send \$1.00 or 4 IRC's for overseas mailing)
- Order by phone or mail • Add \$2 S & H per order (Electronic answering service evenings & weekends)
- Use VISA, MASTERCARD, Check, or UPS COD.

**hamtronics, inc.**

65-Y MOUL RD. • HILTON NY 14468  
Phone: 716-392-9430

Hamtronics® is a registered trademark

**AT LAST —  
A REPEATER  
YOU CAN AFFORD!**

For years, Hamtronics® Modules have been used by individual hams and manufacturers to make repeaters. Now, in the Hamtronics tradition of top quality and superb value, we are proud to offer a complete repeater package.



**JUST LOOK AT THESE PRICES!**

Band	Kit	Wired/Tested
6M,2M,220	\$595	\$745
440	\$645	\$795

Both kit and wired units are complete with all parts, modules, hardware, and crystals.

**CALL OR WRITE FOR COMPLETE DETAILS.**

Also available for remote site linking/crossband & 10M.

**FEATURES:**

- SENSITIVITY SECOND TO NONE; TYPICALLY 0.15 uV ON VHF, 0.3 uV ON UHF.
- SELECTIVITY THAT CAN'T BE BEAT! BOTH 8 POLE CRYSTAL FILTER & CERAMIC FILTER FOR GREATER THAN 100 dB AT ± 12KHZ. HELICAL RESONATOR FRONT ENDS. SEE R144, R220, AND R451 SPECS IN RECEIVER AD BELOW.
- OTHER GREAT RECEIVER FEATURES: FLUTTER-PROOF SQUELCH, AFC TO COMPENSATE FOR OFF-FREQ TRANSMITTERS, SEPARATE LOCAL SPEAKER AMPLIFIER & CONTROL.
- CLEAN, EASY-TUNE TRANSMITTER; UP TO 20 WATTS OUT.

**HIGH QUALITY MODULES FOR  
REPEATERS, LINKS, TELEMETRY, ETC.**

**INTRODUCING —  
NEW 1983 RECEIVERS**

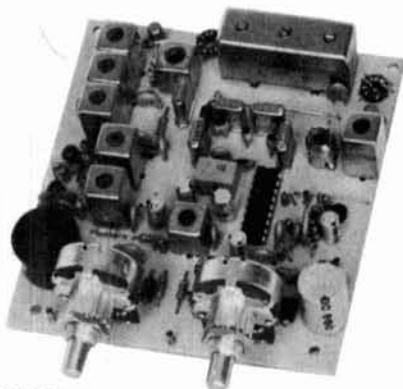

R144 Shown

- **R144/R220 FM RCVRS** for 2M or 220 MHz. 0.15uV sens.; 8 pole xtal filter & ceramic filter in i-f, helical resonator front end for exceptional selectivity (curves at left). AFC incl., xtal oven avail. Kit only \$119.95
- **R451 FM RCVR** Same but for uhf. Tuned line front end, 0.3 uV sens. Kit only \$119.95.
- **R76 FM RCVR** for 10M, 6M, 2M, 220, or commercial bands. As above, but w/o AFC or hel. res. Kits only \$109.95. Also avail w/4 pole filter, only \$94.95/ kit.
- **R110VHF AM RECEIVER** kit for VHF aircraft band or ham bands. Only \$84.95
- **R110 UHF AM RECEIVER** for UHF uses, including special 259 MHz model to hear SPACE SHUTTLE. Kit \$94.95

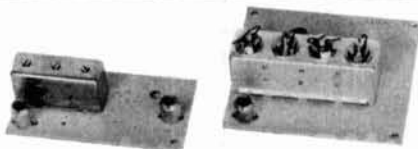

- **HELICAL RESONATOR FILTERS** available separately on pcb w/connectors.

HRF-144 for 143-150 MHz \$34.95  
HRF-220 for 213-233 MHz \$34.95  
HRF-432 for 420-450 MHz \$44.95

(See selectivity curves at left.)



- **COR KITS** With audio mixer and speaker amplifier. Only \$29.95.
- **CWID KITS** 158 bits, field programmable, clean audio. Only \$59.95.
- **DTMF DECODER/CONTROLLER KITS.** Control 2 separate on/off functions with touchtones®, e.g., repeater and autopatch. Use with main or aux. receiver or with Auto-patch. Only \$89.95.
- **AUTOPATCH KITS.** Provide repeater autopatch, reverse patch, phone line remote control of repeater, secondary control via repeater receiver. Many other features. Only \$89.95. Requires DTMF Module.
- **A16 RF TIGHT BOX** Deep drawn alum. case with tight cover and no seams. 7 x 8 x 2 inches. Only \$18.00.

**TRANSMITTERS AND  
ACCESSORIES**



- **T51 VHF FM EXCITER** for 10M, 6M, 2M, 220 MHz or adjacent bands. 2 Watts continuous. Kits only \$59.95



- **T451 UHF FM EXCITER** 2 to 3 Watts on 450 ham band or adjacent. Kits only \$69.95.
- **VHF & UHF LINEAR AMPLIFIERS.** Use on either FM or SSB. Power levels from 10 to 45 Watts to go with exciters & xmtg converters. Kits from \$69.95.

**hamtronics®**

## CABLE TV CONVERTERS VIDEO ACCESSORIES

BUY DIRECT & SAVE

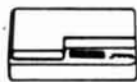

**40 CHANNEL CONVERTER**  
**\$38** Regular \$69

Advanced Solid State design and circuitry allows you to receive mid & super band channels. Restores programming to Video Recorders.



**36 CHANNEL REMOTE CONTROL CABLE CONVERTER**  
**\$88.00**

**DIAMOND D-56 WIRELESS THE ULTIMATE CABLE T.V. CONVERTER**



**56 CHANNEL INFRARED REMOTE CONTROL**  
**\$139.00**

✓ 130

Send \$1 for Complete Catalog  
VISA • MASTERCARD • COD

**DIRECT VIDEO SALES**

P.O. BOX 1329  
JEFFERSONVILLE, INDIANA 47130

CALL

1-800-626-5533

1983-1984

**AMATEUR RADIO**

**CALL DIRECTORY**

THE BARGAIN AT **\$14.95** Plus Shipping



A no frills directory of over **435,000 U.S. Radio Amateurs.** 8 1/2 x 11, easy to read format. **Completely updated.**

**Also available for the first time ever—**

(Alphabetically arranged—Sold separately)

**Geographical Index**

by State, City and Street No. and Call

**Name Index**

by Name and Call

Ordering Information:

- Directory—\$14.95
- Geographical Index—\$25.00
- Name Index—\$25.00

Add \$3.00 Shipping to all orders.

Dealer / Club inquiries welcome

Send your order—enclosing check or money order in U.S. dollars to:

**Buckmaster Publishing**

Whitehall

Mineral, VA 23117 U.S.A.

✓ 117

## short circuits

### vertical phased arrays

The following corrections should be made to part 3 of K2BT's article, "Vertical Phased Arrays" (July, 1983):

Eq. 3 (p. 30) should read:

$$Z_{12} = \pm \sqrt{Z_{22}(Z_{11} - Z_1)}$$

The polar notation in the upper left-hand column of page 32 should include the angle symbol and read:

$$20.4 \angle 132.2^\circ$$

The following lines identifying the driving point impedances in table 3 (page 33) should be corrected as indicated.

3-element in-line array,  $\lambda/4$  spacing:

$$Z_1 - 6.6 - j21 \text{ should read } 15.4 - j17$$

$$Z_2 \ 51.4 + j0 \text{ should read } 36.2 + j0$$

$$Z_3 \ 79.4 - j39 \text{ should read } 75.4 + j43$$

triangular array,  $0.289\lambda$  spacing:

$$Z_1 \ 28.4 - j10 \text{ should read } 20.4 - j10$$

### panoramic adapter

The following corrections should be made to "Design Notes on a Panoramic Adaptor/Spectrum Analyzer" by Rick Ferranti, WA6NCX, (February, 1983):

In fig. 4 (page 30), the connection shown between the transistor's collector and the 3.3k resistor is erroneous. The collector lead is still attached to T1.

In reference to the 31 MHz band-pass filter in fig. 8 (page 31) the notation "space coils 1/2 inch apart . . ." refers to the distance between T<sub>1</sub> and T<sub>2</sub> (centers); the 2-turn windings on the coil should be over the 12-turn windings on each form at the cold end.

A small variable capacitor across the 4.7k resistor was deleted from fig. 9 (page 32), but not from the text. Because the capacitor pulled the oscillator only slightly in frequency, it is not necessary in this circuit.

**BRAND NEW ENGLISH EDITION**

## THE UHF COMPENDIUM

by K. Weiner, DJ9HO

First published in German in 1980 — this book was an instant European best seller. Now available in English — only from Ham Radio Magazine. This hefty, 413 page book is an absolute must for every VHF and UHF enthusiast. The UHF Compendium has been divided into 7 sections to fully cover theory and practical building instructions. Special emphasis has been placed on state-of-the-art techniques such as GaAs Fet preamplifiers and converters. Author Weiner also fully describes all of the test equipment, alignment tools, power measuring equipment and other handy gadgets that will be of use to the UHF/VHF Amateur. All of the projects and designs have been tested and proven and are not engineer's pipe dreams. Antennas are also fully covered with a number of easy-to-build designs as well as large mega-element arrays. Noted VHF enthusiast, Joe Reiser, W1JR, tells us that every ham interested in UHF/VHF should have a copy of this book. Get yours today — only from Ham Radio Magazine.

☐ KW-UHF

Softbound \$23.95

Please add \$2.50 shipping and handling

**Ham Radio's Bookstore**

GREENVILLE, NH 03048



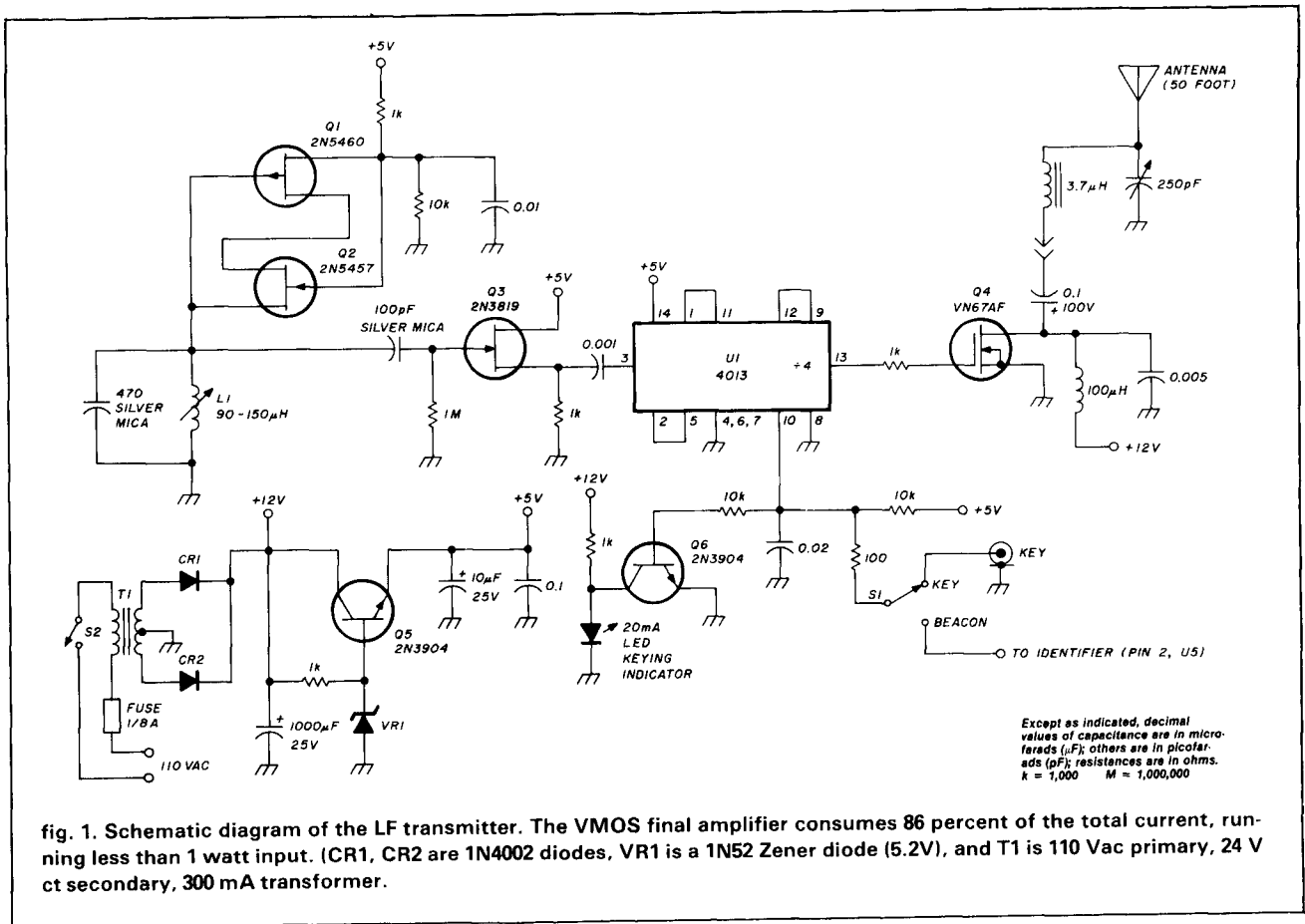

fig. 1. Schematic diagram of the LF transmitter. The VMOS final amplifier consumes 86 percent of the total current, running less than 1 watt input. (CR1, CR2 are 1N4002 diodes, VR1 is a 1N52 Zener diode (5.2V), and T1 is 110 Vac primary, 24 V ct secondary, 300 mA transformer.

## VMOS on 1750 meters

### A CW or beacon transmitter for 160 kHz

Many interesting experiments and enjoyable QSOs can be your reward for operating on the 1750-meter band. No license is required to use the slice of radio spectrum between 160 and 190 kHz, and it requires only simple equipment to provide the legal maximum of 1-watt input to the transmitter. Enthusiasts have made contacts over distances of 700 miles in spite of the antenna-size limit of 50 feet.

I've used my VMOS transmitter to make a contact from East Haven, Connecticut to Owings, Maryland — a span of 250 miles. It can be done consistently as long as very noisy conditions do not exist. Many

schedules have successfully been kept with stations in New Jersey, New York, Maryland, and Massachusetts. My beacon signal has been heard as far north as New Hampshire and as far south as Maryland. Receiving equipment for this band is not at all difficult to build.<sup>1</sup>

D-layer reflection and groundwave propagation modes dominate the band and best results are obtained by installing a good ground system and by keeping antenna coupling-losses low. Radiation resistance for the 50-foot antenna is on the order of 0.02 ohms and the radiation efficiency is therefore very low. Nevertheless, a few milliwatts of effective radiated output does give you usable communications.

By S. J. DeFrancesco, K1RGO, 17 Jeffrey Road, East Haven, Connecticut 06512

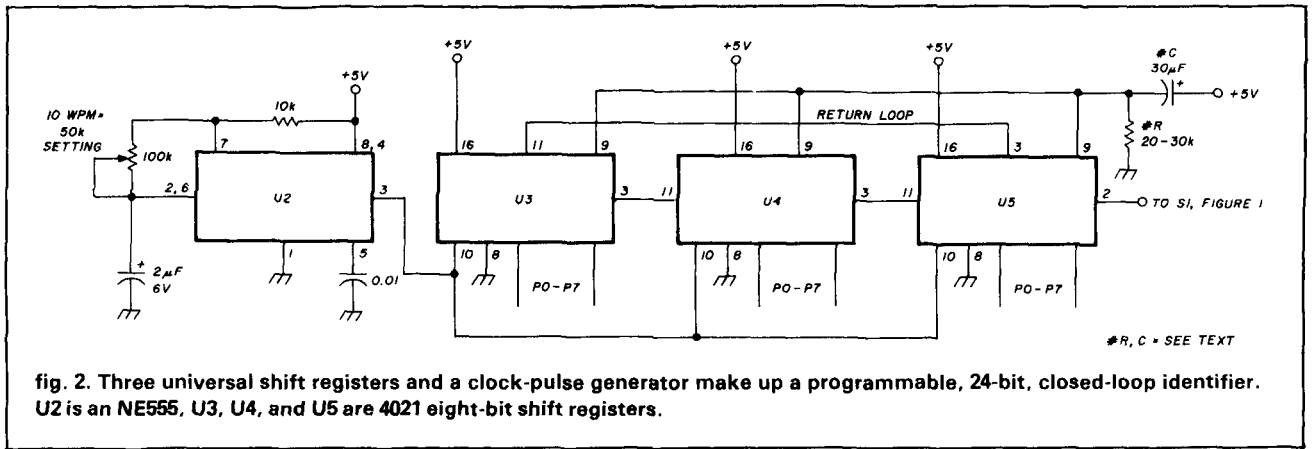

fig. 2. Three universal shift registers and a clock-pulse generator make up a programmable, 24-bit, closed-loop identifier. U2 is an NE555, U3, U4, and U5 are 4021 eight-bit shift registers.

### the transmitter

The transmitter circuit diagram shown in **fig. 1** uses a 600-800 kHz negative-resistance oscillator consisting of Q1 and Q2. L1 is a variable inductor of 90-150 µH. The 470 pF capacitor can be made variable, and an old BC loop stick can be used for L1 instead. Stability is excellent — only a few hertz of drift were observed one hour after the unit was turned on. Isolation is provided by Q3, a source-follower circuit which drives U1. U1 is a CMOS 4013 type-D dual flip-flop used to divide the 600-800 kHz from the oscillator down to 150-200 kHz. The output of U1 drives the VMOS amplifier. The output of Q4 is coupled to the antenna tuning network through a 0.1 uF capacitor. The antenna tuning network consists of a 250 pF variable capacitor and a 3.7 mH coil wound on a ferrite rod. This high Q L/C arrangement resonates the 50-foot vertical antenna to 160-190 kHz.

Transmitter keying is accomplished by gating U1 on and off at pin 10. Q6 is an LED driver connected to indicate keying. S1 is set to key position for manual

CW operation, or BEACON position for continuous-message operation.

### identifier

Three 4021 CMOS universal eight-bit shift registers are used in the identifier for minimum power consumption. In **fig. 2**, U3, U4, and U5 clock inputs are connected in parallel. U2 is a square-wave clock-pulse generator which drives the other ICs. The 100k potentiometer can be adjusted to obtain the desired code speed. The P0-P7 parallel inputs are programmed to provide identification. R\* and C\* are somewhat critical and should be selected for the code speed used. R\*, shown in **fig. 2**, is 30k for 15 wpm or less, or 20k for 20-30 wpm. C\* is 30 µF for this same range of code speeds.

When power is first turned on, P0-P7 parallel inputs are loaded in serial with pin 9 on U3, U4, and U5 in a logic-high state. As C\* equalizes, and pin 9 goes low, the serial-loop mode is activated and the program is stored. It then circulates in a continuous loop. The output (pin 2 of the U5) pulse train is fed to

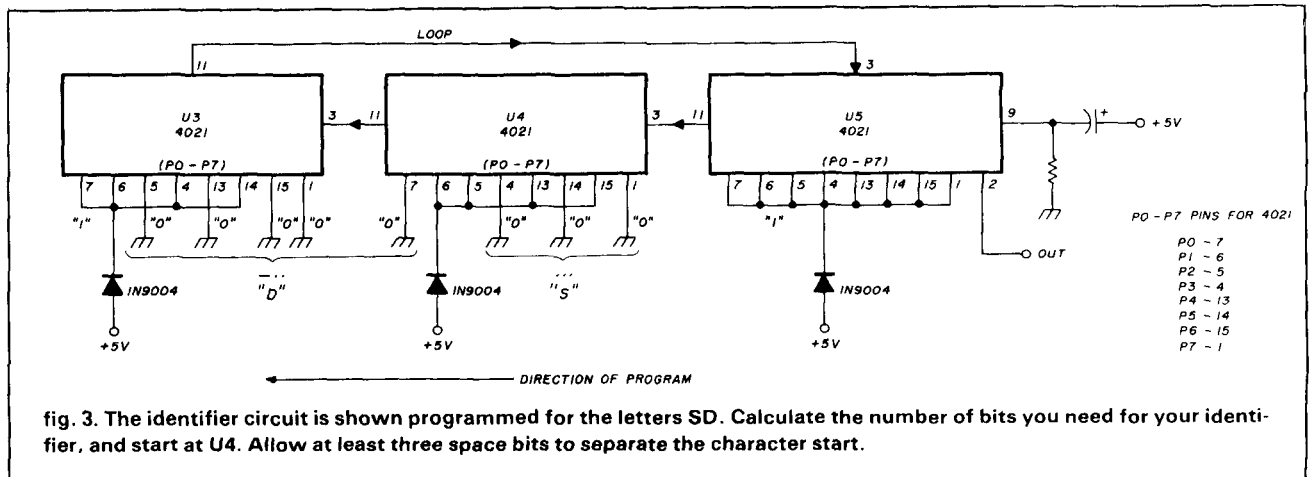

fig. 3. The identifier circuit is shown programmed for the letters SD. Calculate the number of bits you need for your identifier, and start at U4. Allow at least three space bits to separate the character start.

U1 in the transmitter, providing CW transmission in the beacon mode. Code speed is varied by changing the output frequency of U2.

### programming

A dash is equal to three bits (zero) and a dot is equal to one bit (zero). Spacing between dots and dashes to form a character is one bit (zero). Spacing between characters is two bits (1). The identification I use is "SD," consisting of fourteen bits with ten bits to spare. The program is shown in fig. 3, using the P0-P7 parallel inputs. A 0 is an on bit and a 1 is an off, or space, bit. Once the program is wired in, no other preprogramming is needed. If your program appears to drop a bit or two, shut off the power for a few seconds and then switch it back on again; this will reset the program.

### operation

I monitored the transmitter on an RBA-5 low-frequency receiver, and adjusted the VFO to the desired frequency (185 kHz). When I keyed the transmitter, I heard very little key clicking, and a nice, chirp-free signal was generated. I tuned the output capacitor for maximum indication on my field strength meter. An NE-2 neon bulb glowed brightly when touched to the antenna terminal. I then tuned the 250-pF loading capacitor and found that no shift in frequency was being caused by the antenna tuning. I turned the switch to the BEACON mode to evaluate the IDer, and it worked fine.

This system has run twenty-four hours at a time and has been very reliable. Total current drain is 100 mA, of which 86 mA is used by the VMOS power amplifier. Input to the final is around 1 watt, the legal unlicensed limit.

### construction notes

The complete unit can be made very small, including the power supply — it is possible to fit everything except the antenna loading circuit into a 2 × 4 × 2-inch (50 × 103 × 50 mm) Minibox.

The 3.7 mH antenna coil can be air core or low-loss ferrite core. I close-wound 138 turns of No. 26 wire on an old 5/8-inch diameter broadcast-band ferrite core. A 250 or 365 pF variable capacitor can be used with this inductor to resonate the 50-foot vertical antenna. Experimentation with various cores and coils to improve efficiency in the antenna circuit can be evaluated by field-strength readings.

### ham radio

### references

1. DeFrancesco, S.J., K1RGO. "A Fixed-Tuned LF Converter," *ham radio*, January, 1983, page 19.

**STUDY  
TAPES**

**CODE PRACTICE TAPES FROM HRPG — Practice copying Morse Code anytime, anywhere. Whether you're upgrading your present license or just trying to up your code speed, a large assortment allows you to choose exactly the kind of practice you need.**

each tape \$4.95 2/\$8.95 3/\$12.95

### CODE PRACTICE TAPES

Here are three different straight code tapes consisting of randomly generated six character groups sent at different speeds. These tapes are excellent for building both the speed and copying accuracy needed for contesting, DXing and traffic handling.

- |   |  |
|---|--|
| <input type="checkbox"/> <b>HR-STC1 — \$4.95</b><br>7.5 wpm code for 25 minutes<br>10 wpm code for 25 minutes<br>15 wpm code for 25 minutes | <input type="checkbox"/> <b>HR-STC3 — \$4.95</b><br>25 wpm code for 20 minutes<br>30 wpm code for 20 minutes<br>35 wpm code for 20 minutes<br>40 wpm code for 20 minutes |
| <input type="checkbox"/> <b>HR-STC2 — \$4.95</b><br>15 wpm code for 50 minutes<br>22.5 wpm code for 35 minutes                              |  |

### HI/LO SERIES — Code Study Tapes

In this unique series, characters are sent at high speeds with long pauses between each character. For example, HLC4 (15/2.5 wpm) consists of characters sent at a 15 wpm rate, but with 2.5 wpm spacing between each character. These tapes are excellent for the beginner who wants to practice copying higher speed code without the frustration of constantly getting behind.

- |  |   |
|--|---|
| <input type="checkbox"/> <b>HR-HLC1 — \$4.95</b><br>22.5/2.5 wpm code for 80 minutes   | <input type="checkbox"/> <b>HR-HLC3 — \$4.95</b><br>15/5 wpm code for 28 minutes<br>15/7.5 wpm code for 28 minutes<br>15/10 wpm code for 28 minutes |
| <input type="checkbox"/> <b>HR-HLC2 — \$4.95</b><br>22.5/5 wpm code for 20 minutes<br>22.5/7.5 wpm code for 20 minutes<br>22.5/10 wpm code for 20 minutes<br>22.5/13 wpm code for 20 minutes | <input type="checkbox"/> <b>HR-HLC4 — \$4.95</b><br>15/2.5 wpm code for 80 minutes  |

Please add \$1 for shipping.

**Ham Radio's Bookstore**  
Greenville, NH 03048

## CLOSE OUT SPECIAL SAVE 50%

### \* Call Directories \*

The low-cost answer to your call and QTH questions.

### AMATEURS LISTED BY AREA AND CALL SIGN

It's finally been done. A complete directory of all licensed Radio Amateurs in the U.S. at three-quarters the price of the other well-known book. Similar in layout and appearance but printed on higher quality paper for easier reading, this book is a full 8½" × 11" and is very easy to handle. Generic in appearance but, **oh what a value!** Over 410,000 licensed Amateurs listed. ©1983.

- BM-CD** Softbound \$10.45  
(\$7.49 + \$3.00 shipping)

### Two More Call Directories

Here are two other call directories never before available. A bit expensive but well worth every dollar. See who the other Amateurs are in your area. Find those old friends you lost track of many years ago. Perfect for your club or your own library.

### AMATEURS LISTED BY GEOGRAPHICAL LOCATION

- Lists Amateurs in each town in U.S. ©1983.  
 **BM-GA** Softbound \$15.50  
(\$12.50 + \$3 shipping)

### AMATEURS LISTED BY NAME

- An alphabetical listing of all U.S. Amateurs. ©1983.  
 **BM-AL** Softbound \$15.50  
(\$12.50 + \$3 shipping)

**HAM RADIO'S BOOKSTORE**  
Greenville, NH 03048

# Do Kay

**COMPUTER  
PRODUCTS,  
Inc.**

ORDER TOLL FREE

**(800)**

**538-8800**

(CALIFORNIA RESIDENTS)

**(800)**

**848-8008**



**TERMS:** For shipping include \$2.00 for UPS Ground or \$3.00 for UPS Blue Air. \$10.00 minimum order. Bay Area and Los Angeles Counties add 6½% Sales Tax, other California residents add 6% Sales Tax. We reserve the right to limit quantities and substitute manufacturer. Prices subject to change without notice.

VISIT OUR RETAIL STORE

2100 De La Cruz Blvd.  
Santa Clara, CA 95050  
(408) 988-0697

# Do Kay

## STATIC RAMS

2101	256 x 4 (450ns)	1.90
5101	256 x 4 (450ns) (cmos)	3.90
2102-1	1024 x 1 (450ns)	.88
2102L-4	1024 x 1 (450ns) (LP)	.98
2102L-2	1024 x 1 (250ns) (LP)	1.45
2111	256 x 4 (450ns)	2.45
2112	256 x 4 (450ns)	2.95
2114	1024 x 4 (450ns)	8/9.90
2114-25	1024 x 4 (250ns)	8/9.95
2114L-4	1024 x 4 (450ns) (LP)	8/11.95
2114L-3	1024 x 4 (300ns) (LP)	8/12.45
2114L-2	1024 x 4 (200ns) (LP)	8/12.95
2147	4096 x 1 (55ns)	4.90
TMS4044-4	4096 x 1 (450ns)	3.45
TMS4044-3	4096 x 1 (300ns)	3.95
TMS4044-2	4096 x 1 (200ns)	4.45
MK4118	1024 x 8 (250ns)	9.90
TMM2016-200	2048 x 8 (200ns)	4.10
TMM2016-150	2048 x 8 (150ns)	4.90
TMM2016-100	2048 x 8 (100ns)	6.10
HM6116-4	2048 x 8 (200ns) (cmos)	4.70
HM6116-3	2048 x 8 (150ns) (cmos)	4.90
HM6116-2	2048 x 8 (120ns) (cmos)	8.90
HM6116LP-4	2048 x 8 (200ns) (cmos)(LP)	5.90
HM6116LP-3	2048 x 8 (150ns) (cmos)(LP)	6.90
HM6116LP-2	2048 x 8 (120ns) (cmos)(LP)	9.95
Z-6132	4096 x 8 (300ns) (Qstat)	33.95

LP = Low Power Qstat = Quasi-Static

## DYNAMIC RAMS

TMS4027	4096 x 1 (250ns)	1.95
UPD411	4096 x 1 (300ns)	2.95
MMS280	4096 x 1 (200ns)	2.95
MK4108	8192 x 1 (200ns)	1.90
MMS298	8192 x 1 (250ns)	1.80
4116-300	16384 x 1(300ns)	8/10.75
4116-250	16384 x 1(250ns)	8/10.95
4116-200	16384 x 1(200ns)	8/11.95
4116-150	16384 x 1(150ns)	8/13.95
4116-120	16384 x 1(120ns)	8/28.95
2118	16384 x 1(150ns) (5v)	4.90
4164-200	65536 x 1(200ns) (5v)	5.90
4164-150	65536 x 1(150ns) (5v)	6.90

5V = single 5 volt supply

## EPROMS

1702	256 x 8 (1us)	4.45
2708	1024 x 8 (450ns)	3.90
2758	1024 x 8 (450ns) (5v)	5.90
2716	2048 x 8 (450ns) (5v)	3.90
2716-1	2048 x 8 (350ns) (5v)	5.90
TMS2516	2048 x 8 (450ns) (5v)	5.45
TMS2716	2048 x 8 (450ns)	7.90
TMS2532	4096 x 8 (450ns) (5v)	5.90
2732	4096 x 8 (450ns) (5v)	4.90
2732-250	4096 x 8 (250ns) (5v)	8.90
2732-200	4096 x 8 (200ns) (5v)	10.95
2764	8192 x 8 (450ns) (5v)	9.90
2764-250	8192 x 8 (250ns) (5v)	13.95
2764-200	8192 x 8 (200ns) (5v)	23.95
TMS2564	8192 x 8 (450ns) (5v)	16.95
MC68764	8192 x 8 (450ns) (5v)(24 pin)	38.95
27128	16384 x 8Call	Call

5v = Single 5 Volt Supply

## 74LS00

74LS00	.23	74LS173	.68
74LS01	.24	74LS174	.54
74LS02	.24	74LS175	.54
74LS03	.24	74LS181	2.10
74LS04	.23	74LS189	8.90
74LS05	.24	74LS190	.88
74LS08	.27	74LS191	.88
74LS09	.28	74LS192	.78
74LS10	.24	74LS193	.78
74LS11	.34	74LS194	.68
74LS12	.34	74LS195	.68
74LS13	.44	74LS196	.78
74LS14	.58	74LS197	.78
74LS15	.34	74LS221	.88
74LS20	.24	74LS240	.94
74LS21	.28	74LS241	.98
74LS22	.24	74LS242	.98
74LS26	.28	74LS243	.98
74LS27	.28	74LS244	1.25
74LS28	.34	74LS245	1.45
74LS30	.24	74LS247	.74
74LS32	.28	74LS248	.98
74LS33	.54	74LS249	.98
74LS37	.34	74LS251	.58
74LS38	.34	74LS253	.58
74LS40	.24	74LS257	.58
74LS42	.48	74LS258	.58
74LS47	.74	74LS259	2.70
74LS48	.74	74LS260	.58
74LS49	.74	74LS266	.54
74LS51	.24	74LS273	1.45
74LS54	.28	74LS275	3.30
74LS55	.28	74LS279	.48
74LS63	1.20	74LS280	1.95
74LS73	.38	74LS283	.68
74LS74	.34	74LS290	.88
74LS75	.38	74LS293	.88
74LS76	.38	74LS295	.98
74LS78	.48	74LS298	.88
74LS83	.59	74LS299	1.70
74LS85	.68	74LS323	3.45
74LS86	.38	74LS324	1.70
74LS90	.54	74LS352	1.25
74LS91	.88	74LS353	1.25

74LS92	.54	74LS363	1.30
74LS93	.54	74LS364	1.90
74LS95	.74	74LS365	.48
74LS96	.88	74LS366	.48
74LS107	.38	74LS367	.44
74LS109	.38	74LS368	.44
74LS112	.38	74LS373	1.35
74LS113	.38	74LS374	1.35
74LS114	.38	74LS377	1.35
74LS122	.44	74LS378	1.13
74LS123	.78	74LS379	1.30
74LS124	2.85	74LS385	1.85
74LS125	.48	74LS386	.44
74LS126	.48	74LS390	1.15
74LS132	.58	74LS393	1.15
74LS133	.58	74LS395	1.15
74LS136	.38	74LS399	1.45
74LS137	.98	74LS424	2.90
74LS138	.54	74LS447	.36
74LS139	.54	74LS490	1.90
74LS145	1.15	74LS624	3.95
74LS147	2.45	74LS640	2.15
74LS148	1.30	74LS645	2.15
74LS151	.54	74LS668	1.65
74LS153	.54	74LS669	1.85
74LS154	1.85	74LS670	1.45
74LS155	.68	74LS674	9.60
74LS156	.68	74LS682	3.15
74LS157	.64	74LS683	3.15
74LS158	.58	74LS684	3.15
74LS160	.68	74LS685	3.15
74LS161	.64	74LS688	2.35
74LS162	.68	74LS689	3.15
74LS163	.64	74LS783	23.95
74LS164	.68	81LS95	1.45
74LS165	.94	81LS96	1.45
74LS166	1.90	81LS97	1.45
74LS168	1.70	81LS98	1.45
74LS169	1.70	25LS2521	2.75
74LS170	1.45	25LS2569	4.20

## 6500 1MHZ

6502	4.90
6504	6.90
6505	8.90
6507	9.90
6520	4.30
6522	7.90
6532	9.90
6545	21.50
6551	10.85

## 2 MHZ

6502A	6.90
6522A	9.90
6532A	10.95
6545A	26.95
6551A	10.95

## 3 MHZ

6502B	13.95
-------	-------

## 6800

68000	58.95
6800	3.90
6802	7.90
6808	12.90
6809E	18.95
6809	10.95
6810	2.90
6820	4.30
6821	3.20
6828	13.95
6840	11.95
6843	33.95
6844	24.95
6845	13.95
6847	10.95
6850	3.20
6852	15.70
6860	9.90
6862	10.95
6875	6.90
6880	2.20
6883	21.95
68047	23.95
68488	18.95

## 6800

68B00	9.95
68B02	21.25
68B09E	28.95
68B09	28.95
68B10	6.90
68B21	6.90
68B45	18.95
68B50	5.90

## 8000

8035	5.90
8039	6.90
INS-8060	16.95
INS-8073	23.95
8080	3.90
8085	5.90
8085A-2	10.95
8086	28.95
8087	CALL
8088	38.95
8089	88.95
8155	6.90
8155-2	7.90
8156	6.90
8185	28.95
8185-2	38.95
8741	38.95
8748	23.95
8755	23.95

## 8200

8202	23.95
8203	38.95
8205	3.45
8212	1.75
8214	3.80
8216	1.70
8224	2.20
8226	1.75
8228	3.45
8237	18.95
8237-5	20.95
8238	4.45
8243	4.40
8250	9.95
8251	4.45
8253	6.90
8253-5	7.90
8255	4.45
8255-5	5.20
8257	7.90
8257-5	8.90
8259	6.85
8259-5	7.45
8271	38.95
8272	38.95
8275	28.95
8279	8.90
8279-5	9.00
8272	6.45
8283	6.45
8284	5.45
8286	6.45
8287	6.45
8288	24.00
8289	48.95

## Z-80

### 2.5 Mhz

Z80-CPU	3.90
Z80-CTC	4.45
Z80-DART	9.95
Z80-DMA	13.95
Z80-PIO	4.45
Z80-SIO/0	15.95
Z80-SIO/1	15.95
Z80-SIO/2	15.95
Z80-SIO/9	15.95

### 4.0 Mhz

Z80A-CPU	4.90
Z80A-CTC	4.90
Z80A-DART	10.95
Z80A-DMA	15.95
Z80A-PIO	4.90
Z80A-SIO/0	15.95
Z80A-SIO/1	15.95
Z80A-SIO/2	15.95
Z80A-SIO/9	15.95

### 6.0 Mhz

Z80B-CPU	12.95
Z80B-CTC	12.95
Z80B-PIO	12.95
Z80B-DART	18.95

### ZILOG

Z6132	33.95
Z8671	38.95

## DISC CONTROLLERS

1771	15.95
1791	23.95
1793	25.95
1795	48.95
1797	48.95
2791	53.95
2793	53.95
2795	58.95
2797	58.95
6843	33.95
8272	38.95
UPD765	38.95
MB8876	28.95
MB8877	33.95
1691	16.95
2143	17.95

## UARTS

AY3-1014	6.90
AY5-1013	3.90
AY3-1015	6.90
PT-1472	9.90
TR1602	3.90
2350	9.90
2651	8.90
TMS6011	5.90
IM6402	7.90
IM6403	8.90
INS8250	9.95

## INTERFACE

8T26	1.54
8T28	1.84
8T95	.88
8T96	.88
8T97	.88
8T98	.88
DM6131	2.90
DP8304	2.24
DS8835	1.94
DS8836	.98

## VOLTAGE REGULATORS

7805T	.74	7905T	.84
78M05C	.34	7908T	.84
7808T	.74	7912T	.84
7812T	.74	7915T	.84
7815T	.74	7924T	.84
7824T	.74	7905K	1.44
7805K	1.34	7912K	1.44
7812K	1.34	7915K	1.44
7815K	1.34	7924K	1.44
7824K	1.34	79L05	.78
78L05	.68	79L12	.78
78L12	.68	79L15	.78
78L15	.68	LM323K	4.90
78H05K	9.90	UA78S40	1.90
78H12K	9.90		

C, T = TO-220      K = TO-3      L = TO-92

## DIP SWITCHES

4 POSITION	.84
5 POSITION	.89
6 POSITION	.89
7 POSITION	.94
8 POSITION	.94

## IC SOCKETS

	1-99	100
8 pin ST	.12	.10
14 pin ST	.14	.11
16 pin ST	.16	.12
18 pin ST	.19	.17
20 pin ST	.28	.26
22 pin ST	.29	.26
24 pin ST	.29	.26
28 pin ST	.39	.31
40 pin ST	.48	.38
64 pin ST	4.20	call

ST = SOLDER TAIL

8 pin WW	.58	.48
14 pin WW	.68	.51
16 pin WW	.68	.57
18 pin WW	.98	.89
20 pin WW	1.04	.97
22 pin WW	1.34	1.23
24 pin WW	1.44	1.30
28 pin WW	1.64	1.44
40 pin WW	1.94	1.75

WW = WIREWRAP

16 pin ZIF	6.70	call
24 pin ZIF	9.90	call
28 pin ZIF	9.95	call

ZIF = TEXT TOOL (Zero Insertion Force)

## CRYSTALS

32.768khz	1.90
1.0 mhz	4.90
1.8432	4.90
2.0	3.90
2.097152	3.90
2.4576	3.90
3.2768	3.90
3.579535	3.90
4.0	3.90
5.0	3.90
5.0688	3.90
5.185	3.90
5.7143	3.90
6.0	3.90
6.144	3.90
6.5536	3.90
8.0	3.90
10.0	3.90
10.738635	3.90
14.31818	3.90
15.0	3.90
16.0	3.90
17.430	3.90
18.0	3.90
18.432	3.90
20.0	3.90
22.1184	3.90
32.0	3.90

## RESISTORS

1/4 WATT 5% CARBON FILM ALL STANDARD VALUES FROM 1 OHM TO 10 MEG OHM

50 PCS.	1.25
100 PCS.	2.00
1000 PCS.	15.00

## APPLE ACCESSORIES

80 Column Card	129.95
16 K Card	42.50
Fan	38.95
Power Supply	84.95
RF Mod	24.95
Joy Stick (Apple II)	29.95
Paddles Apple	9.95
Z80 Card	129.95
SCRG Switch-A-Slot	19.95
Paddle Adapple	24.95
Extend-A Slot	19.95
Disk Drive	224.95
Controller Card	69.95

## 5 1/4" DISKETTES

### ATHANA OR NASHUA

SSDD	18.95
SDDD	22.95
DSDD	27.95

## PERISOFT

ACCESSORIES FOR APPLE II & Ile  
ALL WITH 1 YEAR WARRANTY BY

## PRINTERLINK

### CENTRONICS PARALLEL INTERFACE

- Simple to use — No configuring required
- Use with any centronics printer — EPSON, OKIDATA, etc.
- Includes Cable & Manual

**\$58<sup>00</sup>**

## MESSENGER

### SERIAL INTERFACE

- Connects to any RS-232 serial device
- 8 switch selectable drivers for printers, terminals and modems
- Includes Cable & Manual

**\$98<sup>00</sup>**

## TIMELINK

### REAL TIME CLOCK

- Applications in file management, word processing, communications, etc.
- Exclusive Alarm Clock feature
- Battery recharges automatically

**\$83<sup>00</sup>**

## NEW BUFFERLINK

### ADD-ON PRINTER BUFFER

- No more waiting for printed output
- Connects easily to any parallel interface
- Expandable from 16K to 64K

**\$138<sup>00</sup> (16K)**

## The Flip Sort™

The new Flip Sort™ has all the fine qualities of the original Flip Sort™, with some added benefits. Along with a new design, capacity has increased 50%, to hold 75 diskettes and the price is more reasonable than ever. **\$19.95 ea.**



## The Flip Sort Plus™

The Flip Sort Plus™ adds new dimensions to storage. Designed with similar elegant lines as the original Flip Sort™, in a transparent smoked acrylic. The Flip Sort Plus™ has a storage capacity of over 100 diskettes and has all the outstanding features you have come to expect from the flip sort Family. **24.95 each**

# Do Kay

2100 De La Cruz Blvd.  
Santa Clara, CA 95050

# technical forum

Have a technical question? Ask your fellow Amateurs through Technical Forum. You'll reach knowledgeable readers ready to help you find the answer you're looking for. Have an answer? Send it in. Every month we'll award a specially selected book from Ham Radio's Bookstore to the writer of the best response to a question previously posed in this column. Address your questions and answers (typewritten, if possible) to Technical Forum, *ham radio magazine*, Greenville, New Hampshire 03048. The opinions expressed in this column are those of the individual authors and do not necessarily represent the views of the publisher or staff of *ham radio magazine*.

## pacemakers and RFI: safety first

We read Edwin M. Hollis's letter (Technical Forum, June, 1983) concerning the use of transmitting equipment by a ham with an implantable cardiac pacemaker.

There is a general misconception that everyone with a pacemaker will "expire" when exposed to an RF field or a microwave oven. The twenty-five or more manufacturers of pacemakers worldwide are concerned about the response of their products to electromagnetic interference and do extensive testing on the products before release. These tests are done by the manufacturer and by independent testing organizations. Virtually all manufacturers include filters and/or shielding of the electronic circuit.

Pacemakers are prescribed for patients who have some abnormality in the normal electrical activity of the heart. Without this normal electrical activity, the heart will slow down or skip beats entirely. The pacemaker monitors this activity and generally puts out a stimulating impulse only when needed. The stimulating impulse "shocks" the heart muscle,

causing the muscle to contract and the heart to beat.

The circuit that monitors the heart activity also looks for interfering signals (EMI, RFI, etc.). If interfering signals are detected, the pacemaker's stimulating pulses will be turned on, instead of shutting off completely. There is a remote possibility of the pacemaker's being inhibited (turned off) if the field is intense. (This warning is included in the patient handbooks and physician manuals.) If this were to occur, the patient might experience dizziness or fainting spells. As soon as the interfering signals were removed, the pacemaker would return to normal operation. No permanent damage would be done to the pacemaker's electronic circuit.

In recent literature, there have been no reported deaths due to RFI exposure of patients with implanted pacemakers. There have been reported cases of patients experiencing fainting spells or dizziness with older pacemaker models that are no longer manufactured.

If a patient is concerned about exposure to RF fields, the pacemaker manufacturer should be contacted.

The address and phone number are printed on the permanent plastic I.D. card given to all pacemaker patients.

Any Amateur with a pacemaker should follow these general rules:

1. Make sure transmitting equipment is in good working order.
2. Maintain a good ground on all equipment.
3. Avoid working on equipment with cover or shields removed.
4. Do not stand near antenna systems radiating power, especially in front of directional arrays.

If you must do any of these things, have someone else nearby to turn off transmitting equipment if any dizziness or fainting spells are experienced. Electrical shock hazard is not increased because of the pacemaker. There is no technical reason why an Amateur Radio operator with an implantable cardiac pacemaker cannot continue to enjoy the hobby by simply exercising a few cautionary measures.

**John W. Bixler, K3EAS**

**Field Program Coordinator**

**William L. Johnson, K3FOW,**

**Electronics Manager**

**Donald A. Henry, W3FE, Engineer**

**Cook Pacemaker Corporation**

**Leechburg, Pennsylvania 15656**

## concern at high levels

I have some information for Ed Hollis, K4CN, on the effects of RFI on pacemakers (Technical Forum, June, 1983).

It depends on the type of pacemaker. Some are RFI powered externally (fig. 1); in these, a secondary coil rectifies the induced voltage to power the pacemaker. There are also nuclear-powered long-term pacemakers, employing a shielded radioactive source, which are implanted in the patient. The most popular pacemakers at present contain a lithium

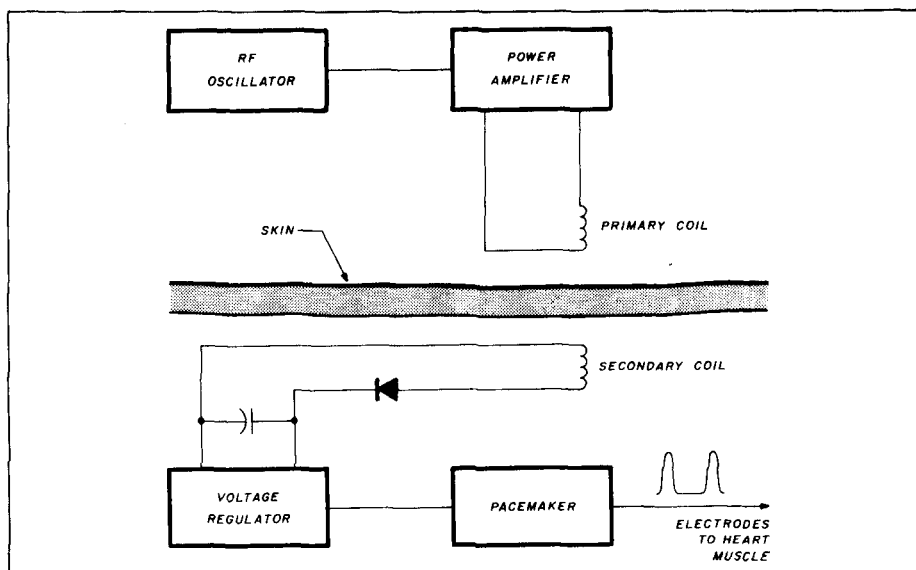

battery which can last up to ten years.

Basically, a pacemaker simulates the periodic electrical pulse which stimulates the heart muscle to a state of contraction. Its circuitry can be a monolithic multivibrator or a blocking oscillator of either the asynchronous or the more complex-demand type used in synchronous pacemaker. The latter depends on ventricular contractions' return pulses which automatically adjust the pulse rate with variations in physical activity. The pulse width for pacemakers varies from 0.5 to 2 ms with amplitudes of 5 to 9 volts.

In the normal ham shack you need not worry about any disruption of the pacemaker operation. *But very high levels of RFI can override the pulsed output*, especially affecting the demand type synchronized pacemaker, which is controlled from the heart muscle. Avoid standing under a broadcast station antenna (running kilowatts), stay away from high ERP microwave dishes, and when adjusting your beam antenna's gamma match, *shut your transmitter off.* — **Salvatore J. DeFrancesco, K1RGO**

## heartwarmer

Dear HR:

I can think of no adequate way of thanking *ham radio* for printing the item "pacemakers and RFI" for me in your June issue (Technical Forum, page 98). The response to the item has been just overwhelming; the value of information gained from the data and letters cannot be adequately measured. The many letters describing personal experiences and offering technical advice were incredible.

It proved several things: first of all, that a lot of Amateurs subscribe to *ham radio*; and what is more important, they read it. If one ever did have any doubts about the type of person the Amateur is, such a response from so many who have taken their time and money to inform another ham (who they never even knew) about a subject which might make the differ-

ence between life or death was heartwarming, to say the least.

From the mail I received it is apparent that the pacemaker, along with other forms of medicine and electronics, has come a long way in the past few years. Even though an Amateur himself is not wearing one of the gadgets, it is nice to know that he will not be endangering a neighbor who might come too close to a transmitting antenna, causing an unexpected problem . . . please thank all the readers who spent their time and money to respond to my question.

The tremendous response to the item also proves without a doubt that there has been and just may still be a vital problem in this area. I'm sorry if I gave the impression that the experience I had in the hospital was recent. It was, in fact, quite some time ago and I have been convinced that many changes have been made since then, as well one could expect. In spite of that I found many not convinced as to the reliability of pacemakers in the presence of RFI; I was also unable to find a recent schematic, which is understandable.

**Edwin M. Hollis, K4CN**

*ham radio* has prepared a list of recent articles on possible RFI interference with pacemaker operation. We would be happy to make that list available to concerned readers or their physicians. Address requests to: PACEMAKERS, *ham radio magazine*, Greenville, New Hampshire 03048. (Enclose large SASE.) — Editor

**SAY  
YOU SAW  
IT IN  
ham radio!**

**TUBES, SEMICONDUCTORS, IC'S  
DIODES AT SUPER LOW PRICES  
IN DEPTH INVENTORY  
EIMAC, SYLVANIA, GE, CETRON**

	OA2	.....	\$2.75	
	3-400Z	.....	115.00	
	3-500Z	.....	99.00	
	4CX250B/7203	.....	58.00	
	4CX1000A/8168	.....	430.00	
	4PR60C/8252W	.....	295.00	
	4X150A/7034	.....	58.00	
	5AR4	.....	4.73	
	5C22	.....	165.00	
	5R4GB	.....	3.85	
	6AK5	.....	4.26	
	6AL5	.....	2.93	
	6AQ5	.....	2.85	
	6CA7	.....	5.81	
	6DJ8	.....	2.75	
	6JG6A	.....	6.56	
	6JS6C	.....	6.05	
	6KD6	.....	6.90	
	6L6GC	.....	5.25	
	6KV6A	.....	6.02	
	6LF6	.....	7.19	
	6LQ6	.....	6.83	
	6MJ8	.....	7.28	
	12AT7	.....	2.93	
	12AU7	.....	2.83	
	12AX7A	.....	2.84	
	572BT/160L	.....	46.00	
	705A	.....	10.00	
	811A	.....	13.50	
	813	.....	40.00	
	829B	.....	40.00	
	832A	.....	38.00	
	833A	.....	185.00	
	866A	.....	9.50	
	872A	.....	24.00	
	M-2057	.....	15.00	
	5670	.....	4.40	
	5684	.....	33.00	
	5687	.....	4.00	
	5751	.....	4.00	
	5814A	.....	3.70	
	5879	.....	5.75	
	5894	.....	65.00	
	6005	.....	5.25	
	6146B	.....	7.50	
	6360	.....	6.50	
	6528A	.....	75.00	
	6550A	.....	7.50	
	6883B	.....	9.00	
	7360	.....	12.25	
	7558	.....	7.00	
	7591A	.....	4.70	
	7868	.....	3.75	
	8072	.....	95.00	
	8417	.....	6.87	
	8874	.....	195.00	
	8875	.....	210.00	
	8877/3CX1500A7	.....	475.00	
	8908	.....	12.95	
	8950	.....	11.50	
	MRF-453	.....	19.95	
	MRF-454/A	.....	19.95	
	MRF-455/A	.....	19.95	
	2N6084	.....	15.00	



**SYLVANIA**

**RECI**

**RAYTHEON**

**NATIONAL**



Full line of Sylvania ECG Replacement Semiconductors Always in Stock. All Major Manufacturers Factory Boxed. Hard To Get Receiving Tubes At Discount Prices.

Minimum Order \$25.00. Allow \$3.00 For UPS Charges. Out of Town, Please Call Toll Free: 800-221-5802 and Ask For "ABE".

**TRANSELETRONIC INC.**

1365 39th STREET, BROOKLYN, N. Y. 11218H  
Tel. 212-633-2800/Wats Line 800-221-5802  
TWX 710-584-2460 ALPHA NYK.

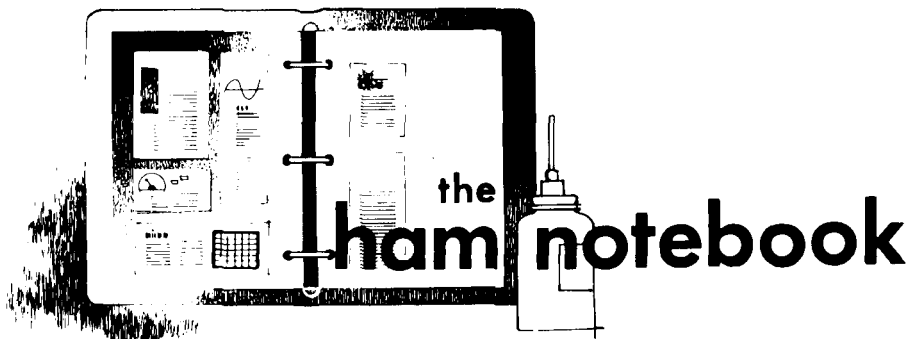

## zero-beat indicator for RTTY

I built the ST-5 demodulator described in *ham radio*<sup>1</sup> but had difficul-

ty finding the zero beat of the incoming signal on my receiver. The ST-5 has a meter for tuning. When the meter reading is identical for MARK and SPACE, the Model 19 machine

provides solid print. However, I found it quite difficult to tune in the signal so that the meter would indicate this condition.

Dave, N2DS, our local solid-state wizard, suggested I make a device using the LM3914 chip\* with its ten-LED output. The LM3914 has ten positions for the LEDs, and the resistors for them are built into the chip. The LM3914 is known as a "bar analog generator."

I developed a plan to have two vertical columns of ten LEDs each. One column would be for MARK and one for SPACE. Required were two LM3914s, a 5-volt regulated power supply, twenty red LEDs, and two resistors, R1 and R2 (fig. 1).

Resistor R1 is 1.21k. I made this resistor using 1k, 200 ohms, and 10 ohms in series (watch tolerances). Resistor R2 is 3.83k. I used a 3k resistor plus an 800-ohm and a 30-ohm resistor in series. You'll need two R1 and two R2 resistors.

Turning this idea into a construction project resulted in a nice visual device to tune in an RTTY signal. The circuit is more economical and better than an oscilloscope with the high voltage involved and its many controls.

## construction

Only three wires are needed to connect the zero-beat indicator to the ST-5. The control circuit (fig. 1) can be built on perf or PC board, which is mounted inside the ST-5 cabinet.

Mount the following components onto the control board: two 2N3904s, two 5k trim pots, two 1k ¼-watt resistors, two 1N4148 silicon diodes, and two 0.068-μF disc ceramic caps. Mount the control board in the ST-5 demodulator so that you can adjust

\*Radio Shack part #276-1767. LEDs are part #276-1622.

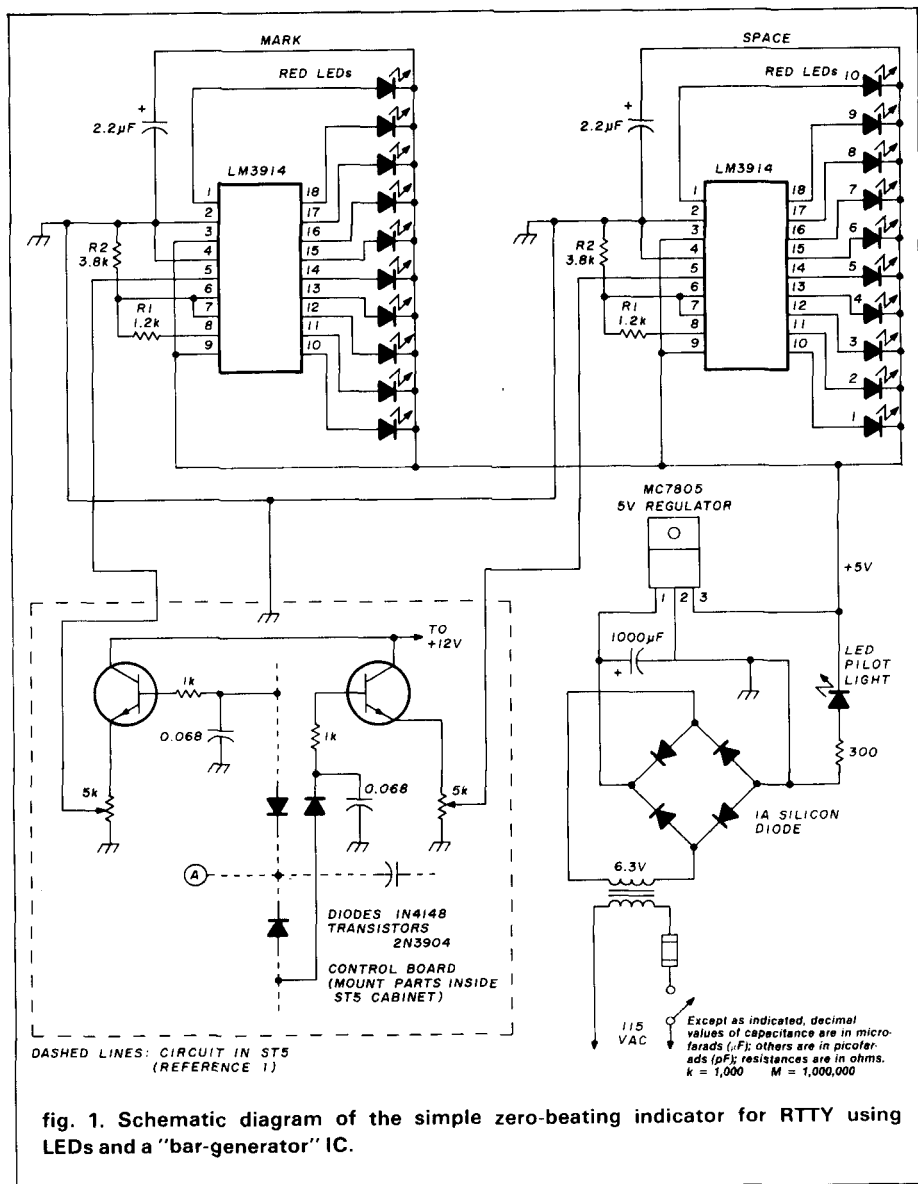

fig. 1. Schematic diagram of the simple zero-beating indicator for RTTY using LEDs and a "bar-generator" IC.



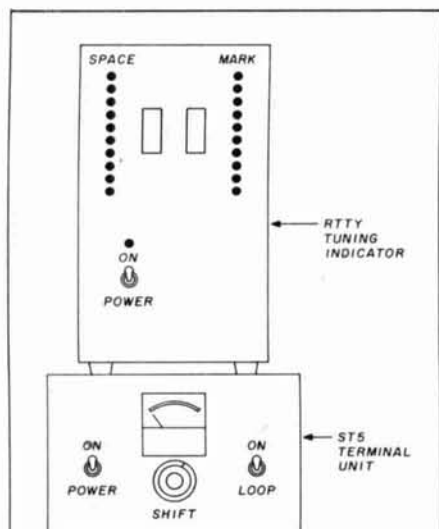

fig. 2. Author's zero-beat indicator mounted on the ST-5 demodulator. Other physical arrangements are possible. Use your ingenuity.

the trim pots easily. In fig. 2 you'll note that I've mounted the LM3914 chips between the vertical columns of LEDs. No big deal. Perhaps you would like to have the LEDs running horizontally. In any event, if you want to use the vertical display, a better way of mounting the LM3914s is to the left of the LEDs, as shown in fig. 1. This makes for easier wiring.

### adjustment

With an input signal, adjust the MARK trim pot so that eight of the ten MARK LEDs light up. Then, with a SPACE signal, adjust the SPACE trim pot so that eight of the SPACE LEDs light. Another method is to tune in W1AW on 3625 kHz. Then make your adjustments, as you'll have a good MARK and SPACE signal. Be sure you get the first 15 minutes of W1AW's transmission; it changes to ASCII during the second 15 minutes.

I'd like to thank Dave Schmarder, N2DS, for his help in completing this project.

### reference

1. Irvin M. Hoff, W6FFC, "The Mainline ST-5 RTTY Demodulator," *ham radio*, September, 1970, page 14.

Jim Dates, W2QLI

## MICROWAVE COMPONENTS

25 MW EXCITER \$49.95  
 45 MHZ SUBCARRIER \$19.95  
 AM VIDEO MODULATOR \$19.95  
 50 MW UP CONVERTER \$149.95

GIZMOELECTRONICS, INC.

P.O. BOX 1205  
 PITTSBURG, KS 66762  
 PH. 316-231-8171

Kansas residents 3% sales tax

✓ 143

## FCC LOWERS REQUIREMENTS — GET YOUR RADIO TELEPHONE LICENSE

FCC changes make obtaining a High-level Radio Telephone License much easier now. Eliminate unnecessary study with our shortcuts and easy to follow study material. Obtaining the General Radio Telephone License can be a snap! Sample exams, also section covering Radar Endorsement.

A small investment for a high-paying career in electronics.

**\$19.95 ppd.**

Satisfaction Guaranteed  
**SPI-RO DISTRIBUTING**

P.O. Box 1538  
 Hendersonville, N. C. 28793

✓ 179

**BUY! SELL! TRADE!**  
 COMPUTER & HAM EQUIPMENT

**COMPUTER\*  
 TRADER**

**ANNUAL  
 SUBSCRIPTION  
 \$15.00**

Low Ad Rates — Mailed Monthly  
 Foreign Subscriptions - \$30.00 Year  
 FREE 50 Word Classified Ad with Subscription Order

**COMPUTER TRADER\***

Chet Lambert, W4WDR  
 1704 Sam Drive • Birmingham, AL 35235  
 (205) 854-0271

Sample Copy — \$1.00

✓ 129

## BUTTERNUT ELECTRONICS COMPANY



**THE WINNERS**

Model HF6V: Completely automatic bandswitching 80 through 10 plus 30 meters. Outperforms all 4- and 5-band "trap" verticals of comparable size. Thousands in use worldwide since December '81! 160 meter option available now. Retrofit kits for remaining WARC bands coming soon. Height: 26 ft/7.8 meters, guying not required in most installations.

Model 2MVC "Trombone": — omnidirectional collinear gain vertical for 2 meters having the same gain as "double-A" types, but the patented "trombone" phasing section allows the radiator to remain unbroken by insulators for maximum strength in high winds. No coils "plumber's delight" construction and adjustable gamma match for complete D.C. grounding and lowest possible SWR. Height: 9.8 ft/2.98 meters.

Model 2MVC-5 "Super-Trombone": — Same advanced features as the basic 2MVC but a full wavelength taller with additional "Trombone" phasing section for additional gain. Height: 15.75 ft/4.8 meters.

All BUTTERNUT ANTENNAS use stainless steel hardware and are guaranteed for a full year. For further information on these and other BUTTERNUT products write for our FREE CATALOG!

**BUTTERNUT ELECTRONICS**  
 405 E. MARKET STREET  
 LOCKHART, TX 78644

# hf hybrids: a second look

Why not try hybrids in hf applications?

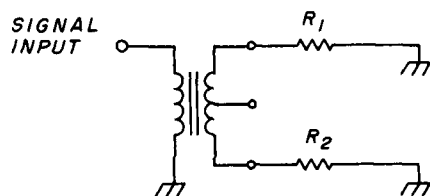

fig. 1A. 180 degree hybrid equivalent circuit.

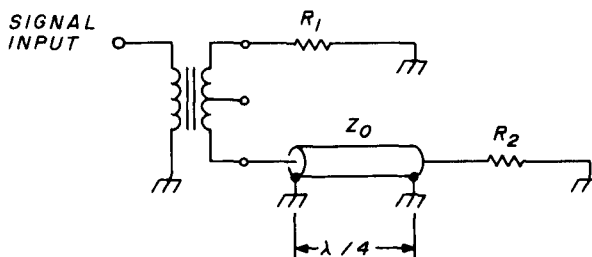

fig. 1B. Quadrature hybrid equivalent circuit.

Hybrids are generally four-port devices used in UHF and microwave designs, where they are easily fabricated as part of stripline or microstrip assemblies. They usually fall into one of two general classes: the 90 degree or quadrature hybrid, and the 180-degree hybrid. Examples of the quadrature type are the side-coupled directional coupler, the branch coupler, and capacitively coupled hybrid.<sup>1</sup> The 180-degree type is probably best exemplified by the ring or "rat race" coupler.

As one might imagine, the quadrature hybrid divides its signal between two outputs which are 90 degrees out of phase with respect to each other. The rat race, on the other hand, provides two outputs which are in phase opposition.

A major difference between the two classes, other than the phase relationship of their output signals, is that in order to obtain a null at the fourth port, the quadrature hybrid requires that the two loads must both match the impedance level for which the device was designed. The 180 degree variety, on the other hand, requires only that the two output loads match each other.

## why?

If we replace our hybrid with yet another and simpler form, a center-tapped transformer, with loads on opposite ends of the secondary coil, (fig. 1A), then as long as the two loads are equal, no signal is present at the center tap, which becomes our fourth port. But suppose we require a quadrature

phase relationship between the two output signals. We then introduce a quarter wavelength of line between one output and its load. This quarter wavelength of line inverts the impedance of that load, so that unless both loads match the impedance of that section of line, no balance will exist, and a signal will appear at the center tap (fig. 1B).

This simple exercise demonstrates why quadrature hybrids must match the loads to the design impedance, while 180 degree hybrids need only to match one load against the other.

The transformer form of hybrid is found to have numerous applications in the high-frequency range. With appreciable power levels, the signal may be introduced into the center tap of the transformer. Dividing into two paths, with opposing magnetic fields, saturation of a ferrite core would be avoided, while the other coil (now the secondary), will show, at its output, any unbalance between the two loads.

The use of such transformer-type hybrids in the high-frequency range has not been generally exploited, but would seem to offer much for compact power dividers, combiners and phase shifting devices.

## reference

1. Henry S. Keen, W2CTK, "High Frequency Hybrids and Couplers," *ham radio*, July, 1970, page 57.

ham radio

By Henry S. Keen, W5TRS, Fox, Arkansas 72051

# ham radio Reader Service

For literature or more information, circle the appropriate number on this card, affix postage and send to us. We'll hustle your name and address to the companies you're interested in.

101 113 125 137 149 161 173 185 197 209 221 233 245 257 269 281 293 305 317 329 341  
102 114 126 138 150 162 174 186 198 210 222 234 246 258 270 282 294 306 318 330 342  
103 115 127 139 151 163 175 187 199 211 223 235 247 259 271 283 295 307 319 331 343  
104 116 128 140 152 164 176 188 200 212 224 236 248 260 272 284 296 308 320 332 344  
105 117 129 141 153 165 177 189 201 213 225 237 249 261 273 285 297 309 321 333 345  
106 118 130 142 154 166 178 190 202 214 226 238 250 262 274 286 298 310 322 334 346  
107 119 131 143 155 167 179 191 203 215 227 239 251 263 275 287 299 311 323 335 347  
108 120 132 144 156 168 180 192 204 216 228 240 252 264 276 288 300 312 324 336 348  
109 121 133 145 157 169 181 193 205 217 229 241 253 265 277 289 301 313 325 337 349  
110 122 134 146 158 170 182 194 206 218 230 242 254 266 278 290 302 314 326 338 350  
111 123 135 147 159 171 183 195 207 219 231 243 255 267 279 291 303 315 327 339  
112 124 136 148 160 172 184 196 208 220 232 244 256 268 280 292 304 316 328 340

*Limit 15 inquiries per request.*

NAME \_\_\_\_\_ CALL \_\_\_\_\_

ADDRESS \_\_\_\_\_

CITY \_\_\_\_\_ STATE \_\_\_\_\_ ZIP \_\_\_\_\_

Please use before December 31, 1983

**November 1983**

\_\_\_\_\_  
\_\_\_\_\_  
\_\_\_\_\_

AFFIX POSTAGE  
OR  
POST OFFICE  
WILL NOT  
DELIVER

**ham**  
**radio**  
*magazine*

READER SERVICE CENTER  
P.O. BOX 358  
ARLINGTON, MA 02174

ATTN: Reader Service Dept.

# JPC/AZDEN<sup>®</sup>

## 4000 SERIES

### FM TRANSCEIVERS

10 METERS & DOWN

*New!*



COMMERCIAL-GRADE  
QUALITY AT AMATEUR PRICES

**EXCLUSIVE 1 YEAR LIMITED WARRANTY! COMPARE!**

#### THE 4000 SERIES



PCS-4300 70-cm FM Transceiver



PCS-4500 6-m FM Transceiver



PCS-4800 10-m FM Transceiver

COMING SOON  
PCS-4200 1 1/4-m FM Transceiver

PCS-300  
2m Handheld  
FM Transceiver  
142-149.995 MHz

110

- **WIDE FREQUENCY COVERAGE:** PCS-4000 covers 142.000-149.995 MHz in selectable steps of 5 or 10 kHz. PCS-4200 covers 220.000-224.995 MHz in selectable steps of 5 or 20 kHz. PCS-4300 covers 440.000-449.995 MHz in selectable steps of 5 or 25 kHz. PCS-4500 covers 50.000-53.995 MHz in selectable steps of 5 or 10 kHz. PCS-4800 covers 28.000-29.990 MHz in selectable steps of 10 or 20 kHz.
- **CAP/MARS BUILT IN:** PCS-4000 includes coverage of CAP and MARS frequencies.
- **TINY SIZE:** Only 2" H x 5.5" W x 6.8" D. COMPARE!
- **MICROCOMPUTER CONTROL:** At the forefront of technology!
- **UP TO 8 NONSTANDARD SPLITS:** Ultimate versatility. COMPARE!
- **16-CHANNEL MEMORY IN TWO 8-CHANNEL BANKS:** Retains frequency and standard simplex or plus/minus offsets. Standard offsets are 600 kHz for PCS-4000, 1.6 MHz for PCS-4200, 5 MHz for PCS-4300, 1 MHz for PCS-4500, and 100 kHz for PCS-4800.
- **DUAL MEMORY SCAN:** Scan memory banks either separately or together. COMPARE!
- **TWO RANGES OF PROGRAMMABLE BAND SCANNING:** Limits are quickly reset. Scan the two segments either separately or together. COMPARE!
- **FREE AND VACANT SCAN MODES:** Free scanning stops 5 seconds on a busy channel; auto-resume can be overridden if desired. Vacant scanning stops on unoccupied frequencies.
- **DISCRIMINATOR SCAN CENTERING (AZDEN EXCLUSIVE PATENT):** Always stops on frequency.
- **TWO PRIORITY MEMORIES:** Either may be instantly recalled at any time. COMPARE!
- **NICAD MEMORY BACKUP:** Never lose the programmed channels!
- **FREQUENCY REVERSE:** The touch of a single button inverts the transmit and receive frequencies, no matter what the offset.
- **ILLUMINATED KEYBOARD WITH ACQUISITION TONE:** Unparalleled ease of operation.
- **BRIGHT GREEN LED FREQUENCY DISPLAY:** Easily visible, even in direct sunlight.
- **DIGITAL S/R F METER:** Shows incoming signal strength and relative power output.
- **BUSY-CHANNEL AND TRANSMIT INDICATORS:** Bright LEDs show when a channel is busy and when you are transmitting.
- **FULL 16-KEY TOUCHTONE<sup>®</sup> PAD:** Keyboard functions as autopatch when transmitting (except in PCS-4800).
- **PL TONE:** Optional PL tone unit allows access to private-line repeaters. Deviation and tone frequency are fully adjustable.
- **TRUE FM:** Not phase modulation. Unsurpassed intelligibility and audio fidelity.
- **HIGH/LOW POWER OUTPUT:** 25 or 5 watts selectable in PCS-4000; 10 or 1 watt selectable in PCS-4200, PCS-4300, PCS-4500, and PCS-4800. Transmitter power is fully adjustable.
- **SUPERIOR RECEIVER:** Sensitivity is 0.2 uV or better for 20-dB quieting. Circuits are designed and manufactured to rigorous specifications for exceptional performance, second to none. COMPARE!
- **REMOTE-CONTROL MICROPHONE:** Memory A-1 call, up/down manual scan, and memory address functions may be performed without touching the front panel! COMPARE!
- **OTHER FEATURES:** Dynamic microphone, rugged built-in speaker, mobile mounting bracket, remote speaker jack, and all cords, plugs, fuses, and hardware are included.
- **ACCESSORIES:** CS-7R 7-amp ac power supply, CS-4.5R 4.5-amp ac power supply, CS-AS remote speaker, and Communications Specialists SS-32 PL tone module.
- **ONE YEAR LIMITED WARRANTY!**

EXCLUSIVE DISTRIBUTOR

**AMATEUR-WHOLESALE ELECTRONICS**

8817 S.W. 129th Terrace, Miami, Florida 33176

DEALER INQUIRIES INVITED

**TOLL FREE... 800-327-3102**

Telephone (305) 233-3631

Telex: 80-3356

MANUFACTURER

**JPC/AZDEN**

**JAPAN PIEZO CO., LTD.**

1-12-17 Kamirenjaku, Mitaka, Tokyo, 181 Japan

Telex: 781-2822452



# NEW PRODUCT ANNOUNCEMENT



HB443DX

## QUAD BAND BEAMS

**7-14-21-28 MHz**  
THE NEWEST INNOVATIVE ADDITIONS to the TET LINE FEATURE TRUE MULTI-ELEMENT PERFORMANCE ON 4, NOT 3, BUT 4 BANDS. ALL ON A SINGLE BOOM!!

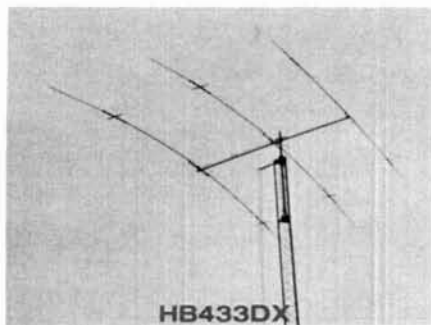

HB433DX

All the usual TET multi-band beam features are included in these two models, including wide bandwidths, increased gain, low SWR, light weight and superior mechanical construction and easy assembly.

**Preliminary Specifications:**

	HB443DX	HB433DX
Active Elements	7 MHz 14 MHz 21 MHz 28 MHz	2 3 3 3
Gain	7/14/21/28	2.1/8.2/8.7/7.3
FB Ratio	9/14/21/28	0/21.7/22.3/20.2
Power		1KW CW
VSWR	7.0 - 7.1 7.1 - 7.25	2.0:1 or better adjustable 2.0:1 or better adjustable 1.5:1 or better
Boom Length	14.0 - 14.5 21.0 - 21.45 28.0 - 29.0	4.0/13.2
Max. Element Length	m/ft.	9.25/30.5
Weight	kg/lb	14.6/32.1
Introductory Price		\$325.00

# TET ANTENNA SYSTEMS

AVAILABLE FROM YOUR AREA DISTRIBUTORS:  
Available October, 1983



2775 Kurtz Street, Suite 11  
San Diego, CA 92110-3171  
Telephone (619) 299-9740  
Telex 181747  
Louis N. Anciaux WB6NMT

## PREVENT HI-TECH HEADACHES

Our Isolators eliminate equipment interaction,



clean up interference, curb damaging power line spikes and lightning bursts.

### ISO-1 Isolator

3 isolated sockets; quality spike suppression; basic protection. . . \$76.95

### ISO-3 Super-Isolator

3 dual isolated sockets; suppressor; commercial protection. . . . . \$115.95

### ISO-17 Magnum Isolator

4 quad isolated sockets; suppressor; laboratory grade protection. . . \$200.95

ESP Electronic Specialists, Inc.  
171 S. Main St., Box 389, Natick, MA 01760  
Toll Free Order Desk 1-800-225-4876  
MasterCard, VISA, American Express

SEND FOR THIS FREE CATALOG NOW



SAVE MONEY HIGH QUALITY FAST DELIVERY

We are utilizing the latest equipment and technology to maintain our quality at reasonable prices.

JAN CRYSTALS

- General Communication
- Industry
- Marine VHF
- Scanners
- Amateur Bands
- CB Standard
- CB Special
- Microprocessor

Call or Write JAN CRYSTALS

P.O. Box 06017  
Ft. Myers, Fl. 33906-6017  
All Phones (813) 936-2397

153

160

## TUNE IN THE WORLD OF HAM-TV!

Amateur Radio operators in the 1980's are discovering the fascinating "World of Amateur Television". Be it Fast Scan TV (FSTV), Slow Scan TV (SSTV), Facsimile (FAX) or somewhere in between. Video communications modes are growing at an exciting pace!

New advancements are taking place in High-Resolution/Color SSTV and the use of personal computers for ATV graphics. SSTV-FAX-RTTY communications. Interest is even growing in MICROWAVE and TVRO applications.

A5 ATV MAGAZINE™ has supported these modes of Amateur Specialized Communications since 1967 — over 17 years! And now, under guidance of the UNITED STATES ATV SOCIETY, HAM-TV will continue to grow rapidly. Interested?

Send SASE for "free" information brochures today!

Special six month TRIAL subscription only \$10.00

One year subscription (12 issues) of the "USATVS Journal" \$20.00

Sample issue available for \$2.50 ppd

A5 ATV MAGAZINE™

P.O. BOX H  
LOWDEN, IOWA 52255

A DIVISION OF QED PUBLICATIONS, INC.  
113



## SAY YOU SAW IT IN HAM RADIO

Tell 'em you saw it in HAM RADIO!



# Food for thought.

Our new Universal Tone Encoder lends its versatility to all tastes. The menu includes all CTCSS, as well as Burst Tones, Touch Tones, and Test Tones. No counter or test equipment required to set frequency—just dial it in. While traveling, use it on your Amateur transceiver to access tone operated systems, or in your service van to check out your customers' repeaters; also, as a piece of test equipment to modulate your Service Monitor or signal generator. It can even operate off an internal nine volt battery, and is available for one day delivery, backed by our one year warranty.

- All tones in Group A and Group B are included.
- Output level flat to within 1.5db over entire range selected.
- Separate level adjust pots and output connections for each tone Group.
- Immune to RF
- Powered by 6-30vdc, unregulated at 8 ma.
- Low impedance, low distortion, adjustable sinewave output, 5v peak-to-peak
- Instant start-up.
- Off position for no tone output.
- Reverse polarity protection built-in.

## Group A

67.0 XZ	91.5 ZZ	118.8 2B	156.7 5A
71.9 XA	94.8 ZA	123.0 3Z	162.2 5B
74.4 WA	97.4 ZB	127.3 3A	167.9 6Z
77.0 XB	100.0 1Z	131.8 3B	173.8 6A
79.7 SP	103.5 1A	136.5 4Z	179.9 6B
82.5 YZ	107.2 1B	141.3 4A	186.2 7Z
85.4 YA	110.9 2Z	146.2 4B	192.8 7A
88.5 YB	114.8 2A	151.4 5Z	203.5 M1

- Frequency accuracy,  $\pm .1$  Hz maximum - 40°C to + 85°C
- Frequencies to 250 Hz available on special order
- Continuous tone

## Group B

TEST-TONES:	TOUCH-TONES:	BURST TONES:
600	697 1209	1600 1850 2150 2400
1000	770 1336	1650 1900 2200 2450
1500	852 1477	1700 1950 2250 2500
2175	941 1633	1750 2000 2300 2550
2805		1800 2100 2350

- Frequency accuracy,  $\pm 1$  Hz maximum - 40°C to + 85°C
- Tone length approximately 300 ms. May be lengthened, shortened or eliminated by changing value of resistor

Model TE-64 \$79.95

**COMMUNICATIONS SPECIALISTS**

426 West Taft Avenue, Orange, California 92667  
(800) 854-0547/ California: (714) 998-3021



# COMPLETE READY-TO-USE SYSTEMS

## ATV TRANSMITTER/CONVERTER



TC-1

**\$399**

- ★ High resolution and color video
- ★ 10 watts output
- ★ Broadcast standard sound
- ★ Tunable downconverter and preamp

Connect to the antenna terminals of any TV set, add a good 450 MHz antenna, a camera and there you are . . . Show the shack, home movies, computer games, video tapes, etc.

## ATV DOWNCONVERTER



TVC-4

For those who want to see the ATV action before they commit to a complete station, the TVC-4 is for you. Great for public service setups, demos, and getting a buddy interested. Just add an antenna and a TV set tuned to CH. 2, 3, or 4 and plug in to 117 volts a.c. **\$89.00**

**TVC-4L extra low-noise version . . . \$105 delivered in USA**

## MODULES



**TXA5-4 Exciter/Modulator . . . . . \$89.00 ppd.**  
Wired and tested module designed to drive PA5 10 watt linear amplifier. The 100 MHz crystal design keeps harmonics out of two meters for talk back. Video modulator is a full 8 MHz for computer graphics and color. Requires 13.8 VDC reg. @ 70 ma. 80 mw output power. Tuned with crystal on 439.25, 434 or 426.25 MHz. Dual frequency model available . . . . . \$115.00 ppd.



**FMA5 Audio Subcarrier Generator . \$29.00 ppd.**  
Puts audio on your camera video just as broadcast does at 4.5 MHz. Puts out 1 V p-p to drive TXA5. Requires low Z mike. 150 to 600 Ω and 12 to 18 VDC @ 25 ma. Works with any transmitter with 5 MHz video bandwidth.



**TVC-2 ATV Downconverter . . . . . \$49.00 ppd.**  
Stripline MRF 901 preamp and double balanced mixer digs out the weak ones and resists intermod and overload. Connects between UHF antenna and TV set. Output channels 2 or 3. Varicap tuner 420 to 450 MHz. Requires 12 to 18 VDC @ 20 ma.  
**Extrasensitive TVC 2L with NE64535 preamp (9 dB NF) . . . . . \$59.00 ppd.**  
**Supersensitive TVC 2G with GaAs Fet preamp (.5 dB NF) ant. mount . . . . . \$79.00 ppd.**

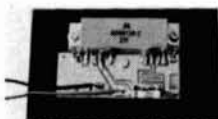

**PA5 10 Watt ATV Power Amplifier . \$89.00 ppd.**  
The PA5 will put out 10 watts RMS power on sync tips when driven with 80 mw by the TXA5 exciter. 50 ohms in and out plus bandwidth for the whole band with good linearity for color and sound. Requires 13.8 VDC reg @ 3 amps.

Call or write for our complete catalog of specifications, station setup diagrams, and optional accessories which include: antennas, modulators, test generators, cameras and much, much more. See Ch. 14 1983 ARRL Handbook.

TERMS: VISA or MASTERCARD by telephone or mail, or check or money order by mail. All prices are delivered in USA. Charge orders normally shipped within 24 hours. Personal checks must clear first.

(213) 447-4565



Let P.C. put you on the air and SAVE!  
All four modules —

**Complete System price \$245.00**

SAVE \$11.00 over price if purchased individually

**P.C. ELECTRONICS** 2522 Paxson Lane  
Tom W6ORG Maryann WB6YSS Arcadia, California 91006

## TOWERS by ALUMA

HIGHEST QUALITY ALUMINUM & STEEL

60 Ft. Alum. Crank-Up Model T-60-H  
TELESCOPING (CRANK-UP) GUYED (STACK-UP) TILT-OVER MODELS  
Easy to install. Low Prices. Crank-ups to 100 ft.

EXCELLENT FOR AMATEUR COMMUNICATIONS

Mobile Trailer Type



40' Steel Crank-Up Model SHO-40

Mobile Truck Type



Over 36 types aluminum and steel towers made—specials designed and made—write for details.

Fixed Base



SPECIAL Four Section 50 Ft. Van Mounted Crank-Up Aluma Tower

**ALUMA TOWER COMPANY**  
BOX 2806HR  
VERO BEACH, FLA. 32960-2806  
(305) 567-3423 TELEX 80-3405

TOLL FREE ORDERS • 1-800-826-5432  
(IN CALIFORNIA: 1-800-258-6666)

AK, HI OR INFORMATION • (213) 380-8000

<p><b>5 KEY ASSEMBLY</b> \$1.00 EACH CONTAINS 5 SINGLE-POLE NORMALLY OPEN SWITCHES MEASURES 3 3/4" LONG</p>	<p><b>MINIATURE 6 VDC RELAY</b> SUPER SMALL SPDT RELAY, GOLD COBALT CONTACTS RATED 1 AMP AT 30 VDC, HIGHLY SENSITIVE, TTL DIRECT DRIVE POSSIBLE. OPERATES FROM 4.3 TO 6 V. COIL RES 220 OHM 1 3/16" x 13/32" x 7/16" AROMAT # RSD-6V <b>\$1.50 EACH</b> 10 FOR \$13.50</p>
<p><b>6 KEY ASSEMBLY</b> \$1.25 EACH CONTAINS 6 SINGLE-POLE NORMALLY OPEN SWITCHES MEASURES 4 1/4" LONG</p>	<p><b>13 VDC RELAY</b> CONTACT SP.N.C 10 AMP @ 120 VAC ENERGIZE COIL TO OPEN CONTACT COIL: 13 VDC 650 OHMS SPECIAL PRICE <b>\$1.00 EACH</b></p>
<p><b>120V INDICATOR</b> NEON INDICATOR RATED 120 V 1/3 W. MOUNTS IN 5/16" HOLE — RED LENS. <b>75¢ EACH</b> 10 FOR \$7.00 100 FOR \$65.00</p>	

SEND FOR NEW LARGER! 48 PAGE CATALOG

**MINIATURE TOGGLE SWITCHES**  
ALL ARE RATED 5 AMPS @ 125 VAC

<p><b>S.P.D.T. (on-on)</b> P.C. STYLE NON-THREADED BUSHING <b>75¢ EACH</b> 10 FOR \$7.00</p>	<p><b>S.P.D.T. (on-on)</b> SOLDER LUG TERMINALS. <b>\$1.00 EACH</b> 10 FOR \$9.00 100 FOR \$80.00</p>	<p><b>S.P.D.T. (on-off-on)</b> SOLDER LUG TERMINALS <b>\$1.00 EACH</b> 10 FOR \$9.00 100 FOR \$80.00</p>
<p><b>S.P.D.T. (on-off-on)</b> NON-THREADED BUSHING P.C. STYLE <b>75¢ EACH</b> 10 FOR \$7.00</p>	<p><b>S.P.D.T. (on-on)</b> P.C. LUGS, THREADED BUSHING <b>\$1.00 EACH</b> 10 FOR \$9.00 100 FOR \$80.00</p>	<p><b>D.P.D.T. (on-on)</b> SOLDER LUG TERMINALS <b>\$2.00 EACH</b> 10 FOR \$19.00 100 FOR \$180.00</p>

**ALL ELECTRONICS CORP.**  
905 S. VERMONT • P.O. BOX 20406 • LOS ANGELES, CA 90006

- QUANTITIES LIMITED
- FOREIGN ORDERS INCLUDE SUFFICIENT SHIPPING
- USA \$2.50 SHIPPING
- CALIF. RES. ADD 6.12%

## RADIO DIRECTION FINDER

The SuperDF

Inexpensive kit and assembled units for use with Hand-Held, Mobile, or Base Station. 100 to 260 MHz or 200 to 550 MHz with one antenna. Non-ambiguous. No overloading. Use with unmodified HT, scanner, or transceiver. No attenuator or "S" meter needed. Can DF signals below the noise. Averages out local reflections while mobile-in-motion. Used by FCC, US Army, State of California, Coast Guard Aux. Prices start at \$125. For details send SASE to; BMG Engineering, 9935 Garibaldi Ave, Temple City, Cal, 91780



**SAY YOU SAW IT IN HAM RADIO**



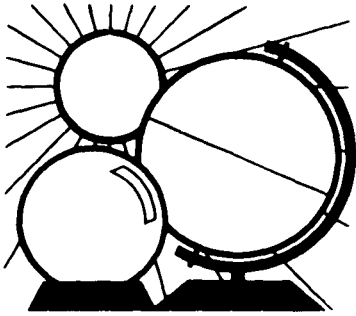

# DX FORECASTER

Garth Stonehocker, KØRYW

## trans-equatorial DX

The autumnal equinox — with its promise of winter DX conditions to come — also signals the return of trans-equatorial openings, with their 5000 to 7000 mile (8000-11,200 km) paths.

A cross-section representation of the ionosphere along the 75-degree west meridian is shown in fig. 1. Data for this drawing was obtained by ionosonde returns off the bottom half of the ionosphere. Note a concentration of contour lines near the center and right (southern latitude) side. The thick line is a ray of energy transmitted from the earth at 20 degrees north with a low take-off (elevation) angle. This ray just grazes the middle maximum and does not return through the lower ionospheric layers or earth bounce before it grazes the second southern maximum; it then bends enough to return to the earth at 30 degrees south. This layer-to-layer reflection accounts for less signal loss

(10-15 dB) than the "normal" intermediate earth reflection type transmission. This low loss makes trans-equatorial propagation very effective in providing excellent DX QSOs with our southern friends.

The maximums are located on both sides of the geomagnetic equator ( $\pm 20$  degrees). The electrons drift-diffuse up the geomagnetic field lines each afternoon until about 2200 local time, mainly during the winter half of the year. Geomagnetic disturbances tend to enhance the electron upward drift from the trough just south of the auroral zone. The dotted lines in the drawing are representative geomagnetic field lines.

Although lower MUFs are now being experienced because of the diminishing solar cycle, one can still expect the 15- and 10-meter bands to have some trans-equatorial propagation openings this winter during the high solar flux days in which geomagnetic disturbances occur. Listen

to WWV on 2.5, 5, 10, 15, or 20 MHz at 18 minutes after the hour for solar flux, geomagnetic A and K indices, as well as for the solar activity and geomagnetic condition report and forecast. If the solar flux exceeds 150 and A is greater than 30, with K greater than 4, expect very good trans-equatorial openings.

## last-minute forecast

On the higher frequency bands (10-30 meters) DX conditions should improve with rising solar flux and flare activity during the two middle weeks of the month. This leaves the first and last weeks for operation on the improving lower bands (30-160 meters). Both night and day DX should be very good this time of the year.

Expect disturbances during the following days in October: 1st, 2nd, 9-15th, 19-21st, 24-30th. This is still the equinox period when the solar wind particles are very effective in producing ionospheric effects and still within those years of maximum solar coronal holes to feed the solar wind. All in all, that's a double dose of interesting DX conditions.

In October the Orionid meteor showers are visible from the 15th to the 25th. The maximum rate will be between ten to twenty per hour on the 20-21st of the month. The moon is full on the 21st and perigee occurs on the 4th of the month.

In most parts of the country, October represents the last opportunity of the year for antenna repair and maintenance. How are your antennas? Are

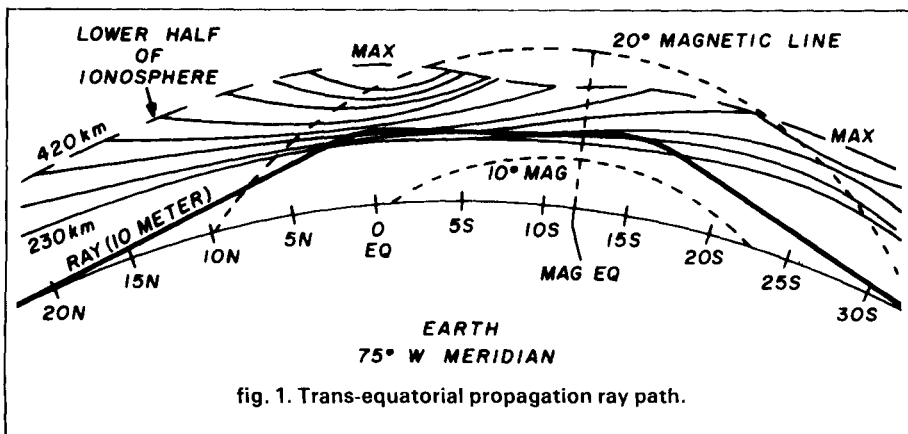

GMT	PDT	WESTERN USA																
		N	NE	E	SE	S	SW	W	NW	ASIA FAR EAST	EUROPE	S. AFRICA	S. AMERICA	ANTARCTICA	NEW ZEALAND	OCEANIA AUSTRALIA	JAPAN	
0000	5:00	20	20	15	10	15	10	10	10	10	20	20	20	20	10	10	10	20
0100	6:00	20	20	15	10	15	10	10	10	10	20*	20	20	20	10	10	10	20*
0200	7:00	20	20	15	10	15	10	10	10	10	15	20	20	20	10	10	15	15
0300	8:00	20	30	20	10	15	10	10	10	10	10	15	20	20	10	10	15	15
0400	9:00	20	30	20	10	15	10	10	10	10	10	10	15	20	10	10	10	15
0500	10:00	20	30	20	15	15	10	10	10	10	10	10	15	20	10	10	10	15
0600	11:00	20	30	20	15	20	15	15	15	15	15	15	15	20	10	10	10	20
0700	12:00	20	30	20	15	20	15	15	15	15	15	15	15	20	10	10	10	20
0800	1:00	20	30	20	20*	20	20*	20	20*	15	20*	20*	20*	20	10	10	10	20
0900	2:00	20	30	20	20	20	20	20	20	20	20	20	20	20	10	10	10	20
1000	3:00	30	30	20	20	20	20	20	20	20	20	20	20	20	10	10	10	20
1100	4:00	30	30	20	20	20	20	20	20	20	20	20	20	20	10	10	10	20
1200	5:00	30	30	20	20	20	20	20	20	20	20	20	20	20	10	10	10	20
1300	6:00	30	30	20*	20	20	20	20	20	20	20	20	20	20	10	10	10	20
1400	7:00	30	20	15	20	20	20	20	20	20	20	20	20	20	10	10	10	20
1500	8:00	30	20	15	20	20	20	20	20	20	20	20	20	20	10	10	10	20
1600	9:00	30	20	15	15	15	15	15	15	15	20	20	20	20	10	10	10	20
1700	10:00	30	20	10	15	15	15	15	15	15	20	20	20	20	10	10	10	20
1800	11:00	30	20	10	15	15	15	15	15	15	20	20	20	20	10	10	10	20
1900	12:00	40	20*	10	15	15	15	15	15	15	20	20	20	20	10	10	10	20
2000	1:00	30	20*	10	10	10	10	10	10	10	10	10	10	10	10	10	10	20
2100	2:00	30	15	10	10	10	10	10	10	10	10	10	10	10	10	10	10	20
2200	3:00	20	20*	10	10	10	10	10	10	10	10	10	10	10	10	10	10	20
2300	4:00	20	20	15	10	10	10	10	10	10	10	10	10	10	10	10	10	20

GMT	MDT	MID USA																
		N	NE	E	SE	S	SW	W	NW	ASIA FAR EAST	EUROPE	S. AFRICA	S. AMERICA	ANTARCTICA	NEW ZEALAND	OCEANIA AUSTRALIA	JAPAN	
0000	6:00	30	20	15	10	15	10	10	10	10	20	20	20	20	10	10	10	20
0100	7:00	30	20	15	10	15	10	10	10	10	20	20	20	20	10	10	10	20
0200	8:00	30	30	15	10	15	10	10	10	10	15	20	20	20	10	10	10	15
0300	9:00	30	30	20	10	15	10	10	10	10	10	15	20	20	10	10	10	15
0400	10:00	40	30	20	15	15	10	10	10	10	10	10	15	20	10	10	10	15
0500	11:00	30	30	20	15	15	10	10	10	10	10	10	15	20	10	10	10	15
0600	12:00	30	30	20	15	20	15	15	15	15	15	15	15	20	10	10	10	20
0700	1:00	40	30	20	20*	20	20*	20	20*	15	20*	20*	20*	20	10	10	10	20
0800	2:00	30	30	20	20	20	20	20	20	20	20	20	20	20	10	10	10	20
0900	3:00	30	30	20	20	20	20	20	20	20	20	20	20	20	10	10	10	20
1000	4:00	20	30	20	20	20	20	20	20	20	20	20	20	20	10	10	10	20
1100	5:00	20	30	20	20	20	20	20	20	20	20	20	20	20	10	10	10	20
1200	6:00	20	30	20	20	20	20	20	20	20	20	20	20	20	10	10	10	20
1300	7:00	20	30	15	20	20	20	20	20	20	20	20	20	20	10	10	10	20
1400	8:00	20	30	15	20	20	20	20	20	20	20	20	20	20	10	10	10	20
1500	9:00	20	20	15	20	20	20	20	20	20	20	20	20	20	10	10	10	20
1600	10:00	20	20	10	15	15	15	15	15	15	20	20	20	20	10	10	10	20
1700	11:00	20	20*	10	15	15	15	15	15	15	20	20	20	20	10	10	10	20
1800	12:00	20	20*	10	15	15	15	15	15	15	20	20	20	20	10	10	10	20
1900	1:00	30	20*	10	10	10	10	10	10	10	10	10	10	10	10	10	10	20
2000	2:00	20	20	10	10	10	10	10	10	10	10	10	10	10	10	10	10	20
2100	3:00	20	20	10	10	10	10	10	10	10	10	10	10	10	10	10	10	20
2200	4:00	20	20	10	10	10	10	10	10	10	10	10	10	10	10	10	10	20
2300	5:00	30	20	15	10	10	10	10	10	10	10	10	10	10	10	10	10	20

GMT	EDT	EASTERN USA																
		N	NE	E	SE	S	SW	W	NW	ASIA FAR EAST	EUROPE	S. AFRICA	CARIBBEAN S. AMERICA	ANTARCTICA	NEW ZEALAND	OCEANIA AUSTRALIA	JAPAN	
0000	8:00	30	20	15	10	15	10	10	10	10	20	20	20	20	10	10	10	20
0100	9:00	30	20	15	10	15	10	10	10	10	20	20	20	20	10	10	10	15
0200	10:00	30	30	15	10	15	10	10	10	10	15	20	20	20	10	10	10	15
0300	11:00	30	30	20	10	15	10	10	10	10	10	15	20	20	10	10	10	15
0400	12:00	40*	30	20	15	15	10	10	10	10	10	10	15	20	10	10	10	15
0500	1:00	30	30	20	15	15	10	10	10	10	10	10	10	15	15	15	15	20
0600	2:00	30	30	20	15	20	15	15	15	15	15	15	15	15	15	15	15	20
0700	3:00	40	30	20	15	20	15	15	15	15	15	15	15	15	15	15	15	20
0800	4:00	30	40	20	20	20	20	20	20	20	20	20	20	20	20	20	20	30
0900	5:00	30	40	20	20	20	20	20	20	20	20	20	20	20	20	20	20	30
1000	6:00	20	40	20	20	20	20	20	20	20	20	20	20	20	20	20	20	30
1100	7:00	20	30	20	20	20	20	20	20	20	20	20	20	20	20	20	20	30
1200	8:00	20	30	15	20	20	20	20	20	20	20	20	20	20	20	20	20	30
1300	9:00	20	30	15	20	20	20	20	20	20	20	20	20	20	20	20	20	30
1400	10:00	20	20	15	20	20	20	20	20	20	20	20	20	20	20	20	20	30
1500	11:00	20	20*	10	15	15	15	15	15	15	20	20	20	20	20	20	20	30
1600	12:00	20	20*	10	15	15	15	15	15	15	20	20	20	20	20	20	20	30
1700	1:00	20	20	10	10	10	10	10	10	10	10	10	10	10	10	10	10	20
1800	2:00	20	20	10	10	10	10	10	10	10	10	10	10	10	10	10	10	20
1900	3:00	20	20	10	10	10	10	10	10	10	10	10	10	10	10	10	10	20
2000	4:00	20	20	10	10	10	10	10	10	10	10	10	10	10	10	10	10	20
2100	5:00	30	20	10	10	10	10	10	10	10	10	10	10	10	10	10	10	20
2200	6:00	30	20	10	10	10	10	10	10	10	10	10	10	10	10	10	10	20
2300	7:00	30	20	15	10	10	10	10	10	10	10	10	10	10	10	10	10	20

The italicized numbers signify the bands to try during the transition and early morning hours, while the standard type provides the MUF during 'normal' hours.  
 \*Look at next higher band for possible openings.

they in sufficiently good condition to last through winter? Do they need to be custom-tailored to your specific DX operating goals? Now's the time to check.

### band-by-band summary

Ten to thirty meters will be open for the entire twenty-four hour period on most days of the month. The bands should peak in all directions just after local sunrise, and again toward the east and south during late evening hours. During darkness, the bands will peak toward the west, in a south-west-northwest arc that will encompass the Pacific area.

Forty and eighty meters will be the most usable nighttime DX bands. Most areas of the world will be workable from dusk until sunrise. Hops shorten on these bands to about 2500 miles for 40 meters and to 1500 miles for 80 meters, but the number of hops can increase since signal absorption in the ionosphere's D region is low during the night. The path follows the direction of darkness across the earth, similar to the way the higher bands follow the sun. Vertical antennas over good ground systems give the lowest take-off angles for long skip on these bands during darkness.

One-sixty meters will be similar to 80 meters, providing good working conditions for enthusiastic DXers who like to work the night and early morning hours. In terms of QRN, this band will be quieter now.

ham radio

## FREE! CABLE LOSS CHART IN FALL CATALOG NEMAL ELECTRONICS COAXIAL CABLE SALE POLYETHYLENE DIELECTRIC

* RG-8/U 96% shield Mil Spec	(\$29.95/100) or 31'/ft
RG11U 96% shield 75 ohm mil spec	25'/ft
RG-58/U double shield (RG-58 size) 50 ohm	45'/ft
* RG58U milspec 96% shield	(\$9.95/100) or 11'/ft
RG62A/U 96% shield mil spec 93 ohm	12'/ft
RG174/U min. 50 Ω mil spec	10'/ft
RG213 noncontaminating 96% shield mil spec	36'/ft
RG214/U double silver shield 50 ohm	\$1.55'/ft
RG214/U tinned copper	65'/ft
RG217/U double shield 50 Ω 5/8" OD	85'/ft

<b>LOW LOSS FOAM DIELECTRIC</b>	
RG-8X (Mini 8) 95% shield	(\$14.95/100) or 17'/ft
* RG8U 80% shield	(\$17.95/100) or 21'/ft
RG-8/U 97% shield 11 ga. (eq. Belden 8214)	31'/ft
RG58U 80% shield	07'/ft
RG58U 95% shield	10'/ft
RG59/U 100% foil shield TV type	10'/ft
RG59/U 70% copper shield	09'/ft
HEAVY DUTY rotor cable 2-16 ga 6-18 ga	36'/ft
Rotor cable 2-18 ga 6-22 ga	19'/ft

<b>CONNECTORS MADE IN USA</b>	
Amphenol PL 259	79¢
PL-259 push-on adapter shell	10/\$3.89
PL-259 and/or SO-239	10/\$5.89
Double Male Connector	\$1.79
PL-258 Double Female Connector	98¢
PL-259 Silver-Teflon Kings	\$1.59 ea
Reducer UG-175 or 176	10/\$1.99
UG-255 (PL-259 to BNC)	\$3.50
Elbow (M359) UHF Elbow	\$1.79
F59A (TV type)	10/\$1.99
UG 21 D/U Type N Male for RG8, Amphenol	\$3.00
UG-88C/U BNC Male for RG-58, Amphenol	\$1.25
UG 273 BNC-PL259 Amphenol	\$3.00
3/16 inch Mike Plug for Collins etc. (cut off)	\$1.25

shipping Call or write for Free Catalog  
**Cable — \$3.00 1st 100 ft., \$2.50 each add'l 100 ft.**  
**Connectors — add 10%, \$3.00 minimum.**  
**Orders under \$20 add \$2 additional plus shipping.**  
**COD add \$2.00. Florida Residents add 5%.**

**NEMAL ELECTRONICS**  
 Dept. H, 12240 N.E. 14th Ave., N. Miami, FL 33161  
 Telephone: (305) 893-3924

✓ 168



## RF TRANSISTORS

FRESH STOCK - NOT SURPLUS

2-30 MHz					
Pin	Net	Match Pin	Pin	Net	Match Pin
MRF412	\$18.00	\$39.00	MRF455	\$13.50	\$30.00
MRF421	27.00	58.00	MRF455A	13.50	30.00
MRF450	12.50	28.00	MRF458	18.00	40.00
MRF450A	12.50	28.00	MRF492	20.00	43.00
MRF453	15.00	33.00	SFR2072	15.00	33.00
MRF435A	15.00	33.00	SFR2769	15.00	33.00
MRF454	16.50	36.00	CD2545	18.50	40.00
MRF454A	16.50	36.00	CD3424	19.00	41.00

High Gain Matched Pairs & Quads Available					
Pin	Net	Pin	Net	Pin	Net
MRF406	\$14.50	MRF475	\$ 5.00		
MRF422	39.50	MRF476	3.50		
MRF433	14.50	MRF477	13.00		
MRF435	42.00	SD1407	37.00		
MRF449	14.50	SD1487	28.00		
MRF449A	14.50	S10-12	14.50		

VHF & UHF TRANSISTORS					
Type	Mount	Rating	Freq	Net Price	Notes
MRF238	(S)	30W	145-175	\$13.00	
MRF240	(S)	40W	145-175	15.00	
MRF245	(F)	80W	130-175	27.00	
MRF247	(F)	80W	130-175	27.00	
MRF492	(F)	70W	27-50	20.00	
SD1416	(F)	80W	130-175	29.50	
SD1477	(F)	125W	130-175	37.00	
SD1441	(F)	150W	130-175	83.50	
2N6081	(S)	15W	130-175	7.75	
2N6082	(S)	25W	130-175	9.75	
2N6083	(S)	30W	130-175	9.75	
2N6084	(S)	40W	130-175	12.00	
2SC1955	—	1W	130-175	15.00	
2SC2289	—	5W	130-175	20.00	
MRF641	(F)	15W	430-470	21.50	
MRF644	(F)	25W	430-470	24.50	
MRF646	(F)	45W	430-470	24.50	
MRF648	(F)	60W	430-470	33.50	

Technical Assistance and cross-reference information on CD, PT, RF, SRF & SD PIN's. Call our Engineering Dept (619) 744-0728  
 WE SHIP SAME DAY C O D or VISA/M C  
 Minimum Order \$20.00 Add \$3.50 Shipping  
 RF Parts Catalog Avail OEM & Quantity Discounts  
 ORDERS ONLY 800-854-1927 ✓ 193

**WESTCOM**  
 1320 Grand Ave. San Marcos  
 California 92069 (619) 744-0728

## A DESIGN EVOLUTION



- Linear (all mode) RF power amp with automatic T/R switching (adjustable delay)
- Receive preamp option, featuring GaAs FETS (lowest noise figure, better IMD). Device NF typically .5 dB.
- Thermal shutdown protection incorporated
- Remote control available
- Rugged components and construction provide for superior product quality and performance
- Affordably priced offering the best performance per dollar
- Designed to ICAS ratings, meets FCC part 90 regulations
- 1 year transistors warranty
- Add \$5 for shipping and handling (Cont. U.S.). Calif. residents add applicable sales tax.
- Specifications/price subject to change

MODEL	FREQUENCY	OUTPUT POWER	INPUT POWER	SUGG. PRICE LESS TAX
	(MHz)	(W)	(W)	\$
1410	144	160	10	225
1410G	144	160	10	265
1412	144	160	30	199
1412G	144	160	30	239
2210	220	130	10	225
2210G	220	130	10	265
2212	220	130	30	199
2212G	220	130	30	239
4410	440	100	10	225
4410G	440	100	10	265
4412	440	100	30	199
4412G	440	100	30	239

1. Models with G suffix have GaAs FET preamps. Non-G suffix units have no preamp.
2. Covers full amateur band.

\*SEND FOR FURTHER INFORMATION\*

**TE SYSTEMS**  
 P.O. Box 25845  
 Los Angeles, CA 90025  
 (213) 478-0591

## TIDBITS

### 2ND OP

by Jim Rafferty, N6RJ

Completely revised and updated with all of the latest information, the latest 2nd Op is an indispensable operating aid for all Radio Amateurs. The 2nd Op gives you at the twist of a dial: prefixes in use, continent, zone, country, beam heading, time differential, postal rates, QSO and QSL record and the official ITU prefix list. Every ham needs a 2nd Op. Order yours today.

1981, N6RJ's 1st Edition.  
 HR-OP \$4.95  
 Please add \$1.00 for shipping and handling.

**HAM RADIO'S BOOKSTORE**  
 GREENVILLE, NH 03048



product

# REVIEW

## Cushcraft 32-19: 19-element 2-meter Boomer

If you've been paying attention to the results of VHF/UHF antenna gain contests, you'll know that the Cushcraft Boomer has been a pretty successful design. In a few instances, Boomers have been able to walk away with top honors for each band in which they were entered.

Using the latest in computer design techniques, Cushcraft engineers optimized spacing and element length to ensure maximum performance. (See **table 1.**) The Boomer also uses a T-match driven element with a 1:1 coaxial balun to provide coaxial decoupling and a low VSWR. One unique new feature on the Boomer is the Trigon three-element reflector assembly. The Trigon design enhances the front-to-back ratio and gives the antenna a sharper forward pattern.

**table 1. Cushcraft 19 element 2-meter Boomer.**

range	144-146 MHz
forward gain	16.2 dBd
front/back	24 dB
weight	12 pounds (5.44 kg)
length	22 feet (6.71 m)
turning radius	11 feet (3.5 m)
wind load	3.5 square feet (0.33 square m)

Assembling this antenna is a very easy job taking less than two hours to complete. All of the elements are measured and pre-cut for ease of assembly. Fasteners are stainless steel to eliminate the problems caused by corrosion. Since the Model 32-19 uses such a long boom (22 feet) Cushcraft has added a supporting truss to provide an extra measure of mechanical stability and to keep the antenna level. All of the aluminum used is a special heat-treated tubing that is designed to take the strongest of storms without damage and keep on performing.

As many of you know, my interest in ham radio has been, for many years, 160 meters. But using the 2-meter Boomer during this June's VHF contest was a real joy. I couldn't help comparing operation on the two different bands; as I carefully and patiently pieced together the calls of stations I worked (there was fading and other propagation anomalies) I felt that my time spent ferreting calls out of the

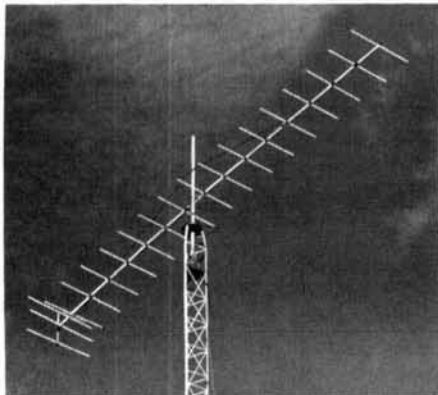

muck on 160 meters had been excellent preparation for two-meter contesting. It was a relief not to have to fight any thunderstorm QRN. I had a lot of fun during the contest and was able to take advantage of the excellent Aurora Sunday night, June 12. Being limited to just 10 watts hurt; plans are now underway to get at least 100 watts cooking in time for the next contest. For information, contact Cushcraft, P.O. Box 4680, Manchester, New Hampshire 03108. RS#301

N1ACH

## the Snyder antenna: model FB 75/80

The best way to describe this 80-meter broadband wire antenna is *simple*. For those who want to operate anywhere between 3.500 and 4.000 MHz without having to adjust wire lengths or a tuner, this 80-meter version of the Snyder product line is an answer.

From the moment of unpacking to final installation, less than 15 minutes is involved. (This assumes that a skyhook at 45 or more feet is available and the coaxial cable is already dressed.) At my location, a heavily wooded area of New Hampshire (for those of you who don't live here, it's *all* heavily wooded), a tree limb at 45 foot height was used as the support. However, telescoping masts, towers, tall poles can all serve that same function.

How does the antenna achieve broadband operation without tuning? It uses a patented technique that achieves this performance by combining a sealed center unit that weighs about one pound (0.45 kg) and contains no reactive elements, according to Snyder, with a middle cable assembly (that looks like a sleeve) and outer lengths of copperweld wire.

### installation

Installation proceeds smoothly if you follow the instructions. In my installation I attached the supporting rope to the convenient small bracket on the center assembly and raised it five feet off the ground. After the coaxial cable

was connected and sealed, and stress relieved (45 feet of RG-8 weighs a bit), I unfurled the middle cable assemblies and payed them out. I attached ropes to the six-inch long end insulators and raised the antenna to its final height while securing the copperweld ends, which I left for last. (Those of us who have worked with copperweld — haven't we all? — can appreciate the small additional amount of time and care required in handling this spring wire. *Unwind only the section of cable that you're working with.*)

The FB 75/80 makes an attractive, sturdy installation as an inverted vee. It can be secured in other configurations as a horizontal dipole, sloping dipole, or as an element in an array. It is highly recommended that if used as a horizontal dipole a center support be provided to bear the weight of the feedline and center insulator.

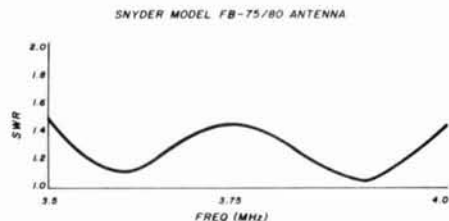

### performance

This antenna has an SWR curve that has the shape of the letter W (see **fig. 1**). Feeding a small amount of power into this antenna at every 25 kHz from 3.5 to 4.0 MHz and using a Bird thru-line wattmeter basically confirmed the manufacturer's specifications. This antenna "wants" to be in the clear away from all large conducting and dielectric objects or obstructions to provide best performance.

On the air comparisons between this antenna in an inverted-vee configuration and a 50-foot apex high sloping delta loop revealed the expected results. Using a rapid switching arrangement it compared favorably (same report) with the Delta loop antenna for most U.S. contacts. The sloping delta loop has the edge for Europe and longer paths. In all fairness it must be mentioned that the sloping delta loop performs as well as my full size 80-meter Bobtail curtain in its favored directions.

### conclusion

The Snyder Antenna Company has accomplished its goal in providing Amateurs with a non-tune broadband basic antenna. It is a pleasure to install and operate with any transceiver and especially complements any of the modern "instantaneous" frequency change solid-state units. In addition to base station use, it is well suited for portable operation be it emergency, field day, or DXpedition. For information about Snyder products, contact the company at 250 East 17th Street, Costa Mesa, California 92627. RS#303

K2RR

# 10GHz GUNNPLEXER transceiver

## BBC Metrawatt model MA3E multimeter

There's no doubt about it: digital readouts are definitely in vogue. So it came as some surprise when an analog multimeter appeared on my desk for review the other day.

BBC Metrawatt entered the American market fairly recently when it introduced a rather complete line of both digital and analog meters. Model MA3E represents a moderately-priced unit that offers a number of appealing features.

My first impression was that this is a very European unit, with its gracefully curved lines in a very neat and functional design. (No wonder — its unique case was designed by Porsche.) To protect the meter when not in use, the unit folds together to make a convenient, easy-to-transport package. The high-impact plastic case is built to withstand industrial use or abuse without compromise in performance.

The MA3E incorporates an electronic amplifier providing a combined total of 35 measuring ranges that include 18 for AC and DC voltages up to 1000 volts; 12 for AC and DC currents up to 10 amperes; and five resistances up to 20 megohms, including a battery check — all while providing a constant input resistance of 10 megohms.

All measuring ranges are manually selected by use of a switch located on the main frame. The viewing angle of the meter can be varied to meet the needs of the user.

The unit operates from an internal 9-volt battery or from an external power supply. Low power consumption ensures long battery life.

The test leads are recessed into the meter and specially shielded to prevent accidental shorting while plugged into the meter. The leads are also threaded to accept alligator clips and other accessories.

The MA3E measures approximately 5-3/4 x 4-1/2 x 1-3/4 inches (146 x 118 x 44 mm) and weighs less than one pound (0.45 kg), without battery.

Luckily the MA3E arrived for review while we were rebuilding WB1AHV, the ham radio Amateur station. While crawling up and down connecting power lines and antenna leads, I found the MA3E to be a real joy to use. The adjustable meter made reading voltages or determining continuity a snap. Being a bit ham-fisted, I accidentally knocked the meter off the operating table, but the rugged case wasn't damaged at all, to my relief.

This is a useful meter that, at under \$200, should find wide acceptance in both Amateur Radio and industrial applications.

Detailed information on the MA3E and other models in the product line are available from BBC-Metrawatt, 6901 West 117th Avenue, Broomfield, Colorado 80020. RS#302

N1ACH



TR10GA

- Complete ready to use 10 GHz fm voice/cw transceiver
- 10 mW power output
- Typical frequency coverage 10.235-10.295 GHz
- Full duplex operation
- Internal Gunnplexer for portable operation
- Gunnplexer removable for tower mounting in fixed location service — three shielded cables required for interconnection
- Powered by 13 volts dc nominal at 250 mA
- 30 MHz i-f
- 10-turn potentiometer controlled VCO tuning
- 220 kHz ceramic i-f filter
- Extra diode switched filter position for optional filter
- Dual polarity afc
- Rugged two-tone grey enclosure
- Full one year warranty
- \$389.95 with 10 mW Gunnplexer
- \$269.95 without Gunnplexer

## Advanced Receiver Research

Box 1242 • Burlington CT 06013 • 203 582-9409

Postpaid for U.S. and Canada. CT Residents add 7-1/2% sales tax. C.O.D. orders add \$2.00. Air mail to foreign countries add 10%



✓ 104

SEMICONDUCTORS :		P.C. BOARDS FOR MOTOROLA BULLETINS	
MRF-208 - 12.00	MHW-252 - 50.00	EB-18A - 12.00	AN-762 - 14.00
MRF-240 - 15.50	MHW-710-1 - 61.00	EB-27A - 14.00	AN-791 - 10.00
MRF-247 - 34.80	MPSH-81 - .50	EB-63 - 14.00	EB-67 - 14.00
MRF-309 - 27.60	MV2205 - .58	KEMET CHIP CAPACITORS: 56 pf, 82 pf, 100 pf, 390 pf, 470 pf; -.50 ea	
MRF-422 - 41.40	78L08CP - .50	680 pf, 1000 pf; -.55 ea	
MRF-454 - 20.00	2N4401 - .75	5600 pf, 6800 pf, .1 uf; -1.00 ea	
MRF-901 - 1.75	2N5190 - 1.50	.33 uf; -1.90 ea .68 uf; -3.90 ea	
SBL-1 Double-Balance Mixer - 6.50		CAMBION RF CHOKES: .15 uh, .22 uh, .33 uh, 4.7 uh, 10 uh - 1.20 ea	
BROADBAND TRANSFORMERS PER MOTOROLA BULLETINS: AN-762, EB-27A, EB-63		UNDERWOOD/SEMCO METAL-CLAD MICA CAPACITORS: 5pf, 10pf, 15pf, 25pf, 30pf, 40pf, 56pf, 60pf, 68pf, 80pf, 91pf, 100pf, 200pf, 250pf, 390pf, 470pf, 1000pf	
We also carry a line of VHF, UHF amplifiers and ATV equipment.			
Call or write for our free catalog.			



## Communication Concepts Inc.



2648 North Aragon Ave • Dayton, Ohio 45420 • (513) 296-1411

✓ 127

## TIDBITS

### THE PRACTICAL HANDBOOK OF AMATEUR RADIO FM & REPEATERS

by Bill Pasternak, WA6ITF

Comprehensive handbook covers just about every facet of FM operation in a simple, easy to understand manner. 45 chapters put all kinds of FM and Repeater topics within easy reach. You get a solid background in FM theory, control devices for repeaters, how to build a repeater, ATV and RTTY application ideas and more. This huge, fact-filled repeater book is a must for anyone interested in FM communication. ©1980. 536 pages, 1st edition.

□ T-1212 Softbound \$12.95

Please add \$1.00 for shipping and handling.

HAM RADIO'S BOOKSTORE  
Greenville, NH 03048

## TIDBITS

### MORSE CODE, BREAKING THE BARRIER

by Phil Anderson, WØXI

Learning the Morse Code does not have to be the painful experience many folks make it out to be. This little booklet is chockfull of helpful and highly recommended hints and tips on how to learn the Morse Code. Uses the high/low method to eliminate the dreaded 10 wpm plateau. ©1982, 1st edition.

□ PA-MC Softbound \$1.50 each

Please add \$1.00 for shipping and handling.

HAM RADIO'S BOOKSTORE  
Greenville, NH 03048

**THE AFFORDABLE REPEATER**  
FROM THE MANUFACTURER OF COMMERCIAL &  
MILITARY EQUIPMENT MADE IN USA AT OUR  
MIAMI, FLORIDA PLANT

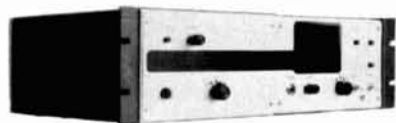

**\$699.** \* Basic Price

**FEATURES:**

- Several Frequency Ranges  
30-50 MHZ, 132-172 MHZ,  
200-240 MHZ, 380-480 MHZ.
- Sensitivity .3 Microvolt 12 DB S/N
- Power Output 30 Watts.
- Four Pole IF Filter.
- Complete separate transmitter  
and Receiver
- 13.6 VDC or 115/220 UAC  
Power Supply.
- 19" Rack Mounting.

**OPTIONS**

- Helical Filter Installed \$65.00.
- 8 Pole Filter Installed \$20.00.
- Cooling Fan Installed \$30.00.
- Duplexer
- Deluxe Cabinets
- Timer
- Tone Panel

**OTHER PRODUCTS**

- Simplex and Full Duplex
- VHF/UHF Mobiles and Bases
- Rural Radio Telephone
- Auto Patch
- HF SSB Transceiver
- Catalogues available upon request

**DEALER INQUIRIES INVITED**

**ITS International Telecommunications Systems Florida Inc.**

8416 N.W. 61 ST. / MIAMI, FLORIDA 33166  
TEL: (305) 593-0214 / TELEX: 525834

✓ 152



**RTTY/CW terminal**

The new Flesher Corp. TU-470 RTTY/CW terminal unit receives up to 300 baud on all three shifts and provides TTL and RS-232 compatible I/O, including bi-polar CW and PTT outputs, for complete remote control and isolation of computer level I/O keying.

Each TU-470 RTTY filter board is a high-sensitivity, high Q, 3 stage, 6 pole active bandpass filter said to provide excellent stability and sharpness. A signal balance restorer circuit has been incorporated to allow reception of non-standard RTTY shifts on mark only. The CW filter/demodulator has a 3 stage, 6 pole filter centered at 750 Hz for CW reception.

The unit also provides crystal controlled AFSK, FSK, 170 Hz narrow preselector filter, built-in 20 or 60 mA loop supply, autostart, threshold control, 5 LED indicators, bar graph tuning, scope outputs, reverse receive, reverse transmit, and much more.



The TU-470 RTTY/CW terminal unit is available wired and tested for \$499.95.

For more information, contact Flesher Corporation, P.O. Box 976, Topeka, Kansas 66601. RS#304

**lightning protector**

The new IS-RCT from PolyPhaser relies on fast 50 nanosecond three-element crowbar gas tubes to provide effective protection from lightning for the hamshack rotor control box.

Designed to be mounted on a ground pipe or grounded tower leg, with terminals down to keep snow and rain off connectors, the unit is housed in a heavy duty stabilized plastic case. All grounding hardware is stainless steel.

**WARNING**

**SAVE YOUR LIFE OR AN INJURY**

Base plates, flat roof mounts, hinged bases, hinged sections, etc., are not intended to support the weight of a single man. Accidents have occurred because individuals assume situations are safe when they are not.

Installation and dismantling of towers is dangerous and temporary guys of sufficient strength and size should be used at all times when individuals are climbing towers during all types of installations or dismantlings. Temporary guys should be used on the first 10' or tower during erection or dismantling. Dismantling can even be more dangerous since the condition of the tower, guys, anchors, and/or roof in many cases is unknown.

The dismantling of some towers should be done with the use of a crane in order to minimize the possibility of member, guy wire, anchor, or base failures. **Used towers in many cases are not as inexpensive as you may think if you are injured or killed.**

Get professional, experienced help and read your Rohn catalog or other tower manufacturers' catalogs before erecting or dismantling any tower. A consultation with your local, professional tower erector would be very inexpensive insurance.

**Paid for by the following:**

**UNR-Rohn**  
Division of UNR, Inc.  
6718 West Plank Road  
Peoria, Illinois 61601  
USA

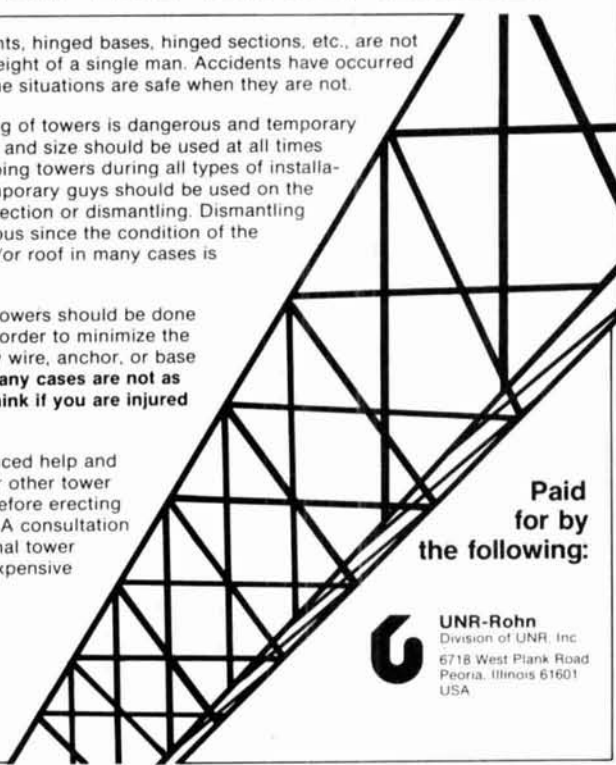

Crimp and/or solder lugs are included. The introductory price is \$29.95.



For information, contact PolyPhaser Corporation, 1500 West Wind Boulevard, Kissimmee, Florida 32741. RS#305

## keyer trainer

The AEA Basic Trainer Model KT-3 is a computerized Morse code instructor. Character speeds are given at 20 WPM with a three-second interval between letters or letter groups. This method of learning helps eliminate the plateau so many Morse code students encounter between 10 and 12 WPM. This system does not encourage the student to learn a "dot-dot-dash-dot" for F, but rather one cohesive sound of dididahdit (at the character speed of 20 WPM). As a result, the student does not have to unlearn bad habits such as counting dots and dashes in order to copy code.

Because the sound of any given letter does not change from 0 to 20 WPM, it is easier for the student to increase copying speed if he or she has learned code at a rate of 20 WPM. To facilitate this learning technique, the minimum programmable speed on the Basic Trainer is 18 WPM character speed. After learning the code, the user can progress up to 99 WPM with the KT-3. Each character is taught separately by repetition. The student progresses only after he is confident he knows the letters being presented by the KT-3.

After the first letter (F, in this case) is learned, a student may progress to the letter K. After learning K, the student activates the computer to present the letters F and K in random sequence at a 20 WPM character speed. This technique continues as the student learns each subsequent letter in the alphabet.

Easy to operate, the KT-3 requires no computer programming skills. An earphone monitor jack is provided for private practice sessions. The KT-3 operates from 12 Vdc (or 117 Vac with optional AC-1 Wall Adaptor).

For details, contact Advanced Electronic Applications, Inc., 2006-196th St. SW, Lynnwood, Washington 98036-0918. RS#306

## six-band high-frequency vertical

Hustler has announced the availability of its new 6-BTV six-band trap vertical for the high-frequency ham bands.

Based on the popular 4-BTV, the new 6-BTV offers full band coverage of 10, 15, 20, 30, and 40 meters with a VSWR of under 1.6:1 at band edges and up to 100 kHz on 75 or 80 meters.

According to the manufacturer, fiberglass reinforced high Q traps, extra-strength aluminum components, and stainless steel hardware combine to make the new 6-BTV the most rugged, high performance, high-frequency vertical available.

The 6-BTV lists for \$199.95. For additional information, contact Hustler, Inc., 3275 North B Avenue, Kissimmee, Florida 32741. RS#307

## fm dual band

Trio-Kenwood has announced the release of a compact new combination 2-meter and 70-centimeter FM radio, model TW-4000A. Among its features are a large, easy-to-read LCD display, ten channels of memory with offset recall, lithium battery memory back-up, dual digital VFO's, priority watch, common channel, programmable memory scan, band scan, and a full 25 watts of rf output on each band.

An optional accessory available for use with the TW-4000A is the VS-1 voice synthesizer unit that announces the operating frequency,



VFO "A" or "B", repeater offset, and the memory channel number when the unit is turned "ON", when another frequency is selected, or when a memory is recalled. The VS-1 is designed to be easily installed inside the TW-4000A.

Additional information is available from Trio-Kenwood Communications, 1111 West Walnut Street, Compton, California 90220.

## AMTOR terminal

The ARQ1000 is a full send-receive terminal for the AMTOR ARQ code. All features of the CCIR 476-2 Recommendation are supported. Modes include: ARQ, FEC, SEL-FEC, and MONITOR. The ARQ1000 may be used with the HAL DS3100 and ST6000, CT2200, CT2100, or CRW6850 terminals or any ASCII or Baudot terminal at baud rates from 45 to 300 baud. Non-volatile keyboard-programmable

# Ducks are getting smaller! and...

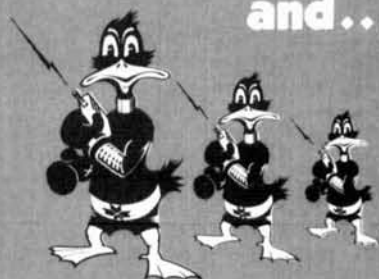

## better!



Actual Size

Because you and the leading radio manufacturers want the best looking, best performing antenna you can buy, Centurion has grown to be the Duck leader. We've developed many smaller and thinner antennas to make hand-held radio perform better and look better. The Style S is the newest Tuf Duck...it measures 3" in length and only 3/8" in diameter, yet it's a full 1/4 wave radiator on VHF.

 **CENTURION**  
**TUF DUCK™**  
**ANTENNAS**

**CENTURION**  
Phone 402/467-4491  
Telex 48-4377 CENTURION LCN  
P.O. Box 82846 Lincoln, NE 68501 2846

## Be BIG on 40 or 80!

Make this the year where you hear and are heard! The sun spot number is dropping fast and there is still time to install your new INSTANTARRAY™ system before the temperature dives. Order now and "own" your frequency during the fall CQ WW tests. Run JA's on 80 in the late afternoons this December and join them for breakfast the next AM. Achieving the 80 & 40 portions of the 5BWAZ & DXCC awards should be fun, not a chore!

Col•Atch•Co will sell you any individual component we make or a whole system! Start off with a single 40 or 80 meter 1/4 wave vertical radiator or purchase a ready-to-erect two or four element INSTANTARRAY™. The complete INSTANTARRAY™ system includes the verticals, their mounts, insulated guys, SS hardware galore, our attractive LOBE SELECTOR control box with self contained DC supply, a really novel beam forming phasing harness and a weatherproof relay box which distributes the power to the vertical radiators. Our 4-40 and 4-80 systems provide low angle 360 degree coverage in 90 degree segments with exceptional rejection of signals from the rear and sides. All of this in milliseconds.

Trying to show you all this in an HR ad is virtually impossible. Hence we have produced a dynamite VHS demo video tape, which tells it all. We will loan you this tape upon receipt of a \$35 deposit which we will either refund when you return our tape or will credit against your first order.

Yes, we also do have a brand new brochure with diagrams, pictures, specs, etc. which we will send you gratis. We accept both MASTERCARD and VISA.

P.O. BOX 230, CARLISLE, MA 01741  
(617) 371-1242

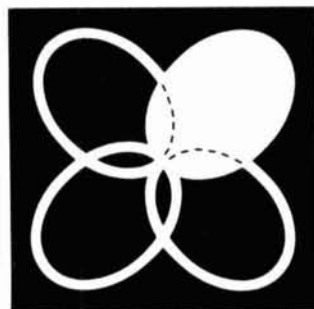

col•atch•co. ✓ 126



ARQ access code, SEL-CAL code, and WRU answer-back codes are included. The ARQ1000 is housed in a cabinet that matches the CT2200 and CT2100. Available options include the DM170 internal demodulator and ARQX10 encryptions module.



For more information, contact HAL Communications Corporation, P.O. Box 365, Urbana, Illinois 61801. RS#311

### single chip code-practice processor

The world's first single chip code-practice processor, the CPP1, is a true 8-bit microcomputer containing all the tables and timing necessary to learn Morse code. By adding a simple dot clock and tone generator to this processor, it is possible to practice Morse code at rates from 1 WPM to over 100 WPM.

The CPP1 is said to eliminate the frustrations of trying to learn code by tape, and promises to put an end to searching for a particular practice group, stopping and rewinding, and having to learn at whatever speeds the tape offers.

For further information, contact Micro Digital Technology, P.O. Box 1139, Mesa, Arizona 85201. RS#309

### base station transceiver

ICOM has announced the introduction of a new base station transceiver for 2 meters, the IC-271A. Covering the entire 2 meter ham band, it features fm/upper sideband/lower sideband and CW modes, has a 25 watt output standard, with an optional built-in power sup-



ply available. It has 32 full function memories. Built-in sub-audible tones selectable from the main tuning dial provide ease of operation. Frequencies, modes, tones and offset may be written into each memory. Scanning is possible with the IC-271A; either the whole band, memories or selected modes may be scanned. The IC-271A features ICOM's new high contrast, two-color display, showing frequency digits in white and control functions in red.

For further information, contact ICOM America, Inc., 2112-116th Ave., NE, Bellevue, Washington 98004. RS#310

### miniature soldering iron

An industrial grade precision miniature soldering iron that heats up quickly, has a non-

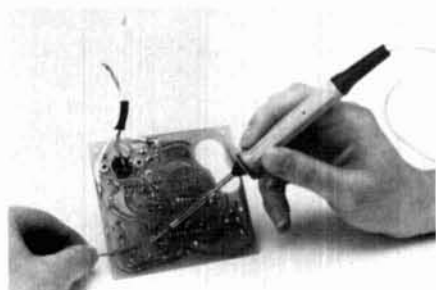

melt handle and is suited for students, hobbyists, and professionals is available from M.M. Newman Corporation.

The Antex Model G Soldering Iron features a wide range of slide-on tips. Designed for delicate circuitry, the tips are directly grounded and heat up in only 45 seconds. Compact and fully portable, the Antex Model G Soldering Iron weighs only 3/4 ounce without cord. Built for continuous or intermittent use, the tip slides directly over the heating element and heats up to 700-750 degrees F. Complete with a premium grade pretinned 3/32 inch tip, the Model G sells for \$15.95.

For more information, contact M.M. Newman Corporation, 7 Hawkes Street, P.O. Box 615A, Marblehead, Massachusetts 01945. RS#312

### multi-outlet panel

A new multi-outlet panel from Flexiduct provides four circuit-breaker-protected outlets for safe use where too few electrical outlets exist.

The new outlet-extender panel features 4 grounded outlets, an on/off switch, a circuit breaker with a push-button reset (to protect from overloads) and a double-insulated cord with a three-prong end plug. It is rated at 15 amps, 125 volts, 1875 watts and is UL listed.

Other Flexiduct safety products include 4 and 6 outlet multi-outlet strips, a plug-in surge suppressor, a multi-outlet surge suppressor,



lay-flat power extensions, over-the-floor cord cover and products for use with telephones.

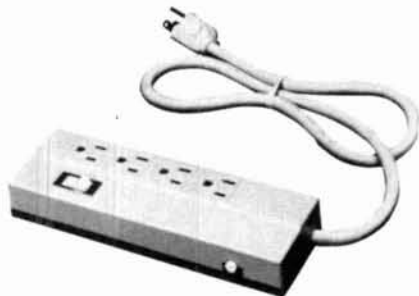

Information on Flexiduct safety products is available from Winders & Geist, Inc., P.O. 83088, Lincoln, Nebraska 68501. RS#313

## two more Kulduckies

Larsen Electronics has added two new antennas to its Kulduckie line. Both the Helical Quarter Wave and the Stout are designed to work with most hand-held radios.

The Helical Quarter Wave antenna combines the best features of the helical and full quarter wave antenna. It is said to deliver better performance with a shorter, more stable antenna than a full quarter wave VHF. The Stout antenna series features a slightly larger diameter helix with a closer pitch for applications in which space is a problem. Both new antennas are available in VHF frequencies 136-142, 142-150, 150-162, and 162-174 MHz.

For more information, contact Larsen Electronics, P.O. Box 1799, Vancouver, Washington 98668. RS#314



## new dish

A satellite TV antenna made by an entirely new method of production has been announced by Total Television, Inc.

The design of the 12 foot diameter dish consists of a heavy-duty expanded aluminum mesh reflective surface supported by twenty-four injection molded ribs connected to an injection molded main support.

The material from which the dish structure is molded is a sophisticated plastic formulated to endure all kinds of weather. Products molded from the plastic material have been used for nearly twenty years to replace concrete in exterior and underground applications. The manu-

# 40 - 80 - 160 VERTICALS

Our verticals include a 1 5/8" x 5' pre-drilled galvanized mounting pipe, a base insulator, slotted sections of aluminum tubing marked for easy assembly, SS hose clamps and all SS bolts, washers, etc. The 1-40 radiator @ \$99 is self supporting and rises 33' above the insulator. The 1-80 radiator uses a unique tilt-up base insulator that allows the assembled 57' radiator weighing circa 35 lbs. to be easily erected. The 1-80 is supplied @ \$217 with two sets of low-stretch, UV resistant mylar insulating guys which attach to the radiator at two levels by SS washers nicopressed through three 6' sections of wire to the mylar to provide electrical loading. 160 kit @ \$48. #16 awg copper radial wire @ \$26/M. Prices FOB Carlisle, MA.



P.O. BOX 230, CARLISLE, MA 01741 or phone (617) 371-1242

# 1984 CALLBOOKS

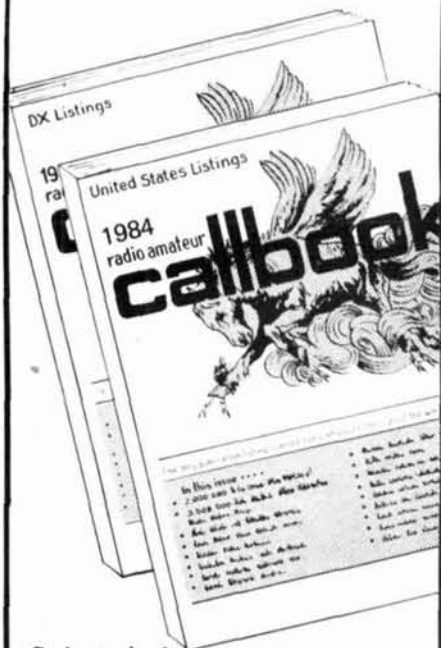

**Order today!**  
**NEW 1984**  
**RADIO AMATEUR CALLBOOKS**  
**READY DECEMBER 1st!**

Known throughout the world for accuracy, the 1984 Callbooks are a better value than ever before. The U.S. Callbook contains over 430,000 listings; the Foreign Callbook has over 400,000. More than 75,000 changes have been made in each edition since last year. *Special features include call changes, Silent Keys, census of amateur licenses, world-wide QSL bureaus, international postal rates, prefixes of the world, and much more.* You can't beat this value! Order your 1984 Callbooks now for earliest delivery.

Each Shipping Total

□ U.S. Callbook	\$19.95	\$3.05	\$23.00
□ Foreign Callbook	18.95	3.05	22.00

Order both books at the same time for \$41.95 including shipping within the USA.

Order from your dealer or directly from the publisher. Foreign residents add \$4.55 for shipping. Illinois residents add 5% sales tax.

### Keep your 1984 Callbooks up to date.

The U.S. and Foreign Supplements contain all activity for the previous three months including new licenses. Available from the publisher in sets of three (March 1, June 1, and September 1) for only \$12.00 per set including shipping. Specify U.S. or Foreign Supplements when ordering. Illinois residents add 5% sales tax. Offer void after November 1, 1984.

RADIO AMATEUR **callbook** INC.

Dept. F  
 925 Sherwood Dr., Box 247  
 Lake Bluff, IL 60044, USA

Tel: (312) 234-6600



## NEW! MULTI-CHANNEL MICROWAVE

Complete Antenna Systems from \$69<sup>95</sup>

Full 800 Mhz Range  
 Tune 1.9-2.7 Ghz  
 Includes all  
 ITFS Channels

DEALERS WANTED

COD's and Credit Card  
 Orders call TOLL FREE

1-800-247-1151



**GALAXY**  
**ELECTRONICS**  
 6009 N. 61 Avenue  
 Glendale, AZ 85301  
 1-602-247-1151



✓ 142

## WARC for FT-101

Modernize any model of the original FT-101 Series by adding *all three* WARC bands for RX and TX!

- Use 10 MHz now; be ready for the others.
  - Increase resale value of your rig.
  - Easy installation, detailed instructions.
  - Includes all crystals, relays, etc.
  - Tested, fool-proof design for all but 'ZD.
- FT-101 WARC Kit #4N ..... **ONLY \$25.**  
 Shipping \$3 (Air \$5). Florida sales tax 5%.

GO FOX TANGO — TO BE SURE!



Order by Mail  
 or Telephone

✓ 140

For other great Yaesu modifications get the top-rated FT Newsletter. Still only \$8 per calendar year (US), \$9 Canada, \$12 Overseas.

### FOX TANGO CORPORATION

Box 15944 H, W. Palm Beach, FL 33418  
 (305) 683-9587

### Custom Mailing Lists on Labels! Amateur Radio Operator NAMES

- Custom lists compiled to your specifications
- Geographic by ZIP and/or State
  - By License Issue or Expiration Date
  - On Labels of Your Choice

Total List: 435,000 Price: \$25/Thousand

**Buckmaster Publishing**

Whitehall, Mineral VA 23117

✓ 118

**SAY YOU SAW IT  
 IN  
 HAM RADIO**



manufacturer says that the material, Structuralite,™ will be unaffected by temperatures ranging from minus 55 degrees to plus 255 degrees F. grees F.

The mesh reflective surface is suitable for 4 GHz microwave signals used in all current U.S. domestic satellites, yet will allow the wind to pass and permits the background to be seen through it.

For further information, contact Total Television, Inc., 17537 N. Umpqua Highway, Roseburg, Oregon 97470. RS#315

### dipole

The new KT5B multi-band dipole antenna from Kilo-Tec is designed for use on the 1.8 MHz through 30 MHz amateur radio bands. It uses no loading coils or traps and will handle 2 kW PEP. The price is \$59.95.

For further information, contact Kilo-Tec, P.O. Box 1001, Oak View, California 93022. RS#316



## plate frames

License plate frames personalized with individual call signs are now available from BHC, Incorporated. Molded from black ABS plastic — the same material used for trim on many new cars, a set of HAM-TAGS consists of two



black frames with white, permanent vinyl letters in the large imprint area. (License plates differ from state to state so drivers would have to check their plates to see if their calls would go at the top or bottom of the frame.) In states that issue only one plate, BHC will furnish a frame for the rear and a plate for the front. HAM-TAGS are \$12.95 per set plus \$1.50 shipping; information is available from BHC, Incorporated, 1716 Woodhead, Houston, Texas 77019. RS#317

## scaleable ac voltmeter

The Slimline II ac voltmeter from Nationwide Electronic Systems, Inc., (NES), scales ac voltage input signal to any desired unit, mounts quickly, and features a large (0.9 inch) LED display which can be easily scaled to read out directly in engineering units. The Slimline will accept the output from a voltage transformer, ac tach generator, or any device with an ac voltage output.

Examples of use include scaling 34.52 Vac from a potential transformer to read directly as 1.726 kV; 0.825 Vac from a current-to-voltage transformer to read directly as 165 ac amps; and 43.5 Vac from ac tach generator to read directly as 783 rpm.

All adjustments and controls for this meter are accessible under the flip-up door located beneath the display. Models are available for ranges from 0 to 200 Vac.

Also available from NES are scaleable dc voltmeters, scaleable ammeters, clocks, counters, process meters, and the unique ASCII Bustle® (BCD/ASCII converter). All NES products are backed by a solid 3-year warranty.

For more information or a copy of the NES Condensed Catalog, contact NES, Inc., 1536 Brandy Parkway, Streamwood, Illinois 60103. RS#318

## field-strength element

An extremely sensitive relative field-strength element, Model 4030, expands the usefulness of the thousands of Thru-line wattmeters in the field by helping to optimize the radiated signal of any transmitter from 2 to 1000 MHz.

Model 4030 employs modern broad-band circuitry instead of the highly reactive resonant networks of most field-strength meters, which

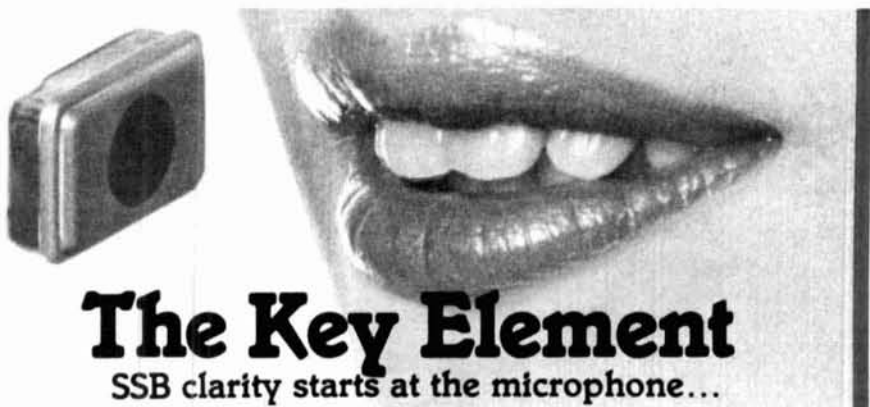

# The Key Element

SSB clarity starts at the microphone...

Heil Sound, the company that pioneered proper audio equalization techniques for major performing groups and communicators, invites you to be part of one of the biggest advancements in Single Sideband transmission since the 'Donald Duck' vs. AM days.

If you are not satisfied with the "sound of your station"—it's no wonder—most "communications" microphones used today were designed for "public address" use, not for sophisticated SSB techniques.

No one microphone can be all things to all Hams, so this new HC-3 element and HM-5 mic were developed only for maximum clarity on SSB transmissions.

The response of this tiny ceramic element rolls off sharply under 350 Hz and above 3100 Hz with a peak at 2400 Hz for high articulation in the speech range.

Hams who care about maximum results in getting over, around and through DX pile-ups now have another weapon in their arsenal... The Key Element!

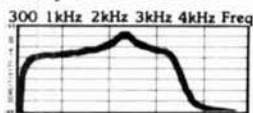

You can easily install this small, advanced HC-3 element, with its broad-range impedance-matching characteristics, into virtually any microphone case you own, or purchase the custom HM-5 mic with HC-3 installed.

"...Have not yet heard an FT-101 sound any better than when used with The Key Element..." —Paul, G3AWP

"...I now have a comfortable feeling that my audio is better than the rig was originally capable of..." —Ken, W9UBS

"...Thank you for the fine report, All reports to date have been excellent..." —Lee, W1SE

For those who desire the ultimate audio into and out of your transmitter/transceiver, consider the ideal combination of the Heil EQ-200 audio equalizer and HM-5 microphone.



For more information, or to order the HC-3 cartridge element at \$19.95 the HM-5 SSB microphone at \$54.95, or the EQ-200P at \$59.95, contact Heil Ltd., Marissa, IL 62257. 618-295-3000.



Hearing Is Believing...

149

limit their utility. The element consists of a flexible receiving antenna, a single high-pass network and a variable gain rf amplifier/detector. A battery-saving feature turns everything off when the element is removed from the wattmeter. Typically full scale deflection is obtained from a one watt CW source at 150 MHz through a quarter wave antenna 8 feet distant. Dynamic range is at least 30 dB and battery life is 100 hours or more.

For more information, contact Bird Electronic Corporation, 30303 Aurora Road, Cleveland (Solon), Ohio 44139. RS#319

## "affordable" repeaters

A new line of repeaters in several frequency ranges is available from International Telecommunications Systems Florida Inc. Ranges include 30-50 MHz, 132-174 MHz, 200-240 MHz, 380-480 MHz, or any band combination. The power output is 30 watts; the unit operates from 13.6 VDC or 115/220 Vac and costs \$499.

For further information, contact International Telecommunications Systems Florida Inc., 8416 N.W. 61st Street, Miami, Florida 33166. RS#320

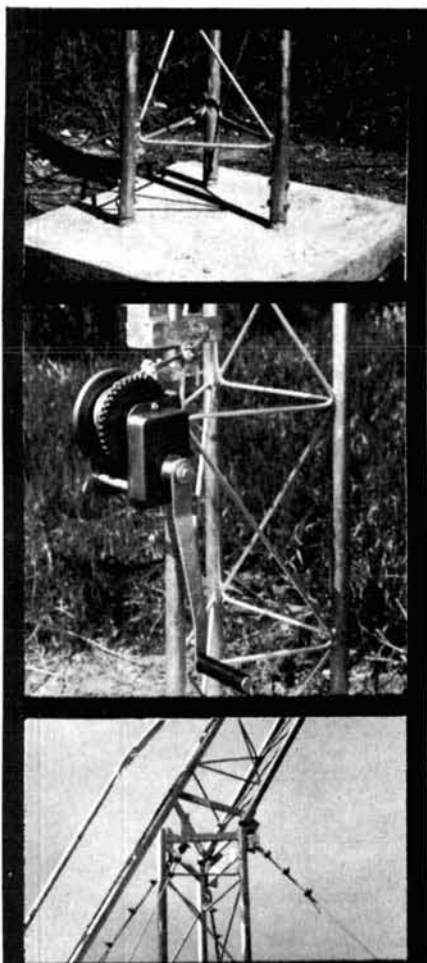

## ROHN<sup>®</sup> "FOLD-OVER" TOWERS

### ■ EASE OF INSTALLATION

ROHN "Fold-Over" Towers are quickly and easily installed. The "Fold-Over" is safe and easy to service.

### ■ ADAPTABILITY

ROHN has several sizes to fit your applications or you can purchase the "Fold-Over" components to convert your ROHN tower into a "Fold-Over".

### ■ HOT DIP GALVANIZED

All ROHN towers are hot dip galvanized after fabrication.

### ■ REPUTATION

ROHN is one of the leading tower manufacturers, with over 25 years of experience.

Write today for complete details.

QUALITY STEEL PRODUCTS BY

# ROHN

Box 2000 • Peoria, Illinois 61656  
U.S.A.

## GET THE MOST FROM YOUR VIC-20/C64

### CASSETTE INTERFACE

- USE ANY STANDARD CASSETTE RECORDER
- CONNECTS TO THE CASSETTE PORT
- CONTROLS THE CASSETTE MOTOR
- NEEDS NO BATTERIES
- COPY FROM RECORDER TO RECORDER
- THIS IS THE BEST ONE! FOR LESS \$\$\$ ONLY \$34.95 POSTPAID. ADD \$2.50 FOR SHIPPING OUTSIDE US. CANADA, MEXICO.



### THE MODEM INTERFACE

- CONNECTS TO THE USER I/O PORT
- NEEDS NO BATTERIES/SOLDERING
- CONNECTS ANY STANDARD MODEM
- USE MODEM AUTOANSWER FEATURES
- COMES WITH A FREE TYPE IN BASIC TERMINAL PROGRAM
- ONLY \$24.95 POSTPAID. ADD \$2.50 FOR SHIPPING OUTSIDE US. CANADA, MEXICO.

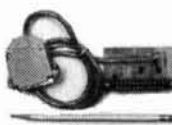

**CHARGE OR COD ORDERS CALL  
1-800-227-3800**

ASK FOR OPERATOR 225

**BYTESIZE** MICRO TECHNOLOGY (206) 236-BYTE  
PO BOX 12309 DEPT SEATTLE, WA 98111

CALL OR WRITE FOR DEALER INFORMATION

✓ 120



**NEW! \$1295** pair

**HAM-TAGS** Tough ABS custom frames. Your call on each vehicle. Available with call at top or bottom of frame, and frame front plate (check your state). \$1.50 shipping.



**BHC, INC.**  
1716 WOODLAND  
HOUSTON, TX 77019  
(713) 522-5755



✓ 150

### CABLE CONVERTER SALE

MAGNAVOX FV-25 - 26 CHANNEL WITH REMOTE CONTROL - VHF-MIDBAND-SUPERBAND - REG \$59.95 - NOW \$49.95

JERROLD JSX-3DIC - 36 CHANNEL WITH IN BAND GATED SYNC DECODER - REG \$209.95 - NOW \$149.95

JERROLD SB-3 - IN BAND GATED GATED SYNC DECODER - USE WITH ANY CONVERTER WITH OUTPUT ON CHANNEL 3 - REG \$149.95 - NOW \$99.95

UHF BLOCK CONVERTER - CONVERTS MIDBAND AND SUPERBAND TO UHF - REG \$39.95 - NOW \$26.95

SEND \$1.00 (REFUNDABLE) FOR CATALOG

ADD \$4.25 SHIPPING/HANDLING FOR EACH UNIT ORDERED

NYS ADD SALES TAX - C.O.D.'S OK

24 HOUR ORDER LINE  
(607) 962-7313

ORDER DIRECT FROM -

**TAYCO COMMUNICATIONS**  
R3-146A NARROWS CREEK ROAD  
CORNING, NEW YORK 14830

✓ 180



## handheld DMM

Keithley Instruments, Inc., has introduced the Model 132 Handheld DMM as their top of the line 3-1/2 digit meter. The unit combines the field service capabilities of Keithley Handheld DMM's with the two most often required additional measurement capabilities, TRMS ac and temperature.



The 132 features unique characteristics: according to Keithley, it is the only handheld DMM which incorporates TRMS and TEMP; carries the lowest price of any handheld TRMS DMM available; and is the only one with an integral TC connector and full probe selection.

Available in both a degree F version (132F) and a degree C version (132C), the 132 has a complete dc voltage range from 200 mV to 1000V with 0.25 percent accuracy, current ranges from 2 mA to 2 A and resistance ranges from 200 ohms to 20 megohms. The 132C measures temperature from -20 degrees to 1370 degrees C, the 132F from 0 degrees F to 2000 degrees F using optional type K thermocouple sensors or probes.

For complete information, contact Keithley Instruments, Inc., 28775 Aurora Road, Cleveland, Ohio 44139. RS#321

## fm transceivers

Amateur-Wholesale Electronics has announced the new PCS-4000 series of FM transceivers. The familiar PCS-4000 covers the 2-meter band plus adjacent CAP and MARS frequencies, from 142 to 149.995 MHz, with 25 watts output. Three new units are now available for 10 meters, 6 meters, and 70 centime-

ters. The PCS-4800 covers 28 to 29.99 MHz in steps of 10 or 20 kHz. The PCS-4500 covers 50 to 53.995 MHz in steps of 5 or 10 kHz. The PCS-4300 covers 440 to 449.995 MHz in steps of 5 or 25 kHz. A 220-MHz unit will soon be available.

The new PCS-4800, PCS-4500, and PCS-4300 employ the same advanced microcomputer chip found in the PCS-4000, providing the versatility and ease of operation found in the 2-meter Azden transceiver. Standard repeater splits, 16 memory channels in two separate banks, up to eight odd splits, dual memory scan, dual programmable band scan, free and vacant scanning modes, and frequency reverse are but some of the features. Each unit has 10 watts or 2 watt selectable output, discriminator scan centering, a digital S/RF meter, busy-channel and transmit LED indicators, and a full 16-key autopatch pad (except for the PCS-4800).

All units come with dynamic remote-function microphone, built-in speaker, mobile mounting bracket, remote speaker jack, and all hardware. The size is 2 inches high by 5-1/2 inches wide by 6-3/4 inches deep. The bright green LED frequency display and illuminated keyboard provide visibility under a variety of ambient conditions. All are designed for mobile or fixed station use.

For further information, contact Amateur-Wholesale Electronics, 8817 S.W. 129 Terrace, Miami, Florida 33176. RS#322

### SSTV/RTTY/CW/FAX tuner

The new "Blinky" Model 959 is a SSTV tuning unit consisting of an op-amp limiter amplifier and six active precision tuned, temperature stable bandpass filters, providing a visual blinking LED indication when a received SSTV, RTTY, FAX, or CW signal is perfectly tuned. The



user simply tunes until all six LED's are blinking at the same time and the SSTV is tuned. For RTTY, FAX, or CW, the user tunes until the first two LED's are blinking (low tones) or the last two LED's (high tone).

"Blinky" Model 959 is made in the United States and sells for \$99.95. For more information, contact TimeKit, P.O. Box 22277, Cleveland, Ohio 44122. RS#324

### digital military time clock

The Model 193A Digital Military Time Format Wall Clock from Benjamin Michael Industries, Inc., features a 1-inch digital display for excel-

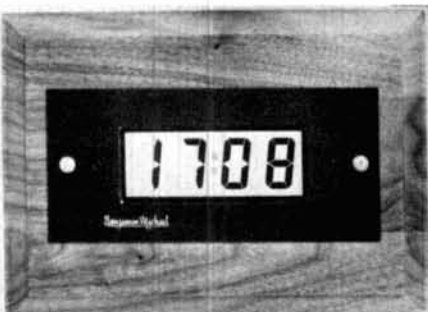

lent visibility. It also features quartz accuracy, total immunity to power line failures and disturbances, and all solid-state construction. The clock will operate for well over one year on a single AA battery.

Housed in a hand-made solid walnut case, the model 193A is priced at \$129.95 plus \$3.00 shipping. For more information, contact Benjamin Michael Industries, Inc., 65 East Palatine Road, Prospect Heights, Illinois 60070. RS#323

## The Best Got Better



MODEL 4381 RF POWER ANALYST

This new generation RF Wattmeter with nine-mode system versatility reads...

IN STOCK QUICK DELIVERY

AUTHORIZED BIRD DISTRIBUTOR

**Webster**  
associates

115 BELLARMINE  
ROCHESTER, MI 48063 ✓ 192

CALL TOLL FREE  
**800-521-2333**  
IN MICHIGAN 313 - 375-0420

## Nampa Satellite SYSTEMS

IDAHO'S LARGEST DEALER

### "HAMS SERVING HAMS" Lowest prices in TVRO INTRODUCING The NSS 80A

.45 F/D Spun Aluminum Dish weighs only 60# - True polar-mount - Quadpod Feed.

— COMPLETE —

SAT-TEC R5000 .....	\$1350
KLM Sky Eye IV .....	1495
Universal Comm. DL2000 ..	1495
AUTO-TECH GLR 500 .....	1595
DRAKE ESR 224 .....	1595
DEXCEL DXP1100-stereo ..	1750
DRAKE ESR 24 .....	1795
Luxor-Stereo .....	1850

All packages include: 8' Spun Aluminum Dish, Polarmount, Polarotor II Polarizer, 110° K LNA, modulator and 100' cables.

— PRODELIN —

10' Dish - .3 F/D - 8 panels - The Ultimate in TVRO Dishes.

— COMPLETE —  
SYSTEM PRICES

SAT-TEC .....	1475
KLM Sky Eye IV .....	1730
Universal Comm. DL2000 ..	1730
AUTO-TECH GLR 500 .....	1750
DRAKE ESR 224 .....	1895
AUTO-TECH GLR 520 .....	1950
DRAKE ESR 24 .....	1995
DEXCEL DXR 1100 with LNC - stereo .....	2095
AUTO-TECH GLR 560 .....	2025
LUXOR STEREO, Infra-Red remote control .....	2125

All packages include 110° K LNA (or LNC), 100' Cable, Modulator, Polarmount, Polarotor II Polarizer.

DEALERSHIPS AVAILABLE

NATIONAL FINANCING  
AVAILABLE WITH AS LITTLE AS  
10% DOWN (O.A.C.)

CALL TOLL FREE  
1-800-654-0795

for info or ordering  
312 12th Avenue South  
Nampa, Idaho 83651

WB6TOC (208) 466-6727 K17D



*Ham Radio's guide to help you find your loc*

### California

#### C & A ELECTRONIC ENTERPRISES

22010 S. WILMINGTON AVE.

SUITE 105

CARSON, CA 90745

213-834-5868

Not The Biggest, But The Best —  
Since 1962.

#### FONTANA ELECTRONICS

8628 SIERRA AVENUE

FONTANA, CA 92335

714-822-7710

714-822-7725

The Largest Electronics Dealer in San Bernardino County.

#### JUN'S ELECTRONICS

3919 SEPULVEDA BLVD.

CULVER CITY, CA 90230

213-390-8003

619-463-1886 San Diego

800-882-1343 Trades

The Home of the One Year Warranty

— Parts at Cost — Full Service.

Habla Espanol

#### SHAVER RADIO, INC.

1378 S. BASCOM AVENUE

SAN JOSE, CA 95128

408-998-1103

Azden, Icom, Kenwood, Tempo,  
Ten-Tec, Yaesu and many more.

### Connecticut

#### HATRY ELECTRONICS

500 LEDYARD ST. (SOUTH)

HARTFORD, CT 06114

203-527-1881

Call today. Friendly one-stop shop-  
ping at prices you can afford.

### Delaware

#### DELAWARE AMATEUR SUPPLY

71 MEADOW ROAD

NEW CASTLE, DE 19720

302-328-7728

800-441-7008

Icom, Ten-Tec, DenTron, Yaesu,

Azden, Santec, KDK, and more.

One mile off I-95, no sales tax.

### Florida

#### AMATEUR ELECTRONIC SUPPLY

1898 DREW STREET

CLEARWATER, FL 33515

813-461-HAMS

Clearwater Branch

West Coast's only full service

Amateur Radio Store.

#### AMATEUR ELECTRONIC SUPPLY

621 COMMONWEALTH AVE.

ORLANDO, FL 32803

305-894-3238

Fla. Wats: 1 (800) 432-9424

Outside Fla: 1 (800) 327-1917

#### AMATEUR RADIO CENTER, INC.

2805 N.E. 2ND AVENUE

MIAMI, FL 33137

305-573-8383

The place for great dependable  
names in Ham Radio.

#### RAY'S AMATEUR RADIO

1590 US HIGHWAY 19 SO.

CLEARWATER, FL 33516

813-535-1416

Your complete Amateur Radio and  
Computer Store.

### Illinois

#### ERICKSON COMMUNICATIONS, INC.

5456 N. MILWAUKEE AVE.

CHICAGO, IL 60630

Chicago — 312-631-5181

Outside Illinois — 800-621-5802

Hours: 9:30-5:30 Mon, Tu, Wed & Fri;

9:30-8:00 Thurs; 9:00-3:00 Sat.

### Indiana

#### THE HAM SHACK

808 NORTH MAIN STREET

EVANSVILLE, IN 47710

812-422-0231

Discount prices on Ten-Tec, Cubic,  
Hy-Gain, MFJ, Azden, Kantronics,  
Santec and others.

### Kansas

#### ASSOCIATED RADIO

8012 CONSER, P. O. BOX 4327

OVERLAND PARK, KS 66204

913-381-5900

America's No. 1 Real Amateur Radio

Store. Trade — Sell — Buy.

### Kentucky

#### L & S RADIO

307 McLEAN AVENUE

HOPKINSVILLE, KY 42240

502-885-8071

Ten-Tec, Azden, Ameritron Sales and  
Service.

### Maryland

#### THE COMM CENTER, INC.

LAUREL PLAZA, RT. 198

LAUREL, MD 20707

800-638-4486

Kenwood, Drake, Icom, Ten-Tec,  
Tempo, Microlog, AEA, Ameritron.

### Massachusetts

#### TEL-COM, INC.

675 GREAT ROAD, RTE. 119

LITTLETON, MA 01460

617-486-3040

617-486-3400 (this is new)

The Ham Store of New England

You Can Rely On.

### Minnesota

#### MIDWEST AMATEUR RADIO SUPPLY

3452 FREMONT AVE. NO.

MINNEAPOLIS, MN 55412

612-521-4662

It's service after the sale that counts.

### Nevada

#### AMATEUR ELECTRONIC SUPPLY

1072 N. RANCHO DRIVE

LAS VEGAS, NV 89106

702-647-3114

Dale Porray "Squeak," AD7K

Outside Nev: 1 (800) 634-6227

#### JUN'S ELECTRONICS

460 E. PLUMB LANE — 107

RENO, NV 89502

702-827-5732

Outside Nev: 1 (800) 648-3962

Icom — Yaesu Dealer

### New Hampshire

#### POLCARI'S ELECTRONICS CENTER

61 LOWELL ROAD

HUDSON, NH 03051

603-883-5005

Southern New Hampshire's only Ham  
Store. Call today for quotes.

### New Jersey

#### ROUTE ELECTRONICS 46

225 ROUTE 46 WEST

TOTOWA, NJ 07512

201-256-8555

#### ROUTE ELECTRONICS 17

777 ROUTE 17 SOUTH

PARAMUS, NJ 07625

201-444-8717

Drake, Cubic, DenTron, Hy-Gain,  
Cushcraft, Hustler, Larsen, MFJ,  
Butternut, Fluke & Beckman  
Instruments, etc.

**Dealers:** *YOU SHOULD BE HERE TOO!*  
*Contact Ham Radio now for complete details.*



# flea market



**RATES** Noncommercial ads 10¢ per word; commercial ads 60¢ per word **both payable in advance.** No cash discounts or agency commissions allowed.

**HAMFESTS** Sponsored by non-profit organizations receive one free Flea Market ad (subject to our editing) on a space available basis only. Repeat insertions of hamfest ads pay the non-commercial rate.

**COPY** No special layout or arrangements available. Material should be type-written or clearly printed (**not** all capitals) and must include full name and address. We reserve the right to reject unsuitable copy. **Ham Radio** cannot check each advertiser and thus cannot be held responsible for claims made. Liability for correctness of material limited to corrected ad in next available issue.

**DEADLINE** 15th of second preceding month.

**SEND MATERIAL TO:** Flea Market, Ham Radio, Greenville, N. H. 03048.

## QSL CARDS

**QSLs & RUBBER STAMPS** — Top Quality! Card Samples and Stamp info — 50¢ — Ebbert Graphics 5R, Box 70, Westerville, Ohio 43081.

**TRAVEL-PAK QSL KIT** — Converts post cards, photos to QSLs. Stamp brings circular. Samco, Box 203-c, Wynant-skill, New York 12198.

**PARTS FOR SALE:** Cleaning out accumulated amplifier parts; tubes, plate, filament and modulation transformers, capacitors, and chokes. SASE. Bill, K3PGB, 1257 Wunderland Road, Roslyn, PA 19001.

**CABLE TV EQUIPMENT,** Channel 3 or 4 notch filter \$20.00. Information \$1.00. Goldcoast, P.O. Box 63/6025G, Margate, FL 33063. (305) 752-9202.

**COLLINS 30S-1,** \$1,650.00. Excellent condition. W5KX, 1732 Willow Point, Shreveport, LA 71119.

**SATELLITE,** Microwave, video, audio components and equipment. Send \$1 for 1983 catalog. DSCO, Department C, 3110 Evelyn Street, Roseville, MN 55113.

## Foreign Subscription Agents for Ham Radio Magazine

Ham Radio Austria  
Karin Ueber  
Postfach 2454  
D-7850 Loerach  
West Germany

Ham Radio Holland  
Postbus 413  
NL-7800 Ar Emmen  
Holland

Ham Radio Belgium  
Sterehouse  
Brusselssteenweg 416  
B-9218 Gent  
Belgium

Ham Radio Italy  
Via Pordenone 17  
I-20132 Milano  
Italy

Ham Radio Canada  
Box 400, Goderich  
Ontario, Canada N7A 4C7

Ham Radio Switzerland  
Karin Ueber  
Postfach 2454  
D-7850 Loerach  
West Germany

Ham Radio Europe  
Box 2084  
S-194 02 Upplands Vasby  
Sweden

Ham Radio France  
SM Electronic  
20 Dis. Ave des Clarions  
F-98000 Auxerre  
France

Ham Radio UK  
P.O. Box 63, Harrow  
Middlesex HA3 6HS  
England

Ham Radio Germany  
Karin Ueber  
Postfach 2454  
D-7850 Loerach  
West Germany

Holland Radio  
143 Greenway  
Greenside, Johannesburg  
Republic of South Africa

**ICOM 211,** \$350.00. Excellent condition. W5KX, 1732 Willow Point, Shreveport, LA 71119.

**KLM PA15-80BL** 2 meter amplifier. 10W-in/80W-out, multimode, mint condx. \$100. MO, bank check. Rich Tashner, N2EO, 163-34 21 Road, Whitestone, NY 11357.

**FOR SALE:** Collins KWM2, PM-2 Collins lightweight AC power supply, Collins mobil mount. Contact by mail Harry E. Lampert, 809 Grim Street, Texarkana, Arkansas 75502.

**CHASSIS** and cabinet kits. SASE K3IWK.

**WANTED:** 4-124A, 4D21, 2E26, 6146A tubes, GE 4EP4A3 P/S. W4BUZ, 1703 Verdun Drive, Rt. 11, Greensboro, NC 27410.

**TENNATEST** — Antenna noise bridge — out-performs others, accurate, costs less, satisfaction guaranteed. Send stamp for details, W8URR, 1025A Wildwood Road, Quincy, MI 49082.

**FOR SALE:** Swap 240, 3 band transceiver. AC and DC supply \$225.00. WA0CKH. R.L. Thompson, 817 Colorado S.W., Huron, SD 57350.

**VLF-LF** preamps, coupler, Loran-C boards. SASE. Burhans Electronics, 161 Grosvenor St., Athens, Ohio 45701.

**SPARK KEYS** wanted for my collection. Also large or unusual radiotelegraph keys, sideswipers, military/spy keys, foreign keys and pre-1950 bugs. K5RW, 1128 Midway, Richardson, TX 75081.

**WANTED:** Kenwood TS-700SP transceiver and MARS-7600 adapter. C.T. Huth, 146 Schonhardt, Tiffin, OH 44883.

**WANTED:** Manuals all precision noise figure indicator 74a, also noise generators 7006, 7010 and 7052. Original or photocopy. Offer to H. Troess, Ostertalstr. 33, D 6680 Neunkirchen, West Germany.

**PRE-1946 TELEVISION SETS** wanted for substantial cash. Finder's fee paid for leads. Also interested in spinning disc, mirror in-the-lid, early color sets, 9AP4 picture tubes. Arnold Chase, 9 Rushleigh Road, West Hartford, Conn. 06117. (203) 521-5280.

**TAPETONE** 6 meter converter with power supply Model XC-50 \$60. Lewis F. Good, 25 Harris Ave., Wellesley, Mass. 02181.

**MUSEUM** now open for radio historians and collectors. Free admission. Old time Amateur (WZAN) and commercial station exhibits, 1925 replica store and telegraph displays. 15,000 items. Write A.W.A. for details: Bruce Kelley, W2ICE, Holcomb, NY 14469.

**COLLECTOR PAYING** cash for Gonset equipment, catalogs, manuals, etc. — unmodified only. State condition and price. F.T. Marcellino, 13806 Parkland Dr., Rockville, MD 20853.

**MOBILE IGNITION SHIELDING.** Estes Engineering, 930 Marine Dr., Port Angeles, WA 98362.

**SELL RCA 7094** tubes, new, your price, make offer. Jim, W4IW, 5012 Perrine Drive, Jacksonville, FL 32210. Tel. (904) 771-3462.

**CABLE CONVERTERS, decoders.** Catalog \$1 refundable. APS, POB 263 HR, Newport, RI 02840.

**TRADE H.P. 208-B** oscilloscope for set of machinist tools from retired machinist or toolmaker. Also have KW Custom built 4-400-A Linear amplifier with vacuum variables, three meters, rack mounted 19" panel, built by Sperry Rand engineer. Like Swiss watch quality. Sell my collection of thirty years receiving tubes, boxed, dollar each. Send me your list of needs for availability and quantities required. W5QJT, P.O. Box 13151, El Paso, TX 79913. Tel. (915) 581-2017.

**IBM-PC RTTY & ASCII.** SASE for full details. E. Alline, NE5S, 773 Rosa, Metairie, LA 70005.

**BUY-SELL-TRADE** Twice monthly publication. SASE for free issue. The Ham Boneyard, 364 Kilpatrick Ave., Port St. Lucie, FL 33452.

**RTTY-EXCLUSIVELY** for the Amateur Teleprinter. One year \$7.00. Beginners RTTY Handbook \$8.00 includes journal index. P.O. Box RY, Cardiff, CA 92007.

**SATELLITE TELEVISION SYSTEM.** Order the 2-year warranted Dexcel/Gould 1100-01 receiver/L.N.C. with precision 9' spun aluminum antenna and ball-bearing polar mount at our call-for-current lowest price (approximately \$1598.00) and we'll complete the system with a Chaparral Polarotor/Control, hook-up assembly, 125' line and installation instructions and assistance. Videosat, Inc., (602) 445-0383, Box 449, Prescott, Arizona 86302.

**HAM HOLIDAY** Sri Lanka. Write to Spangles Travels, 84

Templers Road, Mount Lavinia, Sri Lanka. Enclose 5 IRCs.

**RECEIVERS.** National NC-300 \$95; Hammerlund HQ 100A \$85; Lafayette HR-600 \$35; Knight Star Romer \$30; Hallicrafters HT-18 TX \$25. K6KZT, 2255 Alexander, Los Osos, CA 93402.

**APPLE COMPUTER OWNERS** — Announcing "The Logger" — A very sophisticated, full-featured disk-based log book for ham radio operators. "The Logger" manages over 1900 log entries per standard DOS 3.3 diskette with sixteen separate functions including personalized QSL cards for less than 2 cents each! Unlocked program diskette and User's Guide \$35. pd. U. S. Large SASE for more information. Bob Jackson, Dept. HR, Box 57304, Webster, TX 77598.

**FULL FEATURED,** all speed Baudot and ASCII for your IBM-PC. SASE to: Emile Alline, 773 Rosa, Metairie, LA 70005.

**RS303/U AND FERRITE BEADS** for W2DU's balun (QST March '83) HF \$8, VHF \$6 ppd. Copperweld™ 30% - 18 ga 3c, 14 ga 6c. All Amateur wire and cable (Belden & generic); Larsen, Unadilla, Janel, custom QSL's, crystals. All from Certified Communications. "the CB to 10 meter people", 4138 S. Ferris, Fremont, MI 49412.

**TRADE** Hewlett Packard Oscilloscope Model 120-B for set of machinist tools from retired toolmaker or machinist. Sell collection of 30 years receiving tubes at only a dollar each. Send list of your needs for availability and quantities. W5QJT, P.O. Box 13151, El Paso, TX 79913.

**HALLICRAFTERS \$\$\$** Serious collector needs Hallicrafters and other Ham equipment manufactured before 1940 for restoration and eventual museum exhibit. Need Hallicrafters, National, Hammarlund, Patterson, RCA, RME, Grebe, etc. Condition not important. Also need QST mags Vols. 1 & II and old tubes. All letters answered. Write Dave Medley, WA5YXA, 6621 Duffield Drive, Dallas, Texas 75248.

**LCR BRIDGE** wanted. Prefer one that reads capacitance and inductance reactance in ohms, 0 to 1000 ohms, thru 150 MHz. What have you? W5LCB, Box 54415, Oklahoma City, Okla. 73154.

**WANTED:** Schematics-Rider, Sams or other early publications. Scaramella, P.O. Box 1, Woonsocket, RI 02895-0001.

**SURPLUS ITEMS FOR SALE.** Specific Products standard time and frequency receiver, Model WYYC. Used only 1 yr. Excellent condx. This has a built-in scope. \$385. Lewis F. Good, 25 Harris Ave., Wellesley, Mass. 02181.

**WANTED:** Cash paid for used Speed Radar equipment. Write or call: Brian R. Esterman, P.O. Box 8141, Northfield, Illinois 60093. (312) 251-8901.

**WANTED:** Old RCA, Western Electric tubes. (713) 728-4343. Maury Corb, 11122 Atwell, Houston, Texas 77096.

**WANTED:** Early Hallicrafter "Skyriders" and "Super Skyriders" with silver panels, also "Skyrider Commercial", early transmitters such as HT-1, HT-2, HT-B, and other Hallicrafter gear, parts, accessories, manuals. Chuck Dachs, WD5EOG, The Hallicrafter Collector, 4500 Russell Drive, Austin, Texas 78745.

**COLLINS KW-1** parts wanted. Chuck, Box 766, Dahlgren, Virginia 22448.

**RUBBER STAMPS:** 3 lines \$4.50 PPD. Send check or MO to G.L. Pierce, 5521 Birkdale Way, San Diego, CA 92117. SASE brings information.

**HEATH HR-1680** ham band receiver. 80-10 meters, solid-state, speaker, excellent condition. Great for backup receiver or Novice. \$145. Call Ken at 616-375-6300 work. 616-372-3116 nights or weekends. WB8IKJ.

**RADIO WEST!** High quality coverage communications receivers with Collins filters and other DX modifications! Catalog 50¢ (refundable). Radio West, 3417 Purer Rd., Dept. HR, Escondido, CA 92025. (619) 741-2891.

**ATARI OWNERS** — Amateur Radio software. Dupesheet program with fast machine language search and storage routines, easy to understand manual. Prints, lists, saves and retrieves call signs. 16K tape (2000 calls) \$16.95, 48K disk (5000 calls) \$20.95, ppd. SASE for catalog. Richard M. Donnelly, 2309 McClendon, Houston, TX 77030.

**VERY in-ter-est-ing!** Next 4 issues \$2. Ham Trader "Yellow Sheets", POB356, Wheaton, IL 60189.

**WANTED, MILITARY SURPLUS RADIOS.** We need Collins 618T, ARC-94, ARC-102, 718F-1/2, MRC-95, MRC-108, RT-980/GRC-171, RT-712/ARC-105, RT-804A/APN-171, ARC-114, ARC-115, RT-823/ARC-131 or FM-622, RT-857/ARC-134 or Wilcox 807A, ARC-159, ARC-164, RT-858/APX-72, APN-153, ANTENNA COUPLERS 490T, CU-1658A,



CU1239/ARC-105, CU-1669A, ARC-105, Sperry Rand 3226A1, 3226B1, 690D1, 490B-1. Top dollar paid or trade for new Amateur gear. Write or phone Bill Slep, 704-524-7519, Slep Electronics Company, Hwy. 441, Otto, NC 28763.

**SUPER CQWW CONTEST** programs. TRS-80 Model I, III, (IV in III mode) Completely machine language. Logs 3200+ contacts per band. Automatic identification of country and zone from call letters. Dupe Speed 12000+ contacts per second. Screen displays zones still needed, total points, zones, countries, etc. Automatic cw generator with 2 buffers. Log Print program prepares logs and dupe sheets. \$39.95 Log Preparation program for hand logs. Similar features to above. \$29.95 Free fact sheet and sample printouts. K4SB, 3496 Velma Dr., Powder Springs, Georgia 30073.

## Coming Events ACTIVITIES "Places to go..."

**CONNECTICUT:** The Tri-City ARC Auction, St. James Parish Hall, Poquetanuck, October 29. Setup 9 AM, auction 10 AM until sold out. Admission free. Food available. Talk in on 146.73, 67 or 94 repeaters. For information call WA2RYV (203) 848-9670.

**GEORGIA:** The Alford Memorial Radio Club's 11th annual Hamvention, November 5 and 6, Stone Mountain Park, Stone Mountain. 9 AM to 5 PM Saturday and 9 AM to 3 PM Sunday. FCC exams, seminars, dealers, gigantic flea market, free parking. \$3.00 admission fee includes Saturday night family cookout and variety entertainment. Camping and other amusements at the park. Talk in on 146.16/146.76. For further details: SASE to Lew Howard, W4LHH, 4132 Creek Stone Court, Stone Mountain, GA 30083 or (404) 292-5469.

**INDIANA:** The Allen County Amateur Radio Technical Society will hold their 11th Fort Wayne Hamfest, Allen County Memorial Coliseum, November 13. OSCAR, FSTV/SSTV, Audio and computer forums. Tickets \$2.50 advance (SASE). \$3.00 at door. Children under 12 free. Parking \$1.00. Deadline for advance tickets November 1. Tables \$6.00. Premium tables \$20.00. Talk in .88 and .52. For information: Hamfest Chairman, AC-ARTS, Inc., P.O. Box 10342, Fort Wayne, IN 46851.

**INDIANA:** The Hoosier Hills Ham Club's 22nd annual Hamfest, Sunday, October 9, Lawrence County 4-H Fairgrounds, U.S. 50, Bedford. Admission \$3.00; swap shop \$2.50 with own tables. Gates open 10 AM Saturday, October 8, for flea market setup and campers. Free fish fry, campfire, entertainment, coffee, Saturday night. Talk in on 146.13-73 on 3910 kHz. For information: KA9JTZ, Dick Reistter, Hoosier Hills Ham Club, Box 891, Bedford, Indiana 47421.

**LOUISIANA:** The Twin City Ham Club's Hamfest, Saturday, November 12, West Monroe Convention Center, 8 AM to 5 PM. Dealers — Swap Tables — Fellowship. Talk in 25-85 and 52-52. For information: AE5V, Benson Scott, 107 Contempo, West Monroe, LA 71291.

**LOUISIANA:** Amacom '83, the New Orleans Hamfest-Computerfest, October 15 and 16, Delgado Community College's City Park campus. Sponsored by the Jefferson ARC, Greater New Orleans ARC, the Delta DX Association and the New Orleans VHF Club. Demonstrations, speakers, awards, flea market and commercial exhibits. FCC exams. Admission \$5 advance (incl. two tickets) or \$5 at door (no tickets). Talk in on Jefferson ARC's repeater W5GAD/R on 147.285/885 or 449.0/444.0. For details and reservations: Amacom '83, P.O. Box 73665, Metairie, LA 70033 or call Bill Bushnell, WASMJM, Chairman, at (504) 887-5022. Reservations should be made before October 5.

**MARYLAND:** The Columbia Amateur Radio Association's 7th annual Hamfest, Sunday, October 23, 8 AM to 3:30 PM, Howard County Fairgrounds, 15 miles west of Baltimore. Admission \$3.00. Indoor tailgating and tables \$6.00 additional. Outdoor tailgating \$3.00 additional. Talk in on 147.735/135, 146.52/52. For reservations and information: Ed Wallace, K3EF, 9905 Carillon Drive, Ellicott City, MD 21043.

**MASSACHUSETTS:** The Framingham Amateur Radio Association's 9th annual Fall Flea Market, the largest indoor flea market in New England, Sunday, October 30. We will again be at the Framingham Civic League Building, 214 Concord Street (Route 126) in downtown Framingham. Doors open 10 AM; sellers setup 8:30 AM. Admission \$2.00. Tables \$10.00 (preregistration required). Radio equipment, computer gear, bargains galore! Talk in on 75/15 and 52 direct. For information/reservations: Ron Galka, K1YHM, 3 Driscoll Drive, Framingham, MA 01701.

**MASSACHUSETTS:** The Wellesley Amateur Radio Socie-

ty's annual Fall tailgate flea market, Wellesley High School, Rice Street, Wellesley. Starts 9 AM. Admission \$1.00 for buyers or sellers. Talk in on 147.63/03. For information: Nels Anderson, K1UR, (617) 872-5259.

**MASSACHUSETTS:** The 1983 New England DXCC Dinner, November 5, Concord Lodge of Elks, Baker Avenue, West Concord. DX talk and slide programs, auction begins at 2 PM. Afternoon session \$2.00. Cocktail hour 6 PM followed by a 7-course roast beef dinner. Banquet speaker VK0C/W. Cost for the evening \$14.95. Reservation forms will be mailed in September. Contact Jim Dionne, K1MEK, 31 DeMarco Road, Sudbury, MA 01776.

**MICHIGAN:** The Central Michigan Amateur Radio Club and Lansing Civil Defense Repeater Association will hold their annual Ham Fair, Sunday, October 9, 8 AM to 3 PM, Grand Ledge High School 7 miles west of Lansing. Swap shop, demonstrations, antennas, computers and handcrafted items. Donation \$2.50 adults. Tables 75¢/foot. For information: Rowena Eirod, KA8OBS, 111 Lancelot Place, Lansing, MI 48906, (517) 372-5462; or write Ham Fair '83, P.O. Box 18044, Lansing, MI 48901.

**MICHIGAN:** Electronic Flea Market, Sunday, October 23, Kalamazoo County Fairgrounds, 10 AM to 4 PM. Dealer setup 9:30 AM. Tickets \$2.00 advance; \$2.50 at door. 4 ft. table rental \$2.50 advance; \$3.00 at door. For table reservations and tickets SASE with check to: Ham 10 FM Club of Kazoo, Ken Coasey, KA8RUA, 2825 Lake Street, Kalamazoo, MI 49001.

**NEW ENGLAND:** The Hosstraders will hold their annual autumn swapfest, Saturday, October 8, rain or shine, Deerfield, New Hampshire, Fairgrounds. Admission \$1.00, tailgating included. Friday night camping for self-contained rigs, after 4 PM. Profits benefit Shriners' Boston Burns Hospital. Last May's donation \$2,702.00. For information/map SASE to Norm, WA1IVB, RFD Box 57, West Baldwin, ME 04091; or Joe, K1RQG, Star Rt. Box 56, Bucksport, ME 04416; or Bob, W1GWU, 105 Walton Rd., Seabrook, NH 03874.

**OHIO:** The Northwest Ohio Amateur Radio Club's 9th annual Lima Hamfest, Sunday, October 9, Allen County Fairgrounds (exit 125/126, 1 mile from I-75). Gates open 6 AM. Tickets \$3.00 advance; \$3.50 at gate. Tables \$6.00; half table \$3.50. Free camping, electrical hookup \$7.00. For information/reservations (please enclose check): N.O.A.R.C., Box 211, Lima, OH 45802. Talk in on 146.07/67, 147.63/03, 146.52/52.

**OHIO:** The Marion Amateur Radio Club will hold its 9th annual "Heart of Ohio" Ham Fiesta, Sunday, October 30, 0800 to 1600, Marion County Fairgrounds Coliseum. Tickets \$3.00 advance, \$4.00 at door. Tables \$5.00. Check in on 146.52 or 147.90/30 or 223.34/224.94. For information, tickets or tables contact: Paul Kitzer, W8GAX, 393 Pole Lane Road, Marion, Ohio 43302. (614) 389-5573.

**PENNSYLVANIA:** The R.F. Hill Amateur Radio Club's annual "Winterfest" Amateur Radio Flea Market, Sunday, November 13, Sellersville National Guard Armory, Route 152, Sellersville. Indoor space available \$4.00. Outdoor tailgating \$3.00. Buyers \$2.00. Refreshments on site and nearby. Flying hams land at Pennridge Airport, Perkasie. Talk in on 144.71/145.31 Almont. 146.28/146.88 Souder-ton and 146.52 simplex in local area. For information: P.O. Box 29, Colmar, PA.

**PENNSYLVANIA:** The Irwin Area ARA's Swap & Shop, Saturday, October 15, Circleville V.F.D., off U.S. 30, 3.5 miles west of Penn. Turnpike, exit 7. Flea market, vendors, refreshments, free parking. Talk in on 146.925/325 and 146.52 MHz. For information: Rick Jackson, N3DAA, 39-D Lower Boone Drive, Turtle Creek, PA 15145. (412) 829-1953.

**PENNSYLVANIA:** The Red Rose Repeater Association and SERCOM, Inc., will sponsor a Computerfest, Sunday, October 23, 9 AM to 4 PM, Guernsey Sales Pavilion, east of Lancaster, Rts. 30 and 896. Admission \$3.00. XYL's and children under 14 free. Featuring computers and Amateur Radio equipment. Tailgating \$2.00. Inside tables available by reservation. Talk in on 147.615/015, 146.01/61 and 146.52 simplex. For information: The Computerfest Committee, P.O. Box 5029, Lancaster, PA 17601.

**TENNESSEE:** Hamfest Chattanooga and the State ARRL Convention, October 22 and 23, Chattanooga State Technical Community College, Amnicola Highway, Chattanooga. Forums, contests and non-ham activities. College cafeteria will be serving breakfast and lunch both days. A hospitality party will be held Saturday, October 22, at the Ramada Inn. Phone (615) 894-6110 for reservations and ask for special "Hamfest Chattanooga" rates. Inside dealer and indoor/outdoor flea market spaces available. For information: Hamfest Chattanooga, P.O. Box 3377, Chattanooga, TN 37404 or phone N4DON (404) 820-2065.

**AMSAT** will hold an Amateur Radio Satellite Symposium in conjunction with its annual meeting, Saturday, November 12, Johns Hopkins University Applied Physics

Laboratory, off I-95 between Baltimore and Washington. Program includes tracking OSCAR 10, a report on the W5LFL space shuttle operation, PACSAT and more. Free admission but reservations are required. Contact: AMSAT, P.O. Box 27, Washington, DC 20044 or (301) 589-6062.

## OPERATING EVENTS "Things to do..."

**OCTOBER 1:** The Jackson (TN) Amateur Radio Club will operate special events station K4EP from the historic Casey Jones' Railroad Museum to help celebrate heritage week in Jackson. Operation will be on the lower 25 kHz of the General class phone bands on 80, 40, 20 and 15 meters. All QSL's will be answered with a unique commemorative card. Please SASE. Hams wishing to visit the home of the famous railroader use 147.21 up 600 for information and directions.

**OCTOBER 8 AND 9:** Columbus Day Special Event. Open to Radio Amateurs worldwide. Columbus hams work non-Columbus. Non-Columbus hams work as many Columbus hams as required for certificate. Saturday, October 8, 1400Z to 2400Z, 10 meters phone, 28.6 MHz ± 10 kHz. Sunday, October 9, 1400Z to 2400Z, 15 meters phone 21.4 MHz ± 10 kHz. Exchange name and RST. Score one point for each contact (excluding WBTO). Six points for a WBTO contact. A final score of ten must be submitted within 120 days to be eligible for certificate. Please include SASE. Requests for certificates: Radio Station WBTO, Special Event Coordinator, 280 East Broad St., Columbus, Ohio 43215.

**OCTOBER 8 AND 9:** The Peninsula Radio Operators Society (P.R.O.S.) will operate special event station KB3QV on the grounds of Salisbury State College, Salisbury, Maryland, to help celebrate the Delmarva Folklife Festival. 1600Z to 2100Z both days. Frequencies: 10 through 80 meters General phone bands. QSL information: SASE to P.O. Box 2315, Salisbury, MD 21801.

**OCTOBER 11, 12 AND 13:** The Colquitt County Ham Radio Society will operate club station WD4KOW from the site of the sixth annual Sunbelt Agricultural Exposition, 0900 to 1700 EDT each day. Operations will be in the General portion of the HF bands. Members will be listening for visiting hams on local repeater 146.19/79. Visiting hams are welcome to the Amateur booth at the Expo and to operate the Amateur station. For a special QSL card, please SASE to Colquitt County Ham Radio Society, P.O. Box 813, Moultrie, GA 31768.

**OCTOBER 15 AND 16:** Jamboree on the Air. 0001Z Saturday to 2400Z Sunday. The 26th annual Scouting-ham radio event sponsored by the World Scout Bureau, Geneva, Switzerland. Scouts of all ages are welcome to participate. The World Bureau station, HB9S, the BSA station, K2BSA, and many others will be operating. Exchange friendship greetings, scout talk and experiences. For certificate SASE to Boy Scouts of America, International Division/JOTA cards, 1325 Walnut Hill Lane, Irving, TX 75062-1296. A special pocket patch is available for \$1.00 each pp, any quantity. Send check/M.O. to BSA, International Division/JOTA patch, same address. Frequencies: CW — 3.590, 7.030, 14.070, 21.140, 28.190 MHz. Phone: 3.940, 7.290, 14.290, 21.360, 28.990 MHz plus Novice, RTTY and SSTV frequencies.

**OCTOBER 22 AND 23:** QRP Amateur Radio Club International Fall QSO Party. 1200 UTC Saturday, to 2400 UTC Sunday. Maximum operating time 24 hours. Exchange RS(T), state/province/country and QRP ARCI membership number. Non-members give RS(T), state/province/country and power output. Frequencies: CW — 1810, 3560, 7040, 14060, 21060, 28060, 50360 kHz. SSB — 1810, 3985, 7285, 14285, 21385, 28885, 50385 kHz. Novices and Technicians: 3710, 7110, 21110, 28110. Call CQ QRP de (call sign) CQ QRP Contest etc. Certificates awarded to highest scoring station in each state/province/country with two or more entries. All entries considered for Triple Crowns of QRP award. Send full log data plus separate worksheet showing details, time off the air. None returned. For results and scores include large SASE and one ounce of U.S. postage or IRCs. Logs must be received by November 20, 1983. Send to QRP ARCI Contest Chairman, William Dickerson, WA2JOC, 230 Mill Street, Danville, PA 17621.

**OCTOBER 28:** Suffolk County Radio Club will operate W2DQ from 0000Z, October 28 to 2400Z October 30 to celebrate Suffolk County's 300th birthday. Frequencies: Phone 15 kHz up from lower 40-15 meter General class band edges. Novice 21.135. For a special certificate send large SASE to AC2P.

**OCTOBER 30:** Navy Week Special Event Station. The Laurel, Maryland, ARC will operate K3LDE on board USF Constellation, 1200-2200 UTC. Frequencies: primary 7225, 14225 and 21400 per band cond. Request 3 first-class stamps to cover mailing tube and specially designed certificate to Box 259, Annapolis Junction, MD 20701.

# ANNUAL LAS VEGAS PRESTIGE CONVENTION

# SAROC™



## HACIENDA RESORT HOTEL Las Vegas, Nevada

JANUARY 12-13-14-15, 1984

Cocktail Party hosted by **hamradio** MAGAZINE Friday evening for all **SAROC** exhibitors and **SAROC** Advance or Regular paid registered guests. Ladies' Program on Saturday included with **SAROC** Advance or Regular paid registration at no additional charge for ladies who register. Two HACIENDA RESORT HOTEL Breakfasts or Brunches in the Sunburst room are included with each Advance or Regular paid registration; one on Saturday and one on Sunday. Technical sessions, EXHIBITS, and SWAP TABLES open on Friday and Saturday to all **SAROC** paid registered guests. One SWAP TABLE available free to **SAROC** non-commercial guests holding Advance or Regular paid registration. Main award drawing Saturday afternoon. You must be present to win and ownership of award does not pass until picked up. **SAROC** Advance registration is only \$17.00 per person, if postmarked before January 1, 1984. After January 1, 1984, **SAROC** Regular registration is only \$19.00 per person.

**SAROC** fee of \$2.00 per person for those who want to attend only **SAROC** technical sessions, visit EXHIBIT and SWAP TABLE area. No admission to any function without a **SAROC** paid registration and wearing the **SAROC** registration badge in plain view. **SAROC** coupon book and cellophane badge holder may be picked up at **SAROC** registration desk. Send check or money order to **SAROC**, P.O. Box 945, Boulder City, NV 89005-0945. Refunds will be made after **SAROC** is over to those requesting same in writing and postmarked before January 12, 1984. Special **SAROC** HACIENDA RESORT HOTEL room rate is \$35.00 (plus .50 for telephone and room tax), per night, single or double occupancy. HACIENDA RESORT HOTEL accommodations request via mail to HACIENDA RESORT HOTEL, P.O. Box 15566, Las Vegas, NV 89114 or call toll free 1 (800) 634-6713. Either way they request a FIRST NIGHT'S DEPOSIT TO BE ASSURED A RESERVATION. **SAROC** 1985 scheduled Jan. 10-13.

-----Clip and mail ASAP to **SAROC**, P.O. Box 945, Boulder City, NV 89005-0945.-----

Enclosed is \$\_\_\_\_\_ check or money order (no cash) for \_\_\_\_\_ **SAROC** Advance Registration(s) @ \$17.00 each; after Jan. 1, 1984 **SAROC** Regular Registration is \$19.00 each. Extra drawing tickets for main drawing are \$1.00 ea., limit 5 with each **SAROC** Advance Registration, I want \_\_\_\_\_.

OM \_\_\_\_\_ Please type or print \_\_\_\_\_ Call \_\_\_\_\_ License Class \_\_\_\_\_

YL \_\_\_\_\_ Please type or print \_\_\_\_\_ Call \_\_\_\_\_ License Class \_\_\_\_\_

Address \_\_\_\_\_ Please type or print \_\_\_\_\_ City \_\_\_\_\_

State \_\_\_\_\_ Zip \_\_\_\_\_ Telephone No./AC \_\_\_\_\_

Yes, I want a SWAP Table space (limit one free table per registered guest for Friday and Saturday).

I have attended **SAROC** \_\_\_\_\_ times.  Yes, I plan to attend Ham Radio Magazine Cocktail Party.

I am interested in Antenna, ARRL, Cocktail Party, Computers, CW, DX, FCC, MARS, RTTY, TV, other \_\_\_\_\_

I receive: CQ, Ham Radio Magazine, QST, QCWA, RTTY, 73, Westlink, Worldradio, other \_\_\_\_\_

# SAROC™

P.O. BOX 945, BOULDER CITY, NEVADA 89005-0945

# NEW

## THE



# AMATEUR RADIO CALL DIRECTORY

A new publication from the league which lists in call sign order the addresses of all FCC licensed radio amateurs in the United States and possessions. It also includes a separate listing of all club stations.

ONLY **\$15<sup>75</sup>** POSTPAID

(\$19.75 in Canada and Elsewhere including shipping by surface mail)

Enclosed is \$ \_\_\_\_\_ in U.S. funds or charge \_\_\_\_\_ MASTERCARD \_\_\_\_\_ VISA \_\_\_\_\_ American Express for \_\_\_\_\_ copies of the ARRL Amateur Radio Call Directory(s).

Name \_\_\_\_\_ Call \_\_\_\_\_

Address \_\_\_\_\_

City \_\_\_\_\_ State/Prov \_\_\_\_\_

Zip/Postal Code or Country \_\_\_\_\_

Charge Number \_\_\_\_\_

Good from \_\_\_\_\_ to \_\_\_\_\_

Signature \_\_\_\_\_

THE AMERICAN RADIO RELAY LEAGUE  
225 MAIN ST.  
NEWINGTON, CT 06111

✓ 111

More Details? CHECK — OFF Page 111

# WANTED

HIGHEST PRICES PAID FOR:

## HARRIS RF-301

### &

ASSOCIATED EQUIPMENT

CALL COLLECT: \

### LIBERTY ELECTRONICS, INC.

(212) 925-6048

✓ 158

R-T HV Mark II



### NEW, EASY-TO-USE DESIGN GET TRANSI-TRAP™ LIGHTNING PROTECTION

Protect your valuable equipment from antenna voltage surges caused by nearby lightning, high wind and static build-up. Keeps harmful ARC energy off equipment by safely shunting it to ground. Uses tested, field proven, and replaceable ARC-PLUG™ gas filled ceramic cartridge.

Model LT 200 watts @ 50Ω \$19.95  
Model HT 2kw @ 50Ω \$24.95  
Ruggedized Super Low Loss (.1dB @ 500 MHz)  
Model R-T 200 watts @ 50Ω \$29.95  
Model HV 2kw @ 50Ω \$32.95

See your local dealer or order direct. Pse. include \$2 for shipping and handling. MC and VISA accepted.

## ALPHA DELTA COMMUNICATIONS

P.O. Box 571, Centerville, Ohio 45459  
(513) 435-4772

✓ 106

### GET THE MOST FROM YOUR VIC-20/C64

#### CASSETTE INTERFACE

- \* USE ANY STANDARD CASSETTE RECORDER
- \* CONNECTS TO THE CASSETTE PORT
- \* CONTROLS THE CASSETTE MOTOR
- \* NEEDS NO BATTERIES
- \* COME FROM RECORDER TO RECORDER
- \* THIS IS THE BEST ONE FOR LESS \$\$\$
- \* ONLY \$34.95 POSTPAID. ADD \$2.50 FOR SHIPPING OUTSIDE US. CANADA, MEXICO



#### THE MODEM INTERFACE

- \* CONNECTS TO THE USER I/O PORT
- \* NEEDS NO BATTERIES/SOLDERING
- \* CONNECTS ANY STANDARD MODEM
- \* USE MODEM AUTODIAL/ANSWER FEATURES
- \* COMES WITH A FREE TYPE IN BASIC TERMINAL PROGRAM
- \* ONLY \$24.95 POSTPAID. ADD \$2.50 FOR SHIPPING OUTSIDE US. CANADA, MEXICO



CHARGE OR COD ORDERS CALL

**1-800-227-3800**

ASK FOR OPERATOR 225

PO BOX 12309 DEPT SEATTLE, WA 98111  
BYTESIZE MICRO TECHNOLOGY (206) 236-BYTE

CALL OR WRITE FOR DEALER INFORMATION

# 2 for 1 Performance from MIRAGE

Dual-purpose power amplifiers for HT and XCVR!



- 1-10 Watts Input
- All-mode operation
- 5 year warranty

model:

**B1016 (2 meters)**

1W In = 35W Out

2W In = 90W Out

10W In = 160W Out

with RX preamp!

\$279.95

**C106 (220 MHz)**

1W In = 15W Out

2W In = 30W Out

10W In = 60W Out

with RX preamp!

\$199.95

**D1010 (430-450 MHz)**

1W In = 20W Out

2W In = 45W Out

10W In = 100W Out

\$319.95

There's more, and  
WATT/SWR Meters, too!  
See your nearest Dealer

# MIRAGE MIRAGE MIRAGE

COMMUNICATIONS EQUIPMENT, INC.  
P.O. Box 1393  
Gilroy, CA 95020  
(408) 847-1857  
made in U.S.A.

✓ 164

October 1983 **TR** 105

✓ 121

# SUPER BUYS ON



## YAESU FT-102 high performance HF transceiver

Top of the line from Yaesu at reasonable cost! Covers 160-10 meters including the new WARC bands. Six-digit digital readout, variable bandwidth plus IF shift, variable noise blanker and separate ALC meter with peak hold switch. Built-in speech processor. Built-in power supply for 100, 117, 200 or 234V AC @ 50/60 Hz.

**889.00** List Price 1149.00 Item No. YAEFT102  
Add 8.96 shipping & handling

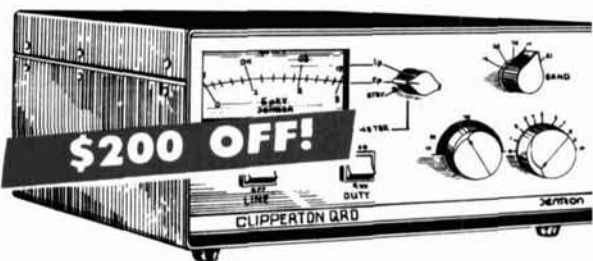

## CLIPPERTON QR07 full power linear HF amplifier

This hefty amplifier offers the best watts-per-dollar buy in amateur radio! Covers 160 through 15 meters and most MARS frequencies. Features 2000 watts PEP input on SSB, adjustable ALC and hi/low power switching. Bypass switch also included. Built-in power supply with forced air cooling. Works on 117V or 234V, AC. Uses four 572B triodes (packed separately).

**599.00** List Price 799.00 Item No. DENQR07  
Add 9.94 shipping & handling



## YAESU FRG-7700 all mode communications receiver

Covers 0.15 to 29.999 MHz. All mode capability SSB (USB, LSB) CW/AM/FM. Features calibrated S-meter, built-in front panel speaker, noise blanker, record jack, built-in on/off timer, selectable AGC, memory, fine tuning and FM squelch. Operates on 100/200/220/240V AC.

**449.10** List Price 499.00 Item No. YAEFRG7700  
Add 4.28 shipping & handling



## KENWOOD TW-4000A mobile 2m/70cm FM transceiver

This new dual band rig covers 142-148.995 and 400.000-449.995 MHz. Features twin digital VFO's, digital frequency display, scannable 10-channel memory plus programmable bandscan. GaAs FET RF amplifier, memory backup, and comes with 16-key autopatch up/down mic and mobile mounting bracket. 25 watts RF output. 13.8V DC required.

**539.95** List Price 599.95 Item No. KENTW4000A  
Add 2.96 shipping & handling



## KENWOOD TR-8400 UHF FM mobile transceiver

Covers 440-450 MHz in 25 kHz steps and features LED frequency display, twin VFO's and 5 memories with memory scan. Fully synthesized operation. Compact, only 5.9"x 2.1"x 7.7" and comes with mounting bracket and mic with up/down scan. RF output 10 watts. Requires 13.8V DC. Now sale priced at Long's!

**299.95** List Price 499.95 Item No. KENTR8400  
Add 9.00 shipping & handling

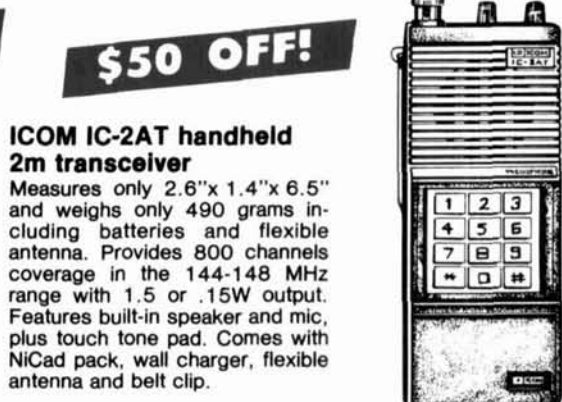

## ICOM IC-2AT handheld 2m transceiver

Measures only 2.6"x 1.4"x 6.5" and weighs only 490 grams including batteries and flexible antenna. Provides 800 channels coverage in the 144-148 MHz range with 1.5 or .15W output. Features built-in speaker and mic, plus touch tone pad. Comes with NiCad pack, wall charger, flexible antenna and belt clip.

**219.00** List Price 269.50 Item No. IC02AT/NICD  
Add 1.98 shipping & handling

# Long's Electronics



MAIL ORDERS: 2700 CRESTWOOD BLVD. BIRMINGHAM, AL. 35210 • SHOWROOM: 3131 4TH AVENUE SOUTH, BIRMINGHAM, AL. 35233

# HAM RADIO GEAR!

**SAVE \$50!**

## YAESU FT-708R 70cm handheld FM transceiver

Features LCD display, 10 memories with memory scan and 440-450 MHz coverage. Built-in keyboard for frequency entry and autopatch functions. Scans up or down in 25 or 50 kHz steps. Hi/low power switch for 200mW or 1W, memory back-up and comes with flexible antenna and rechargeable battery pack.

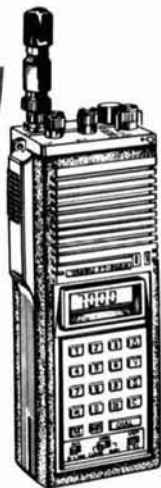

**269.00** List Price 319.00 Item No. YAEFT708R  
Add 1.98 shipping & handling

**\$33 OFF!**

## CUSHCRAFT R3 20/15/10 meter vertical antenna

Offers full performance, yet requires only 1 sq. ft. of mounting space without radials. Covers 20, 15 and 10 meters and comes complete with high Q stabilized traps, all hardware and remote console. Height is 29.9 ft. VSWR 1.2:1 or less.



**296.95** List Price 329.95 Item No. CUSR3  
Add 4.32 shipping & handling

**\$10 OFF!**

## CUSHCRAFT A144-20T Oscar antenna

Offers true circular polarization and 12.2 dB forward gain for extra punch in your signal. You get 38° beam width and the median frequency is 145.9 MHz. Boom length 130 inches. Front to back ratio 20 dB.

**89.95** List Price 99.95 Item No. CUSA14420T  
Add 3.15 shipping & handling



**cushcraft**  
CORPORATION

## CUSHCRAFT A432-20T UHF Oscar antenna

Designed to watch with the A-144-10T in mode J or B and features 10 vertical and 10 horizontal elements for 12.3 dBd circular gain. Boom length 57". Longest element 14". Wind area 0.37 sq. ft. Comes with matching harness for selectable 3-way polarity.

**64.95** Item No. CUSA43220T  
Add 2.37 shipping & handling

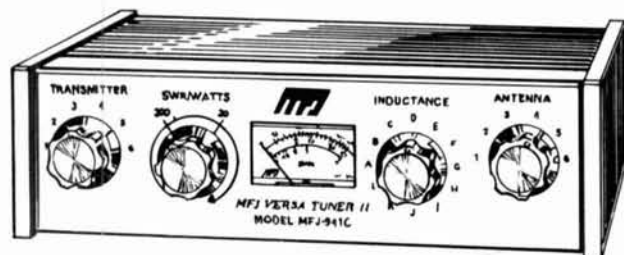
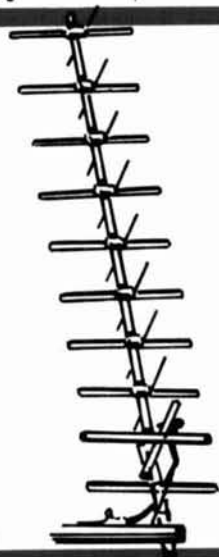

## MFJ 941C Versa Tuner II antenna tuner

Accepts up to 300 watts of RF output. Designed to match any type antenna configuration in the 1.8 to 30 MHz range. Features built-in 1:4 balun, SWR and dual range wattmeter and multiple position antenna switch.

**89.95** Item No. MFJ941C  
Add 2.14 shipping & handling

**SAVE \$120!**

**PLUS \$15 REBATE!**

## Buy the BEARCAT 210XL crystalless scanner & get a \$15 rebate!

This 18 channel scanner covers the six most popular bands. (Low 32-50, High 148-174, 2m Ham 144-148, 70cm Ham 420-450, UHF 450-470 and "T" 570-512 MHz). Features scanning speeds of 5/15 channels per second and AC/DC operation. Buy before Oct. 15, 1983 and get a \$15 rebate from Bearcat.

**229.95** List Price 349.95 Item No. BEABC210XL  
Add 2.24 shipping & handling

Call Toll Free **1-800-633-3410**

IN ALABAMA CALL 1-800-292-8668 9 AM TIL 5:30 PM CST, MONDAY THRU FRIDAY

More Details? CHECK — OFF Page 111

159

October 1983 **77** 107

# RC-85 REPEATER CONTROL BOARD

**NEW!**  
for only \$849.00

SPEECH SYNTHESIS,  
REMOTE PROGRAMMING,  
AUTOPATCH/AUTODIAL,  
LINKING, AND MORE ...  
ALL ON ONE BOARD!

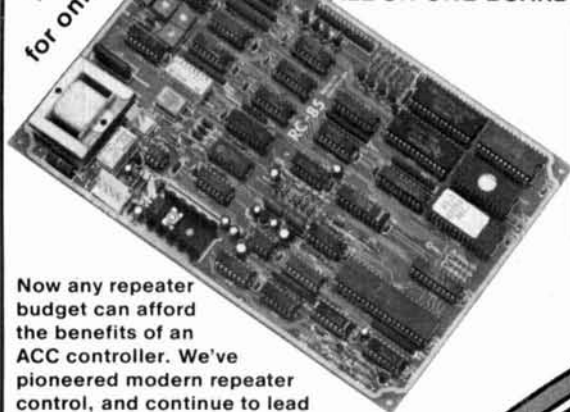

Now any repeater budget can afford the benefits of an ACC controller. We've pioneered modern repeater control, and continue to lead the way in performance, reliability, and value.

Call or write for detailed specifications on the RC-85 Repeater Control Board.

**ACC** advanced computer controls, inc.

10816 Northridge Square • Cupertino, CA 95014  
(408) 749-8330

# Coming in NOVEMBER HAM RADIO SPECIAL RECEIVER ISSUE

Chock-full of state-of-the-art technology.

### Includes:

- Single Sideband Receiver
- Receiver System Design
- EMI Receiver
- Bill Orr, Propagation
- And much more.

Stay tuned for this super special issue.

**ham radio magazine**

Greenville, NH

102

# 25 WATTS...IN THE PALM OF YOUR HAND!



## The Perfect Power Booster for your Hand Held

This compact unit comes complete with dashboard mounting brackets, cigarette lighter power adapter and manual. The unit weighs only 8 oz. and is ready to go!

### MASTER CARD OR VISA

Card No. \_\_\_\_\_ Exp. Date \_\_\_\_\_  
 Signature \_\_\_\_\_  
 Send me \_\_\_\_\_ PA25 units at \$94.50 ea. + tax if applicable  
 To/Name \_\_\_\_\_ Phone \_\_\_\_\_  
 Address \_\_\_\_\_  
 City, State, Zip \_\_\_\_\_

(Ohio residents add 5½% sales tax or 5.20/unit)



835 E. Highland Road • Macedonia, Ohio 44056  
(216) 467-4256 • TWX 810-427-9217

# MOVING? KEEP HAM RADIO COMING...

If possible let us know four to six weeks before you move and we will make sure your HAM RADIO Magazine arrives on schedule. Just remove the mailing label from this magazine and affix below. Then complete your new address (or any other corrections) in the space provided and we'll take care of the rest.

**ham radio**  
Magazine

Allow 4-6 weeks for correction.

Greenville, NH 03048

Thanks for helping us to serve you better.

Here's my new address:

Name \_\_\_\_\_  
 Address \_\_\_\_\_  
 City \_\_\_\_\_ State \_\_\_\_\_ Zip \_\_\_\_\_  
 Call \_\_\_\_\_

**AFFIX LABEL  
HERE**

## MICROWAVE TV ANTENNA SYSTEMS

Freq. 2.1 to 2.6 GHz • 34 db Gain +



TWO YEAR WARRANTY  
PARTS & LABOR

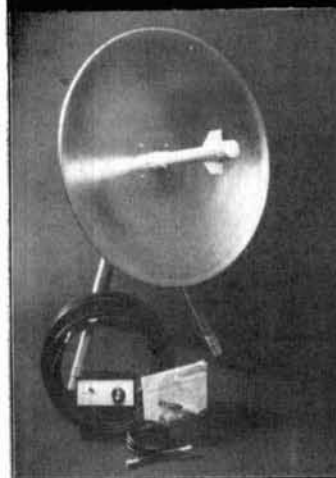

### COMPLETE SYSTEMS

(as Pictured)

Commercial 40"

Rod Style \$ 89.95

Parabolic 20"

Dish Style \$ 79.95

### COMPONENTS

Down Converters

(both types) \$ 34.95

Power Supplies

(12V to 16V) \$ 24.95

Data Info (Plans) \$ 9.95

CALL OR WRITE FOR  
KITS, PARTS, INDIVIDUAL  
COMPONENTS

We Repair All Types Down  
Converters & Power Supplies

**Phillips-Tech  
Electronics**

P.O. Box 34772

Phoenix, AZ 85067

(602) 265-8255

Special Quantity Pricing ☺  
Dealers Wanted



✓ 170



# KCS

## ELECTRONICS CORPORATION

SEMICONDUCTOR PARTS & PRODUCTS

### FACTORY PRIME DEVICES INCLUDE:

- Capacitors  
all types & styles
- Chokes & Coils
- Connectors
- Digital & Linear IC's
- Hardware & Accessories
- IC Sockets
- Memory
- Microwave Semiconductors
- Resistors  
fixed & variable
- Transformers
- Transistors & MORE!

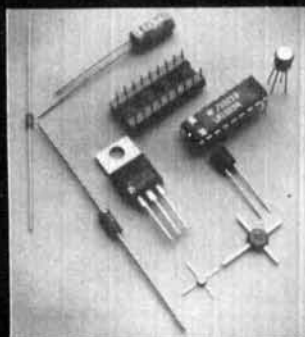

**MANUFACTURERS SUCH AS:** Motorola, National, NEC,  
J.W. Miller, Texas Instruments and more!

**WE STOCK & SUPPLY DEVICES FOR:** OEM's,  
Distributors, Hobbyists, Magazine Projects, Engineers,  
Schools, Technicians & You!

Call or Write for Quantity Pricing  
and FREE Catalog.

P.O. Box 33205  
Phoenix, AZ 85067

**(602) 274-2885**

✓ 154

## Plan Now To Attend The Most "OUT OF THIS WORLD" Event In The History Of Ham Radio!

**COME TO THE ARRL 1984 NATIONAL CONVENTION IN NEW YORK**, the world's greatest city, at the New York Statler July 20-22. Along with the convention's fantastic parties, technical and operating seminars, League committee meetings, banquet, DX gatherings and manufacturers' displays, you and your family can enjoy all there is to do in New York, the cultural capital of the world!

**FOR A TRULY "OUT OF THIS WORLD" EXPERIENCE** we'll be celebrating both the 15th Anniversary of man's first moon landing AND the first off-world amateur radio operation during the STS-9 Spacelab-1 mission. Our special guest will be astronaut **DR. OWEN GARRIOTT, W5LFL**, first ham to operate from space! You can meet W5LFL in person, at the Moon Landing Anniversary Party on Friday evening, July 20th, AND hear him speak at the Banquet on Saturday evening, July 21st.

**IMAGINE, THE MOST IMPORTANT ARRL NATIONAL EVER HELD...AND YOU CAN BE THERE!** Register now to assure your room and banquet reservations. For detailed information and registration forms, SASE to Mike Troy, AJ1J, R.R. 4 - Box 19C, Pound Ridge, NY 10576.

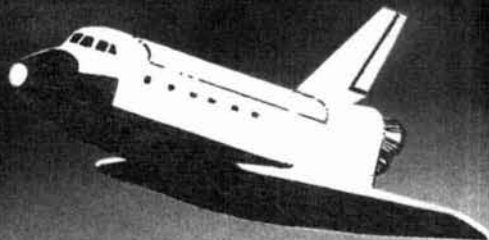

ad prepared by WB2GMK Advertising

# Book Harvest



**\* Call Directory \***

The low-cost answer to your call and QTH questions.

## AMATEURS LISTED BY AREA AND CALL SIGN

It's finally been done. A complete directory of all licensed Radio Amateurs in the U.S. at three-quarters the price of the other well-known book. Similar in layout and appearance but printed on higher quality paper for easier reading, this book is a full 8 1/2" x 11" and is very easy to handle. Generic in appearance but, **oh what a value!** Over 410,000 licensed Amateurs listed. ©1983.

BM-CD

**Softbound \$17.99**  
(\$14.95 + \$3.00 shipping)

## THE UHF COMPENDIUM

Brand New English Edition  
by K. Weiner, DJ9HO

First published in German in 1980 — this book was an instant European best seller. Now available in English, only from Ham Radio Magazine. This hefty, 413 page book is an absolute must for every VHF and UHF enthusiast. The UHF Compendium has been divided into 7 sections to fully cover theory and practical building instructions. Special emphasis has been placed on state-of-the-art techniques such as GaAs Fet preamplifiers and converters. Author Weiner also fully describes all of the test equipment, alignment tools, power measuring equipment and other handy gadgets that will be of use to the UHF/VHF Amateur. All of the projects and designs have been tested and proven and are not engineer's pipe dreams. Antennas are also fully covered with a number of easy-to-build designs as well as large mega-element arrays. Noted VHF enthusiast, Joe Reisert, W1JR, tells us that every ham interested in UHF/VHF should have a copy of this book. Get yours today — only from Ham Radio Magazine.

KW-UHF

**Softbound \$23.95**

## THE FCC RULE BOOK

A Guide to the FCC Regulations  
by Rick Palm, K1CE

This book is more than the FCC part 97 Amateur Rules and Regulations. It presents detailed explanations of rules and is written in an easy-to-read, conversational style. Author Palm gives you the insider's view of how FCC rules are made and how you can influence FCC decisions. You also get a broad overview of how international treaties and agreements impact your hobby. Every U.S. Amateur should have a copy of this most important and up-to-date book in their shack. ©1983, 1st edition.

AR-RB

**Softbound \$3.00**

## RADIO COMMUNICATIONS RECEIVERS

by Cornell Drentea, WB3JZO

Here's a book for every Ham! Complete and detailed history of receivers covering the coherer, the decoherer, Galena crystals, audion and regenerative designs and the tuned frequency receiver. It also includes single, multiple and direct conversions of the superheterodyne design. You get helpful hints and tips on how to solve image problems, selectivity, crystal filters, mechanical and ceramic filters and much, much more. System design, J-fets and synthesizers — it's all here in one complete volume. ©1982, 1st edition.

T-1393

**Softbound \$13.95**

## MICROCOMPUTERS IN AMATEUR RADIO

by Joe Kasser, G3ZCZ

Isn't it time to find out how computers can help you in Amateur Radio? You can use the computer for logging, record keeping and as an operating aid. Hardware and software compatibility is covered along with how to select the right computer. 307 pages. ©1981, 1st edition.

T-1305

**Softbound \$10.95**

## AMATEUR RADIO — THEORY AND PRACTICE

by Robert L. Shrader, W6BNB

W6BNB's Electronic Communication has been considered the absolute "Cadillac" of radio theory license manuals. But the high price of this superb book has kept many from owning a copy. Now Mr. Shrader has come out with a book which presents just those parts of Electronic Communication which are necessary to pass all five classes of Amateur licenses. You save 1/3 off the price of the larger book. A complete guide to Amateur Radio including self-check examinations and quizzes. ©1982, 340 pages (taken from 4th Edition Electronic Communication).

MH-57146

**Softbound \$21.95**

## ARRL ANTENNA BOOK

14th Edition

The Amateur Antenna bible. Includes just about every bit of information you'd ever want to know about antenna design, construction and theory. Starts with wave propagation, antenna fundamentals and transmission line theory, progresses through coupling the transmitter and antenna to the feedline to 9 big, inclusive chapters on how to build different antennas. New large magazine style. ©1982, 14th edition, 200 pages.

AR-AM

**Softbound \$8.00**

## PACKET RADIO

by Robert Rouleau, VE2PY and Ian Hodgson, VE2BEN

Packet Radio could be one of the most important technological developments in Amateur Radio this decade. You should make yourself aware of all the amazing things packet radio can do for you. This comprehensive source-book explains all the principles of packet radio in a non-technical language. You'll learn all about modulation, bandwidths, polling, random access, data rates and more. Plus there is an overview of how the computer is integrated into the packet concept with discussions on the software and peripheral equipment. Finally, the authors give you a detailed description of a packet system in current use. ©1981, 1st Edition, 304 pages.

T-1345

**Softbound \$11.95**

## HEIL HAM RADIO HANDBOOK

by Bob Heil, K9EID

Bob Heil is one of Ham Radio's most dynamic fellows. Dayton's Ham of the Year for 1982 and author of the best selling "10 Meter FM Handbook", he has now come out with a handy handbook for all levels of Amateur Radio interest. 20 chapters cover every aspect of Ham Radio from Day #1 as a new Novice through operating procedures to some basics on how to repair and troubleshoot equipment. Great pains were taken to ensure that 99% of the "most-often-asked" questions are fully and clearly answered. Of particular interest are five chapters dedicated to the art of how to Homebrew. Tools, techniques, p.c. boards and much more. A great gift for a new ham. ©1983, 168 pages.

MP-HH

**Softbound \$9.95**

## HAM RADIO LOGBOOK

A real Ham Radio bestseller. Lies flat just like the other one. But uses both sides of each page to give you twice as many entries per book! Plenty of e-x-i-t-a features make this the Logbook for you. 8 1/2" x 11". ©1982.

HR-LB

**Spiralbound \$2.50 ea.**  
**SPECIAL 3 Logs for \$4.95**



## 2ND OP

by Jim Rafferty, N6RJ

The 2nd Op is an indispensable operating aid for all Radio Amateurs. Gives you at the twist of a dial: prefixes in use, continent, zone, country, beam heading, time differential, postal rates, QSO and QSL record and the official ITU prefix list. Every ham needs a 2nd Op. Order yours today. ©1981, N6RJ's 1st Edition.

HR-OP

**SPECIAL \$4.95**



## CONFIDENTIAL FREQUENCY LIST

5th Edition

by Oliver P. Ferrell

Enjoy tuning across the bands looking for who-knows-what? This book is jam-packed with frequencies and call signs. Hundreds of stations are listed first by frequency and then by callsign. You also get helpful hints and tips. Author Ferrell is known worldwide as one of the most knowledgeable folks around when it comes to SWling. ©1983, 5th edition, 249 pages.

GL-CF

**Softbound \$10.99**

## AMECO AMATEUR LICENSE GUIDES

by Martin Schwartz, W2OSH

Each of these useful books contains a sample FCC-type examination, plus the FCC study questions along with easy-to-understand answers. The questions are grouped according to subject for easier study. Novice, Technician, Advanced and Extra include latest FCC exam information. Latest edition available.

16-01 Advanced Class — 64 pages — **\$1.95**

17-01 Extra Class — 64 pages — **\$1.95**

7-01 Novice Class License Guide — 32 pages **\$1.50**

12-01 General Class License Guide — 64 pages **\$1.99**

## KANTRONICS THEORY CASSETTES

Designed for folks on the run. All you have to do is drop it in the cassette at home, work, or in the car and listen to an interview-style tape covering Novice, General, Advanced or Extra class theory. A great way to reinforce other study methods.

KT-NT Novice Study Tape **\$6.95**

KT-GT General Study Tape Set (2 tapes) **\$11.95**

KT-GQ General Q&A Tape **\$6.95**

KT-AT New Advanced Study Tapes **\$11.95**

(2 tapes)

KT-ET New Extra Study Tape **\$6.95**

## RF CIRCUIT DESIGN

by Chris Bowick, WB4UHY

This book has been written for those who desire a practical approach to the design of rf amplifiers, impedance measuring devices and filters. Experts will find this book to be an invaluable reference source. Students will gain a way to bridge from classroom studies to practical application. The hobbyist will find plenty of practical projects and design ideas. 7 chapters cover from basics to advanced design concepts. You get a complete design run down for multiple pole Butterworth, Chebyshev and Bessel filters. RF Circuit Design also includes a bibliography of books and technical papers to help further your knowledge of circuit design. ©1983, 176 pages, 1st edition.

21868

**Softbound \$22.95**

Please include  
**\$2.50 for shipping and handling.**

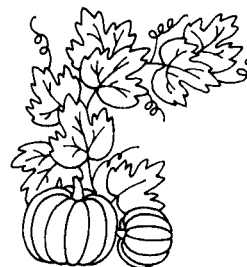

✓ 146

**IN A HURRY? CALL TODAY (603) 878-1441 — CHARGE CARD & COD ORDERS ONLY.**  
**HAM RADIO'S BOOKSTORE**  
**GREENVILLE, NH 03048**



# Advertisers check-off

... for literature, in a hurry — we'll rush your name to the companies whose names you "check-off"

Place your check mark in the space between name and number. Ex: Ham Radio  234

Ace Comm. 101	KCS Elec. 154
ACC 102	KLM Elec. 155
AEA 103, 306	Kantronics 156
ARR 104	Keithley
All Elec. 105	Instruments 321
Alpha Delta 106	Kenpro 157
AEE 107	Kenwood * *
Aluma 108	Kilo-Tec 316
AES 109	Larsen 314
Amateur-Wholesale 110, 322	Liberty Elec. 158
ARRL 111	Long's 159
ATV Magazine 113	Lunar Elec. 160
BBC Metrawatt 302	MFJ 161
BHC, Inc. 317	M M Newman Corp. 312
BMG Eng. 114	Macrotronics 162
Barker & Williamson 115	Madison Elec. 163
Barry *	Micro Digital Tech. 309
Bauman Sales 116	Mirage Comm. 164
Benjamin Michael 323	Morning Dist 165
Bird Elec. 319	Mosley 197
Buckmaster 117, 118	NGC 166
Butternut *	NES, Inc. 318
Bytesize Micro 120, 121	Nampa Satellite 167
California Eastern Lab. 122	Nemal Elec. 168
Calvert Elec. 112	Nuts & Volts 169
Calvert Instruments 196	P. C. Elec. *
Ceco 124	Phillips-Tech 170
C. I. A. *	Polyphaser 305
Centurion 125	Pro Search 171
Col Atch Co 126	RF Products 172
Comm. Concepts 127	Callbook 173
Comm. Spec. 128	Random Access 174
Comp Trader 129	S & W Elec. 175
Cushcraft 301	SAROC *
Direct Video 130	Satellite TV Mag. Spectronics * 176
Dokay 131	Spectrum Inter. 177
Doppler 132	Snyder Antennas 303
DX Tours 133	Spectrum West 178
Electra 134	Spi-Ro Dist 179
Elec. Spec. 135	Tayco Comm. 180
Encomm 136	Telex Comm. 181
Eng. Consulting 137	Telphone 182
European Mgmt 138	TE Systems 182
Flesher Corp. 139, 304	TimeKit 324
Fox Tango 140	Total Television 315
GLB Elec. 141	Transleteronic 183
Galaxy Elec. 142	Tri-Ex Tower 184
Gizmo Elec. 143	Triton Marketing 185
Hal Comm. 144, 311	Tucson Amateur Packet Radio 186
Ham Industries 208	Ungar 187
Ham MasterTapes 145	UNR Rohn 188
H. R. B. 146	Vanguard Labs. 190
Hamtronics 147	Varian 191
Hatry Elec. 148	Webster Comm. 192
Heil Sound 149	Westcom Eng. 193
Hudson Hamfest *	Western Elec. 194
Hustler 307	Winders & Geist 313
Hutchinson Co. 150	Yaesu 195
Icom 151, 310	
I T S. 152, 320	
Jan Crystals 153	

\*Please contact this advertiser directly.

Limit 15 inquiries per request.

**October 1983**

Please use before November 30, 1983

Tear off and mail to

HAM RADIO MAGAZINE — "check off"  
Greenville, N. H. 03048-0498

NAME .....

CALL .....

STREET .....

CITY .....

STATE ..... ZIP .....

## OCTOBER FALLING PRICES

SIGNAL ONE Milspec 1030.....	\$4995.00
AEA MM2.....	140.00
CK2.....	129.00
KT2/KT3.....	99.00 ea.
HAL ST6K.....	229.00
<b>TOKYO HYPOWER</b>	
HC200 Tuner.....	89.00
HC2000 Tuner.....	289.00
HL10160V Amp.....	289.00
HL30160V Amp.....	249.00
KDK 2030 2MFM.....	259.00
SANTEC ST144µP.....	279.00
ST440µP.....	299.00
ST7T.....	230.00
MAXON 49S TX FM Headset Vox.....	39.95
Every club should have a pair!	
SHERWOOD/WELZ.....	10% off list
ROCKWELL KWM380.....	3995.00
COAX SEAL.....	2.00
<b>BENCHER ST2</b>	
Chrome single lever.....	45.00
BIRD 43 & elements.....	Stock
JERSEY SPECIALTY RG213.....	29¢/ft.
RG8X.....	14¢/ft.
450 ohm open wire.....	20¢/ft.
AMPHENOL PL259 silverplate.....	1.25
VAN GORDON Dogbone insulator.....	50¢
WORLD RADIO TV handbook.....	17.50
VIBROPLEX.....	10% off list
<b>BELDEN CABLE</b>	
9258 RG8x.....	19¢/ft.
8214 RG8 foam.....	39¢/ft.
8237 RG8.....	36¢/ft.
8235 300 Ohm kW twinlead.....	20¢/ft.
8000 14 Ga. stranded ant.....	10¢/ft.
8267 RG213.....	46¢/ft.
8448 rotorcable.....	27¢/ft.
9405 heavy rotor cable.....	45¢/ft.
<b>SURPLUS</b>	
TCG 2.5A/1000 PIV epoxy diode.....	19¢
Sprague 500 pF/30kv doorknob capacitors.....	16.00
1000pF/500V Feedthru.....	1.95
CDE .001/20kV.....	1.95
6"x9" copper board.....	2.00
Resistors 1/4, 1/2, 1, 2 Watt.....	10¢ ea.
Caps to 1mFD, 100V.....	25¢ ea.
<b>USED - Subject to prior sale</b>	
COLLINS 75A4.....	295.00
75S1.....	200.00
32S1/AC.....	350.00
DRAKE TR4C/AC4.....	395.00
RV4C.....	100.00
HENRY 3KA.....	1295.00
KENWOOD TS520S (gem).....	395.00
<b>RF POWER LABS</b>	
A1000, C500X demos.....	995.00
COLLINS KWS1/75A4 parts.....	Call
75S1/32S1 parts.....	Call

**MADISON NOTE** - We will talk trades on new equipment, and our used equipment is backed by our reputation. Don't hesitate to try us. We answer our own phones and will deal with our customers one on one... the only way we do business.

Call on Tentec trades

# MADISON Electronics Supply

1508 McKinney  
Houston, Texas 77010  
713-658-0268  
TOLL FREE - ORDERS ONLY  
1-800-231-3057

## Advertisers iNdex

Ace Communications.....	22
Advanced Computer Controls.....	108
Advanced Electronics Applications.....	15
Advanced Receiver Research.....	91
All Electronics.....	86
Alpha Delta Communications.....	105
Alternative Energy Engineering.....	101
Aluma Tower Co.....	86
Amateur Electronic Supply.....	46, 47
Amateur Wholesale Electronics.....	83
American Radio Relay League.....	105
ATV Magazine.....	84
BMG Engineering.....	86
Barker & Williamson.....	9
Barry Electronics.....	60
Bauman Sales, R. H.....	62
Buckmaster Publishing.....	70, 96
Butternut Electronics.....	79
Bytesize Micro Technology.....	98, 105
California Eastern Laboratories.....	5
Calvert Electronics.....	16
Calvert Instruments, Inc.....	29
Ceco Communications.....	30
Central Intelligence Agency.....	101
Centurion International.....	93
Col Atch Co.....	94, 95
Communications Concepts, Inc.....	91
Communications Specialists.....	85
Computer Trader.....	79
Direct Video Sales.....	70
Dokay Computer Products, Inc.....	74, 75
Doppler Systems.....	60
DX Tours.....	101
Electra.....	28
Electronic Specialists.....	84
Encomm, Inc.....	30
Engineering Consulting.....	62
European Management Corp.....	22
Flesher Corp.....	21
Fox Tango Corp.....	96
GLB Electronics.....	37
Galaxy Electronics.....	96
Gizmo Electronics.....	79
Hal Communications Corp.....	49
Ham Industries, Inc.....	108
Ham MasterTapes.....	41
Ham Radio's Bookstore.....	33, 48, 54, 70, 73, 89, 91, 108, 110
Hamtronics, N. Y.....	68, 69
Hatry Electronics.....	37
Heil Sound.....	97
Hudson Hamfest.....	109
Bob Hutchinson Co., Inc.....	98
Icom America, Inc.....	Cover II, 27
International Telecommunications Systems.....	92
Jan Crystals.....	84
KCS Electronics.....	109
KLM Electronics.....	21
Kantronics, Inc.....	63
Kenpro.....	48
Kenwood Communications.....	2, Cover IV
Liberty Electronics.....	105
Long's Electronics.....	106, 107
Lunar Electronics.....	84
MFJ Enterprises.....	1
Macrotronics.....	30
Madison Electronics.....	111
Mirage Communications.....	105
Morning Distributing.....	62
Mosley Electronics.....	57
NGC.....	9
Nampa Satellite Receiver Systems.....	99
Nemal Electronics.....	89
Nuts & Volts Magazine.....	52
P. C. Electronics.....	86
Phillips-Tech Electronics.....	109
Pro Search Electronics.....	56
RF Products.....	60
Radio Amateur Callbook, Inc.....	96
Random Access, Inc.....	16
S & W Electronics.....	22
SAROC.....	104
Satellite TV Magazine.....	60
Spectronics.....	62
Spectrum International.....	48
Spectrum West.....	52
Spi-Ro Distributing.....	79
Tayco Communications.....	98
Telex Communications.....	112
Telphone.....	52
TE Systems.....	89
Transleteronic, Inc.....	77
Tri-Ex Tower Corp.....	52
Triton Marketing Corp.....	55
Tucson Amateur Packet Radio.....	54
Ungar.....	16
UNR Rohn.....	92, 98
Vanguard Labs.....	62
Varian/Eimac.....	7
Webster Communications.....	99
Westcom Engineering.....	89
Western Electronics.....	22
Yaesu Electronics Corp.....	Cover III

# Introducing the **hy-gain**® **EXPLORER 14**

## Remarkably Compact, High Performance Broadband Tribander with Quad-Band Option

### New Para-Sleeve Design

The Explorer 14 is a new antenna design we call PARA-SLEEVE which uses an "open-sleeve" dipole optimized for maximum bandwidth and directivity. Here is the concept. A central dipole, driven directly by the transmission line, has a 1/2 wave resonance on the lowest operating frequency. Two shorter sleeve elements, tightly coupled to the central dipole, modify its impedance to create a 1/2 wave resonance to the highest operating frequency. This para-sleeve system is expanded by the addition of 15 meter traps and 20 meter element tips. A revolutionary new concept for HF tribanders. So unique, we've applied for a patent.

### Broadband Performance

The Explorer 14 will load solid state transceivers to maximum output with VSWR below 2:1, eliminating the need for an antenna tuner. You'll have edge to edge broadband

performance on 20, 15 and 10 meters with gain and front-to-back ratio competitive to giant tribanders that cost twice as much or more. You'll be able to work stations you cannot even hear with a dipole antenna. And, the Explorer 14 handles maximum continuous legal power with a respectable safety margin.

### Short Boom Save Space and Money

If your space or budget was too limited for a long boom tribander, chances are the Explorer 14 will fit both. The boom is only 14' (4.3 m) long and the turning radius requires only 17'3" (5.3 m). The compactness of the Explorer 14 reduces its overall weight and windload surface so you can mount it on a roof tripod, a mast or a tower. For example, the Hy-Gain CD-45II rotator and HG52 tower are a perfect match for the Explorer 14. This saves you the cost of an extra heavy duty rotator and tower.

### Superior Construction

The Explorer 14 includes passivated stainless steel hardware and heavy gauge, pre-formed element and mast brackets. High grade 6063-T832 thick wall swaged aluminum tubing is used throughout. A BN86 balun is included and a new Beta Multi-Match provides DC ground to reduce lightning hazard and precipitation static. It's a rugged, easily assembled antenna that survives winds to 100 mph (160 km/h).

### Quad Band Option

You can add a fourth band, either 30 meters or 40 meters to the Explorer 14 with the QK-710 kit. A kit that attaches to the central dipole and is easily adjusted for either 30 meters (WARC) or 40 meters at minimal extra cost.



Lew McCoy, WIICP, is among the most authoritative writers in amateur radio. For over 30 years he served on the ARRL technical staff with his last position as assistant senior technical editor. Presently he is the technical writer for CQ magazine. Here is what he had to say about the Explorer 14:

"In my opinion, with Explorer 14, Hy-Gain produced a truly high gain, high performance antenna in a small package. The "para-sleeve" design provides the amateur a whole new ball game, particularly in the area of broadbanding. I was really surprised when I actually verified the gain, front-to-back and bandwidth during my recent visit to the Hy-Gain labs and antenna range in Lincoln, Nebraska. The Explorer 14 is a winner."

### Specifications:

Frequencies of operation:	Electrical		
	20M	15M	10M
Under 2:1 VSWR (MHz)	14.0-14.35	21.0-21.45	28.0-29.7
Maximum F/B Ratio (dB)	27	27	21
Maximum Gain (dB)	7.5	8.0	8.0
Maximum Power	Maximum Legal DC Ground		
Mechanical			
Boom Length	14'1 1/2" (4.3 m)		
Turning Radius	17'3" (5.3 m)		
Net Weight	43 lbs. (19.5 kg)		
Wind Surface Area	7.5 sq. ft. (.69m <sup>2</sup> )		

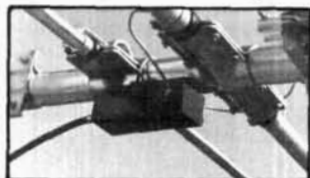
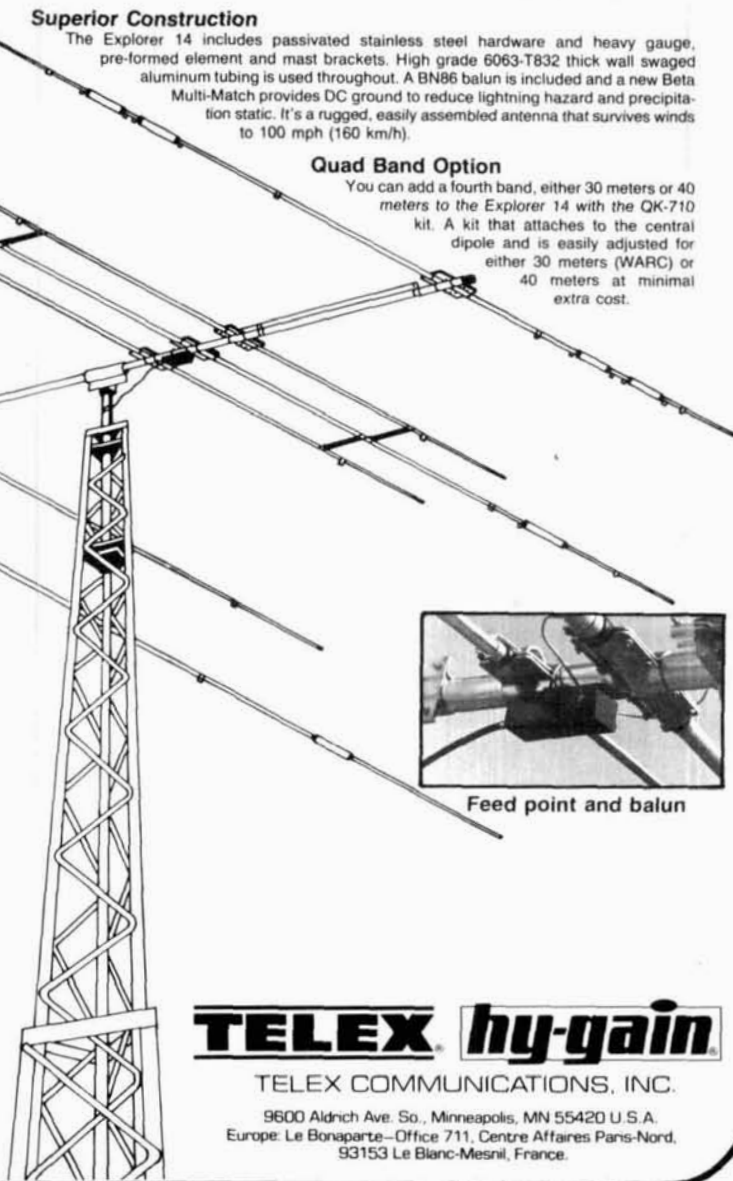

Feed point and balun

## TELEX hy-gain

TELEX COMMUNICATIONS, INC.

9600 Aldrich Ave. So., Minneapolis, MN 55420 U.S.A.  
Europe: Le Bonaparte—Office 711, Centre Affaires Paris-Nord,  
93153 Le Blanc-Mesnil, France.

# FT-230R: QUITE A SIGHT! (AND EASY TO SEE, TOO!!)

Sporting an all-new Liquid Crystal Display, the FT-230R is Yaesu's high-performance answer to your call for a very affordable 2 meter mobile rig with an easy-to-read frequency display! The FT-230R combines microprocessor convenience, a sensitive receiver, a powerful yet clean transmitter strip, and the new dimension of LCD frequency readout. See your Authorized Yaesu Dealer today — and go home with your new FT-230R!



- LCD five-digit frequency readout with night light for high visibility day or night.
- Two VFOs for quick QSY across the band.
- Ten memory slots for storage and recall of favorite channels.
- Selectable synthesizer steps (5 kHz or 10 kHz) in dial or scanning mode.
- Priority channel for checking a favorite frequency for activity while monitoring another.
- Unique VFO/Memory Split mode for covering unusual repeater splits.
- Up/Down band scan plus memory scan for busy or clear channel. Scanning microphone included in purchase price.

- Full 25 watts of RF power output from extremely compact package.
- Built-in automatic or manual tone burst.
- Optional synthesized CTCSS Encode and Encode/Decode boards available.
- Lithium memory backup battery with estimated lifetime of five years.
- Now available: FT-730R  
10 watt 440-450 MHz FM Mobile Transceiver

And don't forget! Yaesu has a complete line of VHF and UHF handheld and battery portable transceivers using LCD display!!!

FT-208R  
FM Handheld  
2 Meters

FT-708R  
FM Handheld  
70 cm



FT-290R - 2 Meters  
SSB/CW/FM Portable

FT-690R - 6 Meters  
USB/CW/AM/FM Portable

FT-790R - 70 cm  
SSB/CW/FM Portable  
430-440 MHz

Price and Specifications Subject To  
Change Without Notice or Obligation

**YAESU**  
*The radio.*



482R

# FM "Dual-Bander"

**NEW**



**2 m & 70 cm in single compact package, LCD, 25 W, optional voice synthesizer.**

## TW-4000A

**KENWOOD's TW-4000A FM "Dual-Bander" provides new versatility in VHF and UHF operations, uniquely combining 2 m and 70 cm FM functions in a single compact package.**

### TW-4000A FEATURES:

- **2 m and 70 cm FM in a Compact Package**  
Covers the 2 m band (142.000-148.995 MHz), including certain MARS and CAP frequencies, plus the 70 cm FM band (440.000-449.995 MHz), all in a single compact package. Only 6-3/8 (161)W x 2-3/8 (60)H x 8-9/16 (217)D inches (mm), and 4.4 lbs. (2.0 kg).
- **Large, Easy-to-Read LCD Display**  
A green, multi-function back-lighted LCD display for better visibility. Indicates frequency, memory channel, repeater offset, "S" or "RF" level, VFO A/B, scan, busy, and "ON AIR." Dimmer switch.
- **25 Watts RF Power on 2 m/70 cm.**  
Hi/Lo power switch.
- **Optional "Voice Synthesizer Unit"**  
Installs inside the TW-4000A. Voice announces frequency, band, VFO A or B, repeater offset, and memory channel number.
- **Front Panel Illumination**

- **10 Memories with Offset Recall and Lithium Battery Backup**  
Stores frequency, band, and repeater offset. Memory 0 stores receive and transmit frequencies independently for odd repeater offsets, or cross-band operation.
- **Programmable Memory Scan**  
Programmable to scan all memories, or only 2 m or 70 cm memories. Also may be programmed to skip channels.
- **Band Scan in Selected 1-MHz Segments**  
Scans within the chosen 1-MHz segment (i.e., 144.000-144.995 or 440.000-440.995, etc.). The scanning direction may be reversed by pressing either the "UP" or "DOWN" buttons on the microphone.
- **Priority Watch Function**  
Unit switches to memory 1 for 1 second each 10 seconds, to monitor the activity on the priority channel.
- **Common Channel Scan**  
Memory 8 and 9 are alternately scanned every 5 seconds. Either channel may be recalled instantly.
- **Dual Digital VFO's**  
Selectable 5-kHz or 10-kHz for 2 m, and 5-kHz or 25-kHz for 70 cm. Depress "UP" or "DOWN" key on the front panel for band change in 1-MHz steps.
- **16-Key Autopatch UP/DOWN Microphone (Supplied)**
- **Repeater Reverse Switch**

- **High Performance Receiver/Transmitter**  
GaAs FET RF amplifiers on both 2 m and 70 cm, high performance MCF's in the 1st IF section, provide high receive sensitivity and excellent dynamic range. The high reliability RF power modules assure clean and dependable transmissions on either band.
  - **Rugged Die-cast Chassis**
  - **Optional Two-Frequency CTCSS Encoder**  
Easily mounted inside the radio, allows DIP switch programming of two different tone frequencies, for 2 m and 70 cm.
  - **"BEEPER" sounds through speaker.**
  - **Easy-to-Install mobile mount**
- TW-4000A accessories:**
- **VS-1 Voice Synthesizer**
  - **TU-4C Two-Frequency Programmable CTCSS Encoder**
  - **KPS-7A Fixed station power supply**
  - **SP-40 Compact mobile speaker**

More information on the TW-4000A and TS-780 is available from all authorized dealers of Trio-Kenwood Communications, 1111 West Walnut Street, Compton, California 90220.

# KENWOOD

...pacesetter in amateur radio

## All mode "Dual-Bander"

### TS-780

**2 m & 70 cm all mode, dual digital VFO's, 10 memories, scan, IF shift...**

### TS-780 FEATURES:

- USB, LSB, CW, FM all mode, covering the 2 m band (144.000-148.000 MHz) and the middle 70 cm band (430.000-440.000 MHz). UP/DOWN band switch.
- Dual digital VFO's with normal/tight drag switch. VFO steps in 20-Hz, 200-Hz, 5-kHz, or 12.5-kHz, plus "FM CH" channel-
- ized tuning. Split (cross) frequency operation possible. F. LOCK switch provided.
- 10 memories include band and frequency data, backed up by internal batteries (not supplied). Battery life exceeds one year. Memories 9 and 10 for priority instant recall.
- Band scan, with selectable 0.5, 1, 3, 5, and 10-MHz scan bandwidth.
- Memory scan selectable for all memories, or 2 m or 70 cm only.
- IF shift circuit rejects adjacent interference.
- High sensitivity and wide dynamic range • 7-digit

fluorescent tube digital display  
• 10 watt RF output • 2 m  $\pm$ 600-kHz TX offset switch with reverse switch • Tone switch for optional TU-4C two frequency tone

encoder unit • VOX and semi break-in CW built-in • FM center-tune meter • Noise blanker for SSB, CW.

Subject to FCC approval

