

ham radio

magazine

- a full-size, lightweight quad
- operation upgrade: part 9
- phase-lock techniques for frequency control
- curing obnoxious autopatch habits

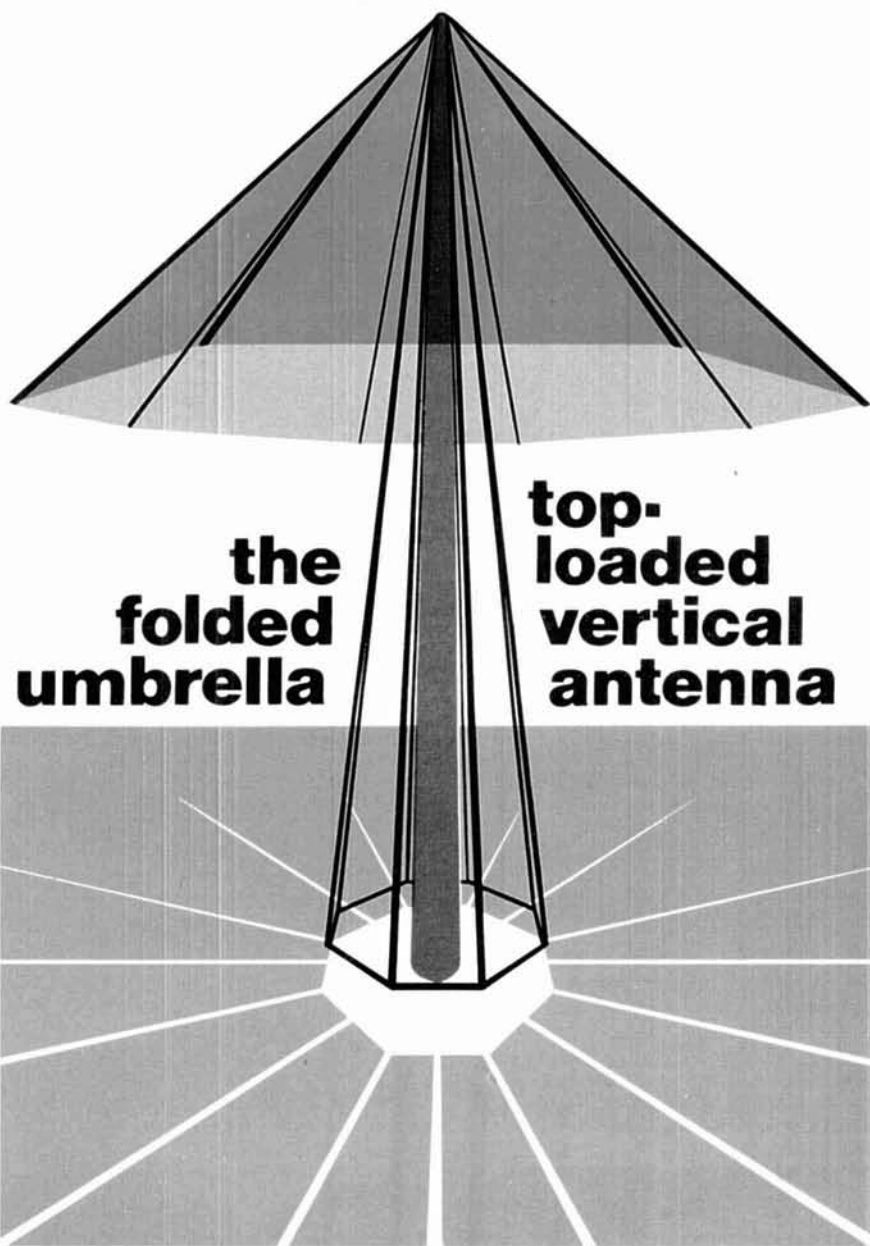

hr

*focus
on
communications
technology*

ICOM Handhelds

2 Meter, 220 or 440 MHz

ICOM's reliable, field proven, handhelds have been the most popular handheld on the market. Here's a few reasons why:

THE TRANSCIVERS. The IC-2AT features full coverage of the 2 meter ham band. The IC-3AT covers 220 to 224.99 MHz, and the IC-4AT has 440 to 449.995 MHz. Each radio is only 2.6in x 1.4in x 6.5in in size. Excellent audio quality is provided by a quality speaker and an electret condenser microphone. All have battery saving 0.15 watt low power. Touchtone® pad is included.*

STANDARD EQUIPMENT. Each transceiver comes complete — ready to use — with BP3 rechargeable battery, AC wall charger, flexible antenna, earphone, wrist strap, and belt clip...all standard.

THE SYSTEM. Accessories for the handheld series are interchangeable among transceivers. Slide on removable battery packs allow quick changing of batteries. Batteries may be charged while removed from the transceiver.

Service manuals for IC-2AT now available-3AT and 4AT available soon.



Battery Pack	Nominal Transceiver Power (watts)
BP2	1.0
BP3	1.5
BP5	2.3

IC-DC1 DC Regulator
12 VDC in/
9.6 VDC out
(comes with DC cord—will not get power from BC30)

IC-BP2 Battery Pack**
7.2 VDC 425 mA
1.5 hr charge

IC-BP3† Battery Pack
8.4VDC 250 mA
15 hr. charge

IC-BP4 †† Battery Case**

IC-BP5 Battery Pack**
10.8 VDC, 425mA
1.5 hr charge

IC-BC30 Battery Charger
117 VAC (Battery Determines Charge Rate)

IC-BC25U AC Wall Charger
117 VAC in (for charging BP3 only)

IC-HM9 Speaker Mic

IC-ML1 12 VDC 144 MHz Booster
10W out/12 VDC
(comes with 5ft coax BNC to PL-259)

IC-CPI Cigarette Lighter Cord w/ Fuse
(charges BP3/powers DC)

Leather Case
Available without cut out for Touchtone pad.

* Also available without Touchtone® Pad
**Requires BC 30 Charger
†Will charge from BC30, BC25U, CPI, or 12 VDC Direct (pack is internally regulated)
††Accept 6 AA size batteries - Alkaline or NiCd (Do not attempt to charge Alkaline batteries)

 **ICOM**
The World System

CT2100

HAL Puts MORE Behind The Buttons

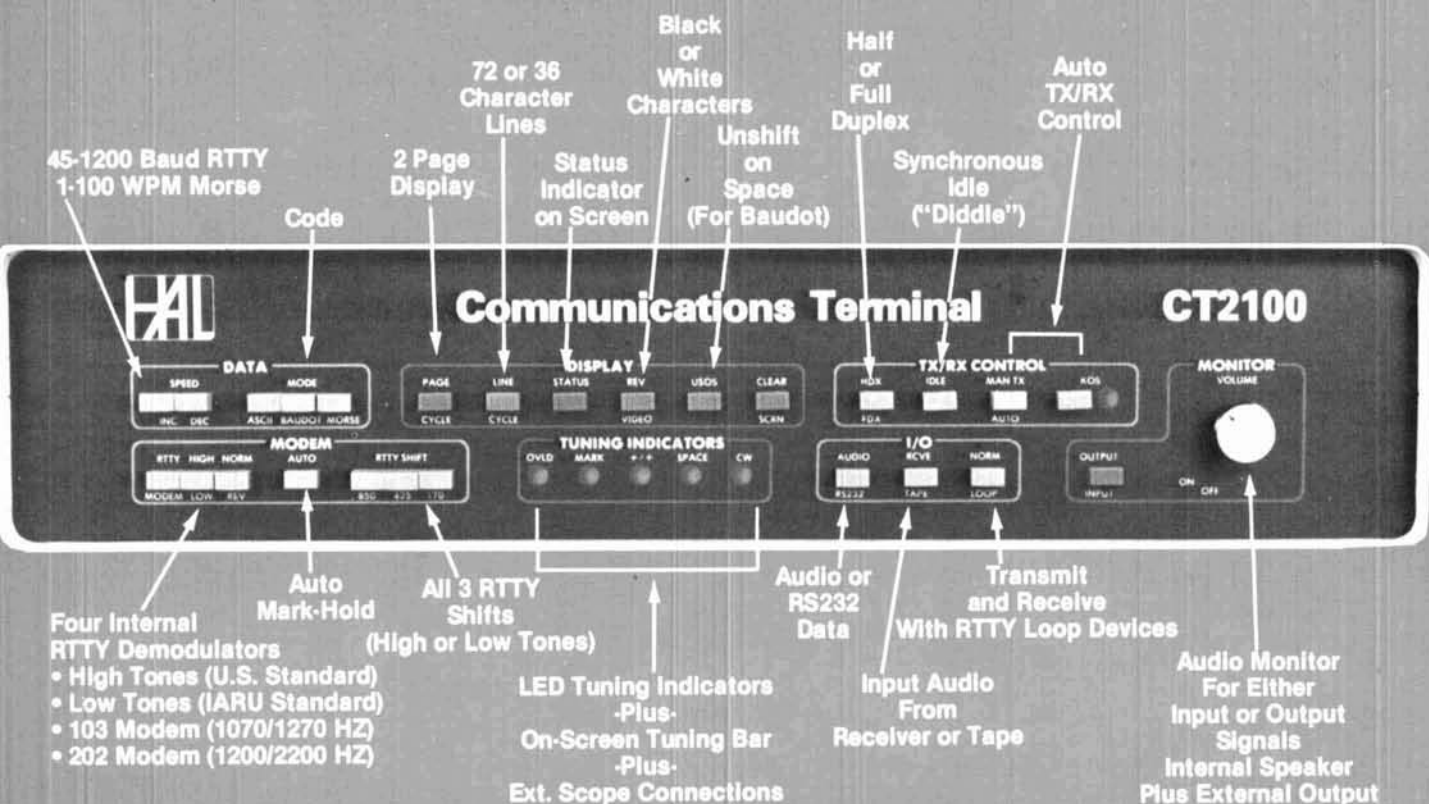

CT2100 System:

- CT2100 Communications Terminal
- KB2100 Keyboard
- Video Monitor
- Printer (300Bd Serial ASCII-MPI-88G)
- RM2100 Rack Adapter
- MSG2100 2000 Character "Brag Tape" ROM

- 24 Line Display
- 2 Pages of 72 Character Lines
- or-
- 4 Pages of 36 Character Lines
- Split Screen (with KB2100)

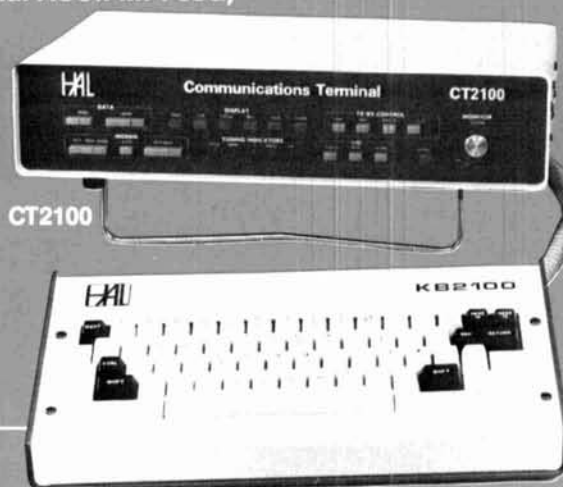

9" TV Monitor

KB2100



HAL COMMUNICATIONS CORP.
Box 365
Urbana, Illinois 61801
217-367-7373

**NOW! HAL Equipment is
in stock at leading Amateur
Dealers.**

introducing a new dimension...

COMPUTERIZED ANTENNA CONTROL FROM PRO-SEARCH™

**For Contesters,
DX'ers, Handicapped
Operators and General
Purpose Ham
Operators:**

**The Most Advanced
Antenna Control
Available...**

- The Only Computerized Unit
- The Only Talking Unit
- The Only Scanning Unit
- The Only Programmable Unit
- The Only Automatic Braking Unit

Contesters:

Pro-Search seeks out a pre-programmed heading, plus stores various common headings and automatically scans for those rare multipliers, giving the operator hands-free operation and more time for contesting.

DX'ers:

Pro-Search loads in short path and long path headings and with the touch of a button, the system works between both headings. Plus you have all of the other features of the Pro-Search to aid you in catching that rare DX station.

Handicapped Operators:

Pro-Search offers ease of operation...control the entire system with just one touch. A talk loop...vocally calls out the headings, allowing blind operators to accurately program and hear their headings.

General Purpose Operators:

Pro-Search has numerous uses. Pre-set beam headings for SKEDS, VHF WORK, and many others. Current headings can be read, by displaying the present directions with LEDs. Pro-Search also displays and stores the last heading worked, which can be recalled by the Auto-Locate system with the touch of a button.

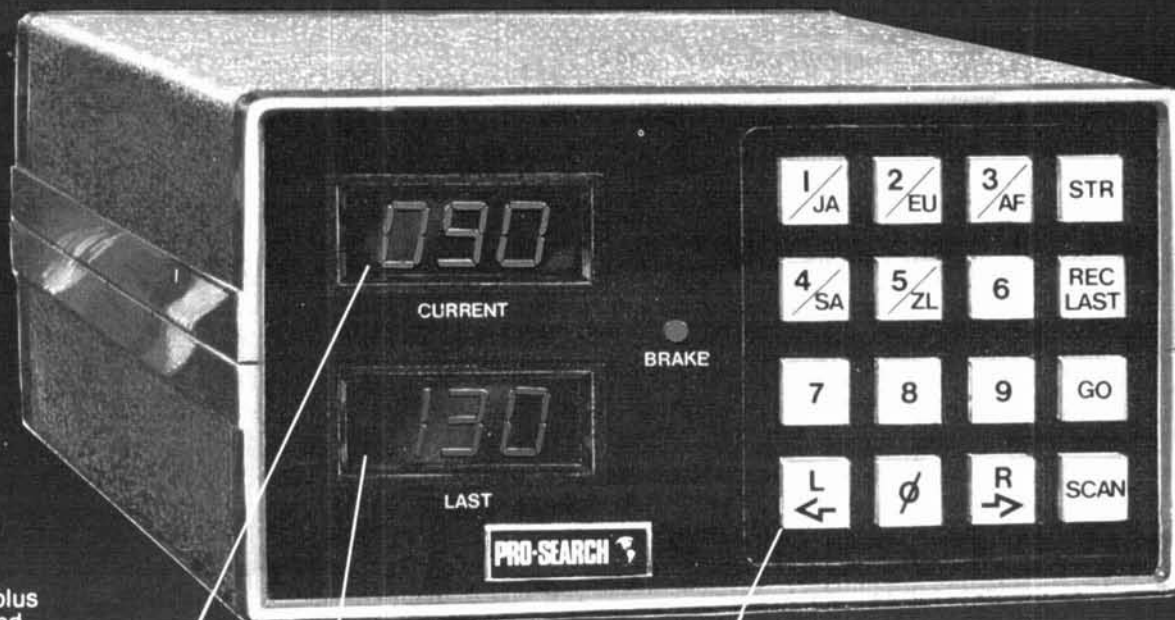

Current Heading Display

Last Heading Display and Visual Confirmation of Computer Instructions

Programmable Keyboard and Memory Functions

Pro-Search Is Adaptable To Many Systems, Simple To Install.

No modifications are necessary.

Disconnect your present antenna control system and connect ours.

Pro-Search is presently used with HAM-M, HAM-II, III, IV, and T^X. Other models will be available to work with the HDR-300, etc.

To Order:

1-800-325-4016
1-314-994-7872 (Missouri)

Or write:

Pro-Search Electronics
A Division of Wurdack and Associates, Inc.
10411 Clayton Road
Suite 305
St. Louis, Missouri 63131

*Patent Pending

PRO-SEARCH
Reaching The World



SAVE \$10.50* with home delivery

Payment enclosed

Bill me later

\$19.50

\$32.50

\$42.50

*(One year newsstand cost \$30.00)

enter my subscription.

Here's my address label, enter my subscription.

1 Year 12 issues \$19.50

2 Years 24 issues \$32.50

3 Years 36 issues \$42.50

U. S. prices only

Name _____

Address _____

City _____

State _____

Zip _____

Check here if this is your renewal (attach label)

Subscribe to **ham radio** magazine

Please allow 4-6 weeks for delivery of first issues.

Foreign rates: Europe, Japan and Africa, \$28.00 for one year by air forwarding service. All other countries \$21.50 for one year by surface mail.

Please
enter my
subscription



BUSINESS REPLY CARD

First Class Permit No. 1 Greenville, NH

Postage Will Be Paid By Addressee

**ham
radio**

Greenville, NH 03048

NO POSTAGE
NECESSARY
IF MAILED
IN THE
UNITED STATES



ham radio

magazine

SEPTEMBER 1982

volume 15, number 9

T. H. Tenney, Jr., W1NLB
publisher and
editor-in-chief

Alfred Wilson, W6NIF
editor

Martin Hanft, KA1ZM
managing editor

editorial staff

Debra Marshall
acting managing editor

Joseph J. Schroeder, W9JUV
Leonard H. Anderson
associate editors

Susan Shorrock
production

Wayne Pierce, K3SUK
cover

publishing staff

J. Craig Clark, Jr., N1ACH
assistant publisher

Rally Dennis
director of advertising sales

Susan Shorrock
circulation manager

ham radio magazine
is published monthly by
Communications Technology, Inc.
Greenville, New Hampshire 03048-0498
Telephone: 603-878-1441

subscription rates

United States: one year, \$19.50
two years, \$32.50; three years, \$42.50

Canada and other countries (via Surface Mail)
one year, \$21.50; two years, \$40.00
three years, \$57.00

Europe, Japan, Africa (via Air
Forwarding Service) one year, \$28.00

All subscription orders payable in
United States funds, please

foreign subscription agents

Foreign subscription agents are
listed on page 73

Microfilm copies
are available from
University Microfilms, International
Ann Arbor, Michigan 48106
Order publication number 3075

Cassette tapes of selected articles
from ham radio are available to the
blind and physically handicapped
from Recorded Periodicals
819 Walnut Street, 8th Floor
Philadelphia, Pennsylvania 19107

Copyright 1982 by
Communications Technology, Inc.
Title registered at U.S. Patent Office

Second-class postage
paid at Greenville, N. H. 03048-0498
and at additional mailing offices
ISSN 0148-5989

Postmaster send Form 3579 to ham radio
Greenville, New Hampshire 03048-0498



contents

**12 folded umbrella top loaded
vertical antenna**

John S. Belrose, VE2CV

18 efficiency of short antennas

Stan Gibilisco, W1GV/4

**28 digital techniques:
inside a phase-frequency detector**

Leonard H. Anderson

33 the ultimate tone decoder

E.M. Dean, WD9EIA
and P.K. Dean, WB9HGZ

36 the K7CW quad

Paul J. Kiesel, K7CW

40 ham radio techniques

Bill Orr, W6SAI

55 questions and answers

58 operation upgrade: part 9

Robert L. Shrader, W6BNB

68 a homebrew microwave antenna

Noel J. Petit, WB0VGI
and Philip A. Johnson

**78 the weekender: precision
battery-voltage monitor for HTs**

Alan Lefkow, K2MWU

94 advertisers index

8 comments
82 DX forecaster
73 flea market
72 ham calendar
80 ham mart

77 ham notes

84 new products
**6 observation and
opinion**
10 presstop
94 reader service



Observation & Opinion

The code-free license . . . the end of Amateur Radio?

On July 1 the FCC commissioners directed their staff to prepare a Notice of Proposed Rule-Making for a code-free Amateur Radio license. As reported earlier in "Presstop," the suggested alternatives include deleting the CW requirement for the Technician license and developing a new Digital license, such as the license now in effect in Canada.

Any proposal for a code-free Amateur license always seems to stir strong emotions in the bosoms of U.S. Amateurs. The concept was firmly rejected just a few years ago when Amateur restructuring (Docket 20282) was under consideration. In response to this new proposal, which seems to have strong, important support from within the FCC, the League has already indicated in the July 9 "Directors' Letter" that it will be taking a firm stand in opposition to any license without a code requirement, based on the ARRL Board action taken at the 1982 Annual Meeting.

Let's back off a bit and review where Amateur Radio is today and how it got there. When Amateur Radio began, code was a necessity since, with spark gaps and crystal detectors, that was the state of the communications art. Even the development of the vacuum tube and radiotelephony didn't significantly alter the value of CW for communication since it was so much more efficient in spectrum and power than a-m telephony. But this is 1982, not 1922, and the technology of wireless and Amateur Radio has made incredible advances in those 60 years.

Most Amateur high-frequency voice operation today uses SSB, a spectrum-conserving, power-efficient mode of communications. Non-voice operation, on the other hand, employs radio-teletype, fast/slow scan ATV and facsimile. In addition, the growing popularity of computers is starting to have an impact on Amateur Radio in the newer forms of communications, such as packet radio and spread-spectrum. In light of these developments, is CW still needed for every Amateur Radio license?

Japan has a code-free Amateur license, and as a result it has the largest and fastest growing Amateur population in the world. Japan's Amateur marketplace has become the healthiest in the world, capable of supporting more companies who produce more new Amateur Radio products than the rest of the world combined. But that's not why we at *ham radio* are advocating that we all take an open-minded look at a no-code Amateur license.

The decision to publish this editorial was very difficult. One might easily say that of course we would want a no-code license since the growth in licensed Amateurs would be good for our business. Actually, we did some real soul-searching to absolutely ensure that our decision came truly from our hearts as the best route for Amateur Radio, and was absolutely not made for business considerations. We sincerely believe some form of code-free Amateur license will best serve the long-term interests of all Amateurs and of the Amateur Radio service.

Projections have been made of the great numbers of new licensees that will appear as soon as the no-code policy is adopted. We think this is overstated. Under one proposal currently offered by the FCC, the license candidate is still going to have to pass at least the equivalent of the Technician/General class written exam. For most people this is probably an even greater hurdle than five words per minute of Morse code. This is especially true in light of the new examination proposals discussed in our July editorial. It now appears these will become real possibilities and could largely eliminate the quick and easy type of answer-memorizing license study.

The greatest threat to Amateur Radio in the United States today is not a code-free Amateur license. It is restrictive legislation like that of Burbank, Illinois, discussed in last month's editorial. It is the encroachment of other services like cable TV, whose continued use of 144 and 220 MHz channels must eventually lead to a confrontation whose outcome is far from clear. It's even the shifting pattern of housing, with economic considerations putting more and more Amateurs into condominiums and other multiple-family dwellings where the opportunity to put up an antenna or even operate a transmitter is severely restricted.

The FCC has indicated its interest in granting Amateur Radio the strongest voice in licensing procedures and regulations that we've ever had. This spring saw a significant change in the upper-echelon leadership at the ARRL. Perhaps the time has come to discard the "what's good enough for grandpappy is good enough for you" mentality that's long saddled any discussion of a no-code license, and consider just how such a license could be incorporated into our Amateur structure without cheapening what we've got.

A growing Amateur Radio is a strong Amateur Radio, and if CW is indeed scaring off today's computer-oriented young people, it's time we did something to bring them back. Remember, a code-free license, whether it's entry level or only for very limited privileges, would not mean that CW itself — or the requirement that CW be mastered in order to achieve greater operating privileges — need ever change!

Joe Schroeder, W9JUV
associate editor

Skip Tenney, W1NLB
publisher and editor-in-chief

W9JUV and *ham radio* Publisher W1NLB are both Extra Class licensees, and both spend almost all their low-band operating hours on CW. For the past several years W9JUV's principle contest activity has been in the various DX contests, using an HW-8 barefoot.

Check the Savings on DRAKE Equipment at AES®



TR-5 9-band transceiver (Reg. \$799⁹⁵) **NOW 699⁹⁵**
 NB-5 Noise blanker (Reg. \$90)..... **NOW 81⁹⁵**



TR-7A 160-10m transceiver (Reg. \$1699) **NOW 1489⁰⁰**

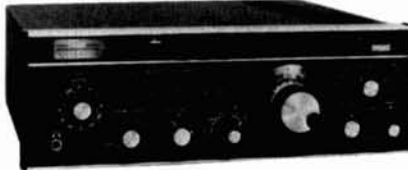

R-7A 0-30 MHz receiver (Reg. \$1649).... **NOW 1449⁰⁰**

TR-5/TR-7A/R-7A Accessories:

- PS-7 25A power supply (Reg. \$299) **NOW 269⁹⁵**
- PS-75 15A power supply (Reg. \$199) **NOW 179⁹⁵**
- MS-7 Speaker **49⁰⁰**
- RV-7 Remote VFO (Reg. \$195) **NOW 174⁹⁵**
- RV-75 Syn. remote VFO (Reg. \$299⁹⁵) **NOW 269⁹⁵**
- MMK-7 Mobile mounting kit (Reg. \$79) **NOW 71⁹⁵**
- FA-7 Cooling fan for TR-5/TR-7A/PS-7 **29⁰⁰**
- AUX-7 Range program board..... **45⁰⁰**
- RRM-7 Range receive module..... **8⁵⁰**
- RTM-7 Range transceiver module..... **8⁵⁰**
- WARC-7 WARC band kit (3-RTM's)..... **24⁹⁵**
- SL-300 300 Hz CW filter (Reg. \$59⁹⁵)..... **NOW 54⁹⁵**
- SL-500 500 Hz CW filter (Reg. \$59⁹⁵)..... **NOW 54⁹⁵**
- SL-1000 1 KHz RTTY filter (Reg. \$59⁹⁵) **NOW 54⁹⁵**
- SL-1800 1.8 KHz SSB/RTTY filt. (Reg. \$59⁹⁵) **NOW 54⁹⁵**
- SL-4000 4 kHz AM filter (Reg. \$59⁹⁵) **NOW 54⁹⁵**
- SL-6000 6 KHz AM filter (Reg. \$59⁹⁵) **NOW 54⁹⁵**
- 7073 Hand microphone w/plug..... **29⁹⁵**
- 7077 Desk microphone w/plug (Reg. \$49)..**NOW 45⁹⁵**
- HS-7 Headset..... **19⁹⁵**
- 1544 R-7A/RV-75 Adaptor kit..... **29⁹⁰**
- 1548 R-7A/TR-7A cable interface kit..... **29⁹⁰**



L-7 2kw linear w/tubes (Reg. \$1400) **NOW 1149⁹⁵**
 L-75 1.2kw linear w/tube (Reg. \$854⁹⁵).. **NOW 729⁹⁵**



- MN-2700 1kw, ant. tuner (Reg. \$349)..... **NOW 309⁹⁵**
- MN-75 200w, ant. tuner (Reg. \$259)..... **NOW 229⁹⁵**
- B-1000 4:1 balun **29⁹⁵**
- AK-75 Multiband antenna **39⁹⁵**
- AA-75 Antenna insulator kit..... **3⁹⁹**



WH-7



CW-75



P-75



SP-75

- P-75 Phone Patch (Reg. \$79⁹⁵)..... **NOW 72⁹⁵**
- LA-7 600 ohm balanced line amplifier..... **49⁹⁵**
- CW-75 Electronic keyer (Reg. \$79⁹⁵)..... **NOW 72⁹⁵**
- SP-75 Speech processor (Reg. \$159)..... **NOW 142⁹⁵**
- WH-7 160-10m wattmeter (Reg. \$129)..... **NOW 109⁹⁵**
- 1525EM TTP microphone (Reg. \$49⁹⁵)..... **NOW 39⁹⁵**



DL-300



TV-3300LP



TV-300HP

- Dummy loads:**
- DL-300 300w dry dummy load..... **26⁹⁵**
 - DL-1000 1kw dry dummy load (Reg. \$59⁹⁵) **NOW 54⁹⁵**
 - FA-7 Cooling fan for DL-1000 **29⁰⁰**

- Equipment protectors:**
- 1549 200w antenna surge shunt..... **24⁹⁵**
 - 3001 Replacement "pill" element..... **5⁰⁰**
 - RP-700 Receiver front-end protector..... **90⁰⁰**

- TVI Filters:**
- TV-42-LP 100w 80-10m low-pass filter..... **14⁹⁵**
 - TV-3300-LP 1kw 80-10m low-pass filter..... **29⁹⁵**
 - TV-300-HP 300 ohm high-pass filter..... **14⁹⁵**
 - TV-75-HP 75 ohm high-pass filter **17⁹⁵**

- Line Filters:**
- LF-2 2-outlet AC line filter (Reg. \$39⁹⁵)..... **NOW 34⁹⁵**
 - LF-6 6-outlet AC line filter (Reg. \$69⁹⁵)..... **NOW 59⁹⁵**

- Test Equipment:**
- DMM 2350 Digital multimeter (Reg. \$95⁹⁵) **NOW 86⁹⁵**



- CS-7 1533 Remote ant. switch (Reg. \$195) **NOW 174⁹⁵**
- 1534 Control console only for CS-7 **117⁰⁰**
- 1535 Remote switch only for CS-7..... **78⁰⁰**

- Misc.**
- 550 Rec. only terminal (Reg. \$499⁹⁵)..... **NOW 449⁹⁵**
 - TR-930 Panasonic 9" monitor (Reg. \$185) **NOW 159⁹⁵**
 - Service manuals for TR-5, TR-7A & R-7A ea. **35⁰⁰**
 - 7037 Extender card service kit, R-7A/TR-7A..... **50⁰⁰**
 - 1982 World Radio/TV Handbook **16⁵⁰**



- Satellite TV Products:**
- ESR-24 Rcvr, SC/ESR24 conv. (Reg. \$995) .. **NOW 889⁹⁵**
 - ESR-24 Rcvr chassis only* (Reg. \$745) **NOW 669⁹⁵**
 - SC/ESR Down conv only* (Reg. \$250) **NOW 224⁹⁵**
 - SA-24 Stereo adaptor (Reg. \$349⁹⁵) **NOW 314⁹⁵**
 - Modulator for Ch. 3 or 4 (Reg. \$79⁹⁵) **NOW 69⁹⁵**
 - SPH-24 Splash proof housing (Reg. \$30) **NOW 26⁹⁵**
 - TM-24 Remote tuning meter (Reg. \$49) **NOW 43⁹⁵**
 - RT-24 Remote control w/30' cable (Reg. \$69) **NOW 59⁹⁵**
 - Internal mounting kit **TBA**
- *Separate units for replacement purposes. Not recommended alone for new installations.

For Satellite TV information call Paul Wittkamp at the Milwaukee store

Buy with Confidence
AES® has Over 25 Years of Experience in Mail Order



Use your CREDIT CARD!

E-X-P-A-N-D-E-D WATS PHONE HOURS
 Our Milwaukee Headquarters will answer the Nationwide WATS line 1-800-558-0411 until 8 pm (Milwaukee time) Monday thru Thursday.
Please use WATS line for Placing Orders
 For other information, etc. please use Regular line.

AES STORE HOURS
Mon. thru Fri. 9-5:30; Sat. 9-3

Call Toll Free: 1-800-558-0411 *In Wisconsin (outside Milwaukee Metro Area) 1-800-242-5195*

AMATEUR ELECTRONIC SUPPLY® Inc.

4828 W. Fond du Lac Avenue; Milwaukee, WI 53216 - Phone (414) 442-4200

AES BRANCH STORES

- | | | | | |
|---|---|--|--|---|
| <p>WICKLIFFE, Ohio 44092
 28940 Euclid Avenue
 Phone (216) 585-7388
 Ohio WATS 1-800-362-0290
 Outside Ohio 1-800-321-3594</p> | <p>ORLANDO, Fla. 32803
 621 Commonwealth Ave.
 Phone (305) 894-3238
 Fla. WATS 1-800-432-9424
 Outside Fla. 1-800-327-1917</p> | <p>CLEARWATER, Fla. 33515
 1898 Drew Street
 Phone (813) 461-4267
 No In-State WATS
 No Nationwide WATS</p> | <p>LAS VEGAS, Nev. 89106
 1072 N. Rancho Drive
 Phone (702) 647-3114
 No In-State WATS
 Outside Nev. 1-800-634-6227</p> | <p>CHICAGO, Illinois 60630
 ERICKSON COMMUNICATIONS
 5456 N. Milwaukee Avenue
 Phone (312) 631-5181
 Outside ILL. 1-800-621-5802</p> |
|---|---|--|--|---|

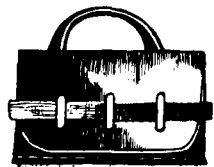

comments

converting the vertical-vee

Dear HR:

A really interesting antenna dubbed the vertical-V caught my eye a year ago. I had to have one.

I built the V for 10 meters, using 8-foot elements. Then, a year later, I decided to get another antenna. Since the V was still in good condition, I made it into a delta loop. The full-wavelength delta has 2 dB gain, and the V has none. More importantly, the vertical is already half a delta loop!

To make the modification, I simply added 2 feet to the length of each element and strung copper wire at the tops of the arms (15 feet for 10 meters) — and unbelievably, it worked!

If you have a vertical-V, please convert it. Believe me, no other mod you're likely to make can beat this one.

Martin Reeves, KA5KWV
Dallas, Texas

hurrah for Bill

Dear HR:

I'd like to nominate Bill Orr, W6SAI, (Ham Radio Techniques) for a Distinguished Service Award for Excellence in Technical Writing.

For more than a quarter century, his ability to communicate complex concepts in a lucid, logically coherent, and systematic manner has made a significant contribution to Amateurs, professional engineers,

and research people. I am continually amazed by his ability to refresh and renew, with a dash of humor and wit, my understanding of topics I had long lost a grasp of, or failed to follow, since the pre-transistor days when I first became an Amateur.

Thanks for his imaginative time-flight into Amateur Radio, circa 2015, A.D. (*ham radio*, May, 1982). I didn't know whether to laugh or cry; I did both!

Best wishes to W6SAI and *ham radio*, always. I hope Bill Orr will be writing for you right through 2015!

Marty Wincott, K2BRY
Harrison, New York

inductance meter

Dear HR:

I constructed Ed Marriner's (W6XM's) inductance meter (*ham radio*, April, 1982) using parts that I had on hand. Here are two changes I made that others who build this unit might be interested in.

I used a PNP transistor in the tuned stage so that the tuning capacitors would be at ground and it wouldn't be necessary to insulate it from the chassis. The emitter was returned to +12 volts through 390 ohms and the collector through the tuned circuit to ground. The bias resistors were also reversed.

I needed more sensitivity with my transistors for the metering circuit to work, so I added a 27k resistor from +12 to the base of the metering circuit transistor.

Norman R. Fisher, WB2LAO
Tuckerton, New Jersey

phonetics

Dear HR:

Concerning KA6NFD's letter in the May issue, I say *brava* to the lady. Those she disagrees with are tin soldiers and moldy figs!

In extremely structured situations, such as MARS, official phonetics are mandatory because of the quasi-mili-

tary frame of reference. The types who attempt to infuse all of Amateur Radio with that sort of inflexible conformism are, in a way, reminiscent of those who burned heretics at the stake. Regimentation is all right for some, I suppose. But how can anyone ever succeed in achieving one-hundred percent conformity in an activity that involves more than a quarter million individuals? And what on earth would be gained by it?

I happen to like using K2 Always Going Zigzag; on the day the FCC makes it mandatory for me to use Alfa Golf Zulu, I will change it. But until then, I will ID according to my personal preference.

Dave Mann, K2AGZ
Kinnelon, New Jersey

for the blind ham

Dear HR:

The Smith-Kettlewell Technical File is a technical journal aimed specifically at the blind and visually impaired Amateur, hobbyist, student, and professional. It's available quarterly at low cost in Braille, large print, and in Talking Book form.

The purpose of the Smith-Kettlewell Technical File is to provide access to state of the art devices, circuits, and techniques for the visually handicapped. It typically includes articles on soldering and construction techniques, IC pin diagrams and application notes, the design of practical aids and the adaptation of test equipment, and bibliographies of technical materials.

The first issue is free. Contact William A. Gerrey, editor, Smith-Kettlewell Institute of Visual Sciences, 2232 Webster Street, San Francisco, California 94115; telephone 415-561-1619.

Bill Gerrey
Editor, S-K Technical File

Also of interest to the blind Amateur may be the Braille DX Service. Contact them at 8347 West 6th Avenue, Lakewood, Colorado 80215. Editor

MFJ KEYERS

Uses Curtis 8044 IC. Iambic operation, dot-dash memories, weight control, solid state keying. RF proof.



\$79⁹⁵

The MFJ-408 Deluxe Electronic Keyer sends iambic, automatic, semi-automatic, manual. Use squeeze, single lever or straight key.

Speedmeter lets you read speed to 100 WPM. **Socket for external Curtis memory**, random code generator, keyboard. Optional cable, \$4.95.

Iambic operation with squeeze key. Dot-dash insertion. **Semi-automatic "bug" operation** provides automatic dots and manual dashes.

Dot-dash memory, self-completing dots and dashes, jam-proof spacing, instant start. **RF proof.**

Solid-state keying: grid block, solid state xmtrs. **Front panel controls:** linear speed, weight, tone, volume, function switch. 8 to 50 WPM.

Weight control adjusts dot-dash space ratio; makes your signal distinctive to penetrate QRM.

Tone control. Speaker. Ideal for classroom.

Function switch selects off, on, semi-automatic/manual, tune. Tune keys transmitter for tuning.

Uses 4 C-cells. 2.5 mm jack for power (6-9 VDC). Optional AC adapter MFJ-1305, \$9.95.

Eggshell white, walnut sides. 8x2x6 inches. **MFJ-406, \$69.95**, like 408 less speedmeter.



\$49⁹⁵

New MFJ-401 Econo Keyer II gives you a reliable, full feature economy keyer for squeeze, single lever or straight key.

Has sidetone, speaker, volume, speed, internal weight and tone controls. Sends iambic, automatic, semi-automatic, manual. Tune function. Dot-dash memories. 8-50 WPM. "On" LED. Use 9V battery, 6-9 VDC, or 110 VAC with optional AC adapter, MFJ-1305, \$9.95. 4x2x3 1/2".

Reliable solid state keying. Keys virtually all solid state or tube type transmitters.



\$64⁹⁵

MFJ-405 Econo Keyer II. Same as MFJ-401 but has built-in single paddle with adjustable travel. Also jack for external paddle. 4x2x3 1/2".

Optional: Bencher Iambic Paddle, \$42.95; 110VAC adapter, MFJ-1305, \$9.95. **Free catalog.**

Order from MFJ and try it. If not delighted, return within 30 days for refund (less shipping).

One year unconditional guarantee.

Order yours today. Call toll free 800-647-1800. Charge VISA, MC. Or mail check, money order. Add \$4.00 each for shipping and handling.

CALL TOLL FREE ... 800-647-1800

Call 601-323-5869 for technical information, order/repair status. Also call 601-323-5869 outside continental USA and in Mississippi.

MFJ ENTERPRISES, INCORPORATED
Box 494, Mississippi State, MS 39762

MFJ DUMMY LOADS

Tune up fast into 50 ohm resistive load. Extend life of finals.



Includes high quality transformer oil.

\$34⁹⁵

New MFJ-250 VERSALOAD Kilowatt Dummy Load lets you tune up fast. Extends life of transmitter finals. Reduces on-the-air QRM.

Run 1 KW CW or 2 KW PEP for 10 minutes, 1/2 KW CW or 1 KW PEP for 20 minutes. Continuous duty with 200 watts CW or 400 watts PEP. Complete with derating curve.

Quality 50 ohm non-inductive resistor. Oil cooled. Includes high quality, industrial grade transformer oil (contains no PCB).

Low VSWR to 400 MHz: Under 1.2:1, 0-30 MHz. 1.5:1, 30-300 MHz. 2:1, 300-400 MHz.

Ideal for testing HF and VHF transmitters. **SO-239 coax connector.** Vented for safety. Removable vent cap. Has carrying handle. 7-1/2 in. high, 6-5/8 in. diameter.

MFJ "Dry" 300 W and 1 KW Dummy Loads.

\$64⁹⁵ **\$26⁹⁵**

MFJ-262

MFJ-260

Air cooled, non-inductive 50 ohm resistor in perforated metal housing with SO-239 connectors. Full load for 30 seconds, derating curves to 5 minutes. **MFJ-260 (300 W).** SWR: 1.1:1 to 30 MHz, 1.5:1 for 30-160 MHz. 2 1/2 x 2 1/2 x 7 in. **MFJ-262 (1 KW).** SWR: 1.5:1 for 30 MHz. 3x3x13 inches.

MFJ HF SWR/Wattmeter

\$29⁹⁵

MFJ-816



New MFJ-816 low cost HF SWR/Wattmeter for 1.8 to 30 MHz range. Toroidal current pickup gives uniform sensitivity over entire HF frequency. **Read SWR,** forward and reflected power in 2 ranges (30 and 300 watts) on two color scale. SO-239 coax connectors. 4-1/2 x 2-3/8 x 2-7/8 in.

Order from MFJ and try it. If not delighted, return it within 30 days for refund (less shipping). **One year unconditional guarantee.**

Order today. Call TOLL FREE 800-647-1800. Charge VISA, MC. Or mail check, money order. **Write for free catalog.**

CALL TOLL FREE ... 800-647-1800

601-323-5869 in MS, outside continental USA.

MFJ ENTERPRISES, INCORPORATED
Box 494, Mississippi State, MS 39762

Hear Police/Fire Weather

on 2 Meter Handhelds with this MFJ VHF Converter.



Scanning Handhelds become Police/Fire Scanners

MFJ-313

\$39⁹⁵

New MFJ VHF converter turns your synthesized scanning 2 meter handheld into a hot Police/Fire/Weather band scanner.

144-148 MHz handhelds receive Police/Fire on 154-158 MHz with direct frequency readout. Hear NOAA weather, maritime coastal plus more on 160-164 MHz.

Mounts between handheld and rubber ducky. **Feedthru** allows simultaneous scanning of both 2 meters and Police/Fire bands. No missed calls.

Highpass input filter and 2.5 GHz transistor gives excellent uniform sensitivity over both bands. Crystal controlled.

Bypass/OFF switch allows transmitting. Won't burn out if you transmit (up to 5 watts) with converter on. Low insertion SWR. Uses AAA battery. 2 1/4 x 1 1/2 x 1 1/2 in. BNC connectors.

Enjoy scanning, memory, digital readout, etc. as provided by your handheld on Police/Fire band.

220 MHz Converter for 2 M Handheld

MFJ-314
\$59⁹⁵

MFJ-314, like MFJ-313 but lets you receive 221-225 MHz on your 2 meter handheld.

Police/Fire/Weather Band Converter for 2 Meter Mobile Rigs.



MFJ-312

\$59⁹⁵

MFJ-312, like MFJ-313 but for mobile 2 meter rigs. Transmit up to 40 watts thru converter without damage. SO-239 connectors. Mobile mounting brackets. Rugged. "ON" LED. Use 12 VDC or AAA battery. 3x4x1 in.

Order from MFJ and try it-no obligation. If not delighted, return it within 30 days for refund (less shipping). **One year unconditional guarantee.**

Order today. Call toll free 800-647-1800. Charge VISA, MC or mail check, money order for amount indicated plus \$4.00 each shipping.

Hear police/fire/weather. Order now.

CALL TOLL FREE ... 800-647-1800

Call 601-323-5869 in Miss. outside continental USA, tech/order/repair info. Telex 53-4590.

MFJ ENTERPRISES, INCORPORATED
Box 494, Mississippi State, MS 39762

A CODE-FREE U.S. AMATEUR LICENSE NOW SEEMS ALMOST CERTAIN, with the FCC staff instructed by the Commissioners July 1 to prepare a Notice of Proposed Rule Making for release later this year. Several alternatives will probably be offered in the NPRM, but the one that seems to have the strongest Commission support is to simply drop the CW requirement from the Technician Class and make it the "Code-Free" license.

Though A Codeless License Is Drawing Increasing support from the Amateur community, the ARRL has already stated its complete opposition to eliminating the CW requirement.

ARRL WILL SUPPORT THE BURBANK (ILLINOIS) LAWSUIT, discussed in last month's "Observation and Opinion." In a special July 9 meeting, the Executive Committee authorized the expenditure of up to \$7500 of League funds to fight the anti-tower and RFI legislation.

The Suit Should Be Filed during August in the U.S. District Court for the Northern District of Illinois, and will seek injunctive relief against enforcement of the ordinance and a declaratory judgment that it is unconstitutional. Constitutional challenges will include the violation of the Amateur and CB operators' right to communicate, intrusion into areas reserved for the Federal government, and violation of due process and equal protection under the law, since it applies only to Amateur and CB antennas.

Despite The ARRL Contribution And Substantial Donations from area clubs and individual Amateurs, additional funding will almost surely be required before this battle is resolved. Contributions to the Burbank Tower Fund can go to Fund Chairman WA9EKA.

420-435 MHZ SHARED USED BY COMMERCIAL RADIOLOCATION WAS AUTHORIZED by the FCC July 22. Meeting on General Docket 80-135, the Commissioners authorized Del Norte Communications to operate spread-spectrum radiolocation throughout the continental U.S. and Alaska, on a non-interference basis. Responding to Amateur objections to the original proposal, the FCC limited Del Norte to spread-spectrum for all its inland operations, and its transmitters must identify periodically by sending "DN" in Morse Code in such a way that it can be copied on a conventional receiver.

Permitting Del Norte On 420-435 MHz Is Not All Bad; Land Mobile has had designs on that part of the spectrum for some time, and the Commission decision to put radiolocation there on a shared basis should protect it from complete loss to Amateurs, as in Canada.

Further Power Limits On 420-450 MHz Amateur Operations near certain military installations have been announced by the FCC in an unrelated action. Effective August 16, 1982, Amateurs within a 100-mile radius of Otis AFB, Massachusetts, Elmendorf AFB, Alaska, and Grand Forks AFB, North Dakota, are limited to 50 watts ERP. The same power limit applies to Amateurs within a 150-mile radius of Beale AFB, California.

A NEW LEAGUE NEWSLETTER WAS JUST ONE of several significant developments to come out of the ARRL July Board meeting in Cedar Rapids. The new publication, which will replace the present "Directors' Letter," will be a bi-weekly that will not only be distributed free to League officials and appointees, but will also be available on a subscription basis to members. Unlike other Amateur Radio newsletters, the ARRL offering will be primarily oriented toward League matters and concerns rather than toward Amateur Radio in general. The initial issue should be published before the end of the year.

New Ad Hoc Committees Were Also Established by the Board to deal with Washington representation, strengthening the CRRL, the Intruder Watch program, and future Amateur volunteer monitoring and exam programs.

An Informal, Off-The-Record meeting with Personal Radio Bureau Chief Jim McKinney was another highlight of the Board's weekend. Although reports of the session are not available, it's certain that the no-code license and similar topics got a thorough going over.

SIX MONTHS IN PRISON PLUS FIVE YEARS PROBATION with 1500 hours of community service was the sentence meted out June 28 to Richard Burton, ex-WB6JAC, by U.S. District Court Judge Manual Real. Burton was convicted June 8 of continuing to operate his Amateur station despite having lost his license a year ago for jamming and indecent language violations. Judge Real had ordered Burton to start serving his sentence immediately, but another judge has since permitted his release on bond pending possible appeal.

NEW METHODS OF SPECIFYING AMATEUR POWER LIMITS are to be proposed in a Notice of Proposed Rule Making that should be released in August. The NPRM, believed to be about ready for presentation to the Commissioners at presstime, will recommend changing the traditional power input limits to power output limitations.

What Output Level Will Actually Be Recommended is still to be decided.

NEW THIRD-PARTY TRAFFIC AGREEMENTS ARE NOW IN EFFECT between the U.S. and Australia, Antigua, and St. Lucia. In addition, the FCC has announced that a reciprocal licensing agreement has been signed with Belize.

THE UOSAT AMATEUR SCIENTIFIC SATELLITE IS STILL LOCKED UP by the inadvertent simultaneous activation of both beacons. New efforts to overcome the resulting receiver desensitizing and command it back into proper operation are under way in California, where SRI's old 150-foot parabola has been brought out of retirement. Its 432 MHz gain is 42 dBd, yielding an incredible 12 megawatt ERP when driven with 750 watts of rf!



MICROLOG

INNOVATORS IN DIGITAL COMMUNICATION

AMATEUR RADIO COMMUNICATION AT ITS FINEST



Both Systems Provide

You won't find as much well thought out programming, circuitry, and features anywhere, at any price! The ATR-6800 combines the best of both worlds, an easy to use video system for CW/RTTY/SSTV with automatic station control and a stand-alone computer with expandable memory & full instruction set in Motorola assembly language. Add the BASIC language option package and you'll have the unique combination of an RFI proof computer and ultimate RTTY/CW HAM station. And don't forget "easy to use." All of us at Microlog are RADIO ACTIVE on RTTY, so there's a lot of personal attention to detail and ease of operation. "Stick-on" command listing and video status display will get you on the air quick and sounding like a pro.

- SIMPLE DIRECT CONNECTION to your Transceiver.
- COMPLETE SYSTEM, built-in Demodulator & AFSK Modulator with keyboard programmable tone pairs.
- SPLIT-SCREEN operation with keyboard selectable line location.
- LARGE, TYPE AHEAD text buffer.
- TEN, programmable message memories, plus ID's WRU & SELCALs.
- RANDOM CODE generator & hand key input for practice.
- Baudot 60 to 132 WPM.
- ASCII 110 & 300 baud.
- SYNC-LOCK MODE for improved ASCII operation.
- RECORDER INTERFACE FOR "BRAG-TAPE" or recording off-the-air.
- CODE CONVERTED Printer output in Baudot or ASCII.
- SSTV/GRAPHICS transmit.
- FULL 63 KEY Computer grade keyboard.

There's a certain thrill to using efficient, reliable digital communications equipment on the air. That's the fun of RTTY. Spice up your Amateur Radio operation with the silent video system that does it all, the Microlog ACT-1. Even if you own a home computer and are considering an out-board interface/program, remember, we've put it all in one RFI tight enclosure that's ready to go as soon as you power up. And, with the "Battery-backed" mem-

ory option, you won't even lose your pre-programmed messages if there's a "blink" in the A.C. The ACT-1 has features that the competition doesn't even have on the drawing board! Check for yourself, you could spend a lot more and still come up short.

ATR-6800 vs ACT-1 The most often asked question we hear is "What's the difference between the ATR & the ACT-1?" The ACT-1 is a dedicated system for RTTY/CW/SSTV. It provides all the functions and features you need for a multi-mode station. Along with this superior "ON-the-AIR" performance, the ATR-6800 extends your operation into the realm of automatic station control and computer programming. Plug-in applications modules expand the ATR's memory to add new HAM oriented programs which are enabled by simple keyboard commands. By adding the BASIC option package, you'll have pre-programmed full community mailbox, contest dupe sheet, personal station log, message editor, BASIC computer language and 16k of battery-backed (non-volatile) memory. We also provide a subroutine list so that you can write programs to directly control the ATR-6800 in easy to use BASIC language. The ATR-6800 then is the expandable, "do everything" system where your imagination is the only limit! The ACT-1 is designed for the HAM who needs the essentials of a complete video system for digital communications.

TECHNICAL SPECIFICATIONS ATR-6800 & ACT-1

INPUTS	100mv min.	SYNC: Transmits "Blank-Fill" in RTTY and BT in Morse when Text Buffer is empty and unit is in transmit. Keyboard command on/off.	TUNING INDICATORS	800 Hz Keyed Regenerated
Speaker Audio	TTL, Keyer, Hand Key	UN-SHIFT on Space: Automatically shifts back to "LETTERS" upon receipt or transmission of space. Keyboard command on/off.	Audio Ref. Tone	LED on Mark (Keydown)
Digital	±12V, 330 Ohm Source	REAL-TIME CLOCK: Keyboard set, always on screen display, hours, minutes, seconds. Can also be inserted in transmit text buffer by keyboard command.	Visual Scope	Tuning ellipse for RTTY
**RS232		WORD WRAP AROUND: Prevents spitting words at the end of a line. Works in receive as well as transmit.	PROGRAMMABLE MEMORIES	
OUTPUT TO TRANSMITTER FOR CW/RTTY/SSTV		CODE PRACTICE: Random 5 char generator sends at any speed you set via the keyboard. Hand-Key input allows use in code practice oscillator that will also read your sending!	10-40 character messages (400 total) or	
+ Voltage Keying	+40VDC @ 300ma Max.	STATUS DISPLAY can be called up to show the condition and control commands for 20 programmable parameters, such as AFSK tone freqs, UNDS, printer, etc. Useful as a "HELP" command in case you misplace the manual. There's also a constant "TOP-LINE" display of Time, Mode, Speed, & Code in use.	*10-80 character messages (800 total) battery backed	
- Voltage Keying	-150VDC @ 50ma Max.	DETECTION MODES	15 characters maximum in standard ID and 17 in RTTY ID	
**Mercury Relay	200VDC or 2 amp (20VA Max.) N.O. & N.C.	Direct	Up to 15 characters	
T/R Change Over	ATR - Relay ±30V @ 2 amp N.O. & N.C.	Demodulator	ATR - 4 memories, up to 15 characters each.	
	ACT-1 - Transistor + 12VDC @ 300 ma. GND on XMT	**Terminal	ACT-1 - 2 memories for printer on and printer off	
AFSK Tones, Range	Keyboard Programmable 500 Hz to 3000 Hz	DATA RATES	**COMPUTER CAPABILITY	
AFSK Tones, Level	Mic Compatible 30-50mv Audio	Morse	Memory	Standard unit has 4000 bytes of RAM for user program. Basic package adds 16K.
Slow Scan	Mic Compatible Audio. Sync 1200 Hz, Black-1500 Hz, White-2300 Hz	Baudot	Language Commands	Basic or Motorola M6800
MISCELLANEOUS CONNECTIONS		ASCII	Tape Interface	Input; Output; Load; Go with Break Point; or Normal Basic
RS 232	±12VDC, 330 Ohm Source Impedance, Negative Mark	Slow Scan	POWER	Store Programs on Audio Cassette
Printer Driver	ATR -		115 VAC, 60 Hz 60 VA Max. Act-1, 30 VA Max (230 VAC, 50 Hz optional)	
	• Hi-speed RS-232 upto 2400 Baud	OUTPUT OPERATING MODES	12 volt version available	
	• Slo-speed Baudot & ASCII Floating Relay for Current Loop Switching	Character outputs when typed	External input for charging expanded battery backed memory, 6-15VDC @ 10 ma. max.	
	• Slo-speed Baudot & ASCII Transistor Switch +40VDC @ 100 ma.	Words sent after "Space Bar"	MECHANICAL	
	• Optional Hi-speed ASCII RS232 @ 2400 Baud.	Line sent after "Return"	ATR-6800:	
Tape Recorder	Mike = 100 mv Audio	Send entire contents of text buffer	Size	14 1/4" W x 12 1/4" D x 4 1/4" H
"Brag Tape"	Speaker = 200 mv Audio		Weight	15 lb.
Scope	Horizontal and Vertical Outputs to Scope for RTTY		ACT-1:	
	Tuning Aid		Size	17.8 W x 3 H x 9.5 D
Morse Speed Tracking	Automatic or Speed Lock		Weight	7 lb.
VIDEO OUTPUT			ATR-6800 & ACT-1:	
1 Volt Peak to Peak, Negative Sync Composite Video (American Standard)			Color	Beige Top, Black Base
European standard available upon request.			Material	AL5052 Aluminum Alloy
VIDEO FORMAT				
Normal	24 lines, 40 characters per line			
Zoom	12 lines, 20 characters per line			
Black on White or White on Black	Keyboard selectable			
Display Split Screen	Any location Line 0 (Off) to Line 20, Keyboard selectable			
SSTV	3 lines, 6 characters per line + graphics			
TEST MESSAGES: Quick Brown Fox and RYRY's in Baudot, U"U" in ASCII, VVV in Morse.				

MICROLOG CORPORATION —18713 Mooney Drive—Gaithersburg, MD 20879 (301)258-8400

folded umbrella top loaded vertical antenna

Design data for
operation on 160 meters
— adaptable to any band

Interest in the 160-meter band has traditionally been limited to a persevering few who delight in the technical challenge of working DX on this "top band" — almost to the exclusion of operation on the other bands. The antenna requirements and the lack of suitable equipment have, to some extent, restricted operations on this band. For example, until recently, few transceivers tuned to the 160-meter band, and most antenna tuners would not tune to this band. Today, however, nearly every manufacturer of Amateur Radio equipment has one or more transceivers that tune to 160.

Popular antennas for the 160-meter band are

various versions of wire radiators. For example, the series of articles by Bob Eldridge¹ describes a double-size G5RV antenna and the G8ON antenna, which is an up-over-down-and-back version of the former. This latter description gives some insight into the problem. Most wire antennas are also too close to the ground to provide good low-angle radiation, and the construction of an efficient vertical antenna for DX is considered by most to be out of reach. A quarter-wave tower antenna would be 125 feet (38 meters) high at 1.815 MHz, which is higher than most Amateurs care to go, and a 5/8-wavelength antenna (an ideal DX antenna) would be 309 feet (94 meters) high.

Practical considerations with regard to height and size usually mean that some form of capacitive top loading must be used to limit the height of the

By John S. Belrose, VE2CV, 3 Tadoussac Drive, Alymer, Quebec, J9J 1G1 Canada

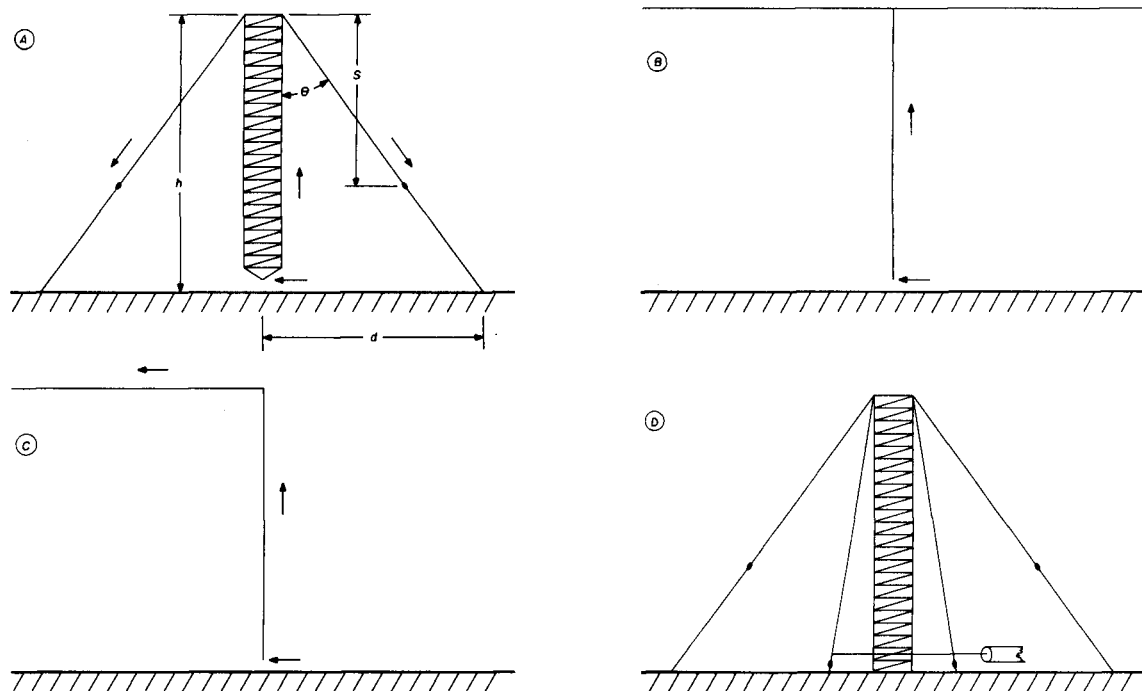

fig. 1. Wire antennas discussed in the text. **A**, the umbrella type top loaded vertical antenna, base-insulated tower (arrows illustrate the phasing of the current on the antenna). **B**, T-type top loaded vertical radiator (insulated base). **C**, L-type top loaded vertical radiator (insulated base), and **D**, folded umbrella antenna.

antenna. The *ARRL Antenna Handbook*² illustrates several methods to realize practical 160-meter antennas; grounded towers supporting plumber's-delight (grounded) beam antennas can be shunt fed for 160-meter operations as described by True.³ In fact this is probably the easiest way to achieve satisfactory operation on this band. Various methods of constructing and feeding 160-meter antennas have been described by Booth.⁴

One of those briefly discussed in the *Antenna Handbook* was the umbrella top-loaded vertical radiator. The umbrella antenna is more economical than the T- or L-type radiators because, for the same performance, it uses only one mast. The other types require two. A further simplification is obtained by folding the vertical element to raise its impedance to that required by the feedline which, if the antenna is resonant, can be connected directly to the transmission line without the need of a matching circuit. While such an antenna is used for fixed point-to-point communications and for broadcasting (Nolan⁵), it is virtually unknown to Radio Amateurs. Furthermore, published information on the umbrella antenna does not give curves that are useful for design. This article explains how to design an umbrella antenna, and it will be shown that a mast height of about 1/10 wavelength (54 feet, or 16.5

meters at 1.815 kHz) can be designed for a radiation efficiency of 70 percent or better, and bandwidth of 200 kHz or less.

the umbrella antenna

The umbrella top-loaded antenna is illustrated in **fig. 1A**. The top loading consists of a number of wires strung obliquely to ground from the top of the radiator, and insulated from the ground. The important parameters for such an antenna are the height, h , of the radiator, the horizontal distance, d , from the base of the radiator to the extremities of the guys supporting the umbrella wires, and the vertical distance, s , from the top of the tower to the height at which the umbrella wires are broken by an insulator. This antenna was first used by Smith and Johnson⁶ at broadcast frequencies in 1947. It was investigated experimentally by Belrose, *et al.*⁷ and by Gangi, *et al.*⁸ These authors, along with Smeby,⁹ examined the antenna theoretically. Smith and Graf¹⁰ have experimentally investigated umbrella antennas using multi-wire rib construction, which is particularly applicable for very short antennas at VLF.

The sketches in **figs. 1A, B, and C** show by the direction of the arrows the phasing of the currents on the umbrella top-loaded vertical, the T-, and the L-type antennas thus illustrating the difference be-

tween these types of radiators. In the case of the T- and L-type radiator, the currents on the flat top and the vertical part of the radiator do not interfere, since these currents are orthogonal to each other in space. Recall that only the currents on the vertical part of the radiator contribute appreciably to the radiation. The currents on the flap top and the image of the flat top in the ground plane are in phase opposition and essentially cancel insofar as radiation is concerned, whereas the currents on the vertical part of the radiator and its image are in phase. However, the current on the umbrella wires have a vertical component that is oppositely directed to the current on the tower; therefore, the radiation from the top part of the tower over the distance s and that from the umbrella wires partially cancel.

If there are many umbrella wires, the current on the top part of the tower over the distance s is essentially "screened." Thus, as the length of the umbrella wires is increased, the radiation resistance first increases due to the increased current area on the tower, then it decreases. The maximum in radiation resistance occurs for $s/h = 0.43$ for umbrella antennas operated on frequencies equal to or less than the fundamental frequency of the antenna. For resonant antennas s/h_0 can be adjusted such that the tower height, $h = h_0/\lambda_0$, is resonant at the operating wavelength, λ_0 .

While these considerations seem to be fairly straightforward, and, although many measurements have been made on short umbrella antennas, insufficient attention was paid to operation at frequencies near the fundamental frequency of the antenna, which is the desirable situation at low and medium frequencies. The author and a colleague in 1970 therefore decided to make an extensive study of the umbrella antenna by modeling, supplemented by measuring the field radiated from full-size low-frequency antennas. The curves presented here, which have not so far been published, summarize the observational data in a very compact way, make clear the performance of the umbrella antenna, and simplify its design.

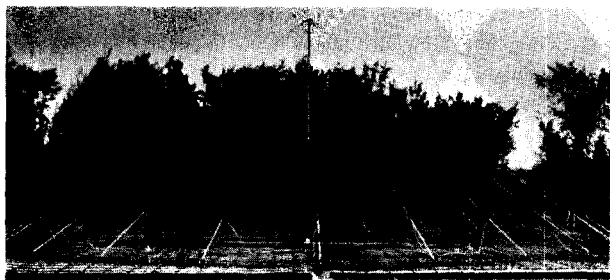

fig. 2. Model umbrella antenna above the elevated ground plane ($N = 24$, $s/h = 0.71$).

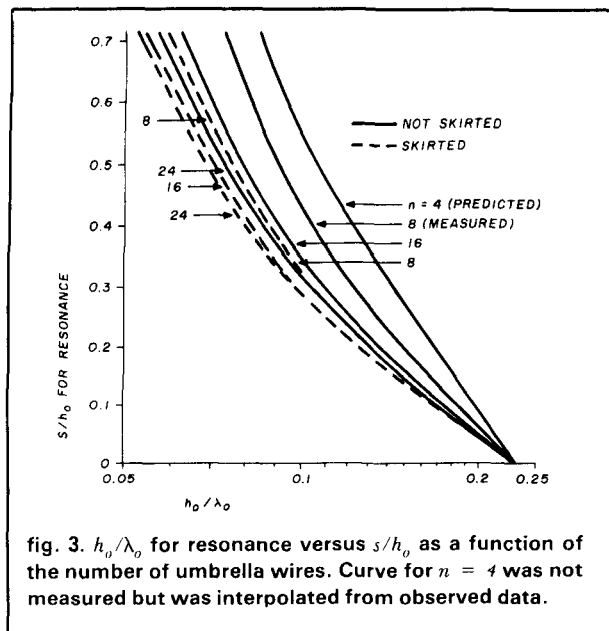

fig. 3. h_0/λ_0 for resonance versus s/h_0 as a function of the number of umbrella wires. Curve for $n = 4$ was not measured but was interpolated from observed data.

experimental setup

The umbrella antenna was modeled as follows. The tower was 1/4-inch (0.6 mm) square aluminum rod 30 inches (76 cm) long. The umbrella wires were No. 24 (0.5 mm) wire. Dimension d/h was fixed and equal to 1.4 (42 inches, or 107 cm for the model). It is clear that d should be as large as possible for maximum top loading, since as d becomes large, the umbrella antenna becomes more like a disk top-loaded radiator. The dimension $d/h = 1.4$ is considered to be a practical design.

The fundamental frequency (for quarter-wave resonance) of the tower alone was measured to be 90.6 MHz. That is, the physical length of the monopole was 82.8 degrees. Laport¹¹ gives $H(\lambda/4) = 84$ degrees for a vertical antenna where $h/2a = 107$ (a is the effective radius of the tower).

The model antenna (fig. 2) was mounted at the center of a 20-foot (6-meter) diameter hexagonal shaped ground plane, which was elevated so that the impedance measuring equipment, a Hewlett Packard vector impedance meter, model 4815A, could be connected directly to the antenna base from beneath the ground plane. A Hewlett Packard frequency counter, model 5247M, was used so that the frequency could be measured accurately.

Several umbrella antenna configurations were constructed full size and the radiation resistance at low frequency was deduced from field strength measurements. A Stoddard model NM-12AT field-strength meter was used. Field strength measurements were made at eight sites in the distance range 3-22 km so that ground loss and site errors could be accounted for. From these measured field strengths

the radiation resistance, R_r , was determined. Using the appropriate radiation resistance together with the measured model antenna resistance, R_a , the ground loss resistance, R_g , could be estimated. Recall that $R_a = R_r + R_g$.¹² For the model at the frequencies of the measurement, R_g was about 3/4 ohms.

experimental results

Antenna impedances for the model were measured over a range of frequencies up to and above the fundamental frequency of the antenna (2-100 MHz) for a) no top loading, b) various amounts of top loading, $s/h = 0.43, 0.57$ and 0.71 ; and c) numbers of umbrella wires, $n = 8, 16$, and 24 , both skirted and not skirted. Graphs summarizing the results of the measurements are given in **figs. 3** through **6**.

The curves in **fig. 3** give the size of the umbrella hat, as measured by the parameter s/h_o , necessary to resonate the antenna of height h_o/λ_o . That is, h_o is the height of antenna, which together with umbrella top-loading s/h_o , resonates at λ_o . Naturally as the height of the radiator increases, less and less top loading is required for resonance, until $h_o/\tau_o = 0.23$ is reached when the antenna is quarter-wave resonant with no top loading ($s/h_o = 0$). The effect of skirting the umbrella wires can also be seen in this figure, which is equivalent to increasing the number of umbrella wires. According to these data, 8, 16, and 24 wires skirted are approximately equivalent to 21, 33, and 40 umbrella wires without a skirt.

The curves in **fig. 4** show how the radiation resistance, R_r , with top loading adjusted for

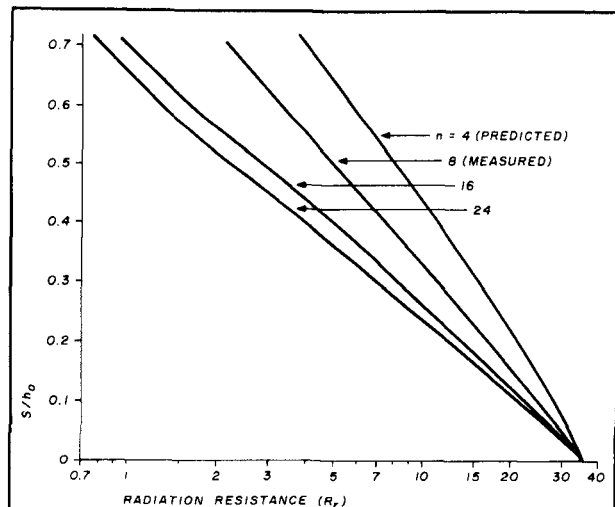

fig. 4. Radiation resistance, R_r , for resonance versus s/h_o as a function of number of umbrella wires. Curve for $n = 4$ was not measured but was interpolated from observed data.

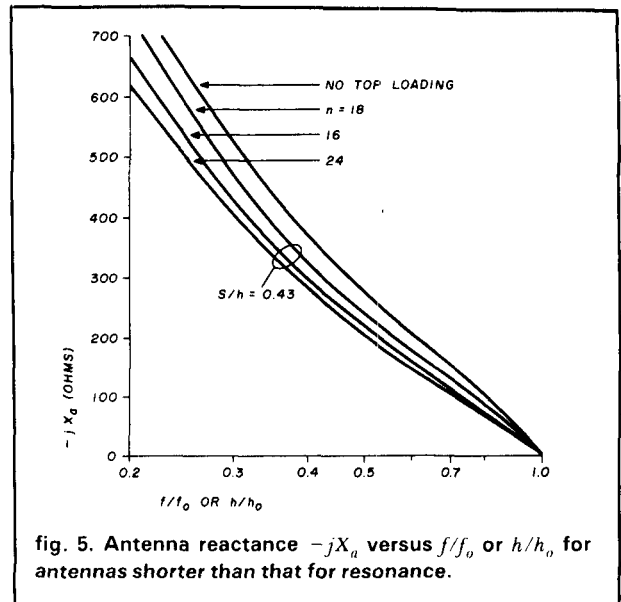

fig. 5. Antenna reactance $-jX_a$ versus f/f_o or h/h_o for antennas shorter than that for resonance.

resonance, increases with decrease in top loading and increase in h ; that is, decreases in s/h_o . As expected, when the top loading decreases to zero or $s/h_o = 0$, R_r is the radiation resistance of a quarter-wave monopole, or 35.5 ohms according to our measurements.

If the realizable antenna height is shorter than can be resonated with optimum top loading; that is, $s/h_o = 0.43$ (for the case where eight umbrella wires are used), the antenna will be capacitively reactive. The curves in **fig. 5** show how the antenna reactance $-jX_a$ increases as the frequency decreases below the resonant frequency, f_o . Since frequency and height scale directly, this graph can also be used to estimate the reactance for an antenna of height h less than h_o for which the antenna is resonant. The graph also gives the reactance for a tower antenna with no top loading ($h/2a = 107$).

The radiation resistance for antenna shorter than that for resonance is calculated according to

$$R_r = R_r(h_o) \left(\frac{h}{h_o} \right)^2 \quad (1)$$

where h is the height of the umbrella antenna and h_o is the height required for resonance.

The curves in **fig. 6** show how the antenna Q -factor increases with increase in top loading; that is, with increase in s/h_o . The curves apply to resonant antenna conditions. The antenna Q -factor can be estimated for full-scale antennas where the ground loss resistance is more than 3/4 ohm from the ratio

$$Q_a = Q_{model} \left(\frac{R_a \text{ model}}{R_a \text{ full scale}} \right) \quad (2)$$

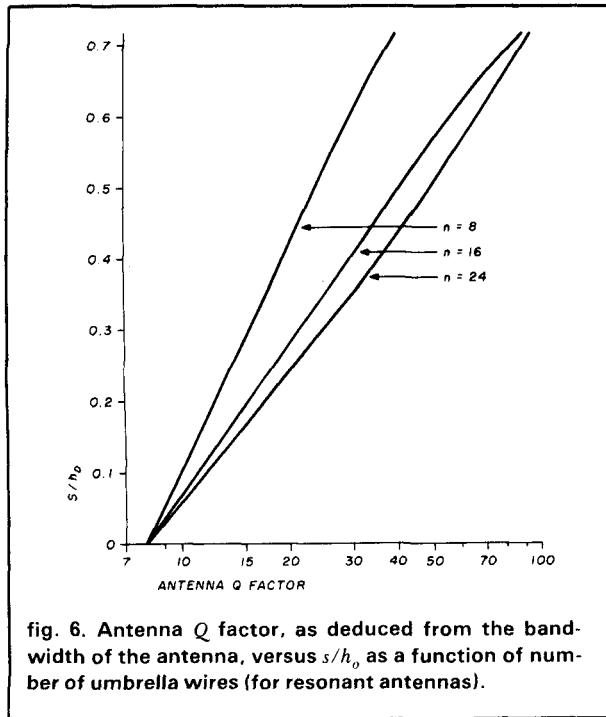

design examples

Resonant antenna. The following considers the design, step-by-step, for a 160-meter antenna

$$f_o = 1.815 \text{ MHz}$$

$$\lambda_o = \frac{984}{1.815} = 542.1 \text{ feet (165 meters)}$$

For $s/h = 0.43$, from **fig. 3**, for an antenna employing eight radials

$$h_o/\lambda_o = 0.1$$

$$\text{or } h_o = 0.1 (542.1) = 54 \text{ feet (16.5 meters)}$$

Suppose we choose a tower having a nominal height of 56 feet (17 meters), comprising seven sections 8 feet (2.4 meters) long. If the tower sections overlap by 4.25 inches (11 cm) the actual height is approximately 54 feet (16.5 meters). Since

$$\frac{d}{h} = 1.4$$

$$d = 75.6 \text{ feet (23 meters)}$$

According to **fig. 4**, the radiation resistance, R_r , is 6.75 ohms. If ground loss resistance R_g is 5 ohms, the radiation efficiency¹² is

$$\begin{aligned} \eta &= \frac{R_r(100)}{R_r + R_g + R_c} \\ &= \frac{6.75(100)}{6.75 + 5 + 0} = 57 \text{ percent} \end{aligned}$$

Note that R_c , the coil tuning loss, is zero since the antenna is resonant.

The antenna Q factor is given in **fig. 6**, $Q_{model} = 20$, and using **eq. 2**

$$Q_a = \frac{20(7.5)}{11.75} = 12.8$$

and the antenna bandwidth is

$$BW = \frac{2f_o}{Q} = \frac{(2)(1815)}{12.8} = 283 \text{ kHz}$$

The factor of 2 accounts for the fact that the antenna bandwidth is doubled when driven by a transmitter that is matched to the load.

Folded umbrella antenna. A further simplification can be obtained by folding the vertical element to raise its impedance to the value required by the feeder. The latter may then be connected directly to the antenna without the need for a matching unit. The mast is grounded at the base (see sketch in **fig. 1D**), and a cage of wires surrounds the tower, connected to the top and insulated at the bottom. The feeder is connected directly to the bottom of this cage of wires supporting the mast and a skirt wire joins their ends.

Four or more wires in the cage will be needed. The antenna must first be made self-resonant; that is, the capacitance of the umbrella top must tune with the inductance of the mast and the cage of wires in parallel. This will require slightly more top loading than discussed above. The input impedance (base of mast insulated), which was estimated above to be about 11.75 ohms, will then be raised by about a factor of four to 47 ohms.

Antenna shorter than resonance. To illustrate use of the curves, suppose we design an antenna of height h that is shorter than that required for resonance (h_o). If the height of the tower is, say, 30 feet (9 meters), then

$$\frac{h}{\lambda_o} = \frac{30}{542.1} = 0.055$$

$$\text{(in metric terms, } \frac{h}{\lambda_o} = \frac{9}{165} = 0.05)$$

For eight umbrella wires, and $s/h_o = 0.43$, see above*, $h_o/\lambda_o = 0.1$.

$$\text{Therefore, } h/h_o = \frac{0.055}{0.1} = 0.55$$

and, according to **fig. 5**,

$$X_a = -j215 \text{ ohms}$$

The radiation resistance is

$$R_r = R_r(h_o) \left(\frac{h}{h_o} \right)^2 = 6.75(0.55)^2 = 2 \text{ ohms}$$

*We could decide to use longer umbrella wires; that is, $\frac{s}{h_o} > 0.43$ or use more of them.

For a tuning coil Q factor of 300,

$$R_c = \frac{215}{300} = 0.72 \text{ ohm}$$

and the radiation efficiency is

$$\eta = \frac{2(100)}{2 + 5 + 0.72} = 35 \text{ percent}$$

The antenna Q factor is

$$Q = \frac{X_a}{R_a} = \frac{215}{5.72} = 37$$

and the antenna bandwidth is

$$BW = \frac{2f_o}{Q} = \frac{2(1815)}{37} = 96 \text{ kHz}$$

ground-screen requirements

As with all short antennas, a radial wire ground screen must be used to realize high radiation efficiency. For a ground loss resistance of 5 ohms, we estimate, (fig. 7) that a ground system of at least ten radial wires would be needed, and these wires should be one-quarter to one-half wavelength long (typically broadcasters employ radial wires 0.412 wavelength long). Note the rather unusual scale in fig. 7; this is because $R_g \propto \frac{1}{n}$, where $n = \text{number of radials}$, and R_g has been plotted versus $\frac{1}{n}$. In fact R_g is in-

versely proportional to the total length of wire employed in the radial ground screen. The more wire that is buried, the lower the ground loss resistance, but there is little point to increasing the number of radial wires to more than 120 or their length to greater than one-half wavelength.

concluding remarks

Design data have been presented for umbrella-type top-loaded vertical antennas for operation on 160 meters. The various curves are plotted as ratios of the height of the antenna to the wavelength and therefore can be used to design such antennas for any frequency. The 54-foot (16.5-meter) high umbrella antenna at 1.815 MHz would be 26 feet (8 meters) high at 3.8 MHz, 14 feet (4.3 meters) high at 7.2 MHz, and 7 feet (2 meters) high at 14.2 MHz. In addition I have shown how to feed a grounded tower vertical radiator — a method that does not seem to have been used by Radio Amateurs. Shunt-fed or gamma-matched grounded towers have been used, but difficulty has been experienced in exciting a "fat" tower employing a "thin" gamma-match element. Besides, the folded unipole type of feed increases the bandwidth over the conventional base-fed radiator; whereas gamma matching introduces additional reactances (the inductance of the gamma section and the capacitances of the tuning and matching elements), which reduce the bandwidth of the radiator.

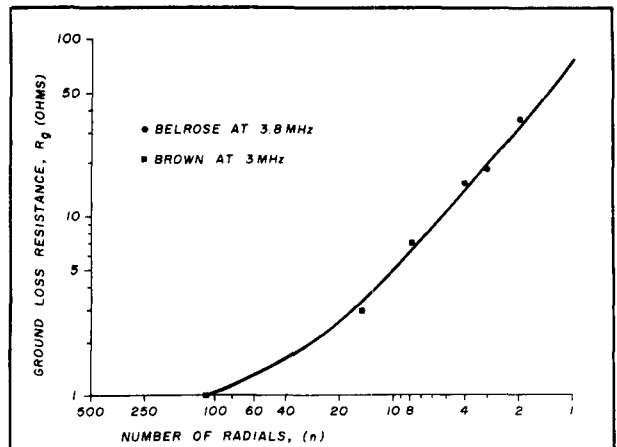

fig. 7. Relationship between ground loss resistance, R_g , and number of radial wires in the ground system. The apparent good agreement between data measured by the author and Brown et al¹³ may be coincidental, although both measurements were made over ground of similar conductivity (about 2×10^{-3} mhos/m).

The radiation from the antenna system, of course, requires a return current flow in the tower. Therefore the tower sections must be carefully bonded by jumper straps if the tower is painted, and a good connection to the ground system must be made at the base of the tower. Adequate insulation must be used, especially at the ends of the active guys.

acknowledgments

Thanks are due to Mr. John A. Orosz, formerly of CRC, who meticulously made the model measurements for this study.

references

1. R.C. Eldridge, "Wire Antennas," parts 1-4, *The Canadian Amateur*, March, April, May, July, 1979.
2. *ARRL Antenna Handbook*, 1974, pages 189-194.
3. J.R. True, "Grounded Vertical Radiators," *ham radio*, May, 1975, page 34.
4. B.A. Booth, "The Minooka Special," *QST*, December, 1974, pages 15-28.
5. S.U. Nolan, "Developments in MF Radiator Systems," *Sound and Vision Broadcasting*, 15, Spring 1974, 1-3.
6. C.E. Smith and E.M. Johnson, "Performance of Short Antennas," *Proceedings of IRE*, 35, October, 1947, pages 1026-1038.
7. J.S. Belrose, et al, "The Engineering of Communication Systems for Low Radio Frequencies," *Proceedings of IRE*, 47, May, 1959, pages 661-680.
8. A.F. Gangi, et al, "The Characteristics of Electrically Short, Umbrella Top-loaded Antennas," *IEEE Transactions on Antennas and Propagation*, AP-13, November, 1965, pages 864-871.
9. L.C. Smeby, "Short Antenna Characteristics-Theoretical," *Proceedings of IRE*, 37, October, 1949, pages 1185-1194.
10. C.E. Smith and E.R. Graf, "Increased Capacity for VLF Umbrella Antennas Using Multi-Wire Rib Construction," *IEEE Transactions on Antennas and Propagation*, November, 1968, pages 766-767.
11. E.A. Laport, *Radio Antenna Engineering*, McGraw Hill, 1952.
12. J.S. Belrose, "Short Antennas for Mobile Operation," *QST*, September, 1953, pages 30-35.
13. G.H. Brown, et al, "Ground Systems as a Factor in Antenna Efficiency," *Proceedings of IRE*, 25, 1937, pages 753-787.

ham radio

efficiency of short antennas

Some unsettling facts about power radiated from short antennas

Because of space limitations, many of us often must use antennas that are shorter than free-space resonant size. This happens, naturally, most often on the lower frequencies, and it's almost a universal practice in high-frequency mobile installations. How *efficient* are these antennas? That depends on many things, but there are ways to measure the efficiency of your antenna. In this article, we will examine the resistance method of determining antenna efficiency. You might be surprised at the results of such a test on your antenna system.

antenna or antenna system?

We can speak of the efficiency of the antenna itself, or we can speak of the efficiency of the entire

antenna system. The latter includes not only the actual radiator, but also the feed line, the transmatch (if any), and the transmitter tank circuit components. In either case, *efficiency* refers to that percentage of the applied power that is actually radiated into space.

For our purposes, when speaking of efficiency, we will be talking about the efficiency of the antenna only. Losses may occur in the antenna conductors, splices in the conductors, loading coils, or the surrounding earth and terrain in general. The object, of course, is to minimize such losses.

radiation resistance

Once an antenna radiates energy, that energy is gone forever: it never comes back. When a resistor dissipates energy, that is also gone forever; in fact, to a transmitting system, radiation is just the same as dissipation. Radiation of energy by an antenna appears to occur across certain values of resistance.

**By Stan Gibilisco, W1GV/4, P.O. Box 561652,
Miami, Florida 33156**

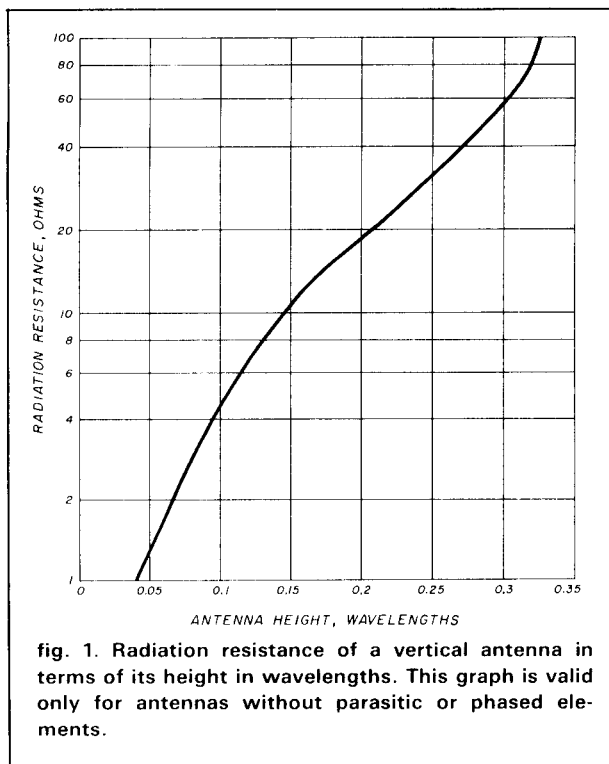

Replacing an antenna with the correct value of resistor allows the transmitting system to perform normally, and in precisely the same way it would with the antenna. The value of this resistance depends on certain characteristics of the antenna, but it is primarily a function of the physical size of the antenna. This property is called the radiation resistance.

For vertical antennas, the radiation resistance is a direct function of the height in wavelengths. **Fig. 1** illustrates this function. For a center-fed antenna in free space, the radiation resistance versus length is shown in **fig. 2**. A dipole (center-fed) antenna acts like two vertical antennas operating in series; note that a dipole whose overall length is x wavelengths has twice the radiation resistance of a vertical whose height is $x/2$ wavelength.

reactance

An antenna is resonant if and only if there is no reactance at the operating frequency. Although resonance is a desirable condition from the standpoint of impedance matching, it is not necessary. Many antennas are not resonant yet still function well. The antenna *system*, however, should always be resonant at the operating frequency in order for the transmitter to deliver the maximum energy into it.

When a vertical antenna is physically shorter than $1/4$ wavelength in free space, or a dipole is shorter than $1/2$ wavelength, it is necessary to put loading

coils in series with the radiator in order to obtain resonance. The shorter the antenna is at a given frequency, the larger the inductor must be.* It is possible, theoretically, to make an antenna resonant no matter how short it is.

When a vertical antenna is physically longer than $1/4$ wavelength, or a dipole is longer than $1/2$ wavelength, it is necessary to use series capacitors to get resonance. This can be done up to any length.

In both of the above-mentioned cases, the coils and capacitors serve to get rid of the reactance in the antenna system. A short antenna is capacitively reactive and needs an inductor to cancel the reactance; a long antenna is inductively reactive and requires a capacitor to cancel the reactance. Short antennas are far more common than long ones, and thus inductive loading is seen much more often than capacitive loading.

Unfortunately, coils always have a certain amount of loss resistance. When we use an inductor in a short antenna to get rid of the reactance, we are left with a pure resistance. But this resistance is not just radiation resistance; some of it is loss caused by the coil. And of course, all the other loss resistances, such as conductor and earth losses, are still in the cir-

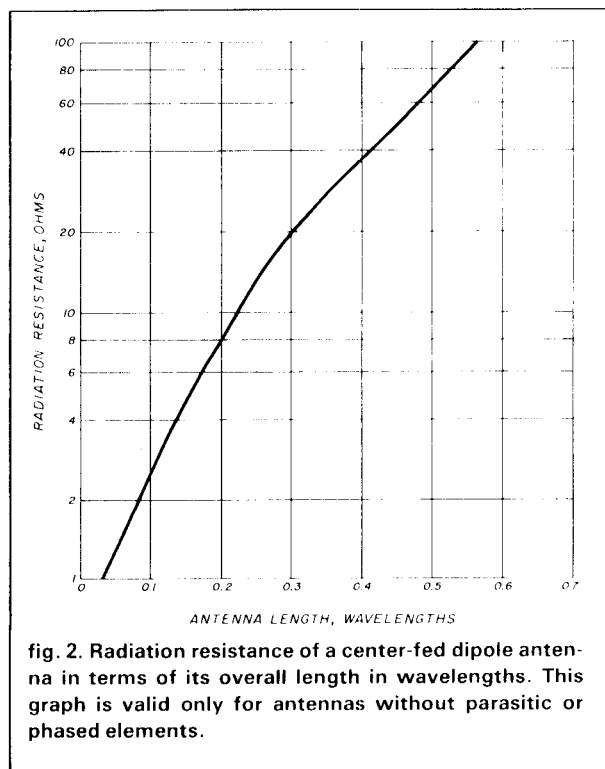

*That is, for a given inductor position in the radiating element. For a given antenna length and frequency, the amount of inductance required gets larger as the coil is moved toward the end of the radiator.

cuit. The pure resistance consists of two components, then: the radiation resistance, denoted by R_R , and the loss resistance, denoted by R_L .

loss resistance

The total resistance of the antenna is

$$R_T = R_R + R_L$$

because R_R and R_L are effectively in series. The value of R_R is a function of the physical length of the antenna, and is thus a constant for a given antenna. Loss resistance, R_L , is a variable; it can be minimized by using a radial or ground screen system, large-diameter conductors, low-loss coils, and the like. Of course, the objective is to minimize R_L .

At resonance, the impedance of the antenna is purely resistive, and has a value of R_T . If the line has a characteristic impedance of Z_0 , then

$$\begin{aligned} SWR &= Z_0/R_T \text{ if } Z_0 \geq R_T, \text{ and} \\ SWR &= R_T/Z_0 \text{ if } Z_0 \leq R_T \end{aligned}$$

Oddly enough, it is often true that the higher the efficiency of the antenna, the higher the SWR. Quite often, a low SWR with a short antenna is an indicator of terrible efficiency! This is because as we minimize R_L , we also minimize R_T , which may already be much smaller than the line Z_0 .

efficiency

To measure the efficiency of an antenna directly, it would be necessary to use instruments that few hams have, and the process would be extremely time-consuming. However, we can get a very close approximation of the efficiency of an antenna by simply measuring its resistance at resonance. To do this, you need an impedance bridge.* Obtaining R_T in this way, and knowing R_R from **fig. 1** or **fig. 2**, the efficiency of the antenna is approximately

$$\text{efficiency (percent)} = 100 R_R/R_T$$

Only the energy delivered to R_R , the radiation resistance, is radiated; that delivered to R_L is lost. The loss resistance is concentrated mainly in the loading coil and the earth near the antenna. Sometimes we cannot install a ground radial system — for example, in a mobile installation. We can make the coil only so big before it gets excessively bulky. Thus, the efficiency of a short antenna is limited by practical considerations.

no impedance bridge?

You most probably have an SWR meter, but

*An impedance bridge is a more sophisticated device than the common SWR bridge. An impedance bridge shows the values of reactance and radiation resistance in an antenna system.

chances are you do not have an impedance bridge. You can still measure the efficiency of a short antenna, in most cases, using only an SWR indicator, because it is much more likely that $R_T \leq Z_0$, when the antenna is short, than vice-versa. (There is a limit to how lossy even the worst installation can be!) Thus

$$SWR = Z_0/R_T; R_T = Z_0/SWR.$$

Determining R_R from **fig. 1** or **fig. 2**, we can calculate the efficiency as before.

For longer antennas (verticals over 1/4 wavelength high or dipoles longer than 1/2 wavelength), it is quite possible that R_T will be larger than the line Z_0 . Unfortunately, using just an SWR meter, we have no way of knowing whether R_T is larger or smaller than Z_0 , except by using intuition. So it is definitely best to use an impedance bridge, if possible, for measuring efficiency. The impedance bridge or SWR meter should, of course, be placed at the point where the line feeds the antenna. Placing the instrument at any other point will cause false readings.*

practical examples

Suppose we have a 40-meter vertical, ground-mounted, and 14 feet (4.3 meters) high with a loading coil at the center, as shown in **fig. 3**. We have managed to install several radials, and measure the SWR at the feed point as 1.0 at resonance. (Resonance is indicated by the frequency where the SWR is minimum, for all practical purposes.)

At 7 MHz, a free-space wavelength is given by

$$\begin{aligned} \text{length (feet)} &= 984/7 = 140.6, \text{ or} \\ \text{length (meters)} &= 300/7 = 43 \end{aligned}$$

and thus 14 feet (4.3 meters) represents about 0.1 wavelength. From **fig. 1**, the value of the radiation resistance, R_R , is approximately 4 ohms.

Since the SWR is 1.0, the value of R_T must be equal to the line impedance, which is 50 ohms. Consequently,

$$\text{efficiency (percent)} = 100 \times 4/50 = 8$$

That's correct. Eight percent!

If the antenna were one-hundred percent efficient, R_T would be equal to R_R , which is 4 ohms. Then the SWR would be 50/4, or 12.5!

To illustrate another example, suppose we have a 75-meter mobile antenna that displays an SWR of 2 at resonance, using no matching transformers of any kind. If this antenna is 8 feet (2.4 meters) high at 3.875MHz, it is a paltry 0.03 wavelength high. In **fig. 1**,

*If an SWR meter is used, the SWR seems to get smaller (closer to 1) as the instrument is moved away from the antenna. If an impedance bridge is used, reactance will be introduced when the instrument is not at the feed point, unless the match happens to be perfect ($R_T = Z_0$).

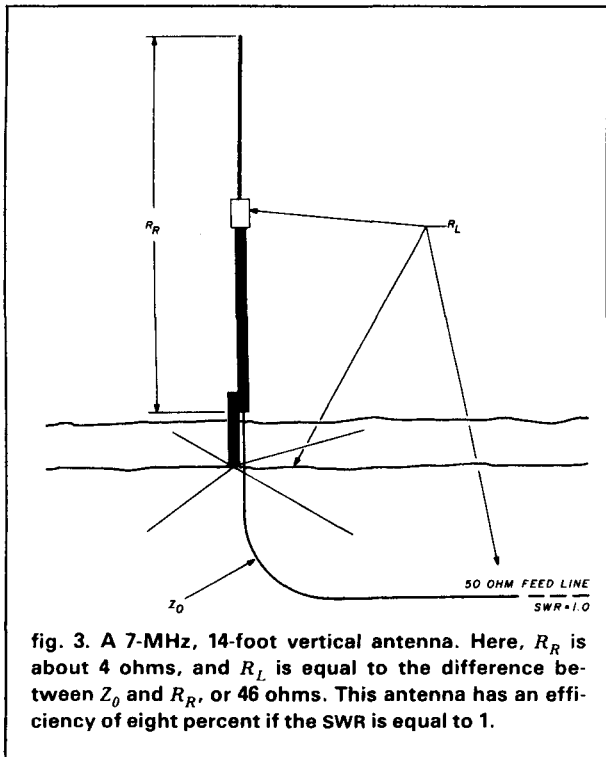

fig. 3. A 7-MHz, 14-foot vertical antenna. Here, R_R is about 4 ohms, and R_L is equal to the difference between Z_0 and R_R , or 46 ohms. This antenna has an efficiency of eight percent if the SWR is equal to 1.

that is just about off the chart; R_R is roughly 1 ohm.

Since the SWR is 2, we may assume that $R_T = 50/2 = 25$. So

$$\text{efficiency (percent)} = 100 \times 1/25 = 4$$

It is possible (though not likely) that R_T is twice Z_0 , or 100 ohms; then

$$\text{efficiency (percent)} = 100 \times 1/100 = 1$$

We would need an impedance bridge to be certain.

conclusion

These results may, in fact should be, unsettling. Short antennas generally are not efficient ones. This is especially true for vertical antennas over less-than-perfect conducting ground.

If a short antenna is made highly efficient by minimizing R_L , it is inevitable that the SWR will be high at resonance. This, however, can be alleviated by using matching networks. If the feed line is short, the matching network can be placed at the transmitter for convenience, since the SWR loss will be rather small in a short run of cable. If the feed line is long or the SWR is extremely high, you would do better to put the matching device at the antenna feed point. Broadbanded matching transformers are available for this purpose.

ham radio

HAL'S SUMMER SPECIALS

- HAL 2304 MHz DOWN CONVERTERS (FREQ. RANGE 2000/2500 MHz)
- 2304 MODEL #1 KIT BASIC UNIT W/PREAMP LESS HOUSING & FITTINGS \$34.95
- 2304 MODEL #2 KIT (with preamp) \$44.95
- 2304 MODEL #3 KIT (with High Gain preamp) \$54.95
- MODELS 2 & 3 WITH COAX FITTINGS IN & OUT AND WITH WEATHER-PROOFED DIE CAST HOUSINGS
- BASIC POWER SUPPLY \$19.95
- POWER SUPPLY KIT FOR ABOVE WITH CASE \$24.95
- FACTORY WIRED & TESTED \$34.95

ANTENNAS & OTHER ACCESSORIES AVAILABLE. SEND FOR MORE INFO.

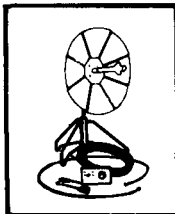

2100-2500 MHZ

*HMR-II COMPLETE UNIT
COMPLETE SYSTEM AS SHOWN. NOT A KIT. INCLUDES A PC BOARD, POWER SUPPLY, CABLES & CONNECTORS—PRE-ASSEMBLED AND TESTED. 24dB GAIN OR GREATER.

- 1 UNIT \$149.95
- 2 UNITS \$139.95 ea.
- 3 OR MORE UNITS \$129.95 ea.

*HAM MICROWAVE RECEIVER

PRE-SCALER KITS

- HAL 300 PRE (Pre-drilled G-10 board and all components) \$14.95
- HAL 300 A/PRE (Same as above but with preamp) \$24.95
- HAL 600 PRE (Pre-drilled G-10 board and all components) \$29.95
- HAL 600 A/PRE (same as above but with preamp) \$39.95

TOUCH TONE DECODER KIT

HIGHLY STABLE DECODER KIT. COMES WITH 2 SIDED, PLATED THRU AND SOLDER FLOWED G-10 PC BOARD, 7-567's, 2-7402, AND ALL ELECTRONIC COMPONENTS. BOARD MEASURES 3-1/2 x 5-1/2 INCHES. HAS 12 LINES OUT. ONLY \$39.95

- NEW—16 LINE DELUXE DECODER \$69.95
- DELUXE 12-BUTTON TOUCHTONE ENCODER KIT UTILIZING THE NEW ICM 7206 CHIP PROVIDES BOTH VISUAL AND AUDIO INDICATIONS! COMES WITH ITS OWN TWO-TONE ANODIZED ALUMINUM CABINET MEASURES ONLY 2 3/4 "x3 3/4 " COMPLETE WITH TOUCH-TONE PAD, BOARD, CRYSTAL, CHIP AND ALL NECESSARY COMPONENTS TO FINISH THE KIT. PRICED AT \$29.95
- NEW—16 LINE DELUXE ENCODER \$39.95
- HAL ECD—16 LINE DELUXE ENCODER INCLUDES PC BOARD, ALL PARTS & CASE \$39.95

HAL ECD—12 LINE DELUXE ENCODER COMPLETE WITH PC BOARD, ALL PARTS & CASE \$29.95

ACCUKEYER (KIT) THIS ACCUKEYER IS A REVISED VERSION OF THE VERY POPULAR WB4VVF ACCUKEYER ORIGINALLY DESCRIBED BY JAMES GARRETT, IN QST MAGAZINE AND THE 1975 RADIO AMATEUR'S HANDBOOK \$16.95

ACCUKEYER—MEMORY OPTION KIT PROVIDES A SIMPLE, LOW COST METHOD OF ADDING MEMORY CAPABILITY TO THE WB4VVF ACCUKEYER. WHILE DESIGNED FOR DIRECT ATTACHMENT TO THE ABOVE ACCUKEYER, IT CAN ALSO BE ATTACHED TO ANY STANDARD ACCUKEYER BOARD WITH LITTLE DIFFICULTY \$16.95

BUY BOTH THE MEMORY AND THE KEYS AND SAVE COMBINED PRICE ONLY \$32.00

PRE-AMPLIFIER

HAL-PA-19 WIDE BAND PRE-AMPLIFIER, 2-200 MHZ BANDWIDTH (-3dB POINTS), 19 dB GAIN

FULLY ASSEMBLED AND TESTED \$8.95

HAL-PA-1.4 WIDE BAND PRE-AMPLIFIER, 10 MHZ TO 1.4 GHZ. 12dB GAIN

FULLY ASSEMBLED \$12.95



CLOCK KIT—HAL 79 FOUR-DIGIT SPECIAL—\$7.95. OPERATES ON 12-VOLT AC (NOT SUPPLIED) PROVISIONS FOR DC AND ALARM OPERATION.

6-DIGIT CLOCK•12/24 HOUR

COMPLETE KIT CONSISTING OF 2 PC G-10 PRE-DRILLED PC BOARDS, 1 CLOCK CHIP, 6 FND COMM. CATH. READOUTS, 13 TRANS. 3 CAPS, 9 RESISTORS, 5 DIODES, 3 PUSH-BUTTON SWITCHES, AND INSTRUCTIONS. WILL RUN OFF ANY 12V A.C. POWER SUPPLY. DON'T BE FOOLED BY PARTIAL KITS WHERE YOU HAVE TO BUY EVERYTHING EXTRA. PRICED AT \$12.95

CLOCK CASE AVAILABLE AND WILL FIT ANY ONE OF THE ABOVE CLOCKS. REGULAR PRICE ... \$6.50 BUT ONLY \$4.50 WHEN BOUGHT WITH CLOCK.

SIX-DIGIT ALARM CLOCK KIT FOR HOME, CAMPER, RV, OR FIELD-DAY USE. OPERATES ON 12-VOLT AC OR DC, AND HAS ITS OWN 60-Hz TIME BASE ON THE BOARD. COMPLETE WITH ALL ELECTRONIC COMPONENTS AND TWO-PIECE, PRE-DRILLED PC BOARDS. BOARD SIZE 4" x 3". COMPLETE WITH SPEAKER AND SWITCHES. IF OPERATED ON DC, THERE IS NOTHING MORE TO BUY! PRICED AT \$16.95

*TWELVE-VOLT AC LINE CORD FOR THOSE WHO WISH TO OPERATE THE CLOCK FROM 110-VOLT AC WHEN PURCHASED WITH CLOCK KIT \$2.95

SHIPPING INFORMATION: ORDERS OVER \$25 WILL BE SHIPPED POST-PAID EXCEPT ON ITEMS WHERE ADDITIONAL CHARGES ARE REQUESTED. ON ORDERS LESS THAN \$25, PLEASE INCLUDE ADDITIONAL \$2.00 FOR HANDLING AND MAILING CHARGES. SEND 20¢ STAMP FOR FREE FLYER.

DISTRIBUTOR FOR
Aluma Tower•AP Products
(We have the new Hobby-Blox System)

HAL-TRONIX
P. O. BOX 1101
SOUTHGATE, MICH. 48195
PHONE (313) 285-1782



"HAL" HAROLD C. NOWLAND
W8ZHX

**VISIT OUR BOOTH
AT THE**



MADISON
Electronics Supply

1508 MCKINNEY
HOUSTON, TEXAS 77010
713-658-0268

OCTOBER 1-3, 1982 ASTROVILLAGE HOTEL

HAM RADIO'S MINI-SHOPPER

New For September

ARRL ANTENNA BOOK 14th Edition

This book is the Amateur Antenna bible. It includes just about every bit of information you'd ever want to know about antenna design, construction and theory. Starting off with wave propagation, antenna fundamentals and transmission line theory, this book progresses through coupling the transmitter and antenna to the feedline to 9 big, inclusive chapters on how to build different antennas. You also get a chapter on antenna and transmission line measurements and Antenna Orientation. This is a must book for your ham shack. New, large, magazine style gets you more bang for your buck! ©1982, 14th edition, 200 pages.

AR-AM **Softbound \$8.00**

AMATEUR RADIO — THEORY AND PRACTICE by R. Shrader, W6BNB

For those of you who didn't buy Electronic Communications because it covered more than you want to know — this is the book for you! It's a complete beginner's text requiring absolutely no previous knowledge of electronics. In a simple, easy-to-comprehend style, Author Shrader covers everything you need to know to pass your Novice through Extra Class license. Each chapter is marked by the class of license the text is covering. Handy quizzes and tests help ensure that you understand the material before you go on to the next chapter. This book can almost make studying for your ticket a painless experience. ©1982, 340 pages (taken from latest Electronic Communications).

MH-57146 **Softbound \$19.95**

Please add \$2.50 to cover shipping and handling.

Call (603) 878-1441

HAM RADIO'S BOOKSTORE
GREENVILLE, NH 03048

CONFIDENTIAL FREQUENCY LIST 5th Edition

by Oliver P. Ferrell

Are you one of those who enjoys tuning across the bands looking for who-knows-what? If you are, you've got to get a copy of this new book. 225 pages are jam-packed with frequencies and call signs. Hundreds of stations from around the world are listed first by frequency and then by call sign. You also get plenty of helpful hints and tips taken from the author's 40+ years in Radio. Author Ferrell is known worldwide as one of the most knowledgeable folks around when it comes to SWling. ©1982, 5th edition, 225 pages.

GL-CF **Softbound \$9.95**

READY REFERENCE by John Markus

Electronics Projects	MH-40459
Special Circuits	MH-40461
Popular Circuits	MH-40458
Communications Circuits	MH-40460
Digital Circuits	MH-40457

These five volumes are filled with many useful circuits that will meet almost any circuit need you might have. Each book is dedicated to one subject area and includes references from hundreds of hobby and professional publications. Portions of each book originally appeared in Modern Electronics Circuits Reference Manual ©1980. We find the five separate volumes easier to use than the original. Of special interest to hams is Communications Circuits. 15 chapters include antennas, code, receiving and transmitting circuits as well as modulator, telephone, teleprinter and television circuits. You can buy them individually or buy them all in a money-saving special. ©1982, 2nd edition.

Softbound \$12.50 each

SAVE \$7.55

Reg. \$62.50 for set of 5

MH-RR **Get 'em all special \$54.95**

SEND FOR FREE BOOK CATALOG.

DUAL DRIVE TRIBANDERS

- 20, 15 and 10 meters • Wideband. Low SWR. No tuner needed
- Exclusive phased dual drive gives higher gain
- Exclusive coaxial capacitors have lower losses, higher Q
- Transmitter power is radiated not lost in the traps
- Full power low loss balun. Gives improved beam pattern

TET Antenna Systems presents three full size trap multiband beams to meet every amateur need. 5 element, 4 element, and 3 element models all with the exclusive TET dual phased drive. This famous drive system originated with HB9CV and was perfected by JA3MP. When you buy TET dual drive you know you have the best. It has more gain - just like adding another parasitic element. And wide bandwidth so you can use your solid-state transceiver on both phone and CW without a tuner.

Only the highest quality materials are used throughout. All aluminum tubing is 6061-T6 alloy. Stainless steel fasteners are provided for all electrical connections. Tubing is cut and predrilled to precision tolerances for easy one afternoon assembly. Light weight and low wind area designs permit use of simpler support structures.

All models feature full 3 Kw PEP power handling, VSWR typical 1.5 or less across all of 20, 15 and, on 10 meters, from 28.0 to 29.2 MHz. Drive impedance is 50 ohms and maximum element length 27'. They accommodate masts from 1 1/2" to 2" diameter, withstand winds to 100 mph and are furnished complete with a low loss balun that easily withstands full rated power. For gain and front-to-back ratio specifications write or call the factory.

	HB35T	HB43SP	HB33SP
Boom Length:	24' 7"	19' 8"	13' 2"
Turn Radius:	18' 10"	16' 9"	15'
Wind Area Ft ² :	7.9	6.6	4.7
Wind load lbs. @ 80 mph:	160	132	102
Boom Dia.:	2"	2"	1-5/8"
Weight, lbs.:	50	38	27
Price:	\$329.95	\$239.95	\$174.75
	+ shipping	+ shipping	+ shipping

TET ANTENNA SYSTEMS

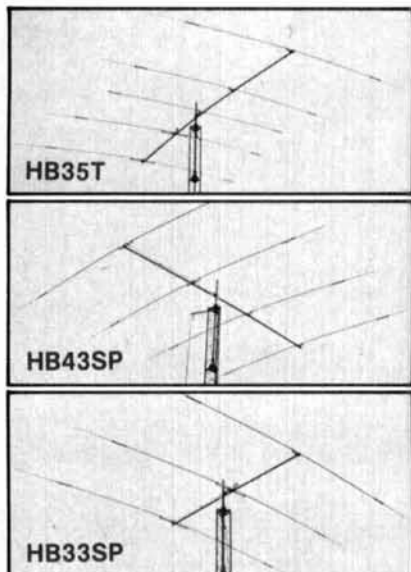

Send for free catalog describing these dual drive beams, our VHF Swiss quads, roof-mount towers, elevation rotators and more. Don't wait any longer to start working rare DX. Order your dual-drive beam today!

BY MAIL:

TET Antenna Systems
1924-E W. Mission Road
Escondido, CA 92025



BY PHONE: 714-743-7025



FAST SCAN

*\$249

A modular approach... for your own custom-designed ATV system... Here's how

TXA5-4 ATV EXCITER/MODULATOR \$89 ppd

This wired and tested module is designed to drive the Motorola MHW-710 module in the PA5 10 watt linear amp. The crystal in the 100 mHz region keeps harmonics out of two meters for talk back. The video modulator is full 8 mHz for computer graphics and color. Requires 13.8 vdc reg @ 70 ma. Tuned with xtal on 439.25, 434.0, or 426.25 mHz. Provision for sync expanding. Two frequencies available.



PA5 10 WATT ATV POWER MODULE \$89 ppd

The PA5 will put out 10 watts RMS power on the sync tips when driven with 80 mw by the TXA5 exciter. 50 ohms in and out, plus bandwidth for the whole band with good linearity for color and sound. Requires 13.8 vdc regulated @ 3 amps.

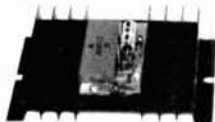

FMA5 AUDIO SUBCARRIER GENERATOR

\$29 ppd

Puts audio on with your camera video just as broadcast TV does at 4.5 mHz. Puts out up to 1 v p-p to drive the TXA5 or VM-2, 3, or 4 modulators. Requires low Z mic (150 to 600 ohms), and +12 to 18 vdc @ 25 ma. Works with any xmtr with 5 mHz video bandwidth.



TVC-2 ATV DOWNCONVERTER... \$55 ppd

Stripline MRF901 (1.7 db NF) preamp and double balanced mixer module digs out the weak ones but resists intermod and overload. Connects between uhl antenna and TV set tuned to channel 2 or 3. Varicap tunes 420 to 450 mHz. Requires +12 to 18 vdc @ 20 ma. Super sensitive TVC-2L with NE64535 preamp (9db NF) stage. \$69 ppd.



***TXA5, PA5, FMA5 and TVC Basic Module Pkg.**

Call or write for our complete list of specifications, station set-up diagrams, and optional accessories which include antennas, modulators, detectors, test generators, cameras, etc. **WE ARE A FULL-LINE SUPPLIER OF ALL YOUR ATV NEEDS.**

TERMS: VISA or MASTER CARD by telephone or mail, or check or money order by mail. All prices are delivered in USA. Allow three weeks after order for delivery.

(213) 447-4565 Charge card orders only

P.C. ELECTRONICS 2522 Paxson Lane,
Tom W6ORG Maryann WB6YSS Arcadia, California 91006

FOR ALL YOUR AMATEUR RADIO NEEDS ...

Call the **GISMO** Gang



DENTRON



CALL TOLL FREE
(for orders only)

800-845-6183

For inquiries and service

803-366-7157

G.I.S.M.O. • 1039 LATHAM DRIVE • ROCK HILL, S. C. 29730

Long's best ham values!

SAVE \$579!



ALL FOR ONLY \$899

List Price 1478.00
I.N. YAEFT107DEAL
Add 9.74 shipping & handling

- One low price! You get**
- FT-107M HF SSB transceiver (a \$1149.00 value)
 - FP-107 Internal power supply (a \$139.00 value)
 - SP-107P speaker/phone patch (a \$65.00 value)
 - DMS-107 digital memory shift (a \$125.00 value)

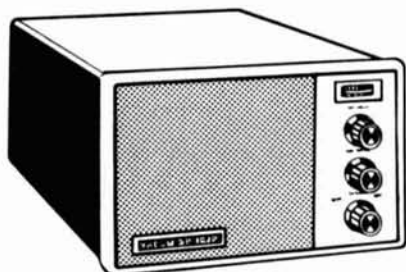

Get the YAESU FT-107M HF SSB transceiver complete with digital memory shift, internal power supply and speaker/phone patch for one unbelievable low price!

A super fantastic buy on a great DX rig and accessories! The FT-107M's all solid-state design makes instant band changes possible and also provides exceptional performance. Features digital and analog frequency display, RF and AF gain controls, variable IF bandwidth using 16 poles of crystal filtering, 12 channel memory and adjustable AGC. Cover 160 thru 10 meters including WARC bands. Comes complete with FP-107 internal power supply, SP-107P speaker/phone patch and DMS-107 digital memory shift. All for one low price!

20% OFF!

DENTRON Big Dummy

Cuts air pollution while providing a standard reference for antenna measurements. Handles 1 kw CW for 10 minutes. Uses standard SO 239 connector. Flat SWR from 1.8-300 MHz. 50 ohms. Supplied with high grade industrial cooling oil.

31.50

List Price 39.50
Item No. DENBIGDUMMY
Add 3.31 shipping & handling

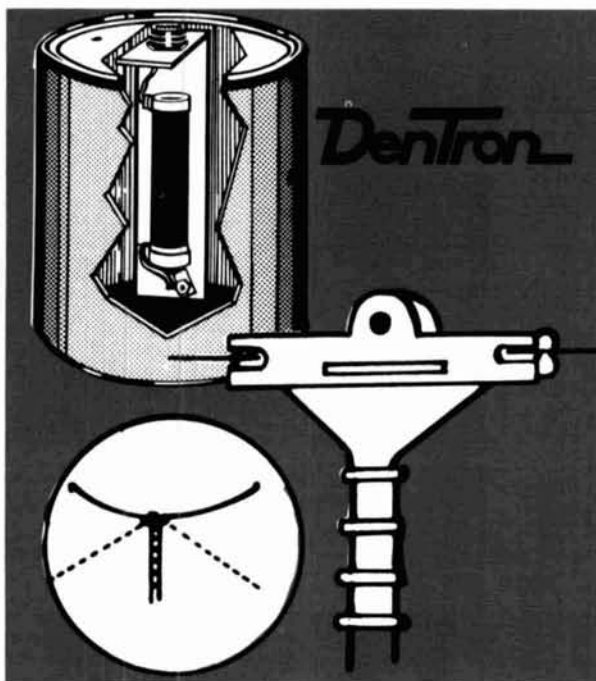

SAVE 20%!

DENTRON all band doublet

Enjoy all band operating capabilities with this flexible antenna system. Covers 160-10 meters and handles 2 kw PEP. Comes factory assembled and ready to erect in any configuration (flat, inverted V, or sloper). 130 ft., but can be shortened if necessary. 470 ohm feedline. Antenna tuner required.

31.50

List Price 39.50
Item No. DENDDOUBLET
Add 2.14 shipping & handling

Long's Electronics



MAIL ORDERS: P.O. BOX 11347 BIRMINGHAM, AL 35202 • STREET ADDRESS: 3131 4TH AVENUE SOUTH BIRMINGHAM, AL 35233

Satellite TV system \$1995!

10 FOOT PARABOLIC

List Price 4015.00

Item No. MISSY19 Shipped Freight Collect

What the system will do:

You can receive up to 60 channels of TV direct from satellites to your home receiver. Movies, sporting events, religious programs, other TV stations and much more.

What the system includes:

1. 10 ft. fiberglass dish made of reflective metal bonded with fiberglass. Weather-resistant and virtually maintenance-free. Comes in 4 sections.

2. Polar mount complete with azimuth and elevation cranks for easy satellite-to-satellite adjustment.

3. LNA mount complete with rotor for turning LNA from horizontal to vertical polarity. Tubing for mount legs not included.

4. KLM Sky Eye IV satellite receiver: Consists of two pieces, receiver and downconverter. Features video inversion, AFC defeat, slide rule tuning and latest single-conversion electronics. Modulator optional.

5. Avantek 4215 low noise amplifier: A 120 degree un-cooled LNA. Takes the weak signals to a TV picture. Uses GaAs FET transistors for maximum performance and powered up the coax line. Urethane coated for weather-proofing.

6. Chaparral feed horn: Provides 0.5 dB gain improvement over conventional rectangular horns. Virtually eliminates system noise.

Note: Customer provides all cables that run from downconverter outside to receiver inside (approx. cost \$80). Customer can use conventional TV set tuned to channel 3 or 4 with optional RF modulator (\$59).

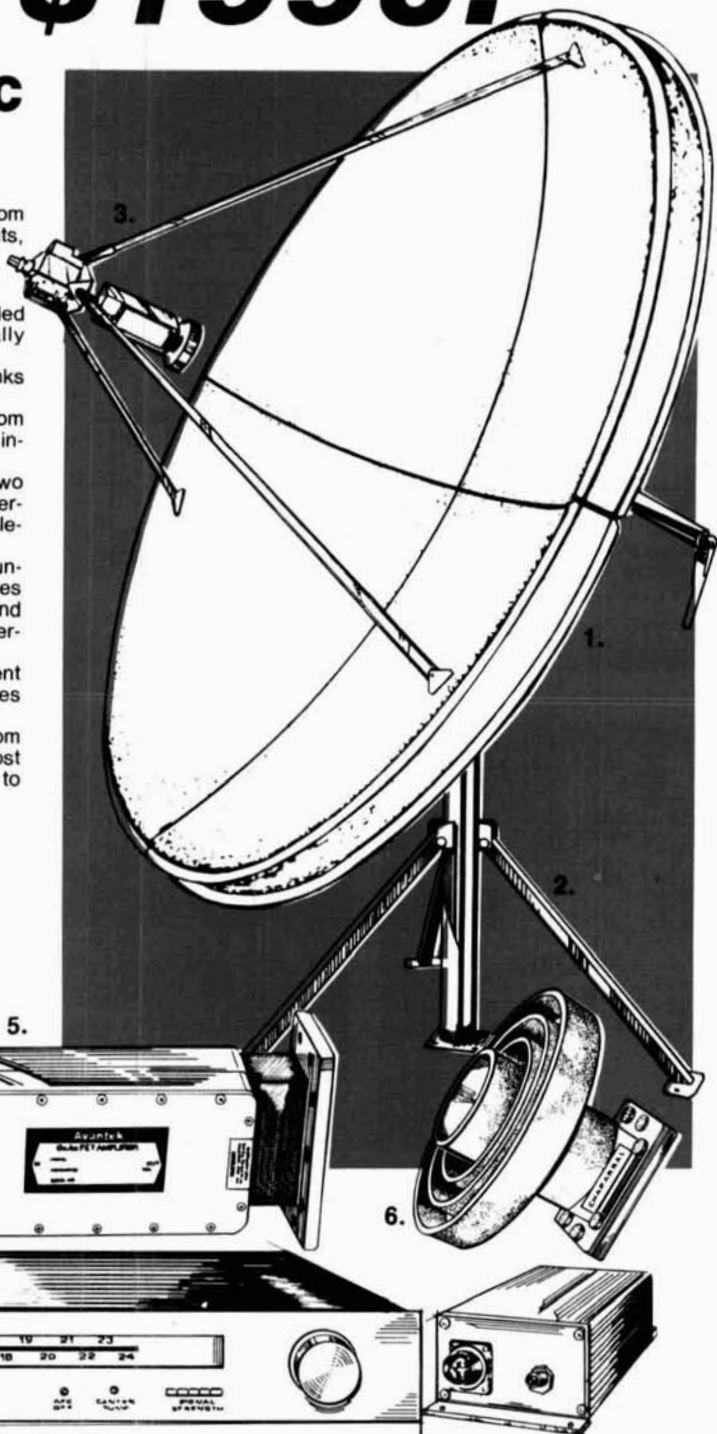

Call Toll Free **1-800-633-3410**

IN ALABAMA CALL 1-800-292-8668 9 AM TIL 5:30 PM CST, MONDAY THRU FRIDAY

Radio Handbook

by Bill Orr

NEW 22nd EDITION

The Radio Handbook has been a best seller for over 45 years. This brand-new edition covers in complete detail all of the latest state-of-the-art advances in electronics. Hams and engineers alike will find this handy, single-source reference an invaluable aid. Chock-full of projects from simple test equipment to complex receivers and amplifiers. Chapters include an explanation of Amateur Radio communications, electronic and electrical theory, tubes and semiconductor devices; a special chapter on RFI and more . . . This invaluable book is a must for every ham-shack. Orders yours today and save. 1136 pages. ©1982 □21874

\$34.95

Please add \$2.00 for shipping and handling.

ham radio's
BOOKSTORE
Greenville, NH 03048

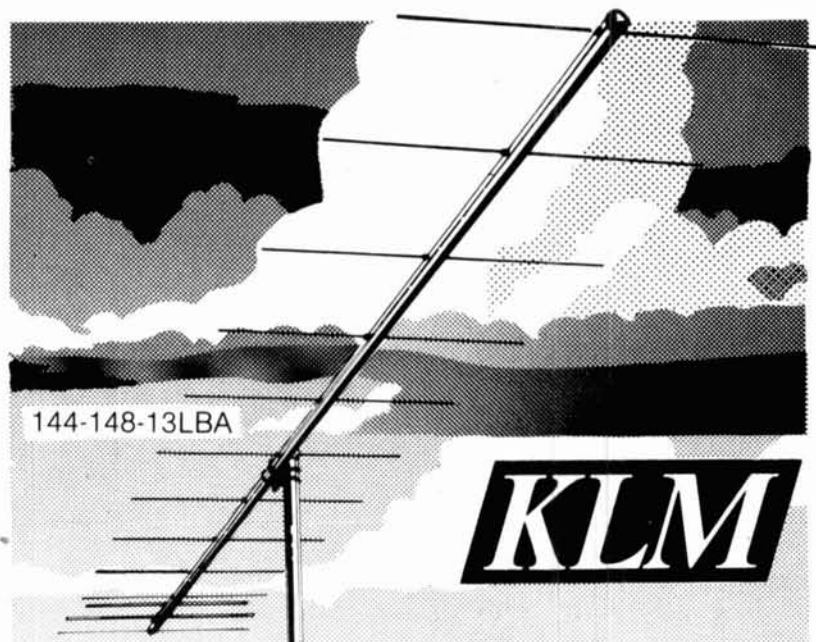

144-148-13LBA

KLM

WHY SETTLE FOR HALF THE BAND?

Enjoy super-gain, low VSWR, and FULL COVERAGE, 144 through 148 MHz, with less weight and windload. Dual-driven elements, balanced feed for a better match and clean pattern.

Bandwidth:	144-148 MHz	Balun:	2KW 4:1
Gain:	15.5 dBd	Boom:	21' .5/1 1/2"
VSWR:	1.2:1 & less	Windload:	1.6 sq ft
Beamwidth:	28°	Weight:	9 lbs

CIRCULAR POLARIZED For the Phase IIIB satellite and terrestrial DX, ATV, and FM. Minimizes multipath and flutter fading. Rugged symmetrical construction.

Bandwidth:	420-450 MHz	Windload:	.5 sq ft
Gain:	12 dBdc	Weight:	3.6 lbs
VSWR:	1.5:1 & less		
F/B:	20 dB		
Baluns:	2KW, 4:1 (2)		
Boom:	88" / 1"		

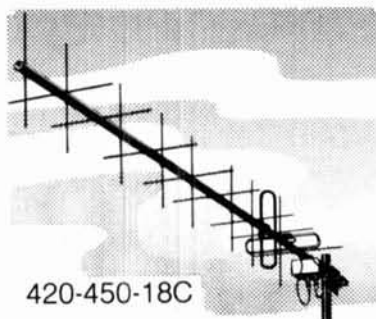

420-450-18C

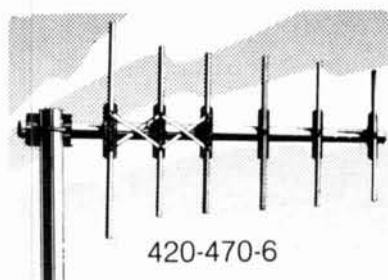

420-470-6

IDEAL for point-to-point and repeater control. Rear-mounted, vertically polarized, compact. Continuous coverage, 420-470 MHz. Direct coax feed suitable for most installations.

Bandwidth:	420-470 MHz
Gain:	8dBd
VSWR:	1.2:1 & less
Beamwidth:	60°
F/B:	20 dB, min
Boom:	2' / 1" O.D.
Weight:	1.2 lbs

SEE YOUR KLM DEALER:

KLM Electronics, Inc. P.O. Box 816, Morgan Hill, CA 95037
(408) 779-7363

Barry Electronics Corp.

WE SHIP WORLDWIDE

WORLD WIDE AMATEUR RADIO SINCE 1950

Your one source for all Radio Equipment!

We Will Not Be Undersold Call: 212-925-7000



Kitty Says: "Shop everywhere, but come to Barry for our unbelievable low prices. For orders only please call: 1-800-221-2683."

YAESU



FT-ONE, FT-102, FT-101ZD
FT-707, FT-230R, FT-480R, FT-720RU, FT-290R



ICOM IC-720A, IC-730, IC-740
IC-25A, IC-251A, IC-2KL, IC-451A

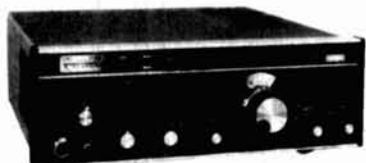

DRAKE TR-5, TR-7A, R-7A, L-7
L-15, Earth Satellite Receiver ESR-24
Digital Multimeter Model #8550-\$95.00

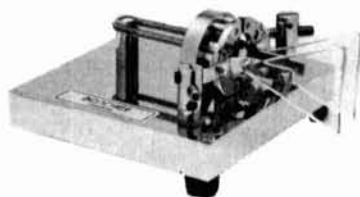

BENCHER PADDLE
4 Vibroplex Keys In Stock



TEN-TEC
Omni "C"



EIMAC
3-500Z
572B, 6JS6C
12BYZA &
4-400A

AEA 144 MHz,
AEA 440 MHz
ANTENNAS

BIRD
Wattmeters &
Elements
in stock

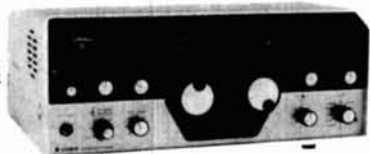

ASTRO 103 150A & 100 MXA
DIPLOMAT 150



ROBOT 400 & 800

HY-GAIN
TOWERS
ANTENNAS &
ROTORS

KANTRONICS
Mini-Reader
Field Day
Code Tapes In Stock



MURCH Model UT2000B



MIRAGE
B-23, B-1016,
C-22 C-106,
D-24, D-1010

DENTRON
Clipperton T, L
Station Master I



DIGITAL
FREQUENCY
COUNTER

Trionyx-
Model TR-1000
0-600 MHz
Digimax-Model D-510 50Hz-1GHz



Land-Mobile H/T
Wilson Mini-Com II
Yaesu FTC-2203, FT-4703
Icom IC-M12 (Marine)
IC-H12



YAESU
FT-208R
FT-708R

SANTEC
HT-1200, ST-7T
ST-144/UP



ICOM
IC2AT
IC3AT
IC4AT



MAIL ALL ORDERS TO BARRY ELECTRONICS CORP., 512 BROADWAY, NEW YORK CITY, NY 10012.

New York City's LARGEST STOCKING HAM DEALER
COMPLETE REPAIR LAB ON PREMISES

BARRY INTERNATIONAL TELEX 12-7670 212-925-7000.
TOP TRADES GIVEN ON YOUR USED EQUIPMENT.

STORE HOURS: MON/FRI - 9 AM to 5:30 PM,
THURS. TILL 7:30 PM, SAT 10 AM to 3 PM.

AUTHORIZED DIST. MCKAY DYMEK FOR
SHORTWAVE ANTENNAS & RECEIVERS.

**"Aqui
Se Habla
Espanol"**

We Stock Yaesu, Icom, Cubic, Drake plus
other Commercial and Marine Radios.

WE STOCK: KLM ANTENNAS, UHF & VHF AMPLIFIERS, NEW
ROBOT MODEL #800, BIRD WATTMETER, HY-GAIN, LARSEN,
SHURE, KDK-2015R, TURNER, ASTATIC, VOCOM, VHF ENG.,
MFJ, KANTRONICS, AVANTI, CORDLESS TELEPHONES,
POCKET SCANNERS, NYE, BENCHER, VIBROPLEX, ALPHA.

WE NOW STOCK COMMERCIAL COMMUNICATIONS SYSTEMS
DEALER INQUIRIES INVITED. PHONE IN YOUR ORDER & BE REIMBURSED.

Amateur Radio Courses Given On Our Premises

Export Orders Shipped Immediately.

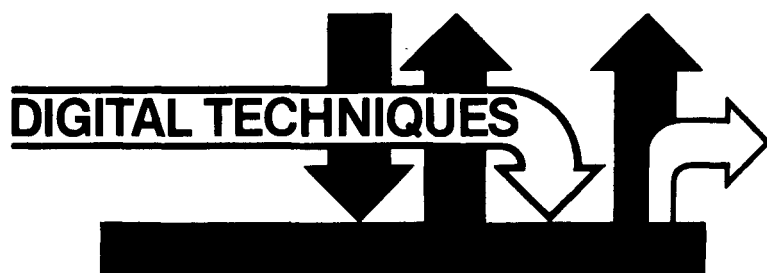

Digital techniques: inside a phase-frequency detector

Widespread use of phase-lock techniques for Amateur frequency control has increased digital circuitry in receivers and transmitters. The heart of a phase-locked loop (PLL) is the phase detector and this article examines one specific device: The Motorola MC4044 phase-frequency detector.

Each PLL should have a phase detector with linear phase response greater than ± 180 degrees and, for lock-in purposes, hold at maximum or minimum output until the controlled frequency comes within phase of the reference. The phase-frequency detector digital section of the MC4044 in fig. 1 does this well. The gate arrangement allows it to be duplicated by three conventional gate packages.¹ The circuit can be duplicated in any digital family.

The MC4044 has TTL input/output and includes a "charge pump," or time-to-capacitor-charge converter. Digital output is a pulse width proportional to phase so a summing integrator can substitute for the

charge pump. Either is part of the loop filter block in fig. 2A. Transfer characteristics of both phase detector and loop filter are shown in fig. 2B. Emphasis will be on the digital portion.

inputs, outputs and the stable state

Gate identification is arbitrarily alphabetical since only NAND gates are involved. Reference frequency is designated R and VCO or divided VCO input is S for signal. Phase detection takes place *only on negative-going transitions* of R and S.

Phase-proportional output is the *low* state time of gate B ($\overline{\text{LAG}}$) or gate D ($\overline{\text{LEAD}}$). Lead and lag is defined as S phase relative to reference R. Gate arrangement symmetry requires the output designations positioned relative to the particular inputs.

Gate states are stable when both inputs are high, or Logic 1, and gates A, C, F, and H are low, or Logic 0. This can be seen in the time-start of timing diagram in fig. 3. Outputs (gates B and D) will remain high; no phase has been detected at time-start.

By Leonard H. Anderson, 10048 Lanark Street, Sun Valley, California 91352

If the stable condition seems confusing, work it out on scratch paper using the "NAND Rule" given in previous articles of this series: Any low input will make the output high; all inputs must be high to make the output low.²

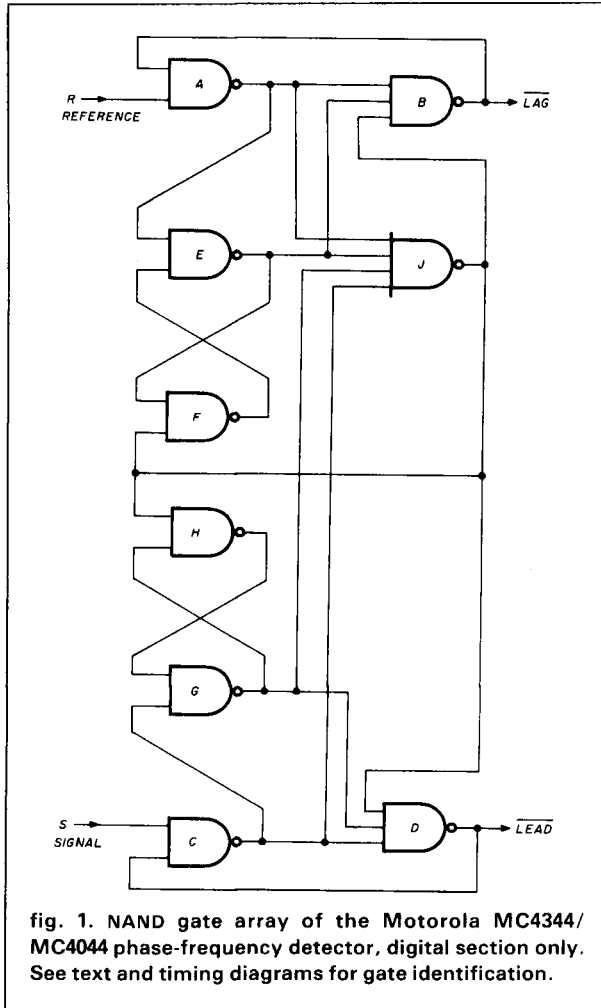

fig. 1. NAND gate array of the Motorola MC4344/MC4044 phase-frequency detector, digital section only. See text and timing diagrams for gate identification.

a rather complex flip-flop

The amount of gate feedback requires "walking through" the circuit in time, always remembering that every gate takes a finite amount of time to change state (propagation delay). Fig. 3 is used for starters with an assumed signal lag. It should be noted that all timing diagrams have exaggerated gate delays for illustration only.

Reference R goes low. Gate A output goes high from the NAND Rule. Gate B goes low since all its inputs are now high and this reinforces holding A low. Gate E doesn't change since it was already held high by F.

Signal S now drops low, C goes high, then D goes low, all similar to R, A, and B. The difference is that all inputs of gate J are now high; E and G were stable

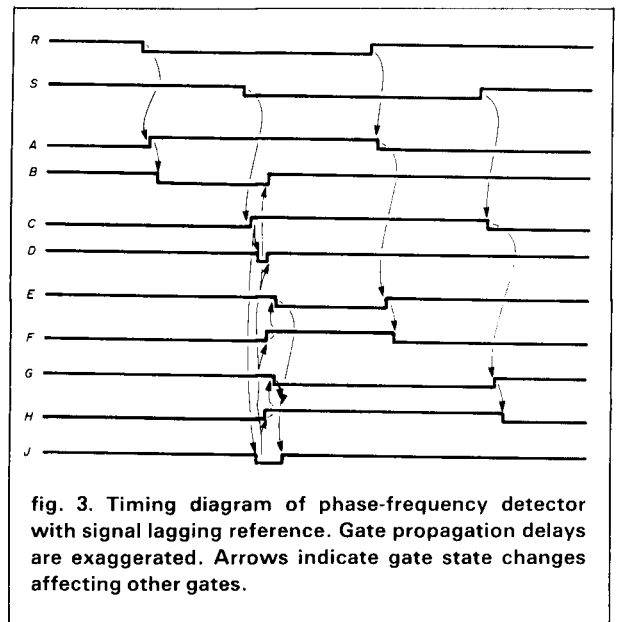

fig. 3. Timing diagram of phase-frequency detector with signal lagging reference. Gate propagation delays are exaggerated. Arrows indicate gate state changes affecting other gates.

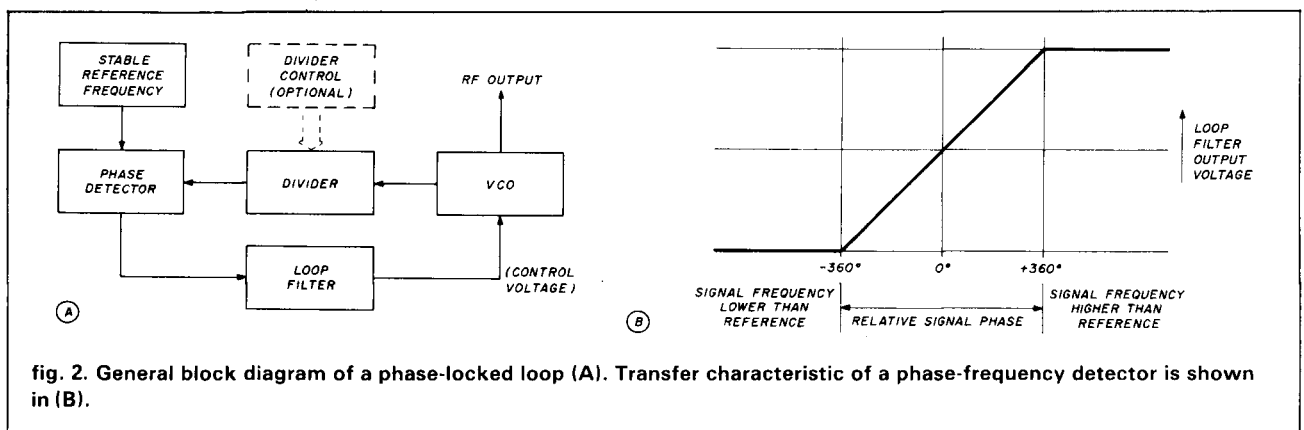

fig. 2. General block diagram of a phase-locked loop (A). Transfer characteristic of a phase-frequency detector is shown in (B).

high, A went high from R, then C went high. Gate J goes low and forces a sequence: Both B and D are made high (D remains low only for the gate delay of J), F and H are forced high.

Gate E must go low since inputs from A and F are both high. Gate G also goes low from C and H. Gate J is reset low from E and G even though A and C are still high. J has remained low for only three gate delays.

Set-reset flip-flops E and F, G and H are required for the intermediate time-state until either R or S return high. When R goes high, A goes low to hold B high. B was forced high due to the input from gate E being low. E will now go high but doesn't change B; the A change occurred first. Gate F returns to its stable low state since all inputs are high.

Returning S high will change, in order: C, G, and H in the same manner as A, E, and F. An important note is that all gate propagation delays are approximately the same so that the time-state changes occur in proper sequence.

\overline{LAG} output is low only for the time difference (phase) of R and S negative transitions. It is low for one extra gate delay but a summing integrator will cancel this via the \overline{LEAD} short low state. Any lag will have the same short low state of \overline{LEAD} plus the extra gate delay time of \overline{LAG} .

short input times and maximum speed

The timing diagram of fig. 4 has a lagging signal input but both inputs are short and do not overlap.

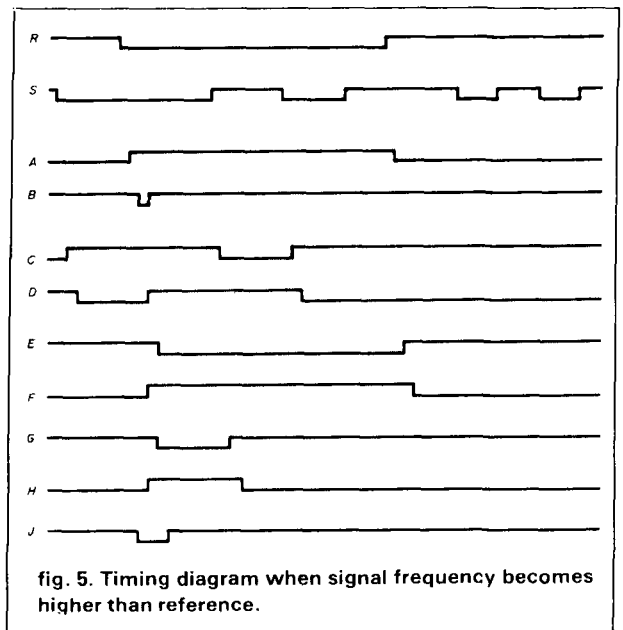
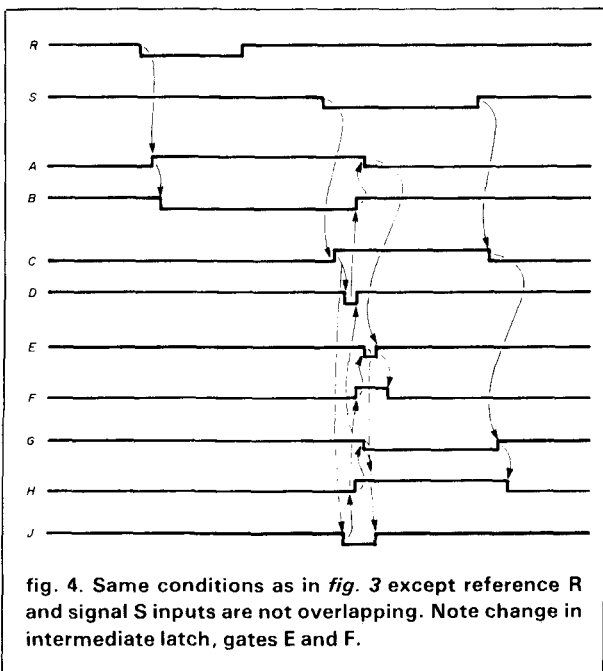

Gates A and B behave as in fig. 3. The difference occurs in the duration of intermediate flip-flop gates E and F.

When gate B is made high by a low J, A goes low since R was high before the negative edge of S. Gate F was forced high by a low J but E would go low due to A still being high. Gate A then drops low to force E high again. E is low for only one gate delay. Gate F resets since J has returned high by way of E and G going low.

The stable state is restored as in fig. 3 when the positive-going edge of S occurs. The \overline{LAG} output still represents the time difference between negative-going transitions of R and S.

The minimum low-state time of R or S is approximately 7 gate delays including the reset time on the positive edge of S. Maximum operating speed is inversely proportional to about 9 gate delays — about 6 MHz at 18 nanoseconds per gate.

letting the signal run faster

Fig. 5 shows an S input leading R, then increasing in frequency. There is a momentary low state of \overline{LEAD} (gate D) followed by a one-gate delay of \overline{LAG} (gate B). Thereafter, \overline{LEAD} will remain low until the next negative-going edge of R. Transfer characteristics of fig. 2B will be satisfied if both detector outputs are averaged.

In-phase maximum output extends very near to ± 360 degrees. The phase-frequency detector would make an excellent, wide-range phase meter when preceded by input comparators and followed by an integrator and analog voltmeter.

question sure to be asked

Fig. 6 shows timing at an absolutely in-phase time situation. No race condition exists and both outputs will go low for only one gate delay; summed outputs are zero. Any nonzero output is due to propagation delay differences between gates B and D, a nanosecond or two.

This timing diagram illustrates the symmetry of the gate arrangement. Inputs and outputs may be interchanged without affecting operation.

The stable state may not exist on power-up. I checked all 2048 combinations on nine gates and two inputs on an Apple II program for automatic settling. Forty combinations do not settle immediately but all will settle on the first arrival of a reference or signal input.

creating an analog output

A Motorola chip can use the on-board charge pump. The reader is referred to Motorola literature for connections and values.³

Greater flexibility is possible with separate op-amp integrators and filters. A summing integrator is given in fig. 7. Open-collector gates are assumed for B and D. The difference in collector return and integrator input resistor value ratios minimize op-amp offset bias; ratios are not absolute.

This integrator is an active lowpass filter with 6 dB

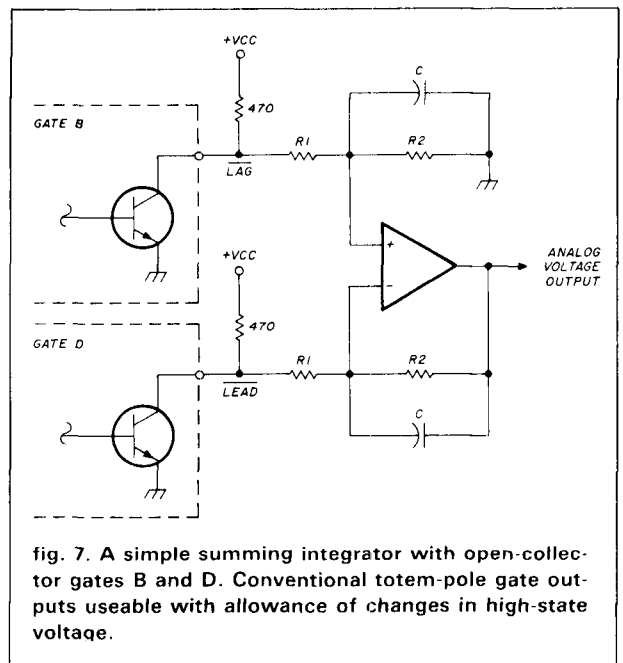
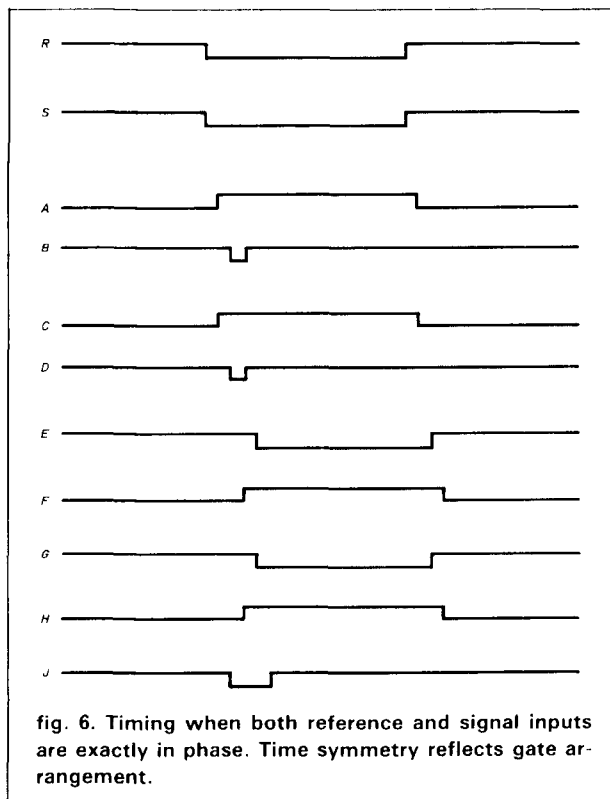

per octave (20 dB/decade) high frequency response. The -3 dB frequency (F_c) is found by:

$$F_c = \frac{1}{2\pi R_2 C}$$

Dc voltage gain is simply R_2/R_1 . Low-frequency gain must recognize that Logic 0 is not zero volts; TTL swings +0.3 to supply voltage with open-collector outputs.

Assuming all resistors are 10 k and C is 0.33 μ F, dc gain is unity and the -3 dB corner frequency is 48.2 Hz. Voltage gain is -26 dB at 1 kHz.

Many variations are possible in the PLL's analog portion. Texts in the bibliography are suggested for the serious experimenter.

references

1. Bob Fanning, K4VB, and Gary Grantland, WA4GJT, "800-Channel 2-Meter Synthesizer," *ham radio*, January, 1979, pages 10-18.
2. Leonard H. Anderson, "Digital Techniques: Basic Rules and Gates," *ham radio*, January, 1979, pages 76-78.
3. John DeLaune, "MTTL and MECL Avionics Digital Frequency Synthesizer," *Application Note AN-532*, Motorola Semiconductor Products, Inc., 1970. Good, concise summary of loop equations.

bibliography

1. Egan, William F., *Frequency Synthesis by Phase Lock*, John Wiley and Sons, 1981.
2. Gardner, Floyd M., *Phaselock Techniques, 2nd Edition*, John Wiley and Sons, 1979.
3. Lancaster, Don, *Active-Filter Cookbook*, Howard W. Sams & Co., Inc., 1980. Good, inexpensive text on active filters.
4. Tausworthe, Robert C., "Theory and Practical Design of Phase-Locked Receivers, Volume 1," JPL Technical Report No. 32-819, Jet Propulsion Laboratory, California Institute of Technology, Pasadena, California, February 15, 1966.

ham radio

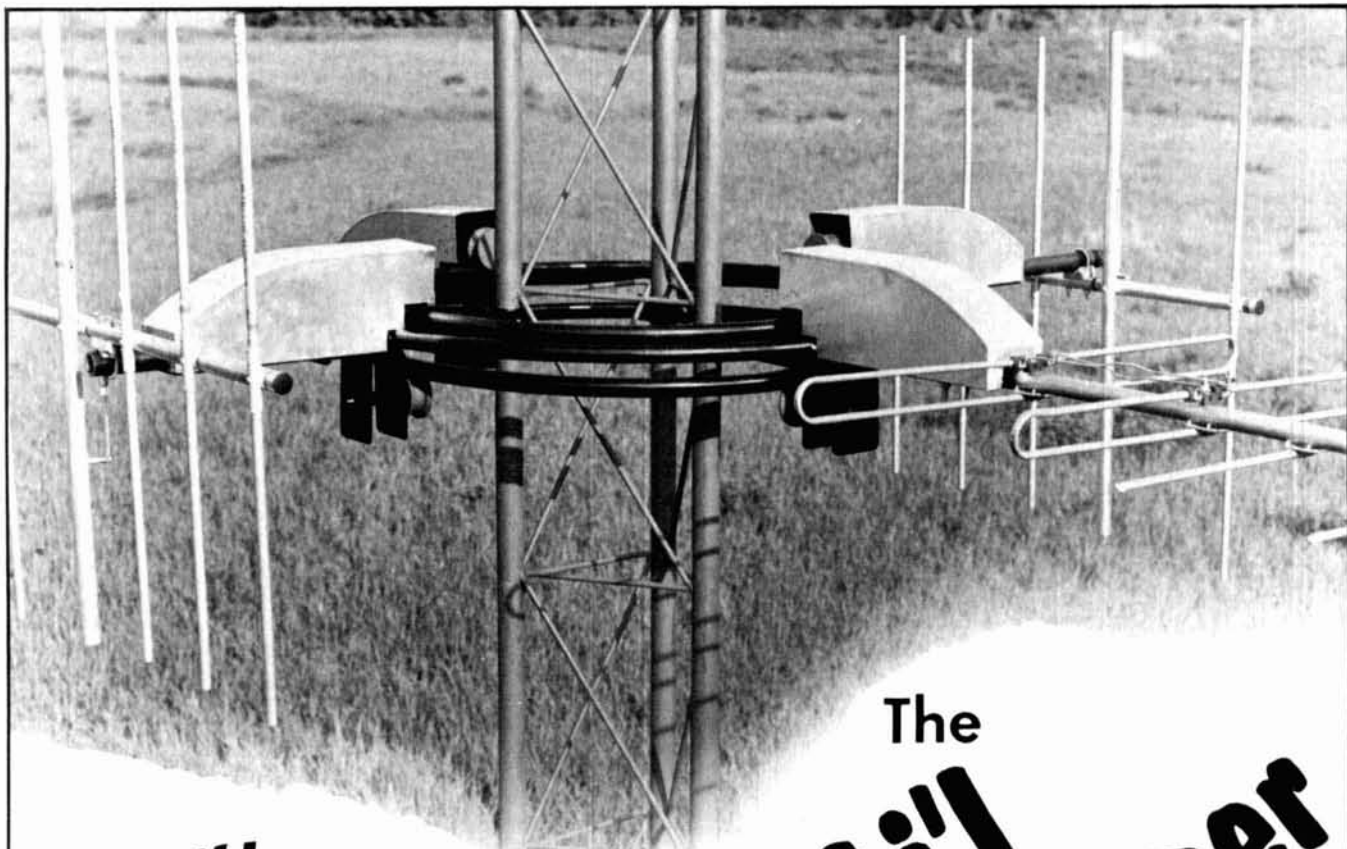

NEW!
POLAR RESEARCH'S

**Multi-Directional, Motor Driven Antenna Mounting
Systems For Discriminating Radio Operators!**

The
**Li'l
Slipper**
(ANTENNAS NOT INCLUDED)

Never before has an antenna mounting system been available to radio operators with the advantages and features of Polar Research's Li'l Slipper. The tremendous versatility and widespread applications of the Li'l Slipper system eliminate any cumbersome, awkward, inefficient and inaccessible antenna configurations due to the old normal single mast, vertical antenna stacking. Greatly reducing tower interference to the radiation pattern of the antenna, the Li'l Slipper's design effectively distributes wind-load evenly on the tower's structure while maintaining all antennas in a true perpendicular position, tangent at any point to the rotor's arc.

Exclusive Li'l Slipper features include a high torque geared drive motor; all electric, end-of-rotation circuitry; acceptance of masts up to 2" O.D. on all four housings; and limitless applications with VHF, Split-Boom, H.F. Beams, Quads, TV/FM antennas, and even UHF Dishes and Corner Reflectors.

INTRODUCTORY PRICE - \$399.95 PLUS SHIPPING

(Visa and Mastercard Accepted)

Call Toll Free 1-800-328-2041

U.S. AND FOREIGN PATENTS PENDING



Polar Research, Inc.

P.O. Box 781

Thief River Falls, MN 56701; Phone (218) 681-7413

the ultimate tone decoder

A simple circuit
that keeps your autopatch
from hanging up on you

If your autopatch has developed some obnoxious habits, such as interrupting your 2-meter conversations with random dial tones or rudely ending your autopatch calls, then this decoder circuit is for you. The phase-lock-loop system used on many autopatch decoders works well for strong signals or signals that are precisely tuned to frequency. When a weak signal or one that is slightly off frequency is encountered, however, the phase-lock-loop decoder tends to false, which results in noise being received as a tone, and tones being rejected as a noise. One cure for a mischievous tone decoder is to require a long delay in activating or dropping the autopatch. A better cure is this state-of-the-art system that uses two new integrated circuits from Mitel.

The system is built around the Mitel 8860 and 8865 DTMF decoder and filter ICs. These chips, introduced in August, 1980, feature high-quality detection, excellent voice and noise rejection, crystal controlled accuracy, and rapid detection time. They are low-power CMOS chips, requiring only about 30 mW apiece. The system will provide a 30 dB dynamic range; in other words, the range of audio levels that it will accept is -30 dB to 0 dB. This wide tolerance of tones means that the user's Touchtone pad audio level is not extremely critical, the way it is with some phase-lock-loop decoding systems. The maximum tone frequency deviation is ± 2.5 percent, compared with the general standard in the telephone industry of ± 1.5 percent.

This circuit will provide either binary or digit-by-digit output. The binary lines are tri-state, which means that the decoder can be connected directly in-

to the data bus of your computer-controlled repeater. The sixteen-line digit-by-digit output can connect to a repeater control that requires a line for each tone decoded. Although many repeaters use only the twelve standard Touchtone pairs, the Mitel chip is able to decode all sixteen pairs.

a case history

The decoder system shown in the schematic has been installed and tested on K9ORU/R, located in Belvidere, Illinois. The repeater formerly used a phase-lock-loop tone decoder, which falsed frequently. Several types of filters and AGC amplifiers were used in trying to correct this problem, but none of them met with much success. Setting a long delay on the auto-patch code ended the falsing, but required users to hold their Touchtone pad buttons down for several seconds to access the auto-patch. Because the long delay wasted air time, and because that decoder had numerous other minor problems, the group looked for an entirely new decoder system. Their research pointed to the Mitel dual-tone multi-frequency (DTMF) chips as the ideal solution, and the circuit described in the schematic was designed around those chips.

The new decoder system cost the K9ORU members about \$65.00 to build and install, using primarily new parts. The Mitel chips themselves cost almost \$50.00, and \$15.00 was spent on other parts, including an aluminum box to house the circuit.

Since this decoder was installed, in early 1981, there has been no falsing of the repeater. The need for a long delay before accessing the autopatch was eliminated, as were all of the minor problems that had afflicted the system. Because the new decoder doesn't need such critical settings of tone frequency, every member's phone pad is able to activate the au-

By E.M. Dean, WD9EIA, and P.K. Dean, WB9HGZ, 415 Superior Avenue, Machesney Park, Illinois 61111

topatch. All phone calls into the repeater for control purposes have worked, from every phone that's been tried. And the microprocessor-controlled automatic dialers used by some of the repeater members can no longer out-dial the decoder.

circuit description

This circuit uses a total of six integrated circuits: one MT8865 DTMF filter; one MT8860 DTMF decoder; one 74154 four-to-sixteen line decoder, and three 7404 inverters, two of which are optional. (Omit the optional 7404s and the sixteen-line output will be normally high, active low.)

Our circuit was constructed on a 2½ × 5 inch perf-board and housed in an aluminum utility box. We connected it to our existing repeater control through ribbon cable and dip-headers.

Referring to **fig. 1**, audio from the receiver is brought into the 8865 filter pin 4 through an 0.015-mF capacitor. This chip is a six-pole bandpass filter that rejects noise, voice, and dial tones, and separates the high and low tone groups. Frequency reference is provided by an internal oscillator in the 8865 that is controlled by an inexpensive 3.5-MHz TV colorburst crystal. This oscillator also provides frequency reference for the 8860 decoder. The high group tones are brought out on pin 10 and the low group tones are brought out on pin 1. They are fed into the 8860 decoder on pins 4 and 13 respectively.

The 8860 performs the actual decoding of the DTMF pairs. Pin 15 of the 8860 provides a logic high whenever a valid tone pair is being received. This output is buffered by a 7404 inverter. It is used to strobe the sixteen-line decoder and to illuminate the

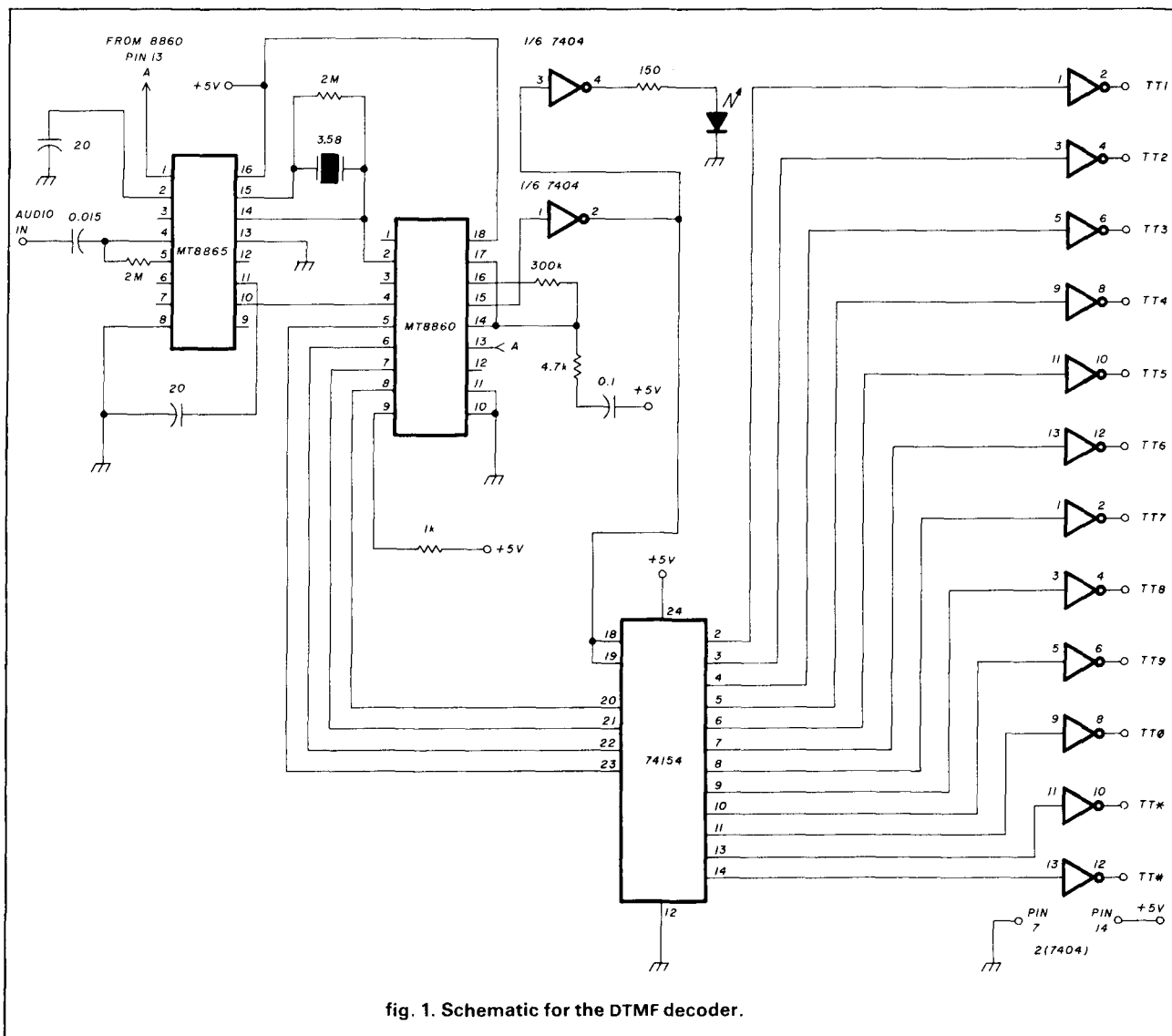

fig. 1. Schematic for the DTMF decoder.

valid tone LED. This LED is placed on the board and is used for diagnostic purposes. The strobe is necessary because the binary lines are latched, and the desired output should present a 1 while the tone is being received. Pin 9 is the output control line. When pulled low, the outputs are put in their high-impedance state. This feature may be used if you are connecting the decoder directly to a computer, but in this instance, we simply tie the line to a logic high through a 1K resistor. Pins 5, 6, 7, and 8 are the binary output lines, which are connected to the binary input line of the 74154. This IC simply decodes the binary number from the 8860 to a single line output of each Touchtone pair.

When the 74154 is enabled by a valid tone signal, it presents a logic low at the output corresponding to the specific tone pair decoded. This low is then inverted by a section of a 7404 to provide an active high signal.

Shown in the schematic are inverters for the twelve standard Touchtone pairs. The four remaining sections of the 7404 used in the valid tone signal circuit may be connected to the 74154 to provide Touchtone pairs A, B, C, and D if desired. The inverters may be left off if an active low is desired.

The entire circuit is powered by a single 5-volt supply.

testing

Apply 5 volts to the unit and connect the audio input to a source of Touchtone signals, either your receiver or a telephone or Touchtone pad. Depress a button on the Touchtone pad. The valid tone LED should light up and the corresponding output should switch to a logic high (approximately 5 volts). Release the button and the light should go out and the output should go to 0 volts. Repeat the procedure for the remaining Touchtone pairs. If you have difficulty, the high and low tone outputs can be monitored at pins 10 and 1 of the DTMF filter using a pair of high-impedance headphones connected through a 0.1-mF capacitor.

final comments

This circuit can easily be built into a new control right on board, or it can be wired into an existing control as we did. If the unit will be located more than 6 inches away from the power supply, the supply leads should be bypassed with a small capacitor to prevent rf pickup. If the output leads will be more than 6 inches long, they too should be bypassed.

Once you put this control into operation, you can expect many years of trouble-free operation. And your autopatch won't hang up on you ever again.

ham radio

State
of the art



by

K.V.G.

9 MHz CRYSTAL FILTERS

MODEL	Application	Bandwidth	Poles	Price
XF-9A	SSB	2.4 kHz	5	\$50.60
XF-9B	SSB	2.4 kHz	8	68.60
XF-9B-01	LSB	2.4 kHz	8	91.35
XF-9B-02	USB	2.4 kHz	8	91.35
XF-9B-10	SSB	2.4 kHz	10	119.65
XF-9C	AM	3.75 kHz	8	73.70
XF-9D	AM	5.0 kHz	8	73.70
XF-9E	FM	12.0 kHz	8	73.70
XF-9M	CW	500 Hz	4	51.55
XF-9NB	CW	500 Hz	8	91.35
XF-9P	CW	250 Hz	8	124.95
XF910	IF noise	15 kHz	2	16.35

10.7 MHz CRYSTAL FILTERS

XF107-A	NBFM	12 kHz	8	\$64.10
XF107-B	NBFM	15 kHz	8	64.10
XF107-C	WBFM	30 kHz	8	64.10
XF107-D	WBFM	36 kHz	8	64.10
XF107-E	Pix/Data	40 kHz	8	64.10
XM107-SO4	FM	14 kHz	4	28.70

Export Inquiries Invited. Shipping \$3.50

MICROWAVE MODULES VHF & UHF EQUIPMENTS

Use your existing HF or 2M rig on other VHF or UHF bands.

LOW NOISE RECEIVE CONVERTERS

1691 MHz	MMK1691-137	\$224.95
1296 MHz	MMK1296-144	119.95
432/435	MMc435-28(S)	69.95
439-ATV	MMc439-Ch x	74.95
220 MHz	MMc220-28	69.95
144 MHz	MMc144-28	54.95

Low NF options, other bands & IFs available.

LINEAR TRANSVERTERS

1296 MHz	1.3 W output, 2M in	MM11296-144	\$374.95
432/435	10 W output, 10M in	MM1435-28(S)	299.95
144 MHz	10 W output, 10M in	MM1144-28	199.95

Other bands & IFs available.

LINEAR POWER AMPLIFIERS

1296 MHz	1 W output	MML1296-10-L	\$ ask
432/435	100 W output	MML432-100	444.95
	50 W output	MML432-50-S	239.95
	30 W output	MML432-30-LS	ask
144 MHz	100 W output	MML144-100-S	264.95
	50 W output	MML144-50-S	239.95
	30 W output	MML144-30-LS	124.95
	25 W output	MML144-25	114.95

All models include VOX T/R switching. "L" models 1 or 3W drive, others 10W drive.

Shipping: FOB Concord, Mass.

ANTENNAS

(FOB Concord, via UPS)

144-148 MHz J-SLOTS

8 over 8 Hor. pol	D8/2M	12.3 dBd	\$63.40
8 by 8 Vert. pol	D8/2M-vert	12.3 dBd	76.95
8 + 8 Twist	8XY/2M	9.5 dBd	62.40

420-450 MHz MULTIBEAMS

48 Element	70/MBM48	15.7 dBd	\$75.75
88 Element	70/MBM88	18.5 dBd	105.50

UHF LOOP YAGIS

1250-1350 MHz 28 loops	1296-LY 20 dBi	\$49.75
1650-1750 MHz 28 loops	1691-LY 20 dBi	55.95

Order Loop-Yagi connector extra: Type N \$14.95, SMA \$5.95

Send 40¢ (2 stamps) for full details of all your VHF & UHF equipment and KVG crystal product requirements



si

(617) 263-2145

SPECTRUM

INTERNATIONAL, INC.

Post Office Box 1084

Concord, MA 01742, U.S.A.

the K7CW quad

A full-size Quad
that's lightweight
and inexpensive

Shortly after my first antenna article was published, I received my degree in geological sciences and took a job that meant moving to Brazil, where I held the call PP6ZAA. As soon as I received my license I got on the air using a borrowed FT-101 and dipole antennas. The responses I could generate with my unusual prefix were many, but I got into a couple of contests and did miserably. My 100 watts and dipoles were just no competition for those hams using gain antennas.

I decided a change in antennas was necessary, and, having been a quad fan ever since my Novice days, I knew what my choice would be. Because my job requires a lot of moving around, I had to have a quad that was light in weight, and easily assembled and disassembled.

I like the delta-loop-type quad mainly because it mounts in such a way that the entire antenna is above the supporting structure. On the other hand, the traditional square or diamond quad has easy-to-

feed wire elements and is not "top-heavy." Both of these two quads, however, are wind-catching rotator damagers.

What I have designed is an antenna that combines the favorable qualities of these two quads. The antenna has two wire loops in the inverted-delta configuration, and it is fed at the bottom of the driven element in the classic wire-quad fashion (break the loop and connect the coax). See **fig. 1**. There are four main spreaders but no boom, and there is an additional bottom spreader which has no major support function. The bottom spreader can be made of very lightweight material because its only functions are to keep the bottoms of the loops in proper position with respect to the rest of the antenna and to support the coax to the driven element.

The four main spreaders are attached to a main spreader hub by means of U bolts. The main hub is bolted to a bracket which, in turn, is U bolted to the mast. The antenna is designed to have 0.2λ spacing between the elements. The bottom spreader is, thus, 0.2λ long.

The reflector loop is connected, on top, to the tips of the two rear main spreaders and to the tip of the rear of the bottom spreader. The loop wire will form an equilateral triangle.

By Paul J. Kiesel, K7CW, 25180 E. Hickory Lane, Broken Arrow, Oklahoma 74012

table 1. Formulas used to obtain proper dimensions of the antenna as labeled in fig. 1.

formulas	notes
$X = \frac{1030}{9.84F}$	Where F = design frequency of antenna (3X = total distance around reflector loop).
$A = \frac{1005}{9.84F}$	3A = total distance around driven element loop.
$H = \frac{X}{2}$	= distance from main hub to top of antenna (the imaginary plane which contains the tips of all four spreaders).
$D = .2\lambda$	where λ = wavelength at design frequency. D = element spacing = length of bottom spreader.
$E = \sqrt{X^2 - H^2} - H$	= distance from bottom spreader to main hub.
$C = \sqrt{2H^2 + \left(\frac{D}{2}\right)^2}$	= distance from hub to where loop is attached to main spreader.

The driven element loop does not form an exact equilateral triangle because of the fact that it is also connected to the bottom spreader (which is horizontal with respect to the ground) and is smaller in size than the reflector. So a little shifting of position of the loop on the spreaders is called for (otherwise the bottom spreader can be tilted to conform, but this will disrupt the visual symmetry of the quad).

A list of formulas for obtaining proper dimensions of the antenna is given in **table 1**. If you follow the table, you will be able to construct the antenna for any frequency. In order to save you time, however, I have done the necessary calculations for frequencies in all the Amateur bands, 80 through 6 meters. These dimensions are found in **table 2**.

The main spreader hub was designed to be simple. It consists of two parts, the hub itself and a bracket which is used to mount the hub to the mast. See **fig. 2**. The hub is fashioned from an 18 × 10 inch (45.72 × 25.4 cm) piece of 3/16-inch (4.76-mm) aluminum sheet. Steel may be used, but I discourage its use because it defeats the purpose of trying to build a light-weight antenna. Before the pieces are bent to form the indicated angles, holes for the mounting bolts and U bolts should be drilled. Locations of the bolt holes for mounting the bracket to the hub are marked. However, each builder must determine for himself the exact locations of the U bolt holes to fit his particular needs with respect to diameter of spreaders and mast (that is, U bolt sizes). Center lines have been drawn on **figs. 3** and **4** to show approximate loca-

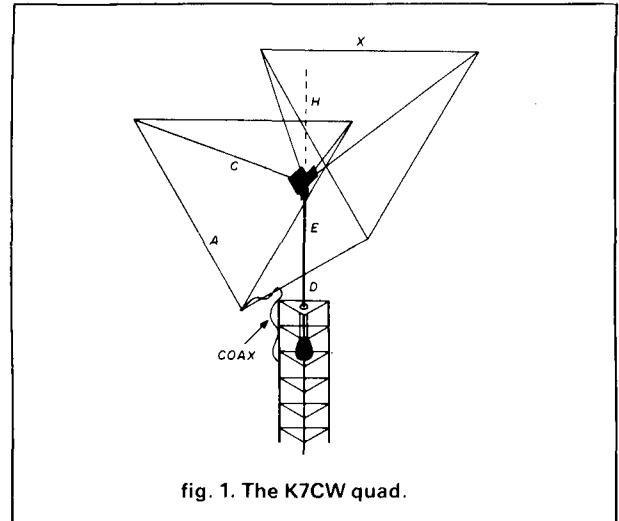

fig. 1. The K7CW quad.

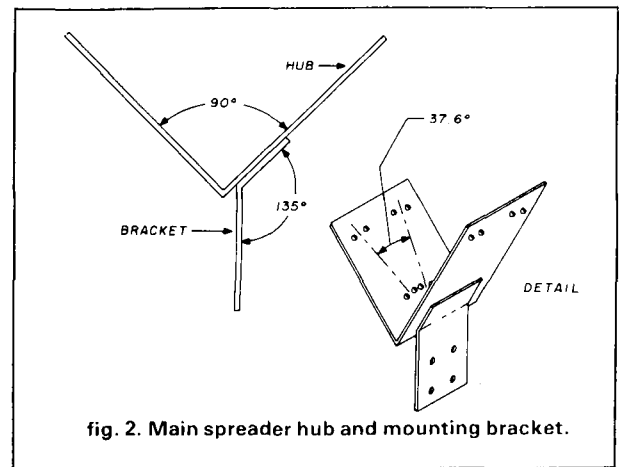

fig. 2. Main spreader hub and mounting bracket.

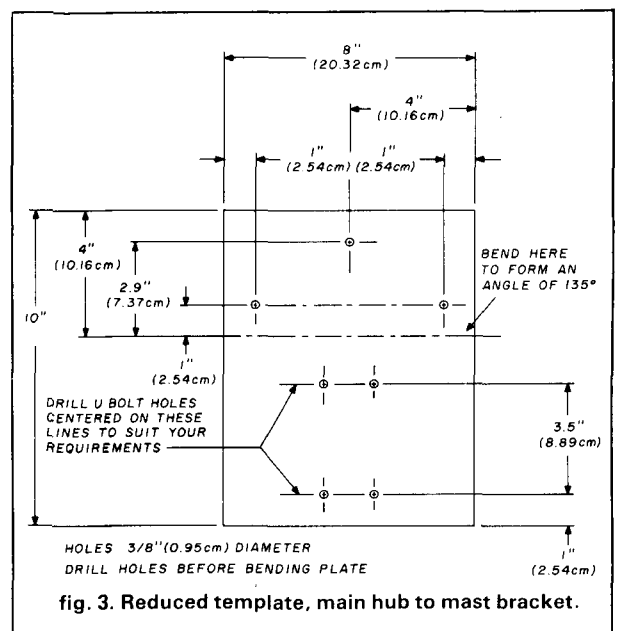

fig. 3. Reduced template, main hub to mast bracket.

tions of the U bolts. It is important to note that the axes of the spreaders must lie on the lines indicated in fig. 4.

An interesting sidelight appeared to me as I designed the antenna. The fact that I assigned (arbitrarily) the distance from the hub to the top of the antenna to be equal to the loop circumference divided by

six, (or $H = x/2$), resulted in an arrangement that would readily allow the addition of other loops for different bands, with proper spacing, simply by the addition of another bottom spreader per band. See fig. 5 and 6. One need only use the formulas in table 1 to determine the proper lengths and locations of the loops within the main structure.

Undoubtedly, it's already occurred to many readers that the antenna could be turned upside down to obtain better weight distribution of the antenna on the tower. See fig. 7. A description of this principle is made by Myers.² At first, it never occurred to me to do this because I'd wanted to get the whole antenna above the tower. However, it seems to me that one could build, say, a 40-meter version of my antenna, invert it on the tower and have a lightweight, low-torque, inexpensive beam with reasonable gain for 7 MHz. The builder might have to beef up the hub somewhat.

The kind of hub I have already described would work well. In this case it could be made of steel. The only modification needed would be to include a hole a bit larger than the mast diameter in the sheet metal before it is bent. Then, rather than having the hub sit on top of the mast, the mast would pass through the hub to be bolted to the bracket above the hub. Now, obviously, 99.99 percent of us won't be able to con-

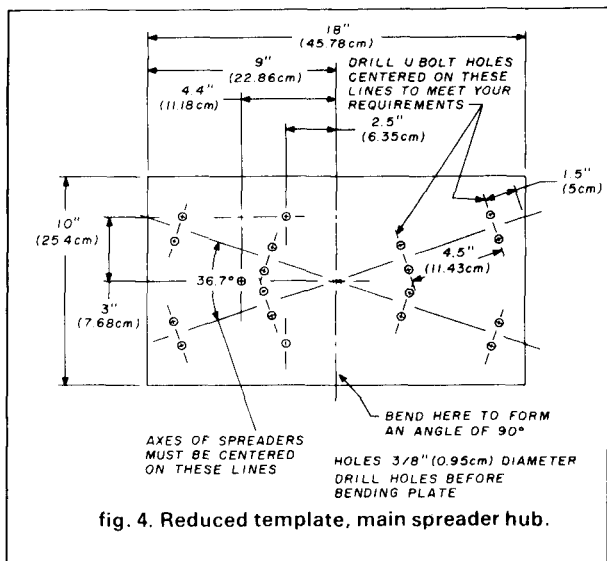

fig. 4. Reduced template, main spreader hub.

table 2. K7CW quad dimensions.

	antenna design frequencies (in meters)						
	3.575 MHz	3.8 MHz	7.05 MHz	7.2 MHz	14.075 MHz	14.25 MHz	21.1 MHz
X	29.2722	27.5389	14.8437	14.5344	7.43503	7.34372	4.95962
Y	87.8165	82.6168	44.5311	43.6033	22.3051	22.0312	14.8789
A	28.5617	26.8705	14.4834	14.1817	7.25457	7.16547	4.83924
B	85.685	80.6116	43.4502	42.5450	21.7637	21.4964	14.5177
H	14.6361	13.7695	7.42184	7.26722	3.71751	3.67186	2.47981
D	16.7832	15.7895	8.51064	8.33333	4.26288	4.21053	2.84360
E	10.7144	10.0800	5.43317	5.31998	2.72141	2.68799	1.81535
C	22.3349	21.0124	11.3258	11.0899	5.67298	5.60331	3.78423
	21.3 MHz	28.15 MHz	28.6 MHz	29 MHz	50.05 MHz	50.125 MHz	53 MHz
X	4.91305	3.71751	3.63902	3.60855	2.09087	2.08774	1.97449
Y	14.7392	11.1525	10.9771	10.8257	6.27261	6.26322	5.92347
A	4.79380	3.62728	3.57021	3.52097	2.04012	2.03707	1.92657
B	14.3814	10.8818	10.7106	10.5629	6.12036	6.11120	5.77970
H	2.45653	1.85876	1.82951	1.80428	1.04543	1.04387	.987245
D	2.81690	2.13144	2.09790	2.06897	1.19880	1.19701	1.13208
E	1.79830	1.36070	1.33929	1.32082	.765311	.764166	.722714
C	3.74870	2.83649	2.79186	2.75335	1.59535	1.59296	1.50655

Note: X = length of reflector loop side
 Y = distance around reflector loop
 A = length of driven element loop side
 B = total distance around driven element loop
 H = distance from hub to top of antenna
 D = bottom spreader length
 ~ = element spacing
 E = distance from bottom spreader to main hub
 C = distance from hub to where loop is attached to main spreader, that is, spreader length

struct an 80-meter version, but go-getters who have lots of room can — and I challenge them to try it. The mechanical problems involved in building a full-size rotatable 80-meter beam are numerous, but I personally helped put a full-size two-element 80-meter beam on top of a 170-foot (51.8-meter) tower, so I know it can be done.

I used bamboo for the spreaders on the first version of the antenna because fiberglass is hard to get in Brazil. Bamboo works well. However, fiberglass would appear to be the best choice for spreader material.

I won't go into a lecture on how well my quad

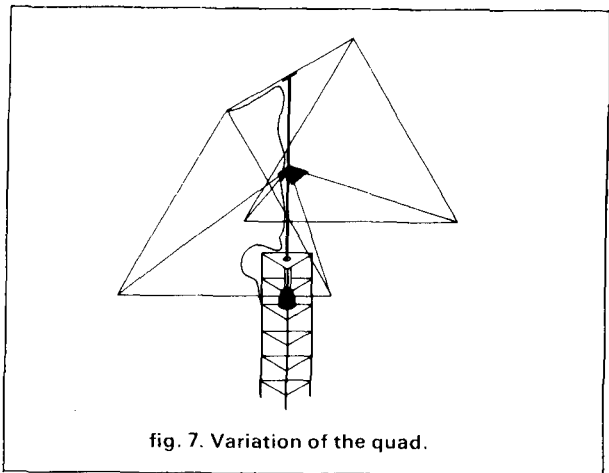

fig. 7. Variation of the quad.

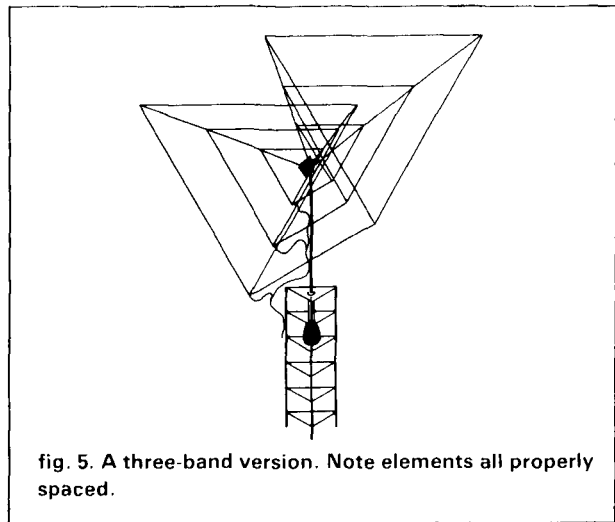

fig. 5. A three-band version. Note elements all properly spaced.

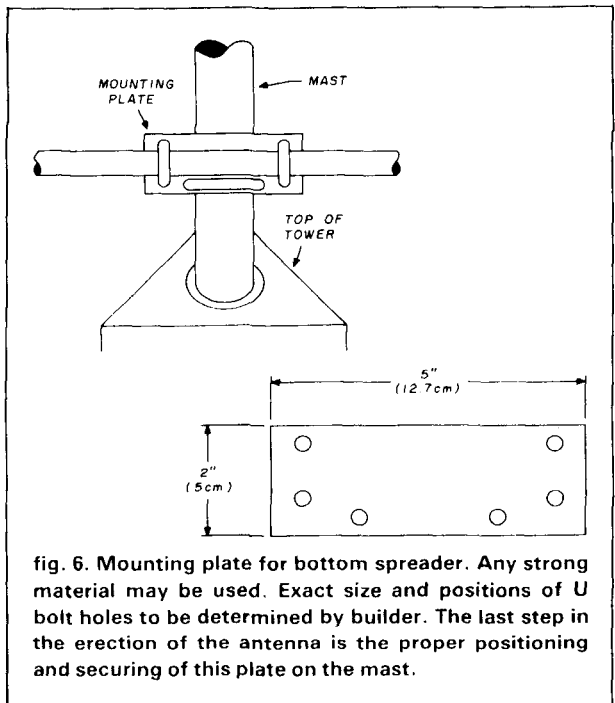

fig. 6. Mounting plate for bottom spreader. Any strong material may be used. Exact size and positions of U bolt holes to be determined by builder. The last step in the erection of the antenna is the proper positioning and securing of this plate on the mast.

works. Everyone knows how good quads are. Let me tell you, though, about the advantages of having an antenna with no boom. Since there is no boom, there is a marked reduction in rotational torque applied to the rotator (caused by wind loading or sudden starts and stops). There can be no appreciable amount of damage to the rotator due to torque because everything on the antenna is flexible. There are, in fact, a lot of advantages to the antenna. Let's go over them.

1. Low torque applied to the rotator — there is no boom.
2. Full-size, two-element, wide-spaced quad.
3. Only four main spreaders instead of eight.
4. Wire elements mean the antenna is easy to feed.
5. Antenna completely above top of tower.
6. Lower cost because of fewer parts.
7. Lower weight because of very little metal.
8. Antenna symmetrical and well-balanced.
9. Antenna easy to fabricate and mount.
10. Easy addition of loops for other bands with simple addition of lower spreader for each new band.
11. Possibility to invert antenna to obtain gravity/balance advantage on tower.

I am very interested in hearing from those who have any comments, suggestions for improvement or questions regarding this antenna.

references

1. P.J. Kiesel, K7CW. "Ultimate Antenna Array," *ham radio*, August, 1978, page 30.
2. R.M. Myers, "Understanding High Frequency Antennas," *ham radio*, June, 1980, page 62 (third paragraph).

ham radio TECHNIQUES

Bill Over
W6SAI

It's the old story: RFI (radio frequency interference) is no problem if you don't have it, but it's hell if you do. This point was emphasized to me a few weeks ago when I became the proud owner of a new microwave oven. I was eager to buy it because of its advantages in quick-cooking — and the oven came highly recommended. No doubt about it: it was a well-made unit and we had a lot of fun doing some experimental cooking with it.

The only problem was that when the oven was running it obliterated the kitchen radio with a raspy sound like that of a chain-saw cutting through a hard oak knot, and it produced a broad, wiggly band across TV channels 2, 4, and 5. I could also hear the same raspy noises on the 160- and 80-meter ham bands.

Now how could a microwave oven operating around 2 GHz cause such RFI on radio and television? The racket sounded so much like an SCR, or light dimmer, that I concluded that it might be the oven's power supply rather than its magnetron that was causing the interference (see **fig. 1**). I

removed one end of the cabinet to expose the control circuits and power supply — and my guess was right. A simple half-wave rectifier system was used.

Holding a small transistor radio near the supply confirmed the source of interference. As far as could be determined, there were no shunt capacitors across the high-voltage rectifier to suppress diode noise or switching transients. And, obviously, no rf filtering in the power leads.

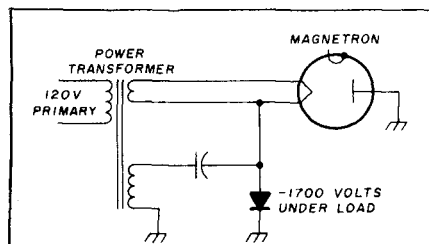

fig. 1. Representative high-voltage power supply for the magnetron in a microwave oven. Voltage under standby load is -2800 volts, dropping to -1700 volts under full load. The RFI filter is placed in primary circuit of the power transformer.

I decided to call the factory about the problem, as I didn't relish the idea of digging into the oven to install haphazard filtering. A phone call to the manufacturer in Iowa brought cold comfort. When I mentioned television interference from the oven, the serviceman immediately asked me if I lived near a Radio Amateur! (That *really* frosted me!) Finally, after admitting that the company knew nothing about the problem, the voice on the phone told me to call the local service depot in San Francisco.

I telephoned the local outfit and finally got through to a gentleman who would level with me (but only after I told him I was in the electronics business and knew what I was talking about).

He readily admitted the problem and said that the ovens manufactured for export outside the United States have an RFI filter in them, but those intended for use in the U.S. do not. (This clearly points up why this country requires FCC jurisdiction over RFI emissions from home entertainment equipment and appliances.)

The upshot was that the manufac-

turer would not *give* me a filter for their noisy product, but they would *sell* me one for \$24 plus a dollar shipping. I bowed to this suggestion and *mailed off a check*. The filter soon arrived in the mail, and I must admit that it was a neat little package, made in Germany. It incorporated both a semiconductor device that protected the oven from line transients and a filter.

No information was included regarding mounting the filter, so I merely drilled a hole in the rear of the cabinet for the filter's single mounting bolt and sandpapered the paint away from the area where the filter would rest. The filter was equipped with residential-type snap-on terminals, and a quick trip to the hardware store turned up matching snap-on lugs. The power cable was snapped on one set of filter terminals and short leads were made up, going from the output terminals of the filter to the terminal board that originally held the power cable.

Once the cabinet had been reassembled, it was immediately apparent that the filter was doing its job. The TVI had disappeared, the racket was gone from the kitchen radio — and also from my receiver in the ham shack!

For those who have RFI from a microwave oven a good power line filter seems to be the answer. The filter I bought was Amana part number B-57178-1. It comes with a mounting bracket (which is useless); and there is no nut for the mounting bolt (but it's easily found in the junk box). To mount the filter, it is necessary to drill a 5/16-inch-diameter hole in the oven cabinet near the power cord. Doubtless the filter would work with other microwave ovens that have the same power rating as my Amana RR-5B.

The sixty-four dollar question is, knowing that the Radarange is a prolific source of RFI, Why doesn't Amana incorporate a line filter in all of their production instead of adding the filter only for the export models? Don't answer that — I know what the

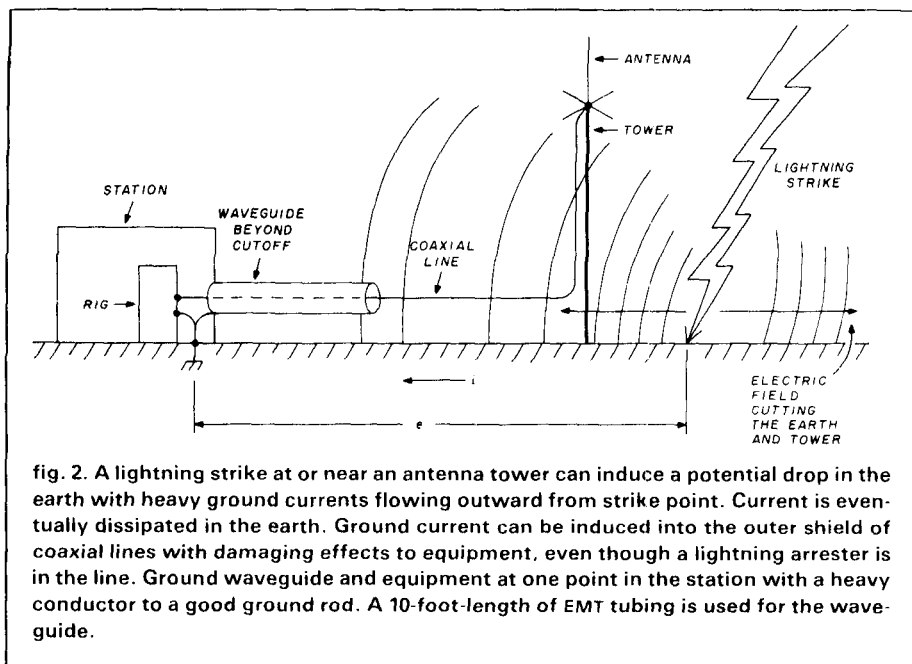

fig. 2. A lightning strike at or near an antenna tower can induce a potential drop in the earth with heavy ground currents flowing outward from strike point. Current is eventually dissipated in the earth. Ground current can be induced into the outer shield of coaxial lines with damaging effects to equipment, even though a lightning arrester is in the line. Ground waveguide and equipment at one point in the station with a heavy conductor to a good ground rod. A 10-foot-length of EMT tubing is used for the waveguide.

reply will be: Why spend a few cents per microwave oven for a filter when perhaps only one customer in a hundred complains of RFI? Consumer organizations seemingly cannot fight such a simplistic philosophy, and the manufacturers have a common ally in the *Electronic Industries Association*, which fights any suggestion of RFI legislation tooth and claw.

In any event, if you own an Amana microwave oven, you can get a filter for it. I'll be interested to hear from readers who have experienced this form of RFI, and I'd like to hear from owners of other brands too. Do other manufacturers incorporate RFI filtering in their products? Is Amana the only manufacturer that evades this problem? Or are they all in the same league? I'd like to know.

lightning protection

Summer is the time for thunderstorms. A cloud-to-ground discharge can have a potential of 300 million volts at hundreds of thousands of amperes. The damaging effect of a stroke results from the power developed by the passage of a large current through a resistance (a human body, for instance). A lightning arrester provides a controlled path to

ground for the lightning energy, shorting it to ground before it can damage the equipment being protected.

A secondary effect of a lightning strike is the tremendous electrostatic field set up in the vicinity of the bolt — up to 5 kV/cm. When the strike reaches earth a great potential is set up between the strike point and "neutral" earth, and earth currents flow outward from the strike point to re-establish equilibrium. These currents can flow along the outside of a coaxial line located in the vicinity of a strike (see fig. 2). This potential can be induced into the inner conductor despite the presence of a lightning arrester in the line, or it can elevate the chassis of the radio equipment to thousands of volts above ground — even though the equipment is normally at ground potential.

One simple way to prevent the coaxial line from rising above ground potential is to pass it through a very simple waveguide-beyond-cutoff filter made of a ten-foot-long piece of electrical (EMT) tubing. The coaxial line is passed through the tubing, and line and tubing are then securely grounded at the station end of the

line (as shown in the illustration). The opposite end of the tubing is not grounded. The ground potential passing along the outer conductor of the line will be shunted back to earth at the grounded end of the filter, thus protecting the equipment, which is grounded to earth at the same ground point. When this approach is used in conjunction with a conventional light-

ning arrester, maximum protection is afforded the equipment in the hamshack during a thunderstorm.

simple antenna for 7/14/28 MHz

A recent issue of *CQ-ham radio* (Japan) described an interesting tri-band antenna used by JK1AYE. It is an updated version of the old off-center-fed antenna that used a 300-ohm ribbon line for the feed system (fig. 3). In this simple design, a 4-to-1 balun and coax line replace the ribbon line. JK1AYE adjusts the lengths of the flat top sections a bit at a time until he achieves lowest SWR in the middle of each band. He claims an SWR value of 1.6-to-1 at resonance on 14 MHz, less than 1.3-to-1 on 7 MHz, and less than 1.2-to-1 at resonance on 28 MHz. Because of the unbalanced antenna there is bound to be some minor radiation from the transmission line, and it is recommended that the line drop down to ground level directly below the antenna so that distortion of the antenna pattern is held to a minimum.

signs used by Charlie, W1PLH. Here are the results of more of his antenna experiments.

The W1PLH-W1BCN compact 15-meter ground plane antenna. Shown in fig. 4 is Charlie's answer to the problem of where to run radials for a ground plane antenna. Simply curl one radial into a circle. The W1PLH-W1BCN antenna is mounted with the feed point about thirteen feet above ground level. Results seem to be equal to those of a full-size radial system. The whip can be adjusted in length to zero-in the resonant frequency at the middle of the 15-meter band (about 21.2 MHz). Bandwidth is quite broad, showing SWR readings of less than 1.8-to-1 at the band edges and near unity at the middle of the band.

The W1PLH 75-80 meter dipole. In my March column I showed a drawing of the W1PLH 80-meter antenna. Charlie has modified this a bit and now gets very low SWR readings across the entire 80-meter band (fig. 5). If you have enough trees or supports to hold this antenna about twenty-five to thirty feet in the air, it should prove to be a good, all-round radiator for the complete band —

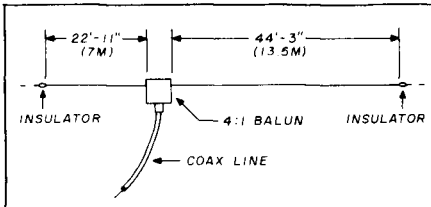

fig. 3. The off-center-fed antenna revisited. This version, used by JK1AYE, is designed for 7, 14, and 28 MHz operation, and it's fed via a coaxial line and 4-to-1 balun. SWR is quite low on all three bands. The antenna is not designed for 21-MHz operation.

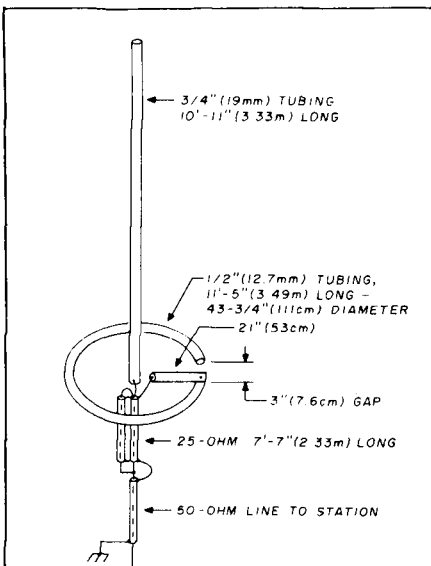

fig. 4. A version of the W1PLH/W1BCN compact 15-meter ground plane. A single radial is bent into a circle lying in the horizontal plane. A short length of aluminum tubing is used to make the connection between the circular radial and outer shield of 25-ohm, quarter-wave transformer section. The transformer is made of two sections of 50-ohm line connected in parallel. Be sure to waterproof all joints of the cables.

W1PLH revisited

In my March, 1982, column I described some interesting antenna de-

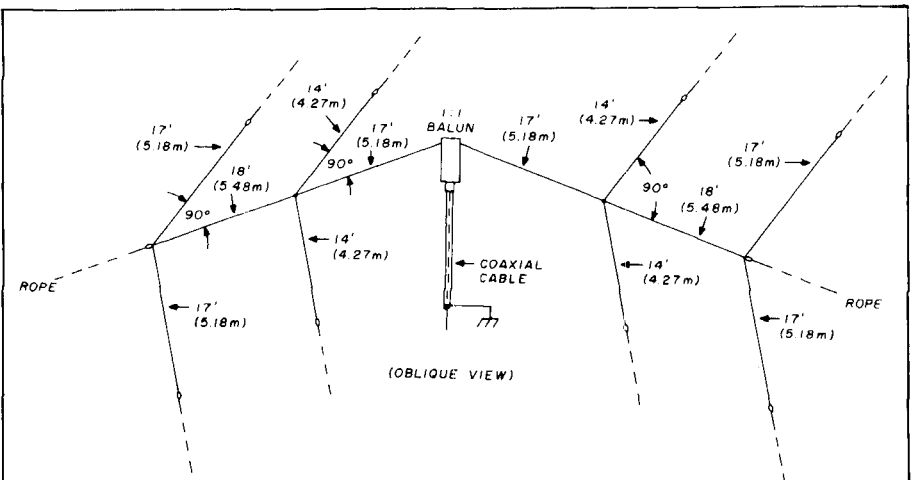

fig. 5. The W1PLH broadband 80-meter short dipole. The antenna is mostly in the horizontal plane with the fan wires sloping down a bit toward the ground. The antenna can be tuned by adjusting the length of the 17-foot-long sections. All portions of the antenna need not be parallel to the ground (a virtual impossibility if you have a lot of trees in the area).

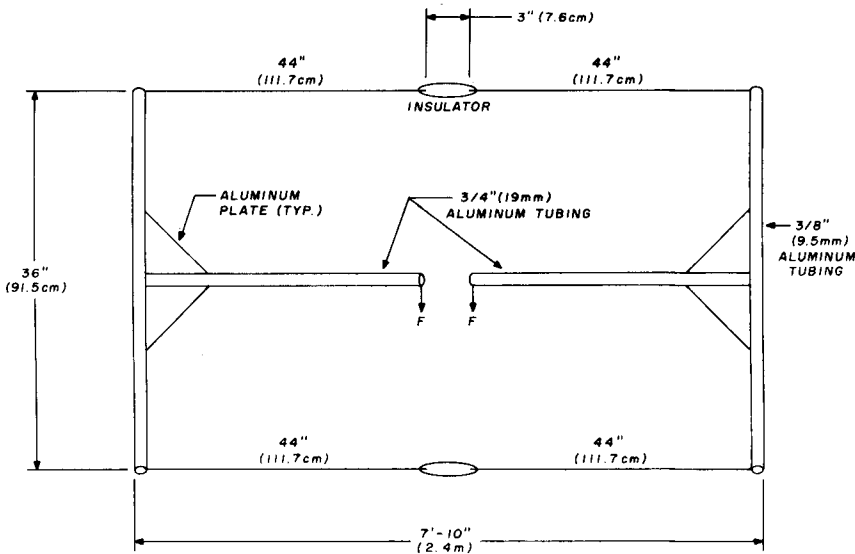

fig. 6. The W1PLH compact 10-meter dipole. It may be placed in either a horizontal or vertical plane. The feedpoint, F-F, exhibits a very low impedance and the antenna is matched to a 50-ohm line via a 1-to-1 balun and a linear transformer made of two sections of 50-ohm coaxial line 5 feet 6 inches (1.67 m) long connected in parallel. A 50-ohm transmission line is used. The end tubing is held to the center tubing by a small aluminum plate pop-riveted in place.

both phone and CW sections! SWR is about 2.4-to-1 at the band edges and near unity at 3.75 MHz. The array is tuned by adjusting the seventeen-foot end sections.

The W1PLH 10-meter compact dipole. Want a small, unobtrusive antenna for 10-meter operation? Charlie has constructed this small antenna that's only 7-1/2 feet long (fig. 6). It's a dipole folded back upon itself and fed via a quarter-wave matching transformer. The pattern is bidirectional and the bandwidth between the 2-to-1 SWR points is about 900 kHz. At the resonant frequency (28.5 MHz), the measured SWR is about 1.2-to-1 or less.

The main, central portion of the antenna is composed of two pieces of 3/4-inch-diameter aluminum tubing, each piece 44 inches long. The center junction is made up of a short plug of Lucite, Plexiglas or phenolic material. At the ends of this short dipole, 36-inch-long outriggers are attached by means of triangular aluminum plates. The outriggers are made of 3/8-inch-

diameter aluminum tubing. The ends of these rods are flattened and drilled for small bolts, and the outer wires (insulated at the center) are attached to these points. The insulators in the wire are made of 3-inch-long sections of plastic rod.

Although drawn in the vertical plane for clarity, the assembly is supported in the horizontal plane with all sections parallel to the ground. And, as with any other antenna, the higher this little dipole is placed the better it will work.

a personal note

At long last, the twenty-second edition of the *Radio Handbook* has come on the market. It is now sold by all the leading electronic distributors and can also be obtained at the *Ham Radio Bookstore*. This 1200-page, hardbound handbook covers hf and VHF communications from A to Z, and from 160 meters to the new 920-MHz ham band. As the editor, I take pride in this new edition! I know you will enjoy it and find it useful!

ham radio



808 N. Main • Evansville, IN 47711

AEA	
MBA-RO Reader	\$269.00
MBA-RC Rcv/Code Conv. Xmt	395.00
MM-2 MorseMatic Ultimate Keyer	135.00
CK-2 Contest Memory Keyer	99.00
KT-2 Keyer/Trainer	89.00
Isopole 144/220 MHz	35.00
ARRL	
Handbook	\$10.00
Ant. Book new & improved	8.00
New License Manual	4.00
ALLIANCE	
HD73 (10.7 sq. ft.) Rotator	\$99.00
U-100 Small Rotator	45.00
ASTRON	
RS7A 5-7 Amp Power Supply	\$49.00
RS12A 9-12 Amp	69.00
RS20A 16-20 Amp	89.00
RS20M 16-20 Amp w/meter	109.00
RS35A 25-35 Amp	135.00
RS35M 25-35 Amp w/meter	149.00
AZDEN PCS 3000/300	\$289.00
Most accessories in stock	call
B&W Folded Dipole (Super Antenna)	\$135.00
BASH Study Guides	\$9.95
BENCHER	
BY-1 Paddle	\$36.00
BY-2 Chrome Paddle	\$45.00
BUTTERNUT HF6V	\$119.00
CUSHCRAFT	
A3 Tribander 3 EL	\$179.00
A4 Tribander 4 EL	229.00
214B 14 EL 2 Mtr Boomer	69.00
DAIWA	
CN 520 1.8-60 MHz Small Mtr.	63.00
CN 620B 1.8-150 MHz Mtr	105.00
DRAKE	
TR7A Xcvr	\$1439.00
R7A Receiver	1399.00
TR5 Xcvr	695.00
ENCOMM (SANTEC)	
ST-144/uP	\$295.00
ST-440/uP	call
HAL	
CT2100 Terminal	\$695.00
KB2100 Keyboard	159.00
CWR685A TeleReader	870.00
HY-GAIN	
TH7DX 7 EL Tribander	call
TH3 MK3S 3 EL Tribander	call
V22 Mtr Vertical "Excellent"	call
HAM IV Rotator 15 sq. ft.	call
Taitwister Rotator 20 sq. ft.	call
Crank-up Towers	call
ICOM	
720A Magnificent Xcvr!	\$1140.00
740 Xcvr Wow!	990.00
730 Excellent Rig!	639.00
251A 2 Mtr All Mode	575.00
290A 2 Mtr All Mode	425.00
25A 2 Mtr Very Small Mobile	305.00
2 AT 2 Mtr Hand Held	235.00
3 AT/4 AT UHF Hand Helds	245.00
KLM	
KT34A 4 EL Tribander	\$309.00
KT34XA 6 EL Tribander "Beautiful Ant."	465.00
KANTRONICS	
Interface	\$169.00
Mini-Terminal Rcv/Code Conv. Xmt	249.00
Mini-Reader Pkg.	225.00
LARSEN NLA 150MM 2 Mtr Mag.	\$39.00
MFJ	
496 Keyboard	\$289.00
941C Tuner	81.00
VHF Converter for 2 Mtr HT's	36.00
MIRAGE	
B108	\$155.00
B1016	239.00
B3016	205.00
ROHN Towers	call
SHURE	
444D Very Nice Mic!	\$50.00
TEN-TEC	
546 Omni C	call
580 Delta	call
525 Argosy	call
TOKYO HY-POWER	
HL32V 25W Amp	\$79.00
HL82V 80W Amp	149.00
HL160V 160W Amp	285.00

This is a partial listing. Please call for accessories and other products not listed. Prices & availability subject to change.



812-422-0231

MON-FRI 9AM-6PM • SAT 9AM-3PM

Write for our new and used equipment list

mail this card today

YES, please send me my **FREE** Heathkit Catalog of easy-and-fun-to-build electronic kits. I am not receiving your catalogs now, and I certainly would like to get them regularly.

FREE HEATHKIT CATALOG

name _____
(Please Print)

address _____

city _____

state _____ **zip** _____

Free
HEATHKIT
CATALOG

PLACE
STAMP HERE
Post Office
will not
deliver mail
without postage

Heath Company
Benton Harbor, MI 49022

Attn: Recruiters

**Expose Your
Recruitment Ads
to the most
Technical
Audience of Radio
Hams Available**

Here's how

Are you looking for a technically qualified person and find that few are available locally? Broaden your search by running an ad in HAM RADIO Magazine. HAM RADIO's readers are the most technically qualified. Over 60% are actively involved in one or more areas of the electronics industry. Their skills range from bench technician to design engineer. Here are some of the benefits from running an ad in HAM RADIO Magazine.

- National coverage at an affordable price
- Specially segmented audience
- Active Hams who do more than just read about electronics — they participate in it

Call today for more information about placing an ad in HAM RADIO. *Get the person you want!*

**CALL TODAY
(603) 878-1441**
Ham Radio
Box 0
Greenville, NH 03048

FREE!



THE IMPORTANT CATALOG FOR THE ACTIVE HAM

Hi-Tech Stations:

Amateur Radio's hottest ideas come from the Ham-licensed engineers at Heath. We have a complete line of world-famous gear you can build from proven kits for unparalleled performance, value and reliability. *There's more for the Ham at Heath!*



Computer Operation:

"Micro"-enhanced ham shacks are the wave of this hobby's future. Pacesetter Amateur Radio enthusiasts are using computers to design antennas, plot beam headings, track OSCAR and transmit RTTY. Heath and the Ham, once again, are the perfect partners in this new adventure.



Guaranteed Courses:

Heathkit/Zenith Educational Courses are the low-cost, time-saving way to learn. We have comprehensive programs to help earn your Novice, General or Advanced Class licenses. You can't fail — Heath guarantees that you will pass! — or we'll refund the purchase price.



Service and Accessory

Equipment: Whether you need a test instrument for electronics service work, manufacturing and design or hobby applications, see us. All Heathkit instruments are units of high-professional quality offering our extra-value capability. Like our 20 MHz dual-trace portable oscilloscope, they're built to last and give you reliable results every time.

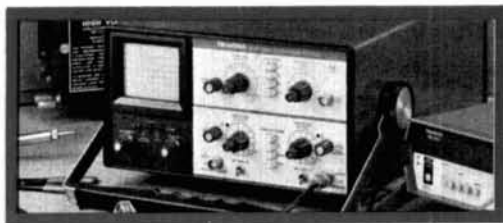

**SEE IT ALL IN THE
BIG, NEW HEATHKIT
CATALOG** and read about our entire line of electronic kits.

**SEND FOR YOURS
TODAY!**

If coupon is missing, write:
Heath Company,
Dept. 122-932,
Benton Harbor,
MI 49022

In Canada: Heath Co.,
1480 Dundas St. East,
Mississauga, ONT
L4X 2R7

Heathkit FREE CATALOG!

Please send my free Heathkit Catalog.
I want to "build in" the quality difference.

Send to: **Heath Co., Dept. 122-932**
Benton Harbor, MI 49022

Name _____

Address _____

City _____ State _____

AM-424R1 Zip _____



SPECIAL OFFER!

UNIVERSAL COMMUNICATIONS

A Division of Innovative Labs, Inc.

SUPER

SUPER SAVINGS SALE ENDS OCTOBER 1 SAVINGS!

2300 MHz DOWN CONVERTER	\$19.95
ASSEMBLED	\$39.95
12v POWER SUPPLY	\$19.95
ASSEMBLED	\$29.95
(Stationary or variable)	
SELECTIVE PRE-AMP	\$26.95
SUPERVERTER I	\$75.00
(Crystal Board and PA)	
CIGAR ANTENNA	\$19.95
4 FT. DISH ANTENNA	\$47.95
(KD-44 25 DB OVERALL GAIN)	
DRIFTMOD	\$1.25
HIGH GAIN TRANSISTOR	\$6.95
VIDEO STABILIZER	\$39.95

KIT SPECIAL #1	
Down Converter,	
Power Supply,	
Cigar Antenna	\$49.95
KIT SPECIAL #2	
Down Converter,	
Power Supply,	
4 Ft. Antenna	\$79.95

For information or ordering
(817) 860-1641

MC, VISA, Phone or Mail Orders Accepted.

Hours, 8:30-4:30 CDST; Mon.-Fri.

Our product may be copied, but the performance is never equaled.

UNIVERSAL COMMUNICATIONS P.O. Box 339 Arlington, TX 76004-0339

Alaska Microwave Labs

4335 E. 5TH STREET ANCHORAGE, ALASKA 99504
(907) 338-0340 DEPT HR

CHIP CAPACITORS

12 22 33 47 68 10 18 22 27 47 100 120	
180 220 270 330 390 470 560 680 820 1K 1.2K	
1.8K 3.9K 8.2K 10K 100K	\$ 60

GaAs FETS

MGF1400 NF 2.0DB @ 4GHZ MAG 15DB	\$19.00
MGF1412 NF 0.8DB @ 4GHZ MAG 18DB	\$85.00
MCF1200 NF 1.0DB @ 1GHZ NF 2.2DB & MAG 14DB @ 4GHZ	\$14.00

COAX CONNECTORS

BNC CHASSIS MOUNT SQUARE FLANGE	\$1.95
BNC PLUG FOR RG-58	\$1.95
SMA CHASSIS MOUNT SQUARE FLANGE	\$6.10
SMA CHASSIS MOUNT PLUG SQ FLANGE	\$8.50
SMA CHASSIS MOUNT STRIP LINE TAB	\$6.75
SMA PLUG FOR RG-58	\$6.75
SMA PLUG FOR RG-174	\$6.75
SMA PLUG FOR 141 SEMI RIGID	\$3.98
TYPE N CHASSIS MOUNT SQUARE FLANGE	\$3.75
TYPE N PLUG FOR RG-9-RG-8	\$3.75
TYPE N DOUBLE MALE	\$7.25
TYPE N FOR 141 SEMI-RIGID	\$15.00
TYPE N CHASSIS MOUNT PLUG SQUARE FLANGE	\$14.00

SILVER PLATING KIT

Will plate Copper, Brass, Bronze, Nickel, Tin, Pewter, Gold, and most white metal alloys \$36.00

VTO

V72T-1 2.7GHZ TO 3.2GHZ MIN POWER OUT 10 MW	
TUNING VOLTAGE 0 TO 20V Vcc +15 VDC @ 60 MA	\$98.00
V72T-1 SAME AS V72T-1 BUT FREQ 3.6GHZ TO 4.2GHZ	\$98.00

TEFLON CIRCUIT BOARD DBL SIDED 1 OZ

APPROX. 3.25" x 5.0" 010	\$5.50
APPROX. 3.25" x 5.0" 0312	\$6.50
APPROX. 3.25" x 5.0" 0625	\$10.50

FEED-THRU CAPACITORS

1000 PF SOLDER TYPE	\$ 50
470 PF SOLDER TYPE	\$ 50

LEADLESS CERAMIC CAPACITORS

1000 PF	\$ 25
---------	-------

NO WARRANTY ON SEMICONDUCTORS

OPEN AT 8 PM EST CLOSED 8PM PST
ORDERS ARE POSTAGE PAID
COD - VISA - MASTERCARD

Be A Better Listener.

Take command of your scanner or short wave receiver with help from **MONITORING TIMES.**

Tune In:

Drug Smugglers
Police Action
NASA Crews
Pirate Broadcasts
Air-To-Ground
Ship-To-Shore
...And More!



Published bi-monthly, the *TIMES* brings you up-to-date, authoritative articles on listening intrigue throughout the radio spectrum.



For a FREE sample issue, please write:

MONITORING TIMES

140 Dog Branch Road
Brasstown, N. C. 28902
OR CALL 1-800-438-8155

THE SUCCESSFUL LAUNCH OF AMSAT'S FIRST PHASE III SATELLITE IN EARLY 1983 WILL BRING UNPRECEDENTED GROWTH TO THIS PRIMARILY VOLUNTEER MANAGED ORGANIZATION. THIS WILL REQUIRE A FULL TIME PROFESSIONAL

EXECUTIVE DIRECTOR/GENERAL MANAGER

THE SUCCESSFUL CANDIDATE WILL
— DEVELOP AND IMPLEMENT INNOVATIVE EDUCATIONAL PROGRAMS TO BRING AN AWARENESS AND APPRECIATION OF SPACE SCIENCE AND TECHNOLOGY AT THE PERSONAL LEVEL TO AMATEURS AND NON-AMATEURS AROUND THE WORLD
— MANAGE AND COORDINATE THE WORK OF HUNDREDS OF VOLUNTEERS WHO DESIGN, BUILD, LAUNCH AND OPERATE THE WORLDWIDE AMATEUR SPACE COMMUNICATIONS SYSTEM.
— OVERSEE THE DAY-TO-DAY OPERATIONS OF AMSAT INVOLVING MEMBERSHIP SERVICES, PUBLICATIONS, PUBLIC INFORMATION AND STAFF MANAGEMENT.
— LEAD A COMPREHENSIVE FUND RAISING ACTIVITY BOTH INSIDE AND OUTSIDE THE AMATEUR RADIO COMMUNITY
THIS POSITION IS LOCATED IN SUBURBAN WASHINGTON, D.C. AND WILL REQUIRE SOME TRAVEL AND WEEKEND WORK. COMPENSATION IS IN THE \$30,000 PER YEAR RANGE, WITH SUBSTANTIAL PERFORMANCE BASED INCENTIVES. AN ENGINEERING/TECHNICAL BACKGROUND IS DESIRABLE. ACTIVE RADIO AMATEUR INTEREST IS MANDATORY. SEND RESUMES TO

SEARCH COMMITTEE/AMSAT

P.O. BOX 27, WASHINGTON, D.C. 20044

DEADLINE IS NOVEMBER 1, 1982.

TIDBITS

2ND OP

by Jim Rafferty, N6RJ

Completely revised and updated with all of the latest information, the latest **2nd Op** is an indispensable operating aid for all Radio Amateurs. The **2nd Op** gives you at the twist of a dial: prefixes in use, continent, zone, country, beam heading, time differential, postal rates, QSO and QSL record and the official ITU prefix list. Every ham needs a **2nd Op**. Order yours today.

© 1981, N6RJ's 1st Edition.

HR-OP \$6.95

Please add \$1.00 for shipping and handling

HAM RADIO'S BOOKSTORE
GREENVILLE, NH 03048

ELECTRICITY

From The Sun
For Amateur Radio

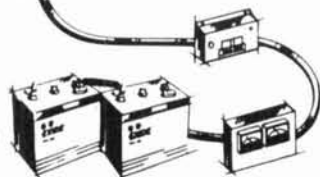
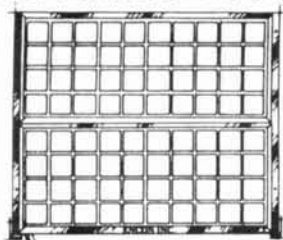

**Photovoltaic Systems,
Components, Hardware
and Accessories.
For Home, Clubs
and Repeater Stations.**

Dealer Inquiry Invited
Send \$3.50 for Catalog to:
ENCON CORPORATION
Dept. H 27584 Schoolcraft
Livonia, MI 48150
(313) 261-4130

**This Publication
is available in
Microform.**



**University Microfilms
International**

Please send additional information

for _____
Name _____
Institution _____
Street _____
City _____
State _____ Zip _____

300 North Zeeb Road
Dept. PR
Ann Arbor, MI 48106

RTTY SCOPE

NEW!



At Last! An RTTY Tuning Scope!

And who else but HAL would bring you such a practical solution to the RTTY tuning problem. If all you have is flashing lights, you know how difficult it can be to match your transmit frequency with that of a received RTTY signal. The RS2100 RTTY Scope ends these problems with an accurate display of the received signal (both signal amplitude and phase). The RS2100 is a matching companion for the CT2100 Communications Terminal and may be used with most HAL and other manufacturers' RTTY equipment. An internal loop supply is included.

- X-Y tuning scope indication
- 1" diameter green phosphor CRT
- Front panel focus, intensity, and position controls
- Internal 200 VDC, 60 ma loop supply
- Two loop keying circuits (high voltage or optical isolator)
- 3-1/2" x 8-1/4" x 10-3/16", 9 lbs net, 12 lbs shipping 120/240 VAC, 50/60 Hz power
- Scope indicator works with CT2100, DS2050, DS2000, CWR685, CWR6850, CWR670, CWR6700, ST5000, ST-6K, ST-5K, and more
- Loop supply works with CT2100, DS2050, DS2000, CWR685, and CWR6850

Write or call for more details. See the RS2100 at your favorite HAL dealer.



HAL COMMUNICATIONS CORP.

**BOX 365
URBANA, ILLINOIS 61801 217-367-7373**

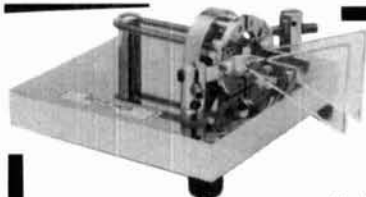

The New Standard... the **Ultimate** **IAMBIC PADDLE**

**Standard \$42.95
Chrome \$52.95
Gold Plated \$150.00**

*At selected dealers or
add \$2.00 handling*

Write:

Modern CW technology at its best! Carefully engineered to make optimum use of today's keyers, the Bencher Iambic Paddle is a symphony of modern materials, design and workmanship. This is the paddle that provides the perfect interface between the CW operator and his rig. Smooth, instantly responsive and fully adjustable to suit your own touch. From the gold plated solid silver contacts to the heavy leaded steel base, it truly is the ultimate.

BENCHER, INC.

333 W. Lake St., Chicago, IL 60606
(312) 263-1808

NEW

TS-930S

"DX-traordinary" ... superior dynamic range, auto. antenna tuner, QSK, dual NB, 2 VFO's, general coverage receiver.



A superlative, high-performance, all solid-state HF transceiver, that covers all Amateur HF bands, and incorporates a 150 kHz to 30 MHz general coverage receiver having an excellent dynamic range.

TS-930S FEATURES:

- 160-10 Meters, with 150 kHz-30 MHz general coverage receiver. Covers all Amateur frequencies, plus WARC, on SSB, CW, FSK, and AM. Incorporates general coverage receiver.
- Excellent receiver dynamic range. Typical two-tone dynamic range, 100 dB (20 meters 500 Hz CW bandwidth).
- All solid-state 28 volt operated final amplifier. Lowest IM distortion. Power input 250 W on

SSB/CW/FSK, 80 W on AM. SWR/ Power meter.

- Available with AT-930 automatic antenna tuner built-in, or as an option. Covers Amateur bands 80-10 meters, including WARC bands.
- CW full break-in. CMOS logic IC, plus reed relay. Switchable to semi break-in.
- Dual digital VFO's, 10-Hz steps, includes band information.
- Eight memory channels. Stores frequency and band data. Internal battery memory back-up, est. 1 yr. life. (Battery not Kenwood supplied.)
- Dual mode noise blanker ("pulse" or "woodpecker"). NB-1, with threshold control, for "pulse" noise. NB-2 for "woodpecker".

- SSB IF slope tuning, allows independent adjustment of the low and/or high frequency slopes of the IF passband.
- CW VBT and pitch control. Variable bandwidth tuning tunes out interfering signals. CW pitch control shifts IF passband and beat frequency. "Narrow-Wide" filter switch.
- IF notch filter 100 kHz, deep, sharp, better than -40 dB.
- Tuneable, peak-type audio filter for CW.
- AC power supply built-in. 120, 220, or 240 VAC, switch selected. (Operates on AC only.)
- Fluorescent tube digital display, with analog type sub-scale, in 20-kHz steps.
- RF speech processor provides

- higher average "talk-power"
- One year limited warranty.
 - Other features: SSB monitor circuit, 3-step RF attenuator, VOX, and 100-kHz marker.

Optional Accessories:

- AT-930 Automatic antenna tuner.
- SP-930 External speaker with selectable audio filters.
- YG-455C-1 (500 Hz) or YG-455CN-1 (250 Hz) plug-in CW filters for 455 kHz IF.
- YK-88C-1 (500 Hz) CW plug-in filter for 8.83 MHz IF.
- YK-88A-1 (6 kHz) AM plug-in filter for 8.83 MHz IF.
- MC-60 (S8) Deluxe desk microphone, with UP/DOWN switches.

TR-7730

Dyna-"mite" ... miniaturized, 5 memories, memory/ band scan.

The TR-7730 is an incredibly compact, reasonably priced, 25 watt, 2 meter FM mobile transceiver, with five memories, memory scan, automatic band scan, plus other convenient operating features. It is available with a 16-key autopatch UP/DOWN microphone, (MC-46), or with a basic UP/DOWN microphone.

TR-7730 FEATURES:

- Dimensions: 5-3/4 W x 2 H x 7-3/4 D, inches. Weighs 3.3 lbs.
- Extended frequency coverage, 143.900-148.995 MHz, in 5 or 10-kHz steps.

- 25 watts RF output power, with HI/LOW power switch.
- Five memories. Simplex or repeater operation, with transmit offset switch. The 5th memory stores receive and transmit frequencies independently, for non-standard splits. Memory back-up terminal on rear panel.
- Memory scan, plus automatic band scan. Locks on busy channel, resumes when signals disappear, or when scan switch is pressed. Scan HOLD

- or PTT switch on microphone cancels scan.
- UP/DOWN manual scan on microphone, either version.
- Four digit LED frequency display.
- S/RF bar meter. LED indicators for BUSY, ON-AIR, REPEATER operation.
- Tone switch for internal tone encoder (not Kenwood supplied).
- Offset switch ± 600 kHz, or simplex. Fifth memory for non-standard offset.

Optional Accessories:

- MC-46 16-key autopatch UP/DOWN microphone.
- SP-40 Compact mobile speaker.
- KPS-7 Fixed station power supply.



TR-8400

Synthesized 70-cm FM mobile rig

- Covers 440-450 MHz, in 25-kHz steps, with two VFOs.
- Transmit offset switch for ± 5 MHz. Non-standard offset uses fifth memory.
- HI/LOW power switch selects 10 or 1 watt RF output.
- Similar to TR-7730 in other features, including five memories, memory scan, automatic band scan, UP/DOWN manual scan, four digit display, S/RF bar meter, LED indicators, tone switch, and same optional accessories.
- Basic UP/DOWN microphone supplied with unit.



TS-830S

"Top-notch"...VBT, notch, IF shift, wide dynamic range

The TS-830S has every conceivable operating feature built-in for 160-10 meters (including the three new bands). It combines a high dynamic range with variable bandwidth tuning (VBT), IF shift, and an IF notch filter, as well as very sharp filters in the 455-kHz second IF.

TS-830S FEATURES:

* LSB, USB, and CW on 160-10 meters, including the new 10, 18, and 24-MHz bands. Receives WWV on 10 MHz.

- * Wide receiver dynamic range. Junction FETs in the balanced mixer, MOSFET RF amplifier at low level, and dual resonator for each band.
- * Variable bandwidth tuning (VBT). Varies IF filter passband width.
- * Notch filter high-Q active circuit in 455-kHz second IF.
- * IF shift (passband tuning).
- * Noise-blanker threshold level control.
- * Built-in digital display, (fluorescent tube), with analog dial.
- * 6146B final with RF negative feedback. Runs 220 W PEP (SSB)/180 W DC (CW) input on all bands.
- * Built-in RF speech processor.
- * Narrow/wide filter selection on CW.
- * SSB monitor circuit.
- * RIT and XIT (transmitter incremental tuning).

Optional accessories:

- SP-230 external speaker.
- VFO-230 external digital VFO with five memories, digital display.
- VFO-240 external analog VFO.
- AT-230 antenna tuner.
- YG-455C (500 Hz) or YG-455CN (250 Hz) CW filter for 455 kHz IF.
- YK-88C (500 Hz) or YK-88CN (270 Hz) CW filter for 8.83 MHz IF.
- KB-1 deluxe heavyweight knob.



TS-130SE

"Small talk"...IF shift, Processor, N/W switch, affordable.

A compact, all solid-state HF SSB/CW transceiver for mobile or fixed base station, covering 3.5 to 29.7 MHz.

TS-130SE FEATURES:

* 80-10 meters including the new 10, 18, and 24 MHz bands. Receives WWV on 10 MHz.

* TS-130SE runs 200 W PEP/160 W DC input on 80-15 meters, 160 W PEP/140 W DC on 12 and 10 meters. TS-130V version at 25 W PEP/20 W DC, all bands, also available.

- * Digital display, built-in.
- * IF shift circuit.
- * Speech Processor, built-in.
- * Narrow/wide filter selection on CW and SSB with optional filters.
- * Automatic SSB mode selection (LSB on 40 meters and below, USB on 30 meters and up). SSB reverse switch provided.
- * RF attenuator, built-in.
- * Effective noise blanker.
- * Final amplifier protection circuit assures maximum reliability. Output power is reduced if abnormal operating conditions occur. For very severe operations, optional cooling fan, FA-4, is available.
- * Dimensions: 3-3/4 H x 9-1/2 W x 11-9/16 D (inches). Weight: 12.3 lbs.
- * Other features: VOX, CW semi break-in with sidetone, one fixed channel, and 25 kHz marker.

Optional DFC-230 Digital Frequency Controller

Frequency control in 20-Hz steps with UP/DOWN microphone (supplied with DFC-230). Four memories and digital display. (Also operates with TS-120S, TS530S, and TS-830S.)

Optional accessories:

- PS-30 matching power supply (TS-130SE).
- KPS-21 power supply (TS-130SE).
- PS-20 power supply (TS-130V).
- SP-120 external speaker.
- VFO-120 remote VFO.
- FA-4 fan unit (TS-130SE).
- YK-88C (500 Hz) and YK-88CN (270 Hz) CW filters.
- YK-88SN (1.8 kHz) narrow SSB filter.
- AT-130 antenna tuner.
- MB-100 mobile mounting bracket.



KENWOOD

TRIO-KENWOOD COMMUNICATIONS

1111 West Walnut, Compton, California 90220

NEW



quality says it all...

ROHN Foldover Towers

ROHN "fold-over" Towers offer unbeatable value. These towers let you work completely on the ground for antenna and rotator installation and servicing eliminating the need of climbing the tower. Send \$2.00 for complete catalog.



UNR-Rohn
Division of UNR, Inc.
P.O. Box 2000
6718 West Plank Road
Peoria, Illinois 61656
Ph. 809-697-4400
USA

Iron Powder and Ferrite TOROIDAL CORES

Shielding Beads, Shielded Coil Forms
Ferrite Rods, Pot Cores, Baluns, Etc.

Small Orders Welcome
Free 'Tech-Data' Flyer

AMIDON
Associates

Since 1963



12033 Otsego Street, North Hollywood, Calif. 91607

In Germany: Elektronikladen, Wilhelm — Mellies Str. 88, 4930 Detmold 18, West Germany
In Japan: Toyomura Electronics Company, Ltd., 7-9, 2-Chome Sota-Kanda, Chiyoda-Ku, Tokyo, Japan

GOT SOMETHING TO SELL?

Try a classified ad in *Amateur Radio's* #1 magazine, *ham radio*.

Non-commercial ads \$.10 per word. Commercial ads \$.60 per word. No agency discounts allowed. 15% discount allowed for ads run 6 consecutive months without change. 33% discount allowed for ads run 12 months without change. Payable in advance. Deadline 15th of 2nd prior month.

From something simple to something exotic, *ham radio* readers are interested. And results prove that they BUY!

Send your ad in today. Send payment with order or give us your MasterCard or VISA and we'll charge your account for you.

Name

Address

City

State Zip

Card Number

Expires MasterCard VISA

HAM RADIO MAGAZINE
Greenville, NH 03048



THE PROFESSIONAL, TOUCH TONE ENCODER

An ultra high quality encoder for professional application. Absolute reliability and function makes the difference. There's a Pipo encoder for every system and application. Totally serviceable, easy to operate and install. Call or write for free catalog and information! (213) 852-1515 or P.O. Box 3435, Hollywood, CA 90028.

PATENTED

• AT&T

PipoCommunications®
Emphasis is on Quality & Reliability

SYNTHESIZED SIGNAL GENERATOR

MADE IN
USA



MODEL
SG1000
\$349.95
plus shipping

- Covers 100 to 185 MHz in 1 kHz steps with thumb-wheel dial • Accuracy 1 part per 10 million at all frequencies • Internal FM adjustable from 0 to 100 kHz at a 1 kHz rate • Spurs and noise at least 60 dB below carrier • RF output adjustable from 5-500 mV at 50 ohms • Operates on 12 Vdc @ 1/2 Amp • Available for immediate delivery • \$349.95 plus shipping
- Add-on Accessories available to extend frequency range, add infinite resolution, voice and sub-audible tones, AM precision 120 dB calibrated attenuator
- Call for details • Dealers wanted worldwide.

VANGUARD LABS
196-23 Jamaica Ave., Hollis, NY 11423
Phone: (212) 468-2720

Here's the ticket to getting your ticket

The new
Station One

\$199⁹⁵
Suggested Retail



Dealer inquiries invited.

A complete 25 Watt, 3-band, CW transceiver that's perfect for the Novice and is packed with fun for you Elmers too! Work it at home base, or plug into a 12V battery for mobile use. Comes complete with transceiver, code key, 3 band dipole, head set, log book, ARRL license manual, plus radio and code course on cassette. Options include matching tuner, NI-CAD 12V portapak, and 120V power supply with speaker.

- 25W input with 10-15W nominal output
- 12.6VDC, 350ma display on, 75ma display off, 2.5 amps transmit
- 5" W x 2 1/2" H x 7" D, 4 lbs.

Features:

- covers all of 80, 40 and 15 meter amateur bands
- sensitivity .5uV for 10dB signal to noise ratio
- selectivity: 800Hz nominal audio shaping
- stability: 100Hz on 80 and 40 meters, 300Hz on 15 meters



DENTRON

1605 COMMERCCE DRIVE
STOW, OHIO 44224 • (216) 688-4973 • TELEX 241-633

ORR BOOKS

BEAM ANTENNA HANDBOOK

by Bill Orr, W6SAI

Recommended reading. Commonly asked questions like: What is the best element spacing? Can different yagi antennas be stacked without losing performance? Do monoband beams outperform tribanders? Lots of construction projects, diagrams, and photos. 198 pages. ©1977. 1st edition.

RP-BA Softbound \$5.95

SIMPLE LOW-COST WIRE ANTENNAS

by Bill Orr, W6SAI

Learn how to build simple, economical wire antennas. Apartment dwellers take note! Fool your landlord and your neighbors with some of the "invisible" antennas found here. Well diagramed. 192 pages. ©1972.

RP-WA Softbound \$6.95

THE RADIO AMATEUR ANTENNA HANDBOOK

by William I. Orr, W6SAI and Stuart Cowan, W2LX

Contains lots of well illustrated construction projects for vertical, long wire, and HF/VHF beam antennas. There is an honest judgment of antenna gain figures, information on the best and worst antenna locations and heights, a long look at the quad vs. the yagi antenna, information on baluns and how to use them, and new information on the popular Sloper and Delta Loop antennas. The text is based on proven data plus practical, on-the-air experience. The Radio Amateur Antenna Handbook will make a valuable and often consulted reference. 190 pages. ©1978.

RP-AH Softbound \$6.95

ALL ABOUT CUBICAL QUAD ANTENNAS

by Bill Orr, W6SAI

The cubical quad antenna is considered by many to be the best DX antenna because of its simple, lightweight design and high performance. You'll find quad designs for everything from the single element to the multi-element monster quad, plus a new, higher gain expanded quad (X-Q) design. There's a wealth of supplementary data on construction, feeding, tuning, and mounting quad antennas. 112 pages. ©1977.

RP-CQ Softbound \$5.95

Please add \$1.00 to cover shipping and handling.

HAM RADIO'S BOOKSTORE
GREENVILLE, NH 03048

ALL NEW 15 Meter Mobile CW & USB



21.000—21.450 MHz

High 10W (PEP) low 2W (PEP); VFO tuning; noise blanker; fine-tune SB, KHz ± CW off-set; digital frequency counter; 13.8V dc @ 3A, negative ground; L 9.5" x W 9" x H 2.5"; weight (2.3 kg) 5.7 lbs.; mobile mounting bracket. **UNDER \$300**

DEALER INQUIRIES INVITED



1275 N. GROVE ST.
ANAHEIM, CALIF. 92806 (714) 630-4541

NOTE: Price, specifications subject to change without notice and obligation.

Questions and Answers

Entries must be by letter or postcard only. No telephone requests will be accepted. All entries will be acknowledged when received. Those judged to be most informative to the most Amateurs will be published. Questions must relate to Amateur Radio. In the case of two or more questions on the same subject, the one arriving the earliest will be used.

I have two questions that I've often wondered about and would appreciate your looking at.

I've often noticed that transmitter power is rated in terms of peak envelope power (PEP). How can I use this figure to estimate the approximate output power of the rig?

Also, I have an older transceiver that displays a mild hum on the received signals, just enough to cover very weak stations. How can this hum be eliminated, and what causes the power supply to jump somewhat when it is first turned on? — Christopher B. Hays, WB0LPV.

As for power output, the Amateur service is the only one in which power limitations are expressed in terms of final-stage input power. In all other services, the output power is used. With certain exceptions, the Amateur limit is 1000 watts to the plate circuit of the final amplifier; while FCC 97.67 doesn't say so, this means the product of the dc plate voltage and the current. This is known as the average power.

When we modulate the transmitter we get an envelope containing the modulation that has peaks and valleys — but there is no simple relationship between the peak and the average level of the human voice. So we "assume" that the PEP is twice the average power. Hence, the limit of 2 kw PEP, or 1 kW CW or average.

Now, the output power is a question of the efficiency of the transmitter's output stage. Assume 55 percent efficiency. If the transmitter is rated at 180 watts input CW, its output is 100 watts CW. If it is rated 360 watts PEP input, it will yield 200 watts PEP output — which is still 100 watts CW! Your primary interest is output power. Since PEP is a function of the individual voice, there is no standard of comparison other than average power output.

As for your "older" transceiver, I have to make some assumptions. My first assumption is that it is a tube-type. If the hum is 60 Hz, it can be heater-to-cathode leakage, remedied by tube replacement. If it is 120-Hz hum, it probably means your filter electrolytic capacitors need replacement — they have a finite life. Also, the cathode bypass capacitors in the audio stages of the receiver section should be checked.

That "jump" you refer to is usually a "grunt" from the power transformer that results from high inrush current. Assuming solid-state rectifiers, when the radio has been off, the filter capacitors look like a short-circuit until they charge. Also, some power transformers are designed so that they are operated at high flux density and with low primary-winding resistance, thus causing a "grunt" that depends on when in the 60-Hz supply cycle they are turned on.

I have a question about the efficiency improvement of a beam antenna. Would it be possible to have a gain in dBs if the beam could be rotated not only in the horizontal but also in the vertical plane, say in line with the radiation angle? Since the latter could be found only by experimenting for the best gain, rotation should also be a possibility. I wonder if any tests have been done in this respect. — Hans W. Schaedel, VE3BWE.

Thirty years ago, there was a ham in Chicago who used two rotators on his 10-meter beam, one for horizontal azimuth and the other for vertical radiation angle. I remember that when we could no longer hear other stations (this was at distances of 15 miles), he would still be very strong because he "tilted" his boom for maximum received signal. The only formal reference I could find was in regard to NBS studies of ionosphere opacity at 50 MHz, but there were no definitive conclusions that are applicable here.

The propagation experts claim that after one skip off the ionosphere the transmitted wave changes polarization, becoming more vertical or circular than it was at the transmitting antenna (which was horizontally polarized). This idea of adjusting vertical radiation lobe angle from ground is

intriguing, but I think you will agree it becomes somewhat impractical with large Yagis; the mechanical problems are difficult to solve.

I might suggest you try a combination: a vertical with a good radial system, a Yagi on a tower than can be raised and lowered, and a horizontal long wire close to ground. By switching among these antennas you might be surprised by the difference in received signals. And you may be surprised to find that the "reciprocity theorem" (that transmitting and receiving capability should be the same) doesn't always hold true! A combination of antennas with different vertical radiation angles can accommodate many point-to-point communications situations. And then there are the slopers and drooping inverted-Vs — if you have enough real estate, you can have a ball.

Why is it when I use my rig on SSB that the current meter shows only about half the tune-up (plate) current and the wattmeter shows only about half the (output) power? — Mike Bruce, KA4BCM.

The answer is found in the characteristics of human speech and the mechanical (ballistic) characteristics of meters. When you tune up on CW, you are injecting a fixed-level audio signal into the low-level audio circuits, or the balanced modulator is set so an actual carrier is transmitted, depending on the type of transceiver/transmitter.

Now, when you speak into the microphone, you no longer have a fixed-level signal. The ratio of peak-to-average in the human voice is about three to one or more; speech is not sinusoidal. When using meters (plate-current, power, VU, etc.), the ability of the meter to follow these instantaneous changes comes into play — the meter needle moves slowly at first, might overshoot, miss a short burst of energy entirely, and slowly settle back. The type of meter you should use to monitor your modulation level is called an oscilloscope — it is not affected by these ballistic

problems to any significant degree. Then you can set your mike control to produce maximum peak output power without flat-topping or distorting. Incidentally, an interesting question arises: How do manufacturers arrive at the ALC maximum line on their meters? I'll wager it's done with a constant-amplitude audio signal at one frequency. So again, use a scope!

What can you tell me about the "gray line," and how can I use it for DX? — Donald G. Ramras, KD6GR.

This topic involves the subjects of short-wave radio propagation and astronomy. Simply, the "gray line" is the "twilight zone," that is, the portion of the earth that delineates daytime from nighttime. This line (really a band) usually occurs ± 30 minutes on either side of local sunrise and local sunset, so we have about two hours of gray line per day. It has been found that hf propagation along this line is extremely efficient. The popular reason given is that the D layer of the ionosphere is minimal or nonexistent then and the signals are not absorbed as they would be during the day.

Astronomy? The position of this path varies with the earth's inclination to the sun. The position of the path can be predicted with the use of a globe, and a piece of cardboard larger than the globe that has a hole cut in it, and a table of inclination angles from the North/South Poles for different dates. A commercial version of this globe specifically designed for the purpose of gray-line prediction is available in Europe.

Insofar as short- or long-path Great Circle propagation is concerned, a signal bounced off the ionosphere will take the path that has the least absorption. Again, this is related to D-layer absorption, affected by the sun striking the ionosphere. The *frequency optimum de travail* (optimum working frequency) for a given path (point-to-point) is determined by the maximum usable frequency, MUF, the highest frequency that can be used for transmission using reflection off the regular ionospheric layers.

The MUF is affected by sunspot activity.

For those interested in pursuing this fascinating subject, the suggested bibliography is: *The Short-wave Propagation Handbook* by Jacobs and Cohen, from Cowan Publishing; *80-Meter DXing* by Devoldere, from Communications Technology, Inc., Greenville, NH; "The Gray Line Method of DXing," by Hoppe, Dalton, Capossela, CQ, September, 1975; and *The ARRL Antenna Book*, Chapter 1, from the American Radio Relay League.

I need a clear, concise definition of an rf ground. I have read that they can be important, especially with QRP operation. — Elliott Gee, KA4PQF.

An rf ground is one that makes a low-impedance connection with earth for frequencies in the radio spectrum. Now, for 60 Hz, it is not much of a problem to contact "earth." A fair sized conductor is connected to a single rod. To improve contact with earth, multiple rods (or radials) should be used, usually the more the better. When operating at rf, however, a problem arises — this single wire has inductance as well as resistance.

For instance, a ten-foot length of #10 AWG solid copper wire has a resistance of about 0.01 ohm and an inductance of 4.13 μ H (assuming it's straight and that most of the current is flowing on its surface — skin effect). At 21 MHz our ground wire looks like 0.01 + j 552 ohms — not very effective! Also, consider that as rf travels along a wire there are standing-waves of voltage (and current) produced. The impedance at any point is the voltage divided by the current. Therefore, the solution is to use several ground wires of different lengths, avoiding lengths that are multiples of quarter-wavelengths in our bands. Then, if one length shows a high impedance at the operating frequency, it is probable that one or more of the other wires will be at low impedance to ground.

SATELLITE
TELEVISION
SYSTEMS



PB RADIO SERVICE
1950 East Park Row
Arlington, TX 76010

Starting from one common point in our shack (the "equipment ground" point), run these different lengths to our ground rods or radial system. Connect each piece of equipment with its own lead (try and keep them the same length to minimize potential differences) to this equipment ground. Use insulated wire so it doesn't rub against any metallic object and create noise. Make solid connections and inspect them periodically. Do not use water pipe or electrical wiring grounds. Use at least #10 AWG wire and keep the run as short as practical, usually out the window along the outside of the building to earth. If all else fails, consider using a counterpoise underneath your antenna. Good luck!

I would like information on the new WARC bands, phone and CW portions — Brian Grant, VE4ALR.

WARC-79 produced three new bands for Amateur use: 10, 18, and 24 MHz. The frequencies from 10.1 to 10.15 MHz, the first to be used, will be on a shared basis with fixed services, and the earliest date of use was to have been January 1, 1982. The other two bands, 18 and 24 MHz, will be exclusive — after the fixed service stations now using these frequencies are reassigned. That will probably be after mid-1989!

The 50 kHz of the 10-MHz band we have will be shared on a secondary basis; that is, they can cause interference to us, but we can't cause interference to them. There is some move toward CW-only use of the 30-meter band, but even this is not universally accepted.

Your British cousin went on the air on January 1, along with some other countries. Here in the States, the FCC is still contemplating the situation, listening to objections from current users of these frequencies and waiting for Senate ratification of the WARC-1979 treaty. It will probably be a while before U.S. hams use this band. Canada has use of this band now.

ham radio

- * PRODELIN 10' ANTENNA
8 peice for easy shipping/Injection molded for precision
- * CHAPARRAL POLAROTOR
Changes polarity in less than half a second/Feed & LNA never moves
- * DEXCEL RECIEVER
Great looks/Great performance/2 YEAR WARRANTY/Dentent tuning/ Built in modulator
- * DEXCEL 120° L.N.C.
Eliminates need for old fashioned LNA/2 YEAR WARRANTY/Best LNC made

*ALSO AVAILABLE

- 1900 to 2500 MHz Microwave Downconverters
- Kit.....\$28.50
- Assembled.....\$48.50
- SLOTTFD APRAY ANTENNA.....\$21.95
- COMMERICAL M.D.S. SYSTEM.....\$169.95

CALL ORDER DEPT. TOLL FREE:
(800) 433-5169



INFORMATION CALL:
(817) 460-7071



*ALSO AVAILABLE
UHF T.V.DECODER,
F-V 3 BOARDS,
PARTS & INFORMATION

Homebrew
Headquarters



R-X
NOISE
BRIDGE
KIT
\$33.45

plus \$2.50 shipping & handling

DON'T TUNE UP ON THE AIR!
USE A NOISE BRIDGE!

IN STOCK:
Ladder Line
Antenna Wire
Antenna Traps
Insulators
SWL Antenna
Portable Whip Antenna
and much more!

Complete parts kit including pre-drilled diecast enclosure. Measures both resistance and reactance.
Resistance limits: 0-250 ohms
Reactance limits: ± 180 pF
Frequency range: 1.5 MHz-30 MHz

Self-contained, uses your receiver as detector.

1982 CATALOG 50c

RADIOKIT

Box 411H, Greenville, NH 03048
(603) 878-1033

FALL '82 SPECIALS

AN/UPM-84 SPECTRUM ANALYZER — 10 MHz to 44.88 GHz in eight bands. 5" CRT display. Resolution: 20 KHz @ 3 db points. Dispersion: 500 KHz — 5 MHz (10-55 MHz), 500 KHz — 25 MHz (55 MHz up). Sensitivity as low as -63 db (10-150 MHz). — 40 db (2 GHz up). Requires 115 VAC 60 Hz 17 1/2" x 19 1/2" x 22". 145 lbs net, 185 sh. Used, repairable. ~~\$495-~~ **\$395.**

Manual, partial repro **\$15.** KIT: w/adapters, attenuators, filters, case **\$100.** w/set purch.

R-388/COLLINS 51J3 RECEIVER - 0.5-30.5 MHz AM-CW in 30 bands. Rackmount. 10 1/2" x 19" x 13". 55 lbs. Used, repairable. ~~\$325-~~ **\$265.**

Checked **\$400-** **\$330.** Manual, partial repro **\$10.**

Prices F.O.B. Lima, O. • VISA, MASTERCARD Accepted.
Allow for Shipping • Write for New 1982 CATALOG
Address Dept. HR • Phone: 419/227-6573

FAIR RADIO SALES

1016 E. EUREKA • Box 1105 • LIMA, OHIO • 45802

RED HOT SPECIALS

KDK FM 2030 w/TT Mike.....	279.00
AZDEN PCS 3000 2m Xcvr.....	283.00
AZDEN PCS 300 2m Handheld.....	283.00
AZDEN PCS 2800 10m FM Xcvr.....	283.00
JANEL QSA5 2m Rcvr. Preamp.....	38.50
SANTEC 144 µP 2m Handheld.....	293.00
CUSHCRAFT Ringo Ranger II.....	33.00
COMMODORE Vic 20 Computer.....	269.00
BEARCAT 20-20 Scanner.....	269.00
KANTRONICS "The Interface".....	165.00
All MFJ Items.....	12% off list
REGENCY M100 Scanner.....	199.00
KANTRONICS Field Day II Code Reader.....	349.00
5/8 wave Mag. Mt. 2m Antenna.....	19.99
ICOM 451A 440 MHz Xcvr.....	699.00

Prices subject to change without notice.
SASE for our Large Specials and Used Equipment Lists

BEN FRANKLIN
ELECTRONICS

115 1/2 N. Main Hillsboro, KS 67063
316-947-2269

operation upgrade: part 9

The ninth part
in a continuing series
designed to help you
upgrade your ticket

The ninth article in this series on upgrading your license presents in reasonably simple terms what is in actuality quite a complete group of theories. The first article (September, 1981) discussed direct current circuits. This was followed by some alternating current theory, active devices Amateurs use, simple power supplies, and practical amplifier circuits. The last two articles discussed the fundamentals of CW transmitters and receivers.

This month we will investigate the radiation of radio frequency energy, or waves, from wires, some basic antennas, wave motion through space, transmission lines, and the SWR meter. You should understand that, without a properly operating antenna, even maximum power input to a transmitter may not produce satisfactory communications.

electromagnetic radiation

When an antenna wire is fed rf ac energy, electrons are forced to oscillate back and forth along the wire. This produces an alternating electromagnetic field around the wire, and an alternating electrostatic field from one end to the other end of the antenna. We will consider only the electromagnetic part, but remember that it could not exist without the electrostatic field being there also.

The fundamental center-fed dipole-type antenna is shown in **fig. 1**. It consists of a half-wavelength ($\lambda/2$) horizontal wire, fed in the middle by a two-wire transmission line (feeder, or feed line). The bottom of the feed line is coupled to a transmitter (if you want to transmit energy) or to a receiver (if you want to receive energy picked up by the antenna).

The antenna wire can be cut to the basic $\lambda/2$ length from a formula based on the velocity of radio wave travel in meters per second (the velocity is roughly 300,000,000 m/s). For a frequency of 7 MHz, or 7,000,000 cycles per second (Hz), the full wavelength can be determined by dividing the velocity by the frequency. So, a 7-MHz signal has a wavelength of

$$\lambda = \frac{300,000,000}{7,000,000} = 42.857 \text{ meters}$$

If 7-MHz ac has a wavelength of 42.857 meters, its

By Robert L. Shrader, W6BNB, 11911 Barnett Valley Road, Sebastopol, California 95472

north magnetic field being radiated from the antenna would travel 42.857 meters outward in the air before the next north magnetic field would be produced around the wire. During this period, the field around the wire would decrease to zero, become a south-polarity field, reach maximum, decrease to zero, and expand out to maximum north again. The magnetic fields build out and back because an alternating electron current is being driven back and forth in the wire by the transmitter. Although 42.857 meters is the full wavelength of a 7-MHz ac wave, the wire can be cut to a half-wavelength ($\lambda/2$) and still allow the electrons to oscillate back and forth in it with minimal opposition.

We might expect that a 7-MHz, $\lambda/2$ antenna would be $42.857/2$, or 21.4 meters long. But that's too easy. A properly operating $\lambda/2$ antenna will be only about 95 percent of our computed length, because of "end effects." You can use one of the following formulas, which include the 5 percent end effect correction, when computing the correct length of a $\lambda/2$ antenna:

$$\text{In meters, } \lambda/2 = \frac{142.5}{f_{\text{MHz}}}$$

$$\text{In feet, } \lambda/2 = \frac{468}{f_{\text{MHz}}}$$

According to your own calculations, to what length should you cut a 7-MHz $\lambda/2$ antenna wire? How about 20.357 meters, or 66.857 feet? Do you agree?

An interesting point regarding an antenna is its impedance. If you were to measure the impedance of a $\lambda/2$ antenna end to end it would be something like 2500 ohms, depending on wire size, height, and so forth. If you cut a $\lambda/2$ antenna in the middle, this opening should exhibit an impedance of about 72 ohms to any feedline coupled to it, again depending on conductor size and height. We will say that a $\lambda/2$ antenna has a center impedance of about 72 ohms. If we connect a pair of wires of just the right diameter and spacing they can also be made to have a characteristic impedance of 72 ohms. If such a parallel-wire transmission line is fed 7-MHz rf ac, it will transfer all of its energy to the 72-ohm opening at the antenna center and all of this energy will be radiated into space by the antenna. Actually, a $\lambda/2$ antenna exhibits a 72-ohm impedance when at any quarter-wavelength ($\lambda/4$) multiple above the ground. If it's only an eighth-wavelength ($\lambda/8$) above ground, the center impedance drops to about 35 ohms. At $3/8$ -wavelength ($3\lambda/8$) above ground, it shows about 98 ohms. At $5\lambda/8$ above ground, it shows about 58 ohms, and so on. Above two wavelengths in height, the center impedance will be constant at 72 ohms.

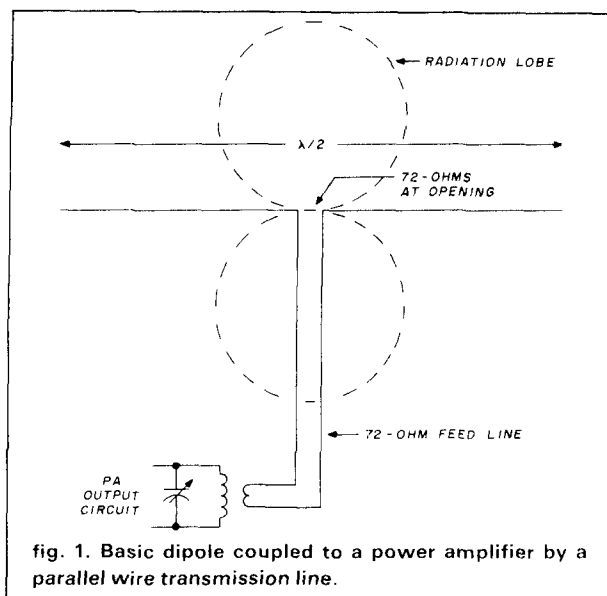

fig. 1. Basic dipole coupled to a power amplifier by a parallel wire transmission line.

Of course, if you change the frequency of the rf ac you are feeding to the transmission line from 7 to 7.1 MHz, the antenna will no longer be in resonance with the ac. The 66.86-foot antenna will now be a little too long (for 7.1 MHz it should be 65.9 feet). Electrons oscillating at 7.1 MHz will not have enough time to reach the end of the antenna before the ac cycle alternates and they must start back again. As a result maximum current never is produced in the antenna and some of the energy which the antenna is unable to accept is reflected back down the transmission line. The reflected energy develops high and low voltage points (loops and nodes) on the transmission line which can make the *line* act as an antenna and radiate rf waves. When the antenna is taking all of the energy and none is reflected back down the line, the voltage across the line at all points is equal and the line is said to be "flat."

When the antenna is not the proper length for the frequency of the ac being fed to it, then the impedance exhibited at the center will no longer be a resistive 72 ohms, and will no longer be a match for a 72-ohm line feeding it. An impedance mismatch always results in less than maximum power transfer, as discussed previously.

In the case of an antenna being too long for the ac frequency being fed to it, the antenna looks inductive (appears to have X_L) to the feeder. The inductive reactance can be cancelled by opening both wires of such a dipole (two $\lambda/4$ s makes a $\lambda/2$) and adding the correct value of capacitance (X_C) to bring the antenna back into resonance. The antenna will now be resonant to the exciting ac and no standing waves (high and low voltage and current points) will be developed on the feed line.

An antenna that is too short for the ac frequency will appear capacitively reactive to the driving source (feed line). Both sides of the antenna can be opened and loading coils with the correct value of inductive reactance can be added to bring it to resonance and make it accept maximum power from the feeder. However, when an antenna is loaded to make it resonant, its center impedance may decrease somewhat.

basic vertical antennas

The basic horizontal antenna is the dipole discussed above. If such an antenna is rotated 90° so that the wire is oriented vertically (assuming the lower end does not touch the ground), it can be called a vertical $\lambda/2$ dipole. Maximum radiation of energy from any $\lambda/2$ antenna is always at right angles to the wire (E and W and skyward for a horizontal antenna laid out N and S). There is essentially no radiation off the ends. The radiation lobes of such an antenna are shown dashed in **fig. 1**. When the dipole is vertical it radiates nothing upward, but radiates equally well in all horizontal directions from the wire. It is said to have omnidirectional, or all-directional, lobes, whereas the horizontal dipole has bidirectional, or two-directional, lobes (disregarding the upward radiation component).

If a second $\lambda/2$ wire is attached to one side of the horizontal dipole we would have a full-wave antenna, fed at the center of one of its $\lambda/2$ sections. We could keep adding $\lambda/2$ sections to one side of the antenna, and the feedpoint could remain where it is. An unlimited number of such $\lambda/2$ sections could be added and it would still be resonant. Whereas a $\lambda/2$ antenna has maximum radiation lobes at right angles to the wire, a 1λ antenna has two lobes, each about 50° from the wire. A $3\lambda/2$ antenna has one lobe at right angles to the wire and two at about 40° from the wire. A 2λ antenna has four lobes, a 3λ has six lobes, and so forth. Every time a $\lambda/2$ is added a new lobe is formed. As the antenna is lengthened the lobes of greatest length (those which contain the most energy) fall closer and closer to the wire. A 4λ or longer "long-wire" antenna becomes most directional in line with the antenna wire, rather than at right angles to it as in a $\lambda/2$ dipole.

It is also possible to use just half of a vertical dipole and use a "ground" connection to make the earth operate as the unlimited number of $\lambda/2$ sections for the other part of a long-wire antenna. In such a case a $\lambda/4$ vertical antenna is developed, **fig. 2**. The earth connection, called a ground, may be a series of four to perhaps twenty $\lambda/4$ wire radials extending out from under the vertical section, as shown. An electrical ground rod might be used but only if it makes a very good electrical connection to an area of exceptional electrical conduction (salt marsh, for example).

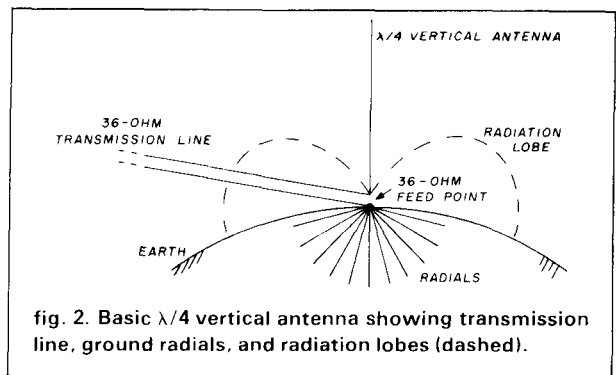

fig. 2. Basic $\lambda/4$ vertical antenna showing transmission line, ground radials, and radiation lobes (dashed).

If the ground system radials are buried under the ground they may be made less than a $\lambda/4$. If the ground is kept wet the radials may not need to be more than $\lambda/10$ long, nor number more than four or six.

The impedance of a vertical antenna, if the antenna wire is opened at the point where the ground radials converge, will be about half that of a horizontal dipole, or about 36 ohms. Feed lines are manufactured in 50-53 ohm and 73-75 ohm values. To match a 36-ohm feed point, two equal-length 75-ohm lines can be paralleled, or a 50-ohm line can be used and the mismatch tolerated (this produces an SWR of 50/36, or 1:1.39, discussed later).

A $\lambda/4$ vertical working against ground has an omnidirectional radiation pattern, but because of the reflection of the radiated wave from the nearby ground the horizontal part of the lobe will be somewhat shorter (shown dashed) than that of a vertical $\lambda/2$ well above ground. We can say the vertical $\lambda/2$ has more horizontal gain than the vertical $\lambda/4$ antenna. The better the ground under any antenna, particularly a $\lambda/4$, the better it will reflect waves from or to the antenna and the more gain the antenna will have.

The polarization of a radio wave is the direction taken by the electrostatic field of the antenna. Thus, a horizontal antenna transmits horizontally polarized waves, and a vertical antenna radiates vertically polarized waves.

solar and ionospheric effects

The earth is surrounded by a band of air, thickest near the earth's surface and thinning as altitude increases up to about 600 miles (1000 km). Ultraviolet energy radiated from the sun can cause ionization (breaking up of atoms and molecules of air in the higher altitudes into positive and negative particles). These ionized particles tend to form into reasonably well-defined bands above the earth's surface, and are referred to as the D, E, and F (F_1 and F_2) layers. Radio waves travel at higher velocity in the areas of lowest density. The top part of a wavefront starting

out at 45° above the horizon, for example, will begin to accelerate more than the part of the wave that started at 44°. This results in the top of the wavefront speeding up, causing the wavefront to bend back down toward the earth, **fig. 3**. Can you see that the same wavefront traveling at different angles from ground might return to earth at different places?

The part of a radio wave that travels directly over the surface of the earth will induce currents into buildings, trees, and the earth itself. It will lose energy and become weaker as it travels. Such a ground wave may produce readable signals for only a few miles if its frequency is in the high-frequency range. Low and medium frequency (VLF, LF, MF) radio waves may produce usable signals for hundreds to thousands of miles. Anyone in the area between the ground wave and the point where the closest reflected (or refracted) wave returns to earth is said to be in the skip zone. In the skip zone you will not be able to hear signals from the transmitter at all. As the day progresses, however, the ionospheric layers change density and the skip zone may close up — or it may lengthen. In general, the higher the frequency, up to about 30 MHz, the longer the paths that will be usable but the longer the skip zones may be. Above 30 MHz, radio waves may bend so little under normal conditions that they pierce the ionosphere instead of being refracted by it, as indicated by the nearly vertical ray shown in **fig. 3**.

It is quite common for one point on earth to be simultaneously receiving the same signal refracted from two different layers or from two different parts of the same layer. Since the path lengths of two such waves are different, the two signals may be in phase and augment each other at a receiver at one moment, or they may be out of phase and cancel each other the next. To the listener the signals are fading in strength. Because of changing solar activity, the ionospheric layers are continually varying in density. As a result, all signals out of strong ground-wave range will continually be fading to a greater or lesser extent. Even ground-wave signals with a path of over a couple of miles will fade to some extent, because of reflections from the ionosphere, from aircraft, or other variables. However, the true ground wave does not change in strength at all, day or night.

It is almost unbelievable how much difference there can be in the strength of two radio signals from the same station if only a couple of hundred hertz apart in frequency. An amplitude modulated (a-m) voice signal consists of a carrier frequency with sidebands out 3 kHz on both sides. If the carrier frequency fades out but the sidebands do not, the signal is still loud, but very badly distorted. As you listen to such signals, first the low frequency sidebands of the voice may fade out, and then the higher frequencies

may fade. This is called selective fading and is one reason why single-sideband (SSB) emissions are so much more satisfactory than a-m. SSB signals have no carrier to fade and cause distortion.

During sunlight hours the layers are most dense. At night, the D layer thins and the two distinct F₁ and F₂ components thin out and rise to form a single F layer.

It is difficult to generalize on the daily variations of radio wave paths for the many different frequencies of our high-frequency bands. We might state that the low frequencies (1.8-2 MHz) are at their best at night for long-distance communications. The higher frequencies (28-30 MHz) tend to be better in the daytime for DX. Sometimes, when the solar activity is great, the layers are so dense that they attenuate radio signals of all frequencies outside of the ground wave range. In general, communications at 50 MHz and higher are made by line-of-sight (direct wave) only. If you can see the other station you can work it. However, VHF and UHF signals do bend down over hills, particularly if the hills present a sharp demarcation to the wavefront. As a result it is not unusual to be able to work such stations that are a little past line-of-sight. The higher your antenna the farther to both the visual and radio horizons. The approximate VHF and UHF radio horizon can be computed to be:

$$D = \sqrt{2h}$$

where D = distance in miles to the radio horizon

h = height of the antenna in feet

The formula allows for the fact that VHF and UHF radio waves traveling over reasonably flat terrain extend somewhat past the visual horizon.

It is possible to transmit radio waves upward and receive reflections back on earth a split second later. If the frequency of these ionosphere "sounding" emissions are checked, it will be found that at any particular time of day, above a certain frequency no return will be produced. From this the *maximum usable frequency* (MUF) can be determined. MUF charts are made up to indicate what frequencies might be best to use at specific times of day, for several days or weeks in advance. Such charts are particularly helpful when you're looking for DX contacts.

The D layer is present only when the sun is nearly directly overhead. If dense, it can absorb lower high-frequency-band radio waves. The E layer, about 75 miles up, is most effective at refracting signals during early morning and afternoon. Some solar flare-ups can develop a sporadic E layer, which can produce some interesting short-skip communications up to 1000 miles or more on the 28 and 50 MHz bands.

Most long distance high-frequency communications make use of refraction from the F layer(s).

Every eleven years the number of sun spots increases producing active DX radio communications. But at any time, if there is a spot on the sun with particularly high activity, its radio effect on earth may be felt again in twenty-seven days, which is the rotational period of the sun on its axis.

When there is a sudden ionospheric disturbance (SID) caused by solar flare-ups, many particles enter the ionosphere. All radio communications can be shut down for hours or days because of the absorption of the energy of radio waves by the highly ionized layers.

Solar particles may stream into the earth's magnetic field and produce visible ionization above the magnetic pole. This illumination is called the aurora, and, in the Northern Hemisphere, is visible roughly north of latitude 45. It is possible to bounce Amateur Radio signals off the auroral sheets and communicate for several thousand miles if both stations point their antennas at the ionized areas. CW is the best means of communications, because of the rapid flutter of such reflected signals.

The troposphere is the band of air from ground level up to about ten miles altitude. The air in the troposphere can form in warmer and cooler layers. Warm air is less dense than cool air, so when VHF or UHF radio waves are radiated into a strata of warm air between two cooler layers, they bend and travel along such a duct for hundreds of miles before the layer decays and they escape, possibly returning to earth. Ducting is most often experienced over large flat areas, such as oceans or deserts.

The variations normally present in air masses slightly above ground level are usable for what is termed scatter transmissions. High-power VHF or UHF radio waves are beamed at the horizon. Normal disturbances in the air 10 to 50 miles out can scatter

the radio wavefronts. Some of the waves may be scattered in a downward direction toward earth and may be picked up as a usable signal several hundred miles away. Metallic wires and objects on top of hills can also produce a scatter effect bouncing signals down into a valley on the far side of a hill as seen from the transmitting station.

coupling the PA to an antenna

There are a variety of methods that can be used to carry radio frequency energy to an antenna from a transmitter. Remember that the far end of any antenna is its high impedance or high voltage point. Exactly $\lambda/4$ from the high impedance point will be the lowest impedance point. The high impedance point of a $\lambda/2$ antenna (or 1λ , 1.5λ , 2λ , etc.) can be directly attached to the high impedance end of the power amplifier (PA) tuned LC circuit, **fig. 4a**. In this way the impedances of antenna and PA tuned circuit are reasonably well matched and the antenna accepts rf power.

A $\lambda/4$ antenna has a high impedance at its far end, but $\lambda/4$ away there is a low impedance (± 40 ohms) point. This end of the antenna wire can be looped and grounded, with the loop coupled to the PA tuned circuit as shown in **fig. 4b**. Since the loop adds inductance to the $\lambda/4$ wire a capacitor should be added to resonate the antenna. If the capacitor is variable it will allow resonating the antenna to any frequency in the band. Such an antenna may be $\lambda/4$, $3\lambda/4$, $5\lambda/4$, and so forth, in length. The third method, **fig. 4c**, is the pi-network described in previous articles. Bringing part of the antenna into the ham shack like this tends to induce rf ac into everything metallic in the shack. (You may be able to draw rf ac arcs off thumbtacks in the wall with a lead pencil!) Such energy is not being usefully radiated and can cause all kinds of difficulties in transmitters, receivers, and other electronic equipment. It is much better to install the antenna somewhere else and run a nonradiating feed line from transmitter (and receiver) to the antenna.

transmission lines

An important point to remember about transmission lines is that they should be matched with an impedance equal to their own characteristic impedance. The characteristic impedance that two parallel wires will have can be computed from the formula:

$$Z_o = 276 \log \frac{d}{r}$$

where Z_o = characteristic impedance in ohms

d = center-to-center distance of separation of conductors in inches (or cm)

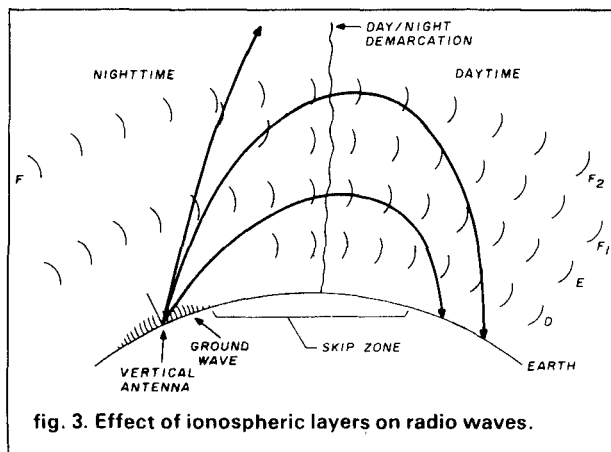

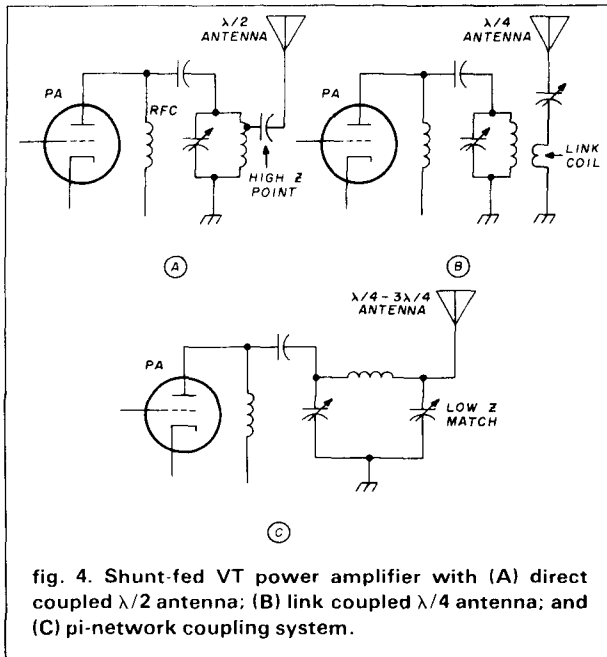

fig. 4. Shunt-fed VT power amplifier with (A) direct coupled $\lambda/2$ antenna; (B) link coupled $\lambda/4$ antenna; and (C) pi-network coupling system.

r = radius of the conductors, in inches (or cm)

If two wires of 0.04-inch radius are six inches apart, the Z_0 will be $276 \log(6/0.04)$, or $276 \log(150)$, or $276(2.176)$, or 600 ohms . Such a feed line would not match a $\lambda/2$ or $\lambda/4$ antenna having 72 or 36 ohm feedpoint impedances. However, if a $\lambda/2$ antenna has high impedances at the end and low at the middle, there must be two points equal in distance from the center where the impedance between the points is 600 ohms, **fig. 5**. This feeder-to-antenna coupling method is called a delta match system. If the $\lambda/2$ is exactly the correct length, the 600-ohm feeder energy will be accepted by the antenna and will be radiated. If the matching points are not properly selected, or if the antenna is not exactly $\lambda/2$ long, not all of the energy will be accepted and some will be reflected back down the transmission line, setting up points of high voltage (loops) and low voltage (nodes). The ratio of loop to node voltages is known as the standing wave ratio (SWR). If SWR is measured at high and low voltage points it may be called VSWR. (If measurements are made at current loops and nodes the SWR will be the same.) The SWR ratio tells us how well the antenna matches the feed line at the feedpoint. The greater the mismatch the higher the SWR. A perfect match would produce a 1-to-1 (1:1) SWR. A 1:2, or even a 1:3 SWR delivers a reasonably high percentage of the PA output power to the antenna. If you have SWR values above 1:3 you should probably improve your antenna system dimensions.

Although open-wire lines discussed above make excellent low-loss transmission lines, it is usually simpler to use coaxial ("coax") types of transmission line. A coaxial line has a center copper conductor surrounded by a solid but flexible plastic (polyethylene) insulating material. This in turn is covered by a metallic wire braid, which is then protected by a black rubbery outer insulating coating. The inner conductor and the braid (sometimes a solid metal tubing) form the two conductors of the transmission line. Whereas the open-wire lines are balanced types (neither wire is grounded), coaxial lines attach the braid conductor to ground, which makes them unbalanced.

A 72-ohm coaxial line coupled to the center opening of a $\lambda/2$ antenna which exhibits a 72-ohm impedance should theoretically transfer all of the rf ac energy from feeder to antenna — but it does not. The capacitance between outer braid to the two sides of the dipole antenna is not the same as the capacitance from the center conductor to the two antenna ends. This means the antenna and feeder are not balanced, so there will be some reflected power and standing waves developed both inside the coax and also along the outside braid. The standing waves on the outer surface of the braid cause the coaxial line to act as a vertical antenna and radiate energy. (The duty of any transmission line is to carry energy without radiating any of it.) A little vertically polarized radiated energy is not all that bad in transmitting, but for receiving, vertically polarized antennas usually tend to pick up more noise than horizontal antennas.

To properly couple an unbalanced coaxial line to the center of a balanced antenna, a balun should be used. This is a *balanced-to-unbalanced* rf transformer of some kind. It might be a 1:1 ratio toroidal (doughnut-shaped) transformer for the antenna-feeder difficulty above. If the coaxial line has a 50-

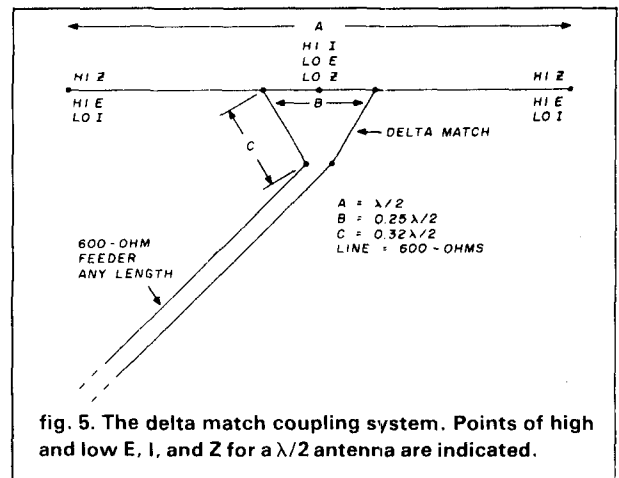

fig. 5. The delta match coupling system. Points of high and low E, I, and Z for a $\lambda/2$ antenna are indicated.

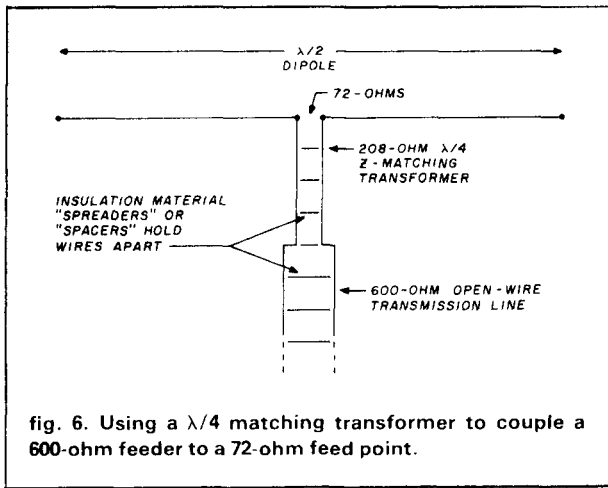

fig. 6. Using a $\lambda/4$ matching transformer to couple a 600-ohm feeder to a 72-ohm feed point.

ohm impedance and it is to match a 72-ohm dipole, the balun should have a 72:50, or a 1:1.44 impedance ratio. Its turns ratio should be the square root of the impedance ratio, or $\sqrt{1.44}$, or 1:1.2 in this case.

A quarter-wavelength-long transmission line can also act as an impedance changing transformer. For example, to match a 600-ohm balanced open-wire feeder to a 72-ohm dipole a $\lambda/4$ of transmission line between feeder and antenna can be used, fig. 6. The proper impedance for this impedance-matching transformer can be determined from:

$$Z_o = \sqrt{Z_1 Z_2}$$

where $Z_o = \lambda/4$ transformer impedance in ohms

$Z_1 =$ antenna feed point impedance in ohms

$Z_2 =$ feeder impedance in ohms

In the problem above, the impedance transformer should be constructed as a $\lambda/4$ open-wire line where $Z_o = \sqrt{72(600)}$, or 208 ohms.

Resonant transmission lines (feeders cut to $\lambda/4$, $\lambda/2$, and so forth) can be used to match impedances also. Every $\lambda/4$ along a resonant feeder (or resonant antenna) the impedance changes from a high value to a low value. If a $\lambda/4$ wave open-wire line (any Z_o value) is coupled to the center of a dipole (a low Z point), at the other end of the $\lambda/4$ line a high impedance will appear. This end of such a balanced resonant line can be connected across the ends of a high impedance tuned LC circuit if it is grounded at the center. If the open-wire line is a $\lambda/2$ long, the low impedance at the antenna will be changed to a high impedance at the center of the line, but back to a low impedance at the transmitter end. A low impedance link coil of a few turns can be used to inductively couple from the PA LC circuit.

When a $\lambda/2$ horizontal dipole has one wire of an

open-wire line attached to the end of the dipole, this is called a Zepp (from Zeppelin) antenna, fig. 7. To make the open end of the open-wire line match the high impedance at the end of a dipole, the feed line must be resonant. If the line is $\lambda/4$ long it will reverse the high Z at the end of the dipole to a low Z , which can be link coupled to a PA tuned LC circuit. If the feed line is $\lambda/2$ long it will repeat the high Z of the end of the dipole and will have to be coupled across the high Z of the PA tuned LC circuit. Since one of the feed lines of a Zepp antenna terminates in the air, the system is not well balanced. This can be corrected by adding a second horizontal $\lambda/2$ wire (shown dashed) to the unterminated feed line, making a double-Zepp (a $2\lambda/2$ in phase) antenna out of it.

For resonant open-wire lines the length in feet can be computed essentially as with antennas, but using $Length = 483/f_{MHz}$ for a $\lambda/2$. When coaxial lines are used, a velocity factor, caused by the slowing of wave travel through the solid plastic insulation between center conductor and braid, must be figured in. A polyethylene insulated coaxial cable will need to be only about 66 percent as long as an open-wire feeder. The length in feet for a resonant $\lambda/2$ coax cable can be computed by the formula, $Length = 319/f_{MHz}$. Here are some velocity factors used to convert electrical to physical lengths of different types of transmission line:

dielectric material used	velocity factor
air-insulated open-wire line	0.975
air-insulated coaxial cable	0.850
polyethylene parallel line (twin lead)	0.820
polyethylene coaxial cable	0.660

The efficiency of an antenna system is essentially

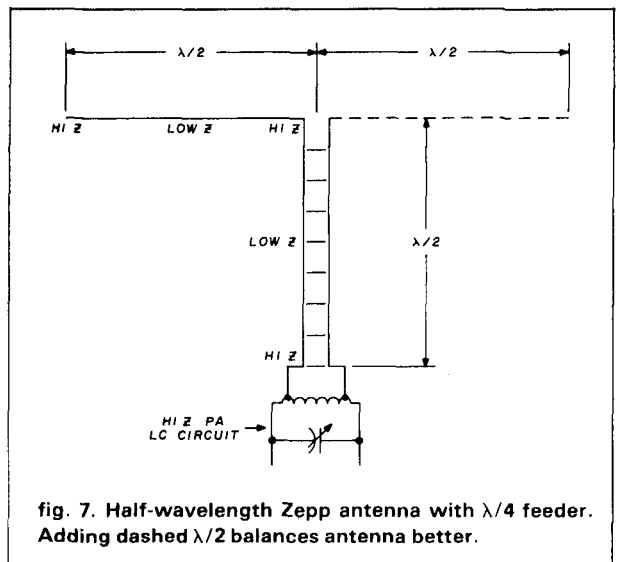

fig. 7. Half-wavelength Zepp antenna with $\lambda/4$ feeder. Adding dashed $\lambda/2$ balances antenna better.

that of the feeder system. There is usually little resistance in an antenna wire to lose power due to $P = I^2R$. Open-wire lines, unless many wavelengths long, may also have very little ohmic resistance and losses. Solid dielectric coaxial cables, however, do have losses. For example, at a certain frequency, a 100-foot-long piece of coax may have a loss of 3 dB. This is a loss of just half power. If 100-watts is fed into the coaxial cable, at the antenna end the power delivered and radiated (assuming a 1:1 SWR) will be only 50 watts. In this case the effective radiated power (ERP) is only 50 watts. Suppose an antenna system has a 2 dB loss in the coupling circuit, a 3 dB loss in the transmission line, and a 1 dB loss in the resistance of the antenna, the total loss would be 6 dB. If 3 dB represents a loss of one half power, then another 3 dB (total of 6 dB) represents a further one half loss, or a total loss to one quarter of the starting power. With 100 watts of rf ac from the PA tuned circuit, the ERP would be only 25 watts. It pays to have a well designed antenna system!

an SWR meter

We have mentioned that mismatching the feed line to the antenna feed point, as well as unbalanced feeder-antenna conditions, can produce a reflected signal back down the feeder that produces standing waves on the feed line. (Standing waves are desirable on resonant antennas, of course. The maximum voltage or current peaks developed on an antenna occurs when the feed line matches the antenna feed point.) But how can we determine the SWR on a transmission line? Is it possible to go along the feed line and measure the voltages present at different points? Perhaps, but this is quite difficult even with open wire lines. What we can do is to use a reflectometer, a meter that compares the energy moving up the feed line with that reflected back down the line. The ratio of the result of these two factors expressed in voltage or current will be the SWR.

If a wire is held a short distance from one feeder wire it will have voltage induced in it from the current flowing in the feeder. The reflectometer, or SWR meter, shown in **fig. 8**, is constructed to present a 50-ohm impedance to the rf ac from the 50-ohm coaxial cables coupled to it so that the meter itself will not reflect any standing waves back to the transmitter. Energy passing from the transmitter to the antenna through the middle conductor of the three wires induces a voltage into the top wire. This voltage affects the meter marked W/A (watts, mA). Any energy being reflected from the antenna feed point will induce a voltage into the lower meter wire and show up on the meter marked SWR. The two potentiometers ("pots") are ganged together. To obtain an SWR reading, first tune the transmitter (and antenna tuner,

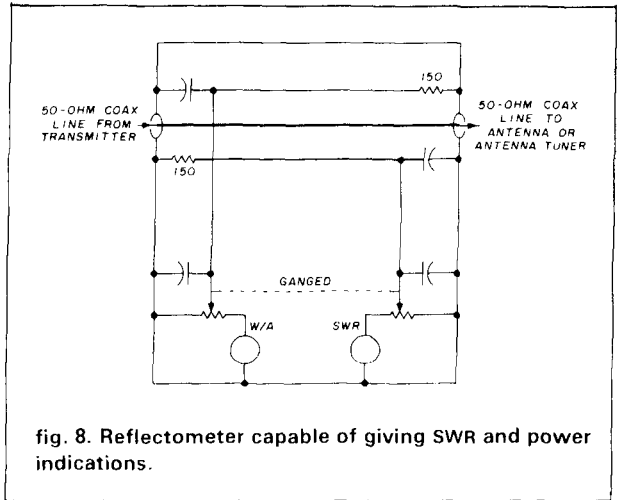

fig. 8. Reflectometer capable of giving SWR and power indications.

if any follows the SWR meter). Adjust the ganged pots so that the W/A meter reads exactly full scale. The reading of the SWR meter will be the standing-wave ratio on the transmission line. Now, retune any antenna tuner following the SWR meter to produce the lowest possible SWR.

This same SWR meter can be used for power indications. First, the antenna is tuned to minimum SWR. Then the ganged pots are set to the predetermined position for the band being used. What the W/A meter now reads is supposed to be the power being transmitted down the feed system. If the SWR is high the power indications may read considerably higher than is possible with the power input computed from PA power supply current and voltage ($P = EI$). If you read a power value much over 60 percent of the dc power supply input power to the PA you should regard the power readings with a jaundiced eye.

FCC test topics

The following Novice class FCC test topics are discussed in this article, but should be understood by Technician/General, Advanced, and Extra class license applicants also:

- frequency and wavelength
- ground wave
- sky wave "skip"
- parallel conductor feed lines
- coaxial cable feed lines
- quarter-wave vertical (dimensions)
- half-wave dipole (dimensions)
- possible causes of unacceptable SWR readings
- acceptable SWR readings
- ground system

The following Technician/General class FCC test topics are discussed in this article, but should be un-

Computer Program Books for Beginners

Everything you need to know to get started programming your own computer. These handy books of programs, each jam-packed with easy-to-understand info for beginners, are crammed with hundreds of tips, tricks, secrets, hints, shortcuts, techniques, plus hundreds of tested ready-to-run programs. For the TRS-80 Color Computer. For the TRS-80 Pocket Computer and Sharp PC-1211, PC-1500 pocket computers.

Color Computer

101 Color Computer Programming Tips & Tricks. learn-by-doing instructions, hints, secrets, shortcuts, techniques, insights, for TRS-80 Color Computer. 128 pages **\$7.95**

55 Color Computer Programs for Home, School & Office. practical ready-to-run software with colorful graphics for TRS-80 Color Computer. 128 pages **\$9.95**

55 MORE Color Computer Programs for Home, School & Office. sourcebook of useful type-in-and-run software with exciting graphics, for TRS-80 Color Computer. 112 pages **\$9.95**

Pocket Computer

Pocket Computer Programming Made Easy. new fast 'n easy way to learn BASIC, make your computer work for you, for TRS-80, Sharp, Casio pocket computers. 128 pages **\$8.95**

101 Pocket Computer Programming Tips & Tricks. secrets, hints, shortcuts, techniques from a master programmer. 128 pages **\$7.95**

50 Programs in BASIC for Home, School & Office. sourcebook of tested ready-to-type-in-and-run software for TRS-80 and Sharp pocket computers. 96 pages **\$9.95**

50 MORE Programs in BASIC for Home, School & Office. ideal source for lots more useful software for TRS-80 and Sharp pocket computers. 96 pages **\$9.95**

derstood by Advanced and Extra class license applicants also:

- vertical and horizontal polarization
- antenna orientation
- feed point impedance; half-wave dipoles, quarter-wave verticals
- line-of-sight communications
- ionospheric layers, D, E, F₁, F₂
- absorption of radio waves
- sunspot cycle
- regular daily variations
- sudden ionospheric disturbances
- ducting, tropospheric bending
- scatter transmissions
- maximum usable frequency
- balanced, unbalanced feed lines
- characteristic impedance of antennas
- antenna-feed line mismatch
- standing-wave ratio, significance of
- physical dimensions of antennas
- use of a reflectometer (VSWR meter)
- sidebands
- single sideband emission
- radiation patterns, directivity, major lobes
- attenuation in antennas

The following Advanced class FCC test topics are discussed in this article, but should be understood by Extra class license applicants also:

- electromagnetic radiation
- wave polarization
- radio-path horizon
- sporadic-E
- auroral propagation
- selective fading
- electrical length of feed lines
- efficiency of antenna
- effective radiated power, given system gains and losses
- velocity factor
- radiation resistance
- loading coil
- voltage and current nodes and loops

For additional information on these subjects you can refer to *Electronic Communication*, or to *Amateur Radio Theory and Practice*, by Robert L. Shrader, W6BNB, McGraw-Hill Book Company, available through Ham Radio's Bookstore, Greenville, New Hampshire 03048.

QTY.	Title	Price	Total

Allow 2-4 weeks for delivery.

SHIPPING **\$2.00**
TOTAL

FROM:

Name _____ Call _____

Address _____

City _____ State ____ Zip _____

Check or Money Order Enclosed

VISA MasterCard

Acct. # _____

Expires _____ MC Bank # _____

**SEND TO: HAM RADIO'S BOOKSTORE
 GREENVILLE, NH 03048**

ham radio

QSK

QSK

QSK

FULL BREAK-IN WITH YOUR PRESENT AMP

\$59⁵⁰_{ppd. u.s.a.}

QSK-1™

Full Break-In Amplifier Module

Full break-in (QSK) is increasingly popular among CW operators due to more and more transceivers featuring full break-in.

The problem is how to accomplish full break-in with your present amplifier.

The **QSK-1™ module is the solution.** It is simple to install, "plug and play" between the transceiver and the amplifier. With the QSK-1™ installed, the transceiver is instantly sensitive to other signals on the band between the transmitted keying pulses. Computerized CW and key board operators will love the QSK-1™.

Enjoy conversation-like CW qso's at a full kilowatt.

Post paid continental U.S.A. \$59.50

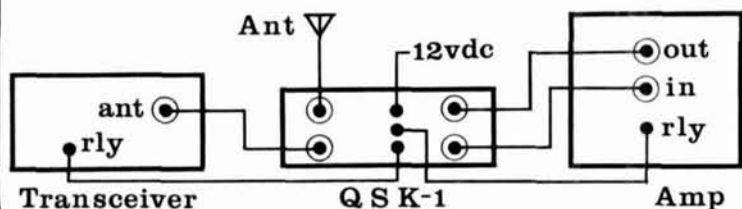
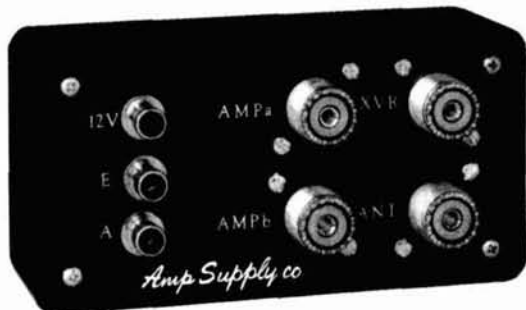

Amp Supply Co.

73 Maple Dr., Hudson, Ohio 44236
216-656-4364

WARNING

SAVE YOUR LIFE OR AN INJURY

Base plates, flat roof mounts, hinged bases, hinged sections, etc., are not intended to support the weight of a single man. Accidents have occurred because individuals assume situations are safe when they are not.

Installation and dismantling of towers is dangerous and temporary guys of sufficient strength and size should be used at all times when individuals are climbing towers during all types of installations or dismantlings. Temporary guys should be used on the first 10' or tower during erection or dismantling. Dismantling can even be more dangerous since the condition of the tower, guys, anchors, and/or roof in many cases is unknown.

The dismantling of some towers should be done with the use of a crane in order to minimize the possibility of member, guy wire, anchor, or base failures. **Used towers in many cases are not as inexpensive as you may think if you are injured or killed.**

Get professional, experienced help and read your Rohn catalog or other tower manufacturers' catalogs before erecting or dismantling any tower. A consultation with your local, professional tower erector would be very inexpensive insurance.

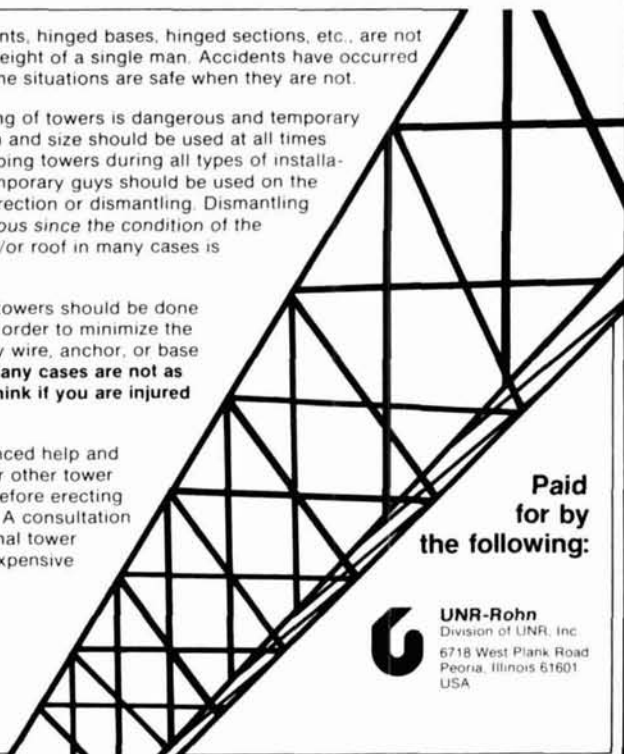

Paid for by the following:

UNR-Rohn
Division of UNR, Inc.
6718 West Plank Road
Peoria, Illinois 61601
USA

APPLIED INVENTION

THE SOURCE FOR SOLID STATE / STATE-OF-THE-ART

GaAs FETS by MITSUBISHI

2M - U Band Very low noise and medium power
BEST BUY: MGF 1402 1.1dBm (13dBG) @ 4GHz \$15.00!
MGF 1412 GUARANTEED 0.8, 0.9 or 1.0 dBm @ 4GHz \$37.50
MGF 1403 GUARANTEED 0.7 dBm @ 4GHz \$34.50
Also: MGF 1200, MGF 1400, MGF 1801 and MORE

Microwave Modules

MITSUBISHI X BAND Hybrid Integrated Circuits with Dielectric Resonator (0-12MHz/°C) GaAs FET Oscillators
FD-1010X 10.4 GHz, 15mw out, UER100 Flange \$37.50
FD-1210Y 11.5 or 12.0 GHz, UER120 Flange \$37.50
* FD-UP11KF Complete Heterodyne Rx, 10.468 GHz LD \$34.50
Use with 2 GHz IF for 12 GHz Satellite TVRO
* FD-OP13KF Doppler Module 10.525 GHz UER100 Flange \$41.00
Modules mechanically tune ± 0.15 GHz, voltage tune ± 4 MHz
* X-Band 15 dBm die cast horn antenna (UER100) \$17.00
* GaAs FET Preamp 1.7-2.1 GHz, 2.0-2.35 GHz, 2dBm \$48.00

Active and Passive Components

OPTOELECTRONICS from MITSUBISHI and SIEMENS
* LASER DIODES 3 mw single mode CW: ML3101 830nm \$100.00
ML4101 780nm \$146.00
IR LED High efficiency 16 mW @ 100 mA LD271 \$ 0.75
PIN PHOTODIODE Large area, fast detector BPW34 \$ 3.00

UNIVERSAL PROGRAMMABLE SWITCHED CAPACITOR AUDIO ACTIVE FILTER
No external R or C. 16 pin DIP. RETICON R5620 \$8.00! Ap. Notes \$ 2.00

MRF 901 Substitute: 25C2876, FT=7GHz, 2.2dBm @ 1GHz \$ 1.50

LEADLESS DISK CAPS 100, 220, 470, 680, 1000 pF 10 for \$ 2.50

MICROWAVE CHIP CAPS Very low loss: VITRAMON P7800 series
G02(0.7-1.4 GHz) G04(1.3-2.6 GHz) G01(2.6-4.2 GHz) \$ 1.00

STRIPLINE SHUTTLE TRIMMERS (VOLTRONICS) 0.1-2.5, 0.5-9.0 pF \$ 3.19

H-O SEALED CERAMIC PISTON TRIMMERS (VOLTRONICS) 0.6-9.0 pF \$ 3.41

* THERMOELECTRIC HEAT PUMPS: 19 Watt, 30x30mm, 8.6 volts \$ 21.00
1.6 Watt, 4.6x4.6mm, 1.5 volts \$ 30.00

WE ALSO STOCK: SMA Connectors, Teflon/Glass PC board, negative voltage converters for GaAs FET bias, ferrite beads and toroids for preamps, GaAs FET circuit designs, and more.

PROMPT SERVICE: SEND FOR CATALOG

MINIMUM ORDER \$5.00 ADD POSTAGE AND HANDLING

* ITEMS (UPS) \$3.75 ALL OTHER ITEMS \$2.50 (FIRST CLASS)

NY STATE RESIDENTS ADD 6% SALES TAX

R.D.2 ROUTE 21 HILLSDALE, NY 12529

518-325-3911

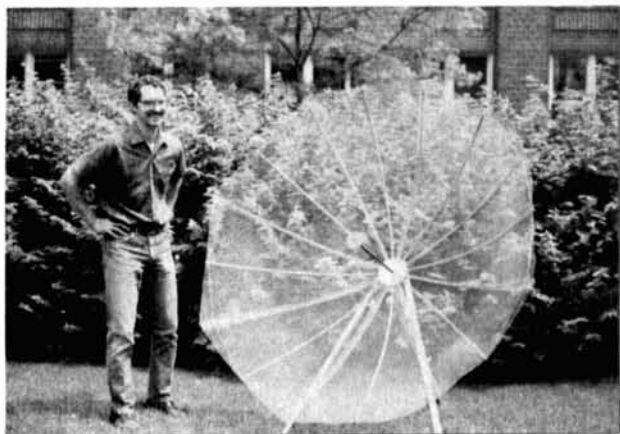

a homebrew microwave antenna

Design and construction
of a parabolic reflector
with dipole feed

A major expense in a satellite ground receiving system is the high-gain antenna.¹ Most Amateur satellite trackers will want to build their own antenna to reduce this expense. Thus, we present a homebrew 68-inch (173-cm) parabolic antenna designed for receiving the 1691 MHz Geostationary Operational Environmental Satellite (GOES) weather facsimile (WEFAX) signal. The reflector of our antenna is identical in size and shape to a surplus reflector we obtained from a 12-GHz radar system. Using the same feed components and receiver with each reflector, we were able to test the gain of the homemade versus the commercial reflector. We found the homemade antenna's gain was within 1 dB of that of the commercial antenna. This difference is most likely due to variations of $\frac{1}{10}$ wavelength (approximately 2 cm) in the reflector's surface. We did not go to great lengths to perfect these surface irregularities, so most antennas built with this design should perform as well or better than our version. **Fig. 1** gives dimensions of the antenna.

The absolute gain of the antenna has not been tested. However, by comparing our receiving sys-

By Philip A. Johnson and Noel J. Petit,
WB0VGI, University of Minnesota, Minneapolis,
Minnesota 55455

tem's overall performance (that is, signal to noise) with a GOES-WEFAX link calculation² it appears that the gain of our two antennas is within 2 dB of the theoretical gain. This indicates that for our parabolic dish at this frequency, our dipole feedpoint design³ is good.

construction details

The reflector was designed to be simple and inexpensive without sacrificing performance. This was accomplished by using a single machined part for a base, 1/2-inch aluminum tube for ribs, and 4 × 4 hardware cloth for the reflector surface. The dipole feed (fig. 2), which is more difficult to construct, is made from 3/8-inch brass rod and 9/16-inch O.D. (0.065-inch wall thickness) brass tube. An alternative tubing that may be easier to obtain is 1/2-inch O.D. with 0.032-inch wall thickness. The advantage of this size feed line is that it is very easy to connect to a UG-58/U connector (type N).

The base of the antenna is machined from 3/4-inch aluminum stock as shown in fig. 3. After the base has been machined, building the reflector is straightforward. Insert two aluminum tubes in opposing holes and pull the ends together until they can be held securely with a 68-inch (173-cm) length of wire. A 16d nail inserted into the hole at the end of each rib will hold the wire in place. Once the tube is held in place, a check with a template (details in fig. 4) must be made to determine if the tube is curved in the shape of a parabola. Ours was not. Tension at the end of a tube will produce a true parabola only for shallower parabolas. For this deep parabola, judicious bends must be made in the tubes until a parabolic shape is obtained. After each pair of ribs is bent, set them aside until all are bent.

When all tubes are bent insert them into the base and string a 1/8-inch (3-mm) cable through the hole at the outer end of the ribs. Correct tension will be applied to the ribs if the wire measures 17.8 feet, or 5.4 meters, which is the 68-inch (173-cm) diameter circle. Fine adjustment of the cable length, and thus tension on the ribs, may be obtained by inserting a turnbuckle in the cable.

The screen is cut from 36-inch (91-cm) wide 4 × 4 hardware cloth as shown in fig. 5. The 36-inch (91-cm) width screen is the exact size needed so that the folded edges of wire will be on the outer rim, preventing many puncture wounds from sharp wires. Tie the screen to the ribs with short pieces of iron wire.

With the reflector finished, mount the feed by removing the UG-58/U and its collar, inserting the brass tube into the hole in the baseplate, and reattaching the UG-58/U (type N) connector and collar. It may be necessary to guide the center conduc-

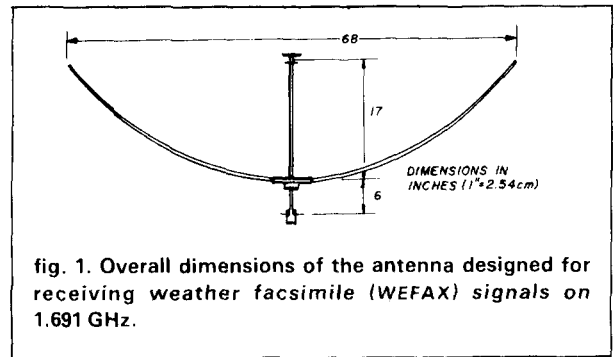

fig. 1. Overall dimensions of the antenna designed for receiving weather facsimile (WEFAX) signals on 1.691 GHz.

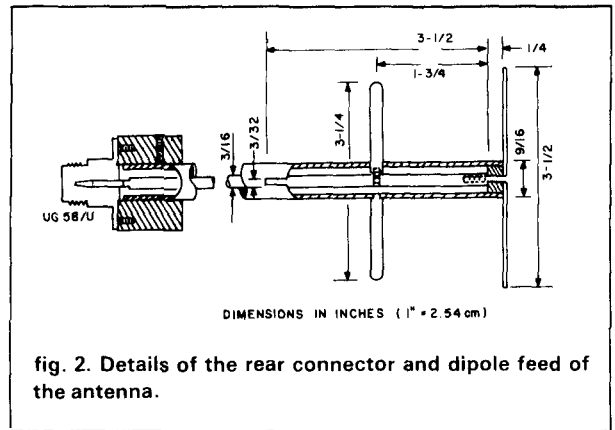

fig. 2. Details of the rear connector and dipole feed of the antenna.

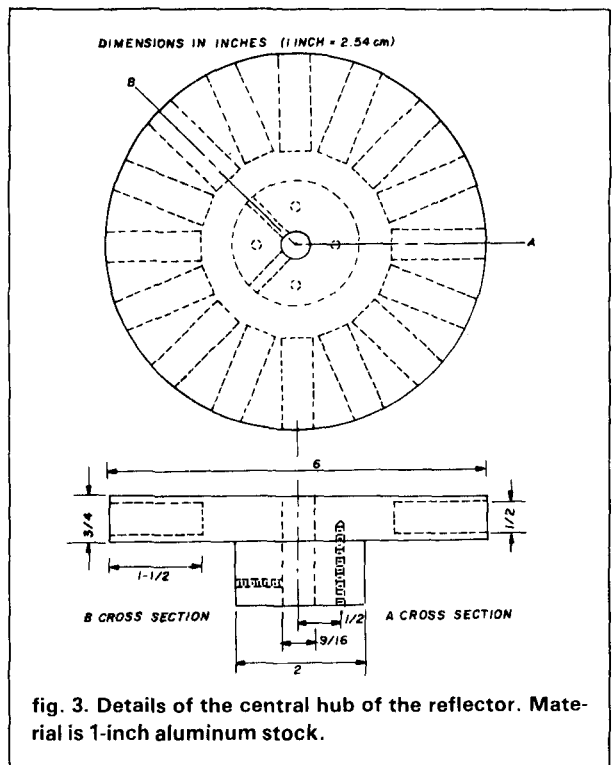

fig. 3. Details of the central hub of the reflector. Material is 1-inch aluminum stock.

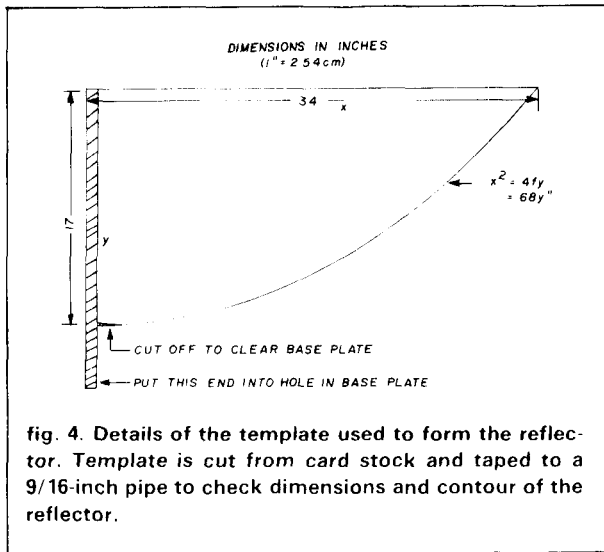

fig. 4. Details of the template used to form the reflector. Template is cut from card stock and taped to a 9/16-inch pipe to check dimensions and contour of the reflector.

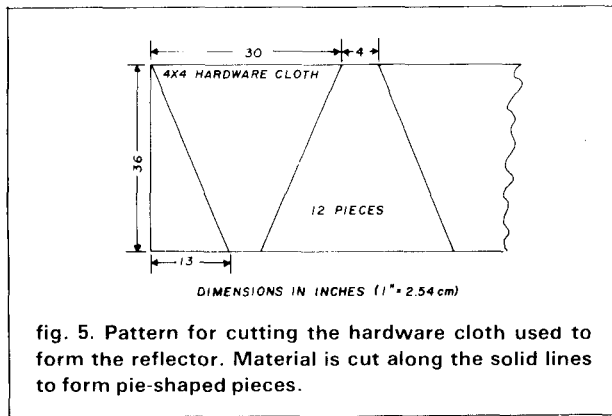

fig. 5. Pattern for cutting the hardware cloth used to form the reflector. Material is cut along the solid lines to form pie-shaped pieces.

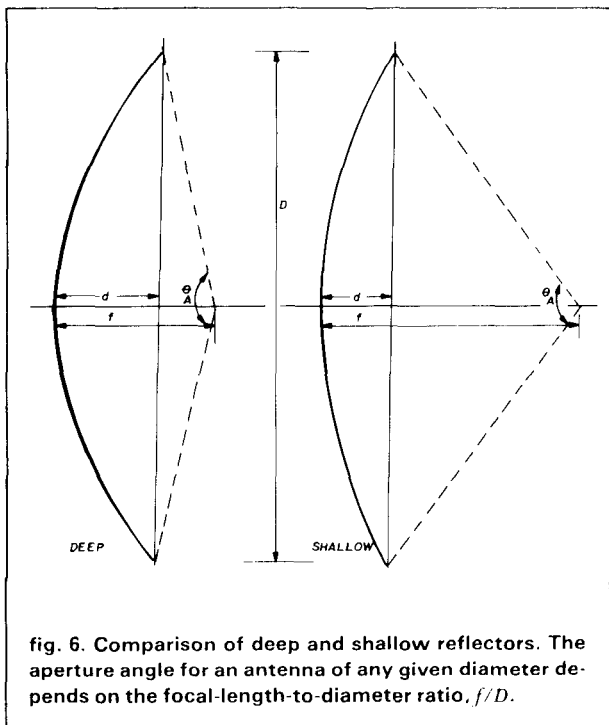

fig. 6. Comparison of deep and shallow reflectors. The aperture angle for an antenna of any given diameter depends on the focal-length-to-diameter ratio, f/D .

tor of the connector into the hole of the UG-58/U shell while slipping it on. Complete and partial kits are available from the authors.⁴ Please send a self-addressed, stamped envelope for details.

After the receiver is hooked up, adjustments for polarization and focal point can be made.

designing your own antenna

The trick of designing antennas with parabolic reflectors is to match the beam width of the feed with the aperture angle of the antenna. There are several types of microwave feeds, each of which has a characteristic beamwidth. Beamwidths range from very broad for dipole feeds to quite narrow for horn feeds.

The aperture angle for an antenna of any given diameter depends on the ratio of the focal length to the diameter (fig. 6). For this reason, parabolic reflectors are described by diameter, D , and the focal-length-to-diameter ratio (f/D). Because the match of the feed with the antenna depends only on the f/D ratio, a particular feed can match a reflector of any diameter. The aperture angle, θ_A , in terms of f/D is

$$\theta_A = 2 \tan^{-1} \left(\frac{1}{2a - \frac{1}{16a}} \right) \quad (1)$$

where $a = f/D$

It is possible to determine the focal length of an existing reflector from the formula $f = D^2/16d$, where d is the depth of the dish. (See fig. 6.)

You may wish to construct a parabolic reflector of a different size and shape than the one presented here. One problem is determining the length of the tubing necessary for constructing a particular parabolic reflector. A formula giving the arc length is

$$s = \sqrt{4x^2 + y^2} + \frac{y^2}{2x} \ln \frac{2x + \sqrt{4x^2 + y^2}}{y} \quad (2)$$

where $x = d$, $y = D/2$

For a parabola with a f/D ratio of 0.25, this reduces to

$$s = \sqrt{2y^2} + y \ln \frac{y + \sqrt{2y^2}}{y} \quad (3)$$

where $y = D/2$

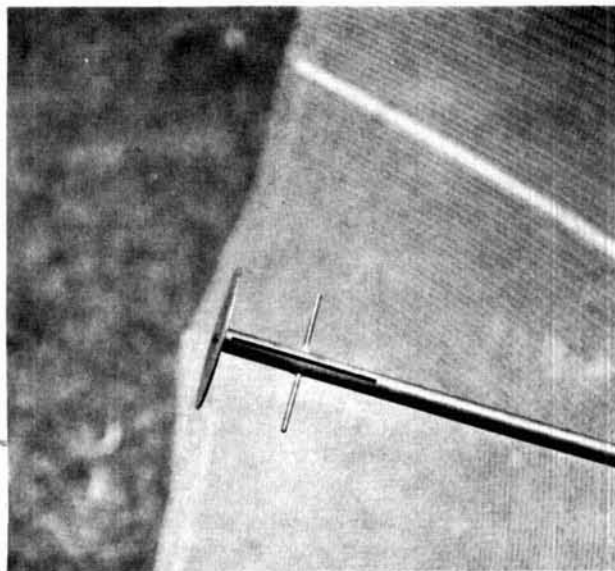

Photo of the feedpoint. The antenna may be redesigned for 1296 MHz or 2304 MHz by modifying the dimensions given for the 1691-MHz antenna. The 9/16-inch pipe is slotted on both sides of the dipole, although only one slot can be seen.

The choice of an antenna with a dipole feed has two general advantages: short focal length and rear feed arrangement. A short focal length makes it unnecessary to support a feed distant from the reflector. The rigid coax is both a support for the dipole and a low-loss waveguide that terminates at a convenient position at the rear of the antenna. The disadvantages are difficulty in constructing the dipole and the severity of bends in the reflector ribs.

Horn-feed antennas have nearly opposite advantages and disadvantages. Advantages are that there will be few or no adjusting bends necessary on the ribs with the shallower dish, and a horn feed is very easy to construct. The great disadvantage is in the difficulty in supporting and adjusting the feed for focus and polarization. Also, a length of hardline coax must be used to minimize loss if the preamp is not mounted out on the horn. Excellent directions are available⁵ for construction of horn feeds.

references

1. D.H. Phillips, "Challenge for Microwave Antenna Designers," *ham radio*, August, 1980, pages 45-47.
2. N.M. Seese, "Ground Stations to Receive GOES WEFAX," NASS, NOAA, Dept. of Commerce, Washington, D.C. 20233.
3. S. Silver, *Microwave Antenna Theory and Design*, MIT Radiation Laboratory Series, vol. 12, McGraw-Hill, New York, 1949, page 254.
4. Northern Microwave, 306 9th St. S.E., Minneapolis, Minnesota 55414.
5. D.S. Evans and G.R. Jessop, *VHF/UHF Manual*, RGSB, London, 1967.

ham radio

Introducing our Latest Model — NOVAX II



NOVAX I

SIMPLEX / DUPLEX
AUTOPATCH



NOVAX II

NOW TWO MODELS TO
SERVE YOU BETTER
YOUR OWN PRIVATE AUTOPATCH

NOVAX
MOBILE CONNECTION

NOVAX interfaces your standard 2 meter, 220, 450, etc. Base station and telephone, using a high speed scan switching technique so that you can direct dial from your automobile or with your HT from the backyard or poolside — Automatically ... Easy installation. Transceivers, featuring solid state switching, offer best results ... Available interfaced with an ICOM 22U.

FEATURES	NOVAX I	NOVAX II
• 3 min. Call duration timer	YES	YES
• Up to 45 sec. activity timer	YES	YES
• Single digit Access Control	YES	NO
• DTMF (Touch Tone)* phone connection	YES	YES
• 4 digit Access Control	NO	YES
• Toll Restrict	NO	YES
• LED Digital Display	NO	YES
• Vinyl covered alum. case size	5" x 6" x 2"	10" x 8" x 1 1/2"
• Directly Interfaces with Repeater	NO	YES
• Rotary Dial System (incl. Last digit dial)	NO	YES—"Option"—\$49.95
• Ring Back (reverse autopatch) "Option"	YES—\$39.95; Kit \$29.95	YES—Wired—\$39.95
• Price	Kit:\$169.95/wired \$219.95	Wired only \$279.95
N.Y.S. Res. add approx. Sales Tax	SHIPPING ADD \$3.50 in U.S.A.	

To order, send
check, money
order to:
MASTER CHARGE
AND VISA ACCEPTED

CURRENT
DEVELOPMENT
CORPORATION
(formerly R.W.D. Inc.)

Box 162 - Tudman Rd.
Westmoreland, N.Y. 13490
or Phone 315-829-2785

* Trademark ATT

STUDY
TAPES

CODE PRACTICE TAPES FROM
HRPG — Practice copying Morse
Code anytime, anywhere. Whether
you're upgrading your present license or
just trying to up your code speed, a large
assortment allows you to choose exactly the
kind of practice you need.

each tape \$4.95 2/\$8.95 3/\$12.95

QSO SERIES

Here's the way to go for those planning to upgrade their present license to General or Extra Class. Both QSO tapes are reproductions of actual on-the-air CW contacts. Similar in content to the FCC code exams. Both tapes are recorded at speeds faster than those encountered in the exams. Get the best practice for that all-important code test by mastering these tapes.

- A 90 minute tape of 25 QSOs sent at 15 wpm
 HR-QSO-1 \$4.95
- A 90 minute tape of 30 QSOs sent at 22.5 wpm
 HR-QSO-2 \$4.95

PLAIN LANGUAGE TEXT SERIES

Now, there's an opportunity to practice copying code in plain language text, any time of the day. The PLT series is excellent for those who are learning code by the word method. These tapes can also be used to improve sending speed and accuracy by using the provided text and a code practice oscillator to send in time with the tape.

- HR-PLT1 — \$4.95 HR-PLT2 — \$4.95
- | | |
|----------------------------|----------------------------|
| 15 wpm code for 20 minutes | 30 wpm code for 20 minutes |
| 18 wpm code for 20 minutes | 35 wpm code for 15 minutes |
| 22 wpm code for 20 minutes | 40 wpm code for 15 minutes |
| 25 wpm code for 20 minutes | 45 wpm code for 15 minutes |
| | 50 wpm code for 15 minutes |

Please add \$1 for shipping.

Ham Radio's Bookstore
Greenville, NH 03048

flea market



RATES Noncommercial ads 10¢ per word; commercial ads 60¢ per word **both payable in advance.** No cash discounts or agency commissions allowed.

HAMFESTS Sponsored by non-profit organizations receive one free Flea Market ad (subject to our editing) on a space available basis only. Repeat insertions of hamfest ads pay the non-commercial rate.

COPY No special layout or arrangements available. Material should be type-written or clearly printed (not all capitals) and must include full name and address. We reserve the right to reject unsuitable copy. **Ham Radio** cannot check each advertiser and thus cannot be held responsible for claims made. Liability for correctness of material limited to corrected ad in next available issue.

DEADLINE 15th of second preceding month.

SEND MATERIAL TO: Flea Market, Ham Radio, Greenville, N. H. 03048.

QSL CARDS

QSLs & RUBBER STAMPS — Top Quality! Card Samples and Stamp Info — 50¢ — Ebbert Graphics 5R, Box 70, Westerville, Ohio 43081.

TRAVEL-PAK QSL KIT — Converts post cards, photos to QSLs. Stamp brings circular. Samco, Box 203-c, Wynant-skill, New York 12198.

QSL CARDS: 500/\$12.50, ppd. Free catalogue. Bowman Printing, 743 Harvard, St. Louis, MO 63130.

QSL SAMPLES: 25¢. Samcards, 48 Monte Carlo Drive, Pittsburgh, PA 15239.

DISTINCTIVE QSL's — Largest selection, lowest prices, top quality photo and completely customized cards. Make your QSL's truly unique at the same cost as a standard card, and get a better return rate! Free samples, catalogue. Stamps appreciated. Stu K2RPZ Print, P.O. Box 412, Rocky Point, NY 11778 (516) 744-6260.

QSL ECONOMY: 1000 for \$13. SASE for samples. W4TG, Box F, Gray, GA 31032.

Foreign Subscription Agents for Ham Radio Magazine

Ham Radio Austria
F. Basi
Hauptplatz 5
A-2700 Wiener Neustadt
Austria

Ham Radio Belgium
Stereohouse
Brusselsesteenweg 416
B-9218 Gent
Belgium

Ham Radio Canada
Box 400, Goderich
Ontario, Canada N7A 4C7

Ham Radio Europe
Box 444
S-194 04 Upplands Vastby
Sweden

Ham Radio France
SM Electronic
20 bis, Ave des Clairons
F-93000 Axaerre
France

Ham Radio Germany
Karin Ueber
Postfach 2454
D-7850 Loerrach
West Germany

Ham Radio Holland
Postbus 413
NL-7800 Ar Emmen
Holland

Ham Radio Italy
G. Vulpatti
P.O. Box 37
I-22063 Cantu
Italy

Ham Radio Switzerland
Karin Ueber
Postfach 2454
D-7850 Loerrach
West Germany

Ham Radio UK
P.O. Box 83, Harrow
Middlesex HA3 6HS
England

Holland Radio
143 Greenway
Greenside Johannesburg
Republic of South Africa

QSL'S: NO STOCK DESIGNS! Your art or ours; photos, originals, 50¢ for samples & details (refundable). Certified Communications, 4138 So. Ferris, Fremont, Michigan 49412.

SSTV CONVERTER, receive and transmit, very good resolution; Microcraft Morse-a-word and RTTY Reader. All in good working condition. Make offer. W2WHK, 210 Utica St., Tonawanda, NY 14150. (716) 692-5451.

WANTED: Micor and Mstr II Base Stations 406-420 and 450-470 MHz. Also 2 and 6 GHz solid state microwave equipment. AK7B, 4 Ajax Place, Berkeley, CA 94708.

COLLINS 755-1 w/CW filter, notch \$225.00. Hamtronics CAY32-5 conv. \$50.00. P432 pre-amp w/case \$20.00. Heathkit SB-500 \$125.00. KLM 420-450 18C w/divider \$70.00. Manuals for all. Dave Wells, 3522 Boston Avenue, Oakland, CA 94602. (415) 531-2800.

CHASSIS and cabinet kits. SASE K3IWK.

R390A SSB Adapter, excellent SSB, RTTY. No receiver modifications needed \$25. G.B. Communications, 963 Birch Bay Lynden Rd., Lynden, Wash. 98264. (206) 354-5884.

TUBES, TUBES wanted for cash or trade. 304TL, 4CX1000A, 4PR60C, 7F7, 7N7, 53, 6L6M. Any high power or special purpose tubes of Eimac/Varian, DCO, 10 Schuyler Avenue, No. Arlington, NJ 07032. (800) 526-1270.

MILITARY technical manuals, catalog \$1.00. Colonel Russell, 9410 Walhampton, Louisville, KY 40222.

DRAKE SATELLITE RECEIVER with modulator installed only \$969. Satellite and Microwave TV catalog \$1.00. TEM Microwave, 22518 97th Ave. No., Corcoran, MN 55374 (612) 498-8014.

WANTED: Yaesu PB-1269, PB-1305A, PB-1306A, PB-1550. Louis Mihalyfy, W8UML, 7929 Rosedale, Allen Park, MI 48101.

WANTED: Hammerlund HQ145. Call Arnie (212) 925-6048.

"ELECTRONIC BONANZA": Bearcat 100 \$289.95, BC-350 \$384.95, BC-250 \$268.00. Regency D-810 \$269.95, M-400 \$239.95. Frequency Directories. Shortwave Receivers. Sony 2001 \$298.99. Kenwood R-600 \$344.95, R-1000 \$419.95. Also Panasonic and Yaesu Receivers. Free UPS Shipping in the Continental USA: GALAXY ELECTRONICS, Box 1202, 67 Eber Ave., Akron, Ohio 44309.

"NEW" K15B Multi-band Dipole 80-10 (WARC), Mini-8 Coax \$17.25/100', 450 Ohm open wire \$14.75/100". Details — Kilo-Tec, P.O. Box 1001, Oak View, CA 93022.

TEKTRONIX LA545A oscilloscope with dual trace plug-in type CA \$425.00. WA5VWK, Carl Dollard, Route 1, Box 458, Van Buren, Arkansas 72956. (501) 474-2156.

WANTED: Surplus 1-3 kW HF transmitter type FRT-15, Collins TDH or equivalent, or higher power up to 20kW SSB not necessary. P.J. Plishner, 2 Lake Ave. Ext., Danbury, CT 06810. WA1LDU.

RTTY-EXCLUSIVELY for the Amateur Teleprinter. One year \$7.00. Beginners RTTY Handbook \$8.00 includes journal index. PO Box RY, Cardiff, CA 92007.

WANT complete set back issues Ham Radio 1960 to 1982. Also books on antennas. W5OMJ, Walter Voikmann, 4738 Denton Dr., Dallas, Texas 75219.

WE WANT your innovative, working antenna and ham product designs for development and marketing. Jon Titus (KA4QVK) Box 242, Blacksburg, VA 24060. (703) 951-9030.

KNOW FIRST! Ham fanatics, you need The Pink Sheets — twice-monthly award-winning Hot Insider Newsletter! Ten pages, acclaimed best! Confidential facts, ideas, insights, news, technology, predictions, alerts! Quoted coast-to-coast! We print what you don't get elsewhere! \$18.00 annually w/money back guarantee! Free sample — SASE (two stamps) W5YI, Box #10101-H, Dallas, TX 75207.

SANTEC HT-1200 with case. Fine. \$200 ppd. cont. USA. KD4WA. (803) 279-6513.

HAVING GONE FROM CB to Amateur Radio three years ago, have a good general coverage receiver, would like a low priced used general coverage transmitter or transceiver, also 6 meter and 2 meter transceiver, tube type or anything. KA0EPP, RR 1, Box 13BA, Zim, MN 55799. (218) 744-3179.

OVERPRINTED: 1981 Fox-Tango Club Newsletters. Sixty loose-leaf pages packed with modifications and information on Yaesu rigs. Only \$6 while they last. Also a few 1980 sets at \$5 (overseas add \$3 each, airmail). N4ML, Box 15944, W. Palm Beach, FL 33406.

2 Meter Quad

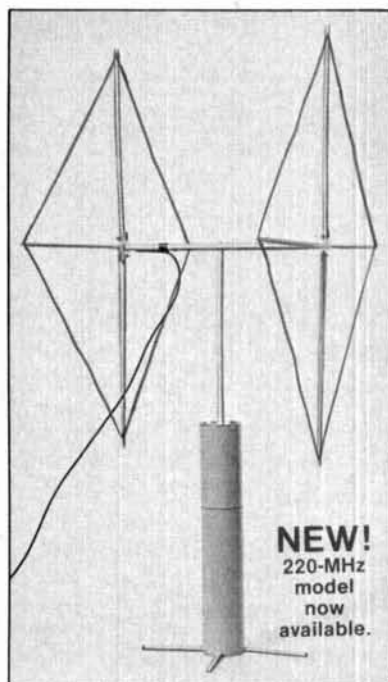

- Portable. Collapsible.
- Folds into its own base for portability.
- For backpackers, apartment dwellers — an antenna that stores compactly when not in use.

New portable quad extends the range of low power two meter transceivers by providing the gain and front-to-back discrimination of a two element quad. Gives the gain of a linear amplifier but does not require additional battery power. Users report full quieting on repeaters that are marginal with 5/8 wave whips.

The entire beam slips into an 18" carrying case to go in your suitcase. For use, it unfolds to form a two element full size quad complete with stabilized mounting stand. Patented design lets you set it up or take it down in minutes. See the cover article **QST** September 1980 for full details.

Order direct or from your favorite dealer. Model A-502 portable 2-meter quad or Model A-505 portable 220-MHz quad \$87.50. Add \$3 shipping/handling. California residents add sales tax.



Palomar Engineers

1924-F W. Mission Rd., Escondido, CA 92025
Phone: (714) 747-3343

September's Super Specials

NEMAL ELECTRONICS COAXIAL CABLE SALE

POLYETHYLENE DIELECTRIC

RG213 noncontaminating 96% shield mil spec	36"/ft.
RG214/U double silver shield 50 ohm	\$1.35/ft.
RG142/U double silver shield 50 ohm Teflon	95"/ft.
RG11U 96% shield 75 ohm mil spec	25"/ft.
* RG 8/U 96% shield Mil Spec (\$27.95/100) or 31"/ft.	
RG62A/U 96% shield mil spec 93 ohm	12"/ft.
RG-55B/U double shield (RG 58 size) 50 ohm	50"/ft.
* RG58U mil spec 96% shield (\$9.95/100) or 11"/ft.	

LOW LOSS FOAM DIELECTRIC

RG-8X (Mini 8) 95% shield (\$14.95/100) or 17"/ft.	
* RG8U 80% shield (\$15.95/100) or 19"/ft.	
RG-8/U 97% shield 11 gauge (equiv. Belden 8214)	31"/ft.
RG58U 80% shield	07"/ft.
RG58U 95% shield	10"/ft.
RG59/U 100% foil shield TV type (\$7.00/100) or 10"/ft.	
Rotor cable 2-18 ga 6-22 ga	19"/ft.

CONNECTORS MADE IN USA

Amphenol PL 259	79¢
PL-259 push-on adapter shell	10/\$3.89
PL-259 & SD-239	10/\$5.89
Double Male Connector	\$1.79
PL 258 Double Female Connector	98¢
1 ft. patch cord w/RCA type plugs each end	3/\$1.00
Reducer UG-175 or 176	10/\$1.99
UG-255 (PL 259 to BNC)	\$3.50
Elbow (M359) UHF Elbow	\$1.79
F59A (TV type)	10/\$1.99
UG 21 D/U Type N Male for RG8 Amphenol	\$3.00
UG 88C/U BNC Male for RG 58 Amphenol	\$1.25
UG 273 BNC PL259 Amphenol	\$3.00
3/16 inch Mike Plug for Collins etc. (cut off)	\$1.25

Call or write for Free Catalog

shipping

Cable — \$3.00 1st 100 ft., \$2.00 each add'l 100 ft.

Connectors — add 10%, \$2.50 minimum.

COD add \$1.50. Florida Residents add 5%.

NEMAL ELECTRONICS

1327 N.E. 119 St., Dept. H, N. Miami, FL 33161

Telephone: (305) 893-3924



FOR SALE: Icom IC-30A, 10W, 450 MHz radio. Best offer. WA6SBM, 335 S. Argyle #122, Fresno, CA 93727. (209) 255-4268.

MANUALS for most ham gear made 1937/1970. Send \$1.00 for 18 page "Manual List", postpaid. HI-MANUALS, Box R802, Council Bluffs, Iowa 51502.

APARTMENT HAMS — Solve your headaches with antennas, grounds, RFI, landlords. Every aspect of apartment/condo operation explained in Handbook of Apartment Operation by Dan Fox, W2IQD. Based on 24 years' experience, this book is praised as "Much needed...a breakthrough". Get on the air and stay on! Only \$12.50 plus \$1.50 p/h. Moneyback Guarantee. Send check or MO to Foundation Publishing, Dept. H9, Box 805, Merrimack, NH 03054.

WANTED: Early Hallicrafter "Skyriders" and "Super Skyriders" with silver panels, also "Skyrider Commercial", early transmitters such as HT-1, HT-2, HT-8, and other Hallicrafter gear, parts, accessories, manuals. Chuck Dachis, WD5EOG, The Hallicrafter Collector, 4500 Russell Drive, Austin, Texas 78745.

SATELLITE TELEVISION: Discount prices on all major TVRO items. Communications Consultants. (501) 452-3149.

YAESU OWNERS: Join your International Fox-Tango Club, now in its eleventh year. Calendar year dues still only \$8 US, \$9 Canada, \$12 airmail elsewhere. Don't miss out, get 1982 top-rated FT Newsletters packed with modifications monthly, catalog of past modifications, free advertisements, technical consultation, FT net (Saturdays, 1700Z, 14.325 MHz), more. Go Fox-Tango! To join, send dues to FT Club, Box 15944, W. Palm Beach, FL 33406.

FOR SALE: Drake DC-4 power supply. Exc. cond. \$85 plus PP and ins. John Austin, 207-03 Hillside Ave., Belaire, NY 11427.

2 METER REPEATER: \$250.00, 20 watt solid state commercial radio on your frequencies with COR and time-out timer. Make your own from my 30 watt solid state Motorola Motram, \$150.00. Call Rick KC5EJ (915) 598-2796 or leave message at (800) 351-0001.

SELL: SB303 \$230, SB401 \$240, SB200 w/10m \$230, made DXCC 290/260. K2LM, L. Reeves, RD3, Glens Falls, NY 12801. (518) 792-5533.

HAM RADIO REPAIR, experienced, reasonable, commercial licensed. Robert Hall Electronics, P.O. Box 8363, San Francisco, CA 94128. W6BSH, (408) 292-6000.

COLLECTORS: HRO-5RA1, w/speaker, w/orig. manual. Best offer. K2LM, L. Reeves, RD3, Glens Falls, NY 12801. (518) 792-5533.

FOR SALE: Alda 103A transceiver with P.S. Excellent condition, hardly used. Call (203) 661-7260.

RUBBER STAMPS: 3 lines \$3.25 PPD. Send check or MO to G.L. Pierce, 5521 Birkdale Way, San Diego, CA 92117. SASE brings information.

TIRED manually copying code? "TAIMD" does fully automatic ASCII conversions, figures speed, 'weight', generates controls. \$169. Telecraft Laboratories, Box 1185, E. Dennis, Mass. 02641.

HAM-AD-FEST™ — Next 6 issues, \$2.00. WA4OSR, Box 973, Mobile, AL 36601.

BUGBOOK III: (Microcomputer interfacing) original edition for collector. Personalized autograph by author Adve Larsen, WB4HYJ \$9.95 pp. Dave Larsen, 844 Hutcheson Drive, Blacksburg, VA 24060.

MOBILE IGNITION SHIELDING provides more range with no noise. Available most engines. Many other suppression accessories. Literature, Estes Engineering, 930 Marine Dr., Port Angeles, WA 98362.

(ROHN TOWERS) — Wholesale direct to users — all products available — write or call for price list — also we are wholesale distributors for Antenna Specialists and Regency FM radios. Hill Radio, PO Box 1405 — 2503 GE Rd., Bloomington, IL 61701 (309) 663-2141.

SAFETY BELTS. \$35.00 and up. Free information. Avatar Co., (W9JVF) 1147 - (H) N. Emerson, Indianapolis, IN 46219.

WANTED: Old bugs for my telegraph and radiotelegraph key collection. I am trying to find each make and model of bug manufactured before 1950. Vibroplex, Martin, McElroy, Johnson, Logan, Bunnell, Signal Corps. A-Z Melehan, etc. Also need junkers for spare parts. K5RW, Neal McCewen, 1128 Midway, Richardson, TX 75081 (214) 235-8636.

CONTESTERS: Package of programs designed for the ARRL OX, CQWW, CQWPX and IARU Radio Sport Con-

tests produces scored, duped log, dupe sheet, QSLs and many valuable operator statistics. TRS-80 Model 1, 48k, 1 or more discs, MX-80 printer required. \$69.95 plus tax non-refundable. Sample printout with SASE. P. Chama-lian, W1RM, P.O. Box 1188, Burlington, CT 06013.

WANTED: New or used MS and coaxial connectors, synchros, tubes, components, military surplus equipment. Bill Williams, PO #7057, Norfolk, VA 23509.

VERY in-ter-est-ing! Next 5 issues \$2. Ham Trader "Yellow Sheets", POB356, Wheaton, IL 60187.

CB TO 10 METER PROFESSIONALS: Your rig or buy ours — AM/SSB/CW. Certified Communications, 4138 So. Ferris, Fremont, Michigan 49412; (616) 924-4561.

AFC SEMI-KITS! Stop VFO drift. See June 1979 HR. \$55.00 plus \$3.00 UPS. Mical Devices, P.O. Box 343, Vista, CA 92083.

HAMS FOR CHRIST — Reach other Hams with a Gospel Tract sure to please. Clyde Stanfield, WA6HEG, 1570 N. Albright, Upland, CA 91786.

Coming Events ACTIVITIES "Places to go..."

GEORGIA: The Augusta Amateur Radio Club's annual Hamfest, September 19, Julian Smith Casino. Admission \$3.00 includes one prize ticket. Extra tickets \$1.00 each. 6/\$5.00. Tailgating \$2.00. Barbecue and bingo for the family. Hospitality Room September 18, 4-11 PM, Ramada Inn West, Room 108-110. Prizes: KDK-2030 2m FM, Icom 2AT, and a surprise third prize. Talk in on 147.72/12. For information: John Schumacher, N4DOU, PO Box 3072, Augusta, GA 30904. (404) 860-4460. 6-9 PM EDT.

GEORGIA: The 9th annual Lanierland ARC Hamfest, September 26, 9 AM, Holiday Hall, Holiday Inn, Gainesville. Free tables/inside display for dealers and distributors. Large flea market, boat anchor auction. Prizes and activities. Free admission. Prize tickets \$1.00 each; 6/\$5.00. Talk in on 146.07-.67. For information: Phil Lovelless, KC4UC, 3574 Thompson Bend, Gainesville, GA 30506. (404) 532-9160.

ILLINOIS: RA-COM '82 sponsored by the Mt. Prospect Amateur Radio Club and Cook County ALERT, October 3, Prospect High School, 801 W. Kensington, Mt. Prospect. Doors open 8 AM. Advance tickets \$1.50; \$2.00 door. Electronic flea market area, commercial exhibits, seminars, door prizes and more. Talk in on 146.52. For information and booth reservations: RA-COM, PO Box 89, Mt. Prospect, IL 60056. Please SASE.

ILLINOIS: The Peoria Area Amateur Radio Club's Superfest '82, September 18 and 19, Exposition Gardens, W. Northmoore Road, Peoria. Gate opens 6 AM, commercial building 9 AM. Admission: \$3.00 advance; \$4.00 door. Forums, displays, flea market. Sunday bus to Northwoods Mall. Full camping facilities. Saturday night get-together at the Heritage House Smorgasboard, 8209 N. Mt. Hawley Rd., Peoria. Free movies Saturday night at Hamfest site. Talk in on 146.16/76, W9UVI. For information and reservations: SASE to Superfest '82, 5808 N. Andover Ct., Peoria, IL 61615.

ILLINOIS: The Sangamon Valley Radio Club's seventh annual Hamfest, Sunday, September 26, Sangamon County Fairgrounds, New Berlin. Indoor/covered outdoor flea market. Exhibits, kids' activities, refreshments. Overnight camping available. Many prizes. Tickets \$2.00 advance; \$2.50 gate. For information: Ken Kinningham, K9IDQ, 2428 South State, Springfield, IL 62704.

SOUTHERN ILLINOIS Shawnee Amateur Radio Association's 26th Hamfest will be September 12 at John A. Logan College in Carterville, Illinois. Offerings include air-conditioned flea market, prizes, forums, computers, refreshments, contests. For details QSL Bill May, KB9QY, 800 Hilldale, Herrin, IL 62948 or 618-942-2511 days.

MARYLAND: The Foundation for Amateur Radio announces its 25th (silver anniversary) Gaithersburg Hamfest, Sunday, September 12, Montgomery County Fairgrounds, Gaithersburg. Saturday program includes a technical session, FCC forum and ARRL forum. Admission \$4.00 each day, combination ticket \$7.50. Proceeds provide scholarships to worthy students and subsidize Auto-Call, the Foundation's official journal. For information: Stuart Meyer, W2GHK, 2417 Newton Street, Vienna, VA 22180. Home: (703) 281-3806. Office: (703) 525-6286.

MARYLAND: The Columbia Amateur Radio Association's 6th annual Hamfest, Sunday, October 10, 8 AM to 3:30 PM, Howard County Fairgrounds (15 miles west of Baltimore). Admission \$3.00, tables \$6.00, tailgating

SEND FOR THIS FREE CATALOG NOW



SAVE MONEY HIGH QUALITY FAST DELIVERY

We are utilizing the latest equipment and technology to maintain our quality at reasonable prices.

- General Communication
- Industry
- Marine VHF
- Scanners
- Amateur Bands
- CB Standard
- CB Special
- Microprocessor

Call or Write
JAN CRYSTALS

P.O. Box 06017
Ft. Myers, FL 33906-6017
All Phones (813) 936-2397

**Bind 'em
and
Find 'em**



Keep those valuable issues of Ham Radio like new. Prevent smears, tears and dog ears. Bind 'em together and enjoy for years to come. You'll be happy you did!

HAM RADIO BINDERS

Beautiful buckram bound, rich brown material with gold embossing. These binders will really dress up your collection of Ham Radio. Year stickers included.

HR-BDL \$6.95 ea.
3 for \$17.95

Please add \$2.00 for shipping and handling.

HAM RADIO'S BOOKSTORE
GREENVILLE, NH 03048

**SAY YOU SAW IT
IN
HAM RADIO**

FCC STUDY GUIDE — RADIO TELEPHONE OPERATOR LICENSE

IT'S AMAZING HOW EASY FCC EXAMS REALLY ARE!



The Original Tests-Answers Exam manual prepares you at home for FCC Radio telephone licenses. You get the complete set of multiple-choice examinations—covering all areas tested on the actual FCC exam. Also included—helpful study tips, short cuts, and "Self-Study Ability Test." These updated FCC Tests-Answers take the mystery out of preparing for current FCC exams. Practical proven Material. \$12.95 postpaid.

SEND TO:
HAM RADIO'S BOOKSTORE
Greenville, NH 03048
Please rush me Tests-Answers for FCC License. My \$12.95 is enclosed.

Name _____
Address _____
City _____ State _____ Zip _____

Call 603-878-1441

\$3.00, indoor tailgating \$5.00. Prizes, refreshments. Talk in on 147.735/135; 146.52/52. For table reservations or information: Sue Crawford, 6880 Mink Hollow Road, Highland, MD 20777. Phone 286-3805.

MASSACHUSETTS: ELECTRONICA — Boston's first public electronics show, Columbus Day weekend, Friday, October 8 through Monday, October 11, Hynes Auditorium. Personal electronics and home entertainment products, computers, games, ham radio, TVRO, CB, cameras, projection TV, security systems, video and stereo systems. Come see and buy the latest in electro-technology.

MICHIGAN: The Adrian Amateur Radio Club's tenth annual Hamfest, Sunday, September 26, Lenawee County Fairground, Adrian. For tickets, tables, info: Adrian ARC, PO Box 26, Adrian, MI 49221.

MICHIGAN: The L'Anse Creuse Amateur Radio Club's 10th annual Swap and Shop, Sunday, September 19, 9 AM to 3 PM, L'Anse Creuse High School, Mt. Clemens. Admission: \$1.00 advance; \$2.00 door. Prizes include \$250.00 first prize, \$100.00 second and \$50.00 third. Talk in on 147.69/09 and 146.52. For information SASE to Maurice Schietecatte, N8CEO, 15835 Touraine Ct., Mt. Clemens, MI 48044.

NEW HAMPSHIRE: The 6th annual Connecticut Valley FM Association's Hamfest/Flea Market, Sunday, September 26, 9 AM to 5 PM, King Ridge Ski Area, New London. Adults \$2.00. Children under 16 free. Flea market setup \$5.00. Food concession by King Ridge. For information: KA1BWE.

NEW YORK: RAGS, The Radio Amateur of Greater Syracuse, annual Hamfest, Saturday, October 2, 9 AM to 6 PM, Art and Home Center, New York State Fairgrounds, Syracuse. Door prizes, tech talks, DXpeditions programs, contests, entertainment. Large indoor flea market. Admission: \$3.00. Flea market space \$6.00. Outdoor flea market space available also. Talk in on 90/30 and 31/91.

NEW YORK - LONG ISLAND: Suffolk County Radio Club's 5th annual Flea Market, Sunday, September 12, Odd Fellows Hall, Jayne Blvd., Port Jefferson Station. Rain date September 19. Door prizes, raffles, refreshments. Buyers \$1.50 each, YLs, XYLs and harmonics, no charge. Sellers \$3.50 each includes car and driver. Talk in on 145.21/144.61 repeater. For information: Floyd, WA2SDI, (516) 234-9376 after 6 PM evenings.

NEW YORK: The Yonkers Electronics Fair and Giant Flea Market, Sunday, October 3, 9 AM to 5 PM, rain or shine, Yonkers Municipal Parking Garage, Corner of Nepperhan Avenue and New Main Street. All-day demonstrations — computers, satellite TV, lasers, Hi-Fi/audio. Hourly prizes, giant auction, 50-50 drawings, instant bingo, free coffee all day. Admission: \$2.00. Children under 12 free. Sellers: \$6.00 per parking space, bring own table. For information: Yonkers ARC, 53 Hayward Street, Yonkers, NY 10704.

NORTH CAROLINA: The Western North Carolina Amateur Radio Society's seventh annual Autumnfest, October 9, Asheville Civic Center. Admission \$3.00 advance; \$4.00 door. Flea market tables \$5.00 at door. Camping facilities available. Talk in on 31/91, 16/76 and 52. For information: WCARS, PO Box 1488, Asheville, NC 28802.

OHIO: The Findlay Radio Club Hamfest is celebrating its 40th anniversary on September 12, 1982, Hancock Recreational Center Arena, N. Main St., I-75, exit 161. Open 6:30 AM to 5:00 PM. Largest Hamfest in Northwest Ohio, second in state. Tickets \$2.00 advance, \$3.00 at entrance. Exhibit tables are \$5.00 per table. Flea market trunk sales \$2.00 per space. Open Saturday for setups and evening entertainment. Talk in 147.75/15. Check in 146.52/52. For reservations and tickets SASE to Findlay Radio Club Hamfest, PO Box 587, Findlay, Ohio 45840.

OHIO: The original forty-fifth annual Cincinnati Hamfest, Sunday, September 19, Stricker's Grove, State route 128, Venice (Ross). Exhibits, prizes, refreshments, flea market, talks, entertainment and a thrilling air show by the Hawks. For information request your copy of the Club magazine, "The Mike and Key" Hamfest Edition, WBALW, WA8STX, K8CKI.

OHIO: The Cleveland Hamfest Association's 8th annual Hamfest, Sunday, September 26, Cuyahoga County Fairgrounds, Berea, 0800 to 1700 hours. Advance tickets \$2.50 prior to August 31; \$3.00 at door. Exhibits, forums, ladies' programs, outdoor flea market. Three main prizes and mobile check-in prize. Talk in on 146.52 with W8QV. For information: Cleveland Hamfest Association, PO Box 27211, Cleveland, OH 44127.

OREGON: The 36th annual Walla Walla Hamfest, Saturday and Sunday, September 25 and 26, Milton-Freewater, Oregon, Community Building. Free registration. Saturday opens 9 AM. Sunday 8:30 AM. Swap and shop, contests, prizes. Ladies bingo. Camping at Fort Walla Walla

**2 for 1
Performance
from
MIRAGE**

**Dual-purpose power
amplifiers for
HT and XCVR!**



- 1-10 Watts Input
- All-mode operation
- 5 year warranty

**model:
B1016 (2 meters)**

1W In = 35W Out

2W In = 90W Out

10W In = 160W Out

with RX preamp!

\$279.95

C106 (220 MHz)

1W In = 15W Out

2W In = 30W Out

10W In = 60W Out

with RX preamp!

\$199.95

D1010 (430-450 MHz)

1W In = 20W Out

2W In = 45W Out

10W In = 100W Out

\$319.95

There's more, and
WATT/SWR Meters, too!
See your nearest Dealer

**MIRAGE
MIRAGE
MIRAGE**
COMMUNICATIONS EQUIPMENT, INC.
P.O. Box 1393
Gilroy, CA 95020
(408) 847-1857
made in U.S.A.

\$ SAVE \$
ON
ICOM



IC-740



IC-720A



IC-730

THE COMM CENTER INC.
Laurel Plaza
Route 198
Laurel, Md.
20810
MD.: 301-792-0600
OPEN TUES. THROUGH SAT.

CALL TOLL FREE
1-800-638-4486

Park. Talk in on 52-52, 19-79, 04-64, 28-88, 16-76 and 3960 KC. For information: Walla Walla Valley ARC, PO Box 321, Walla Walla, WA 99362.

PENNSYLVANIA: The 27th annual York County Hamfest, Sunday, September 26, York Fairgrounds, York, 8 AM to 4 PM, rain or shine. Registration \$3.00. XYLs and children free. Tailgating \$3.00 per space plus registration. Inside tables \$5.00. Hourly door prize drawings from 10 AM to 3 PM. Talk in on 146.37/97 and 52/52. For information: Leroy Frey, K3POR, 170 S. Albemarle St., York, PA 17403.

PENNSYLVANIA: The Pack Rats Sixth annual Mid-Atlantic VHF Conference, Saturday, October 2, Warrington Motor Lodge, Rt 611, Warrington. Advance registration \$3.00; \$4.00 door, includes admission to Hamarama, Sunday, October 3, Buck County Drive-In Theater, Warrington. Flea market admission \$2.00. Tailgating \$4.00 per space. Own tables. Gates open 7:30 AM. Talk in via W3CCX on 146.52. For information: Hamarama '82, PO Box 311, Southampton, PA 18966 or Lee A. Cohen, K3MXX (215) 635-4942.

SOUTH CAROLINA: The 31st annual Rock Hill Hamfest, October 3. For information contact: YCARS, Box 4141 CRS, Rock Hill, SC 39730.

TEXAS: The Wichita Amateur Radio Society's first annual Hamfest, September 25 and 26, National Guard Armory, Wichita Falls. Dealer displays, computer demos, large flea market, ladies activities. Pre-registration \$4.00, ends September 22. Pre-registration prize. Registration at door \$5.00. Grand prize, ladies prizes and other prize drawings. Local talk in on 146.34/93 and 147.75/15. Reservations for tickets, flea market tables to: WARS Hamfest, PO Box 4363, Wichita Falls, TX 76308.

VIRGINIA: The ARRL Virginia State Convention and Tidewater Computer Show - Hamfest - Electronic Flea Market, Saturday and Sunday, October 9 and 10, Virginia Beach Pavilion, 9 AM to 5 PM both days. Admission \$3.50 for both days. Computers, satellite equipment, XYL programs and free bingo. Free transportation to beach or for shopping. Cocktail party Saturday night. Advance ticket drawing for hand held transceiver plus many other prizes. Flea market tables \$5 one day; \$8 both days. For information and tickets: Jim Harrison, N4NV, 1234 Little Bay Ave., Norfolk, VA 23503. (804) 587-1695.

WISCONSIN: The Kettle Moraine Radio Amateur Club's annual Ham, Computer, Video Fest, Sunday, October 10, Waukesha County Expo Center, Waukesha, 8 AM. All indoors. Prizes, food, "happy hour". Tickets \$2 advance; \$3 door. Reserved tables \$3 each 4'. Reservations until October 1. Talk in on 146.52. Send checks to KMRA Club, PO Box 411, Waukesha, WI 53187.

OPERATING EVENTS

"Things to do..."

SEPTEMBER 8: The 20th anniversary of "Howdy Days", starts Wednesday, September 8, 1800 UTC to Friday, September 10, 1800 UTC. All licensed women operators worldwide are invited to participate. Say hello to old friends; meet new ones. Extend an invitation to non-members to join YLRL. Call "CO YL". All bands and modes of emission may be used. No cross band operation. Send logs by October 11, 1982, to: Sandi Heyn, WA6WZN, 962 Cheyenne St., Costa Mesa, CA 92626.

September 11: KN0S will operate from 1300-2200Z to commemorate the 4th annual Burnsville Fire Muster. Frequencies: 7.250, 14.340, 21.400 ± 5 kHz phone. 7.125 CW in AM. 146.16/76 locally FM. For a special certificate send large SASE to: KN0S ARS, PO Box 23349, Richfield, MN 55423-0349.

SEPTEMBER 25: The Beaumont, Texas, ARC will operate W5RIN from 1700Z-2300Z, September 25 and 26 during the "Gladys's City Boom Days" 81st anniversary of Spindletop, home of the Lucas Gusher. Frequencies: phone - 21.280, 14.280, 7.280. CW - low 25 kHz of Novice 10-15-40 meter band. For certificate and brochure on the history of Spindletop send large SASE to: BARC, PO Box 8358, Lumberton, TX 77711.

OCTOBER 9: The Coosa Valley ARC will operate from Rome, GA, from 1200Z, October 9 to 2200Z, October 17 to commemorate Heritage Days. 25 kHz lower side of General Class phone band 80 - 10 meters. For a special certificate SASE to: CVARC, Box 183, Rome, GA 30161.

OCTOBER 12: The Colquitt County Ham Radio Society will operate club station, WD4KOW, from the site of the fifth annual Sunbelt Agricultural Exposition, October 12, 13 and 14. 0900 to 1700 EDST each day. Operations in the General portion of the HF bands. Club members will be listening for visiting Hams on local repeater 146.19/79. For a special QSL SASE to: Colquitt County Ham Radio Society, PO Box 813, Moultrie, GA 31768.

QUALITY VHF/UHF KITS
AT AFFORDABLE PRICES
Call or Write for **FREE CATALOG**
(Send \$1.00 or 3 IRC's for overseas mailing)
See our full page ad in 73 Magazine



FM TRANSCEIVERS
FM & AM RECEIVERS
FM EXCITERS & XMTRS
FM & SSB POWER AMPS
RECEIVING & TRANSMITTING
CONVERTERS FOR FM & SSB
LOW-NOISE PREAMPS
CWID's, COR's, RF TIGHT CASES
*For Repeaters, Links, OSCAR,
ATV, Mobile, Base, Scientific*

hamtronics, inc.

65-U MOUL RD. • HILTON, NY 14468
Phone: 716-392-9430

Hamtronics® is a registered trademark

ISOTRON ANTENNAS
THE BEST THINGS
come in little packages...

FOR 80-40-20 METERS



NEEDS NO RADIALS OR
MATCHING DEVICES

ISOTRON 80 54 IN. HIGH	ISOTRON 40 31 IN. HIGH	ISOTRON 20 17 IN. HIGH
---------------------------	---------------------------	---------------------------

BIG ON PERFORMANCE

SMALL ON SPACE

BILAL COMPANY

(303) 687-3219

STAR ROUTE

FLORISSANT CO 80816

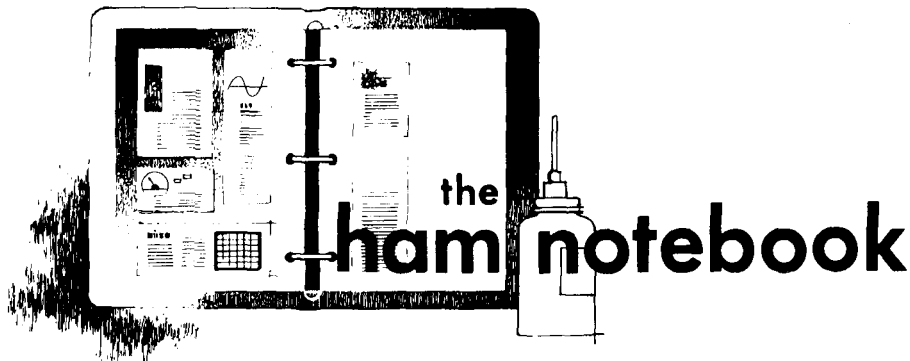

inductive reactance controls fan speed

Living in Florida as I do, I find that temperatures in the shack can rise quickly in summer, particularly when I'm running a linear. Some kind of cooling is desirable. Using a large window fan to cool the shack, I found, had two drawbacks. First off, it was a single-speed type, and just a bit too fast — always blowing papers all over the place. And secondly, as it got older, it developed an annoying rattle at its normal speed.

When I experimentally slowed down the speed of the fan with my Variac, I got both less air blowing around, and the rattle completely disappeared. Not wanting to tie up my very useful Variac for this purpose, I thought up other ways of reducing the fan voltage and speed.

A voltage-dropping resistance would do the job, but resistance dissipates both heat and uses expensive energy. Why not use a reactance to cut down the voltage? I tried first an inductive reactance and then a capacitive reactance. Although both kinds worked, I decided to use an inductive reactance. This was because, when experimenting with capacitors of various sizes for slowing down the fan, I ran into an interesting condition. At some values of capacitance, the capacitive reactance partially cancelled the inductive reactance of the fan, and the fan actually started to run quite a lot faster than its normal speed. So, to avoid problems, I de-

ecided on an inductive reactance to slow the fan down. I found that using the secondary winding of an old filament transformer provided enough reactance to slow the fan to the speed I desired.

William Vissers, K4KI

novel two-tone signal generator

For experimentation and tuning up, a two-tone generator is surely a desirable piece of equipment to have. But being lazy by nature and not too good at building test equipment, I wanted to come up with a simple substitute method.

Like many other Amateurs, I like music and have a Hammond organ. A check with my scope showed that the upper and lower manuals both readily provide a very good sine wave if only one organ stop per manual is pulled out. It was simple to use a couple of variable resistance potentiometers to mix the two tones to the proper level for the audio signal to my transceiver. The tone voltages from the organ can be picked off directly from the output speakers, or at some lower level by tapping into the organ circuitry.

I will admit that this is probably the largest two-tone generator in existence, but it does a very satisfactory job. And for Amateurs who do not have their own organs, I found that it is very easy to put the two tones on a small cassette recorder tape. Several

Amateurs have come over and done this using their own tapes, which they now use instead of building a tone generator of their own. So you save money and time by using something you already have, instead of building a piece of test equipment that you will use only a very small percentage of your operating time.

William Vissers, K4KI

cheap dots

I use black dots when making up printed circuit boards, and they are very expensive: \$4.00 per one hundred dots. The reason is that they are precision drafting aids. Recently I found in a stationery store that you can buy black dots that work just as well, manufactured by the Avery Company or Dennison. Ask the stationer to show you his catalog and you might also see tapes that you can use with the dots. I find that it is cheaper to use shelf paper and cut it out with a razor. It makes a sharp image when etched and the acid does not sneak under it, the way it will with black masking tape.

Ed Marriner, W6XM

decreasing dust buildup

In line with extending the life of my Yaesu FT-101-B transceiver, I have found that dust pulled into the unit by the cooling fan becomes a real problem over an extended period of time. And as I do spend a great deal more time listening than transmitting, I rigged up a simple switching circuit that cuts off the cooling fan when the transceiver amplifier filaments are turned off. There is no noticeable rise in temperature when operating like this. You keep your equipment a lot cleaner this way. And, naturally, a dust cover is a must for all equipment when the station is shut down. Clean equipment will break down a lot less often than equipment coated inside with dust, which, by absorbing moisture, can cause severe corrosion and expensive breakdowns.

William Vissers, K4KI

the weekender

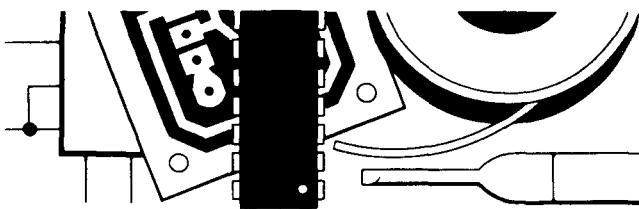

precision battery-voltage monitor for HTs

How often has your HT signal become heavily distorted, or even entirely unreadable, because of dead batteries? With an accurate voltage monitor to flag you before your Ni-Cds die, you can avoid such incidents. And you also gain the peace of mind of knowing that your weak or distorted signal is, in fact, due to your batteries — and not some other cause. The monitor described here is easy to build and adjusts to any battery voltage. It draws about 0.25 mA and consists of only four parts.

The heart of the circuit is a precision voltage-monitor chip produced by Intersil, the ICL8211CPA. This eight-pin miniDIP contains a temperature-compensated voltage reference and other circuitry to make up the basics of a voltage monitor. Because of its CMOS design, the chip is eminently suitable for an rf environment, and it draws only 22 microamperes. Adding a pot, resistor, and LED completes the monitor circuit.

By Alan Lefkow, K2MWU, 17 Jacobs Road, Thiells, New York 10984

Fig. 1 is a schematic of the monitor. A ten-turn pot, R1, divides down the battery voltage to match the built-in reference voltage of IC1 (1.15 volts). When the voltage at pin 3 falls below 1.15 volts, pin 4 of IC1 supplies a constant current of 7 mA, enough to drive a small LED directly. A 2.0-megohm resistor, R2, is used to provide a small amount of hysteresis, an option provided for by IC1. Without hysteresis, the LED could flicker on and off when the monitored voltage varies around the set point, as might be the case on voice peaks during receive. About 0.2 volt of hysteresis is added with R2. Thus, if the monitor were set to trip at a voltage of 10.0 volts, it would turn off when the voltage rose above 10.2 volts.

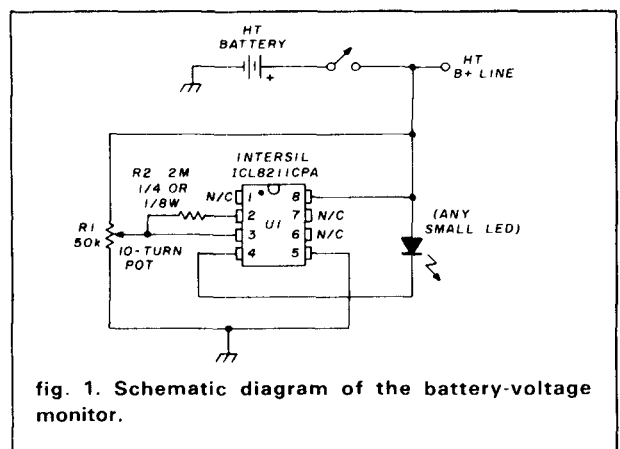

fig. 1. Schematic diagram of the battery-voltage monitor.

UNADILLA/REYCO

HAM products that go the Dx.

Round after round of transmission, durable all-weather UNADILLA/REYCO baluns, traps and kits will take you the distance. Unadilla/Reyco will suppress feedline radiation and maximize antenna efficiency better than any competitive HAM line.

The Big Signal W2AU Balun gives you the right connection between any antenna and transmitter. The W2AU Balun can withstand 600 lbs. of pull, has a built-in lightning arrestor and can handle full legal power. For more than 20 years, it's been the choice of HAMS, Armed Forces and commercial communication around the world.

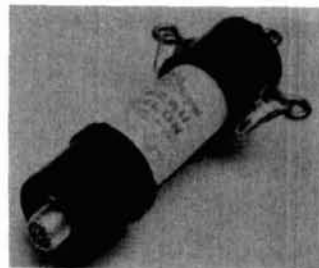

The Old Reliable W2VS Reyco Trap will always give you the perfect dipole. Professionals demand Reyco Traps because they're weatherized and can withstand 500 lbs. of pull. Developed by veteran HAM W2VS, Reyco Traps are paired by precision frequency.

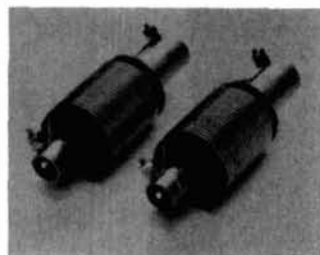

The W2AU/W2VS 5-band Antenna Kit includes everything for low SWR on 40 and 80 meters, and resonants on 10, 15 and 20. The quality crafted components in this kit are time tested by HAMS around the world.

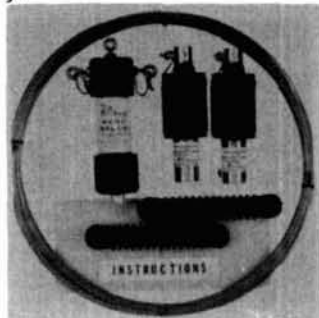

Other Unadilla/Reyco products include low pass filters, quad parts, insulators and endsulators. Call for our free catalog and the name of your nearest dealer. Hamfest managers: we cooperate. Remember: Unadilla/Reyco will take you the distance.

UNADILLA/REYCO

Division of Microwave Filter Co., Inc.

6743 Kinne St., East Syracuse, NY 13057
Toll Free 1-800-448-1666 TWX 710-541-0493
NY/HI/AK/Canada (collect) 1-315-437-3953

FOREIGN HAMS

LONDON: AMCOMM 01 804 1166/VICTORIA: Scalar 725 9677/PUNTA ARENAS: Novedades Rasmussen 22327/BUENOS AIRES: Multi-Radio 773-1266/COL. ANAHUAC: Radiac 2-50-32-40/France: SFL (90) 5339 40 (90) 611258

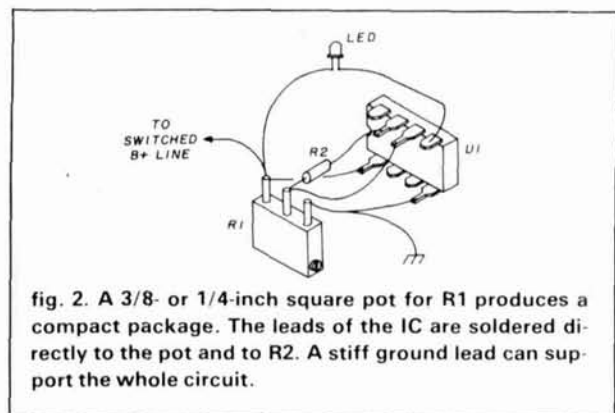

fig. 2. A 3/8- or 1/4-inch square pot for R1 produces a compact package. The leads of the IC are soldered directly to the pot and to R2. A stiff ground lead can support the whole circuit.

For absolute compactness, the parts are wired together using the pins and leads of the parts themselves, as shown in fig. 2. In the author's HT, a Wilson Mk II, the ground wire supports the whole circuit. The LED can be placed anywhere convenient and connected to the circuit with thin wires. The monitoring point (which is also the B+ supply for the circuit) is best picked up just after the HT's ON/OFF switch.

Determining the desired trip point is not difficult. Generally, Ni-Cd batteries are close to the end of their discharge capacity when the voltage per cell falls below 1.2 volts. At 1.1 volts per cell there's about 5 percent capacity left, and at 1.0 volt per cell, the battery can be considered discharged.¹ A convenient trip point, therefore, is 1.1 volts per cell.

Recharging at that point on a regular basis will not cause memory to set in, and allows for a few more minutes of use before the battery voltage really starts to plummet. Hence, if your battery pack has, say, nine cells, the trip point for the monitor would be 9.9 volts. (You can figure out the number of cells your pack contains by dividing its nominal output voltage by 1.2.) Your rig may run on less than 1.1 volts per cell, but to do so entails the risk of reversing voltage on one of the cells, which can kill a battery pack.

The trip point is easily set using an adjustable power supply and DVM. Adjust the pot until the LED turns on at the desired battery voltage, using the power supply as an adjustable source for the HT. The circuit is accurate enough to make use of the greater resolution and accuracy of a DVM. In the author's rig, the monitor was originally set to trip at 9.9 volts. A recent test showed the trip point still at 9.9 volts, three years later!

reference

1. *Nickel Cadmium Battery Handbook*, General Electric, 2nd Edition.

ham radio





Ham Radio's guide to help you find your local

California

C & A ELECTRONIC ENTERPRISES

22010 S. WILMINGTON AVE.
SUITE 105

CARSON, CA 90745

213-834-5868

Not The Biggest, But The Best —
Since 1962.

FONTANA ELECTRONICS

8628 SIERRA AVENUE

FONTANA, CA 92335

714-822-7710

714-822-7725

The Largest Electronics Dealer in San
Bernardino County.

JUN'S ELECTRONICS

3919 SEPULVEDA BLVD.

CULVER CITY, CA 90230

213-390-8003 Trades

714-463-1886 San Diego

The Home of the One Year Warranty

— Parts at Cost — Full Service.

SHAVER RADIO, INC.

1378 S. BASCOM AVENUE

SAN JOSE, CA 95128

408-998-1103

Azden, Icom, Kenwood, Tempo,
Ten-Tec, Yaesu and many more.

Connecticut

HATRY ELECTRONICS

500 LEDYARD ST. (SOUTH)

HARTFORD, CT 06114

203-527-1881

Call today. Friendly one-stop shop-
ping at prices you can afford.

Delaware

DELAWARE AMATEUR SUPPLY

71 MEADOW ROAD

NEW CASTLE, DE 19720

302-328-7728

800-441-7008

Icom, Ten-Tec, DenTron, Yaesu,

Azden, Santec, KDK, and more.

One mile off I-95, no sales tax.

Florida

AMATEUR ELECTRONIC SUPPLY

1898 DREW STREET

CLEARWATER, FL 33515

813-461-HAMS

Clearwater Branch

West Coast's only full service

Amateur Radio Store.

AMATEUR ELECTRONIC SUPPLY

621 COMMONWEALTH AVE.

ORLANDO, FL 32803

305-894-3238

Fla. Wats: 1 (800) 432-9424

Outside Fla: 1 (800) 327-1917

AMATEUR RADIO CENTER, INC.

2805 N.E. 2ND AVENUE

MIAMI, FL 33137

305-573-8383

The place for great dependable
names in Ham Radio.

RAY'S AMATEUR RADIO

1590 US HIGHWAY 19 SO.

CLEARWATER, FL 33516

813-535-1416

Your complete Amateur Radio and
Computer Store.

Illinois

ERICKSON COMMUNICATIONS, INC.

5456 N. MILWAUKEE AVE.

CHICAGO, IL 60630

Chicago — 312-631-5181

Outside Illinois — 800-621-5802

Hours: 9:30-5:30 Mon, Tu, Wed & Fri;

9:30-9:00 Thurs; 9:00-3:00 Sat.

Indiana

THE HAM SHACK

808 NORTH MAIN STREET

EVANSVILLE, IN 47710

812-422-0231

Discount prices on Ten-Tec, Cubic,
Hy-Gain, MFJ, Azden, Kantronics,
Santec and others.

Kansas

ASSOCIATED RADIO

8012 CONSER, P. O. BOX 4327

OVERLAND PARK, KS 66204

913-381-5900

America's No. 1 Real Amateur Radio
Store. Trade — Sell — Buy.

Maryland

THE COMM CENTER, INC.

LAUREL PLAZA, RT. 198

LAUREL, MD 20810

800-638-4486

Kenwood, Drake, Icom, Ten-Tec,

Tempo, DenTron, Swan & Apple

Computers.

Massachusetts

TEL-COM, INC.

675 GREAT ROAD, RTE. 119

LITTLETON, MA 01460

617-486-3040

617-486-3400 (this is new)

The Ham Store of New England

You Can Rely On.

Minnesota

MIDWEST AMATEUR RADIO SUPPLY

3452 FREMONT AVE. NO.

MINNEAPOLIS, MN 55412

612-521-4662

It's service after the sale that counts.

Nevada

AMATEUR ELECTRONIC SUPPLY

1072 N. RANCHO DRIVE

LAS VEGAS, NV 89106

702-647-3114

Pete, WA8PZA & Squeak, AD7K

Outside Nev: 1 (800) 634-6227

JUN'S ELECTRONICS

460 E. PLUMB LANE — 107

RENO, NV 89502

702-827-5732

Outside Nev: 1 (800) 648-3962

Icom — Yaesu Dealer

New Hampshire

TUFTS ELECTRONICS

61 LOWELL ROAD

HUDSON, NH 03051

603-883-5005

New England's friendliest ham store.

New Jersey

RADIOS UNLIMITED

P. O. BOX 347

1760 EASTON AVENUE

SOMERSET, NJ 08873

201-469-4599

800-526-0903

New Jersey's only factory authorized

Yaesu and Icom distributor. New and

used equipment. Full service shop.

ROUTE ELECTRONICS 46

225 ROUTE 46 WEST

TOTOWA, NJ 07512

201-256-8555

ROUTE ELECTRONICS 17

777 ROUTE 17 SOUTH

PARAMUS, NJ 07625

201-444-8717

Drake, Cubic, DenTron, Hy-Gain,

Cushcraft, Hustler, Larsen, MFJ,

Butternut, Fluke & Beckman

Instruments, etc.

Dealers: *YOU SHOULD BE HERE TOO!*
Contact Ham Radio now for complete details.

Amateur Radio Dealer

New York

BARRY ELECTRONICS
512 BROADWAY
NEW YORK, NY 10012
212-925-7000
New York City's Largest Full Service
Ham and Commercial Radio Store.

GRAND CENTRAL RADIO
124 EAST 44 STREET
NEW YORK, NY 10017
212-599-2630
Drake, Kenwood, Yaesu, Atlas,
Ten-Tec, Midland, DenTron, Hy-Gain,
Mosley in stock.

HARRISON RADIO CORP.
20 SMITH STREET
FARMINGDALE, NY 11735
516-293-7990
"Ham Headquarters USA" since
1925. Call toll free 800-645-9187.

RADIO WORLD
ONEIDA COUNTY AIRPORT
TERMINAL BLDG.
ORISKANY, NY 13424
TOLL FREE 1 (800) 448-9338
NY Res. 1 (315) 337-0203
Authorized Dealer — ALL major
Amateur Brands.
We service *everything* we sell!
Warren K2IXN or Bob WA2MSH.

Ohio

AMATEUR ELECTRONIC SUPPLY
28940 EUCLID AVE.
WICKLIFFE, OH (CLEVELAND AREA)
44092
216-585-7388
Ohio Wats: 1 (800) 362-0290
Outside Ohio: 1 (800) 321-3594

UNIVERSAL AMATEUR RADIO, INC.
1280 AIDA DRIVE
REYNOLDSBURG (COLUMBUS), OH
43068
614-866-4267
Featuring Kenwood and all other
Ham gear. Authorized sales and ser-
vice. Shortwave headquarters. Near
I-270 and airport.

Oklahoma

DERRICK ELECTRONICS, INC.
714 W. KENOSHA — P.O. BOX A
BROKEN ARROW, OK 74012
Your *Discount* Ham equipment dealer
in Broken Arrow, Oklahoma
1-800-331-3688 or
1-918-251-9923

Pennsylvania

**HAMTRONICS,
DIV. OF TREVOSÉ ELECTRONICS**
4033 BROWNSVILLE ROAD
TREVOSÉ, PA 19047
215-357-1400
Same Location for 30 Years.

LaRUE ELECTRONICS
1112 GRANDVIEW STREET
SCRANTON, PENNSYLVANIA 18509
717-343-2124
Icom, Bird, Cushcraft, Beckman,
Fluke, Larsen, Hustler, Astron,
Antenna Specialists, W2AU/W2VS,
AEA, B&W, CDE, Sony, Vibroplex.

Texas

MADISON ELECTRONICS SUPPLY
1508 MCKINNEY
HOUSTON, TX 77010
713-658-0268
Christmas?? Now?? See ad index
page.

Virginia

ELECTRONIC EQUIPMENT BANK
516 MILL STREET, N.E.
VIENNA, VA 22180
703-938-3350
Metropolitan D.C.'s One Stop
Amateur Store. Largest Warehousing
of Surplus Electronics.

Wisconsin

AMATEUR ELECTRONIC SUPPLY
4828 W. FOND DU LAC AVE.
MILWAUKEE, WI 53216
414-442-4200
Wisc. Wats: 1 (800) 242-5195
Outside Wisc: 1 (800) 558-0411

**SAY
YOU SAW
IT IN
ham radio!**

STILL MORE USABLE ANTENNA FOR YOUR MONEY ... PLUS 30 Meters!

Butternut's new HF6V auto-
matic bandswitching vertical
lets you use the entire 26-
foot radiator on 80/75, 40,
30, 20 and 10 meters (full
quarterwave unloaded per-
formance on 15 meters). No
lossy traps. Butternut's ex-
clusive Differential Reac-
tance Tuning™ circuitry uses
rugged ceramic capacitors
and large-diameter self-sup-
porting inductors for radia-
tion efficiency and DX per-
formance unmatched by
conventional multiband de-
signs of comparable height.

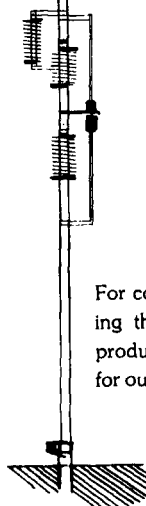

For complete information concern-
ing the HF6V & other Butternut
products, see your dealer or write
for our free catalog.



**BUTTERNUT
ELECTRONICS
CO.**

GARY AIRPORT
BOX 356E Rte. 2
SAN MARCOS, TX 78666

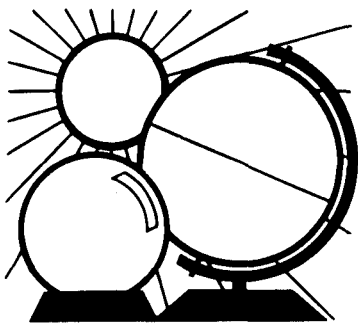

DX FORECASTER

Garth Stonehocker, KØRYW

last minute forecast

Another equinox season is here with its special propagation features. Features to note are these:

- Trans-equatorial one-long-hop openings on the higher frequency bands during geomagnetic disturbances;
- Trans-polar openings (gray-line DX) near twilight on the lower frequency bands during quiet geomagnetic periods between disturbances;
- High ionospheric electron densities giving high maximum usable frequencies (MUFs) favoring long-skip DX on the high bands;
- Some sporadic E layer openings, mainly near twilight for the lower bands;
- Geomagnetic disturbances increase, moving the ionosphere around, creating DX openings in unusual locations and providing an auroral curtain to reflect east/west paths by VHF-auroral scatter.

More detail on equinoctial propagation can be found in the March, May, and September columns of *ham radio* beginning in 1981.

The forecast for September emphasizes that the upper frequency bands (10, 15, and 20 meters) will be excellent for DX during the middle of the month. These ham bands will probably begin to feel the solar flux effects of the eleven-year sunspot cycle, decreasing to an expected 100 or so (150 solar flux units). The beginning and ending weeks will be the worst, these time periods being closest to the 27-day solar cycle mini-

mums. The lower frequency bands (40 through 160 meters) should be very good throughout the month. Overall, average thunderstorm QRN should decrease in the Northern Hemisphere, except for localized QRN, which builds up a day before and a day after a thunderstorm's passing, and while the storm is within sight of your QTH.

The full moon will occur on September 3rd; the moon perigee will occur on the 13th. The autumnal equinox will be on the 23rd at 0846 UT. No significant meteor showers are expected, so activity may be quite mediocre for the meteor-burst DX work.

Last month I presented a formula for determining northern latitude radio quality. It may also be used as a base-line quality number from which you can make your own calibrations to fit your operations. A typical base-line calibration for north Atlantic paths is shown in **table 1**.

table 1. Base-line calibration for North Atlantic paths.

0 - 1.50	useless
1.51 - 2.50	very poor
2.51 - 3.50	poor
3.51 - 4.50	poor-to-fair
4.51 - 5.50	fair
5.51 - 6.50	fair-to-good
6.51 - 7.50	good
7.51 - 8.50	very good
8.51 - 9.50	excellent
9.51 up	unbelievable?

Radio propagation quality (QRK) seems to be made up of signal strength (QRA) and its variability (QSB) factors. The formula uses the radio flux and $\sin^2 X$ values for the signal strength factor. The variability factor

is tied into the geomagnetic A value. A fairly reasonable estimate can be calculated using these assumptions. Give it a try at your station if you've a programmable calculator or computer available.

band-by-band summary

Ten and fifteen meters will be loaded with good DX signals from morning until the early evening hours on many days. Periods of geomagnetic disturbance will limit the number of signals heard, but listen carefully — they can be from very unusual places. Fifteen meters should be open later in the day, after 10 meters, so, hit 10 first and finish off with 15.

Twenty meters will be the main daytime DX band, as it is almost always open to some part of the world. It opens in the east as the sun rises and extends into the late evening hours in the west. Geomagnetic disturbances do not affect this band as much as the higher ones, but look for unusual trans-equatorial DX locations that will come through once in a while. One-hop trans-equatorial DX of 5,000-7,000 miles (8,000-11,200 km) may be possible in the late evening hours during some of these unusual conditions.

Forty and eighty meters will have good short skip during daylight hours and turn to DX after dark. The bands will open in the east soon after sundown, swing toward the south to Latin America about midnight, and end in the Pacific areas during the hour or so before dawn. Some nights these bands will be as good as can be expected during the winter DX season, coming up from November-February. The coastal regions usually have the edge for working the rare DX on these bands.

One-sixty meters will be quieter (QRN) now. This band should have renewed DX possibilities with LORAN phased out and privileges restored.

ham radio

WESTERN USA

MID USA

EASTERN USA

GMT	WESTERN USA										MID USA										EASTERN USA									
	ASIA	EUROPE	S. AFRICA	S. AMERICA	ANTARCTICA	NEW ZEALAND	OCEANIA	AUSTRALIA	JAPAN	ASIA	EUROPE	S. AFRICA	S. AMERICA	ANTARCTICA	NEW ZEALAND	OCEANIA	AUSTRALIA	JAPAN	ASIA	EUROPE	S. AFRICA	S. AMERICA	ANTARCTICA	NEW ZEALAND	OCEANIA	AUSTRALIA	JAPAN			
PDT	N	NE	E	SE	S	SW	W	NW	MDT	N	NE	E	SE	S	SW	W	NW	CDT	N	NE	E	SE	S	SW	W	NW	EDT			
0000	10	—	15	15	—	10	10	10	6:00	10	20	15	10	—	10	10	10	7:00	10	20	15	15	20	10	10	10	8:00			
0100	10	—	15	15	15	10	10	10	7:00	10	—	15	15	15	10	10	15	8:00	15	20	15	15	20	10	10	10	9:00			
0200	10	—	20	15	15	10	10	15	8:00	10	—	20	15	15	15	15	15	9:00	15	40	20*	20	20	10	15	15	10:00			
0300	15	—	20	15	15	10	10	15	9:00	15	—	20	20	15	15	15	15	10:00	20	40	20	20	20	15	15	20	11:00			
0400	20	—	20	20	15	15	10	15	10:00	15	—	20	20	20	20	20	20	11:00	20	40	20	20	20	15	15	20	12:00			
0500	20	—	20	20	20	15	10	20	11:00	20	—	20	20	20	20	20	20	12:00	20	—	20	20	20	15	15	20	1:00			
0600	20	—	20	20	20	15	15	20	12:00	20	—	20	20	20	20	20	20	1:00	—	—	—	—	—	—	—	—	2:00			
0700	—	—	20	20	20	20	15	20	1:00	20	—	20	20	20	20	20	20	2:00	—	—	—	—	—	—	—	—	3:00			
0800	—	—	20	20	20	20	15	20	2:00	20	—	20	20	20	20	20	20	3:00	—	—	—	—	—	—	—	—	4:00			
0900	—	—	—	20	20	20	20	40	3:00	—	—	20	40	20	20	20	20	4:00	—	—	—	—	—	—	—	—	5:00			
1000	—	—	—	20	20	20	20	40	4:00	—	—	—	40	20	20	20	20	5:00	—	—	—	—	—	—	—	—	6:00			
1100	—	—	—	—	—	20	20	20	5:00	—	—	—	—	—	20	20	20	6:00	—	—	—	—	—	—	—	—	7:00			
1200	—	—	—	—	—	20	20	20	6:00	—	—	—	—	—	20	20	—	7:00	20	15	10	20	—	—	—	—	8:00			
1300	—	20	—	—	—	40	20	20	7:00	20	15	—	—	—	20	—	—	8:00	20	15	10	20	—	—	—	—	9:00			
1400	20	20	—	—	—	40	—	40	8:00	20	15	10	—	—	20	—	—	9:00	20	15	10	10	—	—	15	—	10:00			
1500	20	15	15	10	20	—	—	20	9:00	20	15	10	10	—	—	20	—	10:00	15	15	10	10	—	—	15	—	11:00			
1600	20	15	15*	10	20	—	20	20	10:00	20	15	10	10	—	—	20*	—	11:00	15	15	10	10	15	—	20	—	12:00			
1700	20	15	10	10	15	—	20*	20	11:00	15	15	10	10	15	—	—	—	12:00	15	15	10	10	20	—	20	—	1:00			
1800	20	15	10	10	15	10	—	—	12:00	15	15	10	10	15	10	—	—	1:00	15	15	10	10	15	—	20	—	2:00			
1900	20	15	10	10	15	10	—	—	1:00	20	15	10	10	15	10	—	—	2:00	—	15	10	10	15	10	10	—	3:00			
2000	20	15	10	10	15	10	10	—	2:00	—	15	10	10	15	10	10	—	3:00	—	20	10	10	15	10	10	—	4:00			
2100	—	15	10	10	15	10	10	10	3:00	—	15	10	10	15	10	10	10	4:00	—	20	10	10	15	10	10	10	5:00			
2200	—	20	10	10	15	10	10	10	4:00	—	20	15	10	15	10	10	10	5:00	—	20	10	10	15	10	10	10	6:00			
2300	—	20	10	10	15	10	10	10	5:00	—	20	15	10	15	10	10	10	6:00	10	20	15	15	15	10	10	10	7:00			

*Look at next higher band for possible openings.



TR-2500

Trio-Kenwood Communications announces the new TR-2500, a compact 2-meter fm handheld transceiver. The TR-2500 weighs approximately 1.2 pounds yet includes such features as LCD digital frequency display, ten-channel memory with memory scan, built-in five year lithium memory back-up, manual scan, programmable automatic band scan, built-in tunable subtone encoder, built-in sixteen key auto-patch encoder, and 2.5 watts rf output with HI/LO power output switch.



Complete with rubberized antenna with BNC connector, 400-mAH heavy-duty NiCd battery pack, and ac charger, the TR-2500 has a factory suggested retail price of only \$329.95.

For additional information, contact Trio-Kenwood Communications, P.O. Box 7065, Compton, California 90224.

micro-based repeater controller

The RC-850 Repeater Controller is a microcomputer based control system remotely configurable by the owner, with TouchTone™ commands. No hardware or software changes are required.

Remote configurability enables repeaters to be customized without trips to the site, and eliminates dependence on the manufacturer to make changes over the life of the repeater. Configuration parameters are stored in a non-volatile memory which requires no batteries for data retention.

The RC-850 controller's autopatch is based on a store and forward technique — the controller dials numbers into the phone, using TouchTone or dial pulse. Phone number readback helps prevent wrong numbers and allows the control operator to monitor autopatch activity. The user-loadable autodialer speeds dialing of home phone numbers. The emergency autodialer reads back a configurable message for each location, to verify selection of the correct emergency autodial location.

Voice-response telemetry provides remote monitoring capability. A natural sounding speech synthesizer, analog measurement capability, plus configurable meter faces permit readback of user's S-meter, frequency error, or deviation readings, plus power, temperature, and other parameters using external transducers. Users can receive diagnostic information about their signals, and you can remotely monitor your equipment and your site.

The synthesized remote base capability permits linking to other machines and simplex channels, to ex-

tend coverage area or pick up additional operators during emergencies and public service activities. The low power consumption, single supply operation simplifies power backup, and maximizes endurance when commercial power is lost.

Audio processing, including an analog delay line, mutes squelch tails on received signals. TouchTone is also muted — not even a blip of tones gets through. No more annoying double squelch tails and screeching tones.

For more information, contact Advanced Computer Controls, 10816 Northridge Square, Cupertino, California 95014; telephone 408-253-8085.

base station antenna

The Ringo Ranger II has 5.5 dB gain with an additional 5/8 wave section and decoupling radials for a low angle of radiation. Ringo Ranger II antennas are broadband and easily field tuned for quick installation. They are made from the highest quality aluminum, with stainless steel hardware. They cover frequency ranges from 146-512 MHz.



For more information, contact Cushcraft Corporation, P.O. Box 4680, Manchester, New Hampshire 03108; telephone 800-258-3860.

3-band package for vacationing hams

Dentron Radio Co. has introduced a 3-band 25-watt CW transceiver and accessory package designed to help the Novice learn CW operation or to



allow the experienced ham to keep in touch when he's away from a traditional power supply. It will run off any 12 Vdc battery. The transceiver covers 80, 40, and 15 meters and will receive SSB as well as CW. The complete package includes a code key, 3-band dipole antenna, head set, log book, an ARRL license manual, and a complete radio and code course on cassette tape. Optional accessories include a 120 Vac power supply with built-in speaker and antenna tuner.

For more information, contact Dentron Radio Co., Inc., 1605 Commerce Drive, Stow, Ohio 44224; telephone 216-688-4973.

morse code and teletype reception

Commsoft's Cipher89 is a receive-only program for Morse code and radioteletype transmissions. The program features Baudot and ASCII operation up to 1200 baud and Morse code operation from 4 to 99 WPM.



Take Your Choice



Lunar's GaAS FET Preamps on your repeater makes your customers' handheld as powerful as though they were using a 40 watt amp and 30 pound battery.

Typical circuit improvements reported by our customers using Lunar's GaAS FET Preamps indicate a 6 to 9 dB improvement. In other words, by installing a 7 ounce Lunar GaAS FET Preamp at your repeater, your customers' signal from a 5 watt handheld is equivalent to his using a 40 watt amp and 30 pound battery.

Users state that areas which were formerly considered fringe reception areas are now rock solid.

Increase your competitive position by installing a Lunar GaAS FET Preamp in your repeater now.



A Division of Lunar Industries, Inc.
2775 Kurtz Street Suite 11
San Diego, CA 92110
(714) 299-9740 Telex: 181747

REMEMBER THE FUN AT PLAYBOY'S GREAT GORGE RESORT IN 1976 & 1978?

THE ARRL HUDSON DIVISION CONVENTION MOVES BACK TO GREAT GORGE FOR 1982!



If you attended the ARRL Hudson Division Convention in '76 or '78, then you know what a great time we'll be having on the weekend of October 30-31, 1982, at the same fantastic location in Great Gorge, New Jersey. If you missed either of these years, ask someone who was there. You'll hear about all the super activities, seminars, forums, fleamarket and exhibits covering everything from 160 meters to microwave; all modes, all facets of our great hobby... plus, new for '82, even more on computers and TVRO earth stations! As in the past, we also have a full women's program for non-ham XYL's, and the Great Gorge resort has everything in sports and leisure activities you could ever want.

DON'T MISS OUT. RESERVE NOW AND SAVE—TICKETS ARE \$9.00 AT THE DOOR. USE COUPON BELOW.

HARC CONVENTION, POST OFFICE BOX 528, ENGLEWOOD, NJ 07631

Please send me the following 1982 Hudson Division Convention Tickets:

____ (Quantity) REGISTRATION TICKETS @ \$ 7.50 \$ _____

____ BANQUET TICKETS** @ \$24.00 \$ _____

TOTAL ENCLOSED (Make check payable to "HARC") \$ _____

• PLEASE ENCLOSE A STAMPED—SELF ADDRESSED ENVELOPE •

NAME _____ CALL _____

ADDRESS _____

CITY, STATE, AND ZIP CODE _____

FLEAMARKET SELLERS ONLY—CHECK HERE FOR INFO

**INDICATE BELOW ANY SPECIAL REQUESTS FOR BANQUET FOR SEATING (Club table or group seating)

The Best Got Better



MODEL 4381 RF POWER ANALYST

This new generation RF Wattmeter with nine-mode system versatility reads...
IN STOCK QUICK DELIVERY

AUTHORIZED **Webster** DISTRIBUTOR

Webster
associates

115 BELLARMINE
ROCHESTER, MI 48063

CALL TOLL FREE

800-521-2333

IN MICHIGAN 313 - 375-0420



Cipher89 is heavily graphics oriented with many on-screen menus to help the listener identify the format and natures of received messages. Histogram and map modes can be used to correlate data against previous intercepts and to identify the use of encryption.

The program comes with an instruction manual containing chapters covering many aspects of shortwave listening. An audio cassette tape, containing recordings of many types of signals the shortwave listener will encounter, is included.

Cipher89 requires a Heath H-8/H-19 or H-89 computer with 32K of RAM and one disk drive. The program runs under the Heath Disk Operating System (HDOS). In addition, a hardware interface, such as the Commsoft Codem, is required to connect the shortwave receiver to the computer.

The price of the package is \$99.95. A combination package, which includes the program plus a Codem, interconnect cable and power supply is available for \$249.95. For more information, contact Commsoft, Inc., 665 Maybell Avenue, Palo Alto, California 94306; telephone 415-493-2184.

strength of the signal. The stronger the signal, the faster the link equipment is turned on. The first link signal heard enables the transmitter latch board, locking out other receivers. Audio from the receiving link is fed through an active audio equalizer so that audio loss is regained.

Only an external timer from the transmitted latch board and the ID system is needed to use the system. Each receiver delay board and transmitter latch board have dc switching to operate all keying lines.

The complete kit, all boards and components for three receivers and one transmitter site, is available for \$82 plus \$3 shipping and handling.

For more information, contact Heil, Ltd., Heil Drive, Marissa, Illinois 62257.

terrestrial frequency analyzer

The Model 4043 Terrestrial Tracer is a tunable, calibrated wavemeter for diagnostic evaluation of TVRO system terrestrial interference in the 3.7-4.2 GHz band. The tunable notches (approximately 20 dB deep) can be adjusted to obtain best system performance while viewing a transponder which displays symptoms of interference. When best performance is obtained, the calibrated indicators can be used to determine the terrestrial carrier frequency. Then, a permanent microwave notch filter can be fabricated to remove the offender.

The 4043 is installed in the signal

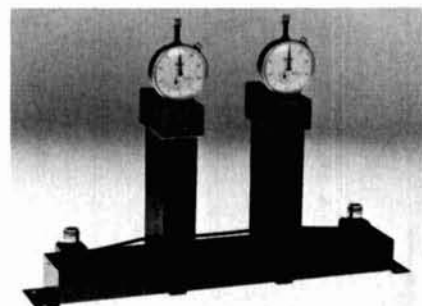

multi-site repeater voting system

Heil Sound has developed a repeater voting system, the VT-3, designed to work with three remote receivers using a UHF radio link between receiver and transmitter sites. The equipment is designed around a delay board that measures the strength of incoming receiver signals. Activation of the link transmitter depends on the



EXPERIMENTOR KIT #101

\$9.95

10.7 MHz F.M. I.F. strip with limiter/discriminator and audio amplifier. Operates on 9-15 VDC with 20 dB S/N @ 10u volts input. Output is 400 MV RMS @ 1 KHZ with 75 KHZ deviation can be tuned to 9 MHz. Easy assembly, complete with instructions. all parts and circuit board 2" x 3".

EK101 '91

EXPERIMENTOR KIT #201

\$9.95

Dual 12V power supply 12VDC with 5% regulation and less than 3% ripple at 100 ma. Each supply is isolated and can be connected for -12V @ 200 ma or 24VDC @ 100 ma. Easy assembly, complete with instructions. all parts including circuit board and power cord 3" x 5".

EK201 '91

LINEAR CHIPS

567 Tone Decoder Chips **IC567 \$1.10 ea.**
386 Low voltage audio amp. 1/2 watt **IC386 1.15 ea.**
MA 3075 F.M. I.F. limiter/detector **IC3075 1.10 ea.**
ULN2211N F.M. Receiver chips with 4W audio **IC2211 1.75 ea.**

3RD OVERTONE CRYSTALS

#25 miniature

CG25 - 39.7 MHZ **CG25 - 42.5 MHZ** **CG25 - 46.0 MHZ**
CG25 - 38.525 MHZ **CG25 - 39.2 MHZ** **CG25 - 39.6 MHZ**
CG25 - 39.5 MHZ **CG25 - 39.0 MHZ** **CG25 - 38.9 MHZ**
\$2.00 ea.



R.F. CHOKE

1/2" square

1 mhy **CH102 .50 ea.**
10 uhy **CH100 .39 ea.**
1 uhy **CH100 .39 ea.**
47 uhy **CHR47 .25 ea.**
33 uhy **CHR33 .25 ea.**



COILS

Hi-Q R.F. Tunable Coils 2" dia and 8" long Ferrite tuning slug

CT 25 14-25 uhy **.50 ea.**
CT 22 12-22 uhy **.50 ea.**



SHIELD CANS

Templated Brass Coil shields 3/8" square 5" tall with 2 hole. Ideal for shielding the CT25 and CT22 coils.

SC 3852 **.25 ea.**



10.7 MHZ SHIELDED COILS

10.7 MHz I.F. Transformer Tunes with 68pt capacitor with isolated 300 ohm output winding

TC 8513 **\$1.00 ea.**

10.7 MHz Discriminator Coil tunes with 120 pf. Perfect for use with F.M. receiver chips such as the MC 1375, ULN 2211 and many others. **DC 2333 \$1.00 ea.**

add 12" shipping and handling fee



MTS



P.O. BOX 1164 • ROUND ROCK, TX 78664 • 512-255-0122

path between the LNA and the down-converter. The unit passes dc for supplying power to the LNA. The 4043 costs \$790.00.

For more information, contact Emily Bostick, Microwave Filter Co., Inc., 6743 Kinne Street, East Syracuse, New York 13057; telephone (in U.S.) 1-800-448-1666.

versatile transceiver

The IC-740 transceiver has front panel or top controls allowing convenient access to all operating functions. Adjustable receiver parameters are: rf preamp, rf gain, noise blanker



(width and level) i-f shift, passband tuning, crystal filter in/out, notch filter, AGC (time constant and on/off), squelch, tone, and audio gain. Transmitter controls are mic gain, VOX, compressor and power (10-100 watts). The IC-740 includes capability of operating in the increasingly popular fm mode.

The IC-740 features dual VFOs with three tuning rates, split operation and memory. Analog control of frequency with the incremental tuning works on TX and RX. You are able to meter receive signal strength, transmit relative rf output, compressor level, ALC and collector current plus a built-in SWR meter.

A large selection of options are available. All items are compatible with the IC-740, including the popular AT-500/100 automatic antenna tuner, as well as the IC-2KL solid-state linear.

For more information, contact ICOM America, Inc., 2112 116th Avenue, N.E., Bellevue, Washington 98004; telephone 206-454-8155.

digital multimeter

Beckman Instruments, Inc., has expanded its line of digital multimeters. The attention-getting DMM is called the Tech™ 320B digital multimeter and has both audible and visual indication of continuity. When it's not possible to see the large LCD, the meter will alert the user when continuity is detected by emitting a single, loud beep. Continuity is also visually displayed (in less than 1/10 of a second) by the appearance of an ohm sign in the upper left corner of the LCD.

Like other Beckman portable DMMs, the Tech 320B features an easy-to-use single center selector switch, 0.1 percent basic Vdc accuracy, 10-ampere ac/dc current ranges, 2,000-hour battery life from a standard 9-volt battery, semiconductor test function, and overload protection on all ranges.

The Tech 320B has twenty-nine ranges and is protected against overload. Voltage ranges are protected to 1,500 volts dc or 1,000 volts RMS ac.



HATRY'S

Your One Stop Shopping Center

TEN-TEC



OMNI \$1289

ICOM



IC 2AT 269.50
IC 3AT 299.00
IC 4AT 299.00

DRAKE



DRAKE TR-7A \$1699

TEMPO

HANDHELDS

VHF S1, S5, and S2

UHF S-4

144, 220 and 440 MHz

Full line of accessories and amplifiers

MFJ

Everything from KEYBOARDS to OSCILLATORS

MIRAGE

VHF & UHF Amps

ANTENNAS

Cushcraft,

Hy-Gain, Larsen,

B&W, A/S

BOOKS BOOKS
BOOKS

HATRY ELECTRONICS

500 LEDYARD STREET

HARTFORD, CT 06114

(203) 527-1881

SHIPPING F.O.B. HARTFORD, CT

1983 CALLBOOKS

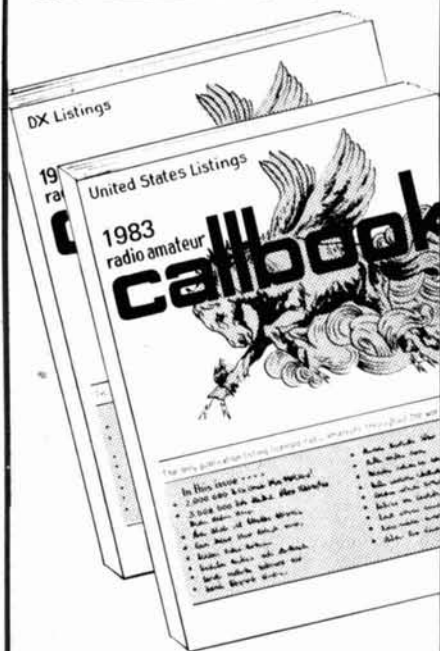

Order today!

NEW 1983

**RADIO AMATEUR CALLBOOKS
READY DECEMBER 1ST!**

The latest editions of the world-famous Radio Amateur Callbook will be available soon. The U.S. edition features over 400,000 listings, with over 75,000 changes from last year. The Foreign edition has over 370,000 listings, over 50,000 changes. Each book lists calls and the address information you need to send QSL's. Special features include call changes, census of amateur licenses, world-wide QSL bureaus, prefixes of the world, international postal rates, and much more. The new 1983 Callbooks will be published December 1, 1982. Order your copies now.

	Each	Shipping	Total
<input type="checkbox"/> US Callbook	\$19.95	\$3.05	\$23.00
<input type="checkbox"/> Foreign Callbook	\$18.95	\$3.05	\$22.00

Order both books at the same time for \$41.95 including shipping.

Order from your dealer or directly from the publisher. All direct orders add shipping charge. Foreign residents add \$4.55 for shipping. Illinois residents add 5% sales tax.



SPECIAL OFFER!

**Amateur Radio
Emblem Patch
only \$2.50 postpaid**

Pegasus on blue field, red lettering. 3" wide x 3" high. Great on Jackets and caps.

**RADIO AMATEUR
callbook INC.**



Dept. F
925 Sherwood Drive
Lake Bluff, IL 60044, USA



All resistance ranges are protected to 500 volts RMS, and current ranges are 2A/250V fuse protected — a spare fuse is included. The 10-ampere ranges are rated up to 20 amps for 30 seconds.

Suggested retail price is \$189. For more information, contact Beckman Instruments, Inc., 210 Ranger Street, Brea, California 92621; telephone 714-993-8803.

UHF Amateur antenna

Hustler, Incorporated has announced a mobile trunk lip-mount co-linear antenna for 438-450 MHz Amateur service. Model BBLT-440 has a unique 5/8-wave design that develops a 5 dB gain, compared to a quarter wave stub, and features a 10 MHz bandwidth with under 2:1 VSWR.

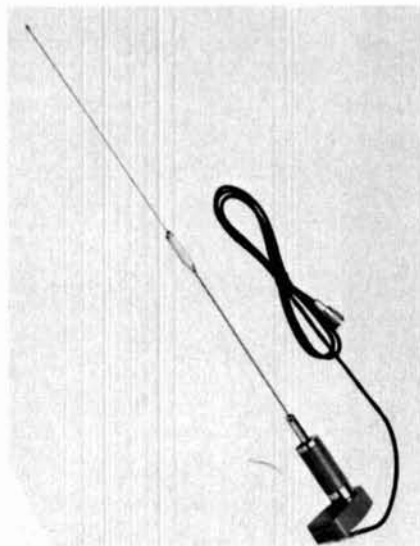

The moisture-sealed impedance transformer features silver plated base to coil contacts and 15 feet of ultra low-loss coaxial cable with connector.

For additional information, write Hustler, Incorporated, 3275 North B Avenue, Kissimmee, Florida 32741.

repeater power amps

A new line of continuous-duty power amplifiers for repeater service has been introduced by Micro Control Specialties. Three different models in the new PA-75 series serve the popular repeater frequencies of 144-148, 220-250, and 420-450 MHz.

Each model in the new PA-75 series provides 75 watts output with 10 to 15 watts of drive from a repeater or base station. The PA-75 also includes a three-section harmonic filter, ac power supply, front panel fuse ac-

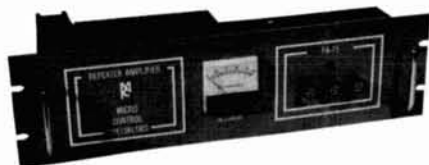

cess, and metering in a handsome rack mount package.

Dependable continuous-duty operation is obtained by using a generous heat sink plus a quiet axial fan arranged to cool both amplifier and power supply components. In addition, efficient 28-volt transistors are used for high reliability and long life.

For further information write to Micro Control Specialties, 23 Elm Park, Groveland, Massachusetts 01834; telephone 617-372-3442.

handheld 4½ -digit multimeter

Fluke's 8060A is a handheld, micro-computer-based 4½-digit multimeter that includes true RMS measurements for ac signals to 100 kHz, frequency measurements to 200 kHz, resistance measurements to 300 megohms, and can store any measurement as an offset value. Voltage measurements can be directly displayed in dBm referenced to 600 ohms, or in relative dB. Continuity testing (with selectable visual/audible indication), conductance, and constant current source diode testing are

SWD-1 VIDEO CONVERTER

FOR CABLE TV

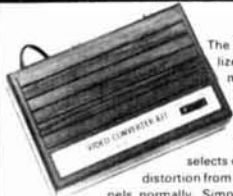

The SWD-1 Video Converter is utilized on cable TV systems to remove the KHz's signal from a distorted video (channel 3 in/out) and also pass thru the normal undistorted/detected audio signal. Rocker switch selects operating mode to remove KHz's distortion from the video or pass all other channels normally. Simple to assemble—less than 30 minutes. Pre-tuned. Input/output Channel 3. Impedance 75 ohms. 117VAC.

SWD-1 Video Converter Kit \$69.95

VTR ACCESSORIES

SIMPLE SIMON VIDEO STABILIZER



Simple Simon Video Stabilizer, Model VS-125, eliminates the vertical roll and jitter from "copy guard" video tapes when playing through large screen projectors or on another VTR. Simple to use, just adjust the lock control for a stable picture. Once the control is set, the tape will play all the way through without further adjustments. Includes 12V power supply.

VS-125 Video Stabilizer, wired \$54.95

SIMPLE SIMON VIDEO SWITCHING BOX



The Affordable Video Control Center

Excellent in isolation and no loss routing system. Simple Simons VSB-300 Video Switching Box enables you to bring a variety of video components together for easy viewing/dubbing. Also you gain the ability to record one channel while viewing another. Unit includes two F-type quick connector ended cables.

VSB-300 Video Switching Box, wired \$19.95

UHF ANTENNAS and ACCESSORIES

MDS-AMATEUR-ETV 32 ELEMENT YAGI ANTENNA



• Not A Kit
• 1.9-2.5 GHz • 38 1/2" Long
• 23dB Average Gain • Commercial Grade
• Die Cast Waterproof Housing with 4 1/4" x 2 1/2" Area for Electronics
• Includes P.C. Probe, F-61 Connector and Mounting Hardware

MAE-2 32 Element YAGI Antenna \$23.95

Kato Sone's Down Converter Kit ★1.9 - 2.5GHz★

Designed for Simple Simon by former Japanese CO Amateur Magazine's UHF Editor/Engineer. Unit utilizes new ingenious Printed Circuit Probe for maximum gain. Circuit board fits inside MAE-2 antenna housing. Requires 1 hour assembly. IC and capacitors pre-soldered.

Model KSOC-KIT 1.9 - 2.5GHz Down Converter Kit \$34.95

Kato Sone's Regulated Variable DC Power Supply

For use with KSOC-KIT 1.9 - 2.5GHz Down Converter. Completely assembled with Attractive Cabinet, TV/Converter Mode Switch, Frequency Control and LED Indicator.

Model KSPS-1A Assembled Power Supply \$23.95



ORDER ALL THREE ITEMS
MAE-2, KSOC-KIT and
KSPS-1A for Only **\$74.95**
Regular price if ordered separately \$82.85
— CO-AX CABLES ARE NOT INCLUDED —

ZYZX VHF-UHF Wideband Antenna Amplifier



Revolutionary New HYBRID IC Broadband Amplifiers

50 MHz - 900 MHz
Model ALL-1 12dB Gain
Model ALL-2 35dB Gain

These units are not available anywhere else in the world. Each unit will serve many purposes and is available in Kit or Assembled form. Ideal for outdoor or indoor use. I/O impedance is 75 ohms. Amplifiers include separate co-ax feed power supply. Easily assembled in 25 minutes. No coils, capacitors to tune or adjust.

ALL-1 Complete kit w/ power supply \$24.95 ALL-1 W/ord/ Tested w/ power supply \$34.95
ALL-2 Complete kit w/ power supply 34.95 ALL-2 W/ord/ Tested w/ power supply 44.95

Our New STVA 14.5dB GAIN, 14 ELEMENT CORNER REFLECTOR YAGI ANTENNA



STVA-3 Yagi Antenna, 14.5dB Gain, Selectable 75 or 300 ohm Channel 60-80 \$19.95
STVA-4 Yagi Antenna, 14.5dB Gain, Selectable 75 or 300 ohm Channel 44-52 \$19.95
RG-58/U 75 ohm Low Loss Coax Cable 5.12\$/ft. F-59 Coax Connector 5.39 ea.
MT-1 Special UHF 75-300 ohm Matching Transformer \$1.45 ea.

Switch to Bambi!™

Electronically

Bambi Electronic Video Switch ... makes switching of your VCR/VTR, Pay TV Decoders, Cable TV, Video Discs, Video Games, Closed Circuit TV, Antennae and Microcomputer as easy as pushing buttons.

The Bambi Electronic Video Switch is an electronic switching network which can accept up to six different sources of video signals and provide the flexibility of directing the inputs to any or all of the three outputs.

Now you can eliminate ... the drudgery of disconnecting and reconnecting your video equipment each time you use it ... the tangled mess of cables which are impossible to trace out ... not being able to use more than one function at a time.

Bambi lets you enjoy using your video equipment the way it should be ... electronically and on line at the push of a button.

Model BEVS-1 Wired

\$129.95



Bambi's front panel was designed with the user in mind. Computer styled construction, with soft-touch keyboard (rated for over 10 million operations), arranged in matrix form allows easy input/output selection without referring to charts. Functions selected through the keyboard are immediately displayed on the 18 LED status indicators.



Check the quality of Bambi against that of much higher priced competition. All solid state electronic switching provides low attenuation (3dB), wide frequency response (40-890 MHz), and excellent isolation between signal sources (each I/O section individually shielded for 65dB min. isolation).

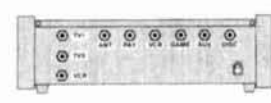

Bambi's Specifications:
• Input/Output Impedance 75 ohm
• Signal Loss 3dB ±1dB
• Noise 40dB ±1dB
• Input Return Loss 12dB min.
• Isolation 65dB min.
• Power Req. 117VAC 60 Hz, 2W
• Dimensions 10 1/2" W x 6" D x 3 1/2" H
• Weight 4 1/2 lbs

7+11 SWD PARTS KITS

MITSUMI VARACTOR UHF TUNER Model UES-A56F \$24.95

Freq. Range UHF470 - 889MHz
Antenna Input 75 ohms
Channels 14-83 Output Channel 3

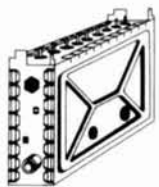

KIT NO.	PART NO.	DESCRIPTION	PRICE
1	VT1-SW	Varactor UHF Tuner, Model UES-A56F	\$24.95
2	CB1-SW	Printed Circuit Board, Pre-Drilled	18.95
3	TP7-SW	P.C.B. Potentiometers, 1-20K, 1-1K, and 5-10K ohms, 7-pieces	5.95
4	FR35-SW	Resistor Kit, 1/4 Watt, 5% Carbon Film, 32-pieces	4.95
5	PT1-SW	Power Transformer, PRI-117VAC, SEC-24VAC, 250ma	6.95
6	PP2-SW	Panel Mount Potentiometers and Knobs, 1-1KBT and 1-5KAT w/Switch	5.95
7	SS14-SW	IC's 7-pcs, Diodes 4-pcs, Regulators 2-pcs Heat Sink 1-piece	29.95
8	CE9-SW	Electrolytic Capacitor Kit, 9-pieces	5.95
9	CC33-SW	Ceramic Disk Capacitor Kit, 50 W.V., 33-pieces	7.95
10	CT-SW	Variable Ceramic Trimmer Capacitor Kit, 5-65pfd, 8-pieces	5.95
11	L4-SW	Coil Kit, 18mh 2-pieces, 22µh 1-piece (prevound inductors) and 1 T37-12 Ferrite Torroid Core with 3 ft. of #28 wire	5.00
12	ICS-SW	I.C. Sockets, Tin inlay, 8-pin 5-pieces and 14-pin 2-pieces	1.95
13	SR-SW	Speaker, 4 1/2" Oval and Prepunched Wood Enclosure	14.95
14	MISC-SW	Misc. Parts Kit Includes Hardware, (8/32, 8/32 Nuts, 6 Bolts), Hookup Wire, Ant. Terms, DPDT Ant. Switch, Fuse, Fuseholder, etc.	9.95
When Ordering All Items, (1 thru 14), Total Price			139.95

7+11 PWD PARTS KITS

INTRODUCING OUR 7+11 PWD PARTS KITS **NEW**

KIT No.	PART NO.	DESCRIPTION	PRICE
1	1VT1-PWD	Varactor UHF Tuner, Model UES-A56F	\$24.95
2	2CB1-PWD	Printed Circuit Board, Pre-drilled	18.95
3	3TP11-PWD	PCB Potentiometers 4-20K, 1-5K, 2-10K, 2-5K, 1-1K, and 1-50k (11 pieces)	8.95
4	4FR-31-PWD	Resistor Kit, 1/4W, 5% 29-pcs, 1/2 W 2-pcs	4.95
5	5PT1-PWD	Power Transformer, PRI-117VAC, SEC-24VAC at 500ma.	9.95
6	6PP2-PWD	Panel Mount Potentiometers and Knobs, 1-1KBT and 1-5KAT with switch	5.95
7	7SS17-PWD	IC's 7-pcs, Diodes 4-pcs, Regulators 2-pcs Transistors 2-pcs, Heat Sinks 2-pcs	29.95
8	8CE14-PWD	Electrolytic Capacitor Kit, 14-pieces	6.95
9	9CC20-PWD	Ceramic Disk Capacitor Kit, 50 WV, 20-pcs	7.95
10	10CT5-PWD	Variable Ceramic Trimmer Capacitor, 5-65pfd, 5-pieces	4.95
11	11L15-PWD	Coil Kit, 18mh 3-pcs, 22µh 1-piece (prevound inductors) and 2 T37-12 Ferrite Torroid cores with 6 ft. #28 wire	6.00
12	12ICS-PWD	IC Sockets, Tin inlay, 8 pin 4-pcs, 14 pin 1-pc and 16 pin 2-pcs	2.95
13	13SR-PWD	Enclosure with PM Speaker and Pre-drilled Backpanel for mounting PCB and Ant. Terms	14.95
14	14MISC-PWD	Misc. Parts Kit. Includes Hardware, (8/32, 8/32 Nuts & Bolts), Hookup Wire, Solder, Ant. Terms DPDT Ant. Switch, Fuse, Fuseholder, etc.	9.95
15	15MC16-PWD	Mylar Capacitors, 14-pcs and Silver Mica Capacitors 2-pieces	7.95
When Ordering All Items, (1-15), Total Price			159.95

SIMPLE SIMON ELECTRONIC KITS, Inc.

3871 S. Valley View, Suite 12, Dept. C, Las Vegas, NV 89103
In Nevada Call: 702-871-2892
Outside Nevada Call: 1-800-782-3716

Available by Mail Order Only
Send Check* or Money Order. Minimum Order: \$16.95. Add 10% Shipping and Handling on orders under \$40.00. For orders over \$40.00, add 5%. Minimum Shipping and Handling \$2.00. Cat. \$1.00 — VISA and Mastercard Acceptable — *Check orders will be held 30 days before shipping

ATTENTION DEALERS!

Interested in making a PROFIT?

Sell our magazine in your store with 100% Return Privileges
Rose will tell you how —
CALL 1-603-878-1441

The Ham Radio Publishing Group

Greenville, NH 03048



CB TO TEN METER CONVERSION KITS

KITS for AM—SSB—FM 40 Channel PLL chassis conversions

DETAILED INSTRUCTIONS for easy installation with minimum time and equipment

BAND COVERAGE flexibility provides up to 1 MHz coverage for most PLL chassis.

PRICES Low cost prices range from \$8.00 to \$50.00

All kits are in stock including several different FM kits.

FREE CATALOG Write or call today.

INDEPENDENT

CRYSTAL SUPPLY COMPANY

P.O. Box 183
Sandwich, Ma. 02563-0183
(617) 888-4302



sample issue only \$2.50 PPD

OUR 15TH YEAR!

AMATEUR TELEVISION MAGAZINE

"FOR THE SPECIALIZED COMMUNICATION RADIO AMATEUR"

	Surface U.S./Canada	Surface All Foreign	Airmail Central S. America	Airmail All Other Foreign
1/2 year	\$ 10.00	\$ 13.00	\$ 20.00	\$ 23.00
1 year	\$ 20.00	\$ 26.00	\$ 40.00	\$ 46.00
2 year	\$ 38.00	\$ 50.00	\$ 78.00	\$ 90.00
3 year	\$ 56.00	\$ 74.00	\$116.00	\$134.00

ATV-SSTV-FAX-RTTY-Satellites-EME
Microwave and Computers.

Published 12 times per year by Mike Stone WB0QCD
P.O. Box H, Lowden, Iowa 52255 0408

hardware and flying leads are supplied for connection to the driven element of beams, quads, or dipoles. Coax termination is to an SO-239 connector.

For additional information, contact Hustler, Inc., Sales Department, 3275 North B Avenue, Kissimmee, Florida 32741.

Daiwa RF-670 speech processor

Daiwa announces a compact audio speech processor that rivals the performance of the rf types at an economical price. The RF-670 will give your signal the boost it needs to cut through QRM. The unique photocoupler design delivers a high level of processing with a minimum of distortion.

Traditional audio processor design is handicapped by the circuitry time constants that limit the ability of the



processor to respond to rapid variations in the level of the input audio signal. The result is distortion and poorer performance. The RF-670's photocoupler/variable gain amplifier design permits a very rapid response to input levels, and the result is clean output and excellent performance. The RF-670 features velcro pads for easy mobile or base mounting.

For more information, contact MCM Communications, 858 E. Congress Park Dr., Centerville, Ohio 45459; telephone 513-434-0031.

also included. A multiplexed LCD display provides special function annunciation, low battery (twenty percent) warning, and a power-up self-diagnostic indication.

The Fluke 8060A is powered by a standard 9-volt alkaline battery (170 hour continuous operation) or optional ac battery eliminator. The 806 priced at \$349, the 8062A, a correlation model without the Hz, dB conductance functions, is \$279.

For more information, contact John Fluke Mfg. Co., Inc., P.O. C9090, Everett, Washington 98206; telephone 206-342-6300.

1:1 balun antenna

Hustler, Inc., offers a 1:1 balun hf Amateur antenna. The balun, model BLN, features a low-loss air core design that eliminates saturation at high power levels while maintaining a uniform power balance in the system. It is rated at 1 kW, and has a bandwidth of 7 to 35 MHz. The stainless steel



base station antenna

Sinclair Radio Laboratories have introduced a new VHF/UHF combination base station antenna for mobile communications systems. Called the

310/210, the antenna uses one SRL-210 and one SRL-310 exposed dipole. The 310/210 offers exceptional bandwidth and efficient coverage for both

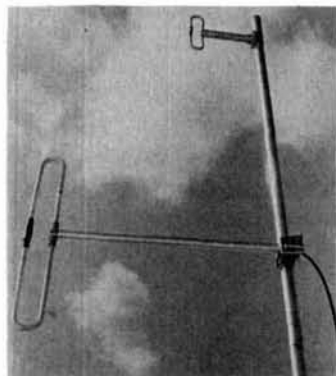

the 138-174 MHz and 406-512 MHz frequency ranges.

This extremely rugged antenna has been designed with the needs of the service shop in mind. The two dipoles are mounted on a 10-foot mast of 1½-inch ISP-schedule aluminum pipe. The 310 dipole is secured to the mast while the 210 dipole is left unassembled for shipping. The antenna can be easily transported and quickly assembled for an on-site test or demonstration.

Both dipoles are spaced one-half wavelength from the mast. This provides a nominal gain of 2 to 2.5 dB in an essentially omnidirectional pattern. VSWR across the full bandwidth is 1.5:1 or better. The 210 dipole can handle 200 watts; the 310 is rated at 75 watts. With half-inch radial ice, the rated wind velocity is 85 MPH. Both dipoles are at dc ground potential for maximum lightning protection.

For further information, contact Sinclair Radio Laboratories, Inc., 14614 Grover Street, Suite 210, Omaha, Nebraska 68144; telephone 800-228-2763.

automatic SWR meter

Palomar Engineers introduces the M-827 SWR meter which computes SWR automatically and displays it on a light bar. The SWR reading is always correct regardless of power level, and the light bar follows

changes instantly. A second light bar displays power. It follows with the speed of light so you can see all the SSB peaks.

The frequency range of the M-827 SWR meter is 1-30 MHz. The SWR scale is 1 to 10 with a logarithmic response that gives much improved resolution where you need it.

The M-827 SWR meter sells for \$97.50. For further information, write to Palomar Engineers, 1924-F W. Mission Road, Escondido, California 92025.

shock mount antenna

Antenna Specialists Co. introduces a new line of professional mobile communications antennas designed around a new concept in shock mounting, called Dura-Flex. In place of the conventional steel shock spring, the antenna is equipped with a tapered, cylindrical shock mount of molded neoprene which performs the basic shock-absorbing function while solving two special problems experienced in several mobile environments.

A/S engineers discovered the high noise levels were being generated in spring-equipped antennas by interaction of metal spring coils, which normally carry a small amount of rf. This



problem is especially noticeable with slightly corroded springs. The solution was to use neoprene along with a material capable of withstanding pounding, flexing, and extremes of temperature. The whip and base mount are mechanically interconnected by means of solid brass threaded connectors totally sealed

RADIO WAREHOUSE



IC 25A
2M 25W XCVR
\$299

FT 208
2M TALKIE
\$299



TR 2500
2M TALKIE
\$289



SUPER
SPECIAL
\$799

TS 830
HF ALL BAND

Clipperton L 2KW Amp
Tuned Input
\$689

Get **THEIR** lowest price
THEN CALL US!

P.O. BOX 2728
DALLAS, TX 75221
Telephone: (817) 496-9000

new COAX SWITCHES

from Barker & Williamson

Model 593

- **Single Pole 3 Position** with grounding of all unused positions
- **Crosstalk** (measured at 30 MHz) is -45db between adjacent outlets and 60 db between alternate outlets



Model 594

- **2 Pole 2 Position**
- **Crosstalk** 45db (measured at 30 MHz)



Specifications for both switches

- **Power** 1 KW-2 KW PEP
- **Impedance** 50-75 ohms
- **VSWR** 1.2:1 up to 150 MHz
- **Dimensions** 1¾" high, 5" wide, 3" deep
- **Weight** 1 lb.
- **Mount** Wall or desk

Available at your B&W dealer



Barker & Williamson, Inc.
10 Canal St. Bristol, Pa. 19007
Telephone: (215) 788-5581



within the shock mount. The connecting braid is totally isolated from the mount through an interior cavity and thus not subject to any strain from deflection. The mount is completely waterproof and may easily be removed.

Dura-Flex-equipped antennas are available in standard roof, trunk lid, cowl, and magnetic mounting configurations at high band and UHF frequencies. The ASP-1450 series, with 3 dB gain, is designed for 138-174 MHz. Three UHF series are offered: Model ASP-1790 (3 dB gain) for 445-512 MHz; Model ASP-1650 (a 5 dB-

gain collinear) for 406-512 MHz; and ASP-1750 series (a deluxe 5 dB-gain collinear with low loss Pro-Flex cable). A 3 dB motorcycle model, ASP-1791, and a no-ground-plane model, ASP-1751, both for UHF, also are available.

For complete technical details and specifications, write to Marketing Department, The Antenna Specialists Co., 12435 Euclid Avenue, Cleveland, Ohio 44106.

static-free soldering iron

The system 9300 soldering iron uses Ungar's Thermo-Duric™ heating element, a non-magnetic iron which conducts static electricity from the tip to a grounded wall plug, preventing

static electricity damage to microcircuits.

An operating temperature of either 700 or 800 degrees Fahrenheit is determined by the heater. Any of the five standard Ungar tips may be used with this iron.



Prices of the Model 9370, which is equipped with a 700 degree heater, and Model 9380, which comes with an 800 degree heater, are \$27.97.

For further information, contact Ungar, Division of Eldon Industries, Inc., 100 West Manville Street, Compton, California 90220; telephone 213-774-5950.

AZDEN PCS-4000 DISCOUNT PRICE

10 amp regulated power supply only \$49.00

Order 24 hours a day (215) 884-6010
FREE UPS - N.P.S. Inc. WA31FQ
1138 BOXWOOD RD. JENKINTOWN, PA. 19046

FACSIMILE

COPY SATELLITE PHOTOS,
WEATHER MAPS. PRESS!
The Faxes Are Clear — on our full size (18-1/2" wide) recorders. Free Fax Guide.

TELETYPE

RTTY MACHINES, PARTS, SUPPLIES

ATLANTIC SURPLUS SALES (212) 372-0349
3730 NAUTILUS AVE. BROOKLYN N.Y. 11224

7th Annual

ELMIRA HAMFEST

Sept. 25 6AM till 5PM

Chemung County Fairgrounds
Horseheads, NY

Tickets \$2 Adv., \$3 At Door

For more info write:

John Breese
340 West Avenue
Horseheads, NY 14845

RTTY Demodulators

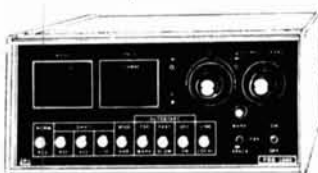

FSK-1000™

Here is no compromise design and construction:

- Unparalleled selectivity achieved with sophisticated limiterless design utilizing ultrasharp active filters and decision level correction circuits
- The most flexible interface system available to computers and high voltage loops
- Built in 170 volt loop supply
- Selectable bandwidths of 55 and 100 Hz. (copies 110 Baud ASCII)
- Continuously tunable shift coverage
- Rugged construction - commercial quality throughout
- Full complement of rear panel connectors for easy interface
- Keyboard activated switch for break in operation
- Individual tuning meters and LED's for quick, accurate tuning



FSK-500™

This RTTY demodulator is designed for computer interface but is a fine stand alone unit:

- Easy computer interface with RS-232 or 5 volt logic signals
- Three shift coverage without straddle tuning
- Selectable bandwidths give you optimal Baudot or 110 Baud ASCII copy
- Input bandpass preselector using active filters
- High voltage loop keyer output
- Autostart built in
- Three shift AFSK keyer plus narrow shift CW ID
- Fully wired and tested: ready to copy!
- The FSK-500 is the best demodulator available for under \$500.00 (Except for our FSK-1000!)
- Positive tuning with meter and LED's



Order direct on Visa or MC

700 Taylor Road
Columbus, Ohio 43230
Call (614) 864-2464

INTERFERENCE HANDBOOK

by William R. Nelson, WA6FQG

RFI is a very sticky problem. It can ruin your operating fun and worse. This brand-new book covers every type of RF interference that you are likely to encounter. Emphasis is placed on Amateur Radio, CB and power line problems. Author Nelson solves the mystery of power line interference — how to locate it, cure it, safety precautions and more. He also gives you valuable steps on how to eliminate TV and stereo problems. To help you understand this perplexing problem even more, this new book gives you interesting RFI case histories, filters to buy or build, mobile, telephone, CATV, and computer problems and ideas on how to solve them. Profusely illustrated and packed with practical, authoritative information. ©1981 247 pages, first edition.

RP-IH

Softbound \$8.95

Please add \$1.00 to cover shipping and handling.

HAM RADIO'S BOOKSTORE
GREENVILLE, N. H. 03048

TUNE IN THE WORLD WITH HAM RADIO

- **NEW EDITION - 80% NEW MATERIAL**
- **NEW CODE PRACTICE CASSETTE**

Over 200,000 persons have used TUNE IN THE WORLD WITH HAM RADIO as their steppingstone into Amateur Radio, the space-age hobby. The third edition of this popular package has been expanded with over 80 per cent new material. The code practice cassette has also been redone and improved. Packed into the *Tune in the World* booklet are chapters on:

EXPLORING HAM RADIO: Hams come from all walks of life; age is no barrier; building your own station; a look back in time.

MANAGING THE RADIO SPECTRUM: The FCC; rules and regulations; the Novice license; licensing classes.

LEARNING YOUR NEW LANGUAGE: The Morse Code — why every ham knows it; how to learn it the right way.

UNDERSTANDING BASIC THEORY: Easy-to-learn explanation of electronic theory and what you need to know to qualify for a Novice license.

SETTING UP YOUR STATION: Choosing a location; how to select your equipment; what antenna to use; glossary.

OVER THE AIRWAVES PAINLESSLY: How to operate; tuning up; safety; identifying stations in foreign countries; awards; clubs; The ARRL and QST.

The booklet consists of 134 pages of text and an additional 26 pages of equipment and publication advertising. The C-60 cassette provides 60-minutes of code practice instruction. The entire package is available for \$8.50 (in U.S. funds) at your favorite dealer or order below:

NAME _____	CALL _____
STREET _____	
CITY _____	STATE/PROV. _____ ZIP/PC _____
Total Enclosed (or charge to MC, VISA or Chargex) \$ _____	
VISA or Chargex No. _____	Expires _____
Mastercard _____	Expires _____
Bank No. _____	
Have you fully completed your order form? Is your check signed or charge number indicated?	
THE AMERICAN RADIO RELAY LEAGUE 225 MAIN ST., NEWINGTON, CT 06111	
HR	



Advertisers check-off

...for literature, in a hurry — we'll rush your name to the companies whose names you "check-off"

Place your check mark in the space between name and number. Ex: Ham Radio 234

Adv. Computer Controls	010	IRL	004
Alaska Microwave	826	Jameco	333
Amateur Elec. Supply	659	Jan	067
ARRL	780	KLM	073
Amidon	005	Kenwood *	
Amp Supply	991	Lewis Elec.	006
Amsat *		Long's	468
Antenna Specialists	018	Lunar	577
Applied Inv.	862	MCM Comm.	971
Atlantic Surplus *		MFJ	082
ATV Magazine	001	Madison	431
Barker & Williamson	015	Micro Control	015
Barry *		Microlog	982
Beckman	011	M.T.S.	996
Bencher	629	Microwave Filter	637
Ben Franklin	864	Mirage	760
Bilal	817	Monitoring Times	848
Butternut *		NCG	007
Commssoft	978	N.P.S.	866
C.D.C.	988	Nemal	968
C.E.S.	002	Boxboro *	
Comm. Spec.	330	P.B. Radio	921
Cushcraft	035	P.C. *	
DenTron Radio	259	Palomar Eng. *	
Doppler	003	Pipo	481
Elmira Hamfest *		Polar Research	008
Encon	019	Pro-Search	983
Fair Radio	048	Callbook	100
Fluke Mfg.	012	Radiokit	801
G.I.S.M.O.	691	Radio Warehouse *	
Hal Comm.	057	Simple Simon	998
Hal-Tronix	254	Sinclair Radio Lab.	016
H. R. B.	150	Spectronics *	
Ham Shack	879	Spectrum Int.	108
Hamtronics, N.Y.	246	TET	009
Hatry	889	The Comm Center	634
Heath	060	Ungar	017
Heil Ltd.	013	Universal Comm.	885
Hudson Convention *		UNR-Rohn	410
Hustler	014	Vanguard Labs	716
Icom *		Webster Assoc.	423
Ind. Crystal	005	Western Elec.	909
		Yaesu	127

*Please contact this advertiser directly.

Limit 15 inquiries per request.

September, 1982

Please use before October 31, 1982

Tear off and mail to
HAM RADIO MAGAZINE — "check off"
 Greenville, N. H. 03048-0498

NAME

CALL

STREET

CITY

STATE ZIP

look here
1-713-658-0268

- Kenwood TS530S New Demo** 600.00
- Kenwood TS930S + Accessories-Call!**
- SANTEC ST 144 UP** 299.00
- TOKYO HiPower-10% Off List-In Stock**
- SIGNAL ONE MILSPEC — SOON!**
- ICOM IC730** 699.00
- IC290A 429.00
- IC22U 269.00
- IC740 989.00
- IC490A 569.00
- IC25A 309.00
- IC720/AC 1298.00
- YAESU FT230R** 299.00
- FT208R/708R** 289.00 ea.
- FT1 2395.00
- FT101ZD-3 749.00
- FT102 CALL
- FT902DM 1249.00
- DRAKE TR5** 699.00
- TR7A 1450.00
- R7A 1400.00
- AEA MM2** 125.00
- MBARC** 399.00
- Tote and Talk Cordless**
- Telephone/Base 149.00
- Robot 800A** 749.00
- Robot 400** 675.00
- HAL CT2100** 699.00
- HAL KB2100** 169.00
- Kantronics Hamsoft** STOCK
- DenTron AT1K** 125.00
- Kantronics Interface** 169.00
- Sherwood, Curtis** 10% Off List
- Kantronics Minireader** 249.00
- ALPHA 78 Hi S/N** 2795.00
- Collins KWM2 Noiseblanker—New Sealed** 200.00
- KLM KT34A** 309.00
- KLM KT34XA** 469.00
- RG214 Nonmil copperbraid coax** 70¢/ft.
- AMPHENOL PL259 Silverplate 1.00**
- SPRAGUE 1000PF/30KV Doorknob Cap** 16.00
- 1000 PF/500V Feed thru** 1.95
- CDE .001/20KV Cap** 1.95
- TCA 25A/1000 PIV Epoxy diode** 19¢ ea.
- Belden 9258 RG8X** 19¢/ft
- 8214 RG8 Foam 36¢/ft
- 8267 RG213 43¢/ft
- 9405 Heavy Rotorcable 45¢/ft

LARGE BOOKSTORE

Mosley 20% Off List
ALL ITEMS GUARANTEED
PLEASE SAY YOU SAW IT IN THIS MAGAZINE AD.

MASTERCARD VISA

All prices fob Houston except where indicated. Prices subject to change without notice, all items guaranteed. Some items subject prior sale. Texas residents add tax. Please add sufficient postage, balance collect.

MADISON
Electronics Supply
 1508 McKinney
 Houston, Texas 77010

Advertisers index

Alaska Microwave Labs	48
Amateur Electronic Supply	7
American Radio Relay League	93
Amidon Associates	52
Amp Supply	67
Amsat	48
Applied Invention	67
Atlantic Surplus Sales	92
ATV Magazine	90
Barker & Williamson, Inc.	91
Barry Electronics	27
Bencher, Inc.	49
Ben Franklin Electronics	57
Bilal Company	76
Butternut Electronics	81
Communications Electronic Specialties, Inc.	54
Communications Specialists	98
Current Development Corp.	
(formerly Roux Wire Die, Inc.) 71	
DenTron Radio Co., Inc.	53
Doppler Systems	54
Elmira Hamfest	92
Encon Corp.	49
Fair Radio Sales	57
G.I.S.M.O.	23
Hal Communications Corp.	1, 49
Hal-Tronix	21
Ham Radio's Bookstore	
22, 26, 47, 48, 49, 52, 53, 54, 66, 71, 92	
The Ham Shack	43
Hamtronics, N.Y.	76
Hatry Electronics	87
Heath Company	47
Hudson Division, ARRL Convention	85
Icom America, Inc.	Cover II
Independent Crystal Supply Company	90
IRL	92
Jameco Electronics	44
Jan Crystals	74
KLM Electronics, Inc.	26
Trio-Kenwood Communications	50, 51, Cover IV
Lewis Electronics	90
Long's Electronics	24, 25
Lunar Electronics	85
MFJ Enterprises	9
Madison Electronics Supply	94
Microlog	11
Micro-Telemetry Systems, Inc.	86
Microwave Filter, Inc.	79
Mirage Communications Equipment, Inc.	75
Monitoring Times	48
NCG	53
N.P.S., Inc.	92
Nemal Electronics	74
New England ARRL Convention, Boxboro	97
P.B. Radio	57
P.C. Electronics	23
Palomar Engineers	73
Pipo Communications	52
Polar Research	32
Pro-Search Electronics	2
Radio Amateur Callbook	88
Radiokit	57
Radio Warehouse	91
Simple Simon Electronic Kits, Inc.	89
Spectronics	54
Spectrum International, Inc.	35
TET Antenna Systems	23
The Comm Center	76
Universal Communications	48
UNR-Rohn	52, 67
Vanguard Labs	52
Webster Associates	86
Western Electronics	54
Yaesu Electronics Corp.	Cover III

Advertisers check-off

... for literature, in a hurry — we'll rush your name to the companies whose names you print below. It's simple to do. Simply select the advertiser's number and name from the Advertisers' Checkoff list found on the same page as the Advertisers' Index. Just print the number and the company's name and drop in the mail.

NUMBER	NAME OF COMPANY	NUMBER	NAME OF COMPANY
_____	_____	_____	_____
_____	_____	_____	_____
_____	_____	_____	_____
_____	_____	_____	_____
_____	_____	_____	_____
_____	_____	_____	_____
_____	_____	_____	_____

Please month _____ July _____ Aug. _____ Sept. _____ Limit 14 inquiries please.

NAME _____ CALL _____

ADDRESS _____

CITY _____ STATE _____ ZIP _____



AFFIX POSTAGE
OR
POST OFFICE
WILL NOT
DELIVER

ham
radio
magazine

READER SERVICE CENTER
P.O. BOX-358
ARLINGTON, MA 02174

ATTN: Reader Service Dept.

Special Edition for Those Seeking a Good Time

October 2 & 3, 1982

THOUSANDS in PRIZES

Biggest Show in the East

The Great Boxboro Convention Returns!!

Remember the fantastic Boxboro hamfest back in 1980? Well here we go again with improvements galore to make the show even better! Located "in the country" on Route 495 at Route 111 the New England ARRL Convention for 1982 features free shuttle bus service to and from a giant free parking area — no more parking worries!!

Prizes Awarded Both Days of Show

Through the generous cooperation of the manufacturers and dealers lucky conventioners will be taking home transceivers, handi-talkies, amplifiers, HF and VHF antennas, rotors, CW & RTTY decoders, and even a Tektronix scope! The list is endless as the affair is non-profit and all surplus funds so directly into prizes.

See Every Possible Make of Ham Gear

Exhibits will be open Saturday 9 to 5. Sunday 10 to 5. Manufacturers and distributors are turning out in force! Virtually everybody will be at Boxboro from all parts of the country bringing with them the latest equipment in HF and VHF plus exotic antennas, test equipment, RTTY, CW plus color and B&W SSTV.

Big Events All Weekend

Two meter fox hunts, YL programs, seminars on all aspects of ham radio including microprocessors, RTTY, color SSTV, DX, a Wouff Hong ceremony, Saturday night banquet, show and dance plus prizes awarded all weekend.

There will be a home brew equipment exhibit and contest, CW and QSL contests. Booths will include AMSAT and MARS, CAP, and the QSL bureau.



FLEA MARKET

New England's only Flea Market

UNDER A GIANT 80' TENT

Come rain or shine! First come — best spaces.

Flea Market Sellers' Permits
\$ 7 per 6'x2½' space (per day) includes a table.

TELL YOUR FRIENDS!

Early Bird Tickets Available by Mail Only!

Registration is \$4 early bird, \$5 at the door. Combination banquet, dance and show tickets are \$13.50 each including tax and gratuity. Order tickets from Arthur Tomkinson, WITHT, 9 Oliver Terrace, Revere, Massachusetts 02151. Include SASE! Make checks payable to FEMARA. The Sheraton Boxboro may be sold out by the time you read this but their address is Boxboro, Massachusetts 01719. You must mention "radio show" to get the convention discount!



Stuck with a problem?

Our TE-12P Encoder might be just the solution to pull you out of a sticky situation. Need a different CTCSS tone for each channel in a multi-channel Public Safety System? How about customer access to multiple repeater sites on the same channel? Or use it to generate any of the twelve tones for EMS use. Also, it can be used to access Amateur repeaters or just as a piece of versatile test equipment. Any of the CTCSS tones may be accessed with the TE-12PA, any of the audible frequencies with the TE-12PB. Just set a dip switch, no test equipment is required. As usual, we're a stickler for 1day delivery with a full 1 year warranty.

- Output level flat to within 1.5db over entire range selected.
- Immune to RF.
- Powered by 6-30vdc, unregulated at 8 ma.
- Low impedance, low distortion, adjustable sinewave output, 5v peak-to-peak.
- Instant start-up.

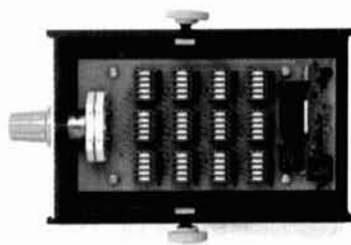

TE-12PA

67.0 XZ	85.4 YA	103.5 1A	127.3 3A	156.7 5A	192.8 7A
71.9 XA	88.5 YB	107.2 1B	131.8 3B	162.2 5B	203.5 M1
74.4 WA	91.5 ZZ	110.9 2Z	136.5 4Z	167.9 6Z	
77.0 XB	94.8 ZA	114.8 2A	141.3 4A	173.8 6A	
79.7 SP	97.4 ZB	118.8 2B	146.2 4B	179.9 6B	
82.5 YZ	100.0 1Z	123.0 3Z	151.4 5Z	186.2 7Z	

- Frequency accuracy, ± 0.1 Hz maximum – 40°C to +85°C
- Frequencies to 250 Hz available on special order.
- Continuous tone

TE-12PB

TEST-TONES:	TOUCH-TONES:	BURST TONES:			
600	697 1209	1600	1850	2150	2400
1000	770 1336	1650	1900	2200	2450
1500	852 1477	1700	1950	2250	2500
2175	941 1633	1750	2000	2300	2550
2805		1800	2100	2350	

- Frequency accuracy, ± 1 Hz maximum – 40°C to +85°C
- Tone length approximately 300 ms. May be lengthened, shortened or eliminated by changing value of resistor

\$89.95

COMMUNICATIONS SPECIALISTS

426 West Taft Avenue, Orange, California 92667
(800) 854-0547/California: (714) 998-3021



FT-230R: QUITE A SIGHT! (AND EASY TO SEE, TOO!!)

Sporting an all-new Liquid Crystal Display, the FT-230R is Yaesu's high-performance answer to your call for a very affordable 2 meter mobile rig with an easy-to-read frequency display! The FT-230R combines microprocessor convenience, a sensitive receiver, a powerful yet clean transmitter strip, and the new dimension of LCD frequency readout. See your Authorized Yaesu Dealer today — and go home with your new FT-230R!



SALE SUBJECT
FCC CERTIFICATION

- LCD five-digit frequency readout with night light for high visibility day or night.
- Two VFOs for quick QSY across the band.
- Ten memory slots for storage and recall of favorite channels.
- Selectable synthesizer steps (5 kHz or 10 kHz) in dial or scanning mode.
- Priority channel for checking a favorite frequency for activity while monitoring another.
- Unique VFO/Memory Split mode for covering unusual repeater splits.
- Up/Down band scan plus memory scan for busy or clear channel. Scanning microphone included in purchase price.

- Full 25 watts of RF power output from extremely compact package.
- Built-in automatic or manual tone burst.
- Optional synthesized CTCSS Encode and Encode/Decode boards available.
- Lithium memory backup battery with estimated lifetime of five years.
- Optional YM-49 Speaker/Microphone and YM-50 DTMF Encoding Microphone provide maximum operating versatility.

And don't forget! Yaesu has a complete line of VHF and UHF handheld and battery portable transceivers using LCD display!!!

FT-208R
FM Handheld
2 Meters

FT-708R
FM Handheld
70 cm

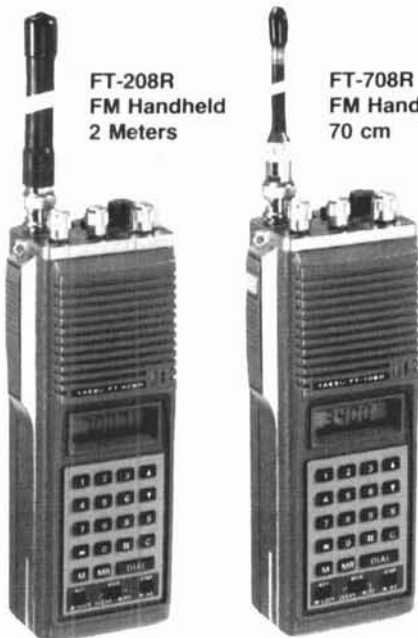

FT-290R - 2 Meters
SSB/CW/FM Portable
FT-690R - 6 Meters
USB/CW/AM/FM Portable



Price and Specifications Subject To
Change Without Notice or Obligation

YAESU
The radio.



482

Watts to see...



Big LCD, Big 45 W, Big 21 memories, compact.

TR-7950

Outstanding features providing maximum ease of operation include a large, easy-to-read (direct sunlight or dark) LCD display, 21 multi-function memories, automatic offset, programmable priority channel, memory and band scans, built-in lithium battery memory back-up, built-in 16-key autopatch, and a choice of a hefty 45 watts output (TR-7950), or 25 watts output (TR-7930).

TR-7950 FEATURES:

• **NEW, large, easy-to-read LCD digital display**

Easy to read in direct sunlight or dark (back-lighted). Displays transmit/receive frequencies, memory channel, repeater offset, (+, S, -), sub-tone number (F-0, 1, 2, 3), tone, scan, and memory scan lock-out. Includes LED S/Rf bar meter, and LED indicators for REVERSE, CENTER TUNING, PRIORITY, and ON AIR.

• **21 NEW, multi-function memory channels**

Stores frequency, repeater offset, and optional sub-tone channels. Memories 1 through 15 for simplex or ± 600 kHz offset. Memory pairs 16/17, and 18/19 are paired for non-standard repeater offset. Memories "A" and "B" set upper and lower scan limits, or for simplex or ± 600 kHz offset. In MEMORY mode, a circle of light appears around the memory selector knob. When the memory selector knob is rotated in either direction to channel 1, an audible "beep" will sound.

• **Choice of 45 or 25 watts output**

The TR-7950 provides a hefty 45 watts output, while the TR-7930 features a more modest 25 watts. A HI/LOW power switch allows power reduction to approx. 5 watts.

• **Long-life lithium battery memory back-up**

Built-in lithium battery has an estimated 5 year life.

• **Automatic offset**

The microprocessor is pre-programmed for simplex or ± 600 kHz offset, in accordance with the 2 meter band plan. "OS" key allows manual change in offset.

• **Programmable priority alert**

The PRIORITY channel may be programmed in any of the 21 memories. With ALERT switch "ON," a dual "beep" sounds when a signal is present on the PRIORITY channel. An OPER switch allows an easy move to the PRIORITY channel.

• **Programmable memory scan lock-out**

"LO" key for programming scan to skip selected memory channels, without erasing the memory.

• **Programmable band-scan width**

The lower limit may be programmed into memory "A," and the upper limit into memory "B."

• **Center stop during band-scan, with indicator**

Stops in center of channel during band-scan, with center tuning indicator.

• **Scan resume selectable**

Scan stops on busy channel. Selectable automatic time resume-scan (approx. 5 sec., adjustable), or carrier operated resume-scan. A scan delay of approx. 1.5 seconds built-in.

• **Scan control using up/down microphone**

Momentarily pressing UP or DOWN button on microphone tunes one step in the selected direction, on memory or on 5-kHz step tuning. Holding the button for about 2 seconds starts UP or DOWN automatic scan action. Scan start also possible using "SC" key on keyboard. Scan may be cancelled by momentarily pressing the PTT switch, or by pressing both UP/DOWN buttons simultaneously.

• **Programmable sub-tone channels**

Optional TU-79 3 frequency sub-tone unit provides keyboard selectable sub-tone channels, which may be stored in memory.

• **Built-in 16-key autopatch, with monitor**

The keyboard functions as a 16-key autopatch during transmit. DTMF tones appear in the speaker output when a key is pressed during transmit.

• **Front panel keyboard control**

Used for selecting frequency, offset, programming memories, controlling scan, and autopatch encode. Keyboard lighting is provided.

• **Extended frequency coverage**

Covers 142.000-148.995 MHz, in 5-kHz steps.

• **Repeater reverse switch**

Locking-type switch, with indicator.

• **"Beeper" amplified through speaker**

• **Compact, lightweight design**

• **Easy-to-install adjustable-angle mobile mounting bracket**

Optional accessories:

- TU-79 3 frequency tone unit.
- KPS-12 fixed-station power supply for TR-7950.
- KPS-7 fixed-station power supply for TR-7930.
- SP-40 compact mobile speaker.

More information on the TR-7950 and TR-7930 is available from all authorized dealers of Trio-Kenwood Communications, 1111 West Walnut Street, Compton, California 90220.

 **KENWOOD**
...pacesetter in amateur radio

Specifications and prices are subject to change without notice or obligation.