

\$2.50

ham radio

magazine

hr 

FEBRUARY 1981

- automatic noise-figure meter 12
- 80-meter receiver 25
- ham radio techniques 40
- repeater security 52

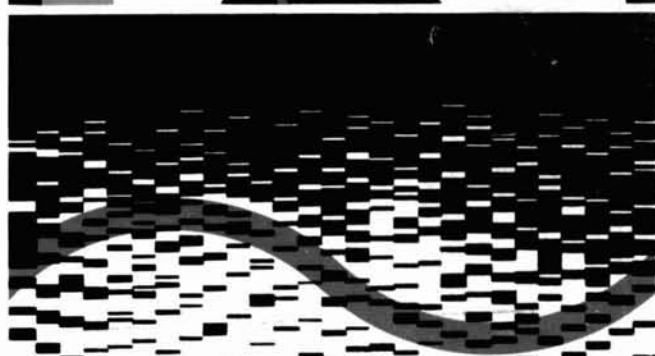
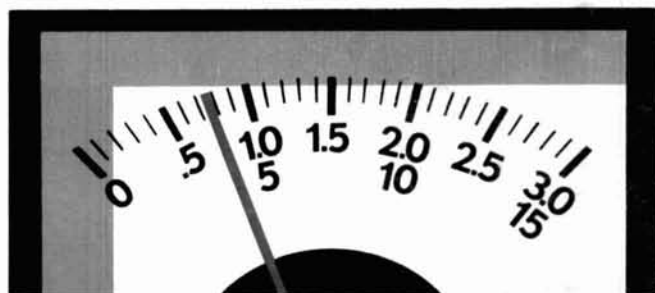

automatic
noise-figure
meter
for
preamplifiers
and
converters

tempo does it again



THE WORLD'S FIRST 440 MHz SYNTHESIZED HAND HELD RADIO

Tempo was the first with a synthesized hand held for amateur use, first with a 220 MHz synthesized hand held, first with a 5 watt output synthesized hand held...and once again first in the 440 MHz range with the S-4, a fully synthesized hand held radio. Not only does Tempo offer the broadest line of synthesized hand helds, but its standards of reliability are unsurpassed...reliability proven through millions of hours of operation. No other hand held has been so

thoroughly field tested, is so simple to operate or offers so much value. The Tempo S-4 offers the opportunity to get on 440 MHz from where ever you may be. With the addition of a touch tone pad and matching power amplifier its versatility is also unsurpassed.

The S-4...\$349.00
With 12 button touch tone pad...\$399.00
With 16 button touch tone pad...\$419.00
S-40 matching 40 watt output
13.8 VDC power amplifier...\$149.00

Specifications:

Frequency Coverage: 440 to 449.995 MHz
Channel Spacing: 25 KHz minimum
Power Requirements: 9.6 VDC
Current Drain: 17 ma-standby 400 ma-transmit (1 amp high power)
Antenna Impedance: 50 ohms
Sensitivity: Better than .5 microvolts nominal for 20 db
Supplied Accessories: Rubber flex antenna 450 ma ni-cad battery pack, charger and earphone
RF output Power: Nominal 3 watts high or 1 watt low power
Repeater Offset: \pm 5 MHz

Optional Accessories for all models

12 button touch tone pad (not installed): \$39 • 16 button touch tone pad (not installed): \$48 • Tone burst generator: \$29.95
• CTCSS sub-audible tone control: \$29.95 • Leather holster: \$20 • Cigarette lighter plug mobile charging unit: \$6

TEMPO VHF & UHF SOLID STATE POWER AMPLIFIERS

Boost your signal. . . give it the range and clarity of a high powered base station. VHF (135 to 175 MHz)

Drive Power	Output	Model No.	Price
2W	130W	130A02	\$209
10W	130W	130A10	\$189
30W	130W	130A30	\$199
2W	80W	80A02	\$169
10W	80W	80A10	\$149
30W	80W	80A30	\$159
2W	50W	50A02	\$129
2W	30W	30A02	\$ 89

UHF (400 to 512 MHz) models, lower power and FCC type accepted models also available.



2050 S. Bundy Dr., Los Angeles, CA 90025 (213) 820-1234
931 N. Euclid, Anaheim, CA 92801 (714) 772-9200
Butler, Missouri 64730 (816) 679-3127

Henry Radio

TOLL FREE ORDER NUMBER: (800) 421-6631

For all states except California.
Calif. residents please call collect on our regular numbers.
Prices subject to change without notice.

Please note, as of Dec. 1, 1980 we will occupy our new world headquarters building with a new Los Angeles address and phone number.

220 MHz station, the S-2 will add tremendous versatility. Price...\$349.00 (With touch tone pad installed...\$399.00)
S-20...\$89.00

Tempo S-1
The first and most thoroughly field tested hand held synthesized radio available today. Many thousands are now in use and the letters of praise still pour in. The S-1 is the most simple radio to operate and is built to provide years of dependable service. Despite its light weight and small size it is built to withstand rough handling and hard use. Its heavy duty battery pack allows more operating time between charges and its new lower price makes it even more affordable.

Tempo S-5
Offers the same field proven reliability, features and specifications as the S-1 except that the S-5 provides a big 5 watt output (or 1 watt low power operation). They both have external microphone capability and can be operated with matching solid state power amplifiers (30 watt or 80 watt output). Allows your hand held to double as a powerful mobile or base radio.
S-30...\$89.00* S-80...\$149.00*
*For use with S-1 and S-5

Tempo S-2
With an S-2 in your car or pocket you can use 220 MHz repeaters throughout the U.S. It offers all the advanced engineering, premium quality components and features of the S-1 and S-5. The S-2 offers 1000 channels in an extremely lightweight but rugged case. If you're not on 220 this is the perfect way to get started. With the addition of the S-20 Tempo solid state amplifier it becomes a powerful mobile or base station. If you have a

DRAKE 7-Line Family

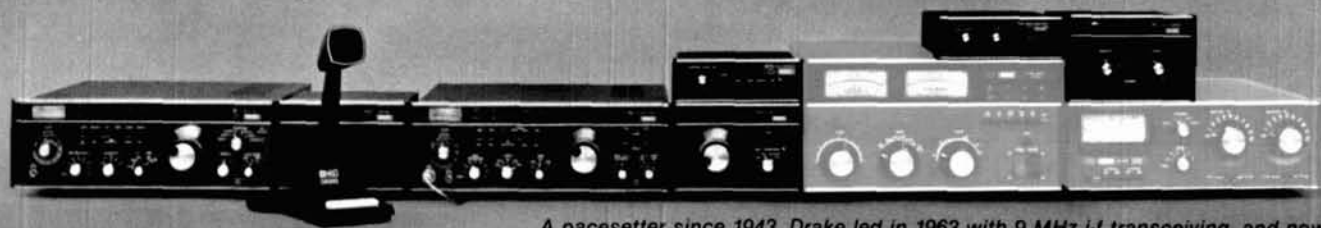

A pacesetter since 1943, Drake led in 1963 with 9 MHz i-f transceiving, and now with 48 MHz i-f "Up Conversion"... Drake brings you tomorrow's state of the art today.

Model 1528

Drake L7

Continuous Duty
160-15* Meters

2kW Linear Amplifier

Temperature-controlled design for "key-down" operation over a wide frequency range.

2 kW PEP, 1 kW cw, RTTY, SSTV operation—all modes full rated input, continuous duty cycle.

160-15* meter amateur band coverage, plus expanded ranges for any future hf band expansions or additions within FCC rules. These ranges also include increased coverage for MARS, embassy, government, or other such services.

The Drake L7 utilizes a pair of Eimac 3-500 Z triodes for rugged use, and lower replacement cost compared to equivalent ceramic types.

Accurate built-in rf wattmeter, with forward/reverse readings, is switch selected. Calibrated 300/3000 watt scales.

Temperature controlled two speed fan is a high volume low noise type and offers optimum cooling.

Adjustable exciter agc feedback circuitry permits drive power to be automatically controlled at proper levels to prevent peak clipping and cw overdrive. Front panel control.

By-pass switching is included for straight through, low power operation without having to turn off amplifier.

Bandpass tuned input circuitry for low distortion and 50 ohm input impedance.

Amplifier is comprised of two units—rf deck for desk top and separate power supply.

Operates from 120/240 V-ac, 50/60 Hz primary line voltage.

DRAKE L7 SPECIFICATIONS

• **Frequency Coverage***: Ham bands 160 through 15 meters*. Non-amateur frequencies between 6.5 and 21.5 MHz may be covered with some modification of the input circuit. • **Plate Power Input**: 2000 watts PEP on ssb and a-m, 1000 watts dc on cw, RTTY, and SSTV. • **Drive Power Requirements**: 100 watts PEP on ssb and 75 watts on cw, a-m, RTTY, and SSTV. • **Input Impedance**: 50 ohms. (Bandpass tuned input) • **Output Impedance**: Adjustable pi-network matches 50 ohm line with SWR not to exceed 2:1. • **Intermodulation Distortion Products**: In excess of -33 dB. • **Wattmeter Accuracy**: 300 watts forward and reflected, $\pm 5\%$ of reading + 3 watts. 3000 watts forward, $\pm 5\%$ of reading + 30 watts. • **Power Requirements**: 240 volts 50-60 hertz 15 amperes, or 120 volts 50-60 hertz 30 amperes. • **Tube Complement**: Two of 3-500Z or 8802/3-500Z or 3-400Z. • **Dimensions: Amplifier** 13.69"W x 6.75"H x 14.25"D (34.8 x 17.1 x 36.2 cm). **Power Supply** 6.75"W x 7.88"H x 11"D (17 x 20 x 28 cm). • **Weight: Amplifier** 27 lbs (12.25 kg), **Power Supply** 42.5 lbs (19.3 kg).

*Export model includes coverage of the 10-meter Ham Band.

Specifications, availability and prices subject to change without notice or obligation.



Model
1539

Drake Matching Networks MN7 and MN2700

Models 1538 and 1539

- **Frequency Coverage**: 1.8 - 30 MHz
- **Antenna Choice**: Matches antennas fed with coax, balanced line (use optional B-1000 Balun), or random wire.
- **Antenna/By-Pass Switching**: Allows matching unit by-pass regardless of antenna in use, and selects various antennas.
- **Extra Harmonic Reduction**: Employs "pi-network" low pass filter type circuitry for maximum harmonic rejection.
- **Built-in Metering**: Accurate Rf Wattmeter and VSWR Reading, pushbutton controlled from front panel.
- **Input Impedance**: 50 ohms resistive.
- **Power Capability**: MN7—250 watts average continuous duty (0-300 W scale). MN2700—1000 watts average continuous duty (2000 watts PEP). (0-200 or 0-2000 W scale).
- **Dimensions**: MN7—13.1"W x 4.53"H x 8.5"D excluding knobs and connectors (33.26 x 11.5 x 21.6 cm). MN2700—13.1"W x 4.53"H x 13"D excluding knobs and connectors (33.26 x 11.5 x 33 cm).
- **Weight**: MN7—10 lbs (4.5 kg). MN2700—11 lbs (5 kg).

Drake MN7 and MN2700 Specifications

• **Frequency Coverage**: 1.8 to 30 MHz. Band Switch marked for 160, 80, 40, 20, 15, and 10 meter amateur bands; however, frequency coverage between amateur bands is possible by using the nearest band positions with a small reduction in matching capability. • **Input Impedance**: 50 ohms (resistive). • **Load Impedance**: 50 ohm coaxial with VSWR of 5:1 or less at any phase angle (3:1 on 10 meters). 75 ohm coaxial at a lower VSWR can be used. • **Balanced Feedlines**: With the Drake B-1000 accessory balun, which mounts on rear panel, tunes feed point impedances of 40 to 1000 ohms, or 5:1 VSWR referenced to 200 ohms (3:1 on 10 meters). • **Long-Wire Antennas**: Feed point impedances up to 5:1 VSWR referenced to 50 ohms. Also, 5:1 referenced to 200 ohms with the Drake B-1000 accessory balun (3:1 on 10 meters). • **Meter**: Reads VSWR or forward power. • **Wattmeter Accuracy**: $\pm 5\%$ of reading $\pm 1\%$ of full scale. • **Insertion Loss**: 0.5 dB or less on each band after tuning. • **Front Panel Controls**: Provide for the adjustment of resistive and reactive tuning, antenna switching, band switching, VSWR calibration, and selection of watts or VSWR calibration, and selection of watts or VSWR functions of the meter. • **Rear Panel Connectors**: The rear panel has four type SO-239 connectors (one for input and 3 for outputs), three screw terminal connections (for long-wire and open-wire feeder systems), and a ground post.

R. L. DRAKE COMPANY



540 Richard St., Miamisburg, Ohio 45342, USA
Phone: (513) 866-2421 • Telex: 288-017

More Details? CHECK—OFF Page 98

february 1981  1



The Majority Leader

In the race of popular demand for quality in fully synthesized, multifeature hand held transceivers, the Santec HT-1200 emerges as the commanding front runner. More than just handy, the Santec stands on a solid platform of big rig features which fully utilize the very latest microprocessor technologies.

When you choose Santec, you opt for 4 modes of automatic scan and search of 10 memories and the whole band. When you choose Santec, you opt for selectable output power of 3.5W or 1.0W, with only a 6ma drain for the optional continuous display of the bright LED readout. When you choose Santec, you opt for variable scan steps in any multiples of 5kHz. And when you choose Santec, you opt for a band range that covers most Army MARS, Navy MARS, and CAP frequencies and the ease of entering all frequencies from the integrated keyboard. Assuredly, when you choose Santec, you opt for the majority leader which hands over features hand over fist.

SUGGESTED RETAIL PRICE: \$379.00

Check the price at your Authorized Santec Dealer today!

CHECK HOW THEY STAND ON THE ISSUES:

SANTEC HT-1200	YAESU FT-207R	KENWOOD TR-2400
Texas Instruments TMS-1000 microprocessor	NEC-650	NEC-650
Rx on 143 to 149.995 MHz Tx on 143 to 148.995 MHz (1200 channels with MARS coverage)	Rx & Tx on 144 to 147.995 MHz, Ham band only (800 channels)	Rx & Tx on 143.9 to 148.495 (900 channels with some MARS coverage)
Direct keyboard entry of all frequencies. Keyboard entry of 5kHz digit which stays in memory	Keyboard entry of 10kHz steps with a switch for 5kHz steps	Direct keyboard entry of Ham band only. MARS frequencies must be entered into a memory by stepping and recalling.
10 programable memories with frequencies preloaded on cold boot.	5 programable memories. All memories loaded with 144.00 on cold boot.	10 programable memories. All memories loaded with 145.00 on cold boot.
Up/Down variable scan steps in any multiples of 5kHz over whole band or auto-scan of 10 memories. Scan (restart) or search (lock) modes for both band and memory modes.	Up/Down scan with 10kHz steps only. Misses every other 15kHz by 5kHz. Locks without restart.	Scans 10 memories only. Restart only: lock mode not available. Continuous band scan/search not available.
Full 16 button TTP with LED display of number as it is dialed.	12 button TTP only.	Full 16 button TTP. Readout of the number dialed is not available.
9.6v 500mah battery (included)	10.8v 450mah battery (included)	9.6v 500mah battery (included)
Tx High: 3.5W (4W nominal) Tx Low: 1W	Tx High: 2.5W Tx Low Tx Low: 200mW	Tx at 1.5W only.
Readout: LED	Readout: LED	Readout: LCD
Volume: 543cc 170mm(H) x 68mm(W) x 47mm(D)	Volume: 664cc 181mm(H) x 68mm(W) x 54mm(D)	Volume: 640cc 192mm(H) x 71mm(W) x 47mm(D)

The Santec HT-1200 is approved under FCC Part 15 and exceeds FCC regulations limiting spurious emissions.

©1980, ENCOMM, INC.

3331 Towerwood Drive, Suite 304, Dallas, Texas 75234, (214) 620-2784, Telex 79-1955

Encomm, Inc.
3331 Towerwood Drive
Suite 304
Dallas, Texas 75234

Please send me more information about the Santec HT-1200 and a list of Authorized Santec Dealers.

NAME _____ CALL _____

ADDRESS _____

CITY _____ STATE _____ ZIP _____

You may send a duplicate of this form.

ham radio

magazine

incorporating

HAM RADIO HORIZONS

FEBRUARY 1981

volume 14, number 2

T. H. Tenney, Jr., W1NLB
publisher and
editor in chief

Alfred Wilson, W6NIF
editor

editorial staff

Martin Hanft, WB1CHQ
production editor

Joseph J. Schroeder, W9JUV
Leonard H. Anderson
associate editors

W.E. Scarborough, Jr., KA1DXQ
graphic production manager

Irene Hollingsworth
editorial assistant

Wayne Pierce, K3SUK
cover

publishing staff

J. Craig Clark, Jr., N1ACH
assistant publisher and
advertising manager

Susan Shorrock
circulation manager

ham radio magazine
is published monthly by
Communications Technology, Inc
Greenville, New Hampshire 03048
Telephone: 603-878-1441

subscription rates

United States: one year, \$15.00
two years, \$26.00; three years, \$35.00

Canada and other countries (via Surface Mail)
one year, \$18.00; two years, \$32.00
three years, \$44.00

Europe, Japan, Africa (via Air
Forwarding Service) one year, \$28.00

All subscription orders payable in
United States funds, please

foreign subscription agents

Foreign subscription agents are
listed on page 73

Microfilm copies
are available from
University Microfilms, International
Ann Arbor, Michigan 48106
Order publication number 3076

Cassette tapes of selected articles
from ham radio are available to the
blind and physically handicapped
from Recorded Periodicals
919 Walnut Street, 8th Floor
Philadelphia, Pennsylvania 19107

Copyright 1981 by
Communications Technology, Inc
Title registered at U.S. Patent Office

Second-class postage
paid at Greenville, N.H. 03048
and at additional mailing offices
ISSN 0148-5989

Postmaster send Form 3579 to ham radio
Greenville, New Hampshire 03048



contents

12 automatic noise-figure meter

Edward T. Gisske, K9IMM

22 ham radio questionnaire:

Icom 701, Drake TR7, Kenwood 520

25 80-meter receiver

Ed Marriner, W6XM

**30 solid-state power
for 1296 MHz**

Jerry Hinshaw, N6JH

40 ham radio techniques

Bill Orr, W6SAI

**48 better audio for
mobile operation**

Ken Glanzer, K7GCO

52 repeater security

Steve Cerwin, WA5FRF

**56 transmission-line circuit design:
part three**

H.M. Meyer, Jr., W6GGV

98 advertisers index

92 DX forecaster

73 flea market

86 ham mart

66 ham notebook

6 letters

**4 observation and
opinion**

8 presstop

98 reader service

94 short circuits

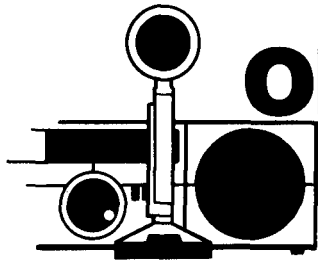

Observation & Opinion

The urge to compete seems to be a part of human nature. Amateur Radio has its share of competition: DXCC, T-Hunts, Field Day. Competition stimulates people to improve, and that's healthy.

Another contest, which was popular years ago but which hasn't received much publicity recently, is the world high-speed CW championship. This is the challenge of challenges for operating skill: to break the record of Ted McElroy, ex-W1JYN, who made the *Guinness Book of World Records* by copying Morse code at a speed of 75.2 words per minute in a contest at Ashville, North Carolina, on July 2, 1939. Ted's record still stands. It's time for someone to try to break it.

Many readers will sniff in disdain at such a contest: "Who needs it?" "What will it prove?" I'm here to tell these people that Morse code is here to stay, like it or not.

Since I became editor of *ham radio*, I've received many letters from readers who scoff at the Morse code requirement in the Amateur license examination. For the most part, their reasons are that Morse isn't necessary for today's communications. I won't argue this point except to say that these people are somewhat misguided and know not whereof they speak. Listen to the parts of the Amateur bands devoted to traffic handling, the extra-class sub-bands, the Novice bands. It's CW, in whatever form.

A contest to break the world's record in Morse code reception is challenging, exciting, and in the best tradition of Amateur Radio for those who like to compete. Ted McElroy's record has been unbroken for 42 years. Who will be the next champ?

We at *ham radio* are proposing a contest for those who wish to try to break Ted's record. The contest will be conducted under official rules similar to those in effect during the contest in Ashville, North Carolina, in 1939. Appropriate prizes will be awarded to the winners.

Right now the contest is in the planning stage. The first contest will probably be held at one of the larger ham conventions in the spring of this year. We haven't yet decided which convention it will be. At any rate, the contest will be held under strictly controlled conditions, in a room devoid of distractions and noise. A contest of this sort must be done by the rules to guarantee fairness to all.

More information on the contest will be upcoming in future issues of both *ham radio* and *HR Report*. Look for it and plan to enter. CW is certainly not dead!

Our *ex-Horizons* readers will find some familiar topics in this issue: an equipment owner's questionnaire on three popular transceivers, Bill Orr's column on "Ham Radio Techniques," and of course Garth Stonehocker's "DX Forecaster." Next month we'll have the results of the Collins KWM2 and KWM2A equipment survey. Also look for the popular Q and A column and an interesting article by W7JWJ on the world's champion high-speed Morse code operator.

Alf Wilson, W6NIF
editor

2A Versatility

10 Options Guaranteed to Make the Extremely Popular 2A and 2AT Even More Popular!



ICOM



BC-30
Battery Charger

IC-CP1
Cigarette Lighter
Cord

IC-DC1
DC Regulator

IC-BP2
Battery Pack

IC-BP3
Battery Pack

IC-BP4
Battery Case

IC-BP5
Battery Pack

IC-HM9
Speaker/Mic

Leather Case

BC-25U
Wall Charger

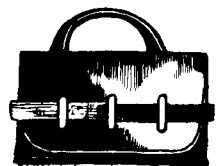

comments

hyperbolic navigation

Dear HR:

Amateur Radio experts often reinvent the wheel in novel ways. A case in point is the article in *ham radio*, September, 1980, by Henry S. Keen, W5TRS, on "Navigational Aid for Small Boat Operators." The whole idea here is basically a hyperbolic navigation method and is markedly similar to the DECCA system used in Europe for many decades. DECCA operates on harmonic-related frequencies in the 75 kHz to 150 kHz range and uses exact integral divisors or multipliers as the intermediate beat frequency, very similar to Keen's idea of the second harmonic or subharmonic of the beat note. A problem that Keen has not addressed is that of "lane jumping," or resolution. At transmitter frequencies in the 10-meter range, the lane width between adjacent hyperbolas will be 5 meters, which taxes the resolution of the phase detector (and the steering navigator) for keeping track of which hyperbola the navigator is seeking.

At short ranges (a few miles), the use of the 1-watt-limit, 1750-meter experimenter band at 160 to 190 kHz might possibly make Keen's idea practical with lane widths of $1/2$ wavelength or 875 meters for one cycle of phase change of the beat note. Thus 875 meters becomes 360 degrees of the phase detector output. Typical phase detectors resolve to 1 per cent or so at audio beat frequencies, so in practice 8.75-meter resolution of the path over a particular hyperbola might be resolved.

Another system is available from

Hastings-Raydist Division of Teledyne Corporation. This has used transmitters in the 500 kHz to 2.5 MHz range, with hyperbolas 100 meters apart and resolution to within 1 meter. Still other worldwide hyperbolic navigation systems like OMEGA (10.2 to 13.6 kHz) and LORAN-C (100 kHz) use time-sequenced bursts or pulses to enable a large number of stations to all transmit on the same frequency and very effectively measure phase difference by the time of arrival or sequential memory-aided phase-locked loop methods. The very high power (1 megawatt) Navy vlf communications transmitters operating in the 14 kHz to 20 kHz range have also been used for worldwide navigation. Here, they are all atomic clock controlled, so all one has to do in principle is to convert the receiver measurement to a common i-f in the audio range at something like 100 Hz.

There are a great many pitfalls in devising new navigation systems that have been thoroughly worked over in the past 50 years. A general reference on the subject is Kayton and Fried *Avionics Navigation Systems*, John Wiley & Sons, published in 1969. Another reference, particularly on the early history of hyperbolic navigation, is NBS Monograph #129, "The Development of LORAN-C Navigation and Timing," U.S. Government Printing Office, \$4.50, published October, 1972. A major problem with any CW-type hyperbolic system is that of proper lane identification; that is, how does the navigator know where to start the phase measurement, which lane or which line of position is he on? The SHORAN system that Keen mentions is not a CW hyperbolic method but rather a direct ranging

time of arrival of pulse technique operating in the 200-300 MHz range. CW hyperbolic systems have largely been replaced by direct ranging ideas using coherent phase-locked transponders, but this always makes the system hardware more complex. When engineers think about these methods, what invariably happens is that the actual working hardware becomes much more complex and expensive than the inventor originally intended. Also, it is very hard these days to come up with something new. There are so many people thinking about the same idea at any given time that ten people will come up with the same idea at once, and there is just too much prior art to study.

Ralph W. Burhans
Athens, Ohio

RST

Dear HR:

I would like to make a comment to the "Observations & Comments," *ham radio*, September, 1980. I wholeheartedly agree with the idea of changing the RST system to something like Q1-Q2-Q3 as reporting signal conditions.

I am not a DXer or contest man, but I have put in some time logging on Field Day. It sure looks ridiculous to see the whole log with just RST 599. The RST system doesn't give a true picture of conditions. I like the Q1-Q2-Q3 because it seems to cover the total spectrum. But as it is done now, the whole contest report could be just all Q3s. Just for the record I think I will start using this system of Q1,2,3 and wait and see how many ask about it. It is worth a try.

George F. Schmidt, W0UCK
St. Louis, Missouri

NEWCOMER OR OLD PRO . . .

ALPHA POWER IS YOUR KEY TO A BIG SIGNAL

ALPHA/VOMAX can boost the "talk power" of any rig up to ten times or more. The new SBP-4 split band speech processor uses the only system more effective than rf clipping — AND distortion is extremely low so your voice sounds natural. Under tough conditions VOMAX can help as much as most linears. Combine VOMAX with a good linear and WOW! It's simple to install and operate with any rig.



ALPHA 374A is a heavy-duty "rock crusher" . . . a full kilowatt (2-KW PEP), No Time Limit, all band, NO TUNE UP desk top linear amplifier. It's a no-compromise ALPHA with a TWO YEAR FACTORY WARRANTY.

Other superb ALPHA s include the "Ultimate LINEAR" ALPHA 77Dx and the new ALPHA 78, which combines NO-TUNE-UP maximum legal power, No Time Limit, and high speed (vacuum relay) CW break-in. Call or write your dealer or ETO direct for illustrated literature on all ALPHA products.

ETO EHRHORN TECHNOLOGICAL OPERATIONS, INC.
P.O. BOX 708, CANON CITY, CO 81212
(303) 275-1613

SPECIAL! LIMITED OFFER!

AZDEN

only \$325⁰⁰
Includes T.T. Pad

You'll have more fun and excitement on 2 meter FM with the AZDEN PCS 3000 because of its popular, state-of-the-art convenience features such as micro-computer controlled full band scan and memory functions, CMOS PL digital synthesized, detachable control head, excellent receiver sensitivity, 25 watts out and much more.

Free U.P.S. — 90 day factory warranty



N.P.S. Inc. WA3IFQ

1138 Boxwood Rd. • Jenkintown, PA 19046
1-215-884-6010

RED HOT SPECIALS

AZDEN PCS-2000, 2 meters	249.00
ICOM 260A, All Mode, 2m	425.00
KANTRONICS CODE READER	360.00
AZDEN PCS-2800 10m FM	228.00
BEARCAT 220 or 250 SCANNER	269.00
ICOM IC 255A, 2 meters	310.00
SWAN ASTRO 150, New Style	750.00
ICOM IC251A, 2m All Mode	615.00
JANEL QSA 5, 2m Pre Amp	36.50
ICOM IC2A HANDHELD w Nicad	215.00
with Touch Tone Pad	239.00
ICOM 551, 6 meters.	408.00
ALL MFJ PRODUCTS	12% off List

Write for our Large Specials and Used Equipment Lists

BEN FRANKLIN ELECTRONICS

115 1/2 N. Main Hillsboro, KS 67063
316-947-2269

FREE

HEATHKIT CATALOG featuring the latest in amateur radio.

- Everything for your amateur radio hobby, including antennas and accessories
- Precision test instruments for the complete test bench
- Innovative self-study programs to help you enjoy your hobby more
- Complete line of computers, terminals, printers software and accessories
- Color TV's, fine stereo components, fuel-efficiency products, convenience items for your home . . .



2-meter equipment



Transceivers

All in easy-to-build, money-saving kits



Wattmeters



Self-study programs for novice and general class license exams



Frequency
Counters

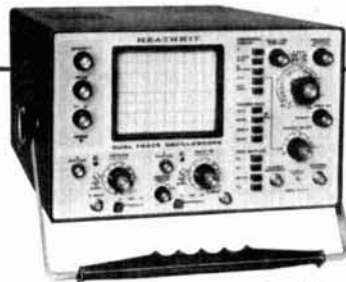

Oscilloscopes



Please send me your latest catalog. I am not currently receiving your catalog.

Send to: Heath Co., Dept. 348-742,
Benton Harbor, MI 49022

Name _____

Address _____

City _____ State _____

AM-414 Zip _____

presstop

PLAIN LANGUAGE AMATEUR RULES docket released in the form of a Notice of Proposed Rule Making, PR Docket 80-279, includes both the texts of the present Part 97 rules and the proposed rewrite, plus explanations. It was printed in the Federal Register of December 19.

Significant Changes, such as the deletion of all logging requirements and addition of a requirement that licensees must keep a copy of the Amateur rules on hand, also include a warning that the FCC can inspect a station "at any time during the business day or any time your station is transmitting or has just finished transmitting." The new rules no longer tell an Amateur how he should make various measurements, but only how the FCC inspector would make them during a station visit. The proposed new rules also clarify rules on interconnects (phone patches), antenna heights, and emergency and prohibited communications. They also include much more information on exams, both written and code, and propose that applicants with FCC Commercial CW licenses get credit for the equivalent Amateur CW exam. The rewrite also endeavors to consolidate and reorganize the rules into a more concise and logical arrangement.

In Addition To Being Printed in December 19's Federal Register, PR Docket 80-729 is also available in limited quantities from the FCC Office of Consumer Assistance, Room 258, 1919 M Street NW, Washington, D.C. 20554. Comments won't be due until June 19, 1981, and Reply Comments on August 19, 1981.

ITALIAN EARTHQUAKE AREA COMMUNICATIONS depended very heavily on Amateur Radio until telephone and other services were partially restored in mid December, with Amateur Radio still providing a major channel for relief traffic. Initial traffic from the disaster area included casualty lists, relayed from VHF links in the area by 18ULL near Naples. Many stations throughout the U.S. and Canada participated, with KALBQ and WB2FID leading the action on 28802 mornings and 14240 later in the day when conditions permitted.

The Need For Transatlantic Relief communications links should continue for at least several more months, because of the extent of the damage (over 26,000 square kilometers devastated) and the magnitude of the U.S.-originated relief effort. KALBQ (18CZW) left for Italy last month to work on the scene and attempt to convince the Italian government to continue its third party OK.

18ULL, Principal Terminal for U.S./Italy traffic, has been shut down several times by aftershock damage. KLM donated a replacement beam, which Alitalia shipped to Naples, to that station.

Participants In Relief communications represent all ethnic backgrounds, KALBQ noted, a graphic demonstration of the fraternal character of the Amateur Radio service.

30-METER BAND OPERATION was begun in early December by VE3QB, using his Canadian commercial callsign, VE9LFZ, for preliminary one-way transmissions with partner VE9LIN (VE3BPD). They plan to operate daily at 1500, 1700, and 1900Z, plus random times evenings starting at 2200Z. CW and (later) ASCII will be the modes, using 10.101 and 10.149 MHz.

VE9LFZ Was Solid Copy on 10.101 MHz in the Midwest Thanksgiving afternoon, with a more than hour-long transmission that peaked as high as 5-6 even though Larry was running only 5 watts to an inverted V. These are test transmissions only, authorized by the Canadian government, and Amateur operations on this band will be illegal until January, 1982.

CALIFORNIA BRUSH FIRES, which destroyed about 350 homes and burned hundreds of thousands of acres in December, brought out plenty of volunteer Amateur Radio support. More than 30,000 acres burned east of El Toro, where more than 50 operators used W6TIO/R and simplex channels to provide Red Cross, paramedics, and fire headquarters with needed radio services. A link with the National Traffic System was also set up providing health-and-welfare communications for the fire fighters, who came in from a seven-state area.

Another 150 Or So Amateurs served in San Bernardino/Riverside areas, where, along with many CBers, they provided communications for the Lake Arrowhead Evacuation Center.

Another Fire In The Big Basin Redwood State Park destroyed 350 acres of young redwoods there. Sixty-five-year-old K6TEH set up his portable 34-94 repeater there at the request of the Division of Forestry. A dozen others also took part.

PHASE III OF FCC'S CALLSIGN assignment system went into effect December 15, and with it all license classes except Novice became eligible to request callsign changes. Any Amateur who now holds a callsign not appropriate for his license class (1x3 for General/Technician, 2x2 for Advanced, 1x2/2x1 for Extra) may request a change to a callsign of the proper format, though without any choice as to the specific callsign he will receive.

FCC's New Form 610 (August, 1980 edition) is required by Phase III, so all previous editions are now obsolete and may not be used. As before, licensees still have the option of retaining their old callsigns when upgrading or changing call areas. A new callsign will not be assigned unless it's specifically requested by the licensee's having checked item 2F on the new Form 610.

Though Both The 4th and 6th call areas are running low on 2x1 callsigns for Extras, the Commission does not expect to be ready to go back to 1x2s until 1983 at the earliest.



MFJ Super Keyboard

For \$279.95 you get: CW, Baudot, ASCII, buffer, programmable and automatic messages. Morse code practice, full featured keyer, human engineering.

Sending CW has always been a task, especially when you get a little tired. Electronic keyers help, but it's still too much work.

Now MFJ has a Super Keyboard that makes sending perfect CW effortless. It also sends Baudot RTTY and ASCII.

"Big deal" you say. "What's so special about that. There are lots of keyboards." Yes, but this one is different.

HUMAN ENGINEERED

A lot of thought has gone into human engineering the MFJ-494 Super Keyboard.

For example, you press only a one or two key sequence to execute any command.

All controls and keys are positioned logically and labeled clearly for instant recognition.

Pots are used for speed, volume, tone, and weight because they are more human oriented than keystroke sequences and they remember your settings.

A meter gives continuous readout of buffer memory and speed. Two characters before full, the meter lights up red and the sidetone changes pitch.

PROGRAMMABLE, AUTOMATIC MESSAGES

Four automatic messages and two programmable message memories (A and B) are provided. Messages A and B can be a total of 30 characters. B starts where A ends.

When recalled, each message takes only one character of the buffer. They may be chained and/or repeated via the buffer.

"Well," you say, "that sure is not much memory." But it's more than it seems because of the built-in automatic messages.

For example, type your call into message A. Then by pressing the CQ button you send CQ CQ DE (message A). Press twice to send twice, etc.

The other automatic messages work the same way: CQ TEST DE (message A), DE (message A), QRZ (message A).

Special keys for KN, SK, BT, AS, AA, and AR.

TEXT BUFFER

The 50 character text buffer sends smooth perfect code even if you "hunt and peck."

Since each automatic or programmable message takes only one buffer character, this gives a far larger effective buffer.

You can preload a message into the buffer. Then when you are ready to transmit press the control key.

You can hold the buffer by pressing the shift key and space bar.

With the buffer in hold, you can send a comment with an external paddle as a keyer. To resume sending buffer, press the control key.

Simply backspace to delete errors.

RTTY: BAUDOT, ASCII

5 level Baudot is transmitted at 60 WPM. RTTY and CW ID are provided via message A.

Carriage return, line feed, and "LTRS" are sent automatically on the first space after 63 characters on a line. After 70 characters the function is initiated without a space. This gives unbroken words at the receiving end and frees you from sending the carriage return.

All up and down shift is done automatically. A downshift occurs on every space to quickly clear any garbles in reception.

The buffer, programmable and automatic messages, backspace delete and PTT control (keys your rig) are included.

The ASCII mode includes all the features of baudot. Transmission speed is 110 baud. Both upper and lower case are generated.

MORSE CODE PRACTICE

There are two Morse code practice modes. Mode 1: random length groups of random characters. Mode 2: pseudo random 5 character groups in 8 separate repeatable list. With answer list.

Insert space between characters and groups to form high speed characters at slower speed for easy character recognition.

Select alphabetic only or alphanumeric plus punctuation. Pause function lets you stop and then resume.

IT'S A KEYSER, TOO

Plug in a paddle to use it as a deluxe full feature keyer with automatic and programmable memories, iambic operation, dot-dash memories, and all the features of the CW mode.

MORE FEATURES

Tune switch with LED keys transmitter for tuning. Tune key provides continuous dots to save finals. Built-in sidetone and speaker.

PTT (push-to-talk) output keys transmitter for Baudot and ASCII modes.

Reliable solid state keying for CW: grid block, cathode, solid state transmitters (300 V, 10 ma. Max, +300 V, 100 ma. Max). TTL and open collector outputs for RTTY and ASCII.

Fully shielded. RF proof. All aluminum cabinet. Black bottom, eggshell white top. 12"D x 7"W x 1 1/4"H (front) x 3 1/2"H (back).

9-12 VDC or 110 VAC with optional adapter.

OPTIONS

MFJ-53 AFSK PLUG-IN MODULE. 170 and 850 Hz shift. Output plugs into mic or phone patch jack for FSK with SSB rigs and AFSK with FM or AM rigs. \$39.95 (+\$3).

MFJ-54 LOOP KEYING PLUG-IN MODULE. 300 V, 60 ma. loop keying circuit drives your RTTY printer. Opto-isolated. TTL input for your computer to drive your printer. \$29.95 (+\$3).

BENCHER IAMBIC PADDLE. \$42.95 (+\$4).

110 VAC ADAPTER. \$7.95 (+\$3).

A PERSONAL TEST

Give the MFJ-494 Super Keyboard a personal test right in your own ham shack.

Order one from MFJ and try it — no obligation. See how easy it is to operate and how much more enjoyable CW and RTTY can be. If not delighted, return it within 30 days for refund (less shipping). One year unconditional guarantee.

To order, call toll free 800-647-1800. Charge VISA, MC or mail check or money order for **\$279.95** for MFJ-494 Super Keyboard, **\$39.95** for MFJ-53 AFSK module, **\$29.95** for the MFJ-54 loop keying module, **\$42.95** for Bencher Paddle, and **\$7.95** for the 110 VAC adapter. Include \$5.00 shipping and handling per order or as indicated in parentheses if items are ordered separately.

Why not really enjoy CW and RTTY? Order your MFJ Super Keyboard at no obligation today.

**TO ORDER OR FOR YOUR NEAREST DEALER
CALL TOLL FREE 800-647-1800**

Call 601-323-5869 for technical information, order/repair status. Also call 601-323-5869 outside continental USA and in Mississippi.

Write for FREE catalog, over 60 products

**MFJ ENTERPRISES,
INCORPORATED**

Box 494, Mississippi State, MS 39762

HI-Q BALUN

- For dipoles, yagis, inverted vees & doublets
- Replaces center insulator
- Puts power in antenna
- Broadbanded 3-40 MHz.
- Small, lightweight and weatherproof
- 1:1 Impedance ratio
- For full legal power and more
- Helps eliminate TVI
- With SO 239 connector



\$10.95

HI-Q ANTENNA CENTER INSULATOR



Small, rugged, lightweight, weatherproof. Replaces center insulator. Handles full legal power and more.

\$5.95 With SO 239 connector

HI-Q ANTENNA END INSULATORS



Rugged, lightweight injection molded of top quality material, with high dielectric qualities and excellent weatherability. End insulators are constructed in a spiral winding fashion to permit winding of loading coils or partial winding for tuned traps.

- May be used for
- Guy wire strain insulators
- End or center insulators for antennas

\$4.95 • Construction of antenna loading coils or multiband traps

DIPOLES

MODEL	BANDS	LENGTH	PRICE WITH HI-Q BALUN	WITH HI-Q CENTER INSULATOR
Dipoles				
D-80	80-75	130	\$28.95	\$24.95
D-40	40/15	66	25.95	21.95
D-20	20	33	24.95	20.95
D-15	15	22	23.95	19.95
D-10	10	16	22.95	18.95
Shortened dipoles				
SD-80	80-75	90	31.95	27.95
SD-40	40	45	28.95	24.95
Parallel dipoles				
PD-8010	80-40/20/10/15	130	39.95	35.95
PD-4010	40-20/10/15	66	33.95	29.95
PD-8040	80-40/15	130	35.95	31.95
PD-4020	40-20/15	66	29.95	25.95
Dipole shorteners - only, same as included in SD models				
S-80	80-75		\$11.95 pr	
S-40	40		\$10.95 pr	

All antennas are complete with a HI-Q Balun or HI-Q Antenna Center Insulator. No. 14 antenna wire, ceramic insulators, 100 nylon antenna support rope (SD models only 50) rated for full legal power. Antennas may be used as an inverted V and may also be used by MARS or SWLs.

Antenna accessories - available with antenna orders:
Nylon guy rope, 450' test, 100' roll \$3.49
Ceramic (Dugzone) Type antenna insulators 70 pr \$5.00
SO 239 coax connectors 55

All prices are postpaid USA 48. Available at your favorite dealer or order direct from:

Van Gorden Engineering
Box 21305, S. Euclid, Ohio 44121 Dealer Inquiries Invited

WHY PAY

FULL PRICE FOR AN 80-10 METER VERTICAL

- ... if you can use only 1/3 of it on 10?
- ... or only 1/2 of it on 20?
- ... or only 3/4 of it on 40?

Only Butternut's new HF5V-III lets you use the entire 26-foot radiator on 80, 40, 20 and 10 meters (plus a full unloaded quarter-wavelength on 15) for higher radiation resistance, better efficiency and greater VSWR bandwidth than conventional multi-trap designs of comparable size. The HF5V-III uses only two high-Q L-C circuits (not traps) and one practically lossless linear decoupler for completely automatic and low VSWR resonance (typically below 1.5:1) on 80 through 10 meters, inclusive. For further information, including complete specifications on the HF5V-III and other Butternut antenna products, ask for our latest free catalog. If you've already "gone vertical," ask for one anyway. There's a lot of information about vertical antennas in general, ground and radial systems, plus helpful tips on installing verticals on rooftops, on mobile homes, etc.

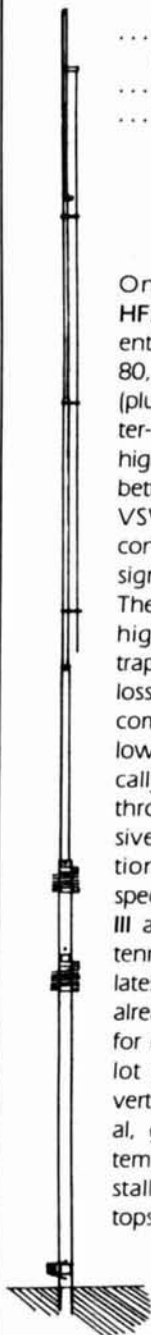

BUTTERNUT ELECTRONICS CO.

P.O. Box #1411
San Marcos, Texas 78666
Phone: (512) 396-4111

CALL TOLL FREE

For the best deal on

- AEA • Alliance • Ameco • Apple • ASP
- Avanti • Belden • Bencher • Bird • CDE
- CES • Communications Specialists
- Collins • Cushcraft • Daiwa • DenTron
- Drake • Hustler • Hy-Gain • Icom • IRL • KLM
- Kenwood • Larsen • Macrotronics • MFJ
- Midland • Mini-Products • Mirage • Mosley
- NPC • Newtronics • Nye • Panasonic
- Palomar Engineers • Regency • Robot
- Shure • Standard • Swan • Tempo
- Ten-Tec • Transcom • Yaesu

Presidents' Birthday Specials

TEMPO S-1, only \$239
with touchtone \$269

ICOM IC-255A (old model, while they last) only \$299

KENWOOD TR-7600A closeout \$269.95

YAESU FT-207R for the best price yet CALL!

APPLE Disk Based System: Apple II or II Plus with 48k RAM installed, Disk II with controller, RF Modulator; NEW DOS 3.3 \$1799

APPLE 16k Special \$995!

Apple prices include prepaid shipping within continental United States. Erickson is accepting late model amateur radio equipment for service; full time technician on duty.

CALL TOLL FREE (outside Illinois only)

(800) 621-5802

HOURS: 9:30-5:30 Mon., Tues., Wed. & Fri.
9:30-9:00 Thursday
9:00-3:00 Saturday

ERICKSON COMMUNICATIONS
Chicago, IL 60630
5456 North Milwaukee Ave.
(312) 631-5181 (within Illinois)

FREE BOOK FLYER

Whether you're interested in Amateur Radio, Electronics, Radio Astronomy, Old-Time Radio, VHF, SSB or just novels that involve Amateur Radio — you'll find a large selection of these books and more! Vast inventory of over 200 titles. Send your name and address to:

HAM RADIO'S BOOKSTORE
Greenville, NH 03048

We'll send you our most current book flyer and add your name to our bookstore list.

MORE PERFORMANCE FOR YOUR DOLLAR! COMPETITORS KNOW ABOUT THE ISOPOLE™

DO YOU? STUDY THE FACTS . . .

The IsoPole is building a strong reputation for quality in design and superior performance. The IsoPole's acceptance has already compelled another large antenna producer to make a major design modification to his most popular VHF Base Station antenna. Innovative IsoPole conical sleeve decouplers (pat. pend.) offer many new design advantages.

All IsoPole antennas yield the **maximum gain attainable** for their respective lengths and a zero degree angle of radiation. Exceptional decoupling results in simple tuning and a significant reduction in TVI potential. Cones offer greater efficiency over obsolete radials which radiate in the horizontal plane and present an unsightly bird's roost with an inevitable "fallout zone" below. The IsoPoles have the broadest frequency coverage of any comparable VHF base station antenna. This means no loss of power output from one end of the band to the other, when used with SWR protected solid state transceivers. **Typical SWR is 1.4 to 1 or better across the entire band!**

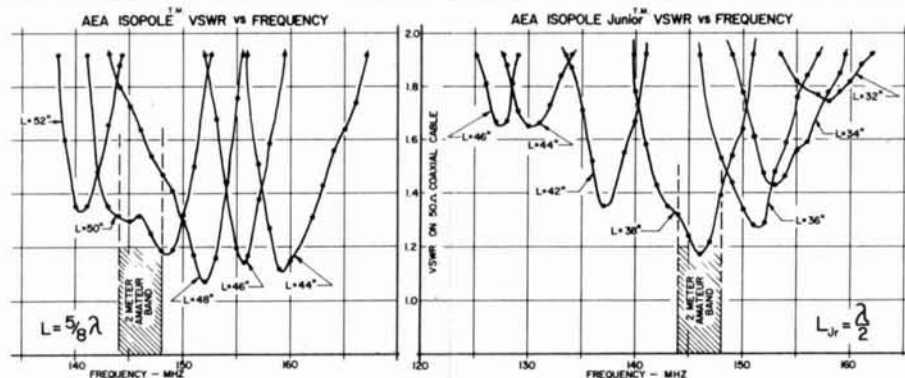

Outstanding mechanical design makes the IsoPole the only logical choice for a VHF base station antenna. A standard 50 Ohm SO-239 connector is recessed within the base sleeve (fully weather protected). With the IsoPole, you will not experience aggravating deviation in SWR with changes in weather. The impedance matching network is weather sealed and designed for maximum legal power. The insulating material offers superb strength and dielectric properties plus excellent long-term ultra-violet resistance. All mounting hardware is stainless steel. The decoupling cones and radiating elements are made of corrosion resistant aluminum alloys. The aerodynamic cones are the only appreciable wind load and are attached directly to the support (a standard TV mast which is **not supplied**)

Operating on MARS or CAP? The IsoPole and IsoPole Jr. antennas will typically operate at least ± 2 MHz outside the respective ham band without re-tuning. However, by simple length adjustment, the IsoPoles can be tuned over a wider range outside the ham bands.

Our competitors have reacted to the IsoPole, maybe you should too! Order your IsoPole or IsoPole Jr. today from your favorite Amateur Radio Distributor. For more information on other exciting AEA products, contact Advanced Electronic Applications, Inc., P.O. Box 2160, Lynnwood, WA 98036. Call 206/775-7373

AEA Brings you the Breakthrough!

PRICES AND SPECIFICATIONS SUBJECT TO CHANGE WITHOUT NOTICE OR OBLIGATION.

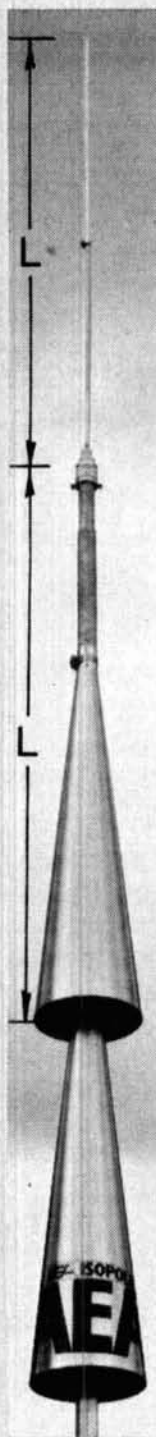

ISOPOLE 144
\$49.95
ISOPOLE 220
\$44.95
MAST NOT SUPPLIED



ISOPOLE
144JR
ISOPOLE
220JR
\$39.95
MAST NOT SUPPLIED



for preamplifiers and converters

A recent article by W6NBI¹ describes an easily duplicated temperature-limited diode noise generator and power supply. This generator provides both a reproducible source of noise and, by measuring the diode plate current, an easy method to measure the noise power output of the source. As will be discussed, verification of a receiver's noise figure by the use of this generator is straightforward, using either the y-factor or twice-power methods.

Optimization of the noise figure of a receiver is quite tedious because each time a parameter is varied, two measurements (insertion of a pad and some calculations) are required. Also, since the two measurements are taken at different times, any gain drift in the system will introduce error into the measurement. If you are willing to restrict the noise source to a temperature-limited diode, it's possible to build a very accurate automatic noise-filter meter that avoids some of the compromises multisource meters must make to accommodate different sources.

derivation of the noise-figure concept

Noise factor (F) of a receiver is defined as

$$F = \frac{S/N_I(\text{Ideal Receiver})}{S/N_A(\text{Actual Receiver})} = \frac{N_A}{N_I} = \frac{\text{Noise Power Actual Receiver}}{\text{Noise Power Ideal Receiver}} \quad (1)$$

and in logarithmic terms

$$\text{Noise Figure (NF)} = 10 \log F \quad (2)$$

It's important to keep the $\log NF$ terms and the numerical ratio F terms separate in your mind; if you mix them up you'll make errors when calculating correction factors.

If we call N_I the noise output power from the

automatic noise-figure meter

receiver when its input is terminated in a 50-ohm resistor at a temperature of 290 K (62 F), then

$$N_I = N_{RA} + N_T G \quad (3)$$

where N_{RA} = receiver added noise power
 N_T = termination resistor noise power
 G = receiver gain

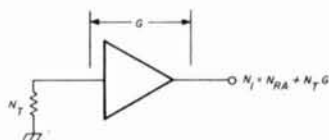

If we then apply an excess noise to the receiver input we can define:

$$N_2 = N_{RA} + N_T G + (EN)G \quad (4)$$

where EN = excess noise power.

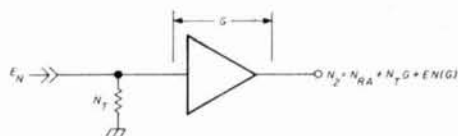

Noise power (N) = kTB

and k = Boltzman's constant $1.374 \times 10^{-23} \frac{\text{Joules}}{\text{°K}}$

T = absolute temperature °K ($\text{°C} + 273^\circ$)

B = bandwidth

then

$$N_T = k T_0 B \quad (5)$$

where $T_0 = 290 \text{ K}$ (62 F) (by IEEE Convention)

$$EN = kTB \quad (6)$$

where T = effective temperature of the excess noise source in °K .

The definition of the noise factor of a receiver (eq. 1) is

$$F = \frac{N_A}{N_I} = \frac{N_I}{kT_0BG}$$

By Edward T. Gisske, K9IMM, 7256 Mineral Point Road, Verona, Wisconsin 53593

The amount of noise added by the receiver is

$$\frac{N_2}{N_1} = \frac{kT_0BG + (F-1)(kT_0BG) + kTBG^*}{kT_0BG + (F-1)(kT_0BG)}$$

$$= \frac{FT_0 + T - T_0}{FT_0}$$

Rearranging

$$F = \left(\frac{T - T_0}{T_0} \right) \left(\frac{N_2}{N_1} - 1 \right) \quad (7)$$

or, in dB

$$NF = 10 \log \left(\frac{T - T_0}{T_0} \right) - 10 \log \left(\frac{N_2}{N_1} - 1 \right) \quad (8)$$

The first term is equal to the excess noise ratio (ENR) of the source expressed in dB

$$NF = ENR(dB) - 10 \log \left(\frac{N_2}{N_1} - 1 \right) \quad (9)$$

The term N_2/N_1 is referred to as the y -factor and is used by automatic noise-figure meters such as the HP-340 series to measure noise figure in the following manner:²

With reference to fig. 1, note that the source is gated on and N_2 is measured; then the source is gated off and N_1 is measured. This sequence is repeated at about a 500-Hz repetition rate. The ENR of the source is known, and N_2 is used to set the gain of the i-f amplifier so that N_2 is a fixed output regardless of the receiver gain. Then, by measuring N_1 , the ratio N_2/N_1 is known. The meter is calibrated to solve the equation:

$$NF = ENR - 10 \log \left(\frac{N_2}{N_1} - 1 \right) \quad (10)$$

This ratiometric measurement factors receiver gain out of the measurement, so it's possible to tune for minimum noise figure without recalibration. Note that the i-f amplifier agc loop must be very tight, as the measurement depends on maintaining a constant reference (N_2) level. The i-f amplifier and detection

*The transition from eq. 6 to eq. 7 may not be obvious to some readers, in view of the appearance of the term $(F-1)$. The equation for N_2/N_1 is correct, however, as the following shows:

By definition, the noise temperature, T , of the input terminating resistor is related to the equivalent noise factor, F , contributed by the terminating resistor by the relationship

$$T = T_0(F-1)$$

rearranging

$$\frac{T}{T_0} = (F-1)$$

therefore

$$(F-1)(kT_0BG) = \frac{T}{T_0}(kT_0BG) = kTBG$$

Note that if $T = T_0$, $(F-1) = 1$. $(F-1)$ accounts for the noise power at the amplifier output due to the input terminating resistor operating at some temperature $T^\circ K$. When $T \neq T_0$, then a correction for overall noise figure is made. Editor.

circuitry must also be linear over a range of agc levels to get a valid N_1 measurement.

Another noise-figure measuring method, usually used for manual measurements, is called the twice-power method. This method forces $N_2 = 2N_1$ by adjustment of the source ENR.

$$NF = ENR(dB) - 10 \log \left(\frac{N_2}{N_1} - 1 \right)$$

$$N_2 = 2N_1$$

$$= ENR - 10 \log \left(\frac{2}{1} - 1 \right)$$

$$NF = ENR \quad (11)$$

Fig. 2 shows a block diagram of the measurement. In practice, the measurement is performed as follows: with the noise source off and the pad out of the circuit; the power meter reading is noted. The source is then activated and the 3-dB pad inserted into the circuit. The source ENR is adjusted to produce exactly the same reading as before. When this condition is satisfied, the ENR of the source is equivalent to the receiver noise figure. The ENR of the source is usually adjusted by padding the source with a precision variable attenuator.

The attenuator setting is subtracted from the known ENR of the source to compute the receiver noise figure. This works for temperature-limited diode, argon discharge, or semiconductor diode sources. With the temperature-limited diode, an additional method of adjusting source ENR is to adjust the diode plate current (by varying the filament current) and thus vary the effective source temperature. Coincidentally, in a 50-ohm system, the noise factor $F \cong \frac{\text{diode plate current}}{1000}$ and noise figure, $NF \cong 10$

$\log I(mA)$. (See reference 1 for a derivation of this relationship.) The advantage of the twice-power method over the y -factor method is that the power-measuring circuit is always operated at the same signal level; therefore linearity of the amplifiers and de-

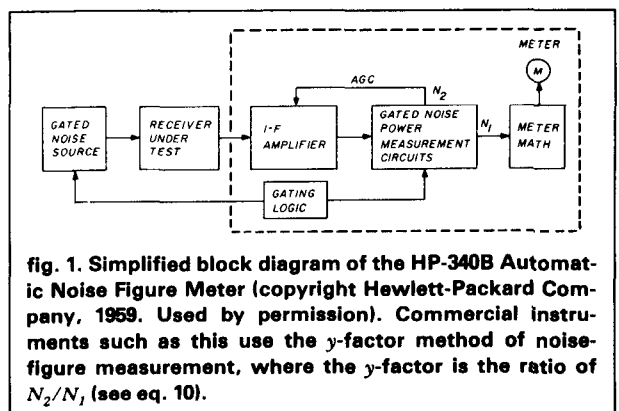

fig. 1. Simplified block diagram of the HP-340B Automatic Noise Figure Meter (copyright Hewlett-Packard Company, 1959. Used by permission). Commercial instruments such as this use the y -factor method of noise-figure measurement, where the y -factor is the ratio of N_2/N_1 (see eq. 10).

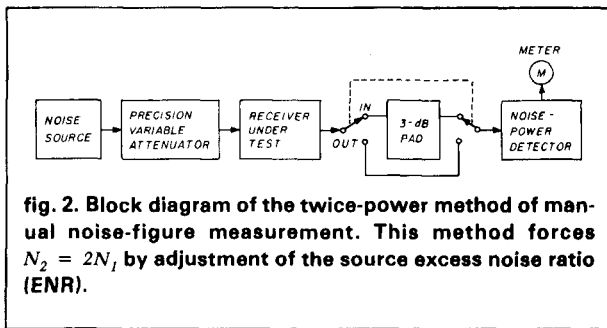

fig. 2. Block diagram of the twice-power method of manual noise-figure measurement. This method forces $N_2 = 2N_1$ by adjustment of the source excess noise ratio (ENR).

tector in the circuit has no effect on the accuracy of the measurement.

an automated twice-power measurement system

Commercial automatic-noise-figure (ANF) meters use the γ -factor method because they're designed to work with a combination of sources, argon discharge, semiconductor or temperature-limited diode, necessary to cover a wide range of frequencies up to the GHz region. Frequencies of major interest to Amateurs are in the 10-600 MHz region. This allows the use of the temperature-limited diode as the only necessary source and greatly simplifies the measurement problem.

With reference to the block diagram of fig. 3 and the timing chart in fig. 4, note that the noise source is gated both in the filament circuit and in the plate circuit. The plate gate turns the source *on* or *off*, and the filament gate adjusts the ENR by pulse-width modulating the filament current. Because of its long thermal time constant, the filament is not used for noise source on-off gating.

The receiver under test can be any combination of amplifiers and/or mixers with an output frequency of 28 MHz and an output impedance of 50 ohms.

The ANF-meter input is through an electronically switched 50-ohm 3dB attenuator. This pad is switched into the circuit when the source is on, and out of the circuit when it is off. A train of noise pulses from the attenuator is fed to the i-f amplifier, which amplifies the noise pulses to a usable level. The input level of this meter should be $7 \mu\text{V}$ (-90 dBm) or greater for proper operation.

The i-f strip output is detected with a half-wave hot carrier diode detector and fed through an amplifier to the two sample-and-hold (S&H) amplifiers. The S&H amplifiers are circuits that will follow the input voltage when in sample mode and hold the final voltage of the sample period in hold mode until updated with a new sample pulse. S&H 1 samples the last half of the *attenuator out-source off* period. Sampling is done in the last half of the period to allow attenuator

and source switching transients to die out. S&H 2 samples the last half of the *source on-attenuator in* period. The outputs of these two S&H amplifiers are presented to the comparator. If the comparator decides S&H 1 output is higher than S&H 2, it turns on the source filament. If S&H 2 output is higher than S&H 1, it turns off the filament. This sample-and-compare cycle is repeated at a 170-Hz rate.

At this update rate, the filament thermal inertia will average the on and off pulses to give a filament temperature corresponding to exactly 3 dB ENR. The S&H 1 output is fed back to the agc input of the i-f strip to reduce the i-f gain for converters or amplifiers with very high gain or poor noise figure. This is a rather loose agc loop but, for this application, where the sample-and-hold amplifiers are compared only to see which one is higher, it's only necessary to keep the i-f output within the common-mode range of the comparator and the linear range of the sample-and-hold amplifiers. The agc loop time constants and loop gain are somewhat critical because this is a sampled-data servo loop. Such loops, unless properly compensated, will tend to be unstable. Linearity of the system is unimportant, as the i-f amplifier, the detector and the S&H preamplifier are all working at the same level of noise when the system is in balance.

The source plate current is detected as a voltage across the 100-ohm resistor in the source plate supply return. As this current is being pulsed by the gating circuitry, S&H 3 is needed to sample during the *source on* period and hold during the *source off* period. S&H 3 output, which is proportional to the source plate current, is supplied to the log amplifier, which converts noise factor to noise figure and allows the meter to have a linear scale. The log amplifier output feeds a "perfect" rectifier, which ensures that only positive voltage reaches the meter. The summing junction of this op amp makes a handy place to supply a calibrated offset voltage to add or subtract a correction factor for the source ENR vs. frequency error and for loss pads.

manual noise figure measurement circuit

This meter can also be used for manual twice-power-method noise figure measurements when it is difficult to get a 28-MHz output from the receiver under test. In this mode the source is turned on all the time, and a comparator monitors a voltage corresponding to desired plate current (set by a front-panel pot) and the voltage across the meter. When the meter voltage is higher than the set-point voltage, the filament is turned off and *vice-versa*. When the source is adjusted to give exactly 3-dB ENR, the

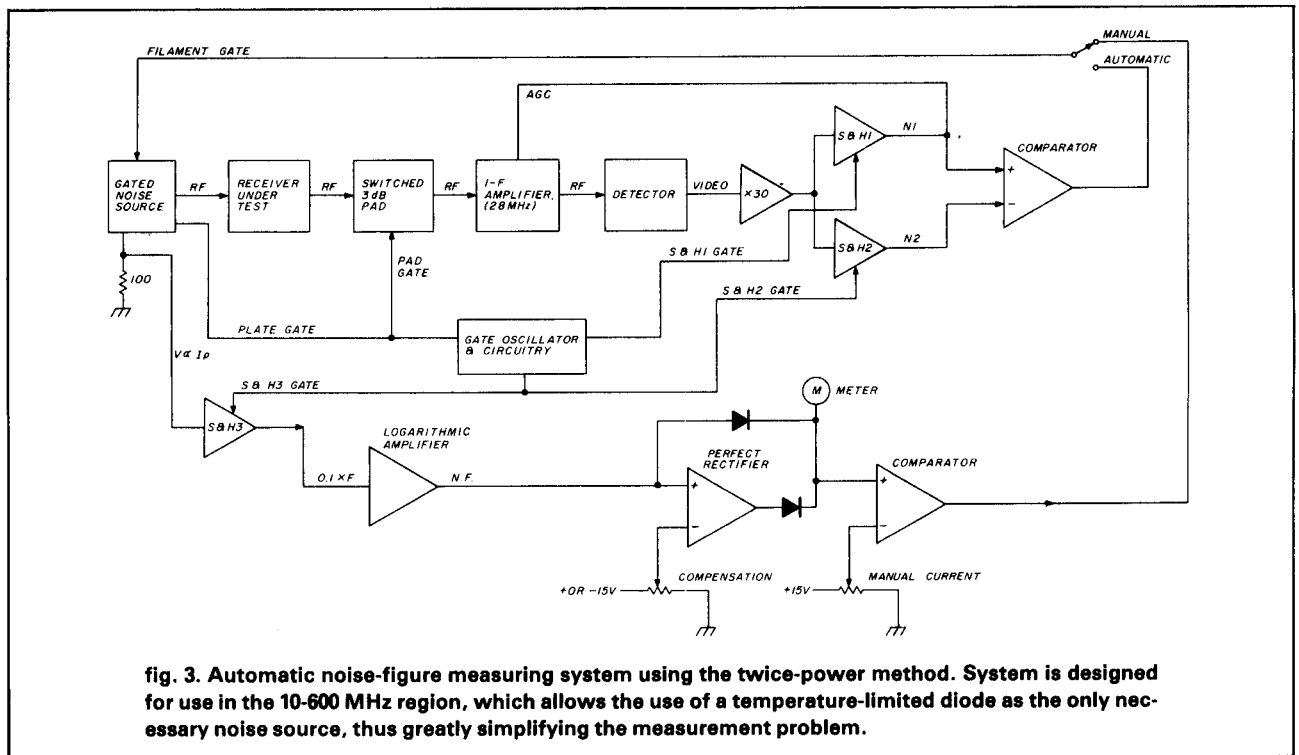

noise figure can be read directly from the meter. The i-f loop is disabled during operation in manual mode.

circuit details

Fig. 5 shows the noise-figure meter schematic. The noise source can be either an HP-343A or the homebrew 5722 source described by W6NBI¹. I prefer the 5722 source because the price for the tube is \$9.00 compared to the \$90.00 that HP charges for their noise diode. The homebrew source, if carefully constructed, should be as good as the HP source. The meter power supply is a fairly conventional $\pm 15V$ regulated supply. The 10- μF bypass capacitors

for U13 and U14 should be mounted immediately at the device terminals or oscillation is a likely result.

The source has a grounded plate, so the 200-volt plate supply has its positive end grounded through the gate transistor, Q1, and the current measuring 100-ohm resistor. Q1 and Q4 form a quasi-Darlington switch designed to minimize base current injection into the current-measuring circuit. The negative end of the plate supply is fed up the filament line to the source. Q2 gates the filament current, and the 6.2-volt zener diode ensures that the maximum filament voltage is 4.9 volts. Q2 is driven by opto-isolators, as it is floating 200 volts below ground.

The receiver noise output is applied to the electronically switched 3-dB pad at the input to the i-f strip. When the voltage at point D is +15 volts, CR5 is turned on and CR4 and CR6 are back biased. This removes the pad from the circuit. When point D is grounded, the pad is switched into the circuit by CR4 and CR6, while CR5 is back biased. This pad should be symmetrically constructed using minimum lead lengths. The ultimate accuracy provided by the ANF meter depends on the accuracy of this pad. One-quarter-watt carbon film resistors and small disc ceramic capacitors should be used for best results. The output of the pad is connected to the next stage through a highpass filter to reduce the effect of switching transients on the next stage. Q4 is a broadband amplifier designed for 50-ohm input and output

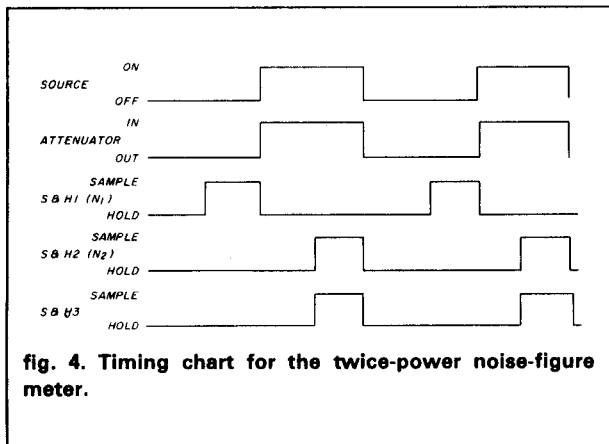

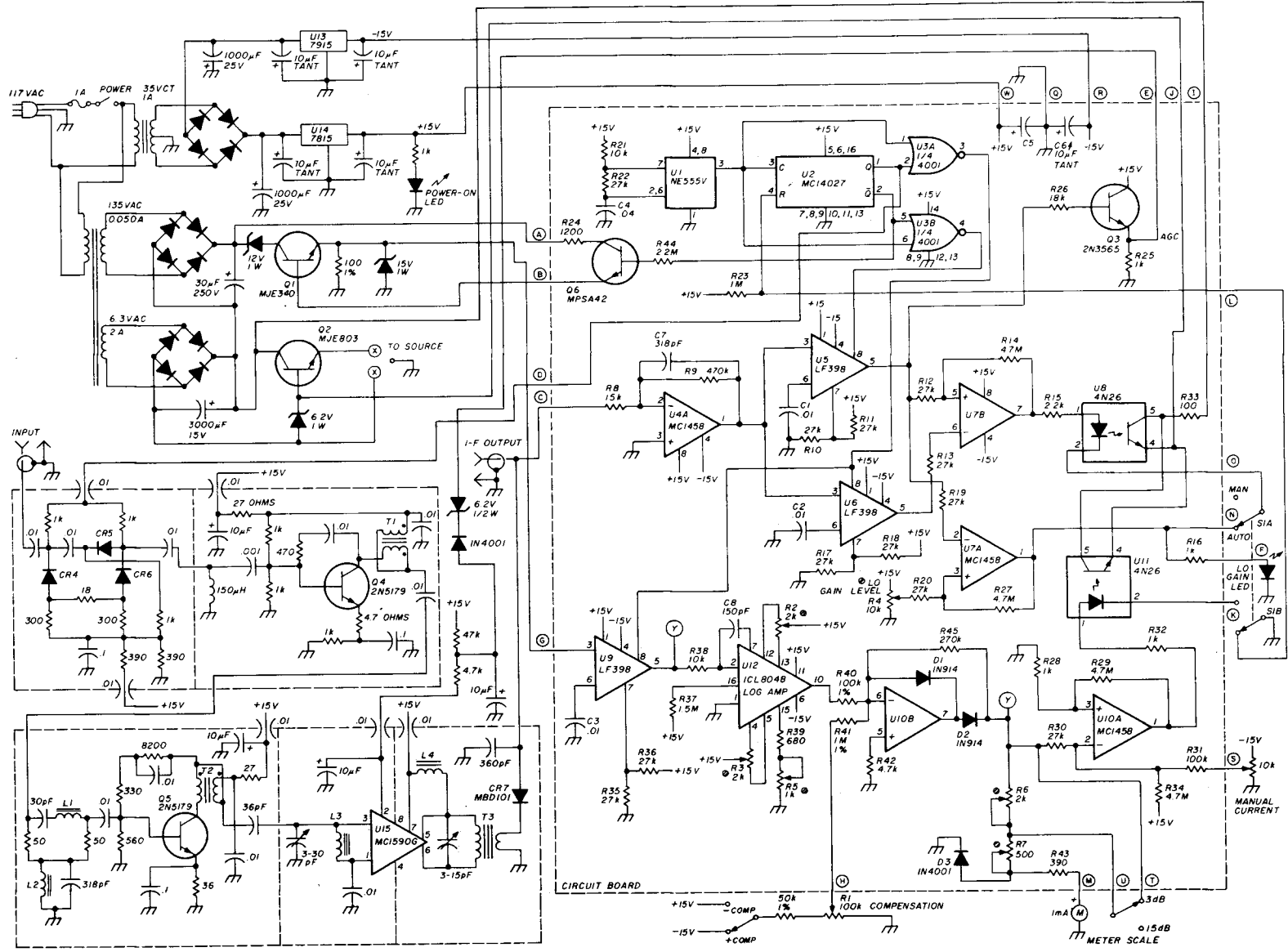

- | | | | |
|--------|--|--------|-------------------------------------|
| C1,2,3 | .01 µF polystyrene or polypropylene. | L1 | 141 No. 22 T37-2 core |
| D4,5,6 | Motorsol MPM3402 PIN diode. | L2 | 31 No. 22 T37-2 core |
| D7 | Motorsol MBD101 hot-carrier diode. | L3 | 111 No. 22 T50-6 core |
| S1 | Double pole double throw, center off, toggle switch. | L4 | 121 No. 22 T37-61 core |
| U5,6,9 | National LF 398 sample and hold amplifiers. | T1, T2 | 61 No. 22 bifilar wound T37-61 core |
| U12 | Intersil ICL8048CCPE log amplifier. | | |

fig. 5. Schematic of the automatic twice-power NF meter.

impedance and has 10 dB gain. A diplexer interstage network tuned to 28 MHz feeds another 11-dB broadband amplifier. The broadband negative feedback amplifiers are used to ensure unconditional stability and proper wideband termination for the pad.

U15, an MC 1590G, provides the bulk of the gain (50 dB) as well as a 60-dB agc range. Both input and output of this amplifier are tuned to 28 MHz; since it packs a lot of gain into a small package, shielding is necessary for stability. A hot-carrier diode coupled to the MC 1590 tank is the detector, and the 360-pF capacitor provides light filtering of the detected noise level. Averaging of the noise level is done by the memory capacitors in the sample-and-hold amplifiers. The detector output is coupled to U4A, which has a dc gain of 31 and provides some additional filtering.

N_1 and N_2 pulses are separated by the sample-and-hold amplifiers U5 and U6. Q3 buffers the output of U5. The 6.2 V zener diode and forward-biased silicon diode level-shift the agc for the MC 1590. The agc level starts at 6.8 volts and goes up with increasing signal level.

U7B compares N_1 and N_2 levels and decides whether or not to turn on the filament in the source. U7A is another comparator that decides if there is sufficient noise signal for an accurate measurement. If the N_1 pulse level is too low, the front panel "low gain" LED is lit, and the cathode of the LED in U8 is elevated to +15 volts. This action disables the filament circuit, keeping the terminating resistor cool and saving the noise tube.

U1, U2, and U3 compose the timing circuit for generating the gate signals. U1, an NE555V, functions as an astable multivibrator at 340 Hz. U2, a flip flop, divides U1's output by 2 and by combining U2 and U1 outputs in U3, the nonoverlapping quadrature sampling pulses are synthesized. In the manual

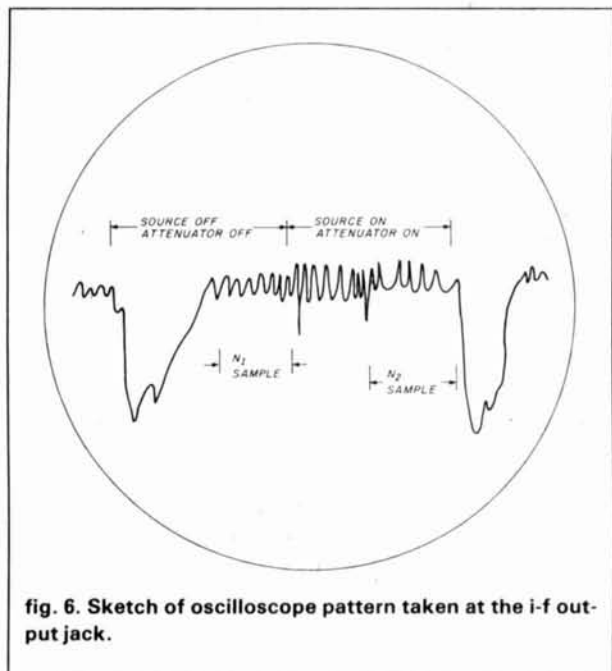
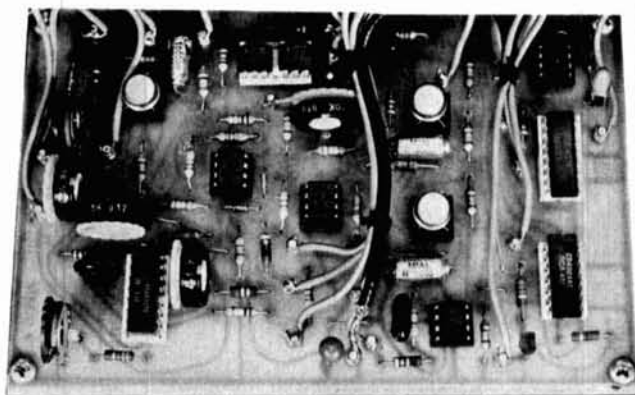

fig. 6. Sketch of oscilloscope pattern taken at the i-f output jack.

mode, U2's reset input is held high. This action enables the source continuously and U9, the meter circuit sample-and-hold amplifier, operates at a 340 Hz rate. In the automatic mode U9 samples during the last half of the source-on period and supplies a smoothed voltage proportional to plate current to the log amplifier, U12. The signal at the output of U12 corresponds to noise factor $\times 0.1$, which the log amplifier converts to noise figure. This chip is quite expensive (about \$35) and can be eliminated if the meter is recalibrated. The meter will now read noise factor and should have 3 mA and 30 mA full-scale positions. If you decide not to use the log amplifier, pull U12 and disable U10B by removing its external components. Connect points Y together and do not install the compensation pot, R1, or its switch.

U10B, a perfect rectifier, blocks negative voltages from pinning the meter down-scale. U12 output is negative for source plate currents of less than 1 mA and -15 V for zero plate current. U10A is the comparator for the manual mode. It decides if the source current, as represented by a voltage across the meter circuit, is higher or lower than the desired current, set by the front panel manual-current control. The 4.7 megohm resistor between the output of U10A and its noninverting input supplies a minor amount of hysteresis, and the 4.7 megohm resistor between the inverting input of U10A and +15 V swamps out any offset in U10A and ensures that the plate current of the source can be zeroed with the manual current control.



PC board.

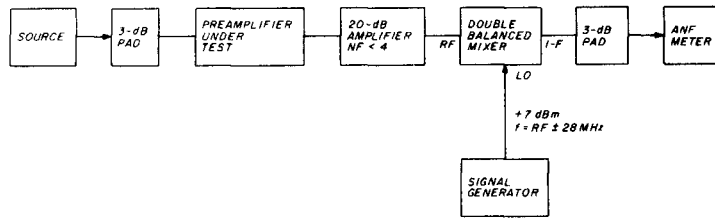

fig. 7. Block diagram showing technique for measuring noise figure of preamplifiers or converters.

construction

The i-f strip is built into an enclosure made of double-sided PC board. All voltages are brought into the strip through feedthrough capacitors. Button ceramic capacitors are used for bypass purposes, and ceramic standoffs are used for unbypassed tie points. Even though the i-f strip operates at 28 MHz, the F_T of Q4 and Q5 is 1.4 GHz, and the MC 1590 operates up to 300 MHz; therefore vhf construction techniques must be used to ensure stability. A shield should be mounted across pins 8 and 4 on the MC 1590 to isolate the input and the output of this stage.

The logic and analog circuits are all on the PC board. Sockets should be used for the integrated circuits as some must be pulled during calibration. All resistors are 1/4 watt 10 per cent tolerance, and all capacitors are disc ceramics unless otherwise noted. The power supply and switching transistors are mounted onto the chassis. Q2 should be bolted to the chassis for a heat sink. This transistor and the rest of the filament power circuit should be treated with caution, as it is at -200 volts.

Don't use a 2-pin connector for the source and rely on the connector shell for a ground; otherwise you may get a 200-volt surprise when you plug in the source with the power on. Use a 3-pin plug with the ground routed through a pin. U13 and U14 should be heat-sinked, and attention should be paid to the wiring of these ICs. Even though they are complementary ICs, the pinouts are different. The meter has a 1-mA 1000-ohm movement and is calibrated for 0-3 and 0-15 dB noise figure by erasing the original scale with an electric eraser and recalibrating with transfer letters. The compensation pot is a 10-turn linear digital readout pot with 10 volts applied across it. Either $+10$ or -10 volts can be used to give -10 dB to $+10$ dB compensation. This adjustment is used to null out the excess ENR of the source with increasing frequency and to compensate for loss pads between the source and the receiver.

checkout and alignment

First unplug all the ICs and confirm that the power supply voltages are correct. If they are, plug in U1, U2 and U3 and see if you get quadrature pulses out of U3A and U3B. Connect a 28-MHz signal generator to the input jack and an oscilloscope to point C. Increase the signal generator output until you see a train of pulses at point C. Peak the U15 input and output circuits. Reduce the signal level to some convenient value and verify that the levels of the pulse train are 3 dB apart. This must be done with a calibrated attenuator of known accuracy. Connect an rf pad (10 dB for example) between the signal generator and the input of the ANF meter. This standardizes the signal-generator output impedance to 50 ohms. Unplug U2 and connect point D to $+15$ V. Connect a DC voltmeter (preferably a digital voltmeter) to the i-f output jack and note the reading on the voltmeter. Then connect point D to ground and plug a 3-dB pad between the 10-dB pad and the ANF meter. The volt-

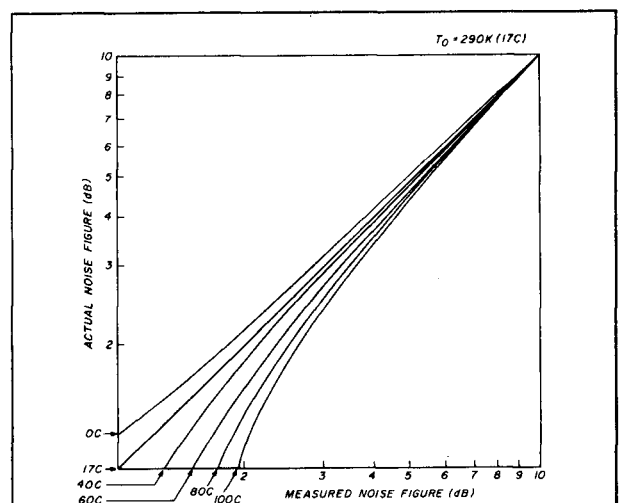

fig. 8. Temperature correction for a temperature-limited diode noise source (courtesy Hewlett-Packard Company).

meter level should remain the same. Disconnect the ground on point D and plug in U2. Plug in U4 and U5, and check to see if the pulse train is amplified by a factor of about 30 in U4A. Increase the signal level and see if the pulse train level at the i-f output jack stabilizes. This verifies that the agc loop is operational. Plug in U6 and U7. With the signal generator set for $7 \mu\text{V}$ and the pads removed, adjust R4 until the low gain LED just goes out. Turn the signal down and the LED should come on. Plug in U12 and temporarily solder a 10 k resistor between pins 2 and 7 of this IC. Ground pin 5 of U9 (make sure U9 is out of the socket), and adjust R3 for zero volts at U12 pin 7. Unsolder the 10 k resistor and unground U9 pin 5.

Connect an accurate source of 0.1 volt to U9 pin 5 (make sure U9 is still out of its socket) and adjust R2 for zero volts at pin 10 U12. Now turn up the source to +10 volts and adjust R5 for exactly -2.0 volts at pin 10 U12. Plug in U10, turn the compensation pot to zero, and adjust the voltage source to +0.2 volts at U9 pin 5. With the meter switch in the 3-dB position, adjust R7 for full scale. Change the meter switch to 15 dB, increase the source voltage to +3.16 volts, and adjust R6 for full scale.

Disconnect the voltage source and plug in the remainder of the ICs. Turn the AUTO STBY MAN switch to manual and plug in the noise source. The manual current control should vary the plate current (as expressed in NF) from zero up to 12 or 14 dB before saturating. Flip the switch to automatic and verify that the filament remains dark.

Connect the output of an amplifier to the input jack and apply power to the amplifier. The filament should light and the low-gain LED should extinguish. The meter should swing to saturation (12-14 dB). Now connect the source to the amplifier. Assuming the noise figure of the amplifier is in the range of the

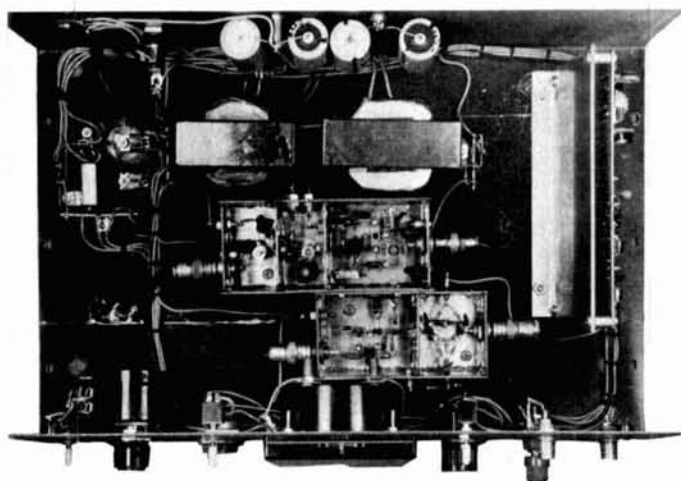

Chassis layout.

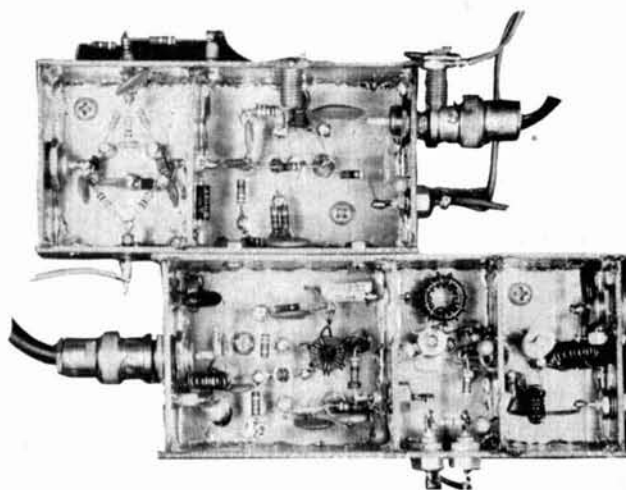

i-f strip.

instrument, the meter should now indicate its noise figure.

operation

The reader is referred to the article by W6NBI on automatic noise-figure measurements for background on proper use of ANF meters.³ A few comments pertaining to this particular meter are in order. Fifty-ohm output impedance of the receiver under test is required for accurate operation of the input pad in the meter. Amplifiers and converters seldom have 50-ohm output impedance, so a 3-dB or greater pad should be inserted between the receiver under test and the meter input. This pad won't cure the mismatch, but it will swamp out its effects on the measurement.

The receiver under test must be stable, since the meter is unable to tell the difference between noise and oscillation. In the same vein, if you are in a high rf-level area, the receiver should be well shielded. I live within three miles of four TV stations, four commercial fm stations, and a multitude of commercial and Amateur repeaters and paging services; consequently I find it difficult to get proper measurements on unshielded converters or preamps.

An i-f output jack is mounted on the front panel for connection to a scope to verify proper operation of the comparison circuitry. Fig. 6 shows what the scope picture should look like. The important thing is that the N_1 and N_2 sample periods should be at the same level. The large negative pulse at the beginning of the source *off* period is caused by the source not turning off immediately. This is because of the finite discharge time of the bypass capacitors in the filament circuit of the source. A 5-way binding post mounted on the front panel is used as a handy source

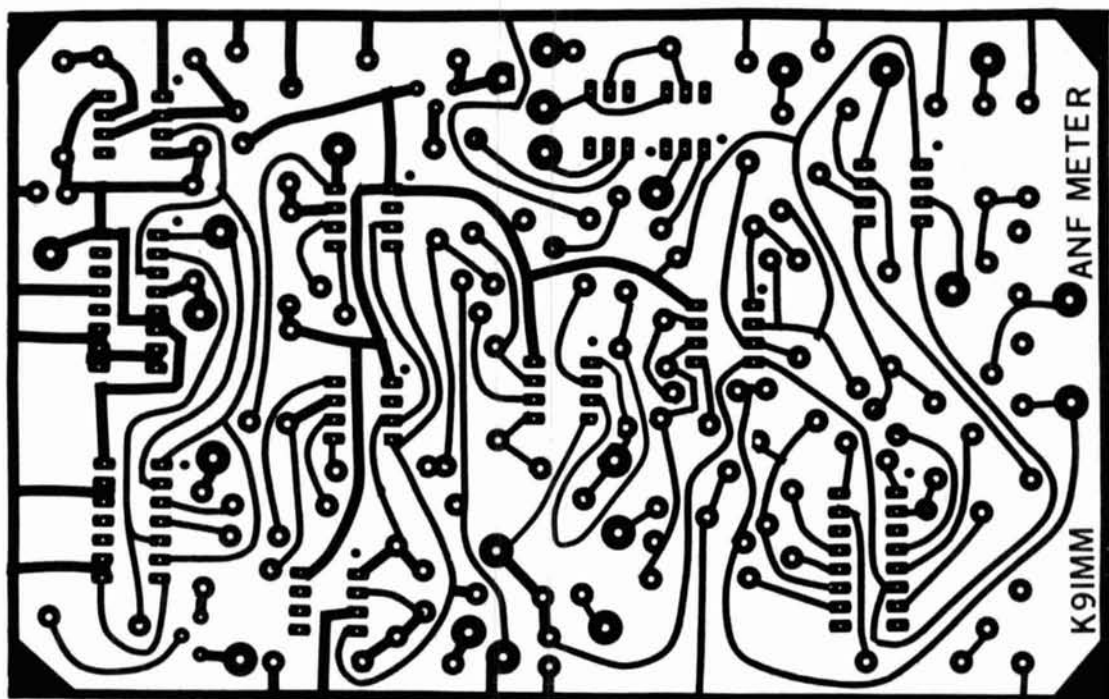

PC-board layout, foil side.

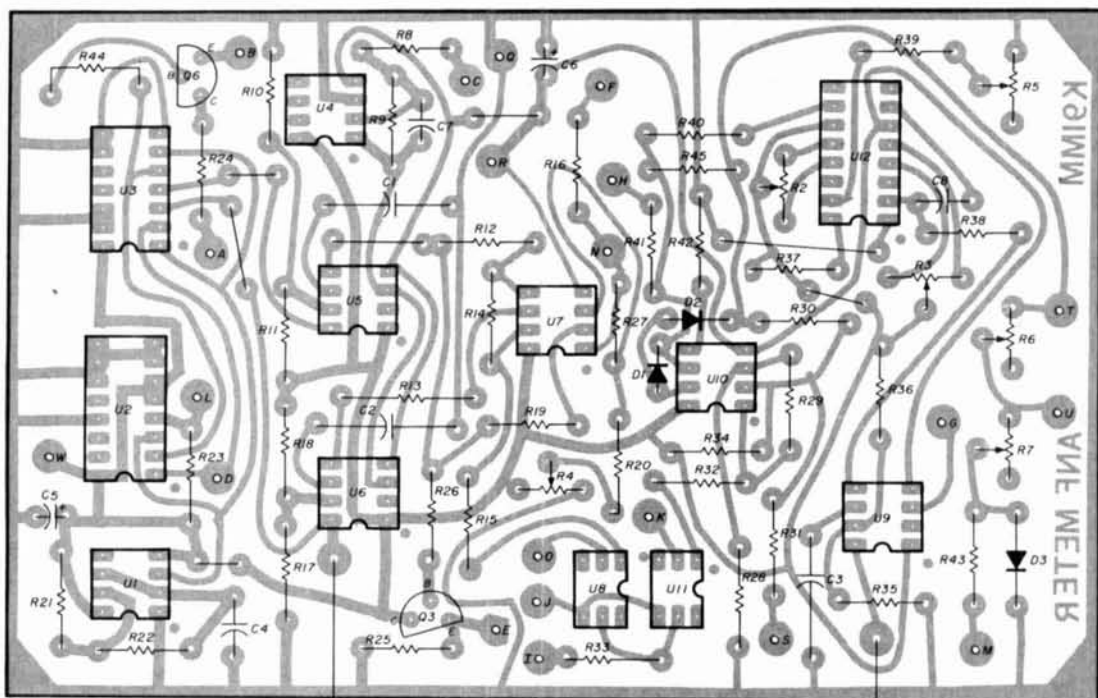

PC-board layout, component side.

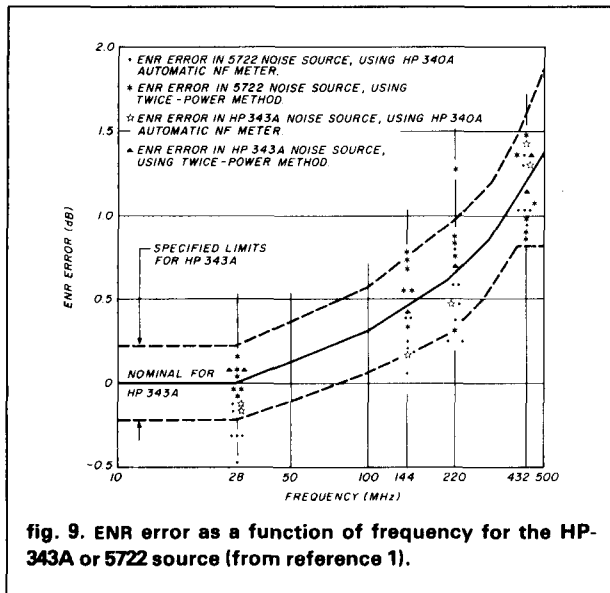

fig. 9. ENR error as a function of frequency for the HP-343A or 5722 source (from reference 1).

of +15 volts to supply converters and amplifiers. When working with preamps with a sub-3-dB noise figure, be aware that the input impedance for best noise figure is seldom 50 ohms. This presents a mismatch to the source and indicates an erroneous noise figure, which is usually too high. A 3-dB pad between the source and the receiver input will swamp out most of the error. The 3-dB-pad effect can be nulled out by the compensation pot, so the meter will read noise figure directly. I use the technique in fig. 7 to measure converters or preamps. The first 3-dB pad terminates the source, and the 20-dB-gain amplifier after the preamp under test reduces the effect of mixer loss on noise figure to a negligible level. The mixer is a broadband, double-balanced mixer (ANZAC MD-108) packaged in a small box with BNC connectors for the ports. The 3-dB pad after the mixer terminates the switched pad in the meter. The signal generator supplies local-oscillator power at $f \pm 28$ MHz. If the amplifier has a reasonable noise figure (≤ 4 dB), and the preamp has a reasonable gain (≤ 15 dB), then the compensation for a 2-meter preamplifier would be figured as follows: At 144 MHz, ENR error is +0.45 dB. A 3 dB pad is used so that compensation is $0.45 \text{ dB} - 3 \text{ dB} = -2.55 \text{ dB}$.

Set the compensation pot to -255 and read the system noise figure directly from the meter.

The method for determining preamplifier noise figure from system noise is:

$$NF_1 = 10 \log \left[F_S - \left(\frac{F_2 - 1}{G_1} \right) - \left(\frac{F_3 - 1}{G_1 G_2} \right) - \dots \right]$$

$NF_1 = \text{preamp noise figure (dB)}$

$F_S = \text{system noise factor}$

$G_1 = \text{preamp numerical gain}$

$G_2 = \text{second stage numerical gain}$

$F_2 = \text{second stage noise factor}$

$F_3 = \text{third stage noise factor}$

Note that this formula uses noise factors and numerical gains, *not* noise figures and decibel gains.

If the source terminating resistor temperature is other than 290 K (62 F), a correction must be made for this error. 290 K (62 F) is below room temperature, and the resistor is very close to a hot tube, so this correction is usually necessary. Unfortunately this is a non-constant error, so the compensation pot can't be used. The best technique is to factor the other errors into the compensation pot correction and then use that figure to work up the temperature correction from fig. 8. The ENR correction for frequency for the HP 343A source and the W6NBI 5722-type source is given in fig. 9. This error should be nulled out as a + compensation with the compensation pot. Be aware that the source accuracy is the limiting factor for the measurement accuracy. I suggested that the hot-cold resistor noise figure measurement system be used to verify the excess-noise ratio output of the source at various frequencies.⁴ If this is done, this meter should be as accurate as the commercial models.

Noise figures, like antenna gains, are numbers that are often claimed but seldom measured. My involvement in this project has been well worth the effort, especially when I see the long faces (mine included) on the owners of "hot" preamps when the meter reads otherwise.

I'd like to acknowledge the assistance of W9XM and WA9ACI in reviewing this paper and for many spirited discussions on the philosophy of noise-figure measurement.

references

1. Robert S. Stein, W6NBI, "Diode Noise Source for Receiver Noise Measurements," *ham radio*, June, 1979, page 32.
2. "Noise Figure Primer," Hewlett Packard Application Note 57, January, 1965.
3. Robert S. Stein, W6NBI, "Automatic Noise Figure Measurements — Fact and Fancy," *ham radio*, August, 1978, page 40.
4. Benjamin L. Lowe, K4VOW/WA5UUM, "Hot and Cold Resistors as UHF Noise Sources," *QST*, September, 1976, page 32.

bibliography

1. Fisk, James R., WIDTY, "Receiver Noise Figure, Sensitivity and Dynamic Range — What the numbers mean," *ham radio*, October, 1975, page 8.
2. Krauss, Geoffrey H., WA2GEP, "VHF Preamplifiers," *ham radio*, December 1979, pg. 50.
3. Intersil 8048/8049 Application Note, Intersil, Inc., Cupertino, California.
4. Operating and Service Manual, Model 340B Automatic Noise Figure Meter, Hewlett-Packard Company, Palo Alto, California.

ham radio

Amateur Radio equipment survey

Detailed reports from owners of several models of popular Amateur Radio gear were featured in various issues of *Ham Radio Horizons*. These reports were received with much favor by readers who were contemplating the purchase of equipment, either new or used.

This month we continue our owners' equipment survey by selecting for review three radios that have enjoyed much popularity in the Amateur community. The radios have been in use long enough so that a fairly broad sample of opinion and experience can now be collected. They are the Icom 701, Drake TR-7, and Kenwood TS-520 series — all high-frequency transceivers.

The items in the owners' report form have been chosen to extract the most information of use to the prospective buyer in making his choice. The results of the survey will show what owners really think about their equipment — what was best liked, what was disliked, what types of problems were encountered and how they were resolved, and in general what owners felt about performance, maintainability, and reliability.

Reading the results of the survey will surely help you decide how to spend your money for that new rig. You can profit from the experience of Amateurs who have learned by doing — putting the equipment to work under actual operating conditions. Such information can be much more meaningful than a laboratory report made from tests under controlled conditions.

The report sheets can be even more useful if comments are added, in addition to answers being checked off where called for. Feel free to let us know your opinions. The more information we can gather, the better we'll be able to serve prospective buyers.

Next month we'll be publishing the first part of our two-part rundown on Collins gear, in which we'll present the data we've collected from users' comments on the KWM-2 and KWM-2A transceivers. In the April issue, we'll appraise the 32S-series transmitters and the 75S-series receivers. As in the past, the readers of *ham radio* have made some perceptive and revealing comments on the equipment they own and use. If Collins equipment interests you, be on the lookout for these two articles.

Owner's Report on Amateur Radio Equipment

(Please report only from your own experience. Type or print clearly.)

1. Make and Model (please circle the exact unit you are reporting on).

ICOM 701

Drake TR7

Kenwood 520

520 S

520 SE

2. What year did you buy it? _____ New? _____ Used? _____

3. Where did you buy it? Dealer _____ Mail Order _____ Individual _____ Flea Market _____

800 Number _____ Other _____

4. Would you buy from the same source again? _____

5. Amount of use: Daily _____ Often _____ Occasional _____ Seldom _____

6. Is this your primary _____ or backup _____ rig?

7. What modes have you used? CW _____ SSB _____ RTTY _____ SSTV _____ AM _____ Other _____

8. What is the rig's best feature? _____

9. Worst feature? _____

10. Have you had any problems? _____ Explain _____

11. Have you had the rig serviced? _____ Where? Manufacturer _____ Dealer _____ Other _____

12. Was the service satisfactory? Yes _____ No _____

13. What accessories have you purchased for this rig? _____

14. Have you been able to obtain all the accessories and parts you need? _____

15. Have you been satisfied with these accessories? Yes _____ No _____

16. If not, why? _____

17. Additional features you would like to see built into a rig of this type _____

18. Give the equipment a score from 1 to 10 (with 1 being poorest, 4 to 6 average, and 10 perfect).

Ease of operation _____

Reliability _____

Durability
(in continuous use) _____

Instruction Book _____

Factory/Dealer Service _____

Quality of Workmanship _____

Performance _____

Maintenance _____

Parts Availability _____

Accessories
(ease of connection) _____

Price _____

Flexibility _____

19. How long have you been licensed? _____ Your Age _____ License Class _____

/ Principal activities: Contest _____ DX _____ Rag Chewing _____

Traffic Handling _____ Experimenter _____

20. What antenna do you use most? Beam _____ Wire _____ Vertical _____ Other _____

21. What rig would you like to see reported on in the future? _____

22. Would you buy this same rig again? _____

23. (Optional: fill in the following only if you wish.)

Submitted by: Name _____ Call _____

Address _____

City _____ State _____ Zip _____

(Signature)

(Your signature authorizes *ham radio* to quote portions of your comments in our report.) May we use your name and/or call?

Yes _____ No _____

Note: If you own more than one of the rigs indicated, please use a separate form for a report on each rig.

Completed survey forms must be returned no later than March 31, 1981, to be included in our report.

Mail To: Ham Radio Owner's Report No. 4, Greenville, NH 03048

80-meter receiver for the experimenter

Basic building blocks
for those
who like to build
their own gear

This simple receiver covers the 80-meter band. Other bands can be received by adding converters. This article has been submitted with the idea of giving other experimenters some ideas about receiver construction. A simple low-frequency i-f filter is also included. It provides a bandwidth of about 1200 Hz — great for CW if the band isn't too crowded. The nice thing about the filter is that it's inexpensive: two crystals at \$2.00 each plus a few other parts (also inexpensive).

description

My receiver was built on a 5 × 9 inch (12.7 × 23 cm) chassis with a panel measuring 9 × 5 inches (23 × 12.7 cm). I found room for a power supply and small speaker. The dial was Japanese. With a switch on the back of the chassis I can change to battery operation instead of the ac supply, thus making a nice portable receiver that will fit into a travel bag.

antenna input circuit

No rf stage was used in this receiver design because I anticipated that converters would be used for higher-frequency bands. An rf stage isn't needed on 80 meters — this saves some space. The antenna is fed directly into an attenuator, which I found necessary to prevent receiver overload. The attenuator was made from a dual 10k-section pot (see **fig. 1**).

The antenna coils are double tuned with separate 100-pF capacitors for simplicity rather than a split stator capacitor. This eliminates the tracking problem and hard-to-find parts.

The antenna coils are wound on red Amidon cores. I used T-80-2, 1 inch (25.4 mm) in diameter, because they were available. The 68-2 will also be correct — anything to resonate at 80 meters. It takes about forty-five turns of no. 26 (0.51-mm) wire using a 100-pF variable for tuning. I used a 50-pF and padded it for resonance at mid-capacitor position. Resonance can be checked using a grid-dip oscillator with a loop around its coil and one around the toroid.

mixer

A 40673 dual-gate MOSFET was used for the mixer. The resistor in gate 1 isn't critical and can be anything from 6.8k to 100k; however, the lower values are better, as overloading is possible with higher values.

I lucked out for a coil in the drain circuit: a small, potted, ceramic toroid about 1 inch (25.4 mm) square. I found it in a bag of coils sold by Radio Shack. It's not listed in their catalog, so it is worth looking for in the store. Otherwise, a J.W. Miller variable slug coil 4515, a 350 μ H to 475 μ H inductance

By Ed Marriner, W6XM, 528 Colima Street, La Jolla, California 92037

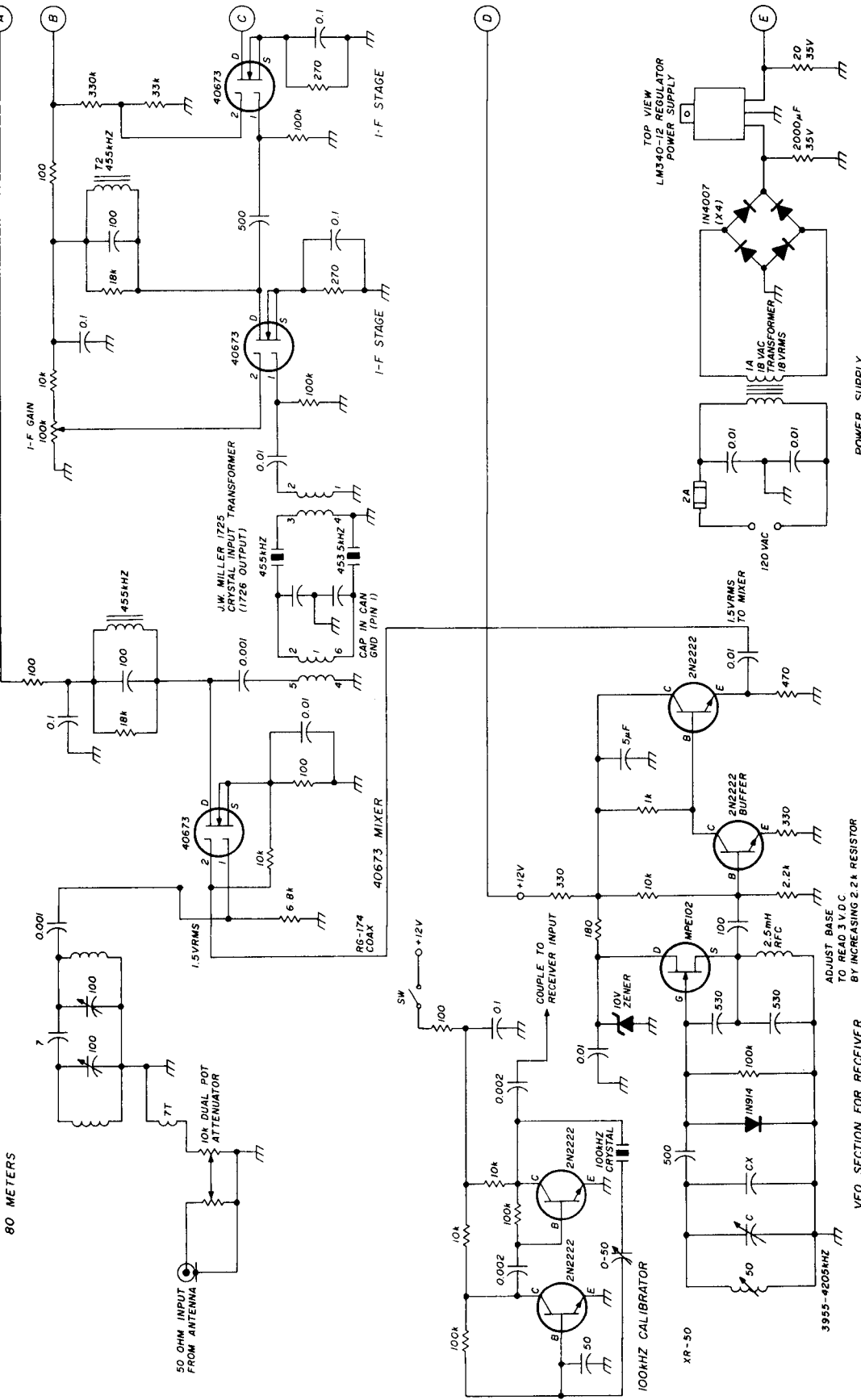

80 METERS

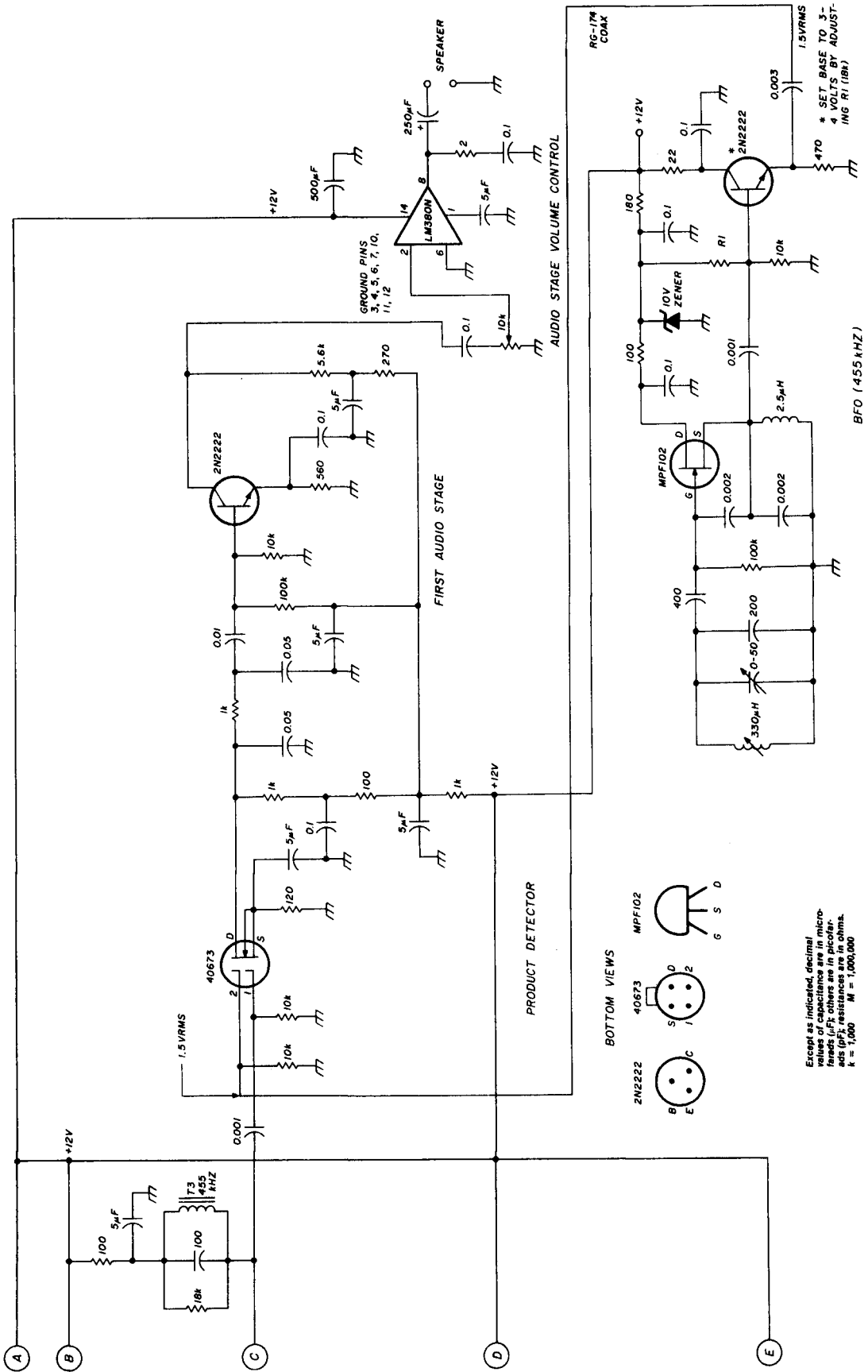

fig. 1. Schematic of the 80-meter receiver. Easy to build and easy to get working, it's a good project for those who like to experiment.

with a 220-pF capacitor should work. Another solution is to use half of an old 455 kHz i-f transformer.

crystal filter

The filter was made with two crystals, one of 455 kHz and one of 453.5 kHz. This is great for CW with a bandwidth of about 1200 Hz. However, a little wider spacing could be in order for SSB. The reason for these particular crystals is they are inexpensive: \$2.00 each from the source indicated. The J.W. Miller Company offers an input and output transformer (1725 and 1726) to match crystals for the filter. Note that the capacitors in the output of the 1725 transformer are inside the can. You don't need to add them; just ground pin 1.

i-f stage

Two i-f stages were used, although it might be possible to get by with only one as the gain of this receiver is pretty high. I used two stages and reduced the gain with the i-f gain control.

product detector and audio

Rather than using a passive detector with diodes I used a 40673, which has some gain, to drive the first audio stage: a 2N2222. The product detector needs about 1.5 volts RMS injection voltage. I've had pretty good luck with this audio circuit, which delivers about 2 watts into a big speaker. Other lower-powered chips are available, but I used this circuit, which is in most of the commercial sets in use at the moment.

BFO

A crystal-controlled BFO could be used, but I've had difficulty making crystals oscillate at this frequency so I used the variable BFO. It's also very useful for zeroing in SSB signals and changing CW pitch. It's very stable, with no pulling.

VFO

The VFO tunes 3955-4205 kHz to cover the 80-meter band. It will take a little playing around to get it right. It's nice if you can borrow a counter or have a receiver that will cover this range. I used a National XR-50 5/8-inch (15.9 mm) diameter slug-tuned form for the coil. I had some silver wire that was nylon covered. It was no. 24 (0.511-mm) diameter. Using this wire, the VFO was very stable, but locating such wire is difficult. (This wire was found at a flea market; enameled wire is the next best choice.)

The variable capacitors available will determine your bandsread: capacitors of 0-50 or 0-100 pF will cover the range, or you can use a switch and two silver mica padding capacitors, which is what I did to cover the 80-meter band in two steps.

The capacitors I used from gate to ground and the coil coupling capacitor also have an effect on the tuning. The coupling capacitor has an effect on the oscillation and its value sometimes must be reduced. However, with the values shown, the VFO worked well and produced 1.5 volts rms — enough for mixer injection. While many circuits don't show buffers, I've found that signals don't pull the oscillator if a buffer is used. Thus, the set is more stable.

construction

Because of the difficulty in obtaining parts these days, it's impossible to specify an exact component (see table 1). I search the surplus ads, flea markets, and surplus stores. One of the best sources is the flea markets that radio clubs sponsor. There I've found all my parts.

This set was made from copper board and black drafting tape and dots, then etching. The board was mounted onto the chassis using spacers. I cut my panels with a hacksaw, with the aluminum held between two pieces of angle iron secured in a vice. After drilling, I dipped the panel in lye water. Or I let the panel set in *Lime Away*, a grocery store product, overnight.

Sometimes I spray the panel with black crackle paint and bake it in the oven at 175F for 15 minutes. The finished products look good. The boards can be dipped into a tinning solution to make them commercial-looking.

Holes for parts are drilled with a number 60 drill. There are a lot of little things you can do to make your homebrew projects look nice if you so desire. Many hams just want them to work, but I like to have them look nice, too.

table 1. Suggested sources for parts.

J.W. Miller Co. 19070 Reyes Avenue Compton, California 90221
Low Frequency Crystals (\$2.00 each): John L. Winton 8062 San Mateo Cr. Buena Park, California 90621
Radio Shack Stores
Integrated Circuits Unlimited 7889 Clairemont Mesa Boulevard San Diego, California 92111
Semiconductor Supermart P. O. Box 3047 Scottsdale, Arizona 85257

ham radio

Quality VHF/UHF Kits at Affordable Prices -

These Low Cost SSB TRANSMITTING CONVERTERS

Let you use inexpensive recycled 10M or 2M SSB exciters on UHF & VHF!

- Linear Converters for SSB, CW, FM, etc.
- A fraction of the price of other units; no need to spend \$300 - \$400!
- Use with any exciter; works with input levels as low as 1 mW.
- Use low power tap on exciter or simple resistor attenuator pad (instructions included).
- Link osc with RX converter for transceive.

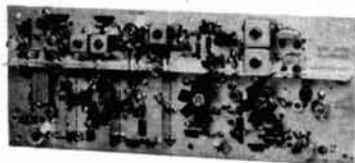

XV4 UHF KIT — ONLY \$99.95

28-30 MHz in, 435-437 MHz out; 1W p.e.p. on ssb, up to 1½W on CW or FM. Has second oscillator for other ranges. Atten. supplied for 1 to 500 mW input, use external attenuator for higher levels.

Extra crystal for 432-434 MHz range..... \$5.95
XV4 Wired and tested \$149.95

XV2 VHF KIT - ONLY \$69.95

2W p.e.p. output with as little as 1mW input. Use simple external attenuator. Many freq. ranges available.

MODEL	INPUT (MHz)	OUTPUT (MHz)
XV2-1	28-30	50-52
XV2-2	28-30	220-222
XV2-4	28-30	144-146
XV2-5	28-29 (27-27.4 CB)	145-146 (144-144.4)
XV2-7	144-146	50-52
XV2 Wired and tested \$109.95		

XV28 2M ADAPTER KIT - \$24.95

Converts any 2M exciter to provide the 10M signal required to drive above 220 or 435 MHz units.



NEW! COMPLETE TRANSMITTING CONVERTER AND PA IN ATTRACTIVE CABINET

Far less than the cost of many 10W units!

Now, the popular Hamtronics® Transmitting Converters and heavy duty Linear Power Amplifiers are available as complete units in attractive, shielded cabinets with BNC receptacles for exciter and antenna connections. Perfect setup for versatile terrestrial and OSCAR operations! Just right for phase 3! You save \$30 when you buy complete unit with cabinet under cost of individual items. Run 40-45 Watts on VHF or 30-40 Watts on UHF with one integrated unit! Call for more details.

MODEL	KIT	WIRED and TESTED
XV2/LPA2-45/Cabt (6, 2, or 220)	\$199.95	\$349.95
XV4/LPA4-30/Cabt (UHF)	\$229.95	\$399.95

Easy to Build FET RECEIVING CONVERTERS

Let you receive OSCAR and other exciting VHF and UHF signals on your present HF or 2M receiver



- NEW LOW-NOISE DESIGN
- ATTRACTIVE WOODGRAIN CASE
- Less than 2dB noise figure, 20dB gain

MODEL	RF RANGE	OUTPUT RANGE
CA28	28-32 MHz	144-148 MHz
CA50	50-52	28-30
CA50-2	50-54	144-148
CA144	144-146	28-30
CA145	145-147-or-144-144.4	28-30
		27-27.4 (CB)
CA146	146-148	28-30
CA220	220-222	28-30
CA220-2	220-224	144-148
CA110	Any 2MHz of Aircraft Band	26-28 or 28-30
CA432-2	432-434	28-30
CA432-5	435-437	28-30
CA432-4	432-436	144-148

Easily modified for other rf and if ranges.

STYLE	VHF	UHF
Kit less case	\$34.95	\$49.95
Kit with case	\$39.95	\$54.95
Wired/Tested in case	\$54.95	\$64.95

Professional Quality VHF/UHF FM/CW EXCITERS

- Double tuned circuits for spurious suppression
- Easy to align with built-in test aids



T51-30	10 Meter, 2W Kit.....	\$44.95
T51-50	6 Meter, 2W Kit.....	\$44.95
T51-150	2 Meter, 2W Kit.....	\$44.95
T51-220	220 MHz, 2W Kit.....	\$44.95
T450	450 MHz, 3/4W Kit.....	\$44.95
T451	450 MHz, 3 W Kit.....	\$59.95
A14T	5 Chan Adapter (T51&T451)	\$9.95

See our Complete Line of VHF & UHF Linear PA's

- Use as linear or class C PA
- For use with SSB Xmtg Converters, FM Exciters, etc.

LPA2-15	6M, 2M, 220; 15 to 20W.....	\$59.95
LPA2-30	6M, 2m; 25 to 30W.....	\$89.95
LPA2-40	220 MHz; 30 to 40W.....	\$119.95
LPA2-45	6M, 2M; 40 to 45W.....	\$119.95
LPA4-10	430MHz; 10 to 14W.....	\$79.95
LPA4-30	430MHz; 30-40W.....	\$119.95

See catalog for complete specifications

FAMOUS HAMTRONICS PREAMPS

Let you hear the weak ones too!
Great for OSCAR, SSB, FM, ATV. Over 14,000 in use throughout the world on all types of receivers.

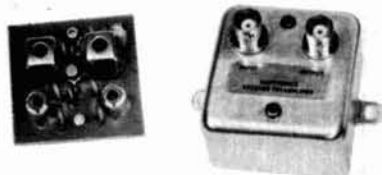

- NEW LOW-NOISE DESIGN
- Less than 2 dB noise figure, 20 dB gain
- Case only 2 inches square
- Specify operating frequency when ordering

MODEL P-30 VHF PREAMP, available in many versions to cover bands 28-300 MHz.

MODEL P432 UHF PREAMP, available in versions to cover bands 300-650 MHz.

STYLE	VHF	UHF
Kit less case	\$12.95	\$18.95
Kit with case	\$18.95	\$26.95
Wired/Tested in Case	\$27.95	\$32.95

NEW VHF/UHF FM RCVRs Offer Unprecedented Range of Selectivity Options

- New generation
- More sensitive
- More selective
- Low cross mod
- Uses crystal filters
- Smaller
- Easy to align

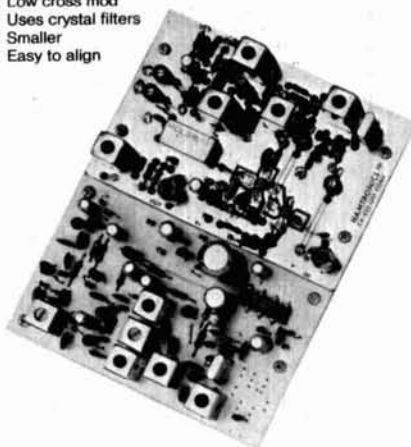

R75A* VHF Kit for monitor or weather satellite service. Uses wide L-C filter. -60dB at ± 30 kHz..... \$69.95

R75B* VHF Kit for normal nbfm service. Equivalent to most transceivers. -60dB at ± 17 kHz, -80dB at ± 25 kHz... \$74.95

R75C* VHF Kit for repeater service or high rf density area. -60dB at ± 14kHz, -80dB at ± 22kHz, -100dB at ± 30kHz.... \$84.95

R75D* VHF Kit for split channel operation or repeater in high density area. Uses 8-pole crystal filter. -60dB at ± 9kHz, -100dB at ± 15kHz. The ultimate receiver!... \$99.95

* Specify band: 10M, 6M, 2M, or 220 MHz. May also be used for adjacent commercial bands. Use 2M version for 137 MHz WX satellites.

R450() UHF FM Receiver Kits, similar to R75, but for UHF band. New low-noise front end. Add \$10 to above prices. (Add selectivity letter to model number as on R75.)

A14 5 Channel Adapter for Receivers..... \$9.95

NEW R110 VHF AM RCVR

AM monitor receiver kit similar to R75A, but AM. Available for 10-11M, 6M, 2M, 220 MHz, and 110-130 MHz aircraft band \$74.95. (Also available in UHF version.)

IT'S EASY TO ORDER!

- Write or phone 716-392-9430 (Electronic answering service evenings & weekends)
- Use Credit Card, UPS COD, Check, Money Order
- Add \$2.00 shipping & handling per order

Call or Write to get
FREE CATALOG
With Complete Details

(Send 4 IRC's for overseas mailing)

HAMTRONICS® IS A REGISTERED TRADEMARK

hamtronics, inc.

65M MOUL RD - HILTON, NY 14468

solid-state power for 1296 MHz

Here's a Class C amplifier
that delivers 2 watts
of output power

In the past few years quite a few construction articles describing preamplifiers, converters, filters, and test equipment for the 1296-MHz band have been published. However, there has been a conspicuous lack of articles about transmitters for this band. This is a serious omission, because, for reasonable communications range, a transmitter power of at least a watt or two is needed — far more than the milliwatts produced by most converters.

background

Most of the 1296-MHz transmitters^{1,2,3} described in the last decade have used surplus microwave tubes as the active components in the final stages. These planar triode tubes, commonly known as "lighthouse" tubes because of their distinctive shape, have been available on the surplus market for many years. And, although amplifiers built around this type of tube are capable of delivering tens or even hundreds of watts output, they suffer from at least two drawbacks that have limited their popularity.

First, the tubes are normally operated in a cavity or coaxial type of structure. Fabrication of these types of matching networks is not particularly difficult, but some machine shop work is generally required. Second, these tubes, usually of the type 2C39 family, are becoming somewhat scarce on the surplus market, as the original users of the tubes have largely switched to diode and transistor devices for medium-power amplification at the lower microwave frequencies.

At the present time, bipolar transistors are commercially available that are capable of at least 40 watts of continuous output at one GHz and 20 watts

at 2 GHz, approximately the same power level to be expected from a single 2C39 tube.

Few Amateurs have built transistor power amplifiers for the 25-cm ham band, however. This is mainly because microwave transistors have a reputation for being expensive, tricky, and easily destroyed⁴. But with recent improvements in technology, rf transistors have become not only better but also more rugged, while the cost per unit has dropped because of the tremendous increase in the volume of production. As a result, transistor amplifiers capable of producing several watts output power are now easily within the technical and financial reach of Amateurs.

This article describes a two-stage amplifier chain that will deliver over 2 watts output. The total gain of the two units together is at least 30 dB, which means that a few milliwatts of drive power from a low-level converter or exciter will produce full output. The amplifiers are sufficiently broadband to cover the entire 1250-1300 MHz range, so that once tuned up they need not be retuned for operating frequency changes.

Construction of these amplifiers is straightforward and only hand-tool work is required. They are built using a mixture of microstrip line and lumped component techniques on copper-clad boards. Each stage is built as a module with 50-ohm input and output to simplify testing and to increase flexibility.

The first stage produces at least 100 milliwatts of linear output power. The gain at this power level is approximately 17 dB. The next stage provides a minimum of 2 watts output. It is operated Class C and has a gain of 13-14 dB. When the two are cascaded together as shown in fig. 1, a 2-milliwatt drive signal will produce over 2 watts output. Alternatively, the first stage may be used alone as lower-power transmitter to produce up to 150 milliwatts of saturated power.

By Jerry Hinshaw, N6JH, 4558 Margery Drive,
Fremont, California 94538

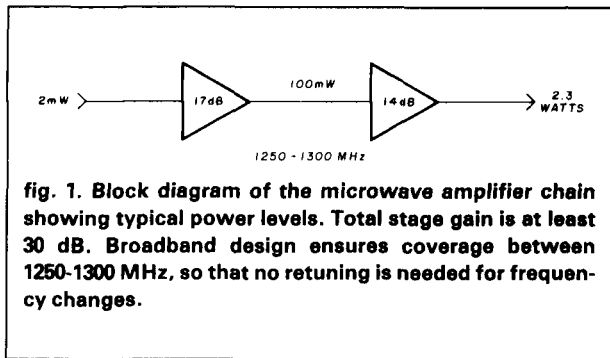

100-mW stage

The first stage of the chain is a linear, Class A amplifier. As such, it's designed using the small-signal, grounded-emitter, s-parameter information provided by the manufacturer.

The transistor used in this stage is a Hewlett-Packard 2N6679, also known as the HXTR 2101. There are several reasons for selecting this transistor in preference over another, even though at approximately \$22 it isn't the most inexpensive device available. This microwave transistor is designed to produce moderately high linear output power and is therefore fully characterized for this type of operation. Second, it has a higher matched gain than most less-expensive transistors. This means that one less gain stage is needed to amplify a signal up to the 100 mW level required to drive the output stage. This reduction in system complexity more than offsets the higher initial cost of this one stage.

The design of this amplifier follows the approach described in detail by Shuch.⁵ Each input and output matching networks consists of a series quarter-wave transmission line transformer that matches the real part of the transistor input or output impedance. Shunt capacitance is used to compensate for the reactive portion of the output impedance. The input impedance of this transistor is by coincidence nearly a pure resistance at this frequency, so that satisfactory matching is achieved without a shunt capacitor at the transistor base. A schematic diagram of this amplifier is shown in **fig. 2**.

The design is accomplished using s-parameter data for 1275 MHz, data which were obtained by interpolating the 1.0- and 1.5-GHz data provided by the manufacturer. Although such a design is, strictly speaking, valid for only this one frequency, in practice the s-parameters do not vary rapidly for small changes in frequency, so the usable range is a band several per cent wide centered at 1275 MHz.

The input impedance of this transistor at 1275 MHz is found to be approximately 5.3 ohms. As it is very nearly a pure resistance, it can be matched with only

a quarter wavelength transformer whose characteristic impedance is 17 ohms. This 17-ohm transformer is realized on 1/32 inch (0.8 mm) glass-epoxy board by a microstrip line approximately 0.225 inch (5.7 mm) wide and 1.14 inches (29.0 mm) long.

At the transistor collector the impedance is approximately 50.6 ohms in series with 110.9 ohms of capacitive reactance. The real part of this impedance presents a good match to the 50-ohm load as it is, without further matching. The reactive part of the impedance is tuned with a capacitor located a quarter wavelength from the transistor. This capacitor must have a reactance of 22.5 ohms, corresponding to 5.7 picofarads at 1275 MHz. The quarter wavelength line itself is 0.056 inch (1.4 mm) wide and 1.15 inches (29.2 mm) long on this 1/32-inch (0.8-mm) printed circuit board material.

Dc power is provided by the constant-current bias network shown in the schematic. In an earlier version of this amplifier a simpler, passive bias scheme was used, but it proved to be a false economy because bias instabilities destroyed the HXTR 2101 transistor. The present circuit automatically compensates for the current gain variations from one transistor to another and for variations that result from temperature changes. Thus it provides for stable, Class A operation. Collector current is held at 25 milliamperes while the collector-to-emitter voltage (V_{ce}) of the rf transistor is stabilized at approximately 15 volts.

construction

The amplifier is built on a piece of double-clad Fiberglass epoxy PC board material 1/32 inch (0.8 mm) thick. One side of the board is left fully clad with copper to serve as a ground plane for the microstrip

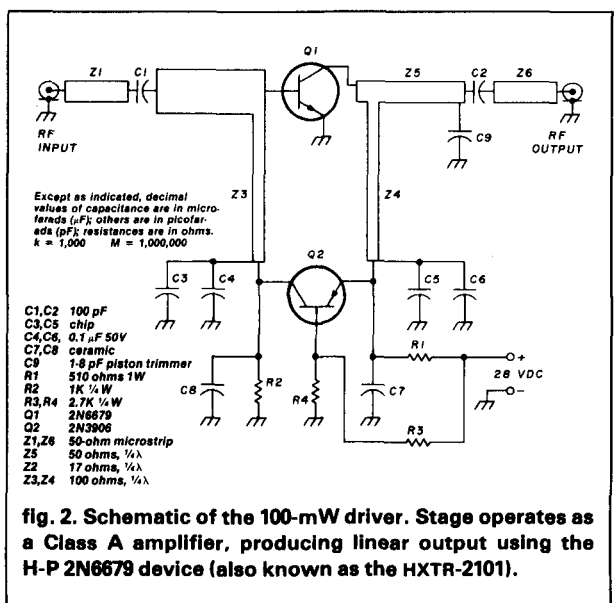

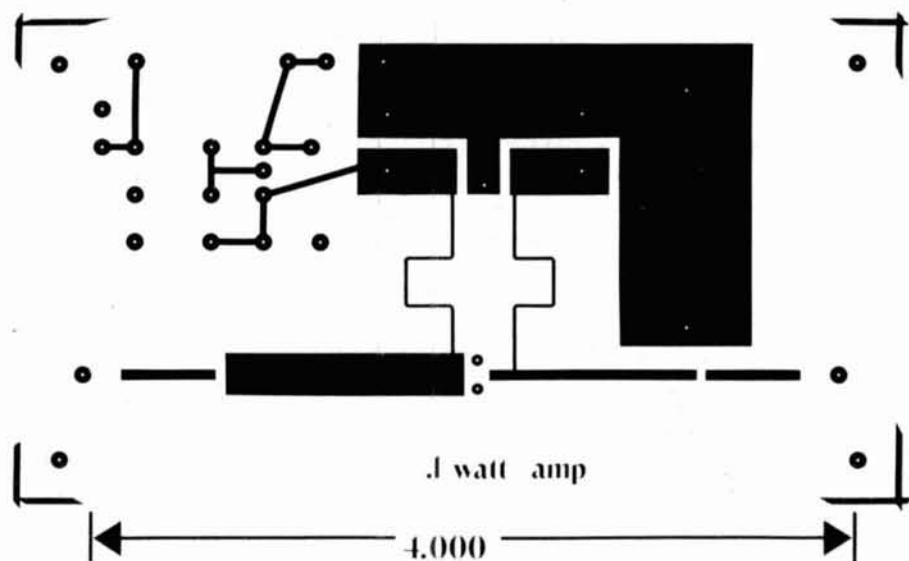

fig. 3. Full-size illustration of the PC board for the 100-mW driver stage.

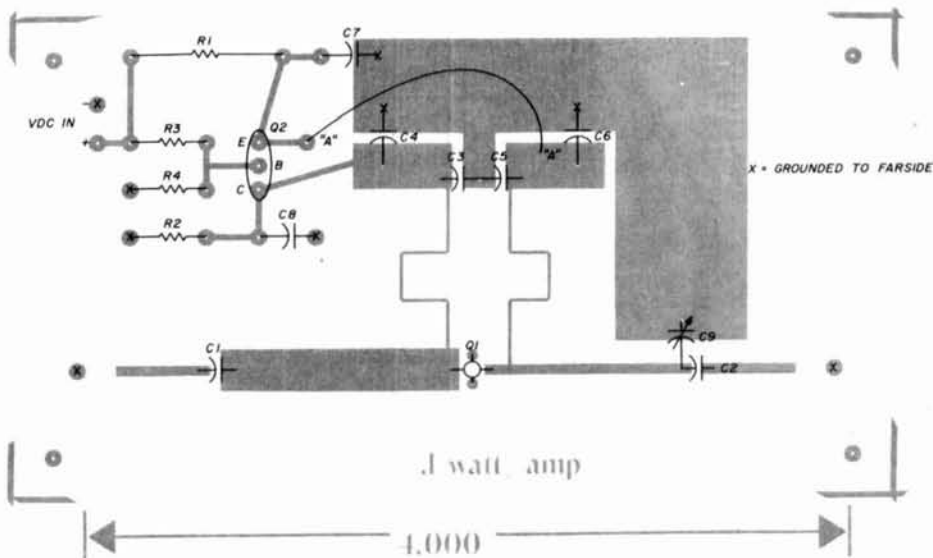

fig. 4. Component placement for the 100-mW stage.

lines. The other side is etched to form the matching and bias circuit mounting areas. A full-scale illustration of this side of the board is shown in fig. 3.

Feedthrough eyelets are mounted in the board at the positions marked on fig. 4 with an X. These eyelets are used to help ensure that the two emitter leads

of the transistor are connected to ground by low impedance paths and at the ground ends of the tuning and bypass capacitors. Solder the eyelets to the copper ground plane on the bottom of the board.

Where component leads will protrude through the board, the ground plane must be cleared away to

prevent shorts. This can be done with a small drill. Clear away enough copper from around the hole to ensure that the component doesn't touch anything but Fiberglass.

Once the fabrication of the board is done, the components are installed as shown in **fig. 4**. The 2N6679 and the chip capacitors are mounted on the top of the board, while the bias circuit components are installed on the ground-plane side. Be careful when soldering the transistor that solder does not flow underneath the package and short out any of the leads. The transistor package is very small, and the leads come quite close together on the bottom side, so that it's easy for even a tiny amount of solder to wick along one lead and short to another. Also, note that the variable capacitor in the output circuit must be mounted right at the output end of the quarter-wave line for maximum performance.

The two emitter leads on the 2N6679 are bent at right angles to the transistor package so that they will fit through the two eyelets to the ground plane side of the board to be soldered. It's important that the emitter leads be connected to the ground plane by low impedance paths if the amplifier is to perform properly. To get a low impedance path, the transistor package should be mounted flush with the PC board so that the emitter leads are as close as possible to the feedthrough eyelets.

The input and output connections are made with small-diameter 50-ohm coaxial cable such as RG-179 or similar. The coax-cable shield is twisted into a pig-tail and run through the hole in the PC board near the end of the microstrip matching lines. Then the shield is soldered to the ground plane of the circuit board. On the etched side of the board, the center conductor is soldered to the end of the microstrip transformer. The distance between the end of the coaxial shield and the center conductor soldered connection should be as short as reasonably possible. A length of 0.2 inch (5.1 mm) works well. A jumper wire is run between the two points marked with an **A** in **fig. 4**.

The completed board is installed in a small sheet-metal chassis box by means of four standoffs. The two coaxial cables are run to connectors mounted in the box wall and a feedthrough capacitor is used to bring in dc power for the amplifier.

tuning

Connect the amplifier to a 28-volt power supply and check to see that the supply current is approximately 30 milliamperes. As a further check of the bias, measure the voltage at the 2N6679 collector. It should be about 15 volts above ground.

If you're hesitant about trying out an untested bias circuit with your somewhat expensive rf transistor,

you can first test the circuit by soldering a small-signal NPN transistor in place of the 2N6679. The amplifier won't work at 1250 MHz, of course, but the small-signal transistor will duplicate the dc operation of the rf transistor. If the bias circuit properly regulates the collector voltage and current of this "fuse," then it is safe to go ahead and install the 2N6679.

Tuning the amplifier requires a signal source of about 1 milliwatt and a power meter or signal detector of some sort. Apply dc power and the rf drive signal, then tune the output matching capacitor until maximum output is seen. If the amplifier is tuned up at 1275 MHz, it will cover the range 1250-1300 MHz with less than a dB of gain "droop" at the band edges. Once the output capacitor is peaked, no other adjustments are necessary.

2-watt stage

The final stage of this chain is a Class C common-base amplifier capable of 2.5 watts output power. The transistor used in this stage is the Motorola MRF2001, the lowest-power member of a family of 2-GHz, common-base power transistors. The 2000 series transistors have been available from several manufacturers for a number of years and have come to be an unofficial standard type of microwave transistor. They have been used in many military and industrial designs, but their high cost has kept them out of the range of most Amateur experimentation. However, in late 1978, Motorola announced a low-cost version of this 2000 series designed to penetrate the commercial marketplace.

These transistors are rated for 2-GHz operation, and this means that their performance in the 1250-1300 MHz range can be fairly impressive. It's generally difficult to achieve high gain and high power output simultaneously, but when the device is operated well below its design frequency these two goals can be more easily met. Thus, the MRF2001, rated at 1 watt minimum output with 9 dB gain at 2 GHz, when operated at 1.3 GHz, easily produces 2 watts with an associated gain of 13-14 dB. The cost of these transistors is about \$19 each.

design

Since this stage is to be operated as a large-signal, Class C amplifier, the s-parameter design approach used to design linear Class A amplifiers is not appropriate. Instead, matching networks must be designed to present to the transistor the impedances that produce the best input match while simultaneously giving the highest output power.

This approach is different in several ways from that used for small-signal linear amplifiers. In the case of a low-level amplifier, the matching networks are

chosen to maximize gain, and perhaps to minimize the input and output VSWR. By contrast, in a large-signal amplifier, only the input circuit is designed to provide a low VSWR to maximize the driver power transferred into the amplifier. This part of the design is not wholly unlike that of the small-signal amplifier.

At the output of the Class-C stage, however, the intent is to provide that matching network which maximizes the output power. This requirement usually means that output VSWR and overall power gain are compromised somewhat in the interest of increasing output power and efficiency. A detailed discussion of this design approach and of the tradeoffs involved is provided by Pitzalis.⁶

To permit such a design the manufacturer publishes typical impedance data for their rf power transistors. The input impedance they specify gives a good match and hence a good power transfer into the transistor. The output impedance they list is that into which the transistor delivers maximum power at a given drive level.

As with the 100-milliwatt stage, the fractional bandwidth required for the amplifier to cover this ham band is small enough so that the design can be at a single frequency. This approach is much simpler than would be a broadband optimization.

The data sheet for the MRF2001 lists the equivalent series input impedance at 1250 MHz as

$$Z_{in} = 7.6 + j10.3 \text{ ohms}$$

The best input match will be obtained with a network that presents the complex conjugate of this impedance to the transistor. Thus, we want to design a network that will transform the real 50-ohm input feedline impedance to

$$Z_{in}^* = 7.6 - j10.3 \text{ ohms}$$

where the asterisk indicates the complex conjugate.

This series input impedance is equivalent to the parallel impedance⁷

$$Z_{in}^* = 21.6 \parallel -j15.9 \text{ ohms}$$

a resistance of 21.6 ohms in parallel with a capacitive reactance of 15.9 ohms.

At 1250 MHz, a capacitor with this reactance has the value of

$$C = \frac{1}{2\pi f X_c} = 8.0 \text{ pF}$$

If this capacitor is shunted to ground very close to the transistor emitter, the result will be a driving impedance at the emitter of 21.6 ohms, a pure resistance without a reactive component.

To transform this pure resistance to the 50-ohm input impedance, we can use a quarter-wave microstrip transformer whose characteristic impedance is

the mean of the two end point resistances, or

$$Z_{input \ line} = \sqrt{(50)(21.6)} = 33 \text{ ohms}$$

This input circuit is shown in the schematic, **fig. 5**.

The required output series impedance is given by the data sheet as

$$Z_{out}^* = 9.6 + j23.1 \text{ ohms}$$

The real part of this series equivalent impedance can be matched with a quarter-wave transformer whose characteristic impedance, as before, is given by

$$Z_{output \ line} = \sqrt{(9.6)(50)} = 22 \text{ ohms}$$

The imaginary term can be dealt with by either a series inductive reactance at the transistor collector or by a shunt capacitive reactance at the transformer output. Since it is easier to obtain good, high-*Q*, variable capacitors than inductors at high frequency, it's better to choose the latter. The reactance required is equal to

$$X_c = \frac{Z_0^2}{X_s} = \frac{(22)^2}{23.1} = 20.8 \text{ ohms}$$

This corresponds to a capacitor of

$$C = 6.1 \text{ pF}$$

A 1-8 pF trimmer capacitor will provide some adjustment range. The completed output circuit is shown in **fig. 5**.

The matching circuits are built on 1/32-inch (0.8-mm) Fiberglass epoxy board material of the type known as G-10. The 33-ohm input line is 0.110 inch (2.8 mm) wide and 1.14 inches (29.0 mm) long. Since the transistor emitter tab is wider than this matching line, and since a shunt capacitor from the emitter to ground is needed, a portion of the required capacitance is distributed in a short open-ended stub. This stub provides about 2.7 pF of the required 8 pF and it is wide enough so that the emitter lead can be soldered over its entire width.

The 22-ohm output transformer is realized with a line 0.190 inch (4.8 mm) wide and 1.11 inches (28.2 mm) long. The output must have a dc blocking capacitor; this should be a microwave chip-type capacitor. A chip capacitor with a 50-mil (1.3-mm) package width will fit the 0.056-inch (1.4-mm) 50-ohm output line with minimum discontinuities. The variable tuning capacitor must be mounted right at the end of the 22-ohm transformer.

Bias voltages are applied to the transistor through two high-impedance quarter-wave lines bypassed to ground at the end away from the matching networks. Since the input is grounded, no dc blocking capacitor is required. At the output, the supply end of the bias line is bypassed to ground with a chip ca-

capacitor in parallel with a higher capacitance ceramic capacitor. The chip capacitor provides effective decoupling at microwave frequencies, while the larger capacitor maintains a low-impedance path to ground down to low frequency.

construction

The construction of this 2-watt stage is complicated somewhat by the fact that both thermal and rf factors must be considered. Good rf circuit techniques are needed so that the potential performance of the amplifier can be achieved, while at the same time the transistor must have a good path for heat transfer, or the heat generated might destroy the

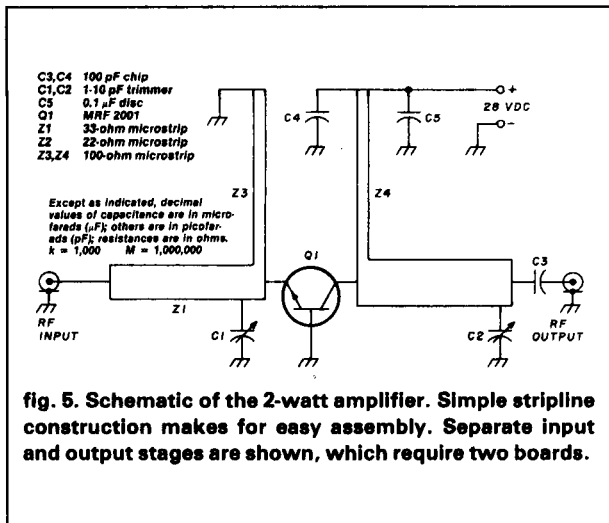

fig. 5. Schematic of the 2-watt amplifier. Simple stripline construction makes for easy assembly. Separate input and output stages are shown, which require two boards.

transistor or shorten its life. For this reason, the transistor package is designed so it can be mounted to a heat sink. If this is properly done, the transistor junction temperature can be kept low enough so that no damage or degradation will occur.

thermal considerations

Heat is a major enemy of power transistors. The temperature of the transistor die or chip inside the package is the critical factor. For a silicon transistor, the maximum allowable junction temperature is usually specified as 392 F (200 C). However, it is very desirable to operate it at a lower temperature than this, since, as a rule of thumb, the transistor lifetime doubles for every 18 F temperature reduction.⁸ If the junction temperature is kept below 302 F (150 C), the average time to failure for a gold-metalized transistor, such as the MRF2001, is measured in decades. Since in Amateur applications a transmitter is used only intermittently, a transistor transmitter operated below this temperature should easily outlive its creator.

The data sheet for the MRF2001 states that the thermal resistance, measured from the transistor junction to the mounting flange of the package, is 45 F per watt of dissipation. If the amplifier has an efficiency* of 50 per cent, then, when it is producing 2.5 watts of rf output, it will also be generating 2.5 watts of heat. This waste heat must be carried away from the die. In this instance the transistor junction will be approximately $2.5 \times 45 F = 112.5 F$ hotter than the case of the package. If the case itself is held at a temperature of 122 F (50 C), for example, the junction temperature will be a fully acceptable 243.5 F (117.5 C).

To keep the transistor's case below this target temperature of 122 F (50 C), it must be coupled to a cool heat sink with a connection of low thermal resistance. At this power level, if the transistor flange is bolted to a small finned aluminum heat sink the transistor case temperature will remain well below 122 F (50 C) when the heat sink is located in a normal room temperature environment.

assembly

Because of the flange mounting transistor, the matching circuit is mounted on two separate circuit boards, one for the input and one for the output. The board material is 1/32 inch (0.8 mm) thick type G-10 Fiberglass epoxy double clad with copper. Full-scale illustrations of the boards are shown together in fig. 6. The other side of the board is left unetched to serve as a groundplane for the microstrip lines. After etching, the boards are separated along the marked edges. Components are mounted on the boards as indicated in fig. 7.

The transistor is bolted directly to a small aluminum heatsink, which is approximately 1.2 by 4 inches (3 by 10 cm) in size. The heat sink is located on the outside of the chassis box with the transistor mounted on it and projecting through the wall of the box in a hole cut with a 1-inch (2.5-cm) chassis punch.

The boards for the input and output circuits are inside the chassis box and are attached to the heat sink with machine screws that run through the box wall. The distance from the bottom of the transistor case up to the bottom of its stripline leads is 0.12 inch (3.0 mm). This distance is taken up by the box wall, which is about 0.05 inch (1.2 mm) thick, by the circuit board thickness of 0.031 inch (0.8 mm), and by a spacer, which is a small piece of the same type of circuit board. Thus the total height is about 0.11 inch (2.8 mm), so that the circuit board traces fit snugly

*Efficiency of rf power semiconductors has been defined in many ways. Here it is taken to be the ratio of the rf output power to the dc collector input power $\times 100$ per cent.

beneath the transistor leads, ready for soldering. A cross-sectional view of this construction method is shown in **fig. 8**. Device outlines are shown in **fig. 9**.

tuning

One of the more challenging problems facing anyone who tries to tune Amateur microwave equipment is to devise test and tune-up procedures that are effective but don't require the use of elaborate

test gear, not available to most hams. For instance, if you have access to a microwave rf sweeping signal generator, a spectrum analyzer and a calibrated power meter, you'll not have any difficulty in tuning this amplifier chain for peak performance. Unfortunately, few of the ham shacks I've visited have been quite so well equipped.

When I first tuned up these two units, I made use of a spectrum analyzer and power meter to tune and

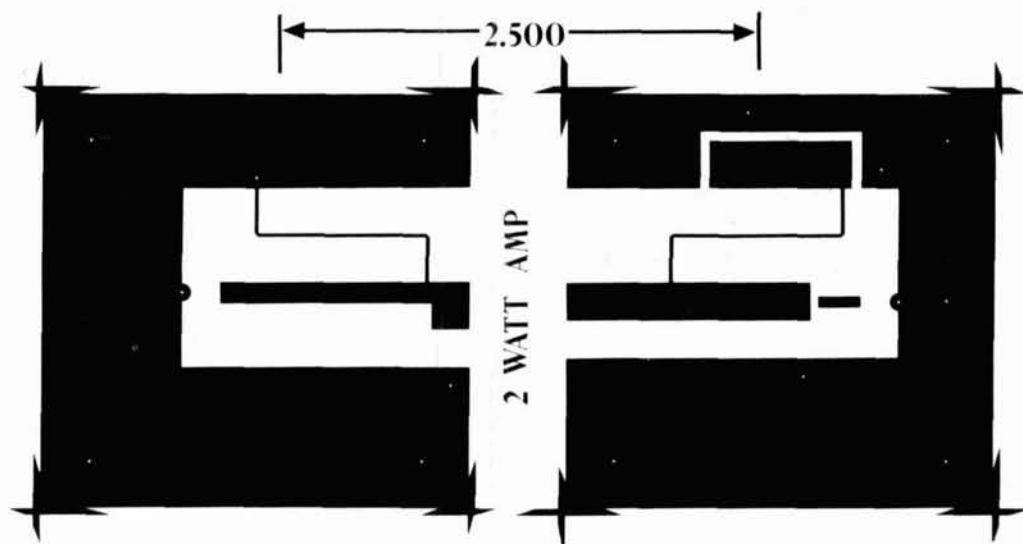

fig. 6. Full-size PC board illustration for the 2-watt amplifier. After etching, the two boards are separated along the marked edges as shown.

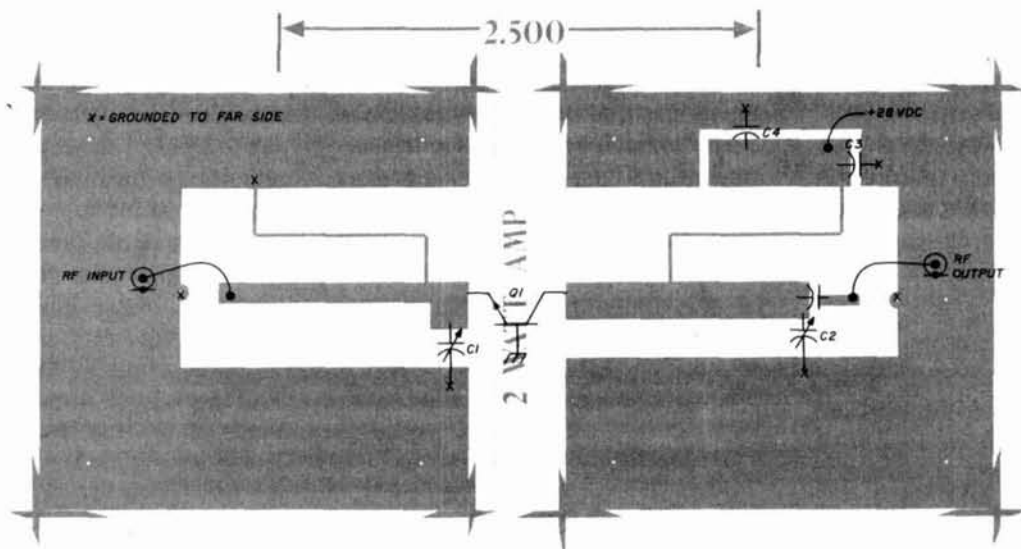

fig. 7. Component placement for the 2-watt amplifier. See text for correct assembly.

to verify that each stage was operating correctly and had clean, spurious-free outputs. Then I detuned them and retuned each at a single frequency using only the power meter, to show maximum signal.

This simplified method worked surprisingly well. Each amplifier had a single peak in output power, a fact that makes tuning with no spectral display easy and not misleading. When the amplifiers are peaked in this way, their bandwidths are wide enough to cover the band and nearly as flat in amplitude response as when they had been tuned with a swept signal source.

To tune up the 2-watt stage using the "no-equipment" approach, you need a signal source that will give a 100-milliwatt output at 1275 MHz, or else at

the operating frequency if you prefer to optimize performance there. The first stage driven with a 2-milliwatt signal will serve as a driver, of course. To indicate power, a receiver with a signal-level meter, an rf power meter, an rf millivoltmeter, or a crystal detector may be used.

The output from the final stage should not be fed directly into most types of signal indicators, though, because the power level expected would probably damage them. The signal must be reduced to a level that the power meter can safely handle.

One way to do this is to use a directional coupler as shown in fig. 10. The amplifier signal is sent through the directional coupler, and a low-level sample of the signal appears at the coupled port.

Alternatively, the output signal can be attenuated with a resistive network as in fig. 11. A suitable attenuator pad can be built to do this. It is a pi-section attenuator with a loss of 20 dB, so that the output of the Class C final stage is reduced in passing through it to a level of about 20 milliwatts. If this is still too much power for your detector, two attenuators can be placed in series.

The attenuator pad can be built using 1/2-watt, 5 per cent carbon composition resistors by following the schematic shown in fig. 12. The 1/2-watt resistors are used because, although 2-watt-rated resistors would be better able to stand the heat generated by the amplifier output, their physical size leads to excessive reactance at high frequency.

I realize that any microwave engineer would cringe

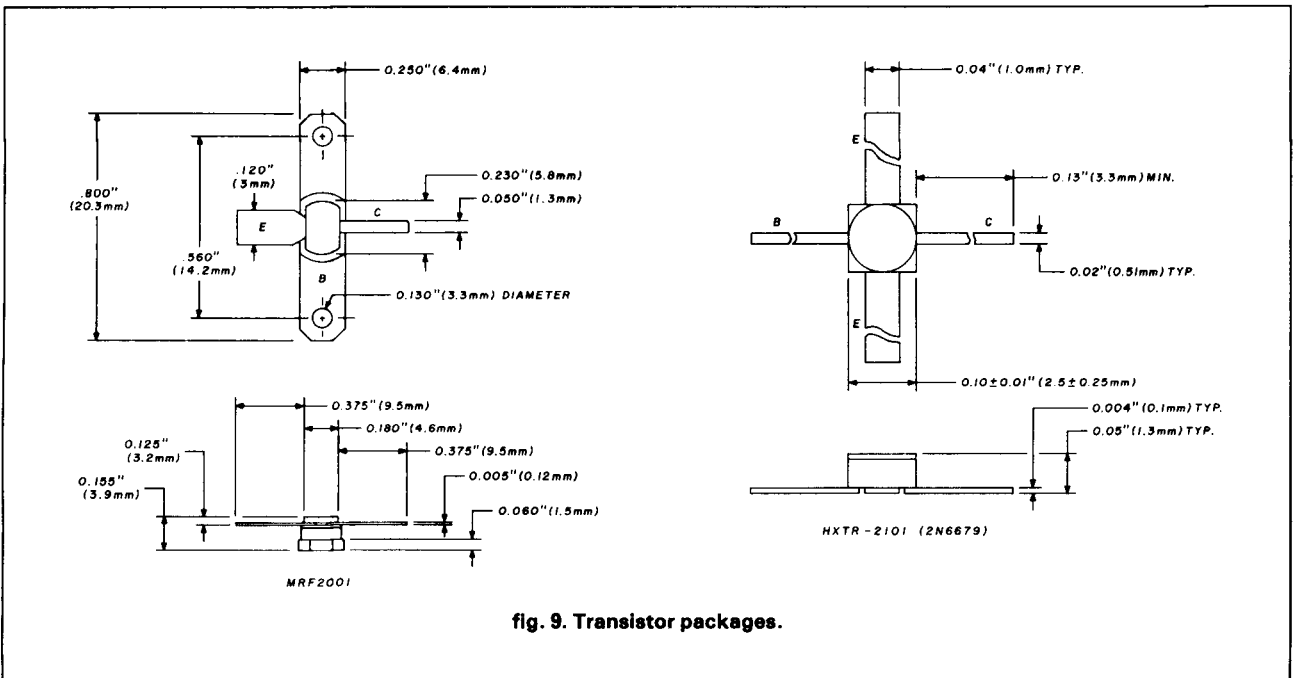
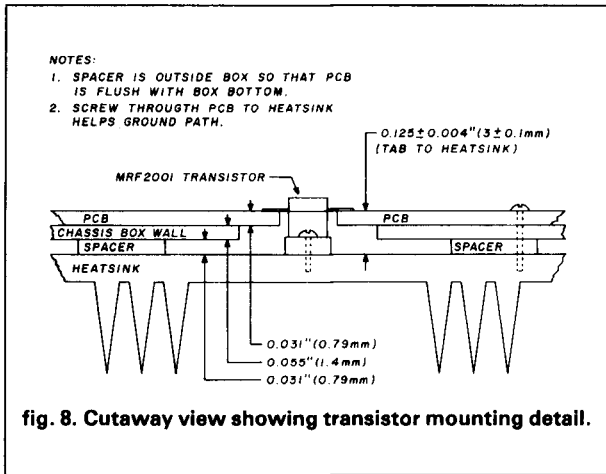

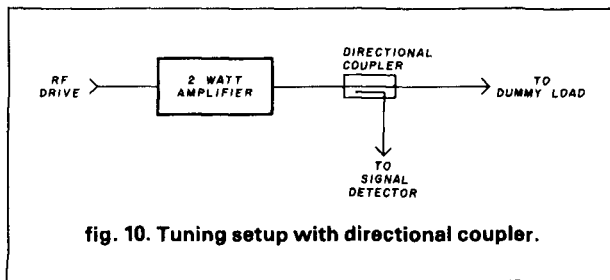

fig. 10. Tuning setup with directional coupler.

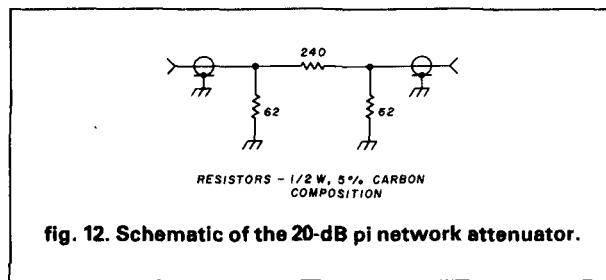

fig. 12. Schematic of the 20-dB pi network attenuator.

at the thought of using such a pi-attenuator at 1300 MHz. However, even though this attenuator is a bit crude, if it's built on a small piece of copper-clad board with the shortest possible lead lengths, it can give an acceptably low VSWR.

This attenuator won't stand 2 watts of rf input for long, so tune rapidly and give the resistors a chance to cool down often. Remember that once heated above a certain point, the resistors will not return to the same resistance they had when new. This will change network attenuation and could lead to errors in tuning.

Once you have the setup together, the hardest part of the task of tuning is done. All that remains is

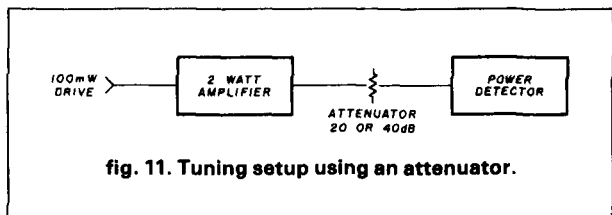

fig. 11. Tuning setup using an attenuator.

to apply the drive signal and peak the two variable capacitors for maximum power output. It's best to go back and forth between the two capacitors a few times; their adjustments do interact a bit.

Fig. 13 shows the final result of this method of tuning. It shows the output of the cascaded system when the input signal is held at a constant 2 milliwatts and swept in frequency from 1250 to 1300 MHz. The output is greater than 2 watts across the band and is nearly 3 watts at the center point.

The final amplifier stage draws about 165 milliamps at 28 volts when producing 2.3 watts output. This indicates that it's operating at approximately 50 per cent efficiency. No attempt was made to tune for better efficiency, although this can often be done.

conclusions

The amplifiers described here are stable, fairly inexpensive, and simple to reproduce. Second stage

output power is sufficient to provide solid horizon coverage for voice communication when used with only a moderate gain antenna. The flexibility of the modular construction means the amplifiers can be adapted to a range of uses.

The final stage was biased as a Class C amplifier for use in an fm system. In SSB or ATV service, however, a more linear amplifier is needed. It is likely, as the manufacturer suggests, that the transistor could be operated in Class B, although I have not tried this.

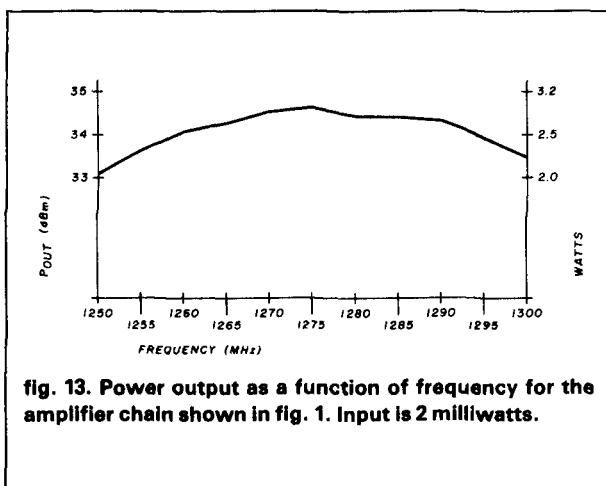

fig. 13. Power output as a function of frequency for the amplifier chain shown in fig. 1. Input is 2 milliwatts.

references

1. Joe M. Cadwallader, "1296 MHz Transverter," *ham radio*, July, 1977, page 10.
2. Ronald Stefanski, "Video Modulated Four-Tube Amplifier for 1270-MHz Television," *ham radio*, June, 1977, page 67.
3. R. Fisher, et al., "1296 MHz Power Amplifier," *ham radio*, March, 1970, page 43.
4. Tom Ormond, "RF Semiconductors: Harder to Abuse and Much Easier to Use," *EDN*, November 5, 1974, page 20.
5. H. Paul Shuch, "Solid State Microwave Amplifier Design," *ham radio*, October, 1976, page 40.
6. Octavius Pitzalis, Jr., and Russell A. Gilson, "Broad-Band Microwave Class-C Transistor Amplifiers," *IEEE MTT-21*, No. 11, November, 1973, page 660.
7. R.S. Carson, *High-Frequency Amplifiers*. John Wiley & Sons, New York, 1975, page 82.
8. Mike Flahie, "Reliability and MTF — The Long and Short of It," *Micro-Waves*, July, 1972.

ham radio

ramsey**the first name in Counters!****9 DIGITS 600 MHz \$129⁹⁵ WIRED**

PRICES:

CT-90 wired, 1 year warranty	\$129.95
CT-90 Kit, 90 day parts warranty	109.95
AC-1 AC adapter	3.95
BP-1 Nicad pack + AC Adapter/Charger	12.95
OV-1, Micro power Oven time base	49.95
External time base input	14.95

The CT-90 is the most versatile, feature packed counter available for less than \$300.00! Advanced design features include: three selectable gate times, nine digits, gate indicator and a unique display hold function which holds the displayed count after the input signal is removed! Also, a 10MHz TCXO time base is used which enables easy zero beat calibration checks against WWV. Optionally, an internal nicad battery pack, external time base input and Micro-power high stability crystal oven time base are available. The CT-90, performance you can count on!

SPECIFICATIONS:

Range:	20 Hz to 600 MHz
Sensitivity:	Less than 10 MV to 150 MHz Less than 50 MV to 500 MHz
Resolution:	0.1 Hz (10 MHz range) 1.0 Hz (60 MHz range) 10.0 Hz (600 MHz range)
Display:	9 digits 0.4" LED
Time base:	Standard-10.000 MHz, 1.0 ppm 20-40°C, Optional Micro-power oven-0.1 ppm 20-40°C
Power:	8-15 VAC @ 250 ma

7 DIGITS 525 MHz \$99⁹⁵ WIRED**SPECIFICATIONS:**

Range:	20 Hz to 525 MHz
Sensitivity:	Less than 50 MV to 150 MHz Less than 150 MV to 500 MHz
Resolution:	1.0 Hz (5 MHz range) 10.0 Hz (50 MHz range) 100.0 Hz (500 MHz range)
Display:	7 digits 0.4" LED
Time base:	1.0 ppm TCXO 20-40°C
Power:	12 VAC @ 250 ma

The CT-70 breaks the price barrier on lab quality frequency counters. Deluxe features such as: three frequency ranges - each with pre-amplification, dual selectable gate times, and gate activity indication make measurements a snap. The wide frequency range enables you to accurately measure signals from audio thru UHF with 1.0 ppm accuracy - that's .0001%! The CT-70 is the answer to all your measurement needs, in the field, lab or ham shack.

PRICES:

CT-70 wired, 1 year warranty	\$99.95
CT-70 Kit, 90 day parts warranty	84.95
AC-1 AC adapter	3.95
BP-1 Nicad pack + AC adapter/charger	12.95

**7 DIGITS 500 MHz \$79⁹⁵ WIRED****PRICES:**

MINI-100 wired, 1 year warranty	\$79.95
MINI-100 Kit, 90 day part warranty	59.95
AC-Z Ac adapter for MINI-100	3.95
BP-Z Nicad pack and AC adapter/charger	12.95

Here's a handy, general purpose counter that provides most counter functions at an unbelievable price. The MINI-100 doesn't have the full frequency range or input impedance qualities found in higher price units, but for basic RF signal measurements, it can't be beat! Accurate measurements can be made from 1 MHz all the way up to 500 MHz with excellent sensitivity throughout the range, and the two gate times let you select the resolution desired. Add the nicad pack option and the MINI-100 makes an ideal addition to your tool box for "in-the-field" frequency checks and repairs.

SPECIFICATIONS:

Range:	1 MHz to 500 MHz
Sensitivity:	Less than 25 MV
Resolution:	100 Hz (slow gate) 1.0 KHz (fast gate)
Display:	7 digits, 0.4" LED
Time base:	2.0 ppm 20-40°C
Power:	5 VDC @ 200 ma

8 DIGITS 600 MHz \$159⁹⁵ WIRED**SPECIFICATIONS:**

Range:	20 Hz to 600 MHz
Sensitivity:	Less than 25 mv to 150 MHz Less than 150 mv to 600 MHz
Resolution:	1.0 Hz (60 MHz range) 10.0 Hz (600 MHz range)
Display:	8 digits 0.4" LED
Time base:	2.0 ppm 20-40°C
Power:	110 VAC or 12 VDC

The CT-50 is a versatile lab bench counter that will measure up to 600 MHz with 8 digit precision. And, one of its best features is the Receive Frequency Adapter, which turns the CT-50 into a digital readout for any receiver. The adapter is easily programmed for any receiver and a simple connection to the receiver's VFO is all that is required for use. Adding the receiver adapter in no way limits the operation of the CT-50, the adapter can be conveniently switched on or off. The CT-50, a counter that can work double-duty!

PRICES:

CT-50 wired, 1 year warranty	\$159.95
CT-50 Kit, 90 day parts warranty	119.95
RA-1, receiver adapter kit	14.95
RA-1 wired and pre-programmed (send copy of receiver schematic)	29.95

**NEW
READ
RECEIVER
FREQUENCY**

**DIGITAL MULTIMETER \$99⁹⁵ WIRED****PRICES:**

DM-700 wired, 1 year warranty	\$99.95
DM-700 Kit, 90 day parts warranty	79.95
AC-1, AC adaptor	3.95
BP-3, Nicad pack + AC adapter/charger	19.95
MP-1, Probe kit	2.95

The DM-700 offers professional quality performance at a hobbyist price. Features include: 26 different ranges and 5 functions, all arranged in a convenient, easy to use format. Measurements are displayed on a large 3 1/2 digit, 1/2 inch LED readout with automatic decimal placement, automatic polarity, overrange indication and overload protection up to 1250 volts on all ranges, making it virtually goof-proof! The DM-700 looks great, a handsome, jet black, rugged ABS case with convenient retractable tilt bail makes it an ideal addition to any shop.

SPECIFICATIONS:

DC/AC volts:	100uV to 1 KV, 5 ranges
DC/AC current:	0.1 uA to 2.0 Amps, 5 ranges
Resistance:	0.1 ohms to 20 Megohms, 6 ranges
Input impedance:	10 Megohms, DC/AC volts
Accuracy:	10.1% basic DC volts
Power:	4 °C cells

AUDIO SCALER

For high resolution audio measurements, multiplies UP in frequency.

- Great for PL tones
- Multiplies by 10 or 100
- 0.01 Hz resolution!

\$29.95 Kit \$39.95 Wired

ACCESSORIES

Telescopic whip antenna - BNC plug	\$ 7.95
High impedance probe, light loading	15.95
Low pass probe, for audio measurements	15.95
Direct probe, general purpose usage	12.95
Tilt bail, for CT 70, 90, MINI-100	3.95
Color burst calibration unit, calibrates counter against color TV signal.	14.95

COUNTER PREAMP

For measuring extremely weak signals from 10 to 1,000 MHz. Small size, powered by plug transformer-included.

- Flat 25 db gain
 - BNC Connectors
 - Great for sniffing RF with pick-up loop
- \$34.95 Kit \$44.95 Wired

ramsey electronics inc.
2575 BAIRD RD., PENFIELD, NY 14526

PHONE ORDERS
CALL 716-586-3950

TERMS

Satisfaction guaranteed - examine for 10 days if not pleased return in original form for refund. Add 5% for shipping - insurance to a maximum of \$10. Overseas add 15% COD. add \$2. Orders under \$10. add \$1.50. NY residents add 7% tax.

ham radio TECHNIQUES

Bill W6SAI

Diana to EME in 20 years

Sharp-eared newcomers to the Amateur bands may occasionally hear operators talking about EME schedules. A recent issue of *QST* magazine listed the scores earned by stations engaging in an EME contest. How did it all get started?

For years man has dreamed of reaching the moon. Jules Verne wrote about it. In 1930, a well-known inventor and science writer told how it would be possible to use the moon

as a reflector to bounce very short radio waves around the earth (fig. 1). But nobody had attempted the task; it was an idle dream. No one was even sure that radio waves would penetrate the ionosphere and reach the moon. Perhaps one day this fanciful idea would take root.

While others dreamed, John DeWitt, Jr., W4ERI, decided to act. A Radio Amateur and avid astronomer, John had combined his hobbies while still in high school, and while a

young student in Nashville, Tennessee, he had constructed vhf receiving equipment sensitive enough so that he could hear radio noise from the Milky Way — noise which Karl Jansky had discovered a few years earlier.

Finally, in 1940, young DeWitt assembled an 80-watt transmitter, a high-gain antenna, and a sensitive receiver and attempted to send a signal from his transmitter to the moon and back. The experiment was a failure and John set about to determine the cause of his problems. He finally understood that more power, bigger and better antennas and a more sensitive receiver were the keys to success.

The onset of World War II brought all of W4ERI's plans to a stop. Amateur Radio was closed down for the duration. But, as John assumed military service, the idea remained planted in the back of his memory. By then a recognized authority in broadcasting, John rose rapidly in the expanding field of military communications, and by 1944 had risen to the rank of lieutenant colonel and was in charge of the Army's Evans Signal Laboratory at Belmar, New Jersey.

The highly classified work of the laboratory drew to a close in August, 1945, with the abrupt end of the war. DeWitt's important jobs quickly evaporated, but he did not have sufficient discharge points to return to civilian life. He fretted under the boredom and inaction.

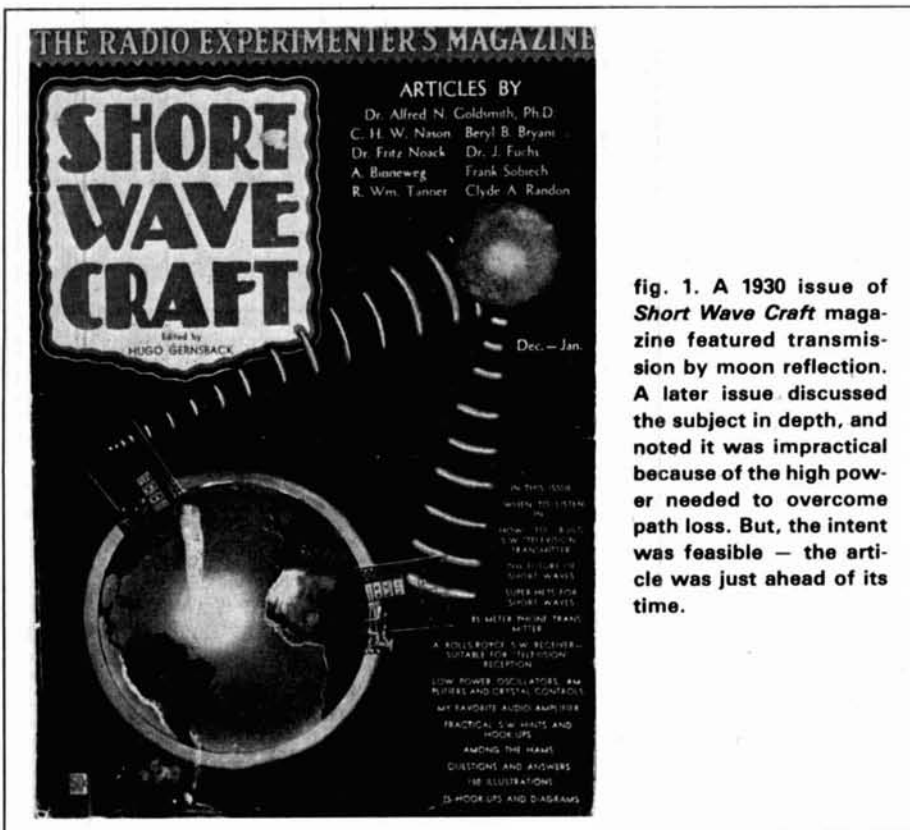

fig. 1. A 1930 issue of *Short Wave Craft* magazine featured transmission by moon reflection. A later issue discussed the subject in depth, and noted it was impractical because of the high power needed to overcome path loss. But, the intent was feasible — the article was just ahead of its time.

project Diana

While John bided his time, the Pentagon had a vital question at hand, brought about by the V-2 rocket attacks on London during the war. Was there a way an enemy could direct a rocket attack on the United States using radio-controlled

work and that reflected signals could be detected from the moon — but nobody was *sure* it could be done.

No matter. DeWitt forged ahead, and by January, 1946, he was ready for on-the-air tests. Preliminary tests in December had been inconclusive but he felt that his team was on the verge of success.

heard the first echo return on a loud-speaker and saw the returned signal on an oscilloscope connected to the receiver. For the first time, man had touched the moon with an electronic signal and the moon had answered back.

Project Diana was a success and fired the imagination of the public in a manner which may seem surprising in today's more technically sophisticated atmosphere. Soon the U.S. Navy had a microwave moonbounce link from Annapolis to Pearl Harbor, and, very shortly, Amateur moonbounce (EME) circuits would come into being.

amateur moonbounce experiments

It was not until July, 1960, that the first two-way Amateur moon-bounce contact was recorded.¹ It happened on the 1296-MHz Amateur band between W6HB (The Eimac Radio Club) and W1BU (The Rhododendron Swamp VHF Society). Hank Brown, W6HB, and Sam Harris, W1BU, and their crews worked for weeks getting the equipment ready to go, and finally made contact. Moonbounce communications, using Amateur power levels, was proven possible and it

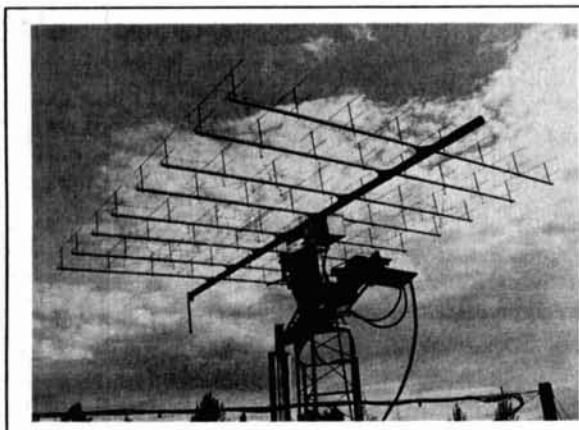

The elaborate 432-MHz moonbounce antenna array of ZE5JJ in Rhodesia boasts 128 elements and can track the moon automatically. Peter has since constructed a parabolic reflector using aluminum angle stock and wire screening. It has been very successful.

rockets? Could radio and radar signals actually penetrate the ionosphere, or not? Perhaps DeWitt and his remaining laboratory staff could provide the answer.

Once given the go-ahead, John assembled his staff and went to work. Among the group were radio amateurs E.K. Stodola, W3IYF, Frank Elacker, ex-W2DMD, and Harry Kauffman, W2OQU (who would be the first to hear a returned echo from the moon).

The transmitter was an old SCR-271 radar set, much modified, which provided 4-kW output on 111.5 MHz. By combining two radar antennas, DeWitt created an array of sixty-four elements and directors which provided a power gain of nearly 22 dB. His crew built a special superheterodyne receiver of very narrow bandwidth and high sensitivity. All of this, everyday equipment now, was state-of-the-art in 1945.

DeWitt and his crew had to design very special test equipment to make sure their exotic moon-bounce station was performing properly. Calculations showed the project would

On the morning of January 10, 1946, DeWitt and his staff fired up the "moonbounce" transmitter. The cumbersome antenna was aimed at the moon, and one-second pulses were sent out every four seconds. Finally, after an agonizing wait, they

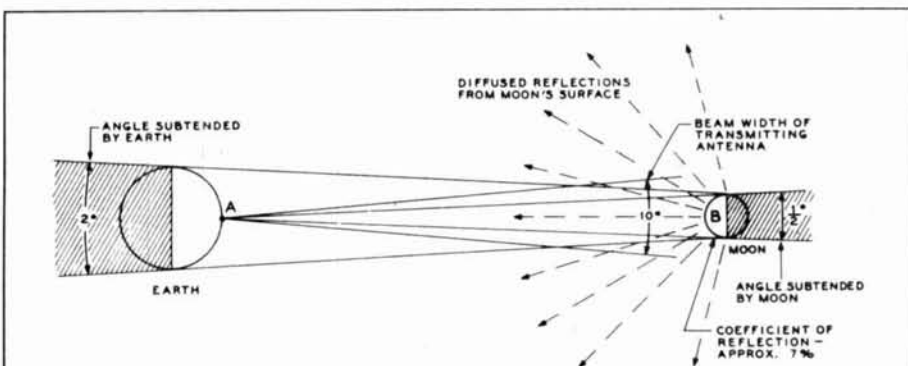

fig. 2. The Earth-Moon-Earth radio circuit. This illustration shows the great obstacles which would seem to make detection of moon-reflected signals highly improbable. The path to the moon and back is about half a million miles and the moon reflects only about 7 per cent of the radio energy striking it. The reflected energy is diffused all over the heavens and only a small portion of the energy which left the radio transmitter is reflected back to earth. Finally, the largest vhf receiving antenna is only a fraction of the earth's pickup area facing the moon. In spite of these staggering difficulties, the earth-moon-earth radio circuit can be made to work with equipment well within the capabilities of many vhf-minded radio Amateurs (drawing courtesy of *Radio Publications, Inc.*).

now remained only to see if other enterprising Amateurs would follow the lead established by these two radio clubs.

Interest grew slowly (possibly because the experiments had been done in a little-used and relatively unknown ham band), and it was not until 1964 that Amateur interest in EME communications was awakened with a jolt when Bill Conkel, W6DNG, ran 2-meter schedules via the moon with Lenna Suominen, OH1NL, of Finland. Here was real moonbounce with everyday Amateur vhf equipment.

Since those early years, EME interest has grown until today hundreds of Radio Amateurs maintain schedules and experimental contacts via the moon on 144, 220, and 432-MHz.² At last, EME has come of age.

the EME path

What kind of equipment and antennas does it take to establish a moonbounce station? Who can be worked? Does all the work have to be done at night?

The moon is about 2160 miles in diameter and orbits the earth at a distance that varies from 221,463 to 252,710 miles. An orbit takes about twenty-eight days and is somewhat eccentric, so that the moon travels across a different segment of sky each night of the lunar month. And, although the moon looks quite large when it is full, it subtends an arc of only about 0.5 degree when seen from the earth (fig. 2). Even the highest gain Amateur vhf antenna has a

EME path loss	distance miles (km)	50 MHz (dB)	144 MHz (dB)	432 MHz (dB)	1296 MHz (dB)	2400 MHz (dB)
Perigee	221,463 (356,334)	177.89	187.08	196.62	206.17	211.43
Apogee	252,710 (406,610)	179.03	188.21	197.76	207.21	212.56

fig. 3. Free-space path loss for earth-moon-earth circuit at perigee (221,463 miles) and apogee (252,710 miles). The nominal 1.14 decibel difference in signal loss between moon perigee and apogee becomes 2.28 decibels for the round trip to the moon and back.

fig. 4. Moonbounce Nomograph provides guideline to successful moonbounce QSO. The graph is based upon 590 watts transmitter power output, zero decibel receiver noise figure, and 100-Hz bandwidth. Lay a straight edge across any two columns and read the desired unknown in the third column. The antenna-gain figures represent a compromise between calculated gain required based upon free space losses and the experience of successful moonbounce experimenters. At 144 MHz, for example, for an average signal-to-noise ratio of zero decibels, a total antenna gain (for both ends of the path) is about 42 decibels. Two 22 decibel gain antennas should do the job.

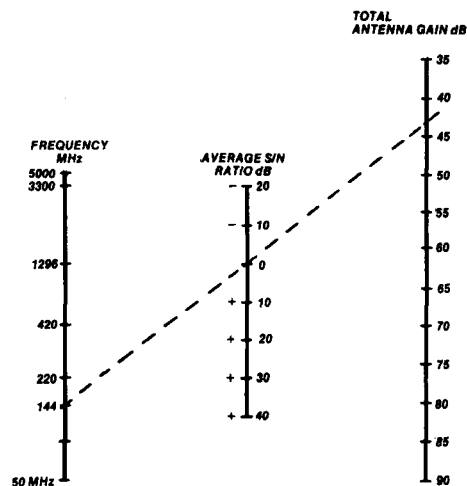

beam width much greater than this, consequently only a small portion of the signal aimed at the moon actually strikes it; the rest passes out into limitless space. Furthermore, an estimated 93 per cent of the signal that does strike the moon is absorbed. Also, as our astronauts verified, the moon surface is exceedingly rough; thus the 7 per cent of the reflected energy is diffused all over space.

Viewed from the moon, the earth subtends an arc of about 2 degrees, and the vhf signal that returns to earth is spread over half the earth's surface, or an area of about 98,470,000 square miles. Clearly, only a small fraction of the transmitted energy ever reaches the eager ears of the moonbounce listener.

the EME path loss

Because radio signals travelling through space are attenuated at the square of the ratio of the frequency, the path loss to the moon and back is 8.3 times (9 dB) greater on 144 MHz than on 50 MHz. A similar increase in loss occurs between 144 MHz and the 420-MHz band, and between the 420 and the 1250-MHz band (fig. 3). In addition, transmitter efficiency and receiver noise-figure both tend to become worse with increasing frequency. Thus, there are compelling reasons to use as low an operating frequency as possible for EME work.

On the other hand, the power gain of a beam antenna of a given size increases by the same ratio that the path loss increases and, because the antenna gain is realized in both transmission and reception, there is a net circuit signal gain with increase in frequency, even after deducting the increased circuit losses.

The various factors point to the use of the 144 MHz and 430 MHz Amateur bands for EME operation: good equipment is available, antenna size is not too great, and there's enough international activity on these bands to make the investment in time and effort worthwhile. On 2 meters, the

portion of the band between 144.00 and 144.10 MHz is an international segment, and it is in this region that a great deal of serious moonbounce activity takes place.

how much power?

how big an antenna?

Fig. 4 provides a guideline to successful moonbounce communications. The scale at the right-hand side of the nomograph labeled Total Antenna Gain shows, for example, that if two stations having a combined antenna gain of about 43 dB and are satisfied with an average signal-to-noise ratio of zero dB, they can achieve two-way communications.

This graph is based upon a transmitter power output of 590 watts, a zero-dB noise figure, and a receiver bandwidth of 100 Hz. I'm sure that no moonbounce station fits these esoteric requirements, but hundreds of them come close, and some may surpass these figures. This is how it is done in the real world.

The Total Antenna Gain scale tells us that if one EME station is equipped with a 26-dB-gain antenna, the station at the other end of the circuit will need only 17 dB antenna gain, all other things being equal. *The greater the antenna gain at one end, the smaller the array needs to be at the other end.* On 2 meters, there are

many stations equipped with high-gain antennas for meteor scatter and other forms of long-distance communication. Long Yagi beam antennas are available from several manufacturers, and many will provide a power gain of 17 dB. Two of them properly arranged can provide about 20 dB power gain. Again, all else being equal, a station equipped with a 20-dB antenna array can theoretically contact another station which has an antenna array with a power gain of 23 dB. And, if contacts are made on a rising or setting moon, the stations can take advantage of ground reflection of the signals to pick up an additional few dB of signal strength.

Moonbounce for everyone. That is just about possible using the new antenna recently assembled by Cushcraft's Chief Engineer, David Olean, K1WHS. Dave's antenna (below) makes it possible for him to contact stations with single Boomers and only modest power. Recently, he contacted Dave Redman, G4IDR, who was using a single Cushcraft 32-19 Boomer and approximately 200 watts at his antenna. Many other hams with single Yagis from Europe and the U.S. have had their first moonbounce contacts this year with K1WHS.

Dave Olean's new antenna consists of 24 Cushcraft Jr. Boomers model 214B. These Boomers are only 15 feet (4.6 m) long. The total antenna gain is about 26 dBd including feedline losses. This is more than sufficient to cover the 450,000 miles (725,000 km) round trip to and from the moon.

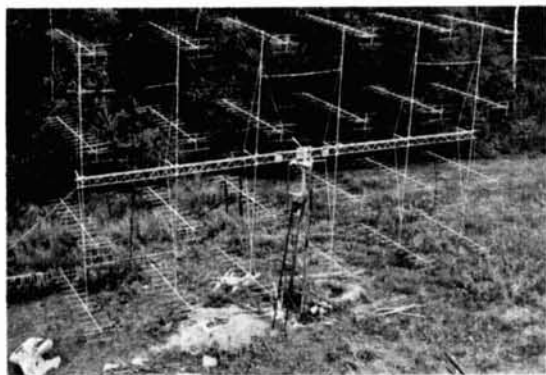

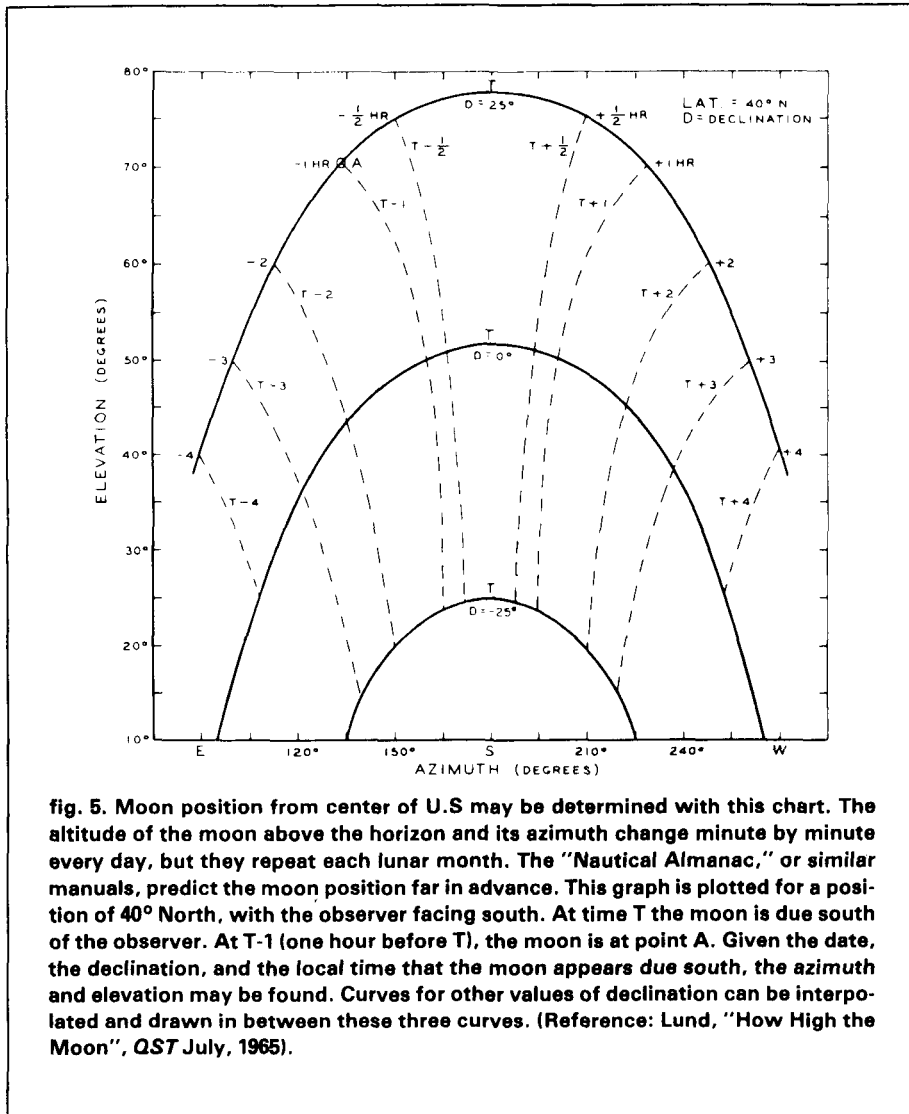

fig. 5. Moon position from center of U.S. may be determined with this chart. The altitude of the moon above the horizon and its azimuth change minute by minute every day, but they repeat each lunar month. The "Nautical Almanac," or similar manuals, predict the moon position far in advance. This graph is plotted for a position of 40° North, with the observer facing south. At time T the moon is due south of the observer. At T-1 (one hour before T), the moon is at point A. Given the date, the declination, and the local time that the moon appears due south, the azimuth and elevation may be found. Curves for other values of declination can be interpolated and drawn in between these three curves. (Reference: Lund, "How High the Moon", *QST* July, 1965).

Today, stations using relatively modest antennas and everyday equipment are enjoying EME contacts on 2 meters. Many vhfers who have good antennas and high power are inadvertently bouncing their signals off the moon without even knowing it.

I recently spoke on the telephone with Dave Olean, K1WHS, who is a prominent 2-meter operator and well-known moon-bounce enthusiast. Dave has an elaborate antenna system, and tells me that he can aim his array at the moon and tune around 144.1 MHz during periods of high activity and hear Amateurs working each other. Their antennas are positioned so that the moon sweeps

through the beam and their signals are reflected back to earth to the waiting ears of K1WHS. Dave guesses that there are probably over a thousand vhf stations in the United States who can work moonbounce but *don't know they have the capability*.

I asked Dave what it took to become an EME experimenter. He told me that if a station had a good 2-meter transceiver (such as the TS-700 Kenwood, or equivalent) a low-noise preamplifier, and a good, high-gain Yagi on a 15-foot boom, *he would hear* moonbounce signals, provided he aimed the antenna at the moon. Hearing signals is the first step to

working stations.

the nitty-gritty

The nice thing about moonbounce is that you can let the other fellow do most of the work. The more antenna gain and power the other fellow has, the less you need. And there are enough serious-minded EME experimenters on the air today that a beginner can get in the game and talk to the big guns without having to make a large expenditure of time, money, or effort.

Of course, for the serious experimenter, there's a lot more to it than just hearing signals. Most moonbouncers have antennas that can track the moon — sometimes automatically. Computer-oriented Amateurs have complete tracking programs worked out showing the position of the moon a year in advance, and have antenna controls that permit automatic moon tracking. But you don't need all of this to get started. Many Amateurs have fixed antennas placed in such a position that the moon will sweep through the beam during the time the moon is mutually visible to operators at both ends of the chosen path. A typical moon-position chart, such as shown in **fig. 5** is useful in positioning the antenna.

Other factors enter the picture, as the moonbouncer soon discovers. Because the moon moves toward or away from the earth at speeds up to 980 miles per hour, *Doppler shift* changes the frequency of the moon-reflected signal. At 144 MHz, the Doppler shift can be as large as 427 Hz. When the moon is rising, the received frequency goes up; when the moon is setting the frequency goes down. Frequency shift is minimum when the moon is perpendicular to the observer.

what does the signal sound like?

It takes a radio signal slightly over 2 seconds to make the trip to the moon and back, so the return echos of your transmission can be easily received. The best way of testing an EME cir-

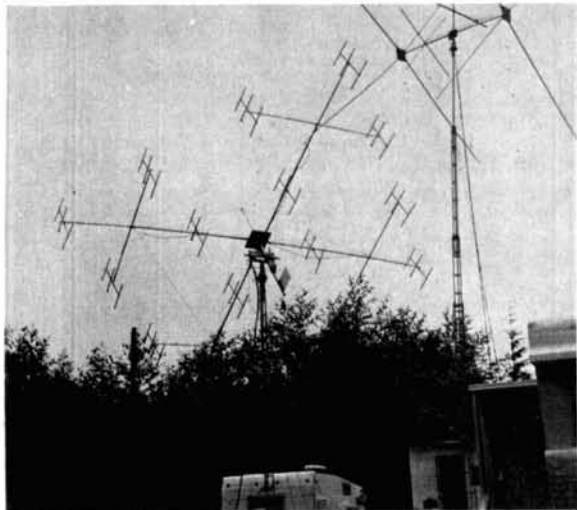

The portable moonbounce station of K6YNB/KL7 (now N6NB) puts Alaska on the map. Note that the 2-meter array (left) is composed of sixteen 3-element quads.

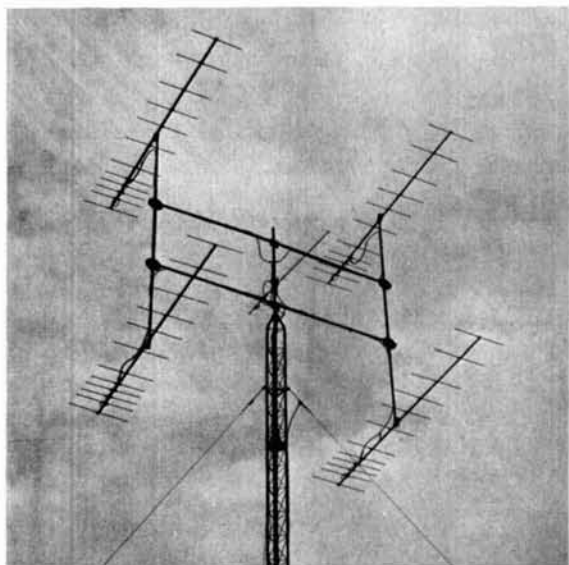

Moonbounce array for 2 meters at WA1FFO is composed of four Yagis, each having 12 elements. All of these big antennas make it easier for you to work moonbounce because the other station does most of the work!

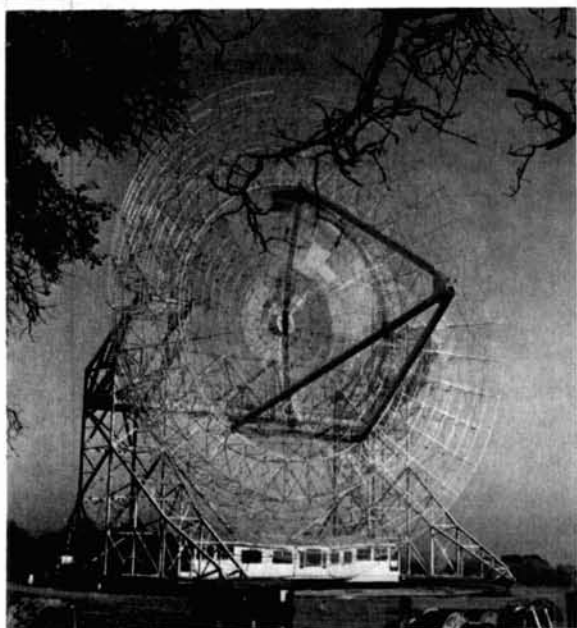

The radio telescope at Stanford University in California is occasionally used for moonbounce experiments in Amateur bands. You can really hear this 200-foot-diameter giant when it is on the air! The whole antenna and control building rotates on a circular metal track. Dominating the skyline above Palo Alto, California, the dish can be seen for miles.

cuit, in fact, is to listen to the return echos of your own transmitter. It is quite an eerie feeling to send CW signals and hear them bounce back at you a short time later. Voice signals returning from the moon have a hollow quality about them that is instantly recognizable to a moonbounce enthusiast.

Plenty of stations are active *today*. A good guess is that there are over 350 moonbounce stations active, in all continents, on the 2-meter and 432-MHz bands. Many of them maintain schedules with each other, but on an active weekend plenty of moonbouncers call CQ to raise another moon-bounce enthusiast. During an EME contest, or other weekend of high vhf activity, there is actually QRM among the many moonbounce signals.

The second article in this series will carry more specific information about moonbounce equipment and activity for the 2-meter enthusiast. Suffice to say that if you have a high-gain Yagi antenna, a low-noise receiver, and sufficient know-how to aim your antenna to the moon, you could be hearing moonbounce signals before the next issue of this magazine reaches you.

If you want additional information about moonbounce, write to me and ask for the booklet "Almost Everything You Want To Know About Moonbounce." It is a reprint of important magazine articles on the subject. Send 30 cents in stamps to cover mailing to: William Orr, c/o EIMAC, 301 Industrial Way, San Carlos, California 94070.

references

1. The full story of John DeWitt is told in the May, 1946, issue of *QST* magazine, and also in the May, 1980, issue of *IEEE Spectrum*. The story of the first two-way Radio Amateur contact via the moon is told in the September, 1960, issue of *QST*.
2. Moonbounce contacts have been made on all Amateur bands between 50 and 2400 MHz. In addition, experimenters at Stanford University in California made moonbounce experiments in the 10-meter band using an array of log periodic antennas 1200 feet long and 75 feet wide.

ham radio

90 WATT AMPLIFIER: \$89.95!

SPECIAL PACKAGE DEAL FACTORY DIRECT ONLY

That's right — 90 watts of linear power for 2 meters class AB1 for FM & SSB for only \$89.95. Also offering a 15 dB gain in-line preamp with integrated T/R relay. A \$29.95 value, for only \$20.00 when purchased with the VJ90L Amplifier.

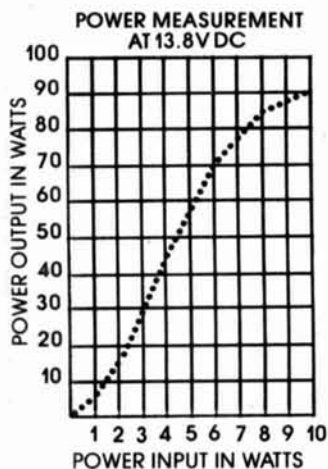

***ORDER TODAY TOLL FREE
(800) 231-9649**

PRICING OFFER EXPIRES MARCH 1, 1981



VJ90L

Each VJ Product component is hand wired and individually tuned for maximum reliability and performance. VJ Products are guaranteed to be free of defects in parts or workmanship for 1 year from the date of purchase. POWER TRANSISTORS ARE EXCLUDED, BUT WARRANTED FOR 90 DAYS. Visa accepted. Immediate shipment guaranteed by VJ Products, Inc.

Please ship: VJ90L @ \$89.95 + \$2.00 shipping
 VJ90L & Preamp @ \$109.95 + \$3.50 shipping

Name _____ Call _____
Street _____
City _____ State _____ Zip _____
Send Check, M/O, or Visa # _____ Exp. Date _____

SERVING THE ELECTRONICS INDUSTRY SINCE 1965 V-J Products, Inc. 505 E. Shaw Street, Pasadena, Texas 77506 (713) 477-0134



**CALL TOLL FREE
1-800-426-7741**



The Northwest's Largest Ham Store

WASHINGTON RESIDENTS CALL 1-800-562-6818

ALASKA RESIDENTS CALL COLLECT 1-206-784-7337

AEA MORSEMATIC



- Dual Microcomputers provide many features.
- Approximately 500 character memory with unique "soft-partitioning."
- Morse trainer mode with programmable speed-up.
- Beacon mode for VHF DX scheduling.
- Automatic serial number sequencing.
- For too many features to describe; use it and you will believe it!

C-COMM
6115-15th AVE. N.W.
SEATTLE, WA. 98107
(206) 784-7337

AEA ISOPOLE VHF ANTENNAS

Finally — a properly decoupled antenna with superior performance at a reasonable cost. Raise more repeaters or increase your simplex distance!

- 144 or 220 MHz bands.
- Achieve maximum attainable gain for a twin 5/8 wavelength antenna.
- Patterns independent of mounting or feedline length.
- Greater than 9 MHz band width.
- Completely weather protected matching network and RF connections.
- Easiest to assemble. Mounts on standard TV master (NOT SUPPLIED).



D800/D802 DIGITAL MULTIMETERS

Measures AC and DC voltage and current, resistance and diode test. Conductance also included in D802. Basic DC accuracy 0.5% D800, 0.1% D802. Complete with test leads, battery and manual.



**Only
\$125 (D800)
\$179 (D802)**

Dealers For: AEA, ALLIANCE, ALPHA, AVANTI, BENCHER, B&W, CDE, CUSHCRAFT, DAIWA, DENTRON, DRAKE, FLUKE, HUSTLER, HYGAIN, ICOM, INLINE, KLM, LARSEN, LUNAR, MFJ, NPC, NYE, ROHN, SHURE, TEMPO, TELEX, TEN-TEC, VIBROPLEX, YAESU, AND MORE.

Mon. thru Sat. 9:00 a.m. to 5:30 p.m.

Prices and specifications subject to change without notice or obligation

SUPER RIG



NEW TEN-TEC

OMNI-C 9 Band Transceiver + HERCULES Solid-State KW Linear

TEN-TEC SUPER RIG IS READY. For every band, every band condition. With the latest in solid-state hf technology, the latest in features. To make communications easier, more reliable — super.

OMNI-C

The new model in this famous series. With new coverage and new features to make it better than ever!

All 9 HF Bands. From 160 through 10 meters, including the new 10, 18 and 24.5 MHz bands. Coverage you can live with—for years and years.

3-Mode, 2-Range Offset Tuning. Offset the receiver section or the transmitter section or the entire transceiver! In 2 ranges: ± 500 Hz or ± 4 kHz. For complete flexibility in fine tuning, a DX work, or net operations.

Seven Response Curves. Four for SSB, three for CW. With new switching to select the standard 2.4 kHz filter, optional 1.8 kHz SSB filter, 500 Hz or 250 Hz CW filters, and standard 450 and 150 Hz CW active audio filters. Up to 16 poles of i-f filtering plus audio filtering to handle any situation.

Built-In Notch Filter and Noise Blanker. Notch is variable from 200 Hz to 3.5 kHz with a depth of more than 50 dB. New noise blanker reduces ignition and line noise. Both standard equipment.

"Hang" AGC. New, smoother operation.

Super Specs. Optimized sensitivity—a balance between dynamic range and sensitivity ($2 \mu\text{V}$ on 160 to $0.3 \mu\text{V}$ on 10 meters) Greater dynamic range: better than 90 dB. And a PIN diode switchable 18 dB attenuator. 200 watts input on all bands! 100% duty cycle on all bands for up to 20 minutes.

Super Convenient. Built-In VOX with 3 up-front controls. Built-In PTT control at front and rear jacks. Built-In Zero-Beat switch puts you on exact frequency. Built-In Adjustable Sidetone with variable pitch and level. Adjustable ALC for full control from low power to full output. 2-Speed Break-In, fast or slow speeds to fit operating conditions. Built-In Speaker eliminates desk clutter. Automatic Sideband Selection—reversible.

Super Design. All Solid-State and Broadbanded—from the pioneer, Ten-Tec. Modular plug-in circuit boards. Functional Styling with convenient controls, full shielding, easy-to-use size ($5\frac{3}{4}''\text{h} \times 14\frac{1}{4}''\text{w} \times 14''\text{d}$).

Super Hercules Companion. Styled to match, plus separate receiving antenna capability, plus transceiver front panel control of linear's bandswitching (one knob does it all).

Full Accessory Line including filters, remote VFO, power supplies, keyers, microphones, speech processors, antenna tuners—all in matching color.

Model 546 OMNI-Series C.... \$1289.

HERCULES

Amateur Radio's first full break-in solid-state kW linear amplifier. With the reliability you'd expect from the pioneer in high-power solid-state technology—TEN-TEC.

All Solid-State. No tubes. Instead, HERCULES uses two 500-watt push-pull solid-state amplifier modules with an output combiner. Super solid.

Broadband Design. No knobs, no tuning. From the pioneer, TEN-TEC. For fast, effortless changing of bands. Super easy.

Automatic Bandswitching when used with OMNI (the OMNI bandswitch also controls HERCULES bandswitching through a motor driven stepping switch). Super convenient.

Full Break-In. HERCULES puts the conversation back into high power CW operation—you can hear between every character you send.

Full Coverage. 160 through 15 meters plus four "AUX" positions for 10-meter conversion by owner and future band additions.

Full Gallon. 1000 watts input on all bands, 600 watts output, typical. Built-in forced-air cooling. Driving power: 50 watts, typical. Adjustable negative ALC voltage. 100% duty cycle for SSB voice modulation; 50% duty cycle for CW/RTTY (keydown time: 5 minutes max.) Continuous carrier operation at reduced output.

Full Protection. Six LED status indicators continuously monitor operating conditions and shut down the amplifier whenever any one exceeds set limits (the exciter automatically bypasses the amplifier under amplifier shut-down for barefoot operation). The six parameters monitored are: 1) overdrive; 2) improper control switch setting; 3) heat sink temp.; 4) SWR; 5) overvoltage/overcurrent; 6) rf output balance. Two meters monitor collector current, voltage, and forward/reverse power. And a highly efficient automatic line voltage correction circuit (patent applied for) eliminates the need for selecting transformer taps, prevents applying too high a voltage to final amplifier devices, becomes operative under low line conditions.

Super Power Supply. Provides approximately 45 VDC @ 24 amperes, operates on 105/125 VAC or 210/250 VAC. Tape wound transformer and choke reduce weight (50 lbs.) and size ($7\frac{1}{2}''\text{h} \times 15\frac{3}{4}''\text{w} \times 13\frac{1}{2}''\text{d}$). Separate enclosure.

Super Styling. Designed to match OMNI, the HERCULES has the same height as OMNI, plus matching bail and matching colors. The front panel is simplicity in itself with two push-button switches (power and mode) plus two knobs (meter and bandswitch), and a "black-out" monitor panel (when unit is off, meters are unobtrusive). Amplifier size is $5\frac{3}{4}''\text{h} \times 16''\text{w} \times 15\frac{1}{2}''\text{d}$.

Model 444, HERCULES amplifier & power supply.... \$1575.

Experience SUPER RIG at your TEN-TEC dealer, or write for full details.

TEN-TEC, INC.
SEVIERVILLE, TENNESSEE 37862
EXPORT 3715 LINCOLN AVE., CHICAGO, ILL. 60646

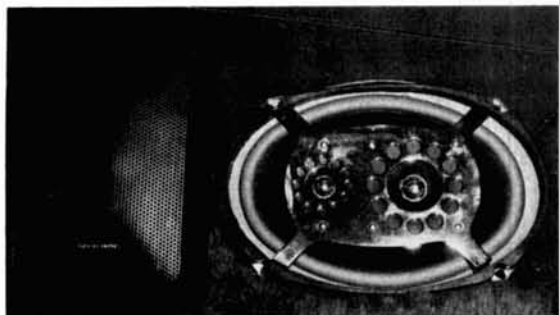

High-quality speakers make a big difference. Speaker is a Radio Shack *Minimus 7* (40 watts peak). Included are mounting brackets that could be used for under-dash mounting. A typical enclosure is shown at left.

better audio for mobile operation

Some suggestions
for improved operating
in your car

The concepts described in an earlier *ham radio* article¹ resulted in many letters to me. The same ideas in that article apply to mobile operation, only more so. When working mobile, you have outside road noise to contend with as well as ignition and other noises. Mobile rigs are now physically smaller; therefore the speakers are smaller, and so it goes. Regardless of speaker size, the audio systems in most of the mobile rigs are deficient.

When the audio gain control is turned up to overcome the various noises, the signal is distorted and most aren't loud enough, even if they aren't distorted. A few sets with small speakers in a small box have produced audio like you've never heard; so it is possible to get good audio from a small box.

loudspeakers

One approach to the mobile audio problem is to use a large speaker and mount it in the car headrest as shown. Lower volume levels are then needed, and

this system works well. Use the largest speaker possible with a tweeter.

Another approach is to use a separate, low-level input, 12-volt audio amplifier connected to the top of the volume control as described in reference 1, with a built-in frequency equalizer to emphasize highs. You can also use an audio booster in conjunction with stereo fm cassette radios. The output of the ham rig can be connected in parallel with one channel or, preferably, switched with a dpdt switch. You then get the needed power gain and frequency-response control. Use high-quality, *large* speakers with mid- and high-range tweeters. My booster has a control to fade in two speakers in the front of the car. These speakers can be mounted under the seat, in the door, or in the ceiling headliner. The main stereo speakers are at the car rear, but the headrest speakers are much closer to your ear. You now will have a wide range of combinations, which produce beautiful and *understandable* audio with no distortion and shaped to your ears' deficiencies by the equalizer.

A suggested hookup is shown in **fig. 1**. I also use stereo earphones, parallel connected when used with the ham set. The new Sennheiser Model 420 is ideal, as it has an open earpiece and therefore doesn't block out road noises. These units are lightweight and can be used for long periods of time. They can, of course, be used with the stereo fm radio.

tone control

A welcome addition to any rig is a tone control that *emphasizes* the highs rather than attenuating them. The average person's ears are being bombarded with

By Ken Glanzer, K7GCO, 202 South 124 Street, Seattle, Washington 96168

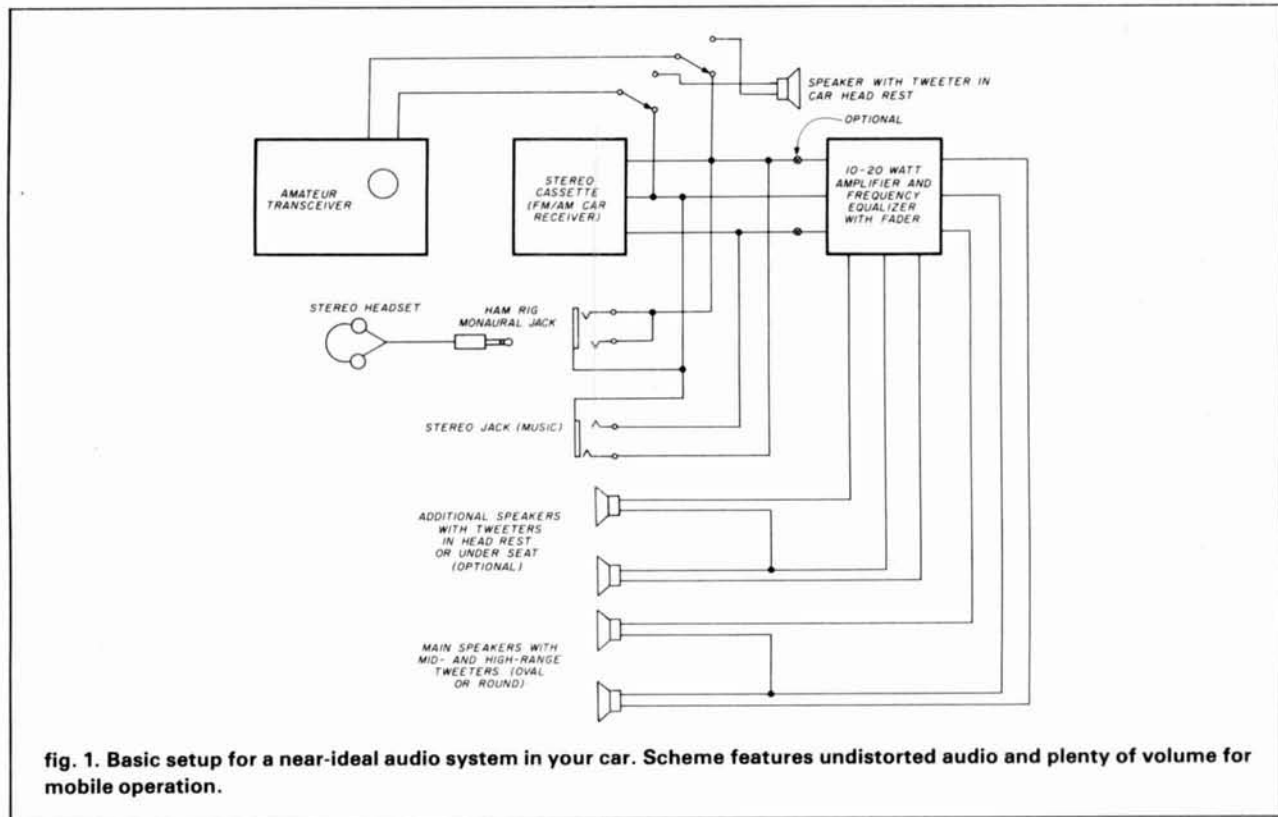

high levels of noise; the loss of high-frequency response is occurring at an earlier age.

I frequently remove the capacitors between the base and collector in the final transistor audio stage, or any other component that cuts the highs. Or, I may alter the values of some components. Many

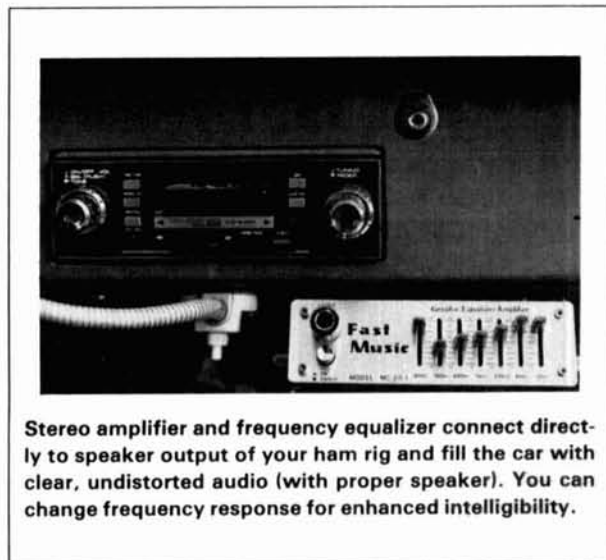
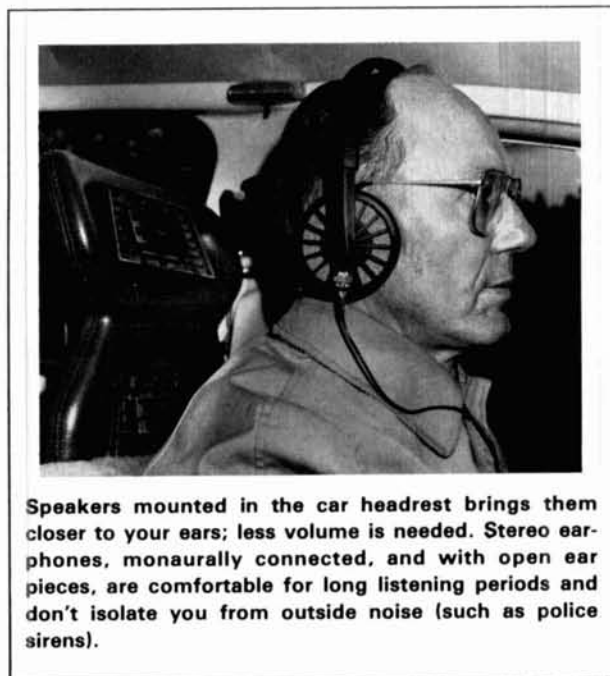

have said, "I can understand what they say on your radio." Many Amateurs are not deaf from the standpoint of *level*, but are "tone deaf." They can't hear the high frequencies. Sometimes, a small tweeter can be installed near one ear with good results.

reference

1. Ken Glanzer, K7GCO, "Better Audio for New or Old Communications Receivers," *ham radio*, April, 1977, page 74.

ham radio



TR-7800

"Easy selection"... 15 memories/offset recall, scan, priority, DTMF (Touch-Tone®)

Frequency selection with the TR-7800 2-meter FM mobile transceiver is easier than ever. The rig incorporates new memory developments for repeater shift, priority, and scan, and includes a built-in autopatch Touch-Tone® encoder.

TR-7800 FEATURES:

- 15 multifunction memory channels, selected with a

rotary switch. M1-M13 ... memorize frequency and offset (± 600 kHz or simplex). M14 ... memorize transmit and receive frequencies independently for nonstandard offset. M0 ... priority channel, with simplex, ± 600 kHz, or nonstandard offset.

- Internal backup for all memories, by installing four AA NiCd batteries (not Kenwood-

- supplied) in battery holder.
- Priority channel (memory "0") and priority alert.
- Covers 143.900-148.995 MHz, in 5-kHz or 10-kHz steps.
- Built-in autopatch DTMF (Touch-Tone®) encoder.
- Front-panel keyboard for selecting frequency, transmit offset, and autopatch encoder tones, programming memories, and controlling scan.
- Automatic scan of entire band (5-kHz or 10-kHz steps) and memories.
- Manual scan of band and memories, with UP/DOWN microphone (standard).

SP-40

Compact, high-quality mobile speaker

- Matches all HF, VHF, and UHF radios for mobile operation.
- Only 2-11/16 inches wide by 2-1/2 inches high by 2-1/8 inches deep.
- 4-ohm input impedance.
- Handles 3 watts of audio.
- Mounting bracket with ferrite magnet. Adhesive-backed steel plate supplied for mounting virtually anywhere.



- Repeater REVERSE switch.
- Selectable power output. 25 W (HI)/5 W (LOW).
- LED S/R/F bar meter.
- TONE switch to actuate subaudible tone module (not Kenwood-supplied).

OPTIONAL ACCESSORIES:

- KPS-7 fixed-station power supply.

TR-8400

"Go synthesized on 440 MHz FM"... 5 memories, memory/band scan

The TR-8400 synthesized 70-cm UHF FM mobile transceiver covers 440-450 MHz in 25-kHz steps and includes five memories, automatic memory and band scan, UP/DOWN manual scan, and two VFOs.

TR-8400 FEATURES:

- Synthesized coverage of 440-450 MHz in 25-kHz steps.

- Five memories and memory backup terminal on rear panel.
- Two VFOs.
- Offset switch for ± 5 MHz transmit offset and simplex operation. Fifth memory allows any other offset by memorizing receive and transmit frequencies independently.

- Automatic scan of memories and of 440-450 MHz band (in 25-kHz steps). Locks on busy channel and resumes when signal disappears. HOLD or mic PTT button cancels scan.
- Up/down manual band scan in 25-kHz steps with UP/DOWN microphone supplied with TR-8400.
- Only 5-3/4 inches wide, 2 inches high, and 7-5/8 inches deep. Weighs only 3.75 pounds.

- TONE switch to activate sub-tone device (not Kenwood-supplied). DTMF (Touch-Tone®) terminal on rear panel.
- Four-digit frequency display and S/R/F bar meter. Other LEDs indicate BUSY, ON AIR, and REPEATER operation.
- HI/LOW (10 W/1 W) RF-output power switch.

OPTIONAL ACCESSORIES:

- KPS-7 fixed-station power supply.
- SP-40 compact mobile speaker.



TR-9000

"New 2-meter direction"... compact rig with FM/SSB/CW, scan, five memories

The TR-9000 combines the convenience of FM with long distance SSB and CW. It is extremely compact... perfect for mobile operation. Matching accessories are available for optimum fixed-station operation.

TR-9000 FEATURES:

- FM, USB, LSB, and CW.
- Only 6-11/16 inches wide, 2-21/32 inches high, 9-7/32 inches deep.

- Two digital VFOs, with selectable tuning steps of 100 Hz, 5 kHz, and 10 kHz.
- Digital frequency display. Five, four, or three digits, depending on selected tuning step.
- Covers 143.9000-148.9999 MHz.
- Band scan... automatic busy stop and free scan.
- SSB/CW search of selectable 9.9-kHz bandwidth segments.

- Five memories... four for simplex or ± 600 kHz repeater offsets and the fifth for a non-standard offset (memorizes transmit and receive frequency independently).
- UP/DOWN microphone (standard) for manual band scan.
- Noise blanker for SSB and CW.
- RIT (receiver incremental tuning) for SSB and CW.
- RF gain control.
- CW sidetone.
- Selectable RF power outputs... 10 W (HI)/1 W (LO).
- Mobile mounting bracket with quick-release levers.
- LED indicators... ON AIR, BUSY, and VFO.

OPTIONAL ACCESSORIES:

- PS-20 fixed-station power supply.
- SP-120 fixed-station external speaker.
- BO-9 System Base... with power switch, SEND/RECEIVE switch (for CW), memory-backup power supply, and headphone jack.



PS-20

TR-9000

BO-9

SP-120



TR-2400

"Hand-shack"... synthesized, big LCD, scan, 10 memories, DTMF (Touch-Tone®)



CONVENIENT TOP CONTROLS

The TR-2400 has the most convenient operating features desired in a 2-meter FM handheld transceiver.

TR-2400 FEATURES:

- Large LCD digital readout. Readable in direct sunlight (virtually no current drain) and in the dark (lamp switch). Shows receive and transmit frequencies and memory channel. "Arrow" indicators show "ON AIR," "MR" (memory recall), "BATT" (battery status), and "LAMP" switch on.

- Keyboard selection of 144.000-147.995 MHz in 5-kHz increments. No "5-UP" switch needed.
- UP/DOWN manual scan in 5-kHz steps from 143.900 to 148.495 MHz.
- 10 memories. Retained with battery backup. "M0" memory may be used to shift transmitter to any frequency for nonstandard-split repeaters.
- Built-in autopatch DTMF (Touch-Tone®) encoder, using all 16 keyboard buttons.
- Automatic memory scan.
- Repeater or simplex operation. Transmit frequency shifts ± 600 kHz or to "M0" memory frequency.
- Reverse switch. Transposes receive and transmit frequencies.
- Subtone switch (tone encoder not Kenwood-supplied).
- Two lock switches to prevent accidental frequency change and accidental transmission.

- External PTT microphone and earphone connectors.
- Rubberized antenna with BNC connector, NiCd battery pack, AC charger, PTT and mic plugs, handstrap, and earphone included.
- Extended operating time with LCD and overall low-current circuit design. Only draws about 28 mA squelched receive and 500 mA transmit (at 1.5 W RF output).
- High-impact case and zinc die-cast frame.
- Compact and lightweight. Only 2-13/16 inches wide, 7-9/16 inches high, and 1-7/8 inches deep. Weighs only 1.62 pounds (including antenna, battery, and hand strap).

OPTIONAL ACCESSORIES:

- ST-1 Base Stand (provides 1.5-hour-quick, trickle, and floating charges, 4-pin microphone connector, and SO-239 antenna connector).
- BC-5 DC quick charger.
- LH-1 leather case.
- BH-1 belt hook.
- PB-24 extra NiCd battery pack.
- **NEW** SMC-24 speaker/mic.

repeater security

A combination lock using CMOS devices

The solution was a nonvolatile control. The problem was a secure, remote controlled electronic combination lock for the local repeater; one which would not forget if it was turned on or turned off if the power should fail momentarily, or if the supply line should suddenly become filled with electronic noise. With thoughts of security, simplicity, and ultra-low power drain in mind, the circuit shown here was devised.

features

The control, designed to operate in conjunction with standard TTL tone decoders, uses a sequence of three digits to effect the turn-on function and a different three digit sequence for turn-off. The digits must be applied precisely in the selected sequence to achieve the desired function. The turn-on process automatically prepares the control to accept the turn-

off sequence and, similarly, the turn-off process prepares the control to accept the turn-on sequence. To safeguard against the possibility of electronically picking the combination lock, provisions were made to accept digits unused in either control sequence as reset inputs. The entire control uses four ICs, four transistors, and ten diodes.

circuit

Referring to **fig. 1**, the combination-lock function is accomplished by a series of D flip-flops. U1A, U1B, and U2A comprise the turn-on function, and U2B, U3A, and U3B comprise the turn-off function. Activation of either function is accomplished by clocking the flip-flop string in sequence. Beginning with U1A (or U2B), each flip-flop enables the succeeding one in the string by taking its D input to a high logic level. In this manner, U2A cannot be clocked until U1B has been clocked, which in turn cannot be clocked until U1A has been clocked. After completion of the turn-on sequence, in the proper order, the falling edge of U2A's \bar{Q} output clocks the

By Steve Cerwin, WA5FRF, 3911 Pipers Court, San Antonio, Texas 78251

latch comprised by gates U4C and U4D to its ON state. This negative-going pulse also is inverted and coupled to the reset inputs of flip-flops U2B, U3A, and U3B, which prepares them for the turn-off sequence.

In the ON state, U4C output saturates the triple-darlington Q1, Q2, and Q3 through a 1 megohm resistor. The open collector output of Q1 may be used to control an external relay. The base lead of Q3 has been brought out on the printed-circuit board for the possibility of using an external master override for either the ON or OFF function.

The unused digit inputs are connected in OR fashion to Q4 through diodes CR1 through CR8. If any one of these inputs is selected, Q4 will saturate, taking one input of gates U4A and U4B to a logic zero level. This will reset both flip-flop strings to their zero

state, thereby effecting the anti-picking feature by neutralizing any accidental progress made by non-authorized attempts to operate the control. Assuming different digits are selected for each sequence input, the odds against someone happening upon the proper combination for either control operation by chance are $16 \times 15 \times 14$ or 3,360 to 1 for a sixteen-button pad. The odds may be increased simply by adding additional data latches to the string.

Nonvolatility was achieved by designing the circuit for ultra-low power drain. All the ICs are CMOS, and the total supply current for all four chips is less than 1 microamp. The power hog in the unit is the base current required to saturate the triple-darlington. This current, 2.9 microamps, is essentially the total supply current drain when the control is on. With only the onboard 100 μ F capacitor across the supply, the con-

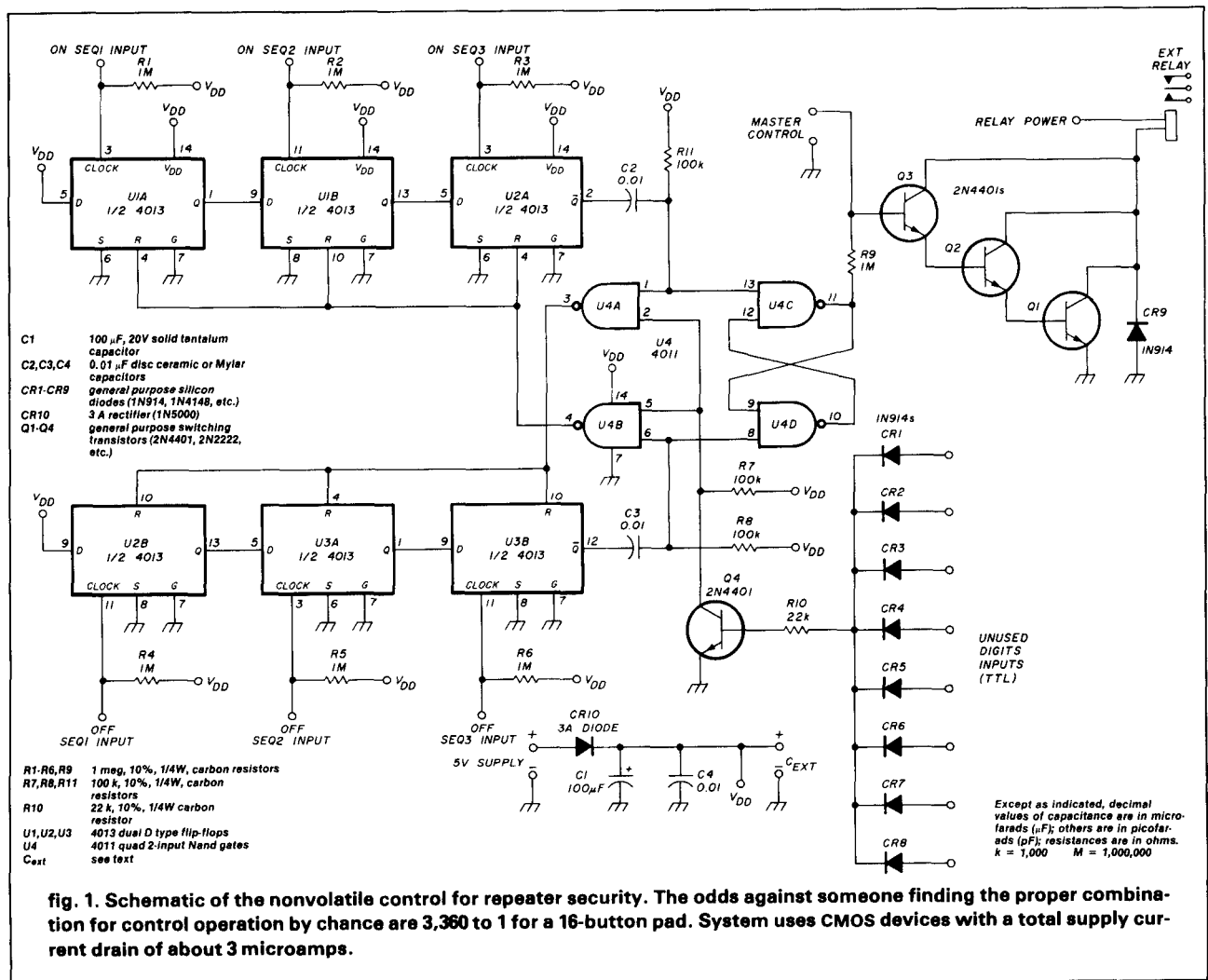

fig. 1. Schematic of the nonvolatile control for repeater security. The odds against someone finding the proper combination for control operation by chance are 3,360 to 1 for a 16-button pad. System uses CMOS devices with a total supply current drain of about 3 microamps.

ok



Wire Wrapping Kit

Model WK-5 is a unique new Wire Wrapping Kit that contains a complete range of tools and parts for prototype and hobby applications, all conveniently packaged in a handy, durable plastic carrying case.

The kit includes Model BW-630 battery wire wrapping tool complete with bit and sleeve; Model WSU-30, a remarkable new hand wire-wrapping/unwrapping/stripping tool; a universal PC board; an edge connector with wire-wrapping terminals, a set of PC card guides and brackets; a mini-shear with safety clip; industrial quality 14, 16, 24 and 40 pin DIP sockets; an assortment of wire-wrapping terminals; a DIP inserter; a DIP extractor and a unique 3-color wire dispenser complete with 50 feet each of red, white and blue Kynar[®] insulated, silver plated solid AWG 30 copper wire.

\$74.95*

OK Machine & Tool Corporation
3455 Conner St., Bronx, N.Y. 10475 U.S.A.
Tel. (212) 994-6600 Telex 125091

*Minimum billings \$25.00, add shipping charge \$2.00
New York State residents add applicable tax

Pennwalt

HAL'S SHOPPER'S GUIDE



NEW!

11C05 1 GHz, pre. Special \$59.95
ATF 417 pre-amp. net Special \$19.95
MRF 901 UHF transistor, 1 GHz Special \$3.95

COMPLETE KITS: CONSISTING OF EVERY ESSENTIAL PART NEEDED TO MAKE YOUR COUNTER COMPLETE. **HAL-600A** 7-DIGIT COUNTER WITH FREQUENCY RANGE OF ZERO TO 600 MHz. FEATURES TWO INPUTS: ONE FOR LOW FREQUENCY AND ONE FOR HIGH FREQUENCY; AUTOMATIC ZERO SUPPRESSION, TIME BASE IS 1.0 SEC OR .1 SEC GATE WITH OPTIONAL 10 SEC GATE AVAILABLE. ACCURACY $\pm .001\%$. UTILIZES 10-MHz CRYSTAL 5 PPM. **COMPLETE KIT \$129**

HAL-300A 7-DIGIT COUNTER (SIMILAR TO 600A) WITH FREQUENCY RANGE OF 0-300 MHz. **COMPLETE KIT \$109**

HAL-50A 8-DIGIT COUNTER WITH FREQUENCY RANGE OF ZERO TO 50 MHz OR BETTER. AUTOMATIC DECIMAL POINT, ZERO SUPPRESSION UPON DEMAND. FEATURES TWO INPUTS: ONE FOR LOW FREQUENCY INPUT, AND ONE ON PANEL FOR USE WITH ANY INTERNALLY MOUNTED HALTRONIX PRE-SCALER FOR WHICH PROVISIONS HAVE ALREADY BEEN MADE. 1.0 SEC AND .1 SEC TIME GATES. ACCURACY $\pm .001\%$. UTILIZES 10-MHz CRYSTAL 5 PPM. **COMPLETE KIT \$109**

FREE: HAL-79 CLOCK KIT PLUS AN INLINE RF PROBE WITH PURCHASE OF ANY FREQUENCY COUNTER

PRE-SCALER KITS

HAL 300 PRE (Pre-drilled G-10 board and all components) **\$14.95**
HAL 300 A/PRE (Same as above but with preamp) **\$24.95**
HAL 600 PRE (Pre-drilled G-10 board and all components) **\$29.95**
HAL 600 A/PRE (Same as above but with preamp) **\$39.95**

NEW!

HAL-1 GHz PRESCALER, VHF & UHF INPUT & OUTPUT, DIVIDES BY 1000. OPERATES ON A SINGLE 5 VOLT SUPPLY. **PREBUILT & TESTED \$79.95**

TOUCH TONE DECODER KIT

HIGHLY STABLE DECODER KIT. COMES WITH 2 SIDED, PLATED THRU AND SOLDER FLOWED G-10 PC BOARD, 7-567's, 2-7402, AND ALL ELECTRONIC COMPONENTS. BOARD MEASURES 3-1/2 x 5-1/2 INCHES. HAS 12 LINES OUT. **ONLY \$39.95**

DELUXE 12-BUTTON TOUCHTONE ENCODER KIT UTILIZING THE NEW ICM 7206 CHIP. PROVIDES BOTH VISUAL AND AUDIO INDICATIONS! COMES WITH ITS OWN TWO-TONE ANODIZED ALUMINUM CABINET. MEASURES ONLY 2-3/4" x 3-3/4". COMPLETE WITH TOUCH-TONE PAD, BOARD, CRYSTAL, CHIP AND ALL NECESSARY COMPONENTS TO FINISH THE KIT. **PRICED AT \$29.95**

FOR THOSE WHO WISH TO MOUNT THE ENCODER IN A HAND-HELD UNIT, THE PC BOARD MEASURES ONLY 9/16" x 1-3/4". THIS PARTIAL KIT WITH PC BOARD, CRYSTAL, CHIP AND COMPONENTS. **PRICED AT \$14.95**

ACCUKEYER (KIT) THIS ACCUKEYER IS A REVISED VERSION OF THE VERY POPULAR WB4VVF ACCUKEYER ORIGINALLY DESCRIBED BY JAMES GARRETT, IN QST MAGAZINE AND THE 1975 RADIO AMATEUR'S HANDBOOK. **\$16.95**

ACCUKEYER — MEMORY OPTION KIT PROVIDES A SIMPLE, LOW COST METHOD OF ADDING MEMORY CAPABILITY TO THE WB4VVF ACCUKEYER. WHILE DESIGNED FOR DIRECT ATTACHMENT TO THE ABOVE ACCUKEYER, IT CAN ALSO BE ATTACHED TO ANY STANDARD ACCUKEYER BOARD WITH LITTLE DIFFICULTY. **\$16.95**

PRE-AMPLIFIER

HAL-PA-19 WIDE BAND PRE-AMPLIFIER, 2-200 MHz BANDWIDTH (-3dB POINTS), 19 dB GAIN. **FULLY ASSEMBLED AND TESTED \$8.95**

NEW!

CLOCK KIT — HAL 79 FOUR-DIGIT SPECIAL — \$7.95. OPERATES ON 12-VOLT AC (NOT SUPPLIED). PROVISIONS FOR DC AND ALARM OPERATION

6-DIGIT CLOCK • 12/24 HOUR

COMPLETE KIT CONSISTING OF 2 PC G-10 PRE-DRILLED PC BOARDS, 1 CLOCK CHIP, 6 FND COMM. CATH. READOUTS, 13 TRANS., 3 CAPS, 9 RESISTORS, 5 DIODES, 3 PUSH-BUTTON SWITCHES, POWER TRANSFORMER AND INSTRUCTIONS. DON'T BE FOOLED BY PARTIAL KITS WHERE YOU HAVE TO BUY EVERYTHING EXTRA. **PRICED AT \$12.95**

CLOCK CASE AVAILABLE AND WILL FIT ANY ONE OF THE ABOVE CLOCKS. REGULAR PRICE . . . \$6.50 **BUT ONLY \$4.50 WHEN BOUGHT WITH CLOCK.**

SIX-DIGIT ALARM CLOCK KIT FOR HOME, CAMPER, RV, OR FIELD-DAY USE. OPERATES ON 12-VOLT AC OR DC, AND HAS ITS OWN 60-Hz TIME BASE ON THE BOARD. COMPLETE WITH ALL ELECTRONIC COMPONENTS AND TWO-PIECE, PRE-DRILLED PC BOARDS. BOARD SIZE 4" x 3". COMPLETE WITH SPEAKER AND SWITCHES. IF OPERATED ON DC, THERE IS NOTHING MORE TO BUY. **PRICED AT \$16.95**

*TWELVE-VOLT AC LINE CORD FOR THOSE WHO WISH TO OPERATE THE CLOCK FROM 110-VOLT AC. **\$2.50**

SHIPPING INFORMATION — ORDERS OVER \$20.00 WILL BE SHIPPED POSTPAID EXCEPT ON ITEMS WHERE ADDITIONAL CHARGES ARE REQUESTED. ON ORDERS LESS THAN \$20.00 PLEASE INCLUDE ADDITIONAL \$1.50 FOR HANDLING AND MAILING CHARGES. SEND SASE FOR FREE FLYER.

DISTRIBUTOR FOR
Aluma Tower • AP Products
(We have the new Hobby-Blox System)



"HAL"
HAROLD C. NOWLAND
W8ZXH

HAL-TRONIX
P. O. BOX 1101
SOUTHGATE, MICH. 48195
PHONE (313) 285-1782

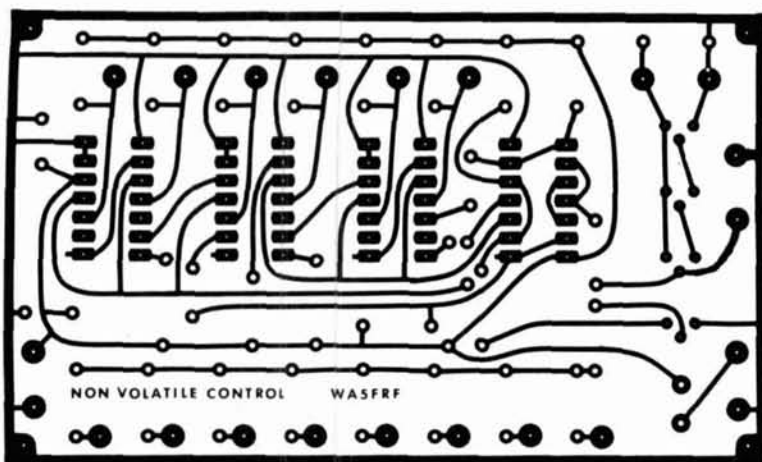

fig. 2. Single-sided PC board layout for the repeater control.

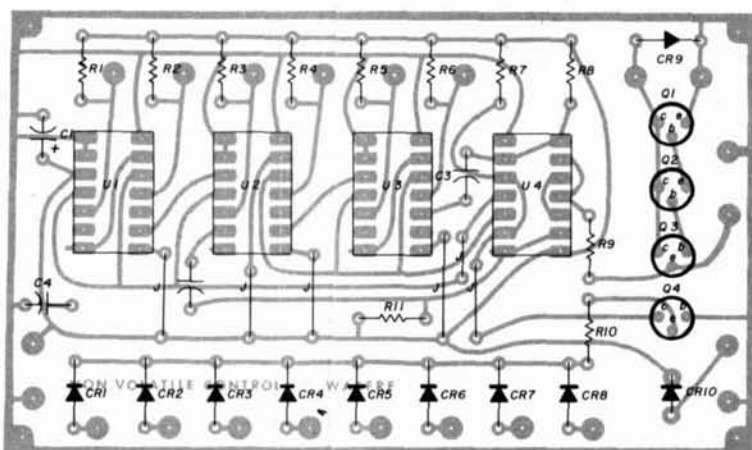

fig. 3. PC-board parts placement.

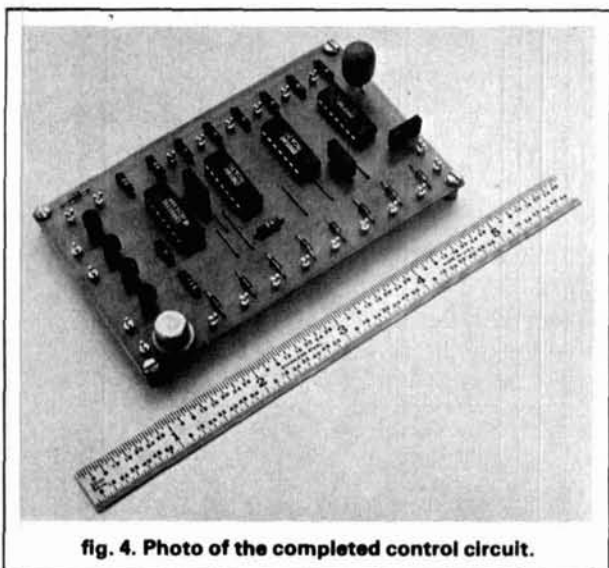

fig. 4. Photo of the completed control circuit.

ontrol will be nonvolatile for several minutes after power failure. This time may be extended to hours if a larger capacitor is supplied externally, or it may be extended indefinitely if an external battery pack is supplied. The control supply bus is isolated from the supply line by diode CR10. CR10, a 3-amp power rectifier, was chosen to withstand the charge-up current of the large supply bypass capacitor and also provides reverse supply protection. Supply voltage must be 5 volts if the unit is to be compatible with TTL tone decoders.

A single-sided printed circuit board layout for the control is shown in fig. 2. Component placement and a photograph of a completed board are in figs. 3 and 4 respectively. To maintain the ultra-low-power drain characteristics, the assembled board must be kept reasonably clean.

ham radio

transmission-line circuit design

Using distributed resonant circuits for VHF/UHF transmission lines

Part 2 of this article, which appeared in the January, 1981, issue of *ham radio*, dealt with the geometry of the first four of twelve common transmission line configurations. In this, part 3 of the article, another set of four transmission line configurations will be examined: circular wire between planes, parallel wires over a plane, circular wire in an open trough, and parallel wires between planes/rectangular box.

Part 4 of this series will deal with the remaining four configurations. Part 5, the last in the series, will provide a summary of what has been discussed and show a design example for a 2-meter amplifier.

circular wire between planes

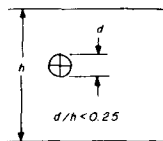

The formulation for the characteristic impedance of this line is similar to that for a single wire over a parallel plane (reference 4):

$$Z_0 = \frac{138}{\sqrt{\epsilon_r}} \log_{10} \frac{4h}{\pi d}; d/h < 0.75 \quad (25)$$

where Z_0 = line impedance (ohms)

ϵ_r = dielectric constant

h = distance between planes

d = wire diameter centered between planes

Fig. 12 shows Z_0 versus h/d for a reasonable range

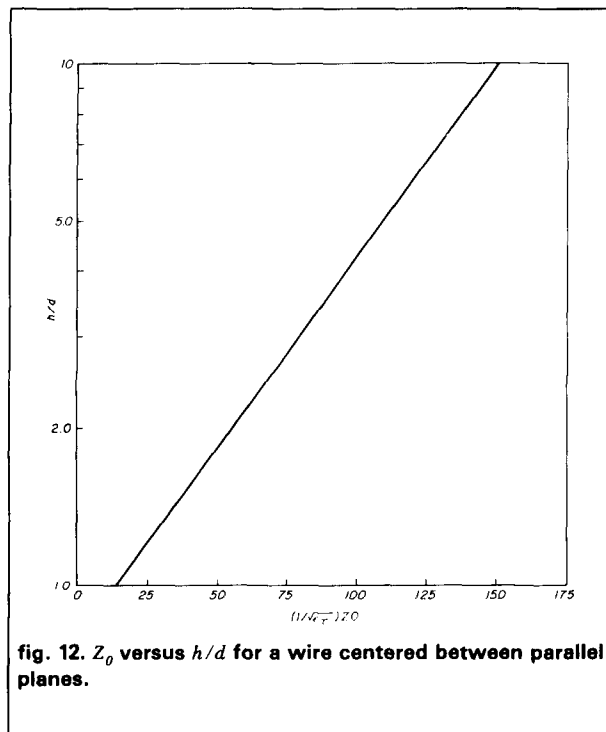

fig. 12. Z_0 versus h/d for a wire centered between parallel planes.

By H.M. Meyer, Jr., W6GGV, 29330 Whitley Collins Drive, Rancho Palos Verdes, California 90274

table 20. HP-67/97 program for calculating Z_0 and h/d for a wire centered between parallel planes.

step	HP-97 key	HP-97 code	step	HP-97 key	HP-97 code
001	*LBLA	21 11	030	3	03
002	STO0	35 00	031	8	08
003	\sqrt{X}	54	032	+	- 24
004	STO1	35 01	033	STO3	35 03
005	RTN	24	034	*LBL3	21 03
006	*LBLB	21 12	035	RCL1	36 01
007	÷	- 24	036	X = 0?	16-43
008	*LBL1	21 01	037	GSB8	23 08
009	STO2	35 02	038	x	- 35
010	4	04	039	10 ^x	16 33
011	x	- 35	040	4	04
012	Pi	16-24	041	+	- 24
013	÷	- 24	042	Pi	16-24
014	LOG	16 32	043	x	- 35
015	1	01	044	STO2	35 02
016	3	03	045	R/S	51
017	8	08	046	*LBLD	21 14
018	x	- 35	047	GTO1	22 01
019	STO3	35 03	048	*LBL9	21 09
020	*LBL2	21 02	049	1	01
021	RCL1	36 01	050	STO1	35 01
022	X = 0?	16-43	051	RCL3	36 03
023	GSB9	23 09	052	GTO2	22 02
024	÷	- 24	053	*LBL8	21 08
025	STO4	35 04	054	1	01
026	R/S	51	055	STO1	35 01
027	*LBLC	21 13	056	RCL3	36 03
028	STO4	35 04	057	GTO3	22 03
029	1	01	058	R/S	51

of values. Table 20 is the HP-67/97 program for calculating Z_0 or h/d or, given L and d separately, calculating Z_0 . Table 21 identifies the storage registers; table 22 shows program control.

table 21. Register contents for HP-67/97 program for calculating Z_0 and h/d for a wire centered between parallel planes.

STO 0	ϵ_r
STO 1	$\sqrt{\epsilon_r}$
STO 2	h/d
STO 3	INTERIM
STO 4	Z_0

table 22. HP-67/97 program control for calculating Z_0 and h/d for a wire centered between parallel planes.

enter ϵ_r	press A
calculates Z_0	
enter h	press ENTER
enter d	press B
calculates h/d	
enter Z_0	press C
calculates Z_0	
enter h/d	press D

Note: If no value for ϵ_r is entered, program assumes $\epsilon_r = 1 = \text{air}$.

parallel wires over a plane

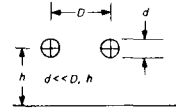

The common application of this line is for push-pull tank circuits with lines spaced much more closely to the ground plane than to the cover. The formulation (reference 4) is:

$$Z_0 = \frac{69}{\sqrt{\epsilon_r}} \log_{10} \left\{ \left(\frac{4h}{d} \right) \left[1 + \left(\frac{2h}{D} \right)^2 \right]^{1/2} \right\} \quad (26)$$

$d < D, h$

where Z_0 = line impedance (ohms)
 ϵ_r = dielectric constant
 h = centerline height of wires over plane
 d = wire diameter
 D = center-to-center spacing between wires

For analysis this equation may be reformulated to

$$Z_0 = \frac{69}{\sqrt{\epsilon_r}} \left\{ \log_{10} \frac{4h}{d} + \log_{10} \left[1 + \left(\frac{2h}{D} \right)^2 \right]^{1/2} \right\} \quad (27)$$

which permits solution if h/d and Z_0 are known, or if h/D and Z_0 are known.

When solving for h/D when Z_0 and h/d are known, eq. 27 may be rearranged for easy solution on the HP-67/97 to

$$\log_{10} \left[1 + \left(\frac{2h}{D} \right)^2 \right]^{1/2} = \left(\frac{Z_0 \sqrt{\epsilon_r}}{69} \right) - \log_{10} \left(\frac{4h}{d} \right) \quad (28)$$

Eq. 28 is transposed when solving for h/d with Z_0 and h/D known.

Fig. 13 is a plot of Z_0 versus h/d for various values of h/D . Table 23 provides an HP-67/97 program for calculating various combinations of knowns and unknowns. Table 24 identifies the storage registers; table 25 shows how the program is controlled.

table 23. HP-67/97 program for calculating Z_0 , h/d , and h/D for two parallel wires over a plane.

step	HP-97 key	HP-97 code	step	HP-97 key	HP-97 code	step	HP-97 key	HP-97 code	step	HP-97 key	HP-97 code
001	*LBLA	21 11	029	9	09	057	10 ^x	16 33	085	9	09
002	STO0	35 00	030	x	- 35	058	X ²	53	086	+	- 24
003	√X	54	031	STO5	35 05	059	1	01	087	RCL5	36 05
004	STO1	35 01	032	RCL1	36 01	060	-	- 45	088	+	- 55
005	RTN	24	033	X=0?	16-43	061	√X	54	089	10 ^x	16 33
006	*LBLB	21 12	034	GSB9	23 09	062	2	02	090	4	04
007	RI	- 31	035	+	- 24	063	+	- 24	091	+	- 24
008	+	- 24	036	STO6	35 06	064	STO3	35 03	092	STO4	35 04
009	STO2	35 02	037	R/S	51	065	R/S	51	093	R/S	51
010	1/X	52	038	*LBLC	21 13	066	*LBLD	21 14	094	*LBL E	21 15
011	STO3	35 03	039	STO4	35 04	067	STO3	35 03	095	STO3	35 03
012	RI	- 31	040	RI	- 31	068	RI	- 31	096	RI	- 31
013	+	- 24	041	STO6	35 06	069	STO6	35 06	097	STO4	35 04
014	STO4	35 04	042	RCL4	36 04	070	RCL3	36 03	098	GTO1	22 01
015	*LBL1	21 01	043	4	04	071	2	02	099	*LBL9	21 09
016	RCL3	36 03	044	x	- 35	072	x	- 35	100	1	01
017	2	02	045	LOG	16 32	073	X ²	53	101	STO1	35 01
018	x	- 35	046	ST-5	35-45 05	074	1	01	102	RCL5	36 05
019	X ²	53	047	RCL1	36 01	075	+	- 55	103	RCL1	36 01
020	1	01	048	X=0?	16-43	076	√X	54	104	RTN	24
021	+	- 55	049	GSB8	23 08	077	LOG	16 32	105	*LBL8	21 08
022	√X	54	050	RCL6	36 06	078	ST-5	35-45 05	106	1	01
023	RCL4	35 04	051	x	- 35	079	RCL1	36 01	107	STO1	35 01
024	4	04	052	6	06	080	X=0?	16-43	108	RTN	24
025	x	- 35	053	9	09	081	GSB7	23 07	109	*LBL7	21 07
026	x	- 35	054	+	- 24	082	RCL6	36 06	110	1	01
027	LOG	16 32	055	RCL5	36 05	083	x	- 35	111	STO1	35 01
028	6	06	056	+	- 55	084	6	06	112	RTN	24
									113	R/S	51

table 24. Register contents for HP-67/97 program for calculating Z_0 , h/d , and h/D for two parallel wires over a plane.

STO 0	ϵ_r
STO 1	$\sqrt{\epsilon_r}$
STO 2	D/h
STO 3	h/D
STO 4	h/d
STO 5	INTERIM
STO 6	Z_0

table 25. HP-67/97 program control for calculating Z_0 , h/d , and h/D for two parallel wires over a plane.

calculates	$\sqrt{\epsilon_r}$	
enter	ϵ_r	press A
calculates	Z_0	
enter	d	press ENTER
enter	D	press ENTER
enter	h	press ENTER
		press B
calculates	h/D	
enter	Z_0	press ENTER
enter	h/d	press C
calculates	h/d	
enter	Z_0	press ENTER
enter	h/D	press D
calculates	Z_0	
enter	h/d	press ENTER
enter	h/D	press E

Note: If no value for ϵ_r is entered, program assumes $\epsilon_r = 1 = \text{air}$.

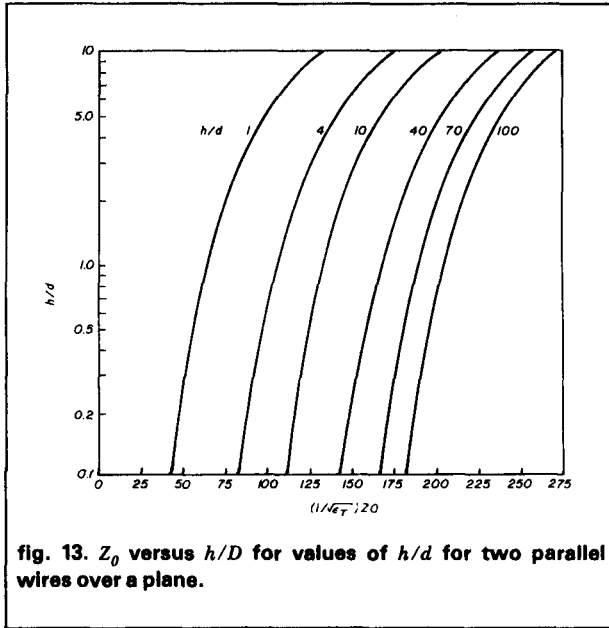

circular wire in open trough

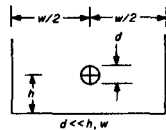

A common application of this configuration is in rf amplifiers, mixers, and local oscillator or multiplier filter elements at 100 MHz and above. The generalized formulation (reference 4) for a circular wire in an open trough is given by:

$$Z_0 = \frac{138}{\sqrt{\epsilon_r}} \log_{10} \left[\frac{4w \tanh \frac{\pi h}{w}}{\pi d} \right] \quad (29)$$

for $d \ll h, w$

- where Z_0 = line impedance (ohms)
- ϵ_r = dielectric constant
- d = wire diameter
- h = centerline height of wire over plane
- w = width of trough with wire positioned in center

The formulation can be simplified considerably if one assumes a square open trough where w (trough width) equals $2h$ (two times the centerline height of the wire over the bottom plane). The resulting formula for a square open trough is:

$$Z_0 = \frac{138}{\sqrt{\epsilon_r}} \log_{10} \left[\frac{8h}{\pi d} \tanh \frac{\pi}{2} \right] \quad (30)$$

and $\tanh \frac{\pi}{2} = 1.0$ (31)

then $Z_0 = \frac{138}{\sqrt{\epsilon_r}} \log_{10} \left[2.5465 \frac{h}{d} \right]$ (32)

Fig. 14 shows h/d versus Z_0 for eq. 32. Table 26 is the HP-67/97 program for calculating Z_0 and h/d . Table 27 shows the registers used. Table 28 shows how the program is controlled.

Table 29 is the HP-67/97 program for calculating $Z_0, h/w,$ and w/d given any two of the unknowns for any rectangular configuration, which is the general solution of eq. 29. Table 30 indicates the storage registers used in the program, and table 31 shows how the program is controlled. Fig. 15 is a plot of Z_0 versus w/d for various values of h/w from eq. 29. Note that eq. 29 is solved directly for Z_0 in table 29. If Z_0 and w/d are given, h/w is solved by using eqs. 33, 34, and 35. A similar variant is used if h/w is known and w/d must be calculated.

$$\frac{Z_0 \sqrt{\epsilon_r}}{138} = \left(\log_{10} \frac{4w}{d} \right) + \left(\log_{10} \tanh \frac{\pi h}{w} \right), \quad (33)$$

recognizing that

$$\tanh x = \frac{e^x - e^{-x}}{e^x + e^{-x}} \quad (34)$$

and $\tanh^{-1} x = 1/2 \ln \left[\frac{1+x}{1-x} \right]$ (35)

table 26. HP-67/97 program for calculating Z_0 and h/d for a circular wire in a square trough.

step	HP-97 key	HP-97 code	step	HP-97 key	HP-97 code
001	*LBLA	21 11	018	1	01
002	STO0	35 00	019	3	03
003	\sqrt{X}	54	020	8	08
004	STO1	35 01	021	x	- 35
005	RTN	24	022	STO4	35 04
006	*LBLB	21 12	023	*LBL2	21 02
007	+	- 24	024	RCL1	36 01
008	STO2	35 02	025	X=0?	16-43
009	*LBL1	21 01	026	GSB9	23 09
010	2	02	027	+	- 24
011	.	- 62	028	STO3	35 03
012	5	05	029	R/S	51
013	4	04	030	*LBLC	21 13
014	6	06	031	STO3	35 03
015	5	05	032	1	01
016	x	- 35	033	3	03
017	LOG	16 32	034	8	08

table 26. HP-67/97 program for calculating Z_0 and h/d for a circular wire in a square trough (continued).

step	HP-97 key	HP-97 code	step	HP-97 key	HP-97 code
035	+	- 24	051	R/S	51
036	STO4	35 04	052	*LBLD	21 14
037	*LBL3	21 03	053	STO2	35 02
038	RCL1	36 01	054	GTO1	22 01
039	X=0?	16-43	055	*LBL9	21 09
040	GSB8	23 08	056	1	01
041	X	- 35	057	STO1	35 01
042	10 ^x	16 33	058	RCL4	36 04
043	2	02	059	GTO2	22 02
044	.	- 62	060	*LBL8	21 08
045	5	05	061	1	01
046	4	04	062	STO1	35 01
047	6	06	063	RCL4	36 04
048	5	05	064	GTO3	22 03
049	+	- 24	065	R/S	51
050	STO2	35 02			

table 27. Register contents for HP-67/97 program for calculating Z_0 and h/d for a circular wire in a square trough.

STO 0	ϵ_r
STO 1	$\sqrt{\epsilon_r}$
STO 2	h/d
STO 3	Z_0
STO 4	INTERIM

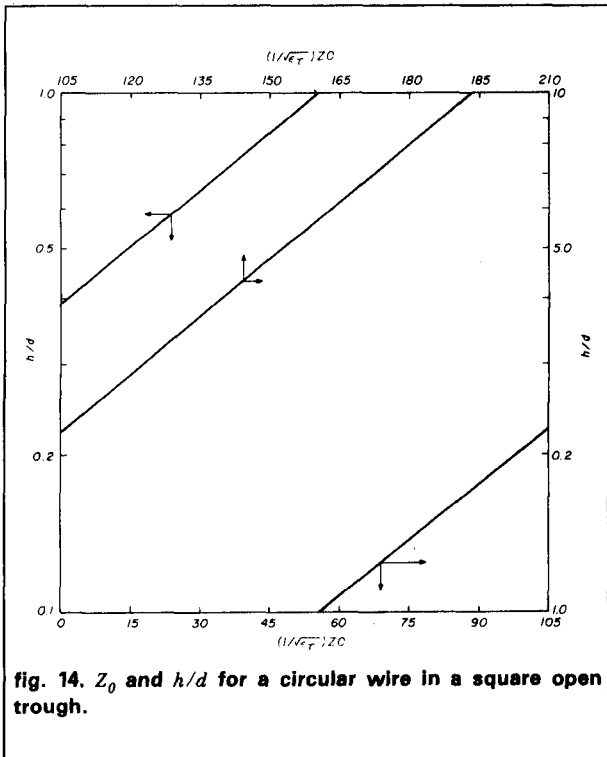

fig. 14. Z_0 and h/d for a circular wire in a square open trough.

table 28. HP-67/97 program control for calculating Z_0 and h/d for a circular wire in a square trough.

enter ϵ_r	press A	
calculates Z_0		
enter h		
enter d	press B	
calculates h/d		Note: If no value for ϵ_r is entered, program assumes $\epsilon_r = 1 = \text{air}$.
enter Z_0	press C	
calculates Z_0		
enter h/d	press D	

table 30. Register contents for HP-67/97 program for calculating Z_0 , h/w , and w/d for a circular wire in a rectangular trough.

STO 0	ϵ_r	STO 6	$e^x + e^{-x}$
STO 1	$\sqrt{\epsilon_r}$	STO 7	$\tanh \frac{\pi h}{w}$
STO 2	h/w	STO 8	INTERIM
STO 3	w/d	STO 9	Z_0
STO 4	$\frac{\pi h}{w} = x$	STO A	INTERIM
STO 5	$e^x - e^{-x}$	STO B	INTERIM

table 31. HP-67/97 program control for calculating Z_0 , h/w , and w/d for a circular wire in a rectangular trough.

enter ϵ_r	press A	
calculates Z_0		
enter d	press ENTER	
enter h	press ENTER	
enter w	press ENTER	
	press B	
calculates h/w		Note: If no value for ϵ_r is entered, program assumes $\epsilon_r = 1 = \text{air}$.
enter Z_0	press ENTER	
enter w/d	press C	
calculates w/d		
enter Z_0	press ENTER	
enter h/w	press D	

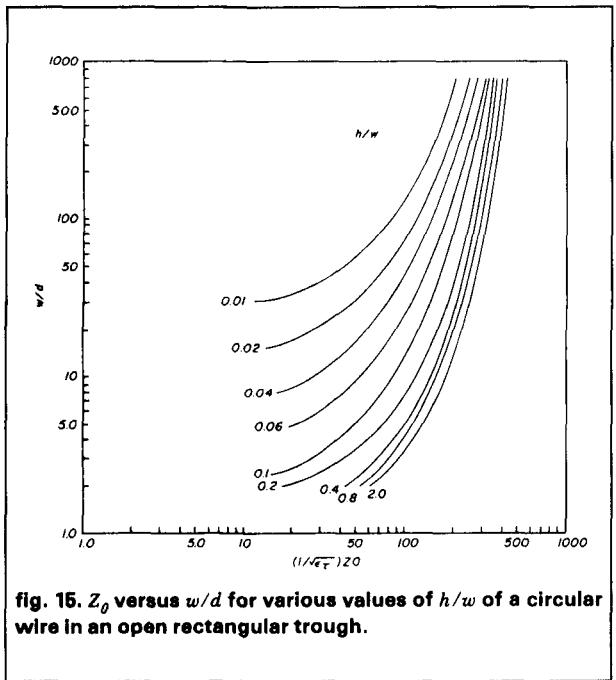
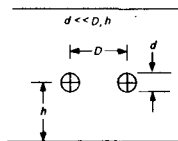

fig. 15. Z_0 versus w/d for various values of h/w of a circular wire in an open rectangular trough.

table 29. HP-67/97 program for calculating Z_0 , h/w , and w/d for a circular wire in a rectangular trough.

step	HP-97 key	HP-97 code	step	HP-97 key	HP-97 code	step	HP-97 key	HP-97 code	step	HP-97 key	HP-97 code
001	*LBLA	21 11	039	Pi	16-24	077	+	- 24	115	STO4	35 04
002	STO0	35 00	040	+	- 24	078	Pi	16-24	116	e ^x	33
003	√X	54	041	LOG	16 32	079	x	- 35	117	STO5	35 05
004	STO1	35 01	042	1	01	080	STOA	35 11	118	RCL4	36 04
005	RTN	24	043	3	03	081	1	01	119	CHS	- 22
006	*LBLB	21 12	044	8	08	082	+	- 55	120	e ^x	33
007	R1	- 31	045	x	- 35	083	STOB	35 12	121	ST+ 5	35-55 05
008	÷	- 24	046	STO8	35 08	084	RCLA	36 11	122	RCL4	36 04
009	STO2	35 02	047	*LBL1	21 01	085	CHS	- 22	123	e ^x	33
010	R1	- 31	048	RCL1	36 01	086	1	01	124	STO6	35 06
011	÷	- 24	049	X= 0?	16-43	087	+	- 55	125	RCL4	36 04
012	STO3	35 03	050	GSB9	23 09	088	1/X	52	126	CHS	- 22
013	*LBL1	21 01	051	x	- 35	089	RCLB	36 12	127	e ^x	33
014	RCL2	36 02	052	STO9	35 09	090	x	- 35	128	ST-6	35-45 06
015	Pi	16-24	053	R/S	51	091	LN	32	129	RCL6	36 06
016	x	- 35	054	*LBL9	21 09	092	2	02	130	RCL5	36 05
017	STO4	35 04	055	1	01	093	÷	- 24	131	÷	- 24
018	e ^x	33	056	STO1	35 01	094	Pi	16-24	132	LOG	16 32
019	STO5	35 05	057	RCL8	36 08	095	+	- 24	133	CHS	- 22
020	RCL4	36 04	058	RTN	24	096	STO2	35 02	134	ST+ 8	35-55 08
021	CHS	- 22	059	*LBLC	21 13	097	R/S	51	135	RCL8	36 08
022	e ^x	33	060	STO3	35 03	098	*LBLD	21 14	136	10 ^x	16 33
023	ST+ 5	35-55 05	061	R1	- 31	099	STO2	35 02	137	4	04
024	RCL4	36 04	062	STO9	35 09	100	R1	- 31	138	+	- 24
025	e ^x	33	063	1	01	101	STO9	35 09	139	Pi	16-24
026	STO6	35 06	064	3	03	102	1	01	140	x	- 35
027	RCL4	36 04	065	8	08	103	3	03	141	STO3	35 03
028	CHS	- 22	066	÷	- 24	104	8	08	142	R/S	51
029	e ^x	33	067	STO8	35 08	105	÷	- 24	143	*LBL8	21 08
030	ST-6	35-45 06	068	RCL1	36 01	106	STO8	35 08	144	1	01
031	RCL6	36 06	069	X= 0?	16-43	107	RCL1	36 01	145	STO1	35 01
032	RCL5	36 05	070	GSB9	23 09	108	X= 0?	16-43	146	RCL8	36 08
033	÷	- 24	071	x	- 35	109	GSB8	23 08	147	RCL1	36 01
034	STO7	35 07	072	10 ^x	16 33	110	x	- 35	148	RTN	24
035	RCL3	36 03	073	RCL3	36 03	111	STO8	35 08	149	R/S	51
036	x	- 35	074	1/X	52	112	RCL2	36 02	150	*LBL E	21 15
037	4	04	075	x	- 35	113	Pi	16-24	151	STO2	35 02
038	x	- 35	076	4	04	114	x	- 35	152	R1	- 31
									153	STO3	35 03
									154	GTO1	22 01
									155	R/S	51

parallel wires between planes/ rectangular box



This configuration is often used for high-powered, push-pull amplifiers. Even though the formulation in eq. 36 does not consider the effects of side walls (only top and bottom planes), good results can be obtained if the lines are centered between the side walls and the distance from either wire to the side wall is at

least greater than $h/2$, as shown in the sketch. A more exact formulation for balanced two-wire lines in a rectangular enclosure is given in reference 4 and discussed later in this section; however, it requires a rather tedious series of calculations.

The following formulation, also from reference 4, is based upon this relationship:

$$Z_0 = \frac{276}{\sqrt{\epsilon_r}} \log_{10} \left[\left(\frac{4h}{\pi d} \right) \left(\tanh \frac{\pi D}{2h} \right) \right] \quad (36)$$

For those who wish the exact relationship, it is given below from reference 4; the geometry is in fig. 16.

$$Z_0 = \frac{276}{\sqrt{\epsilon_r}} \left\{ \left[\log_{10} \left(\frac{4h}{\pi d} \right) \left(\tanh \frac{\pi D}{2h} \right) \right] - \sum_{m=1}^{\infty} \log_{10} \left(\frac{1+U_m^2}{1-V_m^2} \right) \right\} \quad (37)$$

where Z_0 = line impedance (ohms) and $U_m = \frac{\sinh \left(\frac{\pi D}{2h} \right)}{\cosh \left(\frac{m\pi w}{2h} \right)}$ (38)
 ϵ_r = dielectric constant
 h = spacing between planes with the lines centered
 D = centerline distance between the lines
 d = diameter of the lines (lines are assumed to be of equal diameter)
 $V_m = \frac{\sinh \left(\frac{\pi D}{2h} \right)}{\sinh \left(\frac{m\pi w}{2h} \right)}$ (39)

table 32. HP-67/97 program for calculating Z_0 , h/d , and D/h for two parallel wires between planes/rectangular box.

step	HP-97 key	HP-97 code	step	HP-97 key	HP-97 code	step	HP-97 key	HP-97 code	step	HP-97 key	HP-97 code
001	*LBLA	21 11	039	R/S	51	077	÷	- 24	115	RCL5	36 05
002	STO0	35 00	040	*LBLC	21 13	078	STO6	35 06	116	CHS	- 22
003	√X	54	041	STO2	35 02	079	RCL1	36 01	117	e ^x	33
004	STO1	35 01	042	R↓	- 31	080	X=0?	16-43	118	-	- 45
005	RTN	24	043	STO4	35 04	081	GSB8	23 08	119	RCL8	36 08
006	*LBLB	21 12	044	2	02	082	x	- 35	120	÷	- 24
007	R↓	- 31	045	7	07	083	STO6	35 06	121	RTN	24
008	÷	- 24	046	6	06	084	RCL3	36 03	122	*LBL8	21 08
009	STO2	35 02	047	+	- 24	085	4	04	123	1	01
010	R↓	- 31	048	STO6	35 06	086	x	- 35	124	STO1	35 01
011	÷	- 24	049	RCL1	36 01	087	Pi	16-24	125	RCL6	36 06
012	STO3	35 03	050	X=0?	16-43	088	+	- 24	126	RCL1	36 01
013	*LBL1	21 01	051	GSB8	23 08	089	LOG	16 32	127	RTN	24
014	4	04	052	x	- 35	090	ST-6	35-45 06	128	*LBL7	21 07
015	x	- 35	053	STO6	35 06	091	RCL6	36 06	129	1	01
016	Pi	16-24	054	RCL2	36 02	092	X<0?	16-45	130	+	- 55
017	÷	- 24	055	Pi	16-24	093	GSB6	23 06	131	1	01
018	LOG	16 32	056	x	- 35	094	10 ^x	16 33	132	RCL7	36 07
019	STO6	35 06	057	2	02	095	*LBL5	21 05	133	-	- 45
020	RCL2	36 02	058	÷	- 24	096	STO7	35 07	134	+	- 24
021	Pi	16-24	059	GSB9	23 09	097	GSB7	23 07	135	LN	32
022	x	- 35	060	LOG	16 32	098	STO2	35 02	136	2	02
023	2	02	061	ST-6	35-45 06	099	R/S	51	137	÷	- 24
024	+	- 24	062	RCL6	36 06	100	*LBL6	21 15	138	2	02
025	GSB9	23 09	063	10 ^x	16 33	101	STO2	35 02	139	x	- 35
026	LOG	16 32	064	Pi	16-24	102	R↓	- 31	140	Pi	16-24
027	ST+6	35-55 06	065	x	- 35	103	STO3	35 03	141	÷	- 24
028	RCL6	36 06	066	4	04	104	GTO1	22 01	142	STO2	35 02
029	2	02	067	+	- 24	105	*LBL9	21 09	143	RTN	24
030	7	07	068	STO3	35 03	106	STO5	35 05	144	*LBL6	21 06
031	6	06	069	R/S	51	107	e ^x	33	145	CHS	- 22
032	x	- 35	070	*LBLD	21 14	108	RCL5	36 05	146	10 ^x	16 33
033	STO6	35 06	071	STO3	35 03	109	CHS	- 22	147	1/X	52
034	RCL1	36 01	072	R↓	- 31	110	e ^x	33	148	GTO5	22 05
035	X=0?	16-43	073	STO4	35 04	111	+	- 55	149	R/S	51
036	GSB8	23 08	074	2	02	112	STO8	35 08			
037	÷	- 24	075	7	07	113	RCL5	36 05			
038	STO4	35 04	076	6	06	114	e ^x	33			

Note that the open-sided equation (eq. 36) represents the maximum value of Z_0 that can be achieved with no side enclosure. The sum of the series in eq. 37 reduces this value of Z_0 by the closing-in effect of the sides. As a consequence, if eq. 37 and the charts and programs provided here are used, a conservative design will result, permitting the addition of more capacitance than the values calculated, as described in a previous section.

Fig. 17 shows the value of h/d plotted versus D/h for various values of Z_0 . Table 32 is the HP-67/97

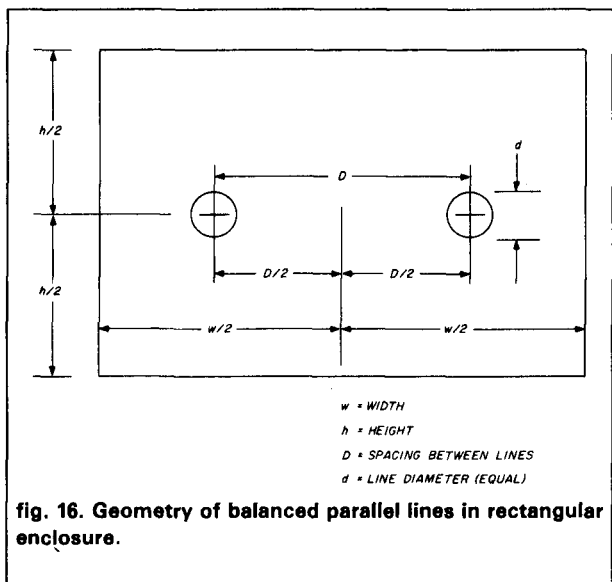

fig. 16. Geometry of balanced parallel lines in rectangular enclosure.

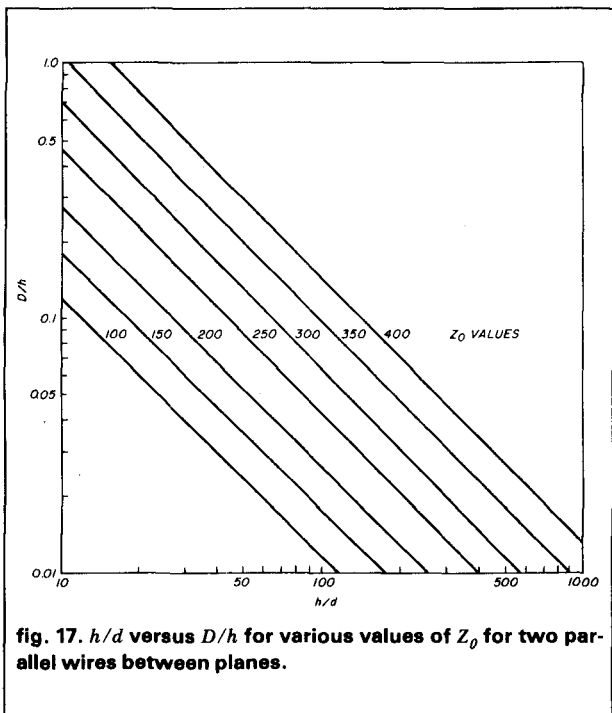

fig. 17. h/d versus D/h for various values of Z_0 for two parallel wires between planes.

program for calculating Z_0 , D/h , or h/d depending on which variables are given. Table 33 shows the registers used in the program, and table 34 describes how the program is controlled.

A more simplified formulation for eq. 36 is used in the program to permit calculation of the desired unknowns:

$$\frac{Z_0 \sqrt{\epsilon_r}}{276} = \left(\log_{10} \frac{4h}{\pi d} \right) + \log_{10} \left(\tanh \frac{\pi D}{2h} \right) \quad (40)$$

table 33. Register contents for HP-67/97 program for calculating Z_0 , h/d , and D/h for two parallel wires between planes/rectangular box.

STO 0	ϵ_r	STO 5	x for $\tanh x$
STO 1	$\sqrt{\epsilon_r}$	STO 6	INTERIM
STO 2	D/h	STO 7	$\tan^{-1} x$
STO 3	h/d	STO 8	INTERIM
STO 4	Z_0		

table 34. HP-67/97 program control for calculating Z_0 , h/d , and D/h for two parallel wires between planes/rectangular box.

calculates	ϵ_r		
enter	ϵ_r	press A	
calculates	Z_0		
enter	d	press ENTER	
enter	D	press ENTER	
enter	h	press ENTER	
		press B	
calculates	h/d		
enter	Z_0	press ENTER	
enter	D/h	press C	
calculates	D/h		
enter	Z_0	press ENTER	
enter	h/d	press D	
calculates	Z_0		
enter	h/d	press ENTER	
enter	d/h	press E	

Note: If no value for ϵ_r is entered, program assumes $\epsilon_r = 1 = \text{air}$.

In the next part of this article, part 4, the geometry and resonant-circuit design of the following configurations will be discussed: circular wire in a square shield, stripline over a plane, stripline centered between parallel planes, and helical resonators.

references

4. Reference Data for Radio Engineers, ITT Corporation, 5th Edition, 1968 (included in subsequent editions).

bibliography

- Bahl, Dr. K.J., "Use Exact Methods for Microstrip Design," *Microwaves*, December, 1978, pages 61-62.
- Gardioli, F.E., "HP-65 Program computes Microstrip Impedance," *Microwaves*, December, 1977, pages 186-187.
- "Letters to the Editor," *Microwave Systems News*, December, 1978, pages 13-14.
- Murdock, B.K., *Handbook of Electronics Design and Analysis Procedures Using Programmable Calculators*, Van Nostrand Reinhold, 1979.

ham radio

ASTRO 103 ÷ MADISON > 9 BAND DXCC

RAVE REVIEWS

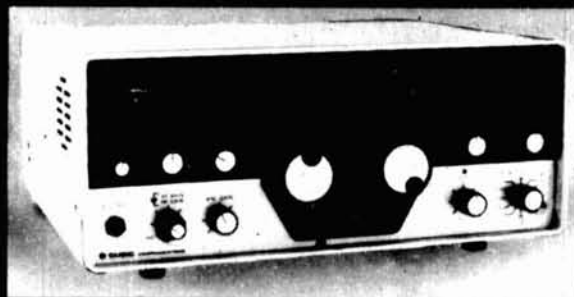

NEW ASTRO 103 WITH NEW WARC BANDS

SPECIFICATIONS

Notch Filter:

Provides 30dB typical notch
attenuation from 4 to 30 kHz

Selectivity: (normal)

16 pole crystal filtering 2.7 kHz at
-6dB, 3.78 kHz at -100dB
Shape Factor 1.4:1

RF Output Power:

100 watts all bands all modes—
limited by ALC to 100 watts PEP or
CW

Sensitivity:

.35Mv for 10dB

Third Order Intercept

Better than -15dBm

Image Rejection:

Better than 70dB

Modes:

USB LSB CW
CWX RTTY

Being only two blocks from WIAW is a horrifying experience for an amateur, since simultaneous 1-KW operation takes place almost around the clock on 80 through 10 meters, to say nothing of operation on 160, 6 and 2 meters! Very few receivers can withstand the onslaught, and tend to crumble when WIAW is operating. Some have survived when front-end attenuation switched in, but none could handle the WIAW. The 102 BXA not only survives without an attenuator, but can function normally when my beam is headed toward WIAW! Your rig is probably the cause of my finally changing to U.S. made equipment.

Doug DeMaw, W1FB
Technical Department Manager
ARRL

This transceiver is the only one I have tested recently that has met all its published specifications or even went beyond. I am specifically impressed with the behavior of the PLL and the AGC. To the best of my knowledge, in this respect, you are better than all current production instruments including the Collins KWM380, which I had tested.

ERIC H. ROHDE

- NOW HEAR THIS -
THE ASTRO 102 AND 103 ARE
NOW HERE AT

MADISON

Electronics Supply

1508 McKinney • Houston, Texas 77010 • (713) 658-0268

A real alternative... The Avanti On Glass Mobile Antenna.

Mounts on glass
— no holes!

- **Receives and transmits through glass.**
- **Superior performance 1/2 wave design.**
- **Superior radiation full Omni-Directional.**

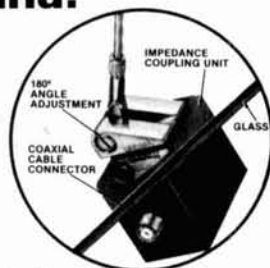

Mounting on glass is easy and effective using new Duo-Bond method which combines quick "drive away" with rugged durability. No holes to drill, no magnet to scratch paint, no clamps. Takes only minutes to install, without tools. No ground plane required. Static and noise cut by up to 30%. Electrical connection are inside and out of sight to prevent crimping or corroding coaxial cable.

Models available for 30-50 MHz, 144-174 MHz, 220-225 MHz and 410-512 MHz

avanti® antennas
"Helping the World Communicate"

AVANTI COMMUNICATIONS
340 Stewart Ave., Addison, IL 60101 (312) 628-9350
In Canada: Cardon Comm., Hamilton, ONT (416) 527-1040

Factory
Direct Only!

THE WORLDS FIRST

1800 CHANNEL FULLY SYNTHESIZED
COMPACT VHF FM MONITOR

AR-22
FACTORY DIRECT
PRICE \$125.00

This price in U.S. only

■ FULL BAND COVERAGE

141.000-149.995 MHz
5 KHZ Steps by digital
switches.

■ SLIM SIZE AND LIGHT-WEIGHT.

5 1/4" (H) x 2 1/2" (W) x 1" (D)
7.1 oz with NiCd Battery Pack



■ COMMERCIAL BAND TYPE (151-159 MHz) IS ALSO AVAILABLE.

■ CREDIT CARDS/MONEY ORDER OR ANY COMMERCIAL GUARANTEED CHECK...U.P.S. COD

ACE COMMUNICATIONS, INC.

2832-D Walnut Avenue, Tustin, California 92680

Phone (714) 544-8281

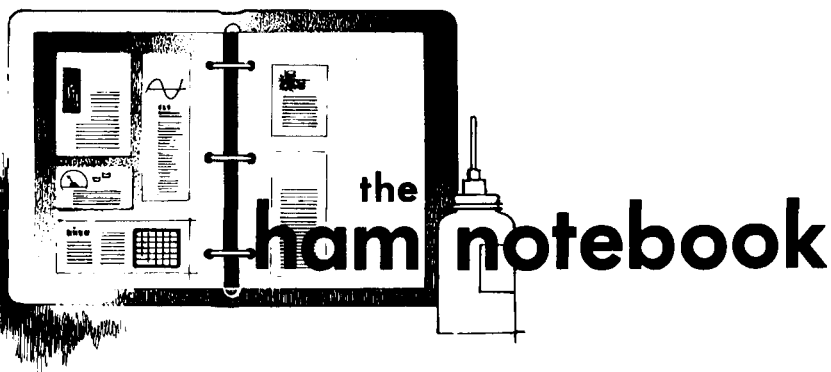

computer control for the KLM antenna rotor

The most obvious approach to microprocessor control of antenna rotors does indeed work! In **fig. 1** two CMOS quad-clocked D latches, U1, are connected in parallel to the first four least-significant digits of an input/output port of a computer. The computer enables first one, then the other latch, leaving behind an 8-bit word.

This byte, a number between 0-255, is converted through the classic "R-2R" network to a voltage between 0-5 volts. This voltage is com-

pared with the voltage returning from the wiper of the potentiometer in the rotor housing.

The comparators turn on solid-state switches, which are connected across the clockwise and counter-clockwise front-panel switches on the rotor control box.

Thus the antenna will rotate in the direction that minimizes the difference between the two voltages.

The two 820k resistors provide a deadband so that when the proper heading is reached, the rotor will stop — not hunt.

Because the quad comparator, U2, loses all resemblance to a comparator

as the inputs approach the upper rail, adjust the 15-turn pot, R, for a comparator input voltage of about 3.5 volts at full rotation. This voltage corresponds to a byte of 180. Then merely have the computer poke down to the latches a number between 0-180, which is one-half the required azimuth heading (or twice the required elevation).

The terminal numbers indicated in **fig. 1** are for the KLM KR-400 and KR-500 rotors. Terminal 8 must be wired to the common connection of the two front-panel direction controls. Solid-state switches can be homebuilt with an opto-triac driver and triac, as in **fig. 2**.

This interface is very precise — four-degree resolution or better at most headings. The circuit will readjust for sudden wind gusts, voltage variations, etc., without complex software. The computer needs only to enter direction data every minute, say, using only a few machine cycles then go on to other work.

I conclude with a report of negative results: my first attempt at such an interface was with the new low-cost RCA CA3162E, two 4-bit magnitude comparators and four latches. The plan was to convert the rotor heading to digital information, then compare. Aside from problems with the multiplex timing of the 3162, this was a wasteful approach. At least ten comparators were at work instead of two!

C.R. Mac Cluer, W8MQW

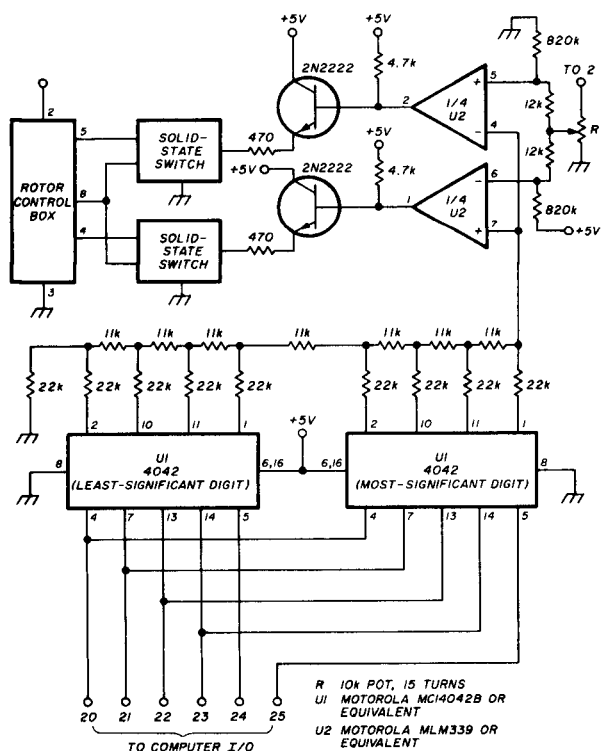
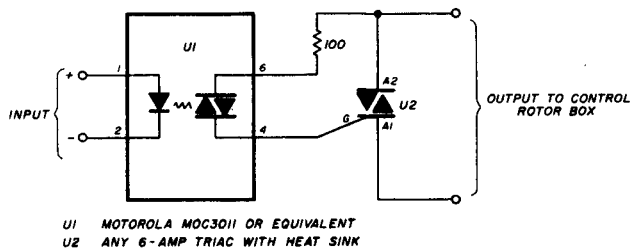

fig. 1, left: Interface circuit for microprocessor control of the KLM KR-400 and KR-500 antenna rotors.

fig. 2, below: Schematic of the solid-state switches, consisting of optically coupled triac driver and 6-ampere triac with heatsink.



U1 MOTOROLA MOC3011 OR EQUIVALENT
U2 ANY 6-AMP TRIAC WITH HEAT SINK

varactor tuning tips

In tuning power varactor doublers, triplers, etc., there is often a sharp or sudden discontinuity in the tuning of one or more of the tuned circuits; a condition known as hysteresis.

While hysteresis is caused by some

non-linearities in the diode function, it seems that it may also be a result of the circuit "Q" aggravating diode non-linearities. I figured that it might be possible to lessen the effect by a reduction in circuit "Q." Accordingly, I reduced the bias resistor in my 144-

to-432 MHz tripler from 92 kilohms to about 12 kilohms. I was pleased to note that circuit performance was actually improved — tuneup was easier, and there was no appreciable loss of power output.

Richard N. Coan, N3GN

woodpecker noise blanker for the Drake TR-7 transceiver

If you have been reading the articles about the "Woodpecker Noise Blanker"¹ and wished your TR-7 could do the same to the "Russian Woodpecker," it can — with just two component changes. The Drake noise blanker for the TR-7 is functionally the same block diagram; the problem is that the one-shot and integrator time constants aren't set up for the Woodpecker.

I increased C831 from 0.001 μ F to 0.01 μ F and the one-shot capacitor

from 0.01 μ F to 0.1 μ F. The results were fair to good. A 10-20 dB over S9 Woodpecker signal would be cut back to S5-6 with no real distortion to SSB, CW, or RTTY. I called Drake about the idea, but they have also made a change which will be in new NB7s to be sold soon. Their results were about the same as regards attenuation of the Woodpecker signal. Drake sent me a copy of their changes and I'll compare it with what I've done.

The noise blanker works best on strong Woodpecker signals (over S7). I have received three Woodpeckers each with its own signature. All have the same rate of 100 millisec-

onds (probably due to a division of the 50-Hz power line) but differ in pulse width and rise time.

The changes are simple and not critical. The only problem is that in my service manual, the pictorial didn't show the position of C840. Fig. 3 shows the area of the schematic where the changes are made, and fig. 4 shows the pictorial of the components to be changed.

I would like to thank W1IHN for allowing me to use his noise blanker to test this idea.

reference

1. Ulrich L. Rohde, DJ2LR, "Woodpecker Noise Blanker," *ham radio*, June, 1980, page 18.

John Bird, K1KSY

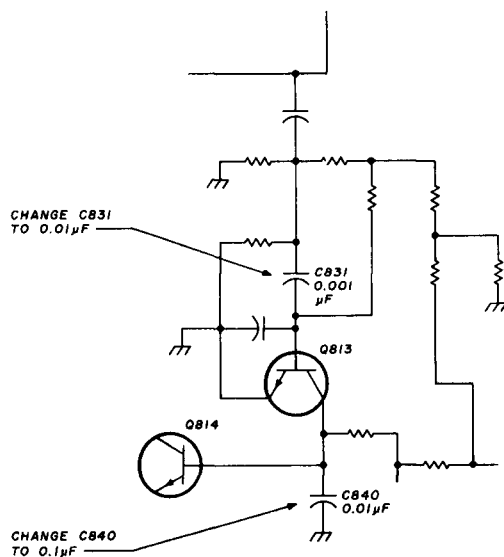

Fig. 3

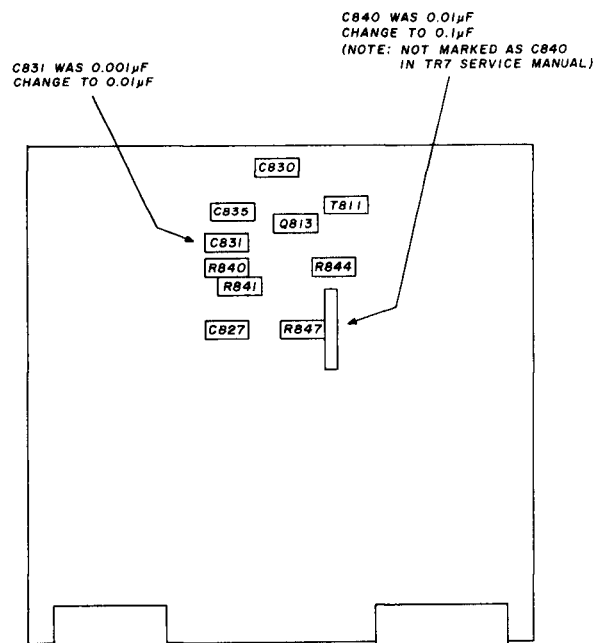

Fig. 4

MHz electronics

1900 MHz to 2500 MHz DOWN CONVERTER

This receiver is tunable over a range of 1900 to 2500 mc and is intended for amateur radio use. The local oscillator is voltage controlled (i.e.) making the i-f range approximately 54 to 88 mc (Channels 2 to 7).

PC BOARD WITH DATA	\$19.99
PC BOARD WITH CHIP CAPACITORS 13	\$44.99
PC BOARD WITH ALL PARTS FOR ASSEMBLY	\$69.99
PC BOARD WITH ALL PARTS FOR ASSEMBLY PLUS 2N6603	\$89.99
PC BOARD ASSEMBLED AND TESTED	\$99.99
PC BOARD WITH ALL PARTS FOR ASSEMBLY, POWER SUPPLY AND ANTENNA	\$159.99
POWER SUPPLY ASSEMBLED AND TESTED	\$49.99
YAGI ANTENNA 4' LONG APPROX. 20 TO 23 dB GAIN	\$59.99
YAGI ANTENNA 4' WITH TYPE (N, BNC, SMA Connector)	\$64.99
2300 MHz DOWN CONVERTER Includes converter mounted in antenna, power supply, plus 90 DAY WARRANTY	\$259.99
OPTION #1 MRF902 in front end. (7 dB noise figure)	\$299.99
OPTION #2 2N6603 in front end. (5 dB noise figure)	\$359.99
2300 MHz DOWN CONVERTER ONLY	
10 dB Noise Figure 23 dB gain in box with N conn. Input F conn. Output	\$149.99
7 dB Noise Figure 23 dB gain in box with N conn. Input F conn. Output	\$169.99
5 dB Noise Figure 23 dB gain in box with SMA conn. Input F conn. Output	\$189.99
DATA IS INCLUDED WITH KITS OR MAY BE PURCHASED SEPARATELY	\$15.00

Shipping and Handling Cost:

Receiver Kits add \$1.50, Power Supply add \$2.00, Antenna add \$5.00, Option 1/2 add \$3.00, For complete system add \$7.50.

★ INTRODUCING THE HOWARD/COLEMAN TVRO CIRCUIT BOARDS ★

(Satellite Receiver Boards)

DUAL CONVERSION BOARD	\$25.00
This board provides conversion from the 3.7-4.2 band first to 900 MHz where gain and bandpass filtering are provided and, second, to 70 MHz. The board contains both local oscillators, one fixed and the other variable, and the second mixer. Construction is greatly simplified by the use of Hybrid IC amplifiers for the gain stages. Bare boards cost \$25 and it is estimated that parts for construction will cost \$270. (Note: The two Avantek VTO's account for \$225 of this cost.)	
47 pF CHIP CAPACITORS	\$6.00
For use with dual conversion board. Consists of 6 — 47 pF.	
70 MHz IF BOARD	\$25.00
This circuit provides about 43 dB gain with 50 ohm input and output impedance. It is designed to drive the HOWARD/COLEMAN TVRO Demodulator. The on-board band pass filter can be tuned for bandwidths between 20 and 35 MHz with a passband ripple of less than 1/2 dB. Hybrid ICs are used for the gain stages. Bare boards cost \$25. It is estimated that parts for construction will cost less than \$40.	
.01 pF CHIP CAPACITORS	\$7.00
For use with 70 MHz IF Board. Consists of 7 — .01 pF.	
DEMODULATOR BOARD	40.00
This circuit takes the 70 MHz center frequency satellite TV signals in the 10 to 200 millivolt range, detects them using a phase locked loop, de-emphasizes and filters the result and amplifies the result to produce standard NTSC video. Other outputs include the audio subcarrier, a DC voltage proportional to the strength of the 70 MHz signal, and AFC voltage centered at about 2 volts DC. The bare boards cost \$40 and total parts cost less than \$30.	
SINGLE AUDIO	\$15.00
This circuit recovers the audio signals from the 6.8 MHz frequency. The Miller 9051 coils are tuned to pass the 6.8 MHz subcarrier and the Miller 9052 coil tunes for recovery of the audio.	
DUAL AUDIO	\$25.00
Duplicate of the single audio but also covers the 6.2 range.	
DC CONTROL	\$15.00
This circuit controls the VTO's, AFC and the S Meter.	

TERMS:

WE REGRET WE NO LONGER ACCEPT BANK CARDS.

PLEASE SEND POSTAL MONEY ORDER, CERTIFIED CHECK, CASHIER'S CHECK OR MONEY ORDER.

PRICES SUBJECT TO CHANGE WITHOUT NOTICE. WE CHARGE 15% FOR RESTOCKING ON ANY ORDER.

ALL CHECKS AND MONEY ORDERS IN US FUNDS ONLY.

ALL ORDERS SENT FIRST CLASS OR UPS.

ALL PARTS PRIME AND GUARANTEED.

WE WILL ACCEPT COD ORDERS FOR \$25.00 OR OVER, ADD \$2.50 FOR COD CHARGE.

PLEASE INCLUDE \$2.50 MINIMUM FOR SHIPPING OR CALL FOR CHARGES.

WE ALSO ARE LOOKING FOR NEW AND USED TUBES,

TEST EQUIPMENT, COMPONENTS, ETC.

WE ALSO SWAP OR TRADE.

(602) 242-8916

2111 W. Camelback
Phoenix, Arizona 85015

NEW — TOLL-FREE NO. 800-528-0180 — please, orders only!

MHz electronics

RF TRANSISTORS

FAIRCHILD VHF AND UHF PRESCALER CHIPS

95H90DC	350 MHz Prescaler Divide by 10/11	\$9.50
95H91DC	350 MHz Prescaler Divide by 5/6	9.50
11C90DC	650 MHz Prescaler Divide by 10/11	16.50
11C91DC	650 MHz Prescaler Divide by 5/6	16.50
11C83DC	1 GHz Divide by 248/256 Prescaler	29.90
11C70DC	600 MHz Flip/Flop with reset	12.30
11C58DC	ECL VCM	4.53
11C44DC/MC4044	Phase Frequency Detector	3.82
11C24DC/MC4024	Dual TTL VCM	3.82
11C06DC	UHF Prescaler 750 MHz D Type Flip/Flop	12.30
11C05DC	1 GHz Counter Divide by 4	50.00
11C01FC	High Speed Dual 5-4 Input NO/NOR Gate	15.40

TRW BROADBAND AMPLIFIER MODEL CA615B

Frequency response 40 MHz to 300 MHz
Gain: 300 MHz 16 dB Min., 17.5 dB Max.
50 MHz 0 to -1 dB from 300 MHz
Voltage: 24 volts dc at 220 ma max. **\$19.99**

CARBIDE — CIRCUIT BOARD DRILL BITS FOR PC BOARDS

Size: 35, 42, 47, 49, 51, 52	\$2.15
Size: 53, 54, 55, 56, 57, 58, 59, 61, 63, 64, 65	1.85
Size: 66	1.90
Size: 1.25 mm, 1.45 mm	2.00
Size: 3.20 mm	3.58

CRYSTAL FILTERS: TYCO 001-19880 same as 2194F

10.7 MHz Narrow Band Crystal Filter
3 dB bandwidth 15 kHz min. 20 dB bandwidth 60 kHz min. 40 dB bandwidth 150 kHz min.
Ultimate 50 dB: Insertion loss 1.0 dB max. Ripple 1.0 dB max. Ct. 0 + / - 5 pf 3600 ohms. **\$5.95**

MURATA CERAMIC FILTERS

Models: SFD-455D 455 kHz	\$3.00
SFB-455D 455 kHz	2.00
CFM-455E 455 kHz	7.95
SFE-10.7 10.7 MHz	5.95

TEST EQUIPMENT — HEWLETT PACKARD — TEKTRONIX — ETC.

Hewlett Packard:

491C	TWT Amplifier 2 to 4 Gc 1 watt 30 dB gain	\$1150.00
608C	10 to 480 mc .1 uv to .5 V into 50 ohms Signal Generator	500.00
608D	10 to 420 mc .1 uV to .5 V into 50 ohms Signal Generator	500.00
612A	450 to 1230 mc .1 uV to .5 V into 50 ohms Signal Generator	750.00
614A	900 to 2100 mc Signal Generator	500.00
616A	1.8 to 4.2 Gc Signal Generator	400.00
618B	1.8 to 4.2 Gc Signal Generator	500.00
618A	3.8 to 7.2 Gc Signal Generator	400.00
618B	3.8 to 7.2 Gc Signal Generator	500.00
620A	7 to 11 Gc Signal Generator	400.00
623B	Microwave Test Set	900.00
626A	10 to 15 Gc Signal Generator	2500.00
695A	12.4 to 18 Gc Sweep Generator	900.00

Alltech:
473 225 to 400 mc AM/FM Signal Generator 750.00

Singer:
MF5/VR-4 Universal Spectrum Analyzer with 1 kHz to 27.5 mc Plug In 1200.00

Ketek:
XR630-100 TWT Amplifier 8 to 12.4 Gc 100 watts 40 dB gain 9200.00

Polarad:
2038/2438/1102A
Calibrated Display with an SSB Analysis Module and a 10 to 40 mc Single Tone Synthesizer 1500.00

TYPE	PRICE	TYPE	PRICE	TYPE	PRICE
2N1561	\$15.00	2N5590	\$8.15	MM1550	\$10.00
2N1562	15.00	2N5591	11.85	MM1552	50.00
2N1692	15.00	2N5637	22.15	MM1553	56.50
2N1693	15.00	2N5641	6.00	MM1601	5.50
2N2632	45.00	2N5642	10.05	MM1602/2N5842	7.50
2N2857JAN	2.52	2N5643	15.82	MM1607	8.85
2N2876	12.35	2N6545	12.38	MM1661	15.00
2N2880	25.00	2N5784	27.00	MM1669	17.50
2N2927	7.00	2N5842	8.78	MM1943	3.00
2N2947	18.35	2N5849	21.29	MM2805	3.00
2N2948	15.50	2N5862	51.91	MM2808	5.00
2N2949	3.90	2N5913	3.25	MM8006	2.23
2N2950	5.00	2N5922	10.00	MMCM918	20.00
2N3287	4.30	2N5942	46.00	MMT72	1.17
2N3294	1.15	2N5944	8.92	MMT74	1.17
2N3301	1.04	2N5945	12.38	MMT2857	2.83
2N3302	1.05	2N5946	14.69	MRF245	33.30
2N3304	1.48	2N6080	7.74	MRF247	33.30
2N3307	12.60	2N6081	10.05	MRF304	43.45
2N3309	3.90	2N6082	11.30	MRF420	20.00
2N3375	9.32	2N6083	13.23	MRF450	11.85
2N3553	1.57	2N6084	14.66	MRF450A	11.85
2N3755	7.20	2N6094	7.15	MRF454	21.83
2N3818	6.00	2N6095	11.77	MRF458	20.68
2N3866	1.09	2N6096	20.77	MRF502	1.06
2N3866JAN	2.80	2N6097	29.54	MRF504	6.95
2N3866JANTX	4.49	2N6136	20.15	MRF509	4.90
2N3824	3.34	2N6166	38.60	MRF511	8.15
2N3927	12.10	2N6439	45.77	MRF901	5.00
2N3950	26.86	2N6459/PT9795	16.00	MRF5177	21.82
2N4072	1.80	2N6803	12.00	MRF8004	1.80
2N4135	2.00	2N6804	12.00	PT4186B	3.00
2N4281	14.60	A50-12	25.00	PT4571A	1.50
2N4427	1.20	BFR90	5.00	PT4612	5.00
2N4957	3.82	BLY568C	25.00	PT4628	5.00
2N4958	2.92	BLY568CF	25.00	PT4640	5.00
2N4959	2.23	CD3495	15.00	PT8659	10.72
2N4976	19.00	HEP76/S3014	4.95	PT9784	24.30
2N5090	12.31	HEPS3002	11.30	PT9790	41.70
2N5108	4.03	HEPS3003	29.88	SD1043	5.00
2N5109	1.66	HEPS3005	9.95	SD1116	3.00
2N5160	3.49	HEPS3006	19.90	SD1118	5.00
2N5179	1.05	HEPS3007	24.95	SD1119	3.00
2N5184	2.00	HEPS3010	11.34	TRWMRA2023-1.5	42.50
2N5216	47.50	HEPS5026	2.56	40281	10.90
2N5583	4.55	HP35831E/		40282	11.90
2N5589	6.82	HXTR5104	50.00	40290	2.48
		MM1500	32.20		

CHIP CAPACITORS

We can supply any value chip capacitors you may need.		PRICES			
1pF	27pf	220pf	1200pf		
1.5pf	33pf	240pf	1500pf		
2.2pf	39pf	270pf	1800pf		
2.7pf	47pf	300pf	2200pf		
3.3pf	56pf	330pf	2700pf		
3.9pf	68pf	360pf	3300pf		
4.7pf	82pf	390pf	3900pf		
5.6pf	100pf	430pf	4700pf		
6.8pf	110pf	470pf	5600pf		
8.2pf	120pf	510pf	6800pf		
10pf	130pf	560pf	8200pf		
12pf	150pf	620pf	.010mf		
15pf	160pf	680pf	.012mf		
18pf	180pf	820pf	.015mf		
22pf	200pf	1000pf	.018mf		

ATLAS CRYSTAL FILTERS FOR ATLAS HAM GEAR

5.52-2.7/8
5.595-2.7/8/U
5.595-.500/4/CW
5.595-2.7LSB
5.595-2.7USB
5.645-2.7/8
9.0USB/CW

YOUR CHOICE \$24.95

NEW — TOLL-FREE NO. 800-528-0180 — please, orders only!

MHz electronics

MOTOROLA Semiconductor The RF Line

MRF454 \$21.83

NPN SILICON RF POWER TRANSISTORS

... designed for power amplifier applications in industrial, commercial and amateur radio equipment to 30 MHz.

- Specified 12.5 Volt, 30 MHz Characteristics -
Output Power = 80 Watts
Minimum Gain = 12 dB
Efficiency = 50%

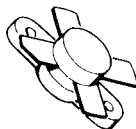

NPN SILICON RF POWER TRANSISTOR

... designed primarily for use in large-signal output amplifier stages. Intended for use in Citizen-Band communications equipment operating at 27 MHz. High breakdown voltages allow a high percentage of up-modulation in AM circuits.

MRF472

\$2.50

- Specified 12.5 V, 27 MHz Characteristics -
Power Output = 4.0 Watts
Power Gain = 10 dB Minimum
Efficiency = 65% Typical

MRF475

NPN SILICON RF POWER TRANSISTOR

... designed primarily for use in single sideband linear amplifier output applications in citizens band and other communications equipment operating to 30 MHz.



\$5.00

- Characterized for Single Sideband and Large-Signal Amplifier Applications Utilizing Low-Level Modulation.
- Specified 13.6 V, 30 MHz Characteristics -
Output Power = 12 W (PEP)
Minimum Efficiency = 40% (SSB)
Output Power = 4.0 W (CW)
Minimum Efficiency = 50% (CW)
Minimum Power Gain = 10 dB (PEP & CW)
- Common Collector Characterization

MRF458 \$20.68

NPN SILICON RF POWER TRANSISTOR

... designed for power amplifier applications in industrial, commercial and amateur radio equipment to 30 MHz.

- Specified 12.5 Volt, 30 MHz Characteristics -
Output Power = 80 Watts
Minimum Gain = 12 dB
Efficiency = 50%
- Capable of Withstanding 30:1 Load VSWR @ Rated P_{out} and V_{CC}

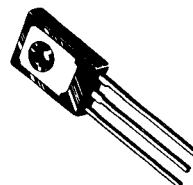

MHW710 - 2

\$46.45
440 to 470MC

UHF POWER AMPLIFIER MODULE

... designed for 12.5 volt UHF power amplifier applications in industrial and commercial FM equipment operating from 400 to 512 MHz.

- Specified 12.5 Volt, UHF Characteristics -
Output Power = 13 Watts
Minimum Gain = 19.4 dB
Harmonics = 40 dB
- 50 Ω Input/Output Impedance
- Guaranteed Stability and Ruggedness
- Gain Control Pin for Manual or Automatic Output Level Control
- Thin Film Hybrid Construction Gives Consistent Performance and Reliability



Tektronix Test Equipment

B	Wideband High Gain Plug In	\$ 51.00
CA	Dual Trace Plug In	120.00
K	Fast Rise DC Plug In	63.00
N	Sampling Plug In	200.00
R	Transistor Risetime Plug In	116.00
W	High Gain Differential Comparator Plug In	283.00
TU-2	Test Load Plug In for 530/540/550 Main Frames	50.00
1A2	Wideband Dual Trace Plug In	216.00
1S1	Sampling Unit With 350PS Risetime DC to 1GHZ	730.00
2A61	AC Differential Plug In	133.00
3S3	Dual Trace Sampling DC to 1GHZ Plug In	250.00
3S76	Dual Trace Sampling DC to 875MHz Plug IN	250.00
3777A	Sampling Sweep Plug In	250.00
3L10	Spectrum Analyzer 1 to 36MHz Plug IN	1000.00
50	Amplifier Plug In	50.00
51	Sweep Plug In	50.00
53B	Wideband High Gain Plug In	25.00
53/54B	Wideband High Gain Plug In	45.00
53/54C	Dual Trace Plug In	112.50
53/54D	High Gain DC Differential Plug In	38.00
53/54G	Wideband DC Differential Plug In	68.00
53/54L	Fast Rise High Gain Plug In	68.00
84	Test Plug In for 580/581 Main Frames	75.00
107	Square Wave Generator .4 to 1MHz	48.00
RM122	Preamplifier 2Hz to 40KHz	63.00
123	AC Coupled Preamplifier	25.00
131	Current Probe Amplifier	50.00
184	Time Mark Generator	363.00
R240	Program Control Unit	150.00
280	Trigger Countdown Unit	84.00
455	Portable Dual Trace 50MHz Scope	2000.00
465	Portable Dual Trace 100MHz Scope	2500.00
503	DC to 450MHz Scope Rack Mount	250.00
535A	DC to 15MHz Scope Rack Mount	263.00
543	DC to 33MHz Scope	300.00
561	DC to 10MHz Scope Rack Mount	150.00
561A	DC to 10MHz Scope Rack Mount	200.00

Scopes with Plug-ins

561A	DC to 10MHz Scope with a 3S76 Dual Trace DC to 875MHz Sampling Plug In and a 3777A Sweep Plug In. Rack Mount	600.00
565	DC to 10MHz Dual Beam Scope with a 2A63 Diff. and a 2A61 Diff. Plug In's	900.00
581	DC to 80MHz Scope with a 82 Dual Trace High Gain Plug In	650.00

Tubes

2E26	\$ 5.00	4CX350FJ	\$116.00	6146W	12.00
3-5007	102.00	4CX1000A	300.00	6159	19.60
3-1000Z	268.00	4CX1500B	350.00	6161	75.00
3B2B/866A	5.00	4CX15000A	750.00	6293	18.50
3X2500A3	150.00	4E27	50.00	6360	6.95
4-65A	45.00	4X150A	41.00	6907	40.00
4-125A	58.50	4X1500	52.00	6939	14.75
4-250A	68.50	4X150G	74.00	7360	12.00
4-400A	71.00	572B/T160L	39.00	7984	10.40
4-1000A	184.00	6LF6	5.00	8072	49.00
5-500A	145.00	6L06	5.00	8106	2.00
4CX250B	65.00	811A	12.95	8156	7.85
4CX250F/G	55.00	813	29.00	8226	127.70
4CX290K	113.00	5894/A	42.00	8295/PL172	328.00
4CX250R	92.00	6146	5.00	8458	25.75
4CX100A	147.00	6146A	6.00	8560A/AS	50.00
4CX350A	107.00	6146B/8298A	7.00	8908	9.00
				8950	9.00

NEW — TOLL-FREE NO. 800-528-0180 — please, orders only!

MHz electronics

MICROWAVE COMPONENTS

ARRA

2416	Variable Attenuator	\$ 50.00
3614-60	Variable Attenuator 0 to 60dB	75.00
KU520A	Variable Attenuator 18 to 26.5 GHz	100.00
4684-20C	Variable Attenuator 0 to 180dB	100.00
6684-20F	Variable Attenuator 0 to 180dB	100.00

General Microwave

Directional Coupler 2 to 4GHz 20dB Type N	75.00
---	-------

Hewlett Packard

H487B	100 ohms Neg. Thermistor Mount (NEW)	150.00
H487B	100 ohms Neg. Thermistor Mount (USED)	100.00
477B	200 ohms Neg. Thermistor Mount (USED)	100.00
X487A	100 ohms Neg. Thermistor Mount (USED)	100.00
X487B	100 ohms Neg. Thermistor Mount (USED)	125.00

J468A	100 ohms Neg. Thermistor Mount (USED)	150.00
478A	200 ohms Neg. Thermistor Mount (USED)	150.00
J382	5.85 to 8.2 GHz Variable Attenuator 0 to 50dB	250.00
X382A	8.2 to 12.4 GHz Variable Attenuator 0 to 50dB	250.00

394A	1 to 2 GHz Variable Attenuator 6 to 120dB	250.00
NK292A	Waveguide Adapter	65.00
K422A	18 to 26.5 GHz Crystal Detector	250.00
8436A	Bandpass Filter 8 to 12.4 GHz	75.00

8439A	2 GHz Notch Filter	75.00
8471A	Rf Detector	50.00
H532A	7.05 to 10 GHz Frequency Meter	300.00
G532A	3.95 to 5.85 GHz Frequency Meter	300.00
J532A	5.85 to 8.2 GHz Frequency Meter	300.00

809A	Carriage with a 444A Slotted Line Untuned Detector Probe and 809B Coaxial Slotted Section 2.6 to 18 GHz	175.00
------	---	--------

Merrimac

AU-25A/	801115 Variable Attenuator	100.00
AU-26A/	801162 Variable Attenuator	100.00

Microlab/FXR

X638S	Horn 8.2 - 12.4 GHz	60.00
601-B18	X to N Adapter 8.2 - 12.4 GHz	35.00
Y6100	Coupler	75.00

Narda

4013C-10/	22540A Directional Coupler 2 to 4 GHz 10dB Type SMA	90.00
4014-10/	22538 Directional Coupler 3.85 to 8 GHz 10dB Type SMA	90.00
4014C-6/	22876 Directional Coupler 3.85 to 8 GHz 6dB Type SMA	90.00
4015C-10/	22539 Directional Coupler 7.4 to 12 GHz 10dB Type SMA	95.00
4015C-30/	23105 Directional Coupler 7 to 12.4 GHz 30dB Type SMA	95.00
3044-20	Directional Coupler 4 to 8 GHz 20dB Type N	125.00
3040-20	Directional Coupler 240 to 500 MC 20dB Type N	125.00
3043-20/	22006 Directional Coupler 1.7 to 4 GHz 20dB Type N	125.00
3003-10/	22011 Directional Coupler 2 to 4 GHz 10dB Type N	75.00
3003-30/	22012 Directional Coupler 2 to 4 GHz 30dB Type N	75.00
3043-30/	22007 Directional Coupler 1.7 to 3.5 GHz 30dB Type N	125.00
22574	Directional Coupler 2 to 4 GHz 10dB Type N	125.00
3033	Coaxial Hybrid 2 to 4 GHz 3dB Type N	125.00
3032	Coaxial Hybrid 950 to 2 GHz 3 dB Type N	125.00
784/	22380 Variable Attenuator 1 to 90dB 2 to 2.5 GHz Type SMA	550.00
22377	Waveguide to Type N Adapter	35.00
720-6	Fixed Attenuator 8.2 to 14.4 GHz 6 dB	50.00
3503	Waveguide	25.00

PRD

U101	12.4 to 18 GHz Variable Attenuator 0 to 60dB	300.00
X101	8.2 to 12.4 GHz Variable Attenuator 0 to 60dB	200.00
C101	Variable Attenuator 0 to 60dB	200.00
205A/367	Slotted Line with Type N Adapter	100.00
195B	8.2 to 12.4 GHz Variable Attenuator 0 to 50dB	100.00
1858S1	7.05 to 10 GHz Variable Attenuator 0 to 40dB	100.00
196C	8.2 to 12.4 GHz Variable Attenuator 0 to 45dB	100.00
170B	3.95 to 5.85 GHz Variable Attenuator 0 to 45dB	100.00
588A	Frequency Meter 5.3 to 6.7 GHz	100.00
140A,C,D,E	Fixed Attenuators	25.00
109J,I	Fixed Attenuators	25.00
WEINSCHL ENG.	2692 Variable Attenuator +30 to 60dB	100.00

COMPUTER I.C. SPECIALS

MEMORY

DESCRIPTION

PRICE

2708	1K x 8 EPROM	\$ 7.99
2716/2516	2K x 8 EPROM 5Volt Single Supply	20.00
2114/9114	1K x 4 Static RAM 450ns	6.99
2114L2	1K x 4 Static RAM 250ns	8.99
2114L3	1K x 4 Static RAM 350ns	7.99
4027	4K x 1 Dynamic RAM	3.99
4060/2107	4K x 1 Dynamic RAM	3.99
4050/9050	4K x 1 Dynamic RAM	3.99
2111A-2/8111	256 x 4 Static RAM	3.99
2112A-2	256 x 4 Static RAM	3.99
2115AL-2	1K x 1 Static RAM 55ns	4.99
6104-3/4104	4K x 1 Static RAM 320ns	14.99
7141-2	4K x 1 Static RAM 200ns	14.99
MCM6641L20	4K x 2 Static RAM 200ns	14.99
9131	1K x 1 Static RAM 300ns	10.99

C.P.U.'s ECT.

MC6800L	Microprocessor	13.80
MCM6810AP	128 x 8 Static RAM 450ns	3.99
MCM68A10P	128 x 8 Static RAM 360ns	4.99
MCM68B10P	128 x 8 Static RAM 250ns	5.99
MC6820P	PIA	8.99
MC6820L	PIA	9.99
MC6821P	PIA	8.99
MC6821P	PIA	9.99
MCM6830L7	Mikbug	14.99
MC6840P	PTM	8.99
MC6845P	CRT Controller	29.50
MC6845L	CRT Controller	33.00
MC6850L	ACIA	10.99
MC6852P	SSDA	5.99
MC6852L	SSDA	11.99
MC6854P	ADLC	22.00
MC6860CJCS	0-600 BPS Modem	29.00
MC6862L	2400 BPS Modem	14.99
MK3850N-3	F8 Microprocessor	9.99
MK3852P	F8 Memory Interface	16.99
MK3852N	F8 Memory Interface	9.99
MK3854N	F8 Direct Memory Access	9.99
8008-1	Microprocessor	4.99
8080A	Microprocessor	8.99
Z80CPU	Microprocessor	14.99
6520	PIA	7.99
6530	Support For 6500 series	15.99
2650	Microprocessor	10.99
TMS1000NL	Four Bit Microprocessor	9.99
TMS4024NC	9 x 64 Digital Storage Buffer (FIFO)	9.99
TMS6011NC	UART	9.99
MC14411	Bit Rate Generator	11.99
AY5-4007D	Four Digit Counter/Display Drivers	8.99
AY5-9200	Repertory Dialler	9.99
AY5-9100	Push Button Telephone Diallers	7.99
AY5-2376	Keyboard Encoder	19.99
AY3-8500	TV Game Chip	5.99
TR1402A	UART	9.99
PR1472B	UART	9.99
PT1482B	UART	9.99
8257	DMA Controller	9.99
8251	Communication Interface	9.99
8228	System Controller & Bus Driver	5.00
8212	8 Bit Input/Output Port	5.00
MC14410CP	2 of 8 Tone Encoder	9.99
MC14412	Low Speed Modem	14.99
MC14408	Binary to Phone Pulse Converter	12.99
MC14409	Binary to Phone Pulse Converter	12.99
MC1488L	RS232 Driver	1.00
MC1489L	RS232 Receiver	1.00
MC1405L	A/D Converter Subsystem	9.00
MC1406L	6 Bit D/A Converter	7.50
MC1408/6/7/8	8 Bit D/A Converter	4.50
MC1330P	Low Level Video Detector	1.50
MC1349/50	Video IF Amplifier	1.17
MC1733L	LM733 OP Amplifier	2.40
LM565	Phase Lock Loop	2.50

NEW — TOLL-FREE NO. 800-528-0180 — please, orders only!

Get on 220 MHz all modes with your present 2 meter rig!

220 is the new frontier in VHF! There is plenty of FM activity now in most areas of the country and SSB and weak signal work is growing rapidly. It's a fact; working on 220 is one of the most rewarding activities since most work is still in the pioneering stages.

You can get on 220 at minimal expense now by adding Lunar's new 220/TV Transverter to your present 2 meter station. It costs about half the price of most all-mode radios yet enables you to work any mode (CW, SSB, FM, SSTV, RTTY) on 220 as you do on 2 meters, using your present 2 meter transceiver.

Installation is easy!

Just connect the Lunar 220/TV to a 220 antenna, your 2 meter transceiver, and a 13.5 power supply; select your mode and GO!

The new Lunar 220/TV is Linearized for maximum utilization of all authorized modes. In addition, it has automatic T-R functions, either RF sensed or hard keyed. In the repeat mode the 1MHz offset adds to the 600 KHz in your 2 meter radio to give you the 1.6 MHz required on 220 MHz.

BASIC SPECIFICATIONS

Rx N.F.: 2.5 dB nom.

Rx Conversion Gain: 25 dB nom.

with Lunar's new 220/TV transverter

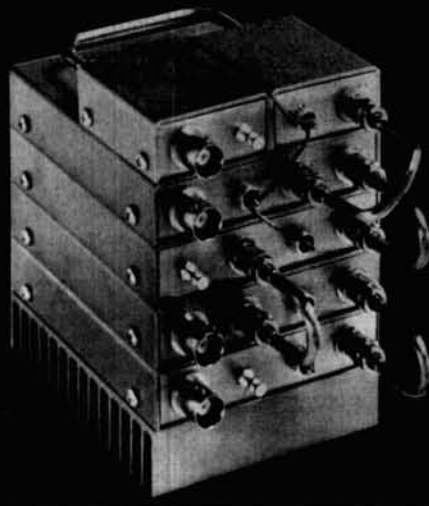

RF Pwr Out: 10 W nom. (CW & PEP)

Power: 13.6 VDC @ 4 A nom.

2 meter drive: 10 W nom.

(Other drive levels available on special order.)

Examples of frequency conversion in the following modes:

SIMPLEX I (Nat'l Call Freq.)

Function	2 Meters	220 MHz
Rx Freq.	146.5	223.5
Tx Freq.	146.5	223.5

SIMPLEX II (Nat'l SSB Call Freq.)

Rx Freq.	144.1	220.1
Tx Freq.	144.1	220.1

REPEATER MODE (2 Meter— 600 KHz Offset Required)

Rx Freq.	147.94	224.94
Tx Freq.	147.34	223.34

See your Lunar dealer or contact Lunar for complete details.



2785 Kurtz Street, Suite 10
San Diego, CA 92110

Telephone: (714) 299-9740 Telex: 181747
Louis N. Anciaux, WB6NMT

WANTED FOR CASH



490-T Ant. Tuning Unit
(Also known as CU1658
and CU1669)



618-T Transceiver
(Also known as MRC95,
ARC94, ARC102, or VC102)

4CX150
4CX250
4CX300A
4CX350A

4CX1000
4CX1500
4CX3000
4CX5000



4CX10,000 4-65 4-250 4-1000
5CX1500 4-125A 4-400 304TL

Other tubes and Klystrons also wanted.

Highest price paid for these units. Parts purchased. Phone Ted, W2KUW collect. We will trade for new amateur gear. GRC106, ARC105, ARC112, ARC114, ARC115, ARC116, and some aircraft units also required.

DCO, INC.

10 Schuyler Avenue
Call Toll Free
800-526-1270

No. Arlington, N. J. 07032
(201) 998-4246
Evenings (201) 998-6475

RF COMMUNICATIONS DESIGN ENGINEER

Wulfsberg, the leading manufacturer, of aviation-related communication equipment including airborne radio telephone, FM air mobile communications and AM air/ground communications equipment, has engineering openings now.

A growing market and new expanded lab facilities cause us to look for engineers with the following qualifications:

- BSEE
- At least 3 years experience in RF circuit and radio design techniques
- Background in digital frequency synthesizers

Outstanding employee benefits including year-end profit sharing.

You can find your life style in this attractive Kansas City metropolitan location. Let us tell you about it. You'll be pleasantly surprised.

If you are interested and qualified, please forward your resume to Jerry Henson, Director of Personnel.



WULFSBERG
ELECTRONICS, INC.

11300 W. 89th Street
Overland Park, Ks. 66214
913-492-3000

Join the Communications Professionals

Equal Opportunity Employer

flea market



RATES Noncommercial ads 10¢ per word; commercial ads 60¢ per word both payable in advance. No cash discounts or agency commissions allowed.

HAMFESTS Sponsored by non-profit organizations receive one free Flea Market ad (subject to our editing). Repeat insertions of hamfest ads pay the non-commercial rate.

COPY No special layout or arrangements available. Material should be typewritten or clearly printed (not all capitals) and must include full name and address. We reserve the right to reject unsuitable copy. Ham Radio cannot check each advertiser and thus cannot be held responsible for claims made. Liability for correctness of material limited to corrected ad in next available issue.

DEADLINE 15th of second preceding month.

SEND MATERIAL TO: Flea Market, Ham Radio, Greenville, N. H. 03048.

SATELLITE TELEVISION — I receive it but made hundreds of dollars of mistakes — Let me show you how not to make them in THE MOST COMPLETE SINGLE REPORT ON STV. \$7, Scott Palmer, 9062 Andromeda Drive, Burkee, Virginia 22015

HELP! A Baptist church affiliated youth summer camp needs Ham help. 2 Meter and HF radios are urgently needed to provide emergency communications from an Appalachian mountain site to the nearest phone, which is five miles away. Donated equipment is tax deductible. Contact Richard Bailey, Amity, PA 15311. (412) 225-1265.

MUST DISPOSE of one ton test equipment and electronics data books, manuals, catalogs, & magazines. Mostly H-P & Tektronix. Some antique material. Sell by piece — SASE for list. Joe Cohen, 200 Woodside, Winthrop, MA 02152.

THE SUPERMARKET OF ELECTRONICS — thousands of items for sale or trade each month. Free classified ad with subscription. Only \$5.00 to Nuts & Volts, P.O. Box 1111-F, Placentia, California 92670.

HOMEBREW QSL CARDS can be made easy — low cost — attractive — proceeds help support Century 21 ARC — SASE for details KA4EBW.

Foreign Subscription Agents for Ham Radio Magazine

Ham Radio Austria
F. Baal
Hauptplatz 5
A-2700 Wiener Neustadt
Austria

Ham Radio Belgium
Stereohouse
Brusselssteenweg 416
B-9218 Gent
Belgium

Ham Radio Canada
Box 400, Goderich
Ontario, Canada N7A 4C7

Ham Radio Europe
Box 444
S-194 04 Uplandia Vasby
Sweden

Ham Radio France
SM Electronic
20 bis, Ave des Clairons
F-89000 Auxerre
France

Ham Radio Germany
Karin Ueber
Postfach 2454
D-7850 Loerrach
West Germany

Ham Radio Holland
MRL Electronics
Postbus 88
NL-2204 Delft
Holland

Ham Radio Italy
G. Vitipelli
P.O. Box 37
I-22063 Cantu
Italy

Ham Radio Switzerland
Karin Ueber
Postfach 2454
D-7850 Loerrach
West Germany

Ham Radio UK
P.O. Box 83, Harrow
Middlesex HA3 6HS
England

Holland Radio
143 Greenway
Greenside, Johannesburg
Republic of South Africa

MOBILE IGNITION SHIELDING provides more range with no noise. Available most engines. Many other suppression accessories. Literature, Estes Engineering, 930 Marine Dr., Port Angeles, WA 98362.

ETCH IT YOURSELF PRINTED CIRCUIT KIT, Photo-Positive Method — No darkroom required. All the supplies for making your own boards, direct from magazine article in less than 2 hours. Only \$24.95, S.A.S.E. for details: Excel Circuits Co., 4412 Fernise, Royal Oak, MI 48073.

SPECTRUM ANALYZER Polarad TSA, STU-1 plug-in 10-1000 MHz, STU-2A plug-in 810-4560 MHz \$350. Gertsch FM-6 Freq. Meter \$150. Bob Fleming WB6PAO, 6519 Jetta Ave., Bakersfield, CA 93308 (805) 399-8968.

HAM RADIO REPAIR — Professional lab, personal service. "Grid" Gridley, W4GJO. April thru October: Rt. 2, Box 138B, Rising Fawn, Georgia 30738. (404) 657-7841. November thru March: 212 Martin Drive, Brooksville, Florida 33512. (904) 799-2769.

MICROWAVE TV downconverters, preamps, parabolic dish antennas, remote tuning. Covers 2000 MHz band. Write for information. LAB-TRONICS, INC., Box 171, Rogers, MN 55374.

FOR SALE: One Hallcraft HT-40 Transmitter. Write W9HWZ in Lancaster, WI 53813.

COLLINS 512-B-2 Transmission Line Coupler. 52 unbal. in 300-600 bal out. 3 kW. Weatherproof enclosure. \$200.00. MSC SI-1800P Digitized voice repeater ID'er. Mint w/manual. \$200.00. WA0VNY/5 512-680-2106. Bob Schmidt 9230 Ridge Grove, San Antonio, TX 78250.

LINEAR AMPLIFIER PLAN BOOK II, 13 plans, 1.6 to 400 MHz, 15 to 1000 watts, 92 pages, \$11.95, CB modification kits, crystals, de-scramblers, other lites, electronic flea market and more in our catalog, \$1.00 refundable. A.P. Systems, P.O. Box 263HR, Newport, R.I. 02840.

KENWOOD TS-520 mint condition with manual in original carton \$475. WRL DUOBANDER 84 SSB transceiver, AC/DC power supply, Shure mobile microphone, manual \$250. HALLCRAFTERS HA-1 electronic keyer, very good condition, with manual \$35. HUSTLER MAST, heavy duty spring, resonators 80, 75, 40, 20 meters \$50. I ship UPS INSURED anywhere USA. Howard Weinstein, K3HW/6, 6769 El Cajon Blvd., Apt. 18, San Diego, CA 92115. (714) 466-8702.

BUY-SELL-TRADE. Send \$1.00 for catalog. Give name address and call letters. Complete stock of major brands new and reconditioned amateur radio equipment. Call for best deals. We buy Collins, Drake, Swan, etc. Associated Radio, 8012 Conser, Overland Park, KS 66204. (913) 381-5900.

MIRROR-IN-THE-LID, and other pre-1946 television set wanted. Paying 500+ for any complete RCA "TRK" series, or General Electric "HM" series set. Also looking for 12AP4, MW-31-3 picture tubes, parts, literature on pre-war television. Arnold Chase, WA1RYZ, 9 Rushleigh Road, West Hartford, Conn. 06117 (203) 521-5280.

CW/SSB FILTERS: IC audio install in any radio, sharp CW, stagger tuned SSB — \$15, \$32. SASE info: W6CBB, 80 W. Mennonite, Aurora, OH 44202.

RF ATTENUATORS: Ideal for T-hunting or test equipment. I have a dozen new unused Texscan CA-1000/50 variable rf attenuators with BNC fittings. Ratings: DC-1000 MHz, 50 ohm impedance, 0.1 watt maximum power dissipation, low insertion loss < 6 dB, continuously variable 0-60 dB with 240 deg. shaft rotation, panel mounting. Far below retail at \$25.00 each. K6GGV, Don Wightman, 1010 Eugene Dr., Fullerton, CA 92632.

MOTOROLA RADIOS WANTED: I need micors, motracs, momcom 70's, H.T.'s, and bases... anything Motorola newer than 12 years. I pay all shipping. Len Rusnak, WA3TJO 301-441-1221.

SELL: Lab Manual for repairs of R-390A. Sell \$40.00. WA4IS 4 Homewood Ave., Taylors, S.C. 29687.

WANTED: Motorola micor base stations. 406-420 MHz. AK7B, 4 Ajax Pl., Berkeley, CA 94708.

COAXIAL DIRECTIONAL COUPLER, Narda 3002-10, 0.95-2.0 GHz, brand new, boxed, \$30 each. Coaxial variable attenuator, ARRA 3952-60, 1.0-2.0 GHz, brand new, boxed \$30 each. DEKASTAT model X604, precision decade, multi-turn potentiometer with attached readout, 1.2 kilohms, 180 mA max., brand new, \$20. New piston trimmers 75¢ each. Add UPS. SASE list. Edward Halton W1WB, Providence College, Providence, R.I. 02918.

YAESU YO-100 monitor scope with manual and original carton, \$145. Comdel RF speech processor, connects between mike and rig, \$85. John Skubick, K8JS, 791-106 Ave., Naples, FL 33940.

500 QSL's, \$10. Catalogue, 743 Harvard, St. Louis, MO 63130.

VARIABLE POWER SUPPLY KITS
12-28 VDC ADJ @ 250 MA
5-12 VDC ADJ @ 500 MA
PARTS INCLUDED ARE:
* TRANSFORMER * PC BOARD
* POT & RESIS. * HEAT SINK
* 1000UF@35VDC * DIODES
* REG. 7805-7812 * HARDWARE
* OSC. SUP. CAP. * INSTRUCTION
12-28VDC PS-0074 \$7.95
5-12VDC PS-0073 \$7.95

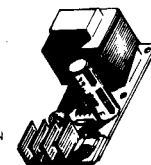

DIODES

PIV	AMP	COST
100	5	\$1.00
100	12	3/1.00
100	40	\$1.35
400	450	\$18.50

Miniature Toggle Switches

1 EA. 10 EA.
SPDT \$1.00 \$8.95
DPDT \$1.50 \$12.95

2200UF 16VDC **25¢**



LED JUMBO'S RED

1 FOR \$1.00
100 FOR \$7.95

SEND FOR NEW CATALOG

SOUND ALERT

6-28 VDC
3-14 MA
\$4.95

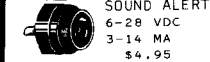

FANS 100 CFM
115VAC 60HZ
4.5" X 1.5"
USED \$6.95
GUARANTEED
NEW \$12.95

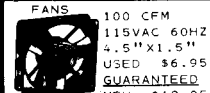

MPF-131
N-CHANNEL DUAL GATE
MOS-FET GOOD FOR 60
& 200MHZ. DATA SHEET
HOUSE MARKED. **50¢**

50 ohm COAX
RG 174U 25 FT.
\$1.75



Touch-Tone Housing.
BLACK only... \$3.50

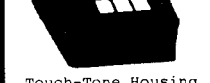

BRIDGES
25 AMP.
50 PIV
\$1.75 EA. 3 FOR \$5.00



POWER SUPPLY MODULE
RATED AT 12V @ 2.5A. CAN
BE MODIFIED BY CHANGING
THE ZENER.
PARTS: 4-3A DIODES, 1-2.5A
FUSE, 1-2200MF @ 35V CAP,
1-12V ZENER, 1-PASS TRANS.
WITH HEAT SINK. \$4.95

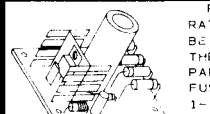

COAX RELAY
12 VDC SPDT
380 MHz @ 100 WATTS
304 ELOS \$6.95
CONTACT



HIGH VOLTAGE SUPPLY
15KVDC @ 30 WATTS
INPUT 115VAC 60HZ
\$9.95

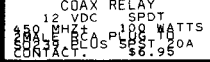

ANTENNAS

ANS PTBS BNC STRAIGH
ANS PTUS UHF STRAIGH

ANS PTB90 BNC 90° ELBOW
ANS PTU90 UHF 90° ELBOW

ANS PTBAJ BNC ADJ ELBOW
ANS PTUAJ UHF ADJ ELBOW

\$7.95
ALL ANTENNAS ARE FOR TWO METERS

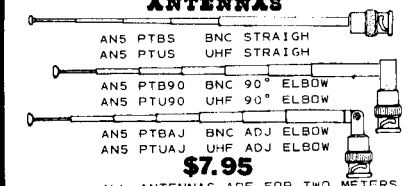

'N'-F/PANEL \$2.25
UG58 \$2.25
UNF-T'2F/M \$2.95
UG36 \$2.95
BNC 90° F/M \$3.75
UG306 \$3.75
BNC-T'2F/M \$4.00
UG274 \$4.00

UHF 90° F/M \$2.50
M358 \$2.50
UHF-F/UHF-F \$1.50
PL258 \$1.50
BNC-M/BNC-M \$3.85
UG914 \$3.85

DM-1 \$2.50
UHF-F/PANEL \$1.65
MIX MATCH 10-50.00
BNC-M/UHF-F \$3.50
UG273 \$3.50
BNC-F/CABLE \$1.00
UG88 \$1.00
BNC-M/UHF-F \$3.50
UG255 \$3.50

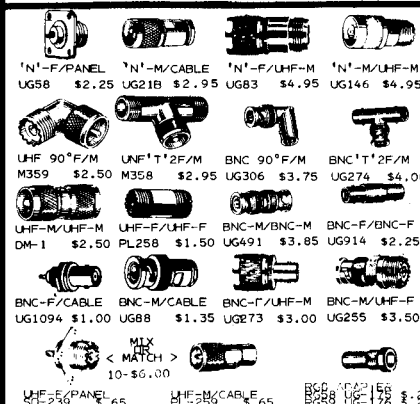

Marlin P. Jones & Assoc.
P.O. Box 12685-E
Lake Park, FL 33403
(305) 848-8236

MC, VISA, COD ACCEPTED

*ADD \$1. ORDERS UNDER \$10. *FLA. RES. 4% SALE TAX
PLEASE ADD SUFFICIENT POSTAGE

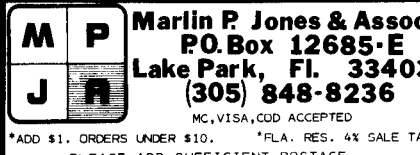

When it comes to
**AMATEUR
RADIO QSL's...**



it's the
ONLY BOOK!
US or DX Listings

1981
callbooks
NOW READY!

Here they are! The latest editions. World-famous Radio Amateur Callbooks, the most respected and complete listing of radio amateurs. Lists calls, license classes, address information. Loaded with special features such as call changes, prefixes of the world, standard time charts, worldwide QSL bureaus, and more. The U.S. Edition features over 400,000 listings, with over 100,000 changes from last year. The Foreign Edition has over 300,000 listings, over 90,000 changes. Place your order for the new 1981 Radio Amateur Callbooks, available now.

	Each	Shipping	Total
<input type="checkbox"/> US Callbook	\$17.95	\$2.55	\$20.50
<input type="checkbox"/> Foreign Callbook	\$16.95	\$2.55	\$19.50

Order both books at the same time for \$37.45 including shipping.

Order from your dealer or directly from the publisher. All direct orders add \$2.55 for shipping. Illinois residents add 5% sales tax.



SPECIAL LIMITED OFFER!
Amateur Radio
Emblem Patch
only \$2.50 postpaid

Pegasus on blue field, red lettering. 3" wide x 3" high. Great on jackets and caps. Sorry, no call letters.

ORDER TODAY!

RADIO AMATEUR
callbook INC.
Dept. F
925 Sherwood Drive
Lake Bluff, IL 60044, USA

FOR SALE: TRS-80 expansion interphase 32K ram, \$450.00, disc drive, \$350.00, phone-mate 800AC with remote, \$225.00, Kenwood TR-9000 all-mode transceiver \$315.00, Mirage B-108 2 meter amp., \$90.00, ADC audio equalizer \$40.00. Mitchell Rakoff, 64-33 98th St., Rego Park, NY 11374. (212) 830-0097.

COLLINS 75S-1, 32S-1, 516F-2. Recent Complete Alignment, Mint condition. Local Sale or Trade Preferred. \$550 or Trade for Mini-Computer. Ray Hill, 32 Tower Rd., Lexington, MA 02173. (617) 862-0696.

FOR SALE: Icom 551D with matching supply, manuals and cartons, 3 months old, \$685.00 plus shipping. Jim, W1VYB (617) 922-3850.

MANUALS for most ham gear 1937/1970. Send 25¢ for "Manual Catalog." H.I., Inc., Box H864, Council Bluffs, Iowa 51502.

WANTED: Schematic, power supply, Topaz Hustler C10 XDG-AC. Jack Graham, 5438 Castlecreek, Houston, TX 77053.

ATLAS DD6-C and 350XL Digital Dial/Frequency Counters. \$175.00 plus \$3.00 UPS. AFC! Stop VFO drift. See June 79 HR. \$65.00 plus \$3.00 UPS. Mical Devices, P. O. Box 343, Vista, CA 92083.

AJAX 147 Foot Broadcasting tower complete with guys \$2,000.00. Will ship. Heath station SB303 \$400.00. HW101 \$550.00. Ps23B \$100.00. MFJ 520BX processor \$50.00. VE5RA, (306) 373-1988.

ROHN TOWER - Buy direct from Worldwide distributor of all Rohm products. Sample prices - 25G sections \$38.72 each, 45G sections, \$88.00 each, FK-2548 fold-over tower with freight paid \$693.00, BX-48 free standing \$218.90. Hill Radio, Box 1405, Bloomington, IL 61701, (309) 663-2141.

HALLICRAFTERS SX-42 receiver 500KC - 110MC \$75., DuMount 5890 frequency, deviation meter and signal generator 25-470 MHz \$50. K6KZT, 2255 Alexander, Los Osos, CA 93402.

WANTED: Cushman Communications Service Monitors, working or non-working units. Also need plug-in modules, manuals, parts, etc., will pay cash or take over payments. Also need RF voltmeters; WB81JX, Fred L. Slaughter, 5844 Grisell Road, Oregon, OH 43618. Phone (419) 698-8597.

AMATEUR RADIO REPAIR: Quality service, reasonable rates, all brands. NOW USA KDK repair center! Amateur Radio Repair Center, 79 Town Square, Mocksville, NC 27026 (919) 998-2627.

WANTED: Hallicrafters SX-117, working or not. Chuck Hanavin, 17 New St., Apt. #4, Newark, DE 19711.

ELECTRONIC BARGAINS, CLOSEOUTS, SURPLUS! Equipment, stereo, industrial, educational. Amazing values! Fascinating items unavailable in stores or catalogs anywhere. Unusual FREE catalog. ETCO-012, Box 782, Plattsburgh, NY 12901. SURPLUS WANTED.

SELL: 10-Meter 60-Watt Motorola MICOR mobile, 4-freq., PL, accessories. Bob K6KGS (714) 225-1273.

ELECTRONIC COMPONENTS: Integrated Circuits, Linear, TTL, CMOS, Low Prices on Capacitors. Resistors 5% Carbon Film Factory Fresh 1/4 Watt \$1.65 Per Hundred, 1/2 Watt \$1.75 Per Hundred. IC Sockets, Trim Pots and More. Send for FREE Catalog. Westland Electronics, 34245 Ford Rd., Westland, MI 48185. (313) 728-0650.

NEED HELP for your Novice or General ticket? Recorded audio-visual theory instruction. No electronic background required. Free information. Amateur License, P.O. Box 6015, Norfolk, VA 23508.

COLLINS ROUND KWM-2A, mint, late complete CP-1 crystal pack, S16F-2 round, mint \$1500. 312B-4 round, mint \$175. 30L-1 round \$550. Kenwood TS-900, VFO-900, two PS-900 absolutely mint \$650. FOB WA6NWP, 52632 RD 426, Oakhurst, CA 93644.

QSL'S WITH CLASS! Unbeatable quality, reasonable price. Samples: 50¢ refundable. QSLs Unlimited, 1472 S.W. 13th St., Boca Raton, FL 33432.

CB TO 10-METER CONVERSIONS. SSB/AM/CW. Let a specialist convert your rig, or buy one complete. Write Conversion Engineering, Box 183, Sandwich, Massachusetts 02563.

MAKE HAM RADIO FUN! Supplement your learning programs with a motivational hypnosis cassette. Tape #3, Learning the Code; Tape #4, Breaking the Speed Barrier; Tape #7, Electronics Theory. Free catalog. For tapes send \$10.95 to John Wolf Hypnosis Center, P.O. Box 497, Hayden, Idaho 83835.

"CADILLAC" of QSL'S - FAST 100 - \$9.95 - Our Design. Send \$1.00 for Samples-Refundable. MAC'S SHACK, P.O. Box 43175, Seven Points, Texas 75143.



HAM

**REPEATER
AUTOPATCH**

Offer your club **COMPLETE** emergency communications

Commercial quality, gold plated contacts, plug in, epoxy glass PC boards. 12 volt DC or 115 volt AC operation - Power supply included. Four digit access - Single digit releases - field programmable. Hybrid network - No switching required. FCC certified telephone line coupler. Auxiliary "In Use" contacts supplied. Land line "call-in" signalling control contacts provided.

Price complete \$498 + \$3 shipping & handling. Master Charge. Bank money order, or certified check acceptable.

Accessories: CES-300 powered tone pad - \$59 BUS-COM Soft-touch® telephone powered mike/pad element - \$34.95.



MONROE ELECTRONICS, INC.
410 Housel Ave., Lyndonville, N.Y. 14098

**SYNTHESIZED
SIGNAL GENERATOR**



MADE IN USA

MODEL
SG 100C
\$329.95
plus shipping

• Covers 100 to 179.999 MHz in 1 kHz steps with thumb-wheel dial • Accuracy .00001% at all frequencies • Internal frequency modulation from 0 to over 100 kHz at a 1 kHz rate • Spurs and noise at least 60dB below carrier • RF output adjustable from 5-500mV across 50 ohms • Operates on 12vdc @ 1/2 amp • Price \$329.95 plus shipping.

In stock for immediate shipping. Overnight delivery available at extra cost. Phone: (212) 468-2720.

VANGUARD LABS
196-23 Jamaica Ave. Hollis, NY 11423

VHF COMMUNICATIONS

is a quarterly radio amateur magazine specializing in VHF, UHF, and microwaves. An introductory annual subscription is \$15.00. USA representative:

SELECTO Inc.

372 D Bel Marin Keys Blvd., Novato, CA 94947
Phone: (415) 883-2478 Telex: 171-046

DIPOLE ANTENNA CONNECTOR



HYE-QUE (HQ-1) dipole connector has coax SO-239 socket molded into glass filled plastic body to accept coax PL-259 plug on feedline. Drip-coat keeps coax fittings dry. Instructions included. Guaranteed. At your dealer or \$5.95 postpaid. Companion insulators \$1.25/pr.

BUDWIG MFG. Co. PO Box 829, Ramona, CA 92065
Ca. Res. add 6% Sales Tax

DEALERS WANTED

TOWERS

by ALUMA
HIGHEST QUALITY
ALUMINUM
& STEEL

60 Ft. Aluminum.
Crank-Up
Model T-60-H

40' Steel
Crank-Up
Model SHD-40

- ★ TELESCOPING (CRANK UP)
 - ★ GUYED (STACK-UP)
 - ★ TILT-OVER MODELS
- Easy to install. Low Prices.
Crank-ups to 100 ft.

EXCELLENT FOR
HAM COMMUNICATIONS

SPECIAL
Four Section 50 Ft.
Van Mounted Crank-Up
Aluma Tower

Over 36 types aluminum
and steel towers made—
specials designed and
made—write for details



ALUMA TOWER CO.
Box 2806HR
VERO BEACH, FLA 32960
PHONE (305) 567-3423
TELEX 80-3405

NEW FROM GLB

A complete line of **QUALITY 50** thru 450 MHz **TRANSMITTER AND RECEIVER KITS**. Only two boards for a complete receiver. 4 pole crystal filter is standard. Use with our **CHANNELIZER** or your crystals. Priced from \$69.95. Matching transmitter strips. Easy construction, clean spectrum, **TWO WATTS** output, unsurpassed audio quality and built in **TONE PAD INTERFACE**. Priced from \$29.95.

SYNTHESIZER KITS from 50 to 450 MHz. Prices start at \$119.95.

Now available in **KIT FORM** — GLB Model 200 **MINI-SIZER**.

Fits any HT. Only 3.5 mA current drain. Kit price \$159.95 Wired and tested. \$239.95

Send for **FREE** 16 page catalog.

We welcome Mastercharge or VISA

GLB ELECTRONICS
1952 Clinton St., Buffalo, N. Y. 14206

HAMS FOR CHRIST — Reach other Hams with a Gospel Tract sure to please. Clyde Stanfield, WA6HEG, 1570 N. Albright, Upland, CA 91786.

QSL ECONOMY 1000 \$12.00 S.A.S.E. for samples. W4TG Drawer F, Gray, Georgia 31032.

DISTINCTIVE QSL's — Largest selection, lowest prices, top quality photo and completely customized cards. Make your QSL's truly unique at the same cost as a standard card, and get a better return rate! Free samples, catalogue. Stamps appreciated. Stu Goodman, K2RPZ Print, P.O. Box 412, Rocky Point, NY 11778 (516) 744-6260.

FREE SAMPLE Ham Radio Insider Newsletter! Send large S.A.S.E. W5YI, Box #10101-H, Dallas, Texas 75207.

MAGAZINE SAMPLES! For a free list of over 135 magazines offering a sample copy, send a stamped, addressed envelope to: Publisher's Exchange, P.O. Box 1368, Dept. 26A, Plainfield, NJ 07061.

VERY in-ter-est-ing! Next 6 issues \$2. Ham Trader "Yellow Sheets", POB356, Wheaton, IL 60187.

DX, YOU BET! THE DX BULLETIN — Best weekly DX info in the world. For **FREE** sample copy, send business-size SASE to: The DX Bulletin, 306 Vernon Avenue, Vernon, Connecticut 06066.

STOP LOOKING for a good deal on amateur radio equipment — you've found it here — at your amateur radio headquarters in the heart of the Midwest. Now more than ever where you buy is as important as what you buy. We are factory-authorized dealers for Kenwood, Drake, Yaesu, Collins, Wilson, Ten-Tec, ICOM, DenTron, MFJ, Tempo, Regency, Hy-Gain, Mosley, Alpha, CushCraft, Swan and many more. Write or call us today for our low quote and try our personal and friendly Hoosier Service. **HOOSIER ELECTRONICS**, P.O. Box 2001, Terre Haute, Indiana 47802. (812) 238-1456.

UPGRADE SUCCESSFULLY! Pass FCC Exams! TRS-80 owners, I'll show you how! KE7C, H-2665 Busby Road, Oak Harbor, WA 98277. SASE please.

CB TO 10 METER PROFESSIONALS: Your rig or buy ours — AM/SSB/CW. Certified Communications, 4138 So. Ferris, Fremont, Michigan 49412; (616) 924-4561.

TRANSMITTER TECHNICIANS — Voice of America has overseas positions available at supervisory and operating levels for experienced transmitter technicians. Duties include operation and maintenance of high power VOA transmitters and related facilities. Applicants must have 3 to 5 years "hands-on" experience in technical operation of broadcast, TV or military fixed-station transmitters. Must be available on a worldwide basis to serve in VOA's radio relay station system. U.S. citizenship required. Starting salary commensurate with qualifications, plus housing and overseas allowances. Full federal fringe benefits apply. Qualified candidates should send standard Federal application form SF-171 to International Communication Agency, MGT/PDE, 1776 Pennsylvania Ave., Washington, D.C. 20547. An Equal Opportunity Employer.

QSL'S: No stock designs! Your art or ours; photos, originals, 50¢ for samples & details (refundable). Certified Communications, 4138 So. Ferris, Fremont, Michigan 49412.

WANTED: Hickok 539 Tester, Hickok CA-5 adaptor, Hallcraft HA-20 VFO. Sell: NCX5MK-2 speaker, AC supply, VX501 VFO all manuals, S.A.S.E. answered. Henry Perka, 18 Warner St., Groton, CT 06340.

Coming Events ACTIVITIES

COLORADO: The Grand Mesa Repeater Society's second annual Western Slope Swapfest on March 7th at the Lincoln Park Barn, 12th and Gunnison, Grand Junction, Colorado. 10:00 AM through 4:00 PM **FREE!** Tables are \$4.00 in advance. Commercial exhibitors, flea market, auction and prizes. Talk-in on 146.22/.82. More info: SASE to Larry Brooks, WB0ECV, 3185 Bunting Ave., Grand Junction, Colorado 81501. (303) 434-5603.

FLORIDA: The Treasure Coast Hamfest on February 21 and 22 at the Vero Beach Community Center. Admission: \$3.00 per family in advance and \$4.00 at the door. Talk-in on 146.13/73, 146.04/64, 146.52/52, 222.34/223.94. More info: P.O. Box 3088, Beach Station, Vero Beach, FL 32960.

Alaska Microwave Labs

4335 E. 5TH STREET
ANCHORAGE, ALASKA 99504
(907) 338-0340



NEW! GaAs FETS

**MGF 1400 NF 2.0DB
AT 4GHZ MAG 15DB
\$28.50**

**MGF 1412 NF .8DB
AT 4GHZ MAG 18DB
\$75.00**



TRANSISTORS

MRF901 FT4 5GHZ \$3.00
BFR90 FT5 0GHZ \$3.00
NEC 02137 FT4 5GHZ \$3.25

HOT CARRIER DIODES

MBD101 UHF—MICROWAVE \$1.50
ND4131 4GHZ NF—5.75 DB \$19.00
4GHZ NF— 6.5 DB \$2.00

CHIP CAPACITORS

1, 2, 2.2, 3.3, 4.7, 6.8, 10, 18, 22, 27,
47, 100, 120, 180, 220, 270, 330,
390, 470, 560, 680, 820, 1000,
1200, 1800, 3900, 8200 \$.60

RF - IF I.C.

MWA-110
RF-IF AMPLIFIER I.C.
1 TO 400 MC 14 DB GAIN TYP
3 TERMINAL IN, OUT, & GROUND \$ 7.95

DUAL GATE MOSFET

RCA 40673 \$ 1.50

COAX CONNECTORS

SMA CHASSIS MOUNT SQUARE FLANGE \$ 5.90
SMA PLUG FOR RG-58 \$ 6.57
SMA PLUG FOR RG-174 \$ 6.57
TYPE N CHASSIS MOUNT SQUARE FLANGE \$ 3.20
TYPE N PLUG FOR RG-9/RG-8 \$ 3.69

FEED-THRU CAPACITORS

500 PF \$.50

TEFLON CIRCUIT BOARD

APPROX 3.5" x 5.0" x .010 \$ 5.50
APPROX 3.5" x 5.0" x .0312 \$ 6.50

CHIP RESISTORS

50 OHM 1/4 WATT \$ 1.50

PISTON TRIMMERS

Triko 201-01M 5-3PF (11-8PF) \$ 2.50



**OPEN AT 8PM EST
CLOSED AT 8PM PST**

**IF YOU DO NOT SEE
WHAT YOU WANT ASK**

**ORDERS ARE POSTAGE PAID
COD-VISA-MASTERCHARGE**

SWAN METERS

THE TOP OF THE LINE

PEAK READING WATT METER WM-2000A reads power in 200, 1000, 2000 watt ranges. 3.5-30 MHz. Reads average or PEP power output. Includes expanded VSWR scale.



IN-LINE WATT METER WM-2000 reads power in 200, 1000, 2000 watts. 3.5-30 MHz. Incl. expanded VSWR scale.



MOBILE WATT METER HFM-200 with remote directional coupler reading 20 or 200 watts. 3.5-30 MHz. Illuminated, with VSWR scale.



SWR BRIDGE SWR 1A with dual reading meters. 1000 watts RF. 3.5-150 MHz. Reads relative power output.



Available only through authorized dealers.

CUBIC COMMUNICATIONS, INC.

305 Airport Rd. • Oceanside, Ca. 92054
(714) 757-7525

ILLINOIS: Sterling/Rock Falls Amateur Radio Society's 21st annual Hamfest on March 8 at the Sterling High School Field House, 1608 4th Ave., Sterling, Illinois. Flea market, free parking, many prizes, and much more. Doors open at 7:30 AM. For advance tickets and tables write: Sue Peters, 511-8th Ave., Sterling, Illinois 61081. Tickets in advance: \$2.00. At the door: \$2.50. Commercial tables are \$5.00 and all others are \$3.00. Talk-in on .52 and WR9AER.25/85.

OHIO: Intercity Amateur Radio Club's Mansfield Mid-Winter Hamfest/Auction on February 15th at the Richland County Fairgrounds in Mansfield. Prizes, flea market, large heated building and more. Starts at 8:00 AM. Talk-in on 146.34/94. Tickets: \$1.50 in advance and \$2.00 at the door. More info, tickets, and/or tables: SASE, Harry Fritchen, 120 Homewood Rd., Mansfield, Ohio 44906. (419) 529-2801.

VIRGINIA: The Vienna Wireless Society, Vienna, Virginia, announces the annual WINTERFEST™ hamfest to take place this year on February 22, 1981. It will be held at the usual place, the Vienna Community Center on Park St. in Vienna, VA beginning at 8 AM.

WEST VIRGINIA: The Plateau Amateur Radio Association's 3rd annual Hamfest on February 15th at the Memorial Building in Fayetteville. Doors open at 9:00 AM. Admission: \$2.50 (children free) and flea market tables are \$2.00. Hot food, free parking, A.R.R.L. display, forums, exhibits, door prizes, XYL programs, and more. All activities indoors. Talk-in on .52 or .19/79. More info: Bill Wilson, 302 Central Ave., Apt. #2, Oak Hill, WV 25901. (304) 469-9910 or 574-1176.

IOWA: The Davenport Radio Amateur Club's tenth annual Hamfest on March 1st at the Davenport Masonic Temple at 7th and Brady (Hwy. 61) from 8:00 AM to 4:00 PM. Over \$2000.00 in major prizes. Tickets in advance are \$2.00 and \$3.00 at the door. Talk-in on the W0BXR/RPT at 146.28/88. Hotel discounts available. Food and drink. Pre-Hamfest Saturday night banquet with guest speaker Paul Grauer, midwest A.R.R.L., S.C.M. Banquet tickets: \$8.00. Paid reservations for banquet by February 18th. For advance tickets, dinner, table reservations or info: Dave Johannsen, 2131 Myrtle, Davenport, Iowa 52804.

MICHIGAN: The 11th annual Livonia Amateur Radio Club's Swap 'n Shop on February 22 from 8:00 AM to 4:00 PM at the Churchill High School in Livonia. Plenty of tables, door prizes, refreshments and free parking. Talk-in on 146.52 simplex. Reserved table space available. More info: send SASE (4x9) to Neil Coffin, c/o Livonia A.R.C., P.O. Box 2111, Livonia, Michigan 48150.

MISSOURI: The Jefferson Barracks Amateur Radio Club's annual auction and Hamfest on March 13th at the Electricians Hall, 5850 Elizabeth Ave., St. Louis. More info: SASE Vivian K. Scott, WD0EMS, 4121 Fabian Dr., St. Louis, Missouri 63125.

NEW JERSEY: The Delaware Valley Radio Association's ninth annual flea market on March 15th at the New Jersey National Guard 112th Field Artillery Armory, Eggerts Crossing Rd., Lawrence Township. Advance tickets: \$2.00, \$2.50 at the gate. Indoor/outdoor flea market, prizes, refreshments and more. Talk-in on 146.07/67 and 146.53. More info or tickets: DVRA, P.O. Box 7024, West Trenton, NJ 08628. SASE please.

NEW JERSEY: Annual Flemington, N.J. Hamfest Saturday, March 21 from 8:30 to 3:00 at the Hunterdon Central High School Field House. 20,000 square feet of heated indoor area. Gigantic flea market, 200 tables, major manufacturers, informative seminars. Bring the XYL, kids and friends. Flemington is a tourist area. Talk in 146.52, 147.375, 147.015, 224.12. Admission \$3.00 donation. For reservations or info call 201-788-4080 or write Cherryville Repeater Assn. c/o W2FCW, Box 76, Farview Ave., Annandale, N.J. 08801.

INDIANA: The LaPorte ARC's "Winter Hamfest" on February 22 at the LaPorte Civic Auditorium, 50 miles southeast of Chicago. Donations: \$2.50 at gate and \$2.00 in advance. Talk-in on .01/.61 and .52 simplex. More info: LPARC, Box 30, LaPorte, Indiana 46350.

OPERATING EVENTS

FEBRUARY 14 and 15 starts off the phone portion of the YL-OM contest. The CW segment will be on February 28 through March 1. Both contests start and end at 1800 UTC. They are to be treated separately and separate logs are to be kept. OMs call "CQ YL" and YLs call "CQ OM". All logs must show ARRL section or country to qualify and must be signed by the operator. No logs will be returned. Logs must show claimed score and be sent to YLRL Vice President, Kay Eyma, WA0WOF, RR #2, Garnett, KS 66032 no later than April 6. Duplicates penalized by the removal of three contacts.



July 25 thru August 7, 1981

Our 22nd year

Have trouble finding time to study for Upgrading? Do it on your vacation at the

OAK HILL ACADEMY RADIO SESSION
in the
Blue Ridge Mountains of Virginia

Two weeks of intensive Code and Theory Study starting at your level.

- Novice to General
- General or Technician to Advanced
- Advanced to Amateur Extra

Expert Instructors — Friendly Surroundings — Excellent Accommodations.
Ham Lab set up for all to use.

"A Vacation with a Purpose"

C. L. PETERS, K4DNJ, Director
Oak Hill Academy Amateur Radio Session
Mouth of Wilson, Virginia 24363

Name _____ Call _____
Address _____
City/State/Zip _____

NEW 1981 EDITION
AMATEUR Radio
EQUIPMENT DIRECTORY
EQUIPMENT DIRECTORY

The most complete directory of Amateur Radio Equipment ever published—over 1,500 products—over 100 manufacturers/distributors. Includes prices, specifications and pictures of transceivers, transmitters, receivers, antennas, towers, tuners, power supplies, microphones, meters, keys, test gear, SSTV, RTTY, VFO's, and more! No ham library is complete without a current edition of this Directory. **BONUS**—Included with each edition is a free newsletter containing the latest prices and product information. Order your copy today! All payments must be in U.S. currency drawn on a U.S. Bank. Prices for the 1981 Edition are as follows (includes postage & handling): U.S. & Canada \$6.95, U.S. & Canada - First Class \$7.95, Foreign (Air) \$10.00. Also, a complete set of 78, 79, 80 & 81 Directories is available for \$15.00 (U.S. & Canada), \$21.00 (Foreign - Air).

KENGORE CORP. DEPT. H
9 JAMES AVE., KENDALL PK., N.J. 08824

FACSIMILE

COPY SATELLITE PHOTOS, WEATHER MAPS, PRESS!

The Faxes Are Clear — on our full size (18-1/2" wide) recorders. Free Fax guide.

TELETYPE

RTTY MACHINES, PARTS, SUPPLIES

ATLANTIC SURPLUS SALES (212) 372-0349
3730 NAUTILUS AVE. BROOKLYN, N.Y. 11224

NOT A SUBSCRIBER? DO IT TODAY!

Use the handy card between pages 2 & 3

OCTOBER 23, 1980 - OCTOBER 23, 1981: The New Bern Amateur Radio Club is sponsoring "The Swiss Bear Award." This award is given for working three different amateur stations in the New Bern area within the above time period. Extracts from logs for QSO's, along with a SASE or two IRC's (for DX stations) should be sent to: New Bern Amateur Radio Club, Inc., P.O. Box 2483, New Bern, NC 28560. Certificate depicting "The Swiss Bear" will be awarded stating that the station has met the requirements for this award.

FEBRUARY 22nd - 28th: The Simon Langton Grammar Schools in Canterbury, England, will be celebrating the 100th anniversary of the founding of the school in 1881. A special events station, active on all HF bands under the call GB4SL, will be used. It is hoped that many past pupils of the school will be contacted; especially licensed Amateurs now residing in the United States. Anyone interested in making a sked should contact: G4BBW, 40 Virginia Rd., Tankerton, Whitstable, Kent or G3LCK c/o G3OSL, Simon Langton Grammar School for Boys, Nackington Rd., Canterbury, Kent, England.

MARCH 14th: The Edison Radio Amateur's Association is celebrating its 40th anniversary by hosting a QSO party. The ERAA group will operate from a commemorative station at "Station A" in Greenfield Village, Dearborn, Michigan. This was Thomas Edison's first power generating station. Contact ERAA and exchange signal report state info. QSL with business size SASE and receive a handsome two color certificate to: Detroit Edison Radio Amateur's Association, 2000 Second Ave., Detroit, Michigan 48226.

MARCH 14th: The Playground Amateur Radio Club (PARC) of Fort Walton Beach, Florida, will operate a special event station at the 1981 Boy Scouts of America - Choctawhatchee District Scout Exhibition. PARC members will operate ARS WB4SFU (Scouts For Unity) from 0000 to 2400 hrs UTC, 14 March, 1981 on 14.290 MHz, 21.370 MHz, and 28.600 MHz SSB. A special commemorative QSL card will be sent to those who QSL with a SASE. The QSL manager is PARC, c/o Joe Giangrosso, WD4JZG, P.O. Box 3075, Fort Walton Beach, FL 32548.

CENTURY 21 ARC - Low power - QRPers - CW nets - Contests - Awards - SASE KA4EBW.

Easy Reading

Larsen Electronics' all new Amateur Catalog makes easy reading. It includes all the antennas, mounts and accessories amateurs want in an easy-to-find order. Full descriptions of all items make it easy for you to determine what you need and just what accessories are included.

On top of that, Larsen's new Amateur Catalog is a handy pocket size so you can keep it with you. It

also includes a complete price list insert so you'll have everything you need to order right in your pocket.

To get your free copy of Larsen's easy reading Amateur Catalog call or write to Larsen Electronics.



COMPLETE ANTENNAS (Price list insert pp. 14-15)

10 Meter: 28-30 MHz
6 Meter: 50-54 MHz
Larsen 10 and 6 meter

- Low silhouette and minimum dimensions for less wind drag
- Low V.S.W.R. - Less than 1.5 to 1
- Radiation pattern only 0.5 symmetrical ground plane
- No springs to deteriorate and degrade performance
- Handles full 200 watts of power
- Just cut and for desired frequency following the chart supplied with your antenna

With Temporary Mounts
Complete with Larsen Kūlrod® Antenna coax cable, PL-259 type plug and your choice of venetian and dismountable mount (see pp. 19-20)

TLM-Style This "top bolted" trunk and mount clamp fits in place. Complete with 17' of RG-58 coax cable, PL-259 plug, plus instructions and instructions for installation. Order your complete antenna and mounting kit.

NLA-27-TLM (10 Meter)
NMO-27-TLM (10 Meter)
NLA-50-TLM (6 Meter)
NMO-50-TLM (6 Meter)

MM-Style The magnetic mount holds and holds the front with care. Complete with 12' of RG-58 A/U coax cable, and a PL-259 type plug. Order your complete antenna and mounting kit.

NLA-27-MM (10 Meter)
NMO-27-MM (10 Meter)
NLA-50-MM (6 Meter)
NMO-50-MM (6 Meter)

GC-Style It clamps to your rain gutter and is designed for positive ground plane to assure full efficiency. Completely assembled with 10' RG-58 A/U coax cable and PL-259 type plug. Order your complete antenna and mounting kit.

NLA-27-GC (10 Meter)
NMO-27-GC (10 Meter)
NLA-50-GC (6 Meter)
NMO-50-GC (6 Meter)

Larsen Kūlrod Antennas
For Better Communication
Mobile • Portable • Base Stations

IN USA:
P.O. Box 1688
Vancouver, WA 98668
Phone: (206) 573-2722

IN CANADA:
183 E. 11th Avenue, Unit 101
Vancouver, B.C. V5T 2C4
Phone: (604) 872-8517

You can hear the difference!

NOW An **8044 with Speedmeter***

from CURTIS

★ EK-480: C-MOS Deluxe Keyer \$134.95
★ EK-480M: Above plus speedmeter 149.95
★ I-480: InstructoMate 124.95
★ M-480: MemoryMate 124.95
★ IM-480: Instructo-MemoryMate 179.95
★ KB-480: Morse KeyboardMate 199.95
★ KB-4900: Morse-RTTY keyboard 379.95

Above prices FOB factory

8044: Keyer-On-A-Chip (ARRL Hdbk 77-81) 14.95
8044-3: IC, PCB, Socket, Manual 24.95
8044-4: Semi-Kit 54.95

*8044M (incl. speedmeter funct.) add \$5.00

8045: Morse Keyboard-On-A-Chip IC 59.95
8045-1: IC, PCB, FIFO, Sockets, Manual 89.95
8045-2: Semi-Kit 159.95
8046: Instructokeyer-On-A-Chip IC 49.95
8046-1: Semi-Kit 79.95
8047: Message Memory-On-A-Chip IC 39.95
8047-1: IC, PCB, RAM, Sockets, Manual 69.95

(add \$1.75 on kits for postage and handling)

Curtis Electro Devices, Inc.
(415) 494-7223
Box 4090, Mountain View, CA 94040

VISA

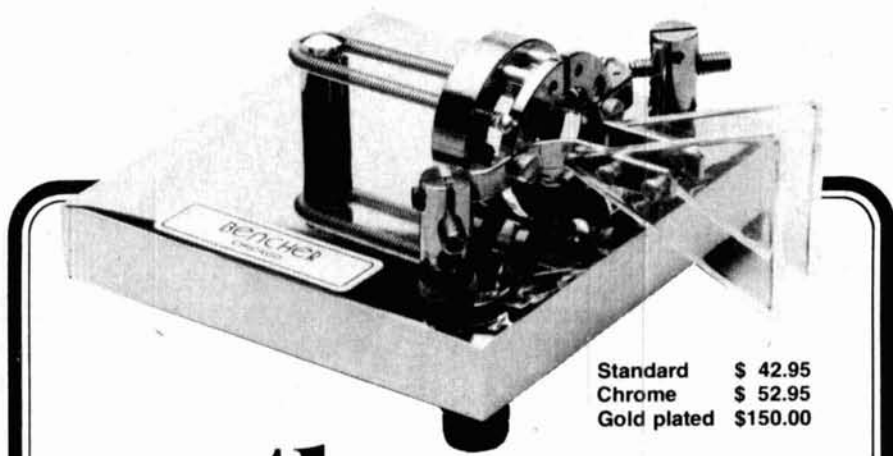

Standard \$ 42.95
 Chrome \$ 52.95
 Gold plated \$150.00

the Ultimate IAMBIC PADDLE

- Full range of adjustment in tension and contact spacing.
- Self-adjusting nylon and steel needle bearings.
- Gold plated solid silver contact points.
- Polished lucite paddles.
- Precision-machined, chrome plated brass frames.
- Standard model has black, textured finish base; deluxe model is chrome plated.
- Heavy steel base; non-skid feet.

WRITE FOR LITERATURE

BENCHER, INC.

333 W. Lake Street, Dept. A
 Chicago, Illinois 60606 • (312) 263-1808

At selected dealers or add \$2.00 handling. Quotation for overseas postage on request.

MINIATURE CW STATION IDENTIFIER



MODEL-97813 — NOW \$74.95

COMPLIES WITH NEW FCC RULES, PARTS 89, 91, 93, 95

• **MULTI-MODE OPERATION:** MANUAL, SEMI-AUTO AND AUTO.

MANUAL MODE — A pushbutton switch triggers the identifier which keys the transmitter for the duration of the ID. cycle.

SEMI-AUTO MODE — The PTT line activates the ID'er if the repeat interval time has elapsed and keeps the transmitter keyed throughout the duration of the ID. cycle.

AUTO MODE — The identifier will key the transmitter and ID every time the repeat interval time has elapsed.

• **CONNECTS DIRECTLY TO MICROPHONE AND PTT INPUTS OF MOST TRANSMITTERS.** MINIATURE SIZE MAKES IT FEASIBLE TO MOUNT INSIDE THE TRANSMITTER.

• **PROGRAMMABLE CODE SPEED, TONE, AND REPEAT TIME.**

• **ADJUSTABLE CODE AUDIO LEVEL.**

• **PREPROGRAMMED MEMORY ELEMENTS** — 254 OR (510 BIT) (OPTIONAL).

• **SIZE — 1 X 4 INCHES**

• **INCLUDES SWITCHES, WIRING AND INSTRUCTION MANUAL.**

MODEL 97813 — NOW ONLY \$74.95 assembled & tested

MODEL 11765 — Beacon CW ID'er with programmable code speed • great for 1750 meter band • 254 bit memory; 510 bit optional • 1.3 x 2.0 PCB • LIST PRICE \$24.95/kit; \$34.95/assembly

All orders must be prepaid or C.O.D. allow four weeks delivery. CA. res. add sales tax. Additional preprogrammed memory elements available. Include \$3.00 shpg/hdlg on U.S., \$5.00 on Foreign orders. One year warranty.

SecurITron Co.

P.O. Box 32145 • San Jose, CA 95132

Phone (408) 294-8383

Radio World

CENTRAL NEW YORK'S MOST COMPLETE HAM DEALER



Featuring Kenwood, Yaesu, Icom, Drake, Ten-Tec, Swan, Dentron, Alpha, Robot, MFJ, Tempo, Astron, KLM, Hy Gain, Mosley, Larsen, Cushcraft, Hustler, Mini Products, Bird, Mirage, Vibroplex, Bencher, Info-Tech, Universal Towers, Callbook, ARRL, Astatic, Shure. We service everything we sell!

Write or call for quote. **You Won't Be Disappointed.**

We are just a few minutes off the NYS Thruway (I-90) Exit 32

OUT OF STATE ONEIDA COUNTY AIRPORT TERMINAL BUILDING
 CALL TOLL FREE

800-448-9338

ORISKANY, NEW YORK 13424
 N.Y. Res. Call (315) 337-0203

Warren - K21XN
 Bob - WA2MSH

2300 MHz DOWN CONVERTER

UNIVERSAL COMMUNICATIONS

DEBORAH and STEVE (WB5KGL)

KNOWN AS THE STOP SIGN BOARD. THIS 2300 MHz DOWN CONVERTER KIT WORKS. THE IMPROVED BOARD EVEN MAKES IT BETTER THAN BEFORE. SO WHY PAY TWICE AS MUCH?

Kit supplied with an 8-page brochure, PC board, Diodes, Chip Caps, Transistors, and all parts to complete a working board...

\$38.50

POWER SUPPLIES AVAIL.

Money Order or Check. Mail or phone
UNIVERSAL COMMUNICATIONS
 P.O. BOX 6302, ARLINGTON, TEX. 76011
817-265-0391

GaAs FETs!

We are the U.S. distributor for

MITSUBISHI

MGF FETs,

the affordable GaAs Fets with the best

price/performance ratio available:

VHF through 12GHz.

1400 - \$28.30 1400A - \$39.15
 1402 - \$50.00 1412 - \$75.00 1403 - \$135.00

Shipped from stock.
 Quantity discounts available.

ALSO: 10GHz GUNN Diodes,
 low-loss PC laminates,
 assembled preamps

From the source

APPLIED INVENTION
 RD2 Rte. 21
 HILLSDALE, N.Y. 12529
 (518) 325-3911

GO MOBILE WITH YOUR H.T.!



Handi-Tek Regulator ALLOWS CONTINUOUS HAND-HELD OPERATION FROM AUTO DC OR BASE SUPPLY WITH NO NI-CAD DRAIN. MODEL K - TR2400 MODEL Y - FT-207R, MK II, MK IV MODEL T - SIMPLE MOD FOR TEMPO S-1, S-2, S-5. GUARANTEED. \$19.95 PPD IN USA. CAL ADD \$1.20 ORDER DIRECT OR SEND FOR SPECS...

HANDI-TEK
 P.O. BOX 2205, LA PUENTE, CA 91746

39.95
 ADD \$2.50 FOR POSTAGE

30 CHANNEL CABLE TV CONVERTER

ORDER No. 185AE047

ENCO ROUTE 9N
 PLATTSBURGH, N.Y. 12901
 Tel. (518) 561-8700

FREE!
 UNUSUAL 96 PAGE ELECTRONIC PARTS & IDEAS CATALOG!

COMM AUDIO PROCESSOR

SELECT: 13 POLE VOICE-FILTER OR 9 POLE 100 Hz BW FILTER WITH SELECTABLE FLAT SKIRTS - ADJUSTABLE TONE-TAG AND ANTI-PHASIC WHITE NOISE - ALL IN SYNTHESIZED BINAURAL

See HR Jan, '80 • COMPLETE SYSTEM, KITS, BOARDS • BROCHURES

Hildreth Engineering

P.O. Box 60003 Sunnyvale, CA 94088

Tell 'em you saw it in HAM RADIO!

ELECTRONICS

Take all 5
of these
fascinating,
info-packed books
for **\$2⁹⁵**

Are you into

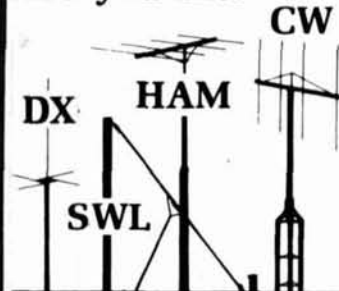

BOOK CLUB

Communications, QSLs, or OSCAR?



... and get one
FREE!

If you're into hamming, this is THE has-everything reference library... from troubleshooting to 10-meter FM to receivers, transmitters, repeaters, and antennas. And you can get in-the-know today by joining the Electronics Book Club. Start saving now with discounts up to 75% on hundreds of fact-filled volumes... PLUS special Members' Bonus Benefits!!

- List price \$82.70
- Over 2,100 pages
- More than 1,600 illustrations

1120
List \$8.95



PLUS... receive a 1981 Electronics Projects Calendar as our extra gift! (List \$4.95)

7 very good reasons to try Electronics Book Club...

- **Reduced Member Prices.** Save up to 75% on books sure to increase your know-how.
- **Satisfaction Guaranteed.** All books returnable within 10 days without obligation
- **Club News Bulletins.** All about current selections—mains, alternates, extras—plus bonus offers. Comes 13 times a year with dozens of up-to-the-minute titles you can pick from
- **"Automatic Order"**. Do nothing, and the Main selection will be shipped to you automatically! But... if you want an Alternate selection—or no books at all—we'll follow the instructions you give on the reply form provided with every News Bulletin
- **Continuing Benefits.** Get a Dividend Certificate with every book purchased after fulfilling Membership obligation, and qualify for discounts on many other volumes
- **Bonus Specials.** Take advantage of sales, events, and added-value promotions
- **Exceptional Quality.** All books are first-rate publisher's editions, filled with useful, up-to-the-minute info

ELECTRONICS BOOK CLUB Blue Ridge Summit, PA 17214

Please accept my Membership in Electronics Book Club and send my 5-volume Amateur Radio Library, plus a free copy of OSCAR: The Ham Radio Satellites and the 1981 Electronics Projects Calendar, all for \$2.95 (plus shipping/handling). If not satisfied, I may return the books within ten days without obligation and have my Membership cancelled. I agree to purchase 4 or more books at reduced Club prices during the next 12 months, and may resign any time thereafter.

Name _____ Phone _____
Address _____
City _____
State _____ Zip _____

(Valid for new member only. Foreign and Canada add 15%.)

HR-281



**Kitty says
By George!
We cannot tell a
lie. Barry's has the
best deals going!
Here are our
Washington's
Birthday Specials!**



The outstanding FT-707,
FT-902 DM or consider the
FT-107 M or the FT-101ZD

FT 720 RVH, 25 watts, 2 meter transceiver. FT
720 RU, UHF transceiver. FT 480, 2 meter, all
mode, 30 watts.

**FEBRUARY FEATURES
COLLINS KWM 380**

and accessories for all major lines

ASTRO 103 plus wattmeters

MIRAGE 2M amplifiers • MURCH UT 2000B

It's Barry's for the Drake TR/DR-7 and R-7

CW Ops — we've got NYE keys, Vibroplex
and Bencher paddles

ICOM 720 All-Band HF

AND THERE'S MUCH MORE!

Bearcat Scanners, HyGain Antennas 2 m
beams & mobile, 18AVT/WB and Rotators

BARRY'S HAS HAND-HELDS

Yaesu FT-207R
Santec HT-1200
Icom IC-2AT



**BARRY'S HAS TUBES -
3-500's, 572's, 6146's and more**

BARRY now carries the ALPHA 76PA
with three 8874 tubes, 2,000W PEP

Just arrived — Kantronics
"MINI READER."

Our lines include:

AEA	CUSHCRAFT	ICOM	SWAN/CUBIC
ALLIANCE	DSI	KLM	TEMPO
ASTRON	DENTRON	KANTRONICS	TRI-EX
AVANTI	DRAKE	MFJ	VHF ENGINEERING
B & W	ETO	MIRAGE	WACOM
BIRD	EIMAC	MURCH	YAESU
COLLINS	ENCOMM	ROBOT	AND MORE...
COMMUNICATIONS	HUSTLER	SHURE	
SPECIALISTS	HY-GAIN	STANDARD	*Ask us for details.

BUSINESSMEN: Ask about BARRY'S line
of business-band equipment. We've got it!

Amateur Radio License Classes:

Wednesday & Thursday: 7-9 pm Saturday 10 am-Noon

**¡ AQUÍ SE
HABLA
ESPAÑOL !**

The Export Experts Invite Overseas orders
— We Ship Worldwide



BARRY ELECTRONICS

512 BROADWAY, NEW YORK, N.Y. 10012

TELEPHONE (212) 925-7000

TELEX 12-7670

FAST SCAN ATV

WHY GET ON FAST SCAN ATV?

- You can send broadcast quality video of home movies, video tapes, computer games, etc. at a cost that is less than sloscan.
- Really improves public service communications for parades, RACES, CAP searches, weather watch, etc.
- DX is about the same as 2 meter simplex — 15 to 100 miles.

ALL IN ONE BOX



TC-1 Transmitter/Converter
Plug in camera, ant., mic, and TV
and you are on the air. Contains
AC supply, T/R sw, 4 Modules
below \$ 399 ppd

PUT YOUR OWN SYSTEM TOGETHER

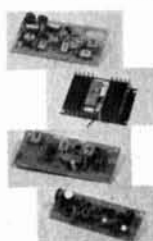

TXA5 ATV Exciter contains
video modulator and xtal on 434
or 439.25 mHz. All modules
wired and tested \$ 89 ppd

PA5 10 Watt Linear matches
exciter for good color and sound.
This and all modules run on
13.8 vdc. \$ 79 ppd

TVC-2 Downconverter tunes
420 to 450 mHz. Outputs TV
ch 2 or 3. Contains low noise
MRF901 preamp. \$ 55 ppd

PACKAGE SPECIAL all
four modules \$ 239 ppd

FMA5 Audio Subcarrier adds
standard TV sound to the
picture \$ 29 ppd

**SEND SELF-ADDRESSED STAMPED ENVELOPE
FOR OUR LATEST CATALOG INCLUDING:**

Info on how to best get on ATV, modules for the builder,
complete units, b&w and color cameras, antennas, monitors,
etc. and more. 20 years experience in ATV.

Credit card orders call (213) 447-4565. Check, Money
Order or Credit Card by mail.



P.C. ELECTRONICS

Maryann
WB6YSS

2522 PAXSON
ARCADIA, CA 91006

Tom
W6ORG



HUSTLER ANTENNAS

5BTV	5-Band trap vertical 10-80 m., reg. \$139.95	\$125.95
4BTV	4-Band trap vertical 10-40 m., reg. \$109.95	98.96
BM-1	Bumper mount, reg. \$18.95	17.06
MO-1	Mast, fold-over, deck mounting, reg. \$22.95	20.66
MO-2	Mast, fold-over, bumper mount, reg. \$22.95	20.66
RM-75	Resonator, 75 meters, 400 watt, reg. \$18.95	17.06
RM-40	Resonator, 40 meters, 400 watt, reg. \$16.95	15.26
RM-40S	Super resonator, 40 meters, KW, reg. \$24.95	22.46
RM-20	Resonator, 20 meters, 400 watt, reg. \$14.95	13.46
RM-20S	Super resonator, 20 meters, KW, reg. \$21.95	19.76
RM-15	Resonator, 15 meters, 400 watt, reg. \$10.95	9.86
RM-10	Resonator, 10 meters, 400 watt, reg. \$10.95	9.86
CG-144	Mobile 2 meter colinear, w/o mount, reg. \$28.95	26.06
CGT-144	2 meter colinear w/trunk mount, reg. \$45.95	41.36

PALOMAR ENGINEERS

	Price	Shpg.
R-X Noise bridge	\$ 55.00	\$2.00
VLF Converter	59.95	2.00
IK Toriod balun, 3 KW SSB, 1:1 or 4:1	32.50	2.00
2K Toriod balun, 6 KW SSB, 1:1 or 4:1	42.50	2.00
IC Keyer, battery operated	117.50	3.00
Loop Antenna, plug-in units, 160/80, BCB, VLF	47.50	2.00
Loop Amplifier	67.50	2.00
Tuner — 10-60 meters, built-in noise bridge	299.95	6.50
CW Filter, 8 pole IC	39.95	2.00

ALSO IN STOCK

Antenna Components • Larsen Antennas
Centurion International Rubber Duck Antennas

WRITE FOR A FREE COPY OF OUR CATALOG

MASTER CHARGE

VISA

All items F.O.B. Lincoln, \$1.00 minimum shipping. Prices subject to change
without notice. Nebraska residents please add 3% tax.

g & c Communications

730 Cottonwood

Lincoln, Nebraska 68510

**HIGH STABILITY
CRYSTALS FOR
FREQUENCY 
OR TIME 
USE THE BEST
BUY
JAN CRYSTALS**

- CB
 - CB standard
 - 2 meter
 - Scanners
 - Amateur Bands
 - General Communication
 - Industry
 - Marine VHF
 - Micro processor crystals
- Send 10¢ for our latest catalog.
Write or phone for more details.

Jan Crystals
P.O. BOX 06017
Ft. Myers, Florida 33906
all phones (813) 936-2397

easy to charge



**Want a new skill to call your own?
Then learn TV and audio servicing
with at-home training from NRI.**

You can learn to service and repair TV, stereos, electronic musical instruments and amplifiers, car and portable radios, record and tape decks, the new video disc and tape players, almost any kind of electronic home entertainment equipment on the market. And as you take NRI's Master Course, you build your own 25" (diagonal) color TV with built-in computer programming that lets you preset a whole evening's viewing. You also build a solid-state stereo receiver with speakers and professional quality test instruments you keep and use.

Designed-for-learning Equipment

The computerized TV, stereo, and test equipment you build are not hobby kits or preassembled commercial units with retrofitted lessons. They are designed by NRI engineers and instructors to give you valuable experience as you build them, reinforce theory with practical demonstrations, and end up as fully operable, high-performance units you'll

be proud to have. And only NRI gives you "power-on" training...you introduce and correct problems in live circuits as you learn.

Build Advanced Technology TV

The NRI TV you build features the latest in video science. Its computerized tuner lets you change channels at the touch of a button, preset up to eight hours of programming, and key lock it in to control children's viewing. It includes automatic tint and chroma controls, automatic degaussing, and automatic fine tuning...oversized speaker, built-in digital clock, 100% solid-state chassis, modular plug-in circuit boards, and the latest development in picture tubes with 100° tri-potential focus in-line gun. And console cabinet is included at no extra charge.

Other kits you build include the NRI stereo, 5" triggered-sweep oscilloscope, digital frequency counter, 10-display TV pattern generator, transistorized volt-ohm meter, and the NRI Discovery Lab* for performing additional experiments and proving theory.

Includes Business Training

Your NRI training includes what you need to build a business of your own. You learn how to set up and run a shop...billing systems...basic book-keeping...business practices. You can start small, even part-time in your basement or garage, make the most of your opportunities to grow into independence.

**Free Catalog...No
Salesman Will Call**

NRI does not employ salesmen. You make your own decision without pressure, with all the facts in front of you in our free, full-color catalog. It describes the course in full, showing all equipment, lesson outlines, and specifics of NRI training. It also shows other exciting courses like Microcomputers and Microprocessors, the big world of Complete Communications, and more. Mail the coupon today for your copy. And see how you can make the most of your talent. If coupon has been removed, write to: NRI Schools, 3939 Wisconsin Ave., Washington, D.C. 20016.





**NEW
5 MODE
KEYBOARD**



Sends Morse, Baudot and ASCII from keys or Morse from paddle. Also random CW with lists for practice. Meters for speed and buffer. Message memories, editing, all prosigns. 110 Baud ASCII, 45.45 Baud Baudot. Continuous control of speed, weight, pitch and volume. PTT, KOS control. Automatic time and serial no.

KB-4900 \$379⁹⁵

Write for information:

**CURTIS ELECTRO DEVICES
INCORPORATED**
 
BOX 4090
MOUNTAIN VIEW, CA 94040
TELEPHONE (415) 494-7223



NRI Schools
McGraw-Hill Continuing
Education Center
3939 Wisconsin Avenue
Washington, D.C. 20016



Please check for one
free catalog only.
**NO SALESMAN
WILL CALL.**

- TV/Audio/Video Systems Servicing
- CB Specialists Course
- Computer Electronics Including Microcomputers

- Complete Communications Electronics with CB • FCC Licenses • Aircraft • Mobile • Marine Electronics
- Digital Electronics
 - Electronic Technology
 - Basic Electronics
- Small Engine Repair
- Electrical Appliance Servicing
- Automotive Mechanics
- Auto Air Conditioning
- Air Conditioning • Refrigeration & Heating Including Solar Technology

Name _____ (Please Print) Age _____

Street _____

City/State/Zip _____

Accredited by the Accrediting Commission of the National Home Study Council

All career courses
approved under GI bill.
 Check for details.

20-021

Compact, economical,
& easy **RTTY**

TU-170



We speak your language

\$169.95 buys the most economical terminal unit kit available today - not the cheapest, but the best for the price. The TU-170 is a single unit that connects your rig, printer, and computer at an economical price. That's a language anyone can understand.

Flesher Corporation

P.O. Box 976 Topeka, KS 66601 913•234•0198
Distributors in Canada and Australia



**The
HAM SHACK**

808 N. Main
Evansville, IN 47710

TEN-TEC

546C	Omni D/Series C	\$1000.00
546	Omni D/Series B	800.00
580	Delta	750.00
570	Century 21	310.00
515	Argonaut	375.00
280	Power Supply	130.00
255	Power Supply/Spkr.	145.00
444	Hercules Amp.	1350.00

Santec

SANTEC HT 1200 \$325.00

CUBIC (Swan)

103	Astro	\$1180.00
102BXA	Astro	985.00
150A	Astro	775.00
100MXA		500.00
PSU6A	Power Supply	170.00
PSU5B	Power Supply	155.00
1500ZA	Amp.	525.00

Write or call Dan, N9APA

812-422-0231

MON-FRI 9AM-6PM • SAT 9AM-4PM

**QUALITY
CRYSTALS**
In Welded Holders

Quick delivery...

Emergency 48 hour service

Visa or MasterCard orders welcome!

Call or write *Cal Crystal NOW!*



CAL CRYSTAL

California Crystal Lab., Inc.
1142 North Gilbert Street
Anaheim, California 92801
(714) 991-1580

A BETTER BALUN

from Barker & Williamson, Inc.

BROAD BAND BALUNS

- Power Rating 2.5 KW-5 KW PEP
- Frequency Range 3.5-30 MHz
- SO 239 CONNECTOR

Types Available

Model BC-1

50 ohms unbalanced to 50 ohms balanced

Model BC-2

50 ohms unbalanced to 200 ohms balanced

Model BC-3

50 ohms unbalanced to 300 ohms balanced

Model BC-4

50 ohms unbalanced to 600 ohms balanced

See your dealer or write:

Barker & Williamson, Inc.
10 Canal Street
Bristol, Pa. 19007



STEP UP TO TELREX

Professionally Engineered Antenna Systems

Single transmission line "TRI-BAND" ARRAY

**MONARCH
TBSEM/4KW**

ILLUSTRATION BALUN



ILLUSTRATION TRAP



By the only test that means anything... on the air comparison... this array continues to outperform all competition... and has for two decades. Here's why... Telrex uses a unique trap design employing 20 HiQ 7500V ceramic condensers per antenna. Telrex uses 3 optimum-spaced, optimum-tuned reflectors to provide maximum gain and true F/B Tri-band performance.

For technical data and prices on complete Telrex line, write for Catalog PL 7



Microcraft's New Morse-A-Word

- Eight character moving display.
- Built-in code practice oscillator.
- Excellent for learning Morse Code.
- Complete — no CRT or expensive extras needed.
- Decodes audio CW signals from your receiver's speaker and displays letters, numbers, punctuation and special Morse characters as the code is received.



- MORSE-A-WORD Kit with 4 character readout MAWK-4 \$149.95
- MORSE-A-WORD Kit with 8 character readout MAWK-8 \$169.95
- MORSE-A-WORD wired & tested with 8 character readout . . . MAWF \$249.95

Send check or money order. Use your VISA or Master Charge. Add \$3.50 shipping and handling for continental U.S. Wisconsin residents add 4% State Sales Tax.

Microcraft

Corporation Telephone: (414) 241-8144
P. O. Box 513HRH, Thiensville, Wisconsin 53092

S-LINE OWNERS ENHANCE YOUR INVESTMENT

with
TUBESTERS™

- Plug-in, solid state tube replacements
- S-line performance—solid state!
- Heat dissipation reduced 60%
- Goodbye hard-to-find tubes
- Unlimited equipment life

TUBESTERS cost less than two tubes, and are guaranteed for so long as you own your S-line.

SKYTEC
Box 535
Talmage, CA 95481

Write or phone for
specs and prices.
(707) 462-6882

GROTH-Type

**COUNTS & DISPLAYS
YOUR TURNS**

- 99.99 Turns
- One Hole Panel Mount
- Handy Logging Area
- Spinner Handle Available

Case: 2x4"; shaft 1/4"x3"

TC2 \$10.00
TC3 \$11.00
Spinner Handle
Add \$1.50

Prices include UPS or Parcel Post

Model TC2: Skirt 2-1/8";
Knob 1-5/8"
Model TC3: Skirt 3";
Knob 2-3/8"

R. H. BAUMAN SALES

P.O. Box 122, Itasca, Ill. 60143

Now get
"real capabilities"
in audio filtering!

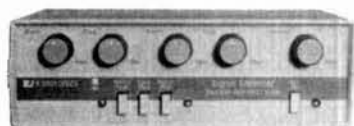

Signal Enforcer™ \$169.95

The Kantronics Signal Enforcer is a high-quality dual filter that gives you greater capabilities in audio filtering.

Here is what Dennis W. Phillips, KA4RUL, of Orlando, Florida wrote about his Signal Enforcer:

"I am the proud owner of your Signal Enforcer dual filter. I really like it. Tops!

I opted to buy a speaker and baffle and your audio filters, so for a little more I got some real capabilities in audio filtering.

I like it... Thanks for a good product. I had them take the top off of the filter and compare it with the (other brand of) dual filter. Well you have it made hands down. That comparison alone would sell anyone on Kantronics. Good workmanship!

The Varifilter, a single audio filter, is an exact duplicate of one Signal Enforcer filter and is built with the same high-quality workmanship. Both models are variable in frequency and bandwidth.

The Signal Enforcer and Varifilter also feature built in 115-230 Vac power supply, constant bandwidth (regardless of frequency), audio amplifier, computer grade parts and precision potentiometers. In addition, the Signal Enforcer includes a demodulator output.

If it is high-quality, expanded capabilities and fine workmanship you are looking for, the Signal Enforcer or Varifilter is your best bet.



Varifilter™ \$119.95

Kantronics

(913) 842-7745
1202 E. 23rd Street
Lawrence, Kansas 66044

State
of the art



by
K.V.G.

XF-9B

Reduce QRM with improved IF selectivity

The XF-9B crystal filter is the heart of good, modern receiver (and transmitter) designs. It is used between the mixer stage and the IC IF amplifier stage to suppress adjacent channel interference by over 100 dBs.



The XF-9B can also be used to upgrade older receiver designs which use vacuum tube or discrete transistor IF amplifier stages. **PRICE \$68.60** plus shipping.

Specification XF-9B

Center Frequency	9.0 MHz	Shape Factor	6:60 dB	1.8
Bandwidth	2.4 KHz		6:80 dB	2.2
Passband Ripple	<2.0 dB	Ultimate Attenuation		100 dB
Insertion Loss	<3.5 dB	Terminations:		500 ohms
				30 pF

Export Inquiries Invited

1296 MHz EQUIPMENT

Announcing the new 1296 MHz units by Microwave Modules.



Low Noise RECEIVE Converter	MMk1296-144
Low Noise RECEIVE Preamplifier	MMa1296
Low Power LINEAR TRANSMITTER	MMI1296-144

Plus all our regular 1296 MHz items: antennas, filters, triplers

TRANSVERTERS FOR ATV OSCARS 7, 8 & PHASE 3

Transverters by Microwave Modules and other manufacturers can convert your existing Low Band rig to operate on the VHF & UHF bands. Models also available for 2M to 70cm and for ATV operators from Ch2/Ch3 to 70cms. Each transverter contains both a Tx up-converter and a Rx down-converter. Write for details of the largest selection available.

Prices start at **\$199.95 plus \$3.50 shipping.**

SPECIFICATIONS:

Output Power	10 W
Receiver N.F.	3 dB typ.
Receiver Gain	30 dB typ.
Prime Power	12V DC



Attention owners of the original MM1432-28 models: Update your transverter to operate OSCAR 8 & PHASE 3 by adding the 434 to 436 MHz range. Mod kit including full instructions \$26.50 plus \$1.50 shipping, etc.

ANTENNAS (FOB CONCORD, VIA UPS)

144-148 MHz J-SLOTS

8 OVER 8 HORIZONTAL POL.	+ 12.3 dBd	D8/2M	\$55.95
8 BY 8 VERTICAL POL.		D8/2M-VERT.	\$65.60
8 + 8 TWIST		8XY/2M	\$57.75

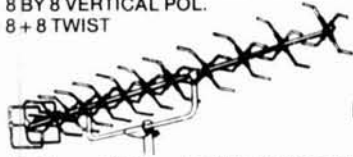

420-450 MHz MULTIBEAMS

For local, DX, OSCAR, and ATV use.

48 EL.	GAIN + 15.7 dBd	70/MBM48	\$69.95
88 EL.	GAIN + 18.5 dBd	70/MBM88	\$95.95

UHF LOOP YAGIS

28 LOOPS	GAIN + 20 dBi	50-ohm, Type N Connector	
1250-1340 MHz	1296-LY	8 ft. boom	\$59.70
1650-1750 MHz	1691-LY	6 ft. boom	\$64.70

Send 30¢ (2 stamps) for full details of KVG crystal products and all your VHF & UHF equipment requirements.

Pre-Selector Filters	Amplifiers	SSB Transverters	
Varactor Triplers	Crystal Filters	FM Transverters	
Decade Pre-Scalers	Frequency Filters	VHF Converters	
Antennas	Oscillator Crystals	UHF Converters	

si

Spectrum International, Inc.
Post Office Box 1084
Concord, Mass. 01742, USA

ANTENNA BOOKS by Bill Orr, W6SAI

ALL ABOUT CUBICAL QUAD ANTENNAS

The cubical quad antenna is considered by many to be the best DX antenna because of its simple, lightweight design and high performance. In Bill Orr's latest edition of this well known book, you'll find quad designs for everything from the single element to the multi-element monster quad, plus a new, higher gain expanded quad (X-Q) design. There's a wealth of supplementary data on construction, feeding, tuning, and mounting quad antennas. It's the most comprehensive single edition on the cubical quad available. 112 pages. ©1977.

RP-CQ

Softbound \$4.75

THE RADIO AMATEUR ANTENNA HANDBOOK

by William J. Orr, W6SAI and Stuart Cowan, W2LX

If you are pondering what new antennas to put up, we recommend you read this very popular book. It contains lots of well illustrated construction projects for vertical, long wire, and HF/VHF beam antennas. But, you'll also get information not usually found in antenna books. There is an honest judgment of antenna gain figures, information on the best and worst antenna locations and heights, a long look at the quad vs. the yagi antenna, information on baluns and how to use them, and some new information on the increasingly popular Sloper and Delta Loop antennas. The text is based on proven data plus practical, on-the-air experience. We don't expect you'll agree with everything Orr and Cowan have to say, but we are convinced that **The Radio Amateur Antenna Handbook** will make a valuable and often consulted addition to any Ham's library. 190 pages. ©1978.

RP-AH

Softbound \$6.95

BEAM ANTENNA HANDBOOK

Here's recommended reading for anyone thinking about putting up a yagi beam this year. It answers a lot of commonly asked questions like: What is the best element spacing? Can different yagi antennas be stacked without losing performance? Do monoband beams outperform tribanders? Lots of construction projects, diagrams, and photos make reading a pleasurable and informative experience. 198 pages. ©1977.

RP-BA

Softbound \$5.95

Please add \$1.00 to cover shipping and handling.

HAM RADIO'S BOOKSTORE
GREENVILLE, N. H. 03048

New!



Twice as
much for less.

HR-LB Here's the log book everyone is talking about. This new offering from HRB is far superior to any other log available today! With over 2,000 entries, you have twice as much space for less cost in comparison to its nearest competitor. There are 80 big (8½ x 11) pages, 30 entries per page for an "easy-count" during contests, a frequency spectrum chart, call sign prefixes and much more. This is unquestionably the best log book value anywhere. 80 pages. ©1978. Spiralbound.

\$1.75

Send check, money order or credit card information plus \$1.00 shipping to:

Ham Radio's Bookstore
Greenville, NH 03048

Hatry Electronics

500 Ledyard St. (South) Hartford, Ct. 06114

203-527-1881

TEN-TEC DELTA 580



160-10 Meter including three new hf bands (10, 18 & 24.5 MHz). Low noise double conversion design. 200 watts input on all bands. 100% duty cycle. Offset tuning. Full break-in. Built-in VOX and PTT.

\$849.00

Call for quote

TEN-TEC ARGONAUT (515)



80-10 Meters. Full break-in. 5 watts input. Built-in T.V.I. filter. Restyled cabinet, easy to read controls. The premier QRP rig.

\$429.00

Call for quote

The JR. MONITOR



The JR. MONITOR™ has it all wrapped up in one neat package. All metal cabinet 5 1/4" w X 2 1/4" h X 6" d. Think of the unlimited possibilities you'll have for experimenting with dozens of antennas! Covers 1.8-30 MHz.

\$79.50

Call for quote

The MT-3000A



DenTron's MT-3000A™ does more than tune coax, random wire, and balanced feed antennas. There is a built-in antenna selector switch for selecting five different antennas, plus lets you tune your station off air through a 250 watt dummy load. Dual in-line forward and reflected watt meters provide continuous monitoring of both power output and antenna tuning. Switchable between 200 and 2000 watts. Continuous tuning from 160 through 10 meters with power handling capability in excess of 3 kW PEP.

\$399.50

Call for quote

The BIG DUMMY



A full 1 kW dummy load, the Big Dummy™ offers a flat SWR, full frequency coverage from 1.8-300 MHz, and high grade industrial cooling oil furnished with the unit. The DenTron Big Dummy is built to last . . . it comes fully assembled and warranted.

\$39.50

Call for quote

AT 1K



A full 1000 watt CW and 1200 watt SSB power handling capability (DC input to amplifier). Matches virtually any feed line. SWR/Relative forward power meter is included for tune-ups without a watt meter. Continuous tuning from 1.8 to 30 MHz.

\$149.50

Call for quote



SHIPPING F.O.B. HARTFORD

COD

ALL BAND TRAP ANTENNAS!



PRETUNED - COMPLETELY ASSEMBLED - ONLY ONE NEAT SMALL ANTENNA FOR UP TO 7 BANDS! EXCELLENT FOR CONGESTED HOUSING AREAS - APARTMENTS LIGHT - STRONG - ALMOST INVISIBLE!

FOR ALL MAKES & MODELS OF AMATEUR TRANSCIEVERS - TRANSMITTERS - GUARANTEED FOR 2000 WATTS SSB 1000 WATTS CW. INPUT FOR NOVICE AND ALL CLASS AMATEURS!

COMPLETE AS SHOWN with 90 ft. RG58U-52 ohm feedline, and PL259 connector, insulators, 30 ft. 300 lb. test dacron end supports, center connector with built in lightning arrester and static discharge - molded, sealed, weatherproof, resonant traps 1" X 6" - you just switch to band desired for excellent worldwide operation - transmitting and receiving! Low SWR over all bands - Tuners usually NOT NEEDED! Can be used as inverted V's - slopers - in attics, on building tops or narrow lots. THE ONLY ANTENNA YOU WILL EVER NEED FOR ALL DESIRED BANDS - WITH ANY TRANSCIEVER - NEW - EXCLUSIVE! NO BALUNS NEEDED!

80-40-20-15-10-6 meter - 2 trap --- 104 ft. with 90 ft. RG58U - connector - Model 998BUA . . . \$69.95
40-20-15-10 meter --- 2 trap --- 54 ft. with 90 ft. RG58U - connector - Model 1001BUA . . . \$68.95
20-15-10 meter --- 2 trap --- 26ft. with 90 ft. RG58U - connector - Model 1007BUA . . . \$67.95

SEND FULL PRICE FOR POSTPAID INSURED. DEL. IN USA. (Canada is \$5.00 extra for postage - clerical-customs etc) or order using VISA - MASTER CHARGE - CARD - AMER. EXPRESS. Give number and ex. date. Ph 1-308-236-5333 9AM - 6PM week days. We ship in 2-3 days ALL PRICES WILL INCREASE. . .

SAVE - ORDER NOW! All antennas guaranteed for 1 year. 10 day money back trial if returned in new condition! Made in USA. FREE INFO. AVAILABLE ONLY FROM WESTERN ELECTRONICS Dept. AR-2 Kearney, Nebraska, 68847



Radio equipment not included

Also Available . . .

Floor Space: 51" Wide by 30" Deep \$192.50

... at last ...

your shack organized!

A beautiful piece of furniture - your XYL will love it!

\$16450 S-F RADIO DESK Deluxe - Ready to Assemble

Designed with angled rear shelf for your viewing comfort and ease of operation.

FINISHES: Walnut or Teak Stain.

Floor Space: 39" Wide by 30" Deep

Additional Information on Request.

Checks, Money Orders, BankAmericard and Master Charge Accepted.

F.O.B. Culver City. (In Calif. Add 6% Sales Tax.)

DEALER INQUIRIES INVITED

S-F Amateur Radio Services



4384 KEYSTONE AVENUE • CULVER CITY, CALIF. 90230 — PHONE (213) 837-4870

Code reading makes ham radio more fun!

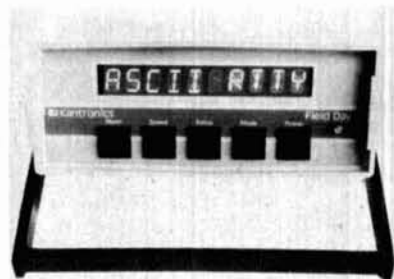

Field Day 2

A code reader can add to the fun of ham radio by allowing you to copy many signals that are too complex or too fast to decode by ear.

You can get in on such things as news-wire service transmissions, weather information and financial reports that are sent by radioteletype (RTTY), ASCII computer language or Morse code.

Some code readers only copy one or two types of signals, but the **Kantronics Field Day 2™** allows you to copy RTTY at 60, 67, 75 and 100 WPM Baud, ASCII at 110 and 300 (if sent as it is typed) WPM Baud and Morse at 3 to 80 WPM.

The **Field Day 2** even has an editing program to improve sloppy Morse. You get more of the message and fewer illegal character signs than with other code readers. With a **Field Day 2** you also get a 24-hour clock, code speed display and TTL compatible demodulator output.

The **Field Day 2** is a complete unit in one package with a large, easy-to-read, 10-character display and is backed with a full-year limited warranty.

Code reading makes ham radio more fun, and now you can get started with one compact, versatile unit, at \$449.95, suggested price, the **Field Day 2**.

Call or visit your Authorized Kantronics Dealer for a demonstration!

Kantronics

(913) 842-7745

1202 E. 23rd Street

Lawrence, Kansas 66044

HAM ART

Ham Radio's guide to help you find your local

Arizona

POWER COMMUNICATIONS CORPORATION
1640 W. CAMELBACK ROAD
PHOENIX, AZ 85015
602-242-6030 or 242-8990
Arizona's #1 "Ham" Store. Kenwood, Yaesu, Icom and more.

California

C & A ELECTRONIC ENTERPRISES
2210 S. WILMINGTON AVE.
SUITE 105
CARSON, CA 90745
213-834-5868
Not The Biggest, But The Best —
Since 1962.

JUN'S ELECTRONICS
3919 SEPULVEDA BLVD.
CULVER CITY, CA 90230
213-390-8003 Trades
714-463-1886 San Diego
The Home of the One Year Warranty
— Parts at Cost — Full Service.

QUEMENT ELECTRONICS
1000 SO. BASCOM AVENUE
SAN JOSE, CA 95128
408-998-5900
Serving the world's Radio Amateurs
since 1933.

SHAVER RADIO, INC.
1378 S. BASCOM AVENUE
SAN JOSE, CA 95128
408-998-1103
Azden, Icom, Kenwood, Tempo,
Ten-Tec, Yaesu and many more.

Connecticut

HATRY ELECTRONICS
500 LEDYARD ST. (SOUTH)
HARTFORD, CT 06114
203-527-1881
Connecticut's Oldest Ham Radio
Dealer

Delaware

DELAWARE AMATEUR SUPPLY
71 MEADOW ROAD
NEW CASTLE, DE 19720
302-328-7728
Icom, Ten-Tec, Swan, DenTron,
Tempo, Yaesu, Azden, and more.
One mile off I-95, no sales tax.

Florida

AGL ELECTRONICS, INC.
1898 DREW STREET
CLEARWATER, FL 33515
813-461-HAMS
West Coast's only full service
Amateur Radio Store.

AMATEUR RADIO CENTER, INC.
2805 N.E. 2ND AVENUE
MIAMI, FL 33137
305-573-8383
The place for great dependable
names in Ham Radio.

RAY'S AMATEUR RADIO
1590 US HIGHWAY 19 SO.
CLEARWATER, FL 33518
813-535-1416
Atlas, B&W, Bird, Cushcraft,
DenTron, Drake, Hustler, Hy-Gain,
Icom, K.D.K., Kenwood, MFJ, Rohn,
Swan, Ten-Tec, Wilson.

Illinois

AUREUS ELECTRONICS, INC.
1415 N. EAGLE STREET
NAPERVILLE, IL 60540
312-420-8629
"Amateur Excellence"

ERICKSON COMMUNICATIONS, INC.
5456 N. MILWAUKEE AVE.
CHICAGO, IL 60630
Chicago — 312-631-5181
Outside Illinois — 800-621-5802
Hours: 9:30-5:30 Mon, Tu, Wed & Fri.;
9:30-9:00 Thurs; 9:00-3:00 Sat.

Indiana

THE HAM SHACK
808 NORTH MAIN STREET
EVANSVILLE, IN 47710
812-422-0231
Discount prices on Ten-Tec, Cubic,
Hy-Gain, MFJ, Azden, Kantronics,
Santec and others.

Kansas

ASSOCIATED RADIO
8012 CONSER, P. O. BOX 4327
OVERLAND PARK, KS 66204
913-381-5900
America's No. 1 Real Amateur Radio
Store. Trade — Sell — Buy.

Maryland

THE COMM CENTER, INC.
LAUREL PLAZA, RT. 198
LAUREL, MD 20810
800-838-4486
Kenwood, Drake, Icom, Ten-Tec,
Tempo, DenTron, Swan & Apple
Computers.

Massachusetts

TEL-COM, INC.
675 GREAT ROAD, RT. 119
LITTLETON, MA 01460
617-486-3040
The Ham Store of New England You
Can Rely On.

TUFTS RADIO ELECTRONICS
206 MYSTIC AVENUE
MEDFORD, MA 02155
617-391-3200
New England's friendliest ham store.

Minnesota

PAL ELECTRONICS INC.
3452 FREMONT AVE. NO.
MINNEAPOLIS, MN 55412
612-521-4662
Midwest's Fastest Growing Ham
Store, Where Service Counts.

New Hampshire

EVANS RADIO, INC.
BOX 893, RT. 3A BOW JUNCTION
CONCORD, NH 03301
603-224-9961
Icom, DenTron & Yaesu dealer. We
service what we sell.

Dealers: *YOU SHOULD BE HERE TOO!*
Contact Ham Radio now for complete details.

Amateur Radio Dealer

New Jersey

RADIOS UNLIMITED
P. O. BOX 347
1760 EASTON AVENUE
SOMERSET, NJ 08873
201-469-4599
New Jersey's Fastest Growing
Amateur Radio Center.

ROUTE ELECTRONICS 46
225 ROUTE 46 WEST
TOWTOWN, NJ 07512
201-256-8555
Drake, Swan, DenTron, Hy-Gain,
Cushcraft, Hustler, Larsen, Etc.

WITTIE ELECTRONICS
384 LAKEVIEW AVENUE
CLIFTON, NJ 07011
201-546-3000
Same location for 63 years. Full-line
authorized Drake dealer. We stock
most popular brands of Antennas and
Towers.

New Mexico

**PECOS VALLEY
AMATEUR RADIO SUPPLY**
112 W. FIRST STREET
ROSWELL, NM 88201
505-623-7388
Now stocking Ten-Tec, Lunar, Icom,
Morsematic, Bencher, Tempo,
Hy-Gain, Avanti and more at low,
low prices. Call for quote.

New York

BARRY ELECTRONICS
512 BROADWAY
NEW YORK, NY 10012
212-925-7000
New York City's Largest Full Service
Ham and Commercial Radio Store.

GRAND CENTRAL RADIO
124 EAST 44 STREET
NEW YORK, NY 10017
212-599-2630
Drake, Kenwood, Yaesu, Atlas,
Ten-Tec, Midland, DenTron, Hy-Gain,
Mosley in stock.

HARRISON RADIO CORP.
20 SMITH STREET
FARMINGDALE, NY 11735
516-293-7990
"Ham Headquarters USA" since
1925. Call toll free 800-645-9187.

RADIO WORLD
ONEIDA COUNTY AIRPORT
TERMINAL BLDG.
ORISKANY, NY 13424
TOLL FREE 1 (800) 448-9338
NY Res. 1 (315) 337-0203
Authorized Dealer — ALL major
Amateur Brands.
We service *everything* we sell!
Warren K2IXN or Bob WA2MSH.

Ohio

UNIVERSAL AMATEUR RADIO, INC.
1280 AIDA DRIVE
COLUMBUS (REYNOLDSBURG), OH
43068
614-866-4267
Complete Amateur Radio Sales and
Service. All major brands — spacious
store near I-270.

Pennsylvania

**HAMTRONICS,
DIV. OF TREVISE ELECTRONICS**
4033 BROWNSVILLE ROAD
TREVISE, PA 19047
215-357-1400
Same Location for 30 Years.

LaRUE ELECTRONICS
1112 GRANDVIEW STREET
SCRANTON, PENNSYLVANIA 18509
717-343-2124
Icom, Bird, Cushcraft, CDE, Ham-
Keys, VHF Engineering, Antenna
Specialists.

SPECIALTY COMMUNICATIONS
2523 PEACH STREET
ERIE, PA 16502
814-455-7674
Service, Parts, & Experience For Your
Atlas Radio.

Virginia

ELECTRONIC EQUIPMENT BANK
516 MILL STREET, N.E.
VIENNA, VA 22180
703-938-3350
Metropolitan D.C.'s One Stop
Amateur Store. Largest Warehousing
of Surplus Electronics.

Preamplifiers

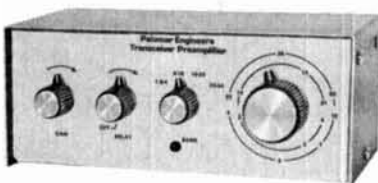

The famous Palomar Engineers preamplifier has been updated and packaged in an attractive new cabinet.

For the SWL there is the P-305 (9-v DC powered) and the P-308 (115-v AC powered) featuring full shortwave coverage, selection of two antennas, 20 db attenuator, 15 db gain control and on-off-bypass switch.

For transceivers, the P-310X features automatic bypass on transmit, adjustable delay for return to receive, and 350 watt transmit capability.

All models have these features:

- Up to 20 db gain.
- Covers 1.8 to 54 MHz in four bands.
- Low noise figure.
- Reduces image and spurious response.
- 8" x 5" x 3". Brushed aluminum control panel. Black vinyl cover.
- SO-239 connectors.
- LED pilot.

Order direct or from your favorite dealer. Model P-305 Receiver Preamplifier for 9-v DC \$77.95. Model P-308 for 115-v AC \$87.95. Transceiver Preamplifier Model P-310X \$107.95. Add \$3 shipping/handling. Calif. residents add sales tax.

Don't wait any longer to pull out weak, rare DX.

Palomar Engineers

Box 455, Escondido, CA. 92025
Phone: [714] 747-3343

ASSOCIATED RADIO**913-381-5900**8012 CONSER BOX 4327
OVERLAND PARK, KANSAS 66204**BUY—SELL—TRADE**
All Brands New & Reconditioned**We Want to DEAL—Call Us—We'll Do It Your Way.**
WE'RE #1**NOTE: SEND \$1.00 FOR OUR CURRENT CATALOG OF NEW AND RECONDITIONED EQUIPMENT.**★ ALSO WE PERIODICALLY PUBLISH A LIST OF UNSERVICED EQUIPMENT AT GREAT SAVINGS.
A BONANZA FOR THE EXPERIENCED OPERATOR.

TO OBTAIN THE NEXT UNSERVICED BARGAIN LIST SEND A SELF ADDRESSED STAMPED ENVELOPE.

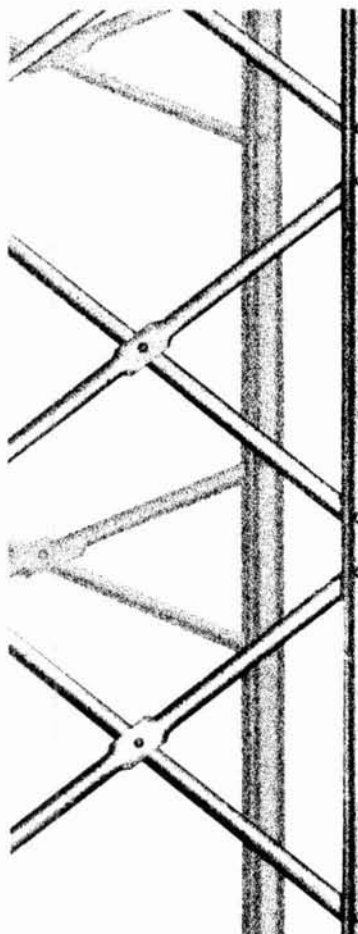
**Rohn**
'BX' TOWERS

- For Home TV, Ham Radio and CB.
- Up to 18 sq. ft. antenna capacity.
- Available to 64' in 8' sections.
- All riveted construction — no welds.
- Breaded channel leg for added strength.
- All steel — galvanized for added life.
- Can be used with Concrete Base Stubs, Cylinder Base or Hinged Concrete Base.

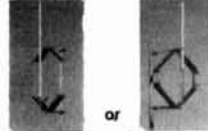
UNR-RohnDivision of UNR Industries, Inc.
6718 West Plank Road, P.O. Box 2000
Peoria, Illinois 61656
U.S.A.**Isotron Antennas**THE ULTIMATE space savers...
for 80 and 40 meters.Designed
and
proved by
WD8EJAHear on
7245 kHz
at
3 & 5 PM
MDT**80 Meters**4 1/2 ft.
8 lbs.
110 kHz*
50Ω coax
\$59.95Length
Weight
Bandwidth
Feed
Price**40 Meters**31 inches
4 lbs.
250 kHz*
50Ω coax
\$49.95

*Limits for 2:1 SWR; center frequency adjustable

Isotron antennas need no radials or matching devices. Feed with 50Ω coax. For indoor or outdoor mounting. Excellent for all amateur uses.

BILAL COMPANY
(303) 687-3219
STAR ROUTE FLORISSANT, CO. 80816**CADELL COIL CORP.**

35 MAIN ST. POULTNEY VT 05768 • TEL. 802 287 4055

COILS FOR HOMEBUILT

Sardine Sender 80 Meter QRP Rig	
QST Oct '79, p. 15	\$8.50
QRP Transmatch-25 Watt Max	
ARRL Handbook p. 350	7.00
Tuna Tin 2-WAS 40 Meter Transmitter	
QST May '76, p. 21	4.75
Mini Miser's Dream Receiver — QST Sep '76, p. 21	13.25
20 Meter Direct Conversion Receiver	
QST Apr '78, p. 12	7.00
Amplifier for HW-8 QRP Transceiver	
QST Apr '79, p. 18	13.30
Harmonic Filter (for above) per band	4.50
Low Frequency Transmitter — S9 Sep '79, p. 23	9.00
Prices include postage.	

BALUNSGet POWER into your antenna. See ARRL Handbook p. 585 or 19-9 or 6-20.
1KW-4:1 Impedance \$12.00 2KW-4:1 14.50
1KW-6:1, 9:1, or 1:1 (pick one) 13.50
2KW-6:1, 9:1, or 1:1 (pick one) 16.00
100W-4:1, 6:1, 9:1, or 1:1 (pick one) 8.00
Many other interesting coil kits in our new list 5C. You must send a stamped envelope to receive our coil kit list.

SEMICONDUCTORS SURPLUS

2822 North 32nd Street, #1 • Phoenix, Arizona 85008 • Phone 602-956-9423

80RY

	Description	Price
18	1K x 8 Eprom	\$ 5.00
6/2516	2K x 8 5V single supply	9.99
4/9114	1K x 4 Static	5.00
7	4K x 1 Dynamic Ram	2.99
7/4116	16K x 1 Dynamic Ram	5.00
12-6	32K Eprom	39.95

U.'s, Etc.

800P	Microprocessor	9.99
8B21P	PIA	6.99
845P	CRT Controller	25.00
850P	ACIA	4.99
852P	SSDA	5.00
8-1	Microprocessor	5.00
80A	Microprocessor	5.00
8A	Microprocessor	10.99
8	Microprocessor	8.99
8A	PIO	9.99
8	SIO/0	22.50
8	SIO/1	22.50
12	8 Bit input/output part	3.99
11	Communication Interface	6.99
1602/AY5-1013	UART	6.99
1000NL	Four Bit Microprocessor	4.99
1482B	PSAT	5.99
17	DMA Controller	8.99
11	64 x 4 FIFO	3.00
1316/F3817	Clock with alarm	5.99
11		60.00
18	8 Bit Microcomputer with programmable/erasable EPROM	60.00
1408L/6	6 Bit D/A	3.25
12502		9.99
12601		9.99

CRYSTAL FILTERS

10001-19880	Same as 2194F
	.7 MHz narrow band
	dB bandwidth 15KHz min.
	dB bandwidth 60 KHz min.
	dB bandwidth 150 KHz min.
	estimate 50 dB insertion loss 1 dB max.
	impedance 1 dB max. Ct. 0+/-5 pf 3600 Ohms
	\$3.99 each

1454 Same as MRF458 12.5 VDC, 3-30 MHz
7.95 each 80 Watts output, 12 dB gain

MRF472

12.5 VDC, 27 MHz
4 Watts output, 10 dB gain
\$1.69 each

CARBIDE Circuit Board Drill Bits
for PCB Boards
5 mix for \$5.00

MURATA CERAMIC FILTERS

SFD 455D	455 KHz	\$2.00
SFB 455D	455 KHz	1.60
CFM 455E	455 KHz	5.50
SFE 10.7 MA	10.7 MHz	2.99

ATLAS CRYSTAL FILTERS FOR ATLAS HAM GEAR

5.52 - 2.7/8	
5.595 - 2.7/8/U	
5.645 - 2.7/8	
5.595 - .500/4/CW	YOUR CHOICE
5.595 - 2.7 USB	\$12.99 each
5.595 - 2.7/8/L	
5.595 - 2.7 LSB	
9.0 - USB/CW	

J310 N-CHANNEL J - FET 450 MHz
Good for VHF/UHF Amplifier,
Oscillator and Mixers. 3/\$1.00

AMPHENOL COAX RELAY

26 VDC Coil SPDT #360-11892-13
100 watts Good up to 18 Ghz
\$19.99 each

78M05 Same as 7805 but only 1/2 Amp @
5 VDC 49¢ each or 10/\$3.00

NEW TRANSFORMERS

F-18X	6.3 VCT @ 6Amps	\$6.99 each
F-46X	24V @ 1Amp	5.99
F41X	25.2VCT @ 2Amps	6.99
P-8380	10VCT @ 3Amps	7.99
P-8604	20VCT @ 1Amp	4.99
P-8130	12.6VCT @ 2Amps	4.99
K-32B	28VCT @ 100 MA	4.99
E30554	Dual 17V @ 1Amp ea.	6.99

EIMAC FINGER STOCK #Y-302
36 in. long x 1/2 in. \$4.99 each

NO ORDERS UNDER \$10

SEMICONDUCTORS SURPLUS

2822 North 32nd Street, #1 • Phoenix, Arizona 85008 • Phone 602-956-9423

MRF203	SP.O.R.	BFW92A	\$ 1.00
MRF216	19.47	BFW92	.79
MRF221	8.73	MMCM918	14.30
MRF226	10.20	MMCM2222	15.65
MRF227	2.13	MMCM2369	15.00
MRF238	10.00	MMCM2484	15.25
MRF240	14.62	MMCM3960A	24.30
MRF245	28.87	MWA110	6.92
MRF247	28.87	MWA120	7.38
MRF262	6.25	MWA130	8.08
MRF314	12.20	MWA210	7.46
MRF406	11.33	MWA220	8.08
MRF412	20.65	MWA230	8.62
MRF421	27.45	MWA310	8.08
MRF422A	38.25	MWA320	8.62
MRF422	38.25	MWA330	9.23
MRF428	38.25		
MRF428A	38.25	TUBES	
MRF426	8.87	6KD6	\$ 5.00
MRF426A	8.87	6LQ6/6JE6	6.00
MRF449	10.61	6MJ6/6LQ6/6JE6C	6.00
MRF449A	10.61	6LF6/6MH6	5.00
MRF450	11.00	12BY7A	4.00
MRF450A	11.77	2E26	4.69
MRF452	15.00	4X150A	29.99
MRF453	13.72	4CX250B	45.00
MRF454	21.83	4CX250R	69.00
MRF454A	21.83	4CX300A	109.99
MRF455	14.08	4CX350A/8321	100.00
MRF455A	14.08	4CX350F/J/8904	100.00
MRF472	2.50	4CX1500B/8660	300.00
MRF474	3.00	811A	20.00
MRF475	2.90	6360	4.69
MRF476	2.25	6939	7.99
MRF477	10.00	6146	5.00
MRF485	3.00	6146A	5.69
MRF492	20.40	6146B/8298	7.95
MRF502	.93	6146W	12.00
MRF604	2.00	6550A	8.00
MRF629	3.00	8908	9.00
MRF648	26.87	8950	9.00
MRF901	3.99	4-400A	71.00
MRF902	9.41	4-400C	80.00
MRF904	3.00	572B/T160L	44.00
MRF911	4.29	7289	9.95
MRF5176	11.73	3-1000Z	229.00
MRF8004	1.39	3-500Z	129.99
BFR90	1.00		
BFR91	1.25	TO-3 TRANSISTOR SOCKETS	
BFR96	1.50	Phenolic type	6/\$1.00

UHF/VHF RF POWER TRANSISTORS

CD2867/2N6439
60 Watts output
Reg. Price \$45.77
SALE PRICE \$19.99

1900 MHz to 2500 MHz DOWNCONVERTERS

Intended for amateur radio use.
Tunable from channel 2 thru 6.
34 dB gain 2.5 to 3 dB noise.
Warranty for 6 months

Model HMR 11

Complete Receiver and Power Supply
\$225.00 (does not include coax)
4 foot Yagi antenna only
\$39.99

Downconverter Kit - PCB and parts
\$69.95

Power Supply Kit - Box, PCB and parts
\$49.99

Downconverter assembled
\$79.99

Power Supply assembled
\$59.99

Complete Kit form with Yagi antenna
\$109.99

REPLACEMENT PARTS

MRF901 \$ 3.99

MBD101 1.29

.001 Chip Caps 1.00

Power Supply PCB 4.99

Downconverter PCB \$19.99

NEW BOGNER DOWNCONVERTER

Industrial version.

1 year guarantee. **\$225.00**

86 PIN MOTOROLA BUS EDGE CONNECTORS

Gold plated contacts

Dual 43/86 pin .156 spacing

Soldertail for PCB **\$3.00 each**

CONTINUOUS TONE BUZZERS

12VDC **\$2.00 each**

110VAC MUFFIN FANS

New **\$11.95** Used **\$5.95**

PL259 TERMINATION 52 Ohm 5 Watts
\$1.50 each

NO ORDERS UNDER \$10

SEMICONDUCTORS SURPLUS

2822 North 32nd Street, #1 • Phoenix, Arizona 85008 • Phone 602-956-9423

1857JAN	\$ 2.50	2N6097	\$28.00
1949	3.60	2N6166	38.00
1947	15.00	2N6368	22.99
1950	4.60	2N6439	40.00
1375	8.00	A210/MRF517	2.00
1553	1.57	BLY38	5.00
1818	5.00	40280/2N4427	1.10
1866	1.00	40281/2N3920	7.00
1866JAN	2.50	<u>40282/2N3927</u>	<u>10.48</u>
1866JANTX	4.00	NE555V TIMERS	
925	10.00	<u>39¢ each or 10/\$3.00</u>	
948	2.00	NEW DUAL COLON LED	
950	25.00	<u>69¢ each or</u>	
959	3.00	<u>10/\$5.00</u>	
1960JANTX	10.00	HEP170 1000 PIV	
1072	1.60	2.5 Amps 25¢ each or	
1427	1.10	<u>100/\$15.00</u>	
1429	7.00	HIGH VOLTAGE CAPS	
1877	1.00	420 MFD @ 400 VDC OR	
1959	2.00	600 MFD @ 400 VDC	
1976	15.00	<u>\$6.99 each</u>	
1070	8.00	NEW ROTRON BISCUIT FANS	
1071	15.00	Model BT2A1 115 VAC	
1108	4.00	<u>\$12.99 each</u>	
1109	1.50	TORIN TA700 FANS NEW	
1179	1.00	Model A30340	
1583	4.00	230 VAC @ .78 Amps	
1589	6.00	Will also work on 115 VAC	
1590	8.00	<u>\$29.99 each</u>	
1591	11.00	DOOR KNOB CAPS	
1635	5.44	470 pf @ 15 KV	\$3.99 each
1636	11.60	Dual 500 pf @ 15 KV	5.99 each
1637	20.00	680 pf @ 6 KV	3.99 each
1641	5.00	800 pf @ 15 KV	3.99 each
1643	14.00	1000 pf @ 20 KV	5.00 each
1645	10.00	2700 pf @ 40 KV	5.99 each
1842	8.00	NEW & USED BCD SWITCHES	
1849	20.00	3 switch with end plates	
1942	40.00	<u>\$8.99 New \$6.95 Used</u>	
1946	14.00		
1862	50.00		
1080	7.00		
1081	10.00		
1082	11.00		
16083	13.00		
16084	14.00		
16095	11.00		
16096	20.00		

ORDERING INSTRUCTIONS

Check, money order, or credit cards welcome. (Master Charge and VISA only) No personal checks or certified personal checks for foreign countries accepted. Money order or cashiers check in U.S. funds only. Letters of credit are not acceptable.

Minimum shipping by UPS is \$2.35 with insurance. Please allow extra shipping charges for heavy or long items.

All parts returned due to customer error will be subject to a 15% restock charge.

If we are out of an item ordered, we will try to replace it with an equal or better part unless you specify not to, or we will back order the item, or refund your money.

PRICES ARE SUBJECT TO CHANGE WITHOUT NOTICE. Prices superseade all previously published. Some items offered are limited to small quantities and are subject to prior sale.

We now have a toll free number but we ask that it be used for charge orders only. If you have any questions please use our other number. We are open from 8:00 a.m. - 5:00 p.m. Monday thru Saturday.

Our toll free number **for orders only** is 800-528-3611.

JUMBO LED's

Red	8/\$1.00
Clear	6/\$1.00
Yellow	6/\$1.00
Green	6/\$1.00
Amber	6/\$1.00

MEDIUM LED's

Red	6/\$1.00
Green	6/\$1.00

NEW GE OPTO COUPLERS 4N26
69¢ each or 10/\$5.00

MICRO-MINI WATCH CRYSTALS
32.768 Hz \$3.00 each

NEW 2" ROUND SPEAKERS
100 Ohm coil 99¢ each

PLASTIC TO-3 SOCKETS 4/\$1.00

NO ORDERS UNDER \$10

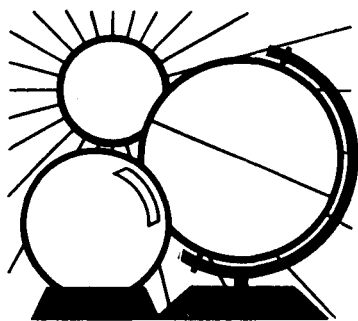

DX FORECASTER

Garth Stonehocker, KØRYW

predictions

We are still in the good old winter DX months with February; expect, however, a couple of periods of short-lived geomagnetic disturbances from solar flares about February 19-21 and February 27-March 4. Another longer-lasting period of disturbance may be expected near February 2-6. The best DX periods are probably about February 7-10 and 22-27.

a look at February

February is the month when changes in the ionosphere portend leaving the winter DX conditions of November, December, and January behind. Longer days are beginning to be seen as earlier sunrises and later sunsets in the northern hemisphere. The 10, 15, and 20 meter bands can be expected to open sooner in the morning and stay open longer into the evening. On the 40, 80, and 160 meter bands, which depend on darkness for their openings, the DX hours can be expected to begin to shrink. The DXer's evening schedule has to wait for sunset. The earlier sunrise decreases the S-meter readings of the long-skip DX, and exchanges it for short skip to the locals. Still, there are many hours in which to take advantage of the superb winter DX.

February is often the month with the highest mean solar radio flux values of the year. This is a long-lasting, averaging effect of the earth's being closer to the sun this time of year, and the winter months of November, December, and January be-

ing geomagnetically the quietest of the year. The combined result is that the ionosphere usually supports the highest daytime high-frequency and vhf DX paths of the year for many of the years of any particular eleven-year solar cycle.

The moon is at perigee on February 9. An annular eclipse of the sun takes place for our down-under and South-Pacific friends. The annular path (maximum duration is 1 minute 11 seconds) goes from the Island of Tasmania south of Australia at sunrise (1928 UT), then south of New Zealand, and across the South Pacific almost to Peru at sunset (0049 UT). The eclipse will be seen across the east side of Australia, across Antarctica (McMurdo from 2110 to 2220 UT), and from Chile, Argentina, Peru and Central America at its end. All this goes on from February 4 (1928 UT) to 5 (0049 UT).

band-by-band summary

Six meters will open occasionally toward Europe, that is, to the east, before noon, toward the south during noontime to afternoon, and toward the west and northwest in the late afternoon into early evening. The best openings are most likely trans-equatorial during high solar radio flux.

Ten and Fifteen meters will exhibit the same pattern as 6 meters but will be open a longer part of the day. This is particularly true this month since it is nearing springtime with its noticeably longer days and its probably

higher maximum usable frequencies from higher solar flux. Short skip (500 to 1500 miles) is part of the fun on these bands, like the lower frequency bands. The short-skip opening pattern, although closer to mid-day, is the same follow-the-sun sequence as mentioned for 6 meters.

Twenty meters is a great band for everyone's pleasure, limited only by QRM. It should be open nearly every day and late into each evening to almost every part of the world. Best DX conditions can be expected just after sunrise and just before sunset for long skip. Short skip will be essentially as given for 10 and 15 meters, except for longer openings during midday.

Forty meters begins its transition into a night band. Short skip during the daytime in winter, however, gives some interesting opportunities for working your close neighbors for the WAS certificate. Then, at evening time, as the long skip (1000 to 2500 miles) develops, reach out for the far states and the WAC certificate. This band is very active to most areas of the world. In late afternoon the band will open to Europe, then swing around to South Africa and Central and South America, and then swing still farther into the Pacific by dawn.

Eighty and One-Sixty meters DX conditions will be very good this month. Soon the atmospheric noise of the spring storms will give days of short skip QRN and local QRN. On toward summer the static will become so bad that DX will have to be forgotten until fall. Take advantage of what's left of this year's quiet winter season. The directional pattern for these bands is similar to that of 40 meters. The low take-off angle of vertical antennas is very useful for DX here. Horizontal antennas are mainly short skip, high-take-off-angle radiators because of being so close to the ground. Look for particularly interesting DX as these bands come in (open) near sunset and go out at sunrise.

ham radio

WESTERN USA

MID USA

EASTERN USA

GMT	WESTERN USA										MID USA										EASTERN USA										EST		
	ASIA	FAR EAST	EUROPE	S. AFRICA	S. AMERICA	ANTARCTICA	NEW ZEALAND	OCEANIA	AUSTRALIA	JAPAN	ASIA	FAR EAST	EUROPE	S. AFRICA	S. AMERICA	ANTARCTICA	NEW ZEALAND	OCEANIA	AUSTRALIA	JAPAN	ASIA	FAR EAST	EUROPE	S. AFRICA	S. AMERICA	ANTARCTICA	NEW ZEALAND	OCEANIA	AUSTRALIA	JAPAN			
0000	10	10	10	15	10	15	10	10	10	10	10	10	20	15	10	15	10	10	10	10	10	15*	20	15	10	15	10	15	10	10	10	15*	
0100	10	10	10	15	10	15	10	10	10	10	10	10	20	15	10	15	10	10	10	10	10	15	20	15	10	15	10	15	10	10	10	15	
0200	10	10	10	15	10	15	10	10	10	10	10	10	20	15*	15	10	10	10	10	10	10	15	20	20*	15*	20	15*	20	10	10	10	15	
0300	10	10	10	15	10	15	10	10	10	10	10	10	20	15	10	15	10	10	10	10	10	20	40	20	15	10	15	10	10	10	10	20*	
0400	15	15	15	20	15	20	15	15	15*	15*	15	15	40	20	15	20	15	15	15	15	15	—	40	20	15	20	15	20	15	15	15	20*	
0500	15	15	15	20	15	20	15	15	15	15	15	15	40	20	15	20*	15	15	15	15	15	—	40	20	15	20	15	20	15	15	15	20	
0600	20	20	20	20	15	20	15	15	15	20*	20	20	40	20	15	20	15	15	20	20*	—	40	20	15	20	15	20	15	15	15	20	1:00	
0700	20	20	20	20	20	20	15	15	15	20	20	20	40	20	15	20	15	15	20	20	—	40	20	15	20	15	20	15	15	15	20	2:00	
0800	—	—	20	20	20	20	15	15	15	20	—	—	40	20	15	20	15	15	20	20	—	40	20	15	20	15	20	15	15	15	20	3:00	
0900	—	—	20	20	20	20	20	20	20	40	—	—	40	20	15	20	15	15	20	20	—	40	20	15	20	15	20	15	15	15	20	4:00	
1000	—	—	20	20	20	20	20	20	20	40	—	—	40	20	15	20	15	15	20	20	—	40	20	15	20	15	20	15	15	15	20	5:00	
1100	—	—	20	20	20	20	20	20	20	40	—	—	40	20	15	20	15	15	20	20	—	40	20	15	20	15	20	15	15	15	20	6:00	
1200	—	—	20	20	20	20	20	20	20	40	—	—	40	20	15	20	15	15	20	20	—	40	20	15	20	15	20	15	15	15	20	7:00	
1300	—	—	20	20	20	20	20	20	20	40	—	—	40	20	15	20*	15	15	20	20	—	40	20	15	20*	15	20	15	15	15	20	8:00	
1400	—	—	20	20	20	20	20	20	20	40*	—	—	40	20	15	20	15	15	20	20	—	40	20	15	20	15	20	15	15	15	20	9:00	
1500	—	—	15	10	10	80	20	20	20	20	—	—	15	10	10	20	15	15	20	20	—	40	20	15	20	15	20	15	15	15	20	10:00	
1600	20	20	10	10	10	—	15	20	20	20	20	20	10	10	10	—	15	15	20	20	20*	20	10	10	10	10	10	10	10	10	20	11:00	
1700	20	20	10	10	10	—	15	15	15	20	20	20	10	10	10	—	15*	15	20	20	20	20	10	10	10	10	10	10	10	10	20	12:00	
1800	20*	20	10	10	10	—	10	15	15	20	20*	20	10	10	10	—	10	15	20	20	—	10	10	10	10	10	10	10	10	10	20		
1900	20	20	15	10	10	—	10	15	15	20	20	20	15	10	10	—	10	15	20	20	—	10	10	10	10	10	10	10	10	10	20		
2000	20	20*	10	10	10	—	10	10	10	15	20	20	15	10	10	—	10	15	20	20	—	10	10	10	10	10	10	10	10	10	20		
2100	15	15	20	10	10	—	10	10	10	15	15	15	15	10	10	—	10	15	20	20	—	15	10	10	10	10	10	10	10	10	20*		
2200	15	15	20	10	10	—	10	10	10	10	15	15	15	10	10	—	10	15	20	20	—	15	10	10	10	10	10	10	10	10	20*		
2300	10	10	20	10	10	—	10	10	10	10	10	10	15	10	10	—	10	15	20	20	20*	20	15	10	10	10	10	10	10	10	15*		

FEBRUARY

Antenna Baluns

NEW! Quad Transformer.

Matches 3-band quads to single 50 ohm coaxial cable.

Model Q3 \$32.50



1 Kw CW, 3 Kw PEP input. For dipoles, inverted Vees, beams, quads. Dependable. Takes temporary overloads in stride. Specify 1:1 or 4:1 ratio.

Model 1K \$32.50



2 Kw CW, 6 Kw PEP input. Far more rugged than any other balun made for amateur use. Specify 1:1 or 4:1 ratio.

Model 2K \$42.50



2 Kw CW, 6 Kw PEP input. Our heavy duty balun with mounting bracket for 2" mast or boom. Specify 1:1 or 4:1 ratio.

Beam Balun \$47.50

Only Palomar Baluns Have All These Features:

- RF toroidal core for highest efficiency.
- Teflon insulated wire.
- Stainless steel hardware. Won't rust.
- Epoxy filled case. Waterproof.
- Wideband 1.7 to 30 MHz.
- White case to reflect the sun.
- Lighting protection built in.

Free brochure sent on request.

How many light weight baluns have you burned out already? Install the balun that will stay up there working year after year.



To order, add \$3 shipping/handling. California residents add sales tax.

Palomar Engineers

Box 455, Escondido, CA. 92025
Phone: [714] 747-3343

short circuits

regulated power supply

The following corrections should be made to the schematic on page 58 of the September, 1980, issue of *ham radio*: M2 is 0-10 amps dc; C1 is 100 μ F; C2 is a 0.01- μ F/100-volt disc ceramic; the capacitor at pin 9 of U1 is 500 pF/100V paper/Mylar.

quads and quagis

In W2PV's quads and quagis article, which appeared in the September, 1980, issue of *ham radio*, fig. 2 on page 38 should be turned 90 degrees to correspond with the caption. On page 45, in the last line of item two in the summary, the ratio should be expressed as width to height (W/H).

measuring inductance and capacitance

The Ham Notetook item on this subject by W2CHO that appeared on page 68 of the July issue should have included this equation:

$$LC = \frac{1000}{(2\pi)^2} \left(\frac{1}{f^2} - \frac{1}{f_0^2} \right)$$

digital logic probe

In fig. 5 of N6UE's digital logic probe article (*ham radio*, August 1980), pin 1 of U1 (not pin 16) goes to V_{DD} . In fig. 6 there should be traces from the emitter of Q1 to ground, from V_{CC} to the collector of Q2, and from the collector of Q1 to pin 2 of Q2.

CW regenerator

The values of two capacitors are incorrect as printed in W3BYM's article (October, 1980, *ham radio*). C3 should have a value of 2.2 μ F, C4 a value of 1.0 μ F.

super quad

The boom pictured in fig. 4 of W3NZ's article (November, 1980, *ham radio*) should be solid PVC, not PVC tubing.

IF WE WERE YOU



MODEL 6154 TERMALINE®

I'D BUY FROM US

YOUR INQUIRY OR ORDER WILL GET OUR PROMPT ATTENTION

AUTHORIZED **BIRD** DISTRIBUTOR

Webster
associates

115 BELLARMINE
ROCHESTER, MI 48063

CALL TOLL FREE
800-521-2333
IN MICHIGAN 313 - 375-0420

COAXIAL CABLE

SEND FOR FREE CATALOG

MIL SPECS — POLYETHYLENE

34¢/ft.	RG213 noncontaminating	34¢/ft.
25¢/ft.	RG11/U 75 ohms	25¢/ft.
10¢/ft.	RG62/U 93 ohms	10¢/ft.

LOW LOSS FOAM

29¢/ft.	RG8U 97% shield, white	29¢/ft.
18¢/ft.	RG8U 80% shield	18¢/ft.
17¢/ft.	RG11U	17¢/ft.
10¢/ft.	RG58U 95% shield	10¢/ft.
11¢/ft.	RG58A/U stranded	11¢/ft.
18¢/ft.	Rotor cable 2-18ga, 6-22ga	18¢/ft.
Shipping \$2.50 first 100 ft., \$1.50 ea. add'l. 100 ft.		

* BELDEN SPECIAL *

24¢/ft.	RG8U 80% shield	24¢/ft.
---------	-----------------	---------

CONNECTORS

PL-259	10/\$5.69	50-239 10/\$5.69 ea.
push-on shell	39¢ ea.	Elbow \$1.79 ea.
UG-175 or 176 Reducer	10/\$1.79	UHF T (M358) \$2.59
Shipping — add 10%. Minimum \$1.50.		

NEMAL

ELECTRONICS

4% Service Charge

Dept. RH1
5685 S.W. 80th St.
MIAMI, FL 33143
TEL: (305) 661-5534

HOT DX INFO!!!

World's Best Known
WEEKLY DX BULLETIN

Calls • Frequencies
• Propagation •

QSL Info for those Rare
and Exotic countries

SEND Business size SASE
for sample copy TO:

THE DX BULLETIN

306 Vernon Ave.,
Vernon, CT 06066

UNADILLA



UNADILLA

FULL POWER - QUALITY

HAM ANTENNA ACCESSORIES

at your dealer

the Big Signal
W2AU
Balun



LONDON:
VICTORIA:
CONCEPCION:
BUENOS AIRES:
COL. ANAHUAC:
HELSINKI:
AUSTRIA
FRANCE
GERMANY

AMCOMM 01 804 1166
Scalar 725 9677
Telecom Trans Chile 25471
Multi-Radio 773-1266
Radiac 2-50-32-40
Erikoismediat (90) 611258
Renox Telex: 76021
SFL (90) 5339 40
Williges (0421) 504021

HAMS - call for our
free catalog PC-80

DEALERS - join over 400
dealers world-wide. Call
us today for no-risk deal.

HAMFEST MANAGERS -
UNADILLA cooperates!
Call us.

US - TOLL-FREE 1-800-448-1666
NY/Hawaii/Alaska/Canada -
COLLECT 1-315-437-3953
TWX - 710-541-0493

Ask for Bonnie, or Emily.

For over 20 years, the choice
of Hams, Armed Forces and
Commercial Communications - world-wide.

"HELICAN-10"



10-Meter
Indoor
Helix
Antenna

the Old reliable
W2VS Traps



- Lo-Pass Filter 2000W
- Quad Parts
- Baluns / Traps
- Insulators
- Wire & Cable
- Connectors
- Antenna Kits

UNADILLA / REYCO Division Microwave Filter Co., Inc., E. Syracuse, NY 13057

MIDCOM



NOW IN STOCK...
FULL LINE OF AEA KEYS
SUPER EFFICIENT ISOPOLE ANTENNAS



LINES:

AEA	ALPHA	CUSHCRAFT	DENTRON	KLM	MOR GAIN	PALOMAR ENG.	UNIVERSAL
AVANTI	BEARCAT	COLLINS	HY GAIN	KENWOOD	MIRAGE	REGENCY	UNARCO-ROHN
ASTRON	BIRD	CDE	HUSTLER	MICROLOG	MFJ	SWAN	VIBROPLEX
ALLIANCE	BENCHER	DRAKE	ICOM	MINI-PRODUCTS	NYE	TEN TEC	KANTRONICS

CALL TOLL FREE **1-800-325-3609** IN MISSOURI
314-961-9990
MID-COM ELECTRONICS • 8516 MANCHESTER ROAD • BRENTWOOD, MO 63144





114.8	3000	118.8	3100
110.8	841	123.0	2150
107.2	262	127.3	2200
103.5	1850	131.8	2250
100.0	770	136.5	2300
97.4	1800	141.3	2350
94.8	1850	146.2	2400
91.5	1500	151.4	2400
88.5	697	156.7	2500
85.4	1750	162.2	2500
82.4	1700	167.9	2550
79.7	1625	173.8	1338
77.0	1600	179.9	2175
74.4	1600	186.2	1477
71.9	1800	192.8	1633
67.0	600	203.5	2900

Communications Specialists TE-64

Food for thought.

Our new Universal Tone Encoder lends it's versatility to all tastes. The menu includes all CTCSS, as well as Burst Tones, Touch Tones, and Test Tones. No counter or test equipment required to set frequency-just dial it in. While traveling, use it on your Amateur transceiver to access tone operated systems, or in your service van to check out your customers repeaters; also, as a piece of test equipment to modulate your Service Monitor or signal generator. It can even operate off an internal nine volt battery, and is available for one day delivery, backed by our one year warranty.

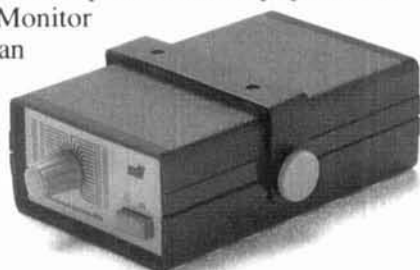

- All tones in Group A and Group B are included.
- Output level flat to within 1.5db over entire range selected.
- Separate level adjust pots and output connections for each tone Group.
- Immune to RF
- Powered by 6-30vdc, unregulated at 8 ma.
- Low impedance, low distortion, adjustable sinewave output, 5v peak-to-peak.
- Instant start-up.
- Off position for no tone output.
- Reverse polarity protection built-in.

Group A

67.0 XZ	91.5 ZZ	118.8 2B	156.7 5A
71.9 XA	94.8 ZA	123.0 3Z	162.2 5B
74.4 WA	97.4 ZB	127.3 3A	167.9 6Z
77.0 XB	100.0 1Z	131.8 3B	173.8 6A
79.7 SP	103.5 1A	136.5 4Z	179.9 6B
82.5 YZ	107.2 1B	141.3 4A	186.2 7Z
85.4 YA	110.9 2Z	146.2 4B	192.8 7A
88.5 YB	114.8 2A	151.4 5Z	203.5 8A

- Frequency accuracy, $\pm .1$ Hz maximum - 40°C to + 85°C
- Frequencies to 250 Hz available on special order
- Continuous tone

Group B

TEST-TONES:	TOUCH-TONES:	BURST TONES:
600	697 1209	1600 1850 2150 2400
1000	770 1336	1650 1900 2200 2450
1500	852 1477	1700 1950 2250 2500
2175	941 1633	1750 2000 2300 2550
2805		1800 2100 2350

- Frequency accuracy, ± 1 Hz maximum - 40°C to + 85°C
- Tone length approximately 300 ms. May be lengthened, shortened or eliminated by changing value of resistor

Wired and tested: \$79.95

 **COMMUNICATIONS SPECIALISTS**

426 West Taft Avenue, Orange, California 92667
(800) 854-0547/ California: (714) 998-3021

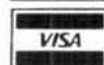

Advertisers check-off

... for literature, in a hurry — we'll rush your name to the companies whose names you "check-off"

Place your check mark in the space between name and number. Ex: Ham Radio 234

Ace Comm. 850	Jones 626
AEA 677	Kantronics *
Alaska Microwave 826	Kengore 538
Aluma 589	Kenwood *
Applied Inv. 862	Larsen 078
Associated Radio 892	Lunar 577
Atlantic Surplus *	MFJ 082
Avanti 775	MHz Elec. 415
Azotic 894	Madison 431
Barker 015	Microcraft 774
Barry *	Microwave Filter 637
Bauman 017	Monroe Elec. 725
Bencher 629	N.P.S. 866
Ben Franklin 864	NRI Schools *
Bilat 817	Nemal *
Budwig 233	OK Machine *
Butternut *	Oak Hill Academy A.R.S. *
Caddell Coil 244	P.C. Elec. 766
Cal Crystal 709	Palomar Eng. *
Comm. Spec. 330	Payne 867
Cubic 111	Callbook 100
Curtis Electro 034	Radio World *
DCO 324	Ramsey 442
DX Bulletin *	S-F A.R.S. 640
Drake *	Securitron 461
ETCO 856	Selecto 895
E. T. O. *	Semiconductors
Encomm 888	Surplus 512
Erickson Comm. *	Skytec 704
Flesher 880	Spectronics *
G & C Comm. 754	Spec. Int. 108
GLB 552	Tab 858
Hal-Tronix 254	Telrex *
H. R. B. 150	Ten-Tec *
H. R. Magazine *	UNR-Rohn 410
Ham Shack 879	Universal Comm. 885
Hamtronics, N.Y. 246	V-J Products 855
Handi-Tek 893	Van Gorden 737
Hatry 889	Vanguard Labs 716
Heath 060	Varian 043
Henry 062	Webster
Hildreth 283	Assoc. 423
Icom *	Western Elec. *
Jameco 333	Wulfsberg Elec. *
Jan 067	Yaesu 127

* Please contact this advertiser directly.
Limit 15 inquiries per request.

February, 1981

Please use before March 31, 1981

Tear off and mail to
HAM RADIO MAGAZINE — "check off"
Greenville, N. H. 03048

NAME

CALL

STREET

CITY

STATE ZIP

DON & MIKE'S FEBRUARY FEATURES

Cubic - Swan 103.....	Call
Astro 150A.....	\$779.00
Astro 100MXA.....	499.00
Mirage B23 1 watt-30 watt amp	89.95
DSI 5600A w/Ant/Ac.....	185.00
Robot 800	699.00
Cushcraft A3 Tribander...	169.00
AEA Morsematic	169.00
Bird 43, Slugs	Call
CDE Ham-4 Rotor.....	169.00
Ham-X	239.00
BT-1 HF/VHF Rotator.....	79.95
FDK Palm 2 Handie with BP/AC	149.00
Cetron, GE 572B.....	34.00
Kenwood Service Manuals Stock	10.00 ea.
Telrex TB5EM	425.00
Telrex Monobanders	Call
Santec HT-1200 Synthesized	339.00

**Order Your
KWM380 Now!
Old Pricing & Free Goods!**

Rockwell Accessories in Stock

Adel Nibbling Tool.....	8.95
Janel QSA5.....	41.95
Rohn Tower	20% off dealer
25G, 45G Sections	
Belden 9405 Heavy Duty Rotor Cable 2#16, 6#18 ...	38¢/ft
Belden 8214 RG-8 Foam ...	32¢/ft
Belden 9258 RG-8 Mini-coax.	19¢/ft
Alliance HD73 Rotor	109.95
Amphenol Silverplate PL259.....	1.00
ICOM 255A 2M Synthesized	339.00
w/touch-tone mike (limited qty.)	
ICOM 260A 2M SSB/FM/CW	449.00

Handi Specials:

Kenwood TS-520SE, TS-130S . Call	
ICOM IC2AT/TTP/NICAD..	249.00
Bearcat 220—\$299.00 300—399.00	
Lunar 2M4-40P	109.00

Call for TS830S, TS130S
plus accessories

MASTER CHARGE • VISA

All prices fob Houston except where indicated. Prices subject to change without notice, all items guaranteed. Some items subject prior sale. Send letterhead for Dealer price list. Texas residents add 6% tax. Please add postage estimate \$1.00 minimum.

MADISON

Electronics Supply, Inc.

1508 McKinney
Houston, Texas 77010
713/658-0268

Advertisers iNdex

Ace Communications, Inc.....	64
AEA, Advanced Electronics Applications	11, 46, 95
Alaska Microwave Labs	75
Aluma Tower Company	75
Applied Invention	78
Associated Radio	88
Atlantic Surplus Sales	76
Avanti Communications	64
Barker & Williamson, Inc.....	82
Barry Electronics	80
Bauman, R.H., Sales Company	83
Bencher, Inc.	78
Ben Franklin Electronics	7
Bilat Company	88
Budwig Mfg. Company	74
Butternut Electronics	10
C. Comm.	46
Caddell Coil Corp.....	88
Cal Crystal Lab, Inc.	82
Communications Specialists.....	96, 97
Cubic Communications, Inc.	76
Curtis Electro Devices	77, 81
DCO, Inc.	72
DX Bulletin	94
Drake, R. L., Co.	1
ETCO	78
Ehrhorn Technological Operations	7
Encomm, Inc.	2
Erickson Communications	10
Flesher Corp.	82
G & C Communications	80
GLB Electronics	75
Hal-Tronix	54
Ham Radio's Bookstore.....	10, 76, 84
Ham Radio Magazine	76
The Ham Shack	82
Hamtronics, N.Y.	29
Handi-Tek	78
Hatry Electronics	85
Heath Company	7
Henry Radio Stores	Cover II
Hildreth Engineers	78
Icom America, Inc.	5
Jameco Electronics	65
Jan Crystals	81
Jones, Marlin P. & Associates	73
Kantronics	83, 85
Kengore Corp.	76
Trio-Kenwood Communications, Inc.	50, 51
Larsen Antennas	77
Lunar Electronics	72
MFJ Enterprises	9
MHz Electronics	68, 69, 70, 71
Madison Electronics Supply	64, 98
Microcraft Corporation	83
Microwave Filter, Inc.....	95
Midcom	95
Monroe Electronics.....	74
N.P.S. Inc.	7
NRI Schools	81
Nemal Electronics.....	94
OK Machine & Tool	54
Oak Hill Academy Amateur Radio Session	76
P.C. Electronics	46
Palomar Engineers	94, 87
Payne Radio	100
Radio Amateur Callbook.....	74
Radio World	78
Ramsey Electronics, Inc.	39
S-F Amateur Radio Services.....	85
Securitron	78
Selecto, Inc.	74
Semiconductors Surplus.....	89, 90, 91
Skytec	83
Spectronics	99
Spectrum International	84
Tab Books, Inc.	79
Telrex Laboratories	83
Ten-Tec	47
UNR-Rohn	88
Universal Communications	78
V-J Products	46
Van Gorden Engineering.....	10
Vanguard Labs	74
Varian, Eimac Division	Cover IV
Webster Associates	94
Western Electronics	85
Wulfsberg Electronics, Inc.....	72
Yaesu Electronics Corp.	Cover III

INTRODUCING SONY'S NEW DIGITAL DIRECT ACCESS RECEIVER!

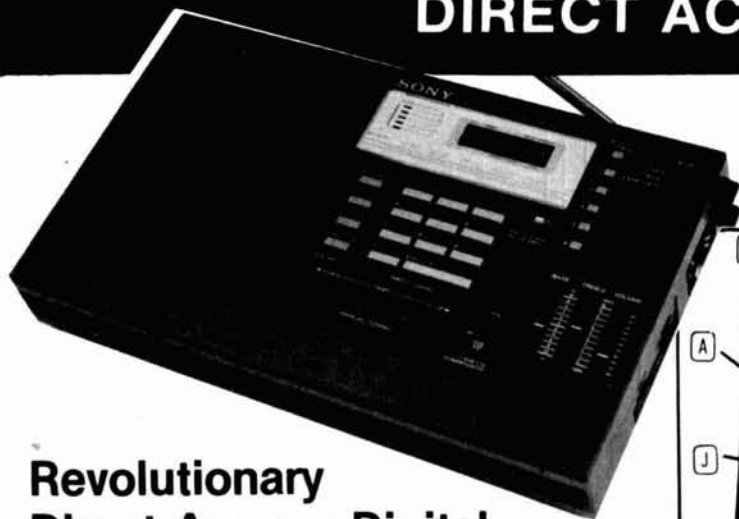

only **\$299⁹⁵** plus \$5.00 shipping

Revolutionary Direct Access Digital Shortwave Scanner

- Continuous Scanning of LW, MW, SW, & FM Bands
- Instant Fingertip Tuning—No More Knobs!
- 6 Memories for Any Mode (AM,SSB/CW, & FM)
- Dual PLL Frequency Synthesized—No Drift!

A WHOLE NEW BREED OF RADIO IS HERE NOW! No other short wave receiver combines so many advanced features for both operating convenience and high performance as does the new Sony ICF-2001. Once you have operated this exciting new radio, you'll be spoiled forever! Direct access tuning eliminates conventional tuning knobs and dials with a convenient digital keyboard and Liquid Crystal Display (LCD) for accurate frequency readout to within 1 KHz. Instant fingertip tuning, up to 8 memory presets, and continuous scanning features make the ICF-2001 the ultimate in convenience.

Compare the following features against any receiver currently available and you will have to agree that the Sony ICF 2001 is the best value in shortwave receivers today:

DUAL PLL SYNTHESIZER CIRCUITRY covers entire 150 KHz to 29.999 MHz band. PLL₁ circuit has 100 KHz step while PLL₂ handles 1 KHz step, both of which are controlled by separate quartz crystal oscillators for precise, no-drift tuning. **DUAL CONVERSION SUPERHETERODYNE** circuitry assures superior AM reception and high image rejection characteristics. The 10.7 MHz IF of the FM band is utilized as the 2nd IF of the AM band. A new type of crystal filter made especially for this purpose realizes clearer reception than commonly used ceramic filters. **ALL FET FRONT END** for high sensitivity and interference rejection. Intermodulation, cross modulation, and spurious interference are effectively rejected. **FET RF AMP** contributes to superior image rejection, high sensitivity, and good signal to noise ratio. Both strong and weak stations are received with minimal distortion.

EXTENDED SPECTRUM CONTINUOUS TUNING

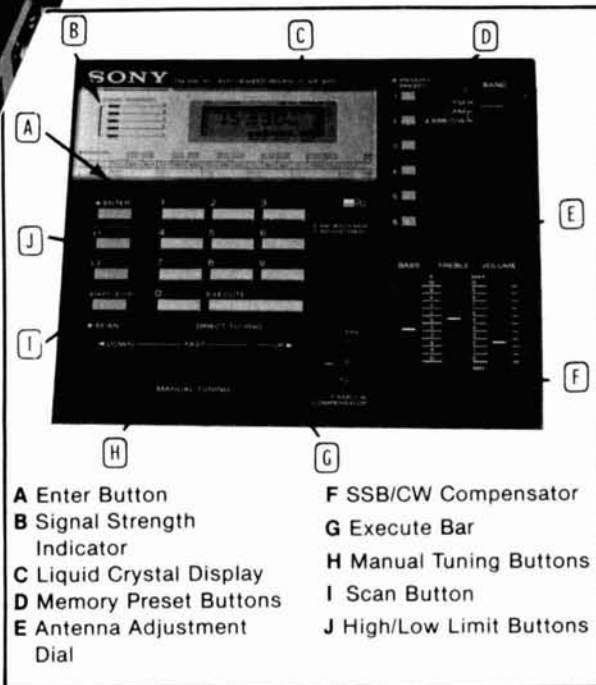

OPERATIONAL FEATURES

INSTANT FINGERTIP TUNING with the calculator-type key board enables the operator to have instant access to any frequency in the LW, MW, SW, and FM bands. And the LCD digital frequency display confirms the exact, drift-free signal being received. **AUTOMATIC SCANNING** of the above bands. Continuous scanning of any desired portion of the band is achieved by setting the "L₁" and "L₂" keys to define the range to be scanned. The scanner can stop automatically on strong signals, or it can be done manually. **MANUAL SEARCH** is similar to the manual scan mode and is useful for quick signal searching. The "UP" and "DOWN" keys let the tuner search for you. The "FAST" key increases the search rate for faster signal detection. **MEMORY PRESETS.** Six memory keys hold desired stations for instant one-key tuning in any mode (AM, SSB/CW, and FM), and also, the "L₁" and "L₂" keys can give you two more memory slots when not used for scanning. **OTHER FEATURES:** Local, normal, DX sensitivity selector for AM; SSB/CW compensator; 90 min. sleep timer; AM Ant. Adjust.

SPECIFICATIONS

CIRCUIT SYSTEM: Fm Superheterodyne; AM Dual conversion superheterodyne. **SIGNAL CIRCUITRY:** 4 IC's, 11 FET's, 23 Transistors, 16 Diodes. **AUXILIARY CIRCUITRY:** 5 IC's, 1 LSI, 5 LED's, 25 Transistors, 9 Diodes. **FREQUENCY RANGE:** FM 76-108 MHz; AM 150-29.999 KHz. **INTERMEDIATE FREQUENCY:** FM 10.7 MHz.; AM 1st 66.35 MHz., 2nd 10.7 MHz. **ANTENNAS:** FM telescopic, ext. ant. terminal; AM telescopic, built-in ferrite bar, ext. ant. terminal. **POWER:** 4.5 VDC/120 VAC **DIMENSIONS:** 12 1/4 (W) X 2 1/4 (H) X 6 3/4 (D). **WEIGHT:** 3 lb. 15 oz. (1.8 kg)



SPECTRONICS, INC.
1009 GARFIELD ST. OAK PARK, IL. 60304

PHONE
(312) 848-6777



If You Want The Finest

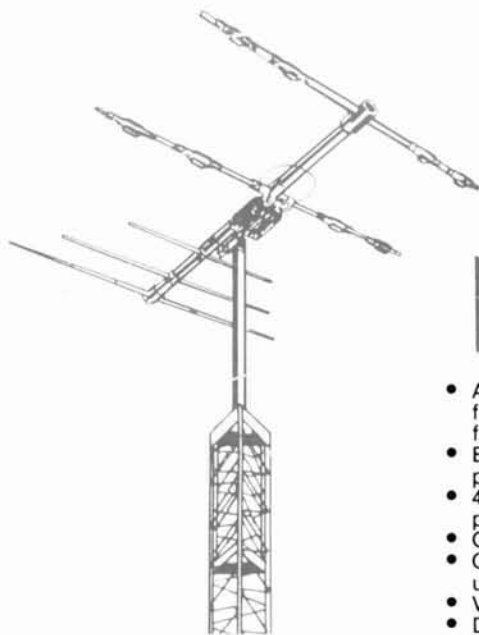

ETO ALPHA 77DX Amplifier

- Alpha 77DX: The ultimate amplifier for those who demand the finest.
- Eimac 8877 Tube — 1500 watts of plate dissipation.
- 4.4 KVA Hypersil®, removable, plug-in Transformer.
- Oil-filled, 25 mfd Filter Capacitor.
- QSK CW: Full break-in, (2) vacuum relays.
- Vacuum Tuning Capacitor.
- Ducted air cooling, large, quiet blower, computer grade.
- Warranty (limited) 24 months, tube by Eimac.
- Other ALPHA's: 78, 76CA, 76PA, 76A, 374A, 77SX (Export Only).



telrex

LABORATORIES

'MONARCH' 10, 15, 20
Meter 'Tri-Band'
Model TB5EM/4KWP



signal/one

CX-11-A Integrated Station



- POWER OUTPUT: 150 watts CW/SSB output all bands (2) MRF 422 Finals.
- OPTIONAL POWER OUTPUT: 200 to 225 Watts CW/SSB output
- SYNTHESIZED FREQUENCY COVERAGE: All amateur bands 1.8-30 MHz in full 1 MHz bands, plus 4 additional 1 MHz bands for future expansion.
- TWO PTO'S: Dual receiving, transceive on either, or split operation.
- QSK CW; Full break-in, vacuum relays. 300 Hz CW Filter built-in.
- SELECTIVITY: Two 8 pole plus one 4 pole filter deliver 20 pole 1.4:1 shape factor (6dB/60dB), plus post detection 1.5, 1.0, .4 and .1 kHz bandwidth.
- BUILT-IN A/C supply, 115/230V, 50/400 Hz, Hypersil® transformer, IF shift, noise blanker, RF clipping, CW keyer, notch/peak filter.
- SERVICING: Self service easiest of any transceiver by using gold-plated sockets for transistor and IC replacement.
- RELIABILITY: Less than 1% failure. 99% of problems resolved in field.
- QUALITY: All military and computer grade. 100% American made.
- PRICE \$5900, mfg. by Signal/one Corp., Phoenix, AZ 85021.

Phone Don Payne, K4ID, for Special Prices, Brochure, and OPERATING EXPERIENCE on the CX-11A and Alphas.

PAYNE RADIO

Personal Phone — (615) 384-2224
P. O. Box 100, Springfield, Tenn. 37172

The New Yaesu FT-902DM



What's so new about the 902?

- **WARC Bands Factory Installed!**
Your FT-902DM won't be "obsoleted" when the new bands become available.
- **True Reading Frequency Counter!**
No need to recalibrate when changing bands or modes.
- **Diode Ring Receiver Front End!**
The industry-standard dynamic range of the FT-901DM is now better than ever.
- **Curtis 8044 IC Keyer!**
Full dot and dash memory are now provided on the built-in keyer.

What's more, the FT-902DM retains these great features of the '901:

- Variable IF Bandwidth
- Built-in memory system
- Audio peak CW filter
- IF rejection tuning
- SSB, CW, AM, FM and FSK
- Digital plus analog readout
- RF speech processor
- Highly stable PLL local oscillator
- Plug-in modular construction
- AC and DC operation built in

The FT-902DM . . . designed to give you the competitive edge!

YAESU
The radio.



Price And Specifications Subject To
Change Without Notice Or Obligation

YAESU ELECTRONICS CORP. 6851 Walthall Way, Paramount, CA 90723 • (213) 633-4007
Eastern Service Ctr., 9812 Princeton-Glendale Rd., Cincinnati, OH 45246 • (513) 874-3100

EIMAC's new high-mu triode/cavity combination. It takes the hassle out of 10 kW VHF transmitter design.

Relax. Now EIMAC offers you the best triode available and a cavity that has been custom designed for it. All you have to do is design them in.

The advantages are impressive. EIMAC's ceramic-metal high-mu triode (3CX10000U7) gives you peak sync power output of 10 kW and a stage gain of 14 dB. That's 2 dB more than with comparable tetrodes.

And there's more. Driving requirements are reduced; screen power supply and screen circuitry are eliminated; and cooling requirements are lessened. The result is ease of maintenance and substantial cost reduction.

There are two EIMAC cavities for your 10 kW combination, the CV-2240 for channels 2-6, and the CV-2250 for channels 7-13. For further information contact Varian, EIMAC Division, 301 Industrial Way, San Carlos, California 94070, (415) 592-1221. Or call any of the more than 30 Varian Electron Device Group Sales Offices throughout the world.

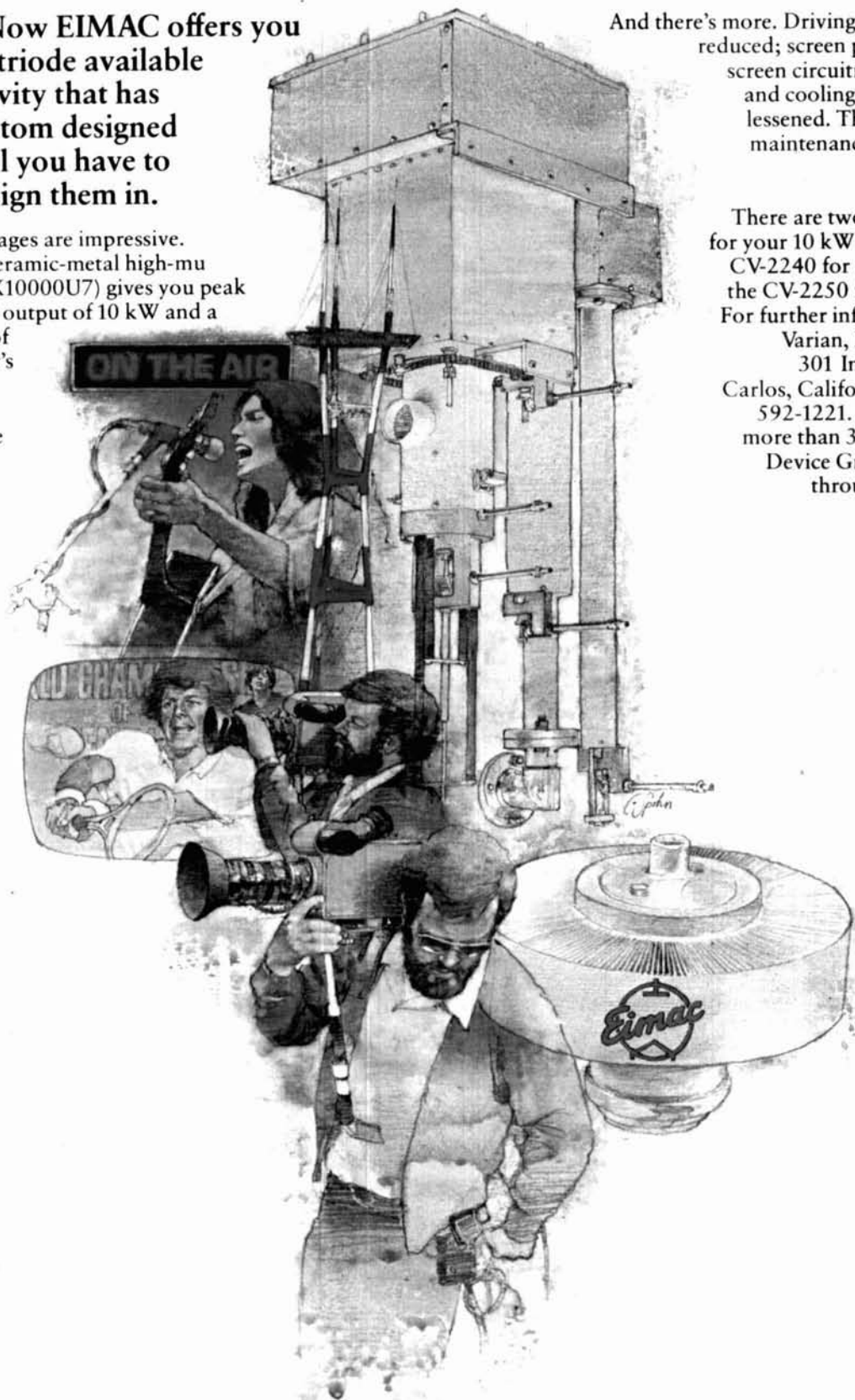

varian