

\$2.00

ham radio

magazine

hr 

DECEMBER 1979

- CMOS 144-MHz synthesizer 14
- log periodic design 34
- low-noise VHF preamps 50
- ni-cad charger 66
- 1969-1979 cumulative index 108



NOW... YOU SAVE THREE WAYS AT HENRY RADIO

1. CALL FOR OUR LOW, LOW CASH
OR CREDIT CARD PRICES
ON ALL MAJOR EQUIPMENT.

2. TAKE ADVANTAGE OF OUR
FANTASTIC MONTHLY
SPECIALS ON SELECTED FINE
EQUIPMENT.

TEMPO
FMH-2
2 METER HANDHELD

KENWOOD
TR-7625
2 METER TRANSCEIVER

DRAKE
TR-7
H.F. TRANSCEIVER

KENWOOD
TS-520SE
H.F. TRANSCEIVER

SWAN
ASTRO 150
H.F. TRANSCEIVER

YAESU
FT-101Z
H.F. TRANSCEIVER

KENWOOD
TS-700SP
2 METER TRANSCEIVER

ICOM
IC-701
H.F. TRANSCEIVER

SWAN
100-MX
H.F. TRANSCEIVER

KENWOOD
TR-7600
2 METER TRANSCEIVER

DRAKE
UV-3
VHF/UHF TRANSCEIVER 6
(AVAILABLE IN DECEMBER)

ICOM
IC-551
6 METER TRANSCEIVER

RM-76
REMOTE MODULE

YAESU
FT-101ZD
H.F. TRANSCEIVER

YAESU
FT-901DM
H.F. TRANSCEIVER

3. ENJOY THE WORLD FAMOUS HENRY RADIO SERVICE.
NO ONE ELSE CAN OFFER YOU THE BACKGROUND OF
EXPERIENCE AND THE VALUE OF RESPONSIBLE
MARKETING LIKE HENRY RADIO.

Henry Radio also offers a broad line of commercial and FCC type accepted amplifiers covering the range of 3 MHz to 500 MHz. Henry amplifiers are in use all around the world. Commercial and export inquiries are invited.

Tempo solid state amplifiers are available at Tempo dealers throughout the U.S.

NEW TOLL FREE ORDER NUMBER: (800) 421-6631

For all states except California
Calif. residents please call collect on our regular numbers

11240 W. Olympic Blvd., Los Angeles, Calif. 90064 213/477-6701
931 N. Euclid, Anaheim, Calif. 92801 714/772-9200
Butler, Missouri 64730 816/679-3127



Henry Radio



DSI Makes It Easy For Santa At Christmas Time

CLIP HERE

Dear Santa,

My choices for Christmas are: (check one or more)

- | | |
|---|---|
| <input type="checkbox"/> Model 500HH (wired) ... \$149.95 | <input type="checkbox"/> Model 5500 (wired) \$ 99.95 |
| <input type="checkbox"/> Model 100HH (wired) ... \$149.95 | <input type="checkbox"/> Model LC 5000 \$149.95* |
| <input type="checkbox"/> Model 5600A-W (wired) .. \$179.95 | <input type="checkbox"/> 5600A-K (kit) \$149.95 |

Use that check received for Christmas for the model of your choice!

• These items are stocked for Christmas delivery •

See your dealers or call our toll free number.

Phone orders received by December 15 have a guaranteed Christmas delivery.

Order now to insure prompt delivery.

DSI INSTRUMENTS, INC. • 9550 Chesapeake Drive • San Diego, Ca. 92123 • (714) 565-8402

Call toll free

(800) 854-2049



California residents call toll free

(800) 542-6253

*Check on Stock for Jan. 1

TERMS: MC VISA AE Check M.O. COD in U.S. Funds. Please add 10% to a maximum of \$10.00 for shipping, handling and insurance. Orders outside of USA & Canada, please add \$20.00 additional to cover air shipment. California residents add 6% Sales Tax.

NEW MFJ-410 "Professor Morse" lets you . . .

COPY CW FASTER AND UPGRADE QUICKER

NEW MFJ Random Code Generator/Keyer sends unlimited random code in random groups for practice. Never repeats same sequence. Tailor level to your ability. Vary speed 5 to 50 WPM. Vary spacing between characters. Speed Meter. Full Feature Keyer.

*Sends unlimited random code.
Never repeats same sequence.
Tailor level to your ability.
Vary speed 5-50 WPM.*



BRAND NEW

\$149⁹⁵

Copy code faster and upgrade quicker. Now you can tailor the level of code practice to your exact needs. Practice copying code anywhere and any time you have a spare moment. Practice at home, in bed, driving to work, during lunch, etc.

The new MFJ-410 "Professor Morse" is a computer-like random code generator and keyer that sends an unlimited supply of precision Morse Code in random groups.

It never repeats the same sequence so you can't memorize it like code tapes.

Vary speed 5-50 WPM and read on speed meter.

Vary spacing between characters and character groups (for example, copy 5 WPM with 13 WPM characters) to give proper character sound at low speed.

Select alphabetic only or alphanumeric plus punc-

uation (period, comma, question, slash, double dash.)

Tone control. Room filling volume. Built-in speaker. **Ideal for classroom teaching.** Earphone jack (2.5 mm) for private listening.

Uses 110 VAC, or 9-18 VDC, or 4-C cells (for portable use). Optional cable for car cigarette lighter (\$3.00). 6x2x6 inches.

Built-in full feature keyer. Volume, speed, internal tone and weight controls. **Weight control** adjusts dot-dash space ratio; makes your signal distinctive to penetrate DRM. Speed meter works for keyer, too. Tune switch keys transmitter for tuning. Reliable solid-state keying: grid block, cathode, solid state rigs. **OPTIONAL BENCHER IAMBIC PADDLE.** Dot and dash paddles have fully adjustable ten-



sion and spacing. Heavy base with non-slip rubber feet eliminates "walking". \$39.95.

Order from MFJ and try it — no obligation. If not delighted, return it within 30 days for refund (less shipping). One year unconditional guarantee.

Order today. Call toll free 800-647-1800. Charge VISA, MC or mail check, money order for \$149.95 plus \$3.00 shipping for MFJ-410 and/or \$39.95 plus \$3.00 shipping for Bencher paddle.

CALL TOLL FREE . . . 800-647-1800

Call 601-323-5869 for technical information, order/repair status. Also call 601-323-5869 outside continental USA and in Mississippi.

MFJ ENTERPRISES, INC.
BOX 494, MISSISSIPPI STATE, MS 39762

NEW MFJ-624 Deluxe Hybrid Phone Patch

Feature Packed: VU meter for line level and null. Has receiver gain, transmitter gain, null controls, bypass switch. Beautiful hum-free audio. RF filtered. VOX or push-to-talk. Works with any rig. Simple patch-in-patch-out installation.

*Crisp, clear hum-free audio
is what phone patching is
all about and MFJ has it.*



BRAND NEW

\$59⁹⁵

This new MFJ-624 Telepatch II hybrid phone patch gives you a combination of performance, features, and quality that you won't find in other phone patches.

PERFORMANCE: Gives you crisp clear, hum-free audio which is what phone patching is all about. Use automatic VOX or push-to-talk. RF pi-filters and PC board construction eliminates RF feedback. Works with any rig.

FEATURES: VU meter monitors telephone line level to prevent crosstalk between telephone channels. Also lets you adjust null depth for maximum isolation between receiver and transmitter.

Separate transmitter and receiver gain controls eliminate readjusting rig's controls after patching. Null control for maximum isolation.

Function switch: OFF for normal operation. ON connects your rig to phone line for patching. NULL switches VU meter to let you adjust for maximum null.

Simple 2 cable installation (plus phone line) when rig has patch-in-patch-out jacks. Connects easily to any rig.

Phono jacks for patch-in-patch-out, speaker, microphone. Screw terminals for phone lines.

Eggshell white, walnut sides. 8x2x6 inches.

QUALITY: Every single unit is tested for performance and inspected for quality. Solid American construction, quality components.

MFJ-620 TELEPATCH HYBRID PHONE PATCH. Same as MFJ-624 but less VU meter. 6x2x6



inches. \$49.95 plus \$3.00 shipping and handling.

One year unconditional guarantee. If not delighted, return it within 30 days for refund (less shipping).

Order today. Call toll free 800-647-1800. Charge VISA, MC or mail check, money order for \$59.95 plus \$3.00 shipping for MFJ-624 and \$49.95 plus \$3.00 shipping for MFJ-620.

CALL TOLL FREE . . . 800-647-1800

For technical information, order/repair status, in Miss., outside continental USA, call 601-323-5869.

MFJ ENTERPRISES, INC.
BOX 494, MISSISSIPPI STATE, MS 39762

ham radio

magazine

DECEMBER 1979

volume 12, number 12

T. H. Tenney, Jr., W1NLB
publisher

James R. Fisk, W1HR
editor-in-chief

editorial staff

Martin Hanft, WB1CHQ
administrative editor

Robert Schneider, N6MR
Alfred Wilson, W6NIF
assistant editors

Thomas F. McMullen, Jr., W1SL
Joseph J. Schroeder, W9JUV
associate editors

publishing staff

J. Craig Clark, Jr., N1ACH
assistant publisher

T. H. Tenney, Jr., W1NLB
advertising manager

James H. Gray, W1XU
assistant advertising manager

Harold P. Kent, WA1WPP
Dorothy A. Sargent, KA1BEB
advertising sales

Susan Shorrock
circulation manager

ham radio magazine
is published monthly by
Communications Technology, Inc.
Greenville, New Hampshire 03048
Telephone: 603-878-1441
Address all editorial and
advertising correspondence to
Greenville, New Hampshire 03048

subscription rates

United States: one year, \$15.00
two years, \$26.00, three years, \$35.00

Canada and other countries (via Surface Mail)
one year, \$18.00; two years, \$32.00
three years, \$44.00

Europe, Japan, Africa (via Air
Forwarding Service) one year, \$25.00

All subscription orders payable in
United States funds, please

foreign subscription agents

Foreign subscription agents are
listed on page 91

Microfilm copies
are available from
University Microfilms, International
Ann Arbor, Michigan 48106
Order publication number 3076

Cassette tapes of selected articles
from ham radio are available to the
blind and physically handicapped
from Recorded Periodicals
919 Walnut Street, 8th Floor
Philadelphia, Pennsylvania 19107

Copyright 1979 by
Communications Technology, Inc.
Title registered at U.S. Patent Office

Second-class postage
paid at Greenville, N.H. 03048
and at additional mailing offices
ISSN 0148-5989

Subscription inquiries and changes of
address should be directed to ham radio
magazine, Greenville, New Hampshire 03048
Please include address label from most
recent issue if possible

Postmaster send Form 3573 to ham radio
Greenville, New Hampshire 03048



contents

14 CMOS 144-MHz synthesizer

Thomas V. Cornell, K9LHA

**24 environmental aspects
of antenna radiation**

John R. Abbott, K6YB

28 Hellschreiber — a rediscovery

Hans Evers, PA0CX

34 log periodic antenna design

Paul A. Scholz, W6PYK
George E. Smith, W4AEO

40 L-band local oscillators

H. Paul Shuch, N6TX

50 low-noise preamplifiers

Geoffrey H. Krauss, WA2GFP

62 variable high-voltage supply

George A. Wilson, W10LP

66 any-state ni-cad charger

William E. Bretz, WA6TBC

- | | |
|------------------------------|---------------------------|
| 4 a second look | 72 new products |
| 126 advertisers index | 8 presstop |
| 104 cumulative index | 126 reader service |
| 91 flea market | 62 repair bench |
| 100 ham mart | 73 short circuits |
| 6 letters | |

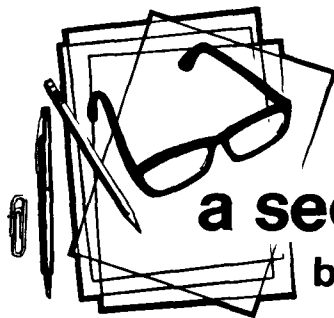

a second look

by Jim Fisk

What appear to me to be arbitrary and capricious decisions by FCC staffers in Washington have shown once again that the FCC bureaucrats are apparently interested in responding neither to public interest or public need. What I'm referring to, of course, was a recent announcement that FCC type acceptance of solid-state wideband amplifiers for the Amateur Service has been terminated *without explanation* by the FCC's Office of Chief Scientist. Are Radio Amateurs to be denied the use of modern solid-state technology because of the autocratic decision of an obscure bureaucrat in a *democratic* government? Is this not a contradiction to paragraph 97.1(c) of the FCC's own Regulations which state that one of the fundamental purposes of the Amateur Radio Service is to encourage and improve ". . . the amateur radio service through *rules which provide for advancing skills in the . . . technical phases of the art?*"

This recent action is just another in a long series of official FCC decisions which are contrary to the needs and desires of the Amateur Radio community — the linear amplifier ban, an unpopular and ridiculous callsign system, equipment type acceptance, the ASCII ban, recommending to the World Administrative Radio Conference (WARC) that CW be an "option" for the Amateur Radio service. This last item is a real dilly and stresses the need for closer congressional scrutiny of the Commission.

Several years ago, as part of the WARC preparations, the FCC formed the Advisory Committee for Amateur Radio (ACAR) and gave them the task of recommending, on behalf of Amateur Radio, what proposals should be made by the United States at WARC '79. ACAR carefully reviewed Article 41, which contains miscellaneous rules pertaining to the Amateur service including a Morse code proficiency requirement for operation below 144 MHz, and proposed no changes. As the WARC preparations proceeded, the FCC released Notices of Inquiry in Docket 20271 which requested public comment on various WARC draft proposals. The Commission requested comment on a proposal of "no change" to Article 41; those who responded supported that proposal. The FCC staff, however, chose to ignore both ACAR's advice and the public comments and recommended to the State Department that the United States' WARC position should include a proposal to delete the requirement for Morse code proficiency!

In Geneva the United States delegation proposed to make the code requirement below 144 MHz a "recommendation" rather than a requirement, a position that was supported by both Canada and Japan. Fortunately, some 15 administrations opposed the move as did every Radio Amateur in attendance. Brazil argued that any change to Article 41 would jeopardize existing reciprocal licensing agreements; Sweden proposed a 28-MHz cutoff; Papua New Guinea suggested 30 MHz. In the end the Papua New Guinea proposal won out and will be recommended for adoption by the conference. In effect, this lowers the frequency for a code-free Amateur Radio license to 30 MHz, a change which affects only six meters. Thus Amateur Radio lost a little — it could have been much worse — and the blame falls directly at the feet of unknown staffers within the FCC.

How could this happen? The *publicly stated* position of the FCC in April, 1977, regarding Article 41 reflected both the advice of ACAR and majority public opinion; its recommendations to the U.S. State Department less than two years later proposed a deletion of the Morse code requirement, in direct contradiction to the public's wishes. Apparently the change was conceived by some staff member (or members) within the Commission in direct violation of the Administrative Procedures Act, and no one in authority felt strongly enough about their public responsibility to veto it. It's no secret that the CB industry has been applying tremendous pressure for a code-free high-frequency operator's license, and this recent effort to sneak an unpopular proposal to an international forum leads one to believe they may have found a responsive element; except for Amateur Radio's friends in the international community, they would have succeeded.

Jim Fisk, W1HR
editor-in-chief



and 6 meters: Nobody Does It Better.



ICOM's new **IC-551** is the all mode 6 meter unit in a compact, easy to use instrument, which uses a built-in microprocessor for frequency control and scanning. The no backlash, no delay dual VFO light chopper system, similar to the **IC-701** and the **IC-211**, is included as a standard feature at no extra cost, and provides split frequency operation as well as completely variable offsets.

For quick access to DX excitement, three memories are provided for programmed beacon watching. The **IC-551** can scan three memories and be programmed to stop on the first one heard. When not scanning, the three memories and two VFO's provide five different frequencies for the operator to select.

The new **IC-551** uses ICOM's famous 100 Hz step digital tuning system, with a fluorescent readout similar to ICOM's RM2 microprocessor. ICOM's dual VFO, single knob tuning spins through the 6 meter band at 10 KHz or 1 KHz steps at the touch of the high speed tuning button and/or mode switch. Your 6 meter operations have never been easier.

- Two Digital VFO's Standard
- AC/DC Power Supply Built-in
- Variable Output from 1 to 10 watts
- Dial Lock Switch for Mobile Use
- Pulse Noise Blanker Standard
- Variable Scan Speed
- Optional FM Unit
- Optional RF Speech Processor and Variable Bandpass Module (similar to the **IC-701** ... makes 10 watts sound like 25)
- Optional VOX Unit with **Microdelay™**



The new **IC-551**, 50 MHz Band Transceiver. At your dealer now.

Also available now: New **IC-551D**, rated at 100 watts.

HF/VHF/UHF AMATEUR AND MARINE COMMUNICATION EQUIPMENT



ICOM AMERICA, INCORPORATED

Sales Service Centers located at:

2112 116th Avenue NE
Bellevue, WA 98004
Phone (206) 454-8155

3331 Towerwood Dr., Suite 307
Dallas, TX 75234
Phone (214) 620-2780

ICOM INFORMATION SERVICE

2112 116th Ave., N.E.
Bellevue, WA 98004

Please send me: IC-551 specifications sheet; full color ICOM Product Line Catalog; List of Authorized ICOM Dealers.

NAME _____ CALL _____

ADDRESS _____

CITY _____ STATE _____ ZIP _____

You may send a machine copy of this form.



comments

linear power amplifiers

Dear HR:

I would like to comment on Bill Orr's article on linear amplifier construction in the June issue. I believe his warning against military surplus tubes is much too conservative. I'm afraid most Radio Amateurs watch costs. New high-power transmitting tubes will go a long way toward driving the cost of a homebrew linear past the cost of a commercial amplifier. I have built a linear using three 813s in parallel, and at 1500 watts PEP it performs beautifully, just as predicted in author Orr's own *Radio Handbook*. Few tubes can beat the 813 for clean response or ruggedness (carbon plate version). I have acquired a collection of six JAN 813s, mostly from other hams; all have been tested in my amplifier and all work beautifully. For a small fraction of the cost of a 3-1000Z or even two 3-500Zs, I have a good set of tubes in my amplifier and a spare set on hand.

If you're considering building your own linear amplifier, read everything you can, such as W6SAI's fine articles, then build it yourself, and scrounge.

**William Brain, KB5EY
Houston, Texas 77040**

Right. There's nothing wrong with buying a surplus 813 from a fellow ham for a few bucks and trying it out in your rig; maybe he'll even take it back if it doesn't work.

It's all a matter of judgment. How about buying a surplus 8877? You can

save nearly a hundred dollars over the user's price if you buy a surplus tube. But what if your "bargain" tube is bad? If you have bought it from a surplus dealer by mail, do you think you will get a refund? Fat chance. It all depends upon how much of a risk you want to take. You don't lose much with a surplus 813 or two.

Being in the power tube business, I am familiar with tear-stained letters from hams who have bought a JAN-branded, expensive, power tube and have been dismayed to find the tube bad and no warranty on it. But if you understand the limitations on warranty with respect to surplus tubes, and have the ability to test your tube immediately upon getting it home (and stand a reasonable chance of getting your money back if the tube is no good), why not? After all, plenty of people lose a wad of money every day at the horse races. But they have the fun of watching the horses run.

**Bill Orr, W6SAI
Menlo Park, California**

memory keyer

Dear HR:

I have just finished building the memory keyer featured in the April issue of *ham radio*; I wish to thank Robert C. Cheek and your magazine for a beautiful and accurate article on the construction of this keyer.

I substituted 21LO2 memory chips for the 2102s and then added a 7400 gate with all inputs tied to ground. A single switch in the 5-volt supply to the 7400 will give a high or inactive output on the four gates; three of these outputs are tied to the chip-enable pins of the 21LO2 memory chips. With the addition of separate switches in 5-volt supply lines to the memory board and the keyer, and a separate supply line with a 70-ohm resistor bypassing the switch to memory board, you can hold the memory in a power-down mode with a drain of less than 40 mA (compared with over 300 mA to the memory board alone at 5 volts).

I found the power supply ran a little warm when the drain was high and

the keyer was left on overnight to retain the memory. The 70-ohm resistor reduces the supply voltage to 1.5 volts to the memory board; the chip-enable pins on the 21LO2s are floating at about 4.5 volts from gates of the 7400 chip. With the 5-volt supply to the 7400 switched off, the gate outputs are inactive and the 21LO2 functions as before the modification. Switching to memory power-down mode must take place before the 5-volt supply to the memory board is opened or else memory is lost. There is a zero time factor from power on to power down.

**William Hansen
Glenwood, Illinois**

split-band speech processor

Dear HR:

Congratulations to Wes Stewart, N7WS, for his fine article, "Split-Band Speech Processor," in September, 1979. Wes mentions that the circuit is sensitive to rf and that the proper use of ferrite beads, bypass capacitors, and rf shielding is important; he is correct. To this end, I would like to suggest that rf bypass capacitors be added in parallel with the 1N914 clipper diodes to prevent rf mixing. Values of several hundred picofarads should be sufficient.

Since symmetry is extremely important in the prevention of second order harmonics, I would also recommend replacing the 1N914 clipper diodes with diode pairs such as Motorola's MSD6150. Using two diodes manufactured on the same substrate provide close matching of V_f and other electrical characteristics. It is also an ideal means of keeping both diodes at the same temperature, ensuring the best clipping symmetry possible. The additions have proven themselves in the processor I am using.

**James D. Allen, WA2SSO
Rochester, New York**

(Continued on page 12)

TS-180S with DFC



The TS-180S with DFC (Digital Frequency Control) is Kenwood's top-of-the-line all solid-state HF SSB/CW/FSK transceiver covering 160 through 10 meters, with outstanding performance and many advanced functions, including four tunable memories to provide more operating flexibility than any other rig!

TS-180S FEATURES:

- Digital Frequency Control (DFC), including four memories and digital up/down paddle-switch tuning. Memories are usable in transceiver or split modes, and can be tuned in 20-Hz steps up or down, slow or fast, with recall of the original stored frequency. (Also available without DFC.)
- All solid-state; 200 W PEP/160 W DC input on 160-15 meters, and 160 W PEP/140 W DC on 10 meters.
- Improved dynamic range, with improved circuit design and RF AGC ("RGC"), which activates as an automatic RF attenuator to prevent receiver overload.
- Adaptable to three new bands, and VFO covers more than 50 kHz and DFC 100 kHz above and below each band.
- Built-in microprocessor-controlled digital display. Shows actual frequency and switches to show the difference between the VFO and "M1" memory frequencies. Blinking decimal points indicate "out of band." (An analog monoscale dial is also included.)
- IF shift (passband dialing to eliminate QRM)
- Dual SSB filter system (second filter is optional) to provide very sharp receiver selectivity, improved S/N, and 30 dB compression with RF speech processor on transmit.

- Tunable noise blanker, to eliminate cross modulation from strong signals when noise blanker is on.
- Selectable wide and narrow CW bandwidth on receive (500-Hz CW filter is optional).
- SSB normal/reverse switch (proper sideband is automatically selected with band switch).
- Dual RIT (VFO and memory/fix).
- Available without DFC. Digital frequency display still included, with differential function showing difference between VFO and "digital hold" frequencies.

OPTIONAL ACCESSORIES:

- DF-180 digital frequency control (for TS-180S without DFC).
- YK-88CW 500-Hz CW filter.
- YK-88SSB second filter for dual-filter system.





WARC NEWS CONTINUED GENERALLY FAVORABLE for the Amateur service, ARRL's WARC team reported from Geneva in early November. Some consideration has now been given to the Amateur bands, and on a world-wide basis, the service is holding its own.

160 Meters: An exclusive 40-kHz slot in Region 1 seems to be within reach; Region 2 looks like it'll keep 1800-2000 kHz with 50 kHz exclusive (probably the bottom end) and 150 kHz shared. Region 3 is also likely to end up with 200 kHz, possibly all on a shared basis though an "Amateur Exclusive" slot is possible.

40 Meters: As of now, the present 7-MHz world-wide allocations appear to have been maintained. However, international broadcasting's desire for new frequencies should still be considered to be a potential threat to a portion of that band.

10 Meters: It was agreed in committee to maintain the 28.0-29.7 slot as Amateur exclusive, worldwide. That committee is discussing the possibility of a separate HF-bands broadcasting conference in the future, and has appointed a large working group to recommend the ground rules for such a conference.

6 And 2 Meters: Present 50-MHz allocations do not appear to have been altered at this time. 144-148 MHz is also retaining the status quo, though some reservations ("footnotes") are believed to have been proposed for the band in some areas.

220 MHz: Amateur and Mobile services have been proposed as "Co-Primary" users for this band, in Region 2 only.

1215 MHz: A reduction to 1240-1300 was voted after considerable discussion by the Working Group. 1215-1240 would go to the Radio Navigation Satellite Service, with 1240-1300 a world-wide secondary allocation for Amateurs and the 1250-1260 MHz subband for Amateur satellite uplinks. The U.S.S.R. indicated it may later suggest a further reduction to 1250-1300 for Amateurs.

Microwave: 10.45-10.50 GHz has been proposed as a world-wide "Amateur Satellite" subband. The present 24 GHz band has been sustained by the Working Group, and the outlook is good for Amateur interests in the millimeter wave area above 40 GHz.

ASCII WAS ACCEPTED, paving the way for its use by Amateurs in the near future, at the Commission's meeting in Washington in mid-October. After considerable discussion, the Commissioners agreed to let Amateurs use ASCII for RTTY and instructed the staff to prepare rules for its implementation. During the discussion identification of Amateur stations operating on RTTY was a key issue, and the present requirement that RTTY users must identify using CW was the telling argument in getting the Commissioners to agree on the ASCII okay.

ANY AMATEUR LICENSE MODIFICATION will now require filing of a Form 610 or 610B, the FCC has decided. Previously, a change in mailing address (only) simply required a note to Gettysburg, though a station location change did require a Form 610 or 610B. For most Amateurs, mailing address and station location are the same. However, most Amateurs who have moved have not been submitting 610s, thus requiring a response from Gettysburg before their request for modification could be processed.

Modified Licenses now will be extended for a full 5-year term effective on the modification date; changes were effective November 12.

WIDEBAND FM ON ALL OF 6 METERS is to be proposed in a new Notice of Proposed Rule Making due shortly from the Commission; the Commissioners decided to throw the issue of 6-meter sub-bands squarely back to the Amateur fraternity by proposing that the band have no divisions by modulation. Strong opposition to the proposed deregulation can be expected from SMIRK and other 6-meter DXers.

AMATEURS WHOSE LICENSES or upgrades were obtained by fraud will soon be the subject of enforcement action, as a result of a recent Commission meeting. In addition, a number of Commission employees who received callsigns in a manner "inconsistent" with Commission procedures soon will be receiving new callsigns. About 50 people in the first category were identified as a result of the FBI investigation that began in Indianapolis back in June, 1977. Many of them, along with other Amateurs who may have taken part in fraudulent licensing schemes, will be facing revocation or suspension proceedings.

No Action Is Planned against non-FCC Amateurs who received special callsign treatment in the past.

LAUNCHING OF THE UNIVERSITY OF SURREY/AMSAT UK UOAST has been approved by NASA. The launch now is scheduled for mid-1981. Plans call for the inclusion of a synthesized telemetry system and a slow-scan TV camera on board the British OSCAR. The TV system will photograph cloud cover and the earth so that Amateurs can receive the pictures directly on their equipment.

A 23-CM LINEAR TRANSLATOR was put into service near San Jose, California in September, after extensive low-level tests. The translator was developed to provide new techniques for orbiting and terrestrial translators using microwave frequencies and to encourage greater 23-cm activity by Amateurs.

The following are excerpts from unsolicited letters and registration cards received from owners of the new TEN-TEC OMNI transceiver.

- "I sold a Yaesu to buy this and am very impressed" —WB5ULA
 "My first QSO with OMNI-A was LA1SV on CW and second was EA8SK on SSB." —N2CC
 "Excellent rig, just as advertised." —WB5TMD
 "Very pleased with performance. QSK feature very slick." —WB0ELM
 "This is my 5th TEN-TEC transceiver in less than 2 years. I loved them all and still have 3." —WB0VCA
 "Through the years I have had complete Drake and Collins stations. I tried a 544 Digital and liked it the best so decided to purchase the 546 OMNI-D Digital." —WA4NFM
 "Your OMNI is the best rig I have had in 20 years of hamming." —K4IHI
 "As a owner of Collins rig, your OMNI-D is the best." —K9JLL
 "I already have an OMNI-A, 544 and a TRITON IV. You may ask why I own so many TEN-TEC rigs. In case there is a great RF famine, I want to be ready!" —WD4HCS
 "You guys really know how to turn on an old timer!" —K8ELS
 "Best operating & most conveniences of any transceiver I've ever used." —W6LZI
 "I like CW. Compared OMNI against IC701 (rcvr) and OMNI won hands down. XYL WD6GSB really enjoys rig on SSB. Finds rig is very stable and digital readout accurate." —AC6B
 "Have checked it out on both modes from "top band" (160) all the way to 29 MHz. Terrific!!!" —W4DN
 "Works well, parts layout and design much better for any possible servicing than other ham gear. The Japanese hybrid sets can't compare to TEN-TEC for audio. Audio reports excellent without special speech processors, etc., to distort the signal." —AG8K
 "I have been using the S-Line over 15 yrs and never thought anything could outperform it. I got the biggest surprise and THRILLED with this OMNI-D even though I have been a ham since 1936." —KV4GD

- "This must be the greatest. I've spent enough money on final tubes to almost pay for this." —KA4BIH
 "This transceiver was recommended to me by old time hams (Xtras) whom I have known for 40 yrs. Has excellent break-in." —N6AVQ
 "Best package job I've ever seen! First licensed 6AAV in 1926. Now in operation—a sweetheart!" —W7LUP
 "From a 32V2/SX115 to an OMNI is a big step!" —K6YD
 "Receiver prominent—transmitter likewise—working comfortable—pleasing design." —OE1FAA
 "First new rig for me in 10 years but seems to be very good." —W5GBY
 "The best transceiver I ever used or owned." —W3TS
 "I wouldn't swap my OMNI for anything on the market, regardless of price." —WD0HTE

OMNI/SERIES B FEATURES

All solid-state; 160-10 meters; Broadband design; Standard 8-Pole 2.4 kHz Crystal Ladder I-F Filter + Optional 1.8 kHz SSB Filter & 0.5 kHz 8-Pole CW Filter; 3-Bandwidth Active Audio Filter; Choice of readout — OMNI-A (analog dial), OMNI-D (digital); Built-in VOX and PTT, Selectable Break-in, Dual-Range Receiver Offset Tuning, Wide Overload Capabilities, Phone Patch Interface Jacks; Adjustable ALC; Adjustable Sidetone; Exceptional Sensitivity; 200 Watts INPUT; 100% Duty Cycle, Front Panel Microphone and Key Jacks; Zero-Beat Switch; "S"/SWR Meter; Dual Speakers; Plug-In Circuit Boards; Complete Shielding; Easier-to-use size: 5 3/4" h x 14 1/4" w x 14" d; Full Options: Model 645 Keyer \$85; Model 243 Remote VFO \$139; Model 252MO matching AC power supply \$139; Model 248 Noise Blanker \$49; Model 217 500 Hz 8-Pole Crystal Ladder CW Filter \$55; Model 218 1.8 kHz 8-Pole Crystal Ladder SSB Filter \$55.

Model 545 Series B OMNI-A ... \$949

Model 546 Series B OMNI-D ... \$1119

To add your name to the fast-growing list of OMNI owners, see your TEN-TEC dealer, or write for full details.

TEN-TEC, INC.
 SEVIERVILLE, TENNESSEE 37862
 EXPORT 5115 LINCOLN AVE. CHICAGO, ILL. 60646

OMNI OWNERS SAY:



Any successor to Rockwell-Collins' KWM-2 better be good. It is. The Pro-mark™ KWM-380.

The remarkable new Pro-mark KWM-380 continues the Rockwell-Collins heritage for quality amateur equipment.

Pro-mark KWM-380 is a complete base station in a smartly styled desktop configuration. The look is unmistakably professional.

All in one unit. AC/DC power supply, speaker and accessory VFO function are built in.

Microprocessor frequency control provides rate selectable tuning in 1 MHz, 1 kHz, 100 Hz or 10 Hz increments. Frequency memory provides split VFO function (half-duplex) for transmit and receiver registers.

The high resolution frequency synthesizer locked to a high stability frequency reference is accurate to 10 Hz with no bandswitch. Eliminate undesired signals with independently selectable I.F. bandwidths and passband tuning. Optional I.F. filters can be selected independent of operating mode.

Pro-mark KWM-380, the mark of the professional. If it wasn't a quantum jump ahead of our highly successful S/Line and KWM-2, we wouldn't have built it. See it soon at your nearby participating Rockwell-Collins distributor. He's listed on the following page. Collins Telecommunications Products Division, Rockwell International, Cedar Rapids, IA 52406. Phone: 319/395-5963. Telex 464-435.



Rockwell International

...where science gets down to business

Specifications†

Frequency Range: Tunable in 10 Hz steps.
Receive mode — 2.0 to 30.0 MHz, 0.5 to 2.0 MHz at reduced sensitivity.

Transmit mode — SSB or CW 160- thru 10-meter amateur bands.

Mode: SSB (voice and RTTY, either sideband selectable), CW, or AM (receive only).

Power requirements: 105, 115, 125, 210, 220, 230, 240, 250, ±5% V ac (Internal strapping option) 50-60 Hz, 12 V to 15 V dc (Connector strapping). 120 W input in receive max; 600 W input in transmit max.

†Subject to change without notice.

Frequency accuracy: Accurate to within ±5 Hz when the 39.6 MHz oscillator and the 455.0 MHz oscillator are set within ± 3Hz. Warm-up time is 10 min.

Frequency stability: Stability is within ±150 Hz over the temperature range of 0-50°C.

TRANSMIT PERFORMANCE

Output impedance: 50 ohms nominal.

Power output: 100 W PEP nominal from 1.6-30 MHz. In CW or RTTY, there is automatic turndown to 50 W after 10 seconds, 50% duty cycle, key down 15 minutes max.

With the optional blower kit, power is 100 W average, 50% duty cycle, key down 1 hour max at 25°C, ½ hour max. at 50°C for all modes.

Unwanted signal suppression: (minimum values below)

Carrier suppression	50 dB
Undesired sideband, 1 kHz ref	55 dB
Harmonics (all)	40 dB
Mixer products	55 dB

Third order distortion: 25 dB below each tone of a two-tone test.

Audio inputs: Microphone — low impedance type, internal strap for HI-Z. Line — 600 ohm input unbalanced impedance; level of 40 mV sufficient to produce full output.

4.205.06

SYNC LOCK I F F

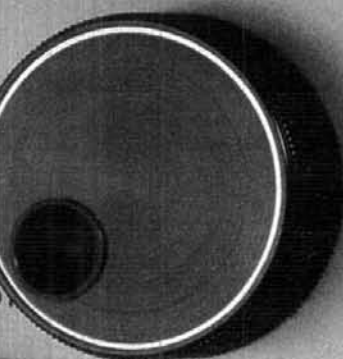

POWER

Rockwell

Collins

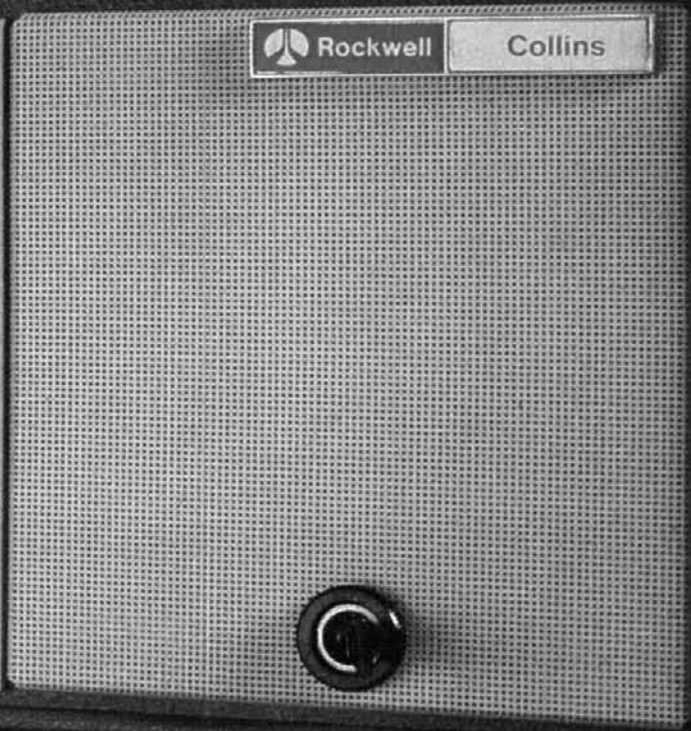

Audio frequency response: Not more than 5 dB variation from 300 to 2400 Hz.

RECEIVER PERFORMANCE

Antenna impedance: 50 ohms

Sensitivity: Not more than 0.5 μ V for 10 dB S+N/N at antenna input for SSB and CW, 2.0 to 30 MHz. Broadcast band attenuation is a nominal 30 dB.

I.F. and image rejection: Greater than 60 dB.

Selectivity: In operating modes of USB, LSB, CW, and AM.

BW at -3 dB (min)	BW at -60 dB (max)
2.1 kHz	4.4 kHz
*1.7 kHz	3.4 kHz
*360 Hz	1.25 kHz
*140 Hz	600 Hz
*6.0 kHz	25 kHz
8 kHz	50 kHz

*optional

Audio output: Not less than $3\frac{1}{2}$ W into 4 ohm load at 1 kHz, at not more than 10% total harmonic distortion. Line audio output, -10 dBm nominal into 600 ohms.

Audio frequency response: Not more than 5 dB variation from 300 to 2400 Hz.

AGC: Audio output variance not more than 8 dB as the RF input varies from 2.0 μ V to 100 mV open circuit.

Intermodulation distortion: Two signals spaced 20 kHz at a level of -10 dBm each will produce IMD down 50 dB min.

Size: 15.50" W (39.4 cm); 6.5" H (16.5 cm) (w/o feet); 7.5" H (19.1 cm) (w/feet); 18.00" D (45.7 cm).

Weight: 50 lbs. (22.7 kg).



**You'd expect
the distributor
who sells
Rockwell-Collins'
new
Pro-mark™ KWM-380
to be an expert.
He is.**

He's your Rockwell-Collins Distributor, a real pro at answering questions and solving problems.

He's especially proud to have been selected to represent the new Pro-mark KWM-380. And he's made it his business to know it inside out. See him soon. He'll be glad to give you a demonstration. And remember, he'll be there to support your needs for years to come. Collins Telecommunications Products Division, Rockwell International, Cedar Rapids, IA 52406. Telex 464-435.

CALIFORNIA

Anaheim — Ham Radio Outlet
Anaheim — Henry Radio Co., Inc.
Burlingame — Ham Radio Outlet
Los Angeles — Henry Radio Co., Inc.
Oakland — Ham Radio Outlet
San Diego — Ham Radio Outlet
San Jose — Quement Electronics
Van Nuys — Ham Radio Outlet

COLORADO

Denver — C. W. Electronic Sales Co.

FLORIDA

Miami — Amateur Radio Center, Inc.
Miami Springs — Argon Electronics Co.
Orlando — Amateur Electronic Supply

GEORGIA

Atlanta — ACK Radio Supply

HAWAII

Honolulu — Honolulu Electronics

ILLINOIS

Chicago — Erickson Communications, Inc.
Peoria — Klaus Radio, Inc.

INDIANA

Terre Haute — Hoosier Electronics, Inc.

KANSAS

Overland Park — Associated Radio Comm., Inc.

LOUISIANA

Metairie — Thomas J. Morgavi Elec.

MARYLAND

Wheaton — Electronics Int'l. Service Corp.

MINNESOTA

Minneapolis — Electronic Center, Inc.

MISSOURI

Butler — Henry Radio Co. St. Louis — Ham Radio Center
St. Louis — Midcom Electronics, Inc.

NEVADA

Las Vegas — Amateur Electronic Supply

NEW HAMPSHIRE

Concord — Evans Radio, Inc.

NEW YORK

Amsterdam — Adirondack Radio Supply, Inc.
Farmingdale, L.I. — Harrison Radio
New York — Barry Electronics Corp.
New York — Harrison Radio
Valley Stream — Harrison Radio

NORTH CAROLINA

Otto — Slep Electronics Company

OHIO

Wickliffe — Amateur Electronic Supply

OREGON

Portland — Portland Radio Supply Co.

PENNSYLVANIA

Trevoise — Hamtronics

TEXAS

Dallas — Electronic Center, Inc.
Houston — Madison Electronics Supply

WASHINGTON

Seattle — ABC Communications
Spokane — HCJ Electronics

WISCONSIN

Milwaukee — Amateur Electronic Supply

comments

(Continued from page 6)

lightning protection

Dear HR:

While I was pleased to see two letters in the July issue complimenting my article on lightning protection, I must take exception to W6RTK's suggestion that the ground wire on a wooden pole be broken into short lengths, with small spark gaps between segments.

The main ground conductor on a wooden pole is one of the most important items in the protection system. The establishment of a low impedance path from the air terminal on top of the pole to ground is necessary to send the greatest possible percentage of the total lightning stroke current directly to ground. Although lightning will certainly jump across the small gaps recommended, the presence of these gaps will have a negative effect on the performance of the overall protection system. I don't know how to quantify the amount of degradation, but I don't think it's wise to take a chance. Also, even if lightning doesn't strike the pole, the breaking up of this ground lead may allow the entire antenna system to acquire a large static charge, possibly sufficient to cause minor equipment damage.

Mr. Caldwell is concerned that this ground wire may have some undesirable effects on the performance of the antenna system; when considered from the standpoint that the ground wire only makes the wooden pole look electrically equivalent to a metal tower, I think it is safe to say that this effect must be minimal.

John E. Becker, K9MM
Prospect Heights, Illinois

quartz crystals

Dear HR:

It has been brought to my attention that a statement in my article on quartz in the February issue was misleading if not incorrect. While it is

true that crystals have high inductance and low motional capacitance, this is not the reason for high Q ; Q is a ratio of the charge stored to the charge dissipated. In crystals the charge is primarily stored by the inductance, so Q is determined by the value of the motional inductance divided by the motional resistance:

$$Q = \frac{2\pi fKI}{RI}$$

Most of us associate high inductance with a large piece of iron wrapped in copper wire — an arrangement which is completely ineffective at rf. With quartz, you must rethink the problem.

Don Nelson, WB2EGZ
Voorhees, New Jersey

10 meters for satellite communications

Dear HR:

I write in response to W1GMP, who suggests (July *ham radio*) that we discontinue the use of 29.360 - 29.502 MHz for satellite communications. To put this into proper perspective, the frequency spectrum reserved for this purpose is no wider than two 25-kHz wide repeaters, adding both input and output bandwidths, yet serves fifty times as many stations on an intercontinental basis.

Apart from the aspect of communications, the use of 10 meters has been the basis of valuable research into sub-horizon communications, E_s and aurora detection and forecasting, and low-level signal techniques; it is also of great value in using Amateur Radio for teaching practical physics, geometry, trigonometry, astronomy, and mathematics through the use of a simple antenna and receiver.

The present maximum in the solar cycle will soon begin to decay, leaving only the satellite devotees to effectively occupy the high end of 10 meters. This will help prevent intrusion and takeover of the top part of the band, safeguarding it by regular, valuable usage.

Pat Gowen, G3IOR
Norwich, England



**Rockwell
International**

...where science gets down to business

WHEN OUR CUSTOMERS TALK... WE LISTEN.



John Fail, KL7GRF/6
Long Beach, CA



Vernelle "Red" Irwin, K9KUW
Kenney, IL

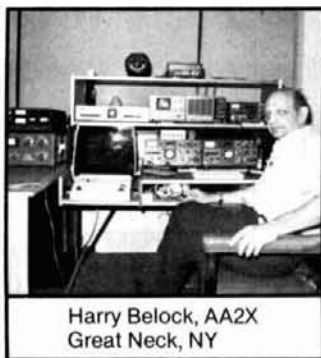

Harry Belock, AA2X
Great Neck, NY

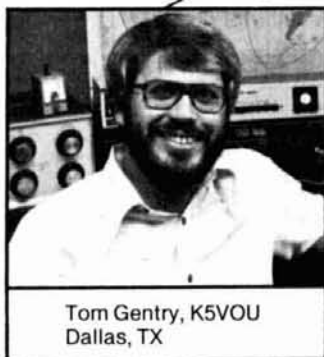

Tom Gentry, K5VOU
Dallas, TX

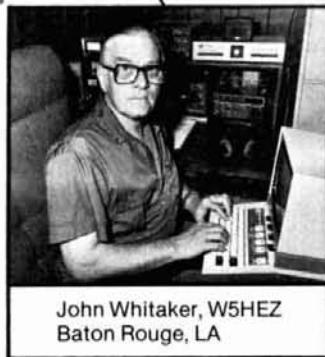

John Whitaker, W5HEZ
Baton Rouge, LA

And we respond with unexcelled RTTY equipment.

One reason RTTY equipment designed by HAL is always state-of-the-art quality is our open channel of communications with customers.

We *want* to hear the "What if's..." and "How about's..." that come from active and dedicated RTTY operators. Our engineers have combined

customer ideas with their own to create the most advanced equipment features and capabilities in the industry.

It adds up to greater enjoyment of RTTY operation and a dependability factor backed with a full one-year warranty.

Write or give us a call. We'll be glad to send you our new RTTY catalog.



HAL COMMUNICATIONS CORP.
Box 365
Urbana, Illinois 61801
217-367-7373

For our European Customers Contact:
Richter & Co., D3000 Hannover 1
I.E.C. Interlco, 6816 Bissone/Lugano

CMOS 2-meter synthesizer

Construction details
of a 2-meter
synthesizer featuring
choice of
output frequency
and CMOS design

Soon after joining the 2-meter fm crowd about three years ago, I learned how limiting "rockbound" mobile operation can be. At the same time, I had been wanting to learn more about frequency synthesizers, and designing and building one looked like the perfect answer to both needs. The result of my labor tunes from 146.000 to 147.995 MHz in 5-kHz steps and provides a variety of output frequencies to permit use with quite a number of rigs. This article will give full details on how the design was thought out, as well as how to build a copy. If you are interested in the subject of synthesizers, want to design one of your own but wonder where to start, or have soldering iron in hand ready to begin building, this article is for you.

design requirements

In addition to the above description, I expected the completed design to meet the following requirements:

1. Thumbwheel switch selection of receive and transmit frequencies
2. High output purity, at least 60-dB spur rejection

3. Self-contained; simple construction and circuitry
4. Minimum of test equipment needed to align and test
5. Minimum modification of 2-meter rig
6. Capable of mobile operation

operating frequency

The first choice was an operating frequency for the synthesizer. By looking at schematics and information on a number of common rigs, I learned that most use a receive crystal near 45 MHz. Transmit frequencies are less consistent and include $f/6$, $f/12$, $f/18$, and $f/24$. The circuit simplicity and purity goals ruled out the use of multipliers; therefore, I picked 45 to 49 MHz, or one-third the channel frequency.

synthesizer concepts

The next step was finding the most suitable method of synthesis. A literature search showed that the most popular type of synthesizer today is an elaboration of the phase-locked loop (PLL). Fig. 1 shows the block diagram of such a system. In this, the VCO (voltage-controlled oscillator) is made to run at N times the reference frequency, f_R , which is normally fixed. Because of loop feedback, changing the divide ratio, N , also changes the VCO frequency to maintain the frequency relationship shown.

Because of its apparent simplicity, this kind of synthesizer seemed like an ideal approach for my design; but, after studying the logic required, some serious complications were obvious. The need for an i-f shift to go from transmit to receive made the design a real mess.

By Tom Cornell, K9LHA, RR2, Box 53A,
Greentown, Indiana 46939

Several synthesizer schematics showed a different approach that looked like it had real promise; **fig. 2** shows the basic block diagram. The design freedom introduced by choice of crystal frequency allows the same variable divider ratio to be used in both transmit and receive. This results in great simplification of the overall synthesizer system.

practical design

This section will cover the more important design considerations.

VCO. The simplest form of VCO is a varactor-tuned oscillator, and a common circuit is shown in **fig. 3**. While a VCO can be developed by trial and error, it is much easier to calculate tank circuit values using the equations shown in the **Appendix** of this article.

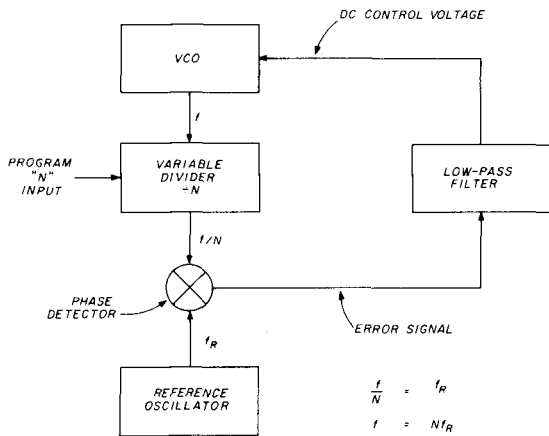

fig. 1. Block diagram of a simple synthesizer using a phase-locked loop.

Assuming a receiver i-f of 10.7 MHz, the minimum and maximum VCO frequencies are:

$$f_{max} = 147.995/3 = 49.33166 \text{ MHz}$$

$$f_{min} = (146.000 - 10.7)/3 = 45.1 \text{ MHz}$$

After picking some varactors (Motorola MV-2209) and suitable end point voltages, I was able to begin using the equations.

$$C_{max} = 50 \text{ pF (1V)} \quad C_{min} = 28 \text{ pF (6V)}$$

Letting $C1 = 330 \text{ pF}$ and $C2 = 33 \text{ pF}$ and assuming 3 pF of transistor and stray capacitance, the total fixed capacitance, T , was 33 pF. The equations then gave $C_p = 88.2 \text{ pF}$ and $L = 0.19 \text{ }\mu\text{H}$. The circuit was built using these values and worked just about exactly as intended.

Oscillator/mixer. Design of the oscillator/mixer has quite an impact on the variable divider, and, after much study I decided on:

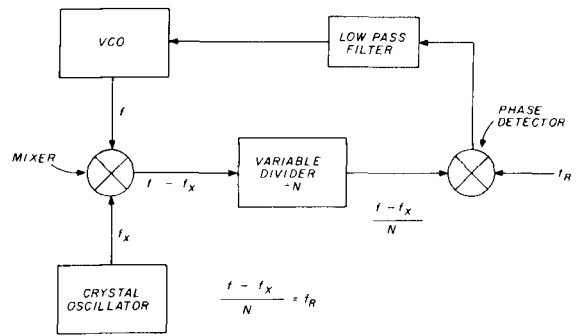

fig. 2. Diagram of a mixing-type synthesizer where the same divide ratio can be used for either transmit or receive, with the change in frequency accomplished by shifting the crystal oscillator frequency.

$$N \text{ at } 146.000 \text{ MHz} = 400$$

$$f_{xtal} (TX) = 48 \text{ MHz}$$

$$N \text{ at } 147.995 \text{ MHz} = 799$$

$$f_{xtal} (RX) = 48 - i\text{-}f/3$$

These numbers are a good illustration of synthesizer operation, and it might help your understanding if you plug them into the equation shown in **fig. 2**.

After selecting these points, design of the oscillator and mixer was relatively uncomplicated. A dual-gate MOSFET with an untuned output circuit was selected as the mixer, and two separate oscillators were used for receive and transmit.

Variable divider. The variable divider design has a lot to do with the complexity of a synthesizer circuit, and an intelligent choice is very important. Some of the divider requirements have already been covered, and the remaining important characteristic is speed. For this kind of synthesizer, the highest divider speed is:

$$f_{in(max)} = N_{max} \times f_R = 1331.66 \text{ kHz}$$

After studying the above requirements and the data sheets of a number of prospective devices, I chose the RCA CD4059 as the most suitable. This IC is a CMOS, 5-stage, BCD-programmable counter which has exactly the capability needed in this design. Additional factors favoring this choice were the inherent properties of CMOS. This logic family offers greater circuit density than TTL. It also consumes far less power, which incidentally means that there will be much less high-frequency energy produced to cause interference in other parts of the synthesizer.

Phase detector. A second CMOS IC, the CD4046, was selected as the phase detector. This is a special purpose device designed specifically for such an

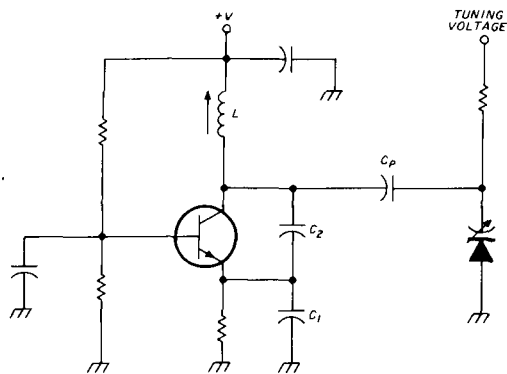

fig. 3. Schematic diagram of the basic VCO oscillator. The computations for the component values are shown in the appendix.

application. In addition to the phase detector, the CD4046 has a lock detection circuit that will be described later.

Lowpass filter. To keep the phase detector switching products from frequency modulating the VCO, a lowpass filter is inserted in the tuning line to the VCO. Because of its inherent phase shift, this filter is also to a large degree responsible for determining the PLL stability. And, while there are formulas for calculating filter values, I felt that the complex relationships involved would dictate some "cut and try" anyway, so that was the design approach I used. A circuit from another synthesizer was used as the starting point, and experimentation helped to determine the final values.

Fig. 4 shows the basic circuit. R1 and R2 together with C1 establish the main cutoff frequency, which must be somewhat less than the system reference frequency. C2 and C3 must be several times smaller than C1 to avoid instability and are included to add to the filtering action. R3 dampens the filter to control overall synthesizer system stability. My design method was to listen to VCO harmonics on an fm receiver and to make a sudden change in synthesizer frequency. R3 was then adjusted until the system demonstrated stable transient behavior.

Reference-frequency circuit. The reference frequency of a synthesizer is normally equal to the channel spacing. For this design, the spacing is 5 kHz and the reference frequency is 5/3 kHz, since the VCO operates at one-third the output frequency. For reasons of stability and accuracy, crystal control is usually considered a must.

After looking at several alternatives, I chose a crystal frequency of 2.56 MHz and a CD4060 CMOS oscillator/divider IC to generate the 5-kHz signal. A CD4027 dual J-K flip-flop was then used to divide by three to get 5/3 kHz.

System tests. When all of the preceding synthesizer circuits were hooked together, Murphy put in his first appearance. Switching from receive to transmit invariably causes the loop to drop out of lock, and output signal purity was awful. The first problem resulted from something I overlooked; transmit/receive switching caused the input frequency to the variable divider to jump by $f/3$, which could exceed the reliable counting speed of that IC. Adding a frequency-shifting circuit to the VCO to retune the tank for the receive and transmit ranges solved the problem.

A buffer amplifier was placed between the VCO and mixer because it was found that the crystal oscillator was the cause of spurs in the VCO output, and the oscillator signal was getting to the VCO through the mixer. Purity now measured better than 60 dB, so I figured the design was adequate. After finishing the rest of the circuits, doing printed circuit artwork, building the synthesizer and hooking it up to my rig, I learned that Murphy doesn't give up very easily! The oscillator/tripler of my rig's receiver degraded purity to only 55 dB. Since the crystal oscillator was still the source of unwanted signals, lowering the output of the crystal oscillator was the logical way to reduce

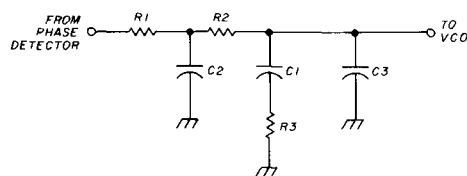

fig. 4. Schematic diagram of the lowpass filter that is inserted between the phase detector and the VCO.

the spurs. Unfortunately, this change resulted in insufficient drive to the variable divider, and new circuit boards were required to add the extra amplifier between the mixer and divider needed to bring the level back up. But the effort was worth it. Purity at the synthesizer output improved to about 75 dB, and at the receiver mixer 65 dB.

Output divider. To obtain the various output frequencies needed from this synthesizer, I made the logical choice of a divider stage driven by the VCO. Of the frequencies listed earlier, only $f/18$ presented any problems. The others could easily be derived by dividing the VCO frequency by 2, 4, or 8. Not providing an $f/18$ output did seem to be a compromise of the original requirements, but the improvement in circuit simplicity looked like a desirable trade-off, especially since only one rig that I knew of (Regency HR-2B) used $f/18$. Builders are still encouraged to consider this synthesizer design even though they may have to substitute for a small portion of the cir-

cuitry in order to get the precise frequencies.

operation

This section will briefly describe the function of the major circuit elements shown in **fig. 5**. The VCO is composed of Q3 and surrounding components. CR1 is the tuning varactor. Three buffer amplifiers and U6, the output divider, follow up the VCO. Buffer Q4 acts as a squaring amplifier to convert the sinewave VCO output to a squarewave suitable to drive NAND gate buffers U5D and U5B. U5D amplifies the $f/3$ VCO signal, and U5B isolates this output from U6 and its back-fed divider products. Any of the four divider outputs from U6, as well as $f/3$ from U5D, can be jumper-selected as the synthesizer receive and transmit output frequencies. NAND gates U5A and U5C actually supply these outputs to the transceiver.

To the left of the VCO are Q2 (the MOSFET isolation buffer) and Q1 (the VCO frequency-shifting transistor). During receive, Q1 is turned on and places C14 across the VCO tank. A TTL logic-level signal at the Q1 collector also serves to turn off the transmit output during receive.

Below Q1 are the two crystal oscillators, which together with mixer Q7 were added to simplify the variable divider design. Either Q5 or Q6 is turned on by application of supply voltage. LC tanks are in series with both crystals to allow slight adjustment of actual oscillator frequency.

The mixer output signal is amplified by Q8 and Q9 to an adequate level to drive U1, the variable divider. As shown, U1 looks deceptively simple; actually, it is very busy inside. The divide ratio is loaded from the switch inputs, U1 counts down N pulses to zero, produces a single output pulse, and then reloads the divide ratio to begin the cycle again.

All the frequency selector switches are shown in two groups below U1. Diode OR-gates between the transmit and receive switches isolate the two groups of switches and allow selection of transmit or receive operation by mere application of supply voltage. Toggle switches are used for both MHz and 5-kHz ranges, since they are all that is necessary and are much cheaper than thumbwheels.

To the right of U1 is the phase detector, U2. This IC provides a tuning voltage for the VCO at pin 13 that is filtered by the lowpass filter composed of R23, R24, R25, C27, C28, and C29. At pin 1 of U2 is the lock-detector output, which is normally high when the PLL is locked and goes low in a series of pulses when out of lock.

Q10 and Q11 amplify and stretch the lock detector pulses of U1 to produce a continuous logic-level signal that both lights the UNLOCKED indicator and shuts off the synthesizer transmit output. C26 serves to slightly delay the turn-on of Q10 so that slight dis-

turbances of the loop don't shut down the transmitter.

ICs U3 and U4 generate the synthesizer reference frequency. U4 contains a crystal oscillator running at 2.56 MHz and a divide-by-512 circuit (in this application) to produce 5 kHz. U3 then divides this frequency by three to produce $5/3$ kHz. C23 allows for exact adjustment of oscillator frequency.

In the power supply, three-terminal regulators U7 and U8 provide 5 and 8 volts respectively. Control gates Q12 and Q13 are driven by the transceiver push-to-talk line and select either receive or transmit operation of the synthesizer by providing logic supply voltages. The input LC filter, L8 and C49, serves to protect the synthesizer from transients and noises from the car's electrical system.

construction

The two synthesizer circuit boards may be assembled in any order, with the exception of the CMOS IC's which should be saved to the last to avoid damage from static electricity. (See **figs. 6** and **7**, respectively, for the circuit board pattern and parts placement diagram.)* Clip a ground wire from the soldering iron to the ground copper of the board when soldering these ICs.

Fig. 8 shows construction of the VCO coil.[†] Since this coil form was chosen for reasons of mechanical rigidity, you will need to cover the completed winding with Q-dope or airplane cement to ensure coil stability. Tighten the shield can to the base by making small impressions on at least two sides of the can into the plastic base with a center punch.

The plastic-molded coils used in the crystal oscillators may prove hard to find, and you can probably substitute most any good-quality coil forms of suitable size. Information on the number of turns is shown in the parts list.

L8, the supply filter choke can be made, or a suitable commercial part used. To make the choke, cut the heads off some small-diameter nails and tape them together to form a core roughly 30-mm (1 1/4-inch) long by 5-mm (3/16-inch) in diameter. Wind a coil of about one-hundred turns of no. 22-26 AWG (0.6-0.4 mm) wire over the core. Finish by covering with electrical tape. Form the leads to fit the circuit board and mount to the board with ordinary string or wire wrapped over the body of the coil.

Install jumpers to select the correct output frequencies for your rig. For receive, connect a small piece of insulated wire from pin 2 of U5 to one of the divider outputs. For transmit, the jumper goes from

*The circuit boards and many components to build the synthesizer are available from Radiokit, Box 429, Hollis, New Hampshire 03049.

†The VCO coil form is a standard 10-mm i-f transformer form. If you are unable to find such a part, it may be purchased from the author for \$1.00.

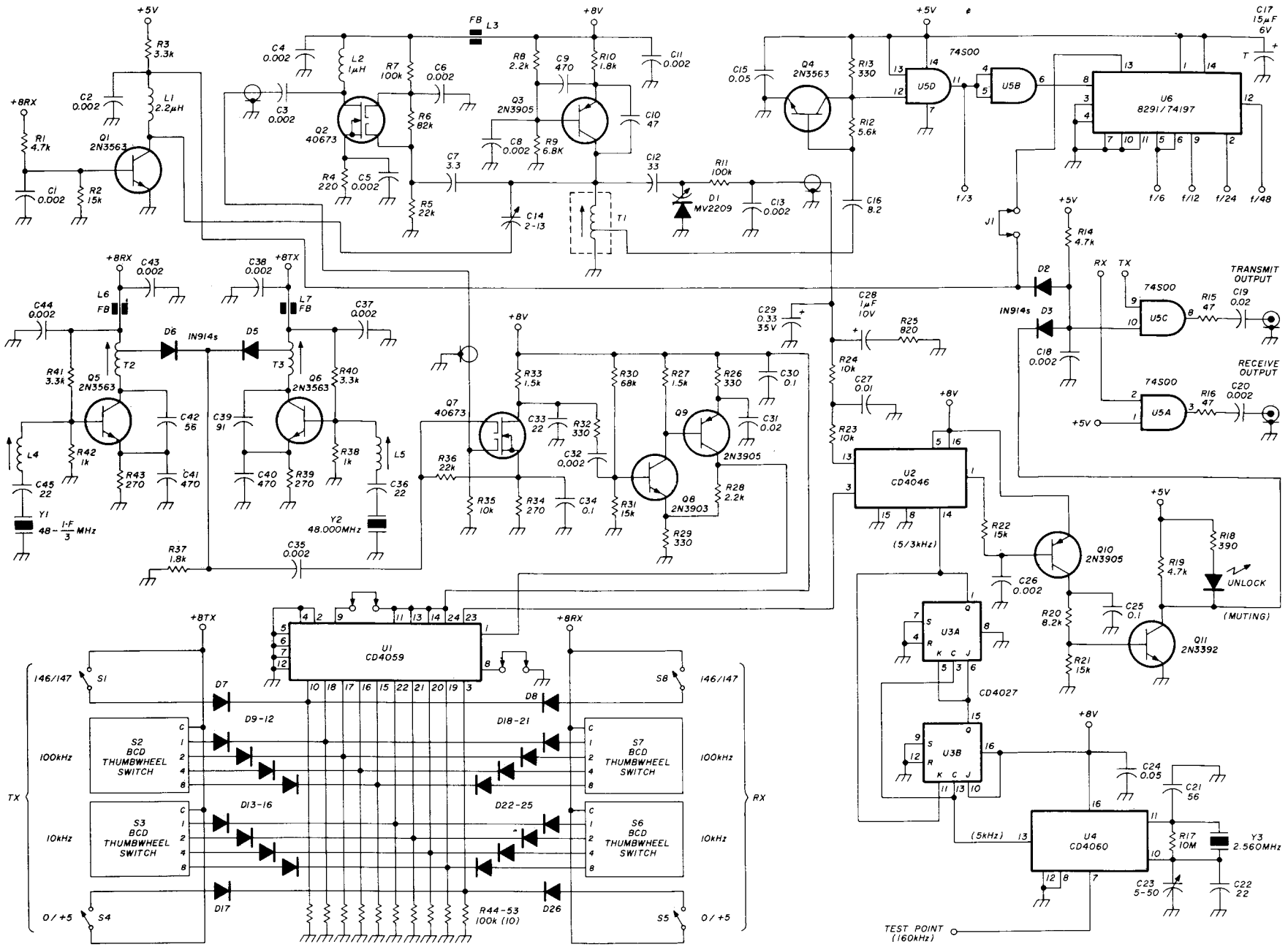

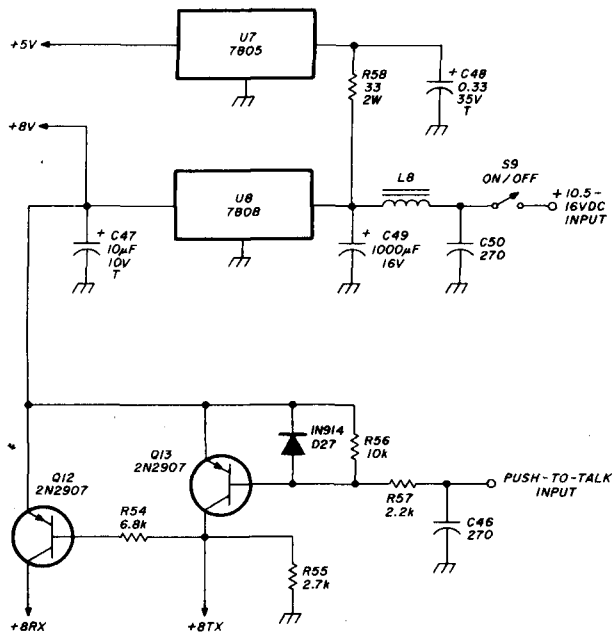

fig. 5. Schematic diagram of the CMOS synthesizer (opposite). The individual portions of this schematic are discussed in the text. All small-valued capacitors are NPO ceramics. Power supply is seen above; parts list is below.

- L4 11 1/2 turns 6.5 mm (1/4 inch) diameter, slug-tuned, close-spaced molded plastic form
- L5 10 1/2 turns, same as L4
- L8 see text
- T1 5 1/2 turns, tap at 2 turns, no. 32 AWG (see fig. 8).
- T2 6 1/2 turns, tap at 1 3/4 turns, spaced 1 wire diameter, no. 26 AWG (0.4-mm) wire, plastic-molded 6.5 mm (1/4-inch) diameter form, J-iron core
- T3 same as T2 except aluminum core
- Y1 $f = (48 - i-f/3)$ MHz, see text (44.4333 MHz, $i-f = 10.7$), same as Y2 except frequency
- Y2 48.000 MHz, series mode, third overtone, 0.0025 per cent tolerance, HC-18/U case
- Y3 2.5600 MHz, parallel mode, fundamental, 32-pF load, HC-6/U case with wire leads, 0.005 per cent tolerance

pin 9 of U5 to a divider output. Note that the receive frequencies actually contain an $i-f$ offset and are really $(f - i-f)/3$, $(f - i-f)/6$, etc. If the $f/3$ receive option is used, install jumper J1 as shown in fig. 7. This will turn off U6 during receive and eliminate some low-level subharmonic spurs U6 produces. If $f/3$ is not used for receive, install jumper J2 instead to allow U6 to operate in both transmit and receive.

Temporarily install interconnecting wires between the two boards to allow circuit alignment. Connect the following: 5 volts, 8 volts, 8 volts RX, VCO tuning voltage (coax), and the VCO buffer output (coax). The synthesizer will operate on 146.000 MHz in this condition.

alignment

Alignment of the synthesizer requires the following equipment: a dc voltmeter (VTVM or high-input impedance), and a-m/fm radio (a portable set is fine), the diode detector probe shown in fig. 9, and a regulated power supply (preferably current limited). Other useful equipment includes a frequency counter (50 MHz, high-input impedance), a grid-dip meter, and a general-coverage receiver.

Connect the synthesizer to a 12-volt supply; it should draw approximately 125 mA. Next, check the 5- and 8-volt supplies, which should be within 5 per cent of the correct value. Test the 8V-RX and 8V-TX lines. With the push-to-talk line open, 8V-RX should read 8 volts and 8V-TX about a volt. Grounding the push-to-talk input should bring the 8V-TX up to 8 volts and drop 8V-RX to zero.

Next, some kind of check on the 2.56-MHz oscillator should be made. There are several possibilities, including connecting the diode probe to pin 7 of U4 (dc output voltage should be around 6.5 volts); measuring the same point with the counter (it should be 160.000 kHz, adjust with C23); and listening with the a-m/fm receiver (antenna near U4) at 640 or 1280 kHz, or listening with the communications receiver at 2.560 MHz. Alignment can be by the counter or by comparing one of the U4 divider products (1.28 MHz, 640 kHz, etc.) with a known frequency such as an a-m radio station.

The easiest method for testing the receive crystal oscillator is to hold a grid-dip meter near T2 as the slug is adjusted. An fm receiver tuned to the second harmonic of the oscillator can also be used, as well as the diode detector probe connected across R37. Adjust the slug of T2 for maximum output and then turn it toward the top of the coil until the dc voltmeter connected to the diode probe reads 0.25 volts. Ground the push-to-talk line, and then make the same adjustment and check on the transmit crystal oscillator and T3. If you are able to use an aluminum slug in T3, remember that, compared with an iron slug, it works backwards.

If the oscillators refuse to run, temporarily bypass the base to ground with a 0.001-to-0.002 μ F capacitor. You can then find out what the free-running frequency of the oscillator is and make corrections in T2 or T3 or the value of C39 or C42. If you can adjust the oscillator in this condition to the crystal frequency, then crystal control should work, too.

If you have a high-impedance counter available, connect it across R37. Adjust the slugs of L4 and L5 to fine-tune the frequency of each oscillator. Without a counter, you may be able later to arrange some type of on-the-air check to adjust frequency.

Measure the VCO tuning voltage with your dc volt-

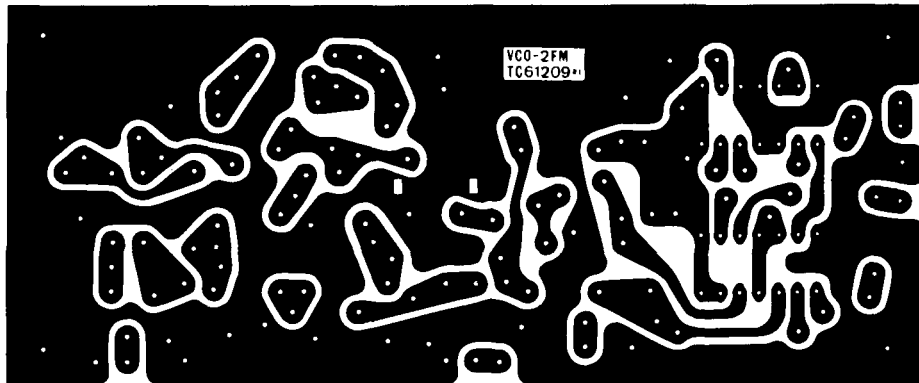
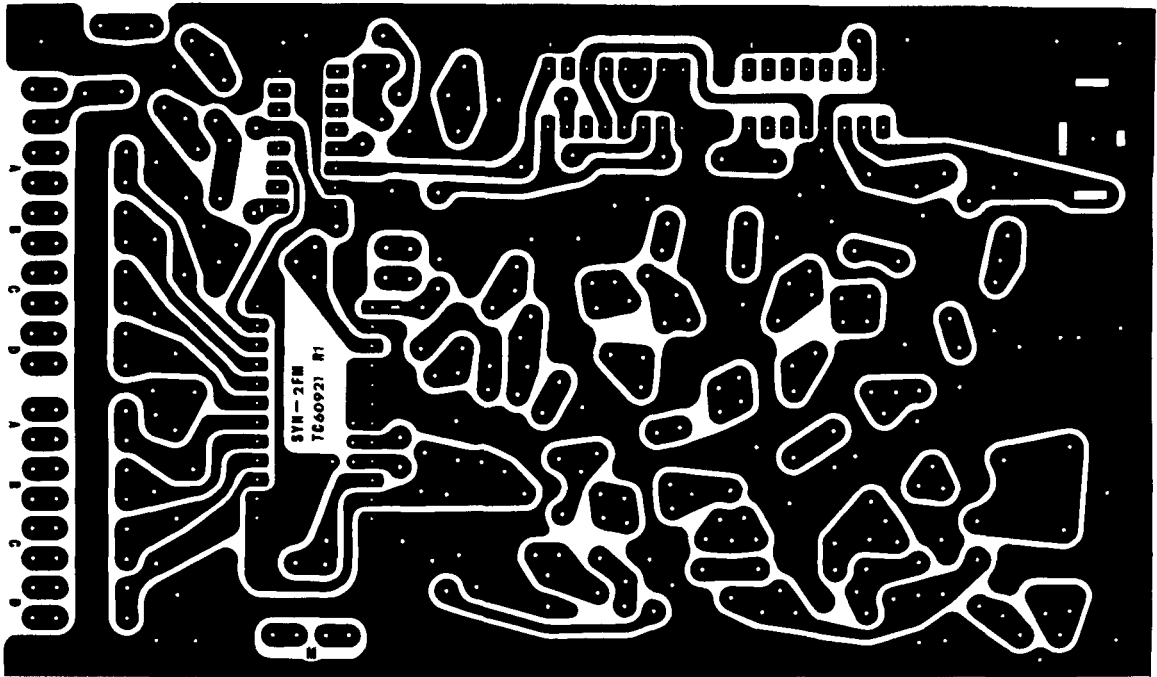

fig. 6. Foil pattern for the synthesizer board (above) and the VCO board (below).

meter and ground the push-to-talk input. If the voltage is 8 volts, turn the slug of T1 toward the top of the can. If the voltage is, instead, zero, turn the slug into the coil. Adjust for a final reading of 1.0 volt. At this point, you should be able to hear the VCO harmonic at about 97.3 MHz on the fm receiver.

If the tuning voltage cannot be adjusted, the problem may be one of several things. A high tuning voltage is caused by a high VCO coil inductance, and a low voltage by low inductance. If slug adjustment is insufficient, the coil turns may need to be changed; the turns can be spread apart or squeezed together. As an alternative, C10 can be changed slightly to get the right tuning range. A dead VCO, mixer, crystal oscillator, or mixer output amplifier will also cause the tuning voltage to go to 8 volts.

Once the VCO works correctly in transmit, remove the ground from the push-to-talk line. Adjust C14 for

a tuning voltage of 1.0 volt and verify operation by listening to the VCO's second harmonic on the fm radio at 90.2 MHz.

final construction

The synthesizer boards may now be boxed to your preference. My experience has indicated two possible critical areas: the VCO board will very likely require a complete shield to keep transmitter rf away from the VCO. For the same reason, wires between the two circuit boards should be kept away from the power/control wires entering the box from the transceiver. Once the unit is assembled, I usually recommend a touch-up alignment of the VCO and crystal oscillators to compensate for any stray capacitance added by the case. When the frequency selector switches have been connected, you will have your first opportunity to check full operation of the syn-

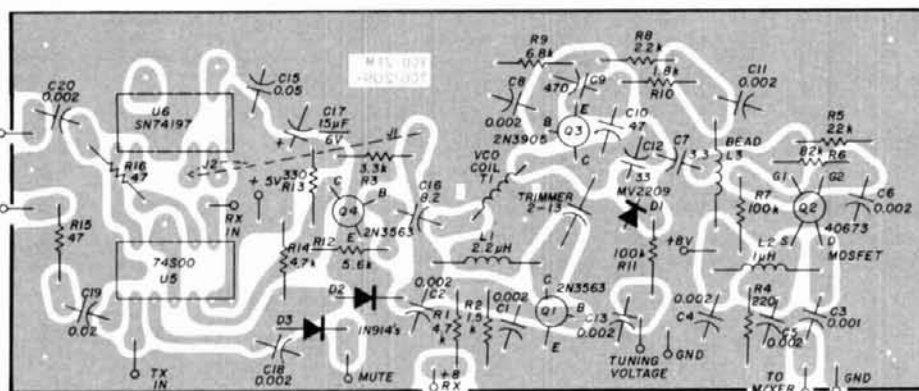
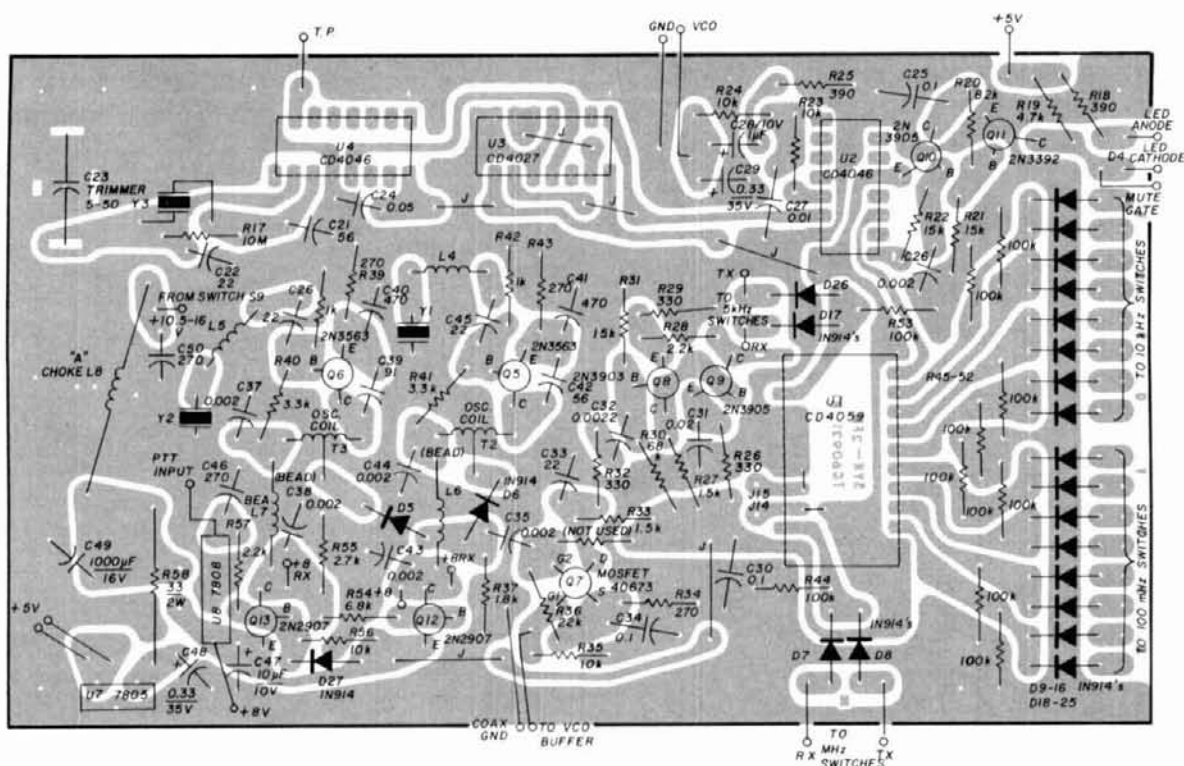

fig. 7. Component placement diagrams for the synthesizer board (above) and the VCO board (below).

thesizer by listening to it on the fm radio or your 2-meter rig.

connecting your rig

Fig. 10 shows the circuits I used to couple the synthesizer to my rig's receive and transmit oscillators. Install these right at the crystal sockets of your rig, drill holes, and mount two coax connectors on the rear of your rig. Connect up the entire system using coax cable. Make sure the inductor tunes to the transmit crystal frequency with the capacitors of your oscillator circuit, and adjust the resistor (470 ohms in fig. 10) to keep the transmit oscillator from running on its own (you will be mighty unpopular on 2 meters if it does).

Next, connect the power and push-to-talk lines from your rig to the synthesizer. Shielded cable is strongly recommended for this purpose.

The synthesizer and transmitter should now be thoroughly tested in the transmit mode, first on a dummy load and then on an antenna. Any rf that gets into the VCO can cause instability and flickering or illumination of the LED indicator. The dummy load check will determine if your rig is feeding rf back from its oscillators into the synthesizer. This condition may be corrected by insertion of a lowpass filter, having a cutoff frequency just above the synthesizer's output frequency, in one or both of the synthesizer output lines. The antenna test is somewhat more complicated in that certain antenna types,

especially the gutter-mount and magnet-base variety can cause appreciable ground currents to flow on the coax. The solution in these cases is wire rerouting away from the synthesizer and possibly within the synthesizer, and use of additional shielded wires plus the VCO shield.

additional possibilities

The simple BCD programming of this synthesizer makes it easily adaptable to some interesting fre-

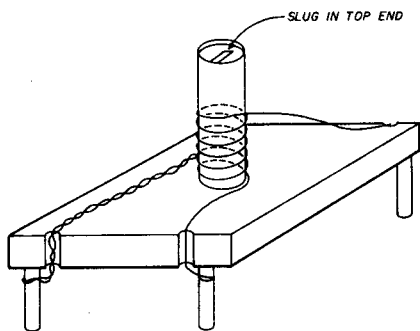

fig. 8. Detailed diagram of the VCO coil. The form is a standard 10-mm shielded slug-tuned form.

quency control methods. Replacing the switches with an up-down counter will allow scanning as well as LED frequency readout. A memory can be used to store favorite channel frequencies, or a microprocessor can be added for all kinds of control functions including scanning all channels, a group of channels, or those you preset. Your imagination is the limit.

When this synthesizer was developed, I intended to build at least one unit to cover 150 to 159.995 MHz to tune some of the vhf mobile channels. That is the

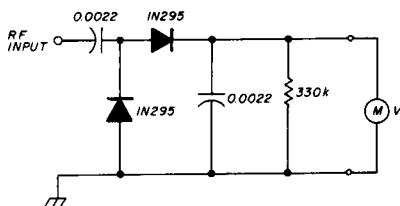

fig. 9. Schematic diagram of an rf diode probe suitable for tuning the synthesizer.

reason for the two jumpers beneath U1. Although I've not had time yet to try this, expanded coverage might appeal to you. This design will, therefore, permit operation over the expanded 2-meter band as proposed by the FCC.

final comments

I hope that this article has proven valuable to you. Should you have questions about the design or prob-

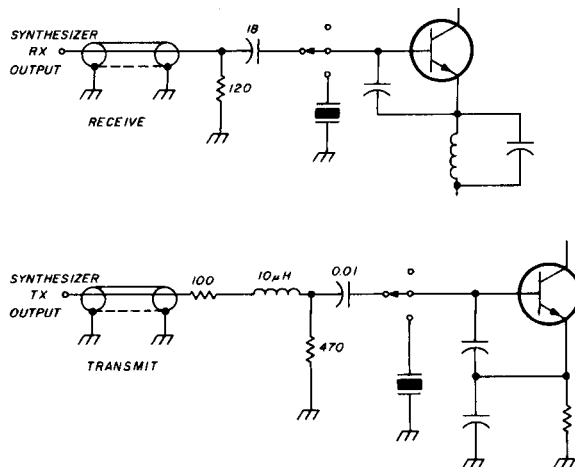
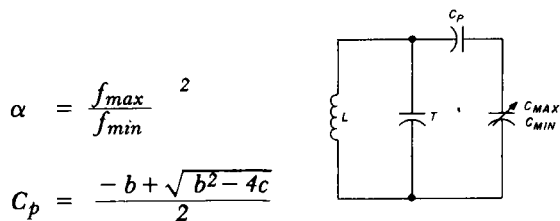

fig. 10. Diagrams of the interface circuits between the synthesizer and the rig's receive and transmit crystal oscillators.

lems in construction, please feel free to write me, but do enclose an SASE.

I'd like to offer my thanks to those who helped me in this project: Dib, K9HLG, and Tom, W9IJ, for their encouragement, counsel, and interest in the project; to Russ, K9AYD, for his valuable ideas on logic and synthesizer design; and to Bill, WA9GUY, for his mechanical help and engraving of the front panel.

appendix



$$\alpha = \frac{f_{max}}{f_{min}}^2$$

$$C_p = \frac{-b + \sqrt{b^2 - 4c}}{2}$$

$$b = \frac{(1 - \alpha) [T(C_{max} + C_{min}) + C_{max} C_{min}]}{(1 - \alpha) T + C_{max} - \alpha C_{min}}$$

$$c = \frac{(1 - \alpha) T C_{max} C_{min}}{(1 - \alpha) T + C_{max} - \alpha C_{min}}$$

$$C_T = T + \frac{C_p C_{max}}{C_p + C_{max}}$$

$$C_T = \text{total tank } C \text{ at } f_{min}$$

$$L = \frac{1}{(2\pi f_{min})^2 C_T}$$

$$= \frac{25330.34 \mu H}{(f_{min})^2 C_T} \quad \begin{matrix} f \text{ in MHz} \\ C_T \text{ in pF} \end{matrix}$$

fact: the sound of the professionals belongs in amateur radio

Experienced operators recognize that the audio quality of the transmitter is limited by the quality of the input from the microphone. On the air, there's no mistaking the crisp, intelligible messages from Shure microphones.

Shure microphones have been the overwhelming choice of professional communications users all over the world for over 30 years. And, many of the milestone improvements developed for the demanding professionals are found on Shure microphones for amateur radio. Described below are just some of the Shure-developed advances that have eliminated many field maintenance costs common to amateur radio microphones.

ARMO-DUR® Case: Lightweight, immune to oil, grease, fumes, salt spray, sun, rust, and corrosion. Prevents RF burn!

"Million Cycle" leaf switch: Just one of the crucial wear points Shure-tested to insure reliability and extraordinary durability.

TRIPLE-FLEX® Cable: Provides three or four times longer flex life than previously available cords on hand-held microphones.

CONTROLLED MAGNETIC® or Dynamic Transducer: The exclusive Shure-designed super-rugged transducers that give excellent voice intelligibility and super reliability.

To improve your on-air intelligibility we suggest the following Shure Microphones for amateur radio applications:

	Mobile Application	Fixed Station Application
SSB	414A* 407A* 577A**	444* 526T Series II
FM	414B* 507B* 577B**	450 526T Series II

*General recommendation: Consult equipment instruction manual for correct microphone impedance.

**Noise-canceling.

SHURE Fixed Station Mics.



**Controlled Magnetic®
Fixed Station
Microphone
(Models 444, 450)**

Our most popular fixed station microphones. Unmatched performance characteristics. Adjustable stand raises microphone for most comfortable talking position.

**New
Transistorized Fixed
Station Microphone
(Model 526T Series II)**

A new design for maximum versatility in fixed station operation. Modulation level (volume) control for high undistorted output with high- or low-impedance inputs.

SHURE Hand-Held Mobile Mics



Omnidirectional Mics (Models 407A, 407B, 507B)

Small, easy-to-handle design, with rugged Dynamic or CONTROLLED MAGNETIC® transducers for excellent voice intelligibility. Hum-shielded and insulated against shock. Model 507B Dynamic version features extended low and high frequency response, especially suitable for mobile FM transmitters. Modular construction simplifies field service.



Compact Mini Mics (Models 414A, 414B)

Ideal for miniaturized or portable communications systems, or where dashboard space is limited. The 414 Series CONTROLLED MAGNETIC® microphones are about half the size and weight of conventional microphones—yet they are rugged units, recommended for critical outdoor or indoor applications.



Noise-Canceling Mics (Models 577A, 577B)

These Shure Dynamic microphones shut out background noise, permit clear transmission even where the noise level is so great that the operator cannot hear himself talking! The ARMO-DUR® case is lightweight, feels natural to the touch. The 577A is high impedance; the 577B is low impedance.

Intelligibility & Reliability



Shure Brothers Inc., 222 Hartrey Ave., Evanston, IL 60204. In Canada: A. C. Simmonds & Sons Limited
Outside the U.S. or Canada, write to Shure Brothers Inc., Attn: Dept J6 for information on your local distributor.
Manufacturers of high fidelity components, microphones, sound systems and related circuitry.

environmental aspects of antenna radiation

How to calculate approximate near-field radiation levels to meet existing environmental standards

At present there's a great deal of interest and controversy regarding non-ionizing electromagnetic radiation and its effect on the environment. This issue, of course, affects Amateur Radio. Suggestions have been made that all nonionizing electromagnetic radiation be eliminated from residential areas, or that such radiation be limited to levels that would make Amateur Radio operation impossible.

Some groups, in a wave of hysteria, are attempting to make *all radiation* illegal. As in most situations of this type, when one looks at the facts, the picture becomes clearer.

In a report by the U.S. General Accounting Office dated March 29, 1978,¹ it states that 10 mW/cm² is the maximum level to which a human should be exposed for 6 minutes per hour, and that 1 mW/cm² is the maximum continuous exposure. In other words, to be completely safe, one should stay at levels of 1 mW/cm² or less. These levels are recommended by the American National Standards Institute (ANSI) for frequencies between 10 MHz through the microwave region.

analysis

I have calculated the approximate separation distances between the radiation source (Amateur antennas) and humans to meet the recommended levels in reference 1. These data are shown in **figs. 1A through 1D** for four Amateur antennas: half wave, quarter wave, eighth wave, and sixteenth wave. Parametric curves show the input power to the antenna at two field-strength levels, 1 mW/cm² and 10 mW/cm².

Looking at **fig. 1A**, one can see that if an Amateur

operates on 7 MHz using a half-wave antenna with 100 watts input, the antenna must be at least 4.6 meters (15 feet) from any human to keep the field strength at 1 mW/cm² or less. At a power of 1 kW input to the antenna, the field at 4.6 meters (15 feet) increases to 10 mW/cm². Thus it's necessary to move the antenna a distance of 7.3 meters (24 feet) from any human to reduce the field to 1 mW/cm².

If the antenna has 10 dB gain in one direction, the equivalent antenna input would be 10,000 watts instead of 1000 watts. The field at 7.3 meters (24 feet) would increase to 10 mW/cm² in the direction of the antenna gain.

The apparent free-space field strength near any antenna can be approximated by:

$$P_{field} = \frac{755L^2 P_{ant} K}{Z_{ant} \lambda^4} \text{ watts/meter}^2 \quad (1)$$

where L = length of antenna (meters)

P_{ant} = power input to antenna
(watts at Z_{ant})

Z_{ant} = input impedance of antenna (ohms)

λ = wavelength in meters (300/ f_{MHz})

$$K = \frac{(\alpha r)^4 + 3(\alpha r)^2 + 5}{(\alpha r)^6} \text{ (values in table 1)}$$

$$\alpha = 2\pi/\lambda$$

r = distance from the antenna (meters)

f = frequency

After the apparent free-space field strength has been calculated in watts/meter² it can be converted to mW/cm² by multiplying the calculated value by 0.1. In other words, 100 W/m² is the same as 10 mW/cm². If the field strength in volts/meter is desired, the following expression can be used:

$$E_{field} = \sqrt{120\pi(P_{field} W/m^2)} \text{ volts/meter} \quad (2)$$

By John Abbott, K6YB, P.O. Box 66, Newhall, California 91322

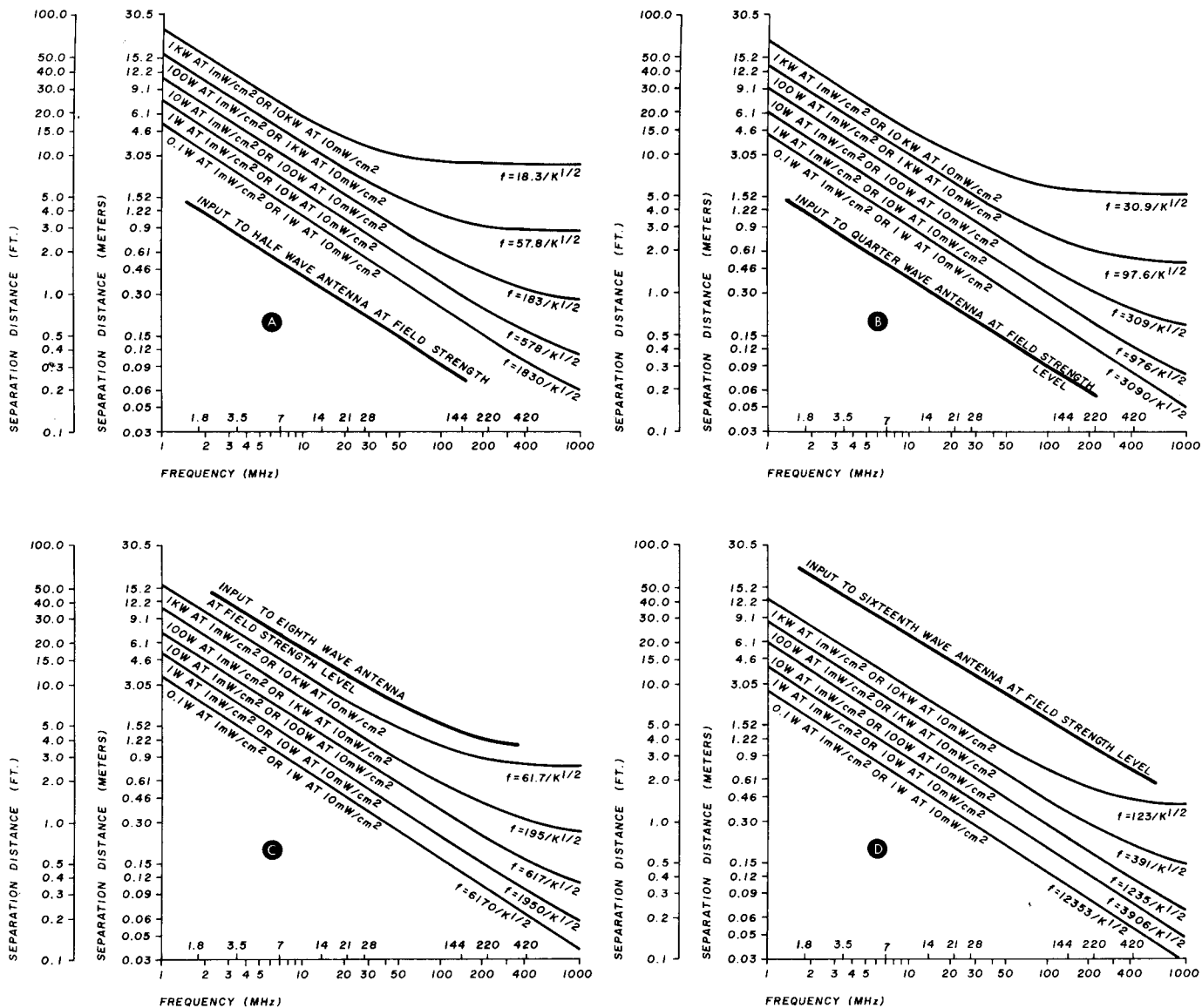

fig. 1. Separation distance as a function of frequency for recommended input power to four Amateur antennas: (A) one-half wavelength; (B) one-quarter wavelength; (C) one-eighth wavelength; and (D) one-sixteenth wavelength.

where 120π is the impedance of free space. Using this expression, 10 mW/cm^2 is the same as 194 volts/meter field intensity.

K values (eq. 1) are shown in table 1 as a function of τ/λ , the ratio of the distance from the antenna in meters to the wavelength in meters. Using this table and eq. 1 for P_{field} , it's possible to calculate the fields at various distances from an antenna to obtain the apparent free-space field intensity. Otherwise, use fig. 1 to make sure that your antenna is always at a separation distance with less than 1 mW/cm^2 field intensity. (A mathematical derivation of eq. 1 is available from *ham radio* upon receipt of a self-addressed stamped envelope).

practical considerations

There should be no problem for most Amateurs in installing an antenna away from houses and areas occupied by humans, except for the 160- and 80-meter bands. In these cases it may be necessary to limit power input to the antenna if necessary distances can't be maintained. The real difficulty lies in the operation of handheld portables above 25 MHz. If adequate separation from the body is maintained, it will be difficult to talk into a handheld unit. You'll have to decide if the risk is worth the exposure.

Mobile operation above 25 MHz should be no problem if simple precautions are followed. Tables 2

table 1. Proximity coefficient *K* as a function of the ratio of distance from antenna, *r*, to wavelength, λ .

ratio of distance from antenna, <i>r</i> , to wavelength, λ <i>r</i> / λ	proximity coefficient, <i>K</i>
0.01	81,000,000.000
0.015	7,170,000.000
0.02	1,282,000.000
0.04	20,620.000
0.06	1,890.000
0.08	364.700
0.10	103.000
0.15	12.300
0.20	3.110
0.25	1.186
0.30	0.640
0.35	0.388
0.40	0.252
0.45	0.187
0.50	0.135
0.60	0.089
0.70	0.0596
0.80	0.0452
0.90	0.0346
1.00	0.0272
1.20	0.01872
1.40	0.01368
1.60	0.0104
1.80	0.0080
2.00	0.00654
2.50	0.00416
5.00	0.001028

and 3 show a summary of approximate operating distances that should prevent overexposure for most Amateur installations.

I'd like to emphasize that, in this article, I make no attempt to account for the shielding effects of buildings or the susceptibility of humans to radiation at any given frequency. The field levels are simply calculated at each frequency shown. It may well be that 1 mW/cm² is more of a hazard at 420 MHz than at 1.8 MHz. Such matters will have to be explored by medical research.

The data presented here will allow Amateurs to estimate field-strength levels from the antennas described in a manner that will meet present recommended criteria. Furthermore, the data will provide ammunition with which to fight pressure groups who are trying to abolish Amateur Radio!

addendum

The effects of radiation from electronic equipment on the environment has become a hot issue of late. The FCC has issued a Notice of Inquiry (NOI), General Docket 79-144 (June 15, 1979) which states in paragraph 33:

"It may be desirable for the Commission to consider the need for applying to the subjects of its jurisdic-

tion one of the existing safety criteria, such as the 10 milliwatt per square centimeter (10 mW/cm²) short-term exposure limit used by ANSI and OSHA . . ."

Furthermore, ANSI is considering reducing this level to 1 mW/cm². What does all this mean to Amateur Radio? The answer is presented in the article above.

If you are concerned you'll want to file comments to the FCC/NOI mentioned above before the December 15, 1979 deadline.

hr report has been publishing material on this subject since early March, 1979. The following excerpts from *hr report** are for those wishing more background information:

PROHIBITION OF RADIO TRANSMISSIONS in residential areas is being considered by the Oregon State Senate. Senate Bill 423, sponsored by Senator Ted Hallock of Portland, proposes sharply restricting all electromagnetic emissions in residential areas.

In Testimony Favoring the bill Merrie Buel, government affairs coordinator for the Oregon Environmental Council, said that medical studies "have found that persons living next to electromagnetic sources often experience serious health effects, including rashes, headaches, dizziness and tingling sensations."

Power Transformers and transmission lines as well as radio and TV transmitters would be curtailed under the bill's provisions, though Senator Hallock and members of the Senate Committee on Environment and Energy have been discussing removing transmission lines from its coverage.

As Written the bill would become effective January 1, 1983, after which violations of the standards established for it would be a misdemeanor punishable by a \$250 fine. However, Ms. Buel termed the \$250 fine "merely a slap on the hand," stating that her group felt that "endangering

table 2. Approximate operating distances between an antenna and humans for 1 mW/cm² or less exposure.

frequency (MHz)	antenna length and minimum separation meters (ft.)			
	with 100 W antenna input for 0.1 mW/cm ² field			
	or 1000 W antenna input for 1 mW/cm ² field			
	half wave	quarter wave	eighth wave	sixteenth wave
1.8	16.8 (55)	13.7 (45)	11.0 (36)	8.5 (28)
3.5	11.0 (36)	9.1 (30)	7.0 (23)	5.5 (18)
7.0	7.3 (24)	5.8 (19)	4.6 (15)	3.7 (12)
14.0	4.9 (16)	4.0 (13)	3.0 (10)	2.4 (8)
21.0	4.0 (13)	3.0 (10)	2.4 (8)	1.8 (6)
28.0	3.7 (12)	2.7 (9)	2.1 (7)	1.5 (5)

**hr report* is published by Communications Technology, Inc., Greenville, New Hampshire 03048.

table 3. Approximate operating distances between portable/mobile antenna and humans.

frequency (MHz)	Antenna length and minimum separation, cm (in.)							
	with 10 W or 1 W antenna input for 10 mW/cm ² * (divide power by 10 for 1 mW/cm ² field)							
	half wave		quarter wave		eighth wave		sixteenth wave	
	10W	1W	10W	1W	10W	1W	10W	1W
50	55.9 (22)	40.6 (16)	48.3 (19)	33.0 (13)	35.6 (14)	25.4 (10)	27.9 (11)	20.3 (8)
144	27.9 (11)	17.8 (7)	25.4 (10)	15.2 (6)	17.8 (7)	12.7 (5)	15.2 (6)	10.2 (4)
220	22.9 (9)	15.2 (6)	17.8 (7)	12.7 (5)	15.2 (6)	10.2 (4)	10.2 (4)	7.6 (3)
420	15.2 (6)	10.2 (4)	12.7 (5)	7.6 (3)	10.2 (4)	7.6 (3)	7.6 (3)	5.1 (2)

* Maximum exposure at 10 mW/cm² should be limited to 6 minutes/hr.

people's health should be considered a much more serious offense." Furthermore, she said, the OEC wants the bill to become law much sooner since, "we suggest that the sooner electromagnetic radiation is under control, the safer the public health." (HRR 245, March 16, 1979).

EFFECTS OF CB ANTENNA RADIATION on the bodies of nearby people is being investigated by the Department of Health, Education and Welfare. The first study, published in a 24-page booklet titled "Measurement of Electromagnetic Fields in Close Proximity of CB Antennas," discusses bumper, trunk lid and rooftop-mounted mobile antennas as well as those on hand-held units. Near field radiation distribution of each type is presented graphically, in an attempt to determine what hazard, if any, radiation presents.

The Study Concludes: "The health implications (of CB antenna radiation) are not clear at this time. The Bureau of Radiological Health is continuing to investigate this matter." HEW is obviously quite concerned with the effects of RF on the population, and with Amateurs running 200 times the power of CBers on frequencies from 1.8 MHz through millimeter wavelengths, our operations are sure to come under careful scrutiny as well — if they haven't already. (HRR 247, March 30, 1979).

AMATEUR RADIO WAS ATTACKED as "one of the main non-ionizing radiation hazards in the United States" at an April 9-10 meeting of the Subcommittee on Public Health Aspects of Energy, in New York. The group is an arm of the New York Academy of Medicine's Committee on Public Health, reports K6YB, who has an article on the effects of Amateur RF radiation on family and neighbors coming out in *ham radio* magazine later this year. (HRR 253, May 18, 1979).

RF RADIATION HAZARDS are the subject of a new FCC Notice of Inquiry, General Docket 79-144, agreed to by the commissioners earlier this month. Although the Commission noted that promulgation of RF radiation health and safety standards is the responsibility of health and safety agencies, it also recognized that it would have to consider radiation exposure standards adopted by other Federal agencies in its licensing activities.

Full Text Of This Potentially very important NOI, which is reported to contain a number of questions on specific areas of concern, hasn't yet been released. With the environment currently a hot public issue, this NOI could easily become a

crucial one for Amateur Radio as well as most other radio services.

Comment Date for Docket 79-144 is December 15, with Reply Comments due March 15 of next year. (HRR 258, June 22, 1979).

ANOTHER FCC PROPOSAL that could affect Amateur Radio is in General Docket 79-163, which proposes changes in the Commission's environmental impact rules. At present those rules offer some leeway with respect to prospective stations that could have a "Major Impact" on the environment when the actual impact would seem less significant. Under the proposed tighter restrictions, it appears formal impact statements would be required of many more applicants, probably including a number of Amateurs, and the Commission would then have to prepare and distribute a written environmental assessment for each such case.

In A Dissenting Statement to the proposed change, Commissioner Washburn makes the point that environmental impact is not the Commission's business and to make it so would add to their already heavy workload and thus increase licensing delays.

Comments On Docket 79-163 are due by August 1. (HRR 260, July 6, 1979).

HIGH LEVELS OF RF RADIATION have been detected by the FCC in its test of some popular personal computers. Tests of computers manufactured by Atari, Apple, Commodore, Heath, Southwest Technical, and Radio Shack have reportedly shown that, in most cases rf radiation levels far exceed allowable Class 1 TV limits.

With The Popularity of home computers sharply on the rise, the FCC plans to use the data it's collected to set up new rules governing all computers that could be used in the home. It will probably be several months before the FCC decides what action to take and files a notice of proposed rule-making. (HRR 261, page 2, July 13, 1979).

references

1. *Efforts by the Environmental Protection Agency to Protect the Public from Environmental Non-Ionizing Radiation Exposure*, U.S. General Accounting Office, Report CED 78-79, March 29, 1978.
2. Richard A. Tell, "Broadcast Radiation: How Safe is Safe?," *Spectrum*, IEEE, August, 1972, pages 43-51.
3. *Reference Data for Radio Engineers*, Chapter 25, "Antennas," Howard W. Sams & Co., Inc., Fifth Edition, pages 25-1 through 25-3.

ham radio

the Hellschreiber

a rediscovery

European Amateurs
are using
a teleprinting system
made from
World-War II surplus —
will it replace RTTY?

The Hellschreiber is a teleprinting machine based on a principle entirely different from that of the RTTY teleprinter. The Hell system (named after its inventor, Dr. Rudolf Hell) could have been invented with the requirements of the Radio Amateur in mind, but strangely enough the Hell system has never been fully accepted by the Amateur fraternity. The reason may be that an enormous number of used RTTY machines flooded the market at low prices after World War II.

Hell and RTTY existed simultaneously for a long time for both military and commercial use. However, Hellschreibers have now disappeared, mainly as a result of the introduction of protected RTTY systems with automatic-request and error-correcting circuits. Most hams have probably never heard of the Hell system as a means of communications.

the Hellschreiber

What is the Hellschreiber? In contrast to the RTTY machine, in which received pulses determine the character to be printed, the Hellschreiber uses the transmitted pulses to *directly* write images of characters on paper tape. Thus, Hell writing could be considered a simple form of facsimile, covering seven image lines per character, with seven elements per line.

Not only has this system of printing character images some very important advantages to offer, but the simple way in which the Hell teleprinter works is extraordinarily elegant. The thread of a fast-turning worm shaft wipes, with high speed, transversely across a slowly moving paper tape. This worm thread is wet with printing ink. Every time the paper is

**By Hans Evers, PA0CX (DJ0SA), Am
Stockberg 15, D-5165 Huertgenwald, West
Germany**

How The Hellschreiber Works

A. Imagine a fast turning worm shaft above a relatively slow-moving paper tape:

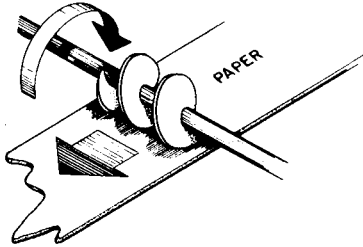

B. The thread on this worm shaft is kept wet with printing ink:

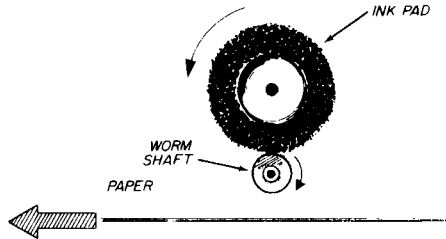

C. Under the paper is a mechanism that taps the paper against the worm shaft by means of an electromagnet:

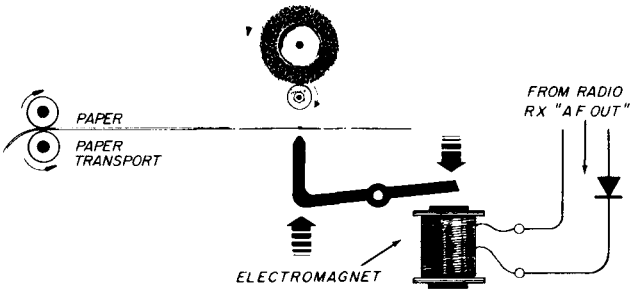

D. What is printed on the paper depends upon the rhythm and the length of time the electromagnet is actuated. For example, if the paper is just tapped, one gets:

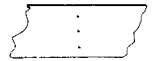

What you see are the little dots where the paper touched the fast-turning worm shaft. If the thread sweeps fast over the paper, and if the electromagnet pushes a bit longer, a little line is printed:

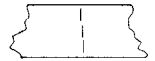

If the tape is tapped in rhythm with the revolutions of the worm shaft, a sequence of little dots is printed:

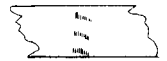

E. Thus, all sorts of simple images can be written; for instance, all the characters of the alphabet:

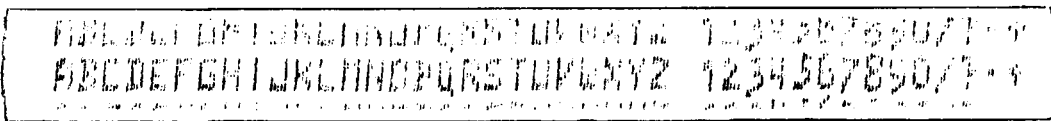

F. Or, if necessary, the characters of anybody else's alphabet, such as Greek, Arabic, or Chinese:

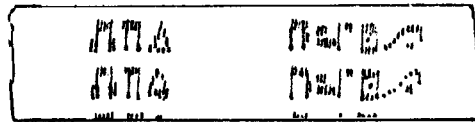

G. What happens if the worm-shaft speed is not quite correct? Nothing serious; the lines of the Hell text threaten to run off the paper tape:



This provides a simple method for determining the correct speed. If, for example, the lines show a tendency to drop, the motor speed must be increased until the lines run straight again. But whatever happens, the text remains legible.

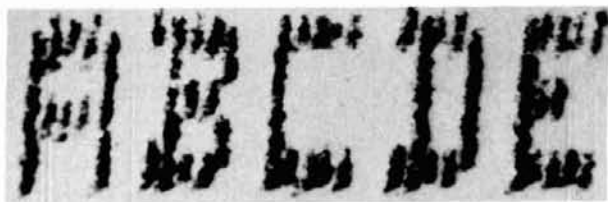

Hell writing. This enlargement shows how each character takes the space of seven image lines. As a result of the relatively slow-moving tape, the characters hang slightly over.

tapped against the turning worm shaft, little lines are formed across the paper tape. Several of these lines together form a character.

The Hellschreiber of the World War II Wehrmacht type we're using runs somewhat slower than the RTTY machine: $2\frac{1}{2}$ characters per second. Nevertheless, a respectable 25 words per minute is achieved. This CW terminology is not misplaced, as Hell and CW have much in common. In fact, given a certain bandwidth, the reliability of Hell communications approaches that of CW.

QRM proof?

During World War II the Hellschreiber proved its reliability. Users recognized that a Hellschreiber could be the only link between an isolated military unit and its headquarters. When all other means of communications failed, often the Hellschreiber managed to get the message through, even when only barbed wire and an earth connection were available as a signal path.

Amateur applications

Our Hell QSOs occur on 80 meters (over here, the official RTTY segment is between 3575-3625 kHz). It's difficult to think of a better part of the radio spectrum for putting the Hell system to the test because of the high QRM level in this portion of the band.

In this context I'd like to mention an interesting side effect. Our modest *prrt, prrt, prrt* Hell signals apparently tend to provoke fury among some hams, who seem to be convinced that the unusual sounds are caused by commercial stations. This turns our little Hell channel into the center of zero-beating and QRZ-blaring stations. This intentional interference does, however, provide us with an invaluable opportunity to test the communications system under highly adverse conditions and is, therefore, to some extent, not unwelcome.

Of course, the interfering transmitter determined to cause serious trouble by tuning carefully zero-beat with our Hell signals may eventually manage to temporarily destroy our communications, provided, of

course, that the signal is stronger than ours. By maneuvering with tuning, bandwidth, and threshold level it's possible to get through. We might lose contact for a moment; however, contact is restored through the foggy QRM clouds on our printouts, and we pick up the text as soon as the characters become distinguishable again. This sort of working on the threshold is possible with Hell: The text, even under the worst conditions, is never subject to errors of a substitution-of-characters type. The character may, however, be difficult to read because of mutilation.

Hell versus RTTY

Under certain circumstances the communications reliability of Hell can be even better than that of CW. The received Hell signal is printed in its original form. At the moment of reception no decision has to be made such as, "Did I hear correctly?" Thus wrong decisions are avoided. The Hell printer enables the reader to decide later on, at his ease, what was actually sent by the distant station.

Some examples are shown of radio Hell-communications in which the printer obviously has great trouble in keeping the text intelligible because of a high noise level or heavy QRM. The examples contain considerably more information than can be deciphered on first sight. If you really take the trouble to read the text, you immediately realize to what the Hellschreiber owes its superior qualities: it calls in the services of a computer, *i.e.*, our human ability to recognize pictures in a chaos of little specks and lines.

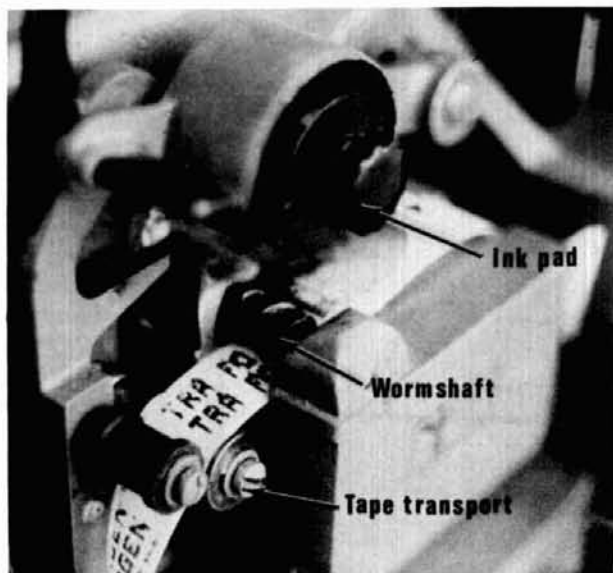

Printing mechanism of the Hellschreiber. The ink pad (felt roll) has been lifted to show the worm shaft. The paper tape is slowly moved by the transport capstan. The electromagnet (not visible) taps the paper tape from below against the fast turning worm shaft.

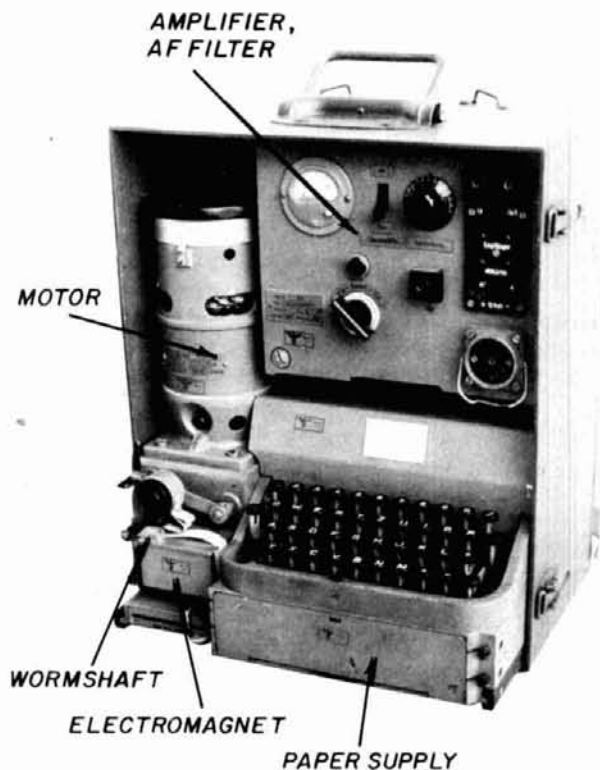

The Feldfernsehreiber. Hellschreiber of the German Wehrmacht (1938) as used on a large scale during World War II. It is with this type of machine that such remarkable results were obtained on the Amateur bands.

The Hell system is less sensitive to interference than RTTY because the Hellschreiber prints the interfering clutter as well as the desired text. This may sound paradoxical, but it becomes understandable if you realize that a teletype printer must translate its received signal into a character before it can decide which key must be pressed. It cannot count upon the services of a "computer." Thus, with RTTY, a single interfering rf spike may result in a wrong decision, turning out a character that has no resemblance whatever to the actual character transmitted. The unprotected teletype character can't warn the reader that it is in error; it can't even indicate that a certain amount of doubt existed during the moment of its selection!

The Hellschreiber, on the other hand, requires no such decisions. The machine just prints, complete with all the received interference. But (and this is the important distinction) although the interference may give the image of the characters an untidy appearance, the Hellschreiber is not capable of changing it. In other words, the Hellschreiber simply leaves to the boss the problem of sorting out the text from the rubbish and doesn't try to disguise the difficult reception conditions.

This is the explanation for the rather amazing fact that you may read Hell text from signals that are only barely audible through an overwhelming amount of QRM; indeed, that it's even possible to decipher Hell signals received *under* the noise level. No wonder we're highly enthusiastic about this fantastic system.

experience with Hell

For three years, almost every week, our little international Hell group (five Dutch, one German, one French, one British) make our regular Hell QSO of an hour or so, using one of the most crowded portions of the 80- and 40-meter bands. Our Hellschreibers are ex-Wehrmacht printers, some of them 40 years old and in fact valuable museum pieces.

As with CW and RTTY, the modest bandwidth requirements of Hell are a great advantage. They are determined by the shortest pulses contained in the signal, being 8.16 ms. This produces a speed of 122.5 baud, requiring a minimum bandwidth of 61 Hz. Even in an overcrowded band it's possible, with a sharp CW filter, to remove most of the QRM or, in case of telephony interference, to keep the bulk of the speech sidebands out of the picture.

Watching a Hellschreiber printer in operation, you can't help being impressed by its imperturbability: While the radio receiver produces the most frightening sort of QRM noises, the machine swallows it all. Quietly, apparently hardly disturbed by it all, it goes on spelling out its characters. Often the QRM is so bad that you need a Hellschreiber to establish that there's still a Hell signal in the air.



Transmitter section of the original Hellschreiber. The coded drum turns one revolution per character. Every time a key is pressed, one turn of the drum produces a series of pulses by the contact with one series of lamellas.

Between transmitter and receiver a certain amount of synchronization is needed, which requires a means of regulating receiver-motor speed. Not that this synchronization is very critical; contrary to what you might expect from a synchronous image-line system, the good old Hell machine is not so easily disturbed by the wrong motor speed. The only thing that might happen is that the written text might drop over the edge of the paper. The text remains legible, however, and, while continuing to read the text, you correct the motor speed by hand until the text prints correctly along the plane of the paper strip. It is this reliable, almost undisturbable, character of the Hellschreiber that makes it such a fine instrument for Amateur Radio communications.

The CW-like disposition of Hell signals permits break-in. Spaces don't produce signals (the tape just runs without printing), so it's possible to cut in between words of the distant station's text. You can even keep watch on the QRM situation between transmitted words.

Hell is economical with transmitted energy. With considerable fewer marks than spaces in its signals, and without start and stop pulses, the average output is about 25 per cent of the maximum output. This low duty cycle permits increased transmitting power.

quo vadis?

It's possible to make a Hellschreiber yourself — something that can't be said for any ordinary tele-



Home made Hellschreiber.

1 [RENDERED AS A NOISY, UNREADABLE SIGNAL]

2 [RENDERED AS A SIGNAL WITH STRONG TELEPHONY INTERFERENCE]

3 [RENDERED AS A SIGNAL WITH A STRONG CW INTERFERENCE]

Reception of Hell signals under extreme conditions.

1. Very weak signal, drowning in the noise. On first sight it's unusable; however, our ability to recognize pictures in a chaos of little specks permits us to read the text into the noise.
2. Interference by a strong SSB telephony signal on the same channel. (Text: "Do you also believe that the other boys are there".)
3. Hell signal exactly zero-beat with equally strong 14-wpm CW signal. (Text: "but as you know the situation is".)

printer. The actual printer consists of only a simple mechanism. This is another advantage of the Hellschreiber. The receiving part is easy to build and may be a good starting point. After gaining some experience with receiving Hell QSOs, you can decide whether it is worthwhile building a Hell transmitter.

We have already built some mechanical Hell printers. Of course, electronics have advanced considerably since 1938, and the dimensions of our modern Hellschreiber can no longer be compared with those of that bulky German design. We now have small electric motors with solid-state speed regulation and we can use refinements such as coils with ferrite cores to pick Hell signals out of overwhelming QRM. Accurately defined Schmitt-triggers are available for separating signals of different levels.

You could even go as far as PA0WV, who has developed a microprocessor displaying received signals as a slowly moving line of characters, complete with interfering pulses (thus fully maintaining all qualities of the Hell system) on an oscilloscope screen.

The transmitter part, "pulse machine," is somewhat more complex to build. In the original Hellschreiber the transmit pulses were produced by a coded drum requiring some mechanical refinements. But a solid-state solution exists here. It was PA0WV again who built the first clock-plus-matrix system that can be hidden under a small keyboard, producing all characters in complete silence.

A converter isn't required for receiving Hell signals. The Hellschreiber can be plugged directly into the headphone jack of any radio receiver (or any telephone line, for that matter). The transmitter output plugs into the KEY jack of any CW transmitter, that's all.

ham radio

FOR THE EXPERIMENTER

INTERNATIONAL CRYSTALS & KITS/OSCILLATORS • RF MIXERS • RF AMPLIFIER • POWER AMPLIFIER

OX OSCILLATOR

Crystal controlled transistor type. 3 to 20 MHz, OX-Lo, Cat. No. 035100. 20 to 60 MHz, OX-Hi, Cat. No. 035101.

Specify when ordering. \$5.22 ea.

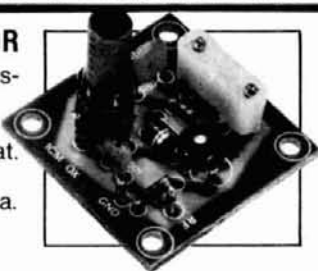

MX-1 TRANSISTOR RF MIXER

A single tuned circuit intended for signal conversion in the 3 to 170 MHz range. Harmonics of the OX or OF-1 oscillator are used for injection in the 60 to 179 MHz range. 3 to 20 MHz, Lo Kit, Cat. No. 035105. 20 to 170 MHz, Hi Kit, Cat. No. 035106.

Specify when ordering. \$5.80 ea.

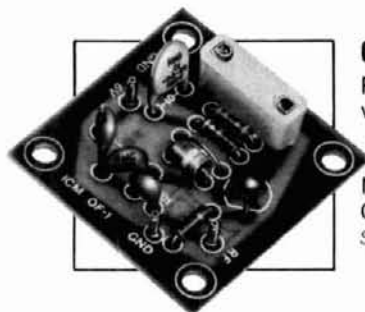
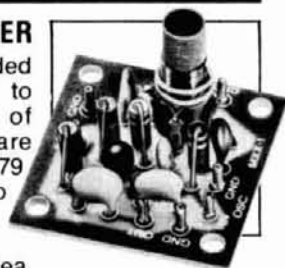

OF-1 OSCILLATOR

Resistor/capacitor circuit provides osc over a range of freq with the desired crystal. 2 to 22 MHz, OF-1 LO, Cat. No. 035108, 18 to 60 MHz, OF-1 H Cat. No. 035109.

Specify when ordering. \$4.48 ea.



PAX-1 TRANSISTOR RF POWER AMP

A single tuned output amplifier designed to follow the OX or OF-1 oscillator. Outputs up to 200 mw, depending on frequency and voltage. Amplifier can be amplitude modulated 3 to 30 MHz, Cat. No. 035104.

Specify when ordering. \$6.06 ea.

SAX-1 TRANSISTOR RF AMP

A small signal amplifier to drive the MX-1 Mixer. Single tuned input and link output. 3 to 20 MHz, Lo Kit, Cat. No. 03512. 20 to 170 MHz, Hi Kit, Cat. No. 035103.

Specify when ordering.

\$5.80 ea.

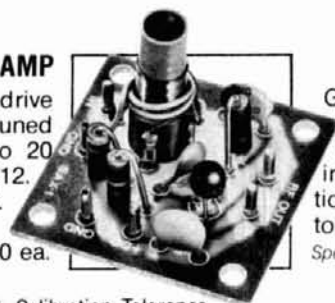

BAX-1 BROADBAND AMP

General purpose amplifier which may be used as a tuned or untuned unit in RF and audio applications. 20 Hz to 150 MHz with 6 to 30 db gain. Cat. No. 035107.

Specify when ordering.

\$6.06 ea.



.02% Calibration Tolerance

EXPERIMENTER CRYSTALS (HC 6/U Holder)

Cat. No.	Specifications	
031080	3 to 20 MHz — for use in OX OSC Lo	
	Specify when ordering	\$6.25 ea.
031081	20 to 60 MHz — For use in OX OSC Hi	
	Specify when ordering	\$6.25 ea.
031300	3 to 20 MHz — For use in OF-1L OSC	
	Specify when ordering	\$5.22 ea.
031310	20 to 60 MHz — For use in OF-1H OSC	
	Specify when ordering	\$5.22 ea.

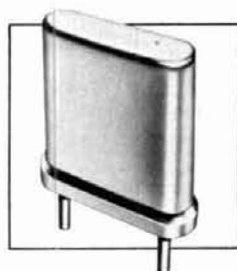

Shipping and postage (inside U.S., Canada and Mexico only) will be prepaid by International. Prices quoted for U.S., Canada and Mexico orders only. Orders for shipment to other countries will be quoted on request. Address orders to: M/S Dept., P.O. Box 34297. Oklahoma City, Oklahoma 73132



INTERNATIONAL CRYSTAL MFG. CO., INC.
10 North Lee / Oklahoma City, Okla. 73102

log-periodic antenna design

The LP is a useful antenna for Amateur applications — it provides constant gain and a low VSWR over a wide frequency range

The **log-periodic (LP) array** is a moderate-gain antenna useful for many Amateur applications. It has the desirable characteristics of constant gain and low VSWR over a wide frequency range. It's very forgiving of construction and design tolerances. Accordingly it doesn't require fancy test equipment or interminable pruning to achieve satisfactory operation. Minor errors may result in somewhat reduced gain but won't markedly affect the basic radiation pattern or front-to-back ratio. Once a design has been completed, it's seldom necessary to make adjustments after the antenna has been erected.

This article deals with the design of LP antennas using simple formulas that can be worked on any 4-function calculator. Also given is a simplified approach using only tables and elementary arithmetic, which allows you to design single or multiband LPs to fit into an available space. Examples shown are for wire antennas. For vhf arrays using tubing, appropriate changes should be made to obtain the effective element length. Robert Carrell presented an excellent paper, "The Design of Log-Periodic Dipole Antennas," which is in the IEEE International Convention Record for 1961. Data for the article here was, in a large part, derived from that paper.

The design gains shown here are approximate and may seem low to many readers. They are given as the free-space pattern gain with reference to a dipole (dBd). Many antenna designs are quoted as dB

above isotropic (dBi) and sometimes include ground reflection gain over a perfect reflecting surface. Such approaches are misleading and can yield numbers anywhere from 2.2 to 8 dB higher over a dipole.

Amateur applications

The LP is particularly useful in split-band operation such as working DX on 40 or 75 meters, where the frequency separation of U.S. and foreign bands is frequently greater than the bandwidth of many other types of antennas, such as Yagis.

In many areas of the world, material such as telescoping aluminum tubing is difficult and expensive to obtain. The LP, either in a fixed configuration or rotatable in a design using forward V-shaped horizontal-wire elements supported by a shaped stress-line diamond, may be built from simple available materials: wire, bamboo, and nylon line. YV5DLT, Ansel Eckels, has built several of the latter configuration that have worked very well.

In all probability the number of Amateur bands will increase in the not too distant future; new bands have been proposed at 10.1, 18.1, and 25.25 MHz. An LP can be designed to cover 10-30 MHz, with performance and size making it comparable to many current triband beams. At least two Amateur manufacturers (KLM and Telrex) have a practical-size LP rotatable array that comes close to meeting this requirement. Alternatively, a multiband Yagi covering six bands would be quite a mechanical challenge. Unless extreme care is taken in trap design, it would be quite lossy.

For those who operate in the vhf bands, a single LP can yield good performance from 50 MHz through 432 MHz. After many years and many other design approaches, the LP has become the standard configuration for most TV antennas.

Don Bostrom, N6IC, in the DXpedition to Wallis Island in 1974, used a homemade LP with good suc-

By **P. A. Scholz, W6PYK**, and **George E. Smith, W4AEO**. Mr. Scholz's address is 12731 Jimeno Avenue, Granada Hills, California 91344. Mr. Smith can be reached at 1816 Brevard Place, Camden, South Carolina 29020

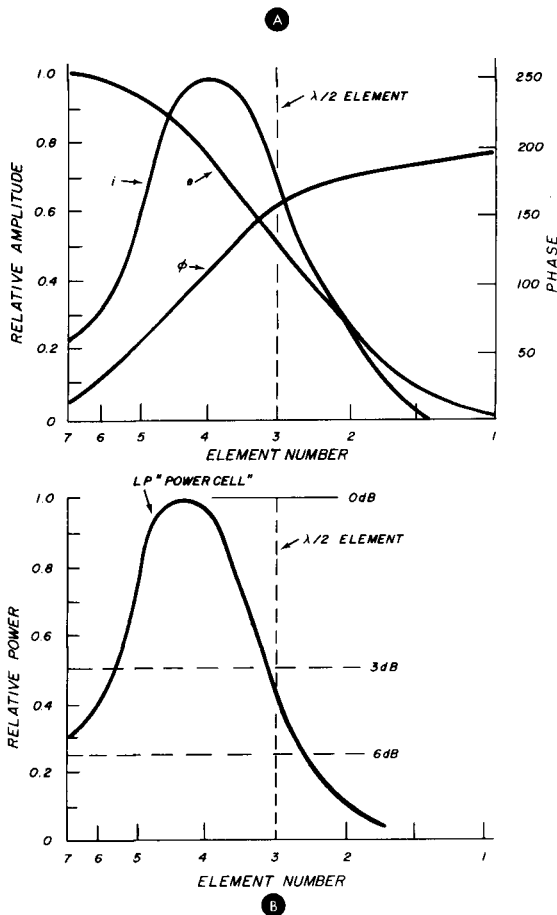
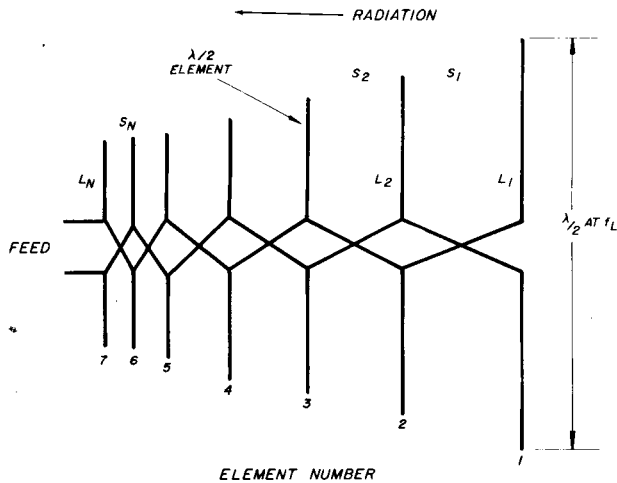

fig. 1. A 7-element LP antenna (A) with equations defining taper factor, τ , in terms of element length, L , and element-spacing relationships, $S_1, S_2 \dots S_N$. Characteristics are shown in (B). Upper curve: voltage, current, and phase at an arbitrary frequency higher than lowest desired operating frequency, f_L . Lower curve: approximate power distribution, illustrating the "LP cell," which occurs in the region where the elements are less than $\lambda/2$ long.

cess. It was a vertically polarized 5-element wire array for 10, 15, and 20 meters.

Compared with the Yagi, the LP will usually have somewhat lower gain. However, it does have a significant advantage in bandwidth and maintains its front-to-back characteristics over the entire design frequency. A properly designed LP working through a balun will allow a solid-state transmitter to operate efficiently over a wide frequency range without an antenna tuner. For example, a 7-element wire beam covering the low end of 80 meters to the high end of 40 meters, and with a good match, can be erected in a space roughly 43 meters square (140 feet square) and will have a gain of about 6 dB.

description

The basic LP consists of a number of dipoles arranged in a plane (fig. 1A). The element lengths, L , and the relative spacing, σ , are arranged in a geometric progression with a taper factor, τ . Each element is connected to the feeder in an alternating manner. The feedline is transposed between each set of elements as the easiest method with wire elements and as an intra-element feedline.

The array operates as a backward-wave antenna; radiation is in the direction of the feed. Propagation velocity is about 0.35. The free-space pattern in the plane at right angles to the elements is similar to a cardioid: egg-shaped in the radiation direction in the plane of the elements. The LP operates over a frequency band defined by the longest element, about $\lambda/2$ long at the lowest frequency, and the shortest element, about $\lambda/4$ at the highest frequency. The gain is constant over this frequency interval; therefore the beam width in E and H planes is constant in free space. Over real ground, the elevation beam maxima will change in angular position with frequency because the effective height in wavelengths will change.

Many configurations have been discussed in *ham radio* and other literature. These include the inverted T monopole, which is a vertically polarized ground-plane array; a configuration using inverted V elements; and truncated LPs, which use fewer than the optimum number of elements.

characteristics

Power to the elements is maximum in the region where the elements are somewhat less than $\lambda/2$ long. This is called the "LP cell" (fig. 1B). The cell at a particular frequency encompasses the longest element, $\lambda/2$, and a few shorter elements. The shortest

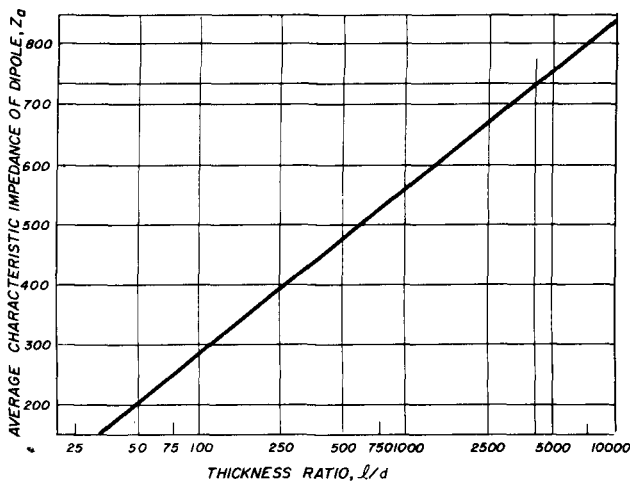

(A)

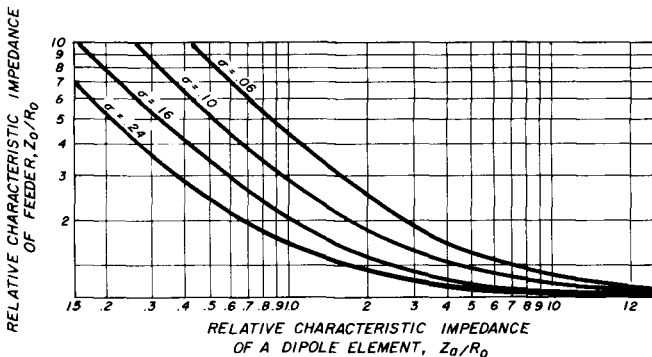

(B)

fig. 2. Data for the LP intra-array feedline design. The "natural" dipole impedance is selected from curve (A), which shows the average characteristic impedance of a dipole, $Z_a = 120 (\ln \ell/d - 2.25)$. (B) shows relative feeder impedance as a function of dipole impedance with spacing factor, σ , as a parameter.

element is approximately $\lambda/4$ long.

The array will operate as an antenna at frequencies lower than that defined by the longest element of $\lambda/2$; however, the front-to-back ratio will degrade rapidly, and the gain will be impaired.

For large taper factors (τ near unity) many elements are within the cell and the array has high gain. For small taper factors only a very few elements will be within a cell, and the gain will be much lower. Table 1 shows how the gain for an optimum-gain design varies as a function of the frequency range and number of elements.

feed system

The LP at low frequencies is usually fed by coax through a balun. The LP feedpoint impedance, unlike that of other antennas, is a function of the natural dipole impedance and the spacing factor, σ . A con-

venient feedline impedance can be used with a balun at the antenna to obtain a low VSWR (fig. 2). Air dielectric should be used to prevent excessive phase shift within the array feed. Any other dielectric increases the spacing factor, σ , in a complex manner. From tests run by W4AEO, the driving point impedance for low-frequency arrays at $\lambda/4$ high is on the order of 225 ohms, with an intra-array feedline characteristic impedance of 450 ohms. Typically the intra-array feedline is formed from 14 AWG (1.6-mm) wire spaced for a feedline impedance of about 450 ohms. This, with a 4:1 balun, results in a close match to 52-ohm coax.

array gain considerations

For each value of taper factor, τ , there is a corresponding value of spacing factor, σ , which yields maximum gain (fig. 3). Smaller-than-optimum spacing factors may be used with consequent loss of gain but without pattern degradation. Larger-than-optimum values of spacing factor cause undesirable lobes. The optimum spacing factor, σ , is approximately 0.19 times the taper factor, τ .

Some commercial rotatable or space-saving arrays have spacing factors as low as 0.03. For example, one may build an array covering 7-30 MHz on a 10-meter (33-foot) boom (sixteen elements, $\tau = 0.895$; $\sigma = 0.03$). It would have about 5.5 dBd gain over this band. With the optimum spacing factor of 0.17, the gain would increase to 7.3 dBd, but the boom length would become 59.5 meters (195 feet). Thus by compromising gain for bandwidth you can build an effective, very broadband array with a practical boom length. This may be more desirable than stacking several potentially interacting Yagi arrays.

mathematical design

Here's a design approach for LP antennas using simple mathematics that can be worked on a 4-function calculator. It is presented to show how the basic design is evolved.

Definition of terms. All of the LP design terms needed for calculator implementation are as follows:

f_H = highest desired operating frequency

f_L = lowest desired operating frequency

$B = \frac{f_H}{f_L}$ = desired frequency ratio

B_s = structure bandwidth; ratio of length of longest-to-shortest element

B_{ar} = array bandwidth of active region (amount by which B_s is reduced to obtain usable bandwidth; $B = \left(\frac{B_s}{B_{ar}}\right)$)

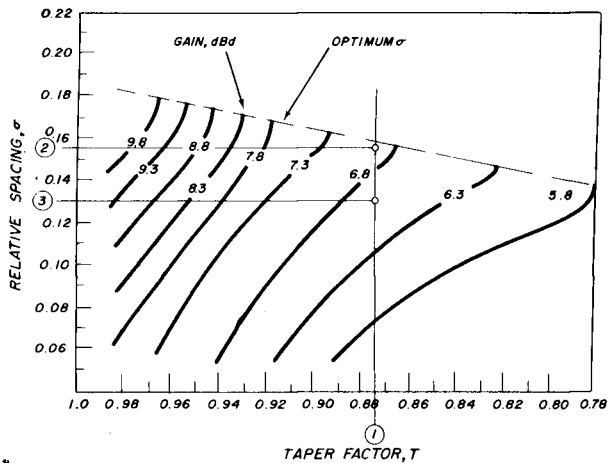

fig. 3. Relative spacing, σ , as a function of taper factor, τ , with contours of constant gain, dBd, as a parameter. Circled values are used in a simplified LP design approach as described in the text.

τ = taper factor

σ = spacing factor

λ_0 = free-space wavelength
 $= \frac{300}{f_{\text{MHz}}}$ in meters; $\frac{984}{f_{\text{MHz}}}$ in feet

λ_L = free-space wavelength at lowest frequency

λ_1 = antenna wavelength using wire
 $= \frac{286}{f_{\text{MHz}}}$ in meters; $\frac{936}{f_{\text{MHz}}}$ in feet

(λ_1 is 5 per cent less than the free-space number because of end effects.)

L = element length
 = array length

S_1 = spacing of first two elements

dBd = gain above dipole, approximately 2.2 dB below isotropic gain (dBi)

design steps for log-periodic antenna

1. Select desired band ratio, $B = \frac{f_H}{f_L}$
2. Select an initial set of values for τ , the taper; and σ , the element spacing factor from fig. 3. Spacing of first element = $\sigma \times \lambda_L$. Other elements spaced at $\tau \times$ previous S
3. Calculate array bandwidth, B_{ar} :
 $B_{ar} = 1.1 + [30.8(1 - \tau)\sigma]$
4. Calculate structure bandwidth, B_s :

$$B_s = B \times B_{ar}$$

5. Calculate array length:

$$\ell = \left(\frac{\left(1 - \frac{1}{B_s}\right) \left(\frac{4\sigma}{1-\tau}\right)}{4} \right) (\lambda_L)$$

6. Calculate number of elements, N :

$$N = 1 + \frac{\log B_s}{\log \frac{1}{\tau}} \text{ and round to next largest}$$

number.

7. Calculate new length

$$\ell' = \frac{\text{rounded } N}{N} \times \ell$$

simplified design approach

Design of an LP array using the basic equations above is arduous, since the designer has little feel for the size of the array until he's made one or more iterations. Furthermore, most first tries won't equate to an integral number of elements. Accordingly, a computer program was written to yield initial data on key array characteristics and in terms of antennas with an integral number of elements, table 1. This table allows an antenna design based on desired parameter such as number of elements, length, and gain. The following example of antenna design uses the curves of fig. 3 and table 1.

A three-band LP antenna is desired covering 14-29 MHz. Length is about 15 meters (50 feet). Proceed as follows:

1. $B = \frac{f_H}{f_L} = \frac{29}{14} = 2.1$ (desired frequency ratio)

2. Desired length is 15 meters (50 feet)

$$\lambda_L = \frac{300}{14} = 21.4 \text{ meters (70 feet)}$$

$$\text{Length} = \frac{15}{21.4} = 0.71\lambda$$

3. From table 1 choose ($B = 2$), and $\ell/\lambda = 0.87$, or $\ell = 0.87\lambda$. The desired length is slightly shorter to stay on the correct, or lower, side of the optimum spacing factor, σ .

$$N = 10, \ell/\lambda = 0.87, \tau = 0.875, \sigma/\lambda = 0.155, \text{gain} = 7 \text{ dB}$$

4. From fig. 3 proceed as follows:

- a. Modify σ of 0.155 by the ratio

$$\frac{0.71 \text{ (desired)}}{0.87 \text{ (table 1)}} = 0.82 \times 0.155 = 0.13 = \sigma'$$

- b. Draw a vertical line through $\tau = 0.875$ (see example in fig. 3).
- c. Draw a horizontal line through $\sigma = 0.155$.
- d. Optimum gain occurs at the intersection (7.0 dB).
- e. Modify by drawing a horizontal line through $\sigma' = 0.13$ to intersect vertical through $\tau = 0.875$.
- f. A new gain occurs, ≈ 6.7 dB (down only 0.3 dB from optimum).

element parameters

$$f_L = \text{MHz}, \quad f_H = 29 \text{ MHz},$$

$$\tau = 0.875, \quad \sigma' = 0.13$$

for a wire antenna, $\lambda/2$

$$L = \frac{143}{f_{\text{MHz}}} = 10.2 \text{ meters (33.4 feet) at } f_L$$

$$S_1 = \sigma' \cdot \lambda_L = 0.13 \times 21.4$$

$$= 2.8 \text{ meters (9.2 feet)}$$

table 1. Number of elements and array length with optimum taper and spacing.

1 one-band operation ($B = 1$)*	N	ℓ/λ	τ	σ/λ	B_s	gain over dipole dBd
	4	0.34	0.79	0.142	2.02	5.9
	5	0.52	0.88	0.155	1.67	7.0
	6	0.73	0.92	0.170	1.52	8.0
	7	0.91	0.927	0.175	1.39	8.9
	8	1.12	0.963	0.178	1.30	9.7
	9	1.33	0.972	0.180	1.26	10.2
	10	1.48	0.978	0.181	1.22	10.6
2 $B = 1.5$	6	0.49	0.810	0.142	2.9	6.1
	8	0.77	0.875	0.158	2.56	7.0
	12	1.35	0.93	0.172	2.21	8.2
	15	1.79	0.95	0.175	2.05	9.0
3 $B = 2$	7	0.52	0.795	0.142	4.0	5.9
	10	0.87	0.875	0.155	3.39	7.0
	14	1.37	0.917	0.170	3.07	8.0
	19	1.97	0.943	0.175	2.8	8.9
4 $B = 3$	9	0.59	0.8	0.142	5.93	5.9
	15	1.18	0.895	0.155	4.80	7.0
	22	1.90	0.932	0.170	4.38	8.0
5 $B = 4$	11	0.65	0.815	0.142	7.64	5.9
	17	1.32	0.89	0.160	6.57	7.0
	24	2.03	0.925	0.170	5.97	8.3

*B desired band ratio (harmonic number) = $\frac{f_H}{f_L}$ For an array covering 14, 21, 28 MHz, $B = \frac{f_H}{f_L} = \frac{28}{14} = 2$

$$S_2 = 2.8 \times \tau, \text{ etc.}$$

$$L_1 = 10.2 \text{ meters (33.4 feet)}$$

$$L_2 = 10.2 \times \tau, \text{ etc.}$$

N	L, in meters (ft)	S, in meters (ft)
1	10.2 (33.4)	2.8 (9.2)
2	8.9 (29.3)	2.4 (8.0)
3	7.8 (25.6)	2.1 (7.0)
4	6.8 (22.4)	1.9 (6.1)
5	6.0 (19.6)	1.6 (5.3)
6	5.2 (17.2)	1.4 (4.7)
7	4.6 (15.0)	1.3 (4.1)
8	4.0 (13.1)	1.1 (3.6)
9	3.5 (11.5)	0.9 (3.2)
10	3.0 (10.0)	
array length		15.5 meters (51 ft)

conclusion

We have presented design details for a log-periodic antenna using simple mathematical formulas. We have also given a simplified approach to LP antenna design using tables and elementary arithmetic. The LP antenna certainly has a place in Amateur Radio. It has advantages of bandwidth which Yagi and quad antennas don't have. A well-designed LP will provide acceptable forward gain and front-to-back ratio over a wide band of frequencies. The LP can be designed with wire elements for lower frequencies — another advantage when aluminum tubing is hard to obtain. An LP antenna can be designed to cover 10-30 MHz with performance and size comparable to that of many current triband beams.

bibliography

- Smith, George E., W4AEO, "Log-Periodic Antenna, 14, 21, and 28 MHz," *ham radio*, August, 1973, page 18.
- Smith, George E., W4AEO, "Log-Periodic Antenna, 7 MHz," *ham radio*, May, 1973, page 16.
- Smith, George E., W4AEO, "Feed System for Log-Periodic Antennas," *ham radio*, October, 1974, page 30.
- Smith, George E., W4AEO, "Graphical Design Method for Log-Periodic Antennas," *ham radio*, May, 1975, page 14.
- Smith, George E., W4AEO, "Log-Periodic Antennas, Vertical Monopole, 3.5 and 7.0 MHz," *ham radio*, September, 1973, page 44.
- Smith, George E., W4AEO, "Improved Log-Periodic Beams," (letter), *ham radio*, May, 1975, page 74.
- Smith, George E., W4AEO, "Log-Periodic Beam, 15 and 20 Meters," *ham radio*, May, 1974, page 6.
- Smith, George E., W4AEO, "Log-Periodic Feeds," (letter), *ham radio*, May, 1974, page 66.
- Smith, George E., W4AEO, "Three-Band Log-Periodic," *ham radio*, May, 1977, page 10.

appendix

intra-array feedline design

The characteristic impedance of the feedline is a function of the natural dipole impedance, Z_a , and the spacing factor, σ . The natural dipole impedance is related to the length-to-diameter ratio of the elements. The optimum intra-array feedline impedance is determined as follows:

- Select the desired driving impedance, R_0
- Determine the mean spacing factor $\sigma'' = \frac{\sigma}{\sqrt{r}}$
- Determine the natural dipole impedance:
 $Z_a = 120 (\ln n \frac{\ell}{d} - 2.25)$, or from fig. A1, where $\frac{\ell}{d}$ is length-to-diameter ratio
- Calculate $\frac{Z_a}{R_0}$
- Determine $\frac{Z_0}{R_0}$, the intra-array feedline modifier, M .

$$\frac{Z_0}{R_0} = \frac{1}{8 \sigma''} = \frac{Z_a}{R_0} + \sqrt{\frac{1}{(8 \sigma'' \frac{Z_a}{R_0})^2} + 1}$$

or from fig. A1,

$$Z_0 = R_0 \times M$$

$$Z_0 = 276 \log_{10} \frac{2D}{d} \text{ for 2-wire line or}$$

$$138 \log_{10} \frac{\sqrt{2D}}{d} \text{ for 4-wire line,}$$

where D = center-to-center spacing, and d = wire diameter.

If a non-optimum intra-array feedline impedance is used, the antenna VSWR will vary considerably with frequency, in a somewhat periodic manner.

design example

Array parameters:

$$\tau = 0.875 \quad \sigma = 0.13$$

$$R_0 = 200 \text{ ohms (with 4:1 balun from 52 ohms)}$$

Mean spacing factor

$$\sigma'' = \frac{\sigma}{\sqrt{\tau}} = \frac{0.13}{\sqrt{0.875}} = 0.139$$

Natural dipole impedance using no. 14 AWG (1.6-mm) wire:

$$\frac{\ell}{d} = \frac{12 \times 21}{0.064} = 3938; \text{ since } Z_a \text{ varies as } \log_e,$$

the mean $\frac{\ell}{d}$ is usually sufficiently accurate

From fig. A1, $Z_a = 72 \text{ ohms}$, and

$$\frac{Z_a}{R_0} = \frac{72}{200} = 3.6$$

Feedline impedance from fig. A1:

$$\frac{Z_a}{R_0} = 3.6 \sigma'' = 0.139 M = 1.3$$

$$\text{or } \frac{Z_0}{R_0} = \frac{1}{8 \sigma''} = \frac{Z_a}{R_0} + \sqrt{\frac{1}{(8 \sigma'' \frac{Z_a}{R_0})^2} + 1}$$

$$= \frac{1}{8 \times 0.139 \times 3.6} + \sqrt{\frac{1}{(8 \times 0.139 \times 3.6)^2} + 1} = 1.28$$

$$= 0.245 + 1.03 = 1.28$$

$$Z_0 = M R_0 = 1.28 \times 200 = 255 \text{ ohms}$$

ham radio

State
of the art



by
K.V.G.

CRYSTAL FILTERS and DISCRIMINATORS

9.0 MHz FILTERS

XF9-A	2.5 kHz	SSB TX	\$43.75
XF9-B	2.4 kHz	SSB RX/TX	\$59.35
XF9-C	3.75 kHz	AM	\$63.80
XF9-D	5.0 kHz	AM	\$63.80
XF9-E	12.0 kHz	NBFM	\$63.80
XF9-M	0.5 kHz	CW (4 pole)	\$44.65
XF9-NB	0.5 kHz	CW (8 pole)	\$79.10

Export

Inquiries

Invited

9.0 MHz CRYSTALS

XF900	9000.0 kHz	Carrier	\$5.15
XF901	8998.5 kHz	USB	\$5.15
XF902	9001.5 kHz	LSB	\$5.15
XF903	8999.0 kHz	BFO	\$5.15
F-05	Hc25/u	Socket Chassis	.50
F-06	Hc25/u	Socket P.C. Board	.50

Shipping

\$1.75

per filter

VHF and UHF FILTERS

ELIMINATE IMD "BIRDIES"	432 MHz PS1432	\$55.95
FROM YOUR RECEIVER.	1296 MHz PS1296	\$55.95
CLEAN UP YOUR TRANSMITTER OUTPUT.	1691 MHz PS1691	\$55.95
	Shipping	\$3.50

OSCAR-J FILTERS

Suppress 2m Tx Third Harmonics. Low 2m loss (0.5 dB typ.). High loss at 435 MHz (30/40 dB).

MM1200-5	30 dB min. atten.	\$31.45
MM1200-7	40 dB min. atten.	\$41.95

NEW!

TRANSVERTERS FOR ATV OSCARS 7, 8 & PHASE 3

Transverters by Microwave Modules and other manufacturers can convert your existing Low Band rig to operate on the VHF & UHF bands. Models also available for 2M to 70cm and for ATV operators from Ch2/Ch3 to 70cms. Each transverter contains both a Tx up-converter and a Rx down-converter. Write for details of the largest selection available.

Prices start at \$189.95 plus \$3.50 shipping.

SPECIFICATIONS:

Output Power	10 W
Receiver N.F.	3 dB typ.
Receiver Gain	30 dB typ.
Prime Power	12V DC



Attention owners of the original MM1432-28 models: Update your transverter to operate OSCAR 8 & PHASE 3 by adding the 434 to 436 MHz range. Mod kit including full instructions \$23.00 plus \$1.50 shipping, etc.

ANTENNAS (FOB CONCORD, VIA UPS)

144-148 MHz J-SLOTS

8 OVER 8 HORIZONTAL POL.	+12.3 dBd	D8/2M	\$54.60
8 BY 8 VERTICAL POL.		D8/2M-VERT.	\$64.00
8 + 8 TWIST		8XY/2M	\$56.35



420-450 MHz MULTIBEAMS

For local, DX, OSCAR, and ATV use.

48 EL.	GAIN +15.7 dBd 70/MBM48	\$63.50
88 EL.	GAIN +18.5 dBd 70/MBM88	\$86.10

UHF LOOP YAGIS

28 LOOPS	GAIN +20 dB	
1250-1340 MHz	1296-LY	\$59.90
1650-1750 MHz	1691-LY	\$63.45

Send 30¢ (2 stamps) for full details of KVG crystal products and all your VHF & UHF equipment requirements.

Pre-Selector Filters	Amplifiers	SSB Transverters
Varactor Triplers	Crystal Filters	FM Transverters
Decade Pre-Scalers	Frequency Filters	VHF Converters
Antennas	Oscillator Crystals	UHF Converters



si

Spectrum
International, Inc.
Post Office Box 1084
Concord, Mass. 01742, USA

compact and clean L-band local oscillators

A clean, L-band local-oscillator system featuring spurious rejection greater than 30 dB with simple test equipment

The recent popularization of microstripline construction for Amateur uhf equipment¹ has made it relatively simple for countless experimenters to build state-of-the-art multipliers, amplifiers, mixers, filters, and the like directly from magazine construction articles. A major exception, unfortunately, has been in the area of microwave local oscillator chains. Most will agree that the LO is the weak link in just about every microwave transmitter, receiver, or converter. Local oscillators generally require extensive tweaking on costly spectrum analyzers, even then often falling short of the required calibration tolerance, stability, and spectral purity. And, since a spurious or drifting LO can negate all the benefits of the very finest low-noise front end or ultra-linear power amplifier, it is evident that the LO requires a great deal of attention. I've been making an effort in recent months to take some of the mystique out of local oscillator design and construction. In this article I shall present the results of that effort — a high-stability, crystal-con-

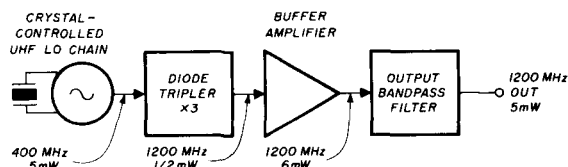

fig. 1. Block diagram of a module LO system for L band. Each block represents a physically separate stage, individually boxed and interconnected by short lengths of coaxial cable.

trolled LO for 1.1 through 1.6 GHz that is only 6.4×10 cm (2.5×4 inches) and employs microstripline construction (with absolutely *no* coils to wind). It can be built for about \$70 in parts, and can be completely aligned with only a VOM and a diode detector.

The basic approach that numerous experimenters (myself included) have used for L-band local-oscillator chains over the past several years is blocked out in fig. 1. I implemented this system modularly, with each of the blocks representing a separate, shielded box, the various modules being interconnected via coaxial cable. The basic 400-MHz oscillator is a version of my recently published uhf LO chain,² driving a diode tripler built on a microstrip bandpass filter board.³ In order to make up the power lost in the pas-

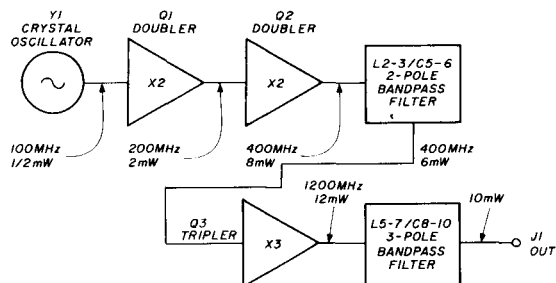

fig. 2. Block diagram of the microstrip local oscillator.

sive multiplier, a buffer amplifier is employed.⁴ The final microstrip filter keeps all spurious frequency components down better than 40 dB with respect to the desired output.

The modular LO chain has some major drawbacks. It is physically large, since each stage must occupy its own separate enclosure to achieve acceptable spurious rejection. The cost of jumper cables, coax connectors, and die-cast aluminum boxes can be

By H. Paul Shuch, N6TX, Microcomm, 14908 Sandy Lane, San Jose, California 95124

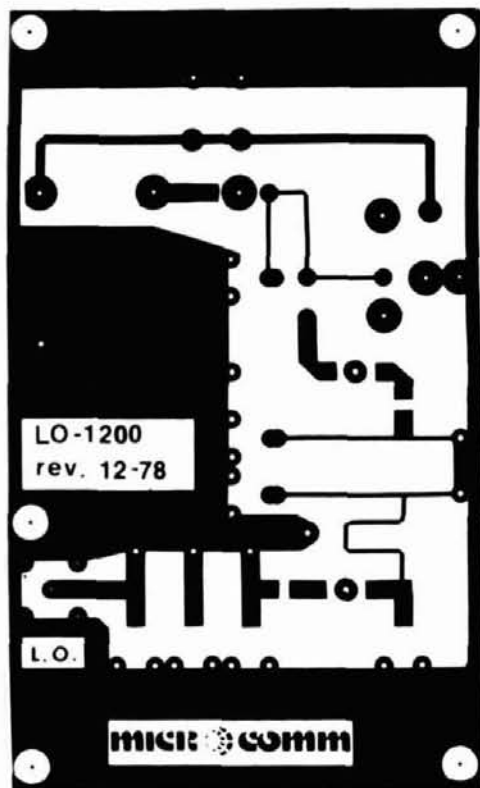

fig. 4. Full-size artwork for the printed circuit board. The reverse side remains unetched, acting as a groundplane.

as those used in my uhf LO, except for a few component substitutions. Oscillator module Y1 is a high-stability, crystal overtone oscillator producing -3 dBm ($1/2$ mW) of output near 100 MHz. This assembly requires a regulated $+9$ volt supply, which is furnished by zener diode CR1. The output port of Y1 exhibits dc continuity to ground, this continuity being essential in providing a bias return for the following stage.

At the input to Q1, common-emitter class-C double stage, C16 is used to resonate Y1's output inductive link, creating a double-tuned, interstage transformer between the oscillator stage and the first multiplier. The output circuit for Q1 consists of microstripline inductor L1 resonated by C4 at 200 MHz.

Collector current for Q1 is limited to 10 mA at R2. This resistor, along with C2 and C13, provide power supply decoupling for the first multiplier stage.

Q2 serves as a second class-C common-emitter doubler. Its input is fed via C3, which is tapped down on L1 for impedance matching. R3 provides base bias return. The collector is shunt-fed by R6, with a

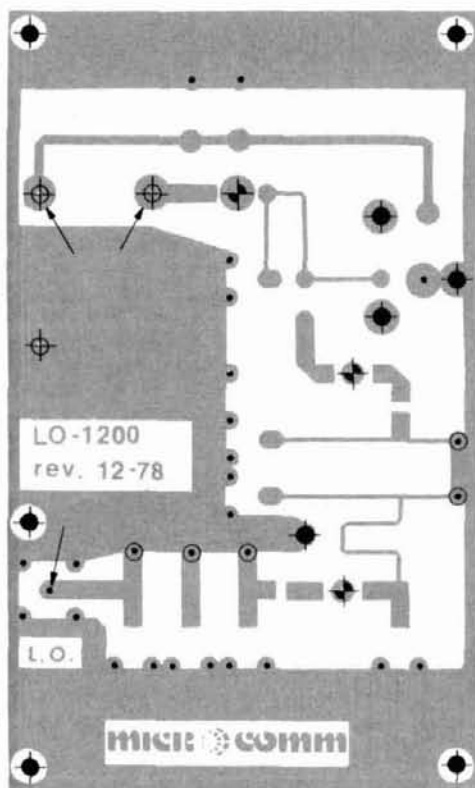

fig. 5. Drilling diagram for the etched side of the circuit board. In addition to the etched side, the three locations marked with arrows are also countersunk on the ground-plane side.

collector current of approximately 15 mA. The output circuit for Q2 consists of two microstripline inductors (L2, L3) resonated at 400 MHz by two piston trimmers (C5 and C6). Inductive coupling between filtering poles, provided by RFC1, suppresses higher-order harmonics at the output of the second doubler. The conversion gain of each doubler — exclusive of any filter losses — is on the order of $+6$ dB.

As mentioned previously, tripler Q3 operates as a parametric multiplier. The input is applied via a low-pass filter consisting of microstripline inductor L4 and piston trimmer C7. The series inductance of C7 is such that it self-resonates at the desired output frequency, maximizing gain at that particular frequency by driving the base impedance of Q3 negative. For this reason, use only the specified capacitor at C7. Shunt collector feed for the active tripler is via R7, with dc decoupling provided by R5 and C15. Collector current for Q3 is on the order of 15 mA, and the stage operates at approximately 3-dB gain.

The output of Q3 is capacitively coupled via C12 into a 3-pole output filter consisting of microstripline

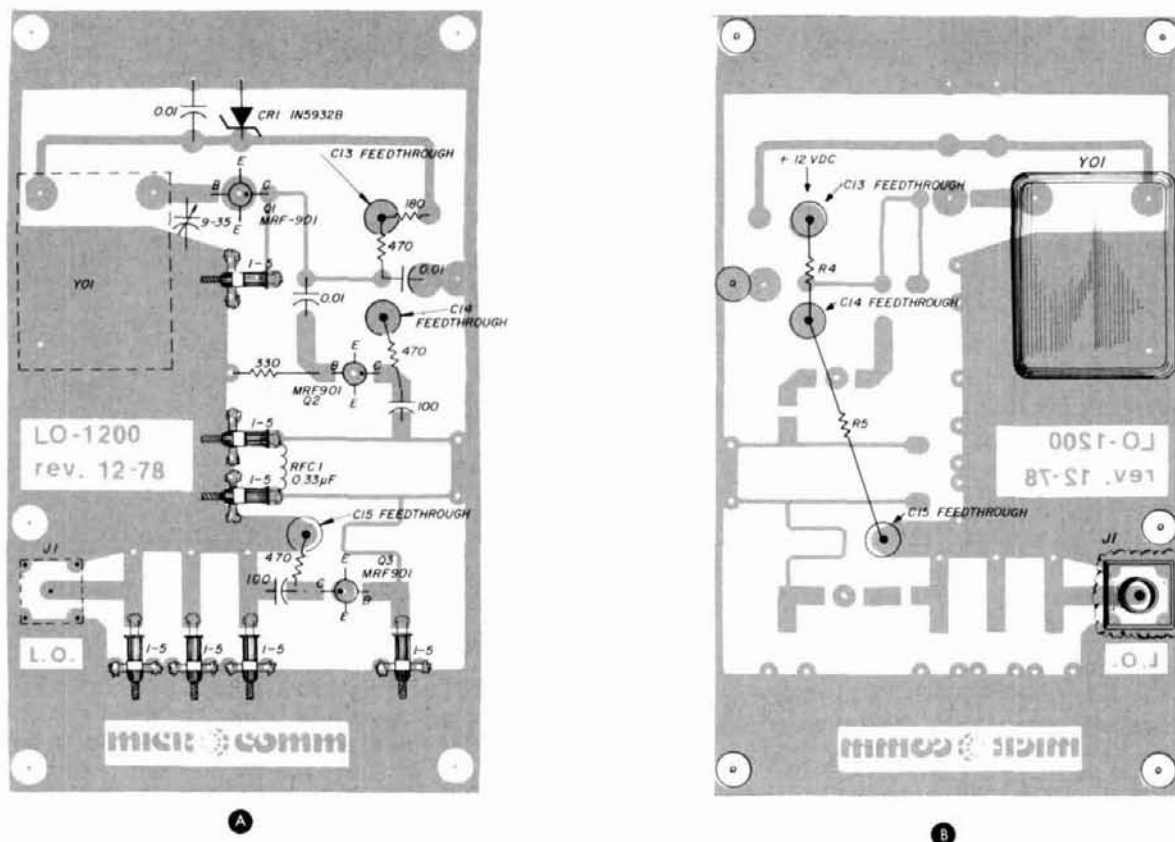

fig. 6. Component placement diagrams for the microstripline and groundplane sides.

inductors L5, L6, and L7, resonated at 1.2 GHz by piston trimmers. Coupling between filter poles is a result of the proximity of the piston trimmer stators; hence, spacing between filter poles is critical.

The final +10 dBm (10-mW) LO output is available on connector J1. This level is suitable for driving most transmit and receive diode balanced mixers.

construction

Assembling the LO is relatively simple, since all circuitry is mounted on a single printed circuit board and the bulk of the critical components are implemented as etched microstriplines. The circuit should be etched on fiberglass-epoxy circuit laminate 1.5 mm (0.063 inch) thick, clad on both sides with 1 ounce per square foot copper. One side of the board is etched in accordance with the artwork supplied in fig. 4, the other side remaining fully clad and serving as a groundplane. It is essential that the pattern of the printed circuit artwork be followed exactly (photo etching is recommended), since the dimensions of the microstriplines are critical and the placement of

the circuits on the board determines the degree of spectral purity achieved. In fact, the layout of the board was changed several times during the development phases in order to optimize performance and ease of tuning.

After the board is etched, it should be drilled as in fig. 5. Be sure to remove a small portion of groundplane metallization from around the holes that will accommodate the center pin J1 and the output and power pins of oscillator Y1. Neglecting this crucial step will result in these pins being shorted to ground, which will obviously have a detrimental effect upon circuit performance! Note that five of the microstripline inductors (L2, 3, 5, 6, and 7) must be grounded through the board. This is best accomplished, as outlined in reference 3, with eyelets 0.5-mm in diameter set with a punch and soldered on both sides of the board.

When mounting components on the printed circuit board, you will find it helpful to refer to the photographs, the schematic diagram in fig. 3, the layout drawings shown in fig. 6, and perhaps to reference

2. I personally find it easiest to install J1 first, soldering the five pins to their respective pads on the microstripline side of the printed circuit board and then running a smooth bead of solder around the body of the connector, securing it electrically and mechanically to the groundplane side. Next, I install feedthrough capacitors C13, 14, and 15. Here I prepare a small solder preform (1 turn of multi-core solder wrapped around the body of the capacitor just under the flange), position the capacitor in its mounting hole, and apply heat to the flange from above. The solder preform will flow, filling the space between the flange and the groundplane. This technique prevents excess solder from accumulating on the groundplane side of the printed circuit board.

Installing the resistors and capacitors according to the layout diagram is relatively easy. Do *not* install power decoupling resistors R4 and R5 at this time; they will be added during the tune-up sequence. When installing the three transistors, note that the raised dot on the plastic package indicates the collector lead. The base lead emerges from the opposite side of the transistor package, with the two emitter leads appearing at right angles to the collector and base. Bend the two emitter leads of each transistor down sharply before installing the transistors in their holes. That way the emitter leads can protrude through to the groundplane side, where they will be bent over and soldered directly to ground.

When installing oscillator stage Y1, care should be taken to prevent traces on the oscillator's printed circuit board from shorting to the groundplane of the LO main circuit board. I recommend installing a thin insulating washer between the oscillator can and the groundplane.

The only additional advice I might offer in microstripline projects is that it is not unusual for component leads to be laid on and soldered directly to printed circuit board traces or pads, rather than running the component leads through holes in the board. For this reason, it is generally helpful to preform and pre-trim the component leads prior to installation.

tune up and test

I cannot overemphasize the importance of employing a systematic, orderly approach in tuning up local-oscillator chains. Tuning for maximum smoke (a favorite Amateur pastime) is a surefire way to make one or more of the multiplier stages oscillate (see **fig. 7**). Further, since the LO chain was designed to provide maximum user flexibility, it may be built for a fairly wide range of frequencies and applications. As a consequence, each of the resonant circuits has a relatively wide tuning range, and it is entirely possible to tune up any one of the multiplier stages on the

wrong multiple, if maximum apparent output power is the only criterion.

In fact, whether a microwave spectrum analyzer is available or not, it's a good idea to pre-align the various piston trimmers to the appropriate part of the spectrum. This is easier than it may sound. If the intended output frequency is below about 1.3 GHz, adjust all seven of the piston trimmer capacitors to *maximum* capacitance (screws all the way *in*). If the

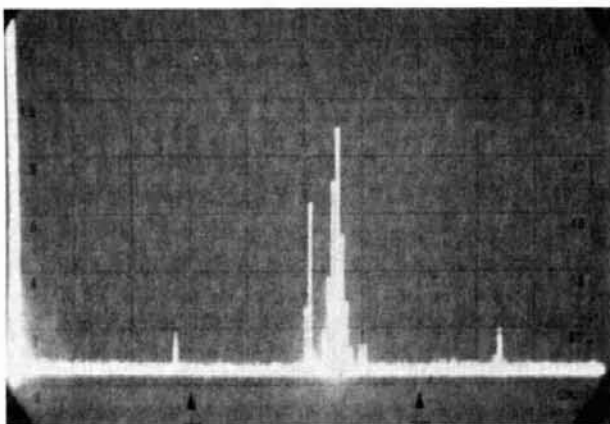

fig. 7. Aligning microwave LO chains for maximum output power often results in a spurious output spectrum. In this case, the LO was tuned for maximum output. The numerous spurs near the desired output are not harmonically related to the crystal frequency. This suggests that they are the result of one of the active stages going into self-oscillation. The horizontal scale is 0 to 2 GHz, with a vertical calibration of 10 dB/cm.

intended output frequency is above about 1.4 GHz, adjust all piston trimmers for *minimum* capacitance (screws almost all the way *out*). And, if the oscillator is intended to operate between about 1.3 and 1.4 GHz, pre-adjust all piston trimmers at about mid-range. Now, as you proceed with the alignment procedure, it should not be necessary to adjust any of these capacitors by more than a couple of turns. Keep this in mind, because if you find yourself adjusting the trimmers more than just a little, you're probably enhancing the *wrong* frequency component.

The approach I recommend for tuning this L-band LO requires no test equipment other than a VOM and a diode detector (or some other means of monitoring relative rf power). It is based upon the principle that, as a class-C multiplier stage is tuned, the signal level applied to the next stage (hence the next stage's collector current) will vary. By knowing what kind of variations to expect and by monitoring stage current closely, it is possible to tune the LO chain to produce an output spectrum such as that shown in **fig. 8**. But it is necessary to monitor the various stage currents

separately, to be sure you're observing proper multiplier action and not oscillation.

With the piston trimmers pre-adjusted as outlined, the next task in aligning the L-band LO is to get the oscillator stage oscillating. On the side of the crystal oscillator can is a small access hole, behind which is found the ceramic trimmer capacitor which resonates the oscillator's collector tank circuit. This trimmer is pre-adjusted at the factory to ensure that the oscillator will start each time power is applied; it should not be adjusted at this time. Rather, it should be possible to optimize drive to the first multiplier stage merely by adjusting C16, which, you'll recall, resonates the oscillator stage's output coupling link.

Apply a well-regulated voltage between +12 and +13 volts to feedthrough capacitor C13. This powers both the oscillator stage and the first doubler. Monitor the current drawn by these two stages as C16 is adjusted through its range. Since the sum of the current drawn by the oscillator stage and its zener regulator will remain constant at between 16 and 22 mA (depending upon the power supply potential), any variation in current as C16 is adjusted represents the collector current of Q1. There is a point in C16's tuning range where the current at C13 will rise smoothly to about 10 mA above its minimum value (that is, 26 to 32 mA, total), and this is the point to adjust C16. Now, momentarily remove V_{cc} from C13. If the current returns to the previous value, all is well. If on the other hand Q1 appears not to be drawing any current (that is, total current at C13 decreases to between 16 and 22 mA), then the oscillator stage is not starting smoothly and it will be necessary to re-adjust Y1's trimmer. Do so *carefully*; it should be necessary to rotate the trimmer only about ten degrees one way or the other, and the current should rise again, indicating oscillation. Now, repeak C16 for the proper rise in current, and again remove and re-apply power. The adjustments of C16 and the oscillator's trimmer capacitor are somewhat interactive, so repeat the above procedure until the oscillator starts reliably each time power is applied.

Once the adjustment of C16 and the oscillator trimmer is completed, do not under any circumstances change their settings while aligning the balance of the local-oscillator chain. I usually paint a dot of nail polish on C16 to lock it down and tape over the access hole in the side of Y1, lest I be tempted to backtrack and screw things up completely! Remember, the objective is to perform a reasonably clean LO alignment without the use of any costly test equipment, so don't jump sequence.

The easiest way to resonate the collector tank of the first multiplier stage is to monitor the current drawn by second doubler, Q2. Apply operating

potential to feedthrough capacitors C13 and C14, and this time monitor the current drawn at C14. This current should peak smoothly at 10 to 12 mA while adjusting C4 no more than two or three turns from its preset position.

Adjusting the interstage circuitry between the second doubler and the parametric tripler is perhaps the trickiest part of aligning this LO because there are three separate trimmer capacitors and the adjust-

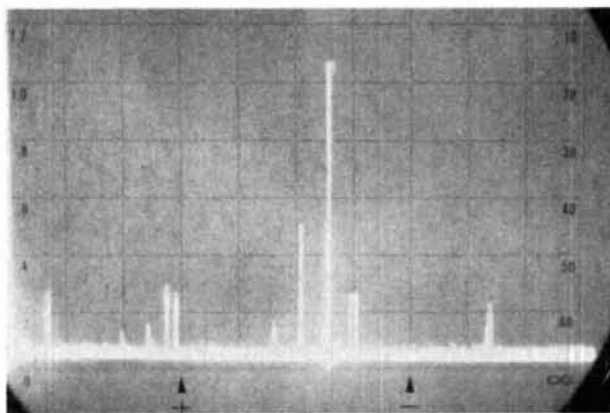

fig. 8. This photograph shows the output spectrum of the L-band LO system after being aligned as described in the article. Spurious rejection of close to 30 dB was achieved with the simple test equipment called for in the article.

ments are all interactive. Note that at this point the only clue you have to proper alignment is the collector current drawn by Q3, so watch it closely. Apply operating potential to all three feedthrough capacitors (C13, 14, and 15), this time monitoring current at C15. First, adjust C7, slightly, just to the point that a few milliamperes of current flow through C15. Now, carefully adjust both C5 and C6 to maximize this current. As before, a peak should occur before the trimmers have been adjusted very far from their preset positions. Once a peak has been found with C5 and C6 both set at approximately the same point, re-adjust C7 slightly. At this point, C4 (the collector tank of the first multiplier) may be adjusted ever so slightly to maximize current at C15. Now, back to C5 and C6 again, then C7 if necessary, and so on until the current at C15 settles in at about 15 mA. Note that when you're done, both C5 and C6 should have their tuning screws protruding by about the same amount.

All that remains is to align the output bandpass filter. An rf-diode detector can be connected to the output connector, the dc from the diode assembly being fed to a sensitive microammeter as an indication of relative rf output. Any other method of measuring relative rf power (bolometer bridge, calorimeter, or similar) may also be employed. The object is

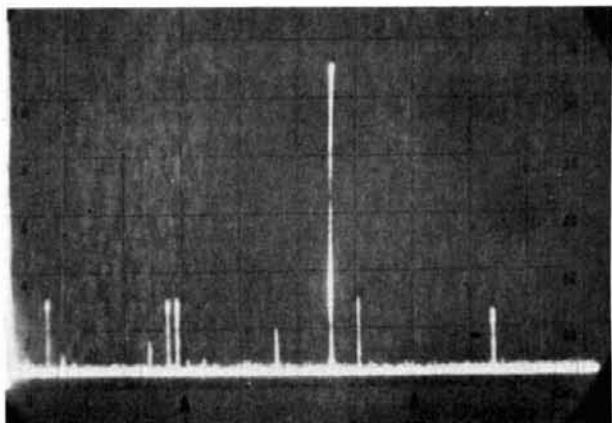

fig. 9. Example of the output spectrum after aligning the local-oscillator chain with a microwave spectrum analyzer. In this case, all spurs are down greater than 40 dB.

to adjust C8, C9, and C10 simultaneously for maximum indicated output (the three trimmer capacitors should all track relatively closely). Keep monitoring the current at C15. If it jumps abruptly, the tripler stage is self-oscillating. It can be tamed down by slightly adjusting C7 until current at C15 returns to its proper value.

With C8, C9, and C10 all peaked at approximately the same setting (not too far, you hope, from the preset position) and output power maximized, one last adjustment to C7 is in order. Adjust this capacitor for the maximum output level obtainable *without causing an increase in the current at C15*. At this point, you may be tempted to go back and repeak all the other trimmer capacitors in the circuit; resist that temptation. You can only disrupt what would in all likelihood be a very clean output spectrum, such as that shown in fig. 8.

Of course, if you are fortunate enough to have access to a microwave spectrum analyzer, adjusting the trimmer capacitors ever so slightly can indeed clean up the output spectrum still further (see fig. 9). But this should be attempted only after the current-sensitive tuning method has been completed and decoupling resistors R4 and R5 installed.

One final thought. Those super-purists fortunate enough to possess a complete laboratory of microwave test equipment will doubtless notice that any tuning adjustment can potentially affect output power, spectrum, and frequency. Thus, you may wish to simultaneously monitor all three parameters during alignment. Fig. 10 is the lab setup I use in aligning these LO chains. The key to the success of this method is the resistive three-way power divider, which applies equal samples of the LO's output signal to the counter, spectrum analyzer, and power meter. The divider is built simply from four 27-ohm,

1/8-watt, carbon-composition resistors, arranged symmetrically in a small shielded box which supports four coaxial connectors.

parts procurement

Readers of my construction articles frequently write asking if I can supply a complete kit of parts for a given project. Unfortunately, I have neither the time nor the inclination to get into that business. But I am not heedless of the plight of the home constructor, and as much as possible like to help identify (or sometimes create) sources for some of the less-common components.

For example, I have in the past endeavored to make etched, drilled, and plated circuit boards available at cost, for the benefit of those experimenters who prefer not to fabricate their own. This project is no exception. I will supply the boards for \$10 each, postpaid anywhere in the U.S. or Canada (\$11 elsewhere).

In a previous article, I mentioned a source of supply for the Triko trimmer capacitors I employ in this and other modules. Unfortunately, I later discovered that the importer had a \$50 minimum order requirement. Thus, I have recently obtained a quantity shipment of the piston trimmer capacitors used in the LO chain, and will gladly supply them to Amateurs in sets of seven pieces (the quantity needed for each LO chain) at \$10.50 per set postpaid in the U.S. or Canada, \$11.50 elsewhere.

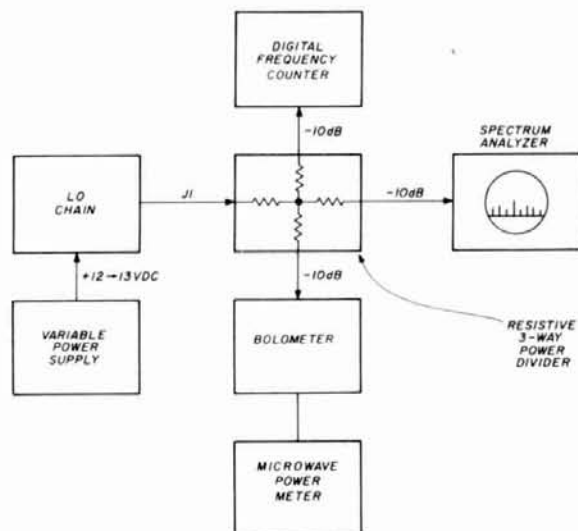

fig. 10. Test configuration for monitoring power, frequency, and output spectrum simultaneously during alignment of the LO chain.

The crystal oscillator assembly designated Y1 is available only from International Crystal Manufacturing Company. I recently spoke to Mr. Royden Free-

land, himself a ham and microwave experimenter, and he assures me that this module will be sold to individual experimenters in single quantities. Be sure to allow six to eight weeks for delivery, as the units employ custom-ground crystals.

The MRF-901 transistors used for Q1, Q2, and Q3 are available from Motorola Semiconductor Company. When I first used this particular transistor in a 1296-MHz preamp a few years ago, the price was \$9 each. Quantity production and improved yield brought the price down to \$4.30 in 1977, and to an unbelievable \$1.45 today. At that price, I'd recommend against trying to substitute any other transistor.

The rest of the components used in the LO are, for the most part, garden-variety. Though not necessarily available at your corner Radio Shack, they should nonetheless be obtainable by most experimenters after a bit of scrounging.

Of course, there are always those who need a microwave LO but prefer not to do the scrounging, building, tuning, and testing themselves. To such individuals I am able to offer a completely built, tuned, and tested Model LO-1200 Oscillator Module, packaged in an enameled die-cast aluminum box, operating at your specified frequency between 1150 and 1555 MHz, for \$160 postpaid. Foreign orders please add \$5 additional postage. This offer is extended to licensed Radio Amateurs only (state your call when ordering), and is restricted to units used for personal, noncommercial applications only. All orders for printed circuit boards, capacitors, or complete LOs must be prepaid in U.S. dollars, and all inquiries must be accompanied by a stamped, self-addressed envelope.

Frankly, I hope nobody takes me up on the above offer. I'd rather design gear than build it for others, and, besides, you're missing out on quite a feeling of accomplishment if you buy your gear ready-made. After all, it is the home constructor to whom this article is dedicated.

Happy building!

references

1. H. Paul Shuch, N6TX, "Microstrip — Magical PC Technique Explained," 73, October, 1978, page 80.
2. H. Paul Shuch, N6TX, "A UHF Local Oscillator Chain For The Purist," ham radio, July, 1979, page 27.
3. H. Paul Shuch, N6TX, "Improved Grounding For The 1296-MHz Microstrip Filter," ham radio, August, 1978, page 60.
4. H. Paul Shuch, WA6UAM, "Low-Cost 1296-MHz Preamp," ham radio, October, 1975, page 42.
5. Paul C. Wade, WA2ZZF, "Clean Local-Oscillator Chain For 1296-MHz," ham radio, October, 1978, page 42.
6. William I. Orr, W6SAI, Radio Handbook, 20th edition, Howard W. Sams, Indianapolis, 1975, pages 20, 66.

ham radio

MY COMPETITION KNOWS ME YOU SHOULD, TOO!



FREE: HAL-TRONIX 1979 Special Clock Kit Plus a FREE Inline RF Probe — with purchase of any Frequency Counter.

COMPLETE KITS: CONSISTING OF EVERY ESSENTIAL PART NEEDED TO MAKE YOUR COUNTER COMPLETE. **HAL-600A** 7-DIGIT COUNTER WITH FREQUENCY RANGE OF ZERO TO 600 MHz. FEATURES TWO INPUTS, ONE FOR LOW FREQUENCY AND ONE FOR HIGH FREQUENCY. AUTOMATIC ZERO SUPPRESSION TIME BASE IS 1.0 SEC OR 1 SEC GATE WITH OPTIONAL 10 SEC GATE AVAILABLE. ACCURACY \pm .001%. UTILIZES 10-MHz CRYSTAL 5 PPM. **COMPLETE KIT \$129**

HAL-300A 7-DIGIT COUNTER (SIMILAR TO 600A) WITH FREQUENCY RANGE OF 0-300 MHz. **COMPLETE KIT \$109**

HAL-50A 8-DIGIT COUNTER WITH FREQUENCY RANGE OF ZERO TO 50 MHz OR BETTER. AUTOMATIC DECIMAL POINT, ZERO SUPPRESSION UPON DEMAND. FEATURES TWO INPUTS, ONE FOR LOW FREQUENCY INPUT, AND ONE ON PANEL FOR USE WITH ANY INTERNALLY MOUNTED HALTRONIX PRE-SCALER FOR WHICH PROVISIONS HAVE ALREADY BEEN MADE. 1.0 SEC AND 1 SEC TIME GATES. ACCURACY \pm .001%. UTILIZES 10-MHz CRYSTAL 5 PPM. **COMPLETE KIT \$109**

PRE-SCALER KITS

HAL 300 PRE (Pre-drilled G-10 board and all components) **\$14.95**
HAL 300 A/PRE (Same as above but with preamp) **\$24.95**
HAL 600 PRE (Pre-drilled G-10 board and all components) **\$29.95**
HAL 600 A/PRE (Same as above but with preamp) **\$39.95**



HAL-1 GHz PRESCALER, VHF & UHF INPUT & OUTPUT, DIVIDES BY 1000. OPERATES ON A SINGLE 5 VOLT SUPPLY. **PREBUILT & TESTED \$79.95**

TOUCH TONE DECODER KIT

HIGHLY STABLE DECODER KIT. COMES WITH 2 SIDED, PLATED THRU AND SOLDER FLOWED G-10 PC BOARD, 7-567's, 2-7402, AND ALL ELECTRONIC COMPONENTS. BOARD MEASURES 3-1/2 x 5-1/2 INCHES. HAS 12 LINES OUT. **ONLY \$39.95**

DELUXE 12-BUTTON TOUCHTONE ENCODER KIT UTILIZING THE NEW ICM 7206 CHIP. PROVIDES BOTH VISUAL AND AUDIO INDICATIONS! COMES WITH ITS OWN TWO-TONE ANODIZED ALUMINUM CABINET. MEASURES ONLY 2-3/4" x 3-3/4". COMPLETE WITH TOUCH-TONE PAD, BOARD, CRYSTAL, CHIP AND ALL NECESSARY COMPONENTS TO FINISH THE KIT. **PRICED AT \$29.95**

FOR THOSE WHO WISH TO MOUNT THE ENCODER IN A HAND-HELD UNIT, THE PC BOARD MEASURES ONLY 9/16" x 1-3/4". THIS PARTIAL KIT WITH PC BOARD, CRYSTAL, CHIP AND COMPONENTS. **PRICED AT \$14.95**

ACCUKEYER (KIT) THIS ACCUKEYER IS A REVISED VERSION OF THE VERY POPULAR WB4VVF ACCUKEYER ORIGINALLY DESCRIBED BY JAMES GARRETT, IN QST MAGAZINE AND THE 1975 RADIO AMATEUR'S HANDBOOK. **\$16.95**

ACCUKEYER — MEMORY OPTION KIT PROVIDES A SIMPLE, LOW COST METHOD OF ADDING MEMORY CAPABILITY TO THE WB4VVF ACCUKEYER. WHILE DESIGNED FOR DIRECT ATTACHMENT TO THE ABOVE ACCUKEYER, IT CAN ALSO BE ATTACHED TO ANY STANDARD ACCUKEYER BOARD WITH LITTLE DIFFICULTY. **\$16.95**

PRE-AMPLIFIER

HAL-PA-19 WIDE BAND PRE-AMPLIFIER, 2-200 MHz BANDWIDTH (-3dB POINTS), 19 dB GAIN. **FULLY ASSEMBLED AND TESTED \$8.95**



CLOCK KIT — HAL 79 FOUR-DIGIT SPECIAL — \$7.95. OPERATES ON 12-VOLT AC (NOT SUPPLIED). PROVISIONS FOR DC AND ALARM OPERATION.

6-DIGIT CLOCK • 12/24 HOUR

COMPLETE KIT CONSISTING OF 2 PC G-10 PRE-DRILLED PC BOARDS, 1 CLOCK CHIP, 6 FND 359 READOUTS, 13 TRANSISTORS, 3 CAPS, 9 RESISTORS, 5 DIODES, 3 PUSH-BUTTON SWITCHES, POWER TRANSFORMER AND INSTRUCTIONS. DON'T BE FOOLED BY PARTIAL KITS WHERE YOU HAVE TO BUY EVERYTHING EXTRA. **PRICED AT \$12.95**

CLOCK CASE AVAILABLE AND WILL FIT ANY ONE OF THE ABOVE CLOCKS. REGULAR PRICE \$6.50 BUT ONLY \$4.50 WHEN BOUGHT WITH CLOCK.

SIX-DIGIT ALARM CLOCK KIT FOR HOME, CAMPER, RV, OR FIELD-DAY USE. OPERATES ON 12-VOLT AC OR DC, AND HAS ITS OWN 60-Hz TIME BASE ON THE BOARD. COMPLETE WITH ALL ELECTRONIC COMPONENTS AND TWO-PIECE, PRE-DRILLED PC BOARDS. BOARD SIZE 4" x 3". COMPLETE WITH SPEAKER AND SWITCHES. IF OPERATED ON DC, THERE IS NOTHING MORE TO BUY. **PRICED AT \$16.95**

*TWELVE-VOLT AC LINE CORD FOR THOSE WHO WISH TO OPERATE THE CLOCK FROM 110-VOLT AC. **\$2.50**

SHIPPING INFORMATION — ORDERS OVER \$15.00 WILL BE SHIPPED POSTPAID EXCEPT ON ITEMS WHERE ADDITIONAL CHARGES ARE REQUESTED. ON ORDERS LESS THAN \$15.00 PLEASE INCLUDE ADDITIONAL \$1.00 FOR HANDLING AND MAILING CHARGES. SEND SASE FOR FREE FLYER.



NOW AN ALUMA TOWER DISTRIBUTOR



"HAL"
HAROLD C. NOWLAND
W8ZXH

HAL-TRONIX
P. O. BOX 1101
SOUTHGATE, MICH. 48195
PHONE (313) 285-1782

Low Cost...High Performance

DIGITAL MULTIMETER



\$99.95 WIRED

Low cost, high performance, that's the DM-700. Unlike some of the hobby grade DMMs available, the DM-700 offers professional quality performance and appearance at a hobbyist price. It features 26 different ranges and 5 functions, all arranged in a convenient, easy to use format. Measurements are displayed on a large 3 1/2 digit, 1/2 inch high LED display, with automatic decimal placement, automatic polarity, and overrange indication. You can depend upon the DM-700, state-of-the-art components such as a precision laser trimmed resistor array, semiconductor band gap reference, and reliable LSI circuitry insure lab quality performance for years to come. Basic DC volts and ohms accuracy is 0.1%, and you can measure voltage all the way from 100 μ V to 1000 volts, current from 0.1 μ A to 2.0 amps and resistance from 0.1 ohms to 20 megohms. Overload protection is inherent in the design of the DM-700, 1250 volts, AC or DC on all ranges, making it virtually goof proof. Power is supplied by four 'C' size cells, making the DM-700 portable, and, as options, a nicad battery pack and AC adapter are available. The DM-700 features a handsome, jet black, rugged ABS case with convenient retractable tilt bail. All factory wired units are covered by a one year limited warranty and kits have a 90 day parts warranty.

Order a DM-700, examine it for 10 days, and if you're not satisfied in every way, return it in original form for a prompt refund.

Specifications

DC and AC volts:	100 μ V to 1000 Volts, 5 ranges
DC and AC current:	0.1 μ A to 2.0 Amps, 5 ranges
Resistance:	0.1 Ω to 20 megohms, 6 ranges
Input protection:	1250 volts AC/DC all ranges fuse protected for overcurrent
Input impedance:	10 megohms, DC/AC volts
Display:	3 1/2 digits, 0.5 inch LED
Accuracy:	0.1% basic DC volts
Power:	4 'C' cells, optional nicad pack, or AC adapter
Size:	6"W x 3"H x 6"D
Weight:	2 lbs with batteries

Prices

DM-700 wired + tested	\$99.95
DM-700 kit form	79.95
AC adapter/charger	4.95
Nicad pack with AC adapter/charger	19.95
Probe kit	3.95

TERMS: Satisfaction guaranteed or money refunded, COD, add \$1.50. Minimum order \$6.00. Orders under \$10.00, add \$ 75. Add 5% for postage, insurance, handling. Overseas, add 15%. NY residents, add 7% tax.



600 mHz COUNTER



\$99.95 WIRED

The CT-70 breaks the price barrier on lab quality frequency counters. No longer do you have to settle for a kit, half-kit or poor performance, the CT-70 is completely wired and tested, features professional quality construction and specifications, plus is covered by a one year warranty. Power for the CT-70 is provided by four 'AA' size batteries or 12 volts, AC or DC; available as options are a nicad battery pack, and AC adapter. Three selectable frequency ranges, each with its own pre-amp, enable you to make accurate measurements from less than 10 Hz to greater than 600 mHz. All switches are conveniently located on the front panel for ease of operation, and a single input jack eliminates the need to change cables as different ranges are selected. Accurate readings are insured by the use of a large 0.4 inch seven digit LED display, a 1.0 ppm TCXO time base and a handy LED gate light indicator.

The CT-70 is the answer to all your measurement needs, in the field, in the lab, or in the ham shack. Order yours today, examine it for 10 days, if you're not completely satisfied, return the unit for a prompt and courteous refund.

Specifications

Frequency range:	10 Hz to over 600 mHz
Sensitivity:	less than 25 mv to 150 mHz less than 150 mv to 600 mHz
Stability:	1.0 ppm, 20-40°C; 0.05 ppm/°C TCXO crystal time base
Display:	7 digits, LED, 0.4 inch height
Input protection:	50 VAC to 60 mHz, 10 VAC to 600 mHz
Input impedance:	1 megohm, 6 and 60 mHz ranges 50 ohms, 600 mHz range
Power:	4 'AA' cells, 12 V AC/DC
Gate:	0.1 sec and 1.0 sec LED gate light
Decimal point:	Automatic, all ranges
Size:	5"W x 1 1/2"H x 5 1/2"D
Weight:	1 lb with batteries

Prices

CT-70 wired + tested	\$99.95
CT-70 kit form	75.95
AC adapter	4.95
Nicad pack with AC adapter/charger	14.95
Telescopic whip antenna, BNC plug	7.95
Tilt bail assembly	3.95

ramsey electronics

BOX 4072, ROCHESTER, N.Y. 14610
PHONE ORDERS CALL
(716) 271-6487

SELECTED SPECTRONICS VALUES!



SPECTRONICS, INC.

1009 Garfield St., Oak Park, Illinois • 60304

(312) 848-6777

OUR BEST-SELLING MULTI-BAND!



MORFAIN

AS LOW AS

\$58⁷⁵

75/40 Meter

- One half the length of conventional half-wave dipoles
- Multi-band, Multi-frequency.
- Maximum efficiency — no traps, loading coils, or stubs
- Fully assembled and pre-tuned — no measuring, no cutting
- All weather rated — 1 KW AM, 2.5 KW CW or PEP SSB
- Proven performance — more than 10,000 have been delivered
- Permit use of the full capabilities of today's 5-band xcvrs
- One feedline for operation on all bands

40-10HD/A	40/20/15/10 Mtrs (36) \$63.25
80-40HD/A	80/40 Mtr bands (69) 61.25
75/40HD/A	75/40 Mtr bands (66) 58.75
75-10HD/A	75/40/20/15/10 Mtr (66) 78.25
80-10HD/A	80/40/20/15/10 Mtr (69) 80.25

2 METER ANTENNAS at BARGAIN PRICES!!



3 db GAIN
MAGNETIC MOUNT

NEW! ONLY

\$19.⁹⁵

Model 287
Wt. 2.5 lbs.

An economical alternative to drilling a hole. A magnetic antenna by a name you can trust at a low, low price.

Model 286 Same but trunk lid..... \$15.95 b

NEW from FINCO

2.8 dbd GAIN
BASE ANTENNA

ONLY

\$9.⁹⁵

Model A2-GP
Wt. 2 lbs.

At last! An inexpensive, omni directional, 144-148 MHz, 1/2 wave antenna. Fits 1 1/4" mast, 50 ohm imp. A good antenna at a very affordable price.

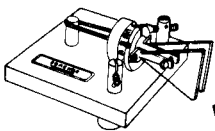

BENCHER

If it's the ultimate in paddles your looking for may we recommend the Bencher. It's simply the nicest one we've seen yet.

BY1 paddle w/black base..... \$39.95 c
BY1 Deluxe model w/chrome base..... 49.95 c

PANASONIC "COMMAND" SERIES

RF-2200

RF-2200 8 BAND AM/FM SW freqs from 3.9 to 28 MHz... Double super heterodyne... Precise calibrated tuning to 10 kHz... Double-check xtal marker at 500 kHz and 125 kHz RF gain control for AM/SW BFO switch for SSB & SW Plus many more features such as ext. jacks for AC ant. & spkr... Big radio features at low price
Plus \$2.50 Shipping



LIST \$179⁰⁰ NOW ONLY \$139⁹⁵

RF 2900

RF 2900 DIGITAL AM/FM SW from 3.2 to 30 MHz 5 digit LED display reads all bands Double superheterodyne 1PL circuitry FM AFC & wide/narrow bandwidth control Fast/Slow tuning Built in AM ant. Telescoping whip for AM/SW BFO pitch control for SSB/CW And much much more for the price
Plus \$2.50 Shipping

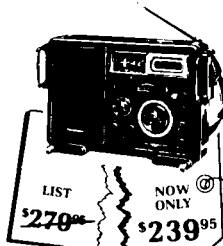

LIST \$279⁰⁰ NOW ONLY \$239⁹⁵

RF-4900

FULL SW COVERAGE FROM 1.6 to 31 MHz. ALL DIGITAL
Plus \$5.00 Shipping



LIST \$409⁰⁰ NOW ONLY \$429⁹⁵

RF-4900 DIGITAL AM/FM, SW coverage from 1.6 to 31 MHz • Full digital readout on all bands • 5 digit fluorescent readout • Premix double superheterodyne • Fast/slow tuning • AFC on FM, Narrow wide selectivity switch for AM/SW • BPO Pitch control • Calibration control • ANL switch for AM • FET RF circuit • RF Gain control • Inc ants for FM & SW and more

IMPROVE YOUR RECEPTION WITH AN AMECO ALL-BAND PREAMP!
• 6-160 Meters
• 20+ dB Gain
• Low Price



MODEL PLF-2 Improves weak signals as well as image and spurious rejection of most receivers. Direct switching to rec. or preamp. Includes pwr. supp. 117 VAC wired & tested
ppd \$49.95



CRAMPED FOR SPACE?

MODEL HQ-1 \$139.50 f

Mini-Products, Inc.

Then you want the antenna that's known around the world for its small size and superior performance. The Multiband HYBRID QUAD for 6, 10, 15 & 20 meters.

- WING SPAN 11 1/2"
- BOOM 54 INCHES LONG
- WIND AREA 1.5 SQ. FT.
- 1200 WATTS P.E.P. INPUT TO FINAL
- FEED LINE 50 OHMS

Trade-ins are always welcome at Spectronics. You'll be surprised how easy it is to move up to that new rig.

Cash paid for clean used gear. That's right...if you no longer need it we can convert that extra rig into cash.

ESTIMATED WEIGHT CODING

After the price of each item you will find a letter, i.e., 19.95 a. To make it easier to figure shipping costs, these letters indicate the approximate weight of the item as follows:

- | | |
|--------------------|---------------|
| a. Less than 1 lb. | f. 20-30 lbs |
| b. 1-3 lbs. | g. 30-40 lbs. |
| c. 4-6 lbs. | h. 40-50 lbs. |
| d. 7-10 lbs. | |
| e. 10-20 lbs. | |

* will be sent truck collect.



FROM

ON GLASS MOBILE ANTENNAS

Modern technology lets you mount a mobile antenna right on the window. Ideal for tough installations. 3 models available

- AH151.3G 144-174 MHz, 3 db gn.... \$33.95 b
- AH220.3G 220 MHz, 3 db gn..... 33.95 b
- AH450.5G 406-512 MHz, 5 db gn..... 36.95 b



Write For
FREE
Equipment
Catalog

vhf preamplifiers

A survey of today's devices and techniques for building a truly low-noise preamp for vhf reception

The vhf converters and preamplifiers of ten and fifteen years ago are inadequate by today's standards. This article presents the results of my experience with many low-noise preamps using modern devices and techniques, all of which have been built and tested as a part of a program to update my vhf station. The problems of wide dynamic range and intermodulation distortion are not addressed in this article.

analysis

Consider a typical vhf receiver (fig. 1). The receiver consists of X stages, where X is some number. Each stage has a noise figure, NF_X , and therefore a stage noise factor, F_X . Each stage has a gain, G_X , which may be an actual gain or it may be a loss as in the feedline, attenuator/filters, or even in the mixer. Noise figure, NF , is expressed in dB; noise factor, F , is nondimensional. NF and F are related by

$$NF = 10 \log F$$

$$F = \log^{-1}(NF/10) \quad (1)$$

The most common error in analyzing system noise performance is to lump noise figures and noise factors — a simple but bold dB symbol after each noise figure helps to differentiate the noise figure numbers from noise factors.

It's well known¹⁻⁴ that the system noise factor, $F_{S,0}$, as presented by the receiver at the antenna, is influenced to some extent by the noise factors and gains of the following stages:

$$F_{S,0} = F_0 + \frac{(F_1 - 1)}{G_0} + \frac{(F_A - 1)}{(G_0 G_1)} + \frac{(F_2 - 1)}{(G_0 G_1 G_A)} + \frac{(F_B - 1)}{(G_0 G_1 G_A G_2)} + \frac{(F_C - 1)}{(G_0 G_1 G_A G_2 G_B)} + \frac{(F_3 - 1)}{(G_0 G_1 G_A G_2 G_B G_C)} + \frac{(F_4 - 1)}{(G_0 G_1 G_A G_2 G_B G_C G_3)} \quad (2)$$

The "gain" of passive elements, such as the feedline and interstage networks (and often the mixer), is actually a loss. That is, a negative gain occurs, which is expressed in dB. When converted into a numerical ratio for use in eq. 2 this "gain" will be less than unity.

Thus a feedline with a 2.2 dB loss has a ratio of 1.66, which means that about 39.7 per cent of the input power is lost in the feedline. The gain, in this case, is -2.2 dB, or $1/1.66 = 0.6$. Noise figure in this portion of the system is essentially equal to the loss, $NF_0 = G_0$, and noise factor $F_0 = \log^{-1}(-G_0/10)$. Therefore $F_0 = 1.66$ and $G_0 = 0.6$.

Similarly, a double-balanced mixer has a negative gain. A double-balanced mixer is a passive circuit to which rf signals and LO inputs are supplied. It uses nonlinear elements (diodes) to derive the i-f signal. However, the double-balanced mixer has a noise figure about 1-3 dB greater than the conversion loss. Thus a typical balanced mixer with a conversion loss of, say, 6 dB ($\text{numerical loss} = \log^{-1}(6/10) = 3.98$) has a numerical conversion gain $G_C = 1/3.98 = 0.25$ but may have a noise figure of 8 dB, or a noise factor of 6.3. The noise figure is greater than mixer conversion loss.

system noise factor: some simplifications

Several simplifications to eq. 2 can be made. Each interstage network can be considered as a portion of the rf amplifier output circuit preceding the interstage circuit. The noise factor, F_4 , of the subsystem following the first stage can be neglected if the first i-f has a gain, G_3 , of at least 100 (20 dB).

The effects of the feedline (G_0 and F_0) can be removed if the first rf amplifier is placed directly at the antenna, and if the first rf amplifier has a gain, G_1 , at least 10 dB greater than the losses in the fol-

By Geoffrey H. Krauss, WA2GFP, 16 Riviera Drive, Latham, New York 12110

lowing interstage network and feedline (G_A and G'_0 , fig. 2A).

Thus the receiving system (fig. 2B), for noise considerations, can be reduced to:

- a) A low-noise preamp at the antenna, which may contain input and output filters as well as the feedline to the second rf amplifier, and which may have an overall stage noise factor, F'_1 and stage gain, G'_1 .
- b) The second rf amplifier with noise factor and gain of F_2 and G_2 .
- c) The frequency conversion stage. For image and noise rejection it includes a bandpass filter as part of

should have at least 10 dB more gain than the noise figure (in dB) of the subsequent portion of the system. However, the noise figure of the subsequent portion is predominantly established by the noise figure in its first stage. Therefore, this stage should have a reasonable noise figure even if adjusted for maximum gain. Thus, if the noise factor presented by the conversion stage is $F'_{S2} = 10$ (or $NF'_{S2} = 10$ dB), the second amplifier stage should have a target gain, G_2 , of $(10 \text{ dB} + NF'_{S2}) = 20 \text{ dB}$ and a relatively low noise factor, F_2 .

If, after the second rf amplifier stage is built and tested, the noise factor, F'_{S1} , of the second rf ampli-

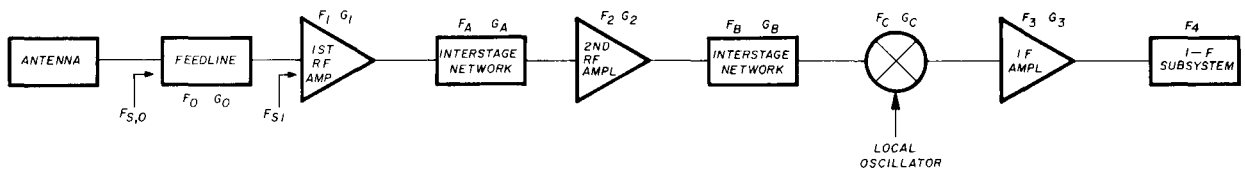

fig. 1. Typical vhf receiver used in the analysis.

an interstage network. It has a noise factor, F'_C , and a stage gain (or loss) of G'_C .

- d) I-f amplifier, which has an input noise factor, F'_3 .

The system noise factor, F'_{S0} , is now

$$F'_{S0} = F'_1 + \frac{(F_2 - 1)}{G'_1} + \frac{(F'_C - 1)}{G'_1 G_2} + \frac{(F'_3 - 1)}{G'_1 G_2 G'_C} \quad (3)$$

noise factor and noise figure

The system noise factor establishes the overall receiving-system signal sensitivity; a low noise factor (and, therefore, a low noise figure) is desirable above 100 MHz. Occasions arise when low noise figures are also desirable below 100 MHz, as in an extremely quiet location for 50-MHz operation. Accordingly, an evaluation of low-noise amplifier stages for 30, 50, 144, 220, and 432 MHz is useful.

Many receiving systems may use more than one preamplifier. In the systems of figs. 1 and 2, first and second preamplifiers are used between antenna and mixer. Regardless of the number of preamplifier stages between antenna and mixer, the general rule is to first adjust the first stage (at the antenna) for minimum noise figure, and then adjust the remaining stages, between the first preamplifier stage and the mixer stage, for maximum power gain. However, as shown by the system noise-factor equations, even the remaining rf amplifier stages should have reasonably low noise figures.

As mentioned, the rule of thumb is that each stage

fier/frequency-conversion/i-f system is measured, for example, as $F'_{S1} = 2$ ($NF'_{S1} = 3$ dB) the requirements for the first preamplifier stage are that the gain, G'_1 , be equal to $10 \text{ dB} + NF'_{S1}$ ($= 13$ dB), with the smallest noise factor, F'_1 , (and noise figure) achievable at that gain for minimizing the total system noise factor, F'_{S0} . The actual value of the system noise factor/noise figure will depend on the device selected for the preamplifier stage.

background information on devices

What devices are available for low-noise vhf preamplifier use, and what performance can be achieved? To give a proper perspective, consider first a short history of low-noise vhf preamplification.

About twenty years ago, in 1958, the predominantly used vhf bands were 50 and 144 MHz. Little was done, except by a few adventurous Amateurs, with the higher frequency bands. The "low" noise figures then achievable were about 4 dB on 50 MHz, typically with cascade-connected triode vacuum tubes such as the twin triodes of the 6BZ7 variety. About 5 dB was obtained with single triode vacuum tubes such as the 6AM4 on 144 MHz.

Serious experimenters tried to obtain type 5842/417A triodes, which could be used to achieve 3-dB noise figures up to about 250 MHz and about 5-dB noise figures at 432 MHz. A better low-noise tube for 432 MHz was the gold-plated 416B, which was occasionally available as pullouts from microwave relay transmitters. The problems of using pullouts, particularly at the relatively high current levels required for

low noise figure operation and the high cost and low availability of special-purpose tubes, deterred widespread Amateur use. Many 432-MHz and most 1296-MHz mixers were of the diode-mixer type, with no preamplification used in many 432-MHz and almost all 1296-MHz Amateur receivers.

Between about 1958 and 1963, vacuum-tube technology progressed to introduce the Nuvistor,[®] a miniature ceramic-metal tube best typified by the 6CW4, which had the high transconductance and low inter-electrode capacitance necessary for high-gain, low-noise preamplification. Noise figures of 3 dB at 50, 144, and 220 MHz were possible, by 1963, in a host of commercially available vhf converters, transverters, and at least one complete receiver (the Clegg Interceptor, for 6 and 2 meters). Versions of the Nuvistor,[®] would even yield 3-5 dB noise figures at 432 MHz, and a few commercial converters and preamplifiers were offered.

With the advent of relatively inexpensive, relatively low-noise preamps, interest in 220 MHz increased, although not as rapidly as in 432-MHz operation. Interest in 432 MHz was greater because the output of a 2-meter transmitter could be tripled for operation on 432 MHz, whereas a completely new transmitter had to be built for 220 MHz.

Parametric amplifiers were noted for very low noise operation but weren't very popular because of the need for a pump oscillator above 1 GHz and for special components.

Solid-state devices. Early silicon transistors did not, in 1963, appear to have any advantage over the new vacuum tubes. Consequently they saw limited use. However, in another five years, by 1968, the pressure of the commercial home-entertainment market forced development of relatively inexpensive and relatively low-noise silicon transistors. Several transistor types became available at sufficiently low cost for Amateur use. The 2N3819 family was often used for i-f amplifiers. The 2N3823 was specified for rf amplification to more than 150 MHz. Devices such as the Motorola MPF-102 family, the 2N2857, and the 2N4416 appeared. Germanium transistors, notably the 2N1742 and the Philco T2028, were available with even better noise figures than most silicon devices. Transistorized preamplifiers and converters were built with noise figures of 2 dB on 10 and 6 meters, 3 dB on 2 meters and 220 MHz, and 4-5 dB on 432 MHz. The use of vacuum tubes in Amateur vhf receiving gear diminished and all but ceased.

By 1973 a host of solid-state devices were available for vhf receiver use. Silicon devices, with better performance vs temperature characteristics than germanium devices, had, in this period, also achieved bet-

ter noise figures than their germanium counterparts.

Best remembered of that group were the devices available from KMC Transistors and from Fairchild Microwave Transistors. The KMC devices (now available under different device numbers from Microwave Associates) were capable of less than 2 dB noise figure at 144 and 220 MHz. With selected devices a 2-dB noise figure could be achieved at 432 MHz. If the preamplifier configuration and matching network were chosen and built with care, some of the FMT devices, such as the FMT 4575, reference 5, were capable of even better performance, but cost was generally prohibitive. The availability of the best FMT devices apparently ceased, as later batches of these devices were rumored to have poor noise figures, compared with the earlier batches, and a "lost recipe" was widely rumored as the cause. Solid-state low-noise vhf preamplifiers, were, however, firmly entrenched by this time.

Devices available today. As this is written, some twenty years after the 6BZ7 and 417A era, noise figures of 1 dB are easily obtained on the vhf Amateur bands. I built and tested forty-four preamplifiers to ascertain the performance that might be expected with a wide range of devices. Not all devices available to Amateurs were tested. Financial considerations limited this program to building units only with devices donated by various sources (including many engineers who wished to have a device evaluated and who arranged for these transistors to be made available to me). Results are shown in **table 1** by band and in order of increasing noise figure. **Table 1** also lists

a) The minimum noise figure, M :

$$M = 10 \log \left(1 + \frac{F-1}{1 - \frac{1}{G}} \right) \quad (4)$$

which is indicative of the minimum noise figure obtained with a cascade connection of several such stages.

b) The return loss, R , through the preamplifier from output to input, which is a measure of preamplifier stability and should be at least 8 dB greater than the forward gain, G , (reference 5).

c) A performance ratio factor, P , indicative of the noise figure vs preamplifier cost, which is changing between units of the same noise figure because of device price.

All preamplifiers in this article require a low-noise active device and a pair of matching networks. The input matching network matches the device input impedance to the antenna impedance (50 ohms). Device input impedance may be different, for mini-

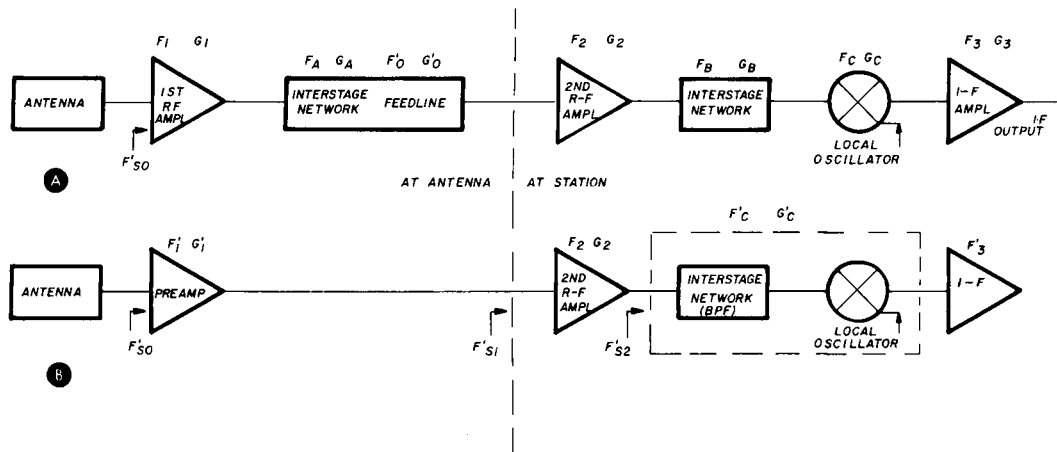

fig. 2. System block diagrams to illustrate how simplifications can be made to the system noise factor, $F_{S,O}$ (eq. 2). The system is divided into two parts: antenna and station. Sketches A and B are used in the text to explain the derivation of the simplified system noise factor, $F'_{S,O}$ (eq. 3).

imum noise-figure operation, from the data sheet values typically given for maximum gain operation. The output matching network matches the device output impedance to 50 ohms.

device choice

Choice of a suitable device should, in general, be governed by the manufacturer's data sheet. It not only lists expected noise figure and associated gain (at that noise figure) at some optimum bias level (generally stated in terms of V_{ce} and I_c for a bipolar transistor, or the equivalent V_{ds} and I_d for an FET device), but also gives

- a) Rf parameters for determining stability and matching-network design.
- b) A frequency range in which best operation of a device may be expected.

These data are advisory — they are typical values, which may be determined by testing a group of devices. They may not always be obtained for all devices of that type but are good starting points.

stability

If the selected device will operate in the desired frequency range, its stability is always the most important consideration. Nothing is achieved if a low-noise preamplifier is unstable with the input or output impedances found in the system. Instability may result in oscillation and may produce birdies, blocking, or other undesirable results.

Tests for stability are well covered elsewhere. However, two concepts should be kept in mind: First, the device should be stable over a wide frequency range, including the frequency of interest,

and second, even potentially unstable devices can be used if care is taken in matching-network design. In this respect, the use of a collector resistance of relatively low value is often helpful and may be found in many of the low-noise preamplifiers discussed in later portions of this article.

bias voltage

The bias voltage and current figures on a device data sheet should always be considered as *nominal* values and should always be varied to achieve best noise figure, assuming that a noise figure test setup is available.

I've tuned several identical preamplifiers containing devices taken from the same shipment. I found

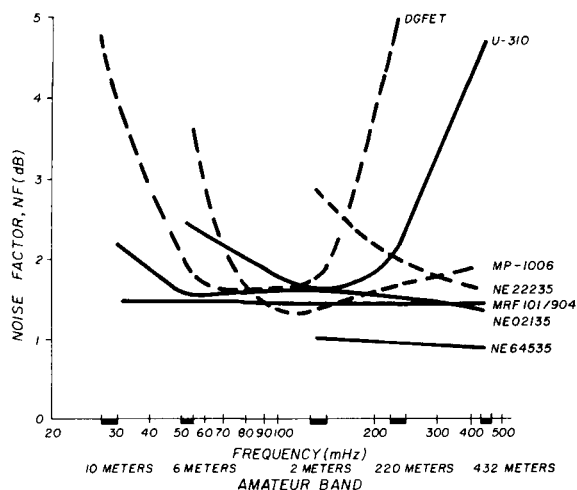

fig. 3. Noise figure as a function of frequency with several devices as a parameter. Note the apparent "useful frequency band" effect, particularly with the dgfet and the U310. Note also the lower frequency limitations shown by devices such as NE22235 and MP-1006.

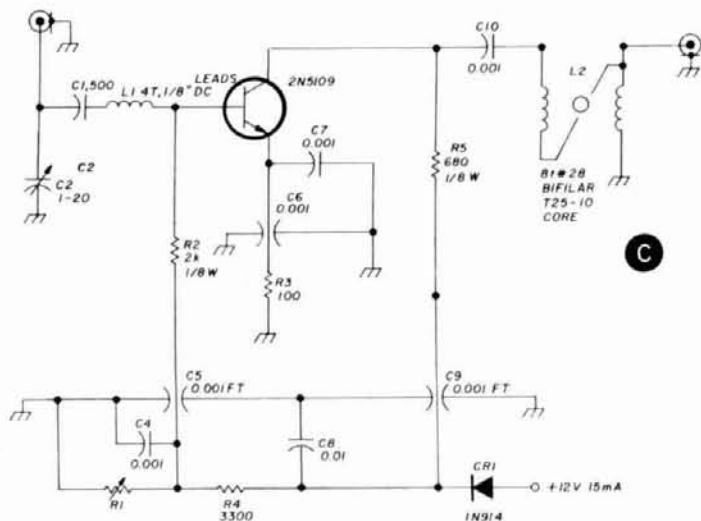
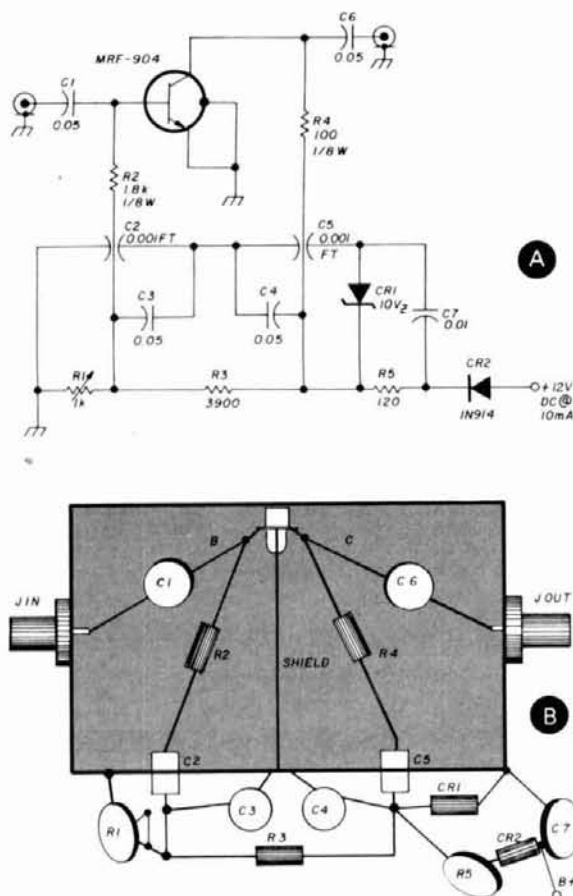

fig. 4. Preamplifiers for 30 and 50 MHz. (A) shows a circuit using the MRF-904, which has very wide bandwidth. (B) is a pictorial layout of the MRF-904 unit. In (C) a 2N5109 is used, which has a 1.7-dB noise factor. Many other devices are usable at this frequency (see text).

that, while almost identical noise figures and gains were achieved, each device had to be biased differently. For example I built and tested four units using NE64535s at 432 MHz; each unit was initially adjusted for data-sheet bias values of 8 volts V_{ce} and 7 mA I_c . All units were then adjusted for minimum noise figure in a test setup using a precision automatic noise figure indicator and noise source:

unit	ultimate NF (dB)		V_{ce}	I_c
	(Y method, +0.3dB; -0.1dB)			
1	0.86		8.6	7.5
2	0.84		7.9	6.4
3	0.91		8.1	10.0
4	0.90		4.9	5.0

S-parameters

Most device data sheets give rf characteristics in terms of S-parameters for gain amplification. While S-parameter design may be new to many Amateurs, several very good articles have appeared.⁹⁻¹³ The design procedures are relatively easy for devices that are unconditionally stable; *i.e.*, having a stability factor, K , greater than unity at the frequency of interest. However, if the device is only conditionally stable (K less than 1) and the input and output S-parameters

(S_{11} and S_{22}) are less than 1, a low-inductance resistor (between 50-200 ohms) may often be used as a collector load to provide a stable preamplifier configuration.¹⁴

Many data sheets don't give noise-related information. Most particularly, the optimum source reflection coefficient, Γ_{os} , is often missing. This is the parameter that should govern the entire design of a low-noise preamplifier.¹⁵⁻¹⁶ Given Γ_{os} , the input matching network is designed to transform the noise matched input impedance, derived from Γ_{os} , to the antenna impedance (generally 50 ohms). The output matching circuit may be designed once the device output impedance, for the device input connected to the optimum noise-match impedance, is known. Thus, both S and optimum-noise parameters should be known.

device frequency range

The range of device operation should be carefully determined from the data sheet. Many devices appear to be designed for a specific application and, in meeting those application requirements, have parameters that limit the useful frequency range. As an example, the dual-gate FET (DGFET) of table 1 is an experimental device designed for a noise figure of less than 2 dB over the frequency range of the commercial fm broadcast band. A low noise figure is obtained near this band at 50 and 144 MHz, while the noise figure at 30 and 220 MHz is very high. These latter frequencies were of no interest to the device designer, so the device characteristics are relatively

uncontrolled at these frequencies. Note also the noise figure (fig. 3) for the NE22235 and NE64535 devices, which are intended for use at 1-4 GHz and 0.5-4 GHz respectively. The noise figure curves show that these two devices were designed for optimum noise figure at frequencies above about 500 MHz. On the other hand, from the noise figure curves of fig. 3, devices such as the MRF901/904 were apparently designed for broadband application use from dc through the vhf range.

Device data sheets frequently give a circuit in which the device is tested, and which often makes a good starting point for design of an Amateur circuit. As the frequency increases, care must be taken in circuit layout. Short lead lengths and high-quality components (of types intended for vhf, uhf, or microwave use) are required.

band-by-band discussion

30-MHz. This band is primarily of interest for either OSCAR downlink or as an intermediate frequency for microwave equipment, such as the Microwave Associates Gunnplexers.[®] In i-f preamplifier application, the preamplifier design following the microwave mixer (generally a diode having 6-10 dB of conversion loss and noise figure) will be an important factor in establishing the overall receiver noise figure.

The MA42001-509, as used in W1HR's two-stage i-f amplifier,¹⁷ certainly has the lowest noise figure of units thus far built and tested. However the cost (about \$16.50 at the time of writing) of the two devices required for each such preamplifier must be balanced against the small loss in system sensitivity if you use a single-stage i-f preamplifier with a less-expensive 2N5109 or MRF901 device. Use of older devices, such as the 2N4416 and MPF102, is not advised; preamplifiers using these devices have been found to be only conditionally stable, even with heavily loaded output circuits.

The MRF-904 is of particular interest. Apparently it was designed from minimum noise figure when inserted into a 50-ohm system. As shown in fig. 4A, matching networks aren't required on either input or output of this transistor in a 50-ohm system. Coupling capacitors C1 and C6 provide dc isolation between input and output feedlines and the device bias circuit. This preamplifier has a very wide bandwidth, as no input or output filtering is used. Output filtering is usually provided by the receiver or converter. The need for, and degree of, input filtering is established by a particular use and location.

For the OSCAR down-link application almost any of the devices yielding less than a 2-dB noise figure should be acceptable, especially in front of a 10-meter receiver having a noise figure of 6-10 dB. I

believe the antenna pattern and pointing accuracy are of greater concern than noise figure in this application.

50 MHz. The background noise at 50 MHz is high enough so that a system noise figure of less than about 2 dB is unnecessary. Most of the devices tested achieved this noise figure for a single-stage preamplifier. The noise contribution of succeeding stages (existing converter and the like) will dictate the preamplifier gain and also indicated that a first-stage noise figure somewhat lower than 2 dB is required if the 2-dB system noise figure is to be achieved.

For example, I presently use a 50-MHz converter with a single 6CW4 rf amplifier preceding a mixer (a remnant of earlier 1960s equipment not yet replaced).

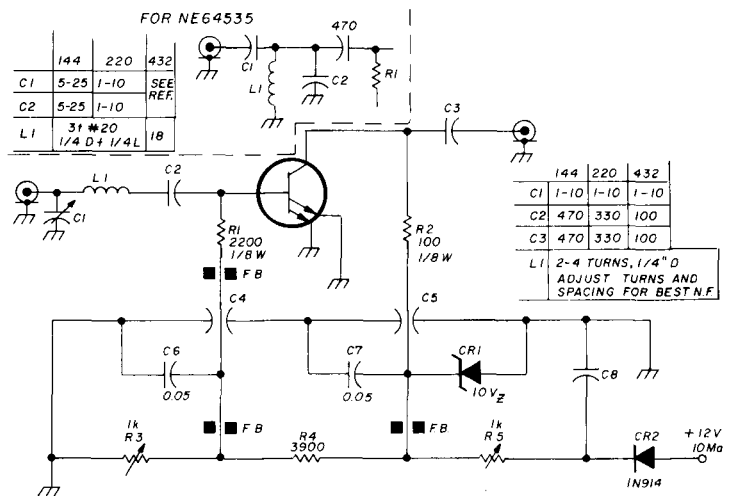

fig. 5. Preamp for 144 and 220 MHz using the MRF-901, NE02135 or NE22235. Design is similar to that by WB5LUA (reference 18).

The converters have input noise figures between 3.5 and 4.5 dB. If the highest expected converter noise figure (4.5 dB) is taken for worst-case analysis, and if a single-stage rf preamplifier with at least 14.5 dB (equal to 10 dB plus the maximum noise figure of the following stage, 4.5 dB) is to be used, then, by the noise-figure equation, $F_S = F_1 + (F_2 - 1)/G_1$, where the value of $F_2 = \log^{-1}(4.5/10)$, with $G_1 = \log^{-1}(14.5/10)$ and $F_S = \log^{-1}(2.0/10)$. Thus $F_S = 1.585$; $F_2 = 2.818$, and $G_1 = 28.184$. These values are substituted into the equation and give

$$1.585 = F_1 + (2.818 - 1)/28.184 = F_1 + 0.065$$

Therefore, $F_1 = 1.585 - 0.065 = 1.52$, and the preamplifier noise figure, NF_1 , should be no greater than $10 \log(1.520) = 1.82 \text{ dB}$.

Devices tested at 50 MHz that are usable for this particular application include MA42001 (0.95 dB NF,

K = 18.92); NE02135 (1.55 dB NF, K = 19.08); MRF-901 (1.67 dB NF, K = 16.87); KD6003 (1.7 dB NF, K = 22.88); and 2N5109 (1.7 dB NF, K = 16.62). An example of a preamp using the 2N5109 is shown in **fig. 4B**.

Other factors, dependent on your needs, may now be considered, such as circuit simplicity, resistance to overload, and preamplifier bandpass characteristics.

Note that many of the low-noise preamplifier circuits are broadband; a high-*Q* input circuit will add undesired noise before the desired signals can be amplified by the device. Of course, if use is intended in an environment near other rf sources, then input filtering may be mandatory to prevent receiver overload. The amount of input bandpass filtering is determined on a case-by-case basis, although use of low-intermodulation-producing, and therefore overload-tolerant devices, such as the 2N5109 provides some leeway in achieving the desired result. I prefer to place a separate low-insertion-loss filter such as a helical resonator or interdigital filter, having steep

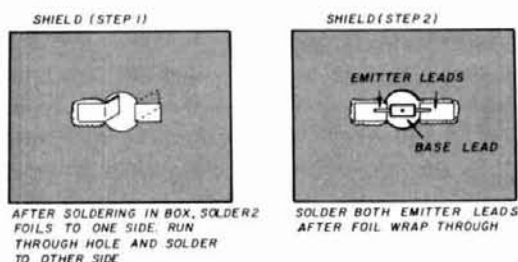

fig. 6. Details of preamp shield construction.

skirts and high out-of-band loss, before the first preamplifier. Such filters have a varying impedance outside the passband of interest, so this reactance may cause a potentially unstable preamplifier to oscillate.

If a 50-MHz i-f system is used with higher frequency (microwave) equipment, the i-f amplifier noise figure may, depending on its total noise figure contribution, require a very low noise configuration using a device such as the MA42001. However, use of such a low-noise-figure preamplifier would usually be expected only when no additional rf amplification is inserted between the antenna and the higher-frequency mixer.

Devices are available for low-noise preamplifiers for the bands up to at least 3300 MHz. Image-rejection considerations at even higher bands, above 5650 MHz, dictate the use of i-fs higher than 50 MHz, so little is gained by using low-noise 50-MHz i-f amplifiers following a microwave mixer. Exceptions always occur — one is a 50-MHz i-f with the mixer portion of a 10-GHz Gunnplexer® transceiver in which a low-noise-figure device, such as the MA42001, would be

advisable. Additional information for 50-MHz preamplifiers is shown in **figs. 4** through **7**.

144 and 220 MHz. The 2-meter band has a sufficiently low background noise to allow very low-noise-figure preamplifiers to be used to advantage. The frequencies of the 2- and 1 ¼ meter bands are relatively close (less than one octave apart). Similar device and circuit design and selection criteria are valid. Furthermore, the 2-meter band is a common i-f for 1296 and 2304 MHz converters, wherein low-noise-figure i-f amplifiers may be used to advantage. The same 2-meter preamplifier may be used between a 2-meter receiver and either a 2-meter antenna or the i-f output of a 1296- or 2304-MHz mixer.

For truly low noise figures, the NE64535, priced at about \$17, provides a 1-dB noise figure in a relatively simple circuit. This device is potentially unstable at all Amateur bands of interest; therefore, the collector circuit (**fig. 5**) is heavily loaded with a 100-ohm, 1/8-watt resistor.

The design is similar to that of WB5LUA (reference 18), but with added shielding between the device base and collector terminals. This shielding must be properly designed, because with improper shielding, the preamplifier exhibits a strong tendency towards oscillation, as noted by WB5LUA in his article. While the 432-MHz preamplifier of that article did not require shielding, at the lower frequencies of 144 and 220 MHz, the greater forward gain of these devices makes full shielding mandatory.

The preamplifiers are built in a box (**fig. 7**) formed of double-sided PC board with a double-sided PC-board shield (**fig. 6**), into which a small hole is drilled. The hole diameter is slightly larger than the device package dimension between the opposed emitter leads. The edges of both copper-clad sides of the shield are soldered to the bottom and two side walls of the basic enclosure. Most important, at least two small strips of copper foil, as found in most hobby shops, are passed through the hole and soldered on each side of the shield.

The opposed pair of emitter leads are soldered to the copper foil straps on the *input* side of the shield after the collector lead is passed through the hole in the shield (see **figs. 6** and **7**). Thus, the base and emitter leads are on the input-circuit side of the shield, and the collector lead extends through the shield to the output-circuit side of the box. Failure to use the copper foil straps under the emitter leads, or soldering the emitter leads to the output-circuit side of the shield, will invariably cause oscillation, even with a resistive collector load.

Note particularly the use of ferrite beads, low-inductance coaxial feed-through capacitors, and the 0.05 μ F low-frequency bypass capacitors in parallel with the feed-throughs, to prevent oscillations at fre-

table 1. Test results obtained by the author on solid-state devices used in forty-four preamplifiers covering 30-432 MHz.

frequency (MHz)	device	mfg.	cost	NF		gain			P	BW (MHz)	frequency (MHz)	device	mfg.	cost	NF		gain			P	BW (MHz)
				(dB)	(dB)	R(dB)	M(dB)	(dB)							(dB)	R(dB)	M(dB)				
30	MA42001	MA	11.50	1.05	18.0	-33	1.06	20.67	1	432	KD-6003	MA	5.00 ⁽²⁾	1.95	16.5	-23	1.99	26.87	T144		
	2N5109	—	1.55	1.44	14.4	-39	1.49	14.23	BB		2N4416	—	0.50	2.00	10.0	-20	2.17	18.48	4		
	MRF-901	M	2.10	1.47	26.2	-34	1.47	14.85	BB		U-310	S	4.00	2.00	9.1	-28	2.22	26.70	4		
	MPF-102	M	0.35	1.60	16.0	-16	1.63	13.61	1		NE22235	NEC	17.00	2.10	29.3	-26	2.10	48.71	BB		
	2N4416	—	0.50	1.62	13.1	-22	1.69	14.67	1		2N5109	—	1.55	4.60	7.9	-21	5.10	51.23	T50		
	MRF-904	M	1.25	1.65	23.0	-34	1.66	15.36	BB		DGFET	—	1.00 ⁽¹⁾	5.00	13.5	-22	5.14	46.26	4		
	NE02135	NEC	4.00	2.15	16.7	-47	2.19	26.28	BB												
	DGFET	—	1.00 ⁽¹⁾	4.80	12.0	-58	4.99	44.91	1												
50	MA42001	MA	11.50	0.95	15.3	-34	0.97	18.92	2	NE24483	NEC	120.00	0.74	15.3	-25	0.76	114.00	GaAs fet			
	2N4416	—	0.50	1.37	13.0	-15	1.43	12.16	2	NE64535	NEC	17.00	0.86	16.0	-24	0.88	22.00	BB			
	NE02135	NEC	4.00	1.55	15.0	-27	1.59	19.08	BB	MSC-H001	MSC	40.00 ⁽³⁾	(1.00)	(20.0)	—	(1.00)	—	—	GaAs fet		
	MRF-901	M	2.10	1.67	25.0	-32	1.67	16.87	BB	NE02135	NEC	4.00	1.27	11.2	-27	1.36	16.37	BB			
	KD6003	MA	5.00 ⁽²⁾	1.70	13.7	-28	1.76	22.88	T144	MRF-904	M	1.25	1.38	11.0	-25	1.48	13.69	BB			
	2N5109	—	1.55	1.72	18.0	-29	1.74	16.62	T50-BB	MRF-901	M	2.10	1.40	16.1	-22	1.43	14.44	BB			
	DGFET	—	1.00 ⁽¹⁾	2.00	13.5	-46	2.07	18.63	2	NE22235	NEC	17.00	1.60	11.0	-26	1.71	48.25	BB			
	MPF-102	M	0.35	2.00	13.2	-27	2.08	17.37	2	MP-1006	AND	11.00	1.90	17.7	-28	1.93	37.64	55			
	MRF-904	M	1.25	2.00	28.0	-34	2.00	18.50	BB	MA42161	MA	>15.00 ⁽⁴⁾	(1.90)	(16.0)	—	(1.94)	—	—			
	U-310	S	4.00	2.50	10.3	-26	2.69	32.28	2	MP-1004	AND	14.00	2.00	12.2	-34	2.11	47.48	BB			
	MP-1006	AND	11.00	3.70	27.0	-29	3.70	70.30	BB	MP-1001	AND	6.00	2.40	16.5	-23	2.46	34.44	BB			
										KD-6003	MA	5.00 ⁽²⁾	4.20	7.7	-23	4.73	62.79	T144			
										U-310	S	4.00	4.70	6.0	-30	5.57	66.84	10			
144	NE64535	NEC	17.00	1.00	22.0	-36	1.00	25.00	BB	notes											
	MP-1006	AND	11.00	1.37	16.6	-28	1.40	26.60	BB	(1) Experimental device — not generally available.											
	MRF-901	M	2.10	1.40	23.0	-28	1.41	14.24	BB	(2) No longer available; MA42003 is a substitute. KD6003 circuit (reference 6) tuned to 145 MHz for all measurements.											
	MRF-904	M	1.25	1.41	17.0	-32	1.43	13.23	BB	(3) Not built. See reference 7 for data.											
	U-310	S	4.00	1.60	12.0	-27	1.69	20.28	2	(4) Not built. See reference 8 for data.											
	KD-6003	MA	5.00 ⁽²⁾	1.67	21.5	-25	1.68	21.84	BB	legend											
	DGFET	—	1.00 ⁽¹⁾	1.75	17.0	-28	1.78	16.03	3	BB Broadband. Input noise matched at measured frequency.											
	NE02135	NEC	4.00	1.81	23.5	-31	1.82	21.84	BB	M Minimum noise figure (dB). (See text.)											
	2N4416	—	0.50	1.90	17.5	-20	1.93	16.40	2	P Performance ratio factor. (See text.)											
	2N5109	—	1.55	2.45	12.5	-23	2.56	24.45	T50	R Return loss through preamp (dB). (See text.)											
	NE22235	NEC	17.00	2.80	17.0	-38	2.84	71.00	BB	Txxx Tuned at frequency indicated for all measurements.											
	MPF-102	M	0.35	3.65	11.0	-24	3.86	32.23	2	manufacturers											
	J-308	S	1.25	6.20	13.0	-18	6.37	58.93	(several measured)	AND AND Transistors, 770 Airport Blvd., Burlingame, California 94010.											
									M Motorola Semiconductors, 4221 East Raymond, Phoenix, Arizona 85040.												
									MA Microwave Associates (G.R. Whitehouse & Co., 17 Newbury Drive, Amherst, New Hampshire 03031).												
									MSC Microwave Semiconductor Corporation, (HAM-TRANS, P.O. Box 383, South Bound Brook, New Jersey 08880).												
									NEC Nippon Electric Company (California Electronic Labs, 1 Edwards Court, Burlingame, California 94010).												
									S Siliconix, 2201 Laurelwood Road, Santa Clara, California 95050.												
220	NE-64535	NEC	17.00	0.96	19.0	-34	0.97	24.27	BB												
	MRF-904	M	1.25	1.35	14.5	-28	1.39	12.86	BB												
	MRF-901	M	2.10	1.40	18.1	-24	1.42	14.34	BB												
	MP-1006	AND	11.00	1.66	15.1	-28	1.71	33.35	8												
	NE-02135	NEC	4.00	1.87	20.8	-30	1.88	22.56	BB												

quencies removed from the frequency to which the preamplifier is tuned. Also note the biasing arrangement. A zener between transistor collector and base is *not* recommended because zeners are themselves often used as noise sources. Thus, even if bypassed, they will inject noise.

As previously stated, arrangement is made for adjusting both the voltage and current at the device collector; noise figure is affected by these parameters. The zener limits the maximum V_{ce} to avoid device burnout; the actual V_{ce} value, adjusted for minimum noise figure, is less than the zener voltage.

The preamplifier may be initially tuned for maximum gain but should be finally tuned using a noise generator. A vacuum-tube noise generator, such as one using a 5722 tube, is discouraged: voltage spikes

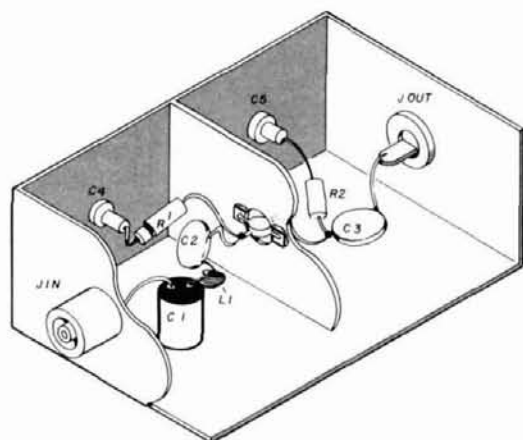

fig. 7. Isometric drawing showing internal construction.

of sufficient amplitude to destroy the transistor may be present.

A semiconductor noise generator is preferred, if available. If a precision noise-figure test set isn't available, you'll find that the units of this preamplifier are close to minimum noise figure when adjusted for maximum gain, at the manufacturer's suggested optimum bias level of 8 volts and 7 mA.

Slightly higher noise figures can be achieved with a variety of lower-cost devices, as listed in **table 1**. Of particular interest is the 2-meter preamplifier using the U310, which is unconditionally stable in a grounded-gate configuration.¹⁹ It has tuned input and output circuits, achieving a relatively narrow bandpass characteristic. The narrow bandpass characteristic prevents preamplifier intermodulation and blockage problems caused by strong signals in the aircraft, business, and other adjacent bands.

432 MHz. This band may, to the purist, be considered above the vhf frequencies. However, it is the

highest-frequency Amateur band at which point-to-point wiring techniques have been found to be generally usable. So it's included as the highest frequency band at which vhf-type preamplifiers may be easily built.

The listings of **table 1** illustrate that high-frequency versions of the 144- and 220-MHz preamplifiers previously discussed do, indeed, give performance unheard of twenty years ago. The best performance is, however, obtained by using microwave gallium arsenide field effect transistors (GaAs fet) devices such as the NE24483²⁰ or MSC-H001.⁷ Because of the inordinately high cost and great susceptibility to damage of these devices, they are used mainly by moonbounce operators. The NE64535 or one of the MRF901 or NE02135 devices in a 432-MHz preamplifier if followed by a converter with a 3-dB input noise figure, will fulfill the needs of most operators of this band. The preamplifier must be installed at the antenna to realize this increase in sensitivity.

Values are shown for 432-MHz operation in the figures for 144-220 MHz preamplifiers having circuits directly extendable to 432-MHz. **Fig. 7** is a typical vhf preamplifier layout that can be adapted to most, if not all, of the preamplifiers discussed in this article.

further construction hints

I've tried both point-to-point and PC-board construction (**fig. 8**). Because full shielding of the preamplifier is desirable in addition to bias-lead filtering, PC technique is more costly and time consuming. Furthermore, if a double-sided PC board is used, with the unetched ground side as part of the shielding enclosure, the microstripline impedances of the circuit traces will have unexpected effects, particularly at 432 MHz. Unless the preamplifier is specifically designed to use microstripline (which will be considerably larger than a point-to-point wired preamplifier at 432 MHz), the low noise figure of modern-day transistors won't be realized.

Microstripline design generally assumes matching at least the resistive component of the input impedance to the data-sheet-specified device impedance. Because the device you use may have a slightly different impedance, optimum match can only be approached but never fully achieved. The illustrated, discrete-component, input-matching circuits allow adjustment for a range of resistive and reactive components of antenna and device impedances.

in summary

This article illustrates that truly low-noise vhf receiving preamplifiers can be built at the present time. Many of the preamplifiers built as part of this program have been tested not only on the lab bench

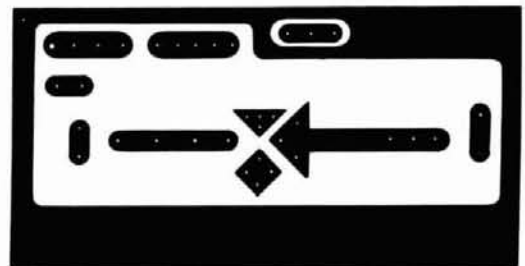
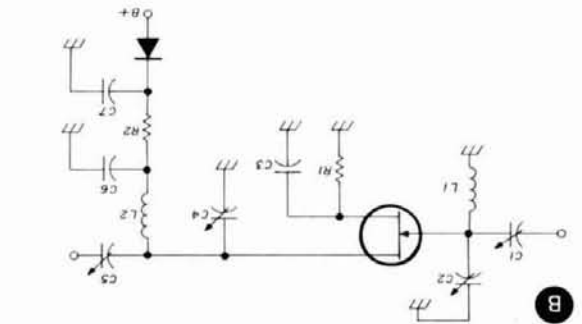
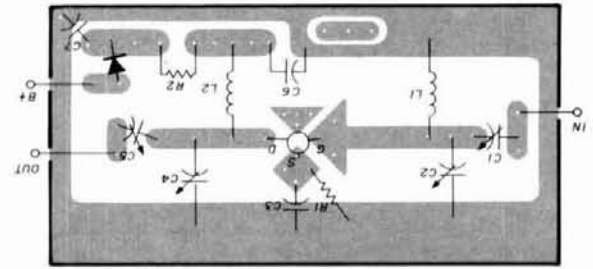
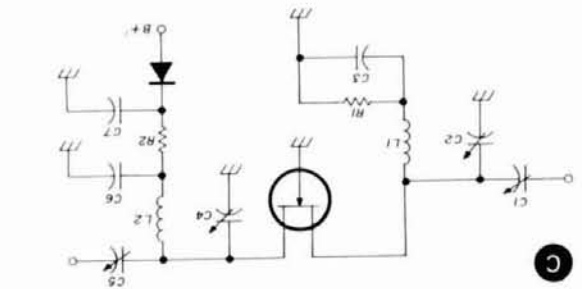
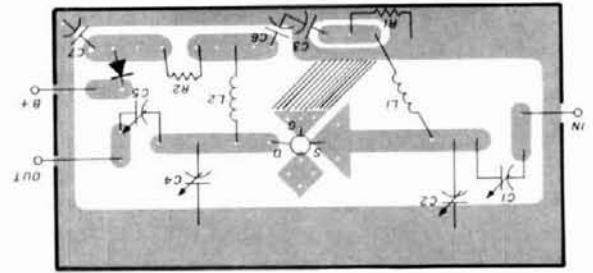
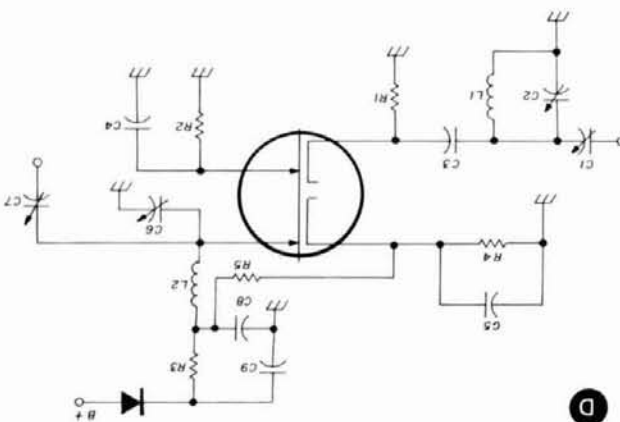
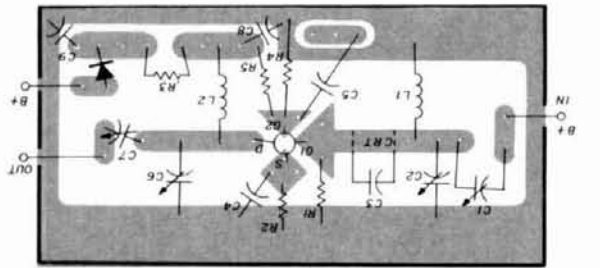
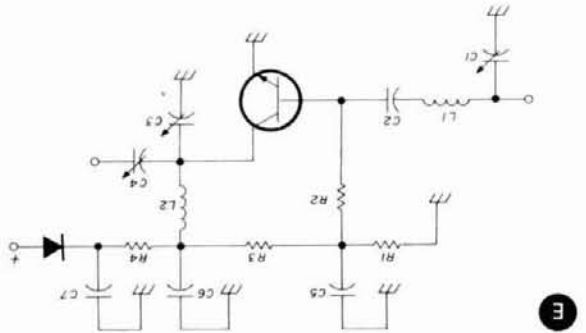
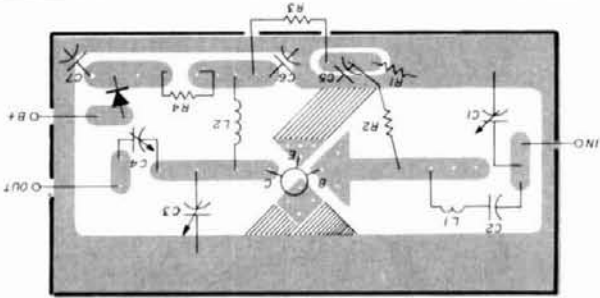

Fig. 8. A "universal" PC board for vhf rf preamps. (A) usable to 225 MHz. Stripline effects above about 300 MHz may seriously affect operation of 432-MHz preamps if a two-sided board is used (reverse side as a ground plane). (B) through (E) show, respectively, circuits for a Jfet, common source; a Jfet, common gate; dgfet, common source; and a bipolar transistor, common emitter. (Note that the arrow on the board points from input to output.)



C

B

A

E

D

but also under contest conditions by W2SZ/1 in various vhf and uhf contests over the past two years. Additional preamplifiers are constantly being built as new devices are received. And, depending on the results eventually derived from such new preamplifiers, an update may be forthcoming. Preamplifiers for 1296 and 2304 MHz are also being built and evaluated. An article covering these preamplifiers will be written when a sufficiently large number have been evaluated.

It should be kept in mind that all noise-figure measurements, especially those below about 2 dB, are not absolute but are relative indications of noise performance of the devices tested. The same test setup with circuits designed and built by one person may or may not result in the same answers obtained by others using identical circuits and procedures.

acknowledgments

I'd like to thank everyone who made devices available to me for construction and test of the preamps in this program. Special thanks are due the RPI Radio Club, W2SZ, for contest evaluation and, to Dick Frey, WB2BXP, for his help and encouragement.

references

1. S. Maas, K3WJQ, "The Meaning of Sensitivity," *QST*, June, 1975, pages 20-22 and 33.
2. R. Lente, DL3WR, *VHF Communications*, 4th Edition, 1975, pages 217-235.
3. D. Vollhardt, DL3NQ, *VHF Communications*, 4th Edition, 1976, pages 234-242.
4. F.E. Gardiel, "Simplified NF Calculations of Cascaded Two-Ports," *Microwaves*, April, 1978, pages 80-81.
5. J. Reiser, W1JR, "Ultra Low-Noise Uhf Preamplifier," *ham radio*, March, 1975, pages 8-19.
6. H. Cross, W100P, "Solving Overload Problems with Vhf Converters," *ham radio*, January, 1973, pages 53-55.
7. P. Wade, WA2ZZF, and A. Katz, K2UYH, "Low-Noise GaAs FET Uhf Preamplifiers," *QST*, June, 1978, pages 14, 15.
8. *Transistor Designers Guide*, Microwave Associates, 1978, pages 28-32.
9. H.P. Shuch, WA6UAM, "Solid-State Microwave Amplifier Design," *ham radio*, October, 1976, pages 40-47.
10. G.J. Clements, VK3TK, (Comments) "Microwave Amplifier Design," *ham radio*, September, 1977, pages 98-100.
11. *High-Frequency Transistor Primer, Part II*, Avantek, 1975.
12. *S Parameters, Circuit Analysis and Design*, Hewlett-Packard, Application Note 95, 1968.
13. *S Parameter Design*, Hewlett-Packard, Application Note 154, 1973.
14. L. Besser and S. Swenson, "Update Amplifier Design with Network Synthesis," *Microwaves*, October, 1977. (Note especially fig. 4.)
15. J.A. Eisenberg, "Designing Amplifiers for Optimum Noise Figure," *Microwaves*, April, 1974, pages 36-44.
16. *Application Bulletin 17 and Application Notes 967 and 970*, Hewlett-Packard.
17. J.R. Fisk, W1HR, "Low-Noise 30-MHz Preamplifier," *ham radio*, October, 1978, pages 38-41.
18. A. Ward, WB5LUA, "Super Low-Noise 432 MHz Preamplifier," *ham radio*, October, 1978, pages 26-29.
19. *Moon Bounce Notes, AS-49-9*, design by W2AZL, Eimac Division of Varian Associates.
20. S. Sando, JH1BRY, "Very Low Noise GaAs FET Preamp for 432 MHz," *ham radio*, April, 1978, pages 22-27.

ham radio



GREGORY ELECTRONICS
The FM Used
Equipment People.

2 Meter Portable

G.E. MASTR PR 36
132-150 MHz - 5 Watts
ALL SOLID STATE
with Ni-Cad Battery

New Low Price
\$138.

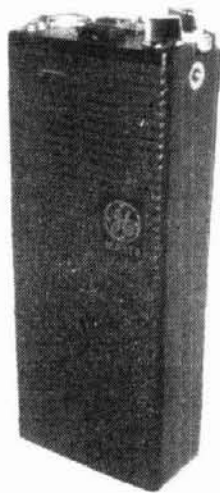

Vehicular Charger 4EP63A (sold only with unit) **\$25.**



GREGORY ELECTRONICS CORP.

245 Rt. 46, Saddle Brook, N.J. 07662
Phone: (201) 489-9000

FAST SCAN ATV

WHY GET ON FAST SCAN ATV?

- You can send broadcast quality video of home movies, video tapes, computer games, etc. at a cost that is less than slocan.
- Really improves public service communications for parades, RACES, CAP searches, weather watch, etc.
- DX is about the same as 2 meter simplex - 15 to 100 miles.

ALL IN ONE BOX



TC-1 Transmitter/Conv
Plug in camera, ant, mic and you are
on the air \$399 ppd



HITACHI HV-62 TV CAMERA
High performance closed circuit
camera just right for atv, with lens
. \$239 ppd

PUT YOUR OWN SYSTEM TOGETHER



TVC-1B CONVERTER tunes 420
mhz down to ch 2 or 3 . . . \$49.50 ppd
TXA5 EXCITER \$69 ppd
PA5 10 WATT LINEAR . . . \$79 ppd
FMA5 Audio Subcarrier . \$24.50 ppd

SEND FOR OUR CATALOG, WE HAVE IT ALL
Modules for the builder, complete units for the operator, antennas,
color cameras, repeaters, preamps, linears, video ider and clock,
and more. 19 years in ATV.

Call 213-447-4565 5-6 pm ur time



P.C. ELECTRONICS

Maryann
WB6YSS 2522 PAXSON
ARCADIA, CA 91006

Tom
W6ORG



Six professional scopes offer build-it-yourself savings.

Save up to 46% when you build it yourself.

Only in the Heathkit Catalog will you find this selection of six professional oscilloscopes, each with its own special features and low price. Compare Heathkit prices with similar assembled scopes and see how much you can save when you build it yourself.

Heathkit Model	Trace	Bandwidth MHz	Vertical Sensitivity*	Delay Lines	Regulated high voltage	Mu-metal shielding	Low kit price
10-4235	dual	DC-35	2mV/cm to 10V/cm	yes	yes	full	\$869.95
10-4510	dual	DC-15	1mV/cm to 5V/cm	yes	yes	full	\$649.95
10-4550	dual	DC-10	10mV/cm to 20V/cm	no	yes	full	\$399.95
10-4555	single	DC-10	10mV/cm to 20V/cm	no	yes	full	\$349.95
10-4205	dual	DC-5	10mV/cm	no	no	partial	\$279.95
10-4105	single	DC-5	10mV/cm	no	no	partial	\$199.95

*Under full bandwidth

Heathkit manuals make kitbuilding easy



Easy-to-follow Heathkit assembly manuals take you step by step from unpacking to final plug-in. Anyone can do it. And when you build it yourself, you can service it yourself.

Your manual becomes a handy service guide.

Replacement parts are readily available from the Heathkit factory or from Heathkit Electronic Centers. And experienced service techs are just a phone call away to help you during building or servicing.

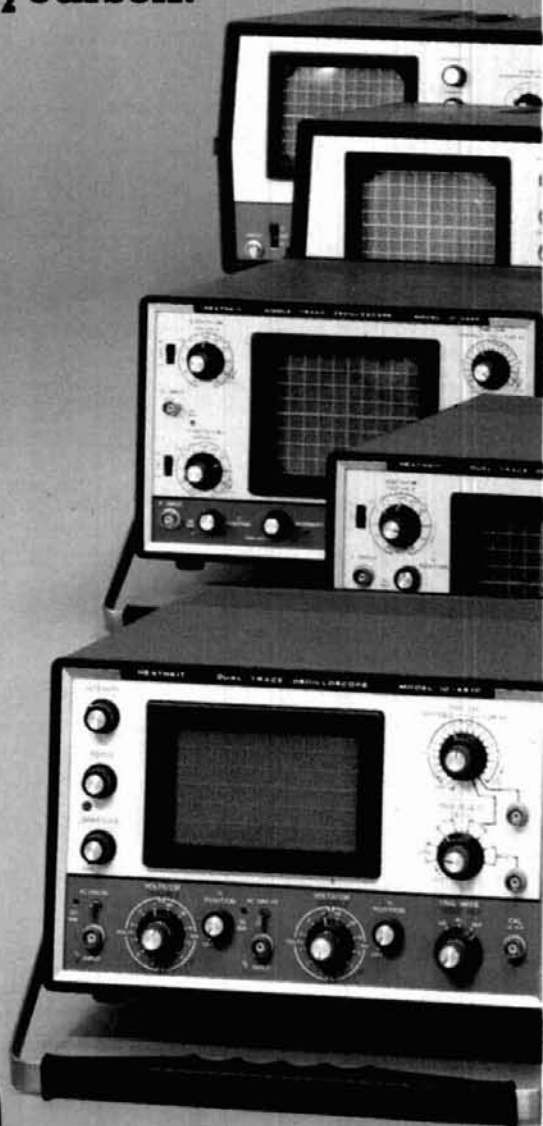
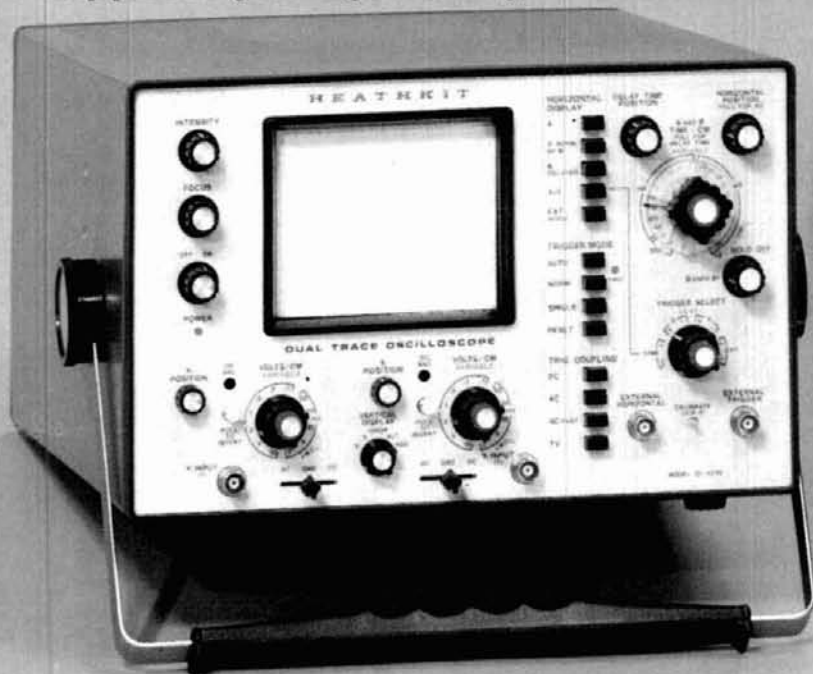

FREE Catalog



Complete details on Heathkit Oscilloscopes and nearly 400 other Heath electronic kits for your home, work or pleasure are in the new Heathkit Catalog. Send for yours today or pick one up at your Heathkit Electronic Center.

Heathkit®

Heathkit Products are also sold and serviced at Heathkit Electronic Centers (Units of Schlumberger Products Corp.) in major cities throughout the U.S. See your white pages.

Heath Company, Dept. 122-600, Benton Harbor, MI 49022

GX-371

repair bench



George Wilson, W10LP

variable high-voltage supply

This workbench supply fulfills a need for test voltages in the 50-500 volt range. It can be built using mostly junkbox parts. It's particularly useful in reforming high-voltage electrolytic capacitors.

The title of this article originally was "The Care and Feeding of Electrolytic Capacitors." When it came time to take pencil in hand it appeared that the power supply needed to condition electrolytic capacitors has wider application and, hence, the more general (if less exciting) title. The supply described is meant to be used for light-duty experimental work. Its occasional utility on the workbench makes it a good investment of the construction time and cost for parts.

circuit description

This is a *high-voltage* supply. Variable-voltage supplies for the range between zero and 50 volts are easily built with solid-state devices and have been described in the literature. The supply described here covers 50-500 Vdc. Output voltage adjustment to amounts less than 50 volts is touchy. So if you're interested in a power supply for lower voltages it's best to use one specifically designed for the purpose.

The circuit (fig. 1) is an ac voltage regulator (similar to those used in light dimmers and universal motor controllers) followed by a high-voltage transformer, rectifier and filter system. High-voltage sili-

con rectifiers are used. Vacuum-tube rectifiers would require a separate filament transformer and switch to provide constant voltage to the filaments. An LC filter is used to provide relatively ripple free dc. The choke also helps protect the 450-volt filter capacitor from current spikes. Note that this capacitor will be working close to its voltage rating at times. A 50-ohm 5-watt resistor can be substituted for the choke if you can't locate a suitable choke.

A separate ac switch is used rather than one connected to the voltage-control pot, which allows setting a voltage and turning the supply off and on without changing the set voltage. The bleeder resistor is primarily a safety device to help limit the voltage output (under light or no-load conditions) and to discharge the filter capacitor when the supply is turned off.

The component values in the ac voltage regulator circuit have been selected to provide relatively good voltage control over the 50-500 volt range. The triac circuit does not excel at the lower end of its control range, but its simplicity and low cost make it otherwise attractive.

(A) Author's experimental version of the variable high-voltage supply. The size and layout of yours will depend on the parts you can obtain. Note the separate on-off switch to allow voltage to be turned off and on without disturbing the variable setting. Terminal strips to mount small parts is recommended. A bottom plate will add safety. Don't omit the fuse. A low-value fuse is a good way to protect the circuit you're working on — a panel fuse mount will allow easy replacement.

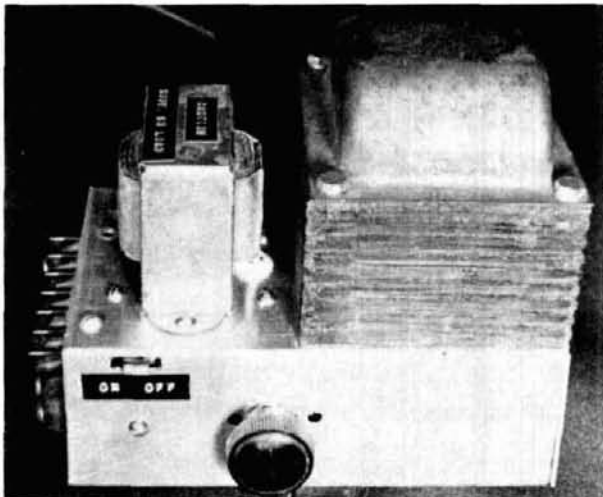

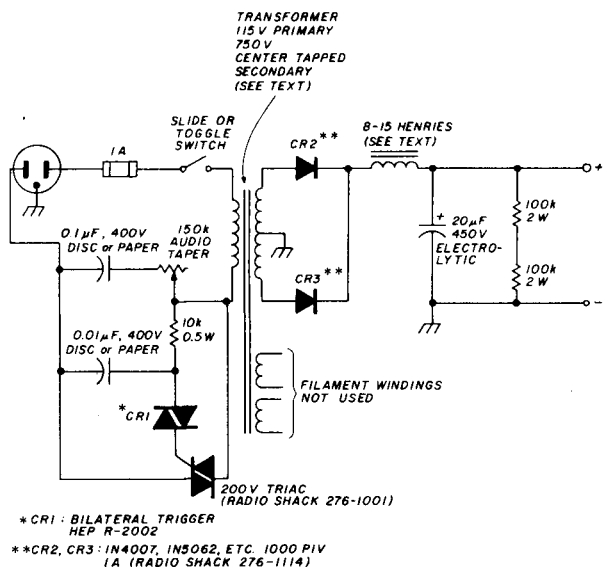

fig. 1. Variable high-voltage supply.

symbol	part	description
C1	capacitor	0.01 µF, 400 V disc or paper
C2	capacitor	0.01 µF, 400 V disc or paper
C3	capacitor	20 µF, 450 V electrolytic
CR1	bilateral trigger	HEP R-2002
CR2, CR3	diode	1N4007, 1N5062, etc. 1000 PIV 1 Ampere (Radio Shack 276-1114)
F	fuse	1 Ampere
L	choke	8-15 Henries (see text)
Q	triac	200-volt triac (Radio Shack 276-1001)
R1	potentiometer	150k audio taper
R2	resistor	10k 0.5 watt
R3, R4	resistor	100k 2 watt
T	transformer	115-volt primary, 750-volt center tapped secondary (see text)

Except for the transformer and choke, the components should be relatively easy to obtain. The best source for the transformer and choke is an old TV set or a flea market. The semiconductors may be Radio Shack or Motorola HEP devices. An audio taper pot is suggested for smooth low-voltage control; a linear control is acceptable. The maximum voltage may be limited by adding a resistor in series with the wiper end of the pot. Take care not to exceed the filter capacitor rating by more than a few volts.

uses

The supply can be used for experimental tube and transistor circuits calling for voltages within its range.

Current output is limited by the transformer or the choke you can obtain. The supply is particularly useful in reconditioning (or reforming) electrolytic capacitors. If you're reactivating an old piece of equipment or using capacitors from the junkbox, it's always best (and frequently necessary) to reform the electrolytic capacitors before applying full voltage. If reforming is neglected, the capacitor may short (completely or partially) internally. This causes heating and promotes further shorting and eventual capacitor destruction. Reforming is accomplished by allowing the voltage across the capacitor to increase slowly to its rated value. This can be done by increasing the voltage slowly by means of the voltage control. Capacitor polarity *must* be observed: The positive side of the capacitor must go to the positive side of the supply.

A better method of reforming electrolytics is to allow them to reform through a high resistance. This may be done by connecting the capacitor to the supply through a 100k resistor (fig. 2). The resistor limits the current to less than 5 mA even if a shorted 450-volt capacitor is connected. A 2-watt resistor is recommended when reforming capacitors with working voltages above 300 volts. The current through the series resistor (and the power dissipated by it) will decrease rapidly if the capacitor can be reformed.

To use the setup in fig. 2, set the supply voltage (A to C) to the capacitor's rated voltage using a voltmeter. Then, with a high-impedance voltmeter connected to points B and C, measure the voltage across the capacitor. This voltage should increase slowly until the capacitor reforms completely. At this time the voltage across the supply (A to C) will be essentially equal to the voltage across the capacitor (B to C).

As in all high-voltage devices, be careful when

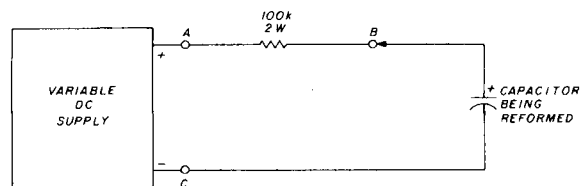

fig. 2. Circuit for reforming electrolytic capacitors. Procedure is described in the text.

assembling and using this device. *Dangerous voltages are present.* Make sure you use well-insulated clip leads in experimental setups and follow the old adage: "Keep one hand in your pocket when working with high voltages."

ham radio

TS-700SP



SP-70

TS-700SP

VFO-700S

The TS-700SP is an all-mode (SSB, FM, CW, and AM) solid-state transceiver covering the entire 2-meter band, including repeater operation on all sub-bands. It's the perfect rig for the serious 2-meter Amateur.

TS-700SP FEATURES:

- All modes...SSB (USB and LSB), FM, CW, and AM.
- VFO tuning from 144 to 148 MHz in four bands.
- Seven-digit readout of receive frequency, with 100-Hz resolution. (Last digit can be eliminated automatically in the FM mode.)
- Simplex and repeater operation, including all repeater subbands. Switchable to REVERSE mode.
- Built-in receiver preamplifier.
- AC/DC capability, for fixed or mobile operation.
- 44 fixed channels with 11 crystals.
- Multifunction meter...S-meter on all receive modes, zero-center meter on FM receive, and RF transmit.
- High-low power switch (10 W/1 W).
- RIT for both VFO and fixed channels.
- Effective noise blanker.

TS-600



SP-70

TS-600 W/VOX-3

The TS-600 is an all-mode (SSB, FM, CW, and AM) solid-state transceiver covering the entire 6-meter band. It's the ideal transceiver to enjoy the many exciting propagation conditions on 6 meters.

TS-600 FEATURES:

- All modes...SSB (USB and LSB), FM, CW, and AM.
- VFO tuning from 50 to 54 MHz in four bands. Main dial graduated at 1-kHz intervals.
- AC/DC capability, for fixed or mobile operation.
- 20 fixed channels with five crystals.
- Effective noise blanker.
- 100-kHz marker.
- Multifunction meter...S-meter on all receive modes, zero-center meter on FM receive, and RF on transmit.
- RIT for both VFO and fixed channels.
- 20 W PEP input on SSB, 10 W output on CW and FM, 5 W output on AM.

OPTIONAL ACCESSORY:

- VOX-3, to provide VOX and semi-break-in CW operation.



The TR-8300 mobile FM transceiver operates in the 70-cm band, on 23 crystal-controlled channels (three supplied). Transmitter output is 10 watts, and a very sensitive and selective receiver is provided.

TR-8300

TR-8300 FEATURES:

- Covers 445.0-450.0 MHz (transmit) and 442.0-447.0 MHz (receive).
- 23 channels, three supplied (446.0 MHz simplex, 446.5 MHz simplex, and 449.10 MHz transmit/444.10 MHz receive).
- Five-section helical resonator and two-pole crystal filter in receiver IF, for improved intermodulation characteristics.
- Call channel switch, for user-desired function (such as subtone).
- High-low power switch (10 W/1 W).
- Monitor circuit, to allow listening to modulation while making frequency adjustments.

TR-7600

TR-7625



The TR-7600 and TR-7625 are Kenwood's popular synthesized 2-meter FM mobile transceivers. Combined with the RM-76 Microprocessor Control Unit, several memory and scanning capabilities are provided.

TR-7600/TR-7625 FEATURES:

- One memory channel.
- Mode switch for simplex or repeater operation. Repeater mode shifts the transmit frequency + 600 kHz or - 600 kHz or to the memory frequency.
- Full 5-kHz coverage from 144.000 to 147.995 MHz.
- Adaptable to any one MARS simplex or repeater channel between 143.7 and 148.3 (with modification kit).

KPS-7

The KPS-7 is a matching AC power supply for the TR-7600 and TR-7625. Output is 13.8 VDC at 7 A ICS (50% duty cycle).



RM-76

ADDED FEATURES WITH RM-76:

- Six memories.
- Automatic memory scan.
- Automatic scan up the band in 5-kHz steps, with selectable upper and lower frequency limits.
- Manual scan up or down the band in single or

- fast continuous 5-kHz steps.
- ± 1 MHz transmitter offset as well as ± 600 kHz and memory offset for repeater operation.
- MARS operation on 143.95 MHz simplex.
- Versatile digital display of transmit and receive frequencies, and operating functions.

TR-2400

The TR-2400 synthesized 2-meter hand-held transceiver features a large LCD frequency readout, 10 memories, scanning, and much more.

TR-2400 FEATURES:

- Large, illuminated LCD digital frequency readout. Readable in direct sunlight, and a lamp switch makes it readable in the dark. Shows receive and transmit frequencies and memory channels, and indicates "ON AIR", memory recall, battery status, and lamp switch on.
- 10 memories, with battery backup.
 - Automatic memory scan, for "busy" or "open" channels.
 - Mode switch for simplex, ± 600 kHz transmit repeater offset, and memory-frequency ("M O") transmit repeater offset.
 - REVERSE momentary switch.
 - Built-in 16-button Touch-Tone generator.
 - Keyboard selection of 5-kHz channels from 144.00 to 147.995 MHz.



ST-1

- Up/down manual scan and repeater or simplex operation from 143.900 to 148.495 MHz in single or fast continuous 5-kHz steps.
- Two lock switches to prevent accidental frequency change and accidental transmission.
- Subtone switch (subtone module not Kenwood supplied).
- More than 1.5 W RF output.
- High-impact plastic case and zinc die-cast frame.
- BNC antenna connector.
- Standard accessories included with the TR-2400 are a flexible rubberized antenna with BNC connector, ni-cad battery pack, and AC charger.

OPTIONAL ACCESSORIES:

- Attractive leather case.
- Model ST-1 base stand, which provides 1.5-hour quick charge, trickle charge, and base-station operation with microphone connector and impedance-conversion circuit for using MC-30S microphone.
- Model BC-5 DC quick charger.



TOP CONTROLS

any-state ni-cad charger

The advantage of constant-potential and constant-current charging techniques are incorporated into this circuit

Have you ever wanted to connect your hand-held to a charger and walk away, knowing the charger will charge the battery as quickly as possible, then automatically become a trickle charger to keep the battery charged until you need it again? Here's a circuit that does exactly that.

ni-cad battery charging

Before describing the charger, a brief review of ni-cad battery-charging technique is in order. There are two basic charging methods: constant potential and constant current.

Constant-potential charging. This is the most rapid method and requires no adjustment to the charger during the charge period. This method requires a charger capable of delivering high currents, because at the start of the charge, the battery has a very low internal impedance. This high-current charge tapers off exponentially as a function of charge time (**fig. 1**). The constant-charge voltage should be set at 1.55 times the number of cells in the battery.

A fully discharged ni-cad can be completely recharged by this method in one hour, although the charge should be continued for three hours or until the current stabilizes for one-and-a-half hours.¹

The major disadvantage of the constant-potential charger is the high initial charge current. Not only

does this require a voltage supply with high-current capability, but it's also possible to damage the battery being charged because of the high initial power being dissipated by the individual cells.

The usual method used to prevent cell damage with constant-potential charging is to monitor the temperature of a cell of the battery being charged and reduce the current to keep the temperature at

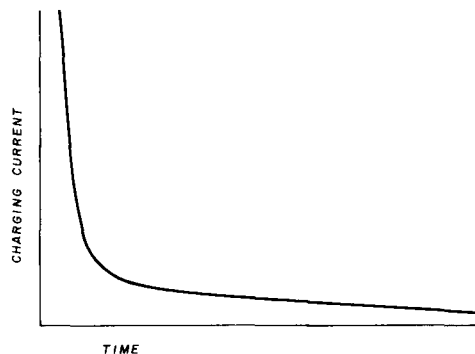

fig. 1. Constant-potential charging of ni-cads at 1.55 volts per cell. This method requires a charger capable of delivering high current.

some predetermined value. This is the system used with Motorola's "rapid charge" batteries and charger. The Motorola NLN-6900A rapid-charge battery has a thermistor that gives the charger battery temperature information.

Constant-current charging. The constant-current method requires a charging source of dc with a voltage of at least 1.8 times the number of cells in the battery. A simple constant-current charger is shown in **fig. 2**. To maintain constant current, the rheostat will require adjusting during the charge as the battery counter emf increases.

Practical values of charging current are usually

By **Bill Bretz, WA6TBC**, Hewlett Packard, 11300 Lomas Boulevard, N.E., Albuquerque, New Mexico 87123

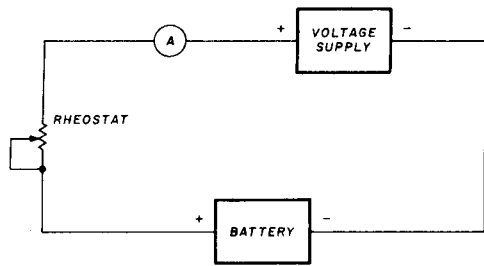

fig. 2. Simple constant-current charger. Constant current is maintained by adjusting the rheostat during the charge period.

selected to accomplish a full charge in three to seven hours. A 1-Ah battery might thus be charged at any current rate between 500 and 200 mA, since it is necessary to put more energy back into the battery than was taken out. A good working figure is to adjust the charging time so that the battery receives at least 30 per cent more energy than the discharge, measured in ampere hours. Cell voltage versus time is shown in fig. 3.

The major disadvantage of constant-current charging is that if the charge current is not terminated when the battery reaches full charge, the cell must dissipate power no longer needed for charging. This causes cell temperature to rise and also causes loss of electrolyte. The most common method of circumventing this problem is to charge the battery at a constant current of 10-20 per cent of its ampere-hour capacity for a minimum of twelve hours. Overcharging the battery at 10-20 per cent is not usually harmful (although not good) to the battery as long as there is ample electrolyte in the cell.

design

The charger shown in fig. 4 is a constant-current, constant-potential battery charger that has the ad-

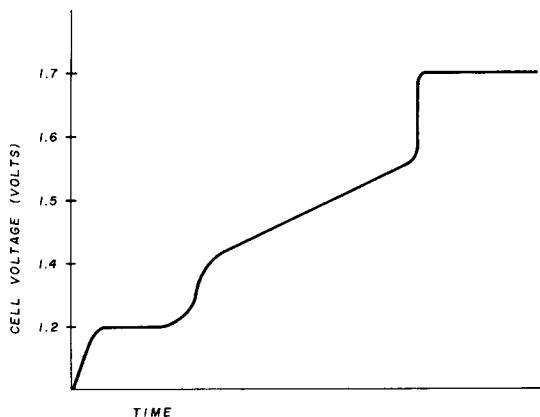

fig. 3. Cell voltage as a function of time using the constant-current charging method.

vantages of both the systems described above and the disadvantages of neither. With this charger, the current is initially constant at a reasonably high level until the battery nears full charge, at which time the current decreases and the charger becomes a constant-potential charger.

R3, R1, Q1, and CR1 form a constant-current source with R1 controlling the amount of current flowing in Q1 emitter. This is the major source of charging current for the battery. When the potential across the battery reaches the point where CR2 and Q2 turn on, Q2 starts pulling away Q1's supply of base current, which reduces the current from the current source, so that the potential across the battery is constant.

A practical charger for a 200-mAh, 12-volt nickel-cadmium battery is shown in fig. 5. This circuit charges the battery at 75 mA until the battery is charged, then reduces the current to a trickle rate. It

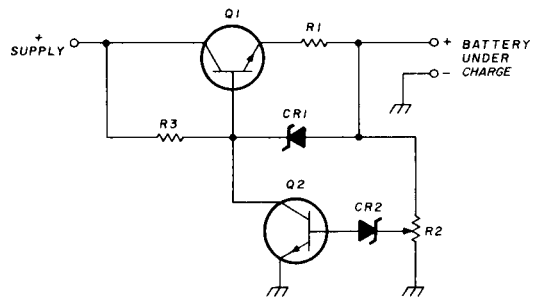

fig. 4. Basic design of the constant-current, constant-potential ni-cad battery charger, which has all the advantages of both techniques and the disadvantages of neither.

will completely recharge a dead battery in four hours and the battery can be left in the charger indefinitely. To set the shut-off point, connect a 270-ohm, 2-watt resistor across the charge terminals and adjust the pot for 15.5 volts across the resistor.

The circuit shown in fig. 6 is built into the base of my HT-220 Omni charger. This circuit is built around the original Motorola power transformer and furnishes a constant-current charge of 200 mA (45 per cent of capacity). The charging lamp becomes a simple pilot lamp for the charger. The original "charge-trickle" switch now functions as an on-off switch for the charger. The pot is set for a voltage of 18.6 volts with a 240-ohm, 2-watt resistor across the charge terminals.

To modify this circuit to furnish different charge currents, the value of R1 may be determined by:

$$\frac{RL}{\text{current desired}} = 5 \text{ volts}$$

The constant-potential voltage can be determined by

1980 is the year for 220 MHz and Lunar can put you there.

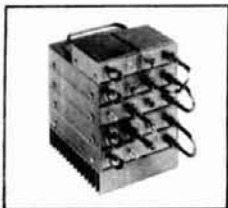

LUNAR TRANSVERTER MODULES

Lunar's line of modules allow complete system flexibility in achieving multi-band VHF/UHF state-of-the-art capability. By combining appropriate modules, EME capability is readily achieved. The basic system is the Downconverter module and the Upconverter module selected to suit your IF requirement. Adding the appropriate Local Oscillator/Filter module puts you on the desired band. Changing LO modules changes bands—thus retaining the converter modules. The basic system yields approximately 6 dB DSB NF and 200 mW RF output (1-5 mW drive at IF).

POWER AMPLIFIERS & PREAMPS

Adding preamps to receive side will yield desired NF, while adding power amplifiers on output will yield desired power level. Filters utilize microwave techniques, including printed capacitors. Power amplifier modules due in early '80's boost the 200 mW to readily desired levels.

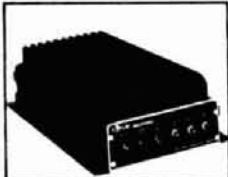

AVAILABILITY LISTING FOR MODULES

* 1 qtr. '80 ** late 1 qtr. '80 *** 2 qtr. '80

Downconverter Modules: (specify IF) model DC-28, DC-50*, DC-144*

Upconverter Modules: (specify IF) model UC-28, UC-50*, UC-144*

Local Oscillator Modules: (specify output band/IF)

Models:

LO-50/28, LO-144/28, LO-144/50* (single freq. models)
LO-144/28/2; LO-220/28/2; LO-432/28/2; LO-144/50/2*; LO-220/50/2*; LO-220/144/2**;
LO-432/50/2**; LO-432/220/2***

Power Amplifier Modules: 10 W PEP output from 200 mW UC module for each band. These modules due 2nd qtr. '80.

Attenuator: Model AT-33 33dB 10W attenuator reducing 10W rigs to 5 mW IF level.



Louis N. Anclaux
WB6NMT

2785 Kurtz Street, Suite 10
San Diego, CA 92110
(714) 299-9740
Telex 181747

DADE RADIO CLUB presents

1980

Southeastern Division Convention
& 20th Annual

TROPICAL HAMBOREE



Flagler Dog Track
Miami, Florida

January 26-27, 1980

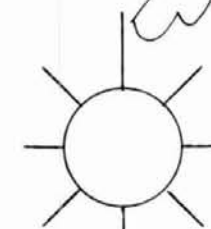

REGISTRATION:
ADVANCE - \$3.00
DOOR - \$4.00

FREE PARKING
INCLUDING OVERNIGHT SPACE
FOR COMPLETELY SELF-CONTAINED RV'S
ADVANCE RV SPACE RESERVATION IS RECOMMENDED

For Additional Information Write:
DADE RADIO CLUB, INC.
P.O. Box 350045 - Riverside Station
Miami, Florida 33135

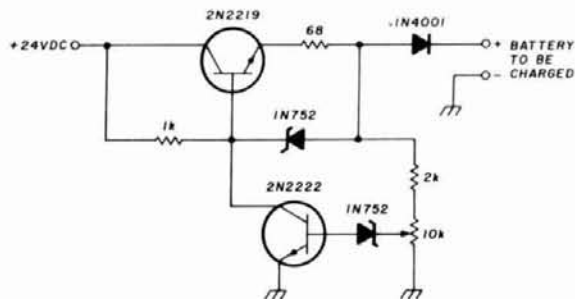

fig. 5. Practical charger for a 200-milliampere-hour, 12-volt ni-cad battery.

multiplying the number of cells by 1.55. The constant-potential voltage can be set by putting a load on the charger that pulls about one-half the desired maximum current and adjusting the pot for the desired voltage across this load. The supply voltage to the charger should be approximately two times the desired constant potential. This circuit will work for

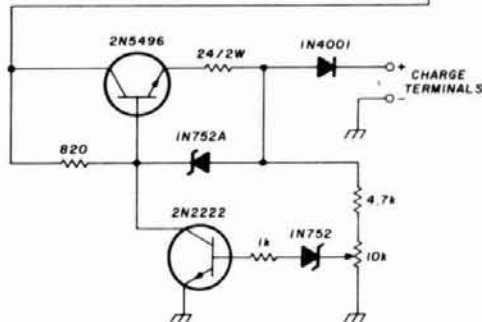
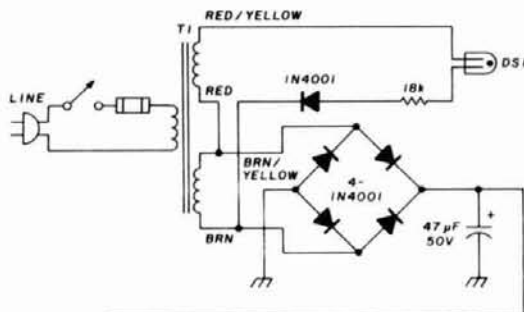

fig. 6. Circuit of author's charger, which is built into the base of an HT-220 Omni charger. Transformer T1 is the original Motorola power transformer.

batteries in the 6-18 volt range with no changes. The maximum current available is 250 mA; however, this could be increased by adding a Darlington connection to Q1.

references

1. NICAD Sintered Plate Nickel Cadmium Storage Batteries Installation and Care, Booklet 527, Nicad Division, Gould-National Batteries, Inc., 1959, page 3.

ham radio

Wilson...

has your needs well in hand.

Today's Amateur demands rugged, rapid and accurate communications between Hams in the know. That's why they choose the Wilson Mark Series of hand-held radios. With exceptional qualities like these . . . why not choose the most popular radio available for yourself?

FEATURES

Advantages such as solid state circuitry, rugged Lexan® case, removable rear panel (enabling easy access to battery compartment) and compact mini-size enhance the Mark Series portable radio's versatility. In addition, Wilson carries a full line of accessories to satisfy almost any of your requirements.

SPECIFICATIONS

The Mark radios offer: • 144-148 MHz range • 6 Channel operation • Individual trimmers on TX and RX xtals • Rugged Lexan® outer case • Current drain: RX; 15 mA, TX; Mark II: 500 mA, Mark IV: 900 mA • A power saving Hi/Lo Switch • 12 KHz ceramic filter and 10.7 monolithic filter included • 10.7 MHz and 455 KHz IF • Spurious and harmonics, more than 50 dB below quieting • Uses special rechargeable Ni-Cad battery pack • LED battery condition indicator • Rubber duck and one pair Xtals 52/52 included • Weight: 19 oz. including batteries • Size: 6" x 1.770" x 2.440".

OPTIONS

Options available, include Touch Tone Pad, CTCSS, Leather Case, Chargers for Desk Top, Travel or Automobile, Speaker Mike and large capacity, small size batteries.

For more details and/or the name of your nearest dealer, contact: Consumer Products Division, Wilson Electronics Incorporated, 4288 So. Polaris Ave., P. O. Box 19000, Las Vegas, Nevada 89119. Phone 702/739-1931.

 **Wilson Electronics
Incorporated**

A Subsidiary of REGENCY ELECTRONICS, INC.

**ACTUAL
SIZE!!!**



Prices and specifications subject to change without notice.

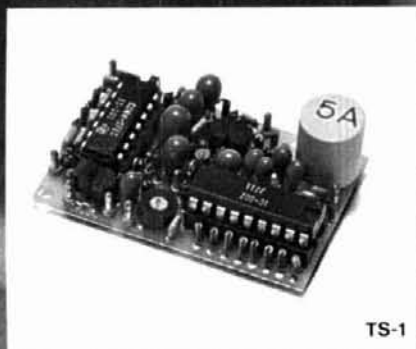

TS-1



TS-1JR

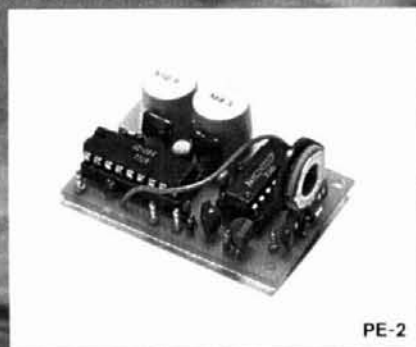

PE-2

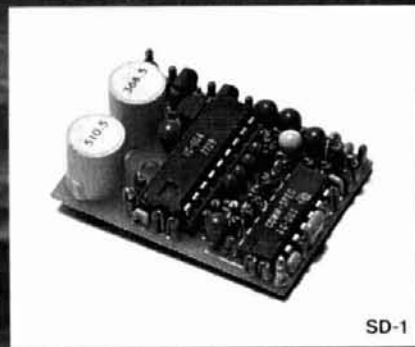

SD-1

THE DAWNING

The age of tone control has come to Amateur Radio. What better way to utilize our ever diminishing resource of frequency spectrum? Sub-audible tone control allows several repeaters to share the same channel with minimal geographic separation. It allows protection from intermod and interference for repeaters, remote base stations, and autopatches. It even allows silent monitoring of our crowded simplex channels.

We make the most reliable and complete line of tone products available. All are totally immune to RF, use plug-in, field replaceable, frequency determining elements for low cost and the most accurate and stable frequency control possible. Our impeccable 1 day delivery is unmatched in the industry and you are protected by a full 1 year warranty when our products are returned to the factory for repair. Isn't it time for you to get into the New Age of tone control?

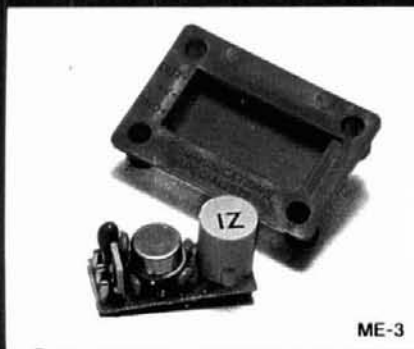

ME-3



TE-8

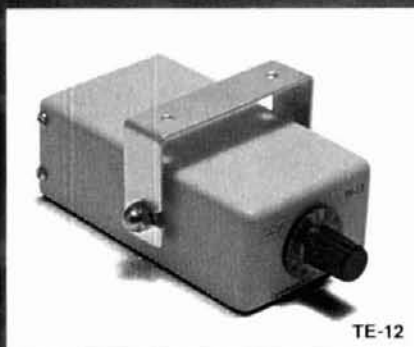

TE-12



ST-1

OF A NEW AGE.

TS-1 Sub-Audible Encoder-Decoder • Microminiature in size, 1.25" x 2.0" x .65" • Encodes and decodes simultaneously • **\$59.95** complete with K-1 element.

TS-1JR Sub-Audible Encoder-Decoder • Microminiature version of the TS-1 measuring just 1.0" x 1.25" x .65", for hand-held units • **\$79.95** complete with K-1 element.

ME-3 Sub-Audible Encoder • Microminiature in size, measures .45" x 1.1" x .6" • Instant start-up • **\$29.95** complete with K-1 element.

TE-8 Eight-Tone Sub-Audible Encoder • Measures 2.6" x 2.0" x .7" • Frequency selection made by either a pull to ground or to supply • **\$69.95** with 8 K-1 elements.

PE-2 Two-Tone Sequential Encoder for paging • Two call unit • Measures 1.25" x 2.0" x .65" • **\$49.95** with 2K-2 elements.

SD-1 Two-Tone Sequential Decoder • Frequency range is 268.5-2109.4 Hz • Measures 1.2" x 1.67" x .65" • Momentary output for horn relay, latched output for call light and receiver muting built-in • **\$59.95** with 2 K-2 elements.

TE-12 Twelve-Tone Sub-Audible or Burst-Tone Encoder • Frequency range is 67.0-263.0 Hz sub-audible or 1650-4200 Hz burst-tone • Measures 4.25" x 2.5" x 1.5" • **\$79.95** with 12 K-1 elements.

ST-1 Burst-Tone Encoder • Measures .95" x .5" x .5" plus K-1 measurements • Frequency range is 1650-4200 Hz • **\$29.95** with K-1 element.



COMMUNICATIONS SPECIALISTS

426 West Taft Avenue, Orange, CA 92667
(800) 854-0547, California residents use: (714) 998-3021





NEW products

Collins KWM-380 transceiver



Collins Telecommunications Products Division of Rockwell International Corporation introduced a new all-solid state Amateur transceiver in October. The new Collins KWM-380 transceiver is a self-contained Amateur station including an internal split frequency VFO function, a built-in ac dc power supply, and speaker. The fully synthesized KWM-380, with *microprocessor controlled tuning*, gives frequency stability and accuracy in four tuning rates, even down to 10 Hz. All frequencies are derived from a single master oscillator, allowing all bands and frequencies of 500 kHz to 30 MHz. Transmit power is 100 watts in upper sideband (USB), lower sideband (LSB), and CW modes within the 160- to 10-meter Amateur bands. In addition to providing four-speed tuning, the KWM-380's microprocessor controls the LED frequency display, band selection, and two-register memory for split-frequency operation without the need for an external VFO unit or separate receiver. The frequency display always shows the exact carrier frequency.

The KWM-380 has no bandswitch or tune-up controls; this enables the

operator to transmit immediately upon dialing in a frequency. Even the transmit lowpass filters are automatically selected by relays. This feature provides split frequency operation on any two frequencies within the Amateur bands.

The front panel meter in the KWM-380 measures signal strength in receive; in transmit, it measures automatic level control (ALC), supply voltage (VC), forward power (FP), and reflected power (RF). Options for the new KWM-380 include a noise blanker for use in transceivers located in high-impulse rf noise environments, a choice of i-f filters for CW and RTTY, and related accessories. A speech processor will be available next year which will increase the average "talk-power" in SSB transmission.

Card Cage construction interconnected with ribbon cables allows the KWM-380 to be easily maintained. The cards can be removed for servicing while the radio is still operational, eliminating the need for extender boards.

The new Collins KWM-380 is available through any authorized Rockwell-Collins dealer/service agency.

new Larsen amateur antenna catalog

Larsen Electronics, Inc., one of the nation's leading mobile-antenna manufacturers, has just published a new catalog for its complete line of Kulrod (R) Amateur antennas.

In addition to mobile antennas, this 12-page brochure also includes base station antennas, Yagis, and antennas for hand-held and portable two-way radios. Available models cover the complete range of Amateur frequencies in the low, vhf, and uhf bands.

The catalog is conveniently arranged with antennas and corresponding mounts on the same page, so it's easy to order the right combination. There is also a complete price list for all equipment.

Copies of the Larsen Amateur Antenna Catalog are available at no charge from any Larsen dealer. They may also be obtained by writing to Larsen Electronics, attention John Beaman, P.O. Box 1686, Vancouver, Washington 98663.

Avanti no-holes 2-meter mobile antenna

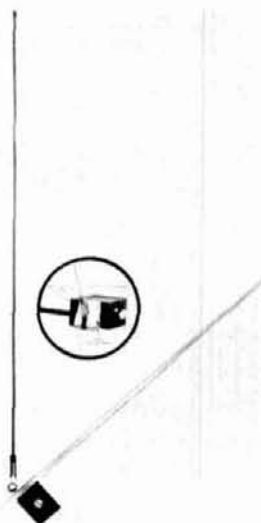

From the research laboratory of Avanti Research and Development, Inc., of Addison, Illinois, comes a remarkable new concept in vhf mobile antennas.

It is an antenna that mounts on glass in minutes without tools, according to the manufacturer. No ground plane is required. There are no holes to drill.

A low-profile, one-inch, stainless steel mount holds the whip to the window by a new aerospace adhesive discovery that is stronger than a 1/4-20 metal bolt. Yet it can be easily removed, according to instructions, and is guaranteed by Avanti to hold securely under even abnormal weather conditions and excessive vehicular vibrations.

There are no external electrical connections to corrode, as the coax cable and capacitor box are mounted inside the vehicle. The new AH 151.3G antenna has been tested as 1

dB better than a conventional 5/8-wave, trunk-mount antenna, according to the manufacturer. It is also claimed to have a more uniform pattern than ground-plane type antennas.

Because this unique 1/2-wave design is mounted higher than a trunk-mount antenna, it offers a higher effective radiation point for maximum performance in all applications. The capacitive coupler forms a highly tuned circuit between the antenna and the radio to ensure maximum performance throughout the 2-meter band.

The stainless-steel whip and hardware connects to a chrome-plated casting. The tough ABS capacitive coupling box houses a tuning coil connected to the radio by a pre-assembled coaxial-cable assembly. All components have built-in Avanti quality.

For more information, contact Avanti Research and Development, Inc., 340 Stewart Avenue, Addison, Illinois 60101.

insulated diode-shorting plugs

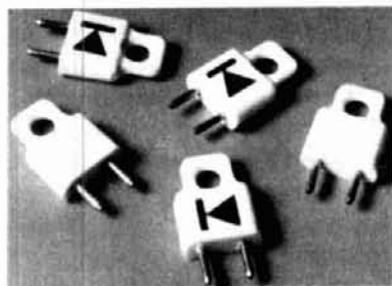

New, insulated diode-shorting plugs that make custom programming panels and links simple, safe, and easy have been developed by the Cambridge Thermionic Corporation of Cambridge, Massachusetts. Cambion insulated diode-shorting plugs have the anode and cathode clearly marked on the bodies to reduce the possibility of polarity reversal. The diodes are molded into the insulation of the popular 0.040-inch diameter

jumper plugs. Cambion insulated diode-shorting plugs with specific diode types are available manufactured-to-order.

The Cambridge firm offers a large selection of 0.040-inch diameter mating jacks suitable for mounting on many board and panel configurations to be used in conjunction with its new insulated diode-shorting plugs. Each diode plug, which is molded into a miniature handle-shaped holder, is designed for unidirectionally joining two points in any patch board with 0.040-inch jacks, printed circuit board, or connector having corresponding alignment and mating portions.

For spec sheets and complete information on these new Cambion insulated diode-shorting plugs, write Cambridge Thermionic Corporation, 445 Concord Avenue, Cambridge, Massachusetts 02138.

Nye Viking receives FCC phone-patch registration

Approval by the FCC for official registration under Part 68 of the FCC regulations has been granted to Wm. M. Nye Company, Bellevue, Washington, which allows the Nye Viking phone patch to be plugged directly into the telephone line without the need (or cost) of a telephone-company-supplied coupling device. However, users must still notify the telephone company that they are connecting the phone patch to the telephone line and must furnish to the company the official registration number and the ringer equivalence number, which are printed on an attached label.

Telephone patches may not be connected legally to party lines or pay telephone lines. Users are cautioned that they must comply with all other requirements of the FCC pertaining to Amateur Radio communications.

The Nye Viking phone patch comes in two models: No. 250-

0046-001, without speaker, which provides connection to your own external speaker; and No. 250-0046-003, with built-in loud speaker, for use with most transceiver installations. Model -001 is priced at \$45.50, and Model -003 at \$55.00 throughout the U.S.A. These new units provide the finest interface connection to telephone lines.

Nye Viking phone patches manufactured before the official FCC approval and registration can be upgraded to approved status with the necessary changes, which include the 2-meter (7-foot) cord and plug to connect into the telephone company line socket. The charge for the complete modifications is \$5 plus \$1.50 for shipping and handling.

Units returned for modification should be carefully packed and contain your name and address, with check or money order covering modification charge and handling. Send by mail or UPS to Wm. M. Nye Company, Inc., 1614 130th Ave. N.E., Bellevue, Washington 98005. Expect a 2-3 week turnaround.

short circuit

updating vacuum-tube receivers

In W6HPH's article on "Updating Vacuum-Tube Receivers" in the December, 1978, issue of *ham radio*, the 2-volt zener diode (CR11 in **fig. 2**) should be replaced with a short circuit. In W6HPH's case, 2 volts was correct because Q12 happened to be a very low transconductance fet, but an average 2N3819 or MPF102 will be biased nearly to cutoff by 2 volts.

Also, in **fig. 2** the transistor in the upper right-hand corner should be marked Q2 — 2N2222, *not* Q12 — 2N3819; in **fig. 3** the trimmer capacitor to the left of L3 (L3 to ground) should be labeled C2. And in **fig. 4** the 5k trim-pot in the upper right-hand corner should be labeled R6; the bypass on pin 2 of Q17 is 0.001 μ F.

DSI GOES LCD

TRUE RMS - 3½ DIGITS - DMM - .1% BASIC ACCURACY

149⁹⁵

LC 5000

FACTORY WIRED

**AVAILABLE
JANUARY 1980**

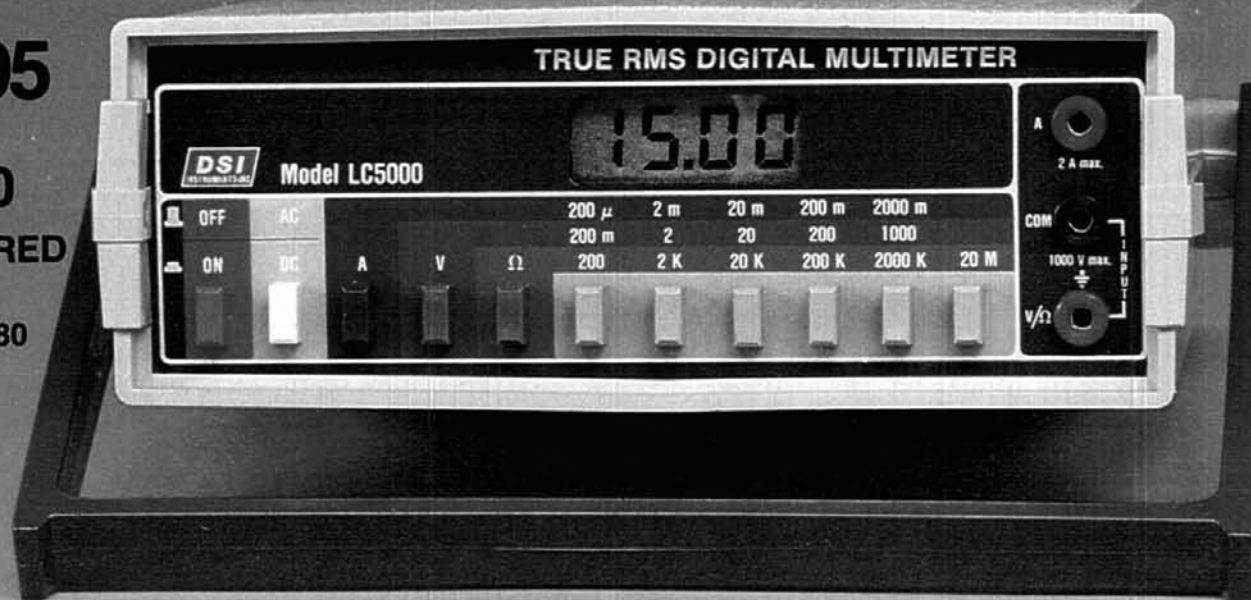

RANGES

- AC TRUE RMS TO 1000V — 200mv, 2v, 20v, 200v, 1000v
- DC VOLTAGE TO 1000V — 200mv, 2v, 20v, 200v, 1000v
- DC CURRENT TO 2 Amps — 200μa, 2ma, 20ma, 200ma, 2A
- RESISTANCE TO 20 Megohms — 200, 2k, 20k, 200k, 2mg, 20mg

AN UNPRECEDENTED DSI VALUE . . .
In a high quality, LSI Design, .1% basic accuracy, 3½ digit DMM and because it's a DSI innovation, you know it obsoletes all competitive makes, both in price and performance.

No longer do you have to settle for small readouts, short battery life, a kit with a bag of parts, a black box with 20 Resistors that need adjustment every time you need to recalibrate, because you only budgeted \$100.00 or \$150.00 for a DMM.

The Model LC 5000 is factory assembled and tested in the USA. DSI has designed in Precision Laser Trimmed

Resistor Networks to provide maximum accuracy, resulting in long time periods between recalibration and a simple two adjustment calibration procedure. The LC 5000 incorporates a fused input circuit to help prevent damage to the DMM. The large .5 inch LCD Readouts are easy to read even in the brightest sunlight and allows for very low battery drain, normally only two battery changes a year is required. The LC 5000 is the perfect lab quality instrument on the bench or in the field — you can depend on DSI LC 5000 to meet all your needs. Buy Quality — Buy Performance — Buy Reliability — Buy DSI.

**FOR INFORMATION — DEALER LOCATION — ORDERS — OEM
CALL 800-854-2049 CALIFORNIA RESIDENTS CALL 800-542-6253**



LC 5000 wired factory burned-in 1 year limited warranty. Prices and specifications subject to change without notice or obligation.
TERMS: MC - VISA - AE - Check — M.O. - C.O.D. in U.S. Funds.
Please add 10% to a maximum of \$10.00 for shipping, handling and insurance. Orders outside of USA & Canada, please add \$20.00 additional to cover air shipment. California residents add 6% Sales Tax.

DSI INSTRUMENTS, INC.

9550 Chesapeake Drive
San Diego, California 92123
(714) 565-8402

**Model LC 5000 \$149.95
LCBA - Rechargeable
Battery Pack Includes
AC Battery Charger . \$24.95**

DSI STOPS BRANDS A thru Z with more counter for less money

FACTORY WIRED 500 MHz • 1 PPM TCXO • 8 DIGITS

99⁹⁵

Without Battery Capability

119⁹⁵

Includes Rechargeable
Battery Pack and AC-9

- Two BNC Inputs
- 1 Meg and 50 Ohm Input
- Factory Wired and Tested
- Made in USA
- 50 Hz to 512 MHz

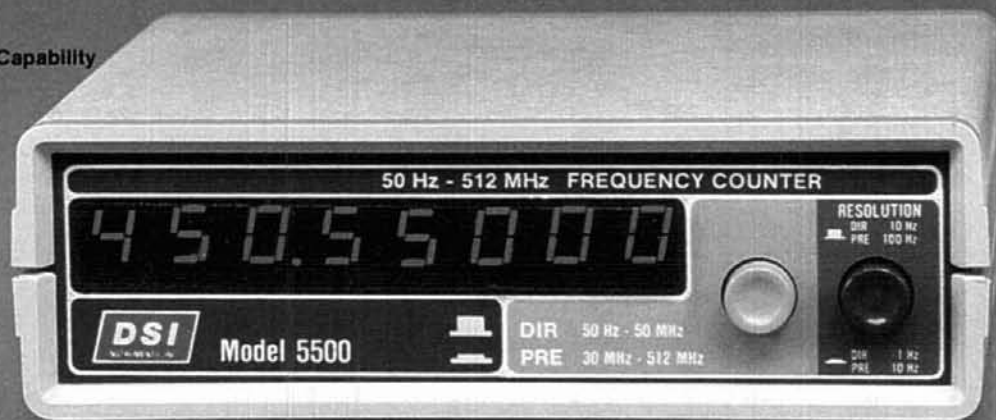

Compare These Features and You Will Buy DSI

- 8 Digits *Not* 6 or 7 Digits
- 1 PPM TCXO *Not* 1.5 PPM - 10 PPM
- Resolution 1 Hz @ 50 MHz *Not* 10 Hz
- Resolution 10 Hz @ 450 MHz *Not* 100 Hz

FREQUENCY COUNTER STRAIGHT TALK

There are only three functional requirements for a frequency counter: 1. Good accuracy over temperature 2. Resolution 3. Sensitivity

Good accuracy over temperature. Crystal oscillators drift with temperature changes. This change is specified in parts per million (PPM). The 5500 TCXO (temperature compensated crystal oscillator) holds an accuracy of 1 PPM from 17° to 40° C. This corresponds to ± 450 Hz at 450 MHz. Counters with 2 PPM accuracy would read to ± 900 Hz at 450 MHz. Counters with 10 PPM accuracy would read to ± 4500 Hz and so on.

Resolution. What is the value of the least significant digit displayed? A counter with 10 Hz resolution would display 146.52000 MHz as 146.52000 i.e. with the last digit left off. A counter with 100 Hz resolution would display 146.5200. The 5500 with 8 Digits is capable of resolving 1 Hz from 50 Hz to 50 MHz and 10 Hz from 50 MHz to 500 MHz. Counters with only 7 digits usually can only resolve 10 Hz to 50 MHz and 100 Hz to 500 MHz. The above effects, accuracy and resolution are cumulative. Example: a seven-digit counter with 1.5 PPM accuracy reading 450 MHz would only be accurate to ± 675 Hz ± 100 Hz (last digit error) or ± 775 Hz. The 5500 with eight full digits and 1 PPM accuracy would be accurate to ± 450 Hz ± 10 Hz (last digit error) or ± 460 Hz maximum. Not bad for \$99.95. You really need that eighth digit to achieve real accuracy.

Sensitivity. The 5500 requires only 10-15 mv of signal to stabilize and achieve an accurate reading. A one watt hand-held can be read with accuracy at a distance of 15-20 ft. from the counter using the T600 antenna. Counters with 150 mv sensitivity will only stabilize at distances of less than a foot.

The outstanding sensitivity of the 5500, the result of its unique engineering design, and built-in preamp assures stable, accurate readings every time you key up your transmitter.

If you are tired of receiving a plastic bag of sometimes surplus, sometimes defective material only to spend all night trying to solder both sides of the PC Board because the manufacturer chose to use low cost PC Boards without plated-thru holes; if you chose a kit because you only budgeted a hundred dollars for a frequency counter, then the DSI 5500 Counter is the answer. It is 100% factory assembled and tested. DSI strives to purchase the highest quality, prime materials imposing the most rigorous quality requirements possible. Every PC Board that DSI manufactures is plated-thru solder re-flowed, and 100% factory assembled, tested and burned-in in the USA, assuring years of trouble-free service. DSI has worked hard to achieve our worldwide reputation for the best price to quality features ratio in the industry. DSI's 5500 now makes it possible to buy a 100% factory assembled accurate 8-digit frequency counter for under \$100.00. Buy quality — Buy performance — Buy cost effectiveness — Buy DSI.

FOR INFORMATION — DEALER LOCATION — ORDERS — OEM
CALL 800-854-2049 CALIFORNIA RESIDENTS CALL 800-542-6253

Model	Price	Frequency Range	Accuracy Over Temperature	SENSITIVITY			Number of Readouts	Power Requirements	Size H W D
				@ 100 Hz - 25 MHz	@ 50 - 250 MHz	@ 250 - 450 MHz			
5500	\$99.95	50 Hz - 512 MHz	TCXO 1 PPM 17° - 40° C	10 - 15 MV	10 - 15 MV	15 - 50 MV	8	*115 VAC or 8.2 - 14.5 VDC	1 1/2" x 5" x 5 1/2"

*With AC-9 Adaptor.

5500 wired factory burned-in 1 year limited warranty. Prices and/or specifications subject to change without notice.

TERMS: MC - VISA - AE - Check - M.O. - C.O.D. in U.S. Funds. Please add 10% to a maximum of \$10.00 for shipping, handling and insurance. Orders outside of USA & Canada, please add \$20.00 additional to cover air shipment. California residents add 6% Sales Tax.



DSI INSTRUMENTS, INC.
9550 Chesapeake Drive
San Diego, California 92123
(714) 565-8402

5500 Wired \$99.95
5500/W 55BA 119.95
Includes Rechargeable NiCad Battery Pack
and AC Adaptor.
T600 BNC Antenna 7.95
AC-9 AC Adapter 7.95

Field Day is ready to go

Trademark

The best code/radioteletype reader and speed-display package available!

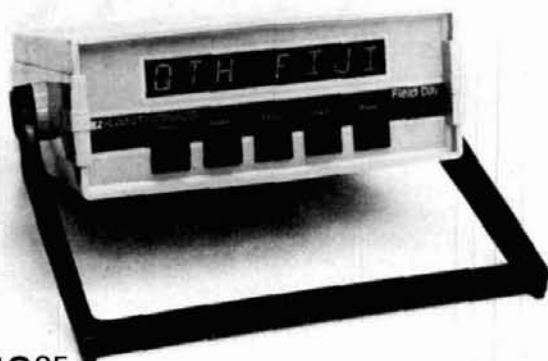

\$449⁹⁵
Plus shipping

We've designed a special **Field Day**, model "B," that is in stock and ready to ship. Right now. Some of the parts designed into the original **Field Day** just couldn't meet your ordering demand.

The **Field Day-B** has a special, high-reliability, 8 character display that costs us about \$40 more than the original displays! But we've still held the original price. We've added a "tuning eye" to make tuning easier and faster. Slow-arrival parts have been designed out, and an improved demodulator circuit has been designed in.

But the best part is they're ready to go now. Get 'um while they're hot.

Alabama - Long's; **California** - Electronics Emporium, Fontana; **Colorado** - H-E-P Enterprises; **Delaware** - Amateur & Advanced Communications; **Florida** - Amateur Electronic Supply, Amateur Radio Center, N & G Distributors, Ray's Amateur Radio; **Georgia** - ZZZ; **Idaho** - Ross Distributing; **Illinois** - Spectronics; **Indiana** - Ham Shack; **Kansas** - Associated Radio; **Kentucky** - Cohoon; **Massachusetts** - Tufts; **Michigan** - Omar; **Minneapolis** - PAL; **Missouri** - Burstein-Applebee, MidCom; **North Carolina** - Bob's Amateur Center; **Nebraska** - Heinrich's Communication; **New Hampshire** - Metz Communication; **New York** - Amerisil Overseas, Barry, Communications Technology, Ham Shack, Hirsch, Kelper, Radio World; **Ohio** - Queen City; **Oklahoma** - Brodie; **South Dakota** - Burghardt; **Texas** - Kennedy Associates, Madison, Tracy; **Virginia** - Tuned Circuit; **Washington** - Northwest Radio; **Wisconsin** - Amateur Electronic Supply; **Ontario** - Metro Ham Shack; **West Germany** - Richter & Company

Kantronics

A commitment to excellence.

1202 E. 23rd Street (913) 842-7745
Lawrence, Kansas 66044
Visa, Master Charge accepted

"CALL FOR QUOTE"

KENWOOD TS-520SE



**MADISON ELECTRONICS
SUPPLY, INC.**

1508 McKinney • Houston, TX 77002
(713) 658-0268
MASTERCHARGE • VISA

WANTED FOR CASH

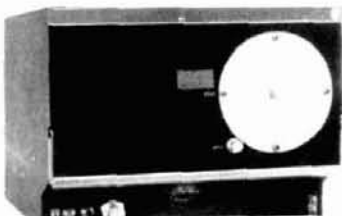

490-T Ant. Tuning Unit
(Also known as CU1658
and CU1669)

4CX150
4CX250
4CX300A
4CX350A

4CX1000
4CX1500
4CX3000
4CX5000

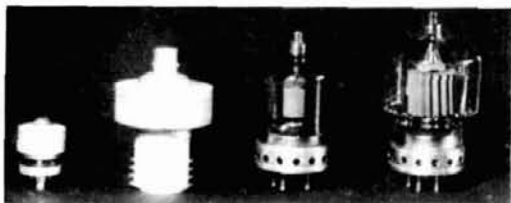

4CX10,000 4-65 4-250 4-1000
5CX1500 4-125A 4-400 304TL

Other tubes and Klystrons also wanted.

Highest price paid for these units. Parts purchased. Phone **Ted, W2KUW** collect. We will trade for new amateur gear. GRC106, ARC105, ARC112, ARC114, ARC115, ARC116, and some aircraft units also required.

DCO, INC.

10 Schuyler Avenue No. Arlington, N. J. 07032
Call Toll Free (201) 998-4246
800-526-1270 Evenings (201) 998-6475

I-800-2228-4097

CALL TOLL FREE

Hy-Gain 3806

2-Meter Hand-Held Amateur Transceiver

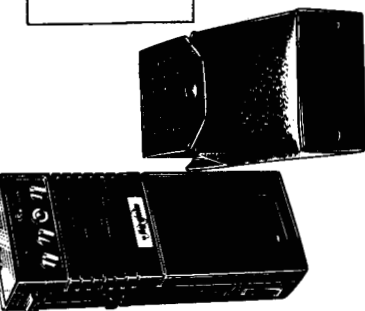

**HOLIDAY
SPECIAL
PRICE**
\$109.95
Good thru 12/31/79 only.

- Low cost, 8-channel, hand-held, provides accurate voice transmission over short to medium distances
- Sharply tuned on-frequency selectivity in the RF amplifier stages plus FET's in the 1st and 2nd mixers for "virtual immunity" to out-of-band signals
- Separate microphone, distortion and cross-modulation
- Separate telephone and speaker elements for enhanced audio
- Internally adjustable mic preamp—a Hy-Gain exclusive
- Specially gasketed case seals out water, dirt and corrosive salt air
- Wastright, high-impact ABS plastic case—ribbed for non-slip grip
- Top-mounted controls for instant access

Accessories:

Model No.	Description	Price
3807	Nucor Battery Pack	\$34.95
1104	Touch Tone Pad	\$44.95
1106	AC Battery Charger	\$ 9.95
1107	Cigarette Lighter Adapter Cord	\$ 9.95
1108	Antenna Adapter Cord	\$ 9.95
1109	Hand Held Car Mount	\$ 9.95
1111	Car Mount Cigar Holder	\$ 9.95
289	Recharge Duck Antenna	\$ 9.95
	Crystal Certificates	\$ 3.95

PLEASE ENCLOSE \$2.00 FOR SHIPPING AND HANDLING PER UNIT

CALL TOLL FREE

I-800-2228-4097

Communications Center

443 N 48th Street
Lincoln, Nebraska 68504
In Nebraska Call (402)466-8402

Antenna Sale!

HY-GAIN

Model	Regular	Special
TH2DX	\$259.95	\$229.95
TH3MK3	322.95	322.95
TH3JR	179.95	179.95
Hy-Quad	139.95	139.95
205BA	219.95	219.95
155BA	259.95	259.95
105BA	329.95	329.95
204MK5	199.95	199.95
204MK4	109.95	109.95
153BA	249.95	249.95
103BA	199.95	199.95
402BA	79.95	79.95
5N-86	89.95	89.95
TH2MK3	59.95	59.95
	189.95	189.95
	15.95	15.95
	119.95	119.95

MOSLEY

Model	Regular	Special
Classic 33	3 el. 10, 15, 20 Mtr. beam	209.95
Classic 36	6 el. 10, 15, 20 Mtr. beam	392.75
TA-33	3 el. 10, 15, 20 Mtr. beam	189.95
TA-36	6 el. 10, 15, 20 Mtr. beam	264.00
TA-33 Jr.	3 el. 10, 15, 20 Mtr. beam	392.75
TA-40KR	40 Mtr. Add On	197.00
		149.95
		89.95

CUSHCRAFT

Model	Regular	Special
ATB-34	4 ele. 10, 15, 20 Mtr. beam	289.95
ATV-4	10, 15, 20, 40 Mtr. Vertical	219.95
ATV-5	10, 15, 20, 40, 80 Mtr. Vertical	69.95
ARX-2	2 Mtr. Ringo Ranger	89.95
AR-6	6 Mtr. Ringo	39.95
ARX-220	220 Mhz. Ringo Ranger	36.95
ARX-450	435 Mhz. Ringo Ranger	39.95
A144-11	11 ele. 144-146 Mhz. beam	30.95

HUSTLER

Model	Regular	Special
3-TBA	3 ele. 10, 15, 20 Mtr. beam	189.95
4-BTV	10-40 Mtr. Vertical	99.95
5-BTV	10-80 Mtr. Vertical	134.95
RM-75	75 Meter Resonator	99.95
RM-76S	75 Meter Super Resonator	16.95
G6-144B	2 Mtr. Base Coilnear	31.95
G7-144	2 Mtr. Base Coilnear	27.50
		79.95
		89.95

ROTORS

Model	Regular	Special
HAM 4	\$149.95	\$139.95
T2X Tailwister	\$199.95	

Call for prices on rotor cable, Coax, Towers, and Accessories. All prices do not include shipping.

**We carry all major brands of ham radios
AT DISCOUNT PRICES**



Kenwood — Yaesu — Drake — ICOM — Dentron —
Ten-Tec — Swan — Tempo — Midland — E.T.O. — Wilson



CALL TOLL FREE

I-800-2228-4097

for Quality Ham Radio Products at Discount Prices

- | | | |
|-----------|---------|--------------------|
| KENWOOD | TAYLOR | E.T.O. ALPHA |
| YAESU | SWAN | VHF ENGINEERING |
| DRAKE | TEMPO | BERK-TEK CABLE |
| ICOM | TEN-TEC | CONSOLIDATED TOWER |
| PANASONIC | MIDLAND | SAY |
| AEA | CDE | SHURE |
| | AUTEK | TELEX |
| | MIRAGE | ROBOT-SSTV |

Our Mail Order Hours (GST)
M-F 8 am to 12 Midnight
Saturday 8 am to 6 pm
Sunday Noon to 8 pm

Call and Talk to
Don WBØYEZ John WBØMWS
Denny WØQR Blaine WBØQLH
Bill KA7CDF Bob WBØRQZ
Joe WAØWRJ Jim KAØCRK



Communications Center
In Nebraska Call (402)466-8402



WILSON SYSTEMS, INC. presents the SYSTEM 36

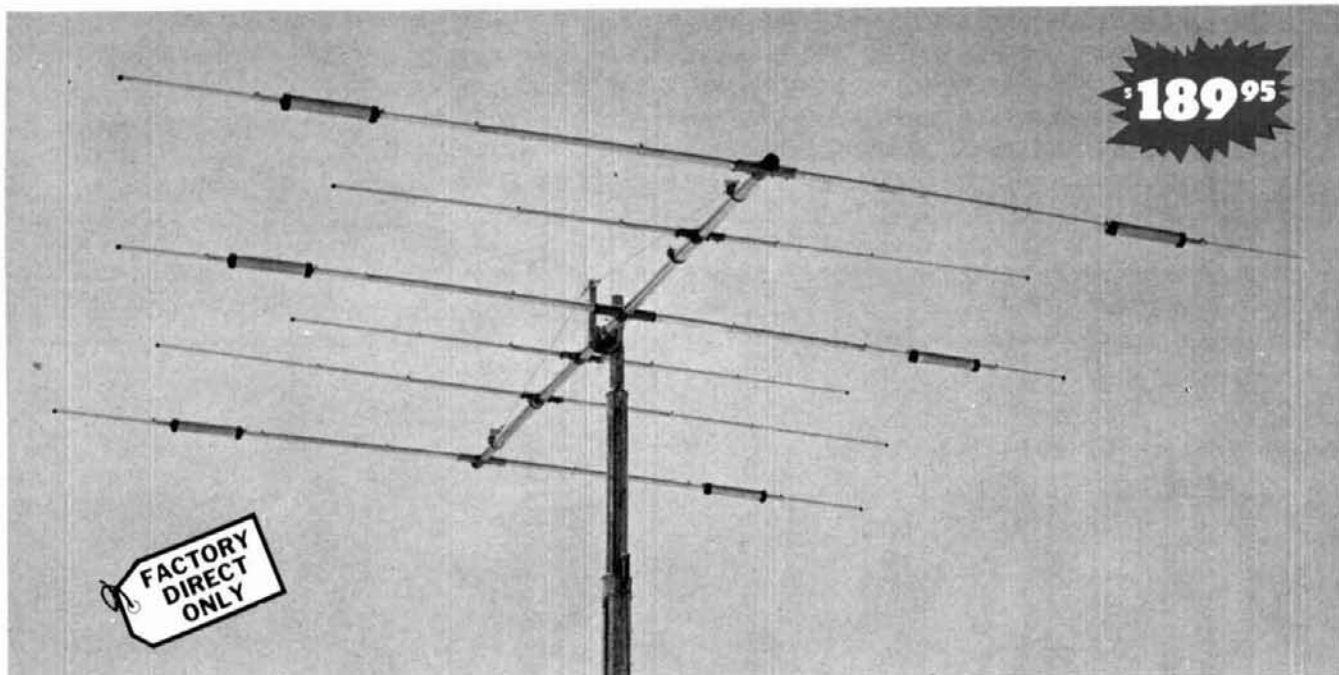

A trap loaded antenna that performs like a monobander! That's the characteristic of this six element three band beam. Through the use of wide spacing and interlacing of elements, the following is possible: three active elements on 20, three active elements on 15, and four active elements on 10 meters. No need to run separate coax feed lines for each band,

as the bandswitching is automatically made via the High-Q Wilson traps. Designed to handle the maximum legal power, the traps are capped at each end to provide a weather-proof seal against rain and dust. The special High-Q traps are the strongest available in the industry today.

SPECIFICATIONS

Band MHz 14-21-28
Maximum power input, Legal limit
Gain (dBd) Up to 9 dB
VSWR @ resonance . . . 1.3:1
Impedance 50 Ω
F/B ratio 20 dB or better

Boom (O.D. x Length) . . 2" x 24'2½"
No. of elements 6
Longest element 28'2½"
Turning radius 18'6"
Maximum mast diameter, 2"
Surface area 8.6 sq. ft.

Wind loading @ 80 mph . . 215 lbs.
Maximum wind survival . . 100 mph
Feed method Coaxial Balun
Assembled weight (approx. 53 lbs.
Shipping weight (approx.) . 62 lbs.

Compare the SY-36 with others . . .

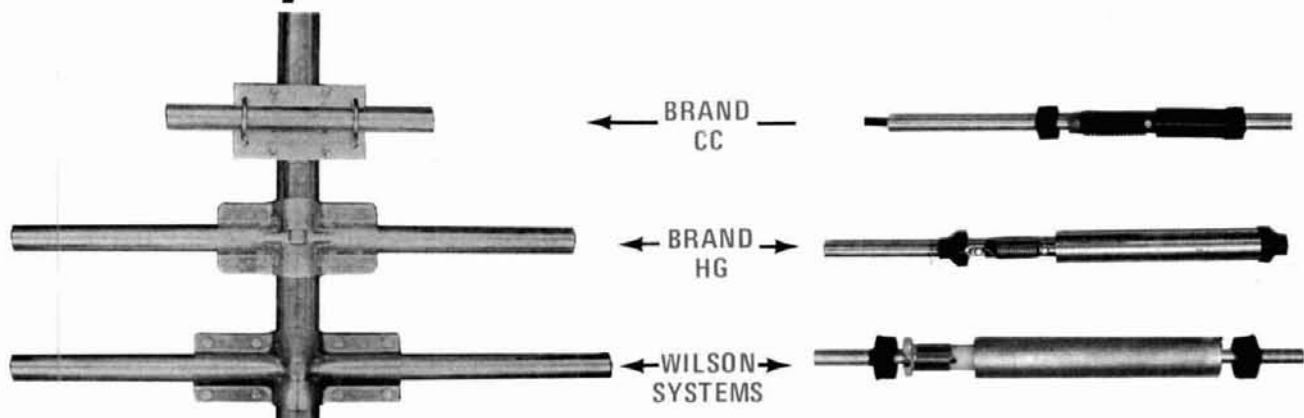

Compare the size and strength of the boom to element clamps. See who offers the largest and heaviest duty. Which would you prefer?

Wilson Systems traps offer a larger diameter trap coil and a larger outside housing, giving excellent Q and power capabilities.

**CALL
FACTORY DIRECT
1-800-634-6898**

**W S I WILSON
SYSTEMS, INC.**

4286 S. Polaris Ave., Las Vegas, Nevada 89103

Prices and specifications subject to change without notice.

WILSON SYSTEMS INC. MULTI-BAND ANTENNAS

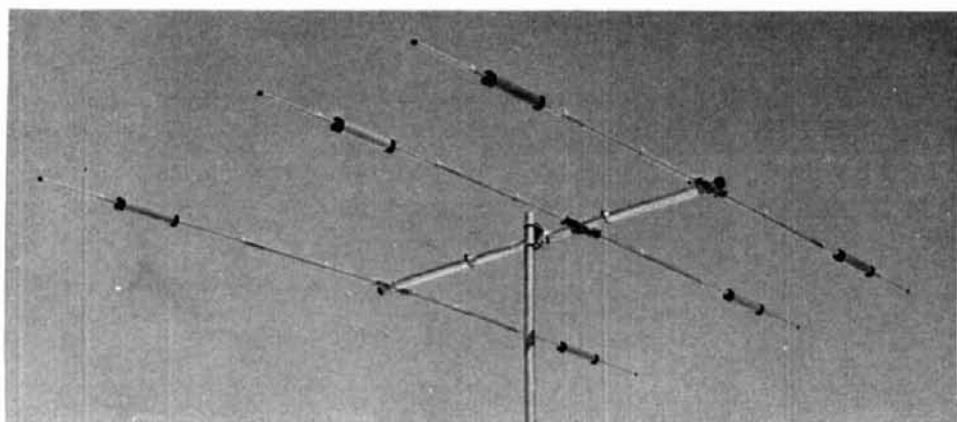

\$139⁹⁵

SYSTEM 33

(FORMERLY SYSTEM THREE)

FACTORY DIRECT ONLY

Capable of handling the Legal Limit, the "SYSTEM 33" is the finest compact tri-bander available to the amateur.

Designed and produced by one of the world's largest antenna manufacturers, the traditional quality of workmanship and materials excels with the "SYSTEM 33".

New boom-to-element mount consists of two 1/8" thick formed aluminum plates that will provide more clamping and holding strength to prevent element misalignment.

Superior clamping power is obtained with the use of a rugged 1/4" thick aluminum plate for boom to mast mounting.

The use of large diameter High-Q traps in the "SYSTEM 33" makes it a high performing tri-bander and at a very economical price.

A complete step-by-step illustrated instruction manual guides you to easy assembly and the lightweight antenna makes installation of the "SYSTEM 33" quick and simple.

The same quality traps are used in the SY33 that are used in the SY36.

SPECIFICATIONS

Band MHz	14-21-28	Turning radius	15'9"
Maximum power input	Legal limit	Maximum mast diameter.	2" O.D.
Gain (dbd)	Up to 8 dB	Surface area	5.7 sq. ft.
VSWR at resonance	1.3:1	Wind loading at 80 mph	114 lbs.
Impedance	50 ohms	Assembled weight (approx.)	37 lbs.
F/B ratio	20 dB or better	Shipping weight (approx.)	42 lbs.
Boom (O.D. x length)	2" x 14'4"	Direct 52 ohm feed—no balun required	
No. elements	3	maximum wind survival	100 mph
Longest element	27'4"		

CALL
FACTORY DIRECT
1-800-634-6898

W S I WILSON SYSTEMS, INC.

4286 S. Polaris Ave., Las Vegas, Nevada 89103

Prices and specifications subject to change without notice.

\$44⁹⁵

WV-1A

4 BAND
TRAP VERTICAL
(10 - 40 METERS)

No bandswitching necessary with this vertical. An excellent low cost DX antenna with an electrical quarter wavelength on each band and low angle radiation. Advanced design provides low SWR and exceptionally flat response across the full width of each band.

Featured is the Wilson large diameter High-Q traps which will maintain resonant points with varying temperatures and humidity.

Easily assembled, the WV-1A is supplied with a hot dipped galvanized base mount bracket to attach to vent pipe or to a mast driven in the ground.

Note:

Radials are required for peak operation.
(See GR-1 below).

SPECIFICATIONS:

- Self supporting—no guys required.
- Input Impedance: 50 Ω
- Powerhandling capability: Legal Limit
- Two High-Q Traps with large diameter coils
- Low Angle Radiation
- Omnidirectional performance
- Taper Swaged Aluminum Tubing
- Automatic Bandswitching
- Mast Bracket furnished
- SWR: 1.1:1 or less on all Bands

GR-1

\$9⁹⁵

The GR-1 is the complete ground radial kit for the WV-1A. It consists of: 150' of 7/14 stranded copper wire and heavy duty egg insulators, instructions. The GR-1 will increase the efficiency of the WV-1A by providing the correct counterpoise.

WILSON MONO-BAND BEAMS

\$209⁹⁵

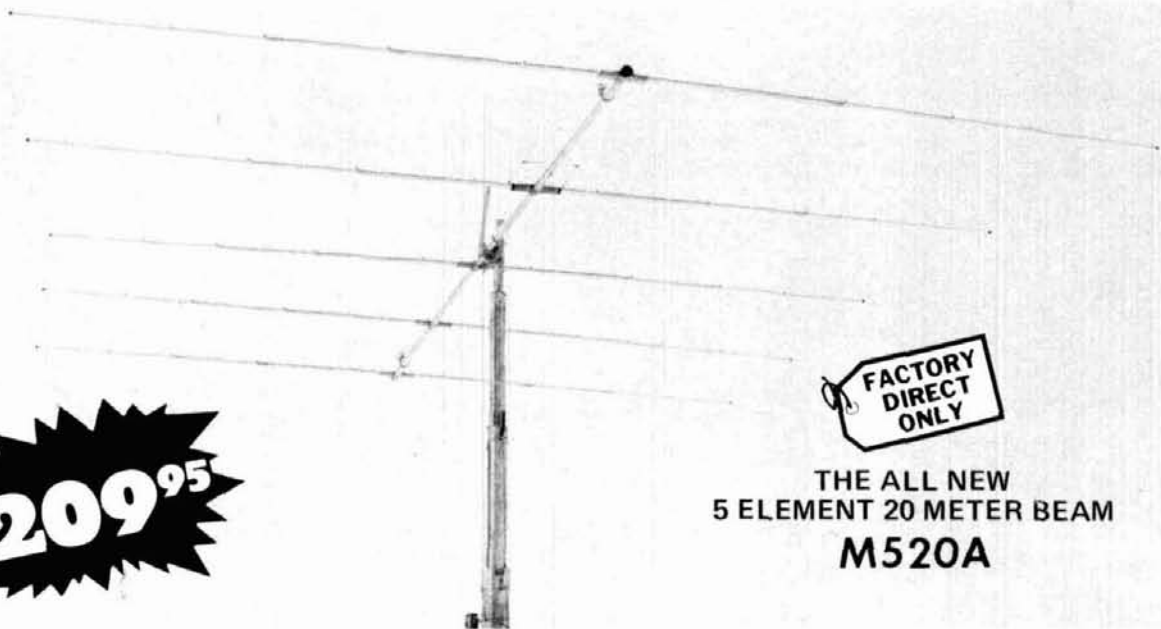

FACTORY DIRECT ONLY

**THE ALL NEW
5 ELEMENT 20 METER BEAM
M520A**

At last, the antennas that you have been waiting for are here! The top quality, optimum spaced, and newest designed mono-banders. The Wilson Systems' new Monoband beams are the latest in modern design and incorporate the latest in design principles utilizing some of the strongest materials available. Through the select use of the current production of aluminum and the new boom to element plates, the Wilson Systems' antennas will stay up when others are falling down due to heavy ice loading or strong winds. Note the following features:

1. Taper Swaged Elements – The taper swaged elements provide strength where it counts and lowers the wind loading more efficiently than the conventional method of telescoping elements of different sizes.
2. Mounting Plates – Element to Boom – The new formed aluminum plates provide the strongest method of mounting the elements to the boom that is available in the entire market today. No longer will the elements tilt out of line if a bird should land on one end of the element.
3. Mounting Plates – Boom to Mast – Rugged 1/4" thick aluminum plates are used in combination with sturdy U-bolts and saddles for superior clamping power.
4. Holes – There are no holes drilled in the elements of the Wilson HF Monobanders. The careful attention given to the design has made it possible to eliminate this requirement as the use of holes adds an unnecessary weak point to the antenna boom.

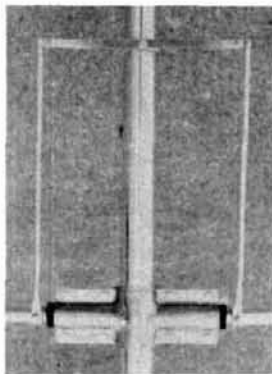

Wilson's Beta match offers maximum power transfer.

The Wilson Beta-match offers the ability to adjust the terminating impedance that is far superior to the other matching methods including the Gamma match and other Beta-matches. As this method of matching requires a balanced line it will be necessary to use a 1:1 balun, or RF choke, for the most efficient use of the HF Monobanders.

The Wilson Monobanders are the perfect answer to the Ham who wants to stack antennas for maximum utilization of space and gain. They offer the most economical method to have more antenna for less money with better gain and maximum strength. Order yours today and see why the serious DXers are running up that impressive score in contests and number of countries worked.

With the Wilson Beta-match method, it is a "set it and forget it" process. You can now assemble the antenna on the ground, and using the guidelines from the detailed instruction manual, adjust the tuning of the Beta-match so that it will remain set when raised to the top of the tower.

SPECIFICATIONS

Model	Band Mtrs	Gain dBd	F/B Ratio	Bandwidth @ Resonance 7:1 VSWR Limit	VSWR @ Resonance	Impedance	Matching	Elements	Longest Element	Boom O.D.	Boom Length	Turning Radius	Surface Area (Sq. Ft.)	Windload @ 80 mph (Lbs.)	Maximum Mast	Assembled Weight (Lbs.)
M520A	20	11.5	25 dB	500 KHz	1.1:1	50 Ω	Beta	5	36'6"	2"	34'2½"	25'1"	8.9	227	2"	68
M420A	20	10.0	25 dB	500 KHz	1.1:1	50 Ω	Beta	4	36'6"	2"	26'0"	22'6"	7.6	189	2"	50
M515A	15	12.0	25 dB	400 KHz	1.1:1	50 Ω	Beta	5	25'3"	2"	26'0"	17'6"	4.2	107	2"	41
M415A	15	10.0	25 dB	400 KHz	1.1:1	50 Ω	Beta	4	24'2½"	2"	17'0"	14'11"	3.1	54	2"	25
M510A	10	12.0	25 dB	1.5 MHz	1.1:1	50 Ω	Beta	5	18'6"	2"	26'0"	16'0"	2.8	72	2"	36
M410A	10	10.0	25 dB	1.5 MHz	1.1:1	50 Ω	Beta	4	18'3"	2"	12'11"	11'3"	1.4	36	2"	20

**CALL
FACTORY DIRECT
1-800-634-6898**

**W S I WILSON
SYSTEMS, INC.**

4286 S. Polaris Ave., Las Vegas, Nevada 89103

Prices and specifications subject to change without notice.

New, Improved Wilson Towers



Hinged Base Plate - Concrete Pad, Heavy Duty Winch



Mounting the House Bracket



The Hinged Base Plate allows tower to be tilted over for access to antenna and rotor from the ground.

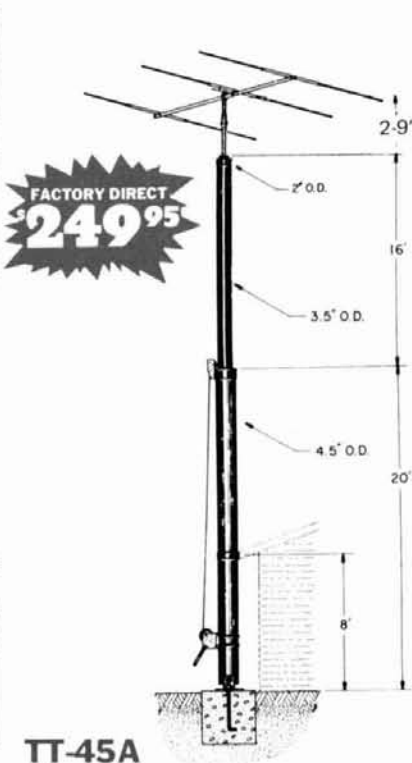

TT-45A

FEATURES:

- Maximum Height 45' (will handle 12 sq. ft. at 38') @ 50 mph
- 1200 lb. winch
- Totally freestanding with proper base
- Total Weight, 243 lbs.

The TT-45A is a freestanding tower, ideal for installations where guys cannot be used. If the tower is not being supported against the house, the proper base fixture accessory must be selected. (Requires 12"x12"x36" of concrete.)

GENERAL FEATURES

All towers use high strength heavy galvanized steel tubing that conforms to ASTM specifications for years of maintenance-free service. The large diameters provide unexcelled strength. All welding is performed with state-of-the-art equipment. Top sections are 2" O.D. for proper antenna/rotor mounting. A 10' push-up mast is included in the top section of each tower. Hinge-over base plates are standard with each tower. The high loads of today's antennas make Wilson crank-ups a logical choice.

FACTORY DIRECT
\$449.95

NEW IMPROVED FEATURE

Heavier wall tubing greatly increases the stress capabilities over the older TT-45 and MT-61.

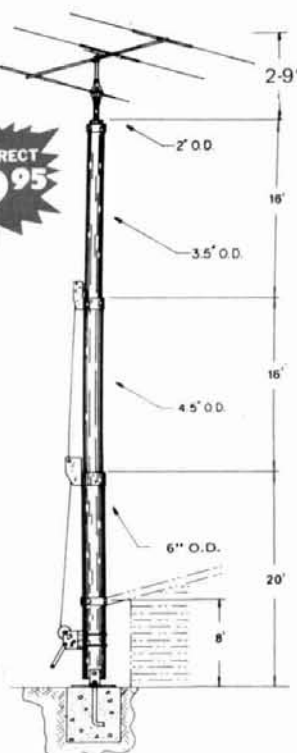

MT-61A

FEATURES:

- Is freestanding with use of proper base
 - Maximum Height is 61' (will handle 12 sq. ft. at 53') @ 50 mph
 - 1200 lb. brake winch
 - 4200 lb. raising cable
 - Total Weight, 400 lbs.
- Recommended base accessory: RB-61A, FB-61A.

The MT-61A is our largest and tallest freestanding tower. By using the RB-61A rotating base fixture the MT-61A is ideally suited for the SY33 or SY-36. If you plan to mount the tower to your house, caution should be taken to make certain the eave is properly reinforced to handle the tower. If not, one of the base accessory fixtures should be used. (Requires 18"x18"x48" concrete.)

TILT-OVER BASES FOR TOWERS

FIXED BASE

The FB Series was designed to provide an economical method of moving the tower away from the house. It will support the tower in a completely free-standing vertical position, while also having the capabilities of tilting the tower over to provide an easy access to the antenna. The rotor mounts at the top of the tower in the conventional manner, and will not rotate the complete tower. (Requires 3'x3'x5 1/2' of concrete.)

FB-45A... \$ 99.95
FB-61A... 129.95

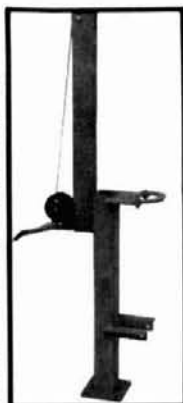

ROTATING BASE

The RB Series was designed for the Amateur who wants the added convenience of being able to work on the rotor from the ground position. This series of bases will give that ease plus rotate the complete tower and antenna system by the use of a heavy duty thrust bearing at the base of the tower mounting position, while still being able to tilt the tower over when desiring to make changes on the antenna system. (Requires 3'x3'x6' of concrete.)

RB-45A... \$139.95
RB-61A... 199.95

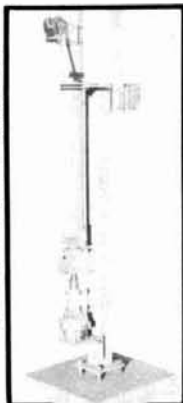

Tilting the tower over is a one-man task with the Wilson bases.

(Shown above is the RB-61A.)
(Rotor not included)

W S I WILSON SYSTEMS, INC.

4286 S. Polaris Avenue
Las Vegas, Nevada 89103
(702) 739-7401

Toll-Free Order Number 800-634-6898

Prices and specifications subject to change without notice.

6 METER BEAMS

Model M68

As low as
\$27.95

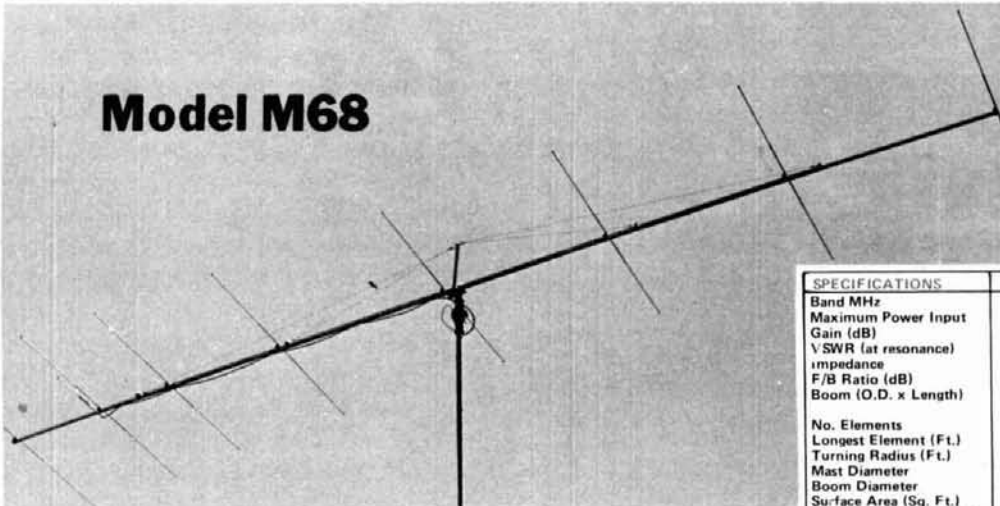

8 elements W-I-D-E spaced on a L-O-N-G 37' boom... for those long hauls to JA and VK land! Choose 4, 6 or 8 elements to put you in the action on six meters.

SPECIFICATIONS	MODEL M68	MODEL M66	MODEL M64
Band MHz	50	50	50
Maximum Power Input	4 Kw	4 Kw	4 Kw
Gain (dB)	13.5	13.0	10.0
VSWR (at resonance)	1.1:1	1.1:1	1.1:1
Impedance	50 ohms	50 ohms	50 ohms
F/B Ratio (dB)	26	25	25
Boom (O.D. x Length)	2" to 1 1/2" x 36'10"	2" x 25'8"	1 1/2" x 11'6"
No. Elements	8	6	4
Longest Element (Ft.)	9'8"	9'8"	9'8"
Turning Radius (Ft.)	19'0"	13'10"	7'6"
Mast Diameter	2" O.D.	2" O.D.	1 1/2" O.D.
Boom Diameter	2" to 1 1/2" O.D.	2" O.D.	1 1/2" O.D.
Surface Area (Sq. Ft.)	5.8	4.5	1.5
Wind Loading @ 80 mph	145	112	37
Assembled wght. Approx.	34 lbs.	26 lbs.	11 lbs.
Shipping wght. Approx.	39 lbs.	31 lbs.	13 lbs.
Matching Method	Gamma	Gamma	Gamma
PRICE	\$84.95	\$54.95	\$27.95

Starting at
\$19.95

2 METER BEAMS

Wilson's new 2 meter series combines the ultimate in design and quality materials. These top performing beams feature 7, 9 or 11 aluminum elements held to the heavy walled boom with the exclusive molded Lexan® boom to element mounting. The four driven elements use Log Periodic design for broad band characteristics providing full 144-148 MHz coverage with less than 1.2 to 1 VSWR across the band. Universal mounting is provided for vertical or horizontal polarization.

SPECIFICATIONS	M27	M29	M211
Band MHz	144-148 MHz	144-148 MHz	144-148 MHz
Gain (dB)	11 dB	13.7 dB	14.5 dB
VSWR	Less than 1.2:1 across band	Less than 1.2:1 across band	Less than 1.2:1 across band
Impedance	50 ohms balanced	50 ohms balanced	50 ohms balanced
Number of Elements	7	9	11
Boom (O.D. x Length)	1" O.D. x 5'4"L.	1" O.D. x 10'0"L.	1 1/2" O.D. x 12'6"
Longest Element	40"	40"	40"
Surface Area (Sq. Ft.)	.8	1.5	2.8
Assembled wght. Approx.	3.5 lbs.	5 lbs.	6 lbs.
Shipping wght. Approx.	6.5 lbs.	8 lbs.	9 lbs.
Turning Radius	38"	64"	78"
PRICE	\$19.95	\$24.95	\$29.95

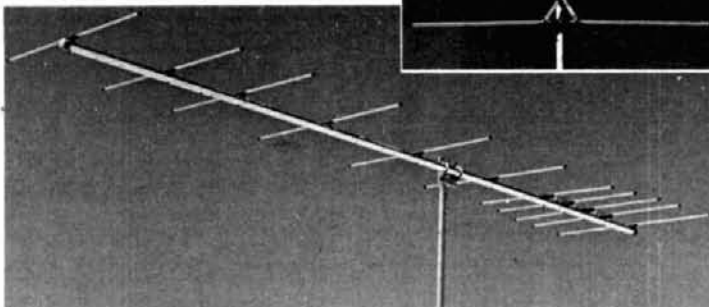

WILSON SYSTEMS, INC. — 4286 S. Polaris
Las Vegas, NV 89103 — (702) 739-7401

FACTORY DIRECT ORDER BLANK

Toll-Free Order Number
1-800-634-6898

WILSON SYSTEMS ANTENNAS

WILSON SYSTEMS TOWERS

Qty	Model	Description	Shipping	Price
	SY33	3 Ele. Tribander for 10, 15, 20 Mtrs.	UPS	\$139.95
	SY36	6 Ele. Tribander for 10, 15, 20 Mtrs.	UPS	189.95
	WV-1A	Trap Vertical for 10, 15, 20, 40 Mtrs.	UPS	44.95
	GR-1	Ground Radials for WV-1A	UPS	9.95
	M-520A	5 Elements on 20 Mtrs.	TRUCK	209.95
	M-420A	4 Elements on 20 Mtrs.	UPS	139.95
	M-515A	5 Elements on 15 Mtrs.	UPS	119.95
	M-415A	4 Elements on 15 Mtrs.	UPS	79.95
	M-510A	5 Elements on 10 Mtrs.	UPS	84.95
	M-410A	4 Elements on 10 Mtrs.	UPS	64.95
	WM-62A	Mobile Antenna: 5/8 λ on 2, 1/4 λ on 6	UPS	19.95
	M-86	8 Elements on 6 Mtrs.	UPS	84.95
	M-66A	6 Elements on 6 Mtrs.	UPS	54.95
	M-46	4 Elements on 6 Mtrs.	UPS	27.95
	M-112	11 Elements on 2 Mtrs.	UPS	29.95
	M-92	9 Elements on 2 Mtrs.	UPS	24.95
	M-72	7 Elements on 2 Mtrs.	UPS	19.95
		ACCESSORIES		
	HD-73	Alliance Heavy Duty Rotor	UPS	109.95
	RC-8C	8/C Rotor Cable	UPS	.12/ft.
	RG-8U	RG-8U Foam-Ultra Flexible Coaxial Cable. 38 strand center conductor, 11 gauge	UPS	.21/ft.

Qty.	Model	Description	Shipping	Price
	TT-45A	Freestanding 45' Tubular Tower	TRUCK	\$249.95
	RB-45A	Rotating Base for TT-45A w/tilt over feature	TRUCK	139.95
	FB-45A	Fixed Base for TT-45A w/tilt over feature	TRUCK	99.95
	MT-61A	Freestanding 61' Tubular Tower	TRUCK	449.95
	RB-61A	Rotating Base for MT-61A w/tilt over feature	TRUCK	199.95
	FB-61A	Fixed Base for MT-61A w/tilt over feature	TRUCK	129.95

NOTE:

On Coaxial and Rotor Cable, minimum order is 100 ft. and in 50' multiples.
Prices and specifications subject to change without notice.
Ninety Day Limited Warranty, All Products FOB Las Vegas, Nevada
PRICES EFFECTIVE NOV. 1, 1979

Nevada Residents Add Sales Tax

Ship C.O.D. Check enclosed Charge to Visa M/C

Card # _____ Expires _____

Bank # _____ Signature _____

Please Print

Name _____ Phone _____

Street _____

City _____ State _____ Zip _____

Prices and specifications subject to change without notice.

MORSE PAK-A the complete **DECODER**

all the features at the least cost

- Auto speed acquisition
- 16 character readout—crawling display
- Speed range 5-75 WPM
- Auto word space
- Plugs into RCVR earphone jack
- Industry's most sophisticated Morse demodulator with AGC
- Attractive, professional enclosure
- LED lock light

* Add \$5.00 for shipping.
 NM residents add 4% sales tax.
 We accept Visa, Master Cards

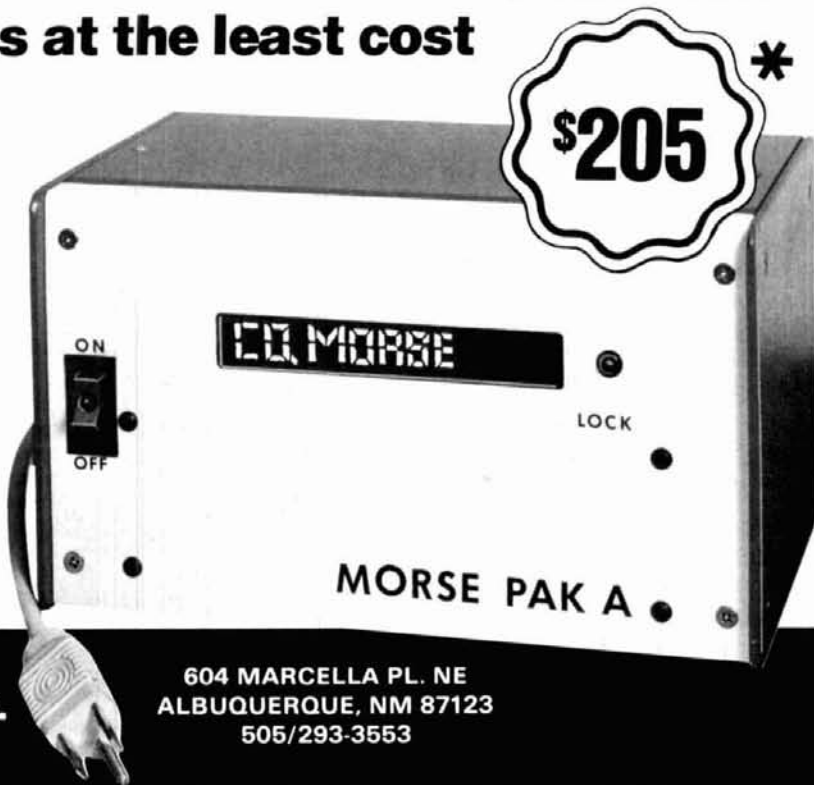

MORSE PAK, Inc.

604 MARCELLA PL. NE
 ALBUQUERQUE, NM 87123
 505/293-3553

CHRISTMAS GIFTS FOR THE HAM IN YOUR FAMILY

PALOMAR ENGINEERS

	Price	Shipping/ Handling
R-X Noise Bridge	\$49.95	\$2.00
VLF Converter	55.00	2.00
All Bands Preamplifier	89.50	2.00
IC Keyer	97.50	3.00
500 Watt RF Transformer	35.00	2.00
2 KW RF Transformer	42.50	2.00
1 K Toroid Balun	22.50	2.00
2 K Toroid Balun	42.50	2.00
Beam Balun (6 KW PEP)	47.50	2.00
Loop Amplifier	67.50	2.00
Plug-in Loop (160/80 meters)	47.50	2.00
Plug-in Loop (broadcast)	47.50	2.00
Plug-in Loop VLF (150-550 KHz)	47.50	2.00
CW Filter	39.95	2.00

LARSEN MOBILE ANTENNA SPECIALS

LM-150 5/8 Wave Whip and Coil	\$21.65	\$2.00
Complete with LM Magnetic Mount ..	34.94	2.00
Complete with LM Trunk Mount	34.42	2.00
NMO-150 5/8 Wave Whip and Coil	\$23.22	\$2.00
Complete with NMO Magnetic Mount ..	38.13	2.00
Complete with NMO Trunk Mount	39.20	2.00

WRITE FOR A FREE COPY OF OUR CATALOG

MASTER CHARGE VISA

All items F O B Lincoln. \$1.00 minimum shipping. Prices subject to change without notice. Nebraska residents please add 3% tax

g & c Communications

730 Cottonwood Lincoln, Nebraska 68510
 Phone (402) 489-4891

Call or Write for Delivery or Quote

ICOM IC701 with AC/MIC



LEAVE A MESSAGE & WE'LL CALL YOU BACK!

All prices fob Houston, except where indicated. Prices subject to change without notice, all items guaranteed. Some items subject prior sale. Send letterhead for Dealer price list. Texas residents add 6% tax. please add postage estimate. \$1.00 minimum. W5GJ W5MBB K5AAD N5JJ AG5K W5VVM WD5EDE. K5ZD WA5TGU WB5AYF K5RC K5BGB WB5USV

MASTERCHARGE • VISA

**MADISON
 ELECTRONICS SUPPLY, INC.**

1508 MCKINNEY • HOUSTON, TEXAS 77002
 713/658-0268

SERIOUS READING

Practical **ANTENNAS** for the Radio Amateur

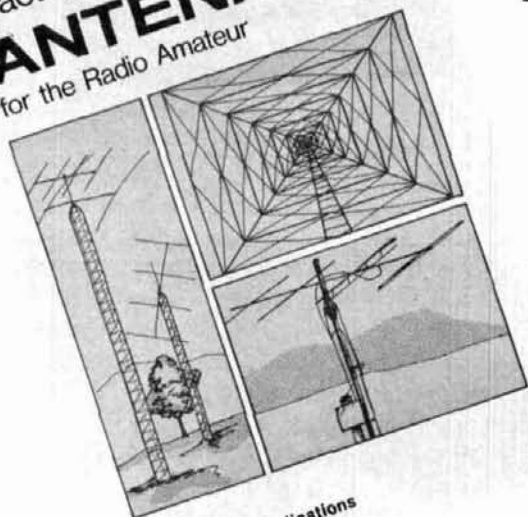

S SCELBI Publications

Practical Antennas for the Radio Amateur

You've never seen an antenna book quite like this! It tells you how to choose, use and build your antenna system. Here's what you get: How to build practical beams, quads and wire antennas Computer-generated beam headings to every known country in the world Charts and tables to eliminate tricky calculations Practical ideas for the newcomer OSCAR antennas Complete bibliography of magazine articles on antennas Antenna safety Trick antennas for portable work Tips on how to keep your antenna up. Durable vinyl cover. Only \$9.95

Brand New Antenna Book!

New format . . . Big diagrams . . . Easy-to-read

By well-known author, Robert Myers, W1XT

In a Hurry? Order Toll Free 1-800-258-5353

Ham Radio's Bookstore

**Greenville
NH 03048**

- Practical Antennas Personal Information Management System
 Introduction to Low Resolution Graphics Calculating with BASIC

Name _____

Street _____

City _____ State _____ Zip _____

Please enclose proper amount for books plus \$1.00 shipping or credit card information.

Personal Information Management System

Keep an automatic log. Compare antenna performance. Catalog your parts and equipment. Keep a mailing list for your club. Plain-talk booklet tells how. Includes ready-to-use program for home computer systems. A bargain at just \$9.95.

Introduction to Low Resolution GRAPHICS

Produce amazing computer graphics — even if you can't draw a straight line. Literally! Learn how to draw lines and shapes, make graphs, draw pictures and even do animation. All the simple secrets are contained in this brand new book. Only \$9.95.

Calculating with BASIC

Use a home computer to calculate voltage across a capacitor, find the value of inductance, determine the capacitance of parallel plates, compute the time to charge a capacitor and convert power, voltage and current to decibels. All the routines needed and more! Just \$7.95.

PIMS Personal Information Management System



Improve your life style

Learn how you can unlock the power of a personal computer for your own benefit. A ready-to-use data base management program.

S SCELBI Publications

Introduction to Low Resolution GRAPHICS



S SCELBI Publications

Calculating with BASIC



For mathematic, finance and statistical, mechanical engineering and electronics

S SCELBI Publications



JAN CRYSTALS
HOLD THE FREQUENCY

- CB
- CB standard
- 2 meter
- Scanners
- Amateur Bands
- General Communication
- Industry
- Marine VHF
- Micro processor crystals

Send 10¢ for our latest catalog. Write or phone for more details.



2400 Crystal Drive
Ft. Myers, Florida 33907
all phones (813) 936-2397

ERC PROMISES UP TO THE MINUTE STATE-OF-THE-ART DESIGN AND PERFORMANCE WE'VE DONE IT FOR 1979

FOUR SIMULTANEOUS FILTERS IN ONE FOR UNPARALLELED QRM FREE RECEPTION (SSB & CW) *PLUS A SPECIAL PATENTED CW PROCESSOR*



**SL-56
AUDIO ACTIVE FILTER
(3.5 x 5.5 x 7.5 INCHES)**

THE BRAND NEW SL-56 AUDIO ACTIVE FILTER SUPERCEDES OUR SL-55 IN BOTH CONCEPT AND PERFORMANCE. CONSOLIDATION OF MANY COMPONENTS HAS ALLOWED US TO MAKE 16 OPERATIONAL AMPLIFIERS (COMPARED TO 6 IN THE SL-55) INTO A FILTER GUARANTEED TO OUT PERFORM ANY OTHER AT A COST ONLY SLIGHTLY HIGHER THAN THE SL-55. THE FEATURES OF THE SL-56 ARE SO ADVANCED FROM ITS PREDECESSOR THAT CALLING IT THE SL-55A IS NOT JUSTIFIED. UNLIKE OTHER FILTERS THAT SIMPLY OFFER A CHOICE OF ONE OR TWO FILTER TYPES AT A TIME (NOTCH, BANDPASS, ETC.) SL-56 PROVIDES WHAT IS REALLY NEEDED --- THE SIMULTANEOUS ACTION OF A 6 POLE 200 Hz FIXED HIGH-PASS FILTER AND A 6 POLE 1600 Hz FIXED LOWPASS FILTER WITH A 60 dB NOTCH WHICH IS TUNABLE OVER THE 200-1600 Hz RANGE. THIS 3 FILTER COMBINATION IS UNBEATABLE FOR THE ULTIMATE IN QRM FREE SSB RECEPTION. ADJACENT CHANNEL QRM IS ELIMINATED ON THE HIGH AND LOW SIDES AT THE SAME TIME AND DOES NOT INTRODUCE ANY HOLLOWNESS TO THE DESIRED SIGNAL. ON CW THE SL-56 IS A DREAM. THE LOWPASS, HIGHPASS AND NOTCH FILTERS ARE ENGAGED ALONG WITH THE TUNABLE BANDPASS FILTER (400-1600 Hz) PROVIDING THE NEEDED ACTION OF 4 SIMULTANEOUS FILTER TYPES. THE BANDPASS MAY BE MADE AS NARROW AS 14 Hz (3dB). ADDITIONALLY, A SPECIAL PATENTED CIRCUIT FOLLOWS THE FILTER SECTIONS WHICH ALLOWS ONLY THE PEAKED SIGNAL TO "GATE ITSELF" THROUGH TO THE SPEAKER OR HEADPHONES (4-2000 OHMS). RECEIVER NOISE, RING AND OTHER SIGNALS ARE REJECTED. THIS IS NOT A REGENERATOR, BUT A MODERN NEW CONCEPT IN CW RECEPTION. THE SL-56 CONNECTS IN SERIES WITH THE RECEIVER SPEAKER OUTPUT AND DRIVES ANY SPEAKER OR HEADPHONES WITH ONE WATT OF AUDIO POWER. REQUIRES 115 VAC. EASILY CONVERTED TO 12 VDC OPERATION. COLLINS GRAY CABINET AND WRINKLE GRAY PANEL.

WARRANTED ONE YEAR FULLY RFI PROOF FULLY WIRED AND TESTED AVAILABLE NOW \$75.00 POSTPAID IN THE USA AND CANADA. VIRGINIA RESIDENTS ADD 4% SALES TAX.

ATTN SL-55 OWNERS: THE CIRCUIT BOARD OF THE SL-56 IS COMPLETELY COMPATIBLE WITH THE SL-55 CHASSIS. OUR RETROFIT KIT IS AVAILABLE AT \$35.00 POSTPAID.

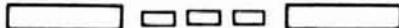

ERC INTRODUCES A BRAND NEW CONCEPT IN THE MEASUREMENT OF VSWR AND POWER ACCEPTED BY THE LOAD

REQUIRES 115 VAC AT LESS THAN 1/16 AMP.



TWO SO-239 COAX CONNECTORS ARE AT THE REAR PANEL.

DIMENSIONS 3.5 x 5.5 x 7.5 INCHES.

WEIGHT IS 2 POUNDS.

COLLINS GRAY CABINET. WRINKLE PANEL - BRIGHT RED LED DIGITS (.33"). DECIMAL POINT IS THE PILOT LIGHT.

1.8-30 MHz

THE MODEL SL-65* (20-2000 WATTS) AND THE QRP MODEL SL-65A* (0.2-20 WATTS) DIGITALLY INDICATE ANTENNA VSWR UNDER ANY TRANSMISSION MODE -- SSB, CW, RTTY, AM Etc. THERE IS NO CALIBRATION REQUIRED AND NO CROSSED METER NEEDLES TO INTERPRET. SIMPLY LOOK AT THE READOUT AND THAT IS THE VSWR. SPEAKING NORMALLY INTO A SSB TRANSMITTER MIC. INSTANTLY CAUSES THE VSWR TO BE DISPLAYED THROUGHOUT YOUR ENTIRE TRANSMISSION. REVERSING THE POSITION OF A FRONT PANEL TOGGLE SWITCH AND THE DISPLAY INDICATES THE NET POWER (FORWARD LESS REFLECTED) THAT IS ACCEPTED BY THE ANTENNA. THE PEAK OF THE NET PEP IS DETECTED AND DISPLAYED WITHOUT FLICKER FOR ANY MODULATION TYPE. DISPLAY UPDATE IS CONSTANT YET FLICKER FREE AS YOU MAY CHANGE THE POWER ACCORDING TO YOUR VOICE. THERE IS NOTHING LIKE THIS QUALITY INSTRUMENT AVAILABLE ANYWHERE ELSE. IT IS THE ONLY VSWR-NET POWER INDICATOR THAT LETS YOU KNOW THE STATE OF YOUR ANTENNAS AND TRANSMITTED POWER AT ALL TIMES WHILE TRANSMITTING. EITHER MODEL IS A SOPHISTICATED DEVICE CONTAINING FOUR CIRCUIT BOARDS AND THIRTEEN INTEGRATED CIRCUITS.

**SL-65
VSWR INDICATOR**

WARRANTY ONE YEAR

**SL-65
NET POWER INDICATOR**

- TWO DIGIT DISPLAY SHOWS VSWR TO AN ACCURACY OF .1 FOR VALUES FROM 1.0 AND 2.2. ACCURACY IS TO .2 FOR VALUES FROM 2.3 TO 3.4 AND TO .3 FROM 3.4 TO 4.0. FROM 4.1 TO 6.2 THE INDICATION MEANS THAT VSWR IS VERY HIGH.

- THE POWER DISPLAYED IS THE DETECTED PEAK OF THE PEP FOR ANY MODULATION. THIS IS THE POWER THAT THE TRANSMITTER IS "TALKED" UP TO. DISPLAY DECAY TIME IS ABOUT ONE SECOND.

- FOR VSWR VALUES NEAR 1.0, THE POWER RANGE FOR A VALID READING IS 20 - 2000 WATTS OUTPUT. FOR HIGHER VALUES THE UPPER POWER LIMIT FOR A FLICKER FREE VALID READING IS SOMEWHAT LESS (35 - 1000 WATTS FOR VSWR AT 2.0).

- THE POWER DISPLAYED IS THAT WHICH IS ACCEPTED BY THE ANTENNA (FORWARD LESS REFLECTED).
- POWER IS DISPLAYED ON THE SAME TWO DIGITS AS VSWR IN TWO AUTORANGED SCALES. 20 TO 500 WATTS AND 500 TO 2000 WATTS. TRIPOVER AT THE 500 WATT LEVEL IS AUTOMATIC EX: A READING OF 1.2 COULD MEAN 120 OR 1200 WATTS. YOU MUST KNOW WHICH RANGE YOU ARE IN.

- DIVIDE THE ABOVE POWER LEVELS BY 100 TO OBTAIN THE PERFORMANCE OF THE SL-65A QRP MODEL.

- ACCURACY IS TO 10 WATTS IN THE LOWER RANGE AND 100 WATTS IN THE UPPER RANGE. DIVIDE POWER SPECS BY 100 FOR SL-65A.

PRICE: \$189.50 POSTPAID IN USA & CANADA. VA. RESIDENTS ADD 4% SALES TAX.

BOOKLET AVAILABLE AT \$2.00 REDEEMABLE TOWARD PURCHASE. * PATENT PENDING.

**ELECTRONIC RESEARCH CORP. OF VIRGINIA
P. O. BOX 2394
VIRGINIA BEACH, VIRGINIA 23452
TELEPHONE (804) 463-2669**

SPECIAL AUDIO VERSION AVAILABLE FOR THE SIGHTLESS • WRITE FOR DETAILS •

NEW — NEW — NEW

TOUCH-TONE® MICROPHONE DATA CODER 5



\$39.00

JUST LOOK AT THESE FEATURES:

- Tough "Mobile Environment" Microphone
- Positive-Action Tactile Keys
- High-Impedance Ceramic or 500-ohm Dynamic Cartridge
- Adjustable Tone Balance and Output Level
- "Positive Hold - Easy Lift" Hanger
- For Vehicle or Hand-held Portable Use
- Complete... **Not a Kit**... **\$39.00**

*Touch-Tone is a registered trade name of AT&T



DATA SIGNAL, INC.
2403 COMMERCE LANE
ALBANY, GEORGIA 31707
Tel. 912-883-4703

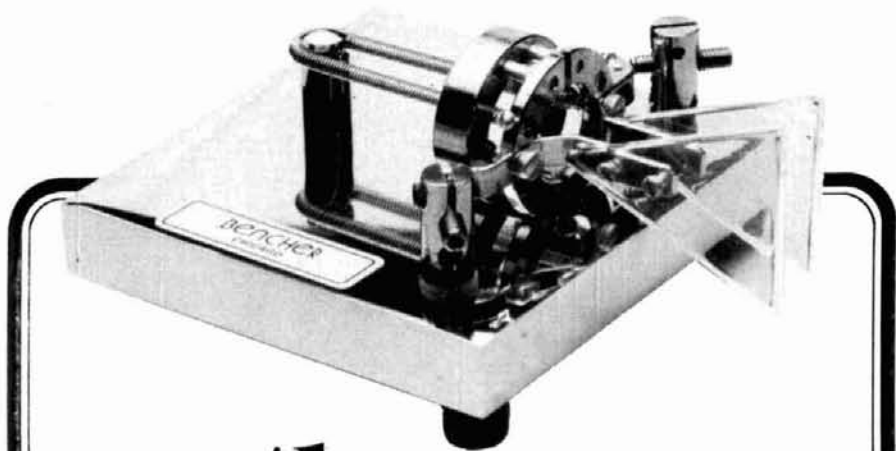

the Ultimate LAMBIC PADDLE

WRITE FOR LITERATURE

BENCHNER, INC.

333 W. Lake Street, Dept. A
Chicago, Illinois 60606 • (312) 263-1808

- Full range of adjustment in tension and contact spacing.
- Self-adjusting nylon and steel needle bearings.
- Solid silver contact points.
- Polished lucite paddles.
- Precision-machined, chrome plated brass frames.
- Standard model has black, textured finish base; deluxe model is chrome plated.
- Heavy steel base; non-skid feet.

Available at selected dealers or send \$39.95 (\$49.95 for chrome model) plus \$2.00 shipping and handling. Overseas amateurs invited to request quotation for air parcel post shipment.

1980

Radio Amateur Callbook



Don't be one of those who waits until the year is half over to buy a new callbook. Invest in a callbook today and get a full year's use out of your purchase. Crammed full of the latest addresses and QSL information.

You'll find:

Boldface calls, names and addresses for every licensed Amateur in the U.S.

CB-US Softbound \$16.95



The Foreign Callbook

DXing is a real joy, but it's even better when you get back QSL cards from the countries you've worked. The most important tool in getting those cards is to have a copy of the 1980 Foreign Callbook on your operating table. Stations are listed by country, call, name and address in bold, easy-to-read type.

CB-F Softbound \$15.95

**HAM RADIO'S
BOOKSTORE**
GREENVILLE, N. H.
(800) 258-5353

HA-2 HORIZONTAL/VERTICAL 2 METER ANTENNA

The HA-2 is a low profile half wave, horizontally polarized omnidirectional 2 meter antenna. Although the HA-2 was designed for mobile operation, it will work well as a fixed or portable antenna and its small size provides the traveling ham with an antenna that can easily be packed in a briefcase. The HA-2 comes complete with RG/58, which is fed through the center of the mast section, PL-259 RF connector and 3/8 24 stud base. A rain gutter mount is recommended for mobile operation.

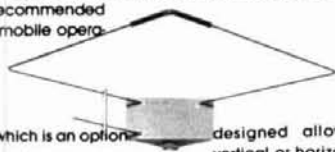

tion, which is an option. To provide more versatility for the HA-2, a vertical change over option mount has been

designed allowing vertical or horizontal polarization, complete change can be made in minutes requiring only a screw driver.

Specifications

Gain	1.92 dBi
VSWR	1.5:1
Bandwidth	4 MHz
Impedance	50 Ohms
Power	150 watts dc Input
Element Size	10 inches square
Mast Length	2.0 feet
Base	3/8" x 24

HA-2 Antenna

\$39.95 postage paid

Pat. Pending #88548
F.C.C. — Certified

Send check or money order to:
SEM CON Inc., Box 2751,
Palos Verdes, CA 90274

*Vertical change over mount \$5.95.

DEALERS WANTED TOWERS

by ALUMA
HIGHEST QUALITY
ALUMINUM
& STEEL

60 Ft. Aluminum.
Crank-Up
Model T-60-H

40' Steel
Crank-Up
Model SHD-40

- ★ TELESCOPING (CRANK UP)
 - ★ GUYED (STACK-UP)
 - ★ TILT-OVER MODELS
- Easy to install. Low Prices.
Crank-ups to 100 ft.

EXCELLENT FOR
HAM COMMUNICATIONS

SPECIAL
Four Section 50 Ft.
Van Mounted Crank-Up
Aluma Tower

Over 36 types aluminum
and steel towers made—
specials designed and
made—write for details



ALUMA TOWER CO.

Box 2806HR
VERO BEACH, FLA. 32960
PHONE (305) 567-3423
TELEX 80-3405

1980
1980
HANDBOOK
See page 90 for super value
on 1980 ARRL Handbook.
1980

TELEMETRY COMMUNICATIONS & INSTRUMENTATION, CORP.

10 GHz GUNNPLEXER® MICROWAVE TRANSCEIVER

FRONT END BY MICROWAVE ASSOCIATES



PHYSICAL SPECIFICATIONS

Size: 6" h. x 9" l. x 5" d.
 Color: Blue Enclosure, Gray Front Panel
 Weight: 3 Pounds
 Speaker Included
 Tripod or Mast Mounting
 Microphone Optional



FEATURES

- LOW COST
- HIGH SENSITIVITY
- AFC
- FUNCTION METER
- TONE OSCILLATOR
- ELECTRONICALLY TUNEABLE
- SQUELCH & VOLUME CONTROLS
- TRANSMIT-RECEIVE TELEMETRY/VIDEO DATA
- AC-DC OPERATION
- MULTIPLE IF FREQ'S
- MODULAR CONSTRUCTION
- WEATHER RESISTANT CASE
- COMPLETELY WIRED/TESTED

THREE MODELS AVAILABLE

TELEMETRY MODEL TMX10

- 10 GHz, 10 MW Gunn Transceiver
- 17 dB Horn Antenna
- 30 MHz Low Noise Pre-Amp
- 10.7 MHz Post IF Amp/Demod
- Crystal IF Filters
- Integrated Circuit Modulator
- Internal Voltage Regulators
- AFC
- Tone Oscillator

VIDEO MODEL TVX10

- 10 GHz, 10 MW Gunn Transceiver
- 17 dB Horn Antenna
- 45 MHz Low Noise Pre-Amp
- 45 MHz Post IF Amp/Demod
- Audio Subcarrier Mod/Demod
- Room for III Video Channels
- Internal Voltage Regulators
- Volume Control

TM/VIDEO MODEL TM/VX10

- 10 GHz, 10 MW Gunn Transceiver
- 17 dB Horn Antenna
- 45 MHz Low Noise Pre-Amp
- 45 MHz Post IF Amp/Demod
- Wideband/Narrowband Operation
- Audio Subcarrier Mod/Demod
- AFC
- AC-DC Power Supply

OPTIONS

- 45, 60, 100, 111 MHz IF Freq Available
- Narrow Band Crystal Filters
- 50 Hz, 220 VAC Power Supply
- Higher Gunn OSC Power Output
- Higher Gain Antennas

PRICE LIST

MODEL TMX10 \$379.95

MODEL TVX10 \$379.95

MODEL TM/VX10 . . . \$529.95

(Combines TM/Video Models)

TCI CORP.

411 N. BUCHANAN CIRCLE #3
 PACHECO, CA 94553

TO ORDER CALL (415) 676-6102

or Write for **FREE DETAILED DATA SHEET** on this and our
VHF/UHF TRANSMITTER & RECEIVER PRODUCT LINE

Prices Subject to Change Without Notice.



SYNTHESIZERS

We have the worlds largest selection of synthesizers for receivers, transmitters and transceivers. For complete details see our 1/3 page ad in the April 1976 issue of this magazine or call or write for additional information. Phone orders accepted between 9 AM and 4 PM EDT. (212) 468-2720

VANGUARD LABS

196-23 JAMAICA AVENUE
 HOLLIS, N. Y. 11423

York electronics

1108
 WILCOX AVE.
 LOS ANGELES
 CA.
 90038

- 3 Digit 5 LED Display Battery or AC operation Model F-R62 DPM Kit - \$29.99
- 3 Digit 5 LED Display Auto Zeroing, Battery or AC Model F-T505a DPM Kit - \$32.99
- Digital Alarm Clock PC B
- 3-1/2 Digit 0.43 LED Display Auto Zeroing, AC operation Model F-M33a DPM Kit - \$44.99
- AC/DC Converter, Power Supply Model F-CPS22c Kit - \$39.99
- 3-1/2 Digit 0.43 LED Display Auto Zeroing, Battery or AC operation Model F-IM107a DPM Kit - \$36.99
- AC/DC Converter, Power Supply Model F-CPS22c Kit - \$39.99
- 4-1/2 Digit 5 LED Display AC operation, 0.005% Accuracy Model F-SX 2021 DPM Kit - \$59.99
- Ohm Converter and DC voltage Model F-OV2b Kit - \$22.69
- We have PC boards already manufactured for Power Supplies for Diff V/A
- For different tens. & intens
- We execute Printed Circuit Boards, your artwork, single sided
- Mail your order now, or send for free details

STEP UP TO TELREX

Professionally Engineered Antenna Systems

Single transmission line "TRI-BAND" ARRAY

MONARCH
 TB5EM/4KWP

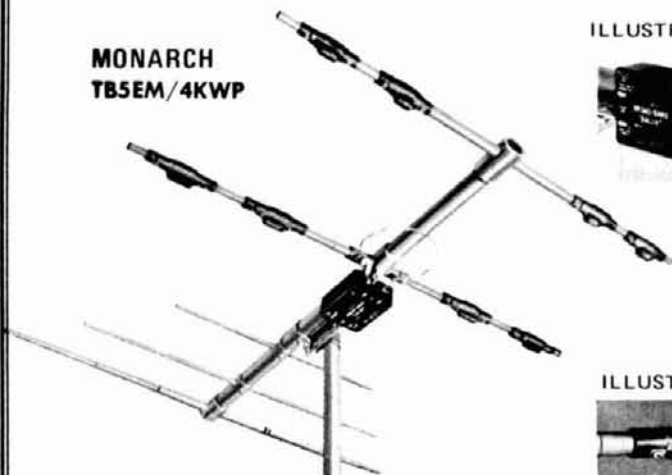

ILLUSTRATION BALUN



ILLUSTRATION TRAP



By the only test that means anything . . . on the air comparison . . . this array continues to outperform all competition . . . and has for two decades. Here's why . . . Telrex uses a unique trap design employing 20 HiQ 7500V ceramic condensers per antenna. Telrex uses 3 optimum-spaced, optimum-tuned reflectors to provide maximum gain and true F/B Tri-band performance.

For technical data and prices on complete Telrex line, write for Catalog PL 7



the Ultimate 1:1 BALUN

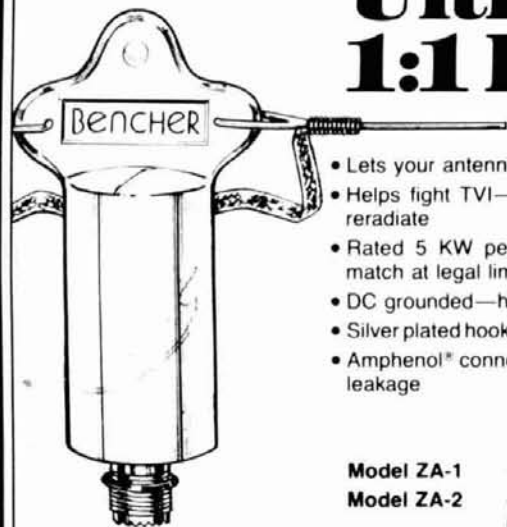

- Lets your antenna radiate—not your coax
- Helps fight TVI—no ferrite core to saturate or reradiate
- Rated 5 KW peak—accepts substantial mismatch at legal limit
- DC grounded—helps protect against lightning
- Silver plated hook-up braid; Custom molded case
- Amphenol® connector; Rubber ring to stop water leakage

Model ZA-1	3.5-30 MHz	\$15.95
Model ZA-2	optimized 14-30 MHz includes hardware for 2" boom	\$17.95

Available at selected
dealers, add \$2.00
postage and handling
in U.S.A.
WRITE FOR LITERATURE

BENCHER, INC.
333 West Lake Street, Dept A
Chicago, Illinois 60606 (312) 263-1808

NEW FROM GLB

A complete line of **QUALITY 50** thru 450 MHz **TRANSMITTER AND RECEIVER KITS**. Only two boards for a complete receiver. 4 pole crystal filter is standard. Use with our **CHANNELIZER** or your crystals. Priced from \$69.95. Matching transmitter strips. Easy construction, clean spectrum, **TWO WATTS** output, unsurpassed audio quality and built in **TONE PAD INTERFACE**. Priced from \$29.95.

SYNTHESIZER KITS from 50 to 450 MHz. Prices start at \$119.95.

Now available in **KIT FORM** — GLB Model 200 **MINI-SIZER**.

Fits any HT. Only 3.5 mA current drain. Kit price \$159.95 Wired and tested. \$239.95

Send for **FREE 16 page catalog**.

We welcome Mastercharge or VISA

GLB ELECTRONICS

1952 Clinton St., Buffalo, N. Y. 14206

Radio World

CENTRAL NEW YORK'S FASTEST GROWING HAM DEALER



Featuring Yaesu, Icom, Drake, Atlas, Ten-Tec, Swan, DenTron, Pace, Palomar, Alda, Midland, Wilson, KDK, MFJ, Microwave Module, Standard, Tempo, Astron, KLM, Hy-Gain, Mosley, Larsen, Cushcraft, Hustler, Mini Products, Universal and Tristao Towers. We service everything we sell! Write or call for quote. **You Won't be Disappointed.**
We are just a few minutes off the NYS Thruway (I-90) Exit 32

**ONEIDA COUNTY AIRPORT TERMINAL BUILDING
ORISKANY, NEW YORK 13424**

**Warren
K2IXN**
Call Toll Free: 1-800-448-7914

**Bob
WA2MSH**
New York State Residents Call: 315-337-2622 or 315-337-0203

NEW ELECTRONIC PARTS

Brand name, first line components. Stocked in depth. 24 hour delivery. Low prices and money back guarantee on all products we carry

STAMP BRINGS CATALOG

SPECIALS	W	D	H	PRICE
Keyboard Enclosures	14"	8 3/4"	3"	\$16.50
	17"	8 3/4"	3"	19.95
	20"	8 3/4"	3"	20.95
	14"	11 3/4"	3"	18.75
	17"	11 3/4"	3"	20.50
	20"	11 3/4"	3"	22.65

Blue Base, specify white or black top.

RTTY

SHIPPING
INCLUDED
IN PRICE

UT4 SPEED CVTR BOARD	
KIT	\$109.95
BOARD ALONE	\$18.95
AUTO CW ID KIT	\$27.90

Daytapro Electronics, Inc.
3029 N. WILSHIRE LN., ARLINGTON HTS., ILL. 60004
PHONE 312-870-0555

BUILD-IT-YOURSELF AVIONICS FOR HAM PILOTS

Free catalogue describes high technology, low cost avionics and test equipment offered in kit form. Product line includes audio panel, aircraft band two-channel transceiver, digital chronometer, navigation and communications test equipment, bench power supply, and more. Shoot us the coupon for details.

Name _____
Address _____
City _____ State _____ Zip _____

(916)
272-2203

**Radio Systems
Technology, Inc.**

RR 5, GRASS VALLEY, CA 95945

MOVING?

KEEP HAM RADIO COMING...

If possible let us know four to six weeks before you move and we will make sure your **HAM RADIO Magazine** arrives on schedule. Just remove the mailing label from this magazine and affix below. Then complete your new address (or any other corrections) in the space provided and we'll take care of the rest.

**ham
radio**

Magazine

Greenville, NH 03048

Allow 4-6 weeks for correction.

Thanks for helping us to serve you better.

Here's my new address:

Call _____
Name _____
Address _____
City _____ State _____ Zip _____

**AFFIX
LABEL
HERE**



CRYSTAL FILTERS

Whether your SSB rig is old or new, there is no easier or essentially less expensive way to significantly upgrade its performance than by improving its IF passband filtering. FOX-TANGO filters are made of specially-treated high-Q quartz crystals, affording excellent shape factors and ultimate rejection exceeding 80 dB. They are custom made for drop-in installation, matching perfectly, both physically and electronically. Our Diode Switching Boards make possible (now or in the future) the addition of a variety of switch-selectable filters affording superior variable bandwidth without the need to buy an expensive new model. If you want the best for less, you'll buy FOX-TANGO. Just tell us the band width(s) desired for your make and model.

8-POLE FILTER BANDWIDTHS IN STOCK										
MAKE AND MODEL OF SET	CW (kHz) ¹					SSB-AM (kHz) ²				SEE NOTE #
	125	250	400	500	800	1.1	2.1	2.4	8.0	
YAESU	\$55 EACH									3
FT-101-F (FR-101)	*	*	*	*	*	*	*	*	*	*
FT-201-FT (7-B)	*	*	*	*	*	*	*	*	*	*
FT-901-FT (10-12)	*	*	*	*	*	*	*	*	*	*
FT-401	*	*	*	*	*	*	*	*	*	*
KENWOOD	\$55 EACH									3
TS-520-RV9	*	*	*	*	*	*	*	*	*	*
TS-430-RB20	*	*	*	*	*	*	*	*	*	2nd IF
HEATH	\$55 EACH									3
ALL BUT SB104	*	*	*	*	*	*	*	*	*	*
DRAKE	FOR PRICES SEE NOTES									3
D-48-C	GUF-1	*	*	*	*	*	*	*	*	BROAD 1st IF
	GUF-2	*	*	*	*	*	*	*	*	NARROW 1st IF
		*	*	*	*	*	*	*	*	VERY SHARP CW (2nd IF)
		*	*	*	*	*	*	*	*	GUD - PRODUCT DETECTOR KIT
COLLINS	SPECIAL \$125 EACH									3
PS-38-C	*	*	*	*	*	*	*	*	*	EQUALS OR EXCEEDS \$400 COLLINS UNIT

- NOTES**
- 1) **250 Hz Filters** Considered to be very sharp, ideal for DX and contest work. Excellent for crowded band conditions, yet not too narrow for ordinary operations. Though superior to audio type filters, crystal filters work well with them.
 - 2) **400 and 500 Hz Filters** Slightly narrower than "standard" units supplied as options. However, Fox-Tango filters are 8 pole, unlike the 6 pole (or less) ordinarily available. Through the use of Diode Switching Boards, both standard-type and sharp (as well as SSB) filters may be used on a switch-selectable basis for flexible operation.
 - 3) **1.1 kHz Filters** Intended to supplement (or supplant) standard SSB filters whose bandwidth is about 33% greater. Useful in overcoming DRM.
 - 4) **2.1 kHz Filters** Provide a modest improvement over broader standard units, but even where the same bandwidth, the superior Fox-Tango characteristics greatly improve performance.
 - 5) **2.4 kHz Filters** Superior replacements for standard units having fewer than 8 poles. Also useful in some speech processors.
 - 6) **8 kHz Filters** Essential for quality reception of short-wave broadcasts, CB signals, etc. ordinarily almost unattainable when SSB filter is used.
 - 3) **Filter Prices** include Airmail Postpaid to U.S., Canada, Mexico. Elsewhere, add \$3 per filter.
 - 4) For FT-560/570/401/401B.
 - 5) Filter marked with star (*) is a new 455 kHz 2nd IF unit for superior R-520S SSB. Similar in quality to Collins unit below. **Introductory price:** \$125 each.
 - 6) **GUF-1** Replaces present 1st IF unit for CW and SSB. Shape factor 1.5, ultimate rejection 100 dB+. Original unit, 4.7 and 65 dB. **Specify** desired bandwidth: 500 or 8 kHz. \$65 each.
 - 7) **GUF-2** Filter plus relays, etc. on PC board. Easy installation. Automatically replaces broad 1st IF unit during CW. **Specify** desired bandwidth: 600 or 800 Hz. Use with or without GUF-1. \$90 each.
 - 8) **SBH125 Filter** Sharpest CW filter available (2nd IF). Front panel selected plugs into rear apron of set. **Special:** \$90 each.
 - 9) **GUD** Converts existing detector to **double-balanced** type, providing better isolation between input and output. Wired and tested PC board, ready for easy installation. **Special:** \$30 each.
 - 10) Special plug-in unit equals or exceeds specifications of \$400+ Collins X455Q200. **Special:** \$125 each.

DIODE SWITCHING BOARDS (DSB)

Permit in-board mounting of one, two (or more) filters than those for which the manufacturer provides room; all switch-selectable using existing front panel switches in some cases. Available for all **Yaesu** and **Kenwood** equipment listed except tube-type sets. **Specify** Make, Model and Filter to be used on DSB.
 Single-filter type \$12 Airmail postpaid worldwide.
 Dual-filter type \$21 Airmail postpaid worldwide.
 Order with confidence. Money back if not satisfied. VISA/MC welcomed.
 Florida residents add 4% (sales tax).

FOX-TANGO CORP.
 Box 15944H, West Palm Beach, FL 33406

Now from J. W. Miller

DAWA DAIWA CORPORATION

Communications Essentials



RF Speech Processor Model RF-660

Increases talk power with splatter free operation. RF clipping assures low distortion. Installs between microphone and transmitter.

Talk Power: Better than 6 dB
 Clipping Threshold: Less than 2 mV at 1 kHz
 Clipping Level Adjustment: Front panel control
 Clipping Level Indicator: LED's
 Monitor Jack on front panel
 Frequency Response: 300-3000 Hz at 12 dB down
 Distortion: Less than 3% at 1 kHz, 20 dB clipping
 Output Level: More than 50 mV at 1 kHz
 Power Requirement: External source, DC Volts 13.5 at 50 mA no signal
 Dimensions: 90 x 25 x 92 mm; 3.56 x 1 x 3.62 in.



RF Speech Processor Model RF-440

Increases talk power with splatter free operation. RF clipping assures low distortion. Simply install between microphone and transmitter.

Talk Power: Better than 6 dB
 Clipping Threshold: Less than 2 mV at 1 kHz
 Panel Meter indicates clipping level
 Bandwidth: 2200 Hz at 6 dB down
 Frequency Response: 300-3000 Hz at 12 dB down
 Distortion: Less than 3% at 1 kHz, 20 dB clipping
 Output Level: More than 50 mV at 1 kHz
 Power Requirement: 115V AC, 60 Hz, 1 W, for self contained AC power supply; or 13.5 V DC, 55 mA for alternate external power
 Dimensions: 150 x 70 x 150 mm; 6 x 2.5 x 6 in.

Exclusive USA agent for these units; inquiries invited.



Write for literature.

**J. W. Miller Division
 BELL INDUSTRIES**

19070 REYES AVE. ■ P.O. BOX 5825
 COMPTON, CALIFORNIA 90224

a NEW antenna principle

PROVEN IN EXACTING TESTS AND MANY YEARS ON THE AIR AT W₉MBH — K₉AST — K8VRM

THE Little GIANT BEAM ANTENNA

A COMPLETELY NEW ANTENNA

only 27 inches high by 22 inches wide

Here is an ultra compact beam antenna which can be tuned to any frequency between 7.0 and 14.5 MHz. Weighing only 18 lbs. this antenna may not outperform a full sized beam but it sure will give you your share of DX and stateside contacts. Will handle 1 KW over a 100 kHz bandwidth.

- Fully weather proof
 - Mounts easily on TV masting
 - Figure 8 pattern
 - Hi-Q, attenuates harmonics
 - Comes assembled & tested
- LITTLE GIANT MODEL 100X1000-40**
 Other models available for 10, 15 & 20 meters
- KITS 10-40 \$122.50**
\$149.50
 Add \$3 trans.

Little Giant Antenna Labs, Box 245, Vaughnsville, Ohio 45893
 Subsidiary "Apollo Products" Village-Twig Co.
419-646-3495

SPLIT-BAND SPEECH PROCESSOR KIT



Punch thru the pileups with up to ten times more talk power.

The new DX-1 Speech Processor Kit features split-band speech processing — a new technique more effective than rf clipping that offers high performance with low distortion; described by N7WS in the September issue of *Ham Radio*. The DX-1 provides up to 15 dB increase in average talk power with shaped audio response for improved intelligibility, but maintains your natural voice quality. Installs simply between your microphone and transmitter.

Increased talk power: Up to 15 dB, adjustable (10 dB recommended under most operating conditions)

Frequency response: 350 Hz — 2.4 kHz at 3 dB down (200 Hz — 3 kHz at 12 dB down)

Harmonic Distortion: Less than 12% at 1 kHz with 10 dB clipping

Requires 12 Vdc at 200 mA

Add \$10 for built-in AC power supply

\$69.95

RADIOKIT

BOX 429-H, HOLLIS, NH 03049 • (603) 465-7660

THIS IS IT

BIRD



MODEL 4431 THRULINE®

RF DIRECTIONAL WATTMETER with VARIABLE RF SIGNAL SAMPLER — BUILT IN IN STOCK FOR PROMPT DELIVERY

AUTHORIZED DISTRIBUTOR

Webster associates

115 BELLARMINE ROCHESTER, MI 48063

CALL TOLL FREE

800 — 521-2333

IN MICHIGAN 313 — 375-0420

DAMES COMMUNICATION SYSTEMS

Merry Christmas and Happy New Year to All!

"please call us on used equipment specials"

201-998-4256
10 SCHUYLER AVE., N. ARLINGTON, NJ 07032

SAROC™



DUNES HOTEL
LAS VEGAS, NEVADA
JANUARY 10-13, 1980

1980 HANDBOOK

BRAND NEW! STEP INTO THE 80'S WITH THE LATEST HANDBOOK FROM THE EDITORS AT ARRL



NEW FOR 1980

Full of exciting new features for the 80's, NOW is the time to order your copy of the 1980 ARRL "RADIO AMATEUR'S HANDBOOK." Internationally recognized and universally consulted, every Amateur should have the latest edition. The new HANDBOOK covers virtually all of the state-of-the-art developments in electronics theory and design. Novices will find it to be an indispensable study guide, while the more advanced Amateur will enjoy building the many new projects.

- Order AR-HB80 Available Softbound \$10.00 November 1979
- Order AR-BB80 Available Hardbound \$15.75 January 1980

HAM RADIO'S BOOKSTORE
GREENVILLE, N. H.

(800) 258-5353

1980
1980
CALLBOOKS
See page 86 for super value
on 1980 Callbooks.
1980

flea market



RATES Non-commercial ads 10¢ per word; commercial ads 60¢ per word both payable in advance. No cash discounts or agency commissions allowed.

HAMFESTS Sponsored by non-profit organizations receive one free Flea Market ad (subject to our editing). Repeat insertions of hamfest ads pay the non-commercial rate.

COPY No special layout or arrangements available. Material should be typewritten or clearly printed (not all capitals) and must include full name and address. We reserve the right to reject unsuitable copy. **Ham Radio** cannot check each advertiser and thus cannot be held responsible for claims made. Liability for correctness of material limited to corrected ad in next available issue.

DEADLINE 15th of second preceding month.

SEND MATERIAL TO: Flea Market, Ham Radio, Greenville, N.H. 03048.

MOBILE HF ANTENNA, 3.5-30 MHz inclusive, 750 watts PEP, center loaded coil, tuned from the base, eliminating coil changing or removing from mount. Less than 1.5 to 1 VSWR on all ham bands. \$119.95 each — contact your local dealer or order from Antek, Inc., Box 415, Route 1, Hansen, ID 83334. (208) 423-4100. Master Charge and VISA cards accepted. Dealer inquiries invited.

KDK 2015R OWNERS. Use memory for any oddball splits. Shows transmit/receive frequencies. Simple, 15 minutes. No holes drilled, no boards lifted. SASE. Details free. WA2HQD, 105-18 131, Richmond Hill, NY 11419. (212) 641-2559.

VERY in-ter-est-ing! Next 3 issues \$1. "The Ham Trader", Wheaton, IL 60187.

HOT CARRIER DIODES by HP 4/\$5, large LEDs red 15/\$2, green or yellow 12/\$2. LED mounting hardware 20/\$2. Koemp — El Co., Box 335B, Keansburg, NJ 07734.

MOBILE IGNITION SHIELDING provides more range with no noise. Available most engines. Many other suppression accessories. Literature, Estes Engineering, 930 Marine Dr., Port Angeles, WA 98362.

Foreign Subscription Agents for Ham Radio Magazine

- | | |
|--|--|
| Ham Radio Austria
F. Bassl
Hauptplatz 5
A-2700 Wiener Neustadt
Austria | Ham Radio Holland
MRL Electronics
Postbus 88
NL-2204 Delft
Holland |
| Ham Radio Belgium
Stereohouse
Brusselssteenweg 416
B-9218 Gent
Belgium | Ham Radio Italy
S.T.E. Via Maniago 15
I-20134 Milano
Italy |
| Ham Radio Canada
Box 400 Goderich
Ontario, Canada N7A 4C7 | Ham Radio Switzerland
Karin Ueber
Postfach 2454
D-7850 Loerrach
West Germany |
| Ham Radio Europe
Box 444
S 194 04 Upplands Vasby
Sweden | Ham Radio UK
P.O. Box 63, Harrow
Middlesex HA3 6HS
England |
| Ham Radio France
Christiane Michel
F 99117 Parly
France | Holland Radio
143 Greenway
Greenside, Johannesburg
Republic of South Africa |
| Ham Radio Germany
Karin Ueber
Postfach 2454
D-7850 Loerrach
West Germany | |

AFC — STOP VFO DRIFT. See June '79 HR. Complete unit \$49.95 + shipping. Read Easton, K6EHV, 3691 Gay Way, Riverside, CA 92504.

REPLACE RUSTED ANTENNA BOLTS with Stainless Steel. Small quantities, free catalog. Elwick, Dept. 360, 230 Woods Lane, Somerdale, NJ 08083.

QSL CARDS 500/\$10. 400 illustrations, sample. Bowman Printing, Dept. HR, 743 Harvard, St. Louis, MO 63130.

SPLIT-BAND SPEECH PROCESSOR circuit boards are now available from the author. See September issue HR. Set of three; includes power supply board and layout, etched, drilled, plated, \$12.50 postpaid. N7WS.

HAM RADIO REPAIR, alignment. Prompt, expert, reasonable. "Grid" Gridley, W4GJO, Route 2, Box 138B, Rising Fawn, GA 30738.

XTAL FILTERS: C-F Networks 9 MHz SSB filter — 2.1 kHz BW, similar to KVG XF9-B, \$25 postpaid. K8DRN, J. Wigganhorn, 1678 NW 84th Dr., Coral Springs, FL 33065. (305) 752-7444.

FERRITE BEADS: w/specification and application sheet - 12/\$1.00. Assorted PC pots - 10/\$1.00. Miniature mica trimmers, 3-40 pF. - 5/\$1.00. Postpaid. Includes latest catalog. Stamp for catalog alone. CPO Surplus, Box 189, Braintree, MA 02184.

WANTED: ROBOT 400 — Prefer Operative, Accept Not Working if price is right. Need 2nd for SSTV Color. W3FAK/AB3T Duffy, Hystone Ave., Johnstown, PA 15905. (814) 288-2130.

RTTY AFSK Modulator PC board. See Feb. 79 Ham Radio. Drilled \$5.00. F. E. Hinkle, 12412 Mossy Bark, Austin, TX 78750.

THE MEASUREMENT SHOP has used/reconditioned test equipment at sensible prices; catalog. 2 West 22nd St., Baltimore, MD 21218.

MANUALS for most ham gear 1937/1970. Send 25¢ for "Manual Catalog." HI, Inc., Box H864, Council Bluffs, Iowa 51502.

WANTED — Hilltop Property near Pollock Pines, California. WA6COA, 4 Ajax Place, Berkeley, CA 94708.

PORTA PAK — Make your FM mobile a self-contained portable. Models in stock for most popular makes. 4.5 amp hr model \$80.00. 9 amp hr \$103.00. Charger included, shipping extra. P.O. Box 67, Somers, WI 53171.

WANTED — Motorola KXN1024 and KXN1052 channel elements. WA6COA, 4 Ajax Place, Berkeley, CA 94708.

DX, YOU BET! THE DX BULLETIN — Best weekly DX info in the world. For FREE sample copy, send business-size SASE to: The DX Bulletin, 306 Vernon Avenue, Vernon, Connecticut 06066.

ROHN TOWER — Buy wholesale from Worldwide distributor. 20G \$27.06 section; 25G \$37.62 section; 45G \$67.76 section; 48 ft. foldover tower, \$605.00; 48ft. BX free-standing \$213.40. Hill Radio, 2503 GE Road, Box 1405, Bloomington, IL 61701. (309) 663-2141.

NORTH AMERICAN DX REPORT — free sample — SASE to Suites R2-R3, 615 S. Frederick Ave., Gaithersburg, MD 20760 — Phone (301) 840-1987.

COSMAC ASSEMBLER runs in 1KB, text editor in one page. Cassette and manual \$19.95, specs for SASE. The Elfr, Box 802H, Clarksville, MD 21029.

WANTED: AFSAV-39C keyers, AN/FRA-86 & AFSAV-133 demods., and type "N" coaxial bulkhead lightning arresters. C.T. Huth, 146 Schonhardt St., Tiffin, OH 44883.

FREQUENCY ALLOCATION CHART. See how the entire radio spectrum is used. 2 kHz to 200 GHz. Send \$3.00. Collins Chart Co., Box 935, Coronado, CA 92118.

STOP LOOKING for a good deal on amateur radio equipment — you've found it here — at your amateur radio headquarters in the heart of the Midwest. Now more than ever where you buy is as important as what you buy. We are factory-authorized dealers for Kenwood, Drake, Yaesu, Collins, Wilson, Ten-Tec, Atlas, ICOM, DenTron, MFJ, Tempo, Regency, Hy-Gain, Mosley, Alpha, CushCraft, Swan and many more. Write or call us today for our low quote and try our personal and friendly Hoosier Service. **HOOSIER ELECTRONICS**, P.O. Box 2001, Terre Haute, Indiana 47802. (812) 238-1456.

COMPLETE HAM STATION \$225. Heathkit DX-100, Drake 2-C, used, excellent. KA1BEB, Kangas Rd., New Ipswich, NH 03071. Tel. (603) 878-1554.

ICOM 701 USER'S CLUB is now operational. Send SASE to NBRT, Rob Pohorence, Dept. HR, 9600 Kickapoo Pass, Streetsboro, OH 44240.

COAX RELAY
12 VDC SPDT
450 MHZ+ 100 WATTS
2 MALE RCA PLUG TD
S0239. PLUS SPST 2DA
CONTACT. \$6.95

HIGH VOLTAGE SUPPLY
15KVDC @ 30 WATTS
INPUT 115AC 60HZ
\$9.95

POWER SUPPLY MODULE
RATED AT 12V @ 2.5A. CAN BE MODIFIED BY CHANGING THE ZENER.
PARTS: 4-3A DIODES, 1-2.5A FUSE, 1-2200MF @ 35V CAP, 1-12V ZENER, 1-PASS TRANS. WITH HEAT SINK. \$4.95

ANTENNAS

ALL ANTENNAS ARE FOR 1/2 WAVELENGTHS.

\$7.95

MPF-131

N-CHANNEL DUAL GATE MOS FIELD-EFFECT TRANSISTOR USED IN VHF AMPLIFIER & MIXER. GOOD FOR RF AMP. AT 60 & 200MHZ HAS DIODE PROTECTED GATES. COMES WITH DATA SHEET. UNITS ARE HOUSE MARKED.

MPF-131..... **50¢**

Touch-Tone Housing. BLACK only...\$3.50

1.0OHM 5WATT RESISTORS
5 FOR \$1.00

50OHM 100WATT
\$2.50 EA.

5V. DIP RELAY

SP ST N.D.

\$1.50

MJE2955 \$1.

CONNECTORS

BNC M/UHF-F UG-255U \$3.00
BNC F/UHF-M UG-273U \$2.50
BNC F/BNC-F UG-914U \$2.00
UHF F/UHF-F PL-25B \$1.50
"N" F/BNC-M UG-349U \$3.75
"N" M/UHF-F UG-146U \$4.75
"N" F/UHF-M UG-83BU \$4.75

2N5589 CASE MT-72 \$2.95
2N5590 CASE TO-117 \$4.95

RGB Adapter UG-175 \$ 2.25
BNC M-CABLE UG-88 \$1.35
BNC F PANEL UG 1274 \$1.00
"N" M CABLE UG-21B \$2.95
"N" F PANEL UG-58 \$2.25

LED JUMBOS

10 FOR \$1.00
100 FOR \$7.95

FANS
100 CFM 115VAC 60HZ 4.5"X1.5" USED \$6.95
GUARANTEED NEW \$12.95

SO-239 65¢
PL-259 65¢
10/56.00 MIX & MATCH

2200UF 15VDC 25¢

VARIABLE POWER SUPPLY KIT

PS1 5-12VDC @ 500MA
PS2 12-28VDC @ 250MA
ALL PARTS INCLUDED \$6.95

COMPUTER GRADE CAPACITORS.

10,000UF @ 50V \$2.95
23,200UF @ 50V 3.50
28,500UF @ 30V 3.00
39,000UF @ 45V 3.50
00,000UF @ 10V 1.00

Marlin P. Jones & Assoc.
P.O. Box 12685
Lake Park, FL 33403
(305) 848-8236

*Fla. residents add 4% sales tax.
*MC & VISA accepted, please include expiration date and signature as on card.
*Add \$1.00 for order under \$10.00.
*Canada & Foreign orders please add sufficient postage.
**USA orders please add 5% postage.

Station ID Timer and Code Practice Oscillator

ONLY **\$19⁹⁵**
IN KIT FORM

\$26⁹⁵
ASSEMBLED PLUS \$2.00 SHIPPING



NEW!

NOW! EAGLE ELECTRONICS INTRODUCES a practical accessory to every amateur station: The TM-1000™ 10 minute ID timer and code practice oscillator will remind you with a loud clear tone when it is time to identify. No longer is it necessary to keep an eye on the clock to be sure you identify in time; **the TM-1000™ keeps track of the time for you.** And, when you're not on the air, you can use it to improve your code speed because it **doubles as a code practice oscillator.**

THE TM-1000™ HAS FULLY ADJUSTABLE volume and tone and its timer is adjustable from 45 seconds to 10 minutes. It comes in an attractive walnut-grain cabinet and is powered by one 9v battery (not included).

THERE'S NO NEED TO WORRY ABOUT missed ID's during roundtables and QSO's anymore. **With the TM-1000™ in your station, you are assured of identifying in time.**

THE TM-1000™ AUTOMATICALLY RESETS after alerting you and can be reset any time by pressing the reset button.

TRADITIONALLY, AMATEURS HAVE endeavored to obey all regulations as closely as possible. **The TM-1000™ is an important aid to help amateurs** maintain that tradition by assuring that identification is accomplished at the proper intervals.

THE TM-1000™ COMES WITH A 1 YEAR guarantee and a 10 day, money back (less shipping) guarantee.

SO ORDER YOUR TM-1000™ STATION ID TIMER/CODE PRACTICE OSCILLATOR TODAY FROM:

EAGLE ELECTRONICS®

BOX 426B, PORTAGE, MI 49081
or call 1-616-375-7469 to order COD or by bank card.
Mich. res. add 4% sales tax.
Optional AC adapter \$7.95 extra.

RF Speech Processors for Drake TR-7, TR-4s, T4Xs

Special 8-pole IF crystal filtering, followed by highly-effective active hard limiting: the key to intelligibility and talkpower. TR-7 processor provides room for an additional accessory filter. All solid-state pin-diode switching. TR-7, TR-4 units feature selectable 16-pole receive. Model 7-SP for TR-7: \$265.00. Model 4-SP for T-4X: \$285.00. TR-4 unit available at a later date.

Mike Equalizer Pre-Processor

Companion to above units, but good between any mike and rig. Can reduce distortion, improve crispness, intelligibility. Easily-adjustable single control tailors both high and low frequencies to optimize response of any microphone. Contains in/out, gain, equalization controls. Model SE-1: \$65.00.

NEW! RF CLIPPERS



Sherwood Engineering Inc.
1268 South Ogden St.
Denver, Colo. 80210
(303) 722-2257

Money back if not satisfied
Add \$3 per order shipping;
\$6 overseas air
Dealer Inquiries Welcome



HI-Q BALUN

- For dipoles, yagis, inverted vees, doublets & quads
- For full legal power & more
- Puts power in antenna
- Broadbanded 3-40MHz.
- Small, light, weather-proof
- 1:1 Impedance ratio
- Replaces center insulator
- Helps eliminate TVI
- Fully Guaranteed



\$9.95
PPD
U.S.A.

Van Gorden Engineering
BOX 21305, S. EUCLID, OHIO 44121

COMM AUDIO PROCESSOR

NEW - Shaped Voice Filter and Anti-Phonic Noise added to Binomial Synthesis and Tone-Tag - Filter

BROCHURES BROCHURES BROCHURES

Hildreth Engineering
P.O. Box 60003 Sunnyvale, CA 94088

FACSIMILE

COPY SATELLITE PHOTOS, WEATHER MAPS, PRESS!
The Faxes Are Clear — on our full size (18-1/2" wide) recorders. Free Fax Guide.

TELETYPE

RTTY MACHINES, PARTS, SUPPLIES
ATLANTIC SURPLUS SALES (212) 372-0349
3730 NAUTILUS AVE. BROOKLYN, N.Y. 11224

SELLING AMPHENOL PL-259 60¢ 10/5.00, RG8U \$15.00/100 ft., Right angle 10/17.00, T-Connector 10/20.00, SASE for list. John Rogers, 1927 Barry, Chicago, IL 60657.

HEATH HW/SB-104 OWNERS: Improve sensitivity, selectivity, intermodulation performance. For info sheet send \$2 and SASE to WB4RRC, Box 461, Warner Robins, GA 31093.

SELLING OUT — Collins KWM-2, 516F-2, sealed relays, excellent \$650. Drake DSR-2, New \$1895. Icom 7015, P/S, Mike, Mint, as New, \$1200. IC-RM-2, New \$150. Astro 200A, Console, P/S, Touch-Tone mike, as New \$925. All FOB, prices firm. WA6NWP, 52632 Rd. 426, Oakhurst, CA 93644.

BUY-SELL-TRADE. Send \$1.00 for catalog. Give name address and call letters. Complete stock of major brands new and reconditioned amateur radio equipment. Call for best deals. We buy Collins, Drake, Swan, etc. Associated Radio, 8012 Conser, Overland Park, KS 66204. (913) 381-5900.

QSL's — \$2.70 per hundred (minimum order, 1000) and up. 32 two-color designs. Send 30¢ stamps for catalog. Satisfaction guaranteed or money back. Since 1934. VP5QED Press, Box 1523, Boca Raton, FL 33432.

STAR-TRONICS monthly picture flyer is full of parts and pieces for the builder. U.S. only. Star-Tronics, Box 683, McMinnville, OR 97128.

SELL complete collection (all 142 issues) Ham Radio magazine. Excellent condition. Make offer. W9SS/W9DDL, Dennis Eksten, 5006 N. Second, Loves Park, IL 61111.

WANTED: VFO, either Heath or Eico. State condition and price. WA2VJL, 442 Englewood, Buffalo, NY 14223.

RECONDITIONED TEST EQUIPMENT for sale. Catalog \$50. Walter, 2697 Nickel, San Pablo, CA 94806.

HAM RADIO MAGAZINES complete set Vol. 1 No. 1 March 1968 through today in HR binders. Mint condition. \$230.00 or trade for ham gear, model railroad items or railroadiana. Steve Hyett, K9ZUF, 1440 Royal St. George Drive, Naperville, IL 60540.

WANTED: ST-6; several used 220 MHz rigs. Michaelson, N7SM, (801) 467-6785.

STATEMENT OF OWNERSHIP, MANAGEMENT AND CIRCULATION
(Required by 47 C.F.R. § 1.627)

1. TITLE OF PUBLICATION: COMMUNICATIONS TECHNOLOGY, INC.

2. ISSUE DATES: 11/13/79, 11/20/79

3. ISSUES DURING PRECEDING 12 MONTHS: 12

4. ANNUAL SUBSCRIPTION PRICE: \$175.00

5. LOCATION OF HEADQUARTERS OR GENERAL BUSINESS OFFICES: 1100 Main Street, Greenville, SC 29604

6. LOCATION OF THE COMPLETE AND NEAREST PRINTING PLANTS: 1100 Main Street, Greenville, SC 29604

7. PUBLISHER: J.R. Drummy, Jr., 1100 Main Street, Greenville, SC 29604

8. BUSINESS OFFICES: J.R. Drummy, Jr., 1100 Main Street, Greenville, SC 29604

9. MAILING OFFICE: J.R. Drummy, Jr., 1100 Main Street, Greenville, SC 29604

10. ESTABLISHED: 1979

11. OWNERS: J.R. Drummy, Jr., 1100 Main Street, Greenville, SC 29604

12. FULL-TIME EMPLOYEES: 1

13. PART-TIME EMPLOYEES: 0

14. TOTAL SALES: \$175.00

15. TOTAL CIRCULATION: 12

16. COPIES OF THIS STATEMENT: 12

17. SIGNATURE OF PUBLISHER: J.R. Drummy, Jr.

ETCOR AC/DC Voltage Tester

- High visibility voltage indicator 120, 208 to 240, 277, 440 to 600 VAC; 120, 240, 400, 600 VDC.
- Positive or negative DC pole identified by neon lamps.
- Provision for quick prod storage in case.
- Case serves as prod holder for one-hand operation. Self-extinguishing, high-impact case for long life.
- Continuous duty rated thru 480V.
- Dimensions: 4-9/16" x 2-1/16" x 7/8". Color: Orange.



VT200 \$12.95

Custom Cables & Jumpers

NEW **NEW**

DB 25 Series Cables

Part No.	Cable Length	Connectors	Price
DB25P-4-P	4 Ft	2-DB25P	\$15.95 ea
DB25P-4-S	4 Ft	1-DB25P/1-25S	\$16.95 ea
DB25S-4-S	4 Ft	2-DB25S	\$17.95 ea

Dip Jumpers

DJ14-1	1 ft	1-14 Pin	\$1.59 ea
DJ16-4	1 ft	1-16 Pin	1.79 ea
DJ24-1	1 ft	1-24 Pin	2.79 ea
DJ14-1-14	1 ft	2-14 Pin	2.79 ea
DJ16-1-16	1 ft	2-16 Pin	3.19 ea
DJ24-1-24	1 ft	2-24 Pin	4.95 ea

For Custom Cables & Jumpers, See JAMECO 1979 Catalog for Pricing

25 PIN-D SUBMINIATURE CONNECTORS

(Meets RS232)

PART NO.	DESCRIPTION	PRICE
DB25P	PLUG (as pictured)	\$2.95
DB25S	SOCKET	3.50
DB51226-1	CABLE COVER for DB25P or DB25S	1.75
DB25P-831	PLUG - Right Angle - P.C. Mount	4.95
DB25S-831	SOCKET - Right Angle - P.C. Mount	5.25

Printed Circuit Connectors

156 Spacing-Tin-Double Read-Out
Bifurcated Contacts
Fits .054 to .070 P.C. Boards

PART NO.	DESCRIPTION	PRICE
15/20 SE	15/20 Contacts - solder eylet	\$1.95
18/36 SE	18/36 Contacts - solder eylet	2.49
22/44 SE	22/44 Contacts - solder eylet	2.99
22/44 WW	22/44 Contacts - wire wrap	3.95
50/100 WW	50/100 Contacts - wire wrap (R881-1) (.125 Spacing)	6.95

Jumbo 6-Digit Clock Kit

- Four .630" ht. and two .300" ht. common anode displays
- Uses MM5314 clock chip
- Switches for hours, minutes and hold functions
- Hours easily viewable to 30 feet
- Simulated walnut case
- 115VAC operation
- 12 or 24 hr operation
- Includes all components, case and wall transformer
- Size: 6 1/2" x 3 1/8" x 1 1/2"

JE747 \$29.95

JE701 6-Digit Clock Kit \$19.95

- Bright .300 ht. comm. cathode display
- Uses MM5314 clock chip
- Switches for hours, minutes and hold modes
- Hrs. easily viewable to 20 ft.
- Simulated walnut case
- 115 VAC operation
- 12 or 24 hr. operation
- Incl. all components, case & wall transformer
- Size: 6 1/2" x 3 1/8" x 1 1/2"

new Micro-Miniature Joystick

- 2 each 100K pots (Linear Taper)
- Printed Circuit Board Mount
- Size: 1" x 1-3/16" x 1-3/16"

Micro-Miniature Joystick **\$4.95**

Digital Stopwatch Kit

- Use Intersil 7056 Chip
- Plated thru double-sided P.C. Board
- LED display (red)
- Times to 99 min. 59.99 sec. with auto reset
- Quartz crystal controlled
- Three stopwatches in one: single event, split (cumulative) & taylor (sequential timing)
- Uses 3 penlite batteries
- Size: 4.5" x 2.15" x .90"

JE900 \$39.95

MICROPROCESSOR COMPONENTS

8080A/8088A SUPPORT DEVICES		MICROPROCESSOR MANUALS	
8080A CPU	\$ 7.95	M-280 User Manual	\$7.50
8212 8-Bit Input/Output	3.25	M-C291-802 User Manual	7.50
8214 Priority Interrupt Controller	5.95	M-2650 User Manual	5.00
8216 Bi-Directional Bus Driver	3.49		
8224 Clock Generator/Driver	3.95		
8226 Bus Driver	3.49		
8228 System Controller/Bus Driver	4.95		
8236 System Controller	5.95		
8251 Prog. Control 1/0 (USART)	7.95		
8253 Prog. Interval Timer	14.95		
8255 Prog. Periph. 1/0 (PPI)	9.95		
8257 Prog. DMA Controller	19.95		
8259 Prog. Interrupt Controller	19.95		

MICROPROCESSOR CHIPS - MISCELLANEOUS

Z80(780C) CPU	\$14.95	745200 256X1 Static Tristate	4.95
Z800A(780-1) CPU	16.95	93421 256X1 Static	2.95
CDP1802 CPU	19.95	UPD414 4K Dynamic 16 pin	4.95
7650 MPU	19.95	UPD416 16K Dynamic 16 pin 250ns	9.95
6502 CPU	11.95	(MK4116) 4K Static	14.95
8035 8-Bit MPU w/clock, RAM, 1/0 lines	19.95	TMS4044 4K Static	14.95
7805 CPU	19.95	TMS4045 1024X4 Static	14.95
TMS9900JL 16-Bit MPU w/hardware, multiply & divide	49.95	2117 16,384X1 Dynamic 350ns (house marked)	9.95

JE600 HEXADECIMAL ENCODER KIT

FEATURES:

- Full 8 bit latched output for micro-processor use
- 3 User Define keys with one being bi-stable operation
- Debounce circuit provided for all 19 keys
- LED readout to verify entries
- Easy interfacing with standard 16 pin IC connector
- Only -5VDC required for operation

Full 8 Bit Latched Output - 19 KEYBOARD

The JE600 Encoder Keyboard provides two separate hexadecimal digits produced from sequential key entries to allow direct programming for 8 bit microprocessor or 8 bit memory circuits. Three (3) additional keys are provided for user operations with one having a bistable output available. The outputs are latched and monitored with LED readouts. Also included is a key entry strobe.

JE600 \$59.95
Hexadecimal Keypad only \$14.95

62-Key ASCII Encoder Keyboard Kit

FEATURES:

- 60 Keys generate the full 128 characters, upper and lower case ASCII set
- Fully buffered
- 2 user-define keys provided for custom applications
- Caps lock for upper case only alpha characters
- Utilizes a 2376 (40 pin) encoder read only memory chip
- Outputs directly compatible with TTL/DTL or MOS logic arrays
- Easy interfacing with a 16-pin dip or 18-pin edge connector

JE610 \$79.95
62-Key Keyboard only .. \$34.95

REGULATED POWER SUPPLY

JE200 5V - 1 AMP POWER SUPPLY	JE205 ADAPTER BOARD
<ul style="list-style-type: none"> Uses LM309K Heat sink provided PC Board construction Provides a solid 1 amp @ 5 volts Can supply up to 15V, 12V and 12V with JE205 Adapter Includes components, hardware & instructions Size: 3 1/2" x 5 1/2" x 2 1/4" 	<ul style="list-style-type: none"> Adapts to JE200 - 15V, 19V and 12V DC/DC converter w/ +5V input Toroidal hi-speed switching XMFR Short circ. protection PC Brd. construction Piggy-back to JE200 board Size: 3 1/2" x 2 1/2" x 9/16"
JE200 \$14.95	JE205 \$12.95

\$10.00 Min. Order - U.S. Funds Only
Calif. Residents Add 6% Sales Tax
Postage - Add 5% plus \$1 Insurance (if desired)

Spec Sheets - 25¢
1980 Catalog Available - Send 41¢ stamp

Jameco ELECTRONICS

PHONE ORDERS WELCOME (415) 592-8097

MAIL ORDER ELECTRONICS - WORLDWIDE
1021 HOWARD AVENUE, SAN CARLOS, CA 94070

ADVERTISED PRICES GOOD THRU DECEMBER

The Incredible "Pennywhistle 103"

\$139.95 Kit Only

The Pennywhistle 103 is capable of recording data to and from audio tape without critical speed requirements for the recorder and it is able to communicate directly with another modern and terminal for telephone "handing" and communications. In addition, it is free of critical adjustments and is built with non-permeable, readily available parts.

Data Transmission Method Frequency-Shift Keying, full-duplex (half-duplex selectable)
Maximum Data Rate 300 Baud
Data Format Asynchronous Serial (return to mark level required between each character)
Receive Channel Frequencies 2025 Hz for space; 2275 Hz for mark
Transmit Channel Frequencies Switch selectable: Low (normal) - 1070 space; 1270 mark; High - 025 space; 2225 mark
Receive Sensitivity -46 dbm acoustically coupled
Transmit Level -15 dbm nominal. Adjustable from -6 dbm to -20 dbm
Receive Frequency Tolerance Frequency reference automatically adjusts to allow for operation between 1800 Hz and 2400 Hz
Digital Data Interface EIA RS-232C or 20 mA current loop (receiver is unpopulated and non-polar)
Power Requirements 120 VAC, single phase, 10 Watts
Physical All components mount on a single 5" by 9" printed circuit board. All components included.
Requires a VOM, Audio Oscillator, Frequency Counter and/or Oscilloscope to align.

TRS-80 16K Conversion Kit

Expand your 4K TRS-80 System to 16K.
Kit comes complete with:
• 8 each UPD416-1 (16K Dynamic Rams) 250NS
• Documentation for conversion

TRS-16K \$75.00

JUST WRAP

- 30 AWG wire
- Daisy chain or point-to-point
- Includes 50 ft. wire
- No stripping or slitting required - just wrap

Part No.	Wire Color	Price
JW-1-B	Blue	\$14.95
JW-1-W	White	14.95
JW-1-Y	Yellow	14.95
JW-1-R	Red	14.95

JUST WRAP Replacement Wire

Part No.	Color	Price
R-JW-B	Blue	50 ft. roll \$2.98
R-JW-W	White	50 ft. roll 2.98
R-JW-Y	Yellow	50 ft. roll 2.98
R-JW-R	Red	50 ft. roll 2.98

JUST WRAP Unwrap Tool \$3.49

50 ft. ea. blue, white, red, yellow wire
• JUST WRAP Tool • Unwrapping Tool

JWK-6 \$24.95

Vacuum Vise

Vacuum-based light duty vise for small components and assemblies. ABS construction. 1 1/2" jaws, 1 1/2" travel. Can be permanently installed.

VV-1 \$3.49

EPROM Erasing Lamp

- Erases 2708, 2716, 1702A, 5203Q, 5204Q, etc.
- Erases up to 4 chips within 20 minutes.
- Maintains constant exposure distance of one inch
- Special conductive foam liner eliminates static build-up
- Built-in safety lock to prevent UV exposure
- Compact - only 7-5/8" x 2-7/8" x 2"
- Complete with holding tray for 4 chips

UVS-11E \$69.95

IDEAL FOR TRS 80 CASSETTE CONTROLLER

Plug/Jack interface to any computer system requiring remote control of cassette functions.
The CC-100 controls cassette motor function - monitors tape location with its internal speaker and requires no power. Eliminates the plugging and unplugging of cables during computer loading operation from cassette.

CC-100 \$29.50



THE NEW AEA MORSEMATIC! 37 FANTASTIC FEATURES!

The amazing AEA MorseMatic. Whether you are a contester, serious VHF DXer, learning code for the first time, studying for a marine radio operator's ticket, or simply a CW enthusiast, you can now own the finest electronic Morse keyer ever built and program it to your specific needs. Count these features!

1. Two custom designed microcomputer chips. 2. Two wpm to 99 wpm in one wpm increments. 3. Selectable dot and/or dash memory.

4. MorseMatic is a memory keyer. 5. 500 Morse character memory (optional to 2,000 characters) 6. Unique "Soft-Partitioning"™ to eliminate wasted memory space. 7. Use entire memory for one message or divide memory in up to ten messages. 8. Message loading begins with first character sent. 9. Easy to load memory. Choice of automatic mode for perfect format or real-time mode for individualizing messages. 10. Special editing mode for memory load correction. 11. Load memory in automatic keyer mode or semi-automatic "bug" mode (garbage in/perfection out). 12. Low power memory hold. 13. Memory limit indicator lights when 20 characters are left in memory. Monitor tone changes when memory overflows.

14. MorseMatic is a Morse trainer. 15. Computer generated Morse trainer. Incorporates ten repeatable (answers available) and one random starting position. 16. Programmable speed-up of code rate from beginning to end of practice session. 17. Select "slow code" or "fast (Farnsworth) code" method. 18. Select five character code groups or random group lengths. 19. Selectable, unselectable, uncommon characters for advanced radio operator training. 20. Use trainer mode to key transmitter for on-air practice.

21. MorseMatic is a beacon. 22. Unique beacon mode for beacons; moon-bounce, scatter or tropospheric DX scheduling. 23. Computers set message code speed to fit programmed transmitting window.

24. MorseMatic has serial number. 25. Automatic serial number sequencing for sweepstakes and other contests. 01 - 9999 (even beacon mode). 26. Serial number placement at any point within message. 27. Serial number repetition with in same message. 28. Easy serial number repeat in next message.

29. Operates with all popular paddles. 30. Easy to learn and use keypad control for all features. 31. Plug in IC's. 32. Independently selectable dot and/or dash weighting. 33. Can be used to key transmitter for tuning. 34. Transmitter keying output for grid block, cathode or transistor circuits. 35. Operates off 8 to 16 volts DC. 36. Fully tested and 96 hour burn-in. 37. Introductory price only \$199.95.

The MorseMatic is also available strictly as a non-memory keyer for only \$79.95 (introductory price). For your free MorseMatic booklet explaining these and more features, or for information about ordering a MorseMatic, write or call Advanced Electronic Applications, Inc., P.O. Box 2160, Lynnwood, WA 98036. Phone 206/775-7373. (Dealer inquiries invited.)



AEA

Brings you the breakthroughs!



Bind 'em and Find 'em

Keep those valuable issues of both Ham Radio and HORIZONS like new. Prevent smears, tears and dog ears. Bind 'em together and enjoy for years to come. You'll be happy you did!

★ ★ ★

HAM RADIO BINDERS

Beautiful buckram binders complete with date labels. Available in our new large size to accommodate HAM RADIO'S hefty issues.

HR-BDL Each Just \$6.95
3 for \$17.95

HAM RADIO MAGAZINE FILES

Your collection of HAM RADIO Magazines is a valuable resource. Here's a brand new, inexpensive way to store them. These sturdy cardboard magazine files keep them clean, neat and up front where you can use them for quick and easy reference.

HR-HRMF \$1.95 each
3 for \$4.95

HAM RADIO HORIZONS BINDERS

Handsome washable binders complete with date labels.

HR-HRDL Each Just \$6.95
3 for \$17.95

HORIZONS MAGAZINE FILES

Your collection of Ham Radio HORIZONS is a valuable resource. Here's a brand new, inexpensive way to store them. These sturdy cardboard magazine files keep them clean, neat and up front where you can use them for quick and easy reference.

HR-HRHF \$1.95 each
3 for \$4.95

ORDER TODAY

Ham Radio's Bookstore
GREENVILLE, NEW HAMPSHIRE 03048

OR CALL TOLL FREE
1 (800) 258-5353

BINDERS

HR-BDL \$6.95 ea. HR-HRMF \$1.95 ea.
 HR-HRDL 3/\$17.95 HR-HRHF 3/\$4.95

CASH CHARGE MC VISA
Exp. _____

Card Number _____

Name _____

Address _____

City _____

State _____ Zip _____

Operate **Legally** Without
An FCC License in
the 160-190 kHz Band



**LOW & MEDIUM FREQUENCY RADIO
SCRAPBOOK (3rd Edition)**
by Ken Cornell, W2IMB

Here's your chance to get on the air and have some legal license-free excitement in the 160-190 kHz range. Explore the enticing world of the low frequencies and uncover some new fun! Complete details on assembling homebrew to work these frequencies plus full info on FCC rules and regulations. A book you just can't afford to miss. 110 pages. ©1977.

HR-LF **Softbound \$6.95**



**ADDENDUM '77/'78
for the Low & Medium Frequency
Radio Scrapbook**
by Ken Cornell, W2IMB

Even more goodies from the 160-190 kHz region. **Addendum '77/'78** is designed to complement **The Low & Medium Frequency Radio Scrapbook**. The technical data is excellent and will provide you "low-fers" even more information, applications, and techniques for these enticing frequencies. Latest revised FCC rules governing the non-licensed communication bands. 68 pages. ©1977.

HR-LFA **Softbound \$3.95**

Be a LOWFER

Join the fun and get on
160-190 kHz this winter

Send your order today or call

**TOLL FREE
1 (800) 258-5353**

Clip & Mail Today!

HR-LF **\$6.95**
 HR-LFA **\$3.95**
Plus shipping **\$1.00**

Total enclosed _____

Charge MC VISA

Expiration _____

Card Number _____

Name _____

Address _____

City _____

State _____ Zip _____

Ham Radio's Bookstore
GREENVILLE, NEW HAMPSHIRE 03048

Loop Antenna

All Palomar Engineers products are made in U.S.A. Since 1965, manufacturers of Amateur Radio equipment only.

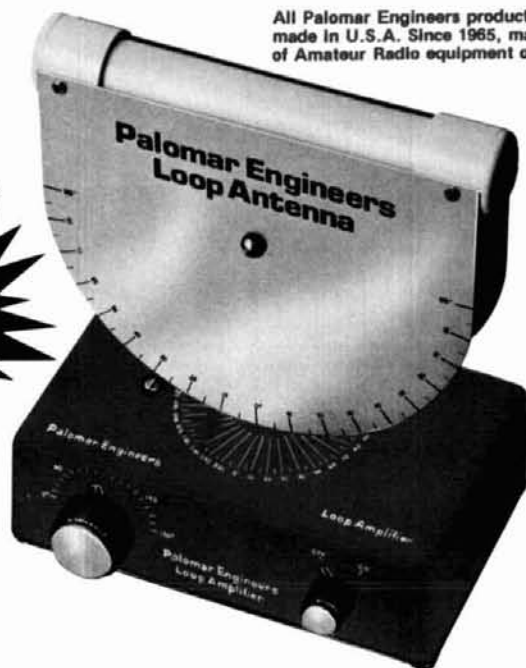

Here is an exciting new device to improve your reception on 160, 80, the broadcast band, and on VLF.

It is well known that loops pick up far less noise than most other antennas. And they can null out interference. Now Palomar Engineers brings you these features and more in a compact, carefully engineered, attractive desktop package.

Unlike ordinary direction-finder loops, it tilts to match the incoming wave front. The result: Deep nulls up to 70 db. You have to listen to believe it!

Does the Loran on 160 give you a headache? The loop practically eliminates it. Broadcast station 2nd harmonic ruining your DX? Turn and tilt the loop and it's gone. Does your friend in the next block with his kilowatt block those weak ones? Use the loop and hear him fade out.

Loop nulls are very sharp on local and ground wave signals but usually are broad or nonexistent on distant skywave signals. This allows local interference to be eliminated while DX stations can still be heard from all directions.

The loops are Litz-wire wound on RF ferrite rods. They plug into the Loop Amplifier which boosts the loop signal 20 db and isolates and preserves the high Q of the loop. The tuning control peaks the loop and gives extra preselection to your receiver.

Plug-in loops are available for these bands:

150-550 KHz (VLF)
540-1600 KHz (Broadcast)
1600-5000 KHz (160 & 80 meters)

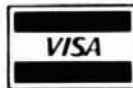

Send for free descriptive brochure.

Order direct. Loop Amplifier \$67.50; Plug-in Loop Antennas \$47.50 each [specify frequency band]. Add \$3 packing/shipping. Calif. residents add sales tax.

Palomar Engineers

Box 455, Escondido, CA. 92025 • Phone: [714] 747-3343

ASTRON POWER SUPPLIES

• HEAVY DUTY • HIGH QUALITY • RUGGED • RELIABLE •

SPECIAL FEATURES

- SOLID STATE ELECTRONICALLY REGULATED
- FOLD-BACK CURRENT LIMITING Protects Power Supply from excessive current & continuous shorted output.
- CROWBAR OVER VOLTAGE PROTECTION on Models RS-7A, RS-12A, RS-20A, RS-35A, RS-20M & RS-35M
- MAINTAIN REGULATION & LOW RIPPLE at low line input Voltage.
- HEAVY DUTY HEAT SINK • CHASSIS MOUNT FUSE
- THREE CONDUCTOR POWER CORD
- ONE YEAR WARRANTY • MADE IN U.S.A.
- VOLT & AMP METER ON MODELS RS-20M & RS-35M

PERFORMANCE SPECIFICATIONS

- INPUT VOLTAGE: 105 - 125 VAC
- OUTPUT VOLTAGE: 13.8 VDC ±0.05 volts (Internally Adjustable: 11-15 VDC)
- RIPPLE: Less than 5mv peak to peak (full load & low line)
- REGULATION: ±.05 volts no load to full load & low line to high line



ASTRON 20 AMP REGULATED POWER SUPPLY Model RS-20M

16 Amps continuous
20 Amps ICS*
5" (H) x 9" (W) x 10.5" (D)
Shipping Weight 20 lbs.
Price \$112.95

Other popular POWER SUPPLIES also available: (Same features and specifications as above)

Model	Continuous Duty (amps)	ICS* (amps)	Size (in.) H x W x D	Shipping Wt. (lbs.)	Price
RS-35M	25	35	5 x 11 x 11	29	\$156.95
RS-35A	25	35	5 x 11 x 11	29	\$138.95
RS-20A	16	20	5 x 9 x 10 1/2	20	\$94.95
RS-7A	5	7	3 1/2 x 6 1/2 x 9	8	\$49.95
RS-4A	3	4	3 1/2 x 6 1/2 x 9	5	\$39.95

*ICS — Intermittent Communication Service (50% Duty Cycle)
If not available at your local dealer, please contact us directly.

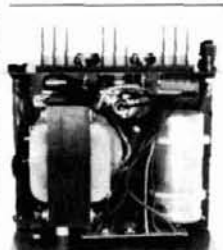

Inside View — RS-12A

ASTRON CORPORATION

1971 South Ritchey Street
Santa Ana, CA 92705
(714) 835-0682

NEWCOMER OR OLD PRO ... ALPHA POWER IS YOUR KEY TO A BIG SIGNAL

ALPHA/VOMAX can boost the "talk power" of any rig up to ten times or more. The new SBP-4 split band speech processor uses the only system more effective than rf clipping — AND distortion is extremely low so your voice sounds natural. Under tough conditions VOMAX can help as much as most linears. Combine VOMAX with a good linear and WOW! It's simple to install and operate with any rig.



ALPHA 374A is a heavy-duty "rock crusher" — a full kilowatt (2-KW PEP), No Time Limit, all band, NO TUNE UP desk top linear amplifier. It's a no-compromise ALPHA with a TWO YEAR FACTORY WARRANTY.

Other superb ALPHA s include the "Ultimate LINEAR" ALPHA 77Dx and the new ALPHA 78, which combines NO-TUNE-UP maximum legal power, No Time Limit, and high speed (vacuum relay) CW break-in. Call or write your dealer or ETO direct for illustrated literature on all ALPHA products.

ETO

EHRHORN TECHNOLOGICAL OPERATIONS, INC.
P.O. BOX 708, CANON CITY, CO 81212
(303) 275-1613

UNADILLA

The WA2ZOT "INTERFILTER"

2000 WATT LO-PASS

LIFETIME GUARANTEE

The only Lo-Pass you'll ever need.



FULL-POWER, QUALITY HAM ANTENNA PARTS

AT YOUR DEALER

- BALUNS-TRAPS-INSULATORS
- QUAD PARTS-ANTENNA KITS
- BOOM/MAST MOUNTS-WIRE
- CABLE-CONNECTORS

Write or call for full Catalog

ASSISTANCE?

Call: HUGH GUNNISON, WA2ZOT
Toll-Free 800-448-1666
(NYS Collect 315-437-3953)

MICROWAVE UNADILLA/REYCO DIVISION
FILTER COMPANY, INC. [Dept. HRH]
6743 KINNE STREET, EAST SYRACUSE, NEW YORK 13057

DEALERS WANTED - OVER 300 WORLD-WIDE

YOU'VE SEEN THE MAGAZINE ARTICLES

Here's what you can expect from the DX ENGINEERING RF Speech Processor

- 6 db INCREASE IN AVERAGE POWER
- MAINTAINS VOICE QUALITY
- IMPROVES INTELLIGIBILITY
- NO CABLES OR BENCH SPACE REQUIRED
- EXCELLENT FOR PHONE PATCH
- NO ADDITIONAL ADJUSTMENTS — MIKE GAIN ADJUSTS CLIPPING LEVEL
- UNIQUE PLUG-IN UNIT — NO MODIFICATIONS REQUIRED



This is RF Envelope Clipping—the feature being used in new transmitter designs for amateur and military use.

Models Now Available
Collins 32S, KWM-2 \$ 98.50 ea.
Drake TR-3, TR-4, TR-6, TR-4C,
T-4, T-4X, T-4XB, T-4XC \$128.50 ea.
Postpaid — Calif. Residents
add 6% Tax

Watch for other models later!

DX Engineering

1050 East Walnut, Pasadena, Calif. 91106

ALL BAND TRAP ANTENNAS!



PRETUNED - COMPLETELY ASSEMBLED - ONLY ONE NEAT SMALL ANTENNA FOR UP TO 6 BANDS! EXCELLENT FOR CONGESTED HOUSING AREAS - APARTMENTS LIGHT - STRONG - ALMOST INVISIBLE!

FOR ALL MAKES & MODELS OF AMATEUR TRANSCIVERS - TRANSMITTERS - GUARANTEED FOR 2000 WATTS SSB 1000 WATTS CW. INPUT FOR NOVICE AND ALL CLASS AMATEURS!

COMPLETE AS SHOWN with 90 ft. RG58U-52 ohm feedline, and PL259 connector, insulators, 30 ft. 300 lb. test dacron end supports, center connector with built in lightning arrester and static discharge - molded, sealed, weatherproof, resonant traps 1" X 6" - you just switch to band desired for excellent worldwide operation - transmitting and receiving! WT. LESS THAN 5 LBS.

160-80-40-20-15-10 bands 2 trap -- 209 ft. with 90 ft. RG58U - connector - Model 777BU ... \$64.95
80-40-20-15-10 bands 2 trap --- 102 ft. with 90 ft. RG58U - connector - Model 998BU ... \$59.95
40-20-15-10 bands 2 trap --- 54 ft. with 90 ft. RG58U coax - connector - Model 1001BU ... \$58.95
20-15-10 bands 2 trap --- 26 ft. with 90 ft. RG58U coax - connector - Model 1007BU ... \$57.95

SEND FULL PRICE FOR POST PAID INSURED DEL. IN USA. (Canada is \$5.00 extra for postage - clerical - customs - etc.) or order using VISA Bank Americard - MASTER CHARGE - AMER. EXPRESS. Give number and ex. date. Ph 1-308-236-5333 9AM - 6PM week days. We ship in 2-3 days. ALL PRICES WILL INCREASE MAR 1-SAVE - ORDER NOW! All antennas guaranteed for 1 year. 10 day Money back trial! Made in USA. FREE INFO. AVAILABIE ONLY FROM.

WESTERN ELECTRONICS

Dept. AR-12

Kearney, Nebraska, 68847

Gift Ham Radio this year and Save

One Year/12 issues

First Gift

\$15

**Each
Additional Gift**

\$11.97

SAVE
20%

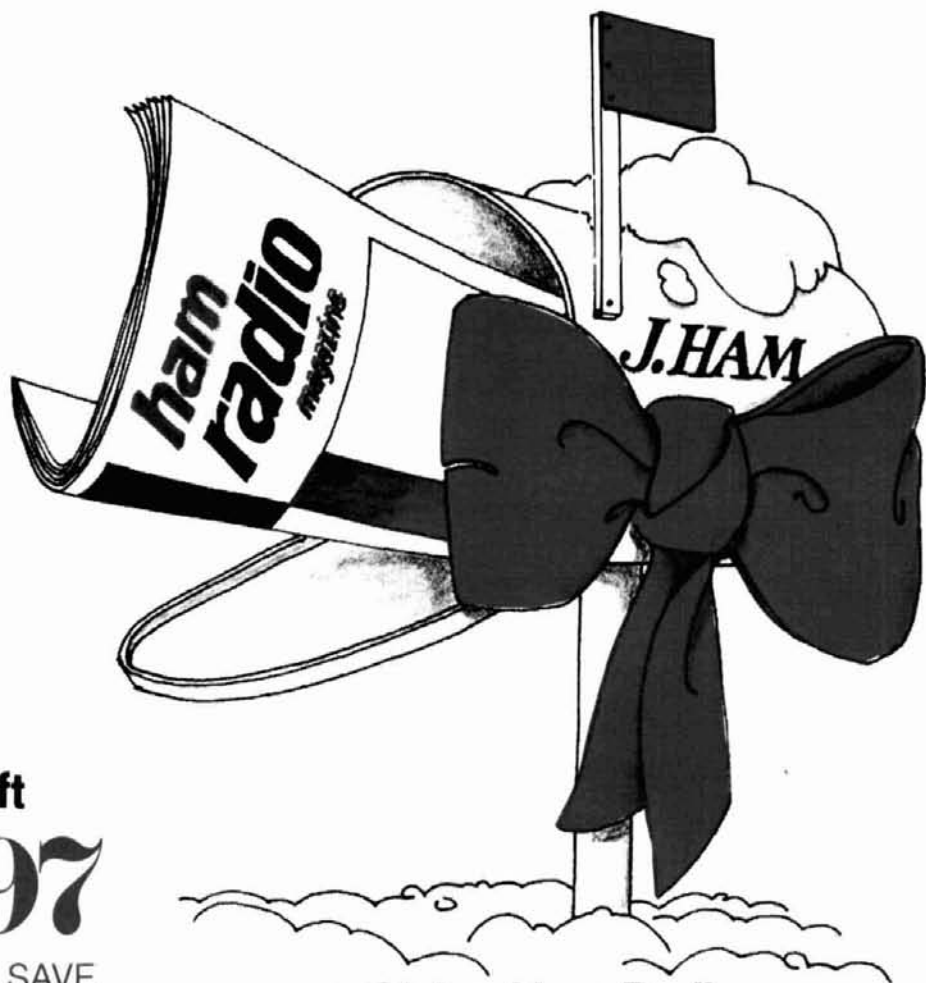

**Giving Ham Radio
is both fun and thoughtful.**

And at the receiving end of a Ham Radio gift subscription it's remembered all year long as a token of your friendship. We have a super busy year planned for 1980. Just take a look at a sampling of what your special amateur friend(s) will see in their 12 big gift issues next year:

- W2PV's series on Yagi Antennas
- Wire Beams for 75 meters
- Touch Tone Decoder
- Solid State VHF Linear Amplifier
- Plus HR's giant annual Antenna & Receiver issues
- Much Much More!

There's never been a better time to give a gift of Ham Radio than now. Gift now and SAVE!

**ham
radio**

magazine

Greenville, NH 03048

Prices U.S. only

**Please use handy
bind-in card.**

Ham Radio HORIZONS

Drake Users' Report

It's new! It's exciting! It's like nothing you ever read before. It's a fascinating report you can't afford to miss.

Nearly 200 actual owners and former owners, hams just like yourself, give you their own factual down to earth report on what they like and what they don't like about the famous and ever popular Drake Twins.

This is just the first installment of what is going to be a super exciting new monthly feature in Ham Radio HORIZONS. Virtually every issue will be examining another popular Amateur rig to find out what you our readers, not some industry or advertiser supported lab, thinks of the gear in question. Chances are we'll be looking at your own rig in the months ahead.

There'll be other surprises too in Ham Radio HORIZONS for 1980 and you'll be in line for them also. New monthly columns, even a new look are among the plans we have in store for you. They all add up to a magazine you can't afford to miss.

Certainly these are features that you'll want to see — every month — fortunately we're prepared to see that you get every issue delivered right to your door. You'll get our big December 1979 issue absolutely free if you take a year (12 issue) subscription. This way you'll be first in line to receive all these exciting owners' reports as they are issued each month, plus all our other fabulous new features. No need to send any money now, we'll be glad to bill you after the first of the year.

The January 1980 issue of Ham Radio HORIZONS will feature the Kenwood 820. On sale 12-26-79 at your favorite radio store or newsstand or subscribe today.

HORIZONS Tells it like it is.

ORDER TOLL FREE
800-258-5353

R4/T4X



Yes — sign me up!

Please send me my free copy of December HORIZONS and enter a one-year subscription.

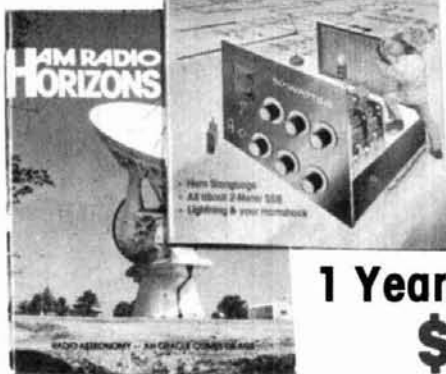

1 Year
\$12

Name _____ Call _____

Address _____

City _____ State _____ Zip _____

The Ham Radio Publishing Group Greenville, NH 03048

**REMOTE CONTROLLED
ANTENNA SWITCHING LETS
YOUR FEEDLINE WORK HARDER . . .**

five times as hard, in fact.
Antenna Mart's Model 50 remote controlled coax switch allows instant switch selection of up to five antennas with a single feedline and a control cable between the operating position and the remote switch location. . .



control unit
with indicator lights

**MODEL 50
Remote Antenna Switch
\$150.00 + \$3 shipping**

. . . AND CLEANS UP YOUR ACT IN THE SHACK!

Eliminates the tangle of feedlines and manual switches usually associated with multiple antennas. With 3kW power rating, high-speed low-loss operation, rugged weather-proof construction and LED indication of antenna in use, it adds up to THE solution to your antenna switching problems.

Order factory-direct or write for complete information on our line of available models.



remote switch



ANTENNA MART
box 1010, i.s.u. station, ames, iowa 50010

515-292-7114

IRON POWDER and FERRITE PRODUCTS

AMIDON
Associates

Fast, Reliable Service Since 1963

Small Orders Welcome Free 'Tech-Data' Flyer

Toroidal Cores, Shielding Beads, Shielded Coil Forms
Ferrite Rods, Pot Cores, Baluns, Etc.

12033 OTSEGO STREET, NORTH HOLLYWOOD, CALIFORNIA 91607

**These CRYSTAL FILTERS
are for you!**

600 Hz 6-Pole First - IF Filter for Drake R-4C

Optimum bandwidth, low loss. Improve the early-stage selectivity. Eliminate those high-pitched beat notes from signals that leak around the switchable second-IF filter. Minimize the chance of strong signals overloading the second mixer, causing intermodulation and desensitization. Both the existing filter and our CF-600/6 can be mounted in the receiver and relay switched to retain phone capabilities. CF-600/6: \$80.00. Relay switch kit: \$33.00.

125 Hz 8-Pole Second - IF Filter for R-4C

Still sharpest available! 275 Hz at -60 dB! Cuts QRM. Ideal for DX and contest work. Unexcelled under crowded band conditions. More selective than audio filters. Puts selectivity in AGC loop. Unlike with audio filters, receiver gain not reduced by QRM outside passband. CF-125/8: \$130.00.

Superior 8-Pole CW Selectivity for TR-4s

350 Hz at -6 dB, 850 Hz at -60dB. Cuts QRM. More selective than 6 pole CW filter in TR-4CW. For all TR-4s S/N 26,000 and above. CF-350/8: \$120.00. Switch and mounting kit: \$10.00.

Signal/One CX-7, CX-11 8-Pole CW Filter

All purpose CW bandwidth, low-loss, 350 Hz. Ideal for RTTY. CS-350/8: \$120.00.

16-Pole R-4C SSB!

Reduce QRM, leakage, overload, blanker false-triggering. Overall shape factor 1.4. 2kHz at -60dB, 2.8kHz at -60dB. CF-2K/8 pair: \$120.00. Relay switch kits start at \$33.00.

**3kHz 8-Pole Filter for
R-4C, R-7, TR-7**

Sharpest AM filter, also wideband SSB in 7-line. Optional two AM filter relay switch kit for R-4C: \$33.00. CF-3K/8 for R-4C, CD-3K/8 for R-7, TR-7: \$80.00.

R-4C FRONT-PANEL DC CONTROL/AGC DUAL-FUNCTION ROTARY SWITCH: \$19.00 Can switch relays for CF-600/6, CF-2K/8, CF-3K/8, and existing 8-kHz first-IF filter.

Sherwood Engineering Inc.
1268 South Ogden St.
Denver, Colo. 80210
(303) 722-2257

Money back if not satisfied

Add \$3 per order shipping;
\$6 overseas air

Dealer Inquiries Welcome



Barry Electronics

. . . Your One Source
For Amateur Radio Gear

**FEATURING THE ALL NEW
COLLINS Pro-mark™
KWM-380 TRANSCEIVER**



- All Solid-State • 100 Watts Output
- Built-in AC/DC • Fully Synthesized
- No Bandswitching • Frequency Memory • Microprocessor Frequency Control
- Rate Selectable Tuning • Famous Collins Quality — Write or call NOW!

YAESU — The New FT-207R Programmable Hand-Held and The Sensational FT-901 Series HF Transceivers

ASTRON — 35-Watt Amplifiers In Stock!

ROBOT — Amateur TV Gear

DENTRON — Fantastic Clipperton L. Buy NOW — SPECIAL PRICE!

Also . . .

- | | |
|----------------------------|-----------|
| AEA | COLLINS |
| ALDA | CUSHCRAFT |
| ANTENNA SPECIALISTS | DSI |
| ATLAS | DENTRON |
| B & W | DRAKE |
| BIRD | EIMAC |
| COMMUNICATIONS SPECIALISTS | E-Z WAY |
| | HY-GAIN |
| | ICOM |

- | | |
|------------|-------------|
| KDK | ROHN |
| KLM | SHURE |
| MFJ | STANDARD |
| MIRAGE | SWAN |
| MOSLEY | TEMPO |
| MURCH | TEN-TEC |
| NEUTRONICS | TRI-EX |
| ROBOT | VHF |
| | ENGINEERING |

We also have:

- ANTENNAS FOR HF & UHF
- ROTORS
- TOWERS
- REPEATERS
- MICROPHONES
- KEYS & KEYSERS
- TUBES and much, more

NEW

Ask about our Amateur Radio License Classes: Novice thru Extra!

The Export Experts Invite Overseas orders — We Ship Worldwide

**BARRY
ELECTRONICS**

512 BROADWAY
NEW YORK, N. Y. 10012
(212) 925-7000

HAM MART

Ham Radio's guide to help you find your local

Arizona

HAM SHACK

4506-A NORTH 16TH STREET
PHOENIX, AZ 85016
602-279-HAMS

Serving all amateurs from beginner to expert. Classes, sales & service.

KRYDER ELECTRONICS

5520 NORTH 7TH AVENUE
NORTH 7TH AVE. SHOPPING CTR.
PHOENIX, AZ 85013
602-249-3739

Your Complete Amateur Radio Store.

POWER COMMUNICATIONS

6012 N. 27 AVE.
PHOENIX, ARIZONA 85017
602-242-6030

Arizona's #1 "Ham" Store. Yaesu, Kenwood, Drake, Icom and more.

California

C & A ELECTRONIC ENTERPRISES

22010 S. WILMINGTON AVE.
SUITE 105, P. O. BOX 5232
CARSON, CA 90745
800-421-2258

213-834-5868 - Calif. Res.
Not The Biggest, But The Best —
Since 1962.

HOBBY-TRONICS

1378 S. BASCOM AVENUE
SAN JOSE, CA 95128
408-998-1103

Atlas, Kenwood, Yaesu, KDK,
Icom, Tempo, Wilson, Ten-Tec,
VHF Engineering.

JUN'S ELECTRONICS

11656 W. PICO BLVD.
LOS ANGELES, CA 90064
213-477-1824 Trades

714-463-1886 San Diego
The Home of the One Year Warranty
— Parts at Cost — Full Service.

QUEMENT ELECTRONICS

1000 SO. BASCOM AVENUE
SAN JOSE, CA 95128
408-998-5900

Serving the world's Radio
Amateurs since 1933.

TELE-COM

15460 UNION AVE.
SAN JOSE, CA 95124
408-377-4479

Connecticut

THOMAS COMMUNICATIONS

95 KITTS LANE
NEWINGTON, CT 06111
800-243-7765 • 203-667-0811
Call us toll free.

Delaware

DELAWARE AMATEUR SUPPLY

71 MEADOW ROAD
NEW CASTLE, DE 19720
302-328-7728

ICOM, Ten-Tec, Swan, DenTron,
Wilson, Tempo, KDK, and more.
One mile off I-95, no sales tax.

Florida

AGL ELECTRONICS, INC.

1898 DREW ST.
CLEARWATER, FL 33515
813-461-HAMS

West Coast's only full service
Amateur Radio Store.

AMATEUR RADIO CENTER, INC.

2805 N.E. 2ND AVENUE
MIAMI, FL 33137
305-573-8383

The place for great dependable
names in Ham Radio.

RAY'S AMATEUR RADIO

1590 US HIGHWAY 19 SO.
CLEARWATER, FL 33516
813-535-1416

Atlas, B&W, Bird, Cushcraft,
DenTron, Drake, Hustler, Hy-Gain,
Icom, K.D.K., Kenwood, MFJ, Rohn,
Swan, Ten-Tec, Wilson.

SUNRISE AMATEUR RADIO

1351 STATE RD. 84
FT. LAUDERDALE, FL 33315
(305) 761-7676

"Best Prices in Country."
Try us, we'll prove it."

Illinois

AUREUS ELECTRONICS, INC.

1415 N. EAGLE STREET
NAPERVILLE, IL 60540
312-420-8629

"Amateur Excellence"

ERICKSON COMMUNICATIONS, INC.

5456 N. MILWAUKEE AVE.
CHICAGO, IL 60630
Chicago - 312-631-5181
Outside Illinois - 800-621-5802
Hours: 9:30-5:30 Mon, Tu, Wed &
Fri.; 9:30-9:00 Thurs; 9:00-3:00 Sat.

SPECTRONICS, INC.

1009 GARFIELD STREET
OAK PARK, IL 60304
312-848-6777

One of America's Largest
Amateur & SWL Stores.

Indiana

KRYDER ELECTRONICS

GEORGETOWN NORTH
SHOPPING CENTER
2810 MAPLECREST RD.
FORT WAYNE, IN 46815
219-484-4946

Your Complete Amateur Radio Store.
10-9 T, TH, F; 10-5 W, SAT.

Iowa

BOB SMITH ELECTRONICS

RFD #3, HIGHWAY 169 & 7
FORT DODGE, IA 50501
515-576-3886

800-247-2476/1793
Iowa: 800-362-2371

For an EZ deal.

Kansas

ASSOCIATED RADIO

8012 CONSER, P. O. BOX 4327
OVERLAND PARK, KS 66204
913-381-5901

America's No. 1 Real Amateur
Radio Store. Trade - Sell - Buy.

Maryland

THE COMM CENTER, INC.

9624 FT. MEADE ROAD
LAUREL PLAZA, RT. 198
LAUREL, MD 20810
800-638-4486

R. L. Drake, Ten-Tec, ICOM, Wilson,
Tempo, DenTron, Mosley, Cushcraft.

Massachusetts

TEL-COM, INC.

675 GREAT RD. RT. 119
LITTLETON, MA 01460
617-486-3040

The Ham Store of New England
you can rely on.

Dealers: *YOU SHOULD BE HERE TOO!*
Contact Ham Radio now for complete details.

Amateur Radio Dealer

TUFTS RADIO ELECTRONICS
206 MYSTIC AVENUE
MEDFORD, MA 02155
617-395-8280
New England's friendliest
ham store.

Michigan

RSE HAM SHACK
1207 W. 14 MILE
CLAWSON, MI 48017
313-435-5660
Complete Amateur Supplies.

Minnesota

PAL ELECTRONICS INC.
3452 FREMONT AVE. NO.
MINNEAPOLIS, MN 55412
612-521-4662
Midwest's Fastest Growing Ham
Store, Where Service Counts.

Missouri

HAM RADIO CENTER, INC.
8340-42 OLIVE BLVD.
ST. LOUIS, MO 63132
800-325-3636
For Best Price and Fast Delivery
Call toll free 1-800-325-3636

Nebraska

COMMUNICATIONS CENTER, INC.
443 NORTH 48TH ST.
LINCOLN, NE 68504
800-228-4097
Lowest Prices in the USA
on Ham Equipment.

New Hampshire

EVANS RADIO, INC.
BOX 893, RT. 3A BOW JUNCTION
CONCORD, NH 03301
603-224-9961
Icom, DenTron & Yaesu dealer.
We service what we sell.

New Jersey

ATKINSON & SMITH, INC.
17 LEWIS ST.
EATONTOWN, NJ 07724
201-542-2447
Ham supplies since "55".

BARGAIN BROTHERS ELECTRONICS
216 SCOTCH ROAD
GLEN ROC SHOPPING CTR.
WEST TRENTON, NJ 06828
609-883-2050
A million parts - lowest prices
anywhere. Call us!

METUCHEN RADIO
216 MAIN STREET
METUCHEN, NJ 08840
201-494-8350
New and Used Ham Equipment
WA2AET "T" Bruno

RADIOS UNLIMITED
P. O. BOX 347
1760 EASTON AVENUE
SOMERSET, NJ 08873
201-469-4599
New Jersey's Fastest Growing
Amateur Radio Center.

WITTIE ELECTRONICS
384 LAKEVIEW AVENUE
CLIFTON, NJ 07011
(201) 772-2222
Same location for 62 years.
Full line authorized Drake dealer.

New York

HAM-BONE RADIO
3206 ERIE BLVD. EAST
SYRACUSE, NY 13214
315-446-2266
We deal, we trade, all major brands!
2-way service shop on premises!

HARRISON RADIO CORP.
20 SMITH STREET
FARMINGDALE, NY 11735
516-293-7990
"Ham Headquarters USA"
since 1925.
Call toll free 800-645-9187.

RADIO WORLD
ONEIDA COUNTY AIRPORT
TERMINAL BLDG.
ORISKANY, NY 13424
Toll Free 800-448-7914
NY { 315-337-2622
Res. { 315-337-0203
New & Used Ham Equipment.
See Warren K2IXN or Bob WA2MSH.

Ohio

**AMATEUR RADIO
SALES & SERVICE INC.**
2187 E. LIVINGSTON AVE.
COLUMBUS, OH 43209
614-236-1625
Antennas and Towers for
All Services.

UNIVERSAL AMATEUR RADIO, INC.
1280 AIDA DRIVE
COLUMBUS (REYNOLDSBURG)
OH 43068
614-866-4267
Complete Amateur Radio Sales and
Service. All major brands - spacious
store near I-270.

Oklahoma

KRYDER ELECTRONICS
5826 N.W. 50TH
MacARTHUR SQ. SHOPPING CTR.
OKLAHOMA CITY, OK 73122
405-789-1951
Your Complete Amateur Radio Store

Pennsylvania

ELECTRONIC EXCHANGE
136 N. MAIN STREET
SOUDERTON, PA 18964
215-723-1200
Demonstrations, Sales, Service
New/Used Amateur Radio Equip.

**HAMTRONICS, DIV. OF
TREVISE ELECTRONICS**
4033 BROWNSVILLE ROAD
TREVISE, PA 19047
215-357-1400
Same Location for 30 Years.
Call Toll Free 800-523-8998.

LaRUE ELECTRONICS
1112 GRANDVIEW STREET
SCRANTON, PENNSYLVANIA 18509
717-343-2124
ICOM, Bird, Cushcraft, CDE,
Ham-Keys, VHF Engineering,
Antenna Specialists.

SPECIALTY COMMUNICATIONS
2523 PEACH STREET
ERIE, PA 16502
814-455-7674
Authorized Atlas Radio
East Coast Service Center.

South Dakota

**BURGHARDT
AMATEUR RADIO CENTER, INC.**
P. O. BOX 73
WATERTOWN, SD 57201
605-886-7314
"America's Most Reliable
Amateur Radio Dealer".

Texas

HARDIN ELECTRONICS
5635 E. ROSEDALE
FT. WORTH, TX 76112
817-461-9761
Your Full Line Authorized
Yaesu Dealer.

CALL TOLL FREE

For the best deal on

- AEA • Ameco • ASP • Atlas
- Belden • Bencher • Bird
- CDE • CIR • CES • Cushcraft
- DenTron • Drake • Hy-Gain
- Icom • KLM • Kenwood
- Larsen • MFJ • Midland
- Mosley • NPC • Newtronics
- Nye • Palomar • Regency
- Shure • Swan • Standard
- Tempo • Ten-Tec • Tonna
- Transcom • Wilson • Yaesu

This Month's SPECIALS!

Yaesu FT-207R Synthesized
2-meter hand held . . . In Stock!

Mirage 2-Meter Amplifier 10 W
in/80 W out, with Rx preamp.,
5-year warranty
Christmas Special . \$139.95!

Xmas Specials from Kenwood:
TS-700SP \$599!
TR-7600 \$299!
TR-7625 \$339!

Above prices subject to change.



CALL TOLL FREE
(outside Illinois only)
[800] 621-5802
for the Erickson price!



Hours:
9:30-5:30 Mon., Tues., Wed. & Fri.
9:30-9:00 Thursday
9:00-3:00 Saturday

ERICKSON
COMMUNICATIONS, INC.
5456 N. MILWAUKEE AVE.
CHICAGO, IL 60630 / (312) 631-5181

SCANNERS

NOW, INTRODUCING SCANNERS

FOR THE KENWOOD TR7600 AND TR7625

KDK 2015R KDK 2016A MIDLAND 13-510 13-513

CLEGG FM-28 YAESU FT227R ICOM IC22S KENWOOD TR7400A

- ★ AED continues to expand its line of quality scanners. Each of the above scanners are custom designed for their respective rigs.
- ★ All scanners install completely inside rig. No obtrusive external connections.
- ★ All are easy to assemble and come complete with detailed instruction manual.
- ★ Scanned frequency displayed on digital readout (except IC22S).
- ★ In the scanner OFF mode the rig operates normally. In the scanner ON mode the scanner locks on an occupied frequency, pauses for a preset time (about 5 secs.) and then resumes scanning.
- ★ This gives you the ability to eavesdrop all over the band without lifting a finger. When you hear something interesting, you flip the switch to the LOCK mode and the rig is ready to transmit.

AED SCANNER SPECIFICATIONS								
	KDK 2015R	KDK 2016A	KENWOOD TR7600 TR7625	KENWOOD TR7400A	YAESU FT227R	MIDLAND 13-510 13-513	CLEGG FM-28	ICOM IC22S
SCAN RATE	Adjustable 100 kHz/sec-1 MHz/sec		50 kHz/sec		200 kHz/sec	100 kHz/sec	100 kHz/sec	100 kHz/sec
SWEEP WIDTH	144-148 142-149 995 or only the MHz segment you select on MHz switch.		complete band or MHz you want		adjustable eg. 146-148 144-146; 146-147	scans the MHz seg. selected by the MHz switch	same as Midland	145.35-147.99
SCAN CONTROLS	2 mini toggle switches mounted on rig - LOCK switch may be mounted on mic.		2 mini toggle switches mounted on rig.		1 mini toggle switch mounted on mic or rig.	2 mini toggle switches mounted on rig.	same as Midland	1 mini toggle switch mounted on mic or rig.
Price per kit	\$39.95		\$39.95		\$34.95	\$39.95	\$39.95	\$34.95
Price pre-assembled	\$59.95		\$59.95		\$54.95	\$59.95	\$59.95	\$54.95

Add \$1.50 for postage & handling.

CHRISTMAS SPECIAL

\$5.00 OFF KIT PRICE

Expires 12/31/79

\$10.00 OFF PREASSEMBLED



AED ELECTRONICS

750 LUCERNE RD., SUITE 120
MONTREAL, QUEBEC, CANADA H3R 2H6
TEL. 514-737-7293



DIPOLE ANTENNA CONNECTOR



HYE-QUE (HO-T) dipole connector has coax SO 239 socket molded into glass filled plastic body to accept coax RG-259 plug on feedline. Drip cap keeps coax fittings dry. Instructions included. Guaranteed. At your dealers or \$5.95 postpaid. Companion insulators \$1.25/pr.

BUDWIG MFG. Co. PO Box 829, Ramona, CA 92065
Ca. Res. add 6% Sales Tax

I PAY CASH

for your military surplus electronics

If you have or know of availability:

TT-98 TT-76 Teletypewriter
phone me collect

Dave — (213) 760-1000

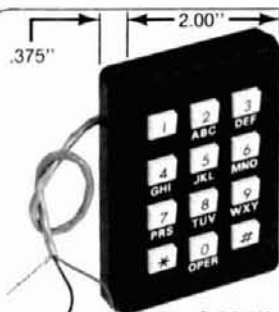

TROUBLE FREE TOUCH TONE® ENCODER

POSITIVE TOUCH (KEYS DEPRESS) • MOBILE • HANDHELD • POSITIVE MOUNT • NO RFI • NO POTTED PARTS (SERVICEABLE) • MIL-SPEC COMPONENTS • SELF CONTAINED • XTAL CONTROLLED • LEVEL ADJUSTMENT FROM FRONT • 4.5 - 60 V.D.C. • WILL OPERATE ANY SYSTEM • LETTERING OPTIONAL

Supplied with: Instructions, schematic, template, hardware. PP-1A designed for Standard Communications Handhelds. (California orders add 6% sales tax.)

NEW PRICES
PP-1 = \$49.00 PP-2 = \$53.00 PP-1A = \$58.00
PP-1K = \$55.00 PP-2K = \$59.00
K-series = Self Contained Delay Relay
M-Series - Detached Frame-for irregular installations

Available at: Ham Radio Center (800) 325-3636
Henry Radio, Los Angeles (213) 272-0861
Electronic Equipment, Virginia (703) 938-3350
CW Electronics, Denver (303) 893-5525
C & A Electronics, Long Beach (213) 834-5868

Send For Complete Dealers List & Catalog

PATENTED © AT&T

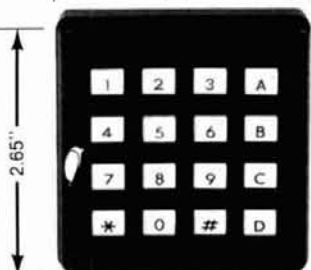

Mail Order To

Pipo Communications

Emphasis is on Quality & Reliability

P.O. Box 3435
Hollywood, California 90028
213/852 1515

IF THIS "CAN" WORK --- THINK WHAT A Hamtronics OR VHF Engineering KIT "CAN" DO FOR YOU !!

RECEIVERS

VHF ENGINEERING FM KITS FOR:

- 10 METERS - RX 28 C
- 6 METERS - RX 50 C
- 2 METERS - RX 144 C
- 1 1/4 METERS - RX 220 C
- 3/4 METERS - RX 432 C



TRANSMITTERS

- TX-50 & PA 50/25
- TX 144 & PA 144/15 - PA 144/25
- TX 220 & PA 220/15
- TX 432 & PA 432/10

HAMTRONICS

VHF & UHF RECEIVING CONVERTERS
RECEIVING PREAMPS FROM 10 METERS TO
3/4 METERS.

VHF & UHF TRANSMITTING CONVERTERS

*"repeaters
unlimited"*

a division of **CREATIVE**
PO BOX 7054 ELECTRONICS
Marietta Georgia 30065
Phone (404) 971-2122 or outside ga.
(800) 241-4547
Call and charge with your Visa or
Master Charge Card



When it comes to AMATEUR RADIO QSL's...



it's the
ONLY BOOK!
US or DX Listings

1980
callbooks
NOW READY!

Here they are! The latest editions. World-famous Radio Amateur Callbooks, the most respected and complete listing of radio amateurs. Lists calls, license classes, address information. Loaded with special features such as call changes, prefixes of the world, standard time charts, world-wide QSL bureaus and more. The new 1980 Radio Amateur Callbooks are available now. The U.S. Edition features over 400,000 listings, over 120,000 changes from last year. The Foreign Edition, over 315,000 listings, over 90,000 call changes. Place your order now.

	Each	Shipping	Total
<input type="checkbox"/> US Callbook	\$16.95	\$1.75	\$18.70
<input type="checkbox"/> Foreign Callbook	\$15.95	\$1.75	\$17.70

Order both books at the same time for \$34.65, includes shipping

Order from your favorite electronics dealer or direct from the publisher. All direct orders add \$1.75 for shipping. Illinois residents add 5% Sales Tax.



SPECIAL LIMITED OFFER!
Amateur Radio
Emblem Patch
only \$2.50 postpaid

Pegasus on blue field, red lettering. 3" wide x 3" high. Great on jackets and caps. Sorry, no call letters.

ORDER TODAY!

RADIO AMATEUR
callbook INC.
Dept. FB 2
925 Sherwood Drive
Lake Bluff, IL 60044



GROTH-Type
COUNTS & DISPLAYS
YOUR TURNS

- 99.99 Turns
- One Hole
- Panel Mount
- Handy Logging Area
- Spinner Handle Available

Case: 2x4"; shaft 1/4"x3"

TC2	\$10.00	Model TC2: Skirt 2-1/8"; Knob 1-5/8"
TC3	\$11.00	Model TC3: Skirt 3"; Knob 2-3/8"

Spinner Handle Add \$1.50

Prices include UPS or Parcel Post

R. H. BAUMAN SALES
P.O. Box 122, Itasca, Ill. 60143

Five* new finger talkers

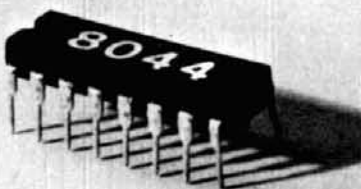

from CURTIS

- * EK-480: C-MOS Deluxe Keyer \$134.95
 - * EK-480M: Above plus speedmeter 149.95
 - * I-480: InstructoMate 124.95
 - * M-480: MemoryMate 124.95
 - * IM-480: Instructo-MemoryMate 179.95
 - 8044: Keyer-On-A-Chip (Replaces 8043) 14.95
- Apr '75 HR. Feb '76 QST. Radio Hdbk '75. ARRL Hdbk '77-79
- 8044-3: IC, PCB, Socket, Manual 24.95
 - 8044-4: Semi-Kit 54.95
 - 8045: Morse Keyboard-On-A-Chip IC 59.95
 - 8045-1: IC, PCB, FIFO, Sockets, Manual 89.95
 - 8045-2: Semi-Kit 159.95
 - 8046: Instructokeyer-On-A-Chip IC 49.95
 - 8046-1: Semi-Kit 79.95
 - 8047: Message Memory-On-A-Chip IC 39.95
 - 8047-1: IC, PCB, RAM, Sockets, Manual 69.95
- (add \$1.75 to kit prices for postage and handling)
- IK-440A: Instructokeyer (Mar '76 QST) 224.95

Curtis Electro Devices, Inc.
Dept. H (415) 494-7223
Box 4090, Mountain View, CA 94040



MORE POWER

- 10 Watts In - 75 Watts Out
- 2 Meter FM or SSB Amplifier
- Featured In MOTOROLA App. Note AN-791
- Complete Kit Model 875-K \$99.95
- See article in Sept. '79 QST pgs. 11-16

COMMUNICATION CONCEPTS, INC.

2648 North Aragon Ave.
Dayton, Ohio 45420
Phone: (513) 294-8425

UHF Kits Also Available Send For FREE Data Sheet

ham radio cumulative index

1969-1979

antennas and transmission lines

general

Antenna control, automatic azimuth/elevation for satellite communications	
WA3HLT	p. 26, Jan 75
Correction	p. 58, Dec 75
Antenna dimension (HN)	
WA9JMY	p. 66, Jun 70
Antennas and capture area	
K6MIO	p. 42, Nov 69
Antenna and control-link calculations for repeater licensing	
W7PUG	p. 58, Nov 73
Short circuit	p. 59, Dec 73
Antenna and feedline facts and fallacies	
W5JJ	p. 24, May 73
Antenna design, programmable calculator simplifies (HN)	
W3DVO	p. 70, May 74
Antenna gain (letter)	
W3AFM	p. 62, May 76
Antenna gain and directivity	
W2PV	p. 12, Aug 79
Antenna gain, measuring	
K6JYO	p. 26, Jul 69
Antenna wire, low-cost copper (HN)	
W2EUQ	p. 73, Feb 77
Anti-QRM methods	
W3FQJ	p. 50, May 71
Bridge for antenna measurements, simple	
W2CTK	p. 34, Sep 70
Cubical quad measurements	
W4YM	p. 42, Jan 69
Dipole center insulator (HN)	
WA1ABP	p. 69, May 69
Diversity receiving system	
W2EEY	p. 12, Dec 71
Dummy load and rf wattmeter, low-power	
W2OLU	p. 56, Apr 70
Dummy load, low-power vhf	
WB9DNI	p. 40, Sep 73
Effective radiated power (HN)	
VE7CB	p. 72, May 73
Feedpoint impedance characteristics of antennas	
W5JJ	p. 50, Dec 73
Filters, low-pass, for 10 and 15	
W2EEY	p. 42, Jan 72
Gain calculations, simplified	
W1DTV	p. 78, May 78
Gain vs antenna height, calculating	
WB8IFM	p. 54, Nov 73
Gin pole, simple lever for raising masts	
WA2ANU	p. 72, May 77
Ground current measuring on 160-meters	
W0KUS	p. 46, Jun 79
Ground screen, alternative to radials	
WB4JGP	p. 22, May 77
Grounding, safer (letter)	
W4SKTC	p. 59, May 72
Ground rods (letter)	
W7FS	p. 66, May 71
Ground systems, vertical antenna	
W7LR	p. 30, May 74
Headings, beam antenna	
W6FFC	p. 64, Apr 71
Horizontal or vertical (HN)	
W7IV	p. 62, Jun 72
Impedance measurements, nonresonant antenna	
W7CSD	p. 46, Apr 74
Insulators, homemade antenna (HN)	
W7ZC	p. 70, May 73
Isotropic source and practical antennas	
K6FD	p. 32, May 70

Lightning protection (C&T)	
W1DTY	p. 50, Jun 76
Lightning protection	
K9MM	p. 18, Dec 78
Comments, W6RTK	p. 6, Jul 79
Comments, W2FBL	p. 6, Jul 79
Letter, K9MM	p. 12, Dec 79
Line-of-sight distance, calculating	
WB5CBC	p. 56, Nov 76
Measurement techniques for antennas and transmission lines	
W4OQ	p. 36, May 74
Measuring antenna gain	
K6JYO	p. 26, Jul 69
Mobile mount, rigid (HN)	
VE7ABK	p. 69, Jan 73
Power in reflected waves	
Woods	p. 49, Oct 71
Reflected power, some reflections on	
VE3AAZ	p. 44, May 70
Reflectometers	
K1YZW	p. 65, Dec 69
Rf power meter, low-level	
W5WGF	p. 58, Oct 72
Sampling network, rf — the milli-trap	
W6QJW	p. 34, Jan 73
Scaling antenna elements	
W7ITB	p. 58, Jul 79
Smith chart, how to use	
W1DTY	p. 16, Nov 70
Correction	p. 76, Dec 71
Smith chart, numerical	
W8MQW	p. 104, Mar 78
Standing-wave ratios, importance of	
W2HB	p. 26, Jul 73
Correction (letter)	p. 67, May 74
Time-domain reflectometry, practical experimenter's approach	
W4OPIA	p. 22, May 71
T-R switch	
K3KMO	p. 61, Apr 69
Voltage-probe antenna	
W1DTY	p. 20, Oct 70

high-frequency antennas

All band antenna portable (HN)	
W2INS	p. 68, Jun 70
All-band phased-vertical	
W47GXO	p. 32, May 72
Antenna, 3.5 MHz, for a small lot	
W6AGX	p. 28, May 73
Antenna potpourri	
W3FQJ	p. 54, May 72
Antenna systems for 80 and 40 meters	
K6KA	p. 55, Feb 70
Army loop antenna — revisited	
W3FQJ	p. 59, Sep 71
Added notes	p. 64, Jan 72
Beam antenna, improved triangular shaped	
W6DL	p. 20, May 70
Beam for ten meters, economical	
W1FPF	p. 54, Mar 70
Beverage antenna	
W3FQJ	p. 67, Dec 71
Beverage antenna for 40 meters	
KG6RT	p. 40, Jul 79
Bobtail curtain array	
W8YFB	p. 81, May 77
Bobtail curtain array, forty-meter	
VE1TG	p. 58, Jul 69
Coaxial dipole antenna, analysis of	
W2DL	p. 46, Aug 76
Coaxial dipole, multiband (HN)	
W4BDK	p. 71, May 73
Collinear, six-element for	
W6YBF	p. 22, May 76

Compact antennas for 20 meters	
W4ROS	p. 38, May 71
Compact loop antenna for 80 and 40 meters	
W6TC	p. 24, Oct 79
Converted-vee, 80 and 40 meter	
W6JKR	p. 18, Dec 69
Corner-fed loop, low frequency	
ZL1BN	p. 30, Apr 76
Installation modified	p. 41, Feb 77
Cubical-quad antenna design parameters	
K6OPZ	p. 55, Aug 70
Cubical-quad antennas, mechanical design of	
VE3II	p. 44, Oct 74
Cubical-quad antennas, unusual	
W1DTY	p. 6, May 70
Cubical quad, improved low-profile, three band	
W1HXU	p. 25, May 76
Cubical quad, three-band	
W1HXU	p. 22, Jul 75
Curtain antenna (HN)	
W4ATE	p. 66, May 72
Delta loop, top-loaded	
W1DTY	p. 57, Dec 78
Dipole, all-band tuned	
ZS6BT	p. 22, Oct 72
Dipole antennas on non-harmonic frequencies (HN)	
W2CTK	p. 72, Mar 69
Dipole beam	
W3FQJ	p. 56, Jun 74
Dipole pairs, low SWR	
W6FPO	p. 42, Oct 72
Dipole sloping inverted-vee	
W6NIF	p. 48, Feb 69
Double bi-square array	
W6FFF	p. 32, May 71
Dual-band antennas, compact	
W6SAI	p. 18, Mar 70
DX antenna, single-element	
W6FHM	p. 52, Dec 72
Performance (letter)	p. 65, Oct 73
Folded umbrella antenna	
WB5IIR	p. 38, May 79
Four-band wire antenna	
W3FQJ	p. 53, Aug 75
Ground-plane antenna: history and development	
K2FF	p. 26, Jan 77
Ground-plane, multiband (HN)	
JA1QIY	p. 62, May 71
Ground plane, three-band	
LA1EI	p. 6, May 72
Correction	p. 91, Dec 72
Footnote (letter)	p. 65, Oct 72
Ground systems for vertical antennas	
W8CBBJ	p. 31, Aug 79
High-frequency amateur antennas	
W2WLR	p. 28, Apr 69
High-frequency diversity antennas	
W2WLR	p. 28, Oct 69
Horizontal-antenna gain at selected vertical radiation angles	
W7LR	p. 54, Feb 76
Horizontal antennas, optimum height for	
W7LR	p. 40, Jun 74
Horizontal antennas, vertical radiation patterns	
WA9RQY	p. 58, May 74
Inverted-vee antenna (letter)	
WB8AQF	p. 66, May 71
Inverted-vee antenna, modified	
W2KTW	p. 40, Oct 71
Inverted-vee installation, improved low-band (HN)	
W9KNI	p. 68, May 76
Inverted V or delta loop, how to add to tower	
K4DJC	p. 32, Jul 76
Large vertical, 160 and 180 meters	
W7IV	p. 8, May 75
Log-periodic antenna, 14, 21 and 28 MHz	
W4AEO	p. 18, Aug 73

Log-periodic antennas, 7-MHz W4AEO	p. 16, May 73	Traps and trap antennas W8FX	p. 34, Aug 79	Corner reflector antenna, 432 MHz WA2FSQ	p. 24, Nov 71
Log-periodic antennas, feed system for W4AEO	p. 30, Oct 74	Triangle antennas W3FQJ	p. 56, Aug 71	Cubical quad, economy six-meter W6DOR	p. 50, Apr 69
Log-periodic antennas, graphical design method for W4AEO	p. 14, May 75	Triangle antennas W6KIW	p. 58, May 72	Feed horn, cylindrical, for parabolic reflectors WA9HUV	p. 16, May 76
Log-periodic antennas, vertical monopole, 3.5 and 7.0 MHz W4AEO	p. 44, Sep 73	Triangle antennas (letter) K4ZZV	p. 72, Nov 71	Folded whip antenna for vhf mobile — Weekender WB2IFV	p. 50, Apr 79
Log-periodic beams, improved (letter) W4AEO	p. 74, May 75	Triangle beams W3FQJ	p. 70, Dec 71	Ground plane, 2-meter, 0.7 wavelength W3WZA	p. 40, Mar 69
Log-periodic beam, 15 and 20 meters W4AEO	p. 6, May 74	Tuning aid for the sightless (HN) W6VX	p. 83, Sep 76	Ground plane, portable vhf (HN) K9DHD	p. 71, May 73
Log periodic design W6PYK, W4AEO	p. 34, Dec 79	Unidirectional antenna for the low-frequency bands GW3NJY	p. 61, Jan 70	Log-periodic, yagi beam K6RIL, W6SAI	p. 8, Jul 69
Log-periodic feeds (letter) W4AEO	p. 66, May 74	Vertical antenna for 40 and 75 meters W6PYK	p. 44, Sep 79	Correction	p. 68, Feb 70
Log-periodic, three-band W4AEO	p. 28, Sep 72	Vertical antenna radiation patterns W7LR	p. 50, Apr 74	Magnet-mount antenna, portable (HN) WB2YYU	p. 67, May 76
Longwire antenna, new design K4EF	p. 10, May 77	Vertical antenna, low-band W4IYB	p. 70, Jul 72	Magnetic mount for mobile antennas W0HK	p. 52, Nov 78
Longwire multiband antenna W3FQJ	p. 28, Nov 69	Vertical antenna, portable W8BNWL	p. 48, Jun 78	Matching techniques for vhf/uhf antennas W1JAA	p. 50, Jul 76
Loop antennas W4OQ	p. 18, Dec 76	Vertical antenna, three-band W9BQE	p. 44, May 74	Microwave antenna, Low-cost K6HIJ	p. 52, Nov 69
Loop receiving antenna W2IMB	p. 66, May 75	Vertical antennas, improving performance of K6FD	p. 54, Dec 74	Mobile antenna, magnet-mount W1HCI	p. 54, Sep 75
Correction	p. 58, Dec 75	Vertical antennas, performance characteristics W7LR	p. 34, Mar 74	Mobile antenna, six-meter (HN) W4PSJ	p. 77, Oct 70
Loop-yagi antennas VK2ZTB	p. 30, May 76	Vertical beam antenna, 80 meter VE1TG	p. 26, May 70	Mobile antennas, vhf, comparison of W4MNV	p. 52, May 77
Low-band antenna problem, solution to W8YFB	p. 46, Jan 78	Vertical dipole, gamma-loop-fed W6SAI	p. 19, May 72	Moonbounce antenna, practical 144-MHz K6HCP	p. 52, May 70
Low-mounted antennas W3FQJ	p. 66, May 73	Vertical for 80 meters, top-loaded W2MB	p. 20, Sep 71	Multiband J antenna WB6JPI	p. 74, Jul 78
Mobile antenna, helically wound ZE8JP	p. 40, Dec 72	Vertical radiators W4OQ	p. 16, Apr 73	Oscar antenna, mobile (HN) W6OAL	p. 67, May 76
Mobile color code (letter) WB6JFD	p. 90, Jan 78	Vertical, top-loaded 80 meter VE1TG	p. 48, Jun 69	Oscar az-el antenna system WA1NXP	p. 70, May 78
Mono-loop antenna (HN) W8BW	p. 70, Sep 69	Vertical-lower antenna system W4OQ	p. 56, May 73	Parabolic reflector antennas VK3ATN	p. 12, May 74
Multiband antenna system VK2AOU	p. 62, May 79	Windom antenna, four-band W4VUO	p. 62, Jan 74	Parabolic reflector element spacing WA9HUV	p. 28, May 75
Multiband dipoles for portable use W6SAI	p. 12, May 70	Correction (letter)	p. 74, Sep 74	Parabolic reflector gain W2TQK	p. 50, Jul 75
Multiband vertical antenna system W0NCU	p. 28, May 78	Windom antennas K4KJ	p. 10, May 78	Parabolic reflectors, finding the focal length (HN) WA4WDL	p. 57, Mar 74
Phased antenna (letter) Thacker, Jerry	p. 6, Oct 78	Windom antenna (letter) K6KA	p. 6, Nov 78	Parabolic reflector, 16-foot homebrew WB8IOM	p. 8, Aug 69
Phased array, design your own K1AON	p. 78, May 77	Zepp antenna, extended W6QVI	p. 48, Dec 73	Quad-yagi arrays, 432- and 1296-MHz W3AED	p. 20, May 73
Phased array, electrically-controlled W5TRS	p. 52, May 75	ZL special antenna, understanding the WA8TKT	p. 38, May 76	Short circuit	p. 58, Dec 73
Phased vertical array, fine tuning W4FXE	p. 46, May 77	3.5-MHz broadband antennas N6RY	p. 44, May 79	Simple antennas, 144-MHz WA3NFW	p. 30, May 73
Phased vertical array, four-element W8HXR	p. 24, May 75	3.5-MHz phased horizontal array K4JC	p. 56, May 77	Switch, antenna for 2 meters, solid-state K2ZSQ	p. 48, May 69
Quad antenna, modified ZF1MA	p. 68, Sep 78	3.5-MHz sloping antenna array W2LU	p. 70, May 79	Two-meter fm antenna (HN) WB8KYE	p. 64, May 71
Quad antenna, multiband DJ4VM	p. 41, Aug 69	3.5-MHz tree-mounted ground-plane K2INA	p. 48, May 78	Vertical antennas, truth about 5/8-wavelength K0DOK	p. 48, May 74
Quad antenna, repairs (HN) K9MM	p. 87, May 78	7-MHz antenna array K7CW	p. 30, Aug 78	Added note (letter)	p. 54, Jan 75
Quads vs Yagis revisited N6NB	p. 12, May 79	7-MHz rotary beam W7DI	p. 34, Nov 78	Whip, 5/8-wave, 144-MHz (HN) VE3DDD	p. 70, Apr 73
Comments, WB6MMV, N6NB	p. 80, Oct 79	7-MHz short vertical antenna W8TYX	p. 60, Jun 77	Yagi antennas, how to design W1JR	p. 22, Aug 77
Receiving antennas K6ZGQ	p. 56, May 70	14-MHz delta-loop array N2GW	p. 16, Sep 78	Yagi uhf antenna simplified (HN) WA3CPH	p. 74, Nov 79
Satellite antenna, simple (HN) WA6PXY	p. 59, Feb 75	160-meter loop, receiving K6HTM	p. 46, May 74	Yagi, 1296-MHz W2CQH	p. 24, May 72
Selective antenna system minimizes unwanted signals W5TRS	p. 28, May 76	160-meter vertical, shortened (HN) W6VX	p. 72, May 76	7-MHz attic antenna (HN) W2ISL	p. 68, May 76
Selective receiving antennas W5TRS	p. 20, May 78	160 meters with 40-meter vertical W2IMB	p. 34, Oct 72	10-GHz dielectric antenna (HN) WA4WDL	p. 80, May 75
Shunt-fed tower (HN) N6HZ	p. 74, Nov 79	vhf antennas		144-MHz vertical, 5/8-wavelength K6KLO	p. 40, Jul 74
Shunt-feed systems for grounded vertical radiators, how to design W4OQ	p. 34, May 75	Antennas for satellite communications, simple K4GSX	p. 24, May 74	144-MHz antenna, 5/8-wavelength built from CB mobile whip (HN) WB4WSU	p. 67, Jun 74
Simple antennas for 40 and 80 W5RUB	p. 16, Dec 72	Antenna-performance measurements using celestial sources W5CQ/W4RXY	p. 75, May 79	144-MHz collinear uses PVC pipe mast (HN) K8LLZ	p. 66, May 76
Sloping dipoles W5RUB	p. 19, Dec 72	Circularly-polarized ground-plane antenna for satellite communications K4GSX	p. 28, Dec 74	144-MHz mobile antenna (HN) W2EUQ	p. 80, Mar 77
Performance (letter)	p. 76, May 73	Collinear antenna for two meters, nine-element W6RJO	p. 12, May 72	144-MHz mobile antenna WD8QIB	p. 68, May 79
Small beams, high performance G6XN	p. 12, Mar 79	Collinear antenna (letter) W6SAI	p. 70, Oct 71	144-MHz vertical mobile antennas, 1/4 and 5/8 wavelength, test data on W2LTJ, W2CQH	p. 46, May 76
Small-loop antennas W4YOT	p. 36, May 72	Collinear array for two meters, 4-element WB6KGF	p. 6, May 71	144-MHz, 5/8-wavelength vertical W1RHN	p. 50, Mar 76
Stressed quad (HN) W5TIU	p. 40, Sep 78	Collinear antenna, four element 440-MHz WA6HTP	p. 38, May 73	144-MHz, 5/8-wavelength, vertical antenna for mobile K4LPQ	p. 42, May 76
Stub bandswitched antennas W2EEY	p. 50, Jul 69	Collinear, six meter K4ERO	p. 59, Nov 69	432-MHz high-gain Yagi K6HCP	p. 46, Jan 76
Suitcase antenna, high-frequency VK5BI	p. 61, May 73	Converting low-band mobile antenna to 144-MHz (HN) K7ARR	p. 90, May 77	Comments, W0PW	p. 63, May 76
Tailoring your antenna, how to KH6HDM	p. 34, May 73			432-MHz OSCAR antenna (HN) W1JAA	p. 58, Jul 75
Telephone-wire antenna (HN) K9TBD	p. 70, May 76			1296-MHz antenna, high-gain W3AED	p. 74, May 78

1296-MHz Yagi array
W3AED p. 40, May 75

matching and tuning

Active antenna coupler for VLF
Burhans, Ralph W. p. 46, Oct 79

Antenna bridge calculations
Anderson, Leonard H. p. 34, May 78

Antenna bridge calculations (letter)
W5QJR p. 6, Aug 78

Antenna coupler for three-band beams
ZS6BT p. 42, May 72

Antenna coupler, six-meter
K1RAK p. 44, Jul 74

Antenna impedance transformer for receivers (HN)
W6NIF p. 70, Jan 70

Antenna instrumentation, simple, (repair bench)
K4IPV p. 71, Jul 77

Antenna matcher, one-man
W4SD p. 24, Jun 71

Antenna tuner adjustment (HN)
WA4MTH p. 53, Dec 75

Antenna tuner, automatic
WA0AQC p. 36, Nov 72

Antenna tuner, medium-power toroidal
WB2ZSH p. 58, Jan 74

Antenna tuner for optimum power transfer
W2WLR p. 28, May 70

Antenna tuners
W3FQJ p. 58, Dec 72

Antenna tuning units
W3FQJ p. 58, Jan 73

Balun, adjustable for yagi antennas
W6SAI p. 14, May 71

Balun, Simplified (HN)
WA0KKC p. 73, Oct 69

Broadband balun, simple and efficient
W1JR p. 12, Sep 78

Broadband reflectometer and power meter
VK2ZTB, VK2ZZQ p. 28, May 79

Couplers, random-length antenna
W2EEY p. 32, Jan 70

Dummy loads
W4MB p. 40, Mar 76

Feeding and matching techniques for
vhf/uhf antennas
W1JAA p. 54, May 76

Gamma-match capacitor, remotely controlled
K2BT p. 74, May 75

Gamma-matching networks, how to design
W7ITB p. 46, May 73

Impedance bridge, low-cost RX
W8YFB p. 6, May 73

Impedance-matching baluns, open-wire
W6MUR p. 46, Nov 73

Impedance-matching systems, designing
W7CSD p. 58, Jul 73

Johnson Matchbox, improved
K4IHV p. 45, Jul 79

Short circuit
p. 92, Sep 79

Loads, affect of mismatched transmitter
W5JJ p. 60, Sep 69

Matching, antenna, two-band with stubs
W6MUR p. 18, Oct 73

Matching complex antenna loads
to coaxial transmission lines
WB7AUL p. 52, May 79

Matching system, two-capacitor
W6MUR p. 58, Sep 73

Matching transformers, multiple quarter-wave
K3BY p. 44, Nov 78

Measuring complex impedance with swr bridge
WB4KSS p. 46, May 75

Mobile transmitter, loading
W4YB p. 46, May 72

RX noise bridge, improvements to
W6BXI, W6NKU
Comments p. 10, Feb 77
p. 100, Sep 77

Noise bridge construction (letter)
OH2ZAZ p. 8, Sep 78

Noise bridge, antenna
WB2EGZ p. 18, Dec 70

Noise bridge, antenna (HN)
K8EEG p. 71, May 74

Noise bridge calculations with
TI 58/59 calculators
WD4GRI p. 45, May 78

Noise bridge for impedance measurements
YA1GJM p. 62, Jan 73

Added notes p. 66, May 74; p. 60, Mar 75

Comments, W6BXI p. 6, May 79

Omega-matching networks, design of
W7ITB p. 54, May 78

Phase meter, rf
VE2AYU, Korth p. 28, Apr 73

Quadrifilar toroid (HN)
W9LL p. 52, Dec 75

Stub-switched, stub-matched antennas
W2EEY p. 34, Jan 69

Swr alarm circuits
W2EEY p. 73, Apr 70

Swr bridge
WB2ZSH p. 55, Oct 71

Swr bridge and power meter, integrated
W6DOB p. 40, May 70

Swr bridge readings (HN)
W6FPO p. 63, Aug 73

Swr indicator, aural, for the visually
handicapped
K6HTM p. 52, May 76

Swr meter
WB6AFT p. 68, Nov 78

Swr meter
W6VSV p. 6, Oct 70

Swr meter, improving (HN)
W5NPD p. 68, May 76

Swr, what is your?
N4OE p. 68, Nov 79

T-Network impedance matching to coaxial feedlines
W6EBY p. 22, Sep 78

Transmatch, five-to-one
W7IV p. 54, May 74

Transmission lines, grid dipping (HN)
W2OLU p. 72, Feb 71

Transmission lines, uhf
WA2VTR p. 36, May 71

Uhf coax connectors (HN)
W0LCP p. 70, Sep 72

towers and rotators

Antenna and rotator preventive maintenance
WA1ABP p. 66, Jan 69

Antenna and tower restrictions
W7IV p. 24, Jan 76

Antenna guys and structural solutions
W6RTK p. 33, Jun 78

Antenna mast, build your own tilt-over
W6KRT p. 42, Feb 70

Correction p. 76, Sep 70

Antenna position display
AE4A p. 18, Feb 79

Az-el antenna mount for satellite
communications
W2LX p. 34, Mar 75

Cornell-Dubilier rotators (HN)
K6KA p. 82, May 75

Ham-M modifications (HN)
W2TQK p. 72, May 76

Ham-M rotator automatic position control
WB6GNNM p. 42, May 77

Pipe antenna masts, design data for
W3MR p. 52, Sep 74

Added design notes (letter)
Rotator, AR-22, fixing a sticky
WA1ABP p. 34, Jun 71

Rotator for medium-sized beams
K2BT p. 48, May 76

Rotator, T-45, Improvement (HN)
WA0VAM p. 64, Sep 71

Stress analysis of antenna systems
W2FZJ p. 23, Oct 71

Telescoping tv masts (HN)
WA0KKC p. 57, Feb 73

Tilt-over tower uses extension ladder
W5TRS p. 71, May 75

Tower guying (HN)
K9MM p. 98, Nov 77

Tower, homemade tilt-over
WA3EWH p. 28, May 71

Tower, wind-protected crank-up
(HN) p. 74, Oct 69

Towers and rotators
K6KA p. 34, May 76

Wind loading on towers and antenna
structures, how to calculate
K4KJ p. 16, Aug 74

Added note p. 56, Jul 75

transmission lines

Antenna-transmission line analog, part 1
W6UYH p. 52, Apr 77

Antenna-transmission line analog, part 2
W6UYH p. 29, May 77

Balun, coaxial
WA0RDX p. 26, May 77

Coax cable dehumidifier
K4RJ p. 26, Sep 73

Coax cable, repairing water damage (HN)
W5XW p. 73, Dec 79

Coax connectors, repairing broken (HN)
W0HKF p. 66, Jun 70

Coaxial cable (C&T)
W1DTY p. 50, Jun 76

Coaxial cable, checking (letter)
W2OLU p. 68, May 71

Coaxial cable connectors (HN)
WA1ABP p. 71, Mar 69

Coaxial-cable fittings, type-F
K2MDO p. 44, May 71

Coaxial connectors can generate rfi
W1DTY p. 48, Jun 76

Coaxial feedthrough panel (HN)
W3URE p. 70, Apr 69

Coaxial-line loss, measuring with
reflectometer
W2VCI p. 50, May 72

Coax, Low-cost (HN)
K6BIJ p. 74, Oct 69

Coaxial transmission lines, underground
W0FCH p. 38, May 70

Connectors for CATV coax cable
W1IIM p. 52, Oct 79

Impedance transformer, non-synchronous (HN)
W5TRS p. 66, Sep 75

Comments, W3DVO p. 63, May 76

Matching transformers, multiple quarter-wave
K3BY p. 44, Nov 78

Matching 75-ohm CATV hardline
to 50-ohm system
K1XX p. 31, Sep 78

Open-wire feedthrough insulator (HN)
W4RNL p. 79, May 75

Remote switching multiband antennas
G3LTZ p. 68, May 77

Single feedline for multiple antennas
K2ISP p. 58, May 71

Transmission line calculations
using your pocket calculator for
W5TRS p. 40, Nov 76

Transmit/receive switch, solid-state vhf-uhf
W4NHH p. 54, Feb 78

Tuner, receiver (HN)
WA7KRE p. 72, Mar 69

Tuner, wall-to-wall antenna (HN)
W2OUX p. 56, Dec 70

Uhf microstrip swr bridge
W4CGC p. 22, Dec 72

VSWR indicator, computing
WB9CY p. 58, Jan 77

Short circuit p. 94, May 77

Zip-cord feedlines (HN)
W7RXV p. 32, Apr 78

Zip-cord feedlines (letter)
WB6BHI p. 6, Oct 78

75-ohm CATV cable in amateur installations
W7VK p. 28, Sep 78

75-ohm CATV hardline matching to 50-ohm systems
K1XX p. 31, Sep 78

audio

Active filters
K6JM p. 70, Feb 78

Audio agc principles and practice
WA5SNZ p. 28, Jun 71

Audio CW filter
W7DI p. 54, Nov 71

Audio filter, tunable, for weak-signal
communications
K6HCP p. 28, Nov 75

Audio filters, aligning (HN)
W4ATE p. 72, Aug 72

Audio filters, inexpensive
W8YFB p. 24, Aug 72

Audio filter mod (HN)
K6HIL p. 60, Jan 72

Audio mixer (HN)
W6KNE p. 66, Nov 76

Audio module, a complete
K4DHC p. 18, Jun 73

Audio-oscillator module, Cordover
WB2GGY p. 44, Mar 71

Correction p. 80, Dec 71

Audio-power integrated circuits
W3FQJ p. 64, Jan 76

Audio transducer (HN)
WA1OPN p. 59, Jul 75

Binaural CW reception, synthesizer for
W6NRW p. 46, Nov 75

Comment p. 77, Feb 77

Distortion and splatter
K5LLI p. 44, Dec 70

Duplex audio-frequency generator
with AFSK features
WB6AFT p. 66, Sep 79

Dynamic microphones (C&T)
 W1D7Y p. 46, Jun 76

Filter for CW, tunable audio
 WA1JSM p. 34, Aug 70

Filter-frequency translator for CW reception,
 integrated audio
 W2EEY p. 24, Jun 70

Filter, lowpass audio, simple
 OD5CG p. 54, Jan 74

Filter, simple audio
 W4NVK p. 44, Oct 70

Filter, tunable peak-notch audio
 W2EEY p. 22, Mar 70

Filter, variable bandpass audio
 W3AEX p. 36, Apr 70

Gain control IC for audio signal processing
 Jung p. 47, Jul 77

Hang agc circuit for ssb and CW
 W1ERJ p. 50, Sep 72

Headphone cords (HN)
 W20LU p. 62, Nov 75

Headphones, dual-impedance (HN)
 AB9Q p. 80, Jan 79

Impedance match, microphone (HN)
 W5JJ p. 67, Sep 73

Increased flexibility for the MFJ Enterprises
 CW filters
 K3NEZ p. 58, Dec 76

Intercom, simple (HN)
 W4AYV p. 66, Jul 72

Microphone preamplifier with agc
 Bryant p. 28, Nov 71

Microphone, using Shure 401A with Drake TR-4 (HN)
 G3XOM p. 68, Sep 73

Microphones, muting (HN)
 W6IL p. 63, Nov 75

Notch filter, tunable RC
 WA5SNZ p. 16, Sep 75
 Comment p. 78, Apr 77

Oscillator, audio, IC
 W6GXN p. 50, Feb 73

Oscillator-monitor, solid-state audio
 WA1JSM p. 48, Sep 70

Phone patch
 W8GRG p. 20, Jul 71

Pre-emphasis for ssb transmitters
 OH2CD p. 38, Feb 72

RC active filters using op amps
 W4IYB p. 54, Oct 76

RC active filters (letter)
 W6NRM p. 102, Jun 78

Receivers, better audio for
 K7GCO p. 74, Apr 77

Rf clipper for the Collins S-line
 K6JYO p. 18, Aug 71

Rf speech processor, ssb
 W2MB p. 18, Sep 73

Speaker-driver module, IC
 WA2GCF p. 24, Sep 72

Speech amplifiers, curing distortion
 Allen p. 42, Aug 70

Speech clipper, IC
 K6HTM p. 18, Feb 73
 Added notes (letter) p. 64, Oct 73

Speech clippers, rf
 G6XN p. 26, Nov; p. 12, Dec 72
 Added notes p. 58, Aug 73; p. 72, Sep 74

Speech clipping in single-sideband equipment
 K1YZW p. 22, Feb 71

Speech clipping (letter)
 W3EJD p. 72, Jul 72

Speech compressor (HN)
 Novotny p. 70, Feb 76

Speech processing, principles of
 ZL1BN p. 28, Feb 75
 Added notes p. 75, May 75; p. 64, Nov 75

Speech processing technique, split audio band
 W1D7Y p. 30, Jun 76

Speech processor, audio-frequency
 K3PDW p. 48, Aug 77
 Short circuit p. 68, Dec 77

Speech processor for ssb, simple
 K6PHT p. 22, Apr 70

Speech processor, IC
 VK9GN p. 31, Dec 71

Speech processor, logarithmic
 WA3FIY p. 38, Jan 70

Speech processor, split-band (letter)
 WA2SSO p. 6, Dec 79

Speech systems, improving
 K2PMA p. 72, Apr 78

RC active filters using op amps
 W4IYB p. 54, Oct 76

Squelch, audio-actuated
 K4MOG p. 52, Apr 72

Synthesizer-filter, binaural
 W6NRW p. 52, Nov 76

Tape head cleaners (letter)
 K4MSG p. 62, May 72

Tape head cleaning (letter)
 Buchanan p. 67, Oct 72

Variable-frequency audio filter
 W4VRV p. 62, Apr 79

Voice-operated gate for carbon microphones
 W6GXN p. 35, Dec 77

commercial equipment

Alliance rotator improvement (HN)
 K6JVE p. 68, May 72

Alliance T-45 rotator improvement (HN)
 WA0VAM p. 64, Sep 71

Atlas 180, improved vfo stability (HN)
 K8KLO p. 73, Dec 77

Autek filter (HN)
 K8EVQ, WA6WZQ p. 83, May 79

CDR AR-22 rotator, fixing a sticky
 WA1ABP p. 34, Jun 71

Cleanup tips for amateur equipment (HN)
 Fisher p. 49, Jun 78

Clegg 27B, S-meter for (HN)
 WA2YUD p. 61, Nov 74

Collins KWM-2, updating
 W6SAI p. 48, Sep 79

Collins KWM-2/KWM-2A modifications (HN)
 W6SAI p. 80, Aug 76

Collins KWM2 transceivers, improved reliability (HN)
 W6SAI p. 81, Jun 77

Collins R390 rf transformers, repairing (HN)
 WA2SUT p. 81, Aug 76

Collins receivers, 300-Hz crystal filter for
 W1D7Y p. 58, Sep 75

300-Hz crystal filter for Collins receivers
 W1D7Y p. 58, Sep 75

300-Hz crystal filter for Collins receivers
 W1D7Y p. 58, Sep 75

300-Hz crystal filter for Collins receivers (letter)
 G3UFZ p. 90, Jan 78

Collins S-line, improved frequency readout for the
 W1GFC p. 53, Jun 76

Collins S-line backup power supply (HN)
 N1FB p. 78, Oct 79

Collins S-line monitoring (HN)
 N1FB p. 78, Aug 79

Collins S-line power supply mod (HN)
 W6IL p. 61, Jul 74

Collins S-line receivers, improved selectivity
 W6FR p. 36, Jun 76

Collins S-line, reducing warm-up drift
 W6VFR p. 46, Jun 75

Collins S-line, rf clipper for
 K6JYO p. 18, Aug 71
 Correction p. 80, Dec 71

Collins S-line spinner knob (HN)
 W6VFR p. 69, Apr 72

Collins S-line, syllabic vox system for
 W0P p. 29, Oct 77

Collins S-line transceiver mod (HN)
 W6VFR p. 71, Nov 72

Collins 32S-series ALC meter improvement (HN)
 W6FR p. 100, Nov 77

Collins 32S-3 audio (HN)
 K6KA p. 64, Oct 71

Collins 32S cooling (HN)
 N1FB p. 74, Nov 79

Collins 32S, improved stability for (HN)
 N1FB p. 83, May 79

Collins 32S-1 CW modification (HN)
 W1D7Y p. 82, Dec 69
 Correction p. 76, Sep 70

Collins 75S CW sidetone (HN)
 N1FB p. 93, Apr 79

Collins 32S-1, updating
 N1FB p. 76, Dec 78

Collins 51J, modifying for ssb reception
 W6SAI p. 66, Feb 78

Collins 51J product detector (letter)
 K5CE p. 6, Oct 78

Collins 51J PTO restoration
 W6SAI p. 36, Dec 69

Collins 516F-2 high-voltage regulation (HN)
 N1FB p. 85, Jun 79

Collins 516F-2 solid-state rectifiers (HN)
 N1FB p. 91, Feb 79

Collins 70E12 PTO repair (HN)
 W6B1H p. 72, Feb 77

Collins 70K-2 PTO, correcting
 mechanical backlash (HN)
 K9WEH p. 58, Feb 75

Collins 75A4 avc mod (letter)
 W9KNI p. 63, Sep 75

Collins 75A4 hints (HN)
 W6VFR p. 68, Apr 72

Collins 75A4, increased selectivity for (HN)
 W1D7Y p. 62, Nov 75

Collins 75A-4 modifications (HN)
 W4SD p. 67, Jan 71

Collins 75A4 noise limiter
 W1D7Y p. 43, Apr 76

Collins 75A4 PTO, making it perform like new
 W3AFM p. 24, Dec 74

Collins 75A-4 receiver, improving overload
 response in
 W6ZO p. 42, Apr 70
 Short circuit p. 76, Sep 70

Collins 75S frequency synthesizer
 W6NBI p. 8, Dec 75
 Short circuit p. 85, Oct 76

Collins 75S receiver, (HN)
 N1FB p. 94, Oct 78

Collins 75S-series crystal adapter (HN)
 K1KXA p. 72, Feb 77

Collins R-388(51J), inter-band
 calibration stability (HN)
 W5OZF p. 95, Sep 77

Collins R390A, improving the product detector
 W7DI p. 12, Jul 74

Collins R390A modifications
 WA2SUT p. 58, Nov 75

Collins R392, improved ssb reception with (HN)
 VE3LF p. 88, Jul 77

Comdel speech processor, increasing the versatility
 of (HN)
 W6SAI p. 67, Mar 71

Cornell-Dubilier rotators (HN)
 K6KA p. 82, May 75

Drake gear, simple tune-up (HN)
 W7DIM p. 79, Jan 77

Drake R-4 receiver frequency synthesizer for
 W6NBI p. 6, Aug 72
 Modification (letter) p. 74, Sep 74

Drake R4C backlash, cure for (HN)
 W3CVS p. 82, May 79

Drake R-4C, cleaner audio for (HN)
 K1FO p. 88, Nov 78

Drake R-4B and TR-4,
 split-frequency operation
 W8BJCQ p. 66, Apr 79

Drake R-4C, electronic bandpass tuning in
 Horner p. 58, Oct 73

Drake R-4C, new audio amplifier for
 W8JGP, K8RRH p. 48, Apr 79

Drake R-4C, new product detector for (HN)
 W8JGP p. 94, Oct 78

Drake TR-4, using the Shure 401A
 microphone with (HN)
 G3XOM p. 68, Sep 73

Drake TR-22C sensitivity improvement (HN)
 K7OR p. 78, Oct 79

Drake T-4X transmitters, improved tuning
 on 160 meters (HN)
 W1IBI, W1HZH p. 81, Jan 79

Elmac chirp and drift (HN)
 W5OZF p. 68, Jun 70

Feedline loss, calculating with a single
 measurement at the transmitter (HN)
 K9MM p. 96, Jun 78

Galaxy feedback (HN)
 WA5TFK p. 71, Jan 70

Genave transceivers, S-meter for (HN)
 K9OXX p. 80, Mar 77

Hallcrafters HT-37, improving
 W6NIF p. 78, Feb 79

Hallcrafters HT-37, increased sideband
 suppression p. 48, Nov 69

Ham-M modification (HN)
 W2TQK p. 72, May 76

Ham-M rotator automatic position control
 WB6GNM p. 42, May 77

Ham-M rotator torque loss (HN)
 W1JR p. 85, Jun 79
 Short circuit p. 92, Sep 79

Ham-3 rotator, digital readout for
 K1DG p. 56, Jan 79

Hammarlund HQ215, adding 160-meter coverage
 W2GKH p. 32, Jan 72

Heath HD-10 keyer, positive lead keying (HN)
 W4VAF p. 88, Nov 78

Heath HD-1982 Micoder for low-impedance operation
 Johnson, Wesley p. 86, May 78

Heath HG-10B vfo, independent keying of (HN)
 K4BRR p. 67, Sep 70

Heath HM-2102 wattmeter, better balancing (HN)
 VE6FM p. 56, Jan 75

Heath HM-2102 vhf wattmeter, high power
 calibration for (HN)
 W9TKR p. 70, Feb 76

Heath HM-2102 wattmeter mods (letter)
 K3VNR p. 64, Sep 75

Heath HO-10 as RTTY monitor scope (HN)
 K9HVW p. 70, Sep 74

Heath HR-2B external speaker and tone pad (HN) N1FB	p. 89, Nov 78	Heathkit SB-series equipment, heterodyne crystal switching (HN) K1KXA	p. 78, Mar 77	Swan 350, receiver incremental tuning (HN) K1KXA	p. 64, Jul 71
Heath HW-7 mods, keying and receiver blanking (HN) WA5KPG	p. 60, Dec 74	Heath ten-minute timer K6KA	p. 75, Dec 71	Swan 350 and 400, RTTY operation (HN) WB2MJC	p. 67, Aug 69
Heath HW-12 on MARS (HN) K8AUH	p. 63, Sep 71	Heathkit Sixer, spot switch (HN) WA6FNR	p. 84, Dec 69	Swan 250, update your (HN) K8ZHZ	p. 84, Dec 69
Heath HW-16 keying (HN) W7DI	p. 57, Dec 73	Heathkit, noise limiter for (HN) W7CKH	p. 67, Mar 71	Telefax transceiver conversion K0QMR	p. 16, Apr 74
Heath HW-16, low-impedance headphones for (HN) WN8WJR	p. 88, Jul 77	Heathkit HW202, fm channel scanner for W7BZ	p. 41, Feb 75	Ten-Tec Argonaut, accessory package for W7BBX	p. 26, Apr 74
Heath HW-16, vfo operations for WB6MZN	p. 54, Mar 73	Henry 2K4 and 3KA linears, electronic bias switching W1CBy	p. 75, Aug 78	Ten-Tec Horizon/2 audio modification (HN) WB9RKN	p. 79, Oct 79
Short circuit	p. 58, Dec 73	Hy-Gain 400 rotator, improved indicator system for W4PSJ	p. 60, May 78	Ten-Tec KR-20 keyer, stabilization of (HN) W3CRG	p. 69, Jul 76
Heath HW-17A, perking up (HN)	p. 70, Aug 70	HP-35 calculator, keyboard cleaning (HN) Anderson, Leonard H.	p. 40, Jul 78	Ten-Tec RX10 communicators receiver W1NLB	p. 63, Jun 71
Heath HW-17 modifications (HN) WA5PWX	p. 66, Mar 71	ICOM-22A wiring change (HN) K1KXA	p. 73, Feb 77	T150A frequency stability (HN) WB2MCP	p. 70, Apr 69
Heath HW-100, HW-101, grid-current monitor for K4MFR	p. 46, Feb 73	ICOM IC-22S, using below 146 MHz (HN) W11BI	p. 92, Apr 79	Yaesu sideband switching (HN) W2MUU	p. 56, Dec 73
Heath HW-100 incremental tuning (HN) K1GUU	p. 67, Jun 69	ICOM IC-230, adding splinter channels (HN) WA1OJX	p. 82, Sep 76	Yaesu spurious signals (HN) K6KA	p. 69, Dec 71
Heath HW-100 tuning knob, loose (HN) VE3EPY	p. 68, Jun 71	ICs, drilling template for (HN) WA4WDL, WB4LJM	p. 78, Mar 77	Units affected (letter)	p. 67, Oct 73
Heath HW-101 sidetone control (HN) A9QM	p. 79, Jul 79	Johnson Matchbox, improved K4IHV	p. 45, Jul 79	Yaesu FT101 clarifier (letter) K1NUN	p. 55, Nov 75
Heath HW-101, using with a separate receiver (HN) WA1MKP	p. 63, Oct 73	Short circuit	p. 92, Sep 79	Yaesu FT-227R memorizer, improved memory (HN) WA2DHF	p. 79, Aug 79
Heath HW-202, adding private-line WA8AWJ	p. 53, Jun 74	Kenwood TR7500, preprogrammed (HN) W9KNI	p. 95, Oct 78		
Heath HW-202, another look at the fm channel scanner for K7PYS	p. 68, Mar 76	Kenwood TS-520 CW filter modification W7ZZ	p. 21, Nov 75		
Heath HW-202 lamp replacement (HN) W5UNF	p. 83, Sep 76	Kenwood TS-520, TVI cure for (HN) W3FUN	p. 78, Jan 77		
Heath HW-2036 antenna socket (HN) W3HCE	p. 80, Jan 79	Knight-kit inverter/charger review W1D1TY	p. 64, Apr 69		
Heath HW2036; Lever action switch illumination (HN) W2IFR	p. 99, Jul 78	Knight-kit two-meter transceiver W1D1TY	p. 62, Jun 70		
Heath HW2036, outboard LED frequency display WB8TJL	p. 50, Jul 78	Measurements Corporation 59 grid-dip oscillator improvements W6GXN	p. 82, Nov 78		
Heath HW-2036, updating to the HW-2036A WB6TMH, WA6ODR	p. 62, Mar 79	Micro Mart RM terminal modification (HN) WA5VQK	p. 99, Jun 78		
Heath HWA-2036-3 crowbar circuit (HN) W3HCE	p. 88, Nov 78	Mini-mitter II W6SLQ	p. 72, Dec 71		
Heath IM-11 vtm, convert to IC voltmeter K6VCI	p. 42, Dec 74	Mini-mitter II modifications (HN) K1ETU	p. 64, Apr 76		
Heath intrusion alarm (HN) Rossman	p. 81, Jun 77	Motorola channel elements WB4NEX	p. 32, Dec 72		
Heath Micoder improvements W1OLP	p. 42, Nov 78	Motorola Dispatcher, converting to 12 volts WB6HXU	p. 26, Jul 72		
Heath Micoder matching (letter) WB8VUN	p. 8, Sep 78	Short circuit	p. 64, Mar 74		
Heath SB-100, using an outboard receiver with (HN) K4GMR	p. 68, Feb 70	Motorola fm receiver mods (HN) VE4RE	p. 60, Aug 71		
Heath SB-102 headphone operation (HN) K1KXA	p. 87, Oct 77	Motorola P-33 series, improving WB2AEB	p. 34, Feb 71		
Heath SB-102 modifications (HN) W2CNQ	p. 58, Jun 75	Motorola receivers, op-amp relay for W6GDO	p. 16, Jul 73		
Heath SB-102 modifications (HN) W2CNQ	p. 79, Mar 77	Motorola voice commander, improving W0DKU	p. 70, Oct 70		
Heath SB-102 modifications (HN) W2CNQ	p. 78, Mar 77	Motrac Receivers (letter) K5ZBA	p. 69, Jul 71		
Heath SB-102 modifications (letter) W1JE	p. 110, Mar 78	National NCL-2000, using the Drake T-4XC (HN) K5ER	p. 94, Jan 78		
Heath SB-102, rf speech processor for W6IVI	p. 38, Jun 75	Regency HR transceivers, signal-peaking indicator and generator for (HN) W8HVG	p. 68, Jun 76		
Heath SB-102, receiver incremental tuning for (HN) K1KXA	p. 81, Aug 76	Regency HR-2, narrowbanding WA8TMP	p. 44, Dec 73		
Heath SB-102, WWW on (HN) K1KXA	p. 78, Jan 77	Regency HR-212, channel scanner for WA05JK	p. 28, Mar 75		
Heath SB-200 amplifier modifying for the 8873 zero-bias triode W6UOV	p. 32, Jan 71	R-392 receiver mods (HN) KH6FOX	p. 65, Apr 76		
Heath SB-200 amplifier, six-meter conversion K1RAK	p. 38, Nov 71	SBE linear amplifier tips (HN) WA6DCW	p. 71, Mar 69		
Heath SB-200 CW modification K6YB	p. 99, Nov 77	SB301/401, Improved sidetone operation W1WLZ	p. 73, Oct 69		
Heath SB-303, 10-MHz coverage for (HN) W1JE	p. 61, Feb 74	Signal One review W1NLB	p. 56, May 69		
Heath SB-400 and SB-401, improving alc response in (HN) WA9FDQ	p. 71, Jan 70	Spurious causes (HN) K6KA	p. 66, Jan 74		
Heath SB-610 as RTTY monitor scope (HN) K9HVV	p. 70, Sep 74	Standard 826M, more power from (HN) WB6KVF	p. 68, Apr 75		
Heath SB-650 using with other receivers K2BYM	p. 40, Jun 73	Swan television interference: an effective remedy W2OUX	p. 46, Apr 71		
Heath SB receivers, RTTY reception with (HN) K9HVV	p. 64, Oct 71	Swan 160X birdie suppression (HN) W6SAI	p. 36, Oct 78		
Heath SB-series crystal control and narrow shift RTTY with (HN) WA4VYL	p. 54, Jun 73	Swan 250 Carrier suppression (HN) WB8LGA	p. 79, Oct 76		
Heathkit Micoder adapted to low-impedance input (HN) WB2GXF	p. 78, Aug 79	Swan 350, curing frequency drift WA6IPH	p. 42, Aug 79		
Heathkit HW-8, increased break-in delay (HN) K6YB	p. 84, Jun 79	Swan 350 CW monitor (HN) K1KXA	p. 63, Jun 72		
		Correction (letter)	p. 77, May 73		

construction techniques

AC line cords (letter) W6EG	p. 80, Dec 71
Aluminum tubing, clamping (HN) WA9HUV	p. 78, May 75
Anodize dyes (letter) W4MB	p. 6, Sep 79
Anodizing aluminum VE7DKR	p. 62, Jan 79
Comments, WA9UXK	p. 6, Nov 79
Antenna insulators, homemade (HN) W7ZC	p. 70, May 73
APC trimmer, adding shaft to (HN) W1ETT	p. 68, Jul 69
Blower-to-chassis adapter (HN) K6JYO	p. 73, Feb 71
BNC connectors, mounting (HN) W9KXJ	p. 70, Jan 70
Cabinet construction techniques W7KDM	p. 76, Mar 79
Capacitors, custom, now to make WB0ESV	p. 36, Feb 77
Capacitors, oil-filled (HN) W2OLU	p. 66, Dec 72
Center insulator, dipole WA1ABP	p. 69, May 69
Circuit boards with terminal inserts (HN) W3KBM	p. 61, Nov 75
Cleplead carousel (HN) WB1AQM	p. 79, Oct 79
Coaxial cable connectors (HN) WA1ABP	p. 71, Mar 69
Coax connectors, repairing broken (HN) W0HFK	p. 66, Jun 70
Coax relay coils, another use (HN) K0VQY	p. 72, Aug 69
Coils, self-supporting Anderson	p. 42, Jul 77
Cold galvanizing compound (HN) W5UNF	p. 70, Sep 72
Color coding parts (HN) WA7BPO	p. 58, Feb 72
Component marking (HN) W1JE	p. 66, Nov 71
Crystal switching, remote (HN) WA8YBT	p. 91, Feb 79
Drill guide (HN) W5BVF	p. 68, Oct 71
Drilling aluminum (HN) W6IL	p. 67, Sep 75
Enclosures, homebrew custom W4YUU	p. 50, July 74
Etch tank (HN) W3HUC	p. 79, Jan 77
Exploding diodes (HN) VE3FEZ	p. 57, Dec 73
Ferrite beads W5JJ	p. 48, Oct 70
Files, cleaning (HN) Walton	p. 66, Jun 74
Ferrite beads, how to use K1ORV	p. 34, Mar 73
Grounding (HN) W9KXJ	p. 67, Jun 69

Heat sinks, homemade (HN) WA0W0Z	p. 69, Sep 70
Homebrew art W0PEM	p. 56, Jun 69
Hot etching (HN) K8EKG	p. 66, Jan 73
Hot wire stripper (HN) W8DWT	p. 67, Nov 71
IC holders (HN) W3HUC	p. 80, Aug 76
IC lead former (HN) W5ICV	p. 67, Jan 74
Indicator circuit, LED WB6AFT	p. 60, Apr 77
Inductance, toroidal coil (HN) W3WLX	p. 26, Sep 75
Inductors, graphical aid for winding W7POG	p. 41, Apr 77
Lightning protection (letter) K9MM	p. 12, Dec 79
Magnetic fields and the 7360 (HN) W7DI	p. 66, Sep 73
Metalized capacitors (HN) W8YFB	p. 82, May 79
Metric conversions for screw and wire sizes W1DTY	p. 67, Sep 75
Microcircuits, visual aids for working on K9SRL	p. 90, Jul 78
Miniature sockets (HN) Lawyer	p. 84, Dec 69
Minibox, cutting down to size (HN) W2OUX	p. 57, Mar 74
Mobile installation, putting together W0FCH	p. 36, Aug 69
Mobile mount bracket (HN) W4NJF	p. 70, Feb 70
Modular converter, 144-MHz W6UOV	p. 64, Oct 70
Neutralizing tip (HN) Z6JP	p. 69, Dec 72
Noisy fans (HN) W8IUF	p. 70, Nov 72
Correction (letter) Nuvistor heat sinks (HN) WA0KCC	p. 67, Oct 73 p. 57, Dec 73
Parasitic suppressor (HN) WA9JMY	p. 80, Apr 70
Phone plug wiring (HN) N1FB	p. 85, Jun 79
Printed-circuit boards, cleaning (HN) W5BVF	p. 66, Mar 71
Printed-circuit boards, how to clean K2PMA	p. 56, Sep 76
Printed-circuit boards, how to make K4EEU	p. 58, Apr 73
Printed-circuit boards, low-cost W6CMQ	p. 44, Aug 71
Printed-circuit boards, low-cost W8YFB	p. 16, Jan 75
Printed-circuit boards, practical photofabrication of Hutchinson	p. 6, Sep 71
Printed-circuit labels (HN) WA4WDK	p. 76, Oct 70
PC layout using longhand WB9QZE	p. 26, Nov 78
Comments, W5TKP	p. 6, Jun 79
Printed-circuit standards (HN) W6JVE	p. 58, Apr 74
Printed-circuit tool (HN) W2GZ	p. 74, May 73
Printed-circuits, simple method for (HN) W4MTD	p. 51, Apr 78
Printed circuits without printing W4ZG	p. 62, Nov 70
Rack construction, a new approach K1EUJ	p. 36, Mar 70
Rectifier terminal strip (HN) W5PKK	p. 80, Apr 70
Rejuvenating transmitting tubes with Thoriated-tungsten filaments (HN) W6NIF	p. 80, Aug 78
Restoring panel lettering (HN) W8CL	p. 69, Jan 73
Screwdriver, adjustment (HN) WA0KGS	p. 66, Jan 71
Silver plating (letters) WA0AGD	p. 94, Nov 77
Silver plating made easy WA9HUV	p. 42, Feb 77
Soldering aluminum (HN) ZE6JP	p. 67, May 72
Soldering tip (HN) Lawyer	p. 68, Feb 70
Soldering tip cleaner (HN) W3HUC	p. 79, Oct 76
Soldering tips WA4MTH	p. 15, May 76

Thumbwheel switch modification (HN) VE3GDX	p. 56, Mar 74
Toroids, plug-in (HN) K8EEG	p. 60, Jan 72
Transfer letters (HN) WA2TGL	p. 78, Oct 76
Transformers, repairing W6NIF	p. 66, Mar 69
Trimmers (HN) W5LHG	p. 76, Nov 69
Uhf coax connectors (HN) W0LCP	p. 70, Sep 72
Uhf hardware (HN) W6CMQ	p. 76, Oct 70
Underwriter's knot (HN) W1DTY	p. 69, May 69
Vectorboard tool (HN) WA1KWJ	p. 70, Apr 72
Volume controls, noisy, temporary fix (HN) W9JUJ	p. 62, Aug 74
Watercooling the 2C39 K6MYC	p. 30, Jun 69
Wire-wound potentiometer repair (HN) W4ATE	p. 77, Feb 78
Wiring and grounding W1EZT	p. 44, Jun 69
Workbench, electronic W1EZT	p. 50, Oct 70

digital techniques

Basic rules and gates Anderson, Leonard H.	p. 76, Jan 79
Counters and weights Anderson, Leonard H.	p. 66, Aug 79
Digiscope WB0CLH	p. 50, Jun 79
Down counters Anderson, Leonard H.	p. 72, Sep 79
Flip-flop internal structure Anderson, Leonard H.	p. 86, Apr 79
Gate arrays for pattern generation Anderson, Leonard H.	p. 72, Oct 79
Gate structure and logic families Anderson, Leonard H.	p. 66, Feb 79
Multivibrators and analog input interfacing Anderson, Leonard H.	p. 78, Jun 79
Packet radio, introduction to VE2BEN	p. 64, Jun 79
Propagation delay and flip-flops Anderson, Leonard H.	p. 82, Mar 79
Self-gating the 82S90/74S196 decade counter (HN) W9LL	p. 82, May 79
Talking digital clock K9KV	p. 30, Oct 79

features and fiction

Alarm, burglar-proof (HN) Eisenbrandt	p. 56, Dec 75
Binding 1970 issues of ham radio (HN) W1DHZ	p. 72, Feb 71
Brass pounding on wheels K6QD	p. 58, Mar 75
Catalina wireless, 1902 W6BLZ	p. 32, Apr 70
Fire protection in the ham shack Darr	p. 54, Jan 71
First wireless in Alaska W6BLZ	p. 48, Apr 73
Hallcrafters history W6SAI	p. 20, Nov 79
Ham Radio sweepstakes winners, 1972 W1NLB	p. 58, Jul 72
Ham Radio sweepstakes winners, 1973 W1NLB	p. 68, Jul 73
Ham Radio sweepstakes winners, 1975 W1NLB	p. 54, Jul 75
Hellschreiber, a rediscovery PA0CX	p. 28, Dec 79
Jammer problem, solutions for UX3PU	p. 56, Apr 79
Comments	p. 6, Sep 79
Nostalgia with a vengeance W6HDM	p. 28, Apr 72
Photographic illustrations WA4GNW	p. 72, Dec 69
Reminiscences of old-time radio K4NW	p. 40, Apr 71

Ten commandments for technicians	p. 58, Oct 76
Use your old magazines Foster	p. 52, Jan 70
Wireless Point Loma W6BLZ	p. 54, Apr 69
1929-1941, the Golden years of amateur radio W6SAI	p. 34, Apr 76
1979 world administrative radio conference W6APW	p. 46, Feb 76

fm and repeaters

Amateur fm, close look at W2YE	p. 46, Aug 79
Antenna and control-link calculations for repeater licensing W7PUG	p. 58, Nov 73
Short circuit	p. 59, Dec 73
Antenna design for omnidirectional repeater coverage N9SN	p. 20, Sep 79
Antennas, simple, for two-meter fm WA3NFW	p. 30, May 73
Antenna, two-meter fm (HN) WB6KYE	p. 64, May 71
Antenna, 5/8-wavelength, two-meter K6KLO	p. 40, Jul 74
Antenna, 5/8 wavelength two-meter, build from CB mobile whips (HN) WB4WSU	p. 67, Jun 74
Automatically controlled access to open repeaters W8GRG	p. 22, Mar 74
Autopatch system for vhf fm repeaters W8GRG	p. 32, Jul 74
Base station, two-meter fm W9JTK	p. 22, Aug 73
Carrier-operated relay K0PHF, WA0UZO	p. 58, Nov 72
Carrier-operated relay and call monitor VE4RE	p. 22, Jun 71
Cavity filter, 144-MHz W1SNH	p. 22, Dec 73
Channel scanner W2FPP	p. 29, Aug 71
Channels, three from two (HN) VE7ABK	p. 68, Jun 71
Charger, fet-controlled for nicad batteries WA0JYK	p. 46, Aug 75
Collinear antenna for two meters, nine- element W6RJO	p. 12, May 72
Collinear array for two meters, 4-element WB6KGF	p. 6, May 71
Command function debugging circuit WA7HFY	p. 84, Jun 78
Continuous tuning for fm converters (HN) W1DHZ	p. 54, Dec 70
Control head, customizing VE7ABK	p. 28, Apr 71
Converting low-band mobile antenna to 144 MHz (HN) K7ARR	p. 90, May 77
Decoder, control function WA9FTH	p. 66, Mar 77
Detectors, fm, survey of W6GXN	p. 22, Jun 76
Deviation measurement (letter) K5ZBA	p. 68, May 71
Deviation measurements W3FQJ	p. 52, Feb 72
Deviation, measuring N6UE	p. 20, Jan 79
Deviation meter (HN) VE7ABK	p. 58, Dec 70
Digital scanner for 2-meter synthesizers K4GOK	p. 56, Feb 78
Digital touch-tone encoder for vhf fm W7FBB	p. 28, Apr 75
Discriminator, quartz crystal WA0JYK	p. 67, Oct 75
Distortion in fm systems W5JJ	p. 26, Aug 69
Encoder, combined digital and burst K8AUH	p. 48, Aug 69
European vhf-fm repeaters SM4GL	p. 80, Sep 76
External frequency programmer (HN) WB9VWM	p. 92, Apr 79
Filter, 455-kHz for fm WA0JYK	p. 22, Mar 72
Fm demodulator using the phase-locked loop KL7IPS	p. 74, Sep 78
Comments Anderson, Leonard H.	p. 6, Apr 79

Fm demodulator, TTL W3FQJ	p. 66, Nov 72	Preamplifier, two meter WA2GCF	p. 25, Mar 72	Single-frequency conversion, vhf/uhf W3FQJ	p. 62, Apr 75
Fm receiver frequency control (letter) W3AFN	p. 65, Apr 71	Preamplifier, two meter W8BBB	p. 36, Jun 74	Single-sideband fm, introduction to W3EJD	p. 10, Jan 77
Fm techniques and practices for vhf amateurs W6SAI	p. 8, Sep 69	Private call system for vhf fm WA6TTY	p. 62, Sep 77	Single-tone decoder WA2UMY	p. 70, Aug 78
Short circuit	p. 79, Jun 70	Private call system for vhf fm (HN) W9ZTK	p. 77, Feb 78	S-meter, audible, for repeaters ZL2AMJ	p. 49, Mar 77
Fm transmitter, solid-state two-meter W6AJF	p. 14, Jul 71	Private-line, adding to Heath HW-202 WA8AWJ	p. 53, Jun 74	S-meter for Clegg 27B (HN) WA2YUD	p. 61, Nov 74
Fm transmitter, Sonobaby, 2 meter WA0UZO	p. 8, Oct 71	Push-to-talk for Styline telephones W1DRP	p. 18, Dec 71	Solar powered repeater design WB5REA/WB5RSN	p. 28, Dec 78
Short circuit	p. 96, Dec 71	Receiver alignment techniques, vhf fm K4IPV	p. 14, Aug 75	Squelch-audio amplifier for fm receivers WB4WSU	p. 68, Sep 74
Crystal deck for Sonobaby	p. 26, Oct 72	Receiver for six and two meters, multichannel fm W1SNN	p. 54, Feb 74	Squelch circuit, another (HN) WB4WSU	p. 78, Oct 76
Folded whip antenna for vhf mobile — Weekender WB2IFV	p. 50, Apr 79	Receiver for two meter, fm W9SEK	p. 22, Sep 70	Squelch circuits for transistor radios WB4WSU	p. 36, Dec 75
Frequency meter, two-meter fm W4JAZ	p. 40, Jan 71	Short circuit	p. 72, Apr 71	Subaudible tone encoders and decoders W8GRG	p. 26, Jul 78
Short circuit	p. 72, Apr 71	Receiver isolation, fm repeater (HN) W1DTY	p. 54, Dec 70	Synthesized channel scanning WA0UZO	p. 68, Mar 77
Frequency synthesizer, inexpensive all-channel, for two-meter fm W00A	p. 50, Aug 73	Receiver, modular fm communications K8AUH	p. 32, Jun 69	Synthesized two-meter fm transceiver W1CMR, K11JZ	p. 10, Jan 76
Correction (letter)	p. 65, Jun 74	Correction	p. 71, Jan 70	Letter, W5GQV	p. 78, Sep 78
Frequency-synthesizer, one-crystal for two-meter fm W0MV	p. 30, Sep 73	Receiver, modular, for two-meter fm WA2GBF	p. 42, Feb 72	Synthesizer, 144 MHz, 800-channel K4VB, WA4GJT	p. 10, Jan 79
Frequency synthesizer, for two-meter fm WB4FPK	p. 34, Jul 73	Added notes	p. 73, Jul 72	Synthesizer, 144-MHz CMOS K9LHA	p. 14, Dec 79
Frequency synthesizer sidebands, filter reduces (HN) K1PCT	p. 80, Jun 77	Receiver performance, comparison of VE7ABK	p. 68, Aug 72	Telephone controller, automatic for your repeater K0PHF, WA0UZO	p. 44, Nov 74
Frequency synthesizers, 600 kHz offset for (HN) K6KLO	p. 96, Jul 78	Receiver performance of vacuum-tube vhf-fm equipment, how to improve W6GGV	p. 52, Oct 76	Telephone controller for remote repeater operation K0PHF, WA0UZO	p. 50, Jan 76
High performance vhf fm transmitter WA2GCF	p. 10, Aug 76	Receiver, tunable vhf fm K8AUH	p. 34, Nov 71	Precautions (letter)	p. 79, Apr 77
IC-230 modification (HN) W8PEY	p. 80, Mar 77	Receiver, vhf fm WA2GCF	p. 6, Nov 72	Test set for Motorola radios K0BKD	p. 12, Nov 73
Identifier, programmable repeater W6AYZ	p. 18, Apr 69	Receiver, vhf fm WA2GCF	p. 8, Nov 75	Short circuit	p. 58, Dec 73
Short circuit	p. 76, Jul 69	Receiver, vhf fm (letter) K8IHQ	p. 76, May 73	Added note (letter)	p. 64, Jun 74
I-f system, multimode WA2IKL	p. 39, Sep 71	Receivers, setup using hf harmonics (HN) K9MM	p. 89, Nov 78	Time-out warning indicator for fm repeater users K3NEZ	p. 62, Jun 76
Indicator, sensitive rf WB9DNI	p. 38, Apr 73	Relay, operational-amplifier, for Motorola receivers W6GDO	p. 16, Jul 73	Timer, simple (HN) W3CIX	p. 58, Mar 73
Interface problems, fm equipment (HN) W9DPY	p. 58, Jun 75	Remote base, an alternative to repeaters WA6LBV, WA6FVC	p. 32, Apr 77	Tone-alert decoder W8ZXH	p. 64, Nov 78
Interference, scanning receiver (HN) K2YAH	p. 70, Sep 72	Repeater channel spacing (letter) WB6JPI	p. 90, Jan 78	Tone-burst generator (HN) K4COF	p. 58, Mar 73
Logic oscillator for multi-channel crystal control W1SNN	p. 46, Jun 73	Repeater control with simple timers W2FPP	p. 46, Sep 72	Tone-burst generator for repeater accessing WA5KPG	p. 68, Sep 77
Magnet mount antenna, portable (HN) WB2YYU	p. 67, May 76	Correction	p. 91, Dec 72	Short circuit	p. 94, Feb 79
Mobile antenna, magnet-mount W1HCI	p. 54, Sep 75	Repeater decoder, multi-function WA6TBC	p. 24, Jan 73	Tone-burst keyer for fm repeaters W8GRG	p. 36, Jan 72
Mobile antennas, vhf, comparison of W4MNW	p. 52, May 77	Repeater installation W2FPP	p. 24, Jun 73	Tone encoder and secondary frequency oscillator (HN) K8AUH	p. 66, Jun 69
Mobile operation with the Touch-Tone pad W0LPQ	p. 58, Aug 72	Repeater jammers, tracking down W4MB	p. 56, Sep 78	Tone encoder, universal for vhf fm W6FUB	p. 17, Jul 75
Correction	p. 90, Dec 72	Repeater kerchunk eliminator WB6GTM	p. 70, Oct 77	Correction	p. 58, Dec 75
Modification (letter)	p. 72, Apr 73	Repeater linking, carrier-operated relay for K0PHF	p. 57, Jul 76	Tone generator, IC Ahrens	p. 70, Feb 77
Mobile rig, protecting from theft (C&T) W1DTY	p. 42, Apr 76	Repeater problems VE7ABK	p. 38, Mar 71	Tone generator, IC (HN) W6IPB	p. 88, Mar 79
Modulation standards for vhf fm W6TEE	p. 16, Jun 70	Repeater, receiving system degradation K5ZBA	p. 36, May 69	Touch-tone circuit, mobile K7QWR	p. 50, Mar 73
Monitor receivers, two-meter fm WB5EMJ	p. 34, Apr 74	Repeater transmitter, improving W6GDO	p. 24, Oct 69	Touch-tone decoder, IC W3QG	p. 26, Jul 78
Motorola channel elements WB4NEX	p. 32, Dec 72	Repeater shack temperature, remote checking ZL2AMJ	p. 84, Sep 77	Touch-tone decoder, multi-function K0PHF, WA0UZO	p. 14, Oct 73
Motorola fm receiver mods (HN) VE4RE	p. 60, Aug 71	Repeaters, single-frequency fm W2FPP	p. 40, Nov 73	Touch-tone decoder, three-digit W6AYZ	p. 37, Dec 74
Motorola P-33 series, improving the WB2AEB	p. 34, Feb 71	Reset timer, automatic W5ZHV	p. 54, Oct 74	Circuit board for Touch-tone encoder W3HB	p. 62, Sep 75
Motorola voice commander, improving W0DKU	p. 70, Oct 70	Satellite receivers for repeaters WA4YAK	p. 64, Oct 75	Touch-tone encoder W3HB	p. 41, Aug 77
Motrac receivers (letter) K5ZBA	p. 69, Jul 71	Scanner, two-channel, for repeater monitoring W8GRG	p. 48, Oct 76	Touch-tone hand-held K7YAM	p. 44, Sep 75
Multimode transceivers, fm-ing on uhf (HN) W6SAI	p. 98, Nov 77	Scanner, vhf receiver K2LZG	p. 22, Feb 73	Touch-tone handset, converting slim-line K2YAH	p. 23, Jun 75
Ni-cad charger, any-state WA6TBC	p. 66, Dec 79	Scanning receiver, improved for vhf fm WA2GCF	p. 26, Nov 74	Transceiver for two-meter fm, compact W6AOI	p. 36, Jan 74
Phase-locked loop, tunable, 28 and 50 MHz W1KNI	p. 40, Jan 73	Scanning receiver modifications, vhf fm WA5WOU	p. 60, Feb 74	Transmitter for two meters, phase-modulated W6AJF	p. 18, Feb 70
Phase modulation principles and techniques VE2BEN	p. 28, Jul 75	Scanning receivers for two-meter fm K4IPV	p. 28, Aug 74	Transmitter, two-meter fm W9SEK	p. 6, Apr 72
Correction	p. 59, Dec 75	Sequential encoder, mobile fm W3JJU	p. 34, Sep 71	Tunable receiver modification for vhf fm WB6VKY	p. 40, Oct 74
Power amplifier, rf 220-MHz fm K7JUE	p. 6, Sep 73	Sequential switching for Touch-Tone repeater control W8GRG	p. 22, Jun 71	Two-meter synthesizer, direct output WB2CPA	p. 10, Aug 77
Power amplifier, rf, 144 MHz Hatchett	p. 6, Dec 73	Repeater interference: some corrective actions W4MB	p. 54, Apr 78	Short circuit	p. 68, Dec 77
Power amplifier, rf, 144-MHz fm W4CGC	p. 6, Apr 73	Simple scope monitor for vhf fm W1RHN	p. 66, Aug 78	144-MHz synthesizer, direct output WB2CPA	p. 10, Aug 77
Power amplifier, two-meter fm, 10-watt W1DTY	p. 67, Jan 74			144-MHz synthesizer, direct output (letter) WB6JPI	p. 90, Jan 78
Power supply, regulated ac for mobile fm equipment WA8TMP	p. 28, Jun 73			Up/down repeater-mode circuit for two-meter synthesizers, 600 kHz WB4PHO	p. 40, Jan 77
Preamplifier for handi-talkies WB2IFV	p. 89, Oct 78			Short circuit	p. 94, May 77

Vertical antennas, truth about 5/8-wavelength	
K0DOK	p. 48, May 74
Added note (letter)	p. 54, Jan 75
Weather monitor receiver, retune to two-meter fm (HN)	
W3WTO	p. 56, Jan 75
Whip, 5/8-wave, 144 MHz (HN)	
VE3DDD	p. 70, Apr 73
144-MHz digital synthesizers, readout display	
WB4TZE	p. 47, Jul 76
144-MHz fm exciter, high performance	
WA2GCF	p. 10, Aug 76
144-MHz mobile antenna (HN)	
W2EUQ	p. 80, Mar 77
144-MHz vertical mobile antennas, 1/4 and 5/8 wavelength, test data on	
W2LTJ, W2CQH	p. 46, May 76
144-MHz, 5/8-wavelength vertical antenna	
W1RHN	p. 50, Mar 76
144-MHz 5/8-wavelength, vertical antenna for mobile	
K4LPQ	p. 42, May 76
144-MHz synthesizer, direct output	
WB2CPA	p. 10, Aug 77
144-MHz synthesizer, direct output (letter)	
WB6JPI	p. 90, Jan 78
220 MHz frequency synthesizer	
W6GXN	p. 8, Dec 74
450-MHz preamplifier and converter	
WA2GCF	p. 40, Jul 75

integrated circuits

Active filters	
K6JM	p. 70, Feb 78
Amplifiers, broadband IC	
W6GXN	p. 36, Jun 73
Applications, potpourri of IC	
W1DTY, Thorpe	p. 8, May 69
Audio-power ICs	
W3FQJ	p. 64, Jan 76
Balanced modulator, an integrated-circuit	
K7QWR	p. 6, Sep 70
Cmos logic circuits	
W3FQJ	p. 50, Jun 75
CMOS programmable divide-by-N counter (HN)	
W7BZ	p. 94, Jan 78
Counter gating sources	
K6KA	p. 48, Nov 70
Counter reset generator (HN)	
W3KBM	p. 68, Jan 73
C L logic circuit	
W1DTY	p. 4, Mar 75
Digital counters (letter)	
W1GGN	p. 76, May 73
Digital ICs, part I	
W3FQJ	p. 41, Mar 72
Digital ICs, part II	
W3FQJ	p. 58, Apr 72
Correction	p. 66, Nov 72
Digital mixers	
WB8IFM	p. 42, Dec 73
Digital multivibrators	
W3FQJ	p. 42, Jun 72
Digital oscillators and dividers	
W3FQJ	p. 62, Aug 72
Digital readout station accessory, part I	
K6KA	p. 6, Feb 72
Digital station accessory, part II	
K6KA	p. 50, Mar 72
Digital station accessory, part III	
K6KA	p. 36, Apr 72
Divide-by-n counters, high-speed	
W1OOP	p. 36, Mar 76
Electronic counter dials, IC	
K6KA	p. 44, Sep 70
Electronic keyer, cosmos IC	
WB2DFA	p. 6, Jun 74
Short circuit	p. 62, Dec 74
Emitter-coupled logic	
W3FQJ	p. 62, Sep 72
Exar XR-205 waveform generator as capacitance meter (HN)	
W6WR	p. 79, Jul 79
Flip-flops	
W3FQJ	p. 60, Jul 72
Flop-flip, using (HN)	
W3KBM	p. 60, Feb 72
Function generator, IC	
W1DTY	p. 40, Aug 71
Function generator, IC	
K4DHC	p. 22, Jun 74
Gain control IC for audio signal processing	
Jung	p. 47, Jul 77
IC arrays	
K6JM	p. 42, Sep 78

IC op amp update	
Jung, Walter	p. 62, Mar 78
IC power (HN)	
W3KBM	p. 68, Apr 72
IC tester, TTL	
WA4LCO	p. 66, Aug 76
Integrated circuits, part I	
W3FQJ	p. 40, Jun 71
Integrated circuits, part II	
W3FQJ	p. 58, Jul 71
Integrated circuits, part III	
W3FQJ	p. 50, Aug 71
I L logic circuits	
W1DTY	p. 4, Nov 75
Logic families, IC	
W6GXN	p. 26, Jan 74
Logic monitor (HN)	
WA5SAF	p. 70, Apr 72
Correction	p. 91, Dec 72
Logic test probe	
VE6RF	p. 53, Dec 73
Logic test probe (HN)	
Rossmann	p. 56, Feb 73
Short circuit	p. 58, Dec 73
Low-cost linear ICs	
WA7KRE	p. 20, Oct 69
Missent ID	
K6KA	p. 25, Apr 76
Modular modules	
W9SEK	p. 63, Aug 70
Multi-function integrated circuits	
W3FQJ	p. 46, Oct 72
National LM373, using in ssb transceiver	
W5BAA	p. 32, Nov 73
Op amp challenges the 741	
WA5SNZ	p. 76, Jan 78
Op amp (741) circuit design	
WA5SNZ	p. 26, Apr 76
Operational amplifiers	
WB2EGZ	p. 6, Nov 69
Phase-locked loops, IC	
W3FQJ	p. 54, Sep 71
Phase-locked loops, IC, experiments with	
W3FQJ	p. 58, Oct 71
Plessey SL600-series ICs, how to use	
G8FNT	p. 26, Feb 73
Removing ICs (HN)	
W6NIF	p. 71, Aug 70
Seven-segment readouts, multiplexed	
W5NPD	p. 37, Jul 75
Socket label for ICs (HN)	
WA4WDL, WB4LJM	p. 94, Jan 78
Ssb detector, IC (HN)	
K4ODS	p. 67, Dec 72
Correction (letter)	p. 72, Apr 73
Ssb equipment, using TTL ICs in	
G4ADJ	p. 18, Nov 75
Surplus ICs (HN)	
W4AYV	p. 68, Jul 70
Sync generator, IC, for ATV	
W0KGI	p. 34, Jul 75
Transceiver, 9-MHz ssb, IC	
G3ZVC	p. 34, Aug 74
Circuit change (letter)	p. 62, Sep 75
TTL oscillator (HN)	
WB6VZM	p. 77, Feb 78
TTL sub-series ICs, how to select	
WA1SNG	p. 26, Dec 77
U/ART, how it works	
Titus	p. 58, Feb 76
Using ICs with single-polarity power supplies	
W2EEY	p. 35, Sep 69
Using integrated circuits (HN)	
W9KXJ	p. 69, May 69
Voltage regulators	
W6GXN	p. 31, Mar 77
Voltage regulators, IC	
W7FLC	p. 22, Oct 70
Voltage-regulator ICs, adjustable	
WB9KEY	p. 36, Aug 75
Voltage-regulator ICs, three-terminal	
WB5EMI	p. 26, Dec 73
Added note (letter)	p. 73, Sep 74
Vtvm, convert to an IC voltmeter	
K6VCI	p. 42, Dec 74
555 timer operational characteristics	
WB6FOC	p. 32, Mar 79

keying and control

Accu-keyer speed readout	
K5MAT	p. 60, Sep 79
Accu-Mill, keyboard interface for the Accu-Keyer	
WN9OVY	p. 26, Sep 76

ASCII-to-Morse code translator	
Morley, Scharon	p. 41, Dec 76
Automatic beeper for station control	
WA6URN	p. 38, Sep 76
Biquad bandpass filter for CW	
N0DE	p. 70, Jun 79
Short circuit	p. 92, Sep 79
Comments	p. 6, Nov 79
Break-in circuit, CW	
W85YK	p. 40, Jan 72
Break-in control system, IC (HN)	
W9ZTK	p. 68, Sep 70
Bug, solid-state	
K2FV	p. 50, Jun 73
Carrier-operated relay	
K0PHF, WA0UZO	p. 58, Nov 72
CMOS keyer, simple	
HB9ABO	p. 70, Jan 79
Cmos keying circuits (HN)	
WB2DFA	p. 57, Jan 75
Code speed counter	
K8TT	p. 86, Feb 79
Constant pitch monitor for cathode or grid-block keyed transmitters (HN)	
K4GMR	p. 100, Sep 78
Contest keyer (HN)	
K2UBC	p. 79, Apr 70
Contest keyer, programmable	
W7BBX	p. 10, Apr 76
CW break-in, quieting amplifiers for	
W1DB	p. 46, Jan 79
CW operator's PAL	
W2YE	p. 23, Apr 79
CW reception, enhancing through a simulated-stereo technique	
WA1MKP	p. 61, Oct 74
CW regenerator for interference-free communications	
Leward, WB2EAX	p. 54, Apr 74
CW signal processor	
W7KGZ	p. 34, Oct 78
Comments, VE3CBJ	p. 6, Jun 79
CW sidetone (C&T)	
W1DTY	p. 51, Jun 76
Dasher	
KH6JF	p. 68, Mar 79
Deluxe memory keyer with 3072-bit capacity	
W3VT	p. 32, Apr 79
Short circuit	p. 92, Sep 79
Differential keying circuit	
W4IYB	p. 60, Aug 76
Electronic hand keyer	
K5TCK	p. 36, Jun 71
Electronic keyer	
OK3JA	p. 10, Apr 78
Electronic keyer, cosmos IC	
WB2DFA	p. 6, Jun 74
Short circuit	p. 62, Dec 74
Electronic keyer, IC	
VE7BFK	p. 32, Nov 69
Electronic keyer notes (HN)	
ZL1BN	p. 74, Dec 71
Electronic keyer package, compact	
W4ATE	p. 50, Nov 73
Electronic keyer with random-access memory	
WB9FHC	p. 6, Oct 73
Corrections (letter)	p. 58, Dec 74
	p. 57, Jun 75
	p. 76, Feb 77
	p. 62, Mar 75
Improvements (letter)	
Increased flexibility (HN)	
Electronic keyer, 8043 IC	
W6GXN	p. 8, Apr 75
Electronic keyers, simple IC	
WA5TRS	p. 38, Mar 73
End-of-transmission K generator	
G8KGV	p. 58, Oct 79
Grid-block keying, simple (HN)	
WA4DHU	p. 78, Apr 70
Improving transmitter keying	
K6KA	p. 44, Jun 76
Key and vox clicks (HN)	
K6KA	p. 74, Aug 72
Keyboard electronic keyer, the code mill	
W6CAB	p. 38, Nov 74
Keying, paddle, Siamese	
WASKPG	p. 45, Jan 75
Keyer modification (HN)	
W9KNI	p. 80, Aug 76
Comments	p. 94, Nov 77
Keyer mods, micro-TO	
DJ9RP	p. 68, Jul 76
Keyer paddle, portable	
WASKPG	p. 52, Feb 77
Keyer with memory (letter)	
Hansen, William	p. 6, Dec 79
Keying the Heath HG-10B vfo (HN)	
K4BRR	p. 67, Sep 70

Key toggle W6NRW	p. 50, Mar 79	Automatic noise-figure measurements		Electrolytic capacitors, measurement of (HN) W2NA	p. 70, Feb 71
Latch circuit, dc W0LPQ	p. 42, Aug 75	Repair Bench W6NBI	p. 40, Aug 78	Fm deviation measurement (letter) K5ZBA	p. 68, May 71
Correction WA7SCB	p. 58, Dec 75	Base step generator WB4YDZ	p. 44, Jul 76	Fm deviation measurements W3FQJ	p. 52, Feb 72
Memo-key WA7SCB	p. 58, Jun 72	Bridge for antenna measurements, simple W2CTK	p. 34, Sep 70	Fm frequency meter, two-meter W4JAZ	p. 40, Jan 71
Memory accessory, programmable for electronic keys WA9LUD	p. 24, Aug 75	Bridge, noise, for impedance measurements YA1GJM	p. 62, Jan 73	Short circuit K6KA	p. 72, Apr 71
Mini-paddle K6RIL	p. 46, Feb 69	Added notes	p. 66, May 74; p. 60, Mar 75	Frequencies, counted (HN) K6KA	p. 62, Aug 74
Morse generator, keyboard W7CUU	p. 36, Apr 75	Bridge, rf noise WB2EGZ	p. 18, Dec 70	Frequency calibrator, general coverage W5UQS	p. 28, Dec 71
Morse sounder, radio controlled (HN) K8QEQ	p. 66, Oct 71	Broadband reflectometer and power meter VK2ZTB, WB2ZZQ	p. 28, May 79	Frequency calibrator, how to design W3AEX	p. 54, Jul 71
Oscillators, electronic keyer WA6JNJ	p. 44, Jun 70	Calibrating ac scales on the vtvm, icvm and fet voltmeter W7KQ	p. 48, Sep 76	Frequency counter, miniature K5WKQ	p. 34, Oct 79
Paddle, electronic keyer (HN) KL7EVD	p. 68, Sep 72	Calibrator, plug-in IC K6KA	p. 22, Mar 69	Frequency counter, modify for direct counting to 100 MHz WA1SNG	p. 26, Feb 78
Paddle for electronic keys ZS6AL	p. 28, Apr 78	Capacitance measurements with a frequency counter — Weekender Moran, John	p. 62, Oct 79	Frequency counter, CMOS W2OKO	p. 22, Feb 77
Paddle, homebrew keyer W3NK	p. 43, May 69	Capacitance meter Mathieson, P. H.	p. 51, Feb 78	Short circuit K4JIU	p. 94, May 77
Programmable accessory for electronic keys (HN) K9WGN/W0USL	p. 81, Aug 78	Capacitance meter, digital K4DHC	p. 20, Feb 74	Frequency counter, front-ends for a 500-MHz K4JIU	p. 30, Feb 78
Push-to-talk for Styleline telephones W1DRP	p. 18, Dec 71	Capacitance meter, direct-reading ZL2AUE	p. 46, Apr 70	Frequency counter, how to improve the accuracy of W1RF	p. 26, Oct 77
RAM keyer update K3NEZ	p. 60, Jan 76	Capacitance meter, direct-reading W6MUR	p. 48, Aug 72	Frequency counter, high-impedance preamp and pulse shaper for I4YAF	p. 47, Feb 78
Relay activator (HN) K6KA	p. 62, Sep 71	Short circuit WA5SNZ	p. 32, Apr 75	Frequency counter, simple (HN) W2QBR	p. 81, Aug 78
Relays, surplus (HN) W2OLU	p. 70, Jul 70	Added note WA5SNZ	p. 31, Oct 75	Frequency counter, simplifying W1WP	p. 22, Feb 78
Relay, transistor replaces (HN) W3NK	p. 72, Jan 70	Capacitance meter, direct reading, for electrolytics W9DJZ	p. 14, Oct 71	Short circuit W6NBI	p. 94, Feb 79
Relays, undervoltage (HN) W2OLU	p. 64, Mar 71	Capacitance meter, simplified WA5SNZ	p. 78, Nov 78	Frequency counters, uhf and microwave W6NBI	p. 34, Sep 79
Remote keying your transmitter (HN) WA3HOU	p. 74, Oct 69	Coaxial cable, checking (letter) W2OLU	p. 68, May 71	Frequency counters, understanding and using W6NBI	p. 10, Feb 78
Reset timer, automatic W5ZHV	p. 54, Oct 74	Coaxial-line loss, measuring with a reflectometer W2VCI	p. 50, May 72	Frequency counters, high-sensitivity preamplifier for W1CFI	p. 80, Oct 78
Sequential switching (HN) W5OSF	p. 63, Oct 72	Continuity bleeper for circuit tracing G3SBA	p. 67, Jul 77	Frequency counter, 50 MHz, 6 digit WB2DFA	p. 18, Jan 76
Step-start circuit, high-voltage (HN) W6VFR	p. 64, Sep 71	Converter, mosfet, for receiver instrumentation WA9ZMT	p. 62, Jan 71	Comment W4IYB	p. 79, Apr 77
Suppression networks, arc (HN) WA5EKA	p. 70, Jul 73	Counter, compact frequency K4EEU	p. 16, Jul 70	Frequency measurement of received signals W4AAD	p. 44, Aug 77
Time base, calibrated electronic keyer W1PLJ	p. 39, Aug 75	Short circuit K4EEU	p. 72, Dec 70	Frequency measurement, vhf, with hf receiver and scaler (HN) W3LB	p. 90, May 77
Timer, ten-minute (HN) DJ9RP	p. 66, Nov 76	Counter gating sources K6KA	p. 48, Nov 70	Frequency meter, crystal controlled (HN) W5JSN	p. 71, Sep 69
Transistor switching for electronic keys (HN) W3QBO	p. 66, Jun 74	Counter readouts, switching (HN) K6KA	p. 66, Jun 71	Frequency scaler, divide-by-ten K4EEU	p. 26, Aug 70
Transmit/receive switch PIN diode W9KHC	p. 10, May 76	Counter reset generator (HN) W3KBM	p. 68, Jan 73	Short circuit W6PBC	p. 72, Apr 71
Typewriter-type electronic keys, further automation for W6PRO	p. 26, Mar 70	Counters: a solution to the readout problem WA0GOZ	p. 66, Jan 70	Frequency scaler, divide-by-ten W6PBC	p. 41, Sep 72
Vox, IC W2EEY	p. 50, Mar 69	CRT intensifier for RTTY K4VFA	p. 18, Jul 71	Correction Added comments (letter) Prescaler, improvements for W6PBC	p. 90, Dec 72 p. 64, Nov 73
Vox keying (HN) VE7IG	p. 83, Dec 69	Crystal checker W6GXN	p. 46, Feb 72	Frequency scaler, uhf (11C90) WB9KEY	p. 30, Oct 73 p. 50, Dec 75
Vox, versatile W9KIT	p. 50, Jul 71	Crystal test oscillator and signal generator K4EEU	p. 46, Mar 73	Frequency scaler, 500-MHz W6URH	p. 32, Jun 75
Short circuit W4OQ	p. 96, Dec 71	Crystal-controlled frequency markers (HN) WA4WDK	p. 64, Sep 71	Frequency scalars, 1200-MHz WB9KEY	p. 38, Feb 75
		Cubical quad measurements W4YM	p. 42, Jan 69	Frequency-shift meter, RTTY VK3ZNV	p. 33, Jun 70
		Decade standards, economical (HN) W4ATE	p. 66, Jun 71	Frequency standard (HN) WA7JIK	p. 69, Sep 72
		Deviation, measuring N6UE	p. 20, Jan 79	Frequency standard, universal K4EEU	p. 40, Feb 74
		Digital counters (letter) W1GGN	p. 76, May 73	Short circuit K2BLA	p. 72, May 74
		Digital readout station accessory, part I K6KA	p. 6, Feb 72	Frequency synthesizer, high-frequency W1DTY	p. 16, Oct 72
		Digital station accessory, part II K6KA	p. 50, Mar 72	Function generator, IC K4DHC	p. 40, Aug 71
		Digital station accessory, part III K6KA	p. 36, Apr 72	Function/units indicator using LED displays K8FOP	p. 22, Jun 74 p. 58, Mar 77
		Diode noise source for receiver noise measurements W6NBI	p. 32, Jun 79	Gallon-size dummy load W4MB	p. 74, Jun 79
		Diode tester W6DOB	p. 46, Jan 77	Gate-dip meter W3WLX	p. 42, Jun 77
		Dip-meter converter for VLF W4YOT	p. 26, Aug 79	Grid-dip meter, no-cost W8YFB	p. 87, Feb 78
		Dummy load and rf wattmeter, low-power W2OLU	p. 56, Apr 70	Grid-dip oscillator, solid-state conversion of W6AJZ	p. 20, Jun 70
		Dummy load low-power vhf WB9DNI	p. 40, Sep 73	Harmonic generator (HN) W5GDQ	p. 76, Oct 70
		Dummy loads W4MB	p. 40, Mar 76	I-f alignment generator 455-kHz WA5SNZ	p. 50, Feb 74
		Dynamic transistor tester (HN) VE7ABK	p. 65, Oct 71		

measurements and test equipment

Absorption measurements, using your signal generator for W2OUX	p. 79, Oct 76
Ac current monitor (letter) WB5MAP	p. 61, Mar 75
AC power-line monitor W2OLU	p. 46, Aug 71
AFSK generator, crystal-controlled K7BVT	p. 13, Jul 72
AFSK generator, phase-locked loop K7ZOF	p. 27, Mar 73
A-m modulation monitor, vhf (HN) K7UNL	p. 67, Jul 71
Antenna bridge calculations Anderson, Leonard H.	p. 34, May 78
Antenna bridge calculations (letter) W5OJR	p. 6, May 78
Antenna gain, measuring K6JYO	p. 26, Jul 69
Antenna matcher W4SD	p. 24, Jun 71
Antenna and transmission line measurement techniques W4OQ	p. 36, May 74

I-f sweep generator K4DHC	p. 10, Sep 73	Prescaler, 1-GHz, for frequency counters W6NBI	p. 84, Sep 78	Swr indicator, aural, for the visually handicapped K6HTM	p. 52, May 76
Impedance bridge (HN) W6KZK	p. 67, Feb 70	Probe, sensitive rf (HN) W5JJ	p. 61, Dec 74	Swr indicator, how to use (repair bench) W6NBI	p. 66, Jan 77
Impedance bridge, low-cost RX W8YFB	p. 6, May 73	Q measurement G3SBA	p. 49, Jan 77	Swr measuring at high frequencies DJ2LR	p. 34, May 79
Impedance bridge measurement errors and corrections K4KJ	p. 22, May 79	Radio Shack meters, internal resistance Katzenberger	p. 94, Nov 77	Swr meter W6VSV	p. 6, Oct 70
Impedance, measuring with swr bridge WB4KSS	p. 46, May 75	Reflectometers K1YZW	p. 65, Dec 69	Swr meter WB6AFT	p. 68, Nov 78
Impulse generator, pulse-snap diode Siegal, Turner	p. 29, Oct 72	Regenerative detectors and a wideband amplifier W8YFB	p. 61, Mar 70	Swr meter, improving (HN) W5NPD	p. 68, May 76
Intermodulation-distortion measurements on ssb transmitters W6VFR	p. 34, Sep 74	Repairs, thinking your way through Allen	p. 58, Feb 71	Swr meters, direct reading and expanded scale WA4WDK	p. 28, May 72
L, C, R bridge, universal W6AOI	p. 54, Apr 76	Resistance standard, simple (HN) W2OLU	p. 65, Mar 71	Correction W6KNE	p. 90, Dec 72
Linearity meter for ssb amplifiers W4MB	p. 40, Jun 76	Resistance values below 1 ohm, measuring W4OHT	p. 66, Sep 77	Tester for 6146 tubes (HN) W6KNE	p. 81, Aug 78
Line-voltage monitor (HN) WA8VFK	p. 66, Jan 74	Resistance values below 1 ohm, measuring (letter) W1PT	p. 91, Jan 78	Test probe accessory (HN) W2IMB	p. 89, Jul 77
Current monitor mod (letter) Logic monitor (HN) WA5SAF	p. 61, Mar 75	Resistance values, measuring below 1 ohm W4OHT	p. 66, Sep 77	Testing power tubes K4IPV	p. 60, Apr 78
Correction Logic probe K9CW	p. 70, Apr 72	Resistor decades, versatile W4ATE	p. 66, Jul 71	Time-base oscillators, improved calibration WA7LUJ, WA7KMR	p. 70, Mar 77
Logic test probe VE6RF	p. 91, Dec 72	Rf current readout, remote (HN) W4ATE	p. 87, May 78	Time-domain reflectometry, experimenter's approach to WA0PIA	p. 22, May 71
Logic test probe (HN) Rossman	p. 53, Dec 73	Rf detector, sensitive WB9DNI	p. 38, Apr 73	Toroid permeability meter WB9JO	p. 46, Jun 77
Short circuit Meter amplifiers, calibrating W4OHT	p. 56, Feb 73	Rf power meter, low-level W5WGF	p. 58, Oct 72	Transconductance tester for fet's W6NBI	p. 44, Sep 71
Meter amplifier, electronic WA9HUV	p. 58, Dec 73	Rf signal generator, solid-state VE5FP	p. 42, Jul 70	Transistor and diode tester ZL2AMJ	p. 65, Nov 70
Meter interface, high-impedance Laughlin	p. 80, Sep 78	Rf wattmeter, accurate low power WA4ZRP	p. 38, Dec 77	Transistor curve tracer WA9LCX	p. 52, Jul 73
Meters, testing unknown (HN) W1ONC	p. 38, Dec 76	RTTY monitor scope, solid-state WB2MPZ	p. 33, Oct 71	Short circuit Transistor tester, shirt pocket W0MAY	p. 63, Apr 74
Microwave marker generator, 3cm band (HN) WA4WDL	p. 20, Jan 74	RTTY signal generator W7ZTC	p. 23, Mar 71	Transmitter tuning unit for the blind W9NTP	p. 40, Jul 76
Milliammeters, how to use W4PSJ	p. 66, Jan 71	Short circuit RTTY test generator (HN) W3EAG	p. 96, Dec 71	Trapezoidal monitor scope VE3CUS	p. 60, Jun 71
Monitorscope, miniature WA3FIY	p. 69, Jun 76	RTTY test generator (HN) W3EAG	p. 67, Jan 73	Turn-off timer for portable equipment W5OXD	p. 22, Dec 69
Monitorscope, RTTY W3CIX	p. 48, Sep 75	RTTY test generator WB9ATW	p. 59, Mar 73	TVI locator W6BD	p. 42, Sep 76
Multi-box (HN) W3KBM	p. 34, Mar 69	RX impedance bridge W2CTK	p. 64, Jan 78	Uhf tuner tester for tv sets (HN) Schuler	p. 24, Aug 78
Multiplexed counter displays (HN) K1XX	p. 36, Aug 72	RX impedance bridge, low-cost W8YFB	p. 34, Sep 70	Vacuum tubes, testing high-power (HN) W2OLU	p. 73, Sep 69
Multitester (HN) W1DTY	p. 68, Jul 69	RX noise bridge, improvements to W6BXI, W6NKU	p. 6, May 73	Vhf prescaler W8CHK	p. 64, Mar 72
Noise bridge, antenna (HN) K8EEG	p. 87, May 78	Comments Noise bridge construction (letter) OH2ZAZ	p. 100, Sep 77	Vhf pre-scaler, improvements for W6PBC	p. 92, Jun 78
Noise bridge calculations with TI 58/59 calculators WD4GRI	p. 63, May 71	Safer suicide cord (HN) K6JYO	p. 8, Sep 78	Voltage calibrator for digital voltmeters W6NBI	p. 30, Oct 73
Noise figure measurements W6NBI	p. 71, May 74	Sampling network, rf — the milli-tap W6QJW	p. 64, Mar 71	Short circuit Voltmeter calibrator, precision Woods, Hubert	p. 66, Jul 78
Comments WB5LHV, W6NBI	p. 45, May 78	Signal generator, tone modulated for two and six meters WA8OIK	p. 34, Jan 73	Vom/vtvm, added uses for (HN) W7DI	p. 94, Feb 79
Noise-figure measurements for vhf WB6NMT	p. 40, Aug 78	Signal generator, wide range W6GXN	p. 54, Nov 69	VSWR bridge, broadband power-tracking K1ZDI	p. 67, Jan 73
Noise figure, vhf, estimating WA9HUV	p. 6, Aug 79	Slotted line, how to use (repair bench) W6NBI	p. 18, Dec 73	VSWR indicator, computing WB9CYY	p. 72, Aug 79
Noise generator, 1296-MHz W3BSV	p. 36, Jun 72	Slow-scan tv test generator K4EEU	p. 58, May 77	Short circuit Vtvm modification W6HPH	p. 58, Jan 77
Oscillator, audio W6GXN	p. 42, Jun 75	Spectrum analyzer, dc-100 MHz W6URH	p. 6, Jul 73	Vtvm, convert to an IC voltmeter K6VCI	p. 94, May 77
Oscillator, frequency measuring W6IEL	p. 46, Aug 73	Short circuit Short circuit Spectrum analyzer for ssb W3JW	p. 69, Dec 77	Wavemeter, indicating W6NIF	p. 42, Dec 74
Added notes Oscillator, two-tone, for ssb testing W6GXN	p. 50, Feb 73	Spectrum analyzer for ssb W3JW	p. 94, Feb 79	Short circuit Weak-signal source, stable, variable-output K6JYO	p. 26, Dec 70
Oscilloscope calibrator (HN) K4EEU	p. 16, Apr 72	Spectrum analyzer, four channel W9IA	p. 24, Jul 77	Weak-signal source, 144 and 432 MHz K6JC	p. 72, Apr 71
Oscilloscope, putting it to work Allen	p. 90, Dec 72	Spectrum analyzer, microwave N6TX	p. 6, Oct 72	WWV receiver, simple regenerative WA5SNZ	p. 36, Sep 71
Oscilloscope, troubleshooting amateur gear with Allen	p. 11, Apr 72	Spectrum analyzer tracking generator W6URH	p. 34, Jul 78	WWV-WWWVH, amateur applications for W3FQJ	p. 58, Mar 70
Oscilloscope voltage calibrator W6PBC	p. 69, Jul 69	Spectrum analyzers, understanding WA5SNZ	p. 30, Apr 78	WWVB signal processor W9BTI	p. 42, Apr 73
Peak envelope power, how to measure W5JJ	p. 64, Sep 69	Ssb, signals, monitoring W6VFR	p. 50, Jun 74	Zener tester, low-voltage (HN) K3DPJ	p. 53, Jan 72
Phase meter, rf VE2AYU, Korth	p. 52, Aug 69	Sweep generator, how to use Allen	p. 35, Mar 72	1.5 GHz prescaler, divide by 4 N6JH	p. 28, Mar 76
Power meter, rf K8EEG	p. 54, Aug 72	Sweep response curves for low-frequency i-f's Allen	p. 60, Apr 70		p. 72, Nov 69
Power meter, rf, how to use (repair bench) W6NBI	p. 32, Nov 74	Switch-off flasher (HN) Thomas	p. 56, Mar 71		p. 88, Dec 78
Pre-scaler, vhf (HN) W6MGI	p. 26, Oct 73	Swr bridge WB2ZSH	p. 64, Jul 71		
Prescaler, vhf, for digital frequency counters K4GOK	p. 26, Oct 73	Swr bridge and power meter, integrated W6DOB	p. 55, Oct 71		
	p. 44, Apr 77	Swr bridge (HN) WA5TFK	p. 40, May 70		
	p. 57, Feb 73	Swr bridge readings (HN) W6FPO	p. 66, May 72		
	p. 32, Feb 76		p. 63, Aug 73		

microprocessors, computers and calculators

Accumulator I/O versus memory I/O
WB4HYJ, Rony, Titus p. 64, Jun 76

CW keyboard, Microprocessor controlled
WB2DFA p. 81, Jan 78

CW trainer/keystroke using a single-chip microcomputer
N6TY p. 16, Aug 79

Data converters
WA1MOP p. 79, Oct 77

Decision, how does a microcomputer make a
WB4HYJ, Titus, Rony p. 74, Aug 76

Device-select pulses, generating input/output
WB4HYJ, Titus, Rony p. 44, Apr 76

Digital keyboard entry system
N2YK/N2GW p. 92, Sep 78

How microprocessors fit into scheme of
computers and controllers
WB4HYJ, Rony, Titus p. 36, Jan 76

IC tester using the KIM-1
W3GUL p. 74, Nov 78

Input/output device, what is a?
WB4HYJ, Rony, Titus p. 50, Feb 76

Interfacing a digital multimeter with
an 8080-based microcomputer
WB4HYJ, Rony, Titus p. 66, Sep 76

Interfacing a 10-bit DAC (Microprocessors)
Rony, Titus, WB4HYJ p. 66, Apr 78

Internal registers, 8080
Rony, Titus, WB4HYJ p. 63, Feb 77

Interrupts, microcomputer
WB4HYJ, Rony, Titus p. 66, Dec 76

Introduction to microprocessors
WB4HYJ, Rony, Titus
Comments, WB4FAR p. 32, Dec 75
p. 63, May 76

Logical instructions
Titus, WB4HYJ, Rony p. 83, Jul 77

MOV and MVI 8080 instructions
Titus, WB4HYJ, Rony p. 74, Mar 77

Register pair instruction
Rony, Titus, WB4HYJ p. 76, Jun 77

Software UART, interfacing a
WB4HYJ, Rony, Titus p. 60, Nov 76

Substitution of software for hardware
WB4HYJ, Rony, Titus p. 62, Jul 76

UART, how it works
Titus p. 58, Feb 76

Vectored interrupts
WB4HYJ, Rony, Titus p. 74, Jan 77

Video display, simple
VK3AOH p. 46, Dec 78

8080 logical instructions
WB4HYJ, Rony, Titus p. 89, Sep 77

8080 microcomputer output instructions
WB4HYJ, Rony, Titus p. 54, Mar 76

miscellaneous technical

Active bandpass filters
WB6GRZ p. 49, Dec 77
Short circuit p. 94, Feb 79

Admittance, impedance and circuit analysis
Anderson p. 76, Aug 77
Short circuit p. 94, Feb 79

Alarm, wet basement (HN)
W2EMF p. 68, Apr 72

Antenna masts, design for pipe
W3MR p. 52, Sep 74
Added design notes (letter)
p. 75, May 75

Antennas and capture area
K6MIO p. 42, Nov 69

Bandpass filter design
K4KJ p. 36, Dec 73

Bandpass filters for 50 and 144 MHz, etched
W5KHT p. 6, Feb 71

Bandpass filters, single-pole
W6HPH p. 51, Sep 69

Bandpass filters, top-coupled
Anderson p. 34, Jun 77

Bandspreeding techniques for resonant circuits
Anderson p. 46, Feb 77
Short circuits p. 69, Dec 77

Batteries, selecting for portable equipment
WB0AIK p. 40, Aug 73

Bipolar-fet amplifiers
W6HDM p. 16, Feb 76
Comments, Worcester p. 76, Sep 76

Broadband amplifier, bipolar
WB4KSS p. 58, Apr 75

Broadband amplifier uses mospower fet
Oxner p. 32, Dec 76

Broadband amplifier, wide-range
W6GXN p. 40, Apr 74

Bypassing, rf, at uhf
WB6BHI p. 50, Jan 72

Calculator-aided circuit analysis
Anderson p. 38, Oct 77

Calculator, hand-held electronic, its
function and use
W4MB p. 18, Aug 76

Calculator, hand-held electronic,
solving problems with it
W4MB p. 34, Sep 76

Capacitors, oil-filled (HN)
W2OLU p. 66, Dec 72

Clock, 24-hour digital
K4ALS p. 51, Apr 70
Short circuit p. 76, Sep 70

Coil-winding data, vhf and uhf
K3SVC p. 6, Apr 71

Communications receivers, designing
for strong-signal performance
Moore p. 6, Feb 73

Commutating filters
W6GXN p. 54, Sep 79

Computer-aided circuit analysis
K1ORV p. 30, Aug 70

Contact bounce eliminators (letters)
W7IV p. 94, Nov 77

Crystal filters, monolithic
DK1AG p. 28, Nov 78

Digital clock, low-cost
WA6DYW p. 26, Feb 76

Digital mixer, introduction
WB8IFM p. 42, Dec 73

Digital readout system, simplified
W6OIS p. 42, Mar 74

Double-balanced modulator, broadband
WA6NCT p. 8, Mar 70

Earth currents (HN)
W7OUI p. 80, Apr 70

Effective radiated power (HN)
VE7CB p. 72, May 73

Electrical units: their derivation and history
WB8EYV p. 30, Aug 76

Electrolytic capacitors, re-forming
the oxide layer (HN)
K9MM p. 99, Jul 78

Ferrite beads
W5JJ p. 48, Oct 70

Ferrite beads, how to use
K1ORV p. 34, Mar 73

Fet biasing
W3FQJ p. 61, Nov 72

Field-strength meter and volt-ohmmeter
WB6AFT p. 70, Feb 79

Filter preamplifiers for 50 and 144
MHz, etched
W5KHT p. 6, Feb 71

Filters, active for direct-conversion receivers
W7ZOI p. 12, Apr 74

Fire extinguishers (letter)
W5PGG p. 68, Jul 71

Fire protection
Darr p. 54, Jan 71

Fire protection (letter)
K7QCM p. 62, Aug 71

Fm techniques
W6SAI p. 8, Sep 69
Short circuit p. 79, Jun 70

Four-quadrant curve tracer/analyzer
W1QXS p. 46, Feb 79

Frequency counter as a synthesizer
DJ2LR p. 44, Sep 77

Freon danger (letter)
WA5RTB p. 63, May 72

Frequency-lock loop
WA3ZKZ p. 17, Aug 78

Frequency multipliers
W6GXN p. 6, Aug 71

Frequency multipliers, transistor
W6AJF p. 49, Jun 70

Frequency synchronization for scatter-mode
propagation
K2OVS p. 26, Sep 71

Frequency synthesis
WA5SKM p. 42, Dec 69

Frequency synthesizer, high-frequency
K2BLA p. 16, Oct 72

Frequency synthesizer sidebands, filter
reduces (HN)
K1PCT p. 80, Jun 77

Frequency synthesizers, how to design
DJ2LR p. 10, Jul 76
Short circuit p. 85, Oct 76

Gamma-matching networks, how to design
W7ITB p. 46, May 73

Glass semiconductors
W1EZT p. 54, Jul 69

Graphical network solutions
W1NCK, W2CTK p. 26, Dec 69

Gridded tubes, vhf-uhf effects
W6UOV p. 8, Jan 69

Grounding and wiring
W1EZT p. 44, Jun 69

Ground plow
W1EZT p. 64, May 70

Gyrator: a synthetic inductor
WB9ATW p. 96, Jun 78

Harmonic generator, crystal-controlled
W1KNI p. 66, Nov 77

Harmonic output, how to predict
Utne p. 34, Nov 74

Heatsink problems, how to solve
WA5SNZ p. 46, Jan 74

Hf synthesizer, higher resolution for
N4ES p. 34, Aug 78

Hybrids and couplers, hf
W2CTK p. 57, Jul 70
Short circuit p. 72, Dec 70

Hydroelectric station, amateur
K6WX p. 50, Sep 77

Impedance bridge measurement
errors and corrections
K4KJ p. 22, May 79

Impedance-matching systems, designing
W7CSD p. 58, Jul 73

Impedance measurements using an SWR meter
K4QF p. 80, Apr 79

Inductors, how to use ferrite and
powdered-iron for
W6GXN p. 15, Apr 71
Correction p. 63, May 72

Infrared communications (letter)
K2OAW p. 65, Jan 72

Injection lasers (letter)
Mims p. 64, Apr 71

Injection lasers, high power
Mims p. 28, Sep 71

Integrated circuits, part I
W3FQJ p. 40, Jun 71

Integrated circuits, part II
W3FQJ p. 58, Jul 71

Integrated circuits, part III
W3FQJ p. 50, Aug 71

Interference, hi-fi (HN)
K6KA p. 63, Mar 75

Interference problems, how to solve
ON4UN p. 93, Jul 78

Interference, rf
W1DTY p. 12, Dec 70

Interference, rf (letter)
G3LLL p. 65, Nov 75

Interference, rf
WA3NFW p. 30, Mar 73

Interference, rf, coaxial connectors can generate
W1DTY p. 48, Jun 76

Interference, rf, its cause and cure
G3LLL p. 26, Jun 75

Intermittent voice operation of power
tubes
W6SAI p. 24, Jan 71

Isotropic source and practical antennas
K6FD p. 32, May 70

Laser communications
W4KAE p. 28, Nov 70

LC circuit calculations
W2OUX p. 68, Feb 77

LED experiments
W4KAE p. 6, Jun 70

Lightning protection for the amateur station
K9MM p. 18, Dec 78
Comments
W6RTK, WB2FBL p. 6, Jul 79

Lighthouse tubes for uhf
W6UOV p. 27, Jun 69

Local-oscillator waveform effects
on spurious mixer responses
Robinson, Smith p. 44, Jun 74

Lowpass filters for solid-state linear amplifiers
WA0JYK p. 38, Mar 74
Short circuit p. 62, Dec 74

L-networks, how to design
W7LR p. 26, Feb 74
Short circuit p. 62, Dec 74

Lunar-path nomograph
WA6NCT p. 28, Oct 70

Marine installations, amateur, on small boats
W3MR p. 44, Aug 74

Matching networks, how to design
Anderson, Leonard H. p. 44, Apr 78

Matching techniques, broadband, for
transistor rf amplifiers
WA7WHZ p. 30, Jan 77

Microprocessors, introduction to
WB4HYJ, Rony, Titus p. 32, Dec 75

Microwave rf generators, solid-state
W1HR p. 10, Apr 77

Microwaves, getting started in
Roubal p. 53, Jun 72

Microwaves, Introduction
W1CBBY p. 20, Jan 72

ICs, digital, basics	
W3FQJ	p. 41, Mar 72, p. 58, Apr 72
ICs, digital flip-flops	
W3FQJ	p. 60, Jul 72
ICs, digital multivibrators	
W3FQJ	p. 42, Jun 72
ICs, digital, oscillators and dividers	
W3FQJ	p. 62, Aug 72
Interference, hi-fi	
G3LLL	p. 26, Jun 75
Interference, radio frequency	
WA3NFW	p. 30, Mar 73
Man-made interference, how to find	
W1DTY	p. 12, Dec 70
Meters, how to use	
W4PSJ	p. 48, Sep 75
Morse code, speed standards for	
VE2ZK	p. 58, Apr 73
Mosfet circuits	
W3FQJ	p. 50, Feb 75
Preamplifier, 21 MHz	
WA5SNZ	p. 20, Apr 72
Printed-circuit boards, how to make your own	
K4EEU	p. 58, Apr 73
Printed-circuit boards, low cost	
W8YFB	p. 16, Jan 75
Q factor, understanding	
W5JJ	p. 16, Dec 74
Radio communications links, basics of	
W1EZT	p. 44, Oct 69
Receiver frequency calibrator	
W5UQS	p. 28, Dec 71
Receiver, regenerative for WWV	
WA5SNZ	p. 42, Apr 73
Receivers, direct-conversion	
W3FQJ	p. 59, Nov 71
Rectifiers, improved half-wave	
Bailey	p. 34, Oct 73
Safety in the ham shack	
Darr	p. 44, Mar 69
Semiconductors, charge flow in	
WB6BIH	p. 50, Apr 71
Semiconductor diodes, evaluating	
W5JJ	p. 52, Dec 71
S-meters, circuits for	
K6SDX	p. 20, Mar 75
Speaker intelligibility, improving	
WA5RAQ	p. 53, Aug 70
Swr bridge	
WB2ZSH	p. 55, Oct 71
Towers and rotators	
K6KA	p. 34, May 76
Transistor power dissipation, how to determine	
WN9CGW	p. 56, Jun 71
Transmitter keying, improving	
K6KA	p. 44, Jun 76
Transmitter, low-power, 80-meter	
W3FQJ	p. 50, Aug 75
Transmitter, multiband low power with vfo	
K8EEG	p. 39, Jul 72
Transmitter power levels	
WA5SNZ	p. 62, Apr 71
Troubleshooting, basic	
James	p. 54, Jan 76
Troubleshooting by voltage measurements	
James	p. 64, Feb 76
Troubleshooting, resistance measurements	
James	p. 58, Apr 76
Troubleshooting, thinking your way through	
Allen	p. 58, Feb 71
Tuneup, off-the-air	
W4MB	p. 40, Mar 76
Underground coaxial transmission line, how to install	
W0FCH	p. 38, May 70
Vertical antennas, improving efficiency	
K6FD	p. 54, Dec 74
Vfo for 40 and 80 meters	
W3QBO	p. 36, Aug 70
Vfo, stable solid-state	
K4BGF	p. 8, Dec 71
Wiring and grounding	
W1EZT	p. 44, Jun 69
Workbench, electronics	
W1EZT	p. 50, Oct 70

operating

Beam antenna headings	
W6FFC	p. 64, Apr 71
Code practice stations (letter)	
WB4LXJ	p. 75, Dec 72
Code practice (HN)	
W20UX	p. 74, May 73
Computers and ham radio	
W5TOM	p. 60, Mar 69

CW monitor	
W2EZY	p. 46, Aug 69
CW monitor, simple	
WA9OHR	p. 65, Jan 71
CW transceiver operation with transmit-receive offset	
W1DAX	p. 56, Sep 70
DXCC check list, simple	
W2CNO	p. 55, Jun 73
Fluorescent light, portable (HN)	
K8BYO	p. 62, Oct 73
Great-circle charts (HN)	
K6KA	p. 62, Oct 73
Great-circle maps	
N5KR	p. 24, Feb 79
Identification timer (HN)	
K9UQN	p. 60, Nov 74
Magazines, use your old	
Foster	p. 52, Jan 70
Morse code, speed standards for	
VE2ZK	p. 68, Apr 73
Added note (letter)	
Protective material, plastic (HN)	
W6BKX	p. 58, Dec 70
Replays, instant (HN)	
W6DNS	p. 67, Feb 70
Sideband location (HN)	
K6KA	p. 62, Aug 73
Spurious signals (HN)	
K6KA	p. 61, Nov 74
Tuning with ssb gear	
W0KD	p. 40, Oct 70
Zulu time (HN)	
K6KA	p. 58, Mar 73

oscillators

AFC circuit for VFOs	
K6EHV	p. 19, Jun 79
Audio oscillator, NE566 IC	
W1EZT	p. 36, Jan 75
Blocking oscillators	
W6GXN	p. 45, Apr 69
Clock oscillator, TTL (HN)	
W9ZTK	p. 56, Dec 73
Colpitts oscillator design technique	
WB6BPI	p. 78, Jul 78
Short circuit	
p. 94, Feb 79	
Crystal oscillator, frequency adjustment of	
W9ZTK	p. 42, Aug 72
Crystal oscillator, high stability	
W6TNS	p. 36, Oct 74
Crystal oscillators	
W6GXN	p. 33, Jul 69
Crystal oscillator, simple (HN)	
W20UX	p. 98, Nov 77
Crystal oscillators, stable	
DJ2LR	p. 34, Jun 75
Correction	
p. 67, Sep 75	
Crystal oscillators, survey of	
VK2ZTB	p. 10, Mar 76
IC crystal controlled oscillators (letter)	
W7KCC	p. 91, Jan 78
Crystal oven, simple (HN)	
Mathieson	p. 66, Apr 76
Crystal ovens, precision temperature control	
K4VA	p. 34, Feb 78
IC crystal controlled oscillators	
VK2ZTB	p. 10, Mar 76
Crystal switching (HN)	
K6LZM	p. 70, Mar 69
Crystal test oscillator and signal generator	
K4EEU	p. 46, Mar 73
Crystals, overtone (HN)	
G8ABR	p. 72, Aug 72
Drift-correction circuit for free running oscillators	
PA0KSB	p. 45, Dec 77
Goral oscillator notes (HN)	
K5QIN	p. 66, Apr 76
Hex inverter vxo circuit	
W2LTJ	p. 50, Apr 75
Local oscillator, phase locked	
VE5FP	p. 6, Mar 71
Monitoring oscillator	
W2JIO	p. 36, Dec 72
Multiple band master-frequency oscillator	
K6SDX	p. 50, Nov 75
Multivibrator, crystal-controlled	
WN2MQY	p. 65, Jul 71
Noise sideband performance in oscillators, evaluating	
DJ2LR	p. 51, Oct 78
Oscillator, audio, IC	
W6GXN	p. 50, Feb 73

Oscillator, electronic keyer	
WA6JNJ	p. 44, Jun 70
Oscillator, Franklin (HN)	
W5JJ	p. 61, Jan 72
Oscillator, frequency measuring	
W6IEL	p. 16, Apr 72
Added notes	
p. 90, Dec 72	
Oscillator, gated (HN)	
WB9KEY	p. 59, Jul 75
Oscillator-monitor, audio	
WA1JSM	p. 48, Sep 70
Oscillator, phase-locked	
VE5FP	p. 6, Mar 71
Oscillator, two-tone, for ssb testing	
W6GXN	p. 11, Apr 72
Oscillators (HN)	
W1DTY	p. 68, Nov 69
Oscillators, cure for cranky (HN)	
W8YFB	p. 55, Dec 70
Oscillators, repairing	
Allen	p. 69, Mar 70
Oscillators, resistance-capacitance	
W6GXN	p. 18, Jul 72
Overtone crystal oscillators without inductors	
WA5SNZ	p. 50, Apr 78
Quadrature-phased local oscillator (letter)	
K6ZX	p. 62, Sep 75
Quartz crystals (letter)	
WB2EGZ	p. 74, Dec 72
Regulated power supplies, designing	
K5VKO	p. 58, Sep 77
Stable vfo (C&T)	
W1DTY	p. 51, Jun 76
TTL crystal oscillators (HN)	
W0JVA	p. 60, Aug 75
TTL oscillator (HN)	
WB6VZW	p. 77, Feb 78
UHF local-oscillator chain	
N6TX	p. 27, Jul 79
Vco, crystal-controlled	
WB6IOM	p. 58, Oct 69
Versatile audio oscillator (HN)	
W7BBX	p. 72, Jan 76
Vfo buffer amplifier (HN)	
W3QBO	p. 66, Jul 71
Vfo design, stable	
W1CER	p. 10, Jun 76
Vfo design using characteristic curves	
I2BVZ	p. 36, Jun 78
Regulated power supplies, designing	
K5VKO	p. 58, Sep 77
Vfo, digital readout	
WB8IFM	p. 14, Jan 73
Vfo for solid-state transmitters	
W3QBO	p. 36, Aug 70
Vfo, high stability	
W8YFB	p. 14, Mar 69
Vfo, high-stability, vhf	
OH2CD	p. 27, Jan 72
Vfo, multiband fet	
K8EEG	p. 39, Jul 72
Vfo, stable	
K4BGF	p. 8, Dec 71
Vfo transistors (HN)	
W1OOP	p. 74, Nov 69
Vxo design, practical	
K6BIJ	p. 22, Aug 70
Voltage-tuned mosfet oscillator	
WA9HUV	p. 26, Mar 79
1-MHz oscillator, new approach	
WA2SPI	p. 46, Mar 79
5-ampere power supply, adjustable	
N1JR	p. 50, Dec 78

power supplies

AC current monitor (letter)	
WB5MAP	p. 61, Mar 75
AC power supply, regulated, for mobile fm equipment	
WA8TMP	p. 28, Jun 73
Adjustable 5-ampere supply	
N1JR	p. 50, Jan 79
All-mode-protected power supply	
K2PMA	p. 74, Oct 77
Arc suppression networks (HN)	
WA5EKA	p. 70, Jul 73
Batteries, selecting for portable equipment	
WA0AIK	p. 40, Aug 73
Battery drain, auxiliary, guard for (HN)	
W1DTY	p. 74, Oct 74
Battery power	
W3FQJ	p. 56, Aug 74
Charger, fet-controlled, for nicad batteries	
WA0JYK	p. 46, Aug 75

Constant-current battery charger for portable operation
K5PA p. 34, Apr 78

Converter, 12 to 6 volt (C&T)
W1DTY p. 42, Apr 76

Current limiting (HN)
W8LPQ p. 70, Dec 72

Current limiting (letter)
K5MKO p. 66, Oct 73

Dc-dc converter, low-power
W5MLY p. 54, Mar 75

Dc power supply, regulated (C&T)
W1DTY p. 51, Jun 76

Diode surge protection (HN)
WA7LUJ p. 65, Mar 72
Added note p. 77, Aug 72

Dry-cell life
W1DTY p. 41, Apr 76

Dual-voltage power supply (HN)
W1OOP p. 71, Apr 69
Short circuit p. 80, Aug 69

Dual-voltage power supply (HN)
W5JJ p. 68, Nov 71

Filament transformers, miniature
Bailey p. 66, Sep 74

High-current regulated dc supply
N8AKS p. 50, Aug 79

IC power (HN)
W3KBM p. 68, Apr 72

IC power supply, adjustable (HN)
W3HB p. 95, Jan 78

IC regulated power supply
W2FBW p. 50, Nov 70

IC regulated power supply
W9SEK p. 51, Dec 70

Instantaneous-shutdown high-current regulated supply
W6GB p. 81, Jun 78

Klystrons, reflex power for (HN)
W6BPK p. 71, Jul 73

Line-voltage monitor (HN)
WABVFK p. 66, Jan 74
Current monitor mod (letter) p. 61, Mar 75

Load protection, scr (HN)
W5OZF p. 62, Oct 72

Low-value voltage source (HN)
WA5EKA p. 66, Nov 71

Low-voltage dc power supplies — Repair Bench
K4IPV p. 38, Oct 79

Low voltage, variable bench power supply (weekender)
W6NBI p. 58, Mar 76

Mobile power supplies, troubleshooting
Allen p. 56, Jun 70

Mobile power supply (HN)
WN8DJV p. 79, Apr 70

Mobile supply, low-cost (HN)
W4GEG p. 69, Jul 70

Motorola Dispatcher, converting to 12 volts
WB6HXU p. 26, Jul 72

Nicad battery care (HN)
W1DHZ p. 71, Feb 76

Ni-cad charger, any-state
WA6TBC p. 66, Dec 79

Nickel-cadmium batteries, time-current charging
W1OLP p. 32, Feb 79

Operational power supply
WA2IKL p. 8, Apr 70

Overvoltage protection (HN)
W1AAZ p. 64, Apr 76

Pilot-lamp life (HN)
W2OLU p. 71, Jul 73

Polarity inverter, medium current
Laughlin p. 26, Nov 73

Power supplies for single sideband
Belt p. 38, Feb 69

Power-supply hum (HN)
W8YFB p. 64, May 71

Power supply, improved (HN)
W4ATE p. 72, Feb 72

Power supply, precision
W7SK p. 26, Jul 71

Power supply protection for your solid-state circuits
W5JJ p. 36, Jan 70
W4IPV p. 78, Sep 77

Protection voltage supply for phase-locked terminal unit (HN)
WA6TLA p. 60, Jul 74

Protection for solid-state power supplies (HN)
W3NK p. 66, Sep 70

Rectifier, half-wave, improved
Bailey p. 34, Oct 73

Regulated power supplies, how to design
K5VKQ p. 58, Sep 77

Regulated power supplies, designing (letter)
W9HFR p. 110, Mar 78

Regulated power supply, 500-watt
WA6PEC p. 30, Dec 77
Short circuit p. 94, Feb 79

Regulated solid-state high-voltage power supply
W6GXN p. 40, Jan 75
Short circuit p. 69, Apr 75

Regulated 5-volt supply (HN)
W6LNF p. 67, Jan 73

SCR-regulated power supplies
W4GOC p. 52, Jul 70

Selenium rectifiers, replacing
W1DTY p. 41, Apr 76

Servicing power supplies
W6GXN p. 44, Nov 76

Solar energy
W3FQJ p. 54, Jul 74

Solar power
W3FQJ p. 52, Nov 74

Solar power source, 36-volt
W3FQJ p. 54, Jan 77

Step-start circuit, high-voltage (HN)
W6VFR p. 63, Sep 71

Storage-battery QRP power
W3FQJ p. 64, Oct 74

Super regulator, the MPC1000
W3HUC p. 52, Sep 76

Survey of solid-state power supplies
W6GXN p. 25, Feb 70
Short circuit p. 76, Sep 70

Transformers, high-voltage, repairing
W6NIF p. 66, Mar 69

Transformers, miniature (HN)
W4ATE p. 67, Jul 72

Transient eliminator (C&T)
W1DTY p. 52, Jun 76

Transients, reducing
W5JJ p. 50, Jan 73

Variable high-voltage supply
W1OLP p. 62, Dec 79

Variable power supply for transistor work
WA4MTH p. 68, Mar 76

Variable-voltage power supply, 1.2 amps
WB6AFT p. 36, Jul 78

Vibrator replacement, solid-state (HN)
K8RAY p. 70, Aug 72

Voltage regulators, IC
W7FLC p. 22, Oct 70

Voltage-regulator ICs, adjustable
WB9KEY p. 36, Aug 75

Voltage-regulator ICs, three-terminal
WB5EMI p. 26, Dec 73
Added note (letter) p. 73, Sep 74

Voltage regulators, boosting bargain (HN)
WA7VVC p. 90, May 77

Voltage regulators, IC
W6GXN p. 31, Mar 77

Voltage safety valve
W2UVF p. 78, Oct 76

Wind generators
W3FQJ p. 50, Jan 75

propagation

Artificial radio aurora, scattering characteristics of
WB6KAP p. 18, Nov 74

Calculator-aided propagation predictions
N4UH p. 26, Apr 79
Comments p. 6, Sep 79

Echoes, long delay
WB6KAP p. 61, May 69

Ionospheric E-layer
WB6KAP p. 58, Aug 69

Ionospheric science, short history of
WB6KAP p. 58, Aug 69

Scatter-mode propagation, frequency synchronization for
K2OVS p. 26, Sep 71

Solar cycle 20, vhf'er's view of
WAS1YX p. 46, Dec 74

Sunspot numbers
WB6KAP p. 63, Jul 69

Sunspots and solar activity
WB6KAP p. 60, Jan 69

Tropospheric-duct vhf communications
WB6KAP p. 68, Oct 69

6-meter sporadic-E openings, predicting
WA9RAQ p. 38, Oct 72
Added note (letter) p. 69, Jan 74

receivers and converters

general

Antenna impedance transformer for receivers (HN)
W6NIF p. 70, Jan 70

Antenna tuner, miniature receiver (HN)
WA7KRE p. 72, Mar 69

Anti-QRM methods
W3FQJ p. 50, May 71

Attenuation pads, receiving (letter)
K0HNO p. 69, Jan 74

Audio agc amplifier
WA5SNZ p. 32, Dec 73

Audio agc principles and practice
WA5SNZ p. 28, Jun 71

Audio filter for CW, tunable
WA1JSM p. 34, Aug 70

Audio filter-frequency translator for CW reception
W2EEY p. 24, Jun 70

Audio filter mod (HN)
K6HIU p. 60, Jan 72

Audio filter, simple
W4NVK p. 44, Oct 70

Audio filters, CW (letter)
6Y5SR p. 56, Jun 75

Audio filters for ssb and CW reception
K6SDX p. 18, Nov 76

Audio-filters, inexpensive
W8YFB p. 24, Aug 72

Audio filter, tunable peak-notch
W2EEY p. 22, Mar 70

Audio filter, variable bandpass
W3AEX p. 36, Apr 70

Audio, improved for receivers
K7GCO p. 74, Apr 77

Audio module, complete
K4DHC p. 18, Jun 73

Bandspredding techniques for resonant circuits
Anderson p. 46, Feb 77
Short circuits p. 69, Dec 77

Bandspredding techniques for resonant circuits
Anderson, Leonard H. p. 46, Feb 77

Bandspredding techniques for resonant circuits (letter)
W0EJO p. 6, Aug 78

Bandspredding techniques (letter)
Anderson, Leonard H. p. 6, Jan 79

Batteries, how to select for portable equipment
WA0A1K p. 40, Aug 73

Bfo multiplexer for a multimode detector
WA3YGJ p. 52, Oct 75

Broadband jfet amplifiers
N6DX p. 12, Nov 79

Calibrator crystals (HN)
K6KA p. 66, Nov 71

Calibrator, plug-in frequency
K6KA p. 22, Mar 69

Calibrator, simple frequency-divider using mos ICs
W6GXN p. 30, Aug 69

Communications receivers, design ideas for
Moore p. 12, Jun 74

Communications receivers, designing for strong-signal performance
Moore p. 6, Feb 73

Converting a vacuum-tube receiver to solid-state
W1OOP p. 26, Feb 69

Counter dials, electronic
K6KA p. 44, Sep 70

Crystal-filter design, practical
PY2PEC p. 34, Nov 76

CW filter, adding (HN)
W2OUX p. 66, Sep 73

CW monitor, simple
WA9OHR p. 65, Jan 71

CW processor for communications receivers
W6NRW p. 17, Oct 71

CW reception, enhancing through a simulated-stereo technique
WA1MKP p. 61, Oct 74

CW reception, noise reduction for
W2ELV p. 52, Sep 73

CW regenerator for interference-free communications
Leward, Libenschek p. 54, Apr 74

CW selectivity with crystal bandpassing
W2EEY p. 52, Jun 69

CW transceiver operation with transmit-receive offset
W1DAX p. 56, Sep 70

Detector, reciprocating
W1SNN p. 32, Mar 72
Added notes p. 54, Mar 74; p. 76, May 75

Detector, single-signal phasing type
WB9CYY p. 71, Oct 76
Short circuit p. 68, Dec 77

Detector, superregenerative, optimizing
Ring p. 32, Jul 72

Detectors, fm, survey of
W6GXN p. 22, Jun 76

Digital display
N3FG p. 40, Mar 79
Comments p. 6, Jul 79

Digital frequency display
WB2NYK p. 26, Sep 76

Digital readout, universal
WB8IFM p. 34, Dec 78

Digital vfo basics
Earnshaw p. 18, Nov 78

Diode detectors
W6GXN p. 28, Jan 76
Comments p. 77, Feb 77

Direct-conversion receivers (HN)
YU2HL p. 100, Sep 78

Diversity receiving system
W2EY p. 12, Dec 71

Diversity reception
K4KJ p. 48, Nov 79

Double-balanced mixer, active, high-dynamic range
DJ2LR p. 90, Nov 77

Dynamic range, measuring
WB6CTW p. 56, Nov 79

Filter alignment
W7UC p. 61, Aug 75

Filter, vari-Q
W1SNN p. 62, Sep 73

Frequency calibrator, how to design
W3AEX p. 54, Jul 71

Frequency calibrator, receiver
W5UQS p. 28, Dec 71

Frequency-marker standard using cmos
W4IYB p. 44, Aug 77

Frequency measurement of received signals
W4AAD p. 38, Oct 73

Frequency spotter, general coverage
W5JJ p. 36, Nov 70

Frequency standard (HN)
WA7JK p. 69, Sep 72

Frequency standard, universal
K4EEU p. 40, Feb 74
Short circuit p. 72, May 74

Hang agc circuit for ssb and CW
W1ERJ p. 50, Sep 72

Headphone cords (HN)
W2OLU p. 62, Nov 75

I-f amplifier design
DJ2LR p. 10, Mar 77
Short circuit p. 94, May 77

I-f detector receiver module
K6SDX p. 34, Aug 76

I-f system, multimode
WA2IKL p. 39, Sep 71

I-f transformers, problems and cures —
Weekender
K4IPV p. 56, Mar 79

Image suppression (HN)
W6NIF p. 68, Dec 72

Intelligibility of communications receivers,
improving
WA5RAQ p. 53, Aug 70

Interference, electric fence
K6KA p. 68, Jul 72

Interference, hi-fi (HN)
K6KA p. 63, Mar 75

Interference, rf
W1DTY p. 12, Dec 70

Interference, rf
WA3NFW p. 30, Mar 73

Interference, rf, its cause and cure
G3LLL p. 26, Jun 75

Intermodulation distortion, reducing
in high-frequency receivers
WB4ZNV p. 26, Mar 77
Short circuit p. 69, Dec 77

Local oscillator, phase-locked
VE5FP p. 6, Mar 71

Local-oscillator waveform effects
on spurious mixer responses
Robinson, Smith p. 44, Jun 74

Mixer, crystal
W2LTJ p. 38, Nov 75

Monitor receiver modification (HN)
W2CNQ p. 72, Feb 76

Noise blanker
K4DHC p. 38, Feb 73

Noise Blanker
W5QJR p. 54, Feb 79

Noise blanker design
K7CVT p. 26, Nov 77

Noise blanker, hot-carrier diode
W4KAE p. 16, Oct 69
Short circuit p. 76, Sep 70

Noise blanker, IC
W2EY p. 52, May 69
Short circuit p. 79, Jun 70

Noise effects in receiving systems
DJ2LR p. 34, Nov 77

Noise figure, the real meaning of
K6MIO p. 26, Mar 69

Phase-locked 9-MHz bfo
W7GHH p. 49, Nov 78

Phaselocked up-converter
W7GHH p. 26, Nov 79

Phase-shift networks, design criteria
G3NRW p. 34, Jun 70

Power-line noise
K4TWJ p. 60, Feb 79

Preamplifier, wideband
W1AAZ p. 60, Oct 76

Product detector, hot-carrier diode
VE3GFN p. 12, Oct 69

Radio-direction finder
W6JTT p. 38, Mar 70

Radio-frequency interference
WA3NFW p. 30, Mar 73

Radiotelegraph translator and transcriber
W7CUU, K7KFA p. 8, Nov 71
Eliminating the matrix
KH6AP p. 60, May 72

Receiver spurious response
Anderson p. 82, Nov 77

Receivers — some problems and cures
WB&JGP, K8RRH p. 10, Dec 77
Ham notebook p. 94, Oct 78
Short circuit p. 94, Feb 79

Receiving RTTY, automatic frequency
control for
W5NPO p. 50, Sep 71

Reciprocating detector as fm discriminator
W1SNN p. 18, Mar 73

Reciprocating-detector converter
W1SNN p. 58, Sep 74

Resurrecting old receivers
K4IPV p. 52, Dec 76

Rf-agc amplifier, high-performance
WA1FRJ p. 64, Sep 78

Rf amplifiers for communications receivers
Moore p. 42, Sep 74

Rf amplifiers, isolating parallel currents in
G3IPV p. 40, Feb 77

Rf amplifier, wideband
WB4KSS p. 58, Apr 75

Selectivity and gain control, improved
VE3GFN p. 71, Nov 77

Selectivity, receiver (letter)
K4ZZV p. 68, Jan 74

Sensitivity, noise figure and dynamic range
W1DTY p. 8, Oct 75

Signals, how many does a receiver see?
DJ2LR p. 58, Jun 77
Comments p. 101, Sep 77

S-meters, solid-state
K6SDX p. 20, Mar 75

Spectrum analyzer, four channel
W9IA p. 6, Oct 72

Squelch, audio-actuated
K4MOG p. 52, Apr 72

Ssb signals, monitoring
W6VFR p. 36, Mar 72

Superhet tracking calculations
WA5SNZ p. 30, Oct 78

Superregenerative detector, optimizing
Ring p. 32, Jul 72

Superregenerative receiver, improved
JA1BHG p. 48, Dec 70

Threshold-gate/limiter for CW reception
W2ELV p. 46, Jan 72
Added notes (letter)
W2ELV p. 59, May 72

Troubleshooting the dead receiver
K4IPV p. 56, Jun 76

Vacuum-tube receivers, updating
W6HPH p. 62, Dec 78
Short circuit p. 73, Dec 79

Vlf converter (HN)
W3CPU p. 69, Jul 76

Weak signal reception in CW receivers
ZS6BT p. 44, Nov 71

Wideband amplifier summary
DJ2LR p. 34, Nov 79

WWW receiver, five-frequency
W6GXN p. 36, Jul 76

high-frequency receivers

Bandpass filters for receiver preselectors
W7ZOI p. 18, Feb 75

Bandpass tuning, electronic, in the Drake R-4C
Horner p. 58, Oct 73

BC-1206 for 7 MHz, converted
W4FIN p. 30, Oct 70
Short circuit p. 72, Apr 71

Collins receivers, 300-Hz crystal filter for
W1DTY p. 58, Sep 75

Collins receivers (letter)
G3UFZ p. 90, Jan 78

Collins 75A-4 hints (HN)
W6VFR p. 68, Apr 72

Collins 75A-4 modifications (HN)
W4SD p. 67, Jan 71

Communications receiver, five band
K6SDX p. 6, Jun 72

Communications receiver for 80
meters, IC
VE3ELP p. 6, Jul 71

Communications receiver, micropower
WB9FHC p. 30, Jun 73
Short circuit p. 58, Dec 73

Communications receivers, miniature
design ideas for
K4DHC p. 18, Apr 76

Communications receiver, miniaturized
K4DHC p. 24, Sep 74

Communications receiver, optimum design for
DJ2LR p. 10, Oct 76

Communications receiver, solid-state
I5TDJ p. 32, Oct 75
Correction p. 59, Dec 75

Companion receiver, all-mode
W1SNN p. 18, Mar 73

Converter, hf, solid-state
VE3GFN p. 32, Feb 72

Converter, tuned very low-frequency
OH2KT p. 49, Nov 74

Converter, very low frequency receiving
W2IMB p. 24, Nov 76

Crystal-controlled phase-locked converter
W3VF p. 58, Dec 77

Digitally programmable high-frequency
communications receiver
WA9HUV p. 10, Oct 78
Comments p. 6, Apr 79

Direct-conversion receivers
W3FQJ p. 59, Nov 71

Direct-conversion receivers
PA0SE p. 44, Nov 77

Direct-conversion receivers, improved
selectivity
K6BIJ p. 32, Apr 72

Direct-conversion receivers,
simple active filters for
W7ZOI p. 12, Apr 74

Double-conversion hf receiver with
mechanical frequency readout
Poroio p. 26, Oct 76

Fet converter for 10 to 40 meters, second-
generation
VE3GFN p. 28, Jan 70
Short circuit p. 79, Jun 70

Frequency synthesized local-oscillator system
W7GHH p. 60, Oct 78

Frequency synthesizer for the Drake R-4
W6NBI p. 6, Aug 72
Modification (letter) p. 74, Sep 74

General coverage communications receiver
W6URH p. 10, Nov 77

Gonset converter, solid-state modification of
Schuler p. 58, Sep 69

Hammarlund HQ215, adding 160-meter
coverage
W2GHK p. 32, Jan 72

Heath SB-650 frequency display, using
with other receivers
K2BYM p. 40, Jun 73

High dynamic range receiver input stages
DJ2LR p. 26, Oct 75

High-frequency DX receiver
WB2ZVU p. 10, Dec 76

Incremental tuning to your
transceiver, adding
VE3GFN p. 66, Feb 71

Low-noise 30-MHz preamplifier
W1HR p. 38, Oct 78
Short circuit p. 94, Feb 79

Monitoring oscillator
W2JIO p. 36, Dec 72

Multiband high-frequency converter
K6SDX p. 32, Oct 76

Outboard receiver with the SB-100, using an (HN)
K4GMR p. 68, Feb 70

Overload response in the Collins 75A-4 receiver, improving
W6ZO p. 42, Apr 70
Short circuit p. 76, Sep 70

Phasing-type ssb receiver
WA0YK p. 6, Aug 73
Short circuit p. 58, Dec 73
Added note (letter) p. 63, Jun 74

Preamplifier, emitter-tuned, 21 MHz
WA5SNZ p. 20, Apr 72

Preamplifier, low-noise high-gain transistor
W2EY p. 66, Feb 69

Preselector, general-coverage (HN)
W5OZF p. 75, Oct 70

Q5er, solid-state
W5TKP p. 20, Aug 69

Receiver incremental tuning for the Swan 350 (HN)
K1KXA p. 64, Jul 71

Receiver, reciprocating detector
W1SNN p. 44, Nov 72
Correction (letter) p. 77, Dec 72

Receiver, versatile solid-state
W1PLJ p. 10, Jul 70

Receiving RTTY with Heath SB receivers (HN)
K9HVV p. 64, Oct 71

Reciprocating detector
W1SNN p. 68, Oct 78

Rf amplifiers, selective
K6BIJ p. 58, Feb 72

Regenerative detectors and a wideband amplifier for experimenters
W8YFB p. 61, Mar 70

RTTY monitor receiver
K4EEU p. 27, Dec 72

RTTY receiver-demodulator for net operation
VE7BRK p. 42, Feb 73

Swan 350 CW monitor (HN)
K1KXA p. 63, Jun 72

Synthesizer, high resolution hf (letter)
DJ2LR p. 6, Jan 79

Transceiver selectivity improved (HN)
VE3BWD p. 74, Oct 70

Tuner overload, eliminating (HN)
VE3GFN p. 66, Jan 73
Attenuators for (letter) p. 69, Jan 74

WWV receiver
Hudor, Jr. p. 28, Feb 77

WWV receiver, fixed-tuned
W6GXN p. 24, Nov 69

WWV receiver, regenerative
WA5SNZ p. 42, Apr 73

WWV receiver, simple (HN)
WA3JBN p. 68, Jul 70
Short circuit p. 72, Dec 70

WWV receiver, simple (HN)
WA3JBN p. 55, Dec 70

WWV-WWWVH, amateur applications for
W3FQJ p. 53, Jan 72

20-meter receiver with digital readout, part 1
K6SDX p. 48, Oct 77

20-meter receiver with digital readout, part 2
K6SDX p. 56, Nov 77

160-meter receiver, simple
W6FPO p. 44, Nov 70

1.9 MHz receiver
W3TNO p. 6, Dec 69

7-MHz direct-conversion receiver
W0YBF p. 16, Jan 77

7-MHz receiver
K6SDX p. 12, Apr 79

7-MHz ssb receiver and transmitter, simple
VE3GSD p. 6, Mar 74
Short circuit p. 62, Dec 74

432-MHz converter
N9KD p. 74, Apr 79

vhf receivers and converters

Converters for six and two meters, mosfet
WB2EGZ p. 41, Feb 71
Short circuit p. 96, Dec 71

Cooled preamplifier for vhf-uhf
WA0RDX p. 36, Jul 72

Filter-preamplifiers for 50 and 144 MHz etched
W5KNT p. 6, Feb 71

Fm channel scanner
W2FPP p. 29, Aug 71

Fm communications receiver, modular
K8AUH p. 32, Jun 69
Correction p. 71, Jan 70

Fm receiver frequency control (letter)
W3AFN p. 65, Apr 71

Fm receiver performance, comparison of
VE7ABK p. 68, Aug 72

Fm receiver, multichannel for six and two
W1SNN p. 54, Feb 74

Fm receiver, tunable vhf
K8AUH p. 34, Nov 71

Fm receiver, uhf
WA2GCF p. 6, Nov 72

Fm repeaters, receiving system degradation in
K5ZBA p. 36, May 69

HW-17A, parking up (HN)
WB2EGZ p. 70, Aug 70

Improving vhf/uhf receivers
W1JAA p. 44, Mar 76

Interdigital preamplifier and comb-line bandpass filter for vhf and uhf
W5KHT p. 6, Aug 70

Interference, scanning receiver (HN)
K2YAH p. 70, Sep 72

Monitor receivers, two-meter fm
WB5EMI p. 34, Apr 74

Overload problems with vhf converters, solving
W1OOP p. 53, Jan 73

Receiver alignment techniques, vhf fm
K4IPV p. 14, Aug 75

Receiver, modular two-meter fm
WA2GFB p. 42, Feb 72

Receiver, vhf fm
WA2GCF p. 8, Nov 75

Receiving converter, vhf four-band
W3TQM p. 64, Oct 76

Scanning receiver for vhf fm, improved
WA2GCF p. 26, Nov 74

Scanning receiver modifications, vhf fm (HN)
WA5WOU p. 60, Feb 74

Scanning receivers for two-meter fm
K4IPV p. 28, Aug 74

Six-meter converter, improved
K1BQT p. 50, Aug 70

Squelch-audio amplifier for fm receivers
WB4WSU p. 68, Sep 74

Ssb mini-tuner
K1BQT p. 16, Oct 70

Terminator, 50-ohm for vhf converters
WA6UAM p. 26, Feb 77

Vhf fm receiver (letter)
W8IHQ p. 76, May 73

Vhf receiver scanner
K2LZG p. 22, Feb 73

Vhf superregenerative receiver, low-voltage
WA5SNZ p. 22, Jul 73
Short circuit p. 64, Mar 74

28-30 MHz preamplifier for satellite reception
W1JAA p. 48, Oct 75

50-MHz preamplifier, improved
WA2GCF p. 46, Jan 73

144-MHz converter (HN)
K0QY p. 71, Aug 70

144-MHz converter (letter)
W0LER p. 71, Oct 71

144-MHz converter, hot-carrier diode
K8CJU p. 6, Oct 69

144-MHz converter, modular
W6UOV p. 64, Oct 70

144-MHz converters, choosing fets for (HN)
K6JYO p. 70, Aug 69

144-432 MHz GaAs fet preamp
JH1BRY p. 38, Nov 79

144-MHz preamp, low-noise
W1DTY p. 40, Apr 76

144-MHz preamp, super (HN)
K6HCP p. 72, Oct 69

144-MHz preamplifier, improved
WA2GCF p. 25, Mar 72
Added notes p. 73, Jul 72

220-MHz mosfet converter
WB2EGZ p. 28, Jan 69
Short circuit p. 76, Jul 69

432-MHz converter, low-noise
K6JC p. 34, Oct 70

432 MHz preamp (HN)
W1DTY p. 66, Aug 69

432 MHz preamplifier and converter
WA2GCF p. 40, Jul 75

1296-MHz converter, solid-state
VK4ZT p. 6, Nov 70

1296-MHz, double-balanced mixers for
WA6UAM p. 8, Jul 75

1296-MHz preamplifier
WA6UAM p. 42, Oct 75

1296-MHz preamplifier, low-noise
WA2VTR p. 50, Jun 71
Added note (letter) p. 65, Jan 72

2304-MHz converter, solid-state
K2JNG, WA2LTM, WA2VTR p. 16, Mar 72

2304-MHz preamplifier, solid-state
WA2VTR p. 20, Aug 72

receivers and converters, test and troubleshooting

Rf and i-f amplifiers, troubleshooting
Allen p. 60, Sep 70

Weak-signal source, variable-output
K6JYO p. 36, Sep 71

Weak-signal source, 144 and 432 MHz
K6JC p. 58, Mar 70

RTTY

Active bandpass filter for RTTY
WA4YY p. 46, Apr 79

AFSK, digital
WA4VOS p. 22, Mar 77
Short circuit p. 94, May 77

AFSK generator (HN)
F8KI p. 69, Jul 76

AFSK generator and demodulator
WB9ATW p. 26, Sep 77

AFSK generator, crystal-controlled
K7BVT p. 13, Jul 72

AFSK generator, crystal-controlled
W6LLO p. 14, Dec 73
Sluggish oscillator (letter) p. 59, Dec 74

Audio-frequency keyer, simple
W2LJT p. 56, Aug 75

Audio-frequency shift keyer
KH6FMT p. 45, Sep 76

Audio-frequency shift keyer, simple (C&T)
W1DTY p. 43, Apr 76

Audio-shift keyer, continuous-phase
VE3CTP p. 10, Oct 73
Short circuit p. 64, Mar 74

Automatic frequency control for receiving RTTY
W5NPO p. 50, Sep 71
Added note (letter) p. 66, Jan 72

Autostart, digital RTTY
K4EEU p. 6, Jun 73

Autostart monitor receiver
K4EEU p. 37, Dec 72

CRT intensifier for RTTY
K4VFA p. 18, Jul 71

Carriage return, adding to the automatic line-feed generator (HN)
K4EEU p. 71, Sep 74

Cleaning teleprinters (HN)
W8CD p. 86, May 78

Coherent frequency-shift keying, need for
K3WJQ p. 30, Jun 74
Added notes (letter) p. 58, Nov 74

Crystal test oscillator and signal generator
K4EEU p. 46, Mar 73

CW memory for RTTY identification
W6LLO p. 6, Jan 74

Digital reperfr/TD
WB9ATW p. 58, Nov 78

DT-500 demodulator
K9HVV, K4OAH, WB4KUR p. 24, Mar 76
Short circuit p. 85, Oct 76

DT-600 demodulator
K9HVV, K4OAH, WB4KUR p. 8, Feb 76
Letter, K5GZR p. 78, Sep 76
Short circuit p. 85, Oct 76

Dual demodulator terminal unit
KB9AT p. 74, Oct 78
Comments p. 6, Oct 79

Duplex audio-frequency generator with AFSK features
WB6AFT p. 66, Sep 79

Electronic speed conversion for RTTY teleprinters
WA6JYJ p. 36, Dec 71
Printed circuit for p. 54, Oct 72

Electronic teleprinter keyboard
W0PHY p. 56, Aug 78

Frequency-shift meter, RTTY
VK3ZNV p. 53, Jun 70

Line-end indicator, IC
W2OKO p. 22, Nov 75

Line feed, automatic for RTTY
K4EEU p. 20, Jan 73

Mainline ST-5 autostart and antispaces
K2YAH p. 46, Dec 72

Mainline ST-5 RTTY demodulator
W6FFC p. 14, Sep 70
Short circuit p. 72, Dec 70

Mainline ST-6 RTTY demodulator
W6FFC p. 6, Jan 71
Short circuit p. 72, Apr 71

Mainline ST-6 RTTY demodulator, more
uses for (letter)
W6FFC p. 69, Jul 71

Mainline ST-6 RTTY demodulator, troubleshooting
W6FFC p. 50, Feb 71

Message generator, random access memory
RTTY
K4EEU p. 8, Jan 75

Message generator, RTTY
W6QXP, W8KCCQ p. 30, Feb 74

Modulator-demodulator for vhf operation
W6LLO p. 34, Sep 78

Monitor scope, phase-shift
W3CIX p. 36, Aug 72

Monitor scope, RTTY, Heath
HO-10 and SB-610 as (HN)
K9HVV p. 70, Sep 74

Monitor scope, RTTY, solid-state
WB2MPZ p. 33, Oct 71

Performance and signal-to-noise ratio
of low-frequency shift RTTY
K6SR p. 62, Dec 76

Phase-coherent RTTY modulator
K5PA p. 26, Feb 79

Phase-locked loop AFSK generator
K7ZOF p. 27, Mar 73

Phase-locked loop RTTY terminal unit
W4FQM p. 8, Jan 72
Correction p. 60, May 72
Power supply for
Optimization of the phase-
locked terminal unit
Update, W4AYV p. 22, Sep 75
p. 16, Aug 76

Precise tuning with ssb gear
W0KD p. 40, Oct 70

Printed circuit for RTTY speed converter
W7POG p. 54, Oct 72

RAM RTTY message generator, increasing
capacity of (HN)
F2ES p. 86, Oct 77

Receiver-demodulator for RTTY net
operation
VE7BRK p. 42, Feb 73

Ribbon re-linkers
W6FFC p. 30, Jun 72

RTTY converter, miniature IC
K9MRL p. 40, May 69
Short circuit p. 80, Aug 69

RTTY distortion: causes and cures
WB6IMP p. 36, Sep 72

RTTY for the blind (letter)
VE7BRK p. 76, Aug 72

RTTY, introduction to
K6JFP p. 38, Jun 69

RTTY line-length indicator (HN)
W2UVF p. 62, Nov 73

RTTY reception with Heath SB receivers (HN)
K9HVV p. 64, Oct 71

Selcom
K9HVV, WB4KUR, K4EID p. 10, Jun 78

Serial converter for 8-level teleprinters
VE3CTP p. 67, Aug 77
Short circuit p. 68, Dec 77

Signal Generator, RTTY
W7ZTC p. 23, Mar 71
Short circuit p. 96, Dec 71

Simple circuit replaces jack patch panel
K4STE p. 25, Apr 76

Speed control, electronic, for RTTY
W3VF p. 50, Aug 74

ST-5 keys polar relay (HN)
W0LPD p. 72, May 74

Swan 350 and 400 equipment on RTTY (HN)
WB2MIC p. 67, Aug 69

Synchrophase afsk oscillator
W6FOO p. 30, Dec 70

Synchrophase RTTY reception
W6FOO p. 38, Nov 70

Tape editor
W3EAG p. 32, Jun 77

Teleprinters, new look in
W6JTT p. 38, Jul 70

Terminal unit, phase-locked loop
W4FQM p. 8, Jan 72
Correction p. 60, May 72

Terminal unit, phase-locked loop
W4AYV p. 36, Feb 75

Terminal unit, variable-shift RTTY
W3VF p. 16, Nov 73

Test generator, RTTY
WB9ATW p. 64, Jan 78

Test generator, RTTY (HN)
W3EAG p. 67, Jan 73

Test generator, RTTY (HN)
W3EAG p. 59, Mar 73

Test-message generator, RTTY
K9GSC, K9PKQ p. 30, Nov 76

Time/date printout
W0LZT p. 18, Jun 76
Short circuit p. 68, Dec 77

Voltage supply, precision for
phase-locked terminal unit (HN)
WA6TLA p. 60, Jul 74

satellites

Amsat-Oscar D
W3PK, G3ZCZ p. 16, Apr 78

Antenna accuracy in satellite tracking systems
N5KR p. 24, Jun 79

Antenna control, automatic azimuth/elevation
for satellite communications
WA3HLT p. 26, Jan 75
Correction p. 58, Dec 75

Antenna, simple satellite (HN)
W6BXY p. 59, Feb 75

Antennas, simple, for satellite
communications
K4GSX p. 24, May 74

Az-el antenna mount for satellite
communications
W2LX p. 34, Mar 75

Calcu-puter, OSCAR
W9CGI p. 34, Dec 78

Circularly-polarized ground-plane
antenna for satellite communications
K4GSX p. 28, Dec 74

Communications, first step to satellite
K1MTA p. 52, Nov 72
Added notes (letter) p. 73, Apr 73

Future of the amateur satellite service
K2UBC p. 32, Aug 77

Medical data relay via Oscar
K7RGE p. 67, Apr 77

Oscar antenna (C&T)
W1DTY p. 50, Jun 76

Oscar antenna, mobile (HN)
W6OAL p. 67, May 76

Oscar az-el antenna system
WA1NXP p. 70, May 78

Oscar tracking program, HP-65
calculator (letters)
WA3THD p. 71, Jan 76

Oscar 7, communications techniques for
G3ZCZ p. 6, Apr 74

Programming for automated satellite
communication
KP4MD p. 68, Jun 78

Receiving preamplifier for OSCAR 8 Mode J
K1RX and Puglia p. 20, Jun 78

Satellite communications on 10 meters (letter)
G3IOR p. 12, Dec 79

Satellite tracking — pointing and
range with a pocket calculator
Ball, John A. p. 40, Feb 78

Signal polarization, satellite
KH6IJ p. 6, Dec 72

Tracking the OSCAR satellites
Harmon, WA6UAP p. 18, Sep 77

28-30 MHz preamplifier for satellite
reception
W1JAA p. 48, Oct 75

432-MHz OSCAR antenna (HN)
W1JAA p. 58, Jul 75

semiconductors

Antenna bearings for geostationary
satellites, calculating
N6TX p. 67, May 78

Antenna switch for meters, solid-state
K2ZSQ p. 48, May 69

Avalanche transistor circuits
W4NVK p. 22, Dec 70

Charge flow in semiconductors
WB6BIH p. 50, Apr 71

Converting a vacuum-tube receiver to
solid-state
W1OOP p. 26, Feb 69
Short circuit p. 76, Jun 69

Diodes, evaluating
W5JJ p. 52, Dec 71

Dynamic transistor tester (HN)
VE7ABK p. 65, Oct 71

European semiconductor numbering system (C&T)
W1DTY p. 42, Apr 76

Fet bias problems simplified
WA5SNZ p. 50, Mar 74

Fet biasing
W3FQJ p. 61, Nov 72

Fetrons, solid-state replacements for tubes
W1DTY p. 4, Aug 72
Added notes p. 66, Oct 73; p. 62, Jun 74

Frequency multipliers
W6GXN p. 6, Aug 71

Frequency multipliers, transistor
W6AJF p. 49, Jun 70

GaAs field-effect transistors, introduction
WA2ZZF p. 74, Jan 78

Glass semiconductors
W1EZT p. 54, Jul 69

Grid-dip oscillator, solid-state conversion of
W6AJZ p. 20, Jun 70

Heatsink problems, how to solve transistor
WA5SNZ p. 46, Jan 74

Impulse generator, snap diode
Siegal, Turner p. 29, Oct 72

Injection lasers, high power
Mims p. 28, Sep 71

Injection lasers (letter)
Mims p. 64, Apr 71

Linear power amplifier, high power solid-state
Chambers p. 6, Aug 74

Linear transistor amplifier
W3FQJ p. 59, Sep 71

Matching techniques, broadband, for
transistor rf amplifiers
WA7WHZ p. 30, Jan 77

Microwave amplifier design, solid state
WA6UAM p. 40, Oct 76

Mobile converter, solid-state modification of
Schuler p. 58, Sep 69

Mosfet circuits
W3FQJ p. 50, Feb 75

Mosfet power amplifier, 160 - 6 meters
WA1WLW p. 12, Nov 78

Mosfet transistors (HN)
WB2EGZ p. 72, Aug 69

Mospower fet (letter)
W3QQM p. 110, Mar 78

Motorola fets (letter)
W1CER p. 64, Apr 71

Neutralizing small-signal amplifiers
WA4WDK p. 40, Sep 70

Noise, zener-diode (HN)
VE7ABK p. 59, Jun 75

Parasitic oscillations in high-power
transistor rf amplifiers
W0KGI p. 54, Sep 70

Pentode replacement (HN)
W1DTY p. 70, Feb 70

Power dissipation ratings of transistors
WN9CGW p. 56, Jun 71

Power fets
W3FQJ p. 34, Apr 71

Power transistors, paralleling (HN)
WA5EKA p. 62, Jan 72

Predicting close encounters:
OSCAR 7 and OSCAR 8
K2UBC p. 62, Jul 79

Protecting solid-state devices from
voltage transients
WB5DEP p. 74, Jun 78

Relay, transistor replaces (HN)
W3NK p. 72, Jan 70

Rf power detecting devices
K6JYO p. 28, Jun 70

Rf power transistors, how to use
WA7KRE p. 8, Jan 70

Snap diode impulse generator
Siegal, Turner p. 29, Oct 72

Surplus transistors, identifying
W2FPP p. 38, Dec 70

Switching inductive loads with
solid-state devices (HN)
WA6ROC p. 99, Jun 78

Thyristors, introduction to
WA7KRE p. 54, Oct 70

Transconductance tester for field-effect
transistors
W6NBI p. 44, Sep 71

Transistor amplifiers, tabulated
characteristics of
W5JJ p. 30, Mar 71

Transistor and diode tester
ZL2AMJ p. 65, Nov 70

Transistor breakdown voltages
WA5EKA p. 44, Feb 75

Transistors for vhf transmitters (HN)
W1OOP p. 74, Sep 69

Transistor testing	
Allen	p. 62, Jul 70
Trapatt diodes (letter)	
WA7NLA	p. 72, Apr 72
Vfo transistors (HN)	
W1OOP	p. 74, Nov 69
Y parameters in rf design, using	
WA0TCU	p. 46, Jul 72
Zener tester, low voltage (HN)	
K3DPJ	p. 72, Nov 69

single sideband

Balanced modulator, integrated-circuit	
K7QWR	p. 6, Sep 70
Balanced modulators, dual fet	
W3FQJ	p. 63, Oct 71
Communications receiver, phasing-type	
WA0JYK	p. 6, Aug 73
Detector, ssb, IC (HN)	
K4ODS	p. 67, Dec 72
Correction	p. 72, Apr 73
Double-balanced modulator, broadband	
WA6NCT	p. 8, Mar 70
Electronic bias switching for linear amplifiers	
W6VFR	p. 50, Mar 75
Filters, ssb (HN)	
K6KA	p. 63, Nov 73
Frequency dividers for ssb	
W7BZ	p. 24, Dec 71
Hang agc circuit for ssb and CW	
W1ERJ	p. 50, Sep 72
Intermittent voice operation of power tubes	
W6SAI	p. 24, Jan 71
Intermodulation-distortion measurements on ssb transmitters	
W6VFR	p. 34, Sep 74
Linear amplifier design	
W6SAI	
Part 1	p. 12, Jun 79
Part 2	p. 34, Jul 79
Part 3	p. 58, Aug 79
Linear amplifier, five-band conduction-cooled	
W9KIT	p. 6, Jul 72
Linear amplifier, five-band kilowatt	
W4OQ	p. 14, Jan 74
Improved operation (letter)	p. 59, Dec 74
Linear amplifier, homebrew five-band	
W7IV	p. 30, Mar 70
Linear amplifier performance, improving	
W4PSJ	p. 68, Oct 71
Linear amplifier, 100-watt	
W6WR	p. 28, Dec 75
Linear, five-band hf	
W7DI	p. 6, Mar 72
Linear for 80-10 meters, high-power	
W6HHN	p. 56, Apr 71
Short circuit	p. 96, Dec 71
Linearity meter for ssb amplifiers	
W4MB	p. 40, Jun 76
Linears, three bands with two (HN)	
W4NJF	p. 70, Nov 69
Minituner, ssb	
K1BQT	p. 16, Oct 70
Modifying the Heath SB-200 amplifier for the new 8873 zero-bias triode	
W6UOV	p. 32, Jan 71
Peak envelope power, how to measure	
W5JJ	p. 32, Nov 74
Phase-shift networks, design criteria for	
G3NRW	p. 34, Jun 70
Power supplies for ssb	
Belt	p. 38, Feb 69
Precise tuning with ssb gear	
W0KD	p. 40, Oct 70
Pre-emphasis for ssb transmitters	
OH2CD	p. 38, Feb 72
Rating tubes for linear amplifier service	
W6UOV, W6SAI	p. 50, Mar 71
Rf clipper for the Collins S-line	
K6JYO	p. 18, Aug 71
Letter	p. 68, Dec 71
Rf speech processor, ssb	
W2MB	p. 18, Sep 73
Sideband location (HN)	
K6KA	p. 62, Aug 73
Solid-state circuits for ssb	
Belt	p. 18, Jan 69
Solid-state transmitting converter for 144-MHz ssb	
W6NBI	p. 6, Feb 74
Short circuit	p. 62, Dec 74
Speech process, logarithmic	
WA3FIY	p. 38, Jan 70

Speech clipper, IC	
K6HTM	p. 18, Feb 73
Added notes (letter)	p. 64, Oct 73
Speech clipper, rf, construction	
G6XN	p. 12, Dec 72
Speech clippers, rf, performance of	
G6XN	p. 26, Nov 72
Added notes	p. 58, Aug 73; p. 72, Sep 74
Speech clipping	
K6KA	p. 24, Apr 69
Speech clipping in single-sideband equipment	
K1YZW	p. 22, Feb 71
Speech processing, principles of	
ZL1BN	p. 28, Feb 75
Added notes	p. 75, May 75; p. 64, Nov 75
Speech processor for ssb	
K6PHT	p. 22, Apr 70
Speech processor, ssb	
VK9GN	p. 31, Dec 71
Speech splatter on single sideband	
W4MB	p. 28, Sep 75
Ssb generator, phasing-type	
W7CMJ	p. 22, Apr 73
Added comments (letter)	p. 65, Nov 73
Ssb generator, 9-MHz	
W9KIT	p. 6, Dec 70
Ssb phasing techniques, review	
VK2ZTB	p. 52, Jan 78
Short circuit	p. 94, Feb 79
Ssb phasing techniques, review (letter)	
WB9YEM	p. 82, Aug 78
Phasing networks (letter)	
W2ESH	p. 6, Nov 78
Speech processor, split-band	
N7WS	p. 12, Sep 79
Ssb transceiver, IC, for 80 meters	
VE3GSD	p. 48, Apr 76
Switching and linear amplification	
W3FQJ	p. 61, Oct 71
Syllabic vox system for Drake equipment	
W6RM	p. 24, Aug 76
Transceiver, high-frequency with digital readout	
DJ2LR	p. 12, Mar 78
Transceiver, miniature 7-MHz	
W7BBX	p. 16, Jul 74
Transceiver, single-band ssb	
W1DTY	p. 8, Jun 69
Transceiver, ssb, IC	
G3ZVC	p. 34, Aug 74
Circuit change (letter)	p. 62, Sep 75
Transceiver, ssb, using LM373 IC	
W5BAA	p. 32, Nov 73
Transceiver, 3.5-MHz ssb	
VE6ABX	p. 6, Mar 73
Transmitter alignment	
Allen	p. 62, Oct 69
Transmitter and receiver for 40 meters, ssb	
VE3GSD	p. 6, Mar 74
Short circuit	p. 62, Dec 74
Transmitter, phasing-type ssb	
WA0JYK	p. 8, Jun 75
Transmitting mixers, 6 and 2 meters	
K2ISP	p. 8, Apr 69
Transverter, low-power, high-frequency	
W0RBR	p. 12, Dec 78
Trapezoidal monitor scope	
VE3CUS	p. 22, Dec 69
TTL ICs, using in ssb equipment	
G4ADJ	p. 18, Nov 75
Tuning up ssb transmitters	
Allen	p. 62, Nov 69
Two-tone oscillator for ssb testing	
W6GXN	p. 11, Apr 72
Vacuum tubes, using odd-ball types in linear amplifier service	
W5JJ	p. 58, Sep 72
Vhf, uhf transverter, input source for (HN)	
F8MK	p. 69, Sep 70
Vox, versatile	
W9KIT	p. 50, Jul 71
Short circuit	p. 96, Dec 71
144-MHz linear, 2 kW	
W6UOV, W6ZO, K6DC	p. 26, Apr 70
144-MHz low-drive kilowatt linear	
W6HHN	p. 26, Jul 70
144-MHz transverter, the TR-144	
K1RAK	p. 24, Feb 72
432 MHz rf power amplifier	
K6JC	p. 40, Apr 70
432-MHz ssb converter	
K6JC	p. 48, Jan 70
Short circuit	p. 79, Jun 70
432-MHz ssb, practical approach to	
WA2FSQ	p. 6, Jun 71
1296-MHz ssb transceiver	
WA6UAM	p. 8, Sep 74

television

Broadcast quality television camera	
WA8RMC	p. 10, Jan 78
Call sign generator	
WB2CPA	p. 34, Feb 77
Camera and monitor, sstv	
VE3EGO, Watson	p. 38, Apr 69
Caption device for SSTV	
G3LTZ	p. 61, Jul 77
Color tv, slow-scan	
W4UMF, WB8DQT	p. 59, Dec 69
Computer, processing, sstv pictures	
W4UMF	p. 30, Jul 70
Display SSTV pictures on a fast-scan TV	
K6AEP	p. 12, Jul 79
Fast-scan camera converter for sstv	
WA9UHV	p. 22, Jul 74
Fast-to-slow-scan conversion, tv	
W3EFG, W3YZC	p. 32, Jul 71
Frequency-selective and sensitivity-controlled sstv preamp	
DK1BF	p. 36, Nov 75
Interlaced sync generator for ATV camera control	
WA8RMC	p. 10, Sep 77
Slow-scan television	
WA2EMC	p. 52, Dec 69
Slow-to-fast-scan television converters, an introduction	
K4TWJ	p. 44, Aug 76
Sync generator for black-and-white 525-line TV	
K4EEU	p. 79, Jul 77
Sync generator, IC, for ATV	
W0KGI	p. 34, Jul 75
Sync generator, sstv (letter)	
W1IA	p. 73, Apr 73
Television DX	
WA9RAQ	p. 30, Aug 73
Test generator, sstv	
K4EEU	p. 6, Jul 73
Vestigial sideband microtransmitter for amateur television	
WA6UAM	p. 20, Feb 76
Short circuit	p. 94, May 77
50 years of television	
W1DTY, K4TWJ	p. 36, Feb 76
Letter, WA6JFP	p. 77, Sep 76

transmitters and power amplifiers

general

Amplitude modulation, a different approach	
WA5SNZ	p. 50, Feb 70
Batteries, how to select for portable equipment	
WA0AIK	p. 40, Aug 73
Blower maintenance (HN)	
W6NIF	p. 71, Feb 71
Blower-to-chassis adapter (HN)	
K6JYO	p. 73, Feb 71
Digital readout, universal	
WB8IFM	p. 34, Dec 78
Digital vfo basics	
Earnshaw	p. 18, Nov 78
Efficiency of linear power amplifiers, how to compare	
W5JJ	p. 64, Jul 73
Electronic bias switching for linear amplifiers	
W6VFR	p. 50, Mar 75
Fail-safe timer, transmitter (HN)	
K9HVW	p. 72, Oct 74
Filter converter, an up/down	
W5DA	p. 20, Dec 77
Filters, ssb (HN)	
K6KA	p. 63, Nov 73
Frequency multipliers	
W6GXN	p. 6, Aug 71
High-voltage fuses in linear amplifiers (HN)	
K9MM	p. 76, Feb 78
Intermittent voice operation of power tubes	
W6SAI	p. 24, Jan 71
Key and vox clicks (HN)	
K6KA	p. 74, Aug 72
Linear power amplifiers (letter)	
KB5EY, W6SAI	p. 6, Dec 79

Tuning up ssb transmitters
Allen p. 62, Nov 69

troubleshooting

Analyzing wrong dc voltages
Allen p. 54, Feb 69

Audio distortion, curing in speech amplifiers
Allen p. 42, Aug 70

Basic troubleshooting
James p. 54, Jan 76

Dc-dc converters, curing trouble in
Allen p. 56, Jun 70

I-f transformers, problems and cures — Weekender
K4IPV p. 56, Mar 79

Logic circuits, troubleshooting
W8GRG p. 56, Feb 77

Mobile power supplies, troubleshooting
Allen p. 56, Jun 70

Ohmmeter troubleshooting
Allen p. 52, Jan 69

Oscillators, repairing
Allen p. 69, Mar 70

Oscillator troubleshooting (repair bench)
K4IPV p. 54, Mar 77

Oscilloscope, putting to work
Allen p. 64, Sep 69

Oscilloscope, troubleshooting amateur gear with
Allen p. 52, Aug 69

Power supply, troubleshooting
K4IPV p. 78, Sep 77

Receiver alignment techniques, vhf fm
K4IPV p. 14, Aug 75

Receivers, troubleshooting the dead
K4IPV p. 56, Jun 76

Resistance measurement, troubleshooting by
James p. 58, Apr 76

Rf and i-f amplifiers, troubleshooting
Allen p. 60, Sep 70

Speech amplifiers, curing distortion
Allen p. 42, Aug 70

Ssb transmitter alignment
Allen p. 62, Oct 69

Sweep generator, how to use
Allen p. 60, Apr 70

Transistor circuits, troubleshooting
K4IPV p. 60, Sep 76

Transistor testing
Allen p. 62, Jul 70

Tuning up ssb transmitters
Allen p. 62, Nov 69

Voltage troubleshooting
James p. 64, Feb 76

vhf and microwave

general

Artificial radio aurora, vhf scattering characteristics
WB6KAP p. 18, Nov 74

A-m modulation monitor (HN)
K7UNL p. 67, Jul 71

Band change from six to two meters, quick
K0YQY p. 64, Feb 70

Bandpass filters, single-pole
W6HPH p. 51, Sep 69

Bandpass filters, 25 to 2500 MHz
K6RIL p. 46, Sep 69

Bypassing, rf, at vhf
WB6BHI p. 50, Jan 72

Cavity filter, 144-MHz
W1SNN p. 22, Dec 73

Short circuit
p. 64, Mar 74

Coaxial filter, vhf
W6SAI p. 36, Aug 71

Coaxial-line resonators (HN)
W47KRE p. 82, Apr 70

Coil-winding data, practical vhf and uhf
K3SVC p. 6, Apr 71

Effective radiated power (HN)
VE7CB p. 72, May 73

Frequency multipliers
W6GXN p. 6, Aug 71

Frequency multipliers, transistor
W6AJF p. 49, Jun 70

Frequency scaler, 500-MHz
W6URH p. 32, Jun 75

Frequency scalars, 1200-MHz
WB9KEY p. 38, Feb 75

Frequency synchronization for scatter-mode propagation
K2OVS p. 26, Sep 71

Frequency synthesizer, 220 MHz
W6GXN p. 8, Dec 74

GaAs field-effect transistors, introduction
WA2ZZF p. 74, Jan 78

Gridded tubes, vhf/uhf effects in
W6UOV p. 8, Jan 69

Harmonic generator (HN)
W5GDQ p. 76, Oct 70

Impedance bridge (HN)
W6KZK p. 67, Feb 70

Improving vhf/uhf receivers
W1JAA p. 44, Mar 76

Indicator, sensitive rf
WB9DNI p. 38, Apr 73

Klystron cooler, waveguide (HN)
WA4WDL p. 74, Oct 74

L-band local oscillators
N6TX p. 40, Dec 79

Lunar-path nomograph
WA6NCT p. 28, Oct 70

Microstrip impedance, simple formula for
W1HR p. 72, Dec 77

Microstrip transmission line
W1HR p. 28, Jan 78

Microwave bibliography
W6HDO p. 68, Jan 78

Microwave communications, amateur standards for
K6HIJ p. 54, Sep 69

Microwave frequency doubler
WA4WDL p. 69, Mar 76

Microwave hybrids and couplers for amateur use
W2CTK p. 57, Jul 70

Short circuit
p. 72, Dec 70

Microwave marker generator, 3cm band (HN)
WA4WDL p. 69, Jun 76

Microwave path evaluation
N7DH p. 40, Jan 78

Microwave rf generators, solid-state
W1HR p. 10, Apr 77

Microwaves, getting started in
Roubal p. 53, Jun 72

Microwaves, introduction to
W1CBY p. 20, Jan 72

Microwave solid-state amplifier design
WA6UAM p. 40, Oct 76

Comment, VK3TK, WA6UAM
p. 98, Sep 77

Noise figure, meaning of
K6MIO p. 26, Mar 69

Noise figure measurements, vhf
WB6NMT p. 36, Jun 72

Phase-locked loop, tunable 50 MHz
W1KNI p. 40, Jan 73

Polaplexer design
K6MBL p. 40, Mar 77

Power dividers and hybrids
W1DAX p. 30, Aug 72

Proportional temperature control for crystal ovens
VE5FP p. 44, Jan 70

Radio observatory, vhf
Ham p. 44, Jul 74

Reflex klystrons, pogo stick for (HN)
W6BPK p. 71, Jul 73

Rf power-detecting devices
K6JYO p. 28, Jun 70

Satellite communications
K1TMA p. 52, Nov 72

Added notes (letter)
p. 73, Apr 73

Satellite signal polarization
KH6JJ p. 6, Dec 72

Solar cycle 20, vhf'er's view of
WA5IYX p. 46, Dec 74

Spectrum analyzer, microwave
WA6UAM p. 54, Aug 77

Spectrum analyzer microwave
N6TX p. 34, Jul 78

Tank circuits, design of vhf
K7UNL p. 56, Nov 70

Uhf dummy load, 150-watt
WB6QXF p. 30, Sep 76

Uhf hardware (HN)
W6CMQ p. 76, Oct 70

Vfo, high-stability vhf
OH2CD p. 27, Jan 72

Vhf beacons
K6EDX p. 52, Oct 69

Vhf beacons
W3FQJ p. 66, Dec 71

Vhf circuits, eliminating parallel currents (HN)
G3IPV p. 91, May 77

Weak-signal communications
W4LTU p. 26, Mar 78

10-GHz cross-guide coupler
WB2ZKW p. 66, Oct 79

10-GHz Gunnplexer transceivers, construction and practice
p. 26, Jan 79

Comments, W6OAL
p. 6, Sep 79

50-MHz bandpass filter
W4EKO p. 70, Aug 76

50-MHz frequency synthesizer
W1KNI p. 26, Mar 74

144-MHz fm frequency meter
W4JAZ p. 40, Jan 71

Short circuit
p. 72, Apr 71

144-MHz frequency synthesizer
WB4FPK p. 34, Jul 73

144-MHz frequency-synthesizer, one-crystal
W0KMV p. 30, Sep 73

220-MHz frequency synthesizer
W6GXN p. 8, Dec 74

432-MHz ssb, practical approach to
WA2FSQ p. 6, Jun 71

440-MHz bandpass filter
WABYBT p. 62, Nov 79

1296-MHz double-stub tuner
K6LK p. 70, Dec 78

1296-MHz microstripline bandpass filters
WA6UAM p. 46, Dec 75

1296-MHz microstrip filter, improved grounding for
N6TX p. 60, Aug 78

2304-MHz stripline bandpass filter
WA4WDL, WB4LJM p. 50, Apr 77

vhf and microwave antennas

Antenna-performance measurements using celestial sources
W5CQ/W4RXY p. 75, May 79

Circularly-polarized ground-plane antenna for satellite communications
K4GSX p. 28, Dec 74

Feed horn, cylindrical, for parabolic reflectors
WA9HUV p. 16, May 76

Feeding and matching techniques for vhf/uhf antennas
W1JAA p. 54, May 76

Ground plane, portable vhf (HN)
K9DHD p. 71, May 73

Log-periodic yagi beam antenna
K6RIL, W6SAI p. 8, Jul 69

Correction
p. 68, Feb 70

Matching techniques for vhf/uhf antennas
W1JAA p. 50, Jul 76

Microstrip swr bridge, vhf and uhf
W4CGC p. 22, Dec 72

Microwave antenna, low-cost
K6HIJ p. 52, Nov 69

Oscar az-el antenna system
WA1NXP p. 70, May 78

Parabolic reflector antennas
VK3ATN p. 12, May 74

Parabolic reflector element spacing
WA9HUV p. 28, May 75

Parabolic reflector gain
W2TQK p. 50, Jul 75

Parabolic reflector, 16-foot homebrew
WB6IOM p. 8, Aug 69

Parabolic reflectors, finding focal length of (HN)
WA4WDL p. 57, Mar 74

Swr meter
W6VSV p. 6, Oct 70

Transmission lines, uhf
WA2VTR p. 36, May 71

10 GHz, broadband antenna
WA4WDL, WB4LJM p. 40, May 77

Short circuit
p. 94, Feb 79

10 GHz dielectric antenna (HN)
WA4WDL p. 80, May 75

50-MHz antenna coupler
K1RAK p. 44, Jul 71

50-MHz collinear beam
K4ERO p. 59, Nov 69

50-MHz cubical quad, economy
W6DOR p. 50, Apr 69

50-MHz mobile antenna (HN)
W4PSJ p. 77, Oct 70

144-MHz antenna, 5/8 wave vertical
K6KLO p. 40, Jul 74

144-MHz antenna, 5/8-wave vertical, build from CB mobile whips
WB4WSU p. 67, Jun 74

144-MHz antennas, simple
WA3NFW p. 30, May 73

144-MHz antenna switch, solid-state
K2SSQ p. 48, May 69

144-MHz collinear antenna
W6RJO p. 12, May 72

144-MHz collinear uses PVC pipe mast (HN)
K8LLZ p. 66, May 76

144-MHz four-element collinear array
WB6KGF p. 6, May 71

144-MHz ground plane antenna, 0.7 wavelength W3WZA	p. 40, Mar 69
144-MHz moonbounce antenna K6HCP	p. 52, May 70
144-MHz whip, 5/8-wave (HN) VE3DDD	p. 70, Apr 73
432-MHz corner reflector antenna WA2FSQ	p. 24, Nov 71
432-MHz high-gain Yagi K6HCP	p. 46, Jan 76
Comments, W0PW	p. 63, May 76
432-MHz OSCAR antenna (HN) W1JAA	p. 58, Jul 75
432- and 1296-MHz quad-yagi arrays W3AED	p. 20, May 73
Short circuit	p. 58, Dec 73
440-MHz collinear antenna, four-element WA6HTP	p. 38, May 73
1296-MHz antenna, high-gain W3AED	p. 74, May 78
1296-MHz Yagi W2CQH	p. 24, May 72
1296-MHz Yagi array W3AED	p. 40, May 75

vhf and microwave receivers and converters

Audio filter, tunable, for weak-signal communications K6HCP	p. 28, Nov 75
Calculating preamplifier gain from noise-figure measurements N6TX	p. 30, Nov 77
Cooled preamplifier for vhf-uhf reception WA0RDX	p. 36, Jul 72
Double-balanced mixers, circuit packaging for WA6UAM	p. 41, Sep 77
Interdigital preamplifier and comb-line bandpass filter for vhf and uhf W6KHT	p. 8, Aug 70
Microwave amplifier design, solid state WA6UAM	p. 40, Oct 76
Microwave mixer, new WA0RDX	p. 84, Oct 78
Noise figure, sensitivity and dynamic range W1DITY	p. 8, Oct 75
Noise figure, vhf, estimating WA9HUV	p. 42, Jun 75
Overload problems with vhf converters, solving W1OOP	p. 53, Jan 73
Preamplifiers, vhf low-noise WA2GFP	p. 50, Dec 79
Receiver scanner, vhf K2LZG	p. 22, Feb 73
Receiver, superregenerative, for vhf WA5SNZ	p. 22, Jul 73
Signal detection and communication in the presence of white noise WB6IOM	p. 16, Feb 69
Signal generator for two and six meters WA8QIK	p. 54, Nov 69
Single-frequency conversion, vhf/uhf W3FQJ	p. 62, Apr 75
UHF local-oscillator chain N6TX	p. 27, Jul 79
Vhf receiver, general-purpose K1ZJH	p. 16, Jul 78
Vhf/uhf preamplifier burnout (HN) W1JR	p. 43, Nov 78
Weak-signal source, stable, variable output K6JYO	p. 36, Sep 71
Weak-signal source, 144 and 432 MHz K6JC	p. 58, Mar 70
10 GHz hybrid-tee mixer G3NRT	p. 34, Oct 77
28-30 MHz low-noise preamp W1JAA	p. 48, Oct 75
30-MHz preamplifier, low-noise W1HR	p. 38, Oct 78
Short circuit	p. 94, Feb 79
50-MHz deluxe mosfet converter WB2EGZ	p. 41, Feb 71
50-MHz etched-inductance bandpass filters and filter-preamplifiers W5KHT	p. 6, Feb 71
50-MHz preamplifier, improved WA2GCF	p. 46, Jan 73
144-MHz converter (HN) K0VQY	p. 71, Aug 70
144-MHz converter, high dynamic range DJ2LR	p. 55, Jul 77
144-MHz converters, choosing fets (HN) K6JYO	p. 70, Aug 69
144-MHz deluxe mosfet converter WB2EGZ	p. 41, Feb 71

Short circuit Letter, W0LER	p. 96, Dec 71
144-MHz etched-inductance bandpass filters and filter-preamplifiers W5KHT	p. 6, Feb 71
144-MHz fm receiver W9SEK	p. 22, Sep 70
144-MHz fm receiver WA2GBF	p. 42, Feb 72
Added notes	p. 73, Jul 72
144-MHz fm receiver WA2GCF	p. 6, Nov 72
144-MHz preamplifier, improved WA2GCF	p. 25, Mar 72
144-MHz preamplifier, low noise WB8BB	p. 36, Jun 74
144-MHz preamp, low-noise W1DITY	p. 40, Apr 76
144-MHz preamp, super (HN) K6HCP	p. 72, Oct 69
144-MHz transverter sing power fets WB6BPI	p. 10, Sep 76
144-432 MHz GaAs fet preamp JH1BRY	p. 38, Nov 79
220-MHz mosfet converter WB2EGZ	p. 28, Jan 69
Short circuit	p. 76, Jul 69
432-MHz converter N9KD	p. 74, Apr 79
432-MHz converter, low-noise K6JC	p. 34, Oct 70
432-MHz fet preamp (HN) W1DITY	p. 66, Aug 69
432-MHz GaAs preamp JH1BRY	p. 22, Apr 78
432-MHz preamplifier, low-noise WB5LUA	p. 26, Oct 78
432 MHz preamplifier and converter WA2GCF	p. 40, Jul 75
432-MHz preamplifier, ultra low-noise W1JAA	p. 8, Mar 75
1296-MHz converter, solid state VK4ZT	p. 6, Nov 70
1296 MHz, double-balanced mixers for WA6UAM	p. 8, Jul 75
1296-MHz local-oscillator chain WA2ZZF	p. 42, Oct 78
1296-MHz noise generator W3BSV	p. 46, Aug 73
1296-MHz preamplifier WA6UAM	p. 42, Oct 75
1296-MHz preamplifier, low-noise transistor WA2VTR	p. 50, Jun 71
Added note (letter)	p. 65, Jan 72
1296-MHz preamplifiers, microstripline WA6UAM	p. 12, Apr 75
Comments, W2DU	p. 68, Jan 76
1296-MHz ssb transceiver WA6UAM	p. 8, Sep 74
1296-MHz rat-race balanced mixer WA6UAM	p. 33, Jul 77
2304-MHz balanced mixer WA2ZZF	p. 58, Oct 75
2304-MHz converter, solid-state K2JNG, WA2LTM, WA2VTR	p. 16, Mar 72
2304-MHz preamplifier, solid-state WA2VTR	p. 20, Aug 72
2304-MHz preamplifiers, narrow-band solid-state WA9HUV	p. 6, Jul 74

vhf and microwave transmitters

External anode tetrodes W6SAI	p. 23, Jun 69
Inductively-tuned tank circuit W6SAI	p. 6, Jul 70
Lighthouse tubes for uhf W6UOV	p. 27, Jun 69
Pi networks, series-tuned W2EGH	p. 42, Oct 71
Ssb input source for vhf, uhf transverters (HN) F8MK	p. 69, Sep 70
Transistors for vhf transmitters (HN) W1OOP	p. 74, Sep 69
Vhf linear, 2 kW, design data for W6UOV	p. 7, Mar 69
Water-cooled 2C39 (HN) WA9RPB	p. 94, Sep 77
2C39, water cooling K6MYC	p. 30, Jun 69
50-MHz customized transverter K1RAK	p. 12, Mar 71
50-MHz heterodyne transmitting mixer K2ISP	p. 8, Apr 69
Correction	p. 76, Sep 70
50-MHz kilowatt, inductively-tuned K1DPP	p. 8, Sep 75

50-MHz 2 kW linear amplifier W6UOV	p. 16, Feb 71
50-MHz linear amplifier K1RAK	p. 38, Nov 71
50-MHz multimode transmitter K2ISP	p. 28, Sep 70
50-MHz SSB exciter K1LOG	p. 12, Oct 79
50-MHz transverter WA9IGU	p. 44, Jul 69
144-MHz 10/80-watt amplifier WB9RMA	p. 12, Feb 79
144-MHz fm transceiver, compact W6AOI	p. 36, Jan 74
144-MHz fm transmitter W6AJF	p. 14, Jul 71
144-MHz fm transmitter W9SEK	p. 6, Apr 72
144-MHz fm transmitter, Sonobaby WA0JZO	p. 8, Oct 71
Crystal deck for Sonobaby K2ISP	p. 26, Oct 72
144-MHz heterodyne transmitting mixers K2ISP	p. 8, Apr 69
Correction	p. 76, Sep 70
144-MHz linear W4KAE	p. 47, Jan 69
144-MHz linear, 2kW, design data for W6UOV	p. 7, Mar 69
144-MHz low-drive kilowatt linear W6HHN	p. 26, Jul 70
144-MHz multimode transmitter K2ISP	p. 28, Sep 70
144-MHz phase-modulated transmitter W6AJF	p. 18, Feb 70
144-MHz power amplifier, high performance W6UOV	p. 22, Aug 71
144-MHz power amplifiers, fm W4CGC	p. 6, Apr 73
144-MHz power amplifier, 10-watt solid-state (HN) W1DITY	p. 67, Jan 74
144-MHz power amplifier, 80-watt, solid-state Hatchett	p. 6, Dec 73
144-MHz stripline kilowatt W2GN	p. 10, Oct 77
144-MHz transceiver, a-m K1AOB	p. 55, Dec 71
144-MHz transmitting converter, solid-state ssb W6NBI	p. 6, Feb 74
Short circuit	p. 62, Dec 74
144-MHz transverter K1RAK	p. 24, Feb 72
144-MHz two-kilowatt linear W6UOV, W6ZO, K6DC	p. 26, Apr 70
144- and 432-MHz stripline amplifier/tripler K2RIW	p. 6, Feb 70
220-MHz exciter WB6DJV	p. 50, Nov 71
220-MHz power amplifier W6UOV	p. 44, Dec 71
220-MHz rf power amplifier WB6DJV	p. 44, Jan 71
220-MHz rf power amplifier, fm K7JUE	p. 6, Sep 73
432-MHz exciter, solid-state W1OOP	p. 38, Oct 69
432-MHz power amplifier using stripline techniques W3HMU	p. 10, Jun 77
432-MHz rf power amplifier K6JC	p. 40, Apr 70
432-MHz solid-state linear amplifier WB6QXF	p. 30, Aug 75
432-MHz ssb converter K6JC	p. 48, Jan 70
Short circuit	p. 79, Jun 70
432-MHz ssb, practical approach WA2FSQ	p. 6, Jun 71
432-MHz stripline tripler K2RIW	p. 6, Feb 70
432-MHz 100-watt solid-state power amplifier WA7CNP	p. 36, Sep 75
1152- to 2304-MHz power doubler WA9HUV	p. 40, Dec 75
1270-MHz video-modulated power amplifier W9ZIH	p. 67, Jun 77
1296-MHz frequency tripler K4SUM, W4API	p. 40, Sep 69
1296-MHz power amplifier W2COH, W2CCY, W2OJ, W1IMU	p. 43, Mar 70
1296-MHz ssb transceiver WA6UAM	p. 8, Sep 74
1296-MHz transverter K6ZMW	p. 10, Jul 77
2304-MHz power amplifier WA9HUV	p. 8, Feb 75

DSI HAS DONE IT AGAIN QUIK-KIT II®

WITH 10 MHz PROPORTIONAL OVEN TIME BASE

DC-BATT-AC (W-AC9)
95% Factory Assembled
External 10 MHz Input
External 10 MHz Output
100% Factory Tested
.2 PPM 10° to
40° C Accuracy
Proportional Oven
9 Digits .5 Inch LED's
0.1 Hz Resolution
to 50 MHz
Auto Zero Blanking

149⁹⁵
MODEL 5600A KIT



WHY BUY A 5600A: Because 95% of the assembly is completed by DSI and you are only one hour away from solving all those difficult bench problems, from setting the frequency of a audio signal to within 1/10 of a Hz to checking the frequency of a 486 MHz mobile radio. Whether you are servicing a VTR, trouble shooting a PLL circuit, the 5600A is the right counter with accuracy that will meet any FCC land mobile, broadcast, or telecommunications requirements. On the bench or in the field the 5600A will do the job you need. The 5600A includes a self contained battery holder providing instant portability or we offer a 10 hour rechargeable battery pack option. Other options include a audio multiplier which allows you to resolve a 1/1000 of a HZ signal and finally a 25db preamplifier with an adjustable attenuator making the 5600A perfect for communications, TV servicing, industrial testing or meeting your QSO the correct frequency every time.

FACTS ARE FACTS: With the introduction of the 5600A. The sun has set on the competition. This may sound like a bold statement on the part of DSI BUT FACTS ARE FACTS. No counter manufacturer except DSI offers a Full Range 50 HZ to 512 Mhz counter with — 9 Digits — 0.1 HZ resolution — .2 PPM 10° to 40° C proportional oven — RF pre-amp — 600 Mhz prescaler — three selectable gate times — oven ready, standby and gate time indicator lights as standard features — For only **\$149.95** kit and **\$179.95** factory wired. In fact the competition doesn't even come close unless you consider **\$200.00** to **\$800.00** close. With DSI having the best price to quality features ratio in the industry, no wonder we've become one of the world's largest manufacturers of high quality frequency counter instrumentation.

FOR INFORMATION — DEALER LOCATION — ORDERS — OEM
CALL 800-854-2049 CALIFORNIA RESIDENTS CALL 800-542-6253

Model	Price	Frequency Range Typ	Accuracy Over Temperature	Sensitivity Typ			Number of Readouts	Power Requirements	Size		
				@ 100Hz-25MHz	@ 50-250MHz	@ 250-450MHz			H	W	D
5600A-K	\$149.95	50Hz-550MHz	Proportional Oven	5-10MV	5-10MV	5-50MV	9	*115 VAC or 8.2-14.5 VDC	3 1/4"	x 9 1/2"	x 9"
5600A-W	\$179.95		.2 PPM 10° - 40° C								
5500 Wired	99.95	50Hz-550MHz	TCXO 1 PPM 17° - 40° C	10-15MV	10-15MV	15-50MV	8	*115 VAC or 8.2-14.5 VDC	1 1/2"	x 5"	x 5 1/2"
500HH Wired	\$149.95	50Hz-550MHz	TCXO 1 PPM 17° - 40° C	25MV	20MV	75MV	8	*115 VAC or 8.2-14.5 VDC or NICAD PAK.	1"	x 3 1/2"	x 5 1/2"

5600A wired factory burned in 1 year limited warranty. 5600A kit 90 day limited warranty. Prices and/or specifications subject to change without notice or obligation.

*With AC-9 Adaptor.

3550 OWNERS

You can add the
35P.2 .22 PPM
10° to 40° C
proportional oven
to your
existing 3550

P.2 **29.95**
factory Installed **49.95**



DSI INSTRUMENTS, INC.
9550 Chesapeake Drive
San Diego, California 92123
(714) 565-8402

TERMS: MC - VISA - AE - Check - M.O. - COD in U.S. Funds. Please add 10% to a maximum of \$10.00 for shipping, handling and insurance. Orders outside of USA & Canada, please add \$20.00 additional to cover air shipment. California residents add 6% Sales Tax.

5600A Kit **\$149.95**
5600A Wired **179.95**
AC-9 AC Adaptor **7.95**
T600 BNC Ant. **7.95**

BUILT-IN OPTIONS

BA56 Rechargeable
10 Hr. Bat. Pack **29.95**
AM56 Audio Multiplier
.001Hz Resolution **34.95**
PA56 25dB Preamplifier
with Attenuator **59.95**

Advertisers check-off

... for literature, in a hurry — we'll rush your name to the companies whose names you "check-off"

Place your check mark in the space between name and number. Ex: Ham Radio 234

INDEX

Adv. Elec. Appl. _____ 677	Jameco _____ 333
AED _____ 710	Jan _____ 067
Aluma _____ 589	Jones _____ 626
Amidon _____ 005	Kantronics * _____
Antenna Mart _____ 009	Kenwood * _____
Astron _____ 734	Larsen _____ 078
Atlantic Surplus * _____	Little Giant _____ 011
Avanti _____ 775	Long's _____ 468
Barry * _____	Lunar _____ 577
Bauman _____ 017	MFJ _____ 082
Bencher _____ 629	Madison * _____
Budwig _____ 233	Microwave Filter _____ 637
Cambridge _____	J.W. Miller _____ 745
Thermionic _____ 810	Morse-Pak _____ 809
Communications _____	William M. Nye _____ 214
Center _____ 534	P.C. Elec. _____ 766
Comm. Concepts _____ 797	Palomar Eng. * _____
Comm. Spec. _____ 330	Pipo _____ 481
Creative Elec. _____ 751	Callbook _____ 100
Curtis Electro _____ 034	Radiokit _____ 801
DCO _____ 324	Radio Sys. Tech. _____ 422
DSI _____ 656	Radio World * _____
DX Eng. _____ 222	Ramsey _____ 442
Dames Comm. _____ 551	Rockwell Collins _____ 258
Data Signal _____ 270	Saroc * _____
Dave * _____	Sem Con _____ 808
Daytapro _____ 455	Sherwood _____ 435
Eagle * _____	Shure Brothers _____ 771
E.T.O. * _____	Spectronics _____ 191
Elec. Research Virginia * _____	Spec. Int. _____ 108
Erickson * _____	Swan _____ 111
Fox Tango _____ 657	TCI _____ 785
G & C Comm. _____ 754	Telrex _____ 377
GLB _____ 552	Ten-Tec * _____
Gregory * _____	Tropical Hamboree * _____
Hal * _____	Van Gorden _____ 737
Hal-Tronix _____ 254	Vanguard Labs _____ 716
H. R. B. _____ 150	Varian _____ 043
HORIZONS _____ 150	Webster _____
H. R. Magazine * _____	Assoc. _____ 423
Heath _____ 060	Western * _____
Henry _____ 062	Wilson Elect. _____ 123
Hildreth _____ 283	Wilson Systems _____ 787
Icom * _____	Yaesu _____ 127
Int. Crystal _____ 066	York Elec. _____ 792

*Please contact this advertiser directly.

Limit 15 inquiries per request.

December, 1979

Please use before January 31, 1980

Tear off and mail to
HAM RADIO MAGAZINE — "check off"
Greenville, N. H. 03048

NAME _____

CALL _____

STREET _____

CITY _____

STATE _____ ZIP _____

MADISON SANTA SAYS



%

WRITE IN
YOUR
BEST QUOTE
FROM THE
"800 GANG."

NOW, LIST THE EQUIPMENT YOU WANT IN THE SPACES PROVIDED BELOW, CUT OUT THIS AD, AND SEND IT TO US WITH YOUR NAME, ADDRESS AND TELEPHONE NUMBER. WE WILL WRITE OR CALL (CHECK ONE) YOU BACK AS SOON AS POSSIBLE WITH THE MADISON QUOTE.

(HINT: DON'T GO BELOW OUR COST).

WE HAVE AN IN-DEPTH STOCK AND LARGE INVENTORY OF MAJOR LINES AND ACCESSORIES.

PLEASE QUOTE ON:

1. 2. 3. 4.

NAME

ADDRESS

TELEPHONE

ZIP

TERMS: ALL PRICES FOB HOUSTON. PRICES SUBJECT TO CHANGE WITHOUT NOTICE. ALL ITEMS GUARANTEED. SOME ITEMS SUBJECT TO PRIOR SALE. SEND LETTERHEAD FOR AMATEUR DEALER'S PRICE LIST. TEXAS RESIDENTS ADD 6% TAX. PLEASE ADD POSTAGE ESTIMATE.

MADISON ELECTRONICS SUPPLY, INC.

1508-D MCKINNEY HOUSTON, TEXAS 77002
713/658-0268 NITES 713/497 5683

Advertisers iNdex

Advanced Electronic Applications	94
AED Electronics	102
Aluma Tower Co.	86
Amidon Associates	99
Antenna Mart	99
Astron Corporation	96
Atlantic Surplus Sales	92
Barry Electronics	99
R. H. Bauman Sales Co.	103
Bencher, Inc.	86, 88
Budwig Mfg. Co.	102
Communications Center	77
Communication Concepts	103
Communications Specialists	70, 71
Creative Electronics	103
Curtis Electro Devices	103
DCO, Inc.	76
DSI Instruments	1, 74, 75, 125
DX Engineering	96
Dames Communications Systems	90
Data Signal, Inc.	85
Dave	102
Daytapro Electronics	88
Eagle Electronics	92
Ehrhorn Technological Operations	96
Electronic Research Corp. of Virginia	85
Erickson Communications	102
Fox-Tango Corp.	89
G & C Communications	83
GLB Electronics	88
Gregory Electronics	60
Hal Communications Corp.	13
Hal-Tronix	47
Ham Radio's Bookstore	84, 86, 90, 94, 95
Ham Radio HORIZONS	98
Ham Radio Magazine	88, 92, 97
Heath Company	61
Henry Radio Stores	Cover II
Hildreth Engineering	92
Icom	5
International Crystal Mfg. Co.	33
Jameco Electronics	93
Jan Crystals	85
Jones, Marlin P. & Assoc.	91
Kantronics	76
Trio-Kenwood Communications, Inc.	7, 64, 65
Little Giant Antenna Labs, Inc.	89
Long's Electronics	128
Lunar Electronics	68
MFJ Enterprises	2
Madison Electronic Supply	76, 83, 126
Microwave Filter, Inc.	96
J.W. Miller Division, Bell Industries	89
Morse-Pak, Inc.	83
P.C. Electronics	60
Palomar Engineers	95
Pipo Communications	102
Radio Amateur Callbook	103
Radiokit	90
Radio Systems Technology, Inc.	88
Radio World	88
Ramsey Electronics	48
Rockwell-International, Collins Division.	10, 11, 12
Saroc	90
Sem Con, Inc.	86
Sherwood Engineering	92, 99
Shure Brothers, Inc.	23
Spectronics	49
Spectrum International	39
Swan Electronics	127
Telemetry Communications & Instrumentation, Inc.	87
Telrex Laboratories	87
Ten-Tec	9
Tropical Hamboree	68
Van Gorden Engineering	92
Vanguard Labs	87
Varian, Eimac Division	Cover IV
Webster Associates	90
Western Electronics	96
Wilson Electronics	69
Wilson Systems, Inc.	78, 79, 80, 81, 82
Yaesu Electronics Corp.	Cover III
York Electronics	87

Discover the unrivaled ASTRO 102BX with Dual PTO's

Plus IF Passband Tuning/Full Band Coverage, Speech Processing, 235 Watts PEP All Bands and Much More.

4-Function Meter
reads "S" units in receive, and selects forward power, reflected power, or ALC in transmit.

Visual Display of Passband Tuning
A series of 8 LED's indicate the equivalent band width and position of the passband from 0.6 to 2.7 KHz as the passband tuning knob is rotated.

300Hz Crystal CW Filter
Cascaded with the passband filters and tunable through the passband. Combined with notch filter yields unrivaled CW performance.

Full or Semi CW Break-in
A must for the avid CW operator!

2 Position CW Wave Shaping
Your choice of soft or hard CW rise and decay time!



Variable AGC Decay
Continuously variable to suit your preference.

Passband Tuning with 16 Pole Filters
Two 8-pole crystal filters in cascade provides a 1.4:1 shape factor at -100dB! The ultimate in selectivity.

Tunable Notch Filter
Provides the ability to "notch out" QRM. When used in conjunction with the passband tuning, provides the ultimate in removing interference.

Dual PTO's
Two independent high stability PTO's provide true split band operation. The digital counter reads the PTO selected, or in split band reads the PTO used for receive, then switches to the transmit frequency selected when the mic is keyed.

All Band Coverage using PLL and Synthesizer for Band Selection
Full coverage of 160 meters through all of 10 meters in 9 ranges . . . diode matrix programmed for now — or for the future!



The ASTRO 102BX with it's companion PSU-6 Power Supply, 1500Z Linear Amplifier and ST-2A Antenna Tuner provides a matched and highly efficient 1500 watt PEP or 1000 watt CW complete station to be complemented by a great Swan antenna.

All Solid State
Quality American
Construction

ASTRO 102BX

SWAN
ELECTRONICS

A member of the Cubic Corporation family of companies

305 Airport Road / Oceanside, CA 92054 / 714-757-7525

CALL TOLL FREE
1-800-633-3410

Prices subject to change without notice. Prices good only while supply lasts.

**200 WATTS PEP!
 KENWOOD
 TS-120S
 All solid state
 HF SSB transceiver**

No tune up! Miniaturized circuits, solid state construction, built-in digital display, IF shift, final transistor protection, VOX, noise blanker, 25 KHz marker. Frequency range is 80 to 10 meters and WWV, modes: SSB and CW, power requirements: RX-0.7A 13.8 VDC, TX-18A 13.8 VDC. 3 1/2" H x 9 1/4" W x 13 1/2" L. Weight: 11.7 lbs.



699.95 List. Call for quote.



**KENWOOD PS-30
 power supply
 optional.
 139.00** List. Call for quote.

**YAESU
 FT-101Z
 high
 performance
 HF transceiver**

Covers 160 thru 10 meters plus WWV, modes: LSB, USB, and CW, built-in power supply, built-in RF speech processor, built-in noise blanker, variable IF bandwidth, analog freq. readout, 6146 final tubes with RF negative feedback, heater switch, VOX, attenuator 10 dB or 20 dB selectable. Power requirements: 100/110/117/200/220/234 volts AC 50/60 Hz.

749.00 List. Call for quote.



**YAESU FT-901DM
 All mode HF transceiver**

Covers 160 thru 10 meters. Variable IF bandwidth, rejection tuning, CW audio peak filter, built-in Curtis keyer, RF speech processor, 10 second tune mode timer, 6146 finals, auto. mic gain control, 25 KHz crystal calibrator and ± 5 KHz clarifier, VOX built-in power supply, 180W DC input for SSB/CW, 80W AM/FSK/FM, DC-DC converter.

1459.00 List. Call for quote



**NEW KENWOOD
 TS-520SE High Quality
 HF transceiver**

200 watts PEP SSB, 160 watts DC CW, 160 thru 10 meters, noise blanker, 3 position amplified-type AGC, RIT, 8 pole crystal filter, built-in 25 KHz calibrator, VOX, PTT, MANUAL operation, speech processor, semi-break-in CW with sidetone, low power tune up 20-dB RF attenuator and built-in speaker.

629.95 List. Call for quote.



**TEN-TEC
 Omni D Series B
 HF transceiver**

Totally solid state. 200W all bands with 50 ohm load. Covers 160 thru 10 meters. Features digital readout, VOX and PTT, 4-position CW/SSB filter, 8 pole crystal filter, crystal calibrator, notch filter, zero beat switch SWR bridge, adjustable sidetone, operates on 12 VDC for mobile, power supply required for fixed station.

1119.00 List. Call for quote.



**ICOM IC-701
 HF transceiver**

All solid state, 100W continuous duty on all bands, all modes. 160 thru 10 meters, dual built-in digital VFO's for split freq. operation, VOX, semi-break-in CW, RIT, AGC, noise blanker and built-in speech processor. IC-701 PS needed for AC operation. Power supply requirements: DC 13.6V negative ground.

1169.00 Call today.



**DRAKE TR/DR7
 Solid state synthesized
 HF transceiver**

Covers 160 thru 10 meters, reception from 1.5-30 continuous, 0-30 MHz with optional AUX-7, modes: USB, LSB, CW, RTTY, AM. True passband tuning, RIT, built-in RF wattmeter/SWR bridge, SSB 250 watts PEP, CW 250 watts, AM 80 watts. Power supply required for AC operation, PS-7 120/240V power supply available.

1395.00 List. Call for quote.



Long's Electronics



MAIL ORDERS: P.O. BOX 11347 BIRMINGHAM, AL 35202 • STREET ADDRESS: 2808 7TH AVENUE SOUTH BIRMINGHAM, ALABAMA 35233
 Remember, you can Call Toll Free: **1-800-633-3410** in the U.S.A. or call **1-800-292-8668** in Alabama for our low price quote. Store hours: 9:00 AM til 5:30 PM, Monday thru Friday.

A Breakthrough In Technology!

THE YAESU FT-207R

MICROPROCESSOR CONTROLLED SYNTHESIZED HANDIE

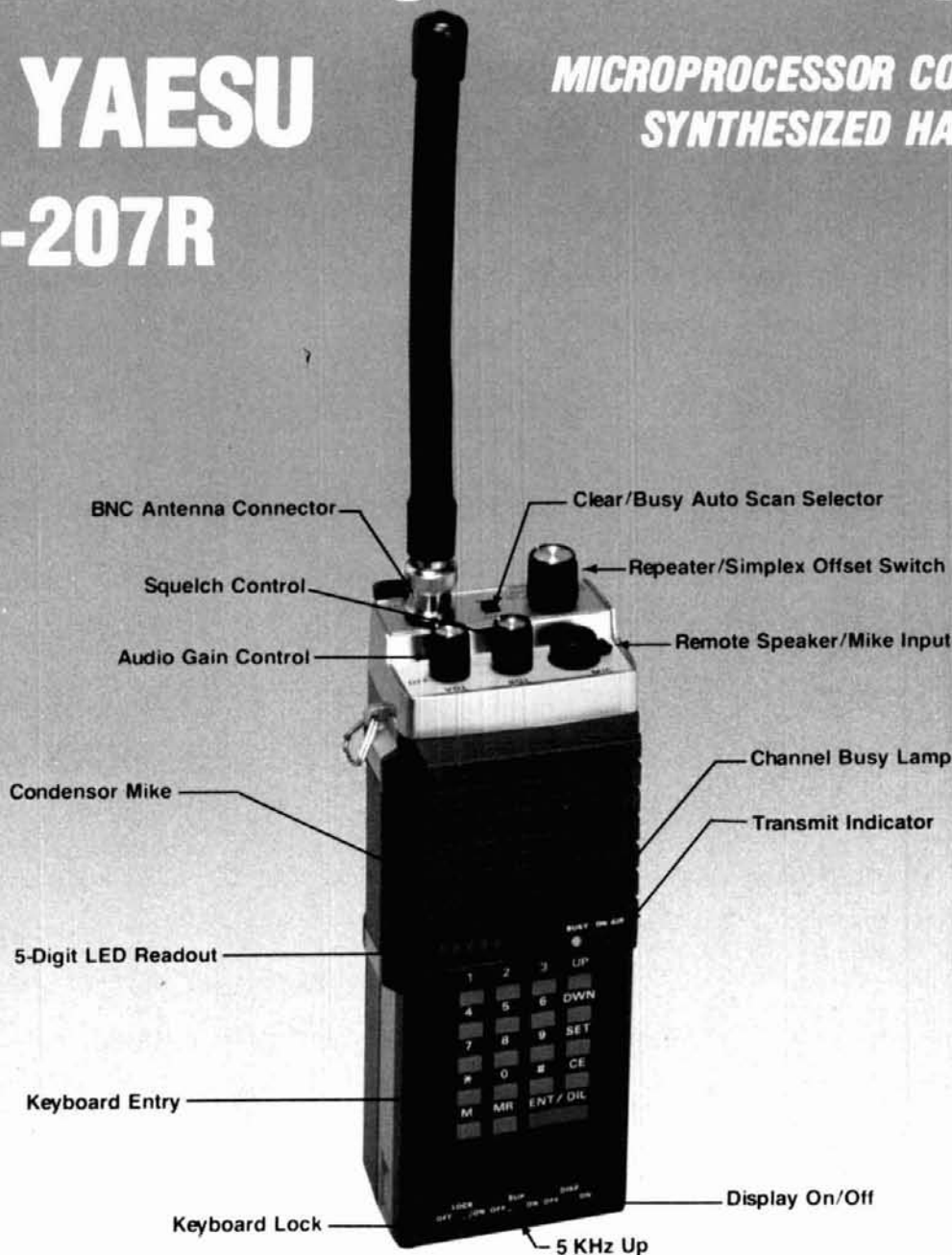

***The Yaesu FT-207R Synthesized Handie
has all the features you could want in a very compact package***

- 144-148 MHz Range
- 10 KHz Steps
- 3 Watts Output
- 4 Memories plus Programmable Offset
- Priority Channel
- Memory and Band Auto Scan
- Optional Equipment:
 - Tone Squelch, Speaker/Mike, Nicads, Battery Charger
- Keyboard Encoded Frequency Entry
- 2 Tone (Touchtone[®]) Input from Keyboard
- Keyboard Lock guards against accidental frequency change
- Odd Splits Can Be Programmed from Keyboard
- Automatic Battery Saver Feature for LED Display
- Rubber Flex Antenna



Price And Specifications Subject To
Change Without Notice Or Obligation

YAESU *The radio.*



679X

YAESU ELECTRONICS CORP., 15954 Downey Ave., Paramount, CA 90723 ● (213) 633-4007
YAESU ELECTRONICS Eastern Service Ctr., 9812 Princeton-Glendale Rd., Cincinnati, OH 45246

EIMAC takes the work out of 25 kW FM transmitter design.

New cavity amplifier and tetrode combo.

The new EIMAC CV-2200 power amplifier cavity assembly and companion 8990 tetrode is ready for use in next generation FM transmitters in the 88-108 MHz band.

EIMAC engineered interface provides capability between tube and cavity design and the result is an amplifier of classic simplicity that combines a useful power output of 25 kW with a stage gain of approximately 20 dB. These numbers make a one tube, high power FM transmitter a reality today.

Cost effective modern design.

EIMAC's cost-effectiveness and modern design are yours in the new cavity and tube combo. Anticipate reduced transmitter down-time and higher revenues with this new amplifier concept. Make sure your new transmitter is EIMAC equipped.

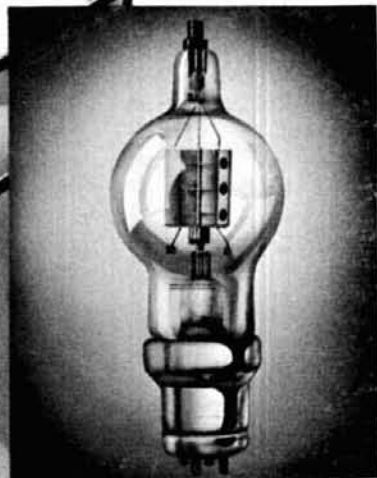
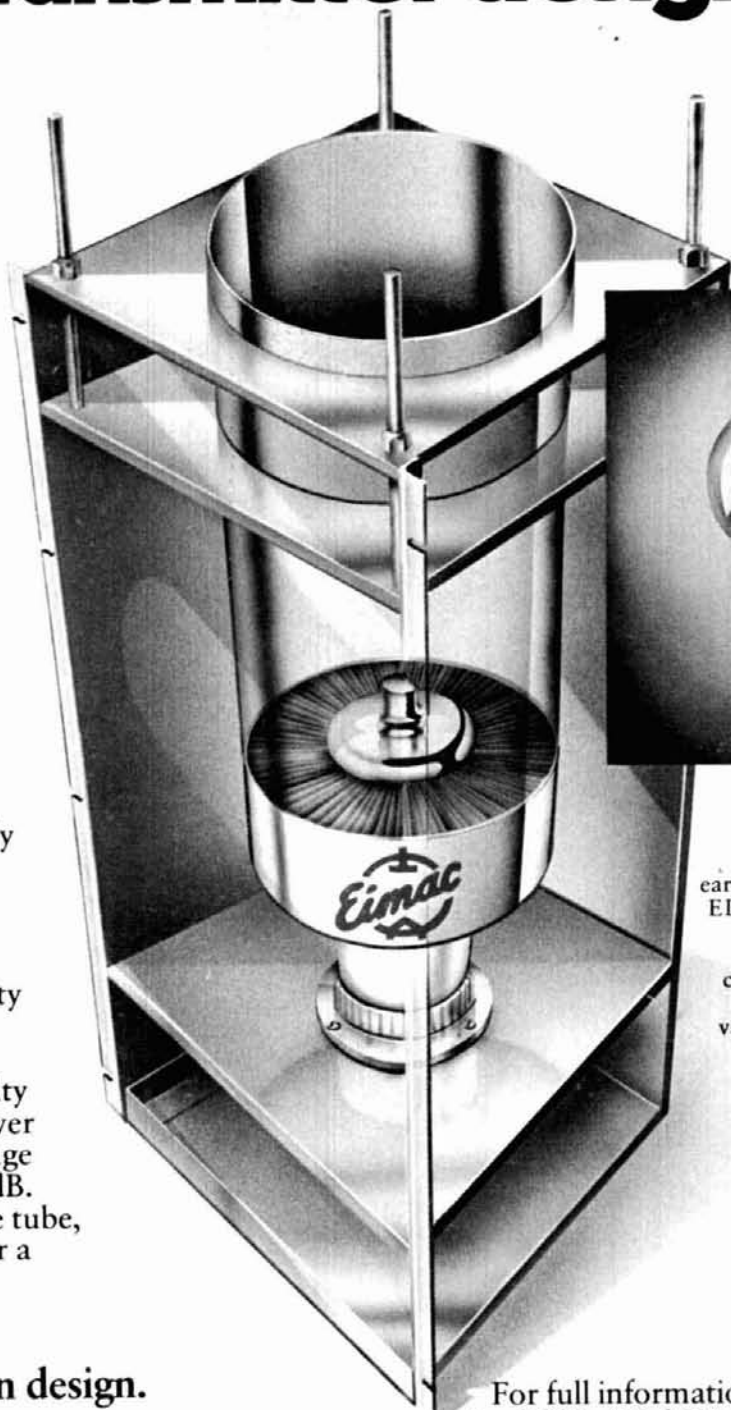

1935, EIMAC was present at the birth of FM broadcasting. Major Armstrong's early transmitter used four EIMAC 150T tubes in the amplifier stages. And EIMAC still retains its commanding position in continuing high power vacuum tube technology.



For full information on the CV-2200, the 8990 (25 kW) and the 8989 (15 kW) write EIMAC, Division of Varian, 301 Industrial Way, San Carlos, California 94070. Telephone (415) 592-1221. Or contact any of the more than 30 Varian Electron Device Group sales offices throughout the world.