

\$1.00

hr

focus
on
communications
technology . . .

ham radio

magazine

MAY 1975

this month

- log-periodic design 14
- phased vertical array 24
- open-grid parabolic reflectors 28
- shunt-fed verticals 34
- simple impedance measurements 46



6th
annual
antenna
issue

QUALITY & PRICE

CUSHCRAFT ANTENNAS OFFER YOU BOTH

Don't be misled by our prices . . . they are based on experience, large quantity buying of materials, great engineering and efficient office personnel. We are happy handling orders to hold the line on prices for you. So . . . why pay more when you can get the best for less!

FM 2 METER ANTENNAS

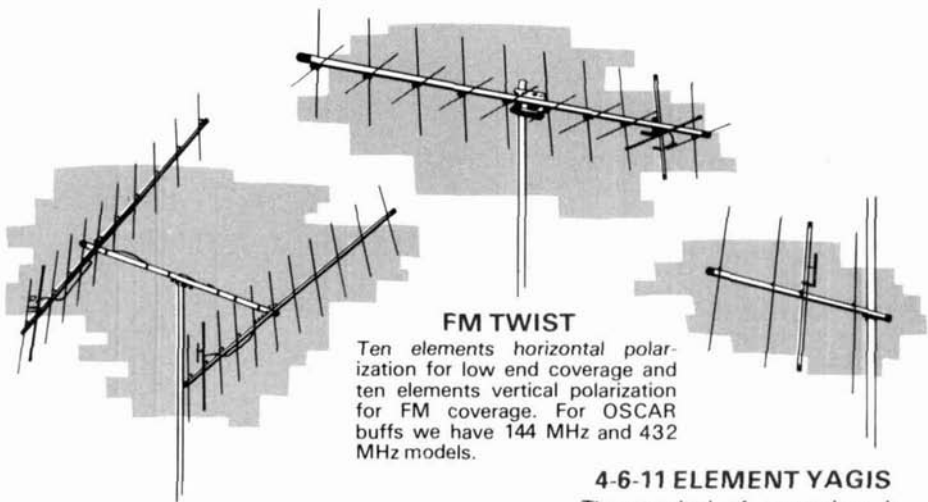

POWER PACK

The big signal (22 element array) for 2 meter FM uses two A147-11 yagis with a horizontal mounting boom, coaxial harness and all hardware.

FM TWIST

Ten elements horizontal polarization for low end coverage and ten elements vertical polarization for FM coverage. For OSCAR buffs we have 144 MHz and 432 MHz models.

4-6-11 ELEMENT YAGIS

The standard of comparison in VHF-UHF communications, now cut for FM and vertical polarization. There are models covering the 450 MHz, 220 MHz and 147 MHz bands. All are rated at 1000 watts with direct 52 ohm feed and PL-259 connectors.

IN STOCK WITH YOUR LOCAL DISTRIBUTOR



cushcraft
CORPORATION

621 HAYWARD ST., MANCHESTER, N.H. 03103

signal/one



for those who demand the finest

the completely new

MODEL CX-11 ... Deluxe Integrated Station

Many New Features

New solid state broadband linear power amplifier 10-160 meters. 360 watts input — requires no tuning — completely self-protected.

New concept front-end design — utilizing **TWO** revolutionary double active quad J-FET balanced mixers — for the ultimate in cross-mod, inter-mod, and overload prevention.

Solid-state modular construction utilizing gold-plated, pins and plug-in sockets for all transistors, IC's, and circuit board connectors.

Five Bandwidths of selectivity are standard — 2.4, 1.5, 1.0, .4, .1 kHz.

Peak notch filter with adjustable notch and peak frequency.

RTTY narrow and wide shift FSK-LSB.

Built-in electronic Keyer with independent speed and weight control and partial or full dot memory.

Built-in Power Supply completely self-protecting — both thermal and current overload, integrated circuit controlled.

New six-digit frequency counter utilizing new 1/2 inch LEDs optimized for a non-blinking, stable display.

ADDITIONAL FEATURES

- Dual VFO's for transceive, split operation, or dual receive.
- Adjustable IF shift.
- Receive or transmit offset tuning.
- Push Button spotting.
- Adjustable R.F. clipping.
- Instantaneous break-in CW.
- Built-in Wattmeter.
- Built-in noise blanker.
- Adjustable R.F. power output.
- Pre-IF, adjustable noise blanker.

Now in production at \$2900

Distributed by

PAYNE RADIO

BOX 525, SPRINGFIELD, TENNESSEE 37172

Phone/write DON PAYNE, K4ID, for a brochure, and trade on your gear. Dial direct day or evenings (615) 384-2224. Personal phone answered only by Don Payne.

Contact the factory for parts and service only

signal/one

Box 127 Franklin Lakes, NJ 07417
Tel: (201) 891-0459

The perfect power meter

The R&S Model NAUS80-A outperforms the BIRD at a lower price . . .

. . . from 25-525 MHz; 1000 MHz (useable) 20 mW-320W.

Check the comparison below and see for yourself.

R&S — NAUS80-A

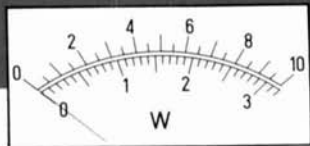

- High Resolution — linear scale
- High Accuracy — 4% of reading $\pm 1\%$ full scale
- Simultaneous incident and reflected power reading (VSWR) (with two separate meters) provides **optimized** performance and time savings
- 5 YEAR WARRANTY ON PARTS & LABOR
- 1 kW overload protection
- 1 head for ALL frequencies and power ranges, no plug-in elements required — also one low price.

BIRD

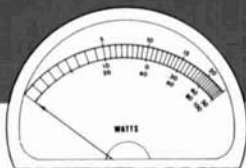

- Compressed log . . . See for yourself
- **5% Full Scale** (% of reading not specified!!!)
- One meter readings make it almost impossible to optimize performance and its extremely time consuming
- 1 year and it excludes semiconductors, tubes, fuses, etc. Ask them for a copy of their warranty . . . you'll be amazed.
- No overload protection — expensive elements can easily burn out.
- Over 30 plug-in elements to achieve the same power/frequency ranges — this more than doubles the R&S price.



ROHDE & SCHWARZ

14 Gloria Lane, Fairfield, N.J. 07006 ■ (201) 575-0750 ■ Telex 133310

- Send me your data sheet.
- Have your sales engineer contact me.
- I would like to see a demonstration.

Name _____

Co. _____

Div. _____ MI. Stop _____

Address _____

City _____ State _____

Zip _____ Phone _____

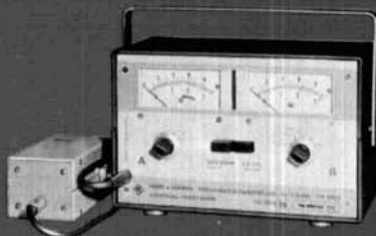

Call or write for more facts
and a free demonstration.

May, 1975
volume 8, number 5

staff

James R. Fisk, W1DTY
editor-in-chief

Patricia A. Hawes, WN1QJN
assistant editor

J. Jay O'Brien, W6GDO
fm editor

James A. Harvey, WA6IAK
James W. Hebert, WA80BG
Joseph J. Schroeder, W9JUV
Alfred Wilson, W6NIF
associate editors

Wayne T. Pierce, K3SUK
cover

T.H. Tenney, Jr., W1NLB
publisher

Fred D. Moller, Jr., WN1USO
advertising manager

offices

Greenville, New Hampshire 03048
Telephone: 603-878-1441

ham radio magazine is
published monthly by
Communications Technology, Inc
Greenville, New Hampshire 03048

subscription rates

U.S. and Canada: one year, \$8.00
two years, \$13.00; three years, \$18.00
Worldwide: one year, \$10.00
two years, \$17.00; three years, \$24.00

Foreign subscription agents

Canada
Ham Radio Canada
Box 144, Goderich
Ontario, Canada, N7A 3Y5

Europe
Ham Radio Europe
Box 444
194 04 Upplands Vasby, Sweden

France
Ham Radio France
20 bis, Avenue des Clarions
89000 Auxerre, France

United Kingdom
Ham Radio UK
Post Office Box 64, Harrow
Middlesex HA3 6HS, England

African continent
Holland Radio, 143 Greenway
Greenside, Johannesburg
Republic of South Africa

Copyright 1975 by
Communications Technology, Inc
Title registered at U.S. Patent Office
Printed by Wellesley Press, Inc
Framingham, Massachusetts 01701, USA

Microfilm copies of current and
back issues are available from
University Microfilms
Ann Arbor, Michigan 48103

Second-class postage
paid at Greenville, N.H. 03048
and at additional mailing offices



contents

8 large vertical antennas

Harry R. Hyder, W7IV

14 log-periodic antenna design

George E. Smith, W4AEO

24 phased vertical array

Jerrold A. Swank, W8HXR

28 open-grid parabolic reflectors

Norman J. Foot, WA9HUV

34 shunt-fed vertical antennas

John R. True, W4OQ

40 1296-MHz Yagi array

Paul F. Magee, W3AED

**46 measuring complex impedance
with an swr bridge**

Randall W. Rhea, WB4KSS

52 electrically-steered phased array

Henry S. Keen, W5TRS

56 80-meter bow-tie antenna

Dwight F. Borton, W9VMQ

66 low-frequency loop antenna

Kenneth Cornell, W2IMB

71 tilt-over tower

Henry S. Keen, W5TRS

4 a second look

126 advertisers index

74 comments

115 flea market

78 ham notebook

84 new products

126 reader service

6 stop press

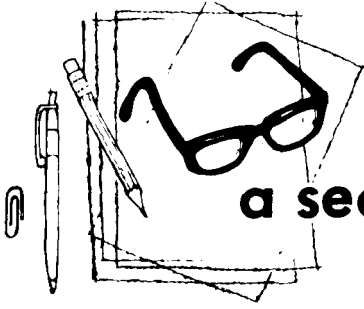

a second look

by Jim
fisk

Power measurement of amateur transmitters is a serious topic of discussion at the FCC these days. Although the amateur restructuring proposal, Docket 20282, has proposed that the maximum transmitter *output* power shall not exceed 2000 watts peak envelope power, a footnote points out that this is only one proposal under consideration by the FCC. The Commission is also looking at alternatives such as PEP input, average power input, ratios of peak to average power output, limitations on the dissipation ratings of final power amplifier devices or even a combination of these. Prose Walker, W4BW, Chief of the Amateur and Citizens' Division, is soliciting suggestions for solutions to this problem, and doesn't want to wait for the Docket comments to hear your ideas. A note to him at 2025 M Street, NW, Washington, DC 20554, with your recommendation, would be appreciated.

Although some amateurs may feel that it makes little difference whether the regulations specify input or output power, at frequencies above 50 MHz or so, where operating efficiencies are much lower, it is extremely important. On the high-frequency amateur bands typical transmitter efficiency is on the order of 70 per cent, but at vhf and uhf efficiency can drop to 50 per cent or even less. That 20 per cent difference can make a considerable difference to the vhf'er who is trying to extend his communications range. And, with the rf wattmeters which are currently available, there seems to be little reason why the amateur power limitations shouldn't be expressed in terms of output power.

Until relatively recently, the accurate measurement of high-frequency rf power required very expensive instruments to which few amateurs had access: matched dummy loads, calorimeters and other thermal devices which could be

calibrated with known dc voltages and currents. Furthermore, the difficulty of *rf power measurements increased with both frequency and power level*. Accurate measurement of 500 watts output, for example, was many times more difficult than the measurement of 50 watts output, even on the hf bands. These measurements were further complicated at vhf and uhf, and accurate measurement of the output of *high-power* vhf transmitters was virtually impossible.

The introduction of toroidal-type directional wattmeters about fifteen years ago solved the problem of high-frequency *average* power measurement (subsequent design improvements have moved the frequency range up to 250 MHz or so), but the difficulty of measuring peak envelope power still remains. At least one coupler (the Collins 302C) added a capacitor to the circuit to make it more of a peak-reading device, but it still reads only about 65 per cent of the actual peaks. Most other types of wattmeters, including absorption types and the popular Bird model 43, theoretically read 40.5 per cent of the actual peak power of a two-frequency signal. The Bird model 4311 reads peak power directly, but it's priced out of the range of most amateurs. However, it should be fairly simple to design a peak-reading amplifier for use with average-reading rf wattmeters that would provide direct measurements of peak envelope power.

Another possibility is the use of a single-tone. Single-tone modulation of a ssb transmitter results in peak envelope power output which equals average power and is indicated correctly on average-reading power rf power meters. However, this technique is not nearly as tidy as a peak-reading rf wattmeter which is always in the line.

Jim Fisk, W1DTY
editor-in-chief

WE'VE GIVEN IT A NEW LOOK!

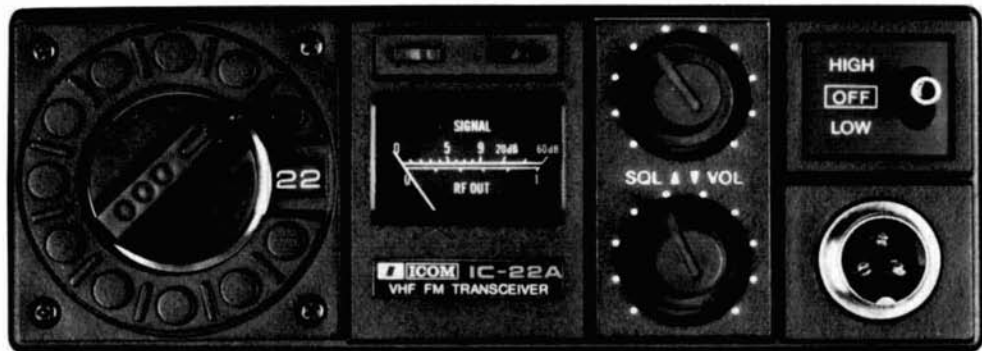

IC-22A

The front panel and control locations have been changed to make the IC-22A even better looking and easier to operate. The new design allows the use of larger channel numbers which may be viewed from the left side or right side by reversing the window position and installing a new dial. (optional at nominal cost)

Inside is the same high quality radio construction and engineering that has made the IC-22 the most reliable, most popular two meter crystal controlled set on the market.

When you join 22 channels of capacity (five supplied) with the unexcelled performance of helical RF filtering in the receiver front end then add solid state T-R switching you get one great radio for your money. All the great features that made the IC-22 so desired are still there. Including, 1 watt/10 watt switch option, trimmer capacitors on both receiver and transmitter crystals plus a 9 pin accessory jack with the discriminator already wired for frequency calibration.

SEE ONE !! BUY ONE !! AT YOUR ICOM DEALER TODAY.

Distributed by:



ICOM

ICOM WEST, INC.
Suite 232-Bldg. 11
300-120th Ave. N.E.
Bellevue, Wash. 98005

ICOM EAST
Suite 307
3331 Towerwood Dr.
Dallas, Tx. 75234



BICENTENNIAL CALLSIGN SCHEME has been released, and as expected, all FCC-licensed amateurs can have some fun with it in 1976 if they're so inclined. State-side alternate prefixes are straight forward, with WA becoming AA, W changing to AC, and repeaters getting an optional AF.

Outside The Contiguous U.S. is where the fun really begins, however, with Samoa becoming AH3 and an Alaskan Novice an All. The partial scheme appears below. Don't rush to cut it out because we'll include a larger scale chart later this year.

Use Of The Alternate Prefixes is entirely optional and no paperwork will be required. Just remember they don't go into effect until 0500Z January 1, 1976, and are good until January 1, 1977.

WA1-WAØ	AA1-AAØ	KB6	AG2	KP4	AJ4
WB1-WBØ	AB1-ABØ	KC4	AL4	KP6	AIØ
W1-WØ	AC1-ACØ	KG6	AG6	KS4	AH4
K1-KØ	AD1-ADØ	KH6	AH6	KS6	AH3
WD1-WDØ	AE1-AEØ	KJ6	AJ7	KV4	AJ3
WR1-WRØ	AF1-AFØ	KL7	AL7	KW6	AG7
WN1-WNØ	AG1-AGØ	KM6	AH7		

CLASS-E CB DECISION DEFERRED again, will be reconsidered "later this year" as a result of March FCC meeting. Commissioners decided that Class-E CB issue could not be properly decided without taking both amateur and Class-D CB "re-structuring" dockets as well as the new automatic transmitter ID docket under consideration at the same time, and Reply Comments on the latest of these aren't due until July 16. Canada's objections to 220-MHz CB were also a factor.

COMMENTS ON DOCKET 20282 are arriving in a steady stream at the FCC, and several hundred have been received so far. Though no tabulation is being kept, most from Extras complain about loss of the exclusive phone bands and those from Generals and Techs bemoan their many losses. Very few flatly reject the proposal.

AMSAT EXPERIMENTER'S CONFERENCE in late March covered lots of ground, and tentative plans are for a "Phase 3" spacecraft on an elliptical orbit for launch in 1978. Like its predecessors, the new satellite would be a truly international project: design work is to be German, construction Canadian and ground support Australian.

Tech Class Licensees can use OSCAR 7, despite report to the contrary in east coast club paper — specific permission was a part of the FCC license issued to the satellite.

AMSAT Dues Will Double July 1 from \$5 to \$10 a year, so it would be wise to renew now for an extended period and save.

OSCAR 6 Telemetry supports the expectation that AMSAT's long lived "bird" will continue to be operational at least through next fall. Battery temperature, considered to be the most critical parameter, is dropping after the expected February peak.

6-METER BAND THREATENED by proposal to add another VHF TV channel. In its comments filed in response to Docket 20264, which pertains to radio call-box systems and their use in the 72-76 MHz band, a prominent Dallas consulting engineering firm has proposed that the public interest would be best served by moving channels 2, 3 and 4 down 2 MHz and putting a new TV channel, dedicated to non-commercial educational use, in the resulting 70-76 MHz band. Present users of the 72-76 MHz slot would move elsewhere, but the other 2 MHz would come right out of the amateur 50-54 MHz assignment!

Whether This Proposal will receive serious consideration by the Commissioners remains to be seen, but this threat — very similar to those of EMS on the high end of 420-450, HIRAN and 220-MHz Class-E CB, shows how others look at the present amateur assignments.



The radio from the radio company.

Since its introduction, the Yaesu FT-101B Transceiver has revolutionized amateur radio. Never before has so much quality, versatility and value been assembled in one compact package.

Here's the radio with just about everything amateurs have wanted: Power. Sensitivity. Reliability. Portability.

With 260 watts SSB PEP, plenty of punch on CW and AM, 0.3 μ V receiving sensitivity, and 160 to 10 meters range. It's a great base station — that's ready to go portable when you are.

Because it's Yaesu — world leader in amateur radio — you know the FT-101B is backed by a solid warranty, a strong dealer network and convenient serviceability. The FT-101B Transceiver. The radio. From the radio company. See your dealer or write for our catalog. Yaesu Musen USA, Inc., 7625 E. Rosecrans, No. 29, Paramount, Calif. 90723.

YAESU
The radio.

large vertical antenna

for 160 and 80 meters

A design approach
for dealing with
problems of erecting
an efficient radiator
to compete on the
two lower bands

The decrease in sunspot activity has caused a renewed interest in low-frequency DX operation. On the 80- and 160-meter bands beams are impractical, and even dipoles must be unreasonably high to get the low-angle radiation necessary for DX. That leaves vertical antennas. Although omnidirectional, they are very good low-angle radiators. In theory, a short vertical radiates as well as a tall one; but in practice, the low radiation resistance of a short vertical, compared with ground and other resistances, makes its overall efficiency low.

My friend Liscum Diven, W7IR, decided to erect a good-sized vertical hoping to increase his DX contest scores on 80 and 160. He is blessed with enough real estate to make this practical, considering the area required for guying and a good ground system. While all amateurs are not so fortunate, the design procedures described in this article are applicable to more modest antennas — or larger ones.

Harry R. Hyder, W7IV, Scottsdale, Arizona 85253

height considerations

The first thing to be decided, of course, was the height. This factor is always a compromise between desired performance and cost. There is no good reason why a vertical, or any other antenna, has to be self resonant. An antenna will radiate all the power it can absorb. When an antenna is an odd multiple of a quarter-wavelength long the feed-point impedance is conveniently low for coax transmission lines, and the reactance is zero; but these are the only advantages to resonant antennas: they are easier to feed.

As for the vertical, the practical efficiency increases until a height of about 0.6 wavelength is reached. At greater heights the vertical radiation angle rises rapidly, making the antenna less desirable for DX.

Since W7IR's antenna was to be used on both 80 and 160, the height could not exceed 0.6x80 meters, or 157 feet (48m). This was a little too high for W7IR's tastes. Top-loading to reduce the physical height while maintaining the electrical height was considered but rejected because of mechanical difficulties.

Even if you're not particularly interested in erecting a vertical antenna, the following piece is well worth reading for a firm grasp on some of the physical aspects of all antennas. The part on characteristic impedance, which is treated in terms of an antenna as a transmission line, should help to dispel some of the misconceptions on antenna theory that we hear on the amateur bands. The graphs of resistance as a function of antenna height-to-diameter ratio, which were taken from reference 1, should provide a convenient design aid for those seriously contemplating the construction of a large vertical antenna. **Editor**

It was finally decided to make the vertical 91 feet (28m) high, consisting of 70 feet (21m) of aluminum lattice tower sections, surmounted by a 21-foot (6.4m) whip that happened to be

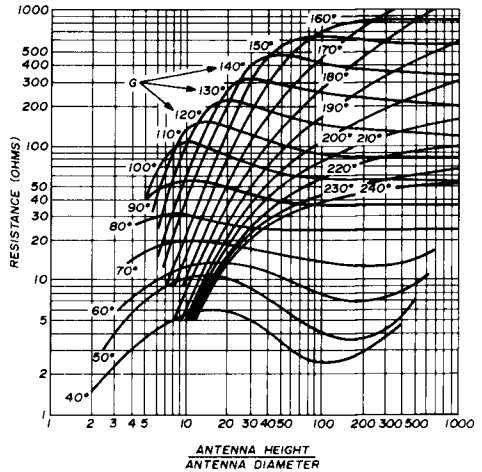

fig. 1. Resistance as a function of antenna height-to-diameter ratio.

available. This configuration would make the electrical height of the antenna 0.347 wavelength on 80 and 0.166 wavelength on 160 meters.

It was decided to guy the antenna at two levels. The base insulator was to be a cluster of heavy-duty ceramic pillars. Since the dead weight of the antenna would be only about 100 pounds (37kg), and ceramic is very strong in compression, this type of base was quite practical.

The guys were to be 1/8 inch (3mm) diameter steel cable, with 6-foot (1.8m) sections of 1/2-inch (13mm) polypropylene rope to insulate the guys from the tower, and small egg insulators to break up the guys. The guy anchors would be 5-foot (1.5m) long earth augers.

matching system characteristics

A lot of thought was given to the matching network. It was decided not to use the usual cut and try method; instead, the network would be engineered. The network was built before the antenna was erected, and required only minor adjustment when installed.

The following characteristics were desired in the network:

1. Obviously it must match the resistance and tune out the reactance. The antenna would be highly reactive on both bands since it would not be resonant on either.
2. It should use as few elements as possible and should be easily switched between bands.
3. It should have a permanent dc path to ground on both bands for lightning protection.

The design achieved all of these objectives.

First to be determined was, "what were we matching?" Any antenna is really a transmission line. Its termination is its own losses to space; but since this is a poor termination, the vswr is very high, as a graph of the voltage and current shows. As with all transmission lines, an antenna has a characteristic impedance. This is *not* the sending-end impedance. What is seen at the sending end is the antenna's losses to space, which are distributed along its length, transformed by the characteristics of the transmission line to a single resistance value called the base radiation resistance of the antenna. This resistance, when multiplied by the square of the current measured at that point, tells how much power is actually being radiated.

The characteristic impedance of the antenna is a function of the length-to-diameter ratio. A thin wire will have a characteristic impedance of 600 ohms

or more; a lattice tower might have a characteristic impedance of 200 ohms or less. The lower the characteristic impedance, the less will be the impedance excursions with frequency at the sending end, which is true of all trans-

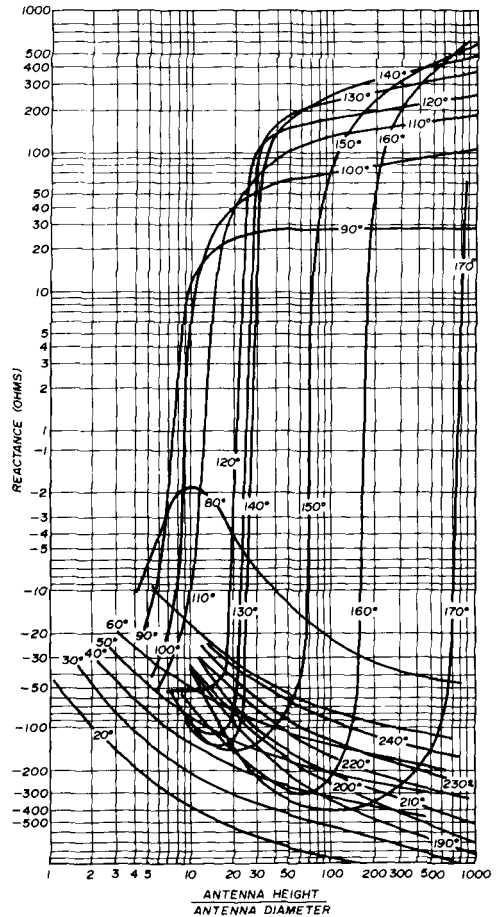
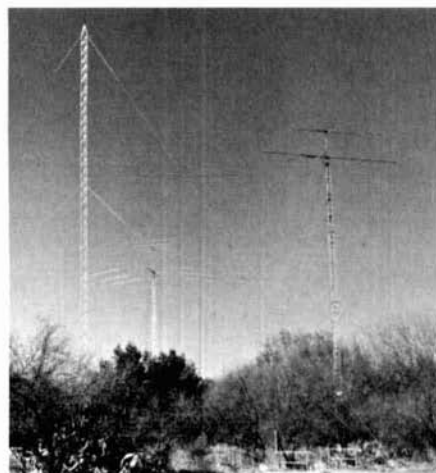

fig. 2. Reactance as a function of antenna height-to-diameter ratio.

mission lines. This means greater bandwidth.

The accurate calculation of the resistance and reactance of an antenna of irregular shape is impractical, but graphs are available that give fairly realistic

values. These graphs, reproduced in **figs. 1 and 2** and described in reference 1, were generated from vhf scale models and give resistance and reactance values for solid cylindrical antennas of different height-to-diameter ratios over a per-



Antenna farm at W7IR includes beams for 20 and 15 meters, right, beams for 40 and 10 meters, center, and 91-foot vertical for 80 and 160 meters, left.

fect ground, with the height of the antenna in electrical degrees as the parameter.

design assumptions

We didn't know how a lattice tower of triangular cross-section related to a solid cylinder, but we guessed that it might be something like the diameter of a circle inscribed within the 11-inches (28cm) on-a-side triangular mast or 6 inches (15cm). We also thought that the top 21 feet (6.4m) of the antenna, which was a small-diameter whip, would reduce this dimension further. Since it was a nice number to work with, our final guesstimate was a height-to-diameter ratio of 200, which proved to be a good choice. Because W7IR's antenna would be 0.166 wavelength on 1.8 MHz and

0.347 wavelength on 3.75 MHz, the electrical heights on those bands would be 59 and 125 degrees respectively.

The graphs, as closely as they could be read, yielded the following R and X values for the two bands:

frequency	resistance, R (ohms)	reactance, X (ohms)
1.8 MHz	7	-160
3.75 MHz	180	±240

We further assumed that the ground system, fair but far from ideal, might represent a loss of 3 dB at 1.8 MHz. Adding 7 ohms, a loss resistance equal to the 1.8-MHz radiation resistance, might compensate for ground-system losses. The effective resistance values thus would be 14 and 187 ohms, respectively.

The antenna would require a series inductive reactance of 160 ohms to tune it to 1.8 MHz, but a shunt reactance was desired to provide a direct path to ground for lightning protection. So the series R and X from the graphs were translated to their equivalent parallel values:

$$Q = \frac{X_s}{R_s}$$

$$R_p = R_s (Q^2 + 1)$$

$$X_p = \frac{R_p}{Q}$$

This gave the following values:

frequency	resistance, R (ohms)	reactance, X (ohms)
1.8 MHz	1820	-160
3.75 MHz	495	+386

Thus a shunt reactance of +160 ohms (14.1 μ H) would tune the antenna. The parallel resistance value of 1820 ohms could most easily be matched by using

the loading coil as an autotransformer, connecting the 50-ohm transmission line to a tap on the coil. The fraction of coil turns across which the line should be connected was:

$$\sqrt{\frac{50}{1820}} = 0.166 = 16.6\%$$

neglecting leakage inductance. This took care of the 160-meter band.

A shunt capacitor would be required to tune the 80-meter band. This circuit would not furnish a direct path to ground, so it was decided to see what would happen if the 14.1- μ H 160-meter loading coil were left in place on 80 meters. At 3.75 MHz this coil would present a reactance of +332 ohms. This reactance in parallel with the +386 ohms reactance of the antenna at 3.75 MHz gave a net reactance of +179 ohms, the resistance being unchanged. When this combination was translated back to series form, the reactance was $R = 57.5$ ohms and $X = +159$ ohms, a convenient value since it meant that on 80, with the 160-meter loading coil in place, the

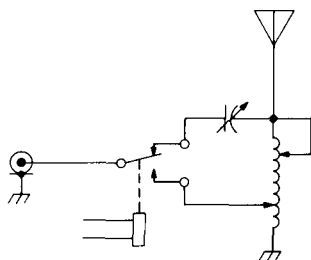

fig. 3. Antenna tuning network for the 2-band vertical with switching relay for changing bands.

transmission line could be connected directly to the base of the antenna through a capacitive reactance of 159 ohms (267 pF) with negligible mismatch. The two-band matching network was thus very simple, consisting of

a single inductor and a single capacitor with a spdt relay to switch bands. The network is shown in fig. 3.

W7IR works both phone and CW on 80, so the bandwidth was calculated by obtaining resistance and reactance values for the antenna and network components at 3.5 MHz and 4 MHz and

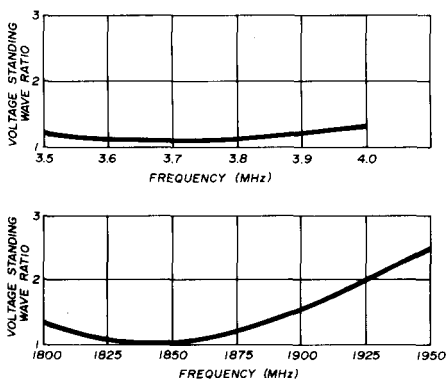

fig. 4. Vswr performance of the large vertical antenna on 80 and 160 meters.

plotting the results on a Smith chart. This data showed that the vswr would be less than 2:1 over the entire band.

construction and tuneup

The network was built into an old breadbox; components were from an old rig. The coil had a Q of over 200 on both bands, so its loss was negligible. The antenna was erected without mishap. A sign-erection truck was hired for the occasion, and a few local hams held guy wires.*

The radials were put in with the aid of a *mole*, which is a tool about the size of a power lawnmower designed for digging shallow trenches for the pipes of underground sprinkler systems. Sixteen

*Also try your local phone company or a tree-trimming service. They have mobile cherry pickers with operators that can often be hired for a fairly reasonable fee. **Editor**

radials about 125 feet (38m) long were installed. More radials would have been desirable and probably will be installed later. But it was only a week before the start of the DX contest, and even with the mole it was hard work. Then came the tune up. Would the network act as predicted? It had already been built.



Author W7IV supporting W7IR's antenna. Concrete base is 18 inches (45.7cm) by 1 foot (30.5cm). Tuning network and ceramic insulators are shown.

It was our intention first to measure the resistance and reactance of the antenna, as a check on the curves and to get an approximation of the actual ground resistance. This would be done by subtracting the 7 ohms radiation resistance at 1.8 MHz taken from the graph from the measured total value. This turned out to be impossible for an unforeseen reason. A local broadcast station produced a signal of 20 volts at the base of the antenna, making use of an rf bridge impossible. The BC station would not shut down for us so the network was tuned, first on 160, by

energizing the network and antenna with enough transmitter power to overcome the BC signal, then adjusting the inductance for maximum voltage across the coil as read by an rf vtvm. Then the transmission line tap on the coil was selected for minimum vswr. Next, power at 3.75 MHz was fed to the network, and the series capacitor adjusted to null the vswr.

The final values came out extremely close to the calculated values. The 160-meter loading coil turned out to be 14 μH (right on the nose) and the 80-meter series capacitor was 320 pF rather than the 267 pF calculated. The transmission line tap on the coil was at 24% rather than 17% of the turns.

Curves of vswr versus frequency are shown in fig. 4. The bandwidth is somewhat greater than calculated. This is not necessarily good, however, since it probably means that the ground losses are higher than assumed.

conclusion

As this is being written, the DX contest has just ended. Contest scores, of course, are highly dependent on conditions and the number of stations and countries participating. But W7IR reports that the overall performance on both bands was far superior to that of the high inverted-vees previously used.

On 160, although activity was sparse and noise levels high, W7IR worked every DX station he heard. On 80, W7IR felt that, for the first time, he had an antenna that really put him in a good competitive position. The antenna gave him the feeling that he was really getting through — every serious DXer knows that's what really counts.

references

1. E.A. Laport, *Radio Antenna Engineering*, McGraw-Hill, New York, 1952.
2. R.E. Leo, W7LR, "Vertical Antenna Ground Systems," *ham radio*, May, 1974, page 30.

ham radio

graphical design method for log-periodic antennas

A no-math approach
to the log periodic
design problem

Anyone who has designed or studied log-periodic antennas is aware of the math involved due to the many variables that enter into the design problem. References 1-5 contain several pages of formulas and refer the reader to four or five nomographs, log tables, etc. Probably this is one of the reasons the log-periodic antenna has been neglected by the amateur fraternity. Furthermore, little information has been published on the design of hf L-P antennas in amateur publications.

When I retired in 1970 I decided to make a study of high-frequency log-periodic antennas. The original antenna in use here has only 7 elements, is limited to 20 and 15 meters, is less than 40 feet (12.2m) long, and is pointed south. Over the past three years it has averaged 8-10 dB gain compared with a 20-meter dipole at the same height. The results obtained from this beam prompted a second, larger log-periodic for 20, 10 and 15 meters having a boom length

of 70 feet (21.3m). Three log-periodics were erected and tested during 1970, and as of this writing 17 have been put up and tested.

This article presents a graphic design approach for log-periodic antennas that eliminates the work associated with the math involved. Four designs are presented first, each having essentially the same boom length and apex angle, but with different numbers of elements. Each should provide approximately 10-dB gain referenced to a dipole at the same location and height above ground.

Additionally, two more log-periodic designs are shown, one with a 54 foot (16.5m) boom that gives about 8-dB forward gain and one with a 100-foot (30.5m) boom. (Both boom lengths are nominal.) This last design is presented for those with enough real estate to accommodate it and the nerve to hang such a monster in the air. It will give 12-dB forward gain (referenced to a dipole) if properly designed and assembled and suspended at least 40 feet (12.2m) above ground. All designs cover 14 to 30 MHz.

the log-periodic antenna

For those readers not acquainted with the log periodic, it is a broadband multi-element, unidirectional, end-fire array capable of 8- to 14-dB forward gain. The front-to-back ratio is usually 10 to 14 dB with side attenuation to about 25 dB. The forward lobe of the

George E. Smith, W4AEO, 1816 Brevard Place, Camden, South Carolina 29020

log-periodics tested here generally runs about 90 degrees in the H plane. Its vertical angle of radiation, or take-off angle, can be controlled fairly well by height above ground. The swr at the feedpoint remains relatively constant over the frequency range for which the antenna is designed, generally not exceeding 2:1 with 1.5:1 as typical; usually varying between 1.1:1 and 1.5:1.

A bandwidth of 10:1 is normal for fixed commercial log-periodics designed to cover frequencies between 3 to 30

erected in a space 40x40 feet (12x12m) giving an 8- to 10-dB gain on 20 and 15 meters.

Most of the log-periodics used here have been of the horizontal dipole configuration and have been tested on 40, 20, 15 and 10 meters. One of the 20-, 15-, 10-meter log-periodics was also tested for a few weeks in the vertical plane. Three of the vertical monopole configurations using a ground plane or counterpoise have been tested on 40 and 80 meters. More recently two of the

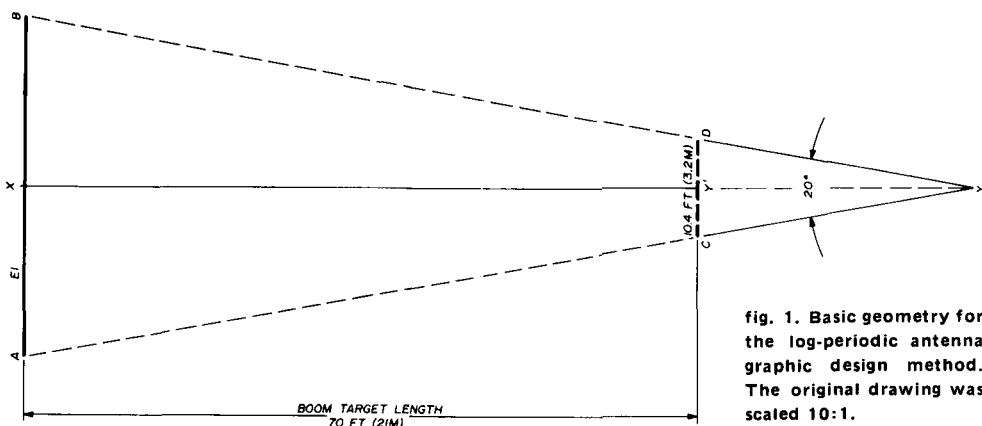

fig. 1. Basic geometry for the log-periodic antenna graphic design method. The original drawing was scaled 10:1.

MHz; however, they are quite long, usually 250-800 feet (76-244m), depending on gain required and beamwidth. Some of the commercial log-periodics having a limited bandwidth of 4-30 MHz are 150-350 feet (46-91m) long, and for 6-30 MHz, 100-250 feet (30-76m) long. The commercial rotary types generally have a boom length of 40 to 74 feet (12-22.5m). Some of these are used at MARS stations.

For amateur applications, a fixed log-periodic wire beam can be limited to a bandwidth slightly more than 2:1, covering 7-14.5 MHz for 40 and 20 meters or 14-30 MHz for 20, 15 and 10 meters without being excessively long. By limiting bandwidth still more, say 14 to 22 MHz, a log-periodic can be

trapezoidal type, one the sawtooth structure and the other the zig-zag, have been tested on 20 meters. Some of these log-periodic antennas have been described in amateur publications⁶⁻¹⁰ with complete dimensions and assembly details.

In addition, several special log-periodics have been designed on paper covering other frequencies. Some covered both MARS and amateur bands; several were for special vhf and uhf TV channels; and, I blush to say, one covered 26-27 MHz for a CBer wanting a good skip antenna.

After designing my first three log-periodics the hard way with the formulas, I felt there must be an easier design method. When designing the

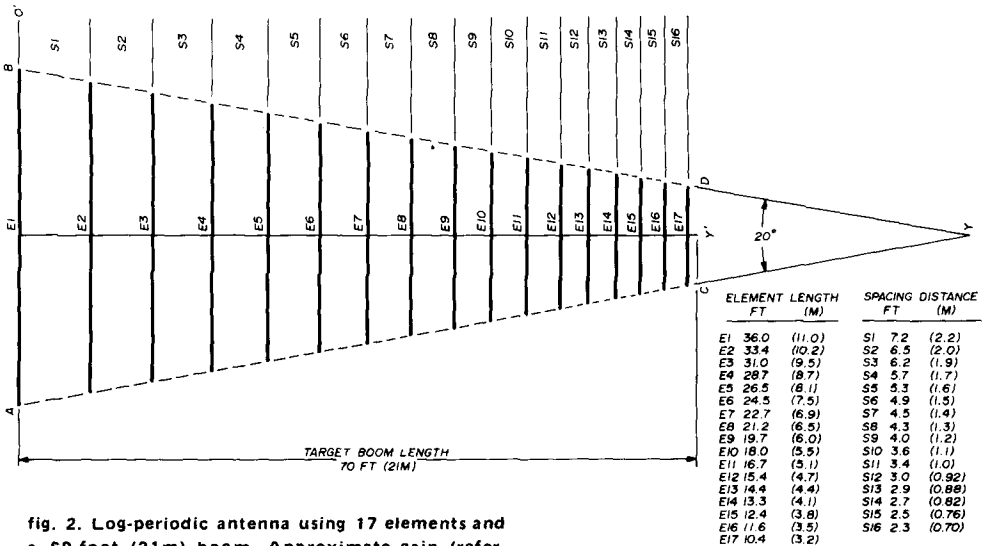

fig. 2. Log-periodic antenna using 17 elements and a 69-foot (21m) boom. Approximate gain (referenced to a dipole) for this design and those in figs. 3 to 5 is 10 dB. All cover 14 to 30 MHz.

original antennas, I always made an assembly sketch on graph paper after arriving at the correct element lengths and spacing distances. Since the outline of a log-periodic results in an isosceles triangle, with the long rear element being the base and the shorter forward elements forming the triangle toward the apex, the following simple no-math graphic design method became apparent. I believe this simple design method will be of interest to any amateur wishing to design a log-periodic for a particular band, bandwidth, or to fit a log-periodic into a given space.

graphic design method

You will need the following materials: graph paper, 1/10 cross section, 8½x10½ inch (21.5x26.7 cm) or larger; an architect or engineer's scale; a protractor; and some French curves (not absolutely necessary but helpful in designing the side catenary lines).

For the first example we will design an L-P for 20, 15 and 10 meters or for operation on any frequency between 14 and 30 MHz.

1. First determine the low- and high-frequency cutoff required or frequencies over which the L-P is to operate, or its bandwidth.

2. Next determine the amount of space available when the L-P is aimed in the desired direction. If there is a space limitation, it may be necessary to reduce the boom length, losing some gain. This is discussed later.

3. Determine the length of the longest (rear) element and the shortest (forward) element:

Rear element. The rear element should be at least 5% longer than the lowest cutoff or operating frequency. Using the usual formulas:

$$\begin{aligned} \frac{1}{2} \text{ wavelength} &= 468/\text{MHz} = 468/14 \\ &= 33.4 \text{ feet (10.2m)} \\ 33.4 + 5\% &= 34.4 + 1.7 \\ &= 35.1 \text{ feet (10.7m)} \end{aligned}$$

Since a slightly longer length is better, we will use 36 feet (10.9m) for the rear

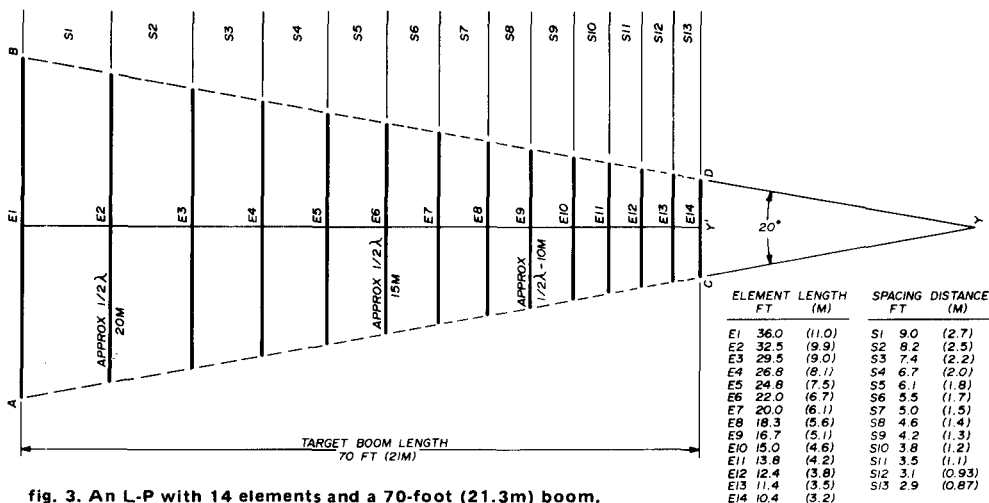

fig. 3. An L-P with 14 elements and a 70-foot (21.3m) boom.

element. This element length will resonate at $468/36 = 13.0$ MHz.

Forward element. The shortest element should resonate 45 to 50% higher in frequency than the desired high-frequency cutoff. From my experience, the swr will be lower by using a high-frequency cutoff plus at least 50%:

$$30 \text{ MHz} + 50\% = 45 \text{ MHz}$$

$$\begin{aligned} \frac{1}{2} \text{ wavelength at } 45 \text{ MHz} &= 468/45 \\ &= 10.4 \text{ feet (3.2m)} \end{aligned}$$

We now have the required length of the rear element, 36 feet (10.9m) and the forward element, 10.4 feet (3.2m)

4. We will now estimate a boom target length to determine a practical distance from the long rear element (E1) to the short forward element. From experience, an L-P designed to cover an octave (2:1 bandwidth) should have a boom length from 1.5 to 3 times the length of the rear element. If the boom length is less than 1.5 times the rear-element length, the apex angle will exceed 40 degrees and the forward gain will suffer. In other words, the gain drops off quite

rapidly for a boom length less than $E1 \times 1.5$, or with an apex angle of more than 40 degrees.

From the L-P formulas and nomographs in the references it will be noted that the α angle (which is $1/2$ the apex angle); relative spacing, σ ; design or scale factor, τ ; and other variables all govern the forward gain, front-to-back ratio, etc. The design factor, τ , given by references 4 and 5, is of special interest because it gives gain figures between 7.5 to 12 dB for various combinations of these formulas. However, the purpose of this article is to eliminate all formulas, so the information above is for those wishing to pursue further study.

We now have sufficient dimensions to start drawing the graphic L-P. In laying out the first antenna, use a scale of 10:1. Referring to fig. 1, proceed as follows:

5. First draw the longitudinal center line, X-Y. Now draw the longest element, E1, (line A-B) determined by step 3 to be 36 feet (10.9m).

6. A boom length of $2 \times E1$ will be used for the first example; $36 \times 2 = 72$ feet (21.6m). We will use 70 feet (21m)

as the target length and try not to exceed this length.

It will be found later that this overall length may vary plus or minus a few feet, but we will try not to exceed an overall length of 70 feet (21m). This will also give us a target length for fore and aft mast spacing.

Now measure 70 feet (21m) along the X-Y centerline from point X (or the rear element) toward Y, making a dot at

8. Draw line A-C and extend it until it crosses the X-Y axis. Next draw line B-D, extending it to also cross X-Y. If all drawings to this point have been accurate, these lines will meet, forming the apex, (Y), of an isosceles triangle, A-Y-B.

9. The next step is to add the remaining elements between the rear element, E1, (line A-B) and the short, forward, target

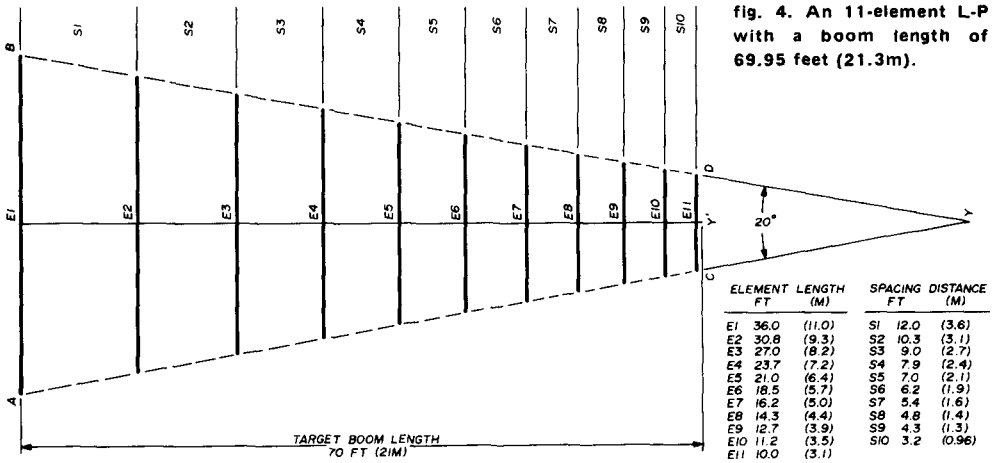

fig. 4. An 11-element L-P with a boom length of 69.95 feet (21.3m).

exactly 70 feet (21m), which will be called Y'.

7. Next draw a temporary (dotted) line, C-D, at the 70 foot (21m) point, making this line 10.4 feet (3.1m), which is the length of the shortest (forward) element. Make certain that the X-Y axis bisects this line, or that the two ends of line C-D are equidistant from X-Y. A permanent line is not drawn here as this is a temporary, or target line. It is a step of the graphic method needed to generate the triangle outline to which the other elements will be added. The final, short element, may not coincide exactly with the boom target length. It may miss this distance by a few feet; however, this has little effect on the performance of the antenna.

element, which should fall near the temporary element (line C-D).

Precise measurements must be made for the remainder of this design. For this reason an accurate scale must be used and the lengths should be read or estimated to 0.1 foot (3cm). Fig. 2 will now be used to complete the L-P. Our next objective will be to determine a correct spacing ratio between the elements.

element spacing

Since a log-periodic antenna can be considered a unidirectional, end-fire array having a series of driven elements, a spacing distance of 0.05 to 0.2 wavelength should provide the best gain, as

the two adjacent elements are out of phase because of transposition between elements, which is required for a log-periodic antenna.

For starters we'll use an element spacing of approximately one-tenth wavelength between elements such as the rear (longest) element, E1, and the following element, E2; and between E2 and E3, etc. An easy method of approaching this spacing is to divide the

triangle. As shown by fig. 2 this length will be 33.4 feet (10.2m). (The remaining elements and element spacing will be referred to as E3...En and S2...Sn, respectively.)

11. Next determine the second spacing distance, S2: $E2/5 = 32.5/5 = 6.5$ feet (2.0m). Mark this distance, S2, draw E3, and measure its length, which will be 31.0 feet (9.4m).

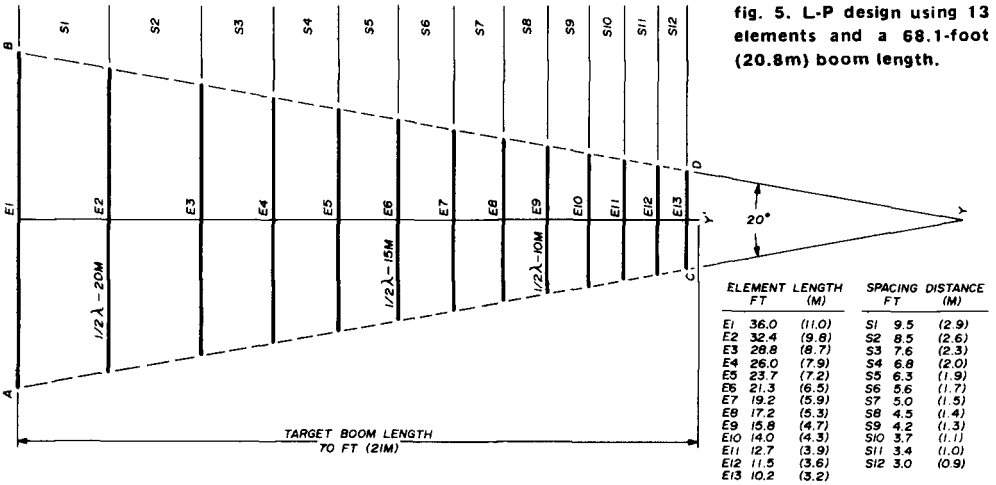

fig. 5. L-P design using 13 elements and a 68.1-foot (20.8m) boom length.

rear-element length by 5: $36/5 = 7.2$ feet (2.2m). For this simple design method, this might be considered similar to the "relative spacing ratio, $\sigma, = dN/21n,$ " or "the mean spacing factor, $\sigma', = dn/21n,$ " or "design ratio, $\tau, = 1n/L1-1,$ " in the log-periodic design formulas, which can be obtained from references 1-5 and 11. We shall, however, proceed with our no-math design method.

10. Refer to fig. 2 and accurately measure 7.2 feet (2.2m) from the center of element E1 (point X) down X-Y and mark the position with a dot. This point will be the location of the second element, E2. Now draw E2 and measure its exact length between the sides of the

12. Continue the mark-draw-measure-divide procedure, very accurately, to obtain the remaining spacing distances and element lengths until the last and shortest element is reached, which should be close to 10.4-feet (3.2-m) long and should be approximately ± 1 foot (30cm) from our boom target length, depending on how accurately the measurements have been made and drawn. We now have all element lengths and spacing distances for a 17-element log-periodic for 14-30 MHz having a boom length of approximately 69 feet (21m). As measured by the protractor, the apex angle is approximately 20 degrees. Considering this angle, number of elements, and the boom length, this

L-P should give a forward gain of approximately 10 dB if the antenna is one-half wavelength above ground, or at least 35 feet (10.7m) on 20 meters.

Although 17 elements are good from an swr standpoint, a smaller number of elements can be used, as mentioned later. Twelve to 13 elements are generally

ratio $L(E)/3$ is used, resulting in only 11 elements. As 12 to 13 elements are a minimum for a 2:1 bandwidth, fig. 5 is generated using a ratio $L(E)/3.8$, which gives 13 elements. This should be the optimum of the four L-Ps all having approximately the same final boom length and apex angle.

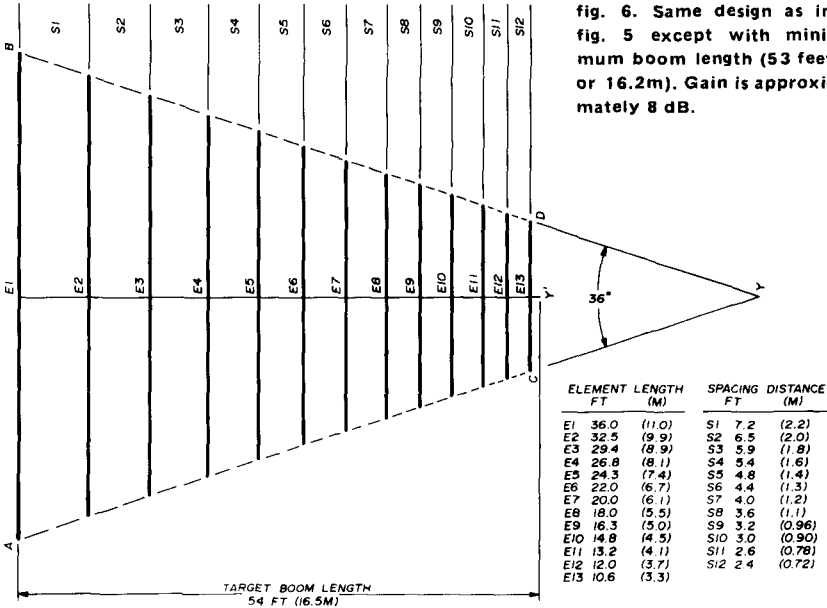

fig. 6. Same design as in fig. 5 except with minimum boom length (53 feet or 16.2m). Gain is approximately 8 dB.

the minimum required for an L-P designed to cover an octave. Using less than 17 elements will reduce weight, cost and labor.

a 14-element design

Fig. 3 illustrates a similar 14-30 MHz L-P also using a 70-foot (21.3m) boom target length but instead of the ratio $L(E)/5$, a ratio of $L(E)/4$ is used, resulting in 14 elements. Note that the boom length is almost exactly 70 feet (21.3m) and the apex angle remains the same as the 17-element L-P, fig. 2.

11- and 13-element designs

Fig. 4 is an equivalent L-P but the

Any one of these designs would have about equal forward gain; however, the 11-element design would probably not have as smooth or flat an swr across its bandwidth due to a minimum number of elements vs bandwidth. The swr might exceed 2:1 on some frequencies.

The 13-element array is one of the L-Ps assembled and being used here. Note that an odd number of elements is suggested from a mechanical assembly standpoint, as explained in some of my previous articles.

From the four L-Ps illustrated in fig. 2, 3, 4 and 5, it will be noted that the elements vary as follows: 11 for $L(E)/3$, 13 for $L(E)/3.8$, 14 for $L(E)/4$, and 17

for $L(E)/5$, each having essentially the same boom length and apex angle. Each should give approximately 10 dB gain.

14-30 MHz log-periodic with minimum boom length

If space is not available for a 70-foot (21.3m) boom length, the minimum length of 54 feet (16.5m) ($E1 \times 1.5$) can be assembled per fig. 6. The ratio of $L(E)/5$ is used, which gives 13 elements. Since this antenna has a length only 1.5 times that of the rear element (or approximately $3/4$ wavelength boom length), and the apex angle is 36 degrees, its gain will probably not exceed 8 dB.

14-30 MHz L-P with 100 foot (30.5m) boom length

For those desiring maximum gain from an L-P for 20, 15 and 10 meters and if space is available, the 14-30 MHz L-P boom length can be extended to approximately 100 feet (30.5m) as illustrated by fig. 7 which, if properly assembled and suspended at least 40 feet (12.2m) above ground, will give a gain of 12 dB.

$L(E)/3.3$ was used for generating this L-P. The boom target length was 100 feet (30.5m). For this drawing the last element, E17, is 101 feet (30.82m) from the rear element starting point, which overshoot our target by 1.1 foot (34cm). Sixteen elements could be used, which would be 98.0 feet (29.9m), but as mentioned previously, an odd number of elements is desirable from a mechanical standpoint; therefore, the extra 1.1 feet (34cm) should be acceptable.

gain vs boom length and apex angle

By the graphic design method we have generated three 14-30 MHz dipole log-periodic antennas having three different boom lengths, apex angles and gain:

boom length		apex angle	approximate gain
feet	meters	(degrees)	(dB)
54	16.5	36	8
70	21.3	20	10
100	30.5	15	12

Thirteen elements are suggested for the shorter 50- and 70-foot (15.2 and 21.3m) L-Ps and 17 elements for the 100-foot (30.5m) length. I have tried all three configurations. A 70-foot (21.3m) L-P is used for my northeast beam and the 100-foot (30.5m), 17-element array for the beam directed west, which has given outstanding performance.

Since the 10-meter band may not be of interest now due to propagation conditions, this portion of the L-P designs can be eliminated by deleting elements shorter than 15 feet (4.6m); i.e., for the 13 element L-P, fig. 5, elements 10, 11, 12 and 13 can be deleted, reducing the length by 14.3 feet (4.4m) leaving a 9-element L-P covering 14-21.5 MHz for 20 and 15 meters.

For the shortest L-P, fig. 6, deleting the four forward elements would reduce the length by 10.9 feet (3.3m) or a boom length of 41.2 feet (12.6m). This 20- and 15- meter beam could then be erected in a space 40 x 45 feet (12.2x13.7m). Likewise, for the 100-foot (30.5-m) L-P, fig. 7, elements 12, 13, 14, 15, 16 and 17 can be deleted, reducing its length 23 feet (7m), leaving an 11-element L-P with boom length of 78.2 feet (23.9m). The deletion of the 10-meter section of these L-Ps will have little effect on the gain on 20 and 15 meters, since the apex angle is unchanged.

40- and 20-meter log-periodics

The same graphic approach can be used for designing an L-P covering 7-14.5 MHz for operation on 40 and 20 meters; however, by doubling the element lengths, spacing distances, and boom length of the 20-, 15- and 10-

meter L-Ps (fig. 2 through 7), 40- and 20-meter L-Ps can be assembled, except possibly that of fig. 7, since it would be over 200 feet (61m) long. The L-Ps of fig. 2, 3, 4 or 5 would become 140 feet (42.7m) long; however, the shortest L-P, (fig. 6), would be only 108 feet (32.9m) long.

By adding four or five short forward elements and extending the boom length slightly, a 40- and 20-meter L-P

In reference 7 a single-band L-P for 40 meters was described which has been tested here. Single-band L-Ps can be assembled for any of the high-frequency bands using the graphic design method. Five elements are sufficient and the swr remains relatively flat across the band for which the antenna is designed. A total of five different single-band L-Ps have been tested here on several bands. With an apex angle of 32 -

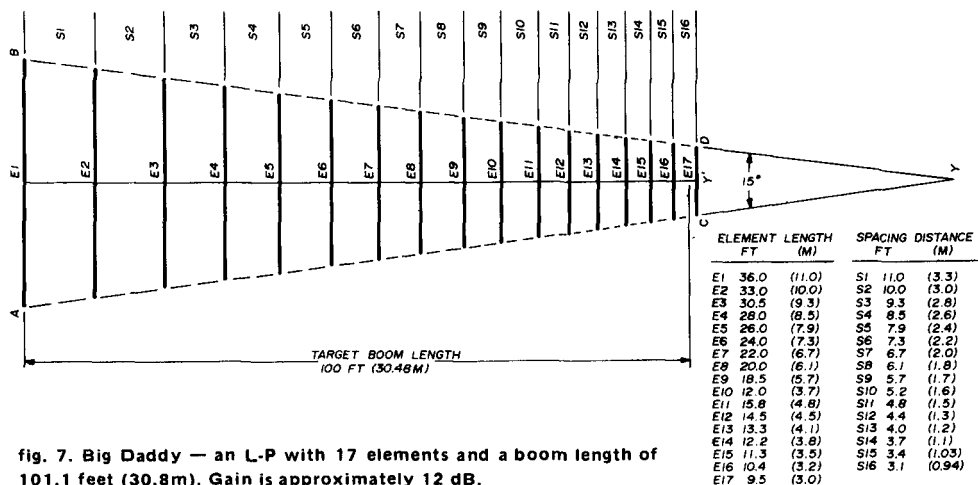

fig. 7. Big Daddy — an L-P with 17 elements and a boom length of 101.1 feet (30.8m). Gain is approximately 12 dB.

can be modified to cover 7 to 21.5 MHz for operation on 40, 20 and 15 meters, which are probably the most-used bands at present. A 40-, 20- and 15-meter L-P was described in reference 7, which was of the skip-band type having a portion deleted between 7 and 14 MHz. An L-P for 40 meters should be at least 70 feet (21.3m) high for DX work.

For those wishing to design an L-P covering a bandwidth greater than a single octave, 12 to 13 elements are about the minimum that should be used. Additional elements can be used as the boom length is increased. For a 3:1 bandwidth, no less than 18 or 19 elements will be required; for 4:1 approximately 21 will be required.

36 degrees, the single-band L-P will generally show a gain of 8 to 10 dB provided it is suspended approximately one-half wavelength above ground.

vertical monopole log-periodic antennas

The vertical monopole L-Ps for 40 and 80 described in reference 9 were also assembled by the graphic design method. The ratio L(E)/5 is best for a single-band, 5-element dipole or monopole L-P since element E2 will be spaced approximately one-quarter wavelength from the shortest element; and the open-wire center feeder, which is one-quarter wavelength from the feedpoint to E2, or the active element, also serves

as an impedance-matching transformer between element E2 and the higher impedance at the feedpoint, which is of the order of 200 - 300 ohms. Thus a 4:1 balun can be used.¹²

summary

Of the nearly twenty different log-periodic antennas I have built and tested, all but the first three (erected in 1970) have been designed by the graphic method. Although this simple procedure may seem crude, and may not be as accurate as an L-P designed entirely by the formulas, all antennas have produced the same results. In addition to the dipole log periodics, I have erected and tested three of the monopole L-Ps, which have quarter-wavelength vertical radiators and ground radials. These were tested on 40 and 80 meters. My graphic design method has also been applied to two of the trapezoidal sawtooth and zig-zag log-periodic designs now being tested on 20 and 15 meters.

I hope the simple non-math graphic design method will be of help to those wanting a special L-P for a particular frequency range or to fit in a limited space. To obtain maximum gain, make

the L-P as long as possible for the given space; this will in turn give a minimum apex angle. Also use a sufficient number of elements to keep the swr relatively flat across the band for which the antenna is designed.

If you plan an L-P for 20, 15 and 10 meters, try to make the boom at least 54 feet (16.5m) long and use a minimum of 13 elements. If you are not interested in the 10-meter band, it would be better to design the L-P to cover 14 to 22 MHz only for 20 and 15 meters, using the 54-foot (16.5-m) boom length for a 9-element 14 to 22 MHz L-P. This would reduce the apex angle to 32 degrees and the gain would be approximately 10 dB vs 8 dB for the 20-, 15- and 10-meter antenna on the same boom length.

acknowledgements

I wish to thank the many amateurs who have assisted in on-the-air tests of these L-Ps for the past four years and for the many letters, phone calls, visits and QSOs by those interested in L-P design. I particularly thank those who have actually erected and are now using L-Ps similar to mine described in the references.

references

1. H. Jasik, "Log Periodic Design," *Antenna Engineering Handbook*, McGraw-Hill, New York, 1961.
2. R. Carrell, "Analysis and Design of the Log Periodic Dipole Antenna," *IRE National Convention Record*, McGraw-Hill, New York, 1961.
3. Carl E. Smith, *Log-Periodic Antenna Design Handbook*, Smith Electronics, Inc., 1966.
4. International Radio Consultative Committee - C.C.I.R., *Handbook on High-Frequency Directional Antennae*, International Telecommunications Union, Geneva, 1966, page 26.
5. A.E. Blick, VE3AHV, "The Design of Log Periodic Antennas," *73*, May, 1965, page 62.
6. G.E. Smith, W4AEO, "Three-Band High-Frequency Log-Periodic Antennas," *ham radio*, September, 1972, page 28.

7. G.E. Smith, W4AEO, "40-Meter Log-Periodic Antennas," *ham radio*, May, 1973, page 16.
8. G.E. Smith, W4AEO, "High-Gain Log Periodic for 10, 15 and 20," *ham radio*, August, 1973, page 18.
9. G.E. Smith, W4AEO, "Vertical Monopole Log-Periodic Antenna for 40 and 80 Meters," *ham radio*, September, 1973, page 44.
10. G.E. Smith, W4AEO, "Mono-Band Log-Periodic Antennas," *73*, Part 1 August, 1973, Part 2 September, 1973.
11. "MF/HF Communications Antennas," Defense Communications Engineering, Installation Standards Manual, DCAC 330-175-1, Addendum 1, 1967.
12. G.E. Smith, W4AEO, "Feed Systems for Log-Periodic Antennas," *ham radio*, October, 1974, page 30.

ham radio

four-element phased vertical array

Design and construction
of a four-element
phased array
for 40 meters
that provides nearly
9 dB forward gain

Jerry Swank, W8HXR, 657 Willabar Drive, Washington, Ohio 43160

For the last ten years, during the Antarctic winter, I have been handling phone-patch traffic from KC4-land on 40 meters. At this end I have been using a pair of phased verticals. In Antarctica they have used log periodics, vees, rhombics and monopoles. I usually receive good signal reports, but their signals are often buried in summer static and difficult to copy.

I have often tried to get the operators in Antarctica to try phased vertical antennas, but they change crews every year, and no one was apparently very interested. Then, three years ago, I began working Byrd Station nearly every night with Bob Conner, and I told him that I thought a set of phased vertical antennas would solve their problem.

When he came back for two-years stateside duty we got together and planned that when he went back to Antarctica in 1974 we would try out the idea. I outlined the plan for the vertical array, and we discussed it thoroughly, planning to ship everything to Antarctica, down to the last solder lug.

The Navy bought four trapped vertical antennas, Hy-Gain 14AVQs, and Bob got the necessary wire and fasteners to mount them. The logistics turned out to be a real cliff hanger with the antennas barely making it on board the last plane into McMurdo Station. It was a great deal of work in the icy weather, but finally, on February 9th, 1974, one vertical was installed. Bob was pretty discouraged, though, because the single vertical picked up so much noise from the big, nearby Navy installation that it was unusable. I told him to be patient and put up another one a half-wavelength away and hook them up as a broadside array. On February 11th the signals from McMurdo came through loud and clear, and Bob said that the interference had dropped almost to zero.

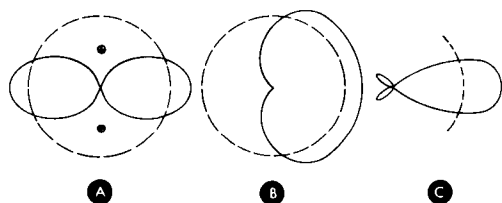

fig. 1. Horizontal radiation pattern of half-wavelength spaced vertical antennas is shown in (A). Pattern at (B) is that of quarter-wavelength spaced verticals. At (C) is pattern of the four-element phased array discussed here.

By arranging the location of a phased array and properly orienting it, noise can be cut as much as 40 dB. In fact, this was the original reason I had gone to phased verticals. The noise from the 7200-volt utility line at my back property line, 12 feet (3.7 meters) from the antennas, put a steady buzz into my receiver at about S6. When I installed

the phased array, the noise dropped practically to zero.

When the four vertical antennas were installed at McMurdo Station, their 40-meter signals began coming in about 0700 GMT at 10 to 40 dB over S9. Everyone there (and here) was ecstatic, and stations all over the states began breaking-in to tell the KC4USV operators their signals had never been so loud. Note that this was before the 40-meter season normally opened. We did not expect to use 40 meters except for tests, and had planned to meet on 20 meters for coordination. We did not expect 40 to be usable until sometime in April.

the array

The broadside array with half-wavelength spacing has very broad nulls on the side and a narrow 60° beam which takes out noise on either side quite well (fig. 1A). The forward gain is about 3.86 dB. Quarter-wavelength spacing of the verticals results in a cardioid pattern (fig. 1B); the beam width is about 120° and the only good null is toward the rear. However, this pattern has a lower forward angle of radiation, and is best for extreme distances. Forward gain is about 4.5 dB.

Combining the half-wavelength spaced broadside array with the quarter-wavelength spaced system (fig. 2) provides nearly 9 dB forward gain. This is better than a three-element beam and at a lower angle unless you have a real man-sized tower. The pattern is similar to that of a Yagi (fig. 1C).

construction

A plan view of the four-element phased array is shown in fig. 3. The phasing lines between the quarter-wavelength spaced elements (A-D and B-C) are 3/4-wavelength long because,

when the velocity factor of the RG-8/U coaxial cable (0.66) is taken into consideration, a quarter-wavelength coaxial line is too short to reach between the elements. The 3/4-wavelength phasing line provides the same phase delay.

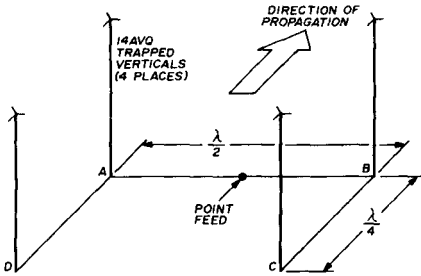

fig. 2. The four-element 40-meter phased array used at KC4USV uses four Hy-Gain 14AVQ trapped verticals.

Although a tee connector is shown between the two half-wavelength spaced elements (A and B), in the installation at McMurdo Station the tee connector is actually located inside the station. Because of the severe weather conditions during the winter, and frequent 100 mph (160 kmh) winds, this system allows either quarter-wave spaced pair to be used separately in case one of the verticals of the other pair is brought down or damaged by the wind.

It would also be possible to feed antennas C and D with one feedline, and antennas A and B with another, placing the phasing line inside the shack. With this system the pattern of the array could be reversed.

The antennas at McMurdo Station are mounted on a hill of volcanic ash and the electrical ground is down about 30 feet (9m). It was originally planned to use ground radial mounting, but the volcanic ash has extremely low conductivity, and the antennas are mounted on about six feet (1.8m) of pipe, so they are located a quarter wavelength above

electrical ground. This is ideal for a ground plane. One radial was installed on the far side and five radials on the near side to support the antennas and provide the best ground plane toward the desired direction (see fig. 3). The radials are each insulated at the outer, high-voltage ends.

performance

Because of poor performance in previous years, in 1974 the Navy installed a Collins log-periodic on a 100-foot (30.5m) tower. We tested the phased array twice against the big log-periodic, once under good conditions, and once under the poorest conditions. The log-periodic had less than 3 dB advantage over the phased vertical array. The old 40-meter beam, used for years, sounds pitiful by comparison.

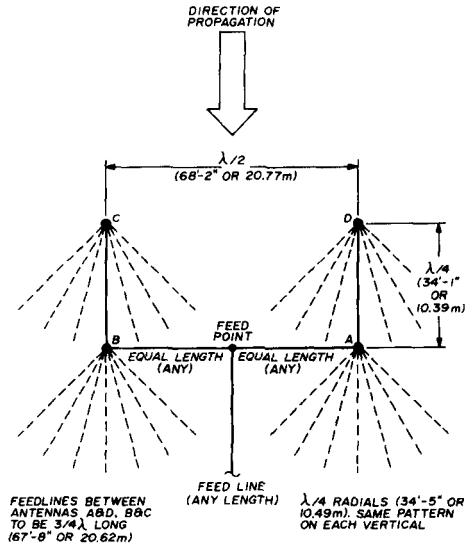
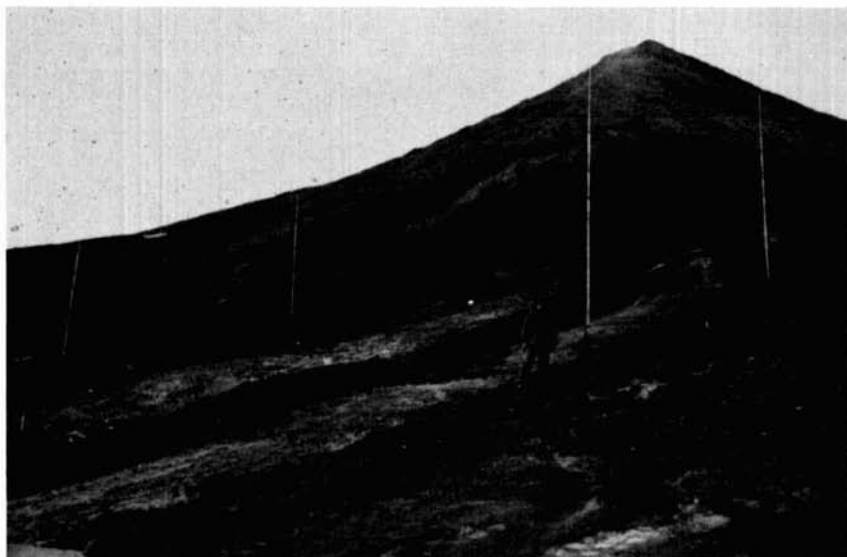

fig. 3. Dimensions of the 40-meter phased array. Gain of this antenna is nearly 9 dB.

An unexpected bonus made the phased array even more valuable. Since the four verticals are trapped designs for operation on 40, 20, 15 and 10 meters, performance on 20 meters is good. By

dropping one cardioid section, the remaining section becomes a half-wavelength end-fire array on 20 (it also works well on 15 meters). Trapped antennas were originally chosen because they were shorter, and less likely to be

stalled temporarily as a half-wavelength spaced broadside pair so contact was resumed in a few days. When the ham shack was rebuilt the four-element phased array was placed back in operation. The big log-periodic on the 100-



The phased array at KC4USV is mounted approximately 6 feet (1.8m) off the ground on a sloping hillside so the rear pair of antennas is about 7 feet (2.1m) higher than the forward pair. This results in an extremely low vertical radiation angle. Standing by one of the antennas is Bob Conner, WB2BCJ, who installed the array at McMurdo Station in Antarctica.

blown down in high winds, so multi-band operation of the array was an added bonus.

postscript

On July 22nd, 1974, an ice storm hit McMurdo Sound with winds to 138 mph (222 kmh), tearing off the roof and one wall of the ham shack. The storm also took out the large elements of the big log periodic, making it unusable on 40 meters. The four 14AVQ verticals in the array, however, were completely undamaged.

All the amateur radio gear was moved to another building and two spare 14AVQ vertical antennas were in-

foot tower, on the other hand, had to wait until summer.

As a sidelight, to show what the weather is like at McMurdo Station, on August 8th a plane came in from Christ Church, New Zealand, 2000 miles away, air dropped nine sacks of mail, weighted with sand, from about 400 feet (122m) and returned non-stop to New Zealand. One bag broke open and three others were carried away by the wind. Two of the three bags were found 20 miles (32km) away and one was finally recovered 45 miles (72km) away. The mail from the broken bag was only partially recovered!

ham radio

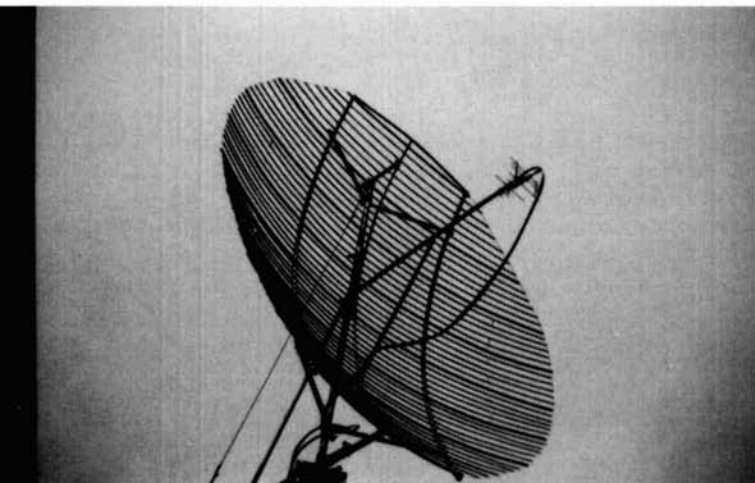

parabolic reflector

element spacing

It's not necessary
to use solid or screened
reflector surfaces —
properly spaced
reflector elements
provide the
same performance

Norman J. Foot, WA9HUV, Elmhurst, Illinois 60126

The subject of parabolic reflector element spacing is like the weather — nearly everybody talks about it, but few people do anything about it. One reason is that there are a large number of parameters relating to good parabolic antenna design, and the matter of reflector element spacing seems to have been lost in the shuffle.*

It is possible to avoid the issue of reflector spacing by adding metal screening or using a solid metal surface as many builders have done.^{1,2} Some of these designs however, take special skills and the cost is likely to be high. As an alternative, an all-metal dish can be purchased on the surplus market.

*Sometime after preparing the material for this article, author WA9HUV discussed it with Edward F. Harris, Chief Engineer with Mark Antennas, and discovered that Harris had done similar work in the 1950s. His report, "Designing Open-Grid Parabolic Antennas," appeared in the November, 1956, issue of *Electronic Industries* magazine.

On the other hand, several low cost parabolic-reflector designs employing aluminum tubing have appeared in amateur radio magazines in recent years.^{3,4} The question is, are these designs really inferior to solid reflector designs, and if so, to what extent? What are the performance compromises one is willing to make when consideration is given to cost, mechanical strength and stability, portability, ease of construction, mounting, wind-loading and weight?

It seems reasonable to assume that if the elements of a reflecting screen are located extremely close together in terms of operating wavelength, then most of the incident energy will be reflected and very little will be transmitted through the screen. On the other hand, if the reflector elements are many wavelengths apart, it seems clear that a large portion of the incident energy should pass through uninhibited. By intuition, it does not seem likely that a screen of reflectors suddenly becomes completely reflective at some critical value of element spacing. It also follows that the screen probably does not become completely transparent when this critical value of element spacing is slightly exceeded. Just how does the reflective property vary with element spacing?

In an attempt to answer these questions I performed a series of experiments. The results, which are the subject matter for the balance of this article, should be of interest to future builders of parabolic reflectors.

test setup

To perform the experiments, a wooden frame 20-inches (51-cm) wide was made of furring strips. Holes were drilled in the sides of the frame 3/4-inch (19-mm) apart so that 24-inch (61-cm) long aluminum tubes, 7/16-inch (11-mm) OD, could be inserted and

stacked like a venetian blind, with the elements separated by 3/4 inch or any multiple of 3/4 inch. A sketch of the frame is presented in fig. 1.

Two kinds of experiments were performed, one to test the transmission and the other the reflective properties of the screen as element spacing was varied. A

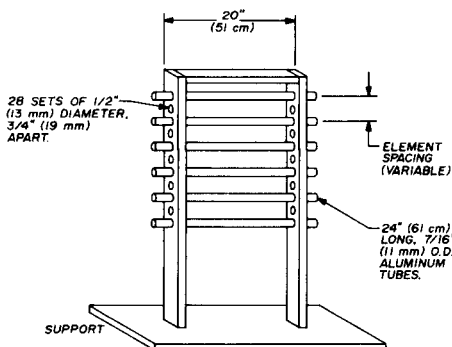

fig. 1. Sketch of wooden frame used to vary the space between reflector elements. Test setups are shown in fig. 2 and 3.

battery-operated 2304-MHz small-signal source driving a circular horn antenna was used as the transmitter.

A similar horn antenna was used to feed a 2304-MHz converter. The 2304-MHz test frequency was chosen so that the reflecting screen could be kept reasonably small. If the experiment were performed at 432 MHz, for example, much longer reflector elements and a physically larger frame would have been required.

In the second set of experiments both the receiving and transmitting horn antennas were located on the same side of the reflector, side-by-side, and oriented so that maximum reflected signal was received. When the reflector was removed, the crosstalk between horns was too small to operate the S-meter in my receiver. The elements of the screen were then added in various combina-

tions of spacing, and the S-meter reading recorded for each case.

test results

In the first set of experiments in which the receiving and transmitting antennas were separated by the screen, very little signal reached the receiving antenna for element spacings up to 1½ inches (38mm). At 2¼ inch (57mm) spacing, the screen became slightly opaque, while at 4 inches (102mm) it was almost completely transparent. It is interesting that for the 3-inch (76 mm) spacing, approximately half of the incident energy was transmitted through the screen. Fig. 2 shows the results of these tests.

Fig. 3 shows the results of the second set of tests. With spacings up to 2¼ inches (57mm), most of the transmitted signal power was reflected into the receiving horn. With 3-inch (76mm) spacing, half the power was reflected and half was transmitted through the screen. This correlates very well with the first set of experiments. For spacings of 3-3/4 inch (95mm) or more,

nearly all of the incident energy passed through the screen.

data analysis

The data shows clearly that the screen is a good reflector for element spacings less than 3 inches (76mm) at

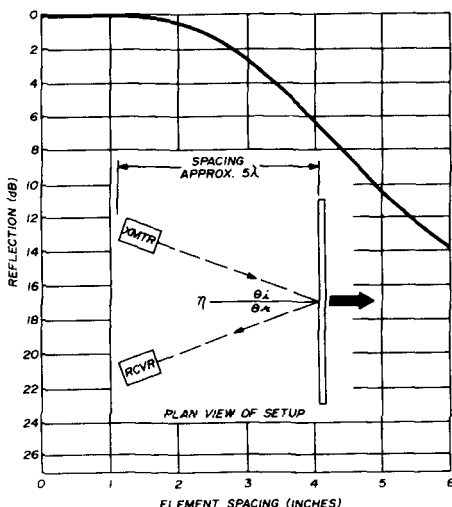

fig. 3. Reflection characteristic at 2304 MHz as a function of reflector element spacing.

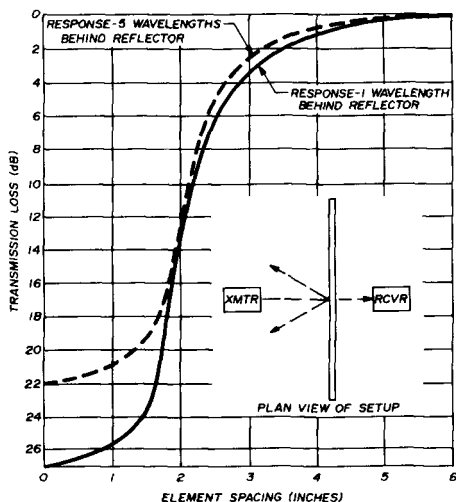

fig. 2. Transmission characteristic at 2304 MHz as a function of reflector element spacing.

2304 MHz, and a poor reflector for spacings greater than 3 inches (76mm). The space between the 7/16-inch (11mm) OD aluminum tubes for a 3-inch (76mm) center-to-center spacing is 2.5625 inches (65mm). Recognize that a free-space half-wavelength at 2304 MHz is very nearly the same value, or 2.563 inches. Further thought suggests that the adjacent elements may operate on much the same principle as a transverse magnetic (TM) mode waveguide.⁵ To test this idea, note that the cutoff frequency in such a case depends on the dimensions of the waveguide in the following manner:

$$\lambda_c = \frac{2ab}{\sqrt{a^2 + b^2}}$$

This equation can be illustrated geometrically as shown in fig. 4. Note that as the a dimension is increased to infinity, which is the case of parallel reflector elements, then $\lambda c/2$ approaches b . This is exactly the result that the experiments led to. In other words, by definition, the cutoff frequency of a curtain of parallel reflector elements occurs when the space *between* adjacent elements is one-half wavelength.

This interesting result also implies that the diameter of the reflectors has little to do with the cutoff frequency, since it is the open space between the reflector elements that is significant. Therefore, the analysis also applies to tubes of different diameters as well as to reflector elements having different cross-sectional shapes.

The experiments also show that at the cutoff spacing, the loss in terms of percentage of power transmitted is 3 dB. This can be interpreted to indicate that the illumination efficiency of a parabolic reflector with element spacing corresponding to the cutoff frequency would be 50%. For example, assume a dish diameter of 12 feet (3.7 meters) operating at 2304 MHz; its gain, if it was well designed in all respects, is given by⁶

$$\begin{aligned} \text{Gain} &= 0.59 \left(\frac{\pi D}{\lambda} \right)^2 = 0.59 \left(\frac{\pi 3.7}{0.13} \right)^2 \\ &= 4703 \text{ or } 36.7 \text{ dB} \end{aligned}$$

where D is the diameter of the reflector, λ is the operating wavelength and the coefficient 0.59 accounts for the illumination efficiency of a well designed dish. If the element spacing was the critical value, however, allowing half the incident power to pass through the elements, the dish gain would be 3 dB less, or 33.6 dB. The overall efficiency of such a dish would be 29% instead of 59%.

It is interesting to note that, even with losses of this magnitude, the ERP of this dish would be over 10 kW when

fed with 5 watts. If the element spacing was reduced to 2 inches (51mm) however, the ERP would increase to over 20 kW at 2304 MHz.

economical 432-MHz design

On the basis of these experimental and analytical results, a parabolic reflector can be built for 432 MHz having only 1 dB reflector loss if the elements are spaced 12 inches (30.5cm) apart. In this case, only 13 reflector elements are needed for a 12-foot (3.7-meter) dish.

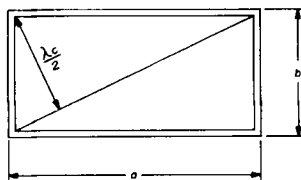

fig. 4. Geometry of the transverse magnetic mode (TM_{11}) in rectangular waveguide (see text).

The design would be very lightweight and would have relatively low wind-cross section. Compared to the ideal dish made of solid sheet metal, this dish would have an illumination efficiency of 47% instead of 59%, and a gain of 21 dB instead of 22 dB.

1296-MHz dish design

It is interesting that 7-foot (2.1-meter) parabolic receiving antennas manufactured for TV use employ 4-inch (10.2 cm) spacing. This makes them useful at 1296 MHz without the addition of hardware cloth or other metal screening if you are willing to accept approximately 1.0 dB reduction in gain compared to a solid metal design. The gain of such a dish is 26 dB at 1296 MHz. If the loss of a dB makes you nervous, the dish diameter can be increased by 12% to compensate for the loss. Thus, a 12-foot (3.6-meter) dish should be made 13 feet (3.96 meters) in diameter, while

the 7-foot (2.1-meter) dish diameter should be increased to nearly 8 feet (2.4 meters) to compensate for 1 dB of reflector transmission loss.

It should be recognized that the parallel element dish is sensitive to polarization and will not work well with dual or

mesh if made of 7/16 inch (11 mm) diameter aluminum tubing.

on the air tests

The 12-foot (3.6-meter) parabolic reflector I use was put into service in 1970. Initially, it was not covered with

table 1. Center-to-center spacing of parabolic reflector elements for 1.0 dB loss of gain.

reflector tubing diameter	frequency (MHz)		
	432	1296	2304
7/16" (11mm)	12.000" (305.0mm)	3.855" (98.0mm)	2.168" (55.0mm)
1/2" (13mm)	12.063" (306.5mm)	9.917" (99.5mm)	2.230" (56.5mm)
5/8" (16mm)	12.125" (308.0mm)	4.042" (102.5mm)	2.355" (60.0mm)
3/4" (19mm)	12.375" (314.5mm)	4.167" (106.0mm)	2.480" (63.0mm)

circularly polarized feed systems such as may be desirable for EME or satellite communications. However, it is entirely feasible to use a second set of reflectors at right-angles to those already described to eliminate polarization sensitivity. Such a dish, if designed for 432 MHz, for example, would have a surface resembling a 12x12-inch (30x30cm)

screening. Tests performed before and after adding expanded aluminum screening both on 432 MHz and 1296 MHz did not indicate any difference in performance or gain.

More recently, comparative tests were run with and without screening on 2304 MHz, and a small reduction in gain was noticed. The radiation patterns on

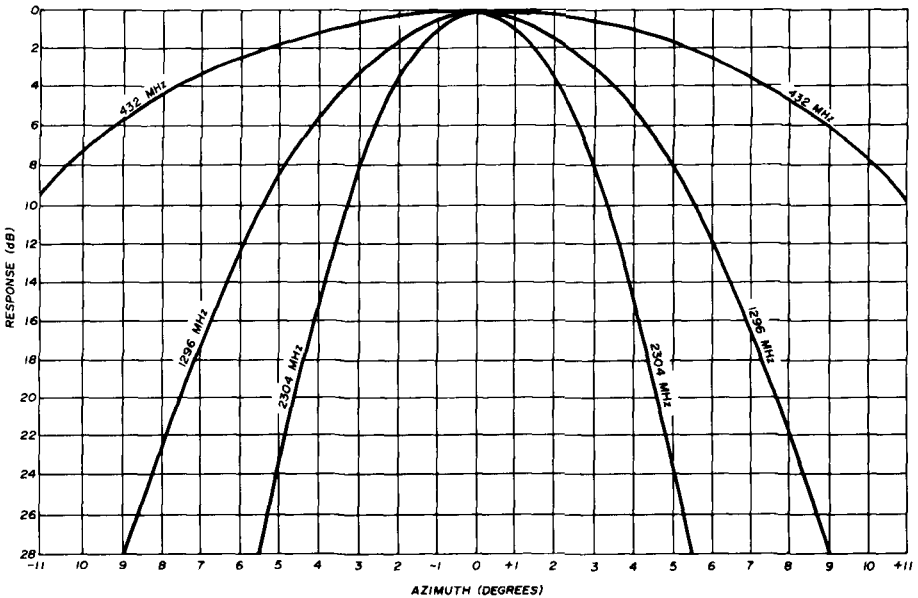

fig. 5. Azimuth patterns of WA9HUV's 12-foot (3.6-meter) parabolic reflector at 432, 1296 and 2304 MHz (photograph of dish is shown at beginning of article).

all three bands did not change however. Fig. 5 shows the patterns of the 12-foot dish without screening for 432, 1296 and 2304 MHz. These patterns were taken with the aid of battery-operated signal sources located approximately 0.2 mile (0.32 km) from the dish, and elevated above ground to the same height as the center of the dish. The pattern test conditions were fairly ideal since the line of sight path was unobstructed, giving essentially free-space conditions.

summary

Probably the most simple and effective parabolic reflector design is the one described in this article. The reflecting elements should be oriented parallel to the direction of polarization of the exciting wave. Thus, for horizontal polarization which is in most general use for amateur purposes, the elements of the parabola should be oriented horizontally. The space between elements should be less than a half wavelength at the highest operating frequency. To reduce the loss through the reflector to 1.0 dB, the space between reflectors should be approximately 0.439λ . Table 1 shows center-to-center spacing for various sizes of tubing for frequencies of 432, 1296 and 2304 MHz.

references

1. Pete Laakmann, WB6IOM, "A Large Homebrew Parabolic Reflector," *ham radio*, August, 1969, page 8.
2. Ray Naughton, VK3ATN, "Parabolic Reflector Antennas," *ham radio*, May, 1974, page 12.
3. "WA9HUV 12-Foot Dish for 432 and 1296 MHz," *QST* (World Above 50 MHz), June, 1971, page 100.
4. Richard Knadle, K2RIW, "A 12-Foot Stressed Parabolic Dish," *QST*, August, 1972, page .
5. G.C. Southworth, *Principles and Applications of Microwave Transmission*, D. Van Nostrand and Company, New York, 1950, page 117.
6. K.E. KcKee (Andrew Corporation), "Optimizing Gain of Parabolic Antennas," *Micro-waves*, March, 1967, page 34.

ham radio



You're Ahead when mobile with a Larsen Kūlrod[®] Gain Antenna

- TOPS IN PERFORMANCE ■
- LOW SILHOUETTE GOOD LOOKS ■
- V.S.W.R. LESS THAN 1.3 TO 1 ■
- HANDLES FULL 200 WATTS ■

Larsen Kūlrod VHF Antennas are the result of over 25 years of practical experience in the two-way radio field. They are rugged, reliable and built with infinite care to assure top performance. Models available to fit all standard mounts and for all popular amateur VHF frequencies. Each is equipped with the exclusive Larsen Kūlrod, your assurance of maximum efficiency and no loss of RF through heat. Comes complete with all instructions. Models for 2 meters deliver a full 3 db gain over 1/4 wave whips . . . the 420-440 MHz and 440-460 MHz collinears . . . 5 db gain and full 100 watts capability.

Sold with a full money back guarantee . . . the most liberal in the mobile antenna field. Whether you work via repeater or simplex you deserve to have a Larsen Kūlrod. Get full fact sheet and prices, today.



© Kūlrod . . .
a trademark of Larsen Electronics

Larsen Antennas

11611 N.E. 50th Ave. P.O. Box 1686
Vancouver, WA 98663
Phone 206/573-2722

how to design shunt-feed systems for grounded vertical radiators

A graphical
design system
for using your tower
as a shunt-fed
vertical antenna

Vertical antennas have several advantages over horizontal dipoles on the lower amateur bands, especially in those cases where the dipole cannot be raised at least one-half wavelength above ground. A recent article showed how to use a 54-foot (16.5m) tower, top loaded with a quad or Yagi, as a grounded vertical radiator on 40 and 80 meters.¹ However, to properly design the shunt-feed matching system for these two lower bands required the use of a good quality impedance bridge. Once the complex input impedance had been determined, a graphical method was used to calculate the components required to match that impedance to a 50-ohm transmission line.²

This antenna system generated a great deal of interest, but since few amateurs have access to an RX impedance bridge, they were unable to use this technique to adapt their own

towers for use on the lower amateur bands. For this reason I decided to make a series of measurements which would be used to generate a set of graphs which would simplify the design of shunt-fed vertical radiators. These graphs are presented in this article.

First, a series of antenna tests were conducted by scale modeling to determine the electrical height of towers which are capacitance loaded by a typical Yagi beam or cubical quad. Further tests were conducted to determine how long the gamma-type shunt feed rod had to be to permit the use of a practical L-network for matching to 50-ohm coaxial cable.

All tests were made with an aluminum-tubing gamma rod about 1 inch (25mm) outside diameter, spaced 10 ± 2 inches (20.3 to 30.5cm) from one leg of the tower. This size was chosen for maximum physical and electrical stability as well as high conductivity. The resultant design curves show the electrical height of the tower, required gamma rod length, and series capacitance, C_s , required to cancel the inductive reactance of the gamma rod. The parallel matching capacitance, C_p , is also given (fig. 1). The series and parallel capacitors should both be air variables so the matching system can be adjusted to provide as low vswr as possible.

using the curves

The graph of fig. 2 shows the relationship of physical height to electrical height of a thin wire (calculated from

John R. True, W40Q, 10322 Georgetown Pike, Great Falls, Virginia 22066

$234/f_{\text{MHz}}$), measured electrical height of a 1½-inch (38mm) diameter conductor (which coincides very closely with the predicted electrical height of a thin conductor), and a tower 1 to 2 feet (30 to 61cm) in cross section, top loaded with a Yagi or cubical quad. If you wish to use your present tower as a vertical antenna for the lower bands, you can determine its electrical height from the data presented in fig. 2.

The data in fig. 3 is for use on the amateur 7-MHz band and shows the length of the gamma rod and required series capacitance for towers up to 90 feet (27 meters) high (about ¾ wavelength on 40 meters). Towers which are taller than this will produce a large lobe of high-angle radiation that reduces the radiation at lower vertical angles. Some shorter towers may actually be shorter, physically, than the recommended gamma rod; in that case more parallel capacitance will be required to match the system to 50 ohms. Fig. 4 shows the same type of data for the 80-meter band (towers higher than 180 feet [54 meters] exhibit the large, high-angle lobe).

The data in fig. 5 is for use on the 160-meter band. Note that a tower which has an electrical height of 90 feet (27 meters) requires a gamma rod which is 60 feet (18 meters) long. Since a 43-foot (12m) tower with a Yagi represents an electrical height near 90 feet, a 60-foot gamma rod is obviously an impossibility. The use of a shorter gamma rod and more parallel capacitance *may* provide a match to 50 ohms, but in this case an rf bridge and graphical solution will save a lot of time.³

Note that for towers with electrical heights near 53 and 70 feet (16.2 and 21.3 meters), a gamma rod approximately 20 feet (6.1 meters) long will provide operation on both 80 and 40 meters (the rod is about a quarter-wavelength long on 80 meters, one-half wavelength long on 40). For operation on both 80 and 160 meters, a similar coincidence occurs for towers which are

electrically near 110 and 135 feet (35.5 and 41.1 meters) high. In this case a gamma rod approximately 40 feet (12.2 meters) long will provide operation on both bands. In either of these dual-band systems adjustments of the parallel tuning capacitor, C_p , will compensate for differences from the specified gamma rod length.

fig. 1. System for using a tower as a shunt fed grounded vertical radiator on 40, 80 or 160 meters.

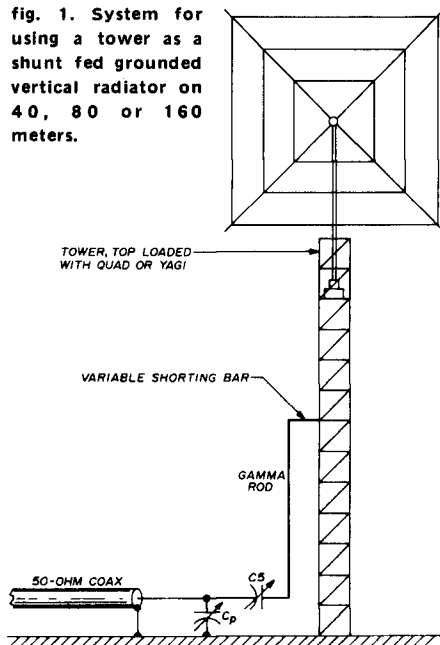

The electrical height of towers higher than 120 feet (36 meters) can be extrapolated by adding about 35 feet (10 meters) for a three-element 20-meter Yagi with a quarter-wavelength boom (about 16 feet or 5 meters); add about 45 feet (13 meters) of electrical height for a multielement beam such as the Hy-Gain TH6DXX. A two-element 40-meter beam adds 50 to 60 feet (15 to 18 meters). Although cubical quads add about 25 feet (7.6 meters), multielement quad designs add little more because the elements are well away from the top of the tower and insulated from it.

matching capacitors

Since the reactance of the series capacitor, C_s , is quite large except in those cases where the tower is approximately a quarter-wavelength high, this capacitor should have a breakdown rating of about 1000 volts for transmitters up to about 200 watts output. For transmitter powers of 2000 watts this capacitor should have a breakdown rating of 5000 volts or more.

Where large capacitance values are recommended, it is suggested that at least half be variable with the rest made up with fixed padding. Note that *both* the stator and rotor of the series capacitor must be isolated from ground.

The ideal matching network for this antenna system would use two vacuum-variable capacitors. These capacitors are not seriously affected by humidity or changes in barometric pressure, and

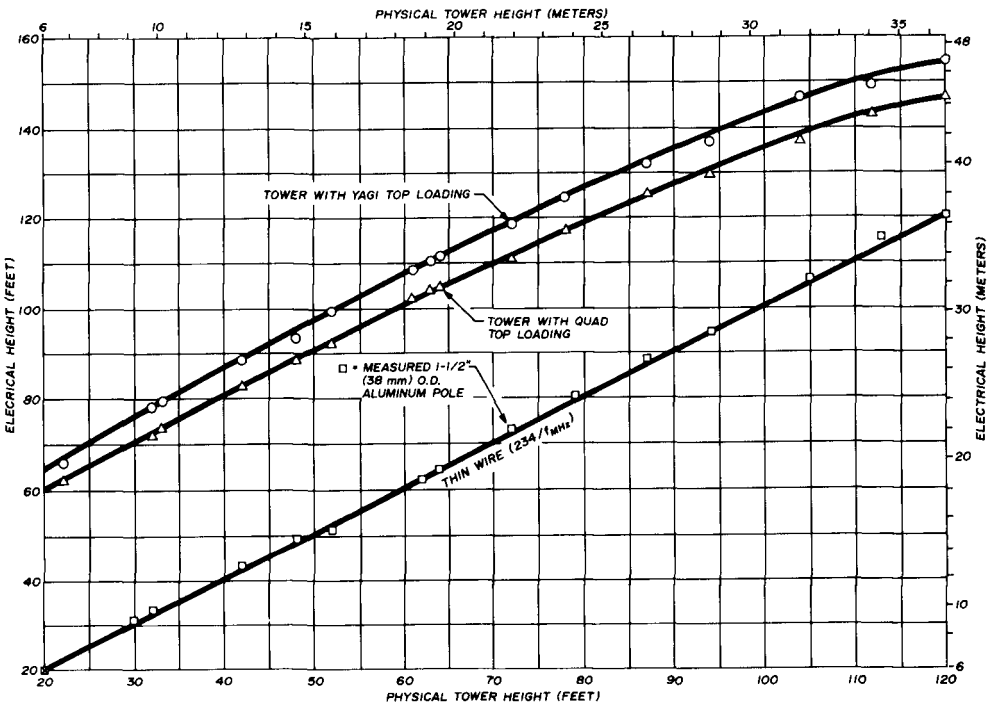

fig. 2. Physical vs electrical height of towers top loaded with Yagi beams or cubical quads.

The parallel matching capacitor, C_p , does not require such a high voltage rating unless excessively high vswr is expected at full power. For a 200-watt transmitter, an old style BC capacitor with 700 to 1000 pF maximum should work nicely. For 2000 watts PEP the parallel capacitor should have a rating of 1500 volts minimum with current-carrying capacity of seven amperes.

they can be connected to small geared motors so they can be controlled remotely from the operating position. A 300-pF vacuum variable rated at 7500 volts, and a 1000-pF vacuum variable with a 2000 volt rating should handle practically any legal amateur transmitter with low vswr.

A remote-control system that I have used for several years is shown in refer-

ence 1. It's obviously a lot easier to remotely control the matching system from your hamshack than it is to traipse out to the backyard in snow, sleet and rain each time you want to shift your operating frequency.

construction

A typical gamma rod installation is shown in fig. 6. On my vertical antenna the gamma rod is mounted with PVC

each side of the PVC pipe, about 1 inch (25mm) in from each end (see fig. 6). Stainless-steel hose clamps are run through the slits in the PVC pipe and around the vertical member.*

If you wish, the same tower may be used on more than one lower-frequency band — simply install gamma rods on more than one leg of the tower. You can use separate capacitance matching systems or remotely controlled vacuum-

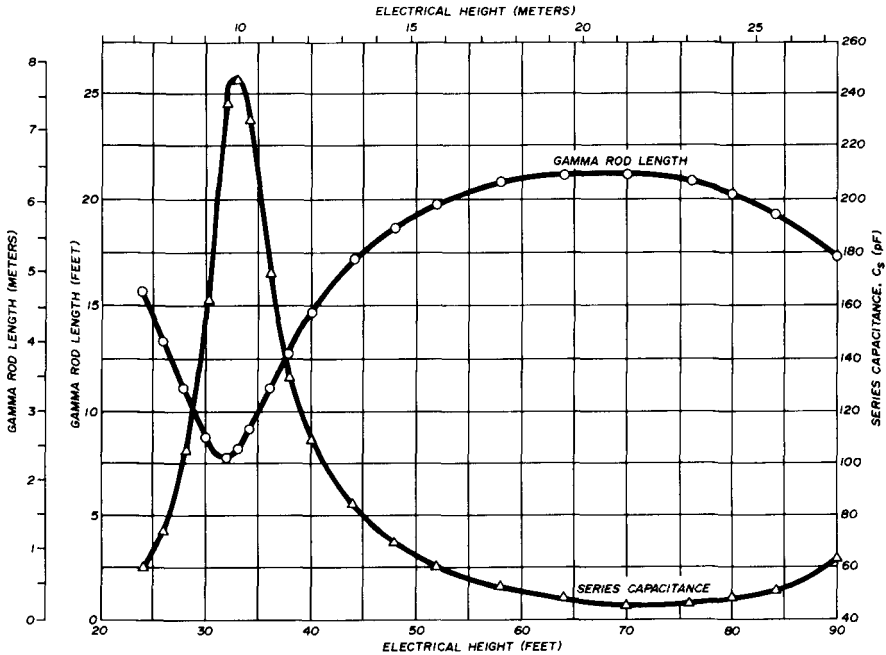

fig. 3. 40-meter vertical. Gamma rod length and series capacitance vs electrical height of tower. Recommended parallel capacitance to match 50-ohm transmission lines is 320 pF (at least 100 pF of which should be variable).

insulators spaced about 10 feet (3 meters) apart. The insulators are made from 1-inch diameter (25mm) PVC water pipe. The movable shorting bar is made from the same material as the gamma rod.

To attach the PVC insulators to the gamma rod, first notch the ends so one end fits around one leg of your tower, the other end around the gamma rod. Then cut half-inch (13mm) long slits on

variables, depending upon your operating requirements. A vertical tower antenna system which I use successfully on both 40 and 80 meters is described in reference 1.

*The author has assembled several pages of how-to hints and additional constructional information which is available from him for the cost of printing and mailing. A self-addressed, stamped envelope to the author will bring a summary of contents and cost.

ground requirements

Remember that the vertical element is only one-half of a vertical antenna system — the vertical element must operate against a good ground plane or the ground losses will be so high that the antenna performs poorly. The so-called ideal ground system consists of

short vertical antennas, consult the excellent series of articles by W2FMI.⁵⁻⁸

The tower which you use to support your higher frequency antennas can easily be used as a practical antenna system for 40, 80 and 160 meters. The graphs presented here will help you to design the necessary shunt-matching

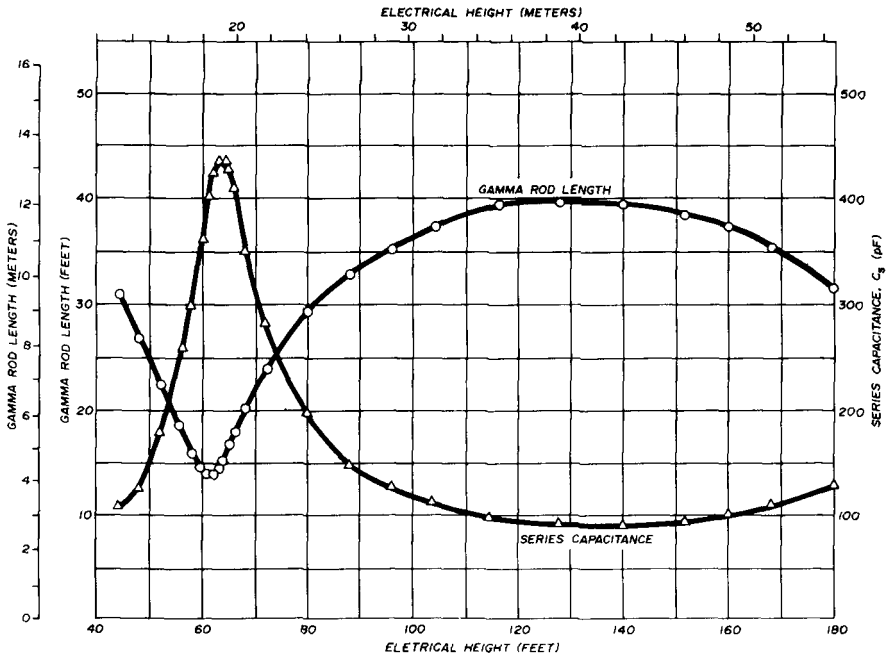

fig. 4. 80-meter vertical. Gamma rod length and series capacitance vs electrical height of tower. Recommended parallel capacitance to match 50-ohm transmission lines is 650 pF (at least half should be variable).

120 equally-spaced, quarter-wavelength radials, but even such an elaborate ground plane as this still introduces about 2 ohms of series loss resistance into the total radiation resistance. Since short vertical antennas are characterized by relatively low radiation resistance, ground resistance loss is higher, proportionately, than it is with vertical elements which are quarter-wavelength or more. A complete discussion of ground system requirements is contained in reference 4. For more information on

system, but note that since conditions vary from one location to another, some adjustments will be necessary to obtain a low vswr. However, with an swr bridge installed near the base of the vertical (very short leads), alternately adjust the series and parallel tuning capacitors until the reflected power approaches zero. If the amount of parallel capacitance for low vswr seems excessive, make the gamma rod slightly longer.

The setting of the series capacitor is rather critical because reactance changes

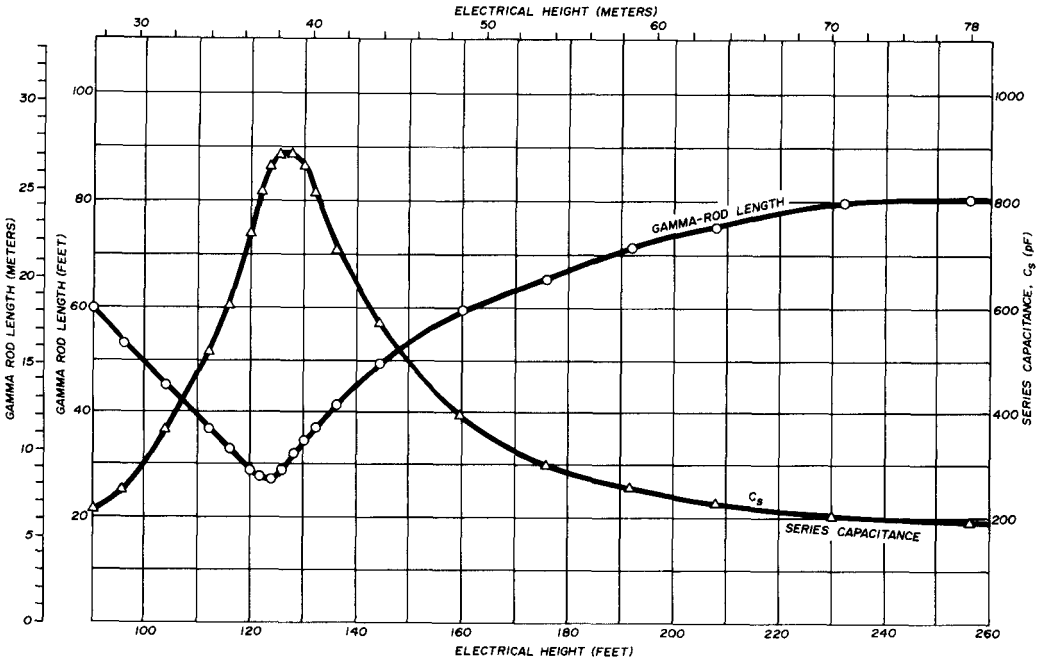

fig. 5. 160-meter vertical. Gamma rod length and series capacitance vs electrical height of tower. Parallel capacitance required to match 50-ohm transmission lines is approximately 1300 pF.

sharply near zero so it may take several tries before you can get the capacitor set exactly right. However, with a good ground system, the shunt-fed grounded tower can provide a very efficient antenna system for relatively little cost.

references

1. John R. True, W4OQ, "Vertical Antenna System," *ham radio*, April, 1973, page 16, and May, 1973, page 56.
2. I.L. McNally, W1NCK, and Henry S. Keen, W2CTK, "Graphical Solution of Impedance-Matching Problems," *ham radio*, December, 1969, page 26.
3. John R. True, W4OQ, "Measurement Techniques for Antennas and Transmission Lines," *ham radio*, May 1974, page 36.
4. Robert E. Leo, W7LR, "Vertical Antenna Ground Systems," *ham radio*, May, 1974, page 30.
5. Jerry Sevick, W2FMI, "The W2FMI 20-Meter Vertical Beam," *QST*, June, 1972, page 14.
6. Jerry Sevick, W2FMI, "The W2FMI Ground-Mounted Short Vertical," *QST*, March, 1973, page 13.
7. Jerry Sevick, W2FMI, "A High Performance 20-, 40- and 80-Meter Vertical System," *QST*, December, 1973, page 30.
8. Jerry Sevick, W2FMI, "The Constant-Impedance Trap Vertical," *QST*, March, 1974, page 29.

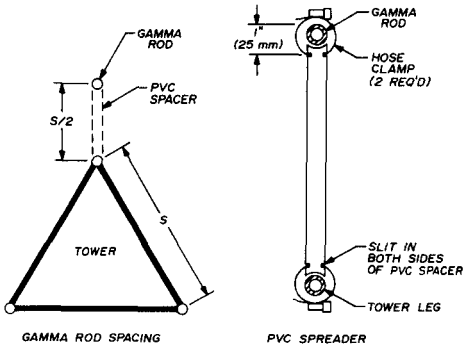
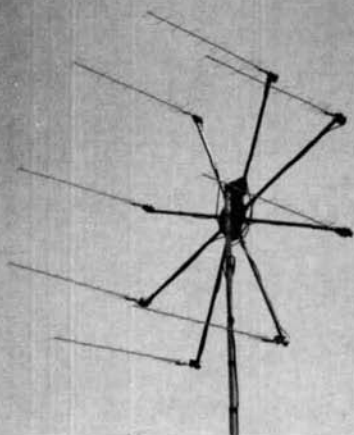

fig. 6. Construction of the shunt feed system for grounded vertical radiators. The spacers are made from PVC water pipe.

ham radio



high-gain 1296-MHz Yagi Array

Construction of a
light-weight
high performance
104-element antenna
for 1296 MHz

The high-gain 1296-MHz array described in this article, which I call the "blowtorch array" and which consists of eight 13-element Yagis arranged in a circle, is light weight, presents little wind resistance, can be rotated with a small TV rotator, and provides gain equivalent to that of a 5-foot (1.5 meter) dish. The

Paul F. Magee, W3AED, Route 2, Box 432, Berlin, Maryland

Yagis, based on a design by W2CQH,¹ use slightly shorter directors than he specified and are designed for use with low-loss 75-ohm CATV coaxial feedline.

yagi construction

The parasitic elements of the Yagis are lengths of number-14 (1.6mm) OD copperweld wire, soft-soldered to a boom made of 1/4-inch (6.5mm) thick-wall brass tubing, 36 inches (91.4cm) long as shown in fig. 1. The copperweld elements provide both physical strength and high electrical conductivity, both of which are required for effective operation.

Before cutting the directors, make up a simple template as shown in fig. 2 so that each of the directors is precisely the same length. This is extremely im-

*Any specific information desired regarding this array can be obtained by enclosing a self-addressed stamped envelope with inquiry to Paul F. Magee, W3AED, R2 Box 432, Berlin, Maryland 21811.

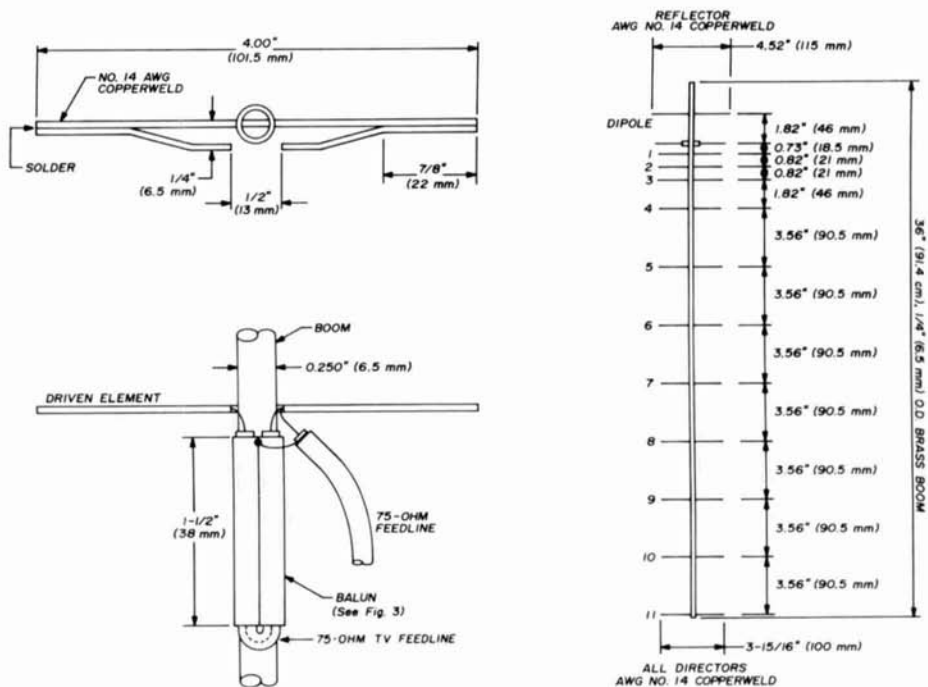

fig. 1. Layout of the 13-element Yagis used in the 1296-MHz blowtorch array. Details of 75-ohm feed system are shown in fig. 3.

portant because very slight differences in length will adversely affect the performance of the antenna.

The driven element is a delta-matched dipole of number-14 copperweld which is soldered to the boom. The delta-matching system consists of two pieces of number-14 soft copper wire soldered to the dipole — this is fed by a balun made from two pieces of ¼-inch (6.5mm) OD copper tubing, 1½ inch (38mm) long, which are soldered on top of the boom as shown in fig. 3. Place the forward end of these two tubes as close as possible to the driven element to minimize lead length to the delta match.

To hold the two balun tubes in the proper position while you are soldering them, bend a small piece of sheet aluminum into a vee which can be held loosely in a vise. Note the short number-14

stud which is soldered between the quarter-wavelength balun tubes — this provides a convenient place to solder the shield of the 75-ohm coaxial phasing

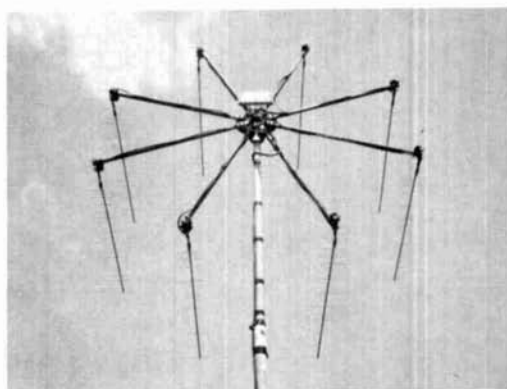

Rear view of the 1296-MHz blowtorch array showing the waterproof enclosure which houses the quarter-wavelength matching transformers.

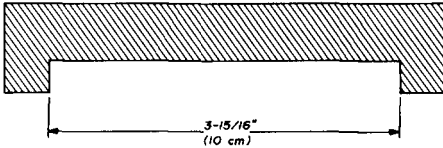

fig. 2. Use of a template is recommended to assure that each of the directors is precisely the same length. For best results, cut each of the directors slightly longer than necessary and file off the ends until each element just passes through the gauge.

line (be sure the phasing lines are connected to the same side of the delta match on all eight Yagis).

After the two copper balun tubes and all elements have been soldered to the boom, strip off the outer jacket and shield from a section of 75-ohm TV feeding (which has a larger diameter than RG-59/U). Fold the balun wire into a U and insert it into the balun tubes. Connect the center conductors to each side of the delta match.

The antenna mount consists of a center hub of 1/8-inch (3mm) thick galvanized steel, 8 inches (20cm) in diameter, to which is attached a spider-shaped arrangement of 3/4-inch (19mm) aluminum tubes, each 31 inches (79cm) long. Short tabs on the top and bottom of the center hub provide space for the

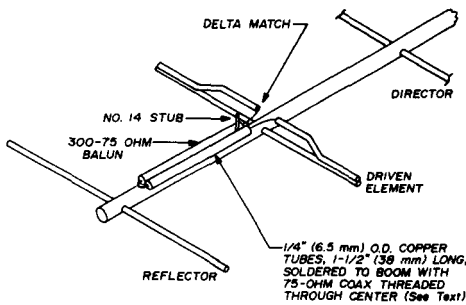

fig. 3. Construction of the 300- to 75-ohm balun used on each of the Yagis. The shield of the coaxial feedline is connected to the short stud.

U-bolts which are used to attach the array to a mast.

The aluminum tubes are attached to the hub with 10-32 screws and strengthening members made from 3-inch (76mm) lengths of 1-inch (25mm) square aluminum channel (see fig. 4). The Yagis are attached to the ends of these tubes with special clamps which

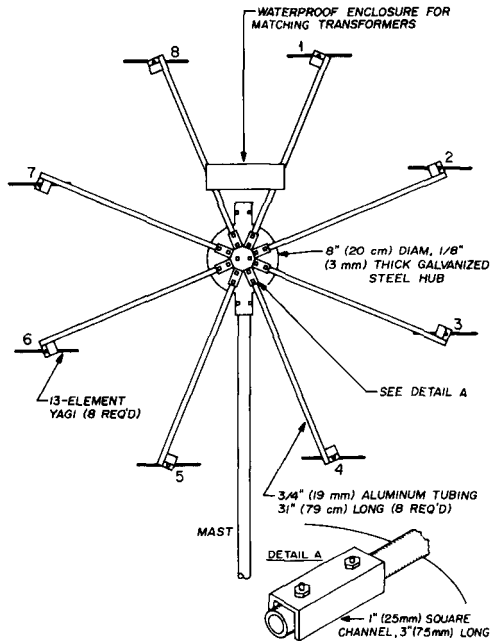

fig. 4. Construction of the antenna mount showing the center hub and eight aluminum antenna-support masts. Main mast is placed in front of the center hub and attached to it with U-bolts.

allow the antennas to be oriented parallel to one another.

The Yagi clamps, shown in fig. 5, are made from 2-inch (51mm) lengths of 1-inch (25mm) square aluminum channel which is attached to the aluminum tubes with small U-bolts made from 1/4-inch (6mm) threaded steel stock. Two small notched aluminum blocks are used to hold the antenna boom to the channel (cut the notch

slightly smaller than the diameter of the boom so the antennas are held very rigidly).

Be sure to use brass nuts on the steel U-bolts. The combination of aluminum clamps and brass hardware doesn't seem to cause any problem as my array shows no ill effects although it has been exposed to the salt air at my station for more than two years.

matching harness

The matching system for the blowtorch array is made up of a system of 50-ohm quarter-wave matching transformers and 75-ohm coaxial feedlines 16 half-wavelengths long (48 inches or 122cm). A schematic diagram of the system is shown in fig. 6. Since the 75-ohm matching lines are an integral number of half-wavelengths long, the 75-ohm input impedance of each of the antennas is repeated at the opposite

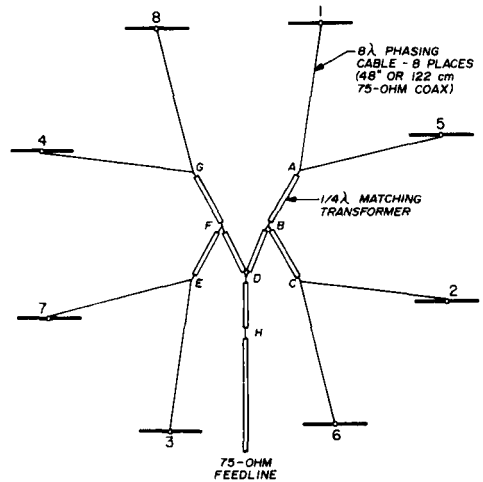

fig. 6. Schematic diagram of the phasing system used with the blowtorch array. Construction of the quarter-wavelength matching transformers is shown in fig. 7.

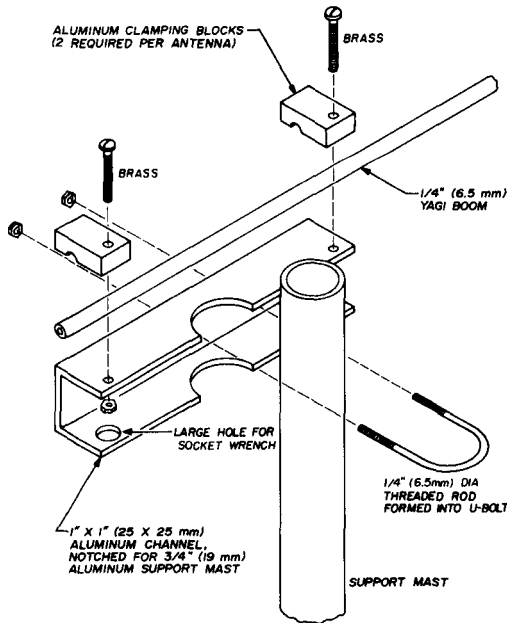

fig. 5. The Yagis are attached to the aluminum support masts with clamps (8 required) which allow all of the beams to be aligned in the same plane.

end. Since two 75-ohm feedlines are connected in parallel at points A, C, E and G, the impedance at each of these points is 37.5 ohms. This is transformed to 75 ohms by a 50-ohm quarter-wave transformer. These transformers are connected in parallel at points B and F, so the impedance at these points is 37.5 ohms. This is transformed to 75 ohms with another 50-ohm quarter-wave transformer (B-D and F-D).

When connected in parallel at point D and transformed with another quarter-wave transformer, the input impedance provides a close match to the 75-ohm feedline. Note that the 8-wavelength matching lines are not connected to adjacent antennas, but to antennas on opposite sides of the array.

The quarter-wavelength matching transformers are soldered to a 3x5-inch (8x13cm) copper sheet as shown in the photograph of fig. 7. The outer conductor of each quarter-wave transformer consists of a 3/16-inch (5mm) OD copper tube, 1/2 inch (38mm) long. Short lengths of RG-58/U coax (strip-

ped of the outer shield and jacket) are threaded through these tubes. Short stubs of number-14 wire, about 3/8 inch (10mm) high, at the feedline end of each of the transformers provides a convenient point for connecting the outer shield of the 75-ohm feedlines. The completed transformer is mounted in a waterproof enclosure which is installed at the center of the array.

be checked individually before they are installed on the large array. First check the vswr and make adjustments as necessary to the delta match for a vswr of 1.2:1 or less. Then check the lobes on each side of the main pattern. If they are not at least 9 dB down, the antenna is not working correctly. This can be checked by connecting a low-power 1296-MHz signal source to the antenna

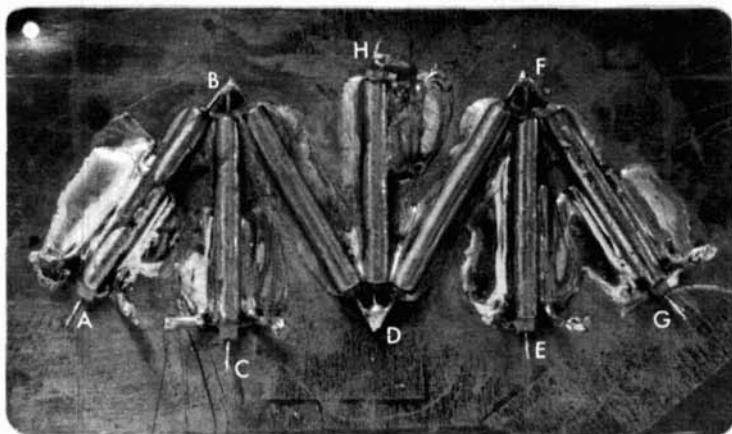

fig. 7. Quarter-wavelength matching transformers are made from 3/16-inch (5mm) OD copper tubing. Letters coincide with the points noted in fig. 6.

When soldering the tubes to the copper sheet make sure they are soldered from one end to the other. You can use a small torch for this, if you wish, but I suggest a husky 200-watt soldering iron. When the transformer assembly has cooled off, the rosin flux can be removed with lighter fluid. (Acid flux can also be used but thoroughly clean off any residue with hot water, baking soda and a tooth brush before you install the sections of RG-58/U.)

testing

Each of the 13-element Yagis should

and measuring the relative field strength about 50 feet (15 meters) in front of the antenna.

When the blowtorch array is completely assembled check the field strength about five feet (1.5 meter) in front of each Yagi; if the phasing system is working properly the field strength in front of each of the antennas should be the same.

reference

1. Reed E. Fisher, W2CQH, "A Successful 1296-MHz Yagi," *ham radio*, May, 1972, page 24.

ham radio

Morse and RTTY from one keyboard?



Meet the two and only.

The HAL DKB-2010 Dual Mode keyboard is one of the most sophisticated products ever offered to the radio amateur. It's an all solid state keyboard that allows you to send either RTTY or CW — with more ease, more versatility than anything you've ever seen before.

In the RTTY mode, you can transmit at standard data rates of 60, 66, 75 or 100 WPM, as well as an optional 132 WPM, 100 baud. In addition to the complete alphanumeric keys, you get 17 punctuation marks, 3 carriage control keys, 2 shift keys, a break key, 2 three-character function keys, a "DE-call letters" key and a "Quick brown fox . . ." test key.

In the CW mode, you can send at speeds anywhere between 8 WPM and 60 WPM. You can also adjust dot-to-space weight ratios to your liking. For CW, you have all alphanumeric keys, plus 11 punctuation marks, 5 standard double-character keys, 2 shift keys, a break-for-tuning key, error key, "DE-call letters" key, plus

2 three-character function keys. Output interfacing is compatible with cathode keying or grid-block keying. A side tone oscillator and built-in speaker allow you to monitor your signal — with adjustable volume and pitch controls.

The DKB-2010 also has a three-character memory buffer which operates in either the RTTY or CW mode, allowing you to burst type ahead without losing characters. A 64-character memory buffer is also available as an option. Key function logic in either mode is governed by LSI/MOS circuitry. All key switches are computer grade.

The DKB-2010 is available assembled or in kit form. Should you choose the kit, you'll find construction easy — the unit consists of three assemblies: power supply board, logic PC board, keyswitch PC board, and pre-assembled wiring harness.

Any way you look at it — as an easy-to-build kit, a complete assembly, as a CW keyboard, or an RTTY keyboard, the HAL

DKB-2010 is a real breakthrough for every amateur. It adds a whole new dimension to the exciting world of amateur radio. Once you've used the DKB-2010, you'll wonder how you ever got along without it!

Prices: \$425 Assembled;
\$325 Kit



HAL Communications Corp.
Box 365, Urbana, Ill. 61801
Telephone: (217) 359-7373

- Enclosed is \$ _____ (Assembled)
\$ _____ (Kit)
Call letters _____
 Charge Master Charge # _____
 Charge BankAmericard # _____
M/C Interbank # _____
Card Exp. date _____
 Please send me the HAL catalog.

Name _____

Address _____

City/State/Zip _____

All prices include U.S.A. shipping.
Add \$10 for air shipment.
Illinois res. add 5% sales tax.

measuring complex impedance

with an swr bridge

Accurate impedance
measurements
can be made
over a wide
frequency range
using a vswr bridge
and the simple
second-data method
described here

Randy Rhea, WB4KSS, 1560 Jennings Way, Norcross, Georgia 30071

Knowledge of the resistive and reactive components of a load is very useful in antenna work, but few amateurs, unfortunately, have the necessary equipment for making the necessary measurements. The simple impedance bridges found in many amateur workshops will measure resistive loads from about 5 to 400 ohms, and if the load is reactive, a true null will not be obtained. For low impedances the readings of these simple instruments approximate the resistive component while for high impedances the readings approximate the total impedance. In between, the readings are a poor approximation to either.

The RX meter, which can accurately evaluate both the resistive and reactive components of a load, on the other hand, is considerably more complex than the simple rf impedance bridge, and is somewhat more difficult to build and operate, especially above about 30 MHz. A practical amateur RX meter described recently has relatively good sensitivity and a moderate impedance range and doesn't require much drive power, but requires a separate inductance assembly for each band of frequencies.¹ Other homebuilt instruments for measuring complex impedances are described in references 2, 3 and 4.

second-data impedance measurement

Because of these problems and others most amateurs try to avoid the measurement of unknown complex impedance. Fortunately, however, there is an alternative: the second-data method. This method permits relatively accurate measurement of complex impedance with a vswr bridge and an external resistor. Since most amateurs have vswr bridges this is a technique that should not be overlooked. Since vswr bridges which work to 600 MHz and above are readily available,⁵ this method has the additional advantage of extending the frequency range.

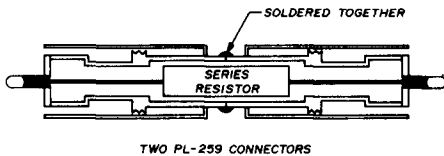

fig. 1. Simple coaxial adapter for the series resistor is made from two back-to-back PL-259 connectors.

In the second-data impedance measuring system the vswr of the load is first measured in the normal fashion and then the vswr is measured with a resistor in series with the load. These two sets of data are adequate to specify the resistive and reactive components of the load. You merely look up the two vswr measurements in a table such as that shown in table 1 and read off the resistive and reactive components. If you wish, the resistive and reactive values may also be plotted on a Smith chart, as will be discussed later.

For measurements up to 20 MHz or so, the series resistor may be soldered in series with the load or clipped in. For higher frequency measurements or when

a coaxial line is used, the series resistor should be installed as the center conductor of an appropriate adapter as shown in fig. 1. The vswr is then measured with and without this adapter in the line.

For best results measurements should be made with a vswr bridge that has good linearity characteristics. The resistance in series with the diode detectors within the bridge should have as high a value as possible, at least 10 kilohms. Check your vswr bridge for no return power (vswr = 1:1) with a good quality dummy load. You can check its accuracy at other standing-wave ratios by using standard composition resistors (with short leads) as loads. The vswr of the load is given by

$$\text{vswr} = \frac{R}{Z_o} \text{ or } \frac{Z_o}{R}$$

whichever is greater than 1. Loads of either 150 ohms or 16.67 ohms, for example, will result in a vswr of 3.0:1 in a 50-ohm system.

The vswr to series complex impedance conversion information shown in table 1 for 50-ohm systems is based on the use of a 27-ohm series resistor. The resistive and reactive values were calculated with an error of less than one percent and rounded off to the nearest ohm.* To illustrate the use of this table, assume that an unknown load exhibits a vswr of 2.4:1. When the 27-ohm resistor is placed in series with the load the measured vswr is 1.8:1. From table 1, the resistive component of the load is 33 ohms; the reactive component, 32 ohms.

*More detailed, computer-generated tables for both 50- and 75-ohm systems are available from the author for \$4.00, postpaid. The tables are calculated for 27-ohm series resistance with 50-ohm systems and 39-ohm series resistance with 75-ohm systems.

table 1. Vswr to series complex impedance conversion for 50-ohm systems using the second-data method of measurement (series resistor = 27 ohms).

vswr of load	vswr with series resistor			vswr of load	vswr with series resistor		
	resistance (ohms)	reactance (ohms)			resistance (ohms)	reactance (ohms)	
1.0	1.53	51	0	3.0	1.0	17	0
				3.0	1.2	17	5
1.2	1.3	43	0	3.0	1.4	19	15
1.2	1.4	44	5	3.0	1.6	21	23
1.2	1.5	48	8	3.0	2.0	28	37
1.2	1.6	53	9	3.0	2.2	33	44
1.2	1.7	59	6	3.0	2.6	47	56
1.2	1.8	61	3	3.0	3.0	71	67
				3.0	3.4	122	57
1.3	1.2	39	0	3.0	3.6	152	13
1.3	1.4	42	8				
1.3	1.6	51	13	4.0	1.25	13	0
1.3	1.8	64	8	4.0	1.5	14	16
1.3	1.9	66	4	4.0	1.75	16	25
				4.0	2.0	19	34
1.4	1.2	36	0	4.0	2.25	22	42
1.4	1.3	38	6	4.0	2.5	27	50
1.4	1.4	40	11	4.0	3.0	38	65
1.4	1.6	48	17	4.0	3.5	58	81
1.4	1.8	61	16	4.0	4.0	95	95
1.4	2.0	71	4	4.0	4.5	193	45
1.5	1.1	34	0	6.0	1.25	9	0
1.5	1.3	36	9	6.0	2.0	11	28
1.5	1.4	38	13	6.0	3.0	19	56
1.5	1.5	42	17	6.0	4.0	34	83
1.5	1.6	46	19	6.0	4.5	45	98
1.5	1.7	51	21	6.0	5.0	62	114
1.5	1.8	56	21	6.0	5.5	90	133
1.5	1.9	64	19	6.0	6.0	143	148
1.5	2.0	73	11	6.0	6.5	288	71
1.5	2.1	76	4	6.0	6.75	306	11
2.0	1.0	26	0	8.0	1.5	6	0
2.0	1.2	27	9	8.0	2.0	8	25
2.0	1.4	30	17	8.0	2.5	10	39
2.0	1.6	34	24	8.0	3.0	13	51
2.0	1.8	41	31	8.0	4.0	20	74
2.0	2.0	50	36	8.0	5.0	32	98
2.0	2.2	64	38	8.0	6.0	51	126
2.0	2.4	83	33	8.0	7.0	87	161
2.0	2.6	102	5	8.0	8.0	194	200
2.0	2.8	102	5	8.0	8.5	385	94
2.4	1.0	21	0	10.0	1.5	5	0
2.4	1.2	22	9	10.0	2.0	6	23
2.4	1.4	24	17	10.0	3.0	10	48
2.4	1.6	28	25	10.0	4.0	14	68
2.4	1.8	33	32	10.0	5.0	21	89
2.4	2.0	39	38	10.0	7.0	45	136
2.4	2.2	47	44	10.0	8.0	68	166
2.4	2.6	74	51	10.0	9.0	114	207
2.4	2.8	98	43	10.0	10.0	245	252
2.4	3.0	121	11	10.0	10.5	481	117

Since the entire range of possible vswr combinations for a series 27-ohm resistor is given in **table 1**, if you measure a larger vswr than shown, there is an error in measurement. For example, if you measure a load vswr of 2.0:1, then install the 27-ohm resistor and measure the vswr again, a new vswr measurement of 4.0:1 reveals an error in

the 25-ohm resistor in series with load the vswr is 2.0:1.

To compute the complex impedance of the unknown load you must first plot two circles on the Smith chart as shown in **fig. 2**. The first circle, circle 1, is a constant vswr circle corresponding to a measured vswr of 3.0:1 and intersects with 3.0 on the real axis. This circle passes through all the resistive and reactive pairs which produce a vswr of 3.0:1, so the impedance of the unknown load must fall somewhere on this circle.

The second circle, circle 2, is another constant vswr circle, this one corresponding to the 2.0:1 vswr measured with the 25-ohm resistor in the line. The final circle, circle 3, which is offset by the amount of resistance in series with the line for the second vswr measurement, represents all the values on circle 1 with $Z_0/25$ (0.5 resistive) added to each point. This circle is easily drawn by adding 0.5 resistive to both points where the circle crosses the real axis (at $0.33 + 0.5 = 0.83$ and $3.0 + 0.5 = 3.5$), and plotting a circle through these two points.

Circle 3 intersects circle 2 at two points. Both points have the same resistive and reactive values, but the reactive values have opposite signs. To transform the intersection on circle 2 to the actual value of the unknown load, 0.5 ohm resistive must be subtracted from the values on circle 2. In this case the intersection on the upper half of the chart is $1.05 + j0.72$. Subtracting 0.5 ohm resistive yields $0.55 + j0.72$. This is the original load and should fall on circle 1. If it doesn't, you made an error in your calculations.

Since this is a normalized Smith chart, the plotted values must be multiplied by the characteristic impedance of the system, 50 ohms. This yields values of 27.5 ohms resistive and 36 ohms reactive for the unknown load. You must still determine whether the reactance is capacitive or inductive (negative

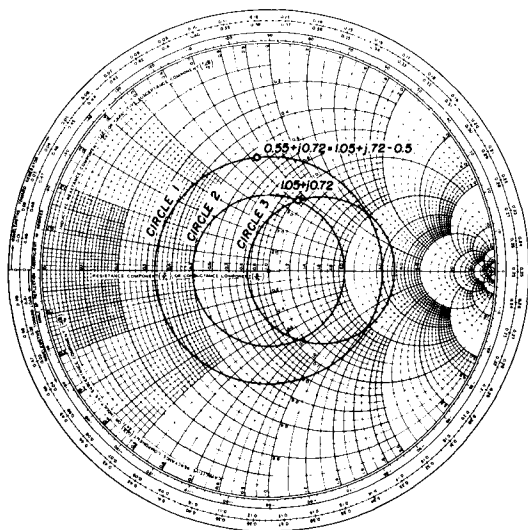

fig. 2. Resistive and reactive impedance values can be plotted on Smith chart using information obtained by the second-data method. Circle 1 represents the vswr of the load, circle 2 represents the vswr of the load with series resistor, and circle 3 shows the vswr of circle 2 displaced by the amount of the resistance (see text).

measurement as it is outside the range of values given.

smith chart computation

If you wish to use the Smith chart to make your impedance calculations, the series resistor does not have to be the same value as that used in computing the chart (27 ohms for 50-ohm systems) — it can be any reasonable value. Assume, for example, that the series resistor is 25 ohms, the measured vswr of the unknown load is 3.0:1, and with

or positive). In some cases you may know beforehand whether the reactance is capacitive or inductive (a half-wave dipole operated above resonance, for example, has an input impedance that is inductive) but in those cases where you must determine the sign of the reactance another measurement is required. After the resistive and reactive components of the load have been determined, the *vswr* is measured again with a capacitive reactance ($X_C \approx X_L$) placed in series with the load. If the resulting *vswr* is less than the original *vswr*, the reactance of the load is *inductive*. If the resultant *vswr* is *greater* than the original *vswr*, the reactance is *capacitive*.

Things are simplified considerably when the impedance measurement can be made directly at the input terminals of the unknown load, but this is not always possible. The usual solution is to take the measurement at the end of a transmission line and use the Smith chart to refer the load back to the antenna feedpoint. Further information

on this subject is provided in references 6 and 7.

accuracy

The accuracy of this method of impedance measurement, of course, is dependent upon the accuracy with which the *vswr* measurements are made. Accuracy of the second-data method is also dependent on the magnitude of the measured impedance with errors increasing with increasing impedance. However, accuracy is acceptable up to about 300 ohms, depending on the accuracy of the *vswr* bridge, and accuracy is quite good around the commonly used system impedances of 50 and 75 ohms.

As an example, consider the case of a quarter-wavelength vertical operating over perfect ground. Its base feedpoint impedance, theoretically, is 36 ohms. If the second-data technique is used with a *vswr* bridge that reads 10% high, the indicated impedance will be 36.7 ohms resistive and 12.7 ohms reactive; the bridge has introduced a small reactive component. As with any electronic measurements, good results are guaranteed only when the measuring instruments have been carefully checked and calibrated.

references

1. G. Hall, K1PLP, and J. Kaufman, WA1CQW, "The Macromatcher, *QST*, January, 1972, page 14.
2. H.S. Keen, W2CTK, "A Simple Bridge for Impedance Measurements," *ham radio*, September, 1970, page 34.
3. G. Pappot, YA1GJM, "RX Noise Bridge," *ham radio*, January, 1973, page 62.
4. W.A. Wildenhein, WB9YFB, "Low-Cost RX Impedance Bridge," *ham radio*, May, 1973, page 6.
5. A.R. Hall, W4CGC, "VHF and UHF Microstrip SWR Indicators," *ham radio*, December, 1972, page 22.
6. G. Hall, K1PLP, "Smith Chart Calculations for the Radio Amateur," *QST*, January, 1966, page 22, and February, 1966, page 30.
7. J.R. Fisk, W1DTY, "How to Use the Smith Chart," *ham radio*, November, 1970, page 16.

ham radio



"How does it load on 160?"



Super Mast
Small in a big way.

For the low profile Ham operator.

It had to happen! The enormous success of Tri-Ex's original Sky Needle—by popular demand—has brought about the design of a miniature Sky Needle for the Tri-Band Beam. We call it **Super Mast**.

It's a special tower for the low profile HAM operator. A roof-topper stretching to 40-feet up. Attaches easily, simply to the side of your garage

or house. A super-easy **Super Mast**. A top-quality Tri-Ex product. Hot dipped galvanized

after fabrication for long life. A slim, clean-line tower. Tops in performance—**Super Mast**.

Shown here in its nested position at 21-feet, this **Super Mast** is supporting a three element 15 meter antenna & rotor assembly. Rush your order now. Visit or

call your local Tri-Ex Tower dealer today. Price of this under-\$300-tower, is subject to immediate change.

Tri-Ex® because of rising steel costs, is subject to immediate change. Order now and save!

TOWER CORPORATION

7182 Rasmussen Avenue, Visalia, Calif. 93277

electrically- controlled phased array

Phased array for the
lower amateur bands
uses hybrid couplers
for electrical control
of the field pattern

On the lower frequency amateur bands, where a rotary antenna may be too cumbersome for convenience, the answer may be a phased array, with electrical instead of mechanical control of the field pattern. Such a system will also be less vulnerable to damage from ice and high winds.

The phasor, which is the heart of this system, is built around a 3 dB quadrature hybrid. Such a hybrid may be regarded as a four-port circuit element, having two input ports and two output ports (fig. 1). When both output ports are terminated by matched loads, a signal injected at either input port will divide equally between the two output ports with a 90° , or quadrature, phase difference between the outputs. Because no signal exists at the remaining input port, the input ports may be seen to be isolated from each other.

Several different designs are available to the experimenter for the construction of such a hybrid.¹ The most compact and convenient form for the lower amateur bands, however, consists of two

capacitively coupled lengths of coaxial line, of whichever characteristic impedance has been chosen for the system (fig. 2). These lengths of coaxial line will each be an electrical one-eighth wavelength at the frequency of interest, while the coupling capacitors will have a reactance equal to the characteristic impedance of the coaxial lines.

theory of operation

If the output ports of the hybrid, instead of being terminated by a pair of matched loads as in fig. 1, are terminated instead with identical lengths of transmission line as shown in fig. 3, the following action will take place as a signal is injected into port 1:

1. The injected signal will divide into two equal parts, one going to port 3, while the other part, after undergoing a 90° phase shift, appears at port 4. Both signals then progress down to the ends of their terminating lines and are reflected back to their respective ports, having traveled back and forth along the line for a total distance equal to twice the actual length of the line.
2. The reflected signal returning to port 3 divides into two equal parts, one of which goes directly to port 1, while the other part, after a 90° phase shift, goes to port 2.
3. The reflected signal at port 4 also divides into two equal parts, one of which goes directly to port 2, where it combines with the component which came from port 3. Note that each of these two components has traveled the same distance and undergone a single

Henry S. Keen, W5TRS, Fox, Arkansas 72051

phase shift of 90° . The other part of the reflected signal at port 4 undergoes a second 90° phase shift and goes to port 1. Both of the components at port 1 can be seen to have traveled the same distance, but are 180° out of phase with each other, and therefore cancel. As a



fig. 1. Block diagram of hybrid coupler. This device divides power between two matched loads.

result, no signal is reflected back to port 1 which is not cancelled out, and no input vswr results. It may be seen, therefore, that any equal change in the lengths of the two terminating lines will result in a phase change in the signal emerging from port 2 which is equal to twice the change in line lengths.

With this last conclusion in mind, it becomes apparent that a reactance change at ports 3 and 4 which is equivalent to that produced by a quarter wavelength, or 90° change in line length, will result in a total phase change of 180° in the signal emerging from port 2. Using lumped constants, instead of transmission lines, to terminate ports 3 and 4, the network shown in fig. 4 will accomplish the equivalent operation.

When the variable phasing capacitor in the circuit of fig. 4 is set at maximum capacitance, it becomes parallel resonant with its shunting inductors, thereby simulating an open circuit. At minimum setting of the phasing capacitor, the series capacitors are trimmed to produce a condition of series resonance, thus simulating an open quarter-wavelength of terminating line. In this manner you obtain a controlled phase shift of up to 180 electrical degrees by merely turning a knob.

Line lengths and coupling capacitances were first computed for a frequency of 7.2 MHz. Assuming a velocity of propagation factor of 0.66 for the RG-58/U cable chosen for the purpose, the transmission lines are each 135 inches (344cm) long. Coupling capacitors for 53.5-ohm coaxial cable are 414 pF. A pair of 220-pF silver mica capacitors were used in parallel. Alternatively, a 330 pF and a 100 pF capacitor were used for a second hybrid, with satisfactory results in each case. (If the system is built with RG-59/U coaxial cable for operation at the 70-ohm level, the capacitors will be about 316 pF.)

In order to determine the length of the transmission line a bit more accurately, a quarter-wavelength of line was fitted with a very small, single-turn coupling loop at one end. This assembly was then carefully grid dipped to frequency, the dipper frequency being checked on the receiver. Small bits of coaxial line were then clipped from the open end of the cable to raise the resonant frequency to the desired value. It is a great deal easier to cut a piece off than to fasten it back on, so be careful if you choose to go this route.

After the correct line length has been obtained, remove the coupling loop, double the line back on itself and cut it in two equal halves. Peel back as little covering and braid as necessary to make connections to the ends of the cables.

To check the hybrid, ports 3 and 4 are first left as open circuits and a

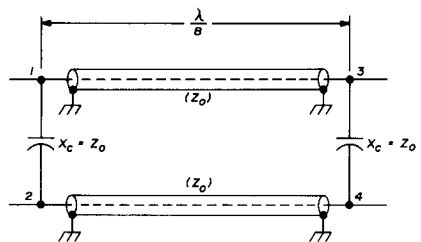

fig. 2. Capacitively-coupled hybrid is used in the phasor which controls the phased vertical antennas.

matched load is placed at port 2. An input vswr reading is now taken at various frequency intervals across the band to determine how well the line lengths have been chosen. At the center frequency a vswr of 1.05:1 or less

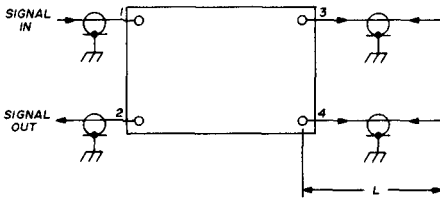

fig. 3. Quadrature hybrid terminated by equal lengths of transmission line.

should be possible if the line lengths and coupling capacitors are correct.

The isolation inherent in the hybrid can be checked by terminating ports 3 and 4 with matched loads, and the output at port 2 measured and compared with that obtained when the loads are not present. A pair of 51-ohm carbon composition resistors were used for this rough check, with the receiver at port 2 used as an indicator. Isolation of 20 to 30 dB was considered to be adequate for the purpose.

Once the hybrid has been checked out satisfactorily, the next step is the alignment of the reactance network. In the first place, the two inductors should be made as closely identical as possible. Both inductors should resonate at the center frequency with the phase control capacitor fully meshed. The grid dipper becomes necessary for this operation. Turns can be spread or squeezed together, and fastened with coil dope.

Once the coils have been trimmed, the phase control capacitor is turned to its minimum setting, and the series capacitors grounded, so that they are temporarily in parallel with the inductors. The series capacitors are now set so that the inductor-capacitor combination is again resonant at the same frequency

of interest. Disconnect the temporary ground connection, and connect the series capacitors to ports 3 and 4 of the hybrid.

Connect a matched load to port 2 again and check the input vswr of the complete phasor. As the phase control capacitor is rotated through its range there should be no change in vswr.

In coupling to two separate antennas, a second hybrid, identical to that used in the phasor, appears to be the best arrangement as shown in fig. 5.

operation

To ensure placing a maximum signal lobe accurately in the direction of a given station, a pair of coaxial relays were hooked up as a reversing switch. The other station is first nulled out as far as possible, then the relays are actuated so that the connections to the transceiver and dummy load are reversed (fig. 5). This places a maximum signal lobe towards the selected station.

It can be seen that if a given station can be completely nulled out, the entire received signal is being routed to the dummy load, rather than to the receiver. Reversal of the order of connection by means of the relays then routes the entire signal from both antennas to the receiver. Since the effect is reciprocal, when transmitting both antennas combine to place a maximum lobe in the direction of the other station. It should not be difficult to calibrate the phase control in terms of direction so that this procedure can be omitted.

Don't expect a complete cancellation of the signal from a given station as no two antennas will have identical, perfectly circular radiation patterns. Maximum to minimum signal reports have varied from 1 to 6 S-units, with rare instances where the signal dropped completely into the noise level. If you consider that one antenna puts out a signal of 100 power units, while the other only puts out 95 units in a given direction, then the best possible cancellation

would still leave 5 units of signal. A ratio of 195 to 5 in power is about 14.1 dB, slightly more than 2 S-units. Therefore it should be apparent that the two antennas should be made as identical as possible.

Another factor in the operation of a system of this type is the spacing between the two antennas. If they are close together, there will be coupling present which will greatly affect the power distribution between them. With a spacing of around 120 feet (37m), the input vswr of the system varies over the phasor range from 1.0:1 to 1.2:1.

While any two relatively identical vertical antennas should perform satisfactorily, the pair I used were less than 15 feet (4.57m) in height, resting on a glass jar set on the ground. As this was a temporary experimental installation, a rather skimpy ground system of eight radials, each 30 feet (10m) long, was used. Matching was accomplished with an L-network.

It appears that the phasing system could be applied to two colinear horizontal dipoles. In addition to being, in many cases, easier to erect, the end-on arrangement of the radiating elements might be expected to show lower mutual coupling between the elements.

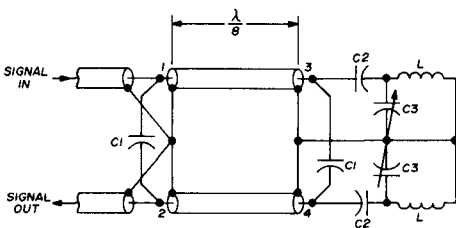

- C1 hybrid coupling capacitors
- C2 reactance network series capacitors
- C3 phase-control capacitor (two 140-pF sections)
- L approximately 14½ turns, 1¼" (32mm) diameter, 1¼" (32mm) long

fig. 4. Circuit for the 7-MHz phasor, showing grounding arrangement for the outer coaxial connections. Setup and test of this circuit is discussed in the text.

While not giving a full 360° coverage as uniformly as vertical antennas, the horizontal system might offer an interesting area for investigation.

It is felt that the results obtained with this experimental (and admittedly temporary) installation justify the con-

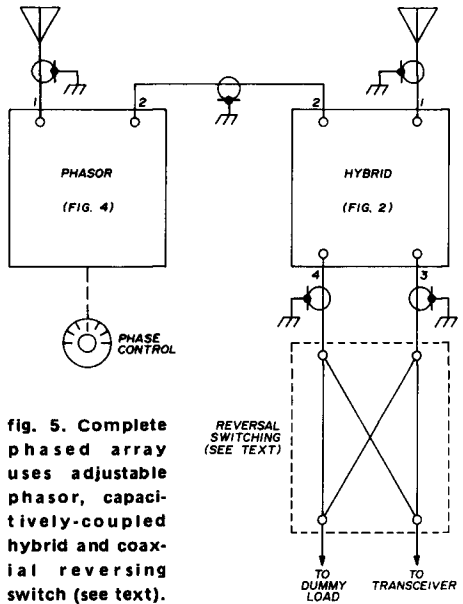

fig. 5. Complete phased array uses adjustable phasor, capacitively-coupled hybrid and coaxial reversing switch (see text).

cept of omnidirectional control of the antenna pattern. Although the wide spacing of the elements of the antenna system results in more lobes than a beam, the total area covered by the lobes should be about the same, with no loss of signal strength in directions of maximum signal as a result of the increased spacing. A vertical antenna system of this kind should offer much to the low-frequency DX man by combining the low-angle radiation of the vertical antenna with control of the directivity.

reference

1. Henry Keen, W2CTK, "High-Frequency Hybrids and Couplers," *ham radio*, July, 1970, page 57.

ham radio

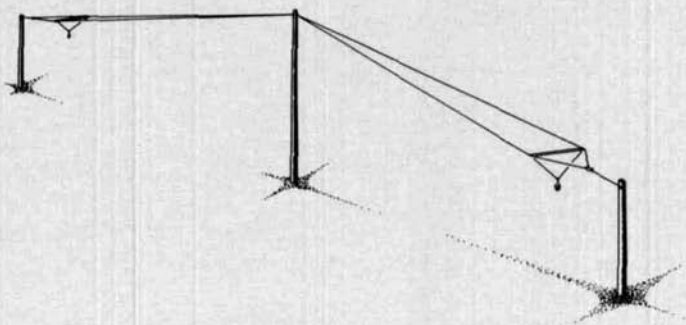

wide bandwidth bow-tie antenna for eighty meters

Discussion of a
bow-tie antenna design
using galvanized-steel wire
that provides
low swr performance
over the entire
80-meter amateur band

Dwight Borton, W9VMQ, Box 93, Zanesville, Indiana

One of the problems requiring a decision when you establish a station is the selection of an antenna or group of antennas for the bands on which you want to operate. To make the best use of your environment and space available requires some study and planning.

In the case of the limited space of a city lot, especially for an 80-meter antenna, special steps may be needed for satisfactory results. A major consideration for an 80-meter antenna is the portion of the band you intend to use. The ordinary single-wire horizontal dipole, when used on this band, for example, will not work well over the entire band without some sort of antenna tuner or matching system. Verticals have the same limitations, but this article is concerned only with a horizontal antenna.

A typical horizontal dipole, resonant at 3.75 MHz, will approximate a series-

resonant circuit as shown in fig. 1. Resistance R represents the radiation resistance which will be about 50 ohms. The inductive and capacitive reactances, X_L and X_C , with a Q of 14 will be about 700 ohms (14×50 ohms) at the resonant frequency.

Fig. 2 shows a swr vs frequency curve for a horizontal, single-wire antenna, resonant at 3.75 MHz, measured and used as a standard of comparison for the experiments that follow. Tests made at four other amateur stations show the curve of fig. 2 to be typical for antennas of this type.

One important fact must be noted at this point: the majority of swr bridges made for amateur use will not provide accurate readings on the 80-meter band because of the non-linearity of the germanium diodes used in the simple bridge circuits. A Heath HM-102 swr bridge was used to obtain the curves presented here. This unit checked very closely with a Waters 365A reflectometer as well as with a standard Bird wattmeter. The typical, simple bridge will measure swr as much as 35% low on 80 meters.

Using the values of fig. 1, the inductive reactance of the antenna at 4 MHz will be $(4/3.75)700 = 747$ ohms; the capacitive reactance, $(3.75/4)700 = 656$ ohms. The net reactance is $747 - 656 = 91$ ohms (inductive). At 3.5 MHz the inductive reactance will be $(3.5/3.75)700 = 653$ ohms; capacitive reactance is $(3.75/3.5)700 = 750$ ohms, and the

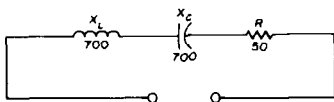

fig. 1. Equivalent circuit of single-wire horizontal dipole. Values are typical of those at resonance.

net reactance is $750 - 653 = 97$ ohms (capacitive). Neglecting the resistance change with frequency, which is small, the impedance at 4 MHz will be approximately $50 + j91$ ohms; at 3.5 MHz the impedance will be approximately $50 - j97$ ohms.

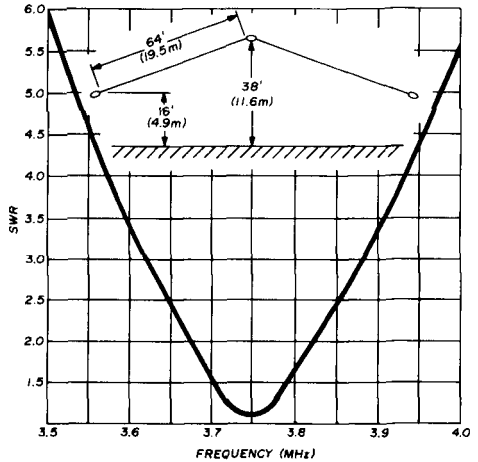

fig. 2. Swr vs frequency curve for single-wire antenna which is resonant at 3.75 MHz (radiation resistance = 45 ohms). Antenna is made from number-14 copper wire.

Fig. 2 shows the swr variations across the 80-meter band for the single copper-wire antenna with the maximum points at about 5.6:1 on the band edges. To reduce the swr (to broaden the frequency range of the antenna) you can reduce the Q by reducing the reactance or raising the radiation resistance. One method of reducing the reactance is by using a larger diameter antenna conductor. However, in most cases this is impractical at low frequencies. To reduce the Q of the single-wire antenna from 14 to 10, for example, would require a diameter of 640 mils or 0.64 inch (16mm). The use of RG-8/U coaxial cable, with the inner and outer sections

connected in parallel, reduced the Q of the antenna to about 12.

A much more practical method of increasing antenna bandwidth is by using the bow-tie or fan configuration shown in fig. 3. With a wire separation of 7 feet

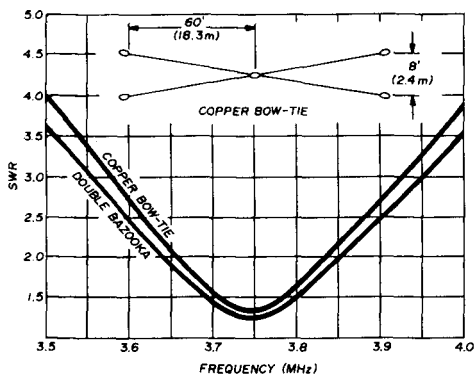

fig. 3. Swr comparison of the copper bow-tie and double bazooka antennas on 80 meters. Radiation resistance of the bow-tie is 35 ohms at 3.75 MHz; radiation resistance of the double bazooka is slightly lower.

(2.1 meters) or more and copper wire, the Q can be reduced to about 10. This brings the swr at the band edges down to about 3.8:1. For swr no higher than 2:1, the bandwidth is increased to 190 kHz.

double-bazooka antenna

The so-called double-bazooka or coaxial antenna is another modification for increasing the bandwidth of the basic horizontal dipole. However, the results were disappointing in the tests I made with this system. With new RG-58/U cable and very careful construction, with open-wire line for the end sections, the best I could obtain was an swr of about 3.5:1 at the band edges, an 8% improvement over the bow-tie (see fig. 3). The use of RG-8/U or RG-11/U for this antenna was not tried.

On the basis of the considerably greater cost and work required to build

the double-bazooka antenna, it compares poorly with the bow-tie. The possible balun characteristic it is supposed to have is difficult to determine and of doubtful value.

galvanized wire

About two years ago, with more antenna experimenting in mind and copper wire in short supply, I obtained a roll of galvanized steel electric-fence wire at a farmers' supply store. When I built a single-wire dipole with this wire, a considerable lowering of swr was noted. The same wire in a bow-tie showed an swr of about 2.5:1 at the 3.5- and 4-MHz band edges. When I checked the radiation resistance at resonance, it was found to be about 50% higher than with copper, or about 75 ohms for a single wire and 50 ohm for the bow-tie (see fig. 4).

Speculation as to the reason for the increased radiation resistance, as well as how much antenna loss may have increased because of the higher resistance of this wire, led to quite a bit of research in reference books and experimenting.

First off, the wire I used is designated as number-16, but this refers to the

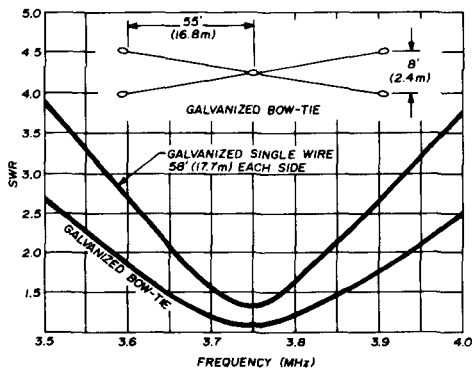
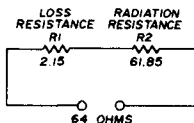

fig. 4. Swr performance of a galvanized single-wire dipole and a galvanized-wire bow-tie. Both antennas are resonant at 3.75 MHz. Radiation resistance of single-wire dipole is 75 ohms; radiation resistance of bow-tie is 50 ohms.

size before the zinc galvanizing is applied. Checking the wire table shows the diameter of number-16 as 50.8 mils (1.3mm). When checked with a micrometer, the wire measured 62 mils (1.5mm). The diameter of number-14 wire is 64 mils (1.6mm) so this wire is very nearly the equivalent. Although the use of galvanized wire for an antenna is by no means anything new, information on its rf characteristics is difficult to find. After failing to find anything in the antenna reference books, some experimenting led me to results that indicate, I think, a loss figure that is not too high when compared to copper.

The resistance tables show zinc with two to three times the dc resistance of copper. And, because of skin effect, most of the antenna rf current will be in the zinc coating. In an effort to get a comparison, equal lengths of number-14 copper wire and number-16 galvanized-steel wire were wound on identical forms and checked for Q at 3.75 MHz with a Q-meter. This test showed the copper-wire coil had a Q about six times that of the galvanized-wire coil. From this data it was assumed that a 6-to-1

fig. 5. Relationship of loss resistance, R1, and radiation resistance, R2.



ratio of rf resistance was fairly correct at 3.75 MHz.

The actual loss resistance of a copper-wire antenna at 3.75 MHz is another thing that is very hard to find in the reference books. The loss resistance is usually considered to be "extremely low" or "negligible," and the only book I could find with anything like a definite statement was *Transmission Lines, Antennas and Waveguides*.¹ On pages 113 and 114 the authors stated that, when using 80-mil (2mm) copper wire at a frequency of 3 MHz, a dipole with

64 ohms load resistance at resonance will have 3% of the 64 ohms as loss resistance. This works out to be 1.92 ohms, and should be nearly the same at 3.75 MHz as the shorter length would just about balance the effect of the

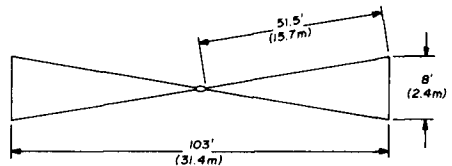

fig. 6. In this modification of the basic bow-tie antenna, the ends are tied together. Bandwidth is affected little by spreads from 6 to 16 feet (1.8 to 4.9 meters). Radiation resistance of this antenna is 50 ohms at 3.75 MHz.

higher frequency. For number-14 copper wire, the smaller diameter should raise this to about 2.15 ohms ($1.92\sqrt{80/64}$).

Fig. 5 shows the relationship of the loss resistance and the radiation resistance. The percentage of power lost in heating the wire, of the total applied to the antenna, would be $R1/(R1 + R2) = 2.15/64 = 3.4\%$; the percentage radiated would be $100 - 3.4 = 96.6\%$. For the galvanized-steel wire, we can assume the loss resistance to be six times 2.15 or 12.9 ohms. It is assumed that this figure for the single galvanized wire will remain substantially the same with average variations in antenna height and inverted-vee angle. For the single galvanized wire, the loss ratio is $12.9/75 = 17.2\%$, yielding an efficiency of 82.8%.

Because the two wires of the bow-tie are in parallel for the antenna current, the effective loss resistance should be about one-half that of the single wire. For the copper and galvanized bow-ties, therefore, the loss resistance should be about 1.08 ohms and 6.45 ohms, respectively. The relative frequency response of the antennas that have been checked

can be expressed by the bandwidth over which they can be used with no more than a 2:1 swr (see table 1). The figure of 2:1 is used because this is the maximum swr specified by many manufacturers for their transmitters or receivers. An swr of 2:1 is also the value

meters) makes very little difference in the swr characteristic. A very wide spreader, however, results in a proportionate reduction in overall length. Fig. 7 shows one arrangement that worked very well with swr performance slightly better than the standard spread.

table 1. Bandwidth of different 80-meter antennas for maximum swr or 2:1 (antenna resonant at 3.75 MHz).

antenna type	load resistance	loss resistance	percent loss	bandwidth
Single copper wire	45 ohms	2.15 ohms	4.8%	165 kHz
Single galvanized wire	75 ohms	12.90 ohms	17.2%	188 kHz
Copper-wire bow-tie	30 ohms	1.08 ohms	3.6%	190 kHz
Double bazooka	35 ohms	—	—	206 kHz
Galvanized-wire bow-tie	50 ohms	6.45 ohms	12.9%	325 kHz

above which line loss begins to mean something.

bow-tie antennas

A useful modification to the basic bow-tie antenna is that of tying the two wires together at the ends as shown in fig. 6. This shortens each side by about one-half of the end separation as shown. The overall length of 103 feet (31.4 meters) is very desirable where space is limited. The end connection can be made by using light-weight aluminum

A simple and economical L-network tuner, as in fig. 8, will allow an antenna cut for resonance at 3.75 MHz to be used over the entire 80-meter band with no more than 1.5:1 swr at the transmitter terminals. The maximum swr on the feedline is only about 2.6:1 so with RG-8/U feedline, the line loss due to swr would be about 0.34 dB at 3.5 MHz and 0.44 dB at 4 MHz, practically negligible amounts.

A comparison of the associated feedline loss of the two bow-tie antennas

table 2. Losses of copper and galvanized bow-tie antenna systems with RG-8/U coaxial feedlines.

antenna type	frequency	antenna loss	feedline loss	total loss
Copper-wire bow-tie	3.75 MHz	0.17 dB	0.50 dB	0.67 dB
Galvanized-wire bow-tie	3.75 MHz	0.65 dB	0.28 dB	0.93 dB
Copper-wire bow-tie	4.00 MHz	0.17 dB	0.88 dB	1.05 dB
Galvanized-wire bow-tie	4.00 MHz	0.65 dB	0.40 dB	1.05 dB

spreaders, a wood spreader with wire connector, or any other method that provides the mechanical spread and the electrical connection.

The spread of the wires can be either horizontal or vertical. A variation of spread from 6 to 16 feet (1.8 to 4.8

(no tuner) is presented in table 2. The larger feedline loss of the copper bow-tie is the result of the low radiation resistance of 30 ohms which results in considerably higher line current. This effect was checked out experimentally with a dummy antenna on the bench.

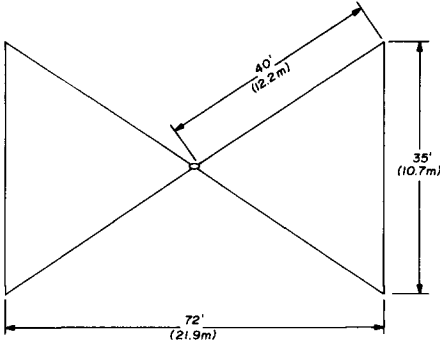
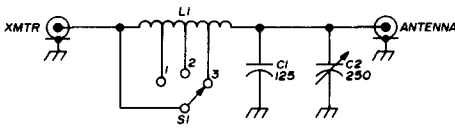

fig. 7. Bow-tie antennas can also be built with a very wide spread as shown here. As well as shortening the overall length of the antenna, this slightly improves the swr performance. Radiation resistance of this antenna is 50 ohms at 3.75 MHz.

Table 2 shows that the price paid in increased loss from the use of the galvanized steel wire is small enough to justify its use for the resultant broadband characteristic of the antenna. Its lower cost, compared to copper, is a fringe benefit. The durability of this wire, if my case is typical, is very good. The same wire has been up for two years with no visible rust. A coating of varnish or lacquer could be applied before putting the antenna up, if desired.



- C1 125 pF mica, 1000 working volts
- C2 250 pF air variable, 0.030" (0.8mm) spacing or greater
- L1 9 turns no. 16, 1-7/8" (48mm) diameter, 1" (25mm) long, tapped at 2, 5 and 7 turns

fig. 8. Simple L-network antenna tuner which can be used to match the bow-tie antenna to 50 ohms over the entire 80-meter band (swr - 1.5:1 or less). Inductor L1 is 9 turns no. 16 airwound on 1-7/8" (48mm) diameter, 1-inch (25mm) long, tapped at approximately 2, 5 and 7 turns. Capacitor C2 should have spacing of 0.03" (0.8mm) or more.

operating Q

The operating Q of the bow-tie antenna can be reduced further by using the parallel compensating circuit shown in fig. 9. This circuit is simple, inexpensive and will work with any dipole to some extent. It makes use of the principle that a parallel tuned circuit has the opposite reactance variation on each side of resonance as that of a series

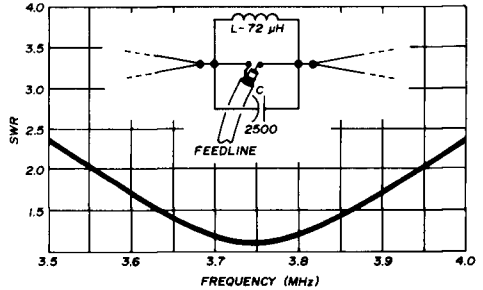

fig. 9. The bandwidth of the galvanized-wire bow-tie antenna can be increased still further by the addition of the parallel L-C circuit shown here (see text). Feedline is 88-feet (24.4m) long.

resonant circuit. When connected as shown in fig. 9, the parallel network will cancel some of the series reactance exhibited by the antenna on each side of resonance. The values of inductance and capacitance were determined by experiment for best results. The capacitance is 2500 pF and the coil is adjusted by means of a grid dipper to resonate with the capacitor at 3.75 MHz.

By shortening or lengthening this antenna, the resonant point can be moved higher or lower to obtain the desired coverage. Eight inches (20.3cm) of change, in each wire, will produce about 80 kHz frequency shift.

Considerable time and effort have been spent to answer two obvious questions: Why does the bow-tie antenna exhibit broader response than a single

wire, and why does the use of galvanized steel wire show the same effect? As for the first question, one reference book indicated that the bow-tie arrangement effectively increased the conductor size. That does not satisfy me. The most logical explanation seems to be that the two parallel wires reduce the inductance while at the same time increasing the capacitance between the halves of the antenna and the ground. The reduction in reactance is great enough to more than compensate for the reduction in radiation resistance, resulting in lower Q.

As to why galvanized steel wire increases the bandwidth of the antenna, it is thought that the 60% increase in feed-point resistance at resonance (in the bow-tie), as indicated by an antenna noise bridge, must be the reason for the lowered Q. Part of this increase is due to the higher loss resistance, of course, and this has been calculated to be about 6.45 ohms while the actual increase is 20 ohms. This would require a ratio of 20/1.08 or about 18.5 times as much rf resistance in the galvanized as the copper antenna. Even considering the limits of the Q meter for making coil comparisons, this is much too great an error to believe possible.

It has been noticed, however, that the galvanized wire, for a given resonant frequency, is about 4% shorter than the copper wire. This could be explained, as suggested by WBØBHG, by a "velocity factor" effect of the current flow slowing down on the higher resistance wire.

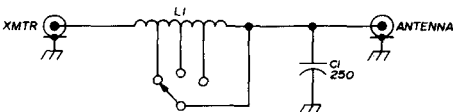
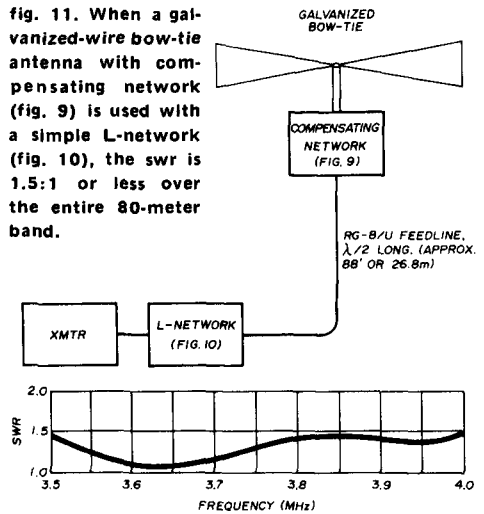

fig. 10. L-network for use with the bow-tie antenna with compensating network shown in fig. 9. Resultant swr curve is plotted in fig. 11. L1 is 9 turns no. 16, 1-7/8" (49mm) diameter, 1" (25mm) long, tapped at 2, 5 and 7 turns. Capacitor C1 is a 250 pF mica, 1000 working volts.

fig. 11. When a galvanized-wire bow-tie antenna with compensating network (fig. 9) is used with a simple L-network (fig. 10), the swr is 1.5:1 or less over the entire 80-meter band.



This might raise the radiation resistance and lower the Q.

One experiment was tried using number-26 copper wire instead of galvanized steel. The swr at the band edges of 80 meters was about 3.2:1 and the radiation resistance about 65 ohms. The rf resistance of number-26 copper, according to the wire table, should be about 85% of the single galvanized-steel wire.

The transmission line used for all tests and swr curves was 88 feet (26.8 meters) long, checked out with a noise bridge for one-half wavelength at 3.75 MHz. It was found experimentally that the circuit of fig. 10, with the values shown, when inserted between the transmitter and feedline, modified the swr curve to that shown in fig. 11. For this result, however, the transmission line must be close to one-half wavelength long. To obtain the averaging out effect the transmission line should be within 5% of one-half wavelength long.

The simple circuit of fig. 10 replaces that of fig. 8 when the parallel compensating circuit at the antenna and a half-wave feedline are both used. This brings the system to the point where no tuning

is needed at all, with very low swr at the transmitter output terminals.

operation

The ability to work across the entire band with no more than 1.5:1 swr, as shown in fig. 11, provides very smooth operation. A variable antenna tuner with a coax fed copper antenna will also cover the 80-meter band but with a much more complicated tuner and with much higher line loss.

Swr curves were run with and without a balun at the center of the antenna. Both straight-core and toroid types were tried. The only observed difference was a downward shift in resonant frequency by about 50 to 75 kHz. Substitution of number-14 galvanized wire with an actual diameter of 75 mils (1.8mm) resulted in a very small change as compared to number-16 wire. A third wire, strung between the two wires of the basic bow-tie, was tried with very little change.

One thing I did notice was that twisting the two wires together at the center, even for 2 or 3 feet (61 to 91cm), raised the swr about 6%. This effect led me to try bracing the two wires about 10 inches (25.4cm) apart at a point about 18 inches (45.7cm) out from the meeting point, but no improvement was observed.

I experienced no difficulties from the wires getting twisted or tangled after the antenna was installed. Winds up to 60 mph (97 kmh) have given no trouble.

All experimental work was carried on jointly with W8URR who first suggested the use of the bow-tie arrangement with which he had already done considerable experimenting. Both he and W8SAY are using the antenna with very satisfactory results.

reference

1. King, Mimnow and Wing, *Transmission Lines, Antennas and Waveguides*, McGraw-Hill, New York, 1945.

ham radio



The "STANDARD" by Heights

Light,
permanently
beautiful
ALUMINUM
towers

THE MOST
IMPORTANT
FEATURE OF
YOUR ANTENNA
IS PUTTING
IT UP WHERE
IT CAN DO
WHAT YOU
EXPECT.
RELIABLE DX —
SIGNALS EARLIEST IN
AND LAST OUT.

ALUMINUM
Self-Supporting
Easy to Assemble
and Erect
All towers mounted
on hinged bases
Complete Telescoping
and Fold-Over
Series available

And now, with motorized options, you can crank it up or down, or fold it over, from the operating position in the house.

Write for 12 page brochure giving dozens of combinations of height, weight and wind load.

ALSO TOWERS FOR WINDMILLS

HEIGHTS MANUFACTURING CO.

In Almont Heights Industrial Park
Almont, Michigan 48003

Due to several acts of vandalism and an office fire, many inquiries were lost. If you have not had a reply, please place your inquiry again.

What's NOW

Put together a wide variety of exciting new products and a dynamic young company on the move and you have DENTRON . . . dedicated to *Making Amateur Radio More Fun.*

HERE'S A REAL PLUS

You will add a real plus to your SSB station when you give it complete 160-meter receive and transmit capability with the exciting new Dentron 160 XV Transverter. Just two simple connections with no modifications and you're on the air.



Let the Dentron 160 AT antenna tuner solve your 160-meter antenna problems the easy uncomplicated way. This transmatch will load any random length antenna from a short whip to an extra-long wire. Use it with virtually any existing HF antenna you already have. Handles maximum legal power. Use with the 160-XV or any other 160 meter equipment requiring a 52 ohm antenna.

Dentron 160 AT Antenna Tuner \$59.95 ppd. USA

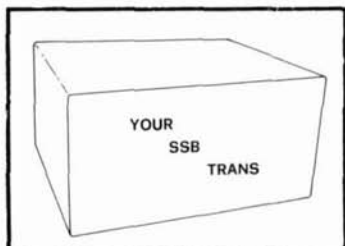

- 5 watts drive gives 100 watts DC input
- 3.8 to 4.0 MHz input
- Matches 50 ohm antenna
- Built in 110/220 V 50/60 Hz supply
- Units are available for the 2 MHz MARS frequency

Dentron 160 XV Transverter

\$199.95 ppd. USA

Making Amateur Radio More Fun!

What's NEW from Dentron

The Brand New 160-V Vertical Antenna

Another eye opener from Dentron, this new vertical antenna will solve your 160, 80 and 40 meter problems. 

- Efficient Vertical Design
- Self Supporting
- Weatherproof
- Quick & easy one man installation
- Covers 160, 80 or 40 meter band with only one adjustment.

160-40V Antenna \$79.50 ppd. USA



Here is another Dentron first, a six band antenna tuner designed to solve virtually any matching problem you may have.

- Covers all bands 160 through 10 meters
 - Handles maximum legal power
 - Matches coax feed, random wire and balanced line
 - Includes heavy duty balun for balanced line
 - Black wrinkle finish cabinet
- 160-10 Super Tuner \$119.50 ppd. USA

Be ready for restructuring — Special Supertuner handles 3 KW PEP amplifiers — \$229.50 ppd. USA

This is the low cost way to match almost any random length wire on the five most used HF bands.

- Covers 80 through 10 meters
- Handles maximum legal power
- Matches random length long wire antennas
- Features Dentron quality and value

Model 80-10 Antenna Tuner \$49.50 ppd. USA



Dentron

RADIO CO., INC.
2100 Enterprise Avenue
Twinsburg, Ohio 44087
Phone: 216-425-8073

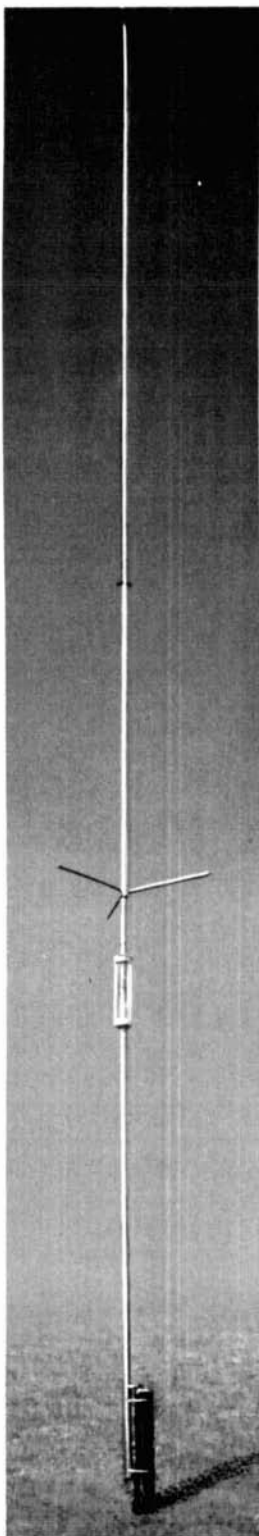

loop antenna receiving aid

A method
for improving
signal-to-noise ratio
on the
lower-frequency bands

You've heard it before and it's worth repeating: "If you can't hear 'em, you can't work 'em." Most hams I've talked to or heard on the air on the lower frequencies use quarter- or half-wave antennas in vertical, horizontal or inverted-vee configurations. While these antennas do a creditable job of transmitting rf, they can be noise collectors for receiving because of their physical size and proximity to man-made noise sources.

Presented here is a scheme that uses a fet preamp or a Q multiplier with a loop antenna which is easy to rotate from the operating position and will allow you to discriminate between signals and noise. The loop is only 18 inches (46cm) on a side with two windings spaced 2 inches

(5cm) apart. A complete parts list and construction drawings are included. The loop structure can be made with a few pieces of wood, and the electronics are simple and inexpensive.

loop antennas

The rotary beam, if designed properly, discriminates well between the desired signal and interference. However, not many amateurs are fortunate enough to have a rotary beam for the lower amateur frequencies. If we sacrifice some gain and use a small loop that will give reasonable attenuation on an interfering signal or noise, we'll have a desirable receiving aid. Such an antenna has been around for years and its characteristics are well documented.^{1,2}

Largely ignored by today's amateurs, the loop antenna was a standard piece of equipment in early ham stations but was generally huge and cumbersome because of the low frequencies in use in those days. The loop doesn't have to be large to be an effective noise discriminator on the lower amateur frequencies in use today. The entire assembly, including antenna and preamp or Q multiplier, can be mounted on your receiver. Used properly, this combination could mean the difference between solid reception and frustration.

Loops have a pattern that exhibits maximum response in the plane of the loop and minimum response in a plane normal to the loop (fig. 1). Note that

Ken Cornell, W2IMB, P.O. Box 721, Westfield, New Jersey 07091

this response is exactly opposite to that of a quad antenna. This suggests that a small loop antenna with appropriate electronics might be useful as a noise discriminator on the higher amateur frequencies when used as a receiving aid with a quad.

receiver input impedance

A loop antenna with its tuning capacitor is a common LC circuit. It could be substituted for the tuned circuit in your receiver rf amplifier. Few hams, however, would want to make the circuit modifications. Most modern receivers use a low-impedance antenna input; and since the basic loop has a high impedance, we need a one-turn loop coupled to the large tuned loop to act as a low-impedance transformer to the receiver input. See fig. 2.

design examples

The first thought that might enter your mind when constructing a loop is to use the number of turns required for the lowest frequency desired, and provide taps in the winding for the higher frequencies, which is not an uncommon practice with coils. My experience using this means has proved that it is not practical. For some reason, the unused turns seem to saturate the loop, and a sharp resonance becomes hard to achieve. Also the directivity pattern becomes questionable. I've found that it's better to wind two separate loops on

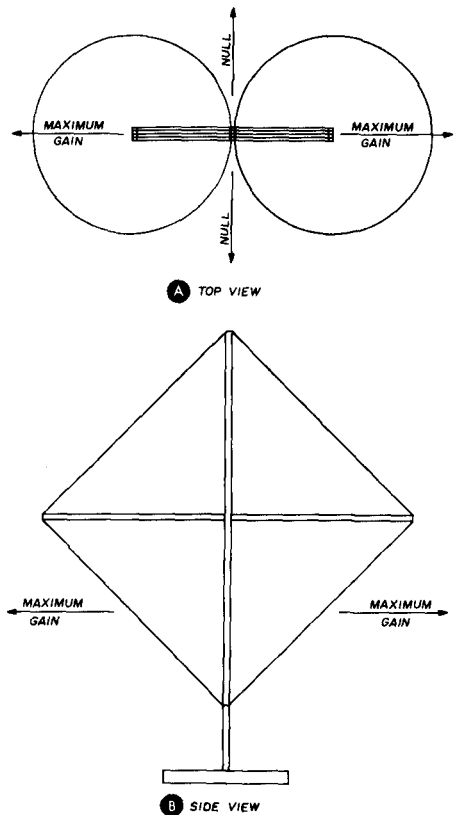

fig. 1. Loop antenna field strength patterns.

the same frame, with the most spacing you can provide between the two windings, e.g., about 2 inches (5cm) will provide excellent performance. I've also found that as far as the LC ratio is

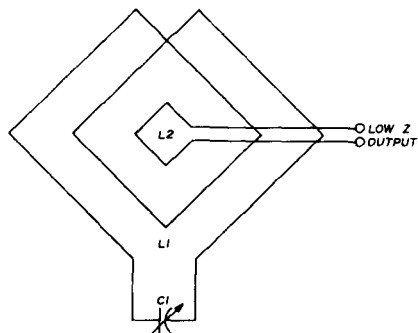
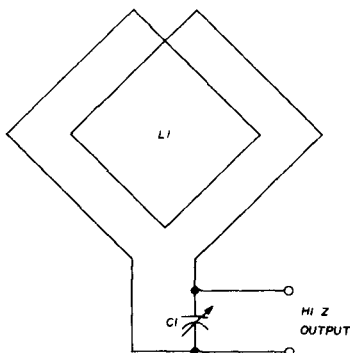

fig. 2. High- and low-impedance loop outputs.

concerned, the higher the capacitance (within reason), the more effective the loop performance.

An example of this is the loop that I will describe. It is approximately 18 inches (46cm) on a side and contains two windings spaced 2 inches (5cm) apart. One winding consists of two turns spaced 1/4 inch (6.5mm) and covers 40 and 80 meters. The other winding consists of 5 turns spaced 1/4 inch (6.5mm) and covers 80, 160 and the high end of the broadcast band. With this arrangement, the loop is more effective on 80 meters using the 2-turn loop with high capacitance than the 5-turn loop with low capacitance.

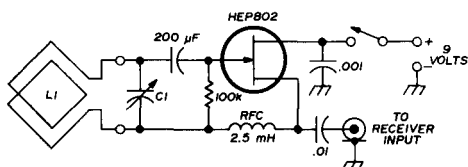

fig. 3. Fet preamp for the loop antenna.

table 1. Parts list for loop antenna.

item	quantity	description	dimensions	use
1	4	wood strip	1/2 x 3/4 inch	loop frame
2	3	support	fig. 6A	loop wire
3	1	support	fig. 6B	bottom loop wire
4	2	loop frame brace	fig. 5	feedback loop L3
5	1	base	to suit	loop support
6	2	support bracket		loop frame
7	2	angle bracket		
8	2	circuit board	3 inches (76mm)	fig. 3 and 4
9	1	wood dowel	see text	feedback loop L3 support
10	1	wood strip	see text	support for ends of L3

The variable capacitor I use came from an old BC set. I wired its two stators in parallel and assume it has a maximum capacitance of 600 pF. I use a small dpdt switch to select the desired loop.

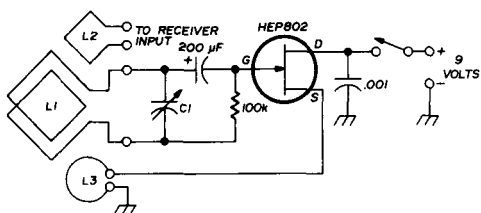

fig. 4. Loop antenna with Q-multiplier. Regeneration control is by means of L1, L3 coupling.

Loop with preamp input. While the loops performed satisfactorily in their basic configuration, as my first experiment I decided to add an rf amplifier using a solid-state device, and the circuit of fig. 3 evolved. Here the loop is connected to the gate of an HEP-802 fet and output to the receiver is taken from the source. Results were good, but I felt that the null could be improved, perhaps by increasing circuit Q.

Loop with Q-multiplier input. Recalling the principles of the Q multiplier, I decided to substitute such a circuit for

the fet preamp (see fig. 4). Feedback control is obtained by an adjustable loop of wire, L3, coupled to the loop, L1. Receiver input is taken from L2. By rotating L3 within the field of L1 the desired amount of regeneration can be

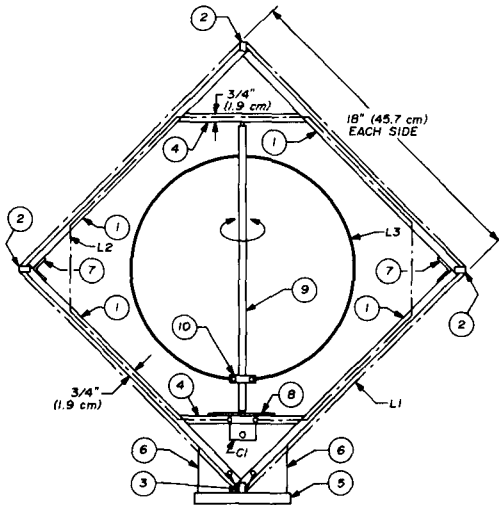

fig. 5. Construction details. Circled numbers refer to table 1. L3 and pieces 9 and 10 are required only if a Q multiplier is used.

obtained, circuit Q is improved, and the null is much more pronounced. Better control is obtained for separating noise from the desired signal.

Note that a loop antenna can also be used as an absorption wavemeter. When using it with solid-state devices beware of placing the loop in a strong rf field.

construction

Fig. 5 and the parts list (table 1) should be self-explanatory. The basic loop contains two windings: a two-turn loop for 40 and 80 meters and a 5-turn loop for 80, 160 and the high end of the broadcast band. Four turns can be used if operation on the broadcast band is not desired.

The structural support for the loop wire is made from two strips of wood fashioned in a cross. The simplest winding is made by starting the wire from the outside, winding around and around, to the inside. The wire is supported on the cross arms with tacks or notches. The size of the frame, number of turns, and spacing will be

determined by the desired frequency coverage.

Another winding pattern is made as a large, square-shaped, wide-spaced solenoid. In this case, short strips of wood are required at the appendage of the supporting arms, with notches to support the wire. Here again the size, number of turns, and spacing will depend on the frequency range desired.

Incidentally, there is a school of thought that reasons as follows: Since the maximum gain of a loop antenna is in the plane of the wires, a loop wound in a wide-spaced solenoid configuration and mounted in a diamond position (points of the square top and bottom) will have a better capture area. While I can't prove it, I am inclined to agree.

Since the wire is the only important element of a loop, the basic construction of the frame can be left to your ingenuity and materials on hand. The frame, of course, should be made with insulating material. I suggest that the wood frame be painted with coil dope.

Fig. 6 details the loop wire support arms. Note that one extra notch for wire is required in the bottom arm due to the winding pattern. I formed the notches in the support arms in the following manner. I drilled the required number of holes in the arms on a line

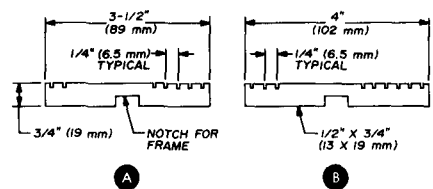

fig. 6. Loop wire support arms.

about 1/8 inch (3mm) in from the outside edge, then clamped the supports in a vise and cut slots into the holes with a hacksaw. Next I folded a piece of sandpaper and widened the slots to suit the wire size. A piece of string a little

Zulu 10... precise GMT plus 10-minute identification alarm.



Only \$39.95

From Corvus, a unique 100% solid-state digital clock packed with features any ham radio operator will appreciate.

Built around a single MOS integrated circuit, Zulu 10 provides 24-hour GMT with to-the-second accuracy. The special alarm alerts you every 10 minutes with a soft, pleasant signal to help you meet station identification requirements. And it's reset with a single "flick of the wrist" motion of the clock.

Feature-packed, trouble-free operation.

- Bright LED display for hours and minutes. Seconds are indicated by a pulsing lamp
- Automatic display dimming for easy viewing
- Attractive, compact silver case
- Pushbutton controls neatly tucked in base
- 60 HZ AC operation
- Full year written warranty

Designed and engineered for the ham radio operator by Corvus Corporation, Dallas-based subsidiary of Mostek Corporation, an industry leader in MOS integrated circuit technology.

Order yours today.

corvus

13030 Branch View Lane, Dallas, Texas 75234

Please send me...Zulu 10(s) at \$39.95 each, plus \$2.65 for postage and handling (add local and state tax where applicable). I've enclosed check money order.

Name _____

Address _____

City _____ State _____ Zip _____

Money back guarantee. If you are not totally satisfied with your Zulu 10, send it back to us within 10 days and your money will be refunded. HR

larger than the wire diameter, rubbed over a candle and worked into the slots, made it easy to obtain proper tension in the loops when securing the ends.

The feedback-loop support dowel should be cut 1/4 inch (6.5mm) shorter

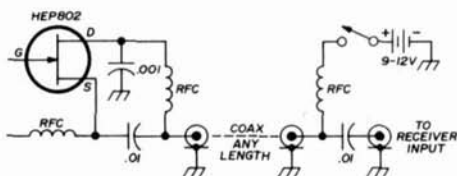

Fig. 7. Suggested power feed for a remote loop with fet preamp.

than the space between the supports. The ends of the dowels should be drilled on the vertical centerline to take a short length of heavy wire. This wire should project 3/8 inch (9.5mm) at the top and 1/8 inch (3mm) at the bottom. The supports should be drilled at their centerline to accept the wire. The dowel is inserted into the top support first, then swung in to the bottom support hole. Rotation to obtain proper feedback is by manual adjustment. In constructing the loop frame, I cut all pieces to proper length and shape, then assembled them using *Pliobond* cement and a few brads.

Fig. 7 is a suggested circuit to supply power to a loop antenna preamplifier through the coaxial transmission line when the loop is in a remote location. I suggest that the voltage drop that might occur in the two rf chokes be checked and, if warranted, the voltage increased.

references

1. Frederick E. Terman, *Radio Engineers' Handbook*, McGraw-Hill, New York, 1943, page 813.
2. Keith Henney, *Radio Engineering Handbook*, McGraw-Hill, New York, 1959, pages 3-26, 19-7, 19-21, 19-116, 19-184.

ham radio

tilt-over tower

uses extension ladder

Tilt-over tower based on the use of a 40-foot aluminum extension ladder is inexpensive and easy to erect

It is difficult to beat the tilt-over tower as a means of supporting your beam antenna as it permits easy access to the elements for adjustments or repairs. Unfortunately, these structures are expensive and require a rather elaborate installation. If you are required to move because of a job change, retirement, or

just plain restlessness, there then arises the problem of what to do with the tower. Many times it must be either given away, or sold at a substantial loss.

The system described here makes use of a readily obtainable aluminum extension ladder which is light, easy to handle, and far less expensive than the usual tower. And if you should move, it is easier to transport or, if necessary, dispose of the ladder which can always be put back to the sort of work for which it was originally intended.

Henry S. Keen, W5TRS, Fox, Arkansas 72051

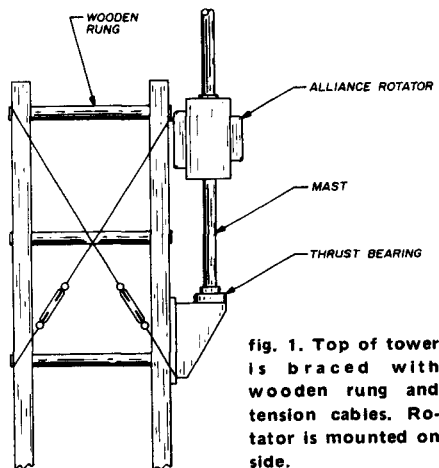

fig. 1. Top of tower is braced with wooden rung and tension cables. Rotator is mounted on side.

construction

After installation of this tower, the whole assembly is erected in the retracted position; the ladder is then extended to its full height for rigging. For my 15- and 10-meter quad an Alliance TV rotator with thrust bearing was mounted on the ladder as shown in fig. 1. To prevent twisting and damage to the ladder from wind action, a wooden rung was inserted at the extreme top of the upper section, with two crossed cables with turnbuckles for tensioning, as

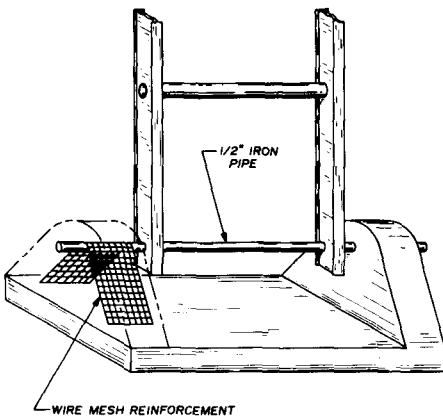

fig. 2. Hinged tilt-over base is made from reinforced concrete.

shown in fig. 1. Don't mount your beam without this modification to the ladder.

The swiveled feet originally installed on the bottom of the ladder were removed by drilling out the rivets and reaming the holes to a diameter permitting the insertion of a length of half-inch (13mm) iron pipe (fig. 2). This pipe becomes the pivot which anchors the bottom of the tower.

The ladder is secured vertically against the end of the house by a lag bolt through a board fitted between the vertical members of the ladder's lower section as shown in fig. 3. An eyebolt to the frame of the house secures a block

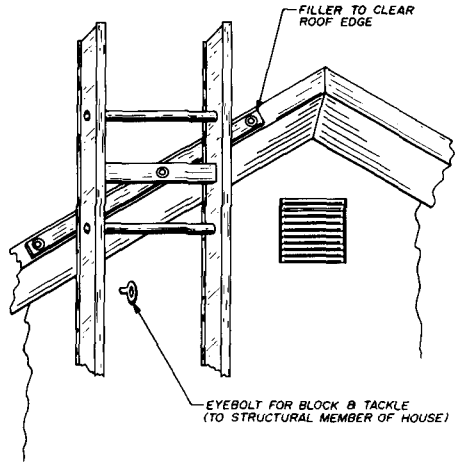

fig. 3. Method of securing the lower ladder section to the house.

and tackle which is used to raise and lower the assembly.

Guy wires are fastened to the ladder by running them through the hollow rungs, and attaching the end as shown in fig. 4. Thus, extreme or continued stresses will not tend to pull the ladder apart.

Ladders of this type are available in lengths up to 40 feet (12 meters). With the additional height provided by the 10-foot (3m) rotating topmast, which supports the quad, a total height of more than 45 feet (13.7m) can be obtained.

With this type of antenna support, as well as with more conventional towers, the problem of neighborhood children,

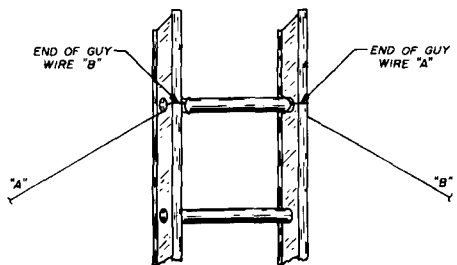

fig. 4. Fastening guy wires to the tower (details of fig. 1 omitted for clarity).

KEYBOARD AND ENCODER KIT

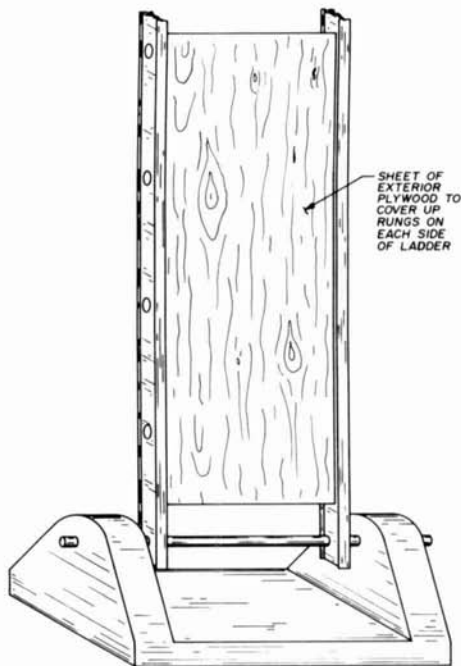

fig. 5. Extension-ladder tower can be child-proofed by adding plywood covers to each side of the ladder.

or your own for that matter, climbing it, with resulting danger of injury, is ever present. The ladder can easily be made "child proof" by using two pieces of outdoor plywood, one on each side of the lower section, so that the rungs are effectively covered up (fig. 5). A conventional tower can be protected in a like manner by proper location of plywood shields so that no hand-holds are present. Means of securing the shield will be left to the ingenuity of the builder. A hasp from one shield through the other, with a padlock, would seem to be an effective arrangement.

This installation has been in place for a year or so, and has been very easy to operate single-handedly, taking a little over an hour to bring down the antenna, make whatever adjustments are necessary and put it back into operation.

ham radio



- ★ 53 Keys
- ★ ASC II Encoder
- ★ For: Terminals
TV Typewriters
Calculators
RTTY Displays
CATV and more

More keys—more features and still the same price. Our KBD-2 comes with "Line Feed", "Cancel" and "Escape" functions for more convenient teletype and computer operation. Two user defined keys are connected to isolated output lines on the connector to allow use as "Here Is", or other such special functions.

Keyswitches are full typewriter travel and response type, arranged in a modified ANSI layout. Full length spacebar with equalizer. Keyswitches are mounted on a fiberglass circuit board. The encoder provides a standard ASC II output and includes a debouncer circuit. ASC II code includes shift and control functions with three user defined keys available. Keytops are first quality double-shot molded types for permanent good appearance. Gold plated contacts on keyswitches. NEW—no surplus parts. Typewriter style—NOT a modified keypunch board.

KDB-2 Kit.....\$39.95 ppd



DEPT H
219 W. RHAPSODY
SAN ANTONIO, TX 78216

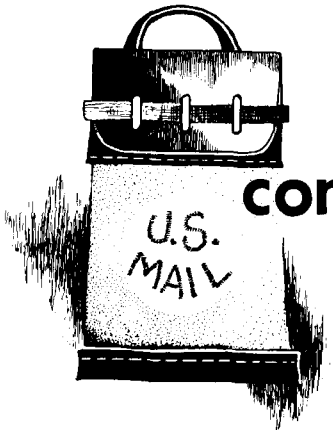

comments

improved log-periodic beams

Dear HR:

When I originally started designing and building fixed log-periodic wire beams, I cut the active elements to resonate near the center of the 20- or 40-meter bands. I later discovered that it was better to cut these elements for the low end of the desired band. In my article on feed systems for log-periodics in the October, 1974, issue of *ham radio*, the rear element (element 1) was shown to be 35 or 36 feet (10.7m to 11m) long for the 20-meter antennas, and 70 to 72 feet (21.3m to 21.9m) long for the 40-meter versions. In these log-periodics the active element (element 2) was 32 to 33 feet (9.8m to 10.1m) and 64 to 66 feet (19.5m to 20.1m), respectively, for the 20- and 40-meter antennas.

I have since found that the forward gain and front-to-back ratio at the low-frequency end is improved by making elements 1 and 2, respectively, 37 feet (11.3m) and 33.4 feet (10.2m) for the 20-meter antennas, and 74 and 66.8 feet (22.6m and 20.4m) long for 40 meters. The remaining elements will be proportionately longer.

When designing log periodics from scratch (see article on page 14), I now use 13.9 MHz and 6.9 MHz, respec-

tively, for the low cutoff frequency of 20- and 40-meter log-periodics. This results in improved performance at the low end while the midband and high-end performance remain the same.

When installing a log-periodic beam, be sure that the area in front of the beam is clear of obstructions or other antennas. If you position your standard dipole or test antenna too close to the front of your log-periodic, it may completely upset the pattern. This was called to my attention by Tony Mony, K4LD. He originally had a 7-MHz inverted-vee only 10 feet (3m) in front of his 7-MHz log-periodic (which showed no gain). When he removed the inverted vee, the log-periodic provided lower swr over the 7-MHz band as well as good forward gain.

George E. Smith, W4AEO
Camden, South Carolina

remotely-controlled gamma match capacitor

Have you ever wished you could adjust that gamma-matching capacitor on your beam from the ground? Or risked your neck up on a tower to get that last couple of tenths of vswr?

Here's a way to make that adjustment right in your shack while sitting down. *Burstein-Applebee** has a surplus TV remote-control reversible motor for \$3.95 (catalog number 18A1465) which has enough torque to do the job. The unit comes with a 10k pot with protrud-

*Burstein-Applebee, 3199 Mercier Street, St. Louis, Missouri 64111.

ing shaft for hand adjustment. I coupled this shaft to an E. F. Johnson 140-pF transmitting variable with an insulated flexible coupler, weatherproofed the whole thing in an aluminum box, and mounted it on the boom near the driven element. Since the Johnson capacitor has a double-ended shaft, a control knob can be added for hand adjustment if you insist. You need a small three-wire cable down to the shack for remote operation and Burstein-Applebee includes a schematic for the motor which operates on 115 volts, 60 Hz.

Since it's an instant start and stop device, with a little practice you can catch it at the bottom of the null. The 10k pot can also be used to work up a servo-control to operate a multi-position wafer switch for remote antenna switching. Disable the detent mechanism of the switch, though, as the motor doesn't have enough torque to overcome it.

Forrest Gehrke, K2BT

antenna mast design

Dear HR:

The technique of antenna mast design discussed in my article "Design Data for Pipe Masts," in the September, 1974, issue of *ham radio* is based on approximations accounting for the fact that pipe masts are highly flexible structures.

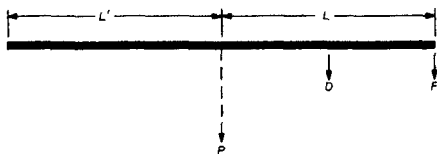

$$L'P = (L' + \frac{L}{2})D + (L' + L)F$$

SOLVE FOR P

WB9DES recommends that such masts be designed by the technique of analysis used for rigid beams. This can be done using the curves of the article as follows:

1. Calculate the length of the top section as in the example.

2. Calculate the second section length in the same way, but treat this as a trial value. For a second trial, refer all upper loads to the top of the second section: From the curves determine the allowable section length, and use this as a second trial value. Repeat until the trial value and graph value agree.

3. Repeat the process of step 2 for each lower section until the desired height is obtained.

Masts designed by this method will deflect less under load, and will have a larger safety factor.

R.P. Haviland, W3MR
Daytona Beach, Florida

speech processing

Dear HR:

My attention has been called to G6XN's article of speech processing in the November and December, 1972, issues of *ham radio* and the subsequent correspondence. I feel that there are still some points to be clarified, particularly in reference to *audio* speech clipping.

It is rightly supposed that *audio* clipping produces harmonic distortion products within the upper registers of the speech spectrum. The superiority of *rf* clipping comes from the fact that such products are largely eliminated. The unwanted distortion products can be regarded as noise and their existence constitutes a decrease in the signal-to-noise ratio, making it more difficult for the listener to perceive the essential speech components. Harmonic products are not, however, the only disturbances produced by *audio* clipping. Largely overlooked is a high-frequency mutilation effect. What happens is that on any extreme swings of the primary low-frequency components, any high-frequency ones get erased by the limiting action of the clipping diodes. This can be seen if one analyzes the result of the clipping of a compound waveform

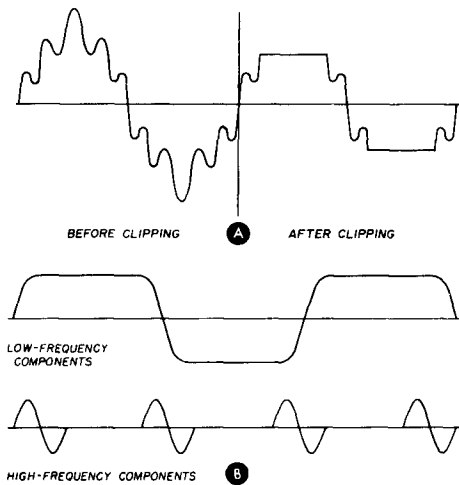

fig. 1. Speech clipping results in mutilation of the higher audio frequencies by the lower ones as shown here. VK4LR suggests a sub-band speech processing system to solve this problem (see text).

consisting of two components of about equal amplitude (see fig. 1A). Separating the two components after clipping (fig. 1B) illustrates that the high-frequency one has been reduced to modulated pulses. In other words, in the presence of a strong low-frequency component and with heavy clipping, any high-frequency component information can only be conveyed during and near the times of zero low-frequency component value. All high-frequency components thus become strongly mutilated. As the human voice relies for the most part on a number of simultaneously occurring frequency components, articulation is destroyed by this high-frequency mutilation as well as from the occurrence of harmonic products caused by wave squaring. While *rf* clipping eliminates the harmonic product problem it does little to cure the mutilation of higher frequency audio components.

One solution I am investigating is that of splitting the speech band into a number of sub-bands and treating these separately by clipping and filtering. The sub-bands are combined after processing

to reconstitute the full speech spectrum. Thus, any harmonic products generated by the lowest sub-band, 350 to 700 Hz, are filtered off by a lowpass filter section set to cut off above 70 Hz. Since the first troublesome harmonic of the lowest possible frequency that can be passed is at 1050 Hz, it is well into the filter rejection region and can cause little offense. Providing several components of the speech waveform do not both fall into the same sub-band, no high-frequency mutilation can occur. Analysis of typical speech pattern shows that the formats generally fall roughly an octave or so apart. Thus simultaneous occurrences of two formats in the same sub-band would be infrequent.

Preliminary test of the multi-sub-band system indicates that very little change in speech quality results when the system is introduced to the circuit. No substantial data has been yet obtained as to the communication gain that might be had, but some reports indicate that the gain is considerable.

L.R. Newsome, VK4LR
Queensland, Australia

reciprocating detector

Dear HR:

I built a reciprocating detector described by W1SNN* and found that the concept of locating the reference filter in the middle of the passband was not acceptable, at least for receivers with high selectivity. To use it, I incorporated another stage of conversion in my Collins 75A3, using the original bfo for beating so that the passband could be shifted in relation to a new reference filter crystal frequency of 80 kHz. With this addition and a circuit modification to make the feedback symmetrical, performance of the circuit has been very worthwhile.

D.H. Gieskieng, W6NLB
Rialto, California

*Stirling Olberg, W1SNN, "Reciprocating Detector," *ham radio*, March, 1972, page 32.

GIANT KILLER



Atlas-210

5 BANDS 200 WATTS
SOLID STATE
SSB TRANSCEIVER

\$599

Don't let the small size fool you. The spectacular Atlas transceiver is truly a Giant Killer. Just 7 pounds of sheer dynamite, it occupies only 0.18 cubic feet. But this is only a small part of the story. There are many other reasons why you will want to own an Atlas Transceiver:

MOST ADVANCED STATE-OF-THE ART CIRCUIT DESIGN, INTRODUCES A NEW ERA IN PERFORMANCE SPECS. We ask you to mark these words. They are not merely an advertising statement.

RELIABILITY. Total value engineering, craftsmanship and quality control give you unsurpassed reliability. With over 1000 Model 180's now on the air, we at Atlas are proud of their most exceptional reputation for performance, reliability, and owner satisfaction. It is safe to say that practically every owner has a love affair going with his Atlas radio. You too can have such an affair.

RECEIVER SENSITIVITY AND RESISTANCE TO OVERLOAD AND CROSSMODULATION, SECOND TO NONE. (Better than anything else we have seen or any other claims.)

SELECTIVITY: A breakthrough in filter design by Network Sciences. Designed specially for Atlas, this filter provides unprecedented selectivity. Only 9200 cycles wide at 120 db down when installed and measured in the Atlas transceiver! Ask any other brand for specs at this level! And to top this off, the front end design of the Atlas makes it possible to utilize this fantastic degree of selectivity!

TRANSMITTER TALK POWER: 200 watts of linear solid state power input, with clear, crisp audio.

NO TRANSMITTER TUNING: Simply connect to a 52 ohm load and you're on the air. Infinite SWR protected.

IDEAL MOBILE SIZE: One-third the size of any other 5 band HF transceiver. Only 3 1/2 in. high, 9 1/2 in. wide, 9 1/2 in. deep.

PLUG-IN DESIGN provides quick removal from mobile mount. Plugs into AC console, as illustrated, giving you a handsome desktop station.

AMERICAN MADE AND GUARANTEED BY:



490 Via Del Norte, Oceanside, California 92054
Phone (714) 433-1983

MODULAR DESIGN with plug-in R.F., I.F., and A.T. circuit boards permits easy servicing.

Model 210 covers 3700-4050; 7000-7350; 14,000-14,350; 21,100-21,450; 28,400-29,100 KHz.

Model 215 covers 1800-2000; 3700-4050; 7000-7350; 14,000-14,350; 21,000-21,450 KHz.

The new 210 and 215 are identical to the former Model 180 except for band coverage.

SPECIAL MARS MODELS, 210M/215M permit out of band operation when used with Model 10X external crystal oscillator accessory.

NOISE BLANKER, optional plug-in. Also VOX, and other accessories.

CUSTOMER SERVICE, second to none. Your satisfaction is guaranteed.

ALL THIS, and priced lower than any other 5 band solid state or hybrid transceiver.



Atlas 210/215	\$599
AR 117 AC Console	\$129
AR 200 Portable AC Supply	\$ 89
Plug-in Mobile Mount	\$ 44

Available NOW at your Atlas dealers. See him for complete details, or drop us a card and we'll mail you a brochure and dealer list.

73 Herb Johnson W6QKI

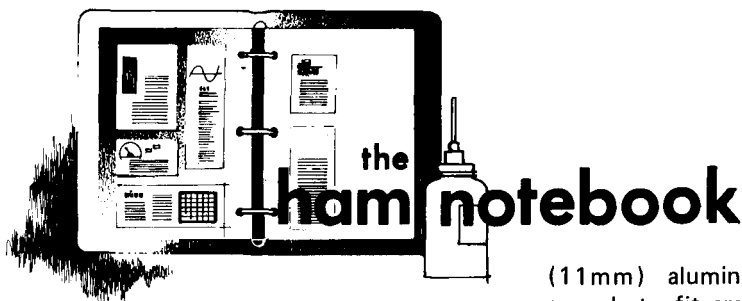

unique method of clamping aluminum tubing

Have you ever tightened the U-bolts around a 1¼-inch (32mm) aluminum tube, only to have it slowly collapse as you torque up the nuts? To add to the frustration, the aluminum tube takes a permanent set which limits the amount of force the clamp can be made to apply.

The use of steel U-bolts to join tubing is common practice with commercial antenna installations. The U-bolts are simple and economical, but their use with aluminum tubing generally leads to the problem mentioned above. An alternative is to fabricate special clamps, such as those illustrated in the *ARRL Handbook*.¹ If minimizing weight on the mast is as important to you as it is to me, then the following description of a relatively simple fix, using commercial U-bolts, should be of interest.

Materials. The parts that are needed are easily made with a bench vise and a hacksaw. If a tube cutter is available, it can also be used to advantage. Parts to be fabricated are a half-section of 1¼-inch (32mm) steel tube about three inches (76mm) long, and two 7/16-inch

(11mm) aluminum tubes just long enough to fit crosswise inside the 1¼-inch (32mm) tubing (about 1-1/8 inch [28.5mm] long). The latter should be a number-16 tube which has an inside diameter of 0.307 inch (8mm).²

Step-by-step procedure. First, using a hacksaw or tubing cutter, cut off a 3-inch (76mm) section of 1¼-inch (32mm) thinwall steel tube and drill a set of holes through it for the U-bolt.

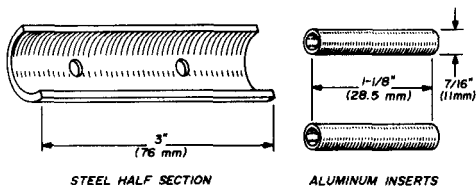

fig. 1. Mechanical parts required for clamping aluminum tubing without deforming it consist of two aluminum inserts and a steel half-section. Assembly of the parts is shown in fig. 2.

(The open end of ¼-inch [6.5mm] steel clamps are generally 1-3/4 inch [44.5 mm] apart.) Second, place the tube crosswise in a vise. Using a hacksaw, cut it in half lengthwise, midway between the two sets of clamp holes. Remove the burrs with a file.

The third step is to cut two lengths of 7/16-inch (11-mm) aluminum tubing

1. *The Radio Amateurs Handbook*, 50th Edition, ARRL, Newington, Connecticut, 1973, figure 22-18, page 634.

2. Lewis McCoy, W1ICP, "Aluminum Tubing—What Sizes Are Available?" *QST*, June, 1969, page 16.

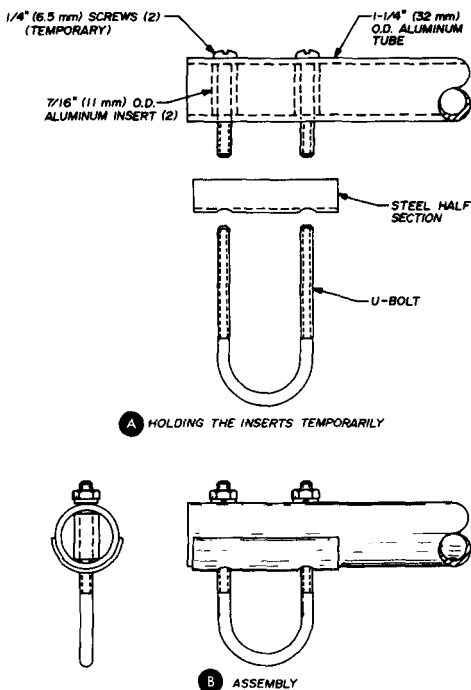

fig. 2. Assembly of the parts for clamping aluminum tubing without deformation. Inserts are held in place temporarily with screws (A) which are pushed out when the U-bolt is inserted (B).

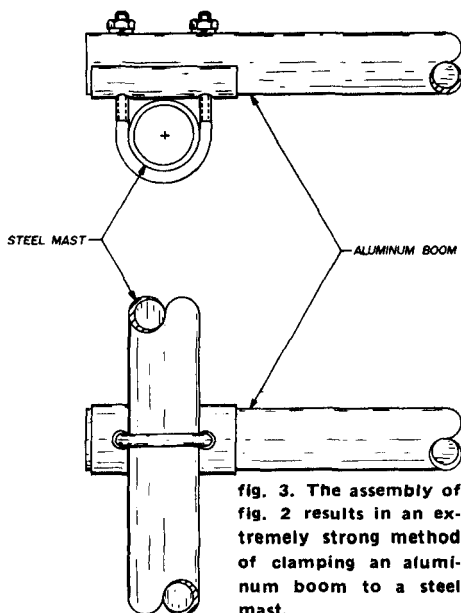

fig. 3. The assembly of fig. 2 results in an extremely strong method of clamping an aluminum boom to a steel mast.

approximately 1-1/8-inch (28.5mm) long, or just long enough to slip cross-wise inside the 1 1/4 inch (32mm) aluminum tube. The finished parts are illustrated in fig. 1.

Assembly. It is necessary to insert the two 7/16-inch (11mm) aluminum tubes inside the 1 1/4-inch (32mm) tubing to mate with the U-bolt holes. The inner tube can be positioned with the aid of long nosed pliers. To hold it in place temporarily, drop a 1/4-inch (6.5mm) screw through the hole; then insert the other 7/16-inch (11mm) tube, holding it in a similar manner. The U-bolt can then be inserted from the bottom, pushing the screws out in the process. Before inserting the U-bolt fit one of the steel half-sections of the clamp as shown in the assembly diagram of fig. 2.

Using the clamp assembly. Fig. 3 shows a typical installation using the modified clamp assembly. Note that the aluminum inserts and the steel half-tube prevent the 1 1/4-inch (32mm) aluminum tubing from collapsing under the force of the U-bolt nuts, either in the vicinity of the clamp or at the junction between the two tubes.

Norman J. Foot, WA9HUV

open-wire feeder feedthrough insulator

Open-wire feeders (ladder line or twinlead) should be kept clear of objects which might unbalance the rf currents on the line. Getting the line from indoors to outdoors can thus be a problem. A feedthrough system can be fashioned from about a foot (30cm) of scrap PVC tubing with end plates cut from a plastic bleach bottle (fig. 4). Run the line through the wall (a screened attic gable vent makes an easily prepared place) and through the tubing. Cut the end plates with tabs to fit the

tubing. Cut a slot in each plate, and enlarge it at the center so as not to severely bind the feeder. Slide the end plates over the feeder, and then into the ends of the tube.

Although the tabs provide enough tension to hold the plates in place, epoxy or PVC glue will insure they stay put. When the glue is set, slide the tube

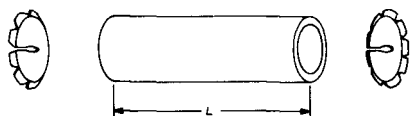

fig. 4. PVC feedthrough for open-wire feeders. Diameter D should be two to three times the line width W , especially if the tube is to pass through metal, solid or screening (the latter being typical of attic vents). The tube should be long enough to allow the feeder line to clear eaves and other objects, both in and out of doors.

into the wall hole. You may want to paint the tube to match the house exterior. Adjust the feeder so that it runs through the center of the tube. A drop or two of epoxy will hold it in place.

Seal the point where the pipe passes through the wall. If the tube passes through screening, hangers can be fashioned from the same bleach bottle used for the end plates. The end plates do double duty by also keeping bugs and squirrels from getting indoors.

L.B. Cebik, W4RNL

dielectric antenna for 10 GHz

Above 1296 MHz it is impractical to use conventional antennas such as simple dipole arrays, Yagis and collinears. Instead, a different class of antennas is found: reflectors (both cylinders and parabolas) and horns. One antenna type

which has seen relatively little amateur application is the dielectric rod antenna, probably because few military and commercial stations use them, and secondly, because their design is largely empirical. Finally, the construction of required tapered dielectric sections is beyond most amateur workshop capabilities.

The antenna described in this article, however, can be easily built by the amateur, and consists of a tapered dielectric slab inserted directly into the waveguide. Amateurs using coaxial systems can merely use a coax-to-waveguide adapter. As can be seen in fig. 5, the taper is not smooth, but varies in abrupt jumps every 5cm (2 inches) along the antenna, which is easier to construct. Inside the waveguide, the jumps are every 2cm (3/4 inch). These dimensions are not critical ($\pm 0.5\text{cm}$ or $\pm 3/16$ inch) but the increments should be uniform. The taper inside the guide matches the impedance of the antenna to the impedance of the waveguide.

The antenna is constructed by laminating strips of 1/10-inch (2.5mm) thick plexiglass window glazing with a solvent

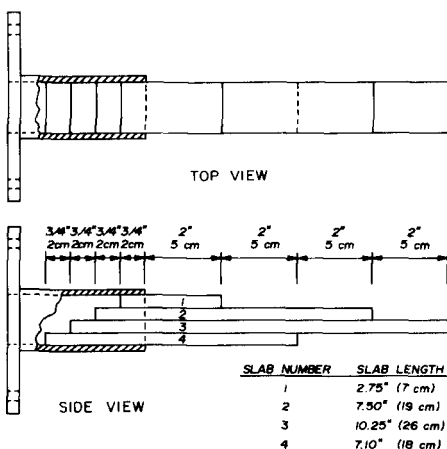

fig. 5. Dimensions of dielectric antenna suitable for use on the amateur 10 GHz band. Vertical and horizontal pattern is shown in fig. 6.

KLM ANTENNAS . . .

They're heard when others aren't

Some well known band openers are:

- KLM's 20 METER 5 ELEMENT "BIG STICK"
- KLM's 6 METER 8 & 11 ELEMENT
- KLM's 2 METER 12, 14 & 16 ELEMENT
- KLM's 220 MHz 14 ELEMENT

AND NOW

KLM'S NEW 432 - 16 Element Long Boom (12')

Specifically Optimized for 432 MHz (430-440)

(8 will give you Eme capability)

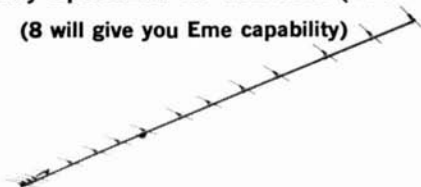

Also . . . Brand New for the 420-450 MHz Band

4 NEW AMPLIFIERS

- PA 10-35C 10 WATTS INPUT 35 WATTS OUT
- PA 2-40C 2 WATTS INPUT 35 WATTS OUT
- PA 10-70C 10 WATTS INPUT 70 WATTS OUT
- PA 2-70C 2 WATTS INPUT 70 WATTS OUT

And . . . Don't forget our NEW ECHO II

2 METER SSB/CW TRANSCEIVER & LINEAR AMPS.



See Your Local KLM Dealer
For The New Spring '75 Catalog
Or Write

KLM ELECTRONICS

1600 DECKER AVE.
SAN MARTIN, CA. 95046
408-683-4240

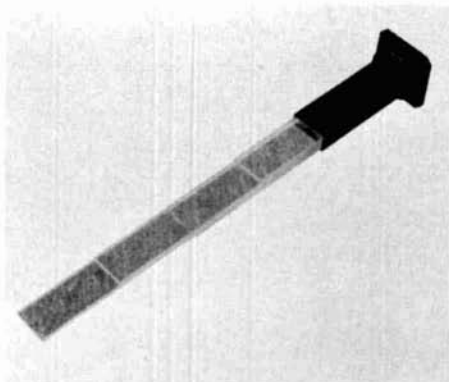

Dielectric antenna for 10 GHz uses laminated strips of 0.1" (2.5mm) plexiglass window glazing. Gain is about 14.5 dB above an isotropic radiator and is flat across the 3cm amateur band.

such as ethylene dichloride. This thickness is chosen because four layers closely match the inside height of the commonly used WR-90 waveguide. All of the strips are 0.9 inch (23mm) wide. The result is a tapered dielectric plug which slides easily into the waveguide. The plug can be secured in the guide with either non-conducting epoxy cement or nylon screws.

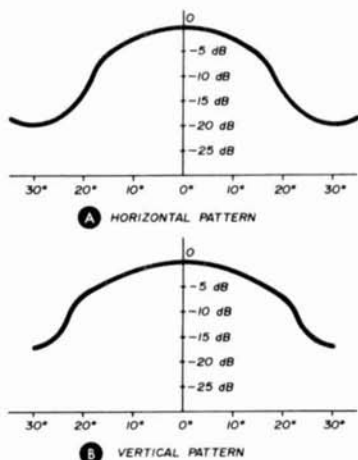

fig. 6. Vertical (A) and horizontal (B) radiation patterns of the dielectric rod antenna at 10 GHz.

A word of caution if you use screws. First, they must not be conductive and second, they should be mounted along the centerline of the wide dimension of the waveguide; otherwise the resultant holes will couple power out of the guide, resulting in lower gain and higher side lobes.

The completed dielectric antenna exhibits a gain of 10 dB above an open-ended section of waveguide or about 14.5 dB above an isotropic radiator, and gain is flat across the 3cm band. The horizontal and vertical radiation patterns are plotted in fig. 6. The vertical beamwidth is 25° whereas the horizontal beamwidth is about 20°.

John M. Franke, WA4WDL

cornell-dubilier ham rotators

Cornell-Dubilier Electronics* has confirmed that the Ham-M and the Ham-II rotators, and also the control units, are interchangeable. Therefore, stand-by spare rotators of either kind can be used with either control unit. Furthermore, all rotator parts have the same stock numbers and internal photographs, so spare parts can be kept on hand and used in either rotator.

In addition to the convenient calibration switch, the addition of a 180-ohm resistor and a 13-volt zener regulator to the Ham-II is a welcome change as it holds the calibration constant under conditions of varying line voltage.

The possibility of burning out the direction indicator potentiometer can be eliminated by placing fuses between the potentiometer and terminal screws 3 and 7, inside the rotator.

Bill Conklin, K6KA

*Cornell Dubilier Electronics, Department C, 118 East Jones Street, Fuquay-Varina, North Carolina 27526.

High-Q Beam Antennas

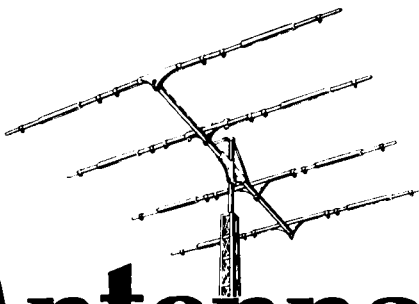

Heavy duty 4-element Tribander

Four working elements on each band in 10, 15 and 20 meters. 24 foot boom permits optimum spacing for maximum forward gain and front-to-back ratio. All traps are precision tuned and weather-proofed. Rugged reliability assures ability to withstand winds up to 100 mph. TB-4HA.

\$249.95

Heavy duty 3-element Tribander

Three working elements on each band in 10, 15 and 20 meters. 16 foot boom requires a lighter duty rotor and tower than the TB-4HA but still provides excellent performance characteristics. Precision tuned and weather-proofed traps are combined with rugged construction. TB-3HA.

\$189.95

Economical 2-element Tribander

Two working elements on each band in 10, 15 and 20 meters. 6.5 foot aluminum boom can easily be raised on an inexpensive mast and operated with a standard TV rotator. Withstands winds up to 80 mph. TB-2A. **\$129.95**

Heavy duty 2-element 40-meter Beam

Two working elements on 15.75 foot steel boom. Maximum forward gain and front-to-back ratio in the CW or phone portion of the 40-meter band is easily achieved for optimum performance. Large high-Q loading coils are weather-proofed. Rugged design easily takes 100 mph winds. MB-40H.

\$199.95

All Swan Beam Antennas are Rated for 2000 Watts and designed to use 52 Ohm coaxial feedlines.

SWAN BEAM ANTENNA SPECIFICATIONS

Antenna Model Number	Average Forward Gain	Front to Back Ratio	Boom Length & Diameter	Longest Element	Turning Radius	Maximum Wind Survival	Wind Load @ 80 mph	Wind Surface Area	Net Weight
TB-4HA	9 dB	24-26 dB	24' x 1.5"	28'-10"	18'-6"	100 mph	148 lbs.	6 sq. ft.	54 lbs.
TB-3HA	8 dB	20-22 dB	16' x 1.5"	28'-2"	16'	100 mph	110 lbs.	4 sq. ft.	44 lbs.
TB-2A	5 dB	16-18 dB	6.5' x 1.5"	27'-8"	14'-3"	80 mph	60 lbs.	1.8 sq. ft.	18 lbs.
MB-40H	4 dB	16-18 dB	15.75' x 1.5"	30'-4"	17'-6"	100 mph	80 lbs.	2.5 sq. ft.	40 lbs.



A subsidiary of Cubic Corporation
305 Airport Road, Oceanside, Calif. 92054

new products

antenna circuit indicator



A new automatic indicating device designed to warn vhf communications equipment operators of antenna problems has been announced by Ascom Electronic Products, a division of The Antenna Specialists Company. Recognizing the fact that mobile communications antennas are often subjected to some degree of damage, and that the problem is usually not immediately detected by the operator, the antenna circuit indicator immediately alerts the operator to a problem. It also helps prevent damage to equipment by eliminating long periods of transmission into extremely high vswr. The indicator, model ASM-104, is an especially valuable device where maintenance of communications is critical.

The new Ascom antenna circuit indicator is designed for easy mounting under the vehicle dash. Two lights are

used to give the operator instant indication of the system's operation. When transmitting, one light indicates the normal condition of rf power being transmitted. Should the second indicator light, showing reflected rf power, it alerts the operator to antenna problems that could affect communications capability. For reliability, LEDs are used for indicators, eliminating bulb burn-out problems. The unit uses no batteries or connection to other power sources, requires only 10 watts or more of rf energy, and operates over a frequency range of 144 to 174 MHz. Complete details on the new ASM-104 indicator are available from Ascom Electronic Products, 12435 Euclid Avenue, Cleveland, Ohio 44106, or by using *check-off* on page 126.

aluminum towers

A new line of fully-assembled, crank-up aluminum communications masts in 40 to 60 foot heights, and prefabricated towers up to 100 feet, has been announced by Fred Franke, Inc. The maintenance-free Aluma Towers are available in a variety of heights and designs for ham radio and commercial and industrial communications systems. The 40-foot tower weighs 56 pounds and the 60-foot model weighs only 95 pounds. Both include the crank-up feature.

The corporation will also manufacture a fixed-guy tower using 10- or 20-foot sections up to a total of 100 feet. The first 50 feet can be assembled on the ground with the remaining units added with special pre-drilled sleeves. The weight of a 10-foot add-on section is only 15 pounds. A special non-guyed tower for mobile homes will also be available. This unit will include a 20-foot high triangular base with a 10-foot extension for a total of 30 feet. The crank-up models, all heliarc welded, are

delivered fully assembled and can be raised on a concrete or driven stake base in less than an hour with no special equipment.

Dealerships for the distribution of the Aluma Towers through retail outlets are being established throughout the country. Inquiries may be directed to Fred Franke, Inc., 1639 Old Dixie Highway, Vero Beach, Florida 32960, or use *check-off* on page 126.

antenna magnetic mount

Using a new type of permanent magnet in a configuration that achieves maximum magnetic pull, Larsen Antennas has just introduced a mobile antenna that has an amazing ability to "stay put." In fact, the hold is so strong that caution must be exercised when placing the mount to be sure you get it where you really want it.

The Larsen Magnetic Mount is available in five different models which accommodate all popular types of mobile antennas including Motorola, GE, DB Products, Antenna Specialists and, of course, all Larsen Models. The unit comes complete with 12 feet (3.7m) of RG-58A/U coax and plug all attached. All that is needed to become operational is to screw the antenna into the base, place the magnetic base on the vehicle roof, fender, trunk or any other convenient spot and run the attached coax to the equipment.

The magnet used on the Larsen mount is guaranteed to be permanent and to stay in place on the vehicle (a flat surface is required) at any highway speed. Design of the mount is such that full capacitance coupling assures adequate ground plane for full antenna efficiency. For more details, write to Larsen Antennas, Post Office Box 1686, Vancouver, Washington 98663, or use *check-off* on page 126.

- REDUCE YOUR PROJECT COSTS
- MONEY-BACK GUARANTEE
- 24-HOUR SHIPMENT
- ALL TESTED AND GUARANTEED

- TRANSISTORS (NPN):
 - 2N3563 TYPE RF Amp & Osc to 1 GHz (pl. 2N918) 6/\$1.00
 - 2N3565 TYPE Gen. Purpose High Gain (TO-92/106) 6/\$1.00
 - 2N3567 TYPE High-Current Amplifier/Sw 500 mA 4/\$1.00
 - 2N3866 TYPE RF Pwr Amp 1-2 W @ 100-600 MHz 1/\$5.00
 - 2N3903 TYPE GP Amp & Sw to 100 mA and 30 MHz 6/\$1.00
 - 2N5108 RF POWER AMP 2 W @ 450 MHz, 1 W @ 1 GHz \$2.50
 - 2N3919 TYPE RF Pwr Amp 3-5 W @ 3-30 MHz \$3.00
 - 2N4274 TYPE Ultra-High Speed Switch 12 ns 4/\$1.00
 - MPS6515 TYPE High-Gain Amplifier hFE 250 3/\$1.00
 - Assort. NPN GP TYPES, 2N3565, 2N3641, etc. (15) \$2.00
 - 2N3638 TYPE (PNP) GP Amp & Sw to 300 mA 4/\$1.00
 - 2N4249 TYPE (PNP) Low-Noise Amp 1 μ A to 50 mA 4/\$1.00
- FET's:
 - N-CHANNEL (LOW-NOISE):
 - 2N4091 TYPE RF Amp & Switch (TO-18/106) 3/\$1.00
 - 2N4416 TYPE RF Amplifier to 450 MHz (TO-72) 2/\$1.00
 - 2N5163 TYPE Gen. Purpose Amp & Sw (TO-106) 3/\$1.00
 - 2N5486 TYPE RF Amp to 450 MHz (plastic 2N4416) 3/\$1.00
 - E100 TYPE Low-Cost Audio Amplifier 4/\$1.00
 - ITE4858 TYPE Ultra-Low Noise Audio Amp. 2/\$1.00
 - TI574 TYPE High-Speed Switch 40 Ω 3/\$1.00
 - Assort. RF & GP FET's, 2N5163, 2N5486, etc. (8) \$2.00
 - P-CHANNEL:
 - 2N4360 TYPE Gen. Purpose Amp & Sw (TO-106) 3/\$1.00
 - E175 TYPE High-speed Switch 125 Ω (TO-106) 3/\$1.00

MAY SPECIALS :		
1N4154 DIODE 30 V/10mA-1N914 exc. 30 V		20/\$1.00
2N3904 NPN TRANSISTOR GP Amp & Switch		5/\$1.00
2556 DUAL 555 TIMER 1 μ sec to 1 hour (DIP)		\$1.00
340T 1A VOLT. REG. - Specify 6, 12 or 15 V		\$1.75
MM5316 Digital Alarm Clock-Snooze/Alarm/Timer		
Hrs, Mins, Secs, 4 or 6 Digit - With Specs/Schematics		\$6.95
MM5736 6-Digit 4-Function Calculator 18 PIN DIP		\$3.95

- LINEAR IC's:
 - 308 Micro-Power Op Amp (TO-5/MINI-DIP) \$1.00
 - 309K Voltage Regulator 5 V @ 1 A (TO-3) \$1.50
 - 324 Quad 741 Op Amp, Compensated (DIP) \$1.90
 - 380 2.5 Watt Audio Amplifier 34 dB (DIP) \$1.29
 - 555X Timer 1 μ s-1 hr, Dif. pinout from 555 (DIP) \$.85
 - 709 Popular Op Amp (DIP/TO-5) \$.29
 - 723 Voltage Regulator 3-30 V @ 1-250mA (DIP/TO-5) \$.58
 - 739 Dual Low-Noise Audio Preamp/Op Amp (DIP) \$1.00
 - 1458 Dual 741 Op Amp (MINI-DIP) \$.65
 - 741 Freq. Comp. OP AMP (DIP/TO-5/MINI-DIP) 3/\$1.00
- DIODES:
 - 1N3600 TYPE Hi-Speed Sw 75 V/200 mA 6/\$1.00
 - 1N3893 TYPE RECTIFIER Stud Mount 400 V/1/2 A 2/\$1.00
 - 1N914 or 1N4148 TYPE Gen. Purp. 100V/10mA 10/\$1.00
 - 1N749 ZENER 4.3 Volt (\pm 10%) 400 mW 4/\$1.00
 - 1N753 ZENER 6.2 Volt (\pm 10%) 400 mW 4/\$1.00
 - 1N755 ZENER 7.5 Volt (\pm 10%) 400 mW 4/\$1.00
 - 1N757 ZENER 9.1 Volt (\pm 10%) 400 mW 4/\$1.00
 - 1N758 ZENER 10 Volt (\pm 10%) 400 mW 4/\$1.00
 - 1N965 ZENER 15 Volt (\pm 10%) 400 mW 4/\$1.00
 - 1N968 ZENER 20 Volt (\pm 10%) 400 mW 4/\$1.00
 - O5 VARACTOR 5-50 W Output @ 30-250 MHz, 7-70 pF \$5.00
 - F7 VARACTOR 1-3 W Output @ 100-500 MHz, 5-30 pF \$1.00

*MAIL NOW! FREE DATA SHEETS supplied with every item from this ad. FREE 739 or 749 Low-Noise Dual Op Amp included (\$1.00 value) with every order of \$10 or more, postmarked prior to 6/30/75.

ORDER TODAY—All items subject to prior sale and prices subject to change without notice. All items are new surplus parts - 100% functionally tested.

WRITE FOR FREE CATALOG offering hundreds of semiconductors not listed here. Send 10¢ stamp.

TERMS: All orders must be prepaid. We pay postage. \$1.00 handling charge on orders under \$10. Calif. residents add 6% sales tax. Foreign orders - add postage. COD orders - add \$1.00 service charge.

ADVA

ELECTRONICS
BOX 4181 AE, WOODSIDE, CA 94062
Tel. (415) 851-0455

**Regency HR-2B gives
a lot to talk over**



American Made Quality at Import Price

**Full 12 Channel, 15 Watts
with HI/LO power switch**

Here is everything you need, at a price you like, for excellent 2 meter FM performance. The 12 transmit channels have individual trimmer capacitors

for optimum workability in point-to-point repeater applications.

Operate on 15 watts (minimum) or switch to 1 watt. 0.35 uv sensitivity and 3 watts of audio output make for pleasant, reliable listening.

And the compact package is matched by its price. **\$229⁰⁰**

Amateur Net

Regency ELECTRONICS, INC.
7707 Records Street
Indianapolis, Indiana 46226

*An FM Model For Every Purpose . . .
Every Purse*



HR-6
12 Channel-25 Watt
6 Meter FM Transceiver



HR-220
12 Channels-10 Watts
220 MHz FM Transceiver

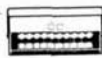

ACT 10-H/L/U
3 Band-10 Channel FM
Scanner Receiver

**programmable
calculator**



A new programmable scientific pocket calculator with significantly more keyboard functions and addressable memories than any previous pocket model was recently introduced by Hewlett-Packard. The new HP-55 is also the first pocket calculator with a built-in digital timer, valuable for short, timed experiments.

The nine-ounce HP-55 features simplified, keystroke programming, with 49 steps of program memory plus branching, testing and editing capability; twenty addressable memories, twice as many as any other pocket model; a total of 86 keyboard functions, operations and conversions; plus a digital timer with 100-hour capacity and the ability to store and recall as many as 10 splits (elapsed time readings within an event). Price of the HP-55 is \$395.00 (domestic USA).

Like other HP pocket calculators, the HP-55 features the RPN (Reverse Polish Notation) logic system with a four-memory stack that holds intermediate answers and automatically brings them back when needed in a calculation. Beyond the standard arithmetic, trigonometric and logarithmic functions (including antilog), the HP-55 will work in any of the three trigonometric modes —

NEW! HR-440

12 Channel 440 MHz FM Transceiver



Delivers 10 Watts of Power and 12 Channel Capability

You'll like the crystal clear transmit and receive performance of this compact 440 MHz unit . . . and so will those listening.

Solid state design brings you the best in American Made circuitry. Features include Automatic Frequency Control and UHF power module. Frequency range is 420-450 MHz, with 0.5 μ v tune-up sensitivity and 3 watts audio output. No need to worry about current drain, either. And all of this for the low, low price of only

\$349⁰⁰

Amateur Net
Regency ELECTRONICS, INC.

7707 RECORDS STREET
INDIANAPOLIS, INDIANA 46226

An FM Model For Every Purpose . . . Every Purse



HR-6
12 Channel-25 Watts
6 Meter FM Transceiver



HRT-2
5 Channel Hand-Held
2 Meter FM Transceiver

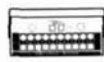

ACT 10H/L/U
3 Band-10 Channel
FM Scanner Receiver

degrees, radians and grads — and allows the user to convert among any of them. The direct polar/rectangular conversion also enables the user to perform vector arithmetic.

The 20 addressable memory registers in the new calculator permit register arithmetic (with 10 memories) and simultaneous two-dimensional vector accumulation. The statistical functions of the HP-55, coupled with the 20 addressable memories, give the user the ability to do two-variable mean and standard deviation, linear regression and linear estimate, curve plotting and four simultaneous linear equations with four unknowns.

The direct conversions on the HP-55, which work both ways, include inches/millimeters, feet/meters, US gallons/liters, pounds mass/kilograms, pounds force/Newtons, degrees fahrenheit/degrees centigrade, and BTU/Joules. Additional capabilities include percentage, root extraction, n factorial (for permutations and combinations), squaring numbers, raising numbers to powers and calculating reciprocals. The constant pi also is included.

HP has added a quartz crystal to the HP-55 circuit to provide a 100-hour timer accurate to ± 0.1 percent. In the timer mode, the calculator display shows hours, minutes, seconds, tenths and hundredths. While the timer is running, the user can take and store up to 10 splits simply by pushing the digit keys. After the timer is stopped the splits may be recalled by pressing the appropriate digit key.

The HP-55 can display up to ten significant digits with a two-digit exponent and appropriate signs, and comes with an owner's handbook, quick reference guide, program notation pad and an ac adapter/recharger that allows the calculator to be operated on ac while its batteries are recharging. The HP-55, like other HP pocket calculators, will be sold through HP's calculator sales force, by direct mail and through leading college



Glade Valley School Radio Session

16th Year — July 26 thru August 8, 1975

Restructuring is coming! Get that license now!

Let the experienced staff from the Glade Valley School Radio Session help you solve that license problem. Whether you are looking for your General, Advanced or Amateur Extra ticket they will help you in every way with their carefully prepared program to get the license you are looking for.

Have a "Vacation with a Purpose" at this beautiful location in the Blue Ridge Mountains. A highly qualified staff and excellent facilities combine to make license study a pleasant memorable experience.

C. L. PETERS, K4DNJ, Director
P. O. Box 458, Glade Valley, N. C. 28627

Please send me the Booklet and Application
Blank for the 1975 Glade Valley School
Radio Session

Name _____ Call _____

Address _____

City/State/Zip _____

ELECTRONIC ENGINEERS

RF COMMUNICATIONS
has immediate openings for
Electronic Project Engineers
and Design Engineers experi-
enced in HF, SSB, VHF/
UHF — FM communica-
tions equipment, or both.

Call or write Ken Cooper, W2FLZ
(716) 244-5830

RF Communications Division



HARRIS
COMMUNICATIONS AND
INFORMATION HANDLING

1680 University Avenue
Rochester, New York 14610 U.S.A.
An Equal Opportunity Employer M.F.

bookstores and department stores.

Two handbooks containing programs for the HP-55 programmable scientific pocket calculator are also available. The \$10.00 books, "HP-55 Mathematics Programs" and "HP-55 Statistics Programs," contain general descriptions of the programs, formulas used in each program solution, numerical examples, user instructions, program listings and register allocations.

For more information, use *check-off* on page 126, or write to Inquiries Manager, Hewlett-Packard Company, 1501 Page Mill Road, Palo Alto, California 94304.

precision balanced mixer

Lithic Systems has announced a precision balanced mixer IC, types LS1596A and LS1596B, which are plug-in replacements for the popular 1596 balanced mixer. The frequency range of the new LS1596A/B has been increased to 250 MHz, and its guaranteed matching characteristics permit untrimmed operation with precision loads and sources. Applications include balanced modulation and demodulation, frequency heterodyning and multiplication, multiplexing and demultiplexing, and phase detection in ssb, dsb, a-m, fm and audio communications systems.

The LS1596A and LS1596B are available in 10-pin TO-100 packages. The LS1596B guarantees 1% internal matching while the LS1596A is specified at 2%. For more information, write to Robert A. Hirschfeld, Lithic Systems, Inc., Post Office Box 478, Saratoga, California 95070, or use *check-off* on page 126.

volt-ohmmeter

A skillful blending of features, quality parts and performance at an attractive low price may make the new RCA WV-547A volt-ohm-milliammeter the best selling general-purpose test instrument

in the electronic servicing field, according to RCA Electronic Instrument officials. Features that are not normally found in any vom test instrument selling under \$50 are included in the new RCA Tech Vom which is priced at only \$19.95. These features include a no-stick taut-band diode-protected meter, dual detent function switch for long life, a rugged high-impact plastic case, accuracies of ± 3 percent dc, ± 4 percent ac with 20,000 ohms-per-volt dc sensitivity, and five functions with one percent precision resistors on all 19 ranges.

Designed for general purpose testing and servicing applications, the new RCA Tech Vom comes complete with test leads. An optional carrying case (WG-447A) is available for \$5.75. Additional information on the RCA WV-547A is available from RCA Electronic Instrument Distributors, from RCA Electronic Instruments, 415 South Fifth Street, Harrison, New Jersey 07029, or by using *check-off* on page 126.

visual display unit



HAL Communications Corporation has announced their new RVD-1005 visual display unit, the second generation version of the HAL RVD-1002, the first visual display unit offered to the teletype operator. The features that have made the RVD-1002 so popular are retained in the RVD-1005, and some new features have been added. For example, the RVD-1005 offers operation at 60, 66, 75 and 100 wpm, manual line feed and letters shift controls, se-

GEM-QUAD FIBRE-GLASS ANTENNA FOR 10, 15, and 20 METERS

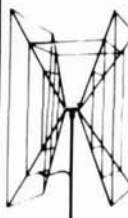

Two Elements \$129.00
Extra Elements \$90.00

Price is F.O.B. Transcona
INCLUDES U.S. Customs Duty
KIT COMPLETE WITH
*SPIDER
*ARMS
*WIRE
*BALUN KIT
*BOOM WHERE NEEDED

WINNER OF MANITOBA DESIGN
INSTITUTE AWARD OF EXCELLENCE

*Buy two elements now — a third and fourth
may be added later with little effort.*

*Enjoy up to 8 db forward gain on DX, with a
25 db back to front ratio and excellent side
discrimination.*

*Get a maximum structural strength with low
weight, using our "Tridetic" arms.*

GEM QUAD PRODUCTS

Box 53

Transcona, Manitoba, Canada R2C 2Z5

DUPLEXER KITS

PROVEN DE-
SIGN OVER 150
SOLD IN U.S.
CANADA, EU-
ROPE. CON-
STRUCTION
WELDED
ALUMINUM IRI-
DITE & SILVER
PLATED

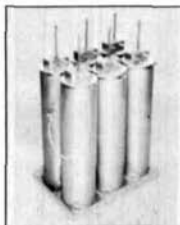

SEE JAN. 74
QST RECENT
EQUIPMENT
ALL PARTS
PROFESSIONAL
QUALITY
EVERYTHING
SUPPLIED

CAN BE ASSEMBLED & TUNED IN ONE EVENING. NO SPECIAL TOOLS. RECEIVER & TRANSMITTER CAN BE USED FOR TUNE UP.

MOD. 62-1 6 CAVITY 135-165 MHz POWER 250W ISOLATION GREATER THAN 100dB 600 kHz. INSERTION LOSS .9 dB MIN. TEMP STABLE OVER WIDE RANGE
PRICE \$349.00

MOD. 42-1 4 CAVITY SAME AS 6 CAVITY EXCEPT ISOLATION GREATER THAN 80 dB 600 kHz INSERTION LOSS .6 dB MAX
PRICE \$249.00

OTHER KITS SOON TO BE AVAILABLE

146 to 148 MHz band pass filter, 1296 & 2304 Interdigital Mixers
144 to 450 MHz 250w tube amp, 130 to 170 MHz notch filter kit

NORTH SHORE RF TECHNOLOGY
9 SOUTH ST SALEM MASS 01970
TEL. (617) 745-4177

WE'RE FIGHTING INFLATION NO PRICE RISE IN '75



FOR FREQUENCY STABILITY

Depend on JAN Crystals. Our large stock of quartz crystal materials and components assures Fast Delivery from us!

CRYSTAL SPECIALS

Frequency Standards	
1000 KHz (HC 13/U)	\$4.50
1000 KHz (HC 6/U)	4.50
Almost all CB sets, TR or Rec	\$2.50
(CB Synthesizer Crystal on request)	
Amateur Band in FT-243	ea. \$1.50
.....	4/\$5.00
80-Meter	\$3.00 (160-meter not avail.)

Crystals for 2-Meter, Marine, Scanners, etc. Send for Catalog.

For 1st class mail, add 20¢ per crystal. For Airmail, add 25¢. Send check or money order. No dealers, please.



Div. of Bob Whan & Son Electronics, Inc.
2400 Crystal Dr., Ft. Myers, Fla. 33901
All Phones: (813) 936-2397

Send 10¢ for new catalog with 12 oscillator circuits and lists of frequencies in stock.



Radio Amateurs Reference Library of Maps and Atlas

WORLD PREFIX MAP — Full color, 40" x 28", shows prefixes on each country . . . DX zones, time zones, cities, cross referenced tables **\$1.25**

RADIO AMATEURS GREAT CIRCLE CHART OF THE WORLD — from the center of the United States! Full color, 30" x 25", listing Great Circle bearings in degrees for six major U.S. cities: Boston, Washington, D. C., Miami, Seattle, San Francisco & Los Angeles. **\$1.25**

RADIO AMATEURS MAP OF NORTH AMERICA! Full color, 30" x 25" — includes Central America and the Caribbean to the equator, showing call areas, zone boundaries, prefixes and time zones, FCC frequency chart, plus useful information on each of the 50 United States and other Countries **\$1.25**

WORLD ATLAS — Only atlas compiled for radio amateurs. Packed with world-wide information — includes 11 maps, in 4 colors with zone boundaries and country prefixes on each map. Also includes a polar projection map of the world plus a map of the Antarctica — a complete set of maps of the world. 20 pages, size 8 3/4" x 12" **\$2.50**

Complete reference library of maps — set of 4 as listed above **\$3.75**

See your favorite dealer or order direct.

Mail orders please include 50¢ per order for postage and handling.

WRITE FOR FREE BROCHURE!

RADIO AMATEUR



callbook INC.

Dept. E 925 Sherwood Drive
Lake Bluff, Ill. 60044

lectable letters-shift-on-space control and automatic carriage return — line feed on line feed (non over-print).

New features include display format of 25 lines, 40 characters per line; automatic carriage return; and speed indicator. The automatic carriage return will line feed on space when space is received after the 34th character. Prevents splitting of short words (will not split words of six characters or less). The speed indicator times the incoming signal and causes an LED to light, showing the operator which speed switch to select. This is especially helpful when tuning unknown commercial stations.

Operation of RVD-1005 is similar to that of the RVD-1002. The incoming signal from the terminal unit, or keyboard, is decoded, stored, and a video signal is generated which is fed to a video monitor or modified TV set. The TV set modification consists only of coupling the video through a capacitor to the first video stage of the set. The TV set should have a power transformer so the chassis is isolated from the power line.

The price of the RVD-1005 is being held at \$575, postpaid in the continental USA (except California, Oregon and Washington, add \$5). For more information, write to HAL Communications Corporation, Box 365, Urbana, Illinois 61801, or use *check-off* on page 126.

wireless telegraphy

For many years, beginning around 1800, the Royal Institution in London sponsored a series of lectures on subjects related to the physical sciences, astronomy and geology. In 1851, when the regular publication of abstracts began, the Institution had already been a major research center for fifty years. Halstead Press, in their *Royal Institution Library of Science*, is reproducing many of the more important lectures. One of the volumes in the series, *Wire-*

less Telegraphy, Edited by Sir Eric Eastwood, traces the development of telecommunications from the 1850s, when the submarine telegraph and Atlantic cable were first discussed. Attention turned to telephony in the 1870s, and then to "Signalling through Space Without Wires," a famous lecture by William Henry Preece in 1897. From 1900 on the lectures were devoted to the development of wireless telegraphy, radio telephony and microwaves.

Marconi was a member of the Royal Institution and a frequent contributor to its famous series of Friday night discourses. Many of his lectures are contained in this book including "Wireless Telegraphy" (1900), "Transatlantic Wireless Telegraphy" (1908), and "Radio Communications by Means of Very Short Waves" (1932). John Ambrose Fleming, most famous for his invention of the diode detector, lectured on developments in radio communications and thermionic vacuum tubes.

Amateurs who are interested in the history of telecommunications will find this series of twenty-two lectures, given over a period of seventy-five years, to be both entertaining and educational. 391 pages, hardbound, \$32.50 from Halstead Press, 605 Third Avenue, New York, New York 10016.

programmable operational amplifier

A new programmable operational amplifier which permits tailoring the electrical parameters to the user's needs has been introduced by Motorola Semiconductor. Programming is achieved by a choice of an external resistor value of a current source applied to the I_{set} input. This allows optimization of dc characteristics such as input current, power consumption and bias current, and ac characteristics such as open-loop voltage gain, slew rate and gain-

UNIVERSAL TOWERS

FREE STANDING ALUMINUM TOWER

10' to 100'
Prices from \$110.00 (30')

**MOST
POPULAR
HAM TOWER
EVER MADE!**

REQUEST
**NEW CATALOG
OF
TOWERS &
ANTENNAS**

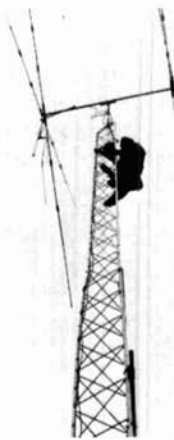

Midwest Ham Headquarters

For Over 36 Years

HAMS! Write For Free Catalog and Wholesale Prices!

ELECTRONIC DISTRIBUTORS, INC.

1960 Peck Muskegon, MI 49441

Tel: 616-726-3196 TELEX: 22-8411

R-X NOISE BRIDGE



- Learn the truth about your antenna.
- Find its resonant frequency.
- Find R and X off-resonance.
- Independent R & X dials greatly simplify tuning beams, arrays.
- Compact, lightweight, battery operated.
- Simple to use. Self contained.
- Broadband 1-100 MHz.
- Free brochure on request.
- Order direct. \$39.95 PPD U.S. & Canada (add sales tax in Calif.)

**PALOMAR
ENGINEERS**

BOX 455, ESCONDIDO, CA 92025



BREAK THROUGH THE PILE-UPS!

WITH THIS ONE...



IT'S THE SPEECH PROCESSOR

- Average to Peak Audio Ratio **MODEL 60** Increased up to 8db.
- Battery Power Internal—1.5MA Drain.
- Frequency $\pm 1-1/2$ db—300-3000 Hz.
- Process Gain Control with In-Out Switch.

MODEL 60W—ASSEMBLED.....\$29.95
 MODEL 60K—KIT.....\$23.95
 200-15K PC BOARD KIT.....\$14.95

ORDER DIRECT OR WRITE FOR BROCHURE
 AND NAME OF NEAREST DEALER.

MATRIC

PHONE: (814) 432-3647
 BOX 185-A • FRANKLIN, PA. 16323

POLICE CALL

FREQUENCIES/CALL LETTERS/
 AREAS OF OPERATION

- Police
- Ambulance
- Rescue Squad
- Fire
- Paramedic
- Government

1975 EDITION

- 9 Volumes now available
- Price...\$4.95 per volume, plus postage and handling.
 .80 per volume for first class or
 .30 per volume for fourth class.
 New Jersey residents add 25¢ per volume for sales tax.
- VOLUME 1 ... Connecticut, Maine, Massachusetts, New Hampshire, New York, Rhode Island, Vermont
- VOLUME 2 ... Delaware, Maryland, New Jersey, Pennsylvania
- VOLUME 3 ... Ohio, Michigan
- VOLUME 4 ... Illinois, Indiana, Kentucky, Wisconsin
- VOLUME 5 ... Iowa, Kansas, Minnesota, Missouri, Nebraska, North Dakota, South Dakota
- VOLUME 6 ... District of Columbia, Florida, Georgia, North Carolina, South Carolina, Virginia, West Virginia
- VOLUME 7 ... Alabama, Arkansas, Louisiana, Mississippi, Oklahoma, Tennessee, Texas
- VOLUME 8 ... Arizona, Colorado, Idaho, Montana, New Mexico, Nevada, Utah, Wyoming
- VOLUME 9 ... California, Oregon, Washington

Send Money Order or Check to:
POLICE CALL MAGAZINE
 LEBANON, NEW JERSEY 08833

bandwidth product, to the user's requirements.

The MC3476 operational amplifier is designed to operate over a power-supply voltage range from ± 6 volts to ± 15 volts. Its low power consumption of 4.8 mW (typical) makes it particularly useful in battery operated equipment. Other features include low input offset and bias current (a maximum of 25 and 50 nanoamps, respectively) and a high input resistance of 5 megohms, typical. The amplifier requires no frequency compensation and has offset null capability and short-circuit protection.

Despite electrical characteristics which compare favorably with some of the better op-amp specifications, the MC3476 operational amplifier price is competitive with some of the lowest cost units currently available. The device is available in both plastic and metal packages. For further information, contact the Technical Information Center, Motorola, Inc., Semiconductor Products Division, P.O. Box 20924, Phoenix, Arizona 85036, or use *check-off* on page 126.

cmos electronic key



A flea power cmos electronic keyer just announced by Curtis Electro Devises uses the new 8043 IC keyer to reduce complexity and increase reliability. The EK-430 contains all the most desirable keyer features such as self-completing dots, dashes and spaces, instant starting clock, iambic operation, dot memory, element weight control

and built-in sidetone with speaker. Powered by either 117 Vac or an inexpensive 9-volt battery, transistor output switching keys up to plus or minus 300 Vdc at 200 mA maximum. Key debouncing circuitry assures trouble free operation on any type of key paddle regardless of the condition of the contacts.

Housed in a low profile, two-tone blue metal cabinet weighing only 26 ounces, the EK-430 is priced at \$124.95 fob the factory. For further information, write to Curtis Electro Devices, Inc., Box 4090, Mountain View, California 94040, or use *check-off* on page 126.

linear ic principles, experiments and projects

This new book by Ed Noll, W3FQJ, was written to introduce the principles of operation of the integrated circuit. Chapter 1 covers basic semiconductor principles: basic IC structures, the pn junction, the bipolar transistor, transistor fabrication and the field-effect transistor (FET). Succeeding chapters explain integrated-circuit structures, basic circuits, operational amplifiers, multi-purpose and special ICs. The last four chapters give a broad coverage of how linear ICs are used in commercial, industrial and test equipment. Home-entertainment audio, a-m, fm and television applications are also stressed. Amateur radio and shortwave enthusiasts will find the projects in Chapters 9 and 10 good examples of the many opportunities for the use of ICs in the two-way radio field. These final chapters also will be appreciated by those who like the learn-by-doing approach; they'll find an intriguing collection of school, lab and home construction projects. 384 pages, softbound, \$8.95 from Ham Radio Books, Greenville, New Hampshire 03048.

"CHOICE OF THE DX KINGS"



All models available "WIDE-SPACED"

2 ELEMENT—3 BAND KIT SPECIAL CONTENTS

- 8 Fiberglass Arms—skyblue color
- 2 End Spiders (1 pc. castings)
- 1 Boom/Mast Coupler—h.d. aluminum
- 16 Wraplock Spreader Arm Clamps
- 1 CUBEX QUAD Instruction Manual

ONLY

\$9995

Add \$8.50 for PPD
Frt. Cont. U.S.
Mailable APO

2-3-4 or more element Quads available

Send 25¢ coin or stamps for complete set of catalog sheets, specs, and prices.

CUBEX COMPANY

P.O. Box 131, Altadena, California 91001
Phone: (213) 798-8106

YOU CAN'T SAY "QUAD" BETTER THAN "CUBEX"

SW-5 — \$79.50



The SW-5 is a remote control switch, not a relay, neon indicator light tells which antenna is in use. It will handle 2KW plus. Remote switch is housed in weather tight box. It takes a six wire control cable to operate the SW-5. It has zero dB insertion loss. No visible effect on SWR. Standard unit comes with UHF connectors. Other connectors available upon request at additional cost. One year guarantee. Other designs available.

ANTENNA MART

Box 7

Rippey, Iowa 50235

Phone 515-436-7718

— **CLEAN SIGNAL** —
— **ALL CHANNELS** —

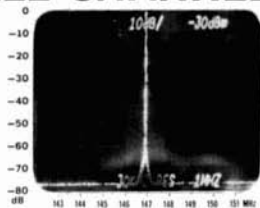

Actual Spectrum Analyzer Photograph of an RP Synthesized Radio

ONLY RP GIVES YOU BOTH
PLUS

- SUPER ACCURACY (.0005%)
- FULL 2M FM COVERAGE

144-148 MHz

WORKS WITH MOST FINE AMATEUR
OR COMMERCIAL GRADE RADIOS

MFA-22 SYNTHESIZER

SEND FOR
FULL DETAILS



RP Electronics

810 DENNISON DRIVE
BOX 1201
CHAMPAIGN, IL 61820
Phone: 217-352-7343

**A COMPLETE MOTOROLA
PORTABLE FOR JUST \$25**



That's right we have just received a shipment of Motorola H-23 High Band Portables. Although they are sold as is they appear to be in good shape and include a microphone, but no antenna or batteries. Currently set up on 154.77 MHz they should be easy to put on two meters.

They're going to go fast so mail your check or money order today for \$25.00 for postpaid shipment anywhere in the U.S.A.

International Affiliates Co., Inc.

147 West 35th Street
New York, N. Y. 10001

**audio sweep generator
and frequency meter
model 140B**



The model 140B is virtually three instruments in one: an audio oscillator, audio sweep generator and frequency meter. It may be operated manually as a conventional oscillator, or swept automatically as a voltage-controlled generator. The generator sweeps over two ranges: a high range from 1 kHz to 20 kHz, and a special expanded low range from 40 Hz to 1 kHz, which allows for a close look at low-end frequency-response problems.

The frequency meter may be used independently. However, when connected to the output of the sweep generator the frequency reading is continuously displayed. Unlike digital counters, which are limited to measuring fixed frequencies, this frequency meter may be used to monitor the changing frequency of the sweep generator or any other external frequency source.

The model 140B is an excellent input source for testing amplifier frequency response, speaker enclosures and tape recorder head alignment. This low cost instrument provides a sine wave output that is variable from 0 to 2.5 volts p-p. Once set, the amplitude remains flat over the entire frequency range. ($\pm 1/4$ dB) sine wave distortion is less than 1.5%. Square wave output is fixed at 8 volts p-p. \$78.95 from Production Devices, 7857 Raytheon Road, San Diego, California 92111. For more information, use *check-off* on page 126.

semiconductor cross reference

The new edition of the semiconductor cross reference and transistor data book is now available from International Rectifier Corporation. The 70-page brochure lists over 44,000 parts and corresponding IR replacements including rectifiers, diodes, zeners, transistors, SCRs and ICs. All are indexed in straight alpha-numeric sequence to facilitate location of the desired part number. Also included are four pages of transistor specifications, showing polarity, case style, maximum current and typical bandwidth and gain. A data sheet on IC replacements lists absolute maximum rating and case style.

To obtain a copy of the cross reference (JD601), write Semiconductor Division, International Rectifier Corporation, 233 Kansas Street, El Segundo, California 90245 or use *check-off* on page 126.

ferrite-core kit

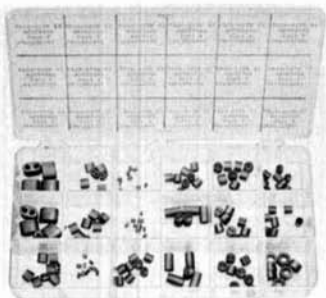

A sample kit containing 18 nickel-zinc and new high permeability manganese-zinc ferrites for winding wideband transformers including baluns can be obtained for \$10.00 from the Fair-Rite Corporation. These cores are useful over a wide frequency range but were selected for their effectiveness at frequencies above 2 MHz. Applications include radio communications, vhf receivers, mobile communications and

NEW! NEW! NEW! DELUXE P.C. KEYS



*The complete P. C. keyer
you can't afford not to buy!*

In either a 5 volt TTL or a 9 volt C-MOS version this new module type IC keyer can be easily adapted to your own custom package or equipment.

Versatile controls allow wide character weight variation, speeds from 5 to 50 w.p.m. plus volume and tone control.

Solid-state output switching saves power, eliminates all those annoying relay problems and is compatible with both grid block and solid-state circuitry.

With its side-tone monitor and 90 day warranty the Data Signal PC Keyer is the one for you.

TTL Keyer Wired \$19.95 Kit \$14.95
C-MOS Keyer Wired \$24.95 Kit \$19.95

Write today for complete details

Data Signal, Inc.

Successor to Data Engineering, Inc.

2212 PALMYRA ROAD, ALBANY, GA. 31701
912-435-1764

CFP Enterprises

Fixed or Mobile HF or VHF

CFP is your source for antennas.

Featuring:

CUSHCRAFT, HY-GAIN, NEW•TRONICS

Looking for some third generation FM gear to hook on to that antenna? We've got that, too. Look for the CFP Minnie Winnie at the big Western New York Hamfest and VHF Conference in Rochester on May 31, 1975. Send us a supply of SASE and we'll send you our regular listing of used equipment as long as your envelope supply lasts. And while you're writing, don't forget to send your Docket 20282 comments to FCC.

CFP ENTERPRISES

866 RIDGE RD.

LANSING, N. Y. 14882

24 Hour Phone:

607-533-4297

Open 8:30 - 5:30
Mon., Tues., Thurs.
By appointment Fri.,
Sat. and evenings.

Closed all
day Wed.
and Sun.

DELUXE RECEIVER PREAMPS

Specially made for both OLD and NEW receivers. The smallest and most powerful single and dual stage preamps available. Bring in the weakest signals with a Data Preamp.

FREQ. (MHz)	USE	STAGES	DELUXE PREAMPLIFIER			
			GAIN	dB	NF	dB
14, 21 or 28	HIGH FREQ.	SINGLE	25	2	\$10.50	\$13.50
		DOUBLE	48	2	\$20.50	\$26.50
28 to 30	OSCAR SPECIAL	SINGLE	25	2	\$12.50	\$15.50
		DOUBLE	48	2	\$24.50	\$30.50
50 to 54	6 METER	SINGLE	25	2	\$10.50	\$13.50
		DOUBLE	48	2	\$20.50	\$26.50
108 to 144	VHF AIRCRAFT	SINGLE	20	2.5	\$ 9.50	\$12.50
		DOUBLE	40	2.5	\$18.50	\$24.50
135 to 139	SATELLITE	SINGLE	20	2.5	\$ 9.50	\$12.50
		DOUBLE	40	2.5	\$18.50	\$24.50
144 to 148	2 METER	SINGLE	20	2.5	\$ 9.50	\$12.50
		DOUBLE	40	2.5	\$18.50	\$24.50
146 to 174	HIGH BAND	SINGLE	20	2.5	\$ 9.50	\$12.50
		DOUBLE	40	2.5	\$18.50	\$24.50
220 to 225	1 1/4 METER	SINGLE	18	2.5	\$ 9.50	\$12.50
		DOUBLE	35	2.5	\$18.50	\$24.50
225 to 300	UHF AIRCRAFT	SINGLE	15	2.5	\$ 9.50	\$12.50
		DOUBLE	30	2.5	\$18.50	\$24.50
1 thru 30	HF BROADBAND		19-36	3	—	\$17.95

Write today for complete details

Data Signal, Inc.

Successor to Data Engineering, Inc.

2212 PALMYRA ROAD
ALBANY, GA. 31701
912-435-1764

other systems operating at high frequencies.

The 18 ferrite core shapes are provided in three different materials along with application data including curves of parallel impedance, reactance and resistance per turn of wire for each sample core. Data also describes how to choose the right material and core size for a particular application.

Application data is available without charge. The sample kit can be ordered by sending a check or purchase order for \$10.00 to Fair-Rite Corporation, Wallkill, New York 12589. For more information, use *check-off* on page 126.

sweep/function generator



A new low-cost sweep/function generator oscillator has been introduced by Exact Electronics. The model 195, priced at \$149.50, is expected to make inroads into audio testing and amateur electronics applications where high performance function generators were not previously available. The new instrument, housed in a compact, rugged case, produces sine, square, triangle and swept waveforms as well as fixed amplitude pulses. Its frequency range is from 2 Hz to 200 kHz in three ranges with a linear/logarithmic frequency control.

An internal sweep generator will sweep 1000:1 (3 decades) on any of the three main frequency ranges. This permits technicians to sweep, either linearly or logarithmically, the entire audio range of amplifiers or speakers without changing ranges or even turning a knob. High and low level sine outputs with

HAMFEST

WESTERN N. Y.
HAMFEST and
VHF CONFERENCE

MAY 31, 1975

Monroe County
Fairgrounds
Rt. 15A
Rochester, N. Y.
(Near Thruway Exit 46)

- Huge Flea Market
- Top Programs
- Award Presentations
- Friday Night Funfest
- FCC Exams

WRITE:
WNY HAMFEST
BOX 1388
ROCHESTER, N. Y.
14603

amplitude control of both are provided. A voltage control frequency (VCF) input permits controlling frequency from an external source. Fully portable, the model 195 is powered by a 9-volt transistor battery, completely eliminating any problems with 60-Hz hum. An optional rechargeable power supply is available.

For more information, write to Exact Electronics, Box 160, Hillsboro, Oregon 97123, or use *check-off* on page 126.

solder slide rule

A handy new slide rule published by Kester Solder provides comprehensive flux selector data on one side and offers solder alloys guides on its flip-side. The pocket size Kester slide rule gives flux choices for 22 metals, ranging from easy-to-solder gold, copper, and tin to very-difficult-to-solder chromium and stainless steel. Thirty-six solder alloys also are listed, along with temperatures at which the solder becomes plastic and becomes liquid. Readers may obtain this slide rule by writing to Kester Solder, 4201 Wrightwood Avenue, Chicago, Illinois, 60639, Attn: Mack Haraburd.

touch-tone decoder board

A new seven-digit *Touch-Tone* Decoder board kit with multiple capabilities has been announced by CTI Manufacturing Company. The new board features full seven-digit Touch-Tone decoding and encoding, uses cmos circuitry, and is installed on a miniature 2¼x3¼-inch (57x82mm) circuit board. The board can be mated with an optional Touch-Tone pad, if desired, or used with existing equipment. The basic kit for the decoder board is priced at \$59.50. For more information, write to CTI Manufacturing Co., Post Office Box 1422, Corinth, Mississippi 38834, or use *check-off* on page 126.

NEW! NEW! NEW! HERE'S THE BEST FOR MOBILE OR MARINE VHF!

MODEL SS-2

LIFE — Bright stainless steel housing, s.s. whip, along with brass beat the effects of salt.

PERFORMANCE — 150 w.

Gain 6 dB over coax ant.
3.7 dB over isotropic
1.5 dB over dipole
Requires **no ground plane**

PHYSICAL DATA —

1½" x 46½", 8 oz.
Alternate mounting.

PRICE — \$45.00 List

Optional bracket \$4.60 list



G.A.M.
Electronics

191 VARNEY STREET
MANCHESTER, NH 03102
TEL. (603) 627-1010

DYCOMM for RF POWER



ECHO III REPEATER



MODEL 34 WATTMETER



A4950



A8949

A COMPLETE LINE OF FM AMPLIFIERS

model — power output — gain — price

6 METER FM

A4950 - 50W - 10db - \$183.
A4960 - 50W - 8db - \$192.
A8949 - 100W - 10db - \$270.

450 - UHF

MODEL 25 - 30W - 7db - \$167.
MODEL 30 - 30W - 9db - \$194.
MODEL 50 - 50W - 5db - \$251.

OTHER PRODUCTS

ECHO III FM REPEATER - \$949.
MODEL 34 WATTMETER - \$70.

2 METER FM

MODEL C - 25W - 4db - \$69.
MODEL D - 50W - 7db - \$99.
SUPER D KIT - 80W - 3.5db - \$60.
MODEL DS - 80W - 3.5db - \$139.
MODEL E - 35W - 10db - \$80.
SUPER E KIT - 40W - 11db - \$60.
MODEL ES - 40W - 11db - \$115.
10 - 100W - 7db - \$209.
1-10-0 - 100W - 14db - \$226.
35-0 - 100W - 4db - \$185.



DYNAMIC

COMMUNICATIONS

948 AVE. "E" P.O. BOX 10116
RIVIERA BEACH, FLA. 33404
(305) 844-1323



IT'S A
NEW
BALLGAME



DATA SIGNAL SCORES AGAIN

NOW WELL ESTABLISHED IN THEIR NEW FACILITIES THE SUCCESSORS TO DATA ENGINEERING ARE LEADING OFF WITH BOTH EXCITING NEW PRODUCTS AND TIME PROVEN FAVORITES. YOU CAN DEPEND ON DATA SIGNAL FOR THE FINEST IN AMATEUR RADIO ACCESSORIES.

AUTOMATIC TOUCH TONE DIALER

Now, by the push of a single button you can automatically dial up to six separate 7-digit telephone numbers. All solid state with automatic PTT operation. Can send telephone number only, or repeater access code plus telephone number automatically.

AD6 Sh. Wt. 2 lbs. without keyboard **99.50**
AMD-6 Sh. Wt. 2 lbs. with keyboard **119.50**
 Factory programming of #s **7.50**

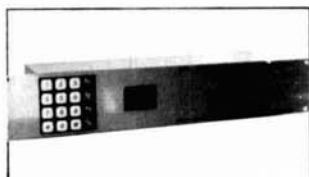

DELUXE REPEATER AUTO PATCH

The auto-patch your club will be proud to own. It's complete in every aspect. Two 1-4 digit access codes, one 1-4 digit disconnect, rotary dial or regenerated Touch Tone output, dial-in capability, "1", "0" and numerical disconnects, ID by-pass, audio monitor, keyboard, digital readout, plus many more features. Send for brochure. Rack mount only.

RAP-101 Sh. Wt. 15 lbs. **549.00**

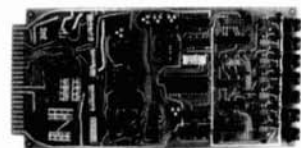

TOUCH TONE REGENERATOR

Give your Auto Patch users and the telephone exchange a break. Now all touch tone digits received by the telephone exchange is from ONE touch tone standard and not from a multitude of individual pads. Regeneration eliminates miss-dials caused by pads with off-frequency tones, incorrect amplitude adjustments, improper tone length, split tone bursts, etc. Includes complete 16-digit decoder plus rotary dial capability. PC board and rack mounting available.

DCR-71 **PC 249.00** **Rack 325.00**
 Sh. Wt. 2 lbs. Sh. Wt. 8 lbs.



REPEATER AUTO PATCH

It's complete — a single digit access/disconnect Auto Patch facility. All you need is a repeater and the phone line. Complete with automatic disconnect, dial-in capability, two way audio monitor plus remote control. When used with a rotary dial exchange, Data Signal's DPC-121 dial converter is also required. P.C. board or Rack Mount available.

RAP-2 **PC 99.50** **Rack 149.50**
 Sh. Wt. 2 lbs. Sh. Wt. 8 lbs.

TOUCH TONE TO DIAL PULSE CONVERTER

Don't let the lack of a Touch Tone telephone exchange prevent your repeater club from going auto-patch. Convert 0-9 TT digits to Bell System compatible dial pulse code. Uses anti-falsing TT decoder, 64-digit memory and solid state pulsing. Starts dialing on first incoming digit. Memory will not overload. Cancel function. * and # output provided for control purposes. PC Board and rack mount available.

DPC-121 PC **195.00** Rack **285.00**
Sh. Wt. 2 lbs. Sh. Wt. 10 lbs.



TOUCH TONE KEYBOARD/ENCODER

The smallest, thinnest keyboard with built-in touch tone encoder. Only 1/4" thick. Completely self-contained, designed for mounting directly to hand-held portables. Operating temperature -20°F to +150°F. R. F. proof.

DT-4M Miniature Encoder 2 1/4" x 3" x 1/4" **89.95**
Sh. Wt. 1 lb.

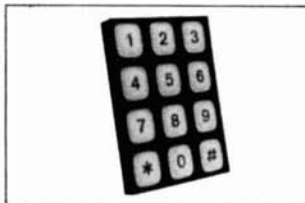

TOUCH TONE PADS

Standard size 12 and 16 digit Touch Tone Pads. Automatic PTT operation with 1 1/2 second transmitter hold. Self powered via internal 9V battery. Audio and PTT outputs, TTP-1 and TTP-2 also has low volume audio monitor for acoustically coupling of tones to microphone. Zero quiescent current. Operating temperature -20°F to +150°F. R. F. proof.

TTP-1 16 digit 3" x 5 1/2" x 1 1/2". Sh. Wt. 2 lbs. **79.50**

TTP-2 12 digit 3" x 5 1/2" x 1 1/2". Sh. Wt. 2 lbs. **59.50**

TTP-3 12 digit 2 1/4" x 4 1/4" x 1 1/2" Sh. Wt. 2 lbs. **59.50**

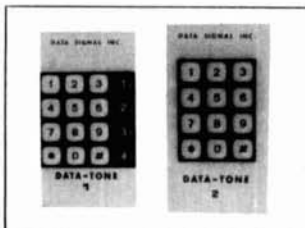

ANTI-FALSING TOUCH TONE DECODER

Now, a true anti-falsing decoder, immune to high noise and voice falsing. 12 to 16 digit capability. Single 5-volt power supply. Heavy duty transistor output. Complete p. c. board or standard 19" rack available.

TTD-126-12 12 digit PC **149.95** Rack **219.95**

TTD-126-16 16 digit PC **169.95** Rack **239.95**

Sh. Wt. 2 lbs. Sh. Wt. 10 lbs.

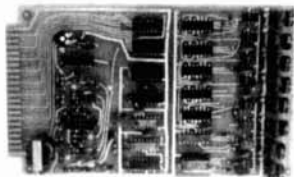

ORDER TODAY OR WRITE FOR COMPLETE DETAILS

DATA SIGNAL, INC.

Successor to Data Engineering, Inc.

2212 PALMYRA ROAD, ALBANY, GA. 31701

912-435-1764

Wilson Electronics



WILSON 204 MONOBANDER

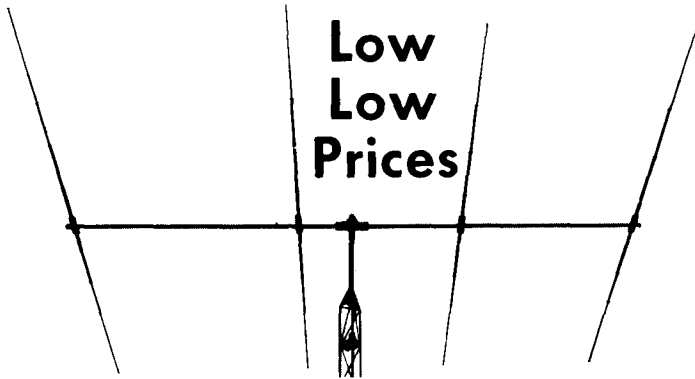

The Wilson 204 is the best and most economical antenna of its type on the market. Four elements on a 26' boom with Gamma Match (No balun required) make for high performance on CW & phone across the entire 20 meter band.

The 204 Monobander is built rugged at the high stress points yet using taper swaged slotted tubing permits larger diameter tubing where it counts, for maximum strength with minimum wind loading. Wind load 99.8 lbs. at 80 MPH. Surface area 3.9 sq. ft., Weight 50 lbs., Boom 2" OD.

All Wilson Monoband and Duoband beams have the following common features:

- Taper Swaged Tubing
- Full Compression Clamps
- No Holes Drilled in Elements
- 2" or 3" Aluminum Booms
- Adjustable Gamma Match 52 Ω
- Quality Aluminum
- Handle 4kw
- Heavy Extruded Element to Boom Mounts

- **M204** 4 ele. 20, 26', 2" OD **\$119.95**
- **M203** 3 ele. 20, 20', 2" OD **\$ 89.95**
- **M155** 5 ele. 15, 26', 2" OD **\$119.95**
- **M154** 4 ele. 15, 20', 2" OD **\$ 79.00**
- **M105** 5 ele. 10, 20', 2" OD **\$ 69.00**
- **M106** 6 ele. 10, 26', 2" OD **\$ 89.00**
- **M104** 4 ele. 10, 17', 2" OD **\$ 49.00**
- **M340** 3 ele. 40, 40', 3" OD **\$349.00**
- **M240** 2 ele. 40, 16', 3" OD **\$199.00**
- **M520** 5 ele. 20, 40', 3" OD **\$189.00**
- **M715** 7 ele. 15, 40', 3" OD **\$159.00**
- **DB45** 4 ele. 15, 5 ele. 10, 26', 2" OD **\$129.95**
- **DB43** 4 ele. 15, 3 ele. 10, 20', 2" OD **\$ 99.00**
- **DB54** 5 ele. 20, 4 ele. 15, 40', 3" OD **\$209.00**

All Wilson Antennas are FACTORY DIRECT ONLY! The new low prices are possible by eliminating the dealer's discount. All antennas in stock. If you order any antenna you may purchase a CDR Ham II for \$124.95 or a CDR CD44 for \$84.95. Send check or money order, or phone in BankAmericard or Master Charge. All 2" Boom antennas shipped UPS or PP. 3" by truck.

Wilson Electronics Corporation

P. O. BOX 794 HENDERSON, NEVADA 89015

702-451-5791

Thousands...

of Drake
TR-3 and TR-4
Sideband
Transceivers
are giving
dependable
service...

many of them
since 1963!

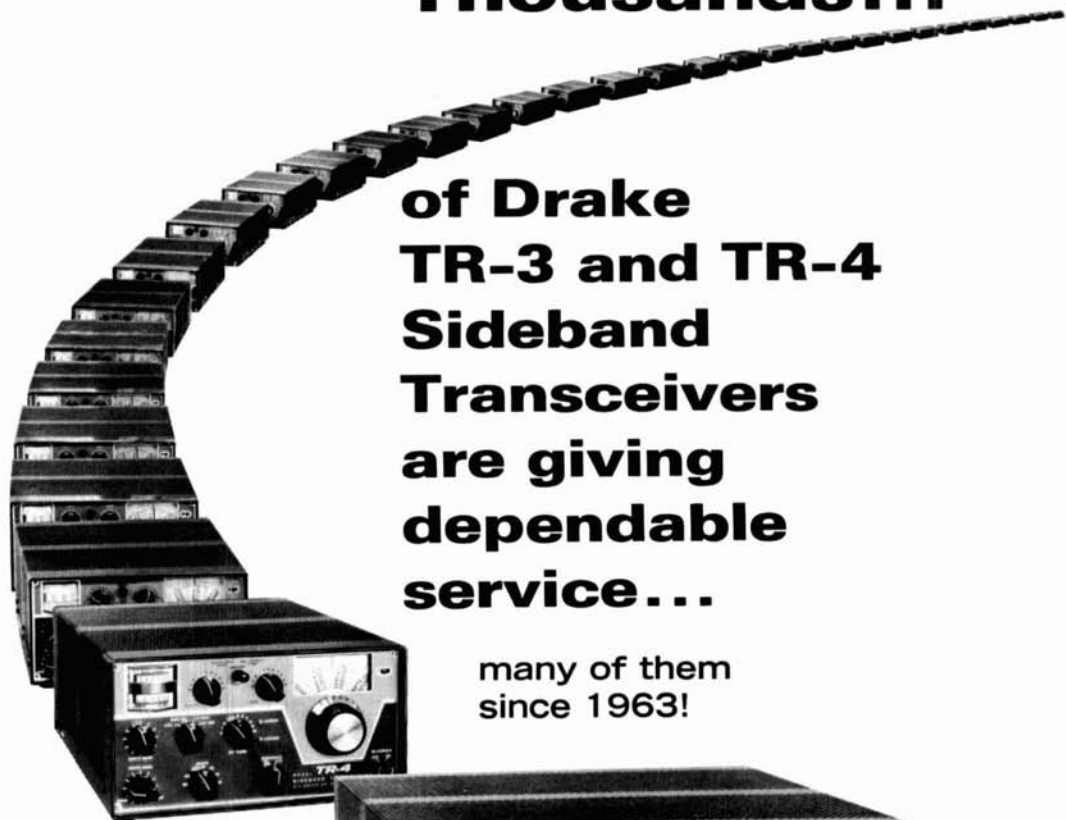

And now **TR-4C**
the Drake
is already surpassing their record!

Now at your dealer's

R. L. DRAKE COMPANY

540 Richard St., Miamisburg, Ohio 45342

Phone: (513) 866-2421 Telex: 288-017



SUPER CW FILTER

The IMPROVED CWF-2BX offers RAZOR SHARP SELECTIVITY with its 80 Hz bandwidth and extremely steep sided skirts. Even the weakest signal stands out.

Plugs into any receiver or transceiver. Drives phones or connect between receiver audio stage for full speaker operation.

- Drastically reduces all background noise
- No audible ringing
- No impedance matching
- No insertion loss
- 8 pole active filter design uses IC's
- Bandwidth: 80 Hz, 110 Hz, 180 Hz (selectable)
- Skirt rejection: at least 60 db down one octave from center frequency for 80 Hz bandwidth
- Center frequency: 750 Hz
- 9 volt transistor battery not included.

- 400 Hz or 1000 Hz center frequency available add \$3.00.

IMPROVED CWF-2BX, assembled \$23.95

CWF-2, PC board, includes 4 position selectivity switch . . \$16.95

CWF-2, kit \$14.95



A STACK FOR CW MEN

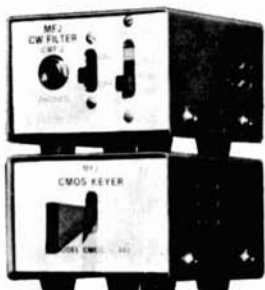

4 x 3 1/4 x 2 3/16 inch

Dealer Inquiries Invited

CMOS ELECTRONIC KEYS

Feature for feature the CMOS-440RS gives the most for your money: • State of the art design uses digital CMOS ICs and NE555 sidetone • Built-in key with adjustable contact travel • Sidetone and speaker • Adjustable tone and volume • Jack for external key • 4 position switch for TUNE, OFF, ON, SIDETONE OFF • Two output jacks: direct relay, grid block keying • Uses 4 penlight cells (not included) • Self completing dots and dashes • Jam proof spacing • Instant start with keyed time base • Perfect 3 to 1 dash to dot ratio • 6 to 60 WPM • Relay rated 250 VDC, 1 1/2 amp, 30 VA

CMOS-440RS, Deluxe . . \$37.95

Write for FREE catalog and CW filter test reports. Please include \$1.50 per unit for shipping and handling. Money back if not satisfied. One year UNCONDITIONAL guarantee.



MFJ Enterprises, P. O. Box 494, Miss. State, MS 39762, (601) 323-5869

The DELA-BRIDGE I

Analyzes antenna characteristics, simplifies adjustment.

The DELA-BRIDGE I, when tied into your grid dip meter or low power exciter, quickly and easily analyzes: (1) Existing antenna & feedline characteristics, (2) Tuning & loading coils, (3) Filter & interstage coupling networks. Direct readout then lets you adjust for optimum performance.

DELA-BRIDGE I Specifications:

FREQUENCY RANGE: 50 KHz to 250 Mhz

RESISTANCE RANGE: 0 to 500 Ohms, balanced or unbalanced, log scale

SIGNAL REQUIREMENTS: 1 MW to 2 Watts maximum from any grid dipper or signal generator

POWER REQUIREMENTS: Internal 9V battery

ACCURACY: ±3% at 50 Ohms

TO READ & INTERPRET: Complete null and reactance determination—not frequency sensitive—internal integrated circuit amplifier allows use with low signal inputs



DELA-BRIDGE I guaranteed for 1 year by Delavan Electronics, Inc.*

Delavan Electronics' new Amateur Products Group might be a new name to you, but we're no stranger to amateur radio operations and equipment. Delavan is well funded and deeply involved in aerospace and industrial controls. Delavan stands behind its products 100% and guarantees the DELA-BRIDGE I unconditionally for 1 full year.

Order your DELA-BRIDGE I today!

DEHAVAN ELECTRONICS, INC. AMATEUR PRODUCTS GROUP

14441 North 73rd Street • Scottsdale, Arizona 85260 • (602) 948-6350
*Dunn's Number: 05-689-6756

Gentlemen:

Please send me one DELA-BRIDGE I @ \$39.95, completely assembled & tested

Please send me one DELA-BRIDGE I ready-to-assemble Kit @ \$29.95

Arizona residents add 5% sales tax. Out-of-state residents add \$2.50 to cover handling and airmail postage.

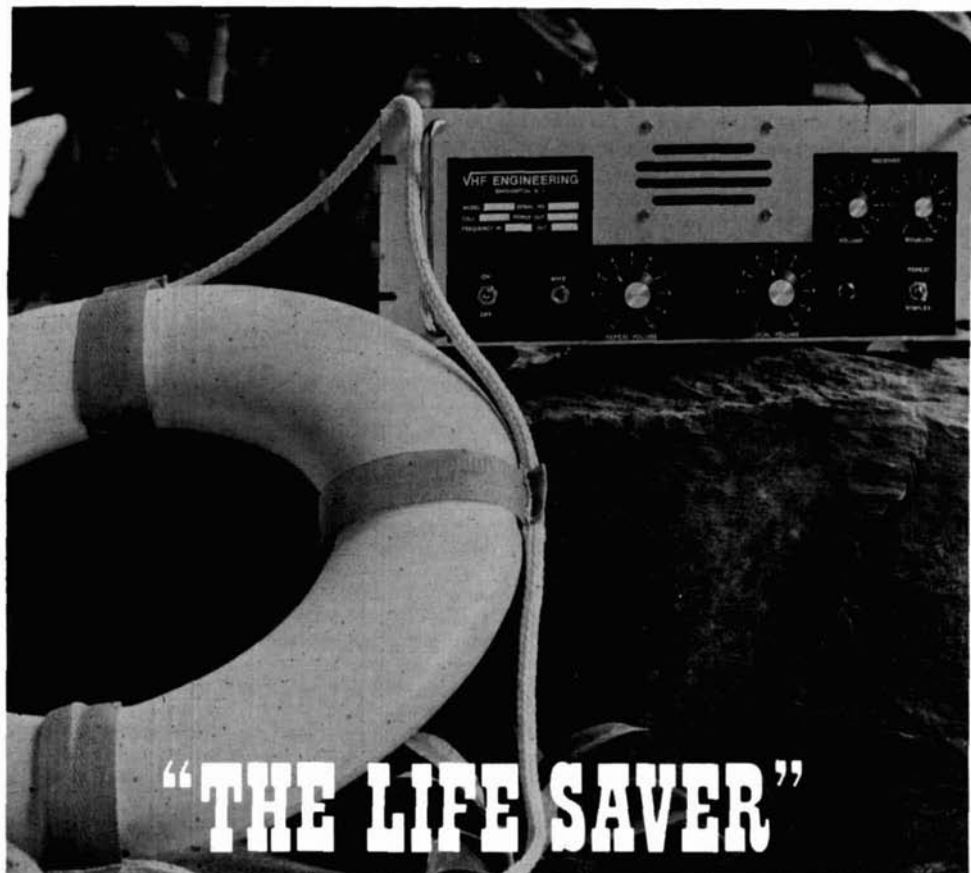

“THE LIFE SAVER”

Problem Your local club has decided to put up a repeater, but funds are limited and you know that an old commercial tube rig converted will work but never will be first rate.

Solution “The Life Saver” — A state of the art completely solid state repeater. Complete including CW-ID, control circuitry, power supply (12V 12Amp) and all hardware. Packaged to take up to 25,000 microvolts before desensing.

PRICES

Kit	\$364.95	Factory wired and tested	\$595.00
-----	----------	--------------------------	----------

Need Cavaties? With kit or wired and tested repeater, add \$399.95 for commercial grade 6 cavity system.



320 WATER ST. • PO BOX 1921 • BINGHAMTON, NY 13902 • 607-723-9574
DIVISION OF BROWNIAN ELECTRONICS CORP.



SAROC HAWAIIAN HOLIDAY

including

SAROC's First Hawaiian Convention

**Spend 8 fabulous days in exciting Hawaii
on SAROC's Hawaiian Holiday**

Your holiday includes:

- Attendance at the SAROC Hawaiian Convention
- 7 nights at the Sheraton Waikiki on famous Waikiki Beach
- Optional visit to the other islands
- Round trip air transportation from Los Angeles or San Francisco on Western Airlines
- Connecting flights from selected Eastern and Mid-Western cities via United Airlines
- Leave July 17, 1975 — Return July 24, 1975

*Combine your favorite hobby with beautiful Hawaii
and you have a vacation you'll never forget.*

All travel arrangements by Del Webb World Travel Co.

for further details write

SAROC

Box 945

Boulder City, Nev. 89005

GOODIES

HERE ARE SOME REAL GOODIES AT DOWN TO EARTH PRICES. QUANTITIES ON SOME ITEMS ARE LIMITED . . . IF YOU SEE SOMETHING YOU LIKE DON'T DELAY . . . ORDER NOW.

SOLID STATE RECEIVER STRIPS

WE HAVE JUST GOTTEN IN SOME CLEAN GENERAL ELECTRIC MASTER PRO HI BAND RECEIVER STRIPS. THESE STRIPS ARE SOLID STATE AND IDEAL FOR REPEATER USE OR JUST PLAIN MONITORING . . . CHECK THESE FEATURES. . .

136-150 MHz Range 2 Freq Narrow Band

ONLY \$100.00 ea.

SOLID STATE TRANSMIT STRIPS

WE HAVE A LIMITED QUANTITY OF TRANSMIT DECKS FROM THE HI BAND GENERAL ELECTRIC PORTA MOBILE UNITS. THEY ARE EXCEPTIONALLY CLEAN, 136-150MHZ RANGE, CAPABLE OF PROX 6 WATTS OUTPUT. EXCELLENT EXCITERS FOR FM OR CONVERSION TO USE ON OSCAR.

ONLY \$49.00 ea.

MOTOROLA GOODIES

ATTENTION REMOTE BASE OPERATORS

Here are some special T-Power mobiles just for you. They are Motorola X43BGT type units. They are 2 freq transmit 150 MHz and 2 freq, PL*, dual squelch, narrow band receive on 450. Ideal for use with your remote base. Less accs.

\$39.00

IF YOU DON'T NEED THE WHOLE RADIO HERE ARE SOME STRIPS

UHF "B" RECEIVERS

These are the 2 freq, PL* dual squelch, narrow band receivers from the X43BGT. They are the same size as a hi band "G" strip. Ideal for link receivers

\$25.00

T-SUPPLIES

From the X43BGT. Unit comes with the supply, and heatsink. Can be converted for use with your T41 or T43 radio. Here's your chance to update your vibrator rig

\$10.00

30 WATT HI BAND TRANSMIT STRIPS

Motorola "G" series transmit strips. No weird tubes. Uses 6146 final. Ideal for FM or can be converted for use as an OSCAR transmitter.

UNBELIEVABLY PRICED AT

3 for \$12.00

*PL Registered Motorola trademark

TERMS OF SALE: Sales to licensed Radio Amateurs for use on Amateur freqs only. All prices FOB Oak Park, IL. Check with order, COD or you can charge to your BankAmericard or Master Charge.

STORE HOURS: Mon.-Thurs. 9:30-6:00, Fri. 9:30-8:00, Sat. 9:30-3:00. Closed Sun. & Holidays
INQUIRIES WITHOUT ZIP CODE OR CALL . . . NO ANSWER

WANTED: Good used FM & test equipment. No quantity too large or small. Finders fees too.



SPECTRONICS INC.

1009 GARFIELD STREET

OAK PARK, ILL. 60304

(312) 848-6778

AMATEUR SALES ONLY / SPECTRONICS / The U.S. people





CRYSTAL FILTERS and DISCRIMINATORS

1 27/64" x 1 3/64" x 3/4"



by
K.V.G.

10.7 MHz FILTERS

XF107-A	14kHz	NBFM	\$40.60
XF107-B	16kHz	NBFM	\$40.60
XF107-C	32kHz	WBFM	\$40.60
XF107-D	38kHz	WBFM	\$40.60
XF107-E	42kHz	WBFM	\$40.60

CRYSTAL SOCKET (for XM107-S04) type DG1 \$1.50

Shipping 50¢ each

10.7 MHz FILTERS CONT'D.

XM107-S04	14kHz	NBFM	\$18.95
XF102	14kHz	NBFM	\$7.95

10.7 MHz DISCRIMINATORS

XD107-01	30kHz	NBFM	\$22.10
XD107-02	50kHz	WBFM	\$22.10

(Export inquiries invited)

J-BEAM ANTENNAS

435 MHz



MULTIBEAM 70/MBM46 \$51.75 ea.
Gain, Ref Dipole 17.3 dB
Feed impedance 50 Ω

145 MHz



8 OVER 8 D8/2M \$39.95 ea.
Gain, Ref Dipole 12.6 dB
Feed impedance 50 Ω

STACKING HARNESS: —

2 Way PMH2/70	\$12.80	PMH2/2M	\$15.35
4 Way PMH4/70	\$28.25		

SVMK/2M Vertical Polarization Mounting Kit \$8.75

Write for detailed specifications.

F.O.B. Concord, Mass.

Shipping: Via U.P.S.



SPECTRUM
INTERNATIONAL
BOX 1084 CONCORD
MASSACHUSETTS 01742
U. S. A.

NEW



NEW

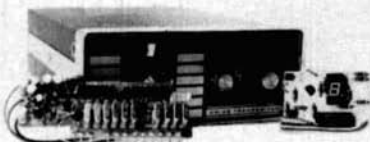

10 CHANNEL SCANNER

For All Regency HR series 2, 2A, & 2B
MT-15, MT-25, & AQUAFONE Transceiver

FEATURES:

- Selectable Priority Channel (Selected By Channel Selector Switch)
- 10 Second Delay Before Scan Resumes After Transmit
- 2 Second Delay Before Scan Resumes After Signal Loss
- Plugs Into Existing Crystal Sockets. Simple 5 Wire Hook-Up Without Major Modification To Radio
- Simple Modification For Selective Channel Bypass
- Optional Digital Channel Display

ORDER

MODEL NUMBER AMATEUR & DLR. NET PRICES

SCANN 10B 10 Channel Scanner \$52.50

(Wired Only)

D10B Digital Channel Display \$21.75

(Wired Only)

NET PRICE FOR BOTH . . . \$74.25

(SUGGESTED LIST PRICE FOR BOTH - \$109.95)

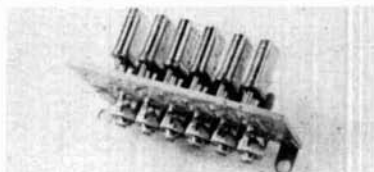

6T-HR2-3 CRYSTAL DECK

Adds 6 more xmit FQ's to your HR2 or HR2A. Allows full 12 channel xmit. Improvements include smaller board, easier installation, and allows netting without removing the radio speaker.

6T-HR2-3

Kit \$11.50

6T-HR2-3

Wired \$15.50

NOTE: We're still making the best MOSFET PREAMP on the market for the size and price — Model HF 144 U. Kit \$11.95; Wired \$17.95

All prices include postage.

ORDER FROM

Topeka FM Communications & Electronics

A Division of Topeka FM Communications, Inc.

125 Jackson

Topeka, Kansas 66603

913-233-7580

Kansas Residents Add 3% Sales Tax

There Is a Difference In Quartz Crystals

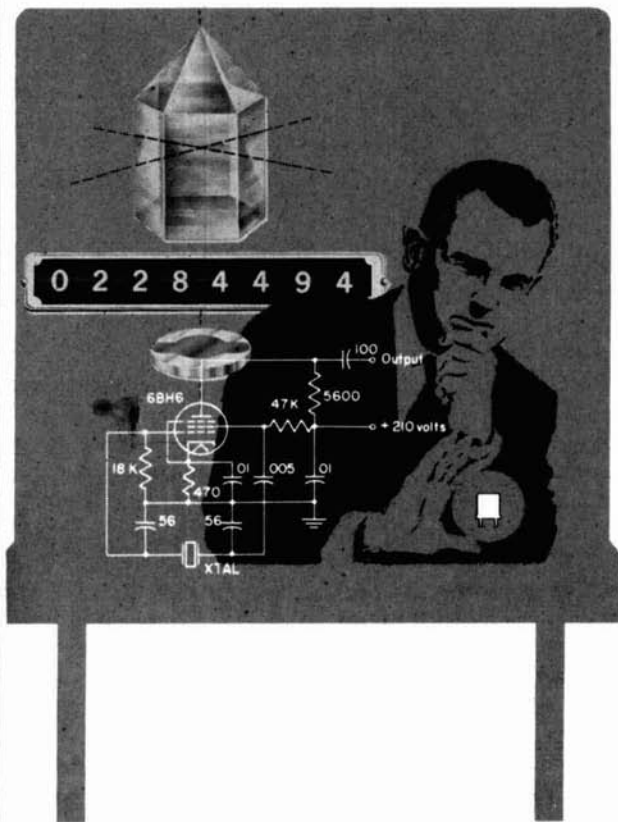

Space age communication equipment demands a crystal that meets all standards of technical advancement. Crystals that were acceptable some years ago do not meet present day specifications. As a general rule, your crystal must be selected from the best quartz . . . (no throw off cuts). Tight tolerances demand selected angles of cut. The x-ray is important in making this selection. The crystal should be preaged with stress cycling. It should be checked for frequency change vs temperature change. It must be checked for optimum spurious response. It should be calibrated to frequency with the correct oscillator. International Crystals are manufactured to meet today's high accuracy requirements. That's why we **guarantee all** International crystals against defective materials and workmanship for an unlimited time when used in equipment for which they were specifically made.

WRITE FOR CATALOG



CRYSTAL MFG. CO., INC.
10 NORTH LEE
OKLAHOMA CITY, OKLA. 73102

NASEM

HAM/HOBBY/EXPERIMENTER GRADE
SEMICONDUCTORS

- OUR DATA/APPLICATION SHEET ENCLOSED WITH EACH TYPE SHIPPED
- EVERY UNIT 100% PARAMETER AND FUNCTION TESTED TO OUR GUARANTEED LIMITS ON THE SAME FAIRCHILD COMPUTER-TYPE HIGH SPEED TESTER USED BY MAJOR SEMI COMPANIES.

COMMUNICATIONS INTEGRATED CIRCUITS			
IC Type	Description	Case	Price ea.
NA555	Versatile Timer	8-DIP	0.99
NA555-2	Dual Timer	16-DIP	1.55
NA370	AGC/Squelch/VOX	10-T05	1.20
NA371	Versatile RF/IF	10-T05	1.29
NA3018	4-Trans. Array	12-T05	0.89
NA3026	Dual Diff. Array	12-T05	0.99
NA3086	5-Trans. Array	14-DIP	0.45
NA3036	Dual Darlington	10-T05	0.75
NA1595	Analog Multiplier	14-DIP	1.90
NA8038	VCO/Sine/Sq./Tri.	14-DIP	4.50
NA1596	Bal. Mixer/Mod.	10-T05	1.20
NA376	Voltage Reg., Pos. Low Stbby	8-DIP	1.25
NA723	Voltage Reg., Pos./Neg.	10-T05	0.99
NA741	Op. Amp	8-DIP	0.45
NA1303	Stereo Preamp	14-DIP	0.99
NA1304	Stereo Multiplex Decoder	14-DIP	1.20
NA2111	FM IF Strip/Quad. Detector	14-DIP	2.25
NA3075	FM IF Strip/Det./Preamp	14-DIP	2.45

TRANSISTOR BAGS			
IC Type	Description	Case	Price ea.
2NA2222	NPN Trans., Bag of 12	TO18	2.00
2NA2907	PNP Trans., Bag of 12	TO18	2.00
2NA3904	NPN Trans. Plastic, Bag of 20	TO92	3.00
2NA3906	PNP Trans. Plastic, Bag of 20	TO92	3.00

APRIL-MAY SPECIAL

NA8038 VCO

Triangle Sine Square

Wave Function Generator

3 for \$9.95

RADIO TRANSMITTER ON A CHIP!

- OSCILLATOR • BUFFERS • MODULATOR •
- CONTROLLED POWER OUTPUT STAGE •

NA2000 100Mw AM on 10 Meters 9.95

NA2001 250Mw AM on 10 Meters 14.95

in stud mount package

Both types usable at reduced output at 6 Meters and above. Requires external crystal and 2 tuned circuits. With Data/applications.

TERMS:

Prepaid U.S. orders over \$10.00, we pay shipping.

Prepaid U.S. orders under \$10.00, add \$1.00 chg.

Prepaid Foreign orders over \$10.00, add postage.

Prepaid Foreign orders under \$10.00, add \$1.00

plus postage.

COD U.S. orders over \$10.00, add \$1.50 chg.

COD U.S. orders under \$10.00, add \$2.50 chg.

No Foreign COD orders.

California residents add 6% sales tax.

Confused? Please read again before ordering.

NASEM, Box AI, Cupertino, Ca. 95014

2 Rigs in one!

Comcraft's NEW VHF Two-Band Transceiver for 2 and 1 1/4 meters with Digital Frequency Synthesis



The new CST-50 Two-Band Transceiver provides coverage of two complete amateur bands with all the features needed by most operators. Imagine! The two most popular VHF bands in one rig with Phase Locked Loop frequency synthesis. In the CST-50 all frequencies are generated digitally by reference to one highly accurate and easily adjustable crystal. As soon as a new repeater is on you can use it, no waiting for crystals. Write for further information.

- Covers entire 2 meter and 1 1/4 meter bands
- Covers MARS, CAP and CD frequencies from 142 to 149.995 MHz
- Full digital frequency synthesis with 5 kHz steps
- Lighted thumbwheels for night mobile operation
- No crystals to buy — ever
- Built in repeater offsets of 600 kHz, 1 MHz and 1.6 MHz
- 25 watts output on each band
- No transmitter retuning across either band
- FM-AM receiver
- 8 pole crystal filter
- Front mounted speaker

- PTT microphone and mobile mount included
- Operates on 12 volts DC
- AC supply available
- Accessory connector for tone burst and tone coded squelch

CST 50 two band transceiver \$869.95

CPS 6 AC power supply \$139.95



MADE IN USA by

COMCRAFT

P O BOX 266, GOLETA, CA 93017

an extraordinary combination of digitally synthesized receivers...

each with built-in capacity to satisfy
a broad spectrum of singular applications.

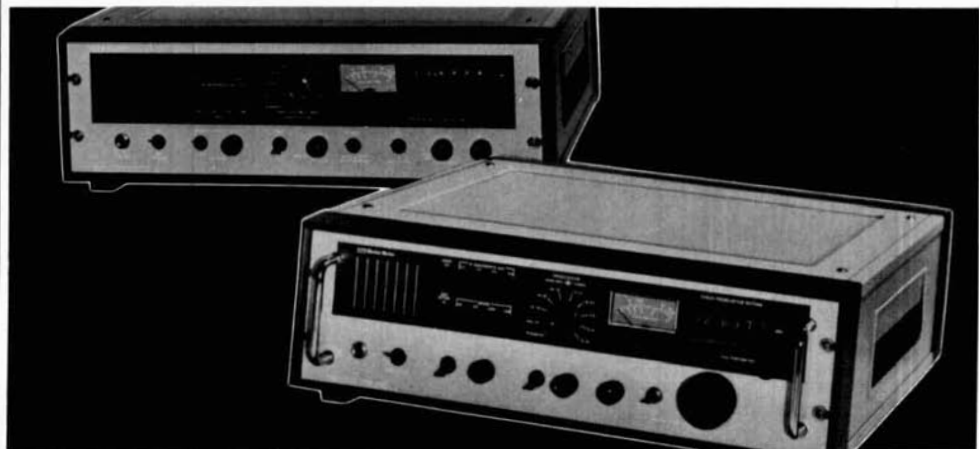

ITT Mackay Marine 3020A and 3021A Radio Receivers feature solid state construction, dual conversion and super-heterodyne design providing continuous frequency coverage from 15kHz to 29.9999MHz. Frequency selection is accomplished by step tuning, while the 3021A Receiver uses sweep tuning. These receivers meet strict requirements of British MPT, German FTZ, Norwegian NTA, Dutch and Spanish PTT and Canadian DOC, and can be used wherever maximum reliability and ease of maintenance are required.

Write or call Ed Engebretson, General Sales Manager (K4IQD), today for complete information on these two quality, high performance receivers.

ITT Mackay Marine, 2912 Wake Forest Road, Raleigh, North Carolina 27611. Telephone: (919) 828-4441.

ITT Mackay Marine
Mr. Ed Engebretson, General Sales Manager
2912 Wake Forest Road
Raleigh, North Carolina 27611

Please send complete FREE information on the exciting new:

- 3020A Step Tuning Receiver
 3021A Sweep Tuning Receiver

NAME _____ TITLE _____

COMPANY _____

ADDRESS _____

CITY _____ STATE _____ ZIP _____

COUNTRY _____

Federal Supply Schedule Group 58 Part VII,
Contract GS-OOS-24016

ITT Mackay Marine

Autoranging multi-function counter

\$349

1900A

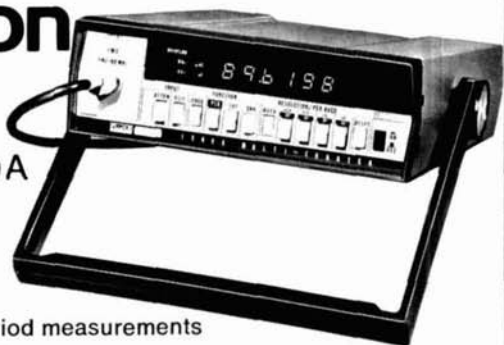

- Traditional Fluke quality
- Autoranging in both frequency and period measurements
- 5 Hz to 80 MHz, high sensitivity — 25 mV
- Event counting to 10⁶ events, automatic overflow
- Six digit LED display with automatic annunciation
- Optional battery operation and data output
- Full 12-month guarantee
- Service centers coast to coast
- Available from stock

FLUKE
COUNTER DIVISION

John Fluke Mfg. Co. Ltd.
Counter Division
P.O. Box 1094 Station D
Buffalo, N.Y. 14210
Phone (716) 842-0311
TWX 610-492-3214

K-ENTERPRISES



PD 301 PRESCALER with Power Supply

Kit \$43.50 Assembled \$55.50

Add \$1.50 Postage & Insurance

Model PD 301 is a 300 MHz prescaler designed to extend the range of your counter ten times. This prescaler has a built-in preamp with a sensitivity of 50 mV at 150 MHz, 100 mV at 260 MHz, 175 mV at 300 MHz. The 95H90 scaler is rated at 320 MHz. To insure enough drive for all counters, a post amp. was built-in. The pre-amp has a self contained power supply regulated at 5.2V ± .08%. (Input 50 Ohms, Output Hi Z)

All prescalers are shipped in a 4" by 4" by 1½" cabinet. All are wired and calibrated.

K-ENTERPRISES

1041 East Highland, Shawnee, Okla. 74801

Phone: 405-273-9024

2 METER FM

PORTABLE PLEASURE
from ERICKSON . . .

SRC-146A SPECIAL

with your choice of

- Rubber antenna
- Leather case
- Ni-cads
- Charger
- Remote mike
- Speaker mike
- Extra crystals
- PL, tone burst and TT pad

Put together your own package . . .

. . . then call or write

for the ERICKSON deal!

plus ICOM/TP/L/TEMPO/ASP
SBE/KENWOOD/CUSHCRAFT/LARSEN



ERICKSON COMMUNICATIONS

4135 Main Street (New Location)
Skokie, IL 60076 (312) 677-2161
Hours: 9-4 M-S; 6:30-9 M, Th

**NOW
available
for the first time
in North America**



the all NEW synthesized VHF FM TRANSCEIVER the KDK-144

Compare the features:

- SYNTHESIZED — no more crystals
- L.E.D. READOUT — for quick, easy readability
- 10KHZ FREQUENCY DIAL UP CAPABILITY 146-148 MHZ — Perfect for the 2nd generation of repeaters and simplex channels
- 600 KHZ UP AND DOWN REPEATER CAPABILITY
- POWERFUL 2W AUDIO OUTPUT
- 10W.R.F. OUTPUT

Compare the sizes:

- KDK-144 2" x 6 3/8" x 7 3/4" Deep
- ICOM AC-230 2 9/32" x 6 1/8" x 8 1/2" Deep
- CLEGG FM 27B 3 1/2" x 7 3/8" x 9 1/4" Deep

ONLY
\$399
F.O.B. Blaine Wash.

HAM IMPORT SALES

P.O. Box 1009 Blaine Wash. 98230

(Washington State Residents add 5% Sales Tax)

Please Rush me a KDK-144. Enclosed is a cheque

money order for \$399. (plus sales tax if applicable)

NAME:

ADDRESS:

ZIP:

H-1-5

March 1968 (first issue)

FEATURING: 5-band SSB exciter, IC-regulated power supply, Remotely-tuned 10-meter beam, Transistor curve tracer, Double-balanced mixers.

May 1969

FEATURING: Potpourri of integrated-circuit applications, FM repeater receiver performance, RTTY converter, IC noise blanker, The ionospheric e-layer.

August 1969

FEATURING: Homebrew Parabolic Reflector, Solid-state Q-5er, Frequency calibrator with mos IC's, New multiband quad antenna, Troubleshooting with a scope.

September 1969

FEATURING: FM techniques and practices, IC power supplies, 1296-MHz varactor tripler, Tunable bandpass filters, Amateur microwave standards.

October 1969

FEATURING: Hot Carrier Diodes, Low-cost linear IC's, Diversity antennas, solid-state 432-MHz exciter, Tropospheric duct communications.

November 1969

FEATURING: Op Amps theory, selection & application, WWV receiver, Multiband antenna, Electronic key, Six-meter collinear.



December 1972

FEATURING: Satellite communications, UHF swr bridge, RTTY monitor, receiver, FM channel elements, helical mobile antenna.

January 1973

FEATURING: Matching networks, digital readout VFO, fm repeater recoder, six-meter preamp, tuneable phase locked loop.

February 1973

FEATURING: Communications receiver design, rf speech clipper, fm receiver scanner, Plessey SL600 integrated circuits, solid-state noise blanker.

March 1973

FEATURING: Solid-state 80-meter transceiver, reciprocating-detector receiver, AFSK generator, electronic keyers, mobile touch-tone.

June 1973

FEATURING: Digital RTTY autostart, fm repeater installation, micropower receiver, broadband amplifiers, logic oscillators.

July 1973

FEATURING: SSTV test generator, carrier operated relay, VHF receiver, two-meter frequency synthesizer, antenna matching.

June 1971

FEATURING: A practical approach to 432-MHz SSB, FM carrier-operated relay, Audio agc systems, Practical IC's, Low-noise 1296-MHz preamp.

June 1972

FEATURING: 5 Band solid-state communications receiver, FM repeater control, SSTV synch generator, microwave experimenting.

August 1972

FEATURING: Frequency synthesizer for Drake R-4, 2304 MHz preamp, audio filters, RTTY Monitor scope, mobile touch-tone.

October 1972

FEATURING: 4 channel spectrum analyzer, HF frequency synthesizer, all-band dipole, 160 meter vertical, multi-function IC's.

HAM RADIO BINDERS

Collector's items deserve the best protection you can give them, and we know of no better than our handsome Ham Radio Binders. Bound in washable buckram and supplied with year labels to identify each volume. Each binder holds 12 issues.

\$5.00 each 3 for \$13.50

HAM RADIO BOUND VOLUMES

Here is a handsome addition to your library. Twelve issues (a full year) of Ham Radio bound into a rugged, good looking, hard cover book. Certainly the most deluxe way to collect Ham Radio and perhaps the only way to acquire some out of print back issues. Years 1971, 1972, 1973 and 1974 available.

\$14.95 each

There's no place like a good collection of HAM RADIO back issues to find answers you're looking for. Go over the list above and find the ones you need.

- March 1968 (first issue)
- May 1969
- August 1969
- September 1969
- October 1969
- November 1969
- June 1971
- June 1972
- August 1972
- October 1972
- December 1972
- January 1973
- February 1973
- March 1973
- June 1973
- July 1973

Just \$1.00 each ppd.

Binders \$5.00 each 3 for \$13.50

Bound Volumes \$14.95 Specify year(s)



Enclosed is for
the items I have checked.

GREENVILLE, NH 03048

Name..... Call.....

Address.....

City.....

State..... Zip.....

FROM MURCH ELECTRONICS the UT2000A

THE ULTIMATE TRANSMATCH

MULTIBAND ANTENNA 10 - 80 M



Similar to the one in Lew McCoy's article
July 1970 QST also 1972 Handbook

- Use with any coax or end fed random wire antenna, ideal for apartment dwellers
- 2 kW P.E.P. (1 kW continuous) 1:1 SWR to transmitter
- 10-80 continuous, including MARS
- Use with any wattmeter or SWR indicator
- Heavy duty throughout (4000 volt capacitors)
- Rotary Inductor with turns counter
12" w 12" d x 5 1/2 h, 12 lbs shipping weight
- Field Proven 4 years
- Sealed center insulator, 102 ft. wire, 30 feet heavy duty twin lead
- Coax fitting to connect twin lead to 52 ohm transmission line (68 feet or more, not included)
- Ready to use. Great on all bands without a transmatch. Even better with the Ultimate Transmatch

MODEL UT-2000A

New price effective August 1, 1974
\$139.95 FOB

MODEL 68A, 2000 w P.E.P.

\$44.50 p.p.

MURCH ELECTRONICS INC.

Box 35 Franklin Maine 04634

Phone 207-565-3312

NEW!

500 MHZ COUNTER



* HIGH SENSITIVITY:

50 mv 10 Hz to 50 Mhz
150 mv 50 Mhz to 500 Mhz

* HIGH ACCURACY:

SEVEN DIGIT LED DISPLAY
.0001% TEMP COMPENSATED TIME BASE
RESOLUTION: 0.1 Hz at 1 Mhz
100 Hz at 500 Mhz

ONLY \$525.00

* FULLY PORTABLE

BUILT IN NiCad BATTERY PACK

Using the latest LSI technology the new UHF 500 B counter offers all of the performance of units costing up to \$1600. Capable of measuring PL frequencies on up through 500 Mhz (minimum, typical 525 Mhz) it answers the needs of the amateur for a superior quality counter at a reasonable price. Write for complete data.

500 Mhz prescalers available
from \$89.00

LEVY ASSOCIATES

PO BOX 961 R
TEMPLE CITY, CALIF 91780

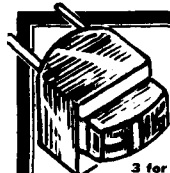

SEE-THRU
MINI.....
S-METER
Only
3 for \$3 \$1.49

Mini sized meter. 1/2 x 3/4" indication with RED and BLACK face. Red indicating needle.

WRISTWATCH
LIQUID
CRYSTAL
DISPLAY



3 1/2 digit, 7-segment only 1 1/16 x 1 1/16 x 1 1/4". Includes readout, pocket, "slide-in-place chrome slide face plate". Same display as found in \$200. units.



"BLASTAWAY"
ON IN4000
RECTIFIER PRICES

Type	PIV	Sale
IN4001	50 10 for 45c	
IN4002	100 10 for 55c	
IN4003	200 10 for 65c	
IN4004	400 10 for 75c	
IN4005	600 10 for 85c	
IN4006	800 10 for 95c	
IN4007	1000 10 for 1.25	

Sanken Watts Sale
SI-1010G 10 \$ 8.88
SI-1020G 20 14.95
SI-1030G 30 18.88
SI-1050G 50 29.95

SANKEN HYBRID
AUDIO POWER AMPS
All amplifiers, flat within 1/2 db from
hz to 100,000. Each unit properly heat-sinked, with
heavy-duty connecting tie lug connections. Single-ended
pushpull output. Power supply required 24VDC.
Output to 8 ohms. Order by Stock No.

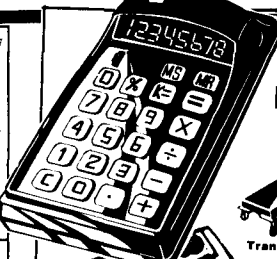

IT'S NEW! NEVER OFFERED BEFORE!
9-FUNCTION, 8-DIGIT
MEMORY CALCULATOR KIT

It's the easiest multi-function kit today!

* DOUBLE MEMORY
* Percent, Constant,
Display Restore
* 4-Function
Arithmetic
* 22 KEYS!
Only
\$26.95

EASY TO PUT TOGETHER! You bet it is... imagine 2
no resistors, capacitors, but it ONLY requires 2
CHIPS and a READOUT! How's that for simplicity? The
2 Memory keys are MS Memory Storage and MR
Memory Recall (requires very little soldering). The
display restore key is to conserve battery life. Your
operation. By depressing "D" key, the display is
restored! Uses 6 N cell batteries. Red decimal appears
on left to show when batteries need replacement or
arithmetic Has Decimal, Clear, Constant, Percent, and
pocket size 5 1/4 x 3 x (2 1/4" back side) x 1 1/4"
front side of angular display panel. h.c. case. Nifty
unit for business, school, home, and for the outdoors.
Slips into any pocket, briefcase with ease. Easy-to-
use and pictorial instruction booklet and how-to-
use-book.

Kit includes: case, 22-key keyboard kit, ON-OFF
switch (part of keyboard), PC board, driver and memory
calculator chips, 9-digit "bubble" magnifier LED array,
array cable, AC adapter jack & wires, battery case, 6
battery card display, instruction and pictorial step-by-
step construction booklet.
* AC ADAPTER FOR ABOVE \$2.95

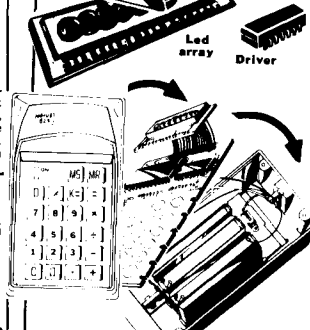

555 Timer

OR
Dual 741
558
2 for \$1
Sale good till
July 15, 1975

NATIONAL
LM-340T VR's
Buy 3 - Take 10%
Type Volts
LM-340-05T 5 v
LM-340-08T 8 v
LM-340-08T 8 v
LM-340-12T 12 v
LM-340-15T 15 v
LM-340-18T 18 v
LM-340-24T 24 v
1.75 Each

'ALL LED' MONSANTO READOUTS
*36 LED matrix

MONSANTO TYPE	CHAR. HT.	EA. CH	Quantity Discounts
MAN-1	.27	\$2.95	3 for \$ 7.
MAN-2	.32	4.95	3 for \$14.
MAN-3	.12	1.00	3 for \$2.80



OPCOA SLA-1
REFLECTIVE LED READOUT 3 for \$ 6.
Red \$2.50
Yellow Litronix 707
Green Red \$2.50



Touch Keyboard Kit \$4.95
Kit includes 4 x 2 1/2" G-10 glass etched pc board
with 10 OAK "smooth touch" white keys with black
numerals, plus diagram on "touch tone encoder". Makes
many "keyboard systems" readily available.

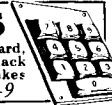

Imagine a chip (MK50250) "Beeper" and audible alarm!
All others are external. It also features internal bright-
ness control. The CT7001 requires external triggering
of alarm, date of the month and direct drive to LED
readouts. Both require minimum current drain and
voltages, for either 4 to 6 LED readouts, 12 or 24
hours, AM and PM.

'BEEPER' AND "DATER"
CLOCK ON THE CHIPS
MK50250 BEEPER ONLY \$ 8.50
CT7001 Alarm and Date. \$ 6.95



SCRs! TRIACS!
QUADRACS!
SAME PRICE
SALE!
10-Amp Power
Tab Plastic Units

CLOCK CHIPS
ON A "DIP" as Low as 3.95

WITH DATA SHEETS	PRICE
MMS311 6-digit 28-Pin	\$5.50
MMS312 4-digit 24-Pin	5.50
MMS313 6-digit 28-Pin	5.50
MMS314 6-digit 24-Pin	5.50
MMS316 4-digit 40-Pin, alarm	5.50
MMS316-A no alarm	3.95

PRV	Sale
50	\$.75
100	.95
200	1.25
300	1.50
400	1.75
500	2.25
600	2.50

Inflation-Fighting
IC PRICES

Type	Sale	Type	Sale	Type	Sale
SN7400	.22	SN7443	1.00	SN74163	1.75
SN7401	.22	SN7444	1.00	SN74164	2.85
SN7402	.22	SN7445	1.00	SN74165	2.85
SN7403	.22	SN7446	1.10	SN74166	1.85
SN7404	.27	SN7447	1.10	SN74174	2.25
SN7405	.24	SN7448	1.45	SN74175	1.99
SN7406	.79	SN7450	.27	SN74176	1.25
SN7408	.27	SN7451	.28	SN74177	1.25
SN7409	.27	SN7453	.28	SN74180	1.10
SN7410	.19	SN7455	.28	SN74181	3.95
SN7411	.31	SN7462	.39	SN74182	1.05
SN7413	.89	SN7464	.39	SN74190	1.49
SN7414	2.25	SN7471	.55	SN74192	1.59
SN7415	.45	SN7472	.42	SN74193	1.59
SN7416	.45	SN7474	.39	SN74195	1.10
SN7417	.50	SN7475	.91	SN74197	1.10
SN7420	.22	SN7476	.52	SN74198	2.45
SN7422	.29	SN7477	.52	SN74199	2.45
SN7423	.39	SN7478	.79	SN74198	2.45
SN7425	.35	SN7480	.59	SN74199	2.45
SN7426	.31	SN7475	.91	SN74200	7.50
SN7427	.35	SN7476	.52		
SN7430	.24	SN7477	.52		
SN7432	.28	SN7478	.79		
SN7437	.45	SN7479	.79		
SN7438	.45	SN7480	.59		
SN7440	.49	SN7481	1.25		
SN7442	1.00	SN7482	.99		
		SN7483	1.19		
		SN7484	1.29		
		SN7485	1.29		
		SN7486	1.45		
		SN7487	1.45		
		SN7488	1.45		
		SN7489	1.45		
		SN7490	1.45		
		SN7491	1.45		
		SN7492	1.45		
		SN7493	1.45		
		SN7494	1.45		
		SN7495	1.45		
		SN7496	1.45		
		SN7497	1.45		
		SN7498	1.45		
		SN7499	1.45		

FULL EPOXY SILICON BRIDGE RECTIFIERS
WAVE PIV 2 Amp 6 Amp 10 AMP
50 \$.69 \$.88 \$ 1.49
100 .79 .99 1.69
200 .95 1.25 1.89
400 1.15 1.50 2.09
600 1.35 1.75
800 1.59 1.95
1000 1.79 2.25
6 Amp 1/2 x 1/2 x 3/16 sq.
Code: 2 amp
TO-6 case

BIGGEST
MAN-7
SALE
\$1 \$2.50
7-segment "reflective bar"
version of the famous
MAN-1. Minimum in a
light efficiency and con-
struction. Looks like, acts
like, the MAN-1. Pin con-
nections same. Wide angle
viewing. 0.27" character
height, color red.

MAN-5 as MAN-7 except green \$ 1.49
MAN-8 as MAN-7 except yellow \$ 1.49

Terms: add postage Rated: net 30
Phone Orders: Wakefield, Mass. (617) 245-3829
Retail: 16-18 Del Carmine St., Wakefield, Mass.
(off Water Street) C.O.D.'S MAY BE PHONED

20c CATALOG Fiber Optics, IC's, Sem's, Parts
MINIMUM ORDER — \$4.00

POLY PAKS
P.O. BOX 942 H LYNNFIELD, MASS. 01840

flea market



■ **RATES** Commercial Ads 35¢ per word; non-commercial ads 10¢ per word payable in advance. No cash discounts or agency commissions allowed.

■ **COPY** No special layout or arrangements available. Material should be typewritten or clearly printed and must include full name and address. We reserve the right to reject unsuitable copy. **Ham Radio** can not check out each advertiser and thus cannot be held responsible for claims made. Liability for correctness of material limited to corrected ad in next available issue. Deadline is 15th of second preceding month.

■ **SEND MATERIAL TO:** Flea Market, Ham Radio, Greenville, N. H. 03048.

THE CALGARY CENTENNIAL AMATEUR RADIO CONVENTION will be held on August 1-2-3, 1975. For further information write immediately to '75 Convention, Box 592, Calgary, Alberta T2P 2J2.

ROCHESTER, N. Y. — Western New York Hamfest date is Saturday, May 31st, at the Monroe County Fairgrounds. Hotel headquarters is the Rochester Marriott. FCC exams at the Hamfest. Information? Write: WNY Hamfest, Box 1388, Rochester, N. Y. 14603.

HAMFEST, Manassas, Virginia, Sunday, June 8, 1975. Prince William County Fairground, 1/2 mile south of Manassas on Rt. 234. Grand stand prize drawings; parking for 1000+ cars, hard standing for 200+; flea market spaces; indoor and outdoor exhibit bldgs.; refreshments on grounds. Door Prizes: 1st - \$100.00, 2nd - \$50.00, 3rd - \$25.00 and many merchandise prizes! Several special activities: 2 YL programs, ECARS, FM clinic, Others. Tailgating \$2.00. Dealers & manufacturers write for exhibit space reservations. Advance Registration \$1.50, \$2.50 at gate. Under 12 no charge. For tickets write, Ole Virginia Hams A.R.C., Inc. c/o Tim Wayne, WA4GVX, 1708 Sharp Drive, Woodbridge, Virginia 22191.

QSL'S — BROWNIE W3CJI — 3035B Lehigh, Allentown, Pa. 18103. Samples with cut catalog 35¢.

WI9NDY will operate 1400 to 2100 GMT, May 25, 1975, the day of the 1975 500 Mile Race. The primary frequencies will be 3.905, 7.275, 14.295, SSB and 146.52 FM. During the course of the operation, the following frequencies will also be operated: 7.015 CW, 21.355, 28.505, 50.105 SSB; 52.525, 146.94 FM. A special commemorative QSL will be issued. QSL to: Red Cross Radio Club, 441 East Tenth Street, Indianapolis, Indiana 46202.

TELETYPE EQUIPMENT FOR SALE for beginners and experienced operators. RTTY machines, parts, gears. Send us a list of your teletype needs. Atlantic Surplus Sales Co., 1902 Mermaid Ave., Brooklyn, New York 11224. Call us first (212) 266-2629.

ZL2MHF 28.170 MHz BEACON. Now in operation as part of the RSGB World Wide 10 m Beacon network with F1 call sign given about every 10 seconds. Power input: 90 watts. Reports to: The Secretary, N.Z.A.R.T. Upper Hutt Branch 63 Inc., P. O. Box 40212, Upper Hutt, New Zealand. Operation is continuous.

SELL: Need money for summer school. Clegg Interceptor V.H.F. Receiver, \$195. Motorola T53GKT, \$100. Model 28KSR, \$250. E. Wagner, 1018 Birch Haven Cir., Monona, Wis. 53716.

CHICAGO HAMFEST. Six Meter Club of Chicago Inc., 18th Annual Picnic and Hamfest, Sunday, June 8, 1975 at Santa Fe Park, 91st Street and Wolf Road in Willow Springs, Illinois. Food and drinks available, Swap and Shop section (manufacturers also invited). Advance registration, \$1.50, admission at gate \$2.00. For further information and advance tickets, contact Val Hellwig, K9ZWW, 3420 S. 60th Court, Cicero, Illinois 60650.

EVANSVILLE TRI-STATE ARS will hold their annual hamfest on May 18, 1975 at the 4-H fairgrounds, US41, 3 miles north of town. Overnight camping, auction, flea market, door prizes, and ladies bingo. For information contact Jay, WB9ICL, R#1, Box 56M, Wadesville, In. 47638.

POTOMAC AREA VHF SOCIETY annual hamfest on Sunday, May 4, 1975 at the Agricultural Center in Westminster, Maryland between the hours of 9 a.m. to 5 p.m. There will be a registration of \$3. Talk-in will be on 146.94 & 52. For information contact K3DUA or WA3NZL.

POLICE CALL. A complete listing including frequency and location of VHF-UHF public service stations. Nine volumes cover the whole USA. Order the volume for your state. Only \$4.95 plus 25¢ shipping. HAM RADIO, Greenville, N.H. 03048.

DURHAM, NORTH CAROLINA F.M. Association Hamfest, weekend of May 17 and 18, 1975. Write WA4DXN for details.

YAESU FT-101 OWNERS — VOX hang-up problems? Get special April 1975 issue of monthly FT Newsletter. Send dollar bill, creditable towards dues if you join the International Fox-Tango Club. Or business-size SASE for complete information. Milt Lowens, WA2AQ, 3977-F Sedgwick Ave., Bronx, N. Y. 10463.

ALL-ELECTRONIC FLEA MARKET AND AUCTION sponsored by LIMARC, on Sunday, June 1st (rain date June 22) from 10 a.m. to 6 p.m. at the New York Institute of Technology at Route 25 A and Whitney Lane, Old Westbury, N. Y. Auction at 4 p.m. Items to be sold include communications equipment, hi-fi, TV, components, test equipment, etc. Admission \$1 for buyers and \$2 for sellers. Call in 25/85. Refreshments available. Ed Piller, W2KPO, Publicity Chairman, 80 Birchwood Park Drive, Syosset, N. Y. 11791. (516) 938-5661.

NEW CANADIAN MAGAZINE. "Electronics Work Shop". \$5.00 yearly, sample \$1.00. ETCOB, Box 741, Montreal, H3C 2V2.

BIRMINGHAMFEST CONVENTION, Saturday, May 3rd at 1:00 p.m. and Sunday, May 4th at 7:30 a.m. More info from WB4JOY.

TRADE OR SELL: 4CX5000A's used, other transmitting tubes, 6M converters, 2M antennas, other gear. Antique tubes, etc. Want digital DIP IC's, RAM's, ROM's, etc. SASE for list. Len, C2CDS, 383 Pittsburgh Ave., Massapequa Park, N. Y. 11762.

THE 3rd ANNUAL DES MOINES HAWKEYE HAM FEST will be held on Sunday, June 8, 1975 at the Iowa State Fairgrounds. Plenty of free parking. Flea market, covered display booths available, small charge; open arena, no charge. Dealer displays, prizes, XYL activities. Camping available, small charge. Registration \$1.50 advance/\$2.00 at gate. Write Des Moines Radio Amateur Association, Box 88, Des Moines, Iowa 50301.

TRAVEL-PAK QSL KIT — Send call and 25¢; receive your call sample kit in return. Samco, Box 203, Wynantskill, N. Y. 12198.

TELL YOUR FRIENDS about Ham Radio Magazine.

Antennas TA-33, TA-36, TH6-DXX, etc.

Savoy DGA-2M, 2 meter collinear	\$29.95
Trunk lip bracket for DGA-2M	\$14.95
HyGain 1/4 wave 2M grd plane	\$13.00
Hustler 4 BTV Vertical Antenna	\$79.95
HyGain 18V 10-80 m. vertical	\$33.00
HyGain BN86 Deluxe Balun	\$15.95
HyGain 18 AVT/WB 10-80 meters vertical	\$97.00
Newtronics CGT-144 5.2 dB gain, Trunk lip mount	\$39.95
Newtronics G6-144A fixed station antenna 6dB gain	\$52.00
Gold Line Single Pole, 5 position coaxial switch, wall bracket or panel mount, 1 KW AM	\$17.95
Times Wire & Cable, T-4-50, RG-8 foam	28¢/ft.

Bird

We are official distributors for Bird Wattmeters and elements.

C.D. Ham II Rotator

New Improved \$159.95 net **\$139.95**
SAVE \$20

CD-44	\$99.95
8 conductor cable for HAM II or CD-44	16¢/ft.
IC-230	In Stock now. Call or write!
Drake — Most in stock for immediate shipment.	
Collins Model 180-S1 Kilowatt Antenna Tuner. 3 to 30 MHz w/vac. variable, reg. \$750. Sale \$295.00	
Johnson small matchbox, Nye small matchbox and Millen KW Transmatch.	
Astatic D-104 Mike	new \$26.10
Astatic UG-8 Stand for D-104	new \$19.95
B & W 850A or 852 for PiNet Band switching inductor for	\$66.75
B & W 334A Dummy Load-Wattmeter 0-300MHz 52Ω, 0-10, 100, 300, 1000 watts	\$149.95
B & W 374 Dummy Load-Wattmeter 0-300MHz, 52Ω 0-15, 50, 300, 1500 watts	\$175.00

BARRY 512 Broadway NY, NY 10012

DEPT. H-5
212-WA-5-7000

ELECTRONICS

TELEX 12-7670

Add shipping-excess refunded-Quoted FOB N.Y.C.

Sockets for 8072, 8121, 8122	\$3.95
MC Jones Mod. 575.5 Micro Match SWR bridge, N Connectors. Use with 200 μa meter. New value \$100.00	\$24.95
Johnson 154-10 or equal. Single section 23 thru 347 pF for KW transmatch. Replaces Millen 16520	\$35.00
Johnson 229-202 18 mH variable inductor 10 to 80M for KW transmatch	\$35.00
Johnson 229-203 28 mH variable inductor 10 to 160M for KW transmatch	\$37.00
EBC Jr.-2 meter FM synthesized XCVR	\$599.00
B & W Minductors - Air-Dux coil stock	
Kenwood TS-520	\$629.00

Stocking TEN-TEC — Fast Availability!
Clegg FM-27B and other Clegg products in stock.

Finest SSTV **VENUS** Latest Models Ready to Operate
SS-2, SLOW SCAN MONITOR \$349.00
C1, FAST SCAN/SLOW SCAN CAMERA & CONVERTER \$469.00

NPX POWER SUPPLIES

115 VAC Input - 12 VDC 4 amps out	\$29.95
Same as above but regulated	\$47.95
Model 108R — 115 VAC/13.6 VDC 8 amps continuous 12 amps surge. Regulated	\$63.95

CONSTANT VOLTAGE TRANSFORMER. Input 115 VAC @ 60Hz output, 24V @ 15 amps \$14.95 ea. Call Barry for thousands of unadvertised specials
Hammarlund Dual Section 320/320 per section Xmit'g Capacitor \$24.95 |

NEW ARRIVALS: Heath SB-620, Delta OIB-1 Impedance Bridge, Tempo CL146, Standard SR-C826M.

Tubes for worldwide and domestic, commercial service. Large stocks of meters and capacitors.
BARRY BUYS UNUSED TUBES — Send Your List. Tube Headquarters. Diversified Stock. Heavy Inventory of Eimac tubes, chimneys, sockets, etc. 3-500Z or 3-400Z
Specify \$50.00

a NEW antenna principle

PROVEN IN EXACTING TESTS AND MANY YEARS ON THE AIR AT W0MBH — K0AST — K8VRM

THE *Little* GIANT BEAM ANTENNA

only 27 inches high
by 22 inches wide

A COMPLETELY NEW ANTENNA

Here is an ultra compact beam antenna which can be tuned to any frequency between 7.0 and 14.5 MHz. Weighing only 18 lbs. this antenna may not outperform a full sized beam but it sure will give you your share of DX and state-side contacts. Will handle 1 KW over a 100 kHz bandwidth.

- Fully weather proof
- Hi-Q, attenuates harmonics
- Mounts easily on TV masting
- Comes assembled & tested
- Figure 8 pattern

LITTLE GIANT MODEL 100X1000-40 **\$149.50**

Other models available for 10, 15 & 20 meters Add \$3 trans.

Little Giant Antenna Labs, Box 245, Vaughnsville, Ohio 45893

Subsidiary "Apollo Products" Village-Twig Co.

419-646-3495



RTTY VIDEO DISPLAY UNIT

1000 CHARACTERS—ANY TV SET
VIDIATYPE
MODEL 872 \$550
WRITE FOR BROCHURE

LELAND ASSOCIATES
18704 GLASTONBURY RD.
DETROIT, MI. 48219

VHF/UHF

**CONVERTERS
PREAMPS**

Ten meters through 432 MHz. A post card will bring our full 1974 Catalog.



JANEL laboratories

BOX 112, SUCCASUNNA, NJ 07876
Telephone: 201 584 6521

PHOTOSTAMPS make your QSL's, letters, business cards distinctive and unique — Put your face where your name is! Your photo on sheet of 100 stamps gummed, perforated, guaranteed. Quick! Send your photo and \$3.00 to: Kendall Baker, 5342 LaLuna, LaPalma, CA 90620.

WANTED: CRYPTOGRAPHY manuals, books, devices. WN2TSD, 17 Alfred Road, Merrick, New York 11566.

THE JACKSONVILLE AREA AMATEUR RADIO CLUB will hold their 11th Annual Hamfest, Sunday, June 29, 1975 at the Morgan County Fairgrounds as in previous years. A large trading area available for rain or shine. Talk-in via WR9ACS, 16/.76 and .94 direct.

MOBILE IGNITION SHIELDING provides more range with no noise. Available most engines in assembled or kit forms, plus many other suppression accessories. Free literature. Estes Engineering, 930 Marine Dr., Port Angeles, WA. 98362.

FOR SALE, 30 crystals, all for 40 meters, 7023 thru 7034 and 7050, 7052, 7075, 7077, 7085, 7088, 7090, 7095, 7101 plus a few Novice crystals. \$3.00 each. Don't need as I now have a vfo. Call me on 7075 kHz at 0200 GMT on Saturday nights. Gayle Sabonaitis, WA10PN.

RADIO LICENSE — Exact reproduction, including signature. Engraved in solid brass. Send GOOD Xerox copy, with \$5.00, to Metal Art Graphics, 1136 Potomac Ave., Hagerstown, Md. 21740. Md. residents please include state sales tax.

INDIANAPOLIS HAMFEST, Sunday, July 13, 1975. Marion County Fairgrounds. Admission \$2.00 per person, children under 12 years, free. Forums all day, ladies' and children's activities. Good food, free coffee and donuts until 10:00 a.m. Inside flea market \$2.00 with vehicle, free without vehicle. Free outside flea market. Commercial booth available, \$25.00. For information or tickets write: Indianapolis Hamfest Association, Inc., P. O. Box 1002, Indianapolis, Indiana 46206.

CLEGG, SWAN, CUSHCRAFT at prices I dare not publish. Call or write W0NGS, Bob Smith Electronics, 1226 9th Ave. North, Fort Dodge, Iowa 50501. (515) 576-3886.

TRANSISTOR REGULATED one ampere DC supply. 1-13.8 volts adjustable. Handsome styling with large voltmeter. \$29.95. Send S.A.S.E. for information. C.O.D.'s send \$5.00 deposit. E-Z Sales, Inc., 2050 Fairfield Ave., Bridgeport, Connecticut 06605.

COMING TO FLORIDA? Use our Club station or your own rig and our all-band antennas to work DX or your home town. All hams welcome. Details — H. E. Saxton, W4QED, c/o Spanish River Inn, Delray Beach, Fla. 33444.

MONTREAL HAMFEST 75, Aug. 3. MacDonald College Farm, Ste. Anne de Bellevue. Prizes, giant flea market, technical sessions, family fun \$2.50/adult. Info contact — Montreal Hamfest, Box 201, Pointe Claire-Dorval, Quebec H9R 4N9.

QSLs. SECOND TO NONE. Same day service. Samples airmailed 25¢. Include your call for free decal. Ray, K7HLR, Box 331, Clearfield, Utah 84015.

YAESU FT-101 OWNERS — Want to boost both receiver sensitivity/selectivity and transmitter talk-power by 5 to 10dB? Send a dollar for February 1975 issue of monthly FT Newsletter. Creditable towards dues if you join the International Fox-Tango Club. Or send business-size SASE or two IRCs for complete club information. Milt Lowens, WA2AOQ, 3977-F Sedgwick Ave., Bronx, N. Y. 10463.

PRINTED CIRCUIT TECHNIQUES for the hobbyist. Booklet: \$2.00. H. S. steel and carbide drill bits and PC artwork. Send SASE for flyer. Trumbull, 833 Baira Dr., El Cerrito, Ca. 94530.

HEAT SINKS: IERC Beryllium copper types for TO-5 & TO-18 transistors. Special — 10 assorted — \$1.00, postpaid. CPO Surplus, Box 189, Braintree, Ma. 02184.

HP-5103A SYNTHESIZER, \$2500/offer. Collins 30S-1, \$895. Tektronix 531A, \$375. WA6FAD, 528 Bonita, Pleasanton, California 94566 (1-415-846-1459).

AMSAT

*The team
that brought
us OSCAR 7.*



The Radio Amateur Satellite Corporation (AMSAT) is a non-profit, tax-exempt organization founded in the greater Washington, D. C. area five years ago. It is a membership organization open to all radio amateurs and interested non-amateurs. AMSAT's satellite programs are supported entirely from donations, membership dues, and grants.

Join AMSAT. Learn more about how you can participate with the exciting AMSAT-OSCAR 6 communications satellite, and with OSCAR 7 which promises to be even better! Receive the quarterly AMSAT Newsletter with the latest information on this new ham radio frontier. For membership information, write the Membership Committee, AMSAT, P. O. Box 27, Washington, D. C. 20044.

525 MHz UHF PRESCALER

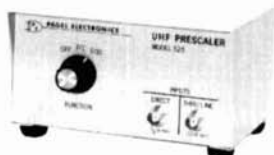

Divides any frequency between 25 MHz and 525 MHz by ten to allow a 50 MHz counter to measure frequency in the UHF bands. Sensitivity is better than 50 millivolts at 500 MHz. Also includes a built-in 20dB preamp for frequencies between 1 MHz and 50 MHz to give extra gain for measuring oscillators. A thru-line sampler allows direct connection of transmitters up to 100 watts. Operates on 8 to 15 volts DC or AC line. Add \$2.00 for shipping in cont. U.S.

UHF PRESCALER . . . \$159.00



6742-C TAMPA AVENUE / RESEDA, CALIFORNIA / 91335

(213) 342-2714 (213) 345-1833

WANTED

MILITARY SURPLUS ARC-51BX, ARC-94, ARC-102, ARC-131, ARC-134, 618T, 807A, TRANSCEIVERS. ARN-82, ARN-83, 51R-8A, 51Y-4A RECEIVERS. 490T, CU1658, CU1669 ANTENNA COUPLERS. ALSO CONTROL HEADS FOR ABOVE. TOP DOLLAR PAID OR TRADE FOR NEW HAM GEAR. WRITE OR PHONE BILL SLEP (704)524-7519.

SLEP ELECTRONICS  CO.

P. O. BOX 100, HIGHWAY 441, DEPT. HR
OTTO, NORTH CAROLINA 28763

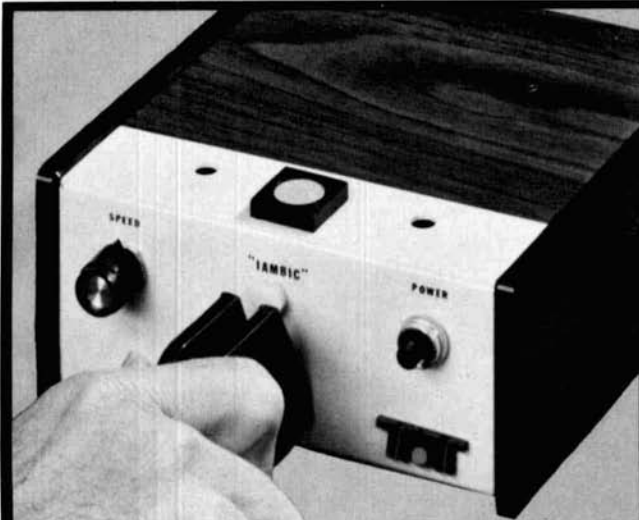

Soft Touch

A smooth rhythmic feel—a slight but definite "break"—these are among the highly desirable features that make the operation of a Ten-Tec keyer a delightful experience. The KR50 paddle suspension employs ball bearings and adjustable electromagnetic forces to achieve the unique "soft touch" that means smoother, more articulate and relaxing QSOs for you. Write for details.

KR5-A

Single paddle straight keyer. Self-completing characters. Pre-set weighting. Over-ride touch switch. Excellent "feel". 6 to 14 volts, DC.

PRICE \$38.50

KR20-A

Same as KR5-A but with built-in monitor oscillator and AC power supply. Decorator style case. 117 VAC or 6 to 14 VDC.

PRICE \$67.50

KR50

Top-of-the-line iambic squeeze keyer. Full dit and dah memories, defeatable. Automatic weight correction vs speed. Over-ride touch switch and monitor oscillator. 117 VAC or 6 to 14 VDC.

PRICE \$110.00

TEN-TEC
INCORPORATED
SEVIERVILLE, TENNESSEE 37862

DIPOLE ANTENNA CONNECTOR



HYE-QUE (HQ-1) dipole connector has coax SO-239 socket molded into glass filled plastic body to accept coax PL-259 plug on feedline. Drip-cap keeps coax fittings dry. Instructions included. Guaranteed. At your dealers or \$3.95 postpaid. Companion insulators 2/\$.99.

BUDWIG MFG. Co. PO Box 97H, Ramona, CA 92065

NEW

SCANADAPTOR

NEW

Update your Regency HR-2A, 2B to scan 6 channels. Wired and tested with instructions for simple installation. New front panel with LEDs. Use your present crystals, no modification to set. Everything fits inside.

\$49.95 pp. complete

ElectroLogic
INCORPORATED

ROUTE 3, BOX 75, LEXINGTON, S. C. 29072

Webster
radio

Everything from Set to Signal!

2802 E. Ashlan Write for catalog
Fresno, Calif. 93728 Phone (209) 224-5111



FT101B Yaesu
\$649.00

RTTY

- Phase-lock loop RTTY PC boards
 - Phase-continuous afsk PC boards
- AOK for Oscar 7 telemetry send S.A.S.E. for info.

DIGICOM

22 Hartshorn Ave., Worcester, Mass. 01602

QUALITY, VALUE, INTEGRITY,
VARIETY AND FAST PPD. DELIVERY.

WANT SOME? Try TRI-TEK



10¢ Stamp For Latest Flyers Full of New and Surplus Electronics Bargains.

Tri-Tek, Inc. Box 14206, Phoenix, Az. 85063
Store Location: 6522 N. 43rd Ave., Glendale, Az.

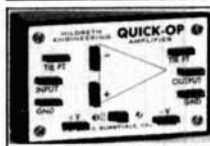

HILDRETH ENGG.

Experiment with Op-Amps the easy way. Contains 741C Op Amp, Solderless-connectors, Switch,

\$14.95 POSTPAID. ADD \$1.00 TO INCLUDE BATTERIES P.O.

Cal Residents 5% Tax **QUICK-OP** BOX 3 Sunnyvale Cal 94088

SPACE SAVER TOWERS & MASTS

CZ series towers, cranks up, installs without guy wires. New lacing design creates greater strength. Mini and Magna rotating masts . . . high strength galvanized tubing, self supporting crank-up.

For complete details and prices please check your local dealer or write Certified Welders L.A. City License #634

TRISTAO TOWER CO.
P.O. Box 115, Hanford, California 93230

NEW YORK CITY Second Annual Hall of Science Radio Club Auction Flea Market, Saturday, June 7 at World's Fair Grounds, Flushing, L. I. No sellers commission but 10% fee on auctioned items. Admission \$2.00. Zoo, boating, children's farm, art and science museums adjacent. Field Day goodies galore. Box 1032, Flushing, 11352.

HYDROPONICS for XYL while QRL — Build yourself garden components, books, nutrients. 5-page catalog, send 40¢; refundable. Incorporated 1971. BURWELL GEOPONICS, Box 125-EB, Rancho Sanfe, CA 92067.

DO-IT-URSELF EXPEDITION — Stay at ZF1SB — Cayman Is. Vertical antenna and Caribbean at your doorstep. Diving/fishing if band folds. Write Spanish Bay Reef Resort, Box 800K, Grand Cayman, B. W. I.

MANUALS for Govt. surplus gear, only \$6.50 each: URM-25D, R-220/URR, SP-600JX, TT-63A/FGC, TS-497B/URR, R-274/FRR, TS-382D/U, ALR-5, URM-32, TS-173/UR, TS-174/U, TS-175/U, BC-779B, TS-34A/AP, CV-591A/URR, TS-413A/U, SG-3/U, TS-452B/U, LM-21, PRC-10, BC-639A, LP-5, OS-8B/U, OS-8A/U, OS-8C/U, BC-348JNQ, TV-2/U, OS-46/U, CV-278/GR. Immediate delivery. Thousands more in stock for radar, teletype, test sets, scopes, receivers, transmitters. Send 50¢ (coin) for 20-page catalog. W3IHD, 7218 Roanne Drive, Washington, D. C. 20021.

TELETYPEWRITERS — Kleinschmidt — portable, fixed, sets, punches, parts, reconditioned, reasonable. Mark/Space Systems, 3563 Conquista, Long Beach, Calif. 90808. 213-429-5821.

FIGHT TVI with the RSO Low Pass Filter. For brochure write: Taylor Communications Manufacturing Company, Box 126, Agincourt, Ontario, Canada. MIS 3B4.

KLM, BRIMSTONE 144, Regency and Bearcat scanners. Receive discount when you mention Ham Radio ad. Narwid Electronics, 61 Bellot Rd., Ringwood, N. J. 07456. 201-962-4695.

SURPLUS TEST EQUIPMENT, VHF and microwave gear; write for bulletins. David Edsall, 2843 St. Paul, Baltimore, Md. 21218.

EASTERN SHORE OF MARYLAND HAMFEST — sponsored by The Easton Amateur Radio Club on June 8th, 1975 from 10 a.m.-4 p.m. rain or shine. Only 35 minutes south of the Bay Bridge, one block off Rt. 50, in Trappe, Md. between Easton and Cambridge, at the old Trappe Elementary School on Main St. Talk in on 146.52 & 94 & 146.445/147.045 rpt. Cambridge. Tables, food, drinks, ladies program, prizes and plenty of room for tailgaters. Admission \$2, or \$4 for those wanting to tailgate. Contact, K3RUQ.

TELETYPEWRITER PARTS, gears, manuals, supplies, tape, toroids. SASE list. Typetronics, Box 8873, Ft. Lauderdale, Fl. 33310. Buy parts, late machines.

MOBILE OPERATORS. Tired of ignition noise? Send SASE for info on Shielded Ignition Systems. Summit Enterprises, 20 Eider St., Yarmouthport, Mass. 02675.

MANUALS for most ham gear made 1940/65, some earlier. Send SASE for specific quote. Hobby Industry, W0JJK, Box H-864, Council Bluffs, Iowa 51501.

TELETYPE EQUIP. FOR SALE: Model 28 printer, keyboard, cabinet, loop supply, all complete. Also, military R-390 receiver and URA-17A converter. All equipment like new. Make best offer. Floyd Martin, WA4VVA, Rt. 3, Box 56-D, Pensacola, Fla. 32503, (904) 477-9684.

WANTED: tubes, transistors, equipment, what have you? Bernard Goldstein, W2MNP, Box 257, Canal Station, New York, N. Y. 10013.

COLLINS 75A4 RECEIVER. \$350. WA8OBG/1, 24 East St., Stratford, CT 06497, 203/375-6679 evenings.

HOMEBREW TABLETOP LINEAR — Self contained 572-B's. See QST, Feb. 1966; pair 4-400's es filament xformer; pair 813's es filament xformer. All reasonably priced. Paul Rich, Box 264, Cody, Wyo. 82414.

QSL's, Sample catalog 20¢. N & S Print, P. O. Box 11184, Phoenix, Ariz. 85061.

NEW NEW NEW

Repeater ID'er

MODEL IDC 100

- * All Solid State CW ID and timer/control circuitry on 3 x 6 board
 - * Unique activity sensing circuit allows ID only at end of transmission - no ID over conversation
 - * Requires 5vdc @ 200 ma, regulated
- Wired, tested, and programmed with your call **\$46.50** ppd U.S.A.
(Mo res add 4% s.t.)

Hale Electronics

P.O. Box 682 — Cape Girardeau, Mo. 63701

— write for further details —

CATALOG

GOVERNMENT SURPLUS ELECTRONIC EQUIPMENT For 1975

**FREE UPON REQUEST! Write for
Copy of Catalog WS-75 Now!**
Address: Attention Dept. HR

FAIR RADIO SALES

1016 E. EUREKA • Box 1105 • LIMA, OHIO • 45802

KW BALUN KIT STILL ONLY \$5!

The AMIDON Toroid Balun Kit makes a modern, compact antenna transformer that can be wired for either 4:1 or 1:1 impedance ratio. The balun is ideal for use between a coaxial feedline and a balanced antenna. It reduces coax radiation and properly balances the energy for application to the antenna's feedpoint. The balun also acts as an isolation device and removes the capacity of the coax from the antenna which extends the low SWR frequency range of the array. Baluns made from this kit can be used to advantage on these antenna types: Dipole, Quad, Beam, Inverted Yee, Windom and Folded Dipole.

SEND FOR
FREE FLYER!

AMIDON
Associates

Pack & Post: 50¢

12033 OTSEGO STREET • NORTH HOLLYWOOD, CALIF. 91607

RMS CORPORATION

THE ELECTRONIC STORE

675A GREAT ROAD (ROUTE 119)

LITTLETON, MASS. (617) 486-4973

ICOM MATRIC-KEYERS

HUSTLER ANTENNA SPECIALISTS

VHF ENG. KITS VENUS SSTV

LARGE INV. COMPONENTS USED EQUIP.

1-495 to Rte. 119 Groton Exit 19
2 miles on Right

FLEA MARKET FLEA MARKET

MAY 17 SEPT. 20

9 A.M. - 5 P.M. 9 A.M. - 5 P.M.

\$3.00 PER SELLER FREE TO BUYERS

Station Identifier

\$75



The CWID-50 provides automatic ID for repeater stations in perfect Morse code. Has factory-programmed IC memory. Brochure describes CWID-50 and CWID rack models.

control signal co 3954 W. COLUMBIA PLACE
DENVER, COLORADO 80227



DELUXE PORTA-PAK **\$59.95**
ups prepaid

REGULAR PORTA-PAK **\$39.95**
ups prepaid

PORTA-PAK

P. O. BOX 67

SOMERS, WISCONSIN 53171

PRINTED CIRCUIT BOARDS

Available for any amateur project appearing with artwork in any amateur periodical.

Write for complete details and prices

D. L. "Mac" McClaren, WBURX

Printed Circuit Service for the Amateur

19721 Maplewood Ave. Cleveland, Ohio 44135
216-267-3263

ATT. ALL FT-101 OWNERS

5-10 dB extra talk power. Better RX gain and selectivity. "In terms of cost effectiveness the best investment for years" - G5RP. Price \$115, post paid. Details, Holdings Ltd., 39/41 Mincing Lane, Blackburn. BB2 2AF. England.

Now avail. from FT Club. Write WAZA0Q
G3LLL's RF Clipper



CASHARONIE

Money! You can get top dollars now for U.S. surplus electronics, particularly Collins. Write or call now for your bigger than ever quote. Space Electronics Corp., 76 Brookside Ave., Upper Saddle River, N.J. 07458 (201) 327-7640.

LOGIC NEWSLETTER

LOGIC MICRO/MINI-
COMPUTER NEWS

SAMPLE COPY \$1.00

LOGIC NEWSLETTER

POB 252

WALDWICK, N.J. 07463

**Last Year Over \$10,000
in PRIZES Given Away!**

**This Year BIGGER & BETTER
Than Ever!**

47th. ANNUAL

**ATLANTA HAM RADIO FESTIVAL
&**

ARRL STATE CONVENTION

TWO GREAT DAYS . . . JULY 5th. & 6th.

*Royal Coach Motor Inn
I-75 North at Howell Mill Road*

LATEST HAM EQUIPMENT

GIGANTIC SHELTERED SWAP AREA

Special LOW rates for Motels and
Many Atlanta Attractions. Special
Activities and Prizes for XYLs and
Junior OPs.

**ARRL FORUM . . . MARS MEETINGS
TECHNICAL PROGRAMS**

*For Information & Registration Forms
WRITE:*

ATLANTA HAM FESTIVAL

P. O. Box 76553

Atlanta, Georgia 30328

radio communication

If you want an excellent technical magazine then this is the one for you. Want to know what British amateurs are up to? This is the only publication which gives complete coverage of amateur radio in Great Britain. Well written and very interesting.

Your subscription also covers a one year membership in the Radio Society of Great Britain.

1 Year (12 issues) \$12.00

Radio Communication

Greenville, NH 03048

WANTED: PL-172A or 8295A ceramic pentode, pull or new. K4CFJ, 265 Kenlock, Lexington, KY. 40503.

WANTED: GENERAL CLASS (or higher) hams to join 4,500 member Morse Telegraph Club. Hundreds of hams already belong. Send modest \$3 annual dues (includes subscription to great slick paper newspaper "Dots and Dashes") to GST A. J. Long, 520 West Schwartz Street, Salem, Ill. 62881 for membership card and assignment to nearest chapter.

FREE Bargain Catalog. LEDS, Xtals, microphones, headsets, IC's, relays, ultrasonic devices, precision trimmer capacitors, unique components. Chaney's, Box 15431, Lakewood, CO 80215.

EXCLUSIVELY HAM TELETYPE 21st year. RTTY Journal, articles, news, DX, VHF, classified ads. Sample 30¢. \$3.00 per year. Box 837, Royal Oak, Michigan 48068.

WANTED: Early issues of R/9, Modern Radio and The Oscillator. Also need early issues of the ARRL Handbook and Radio Handbook to complete my collection. Please furnish price and condition in first letter. Jim Fisk, WIDTY, Ham Radio Magazine, Greenville, NH 03048.

PC's, Send large S.A.S.E. for list. Semtronics, Rt. #3, Box 1, Bellaire, Ohio 43906.

BUY—SELL—TRADE. Write for monthly mailer, give name, address, call letters. Complete stock of major brands new and reconditioned equipment. Call us for best deals. We buy Collins, Drake, Swan, etc. SSB & FM. Associated Radio, 8012 Conser, Overland Park, Ks. 66204. 913-381-5901.

YOU'RE NOT UP-TO-DATE if you're not reading **HR REPORT.** The most complete, most accurate and most timely source of news ever offered to the amateur. Now mailed weekly — 52 issues per year just \$12. HR REPORT, Greenville, NH 03048.

DRAKE TR-4, AC-4, DC-4, MS-4, RV-4, \$625. TR-4 just factory aligned. SB-200, \$190. WA3JGS, Dom Ronco, 4067 Ford Road, Philadelphia, Pa. 19131.

CW ENTHUSIASTS add selectivity to your rcvr. with an active filter. It features 20 hertz bandwidth, variable center freq., and its own speaker. If interested, write K. Fee Electronics, P. O. Box 229, Watertown, N. J. 08758 or call 609-698-3589.

FM — YOUR KNIGHT TR-108. Complete kit. Use xtal-vfo. \$19.95 ppd. Check or M.O. Calif. res. 6%. Revilo Color, 4725 W. Washington Bl., Los Angeles, CA 90016.

OSCILLOSCOPES FOR SALE. Tektronix 535A \$425. LaVoie LA-545 (Tektronix 545A copy) \$475. AN/USM-140C \$325. AN/USM-32 \$85. AN/USM-50C \$100. All are repaired, aligned and include manuals. James Walter, 2697 Nickel, San Pablo, Ca. 94806.

CANADIAN JUMBO SURPLUS and Parts Catalogs. Bargains Galore. Send \$1. ETCO-HR, Box 741, Montreal "A" H3C 2V2.

FREE: 8 Extra Crystals of your choice with the purchase of a new Icom IC-22A at \$249. With the 10 crystals which come factory-installed in the IC-22A, this gives you a total of 18 crystals! For equally good deals on Drake, Collins, Regency, Ten-Tec, Kenwood, Swan, Atlas, Midland, Standard, Tempo, Alpha, Genave, Hy-Gain, CushCraft, Antenna Specialists, Venus, Hustler, Mosley, and others, write or call Hoosier Electronics, your ham headquarters in the heart of the Midwest, and become one of our many happy and satisfied customers. Hoosier Electronics, P. O. Box 2001, Terre Haute, Indiana 47802. (812)-894-2397.

VERY in-ter-est-ing! Next 5 big issues \$1. "The Ham Trader," Sycamore IL 60178

HAM RADIO has all the license manuals you need! Write for details.

WANTED: Vertical and horizontal plug in units for Tektronix 647A or R647A oscilloscope. Preferably 10A2A vert. and 11B1 horz. Write or call giving price and cond. Carl Satterwhite, W6FPX, 744 W. Ave. H-6, Lancaster, Calif. 93534.

NEW!

450 MHz CONVERTER KIT FOR HAM OR COM'L.

BANDS, \$20 LESS XTAL(S).

- PREAMP FOR 432-450-470 MHz, ETC., KIT \$15/WIRED \$25.
- VHF PREAMP KITS \$6, WIRED \$10 — FREQ. FROM 20 TO 230 MHz.
- LED SCANNER KITS \$10.
- VHF RECEIVER & CONVERTER KITS.
- CLUB & DEALER INQUIRIES INVITED.

— SEND SASE FOR LITERATURE —

HAMTRONICS, INC.

182 BELMONT RD., ROCHESTER, N. Y. 14612

LOGIC PROBE KIT



\$14.95

(plus shipping)

Now! A Digital Logic Probe kit at a realistic price. Red, Green, and Yellow light emitting diodes signal the presence of logic levels encountered in digital circuitry. Utilization of transistor and integrated circuit switching techniques permit the DIGAPEAKE-A to indicate logic 1, logic 0, and pulsing circuit conditions. Complete kit including easy instructions is available now from . . .

Chesapeake Digital Devices Inc.

P.O. BOX 341

Harve de Grace, Md. 21078

ALUMINUM TOWERS

- ★ TELESCOPING
- ★ WALL MOUNTED
- ★ GUYED
- ★ FREE STANDING

EXCELLENT FOR:

HAM COMMUNICATIONS

QUALITY MADE • LOW PRICED

ALUMA TOWER DIVISION

FRED FRANKÉ, INC.

BOX 2806HR VERO BEACH, FLA. 32960

PHONE (305) 567-3415

SOME TERRITORIES AVAILABLE

ARR-52 SOLID STATE VHF RECEIVER

Easily converted to 2-meter FM. Now set for 163-173 MHz, 16 channels. \$19.95 postpaid continental US. Includes schematic diagram and conversion details. As described in the Surplus Sidelights Column, (Pg. 58 Oct. CQ).

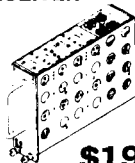

\$19.95

OVER 200 SOLD POSTPAID

BankAmericard & COD Welcome

Electronic Equipment Bank, Inc.

516 Mill Street, N.E. Vienna, Virginia 22180

(703) 938-3350

**YOU WOULDN'T
START A LOG
IN MARCH**



RIGHT NOW

is the time to order your

75 callbook

Don't wait until 1975 is half over. Get your new **Callbooks** now and have a full year of the most up-to-date QSL information available anywhere.

The new **1975 U. S. Callbook** will have over 300,000 W & K listings. It will have calls, license classes, names and addresses plus the many valuable back-up charts and references you have come to expect from the **Callbook**.

Specialize in DX? Then you're looking for the new, larger than ever **1975 Foreign Callbook** with over 225,000 calls, names and addresses of amateurs outside of the USA.



**Foreign Radio
Amateur Callbook
DX Listings**

\$11.95
with
3 Service Editions
\$17.95

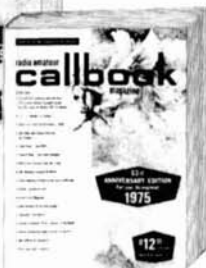

**United States
Callbook**
All W & K Listings
\$12.95
with
3 Service Editions
\$18.95

Order from your favorite electronics dealer or direct from the publisher. All direct orders add 75¢ shipping and handling per Callbook.

**WRITE FOR RADIO AMATEUR
FREE BROCHURE**  **callbook INC.**
Dept. E 925 Sherwood Drive
Lake Bluff, Ill. 60044

QRP TRANSMATCH for HW7, Ten-Tec, and others. Send stamp for details to Peter Meacham Associates, 19 Loretta Road, Waltham, Mass. 02154.

READ 10 Hz ON COLLINS. Expanded stiff paper scale reads 100 hertz. Second scale, 10:1 vernier, reads 10 hertz. Drawn with Bridgeport to 30 second accuracy. Photo-reduced to fit Collins knob. Instructions and dials \$2.85. Gilson, 145 Randall, Suffield, Conn. 06078.

VACATIONLAND HAMFEST Sunday, May 18, 1975; Erie County Fairgrounds near Cedar Point. Huge flea market area. First Prize — Regency HR-2B. Tickets - \$1.00 advance, \$1.50 at gate. Information: Hamfest, P. O. Box 2037, Sandusky, Ohio 44870.

HOMEBREWERS: Stamp brings list of high quality components. CPO Surplus, Box 189, Braintree, Mass. 02184.

RTTY EQUIPMENT: NEW Mod Kits to convert M28 sprocket-feed to friction-feed, \$45.00. New M28 LESU loop supplies, \$10.00. M28 typeboxes, \$20.00 (WX, COMM, or fractions). M28ASR motors, \$25.00. M19 covers, \$15.00. M15-19 bases, \$7.00. Model 28KSR's, ASR's, parts. SASE for complete list & prices. Mint Motorola T53GKT, 2-meter FM, \$225.00. Lawrence R. Pflieger, P. O. Box 21956, Milwaukee, WI 53221.

SOCIETY OF WIRELESS PIONEERS offers Life Membership to active and former C.W. operators on comm'l., military, gov't., etc. wireless/radio circuits. Contact: Society of Wireless Pioneers, Dept. H, P. O. Box 530, Santa Rosa, California 95402.

POWER SUPPLIES FOR THE HOMEBREWER — 1.2 kVA power transformer - input 115V 60Hz, output 1000V 900mA 600V 250mA and 6.3V 10.4A - \$69.50. Miniature transformer with built-in wave rectifier - input 115V 60Hz, output 10V(DC) 100mA - ideal for NiCad charging - \$5.65. Universal AC/DC power supply kit - supplies plate and filament power from 12.6V DC or 115V 60Hz AC by changing leads - output 750V 200mA and 12.6V 6A from 115V or 750V 200mA from 12.6V DC input - all parts except chassis, terminals and wire - \$39.50. Michigan residents include sales tax. All items postpaid - no C.O.D.'s - for fast service use M.O. or cashier's check. S.A.S.E. for specs. M.E.C. Sales Div., P. O. Box 611, Madison Heights, Mich. 48071.

PORTA-PAK the accessory that makes your mobile really portable. \$59.95 and \$39.95. Dealer inquiries invited. P. O. Box 67, Somers, Wisc. 53171.

HOW TO PASS EXAMINATIONS, \$2.00. Swank, 657N Willabar, Washington Court House, Ohio 43160.

KENTUCKY HAM-O-RAMA — Sunday, June 1 at Boone County Fairgrounds, Burlington, Kentucky. 10 miles south of Cincinnati near I-75. Features prizes, indoor exhibits, flea market, refreshments. Tickets: \$1.50 advance, \$2 at door. Contact: WABOGS, 6381 Mullen Rd., Cincinnati, Ohio 45239.

SIGNAL/ONE OWNERS: Special one year service-contract. Write for details. CX7A, mint, \$1295. Tuneable audio filter, 50db notch, also has peak and low-pass included, \$69.50. Pace Electronics, 5717 Genematas, Tucson, Arizona 85704. (602-888-5234).

NOW PAYING \$2000.00 and up for ARC-94/618T ARC-102/618T. \$1200.00 and up for ARC-51BX, \$1500.00 and up for 490T-1 antenna couplers. We also need these control boxes — C-6287/ARC-51BX, C-6476/ARC-51BX, C-714E-2. We also need R-1051 receivers, RT-662/GRC-106 transceivers. We buy all late aircraft and ground radio equipment. Also pack radios. We are buyers not talkers. Bring your equipment in, you are paid on the spot. Ship it in, you are paid within 24 hours. We pay all shipping charges. If you want the best price for your equipment, call us. Call collect if you have, and want to sell or trade. We also sell. What do you need? D & R Electronics, R.D. #1, Box 56, Milton, Pa. 17847. Phone — 717-742-4604 - 9:00 a.m.-9:00 p.m.

RADIO EXPO '75: September 6 & 7, fair grounds, Grays Lake, Ill. Seminars, flea market, manufacturer's exhibits, camping. Information: Write EXPO, Box 1014, Arlington Heights, Illinois 60006

BUILDING A REPEATER? See Hale Electronics ad this issue.

HAMFEST! Indiana's friendliest and largest Spring hamfest. Wabash County Amateur Radio Club's 7th Annual Hamfest will be held Sunday, May 18, 1975, rain or shine at the 4-H Fairgrounds in Wabash, Indiana. Large flea market (no table or set up charge), technical sessions, bingo for XYL's, free overnight camping, plenty of parking. Lots of good food at reasonable prices. Admission is still only \$1 for advance tickets, \$1.50 at the gate. For more information or advanced tickets write: Bob Mitting, 663 Spring St., Wabash, Indiana 46992.

THE NORTH FLORIDA AMATEUR RADIO SOCIETY has announced the revival of the "Wacky Wing Dinger" certificate. To qualify for the Wacky Wing Dinger certificate, out-of-town U.S. amateurs must work 7 members of the Wacky Wing Ding Society. DX stations (including KH6, KP4, KL7, etc.) must work 3 members. Send a list of contacts listing stations worked, time, date, frequency, and signal report along with \$2.00. Free endorsements are offered for 10, 20, 30, 40, 50, 60, 70, 80, 90 and 100 contacts. Applications go to: North Florida Amateur Radio Society, Billy Williams-WA4UFW, 911 Rio St. Johns Dr., Jacksonville, Fla. 32211.

RECIPROCATING DETECTOR, write Peter Meacham Associates, 19 Loretta Road, Waltham, Mass. 02154.

HALLICRAFTER SX28, speaker. QST's Dec. 1955 to Aug. 1962. Best offer, F.O.B. K3IQH, 1708 Glenpark, Silver Spring, Maryland.

OSCAR SLIDES, set of 5, \$1.25. Launch and spacecraft. Proceeds AMSAT. K6PGX, P. O. Box 463, Pasadena, CA 91102.

RECONDITIONED TEST EQUIPMENT for sale. Catalog \$.50. Walter, 2697 Nickel, San Pablo, Ca. 94806.

COLLINS 75A3, mint, 800 cycle 2.5MHz. mechanical filters, product detector, \$350.00. W3WFA, R. Serrano, 34 Beech Ave., Aldan Del. Co., Pa. 19018.

LIONEL TRAINS WANTED. Looking for several different sets, some old, some newer. If you have any trains packed away and not in use I would like a chance to buy or trade them from you. Will trade test equipment, TEK, H.P., GR., etc., scopes, gen., meters, or have some new 2 meter gear. Send description, like numbers, colors, condition to: Dick Robinson, 516 Mill St. N.E., Vienna, Va. 22180. Phone 703-938-3350.

SELL: Round Emblem KWM2 \$900.00, Long Emblem 75S3B \$575.00, KWM2 q multiplier, noise blander \$725.00, CP1 Xtal Pack \$160.00, MP1 DC Supply \$75.00, KWM2A with plug in relays \$850.00, a DELTRON DC supply variable 0-15 volts and up to 10 Amps. only \$65.00. Call Marty 215-884-6010.

WANTED: HALLICRAFTERS T-54, early 7-inch TV receiver in metal cabinet with pushbutton tuning. Any condition, including parts only. Also manufacturer's service manual (not Photofact). Please write: Carl Sarver, 6011 N. River Rd., Waterville, Ohio 43566.

WANTED: R-390-A Receiver not in working condition, will pay cash and shipping if the price is right. Will only accept R390A only. No plain 390 wanted. WAIS, George Tate, 306 Thornwood Dr., Taylors, S. C. 29687.

S.R.R.C. HAMFEST, June 1, Bureau County Fairgrounds, Princeton, Illinois. Please furnish large self addressed stamped envelope for details. SRRC/W9MKS, RFD #1, Box 171, Oglesby, Illinois 61348. Phone 815-667-4614.

WORLD QSL BUREAU. The only QSL Bureau to handle all of your QSLs to anywhere; next door, the next state, the whole world. Just bundle them up (please arrange alphabetically) and send them to us with payment of 6¢ each. 5200 Panama Ave., Richmond, CA 94804.

YOUR AD belongs here too. Commercial ads 35¢ per word. Non-commercial ads 10¢ per word. Commercial advertisers write for special discounts for standing ads not changed each month.

LEARN RADIO CODE



\$9.95

Album contains three 12" LP's 2 1/2 hr. instruction

THE EASY WAY!

- No Books, To Read
- No Visual Gimmicks To Distract You
- Just Listen And Learn

Based on modern psychological techniques—This course will take you beyond 13 w.p.m. in LESS THAN HALF THE TIME! Available in Cassette also for only \$10.95.

EPSILON [E] RECORDS

508 East Washington St., Arcola, Illinois 61910

CASH FOR 2-WAY FM RADIO MOTOROLA, GE, RCA, ETC. EQUIPMENT

MOBILES, BASES, PORTABLES, MOBILE-TELEPHONES REPEATERS, REMOTE CONTROLS, TONE EQUIPMENT

— 2-WAY TEST EQUIPMENT —

(Operational Units Only)

- Commissions/Finders Fees •

CAL-COM SYSTEMS, INC.

701-51A KINGS ROW, SAN JOSE, CALIFORNIA 95112
Telephone 24 Hours 408/998-4444

ELPROCON

1 WATT 2 METER TRANSMITTER



- TWO CHANNEL CAPABILITY
- FREQUENCY RANGE 144-148 MHz
- POWER OUTPUT 1 WATT INTO 50 OHM LOAD
- SUPPLY VOLTAGE 12 VDC
- MULTIPLICATION FACTOR 8X
- NARROW BAND FM ± 5 KHZ
- RUGGED BALANCED EMITTER OUTPUT TRANSISTOR
- SIZE 3 3/4" X 1 3/8"
- CRYSTALS NOT SUPPLIED
- \$27.95 plus \$2.00 postage COD or money order only

ELPROCON

DEPT. DS • 1907 W. CAMPBELL
PHOENIX, ARIZONA 85015

THE ULTRA-BAL 2000

NOW ----- An extremely rugged, weather-proof BALUN!

- Full 2KW, 3-30 MHz., 1:1 or 14 ratios.
- Special Teflon insulation. May be used with tuned lines and tuners.
- With dipole insulator and hang-up hook.

ONLY \$9.95ppd. (state ratio)

At your dealer or order direct

K.E. Electronics Box 1279, Tustin Calif. 92680



New! BALUN

- 1:1 for dipole or inverted Vee.
- 1.7 to 30 MHz. Full KW power.
- STRONGER. Heavy stainless steel bolts take antenna tension.
- BUILT TO LAST. Sealed and epoxy filled. Absolutely waterproof.
- EFFICIENT. Heavy ferrite toroid core.
- PROVEN. In worldwide use from desert to tundra.

- Complete with balun, 2 1/4" diameter, 10 ounces \$14.95 PPD
- Center insulator without balun, 1 5/8" diameter, 4 ounces \$7.95 PPD
- Order Direct. Postpaid USA & Canada. Calif. residents add sales tax.

PALOMAR ENGINEERS

BOX 455, ESCONDIDO, CA 92025

LICENSE GUIDES

We don't know if it's Restructuring, the economy, or just a renewed interest in amateur radio, but more radio license guides of all types have been purchased this year than ever before. Here's your chance to get on the bandwagon. We've got 'em all and they're in stock for immediate delivery.

THE RADIO AMATEUR'S LICENSE MANUAL from ARRL

This study guide and reference book covers all grades of amateur licenses. Complete with typical questions and answers to typical FCC amateur examinations. Also contains the amateur regulations. Certainly the most used publication of this type anywhere.

Order AR-LG

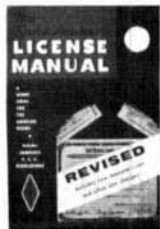

Just \$1.50

RADIO AMATEUR THEORY COURSE

by Martin Schwartz



A complete, simplified home study theory course in radio covering the requirements for the Novice, Technician and General Classes of Radio Amateur Operator licenses. Contains 14 lessons, 3 study guides and over 400 FCC-type multiple-choice questions, similar in content and format to the actual FCC test - all under one cover. 1974 Edition.

Order 102-01

320 pages — \$4.95

AMECO CODE COURSES ON CASSETTE TAPES

The famous Ameco Code Courses are now available on tape in standard cassette form. This new tape format will make Ameco code courses even easier to use. As an extra bonus each Ameco Cassette Code Course consists of nearly twice the material contained on the older records at only a slight increase in price.

JUNIOR CODE COURSE

Covers from start to 8 WPM
Order 100-T

\$4.95

ADVANCED CODE COURSE

Covers from 8½ to 18 WPM
Order 103-T

\$4.95

SENIOR CODE COURSE

A double length tape covering the complete Junior and Advanced Courses start to 18 WPM
Order 102-T

\$8.95

AMECO AMATEUR LICENSE GUIDES

by Martin Schwartz

Each of these useful books contain a sample FCC-type examination, plus the FCC study questions with easy-to-understand answers. The questions are grouped according to subject for easier study.

RADIO AMATEUR QUESTION AND ANSWER GUIDE

Order 5-01

Covers Novice, Technician and
General Class Exams

Only 75¢

ADVANCED CLASS RADIO AMATEUR LICENSE GUIDE

Order 16-01

Just 75¢

EXTRA CLASS RADIO

Order 17-01

AMATEUR LICENSE GUIDE

Only 75¢

AMATEUR RADIO LICENSE STUDY GUIDES from TAB

This set of books is designed to help the reader who is working to pass any of the FCC amateur exams. In an informal, practical style you are given a good technical background to help win that passing grade. Particularly recommended as additional study material. Originally appeared in 73 magazine.

Amateur Radio Novice Class License Study Guide	Order T-573	\$3.95
Amateur Radio General Class License Study Guide	Order T-551	\$6.95
Amateur Radio Advanced Class License Study Guide	Order T-527	\$3.95
Amateur Radio Extra Class License Study Guide	Order T-543	\$4.95

Please add 25¢ per item shipping and handling

ham radio

Greenville, NH 03048

IDEAL FOR 2M POWER — Transformer, 115 VAC primary, 18 volt, 5 amp ccs or 7 amp intermittent duty secondary \$6.00 ea. ppd.

NEW NEW NEW

Transformer — American Made — 115V Primary — 12V sec. — 250 mills — for P.C. Board Mounting. Size: 1½" x 1½" x 1½", 3.5 ounces. Price: \$1.20 ea. ppd.

Antenna Wire No. 14 Soft Drawn Copper Wire. Poly-Thermeleze insulation 6¢ foot ppd.

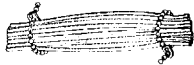

RED NYLON CABLE TIES
BALL-BEAD TYPE — 4¼" LONG
Price is 70 for \$1.00 ppd.

UNPOTTED TOROIDS — All toroids are center tapped, 88MHY or 44MHY
Price is a low 5 for 2.75 ppd.

PL-55 TYPE PHONE JACKS
High quality American made Jacks. ¾" inch mounting with hex nut. Extends 1½" behind the panel.
Price: 50¢ each or 3 for \$1.25 ppd.



ILLUMINATED ROCKER SWITCH

American made UL approved.
Rating: 125 Volt AC 3 Amp
125 Volt DC .5 Amp

DPDT with a 6 volt illuminating bulb. Your choice of color. Red or White.
Price is 80¢ each or buy 3 for \$2.25 ppd. U.S.A.



9 PIN SOCKET — SNAP-IN MINIATURE for P.C. Board Mtg.
6 for \$1.00 ppd.

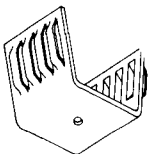

ALUMINUM HEAT SINK
Very nice American made heat sink. 1/16 inch thick and approx. dimensions are 1" x 1" x 1" high with an ½ inch hole in the center.
Price is a low 35¢ each or 3 for \$1.00 ppd.

NEW — JUST ARRIVED —

Similar to above but drilled to fit T03 Transistor
45¢ ea. or 3 for \$1.25 ppd.

INTEGRATED CIRCUITS

7400 33¢ ea. 741 c Op Amp 55¢ ea.
7473 60¢ ea. 723 Regulator \$1.00 ea.

NEW NEW NEW

NEW ALARM SYSTEM PC BOARD
Assy. All new. Factory overrun.

Contains:

- 2 ea. Epoxy Transistor,
- 3 ea. small Silicon Diodes,
- 2 ea. 1000 mfd ea. 16V. Caps.,
- 5 ea. ½ watt Resistors,
- 1 ea. 4 PDT Guardian Relay 12V,
- 1 ea. 12V SPDT Relay

Price is \$3.20 ea. ppd.

SPST SLIDE SWITCHES (Red) Made by Stackpole — 4A, 125V A.C. 22¢ ea. ppd.

NEW NEW NEW

SPDT MINI-SLIDE SWITCH, Imported, black, ¾" O.C. with two 6" leads 40¢ ea. ppd.

AMERICAN MADE POWER CORD, 6 foot, gray, 7A, plugs into auto liter socket 75¢ ea. ppd.

NEW NEW NEW

Sperry SP-332 contains two 7 segment readouts, .330 high, side by side layout, black glass face, orange characters with decimal. ¾ in. square. W/specs.

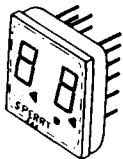

\$3.50 each, 3 for \$10.00

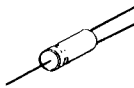

NEW NEW NEW

AMERICAN MADE DUAL
Electrolytic 1000 & 500 MFD. 15V, long leads. ¾" dia. x 2¼" long.
55¢ each, 3/\$1.50 ppd.

UNPOTTED TOROIDS — All toroids are center tapped, 88MHY or 44MHY
Price is a low 5 for \$2.75 ppd.

NEW SIZES — VERTICAL MOUNT PC BOARD POTENTIOMETERS

American made (CRL) high quality pots. Available in the following sizes: 750 ohms, 1500 ohms, 25,000 ohms, 50,000 ohms, 100,000 ohms.
Price is 5 for \$1.00 ppd.

6 foot AC Line cords — 45¢ ea. ppd.



3 inch 4 ohm VC Square frame with 4 mounting holes.
\$1.20 each ppd.

COOL 30-0-30 V - 2.5 AMP SHIELDED TRANSFORMER — NEW — AMERICAN MADE YES — 3 pound with 1¾" deep core vertical end bell mount. 2¼" w. x 3" h. x 3¼" deep, with 6.3 V - 1A winding. \$4.85 ppd.

NEW . . . Red 6 foot #18-2 line cord with flanged safety plug — 55¢ ppd.

ZENERS

All Units Tested And Guaranteed

400 MILLIWATT UNITS — 3, 3.3, 3.6, 3.9, 4.3, 4.7, 5.6, 6.2, 6.8, 7.5, 8.2, 9.1, 18, 22, 24, 27, Volts.

1 WATT UNITS — 10, 11, 12, 13, 15, 16, 18, 20, 22, 27, 30, 33, 39, 43, 47, 51, 56, 62, 68, 75, 82, 91, 100, 110, 120, 130, 150, 160, 180, Volts **ALL UNITS 10% — 4 for \$1.00 ppd.**
5% — 3 for \$1.00 ppd.

NEW NEW NEW NEW NEW

.1 MFD, 10V, CRL DISC CAPACITOR ¾" dia., long leads 11¢ ea., 10 for \$1.00 ppd.

Power Transformer. 115 Volt AC Primary. Secondary #1: 32-0-32 Volt @ 1 Amp. Secondary #2: 6.3 Volts. Low Current For Pilot Lights. Size 2½" x 2½" x 3".
Price: \$2.50 Each ppd.



1¼ inch miniature alligator clips. Bright vinyl red or black insulator. Nickel plated.

9 for \$1.00

SEND STAMP FOR BARGIN LIST

Pa. residents add 6% State sales tax
ALL ITEMS PPD. USA.

Canadian orders for less than \$5.00 add \$1.00 to cover additional postage costs.

m. weinschenker
K 3DPJ BOX 353 · IRWIN, PA. 15642

Advertisers check-off

... for literature, in a hurry — we'll rush your name to the companies whose names you "check-off"

Place your check mark in the space between name and number. Ex: **Ham Radio** 234

INDEX

Adva _____ 265	International _____
Amsat * _____	Crystal _____ 066
Amidon _____ 005	International _____
Antenna Mart _____ 009	Rectifier _____ 310
Ascom _____ 010	Jan _____ 067
Atlanta Ham Fest. * _____	Janel _____ 068
Barry * _____ 198	K. E. _____ 072
Budwig _____ 233	K-Enterprises _____ 071
CFP _____ 022	KLM _____ 073
CTI Mfg. _____ 307	Kester Solder _____ 315
Cal-Com _____ 282	Larsen _____ 078
Chesapeake _____	Leland _____ 193
Digital _____ 298	Levy _____ 291
Comcraft _____ 028	Lithic _____ 314
Control Signal _____ 136	Little Giant _____ 011
Corvus _____ 299	Logic _____ 133
Cubex * _____	McClaren _____ 155
Curtis _____ 034	MFJ _____ 082
Cush Craft _____ 035	Metric _____ 084
Data Signal _____ 270	Motorola _____ 160
Dentron _____ 259	Murch _____ 304
Delavan _____ 235	Nasem _____ 249
Dev-Tronics _____ 294	Northshore _____
Digicom _____ 278	RF Tech. _____ 296
Drake _____ 039	Pagel _____ 092
Dycomm _____ 040	Palomar _____ 093
Eimac _____ 043	Police Call Mag. _____ 199
Electro Logic _____ 300	Poly Paks _____ 096
Electronic Dist. _____ 044	Porta-Pak _____ 274
ELPROCON _____ 301	Production _____
Epsilon _____ 046	Devices _____ 313
Erickson _____ 047	RCA _____ 312
Exact Elect. _____ 309	RF _____ 305
Fair _____ 048	RMS _____ 239
Fair Rite _____ 311	RP _____ 098
Fluke _____ 049	Callbook _____ 100
Fred Franke _____ 289	Regency _____ 102
Gam _____ 237	Rochester _____
Gem Quad _____ 295	Hamfest _____ 217
Glade Valley _____ 213	Rohde & Schwarz _____ 306
HR Report _____ 150	SAROC _____ 146
Hal _____ 057	Signal/One _____ 262
Hale Elect. _____ 302	Slep _____ 232
Haistead Press _____ 308	Southwest Tech. _____ 263
Ham Import _____ 290	Space Elect. _____ 107
Ham Radio _____ 150	Spectronics _____ 191
Hamtronics _____ 246	Spectrum _____ 108
Heights _____ 061	Swan _____ 111
Henry _____ 062	Ten-Tec * _____
Hewlett Packard _____ 281	Topeka FM _____ 115
Hildreth _____ 283	Tri-Ex _____ 116
Holdings _____ 252	Tri-Tek _____ 117
Hy-Gain _____ 064	Tristao _____ 118
ITT, Mackay _____	VHF Engineering _____ 121
Marine _____ 184	Webster _____ 255
Icom _____ 065	Weinschenker _____ 122
International _____	Wilson _____ 123
Affiliates _____ 303	Yaesu _____ 127

*Please contact this advertiser directly

Limit 15 inquiries per request.

May 1975

Please use before June 30, 1975

Tear off and mail to
HAM RADIO MAGAZINE — "check off"
 Greenville, N. H. 03048

NAME _____ CALL _____
 STREET _____
 CITY _____
 STATE _____ ZIP _____

Advertisers Index

Adva Electronics _____	85
Amsat _____	117
Amidon Associates _____	119
Antenna Mart _____	93
Atlanta Ham Festival _____	120
Atlas Radio Co. _____	77
Barry _____	118
Budwig Manufacturing Co. _____	118
CFP Enterprises _____	95
Cal-Com Systems, Inc. _____	123
Chesapeake Digital Device, Inc. _____	121
Comcraft Co. _____	108
Control Signal _____	120
Corvus Corporation _____	70
Cubex Company _____	93
Cush Craft _____	Cover II
Data Signal, Inc. _____	95, 96, 98, 99
Dentron Radio Co. _____	64, 65
Delavan Electronics, Inc. _____	102
Dev-Tronics _____	128
Digicom _____	118
Drake, Co. R. L. _____	101
Dycomm _____	97
Eimac, Div. of Varian Assoc. _____	Cover IV
Electronic Equipment Bank, Inc. _____	121
Electro Logic _____	118
Electronic Distributors _____	91
ELPROCON _____	123
Epsilon Records _____	123
Erickson Communications _____	110
Fair Radio Sales _____	119
Fluke _____	110
Fred Franke, Inc. _____	121
Gam Electronics _____	97
Gem Quad Products _____	89
Glade Valley School Radio Session _____	88
HR Report _____	122
Hal Communications Corp. _____	45
Hale Electronics _____	119
Ham Import Sales _____	111
Ham Radio _____	112, 120, 124
Hamtronics, Inc. _____	121
Heights Manufacturing Co. _____	63
Henry Radio Stores _____	Cover III
Hildreth Engineering Co. _____	118
Holdings Ltd. _____	120
Hy-Gain Electronics Corp. _____	127
ITT, Mackay Marine _____	109
Icom _____	5
International Affiliates Co., Inc. _____	94
International Crystal Mfg. Co., Inc. _____	107
Jan Crystals _____	90
Janel Labs _____	116
K. E. Electronics _____	123
K-Enterprises _____	110
KLM Electronics _____	33
Larsen Electronics _____	116
Leland Associates _____	113
Levy Associates _____	113
Little Giant Antenna Labs _____	116
Logic Newsletter _____	120
McClaren _____	120
MFJ Enterprises _____	102
Matrix _____	92
Murch Electronics, Inc. _____	113
Nasem _____	108
Northshore RF Technology _____	89
Pagel Electronics _____	117
Palomar Engineers _____	91, 123
Police Call Magazine _____	92
Poly Paks _____	114
Porta-Pak _____	120
RF Communications _____	88
RMS Corporation _____	119
RP Electronics _____	94
Radio Amateur Callbook, Inc. _____	90
Regency Electronics, Inc. _____	86, 87
Rochester Hamfest _____	96
Rohde & Schwarz _____	2
SAROC _____	104
Signal/One _____	1
Slep Electronics Co. _____	117
Southwest Technical Products _____	73
Space Electronics Corp. _____	120
Spectronics FM _____	105
Spectrum International _____	106
Swan Electronics _____	83
Ten-Tec, Inc. _____	118
Topeka FM Communications _____	106
Tri-Ex Tower Corp. _____	51
Tri-Tek, Inc. _____	118
Tristao Tower Co. _____	118
VHF Engineering, Div. of _____	
Brownian Elect. Corp. _____	103
Webster Radio _____	118
Weinschenker _____	125
Wilson Electronics _____	100
Yaesu Musen USA _____	7

No room? Get a ###hy-gain vertical antenna!

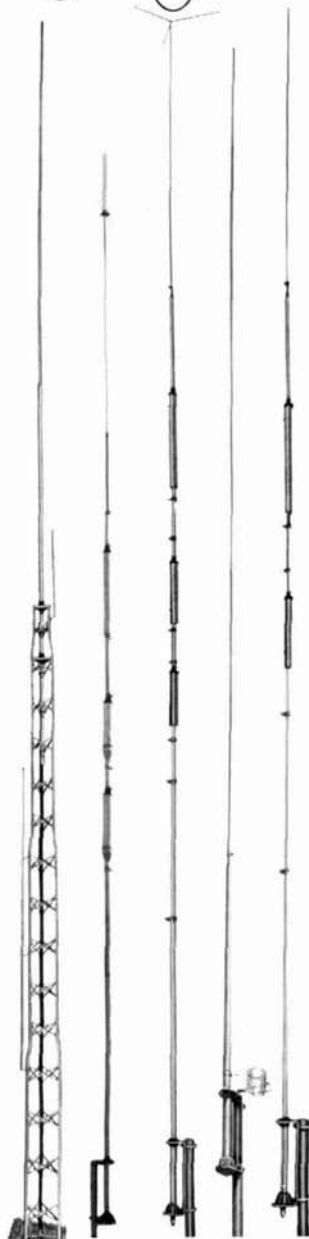

No. 182 No. 386 No. 193 No. 385 No. 384

Even if you're limited to just a few square feet of real estate, you've got room for a high performance Hy-Gain multi-band vertical. Great coverage in minimum ground space, or roof mount for optimum performance using Hy-Gain 12RMQ or 14RMQ Roof Mount/Radial Kit. All these antennas are entirely self-supporting.

18HT Hy-Tower 6 thru 80 meters

Unquestionably the finest multi-band omnidirectional vertical antenna available. Entire structure is radiating element with automatic band switching. All hardware iridited. Unique stub decoupling for 50 ohm input on all bands. Also operates 160 meters with loading coil. Takes maximum legal power with ease. No roof mount. Ht. 50'. Wt. 100 lbs.

Order No. 182

18AVT/WB 10 thru 80 meters

True $\frac{1}{4}$ wave resonance on all bands, automatic band switching and optimum wide-band performance combine to make the 18AVT/WB one of the most popular amateur antennas. Three heavy duty Hy-Q Traps, top loading coil, extra heavy duty construction. Roof mount with 14RMQ. Ht. 25'. Wt. 10.7 lbs.

Order No. 386

18V 10 thru 80 meters

Low cost, high efficiency, and quality construction make the 18V ideal for budget-conscious HAMs. Easily tuned to any 10-80 meter band by adjusting feed point at base inductor. Highly portable. Roof mount with 14RMQ. Ht. 18'. Wt. 4.6 lbs.

Order No. 193

14AVQ/WB 10 thru 40 meters

Improved for even greater wide-band performance! Three separate Hy-Q Traps with oversize coils for extremely high Q. $\frac{1}{4}$ wave resonance on all bands. Outstanding low angle radiation pattern. Roof mount with 14RMQ. Ht. 18'. Wt. 8.6 lbs.

Order No. 385

12AVQ 10, 15 and 20 meters

Inexpensive tri-band vertical for performance with minimum investment in space and equipment. Low radiation angle. Roof mount with 12RMQ. Ht. 13'6". Wt. 6.8 lbs.

Order No. 384

For prices and information, contact your local Hy-Gain distributor or write Hy-Gain.

###hy-gain

Hy-Gain Electronics Corporation; 8601 Northeast Highway Six; Lincoln, NE 68507; 402/464-9151; Telex 48-6424. Branch Office and Warehouse; 6100 Sepulveda Blvd., #322; Van Nuys, CA 91401; 213/785-4532; Telex 65-1359. Distributed in Canada by Lectron Radio Sales, Ltd.; 211 Hunter Street West; Peterborough, Ontario.



DEV-TRONICS SI-36



THE ELECTRONIC SCIENTIFIC SLIDE RULE WITH FUNCTIONS TO ENABLE YOU TO SOLVE ALMOST ANY PROBLEM, ANYWHERE, ANYTIME! JUST PRESS THE KEYS.

ORIGINALLY PRICED AT \$179.95-NOW ONLY \$109.95 or \$89.95 as a kit with completed and pretested electronic boards including instructions for assembly.

COMPLETED UNITS AND KITS FURNISHED WITH CARRYING CASE, NI-CAD RECHARGEABLE BATTERIES AND CHARGER.

ONE (1) FULL YEAR WARRANTY.

The SI-36 is Dev-Tronics first in a family of scientific calculators for the engineering and scientific fraternity featuring fully depressed keyboard with detent and click. It is a precision built, quality calculating machine with advanced design and algebraic keyboard entry (as you would normally write an algebraic

problem) with the capability of solving detailed business problems and complex scientific arguments. Because of the designed-in flexibility of the SI-36 calculator to operate off throw-away and/or rechargeable batteries, you never have a loss of the use of this calculator when you are away from your charger. Merely replace your rechargeable batteries with commonly available 1.5 volt penlite cells to restore normal operation.

BROAD RANGE OF APPLICATION: Computes natural and common logs and antilogs. It calculates sine, cosine and tangents of trigonometric calculations and their inverses. Scientific notation and display range from 1.0×10^{-99} to $9.999999999 \times 10^{99}$. For ease of entry it features special (2 level) parentheses keys, will handle non-scientific notation with a 10 digit mantissa, 2 sign digits and 2 scientific notation digits.

This is an amazing calculator costing much less than comparable machines priced to \$225.00 But, don't compare price; compare features and functions.

Compare!

FEATURES/FUNCTIONS	DEV-TRON SI-36	TI SR-50	HP-35
BATTERY SAVER CIRCUIT/INDICATOR	YES	NO	NO
ROUNDING TO TEN DIGITS	YES	YES	NO
ALGEBRAIC NOTATION (SUM OF PRODUCTS)	YES	YES	NO
DEGREE/RADIAN KEY	YES	YES	NO
MEMORY (OTHER THAN STACK)	1	1	1
KEYS	36	40	35
LOGIC	ALGEBRAIC	ALGEBRAIC	POLISH
LOG ₁₀	YES	YES	YES
TRIG (ARC, SIN, COS, TAN)	YES	YES	YES
DEGREE ↔ RADIAN CONVERSION	YES	YES	NO
DEG/RAD MODE SELECTION	YES	YES	NO
Y ^x , x ^y	YES	YES	YES
K ^x	NO	YES	NO
√x	YES	YES	YES
√y x ← y	YES	YES	NO
%	YES	YES	YES
EXCHANGE X WITH Y	YES	YES	YES
BIGGEST DISPLAY	YES	NO APPROX. 20% SMALLER	NO APPROX. 20% SMALLER
3 PARENTHESIS LEVELS (BRACKETING)	YES	NO	NO
DISPLAY SHUT OFF/ DATA HOLD	YES	NO	NO
SCIENTIFIC NOTATION	YES	YES	YES

DEALERS OF THE MONTH:

HAMTRONIC'S (215-757-5300 or 215-357-1400)
4033 Brownsville Road, Trevese, Pennsylvania 19047

QUEMENT ELECTRONICS (408-998-5900)
P. O. Box 6000, San Jose, California 95150

I Enclose \$ () Check () Money Order () Charge to my: () BankAmericard () Master Charge () American Ex.

Expires:
My Credit Card Number

Signature Mast.Chg.Int'l bank No.....

Quantity	Unit Price	Total
SI-36 with chg. & rechg. batts.		
SI-36 kit/w chg. & rechg. batts.		

Idaho residents add 3% sales tax
Add \$2.50 ship/handling single units
Add \$1.50 per unit ship/handling on multiple purch.
GRAND TOTAL

NAME

ADDRESS

CITY STATE ZIP

MAIL THIS COUPON TO: DEV-TRONICS, Inc., ROUTE ONE,
TWIN FALLS, IDAHO 83301

PUT MORE REACH IN YOUR FM WITH A TEMPO RF POWER AMPLIFIER FROM HENRY RADIO



With the simple installation of a Tempo VHF or UHF power amplifier you can extend the range of your mobile FM transmissions far more than you dreamed possible.

They operate in the VHF frequency range of 135 to 175 MHz and the UHF range of 400 to 512 MHz, offering a wide choice of power outputs. They effectively increase the range and clarity of two way communications under all operating conditions, can be used with hand held units, low or medium power mobile transceivers or in repeaters.

Altho moderately priced, Tempo amplifiers offer meaningful savings in new equipment costs and greater efficiency in either new or existing communications systems. Are compact, reliable, fool-proof to operate and are available for immediate delivery.

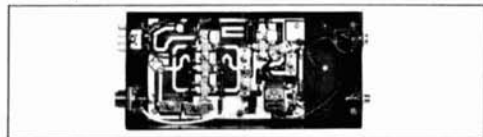

Modern solid state technology is used throughout, along with conservatively rated components to assure the highest possible reliability. Microstrip design on glass epoxy circuit boards give added resistance to damage from shock or prolonged vibration.

FCC type accepted models also available.

Available at select Tempo dealers throughout the U.S.

*High performance at low cost...
the Tempo FMH*



Excellent performance at low cost. The Tempo FMH is a compact two watt VHF/FM transceiver offering high quality performance and features usually found on more expensive units. Six channel capability, completely solid state, lightweight and reliable. A perfect companion for the Tempo RF power amplifiers. Plugged into the amplifier, the hand held FMH becomes a mobile with much greater power. \$199.00

FMH-MC for marine & commercial service also available.

The Tempo 6N2

Meets the demand for a high power six meter and two meter power amplifier. Using a pair of Eimac 8874 tubes it provides 2000 watts PEP input on SSB and 1000 watts input on CW and FM. Completely self-contained in one small desk mount cabinet with internal solid state power supply, built in blower and RF relative power indicator

2 meter only	\$795.00
	\$695.00

For prices and specifications please write

Henry Radio

11240 W. Olympic Blvd., Los Angeles, Calif. 90064

931 N. Euclid, Anaheim, Calif. 92801
Butler, Missouri 64730

213/477-6701
714/772-9200
816/679-3127

Prices subject to change without notice.

First Family



Eimac
division
varian