

AMATEUR TELEVISION QUARTERLY

VOLUME 6 #4
FALL 1993
OCT. NOV. DEC.
ISSN 1042-198X
USPS 003-353

PROJECTS:
BETTER ATV AUDIO
10 GHZ ATV REPEATER
BETTER ANTENNA PATTERNS,
HORIZONTAL OMNI ANTENNAS THAT WORK!
MUCH MORE!

\$4.95 USD

**NEW AWARD PROGRAM
FOR FSTV, SSTV, FAX**

W9NBG **Q#1**

AMATEUR TELEVISION QUEST

KNOW ALL BY THESE PRESENTS THAT

THE HOLDER OF THIS CERTIFICATE HAS DEMONSTRATED KNOWLEDGE AND DESIRE TO COMMUNICATE IN THE VIDEO ARTS, AND AS SUCH IS HEREBY ELECTED TO THE

ATQ SOCIETY

TO SEEK AND QSO WITH OTHER VIDEO EQUIPPED STATIONS AND BY EXCHANGE OF THE PERSONALIZED ATQ NUMBER, QUALIFY FOR ALL BENEFITS AND AWARDS OF THE

ATQ SOCIETY.

ISSUED THIS 14TH DAY OF AUGUST, 1993. HENRY RUH KB9FO

**AMATEUR TELEVISION QUANTUM
AWARD**

KB9FO

HAS SUCCESSFULLY TRANSMITTED AND RECEIVED
VIDEO SIGNALS FROM

20	40	80	160	320
----	----	----	-----	-----

AMATEUR TELEVISION STATIONS

ISSUED: 8-14-1993 NUMBER 2

SPONSORED BY
ATVQ MAGAZINE
HENRY RUH, KB9FO
PUBLISHER

**ATV DX QUEST
MEMBERSHIP**

**ACHIEVEMENT
AWARDS FOR
DX & STATIONS
WORKED**

**YOUR ATV QUEST
NUMBER INSIDE**

ENDORSEMENTS
FSTV 440 MHZ

**AMATEUR TELEVISION QUEST
AWARD**

KB9FO

HAS SUCCESSFULLY TRANSMITTED AND RECEIVED
VIDEO SIGNALS FROM

500 miles

ISSUED: 8-14-1993 NUMBER 001

SPONSORED BY
ATVQ MAGAZINE
HENRY RUH, KB9FO
PUBLISHER
IDEA AND DESIGN BY
P. L. SCHUBERT

Amateur Television Quarterly (ISSN 1042-198X) is published four times per year for \$18 per year (US) by Henry B. Ruh, 540 Oakton St., Des Plaines, IL 60018. Second class postage paid at Des Plaines, IL and additional mailing offices. POSTMASTER: Send change of address to: ATVQ, 540 Oakton St., Des Plaines, IL 60018.

Subscriptions and submissions should be sent to: Amateur Television Quarterly, 540 Oakton, Des Plaines, IL 60018. Telephone orders and inquiries may be placed using Visa or MasterCard at 708 298 2269. FAX mail, 708 803 8994. Unless instructed otherwise, subscriptions start with the current issue. Issues are also available at most ham radio stores. SUBSCRIPTION RATES: \$18 US, \$22 Canada, \$29 elsewhere per year. Order forms in centerfold.

Amateur Television Quarterly is copyright 1993. All rights reserved. No portion may be reproduced without written permission. Non US publications may reproduce portions provided credit is provided in the title page. Ham Clubs may obtain blanket permission by sending a request and a copy of their newsletter.

STAFF:

Publisher: Henry Ruh KB9FO	Subscription mailing: Bleich & White Inc
Asst. Publisher Bill Brown WB8ELK	Database: Professional Services Inc.
Retail sales: Sylvia Ruh	Cartoons: Robert Beasley K6BJH
Text Entry: Debra Gillespie	

BACK ISSUES

Amateur Television Quarterly is sold out every issue. Back issues may be obtained from EFS Copy Service, 4011 Clearview Dr., Cedar Falls, IA, 50613 319 266 7040. A cumulative index was published in VOI 4 #3 (July 1991). Next index will be in January 1994.

GOODIES IN THIS ISSUE

- | | | |
|----|---|--|
| 5 | AMATEUR TELEVISION QUEST AWARDS , | something worth working for! |
| 11 | SILENT KEYS, | the sad passing of our ATV friends |
| 11 | 7th ANNUAL ATV PARTY, | atv FUN central, IL and St. Louis (you'll come now!) |
| 13 | A GREATLY IMPROVED ATV SOUND SYSTEM, | Don, W9NTP speaks up! |
| 20 | HAMFEST ANNOUNCEMENTS, | Ft. Wayne and Odessa sked eyeball qso's for all |
| 21 | THOSE LITTLE DB'S, | dxing is a simple matter of better coax and antenna. |
| 22 | THE ADVENTURES OF THE MASKED RADIO OPERATOR, | and his constant companion too-weigh |
| 24 | RADIO SCAN ENDS; AEA quits ATV | ham business silent keys |
| 25 | MOUNTING OF HORIZONTAL OMNI ANTENNAS, | W6OAL puts you behind the wheel |
| 32 | THE ARRAY, | continuing saga of the KB9FO antenna farm. |
| 33 | CENTRAL ATLANTIC ATV NET, | atv repeaters ban together! |
| 34 | SUPER FRONT TO BACK RATIO, | two yagi's are better than one! |
| 37 | HAM SHOWS | a review |
| 38 | NEXT ISSUE | a peek ahead |
| 39 | BUILD A 10 GHZ ATV REPEATER, | Sevenside ATV Group shows how easy it is! |
| 45 | 10 GHz ATV, QUICK AND EASY, | it's not as exotic as you may think! |
| 47 | HORIZONTAL OMNI ANT WITH GAIN! | ATCO discovers 6 db in wheels! |
| 48 | Q COMES TO YOU, | our next ATV mobile trip is the mid south. |
| 51 | SIMPLIFIED ALFORD SLOT FOR 70 CM, | save \$400 and 16 weeks! |
| 52 | HAM TEACHER PROVIDES MINI COURSE IN WISCONSIN SCHOOL, | start them young! |
| 52 | YOUR PERSONAL QUEST MEMBERSHIP CERTIFICATE! | FOR YOUR SHACK WALL! |
| 54 | ORGy NOTES, | AM vs FM, the real scoop! |

ADVERTISER INDEX

ATV ELECTRONICS	47	MICRO COMPUTER CONCEPTS	6
ATV WORLD	cover III	MICRO VIDEO PRODUCTS	48
ATVQ	27, 28, 29, 30, 31	M2 ENTERPRISES	7
COMET ANTENNAS	45	OLDE ANTENNA LAB	cover IV
DOWN EAST MICROWAVE	cover IV	PAULDON ASSOCIATES	4
ELKTRONICS	50	PICOTRONICS	36
ESF COPY SERVICE	20	PARABOLIC	35
FUN TECH	cover IV	PC ELECTRONICS	40, 41, 42, 43
HARLAN TECHNOLOGIES	19	RUTLAND ARRAYS	cover IV
HF TECHNOLOGY	15	SPECTRUM INTERNATIONAL	11, 23
INTERNATIONAL CRYSTAL	26, 31	WYMAN RESEARCH	COVER II, 12

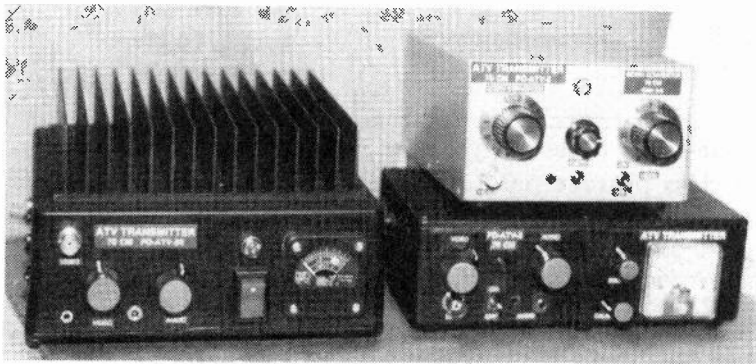

PD-ATV-50 70 CM ATV Transmitter 50 watt output

TRANSMITTER HOUSED IN A 7 1/4" x 7 1/4" DIECAST BOX
 SIZE: 6 1/2" x 7" x 1 1/4" HEAT SINK (15 FINS).
 METER INCLUDED FOR MONITORING POWER OUTPUT.
 SAMPLER (3 STAGES) OUTPUT HAS A BNC JACK FOR SCOPE AND VID.
 MONITORING
 SWITCH SELECTION OF 2 FREQUENCIES 439.25 and 434.00
 YOU CAN ORDER FREQUENCIES OTHER THAN THOSE LISTED
 HEAVY DUTY "OFF-ON" 15A SWITCH. A RED LED "TRANSMIT" LIGHT
 THERMISTOR PROTECTED
 VIDEO AND AUDIO LEVEL CONTROLS ON FRONT PANEL
 A "N" CONNECTOR FOR ANTENNA AND A BNC FOR RECEIVING OR DOWN
 CONVERTOR
 SUB-CARRIER SOUND
 POWER MODULE "BRICK" (M67728) 50 WATTS OUTPUT
 AVERAGE VIDEO OUTPUT 32 WATTS
 HEAVY DUTY RELAY
 POWER VOLTAGE RED POSITIVE BINDING POST AND BLACK GROUND
 (2) CONTROLS ON BACK FOR SAMPLER OUTPUT AND VIDEO LEVEL OUTPUT
 PRICE: \$579.00

PD-ATV-5 70 CM ATV Transmitter 5 watt output (10 W. P.E.P)

TRANSMITTER HOUSED IN A 4 1/4" x 7 1/4" DIECAST BOX
 ALUMINUM BLOCK HEAT SINK 1/4" DEEP x 4" x 2" OPTIONAL FIN TYPE.
 METERED SAMPLER FOR MONITORING POWER OUTPUT
 THE (3) STAGE SAMPLER HAS BOTH R.F. CH.3 OR CH.4 ("F" CONNECTOR) AND
 A VIDEO OUTPUT "BNC" CONNECTOR.
 SWITCH SELECTION OF (2) FREQUENCIES (439.25 OR 434.00)
 YOU MAY SELECT OTHER FREQUENCIES IF DESIRED
 TOGGLE SWITCH - 10 AMP CAPACITY
 A "RED" XMIT LIGHT WHEN TRANSMITTER IS OPERATING
 VIDEO AND AUDIO LEVEL CONTROLS ON FRONT PANEL
 BNC JACK FOR VIDEO INPUT AND 1/8" JACK FOR MICROPHONE USE
 SUB CARRIER SOUND
 POWER MODULE OUTPUT - 5 WATTS
 AVERAGE VIDEO OUTPUT 2-3 WATTS
 RED BINDING POST (+) VOLTAGE 12-13.8V
 BLACK BINDING POST (-) GROUND
 METERED 0-50-FOR POWER OUTPUT OBSERVATION
 SAMPLING POWER AND VIDEO LEVEL CONTROLS ON FRONT PANEL
 ANTENNA "N" CONNECTOR
 PRICE: \$293.00

SIZE 7" x 5" x 3" HIGH (LIGHT GREY WITH BLUE TOP) TRANSMITTER OUTPUT
 IS 5 WATTS. RECEIVER IS DOWN CONVERTER - CH. 3 or 4 ("F" CONNECTOR)
 HEAVY ALUMINUM BLOCK HEAT SINK 4" x 2" x 1/4" DEEP. BRICK POWER
 MODULE. SWITCH ON BACK PANEL FOR FREQ CHANGE.
 BI-COLOR LED (GREEN RCY - RED XMIT)
 "OFF" - "ON" SWITCH. IN DOWN POSITION RCY. GREEN (LIGHT) (UP XMIT
 RED LIGHT) VIDEO INPUT "BNC" CONNECTOR ON FRONT PANEL
 ANTENNA "BNC" CONNECTOR ON REAR PANEL
 RELAY CONTROLLED
 AUDIO JACK 1/8" AND PTT 3/32" JACK FRONT PANEL
 SUB CARRIER AUDIO SOUND
 VIDEO AND AUDIO LEVEL CONTROLS ON FRONT PANEL
 DOWN CONVERTER RECEIVE CONTROLS ON FRONT PANEL
 PRICE: \$399.00

PD-ATV-4 70 CM Transceiver

ATV INTERDIGITAL FILTERS

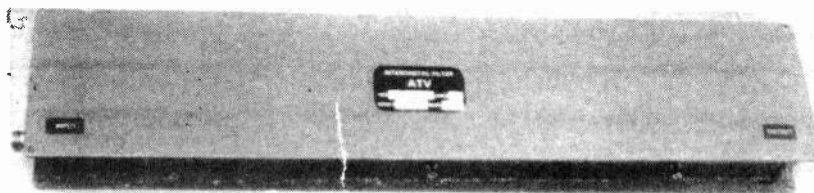

439.25\$170.00 434.00 ...\$170.00 426.25 ...\$170.00
 423.25\$170.00 & others in the 70 cm band\$170.00
 910.25 & others in the 33cm. band \$165.00

PREAMPLIFIERS

TOWER MOUNTED DIECAST 125 WATT CAPACITY
 DESIGNED FOR PACKET-FM-SSB-ATV

100 miscs. & 1/2 sec. switching
 MAGNACRAFT RELAYS & DIODE PROTECTION
 SINGLE GATE GaAs Fet, Transistor
 NF 0.6db G 16db.

PD-440TR-L 420-450mhz.....\$123.00
 SAME with ISOLATOR 135.00

TOWER MOUNTED DIECAST 75 WATT CAPACITY

FAST SWITCHING
 SPECIAL RELAYS & DIODE PROTECTION
 SINGLE GATE GaAs Fet Transistor
 NF 0.6db G 13-17db.

TPD-900-TR-L 900mhz. \$179.00
 TPD-1200-TR-L 1.2ghz.... 179.00

NON SWITCHING TYPES

PD-440S (70cm) 420-450mhz. ..\$56.00
 Diecast

TPD-900 900mhz. 82.00
 diecast

TPD-1200 1.2ghz 82.00
 diecast

YOUR CHOICE OF CONNECTORS
 PREAMPS from 2 meters -thru 2.3ghz.

WRITE OR CALL FOR CATALOGUE

POWER AMPLIFIERS

ATV - SSB - FM - CW - PACKET - REPEATER / 2 Meters - 1.2 Ghz.	144-148 Mhz. Preamp. Incl. FM	4-5 watts = 35W T/R	\$129.
PD-144N	144-148 Mhz. Preamp. Incl. Linear	4-5 watts = 35W T/R	139.
PD-144-3	144-148 Mhz. Preamp. Incl. Linear	4-5 watts = 35W T/R	139.
PD-144N-2FM	144-148 Mhz. Preamp. Yes	FM	4-5 watts = 60W T/R 175.
PD-220N	222 Mhz. " No	FM	4-5 watts = 35W T/R 119.
PD-440N	420-450 Mhz. " No	Linear	1/2 or 4-5W = 18W T/R 119.
PD-440N	420-450 Mhz. " Yes	"	1/2 or 4-5W = 18W T/R 143.
PD-440N-1	" " No	"	1/2 or 4-5W = 35W T/R 155.
PD-440N-1	" " Yes	"	1/2 or 4-5W = 35W T/R 179.
PD-440N-2	" " No	"	1/2 or 4-5W = 60W T/R 285.
PD-440N-2R	" " No	"	3-4W = 60W 199.
PD-440N-3	" " No	"	3-4W = 60W T/R 235.
PD-440NM	" " No	"	1/2 W = 6W T/R 75.
PD-440NM	" " No	"	1/2 W = 6W T/R 118.
PD-900N	902-928 Mhz. " No	FM	1/2 W = 10W 65.
PD-900N	902-928 Mhz. " No	FM	1/2 W = 10W T/R 90.
PD-33LHP	902-928 Mhz. " No	Linear	1 W = 18W 265.
PD-33LHP	902-928 Mhz. " No	"	1 W = 16W T/R 299.
PD-33LP	" " No	"	1 W = 6.5W 119.
PD-33HP	" " No	"	6 W = 15W 125.
PD-33VLP-1	" " No	Hybrid	5mW = 8W 123.
PD-33VLP	" " No	Linear	1/2 W = 1.5W 59.
PD-33 Doubler	70 cm. = 33 cm.	"	1/2 W = 1/2W 85.
PD-33 Doubler	70 cm. = 33 cm.	"	1/2 W = 1.0W 85.
PD-1200N	1.2 Ghz. Preamp No	"	1 W = 18W 149.
PD-1200N-2	1.2 Ghz. " No	"	1 W = 16W T/R 203.
PD-1200N-3	1.2 Ghz. " Yes	"	1 W = 16W T/R 299.
PD-1200N-1	1.2 Ghz. " No	"	3 W = 36W 285.

Preamplifiers: 2 mtrs. - 2.3 Ghz. \$25.00 - 139.00

VHF - UHF MICROWAVE PRODUCTS Preamplifiers / Power Amplifiers 144 Mhz. - 2.3 Ghz.

P.A. for repeater or commercial use. Output: 1.5 watt to the 85 watt range. We will custom build if desired. Power amps. for use in the 800 mhz. region using the "HOME VIDEO" system transmitters. Ex: GEMINI VC-2000. ATV line samplers for ATV use. Power Meter included. Interdigital Filters: 70 cm. & 33 cm. Aluminum Welded 7 pole, \$170.00 and up. ANTENNA SWITCH BOXES: 20-300 watts, 2 mtrs. - 2.3 Ghz. Prices reasonable. Made in the U.S.A. All products are warranted. Call or write for catalog.

pauldon
ASSOCIATES

210 Utica St., Tonawanda, NY 14150
(716) 692-5451

DOWN CONVERTERS FOR 70 & 33 CM.

SAMPLERS (LINE) 70-23cm RANGE.
 VARIOUS PRICES WITH OUTPUT METERS.

BRICKS ON BOARDS: \$35.00 to \$150.00

Amateur TELEVISION Quest AWARD PROGRAM

ANNOUNCING THE FORMATION OF THE ATQ SOCIETY.

Over the span of several weeks in July and August, a number of QSO's on the local repeater have centered around getting more ATV activity going. From the group sprung several ideas. Tom W9NBG, a Des Plaines ATV'er provided an outline and drawing which have inspired the Q awards. These are designed to loosely follow the WAS (Worked Atv Stations) (Quantum) and DXCC (Quest) awards. The system resembles the SWOT and SMIRK VHF programs in operation. The program is sponsored by ATVQ Magazine, but the participants do not have to be subscribers.

QUANTUM AWARD

It is not possible to work ATV stations in all 50 states from a single location. So to provide a similar award program, the Quantum award is for WAS (Worked Atv Stations). The ATV station contacts other ATV stations, exchanges Quest numbers (Q number) in VIDEO only, and gets 1 contact point. Thus a sync bar signal is NOT good enough to qualify as a contact. A full video exchange must take place. The station may use simplex, ATV repeaters, or may gain 1/2 point for a one way reception of, for example, an ATV Balloon, or other drone/beacon signal. The repeater station does NOT count as a contact.

Because ATV is in clumps, groups of stations in an area, usually separated by vast spaces to the next group, ie Kansas City does not regularly contact St. Louis, there is a limit to the number of "local" contacts a station could make, normally limited by the number of active stations in the area. This would seem to give big cities an advantage over small towns. To even the playing field, a station can operate portable, mobile or otherwise, 25 miles away from the stations normal fixed QTH and count as a second station.

Example: Station A5TV contacts N5TV and both

operate from their home QTH. They exchange Q numbers and each gets 1 point. A5TV now goes to a point 25 miles away from his home QTH and again works N5TV. Again Q numbers are exchanged and both get another point. N5TV now goes to a place 25 miles from his home QTH and works A5TV again. They exchange Q numbers in video and get a third contact point. There is no limit to the number of locations except each must not be closer than 25 miles from any other point used previously. Thus you could locate a number of points at 25 mile intervals in the same direction or orthogonally to achieve any number of possible contact points. This allows for portable or mobile operation anywhere!

AWARD LEVELS

A Certificate suitable for framing will be awarded each station which has succeeded in contacting the following number of ATV stations: 20, 50, 100, 150, 200, & higher levels in increments of 100 will also be awarded. **Multiple bands and multiple modes count as separate contacts!**

QUEST AWARD

In addition to working a number of stations, it is thought that there should be a form of DXCC to recognize DX achievements in video. This award is based on distance in 100 mile increments. The award will recognize 2-way video contact made as described in the QUANTUM award. To qualify the ATV station contacts another ATV station, ex-

changes 2-way video and Q number. If the station is more than 100 miles distant, the stations qualify for the ATVDX-I award (100 miles), likewise for 200, 300, 400 ... up to 1,000 miles for ATVDX-X and higher awards as are necessary for longer distances. **Multiple bands are recognized as separate contacts.**

VS-100 ATV Repeater Controller

- * Ten Video inputs and four audio inputs.
- * Three operational modes: Repeater, Scan & Manual.
- * Built in CW ID programmable with touch tone.
- * Control receiver input for touch tone control.
- * Touch tone programmable control and user codes.
- * Eight AUX TTL touch tone controlled outputs.
- * 19"w x 1.75"h x 8"d enclosure with 115 VAC power supply.
- * Video ID input with support for ELKTRONICS video ID.
- * Built in sync detector (VOR board).

Micro Computer
Concepts AMERICAN

813-376-6575

Visa, MC, MO, checks, COD

8849 Gum Tree Ave, New Port Richey, Fla 34653

Amateur TELEVISION Quest **AWARD PROGRAM**

JOINING ATQ SOCIETY APPLYING FOR AWARDS

Any ham or SWL may join ATQ Society. Each member receives a full color certificate of membership suitable for framing. Each certificate has a personal Quest ID number, which is used in the exchange of video contacts with other ATQ members. Each member's number is unique. Subscribers of ATVQ Magazine who have their ham call on file will receive their certificate automatically. Otherwise they must comply with the non subscriber application. Non ATVQ Subscribers may send \$2.50 in stamps or cash or check to cover the cost of printing the full color certificate and mailing.

In return mail each applicant will receive their handsome full color certificate (as shown on the cover of this issue) on 11 x 8.5 heavy certificate stock, printed with their call letters and personal Quest number. Non hams (SWL's etc) will be issued the same certificate but will have a Q call sign assigned in place of the ham call letters. For example Q1AA, etc for each call district.

Upon reaching each plateau, an ATV station may apply for the appropriate award. A log should be submitted to ATVQ Magazine with the following information:

The call, name, address and Q number of the applicant. Listing of the name and call and Q number of each contact, date and time of each contact and band on which the contact is made. Enclose \$3 per certificate to cover the cost of color printing and postage in stamps or cash.

By return mail the applicant will receive the certificate for which qualified. In some instances verification will be made to keep things on the up and up.

STARTING DATE

To give everyone an equal footing, the start date for any qualifying contacts is Oct 1, 1993. Only contacts made after this date qualify for the awards.

The 440-18 is a carefully computer optimized broadband yagi featuring an excellent pattern and good gain across its bandwidth. It can be mounted vertically or horizontally.

OTHER ANTENNAS OF INTEREST FOR ATV USE!

420-450-11
420-5-5
432-9WL

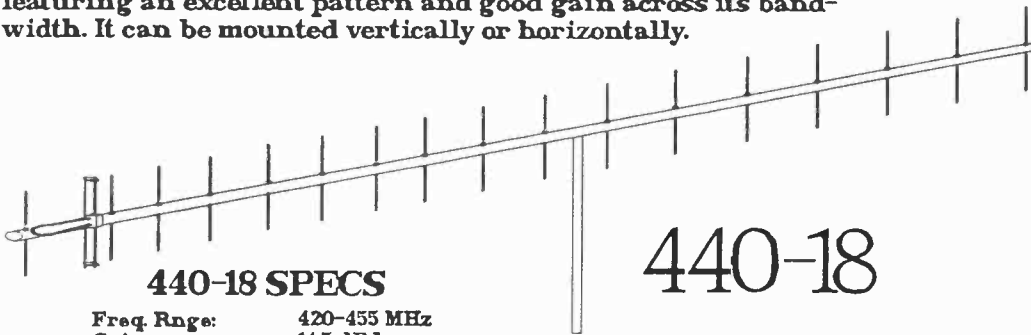

440-18 SPECS

Freq. Range: 420-455 MHz
Gain: 14.5 dBd
Frt to bck.: 23 dB
W. Area: .875 sq. ft.
Boom Lg: 11.33 ft.
Trn. Rad.: 6 ft.

440-18



ATV

Is important to us!

M² Enterprises

**7560 N. Del Mar Fresno, CA 93711
(209) 432-8873 FAX (209) 432-3059**

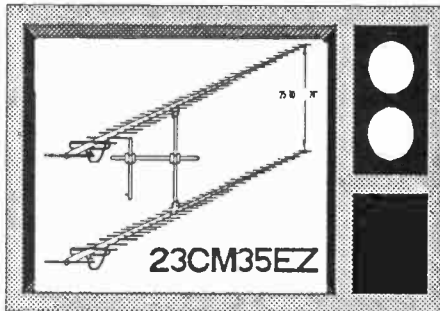

23CM35EZ SPECS

Freq. Range: 1250 to 1300
Gain: 18.4
Frt to Bck: 25 dB
W. Area: 0.6 Sq. Ft
Boom Lng: 120 in
Trn. Rad: 6 Ft.

THE RULES

1. Become a member of ATQ Society.
2. Obtain membership Q number.
3. Exchange the Q number only in VIDEO MODE (never voice or other method).
4. AM or FM video may be used.
5. Any ATV band may be used INCLUDING SSTV or FAX.
6. Modes should be kept separate. Awards will be made for each mode and each band on which qualified. (ie 20 contacts on 440 MHz FSTV, 20 contacts on 1255 MHz in FM mode FSTV, 20 contacts on HF in SSTV, etc).
7. The highest award made in each category will be published regularly and top winners will be honored at Dayton Hamvention each year.
8. Don't cheat! It only lowers the value of the award you pin on the wall.
9. Make a separate application for each award certificate.
10. HAVE LOTS OF FUN!
11. Quantum awards may be qualified on any ATV band and any VIDEO mode. (RTTY and PACTOR pictures DO NOT COUNT!)
12. QUEST awards are only for contacts above 50.1 MHz. (SSTV on 6, 2, 220) FSTV/SSTV on 420 MHz and above.
13. Repeaters may NOT be used for DX awards (Quest), only direct contacts.
14. SWL contacts count as 1 point for each station received. Hams who "intercom" in voice and receive only on

- video may count 1/2 point per station.
 15. Balloons and other beacon stations count towards Quantum awards but only as 1/2 point.
 16. Satellite (OSCAR) contacts count for QUANTUM but not QUEST awards.
 17. HAVE MORE FUN!
 18. Do not send QSL's, video tapes, photos unless you want them used in ATVQ magazine writeups (much appreciated). They are NOT necessary for awards but make good reading!
 19. Clubs may participate as club stations.
 20. Recruit other ATV stations to become Quest Society members and expand the possible Q number list!
- For further information contact ATVQ, 540 Oakton St., Des Plaines, IL 60018

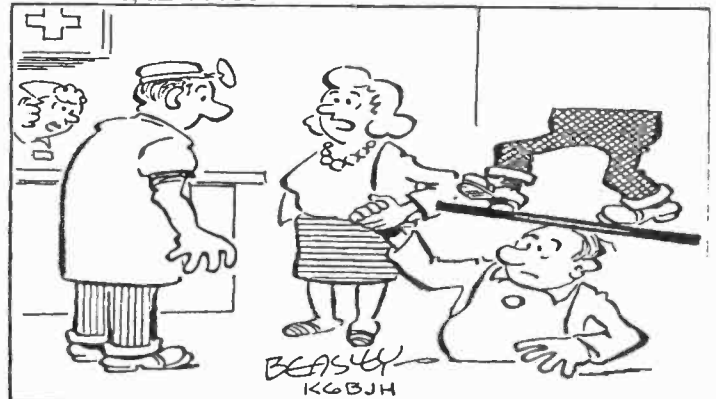

THE PICTURE ON HIS ATV MONITOR STARTED ROLLING A MONTH AGO, AND HE'S BEEN TRYING TO WATCH IT EVER SINCE!

AWARD CERTIFICATE SUMMARY

QUEST ATV DX

BANDS: 6 meters and up
MODES: SSTV, FAX, AM FSTV, FM FSTV
LEVELS: 100 mile increments per mode per band
QUALIFICATION: one or more contacts at distance.
EXCHANGE: 2 way video, both call signs in video, Q number in VIDEO.
REPEATERS: not allowed, only direct QSO.
AERONAUTICAL STATIONS: separate endorsement only
APPLICATION: log with date, time, band, call, Q number, mode.
EACH MODE AND BAND ARE SEPARATE
MAILING FEE \$3 per certificate

QUANTUM Worked Atv Stations

BANDS: HF, 6, 2, 220, 430, 900, 1200, 2300, & up
MODES: SSTV, FAX, AM FSTV, FM FSTV
LEVELS: (QSO's) 20, 50, 100, 200, additional 100 increments
EXCHANGE: 2 way video, both call signs in video, Q number in VIDEO.
REPEATERS: allowed for QSO but do not count as stations.
AERONAUTICAL STATIONS: allowed as 1/2 point. APPLICATION: log with dates, times, bands, calls, Q numbers, mode.
EACH MODE AND BAND ARE SEPARATE
MAILING FEE \$3 per certificate

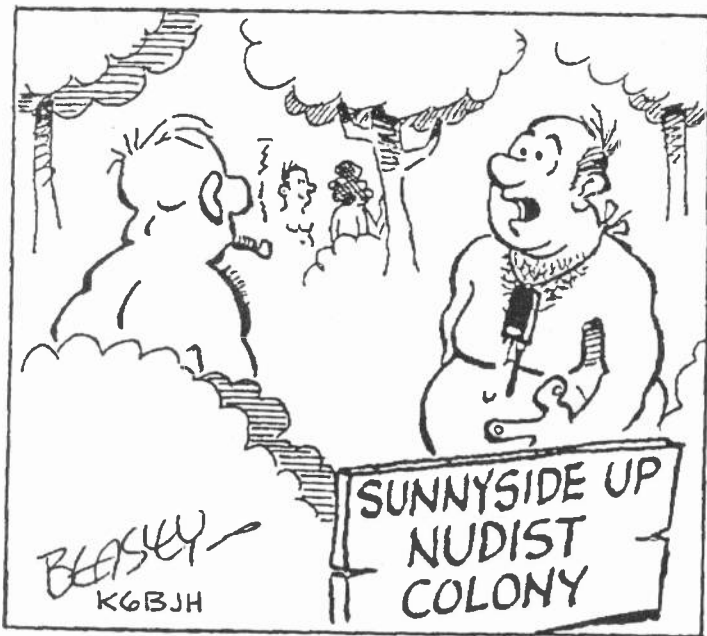

HAVE YOU FIGURED OUT A GOOD PLACE TO HANG YOUR HANDHELD?

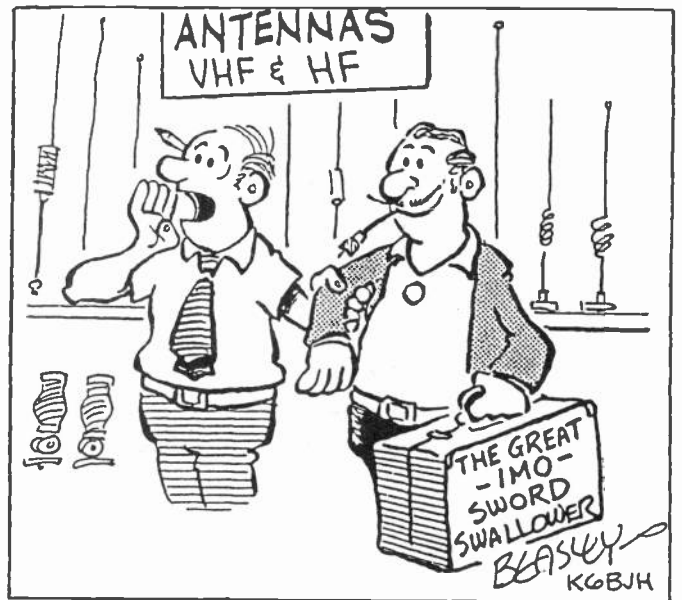

HEY RUSS, CAN YOU COME HERE AND SHOW ME WHAT TO DO? I THINK THIS GUY JUST SWALLOWED ONE OF OUR 5/8 WAVE MAGMOUNTS!

Southern New England ATV NET

The SNEATV net serving the New England area from W1NI in Connecticut operates at 7:30 PM local on 4439 KHz. Stations looking for activity and local ATV repeater info for the southern New England area should check in. Support your local repeater!

Statement of Ownership and Management and Circulation. Title of Publication, Amateur Television Quarterly. Publication number 003-353. Date of filing 9-6-93. Frequency of issue: quarterly. Number of issues published annually: 4. Annual subscription price: \$18. Mailing address of known office of publication: 540 Oakton St., Des Plaines, IL 60018-1950 Cook County. Mailing address of headquarters of publisher: 540 Oakton St. Des Plaines, IL 60018-1950 Publisher: Henry Ruh, 540 Oakton St., Des Plaines, IL 60018-1950. Editor: Bill Brown 12536 TR 77 Findlay, OH 45840-9065. Owner: Henry Ruh 540 Oakton St., Des Plaines, IL 60018-1950. Bondholders, mortgages and other security holders: none. Average number of copies each issue during preceding 12 months: total copies 2500. sales through

dealers, carriers and counter sales 826. Mail subscriptions 1604. Total paid and or requested circulation 2430. Free distribution 52. Total distribution 2482. Copies not distributed 18. Returns: none. Total 2500. Actual number of copies of single issue published nearest to filing date: Total number of copies 2500. Sales through dealers and carriers and counter sales 713. Mail subscriptions 1768. Total paid and or requested circulation 2481. Free distribution 17. Total distribution 2498. Copies not distributed 2. Returns none. Total 2500. I hereby certify that the statements made by me above are correct and complete. (Signed) Henry Ruh, Owner.

LOG INSTRUCTIONS:

CIRCLE THE MODE IN THE UPPER LEFT CORNER THAT YOU ARE OPERATING (Mobile, Portable, Fixed).
 ENTER THE DATA AT THE TOP OF THE PAGE. AWARD CATEGORY IS QUEST, QUANTUM OR SWL.
 ENDORSEMENTS: sstv, fax, fstv, FMVIDEO (FAST SCAN).

BANDS AND LEVEL. IE fm fstv 100 STATIONS; sstv 50 qso'S, mobile fstv 200 MILES. ETC.

LOG COLUMNS: STATION, THE STATION YOU ARE IN QSO WITH,

DATE: THE DATE OF THE QSO.

BAND/MODE: FREQUENCY (450, 900 ETC) MODE: SSTV, FAX, AM FSTV, FM FSTV

M/P/F: WHAT THE OTHER STATION IS OPERATING F= HOME QTH, M= VEHICLE IN MOTION, P= FIXED LOCATION (IN OR OUT OF A VEHICLE) AWAY FROM THE HOME QTH.

Q#, THE Q NUMBER OF THE OTHER STATION

DISTANCE: FOR DISTANCE AWARD (QUEST) AND FOR PORTABLE/MOBILE OPERATION WHEN THE OTHER STATION IS AT 25 MILE INTERVALS (SEE RULES).

QTH: WHERE THE MOBILE/PORTABLE STATION IS LOCATED.

QSO #: START WITH 1 AND COUNT UP TOWARDS EACH AWARD.

suggestion: USE SEPERATE SHEETS FOR EACH AWARD TYPE YOU ARE WORKING TOWARDS.

A SEPARATE LOG FOR YOUR FIXED, PORTABLE, MOBILE OPERATION, AND EACH MODE AND BAND YOU USE.

EXAMPLES:

A CONTACT COULD COUNT FOR MORE THAN ONE AWARD. K1AA WORKS K1AB FROM HIS HOME QTH ON FSTV 440 MHZ. THEY ARE 2 MILES APART. COUNT AS 1 QSO. K1AA GETS IN HIS CAR AND WORKS K1AB IN HER HOME AS HE DRIVES TO A POINT 27 MILES FROM HIS HOME. COUNT AS 1 QSO AND AS ONE MOBILE QSO. K1AA ARRIVES AT REMOTE SITE AND WORKS K1AB. COUNT AS A QSO AND AS A PORTABLE QSO AND AS A 25 MILE CONTACT. K1AB GETS IN HER CAR AND DRIVES TOWARD A HILL 25 MILES FROM HER HOME AND WORKS K1AA AS SHE DRIVES. COUNT AS ONE QSO AND AS ONE MOBILE QSO. WHEN SHE ARRIVES SHE AGAIN WORKS K1AA AS PORTABLE, MORE THAN 25 MILES FROM HER HOME QTH. COUNT ANOTHER QSO AND AS A PORTABLE QSO. IF K1AA AND K1AB ARE NOW 50 MILES AWAY, COUNT AS A 50 MILE QSO.

POINTS: K1AA	5 QSOS	K1AB	5 QSO'S	(1 F-F, 1 M-F, 1 P-F, 1 P-M, 1 P-P)
	1 MOBILE QSO		1 MOBILE QSO	(1 M-F)
	3 PORTABLE QSO		3 PORTABLE QSO	(1 P-F, 1 P-M, 1 P-P)

BOTH STATIONS CAN CONTINUE FOR A MOBILE TO MOBILE, OR MOVE 25 MILES FROM BOTH THEIR HOME WTH AND THE PORTABLE LOCATION FOR A NEW 25 MILE POINT TO COUNT AS YET ANOTHER STATION.

QUICK AND EASY MULTIPLICATIONS

K1AA NOW SWITCHES TO 1255 MHZ AND WORKS K1AB EXACTLY AS ABOVE. ALL THE NEW QSO'S COUNT TOWARDS QUANTUM (NUMBER OF QSO'S) SINCE CONTACT IS ON A DIFFERENT BAND. (NOW K1AA WOULD HAVE 10 QSO'S). WHILE ON 1255 MHZ K1AA SWITCHES FROM AM VIDEO TO FM VIDEO AND REPEATS THE CONTACTS. Q1AA NOW HAS 5 MORE QSO'S (TOTAL 15) 3 MOBILE QSO'S AND 9 PORTABLE QSO'S.

STATION K1AB CAN ALSO DO TH E SAME TO INCREASE HER SCORE.

EACH STATION COULD MOVE TO OTHER POINTS WHICH ARE MORE THAN 25 MILES FROM ALL PREVIOUS POINTS USED AND INCREASE THEIR SCORES AGAIN.

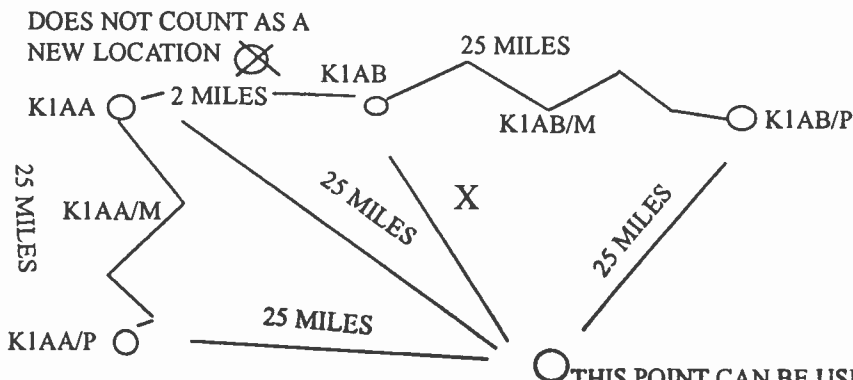

DOES NOT COUNT AS A NEW LOCATION

25 MILES

K1AA/P

THIS POINT CAN BE USED IF IT IS MORE THAN 25 MILES FROM ALL THE OTHER POINTS USED BY K1AA OR K1AB IN THE EXAMPLE.

THIS IS FOR VHF/UHF ONLY FOR HF, ONLY 3 POSSIBLE LOCATIONS QUALIFY, HOME QTH, MOBILE AND ONE PORTABLE LOCATION, ALTHOUGH ALL PORTABLE LOCATION QSO'S COUNT, EVEN FROM MULTIPLE SITES. (IE JAPAN, BERMUDA AND CANADA ALL COUNT AS ONE PORTABLE OPERATION)

USE ANY COMMON MAP TO DETERMINE DISTANCES.

POINT X COULD BE USED BY K1AA TO CONTACT STATIONS OTHER THAN K1AB AS IT IS MORE THAN 25 MILES FROM HIS QTH BUT NOT K1AB'S QTH

IN MEMORIAM

We are saddened by the passing of long time ATV'er Vic Leisner W3LGV. Vic was a very active ham and was responsible for one of the Daytona Beach ATV repeaters. His expertise and friendship will be missed by all. Vic is survived by his wife June, also an active amateur. Sylvia and I were privileged to have met both on a trip to Florida several years ago and they told us of how they had met over ham radio and then got married.

Also we are sad to report the passing of Frank W3QNI. Frank was an "ol timer" ATV'er and ham from Pittsburgh, liked by all. Frank created both the Steel City ATV repeater and the Acme, PA machine that is now operated out of Uniontown, PA. Frank was the third ATV station I had ever worked of FSTV and I was mobile at the time on the PA Turnpike, going to a Gathersburg hamfest where I met Al and Ron who were publishing A5 magazine.

ATV PARTY

The seventh annual central Illinois/St. Louis area ATV Banquet will be held on November 27th, 1993 at the Ariston Restaurant in Litchfield, IL. Attendance last year was over 80. In addition to an ATV program and speakers, there will be a prize drawing. For RSVP and information, contact Scott Millick K9SM, 217 532 3837.



NO RUBBER DUCKS!

1691 MHz Weather Satellite System

Spectrum International, Inc. is pleased to announce their appointment as North American and International distributor of Time-Step Electronic's Weather Satellite Receiving System.

This high quality, low cost system consists of:

1691 MHz GaAs FET Pre-ampl. model TS-1691-P.Amp	\$450
1691 HGz Receiver model TS-1691-Recvr	\$450
Decoder Board & Software model TS VGA-SAT 4	\$399

Also available to complete the system are:

Low Loss (microwave) Coaxial Cable (65 ft) with connectors. model 1691-coax ass'y	\$ 70
1691 MHz Loop-Yagi Antenna model 1691-LY(N)	\$ 99
1691 MHz Loop-Yagi Extension model 1691-LY-XTN	\$ 85
Demonstration Disc (IBM-PC VGA compatible) of signals recorded from WX-SAT system.	\$ 3

Shipping: FOB Concord, Mass.
Prices subject to change without notice.



SPECTRUM INTERNATIONAL, INC.
Post Office Box 1084 Dept. T
Concord, Mass. 01742, U.S.A.
Phone: (508) 263-2145
FAX: 508-263-7008

WYMAN RESEARCH INTRODUCES NEW TRIDON LINE

ONLY
\$249.95

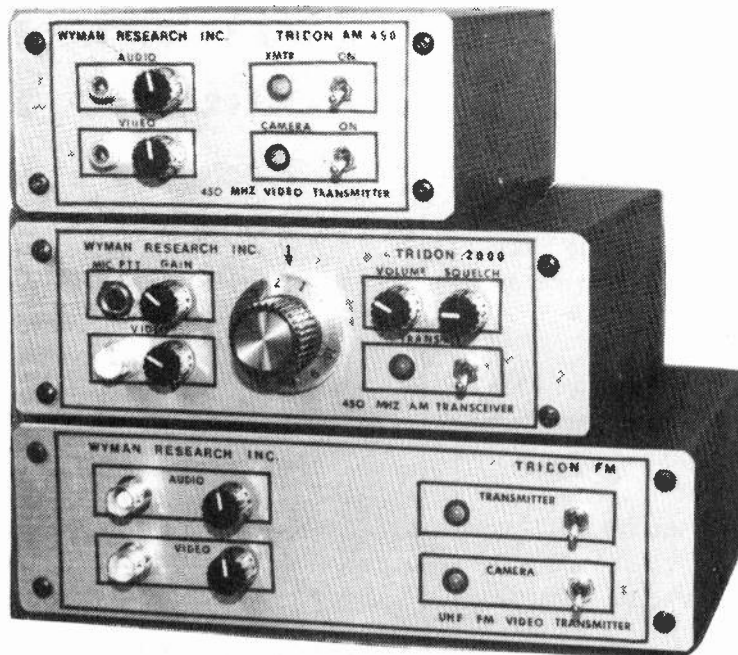

TRIDON AM 450 MHZ
TRANSMITTER

\$329.95

TRIDON 2000 AM
450 MHZ TRANSCEIVER

\$359.95

TRIDON FM
TRANSMITTERS
900 MHZ
1200 MHZ

ALSO 440 MHZ TOO

450 TRANSMITTER

- POWER OUTPUT IS 3 W PEAK
- TWO INDEPENDENT AUDIO SYSTEMS (Sub-carrier and On-carrier)
- 10 PIN CAMERA CONNECTOR ON BACK-BNC OR RCA CONNECTORS ON FRONT
- SYNC STRETCHER FOR OPTIMUM COMPOSITE VIDEO
- STANDARD CRYSTAL FREQUENCY: 439.25 MHZ or 434.00 MHZ
- POWERS VIDEO CAMERA (10 Pin Connector)
- REQUIRES 13.8V DC AT 600 MA PLUS CAMERA POWER (1 amp)
- RF TIGHT ALUMINUM CABINET WITH BRUSHED ALUMINUM PANEL CUSTOMED DESIGN-ED BY W9YL
- CABINET SIZE: 2.2"x5.25"x5.5"
- INCLUDES SEND-RECEIVE RELAY

FACTS 450 TRANSCEIVER

- POWER OUTPUT - 3 W PEAK
- 10 PIN CAMERA CONNECTOR ON BACK PANEL, BNC OR RCA CONNECTOR ON FRONT PANEL
- MONITOR VIDEO FROM CAMERA OR DETECTED VIDEO OUTPUT
- ALL NEW VIDEO AND AUDIO CIRCUITRY WITH SYNC STRETCHER
- NEW TWO CHANNEL AUDIO SYSTEM ON TRANSMIT (SEE OPTIONAL RECEIVER BELOW)
- NEW MORE POWERFUL VIDEO TRANSMITTER
- STANDARD CRYSTAL FREQUENCY: 439.25 MHZ or 434.00 MHZ
- .8 DB NF GaAsFET PRE-AMPLIFIER
- RF TIGHT ALUMINUM CABINET WITH BRUSHED ALUMINUM PANEL CUSTOMED DESIGN-ED BY W9YL
- SIZE: 2.2"x7"x5.75"
- RELAY SWITCHED ANTENNA

FM TRIDONS

BOTH HAVE —

- PRE-EMPHASIS CIRCUITRY
 - "N" CONNECTOR
 - RF TIGHT ALUMINUM CABINET WITH BRUSHED ALUMINUM PANEL CUSTOM-ED DESIGNED BY W9YL
 - CABINET SIZE: 2.2"x8.2"x5.5"
 - REQUIRES 13.8 V DC AT 2 AMPS
 - LARGE HEAT SINK
- 900 MHZ OR 430 MHZ**
- 915 OR 430 MHZ FM-ATV TRANSMITTER
 - POWER OUTPUT IS 8 WATTS
 - 4.5 MHZ AUDIO SUB-CARRIER
 - USES NEW PHASE LOCK LOOP CRYSTAL CONTROLLED EXCITER
- 1200 MHZ**
- 1255 MHZ FM-ATV TRANSMITTER (Any optional freq.)
 - POWER OUTPUT IS 4-5 WATTS
 - 6 MHZ AUDIO SUB-CARRIER (Requires 1 V PP Audio)
 - USES NEW PHASE LOCK LOOP CRYSTAL CONTROLLED EXCITER

WYMAN RESEARCH, INC.

R.R. #1 BOX 95
WALDRON, INDIANA 46182
(317) 525-6452

Don & Sue Miller
W9NTP
W9YL

INDIANA RESIDENTS 5% SALES TAX

SHIPPING \$4.50

A GREATLY IMPROVED SOUND SYSTEM FOR ATV

by
Don Miller W9NTP

Many of us have struggled over the last forty years of ATV operation trying to obtain better subcarrier sound for our stations. Although we do get sound through our transmitters, we often hear complaints of hum, low volume, and non-existent sound. Recently there have been a rash of complaints from the FM repeater groups concerning the second harmonic of the 4.5 Mhz subcarrier (448.25) getting into one of the repeaters receivers above 440 Mhz. This interference can be reduced or eliminated with suckout filters but vestigial sideband filters only reduce this problem unless they have very sharp skirts. Remember our upper sideband uses nearly the same spectrum as the FM repeaters. One solution for this problem is to use the lower sideband for our repeater receiver input. This technique, together with an upper sideband vestigial rejection filter, such as used on the Chicago ATV repeater, will completely solve your FM repeater interference to your ATV repeater on 439.25 MHz and the 448.25 MHz interference to the FM repeaters. This has been in use in Indianapolis, Indiana ATV repeater for over 12 years and it has never been bothered by FM repeaters. In fact the repeater trustee has an FM audio repeater on 443.75 MHz (upper sideband audio frequency) and the ATV repeater does not know that it exists.

PHOTO ONE

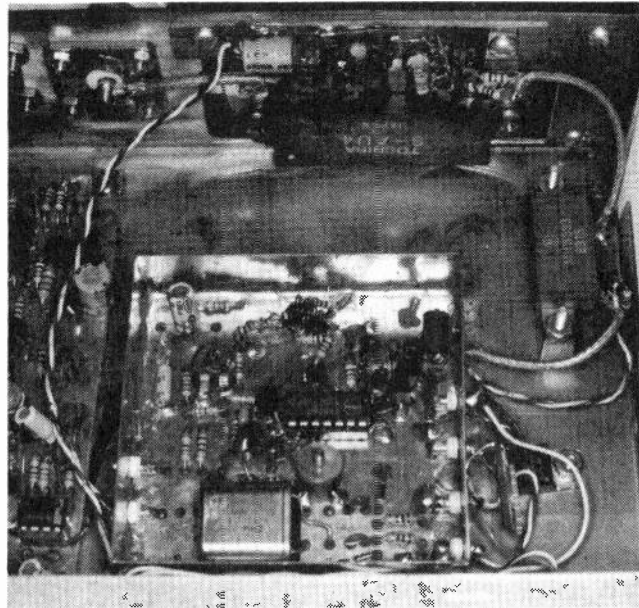

ATV'ers have greatly copied the technical design of commercial TV stations with few exceptions. One difference is the way audio is generated. Commercial stations use two transmitters spaced 4.5 MHz apart. [Ed. note: not any more, the trend is for common amplification of audio and video using IF modulation and conversion to the operating frequency in very linear stages.]

The TV receivers sold in the early 1950's had two local oscillators which were difficult to keep tuned so that the receiver would keep tuned so that the receiver would receive both video and sound at the same setting of the tuning knob. Many of us were in college then and we made quite a bit of money retuning those old Admiral sets so that they would receive video and sound at the same time. They needed to be retuned about every four months (in between semester spending money!).

To solve this difficult problem, TV engineers decided that the video carrier frequency could be used as the local oscillator for the recovery of the sound carrier if the sound IF was chosen to be 4.5 MHz. Restrictions had to be placed on the modulation levels of the video. The video carrier can not be cut off by over modulation, otherwise the sound would have severe hum superimposed from the frame sync signal

(60 Hz). This has worked well for the last 40 years.

Hams looking for a way to accomplish the same result found that if an audio modulated FM subcarrier of 4.5 MHz was added to the video signal which modulated the ATV transmitter, the TV receiver could be tricked into thinking that it was receiving a commercial signal with audio.

This simple solution was not without several problems. The first was the generation of a stable 4.5 MHz source that was capable of being wideband modulated and still be stable enough to stay in the 4.5 MHz IF frequency passband of the receiver. Since this 4.5 MHz subcarrier must pass through the video modulator, it competes for the dynamic range of the video modulator because both the audio subcarrier and video signal add together complicating the modulation process. Non-linearities of the solid state devices contribute to spurious signals such as the second harmonic of the 4.5 MHz subcarrier which appears in the FM repeater band.

There are several ways to correct these deficiencies but none of them are completely satisfactory. The FM audio modulated carrier can be generated in several ways.

Most manufacturers use a varactor modulated free

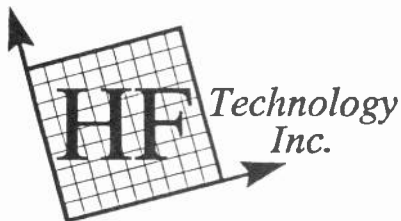

HIGH FREQUENCY TECHNOLOGY INC.
457 SANTA FE TRAIL
CARY, ILLINOIS 60013
(708) 639-4336

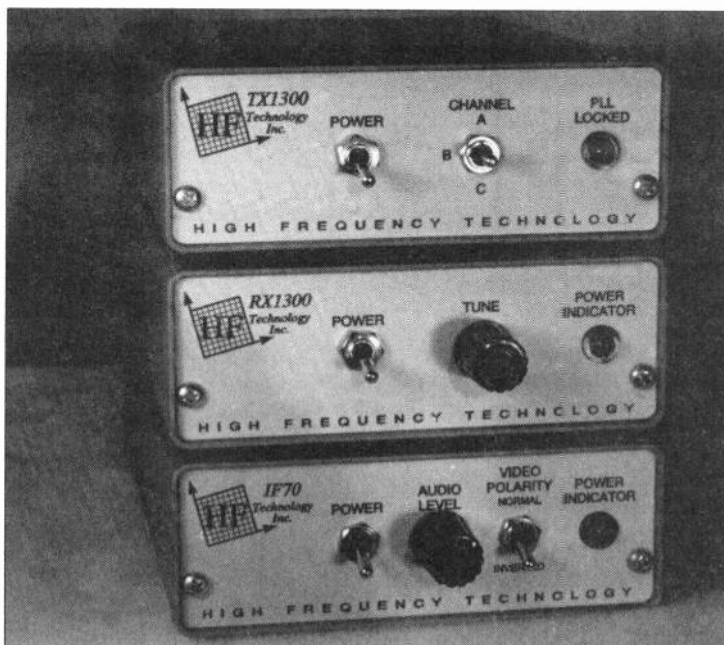

TX1300 \$349.00
NEW 1 WATT
VERSION!

RX1300 \$219.00

IF70 \$199.00

**COMMERCIAL
QUALITY
AMATEUR
TELEVISION**

IF70 Specifications:

IF Input Frequency: 70 MHz nominal
IF Bandwidth: 16 MHz
IF Sensitivity (3 dBQ): less than -85 dBm
IF Sensitivity (20 dBQ): less than -72 dBm
*Overall Sensitivity (3 dBQ): less than -95 dBm (P1 picture)
*Overall Sensitivity (20 dBQ): less than -90 dBm
*Overall Sensitivity (40 dBQ): less than -80 dBm (P5 picture)
IF Input Dynamic Range: -85 to +5 dBm
Video Bandwidth: 15 Hz to 4.2 MHz CCIR de-emphasis
Video Output: 1 Vp-p into 75 Ω @ 4 MHz peak dev.
Differential Gain Variation: less than 2 % p-p
Differential Phase Variation: less than 1.5° p-p
Subcarrier Detection Range: 4.5 to 8.0 MHz
Audio Bandwidth: 15 Hz to 15 KHz +/- 3 dB
75μs de-emphasis
Audio Output: Line Level greater than 8 V

* Measurements made with RX1300 downconverter

All units are powered by 11 to 15 VDC. Enclosure dimensions are approximately Length: 6.5"

Width: 4.2"
Height: 1.5"

Also available... complete line of 450 MHz FMATV equipment: TX450 FMTV transmitter @ \$199.00; RX450 AM/FM ATV downconverter @ \$149.00, for use with the IF70 for high performance FM system or for AM applications. Also available shortly, a complete line of FMATV equipment for the 13 cm band. Custom versions of the above equipment can be manufactured to order. For information or to place orders phone: 708 639-4336 note new address and phone number ! VISA and MC accepted. To order by mail or for additional information write to HFT Inc. 457 Santa Fe Tr. Cary, Illinois 60013. Please add \$5.00 for shipping and handling, Illinois residents add sales tax. Some specifications are subject to change without prior notice.

TX1300 Specifications:

Frequency of Operation: 3 PLL synthesized user selectable channels 1240-1300 MHz
Emission Type: FM, NTSC video with subcarrier audio channel adjustable 4.5-8.0 MHz +/- 4 to +/- 11 MHz adjustable, nominally set to +/- 4 MHz
Deviation Video: +/- 25 KHz adjustable
Deviation Audio: 15 Hz to 8 MHz
Video Bandwidth: CCIR pre-emphasis (maximum video response dependent upon the choice of sound subcarrier frequency)
Audio Bandwidth: 15 Hz to 15 KHz +/- 3 dB
75μs pre-emphasis
RF Output Power: 1 Watt nominal into 50 Ω

RX1300 Specifications:

Frequency of Operation: Continuously varactor tuned channels 1240-1300 MHz
Emission Type: FM or AM, linear downconversion use IF70 for FM IF/detector use TV chan 3-4 for AM IF/detector
IF Frequency Range: 70 MHz (FM operation) TV channel 3 or 4 (AM operation)
Noise Figure: less than 2.5 dB Unconditionally stable, no tuning required
Input Compression (1dB): -20dBm
Conversion Gain: greater than 20dB

BETTER AUDIO FOR ATV

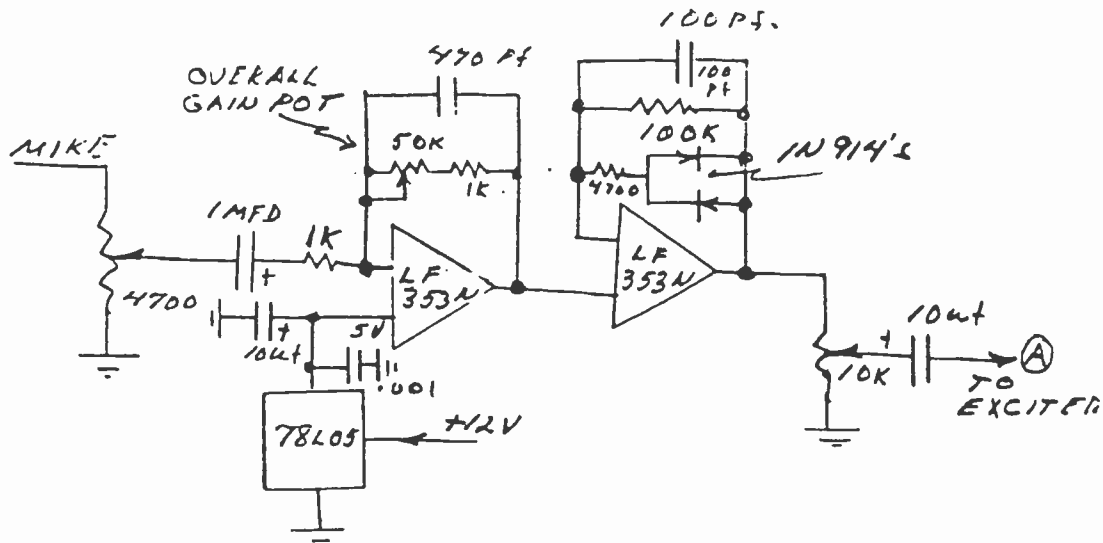

FIG. 2 MICROPHONE AMPLIFIER

viding audio in ATV systems, remember that a subcarrier system has twice the bandwidth of a normal TV station. The subcarrier is 4.5 MHz away from the video carrier and has symmetrical modulation on both sides of the video carrier. This makes the ATV spectrum 9 MHz wide. I wonder why we are not using FM ATV on 450 MHz, it is not much wider. Verify this by looking at a comparison of the AM spectrum and FM spectrum on a spectrum analyzer.

ATVers should be using the lower sideband on 439.25 MHz to eliminate the FM repeater interference that is slowly moving down into our legal upper sideband. All of this advertisement about vestigial sideband in the exciter is misleading. Vestigial sideband is good. It should be generated by a good filter placed in the coax leading to the antenna. This is another point missed by the amateur in copying the system in use by commercial stations. Filters can be used to eliminate either sideband.

Before I go ahead and develop the audio system that is superior to anything previously discussed, let me remind you that there is very little power in the audio subcarrier regardless of how it is generated. As an example, if the audio subcarrier is set at a level of 20 dB below the video subcarrier, the audio power is 1/100th of the video power. If you are running 100 watts of video, then the subcarrier will only be 1 watt. It is no wonder that you fail to hear your friend on the TV set under DX conditions? Subcarrier is best used for repeater operation where there is sufficient signal to produce P4-P5 pictures.

If you want super audio for ATV dxing, use video carrier audio. This is narrow band audio FM modulation of the AM video modulated carrier. The audio power is the same power as the video power. In other words, 100 watts of video has 100 watts of audio. The only drawback is that the TV set cannot detect the signal unless a locally generated signal offset by 4.5 MHz is used. Most of us use a separate receiver tuned to 439.25 MHz and a TV set for the video for our ATV dxing. This method results in 100-200 mile ATV dxing every day of the week.

For improved audio on our ATV receivers, consider a separate transmitter for the sound. You will recall that this is the way the commercial TV stations have always transmitted their audio. This means that we must have a transmitter that has some power, crystal controlled, and have the capability of being deviated at least 25 Khz.

Wide deviation FM transmitters can be designed in several ways. The conventional way of generating this wideband audio is to modulate a low frequency crystal oscillator with FM audio and multiply the output to the desired output frequency with multiplying stages. The deviation is multiplied the same way as the frequency is multiplied. There is nothing wrong with doing it this way but it becomes complicated when you consider all the multiplying stages and their required bandwidth for each.

There is another way to accomplish the same result without using multiplier stages which only requires a few active components. With present day synthesizers it becomes

BETTER AUDIO FOR ATV

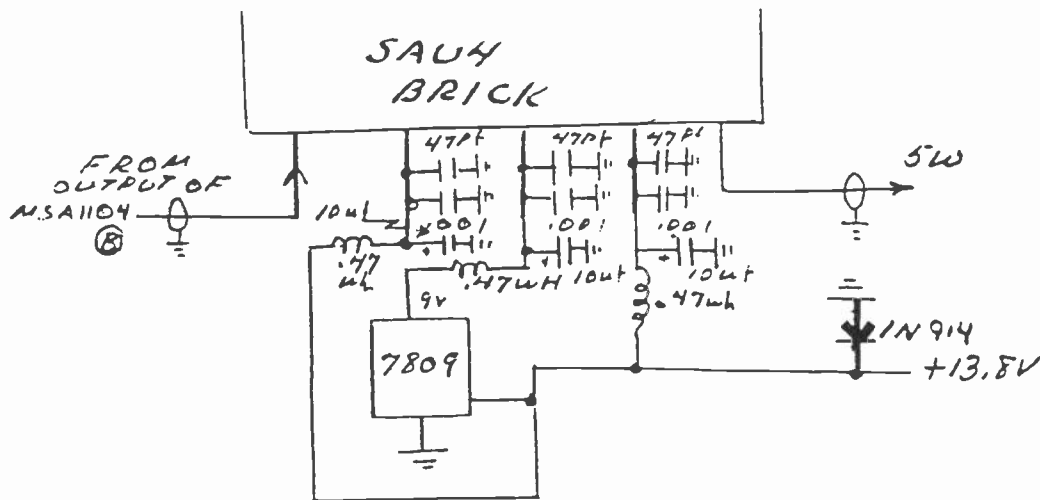

FIG 3 "BRICK" AMPLIFIER FOR EXCITER

very easy to do this. All that is required is a free running oscillator on the required frequency. This is 443.75 MHz for a transmitter video frequency of 439.25 MHz. Remember that this way of generating sound results in audio only on one side of the video carrier, unlike the video audio sub carrier that we all use. This 443.75 MHz oscillator frequency is divided by 256 resulting in a frequency of 1.7333 MHz which is phase locked to a crystal that is oscillating at the same frequency. This only requires 4 semiconductors with no adjustments of any kind for the builder after the circuit is locked. The audio voltage is then inserted into the phase locked circuit which deviates the output frequency at 443.75 MHz the required amount.

Those of you that operate FM ATV on 439.25, 915 and 1280 MHz will recognize that this is the same circuit design that is used to build simple FM ATV stations. Let us look at the circuit diagram shown in Figure 1.

The oscillator uses a BFR96 with a single tank. This series resonant circuit comprises an inductor and two varicap diodes (BB405G) connected between the collector and the base of the oscillator transistor through varactor diodes. A small choke is used to set the frequency. The output of the oscillator is buffered and amplified by a MSA 1104 MMIC IC. The output of the MMIC provides 50 mW of output to drive another amplifier. The signal is also fed through a small capacitor and resistor to the frequency divider circuit which uses a Plessey SP5060 or SP5070.

A 2N3904 transistor is used as a pump for the phase lock circuit. The SP5060 integrated circuit has an internal crystal oscillator. The required crystal has a frequency of 1/256 of the output frequency. A small capacitor across the crystal provides some netting action. The output of the 2N3904 is connected back to the two varactor diodes through proper resistors connected together with a DC adjustable pot, voltage to lock the circuit. The audio voltage is connected to the varactor diodes through isolation resistors. A pot across the audio voltage source sets the proper deviation for the sound carrier.

This circuit has multiple crystal output frequencies. It should be built with at least two switchable frequencies. The audio should be on 443.75 MHz (1.7333 MHz crystal) for normal ATV operation on 439.25 MHz. If you are going into your repeater on the lower sideband (greatly preferred to eliminate interference to/from the FM repeaters) you will need to have a crystal giving an output on 434.75 MHz (1.6982 MHz).

A simple audio mike amplifier is shown in figure 2. This amplifier will provide audio voltage for any microphone to drive the FM exciter. It has an overall gain pot in the operational amplifier feedback loop. A pot across the mike source is a panel adjustment.

Now that we have a high quality audio modulated sound carrier, the question now arises how to use it with our ATV transmitters. The 50 mW output can be used to

BETTER AUDIO FOR ATV

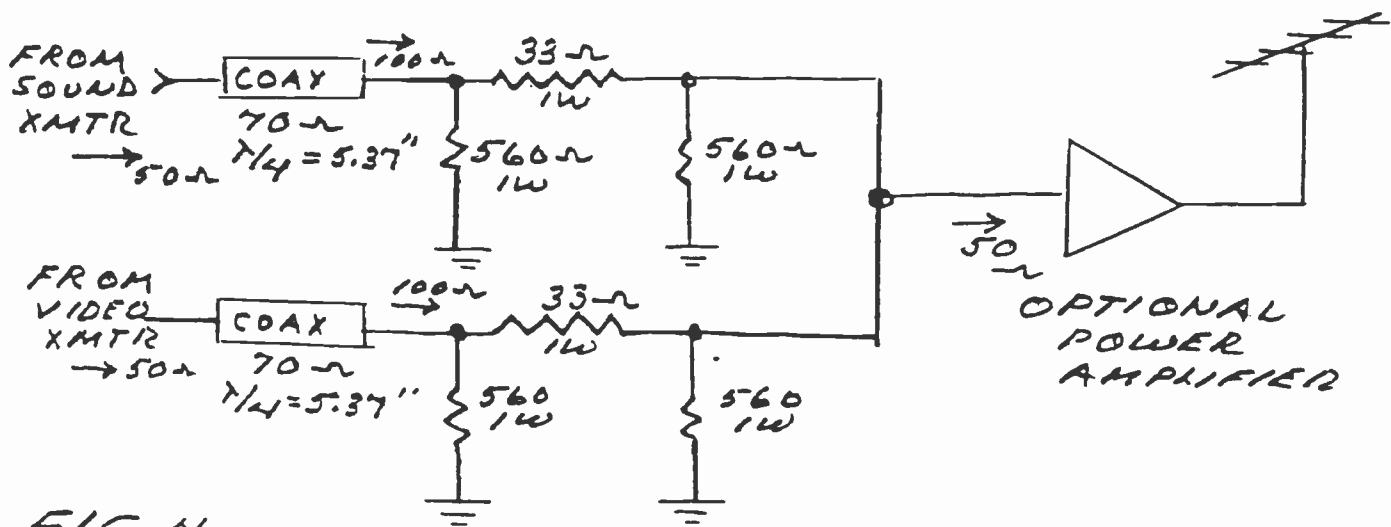

FIG. 4

3 DB PADS FOR ADDING TWO SIGNALS BEFORE AMPLIFICATION

drive a SAU-4 or other higher power "brick." This is shown in figure 3.

Depending on how we have designed our station we could simply connect the sound transmitter to a separate antenna and start talking with the ATV transmitter connected to another antenna. This sound antenna can be very simple. This is what we do at the station of W9NTP/W9YL. We simply use the Oscar antenna and everyone on the repeater 40 miles away raves about the excellent sound coming out of the repeater.

Another way to add the two signals for use with one amplifier and one antenna is to use a combiner which adds the two outputs across one load (antenna). Nature being what it is, this will cost us some output power.

The simplest way to do this is through a 3 dB isolation pad on each transmitter. This is shown in figure 4. The 3 dB pad is designed for 100 ohms., In order to provide proper impedance matching for each transmitter, a quarter wave piece of 70 ohm coax (.8 velocity factor) is used to match the transmitters.

This reduces the output power of each transmitter to one half of its former value. The amateur must be careful in amplifying the combined signal or the following non-linear solid state amplifier will produce spurs on both sides of the video (modulation) carrier. This is the reason that I use

two antennas at my station. Remember that the amplifier on the sound transmitter does not have to be linear. It is like any other FM transmitter except that it is deviated much more for TV sound reception.

How do you make sure that you have enough power to produce audio on the output of your repeater? The way that I do it is to call a friend on two meters and ask him to bring up a signal on the ATV repeater without subcarrier. This repeater is 40 miles away. This makes the TV receiver produce audio noise. I gradually bring up the power level of the sound transmitter until the noise on the TV receiver quiets. Since my two antennas do not have the same gain and the Oscar sound antenna is on the roof of the garage while the ATV antenna is on a 100 foot tower, I have found that this method works well. The ratio of power level that I have found that works is about 20 watts for a 400 watt ATV signal. This ratio is not proper for the reader since his station will have difference antennas at different heights.

A photograph of the circuit components is shown in Photo 1. The SAU-4 is on the back panel. A small "brick" between the exciter and the SAU-4 is no longer used in the present design. Photo 2 shows the unit which was modified from one of the standard 450 MHz FM ATV video transmitters manufactured by Wyman Research Inc.

I hope that the reader will build this circuit and try



SLOW SCAN TV with the Sound Blaster!



**New! Copy 8,12,24,36
sec. B&W, 36 & 72 sec.
Color (in B&W), Scotty
1 & 2 (in B&W) with
your Sound Blaster
compatible sound card.**

Requires PC, VGA 640x480-256 colors, and Sound Blaster compatible card.

ONLY \$40.00 - Shipping \$5
Illinois residents \$2.50 tax

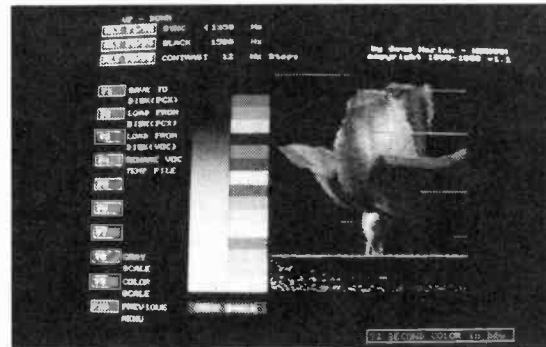

What people say....

- ⇒ *What a neat program!*
- ⇒ *I'm delighted with your support!*
- ⇒ *Great job! Nice graphics!*

**Harlan Technologies
5931 Alma Dr. - Rockford, Illinois 61108
815-398-2683**

BETTER AUDIO FOR ATV

for better sound through the repeaters. Parts and some modifiable boards are available from Wyman Research Inc. I would like to hear from readers that build this circuit and wish to compare results.

For those not enjoying the FM ATV DX fun on 1280 MHz you are missing lots of amateur fun. The Ohio valley hams (Indiana and Ohio) are transmit-

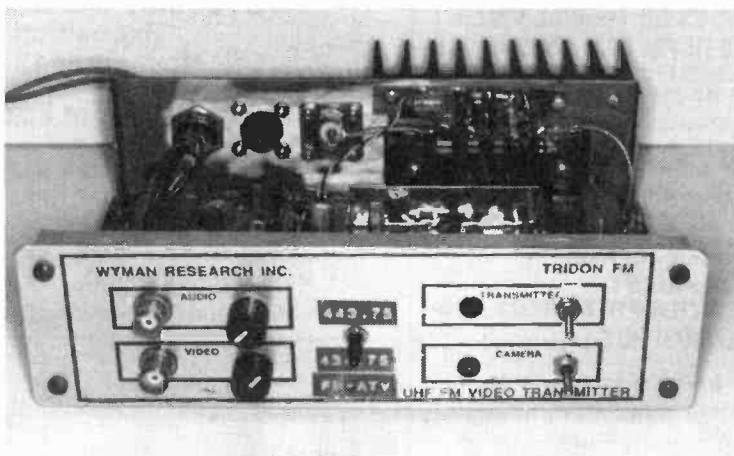

ting 1280 MHz FM ATV signals 100 to 200 miles most days. There is lots of room for experimentation on this band. Hams should be building circuits and testing antennas. That is why amateur radio has continued to exist until today. 73 Don Miller W9NTP, owner Wyman Research Inc.

PHOTO TWO

CORRECTION: In the July issue of ATVQ, the person holding the SSTV equipment was incorrectly identified to ATVQ. The picture on the cover and in the Dayton SSTV article is Felipe Rojas, and his home built unit is the Superscan 2001.

ESF COPY SERVICE

RALPH WILSON WBOESF

BACK ISSUES OF YOUR

FAVORITE MAGAZINES

ATVQ AMATEUR TELEVISION

QUARTERLY

RTTY JOURNAL A5/SPEC-COM

SEND FOR PRICE LIST

4011 CLEARVIEW DR

CEDAR FALLS, IA 50613

319 266 7040

West Texas Amateur Radio Club TENTH ANNUAL Odessa Hamfest Convention

OCTOBER 16th. & 17th., 1993

**ALL UNDER ONE ROOF
! 20,000 SQ. FEET OF IT !**

**GRAND PRIZE - KENWOOD TS-50S HF TRANSCEIVER
SECOND GRAND PRIZE - KENWOOD TH-78A DUAL-BAND HT
3RD GRAND PRIZE - KANTRONICS KPC-3 TNC
PRE-REGISTRATION PRIZE - KENWOOD TM-732 DUAL-BAND MOBILE**

(MUST BE POSTMARKED NO LATER THAN OCT. 11, 1993)

Holiday Inn Convention Center - 6201 East Business 20 - Odessa, Texas

HAMFEST HOURS: 8 AM - 6 PM SATURDAY, 8 AM - 2 PM SUNDAY
SETUP: 4 PM - 10 PM FRIDAY & 8 AM SATURDAY

THE HAMFEST WILL START PROMPTLY AT 8 AM SATURDAY
WATCH FOR THE REGULAR FLYER IN MID SEPTEMBER

SPECIAL PACKAGE PRICE !

**1-PRE-REGISTRATION & 20 EXTRA PRIZE TICKETS
\$20.00 (\$7.00 SAVINGS)**

Mail Pre-Registration Form And Check To: West Texas Amateur Radio Club, Box 7033, Odessa, TX 79760-7033

NAME _____ CALL _____
NAME _____ CALL _____
ADDRESS _____ CITY _____ STATE _____ ZIP _____

SPECIAL PACKAGES @ \$ 20.00 _____

PRE-REGISTRATIONS @ \$7.00 _____ (\$8.00 AT THE DOOR)

TABLES @ \$8.00 _____

EXTRA PRIZE TICKETS (\$1 DONATION) _____

GRAND TOTAL \$ _____

AC-ARTS
Presents
The

21st
Annual

FORT WAYNE HAMFEST

& Computer Expo

Allen County War Memorial Coliseum
Exposition Center
November 13-14, 1993

108,000 sq. ft. of space - all indoors

- Commercial Vendors ⇔ Large Flea Market •
- National Manufacturers ⇔ New & Used Dealers •
- Computer Hardware ⇔ Computer Software •
- Forums & Meetings ⇔ Ladies Activities •
- Main and Hourly Prizes ⇔ All Under One Roof •

Commercial and flea market space available - Over 800 Tables

Hours: Saturday 9 - 4 EST
Sunday 9 - 3 EST

No advance ticket sales

Admission: \$5.00
11 and Under Free

Coliseum Parking: \$2.00 per vehicle

Talk-in: 146.88 (-)

Tables: \$15 Flea Market
\$30 Premium
Electricity \$25 Extra

For Table/Ticket orders or info, send a self-addressed, stamped envelope to:

AC-ARTS
P. O. Box 10342
Fort Wayne, IN 46851

or call
Table Info: John Rufner at 219-483-6305
General Info: Don Gagnon at 219-484-3317

1993 INDIANA STATE A.R.R.L. CONVENTION

Sponsored by:

ALLEN COUNTY AMATEUR RADIO TECHNICAL SOCIETY



Those little dB's!

The beginners corner

QST recently ran an article on the centiBel (a tenth of a deciBel) and explained how they can add up to substantial losses. A few tenths of a dB here and there do add up. But what does it really mean to gain another 3 or 5 dB in fast scan TV?

Without too much fanfare, lets remind ourselves that the signal strength at the receiver is the most important part of communications. The distance you can communicate is strictly limited by that single factor more than anything else. Now, when I say at the receiver I must add, the ratio of the desired signal to the noise floor of the receiver. It makes no sense to have 25 microvolts of signal if the receiver takes 100 microvolts to have a minimum discernable picture (sync bars) as some receivers do!

Wait a minute! The typical FM mode radio is rated at better than 1 microvolt sensitivity. Sure it is, but that is with a 12 dB carrier to noise ratio (SINAD) and a lot less bandwidth...a factor of 20 KHz to 6 MHz. If we double the bandwidth, we double the noise voltage at the front end of the receiver. Yeah, the deviation is 5 KHz for narrowband FM. Carson's rule says twice the deviation plus twice the modulation frequency = bandwidth. Twice 5 KHz deviation plus twice 5 KHz highest modulation frequency = 20 KHz bandwidth. Meanwhile the TV receiver is 6 MHz wide. No conversion since it is AM.

The formula for determining the free space path loss for any signal in dB is $36.6 + 20 \log f + 20 \log d$ where f is the frequency in MHz and d is the distance in miles. At the 900 MHz band, this means a path loss of 96 dB at 1 mile. At two miles 102 dB, at 10 miles 116 dB. At 100 miles, 126 dB. At 1,000 miles, 136 dB. At 10,000 miles, 146 dB. Now think about this for a moment. The first 6 dB doubled your distance (1 mile to 2 miles). Another 6 dB doubles your distance again. 10 dB increases your distance 10 times. In other words, all else being equal, if you can find 6 dB of signal loss, and your range has been 35 miles, you can now get the same signal strength at 70 miles! Four more dB and you just went from 70 miles to 350 miles! **This is independent of frequency!** Hey, do you think those little dB's are important now?

Where are you going to find them! A dB here and a dB there add up (just as the QST article explained). The typical ATV station has a shack located rig, a single yagi

antenna and some coax. The typical complaint I hear from these stations is the lack of distance. Why am I not surprised! Read the preceding paragraph again! Lets say you have 10 watts, 10 dB antenna gain and 5 dB coax loss. You have 5 db gain over 10 watts or roughly 30 watts ERP. Lets get a better antenna, say 16 dB gain and reduce the coax loss to 1 dB (a gain of 4 dB). Now there is 10 watts plus 16 dB minus 1 dB or 15 dB over 10 watts = 300 watts ERP. There was a gain of 10 dB between the two systems and your DX potential just went up by a factor of 10 -- from 35 miles to 350 miles. Yes it is just that easy to go from local to DX. The better station is now mostly limited by propagation variances not by station specs for any normal propagation condition and better equipped to work DX when the band opens from tropo.

Lets add a preamp. The gain of the preamp is not as important as the noise floor improvement. Most preamps are about 20 dB gain (voltage). The improvement comes in the reduction of the noise which is an improvement in the carrier to noise ratio. If your receiver has a 2 dB noise floor (typical) and you had 5 dB coax loss, you have an effective 7 dB noise floor! Improving the coax and adding an in-shack preamp with a .5 dB noise figure just provided 5.5 dB improvement, roughly enough to double your range! Back to our example, you just went from 35 miles to 70 miles, or 10 to 20 etc. Putting the preamp at the antenna improves it to .5 dB noise floor since you have nearly zero coax loss to add to the noise floor since the loss is after the preamp gain. Good coax will still provide an improvement.

Don't forget those trees! At 450 MHz and up, the attenuation due to foliage is enormous. If your antenna is 35 feet high, and looks into the trees, moving it to 60 feet to be above the trees can easily gain you 6 dB of signal, plus the advantage of more height. I have a short home video (12 minutes) which I show at hamfests which scans the horizon at my roof top antenna (35 feet) and mostly what you see is trees. At 70 feet (center of my tower mounted antennas) you have a good view of the distant horizon and most of the buildings which stick up above the trees up to 40 miles away. A radio horizon of a few yards to tens of miles, simply by getting above the trees. Local stations report a 2 P unit improvement between a simple antenna located at each height. With the 26 dB gain array, well.....

The Adventures of the Masked Radio Operator and his Constant Companion Too-weigh.

based on an actual QSO!

It's a great day for antenna plantings!

Yeah, I got a package of seed the other day and the weather is right for planting.

For fertilizer I use aluminum sulfate. I suppose it takes a lot of iron for yours, huh?

Maybe we should just visit the forests of Iron Mountain Michigan and cut one down?

It is against the law to cut trees and take them home from the forest. It is probably against the law to cut the towers and take them home too.

Naw, you can get a harvesting permit. They let you take out the smaller ones so the bigger ones can live longer and mature. There's one over here with at least 40 or 50 growth rings. It must be nearly 300 feet. It's got a lot of branches too, look at all that aluminum sticking out on the sides.

I use copper sulfate for fertilizer too. The copper is a better conductor and it turns a nice blue, like the stuff you put in a toilet

bowl. The higher conductivity lowers the Q and makes it more broadband so you can use it on more frequencies.

It's good to know you can get a harvesting license. Otherwise, the UP would be overgrown with towers by now.

You're right. But they don't let you take the big ones out, those are only for commercial ap-

the thought of the towers being electrified. Wait till OSHA learns of the RF hazards. I bet there will be exposure limits set for towers in the near future. Probably weight limits too.

The Clothe-the-Animals movement will want us to provide overcoats. Imagine their chagrin at the bare naked metal bodies showing all over.

Jimmy Swagert will get caught in a midnight raid and have to go on TV and beg forgiveness for having sex with one in the forest.

What about gay rights? We can't have a lot of the same type tower housed together. Jerry Fallwell will have a fit and the

Gay Rights people will be picketing that we have segregated the gay towers from the straight towers.

We may have to mix steel and aluminum towers in the same neighborhood or risk being labeled racist.

I don't think we can breed interracial towers,



maybe a compromise, a steel tower with aluminum masts or an aluminum tower with a steel mast. Or a guyed tower with a self supporting tower.

Self supporting? Does self supporting mean they can't collect welfare or food stamps?

No, it means they are in slavery, man. Forced servitude, made to carry heavy burdens of antennas and coax their entire life. A miserable life. Not even cable TV except in a few locations. That's cruel and unusual punishment!

So then, the non self supporting towers get government assistance, tax breaks, food stamps, ADC, and such?

Yeah, guy wires too but not enough to make them self supporting, only enough to keep them alive, sheltered and fed. Call it the working poor.

Will the abortion rights people be on us? Will we be able to abandon a tower project after we pour the base concrete or will we have to have the concrete removed? When does the tower become a viable being: when the permit is issued, when the foundation is poured or when it has been erected? What if its an *in vitro* fertilization?

You mean a test bench baby? Does planned parenthood know? The fundamentalists may not let us teach about erections either!

What about tower rights?

Will towers be allowed to have self determination, vote or hold public meetings? This could lead to severe First Amendment

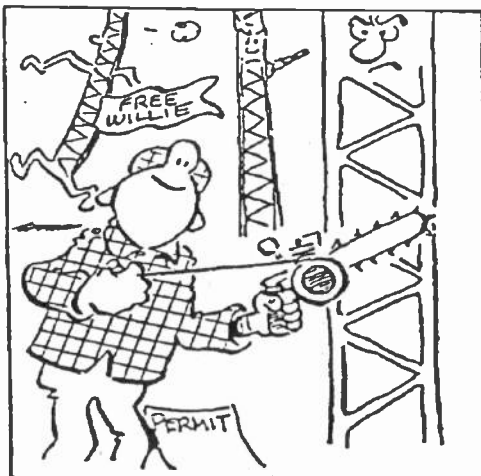

plications.

You have to be careful. The towers that grow in the Upper Peninsula often have stunted growth from the short summers and lack of lime and carbon. Some are soft and bend in the wind too much.

Where do the aluminum towers grow?

At the Kaiser farm on the isle of Alcoa.

I suppose when the Sierra club finds out about this we won't be allowed to harvest the towers anymore.

Another endangered species to be protected. Maybe we can start a zoo and gather two of each specie, guyed and unguyed, tapered and straight, short and tall. We can start a captive breeding program.

That won't work. There will be Free Willie followers who will want to come by in the night and set the towers free. They will think we are being mean to them making them hold rotors and antennas and tied up with coax.

Not to mention the ones we put lights on. They will cringe at

si JAYBEAM

SPECTRUM INTERNATIONAL, INC.

Post Office Box 1084 Dept. T
Concord, Massachusetts-01742
508-263-2145 — Fax #263-7008

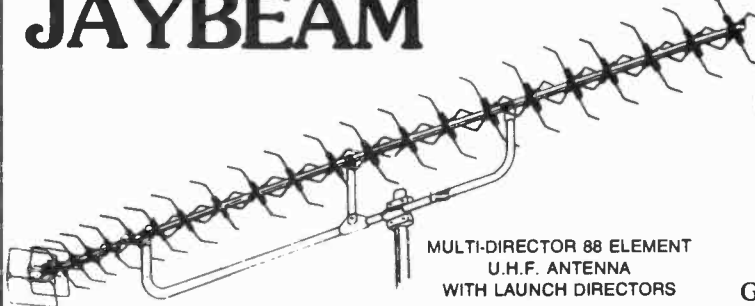

MULTI-DIRECTOR 88 ELEMENT
U.H.F. ANTENNA
WITH LAUNCH DIRECTORS

MBM88/70cm

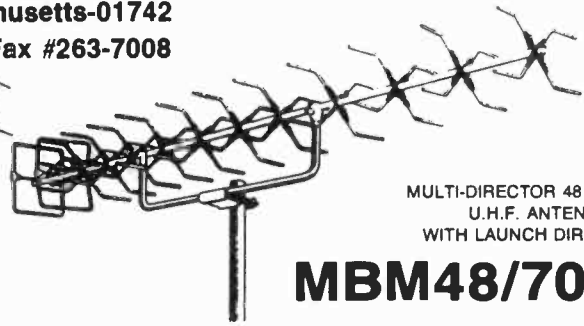

MULTI-DIRECTOR 48 ELEMENT
U.H.F. ANTENNA
WITH LAUNCH DIRECTORS

MBM48/70cm

General Specs:-
Frequency Range
Impedance
(Built-in Balun)

420 MHz - 450 MHz
50 Ohms

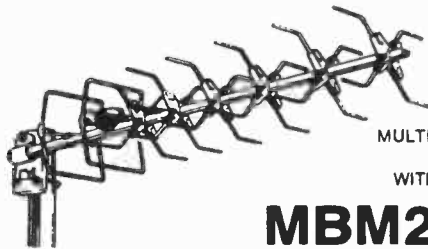

MULTI-DIRECTOR 28 ELEMENT
U.H.F. ANTENNA
WITH LAUNCH DIRECTORS

MBM28/70cm

Gain
Beamwidth (E)
(H)
Boom Length

	MBM48	MBM88
Gain	14.0dBd	18.5dBi
Beamwidth (E)	28 deg	23 deg
(H)	35 deg	28 deg
Boom Length	6 ft	13 ft
	\$ 115.00	\$ 160.00

VHF/UHF BANDPASS FILTERS



KNOCK OUT INTERFERING
QRM OR SELF-DESENSE!

The PSf . . . series of Band Filters are for receiver pre-selector and transmitter use. The filters are 3 pole, 7% bandwidth, 0.1 dB ripple designs with 30 dB shape factor of 4:1.

The PSf . . . ATV series of TV Channel Filters are 5 pole, 6 MHz bandwidth designs. They are used to protect your TV receiver from inband QRM and to "strip-off" the unwanted sideband of your transmitted vestigial sideband signal.

BNC Standard
TNC or Type 'N' optional
(slightly higher prices)

Model	PSf144	PSf220	PSf432	PSf900	PSf1296	PSf1691
Freq (MHz)	140-150	216-228	420-450	890-940	1250-1340	1650-1750
Loss (typ)	0.1 dB	0.1 dB	0.15 dB	0.2 dB	0.25 dB	0.25 dB
	\$200.00	\$160.00	\$105.00	\$125.00	\$125.00	\$125.00

Model	PSf421-ATV	PSf426-ATV	PSf439-ATV	PSf910-ATV	PSf1253-ATV
Loss (typ)	2.0 dB	2.0 dB	2.0 dB	2.5 dB	3.0 dB
Std conns.	BNC	BNC	BNC	N	N
	\$155.00	\$155.00	\$155.00	\$180.00	\$180.00

All prices FOB Concord, Mass.

PRICES SUBJECT TO CHANGE WITHOUT PRIOR NOTICE

SPECTRUM INTERNATIONAL, INC.

Post Office Box 1084-T
Concord, Massachusetts-01742
508-263-2145



MASKED RADIO OPERATOR...



problems. Certainly a Constitutional question arises here. Can the tower speak for itself or can only hams speak for towers or must it have Miranda rights.

Or tower lefts? Yeah, what if you left your tower, is that a "Home Alone" tower? Can you adopt an abandoned tower?

Sure you can, but you have to pay the lawyer a big fee. In Michigan you may

have to give it back to the natural parents too.

What about the handicapped towers, the ones with only two legs? Will we have to make special accommodations, provide crutches or access ramps?

No, but they don't have to take a code test.

If it holds a TV antenna will we have to limit the violence of language the tower is exposed to?

Its only allowed to have adult viewing after 11 PM and it

doesn't have to watch Howard Stern. There is a list of 7 words you can't say in front of a tower than is under 21 feet tall.

So with all the Government hassle, I suppose it's better to just throw those tower seeds away now and forget about putting one up?

Can't! The EPA has decided that the seeds are carcinogenic and a toxic waste. I have to pay the Government a fee and get a special waste hauler in here to take the seeds away. I also have to get a permit from the Conservation Dept. since I had clear cut the land and now won't be planting replacement towers.

Well at least you can get an antenna farm subsidy for not planting the acreage this year. But don't you have to pay the imputed tax on the QSO's you would have had if you did put the tower up?

Yes, but there is a standard deduction of 1200 QSO's for HF and 600 for VHF so I will only have the alternative minimum tax this year.

It was never this hard in the old days! Lirpa Loof OF9BK



SILENT KEYS IN ATV BUSINESS

Radio Scan/Amateur Communications quits; AEA quits ATV

In five years, Manny KC4LFO and Rita KC4MJG, of Radio Scan aka Amateur Communications Magazine have become fixtures on the ham radio landscape. Their publications have had a fresh high quality high value approach to ham radio. The magazine should have easily become the next 73 and more. Circulation was good and the layout attractive.

Yet, advertisers, the folks who pay the freight for any ham radio magazine, just did not support the effort sufficiently. Amateur Communications ends its publication as of August 1993. I will miss the magazine, and its fine staff. It is truly a sad day for ham radio, equal to the last day of Ham Radio Magazine. We wish Manny and Rita well in their commercial ventures.

AEA

The major manufacturers are all saying business is down. Over taxed and over worked middle America just doesn't have the time or money to invest in Ham Radio as a hobby as it has in the past. New equipment gets more expensive to where few can afford a new rig for \$3,000 or more.

Competition for the ad dollars that are available is fierce. It is no secret that 73 has cut staff and hamfests and is likely surviving on its sister publications income. QST made a major increase in ad rates recently which dries up available ad dollars for other publications. While helping QST, this hurts Ham Ra-

dio as there is less variety to attract new interests and new businesses. Not every topic is well covered in QST which only reaches about 30% US hams and many remember Incentive Licensing which hurt Ham Radio more than any other event in history.

Here at ATVQ, we are going to miss the support of AEA which has given up on the ATV market, unable to garner market share for their products, despite producing a good product with a professional look.

There is opportunity here. The cottage industries and entrepreneurs can produce products which Big Business cannot because of the costs of overhead, cost of money (funds tied up on inventory, parts, process and distribution) which the work at home can absorb as already existent.

The unfortunate fallout will be that other manufacturers will also now discount the idea of making ATV equipment having seen the failure of Robot Research, TD Systems and AEA, who join VHF Engineering, Klitzing, Apron, Xtronix, M-Tech, Venus, SEEC, RCA, GE, Hammerlund, Hallicrafters, Swan, Midland, Clegg, Eico, Heath, Polycom, Utica, Lafayette, Allied Radio, Ameco, SBE, National, Atlas, Dentron, Drake, WRL, Johnson, Motorola, Regency, JK Knight, Multi-Eimac, and other former manufacturers of ham equipment.

The Mounting of Horizontal Omni's

Dave Clingerman - W60AL

The time has come, to talk about the mounting, now that hundreds of "Wheel" antennas are in service, These antennas in the 70 cm, 33 cm, 23 cm, and 13 cm bands are in operation through out the United States, Canada and Mexico on ATV repeaters, beacon transmitters and mobiles of all description (land air & sea) for 432.1 MHz SSB work and ATV.

The mounting I wish to fervently address in this message is the tower mount. I receive calls, letters and fax's from a few users, very few - thank goodness, telling of horror stories concerning the patterns and elevated VSWR readings they are receiving from the "Little Wheels", "nano Wheels", "Mini Wheels" and "Micro Wheels". My first question is, "How are you mounting it?" And, what I hear is not the way a horizontally polarized omni antenna should be mounted, following some logical and basic engineering practices.

There are some things you can get away with in antenna installations and some things you just can't. Let me elaborate for a moment on a couple of these situations. When we mount a vertically polarized antenna like a Ground Plane, a 5/8 Collinear or a Station Master (coaxial Collinear) the best place to mount it is as high as possible and as much in the clear as possible. Where is such a place; on top of a tower, roof or building of course? We have seen Station Masters mounted part way up on a tower and for myself I've wondered why. Maybe for coverage, a quarter wavelength off the side of a tower will **increase the gain** of the array by maybe 3 dB and place the lobe of the now formed cardioid in a specific direction. This may have actually been intentional in order to effect a certain area wished to be covered or to reduce interference to or from a co-channel user.

I marvel at the intelligence of the installer who takes a perfectly good Yagi, mounts it vertically with a metallic torque pole in parallel with the elements and within a few inches of them. I suppose the first complaint they have is that the array is no good because a very difficult time is being had trying to get the VSWR down below 5:1. The modern day FM rig will usually shut down every time it's keyed, in this instance, due to the internal VSWR protection circuit that won't stand more than a 1:1.5 SWR. There are numerous ways to mount Yagi antennas vertically without destroying what it was made to do. The second complaint is, "My Ground Plane works better than this!"

The main point of all this is to emphasize that you don't put metallic objects in the pattern of an antenna and

expect them to perform to the manufacturers specifications. Any object a half wavelength away will have a minimal effect on the array depending on its size, a full wavelength is better - again depending on size. However, no matter how far a radiating device is placed off a mounting structure, say if it's a one story bank building or the Eiffel Tower, it will have an effect. The same goes for radio/television towers (antennas), sticks, torque poles and what ever else you can dream up on which to mount an antenna.

As I have mentioned, with vertical arrays you can use the mounting structure to an advantage in some cases. **WARNING**, this is not the case with horizontal omni's. You are entering into some very different philosophy when you Start dealing with these. I have even been told by professionals that there is no such thing as a "Horizontal Omni" or an array what exhibits horizontal polarization with a constant phase center That is perpendicular to the E-plane and runs equidistant in radius, axially through the array. So much for book learned knowledge, Einstein's often heard quote, "Imagination is more important than knowledge", may here be apropos. Hopefully experience has been and is one of our best teachers, not so much of knowledge but of a stimulus for imagination.

It should go pretty much without saying that if you place a Horizontal Omni Array in 'free space' it will perform to a certain set of measurable characteristics that are close to theoretical. Certain conscientious manufacturers of antennas take into consideration the fact that their products will not be used in 'free space' but in real world situations and allow for some of these misgivings; however, they can't rewrite the Laws of Physics. If you mount a horizontally polarized omni next to a structure it will be affected by that structure no matter whether it is wood, metal, plastic, fiberglass or PVC, to some degree. There will be some effect simply due to the fact that there has been a change in the index of refraction of the medium in which the array is intended to perform.

The most prevalent problem in the mounting of ATV antennas is in trying to get the best coverage possible with an existing structure and the best possible array. I can not stress strongly enough that if an existing structure is to be used then get your antenna on top of that structure and in the clear. A "Little Wheel" antenna or an array of "Little Wheels" (called a stacked Pair - for two, or a quad Array for four) is on the order of 14" in diameter and =6' tall, depending on frequency. If a quad Array is stood off an existing structure, say of metal, there is going to be rera-

mounting of horizontal omni's

diation from that structure. Due to the irregularity of the structure there are going to be a multitude of reflections in a multitude of directions. Interference patterns will be set up that will effect the advertised pattern. There will be nulls and dips and holes all over the place. Further, you are just not going to transmit through that metal tower or structure either. So, if you expect to have an omni pattern, help the situation by placing the array in the clear above the mounting structure not next to it and then complain that the pattern is shot full of holes.

If you can only get up so high on an existing structure and not to the top then another method of achieving omni coverage has to be considered and explored. If you're up against a hill or a building why even attempt an omni. There are other ways of accomplishing the task without sacrificing an 'omni'. If you can only cover 180° of need to coax 180° then why not try a series of corner reflectors fed in phase, a Half Biconical or a Curved Plane Extended expanded Collinear Array? I will be more than happy to work with any group contemplating ATV antennas on, next to or atop tall places.

The only option you may have is to go vertical but then you'll have to accept the interference and or desensing you could receive from other services operating in the same vicinity. Who are your neighbors? Well, on the bottom side of our 70 cm band we have from 406 - 420 MHz government trunked radio systems, above this band, 450 - 470 MHz we have land mobile radio (LMR), broadcast remote, pager transmitters and even a little radar to name a few. Above and below, both services are vertically polarized. You pay your money and you take your chances!

How about horizontal polarization? For starters you have the center of your pattern on the horizon. If you have to work with other services present in the near vicinity you will gain at least 20 dB isolation from possible interference sources. You will also reduce the effects of man-made noise which is vertically polarized. Last and in reiteration, I can not stress enough the importance of getting a horizontally polarized array up in the clear and away from surrounding objects especially metal objects.

Good luck, please call or write if I can be of assistance 73, Dave - W6OAL

Designed specifically for amateur television in the 70cm band...

FL407 INTERDIGITAL FILTER

7-Pole Interdigital Vestigial Sideband Filter for Frequency Ranges of 420 MHz to 440 MHz

The 6 MHz nominal bandwidth and low loss design are perfect for transmitter or receiver use. Two filters can be used for repeater applications.

Heavy duty construction insures stable operation and long life.

Ordering Information: The FL407 may be ordered on any frequency between 420 and 440 MHz. Please specify video carrier frequency when ordering.

Dimensions HWD:
2 1/8" x 8 13/16" x 20 5/8"

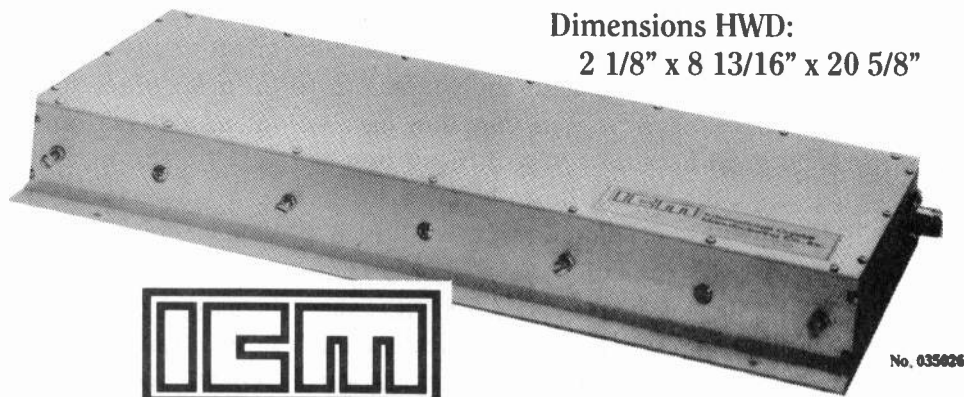

No. 035026



International Crystal Manufacturing Co., Inc.

P.O. BOX 26330 • 701 W. SHERIDAN • OKLAHOMA CITY, OK 73126-0330 • (405) 236-3741 • FAX (405) 235-1904

ATV BOOKS

THE BEST OF BOTH WORLDS

NON TECHNICAL

TECHNICAL

ATV SECRETS FOR ASPIRING ATV'ERS

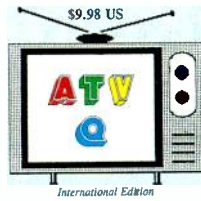

International Edition

Volume I

Everything you wanted to know about ATV but didn't know whom to ask!

FEATURING:

HAM TV ON EARTH AND IN SPACE
GET STARTED: HAM TV CHEAP AND EASY
FUN WITH HAM TV
PUBLIC SERVICE HAM TV
THE SKY WAS THE LIMIT: BALLOON, ROCKET & R/C ATV
NASA SPACE SHUTTLE ATV
INDEX TO OVER 500 ARTICLES, FEATURES, BUILD-IT PROJECTS FOR ATV

First Edition

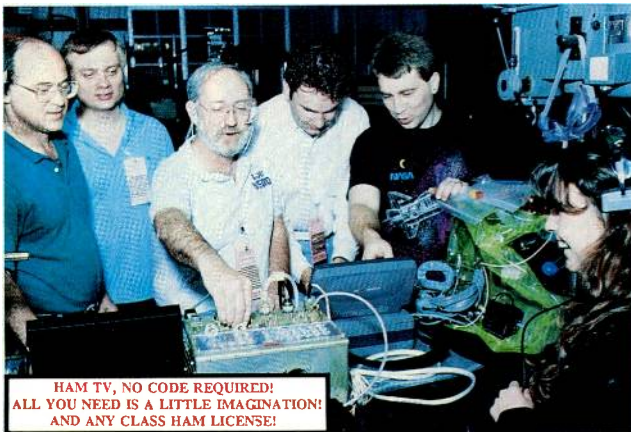

HAM TV, NO CODE REQUIRED!
ALL YOU NEED IS A LITTLE IMAGINATION!
AND ANY CLASS HAM LICENSE!

FINAL CHECKOUT OF STS 37 ATV GEAR FOR SAREX. NASA Photo.

ATV SECRETS

volume one,

FOR ASPIRING ATV'ERS,

AS REVIEWED IN OCTOBER 1992 ISSUE OF QST.

ATV SECRETS is a **great place to start** your ATV adventure. Its 64 pages are tightly packed with **succinct information** to cover all aspects of getting started, where to find activity, equipment, how to DX, and **answers frequently raised questions** of power, antennas, vestigial sideband operation and more. It also includes an **index to over 500 items** which have appeared in ATVQ Magazine. Everything you need to know to enjoy ATV in one place!

\$9.95 plus \$1.50 post (US), \$1.90 (Canada) \$2.90(DX)

TV SECRETS

Volume II



\$24.95 USD
International

Television Topics and Projects for Novice to Expert

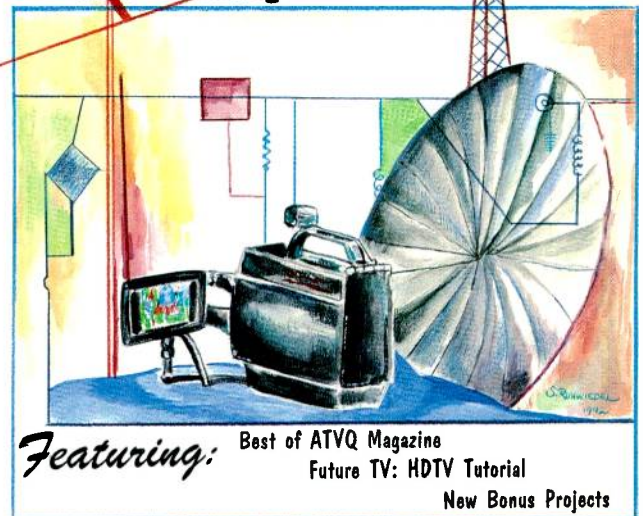

TV SECRETS

volume two,

for advanced ATV'ERS,

As published in the October 1992 issue of QST.

A mammoth book, with **292 pages** of technical material. **Over 40 authors** present **over 90 technical projects** and theory topics to fully acquaint anyone from **novice to expert** in the how and what of TV, video and ham TV. Divided into 11 chapters, the book presents **tested projects** for all areas of interest in ham TV including antennas, amplifiers, repeaters, receivers, transmitters, video accessories and more. Suitable for all knowledge levels from novice to expert.

\$24.95 plus \$2.90 post (US) \$3.80 (Canada) \$6.50(DX).

ATV BOOKS

From the BATC available through ATVQ

ATV COMPENDIUM

104 pgs. 8.25 x 5.75 1989

A collection of **projects and useful topics** from issues of CQ-TV, compiled by Mike Wooding G6IQM. A high quality work with projects that work in both NTSC and PAL video systems. The BATC offers **circuit boards and kits** for most items they publish at reasonable cost. This book is OUT OF PRINT. A limited quantity of copies are on hand.

Available from ATVQ at \$14.95 POST PAID.

AN INTRODUCTION TO AMATEUR TELEVISION

154 pgs. 8.25 x 5.75 1992

A collection of **projects and useful topics** including 24 cm ATV and a modular remote control station. Written and compiled by Trevor Brown G8CJS and Mike Wooding G6IQM. A high quality work. **Circuit board layouts** are provided and most projects are available as **circuit boards or kits** from the BATC at reasonable cost.

Available from ATVQ for \$14.95 POST PAID

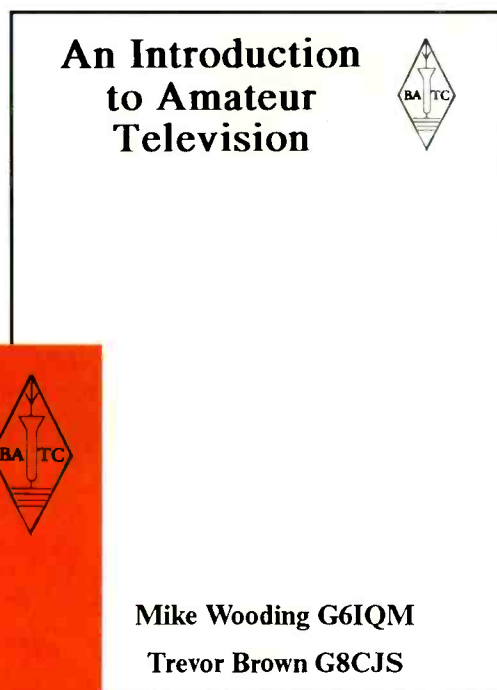
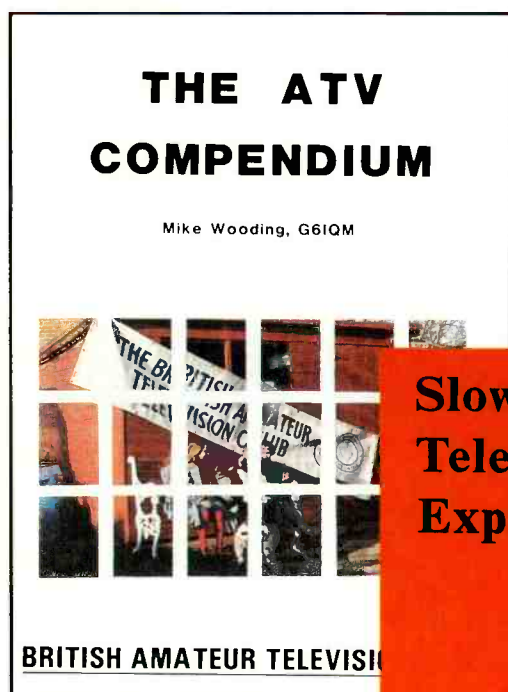

Slow Scan Television Explained



Mike Wooding G6IQM
Trevor Brown G8CJS

The latest word in SSTV!

SLOW SCAN EXPLAINED

Mike Wooding G6IQM

equipment, home studio operation and tips for good pictures, examples of various video modes and **construction projects** for a complete SSTV station.

Now you can find the latest information about SSTV in one place. The newest book from the BATC contains all the current modes including the Scotty modes. Also included are complete descriptions of popular commercial

The written explanation of how SSTV works and the various modes is the best ever written. Everything you need to know in one place to enjoy SSTV as never before. Includes color operation as well.

Available from ATVQ for only \$14.95 post paid.

ATV MAGAZINES

CQ-TV

VHF

COMMUNICATIONS

A quality quarterly publication covering mostly British ATV activity, club news and usually several **good technical projects** per issue. Typically 100+ 5.75 x 8.25 pages per issue. Most projects will also work or can be adapted to NTSC standards from PAL.

Covers video, ATV, SSTV, **ATV repeaters** with **construction projects**. Most projects also have **circuit boards and kits** available at reasonable cost from the BATC.

USA residents may subscribe via ATVQ for \$21/yr which includes all foreign funds exchange fees.

A high quality technical publication with mostly technical projects for VHF-UHF, Microwave and ATV. Projects are renowned for their quality. The publication also offers **PC Boards** and **kits** for projects. Probably **the best technical ham radio magazine today!** Authors are world famous hams and articles are technically sound.

USA residents may subscribe via ATVQ for \$27/yr which includes all foreign funds exchange fees.

CQ-TV

MAGAZINE
No. 140

BRITISH AMATEUR TELEVISION CLUB

NOVEMBER 1987



Repeaters list - Servicing the TVRO modules - Sound demod SCART - VSWR - Sync separ Reviews - Portable generat Building repeaters - A/V fac TV software - Contest new Time base correction

ATVQ Continuing the heritage of great US ATV publications, with topics and projects for all levels from novice to expert, plus FCC news, club and operating news, equipment reviews, build-it projects, covering all aspects of ham TV including FM-TV and HDTV.

AMATEUR TELEVISION QUARTERLY

VOLUME 6 #1
JAN., FEB., MARCH 1993

ISSN 1042-198X
USPS 003-353

AN ATV VIEW
FROM SPACE

\$100 ATV STATION
UPDATE ON EDTV
R/C ATV
ATV STUDENTS
AND SPACE

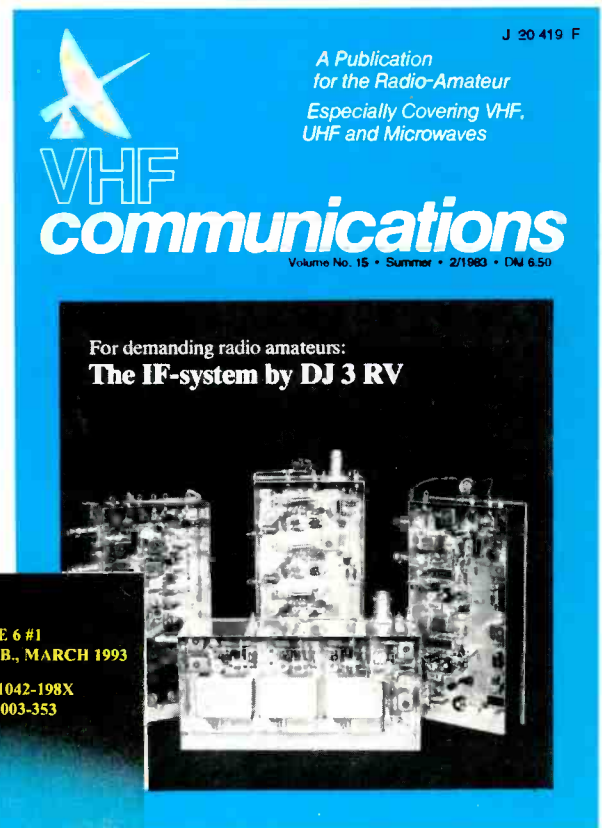

Published four times per year. a must read for any video hobbist. Just the facts without hype \$18/yr US, \$22 Canada, \$29 DX. multi-year discounts, see order page. ATVQ sponsors the annual friday night Dayton ATV Party featuring expert speakers, live demos, socializing and ATV fun. Published by Henry KB9FO and Bill WB8ELK.

I GOT MINE, DO YOU HAVE YOURS?

CLOSE OUT SPECIAL

The **ATVQ Indian Head Test Pattern** coffee mug. Just the thing to add class to your shack and hold your favorite beverage! **Holds 12 oz.** This fine china mug is a limited edition with the famous test pattern on one side and the famous ATVQ logo on the other. The colors are TV black for the art work and antique tan for the cup. Shipping weight is over a pound! This is a **quality product** and not available anywhere else. Show your video hobby with pride or use as **great gifts** for video friends.



Only \$5.99 plus postage (\$2.90 US, \$3.50 Canada). Satisfaction guaranteed!

ORDER FORM:

>>PUBLICATIONS<<

- > **ATV SECRETS for Aspiring ATV'ers: Vol 1.** An introduction to Amateur Television 64 pages 100 illustrations. \$11.45 post paid _____
- > **TV SECRETS, Topics and Projects for Novice to Expert: Vol 2.** 90 technical projects 292 pages none bigger, none better! \$27.75 post paid _____
- >>>SPECIAL: Both Vol 1 and Vol 2 of ATV Secrets..... \$34.95 post paid _____
- > **An Introduction to Amateur Television, BATC,** 156 pages, \$14.95 post paid _____
- > **ATV Compendium, BATC,** 104 pages..... \$14.95 post paid _____
- > **Slow Scan Explained, BATC,** 150 pages \$14.95 post paid _____
- > **Full Color test chart set,** color bars, registration, gray scale, frequency response on 4 sided heavy enamel stock \$5.00 post paid _____
- > **ATVQ Indian Head test pattern 12 oz. coffee mug.** Fine china collectors item..... \$8.69 post paid _____
- > **ATV IS FUN AND INEXPENSIVE,** 8 page handout for ATV demos, clubs, hamfests, to build interest and activity.....pkg of 25 \$5.50 post paid _____

>>VIDEOS<<

- > **An ATV Balloon Adventure.** 30 min on VHS. Watch as KB9FO in Chicago, DX's a 1 watt ATV signal launched on a balloon from Dayton Ohio. Shows how to find signal, tracking, advantage of preamp, live action with narration and intro and wrap-up. Great for ATV demos, hamfests and club meetings. NO MUSIC! \$6.49 post paid _____
- > **TV Bloopers.** Remastered from HI-8 and 3/4". Nearly 12 hours of US TV Bloopers (US set) and 12 nearly 12 hours of foreign TV bloopers. Rated R/X. (N,L, S, adult themes!) Varied quality due to multiple sources and vintages of material. Includes classic gags, commercials, goofs, stumble tongs, "Christmas" events and broadcast and non broadcast material. US set \$59.95 post paid _____
- DX set \$59.95 post paid _____
- BOTH (24 hrs!) \$99.95 post paid _____

>>SUBSCRIPTIONS<<

- > **CQ-TV** from BATC. 4 issues per year, subs run by calendar year. \$21/yr _____
- Good technical and operational material, kits \$27/yr _____
- > **VHF Communications.** 4 issues per year, subs run by calendar year. Excellent technical material and projects, kits years _____ \$ _____
- > **ATVQ,** A must read for any ATV'er. 4 issues per year. Factual, topical, informative, the #1 source in the western hemisphere! TOTAL \$ _____

RATES	US	CANADA	DX
1 yr	18	22	29
2 yr	32	39	49
3 yr	45	49	69
4 yr	59	65	89
5 yr	75	80	109
LIFE	359	399	499

**Send to: ATVQ, 540 E. Oakton St.,
 Des Plaines, IL 60018
 VOICE MAIL INSTANT ORDER LINE
 708 298 2269 FAX 708 803 8994.
 VISA/MASTERCARD ACCEPTED.**

NAME: _____ HAM CALL: _____

ADDRESS: _____

CITY: _____ STATE: _____

ZIP: _____ COUNTRY: _____

PHONE: _____

CHARGE NUMBER: _____ EXP: _____

SIGNATURE: _____

START WITH _____ ISSUE. (current, next, past)



CUSTOM CRYSTALS

Crystals for many applications

For over 40 years, ICM has manufactured the finest in quartz crystals for every conceivable purpose.

A wide selection of holders are available to fit most any requirement. Our computer database contains crystal parameters for thousands of equipment types.

Need crystals for communications, telemetry, industrial, or scientific applications? Let ICM's sales department assist you to determine which type of crystal is best for you.

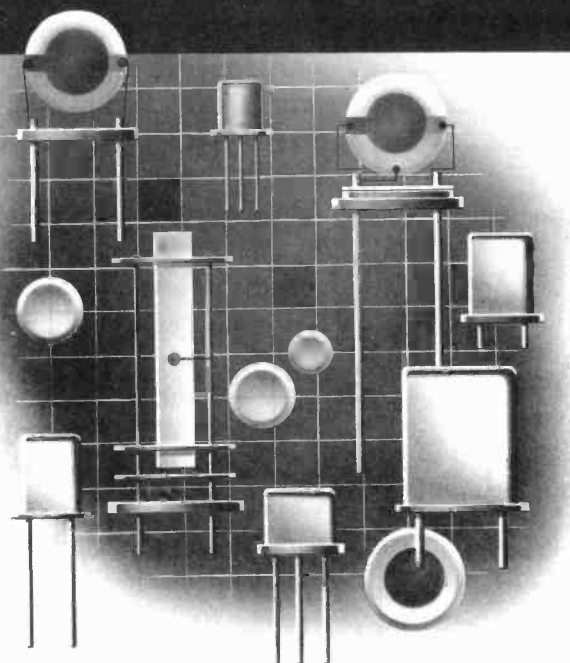

Can we solve your crystal problem?

For special purpose crystals, special holders, special sizes, call our crystal sales department. We will be pleased to provide recommended data.



International Crystal Manufacturing Co., Inc.

P.O. Box 26330, 701 W. Sheridan,
Oklahoma City, OK 73126-0330
Phone (405) 236-3741
Telex 747-147
Facsimile (405) 235-1904

THE ARRAY

by Henry KB9FO

In the last issue I described my new antenna array. If you look at the photo again, you may notice there is a person standing in the middle of the array. That's Mike WA6SVT who helped put it up. He's the tiny dot near the mast in the middle! I said this was the best antenna system I've ever had, including my 170 foot tower and array in Michigan (WB8HEE) my twin 100 foot towers with HF monobanders and VHF/UHF stacked arrays in Indiana (WB9WWM/KB9FO) and my previous array of Cush Craft Boomers and MBM-88's. I gave a few examples of contacts made in the first few days of the array. Well, here's another example. I fired up the new Yaesu 736R the first week of September on an average band condition night. No enhancements. I had tried for 5 years to work St. Louis - John KD0LO and Dave WB0ZJP with no luck. There was just never any signal there to be worked.

The sked was for 8 PM. On the dot, we had an arm chair copy QSO which also included W0DQY and W9LCR. John runs a single K1FO yagi at 40 feet. Dave has stacked antennas at 70 feet. The QSO started on 2 sideband. DQY was cross polarized to me on 2 meters and we still had good copy! I run four M2 vertical polarized on 2 meters since most of the stations on ATV have some 2 meter beam for FM local/repeater use, few have a second for all out 2 meter DX. After about 20 minutes of Holy Cow!!! QSO, on 2 SSB and FM mode. We then went to 439 SSB. The Yaesu 736 BAREFOOT produced a Q5 QSO in SSB, and adding the 100 watt Mirage pushed it to S9. The receive was so quiet I thought it wasn't working. There is very little background noise on 440 with this radio. Yet Dave's audio blasted out of

the speaker at S ZERO! John's audio was less even though he had a higher signal level on the meter. We hadn't figured that out as both are using the same radio. Had I had a 6 foot jumper coax made up we would have tried 1296 with my 10 watts and Dave's 100 watts. John didn't have TX bypass for his 440 preamp, so we went back to 2 meters. I still have not connected any of my mast mounted ARR and Pauldon Associates GasFET preamps, so the RX was barefoot on all bands. Talk about excitement! 300+ miles on dead band conditions, and there are three ridges up to 400' higher than my QTH so it can never be a clear shot between us.

My next conquest is Minneapolis which is about 400+ miles NW. That will complete the circle (having already worked Michigan and Ohio) for ground wave. Based on signal strengths, it should be possible to get 500 mile dead band ground wave (back scatter perhaps) range with this array which is only 60 feet at its center. What this means is this: with known "intercom" QSO possible, any band opening will automatically make ATV possible between these locations. The "intercom" path has been established to talk in any effort for ATV. As free time permits I will attempt an FM TV contact to St. Louis (they have FM TV equipment down there!)

The point of all this is to encourage you to upgrade your stations with good coax and good antennas. As I explain at hamfests, DX is simply providing enough dB's to where you can hear the worms crawl a block away. Well, enough to at least be only noise limited in your system. Check out my one pager on those little dB's. Also note, that this range is being covered with as little as 25 watts (The Yaesu barefoot) and higher power only made the Q5 signal more armchair copy and allowed the smaller stations to also receive the signal as well as the cross polarized 2 meter station. One hundred watts on 440 SSB is a healthy signal as is 100 - 200 watts on 2 meters, either of which can be had for the price of a modest Mirage or RF Concepts amplifier.

On the repeater this morning W9LCR was in the roundtable and he was also excited about having worked a new grid square (St. Louis) on 2 sideband. We decided I should print some new QSL's which have the array photo and the caption in big letters is "You have been worked by "THE ARRAY", followed by small print KB9FO. (LCR is Little Crystal Radio). Tom W9NBN (Nothing But Garbage) was excited about working the KB9FO ATV repeater P5 with his 1 watt and dipole (about 2.5 miles away) with the RPT antenna only 20 feet up (going to 50 feet soon).

Well tonight is the wife's birthday, so no ham shack work, only dinner and gifts. More news next time. Don't forget, Hams Should Be Seen as Well as Heard! 73 Henry.

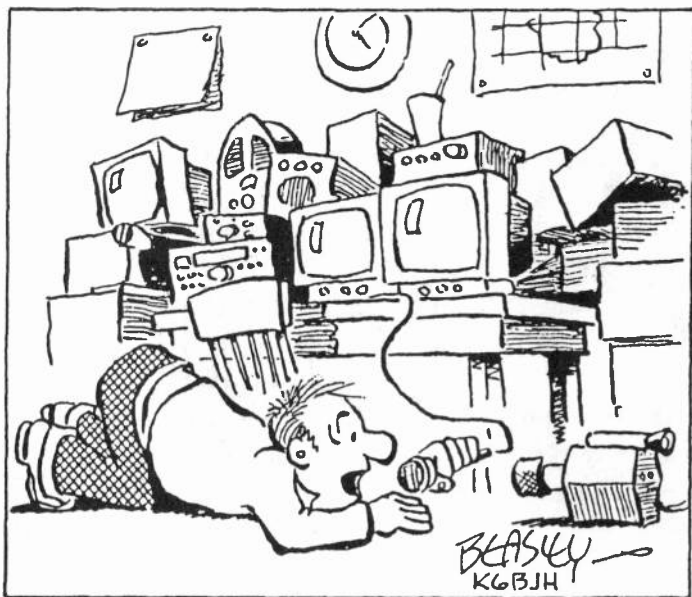

NO, I'M NOT TRYING FOR SPECIAL EFFECTS, I JUST COULDN'T FIND A PLACE TO SET THE CAMERA

CENTRAL ATLANTIC ATV NETWORK

by John Jaminet, W3HMS of Mechanicsburg, PA.

The second full meeting of this newly formed society was held on Sunday 13 June 1993 at Poor Jimmy's Restaurant, 2360 Polaski Highway (Route 40), Northeast, Maryland about 12 miles south of Elkton,

We had a good crowd, for summer, of 23 highly-charged ATVers/enthusiasts from Delaware, Maryland, New York, New Jersey, Pennsylvania, and Virginia. There was much "show and tell" and I, for one, was quite happy to see the enthusiasm with which people demonstrated and discussed their gear. Unlike so many groups, we had about 1 per cent of our time in business matters and 99% in technical topics. To me, it was refreshing to reinvigorate the motivation for the pursuit of ATV. I think we have synergism at work here and I look forward to more and more good technical topics. The Baltimore contingent, led by Bob Bennett, W3WCQ, was in charge of the program arrangements. Bob was unable to attend so Heru Walmsley, W3WVV took charge:

a. Heru, W3WVV discussed a 10 GHz spectrum analyzer, demonstrated 10 GHz FM TV with Gunnplexors and gave us ideas for using wave guides.

b. Ron, K3ZKO presided over activity reports from the several cities/areas in the CAATN, i.e. Philadelphia and York in PA, Baltimore, MD, Wilmington, DE, Virginia, and New Jersey.

c. Dick Goodman, WA3USG, presented the results of using an interesting PC program which produces digitized terrain maps with propagation paths showing clearly if a path between two stations is usable. In mountainous PA. this is vital!

d. Paul Seman, W3CSU, discussed electrical safety which a neat new twist. He used an ohm meter to measure the dry and wet resistance between the hands of all present. Then he gave each person a paper on which he portrayed what would happen to them if they got across a power circuit. I liked this briefing...it certainly will make us all just a bit more safety conscious!

e. Fred Merker, K3TAZ showed us a video tape and discussed his experiences with using ATV in an ultralight airplane. His video and commentary gave us all a good sense of what ultralight flying is all about. His shots showing the mounted equipment confirmed again the notion that "a picture is worth 10,000 words."

f. Fred Merker, K3TAZ, briefed is on high definition TV tests he had seen in recent months. He gave an overview of how it will work. The impacts on ham TV were discussed, no clear conclusions were reached.

g. Russ Barber, N3HPX, showed us visually the effects of signal attenuation and augmentation as may be caused by preamps and transmission lines in terms of P Ratings versus the microvolt level. A very impressive demonstration of what is possible in terms of levels and what can go wrong.

h. A Repeater Interlinking/Standards Committee report was made by the Chairman, Dick Goodman, WA3USG. The members are Bob Bennet, W3WQC, Russ Barber, N3HPX, Ron Cohen, K3ZKO and Dave Stepnowski, KC3AM. An open technical discussion once again focused on just what are the objectives of intercity linking, who has the control, how is it exercised, what bands, how many cities on at the same time. etc. Many stated that the committee needs to define the standards quite clearly in a "strawman standard for intercity linking" for review/debate at future meetings.

Our CAATN group will have approximately four meetings per year in March, June, September and November of 1993 at a centrally located site, often at Poor Jimmy's Restaurant on Highway 40 near Elkton, MD. The group again enjoyed a superb breakfast and dinner..... thanks, Poor Jimmy's. The CAATN officers are: Ron Cohen, K3ZKO of Philadelphia, Captain Video Emeritus, Chairman and John Jaminet, W3HMS of Mechanicsburg, PA is Vice-Chairman. The Business Manager is Paul Seman, W3CSU and the Newsletter Editor is Henry C. Ward, N3GCE. Regional coordinators are: Philadelphia, PA: Ron Cohen, K3ZKO and Russ Barber, N3HPX; York, PA: John Shaffer, W3SST and Dick Goodman, WA3USG; Baltimore, MD: Bob Bennett, W3WCQ; Wilmington, DE: Dave Stepnowski, KC3AM and Andy Alvarez, N3CUJ; Richmond, VA: Charles Bishop, AC4QG; Doylestown, PA: Dave Waustsen, N3LHY; Red Bank, NJ: Ken Barber, W2DTC.

For additional information, contact John Jaminet, W3HMS, at 717-697-3633 or packet @ K3WKK....73, John

Super front to back ratio using two Yagis.

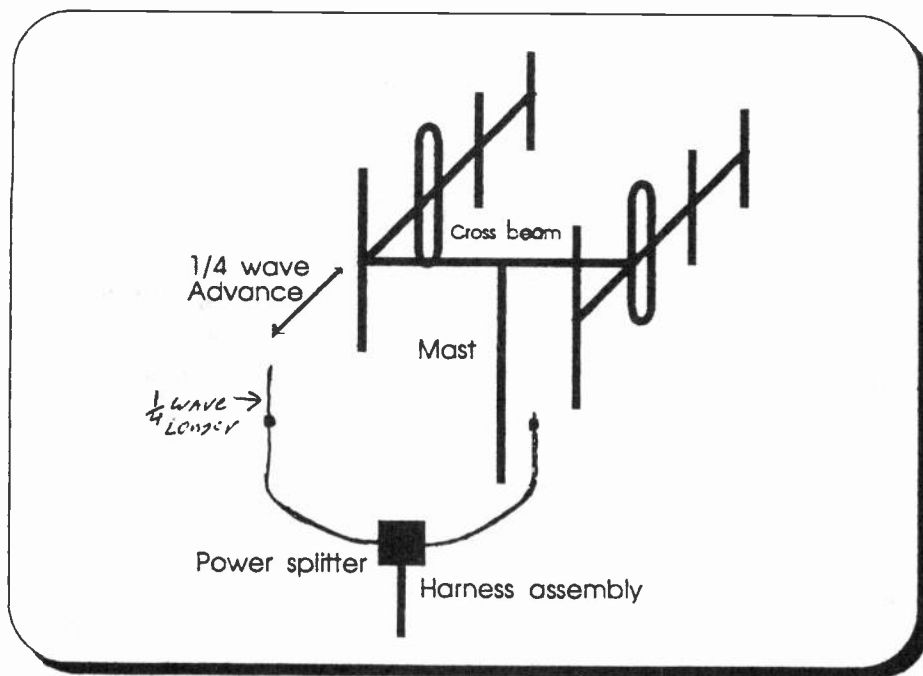

ATV SO.CAL, de WA6SVT

434 activity on some evenings can be intense, sometimes when two or more repeaters are used or simplex is in operation on 434 we all need to be considerate and also must stress monitoring 146.43 and ask if the frequency is in use on video. Many ATV ers are forgetting to use the calling frequency on 146.43 or see a weak picture on the repeater and assume they are too far away to be using the repeater and key up on top of them. I have also heard a few claiming that others are purposely jamming. It is poor practice to make this claim without positive proof. It may be better to say he is unintentionally QRMing.

We all are stuck with 434 for use on simplex and several repeater inputs so co-operation will help keep frustrations down. Enclosed within the newsletter is a way to stack two like antennas to vastly improve the front to back ratio to minimize 434 co-channel ATV use. 146.43 MHz talk back on the ATN repeaters will be PL. squelched. The PL. frequency is 100 Hz also known as 1Z. This will remove undesired QRM and stations not intending to talk back into the ATN repeater.

This article is in response to the 434 co-channel usage problem. Most Yagi or collinear arrays have 15 to 25 dB front to back ratios. This gives poor co-channel perfection if a station is in between two repeaters or simplex and desires to use one repeater but not wishing to QRM activity on the other repeaters or simplex. AM television has QRM that is noticeable to -53 dB below desired carrier. 40 dB is tolerable QRM and -30 dB is objectionable. One solution is FM TV as QRM is tolerable to -10 dB below carrier. This may be the way to go on the higher bands it would not be acceptable because of the wide band with it occupies if used on 434 MHz. High performance - dish antennas work excellent as they have 50 to 60 dB front to back ratios. Do to the large size 8 foot plus diameter and \$3500 plus price tags

this is not the way to go. Some improvement can be made by stacking but usually improves front to side more than front to back. Now for an easy, cheap solution that works and has a 3 dB improvement in forward gain as well. A typical phasing harness splits the signal to two antennas in phase to achieve gain. of one antenna is 180 degrees out of phase the signals cancel. Now here it is, the easy solution by offsetting one antenna one quarter wavelength physically in front of the other antenna and adding a quarter wavelength more coax (remember velocity factor on the calculations) on the physically advance antenna this will restore the signal from both antennas in phase. The

signal off the back will be additive as to the phase shift ($90^\circ + 90^\circ - 180^\circ$) and cancel out the back lobe. Fine adjustment could be slight boom shift within the mounting bracket to optimize cancellation off the back.



WE CAN'T NAIL HIM FOR PLAYING MUSIC ON THE BAND, THAT'S NOT "MUSIC"---HOW ABOUT "EXCESSIVE REGENERATIVE FEEDBACK?"

NEW GENERATION OF 24 cm FM-TV

Get linked with near broadcast quality.

65 x 35 x 160 mm

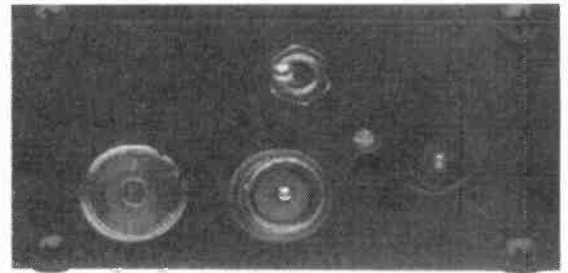
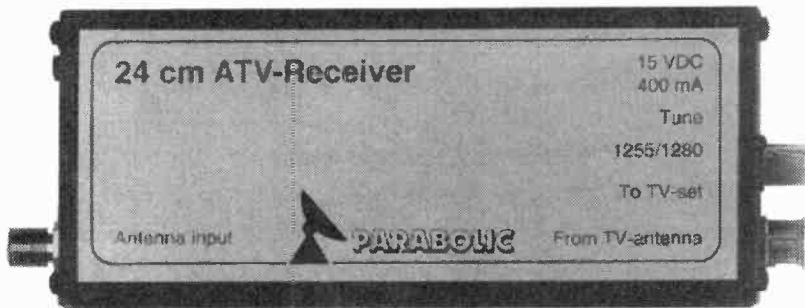

The world's smallest satellite receiver with modulated output on 48.25 MHz with audio on 53.75 MHz. (European use only).
\$179 + shipping \$12.

65 x 35 x 160 mm

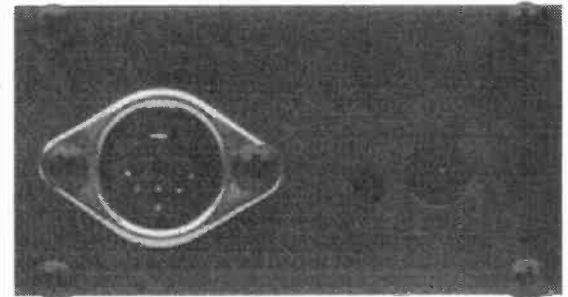
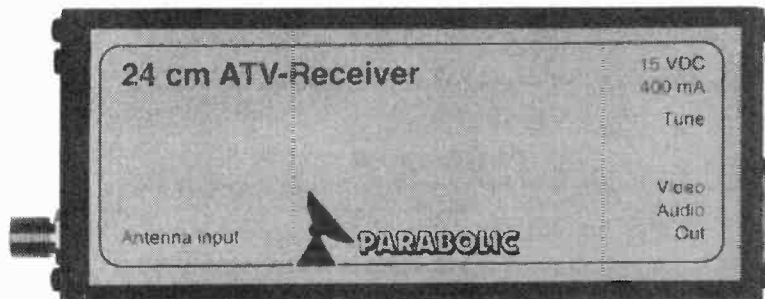

Same receiver with Video and Audio outputs. Will tune approx. 1200 to 1500 MHz. Both receivers deliver voltage for a preamp through the coax cable.
\$179 + shipping \$12.

65 x 35 x 160 mm

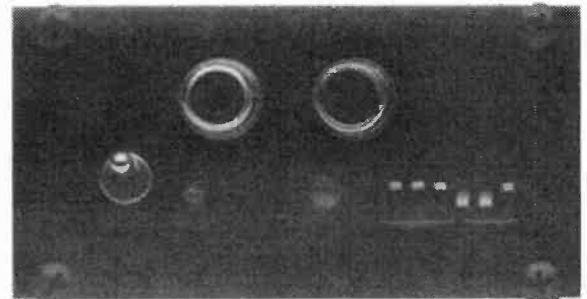

200 mW FM-transmitter that tunes between 1240 and 1279 MHz in 1 MHz steps. Will drive the M57762 to about 10W. One year guarantee.
\$249 + shipping \$12.

All modules use 15VDC max 400mA (incl. preamp) but 13.8VDC is OK. The transmitter will work as low as 10VDC. A preamp with 1,0dB NF and 40dB gain is also available at \$169.

Buy both receiver and transmitter and we ship free.



PARABOLIC
Systems AB

Fax: +46 - 300 40621

P.O. Box 10257 · S-434 23 Kungsbacka · SWEDEN

EURO 600 SAT MODULE

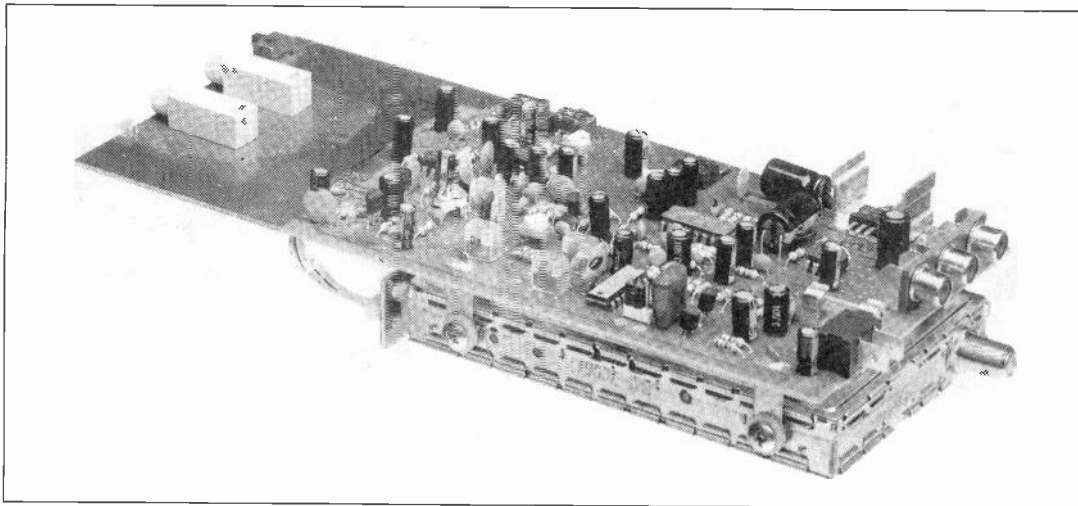

TUNING

POWER LED CHANNEL AUDIO AFC AFC

900 - 2000 MHZ 5,2 - 8,5 MHZ

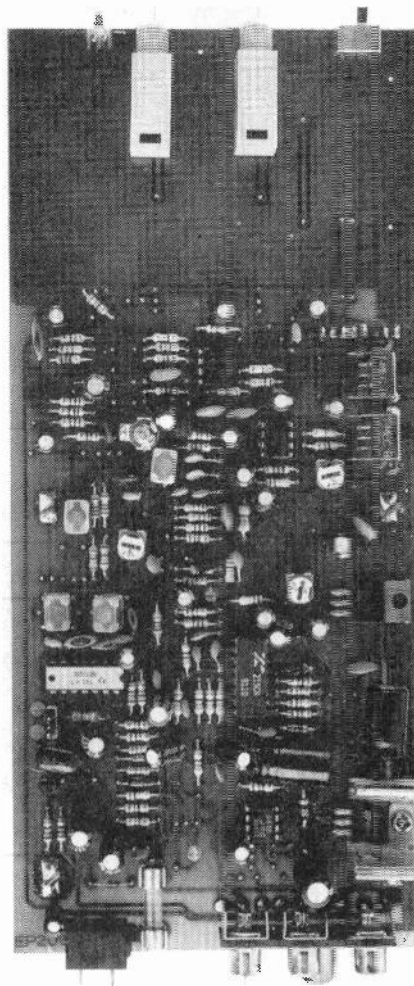

VIDEO LINEARITY

VIDEO 0,5 - 1,5 VOLTS P/P

AUDIO LEVEL

CLAMP CLAMP

: + 17,5 V DC

: 400 mA LNB

: Type F connector

: 950 - 2000 MHZ ADJ.

: 5,2 - 8,3 MHZ

: - 65 dBm

: 6,5 dB

: Switchable (on,off)

: 16/27 MHZ switchable

: 50 HZ - 5 MHZ

: Pal/NTSC/SECAM CCIR 405-1

: neg/pos. switchable

: 1V P/P ADJ.

: RCA Femelle

: RCA Femelle

: RCA 50 HZ - 8,5 MHZ

16 MHZ B/W
27 MHZ

LNB POWER
LNB

AFC - CTR

AUDIO RANGE

+ 17,5 Vdc
400 mA LNB

AUDIO VIDEO BASEBAND
50 HZ - 8,5 MHZ

PICOTRONIC
Inh. H. Boertzler • Zollamtstraße 48
D-6750 Kaiserslautern • W.-Germany
Telefon 06 31/2 91 87 • Fax 49-6 31/2 95 79

HAM SHOWS!



the hamfest which was transmitted from my handy-cam back to the forum and to two booths which were set up for ATV RX. The second half of the forum was turned over to the local groups to show and tell about the area's ATV repeaters. Ron Cohen explained his ATV repeater system which covers the greater Philly area and is HORIZONTALLY polarized. The repeater uses the multiple ring antenna (Also known as a halo) which provides good gain, low cost and omni-directional horizontal polarization. Much cheaper and better performing than a commercial drain pipe antenna being offered for \$400 and a 12+ week wait!

Hey, this is nice! My first thoughts as I entered the Sheraton convention center in Valley Forge, PA, just west of Philadelphia. Ham conventions are more work and little pleasure if you are an exhibitor. This was a pleasant change from the sweat box exhibit hall of Dayton's Hara Arena. Well, lit, well ventilated and temperature controlled. Easy access and connected to two hotels. Ham Shows, a commercial venture from Kansas, works WITH a local club to produce a quality ham flea market/convention. The turnout at this first effort was a success from all stand points. Even the efforts of one local club to boycott the event failed and the rain failed to dampen spirits. Attendance Saturday was SRO with over 3500 at the gate, and Sunday had a good turnout as well.

All major manufacturers and many smaller ones were in the commercial area and few tables in the flea market went empty. RF Concepts displayed their new HT power amps. Designed for 1-5 watt input (3 watts for rated output) they operate on 2 meters and 450 MHz with 50 watts or more output. The units looked very well built as can be seen in the photos. Downeast Microwave had their antennas on display as well as their line of transverters, preamps and power amps. AEA did not display their ATV transceiver.

The ATV forum was well attended. A nice touch was the convention, working with the local club, had an ATV'er stand in my booth while I gave the ATV presentation. I showed the antenna array construction tape (The Array!) and spoke on how easy it is to gain those little dB's needed for DX by improving your coax and adding a mast mounted preamp. Also provided was a lookie talkie tour of

In this issue, you will also find a cheap and easy (about \$20) slot antenna for horizontal omni gain you can easily build in a half day. The stacked wheel antennas from Olde Antenna Lab also work better and offer more gain at lower cost than the drain pipe slot antenna from Iowa, as well as off-the-shelf delivery!

The room at the Sheraton was on convention special rate of \$75, the usual rate for my room is \$290 per

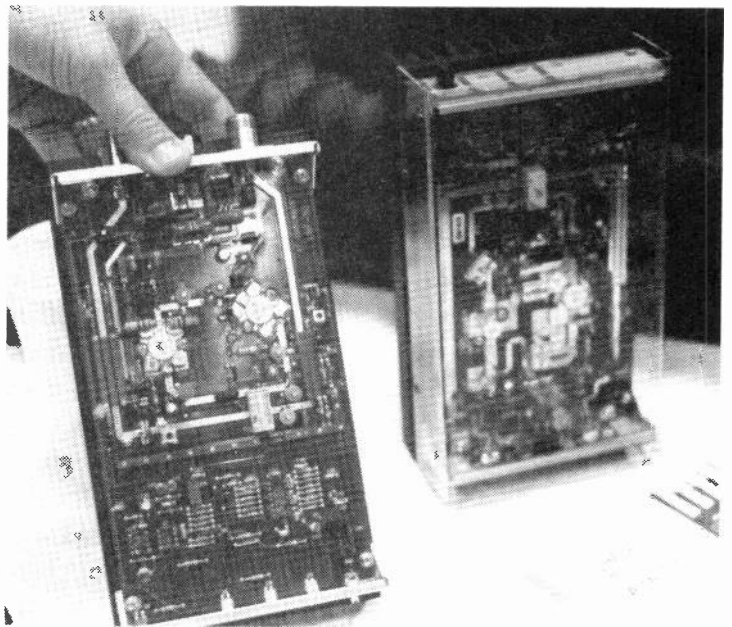

night! I had a penthouse suite, with two floors, private sun deck, built in TV, stereo, hot tub/whirlpool. There are several of these on the penthouse floor, each in a different Mine was more like Star Trek. The whirlpool bath felt really good after and before each day's efforts.

HAM SHOWS

NEXT ISSUE

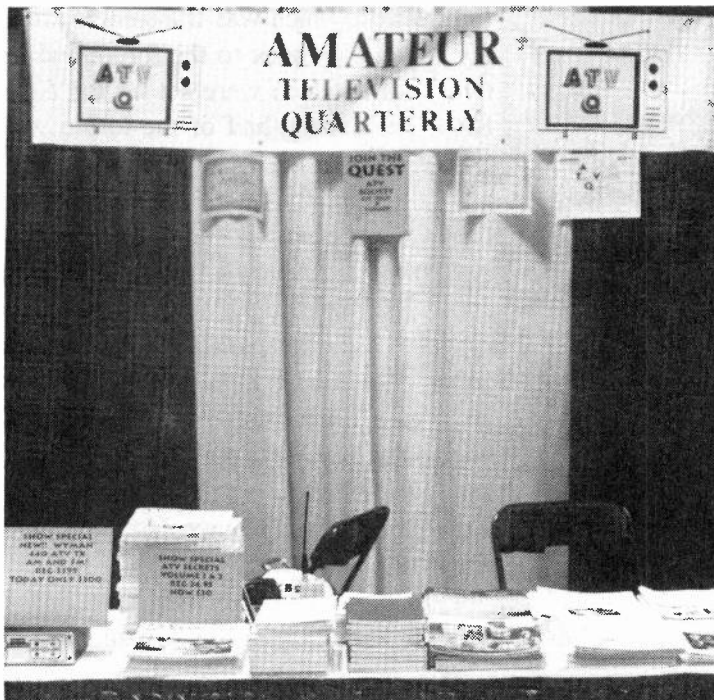

Local hospitality provided by Ron Cohen K3ZKO, included a tour of the new river front area which now boasts some great restaurants, a trolley museum, and nice views. A river taxi can take you from marina to marina or to restaurants or museums. The room also had a view towards the ATV repeater and Ron and I could see the repeater tower, so next time I can avail myself of the tower just outside the room on the roof and put up a temp antenna! The large circular bed was, well... very comfy... ahem. The skylight at sunrise provided an eerie blue glow from the metallic wall paper, much like you might expect in outer space as the room goes from black to dark blue to daylight blue. A very nifty effect. Ron and I also toured the cave room and a few others. One of the attractions is to exchange tours with other guests. The hotel food was very good, above standard even for Sheraton.

The flea market had scant ATV gear, but a few vendors had cameras, camcorders and other consumer stuff. There was a good selection of parts and hardware for the home builder. The next Ham Shows ATVQ will attend will be next summer in Chicago at Pheasant Run, a dinner/playhouse /hotel/convention center in Dupage county about 40 minutes west of downtown Chicago. You all come now! 73 KB9FO

The January issue will contain a complete cumulative index to all articles and features that have been published in ATVQ. I also expect to have an excellent article on impedance matching using stubs. I had a short article on broadbanding tube amps in an issue a while back which used stubs to broaden the amp input or output. The new article gives a complete explanation of how these work, how to build them and tune them!

Thanks to the many that have returned your survey forms which were in subscriber copies of the last issue. The feedback is much appreciated and the statistical results will be sent to several prospective advertisers. Most ham magazines have a page of ads for each page of editorial copy. Occasionally I get a comment about the number of ad pages. ATVQ has averaged 30- 35% ad pages which is almost enough to cover costs. With the loss of the AEA color ad, we will have to have 40-45% ad pages to cover costs. Sorry, but that is the economics of the business.

This issue I also put together differently than past issues. I usually start by selecting the major items for an issue, place them, then place the ads, then place filler (short) items to fit the spaces left. Now that I am getting more proficient with PageMaker 5.0, I am able to place the ads first (so I don't mess up and leave out Wyman's ad as happened last issue) then fill in the spaces with the major then smaller items. This seems to have worked out better and also allows a more friendly read. I am able to move items around easier from page to page to vary the look of the pages. This issue was assembled page by page over a period of five weeks, rather than doing individual pages and doing a manual assembly at the end to make everything fit.

The California ATV'ers have also promised the inside scoop on the Kenwood ATV transceiver some have in CA land that we showed last issue. We are waiting for the diagram and board layout for this item. Also look for a 1296 amplifier project next issue!

BE FAMOUS

Send in your articles, news and club letters. Remember ATVQ is NOT my full time job, I only spend 90% of my spare hours doing this so I don't fill my log book too quickly!

A sked to MN didn't result in a QSO, but band conditions were rotten. I did work Toronto via the Pittsburg, PA 145.27 repeater while I was MOBILE in down-town Chicago 9-24-93 in the morning while driving to work!! Where were you ATV'ers???

10 GHz ATV REPEATER

FROM P5, SEVERN SIDE ATV GROUP
 BLOCK DIAGRAM OF A 10 GHz ATV REPEATER FOR BRISTOL
 by Ted Halliday G3JMY

This diagram should be read in conjunction with the technical description

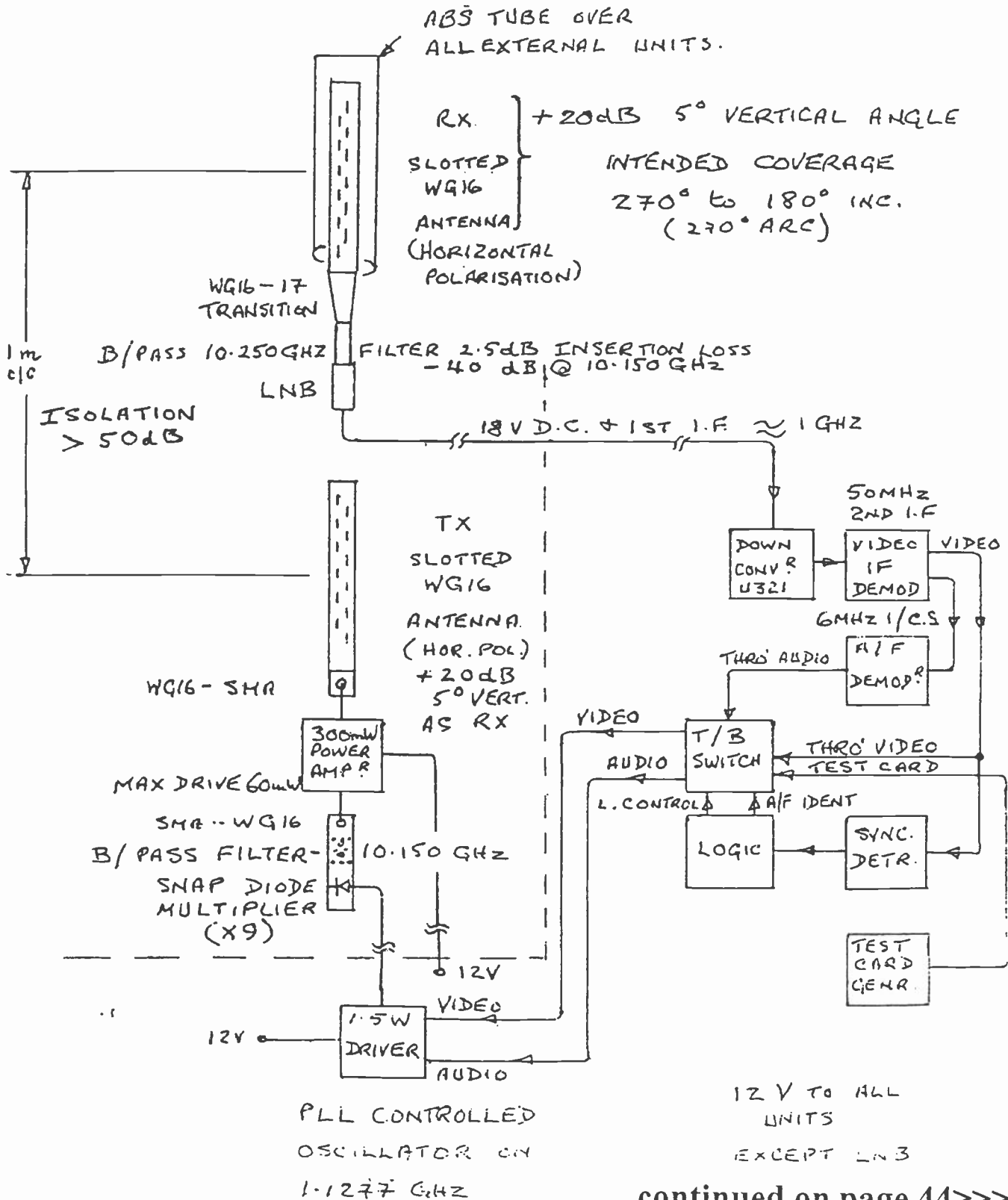

continued on page 44>>>



ELECTRONICS

P.C. ELECTRONICS 2522 PAXSON LANE ARCADIA CA 91007-8537 USA
TOM (W6ORG) & MARYANN (WB6YSS) O'HARA (818)447-4565

24 hr FAX order line (818) 447-0489



TC70-10 ATV TRANSCEIVER

All in one box



ONLY \$499 delivered

>10 Watts
p.e.p. Out
Made in USA

TC70-10 Transceiver lets you get on right away with all the power most will need in one box - *90 Miles line of sight

- Adjustable peak envelope power RF output
Typical range from 2 to 15 Watts allows proper adjustment to fully drive the RF Concepts 4-110 or Mirage D1010-ATVN to full 100 Watts output for DX, without sync or audio clipping.
- Separate mic and line audio volume controls
Lets you do voice over commenting on video tapes
- Rugged 7.5x7.5x2.7" black die cast alum. box
Stands up under rough public service applications and takes up less space on the operating table than 1 Watt plus amp.
- True Final RF detected video monitor output
lets you properly set the video gain control based on final output RF rather than low level. Camera video is at this jack during receive for focus & lighting set up before transmitting.

Front panel jacks accept composite video and line audio from your camcorder or VCR plus a low Z mic with push to look. Sensitive GaAsfet downconverter tunes whole 420-450 MHz 70cm band down to your TV channel 2, 3 or 4. Comes with one crystal you specify on 439.25, 434.0, 427.25 or 426.25. Second switch selectable crystal add \$15. Requires 13.8 Vdc @ 3 Amps.

P.C. Electronic pioneered the ATV transceiver in 1977 with the 10 Watt TC-1. While the change in 1985 to the 1.5 Watt units gives the flexibility of selecting 15, 50 or 70 Watts depending on the situation, many long time ATVers said they missed the old 10 Watter which did just fine in most cases for local and repeater use - *90 miles snow free line of sight using 14 dBd beams. You've always been able to build your own 10 Watt system from some of the basic modules on page 2 (TVC-2G, TXA5-70, FMA5-F and PA5), but now we have a ready to go alternative in a rugged die cast aluminum box.

Transmitting equipment sold only to licensed Tech class radio amateurs, verified in the Callbook, for legal purposes. If newly licensed or upgraded, mail or fax copy of license. However, receiving downconverters available to all (pgs 4 and 5).

COMPLETE 70CM ATV STATION

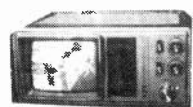

Your TV set

+



+



+

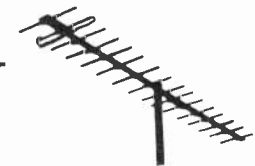

Your video camera or camcorder

+

TC70-10...\$499
ATV Transceiver
10 Watts p.e.p. min.
13.8 Vdc @ 3A power supply req.
specify transmit frequency(s)
Remember when comparing prices, ours include UPS surface shipping.

Optional 100 Watt Amplifiers
RF Concepts 4-110.....\$349
Mirage D1010-ATVN ...\$349
25 Amp pwr supply req.

Antennas - see pg 5
KLM 440-16X 14dBd \$129
KLM 440-10X 11 dBd \$72
KLM 440-6X 8.9 dBd \$60
RUTLAND FO22-ATV 15.8 dBd \$115

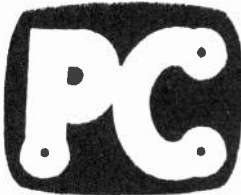

ELECTRONICS

P.C. ELECTRONICS 2522 PAXSON LANE ARCADIA CA 91007-8537 USA
TOM (W6ORG) & MARYANN (WB6YSS) O'HARA (818)447-4565

24 hr FAX order line (818) 447-0489



NEW - THE ATV TWINS

THE LOW COST
PROGRESSIVE
ALTERNATIVE
TO A TRANSCEIVER

Made in U.S.A.



TX70-1b Transmitter only \$279 delivered UPS TVC-4G Downconverter \$89

Not Sure what ATV is all about and your hobby budget's tight? Start with the tried and true TVC-4G Downconverter to see the action for just \$89. Then later, when you want to transmit, just add the TX70-1b companion Transmitter at only \$279.

TX70-1b SPECIAL FEATURES:

- * Two frequency 1.5 W p.e.p. transmitter properly matches linear amps with adjustable internal sync stretcher & blanking level on the time proven KPA5 transmitter board
- * Built-in RF T/R relay board switches antenna and applied 13.8 Vdc between transmitter and your external ATV downconverter
- * Full 25 kHz dev. broadcast standard 4.5 MHz sound subcarrier with independent mic and line audio controls allow voice over commenting while showing home video tapes. Accepts low impedance dynamic mics with "Push to Look" switch.
- * Transmit RF detected composite video outputs to monitor phono jack on back to see what you are transmitting. In receive you see your own direct camera video at this jack to enable focus and lighting set-up before flipping the switch into transmit.
- * RCA phono jack camcorder or VCR composite 75 Ohm video and line audio inputs, type N 50 Ohm antenna input, and 50 Ohm BNC output to downconverter connectors
- * Small attractive shielded cabinet - 7.3 x 4.7 x 2.1", 1lb. 11 oz.

Just plug in your camera, VCR, camcorder, etc. composite video and audio, 70cm antenna, 12 to 14 Vdc @ .5A, and you are ready to transmit live action color or black and white pictures and sound to other amateurs. Specify 439.25, 434.0, 427.25 or 426.25 MHz transmit frequency. 1 crystal included, second crystal add \$15.

*Transmitting equipment sold only to licensed Tech class or higher radio amateurs verified in the Callbook for legal purposes. If newly licensed or upgraded, mail or fax copy of license.

WHAT ELSE DOES IT TAKE TO GET ON ATV?

Any code free Tech class or higher amateur can get on 70cm ATV. Any video camera, camcorder, VCR or computer with a composite video output can be plugged into the front panel phono jacks for both audio and video.

Start by selecting a 70cm antenna and connecting a TVC-4G downconverter to your TV set to receive. Add the Transmitter along with your camcorder and 13.8 Vdc from a regulated power supply capable of .5 Amps and you are on the air.

DX with TX70-1b's and FO22-ATV antennas line of sight and snow free is over 22 miles, 7 miles with the 440-6X normally used for portable uses like parades, races, search & rescue, damage assessment, etc. For greater DX or punching thru obstacles add either of the ATV compatible 15, 50 or 70 watt amps listed below.

The TX70-1b has full bandwidth for color, sound and live action just like broadcast. You can show the shack, home video tapes, computer programs, repeat SSTV, weather radar, or even Space Shuttle video if you have a home satellite receiver. See ARRL Handbook chapt. 20 & 7 for more info & Repeater Directory for local ATV repeaters.

BUY AN AMP WITH THE TX70-1b & SAVE!
50 WATT WITH D26N-ATV...\$499
70 WATT WITH D100-ATVN...\$599

Most telephone orders shipped within 24 Hours

7/93

COMPLETE 70CM ATV STATION



+



+



+

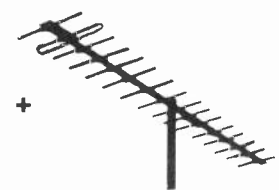

Your TV set



Your video camera
or camcorder

TX70-1b-\$279 & TVC-4G-\$89
ATV Xmit & Rec
1.5 Watts p.e.p. 13.8 Vdc
Power Supply
required

pg 3

Remember when comparing prices, ours include UPS surface shipping.

Optional Amplifiers

Mirage D15N 15 Watts RF out\$169
Mirage D26N 50 Watts RF out.....\$239
Mirage D100ATVN 70 Watts out..\$349

Antennas see page 5

KLM 440-16X 14dBd \$129
KLM 440-10X 11 dBd \$72
KLM 440-6X 8.9 dBd \$60
RUTLAND FO22-ATV 15.8 dBd \$115

HAMS, call 818 447-4565 for your free complete ATV catalogue now!



ELECTRONICS

P.C. ELECTRONICS 2522 PAXSON LANE ARCADIA CA 91007-8537 USA

TOM (W6ORG) & MARYANN (WB6YSS) O'HARA

(818) 447-4565

24 hr FAX order line (818) 447-0489



THE "KREEPIE PEEPIE" ATV TRANSMITTER

THIS IS THE ATV TRANSMITTER BOARD YOU HAVE READ ABOUT THAT HAS SURVIVED MANY BALLOON FLIGHTS TO OVER 100,000 FEET AND BACK. ALSO USED FOR R/C MODELS WHERE AN ALL IN ONE BOARD WITH SOUND IS DESIRED OR DEDICATED LINKS AND REPEATERS. JUST THE THING FOR THE BUILDER WHO WANTS TO PACKAGE AND MAKE HIS OWN PORTABLE 70 CM ATV TRANSMITTER OR HOME TRANSCEIVER WITH A WIRED AND TESTED BOARD.

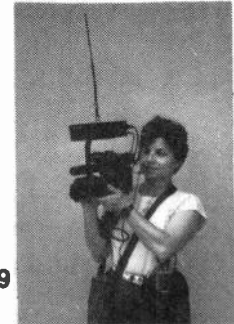
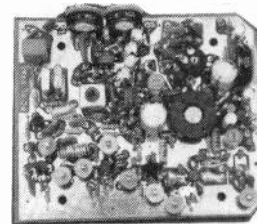
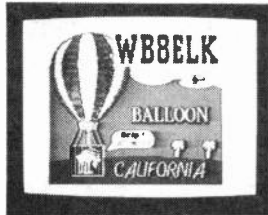
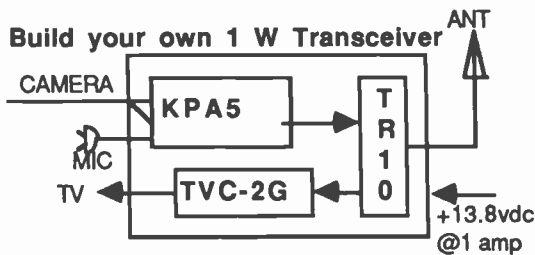

KPA5-F board only \$169

KPA5-E 70CM ATV XMTR BOARD FEATURES:

- 1.5 Watts P.E.P. typical RF output. Run barefoot for portable, but if needed for greater DX, the output properly matches the Mirage D15N 15 watt, D26N-ATV 50 Watt linear amp for full output or D100TVN to over 70 Watts with its adjustable sync stretcher.
- FULL COLOR AND SOUND on a small 3.25x4" board
- Wired and tested board runs on external 13.8 Vdc @ 300 mA. supply or 12 V battery. Weighs only 3 oz.
- Accepts composite video from cameras, camcorders, VCRs, computers, etc. 2 audio inputs, one for low Z dynamic mic, & one line level from most cameras & VCRs. Transmit monitor output enables seeing your own true RF detected video.

KPA5 APPLICATION:

PORTABLE CORDLESS TV CAMERA. Think of it as a video HT. Place the KPA5 in one of the L.M.B. Diecast aluminum boxes, AEA HR-4 half wave "hot rod" on top or at the end of 50Ω coax attached to a headset. Plug into a 12-14 v source such as a 12 Vdc battery pack. Depending on terrain & receiving antenna DX is typically over 1 mile. With KLM 440-16Xs at both ends DX is 22 miles snow-free line-of-sight.

Price only \$169 supplied with one xtal on 426.25, 434.0, 427.25 or 439.25. 2nd xtal add \$15. Specify frequency(s) when ordering, check with local ATVs, ARRL Repeater Directory or call us. Sold only to Technician class (including new code free Tech) or higher licensed radio amateurs.

ACCESSORIES:

- L.M.B. CAB247 7.3x4.7x2" roomy aluminum box.....\$20
- CAB234 4.6x3.6x2" aluminum box, smaller tighter fit.....\$13
- 100 Ohm panel pot for video gain control.....\$5
- TR-10 RF T/R relay module, mounts on chassis N conn.....\$29
- TVC-4G..\$89 or TVC-2G..\$49 Downconverter (pg 5)
- VOR-2a Video (horiz sync) operated relay board.....\$45
- MIRAGE D15N-ATV 1.5 in /15 out all mode amp.....\$169
- MIRAGE D26N-ATV 1.5 in / 50 out all mode amp.....\$239
- MIRAGE D100TVN 1.5 in/70 out all mode amp.....\$349

- AEA HR-4 "Hot Rod" half-wave portable antenna.....\$24
- 450 ISOPOLE omni 4 dBd vert. gain antenna.....\$89
- KLM 440-6X 8.9 dBd ant., 28" boom, >50 deg. BW.....\$60
- KLM 440-10X 11.2 dBd, antenna, 64" boom.....\$72
- KLM 440-16X 14 dBd antenna, 10.5 ft boom.....\$129
- UG21 type N male connector for Belden 9913 coax.....\$5
- UG58 N female flange type chassis connector.....\$2
- 800J 10 pin VHS color camera chassis connector.....\$10
- 800P 10 pin VHS color camera cable male plug.....\$15

SMALL TXA5-RC 1 WATT ATV TRANSMITTER.....\$129

Designed primarily for Radio Control models, rockets, balloons, etc. with it's small 2.25 x 4 inch size and 2 oz. weight. Adjustable power output from 1.5 p.e.p. to 100 mW. Draws 350 MA @ 13.8 Vdc and 1 Watt, 200 ma at .100 mw Has adjustable sync stretcher and provisions for sound from the FMA5-F board (pg 2) in case your application needs higher power sometimes or subcarrier sound. Comes wired and tested ready for you to mount in a shielded enclosure, connect up coax from antenna and camera and wires to power source. Plan on shielding your R/C receiver and adding the simple antenna low pass filter supplied with the application note. Receive with one of our 70 cm downconverters listed on page 5 and a TV set Specify freq., 426.25 MHz suggested for R/C, other standard ATV freq. avail.

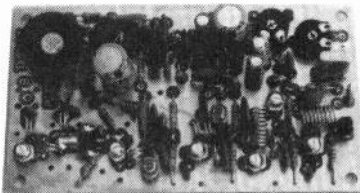

TXA5-RC

See page 8 & 10 for mini cameras New TXA5-70a board can also be used for R/C applications where 2 frequency capability is desired. Same size as TXA5-RC but 80 mw.for .25 to 5 mile DX, or add 10 Watt PA5 amp for 3 to over 100 mile line of sight DX. See pg 2.....\$89

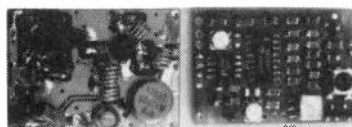

ATVM-70 Transmitter MSC-2 Sound

NEW MICROTEK ATVM-70 mini ATV transmitter board.....\$129

Only 1.0 x 1.3 inch, wired and tested board. See article in July 91 73 Magazine page 9. Nominal output 80 mw. Capable of driving the PA5 for higher power. Requires 7.0 to 10.0 Vdc maximum at <100 ma. Only 434.0 MHz is available with the SAW oscillator. Also Great for R/C models, robots, demos or short links. Snow free line of sight DX 1/4 mile dipole to dipole or up to 5 miles with KLM 440-16x's.

NEW companion MSC-2 4.5 MHz sound subcarrier board, same board size as xmtr....\$59



P.C. ELECTRONICS 2522 PAXSON LANE ARCADIA CA 91007-8537 USA
 TOM (W6ORG) & MARYANN (WB6YSS) O'HARA (818)447-4565

24 hr FAX order line (818) 447-0489



420-450 MHz ATV DOWNCONVERTERS

GET STARTED WITH ONE OF THESE TO SEE THE ACTION!



Space Shuttle video



TVC-4G

TVC-4G PACKAGED DOWNCONV. with AC supply.....\$89
 Contains the sensitive TVC-2G board in a black die cast 4.7x3.7x2.1 inch aluminum box ready to go with 120 Vdc 60 Hz to 12Vdc 100 ma. wall plug power supply. N connector antenna input and F output to TV. Companion downconverter to our TX70-1b transmitter and other TX boards. TVC-4G is handy for ATV portable, mobile, demos, or getting a friend on. Also used in community pay TV systems outside USA.

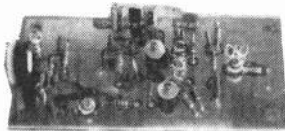

TVC-2G 2"x4"

TVC-2G GaAsFET TUNEABLE DOWNCONV. BOARD.....\$49
 Wired and tested module connects between 70cm antenna and TV set tuned to channel 2, 3, or 4. Varicap tunes whole 420-450 MHz 70CM amateur band. Sensitive 1 dB NF dual gate GaAsfet used in both the preamp and mixer stages. Double tuned bandpass filter rejects strong UHF broadcast interference. 25 dB gain. Requires +11 to 18 Vdc @25 mA, shielded enclosure, knob, 10K pot, switch, fuse and connectors.

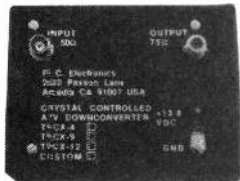

TVCX-4

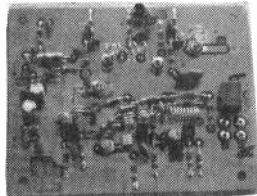

TVCX-70 3"x3.8"

TVCX-70 XTAL CONTROLLED GaAsFET DOWNCONV....\$99
 Crystal controlled version of tuneable TVC-2G board used in repeaters or unattended operation with wide temperature variations or at a public service event where a tuning knob might be touched by unauthorized persons. Specify input frequency (421 to 440 MHz) and output (ch 3 or IF). +11 to 15 Vdc @ 50 mA external power, shielded enclosure and connectors required. 2 freq. add \$15. LMB CAB-234 box...\$13
TVCX-4 is the TVCX-70 board ready to go in the CAB-234 box ...\$129

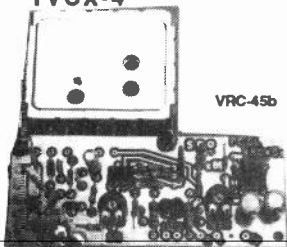

VRC-45b

VRC-45b 45.75 MHz IF/receiver module. 2 composite video outputs, squelched line & speaker audio outputs. Used with TVCX-70 in a CAB-247 box for complete receiver. 4x3.75". 12V @ .25A.....\$99



KP2

MIRAGE KP2 ANTENNA MOUNTED PREAMP.....\$159
 If your coax loss is greater than 3 dB then this preamp can make a difference. Automatic T/R switching 1/4 to 150 Watts. .6 dB NF 15 to 25 dB gain. N conn. Req. 12 to 14 Vdc - included dc coupler in shack.

KLM, SWIECH & RUTLAND BROADBAND BEAMS FOR ATV

KLM 440-6X 8.9 dBd gain, 28" boom, vertical or horizontal polarization rear mount. Ideal for point to point, fixed at a repeater or small enough to be portable at public service events to minimize multipath ghosts and get some gain at the same time. Wide 60 degree beam width. All 5 include 50 Ohm balun with Type N female conn.\$60 del.

SWIECH COY4327EL 10 dBd, 4' boom, an extra dB over the 6X for 5 more bux..\$65

KLM 440-10X 11.2 dBd gain, 64" boom. Bigger version of the 6X....\$72 delivered

KLM 440-16X 14.2 dBd gain, 10.5 ft boom, center mounted. full 420-450 MHz bandwidth, and very rugged\$129 delivered

RUTLAND FO22-ATV 15.8 dBd, 420-450 MHz, 14 ft boom, center mtg...\$115 del.

The antenna, coax and tower height are the most important part of your ATV system and deserves your most care and attention. ATV antennas must have broad bandwidth in addition to high gain and low VSWR. Few other antennas work well at both 439 and 421 MHz. The three KLM, one Swiech and Rutland antennas listed here fit the requirement and have a long history of rugged operation with ATVers. The gains listed have been proven out at VHF/UHF conference antenna measuring contests, they are not marketing hype. All four beam antennas listed here take up to the maximum legal power limit. Balun or matching network with female type N connector is included. We suggest using Belden 9913 (2.6 dB/100') or better 50 Ohm low loss coax or hard line. Belden 8214 (4.2 dB/100') is more flexible and is fine for runs less than 50 feet.

AEA 450 ISOPOLE OMNI 3-4 dBd GAIN ANTENNA. 50 ohm type N, 1.25" mast mount.....\$89

DIAMOND F718 9.3 dBd OMNI 15' long, F718L=420-430, F718J=430-440 & F718A=440-450 MHz.....\$219

ANTENNA, TRANSMITTER & RECEIVER ASSEMBLIES FOR 10 GHz ATV REPEATER

BY G3JMY TED HALLIDAY

All items are mounted inside a 69 mm diameter white ABS tube + expansion housing. Top cap of nylon pressed on.

1. Receive antenna is a 20-slot, semi-omni, WG16 waveguide, optimized for 10.250 GHz, the input frequency. Antenna fitted with sliding short at the top end and 3 matching screws at base (middle screw only is inserted into the waveguide for best match, i & 3 are flush).

2. Base of antenna connected to tapered WG16 - WG17 transition.

3. Transition connected to a WG17 multi-cell filter, tuned to 10.250 GHz. Filter insertion loss measured 3 dB.

4. Filter connected to satellite LNB, retuned for 10 GHz operation

5. Low-loss cable from LNB passes down behind lower TX assembly.

6. Transmit antenna is a 20-slot, semi-omni, WG16 waveguide, optimized for 10.150 GHz, the output frequency. Antenna fitted with sliding short at the top and 3:8 BA matching screws at base (all screws have been adjusted for best output, return loss almost 0). The top of the TX antenna is 1 M below the base of the RX antenna to give at least 50 dB isolation between the two. The flat (5 degree) vertical beam angle increases the isolation greatly. Also the ABS tube appears to have no effect on either antenna regarding match or gain.

7. WG16 - SMA transition connected to base of antenna, sliding short adjusted for maximum output.

8. MGF 1801 GaAsFET PA connected via SMA + semi-rigid coax to transition. Power supply of 12 to 14V is by means of the drive coax screen (OV) and a separate 12 to 14V wire terminating at the bottom cover. The PA output at the waveguide flange is at least 250 mW. The PA box contains an 8V regulator and a polarity inverter for bias. The idle current measured at ground level is set to a warmed-up value of 120mA. The current under full-drive conditions is 134mA. This means that correct operation of the PA can be monitored from the ground, via a 150mA meter.

9. SMA - WG16 transition connected to PA via SMA + semi-rigid coax Sliding short adjusted for maximum output.

10. Two-cell pin filter in WG16 from transition adjusted to 10.150 GHz. The filter reduces any multiples of 1127.778 MHz above and below 10.150 GHz to an unmeasurable low level. The WG16 itself acts as a further filter to the lower frequencies. At the lower end of the waveguide is the launching probe of the DJ7VY multiplier, an adjustable sliding short terminating the system.

11. The DJ7VY multiplier is housed in a cylindrical brass housing, containing a tapered coaxial line, with trim capacitor, and a SNAP varactor diode, MD 4901, tapped into the outer end of the line. A coaxial shunt capacitor terminates the outer end of the line, which is then coupled to capacitor half-Tee matching section. Drive to this section is at 1127.778 MHz at a level of roughly 1.5 W, from a modified Worthington ATV transmitter via low loss coax (7 M).

The RX and TX antennae are both horizontally polarized and have a minimum beam-width in azimuth of 90 degrees. They radiate on the same side, which is marked on the outside of the tube with dashed lines. In several tests it was evident that the radiation outside the minimum angle was considerable and the total beam angle could be as much as 270 degrees for stations within, say, 15 km of the repeater.

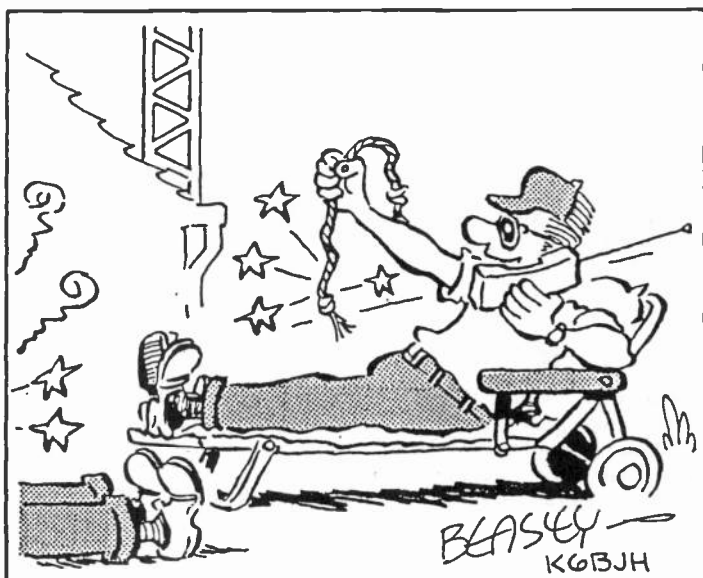

HEY, BURT -- YOU SUGGESTED I USE A CHOKE TO SOLVE MY TVI PROBLEM --- IT WORKED!

see diagram on page 39

COMET

ANTENNAS FOR THE PROFESSIONAL AMATEUR

CYA-1216E
 16 Element Yagi Beam 1200-1300MHz
 Gain: 16 dB
 VSWR: 1.5:1 or less
 Impedance: 50 ohms
 Max. Power: 100 watts
 Polarization: Vertical or Horizontal

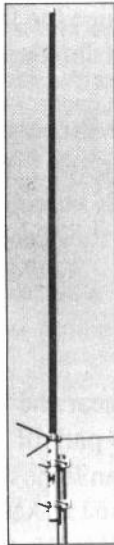
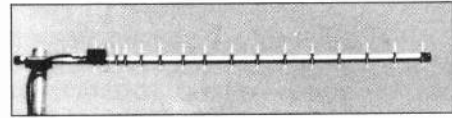

CA-1243Z
 Dual Band
 440-450MHz
 1250-1300MHz
 Base/Repeater Antenna
 5/8 Wave x 4 446MHz
 5/8 Wave x 9 1200MHz
 Gain: 44.9 dBS
 1200 12.8dB
 Impedance: 50 ohms
 VSWR: 1.5:1 or less
 Max. Power: 446 150 watts
 1200 50 watts
 Length: 7' 5"
 Weight: 2 lbs. 3 ozs.
 Connector: N-type
 Construction: Heavy Duty Fiberglass

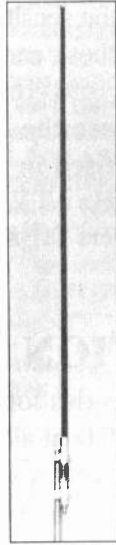

CA-1221S
 Mono Band
 1260-1300MHz
 Base/Repeater Antenna
 1/2 Wave 21 Step
 Collinear
 Gain: 15.5dB
 Impedance: 50 ohms
 VSWR: 1.5:1 or less
 Max. Power: 100 watts
 Length: 8' 6"
 Weight: 2 lbs. 3 ozs.
 Mounting Mast Diameter: 1 1/2 - 2 1/2 inches
 Connector: N-type

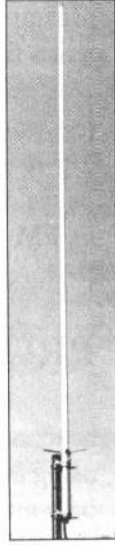

PYA-913
 Base 13 Element Yagi
 904-920 MHz
 Gain: 15.8dB F/B ratio over 20dB
 Max. Power: 150 watts
 VSWR: 1.5:1 or less
 Length: 4' 8"
 Connector: N-type
 Construction: Aluminum

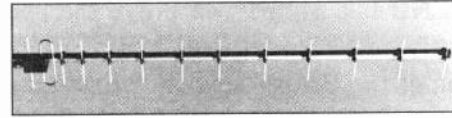

MINI SWR Power Meters

		Max. Power	Insertion Loss
CM-200	140-150MHz	45 watts	0.1dB
CM-300	200-240MHz	60 watts	0.2dB
CM-400	420-460MHz	50 watts	0.2dB
CM-420	140-460MHz	50 watts	0.1-0.2dB
CM-900	840-950MHz	40 watts	0.2dB
CM-1200	1225-1325MHz	60 watts	0.25dB

Measurements: 2.25" w x 2.25" h x 1.1" d
 Weight: 5.25 oz.
 CM-200, 300 and 400 have SO 239 Connectors
 CM-420, 900 & 1200 have N Connectors

FP-19
 Base/Repeater
 905-925MHz
 Gain: 16dB
 Impedance: 50 ohms
 VSWR: 1.2:1 or less
 Max. Power: 100 watts
 Length: 7' 4"
 Connector: N-type
 Construction: Heavy Duty Fiberglass

CF-4130 446/1200MHz
 dB Loss: 1.3-460MHz 0.2dB
 900-1400MHz 0.3dB
 Band Rejection: 55dB Down
 Max. Power: 146MHz 800W PEP
 446MHz 500W PEP
 1200MHz 200W PEP
 Connectors: N-type



NCG CO. 1275 North Grove Street • Anaheim, CA 92806 • (714) 630-4541 • Orders (800) 962-2611

CALL FOR THE DEALER NEAREST YOU!

10 GHz

by John Hudson G3RFL

Well, now that your brain is in gear, how about entering the dream world of real Microwave, 10 GHz? It was thought many years ago that these frequencies were only for line of sight use and no good for communications at all. If you think that, you can't build or work on these frequencies as well as on the other bands. Then take the T off can't and you can see that you can! I personally have found it easier and cheaper to get on FM ATV and narrowband 10GHz than on HF, 24 cm or Top Band. Due to so much cheap second hand or new satellite equipment such as LNB's Dishes, receivers, squarials etc., now being easily available through many sources at nearly giveaway prices, we are able to play and develop in an experimental way.

AERIALS

The RSB aerial (squarial) can be used easily on 10 GHz without many modifications and seems to give as much gain as a 21" dish. Because the front of the RSB aerial is flat and the feed is at the back, there is no loss due to the LNB attenuation or any loss due to the dish curvature errors. The

only snag is that it is very sharp in both V and H planes; about 2 degrees plus or minus so care must be taken when mounting.

POLARIZATION

If you replace the LNB for a Linear type then the aerial transmits in a linear form and not as the original "right hand" polarization. The original LNB has a device that to me looks like a PTFE tube covering the cavity probe 13 mm long by 3.8 mm diameter and is tuned by a screw to correct for matching.

What I think happens (!) is that the PTFE covering the probe creates a very small phase delay between one half of the 250 phased dipoles and thus forces it to turn in a given direction causing a cork-screw effect (circular polarization) Removing the screw after much force will allow you to remove the PTFE tube through the screw hole and then replace the screw for matching use.

continued >>>

Q COMES TO YOU

During Thanksgiving week, Henry and Sylvia will be traveling in the ATVQ mobile, with ATV gear and 2, 440 and 6 meter FM. We will be looking for cheap motels which allow dogs (three this trip) and local QSO's and eye-balls!

Our route will take us from Chicago to Indianapolis, St. Louis, Tulsa, OK City, Dallas/Ft. Worth, Houston, Austin, New Orleans, Baton Rouge, Memphis and the interstates in between! Drop us a card or a call if you have info in these areas for hotels/motels which allow dogs, and to let us know on what frequencies to find you. We will follow the listings we have published and also 144.34 as the normal 2 meter frequency for voice. ATV will be available on 440 and 1255 MHz. SOrry, no 900 this trip. Let us know if you would like a visit! We start Nov 20th. BCNU on ATV! (get those Quest points!!)

Micro-Video Camera SMALL SIZE 2"x3"x1"

Feather Weight 4 oz.
NTSC Output 240 TV Lines
Low Light 2 Lux 7-15 VDC/<100ma.
Typical Applications: ATV, Robotics, Computer Vision, Security, Remote Monitoring, Phone Vision

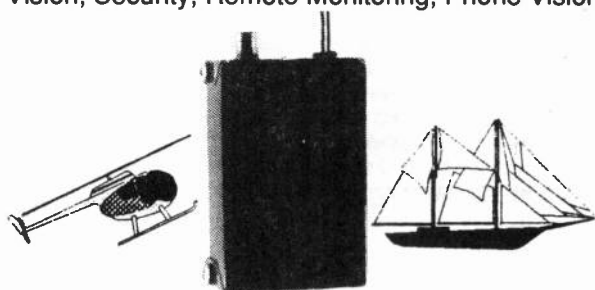

Factory New \$229.95

Add \$5.00 S/H Ca. add 6.75%

Micro Video Products

1334 So. Shawnee Dr. • Santa Ana, CA 92704

1-800-473-0538 (714) 957-9268

Horizontally Polarized An, OMNI with Gain Ya Say?

stacked mini wheels plus two other single wheels (one for 440 mhz and one for 1280 Mhz - more on these antennas in a later article). They arrived about a month later (Dave makes these antennas in his free time - he has a full time job as a Radio Frequency Manager/Engineer for the Government.

Stacked Mini-Wheel Construction

To my surprise when I opened the shipping box from W60AL, the antenna came in two sections (two antennas per section) joined by an "N" connector "T". I expected to see 75 ohm phasing lines (coax) but instead, Dave made the phasing lines out of copper tubing with a center conductor forming the coaxial phasing lines. What a neat idea! The mini-wheels are soldered directly on the ends of the copper tubing phasing lines, thereby eliminating connector losses, one wave length long (5/8 wave length physical spacing each section). One antenna is inverted from the other to achieve proper phasing. The top section with two antennas are tapped 2 1/4 wave up from the lower of the top section antenna and the bottom section is tapped a 1/4 wave down from the top antenna on the bottom section. This "top" section of each phasing line is 3/4 wave long terminating to a

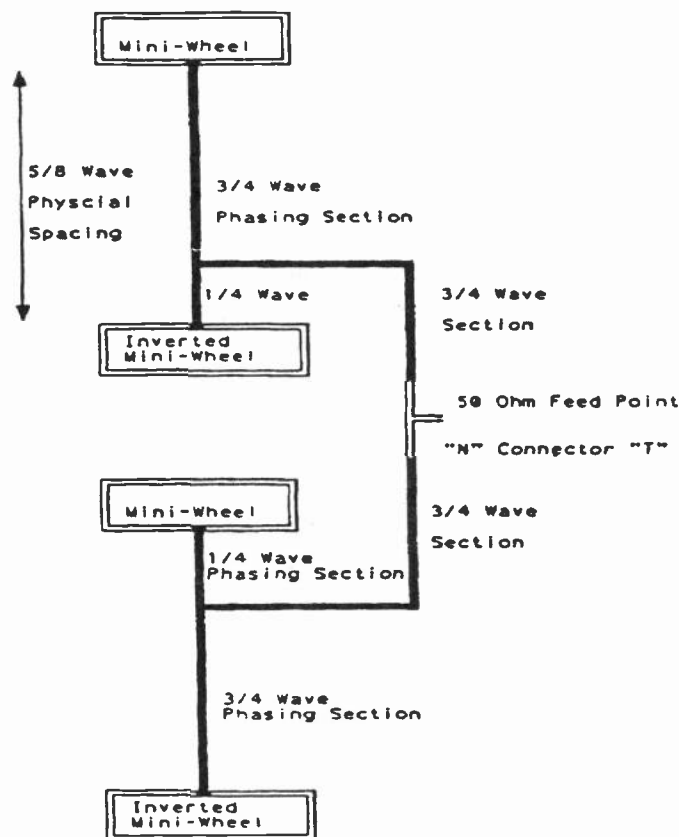

horizontal omni gain antenna

"N" connector. The two sections are joined with an "N" Connector "T". The antenna by itself does not self support and requires that it be fastened to a PVC pipe (about 8 feet long). The antenna will require some more work to help it withstand Ohio Tornadoes, but more importantly, our ice storms in the winter, especially, when it gets mounted 50 floors up!)

Checking it out

After an initial false start, careful strength measurements were made of the existing single mini wheel on the beacon from a line of sight distance of 4.5 miles away using a military DB attenuation box with 1 db steps. It took 26.5 db (averaged over 30 minutes) to put the beacon's signal below PO - no signal detectable. The new stacked 4 mini wheels were installed within a two hour period. The same test was run with the attenuation box, but this time it took 33 db of attenuation (average) to achieve the same result. An apparent gain of 6.5 db over the single mini-wheel Why 6.5 db instead of the theoretical 6.0 db? Maybe it was because the single mini wheel was positioned such

that I was receiving its signal from one of the -0.3 db notches caused by the overlapping of the elements. Most likely however, it was because of the capability/accuracy of the "db" Attenuation box (after all, it was built for the military!) I'm sure my statistical sampling methods were Statistically valid. Most of the On-The Air tests also confirm about a 1 -P unit improvement in the Repeater/Beacon's performance-Reports so far have been received by W8CJW, KB8MDE, WB8URI, WA3DTO WA8RMC, WA8TTE, KA8ZNY, KB8EWX, WB8LGA, W8DMR, N8LRG, K8JGY and others. Most stations reported about a one 1 P unit improvement except for WA8RMC and W8DMR. There are a couple of theories on why those two stations were discriminated against, but that's another article!

An ATV antenna that horizontally polarized, OMNI Directional and has 6 db of gain It looks like we may have found one! WB8CJW has completed his ZIG-ZAG antenna. I look forward to see how it compares with the Mini-Wheels.

W8DMR HAS ADVISED ATVQ THAT THERE WILL BE AN UPDATE ON THIS ANTENNA AND REPEATER SHORTLY, Don't Get all excited yet!

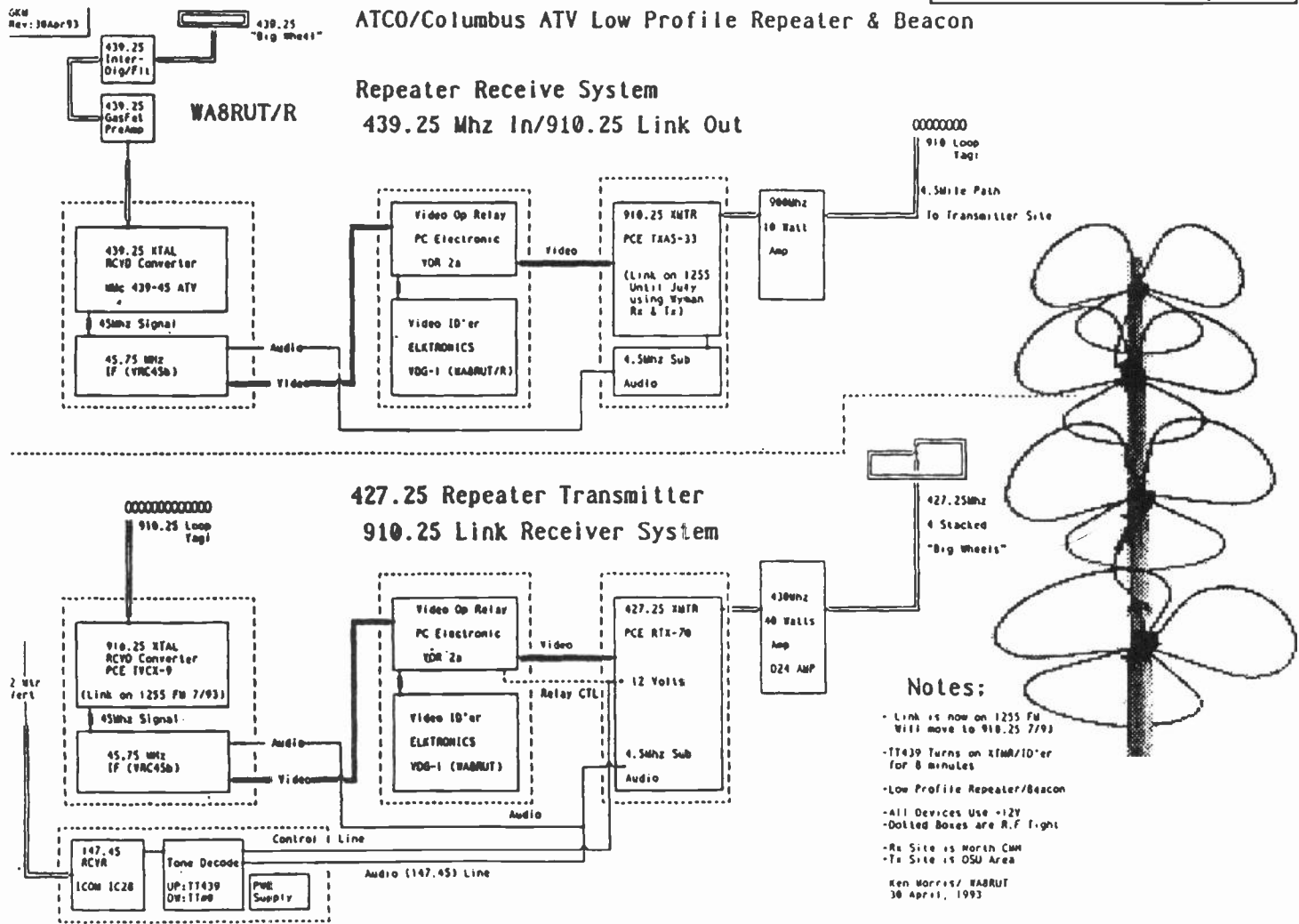



ELKTRONICS

12536 T.R. 77
Findlay, OH 45840
(419) 422-8206

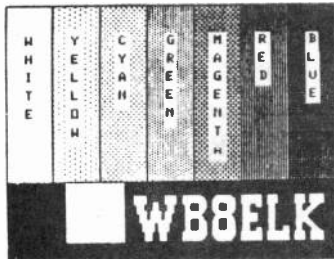

INTRODUCING THE
VDG-1

VIDEO I.D.

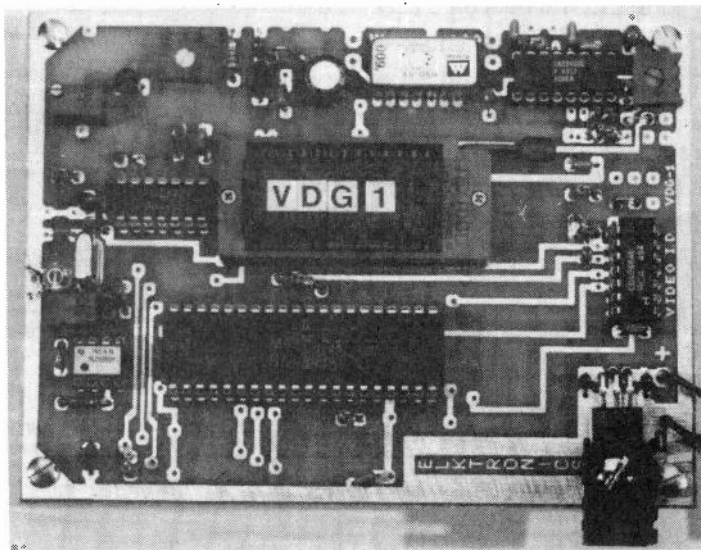

KAOJAW

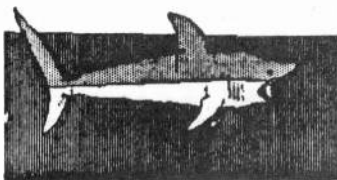

KABEEE

Jim
Marion Ohio

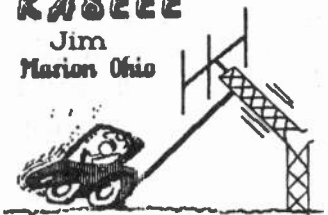

N9CAI / P



KA8ZNY

GROVEPORT



- Instant Video Source
- 4 Graphics Screens (2 Hi-RES / 2 Colorbar)
- 12 V D.C. Operation
- Video Relay for switching in live camera video
- Built-in Sequencer/Timer (Steps through all 4 screens)



VDG-1 with Pre-Programmed Custom Callsign Logo
- \$99 ppd.

(Quick-release socket option)
- \$10

Call or Write for CATALOG of available Graphics

Additional Programmed EPROMS
- \$19

Now available as a Kit
- \$89 ppd. Blank PCB - \$19

KA8LWR



IN BUCYRUS, OHIO

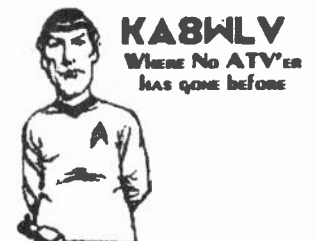

SIMPLIFIED 70cm ALFORD SLOT

Low Wind Load No Howl No Cut Fingers Cheap WORKS!

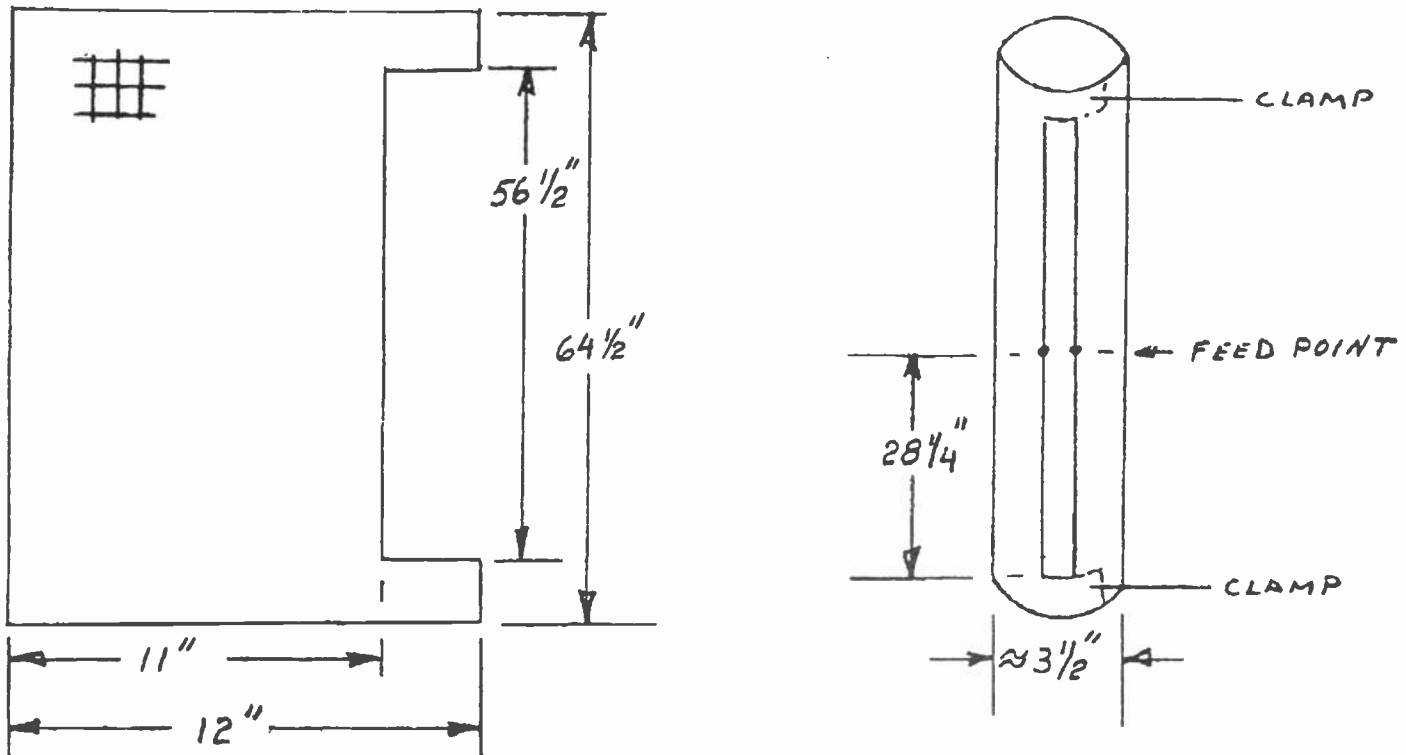

MATERIAL: 1/2" square galvanized hardware cloth (screen).

PROCEDURE:

- 1) Cut material to pattern shown.
- 2) Form material and clamp overlaps such that a 1/2" uniform width slot is obtained.
- 3) Attach a 4:1 balun at the feed points and bring feedline through rear of antenna perpendicular to the feed point.
- 4) Fasten a 1/2" wide by 2" long metal tab (capacitor) to one feed point and extend tab length across slot.
- 5) Using an appropriate VSWR test set-up, adjust slot width (keep uniform spacing) and tab capacitance (spacing) to achieve the lowest VSWR possible.

NOTES:

- A) If the antenna is to be used for ATV, use an ATV RF source, NOT CW. This will ensure best match over the desired bandwidth. There is a difference! However, if tuned to a 425MHz CW signal, the VSWR will be less than 1.3:1 from 420 - 450 MHz.
- B) The antenna may be mounted from either end by any method that does NOT enter the slot area. It may also be axially clamped to a mast along a line opposite the slot.
- C) Run feed line along the OUTSIDE axially and opposite to slot.

HI-SPEC P.O. Box 387 Jupiter, FL 33468 (407)746-5031 1/93

ATVQ, FALL 1993

MEDFORD MIDDLE SCHOOL HAM MINI COURSE

MIKE N9GHZ

Medford Middle School again offered its students an opportunity to sign up for several mini courses, including the fourth consecutive year for Ham Radio class.

Frank K9LRS, a teacher at Medford presented the ham radio course, assisted by Mike Schoenfuss K9GHZ and Guy KB9GPJ to 14 students. Students were introduced to Morse code, viewed two ARRL movies and assembled mini kits. Soldering, component identification and circuit purpose were explained using the mini kits as well as safety in soldering.

The students were involved in two-way QSO's with local hams, K9LRS, K9GHZ, KB9GPJ and K9MN using ATV, FM voice and packet. Pictured below, Jim K9MN and teacher Frank K9LRS with Heath SB301/401 used to demonstrate HF communications. Top right, some students observe their classmates via ATV. Middle right, Guy demonstrating the use of 2 meter handheld and ATV camera used for ATV. Bottom right, students using packet and other ham equipment during the course.

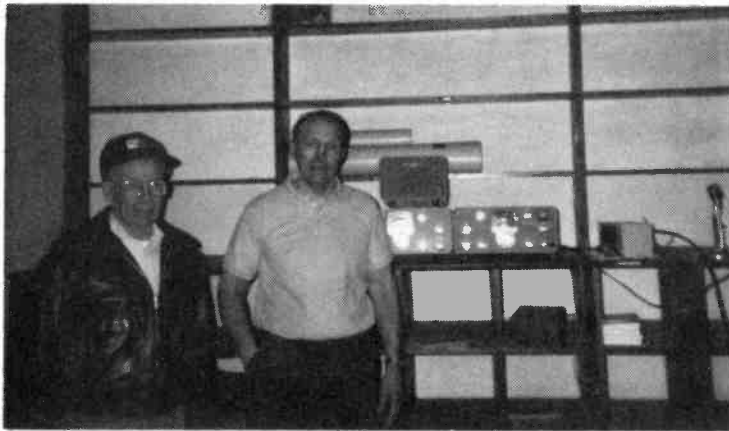

I BELIEVE YOU'VE CLIPPED OUR DEMO TO YOUR TROUSERS, SIR--- NOTICE THE POWERFUL NEW VANADIUM STEEL BELT CLIP?

QUEST MEMBERSHIP CERTIFICATES

ARE BEING MAILED SEPARATELY TO SUBSCRIBERS WHO ARE CURRENT AND HAVE THEIR HAM CALLS ON FILE. IF YOUR SUBSCRIPTION IS EXPIRED, YOUR MEMBERSHIP CERTIFICATE WILL BE MAILED WHEN YOUR RENEWAL IS RECEIVED. NON SUBSCRIBERS AND EXPIRED SUBSCRIBERS MAY FOLLOW THE PROCEDURE IN THE PROGRAM ANNOUNCEMENT.

The w6ORGy Notes

By Tom O'Hara, W6ORG

TO DEVIATE OR NOT TO DEVIATE - THAT IS THE QUESTION Part 3

Last time I promised you the definitive test. At first I thought the usual carrier to noise or picture to noise or even P unit graph would be the classical engineering way to present it. But then, how useful would it be to the average ATVer and would it really answer the questions hams have been asking?

Have you turned to page 37-7 in the good book according to Newington? That's the 1993 ARRL Handbook for those that don't have a sense of humor. The P unit can have all kinds of interpretations depending on the eye of the beholder. It is difficult to put an official P unit pix in print since it has to go from the photographers idea of a P unit change, through the camera and films contrast interpretation of the TV screen, and then through the printers half tone screen process before you get to add your calibrated eye ball.

So what makes more sense to me, as a usable reference, are observable points most of us see and hear while operating. Starting at the bottom of the scale is just seeing sync bars in the noise, then sync lock, first audio or color and on up to full quieting audio or seeing all colors in the noise. At the top is snow free which I define as about 40 to 45 dB above the noise or the same as most of the cameras we use in ATV as a practical limit.

There are still plenty of variables for those who's greater interest in the hobby is to nit pick dB's, get some one else up on FM to send their pictures to, or play one up manship games with interpretations, details, etc., so it would not matter to them how this test was done anyway.

But to attempt an honest real world comparison to simulate what you would do in your shack with available amateur gear, I used the same P. C. Electronics TVC-4G down converter ahead of both the AM and FM receivers and same TV/monitor. I had intended to use the HFT RX1300 23cm down converter, but it did not arrive in time. Although the

TVC-4G was just handy for the tests on 434 MHz, I don't recommend 70cm FM ATV, even though legal if you make sure your deviation doesn't go outside of the band, because one FM ATV channel takes up 17 to 21 MHz of the 30 MHz available.

With both tests I made sure that there was sufficient gain to be at or above the bandwidth noise floor of both systems so that any differences in system gain or noise figures would not be a factor. I guess you could say my ears and eyeballs for hearing first sound and sync bars could be a dB or two off what some one else might perceive, but for the purpose of comparison that doesn't matter much either.

On the AM side I used a CATV generator on cable channel 59 and verified its peak envelope power on both a micro volt meter and spectrum analyzer. Its output went through step attenuators to the TVC-4G down converter. I also verified that the sound subcarrier was set to -15 dBc. The down converter output on channel 3 went directly to the TV set just as you would normally have in your own shack. I used a Radio Shack 13" color TV/monitor for both systems - I think these are perfect for the shack with one on simplex, one on the repeater output and a third on the camera/transmit monitor output - They are usually on sale for \$229 once or twice a year.

For the FM tests I use a modified Wavetek sweep generator with the video and 6 MHz sound inserted in the varicap line. The video deviation is set to 4 MHz with 1 volt pk-pk input and the sound is set to 10 dB down and with the proper pre-emphasis per the FM ATV standard in chapter 20 of the ARRL Handbook. The modulation was checked on the spectrum analyzer as well as the power before going through the same step attenuators to the down converter.

The HFT IF70 FM ATV receiver has a 70 MHz input which is well within the output range of the down converter that was used for AM tests on channel 3 (61.25 MHz). Most FM receivers need a lot of gain ahead of them so I added an amp ahead of it while looking at a first color picture to see if it was enough. Not this one, it

only wanted about 20 dB minimum ahead of it with 25 dB the maximum before no change could be seen. The down converter was measured at 25 dB so no additional amplification was necessary ahead of the HFT70. The video output went to the video in jack of the RS TV/monitor and a speaker plugged in to the HFT IF70's audio out jack.

Now the AMers might say that the comparison is not fair as far as power due to the pep vs. average difference. But again this is a real world (or shack) comparison where most hams will run the their amps to their power limit be it AM or FM. If you are on FM your going to be in saturation (until it burns up or the thermal cut out stops you - don't forget to blow more air for the higher continuous dissipation) which is about the same point of peak sync in an AM system.

WHAT'S IT ALL MEAN?

Well if you are going to the extra expense of FM ATV then you want to know if your situation will put you in the "FM advantage" part of the curve. You can see that if you are a "just want to see the call sign DXer" then AM is for you. You will be able to detect a weak signal AM ATVer up to 4 times farther away. If the signal is between 5 and 200 micro volts and you want the best picture you can get then FM will do it. With any signal above 200 micro volts it doesn't matter because both are snow free.

To put some line of sight miles to it, assuming 1 Watt on 1253.25 (AM) or 1252.0 (FM), 3 dB loss in coax and 16.2 dBd loop Yagi's at both ends, all normal earth bound paths are great for either mode to get a picture. If you have a balloon or Space Shuttle the sync lock miles are 800 AM and 300 FM. The cross over where AM and FM are equal at -95 dBm (4 uV) between first color and first audio the DX is 200 Miles. But for snow free it goes down to 6 AM and 25 FM.

Antenna mounted preamps are almost a must with FM systems as each dB of coax loss gets multiplied going back down the advantage curve. In AM the dB loss is one for one and not as striking a change when an antenna preamp is added.

AM vs. FM ATV

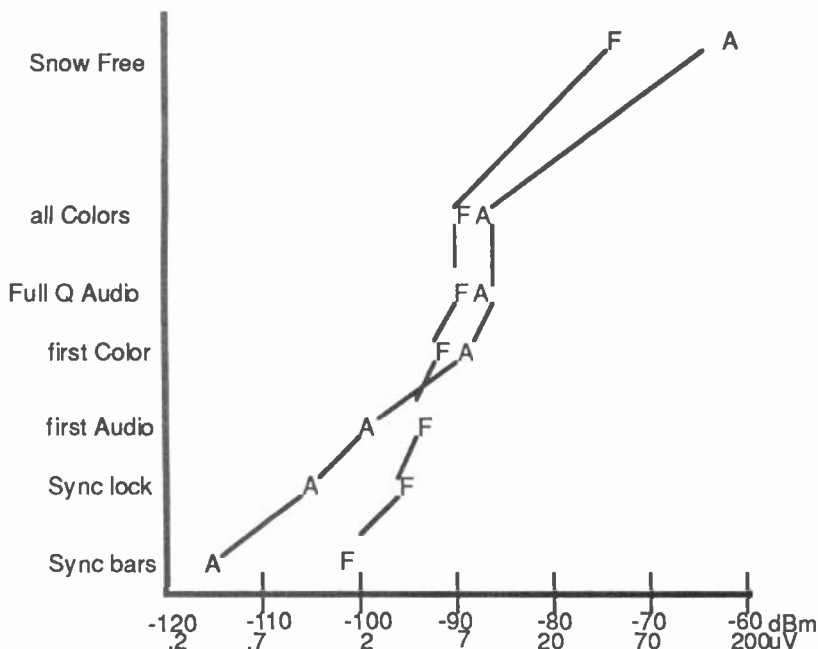

SYNC BARS (-115 vs. -102 dBm)

For DXers this is what you are straining your eye balls to see in the snow. If you can see these few lines rolling through you have a chance maybe by a few clicks of the rotor one way or another or the inversion lifting just a little more. The AM sync bars could be seen at -115 dBm (.4 uV) and the FM at -102 dBm (1.8 uV), a difference of 12 dB. So all things being equal you can see sync bars up to 4 times farther with AM vs. FM.

SYNC LOCK (-105 vs. -96 dBm)

At this level where the few visible blanking lines go from diagonal to snapping in place, you can most likely make out large black call letters against a white background as well as their Q number in the snow. Now ATV communication can begin with something usable in the picture. AM still is almost 4 times farther but notice that FM has picked up a dB in the difference. For you micro volt people it's AM 1.2 and FM 3.5. A side note: some DXers double their receive distance by reducing the bandwidth (at the cost of color, sound and resolution) to about 1/2 MHz and still are able to see large call letters in the noise. It might be interesting to try that with FM to see the results. The HFT IF70 FM ATV receiver has a 3 dB bandwidth of 15

MHz which would give 1.4 times more distance than those that use converted satellite receivers with their 30+ MHz IF bandwidth.

FIRST AUDIO (-100 vs. -95 dBm)

Notice that the FM still takes a stronger signal but has narrowed the gap to 5 dB. AM audio can be heard down in the noise almost twice as far as FM. This will vary with the individual sound injection of the transmitters. Older AM transmitters may be at -18 dBc or less which was a compromise many of us did back when the more non-linear Motorola bricks were used and gave sound crosshatch in the video (triple beat intermod) if turned up too high. With the linear SAU4 bricks and 1 Watt transmitters out in the last 5 years or so set at the maximum -15 dBc, the sound does indeed go much farther as the tests show.

FULL QUIETING (-87 vs. -90 dBm)

Now we cross over in the sound quality to FM by 3 dB. AMers might again cry foul by saying that most amateurs use mixed subcarrier sound that can be set at no more than -15 dBc where the FM standard is 10 dB below peak video. But again this is the real world. If AMers really want to go more than twice as far with the sound then you can go as high as -7 dBc with a separate sound

transmitter. However since just getting color in the snow and full quieting sound are about the same level, it becomes an individual value judgment as to whether the time, money and effort are worth it. Most opt to just use the 2 meter coordination frequency which goes much farther than AM or FM subcarrier sound or even on-carrier audio, and most everybody already has a 2 meter transceiver.

COLOR (-89 vs. -92 dBm)

Finding the actual color point was somewhat difficult to judge. I noted where I could just see the red bar which showed up first. All colors showed up within 2 dB stronger after that with both systems. FM had a 3 dB advantage over AM or 1.4 times the distance. As you can see from the first color point on, FM crosses over and walks away at an increasing rate over AM.

SNOW FREE (-61 vs. -74 dBm)

Starting about -93 dBm (5 uV) the FM advantage can easily be seen. Thanks to the limiters, the signal to noise ratio improves at a much greater rate. At snow free there was a 13 dB difference or FM goes more than 4 times farther than AM at this signal level. I'll leave the relative P unit interpretation over this wide signal strength range to you.

Next time

The HF Technology TX1300 1 Watt transmitter just arrived as I am completing this quarters ORGy notes. Along with it, thanks to Bill at Downeast Microwave, I have the loan of one of his 18 Watt brick PA's to match up with it in the tests. So look for the 1 Watt FM ATV transmitter review next time fans. Those who can't wait can call me. The HFT 70 FM receivers are now in stock at P. C. Electronics at \$199 and any of our down converters can be ordered for 70 MHz output to drive it. HFT also makes the RX1300 down converter which should be available soon.

73, Tom O'Hara, W6ORG
2522 Paxson Ln
Arcadia CA 91007
818 447-4565

1 - 800 - 4 - A - HAM - TV

1-800-424-2688

*** TRI BAND RX ! ***

SINGLE BAND TRANSCEIVER

\$479.95

RX 420-450 Mhz TV Ch 3/4 Output
 -- OR --
 RX on 1.2 Ghz TV Ch 7/8 Output
 -- OR --
 RX on 900 MHz TV Ch 2/3 Output
 -- AND --
 TX 420-450 Mhz 10 W. 4 Channel
 Video Monitor output on TX
 Type "N" Connectors Available

Simple Front Panel Layout
 Connectors all on Rear Panel
 May Upgrade to Dual or Tri RX
 High Grade Cabinet
 Individual RX TV Outputs
 Spare Set A/V Jacks on Rear
 Made in USA by HAMS

DUAL BAND RX TRANSCEIVER

\$569.95

TRI BAND RX TRANSCEIVER

**** NEW ITEM ****

\$659.95

RX on any of 2 or 3 bands AND
 TX 420-450 Mhz 10 W. 4 Channel
 Video Monitor output on TX

High Quality FR-4 Ckt Brds
 Solder Mask and Silk Screen
 Drive Amps to Full Output

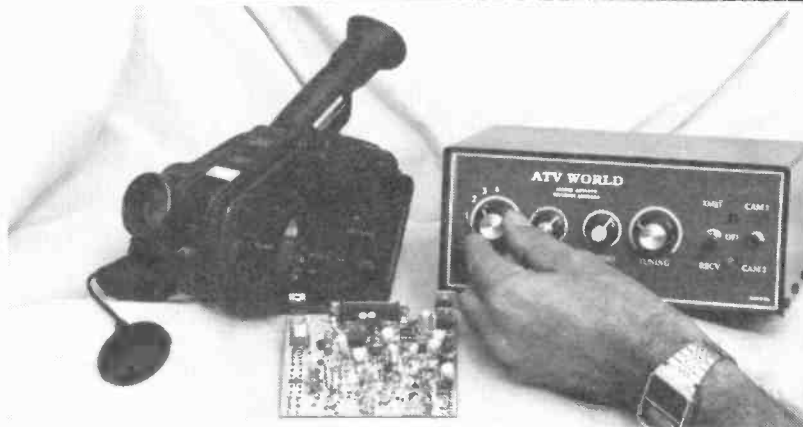

Cabinet Silk Screen NO Hardware	\$29.95
Cabinet with All Hardware	\$64.95
TX 4 Channel 10 Watt	\$199.95
TX 4.5 MHz PPL Option	\$49.95

900 MHz Loop Yagi Antenna	\$99.95
1200 MHz Loop Yagi Antenna	\$99.95
1.2 Ghz 900 MHz or 430 Mhz RX	\$99.95
RX Freq Synth Option	\$69.95



AMATEUR TELEVISION WORLD

3713 W. CHARLESTON AVE.

GLENDALE, AZ. 85308

1-800-4-A-HAM-TV

1-800-424-2688

1-602-978-4348

DOWN EAST MICROWAVE

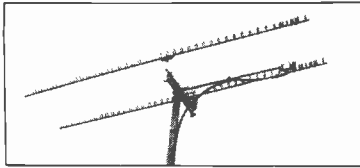

MICROWAVE ANTENNAS AND EQUIPMENT

- Loop Yagis • Power Dividers • Complete Arrays • GaAs FET Preamps
- TROPO • EME • Weak Signal • OSCAR • Microwave Transverters

902 1269 1296 1691 2304 3456 MHz

2345 LYK45el 1296 MHz 20dBi \$89
1345 LYK45el 2304 MHz 20dBi \$75
3333 LYK33el 902 MHz 18.5dBi \$89

Above antennas kits available assembled

Add \$8 UPS s/h

Add \$11 UPS s/h West of the Mississippi

MICROWAVE LINEAR AMPLIFIERS SSB, ATV, REPEATER, OSCAR

2316 PA 1w in 18w out 1240-1300 MHz \$265
2335 PA 10 in 35w out 1240-1300 MHz \$315
3318 PA 1w in 20w out 900-930 MHz \$265
3335 PA 10 in 40w out 900-930 MHz \$320
23LNA preamp 0.7dB N.F. 1296 MHz \$ 90
33LNA preamp 0.9dB N.F. 902 MHz \$ 90

NEW PRODUCT ANNOUNCEMENTS

New Loop Yagis

1845 LY Loop Yagi 1691 MHz 20dBi \$99
945 LY Loop Yagi 3456 MHz 20dBi \$89
Above antennas assembled and tested

New Preamps

13LNA 0.7dB N.F. 12 dB 2.3 GHz \$140
18LNA20 0.8dB N.F. 20 dB 1.69 GHz \$140
SLNA 1.0dB N.F. 10 dB 2-2.7 GHz \$150

New Wideband Power Amplifiers

2370 PA 3w in 70w out 1240-1300 MHz \$695
2340 PA 2w in 35w out 1240-1300 MHz \$355
2318 PAM 1w in 18w out 1240-1300 MHz \$205

Rack mount Amplifiers for repeater use available.

NO TUNE MICROWAVE LINEAR TRANSVERTERS

From SHF SYSTEMS a new line of transverters designed by Rick Campbell KK7B and Jim Davey WABNLK

Available in kit form or assembled/tested

- 903 1269 1296 2304 3456 MHz
- microstrip filters eliminate tune-up
- 2m i.f. PIN diode switched
- sequencer standard in complete unit
- low profile packaging, mast mountable

All active equipment - 13.8V

DOWN EAST MICROWAVE
BILL OLSON, W3HQ7
Box 2310, RR-1 Troy, ME 04987
(207) 948-3741

Sky Spy RPV

FOR THE HOBBYIST

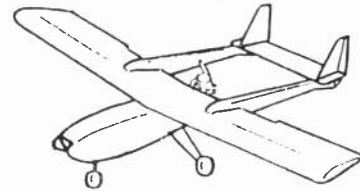

6' WING SPAN

.60 SIZE

DESIGNED TO CARRY
A CCD CAMERA AND
1 WATT TRANSMITTER

PLANS - \$16.99 ppd. Includes
Assembly Instructions
or send S.A.S.E for more details.

FUNTECH P.O. BOX 772747
HOUSTON, TX 77215-2747
(713) 690-8471

NOW THERE IS NO REASON NOT
TO TRY RC AIRBORNE ATV!

RUTLAND ARRAYS

DELIVERS

THE HIGHEST GAIN ATV ANTENNA YOU CAN BUY!

Model: **FO22-ATV**

MEASURED GAIN > 15.8 dBd

Model: **FO22-ATV**

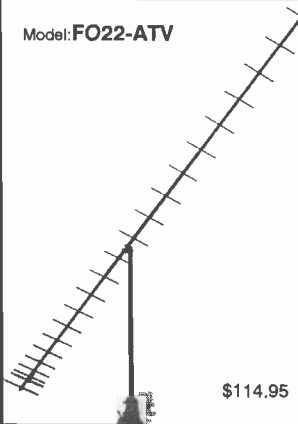

\$114.95

ELECTRICAL SPECIFICATIONS:

Gain bandwidth 420-450 MHz
VSWR < 1.33:1 415 to 450 MHz
E-Plane beamwidth 23 Deg.
H-Plane beamwidth 24 Deg.
Sidelobe attenuation

1st E-Plane -17.5 dB
1st H-Plane -15.5 dB

Maximum power 1500 Watts

F/B ratio 22 dB

Impedance 50 ohm

MECHANICAL SPECIFICATIONS:

Length 14 Ft.

Boom 1" OD 6061 T-6 Al

Elements 3/16" Al rod

Mast up to 1.5" dia.

Wind surface area78 Sq.Ft.

Wind survival 90+ MPH

All Stainless Steel Element Hardware

Coax connector N-type

Polarization: Horizontal or Vertical

ALSO AVAILABLE
SIX METER, TWO METER, 222 MHz, 432 MHz ANTENNAS
POWER DIVIDERS — STACKING FRAMES

CALL OR WRITE FOR OUR NEW CATALOG

AVAILABLE FROM

Down East Microwave
Troy, ME
Fred Gore, KA1TBS
Southwick, MA
P.C. Electronics
Arcadia, CA
Stewart Electronics
St. Charles MO.
Wyman Research
Waldron, IN

RUTLAND ARRAYS

1703 Warren St
New Cumberland Pa 17070
Orders 1-800-536-3268 Info. 1-717-774-3570
7pm-10pm EST
PA residents add 6% State Tax
UPS S/H \$5.00

CANDELABRA

(BRAND NEW PRODUCT)

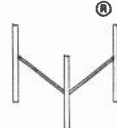

AS USED BY

“THE EDGE of SPACE SCIENCES”

- Omni Broadband Radiator
- Vertical Polarization, w/Slight Down Tilt
- Very Lightweight (3 oz.)
- Balloons, Kites, R/C & Rockets
- Available for 70cm, 33cm, 23cm & 13cm

Reports indicate, Broadcast Quality Video
At The Launch Sites.

BE ONE OF THEM!

Assembled/ — \$59.95
Tested

WRITE FOR INFO

Add \$3 for P & H — SPECIFY BAND
& CONNECTOR

Send postcard (QSL) for catalogue

Dave Clingerman W60AL
Olde Antenna Lab
4725 W. Quincy
DENVER, CO 80236
(303) 798-5926 — Talk To My Machine