

AMATEUR TELEVISION QUARTERLY

WINTER 1992
VOLUME 5 #1
January, February, March 1992

\$4.95



ISSN 1042-198X
USPS 003-353

left: NAT W7OQF and GOEFF KB7BY view 1289 MHz. FM ATV video link from Redmond Mt. CA at Pt. Potosi, NV near Las Vegas at the west end of the bi-state ATN system. right: Bill KB6MCU at Santiago Peak, CA ATV RPT on 1253 MHz.



BUILD: Video proc amp, video low pass filter, 12 watt ATV transmitter, 440 MHz QRM filter, 2304 MHz. power amp, broadband amp cavity design, MORE!



THE BEST OF BOTH WORLDS.

The pacesetter IC-R9000 truly reflects ICOM's long-term commitment to excellence. This single-cabinet receiver covers both local area VHF/UHF and worldwide MF/HF bands. It's a natural first choice for elaborate communications centers, professional service facilities and serious home setups alike. Test-tune ICOM's IC-R9000 and experience a totally new dimension in top-of-the-line receiver performance!

Complete Communications Receiver. Covers 100KHz to 1999.8MHz, all modes, all frequencies! The general coverage IC-R9000 receiver uses 11 separate bandpass filters in the 100KHz to 30MHz range and precisely-tuned bandpass filters with low noise GaAsFETs in VHF and upper frequency bands. Exceptionally high sensitivity, intermod immunity and frequency stability in all ranges.

Multi-Function Five Inch CRT. Displays frequencies, modes, memory contents,

operator-entered notes and function menus. Features a subdisplay area for printed modes such as RTTY, SITOR and PACKET (external T.U. required).

Spectrum Scope. Indicates all signal activities within a +/-25, 50 or 100KHz range of your tuned frequency. It's ideal for spotting random signals that pass unnoticed with ordinary monitoring receivers.

1000 Multi-Function Memories. Store frequencies, modes, and tuning steps. Includes an editor for moving contents between memories, plus an on-screen notepad for all memory locations.

Eight Scanning Modes. Includes programmable limits, automatic frequency and time-mark storage of scanned signals, full, restricted or mode-selected memory scanning, priority channel watch, voice-sense scanning and scanning a selectable width around your tuned frequency. Absolutely the last word in full spectrum monitoring.

Professional Quality Throughout. The revolutionary IC-R9000 features IF Shift, IF Notch, a fully adjustable noise blanker, and more. The Direct Digital Synthesizer assures the widest dynamic range, lowest noise and rapid scanning. Designed for dependable long-term performance. Backed by a full one-year warranty at any one of ICOM's four North American Service Centers!

ICOM

CORPORATE HEADQUARTERS
 ICOM America, Inc., 2380-116th Ave. N.E., Bellevue, WA 98004
 Customer Service Hotline (206) 454-7619
 CUSTOMER SERVICE CENTERS
 18102 Sky Park South, Ste. 52-B, Irvine, CA 92714 /
 1777 Phoenix Parkway, Suite 201, Atlanta, GA 30349
 ICOM CANADA, A Division of ICOM America, Inc.,
 3071 - #5 Road, Unit 9, Richmond, B.C. V6X 2T4 Canada
 All stated specifications are subject to change without notice or obligation.
 All ICOM radios significantly exceed FCC regulations limiting spurious emissions. R9000791

STAFF

PUBLISHER, EDITOR

Henry Ruh KB9FO

CO-PUBLISHER

Bill Brown WB8ELK

PHOTO EDITOR

Dave Williams WB0ZJP

TEXT ENTRY

Debra Gillespie

Henry Ruh KB9FO

Bill Brown WB8ELK

MAILING

Jan Robinson

ADVERTISING

Walt Garrett N0MAL

Amateur Television Quarterly

(ATVQ) is published four times per year. Subscriptions are \$18 year US, \$22 Canada and \$35 DX. All mail should be sent to: Amateur Television Quarterly Magazine, 1545 Lee St., Suite 73, Des Plaines, IL 60018. Post Master NOTE: Change of address should be sent to Amateur Television Quarterly Magazine, 1545 Lee St., Suite 73, Des Plaines, IL 60018. Phone 708 298 2269.

For subscription and other inquiries reach us at VOICE MAIL 708 298 2269. FAX 708 803 8994. Leave your zip code when making inquiry about subscriptions. ATVQ is available in most Ham Radio stores.

Amateur Television Quarterly is Copyright 1992. All rights reserved. No portion may be reproduced without written permission. Non-US publications may reproduce portions provided credit is given in the title page of any item used. Ham clubs may obtain blanket permission by sending a copy of the club newsletter and a request for reprint authority.

Amateur Television Quarterly is mailed as Second Class Printed Matter, USPO permit # 003-353. Principle office of entry, Des Plaines, IL 60018. Additional mailings are made by First class Mail, Third Class single copy and bulk mail permit # 110, Des Plaines, IL and additional Post offices.

BACK ISSUES

ATVQ has sold out of every issue published. We have no back issues available. Back issues may be available at some retail ham stores.

REPRINTS

Reprints of ATVQ issues and articles

ESF COPY SERVICE,
4011 Clearview Dr.
Cedar Falls, IA 50613.
319 266 7040

INDEX OF ARTICLES

ARE YOU IN ORBIT? ATV NEWS

New ATV activity for educators 2

THE LIGHTER SIDE OF A BALLOON LAUNCH

A YL looks at ATV antics 9

ASK THE DOCTOR

Multitube cameras mystery solved 10

SEND US YOUR LOCAL INFO

Who's out there and where? 11

THE W6ORGy NOTES

Tom O'Hara reprises his column 12

WESTLINK REPORT LOOKS AT ATV

Bill Pasternak has his say about ATV 16

BUILD A VIDEO PROC AMP AND LOW PASS FILTER

Correct the level and eliminate the buzz 19

BUILD A 12 WATT 900/1200 FM VIDEO SYSTEM

Cheap and easy SHF ATV project 23

BUILD A SIMPLE 24 CM FM ATV TRANSMITTER

Another FM video project for SHF ATV! 28

BUILD CHEAP AND SIMPLE MICRO LOOKIE-TALKIE

All ATV projects should be this quick 31

440 QRM NOTCH FILTER

Useful for transmit and receive 32

BROADBAND YOUR TUBE AMPLIFIER

Eimac cavity design to flatten your signal 34

USING THE KENWOOD RZ-1 FOR ATV

Kansas City says thumbs down 40

GLADESVILLE ATV ON SATELLITE

ATV down under gets on top of things 41

FRANKLIN HS LAUNCHES AGAIN

Boys and girls, can you say high voltage? 43

TMARC BAND PLANS

How the middle Atlantic organizes 46

COMMENTS TO FCC ON 97.113

Speaking of public service... 51

BUILD A 2304 MHZ. POWER AMP

Great links to get above the crowd. 54

ADVERTISING INDEX

AEA	BC
AGAF	50
All Communications	IBC
AMSAT	4
ATV Electronics	33
B & B Techno GmbH	27
Comet Antennas	21
Discount Video Tape	21
Down East Microwave	48
Elktronics	8
Hi-Spec	45
ICOM America	IFC
ICM	18

Lindsay Antennas	39
Micro Computer Concepts	45
Micro Video Products	48
N A R A	22
Olde Antenna Lab	48
Pauldon Associates	26
P C Electronics	14, 15
Rutland Arrays	48
Science Workshop	49
Spectrum International	10, 42
Video Control Inc.	4
Wyman Research	7
Subscription and Book forms	29, 30

TAMPA BAY - FLORIDA WEST COAST ATV ACTIVITY IS FINALLY IN HIGH GEAR!

Lloyd N4UYO

There are 20 to 30 semi-active ATVers in the Tampa Bay area (including Tampa, St. Petersburg, Clearwater and Sarasota).

However, because of the moderately great distances between cities due to the large bay in the middle of everything, and the uncoordinated use of five separate frequencies, there have been disappointingly few successful ATV contacts until recently.

All this is changing now that several area ATVers have gotten together and received coordination from the Florida Repeater Council and built an ATV repeater system with 421.25 output, 434.00 input and an auxiliary in/out on 1253.25 (call N4UYO/R).

The system is located on a broadcast tower on the west side of Tampa.

When not being used as a repeater, we hope to add Touch-Tone selected video sources:

- . Live surveillance camera watching the long traffic bridges across Tampa Bay
- . Live weather radar
- . Nasa select video
- . Weather satellite

John Sims, Florida Repeater Coordinator, reports that Miami, Ft. Meyers, Melbourne, Daytona Beach, Jacksonville, Tallahassee and finally Tampa have all been coordinated on 434.00 in, 421.25 out.

With a couple of hundred miles between each of these cities, this band plan should work out quite well.

Additionally, this should make for some interesting state wide round-tables during the seasonal "Tropo Ducting" band openings.

SAVANNAH HAMFEST

The Savannah ATV Society televised the Statesboro, Georgia Hamfest, the home town of Larry E. Price W4RA, President of the American Radio Relay League. Eye QSO cards and QSL cards were given to all who stopped by to see and learn about ATV.

#1 ATVer in Savannah, Georgia, W4LHS, J. C. Lewies, runs 500.000 watts and 1500 foot antenna on 518 MHz. channel 22. Stop by to help the Savannah ATV Society at the Statesboro, Georgia Hamfest.



TV PRODUCTION EQUIPMENT AT CES

For those of you who couldn't make it to the winter CES show in Chicago, here are photos of some of the video goodies you should look for in your video store. The know twisters of the world should rejoice at some of these goodies which include video switchers with built in digital special effects, built in frame synchronizers, so you can use any source at hand without need of genlock, and complete computer production facilities to use

with your Mac, IBM or Commodore computers. Micro camcorders were also plentiful. I purchased a pair of Sony CCDV5000 hi-8 special effects CCD cameras and Panasonic MX10 digital video mixer/effects switcher and a JVC TBC/frame synchronizer and Sony EVO9700 dual deck HI-8 editor. These can really put out some good video programs! I have a few on hand if you send a VHS tape.

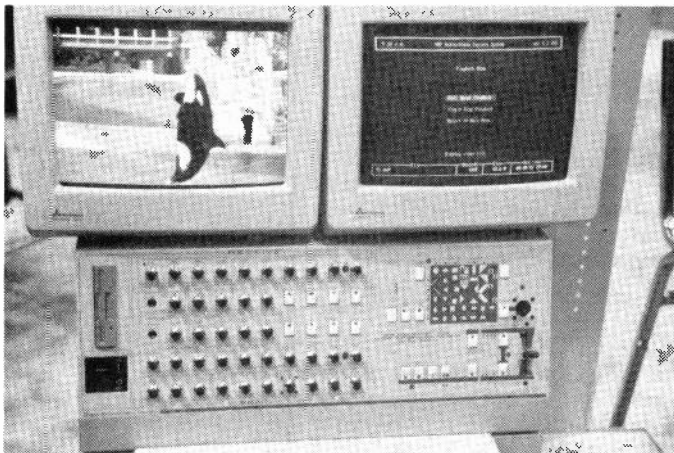
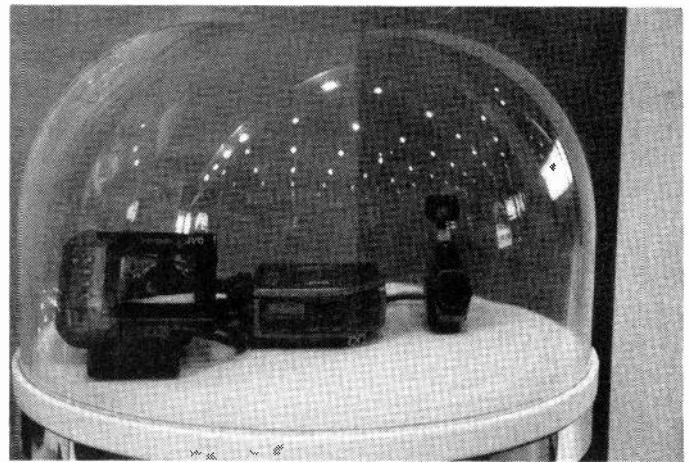
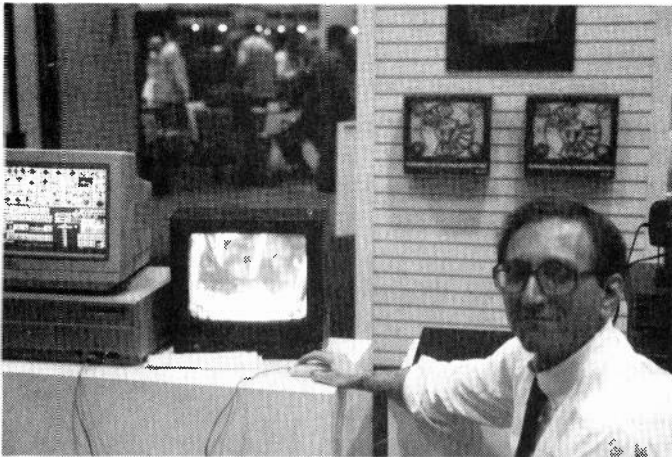



PC-TV T.M.

VGA TO NTSC CONVERTER



Create your own video I.D.s and animated CQ calls on a **VGA** AT-compatible computer and with the PC-TV, model 28, convert them to Broadcast quality NTSC for transmission over **ATV**. The PC-TV converter board mounts in the computer and is connected in line with the VGA monitor cable. A memory-resident software program monitors the VGA board, and with a key stroke, can be turned on or off. Conversion is in Real Time and can display full - action animation.

PC-TV Model 28 assembled and tested \$264.00 us
 PC-TV Model 28 as you build kit \$164.00 us
 Please add \$5.50 shipping and handling. Bank cards accepted.

VIDEO CONTROL INC. 15512 N.E. 28th AVE.
 VANCOUVER, WA 98686

CALL US TODAY 206-693-3834

Put **VGA** graphics power in your **ATV** transmissions with this **VGA-to-NTSC** converter

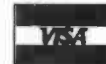

SATELLITE TRACKING MADE EASY

WITH SOFTWARE FROM
 **AMSAT**

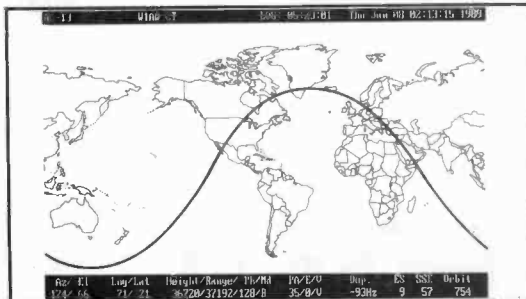

Line representation of QuikTrak 4.0 World Map

QuikTrak 4.0

Whether you want to identify the next time Oscar 13 will provide communications between two cities or if you just want to know the next time you can visually sight the Soviet space station MIR, QuikTrak will let you plug in the latest Keplerian elements for up to 100 satellites using a new full screen editor. QuikTrak also supports autotracking. *Hardware requirements*, IBM PC, AT, PS/2, or clone with a minimum 512K memory. CGA or EGA graphics required. Numeric coprocessor not required but recommended.

InstantTrack 1.0

For those concerned with greater speed and capability, InstantTrack offers all of QuikTrak's features plus instant visibility for your "favorite" satellites before you issue the first keystroke. More than 200 satellites and 1754 cities are on the menu and will be in full-color high-resolution EGA or VGA modes. *Hardware requirements*: IBM PC, AT, PS2 or clone with at least 512K memory. EGA or VGA graphics required. Numeric coprocessor not required but recommended. Mouse not required but can be used on the map screens.

These are only a few of the features of QuikTrak and InstantTrack. The figures below reflect suggested donations to defray production expenses and benefit AMSAT's non-profit, educational activities.

	Recommended Donations:	Member	Non-Member
QuikTrak 4.0	5 - 1/4"	\$55	\$75
InstantTrack 1.0	5 - 1/4"	\$50	\$70
AMSAT membership \$30/yr U.S.; \$36/yr Canada & Mexico; \$45/yr Foreign			

AMSAT PO Box 27 Washington, DC 20044
 301-589-6062 Voice, 301-608-3410 Fax

ATV NEWS

ARE YOU IN ORBIT?

We have had reports from several areas of hams in orbit!

Many schools and hams have gotten together to put together an educational experience for students simulating in part the experiences of being in orbit. The system works like this. A school bus is converted to a mobile lab, equipped with ham TV, ham radio, various science experiments and students. A ham and a teacher ride with the students in the bus which is driven around the area, "in orbit" while students and teachers back in the school conduct class. The orbiting students report back via ham radio/ham TV on their various experiments and experiences. Meanwhile the students and teachers in the school relay information and communicate with the orbiting students. Its a low cost alternative to space camp to be sure! Blocking out the windows with black drapes adds an effect of being in space, as does adding a video camera to look "outside". The use of radios and ham TV allow two way communications simulating that of the real space shuttle missions. So far we have only had phone reports of the success of these efforts. We would welcome pictures and first hand accounts of efforts along these lines. This could certainly be an individual or club ham effort!

FCC PROPOSES RULE CHANGES

There has been a lot of hot comments in the ham press about 97.113, prohibited transmissions and various accounts of comments to allow "business" communications on ham radio. But "Business" communications are not the only prohibited communications which are violated daily by hams. ATVQ has received many inquiries about the legality of transmitting NASA Select programs (non space shuttle mission flight material) as well as questions about public service and even weather radar. Needless to say the advice we provide is directly from John Johnston of the FCC's PRB in Washington.

There are many circumstance specific cases where the ham bar stool lawyers get their jollies by interpreting the rules as narrowly or as widely as their personality and ego's permit. Hams trying to provide valued public safety communications services be it for the Red Cross, local EC's, or public agencies, even public events as parades, sports events, and severe weather related communications have often come under fire from the "legal experts" who question our right to provide these communications services. Seems every area has at least one ham who insists on being the local interpreter of the rules, a job best left to the FCC and common sense.

The FCC is now considering changes to the rules to allow in specific or general language, these types of communications in (hopefully) clear and easily understood rules. Well, there are always nit pickers. In harmony with the various inquiries and requests from ATV operators, clubs and repeater owners ATVQ has sent a letter of comment to the FCC concerning these matters.

In short, it requests that any rules changes clearly permit the continuation of these public safety communications as we now provide. The circumstances would be limited to not-for-hire operations to support public safety in connection with any public event, NOAA, NWS, NASA or any other function sponsored by WINTER 1992 VOL. 5 #1

any non-profit club, organization or corporation. In addition, the communications should not be limited to any mode in use today or to be developed. Also, the material available from non copyright sources such as NASA Select non mission material, FCC library films, or station generated material including the "retransmission" of weather or other safety information, regardless of source (NWS teletype, weather radar, NOAA weather radio etc) should be permitted in any mode at any time. Likewise, the inclusion of incidental or background sound which may include music be permitted. The example cited is if you are giving aid to an injured person and someone is playing a radio in the area, the rules now absurdly require that you not transmit since you would be "broadcasting" music! The full text of the letter of comment is printed in this issue. Agree or disagree, but let your comments be known.

While ordering Pizza may be a bit too business, certainly no communication provided for the express purpose of providing important public safety communications, information of a scientific and educational nature from a public or ham source transmitted to another ham should not be limited to CompuServe, Ma Bell and the US Post Office services. "Sorry OM, I have the tornado location here in my computer but I can't send the video of it to you because its a retransmission of information gathered by another radio signal 6 computers away." (OK, the rules say in an emergency you can do just about anything, but how do you practice for the real thing?) 73 Henry KB9FO

FLORIDA

The LISATS group (Cocoa Beach) ATV repeater is going great guns and recently added new equipment including a Tektronics 527 scope and a Mirage preamp. The input is 434.0 and output at 421.25. Local contact via 144.34 or 446.25 simplex. The system now has 8 modes of video operation. Operators are cautioned to used only the power necessary as high power could also key up the Daytona ATV repeater just north. Net is tuesdays at 1930E.

KANSAS CITY

The KCATVG now have their BBS on line, brainchild of Gary N0OXV. BBS input is 144.990. The local ATV net is sunday nights. The repeater just moved the receiver to a new location 150 feet higher at a different tower site. New to ATV in KC? Contact via PO Box 28741, KC, MO 64118 ATV'ers meet locally on 145.430 simplex.

EVANSVILLE, IN

A new ATV repeater is reported in Evansville operating as WB9PLR/ATV-R. 439.25 in, 427.25 out, 18 watts with vertical polarization.

DAYTON HAMFEST

The ATVQ friday night ATV gathering same place as last year, Holiday Inn North, 7:30-? As always FREE admission, snacks and lots of great speakers, & surprises. Don't forget your HOMEBREW entries for the \$100 CASH prize! Also booth 339!

ATV NEWS

NEW AT Q

1991 has been a good year here. Besides a better job, ATVQ continues to grow and the ham shack continued to sprout new growth. Need a computer? We just retired the Tandy 1000TX with 20 meg HD, 768K, 80286/80287, dual drives (3.5, 5.25) VGA, modem, etc. This has been a good computer but times change. With a huge box of programs to run the 20 meg drive just got to be to full of ATVQ text files. We'll sell it at a reasonable price, if interested drop a line or call.

The new computer is a 486-33 with 1.2 Gigabyte SCSI HD, two floppy drives, 64 meg on board, tape backup, hi-res VGA, Windows and a bunch more. What a barn burner! With QEMM stacking memory I think we can fit at least 10 more years of ATVQ files easily in the 2.4 Gbyte space! And FAST! Phew, the boot up and sort functions are hours faster. A sort of the subscription file took hours now it takes minutes. Partly a problem of the program, but the 486-33 is amazingly faster than the 286/287-10.

NEW RF PLANT

We took down the old DX king array and tower. Its available cheap! 40 feet of Rohn HDBX tower, 4, 88 element J-Beams for 450 with RG214 harness, power divider, stacking frame etc. Also 2 Cush Craft 4218XL 2 meter "boomers" with RG214 harness, power divider, stacking frame, and 1, 6 element Cush Craft 6 meter beam ("Boomer") tuned to 50.1. All available, on ground, cheap. Some wind damage but easily corrected. Keen readers will note the Henry 2004 was sold, its 800 watt output was just too little.

The new array consists of a new Rohn 45G FOK, 4, M2 long boom 2 meter yagis, 8, M2 long boom 432 yagis, my old 900 and 1200 quad loop yagi arrays and 1 5/8" heliax. With the new amp, when done should be about 800,000 watts ERP on ATV and 400,000 watts ERP on 2 meters. Oh yeah, the entire array is AZ/EL mounted for satellite, moonbounce and tropo injection! The minus 10 degree F temps have slowed construction but by spring look for a big signal from ATV HQ! I'm using 1/2" Heliac for harness cables too. The usual low gain verticals will go back up for local contacts, along with the KLM 18CY 450 mobile ATV yagi and mobile KLM 1200 yagi for vertical contacts. The array is otherwise all horizontal polarization. I will have bigger mobile antennas this summer to replace the pint sized beams! The new array should also be fun to fiddle with the R7000 Icom receiver Santa delivered.

KENWOOD SERVICE

Last August I dropped \$1100 for a Kenwood 941 three band (144, 450, 1200) mobile unit. The radio has great specs and operations. The power level drives my Mirage amps to maximum output. It has a nifty design which allows for remote mounting of the radio, with only a small control head, mic and speaker to be mounted in the open drivers area of a vehicle. In September some low life dropped a spark plug out their pocket as the removed my mobile phone head, and control head of the TM941.

I called Kenwood service but they did not have a complete control panel in stock (this is a very new unit) but wanted to sell
PAGE 6

me the individual parts! I sent a letter and fax to Wayne Yoshida, national sales manager for amateur products at Kenwood. His staff were helpful in securing a replacement control head ahead of regular stock from Japan. Kenwood plans to make the control head available as a separate item soon. This also allows you to have several control heads, so you can move the "radio" portion from car to truck top plane or boat, savings a lot of \$\$ as you don't need to purchase complete radios for each. The mic and speaker plug in so you can take those with you as well, or with two thumb screws, remove the control panel and leave only wires behind and take the whole radio.

ORDER OF THE IRON TEST PATTERN

ATVQ has been able to obtain a limited supply of limited edition 12 oz. coffee mugs with an original Indian Head test pattern. This is the real McCoy! See picture below! Anyone who wants a copy of the original test pattern and have a nice drinking mug need never be without again. The test pattern can be seen on the Allen Havey comedy show on satellite "Comedy Channel." A true collector item. ATVQ purchased the entire lot so none are available anywhere else. We have a few hundred on hand for only \$9.95 plus \$2.50 UPS. The mug is an antique off white and the test pattern is in a dark "chocolate" brown which shows black on TV! The mug is high quality and oversize as most coffee cups are 9 or 10 oz. Be proud of your video and join the ranks of the members of the Iron Test Pattern with your own IHTP. ATVQ will be giving one of these treasures to anyone who sends in an article published in the April or July issues (1992)! How's that for incentive!! Send your orders or articles to ATVQ, 1545 Lee. Des Plaines, IL 60018. FAX 708 803 8994. TAD 708 298 2269.

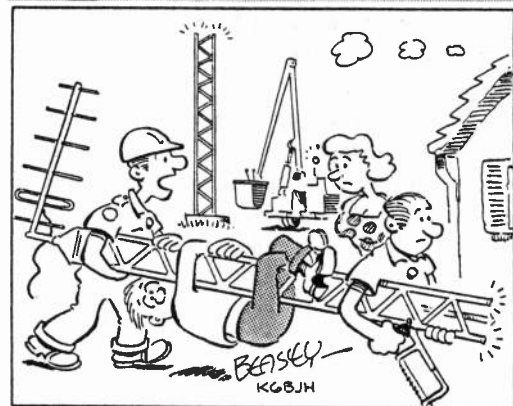
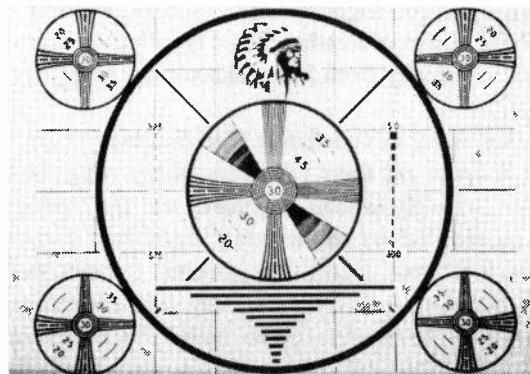

SORRY ABOUT THE TOWER, MA'AM---WE COULDN'T PRY
YOUR HUSBAND LOOSE

ATVQ DEVOTED ENTIRELY TO HAM TV

WYMAN RESEARCH INTRODUCES NEW TRIDON LINE

ONLY
\$249.95

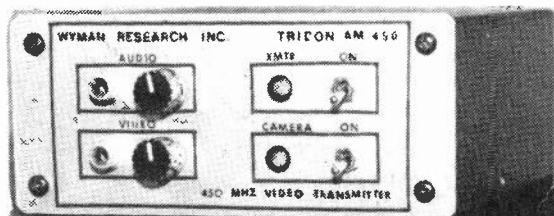

TRIDON AM 450 MHZ
TRANSMITTER

\$324.95



TRIDON 2000 AM
450 MHZ TRANSCIEVER

\$359.95

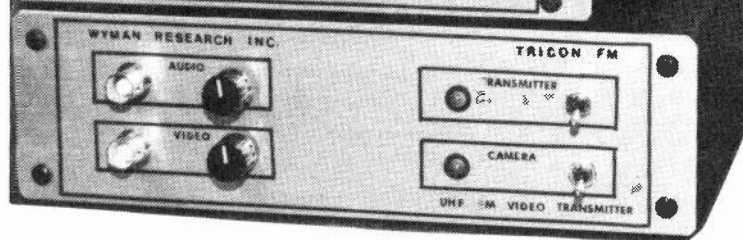

TRIDON FM
TRANSMITTERS
915 MHZ
1255/1280 MHZ
ALSO 430 MHZ

450 TRANSMITTER

- POWER OUTPUT IS 3 W PEAK
- TWO INDEPENDENT AUDIO SYSTEMS (Sub-carrier and On-carrier)
- 10 PIN CAMERA CONNECTOR ON BACK-BNC OR RCA CONNECTORS ON FRONT
- SYNC STRETCHER FOR OPTIMUM COMPOSITE VIDEO
- STANDARD CRYSTAL FREQUENCY: 439.25 MHZ or 434.00 MHZ
- POWERS VIDEO CAMERA (10 Pin Connector)
- REQUIRES 13.8V DC AT 600 MA PLUS CAMERA POWER (1 amp)
- RF TIGHT ALUMINUM CABINET WITH BRUSHED ALUMINUM PANEL CUSTOMED DESIGN-ED BY W9YL
- CABINET SIZE: 2.2"x5.25"x5.5"
- INCLUDES SEND-RECEIVE RELAY

FACTS 450 TRANSCIEVER

- POWER OUTPUT - 3 W PEAK
- 10 PIN CAMERA CONNECTOR ON BACK PANEL, BNC OR RCA CONNECTOR ON FRONT PANEL
- MONITOR VIDEO FROM CAMERA OR DETECTED VIDEO OUTPUT
- ALL NEW VIDEO AND AUDIO CIRCUITRY WITH SYNC STRETCHER
- NEW TWO CHANNEL AUDIO SYSTEM ON TRANSMIT (SEE OPTIONAL RECEIVER BELOW)
- NEW MORE POWERFUL VIDEO TRANSMITTER
- STANDARD CRYSTAL FREQUENCY: 439.25 MHZ or 434.00 MHZ
- .8 DB NF GaAsFET PRE-AMPLIFIER
- RF TIGHT ALUMINUM CABINET WITH BRUSHED ALUMINUM PANEL CUSTOMED DESIGN-ED BY W9YL
- SIZE: 2.2"x7"x5.75"
- RELAY SWITCHED ANTENNA

FM TRIDONS

BOTH HAVE —

- PRE-EMPHASIS CIRCUITRY
- "N" CONNECTOR
- RF TIGHT ALUMMINUM CABINET WITH BRUSHED ALUMINUM PANEL CUSTOM-ED DESIGNED BY W9YL
- CABINET SIZE: 2.2"x8.2"x5.5"
- REQUIRES 13.8 V DC AT 2 AMPS
- LARGE HEAT SINK
- 900 MHZ OR 430 MHZ
- 915 OR 430 MHZ FM-ATV TRANSMITTER
- POWER OUTPUT IS 8 WATTS
- 4.5 MHZ AUDIO SUB-CARRIER
- USES NEW PHASE LOCK LOOP CRYSTAL CONTROLLED EXCITER
- 1200 MHZ
- 1255 MHZ FM-ATV TRANSMIT-TER (Any optional freq.)
- POWER OUTPUT IS 4-5 WATTS
- 6 MHZ AUDIO SUB-CARRIER (Requires 1 V PP Audio)

WYMAN RESEARCH, INC.

R.R. #1 BOX 95
WALDRON, INDIANA 46182
(317) 525-6452

INDIANA RESIDENTS 5% SALES TAX

Don & Sue Miller
W9NTP
W9YL

SHIPPING \$4.50



ELKTRONICS

12536 T.R. 77
Findlay, OH 45840
(419) 422-8206

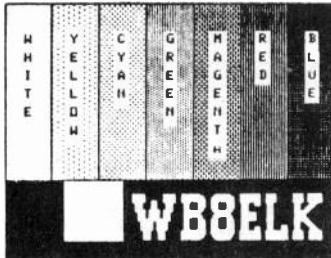

INTRODUCING THE

VDG-1

VIDEO I.O.



KA0JAW

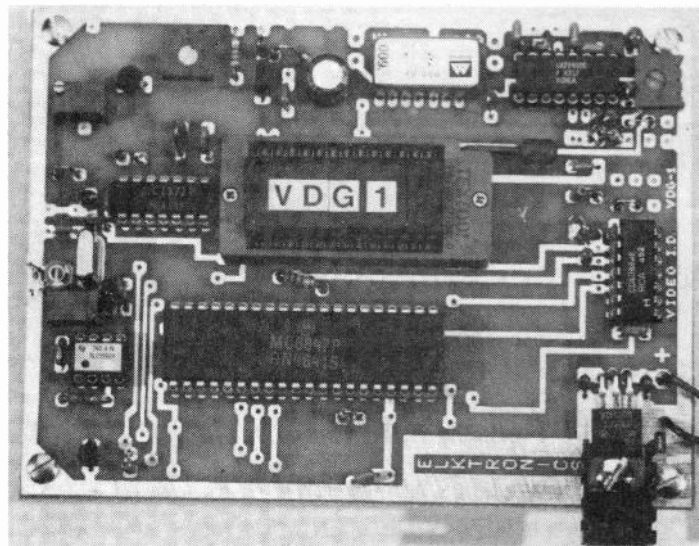
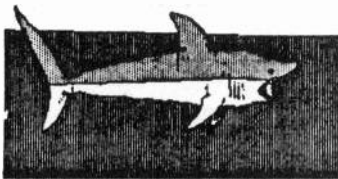

KA8EE

Jim
Marion Ohio

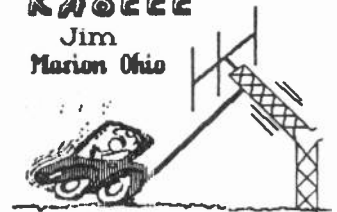

N2CAI / F



KA8ZNY

GROVEPORT



- Instant Video Source
- 4 Graphics Screens
(2 Hi-RES / 2 Colorbar)
- 12 V D.C. Operation
- Video Relay for switching in live camera video
- Built-in Sequencer/Timer
(Steps through all 4 screens)

VDG-1 with Pre-Programmed Custom Callsign Logo

- \$99 ppd.

(Quick-release socket option)

- \$10



KA8LWR



IN BUCYRUS, OHIO

**Call or Write for CATALOG
of available Graphics**

Additional Programmed EPROMS

- \$19

Now available as a Kit

- \$89 ppd. Blank PCB - \$19

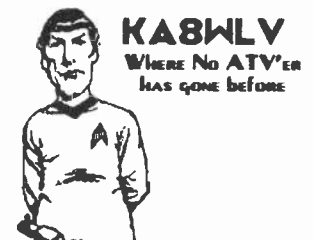

The Lighter Side of a Balloon Launch

by Barb Crist KB9BSV (XYL of balloon launcher Chuck WB9IHS)

I don't think most hams have any idea how much work and preparation goes into a balloon launch. They probably don't have any idea how much money goes into it either. Maybe I can shed some light on this subject.

First, there's the balloon. Where to get it, what size to get, how much helium to put into it to make it go the distance you want it to go. Of course, there is also the helium. It has to be paid for and picked up. Phone calls are necessary. You want to get the most for your money and not have to travel a lot of miles or have to wait a month to get the balloon in the mail. If you don't know what size to get, you must make a lot of phone calls to other hams to find the answer to that question.

Then we have the parachute. Should we buy it or make it? If we buy it, where do we go for that? More phone calls and then an obvious wait for mail to arrive. If we make it, what do we make it out of, and how do we cut it. And how do we make it visible to airplanes?

We will also need a launch site. Sometimes this can be a mystery. You need lots of open space. This could take some time and consideration and, of course, more phone calls.

The next thing to consider is a reflector so that airplanes can see it and the air traffic control center can detect it. The FAA must be informed of this balloon launch. Who is going to do that? And when? More phone calls.

Now, should we have a camera on the package? If so, should it be color or black and white and where are we going to get it? Can we have it donated? (More phone calls). Or, do we have to buy it. Maybe one of our ham buddies has something we can use. (More phone calls). Well, then, maybe we should have TWO cameras. More phone calls. More work.

We need to figure out what frequencies we are going to use. What kind of range, how much power. Will it be CW, FM or what? And, who are we going to try to reach. More decisions, more thinking, and more phone calls.

So; now we are going to think about the package or packages that go up with this balloon. First of all, what are we going to use for a package? It must be lightweight material. This could take some traveling and more phone calls. The big problem I see is what goes into the package and making sure everything works the way we want it to. Many hours of work and thinking goes into this problem. Many hours of testing. Maybe a test balloon flight, if necessary. Now, what to put on the outside of the package so the farmer doesn't shoot it when it lands in his field. We must also line-up the foxhunt team for the launch. We want to make sure we get our package back. We sure don't want to have to put another one together!

If we want a plane to spot our balloon, this must also be set up before hand. Lots of planning, building, thinking and organization. And many, many phone calls as well as checking and rechecking of equipment.

OK; so now how do we notify everyone of the launch? The ATV net, packet bulletins, newsletters and, of course, more phone calls. Who is going to do what job at the launchsite? Who is available on that day? Who is capable? Who has the equipment you need, and what do you do if the launch date is changed? These are just a few of the concerns of the balloon launcher.

Well - the big day is finally here - it RAINS - I guess someone should have called the Weatherman!
Lots of Work - but - Can be lots of FUN.

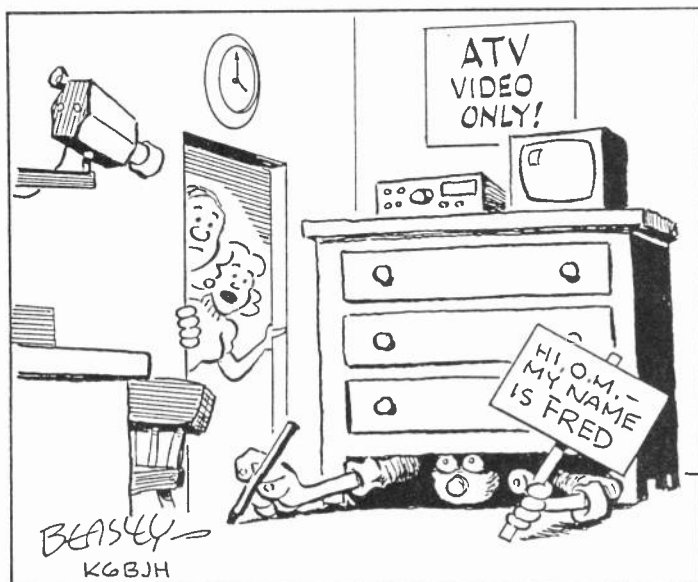

YES, REALLY, FRED IS IN HIS SHACK-- I BELIEVE HE'S A LITTLE CAMERA SHY, AND SUFFERS FROM MIKE FRIGHT !

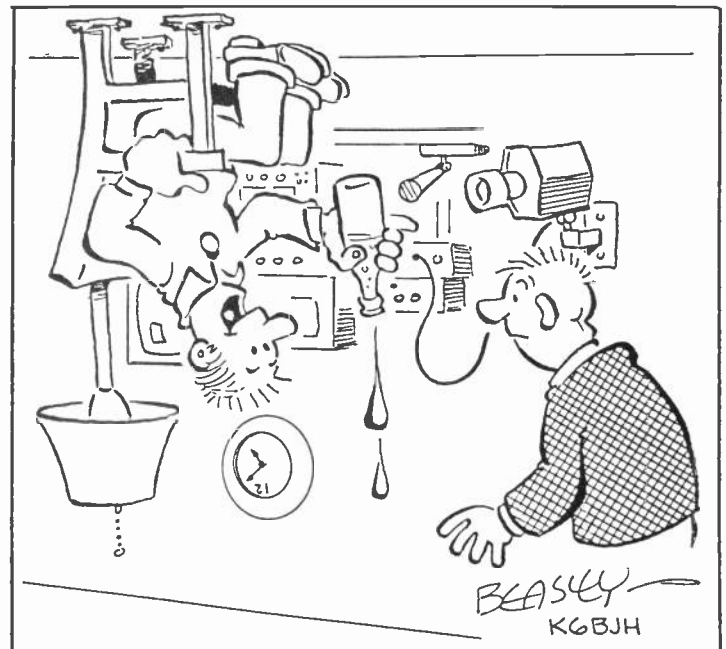

I LOVE TO GO ON CAMERA THIS WAY-- REALLY BLOWS THEIR MINDS!

1691 MHz Weather Satellite System

Spectrum International, Inc.
is pleased to announce
their appointment as
North American and International
distributor of
**Time-Step Electronic's Weather
Satellite Receiving System.**

This high quality, low cost
system consists of:

1691 MHz GaAs FET Pre-ampl. model TS-1691-P.Amp	\$175
1691 HGz Receiver model TS-1691-Recvr	\$450
Decoder Board & Software model TS-VGA-SAT3	\$300
Decoder Board & Software model TS VGA-SAT 4	\$399

Also available to complete
the system are:

Low Loss (microwave) Coaxial Cable (65 ft) with connectors. model 1691-coax ass'y	\$ 55
1691 MHz Loop-Yagi Antenna model 1691-LY(N)	\$ 97
1691 MHz Loop-Yagi Extension model 1691-LY-XTN	\$ 80
Demonstration Disc (IBM-PC VGA compatible) of signals recorded from WX-SAT system.	\$ 5

Shipping: FOB Concord, Mass.
Prices subject to change without notice.



SPECTRUM INTERNATIONAL, INC.
Post Office Box 1084 Dept. T
Concord, Mass. 01742, U.S.A.
Phone: (508) 263-2145
FAX: 508-263-7008

Ask the Doctor!

Q. I've got a 3 tube Hitachi FP-1020. What would cause the red to be out of register? Red appears larger than green or blue horizontally but OK vertically, any suggestions?

Reply: One of the reasons tube cameras have fallen to giveaway prices has been the shift away from cameras which require registration. Solid state (CCD) cameras don't have these problems. The FP1020 is a good camera for ham use but requires some attention on a regular basis. Most multi-tube cameras have controls for controlling the horizontal and vertical size plus distortion controls called SAW and parabola. These are used with linearity and centering controls to make the images from all three tubes coincide. It sounds like the red horizontal size control is defective or misadjusted.

Normal alignment procedure for geometry would be, first set up on a ball chart. If the camera has a -G (green invert) switch, turn this on. Using green as reference, adjust the green size, linearity, saw, parabola and centering controls to get a correct image. Next select red with -G on and overlay red. The screen should look mostly as canceled images. As the images come into register they overlap and since green is inverted, they cancel. If you have a scope you can see this. It is easier to see the spikes from the chart lines cancel on the scope. Follow the order of center, size, linearity, saw, parabola to get the best registration possible. After red, turn red off and overlay blue on -Green. When all three have been done, turn red back on and make any final touch-ups. You would perform beam focus before any of these adjustments since this rotates the image. Follow geometry with video gain, linearity adjustments using a grey scale chart. Finally, colorimetry (black balance and white balance) to finish off. Make the positions of the controls for later reference should you need to adjust later. Also note any controls which are at end of range. An end of range condition often means there is a circuit defect.

If normal alignment does not solve the problem you may have a circuit defect in horizontal deflection possible a yoke, since all three tube coils are normally driven in parallel in simpler cameras. One "far out" problem might be position of the tube in the deflection coil. This is best checked with the back focus adjustment. Zoom in on a distant object and focus the lens, now zoom out and check the red, green and blue signals to see if the focus is optically correct on each. If one tube is not at the same position relative to its deflection coils as the others, it will distort the image. This may have been corrected vertically with the size controls but be out of range on the horizontal size control.

If all else fails, there are good solid state cameras on the market for as little as \$300 that make good color pictures, including some seasonal sales on camcorders as stores dump old stock.

EARTHWINDS

The Earthwinds flight as we were going to press had a scheduled lift off of Feb. 1. The Round The World Balloon flight will be carrying only a 10 meter Ham Radio and no Ham TV equipment.

LOCAL ATV INFORMATION

Several groups sent in a filled out page of local information from the 8 page pullout section last issue. The pullout section was to provide readers with a handout to attract other/new ATV'ers. Bulk quantities of the handout are available from ATVQ at minimal cost. But the idea of sending in your local information using this form was a good one! Rather than having to read through all the back issues to gather information about local clubs, repeaters, hamfests etc, we would like to put together a booklet which contains a compiled accurate up to date listing of all repeaters, local ATV clubs, local nets etc. Everyone who sends in an information sheet filled in with local info will get a complete set sent back. This is a handy way to promote mobile/portable operation and help those who travel, find ATV activity. Kindly fill in the blanks below and return to ATVQ as soon as possible. Also indicate if your repeater is operating, being built or planned. Please print neatly so I can read it! Thanks.

ATV VOICE COORDINATION FREQUENCY

NET TIME, FREQUENCY AND DAY

ATV REPEATER CALL _____

INPUT _____ OUTPUT _____

H/V _____ POWER (ERP) _____

CLUB CONTACT ADDRESS _____

LOCAL CLUB NAME _____

MEETS _____

AT _____

OTHER INFO: _____

REGULAR ACTIVITIES:

HAMFEST INFO:

ACTIVE STATIONS

CALL/NAME

QTH

Other information:

HELP NEEDED

Inexperienced ham just getting started in ATV purchased two Telrex 440 15 element yagis with 300 ohm driven elements at local hamfest. Model and Serial numbers not available at this time. Telrex is currently out of business and has discarded all files. Looking for anyone with previous experiences or who is currently using this antenna for suggestions, literature, and moral support. Please respond by mail to Doug Garber N9JRK, 509 North Main Street, Morton, Illinois 61550.

The w6ORGy Notes

By Tom O'Hara, W6ORG

No the regular column is not back, but after a year the ORGy note folder has filled up with some useful stuff that I thought needed to come out in Bill and Henry's rag.

434.0 or 439.25 LVSB?

This is a big decision now happening in many parts of the country. I have written on it many times in this and other magazines, and it has finally hit many areas now. I think it is due to the increase in 440-450 FM repeaters and packet links. The new Tech and loss of 2 MHz of 220 have made many more than normal look to 70 cm to put a machine on. Wind shear transmitters are coming on 449 MHz forcing FM repeaters to look lower.

Receiving 439.25 normal Upper vestigial sideband in a TV set is incompatible with FM repeaters that have an input or output below 444. And if at the same or near by hilltop, even above that frequency. The FM just cannot be rejected in the TV receiver IF filter passband, and the ATV color and sound will get into the FM receiver if it is within 200 kHz of 442.83 and 443.75.

Florida and states West of the rockies elected some time ago to go to 434.0 before packet links came on 433-435. Packet and FM links could use 438-440 instead with the exception of the 438.5 sound subcarrier frequency. No changes have to be made to the ATV equipment. While tests with weak signal stations on 432 and Satellite users above 435 showed little interference, there is occasional interference to ATV when satellite users transmit.

The Mid-America Coordination Council elected to go to 439.25 lower VSB. The two USB

subcarrier frequencies will be skipped on FM repeater assignments to avoid interference from DSB or UVSB ATV transmitters. Interference to LVSB ATV will depend on how close the FM transmitter is, relative power and how far above 441 MHz it is.

To go to lower VSB, the receive can be done with a little work to the downconverter to put the local oscillator on the high side of the input, and on the transmitter, to equalize both side-bands for compatibility to receive on either VSB.

The local oscillator trimmer caps in the TVC-2G (C4) and TC70 (C9) downconverters, can be tuned toward minimum capacity while watching for a strong 439.25 station to reappear, or sample with a pick up antenna near the oscillator and tune for 500.5 MHz instead of 378 MHz, on channel 3. You may need to add a 5 pF disc right at the Mixer GaAsfet Gate 2 to ground with short leads to keep the stripline resonance from sucking out the oscillator at the new higher frequency.

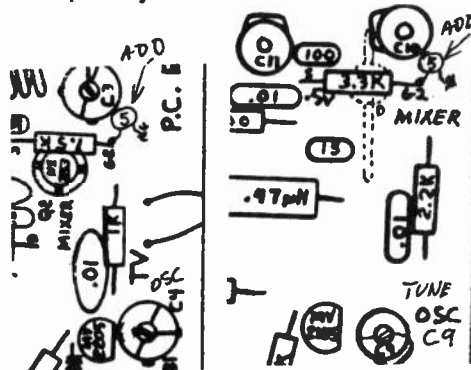

TVC-2G

TC70-1d

This mod can also be made for those that want to use the VRC-45 receiver module instead of a TV set in order to drive a monitor. The oscillator would then be slightly

moved up to 393.5 for lower VSB or farther up to 485 MHz for normal upper VSB at 45.75 MHz.

One drawback to going to high side injection is that the image is now well into the UHF TV band. You may have to try using another channel between 2 and 6 instead of 3 to avoid channel 28, 29 or 30 from taking over.

The new tuning range will only be about 10 MHz. If you want the band spread back to tune the whole band, then you can put a solder braid short 1/4" up from the cold end of the stripline oscillator inductor. Don't expect much after modifying for LVSB however when trying to tune in a UVSB repeater output on 421 or 426, or a 439 simplex station unless his transmitter has been modified for equal sidebands. A second unmodified downconverter for normal USB on frequencies below 439.25 can be used.

To equalize the sidebands on the P.C. Electronics transmitters, lift the modulator side of the 22 ohm resistor that feeds the driver collector, and connect it to the transmit + on a trace connected to the modulator collector. Check for shorts before you fire up.

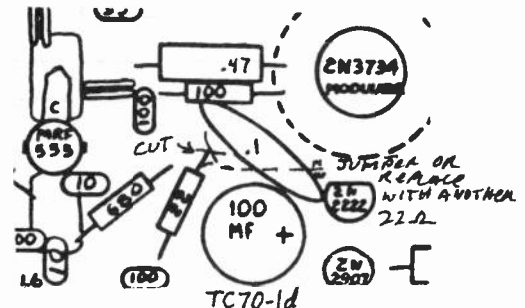

This modification will give equal sidebands instead of the normal 10 dB or more reduction of the LSB. There is a little reduction in modulation depth with this but most people turn their video gains up too far anyway.



P.C. ELECTRONICS 2522 PAXSON LANE ARCADIA CA 91007-8537 USA

TOM (W6ORG) & MARYANN (WB6YSS) O'HARA

(818)447-4565

24 hr FAX order line (818) 447-0489



**READY FOR AN ATV REPEATER OR LINK IN YOUR AREA?
WE HAVE THE MODULES AND SOURCES FOR INBAND OR CROSSBAND**

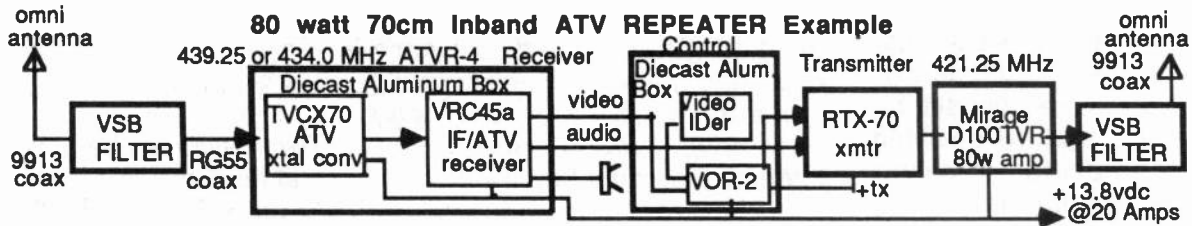

Select an ATVR Receiver and a RTX Transmitter for the bands you want, add the appropriate linear amp, VSB filters & antennas, ID & VOR-2, power supply and coax for your own repeater. We suggest low in / high out for crossband. Ask for a copy of our ATV Repeater article before you start, to do it right the first time, and also listed are recommended sources of filters, antennas, IDers, etc. Most can put together a good working ATV repeater for under \$2000.

TRANSMITTERS ready to go in a 7.3x4.7x2 die cast aluminum box for tight RF shielding. >1 Watt p.e.p. output for proper drive to companion amplifiers. Adjustable sync stretcher to enable set up of the right video to sync ratio after an amplifier is added. Independent mic and line audio inputs. Requires 13.8 Vdc at 500 ma.

RTX-70 specify repeater or link output frequency, 421.25 MHz most popular for inband output.....\$299

MIRAGE D100ATV-R 90 Watts p.e.p on ATV continuous duty 70cm repeater amp.....\$499

RTX-33 specify frequency - 923.25 MHz is the most used crossband repeater or link frequency.....\$329

RTX-23 specify frequency - 1253.25 MHz best first repeater output crossband freq., then 1277.25 MHz.....\$329

We suggest Downeast Microwave for 900 and 1200 MHz repeater amps to match our transmitters.

RECEIVERS ready to go in a 7.3x4.7x2 die cast aluminum box for tight RF shielding. Contains a TVCX crystal downconverter and VRC-45 receiver. Two composite video outputs, squelched speaker and line audio outputs. Requires 13.8 Vdc at 300 ma.

ATVR-4 specify frequency - 439.25 or 434.0 most popular for inband or crossband.....\$299

ATVR-9 specify frequency - 910.25 most popular, 923.25 also available.....\$309

ATVR-12 specify frequency - 1253.25 link, 1277.25 or 1289.25 rpt input.....\$329

VOR-2a Video Operated Relay board...\$45, keys RTX upon detection of horizontal sync plus 10 min. & end of transmission momentary relay for switching to video ID to meet FCC regs. See review in July 91 73 Magazine page 26.

LMB CAB 247 7.3x4.7x2 die cast aluminum box. Great for housing VOR-2a and video ID boards...\$20

DOWNCONVERTER DISCOUNT of 10% is available to Repeater groups and clubs if you order 5 or more per item of the downconverters below. The order must be sold and shipped to one person at one time. It helps to have some extras available for new people to try out your repeater or use at demos at other clubs and schools. All downconverters have a GaAsfet preamp and mixer for low noise and high dynamic range. Get a board if you want to package your own. You will need a shielded cabinet with knob, switch, connectors and 11 to 14 Vdc power supply. Or get one ready to go.

TVC-2G tunes 420-450 MHz down to TV ch 2, 3 or 4. Wired and tested board, put in your own cabinet..\$49

TVC-4G ready to go in a cabinet with AC to 12V wall plug supply - contains TVC-2G.....\$89

TVC-9 tunes 902-928 MHz down to TV ch 2, 3 or 4. Wired and tested board, put in your own cabinet...\$59

TVC-9G ready to go in a cabinet with AC to 12V wall plug supply - contains TVC-9.....\$99

TVC-12G tunes 1240 to 1300 MHz to TV ch 7 or 8. In cabinet with wall plug AC to 12V supply.....\$109

ANTENNAS

F718 Diamond vertical omni 9.3 dBd gain, 15 ft long. Specify 70cm video carrier frequency.....\$219

440-6X KLM 8.9 dBd gain 420-450 MHz 6 element beam. 28" boom, end mounted.....\$59

440-10X KLM 11.2 dBd gain 420-450 MHz 10 element beam 64 " boom, end mounted.....\$72

440-16X KLM 14.2 dBd gain 420-450 MHz 16 element beam 10.5 ft boom, center mounted.....\$129

3318LYARM Downeast Microwave 14.2 dBd gain 902-928 MHz beam. 6 ft boom, end mounted....\$82

F1230 Diamond vertical omni 11.3 dBd gain, 10.5 ft long\$159

2424LYRM Downeast Microwave 16.2 dBd gain 1240-1300 MHz beam. 6 ft boom, end mounted...\$82

1/92

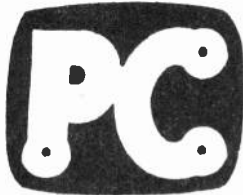

ELECTRONICS

P.C. ELECTRONICS 2522 PAXSON LANE ARCADIA CA 91007-8537 USA

TOM (W6ORG) & MARYANN (WB6YSS) O'HARA

(818) 447-4565

24 hr FAX order line (818) 447-0489



TWO NEW MODULES FROM P.C.

THE SMALL VIDEO & AUDIO HANDIE LOOKIE IS HERE

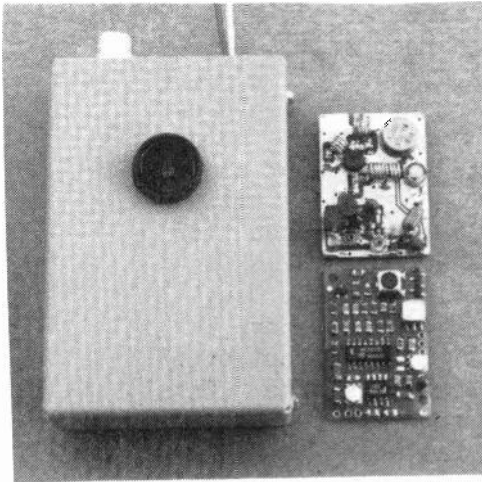

MICROTEK ATVM-70 Mini ATV Xmtr Board.....\$129

Wired and tested board is only 1.0 x 1.3 inches! See article in July 91 73 Magazine page 9. Great for building a Handie-Lookie, R/C models, robots, demos, check out downconverters or short links. Nominal output 80 mw. Capable of driving the PA5 for higher power. Blanking pedestal pot, but no sync stretching. Requires 7.0 minimum to 10.0 Vdc maximum at <100 ma (9 volt battery). Weight <1 oz. Snow free line of sight DX is 1/4 mile dipole to dipole or up to 5 miles with KLM 440-16X's at both ends. Small size is due to the use of a SAW oscillator module that eliminates multiplier stages, but makes it available only on 434.0 MHz. Check your areas frequency coordination & usage before ordering.

NEW MSC-2 companion Sound Board.....\$59

Has inputs for mic or line level audio. Same size as the mini transmitter board. Requires 7 to 10 Vdc at <20 ma.

Microvideo B & W CCD mini camera.....\$229

Just the thing to complete your Handie-Lookie. The whole thing can run off 9V batteries! Size is only 3 .125 x 2 x .875 and accepts 7 to 15 Vdc at 85 ma. 2 lux sensitivity and 240 line resolution. Standard 1 V video out through a RCA jack atop the shielded case.

YOU ASKED FOR A SUPERIMPOSED CALL IDER

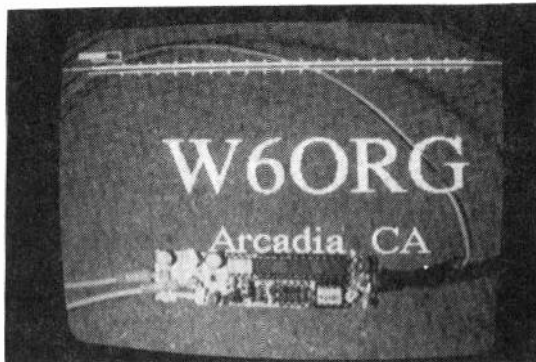

NEW HIGH TECHNOLOGY FLIGHT GVID IDer.\$175

This small .8 x 3.15" board can overlay your call, location and any other information in white letters on any clean video source such as from a camera, VCR, TVRO or weather radar. This is not for repeater video with less than P4 signals. The information is held in a PROM, so no loss when power fails. Ideal for putting in the video line from NASA Select or weather radar to meet the legal requirement and still not interrupt with a full screen video id source just when the best picture comes on. Or it can relieve you of remembering to ID at the home station or at public service events. There is an automatic 5 minute timer that turns it on for 10 seconds or run continuous. Also has one switch and one analog telemetry input. Req. 5 Vdc @ 120 ma. Small enough to be put inside most chassis and connect between video jack and transmitter board.

Hams, call or write now for our 1992 Catalog. We are your one stop for all your ATV needs for the 400, 900 and 1200 MHz amateur bands. Value plus quality from 30 years in ATV. We are always looking for and checking out new products from small manufacturers that pass our strict standards and add to our catalog like the two above.

Transmitting equipment sold only to licensed radio amateurs verified in the Callbook or send copy of new license.

1/92

NOW YOU CAN SEE THESE DEALERS FOR THE TC70-1d AND TUNEABLE DOWNCONVERTERS:

A-Tech	Bill or Tony	2210 Magnolia Blvd	Burbank	CA	91506	(818) 845-9203
Jun's	Raul	5563 Sepulveda Bl.	Culver City	CA	90230	(213) 390-8003
Henry Radio	Paul	2050 S. Bundy Dr	Los Angeles	CA	90025	(213) 820-1234
The Base Station	Art	1839 East ST.	Concord	CA	94520	(415) 685-7388
IRC	Juan	5001 NW 72nd Av	Miami	FL	33166	(305) 594-4313
Honolulu Electronics	Richard	819 Keeaumoku St	Honolulu	HI	96814	(808) 949-5564
Stewart Electronics	Dale	1411-C 1st Capital Dr.	St. Charles	MO	63303	(314) 949-8890
Oklahoma Comm Center	Glen	9500 Cedar Lake Av	Oklahoma City	OK	73114	(800) 765-4267

THE AMATEUR RADIO NEWSLINE, INC.
28197 ROBIN AVENUE
SAUGUS CA. 91350
TEL:(805) 296-7180
MCI MAIL: 324-1437
PRODIGY: SJTG53A
TELEMAIL: BPASTERNAK
GENIE: B.PASTERNAK
TELEX: 6503241437 WESTRADIO

Dec. 3, 1991

Dear Henry,

Just completed reading ATV Secrets. A very good book for the beginner, but like every other publication of its kind, it fails to really detail an essential. That is the material to be transmitted; IE: programming.

Long ago, back when I was still a "W2" I had a short lived interest in ATV. I built a station out of some old RCA land mobile gear, home-brewed a downconverter; put 46 elements on my 7 story apartment house roof and spent three glorious weeks being totally bored stiff! After seeing "Pauls dog" for the 44th time and "Mikes slides of Borneo" for the 70th time, I disconnected it all and packed it away in WA2INM's basement -- where it probably sits rusting and rotting to this day.

Even out here in "Hollyweird" its not all that different. Here we sit in the film and TV capitol of the world, and with the exception of hams covering the Rose Parade and a few yachting regalia's, the content of programming has not gotten much better than the days of "Borneo" color slides in blazing black and white. Listening to KV4FZ rant and rave on 14.313 is a lot more interesting than anything that ATV has to offer -- and I am no fan of KV4FZ!

If ATV is ever to succeed and become even 1/10th as popular as FM or SSB, then it has to offer something more than Fred and Joe, sitting in their shorts, drinking a Coors and looking at one another. With the relatively low cost of good quality home video gear and a lot of imagination, the programming content of ATV could become something that would make people want to stay in ATV -- not just past through it.

Both of us have spent our lives as professional broadcasters. We both know that there are two sides to any broadcast operation; the technical and the creative. Currently, the vast majority of ATVers are the technicrats. They are so concerned with the technical quality of their signal, that they give no thought whatever to the content of the communications that they are transmitting. It is RF purely for the sake of transmitting RF, and nothing more.

What professional broadcasting has and what ATV disparately needs is a corps of creative talent. We need hams who are willing to be writers, producers, directors and on-camera talent to go out, dream up some truly innovative programming ideas and carry these ideas to a logical conclusion!

Henry -- I have to tell you that every time I bother to tune in on local ATV and see the same "crapola" that I have seen the past 15 or 20 years, I can easily understand why ATV is a truly transient mode. Its attraction wears thin very quickly and the ham who was so gung-ho in September has gone off to Packet or back to his FM repeater by January.

So, what can be done to turn this around. I suggest that ATVQ get involved. Here are some ways:

1) Openly solicit and print articles on basic teleproduction using home video gear.

2) Solicit and print articles dealing with professional teleproduction: IE: how shows are written; how to block a show; how to edit a show; proper camera technique; how to properly shoot for news (ENG) etc. (Most video of balloon flights has been atrocious, and I would not sit through that crap!)

3) Solicit and print articles from those of us who produce and direct the ham videos.

4) When new ham radio related videos come out, review them for content and interest.

5) Solicit and print articles about broadcast and film professionals who are also ATVers!

6) Consider contracting out for writing and then publishing an ATV Show Production Guidebook.

7) Run an annual contest for the best ATV shows -- hold the ATV Emmy Awards -- tape it and bicycle the tape around to all ATV repeaters every year.

8) Form an ATVQ national ham radio news bureau; solicit tape of major ham happenings and produce a monthly 10 minute ATVQ Video News Review a la my audio Newsline. Maybe get Bass to run it up on his satellite, or block buy 15 minutes a month on W5 or wherever. You know that time can be had almost for a song! Think of showing an FCC meeting where a major rules change to the A/R service occurred; or the Rockoon launch; or kids in a school playing ATV games, etc

There are probably 10's of thousands of other -- and maybe even better ideas, but at 2 AM and sitting with this flu-bug, it is hard to think of them. I will add that I would find it hard to believe that among ATVQ's reader base there are not some professional writers, producers, directors, cameramen and actors that cannot be hit on to supply this kind of input.

Suffice to say that ATV can be made interesting to a lot more hams if it offers a bit more than Petes parakeet and Mary's sewing box. Until it does, I am afraid that I and a lot of others will watch HBO instead.

Henry, its your deal.

73

Bill Pasternak, WA6ITF

REPLY: We are printing Bill Pasternak's letter as an alternative point of view on ATV. ATVQ is always open to ideas and there are several with merit in Bill's letter. ATVQ solicits articles on all subjects of video but we, as any publication, can only print what is sent in or we write ourselves. Any successful publication is a reflection of its readers interests. To date we have received lots of letters asking for technical and news items, operational hints and topical news. The "soft" items of production we have printed bombed big time. Our usual feature of TV Fundamentals brings regular thank you mail from new ATV'ers who lack basic information about video and TV. Tom's Q&A column which ran for two years, and returns in this issue has been one of the top interests of readers.

Personally I would think readers interested in TV production should be subscribing to Video or Videographer, two fine general interest publications, but I am always willing to try new areas. Bill is correct in that a good portion of ATV is as exciting as RTTY, FM or SSB contacts...just general conversation with a view. But there are many instances of interesting video. One hinderance is criticism from some operators who don't agree that we should produce "programs".

In Chicago we have one technocrat who makes it his mission to tell everyone else what they can and can't put on his private ATV frequency. His tactic is to ridicule any attempts to provide more than talking heads, shots of the shack/QSL card, and will deliberately QRM a station using the local repeater, to use the frequency. When the local weather radar remote base operation started a few years ago, his answer was to ridicule the effort from

his "local base" weather station (in his shack) with a fan blowing a wind vane and other novelty toys while making snide comments. Entertaining? Perhaps to his ego, certainly not supportive of the serious effort to supply area hams with live NWS weather information. And don't try to operate a ATV repeater within 200 miles of his DX operation!

Its hard for other users to endure this when they just want to have fun and not get involved in local politics. This is not unique to ATV mode, witness 20 meters! How many hams want to invest thousands in ham gear and thousands more in an editing suite, multiple VCR's, editor, cameras, special effects in order to produce a "program" just to get on the air? Even with that, it takes a lot of time to make a "program." We do it for special occasions, or show the raw footage of the hamfest, field day, or other events. I don't know how many budding Steven Spielbergs are out there wanting to produce the ATV version of ET. But that doesn't mean we shouldn't. By all means employ your imagination and video skills and put together some interesting videos. The WWATS club sponsored a contest for best home video a couple of years ago and the number of entries was disappointing. The local group produced a good ATV video program and a good ham radio movie. There is no reason why others cannot do the same.

Feel free to send us or Bill any comments. We will print the interesting comments in future issues. Also feel free to comment on what we have in ATVQ. What are your favorite and least favorite articles? As I have always said, ATVQ is run by its readers. Let us know what you want and we will try to provide it. 73 Henry KB9FO

Designed specifically for amateur television in the 70cm band...

FL407 INTERDIGITAL FILTER

7-Pole Interdigital Vestigial Sideband Filter for Frequency Ranges of 420 MHz to 440 MHz

The 6 MHz nominal bandwidth and low loss design are perfect for transmitter or receiver use. Two filters can be used for repeater applications.

Heavy duty construction insures stable operation and long life.

Ordering Information: The FL407 may be ordered on any frequency between 420 and 440 MHz. Please specify video carrier frequency when ordering.

Dimensions HWD:
2 1/8" x 8 13/16" x 20 5/8"

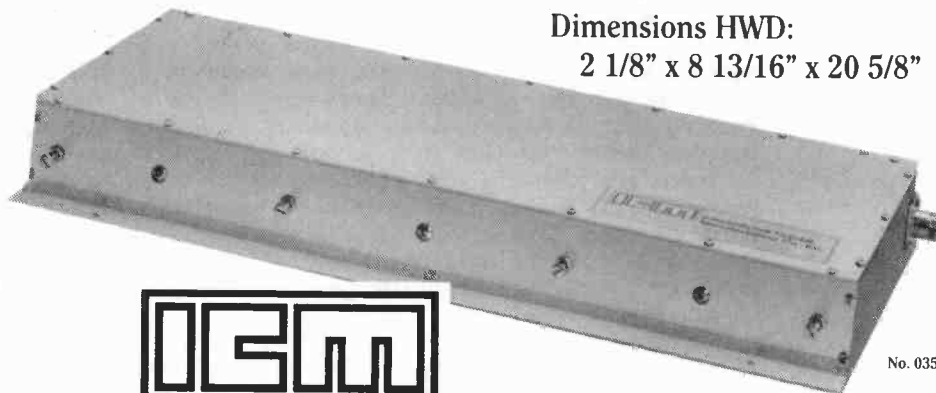

International Crystal Manufacturing Co., Inc.

P.O. BOX 26330 • 701 W. SHERIDAN • OKLAHOMA CITY, OK 73126-0330 • (405) 236-3741 • FAX (405) 235-1904

CUSTOM CRYSTALS

Crystals for many applications

For over 40 years, ICM has manufactured the finest in quartz crystals for every conceivable purpose.

A wide selection of holders are available to fit most any requirement. Our computer database contains crystal parameters for thousands of equipment types.

Need crystals for communications, telemetry, industrial, or scientific applications? Let ICM's sales department assist you to determine which type of crystal is best for you.

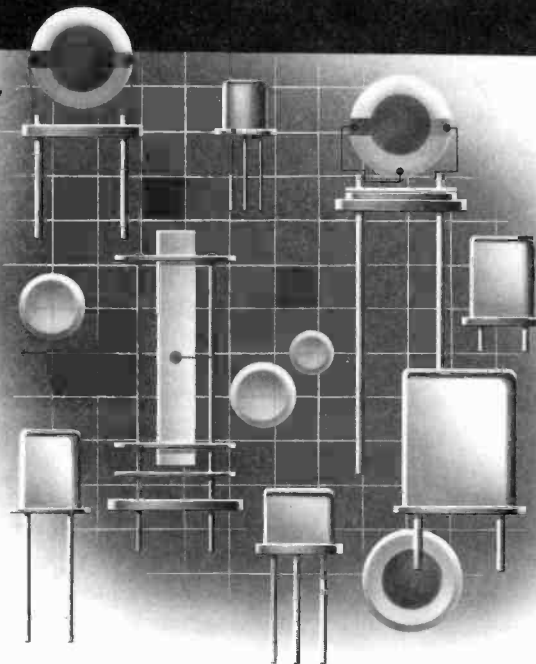

Can we solve your crystal problem?

For special purpose crystals, special holders, special sizes, call our crystal sales department. We will be pleased to provide recommended data.



International Crystal Manufacturing Co., Inc.

P.O. Box 26330, 701 W. Sheridan,
Oklahoma City, OK 73126-0330
Phone (405) 236-3741
Telex 747-147
Facsimile (405) 235-1904

TV PROC AMP and VIDEO LPF

This is a simple video processor. The NE592 video op-amp and 2N2222, or 2N2219 emitter follower is a video amp that has been used for many years. I obtained that info from Larry Oakes WB9XAJ and Paul Bohrer W9DUU. The synch stretcher and color burst boost were added by me.

The 33 pf cap in series with a 10K variable resistor across the gain control boosts the higher frequency components of the video. This boosts the color burst and color subcarrier. There is a very slight color shift in the red hue when the boost is on high. Of course, higher frequency noise is boosted, but this is normally not seen by viewers over the air. A switch turns the boost off.

An LM1881 provides synch stretching. The LM1881 is a synch separator that is available from Digi Key, 1-800-344-4539. The combined synch out of the LM1881 is fed to the base of the emitter follower. The final transistor can be a 2N2222, but use

a good 2N2222 from Digi Key, not the grab bag from Radio Shack. The 100 UF cap must be physically right at the emitter of the transistor with a short run to the ground. Note the LM1881 runs with 5 volt power. A LM7805 does a good job of providing the 5 volts.

The video can be inverted with S3. The input is high impedance with S1 open and 75 ohms with S1 closed. Output is 75 ohms.

This device is handy to correct synch, and color burst level when recording ATV signals with a VCR and to correct low synch or color burst on a transmitter. Thanks to KE96F Mike Deiss and KC9JX Tom Elze for the ORCAD computer drawing of the schematic.

The 5 Mhz cutoff low pass filter is from a design provided by W9DUU. It is used to keep the video under 5 Mhz to avoid interference to others caused by too wide a signal. It is used after the amp and before your transmitter. 73 WA9BVS

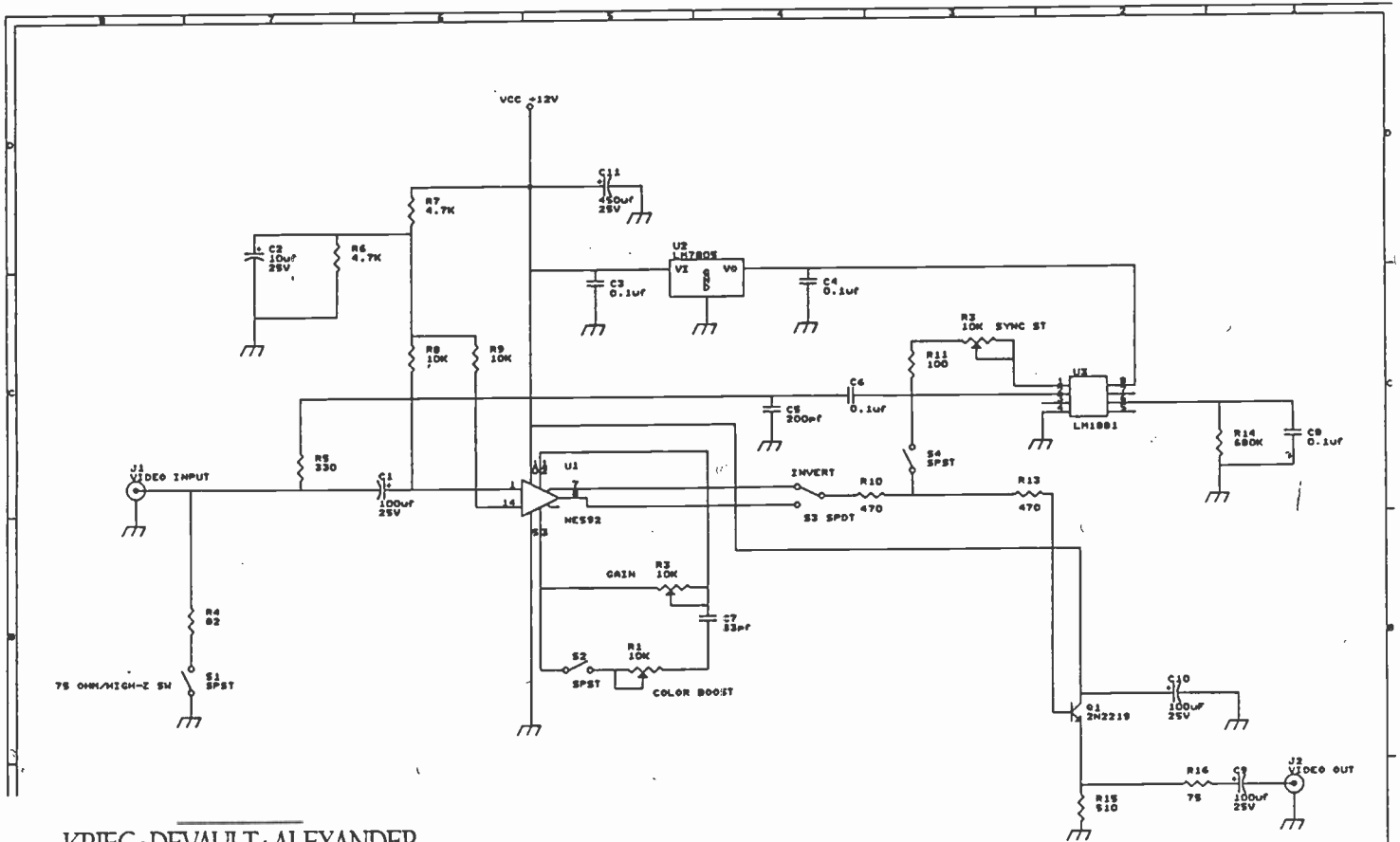

KRIEG · DEVAULT · ALEXANDER
& CAPEHART
ATTORNEYS AT LAW

MALCOLM C. MALLETTE

Note: Digi-Key Corp. 1-800-344-4539 (1-800-DIGI-KEY)

One Indiana Square · Suite 2800 · Indianapolis, IN 46204-2017
317/636-4341 · Telecopier 317/636-1507

WABVS ELECTRONICS INDIANAPOLIS, IN			
Title PROCESSING VIDEO AMPLIFIER			
Size	Document Number	REV	
0	1	1	1
Date	02/08/91	15	1991/1/15

TV PROC AMP and VIDEO LPF

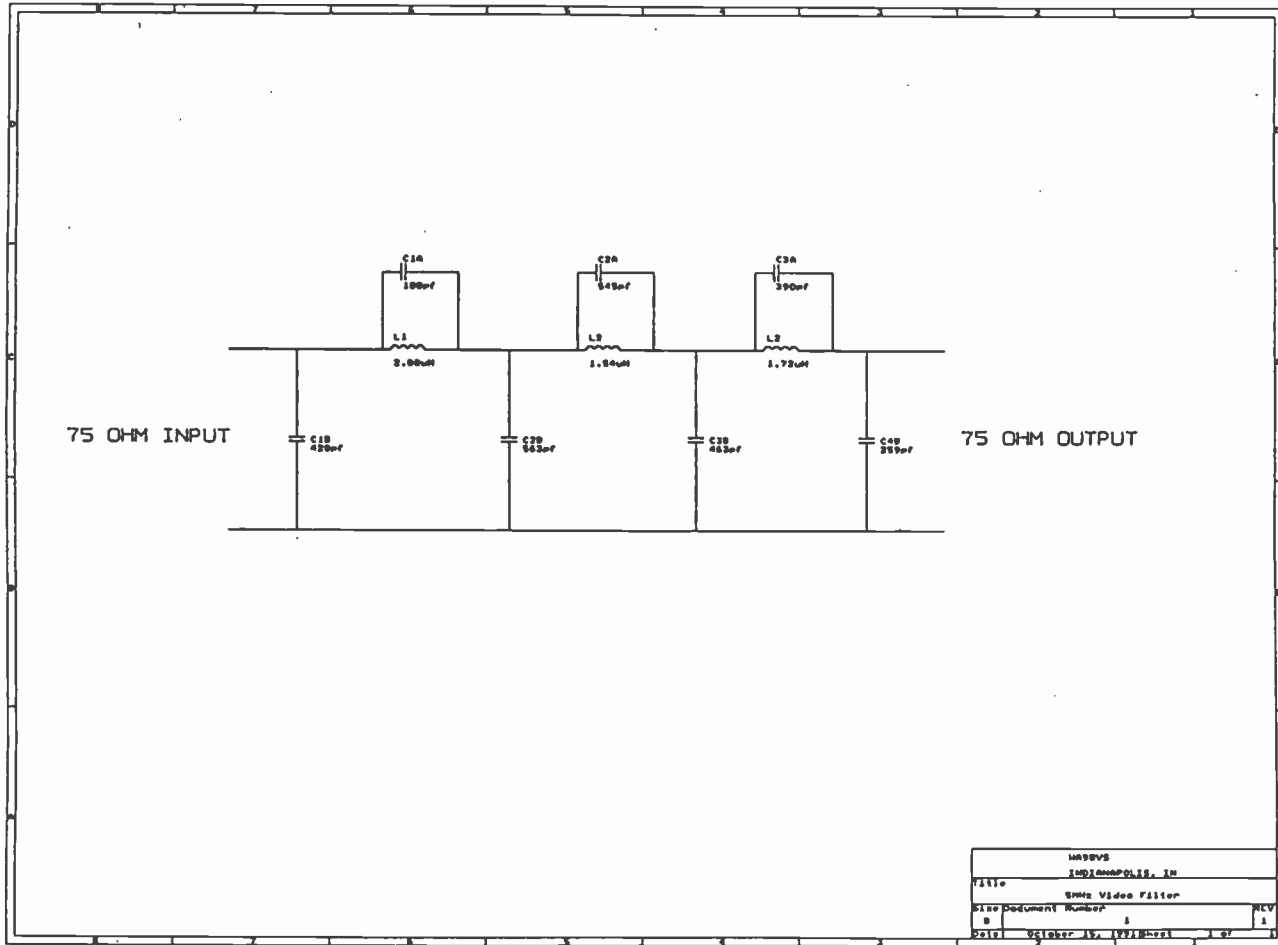

5MHz Filter

Date/Time run: 10/05/81 21:19:05

Temperature: 25.0

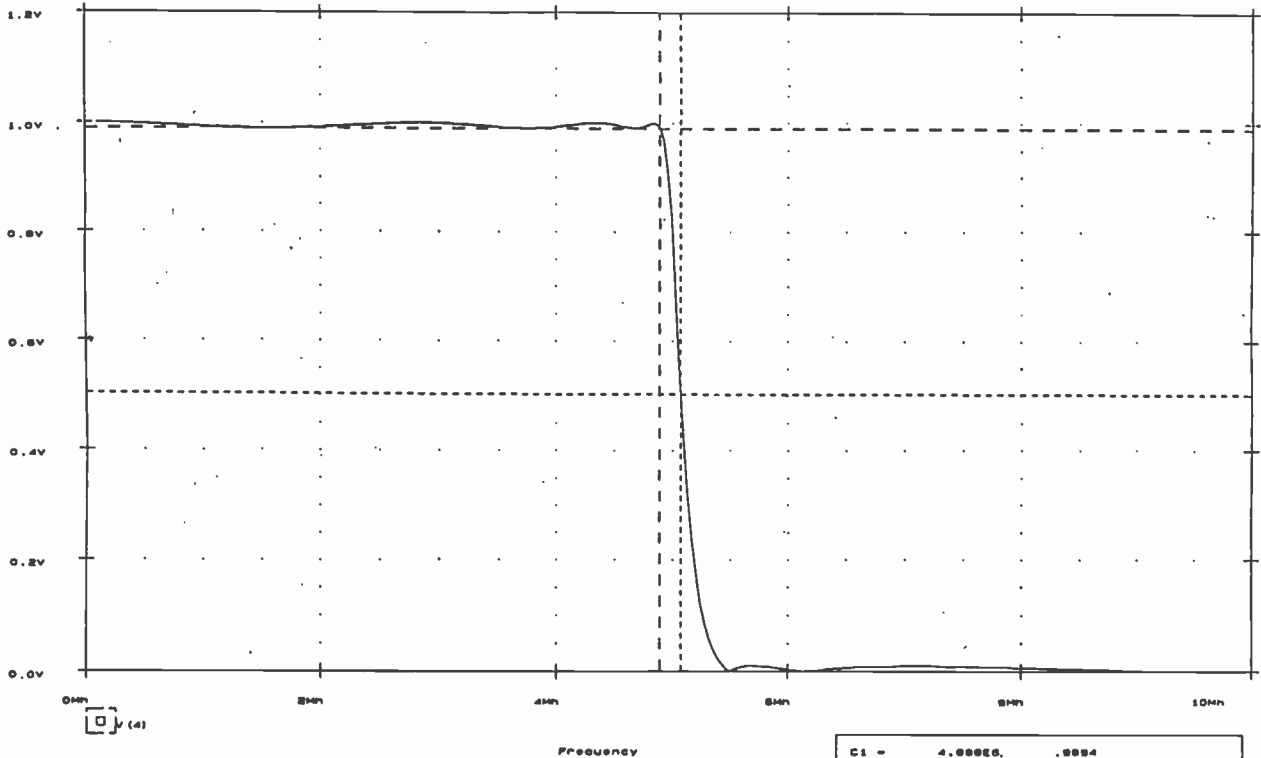

C1 -	4.000E6	.0004
C2 -	0.073E6	.0007
diff -	-183.383	.4867

COMET

ANTENNAS FOR THE PROFESSIONAL AMATEUR

CYA-1216E

16 Element Yagi Beam 1260-1300MHz
 Gain: 16.5dBi Length: 4'5"
 VSWR: 1.5:1 or less Weight: 7 lbs. 11 oz.
 Impedance: 50 ohms Mounting Mast Diameter: 1'-2 1/2"
 Max. Power: 100 watts Connector: N-type
 Polarization: Vertical or Horizontal Construction: All Aluminum

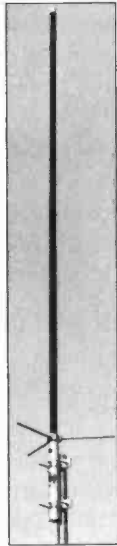
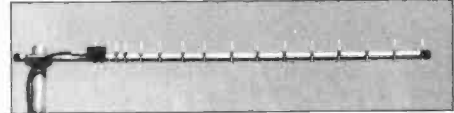

CA-1243Z

Dual Band
 440-450MHz
 1250-1300MHz
 Base/Repeater Antenna
 5/8 Wave x 4 446MHz
 5/8 Wave x 9 1200MHz
 Gain: 446 9.4dB
 1200 12.6dB
 Impedance: 50 ohms
 VSWR: 1.5:1 or less
 Max. Power: 446 150 watts
 1200 50 watts
 Length: 7'5"
 Weight: 2 lbs. 8 oz.
 Connector: N-type
 Construction: Heavy Duty
 Fiberglass

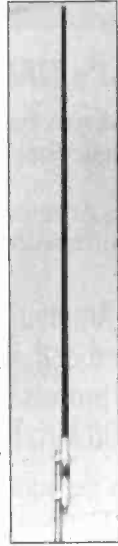

CA-1221S

Mono Band
 1260-1300MHz
 Base/Repeater Antenna
 1/2 Wave 21 Step
 Collinear
 Gain: 15.5dB
 Impedance: 50 ohms
 VSWR: 1.5:1 or less
 Max. Power: 100 watts
 Length: 8'6"
 Weight: 2 lbs. 3 oz.
 Mounting Mast Diameter:
 1 1/2-2 1/2 inches
 Connector: N-type

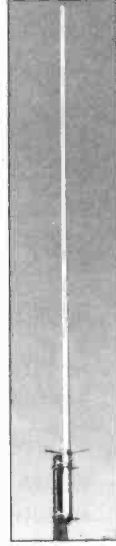

PYA-913

Base 13 Element Yagi
 904-920 MHz
 Gain: 15.8dBi F/B ratio
 over 20dB
 Max. Power: 150 watts
 VSWR: 1.5:1 or less
 Length: 4'8"
 Connector: N-type
 Construction: Aluminum

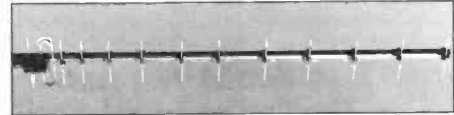

MINI SWR

Power Meters

Model	Frequency Range	Max. Power	Insertion Loss
CM-200	140-150MHz	45 watts	0.1dB
CM-300	200-240MHz	60 watts	0.2dB
CM-400	420-460MHz	50 watts	0.2dB
CM-420	140-460MHz	50 watts	0.1-0.2dB
CM-900	840-950MHz	60 watts	0.2dB
CM-1200	1225-1325MHz	60 watts	0.25dB

Measurements: 2.25" w x 2.25" h x 1.1" d
 Weight: 5.25 oz.
 CM-200, 300 and 400 have SO 239 Connectors
 CM-420, 900 & 1200 have N Connectors

FP-19

Base/Repeater
 905-925MHz
 Gain: 16dBi
 Impedance: 50 ohms
 VSWR: 1.2:1 or less
 Max. Power: 100 watts
 Length: 7'4"
 Connector: N-type
 Construction: Heavy Duty
 Fiberglass

CF-4130 446/1200MHz
 dB Loss: 1.3-460MHz 0.2dB
 900-1400MHz 0.3dB
 Band Rejection: 55dB Down
 Max. Power: 446MHz 800W PEP
 446MHz 500W PEP
 1200MHz 200W PEP
 Connectors: N-type

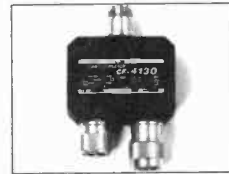

NCG CO. 1275 North Grove Street • Anaheim, CA 92806 • (714) 630-4541 • Orders (800) 962-2611

CALL FOR THE DEALER NEAREST YOU!

DISCOUNT VHS TAPE!

WHY PAY FULL PRICE FOR STANDARD GRADE TAPE WHEN YOU CAN GET PREMIUM TAPE FOR LESS??

When a mass duplicator buys tape by the hundreds of millions they get a great price for the best tape manufacturers can produce. Now, you can buy the same premium grade tape used by all major movie duplicators at a fraction of the price you pay in your local store for regular grade tape. All you give up is a fancy box painted up with the manufacturers sales pitch and the fancy label, also printed with the manufacturers sales pitch! What you get is the best VHS tape you can buy, from a major US manufacturer (the name is right on the tape shell) with a plain box and a plain self stick label. Not only can your collection look better without the color confetti boxes but you get better tape and save money at the same time. Prices are for a box of 10 tapes. We sell only by 10 lots (10, 20, 30, 100 etc). These are duplicator custom loaded T-120's (or 90, 60, 30, see list) factory fresh (not used, not one pass rejects) Since these were for duplicator use, they have been detabbed, just put clear tape over the record tab hole to record.

NOBODY CAN BEAT THESE PRICES!

SIZE	BOX OF 10	BOX OF 40	100 UP	
T-120	32.90	31.90/10	31.00/10	Only \$3.10 each!
T-90	29.90	28.00/10	26.00/10	Only \$2.60 each!
T-60	26.90	25.00/10	23.50/10	An incredible \$2.35 per tape!!
T-30	23.90	21.00/10	20.00/10	Unheard of \$2 a tape!!!

Prices are plus shipping. Visa/Master card accepted. Send orders to: ATVQ, Video Tape at Discount, 1545 Lee St., Des Plaines, IL 60018. UPS does not deliver to PO box numbers. Illinois residents include sales tax. Ordered filled from STOCK! No waiting!

Join the National Amateur Radio Association

and receive your monthly issue of

The Amateur Radio Communicator!

Who Reads The Amateur Radio Communicator?

- Anyone interested in obtaining an Amateur Radio license
- New Amateur Radio operators
- Public and private school teachers who want to introduce their students to Amateur Radio
- Amateurs who are now, or want to become, ham radio instructors
- VE's (volunteer license examiners) who administer the Amateur Radio exams
- Amateurs concerned about the future of the Amateur Radio Service

What Will You Gain When You Join NARA and Receive the Communicator?

- 1 You'll get the latest facts on what's happening in Amateur Radio
- 2 The knowledge to help you get the most from the Amateur Radio Service
- 3 You'll be helping to insure a solid future for the Amateur Radio Service

This means an exciting future for you as an Amateur Radio operator!

Here's What You'll Find in the Communicator!

Each month, the *Communicator* will include clear and informative articles on topics such as:

- Passing the Amateur Technician Class exam
- Erecting your first antenna
- Different types of Amateur communications
- Getting materials for your radio classes
- Classroom demonstration techniques
- Obtaining commercial support for your classes
- Keeping your students motivated
- Publicizing your Amateur Radio class
- The latest details on rules and regulations
- Up-to-date information on the VE program
- The latest news on proposed changes to the Amateur Radio Service
- Repercussions that regulation changes will have on the future of Amateur Radio

NARA publishes the only non-commercial ham magazine that addresses these subjects in a simple-to-understand manner.

What's NARA Doing?

The goals of NARA are to:

- Get more people licensed in the Amateur Service.
- Save the various Amateur bands (frequency ranges) from confiscation by commercial interests.

▶ In the past year, Amateur Radio has lost part of the 220-MHz band and, in some areas of the country, is in the process of losing access to another band (900 MHz).

NARA is striving to get more people involved in the Amateur Service so we can increase activity and retain our remaining Amateur bands.

When you join NARA, your membership dollars will be used to **further these goals**. Let's face it—with a subscription cost of only \$10.00 per year, **you won't find a better value in Amateur Radio!!** Join today! It's easy. Just complete the subscription form below and mail your check or money order. For the fastest service, call 1-800-GOT-2-HAM (1-800-468-2426) with your VISA or MasterCard number.



I want to join NARA and receive my monthly copy of *The Amateur Radio Communicator*.

- One year (with 12 issues) for \$10.00
- Two years (with 24 issues) for \$18.00
- Three years (with 36 issues) for \$25.00

(Please print) Form of Payment MC ___ VISA ___ Check ___

Name _____ Call _____

Address _____

City _____

State _____ ZIP _____

MC/VISA _____ Exp _____

Signature _____

Please make your check or money order made payable to:
National Amateur Radio Association

12 WATT 900/1200 MHZ. ATV SYSTEM

by Earl Campbell KS8J and Greg Stayton NT7L

The 12 watt FM ATV transmitter is built around an Avantek VTO 8090 oscillator. This provides a voltage tuneable 20 milliwatt source that covers the 900 and 1.2 GHz. bands without the necessity of strip line circuits.

Although its price of \$129 is somewhat high, the ease and compactness of circuit construction may well be worth the cost. An other advantage is that by replacing the oscillator a transmitter for any band up through 10 GHz. can be readily made. Before rushing off to build a 10 GHz. system, one significant disadvantage of the oscillator is again the price of \$480. These Avantek oscillators were developed for spread spectrum and electronic counter measure transmitters.

A 6 MHz. sub-carrier generator circuit copied from the ATV Electronics 5 watt transmitter (with a slightly different value of inductance for L2) was used. This circuit buffers the audio input with a 741 op amp that is then coupled into a voltage controlled 6 MHz. oscillator. Audio gain is adjusted by R16 and audio deviation is adjusted by R10. The 6 MHz. sub-carrier audio is then summed with the video at the negative end of C8.

BASIC CIRCUIT DESCRIPTION

As shown in the schematic a high speed operational amplifier LM63611, is used to modulate the VTO. The center frequency is set by R12 from a regulated 12 volt DC source. The video is input through a pre-emphasis network consisting of C1, C2, R1, R2, R3, R21 and L1 to follow standard FM video practice. This provides the necessary boost in high frequency components of the modulation to provide good FM modulation. The amount of frequency deviation of the VTO is provided by adjusting the video gain of the LM6361 op amp with the 100 ohm pot, R5. The video is coupled from the pot to the op amp with C8. Capacitor C8 must be installed with the correct polarity as shown in the schematic so that the positive voltage on the summing junction of the op amp is on the + end of the capacitor. A fixed gain through the op amp is provided by R8 and R6 which is approximately a voltage gain of two (1000/470).

TRANSMITTER SYSTEM

The Avantek VTO provides 20 milliwatts of drive to a 900 Mhz. class C brick amplifier to produce 12 watts of output power. Because FM modulation is used instead of AM, a class C amplifier is all that is needed and produces excellent picture clarity. A 900 MHz. interdigital filter that was left over from a previous repeater experiment was added to the output of the RF amplifier with no effect what so ever on the picture. Only 3 MHz of deviation was required to produce good color and sound at the receive end. To set the 3 MHz. deviation for the 0 dB crossover frequency of the video pre-emphasis filter it is necessary to input a 762 KHz. signal at 0.61 volts P-P into the video input. While observing the RF output on a spectrum analyzer or watching the signal strength of the carrier on a receiver, adjust the deviation pot R5, to null the RF carrier. A block diagram of the transmitting system has been included.

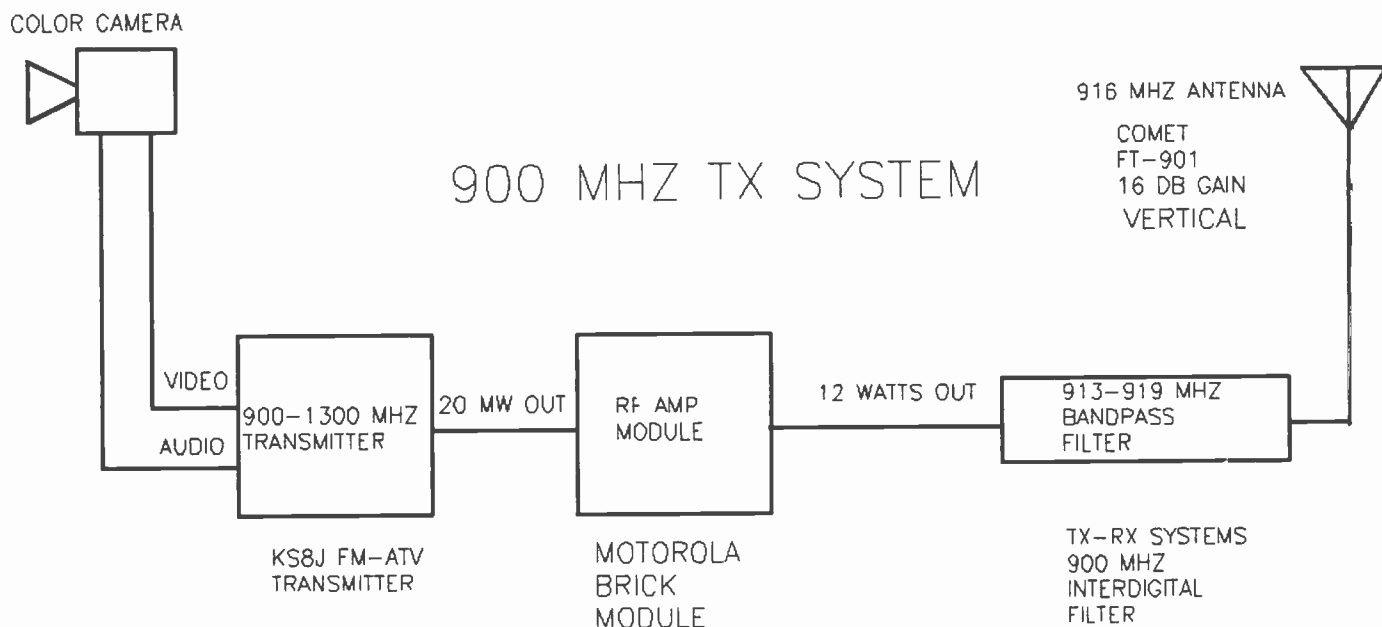

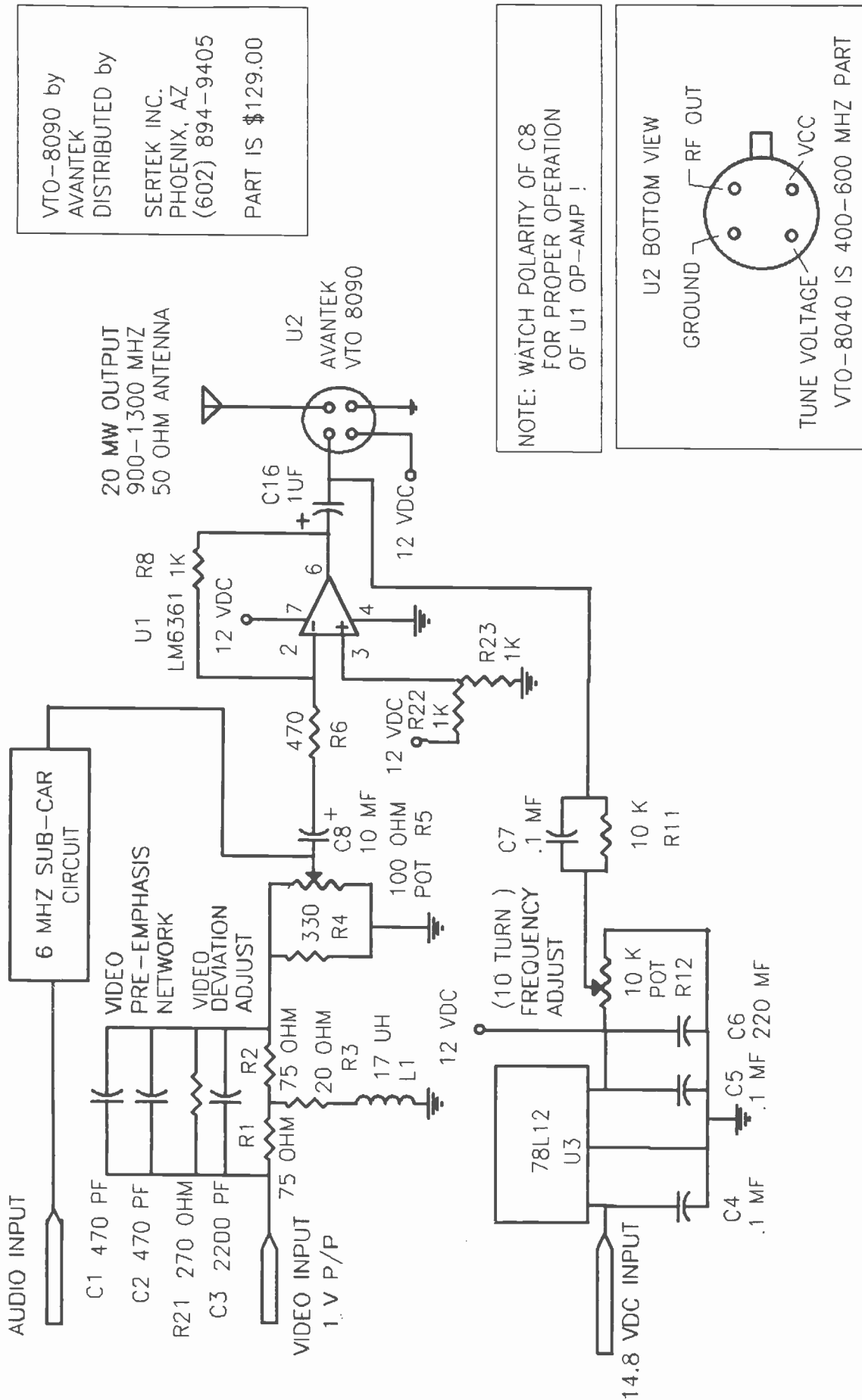

VTO-8090 by
 AVANTEK
 DISTRIBUTED by
 SERTEK INC.
 PHOENIX, AZ
 (602) 894-9405
 PART IS \$129.00

20 MW FM-ATV TRANSMITTER by KS8J

12 WATT 900/1200 MHZ. ATV SYSTEM

RECEIVING SYSTEM

The receiving system was located at NT7L's station about 2 miles from KS8J transmitting station. It consists of a homebrew 19 dB array of 4, eight turn helical wound for 900 MHz. The actual gain for the helical receive array receiving the vertical polarized KS8J signal is 16 dB. The receiving antenna was then connected via 9913 coax to a 900 MHz. "Rabbit" down converter purchased from K-Mart for \$29. The down converter has a wide enough IF bandpass to provide an adequate 70 MHz signal to a satellite TVRO receiver (provided by Don KD7BU) to provide a P5 picture from a TV or monitor. The TVRO receiver IF bandpass is usually too wide for terrestrial FM TV for good signal to noise ratio although it was entirely adequate for this series of tests. To narrow the IF bandpass, a 12 MHz bandpass SAW filter can be used in place of the 28 MHz filter usually in such receivers.

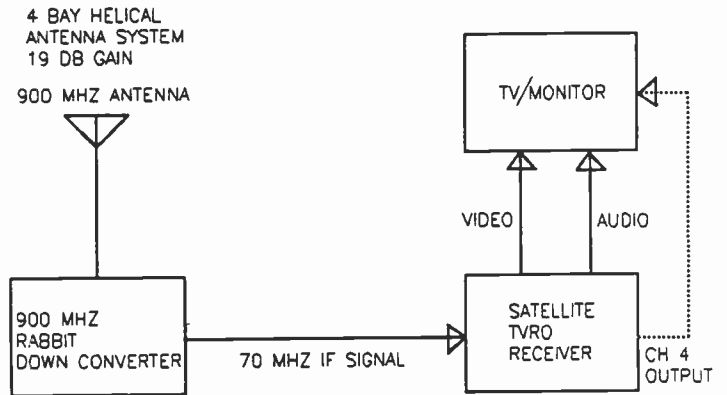

900 MHZ FM-ATV RX SYSTEM

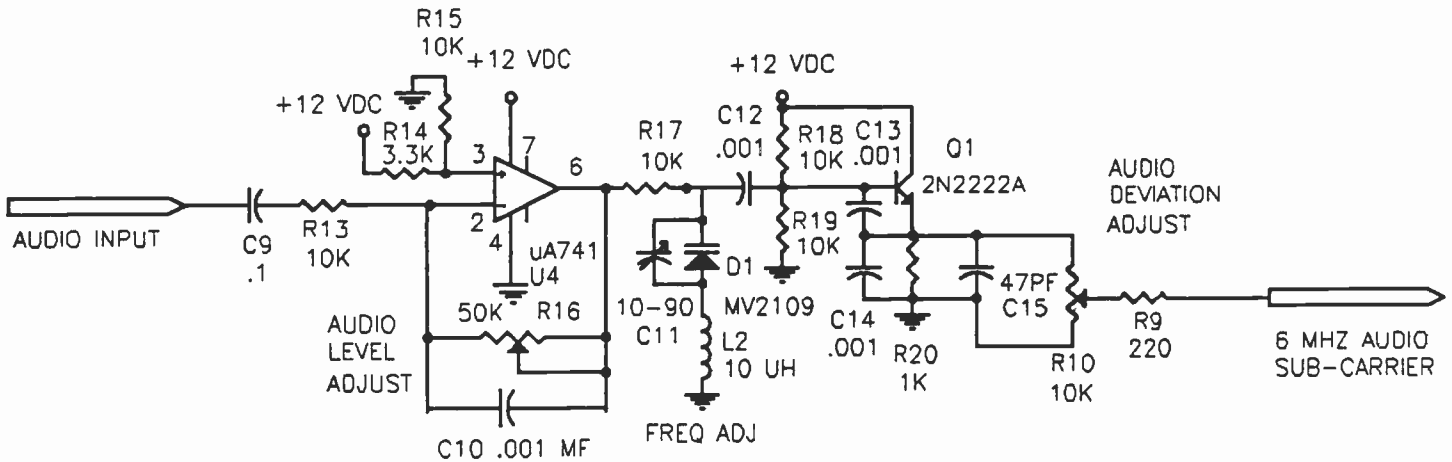

6 MHZ SUB-CARRIER CIRCUIT

EDITORIAL COMMENT: Readers should note that FM video systems depend upon deviation and receiver bandwidth for signal to noise ratio (Carrier to noise ratio) and baseband video level. The system described using a TVRO receiver will likely have low video level and suffer less than optimum FM video S/N ratio because the deviation of the transmitter is low compared to the bandwidth of the TVRO receiver. The ARRL suggests a deviation of 2 MHz. for ham radio, commercial satellite uses 17 MHz. and up to 34 MHz. bandwidth. The system could be improved by adding a narrow receive filter (8MHz.) and a video amp stage to increase baseband output to 1 volt p-p using 2-3 MHz. deviation. At the close range used by the author these effects may not have been noticed. Readers should experiment with increasing distances before trying this system for a long haul ATV operation, or invest in commercial ATV FM equipment.

DESCRIPTION

THIS INTERDIGITAL FILTER IS OF THE SEVEN POLE DESIGN. THIS MEANS THERE ARE SEVEN TUNEABLE RODS INSIDE THE BOX. THE FREQUENCY CAN BE ADJUSTED APPROXIMATELY 6 MHz. ADJUSTMENT IS ACCOMPLISHED BY THE ADJUSTING SCREWS AT THE END OF EACH ROD. INSERTION LOSSES OF LESS THAN 1 DB HAVE BEEN OBTAINED WITH THIS DESIGN. OUT OF BAND ATTENUATION WAS >80 dB +/- 12 MHz FROM THE VSB PASSBAND. ATTENUATION AT THE LSB SOUND SUBCARRIER FREQUENCY WAS 30 dB.

VSB FILTERS 439.CH MHZ. \$130
910.25 MHZ. \$145

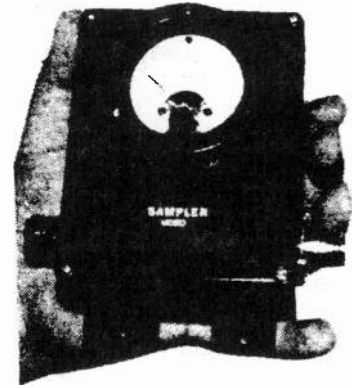

PAULDON ATV VIDEO SAMPLER
Model PD-VD-1 \$65.00

ATV
VIDEO SAMPLER

This unit picks up your transmitted ATV signal by sampling the transmission line with negligible insertion loss. It uses 2 "N" connectors for input and output connections. A BNC is used on the video output. The detected output is connected to your monitor and scope so that you may accurately adjust your transmitter for proper video & sync levels. We provide two different models. Both have relative power output meters, but one has a greater accuracy. There are 2 PC controls, one for video level and the other for power output. This beats an on the air adjustment.

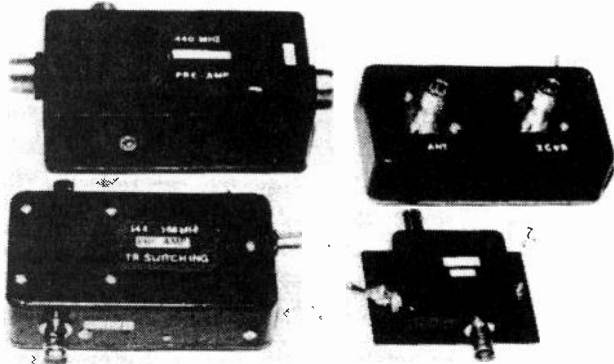

PREAMPLIFIERS

PD-144E is a 144 to 148Mhz. dual gate low noise preamplifier (0.6 - 0.7db.) with a gain between 18 & 20db. It uses a NEC 41137 or equivalent transistor. It has a tuned input only, using 2 ceramic capacitors. The drain output has a load resistance and a cap. output. This gives a low noise performance. The unit comes with either BNC or SO-239 connectors. Supply voltage should be between 12 and 13.8 volts. It has a 5 volt regulator in the unit and is diode protected. Antenna input is also protected by reverse diodes. \$41.00 & \$46.00

PD-144TR A T/R switched unit is also available and will handle a max power of 35 Watts. \$69.00

PD-144TR-L is a preamplifier which will handle 100 watts through and has diode protection during the relay switching time. Grounded relay contacts are in the unused poles while the preamplifier is in service. The preamplifier is automatically switched out of the circuit when RF is detected during transmission time. Most of the units have a 1 to 1.5 second delay unless you desire fast switching service. It is in a wx resist painted diecast box with installation for a connector down position to help reduce contamination. The box is sealed so that water should not be a problem. SO-239 connectors are normally used, but "N" may be requested. We custom build the mounting bracket and clamp so that it can be either mast or boom mounted.

FOR VOLTAGE FEED THRU COAXIAL CABLE OR F/T CAP. CONNECTION \$129.00

PD-220E for the 220Mhz. band is the same as PD-144E \$39.00 & \$44.00

PD-440S 70cm. 426 to 450Mhz. preamplifier is a SINGLE GATE type using either a NEC 2SK-571 or a Mgf 1302 transistor. Noise figure is 0.6db. and has a gain of 16db. or better. It operates from a 12 to 13.8 volt supply, is diode protected and has a 5 volt regulator for stability. The source leads are by-passed with disc capacitors and the input uses a high "Q" piston Trim Pot. The output is not tuned so that the noise figure is consequentially low. A Toroid is used in the output, with capacitor coupling to the output. In this model either BNC or "N" connectors are used. \$49.00 & \$51.00

PD-440TRL is a tower mounted 70CM. pramplifier whose description is similar to that of the PD-144TR-L except has "N" connectors.

FOR VOLTAGE FEED THRU COAXIAL CABLE OR F/T CAP. CONNECTION \$129.00

PD-900 is a 902-928Mhz. preamplifier with a noise figure of 0.6 to 0.7db. and a Gain of 14 to 16db. With BNC. \$60.00
"N" Connectors \$68.00

PD-900TR is a R.F. sensed preamplifier and can be transmitted through with a maximum power of 20 Watts. \$119.00

PD-1200 and PO-1200. SAME AS THE PD900) \$60-68 & \$119.00

PD-2300 is for the frequency range of 1.8-2.4Ghz. \$72.00
No T/R Switching Capability.

FOR ADDITIONAL INFORMATION SEE CATALOG

Special Prices on Many Products

WARRANTY IS 1 YEAR ON LABOR AND 6 MONTHS ON PARTS (SEE OUR GUARANTEE FOR THE EXCEPTION). YOU MAY RETURN ANY UNIT WITHIN 30 DAYS IF YOU ARE DISSATISFIED OR IF THE UNIT DOES NOT PERFORM TO YOUR SATISFACTION.

- BRICKS:** SAU-11 900 MHZ. \$19.00; on wired P.C. Boards \$25.00
M57762 1.2 Ghz. \$72.00; on wired P.C. Boards \$99.00
SAU-4 440 Mhz. on wired P.C. Boards 18W. \$86.00
M57745 440 Mhz. on wired P.C. Boards 35W. \$120.00
SAV-7 144 - 148 Mhz. wired P.C. Boards 35W. \$89.00
M57727 2 mtr. Linear wired P.C. Boards 35W. \$98.00

POWER AMPLIFIERS:

- 144 - 148 Mhz. PD-144 N F.M. 35 watt output (2W. in) T/R \$109.00
SAME with preamplifier \$129.00
PD-144N-1 Linear 35 watt output T/R \$125.00
PD-144N-2 F.M. 60 watts (2W. in) T/R \$159.00
WITH PREAMPLIFIER \$179.00
225 Mhz. PD-220N F.M. 35 Watts output (2W. in) \$123.00
426 - 450 Mhz. PD-440N Linear 18 watts output (2W. in) \$119.00
PD-440N-1 Linear 35 Watts out (2W. in) \$155.00
Same with Preamplifier \$173.00

NEW: Linear P.A. (Mini) 100MW. = 1W. & 1W. = 6W. \$55.00 - \$65.00

ABOVE FOR 70 Cm. Band. LETS YOU GET FULL POWER FROM YOUR LARGE P.A. AS AN IN BETWEEN AMP. PRODUCES GOOD VIDEO & COLOR ON ATV.

- 902-928 Mhz. PD-900 DOUBLER 70 CM. = 33CM. \$45.00 & \$85.00
Above 1/2 W. in 1/2 W. or 1 W. out.
PD33VLP mini Amplifier (1/2 W. = 1.5W. \$49.00
PD-900N F.M. 1/2 W. = 10W. \$50.00 or \$65.00
Above may be used on ATV with 2 to 3 watts output.
PD-33LP 1W. in = 6-7W. output \$99.00
PD-33HP 5 W. in = 16W. output \$119.00
PD-33LHP 1W. in = 17W. output \$110.00
1.2 Ghz. PD-1200N 1W. in = 18W. output \$149.00 & \$165.00
PD-1200TR 1W. in = 16W. output T/R \$195.00
PD-1200N-1 2W. in = 36W. output \$285.00
Above P.A. has a P.C. Board Combiner

2 mtr. & 70 CM

DUPLEXED POWER AMPLIFIER: 35W. out on 144-148 Mhz. \$225.00
18W. out on 440Mhz.
Input power 2 watts.

DUPLEXERS: 70 CM & 2 Mtr. (100W.) \$25.00
Attenuators: (ALL BANDS) R.F. \$6.00

ATV SAMPLERS: \$45.00 \$60.00 \$65.00
FM Audio Transmitters & Receivers (Single Frequency)
TRANSMITTERS 1W. output 902-928 Mhz. less xtal \$239.00
RECEIVERS FOR 902-928Mhz. less xtal \$179.00

KITS FOR 2 METERS, INQUIRE



210 Utica Street Tonawanda, NY 14150 (716) 692-5451

ATVQ DEVOTED ENTIRELY TO HAM TV

SAARPARABOL

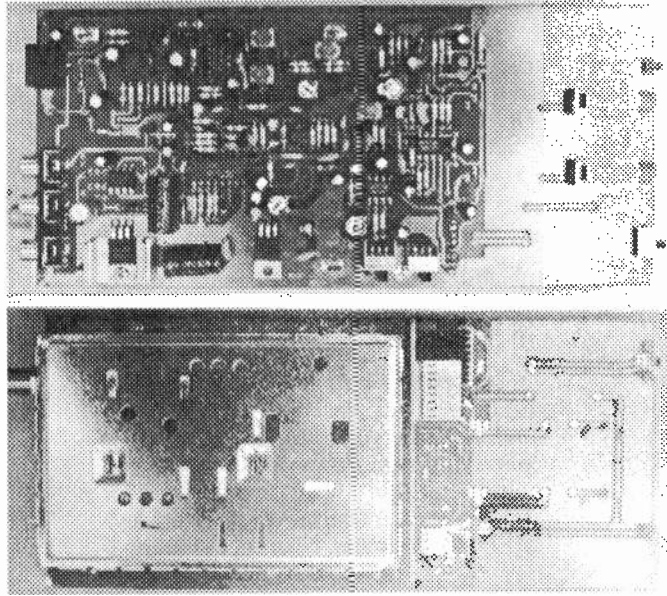

E-600 FM & SAT TV RECEIVER: 100x225mm

Technical data	: Euro 600 SAT drop-in module
Power supply	: via AMP connector and ground connection
Operating voltage	: +15 - 17.5V (over-voltage protection above 18V)
Current requirement	: approx. 400mA without LNB
IF Input connector	: F female
Input frequency	: 950-1750MHz adjustable
Input sensitivity	: 65dBm typically
LNB power feed	: switchable on/off
IF bandwidth	: 16/27MHz switchable
RCA/Phono/Cinch baseband output	: 50Hz - 8.5MHz
Video connector	: RCA/Photo/Cinch female
Video bandwidth	: 50Hz - 5MHz
Video de-emphasis	: PAL/NTSC/SECAM (CCIR 405-1)
Video polarity	: neg/pos switchable
Video output level	: 1V peak to peak adjustable
Audio connector	: RCA/Phono/Cinch female
Audio tuning range	: 5.2 - 8.3MHz
Audio output level	: 775mV/600 ohms

.....
All units are ready for instant hook-up-and-go operation. Adjustment of the trimmer presets should only be carried out following full examination of the circuit.
.....

B&B techno GmbH — Germany-West
Schulstr. 9, D-6652 Bexbach-Frankenholz, Fax ++49 6826 80270, Tel. 6607

A Simple 24cm FM-ATV Transmitter

RICHARD CARDEN VK4XRL

There is a move, in ATV in SHF bands, to frequency modulation of the carrier by the video signal. This is to take advantage of the desirable characteristics of FM used for so long in the VHF/UHF bands. Satellite TV receiving units now available make use of FM.

Here is a simple free running FM oscillator design, suitable for test purposes or short range use.

The composite video signal is passed through a 3 dB attenuator to a standard CCIR 401D pre-emphasis network (switchable for testing). The pre-emphasized signal is amplified by a NE592 IC. The preset gain control is set to give the correct output level and hence the correct carrier deviation.

The signal is buffered by a BC107, and capacitively coupled to a varicap diode in the tank circuit of the oscillator. The DC bias is determined by the 10 kΩ "Set Frequency" preset potentiometer.

The oscillator is a common base voltage controlled design, using a BFR96 transistor. The BB405 varicap is connected via a 2.2 pF capacitor to L1, which is the uncut collector lead of the BFR96.

To set the unit up, tune the "Set Frequency" control through its range and make a graph of oscillator frequency versus voltage. From this graph, determine what signal levels are required for 1.127MHz and 4MHz peak to peak deviation of the carrier. Now set the unmod-

ulated carrier frequency to the desired channel (1250 MHz or 1283 MHz +/- 1 MHz, per FMTAG bandplan) with a counter or calibrated receiver. Either,

—apply 1V p-p of 50KHz (or lower frequency) to the input and adjust the gain pot for the signal level at the varicap to produce 1.127MHz deviation, or,

—apply 1V p-p of 1.512MHz (the CCIR crossover frequency) to the input and adjust the gain pot for the signal level at the varicap to produce 4MHz deviation.

Reference

"FMATV", *Break-In* September 1987, by Doug Ingham ZL2TAR.

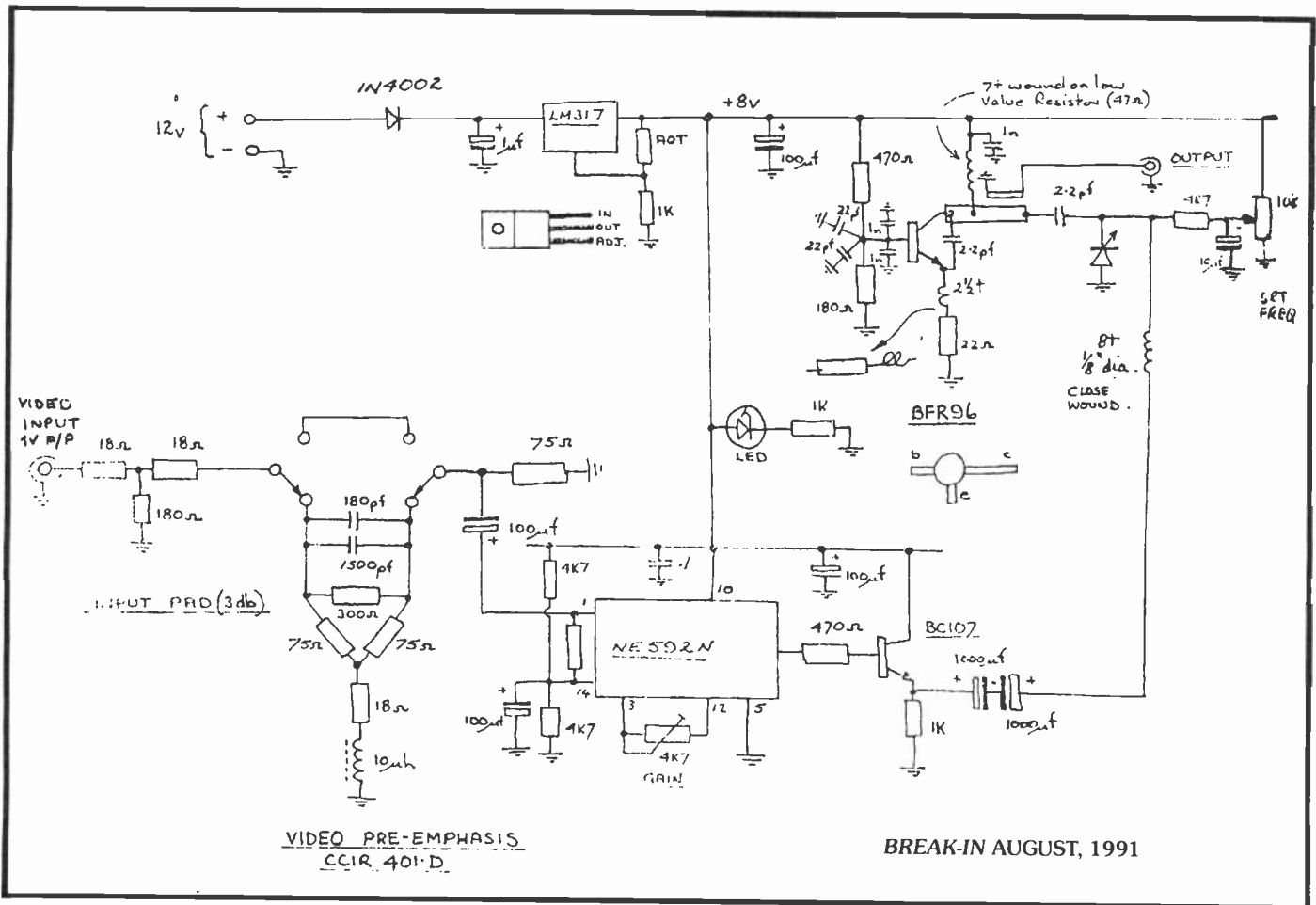

**The #1 ATV magazine in the world
invites you to SUBSCRIBE Now!**

This is your 'Q' to subscribe to AMATEUR TELEVISION QUARTERLY!

There is no better source for ATV than ATVQ. Every issue of ATVQ brings you the latest in: ATV ACTIVITY ON EARTH AND IN SPACE! PUBLIC SERVICE ATV ACTIVITY, BUILD-IT PROJECTS, FIRST HAND ACCOUNTS OF ATV ACTIVITIES, NEWS, ARTICLES AND FEATURES, INSIGHTS FROM THE EXPERTS, NEW PRODUCT REVIEWS, TECHNICAL INFO, AND LOTS MORE!! Don't miss the action subscribe NOW! More non ad copy than the average issue of 73, CQ and more technical articles than QST! Subscribe to Amateur Television Quarterly (ATVQ) today!

Rates:	US	CANADA	DX	NOTE: rates effective Oct 1, 1991
1 yr	\$18	\$22	\$35	
2 yr	33	40	65	
3 yr	48	58	90	
4 yr	63	76	110	
5 yr	75	94	125	
LIFE	400	500	875	

NAME _____ CALL: _____ PHONE _____

STREET: _____

CITY: _____ STATE/PROV: _____ ZIP: _____ +4 _____ COUNTRY: _____

Voice coordination frequency for ATV in your area? _____

Amateur Television Quarterly (ATVQ)

Your quality authoritative accurate source every issue. Yes, enter my subscription to Amateur Television Quarterly. I've enclosed a check or money order. Or bill my Visa or M/C: # _____ expires: _____ . sign name here: _____

OTHER PUBLICATIONS AVAILABLE THROUGH ATVQ

- CQ-TV quarterly publication of the British Amateur Television Club. \$21/yr _____ yrs \$ _____
- VHF Communications, quarterly publication of VHF and up construction projects. \$27/yr. _____ yrs \$ _____
- BATC SSTV Handbook. Quality reference for slow scan TV. \$11.25 _____ copies \$ _____
- BATC ATV Compendium Collection of quality build it projects. \$11.25 _____ copies \$ _____

(Foreign subscriptions include a funds exchange fee, books are post paid.)

NEW BOOK

ATV SECRETS FOR ASPIRING ATV'ers. Everything for the beginning ATV'er. topics cover all aspects of ATV operations, DX, fun things to do, cheap and easy ways to get started, essential information on making contact, getting local ATV info, examples of ATV activity & index to over 500 recent articles and features about ATV. \$11.50 post paid or \$9.50 with ATVQ new subscription order. (Canada \$12.50/\$11.) _____ copies \$ _____

VIDEO TAPES that can't be shown on commercial TV!

- British TV out-takes and bloopers (approx. 12 hours) Rated hard R. \$60/set of 6 tapes. _____ copies \$ _____
- US TV out-takes and bloopers (approx 12 hours). Rated hard R. \$60/set of 6 tapes. _____ copies \$ _____

SEND TO: AMATEUR TELEVISION QUARTERLY (ATVQ)

1545 LEE ST. #73

DES PLAINES, IL 60018

CHARGE BY PHONE: 708 298 2269 FAX 708 803 8994

Note: There is a 6.5% bank fee on charge orders.

from the publishers of ATVQ

ATV SECRETS FOR ASPIRING ATV'ERS

Volume I

If you enjoy ATV and would like more information about ham TV then you should order Volume I of **ATV SECRETS**. Volume I is a non technical guide to everything you ever wanted to know about ham TV but didn't know whom to ask. Volume I includes clear easy to understand explanations of all aspects of HAM TV. Twenty five topics cover television theory, with accurate charts and useful information about video and ham TV operations. Like ATVQ, **ATV SECRETS** Volume I is highly illustrated with over 110 photos, charts and diagrams. **ATV SECRETS** is entirely new and includes information not available anywhere else.

NO LIGHTWEIGHT!

OVER 20,000 WORDS, OVER 110 PHOTOS, DIAGRAMS, CHARTS, ILLUSTRATIONS

ATV SECRETS Volume I is available now. An easy to read, fun tour of every aspect of ham TV. It is a highly condensed essence of ATV operations and technical information about receivers, transmitters, how to DX, What your watt meter is really telling you and much more. It contains no fat, no hyperbole, no trivial matters, no obscure useless information, no 20 year old reprints; just the facts in easy to understand language! **ATV SECRETS** Volume I is destined to be a life long reference book for any video active ham or video hobbyist.

Cover price \$9.98

Order form: Yes, its time to enjoy ham radio again with ham TV. I would like to know more and get the background information that will enable me to fully enjoy, understand and operate ham TV. Here is my order.

NAME _____ CALL _____

ADDRESS _____

CITY _____ STATE _____ ZIP _____

Please send _____ copies of **ATV SECRETS** Volume I at the post paid price of \$11.50 each. (Canada \$12.25)
Check/Visa/Mastercard

Card # _____ EXP _____ Signature _____

Send to: ATVQ, 1545 Lee St., Des Plaines, IL 60018. Or Phone 708 298 2269, FAX 708 803 8994.

A GREAT CHRISTMAS GIFT FOR THAT SPECIAL PERSON IN YOUR LIFE!

from the publishers of ATVQ

A SIMPLE AND CHEAP LOOKIE TALKIE

Henry KB9FO

Looking for a one afternoon project? How about a .1 watt 434 MHz. lookie talkie! Photo 1 shows two units with a scale for size comparison. The left box is an original microcam from MicroVideo Concepts. It consists of a CCD black and white camera in a small bud box with an rca jack for video output and two wires for 9 volts DC power. The photo on the right is a completed lookie talkie using the Microcam, a Micro ATV transmitter and sound board and 9 volt battery. The slightly larger box has an on-off switch added and a BNC connector for the RF output. Shown here with an AEA "Hot Rod" half wave rubber ducky antenna. The box is slightly longer just enough to fit the 9 volt battery below the camera circuit boards. This is seen in the side view, photo 2. A foam strip sticky on both sides was used to mount the 434 MHz. transmitter and audio subcarrier boards to the camera boards. These provide insulation and shock resistance. The entire package still fits in the palm of your hand.

Wiring is simple enough, remove the cable from the rca jack and solder it to the micro transmitter video input. DC is fed to all three units through the on-off switch. I found a single 9 volt batter was good for about 8-10 hours of operation and there was space enough to add a second batter in parallel for longer operation. I used alkaline 9 volt batteries. This was shown at the October Indianapolis ATV club meeting and the picture was

received P5 on Don Miller's demo ATV receiver using no antenna from 50 feet. Its great for local demos where you need a quick and small ATV transmitter, and few will notice what it is.

You can replace the RD antenna with a 1/4 wave wire up your sleeve or wherever and put the camera in a pocket, hat, or hidden where you like for some fun. The image is in focus from a couple inches to infinity and the lens can be focused for even closer work if needed. The sensitivity was good and there was no problem transmitting city lights from the roof of the Hancock one night! Line of sight range was 24 miles from 1080 feet HAAT! at P4. For audio input, any small mic can be used. I used a micro sized mic element inside the box with only a couple of small holes in the box end to let sound in.

If you want to use the unit with external power, DO NOT connect it to 12 volts! The units are rated at 9 volts maximum DC input, so use a regulator, a 7808 in a plastic case is fine since current draw is low. You could use the case as a heat sink for the regulator but it doesn't get warm. This can also be used as a "tower cam" or self contained R/C model camera/transmitter. The battery and metal box weigh more than the electronics! A Tektronics 7L12 spectrum analyzer was used to look at the RF output which is very clean double sideband ATV. All components are available from PC Electronics except the custom housing.

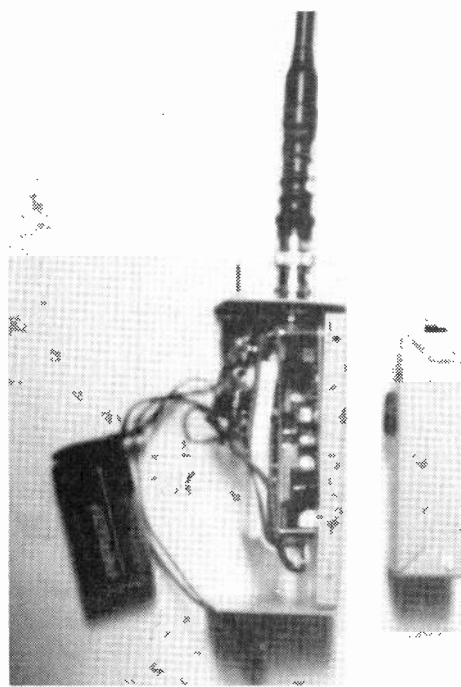
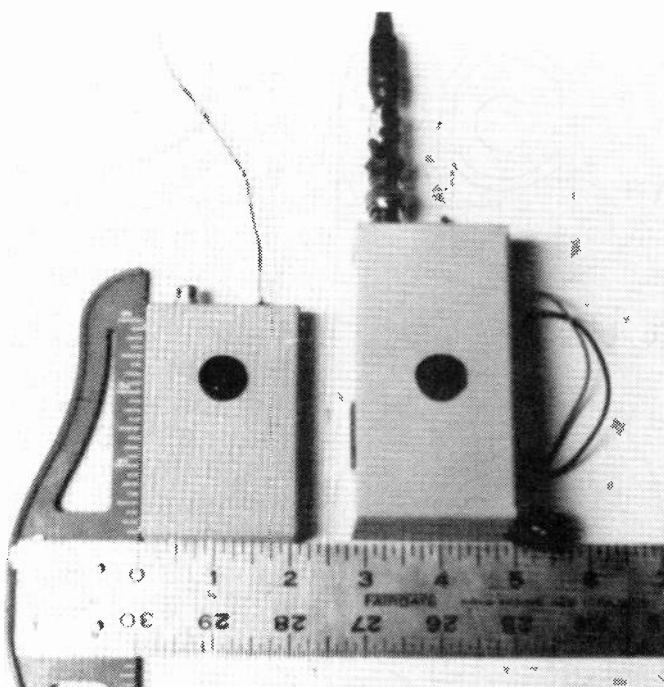

440-QRM FILTER

Filter designed by WB9YAJ text by KB9FO

A simple to make filter to provide a notch to tune out QRM on your ATV receiver, or eliminate unwanted signals from your transmitter output.

The filter is a high Q helical design made from copper pipe and wire and an BNC connector. The diagrams show all the construction details necessary to duplicate this design. This diagram shows the use of short 4-40 screws to hold the end caps in place. Alternately the copper plumbing caps can be soft soldered after assembly and trial tuning if desired. The tuning screw does not come in contact with the coil inside the cavity. Connection to the receiver circuit is by a BNC T connector and should be located close to the receiver input.

The copper coil, made from 14 gauge copper wire is soldered directly to the sides of the copper pipe section. The BNC center conductor is soldered via a short straight jumper to the bottom of the first turn of the coil as shown. Dimensions should be followed closely for best results. Be sure to use a brass screw for the tuning adjustment.

To remove receive QRM the notch filter is tuned by watching the ATV receiver in the presence of both a desired TV signal and the undesired FM repeater or other signal. Simply turn the screw until the interference is minimized. Alternately, you can put the filter at the antenna jack of a narrowband receiver tuned to the

interference frequency while watching the S meter, tune the screw for minimum signal. Typically 26-30 dB of rejection can be achieved. The Q of the filter is very high, so tune slowly. The notch is quite narrow, only a few kilohertz wide at the peak so there is minimal effect on the video signal when in use. Several units can be made and connected together with short coax cables to reject more than one signal as needed. Once tuned the units are very stable.

The robust construction of the filter was designed to eliminate transmitter IMD products (such as the second harmonic of sound sub-carrier) as needed to prevent interference to other stations. The second harmonic of the sound carrier of a 439.25 videoseg falls at 448.25, a repeater input. IMD products are created in all amplifiers as a non-linear distortion. This is why an amplifier can restore the lower side-bands of a VSB filtered exciter. To avoid accidentally notching your main carrier, tune the filter using a receiver and low power signal, or tuned to the undesired transmitter signal. Then connect the filter to the transmitter output and make any fine adjustment necessary.

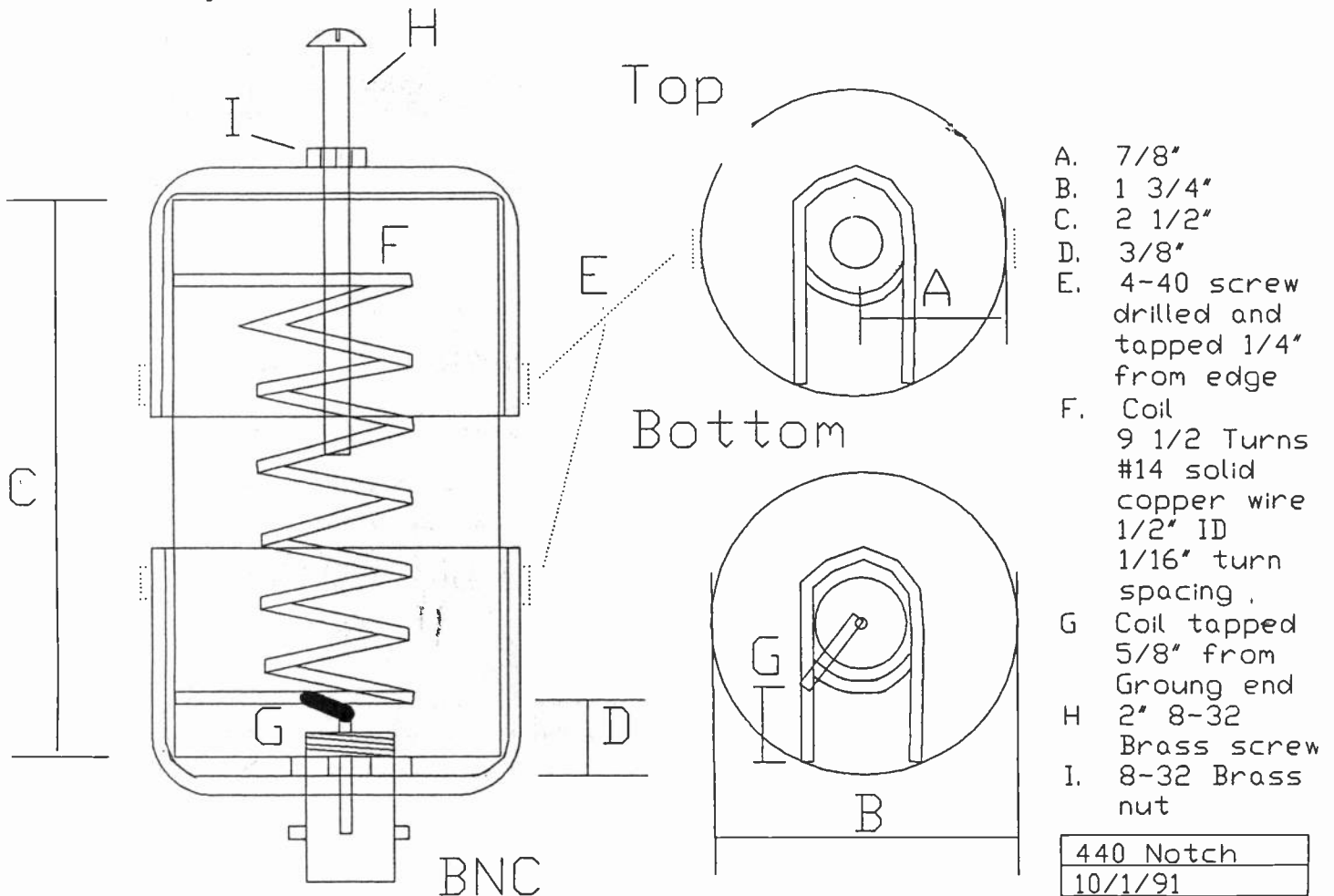

ATV-5 TRANSMITTER

TEN GREAT REASONS TO TRY OUR NEW 70 CM AMATEUR FSTV TRANSMITTER !!

- 5 WATT AVERAGE RF POWER
- .5-5W ADJUSTABLE RF OUTPUT !
- INCLUDES AUDIO INPUT
- FOUR SWITCHABLE CHANNELS
- DRIVES 50W M67728 BRICK
- ADJUSTABLE SYNC STRETCHING
- CLEAN VIDEO, 300V/USEC AMP
- EXTREMELY SMALL SIZE!
(3.5 X 4.0 INCHES)
- MAY BE PURCHASED WITHOUT
POWER MODULE

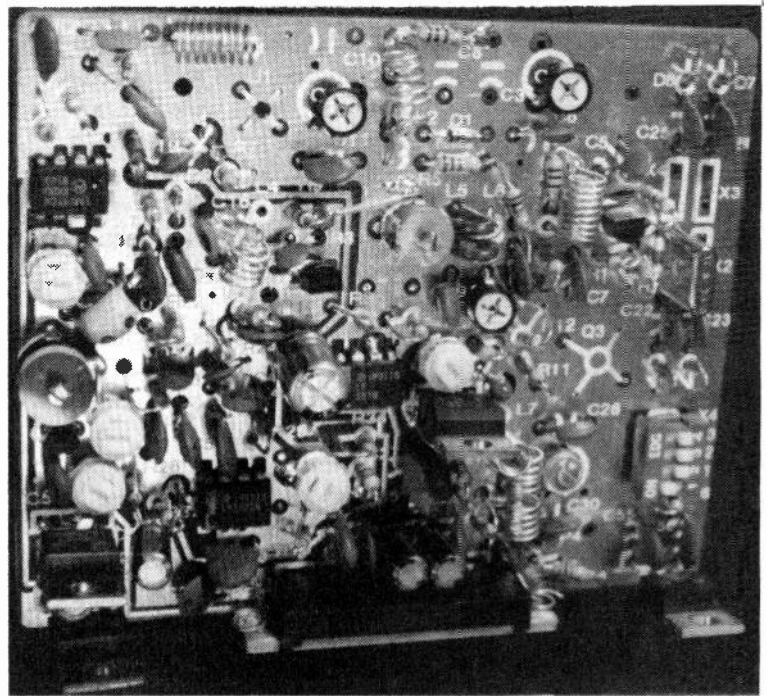

● HOLIDAY SPECIAL!!

NOW \$189.00

\$149.00 LESS 5 WATT MODULE

(CHECK OR MONEY-ORDER)

PHONE: (602) 843-3585

Calls accepted after 6pm M-F (local) Includes one xtal for 434 MHz. Additional frequencies for 426.25, 427.25, and 439.25 are \$15 ea. 421.25 available if a VSB filter is used for a repeater transmitter. Include \$5 for shipping and handling. AZ residents add 6.7% sales tax.

MODULE CAN BE PURCHASED AND SOLDERED IN LATER FOR 5 WATT AVERAGE OUTPUT POWER. POWER WITHOUT MODULE FROM DRIVER IS APPROXIMATELY 50 MILLIWATTS.

ATV ELECTRONICS
16807 N. 46LN
GLENDALE, AZ 85306

BROADBAND YOUR TUBE AMPLIFIER!

Henry KB9FO

Tired of low color and sound carriers from your narrow band tube amplifier. Ever wonder how commercial TV stations get nice flat response from Tetrodes, Klystrons, and other tubes? Want to get your 'RIW amp to perform? Read on...

Transistor amps are generally favored over tube amps for ATV operation lately for several reasons. One reason is the flat response or RF passband of the solid state amp. Tube amps generally have single tuned input and outputs as solid state amps do, but the higher impedances of tubes cause the amp to be rather narrow in RF passband. The typical K2RIW design 450 amp using a pair of 4CX250's has a passband of about 2 MHz at -3 db, and often sound is as low as -10 dB or more. Pre-emphasis and cathode vs grid modulation help but its just not a 8 MHz wide design.

The Henry 2004 amp I used was a little better, using a triode with lower internal capacitances than the 4CX250 tubes commonly used. But the power at only 800 watts PEP (usually 600 on video) and the rolloff was still present. True, locals had no problem seeing color or hearing sound, but the was probably more a function of raw power than good bandwidth!

Commercial amplifiers use multiple tuned circuits to achieve flat response. In the Klystron, the cavities are tuned at various frequencies across the 6 MHz wide signal to produce a flat output RF passband. Flat in TV is less than 1 dB dip. The more conventional tubes, tetrodes, Klystrodes (a tetrode/klystron hybrid) have tuned lines on the input and output to broaden response.

Think back to your old days of double tuned IF amps to get broad response for FM broadcast service or TV reception. If you look at some models of TV alignment generators you will see a double hump bandpass response! Well, dig them out of the junk pile its time to sweep your amplifiers!

The diagram below shows schematically a multiple tuned input or output circuit. You can add this to any amplifier. Construction considerations are that you need to be able to handle the power and current in your tuned lines appropriate for your amplifier. Copper pipe from a plumbing supply will do nicely. Make a section 1 wavelength long. Cut out access points starting at 1/4 wavelength from your amplifier end at 1/8 wavelength intervals. Each of the T sections is 5/8 wavelength long to give plenty of adjustment range.

The tuning is accomplished by moving a short between center conductor and outer conductor while observing the passband response. Here you need a spectrum analyzer and sweep generator such as the Science Workshop Poor Man's units. **DO NOT TRY AND ADJUST THE CIRCUITS WITH TRANSMIT POWER!** You want to use low power to make the adjustment, then lock the contacts in place before applying high power (more than 2 watts).

While working with Henry Radio to try and get them to make a good ATV amp, I contacted Eimac to see if they had ready made tuned lines. While not off the shelf items, Eimac did share the following diagrams so you can build your own tuned lines. Eimac suggests having the tuned circuit 1/2 wavelength from the plate line of the tube. Remember, impedances repeat at 1/2 wavelength intervals. Don't forget to allow for propagation/velocity factor on whatever coax cable you use.

When adjusting the tuned lines you will notice that each line

will have dominant control of one point in the RF spectrum. The tuning method is basically trial and error but you want to achieve a flat overall response. This means NOT tuning for maximum level at the tube and at the tuned line section, but adjusting them both to "bring up the middle and flatten out the ends. This is not a tune for max smoke situation. I have a 30 minute video tape of how this is done in a commercial TV transmitter. I can send you a copy if you send a blank VHS tape and return postage. The video was shot on HI-8 using commercial TV sweep equipment, but the effect and the procedure is the same.

It is also the case that the tuned lines are not in length order nor frequency order when tunes. Often in a multi line circuit the lengths vary by 2-3 inches and there is no physical order to which line is longest or shortest, ie they don't get shorter as you get farther away from the amplifier end of the line. The diagrams for the tuned cavity are courtesy Eimac corp.

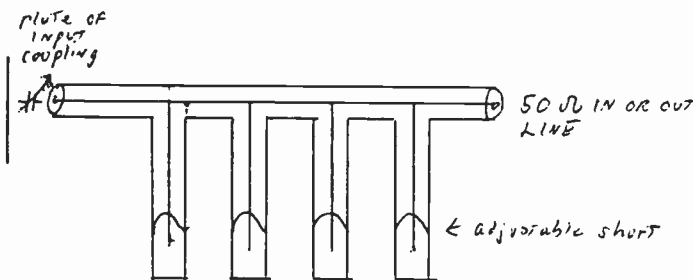
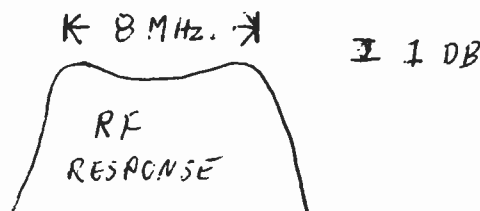

ITEM	DESCRIPTION OF MATERIAL	PART NUMBER	QTY
1	TOP PLATE	188566	1
2	CAP-INNER TUBE	188569	1
3	BODY, RESONATOR	188439	1
4	TUBING, CLAMP	188570	1
5	INNER TUBING	188567	1
6	BTM. PLATE	188571	1
7	TUNING DISK		1
8	NUT, BRASS, 1/4-20		1
9	FHMS, BRASS, 1/4-20 x 1 1/2 LG		1
10	CONNECTOR-ASSY	188404	1

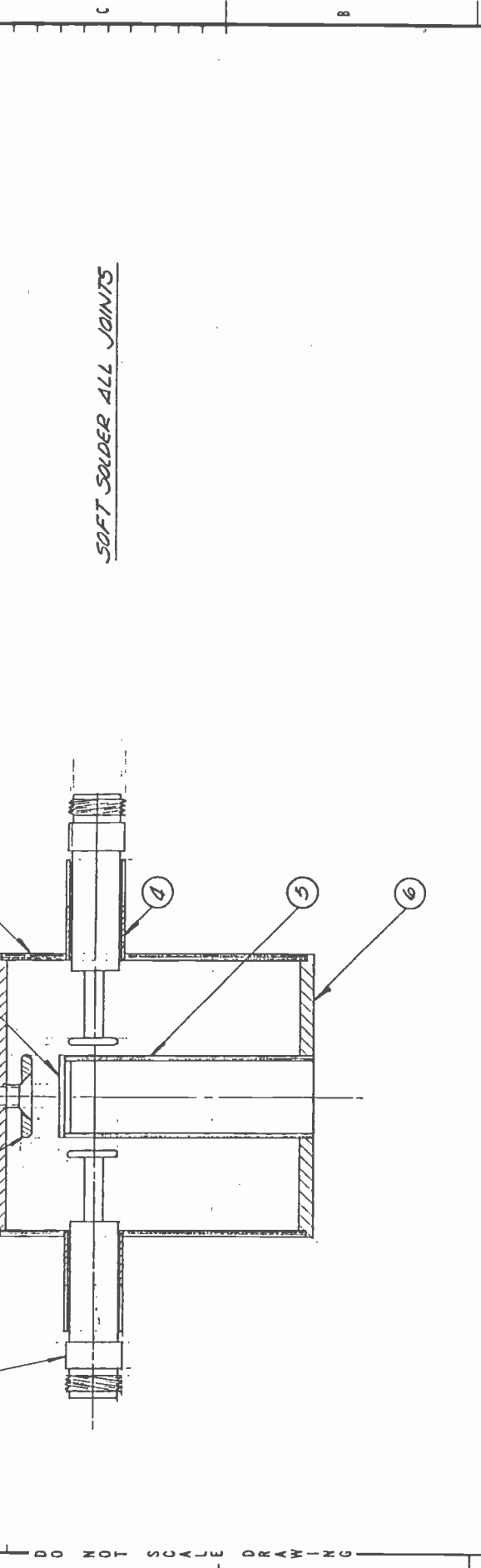

TYPE OR MODEL	NEXT ASSEMBLY	
1		
DESCRIPTION OF CHANGE	DATE	APPROVED
	12/1/86	BM
	DATE	APPROVED
NUM	RESONATOR-CAVITY	
ED	A30 MME	
DFT	NOT OTHERWISE SPEC: FRAC = ANG =	
CHK	SCALE FULL	
DATE	FIN. V DEC. X = .XX = .XXX =	
REV	EIMAC 5/1 - B X188565	
	DIVISION	SIZE
		DRAWING NO.
		REV

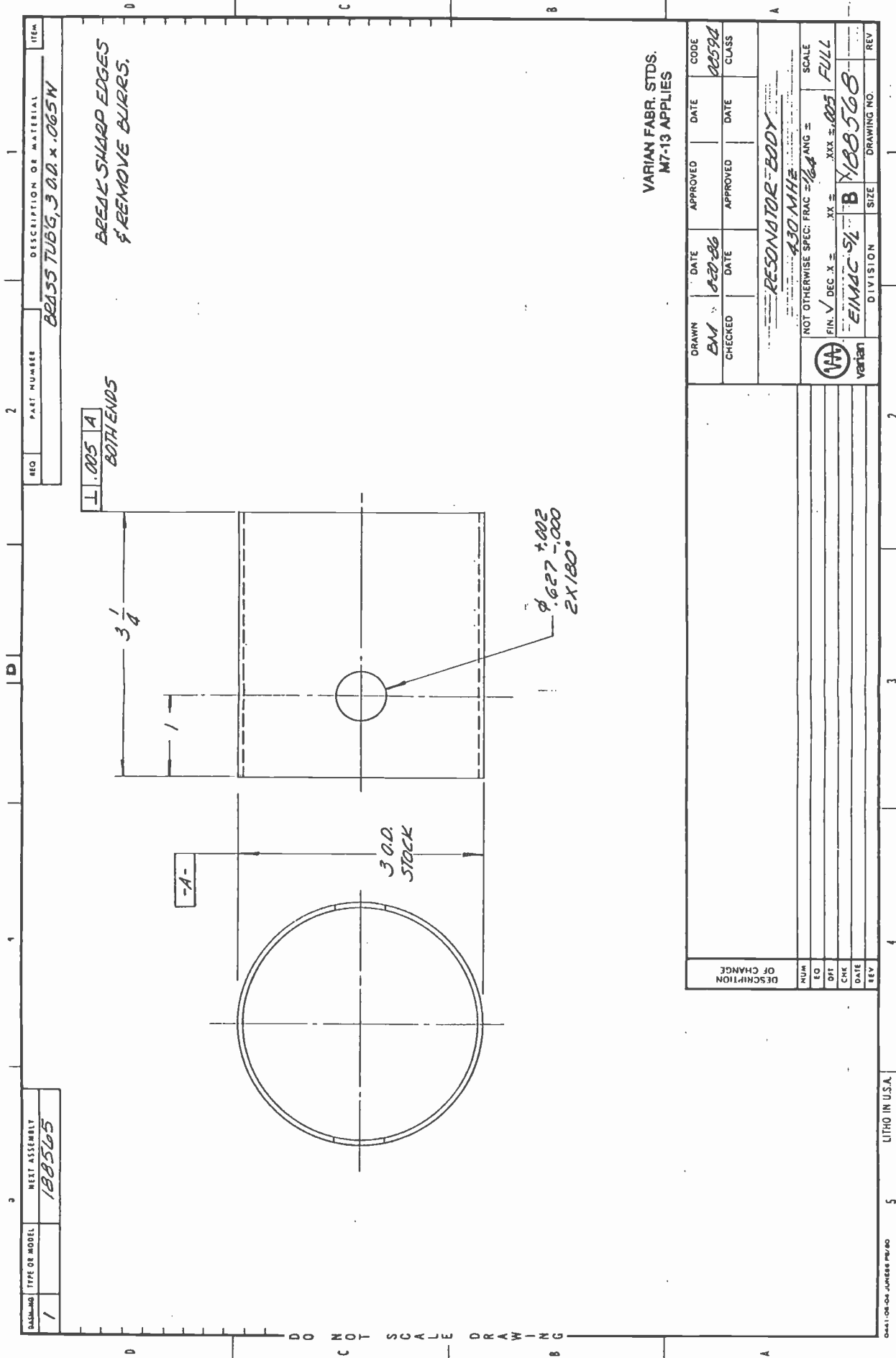

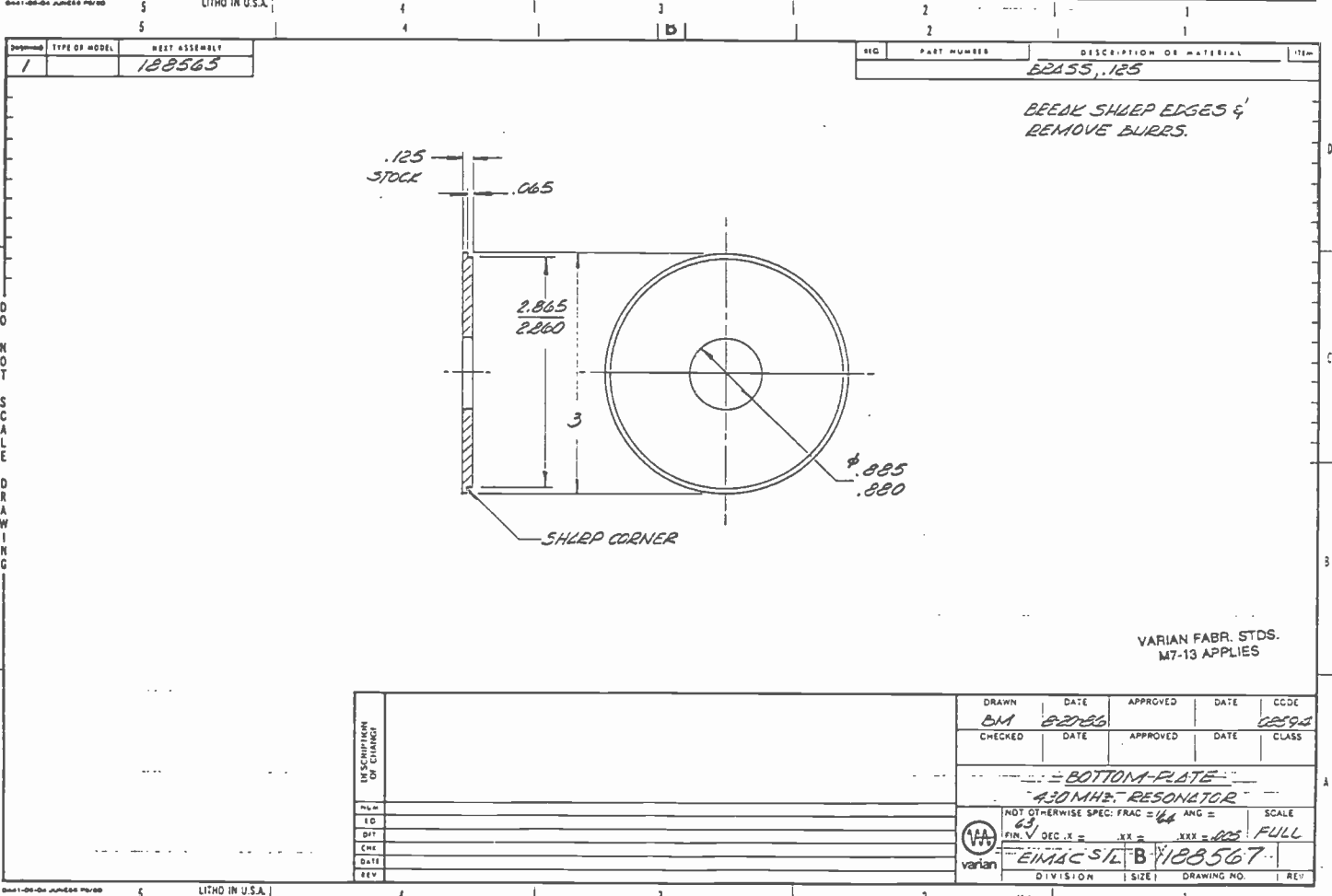
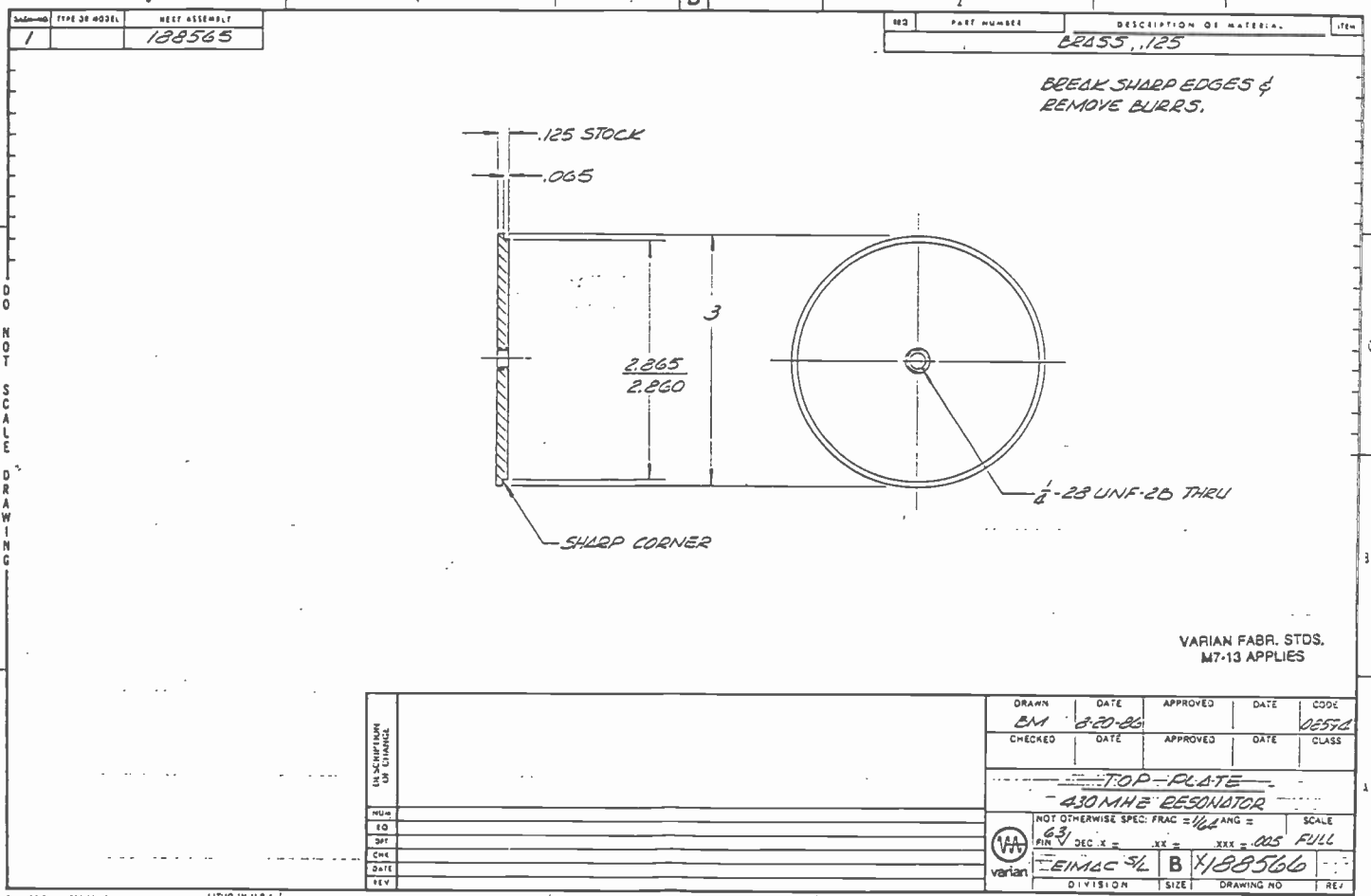

DRAWING	TYPE OR MODEL	NEXT ASSEMBLY	REQ	PART NUMBER	DESCRIPTION OR MATERIAL	ITEM
1		188565			BRASS TUB G, 7/8 OD x .063 W	
BREAK SHARP EDGES & REMOVE BURRS.						
VARIAN FABR. STDS. M7-13 APPLIES						
DRAWN EM		DATE 8-20-86	APPROVED	DATE 10-24	CODE 28594	
CHECKED		DATE	APPROVED	DATE	CLASS	
INNER TUBING 430 MHz RESONATOR						
NOT OTHERWISE SPEC. FRAC = 1/64 ANG =						
FIN. V DEC. # = .32 = .32 = .32 = FULL						
EIMAC 5/4 A X 188570						
DIVISION SIZE DRAWING NO. REV						

DRAWING	TYPE OR MODEL	NEXT ASSEMBLY	REQ	PART NUMBER	DESCRIPTION OR MATERIAL	ITEM
1		188563			BRASS, 1/8 THK	
BREAK SHARP EDGES & REMOVE BURRS.						
VARIAN FABR. STDS. M7-13 APPLIES						
DRAWN EM		DATE 8-20-86	APPROVED	DATE 10-24	CODE 28594	
CHECKED		DATE	APPROVED	DATE	CLASS	
TUNING DISK 430 MHz RESONATOR						
NOT OTHERWISE SPEC. FRAC = 1/64 ANG =						
FIN. V DEC. # = .32 = .32 = .32 = 2:1						
EIMAC 5/4 A X 188571						
DIVISION SIZE DRAWING NO. REV						

DRAWING	TYPE OR MODEL	NEXT ASSEMBLY	REQ	PART NUMBER	DESCRIPTION OR MATERIAL	ITEM
1		188565			BRASS, .125	
BREAK SHARP EDGES & REMOVE BURRS						
VARIAN FABR. STDS. M7-13 APPLIES						
DRAWN EM		DATE 8-20-86	APPROVED	DATE 10-24	CODE 28594	
CHECKED		DATE	APPROVED	DATE	CLASS	
CAP-INNER TUBE 430 MHz RESONATOR						
NOT OTHERWISE SPEC. FRAC = 1/64 ANG =						
FIN. V DEC. # = .32 = .32 = .32 = FULL						
EIMAC 5/4 A X 188569						
DIVISION SIZE DRAWING NO. REV						

APPLICATION				REVISIONS			
QTY	USED ON	NEXT ASSY	LTR	DESCRIPTION	ECO	DATE	BY/APPD
1	CV-8060	188060	A	ADD CV-8060, CV-8075	WP	4-27-88	VC
1	CV-8075	188075					

QTY	PART NUMBER	DESCRIPTION	CODE	IDENT	ITEM
1	188447	DISC, INPUT			4
1	188492	DISC, 100D			3
1	188035	TUBING, CONN.			2
1	188035	CONN. MOD.			1

LIST OF MATERIALS			
UNLESS OTHERWISE SPECIFIED DIMENSIONS ARE IN INCHES	CONTR NO.	DIV	EIMAC, Division of Varian
SPEC. 3/4, 1/2, 3/8, 1/4, 3/16, 1/8, 1/16, 1/32	DR EM	DA 1-2-86	
TOLERANCES: 1/16, 1/32, 1/64	CH Gm	8-2-85	
ANG ± 1°	APPD		
VARIAN FABR STDS M7-13 APPLIES	DESIGN ACTIVITY APPD	SIZE A	CODE IDENT 08594
	APPROVED	SCALE FULL	DWG NO. X188404
			SHEET 1 OF 1

CONNECTOR - ASSY (OUTPUT)			
NOTED			
SUPERSEDES 188052			

ANTENNAS by *Lindsay*

Amateur TV Repeaters, Verticals and Yagis Transmit & Receive Antennas

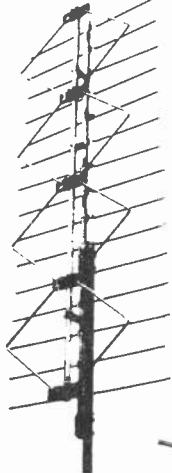

4ZZ-420



AC-144

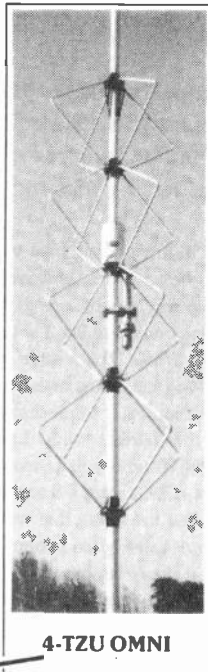

4-TZU OMNI

ATV-8 SLOT

LPTV & MMDS Transmit & Receive Antennas

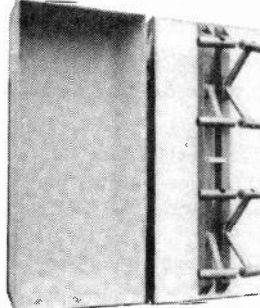

UP-1469

LS4
LS8
LS16
SLOT

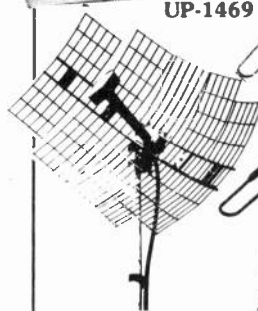

MDG-2717

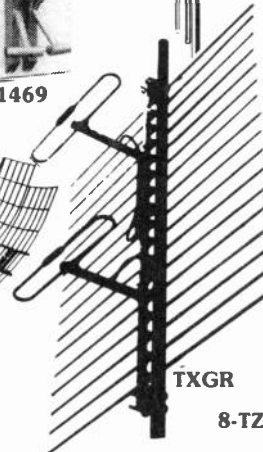

TXGR

8-TZU

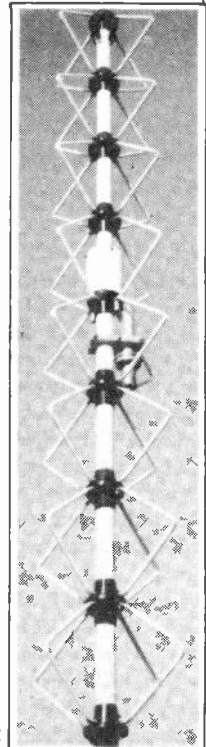

Cable TV & SMATV Headend Yagis, Log Periodics, Pre Amps and CLI Antennas

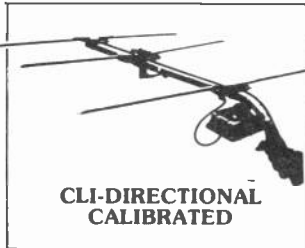

CLI-DIRECTIONAL CALIBRATED

ZIG-ZAG SERIES



'FREE' SITE SURVEYS UPON REQUEST ...

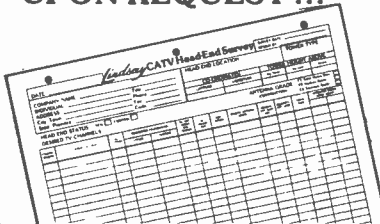

Commercial 2 Way Cellular Base Station and STL Antennas

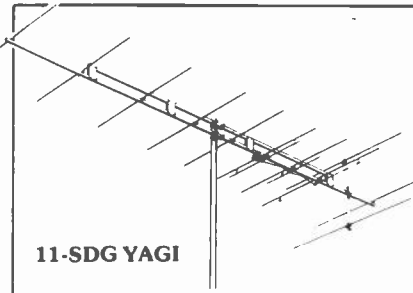

11-SDG YAGI

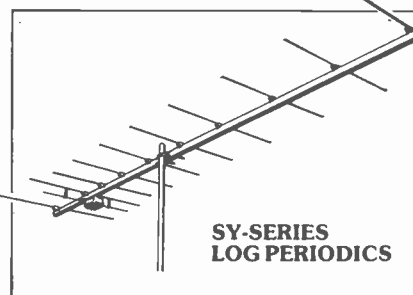

SY-SERIES LOG PERIODICS



CS-144

DEALERS AND DISTRIBUTORS WANTED WORLDWIDE

LINDSAY SPECIALTY PRODUCTS
50 Mary Street, Lindsay, Ontario, Canada K9V 4S7

Telephone:
(705) 324-2196

Fax:
705-324-5474

USING THE KENWOOD RZ-1 FOR ATV

Tim Craft, NØLGN

from KCATVG "Channel One"

During last summer's ATV contest, I found myself doing a lot of antenna turning so that I could look at the repeater and then look back out to the northeast for the Great Lakes DX. At that point I decided on setting up a dedicated repeater receiver. Not having unlimited financial resources, the ICOM R-9000 was not a viable choice! The ICOM R-7000 was priced right, but only had provisions for ATV at 1.2 Ghz with an optional adaptor. The next available rig was the Kenwood RZ-1 wideband receiver.

There was one on the shelf at Missouri Radio for \$499.95. I checked out all the data and figured I had not only solved my dedicated receiver problem, but I also had a unit which would function as a regular scanner covering 500 KHz. to 905 MHz. in AM, FM and wide FM.

The RZ-1 is a compact unit measuring 7" x 2" x 7", enabling easy mobile application and in-dash mounting on most vehicles. This could be an attractive feature to some who live in states that have a problem with public service frequency capable radios being installed in cars. The radio looks like a regular Kenwood car stereo to the "uninformed". The RZ-1 does provide left and right line out jacks on the back panel for stereo sound; however, you would, of course, need to input those signals to an audio amp or stereo controller. A jumper is supplied that must be installed inside the unit. Disable the interior speaker if the line out jacks are used.

Hooking up the radio is easy. Power requirement is 11 to 16 VDC and total draw is about one amp. There are two antenna connections. Port One accepts your standard vehicle antenna lead and Port Two is a SO-239. There is a three position switch which when set to "Auto" makes Port One active for 500-1630 KHz. AM and 87-108 MHz. FM, and Port Two active for the remainder of the bands. By placing the switch in either position One or Two, that antenna is then active for all frequencies. The VIDEO OUT jack is usable from 60-905 MHz.

The RZ-1 is easy to operate. Tuning is accomplished by turning the VFO knob, pressing the up/down keys, or by direct number key entry. Selectable tuning steps are 5 KHz., 12.5 KHz., 20 KHz. and 25 KHz. There are 100 memory channels to store your favorite stations. Each block of ten memory channels can store a band area to scan so that ten preset scanning areas are available at the push of a button. The scan function can be set to Seek, Carrier, Time or Audio.

For an antenna, I connected the RZ-1 to a Diamond Discone at about 25 feet. This provided good performance on most signals above 60 MHz. and even fairly decent video from the "Big Three"

EDITORIAL COMMENT: The substance of this article from the Kansas City ATV group is basically correct. However, Kenwood does not promote the RZ-1 for this purpose. Wayne Yoshida, Kenwood's national sales manager was informed of this article before publication and his reply comments are summarized. The spec sheet indicates the sensitivity as 5 microvolts and the bandwidth is quite wide. It is a consumer type radio not intended for amateur radio or professional use. Wayne suggests that before purchasing any unit that the spec sheet be read carefully to avoid disappointment by purchasing a unit not suitable for a specific application. Or call the manufacturer to get a second opinion as the salesperson may not have good information or is only interested in making a sale. The RZ-1 is used, for example, at Denver's Stapleton airport for monitoring services and serves well in this non DX situation. Also the authors comments about the ICOM R7000 are incorrect. I (Henry KB9FO) own the R7000 and TV adaptor. The TV adaptor takes the 10.7 MHz if output and provides a video demodulation of the signal. It operates at all frequencies tuned by the R7000, from 25 MHz. to 2 GHz. The information clearly states that the user tunes to the audio carrier (+4.5 MHz up from video in the US/Canada) to receive video. Actually I see weak video when tuned to the video carrier. As you approach the aural carrier my screen goes to blank white, then within a few 10's of KHz, the video is clearly visible, in color, with full sound. If you do not know the carrier frequency, you can use the center tune mode of the S meter to fine tune the signal. I find it useful to monitor the CATV signals which leak in P5 from 300 feet away (Thanks to bad cable equipment maintenance by TCI!) or viewing any local TV signals off-air. Even broadcast FM. Four IF bandwidths allow good reception of all modes of FM signals to be found. As a DX receiver, it has fair sensitivity, better than a

TV stations in town despite the vertical polarization. Some stations which were too weak to be seen did, however, supply clean audio. When reception of the local ATV repeater was attempted, synch bars were my only reward. When I checked this against my cable-ready TV using the same antenna, I was able to obtain a P-1 Black & White. Even after obtaining a KP-2/440 mast mounted pre-amp, there was little improvement through the RZ-1, but the TV jumped to P-3 black & white. This indicated to me that sensitivity was a term the engineer on the RZ-1 was not all that familiar with. Later, I was able to get a P-2 black & white on Dale, WAØNKE who was transmitting 7 watts into an AEA 16 element beam direct to my AEA antenna from less than a mile away!

Other modes and bands that were used seemed to do fairly well, especially in the short-wave areas when I connected it to my Cushcraft AP-8. Not having SSB in the RZ-1 makes it useless for a back-up Ham receiver, even though sensitivity in that area appears to be acceptable. Distant CB stations came in well with not much of a discernable difference to that of my TS-850S received signal. Public service and Amateur bands reception up to 174 MHz. seemed acceptable but all UHF bands were way below the signal being pulled in by my Icom 24AT handheld! Cellular Phone was detected on about seven or eight cell channels, so it appeared that the receiver came alive again at least from 850 MHz. and up.

Overall the RZ-1 appears to be an average scanner with good frequency coverage and sufficient sensitivity for short wave and local VHF bands up to 200 MHz. Kenwood needs to make the squelch active on AM, instead of just on FMn (FM narrow) to A/C scanning a bit more enjoyable. I did find the Message feature attractive, especially for someone who is not into radios all that much and can't relate to frequencies. With the Message feature you can program the memory channel to display the name of the station instead of the numbers, such as: TV-5, ATV-WX, or KCPD, etc.

If you are looking for a dedicated or secondary ATV receiver, save some money and buy a nice little cable-ready TV set. It will do a much better job!

regular TV set but not as good as ATV receivers with optimum design for RF at 420 Mhz. You can get good sensitivity and bandwidth but not also with wide frequency coverage for much less than \$10,000 since it requires narrow RF filters, tuned in tandem with the conversion stages to eliminate birdies, intermod and front end noise. There is no free lunch! The R7000 is a fine unit for its intended purposes, general VHF-UHF-SHF listening, signal monitoring and "scanning" hobbies. Likewise the RZ-7 is a fine radio for its intended use as a local receiver, signal monitor and VHF short range "scanner". Also the RZ-1 uses PLL circuits, thus the slow scanning rate of 1 channel/sec. If you want a "Scanner" radio Wayne suggests the Bearcat radios as good choices.

The purpose of publishing this is to make a point that even true statements need to be analyzed to be put in context. The RZ-7 is not a good choice for an ATV DX receiver. It was never designed as such. A lot of this type of information is passed around ham radio circles and in general is an unfair "rap" of the manufacturers, in this case Icom and Kenwood. ATVQ suggests that before you purchase equipment, or rely on published user notes or passed-on comments about equipment that the reader seek more information. There are publications which thrive on printing items out of context, or pick facts to make their own straw arguments seem "right" but when all the facts are known the "truth" is often the reverse of what was published or said. The manufacturers are more than happy to provide you with accurate information about a product (and are required to do so by law). As consumers we need to make good choices based upon facts and not opinions disguised as facts so we are not disappointed with our purchases. Kenwood, Icom, Yeasu, Alinco want you to be satisfied and are willing to say, don't buy this for that application because it was not designed to do that. 73 Henry.

GLADESVILLE ARC AND ATV ON AUSSAT

Wayne Griffin ZL1UJK

While in Sydney recently, I had the opportunity to visit Keith VK2ZZO in Gladesville on the North Shore. His QTH also houses the Gladesville Amateur Radio Club's ATV studio. This studio is used to produce and transmit material for WIA on the technical and educational aspects of Amateur Radio, plus material from ATVers and groups. It also had the distinction recently of broadcasting live to much of Australia via Aussat.

The studio is quite impressive to see in action. The Gladesville group broadcast live 1930 to 2300 hours four nights a week; Wednesday, Friday, Saturday and Sunday. The transmissions are on UHF about 579 MHz. (channel 35), with 30 W peak sync going to a collinear on the roof. The program material consists of presenters reading news and pre-prepared material on tape, all about Amateur Radio events and techniques.

The ATV signal can be readily received on the North Shore and the south and western parts of metropolitan Sydney. Being on CH35, there is also an audience among the general public, who often come across it when tuning their sets for other UHF TV stations. Keith told me that this was how an Aussat executive first heard of them. He contacted them, wanting to know more about the group and what they did.

Aussat were impressed by what they saw and offered the free use of a satellite transponder for three hours to the group to transmit wideband ATV around Australia, i.e., fast scan 625 line PAL color.

The first transmission was on November 14, 1990. The Aussat earth station is located in Belrose, also on the North Shore. Its uplink frequency is in the Ku band at 14.281 Ghz to Aussat-2, transponder 5. The downlink on 12.533 Ghz covers most of Australia, with a spot beam to Western Australia. Linking to Belrose from Gladesville required additional help; the ABC provided microwave equipment via TAFE (technical institutes).

The satellite downlinks in the state capitals were fed into the local ATV repeaters, which made it easy for most ATVers and non ATVers to view the transmission. Transmission was one way only, the Gladesville being the master control station.

The opening segment of the Aussat transmission featured an interview with Aussat's managing director Graham Gosewinckel being interviewed by presenter Doug Mackie VK2XGX, followed by a typical Gladesville educational presentation and prerecorded tapes from the various ATV groups around the country, made especially for the occasion. They received many reports from amateurs for this transmission; certainly an historic event for all involved.

Speaking to Keith more recently, he advised that Gladesville did another Aussat transmission on February 27, and are due for a third on July 24. Another one is planned for around September. Here is a report by Keith himself. He writes:

ATV Report on Aussat ATV transmission..

Well, how do you write a report when you are only now setting one's feet back to earth.

Aussat, oh yes! what a wondrous night that was. For myself, it started at 0730 hours and as I had planned the day very carefully, nothing could go wrong, or could it. Wednesday was left to finally time the tapes and write up the running sheets, simple. No so, I forgot to allow for phone calls.

After the first ten I stopped counting. Most were from ABC TC TAFE North Sydney and Aussat Belrose, all concerned with and about the test transmission. By 1500 hours the pressure was on and the running sheets not finished. The ABC link people arrived, Tom King (Media) and then some of the crew arrived, more of me was required to make decisions and the time flew by.

I eventually hid in another room to finish the running sheets before the transmission started but only two sheets of four were finished by then. Number three was finished after the start of the transmission and number four never happened.

The transmission from our end had no equipment failures as seen on Channel 35 +, however, there were problems with the system outside of our station which appeared to be commercial apparatus elsewhere and after 40 minutes into the transmission all was fixed. There were 130 signal reports by radio and phone and also some letters. These reports were taken in the garage where the food was, and a TV looking at 35 +.

If you are sick of everybody talking about Aussat test transmission, remember this, that nowhere in the world had any Amateur Radio club transmitted wide band television through their country's communications satellite.

I wish to thank the crew and all the helpers for making this a world first totally, beyond belief, success. Thank you all. Keith VK2ZZO.

Interested readers may wish to read the article in the March 1991 issue of Electronics Australia. I also have a video of the first Aussat transmission, if you are interested.



SPECTRUM INTERNATIONAL, INC.

Post Office Box 1084-T
 Concord, Massachusetts-01742
 508-263-2145

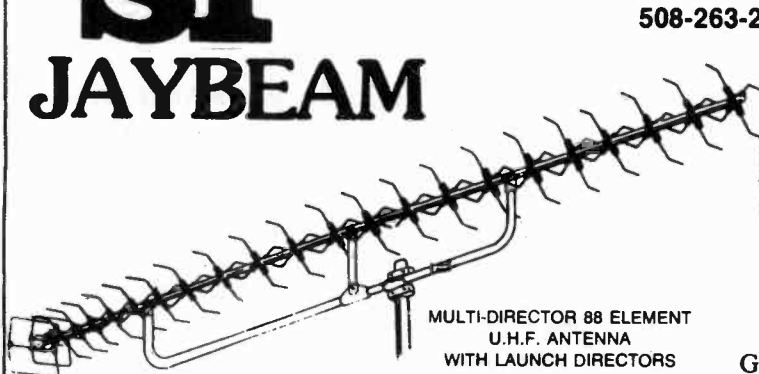
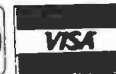

MULTI-DIRECTOR 88 ELEMENT
 U.H.F. ANTENNA
 WITH LAUNCH DIRECTORS
MBM88/70cm

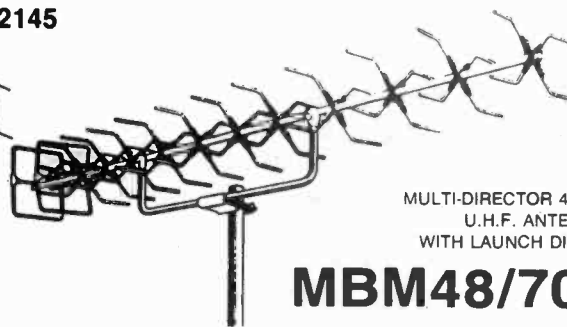

MULTI-DIRECTOR 48 ELEMENT
 U.H.F. ANTENNA
 WITH LAUNCH DIRECTORS
MBM48/70cm

General Specs:-
 Frequency Range
 Impedance
 (Built-in Balun)

420 MHz - 450 MHz
 50 Ohms

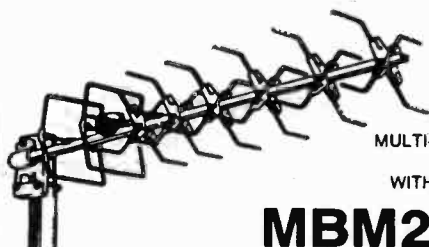

MULTI-DIRECTOR 28 ELEMENT
 U.H.F. ANTENNA
 WITH LAUNCH DIRECTORS
MBM28/70cm

	MBM28	MBM48	MBM88
Gain	11.5dBd	14.0dBd	18.5dBd
Beamwidth (E)	40 deg	28 deg	23 deg
(H)	45 deg	35 deg	28 deg
Boom Length	4 ft	6 ft	13 ft
	\$ 60.00	\$ 115.00	\$ 160.00

VHF/UHF BANDPASS FILTERS

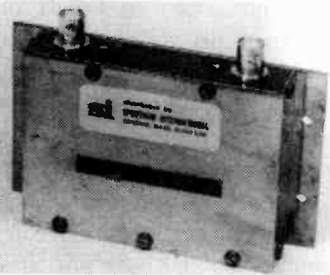

KNOCK OUT INTERFERING
 QRM OR SELF-DESENSE!

The PSf . . . series of Band Filters are for receiver pre-selector and transmitter use. The filters are 3 pole, 7% bandwidth, 0.1 dB ripple designs with 30 dB shape factor of 4:1.

The PSf . . . ATV series of TV Channel Filters are 5 pole, 6 MHz bandwidth designs. They are used to protect your TV receiver from inband QRM and to "strip-off" the unwanted sideband of your transmitted vestigial sideband signal.

BNC Standard
 TNC or Type 'N' optional
 (slightly higher prices)

Model	PSf144	PSf220	PSf432	PSf900	PSf1296	PSf1691
Freq (MHz)	140-150	216-228	420-450	890-940	1250-1340	1650-1750
Loss (typ)	0.1 dB	0.1 dB	0.15 dB	0.2 dB	0.25 dB	0.25 dB
	\$190.00	\$160.00	\$105.00	\$105.00	\$105.00	\$105.00

Model	PSf421-ATV	PSf426-ATV	PSf439-ATV	PSf910-ATV	PSf1253-ATV
Loss (typ)	2.0 dB	2.0 dB	2.0 dB	2.5 dB	3.0 dB
Std conns.	BNC	BNC	BNC	N	N
	\$155.00	\$155.00	\$155.00	\$180.00	\$180.00

All prices FOB Concord, Mass.

PRICES SUBJECT TO CHANGE WITHOUT PRIOR NOTICE

SPECTRUM INTERNATIONAL, INC.

Post Office Box 1084 Dept. T
 Concord, Massachusetts-01742
 508-263-2145 — Fax #263-7008



FRANKLIN, INDIANA HIGH SCHOOL SENDS UP ANOTHER ONE!

On October 12th, the students at Franklin High School sent another of their experiments aloft (dubbed Spectra II). This was an ambitious undertaking consisting of two WATEC color TV cameras (credit card size and expensive!), a 10m FM transmitter on 29.6 MHz (designed by John Lutz N9JL - who organized the Drifter 1 flight) and a 2m FM receiver.

The Wyman ATV transmitter was moved up in frequency to 440.265 MHz so that the FM on-carrier audio could easily be received by those with FM HTs and home stations that don't tune below 440. The idea was to use the 2m FM receiver and link it to the on-carrier sound as well as the 10m FM transmitter to make a cross-band voice repeater! Schools from all over the midwest were ready to hook up via the balloon repeater to communicate with other participating schools.

A Samsung AF-Slim 35mm film camera was attached to try to get some photographs as well. Several hundred spectators showed up at the launch site as the payload was readied and the balloon inflated. With the chase plane circling overhead, the moment of truth arrived and the balloon was ready for launch. The winds were approaching 20 knots and was sure to make for a rough takeoff.

Chuck WB9IHS ran with the wind while carrying the payload and balloon and gave it a big shove for what looked like a clean takeoff considering the adverse conditions. But an unfriendly high tension line decided to make a grab for the payload and succeeded in snagging everything! With the balloon and parachute flapping fiercely in the high wind, the package dangled just out of reach from the LIVE power line. Fortunately, the power company showed up to rescue the package. Just as the lineman was about to turn off power to the line, the antenna and the coax to the 10m

FM package shorted out the lines and blew out the breaker on the electric pole!

Unfortunately, the 10m FM transmitter and the 2m FM receiver were charred beyond repair and had to be removed. At least the ATV section seemed to still work. Since they had an undamaged balloon they decided to go fly the ATV and 10m CW transmitter. This time liftoff was flawless, but it shortly became evident that the video was out of focus and appeared as a whited out picture for distant stations.

Apparently the lenses had worked loose during all the abuse during the first liftoff attempt. Fortunately, the transmitters worked throughout the flight and the payload was quickly located by the chase crew and chase plane shortly after landing. It landed just north of the Ohio River high up in a tree. The landing site was way off the beaten path and required a lot of cross-country hiking through dense woods (and brambles) for the dedicated chase team to reach the payload (credit card size TV color cameras are definitely worth the effort!)

It was great fun to listen in on the HF net during the flight. Net control Steve Smith WA4VWV certainly kept us entertained with the great way he kept us informed. Lots of stations around the midwest checked in. Although the picture was whited out, good reception reports came in from several surrounding states.

Look for future efforts from the Franklin HS aerospace class. They definitely have an interesting variety of payload planned.

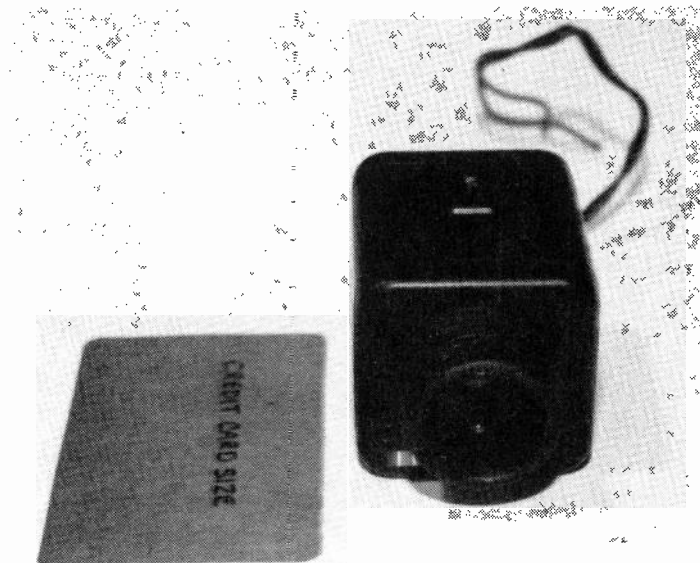

Photo A. The credit card sized WATEC color camera (1 of 2 used in the payload. For more information on this camera contact Bruce Dawson and Associates, 1752 Frankfort Ave., Louisville, KY 40206. Tel: (800) 633-0195.



Photo B. The balloon is abused by very strong winds just prior to takeoff.

FRANKLIN, INDIANA HIGH SCHOOL SENDS UP ANOTHER ONE!



Photo C. Snagged by the high tension lines!

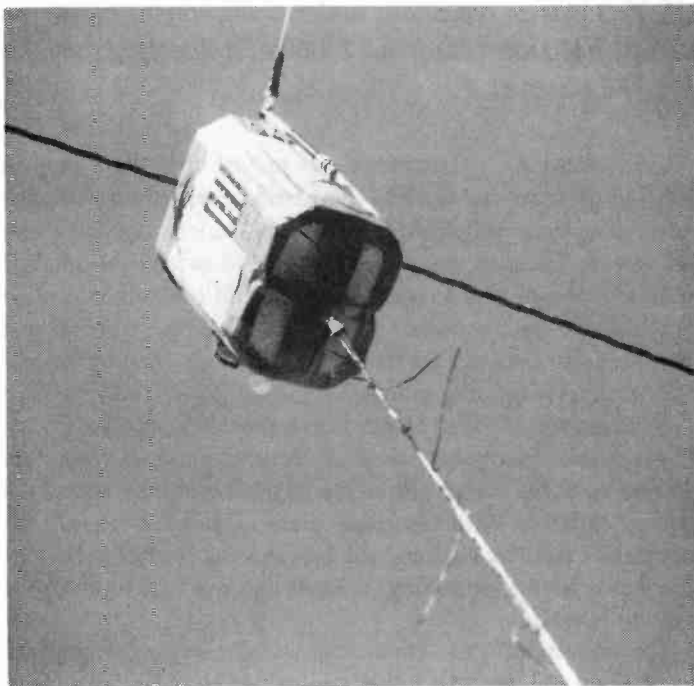

Photo D. Close up of the 10m FM transmitter and 2m FM receiver package just before it got charred.



Photo E. Spectacular view of the Indiana countryside taken with the on-board 35mm film camera.

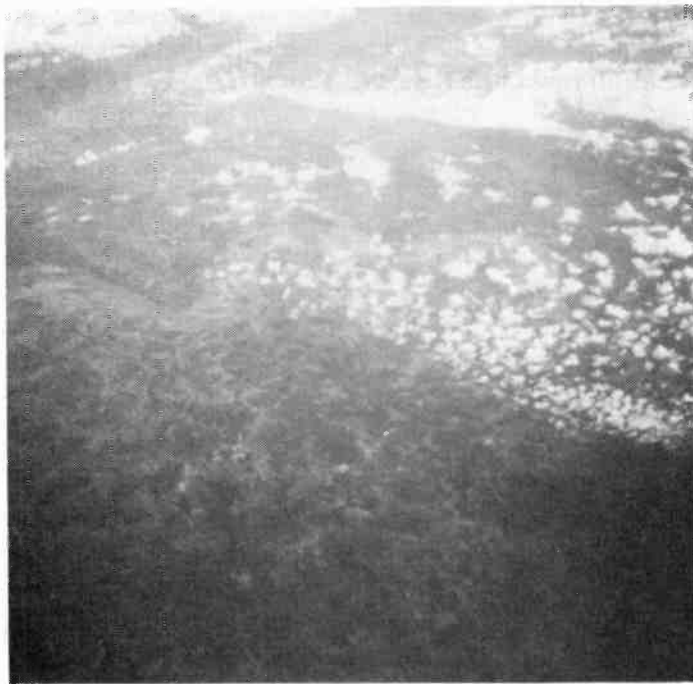

Photo F. High above the Ohio River (taken with the on-board 35mm camera)

NEW!

From
Micro
Computer
Concepts

**VS-100
ATV REPEATER
CONTROLLER
Remote Video Switcher**

- Repeat, Scan, and Manual Modes
- 10 Video and 4 Audio Inputs
- Touch Tone Controlled
- Video ID Input/ELK Board Support
- ATV and Audio Repeat Control
- Features for ATV Use
 - Space and Power for Ad-on's
 - 19" w x 1.75" h x 10" d Enclosure

VS-100 Wired & Tested w/Manual . . . \$ 399.95
 Manual \$ 9.95
 Phone Line Interface \$ 99.95



Micro Computer Concepts
 7869 Rustic Woods Drive • Dayton, OH 45424

513-233-9675

NEW!

From
Micro
Computer
Concepts

**VS-100
ATV REPEATER
CONTROLLER
Remote Video Switcher**

- Repeat, Scan, and Manual Modes
- 10 Video and 4 Audio Inputs
- Touch Tone Controlled
- Video ID Input/ELK Board Support
- ATV and Audio Repeat Control
- Features for ATV Use
 - Space and Power for Ad-on's
 - 19" w x 1.75" h x 10" d Enclosure

VS-100 Wired & Tested w/Manual . . . \$ 399.95
 Manual \$ 9.95
 Phone Line Interface \$ 99.95



Micro Computer Concepts
 7869 Rustic Woods Drive • Dayton, OH 45424

513-233-9675

UHF POWER

Products that
WORK !!

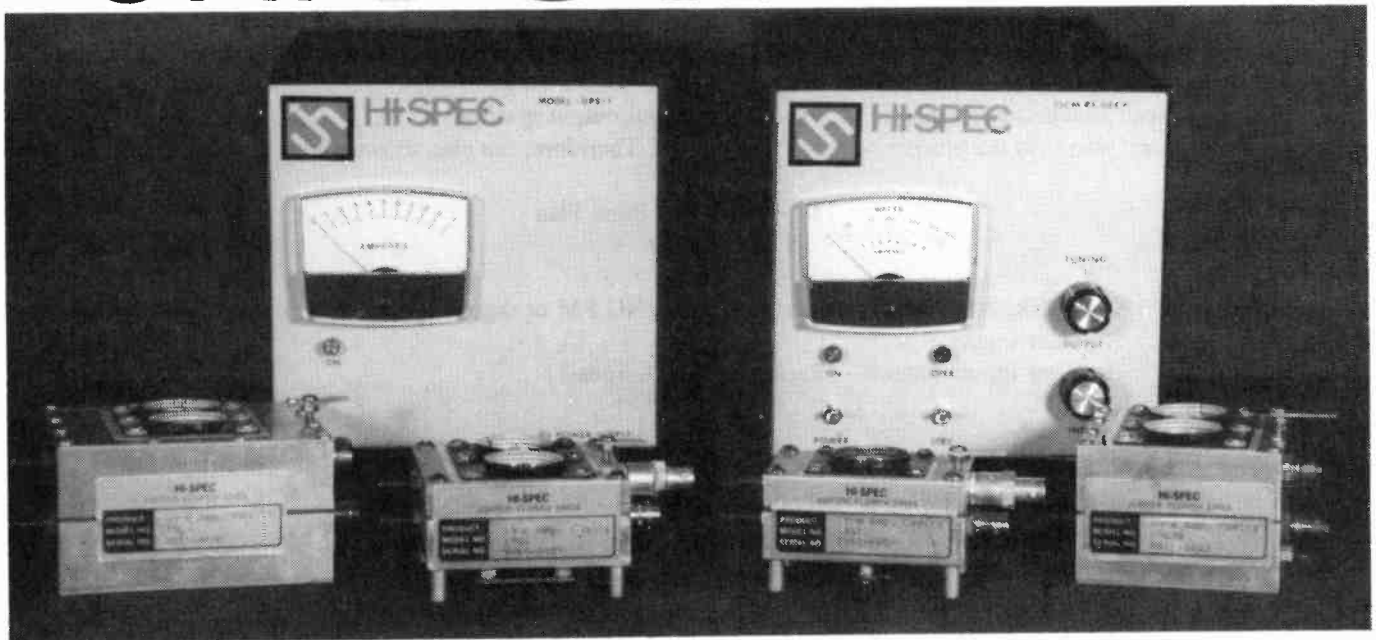

- >> 200 Watt Base or Repeater Amplifiers
- >> Interdigital Filters (VSB)
- >> Amplifier Cavities
- >> Custom Design Services

"Quality products since 1984"



Hi-SPEC

P.O. Box 387
 Jupiter, Florida 33468
 (407) 746-5031

TMARC BAND PLAN

T-MARC The Middle Atlantic F.M. and Repeater Council BAND PLANS

The following band utilization plans for the bands between 29 and 450 MHz. are recommended in the T-MARC area. These band plans are basically the same as the nationally recognized plans as recommended by the ARRL. T-MARC will be happy to discuss these plans with any interested party or group.

29.30 - 29.70 MHz. Band Plan

29.30 - 29.51	Amateur Radio OSCAR satellites (NO FM operation)
29.52 - 29.58	Repeater inputs
29.60	International simplex calling frequency
29.62 - 29.68	Repeater outputs

(20 KHz. spaced channels beginning at 29.52, 100 KHz. input/output spacing)

50 - 54 MHz. Band Plan

50.00 - 50.10	CW
50.00 - 50.60	CW, SSB, AM, Beacons
50.62 - 50.78	Digital
50.80 - 51.00	Radio-controlled models (NO voice or digital operation)
51.00 - 51.10	Pacific DX Window
51.62 - 51.78	Digital (can be paired with 50.62 - 50.78)
52.01 - 52.49	Repeater inputs
52.50 - 52.60	Simplex
52.525	National simplex calling frequency
52.61 - 52.99	Repeater inputs
53.01 - 53.99	Repeater outputs
53.0, .1, .2, .3, .4, .5, .6, .7, .8, .9	Radio controlled models
53.30	Used in emergency areas for RACES communications with military stations on matters requiring coordination (See Section 97.407(b)(3))

(20 KHz. spaced channels beginning at 52.01, 1 MHz. input/output spacing.)

NOTE: The 6-meter band plan is in the process of being reexamined. Therefore, the plan shown above may be revised in the future.

144 - 148 MHz. Band Plan

144.00 - 144.10	CW
144.00 - 144.50	CW, SSB, AM, Beacons, Satellites, etc. (NO FM or digital operation)
144.51 - 144.89	Repeater inputs
144.91 - 144.99	Repeater inputs/outputs - "Replexers" (NO digital)
145.01 - 145.09	Digital
145.11 - 145.49	Repeater outputs
145.50 - 145.70	Digital
145.80 - 146.00	Satellites (NO FM or digital operation)
146.01 - 146.40	Repeater inputs
146.415 - 146.595	Voice Simplex (NO digital operation)
146.52	National simplex calling frequency
146.61 - 147.39	Repeater outputs
147.405 - 147.60	Voice Simplex (NO digital operation)
147.615 - 147.99	Repeater inputs

(Below 146 MHz., 20 KHz. spaced channels beginning at 144.51. Above 146 MHz., 15 KHz. spaced channels beginning at 146.01. 600 KHz. input/output spacing.)

TMARC BAND PLAN

T-MARC The Middle Atlantic F.M. and Repeater Council
BAND PLANS

222 - 225 MHz. Band Plan

222.00 - 222.10	CW, SSB, Beacons, etc. (NO FM or digital operation)
222.10 - 223.38	Repeater inputs
223.40 - 223.48	Digital
223.50 - 223.58	Voice Simplex (NO digital operation)

420 - 450 MHz. Band Plan

420.0 - 425.0	Misc. repeater, control and link operations
425.0 - 431.0	ATV
430.0 - 431.0	Digital (100 KHz. wide-band channels centered at 430.05, 430.15, 430.25, 430.35, 430.45, 430.55, 430.65, 430.85, 430.95 [excludes 430.75])
431.025 - 431.10	Digital (Four 25 KHz. spaced channels)
432.0 - 433.0	CW, SSB, Beacons, etc. (NO FM or digital operation)
433.0 - 435.0	Repeater control and links
435.0 - 438.0	Satellites (NO FM or digital operation)
438.0 - 444.0	ATV
440.0 - 440.9	Repeater control and links
440.925 - 441.075	Digital (Seven 25 KHz. spaced channels)
441.1 - 441.975	Repeater control and links
442.0 - 444.975	Repeater inputs and outputs (Repeater inputs on ODD 25 KHz. channels, i.e., 442.025-in/447.025-out, 444.975-in/449.975-975-out; repeater outputs on EVEN 25 KHz. channels, i.e., 447.000-in/442.000-out, 449.100-in/444.100-out)
445.0 - 445.9	Repeater control and links
445.925 - 446.075	Voice simplex - Seven 25 KHz. channels (NO digital operation)
446.00	National voice simplex frequency
446.1 - 446.975	Repeater control and links
447.0 - 449.975	Repeater outputs and inputs (See 442.0 - 444.975)

(Channelized operations use 25 KHz. spaced channels, 5.0 MHz. input/output spacing)

T-MARC Corresponding Secretary
Gary Hendrickson, W3DTN

Editorial Comment:

ATVQ disagrees with the T-MARC bandplan in that it assigns the national ATV frequency 439.25 (438-444) to a number of other user groups including digital, repeaters, repeater control and repeater links. It would be much better to locate these non ATV uses to the sparsely used 900 MHz. band or 1280 MHz. band where they would not interfere with ATV simplex operation on 439.25 or ATV repeater input operation on the same frequency. If memory serves right, Gary was an FCC official who harrassed the Metrovision Group back in the 1970's and is continuing to harrass ATV operations in his position with T-MARC. It is suggested here that T-MARC recognize that ATV has as much right to operate as other modes and interference has always been from other modes to ATV. In congested areas many ATV operations have switched or are switching to lower sideband operation at 439.25 (434-440). This includes Indianapolis, Kansas City, Chicago, and other areas where deliberate QRM from digital and FM users has made uppersideband operation difficult to impossible.

WHEELS

(Little, Nano, Mini, Micro)

“AS USED AT THE
EDGE of SPACE”

- Omni Broadband Radiators
- Horizontal Polarization
- Very Lightweight (3 oz)
- Balloons, Kites, R/C & Rockets
- Available for 70cm, 33cm, 23cm & 13cm

Reports indicate “Wheels” have been used on virtually
EVERY successful ATV Balloon launch to date.

BE ONE OF THEM!

Assembled/ — \$29.95
Tested
KIT — \$24.95

Add \$3 for P & H — SPECIFY BAND
& CONNECTOR

Send postcard (QSL) for catalogue

Dave Clingerman W60AL
Olde Antenna Lab
4725 W. Quincy
DENVER, CO 80236
303-798-5926

Micro-Video Camera SMALL SIZE 2"x3"x1"

Feather Weight 4 oz.
NTSC Output 240 TV Lines
Low Light 2 Lux 7-15 VDC/<100ma.
Typical Applications: ATV, Robotics, Computer
Vision, Security, Remote Monitoring, Phone Vision

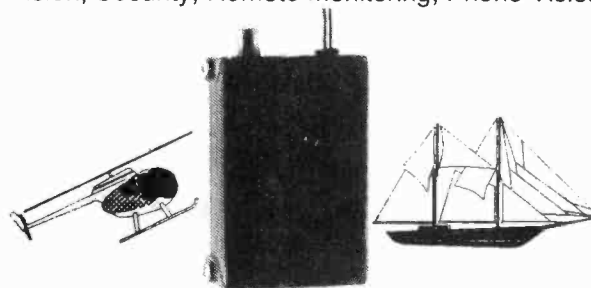

Factory New \$229.95

Add \$5.00 S/H Ca. add 6.75%

Micro Video Products

1334 So. Shawnee Dr. • Santa Ana, CA 92704
1-800-473-0538 (714) 957-9268

RUTLAND ARRAYS ANNOUNCES THE HIGHEST GAIN ATV ANTENNA YOU CAN BUY!

Model: **FO22-ATV**

MEASURED GAIN >15.8 dBd

Model: FO22-ATV

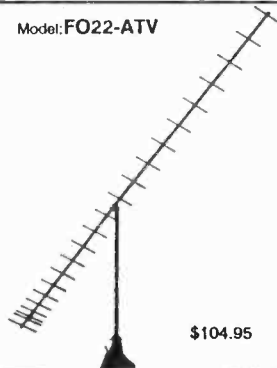

\$104.95

ELECTRICAL SPECIFICATIONS:
Gain bandwidth 420-450 MHz
VSWR < 1.33:1 415 to 450 MHz
E-Plane beamwidth 23 Deg.
H-Plane beamwidth 24 Deg.
1st E-Plane sidelobe -17.5 dB
1st H-Plane sidelobe -15.5 dB
Maximum power 1500 Watts
F/B ratio 22 dB
Impedance 50 ohm

MECHANICAL SPECIFICATIONS:
Length 14 Ft.
Boom 1" od 6061 T-6 AL
Mast up to 1.5" dia.
Wind surface area78 Sq.Ft.
Wind survival 90+ MPH
All Stainless Steel Element Hardware
Coax connector N-type
Polarization: Horizontal or Vertical

ALSO AVAILABLE

RA4-50, RA7-50, RA8-2UWB, FO12-144, FO12-147, FO15-144
FO16-222, FO22-432, FO22-ATV, FO25-432, FO33-432, FO11-440
POWER DIVIDERS ——— STACKING FRAMES

WE SUPPLY THOSE HARD TO FIND PARTS FOR THE HOME BUILDER
3/16" Delrin insulators \$18.95/100. 3/16" Stainless keepers \$15.50/100
Add \$5 UPS S/H for each antenna, \$7 west of the Mississippi
CALL OR WRITE FOR OUR NEW CATALOG

AVAILABLE FROM

WYMAN RESEARCH
WALDRON, IN
FREDRICK GORE KAITBS
SOUTHWICK, MA
STEWART ELECTRONICS
ST.CHARLES, MO

RUTLAND ARRAYS
1703 Warren St
New Cumberland Pa 17070
(717) 774-5298 7-10pm EST

PA residents add 6% state sales tax

DOWN EAST MICROWAVE

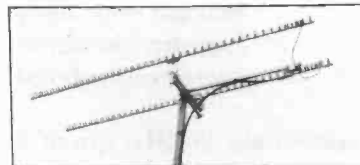

MICROWAVE ANTENNAS AND EQUIPMENT

• Loop Arrays • Power Dividers •
Complete Arrays • GaAs FET Preamps
• TROPO • EME • Weak Signal • OSCAR •
Microwave Transverters
902 1269 1296 1691 2304 3456 MHz

2345 LYK45el 1296 MHz 20dBi \$89

1345 LYK45el 2304 MHz 20dBi \$75

3333 LYK33el 902 MHz 18.5dBi \$89

Above antennas kits available assembled.

Add \$8 UPS s/h

Add \$11 UPS s/h West of the Mississippi.

MICROWAVE LINEAR AMPLIFIERS SSB, ATV, REPEATER, OSCAR

2316 PA 1w in 18w out 1240-1300 MHz \$265

2335 PA 10 in 35w out 1240-1300 MHz \$315

3318 PA 1w in 20w out 900-930 MHz \$265

3335 PA 10 in 40w out 900-930 MHz \$320

23LNA preamp 0.7dB N.F. 1296 MHz \$90

33LNA preamp 0.9dB N.F. 902 MHz \$90

NEW PRODUCT ANNOUNCEMENTS

New Loop Yagi

1845 LY Loop Yagi 1691 MHz 20dBi \$99

945 LY Loop Yagi 3456 MHz 20dBi \$89

Above antennas assembled and tested

New Preamps

13LNA 0.7dB N.F. 12 dB 2.3 GHz \$140

18LNA20 0.8dB N.F. 20 dB 1.69 GHz \$140

SLNA 1.0dB N.F. 10 dB 2-2.7 GHz \$150

New Wideband Power Amplifiers

2370 PA 3w in 70w out 1240-1300 MHz \$695

2340 PA 2w in 35w out 1240-1300 MHz \$355

2318 PAM 1w in 18w out 1240-1300 MHz \$205

Rack mount Amplifiers for repeater use available.

NO TUNE MICROWAVE LINEAR TRANSVERTERS

From SHF SYSTEMS a new line of transverters

designed by

Rick Campbell KK7B and Jim Davey WA8NLC

Available in kit form or assembled/tested

- 903 1269 1296 2304 3456 MHz
- microstrip filters eliminate tune-up
- 2m i-f, PIN diode switched
- sequencer standard in complete unit
- low profile packaging, mast mountable

All active equipment - 13.8V

DOWN EAST MICROWAVE
BILL OLSON, W3HQT
Box 2310, RR-1 Troy, ME 04987
(207) 948-3741

ATVQ DEVOTED ENTIRELY TO HAM TV

NEW FOR '92

Interest in the Poor Man's Spectrum Analyzer has prompted many users to want to exchange ideas about modifications, packaging and applications. I've been accumulating this kind of information over the years, through the mail and at hamfests around the country. It has been suggested that I ought to compile all this data, put it into a book, so that others who might be interested could benefit from this kind of information. It could serve as a "clearing house" of ideas... where you could learn what others have accomplished, and could provide the opportunity for you to personally contact the individuals who developed the modifications

Book Price \$24.95

BUILD YOUR OWN SPECTRUM ANALYZER

FROM SCIENCE WORKSHOP, HOME OF THE "POOR MAN'S" SPECTRUM ANALYZER

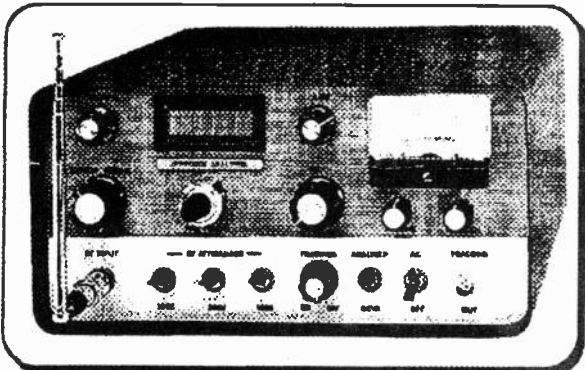

Murray (WA2PZO) & Bruce (WA2DRO) Barlowe

Magazine article reprints.	User's modifications.
Theory of operation.	Additional options.
Layout drawings & photos.	Latest documentation.

BEHAR USER FEEDBACK 1

CRYSTALS AS FILTERS

John Behar, WB0CMC

In this paper I will discuss the application and effect of your radio crystal resonators (CR) and resonating impedances (RI) as a component in the low band with filter used in the "Poor Man's Spectrum Analyzer" incorporated in the units built by Science Workshop Inc. (SWI).

In order to make a spectrum analyzer truly sensitive to signals as to their purity, resonance characteristics and general characteristics it and stated that signals are must have a variety of adjustable band width. One must be aware to observe dynamic impedance to the extent described by typical and its equations. These equations set as the resulting power of the magnitude of two separate elements or filter for a given filter bandwidth.

The response curve of the filter is one of interest, since this will be the display produced by observing a single unmodulated signal in this respect the two 270 Hz quartz filters supplied with the SWI are ideal for that band width. They have identical, a gaussian curve with two edges in that same band. They have also in its operation, resonance, critical quartz filter. Any signal 2 Hz or crystal has what is called a clear pass. It expresses the type of the primary response to resonance at other, non-resonance frequencies.

The circuit in Fig 1 is a basic crystal resonator filter.

Fig 2 and 3 show two different crystals set to the same frequency, 16.7 MHz, but with considerably different Q or characteristics. Performance is 2000:1. Various is. Calibration. It is clear from this that with the

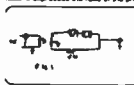
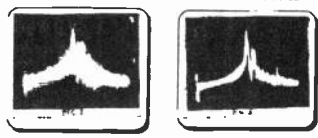
described in the book. Well, I've decided to do just that! The book includes reprints of articles from Ham Radio Magazine and Communications Quarterly, interfacing to PC's, a discussion of sidebands, plus dozens of ways users have improved performance!

The first of what I hope will be a series of books, is at the printers now, and should be available for shipment by the time you see this announcement.

If you have come up with modifications or new applications and would like to share them, send them to me ASAP! If we use it, we will send you a complimentary copy of Volume 2.

TO ORDER, SEND \$24.95 + \$2.50 S/H TO:

**SCIENCE WORKSHOP
BOX 310
BETHPAGE, NY 11714**

ATV

Made in
Germany

4
Issues per
Year
delivered
on
Time!

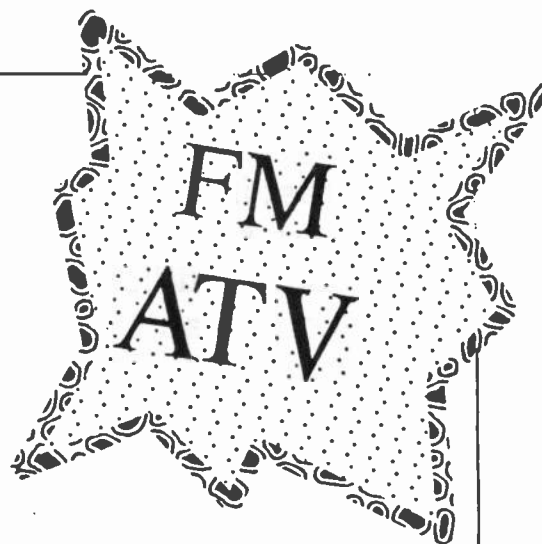
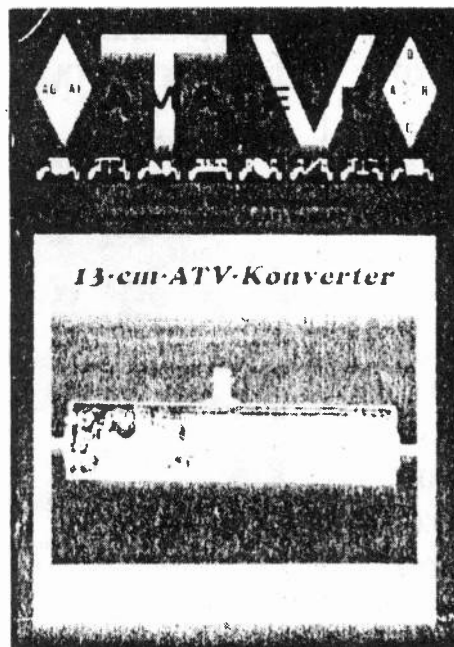

32
Pages
per
Issues

TV-Amateur

Official Publication of

AGAF

(Amateur-Television-Group)

AGAF

Postbox 4039

D-W-5840 Schwerte 4

Fax 0049-2304-72948

AMATEUR TELEVISION QUARTERLY

1545 Lee St. # 73
Des Plaines, IL 60018
708 298 2269
FAX 708 803 8994

1-14-92

Before the
FEDERAL COMMUNICATIONS COMMISSION
WASHINGTON, D.C. 20554

In the Matter of:)
Proposal to modify section 97.113)
"Prohibited transmissions")

The Commission is currently considering modification of the rules to allow for specific types of Communications now prohibited by statement or drawn inference and interpretation of the Rules for the Amateur Service. Amateur Television Quarterly Magazine via its publisher, Henry B. Ruh KB9FO, representing an estimated 9,000 amateur radio operators engaged in ham television activity, hereby submits for consideration its comments which are pertinent to an area of this topic specifically of interest to Amateur Television (A5) operators, Amateur Television Repeater operators and other hams involved in emergency and public service operations.

As Commission Staff members are aware, from conversations with myself, Henry B. Ruh KB9FO and through news in our publications, there is a growing segment of ham radio operators which engage in ham television operation on the 420 MHz. and up frequencies. Many of these hams operate public service communications for life safety purposes for various public and private sector events such as parades, walk-a-thons, various sports races, and similar gatherings. In addition, many individual and repeater operators have provided weather information including the visual transmission of rainfall and wind data as commonly displayed on doppler type radar systems operated by the United States Weather Bureau, NOAA, private radar station operators and ham owned radar stations. In addition there have been a number of stations which relay the permitted NASA Select video feeds of shuttle missions to other hams which are engaged in educational and private interest of sciences.

The Commission's Rules have never specifically referred to the use of ham radio as support for these various activities regardless of whether CW, SSB, FM, FAX, RTTY or ATV modes are used with the exception of the specific authorization for NASA Select.

There is no question that the Amateur service provides valuable public safety communications without compensation for these services listed above. It is our position that this should remain so. However, there have been a number of instances where it is not clearly determinable because of specific circumstances if these activities constitute "Business" communications as might be interpreted by different factions.

The interest of the Amateur community to continue to provide these life safety communications is without a doubt well intentioned and a benefit to Society and ham radio as practical applications of technical skills, training for serious disaster communications.

On behalf of those interested in continuing these activities we hereby request that the Commission consider including in its Permitted communications for Amateur stations, these types of communications in all modes. I stress all modes since there has been widespread use of, as example, the relaying of NOAA, NWS teletype information under all circumstances, yet there is a question about relaying the NWS/NOAA and other source weather Radar PPI display video via amateur radio. As was clearly demonstrated when NASA tried to explain in words to orbiting astronauts how to make a "fly swatter" from a clip board to turn on a satellite launched into orbit, a picture is worth a thousand words. Descriptions of a PPI display via words can be confusing, long and inefficient, whereas a simple video display of a map with the weather information on it is instantly interpreted by any trained observer or person familiar with map readings and color scales. There are already thousands of hams who receive satellite FAX weather maps via analog and digital signals. The direct reception of the video signal from a similar data source should not be eliminated nor questioned as a data source rather than as a "re-transmission" of a signal any more so than connecting a video output from a computer is a "re-transmission" of the data that was received from other than the computer keyboard! The radar pulses are not being retransmitted, nor are the microwave linked data carriers from a phone line.

Likewise, there are materials available from NASA via satellite and even from the FCC library of films which are of interest to hams. Currently, these cannot be transmitted although in many instances they are and have, even in the presence of FCC officials (*1) who made no objection or mention of the content. Likewise, there is incidental music on the NASA programs or possibly even from a passing band, hand carried radio or cassette player in any public event. The "background" or incidental audio (music in this example) is prohibited and some would interpret the rules to mean that an amateur station must quit transmitting while in the presence of these sounds, even though they have nothing to do with the voice or video transmission in progress. Imagine if you will, trying to relay a life safety message while hovering over a person injured in some way and having to end the transmission because someone nearby happens to have a radio playing music! Absurd to be sure. If the word "Broadcasting" of music is interpreted as meaning, "to play, live or recorded music, for the public enjoyment and entertainment as part of an entertainment program intended to be received by non amateur stations then there is not a problem with the transmission of music as incidental to the communications of the Amateur station. This would be a better regulation than a prohibition on music in total as now read in the rules.

Therefore, it is requested that the Commission consider its definition of "Broadcasting" as applied to the Amateur service as being different than that as defined for public broadcast services, ie AM, FM, TV Broadcast/cable services (Part 73 license holders). This would permit amateur stations to transmit communications while in the presence of incidental material that is within "mic" range of the amateur station.

There is yet another area where the Music prohibition discourages amateur radio usage by a population segment, those in the music industry. A musician cannot, for example, use Amateur radio to communicate to another amateur radio station to explain and demonstrate how a new sound was generated by a MIDI device, synthesizer or natural musical instrument. Certainly, we are not interested in listening to full concerts or recitals, but a note or two would allow such exchanges. This same communication does not seem to be prohibited in any other service, ie common carrier, or other commercial, for-hire communications systems!

It would seem that the music prohibition should stem from an infringement on commercial/public broadcasting and copyright, not as a form of communication. I will let the Commission staff think out how this can be accommodated! It is surely a circumstance specific question!

SUMMARY

It is requested that public service, life safety communications, including the relay of information from any source not protected by copyright, specifically, weather, life safety and related information be permitted in any mode, or simplex or repeater operation, including "retransmission" of any NASA Select, NOAA, NWS data, information and program sources and Amateur Station generated communications be permitted as a not-for-hire communication service for all Amateur stations. These communications to be permitted for the purpose of communications between any amateur station and any other amateur station, for personal communications and permitted as support of public safety efforts associated with any non-profit organization, club or Corporation.

Further, any permitted communications should be understood as including any transmission form, both current and yet to be developed.

Footnotes:

*1 For example, the FCC film which details the FOB efforts to find transmitters during WWII has been transmitted in the presence of the FCC in Washington DC, though there is incidental music to the movie soundtrack.

Yours truly,



Henry B. Ruh KB9FO
Publisher, ATVQ

2304 MHz POWER AMPLIFIER USING 7289 OR SIMILAR TUBE

by Barry Malowanchuk, VE4MA

INTRODUCTION

This amplifier was created to fill an existing void in power amplifier designs available for 2304 MHz. Previous designs by WA9HUV, OE9PMJ and OZ9CR have required extensive machine work or used exotic tubes. This design uses readily available materials in critical areas and can be built with simple hand tools. The design was developed using the principles presented by Buzz Miklos, WA4GPM, in his paper "Coaxial Cavity Amplifiers" presented at the 1985 Central States VHF Conference.

OUTPUT CIRCUIT

The amplifier will operate using any of the 2C39 or 7289 like tubes. The input and output circuits will accommodate the range of internal capacitances. The output circuit is a loaded $3/4$ wavelength resonator, while the input coaxial line is a $5/4$ wavelength resonator. The input and output cavities use modified UG58A/U chassis mount "N" connectors as a capacitive coupling probe. The plate tuning capacitor is a large diameter $5/16$ " brass "toilet flange" bolt with approximately 18 threads per inch. The plate tuning will be very sharp and a bolt with finer threads is recommended. I have used a $3/8$ " - 24 T.P.I. unit and found it very satisfactory. An option would be to make the anode cavity approximately $3/16$ " longer (overall cathode line length is unchanged but more of it will have to be inside the anode cavity) which will require less tuning capacitance. The change in capacitance for a change in length will be smaller nearer the outside wall.

INPUT CIRCUIT

The cathode cavity is tuned with a sliding RF short. This short uses conventional finger stock in contact with the inside of the $3/4$ inch copper water pipe as the sliding coaxial quarterwave stub moves along the $7/16$ " OD cathode line. The bottom two inches of the cathode line is covered with a thin plastic sheet material. I used Teflon,

but mylar tape (transparent "Magic" tape or the brown packing tape) should work well. The $3/4$ inch long piece of $1/2$ " OD hobby brass tubing in the RF short slides along on the tape. It should be smooth inside to prevent damage to the tape. Two short $1/16$ " brass rods extend out the bottom of the cavity to allow adjustment.

The input coupling probe, like the output probe, is a UG58A/U "N" type coaxial connector with the mounting flange removed. A #8-32 brass nut is soldered to the end of the center conductor and for the input probe only a thin piece of Teflon or mylar tape covers the end of the probe to prevent shorting out the input, when pushed all the way in. The probe will optimize within $1/16$ " of the center conductor. The copper input and output mounting sleeves were cut from a straight splice fitting for $1/2$ " copper water pipe. These were slotted and accept a small hose clamp to secure the coupling probes.

The cathode line assembly in my case was a surplus unit. The $7/16$ " outside dimension is important and should be adhered to, although $\pm 1/16$ " may work out all right if you adjust the dimensions of the $3/4$ " long piece in the RF short accordingly. The cathode line must be mechanically secured at the bottom without shorting out the cathode or filament voltage. This was achieved by securing the bottom of the cathode line to an $11/16$ " wide piece of epoxy board (no copper). A $7/16$ " hole was drilled in the center of the 2" long board to let the cathode line pass through. Two short pieces of approximately $7/16$ " ID tubing or two flat washers are soldered to the cathode line on opposite sides of the board to hold it in place. The epoxy board is secured to the outside of the $3/4$ " cathode line with two right angle brackets and a hose clamp. The push rods attached to the cathode tunable short, straddle the epoxy board as they emerge.

TUNEUP AND RESULTS

The amplifier tunes very easily and smoothly. The amplifier should tune with the probes, etc. in the positions shown in Figure 1. Adjust the idling current for 50 mA and apply a few watts of cathode drive. Adjust the cathode short and the

input probe for maximum plate current. With a suitable RF indicator, adjust the plate tuning for maximum output. It will be a very sharp peak. Then alternately adjust the output probe and tuning for maximum power. With good tubes, I have seen greater than 50W output at efficiencies near 25%.

One final comment is required concerning cooling. No attempt has been made to use air cooling. My experience on 23 cm with these types of tubes is that water cooling is the only way to eliminate thermal drift of the output power. The two versions of this amplifier I have built have no significant drift with the 7289 type tubes. A slight amount appeared with a 7211 tube but this was not enough to be of concern.

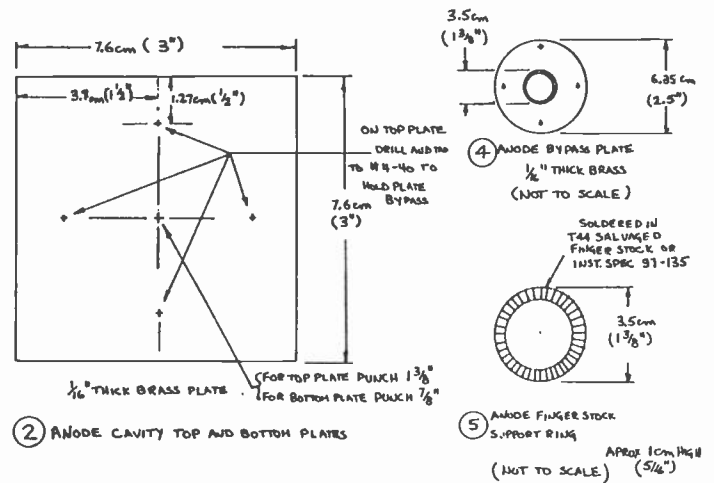
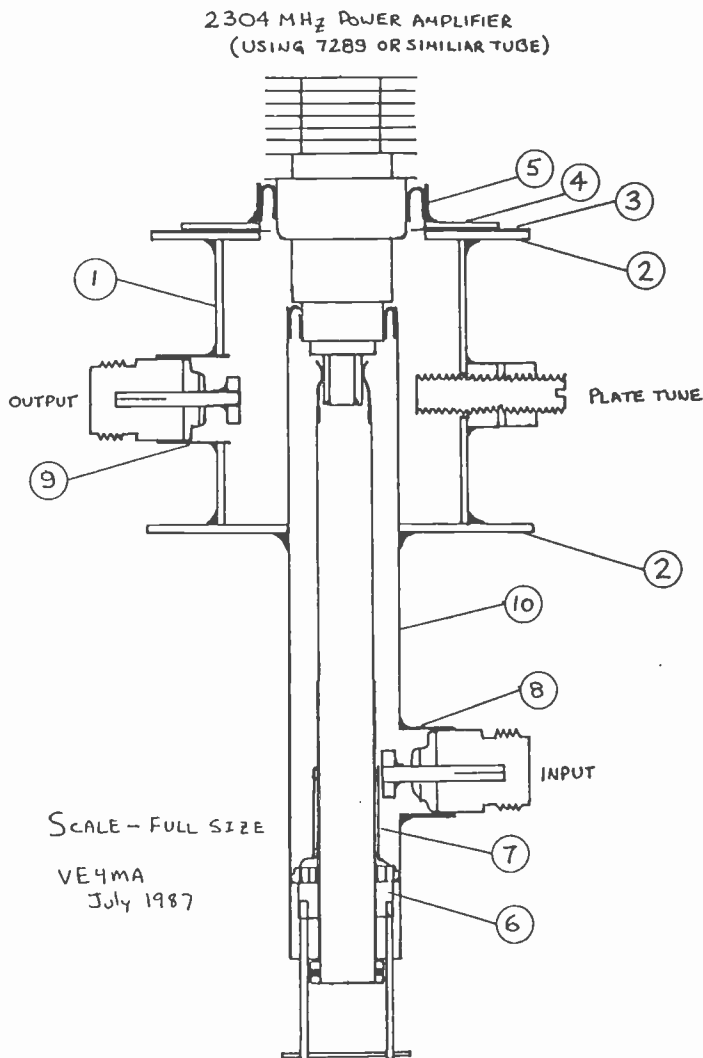
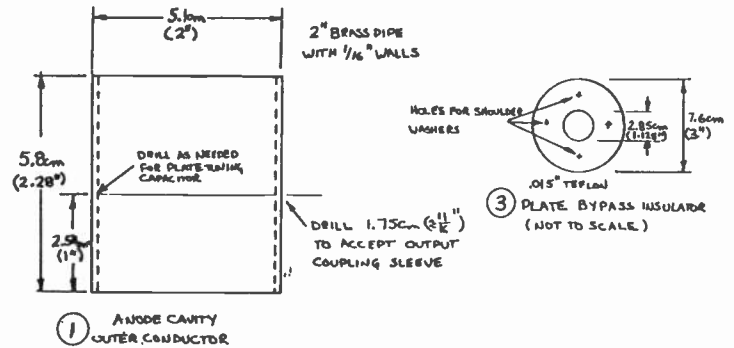

VE4MA
JULY 1987

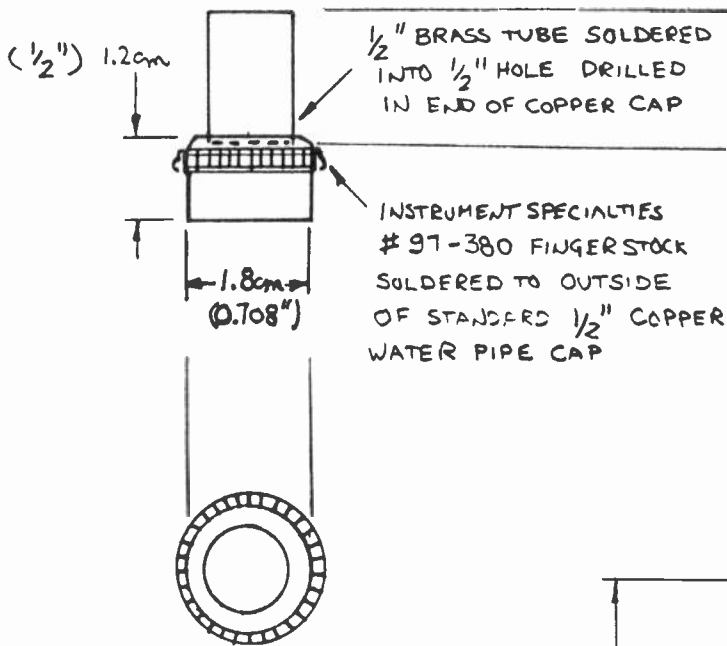

⑥ TUNABLE CATHODE SHORT

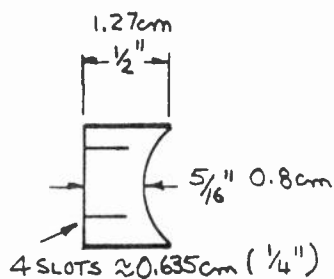

⑧ INPUT PROBE MOUNTING SLEEVE

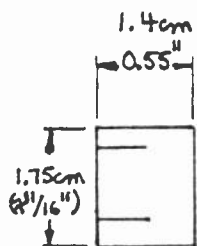

⑨ OUTPUT PROBE MOUNTING SLEEVE

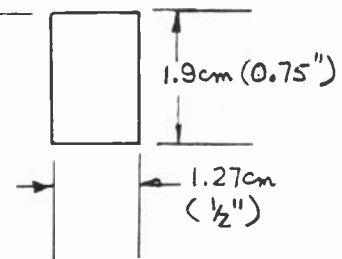

⑦ SLIDING QUARTERWAVE STUB

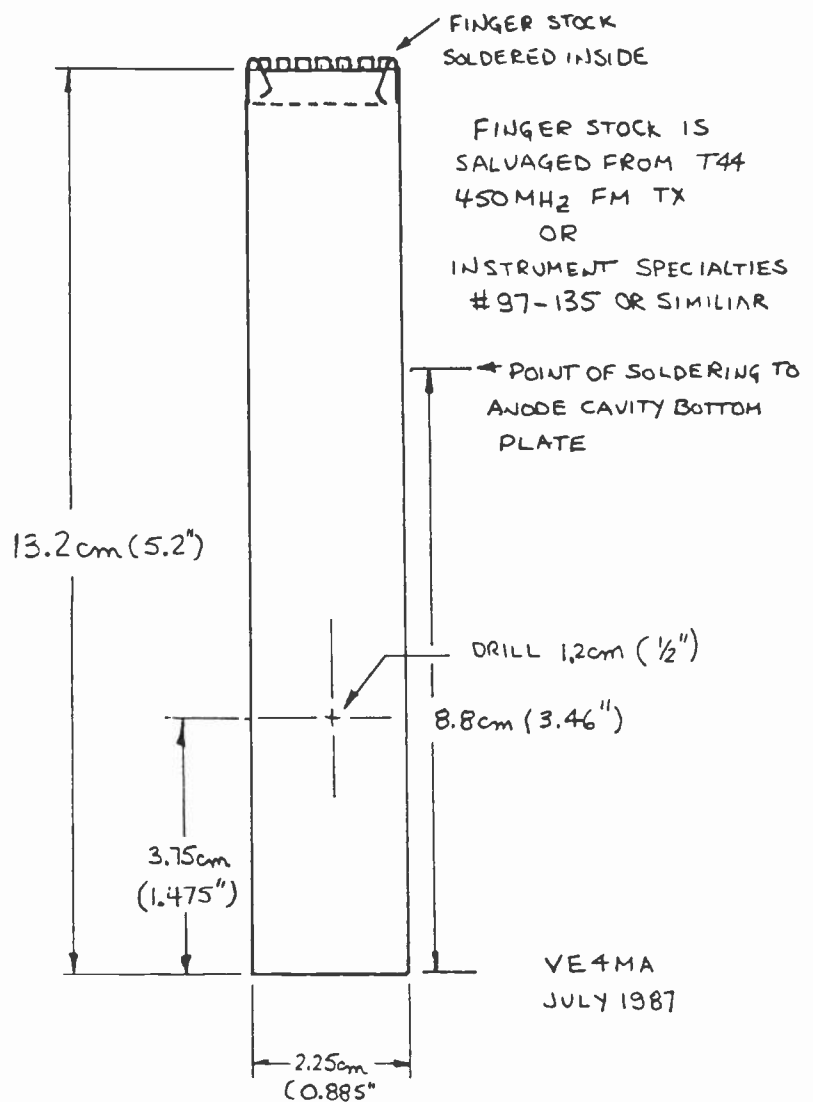

⑩ CATHODE CAVITY OUTER CONDUCTOR

all **in** **COMMUNICATIONS**®
THE INTERNATIONAL PRODUCT HIGHLIGHTS MAGAZINE

Premieres In August

All in Communications
is dedicated to those people
with the knowledge and power to make informed
buying decisions within the commercial industry.

The first bilingual international product highlights magazine will be 8 1/2" X 11" standard size, printed in glossy paper. It will consist of 84 pages, out of which the first half will be in English with the other half translated into Spanish. It will serve as a technical dictionary for all those who would like to do business in a market where the only obstacle is the language barrier. With *All in Communications*, the problem is solved!

For more information about this unique bilingual publication, contact our Advertising Department.

PHONE 305 · 594 · 7735

FAX 305 · 594 · 7677

Don't Be An Amateur Band Hog.

If you're using a traditional double-sideband (DSB) Amateur Television transceiver, you're, in effect, hogging the band. DSB not only wastes power on the unused sideband, but uses almost twice the spectrum necessary. Not good, considering how limited the spectrum is to begin with.

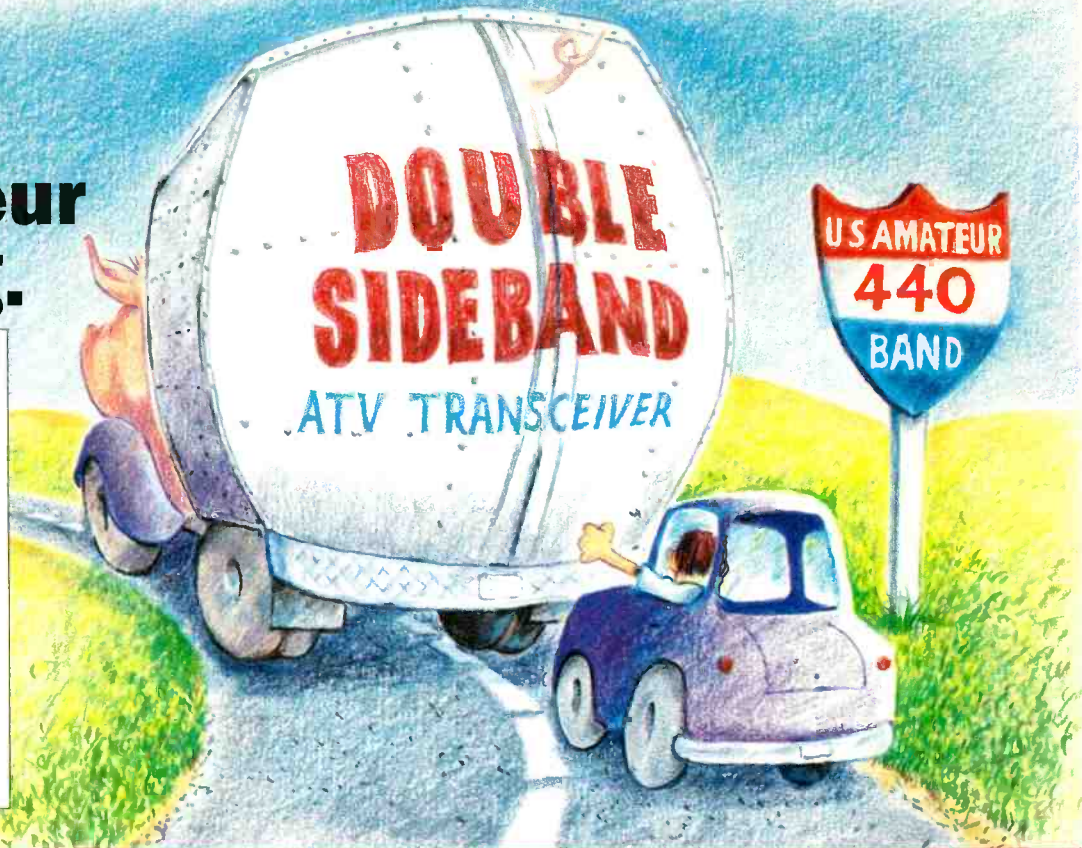

VSB-70 with Vestigial Sideband



Advanced Electronic Applications, Inc.

P.O. Box C2160/2006 196th St. S.W. • Lynnwood, WA 98036
Tech Support & Sales (206) 775-7373 • Office (206) 774-5554
CompuServe User ID 76703, 1012 • Brochure InfoLine (800) 432-8873

All stated specifications subject to change without notice or obligation.
© AEA, Inc. 1991. All Rights Reserved.

The VSB-70 from AEA is the only amateur television transceiver that uses Vestigial Sideband (VSB), the same modulation method used by commercial TV stations. Our VSB technology reduces the unwanted sideband over 40dBc! More power where it should be and less wasted spectrum space.

Also available is the ARLA-70 mast-mount linear amplifier (with power supply), which boosts your signal while preserving the characteristics of VSB.

Be a good spectrum neighbor. Use the AEA VSB-70 ATV System.

For a complete specification sheet on the VSB-70 or any other product, call 1-800-432-8873.