

# AMATEUR TELEVISION QUARTERLY

JANUARY 1991  
VOL. 4 #1

ISSN: 1042-198X  
USPS 003-353

DEVOTED ENTIRELY TO AMATEUR TELEVISION

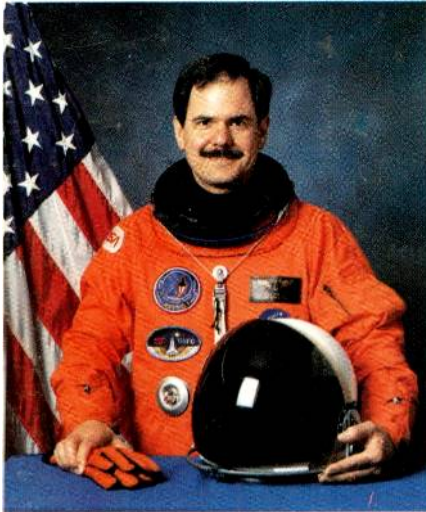

**Dr. Ron Parise WA481R STS 35 Ham in space story inside.**

**Ham Radio TV Programs fill Satellite TV Channels**  
**“More Than Radios” the movie see it via satellite**  
**Feb. 24**

**Super VSB Filter**

**H.R. 73 - Effort to save Ham frequencies**

**J.O.T.A. ATV**

**Much More**



**BATC Convention 90 story inside.**



**Jan is looking for you: Build this ATV transceiver - Lookie-Talkie inside.**

21  
expires: V4 #4  
AJ2X Mark R. Nelson  
17 Wentworth Rd.  
Natick MA 01760 USA

ICOM

IC-970 All Mode Transceiver

# Tomorrow's Transceiver Today.

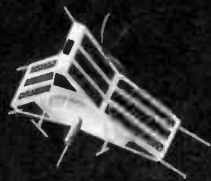

## The New IC-970

Designed for the serious operator on 144, 440 and 1200MHz, ICOM's IC-970 brings futuristic technology to DX, digital and satellite communications.

### Versatile Communications.

The IC-970 comes fully equipped as an all mode dual bander for 144MHz and 440MHz. Expand your limits on 1200MHz with the optional UX-97 band unit or listen to the world with the UX-R96 50-905MHz receive unit.

### Satellite Communications.

Reach beyond the stars, communications via satellite has never been easier. The amazing IC-970 automatically tracks uplink and downlink frequencies as the tuning control

is rotated. Ten memory channels specially designed for quick satellite communications emphasize ICOM's total commitment to your future communications needs.

### Progressive Quality Throughout.

Dual band watch lets you receive both main and sub band audio simultaneously. Multiple scanning systems on the main and sub bands, plus 99 memories, an easy-to-read multi-function display and ICOM's DDS system create the transceiver of tomorrow. Additional features include a built-in pager, code squelch function, direct keyboard entry and ICOM's CI-V system.

See tomorrow's transceiver today at

your local ICOM dealer. You'll see why the IC-970 is the transceiver of a new generation!

CORPORATE HEADQUARTERS  
ICOM America, Inc., 2380-116th Ave. N.E., Bellevue, WA 98004  
Customer Service Hotline (206)454-7619  
CUSTOMER SERVICE CENTERS  
3150 Premier Drive, Suite 126, Irving, TX 75063  
1777 Phoenix Parkway, Suite 201, Atlanta, GA 30349  
3071 - #5 Road, Unit 9, Richmond, B.C. V6X 2T4 Canada  
2380-116th Ave. N.E., Bellevue, WA 98004

All stated specifications are subject to change without notice or obligation. All ICOM radios significantly exceed FCC regulations limiting spurious emissions. 970190

For a brochure on this or any other ICOM product, call our Toll-Free Literature Request Hotline 1-800-999-9377.

**ICOM**  
First in Communications



# CONTENTS

V3 #4  
OCTOBER 1990

## STAFF

**PUBLISHER:**  
Henry Ruh KB9FO  
**CO-PUBLISHER**  
Bill Brown WB8ELK  
**SALES MANAGER**  
Pamela Dass  
**PHOTO EDITOR**  
Dave Williams WB0ZJP  
**TEXT ENTRY**  
Nicki Sell  
**MAILING**  
Jan Robinson

**Amateur Television Quarterly**  
(ATVQ) is published four times per year. Subscriptions are \$15 year US, \$20 Canada and \$25 DX. All mail should be sent to: Amateur Television Quarterly Magazine, 1545 Lee St., Suite 73, Des Plaines, IL 60018. Post Master NOTE: Change of address should be sent to Amateur Television Quarterly Magazine, 1545 Lee St., Suite 73, Des Plaines, IL 60018. Phone 708 298 2269. FAX 708 291 1644. MCI E MAIL, ATVQ.

Inquiries about advertising should be sent to: Pamela Dass, PO Box 105, West Peterborough, NH, 03468. She can be reached at 603 924 6119 or 603 924 9455.

For subscription and other inquiries reach us at 708 298 2269. Leave your zip code when making inquiry about subscriptions. ATVQ is available in most Ham Radio stores.

Amateur Television Quarterly is Copyright 1990. All rights reserved. No portion may be reproduced without written permission. Non-US publications may reproduce portions provided credit is given in the title page of any item used.

Amateur Television Quarterly is mailed as Second Class Printed Matter, U. S. P. O. permit # 003-353. Principle office of entry, Des Plaines, IL 60018.

## BACK ISSUES

ATVQ has sold out of every issue published. We have no back issues available. Back issues may be available at some retail ham stores.

## REPRINTS

Reprints of ATVQ issues and articles are available from:

**ESF COPY SERVICE,**  
4011 Clearview Dr.  
Cedar Falls, IA 50613.

JANUARY 1991 VOL. 4 #1

## INDEX OF ARTICLES

THE MIAMI CROSS BAND ATV REPEATER	
Sunny south ATV	5
J.O.T.A.	
Scout's ATV activity	9
MORE THAN RADIO'S	
See the Movie Feb. 24th!!	12
THE LOOKIE-TALKIE	
Really portable ATV!	13
SUBSCRIPTION FORM	
Special Club deal still available	16
MEET ME IN ST. LOUIS	
A new x-band ATV repeater	17
ATTRACTING NEW HAMS	
Latest ARRL poster promotion	18
SAREX STS 35	
A review and perspective	21
THE KENSINGTON CHALLENGE	
ATV Public Service in sports	25
C-64 COMPUTER PROGRAMS	
More video from your Commadore!	26
THE LOG ANTENNA PROJECT	
Build this VHF-UHF antenna	29
LITTLE WHEEL UPDATE	
Latest on the pizza box antenna	37
HUMOR	
What they really say when they talk	38
BATC CONVENTION 90	
A visit to an ATV hamfest	39
ATV NEWS SHORTS	
ATV activity is obviously increasing	41
CROSS COUNTRY ATV BALLOON ADVENTURE	
Air Power ATV thousands will see	49
AUTHOR'S UPDATES	
Making the great better	50
INSIDE VITS AND HOW TO GET THEM	
Stealing test signals you can use	51
AUTO-RECORD YOUR VCR	
Reader answers his own quest	54
2.3 GHz. ATV USING AN MDS RECEIVER	
Cheap and easy SHF equipment	57
MORE NEWS	
8 pages wasn't enough!	59
NORTH CAROLINA LIVE BALLOON	
ATV SPY over head!	61
SUPER VSB FILTER	
Going beyond the Interdigital	63
SIMPLE DTMF DECODER	
Simple decoder for simple uses	65

## ADVERTISER INDEX

AEA	BACK COVER
AMSAT	23
Comet/NCG Antennas	4
C.A.T.S.	16
Down East Microwave	11
Elktronics	4, 15
ICM	23, 25
ICOM	IFC
LINSASY Antennas	IBC
Mitchell Industries	31
OLDE Antenna Lab	31
Pauldon Associates	58
P.C. Electronics	19, 20
Radio Scan Magazine	11
Rutland Arrays	59
Spectrum International	55
T. D. Systems	56
Tootlevision LPTV	60
Unadilla	11
Wyman Research	7

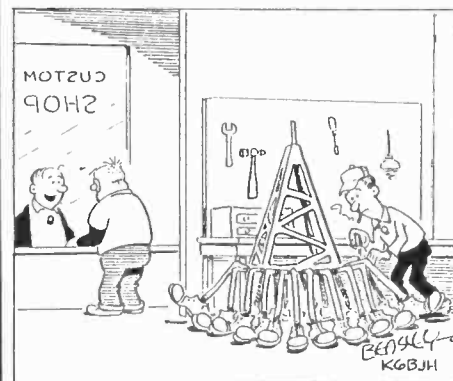

HAVE YOU FINISHED BUILDING MY 50 FOOT TOWER?

## AUTHORS COMPENSATION

ATVQ pays authors of original technical material. Compensation varies from \$5 to \$35 per item according to published length. Authors may receive the compensation as an extension of their subscriptions or cash.

ATVQ is always looking for news, activities and technical material. Send all contributions to ATVQ, 1545 Lee St. #73, Des Plaines, IL 60018. Photos should be in black and white but color are acceptable. Diagrams should be in black ink and neatly drawn.

# COMET

ANTENNAS FOR THE PROFESSIONAL AMATEUR

## CYA-1216E

16 Element Yagi Beam 1260-1300MHz  
 Gain: 16.6dB Length: 4' 5"  
 VSWR: 1.5:1 or less Weight: 7 lbs. 11 oz.  
 Impedance: 50 ohms Mounting Mast Diameter: 1'-2 1/2"  
 Max. Power: 100 watts Connector: N-Type  
 Polarization: Vertical or Horizontal Construction: All Aluminum

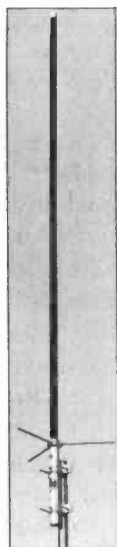
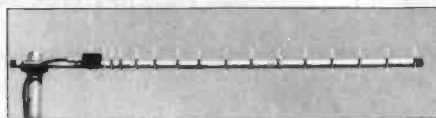

## CA-1243Z

Dual Band  
 440-450MHz  
 1250-1300MHz  
 Base/Repeater Antenna  
 5/8 Wave x 4 446MHz  
 5/8 Wave x 9 1200MHz  
 Gain: 446 9.4dB  
 1200 12.8dB  
 Impedance: 50 ohms  
 VSWR: 1.5:1 or less  
 Max. Power: 446 150 watts  
 1200 50 watts  
 Length: 7' 5"  
 Weight: 2 lbs. 8 oz.  
 Connector: N-Type  
 Construction: Heavy Duty  
 Fiberglass



## CA-1221S

Mono Band  
 1260-1300MHz  
 Base/Repeater Antenna  
 1/2 Wave 21 Step  
 Collinear  
 Gain: 15.5dB  
 Impedance: 50 ohms  
 VSWR: 1.5:1 or less  
 Max. Power: 100 watts  
 Length: 8' 6"  
 Weight: 2 lbs. 3 oz.  
 Mounting Mast Diameter:  
 1 1/4"-2 1/2" inches  
 Connector: N-Type

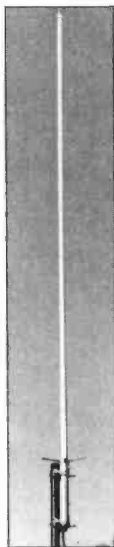

## PYA-913

Base 13 Element Yagi  
 904-920 MHz  
 Gain: 15.8dB F/B ratio  
 over 20dB  
 Max. Power: 150 watts  
 VSWR: 1.5:1 or less  
 Length: 4' 8"  
 Connector: N-Type  
 Construction: Aluminum

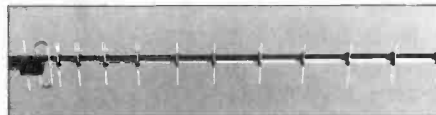

## MINI SWR

		Max. Power	Insertion Loss
CM-200	140-150MHz	45 watts	0.1dB
CM-300	200-240MHz	60 watts	0.2dB
CM-400	420-460MHz	50 watts	0.2dB
CM-420	140-460MHz	50 watts	0.1-0.2dB
CM-900	840-950MHz	60 watts	0.2dB
CM-1200	1225-1325MHz	60 watts	0.25dB

Measurements: 2.25" w x 2.25" h x 1.1" d  
 Weight: 5.25 oz.  
 CM-200, 300 and 400 have SO 239 Connectors  
 CM-420, 900 & 1200 have N Connectors

## FP-19

Base/Repeater  
 905-925MHz  
 Gain: 16dB  
 Impedance: 50 ohms  
 VSWR: 1.2:1 or less  
 Max. Power: 100 watts  
 Length: 7' 4"  
 Connector: N-Type  
 Construction: Heavy Duty  
 Fiberglass

## CF-4130

446/1200MHz  
 dB Loss: 1.3-460MHz 0.2dB  
 900-1400MHz 0.3dB  
 Band Rejection: 55dB Down  
 Max. Power: 146MHz 800W PEP  
 446MHz 500W PEP  
 1200MHz 200W PEP  
 Connectors: N-Type



NCG CO. 1275 North Grove Street • Anaheim, CA 92806 • (714) 630-4541 • Orders (800) 962-2611

**CALL FOR THE DEALER NEAREST YOU!**

## Pocket Power Converter

**MODEL PC100 + - \$ 149 ppd.**

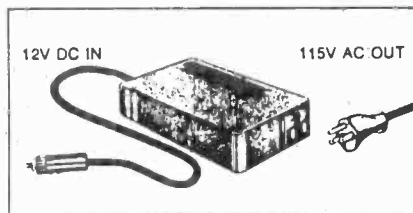

The Pocket Power Converter is the perfect way to operate your AC powered computer or peripherals from battery power.

Advanced technology and solid engineering have come together to make the Pocket Power Converter the smallest, most versatile and most reliable product of its kind.

Built-in features like instant-on, ultra high efficiency, complete electronic protection, low battery alarm (at 10.7 volts), and low voltage shutdown make it trouble free and simple to use.

### Specifications

Voltage In: 10-15 VDC  
 Voltage Out: 115 VAC RMS  
 Output Frequency: 60 Hz  
 Peak Power: 200 Watts  
 Constant Power: 100 Watts

Height: 1.2" (3.0 cm)  
 Width: 3.5" (11.5 cm)  
 Length: 4.5" (9.0 cm)  
 Weight: 14 oz. (400 grams)  
 Warranty: 6 months

## WA6SVT VIDEO PROCESSOR

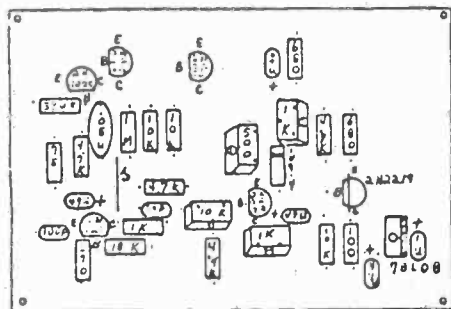

- INDEPENDENTLY CONTROL VIDEO & SYNC LEVELS
- CAN ADJUST COLOR BURST LEVEL
- SET WHITE CLIP LEVEL

Assembled / Tested ..... \$39  
 Kit ..... \$29  
 PC Board ..... \$ 7

## ELKTRONICS

12536 T.R. 77  
 Findlay, OH 45840  
 (419) 422-8206



# CROSSBAND ATV REPEATER

By Armando A. Fernandez, KA4GAQ

**W**hen two ATV stations are communicating in a QSO, it's possible to maintain optimum conditions during the contact without moving the antennas. But when several stations show up at the same time, there are two choices which can be made:

The first is to transmit with vertical omnidirectional antennas and increase the transmission power because omnidirectional antennas have an approximate gain of 5 to 7 dB, in comparison to the typical ATV directional antennas which have 14 to 18 dB gain. That is why the transmission power must be increased, to compensate for the antenna loss while transmitting and receiving.

The second, and the most common, choice is to use a repeater so that none of the many ATVers need to move their antennas to receive a strong audio and video signal. Likewise, the transmission power will not need to be increased.

Figure 1 shows several of the ATVers of the America Radio Club, KA4GAQ. These photographs were taken from the same monitor which corresponds to the repeater transmission. The repeater mixes black and white and color video signals, depending on the transmitting camera used by the operator.

The height is approximately 200 feet, and the average power is 15 watts. Since the transmitter's power varies according to the lighting in use, ours has a 4 to 5 watt variation. The reach is about 20 miles, confirmed by Peter de la Rosa, KC4LFV,

who lives in Kendall, over 17 miles away from the repeater in Hialeah.

Figure 2 represents the repeater in block sections. The receiving antenna is a 400 MHz omnidirectional, to be able to receive the incoming signals from the operators. This is located at the top of the system, and 10 feet below is a 900 MHz transmitter omnidirectional antenna, so that all the operators receive the signal at the same time. This 10 foot separation only applies to crossband repeaters. If this repeater was transmitting and receiving on the same band, it would need no less than 20 feet of separation between antennas, depending on the transmission power.

The radio frequency signal is received by the 400 MHz antenna and passes the interdigital filter (A), which can be of 5 or 7 poles. In addition, this filter does not allow interference outside of this band to pass.

The RF signal then passes to the amplifier (B), which contains a low noise level transistor known as Gafet. This level at the 400 MHz frequency is only 0.5 dB.

Gain at 400 Mhz is approximately 14 dB. Later, this amplified signal passes by the converter (C), which has another Gafet. The signal mixes here with a crystal-controlled oscillator. This action will produce an intermediate frequency to carry video on 45.75 MHz.

The board contains an intermediate frequency amplifier, which receives the signal from the converter (C)

and includes two detectors, one of AM video and the other of FM audio with 25 kilocycle bandwidth. There are also two video and one audio ports in D. One of the video ports is connected to the enhancer (E), thereby improving the video quality which may have been lost during modulation, etc. The other video port is coupled to block H, which includes a relay of operation by video on the board. The audio port will be connected to the signal exciter in I.

The enhancer is applied to the exciter in I. Block H, which receives the video signal, contains a video operational relay as well as a timer that emits the station identification every ten minutes. The 900 MHz transmitter is activated when the exciter receives a 13.8 watt signal that came from the VOR.

The 1 watt outgoing signal of the exciter (I) is passed to the amplifier (J) which increases the transmission power to 22 watts.

This then goes to the 900 MHz interdigital filter (K) which adjusts the lateral side band according to the FCC regulations. After passing this process, the video and the audio signal go to the antenna. The exciter and the amplifier should be set at 900 MHz.

The 220 MHz receiver and two-tone decoder (F) acts like a remote control for the repeater. Several tone combinations would leave the repeater inactive, while another combination could put the repeater back on the air. >>

FIGURE 1

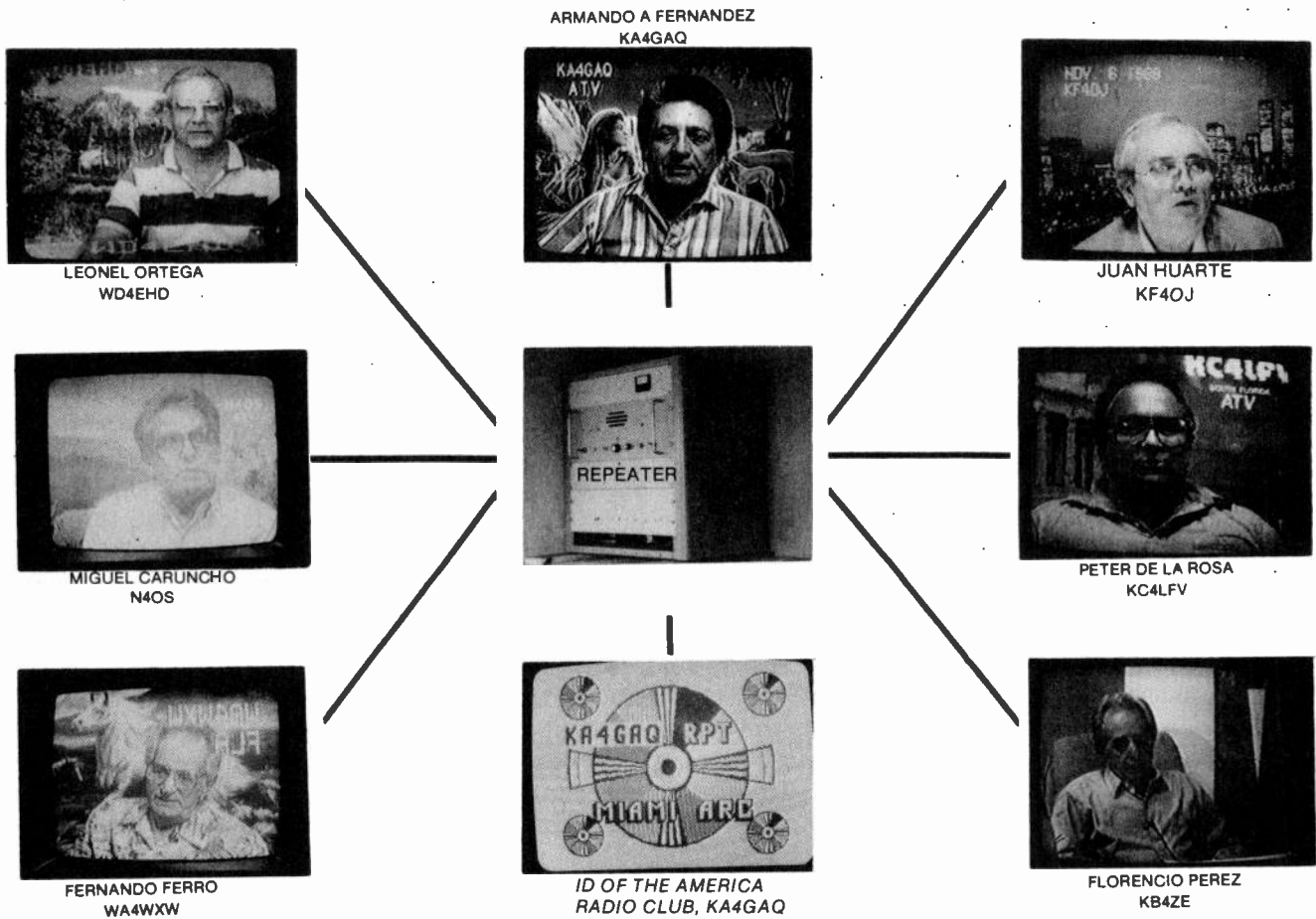
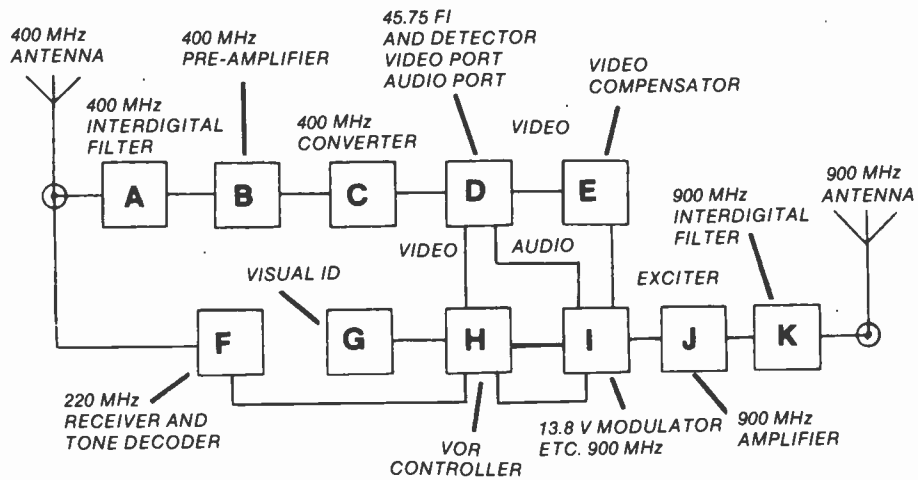

FIGURE 2



# WYMAN RESEARCH INTRODUCES NEW TRIDON LINE

ONLY  
\$229.95

TRIDON AM 450 MHZ  
TRANSMITTER

\$319.95

TRIDON 2000 AM  
450 MHZ TRANSCEIVER

\$399.95

TRIDON FM  
TRANSMITTERS  
900 MHZ  
1200 MHZ



## 450 TRANSMITTER

- POWER OUTPUT IS 3 W PEAK
- TWO INDEPENDENT AUDIO SYSTEMS  
(Sub-carrier and On-carrier)
- 10 PIN CAMERA CONNECTOR ON BACK-BNC OR RCA CONNECTORS ON FRONT
- SYNC STRETCHER FOR OPTIMUM COMPOSITE VIDEO
- STANDARD CRYSTAL FREQUENCY: 439.25 MHZ or 434.00 MHZ
- POWERS VIDEO CAMERA (10 Pin Connector)
- REQUIRES 13.8V DC AT 600 MA PLUS CAMERA POWER ( 1 amp)
- RF TIGHT ALUMINUM CABINET WITH BRUSHED ALUMINUM PANEL CUSTOMED DESIGN-ED BY W9YL
- CABINET SIZE: 2.2"x5.25"x5.5"

## FACTS 450 TRANSCEIVER

- POWER OUTPUT - 3 W PEAK
- 10 PIN CAMERA CONNECTOR ON BACK PANEL, BNC OR RCA CONNECTOR ON FRONT PANEL
- MONITOR VIDEO FROM CAMERA OR DETECTED VIDEO OUTPUT
- ALL NEW VIDEO AND AUDIO CIRCUITRY WITH SYNC STRETCHER
- NEW TWO CHANNEL AUDIO SYSTE ON TRANSMIT (SEE OPTIONAL RECEIVER BELOW)
- NEW MORE POWERFUL VIDEO TRANSMITTER
- STANDARD CRYSTAL FREQUENCY: 439.25 MHZ or 434.00 MHZ
- .8 DB NF GaAsFET PRE-AMPLIFIER
- RF TIGHT ALUMINUM CABINET WITH BRUSHED ALUMINUM PANEL CUSTOMED DESIGN-ED BY W9YL
- SIZE: 2.2"x7"x5.75"
- RELAY SWITCHED ANTENNA

## FM TRIDONS

### BOTH HAVE —

- PRE-EMPHASIS CIRCUITRY
  - "N" CONNECTOR
  - RF TIGHT ALUMMINUM CABINET WITH BRUSHED ALUMINUM PANEL CUSTOM-ED DESIGNED BY W9YL
  - CABINET SIZE: 2.2"x8.2"x5.5"
  - REQUIRES 13.8 V DC AT 2 AMPS
  - LARGE HEAT SINK
- ### 900 MHZ
- 915 MHZ FM-ATV TRANSMITTER
  - POWER OUTPUT IS 8 WATTS
  - 4.5 MHZ AUDIO SUB-CARRIER
  - USES NEW PHASE LOCK LOOP CRYSTAL CONTROLLED EXCITER
- ### 1200 MHZ
- 1255 MHZ FM-ATV TRANSMIT-TER (Any optional freq.)
  - POWER OUTPUT IS 4-5 WATTS
  - 6 MHZ AUDIO SUB-CARRIER (Requires 1 V PP Audio)
  - USES MILITARY QUALITY WOOD-DOUGLAS CRYSTAL CONTROLLED EXCITER

# WYMAN RESEARCH, INC.

R.R. #1 BOX 95  
WALDRON, INDIANA 46182  
(317) 525-6452

INDIANA RESIDENTS 5% SALES TAX

Don & Sue Miller  
W9NTP  
W9YL

SHIPPING \$4.50

# THE BATC

## ARE YOU A MEMBER ?

YOU CAN BE FOR AS LITTLE AS \$18 PER YEAR

(\$27 PER YEAR TO RECEIVE YOUR MAGAZINE BY AIR MAIL)

FOR THIS VAST SUM YOU WILL RECEIVE FOUR ISSUES OF THE CLUB'S MAGAZINE, CQ-TV, WHICH IS ALWAYS PACKED WITH UP-TO-DATE PRACTICAL INFORMATION ON ATV DESIGNS. PRINTED CIRCUIT BOARDS AND SPECIAL COMPONENTS ARE ALSO AVAILABLE FROM THE CLUB AT REDUCED RATES. A SERIES OF HANDBOOKS HAVE ALSO BEEN PUBLISHED BY THE CLUB, DEALING WITH ALL ASPECTS OF ATV, FROM SETTING UP YOUR FIRST STATION, TO THE LATEST IN STATE-OF-THE-ART MICROWAVE GEAR. MANY OTHER SERVICES AND FACILITIES ARE AVAILABLE TO MEMBERS AND PRACTICAL HELP IS AVAILABLE ON ANY TV RELATED TOPIC

FOR FURTHER INFORMATION AND MEMBERSHIP APPLICATION FORMS ETC, CONTACT OUR UNITED STATES AGENT DON MILLER AT:

WYMAN RESEARCH INC, BOX 95, WALDRON, INDIANA 46182  
TEL: (317) 525 6452

(CHEQUES PAYABLE TO WYMAN RESEARCH PLEASE)

## *COMING IN THE NEXT ISSUE OF* **CQ-TV**

CONSTRUCTION AND TECHNICAL ARTICLES FEATURING: A VIDEO MIXING DESK & EFFECTS GENERATOR, VIDEO FILTER FOR 70CM, SATELLITE DISH EL/AZ CONTROLLER, TUNED UHF PREAMPLIFIER, MORE 10GHZ ATV TX/RX PROJECTS, STUDIO VISION & AUDIO TECHNIQUES, DIGITAL VIDEO FOR ATV VIA PHASE 3 & 4 SATELLITES, PLUS LOTS OF NEWS & VIEWS. MAKE SURE YOU GET YOUR COPY, SEND YOUR SUBSCRIPTION TO DON AND JOIN THE 2500 ATV'ers WORLDWIDE WHO MAKE UP AND ENJOY BEING A PART OF

THE BRITISH AMATEUR TELEVISION CLUB



# JOTA INCLUDES ATV

**Fred Merker K3TAZ**

*On October 20, 1990 Explorer Post #173, which is headed by Gene KA3PRG, got involved in the JOTA (Jamboree on the Air). This is a Boy Scout world wide event which exposes scouts to amateur radio. The post setup 3 amateur radio stations in Carroll County Maryland.*

Each station was located about 10 miles from the other. All stations had equipment for HF, 2 meters and ATV. The southern most station in the county was assembled at the Winfield Fire Department. Harold, N3GFZ operated the ATV station at the Winfield fire Department. The central location for the event was the Emergency Operations Center in Westminster, Md. The ATV station at the E.O.C. was manned by Fred, K3TAZ. The northern station was in Manchester, Md at a church where a scout troop meets on a regular basis. Dick, WA3USG, traveled south from his home QTH in Mechanicsburg, PA to operate the ATV equipment from that point. We were fortunate enough to have an airplane equipped for ATV do flybys. John, N3AGG, piloted the plane so the scouts could get a view of themselves from the air. The camera operator in the plane was Junior, N3ACJ. Over 70 Scouts were able to see the stations in operation.

Winfield was operating with P.C. Electronics equipment and a 48 element J Beam. The E.O.C. used a homebrew 16 element collinear with a mast mount Advanced Receiver Research pre-amp. A 0.5 watt exciter drove a D1010 amplifier to about 5 watts. The receive converter was a TVC-2G by P.C. Electronics. The station at the E.O.C. was operated 100% on battery power. The necessity of line of sight communications moved the ATV station to the highest point



2 scout leaders and 4 scouts view the ATV setup on hilltop behind E.O.C. (please note make-shift sun shade for 5" monitor)  
JANUARY 1991 VOL. 4 #1

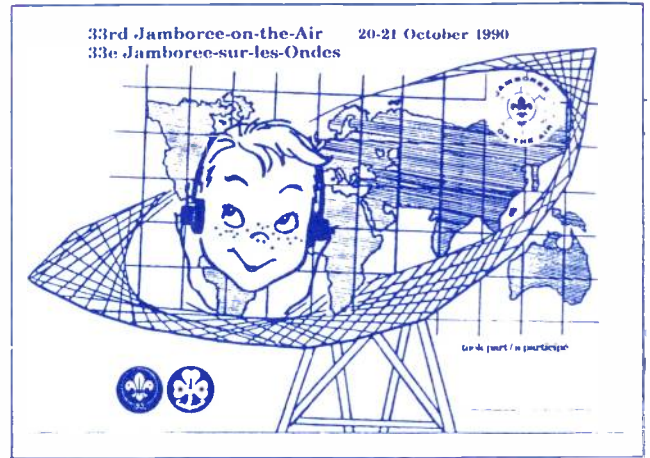

JOTA Participation Card from the World Organisation of the Scout Movement.

behind the E.O.C. which is about 75 to 100 feet higher than the parking lot level. Fortunately the temperatures were mild and the sky was blue. For a event in late October this was indeed something to be happy about.

P4 signals were enjoyed by the participants between Winfield and the E.O.C. The path to the north was not as good. It was at best a P1. Previous tests had shown the path from the E.O.C. to Manchester was going to be marginal. So it was hoped that increased antenna height and receive gain (mast mount preamp) would make a big improvement on the path loss. However, our ever present friend 'Murphy' caused a 2x4 29 foot antenna support to break while the antennas were being put up. So the antenna height was only about 10 feet. The Manchester station also ran a 16 element collinear with mast mount pre-amp. The station operated on 10 watts of power with equipment that was mainly homebrew. John's flybys were definitely the saving event for the ATV operators.

All signals from the airplane were P5+. The scouts ran out from the Manchester station to see the airplane that was taking pictures of the building and surrounding area. The H.F. operators for the JOTA included Eric N3IFB, Joe KD3UV and Bill N3GWW. Everyone involved enjoyed themselves and we are hoping for better signal paths and greater participation next year.



ATV setup on hilltop behind Westminster, Md. E.O.C. Please note tower with ham antennas a tower for municipal antennas and CATV antennas & tower.

**PHOTO CAPTION INFO**

The five outdoor pictures were all taken at the Emergency Operations Center in Westminster, Md. The three outdoor shots which do not include people are pictures of the station and the plane with the ATV transmitter and camera. The wide shots show the airplane small but in the upper right hand corner. In the third picture the airplane is clearly visible to the upper left of the 16 element collinear. Indoor shots are taken at the ham station inside the E.O.C. The adult in the scout uniform is Gene Martin KA3PRG. He is the adult leader of Explorer Post #173.



Gene Martin KA3PRG center (using microphone) 2 scout leaders & 4 scouts watch station operation.

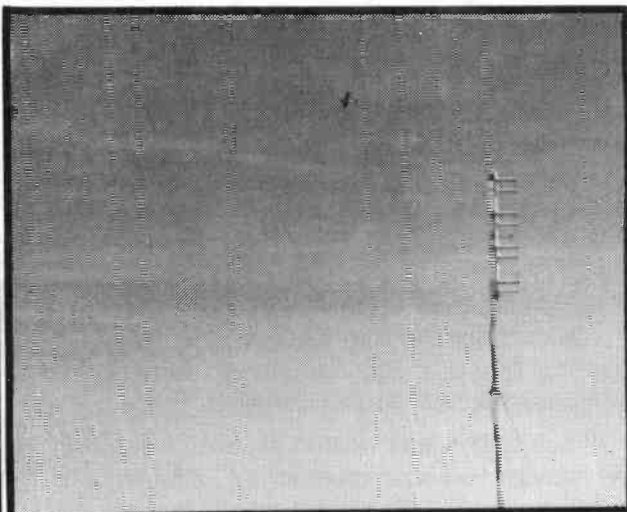

N3AGG John & N3ACJ Junior Fly over Emergency Operations Center in Westminster, Md.



Gene Martin KA3PRG (right) helps a young scout talk on ham radio.

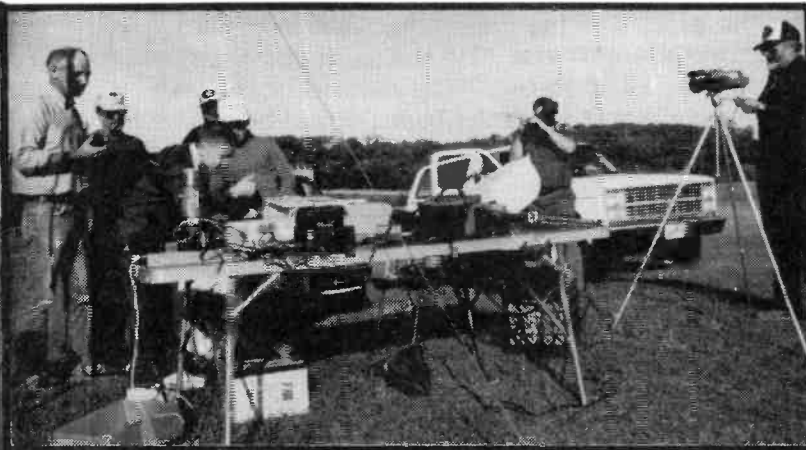

Young scout talks and sees Harold N3GFZ at Winfield site left of pic Joe N3IMN 2nd from rt. Gene KA3PRG right Junior N3ACJ.



Scout poses for picture as he holds a "what do I say" form.

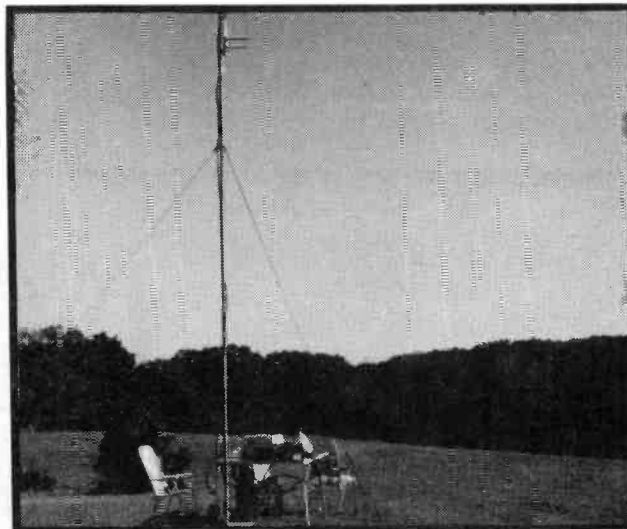

Hilltop ATV setup behind Westminister, Md. E.O.C. N3AG & N3ACJ flyby in upper right hand corner.

## DOWN EAST MICROWAVE

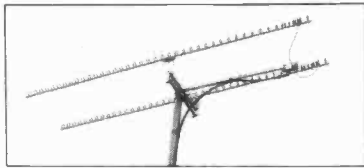

### MICROWAVE ANTENNAS AND EQUIPMENT

- Loop Yagis • Power Dividers • Complete Arrays • GaAs FET Preamps
- TROPO-EME • Weak Signal • OSCAR • Microwave Transverters

902 1269 1296 1691 2304 3456 MHz

2345 LYK45el 1296 MHz 20 dBi \$89  
 1345 LYK45el 2304 MHz 20dBi \$75  
 3333 LYK33el 902 MHz 18.5dBi \$89  
 Above antennas kits available assembled.  
 Add \$8 UPS s/h  
 Add \$11 UPS s/h West of the Mississippi.

### MICROWAVE LINEAR AMPLIFIERS SSB, ATV, REPEATER, OSCAR

2316 PA 1w in 18w out 1240-1300 MHz \$255  
 2335 PA 10 in 35w out 1240-1300 MHz \$315  
 3318 PA 1w in 20w out 900-930 MHz \$265  
 3335 PA 10 in 40w out 900-930 MHz \$320  
 23LNA preamp 0.7dB N.F. 1296 MHz \$90  
 33LNA preamp 0.9dB N.F. 902 MHz \$90

### NEW PRODUCT ANNOUNCEMENTS

#### New Loop Yagis

1845 LY Loop Yagi 1691 MHz 20dBi \$99  
 945 LY Loop Yagi 3456 MHz 20dBi \$89  
 Above antennas assembled and tested

### New Preamps

13LNA 0.7dB N.F. 12 dB 2.3 GHz \$140  
 18LNA20 0.8dB N.F. 20 dB 1.69 GHz \$140  
 SLNA 1.0dB N.F. 10 dB 2-2.7 GHz \$150

### New Wideband Power Amplifiers

2370 PA 3w in 70w out 1240-1300 MHz \$695  
 2340 PA 2w in 35w out 1240-1300 MHz \$355  
 2318 PAM 1w in 18w out 1240-1300 MHz \$205

Rack mount Amplifiers for repeater use available.

### NO TUNE MICROWAVE LINEAR TRANSVERTERS

From SHF SYSTEMS a new line of transverters designed by Rick Campbell KK7B and Jim Davey WA8NLC

Available in kit form or assembled/tested

- 903 1269 1296 2304 3456 MHz
- microstrip filters eliminate tune-up
- 2m i-f, PIN diode switched
- sequencer standard in complete unit
- low profile packaging, mast mountable

All active equipment • 13.8V

DOWN EAST MICROWAVE  
 BILL OLSON, W3HQ7  
 Box 2310, RR-1 Troy, ME 04987  
 (207) 948-3741

## INLINE™ Coaxial Antenna Relay Switching System

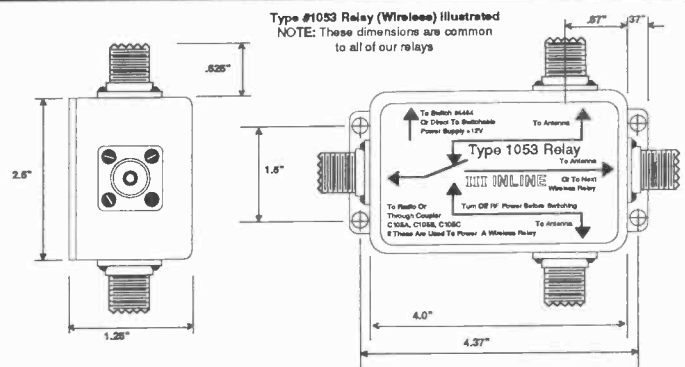

- Rugged Construction
- Waterproof
- High Reliability
- No Insertion Noise
- Uses a Single Coax
- Economical

INLINE™ coaxial relays are rugged, weatherproof devices that can be mounted on virtually any surface, indoors or out, wherever the relay is used to switch between two or more antennas while using only a single coaxial cable to the transceiver. Our relays are available in one of two styles WIRED or WIRELESS.

The WIRELESS style uses a separate coupler module installed near the radio. The coupler combines the RF signal and the relay energizing voltage to allow the coaxial cable to carry both signals simultaneously yet independently. This permits existing systems to be expanded with little modification. These relays and couplers have narrower bandwidths than the wired models, since their internal circuits contain filters which minimize harmonics beyond the relays' passband.

INLINE™ relays and couplers are capable of high power operation yet contribute no insertion noise in the receiving or transmitting modes. The INLINE™ design uses technology incorporating microstrip techniques resulting in a relay life expectancy of at least 10,000,000 transfer operations, offering many years of trouble free service in the field.

INLINE™ couplers can also be used to utilize D.C. voltage remotely via the coaxial cable to power other devices such as amplifiers and other equipment. Isolated D.C. energized relays are also a modification which is available and permits three-way switching in mobile applications from a common power source.

DESCRIPTION	TYPE 105	TYPE 105U	TYPE 105N	TYPE 105S
Switch Type	Two Position	Two Position	Two Position	Three Position
Frequency to...	180MHz	300MHz	950MHz	180MHz
Impedance	50Ω	50Ω	50Ω	50Ω
Energizing Coil	190Ω±10%	190Ω±10%	190Ω±10%	190Ω±10%
Energizing DC	±10V to ±16V	-12V to 0V to +12V	-12V to 0V to +12V	-12V to 0V to +18V
Insertion Loss Max. (DB)	0.2 to 30MHz 1.0 to 180MHz	0.2 to 250MHz	0.4 to 500MHz 1.8 to 950MHz	0.2 to 30MHz 1.0 to 180MHz
VSWR (or "SWR")	1:1.1	1:1.1	1:1.2 to 500MHz 1:1.25 to 950MHz	1:1.1 to 30MHz 1:1.4 to 180MHz
Insertion Noise	NONE	NONE	NONE	NONE
RF Power W.CW	1250W to 30MHz 160W to 180MHz	750W to 100MHz 900W to 250MHz	300W to 500MHz 125W to 950MHz	1250W to 30MHz 150W to 180MHz
RF Power W.SSB	2500W to 30MHz 300W to 180MHz	1400W to 100MHz 1200W to 250MHz	700W to 500MHz 250W to 950MHz	2500W to 30MHz 300W to 180MHz
RF Power W.AM/RTTY	750W to 30MHz 150W to 180MHz	400W to 100MHz 400W to 250MHz	200W to 500MHz 100W to 950MHz	750W to 30MHz 150W to 180MHz
Crosstalk (DB)	-45 to 30MHz -30 to 180MHz	-45 to 100MHz -40 to 250MHz	-35 to 500MHz -30 to 950MHz	-45 to 30MHz -30 to 180MHz
Switching Time (Sec.)	0.01	0.005	0.005	0.01
Standard Connectors	SO239	BO239	Type N	SO239
Suggested Couplers	C105A (fixed) C105B (on/off)	C105U (fixed) C105BU (on/off)	C105N (fixed) C105BN (on/off)	C105C (on/off)

# Unadilla

87 Belmont Street North Andover MA 01845  
 PH# (508) 975-2711 FAX (508) 474-8949

# RADIO SCAN

MAGAZINE

SPECIAL AMATEUR REPORT

Introductory  
**SAVING**  
 Certificate

Only \$14.95, A Saving of \$21.00 (12 issues).

This Certificate entitles the bearer to subscribe to *Radioscan Magazine*, and get up to \$21.00 off the cover price. Complete and return with your payment of \$14.95 by check or Money Order to:

**RADIOSCAN MAGAZINE**

Our new address is:

**8250 N.W. 27th Street, Suite 301**

**Miami, Florida 33122**

**(305) 594-7734**

Name \_\_\_\_\_ Call \_\_\_\_\_

Address \_\_\_\_\_

City \_\_\_\_\_ State \_\_\_\_\_ Zip \_\_\_\_\_

Please allow 4-6 weeks for first issue. Spanish version available.  
 Subscription outside U.S.A., \$50.00 by air mail.

# MORE THAN RADIOS

## THE MOVIE

WORLD PREMIER VIA SATELLITE

SUNDAY FEBRUARY 24TH

4 PM EST

WESTAR 5 TRANSPONDER 22

AUDIO 6.2/6.8

*Program rundown:*

*Slate: Icom presents a World Premier Event*

*show reel program rundown:*

*Opening credits*

*Greetings by Roy Neal*

*Intor of "More Than Radios" by Roy Neal*

*Feature Presentation of "More Than Radios"*

*Bridge to PSA by Roy Neal*

*Presentation of at least three new Ham Radio PSA's*

*Reminder of availability of tapes of both presentations and close by Roy Neal*

*Closing Credits for World Premier*



Scenes from the movie

# The "LOOKIE-TALKIE"

by Earl Campbell KS8J

*I've always enjoyed the challenge of operating with portable ATV. With the advent of micro-miniature TV cameras, TV receivers and transmitters a truly portable ATV system in one complete package is now a reality!*

Also since the local ATV repeater has a wide range of local coverage, good results can be had with just a rubber duck style 70 cm. antenna.

With this goal in mind I decided to put together the "Lookie-Talkie". Instead of lugging boxes of cables and equipment out to my car whenever I want to operate portable or operate from a jet at 35,000 feet, I just grab my Lookie-Talkie and head instantly for the door.

(Ed. Note: Earl has operated ATV from quite a few flights in a research jet in many locations across the country - he recently took the Handie-Lookie on a flight that took him from Arizona to Italy!). As you can see from the pictures, the unit I designed is quite small for a complete ATV station. I have a switch and RCA jacks on the unit so I can switch between the local B/W camera and any external color video and audio. A BNC connector allows me to use a rubber duck or attach a higher gain antenna to the package.

Here's a list of the components to duplicate the Lookie-Talkie:

Radio Shack Pocketvision 22 color LCD TV

PC Electronics KPA-5 Kreepie Peepie ATV transmitter

70 cm GaAsFET preamp

Bud Box plastic enclosure ( 7.5" x 4.5" x 2.0")

Rubber Duck 450 MHz antenna

12 volt Gel Cell (1.2 Ah)

Mitchell Micro-Camera or GBC model CCD-100 B/W camera

Misc. switches, connectors, etc.

The Radio Shack Pocketvision 22 (can use model 23 or 24 as well) does not need any modifications to tune the entire 70 cm ATV band. It has very good sensitivity even without the GaAsFET preamp. Just tune it below channel 14 on the UHF band to receive ATV directly. I cut a hole just slightly smaller than the size of the TV receiver case in the Bud Box lid. I then took the back off of the TV and sandwiched the lid of the Bud Box between the two halves of the TV receiver. This way I had more room to install the transmitter and camera. I removed the CCD-100 TV camera from it's case to conserve room as well and mounted it the lid of the Bud Box with a hole drilled for the lens.

**JANUARY 1991 VOL. 4 #1**

Power for the TV set is obtained from the 12 volt gel cell battery through a 5 volt regulator. The center pin of the 7805 is ground. I placed diodes in series with the center pin of the regulator to raise the output voltage to 6 volts (or you could order a 7806 from Mouser Electronics). Everything else operates directly from the 12 volt gel cell battery.

The Lookie-Talkie draws about 400 mA in the receive mode and pulls 700 mA in transmit. With the 1.2 Ah battery you should expect a little over 2 hours of operation. An external battery jack can be wired in to allow extended operation from a car battery or extra pack without opening the package. I've had a blast operating the Lookie Talkie and plan to keep making the package even smaller! [Ed. Note: Anyone who makes a smaller Lookie or has a source of micro-TVs or cameras please send us in the details, I'm sure we'd all like to see just how small a Lookie-Talkie can get.]

Suppliers:

KPA-5 transmitter --P.C. Electronics, 2522 Paxson Lane, Arcadia CA 91007-8537. Phone: (818) 447-4565.

Micro-TV camera -- Mitchell Industries, 1334 Shawnee Dr., Santa Ana CA 92704. Phone: (800) 427-6268 or (714) 957-9268.

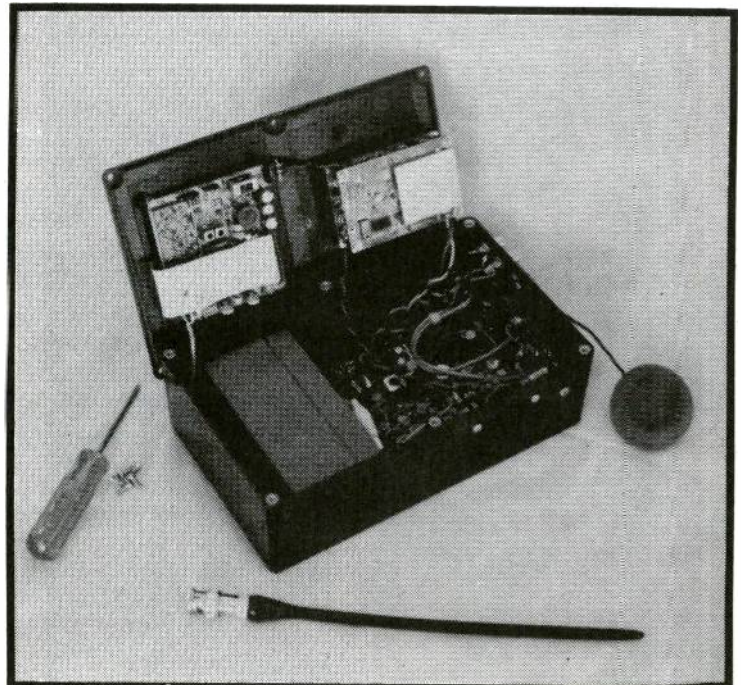

Orange square is 12VDC Batt camera is at left top P.C.dreepie peepie is at right top.

# The "LOOKIE-TALKIE"

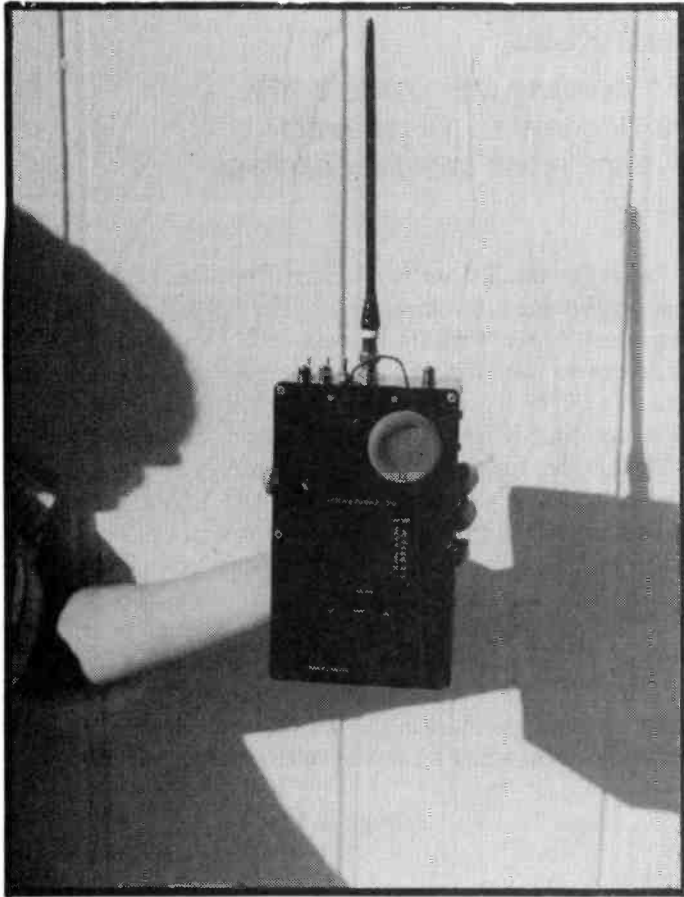

You see FT-470 for size comparison. Look close & see W7LNX on Rx on LT.

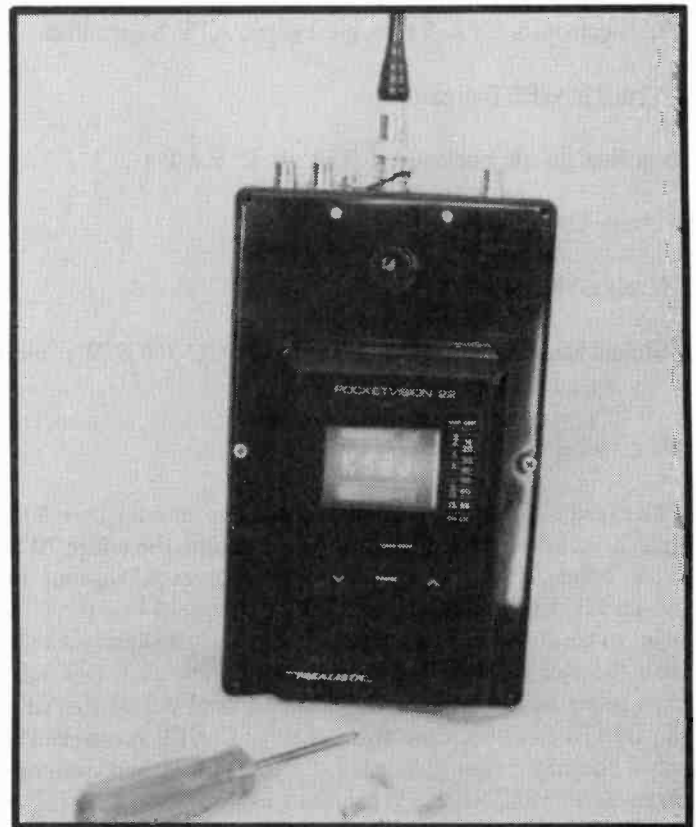

Live off the air pic of KS8J Rptr received by the Lookie-Talkie!



# ELKTRONICS

12536 T.R. 77  
Findlay, OH 45840  
(419) 422-8206

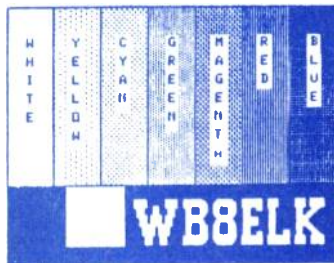

INTRODUCING THE

**VDG-1**

**VIDEO I.O.**

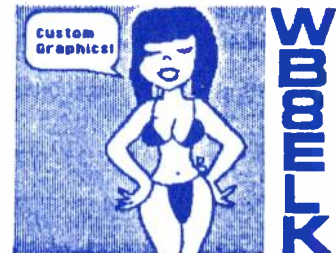
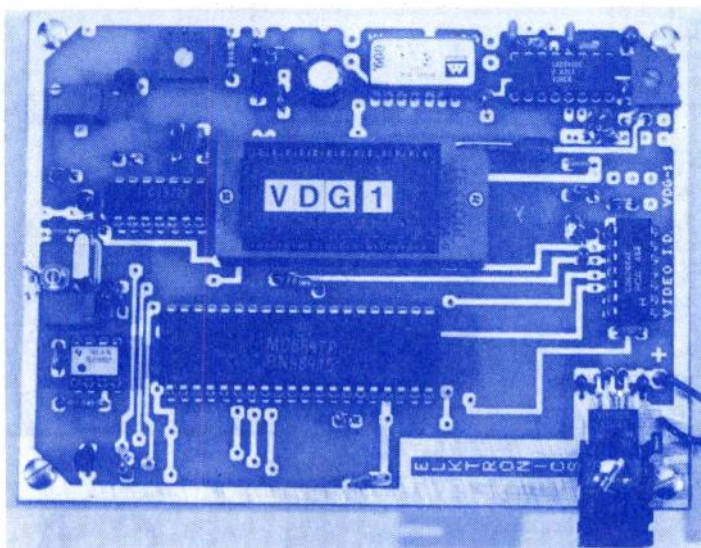

## KA0JAW

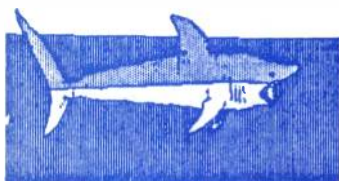

## KA8EE

Jim  
Marion Ohio



## N2CAI /r



## KA8ZNY

GROVEPORT



- Instant Video Source
- 4 Graphics Screens (2 Hi-RES / 2 Colorbar)
- 12 V D.C. Operation
- Video Relay for switching in live camera video
- Built-in Sequencer/Timer (Steps through all 4 screens)



VDG-1 with Pre-Programmed Custom Callsign Logo

- \$99 ppd.

(Quick-release socket option)

- \$10

**Call or Write for CATALOG of available Graphics**

Additional Programmed EPROMS

- \$19

Now available as a Kit

- \$89 ppd. Blank PCB - \$19

## KA8LWR



IN BUCYRUS, OHIO

## KA8WLV

WHERE NO ATV'ER HAS GONE BEFORE



# Special Club Offer

## AMATEUR TELEVISION QUARTERLY SUBSCRIPTION

DEVOTED ENTIRELY TO AMATEUR TELEVISION

US Delivery Canada Elsewhere

<input type="checkbox"/> 1 YR	\$15	\$20	\$25
<input type="checkbox"/> 2 YR	\$30	\$40	\$45
<input type="checkbox"/> 3 YR	\$40	\$55	\$65 (all US Funds)
<input type="checkbox"/> 4 YR	\$50	\$70	\$85
<input type="checkbox"/> 5 YR	\$60	\$85	\$100

**VISA AND MASTER  
CARD ACCEPTED**

**SUBSCRIBER HOTLINE  
708 298 2269  
SUBSCRIBE TODAY  
VISA OR MASTERCARD**

Call: \_\_\_\_\_ Name: \_\_\_\_\_

Address: \_\_\_\_\_

City: \_\_\_\_\_

State/Prov: \_\_\_\_\_ ZIP: \_\_\_\_\_ Country: \_\_\_\_\_

Gift? \_\_\_\_\_ From: Call: \_\_\_\_\_ Name: \_\_\_\_\_

Optional Info

operate: FSTV SSTV FAX other \_\_\_\_\_

ATV/SSTV bands \_\_\_\_\_

Phone (kept confidential) \_\_\_\_\_

Best ATV or SSTV DX \_\_\_\_\_

Grid locator or Lat/Lon. \_\_\_\_\_

ATV RPT? \_\_\_\_\_ QTH \_\_\_\_\_

Station Equipment \_\_\_\_\_

Comments: \_\_\_\_\_

AMATEUR TELEVISION QUARTERLY  
1545 Lee St., Suite 73  
Des Plaines, IL 60018

Card # \_\_\_\_\_

Expires \_\_\_\_\_

Signature \_\_\_\_\_

## SPECIAL CLUB OFFER

We have been receiving good response to a special club offer mailed to ham radio clubs in the US. So we will offer it to the ATV clubs too! This offer is for **NEW SUBSCRIBERS** only!

Copy the subscription forms in this issue. Take them and this copy to your local club meeting. Send in 5 or more **NEW SUBS** (not renewals) and save \$3 per yr--that's \$12/yr/sub. Send in 10 or more and save \$4 each --that's \$11/yr. Send in 20 or more and save 1/3, 33%, \$5/yr/sub--that's \$10 per year. **NO LIMIT.** Offer expires Sept 1, 1991! The discount is based upon the number of subs you send to us in a single envelope. Hurry! Don't let your friends miss another issue of the Q!



## C.A.T.S.

Rotors, Parts and Repair Service  
Reconditioning Large or Small  
American Made Rotors  
Repairs-\$20.00\*  
Rebuilds-\$40.00\*

All parts in stock for immediate delivery.  
New units for sale. Trade-ins welcome.



**R  
O  
T  
O  
R  
S**

**P  
A  
R  
T  
S**

## C.A.T.S.

7368 S.R. 105 Pemberville, OH 43450  
Call N8DJB at (419) 352-4465 10:00-5:00

\*LABOR ONLY-PARTS & SHIPPING ADDITIONAL



# MEET ME IN ST LOUIS, LOUIS



ABOVE:View from the rptr site looking North towards DesPlaines.LOWER RT:Some local QRM at the site (tightened 60 f-connectors).LOWER MID: KAOLZNinstalling antennas.LOWER LFT:KAOLZN & KDOLO coring hardline(only 20ft.run)

**THE ST. LOUIS ATV REPEATER IS ON THE AIR!** In mid october, KAOLZN found a home for the ATV repeater. Huck Oberlin owner of the Holiday Inn at Westport Plaza offered a rooftop spot towering over average terrain in St.Louis at a mighty 750 ft. above sea level.The input freq. is 923.250 Mhz and output at 421.250 Mhz. A Hustler G-6 is currently in use for the txmit ant, and a comet FP-19 for the receive. During its first weekend on the air,the output was seen in West Lafayette Ind. by KA9TGX. Next time you're in St.Louis, be sure to stay at the WESTPORT HOLIDAY INN...don't forget you're ATV gear !

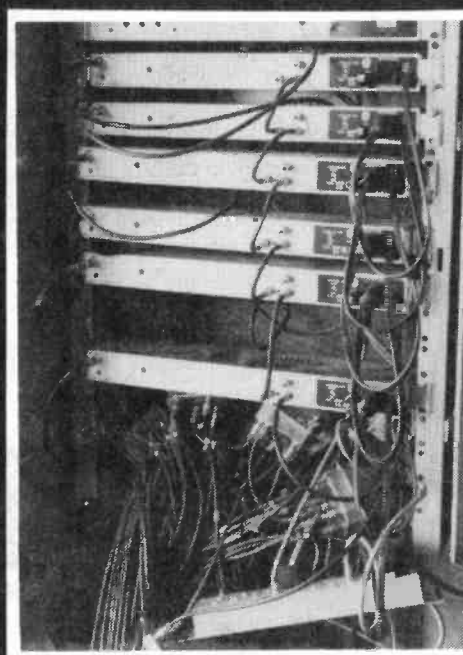
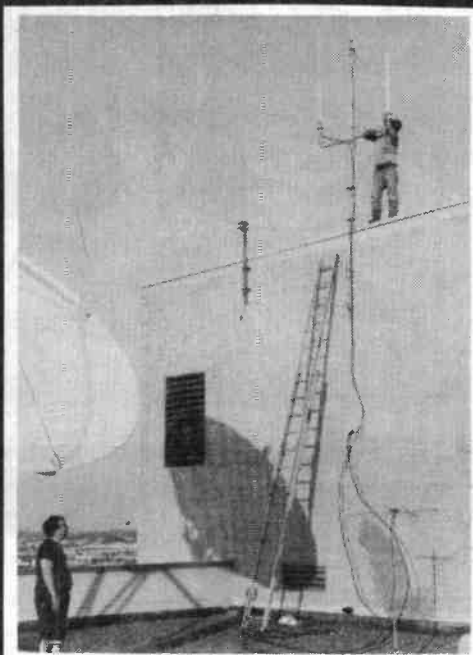
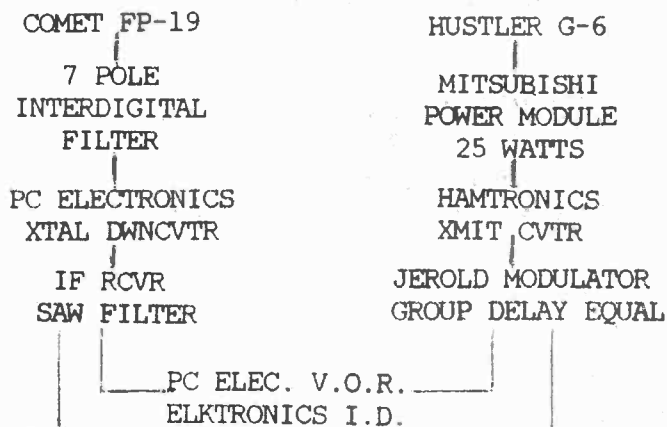

# GET INTO THE MAGIC OF HAM RADIO

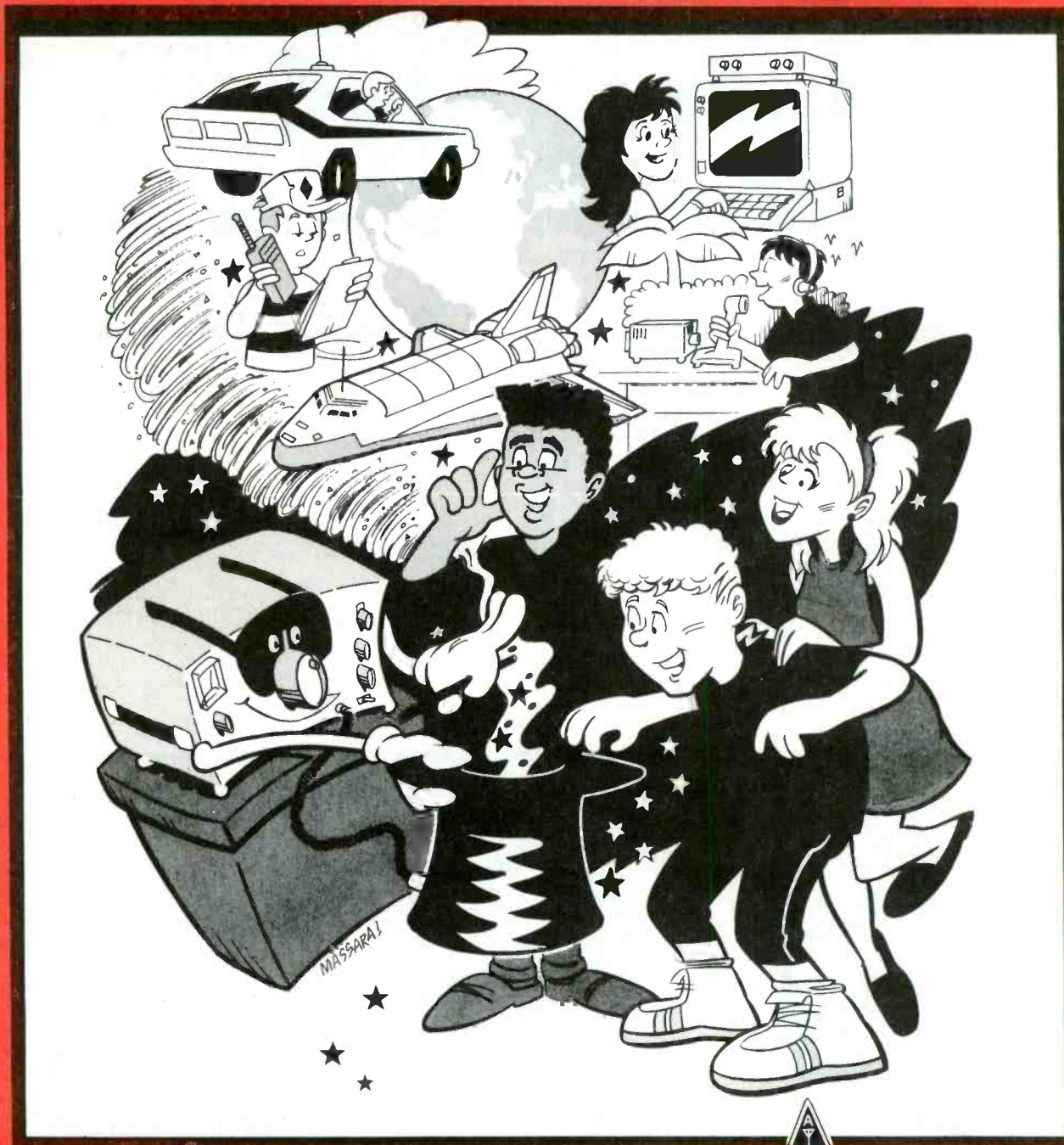

Travel the radio waves across our country and around the world.



THE AMERICAN RADIO  
RELAY LEAGUE  
NEWINGTON, CT 06111

Join the group that's into the magic of making new friends and discovering adventures with Ham Radio-this is one trip you don't want to miss!





**ELECTRONICS**

**P.C. ELECTRONICS 2522 PAXSON LANE ARCADIA CA 91007-8537 USA**

**TOM (W6ORG) & MARYANN (WB6YSS) O'HARA**

**(818)447-4565**

24 hr FAX order line (818) 447-0489



## THE "KREEPIE PEEPIE" ATV TRANSMITTER

THIS IS THE ATV TRANSMITTER BOARD YOU HAVE READ ABOUT THAT HAS SURVIVED MANY BALLOON FLIGHTS TO OVER 100,000 FEET AND BACK. ALSO USED FOR R/C MODELS WHERE AN ALL IN ONE BOARD WITH SOUND IS DESIRED OR DEDICATED LINKS AND REPEATERS. JUST THE THING FOR THE BUILDER WHO WANTS TO PACKAGE AND MAKE HIS OWN PORTABLE 70 CM ATV TRANSMITTER OR HOME TRANSCEIVER WITH A WIRED AND TESTED BOARD.

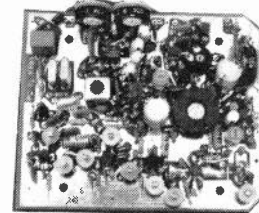
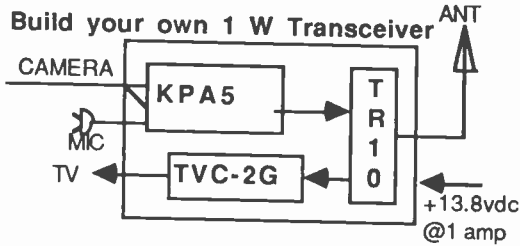

**KPA5-E board only \$169**



### KPA5-E 70CM ATV XMTR BOARD FEATURES:

- 1.5 Watts P.E.P. typical RF out.put. Run barefoot for portable, but if needed for greater DX, the output properly matches the Mirage D15N 15 watt, D26N-ATV 50 Watt linear amp for full output or D100TVN to over 70 Watts with an adjustable sync stretcher.
- FULL COLOR AND SOUND on a small 3.25x4" board
- Wired and tested board runs on external 13.8 Vdc @ 300 mA. supply or 12 V battery. Weighs only 3 oz.
- Accepts composite video from cameras, camcorders, VCRs, computers, etc. 2 audio inputs, one for low Z dynamic mic, & one line level from most cameras & VCRs. Transmit monitor output enables seeing your own true RF detected video.

### KPA5 APPLICATION:

**PORTABLE CORDLESS TV CAMERA.** Think of it as a video HT. Place the KPA5 in one of the Hammond Dicast aluminum boxes, AEA HR-4 half wave "hot rod" on top or at the end of 50Ω coax attached to a headset. Plug into a 12-14 v source such as a 12 Vdc battery pack. Depending on terrain & receiving antenna DX is typically over 1 mile. With KLM 440-16Xs at both ends DX is 22 miles snow-free line-of-sight. Price only \$169 supplied with one xtal on 426.25, 434.0, 427.25 or 439.25. 2nd xtal add \$15. Specify frequency(s) when ordering, check with local ATVers, ARRL Repeater Directory or call us. Sold only to licensed radio amateurs.

### ACCESSORIES:

- Hammond 1590D 7.3x4.7x2" roomy alum. box.....\$18
- 1590C 4.6x3.6x2" aluminum box, smaller tighter fit.....\$12
- 800J 10 pin VHS color camera chassis connector.....\$10
- 100 Ohm panel pot for video gain control.....\$5
- TVC-4G 420-450 MHz to CH3 receiving downconv.....\$89
- TR-10 RF T/R relay module, mounts on chassis N conn....\$29
- MIRAGE D15N-ATV 1.5 in /15 out all mode amp.....\$159
- MIRAGE D26N-ATV 1.5 in / 50 out all mode amp....\$219
- MIRAGE D100TVN 1.5 in/50 out all mode amp.....\$319

- AEA HR-4 "Hot Rod" half-wave portable antenna.....\$23
- 450 ISOPOLE omni 4 dBd vert. gain antenna.....\$89
- KLM 440-6X 8.9 dBd ant., 28" boom, >50 deg. BW.....\$57
- KLM 440-10X 11.2 dBd, antenna, 64" boom.....\$68
- KLM 440-16X 14 dBd antenna, 10.5 ft boom.....\$119
- UG21 type N male connector for Belden 9913 coax.....\$5
- UG58 N female flange type chassis connector.....\$2
- VOR-2 Video (horiz sync) operated relay board.....\$45

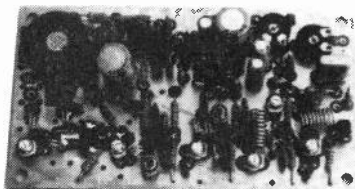

### NEW SMALL TXA5-RC 1 WATT ATV TRANSMITTER.....\$129

Designed primarily for Radio Control models, rockets, balloons, etc. with it's small 2.25 x 4 inch size and 2 oz. weight. Adjustable power output from 1.5 p.e.p. to 100 mW. Draws 250 MA @ 13.8 Vdc. Has adjustable sync stretcher and provisions for sound from the FMA5-E board (pg 2) in case your application needs higher power sometimes or subcarrier sound. Comes wired and tested ready for you to mount in a shielded enclosure, connect up coax from antenna and camera and wires to power source. Plan on shielding your R/C receiver and adding the simple antenna low pass filter outlined in the application note supplied. Receive with one of our 70 cm downconverters listed on page 3 and a TV set Specify frequency, 426.25 MHz suggested for R/C, other standard ATV frequencies available. Sold only to verified licensed radio amateurs in the Callbook or send copy of new license.



### UNIDEN VM110 CCD BLACK & WHITE CAMERA.....\$125

Low cost per crash camera just right for R/C applications or second camera for call letter ID or DX. Size 4.7x3.9x2.2" and weighs less than 7 ounces. Requires 11 to 14 Vdc at 200 MA. Lens included. 19440 pixel, 120 line resolution with standard composite video output.

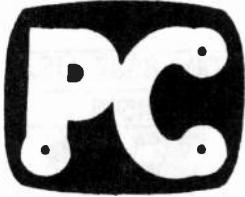

P.C. ELECTRONICS 2522 PAXSON LANE ARCADIA CA 91007-8537 USA  
 TOM (W6ORG) & MARYANN (WB6YSS) O'HARA (818)447-4565

24 hr FAX order line (818) 447-0489



ELECTRONICS

**NEW TX70-1A AND RTX-70 TRANSMITTER**

The family of full feature ATV transmitters for home, link or repeater use is now complete. We have models for all 3 of the popular ATV bands - 23, 33 and now 70 CM.



TX Series

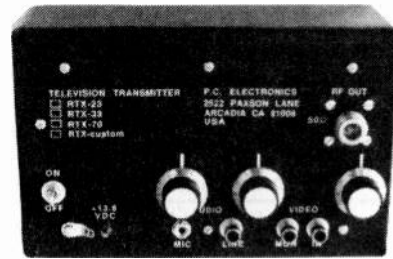

RTX Series

**Features found on all 3 transmitters:**

- >1 Watt pep with adjustable sync stretcher to properly match amateur linear amps. Sets the blanking pedestal for proper video to sync ratio to compensate for the linear amps high power gain compression curve.
- RF detector right on antenna output to see what is really going out on the air and that your video gain, focus, etc. throughout the whole transmitter is set up correctly. Detected composite video monitor outputs to a RCA jack in transmit, and loops thru in receive to enable camera set up before flipping the transmit switch.
- Independent gain control of mic and line audio to enable external mic mixing with VCR or camera mic audio. New temperature compensated 4.5 MHz sound subcarrier generator with line audio pre-emphasis and soft limiting between the broadcast standard 25 kHz average & 40 kHz peak deviation.

**CHOOSE THE TX SERIES FOR HOME AND PORTABLE USE.** Has built-in RF T/R relay switching for easy connection through a BNC cable to the companion TVC downconverter. Rear panel video & audio jacks for VCR or Camcorder, or use front panel VHS camera jack. Mic & push to look jacks in front. Shielded cabinet 7x7x2.5", 1.6 lbs.

- NEW TX70-1A** has 2 frequency capability in the 425-440 range, 1.5 W pep on sync tip typical output.....\$279  
 one crystal included - we stock most used 439.25, 434.0 & 426.25, plus 427.25 & 425.25. 2nd crystal add \$15.
- TX33-1** single frequency - specify 910.25 the most common simplex, 911.25 or 923.25 MHz .....\$329
- TX23-1** single frequency - specify 1289.25 the most common simplex, 1277.25, 1265 or 1253.25 MHz.....\$329

**CHOOSE THE RTX SERIES FOR DEDICATED REPEATER AND LINK USE.** Uses same transmitter in a completely shielded Hammond 1590D diecast aluminum box but without T/R switching.

- NEW RTX-70** specify repeater or link output frequency, 421.25 MHz most popular for inband output.....\$299
- RTX-33** specify frequency - 923.25 MHz is the most used crossband repeater or link frequency.....\$329
- RTX-23** specify frequency - 1253.25 MHz best first repeater output crossband freq., then 1277.25 MHz.....\$329

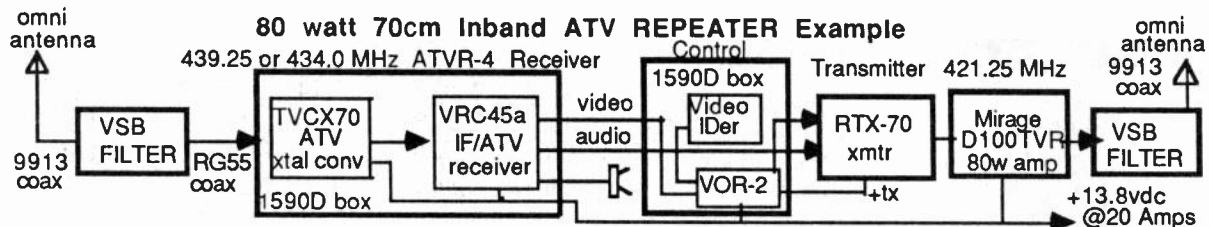

Select an ATVR Receiver (catalog pg 4) & a RTX Transmitter for the bands you want, add the appropriate linear amp, VSB filters & antennas, ID & VOR-2, power supply and coax for your own repeater. We suggest low in / high out for crossband. VOR-2 Video Operated Relay board...\$45, keys RTX upon detection of horizontal sync. 10 min. & end of transmission momentary relay for switching to video ID to meet FCC regs. Contact Bill Brown, WB8ELK at (419) 4228206 for the VDG-1 video IDer directly. 33 & 23 CM Amps - Downeast Microwave Bill (207)9483741, Omni gain Vertical Ant - NCG Co. Bruce (714) 6304541, VSB Filters - TX/RX Systems Jon (716) 5494700.

**CALL TO DISCUSS YOUR APPLICATION & TO GET A COMPLETE CATALOG NOW!**

# SAREX

## The Long Awaited Event

### By Lionel Remigio, KC4CLD

#### reprinted from Radio Scan

January 1991 issue.

For months, radio amateurs around the world patiently awaited the moment which finally came on December 2, 1990. At 06:49 UTC, the space shuttle Columbia lifted off from the Kennedy Space Center in Florida, carrying seven crew Members among whom was Payload Specialist Dr. Ronald A. Parise, WA4SIR, in charge of the Space Amateur Radio Experiment (SAREX) sponsored by the ARRL, AMSAT and NASA.

Dr. Parise has the double mission of also working with the Astro-1 astronomical laboratory. The shuttle's flight is primarily dedicated to the research of a single discipline, astrophysics.

The launch went off as planned. By midday, we received transmissions from the shuttle, relayed by the Goddard Amateur Radio Club at the Goddard Flight Center in Texas. The work went along as expected, with the exception of a few computer problems and instruments which were controlled manually until satisfactory operation was restored.

#### Puerto Rico, The First Contact

The Sunday, Ramon Gonzalez, WP4XQ, contacted the SAREX packet robot at 00:09:01 AST. He received the number one indicating that his was the first QSO with the Columbia. Gonzalez, who is a computer programmer and analyst, was only one of a few Puerto Rican hams who made contact with the shuttle while it flew 190 miles above the Earth, at 28.5 degrees over the Atlantic.

#### How WP4XQ Contacted The Shuttle

The equipment Gonzalez used to make his QSO with SAREX were not at all sophisticated. It was an ordinary rig, proving that patience is often enough. He used the following equipment:

Hustler G7-144 antenna at a height of 10 ft.  
Icom IC-275A with 25 watts of power TNC AEA PN-232  
LANLINK Ver. 1.58 terminal program and a Toshiba T1000 portable computer.

#### SAREX

The QSO robot which was the heart of the SAREX experiment permits any station to make contact with Dr. Parise. It assigns the ham a number and disconnects, allowing the greatest number of QSOs with numbers 794 and 795, as well as the disconnecting of WA4SIR with other stations, one of which was in Canada.

The greatest problem with contacting the Columbia involved Dr. Parise's availability usually when the shuttle was over South America and Australia. This schedule limited some of SAREX's operations.

Another Aspect of the mission influencing communications was the shuttle's low orbit. The Columbia's fast pass limited the contacts' duration. Had the shuttle been flying at a higher altitude, the opportunity to contact Dr. Parise would have been longer, allowing for more QSOs.

#### The Work Sessions

Dr. Parise had twelve work sessions.

Session 0, at 03:16 on December 3, tested phone lines and several HF retransmissions through NASA stations. These experiments were conducted during a flyover of Australia and VK6IU of Carnavon, VK5AGR of Adelaida, and VK2AS of Sydney were contacted. Although Parise was not heard during this session, SAREX was functional. However, it was not pointed towards the Earth and, therefore, QSOs were few and far between. Nevertheless, Dr. Parise contacted NZ8W during a pass of Florida during this session.

Session 1, at 17:11 the same day, was a partial success. PY2BJO of Brazil tried several times until finally establishing contact with WA4SIR.

Session 2, at 16:00 on December 4, was a success. During the 9 minute pass over the US, PY2BJO again established contact with phone patch via stations KK9T, WA5TET, and WB4TGB.

Session 3, at 02:31 on December 5, was the greatest success. The three Australian stations mentioned in session 0 contacted stations W6BYE, N7NHM, and WB5OAP who sent students' questions to Dr. Parise. This 20 minute session really impressed the students listening. Other sessions continued as follows:

Session	Date	Time(UTC)	QTH
8	12/7	1540-1550	PY
9	12/8	1606-1616	PY
10	12/9	1631-1641	PY
11	12/10	0303-0317	VK



*Designed specifically for amateur television in the 70cm band...*

# FL407 INTERDIGITAL FILTER

**7-Pole Interdigital Vestigial Sideband Filter for Frequency Ranges of 420 MHz to 440 MHz**

The 6 MHz nominal bandwidth and low loss design are perfect for transmitter or receiver use. Two filters can be used for repeater applications.

Heavy duty construction insures stable operation and long life.

**Ordering Information:** The FL407 may be ordered on any frequency between 420 and 440 MHz. Please specify video carrier frequency when ordering.

**Dimensions HWD:**  
2 1/8" x 8 13/16" x 20 5/8"

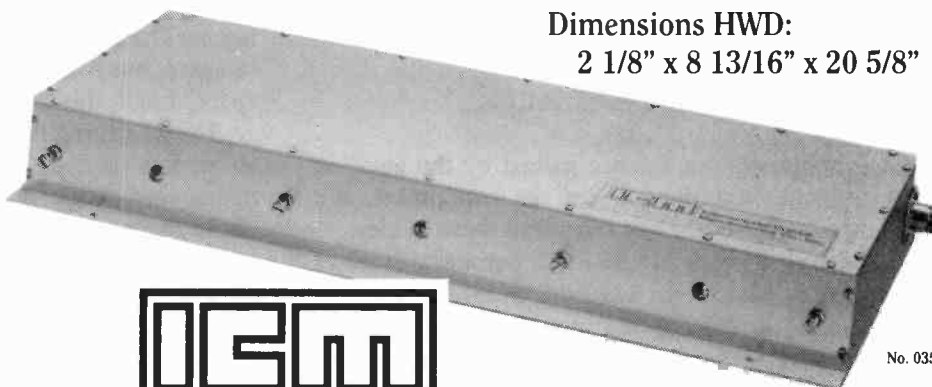

No. 035026



**International Crystal Manufacturing Co., Inc.**

P.O. BOX 26330 • 701 W. SHERIDAN • OKLAHOMA CITY, OK 73126-0330 • (405) 236-3741 • FAX (405) 235-1904

## SATELLITE TRACKING MADE EASY

WITH SOFTWARE FROM

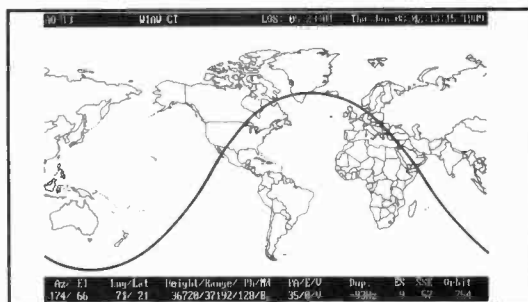

Line representation of QuikTrak 4.0 World Map

### QuikTrak 4.0

Whether you want to identify the next time Oscar 13 will provide communications between two cities or if you just want to know the next time you can visually sight the Soviet space station MIR, QuikTrak will let you plug in the latest Keplerian elements for up to 100 satellites using a new full screen editor. QuikTrak also supports autotracking. *Hardware requirements*, IBM PC, AT, PS/2, or clone with a minimum 512K memory. CGA or EGA graphics required. Numeric coprocessor not required but recommended.

### InstantTrack 1.0

For those concerned with greater speed and capability, InstantTrack offers all of QuikTrak's features plus instant visibility for your "favorite" satellites before you issue the first keystroke. More than 200 satellites and 1754 cities are on the menu and will be in full-color high-resolution EGA or VGA modes. *Hardware requirements*: IBM PC, AT, PS2 or clone with at least 512K memory. EGA or VGA graphics required. Numeric coprocessor not required but recommended. Mouse not required but can be used on the map screens.

*These are only a few of the features of QuikTrak and InstantTrack. The figures below reflect suggested donations to defray production expenses and benefit AMSAT's non-profit, educational activities.*

	Recommended Donations:	Member	Non-Member
QuikTrak 4.0	5 - 1/4"	\$55	\$75
InstantTrack 1.0	5 - 1/4"	\$50	\$70

**AMSAT membership \$30/yr U.S.; \$36/yr Canada & Mexico; \$45/yr Foreign**

**AMSAT PO Box 27 Washington, DC 20044**  
301-589-6062 Voice, 301-608-3410 Fax

## How SAREX Was Worked

In Miami, information about contacting the shuttle was constantly being distributed. Various groups used repeaters to transmit the Keplerian Elements and the trajectory, as well as the schedule for passes and any other information which might help amateurs make contact.

One of the most active repeaters in South Florida for this effort was on 146.925, where a great number of packeteers shared information about Dr. Parise and the shuttle.

On the night of December 6, many amateurs anxiously awaited the expected contacts, at the scheduled time. And they heard...nothing but silence. Apparently, something happened aboard the shuttle prohibiting normal SAREX operation.

### The Positive Aspects of SAREX

Without a doubt, the experience gained by the amateur community was the best thing about the experiment. We learned about satellite vocabulary related to these modes.

After realizing that previous SAREX experiments (such as those conducted by Dr. Owen Garriott, W5LFL, and Dr. Anthony England, W0ORE), did not interfere with the principal missions, NASA seems to be giving its full support to radio amateur experiments. This must also be considered a success for amateurs. The growing interest for ham radio among scholars and even regular people who had never even been involved in contests was another positive aspect of SAREX.

### The Negative Aspects Of SAREX

There was a lack of organization and effectiveness in the packet network's distributing of messages on time. Those who knew the details of SAREX had no problem in reaching the orbiter, but those of us who did not have that kind of experience found a great lack of help on the packet net. The bulletins which did arrive, at least in Florida, arrived at the area BBS on December 10, just hours before Columbia's return to Earth.

Another problem was the mode used by WA4SIR, when many were awaiting his contacts in packet, he transmitted in voice. Any amateur would be confused in this case, regardless of the amount of experience. Until May, the packet net flooded with SAREX bulletins, but this time there was nothing. I am not saying that SAREX was a failure because, it was not. But it was in fact an experiment, just as the name said. Nothing is certain in an experiment. The antenna problems may be solved in future SAREX missions by choosing a better position.

## SAREX Summary

The total number of voice QSOs conducted by Dr. Parise has still not come in; neither has the number of those conducted by the packet robot aboard the STS-35.

### Not Everything Is Lost

For those of you who were not able to contact the shuttle, there is good news, though.

Cosmonaut Musa Manarov, U2MIR, returned to the MIR space station and began operating on 2 meters. On the same 145.550 simplex frequency. WA10MM reported a contact with him on December 2. Manarov was very active last time he was in space, but it is not known how long he will be aboard the space station this time.

The 51 degree inclination orbit of the MIR makes it easy to work in comparison to the space shuttle, which had a 28.5 degree inclination orbit. This made it difficult for stations above the 40 degree latitude to contact SAREX.

To follow good news with better news, in January, Manarov should receive an experimental packet station for permanent installation aboard the MIR space station. This module works the AFSK (FM) with the normal AX25 protocol.

Manarov will also use a vocal synthesizer to transmit greetings in Russian, English and German. Best of all, unlike Columbia's interior antenna located by the pilot's window, MIR's antenna will be on the exterior.

If you could not contact Dr. Parise and the shuttle try to contact U2MIR on the same frequency.





# CUSTOM CRYSTALS

## Crystals for many applications

For over 40 years, ICM has manufactured the finest in quartz crystals for every conceivable purpose.

A wide selection of holders are available to fit most any requirement. Our computer database contains crystal parameters for thousands of equipment types.

Need crystals for communications, telemetry, industrial, or scientific applications? Let ICM's sales department assist you to determine which type of crystal is best for you.

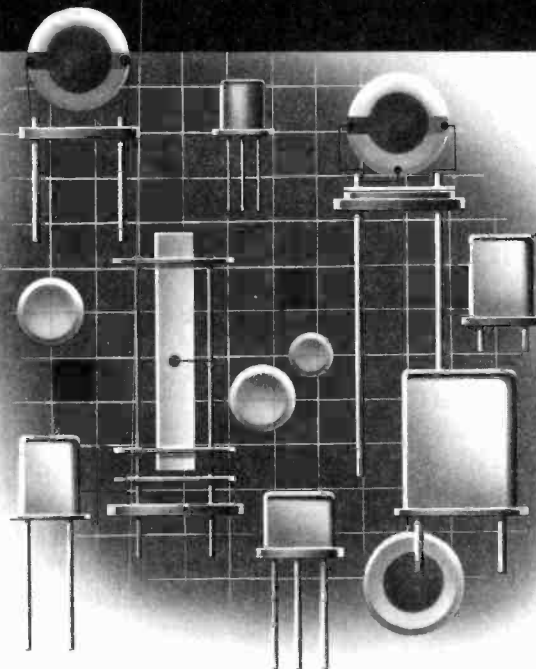

## Can we solve your crystal problem?

For special purpose crystals, special holders, special sizes, call our crystal sales department. We will be pleased to provide recommended data.



**International Crystal  
Manufacturing Co., Inc.**

P.O. Box 26330, 701 W. Sheridan,  
Oklahoma City, OK 73126-0330  
Phone (405) 236-3741  
Telex 747-147  
Facsimile (405) 235-1904

## The Kensington Challenge

### John W. Moore KD1E

*Milford Mi. ARC Successful in First ATV Public Service Event*

*On September 22, 1990 two members of the Milford Amateur Radio Club provided ATV coverage of the 15k "Kensington Challenge" run.*

It was the first attempt by the club to use ATV for a public service event. This foot race was run along a bike path in one of the regional parks. The course went around a large lake with the half way point being directly across from the starting point.

Over 1200 runners participate in this event. The club has provided communications for this run for over 5 years. Our main concern is to provide rapid reports of any medical emergencies that may occur on the course. We also help coordinate communications from the registration, starting, half way, and first aid areas. With many people milling around the registration area during the race we felt it was a good opportunity to provide an added service, and to promote ATV. John KD1E, and Ernie WA8DMW had recently put together transceivers using PC Electronic modules and were willing to set up some basic ATV coverage.

Ernie set up his station at the registration area using his transceiver, a 13" color TV, and a UHF Bow Tie antenna that KD1E had purchased at a swap for \$5.00. KD1E set up his station at the halfway point. It consisted of a 1.5 watt transceiver driving a

Mirage D26 amplifier to a KLM 6 el beam. A Magnavox Camcorder was used to telecast and record the activity at half way point. I'm sure we didn't need the 50 watts for the 1 mile shot across the lake but we wanted to make the picture as good as possible.

The event turned out very well, with a large group of people constantly monitoring the progress of the Run, and looking for their favorite runners. The small TV was not adequate for this type of viewing, but the color, sound, and signal were all excellent. There were many excellent compliments from the spectators, and a huge groan when I tripped over some cables, and disrupted the transmission.

The coverage of this event was certainly not the quality and precision of the Rose Parade ATV effort, but you have to start somewhere. Right? All in all we had fun and the public sure enjoyed it. Next year the race organizers plan to have a 50" monitor at the registration area, and they want to provide a color commentator at the halfway point. I hope this short article will show that just two people can get some ATV activity going in their area, and have lots of fun doing it.

## MORE C-64 ATV PROGRAMS N7AON

Here are some more C-64 video programs. I also have VIC 20 stuff. Test patterns etc. Ham formula programs for both computers, SSTV for C-64. One of the included programs is modified & renumbered from WA8KQQ. It now includes white, yellow, cyan, grey, purple, red, blue white color blocks. It puts blocks of color with their names in. ANY key changes background colors to give interesting patterns. Have American flag that plays Star Spangled banner in 3 part harmony. Tones of music, sound effects etc. My Dr. Who music has neat graphics too.

```

10 REM COLOR BLOCKS
20 G=13*4096
30 POKE G+33,0
40 S$="[RGHT][RGHT][RGHT][RGHT][RGHT][RGHT]"
50 PRINT "[CLR]"
60 CD$="[BLK][WHT][RED][CYN][PUR][GRN][BLU][YEL][ORNG][BRWN][LRED][GRY1][GRY2][LGRN][LBLU][GRY3]"
70 DATA "[RGHT][RVON][WHT]BLACK[RGHT]", "[RGHT][RGHT][RVON][WHT]WHITE[RGHT]", "[RGHT][RGHT][RGHT][RVON][RED]RED[RGHT][RGHT]"
80 DATA "[RGHT][RGHT][RVON][CYN]CYAN[RGHT][RGHT]", "[RGHT][RVON][PUR]PURPLE[RGHT]", "[RGHT][RGHT][RVON][GRN]GREEN[RGHT]"
90 DATA "[RGHT][RGHT][RVON][BLU]BLUE[RGHT][RGHT]", "[RGHT][RVON][YEL]YELLOW[RGHT]", "[RGHT][RVON][ORNG]ORANGE[RGHT]"
100 DATA "[RGHT][RGHT][RVON][BRWN]BROWN[RGHT]", "[RGHT][RGHT][RVON][LRED]PINK[RGHT][RGHT]", "[RGHT][RVON][GRY1]GRAY 1[RGHT]"
110 DATA "[RGHT][RVON][GRY2]GRAY 2[RGHT]", "[RVON][LGRN]LT GREEN", "[RGHT][RVON][LBLU]LT BLUE"
120 DATA "[RGHT][RVON][GRY3]GRAY 3"
130 FOR X=0 TO 3
140 FOR Y=1 TO 5
150 FOR Z=1 TO 4
160 PRINT " [RVON]"MID$(CD$,X*4+Z,1)" [RVOF] ";
170 NEXT Z
180 NEXT Y
190 IF X<>3 THEN PRINT
200 NEXT X
210 PRINT "[HOME][DOWN][WHT]"SPC(1)"|_____|"SPC(32)"| "
220 PRINT SPC(1)"|_____|"SPC(32)"| "
230 PRINT SPC(1)"|_____|"
240 PRINT "[HOME]";
250 FOR X=1 TO 4
260 READ A$,B$,C$,D$
270 PRINT "[DOWN][DOWN][DOWN][DOWN]";
280 IF X=1 THEN PRINT "[UP]";
290 PRINT "[RGHT]"A$,"[RGHT]"B$,"[RGHT]"C$,"[RGHT]"D$
300 NEXT X
310 GET A$
320 IF A$="" THEN 310
330 POKE G+33,PEEK(G+33)+1 AND 15
340 GOTO 310

```

READY.

---

FOR SALE...I have a few SGS TEA5114 I-C's for sale. (This is a VIDEO SWITCH used in many BATC circuits). \$3.95 PP. Check or M.O. to: W600C, CHUCK HARTLEY, P.O. Box 614, SAN CARLOS, CA 94070

# MBC-TV

Satellite Network  
Presents

# H A M R a d i o News!



Vern Van Valkenburg W0VV

A weekly news  
program of special  
interest to amateur  
radio operators.

Check local TV listings for  
showtimes in your area.

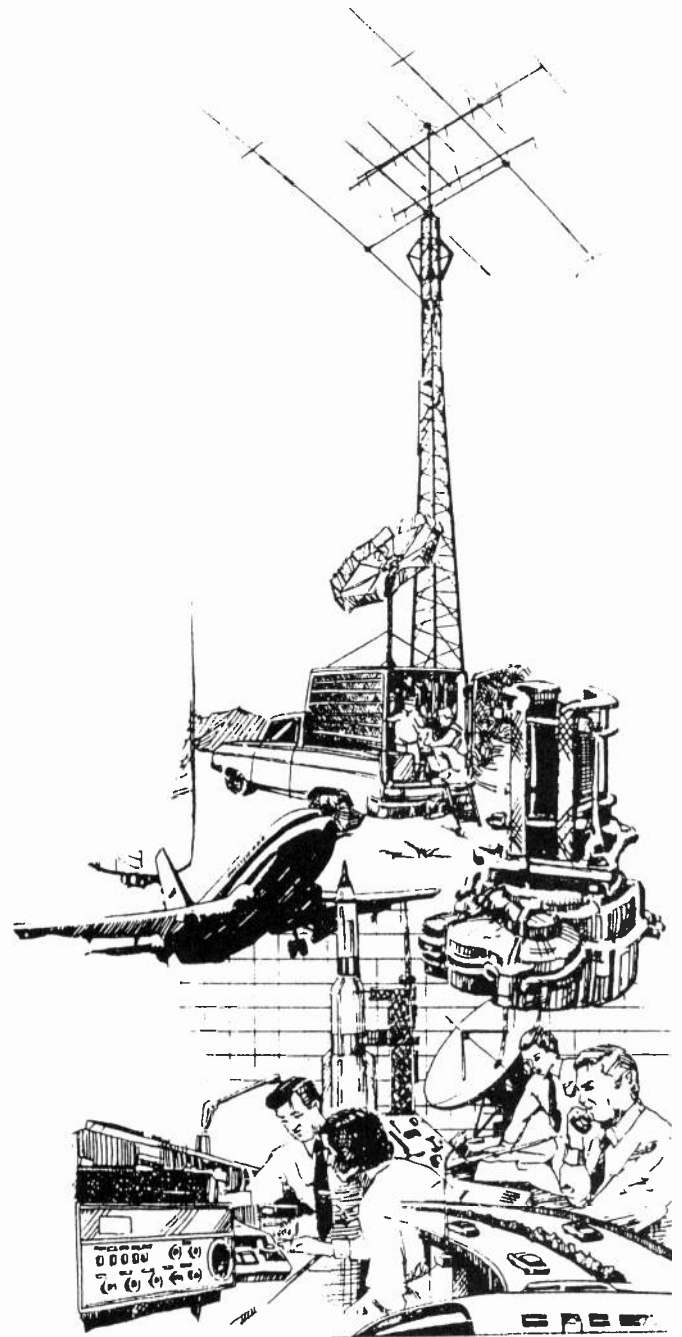

**MORAN BROADCASTING COMPANY**  
SATELLITE TELEVISION NETWORK

JACK MORAN *W6FUG*

# MORE C-64 ATV PROGRAMS N7AON

```

10 PRINT CHR$(147)
20 POKE 53280,7
30 POKE 53281,7
40 POKE 646,0
50 PRINT "[DOWN][DOWN][DOWN][DOWN][DOWN][DOWN]"
60 PRINT "          COLOR TV ALIGNMENT CHARTS"
70 FOR DW=1 TO 1000
80 NEXT
90 PRINT "          [DOWN]BY W8KQQ"
100 FOR DW=1 TO 1000
110 NEXT
120 PRINT "          [DOWN]MODIFIED BY N7AOU"
130 FOR DW=1 TO 1000
140 NEXT
150 PRINT "          [DOWN]TO CHANGE PATTERN USE F1 (WAIT)"
160 FOR DW=1 TO 5000
170 NEXT
180 PRINT CHR$(147)
190 POKE 53280,0
200 POKE 53281,0
210 FOR I=1 TO 24
220 PRINT "[RVON][WHT]  [YEL] N [CYN] 7 [GRN] A [PUR] 0 [RED] U [BLU
]  [WHT] ATV [RVDF]"
230 NEXT
240 GOSUB 340
250 FOR I=1 TO 24
260 PRINT ".....";
270 NEXT
280 GOSUB 340
290 FOR I=1 TO 24
300 PRINT "++++++++++++++++++++++++++++++++++++";
310 NEXT
320 GOSUB 340
330 GOTO 180
340 GET A$
350 IF A$="" THEN 340
360 PRINT CHR$(147)
370 RETURN
380 REM CHANGE CALL LETTERS IN LINE 220 TO SUIT

```

READY.

```

10 FOR BA=0 TO 15
20 FOR BO=0 TO 15
30 POKE 53280,BA
40 POKE 53281,BO
50 FOR X=1 TO 2000: NEXT X
60 NEXT BO: NEXT BA

```

READY.

# LOG PERIODIC FROM NECESSITY TO FINISHED PRODUCT

by

Dave Clingerman, W6OAL

Today most of us have had some experience with the FM mode of communications on the VHF/UHF bands, most likely Two Meters.

Some have become disillusioned with the type and style of operation or do not wish to contend with the crowding and have turned to the other bands, e.g. 220 MHz., 450 MHz.

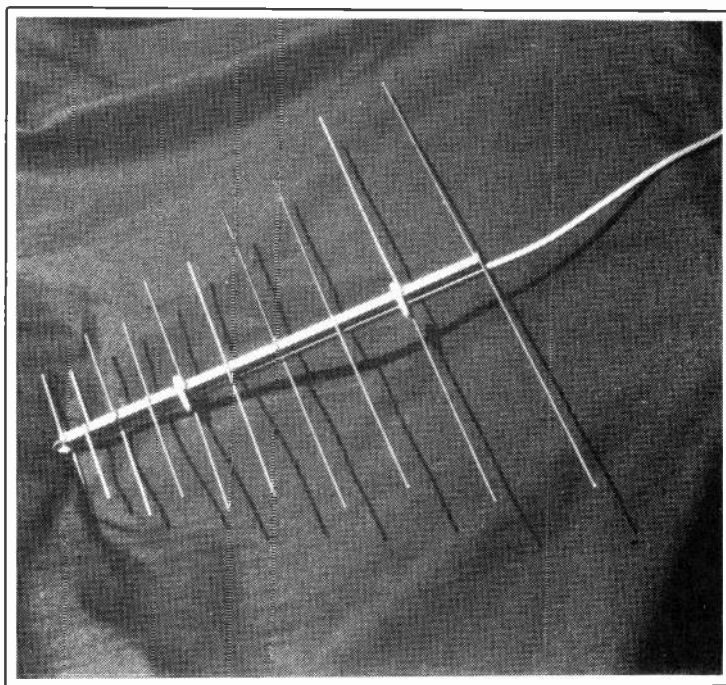

A lot of HAMS, due to antenna restrictions, are only able to maintain their hobby through FM operation, others are very happy using this mode only. Whatever the case antennas become a problem when another band on which to operate is contemplated. The old reliable "Ground Plane" is usually the first radiating device that goes up when a new VHF/UHF rig is purchased. I know it to be true in my case. After a few weeks we realize a little gain would be desirable and in some cases directivity. The apartment dweller or the individual hampered by zoning restrictions is left in somewhat of a quandary as to how the antenna situation should best be handled. Convincing landlords of your needs and pacifying neighbors can be a real art. What's to be done, another ground plane on the balcony rail or hidden in the attic? Again, no gain and no directivity. Those with the tri-band VHF/UHF transceivers are faced with erecting three different antennas from the start, three

JANUARY 1991 VOL. 4 #1

feed lines and a wealth of connectors, not to mention a coax switch.

One of several solutions to the problem is a frequency independent antenna. A device that would cover 144 MHz to 450 MHz, have some gain and a respectable front-to-back (F/B) ratio would surely be desirable. Separate gain antennas for three bands could result in considerable capital expenditure, something I'm sure none of us look forward to in this day and age. Home brewing will surely cut cost, and furthermore, why pay three times the price when one antenna will do the job? Of course I'm not talking 18 dB gain per band and who needs it? When I see an antenna 20' to 25' long, vertically polarized and know that the furthest local repeater is no more than 20 miles away, I get a little turned off. Some other desirable features of a frequency independent antenna are not to sharp a beam width, low VSWR and no pattern distortion when mounted. How often have you seen a vertically polarized yagi bolted directly to a torque pole? You know the VSWR has gone to sour and who knows what the pattern looks like.

The Log-Periodic Antenna meets all the mentioned criteria and then some. I've been associated with log-periodics for many years, in one form or another. Probably my first encounter with the log-periodic was at the Naval Air Test Center, Patuxent River, Maryland in the late '50's. Such an array was used at the R&D HF facility, which I used on the HAM bands. The antenna was usable from 40 meters right up through 6 meters maintaining the same gain and a respectable VSWR on every frequency throughout the range. Five bands, no antenna switching, impressive and **BIG**. Through the years since then, I have used the log-periodic theory and concept where ever frequency independence was needed in my various projects. L-P driven yagis are not new by any stretch of the imagination and L-P configured vertical arrays have been around for years. The TV antenna industry thrives on the L-P principals.

In the following design and instruction I am not trying to reinvent the wheel nor may the design be optimum, but it solves problems of space and expensive hardware. This L-P is small enough to be rotated in an attic space. My objective was to design an array around the following criteria:

# LOG PERIODIC FROM NECESSITY TO FINISHED PRODUCT

Compactness	4.5' x 40"
Frequency	144 MHz - 450 MHz
Gain	6 dB - 10 dB
Front-to-back	15 dB - 20 dB
Beam width	≤ 90°
Polarization	Vertical
Mounting	Single point (non-obstructive)
Elements	10 - 13
VSWR	≤ 1.5:1
Weight	< 10 lbs.

Past articles on Log-Periodic arrays have bent toward the parallel boom construction<sup>1</sup>. Two things apparent in those articles are (1) a VSWR of 2.5:1 or greater and (2) difficulty in mounting.

A goodly number of today's transmitters, transceivers with solid state finals shut down with a 2:1 VSWR. Secondly, the mounting, if mounted horizontally on a torque pole, is usually metal and will disturb the pattern. Further, the VSWR will be elevated. Even if the torque pole is made of wood or fiberglass, for balance, it will be placed in the structures active region<sup>2</sup> and upset normal current distribution. The design described herein places a very minimum amount of foreign material in the active region and still allows a single point mount for vertical polarization.

Before explaining the design, some terms must first be defined. As in any concept or discipline, there are certain terms and the ones used here are used repeatedly and total familiarization with them will certainly prove beneficial.

$\alpha$

(alpha) is the angle determining the slope of the elements from the apex to the lowest frequency dipole.

$\tau$

(tau) is the periodic function or sometimes referred to as the design ratio.

$\psi$

(psi) is the angle between the two plane structures.

Tau and element length/spacing are related by the following equation:

$$\tau = \frac{LN-1}{LN} = \frac{d_{n-1}}{d_n}$$

L is the length of the element

d is the distance between elements

Example: If the longest element or any element is say 40" (LN) and the next shortest element is 38" (LN-1), then  $T = 38/40 = 0.95$ .  $\tau = 38/40 = .95$

Tau need not be exactly the same for element length and spacing; however, it is highly recommended<sup>3</sup>. Both alpha and psi are determined either experimentally or from

graphs<sup>4</sup>. I prefer the graphs. From graph #1 I selected alpha of 30° for a low VSWR and tau of 0.89 to allow more elements per boom length. Graph #1 presents some conflicting data as to tau and Zo.

I attempted to clear up this conflict by interpolation in graph #2, Note this interpolation for alpha = 30° and tau = 0.89. Also on this graph where psi is 30°, Zo is equal to 200 ohms thereabouts. Again some conflicting data is involved in this graph. This is why there is some latitude in the criteria. Graph #3 allows us a ballpark prediction for front-to-back ratio. The F/B will be approximately 20 dB, the gain approximately 6 dB and an H plane beam width of approximately 90°. A look at graph #4 suggests the tau selected is in the ballpark for alpha equal to 30° and extending the E plane beam width line off the chart to a tau crossing indicates a half power beam width of 90°. Once the fly specks are separated from the pepper, the empirical data suggests the following:

Gain	6 dB
F/B	20 dB
BW (E&H)	90°
VSWR	1.5:1

The trigonometry comes next to lay down the physical structure. Starting the layout with an isosceles triangle gives vision to the plane structure, allow the apex to be 30° depicting alpha. Let the base be LN and inscribe an altitude from apex to LN.

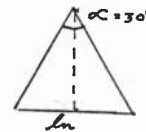

$$L_n = \tau/2, \quad \frac{300 \times 0.95}{F_{MHz}(L_n)} = 80^\circ = \tau, \quad \tau/2 = 40''$$

Since the altitude bisects the triangle, the angle alpha is halved,  $A/2 = 15^\circ$ , LN is also halved,  $LN/2 = 20''$ .

The boom length can now be determined as follows:

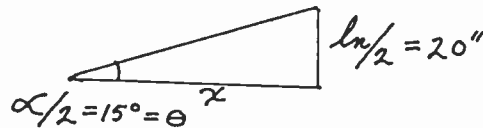

The X dimension is first determined by:

$$\tan \theta = \frac{Y}{X} = \frac{L_n/2}{X} = \frac{20''}{X}$$

$$X = \frac{20''}{\tan \theta} = \frac{20''}{\tan 15^\circ} = \frac{20''}{0.2679} = 74.64''$$

This (74.64") is not the boom length. It is only the dimension from LN to the apex. The upper frequency limit of 450 MHz. will determine the length of the shortest element.

$$\tau_{450} = \frac{300 \times 0.95}{F_{MHz}(450)} = 0.63M \times 39.37 = 25''$$

$$\tau/2 = 12.5'', \quad L_n/2 = 6.25''$$

Now construct another triangle as follows:

**ATVQ DEVOTED ENTIRELY TO HAM TV**

# LOG PERIODIC FROM NECESSITY TO FINISHED PRODUCT

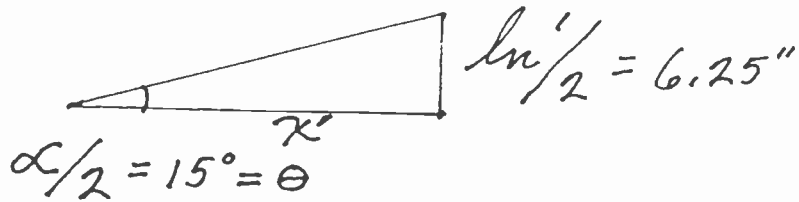

$$TAN \theta = \frac{y}{x} = \frac{ln'/2}{x} = \frac{6.25''}{x}$$

$$\chi' = \frac{6.25''}{TAN \theta} = \frac{6.25''}{TAN 15^\circ} = \frac{6.25''}{0.2679} = 23.33''$$

$$BOOM = x - \chi' = 74.64'' - 23.33'' = 51.31'' (52'')$$

## Micro-Video Camera

SMALL SIZE 2" X 3" X 1"  
Feather Weight < 8oz.  
NTSC Output 240 TV Lines  
Low Light 2 Lux 7-15 VDC/<100ma.  
Typical Applications: ATV, Robotics,  
Computer Vision, Security, Remote monitoring

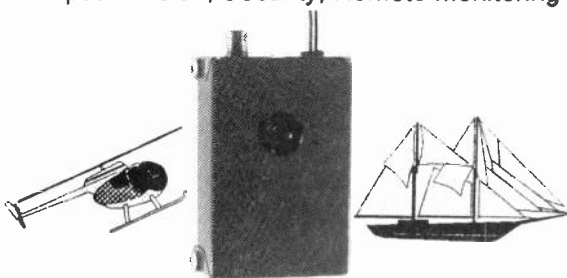

Factory New \$324.95  
NOW ATV Special  
2 or more \$284.95 ea.

Add \$5.00 S/H Ca. add 6.25%

## MITCHELL Industries

1334 Shawnee Dr. • Santa Ana, CA 92704  
1-800-473-0538 (714) 957-9268

## WHEELS

( Little, Mini, Micro )

### "AS USED AT THE EDGE of SPACE"

- Omni-Directional ANTENNA
- HORIZONTAL Polarization
- Very Lightweight
- Used on Balloons, Kites, R/C
- Available for 70cm, 23cm & 13cm  
( 33cm Special Order )

P4 signals have been sent 393 mi.  
Using 3 watts into a little-WHEEL  
From the Edge of Space.\*

Assembled/ — \$24.95  
Tested

KIT — \$19.95

Add \$3 for Postage - SPECIFY BAND  
& CONNECTOR

Dave Clingerman W6OAL  
Olde Antenna Lab  
4725 W. Quincy # 1014  
DENVER, CO 80236

\* - (KDØFW Balloon Flight - FEB. 10, 1990)

# LOG PERIODIC FROM NECESSITY TO FINISHED PRODUCT

Boom = X-X' = 74.64" - 23.33" = 51.31" (52")

Table #1

The element lengths are now to be calculated, LN equals 40". This is the starting point and from here  $LN-1 = LN \cdot \tau$ , etc. Since the elements on each of the two booms are  $\lambda/4$  lengths, the calculations are made only for single boom elements. See table #1 for element lengths and spacing.

The following are HP-25 Programs for length and spacing.

Lengths		Spacing		
Rφ=0.89		Rφ=0.89		
↑L1 R/S 01/31		↑74.64, R/S		
RCLφ	02 2400			
X	03-61	ST01	01	2301
R/S	04-74	RCLφ	02	2400
GT001	05-1301	X	03	-61
		STO2	04	2302
		RCL1	05	2401
		X↔Y	06	-21
		-	07	-41
		R/S	08	-74
		RCL2	09	2402
		GT001	10	1301

L1	20.00	S1	8.21
L2	17.80	S2	7.31
L3	15.84	S3	6.50
L4	14.10	S4	5.79
L5	12.55	S5	5.15
L6	11.17	S6	4.58
L7	9.94	S7	4.08
L8	8.85	S8	3.63
L9	7.87	S9	3.23
L10	7.01	S10	2.88
L11	6.24		

Structural layout, solid line elements are on one boom and the dotted line elements are on the other boom.

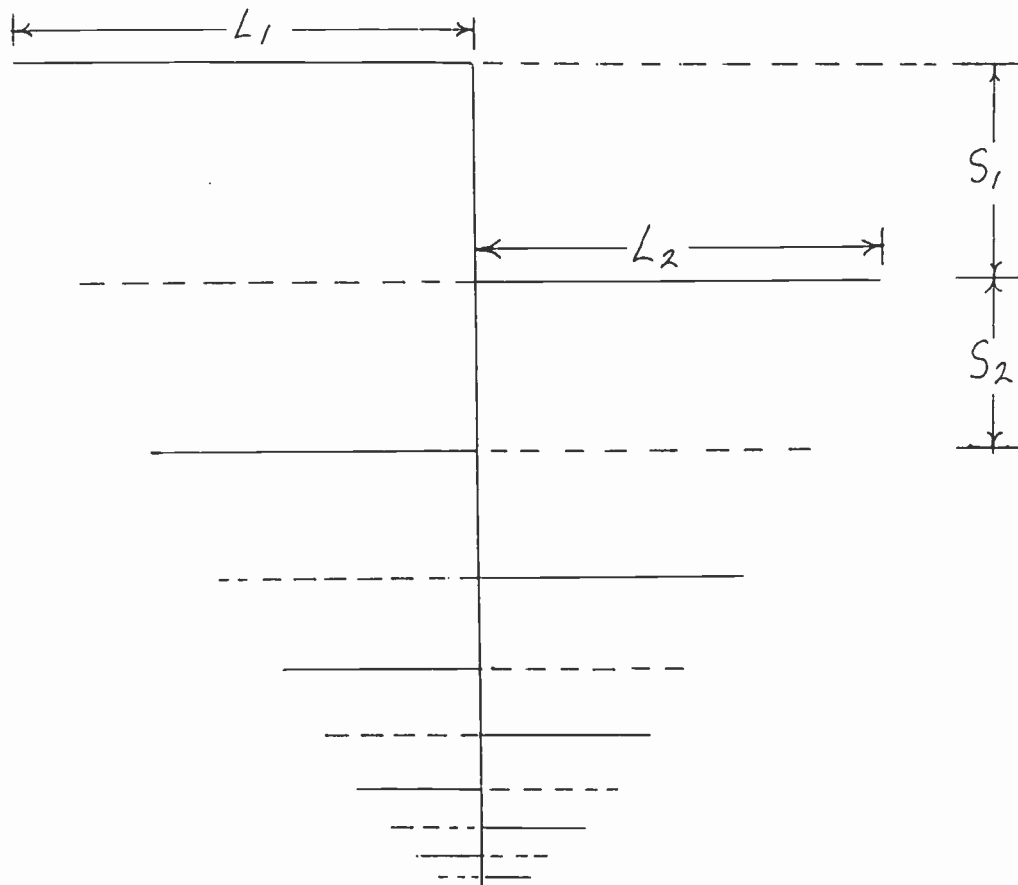



# LOG PERIODIC FROM NECESSITY TO FINISHED PRODUCT

## Construction

The booms are drilled to accommodate the elements which are .049" wall, 5/16" O.D. tubing. The elements may be taped with a 1/4 x 20 tap and bolted to the opposite wall from the element entrance hole. The boom stock is .049" wall, 1/2" O.D. aluminum.

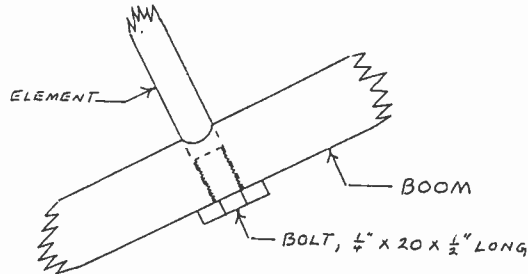

Element to Boom Attachment Figure

The two elemented boom sections are placed together at the short element ends, 1/2" spacing and held in place with a strip of G-10 fiberglass, 1/8" x 1" x 2". Halfway down each boom place the wooden cross arm shown below. This cross arm will spread the booms at 30°.

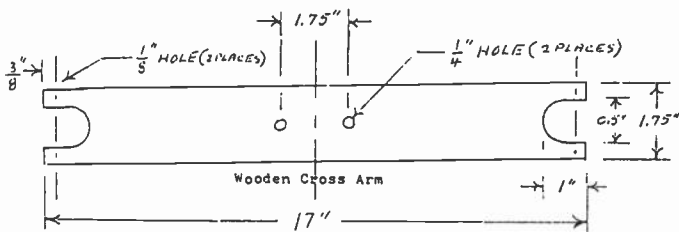

The coaxial matching section is as follows:

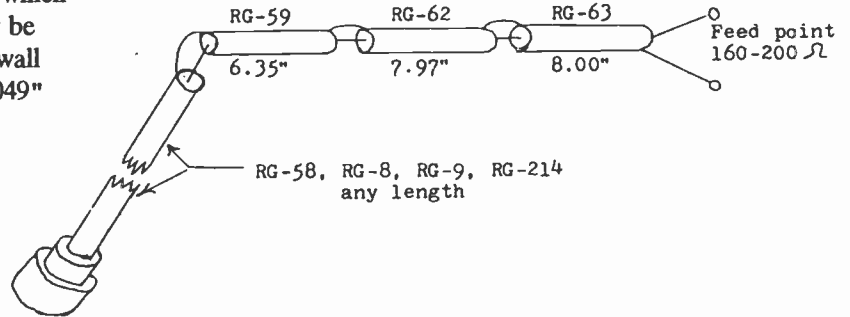

The individual sections are  $\lambda/4$  at  $\approx 300$  MHz. They are calculated as follows:

$$Z_0 = \frac{138}{\sqrt{\epsilon_r}} \text{ LOG } \frac{D_2}{D_1}$$

Coax	$Z_0 \epsilon_r$
RG-59	752.399
RG-62	931.525
RG-63	1251.512

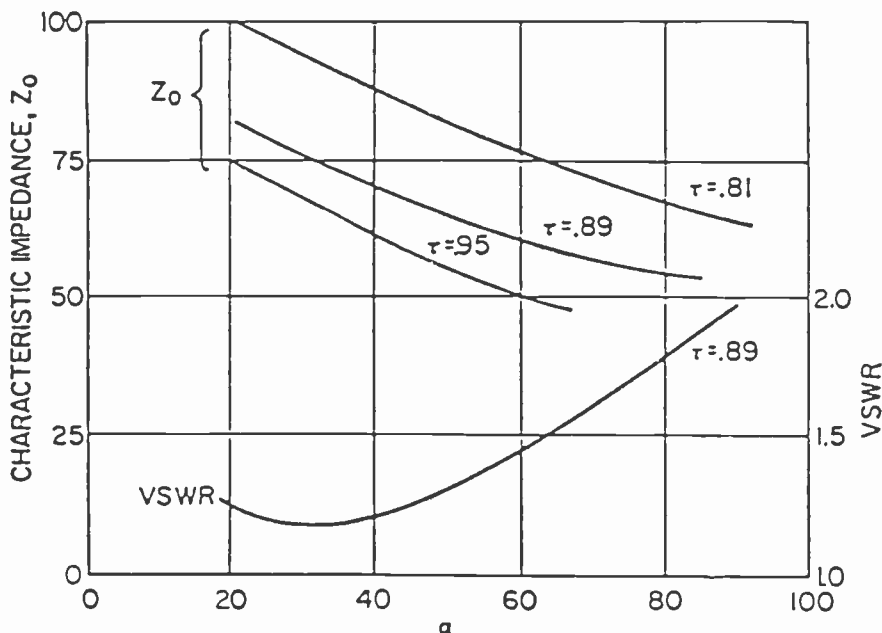
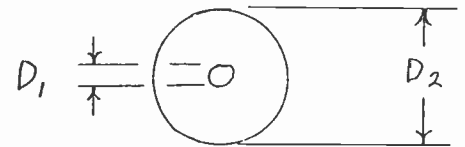

GRAPH #1 Variation of  $Z_0$  and VSWR with  $\alpha$  for log-periodic dipole array

# LOG PERIODIC FROM NECESSITY TO FINISHED PRODUCT

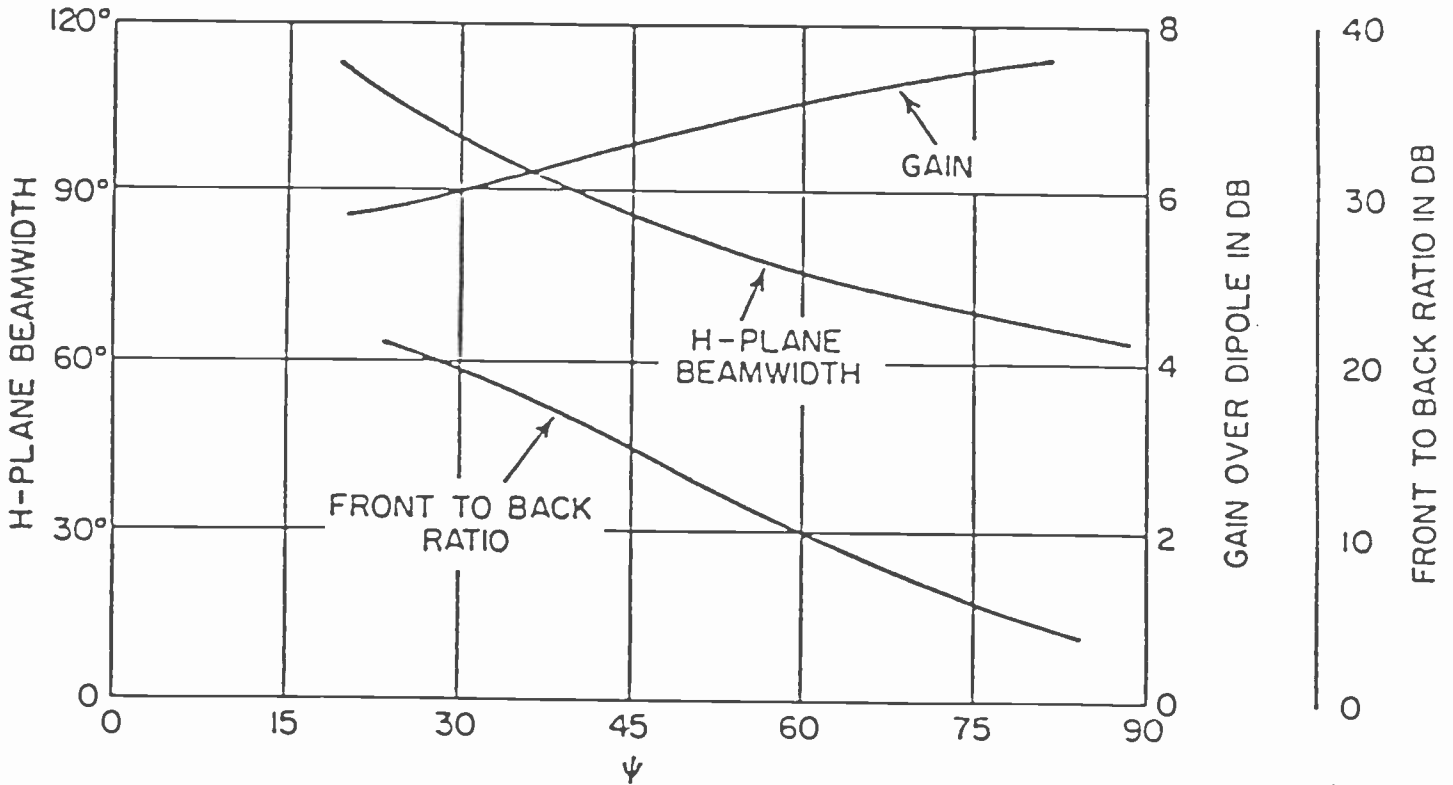

Effect of angle  $\psi$  on pattern characteristics. GRAPH #3

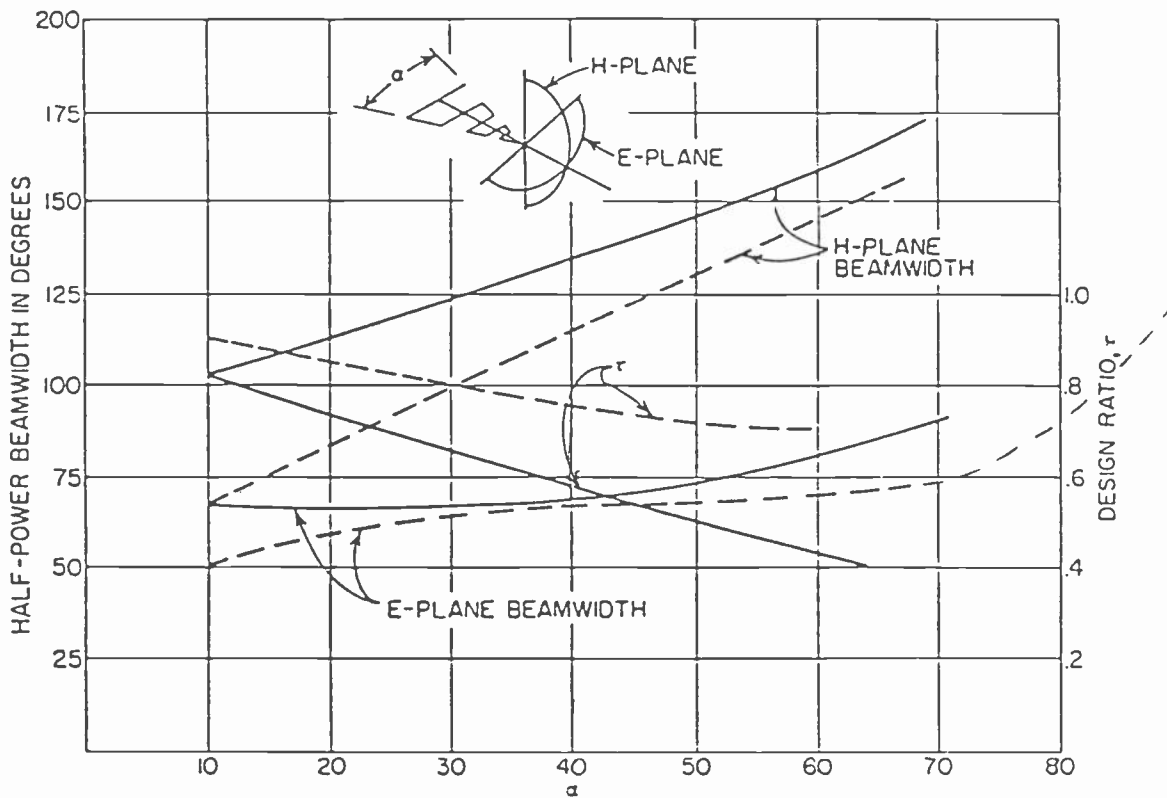

Pattern characteristics of wire trapezoidal tooth element for: ——— Approximate minimum value of  $r$ . - - - A larger value of  $r$ .

GRAPH #4

# LOG PERIODIC FROM NECESSITY TO FINISHED PRODUCT

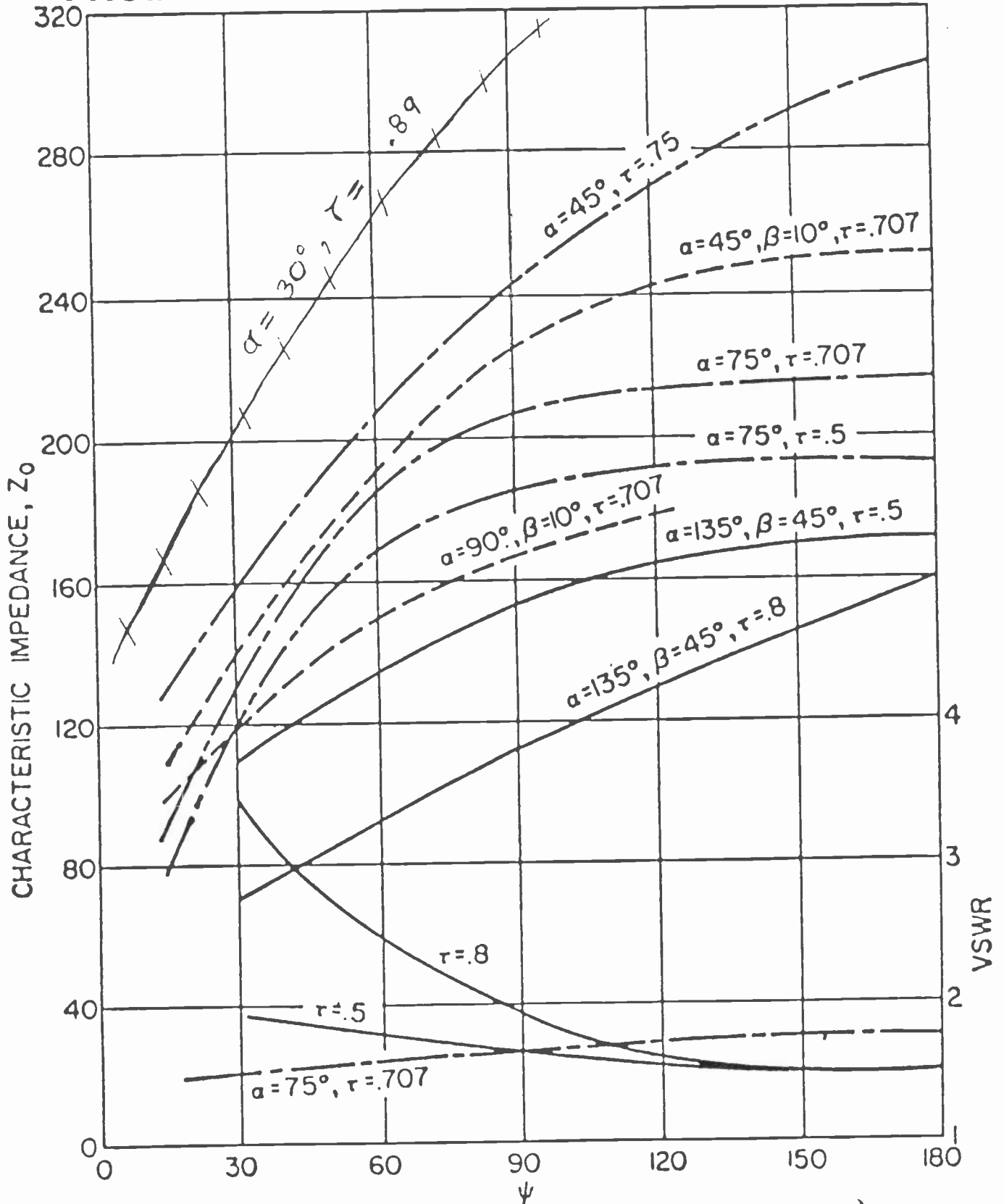

Variation of  $Z_0$  and VSWR with  $\psi$ , Circular teeth (---)  
 Trapezoidal teeth (-.-.-), Wire Trap. teeth (— — —)  
 Dipoles - interpolation (+ + +)

GRAPH #2

# LOG PERIODIC FROM NECESSITY TO FINISHED PRODUCT

After the matching section is constructed and the junctions taped up, the feed point end is attached to the short element ends of the booms with sheet metal screws. Tape the matching section to both the fiberglass separator and the wooden cross arm. Use a TV "U" bolt with serrated clamp at the wooden cross arm to affix the array to the mast. As mentioned in the criteria, the mast or torque pole would not interfere with the pattern as it is at least a quarter-wave from any active element. The down the boom balun<sup>5</sup> is not required because the discontinuities created by the matching section is sufficient to decouple the coax from the array.

The Scanner Enthusiast may use this antenna for his greater listening pleasure and following the design information may construct such an array to cover 50 to 500 MHz.

I'd like to thank Mr. Steve Ball (WA6ZQJ), Senior Engineering Technician, Raytheon (Goleta, CA) for the computer analysis on the matching section, and also Dr. Kenan Bakin, Resident Scientist, Teledyne Electronics for his encouragement and time spent reviewing the manuscript.

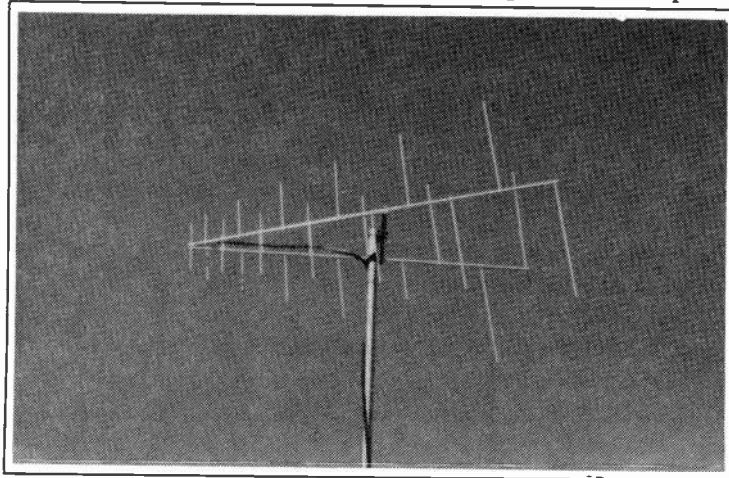

## References

1. William I. Orr, W6SAI  
Radio Handbook, 18th edition  
Editors and Engineers, Ltd. 1970
2. Walter H. Buchsbaum  
Buchsbaum's Complete Handbook of Practical Electronic Reference Data  
Prentice-Hall, Inc. 1978
3. Robert S. Elliot  
Antenna Theory and Design  
Prentice-Hall, Inc. 1981
4. Henry Jasik  
Antenna Engineering Handbook  
McGraw-Hill Book Company 1961
5. The A.R.R.L. Antenna Book  
American Radio Relay League 1964
6. George Monser  
Pyramidal TV/FM Antenna  
Popular Electronics, July 1969

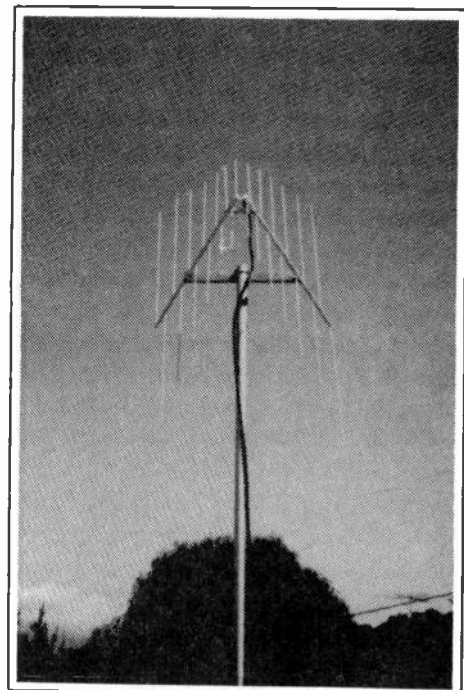

Input refl. coef. and VSWR in 50. ohm system with 160.0 ohm load

F(MHz.)	Rbo (Magn + Angle)		VSWR	Return Loss/Gain(DB)
50.000	0.454	-34.9	2.66-1	-6.87
75.000	0.363	-53.1	2.14-1	-8.79
100.000	0.241	-70.7	1.63-1	-12.37
125.000	0.104	-79.9	1.23-1	-19.67
150.000	0.051	12.0	1.11-1	-25.77
175.000	0.141	23.4	1.33-1	-17.00
200.000	0.198	10.3	1.49-1	-14.08
225.000	0.211	-3.6	1.54-1	-13.49
250.000	0.189	-14.5	1.47-1	-14.48
275.000	0.145	-16.3	1.34-1	-16.75
300.000	0.119	-0.1	1.27-1	-18.49
325.000	0.188	16.2	1.34-1	-16.78
350.000	0.188	14.5	1.46-1	-14.50
375.000	0.211	3.7	1.54-1	-13.50
400.000	0.198	-10.2	1.49-1	-14.07
425.000	0.142	-23.4	1.33-1	-16.94
450.000	0.052	-12.9	1.11-1	-25.64
475.000	0.102	79.9	1.23-1	-19.80
500.000	0.239	71.0	1.63-1	-12.42
525.000	0.362	53.4	2.14-1	-8.82
550.000	0.453	35.1	2.65-1	-6.88
575.000	0.506	17.4	3.05-1	-5.91
600.000	0.524	0.2	3.20-1	-5.62
625.000	0.507	-17.0	3.06-1	-5.90
650.000	0.454	-34.7	2.67-1	-6.85
675.000	0.365	-52.9	2.15-1	-8.76
700.000	0.242	-70.5	1.64-1	-12.31

## LITTLE WHEEL UPDATE

### Olde Antenna Lab

### Dave Clingerman W6OAL

*The Little Wheel is a 70 cm (420-450 MHz.) antenna that is used mostly for portable ATV operation. it has also been used with great success for mobile and fixed 432 SSB operation.*

The Little Wheel is an omni-directional horizontal radiator that has the gain of a dipole. There is also some circular polarization above and below the antenna's horizontal plane. The device is essentially three broad-band monopoles in parallel. These parallel monopoles have a terminal impedance of 12 ohms and are somewhat inductive. The terminal impedance is brought back to 50 ohms through the use of a fairly low "Q" capacitive stub. These antennas are constructed of brass and assembled using a very good grade of 60/40 solder. They are virtually indestructible, but should an element tear loose, simply hit it with a hot iron and it's back in service.

I've shipped quite a few of these antennas out both in kit form and assembled/tested. They've been used for all kinds of amazing applications: kites, balloons, R/C models, private aircraft, cars, trucks as well as ATV repeater sites (stacked versions). The balloon experiments have been fun: The KDØFW balloon flight over Kansas City used a Little Wheel to help send a P4+ signal nearly 400 miles to the west (Kansas/Colorado border) using just 3 watts. Several of WB8ELK's balloon flights have also used these antennas with excellent results.

Thanksgiving the Denver group launched a balloon with a Little Wheel whose signals were seen in Nebraska, Oklahoma, Kansas and of course Colorado. The package resembled a bird of sorts which caused the launch to be called "Send a Turkey to Kansas". Well we almost made our goal, it travelled 137 miles east of Denver.

Larry Hilliers N8EWV and Jon Pifer WM8W in Ohio have both used the wheel with success for their ATV kite experiments as well.

One of the first articles I had published on the Little Wheel included a plot of the return loss (S11) vs Frequency. This plot showed the most resonate point in the 400-450 MHz. range. It also illustrated the nice smooth sides of the curve into and out of

resonance although steep sided and a fairly broad area of maximum resonance.

As a result of this plot, several have responded that it appeared to them that the antenna had too high a "Q" to support a 6 MHz. wide signal. The plot shown was what is known as a S11 Log Mag graph. It purposely enhances the off-resonance points (takes the logarithm of the magnitude) in order to show the exact resonance point. I should have shown the actual S11 SWR plot from the HP Automatic Network Analyzer (ANA). If you take the antilog of the Log Mag plot, you'll see that the SWR bumps along below 1.5:1 around a 10 MHz. wide range. I.E., an antenna cut for 421.25 MHz. will easily pass 420-430 MHz.. For 426.25 you get 425-435 MHz.; 434 has a range of 433-443 MHz. and for 439.25, a range of 438 to 448 MHz.. In other words, the Little Wheel will definitely pass a 6 MHz. wide ATV signal.

I am asked from time to time why I don't use a physical capacitor to resonate the low-Z (12 ohms) structure of the Little Wheel rather than a shorted stub. Dr. Paul Schuch N6TX taught me all about stubs that are less than a quarter wave length and I like what I learned. His paper, "Tricks at Twelve Ninety Six" has to be a classic for the RF circuit designer. The late Don Lund WAØIQN found on a 2400 MHz. Little Wheel (Micro Wheel) that a stub became, at this frequency, too small to be practical and created a capacitor using RG-141 coax. Granted this works, but I have had success with a wide capacitive stub (less than quarter- wavelength).

A 2.5% bandwidth is all I need at 70 cm to pass a 6 MHz. signal. If I were to use a physical capacitor I would, of course, lower the "Q" of the antenna, but I would also destroy some of the efficiency. If, like WAØIQN, I used a piece of RG-141 as a capacitor it would stick up above the structure and I wouldn't be able to ship the antennas in my old pizza boxes! Why screw with success?

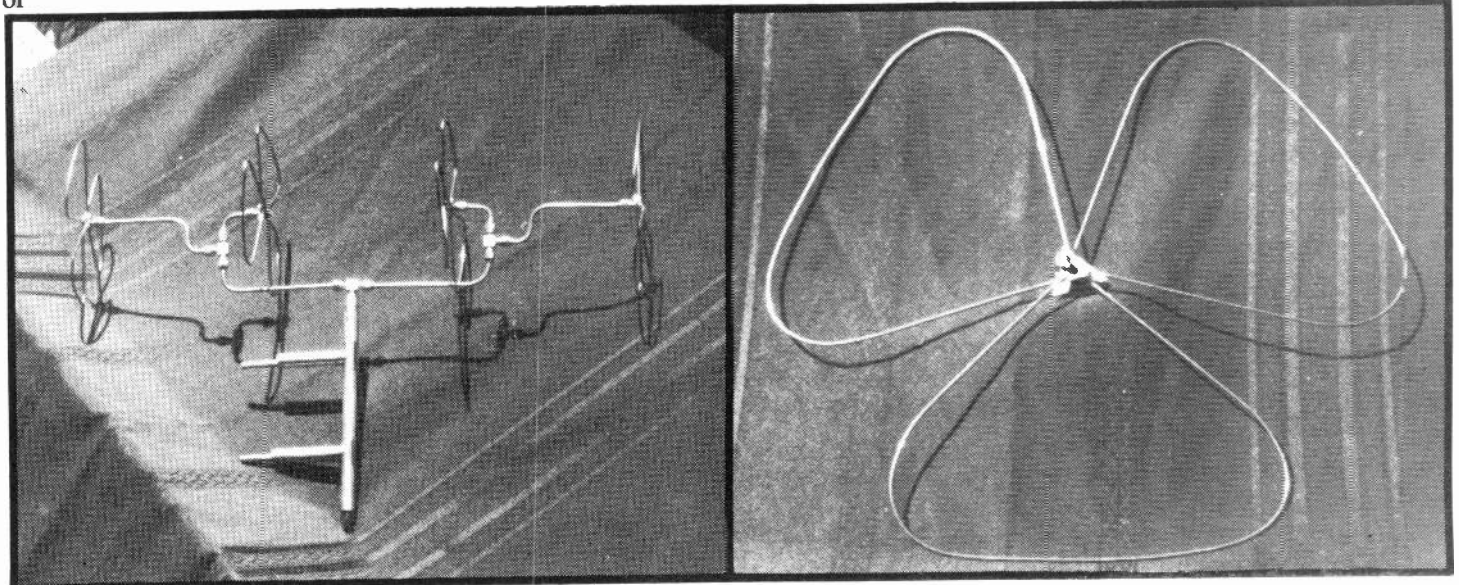

## Reading Between The Lines

By Jon Titus

*Reading technical articles can be amusing  
if you learn how to read between the lines.  
Here are comparisons of what authors say  
and what they actually mean.*

### WHAT THEY SAY:

It didn't operate as was predicted  
A high transient thermal effect.  
After many experiments, we found a solution.  
  
A typical sample...  
  
We ran transients tests.  
Here are the fundamental engineering principles.  
You can solve the equation numerically.  
However, you can't reach the theoretical maximum power output.  
The gain figure is sub-optimal  
  
We haven't optimized the amplifier's efficiency.  
Performance is extremely good.  
  
We thank Joe Smith for his comments about our manuscript.  
The authors want to thank Elizabeth Scott for her assistance  
We can show that...  
  
It's interesting to compare...  
  
As a first approximation...  
You can improve method.

### WHAT THEY MEAN:

It burst into flames.  
We burned our fingers on the diode  
We fiddled with it for a long time and finally got it to work.  
The only time it did more or less what we wanted it to.  
The fuse blew every time we turned it on.  
We lifted this from another article.  
We got eight answers that look vaguely right.  
You'll destroy all the output buffers if you adjust R when the power is 22dBs.  
It's giving 2 W out for 10 W in and the output transistors are glowing red.  
It worked for three hours and then died.  
It didn't burn up when we turned it on.  
  
Joe Smith completely rewrote the article at the last minute.  
Ms. Scott finally got the circuit to work.  
  
Well, it's not at all clear to us, but we're shaming you into taking it for granted.  
  
It isn't of the slightest interest, but it fills more space, we'll get paid more, and we can take a shot at Fred's article published...  
  
This value is flagrant guesswork.  
Nothing we tried had a hope of working.  
  
Thanks, from January 1991 Radio Scan.

## BATC 90 CONVENTION A visit to Harlaxton Manor by Howard Cochran W4PPN

*Everyone who has been to the Dayton Hamvention is well aware of the flea market and the vast display of commercial products along with the seemingly endless schedule of forums.*

To me the most interesting part of the hamfest comes in the evening. It is then that the area of interest to me (ATV) comes to life. During the 1988 Hamvention I had the pleasure of meeting and listening to two visitors from the British Amateur Television Club (BATC), Trevor Brown G8CJS and Andy Emmerson G8PTH. Trevor was a guest speaker at the meeting and I owe him a vote of thanks for helping me plan my visit to the 1990 BATC annual convention.

It was early fall of 1989 when I made up my mind that the trip to England was going to be for real. One of the deciding factors was the three round trip tickets to London that I had obtained via one of the frequent flyer programs. It was easy to make the decision now that the most expensive part of the trip was taken care of!

I decided to call Trevor G8CJS on the telephone to find out details of the 1990 BATC convention. Unlike Dayton, the BATC convention varies in the date and location it is held each year. After a very interesting chat with Trevor, I found out that the 1990 bash would be held at Harlaxton Manor in Grantham, England. I picked up the latest issue of CQ-TV (put out by the BATC) which filled in most of the remaining questions about the convention.

On the day of our arrival, after a long and tiring flight, we all piled into the rental car for the trip to destination in York. After studying the layout of cockpit (steering wheel on the right) for a few minutes and contemplating the adventure of driving on the left side of the road, I informed my family that they were soon to be in for a rather sporty time. I also directed them not to talk unless they sensed some dire emergency, like someone about to run into us! Fortunately we only had five miles to travel to our hotel. My wife and son finally did speak and congratulated me on a commendable effort in getting them there in one piece.

On Sunday May 6, we headed for the A1 highway and headed out to Grantham for our first British hamfest. I was on cloud nine since we were going to a hamfest devoted entirely to Amateur Television!

It would be difficult to believe that a more beautiful venue could have been chosen for the convention. Harlaxton Manor, now owned by the University of Evansville, (Indiana) it was built over a period of years in the 1830s and 40s by a bachelor named Gregory Gregory (1786-1854). In 1948, the Jesuits purchased the manor and proceeded to use the property as a seminary. Their occupation was brief and in 1966 the property was leased to Stanford University and then to the University of Evansville.

With the college program firmly established, Dr. William Ridgway purchased the property and 104 acres of the estate. There are approximately 160 students in residence during the school year. During vacation periods, the house becomes a

setting for conferences, antiques fairs, wedding reception and now the site of the annual BATC convention.

The manor was filled with vendors of all kinds of electronic parts. I visited the Bonex stall in search of parts for one of the projects in CQ-TV. The Severnside Group were selling some real neat antennas for the 1.2-1.3 GHz. band. Bob G8OZP was demonstrating his 10 GHz. repeater! He had a remote camera and transmitter set up outside and behind the manor with it pointed down toward his location inside the building.

The BATC staff was there as well along with their collection of all of their circuit boards in support of the do-it-yourself articles. I picked up a set of boards for the 432 MHz. Vestigial Sideband transmitter for K4NHN.

The circular driveway inside the gates was filled with tailgaters and the BATC had their mobile TV van there as well. A demonstration of airborne R/C ATV was presented. Most of the material available would not work on U.S. standards so alas the bargains had to be left behind. I did notice some WW-II electronics that looked in excellent shape. Speaking of WW-II, the First Airborne Division, British Paratroopers, was housed at Harlaxton during the second World War.

I arranged to visit Trevor the following day at his home in Leeds. It was during this visit that he gave me a demonstration of the computer program that is used to control their 1.2 GHz. ATV repeater. As you guessed by now, most of their activity is on 1.2 GHz. and uses FM modulation as opposed to the AM modulation we use in the U.S. The quality is excellent and permits the use of higher power without all of the complex problems we run into over here.

Would I do this trip again? The answer, without reservation, is a resounding YES! Just as soon as I earn enough points to get my free airline tickets.

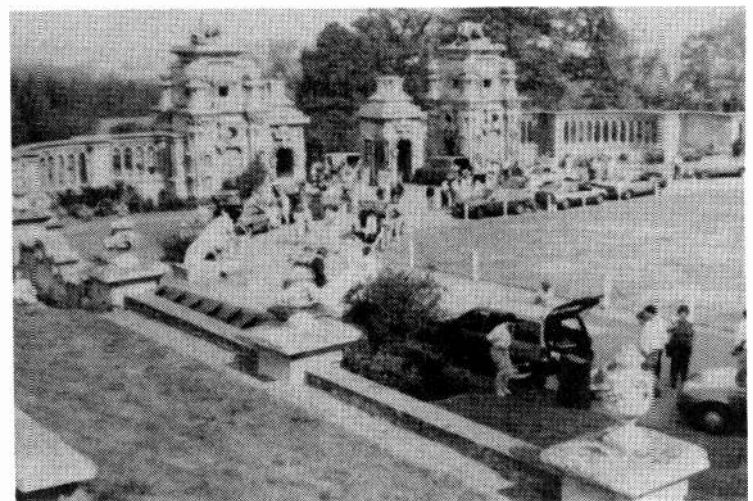

Tail Gate Sales at the 1990 BATC Convention.



1990 BATC Convention, Harlaxton Manor, Grantham, England.



Slow Scan as well as Fast Scan.

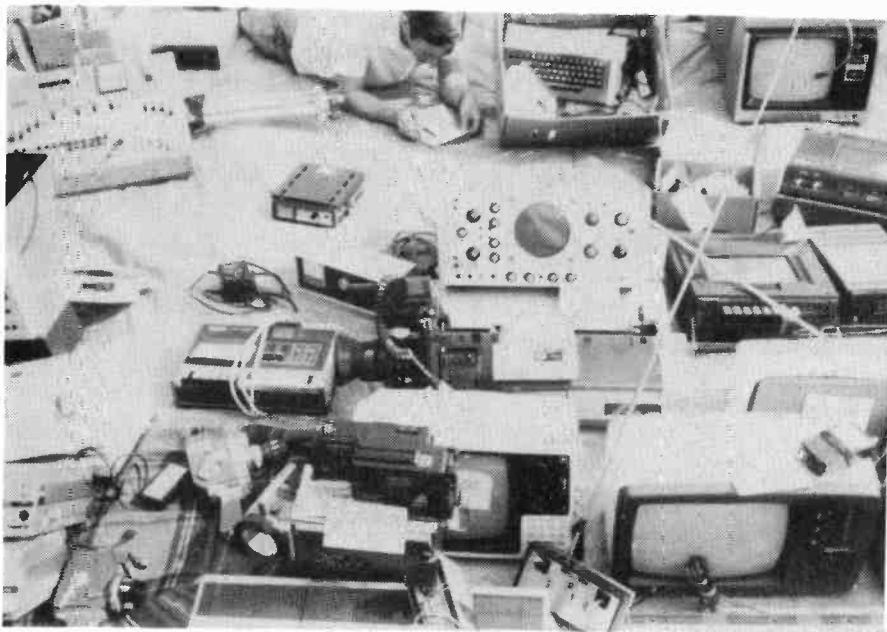

Goodies Galore.

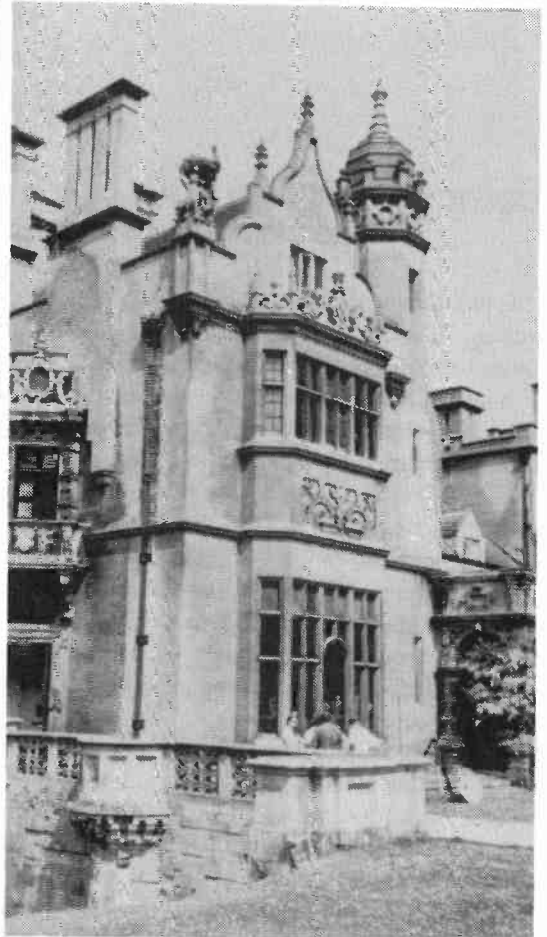

Outside the Cafeteria Harlaxton Manor, site of 1990 BATC Convention.

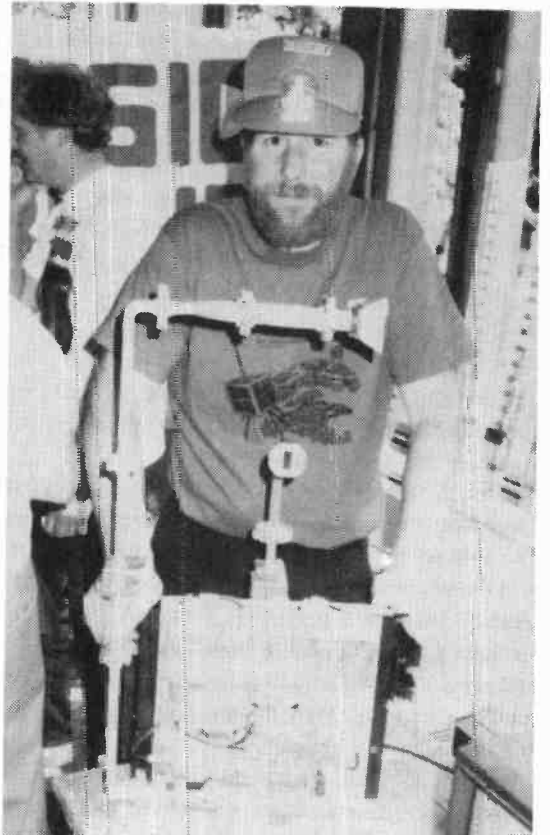

Bob Platts G8OZP and his microwave repeater 1990 BATC Convention.

ATVQ DEVOTED ENTIRELY TO HAM TV



## ATV NEWS SHORTS

### ATV AT THE ROSE PARADE

The annual Rose Parade went off uneventful due to the beautiful weather this year. ATV was under the direction of Cam KI6VK. Two portable repeaters were used, one brought down from Crestline by Mike WA6SVT (434/919.25) and one from the Los Angeles County RACES outputting on 1289.25. The Mt. Wilson K6KMN 434/1241.25 repeater was also used as a back-up.

### ANOTHER CALIFORNIA ATV REPEATER

A new repeater in Southern California in the land of "split pea soup" and "Danish pastry." K3NXF 434 in, 1253.25 out located in Buellton, CA. This is in the Santa Ynez valley home of a tourist area of Solvang and Andersen's split pea soup. This is about 50 miles NW of Santa Barbara. The repeater is also portable for public service events.

### TESTS OF NEW AEA ATV AMP

Hap Griffin is testing the new AEA mast mounted amp/pre-amp/power supply system and will have a story about it in the next issue (April) of ATVQ. He says it looks good so far and has been communicating his findings to AEA's Al Chandler, who will be a speaker at the Friday night ATVQ Dayton ATV Party at the Holiday INN North (7:30-11:00).

### ATVQ VISITS

ATVQ travel plans include the Miami Tropical Hamboree on Feb 2-3, look for our commercial booth. Also DAYTON, look for our double commercial booth! We will have a lot of equipment goodies at Dayton, so do a little flea market shopping inside!

### ATVQ TO REPRESENT BATC

ATVQ has been approached by the BATC to be one of their representatives for subscriptions and other items. We are currently awaiting formal paperwork and subscription/order forms and should have this service in place by Dayton. The BATC's publication CQ-TV has been around for 150 issues (4 issues per year) and is highly regarded.

The topics are similar to those found in ATVQ, mainly technical material. While some are PAL 625 system only, most projects also have NTSC 525 capability or are easily converted to NTSC 525 with simple parts changes, usually noted in the articles. Last year at least 4 BATC members visited Dayton and the ATVQ booth and ATVQ ATV Party and they will be back again this year. (Photo below)

### NEW ATV HF NET

Dan K6DFM in Encino, CA and Ron W6YCF in Cambria, CA have started an informal ATV NET on Sundays, 11 AM PST on 7243 Khz.  $\pm$ . They invite any ATVers to join in and share what is going on in their area on ATV. The Sunday QSO's begin when Ron moved out of the LA area and missed talking to the large number of ATVers here and staying up on the latest and greatest developments in ATV. This NET can be very effective in swapping techniques and ideas and info. This is especially true for Balloon or aircraft flights that can be seen for hundreds of miles.

Ed Note: Don't forget the "east" has a regular ATV net on Tuesday nights on 3871 KHz. at 8PM EST Usual NCS is W9PRD, WB9IHS and WB8ELK.

### AEA

is seeking nominations for its 1991 Amateur Ambassador Award. The AEA Amateur Ambassador is an amateur who, in the opinion of the judges, has done an outstanding in promoting amateur radio both within and outside the hobby/service. Traditionally, this award is made at the ARRL National Convention, with the winner brought to the convention expense paid and where he is presented the Amateur Ambassador trophy and a cash award. All nominations must be on an AEA Amateur Ambassador nominating form available from Advanced Electronics Applications, Inc., 2006-196 Street S.W., P.O. Box C-2160, Lynwood, WA 98036, (206) 775-7373. Tnx N7ML

### LISATA ATV MOBILE UNIT RELAYS SKYBEACON II VIDEO TO DAYTONA

LISATA gave the official "ATV is Go" for the successful launch of the Daytona Beach ARA's Skybeacon II ATV balloon at Deland, Florida on September 15th. Ernie, K4RBD, and Steve Bryan, LISATA videographer, setup the 434.0 MHz video link from Ernie's van ATV station to the Daytona Beach K4BV ATV repeater. Various net control stations were able to then see the actual launch preparations inside and outside the Mission Control hangar. Other ATVer's on site connected to K4RBD's video switching so multiple cameras were selectable.

Video taken by Bryan has been edited with video recorded from the balloon on-board video received by K4BV and recorded by W3LGV and will be shown at the December LISATA meeting. K4GCC, N4LIY, and KC4RCU handled net control duties for the Brevard net.

The balloon reached 100,000 feet and the telemetry was heard in South Carolina. Video was seen all over Central Florida.

## ATV NEWS SHORTS

### HOME BREW CONTEST

As in past years, we will have a home brew contest at the ATVQ ATV Friday night party. The rules are the same and as simple as always:

1. Bring your home brew item or if too large to carry, bring photos and a description not to exceed 2 typewritten pages (that's less words if you write it longhand). There will be tables for display of your handy-work.
2. Judges will be chosen from those in attendance.
3. The judges will make a decision about the entries.
4. We will award \$100 CASH to the winner, or \$50 to two winners if there is a tie. The prize is CASH, not a check, IOU or credit on a subscription; CASH you can use to buy goodies at the hamfest or whatever you wish.
5. Have a good time at the party.

### ATV IN SPACE

ATV'ers are awaiting results of the next Space Shuttle amateur radio experiment (SAREX) which will feature ATV (fast scan) receive in the 440 MHz. band. Contacts are limited to STA authorized stations only, do not try to contact shuttle. STA authorizes satellite communications on wideband signal which exceeds satellite amateur band frequency limits.

STS 37 will use annual slot antenna. This works like 1/4 whip. Tests show that orbiter must be near vertical. This will produce a "cone of silence" over dead center overhead because of nature of whip radiation pattern. The receiver is a space modified version downconverter as shown on the cover of the July 1990 issue of ATVQ.

Contacts will be likely limited to two stations due to time constraints on astronauts, Ken Cameron KB5AWP and backup is Jay Apt N5QWL. Launch date is expected to be April 8th. The rest of the shuttle crew are also hams. Steve Nagel N5RAW, Lynda Godwin N5RAX, Jerry Ross KB5DHP. Thanks Lou W5DID.

### BAND OPENINGS FREQUENT

In the past couple of months a number of band openings have occurred. The photos on this page were taken by Bill, WB8URI. All stations were worked in May or June of this year. Stations worked but not recorded include the following: K9LZJ, KB9BFB, K9AWS, and N9INK (all through the Indianapolis vertically polarized ATV repeater K9LPW/R transmitting on 425.25 MHz), and W8YDS in Cleveland. All reports were P5 both ways. For your information, ATVer's in Cleveland; Erie, Pennsylvania; and Buffalo, New York, are horizontally polarized on 2-meters.

### NEWSMAN DOUGLAS EDWARDS DIES

A friend of amateur radio and TV's first anchorman, Douglas Edwards died Oct 13 at age 73, from cancer. His broadcast career began during WWII as a radio correspondent. That led him to a 40 year TV career starting in 1948.

Edwards narrated a series of amateur radio news spots for ARRL during the 1980's. His voice can also be heard in two ARRL films, The World of Amateur Radio and The new World of Amateur radio. Mr. Edwards was guest speaker at the 1984 NY and 1966 Boston ARRL conventions. (ARRL letter 10-19-90)

Ed. note: Mr. Edwards was also the first network anchor to be on video tape when Ampex introduced the VR1000 VTR in 1956.

### HOUSE BILL TO PROTECT HAM SPECTRUM

On the first day of the 102nd Congress, a bill to prevent the loss of radio spectrum by the Amateur Radio Service was introduced by Rep. Jim Cooper (D-TN). Cooper is a member of the House Subcommittee on Telecommunications and finance where the bill is likely to be referred for consideration. The bill, The Amateur Radio Spectrum Protection Act of 1991 is designated as H. R. 73.

The legislation proposes that "the FCC shall not diminish existing allocations of spectrum to the ARS after January 1, 1991. The FCC shall provide equivalent replacement spectrum to the ARS for any frequency reallocation after 1-1-91.

In commenting on HR73 ARRL president Larry Price W4RA, welcomed Rep. Cooper's support of ham radio and expressed hope that many Congressmen will join him as co-sponsors.

Rep. Coopers comments in the findings portion of the bill cite many topics of public service provided by ham radio operators, performed in voluntary support of the community and nation. He notes that the FCC also has taken action over the years which resulted in the loss of over 100 Mhz of spectrum of ham radio bands. From ARRL letter 1-8-91

ATVQ urges its readers to write their congressmen to support HR73. While it can't over-ride international treaty (WARC) it can provide relief from losses with some form of compensatory spectrum space elsewhere (within international Treaty limitations).

### DAYTON ATV ACTIVITY ON INCREASE

Activity has increased on the Dayton ATV repeater since the Dayton Hamfest. Under enhanced conditions, W8BI/R can be seen in the Columbus area. The station is vertically polarized on its output frequency of 426.25 MHz. Identifying on 147.45 MHz will bring up the W8BI/R test pattern.

## MORE ATV NEWS SHORTS

### ECAT/W1BHD continued

In case anyone is interested I still have a few items left over. For the collector I have a Harvey-Wells 10 Watt transmitter Model UHX-10-39 with some coils, that I used in 1939 as a mobile transmitter to demonstrate to the Malden Police why they should get an FCC license for their patrol cars. Also I have a receiver with all the coils, and I even have a 42 inch round mirror mounted in a frame. Any interest?

Best 73, Mel, W1BHD

### from: Roy Neal, K6DUE Chairman, SAREX Working Group

Dear Friends,

Letters and telephone calls from over 850 ham teachers and hams assisting teachers surpassed our highest expectations for interest in SAREX, the Shuttle Amateur Radio Experiment. In response, ARRL developed printed lesson plans, news releases and resource materials, coordinated relay systems, sponsored videotapes, publicized mission information (a budget of \$15,500.00) and provided \$8,000.00 for hardware for STS-35 with Dr. Ron Parise, WA4SIR, on board. Working in partnership with AMSAT/NA, we've handled hundreds of small details in order to pull together a winning combination: Youth and Amateur Radio! A second SAREX mission, STS-37, will feature pilot Ken Cameron, KB5AWP, and the rest of his crew (all licensed hams!), operating voice, packet, and fast and slow scan television in the Spring.

We have several industry donations so far, but with your help, thousands of America's youth will continue to be enchanted with the thrills of space, technology and Amateur Radio. You can be responsible for instilling a desire in these youngsters to be an astronaut, an engineer, a computer designer and a ham radio operator. Every donation toward SAREX that we receive will be acknowledged with gratitude and appropriate publicity. Every contribution is tax deductible to the extent allowed by law, as the ARRL is a 501 (c) (3) organization. Make your check payable to the ARRL SAREX Fund to insure its use in this cause.

Please be a part of the adventure of stimulating our country's youth. You'll be proud to be counted in on this effort. ARRL is doing its part, including helping to license even more of Houston's astronauts. Our future goal? Ham radio on the space station! Your generosity will directly affect the future of Amateur Radio and our country's worldwide competitiveness! We need you!

from: Douglas Moon K5KMN  
K6KMN TV Repeater  
P.O. Box 491  
Lancaster, CA 93534

On behalf of the 100 or so high school students that pass through my physics classroom each day and myself, I wish to express my appreciation for the re-broadcast last week of the STS-35 shuttle mission. It's the best TV I have watched in years.

Having the shuttle mission on all day in our classroom brought space science and astronomy home to my students in a way that no text book or video tape ever could. It was high drama, filled with frustration and depression, excitement joy and tears of accomplishment all played out in real time, live from space.

While the network news and newspapers made the mission sound like a bad TWA flight to New York, the actual telecast showed it for what it really was. We saw a week of real astronomy science. We were on the cutting edge. We saw significant scientific discoveries, international diplomacy and even got a Galileo fly-by and a good dose of Magellan at Venus in the bargain.

My students had the opportunity to talk to Ron Parise, WA4SIR, themselves as part of the SAREX experiment. You may have seen them on TV (CH 2,4,7,9,) Tuesday evening or in Wednesday's LA times. We have participated in all the SAREX since Owen Gariet W5LFL. We received SSTV from Tony England W0ORE and are in the SAREX tape produced by Frosty Oden for the ARRL. We are an AMSAT member school and regularly work with the Microsat Satellites as part of our physics program.

I'm sure it is a sacrifice for your repeater association members to give so much time on the air for the shuttle missions but speaking as one teacher in one school, I certainly appreciate the fact that you do re-broadcast the missions and hope you will continue the practice. 73, Dave Reeves KF6PJ  
Trustee H.S. ARC WA6BYE

### OHIO

Reports submitted by Bill, WB8URI.

#### NEW STATIONS ON 1200 MHz.

Two new stations capable of transmitting FM video are KA8WEX and W8AER. Phil has successfully frequency locked his TVG 12A and is running about five watts on 1280 MHz. Dave has mounted his five watt rig at the antenna to eliminate feed line losses.

#### TWO NEW STATES FOR WB8URI

On 4 May 1990, Bill worked N8KKY, Pete, in Mineral Wells, West Virginia, (near Parkersburg) and received a P2 report. On 6 June, Bill got a P2 from N4MEY, Curt, located in Nashville, Tennessee. Both stations were worked on 439.25 MHz.

## MORE GOOD NEWS FROM THE ATV WORLD

### HOSPITAL ATV BRINGS SMILE

by W8DMR

The Ohio Amateur Television Group (ATCO) held their Fall Event on October 14th. The event featured three items of interest, namely, (a) the HAM-CAM mobile unit from Marysville, (b) a description of the Warren ATV Repeater, and (c) a Show-N-Tell of ATV equipment. See HAM-CAM story elsewhere in this issue.)

One of the ATCO members, W8AER, Dave Sears recently underwent a triple heart bypass operation. He is recovering, but was still in the hospital. His 79th birthday was also on October 14th and he could not attend the Fall Event. His room was on the 4th floor.

The HAM-CAM, running 1 Watt on 439.25 MHz, transmitted video toward the hospital. Manned by W8BJN, Gene Kirby, the attending members wished Dave, W8AER, a happy birthday and speedy recovery.

Dave, using a 2 meter HT at the hospital, passed his comments back to the Fall Event group. WM8P, KB2ARL and W8DMR took the 5 element loop yagi and 10 inch color TV receiver at the hospital.

Dave's comments were "I did not know that I had that many friends@" Dave's hospital stay is in the 4th week. Dave is ATCO's senior member and lives in Reynoldburg, Ohio.

Submitted by W8DMR; Bill Parker

### THE ACRONYM "HAM"

The following story has been abstracted from the October 1990 issue of WORLD RADIO for the purpose of putting to bed the question of the origin of "HAM" as applied to Amateur radio. Since the essential contents of this article are stated in the Congressional Record, I for one am satisfied that it is the true story.

The acronym "HAM", as applied to Amateur Radio, dates back to 1908. It was the call letters of the first Amateur wireless station operated by three members of the Harvard Wireless Club. They were Albert Hyman, Bob Almy and Reggy Murray. At first they called their station "Hyman-Almy-Murray", but tapping out such a long name in Morse Code soon called for a revision. They changed their call sign to HY-AL-MU, using the first two letters of each name.

Early in 1909 some confusion resulted between HYALMU and the Mexican ship named Hyalmo. It was then decided to use only the first letter of each name and the call became HAM.

In the early days, Amateur Radio operators picked their own frequencies and call signs. Then, as now, some Amateurs had better signals than some commercial stations. This resulting confusion finally came to the attention of Congressional Committees, and they in turn gave much attention to proposed legislation designed to critically limit amateur activities.

PAGE 44

In 1911, Albert Hyman chose the controversial legislation bill as his thesis at Harvard. His instructor insisted that a copy be sent to Senator Davis Walsh, a member of one of the Committees hearing the bill. The Senator was so impressed that he sent for Hyman to appear before the Committee.

He took the stand and described how their little station was built. He almost cried when he told the crowded committee room that if the bill went through, they would have to close the station. They could not afford the license fee and other requirements called for in the bill.

The debate started and the little HAM became the symbol of all the little Amateur stations in the country crying out to be saved from the menace and greed of the big commercial stations that didn't want them around. Finally, the bill got to the floor of Congress and every member talked about the poor little "HAM" station. That's how it got started!

You'll find the story in the Congressional Record. Nationwide publicity associated radio station HAM with Amateurs. From that day to this and probably to the end of time, in radio language, an Amateur is a "HAM".

### DAYTON ATV PARTY

This year's ATVQ ATV party has a new location. Last year's mammoth event was in the "La Quinta aka etc". We filled two suites with fun talks, movies, demonstrations, food, drinks and ATV'ers! This year it will offer the same great attractions, fun, food, ATV, hams, drinks, it's still FREE, it's still FRIDAY NIGHT, but located a couple hundred yards east across the I-75 E-way at the HOLIDAY INN NORTH in the GRAND BALLROOM. This has a capacity of over 300 seats, where it was difficult to stuff the 200 attendees last year into two rooms each designed to hold 75, which made it a little tight! So fear not claustrophobia! This year we will have top class facilities. Be sure to plan to attend.

The ATVQ ATV PARTY starts at 7:30 pm and while scheduled to 11:00, I am sure as last year there will be folks gathered into groups to socialize to the small hours of the morning! Holiday Inn will cater in munchies and coffee. We will ferry in soft drinks.

This year among other great items we will feature speakers from AEA (Dr. Chandler) Spectrum International (John Beanland) and show the WWATS produced newest ham radio movie, "More Than Radios".

Walk-ins are welcome but if you drop by our double commercial booth Friday before the party, you will be given a door prize ticket FREE for a drawing for TV goodies during the get together later. All who attend will also get a ticket at the door, so you have twice the chance to win if you drop by the ATVQ booths FIRST! (It also gives us an idea of how much food and drinks to buy for the party later!) Prizes will be announced in our APRIL issue.

ATVQ DEVOTED ENTIRELY TO HAM TV

## ATV NEWS SHORTS

### Mt. Diablo ATV - SF Bay Area

Don Smith W6NKF has donated the ATV repeater on Mt. Diablo to the Mt. Diablo Amateur Radio Club. This club has over 300 members and operates repeaters on three of the VHF and UHF bands. The club also sponsors a digipeater W6CX-1. Look for some new high-tech additions including a video weather station and a new scrolling message board. The new callsign will be W6CX/ATV or W6CX/r. - Thanks to Mike Scott N6GOZ for this information (from Compuserve's HAMNET forum).

### Treasure Coast ATV

ATVers on the east coast of Florida have formed the Treasure Coast Amateur TV Network (TCATN). They have an inband ATV repeater in the works and plan to install it initially in the Port St. Lucie area. They eventually plan to provide P5 coverage from Vero Beach to the north down to Stuart to the south. Input is on 434 MHz. and output on 421.25 MHz. They may have switchable directional antennas both north and south as most members are located only in these two directions from the repeater site. Thanks to Cal Schmidt N4MIY for this information (from Compuserve HAMNET forum).

### Compuserve HAMNET

Those of you who have Compuserve accounts may be interested in logging onto the HAMNET forum. This is a very active group with items of interest covering the whole spectrum of amateur radio. A number of ATVers log onto this regularly. It's hoped that a special category for ATV may also be instated soon. Two very active ATVers that regularly check in are Mike Scott N6GOZ (CS# 73260,1136) and Cal Schmidt N4MIY (CS# 72067,2446). This looks like a great way to keep the ATV world posted of upcoming activities and news. See you on HAMNET! - Bill WB8ELK.

### Greenfield MASS

Ed Scutnik KC1RH has installed an ATV repeater (KC1RH/r) on top of a 1200 foot hill north of Greenfield, Massachusetts about 5 miles south of the Vermont border. Input is on 439.25 MHz. with outputs on 421.25 MHz. and 1241.25 MHz. (all vertical). Talk frequency is via 144.34 MHz. The repeater has been seen over north-central MASS, southern Vermont and parts of SW NH.

### Soapstone Mountain CT

The W1HGJ/r ATV repeater is active on top of Soapstone Mountain, CT (The 147.00 repeater is located here as well). Soapstone Mountain is located in northern CT just south of

Springfield, MASS. Input is on 439.25 with an output on 426.25 MHz. (horizontal). Talk frequency is on 144.34 MHz. with an activity night each thursday at 7:30 or 8:00 pm. EST. Thanks to Dave WA1UQC in Collinsville CT for the info.

### Mt. Mansfield VT

The Burlington, Vermont group recently braved the elements (not just those of antennas!) to install their cross-band repeater on top of 4500 foot high Mt. Mansfield. Input is on 426.25 MHz. with output on 923.25 MHz. P4 to P5 coverage into a wide area of nearby Burlington, northern VT and some parts of eastern NY state has been reported. Thanks to Ed N1QG for this news.

### N. Milford CT

ATVers in the New Milford area of central CT have put up an ATV repeater (KA1EUE/r) on top of Carmen Hill. Input is on 426.25 MHz. with outputs on 439.25 and 923.25 MHz. (vertical). They currently use 146.55 MHz. for their talk frequency. Located 65 miles NE of NYC it should cover a good portion of south central CT. - from Lee KA1EUE.

### Nashville TN

Bob KJ4ZQ has been sending out a test signal on 421.25 MHz. from the Nashville area. He eventually plans to have a fully operating repeater. Stations are far away as Kentucky and Huntsville AL have seen the signal during band enhancements. Local ATVers can be reached on 144.34 as well as through the 146.64 repeater.

## SATELLITE HAM RADIO TV PROGRAM

Those tuning around the satellite TV channels may have been surprised to see a satellite delivered TV program about HAM RADIO! The program was on Satcom 3 Channel 4 at 9 PM to 10 PM CST. The host was Jack WB2YQT of Auburn, NY. The program was obviously intended for the non-ham, non technical viewer. The program, on video tape, was mostly Jack in his ham shack explaining in non technical terms (mostly) in a very slow delivery, ala Mr. Rogers Neighborhood, info about ham radio, his ham shack equipment which it was explained was for HF operation (75 meters was displayed) and also a quick look at UHF (440 FM) and 2 meters (FM). Simplex and repeater operation were demonstrated as Jack kerchunked a couple of repeaters and the CW ID was heard. It was explained to the audience that the repeaters were some distance away (50-70 miles). He also demonstrated his rotator. Jack also explained how cheap equipment could be found (a \$20 transmitter and near free receiver, of very old vintage) and how he made a 160 meter antenna from some wire

## EVEN MORE ATV NEWS SHORTS!!!!

for \$20 and how it also worked on other bands. Jack also showed an antenna tuner but did not explain how it worked.

While very mundane for an active ham, the program probably did well for those who have never had any contact with ham radio or technology. Jack also mentioned a few times during the program that it was sponsored by CQ Magazine, announcing an 800 number to subscribe.

The end of the show had a hand made card listing a mailing address as a PO Box in Syracuse, NY. There were no credits to say who actually produced the program. There was an appeal for material, on video tape if possible, for future programs. It was expressed that this was a WEEKLY program. So tune up those TVRO systems and tune in.

The next week the program centered on putting a UHF connector on RG-8 coax and began Morse Code lessons.

If this program lasts, and the San Diego/Burbank TVRO program MBC gets off the ground, the public will have two sources to gain some insight into ham radio. All we have to do is make sure the crazies among us don't corrupt the content with hour long commercials as some ham columns in other magazines have been.

### KANSAS CITY

What's Happening Locally?  
by Dale - WAØNKE  
from Channel One

The ATV activity has been steadily picking up during the summer this year. Probably the greatest influence is the repeater/wx radar that is the focal point of most viewers. Also, important is the nice public relations work, by Gary - KGØR and John - WRØJ, who introduced several of the local RADIO SHACK stores to the ATV repeater. I have had the odd experience of having several RADIO SHACK employees recognize me when I visit their stores. They have seen my ATV signal on their TVs while they were working.

The weekly Sunday night ATV net had been getting 15 to 16 check-ins regularly and is much easier to check-into since the ATV repeater now functions without the need of tone control. It seems that the improvement to the repeater of control using horizontal-sync detection has multiplied the use of the repeater. It is now as easy to use as any FM repeater.

### FROM WESTLINK

#### NEED A GaAsFET PREAMP

that is high quality, mast-mounted and RF or coax switched? Ampire may have what you need. Its line features helical filters for excellent out-of-band signal rejection. The model 146 is RF switched and covers the entire two meter band. Other models are available for 420-450 and several out-of-band models are available without the helical input filters. For pricing information contact Ampire Inc., 10240 Nathan Lane,

Maple Grove, MN 55369; (612) 425-7709.

### ICS ELECTRONICS, LTD.

claims that its MET-2 is simply "the ultimate weather satellite receiver system" on the market today. When connected to an IBM-PC or clone, ICS says that the MET-2 is capable of receiving the full resolution of the European MetroSat 4 weather satellites in any display from CGA to 1024 x 768 x 256 gray levels!

Results with the MET-2 can give photographic quality, and options are available to use the receiver to decode signals from the United States NOAA low earth orbiting satellites as well. The receiver comes complete with a 3 meter long Yagi antenna, a low noise pre-amplifier, 20 meters of cable, a power supply and basic software for IBM, SATARI and Amiga computers. For information and pricing write ICS Electronics, Ltd., Unit V, Ruthford Industrial Estate, Ford, Arundel, West Sussex. BN18 OBD, England. Telephone (01) 0903-731101; fax (01) 0903-731105.

### DO YOU MISS HAM RADIO MAGAZINE?

Well, this editor may not have built everything described in the former mainstay of technical publishing in amateur radio, but it felt like a member of the family passed away when Ham Radio closed down. But not to worry! We have just received the premier issue of CQ's Communications Quarterly, "The Journal of Communications Technology". Very ably edited by Terry Northrup, KA1STC, the 120 page book delivers what publisher Dick Ross, K2MGA promised when he and his CQ organization took over the ailing magazine. Former Ham Radio Associate Publisher Craig Clark, NX1G, brings his expertise to the new quarterly as does Alf Wilson, W6NIF, the senior technical editor. Our good friend Arnie Sposato, N2IQO is Communications Quarterly's advertising manager. With a cover price of \$9.95, you can subscribe for \$27.95 in the USA, \$39.95 overseas. Call (800) 457-7373 and become a charter subscriber. (You may write Communications Quarterly, 76 North Broadway, Hicksville, NY 11801). Every amateur should have some continuing technical education. Westlink suggests you get it here.

### WAYK-TV HOSTS LISATA MEETING

Bob Russ, Chief Engineer of WAYK-TV, Channel 56, was host for the September 18th LISATA meeting at the studios in Palm Bay, Bob toured a group of 20 through the TV transmission and video facilities and then turned their main studio over to us for the meeting. His demonstrations and tour were outstanding and he had coffee available, too. This view of a smaller TV station operation was most applicable to ATV and allowed the members to see how they might operate their ATV setups.

ATVQ DEVOTED ENTIRELY TO HAM TV

## MORE ATV NEWS SHORTS

### MINNESOTA ATC

The monthly breakfast of the Minnesota Fast Scan Amateur Television Club (Mn/FAT) 2m contact freq. 147.57 ATV RPTR 439.25 input 421.25 output Weekly Net Sunday 9:00 P.M. local time 2m RPTR 147.12 / 72 Net Control WBØYNH (Bob). Check in via video or audio on 2m. Average 10 to 12 checking per net. Past two years several club members gave video support to the command center during the annual national disaster medical service exercise. Using 4 to 5 cameras and monitors connected via 75 cable, 70cm xmitters and 33cm stuff. Activity in the area here very strong. Tnx 73 Bob WBØYNH

### SOUTH CAROLINA

Joe D. Oliver, P.O. Box 338  
Hardeeville SC 29927

Hello and greetings from the Hardtimeville South Carolina home of KB40DE. I'm enclosed a photo of my car. I saw in some of your ATVO magazines issues car tags. Here's one you might like "SOUTH CAROLINA ATV". Or if you happen to see an 87 Sabaru with a Rib Cage on the back with ATV tag ATV, you'll know KB40DE is around.

This may be old news. I went to the Sumter Hamfest in Sumter SC on Oct. 27, 1990 and had a good time I saw the ATV balloon images on TV. The signal was about P1 and the 2M signal good copy about S7 on 146.52. 73 and hope to see you on ATV.

### SAVANNAH, GA

De KB40DE The Savannah GA ATV Repeater is still off the air until we can find a new site. ID for the rpt is N40YT. The input is 434 MHz. The output is 421.25 MHz.



### ECAT/BOSTON

At the October meeting of ECAT, the incoming president, Ed, KA1AFE made a motion to give to an outstanding pioneer in ATV a life membership. A vote was taken, and unanimously accepted, that W1BHD, be granted the only life membership in the East Coast Amateur Television W1BHD, Mel, has been with ECAT since it was originally founded as NEAT (New England Amateur Television). He has been an inspiration in the development of quality video transmissions for more than a decade. Unfortunately due to his QTH, Mel is not able to get into the repeater anymore, but he still claims to see the test pattern at times. Mel claims that he spent many an hour testing with Tony, K1VTE, when he was setting up the original ATV repeater on windy Hill, in Malden. Truly one of the pioneers in ATV, Mel says he was broadcasting TV signals on channel 3 long before there was a channel 2. He also gave a few dates, such as, WBZ-TV went on the air on June 9, 1948, WNAC-TV on June 21, 1948, and W1BHD-TV on November 20, 1948 went on the air.

Being known to have incited some ATV riots, Mel says "I have to earn my pay somehow!". Congratulations, Mel, and the best of 73's from all of us!

### Mel Dunbrack, W1BHD

As most of you know by now, the "museum" of W11HBD/-WR1AAA has closed its doors as of October 1, 1990. All the repeaters, lots of parts, and radio related equipment has gone to radio heaven via several truck loads. I was cleaned out to the point where echoes can be heard throughout the house.

The trusteeship of the Middlesex Repeater Association has been turned over to K1SVP/W1NO, Sonny Casio of Saugus, including the repeaters all associated equipment. It is still operating in fine shape at this new location in Saugus. It took the last 17 years to tame the repeaters and bring them to their current state of operation.

Since 1917 I have been a wireless/radio buff and have done a lot of collecting of memorabilia including gear and especially related documents and histories. I finally reached the point where I felt it was time to take a breather. But I am still hanging on to the old ATV equipment. ATV has been my first love since 1924. Fortunately I have some fine photographs of the "OLE MUSEUM" thanks to my good friends Les, W1PL and Butch, W1OKB who came over a few years back and did some excellent photography work. So, at least, I have some good recorded momentos of the good old days. Hi. (continued next page)---

## ATV NEWS SHORTS

### NARA

ATVQ has long supported the efforts of Don Stoner, head of the National Amateur Radio Association (NARA). We have published portions of his appeals and notes related to hams helping teachers provide inspiration and exposure to students of ham radio. We expect to continue to do so. However, in response to mail received at ATVQ intended for NARA, we would like to mention that there is no business connection between NARA and ATVQ. We are two separate entities. While we provide mutual support because of common goals, donations and mail for NARA should be sent to NARA and not to ATVQ. We know some confusion was created when we ran a two page news item about NARA in which the camera ready appeal for support of NARA failed to include their address. While we are happy to forward the mail to NARA, readers should be aware it will reach the NARA much quicker if it is sent directly. The address for the NARA is:

16541 Redmond Way # 232, Redmond, WA  
98052.

The correct address for ATVQ is unchanged and remains as published in every issue, 1545 Lee St. #73, Des Plaines, IL 60018, 708 298 2269.

### NASA USES K4GCC AUDIO FOR VIEW SITE! Official Request From NASA-PA VIEWING SITE MOVE RESULTS IN QUERY FROM ENGLAND RE CW ID

John Anderson, K4GCC, recently got a letter from an English couple, both hams, whose daughter had recorded a video at a launch attempt of the Space Shuttle. The couple was at the NASA viewing site. When the tape was played back at home in England, the parents heard the CW ID of K4GCC. They probably thought John had PAI and so the couple scrambled a letter off to John quickly, asking why his call was on NASA's PA.

The explanation: because a fueled Titan 4 was on Pad 41, NASA had to move the traditional NASA Causeway viewing site to the west for Range Safety reasons. NASA's temporary site was not prewired with their Launch Commentary line. NASA-PA people remembered that K4GCC's 146.34/94 repeater carried their audio so the NASA called John up to get permission to use his audio!!!

John, at first reluctant, decided he could assist the government in their plight and said, "Why sure..." Thus the ID on the video/audio recording. A letter explaining all this was dispatched to England. (from LISATS)

### Thanksgiving Day Midwest Band Opening! Mel Alberty KA8LWR

ATVers in the midwest were given a special treat on Thanksgiving day and evening. The band went completely wild! This opening was similar to the fantastic one during Thanksgiving Day 1986 where 400 to 500 miles contacts were made. Contacts approaching 500 miles were made P4 or better during this years opening! 2 meters sounded like a 20 meter DXpedition.

Here's just a partial list of some of the amazing ATV stations seen here in Bucyrus, Ohio (50 miles north of Columbus).

Our first contact was with Don W9NTP in Waldron IN with a booming signal and ATV picture. Don was working Ralph W2RPO in Lockport NY with almost snow-free two way pictures (a distance of 490 miles!). They were both seen going through the KD8PE/r ATV repeater as well in Beloit Ohio with P5 signals. Then followed an incredible clatter on 144.34 with a jumble of ATV signals coming in from Kentucky, Indiana, Illinois, Wisconsin, Michigan, Pennsylvania and New York. Stations seen here were: N8EWV, KE8II, N8CYV, WB9YQW, N9FFP, W8VKR, WA8SAJ, WB9YTW, KB9BFB, WB9LHD, WA9BVS, W9PRD, K9KLM, KA9DZR, K9OVR, KA9TGX, K9SM, WB9IHS, K9OMO, N8COD, W8YOS, WB8VNC, K8HVA, WA8ZAH, N8DOD, K8PYQ, KA8YLY, W3ZQS, W2RPO and W4HTB!

From KA8LWR to all who watched the band opening on Nov. 22, 1990, thanks for all of the great pix and we'll be looking for again soon!

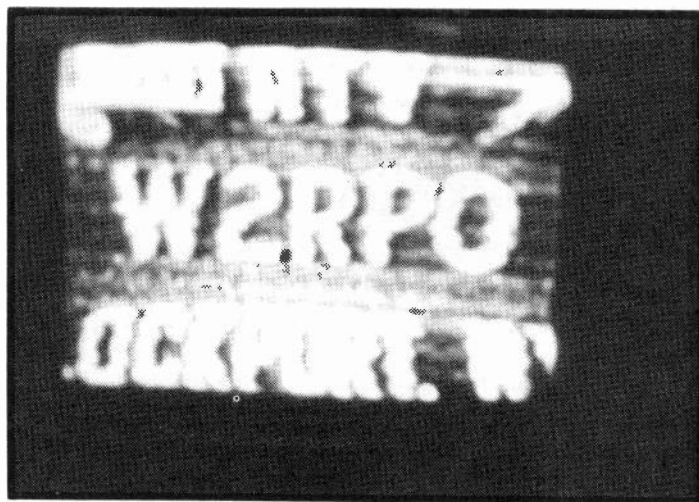

Ralph W2RPO in Lockport, NY as received by Don W9NTP in Waldron, IN. Distance of 490 miles! Thanksgiving Day 1990.



# CROSS COUNTRY BALLOON ATV ADVENTURE

**Bill Brown WB8ELK**

*This spring, three balloonists plan to attempt a nonstop cross-country flight. The large helium balloon will lift a gondola and a unique ballast balloon which hangs below the gondola to a constant altitude of 17,500 feet. The special ballast balloon allows the crew to precisely adjust their altitude by either pressurizing or releasing air within it. This acts as a variable weight and offsets the variations in lift that occur throughout the day in the main helium balloon.*

The captain of this venture is Larry Newman KB7JGM. Larry is captain of a Boeing 757 for America West Airlines and is also an accomplished balloonist. He's flown on both the Double Eagle II trans-Atlantic flight and Double Eagle V trans-Pacific flights. This cross-country adventure is a warm-up flight to gain more experience with their unique dual-balloon system. If all goes well they will attempt the first ever nonstop Round-the-World balloon flight next November. The crew for the global flight will be Newman, Dzhanibekov and Richard Branson (owner of Virgin Atlantic Airlines). [Ed. Note: See the October 90 issue of Popular Science for a complete description of the global balloon system.] The global flight will fly in the jet stream at 35,000 feet. The typically high winds at this altitude make it possible to complete the trip in under two weeks. A special pressurized gondola has been constructed to keep out the harsh environment and low pressures encountered at this altitude.

Since this spring's flight is at a much lower altitude (17,500 feet), an open-air gondola is being used. The cross-country balloon will depart early in the morning from a blimp hangar in Orange County, California. Typical March wind patterns could take the crew from southern California across northern Arizona and New Mexico to Kansas City, Iowa, Illinois, Indiana, Ohio, Pennsylvania and finally a landing in New York state. Keep in mind that this is only an estimate, the flight could take a different route. The predicted flight path will be more accurate a few days before liftoff.

Larry KB7JGM plans to bring along HF equipment to communicate with hams as he flies along. Listen for him during daylight hours on 28.385, 21.385 and 14.330 MHz. In addition, he will be operating on 144.34 MHz. on 2 meters and will have a complete ATV station mounted on the railing of the gondola.

The ATV station will be running about 5 watts on 434 MHz. (possibly 439.25 MHz. when over the eastern half of the country). Polarization is switchable between vertical and horizontal depending on the area. When Larry is not operating live from the ATV station, the live color TV camera can be operated remotely via commands from several ground stations along the route. The camera will be mounted on an Az/El mount looking out towards the horizon and can be moved to look at the crew in the gondola and up and down to look at the balloons. Also, there are currently plans to add a 1 watt 1255 MHz. FM ATV transmitter to this system. During the night, there is the possibility of setting up the system as a cross-band ATV repeater! 434 (or 439.25 MHz.) AM input and 1255 MHz. FM output. Those of you with 1200 MHz. AM

receive stations can slope tune the FM signal for reasonable results.

Real-time telemetry showing the Altitude, Lat/Lon position, Temperature, Ground Speed and Bearing will be superimposed over the live video downlink. These will appear in two lines of text at the bottom of the picture. This is a similar system to the prototype that was flown in the weather balloon flights from Champaign, Illinois and Wapakoneta Ohio during 1989. Bob Rau N8IYD from High Technology Flight now manufactures these modules. We will be using his MCM3 flight computer board and the VO1 video overlay module. Bob can be contacted at (313) 482-2670 for further information on this system. His address is 1450 Jeffery St., Ypsilanti MI 48198-6319.

The Altitude, Latitude and Longitude as well as ground speed and bearing information is all possible with a special new board set from Magellan. This two board system along with an antenna module comprises a complete GPS (Global Positioning Satellite) receiver for under \$1000. More info on this system can be obtained from Magellan Systems Corp., 260 E. Huntington Dr., Movrovia CA 91016. (818) 359-4455. We hope to interface a voice talker circuit to the flight computer to send out the balloon's position via 2 meters as well as on 28.385 MHz. That way we can all track the crew's progress across the country.

From their vantage point of 17,500 feet, the line-of-sight range will be about 160 miles either side of the flight path. Basically they'll have 320 mile wide ATV coverage as they travel along. Keep on eye out for some very spectacular ATV activity this March!

Updates on the launch date as well as finalized frequencies will be sent out to packet BBSs nationwide prior to the flight. Also look for the weekly AMSAT nets on 75m (3.840 MHz. 9pm local time tuesdays) and of course on the ATV net on 3.871 MHz. every tuesday night from 8 - 9:30 pm EST.

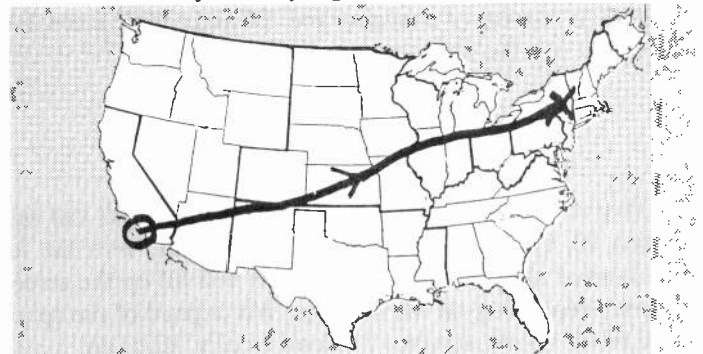

Possible flight path of the March "Earthwinds" cross-country test flight.

## AUTHOR'S UPDATES

### RGB TO NTSC ENCODER

April 1990, Page 28, RGB to NTSC Encoder  
Subject: Incorrect output circuit configuration

The video output circuit for the IC U1, MC 1377, is shown incorrectly and will not function properly, if at all. Pin 9, the video output is from an emitter follower circuit with an internal 4.7K resistor. The series capacitor, C1, 10 Mfd. is too small a value to connect to R3, a 75 ohm resistor. Not only will the waveform be distorted, but also incorrect amplitude.

Pin 9 of IC U1 should connect first to a series 75 ohm resistor. Then, to the video output jack J1. Next an 75 ohm terminating resistor must be used. This resistor may be the input to the TV transmitter. It must be a DC connection with out any series coupling capacitor for the emitter follower to operate properly. See the schematic diagram included. This information was taken from the MC 1377 Application Note, AN 932 provided to the writer from WB6P, Tom Gould. Submitted by W8DMR, Bill Parker, Columbus Ohio.

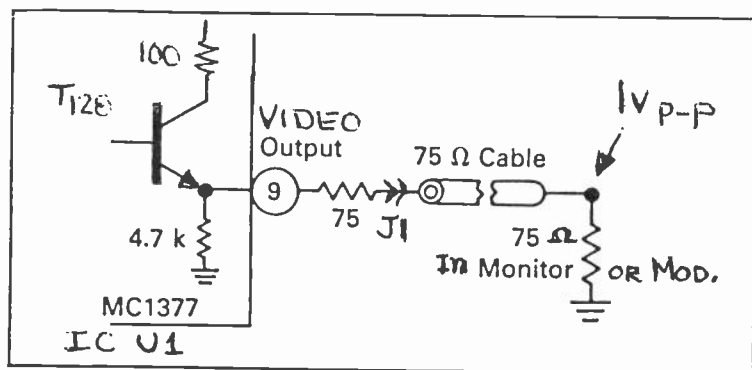

FIGURE 1

### John Neeley, K6YDW

In going over that C/64 program from WA8KQQ on page 39 of Vol. 3 #4, I found an error will not allow the program to work. It consists of changing line 200 and adding a new line, 205. Here are the changes:

```
200 GET A$
205 IF A$=" " THEN 200
```

Otherwise, it works quite well. Since I have a lx3 call sign, in line 20, I placed 5 spaces between colors, with the letter/number at space location 3, which will fill up the screen. Course, depending on the call sign, will depend of the spaces used to fill up the screen. 73, John Neeley, K6YDW  
P.O. Box 6672 Tahoe City, CA 95730

### THE PLESSEY SP-5060 PLL

In the October 1989 issue of Amateur Television Quarterly, an article about a low cost 23 cm (1280) MHz phase-locked loop exciter has created much interest. Several ATCO members have inquired regarding a source to purchase the SP-5060 IC. The fixed modulus frequency synthesizer may be purchased in quantities of six or more at a cost of \$15.05 per piece from Pioneer Electronics, 1200 Troy Street, Dayton, Ohio 45404 (allow six to seven weeks for delivery). Dick, W8RVH, located this source about three months ago. W8RVH, WB8URI, WM8P, W8DMR, and others have successfully duplicated the 23 cm PLL exciter using the PC TVG-12A free-running oscillator and the SP-5060 IC. The total cost to construct the exciter was less than \$48.25.

Submitted by Bill, W8DMR

### TVG 12A FREQUENCY LOCK

Here is some information for those of you who will be attempting to frequency lock the TVG-12A. Although it seems to be no problem to lockup this unit, some difficulty has been encountered when following it with two brick amplifiers. Try the following: first, replace the coax from the TVG-12A to the brick amp with 1/8" hardline as short as physically possible; then solder a 57 ohm resistor with leads as short as possible from the output to the ground; finally, vary the voltage on pin 2 of the SC 1043 brick from 8 volts down to 4 volts.

Submitted by Bill, WB8URI

Changes by author Tom Gould WB6P to  
Colorbar Generator article, October 1990  
ATVQ.

1. The value of R2 should be 56K not 43K ohms
2. C51 on the component layout diagram should be changed to C25
3. On the top side circuit board layer the grounded side of C24 and C25 should be connected to the ground plane.

**SUBSCRIBE  
TODAY**

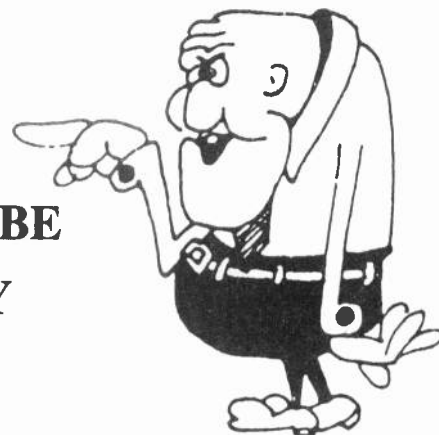

# VERTICAL INTERVAL TEST SIGNAL MONITOR

## BY JOHN P. SPAETH KDØLO

*Most commercial broadcast UHF/VHF/CATV and satellite TV stations broadcast test signals which are transparent to the regular TV programming. These signals are hidden from normal view within the vertical blanking interval.*

As you know, this is the time period when the CRT displays beam is turned off to allow for repositioning at the end of a field scan. These "hidden" test signals can be of particular value to the amateur ATV station operator in measuring his/her transmitters performance. We would do this just as a commercial broadcast station would and for the same purpose.

First generate a test pattern at composite baseband video level, then feed that signal through your baseband processing equipment and finally your transmitter. After demodulating the output, one can compare the baseband test signal at the input, to the same signal after it has been transmitted and demodulated. The signals should look identical at the input and output in an ideal transmit and receive situation. Unfortunately in reality the video signal is exposed to many distortions between the time it leaves the camera and is seen again on the TV set.

It is the attempt to measure these video distortions in our systems that compel us to generate test signals.

There are several ways to generate video test signals. Unfortunately most of the test generators which produce vertical interval test signals (VITS) do not fit the ham radio budget. And although a test generator would not have to produce its signal during the vertical interval, even a stand alone unit capable of producing baseband test signals might cost several hundred dollars.

Another method of producing usable test signals would be to point the camera at a test chart. These are produced to simulate a variety of response frequencies. You all remember the old Indian head test chart. Those feathers had meaning Kemosabi! The problem with that method is that the test signal is prone to distortions in lighting, internal camera processing etc.

Still another method to produce usable video test signals is with a computer. One could actually produce a screen full of characters which would simulate a variety of test frequencies. However most computers today are not NTSC compatible, and once again could not be fed into the system direct. An NTSC computer such as the AMIGA or MACINTOSH with appropriate genlock output boards are very expensive.

Since we've already determined that most broadcast TV stations transmit VITS on their vertical interval, why not put those test signals to work for us in the shack. To do this we will enlist the help of an old friend the National Semiconductor LM-1881 sync-separator chip.

Fig 1 shows a circuit that will select a single video line for viewing as determined by the binary coded data applied to lines b0-b7. The circuit will provide a single line out for each field in an interlaced video system. Two counters are needed for selecting lines 15 to 253. If the output of the circuit is used to drive a high impedance load such as a scope, it may be used as is. However if the output is to be used as a test signal

source for your transmitter, a buffer will have to be added to drive the low impedance video input of your TV transmitter.

As you can see from fig 1, the circuit will take composite video in and allow you to select any line for VITS, VIRS, TELE and other interval signals. You would receive a commercial broadcast TV station on your TV set or vcr, (make sure its P-5 plus) and take the composite video output to feed the video input of the circuit. After adding a hi Z to low Z buffer, the output of the circuit can be fed to your transmitter. Of course the transmitter must be fed into a dummy load at this point since FCC 97.113 prohibits us from retransmitting a non-amateur signal!

You would then use a detector at the output of your transmitter like the one from PC Electronics which will restore your received rf to baseband video. This detected baseband video is then compared to the source video, and the system tests are underway. The following test signals will be considered for evaluating our systems.

1. MULTIBURST : On line 17,field 1, consisting of sequential bursts of sine waves at frequencies of .5, 1.5, 3.0, 3.5, and 4.2 MHz.,(Ed. note, other frequencies may also be used) preceded by a reference white-level pulse at 100 IRE units. The bursts are 40 IRE units peak to peak from 10 to 50 IRE units.

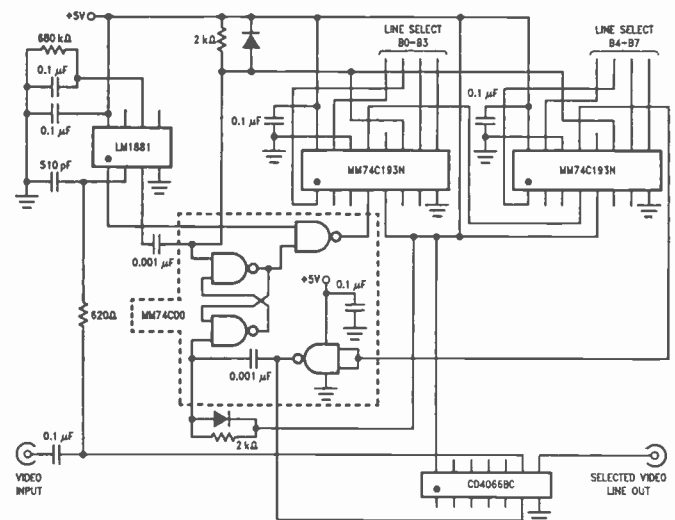

FIG.1 Test Pattern Selector

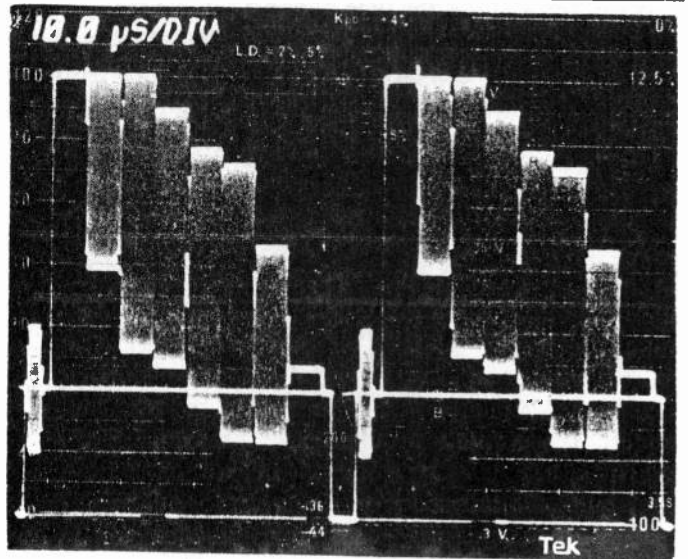
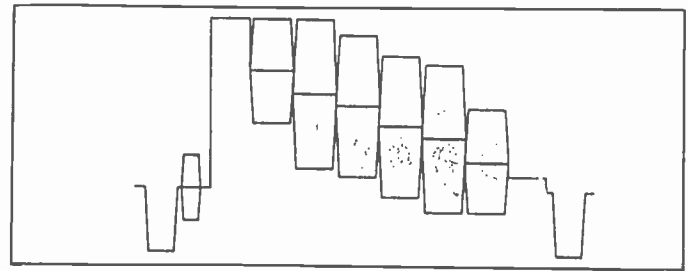
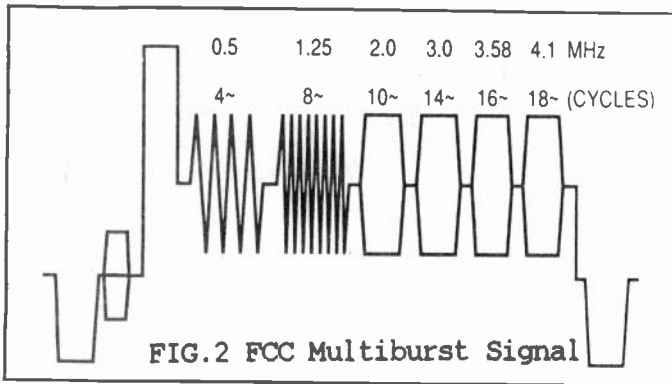

FIG.3a,3b 75% color bars with 100% white and as shown on monitor

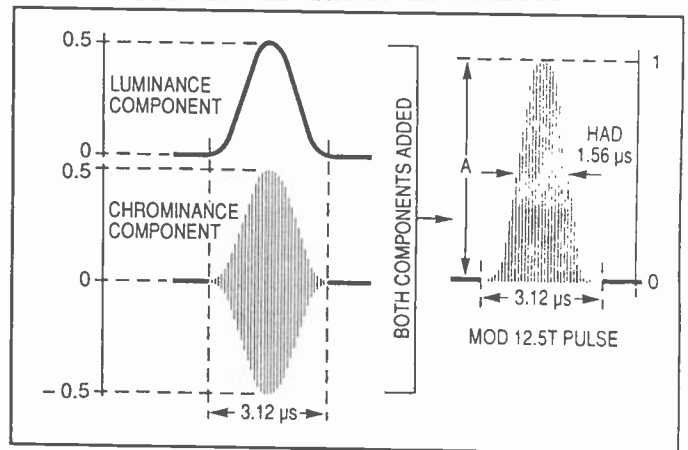
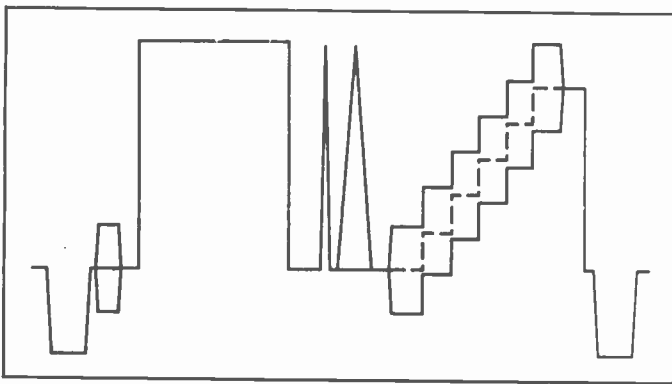
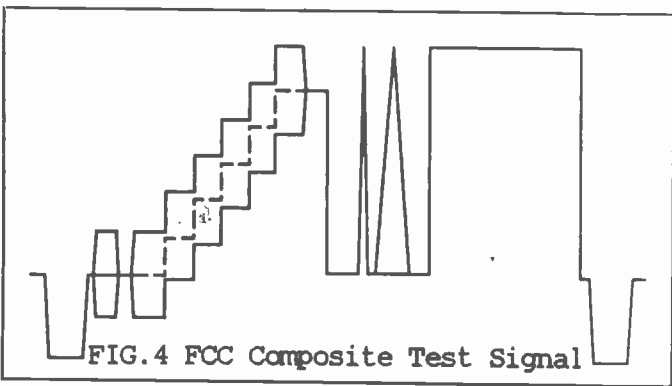

FIG.6 Chroma & Luma components of the modulated 12.5T pulse.

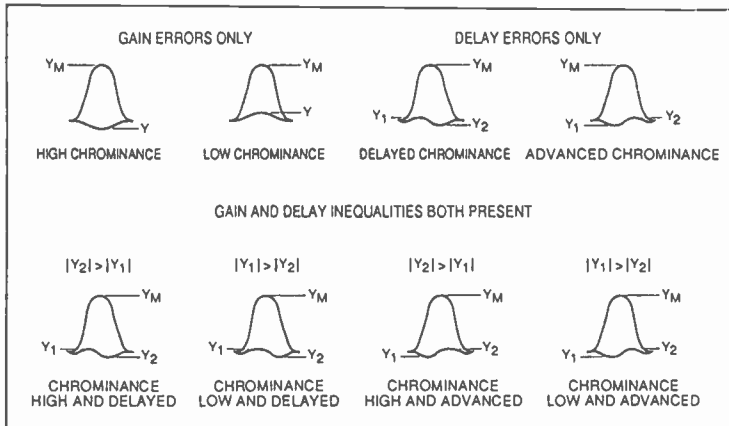

FIG.7 Gain and Delay Distortions on 12.5T

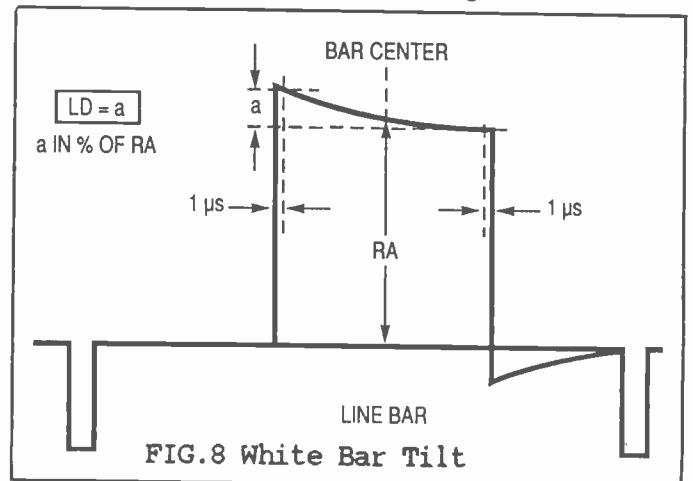

FIG.8 White Bar Tilt

ATVQ DEVOTED ENTIRELY TO HAM TV

## VERTICAL INTERVAL TEST SIGNAL MONITOR

2. COLOR-BARS : on line 17,field 2.
3. COMPOSITE VITS consisting of modulated stairstep, 2T pulses (sine squared and 12.5) and white bar:Line 18 field 1 or 2 typical. The multiburst signal described above is graphically illustrated in fig 2.

This "packet" of frequencies can be transmitted through your system for a quick approximation of your systems ability to pass frequencies in the video passband. In this sense it is like using a sweep generator to sweep your system. Although it is not a good detector of non-linear distortions in your system, it certainly will tell you how your system is passing the high vs low frequencies. The color bar test signal described above is graphically illustrated in fig 3.

This test pattern is most useful for determining sync to picture ratio and for colorburst amplitude and width and subcarrier phase distortion caused by nonlinearities in your system.

By far the most useful measure of system performance is the composite FCC or NTC-7 VITS. These signals are illustrated in fig 4 & 5. The modulated 12.5T pulse is made up of a sine-squared luminance pulse and a chrominance burst with a sine-squared envelope as shown in fig 6.

Gain errors frequently exhibit themselves as attenuation or over saturation of color information. The effects of delay and gain distortions are seen in fig. 6.

The white bar is also a test of delay distortions. The top of the white bar should be parallel to your scope graticule markings. If it is not your video is said to have tilt. Again this is a time (delay) measurement and it will likely show up as uneven brightness in your picture from one side to another.

Of course once you make your test measurements, and find out how awful your video transmitter looks on the test equipment what do you do?

Well, you could take up stamp collecting or simply realize that broadcast standards simply aren't needed for ATV. However, these measurements can point to flaws in a malfunctioning system, can help with the tuning of interdigital filters and tube amplifiers which can cause large group delay non-linearities, and can help you keep track of your systems performance over time if a baseline is established for your station. So that even if "broadcast standards" cannot be attained with your system, these VITS can be an effective diagnostic tool for your ATV station. 73's KDØLO

(NOTE:all waveform diagrams are courtesy of Tektronics,Inc.)

## 23 cm FM ATV COORDINATION from Tom O'Hara W6ORG

*When the 23 cm ARRL band plan was formulated in the early 80's, FM ATV was being experimented with by just a handful. It was determined that even though the occupied bandwidth would exceed the 10 MHz wideband experimental slot centered at 1265 by a little for FM ATV simplex (it would stay inside if 4.5 MHz sound subcarrier is used), there was not enough FM ATV activity at that time to warrant presenting two differing bandplans to allow for both ATV AM or FM repeaters.*

In all but the most populated areas of the county, the possibility of interference from non-coordinated FM ATV on the 23 cm band will not occur for many years. But now is the time to consider and discuss local standards to minimize future hassles.

If we use the modulation standards listed in Table 1, page 20-12 in the ARRL Handbook, the occupied bandwidth will be a little over 12 MHz (12.8 MHz if 6 MHz sound at 4 MHz deviation, 5.5 MHz sound subcarrier would put you just under 12 MHz). One FM ATV channel will replace two AM ATV channels. There is no room for a combined 12 MHz slot above 1270 given existing FM voice repeaters, but the two AM ATV channels below 1260 do make it possible if there are no existing links or digital systems in place, or so few that they are willing to move.

The question then becomes what are the practical frequencies to move the FM voice link and digital channels to. The links and digital systems use back to back synthesized mobile transceivers also, so there is no practical equipment degree of difficulty for a specific offset or frequency. There is one difficulty for a FM ATV repeater input, however, if the link transmitter is located at the same site it can capture the ATV receiver, and vice versa.

I suggest centering the FM ATV carrier at 1252 MHz. The links would then occupy 1240-1242 pairing with 1258-1260. Which would be the link input or output at a location would depend on whether the ATV system at 1252 was an input or output. The adjacent 1240-1242 would be the same in this case as the ATV system. Digital systems at 1242-1246 would also follow this input or output logic paired with 1297-1300. By keeping all receivers at a site regardless of mode close in frequency to each other, it allows the filters in the antenna lines to have the most rejection to the transmitters.

The frequency could just as easily be 1248 with the digital segment above the ATV segment, but 1252 is just closest to the British 1255 MHz frequency that many use now. Also the link segment at 1258-1260 is unchanged.

Each area will have to get together with their local Frequency Coordinator when the first 23 cm ATV repeater is about to be built to determine whether to stay with the ARRL band plan in this segment for 2 AM systems, or modify it for an FM system. Your feedback is requested.

Tom O'Hara, W6ORG  
ARRL Technical Advisor for  
ATV and Spectrum Management

# AUTO RECORDING ON A VCR

by  
John Neeley, K6YDW

In Vol. 3 #4 issue of ATVQ, on page 64, paragraph 3 of my letter, I asked the question, "... anyone has come up with a reliable circuit for Auto Recording on VCR when not at home?" Well, it looks like I have answered my own question, as I have come up with a very simple circuit which does the job.

The circuit is the same one that was on page 36, Vol. 3 #3, which was an article by AHZAR/8, which was a sounder when video was detected, to let you know of the activity on the channel. Well, with a few modifications, it will also work to control a VCR to record when video is present, and shut off when none exist. Instead of driving a Piezo Sounder, my circuit operates a DPDT relay, which then operates the Remote Control Unit of my VCR.

Not knowing at the time just what kind of relay I was going to require, I tore into the Remote Control Unit of the VCR, since we never used it anyway, and using an Ohm-meter, I found which pads went to the RECORD, PLAY and STOP sections. My VCR, an older Hitachi VT-33A model required both the RECORD and PLAY buttons to be pushed at the same time for recording. I found that I could just place a permanent jumper across the RECORD switch, and then use one set of relay contacts (normally open) to activate the PLAY switch when the relay enabled.

The second set of relay contacts (normally closed) went across the STOP switch. The relay I used was a RS 275-249, but depending on just what is required in your recorder, it may take something else.

To tune the decoder board, place a frequency counter on the test point (per AH2AR/8 article), and adjust the potentiometer to where the counter reads 15,734 hz, and that is all there is to it. When video is applied to the input, the horizontal sync is detected, the output of the decoder goes LOW, thereby enables the relay.

That is all there is to it; very simple and works GREAT! Even though it doesn't have some delay built in, to prevent operation in the event of noise, etc., it seems to do the thing I wanted it to do, and that was to record incoming video when I'm not in attendance. I put everything into a 7"x7"x2" aluminum box, including the Remote Control Unit and a 12 volt power supply, and now it sets on top of the VCR waiting for any incoming ATV video. Now I won't miss anything on the channel while not in the shack. It can also be used as a home remote recorder, while roaming around the neighborhood or house, taking pictures of the kids, etc., with your portable ATV setup. John Neeley, K6YDW, P. O. Box 6672, Tahoe City, CA 95730

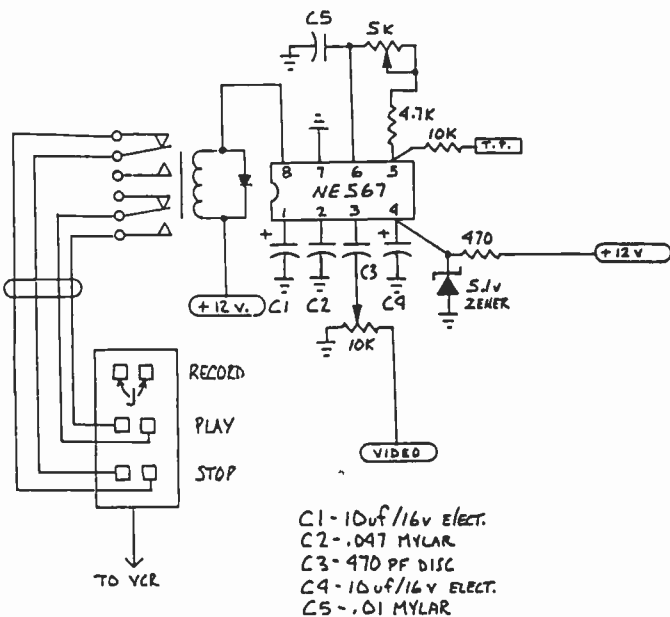

- C1 - 10uf/16v ELECT.
- C2 - .047 MYLAR
- C3 - 470 PF DISC
- C4 - 10uf/16v ELECT.
- C5 - .01 MYLAR

VCR CONTROLLER  
K6YDW 12-90

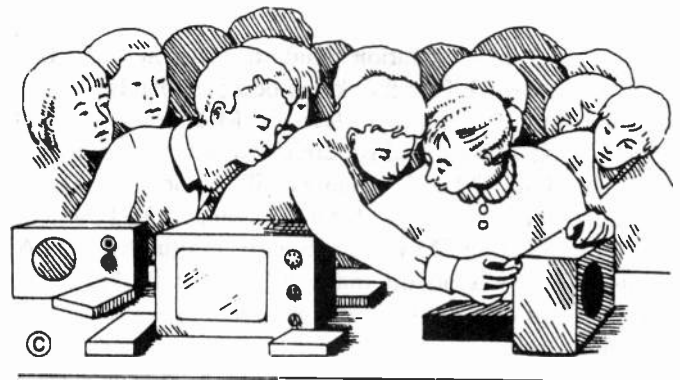

# si JAYBEAM

## SPECTRUM INTERNATIONAL, INC.

Post Office Box 1084 T  
Concord, Massachusetts-01742  
508-263-2145

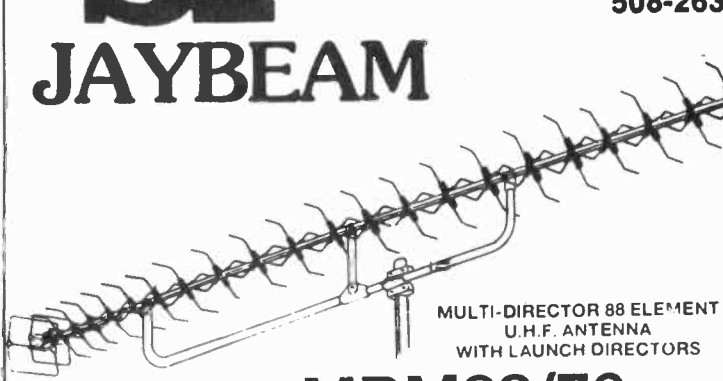

MULTI-DIRECTOR 88 ELEMENT  
U.H.F. ANTENNA  
WITH LAUNCH DIRECTORS  
**MBM88/70cm**



MULTI-DIRECTOR 48 ELEMENT  
U.H.F. ANTENNA  
WITH LAUNCH DIRECTORS  
**MBM48/70cm**

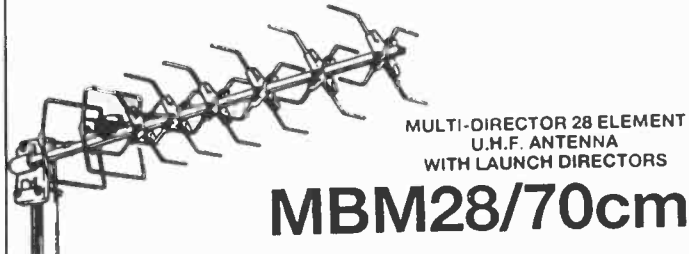

MULTI-DIRECTOR 28 ELEMENT  
U.H.F. ANTENNA  
WITH LAUNCH DIRECTORS  
**MBM28/70cm**

General Specs:-  
Frequency Range  
Impedance  
(Built-in Balun)

420 MHz - 450 MHz  
50 Ohms

	MBM28	MBM48	MBM88
Gain	11.5dBd	14.0dBd	18.5dBi
Beamwidth (E)	40 deg	28 deg	23 deg
(H)	45 deg	35 deg	28 deg
Boom Length	4 ft	6 ft	13 ft
	\$ 60.00	\$ 110.00	\$ 150.00

### VHF/UHF BANDPASS FILTERS

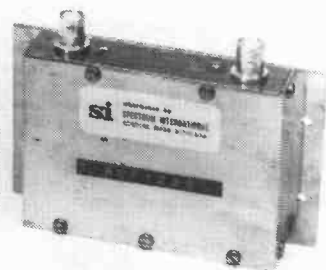

KNOCK OUT INTERFERING  
QRM OR SELF-DESENSE!

The PSf... series of Band Filters are for receiver pre-selector and transmitter use. The filters are 3 pole, 7% bandwidth, 0.1 dB ripple designs with 30 dB shape factor of 4:1.

The PSf...ATV series of TV Channel Filters are 5 pole, 6 MHz bandwidth designs. They are used to protect your TV receiver from inband QRM and to "strip-off" the unwanted sideband of your transmitted vestigial sideband signal.

BNC Standard  
TNC or Type 'N' optional  
(slightly higher prices)

Model	PSf144	PSf220	PSf432	PSf900	PSf1296	PSf1691
Freq (MHz)	140-150	216-228	420-450	890-940	1250-1340	1650-1750
Loss (typ)	0.1 dB	0.1 dB	0.15 dB	0.2 dB	0.25 dB	0.25 dB
	\$ 99.00	\$ 99.00	\$ 99.00	\$ 99.00	\$ 99.00	\$ 99.00

Model	PSf421-ATV	PSf426-ATV	PSf439-ATV	PSf910-ATV	PSf1253-ATV
Loss (typ)	2.0 dB	2.0 dB	2.0 dB	2.5 dB	3.0 dB
Std conns.	BNC	BNC	BNC	N	N
	\$150.00	\$150.00	\$150.00	\$175.00	\$175.00

All prices FOB Concord, Mass.

PRICES SUBJECT TO CHANGE WITHOUT PRIOR NOTICE

## SPECTRUM INTERNATIONAL, INC.

Post Office Box 1084  
Concord, Massachusetts-01742  
508-263-2145



NOW DISTRIBUTED BY:  
**ALLIED APPLIANCE & RADIO**  
 4253 S. BROADWAY  
 ENGLEWOOD, CO 80110



\* Soft Touch Electronic Switching  
 \* Upgrades to Other Bands

\* Low Loss Cable NOT Required  
 \* Built in Modulator

**ATV**

**AM & FM**

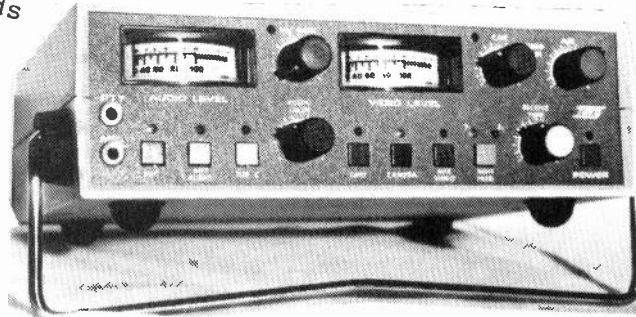

\* Automatic Mic Level

\* Video White Clipping Provided  
**CU-125 CONTROLLER**

\* AM, FM Or Both Modes

For Smooth, Easy Operation, and Flexibility in Your ATV System, Build up Your Own Station By Selecting the Appropriate R.F. MODULES of Your Choice.

The CU-125 Control Unit Produces All The Control, and Processing Needed To Send And Receive ATV Pictures on Any Of The Bands Covered By Our Transmitter and Receive Modules.

If You Decide To Update Your Band Of Operation Or Try A Different Mode, Just Add The Required Transmitter, Converter, or Both At The Antenna And Your In Business Without loosing the Old System. Just Switch Between The To.

**RCC-10 RECEIVE CONVERTER CONTROLLER**

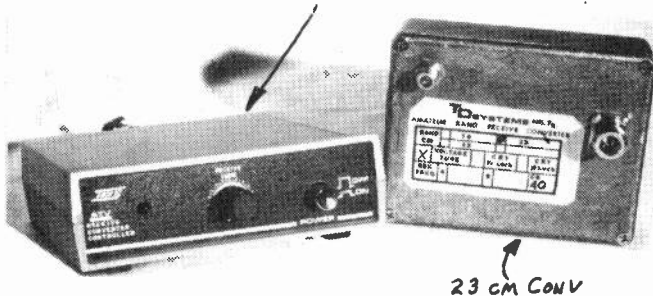

23 CM CONV

Incorporated in the CU-125 Control Unit is two Independent Video Inputs, One 10 Pin, and One RCA Jack. Each with Its Own Video Level Control. Each Video Input after Selected, is Applied To A Video White Clipper Where Any Video Overdrive Is Clipped Off, Reducing The Possibility Of Over Modulation An Automatic Pedestal Control Keeps The Proper Clipping Level At All Time. A Low Pass Filter IS Also Added To Remove Any High Frequency Noise On the Video Or Spurs Caused by The Clipping Action. One Item That Can Be Added At This Point Is a Small Sync Stretcher PC Board That Mounts On The CU . From This Point A Low Impedance Line Driver Amplifies And Drives The Processed Video Down The Coax To The Transmitter. A Video Output Monitor Jack Is Also Included To Monitor The Processed Video Before Or During Transmitting.

Both V.U. Meters And Led Clip Indicators And Monitor Outputs Jacks Is In Full Operation Before And During Transmission.

External Mic Audio Is Applied To An Automatic Gain Control Amp With An Input Level Control Added To Vary The Amount Of Audio Before Compression Starts. Aux Audio Is Applied To A Rear Pannel RCA Connector With Its Own Level Control. A RCA Output Jack Is Also provided To Enable Monitoring The Audio AS Its Applied To The Audio Sub Carrier Gen.

A Crystal Controlled Sub Carrier Generator Is Also Provided Programed To 4.5 Mhz. Other Frequencies Can Be Programed By Changing PC Straps. Sub Carrier Injection Level Is Also Adjustable.

Power Requirements For The CU-125 And All Modules Is 12-14.5v D.C. Input. Complete Regulation And Filtering Makes This Unit Ideal For Base Or Mobile Operation Little Affected By Voltage Fluctuation.

CU 125 CONTROL UNIT \$229.00  
 Box Size 2.52 x 8.10 x 6.12"

FM DEMOD BOARD  
 SPECIALLY DEVELOPED NARROW BAND FM DEMOD  
 MODULE WITH AN AGC IF, SHARP SLOPED SAW  
 FILTER, AND A NEWLY DEVELOPED LOW THRESHOLD  
 PHASE LOCK LOOP VIDEO DETECTOR

AM TRANSMITTERS	
70 CM -- T70A	\$132.00
33 CM -- T33A	\$137.00
23 CM -- T23A	\$137.00
To add 2nd Frequency	\$10.00
If on carrier audio modulation is required	\$10.00
FM TRANSMITTERS	
33 CM -- T33FM	\$138.00
23 CM -- T23FM	\$138.00
FM DEMOD BOARD	\$169.00

(Installs in CU 125, Required to receive FM ATV)

SHIPPING & HANDLING  
 Texas Residents add 7% sales tax

REC CONVERTERS	
70 CM -- RVT-70	\$89.00
33 CM -- RVT-33	\$103.00
23 CM -- RVT-23	\$109.00
FOR CRYSTAL CONTROL OPTION	\$30.00
To add 2nd Frequency	\$10.00

**NEW!**  
 RCC-10 RECEIVE <sup>44.50</sup>  
 CONVERTER CONTROLLER

**T.D. SYSTEMS**  
 2420 SUPERIOR DR. 'B'  
 PANTEGO, TX 76013  
 817-861-5864





# Phillips-Tech Electronics

## WHAT IS AN AMATEUR MICROWAVE RECEIVER?

Our microwave TV antenna is a true parabolic 20" spun aluminum dish which receives microwave signals that are transmitted from a local transmitter to a specific area. The microwave transmitter(s) are generally placed in the same location as the network TV towers broadcasting in that specific area. The receiver is a voltage tuneable down converter which converts microwave signals, broadcast between the 1900 MHz - 2700 MHz range, "down" to the 70 MHz VHF channels 2 through 6. Signals in this frequency band may include amateur TV, educational, sports, movie, and weather programs. These broadcasts may be different from location to location.

These systems will not receive direct satellite transmissions, physical cable connections, or microwave telephone communications.

## Reception Range

The reception range of microwave signals is limited to line-of-sight distances. Transmitter height, receiver height, and local topography combine to determine the maximum distance of reception in any area. The reception distance can approach 50 miles under good conditions and extend beyond 90 miles under exceptional circumstances. Reception is a function of broadcast power. The rule-of-thumb is approximately one mile of reception for every watt of broadcasted power, i.e. 100 watts broadcasted power equals approximately 100 miles of usable reception. Trees, buildings, and other obstructions can inhibit quality of reception. A field test of your location is the surest method of knowing your particular situation.

## Types Of Service

These antennas have many capabilities. The most common is the Multi-point Distribution Service frequencies, i.e. 2150 - 2160 MHz. There can be up to three channels broadcast in this MDS range for any specific location.

The next most common are the IFTS frequencies, 2500 - 2160 MHz. There can be up to three channels broadcast in this MDS range for any specific location.

The next most common are the IFTS frequencies, 2500 - 2686 MHz. IFTS is the Instructional Fixed Television Service. These channels contain data and educational programming transmitted by local colleges, universities and major corporations.

The third most common are the MMDS frequencies. MMDS is the Multi-point, Multi-channel Distribution

Service. These broadcasts are licensed under the IFTS frequencies (2500 - 2686 MHz). The IFTS and MMDS programming varies from area to area if available. In the near future there may be as many as 3,000 new transmitters in the USA alone.

## Do You Have A Signal?

There are several methods of determining whether or not our equipment will work for you. One method would be to look on the rooftops of the buildings and homes in your town or city. Another method is to call us. We are familiar with many of the locations that have operating transmitters. You may also write to the FCC in Washington, DC, for a list of the 1900 - 2700 MHz transmitters licensed to operate in your specific area.

## 12-Channel Microwave TV System



## Description

This new system was originally designed for the multi-channel IFTS frequencies. However, it has proven to operate exceptionally well for the entire 1900 - 2700 MHz band of any 120 MHz segment at one time. The down converter mounts the dish antenna and receives the signal from the probe feed horn.

This unit comes standard with hi-gain transistors and is versatile with up to 12-channel tuning capability. Recommended for reception of 20 to 50 miles. For fringe area locations over 50 miles, we recommend the Ultra Hi-Gain/Low-Noise transistor option, Part #64535. Add \$15 per system.

For more information, contact Phillips-Tech Electronics at PO Box 8533, Scottsdale, AZ 85252. Phone (602) 947-7700

# TOWER MOUNTED PREAMPLIFIERS WITH 100 WATT CAPACITY

PD-144TR-L  
(2 mtrs.)  
\$129.00

PD-220TR-L  
(220Mhz)  
\$129.00

PD-440TR-L  
(70 Cm.)  
\$139.00

N.F. 0.6 DB Gain 18 DB

N.F. 0.5 DB Gain 16 DB

## PREAMPLIFIERS

PD-144 dual gate 0.6 db. NF & 18 db. gain (2 mtr)	\$47.00
PD-144TR same but T/R switched	\$79.00
PD-220 dual gate 220Mhz.	\$47.00
PD-220 same but T/R switched	\$79.00
ABOVE IN KIT FORM NOT T/R	\$18.00 & \$35.00
PD-440S 70cm NEWEST DESIGN	
NF 0.5 db. & gain 18db.	\$67.00
PD900 33 cm. 0.6db. & gain 17db. (BNC) & PD-1200 (23cm) Same Specs.	\$75.00
In diecast box with "N" connectors	\$86.00
With T/R switching	\$129.00
PD-2300 2.3 Ghz. Can be used on 1.8ghz.	\$95.00
NF 1db. Gain = 17db.	
ATV-SAMPLERS Low Insertion Loss	\$49.00 & \$63.00
Transverter Kits for 900 mhz.	\$199.00
BRICKS & EXCITERS FOR 900mhz., 1.2ghz. & 70cm.	Call or Write
FREE CATALOG	Call or Write

ALL PRODUCTS ARE WARRANTED FOR 1 YEAR PARTS & LABOR  
EXCEPTION: Overdrive on P.A. or transmitting thru a preamplifier which is not a T/R type.  
Money back within 30 days if you are not satisfied.

## POWER AMPLIFIERS

	440 Mhz.	
PD-440N 1 to 2 watts in 18 watts out (linear) T/R		\$109.00
2 to 4 watts in 25 watts out (linear) T/R		\$149.00
	902 to 928 Mhz. FM & Linear	
PD-900 1/2 watts in 8 to 10 watts out (FM)		\$50.00
Same but larger heat sink		\$65.00
1 watt in 18 watts out (linear)		\$210.00
Same but T/R switched		\$260.00
PD-1200N Brick Type 1 watt in 18 watts output 1.2 Ghz.		\$149.00
Same as above but larger heat sink		\$165.00

## POWER AMPLIFIERS

1.2 Ghz.

P.A. - Listed below are in diecast boxes

PD-1200TR (1 watt in 16 watts out T/R switched)	\$199.00
PD1200N-1 (2 watts in 30 watts out)	\$289.00
PD1200N-2 (4 watts in 50 watts out)	\$525.00

## ATV

Video Sampler

This unit picks up your transmitted ATV signal by sampling the transmission line with negligible insertion loss. It uses 2 "N" connectors for input and output connections. A BNC is used on the video output. The detected output is connected to your monitor and scope so that you may accurately adjust your transmitter for proper video & sync levels. We provide two different models. Both have relative power output meters, but one has a greater accuracy. There are 2 external controls, one for video level and the other for power output on PD-VD1. This beats an on the air adjustment.

PD-V.D.	\$49.00
PD-V.D.-1	\$63.00

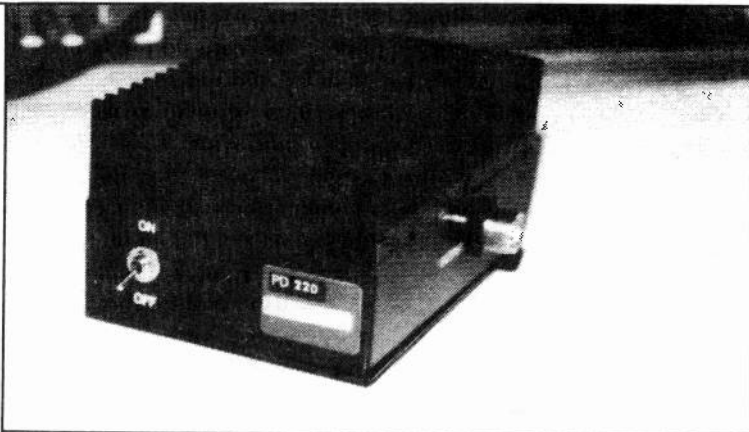

**pauldon**  
ASSOCIATES

210 Utica Street  
Tonawanda, N.Y. 14150  
716-692-5451

# STILL MORE ATV NEWS FROM EVERYWHERE!

## IDAHO

Lowell A. Morton ATVR/WA7MXN  
6911 Northview Ave. Boise, Idaho 83740

I sent in an article a while back on an antenna for ATV which you published, and I thought you might like some additional information on our Boise County ATV Club Repeater, which George Howard and I started building about 3 years ago. It is now on the air with the help of a good friend and fellow amateur Brian Rayl, N7MOE who works for Hewlett Packard Company here in Boise. He built a driver and final amplifier for it using a cable TV line amp driving two SAU4's, and it puts out a clean 10 watts. His driver and final system replaced a transistor one which I had built and worked but has poor resolution. Our repeater is located here in Boise on InterMod Point (Shaffer Butte), which is 7582' high, and a good location for and ATV Club Repeater.

Brian, N7MOE also designed the touch-Tone Decoder, and Doc Gavin, K7PKT built a really nice feed horn for our 4' receive Dish. I built the LMX Mixer and Oscillator, and supplied the ISS Modulator and Demodulator, as well as the Rack and Panels and Control Control Receiver. Brian wrote a special program for his ATARI computer, which is stored in an EPROM that is in a plug in Module in it, and it send out our Identification in Color in beacon mode. When a signal comes on the input, the Beacon Id drops and it is on the air. We have a timer that Id's exactly Every 10 Minutes automatically all of the time the system is up. We have a talk in on the Control Receiver, which allows our audience participation, (IE. Directed transmissions), a must to make us legal, so as not to have any chance of being accused of broadcasting.

We carried the complete shuttle video through Brian's Satellite System from the NASA Channel, and the system ran continuously for 10 days solid, 24 hrs. a day, with no break in carrier with no degradation of picture, and we had quite an audience. We are really having a good time with this, and plan an input on 434, and an output on 1253.250 in the near future for duplex operation. I have enclosed a systems diagram of the ATV Repeater, as well as a really nice beam designed by Russ Miles, W7AHS which you may publish if you wish. The beam is really fine for either receiver or transmitter use.

The TX/RX vestigial side band filter that Brian, N7MOE installed on the Repeater works perfectly, and makes the system really fine. Most everyone with a cable ready set can pick it up with only rabbit ears in the valley. A good antenna with a preamp brings in a network quality picture. I have enclosed a copy of the N7MOE Amplifier schematic which has 20+ dB of gain and really works fine with a -57 dBm Noise Figure, as well as schematic of his touch-tone decoder, which is re-programmable four times with a master reset function, as well as latching functions on all gates and has a short time window for high security. I would be glad to correspond with anyone about our ATV System or related equipment if you find that anyone interested.

## RUTLAND ARRAYS PROUDLY ANNOUNCES THE FO22-ATV

MEASURED GAIN >14.8 dBd FROM 420 TO 450 MHz

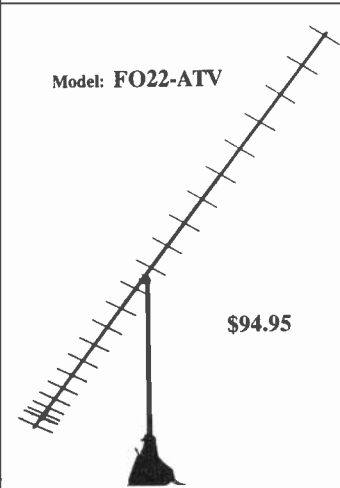

**ELECTRICAL SPECIFICATIONS:**  
Gain peak ..... 15.8 dBd (436 MHz)  
VSWR ..... < 1.33:1 415 to 450 MHz  
E-Plane beamwidth ..... 23 Deg.  
H-Plane beamwidth ..... 24 Deg.  
Sidelobe attenuation  
1st E-Plane ..... -17.5 dB  
1st H-Plane ..... -15.5 dB  
Maximum power ..... 1500 Watts  
F/B ratio ..... 22 dB  
Impedance ..... 50 ohm

**MECHANICAL SPECIFICATIONS:**  
Length ..... 14 Ft.  
Boom ..... 1" OD 6061 T-6 Al  
Elements ..... 3/16" Al rod  
Mast ..... up to 1.5" dia.  
Wind surface area ..... .78 Sq.Ft.  
Wind survival ..... 90+ MPH  
All Stainless Steel Element Hardware  
Coax connector ..... N-type  
Polarization: Horizontal or Vertical

### ALSO AVAILABLE

RA4-50, RA7-50, RA8-2UWB, FO12-144, FO15-144, FO16-220,  
FO22-432, FO22-ATV, FO25,432, FO33-432, FO22-440  
POWER DIVIDERS ..... STACKING FRAMES

WRITE FOR INFORMATION ON OUR  
COMPLETE LINE OF VHF/UHF HIGH  
PERFORMANCE YAGIS

AVAILABLE FROM:  
WYMAN RESEARCH  
OR

RUTLAND ARRAYS  
1703 Warren St.

ADD \$5 UPS S/H  
\$7 West of the Mississippi  
PA residents add 6% State sales tax

New Cumberland, PA 17070  
(717) 774-5298 7-10 pm EST

### PHOENIX ATV

Here is what's commonly used  
in the Phoenix area.

Type/Polarization	Frequency/Mode	Comments
Simplex/Vertical	145.17 NBFM Voice	Used for local ATV "ragchew"
Simplex/Vertical	434.00 VSB Video	Mode is the same as
KS8J & WA7UMH repeater input.	438.50 WBFM Audio	standard B*cast TV
Simplex/Vertical	427.25 VSB Video	
K2NN Repeater	431.75 WBFM Audio	
Output	(Cable CH 58)	
Repeater Out/Vertical	421.25 VSB Video	Repeater currently
KS8J Repeater	425.7 WBFM Audio	located at on top of
	(Cable CH 57) Shaw Butte	
Simplex/Vertical	910.25 VSB Video	
	914.75 WBFM Audio	
Simplex/Vertical	1245.00 FM Video	
	4 Mhz Deviation	
	6 Mhz Audio Sub-Carrier	
Simplex/Horizontal	1253.00 VSB Video	(Inactive)
Output - WA7UMH Rept.	1257.50 WBFM Audio	
Simplex/Vertical	1265.00 FM Video	
K2NN Repeater Input	6 Mhz Audio Sub-carrier.	

We encourage anyone with interest in ATV to join us during our weekly net and monthly meetings...

# COMMERCIAL VHF TV STATION

## For less than \$5,000 complete!

**DON'T DELAY - ORDER YOURS TODAY!**

Limited time offer:  
Special  
Purchase Price  
only \$33.00!

### SUBJECTS COVERED:

- Introduction to LPTV
- Predicted Coverage
- Selecting your Site
- Selecting an Available Channel
- FCC Licensing Process
- Equipment Needed
- Building your station(s) into a TV Network
- Programming
- Federal Tax Incentives
- And Much, Much More!...



**Harry Tootle, WB7PVO**  
President/General Manager  
TootleVision Broadcasting/Tulsa TV33

### HERE'S YOUR INVITATION INTO THE **NEW** AND EXCITING FIELD OF LPTV BROADCASTING!

**That's Right!** Low Power, VHF or UHF TV Broadcasting stations are NOW available in cities across America! Broadcast your favorite music, videos, contests, talk shows, and advertising, 1 hour per week, or 24 hours per day!... Operational costs can be less than **25¢ per hour!**

We can assist you getting your license and show you how to COMPLETELY get "on-the-air" for LESS THAN a few thousand dollars!

LPTV channels are rapidly diminishing, and once they're gone... they will be *gone forever!*

**THE NEXT LPTV FILING WINDOW IS CURRENTLY SCHEDULED FOR END OF SPRING 1990!!**

Don't miss this *Once-in-a-Lifetime Opportunity!* Get all the facts! Order your **GOLD RUSH OF THE AIRWAVES** book and audio cassette tape, today!

If you are not COMPLETELY satisfied, return the package within 30 days, and we will promptly refund your purchase price!

Send \$33.00 plus \$7.50 (S/H) to:

**TootleVision 2606 So. Sheridan Rd. Tulsa, OK 74129**  
**FOR FASTER SERVICE, W/VISA or M/C - CALL NOW!**

**1 (800) 332-LPTV**

**(800) 332-5788 OR (918) 836-1120**

**COD add \$10.00**

**Send us your self-addressed, stamped envelope for more information.**

**(Allow 5-7 days - OKLA res. add 7%)**



## N.C. "LIVE CAMERA" BALLOON

At 1:24 pm on October 27, 1990, a helium balloon lifted off from the campus of South-eastern Community College (SCC) near Whiteville NC. The balloon carried a payload designed by SCC students aided by Bob Rau N8IYD and Bill Brown WB8ELK.

The payload consisted of a B/W SONY HVM-322-BNC camera hooked up to a P.C. Electronics KPA5-RC 1 watt transmitter on 439.25 MHz. Carl Lyster WA4ADG put together a 100 mw 2 meter FM voice transmitter and digitized voice ID. Instructors Ben Frink and David Couvillon organized an effort by the school's Electrical Engineering and Practical Physics class to design and calibrate a pressure sensor circuit. This circuit sent out a tone between the voice IDs to indicate the altitude.

Since the winds were extremely light, we were able to achieve a clean takeoff from the parking lot next to the electronics building. It was a crystal clear day with unlimited visibility. Spectacular views of the North and South Carolina countryside were transmitted down to the crowd watching on a TV set at the campus.

At 10,000 feet, the Atlantic seaboard came into view (about 40 miles to the east). As the balloon went higher, more and more of the Ocean could be seen. At 65,000 feet nearly 200 miles of the North and South Carolina coastline was visible.

ATVets across the southeast received the balloon signals. At the Sumpter, SC hamfest, Hap Griffin WA4UMU set up a receive site allowing attendees to watch and listen in. Fred Tuck WD4KTI and Don Fortner K4SAO were able to watch from Fred's location in Lyman SC, 200 to the west. One of the most impressive reports came in from Ken Gallagher W3DFS in Adelphi, Maryland (350 miles to the north). As the balloon passed above 65,000 feet he started to receive sync bars and a weak 2 meter signal. Within a couple of minutes, he had full-quieting 2 meter reception and a SNOW-FREE full-color image for nearly 10 minutes (not bad for 1 watt).

Unfortunately, the live-TV camera died at the moment of his first acquisition and he only could view the video ID screens. We think the internal voltage regulator in the camera overheated.

At the maximum altitude of about 80,000 feet the balloon burst. Since the skies were so incredibly clear we were able to view it with binoculars almost up to burst altitude. As we were only 40 miles west of the ocean, we were quite concerned of a possible spla-

shdown. Fortunately, the upper level winds were light and the package parachuted down just 8 miles from the shore. The payload parachuted back to earth to land in a clearing near a hunting lodge just west of the city of Wilmington, NC. Hams from the Wilmington area triangulated the touchdown point and several chase cars headed into the area, but due to the dense forest, no signals were heard. At one point I heard a brief squelch break, but we drove on when nothing else was heard. It turned out I did, indeed, hear the payload as we passed within a mile of it! Hams across southeastern NC aided in the tracking and recovery effort. Special thanks go out to Herman Carr KI4SR, Janos Balogh N4BGU, Eddie Sellers W4NTQ, Doug Buffkin WD4ECC, John Haynie WD4PAN, Jerry Tate K4GMP and Lindbergh Holden K4HZR for their help in this event.

The package was found the next day by Charles Braye, as he passed by it on a logging road near the hunting lodge. At first he thought it was a pile of trash lying in the ditch next to the road. He needed some string and started retrieving some off of our package when he saw the reward sign. It's a good thing we didn't find it ourselves since he had to ward off a rattlesnake resting near the payload!!



(l. to r.) Colonel Spears, David Courillon, Ben Frink, Bob Rau (N8IYD) & Bill Brown WB8ELK.

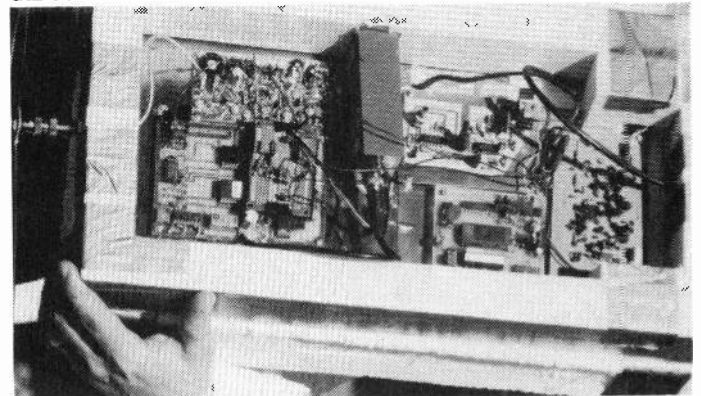

Internal view of the payload.

# N.C. "LIVE CAMERA" BALLOON

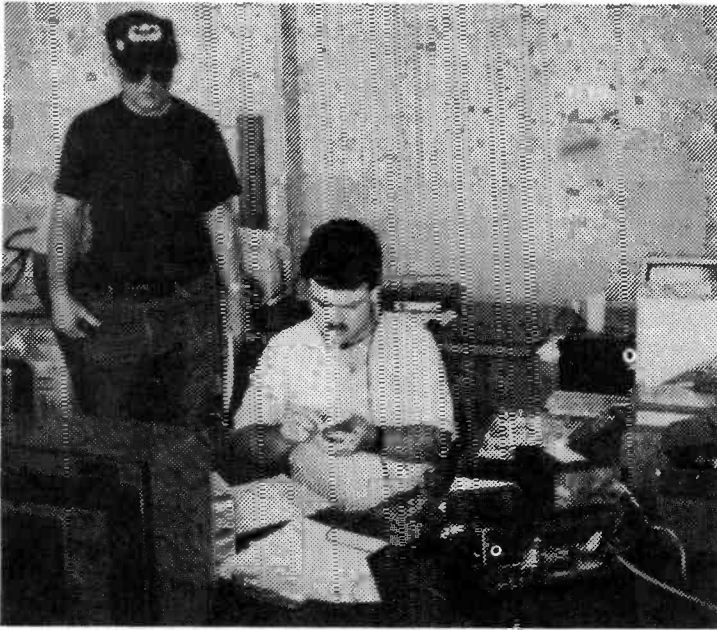

John Bayne NYEEB crunches numbers shortly before SB-2 launch. Rick Klewy WB4QAC, the RDF team leader, looks on.

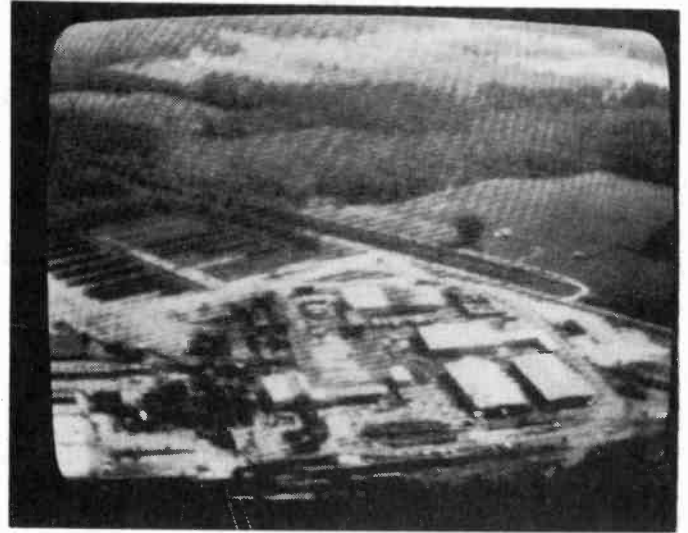

Georgia Pacific just after lift off.

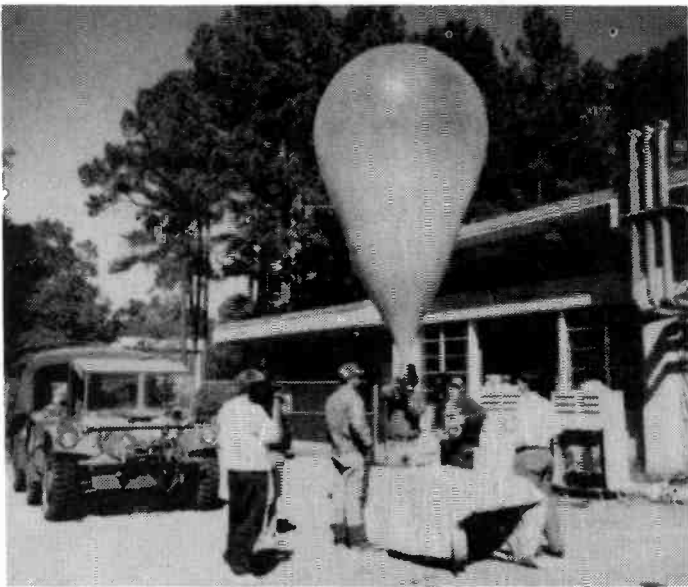

Balloon inflation.

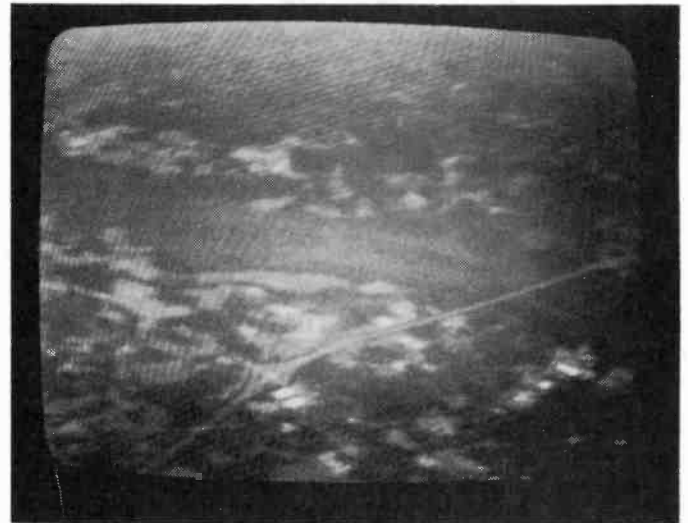

Whiteville, N.C. - 10,000'.



Mr. Braye found the SCC Balloon package in rural Pender County, N.C.

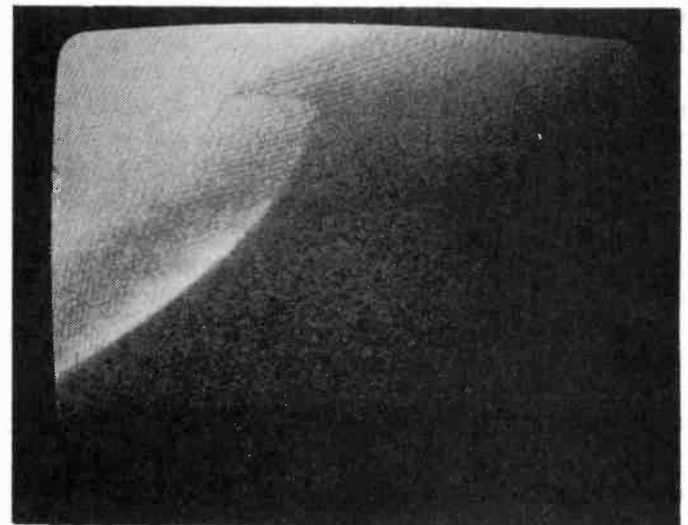

S.C. Coastline to Santee Point. Highest Altitude Photo. 65,000'.

# Super VSB Filter (using a 2m cavity and VSB filter)

**Steve Franklin WB5KGL**

In order to keep the lower sideband clean on an ATV repeater operating with an output on 421.25 MHz., an additional set of filters can be used along with an interdigital filter to fully clean up the lower sideband. This was done in the Dallas, Texas area to avoid any possible problems that might occur with government services below 420 MHz.

At the time, no 70cm cavities were available, so I used two surplus 2 meter cavities operating at their 3/4 wavelength for 420 MHz.

Use just one of the connectors in the cavity. If a loop is attached to the other connector in the cavity, just remove it.

A length of quarter inch wide brass strip is attached to the center of the connector inside of the cavity. The other end is attached to the cavity's center rod using a hose clamp about 2 inches down from the top of the cavity.

The interdigital filter used was built by Arlyn AA5BY and Quane W4WGB. Be sure to use a low pass filter as shown since interdigital filters will pass odd harmonics.

Adjust the cavity's tuning rod to achieve maximum cutoff below 420 MHz. as shown on the graph.

Steve Franklin, 2420 Superior Dr., Suite B  
Pantego, TX 76013

## 421.250 MHz VSBF.

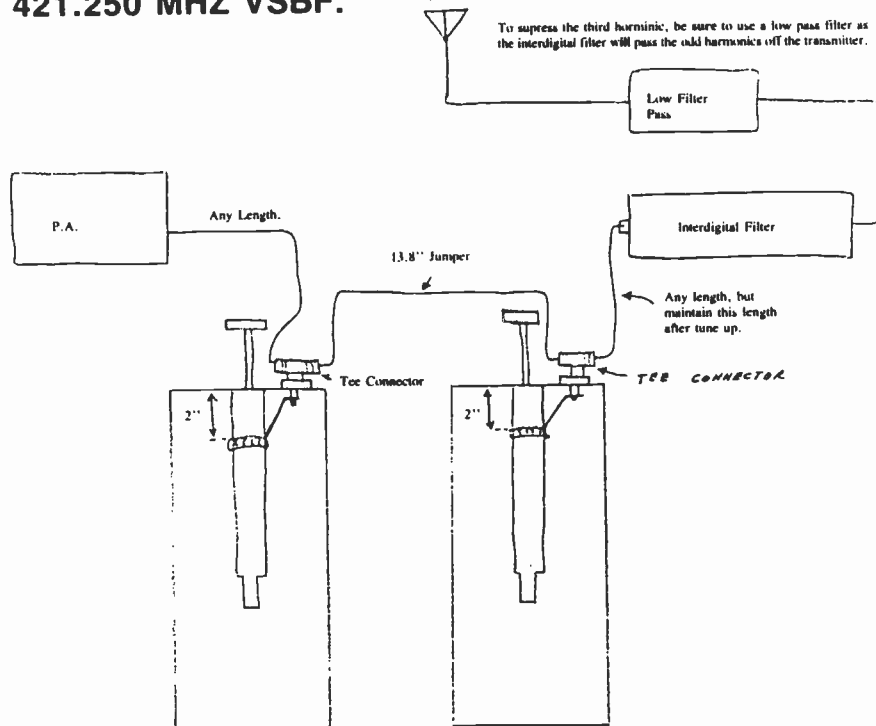

Fig. 1

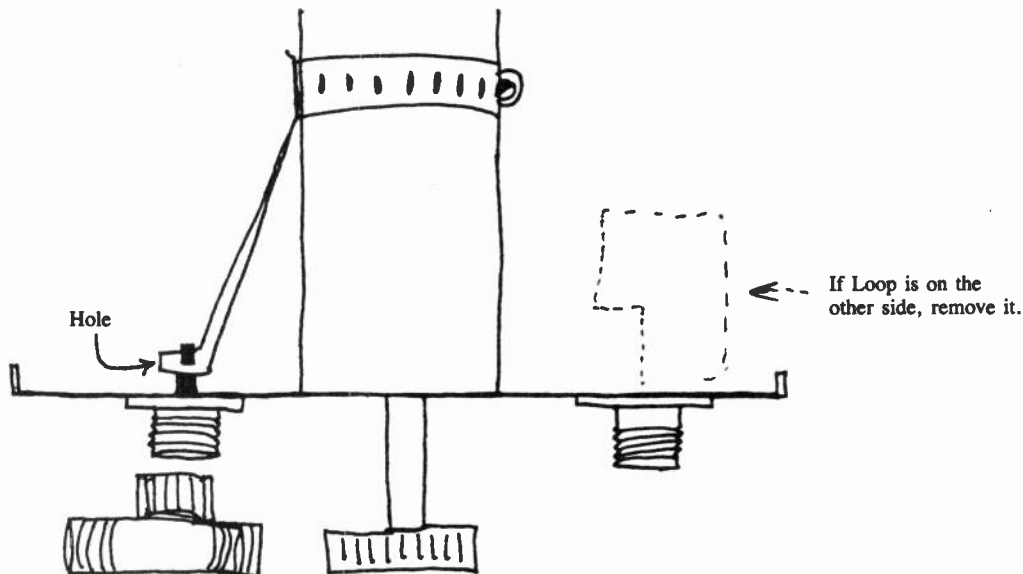

Fig. 2

NOTICE: This is an inductive tap and this will allow the notch to fall very sharply as frequency moves down as needed.

# Super VSB Filter (using a 2m cavity and VSB filter)

**Interdigital  
B.P. Filter  
Response.**

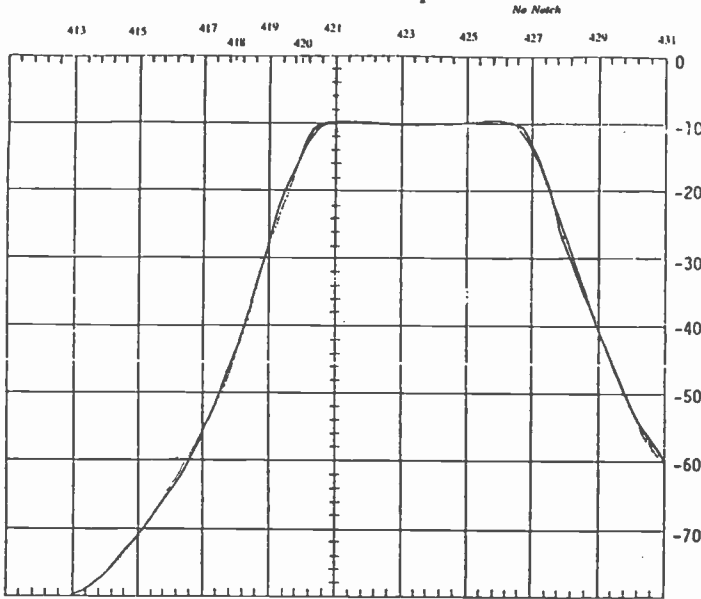

Fig. A

**NOTCH FILTERS  
Response.**

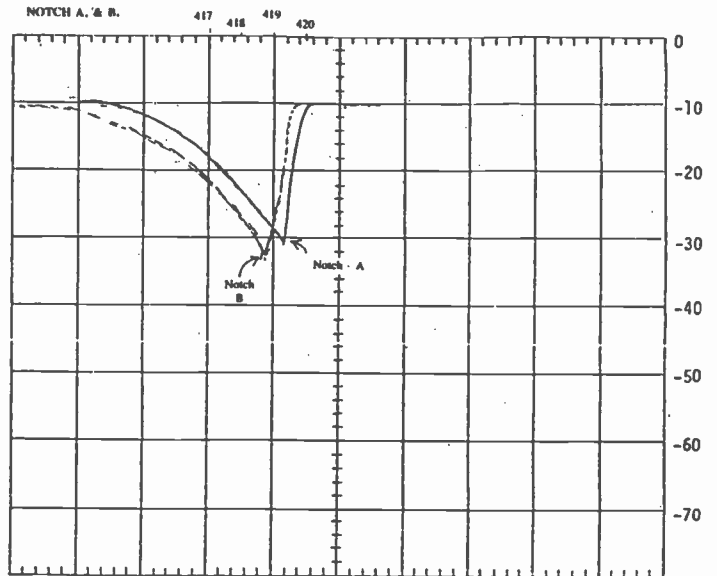

Fig. B

**BPF & NOTCHES COMBINED**

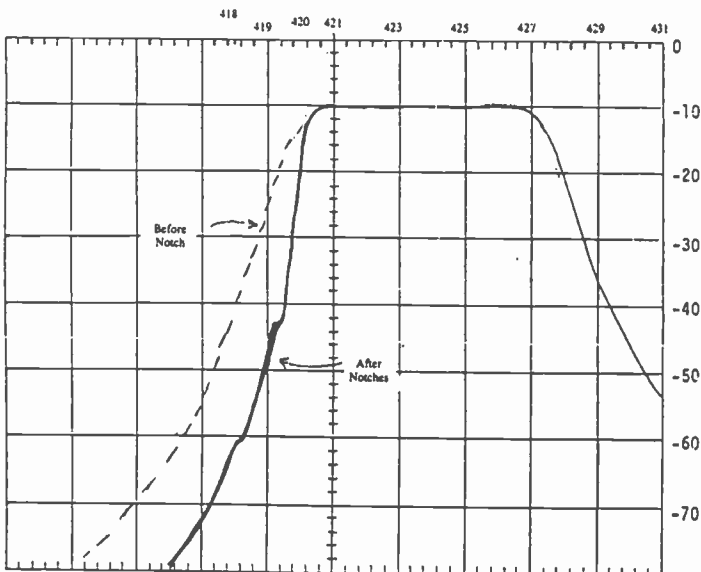
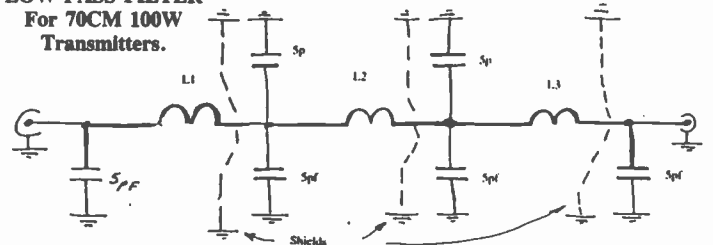

Fig. C

**LOW PASS FILTER  
For 70CM 100W  
Transmitters.**



L1 - L3  
2 Turns #12

.5" ID  
1" Long

5pF CAPS. Are Unelco Metal Mica Caps.

-82 db at 1250 MHZ

Fig. D



# SIMPLIFIED TOUCH TONE CONTROL

by Dale Lam - WA0NKE

Have you ever wanted to remotely control your ATV transmitter? Maybe you wanted to chase your own ATV signal, but hesitated to leave your transmitter turned on continuously for an hour or more until you could get back. The circuit presented in this article allows remote control of two different functions, with the use of the touch tone pad on your FM hand held or mobile rig. It is easy to build and the cost is reasonable (cheap).

## COST:

This is a simplified application of a very complex and reliable integrated circuit that is available from Radio Shack. At the current sale price of \$4.95 instead of the original \$12.95 price it is a real bargain. Additional parts and the board to build it on (no copper etching or hole drilling is necessary) are also in the Radio Shack store. Total cost for this project is about \$30 if all parts are bought new, but many parts are common and may be found in the junk box. The 3.579545 Mhz crystal can be found in a junk color TV set, though it only costs \$1.69 new.

## DESCRIPTION:

The touch tone decoder chip (SSI-202) is the heart of this circuit. It is quite sophisticated internally, assuring good tone detection over a wide range of input audio levels. It provides tone decoding of all 16 standard two-tone signals. If all 16 tones are needed, the cost and complexity of the circuit escalate. By using only one additional IC (CMOS 4013 with two D-type flip-flops inside), two of the tones can be decoded and latched, and used to drive two independent relay switched functions. LED indicators are used to display the activity state of each output circuit. The overall circuit operates on 5 volts DC, but since most ATV transmitters only have 12 volts DC available, a voltage regulator was added. Audio from the speaker jack of a receiver is used to provide the input to the circuit.

## COMPONENT OPTIONS:

Most of the components may be replaced by substitutes due to the noncritical nature of the functions they perform. Part numbers are provided for Radio Shack components, but that is not the only place to get the parts. The LEDs can be replaced by others, though these were chosen due to their high light output

using very little current. The FETs may be replaced with most any N-Channel device. The relays used were chosen for both their small size and current requirement (only 20 ma each). Other relays may be used if the voltage requirement is 5 volts DC and the coil resistance is not smaller than 20 ohms. The values of C3 and C4 are not critical, being used only to suppress oscillations internally generated in the 7805 regulator. Capacitor C2 is used to keep RF from entering the tone decoder chip, and could range from .001 mfd to 100 pfd. Resistors R3 and R5 are used to pull the outputs of the 4013 chip to ground when they should be logic low. A value of 10k to 68k should work fine for R3/R5. Even resistor (R2) that parallels the crystal may have a value ranging from 1 meg to 10 meg. Considering these wide ranges of substitutes allowable, you may find that your junk box is able to keep your total cost down on this project

## OPERATION:

When power is applied to the decoder, its initial status is unknown and may have one or both outputs turned ON. To avoid possible problems, always have the outputs disconnected until you control them into the needed ON/OFF states. The audio can come from the speaker output of a radio. I run mine in parallel with the external speaker. Adjust the volume of the radio so that consistent tone detection occurs. My experience shows that audio that is high in volume is better than audio that is too low. Audio level is not at all critical as long as it is above a minimum threshold.

The number 3 key should activate relay RLY1 and LED1, while the number 2 key activates RLY2 and LED2. When the LEDs are ON, the relays make contact to ground, and when OFF the relays are OFF and no current flows through the output wires. If LED1 is OFF, then hitting the 3 key will turn it ON. The next time the 3 key is hit, it will turn OFF. The same follows with the 2 key. An interesting key is the A key. It will toggle the ON/OFF states of the two LEDs at the same time. Because the full capability of the decoder is not used, meaning that the four binary data lines aren't fully decoded, other keys will also affect the relays. If the function you want to control needs to be isolated from ground, then just remove the connection that goes to ground from a relay. The relays specified have contacts that are rated at 1 amp @ 125 VAC.

## CONCLUSION:

The use of this simple touch tone decoder circuit will allow you to remotely control your ATV

From "CHANNEL ONE"

# SIMPLIFIED TOUCH TONE CONTROL

by Dale Lam - WA0NKE

transmitter or any other device. You only need a receiver at the ATV transmitter site and a suitable touch tone transmitter with you for control. The question arises whether it can be made to control 16 different functions, and the answer is certainly, "YES.". However, the added components add another \$80 to the cost. Another chip called a 4-to-16 decoder would have to be added, also. Then the project isn't "simple" anymore. Have fun controlling the world with your hand held rig.

## PARTS LIST

### Capacitors:

- C1/C4 .1 mfd @ 50 wvdc (RS 272-1069)
- C2 470 pfd @ 50 wvdc (RS 272-125)
- C3 .01 mfd @ 50 wvdc (RS 272-1065)

### Diodes/LEDs:

- D1/D2 1N914 small signal (RS 276-1122)
- LED1/LED2 high brightness red leds (RS 276-087)

### ICs/Transistors:

- IC1 7805 +5 vdc regulator (RS 276-1770)
- IC2 SSI-202 touch tone decoder (RS 276-1303)
- IC3 4013 CMOS dual D-type flip-flop (RS 276-2413)
- FET1/FET2 BS-170 n-channel TMOS (RS-276-2074)

### Resistors:

- R1 5.1K 1/4 watt
- R2 1M 1/4 watt
- R3/R5 56K 1/4 watt
- R4/R6 4.7K 1/4 watt
- (All resistors contained in package RS 271-309)

### Miscellaneous:

- RLY1/RLY2 SPST 5 volt DC reed relay (RS 275-232)
- XTAL 3.579545 MHZ (RS 272-1310)
- circuit board (RS 276-170)
- 14 pin DIP socket (RS 276-1999)
- 18 pin DIP socket (RS 276-1992)

## TOUCH TONE DECODER

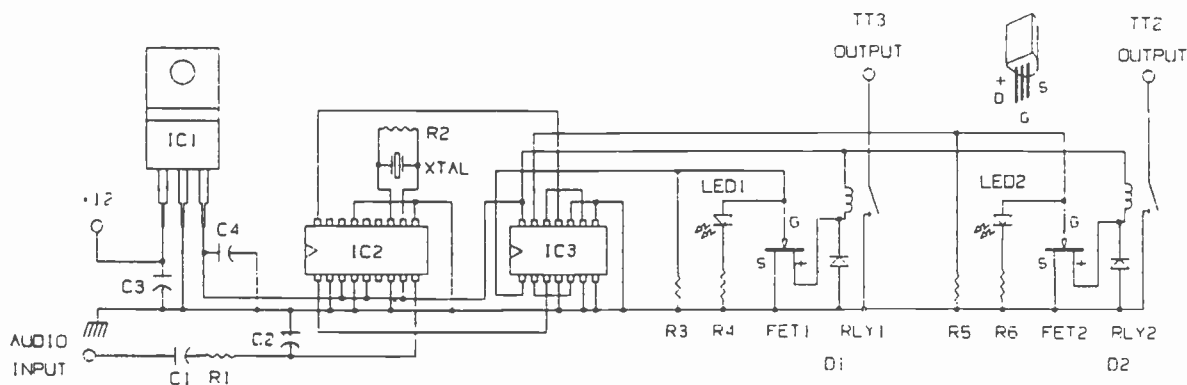

# ANTENNAS by

# Lindsay

**Amateur TV Repeater, Verticals and Yagis Transmit & Receive Antennas**

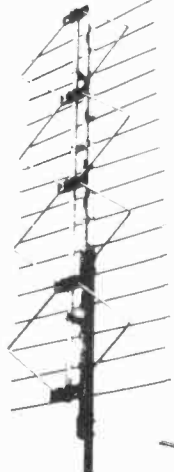

4ZZ-420

AC-144

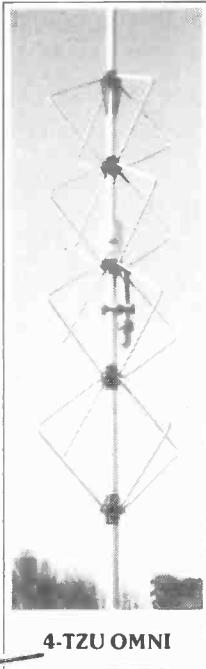

4-TZU OMNI

ATV-8 SLOT

**LPTV & MMDS Transmit & Receive Antennas**

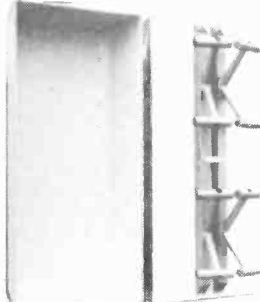

UP-1469

LS4  
LS8  
LS16  
SLOT

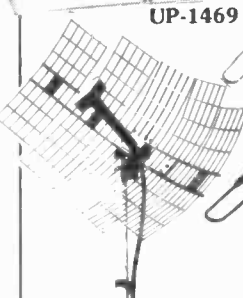

MDG-2717

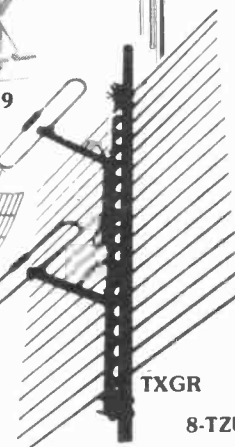

TXGR

8-TZU



**Cable TV & SMATV Headend Yagis, Log Periodics, Pre Amps and CLI Antennas**

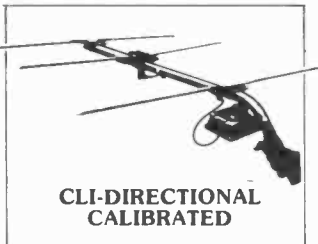

CLI-DIRECTIONAL CALIBRATED

ZIG-ZAG SERIES

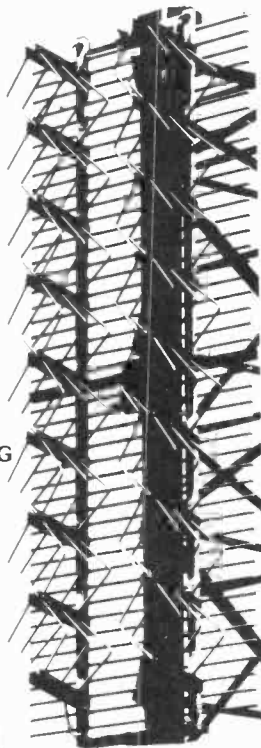

**'FREE' SITE SURVEYS UPON REQUEST ...**

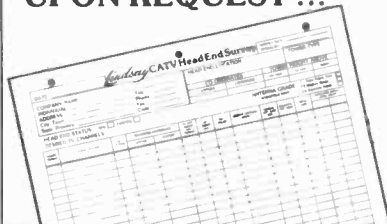

**Commercial 2 Way Cellular Base Station and STL Antennas**

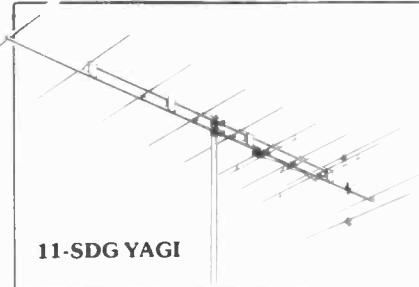

11-SDG YAGI

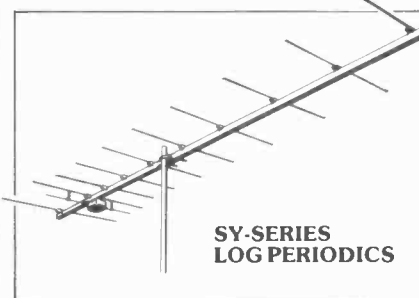

SY-SERIES LOG PERIODICS

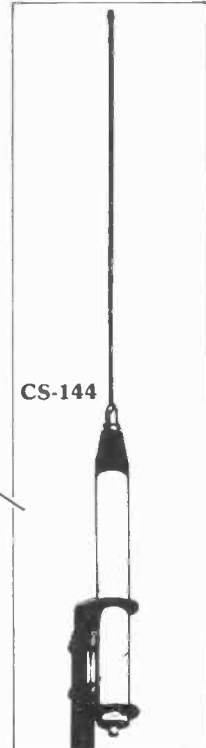

CS-144

**DEALERS AND DISTRIBUTORS WANTED WORLDWIDE**

**LINDSAY SPECIALTY PRODUCTS**  
50 Mary Street, Lindsay, Ontario, Canada K9V 4S7

Telephone:  
(705) 324-2196

Fax:  
705-324-5474

# INTRODUCING **AEA**'S NEW ATV SYSTEM



**A**dd a new dimension to your amateur radio communications with AEA's Amateur Television (ATV) system. If you hold at least a technician-class license, you can transmit and receive live or taped audio and video Fast-Scan TV (FSTV) information that rivals broadcast quality. Now you can share more than conversation over the air with this new mode of "personal communications."

### It's Easy and Inexpensive.

If you have a video camera or camcorder and a standard TV set, you may already own the most expensive components of an ATV system. AEA's ATV system includes a transceiver and antenna. Simply connect the camera, TV and the antenna to the transceiver, and you're on the air LIVE with one watt P.E.P.! Your TV set will monitor your transmitted and received pictures. If you want to broadcast with more power, AEA also offers a 50 watt mast-mounted linear amplifier with power supply.

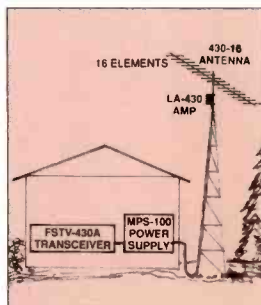

Two frequencies can be selected from the front panel for transmission (one crystal is included). The AEA design is also optimized for superior video and audio quality without sync buzz even with weak signals. The FSTV-430A is the only transceiver you need to work ATV and it also allows you to use the same TV set to monitor your transmitted and received pictures.

**The FSTV-430A Transceiver** features a low-noise UHF GaAsFET preamp with a typical noise figure of less than 1.5dB and a crystal-controlled or variable tuning down converter. Output is available on channel 3 or 4 for signal reception AND monitoring transmissions. Two frequencies can be selected from the front panel for transmission (one crystal is included). The AEA design is also optimized for superior video and audio quality without sync buzz even with weak signals. The FSTV-430A is the only transceiver you need to work ATV and it also allows you to use the same TV set to monitor your transmitted and received pictures.

**The LA-430/50 Amplifier with Power Supply** gives a boost to your ATV signal. It includes a 50W P.E.P. mast-mounted Linear Amplifier (**patent pending**) covering 420 to 450 MHz and a GaAsFET preamp which utilize the antenna feedline for DC power. The mast-mount eliminates the line loss between the amplifier/preamplifier and the antenna to improve both transmission and reception, and is the equivalent of a 100W amplifier in the shack with a 3dB line loss. The amplifier is housed in a weather-resistant alodized aluminum case. The MPS-100 power supply also provides a 13.6 volt output for the FSTV-430A.

**The 430-16 Antenna** is a high-performance, computer-optimized yagi specifically designed for ATV operation. It features broadband frequency coverage from 420 to 440 MHz, 14.3dB gain, O-ring sealed connectors, 28 degree E plane and 32 degree H plane beam widths and 16 elements on a 10-foot boom.

**See AEA's FSTV System** at your local authorized AEA dealer. Put yourself in the ATV picture and join the fun!



### What is the advantage of Vestigial Sideband (VSB)?

AEA's FSTV-430A Vestigial Sideband operation drastically reduces adjacent-channel interference. VSB requires much less bandwidth than existing double-sideband designs; it's the standard method of modulation required by the FCC for all U.S. broadcast TV stations. Similar in principle to SSB, VSB puts all of the audio energy and most of the video in ONE sideband instead of two. Using about half the spectrum space of competitive units, the FSTV-430A is the ONLY ATV unit that conserves spectrum space by using VSB. Even with AEA's LA-430/50 amplifier, one sideband is reduced more than 30dB. VSB presents an obvious advantage to the bandwidth-conscious ATV operator.

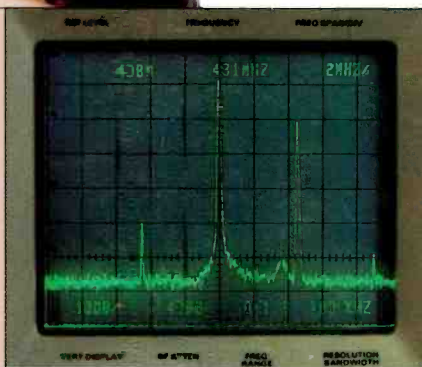

## Advanced Electronic Applications, Inc.

2006-196th St. SW/P.O. Box 2160 Lynnwood, WA 98036 206-775-7373

Prices and specifications subject to change without notice or obligation. Dealer inquiries invited. Copyright 1989.

**AEA Brings You  
A Better Experience.**