

AMATEUR TELEVISION QUARTERLY

Devoted Entirely to Amateur Television

Vol. 2 #1

60 Pages

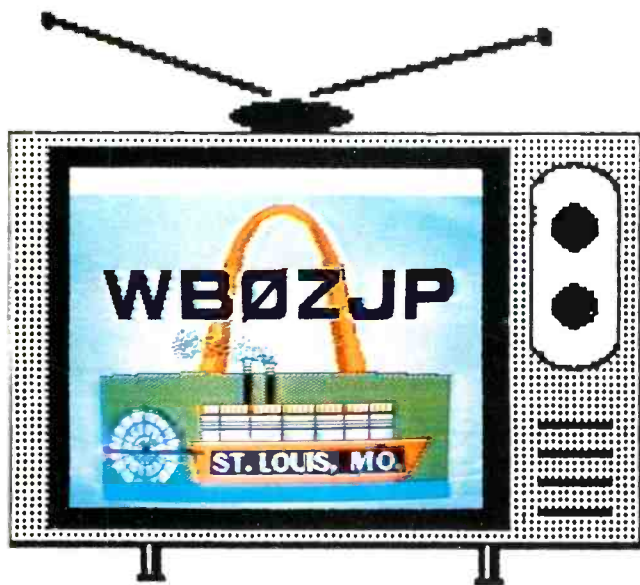

PUBLIC SERVICE ATV TO BE SEEN WORLD WIDE — LIVE — JANUARY 2 pg. 3

COMPLETE HELIUM BALLOON STORY FROM BILL WB8ELK pg. 22

COMPLETE D1010 ATV MODIFICATION & TRANSMITTER Q&A BY TOM W6ORG pg. 24

PLUS PAGES OF OPERATING NEWS, NUMEROUS TECHNICAL ARTICLES & MORE

Amateur Television Quarterly is published quarterly by Henry Ruh KB9FO, 540 Oakton St. Des Plaines, IL 60018-1950. Annual subscription rate for domestic delivery is \$15 per year. Canadian delivery is \$20 per year and other countries \$25 per year. Second class postage pending at Des Plaines, IL. and additional offices. POSTMASTER: Send change of address to ATVQ, 540 E. Oakton St., Des Plaines, IL. 60018-1950. All inquiries, subscriptions and contributions should be sent to ATVQ, 1545 Lee St., Suite 73, Des Plaines, IL 60018. ATVQ business phone for inquiries and other communications: 312-298-2269. An electronic butler will take your message. Or contact any of the staff directly.

Publisher: Henry Ruh KB9FO

Co-Publisher: Bill Brown WB8ELK

Editor: Sylvia Kurcz (call pending)

Technical editor: Tom O'Hara W6ORG

(Henry and Sylvia are to be married Feb. 11 at St. Zachery Parish, Des Plaines, IL.)

JANUARY 1989 CONTENTS:

WORLD TO SEE PUBLIC SERVICE ATV JANUARY 2ND. Ernie WB6BAP Page 3

OPERATING NEWS Pages: 3, 4, 5, 6, 10, 11, 17, 19

CONSUMER WARNING Black Hole Disposal Unit Page 7

THAT NEW VIDEO CAMERA Donna Bocian Page 8

YOUR HOME VIDEO TAPE LIBRARY Staff Page 9

ATV DAY IN LA photo story Page 10

MICROWAVE OVEN FOR FM ATV ON 2300 Mhz Central Indiana ATV Club Page 14

SPECTRUM CRUNCH New Broadcast TV Standards for HDTV/ACTV Staff Page 16

UNIVERSAL HIGH-RES COMPUTER INTERFACE QM Electronics Page 17

BACK TO BASICS Ohm's law to make big money Henry KB9FO Page 18

CALCULATE YOUR ERP Bill Parker W8DMR Page 19

TAKE TO THE ROAD WITH MOBILE ATV Bill WB8ELK Page 20

HELIUM BALLOON ATV PROJECT The COMPLETE story Bill WB8ELK Page 22

ATVQ & A 1 Watt D1010 ATV conversion & other tx amplifier topics. Tom W6ORG Page 26

24 CM GasFET CONVERTER G. Wehrhahn DD9DUK page 41

ELKTRONICS VDG-1 VIDEO ID complete info package Page 44

MODIFY THE RADIO SHACK SEG FOR "SPECIAL" EFFECTS John WD0LO Page 48

ATCO FOXHUNT ATCO Page 50

STATISTICAL ANALYSIS OF TEST AND MEASUREMENT Jed Hayes Page 51

TENKAI TV SET CONVERSION FOR 420-450 and 900-915 MHZ ATV Bill WB8ELK Page 58

CHANGE YOUR VIDEO LABELS FROM A SOFT BLUR

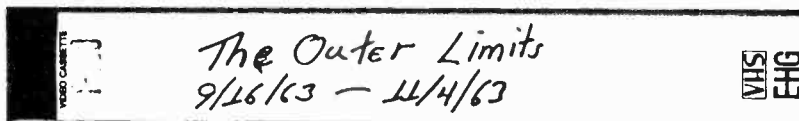

AND SHARPEN THEM TO CRYSTAL CLARITY!



Our labels give you control over your video collection. With no pre-printing on our labels you can let your imagination go and still have neat professional looking labels. In addition to being blank our labels are pressure sensitive, with pinfeeds, and on continuous forms. They can be used with equal ease on your computer printer or typewriter. Please specify your choice of our colors when ordering.

	200/pack	1,000/pack
VHS Spine Labels	\$10.95	\$43.95
BETA Spine Labels	\$10.95	\$43.95
VHS Top Labels	\$11.25	\$44.75
BETA Top Labels	\$11.75	\$46.85

Please specify your choice of color when ordering. Our labels are available in the following colors: **White, Blue, Green, Red, Yellow, or Light Wood**

Please include \$2.50 for shipping and handling. Virginia residents please add 4.5% sales tax

VIRGINIA SPECIALTY PRODUCTS
DEPT. AQ
P. O. BOX 985
VIENNA, VA 22180

For a sample packet of labels send \$1.00. Dealer inquiries invited.

"ATVQ"

ATV TO BE SEEN AROUND THE WORLD

For the first time public service ATV coverage of the Pasadena Tournament of Roses Parade will be available to hams, TVRO owners, and cable subscribers throughout the western hemisphere. The behind-the-scenes video coverage provided to the Tournament of Roses Parade by the Southern California ATV'ers will be simultaneously uplinked over Galaxy-2 satellite 74 deg. W., on transponder 5. In an effort to promote the increased use of amateur fast-scan TV to improve public service communications. Anyone with a working TVRO receiver should be capable of receiving good quality color pictures from this satellite from anywhere in the western hemisphere.

This will be the 100th anniversary of the Parade and the 11th year of ATV participation. The schedule of events will include an introductory video tape presentation starting at 8:00 AM PST on the morning of January 2nd, 1989. (Not New Year's Day this year.) This will be followed by live coverage beginning at approx. 8:15, ending at approx. 10:15 AM PST. Some 35 ATV'ers will be operating a dozen fixed, mobile and portable ATV stations along the five mile parade route. They will be transmitting thru a portable ATV repeater and several microwave links to four monitoring sites each with numerous monitors. It is hoped that this experiment will inspire others to extend their public service capabilities into the exciting world of Amateur Television. For additional information contact: Phil Smith WB6LQP at 818-573-9608 or Hank Landsberg WB6MEU at 818-355-3656.

NOTE: On some TVRO receivers the downlink may appear on channel 9 or 10 so you may need to scan Galaxy 2.

TNX Ernie WB6BAP.

----- OPERATING NEWS FROM USA

ATV OUT WEST

At a loss to attract new atv'ers in your area? The Western Washington ATV Club has put together a great video. W7SRZ, Chuck Northcutt hosts the 12 minute presentation, "This is ATV" which a lively demonstration and introduction to ATV. The program highlights live ATV QSO's with many of the more than 50 members of the club centered in the Seattle and Bellevue, WA area. Featured on the show are Lou, K7YZZ showing a miniature transmitter and downconverter K6HVI, Gary introduces the local ATV repeater showing

the various units built and in use. Dick, W7TWU shows public service uses of atv. N7ML explains how after being on the air for only two days he has already worked 35 miles with his 50 watt station. Other hams show WEFAX retransmitted from their computer, views of the shack and the stuff we all do on video QSO's. Altogether the tape is 12 minutes long. The program is repeated twice the first being with background music and a second identical program following which has had the background music removed. One for public exhibition and one for over the air use! For a copy of the tape write to the Western Washington Association, 353 S. 116th Street, Seattle, Washington 98168 or phone 206 243-6432. The tape was recorded on 3/4", well edited and has high production values and makes a fine presentation of ATV.

ATV IN WASHINGTON D.C.

ATVQ staffers Henry and Sylvia traveled to Washington D.C. over the Labor Day weekend. While there we visited the father of the ATV repeater, Bruce Brown WA9GVK. Bruce built the first ATV repeater WR4AAG in Alexandria, VA. with the Metrovision ATV Club in 1974. It was featured in a TV. GUIDE article in 1975. The Metrovision club has about 70 members and they meet on the repeater for a local net every Sunday night. We happened to be able to enjoy Bruce's hospitality and sat in his shack for the net which had nearly 20 check-ins. Not bad for a holiday weekend when D.C. is a ghost town! The system still operates as it did over 13 years ago, 439.25 in and 426.25 out using vertical polarization. The site has remained the same in Alexandria, VA although many improvements have been made in the system over the years to filter out interfering FM RPT signals. The system still passes color and they use on carrier sound on input and 4.5 Mhz sound on output. They are currently working on moving frequencies down 6 Mhz on RX and TX to escape the ever intruding FM RPT interference. This is being done with the cooperation of the local FM repeaters.

Photo later in this issue.

----- LA PORTE, IN ATV

Alan Rutz, WA9GKA reports activity has been low, but WB9LWP, Carl and WB9QPA, Lee in Westville are on 439.25 sometimes. The interest dropped about

"Devoted to Amateur Television"

5 years ago when cable TV came to town and took over the televising of the 4th of July parade which was an event our local ham club had featured for about 14 yrs. This dates back to black and white days with lots of tubes. There is still interest in ATV besides Carl and Lee. Besides myself there are WD9ARW, Rich, WB9TSC Lynn, WA9OCQ Earl and KA9RVC Jim. My ATV is rusty but I am working on one item which may be convertible to ATV. I have made a dielectric-tuned oscillator for 904 Mhz and although it produces only 10 milliwatts output it is clean, lends itself to wide-band FM modulation and presently I am working on the MMIC amplifiers to raise its output to 1 watt. I don't know if I could write an article about it but to me it's neat!

East Coast ATV (ECAT)

ECAT Inc. is a non-profit association of video experimenters and radio amateurs who are dedicated to the advancement of interactive community techniques and education. The current membership includes over 40 ATV ops located throughout eastern Mass. and southern NH.

ECAT meetings are held monthly on the third wednesday at 78 PM at Bickford's restaurant on route I-93. Most members arrive early for a snack or a meal but that is not required. There is a short business meeting followed by a briefing on the technical state of affairs on the hill which usually leads to a lot of technical socializing. Non-members are welcome. Other group activities include annual demos at the Museum of Science and talks and demos at the request of other ham clubs and community groups.

ECAT has been providing radio and TV services to hams, communities and non-profit organizations in eastern MA since 1979 and is affiliated with ARRL.

REPEATERS

ECAT supports the activity of ATV stations by operating and maintaining two ATV repeaters. The FM voice repeater operates on 145.29 with standard -600 offset. The ATV repeater operates in full color NTSC on 421.25 with input frequencies of 434.00 and 911.25. The FM repeater can be used for voice coordination of ATV activity or standard 4.5 Mhz subcarrier can be used on the ATV RPT. The FM Repeater includes a full duplex autopatch with Bay State East telco service open to all members

in good standing.

Both repeaters are currently located on Boston Hill in North Andover, MA at an elevation of about 430 feet. They have excellent coverage at the elevation covering greater Boston and southern New Hampshire areas except for small pockets hidden by hills such as Great Blue Hill. This is a temporary location as there are plans to move in the future to an even better and much higher site closer to Boston.

The ECTA TV RPT system is the most sophisticated of its kind and the only system serving eastern New England. The system was built by participating ham operators who are also professionals in the fields of radio and TV broadcasting and communications. The system allows low power ATV and radio stations to communicate via audio/video over a geographical area greater than if they were unassisted by the RPT. ECAT is funded entirely by membership dues and other donations and depends upon the assistance and co-operation of communities and individuals for its continued existence. New members are always welcome. Annual dues for individuals are \$20. Family memberships are \$30. Application with one year dues should be sent to the corporate address; PO Box 669, Melrose, MA 02176. If you have questions please talk to a member or officer. Officers in 1988 are: President: Dave WBLCEA, VP: Paul KALLFD, SEC: Jay WLELX, Tres: Morrin KALHAJ, trustee: Ed KALAFE.

FROM AROUND THE USA

Bob Bruninga WB4APR works 439, 902 and 1296 from Annapolis, MD. He can be found on Metrovision ATV RPT and the Baltimore BRATS ATV RPT. He is currently working on a cross-link ATV system with the two groups. ATVQ has been promised an article about the project for a future issue.

Peter Kemp KZ1Z of Bethel, CT writes that he would like to see an ATV RPT in his area. Interested ATV'ers should contact Pete to share plans and ideas to get this going.

Fred K4ZS in Titusville, FL says his best DX is 10 miles using a PC exciter and 18 db Gain antenna. He is vertically polarized and looking for new stations.

Elmer KM3E writes that he just bought the K2QIE ATV RPT which was to serve the Binghamton, NY area but was never operational. He is moving it to

"ATVQ"

the Wilkes-Barre, Montrose PA area and expects to get it operational this winter. He purchased the repeater from W3NEN in Williamsport, PA. His best DX using a D24, TC70 and 2 88 el J-Beams is Wilkes-Barre from Montrose, PA QTH.

Mark AJ2X of Natick, MA asked if we have a FAX or computer modem.

Henry has a FAX at work you can access. ATVQ also has two computers a Tandy 1000EX fully loaded with 640K, dual floppy drives and three ports and a Hayes modem. The second is a Tandy 1000TX also fully loaded with hard drive, 3.5 and 5.25 floppy drives, 3 ports and Hayes modem. We do not have a capture program to receive files though. Anyone out there want to send us one to use? ATVQ is using Word-Perfect 5.0 for editing and can take floppies formatted for this program or any text file accessible to this program. We can also take disks with text files in Tandy Deskmate but we've not used that program yet.

ARTICLE DEADLINES

Deadline for the next issue of ATVQ is March 1, 1989. Please have your material to us by that date for inclusion in the Dayton issue. Also we appreciate any comments you have about this new effort to bring credibility to ATV!

MORE NEWS

Bob W4DPM in Orland, FL works ATV using VHF Engineering and PCE hardware with a KLM 27. He also works SSTV. Bob is looking for more local stations and would like to see some DX from the rest of us!

Jeff WA8SAJ says his best dx is 511 miles! to K0IWA in Iowa. Jeff is in Willoughby, OH uses a KLM 27, D1010 TC70 and preamp. Next enhancement look towards Cleveland for Jeff's signal. It has been seen P5 in Chicago by KB9FO (who's best DX is only 490 miles to Ralph K2RPO in Lockport, NY using 4 88's, Henry 2004 and a lot of other goodies!) But read about Frank W5VDS below...

W2MTE William works SSTV and FSTV and has a best DX of 55 miles from Schenectady, NY. Must be those 6,000 foot mountains blocking him. He runs a Mirage amp and KLM ant.

Ken W3DFS in Adelphi, MD was worked by the ATVQ staff in Virginia on 2 meters and later on the Metrovison ATV net. His best DX is 300 miles using an array of 4 K1FO's and a Henry 2004. He

also works 925 and 10Ghz. (Thanks for the help Ken!)

Tom KJ4D in Hamden, CT says he is using J-Beams and his best DX is Norfolk, VA. You can find Tom on the W1NRE-ATV RPT in New Haven.

Keith WA1HZK operates from East Hempstead, NH through the K1CEU ATV RPT in Deerfield, NH. The RPT is at 1100' with 100' W on 439.25 in, 426.25 out. The repeater was built by WA1HZK and K1CEU. They would like to get more local activity.

Frank W5VDS in Wimberly, TX operates on 70cm, 23cm and 3cm. His best DX is also the best we know of (any challengers?) at 937 miles on 70cm to WA4GRK who thus is co-owner of this record! Frank has also a 172 mile DX on 23 cm to WA5HNK. He runs the Henry amp and 2 48 el J-Beams on 70 cm, a 4' dish on 23cm and a Gunnplexer on 3cm which feeds a 1 watt TWT (Traveling Wave Tube) on a 4' fixed dish and a portable 25" dish. Wow! Got the Hot Dogs handy? The rest of his station is GasFET's and other goodies. Guess the Texas brags are true!

KBOWG, Everett, in St. Louis operates SSTV and FSTV. His best DX is Australia on SSTV using a TS940 and Heath SB220.

Randy WA4HUV in High Point, NC is just starting and would like some help from other local ATV'ers. Randy has a 767GX and KLM antenna and needs to know who is in his area to work ATV.

John WB2GIT in Rumson, NJ has a best DX of 135 miles using a D24 and home brew 10/10 beams. We works the W1NRE ATV RPT also.

Bob WB0YNH in Minneapolis works SSTV and FSTV. His best DX is EM29 on 2 SSB. He runs a KLM 27, D24 and can be found on the KB0GL ATV RPT which is 439.25 in and 421.25 out HORIZONTAL POLARIZED.

W3QNI in Bethel Park, PA is using a D1010 and 44 el J-Beams He has a beacon on 421.25 so something to look for on band openings.

Paul KH6HME sent us his Aloha from Pahoia, HI. (Meanwhile we look forward to a heavy snow/wet/cold winter in Chicago!)

WD40 in Vienna, VA says his best DX is Norfolk, VA 170 miles away. He uses KLM 27 and D1010 and preamp. He also is on the Metrovison ATV RPT.

Tom W2JJK in Titusville, NJ is just getting started. He just ordered some goodies this fall and is looking for contacts in the Philly and NYC area and

"Devoted to Amateur Television"

locals to get him started.

Jim KA3KIU in Warminster, PA is well equipped for ATV and looking for contacts on 439.25. (Don't forget the ATV net on Tuesday nights, 3871 Khz, NET CTL is WB8ELK in Findlay, OH. Its a good place to get skeds and find new stations in your area to work.)

John WA4MTG in Wetumpka, Alabama claims, "I'm the only FSTV station in the south which includes Alabama, Mississippi, Tennessee, Florida." He has a lot of ATV gear, high power, big antennas, preamp and he wants to see some ATV! He asks that we publish his phone #:205 567 2985 because he feels all alone on ATV. (Our master list of ATV'ers lists about 90 stations in these states so how about giving John a call! We actually have more stations listed in Alabama than are active in Chicago!)

Frank WB4FUJ in Lovettsville, VA wrote to remind us that he was the first to bring aeronautical ATV to us through the WR4AAG (now WA9GVK) Metrovision ATV RPT more than 15 years ago! (Frank, I remember because we almost got to work plane-to-plane from my ATV equipped Cessna when I was flying to DC for the WARC meetings in '75-'80 but W6ORG, Tom, got the honors over NV/AZ when we played "dog fight" in April of 78. KB9FO)

Bruce WB8UGV in Centerville, OH is an avid DX'er on 70, 33, 23 cm. He has worked Chicago as his best DX using a Regency HR440 lots of goodies preamp and 88 el J-Beam. He is also the constructor and control op of W8BI ATV RPT in Dayton, OH. Bruce recently moved to Fort Wayne and is looking for Contacts.

W5KJK Warren Honey promises a beginners column on atv for ATVQ. It will cover antennas, equipment and operating conventions. Warren is in Galveston, TX.

ATV'ers in Monterey, CA should contact D. L. McKinney KC3RL. He is the president of the Monterey ATV club and writes that they have quite a group out there. He works WEFAX, SSTV and also FSTV on 439.25, 421.25 and is always looking to help new stations.

Hats off to KE7SA, Chuck, and his buddies of the Western Washington ATV club for producing a splendid ATV promo video tape. (see story earlier). Chuck and the other members are a great bunch of ATV'ers and are largely responsible for AEA getting into the ATV product business. You never know what good

things will happen when you put up an ATV RPT!

EPILOGUE

We at ATVQ received hundreds of well wishes for our effort from all over the world. We appreciate the kind words and support. We hope you enjoy this issue of ATVQ and will continue to send us operating news, station write-ups, DX reports, club activities, club newsletters, articles, photos and other material which you would like to share with the rest of the ATV community. Also don't forget that like any magazine we survive on subscriptions and need your help in spreading the word about our new ATV Publication. Feel free to write us with comments and ideas. We also have a 24 hr business phone and electronic butler in the ATVQ ham shack you can call: 312-298-2269. We also are looking for ATV club rosters and individual ATV'ers to add to our master ATV'er list. This is used to help us in FCC matters. The ATV'ers do not have to subscribe to any magazine or be a club member to be on the master file. It's just a way of keeping track of the ATV Universe. There is strength in numbers! Among other things we would like to know if you find the type size big enough, too big or too small? Do you like the layout and style. What features do you like best? Classified ads are free to subscribers so be sure to send in yours.

----- AT THE WIRE NEWS

Don Smith W6NKF of Martinez, CA was featured in the Contra Costa, CA section of the LA Times for his ham/space activities. The article tells about Don's round-the-clock ATV operation during the Discovery space shuttle flight. Don receives the direct NASA satellite video feed and re-transmits it via ATV to his local area. The article gave readers ample info about ATV, the local ATV activity including tips on how to use a scanner and a cable ready TV to receive the ATV signals. Don and his fellow Mount Diablo ARC are also mentioned doing public service for the fire department and other activities. A three column wide picture of Don in his shack impressively attracts readers to the story which appeared in the September 30 issue.

ATVQ. DEVOTED ENTIRELY TO AMATEUR TV
AMATEUR TELEVISION QUARTERLY

"ATVQ"

CONSUMER WARNING!!

This is a letter of warning to all people who saw the advertisement for Black Hole Disposal Units in your September issue of ATVQ. Avoid buying or inform us immediately if you have purchased that item so that it can be properly disposed of.

Legal action is now being taken against the company, "Nothingness Unlimited" for consumer fraud and the selling of hazardous products. Subatomic sized black holes though they are efficient in disposal of garbage are not maintenance-free and thoroughly safe as was advertised. Black holes of such a small size in fact, radiate tremendous amounts of heat and will thermally run away and explode in a gamma pulse if left unattended. A very dangerous item for the consumer, and it of course, does not live up to its infinite warranty. Further, anything disposed of accidentally cannot be recovered. Several families have already lost their pets and valuables such as rings and children to these units. The claim that Black Holes are available in seven decorator colors is pure outright fraud though impossible for the ordinary buyer to disprove. In fact we are

lobbying or the complete eradication of commercial Black Holes below a certain mass limit to prevent unscrupulous companies like Nothingness Unlimited from taking advantage of the poor consumer in the future. Claims from the company that they are responsible for the absorption of all unanswered CQ's and provide the occasional LDE (long delayed echo) are highly dubious although the Post Office has filed an amicus curiae claiming that the accidental misuse of one of the companies disposal units caused the loss of over 3 million pieces of mail last year.

We are, however, having difficulty locating the company or company officials. It seems that they, their office furniture and records have disappeared without a trace. All we have is rumors that the company liquidated itself into of it's own Black Holes. Any information leading to the whereabouts of the company will be greatly appreciated. A copy of the ad has been reproduced to assist your memory of this company.

73 Lirpa Loof, OF9BK Consumer affairs director.



Black Hole Disposal Units

For bathroom, kitchen— everywhere! When it comes to Black Holes, nobody knows more about their control and installation than Nothingness Unlimited. ■ Whatever your disposal needs, Nothingness has precisely the right Black Hole for the job: subatomic for your toilet or kitchen facility—dust-particle-size for those "giant" waste problems. ■ Nothingness units are easy to install, maintenance-free and thoroughly safe. And they come in 7 decorator colors (take our word for it). ■ Call today and find out how little it costs to get our holes working for you.



CLOSE/UP MODEL BH23
Avocado and Brushed Chrome
Infinite Warranty

Nothingness Unlimited

FILLING YOUR NEEDS WITH NOTHING AT ALL.

Free Space Path, Signal Reception Distance in Miles.

Horizontal Angle	VHF			UHF						
	10W Lowband Ch 2-6	10W Highband Ch 7-13		100W			1000W			
	Omni 20W ERP	90° 80W ERP	Omni 40W ERP	90° 160W ERP	Omni 710W ERP	220° 1000W ERP	80° 2450W ERP	Omni 7100W ERP	220° 10000W ERP	80° 24500W ERP
Rabbit ears or loop indoors	3	6	3.5	7	3	4	5.5	9.5	12.5	17
Small outdoor	12	24	10	21	9	11	16.5	28	35	52
Large outdoor	17	34	15	30	15	18	28	47	56	88
Large outdoor w/preamp	20	40	21	42	30	36	56	95	114	177

Low band in particular and to a lesser extent high band reception may be inhibited by man made noise and long distance co-channel interference.

Heavy foliage will reduce usable distance of UHF signal to about 1/4 of above distance. Reception at distances in excess of 40 miles will frequently be limited by earth's curvature.

ERP (Effective Radiated Power) is typical practical value for transmitter power shown. Distances in this chart are based upon distance only and assume a "free space" propagation path exists to receiving antenna.

COPYRIGHT NOTICE

ATVQ Amateur Television Quarterly. Copyright 1988. All rights reserved. No portion of ATVQ in whole or in part may be reprinted without written permission of the copyright holder. Publications in foreign countries may reproduce portions of a current issue provided source credit is printed in the heading of any such reproduction and a copy of the publication containing the reproduction is sent to ATVQ.

ATVQ editorial policy is to provide technical material of interest to those interested in visual communications. We invite contributions which are about any aspect of amateur television. ATVQ evaluates all material published for accuracy. Construction projects are evaluated for likelihood of repeatability by another builder. Because of variance in construction technique exact results may vary depending on the critical nature of some signals but a working unit must have been built or demonstrated prior to our publication of an article. ATVQ makes no guarantee of a builders success. When additional information is needed the article will indicate that the reader should contact the author prior to construction for additional information.

"Devoted to Amateur Television"

THAT NEW VIDEO CAMERA

by Donna Bocian

If you've just acquired a video camera or are thinking about buying one, here are some tips to make it a little bit easier.

Read the instructions. Sure, video cameras are simple to use and while most of the cameras are similar there are some differences. Besides why be embarrassed when your kid shows you how to do something with the camera you did not know it could do?!

Get acquainted with the camera. Learn what it can and can't do. Learn how to change batteries, focus, zoom. Have fun with your efforts. Practice.

Don't expect expert results on the first try. Video tape has the advantage of being erasable. Take plenty of practice shots in different types of light to learn the effects of the color balance control. Pan around the room, take close-ups and distance shots to get comfortable with the working distance of the lens.

Auto-focus or manual? Even though you may want to rely on the auto focus most of the time, there are situations where it will not work well. Auto-focus tends to focus on the closest object and may not work well if your subject is behind a fence such as little league up at bat, behind glass or if it is raining or snowing.

Frame your shots. Don't cut off or leave too much space above heads. Make sure there are no distracting objects in the background or edges of your shots. Keep horizontal level. Practice shooting from various angles, heights and distances to get exactly the shot you want.

Make special effects special. Zooming, panning, tilting, focusing from a close object to a distant one all make interesting effects in your finished product. Overdone they can be distracting and unsettling for the viewer. Learn how to use these effects and when to use them. Several books on video production can be found in the library which explain good photographic technique for video.

Don't forget the sound. Learn how your microphone works how much excess noise it picks up and how far away subjects can be and still get good sound with out room boominess. Different rooms have different effects on sound. Hard walls and floors add more room reverb than the typical home living

room with carpeting and lots of furniture. Use an external mike with a directional pick-up pattern. You may need a windscreen for out door shots to avoid rumble from wind noises. Shots from moving vehicles including roller coasters will require special techniques to avoid wind noise.

Tell a story. More important than what the pictures look like is what they say. When video taping an event have a beginning, middle and end. If you are recording a birthday party start before the party. A shot of the invitation is a good beginning. Pan around the room before guests arrive. Show decorations. Watch the pile of presents grow and the guests arrive. If this is a children's party are games played? Film the cake before, during and after the candles are blown out to capture the story. Perhaps ending with the children playing with the presents and the "mess" left over or a tired mom and dad after the event.

Edit. While you did your best there might be fuzzy shots, or jerky camera movements or shots which your relatives don't want you showing upon threat of disinheritance! You may want to change the order of some shots to make the tape more interesting. If you have special effects in your playback equipment, still frame, backwards play or picture-in-picture, you may want to add these into your finished product or add scenes from your other tapes.

Enjoy. A video library can replace your photo album and scrapbook. You can pose for a picture but you can perform for the video camera. Look for novel opportunities and creative ways to edit your family or ham events.

Five Ideas for Video Presents

As VCR's become more and more common the idea of making video presents or for friends and family becomes more practical. Careful editing of tapes can create special video for gift giving at Christmas or make that special DX QSL live and in color! Here are five ideas to start.

1. Clips of the children's birthday party can be accumulated and each year can be added to the collection. This applies to any recurring event such as hamfests, field day or other events.

2. A short video of various family activities throughout the year. Many families write a Christmas time "yearly newsletter" telling relatives who may

not be close enough to visit. A Year In Review is a nice gift.

3. Short videos of graduations and other family events with a personalized message at the end can be sent to family members unable to attend.

4. A cumulative video of various family gatherings can be built up over the years to show family growth new members, weddings and other blessed events.

5. A family album for grandparents for living memories of the family tree as it grows.

Which Camera to Buy

As important as learning how to use your camera correctly is choosing the camera wisely. Think about what kind of video recording you are going to do and who is going to do it! A complicated unit with lots of knobs and features may be fine for you if you are technically minded but be totally unusable by other family members who are more accustomed to "point and shoot" film cameras. Weight is a factor if you travel on foot or take it to the amusement park. Lugging around a 16 pound camera all day is no fun and often will get in the way of your enjoying the park. Having titles and fancy effects built into the camera may be nice but you can also add these later at home when the time it takes to add these effects will detract from the time you have to shoot and enjoy the event. No one likes to wait while you fiddle with the camera controls to add titles, effects or other "extras" when they were there to enjoy something else.

As for extra equipment, a lightweight tripod is the most useful accessory and will make shots easier. You can also park the camera on the tripod and get into the shot yourself. Otherwise, if you are the camera person, you will constantly be the missing family member in your keepsakes. It also helps to hold the camera steady for long time intervals. Above all have fun. The camera purchased should not interfere with your fun. It should enhance your activities and make your life more enjoyable. 73 Donna Bocian, 3905 N. Panama, Chicago, IL.

The Author

Donna is a professional writer and photographer working as a freelancer in Chicago. Donna has produced several videos shown locally and has written on this subject for several publications.

Has your home tape library gotten messy? Do you have tapes in a multi-colored collage of boxes from sixteen brands of tape? Are your boxes getting tattered and scuffed? Having a hard time finding your QSO tapes or video QSL's among the home movies of the wife and kids? Does your library look more like your spare cable box than an organized shelf of memorabilia? Hark! There is help!

If my own collection is any gauge of a typical videophile, ATV'er or movie buff then the above probably apply to most of us. I have over the years collected about 500 tapes from at least 12 tape brands in as many different boxes from Brand X specials to super high grade. The problem is not only does it take up a lot of space but the YL thinks its UGLY! While trying to salvage myself and my tapes from the wrath of the cleaning lady and my fiance' I came across two products which made life easy. The products also gave rise to a way to organize my collection of VHS, Beta, 3/4" U-Matic, old EIAJ-1, half inch reel-to-reel, non EIAJ-1 half inch, 2" highband Quad and 1" format video tapes. If that sounds strange remember I've been at this for 22 years and have seen 50 formats come and go!

If you could organize your collection into the same size boxes, ignoring for the moment that the commercial tape we buy are different by title, some in large vinyl cases, some in cardboard sleeves, VHS being larger than Beta, then you could create a library of uniform size items which makes storage easy and neat. If you could then organize them into easily recognizable sections for commercial product, copies, ATV/SSTV videos, home movies and other categories you may have. Thus our problems are solved. EUREKA!! Such a scheme is easily done...once you know where to get the necessary items: namely uniform boxes and neat tape labels.

Tape labels to the rescue!

One of our premier issue advertisers is a supplier of tape labels similar to those used by the major duplication houses which print them for all those tapes you find in the rental stores. They are available completely BLANK which is an advantage over the ones which come from the tape manufacturer which have the brand name and

"Devoted to Amateur Television"

other sales material printed all over in trashy color schemes. The blank labels are available from Virginia Specialty Products, Box 985, Vienna, VA 22180. They fill this need exactly. You can type on them with a standard typewriter or use your computer printer. By using color coded labels you can organize your categories of tapes and keep them together easily. If you find a red label among the blue labels you know someone has been messing in your sacred supply of bloopers or home video keeping your collection together. This makes finding the one tape you want to show Aunt Bee a lot easier: so you can get back to working DX on ATV: which happened to be P5 the night she came over: and your YL insisted you show her the video of the kids school play!

In quantities of 200 or 1,000 you can afford to have several colors on hand. Your tapes can be organized in a matter of a few hours or minutes, depending on the size of your tape library. Best of all the YL will no longer be able to complain about the mess of unorganized tapes thus removing the threat of eviction!

THE PERFECT BOX

The second item you need to make your collection of tapes look neat is a case of uniform size for all your VHS and Beta tapes. In this case, no pun intended, ATVQ to the rescue. No, we are not starting a video boutique but the manufacturer of this item will not sell to the public. The item is a white vinyl case with a full sleeve. The white box is not objectionable to the YL's and does not clash with the labels you get from VSP. The case will hold either Beta or VHS tapes there is no case size difference if you happen to have both formats. You can also save your mini or C-VHS tapes in the same box. The Case has a full sleeve. This is a clear vinyl cover which acts like a pocket and covers the back, spine and face of the box. This lets you put your label on the spine under the sleeve so it is protected from kids, cats and the other hazards of life. The front and back areas of the case can also have labels. In the hamshack I put the balloon QSL card I got from WB8ELK and W9PRD inside the sleeve. Not only does it protect the special card, it tells me at a glance what the program is on this tape. It can also hold any computer graphic, postcard, photo or other item you have that you may have to make

your own "movie" cover. The effect is very pleasing to the YL since she can now select the home movies of the kids and the case has a color photo of the kids. Now there is no mistaking where the tape goes when done and you didn't have to pull the photo album out of the bottom of your dresser drawer just to find a photo of the kids! Such a deal! ATVQ will supply readers needs for cases at pass-through cost. That's our cost plus the cost of shipping and boxing them to send on to you. We are not in the case business but since we can buy them by the case and you probably don't need 600 at a time to buy direct, this is how you can get some. The cost: \$1.25 each in quantities of 10 or multiples of 10 only. Send a check to ATVQ for the amount you want.

So now you can clean up your library at reasonable cost. Use your imagination or get the family involved to make nice covers for the cases using your computer or photos and put on a nice spine label on the case and a nice spine or face label on the tape and wind up with the nicest looking tape library in town. Your YL will love you for it!. KB9FO.

LOS ANGELES ATV DAY

Saturday Nov.5th was ATV Day in Los Angeles & Ham stores featured ATV equipment and demonstrations. The best attended was at A-Tech in Burbank. Several members of the So. Cal. ATV Club were on hand to show ATV, ATV equipment and ATV RPT operation. ATVQ publisher Henry Ruh KB9FO flew out for the weekend and was in attendance helping convert on-lookers to ATVers. Also on hand were Tom W6ORG and Maryann WB6YSS of P. C. Electronics demonstrating their equipment. PCE items are now available from A-Tech which has a permanent ATV station operating on 434, 910 and 1285 Mhz! Ernie Williams WB6BAP was also on hand to tell on-lookers about public service uses of ATV including coverage of the Tournament of Roses parade which is an annual ATV event.

Several shoppers went home with new ATV equipment and ATVQ received a large number of new subscribers that picked up subscription forms at the store. A-Tech will also be stocking issues of ATVQ.

PHOTOS ON NEXT PAGE-----

“ATVQ”



Ernie, WB6BAP, Bill Smith (owner of A-Tech) N6MQS, Henry KB9FO, Maryann WB6YSS and Tom W6ORG in front of the A-Tech store.



Bill helps a customer purchase ATV equipment while Tom, Maryann look on.

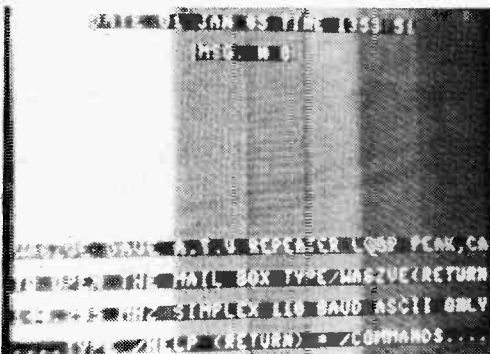

Off-air signal from ATV RPT system. Picture was in full color on monitor.

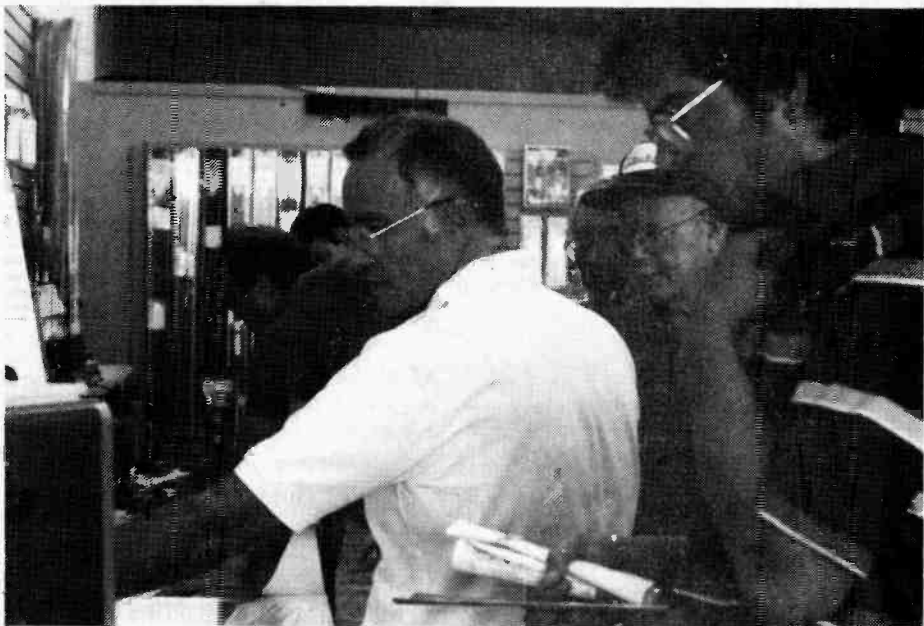

Tom demonstrates live ATV RPT while several customers look on.

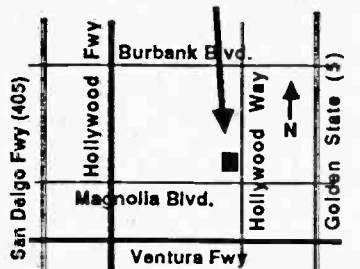

A-TECH

- Amateur Radio
- Police and Fire Scanners
- Apple Computer Software
- Two-way Business Radio

1033 Hollywood Way
Burbank, CA 91505
(818) 845-9203

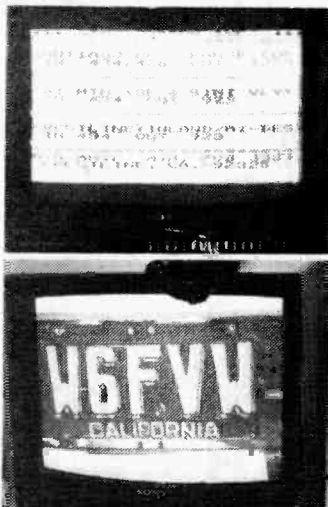

Live video (in color with sound) from W6FVW.



Live video from N6BPU in color with sound.

WYMAN RESEARCH, INC.

ENJOY THE ADVANTAGES OF FM-ATV:

- BETTER LINEARTY - GREATER AVERAGE POWER
- NO SYNC. SIGNAL COMPRESSION
- SIGNAL TO NOISE IMPROVEMENT WITH FM
- BETTER SIGNAL TO NOISE RATIO WITH PRE-EMPHASIS
- IMPROVED CO-CHANNEL INTERFERENCE IMMUNITY
- IMMUNITY FROM FADING

TUNABLE 1200 MHZ FM-ATV RECEIVER

PRICE: \$499.95

- RECEIVER IS VARACTOR TUNED (1215-1325 MHZ)
- HAS AUDIO SUBCARRIER RECEIVER (6MHZ)
- HAS DE-EMPHASIS CIRCUITRY (SWITCHABLE)
- HAS AFC, LIGHTED TUNING METER, INTERNAL SPEAKER
- HAS VIDEO AND AUDIO OUTPUTS
- DELUXE CABINET (6 IN. x 9 IN. x 2.5 IN.)
- HAS GaAsFET FRONT END



TRANSMITTER 1255 MHZ

PRICE: \$499.95

- POWER OUTPUT 5 WATTS
- 4MHZ DEVIATION-CRYSTAL CONTROLLED
- 6 MHZ AUDIO SUBCARRIER
- INTERNAL POWER SUPPLY
- PRE-EMPHASIS CIRCUITRY
- CABINET SIZE (6 IN. x 6 IN. x 9 IN.), FAN COOLED
- OPTIONAL ANTENNA RELAY

NEW FM-ATV RECEIVER RECEIVES BOTH TUNES 902-926 MHZ AM-ATV AND FM-ATV 420-450 MHZ

PRICE: \$574.95

- RECEIVES FM-ATV ON 900 MHZ BAND AND 450 MHZ BANDS WITH VIDEO AND AUDIO OUTPUTS
- RECEIVES AM-ATV ON BOTH 900 and 450 MHZ BANDS WITH OUTPUT ON TV CHANNEL 3 OR 4
- HAS 6 MHZ AUDIO SUBCARRIER FOR FM-ATV
- HAS DE-EMPHASIS CIRCUITRY FOR FM-ATV
- HAS INTERNAL SPEAKER (FM-ATV)
- HAS GaAsFET CIRCUITRY
- HAS LIGHTED TUNING METER
- DELUXE CABINET (6 IN. x 9 IN. x 2.5 IN.)
- REQUIRES 12V. AT 100 MA.

OTHER FM ATV EQUIPMENT

PRE-AMPS FOR 450 MHZ-\$39.95, 900 MHZ-\$105.00, 1250 MHZ-\$105.00
ANTENNAS-LOOP YAGIS FOR 900 MHZ AND 1250 MHZ-\$100.00 EACH
ANTENNAS FOR 450 MHZ-YAGIS AND J-BEAMS- \$55.00 TO \$135.00
PRE-EMPHASIS/DE-EMPHASIS ASSEMBLED BOARDS-\$25.00

1250 MHZ AMPLIFIERS -

1 WATT IN 18 WATTS OUT-TRANSISTOR TYPE-\$254.95

1 WATT IN 20 WATTS OUT-"BRICK" TYPE-\$239.95

(BOTH OF ABOVE ARE IN DIE CAST BOX WITH HEATSINKS, "N" CONNECTORS)

150 MW IN 5 WATTS OUT, HEATSINK, "N" CONNECTORS, "BRICK" TYPE-\$150.00

WE ALSO HAVE ALL EQUIPMENT FOR 450 MHZ AM ATV AT REASONABLE PRICES.
LET US KNOW YOUR ATV NEEDS.

WYMAN RESEARCH, INC.

Don & Sue Miller
W9NTP
W9YL

R.R. #1 BOX 95
WALDRON, INDIANA 46182
(317) 525-6452

SHIPPING \$4.50

INDIANA RESIDENTS 5% SALES TAX

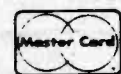

5%
Added



"ATVQ"



BATC SPANS THE GLOBE

The BRITISH AMATEUR TELEVISION CLUB (founded in 1949), represents the interests of amateur television enthusiasts throughout the world. With a current membership of over 2,500, the BATC is the largest and oldest such organisation in existence.

Amateur TV is an all-embracing hobby and includes such activities as: TRANSMITTING TV - COMMUNICATION - HOME-CONSTRUCTION - VIDEO RECORDING - SPECIAL EFFECTS - DIGITAL PICTURES - HOME TV STUDIOS - SLOW-SCAN TV - AMATEUR PRODUCTIONS - SATELLITE TV - OUTSIDE BROADCAST - DX-TV - REPEATERS etc. The list is endless.

As a member of the BATC you get a free quarterly magazine which is always packed with up-to-date, practical information and designs. Printed circuit boards and special components for projects are available from your U.S. agent and there is an ever-changing series of handbooks devoted to amateur TV, covering everything from starting new to the most advanced techniques. Many other services and facilities are available to members, and practical help is available on any TV related topic.

Find out about the BATC now - you won't regret it

Our agent for North America is Don Miller, W9NTP, who has full up-to-date information on all BATC affairs including application forms, sales price lists, publications lists and project details for existing printed circuit boards.

All money - including annual subscriptions - is payable to Wyman Research in U.S. dollars, making it very easy to be a BATC member.

WYMAN RESEARCH INC. BOX 95, WALDRON, INDIANA 46182. (317) 525-6452

"Devoted to Amateur Television"

MICROWAVE OVEN ATV FOR ATV EME?

David Pacholok who works for Creative Electronics in Sleepy Hollow, IL has come up with a novel approach to high power on 2390 Mhz FM ATV. He has converted a cheap home microwave oven for FM ATV. His design produces over 250 watts at this frequency! The inexpensive magnetron used in these ovens can produce up to 650 watts of RF power in oven use which is RF to cook food.

WARNING! CONSTRUCTION OF THIS TRANSMITTER MUST BE DONE WITH EXTREME CAUTION AS THE POWER LEVEL IS HAZARDOUS AND COULD BE LETHAL!! USE A MICROWAVE LEAKAGE DETECTOR AT ALL TIMES. SHUT DOWN IMMEDIATELY IF YOU EXPERIENCE ANY WARMING OF BODY PARTS OR BLURRED VISION. DO NOT WEAR CONTACT LENSES WHILE WORKING AT THIS POWER AND FREQUENCY!!!

A microwave oven magnetron is a self contained cross field power oscillator. Built in cavities primarily determine oscillation frequency with anode voltage and magnetic field having 2nd order effect. As a first step in transmitter design magnetron current, voltage and frequency were measured and plotted independently to quantify magnetron performance in a modified oven cavity. These tests led to the following conclusions about magnetron performance.

A). The 2M189A magnetron is a current operate device. Anode cathode voltage changes only about 1% with a 2:1 cathode current change.

B). Power output is linear as a function of cathode current.

C). Output frequency is non-linear but monotonic function of cathode current with increased current causing an operating frequency increase. Average frequency "pushing" coefficient is about .1 Mhz/ma providing a maximum useable frequency swing of 20 Mhz.

From the above AM DSB video is ruled out owing to the large incidental FM caused by the magnetron "pushing coefficient". On the other hand an FM deviation of 2 Mhz would cause only about 15-20 percent incidental AM modulation. This strongly suggests investigation of wideband FM video transmission. In that a design goal is compatibility with existing VSB receivers a test was performed with an FM video modulated Wilton 610C sweep generator and a 5" monochrome portable receiver with MDS down

converter. The test results were encouraging with the TV local oscillator adjusted to provide slope detection of the video IF skirt. A fair quality picture was obtained. H and V sync lock occurred from deviations of 700 KHz to 3.0 Mhz with picture visually optimum at about 2.2 Mhz deviation.

Without detailing the calculations for system noise temperature, antenna gain, receiver bandwidth, etc. for an EME link, suffice it to say that moon bounce has been accomplished with as little as 5 watts at 2340 Mhz with a 12 foot parabolic antenna. The 20 db improvement over this power level offered by this transmitter suitably phaselocked might help make EME possible for those amateurs not so technically inclined or financially well endowed. Phase locking should increase transmitter cost by about 20% to about \$240. This approximates the cost of just the driver and final transistors using bipolar or GasFET for a 5 watt transmitter at this frequency.

Building a transmitter from an oven magnetron meets the following goals. The cost is low, about \$200. Power is high at 250 watts MINIMUM. The majority of parts are available from Radio Shack and similar places to build an FM video modulator and power amp to current modulate the magnetron. The emission type is compatible with the bandwidth of the 12.4 cm band (2390-2450 Mhz). Frequency emission is compatible with ATV down converters for 2100 to 2650 Mhz. Many of these were sold in the \$50 to \$250 range through magazines and flea markets. Basic transmitter scheme is adaptable to other emission modes such as narrow band FM with additional phase-lock circuitry to stabilize frequency and track out phase noise and incidental FM. FM Video is inherently immune to multi-path and therefore ATV EME is possible. Multi-path caused by the uneven reflection surface of the moon makes AM TV EME impossible. Preemphasis of the video signal would improve performance to that expected for other FM TV systems on other bands. The use of inexpensive satellite receivers for true FM reception would improve system performance and increase range and picture quality.

Suggestions for other emission modes other than FM video:

Magnetrons are inherently dirty RF sources spectrally speaking. Wideband noise skirts using the 2M189 magnetron

"ATVQ"

are several hundred kilohertz wide. NBFM requires a clean RF course, one of low phase noise and incidental FM. If a phase lock or frequency lock loop is employed to track out the inherent noise modulation the non-inverting input of an opamp can be used as a varactor input to a conventional VCO. It is critical that the low frequency reference source be exceptionally clean as frequency multiplication increases PM noise by 6 db per octave or 20 db per decade. It is critical that loop bandwidth as set by the loop filter corner frequency and phase detector reference frequency by higher by a factor of 5 or more than the highest modulation frequency needed. The 2450 Mhz RF frequency division problem can be solved by a fairly new NEC IC the UPC 585G at only \$7, a divide by 4 pre-scaler with a maximum toggle of 2.5 Mhz.

Frequency locking is also possible with a 2430 Mhz FM receivers discriminator DC coupled. Such a receiver was constructed with a 121 Mhz crystal oscillator/buffer delivering 100 mw into a medium barrier schottky diode 20th harmonic generator into which was injected about 10 mw of magnetron RF. The diode functioned both as a mixer and a multiplier with a conversion loss of about 60 db providing an IF output of -50 dbm which is about 40 db above the limiting threshold of the RCA CA3189 FM IF amp/detector IC employed to complete the loop. Frequency stability and phase noise suppression in that an FLL tracks with some inherent frequency error as infinite loop gain cannot be achieved. In common with PLL the FLL needs a low phase noise LO and sufficient loop bandwidth. The FLL described reduced magnetron incidental FM and noise from about 50 Khz RMS to about 1 Khz RMS noise deviation. A 10 DB reduction to 300 Khz noise deviation should provide a S/N ratio of 20 db for a 3Khz deviated audio tone which is entirely acceptable for amateur voice and data transmission. For more information contact Dave directly.

From the Central Indiana ATV Club.

ATVQ TO VISIT DAYTONA BEACH

Henry Ruh KB9FO, publisher of ATVQ will visit the central FL area to meet with local ATV RPT representatives and other parties Thanksgiving week. Henry will be operating mobile with 100 W ATV and a 20 el H/V beam on his Bronco to work area ATV'ers. Report next issue.

Announcing

BetaPhile B Club

for those who choose the superior video format

Betaphiles Unite! Join the **Betaphile Club**

A club for Betaphiles? . . . Who's a Betaphile?

A Betaphile is a quality conscious video owner who isn't influenced by the marketing hype over the inferior quality VHS format. A Betaphile takes video more seriously than John Q. Public who can't even set his program timer, never mind edit a program. A Betaphile likes being on the cutting edge of technology every step of the way, but doesn't like Beta being ignored in video magazine articles or in their new product sections. Betaphiles consider their equipment to be more than just appliances! If you think you might be a Betaphile . . . join the club!

Benefits and privileges of membership in the Betaphile Club:

● Membership kit

Soon after joining the club you will receive a membership kit that includes a handsome plastic membership card with your unique number, an "I love Beta" key chain to carry with you, a bumper sticker, a membership button proclaiming your Betaphile status, and a "Call to Action" that describes the club's goals and how you can help further them.

◀ Newsletter: "The Betaphile Recorder"

Be both informed and entertained by your subscription to the Betaphile Club's bi-monthly members-only newsletter. It contains up-to-date articles dealing with subjects of concern to Beta recorder owners. ED Beta developments, club news, letters, questions and answers, contests, surveys, machine reviews, production ideas, comedy, all this and more in the only publication dedicated to Beta . . . "The Betaphile Recorder".

▶ Betaphile contact nationwide

Hear the views of fellow Betaphiles from around the country. The Betaphile Club will promote the exchange of ideas and work to be a clearinghouse for Beta information. Participate in the sharing of information, video experience, and opinions. Club members are encouraged to submit contributions to the newsletter and if they are published it will qualify the member for a prize.

▶▶ Pro-Beta merchandise

Declare your proud support and increase the visibility of the Beta format with bumper stickers, T-shirts, and buttons. These and other products will be available through the club at membership discounts.

■ Special offers to members

From time to time the club will announce or arrange special offers to members by other companies on various products and services.

■ Organizational benefits

Be a part of a nationwide organization for Beta owners and users. Help prove the skeptics wrong about the future of the Beta format. The Betaphile Club will help represent the views of Betaphiles in various forums, and promote interest in the Beta format. The club will also show both tape manufacturers and software distributors that a large and loyal market still exists. Align yourself with other Beta supporters, let's all work together for a Beta tomorrow!

The Betaphile Club . . . bringing together Betaphiles in support of the format, in numbers too large to ignore! Join us and make a difference!

▲ If you would like to accept our invitation to join the Betaphile Club for 1 year, please send a check or money order for \$15.00 along with the completed membership entry form for a copy to:

Betaphile Club
New Membership Dept.
P.O. Box 40373
Tucson, AZ 85717-0373

Betaphile Club
P.O. Box 40373
Tucson, AZ 85717-0373

New member form
1/88

Yes, I'm a Betaphile. Please enter my one year membership into the Betaphile Club: Enclosed are my \$15.00 dues.

Name: _____

Address: _____

Year first owned Beta _____ (Please print)

No. of machines . . . Beta _____ 8mm _____ VHS _____ Other _____

Please list make and model of Beta machines:

Do you own Beta prerecorded software? _____

Do you make your own video productions? _____

©1988 Betaphile Club

The Betaphile Club is not affiliated with the Sony corporation.

"Devoted to Amateur Television"

SPECTRUM CRUNCH

There was an editorial in a recent issue of a major ham magazine about the possibility of the new HDTV systems being a source of pressure to steal more of the ham bands. The FCC has stated publicly that they (FCC) will not accept a proposal for over-the-air HDTV or ACTV systems which exceed current channel band-widths. Early proponents of HDTV (high definition TV) or ACTV (advanced compatible TV) had developed in the lab several different systems. Proposals ranged from using side-by-side channel assignments for the added space needed for the 1125 line systems, to pairing one VHF and 1 UHF channel. Propagation problems eliminated the VHF UHF pairing proposal, at least for now. The proposal to use double channels is out of the picture because of the interference it would cause to adjacent market stations. As we know you cannot have channels 2 and 3 or similar channel pairs because the TV receiver experiences interference between the adjacent sound and video signals. There are other "taboos" caused by receiver response, images, and other receiver problems. The premise of the HDTV/ACTV systems is that the public is now aware that plain vanilla NTSC is not as good as it can be. Proponents of high quality video found in laser disk, Super VHS, etc, say that with large screen TV the consumer is now aware of the difference in quality and will demand better TV from broadcasters. Cable has already begun to embrace the new HDTV systems and many major cable operators are expanding their systems to allow for the super wide signals. The Japanese TV systems are going to satellite distribution of HDTV for direct to home transmissions. Europe is also looking at satellite distributed HDTV systems although because of their current scan rate differences, their HDTV will also have different scan rates than US.

The US systems which fit into the existing 6 Mhz spectrum space employ a number of different techniques to squeeze more information into the signal. One system uses a better NTSC encoder and decoder to eliminate the cross luma/cross chroma products which give regular NTSC color the edge-crawl effect. Another system provides a cinema aspect ratio signal rather than the 4:3 we have on regular TV. This is done by squeezing the extra video on the edges and the top digitally in the

transmission then spreading the data out again. A regular TV sees the regular picture as usual, the cinema screen TV receiver sees the bigger picture with the extra information. If you under-scan the regular TV you would see the extra material as a squeezed picture along the edges,. A regular TV signal would have a black edge on all sides where the extra material would have been.

Faroudja Labs is currently testing the ACTV system using better NTSC encoders/decoders. NBC and others are testing the 19:6 ratio squeezed video system. Other systems are also being tested. For now anyway, there does not seem to be any pressure to steal adjacent ham bands for more TV. There is however, an effort to change the microwave bands at 3.3, 5 and 10 Ghz from ham to other uses. Be prepared for the next frequency grab. Also 2304 may be in for a grab since it is in the middle of two adjacent TV microwave delivery bands used for instructional and MMDS (multiple TV channel cable) channels and the space would provide these operations with more available spectrum. Meanwhile back on 220....KB9FO.

DAYTONA FLORIDA ARA NOW FREQ. COORD.

An October 21 letter from the Daytona Beach Amateur Radio Association Inc addressed to Thomas King WB4ILH, president of the Florida Repeater Council Inc. by DBARA president Stephen Rice K8SR was sent to ATVQ with a request for reprint. The letter establishes the DBARA as a new FC for central FL. for 70 cm (only). The DBARA cites several problems of interference on the 450 band which the DBARA says was caused by the improper actions of the current FC. The letter also cites efforts at the Dayton Hamvention to solve these problems which were not then acted upon. DBARA operates K4BV repeater and in their letter also represent other central Florida repeaters including ATV. Those involved in FL FC should contact the DBARA, Frequency Coordinating Committee, PO Box 9852, Daytona Beach, FL 32020-9852. Info from Stephen Rice K8SR, President of DBARA

ATVQ IS THE ONLY PUBLICATION IN THE WESTERN HEMISPHERE DEVOTED ENTIRELY TO HAM TV.

"ATVQ"

UNIVERSAL AMATEUR RADIO HIGH RESOLUTION COMPUTER INTERFACE

QM Electronics (D. Girton N7QM) is looking for someone to manufacture the following unit. Not for QM but to get the ball rolling on a year old design.

A newly developed device for color and B&W SSTV & FAX has been designed by QM. Transmit modes are AM, FM and RDM (Random Digital Modulation). Included is hi-res AM-FAX to copy US NOAA and USSR METRO polar orbiting and geostationary WX sats. Picture display resolution is limited only by the computer display resolution. The available SSTV and FAX pix resolution is 2048 pixels per line and 2048 lines per pix. Pixel gray levels are dip switchable at 16, 64 or 256 corresponding to 4, 6 or 8 bits per pixel to match each computer. No more SSTV multi-path sync distortion. Work your visual communications, SSTV or FAX right down to the noise level. Copy FM-FAX press wire photos, WX charts and GEOS wefax on HF or via AM-FAX direct on VHF-UHF. A special Wefax feature allows you to colorize your own B&W Wefax pix as you copy them. Another feature is half screen zoom, left or right half, to allow you to print either visual or infrared pix at full screen width. A polar Wefax sat feature is included to print polar Wefax sat pix upside down and backwards for the south to north passes so the top of the screen is always north and the right side is east: map standard. All common FAX speeds are included plus medium and slow SSTV speeds. The color system for both FAX and SSTV is line sequential RGB. With our color system it is impossible to get out of color sync. Our adjacent line resolutions with in a few NANO SECONDS which allows printing pictures of up to 2048 pixels per line with a minimum of adjacent line mis-register. This is very important for hi-res pix. Plus many more SSTV and FAX features such as 3D and TX/RX AM color SSTV and FAX to work OSCAR. Doppler frequency shift won't change the color shades or saturation of B&W & color pix. All this and more for the next generation state-of-the-art of ham radio SSTV & FAX. We would definitely like to demonstrate this new product at '89 Dayton. It could be available as early as January '89. This unit is intended mainly to operate SSTV & FAX at about 512 x 512 & above pix display resolution. This is 4 times current resolution. It will also work at lower resolution. There are now personal computers at reasonable prices

capable of this hi-res display. The unit is designed so it will operate SSTV and FAX with any computer. Of course a VIC 20 would not have the same pix quality as an IBM PS/2, Apple, Macintosh, etc but they can communicate between each other. There are dip switches to set pixel per line and lines per picture to match your computer display resolution from 128 x 128 to 2048 x 2048. The computer program requirements are minimal because all timing is done within the interface. The interface has an 8 bit parallel A/D converter to the computer and 8 bit D/A converter from the computer. The required computer program of about 100 lines is passive so people with little programming experience can write their own programs. It is no longer necessary to spend 6 months writing a complex SSTV and FAX computer program. The program can be written in about a day by an experienced programmer. The choice of program language is yours. There is no limit to program add-ons such as graphics, enhancement etc. You can use whatever computer you want.

Now that the design work is finished who will manufacture and sell it? We seek someone to produce and sell this unit. It should sell for around \$800. It should be a long time before it becomes obsolete as it uses commercial standards and speeds. It can be moved from computer to computer. It has no ROM's, PROM's MEMORIES, MICROPROCESSORS, just straight forward circuits. It is unlikely that ham radio would exceed the 2048 x 2048 resolution capability. Interested electronic manufacturers should contact QM Electronics, 1153 Fisher Rd. Winterhaven, CA 92283. Thanks, N7QM.

----- PORTLAND ATV'ER ON TV

It wasn't 20/20 or 60 Minutes but the KOMO Channel 4 news team which arrived at the QTH of Chuck, W7SRZ on September 14th. Hurricane Gilbert was in the news and the KOMO news team wanted info about ham radio's part in this emergency.

Chuck tuned in the Hurricane net and there was traffic being passed in regard to the storm. The KOMO crew took about 10 minutes of video and interviewed Chuck. After spending about an hour in the ham shack the crew departed. With all that Chuck got his 40 seconds of glory that evening on the 5 o'clock news. . TNX WWATS NEWS.

"Devoted to Amateur Television"

BACK TO BASICS

Learn Ohm's law and earn big bucks! Does anyone remember Ohm's law? It seems that either the schools are lax in instruction of basic electronic fundamentals such as Ohm's law or we as technically minded people tend to forget the fundamentals. I remember back in the 60's when virtually every technician working on CB radios knew to replace tube rectifiers with diodes to gain a few more volts or change the screen resistor value on the final or the B+ series resistor in the power supply to get the little 5 watts up to whatever the devices and power supply would produce. One manufacturer even used a 2E26 later a 6L46 with a huge screen resistor in their 5 watt-er to boost sales knowing that as soon as word got out that this unit could produce 25 to 50 watts the tech's would snatch them up. The point being not how CB went to pot because of illegal power but that there were a lot of folks who knew fundamentals of Ohm's law and could apply it to a piece of equipment. Where are these people now?

I'm now manager for a large electronic firm and have a number of openings for folks who can repair broadcast level technical equipment. Mainly tape machines, audio/video DA's, monitors, switchers etc. The greatest qualification these candidates seem to have is they either know how to pronounce TV or have watched the 6 o'clock news. Even those coming with prior experience in military or broadcasting don't know the basics. Military training seems to be the worst with one candidate who had 20 years military training and was an instructor for electronics. This candidate didn't even know color TV as his experience was totally black and white! Other broadcast maintenance background candidates couldn't even answer the simplest questions about Ohm's law or video tape. Now we are not talking about an entry level position. The job pays up to \$50K depending upon experience. Is it too much to ask the person who wants to get paid the big bucks that they know a little basic electronics? Here are a couple of sample questions to give you an idea of the level of ability at which we screen folks.

1) In a circuit we have a device which is 1 ohm. When we connect this device to 100V AC it uses 100 watts of power. If we then connect the device

to 200V AC how much power will it use?

2) We have a simple "perfect" circuit in which the source is 600 ohms impedance and the load is 600 ohms impedance. The load and source are connected with a simple pair of wires with no significant loss. How much power is dissipated in the load?

The answer to the first question is 400 watts. If we double the voltage the current is doubled as well so you have 4X the power. Answers received ranged from 50 watts, 100 watts and 200 watts. Or you could use $I^2 R = P$ first solving for I at 200 volts and 1 ohm which would give you 400 watts.

The correct answer to the second question is half. We don't even care what the actual values of E, I and P are since we want to know what percentage or portion of the power is consumed in the load. Since a source and load represent a series circuit and each is of equal impedance (or resistance) the voltage drop must be equal across both parts, thus the power is equally divided between the two. It took AC generator engineers years to realize that matching the source to the load was not a good idea because they would burn up the generator dissipating half of the power generated as heat in the generator. Power generation of any kind is usually done with a very low impedance generator to minimize heat or power loss in the generator which then feeds a basically high impedance (or higher) AC distribution system. Low source impedance also means that the power in one distribution leg remains fairly constant despite changes in load on distribution legs. Otherwise your lights would dim every time an industrial plant on the other side of town powered up. An ideal situation would be if you have a zero or negative value for the source. Also known as a constant voltage source. You then have all branches of the distribution system isolated at the zero impedance point.

This is used in audio distribution where you want to have a number of 600 ohm Z outputs which are isolated from each other but do not want the expense of numerous output active devices, one for each line. You build a very low Z output circuit then add a series resistance equal to the line load you expect. You now have isolation near infinity and can actually short one line with nearly no effect on other outputs. If you lose one feed line the

"ATVQ"

others continue to work. You can do this with a multiple antenna array. By having a series of antennas all connected to a common low impedance feed point if one antenna fails the other sections will continue to work. This is done with tuned coax sections for antennas rather than resistors but the effect is the same. By now you get the idea. Even in our ham stations we can benefit from a good working knowledge of the basics. Knowing the latest industry buzzword does little if you cannot apply that knowledge. Now if any of you are looking for a job, call 312 291-1150. But before you do, be sure that you know Ohm's law and have some experience in repair of broadcast equipment! KB9FO.

ATV IN VERMONT

ATV is alive and well in the Burlington, VT area. Some of the active ATVer's are N1QG, KALLEX, K1HGY, K1LJL, W1LDKW, WA2CHY, N1CVA, and N7IGH. The Burlington group have a net every Sunday night at 8pm meeting on the 146.61 repeater. Someone from the group usually monitors the .61 machine and a CQ ATV usually nets a member. Also 145.51 Mhz is used for a simplex calling frequency. Randy, KALLEX, ED, N1QG & others in the group are assembling an ATV repeater system which will be placed at split sites. The receive system on 439.25 Mhz horiz. will be located at the Burlington Int'l Airport using an Alford Slot antenna and the transmitter on 426.25 Mhz will be located in downtown Burlington on the Red Cross building. The two sites will be linked on 923.25 Mhz. In addition there will be a weather radar feed from the airport. Burlington is surrounded by some of the tallest mountains in the area (4500') and eventually the ATV system may be located on one of these sites for some exceptional coverage of a good part of VT and parts of upstate N.Y. and NH. Bob, K1C1MC (ex-WA6SSN), Randolph, VT. is perhaps one of the loneliest ATV'ers in the state of Vermont and would love to see some activity in the central part of the state and hopes to eventually get over the mountains to the Burlington group. He is a regular checkin to the 8pm Tuesday night ATV net on 3.871 Mhz as well as Jack, K1HGY.

PROGRAM TO CALCULATE YOUR ATV ERP

by Bill Parker W8DMR

```
10 CLS 'TI USE CALL CLEAR; C64 USE ?"HEART"
20 PRINT "*** CALCULATE YOUR ATV ERP ***"
30 PRINT " (Effective Radiated Power)"
40 PRINT
50 INPUT "WATT METER READING (W/VIDEO): ",WA
60 PRINT
70 INPUT "ESTIMATED FEEDLINE LOSS (DB): ",FL
80 PRINT
90 INPUT "ESTIMATED ANTENNA GAIN (DBD): ",AG
100 PRINT:PRINT:PRINT
110 VP=WA*1.6805
120 EXPO=10^(FL/10)
130 FLL=1/EXPO
140 PA=VP*FLL
150 GAIN=10^(AG/10)
160 ERP=GAIN*PA
170 ERP=INT(ERP*10+.5)/10
180 PRINT "ERP IN WATTS (SYNC TIP): ";ERP
190 PRINT:PRINT:PRINT
200 GOTO 40
290 'TO CHECK USE WA=10; FL=3;AG=10
300 'ANSWER = 84.2 W. ERP
310 END
```

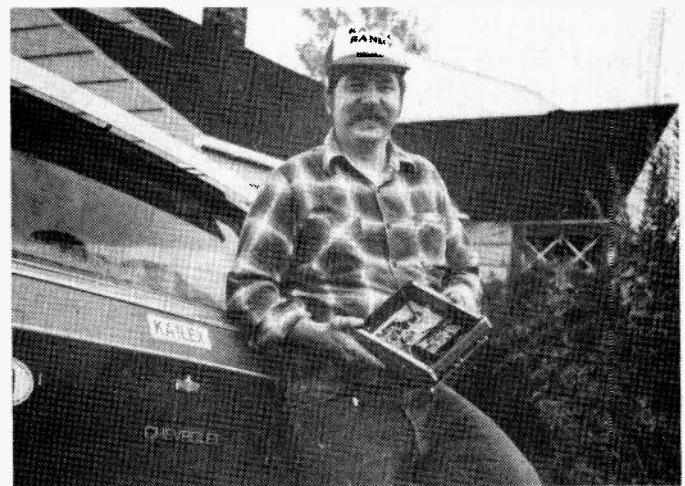

K1LX holding ATV-RPTR component.

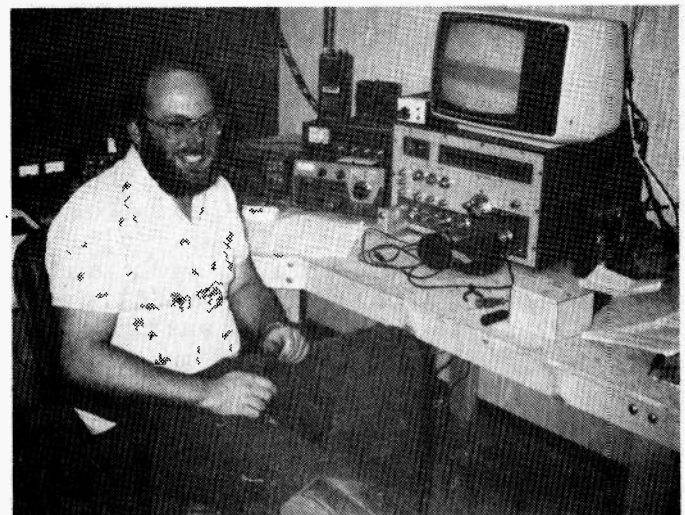

K1C1MC looking for contacts.

"Devoted to Amateur Television"

TAKE TO THE ROAD WITH MOBILE ATV
by Bill, WB8ELK

Mobile ATV operation is quite an enjoyable way of working ATV'ers you may not normally see. Whenever I take a vacation trip I usually load up the car with my ATV equipment and do my best to work ATV'ers as I drive along the highway. To get that undeniably P5 picture I have been known to drive right up to the home QTH's of many an ATV'er. Even with low gain rooftop antennas driving up to high ground really makes a difference (A good tall mountain or hill will more than make up for the 10db+ gain loss!). While driving alongside Lake Erie last summer I finally observed the "Lake Effect" first hand as I drove into a Band Opening! A two-way contact was made with Ralph, W2RPO over a 100 mile path. Ralph was P5 and was able to see my 1 watt signal at a P3 level at times. All kinds of vehicles have been used for ATV mobile, W6ORG has operated motorcycle mobile providing support for the Rose Parade for many years and has recently been running Helicopter mobile. Also the Indianapolis ATV group used a helicopter mobile to provide coverage for the Pan-AM games with great success. Many aeronautical flights have been made using just a quarter wave whip on the landing gear. At 10,000 feet using just 1 watt of power it is not unusual to transmit a watchable picture beyond 130 miles. Mel, KA8LWR and I made a flight this summer running 40 watts from his Cessna. Even though only running a vertical whip and considering the cross-polarization loss (Most activity in the Midwest is horizontal) P4 pictures were received out to 130 miles.

I would like to describe a set-up which can be put together quickly for some mobile fun. Any of the commercially available ATV transmitters or transceivers can be used as long as they can be powered off 12 Volts DC. If running an amplifier such as the D1010N be sure that your car's fusebox circuit can handle the potential 20 amp current. I usually drive my amp with only 1 watt to keep the current drain below 10 amps. If running with an ATV transceiver then any TV that is battery operated will work when using channel 3 as an IF. However, if using a separate Transmitter you may want to modify

a TV set to receive the ATV frequency directly. In my case I use the TENKAI CT-205 described in this issue. Other TV sets which require no modification and are quite sensitive are the Radio Shack B/W LCD and their Color LCD portable (PocketVision 22). These two sets will tune down to 421.25 Mhz. My favorite way to determine which sets in a TV store will tune to the ATV frequencies is to drive my ATV mobile station into the store's parking lot, go into the store and find the ones which can tune my signal. It's always fun to watch the salesman's expression when I explain that the picture on the set is coming from my car!

When in a vertically polarized area, I use a Larson mag-mount with a 1/4 wave whip for 439.25 Mhz with good success (6 5/8"). To produce an omnidirectional signal when travelling through an area where horizontal polarization is used presents some problems. Several omnidirectional designs have been built such as the Turnstile and Big Wheel. However, two of the simplest and best performing antennas to date have been the KS8J "Beach Ball" and the N9AB Dual Loop. Both of these have been used on the Helium Balloon flights with good success. The "Beach Ball" has more gain than the Phased Dual Loop but does have two sharp nulls in the pattern. The Beach Ball antenna consists of two full wave loops at right angles to each other connected together as shown in Fig. 1. The top of the two loops should be shorted together at the point of minimum SWR. The Phased Dual Loop antenna is very similar to the Beachball with the exception of a 92 ohm phasing line between the loops. This antenna provides a virtually omnidirectional pattern but with slightly less gain. For those who want all the gain possible from a mobile the 2 element Quad built by W8RSK (Fig. 2) has worked tremendously well. It's gain was measured at 6 dbd at the ATCO Antenna Party and although having a beamwidth of 60 degrees is still broad enough to work well from a car. I have to build a miniature antenna rotor for it as I'm starting to wear a hole in the paint on the roof! The alternative is to drive to a large parking lot and drive in circles. This antenna is directional enough to use in Foxhunts and has been used effectively to help track down the W9PRD balloon in Kentucky and find the Fox in the last

Columbus, Ohio ATV Foxhunt, ATCO Group. The Quad is built using the end section of a fiberglass fishing rod (Fig. 2). The last three inches are sawed off and epoxied at a right angle to the end to act as a crossarm support for the quad elements. A Female BNC connector is mounted onto a Larson or similar mag-mount antenna base. The metal sleeve of the fishing rod is placed into the BNC connector and soldered to it to support it. Alternately, you could solder a nut onto the fishing rod that will fit the standard Larson bolt coming out of the Mag-mount. The spreaders for the quad are made out of lightweight plastic tubes 10 1/4" long. These were found in model airplane hobby shops and are called pushrods (use the yellow colored ones). The wire inside the pushrods is removed leaving the plastic for the supports. If you can't find pushrods then any sturdy plastic tube or rod of 1/8" diameter will work. Holes just big enough for the plastic tubes are drilled at right angles in the ends of the 3" crossarm. Epoxy the plastic tubes in place. Small holes are poked through the tubes near the ends to allow the #22 gauge wire (Enamel coated magnet wire) to be routed through the supports. The reflector is 28.5" long and the driven element is 27" long. (Cut the wire to 29" and use 1" on each end to wrap around the center insulator.) After threading the wire through the small holes in the spreaders solder the ends of the wire together on the reflector and wrap the ends of the wires on the driven element through two small holes drilled through both ends of the center insulator. This will bow the spreaders into an arc which will keep the spacing between elements correct even in the high winds encountered in mobile operation (It's been tested to 85 mph but don't tell the Highway Patrol!). A small 1/2" spacer of plastic or wood about 3/16" diameter or so is used for the center insulator of the driven element. Remove the coax from inside of the Mag-Mount and attach the end to either side of the center insulator on the driven element. Tape or tie-wrap the coax down the fishing rod and adjust the length of the driven element for minimum SWR. The Reflector is then adjusted for best Front/Back ratio. Mobile ATV is a lot of fun but remember to Keep your eyes on the Road every once in a while!!

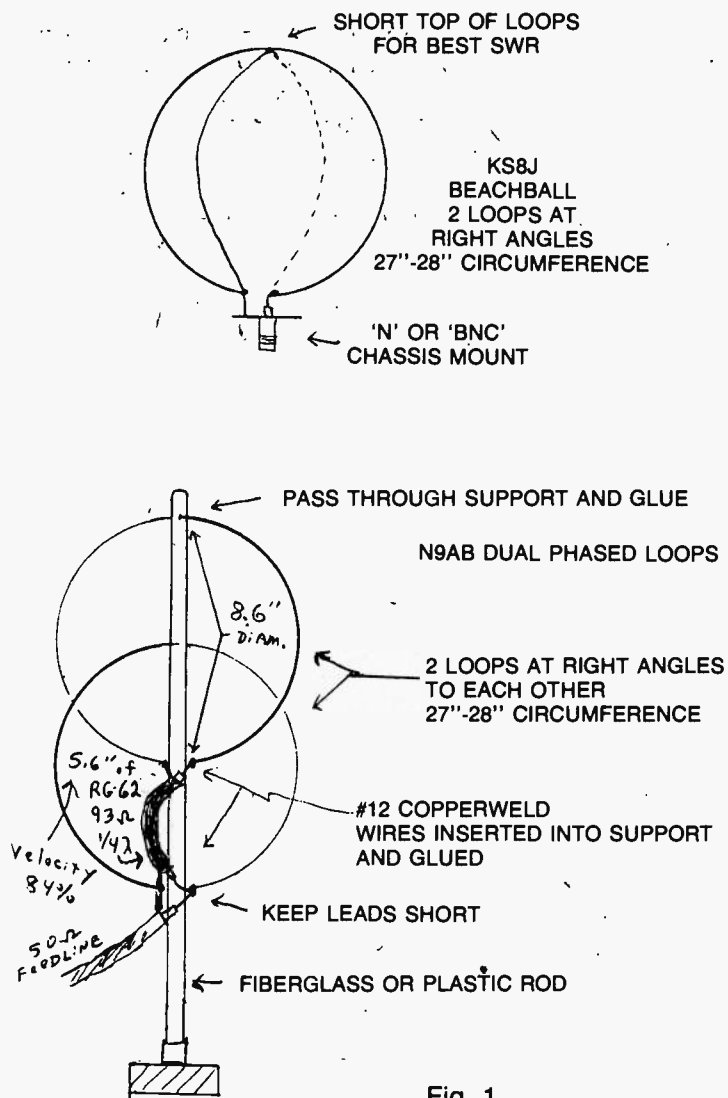

Fig. 1

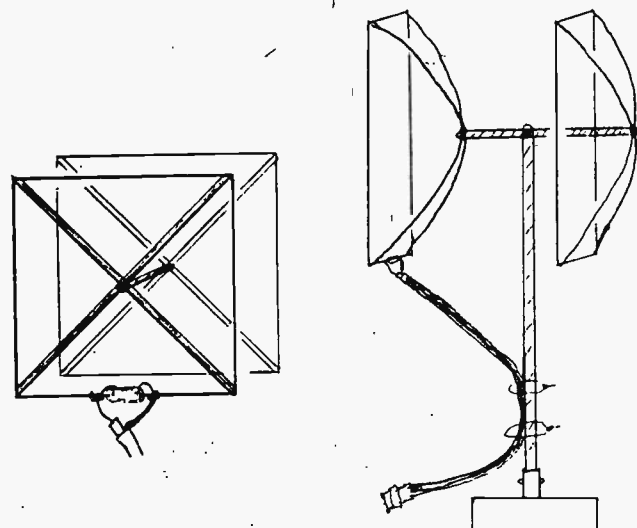

Fig. 2 MOBILE QUAD

"Devoted to Amateur Television"

HELIUM BALLOON ATV PROJECT by WB8ELK Bill Brown

Since 1987 there have been 4 launches of Amateur Radio equipment aboard high altitude helium balloons in the U.S. The following is a summary of the results of the flights and plans for the future.

WB8ELK Balloon #1

"First Flight" (Aug. 15, 1987)

This was the first launch of an ATV transmitter aboard a helium balloon. The electronics package consisted of a 1 Watt P.C. Electronics KPA5 ATV transmitter, VDG-1 Video ID, 40 mW 2m FM transmitter, and a GLB CW ID. This was all packaged in a styrofoam container with 1/2" thick walls. This flight demonstrated the need to obtain twice as much helium than required as we only had 2 ounces of positive lift when the helium ran out. This resulted in a very hair-raising launch as the package bounced across the soybean fields before finally taking off from WA8HDX's farm east of Findlay, Ohio. Although the batteries died out at 70,000 feet due to the cold temperatures and low pressure, the chase team was able to view the balloon through binoculars for several hours. Unfortunately, it disappeared from view when the balloon burst and was lost. We had to rely upon the backup recovery system (A very large REWARD sign) which paid off when a farmer 26 miles away found it in his soybean field six weeks later. Even with the very low power levels this flight demonstrated the advantages of altitude for line of sight coverage as stations as far away as Chicago, IL and Buffalo, NY (290 miles) were able to view the ATV signal and reception of the 2m signal was heard in St. Louis, MO and Baltimore, MD (400 miles).

W9PRD/WB8ELK Balloon # 2

"The Next Generation" (June 4, 1988)

After observing the first ATV flight Bob, W9PRD decided to organize a flight from Greensburg, Indiana. A package was put together with a 1.5 Watt Wyman Research ATV transmitter, VDG-1 Video ID, 400 mW Johnson 2m FM transmitter, and a CW ID. This was packaged in 2 inch thick styrofoam painted black in order to maintain internal temperature. In addition Chuck, WB9IHS, found a super battery system (SAFT LX2649) which allowed the package to operate for over 7 hours. The ATV antenna was the KS8J dual loop "Beach ball" which provided

some gain over the turnstile used in the first flight but induced periodic fading due to two sharp nulls in the antenna pattern. After another rough launch (Enough helium but 25 knot wind gusts!) the balloon achieved the highest altitude of about 115,000 feet. At this altitude the ATV picture was viewed in Dubuque, Iowa to the west and in London, Ontario to the east at 400 mi. The two meter signal made it as far as Des Moines, Iowa (450 miles-WORPK).

In what has to be called the "Ultimate FOXHUNT" the Indianapolis Foxhunters set out in several cars to chase after the package. Since the balloon went directly into the Jet Stream it actually was travelling over 100 mph ground speed! When the balloon burst it was quite exciting to view the rapid flutter on the ATV picture as the package spun wildly about during the initial few minutes of descent. When the package landed the chase team was still over 30 miles away. After 5 hours wandering the backroads of southern IN the group converged on English, IN. Paul, W9DUU hacked his way through the brambles and under-brush over several hills to finally find it hanging from a tree in the middle of the Hoosier National Forest!

W9PRD Balloon # 3,

"Return of the BALLOON" (Oct. 8, 1988)

After the addition of a new more omnidirectional ATV antenna (N9AB phased dual loops) the W9PRD balloon package was ready for yet another flight. This was a well organized launch effort that even NASA would've been proud of complete with a "Mission Control" center located in WB9IHS's camper with HF links and a tracking system. Mother Nature finally decided to give us a break (NO WIND!) which resulted in a picture perfect launch. The 2m FM signal died during the first 5 minutes of flight (burned out final). The ATV signal performed flawlessly and was seen in Dubuque, Iowa (KA0JAW - 360 miles) and Erie, PA (W3POS - 350 miles). Since the antenna was more omnidirectional than the June launch most stations reported about a P-Unit less signal strength but with much less fading.

At least six chase cars and one airplane set out to catch up with the balloon with all kinds of direction finding equipment. At balloon burst the chase team headed for northern Kentucky just south of Cincinnati in order to possibly see it land. When

"ATVQ"

the package landed the chase team was about 3 miles north of the site near the town of Sugartit, Kentucky. Unfortunately, it had gone behind some hills and the signal was lost. Paul, W9DUU gave us a final location fix from the chase plane and landed to join in the hunt. After an hour of roaming over the many rugged hills with no accessible roads a weak picture was finally seen. Finally a shout of "It's P5+!" was heard and the balloon was found by Larry, WB9YAJ lying in someone's front yard in plain view of a two lane highway just west of Union, Kentucky. Although no one was home, I'm sure the neighbors had quite a story to tell them about all the people from Indiana who parked in their drive and took pictures of something in the yard!

WB8ELK/KA8TEF Balloon # 4

"The Flight of the PACKET DIGI"
(Oct. 23, 1988)

The Packet Balloon package was built in order to see how effective a very wide coverage digipeater could be and to provide some idea of what a packet operation would be like from the Space Shuttle. The electronics package consisted of an 2.5 Watt ICOM 2A Handie-Talkie on 144.99 Mhz, a PAC-COMM micro-TNC and a 3.5 Ah Lithium cell battery pack. Since the package generated little heat we used 3 inches of Celotex insulation to house the digipeater. The antenna was a 1/4 wave groundplane mounted on top of the package. The digipeater was set up to beacon every 30 seconds and allowed stations to digipeat through it or to directly connect for a special message. To help the chase team home in on the signal, a timer circuit keyed on the transmitter for 30 seconds every 5 minutes. There was also a thermistor sensor on the timer which varied the on-time which indicated the internal temperature. The insulation must've worked as the temperature remained over 50 degrees during the flight. Since the package weighed nearly 4 pounds and due to the increasing winds at the launch site (over 15 knots) it was decided to fill the balloon up to over 8 lbs. of lift. This was the most lift of any flight so far and resulted in a beautiful launch (although nearly taking me with it!). The drawback with using a lot of helium is that the maximum altitude that can be reached is reduced. After a flight of 2 hours the balloon burst at 80,000 feet and parachuted back to earth. By

this time the Packet signal was being heard from west of Chicago to east of Williamsburg, Virginia, over 350 miles. S-meters were pegged out to over 300 mi and several reports of being heard with HT's in basements and mobiles hundreds of miles away. An HF information net was run on 40 meters by Rick, WA3USG in Mechanicsburg, PA. Rick has been Balloon Net Control for all of the balloon flights and did a fantastic job of keeping everyone informed of the launch and logging reception reports. After 3 flights of seeing and hearing nothing in eastern PA, he finally was rewarded with a 60 over S9 signal as the balloon drifted east! Over 100 stations were able to digipeat through the balloon and over 300 stations were able to connect directly to it in over 8 states. Since hundreds of stations were trying to hook up to the balloon simultaneously it took persistence and a lot of power to make it through! This flight was quite a demonstration of the "Hidden Transmitter" problem with high profile digipeaters where packets collide when stations can't hear each other. Future Packet Balloons will carry the SAREX Space Shuttle software which should allow over 500 connects/hour. Temperature and pressure measurements will be made with a microprocessor circuit and sent out via the Beacon Text.

The chase team consisted of Randy (WA8GAU), Mel (KA8LWR), Phil (KA8TEF) in Bob Horvath's van using a Spectrum Analyzer as a very expensive signal strength meter and Frenchy (W8KDT) in the chase plane. After the balloon landed W8KDT had a strong signal near the town of Norwalk, Ohio but had to land due to increasingly bad weather and icing before he could locate the package. Unfortunately the ground teams couldn't hear any signal and gave up after several hours. A message was posted that evening on packet BBS's all over Ohio. It read "Help me find the Packet Balloon...It's crying for help and wants to come home!". At 9am Monday morning nearly 24 hours after launch, KA8BTJ in Marblehead, Ohio saw the message and tuned in to 144.99 Mhz. He was quite surprised to hear a full-scale signal from the balloon to the northwest. At 10:45 am he heard the final packet blurps as the batteries died. Using his beam heading it's thought that the balloon landed on Put-In-Bay Island in the middle of Lake Erie...hopefully someone will find it

"Devoted to Amateur Television"

while hiking through the woods soon... Although there is the disturbing thought that it may be hanging from the yardarm of a freighter heading for Europe!

"BALLOONS of the FUTURE"
(Coming soon to an ATV receiver near you!)

The WB8ELK Live Color CCD Camera flight will occur during the Winter of 1988-89 and will be launched from the Mojave Desert in California. The package will consist of a Color CCD Camera donated by Rick, WA3USG and will use a P.C. Electronics 1 watt KPA5 ATV transmitter. This should provide some exciting video as everyone can ride with the balloon camera up to the edge of space. Hopefully some method of preventing the package from spinning can be worked out or those viewing the ATV signal will have to take Dramamine! The Southern California ATV Club will provide ground and tracking support and there may be 2 Helicopters on the chase team as well as some Dirtbikes and All-Terrain vehicles (ATV's). The signal should be seen over a good part of California, Arizona and Nevada.

In the spring of 1989 W9PRD and N9RM plan a balloon launch from Kentucky. The balloon will send a picture to all of the engineering departments of the University of Kentucky as well as ATV-ers in over 10 states. Each campus will feed the received signal into their internal cable TV system so that students all over the state may see the ATV signal. Hopefully this experiment will inspire some of the students to get involved in Amateur TV in the future!

In the next two years I plan to fly a special superpressure balloon across the country from California and have it parachuted down near the East Coast. If all goes well the next step will be a "Round the World" flight. NOTE: A video tape is available of all 4 flights including an ATV demo, ATV DX and aeronautical mobile flights for \$20 ppd. I will make available a detailed booklet of information describing all aspects of sending up a balloon, including balloon lift tables, suggested insulation, packaging, battery curves, FAA requirements and tracking programs for predicting the balloon path. The cost for this will be \$10. All proceeds will be used to keep the balloon ATV project flying. KEEP LOOKING UP! WB8ELK BILL BROWN 12536 TR 77, FINDLAY, OH 45840.



Balloon Transmitter Screen.

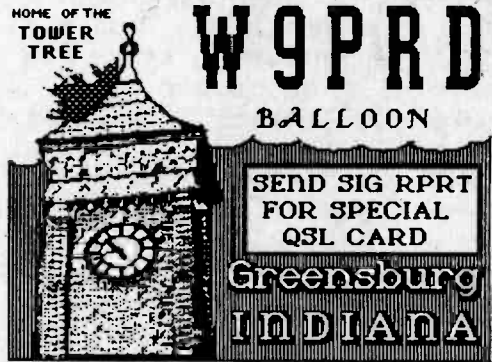

Balloon Transmitter Screen.

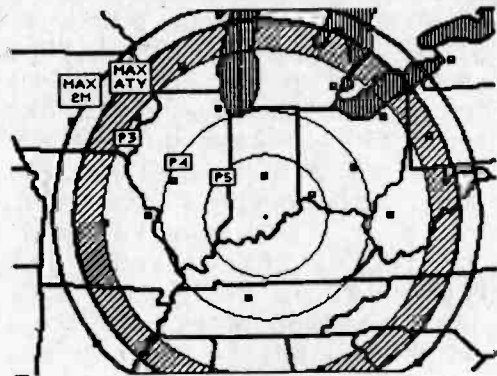

Range at 115,000 feet.

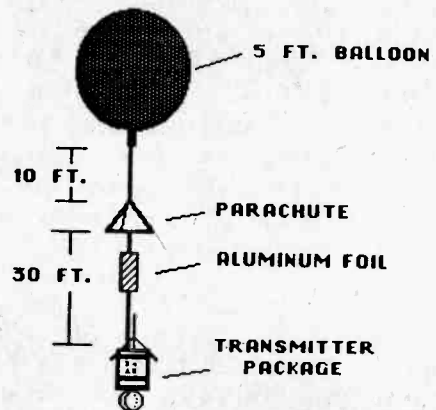

Typical Balloon Package.

“ATVQ”

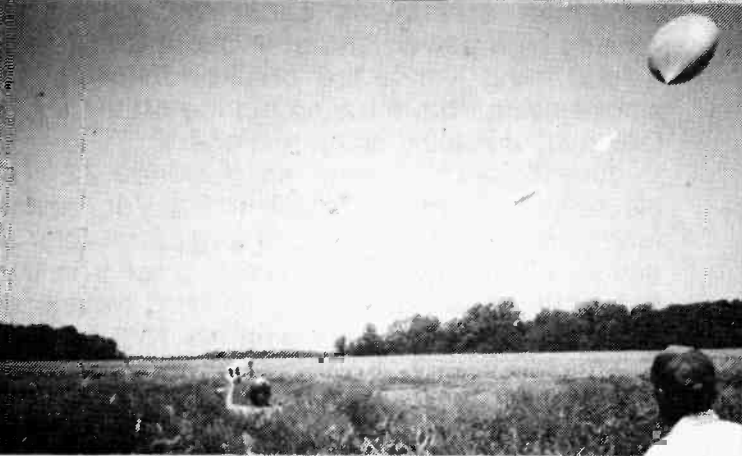
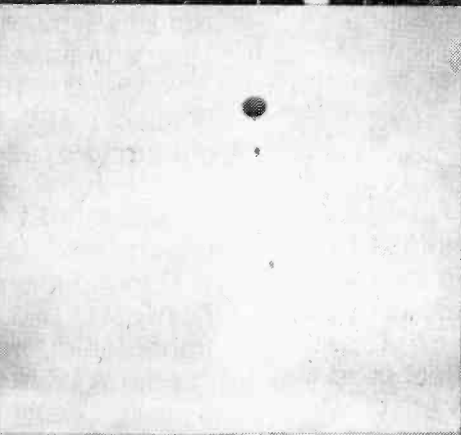
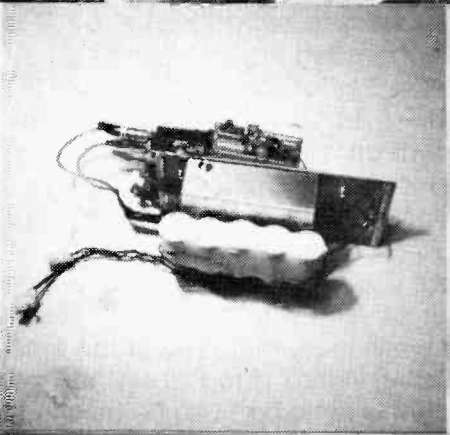
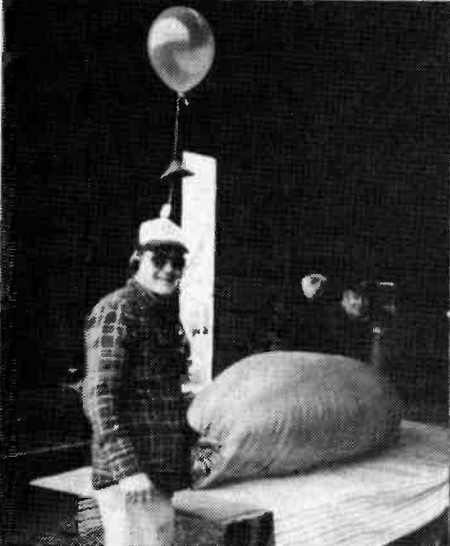
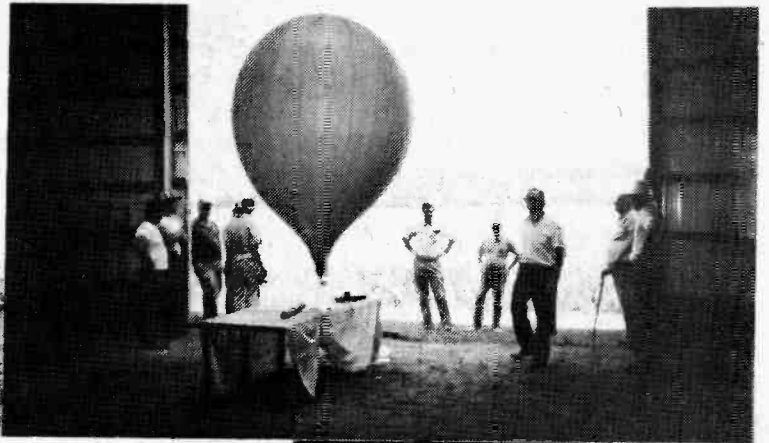

ATV Q & A

By Tom O'Hara, W6ORG

This column will be devoted to answering your technical questions about ATV. You may send them to me or ATVQ. The questions selected for publication may be a composite of those received and reflect what we believe will be of general use and interest to other ATVerS.

The questions you send in should also be general in nature. In other words how to repair your specific piece of gear, or is the xyz video camera better than the Rice Box Super 8 Zoomer would not necessarily be appropriate. In this issue, amateur linear amplifiers, specifically the Mirage D1010N, used in the ATV mode are covered.

I will attempt to present the plus and minus aspects for you to make the judgement of what you want to do in your specific circumstance, rather than pontificate the only way to go. A personal opinion, preference or what is used in my area will be stated as such.

WHAT IS DONE IN THE MIRAGE D1010N TO MAKE IT THE ATV VERSION?

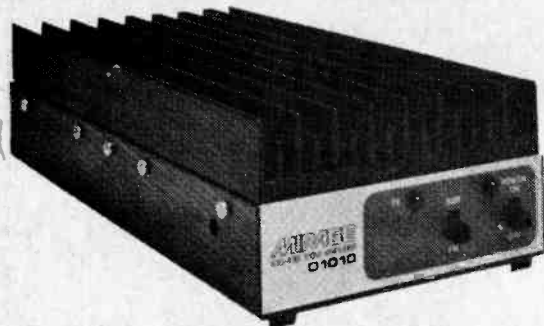

This is one of the most asked questions by those both anticipating buying an amp as well as those who already have one standard unit they bought for FM or satellite work.

The follow on question is "does it affect other modes?" The answer is that it has no affect or change to operation on other modes, gains, bandwidth, etc., and if anything, the ATV version improves SSB quality in older units.

There are a number of different generations over the years of D1010N's with different mods in them, so one simple description will not cover all. But let me start with the present model which has been out for about 2 years. The only difference today between the D1010N and the D1010N-ATV is the removal of the two low

frequency feedback networks between the base and collector of the final transistors for ATV.

This low frequency network in the standard unit was put in originally to prevent a low frequency oscillation occurring and blowing out the finals under a high VSWR. Later, a 50 ohm inductive (wirewound) resistor was put in the RF output line in order to present a lower VSWR at low frequencies and yet have no affect, due to it's inductance, at UHF frequencies.

The problem with this feedback network was that the oscillations that it was to suppress were also near the color and sound subcarrier frequencies. The result was color shift, ringing and distortion.

So those with D1010N's purchased from retailers other than P.C. Electronics can simply remove the two networks if the 50 ohm wirewound is present. I know there are none of you ATVerS who would do that, HI, but the D1010N-ATV can be ordered special by any Mirage retailer. I do caution however that removing the cover will break the seal Mirage puts on as part of their warranty agreement.

If you are not sure of the generation of your D1010N and want to be sure to preserve the warranty you may want to send the unit back to Mirage to have it upgraded and checked out.

Older D1010N's may or may not have all the .1 discs, 100 mF electrolytics and 470 mF electrolytic added on the collector and bias supply lines. This was the primary change I incorporated back in 1982 when I was writing the article for QST (Aug.) on ATV amplifiers.

I found this out the hard way. I got a Mirage D1010N to try out on ATV with the TC-1, 10 watt transceivers, we were manufacturing at the time. On the ATV net that night I "fired" it up and got over 100 watts on the sync tip. While talking to a number of stations about the glories of running high power, and after about 5 minutes, a loud bang like a fire cracker followed by smoke rising from the amp put me off the air. I took a lot of kidding about that one.

Investigation showed an exploded 22 mF electrolytic on the collector +13.8 Vdc power feed point. I replaced it and found that after a minute it got very hot. A scope placed on the plus side of the cap showed a weird waveform similar to video that went from the 13.8 applied

"ATVQ"

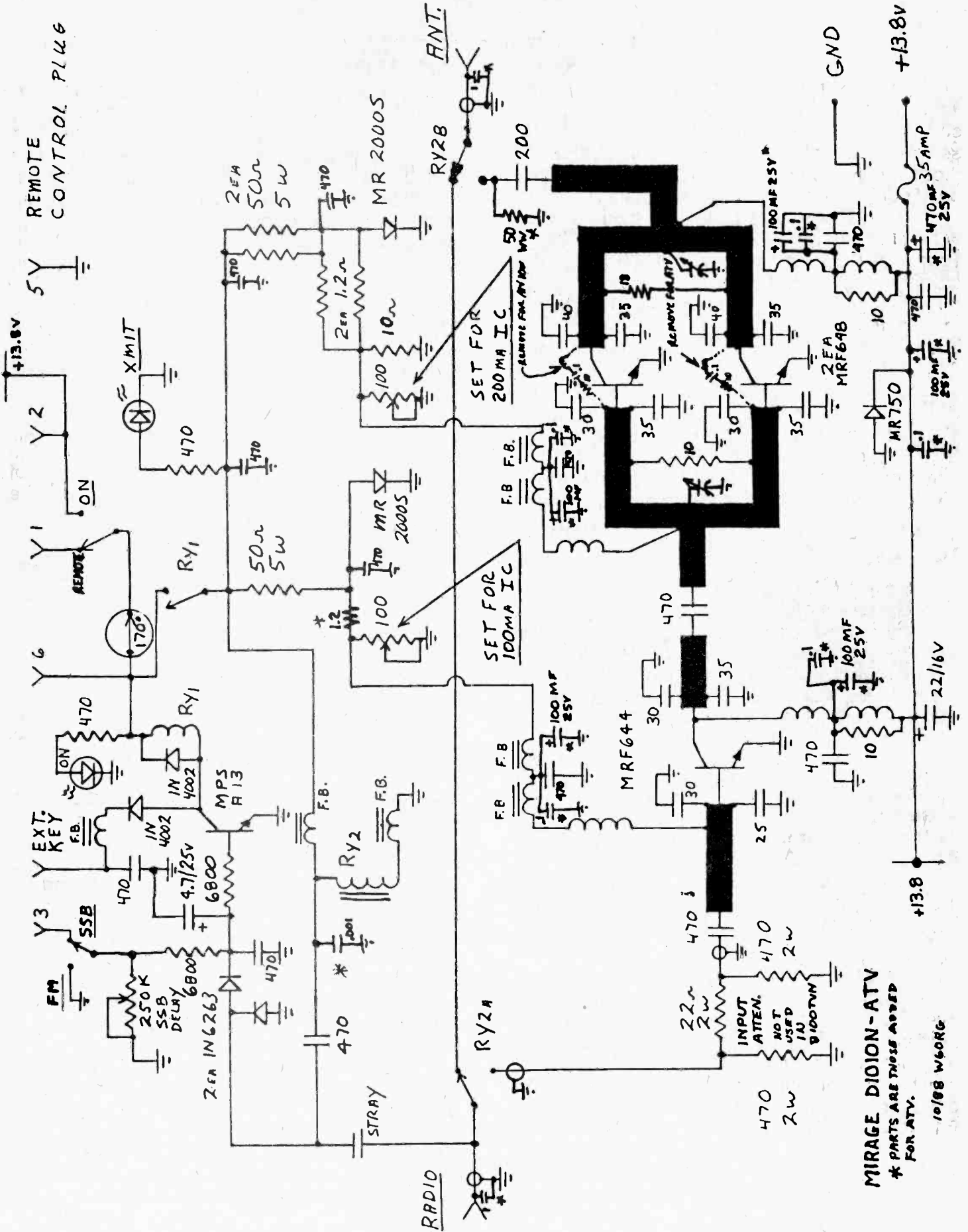

MIRAGE DIDION-ATV
 * PARTS ARE THOSE ADDED FOR ATV.

10/88 W6ORG

voltage swinging down to about 6 volts. This meant that there was a lot of circulating current through the cap and that the modulation was being loaded by the varying voltage. The scope showed that the voltage at the Astron RS-20M power supply terminals was solid. The AC waveform increased on the 13.8 Volt line as the probe got closer to the amp transistors.

The D1010N draws almost 20 Amps peak at 100 watts RF out. The voltage is developed across the resistance and inductance of the power leads, fuse, RF chokes, etc., that are in series between the power supply and RF power transistors.

While the DC resistance may seem low with the large power supply wires, but it doesn't take much to drop some voltage. Extending the power supply leads is asking for trouble. Remember that a DC resistance of only a tenth (.1) of an ohm drops the voltage at the transistors 2 Volts with 20 Amps current draw. This assumes a rock solid regulated power supply. But more significant is the inductive reactance of the leads when you figure that the video waveform has components up to 5 MHz.

Therefore the caps are added to give low impedance energy storage as close as possible to the RF power transistors. The caps I added still give an acceptable 1/2 volt peak to peak power supply variation. Since the 100 mF electrolytics have significant inductance, loss, and no longer look like a capacitor at higher frequencies, they are paralleled with .1 discs.

The 100 mF and .1 mF's are placed on the voltage supply side of the RF chokes that feed the RF transistor collectors and bases. The reason that this works with the Mirage amp and causes other manufacturers amps to go into low frequency oscillation is that Mirage uses two series RF choke networks between the transistor and common power feed point. This prevents a feedback path between the collectors of the finals and driver.

Most hams assume that the modifications for ATV are to widen the bandwidth. Transistor power amps are naturally wide bandwidth due to the low Q matching networks characteristic of the beasts. The two trimmer caps on the final transistor tune quite broadly and may only need touching up for the last watt of output if used on FM at the high end and then switched down to 426.25 MHz ATV. I added the electrolytic caps only to keep the bias and power supply voltages rock solid for AM video frequencies up to 5 MHz.

DO I RUN THE SWITCH IN FM OR SSB MODE FOR ATV WITH THE D1010N?

Actually it doesn't matter. The FM/SSB switch in most transistor amps only affects the amount of time the automatic RF T/R switching will hold in after the input RF drops out. The SSB hang time is adjustable by a pot accessible through a hole in the side of the amp. The switch has nothing to do with the linearity of the amp.

I suggest putting it in the SSB position only because in some cases of an all white picture or low drive, the RF detector may think this is too low an input and drop out or chatter the T/R relay if in the FM position. There is a pot to set the SSB hang time just behind the front panel on the RF output side.

There was some problem with D1010N's not keying on when driven at low levels and also not putting out much power. There was a period of time where a new technician at Mirage was improperly setting the transistor bias pots. The pots were set for almost zero bias current.

There is an easy way to set the two bias pots without even going inside the amp. Turn both pots to zero which is full counter clockwise. These pots are located just behind the power on-off switch. Connect an Amp meter in the +13.8 Vdc line. With no RF drive, external key the amp at it's RCA phono jack. You should read about .6 Amps. Slowly turn up the driver bias pot (the one closer to the front panel) until the current increases 100 mA. Next set the finals bias pot for an increase of 200 mA.

WHAT IS THE DUTY CYCLE OF THE D1010N ON ATV?

For longevity, I suggest not exceeding 150 degrees F at the transistor mounting screws. What eventually kills transistors is junction temperatures above 200°F and the repetitive heating and cooling of the lead bonds inside. The heatsink screws are an easy place to put a temperature probe, but there is a lot of thermal resistance between the screws and the transistor dies. The temperature may be 50 degrees higher at the transistor die.

Tests I have run on the D1010N using this criteria suggest that 5 minutes on and 5 minutes off for FM and CW type modes is safe at the full 100+ watts output. This is with the amp in the open and nothing next to it that prevents it's normal convection cooling in the nominal 72 degree home environment. However if the

"ATVQ"

internal 170 degree thermal cutout is ever activated you need to change your operating habits or it may cost you some transistors some time in the near future.

Since the average power dissipation with ATV is about 60% that of CW power, the full 100+ watt peak power transmit time is about 10 minutes. If driven by one of the 1 watt transmitters, this time is 20-25 minutes.

You can extend the time by blowing some air across the heatsink fins. Radio Shack has some 12 Vdc and 120 Vac fans that work well, however the amount of time will depend on ambient temperature and air flow. However Repeater owners and long winded types should consider the large heatsink repeater versions; Mirage D1010NR-ATV or D100TVNR.

Since most will not have a thermometer that they can connect to the transistor mounting screw, I suggest running the amp normally with the blower going until the 170 degree thermal cut out actuates one time. Note this key down time and make your absolute maximum key down time 75% of this.

WHAT KIND OF POWER CAN I EXPECT OUT OF THE D1010N-ATV WITH ONE OF THE ONE WATT 70CM ATV RIGS?

The amp gets heavy into compression around 70 watts out with 3 watts drive. You reach 100 watts out with 6 watts drive. So an increase of 3 dB of input power only increases the output little more than 1.5 dB. Below 70 watts the amplitude linearity is quite good. While the 1 watt transmitters have sync stretching to compensate for the amp gain curve, the pedestal hardly has to be touched with these rigs. Picture quality then is better when driven by the 1 watt transmitters than with the 10 watt ones.

The TC70-1 and KPA5's typically have 1.5 watts out on the sync tip. This will give about 45-55 watts out on the sync tip with the D1010N-ATV's. This is with both rigs running from a 13.8 Vdc regulated power supply into a 50 ohm dummy load.

You can get 70 watts p.e.p. out with the new D100TVN. This is just the D1010N-ATV with the input attenuator removed. Mirage put a pi resistive attenuator at the input of the D1010N driver transistor so that 10-15 watt multimode rigs could be used with the amp. This is because the MRF644 driver transistor has a maximum input power rating of 8 watts.

Nominal ATV key down time at 70 watts p.e.p. is 20 minutes.

If you are buying an amp for use with a 1 watt ATV rig or FM HT then this amp might be preferable. If you already have a D1010N then you can remove the two 470 ohm and one 22 ohm 2 watt carbon resistors, and run a short piece of RG174 50 ohm coax from the RF input stripline to the T/R relay side of the attenuator network. This replaces the small coax from the stripline input to the opposite side of the pi attenuator. The coax must be dressed and soldered to ground exactly like the original coax.

Remember that if you do make this change yourself you have voided the warranty and that maximum power input cannot exceed 8 watts or you can blow the MRF644.

IS THERE SOME WAY TO REDUCE RECEIVE INSERTION LOSS?

Yes, you can put 1 pF disc caps with short leads from the center pin of the input and output chassis N connectors to ground. Connect the cap within 1/8" of the flange surface on the center pin, and direct to the solder lug as close as possible to the mounting screw. This tunes out the small mismatch caused by the long shield pig-tail of the coax and solder lug at the connector.

This addition gave a little better than 1 dB improvement in insertion loss during receive, lower input VSWR and a few extra watts RF power output. Total insertion loss after modification was 1.6 dB. Most of the receive insertion loss in power amps is from the impedance bumps in the T/R relay.

1.6 dB will hardly be noticed on received ATV pictures, but the best way to eliminate it plus the feedline loss is an antenna mounted preamp. The preamp must have good T/R switching and protection to handle the high power. The Advanced Receiver Research, Henry Radio, and others now have inline RF switched preamps, but make sure you ask for the ones that will take up to 100 watts.

I DONT HAVE A BIRD WATTMETER OR 100E SLUG. HOW CAN I SET THE BLANKING PEDISTAL?

Buying a good quality RF wattmeter and slugs represents quite an investment for once in a while use. Blanking pedestal set-up must be done to compensate for the differences between

“Devoted to Amateur Television”

transmitter output, amplifier gains, power supply voltage, coax loss, etc. that vary from unit to unit. If there are no close by hams that have a wattmeter, and could come by for this one time set up, it is difficult to know if your amp is set up right.

A rough approximation however can be done with any RF power meter or field strength meter that accurately reads out in voltage or current. You could also use the amp meter on your regulated power supply or one that can be put in the + lead temporarily.

The set up would be the same as if you had the proper watt meter. That is, with no video connected to your transmitter, find and adjust the blanking pedestal pot in the modulator for maximum indication or amplifier current. Then back it down to 75% of that maximum value in the case of an RF output device, or 80% with the power supply Amp meter.

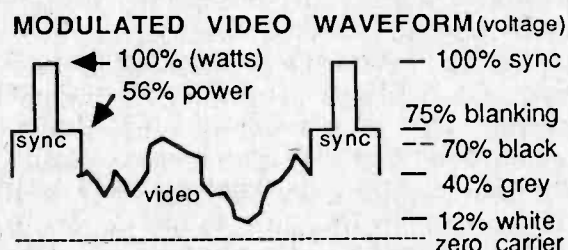

You may ask why 80% and not 75% as would be done by measuring the RF voltage? This is because some of the current you are measuring goes to the T/R relay, transistor bias, and other circuits.

This is not very accurate, but is a starting point to get you on the air. You may try getting on the air with a transmitter that does not drive the amp to full output without doing anything because the peak power will probably still be in the linear portion of the amps input vs. output gain curve. The set up is more important when the amp is driven into saturation by the sync pulse. Never detune an RF stage to match an amps input power range, use a RF attenuator.

WHY DO I GET SO MUCH MORE SYNC BUZZ IN THE AUDIO WITH THE POWER AMPLIFIER IN LINE?

The simple and inexpensive way we mix sound subcarrier with the video in the modulator can be degraded in the not-so-linear amateur linear amps. Also, since the sound piggy-backs on the video waveform, it can be cut off during white peaks as well as sync tips. The resulting

non-linearity and or clipping of the sound subcarrier gives a buzz in the audio depending on your TV receiver's AM rejection in the sound IF limiter.

Note the video modulated waveform figure. If you mix in sound that has an amplitude of about 20% of the peak to peak amplitude of the video, you can see that at the 12% white level the added sound will swing +/- 10%. If your video gain is set too high where the white peaks are greater than 10%, then the audio will swing down to nudge zero carrier. Since the carrier is cut off repeatedly every pass of the horizontal sweep, you get the buzz in the receiver.

In like manner, if the sync tip is stretched into full compression of the amp, then there is no "head-room", as the audio people call it, for the sound subcarrier to add above it. This is why 1 watt transmitters generally have better audio than 10 watt transmitters when driving the D1010N-ATV. Ideally for the 10 watt transmitters, it would be nice, but difficult for most ATVer's to set up, to have a maximum sync tip adjustment to set the sync tip power output to around 80 watts to allow head-room to 100 watts for the sound subcarrier swing.

Those with 1 watt transmitters driving newer D24N's with their higher gain may also experience audio buzz from sync tips driving the amp into compression.

So watch the video gain for white level clipping, and drive the amps within their linear range if possible, otherwise a little sync buzz in the audio has to be accepted.

One other possibility is the higher power being radiated is getting into the microphone and being detected. Electret mics especially can act as good AM detectors. The cure is to put a 220 pF disc cap directly across the mic element.

WHY DOES THE AUDIO DIE OUT ABOUT THE SAME TIME THAT COLOR DOES OR ABOUT P2-3? BROADCAST TV DOESN'T!

The 4.5 MHz sound subcarrier is mixed with the video about -18 dB below the video carrier in most ATV rigs. This is a very simple and inexpensive way to do it, and is about the same level that TV translators do. They are limited by the FCC to -15 dBc. Broadcast transmitters use separate sound transmitters at -7 to -10 dBc and either use a separate antenna or diplexer.

"ATVQ"

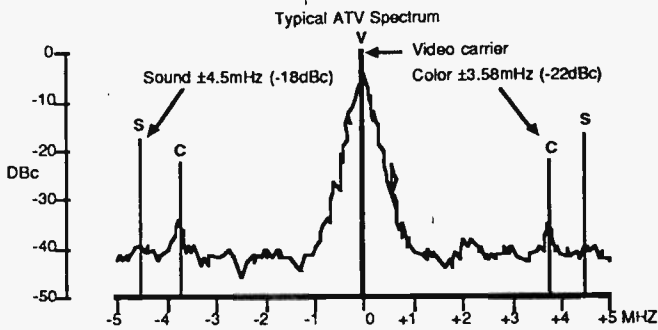

If you try to inject the sound at a higher level, you run into the old head-room-sync buzz problem, as well as intermod. Intermod shows up as cross-hatch in the color video depending on color and sound subcarrier levels and frequency. Professional TV people call this triple beat. The difference between the color and sound subcarrier frequencies mixes with the carrier resulting in about a 921 KHz interference signal in the video.

Therefore the higher the sound subcarrier and the greater the non-linearity of the amp(s) the greater the cross-hatch interference. If the sound and color frequencies are right on within 2 KHz most of it will cancel and the 921 KHz triple beat not show up until it is about -30 dBc.

A separate sound transmitter would be great since it's amplitude would not vary with the video modulation. Most suggest simply crystalizing up an existing FM communications transmitter to another antenna. The difference is that ATV runs 25 KHz deviation, peaking to 40 KHz, with 75 microsecond pre-emphasis, and communications transmitters run 5 KHz deviation and 750 microsecond pre-emphasis. The result would be very low level audio with lots of treble. You might be able to crank the deviation up some and reduce the cap in the pre-emphasis circuit a factor of 10, and have the receiving stations turn up their TV sets volume.

The other problem with a separate sound transmitter is setting the difference frequency to within 2 KHz of 4.5 MHz. You will need a frequency counter to first check the video carrier with no video connected, then readjust the FM transmitter frequency to 4500 KHz above the video carrier.

The radiated power leaving the antennas should be no more than -7 dB sound carrier below the video carrier. So you will have to calculate the effective radiated power of each system. The antennas should also have some

isolation to prevent transmitter final generated intermods.

WHY IS IT THAT WHEN I RUN A PROFESSIONAL VESTIGIAL SIDEBAND TV GENERATOR THROUGH A N AMATEUR LINEAR AMP OR EVEN HOMBREW BIASED UP RF AMPS, I GET DOUBLE SIDEBAND AND ALL THE OTHER MINOR LIMITATIONS I GET WITH MY CONVENTIONAL ATV RIG?

This subject could take up many, many pages and is most asked by those coming from weak signal work who are used to transverters driven by multimode or SSB rigs, or those with professional test equipment. SSB voice distortion from intermod is much more forgiving to the listener interested in DX than IM in a video picture. It is not difficult to generate very linear AM signals and amplify them at power levels up to around 10 milliwatts. But above this level is another ball game.

Channel 3 RF video modulators output between -30 to -40 dBm (\emptyset dBm = 1 milliwatt in 50 ohms). The good SAW VSB filters used in the better ones don't like more than -10 dBm at their inputs and they themselves have around 26 dB of insertion loss. So to get to 100 watts (+50 dBm) of power you need to go through about 80 dB of amplification and a good mixer.

There are double-balanced mixers plus lots of small signal RF transistors and MMIC's available that will maintain the VSB and add very little intermod products to about +10 dBm (10 mW). There are even some good linear devices made for cable amps that have the triple beat specified better than -55 dBc up to almost a watt, but now you are starting to talk dollars, 24 V and high current from true class A linear devices.

Biasing communications transistors made for FM to class B does not automatically make a transistor linear when it comes to large signal devices. You have to look at the power input to output curves on their data sheet to see if the amplitude non-linearity is acceptable. What you won't see is the reactive change between transistor elements at different drive levels. Those of you who grew up with tubes will remember this as the Miller effect.

It is usually the capacitive reactance variation that causes the intermod. If a transistor is not designed to minimize IM for use in a linear AM system then, the IM products will show up as

“Devoted to Amateur Television”

if the lower sideband was reinserted. The reactive change with drive level gets more pronounced as frequency and power goes up.

Most of the devices used in UHF amateur power amplifiers are made for class B-C. Efficiencies are around 30-40%. A good true linear class A amp is going to have efficiencies around 10-20%. Per stage gain is going to be less, and most of these devices are made for 24 Volts. Therefore heatsink size and total cost is going to be at least 5 times more to maintain the vestigial sideband and triple beat close to that coming out of the driver.

As a practical matter, VSB transmission is only a necessity for the repeater transmitter to minimize IM products and noise from getting into it's own receiver or others on the same hill top, or those who are giving interference to other mode users in the same neighborhood.

A repeater will still need a good quality VSB filter on the antenna line even if the amp output preserves the VSB because the broadband noise from the last amplifier is strong enough to desense or interfere with other receivers in the band close by. Also a filter must be used to keep other transmitters picked up on the transmit antenna from mixing in the amp.

CAN'T I GET MORE POWER OUT USING VSB JUST LIKE VOICE DID GOING FROM AM TO SSB? AND WON'T THAT GIVE US MORE ATV CHANNELS?

Note the typical ATV spectrum figure. The Vestigial LSB only cuts off about 5% of the total power. Unlike SSB, the amount of power it cuts off is insignificant as far as making available more power in the desired signal. Most of the power in an ATV signal is in the first MHz. The levels are low and random, depending on what is in the picture, until the color subcarrier.

Vestigial sideband, carrier + full USB to 4.75 MHz + 1.25 MHz of the LSB, is a requirement of broadcast transmitters to enable use of another station on the adjacent TV channel (6 MHz per channel) at least 55 miles away. In any given area every other channel is assigned. Channel 4 and 5 is an exception with a 4 MHz hole between them.

So there is still only room for 2 channels in the 70cm band in the same area separated ideally by 12 MHz for least chance of interference VSB or not. Cable TV can stack every channel because they equalize all signals to the same level and use sharp filters. Over the

air transmitted signals, of course, will have all different levels where a weak signal on one channel would be wiped out by a strong adjacent.

WHAT ABOUT INTERFERENCE FROM ATV TO OTHER MODE USERS IN THE 70CM BAND?

So as far as interfering with other modes, the probability is low outside of the first MHz of the video carrier and +/- 200 KHz outside of the color and sound subcarriers.

We had to prove 434.0 MHz for ATV back in the early 70's to the 435 MHz Satellite, 432 weak signal, and below 431 MHz FM link and control people in Southern California when we came up with a workable 70 cm bandplan. The rapid growth of 440-450 MHz FM repeaters here, beginning in the late 60's, necessitated the frequency change.

The only interference noted during the tests was to a weak signal DXer who was about 2 miles away. Close by strong signal overload or IM can happen on any band or mode depending on signal level and distance. So the solution to this problem was to coordinate 2 meter simplex calling frequencies for each mode.

Each mode user upon receiving interference can simply come up on the appropriate 2 meter coordination frequency and work out the individual problem. Usually ATVer's will stay off during a UHF DX contest or satellite pass, and the others will do likewise if we have a public service event, net, etc. The band plan here in the highest communications density area of the country has worked out for over 15 years through the sound technical know how and cooperation among all the different interests of the amateur community.

The frequency coordination committee has a technical committee made up of a few of the best technically qualified people from each of the different modes. Band plans are then determined on a technical basis to best fit everybody in rather than by the loudest person or largest group.

Send those cards and letters in with both your questions and comments. From talking to many of you on the phone everyday I know there is a wide range of interests, applications, and technical problems and solutions in different parts of the country. 73, Tom, W6ORG

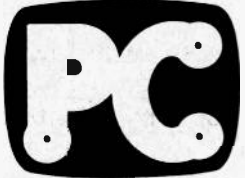

PC ELECTRONICS

P.C. ELECTRONICS 2522 PAXSON LANE ARCADIA CA 91006-8537 USA
TOM (W6ORG) & MARYANN (WB6YSS) O'HARA (818) 447-4565



\$299*

Designed and built in the USA
Value plus quality from over 25 years in ATV

TC70-1 TRANSCEIVER

AMATEUR TELEVISION



SMILE YOU'RE ON TV!

WITH OUR TC70-1 ALL-IN-ONE BOX ATV TRANSCEIVER, YOU TOO CAN EASILY TRANSMIT LIVE ACTION COLOR VIDEO & SOUND JUST LIKE BROADCAST TV TO OTHER AMATEURS, SO SMILE FOR THE CAMERA!

TC70-1 SPECIAL FEATURES:

- * Sensitive UHF GaAsfet tuneable 420-450 MHz downconverter
- * Two frequency >1 watt p.e.p. transmitter. 1 crystal included
- * Crystal locked 4.5 MHz broadcast standard sound subcarrier
- * 10 pin VHS color camera and RCA phono jack video inputs
- * PTL (push to look-same as push to talk for video) T/R switching
- * Transmit video monitor outputs to camera and phono jack
- * Small attractive shielded cabinet - 7 x 7 x 2.5"
- * Requires 13.8 Vdc @ 500 ma. + color camera current

Just plug in your camera, VCR, camcorder, etc. composite video and audio (10 pin jack on front or phono jacks on back), 70cm antenna, 12 to 14 Vdc, and you are ready to transmit live action color or black and white pictures and sound to other amateurs. Sensitive downconverter tunes the whole 420-450 MHz band down to input to your TV set on channel 3. Specify 439.25, 434.0, or 426.25 MHz transmit frequency. Extra transmit crystal add \$15.

*Transmitting equipment sold only to licensed radio amateurs verified in the Callbook for legal purposes. If newly licensed or upgraded, send copy of license. Receiving downconv. available to all starting @ \$49 (TVC-2G).

WHAT ELSE DOES IT TAKE TO GET ON ATV?

Any Tech class or higher amateur can get on 70cm, novices now on 23cm ATV. Any video camera, camcorder, VCR or computer with a composite video output can be plugged into the front panel 10 pin VHS jack or rear panel phono jacks for both audio & video.

DX with TC70-1s and KLM 440-27 antennas line of sight and snow free is about 22 miles, 7 miles with the 440-6X normally used for portable uses like parades, races, search & rescue, damage assessment, etc. For greater DX or punching thru obstacles add either the ATV compatible 15 or 50 watt amplifiers listed below.

The TC70-1 has full bandwidth for color & sound, like broadcast. You can show the shack, home video tapes, computer programs, repeat SSTV, weather radar, or even Space Shuttle video if you have a home satellite receiver. See the ARRL Handbook chapt. 20 & 7 for more info & Repeater Directory for local ATV repeaters.

PURCHASE AN AMP WITH THE TC70-1 & SAVE!
50 WATT WITH D24N-ATV.....\$499
70 WATT WITH D100ATVN.....\$599

COMPLETE 70CM ATV STATION

10/88



YOUR TV SET

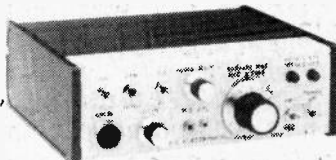

TC70-1...\$299
ATV Transceiver
>1 WATT P.E.P.

13.8Vdc
Pwr. Sup.



Mirage D15N.....\$149
(optional) 15 watts RF out.
RF Concepts RF4-32..\$155
(opt) typ 15W pep, GaAsfet preamp.
Mirage D24N.....\$209
(optional) 50 watts RF out

KLM 440-27 14dBd \$107
KLM 440-10X 11dBd \$65
KLM 440-6X 8.9dBd \$51

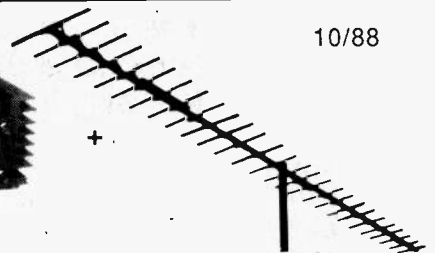

YOUR HOME TV CAMERA

*All prices include UPS surface shipping in cont. USA

NEW D100ATVN....\$309
(opt.) 70 watts RF out.



P.C. ELECTRONICS 2522 PAXSON LANE ARCADIA CA 91006-8537 USA
 TOM (W6ORG) & MARYANN (WB6YSS) O'HARA (818) 447-4565

READY TO GO ATV STATION



THIS IS THE QUICKEST AND EASIEST WAY TO GET ON ATV AND ENJOY THE FUN!

Connect up your TV set tuned to ch 2,3 or 4 to the TC70-1 TV output for receiving, plug in your camera, VCR, or computer video and audio for transmitting. With 1 watt and KLM 440-27 antennas (assumes 3 db coax loss) at each end the snow free line of sight DX is 22 miles. The smaller 440-6X at one end, usually for portable work, gives half (6db less gain) the distance. For greater DX or non line of sight conditions (usually over 15 miles) add the Mirage 50 watt amp for up to 154 miles. The TC70-1 and camera can be run off a Radio Shack 22-124 power supply or all units from a regulated 13.8vdc 12 amp power supply.

OR BUILD YOUR OWN CUSTOM ATV STATION:

PORTABLE

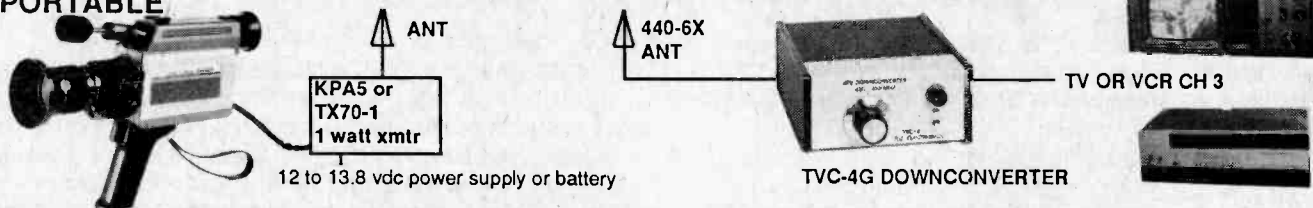

Run portable ATV like you would a HT, but when back at the base station or mobile, you could plug it into the 50 watt amp for greater DX. Truly the most versatile for cordless home video taping, public service work, or general ATV contacts. Snow free portable line of sight DX with a ground plane on the KPA5 and an Isopole omni at the receive end is 2.5 miles, 11 with a 440-6X antenna. Connect the output of a TC70-1, TVC-4G, or TVCX-70 downconverter to your TV set or VCR tuned to channel 2, 3 or 4, which ever is open in your area, to receive. It's easy!

10 WATT BASIC MODULE TRANSCIVER

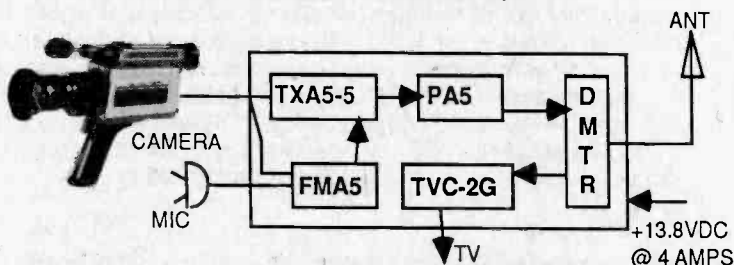

1 WATT TRANSCIVER

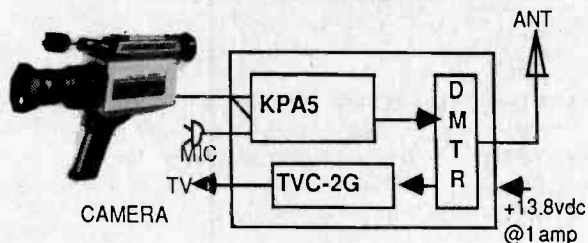

Build your own ATV transceiver using the standard 10 watt set of modules as described in ch 20 of the 1987 ARRL Handbook, and if higher power is desired, add the 100 watt Mirage D1010N-ATV. A small 1 watt transceiver can also be built up and amplifiers added to run 50 watts. For more info on video see chapt 7 in the 1987 ARRL Handbook.

To find out the ATV frequencies in your area check the ARRL Repeater Directory, or call us to find out who else might be on. Many use a 2 meter FM simplex calling frequency to not only initiate the ATV contacts but to enable all receiving stations to talk back in full duplex to the video transmitting station who is talking on the sound subcarrier. 144.34, 144.91 & 146.43 are the most popular, check to see what is used in your area. With an omni on 2 meters you should be able to get any ATVers within range that would take beams on 70cm. The 2 meter channel makes ATV interactive with more stations, easier to tell if there is activity, better for talking in beam headings, fine adjustments to video level, camera angle and focus, and other technical information. You will find that putting most of your time and money into a good antenna system will pay off the most. Since trees and other foliage attenuate 70cm RF greatly, the antenna must be up as high as possible. The RF horizon for a 50ft tower is only 10 miles. Use good 50Ω tight braid coax, weather proof and take great care in putting together the connectors.

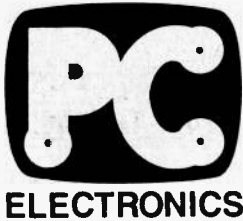

P.C. ELECTRONICS 2522 PAXSON LANE ARCADIA CA 91006-8537 USA
 TOM (W6ORG) & MARYANN (WB6YSS) O'HARA (818) 447-4565

THE "KREEPIE PEEPIE" ATV TRANSMITTER

1. 1.5 watts typical output on sync tip (@13.8 vdc) matches 15 & 50 watt amps for full linear output.
2. Now you can see your own transmitted video with the on-board RF detector/monitor 1 v output.
3. Final RF output test point for setting up blanking pedestal with a DC voltmeter.
4. Improved lower distortion subcarrier sound generator for cleaner audio and 4.5 mHz stability.
5. All this at no increase in price! Single freq. KPA5-c board still \$159 delivered*. Two freq. \$174.

TX70-1 READY TO GO ATV TRANSMITTER contains the KPA5-d & TR-10 T/R relay in a small 6x5.2x2.5" shielded cabinet. Same xmit functions as the TC70-1 including both the 10 pin "VHS" camera & RCA phono jack video/audio inputs. If you are one of those who started with just a downconverter, saw some pictures and was bitten by the ATV bug, then this ATV transmitter is for you - just connect its input to the downconverter BNC connector on the back of the TX70-1. \$239

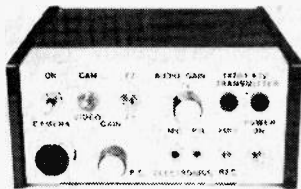

TX70-1 \$239 DELIVERED

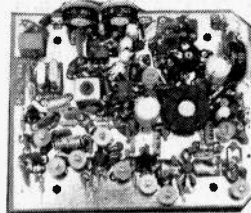

KPA5-d board still only \$159

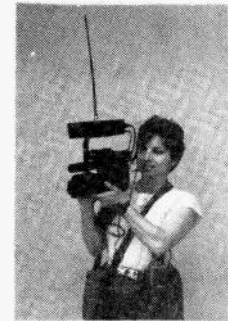

KPA5. 70CM ATV XMTR BOARD FEATURES:

- >1 WATT P.E.P. RF OUTPUT ON SYNC TIP. Run barefoot for portable. Output properly matches Mirage D15N, RFC4-32 15 watt or D24N-ATV 50 watt linear amp for full output and the Mirage D1010N-ATV to over 50 watts
- FULL COLOR AND SOUND on a small 3.25x4" board
- Wired and tested board runs on external 13.8vdc @ 300ma. supply or 12 V battery
- Accepts composite video from cameras, camcorders, VCRs, computers, etc.
- 2 audio inputs, one for low Z dynamic mic, & one line level from most cameras & VCRs
- Supplied with one xtal on 426.25, 434.0, or 439.25. 2nd xtal add \$15. Specify freq. when ordering, check with local ATVers, ARRL Repeater Directory or call us. Only 2 channels available in any given area due to video bandwidth of 9.1 mHz.
- * Price still \$159 delivered via UPS surface in contiguous USA. Transmitters sold only to licensed Technician class or higher amateurs for legal purposes. We verify name, call letters, & QTH in the Callbook. If recently licensed or upgraded send a copy with order.

KPA5 APPLICATIONS:

- **PORTABLE CORDLESS TV CAMERA.** Think of it as a video HT. Place the KPA5 in one of the Hammond Dicast aluminum boxes, AEA HR-4 half wave "hot rod" on top or at the end of 50Ω coax attached to a headset. Plug into a 12-14 v source such as the Radio Shack 12v 5Ah battery power pack (23-182). Depending on terrain & receiving antenna DX is typically over 1 mile. With KLM 440-27s at both ends DX is 22 miles snow-free line-of-sight.
- Transmit the video to a remote VCR rather than lug it.
- Great for public service events: marathons, parades, damage assessment, search & rescue, CAP, etc.
- Mount in a R/C airplane, rocket, balloon, or robot to enable remote control when the vehicle is out of sight.
- Put it in your own cabinet for base, portable or mobile. When more power is needed, connect to one of the Mirage or RF Concepts amps listed below.
- Put a KPA5 in a dicast box with a VOR (video operated relay) to make a hill-top video repeater. Repeat other ATVers, weather radar or Space Shuttle video.

WHAT IS REQUIRED FOR A COMPLETE OPERATING SYSTEM? A TVC-2G, TVC-4G or TVCX-70 downconverter connected to any TV set or VCR tuner tuned to an open channel of 2, 3 or 4, and coax cable to a good 70cm antenna to receive. Connect up the TX70-1 or package up the KPA5, add 12 to 14 vdc, antenna, and any home video camera, camcorder, VCR, or computer with composite video output and you are on the air. IT'S THAT EASY!

ACCESSORIES:

- TVC-2G GaAsfet downconv. board wired & tested....\$49 varicap tuned, 420-450 MHz to ch3. Req 12vdc
- TVC-4G (TVC-2G in cabinet with 120vac supply)....\$89
- TVCX-70 crystal controlled GaAsfet downconv.....\$99 specify in freq. & out on ch 3 or 45mhz IF. 2 freq.....\$114
- Hammond 1590D Use for KPA5. 7.3x4.7x2".....\$17
- 1590C 4.6x3.6x2" aluminum box. Fits TVCX-70.....\$11
- 800J 10 pin VHS color camera chassis connector.....\$10
- VOR Video (horiz sync) operated relay board.....\$25

- MIRAGE D15N-ATV 1in /15 out all mode amp.....\$149
- RF CONCEPTS rfc4-32 15w + GaAsfet preamp.\$155
- MIRAGE D24N-ATV1in / 50 out all mode amp....\$209
- AEA HR-4 "Hot Rod" half-wave portable antenna.....\$21
- 450 ISOPOLE omni 4dDd vert. gain antenna.....\$65
- KLM 440-6X 8.9dDd ant., 28" boom, >50 deg BW....\$51
- KLM 440-10X 11.2dDd, antenna, 64" boom.....\$65
- KLM 440-27 14dDd, 36 deg. BW antenna.....\$107
- UG21 type N male connector for larger ID coax.....\$5

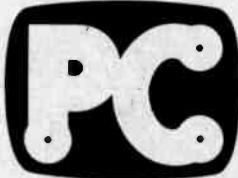

ELECTRONICS

33cm (902-928 MHz) ATV SYSTEMS

Get on the new band with these modules, snow-free line-of-sight DX is 10 miles running 1 watt 23 element beams and our GaAsfet downconverters. Use for full duplex ATV with your 70 or 23 cm system, crossband repeater, links, or get away from the crowd and interference. We have or can direct you to everything you need for ATV on this new band.



TXA5-33 1 WATT ATV TRANSMITTER BOARD.....\$139
 Over 1 watt p.e.p. on sync tip. Sync stretcher. RF/video demod of output built-in to drive a video monitor. Requires FMA5 or FMA5-E for sound subcarrier & 13.8Vdc @ 500mA. 3"x5" wired and tested board on your specified frequency of 910.25 or 911.25 MHz (simplex) and 923.25 MHz (repeater output). For 20 watts output, the TXA5-33 matches the Downeast Microwave amp (call them at [207] 948-3741). TR-23 module gives low loss T/R antenna switching between TXA5-33 & TVC-9. \$29

TVC-9 33CM DOWNCONVERTER BOARD (902-928 MHZ TO CH3).....\$59
 Hot dualgate GaAsfet in preamp & mixer. 25dB gain. 2"x4" wired & tested board. Varicap tuned. Place in your own shielded enclosure with frequency control pot/knob, RF connectors 12Vdc power for use in the shack. For antenna mounting to save feed line loss, mount in a 1590C box (\$11) with the DCD (\$8) dc decoupler board to power and tune thru a single 75Ω coax from the DCB (\$59) control box in the shack.

TVC-9G Our TVC-9 in 4x2.5x7 shielded cabinet with 120Vac to 12Vdc ps.....\$99

TVCX-33 xtal controlled board. Specify input freq. & ch.3 or 45.75 mH IF out\$109

TONNA 20923 33CM YAGI ANTENNA 23 ELEMENT 16.3 dBd.....\$67
 8.3ft boom. 50-ohm type N male cable.

23cm (1240-1300 MHz) ATV SYSTEMS

There are 5 ATV channels on this band starting at 1241.25 with 12 MHz spacing, 3 for repeaters, and 2 simplex. Novices can now run ATV simplex on 1289.25 MHz. Run simultaneous audio and video with another ATVer on 70 or 33cm. Have multiple camera sites on the air at the same time for public service events. Crossband repeaters allow users to see their own video coming back and also frees up the other 70cm channel for simplex. See in-band ATV repeater block diagram on last page. Substitute RTX-23 or RTX-33 transmitter and amp for KPA5 and D24 amp transmitter for crossband operation.



NEW TX23-1 ONE WATT 23CM ATV TRANSMITTER.....\$299
 Ready to go transmitter crystalized for 1289.25 MHz (others special order-see ARRL bandplan). Plug in any camera, camcorder, VCR, etc. with a composite video output into the front panel VHS 10 pin or rear panel phono jacks. Transmit video monitor output. Jacks for low Z mic and line level audio. Push to talk (same as push to talk - but with video added) T/R and antenna switching, plug in antenna 50Ω coax from TVC-12G downconverter in back. Requires 13.8Vdc reg. @ .5A. Matches Downeast Microwave (call Bill at 207 948-3741) 18 watt amp. Novices and recent upgrades send copy of license if not in Callbook.

NEW RTX-23 Repeater/link version in a Hammond 1590D diecast aluminum box . \$299

TVC-12G GaAsfet 23CM DOWNCONVERTER.....\$109
 Sensitive dual gate GaAsfet used in preamp & mixer stages. Tunes whole 1240-1300 MHz band to TV CH 7 or 8. Shielded 4x2.5x7 cabinet. 120Vac to 12Vdc wall plug incl.

TVC-12GA ANTENNA MOUNTED GaAsfet 23CM DOWNCONV.....\$109
 Diecast aluminum boxed version of the TVC-12G, mounts at antenna to save feedline losses. Powered & tuned with 10-18Vdc thru output 75Ω coax from DCB at shack. DCB Control Box, also contains IF amp for driving both TV & VCR tuner.....\$59

TXTV ATV EXCITER/MODULATOR for TRANSVERTERS.....\$89
 Designed for most 2 meter in/ 23cm out transverters. 100 mw drive at 2 meters. Specify if your transverter is set up for 1296 or 1269 so we may xtal for 1289.25 or 1265 MHz ATV. Use FMA5 or FMA5-E for sound. 13.8Vdc @ 70mA. 5.4"x2.8".

TONNA 20624 23CM YAGI ANTENNA 23 ELEMENT 16.3 dBd.....\$67
 5' 10" boom. 50 ohm type N male cable.

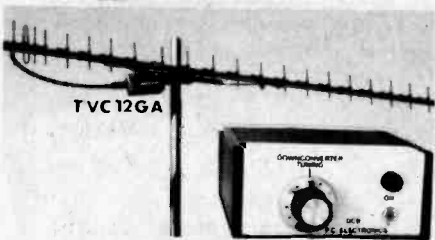

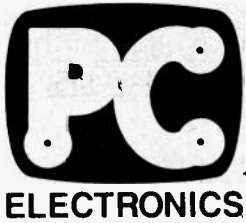

P.C. ELECTRONICS 2522 PAXSON LANE ARCADIA CA 91006-8537 USA
 TOM (W6ORG) & MARYANN (WB6YSS) O'HARA (818) 447-4565

420-450MHZ ATV DOWNCONVERTERS

GET STARTED WITH ONE OF THESE TO SEE THE ACTION!



TVC-2G 2"x4"

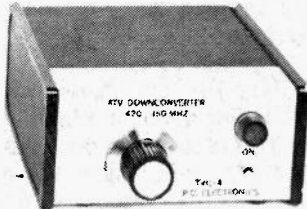

TVCX-70 3"x3.8"

TVC-2G GaAsFET TUNEABLE DOWNCONV. BOARD.....\$49
 Wired and tested module connects between 70cm antenna and TV set tuned to channel 2, 3, or 4. Varicap tunes whole 420-450 MHz 70CM amateur band. Most sensitive dual gate GaAsfet used in both the preamp and mixer stages. Double tuned bandpass filter rejects strong UHF broadcast interference. 25dB gain. requires +11 to 18Vdc.

TVC-4G PACKAGED DOWNCONV. with AC supply.....\$89
 Contains the sensitive TVC-2G board in a shielded 4x2.5x7 cabinet ready to go with 120Vdc 60Hz to 12Vdc wall plug. BNC antenna input and F output to TV. Handy for ATV portable, mobile, demos, or getting a friend on. Also used in community TV systems outside USA.

DCB DOWNCONVERTER REMOTE CONTROL BOX.....\$59
 Provides variable 10 to 18Vdc up to 200 ma power up thru coax for antenna mounting downconverter boards (TVC-2G, TVC-9, & TVC-12GA). Use DCD module (\$8) with 70 or 33cm downconverter boards in a weatherproof box at the antenna for highest sensitivity. Also contains 15 db gain line amp in the shielded 5x2.5x7 cabinet.

TVCX-70 XTAL CONTROLLED GaAsFET DOWNCONV....\$99
 Crystal controlled version of TVC-2G board used in repeaters or unattended operation with wide temperature variations. Specify input (421 to 440 mHz) and output (ch3 or IF). 12Vdc. Mount in Hammond 1590C (\$11) diecast aluminum box. 2 frequency add \$15.

*ATTENTION CLUBS, GROUPS, & EXPORTERS: THESE QUANTITY DISCOUNTS ON THE ABOVE LISTED DOWNCONVERTERS APPLY; 5-25 10%, 25-49 15%, 50-99 20%, & 100 UP 25%. (All shipped to one address).

KLM BROADBAND ANTENNAS FOR ATV

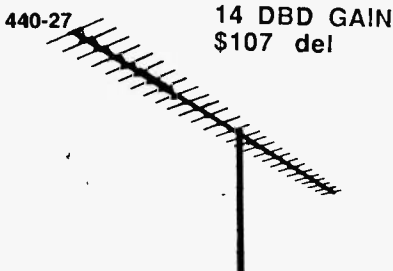

14 DBD GAIN
\$107 del

KLM 440-10X NEW 11.2DBD, 64" boom.
 Rear H or V mount on 1.5" dia mast.\$65del

440-6x

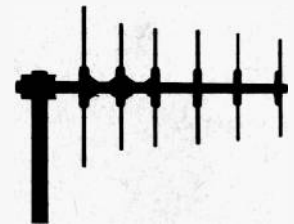

ATV antennas must have broad bandwidth in addition to high gain and low VSWR. Few other antennas work well at both 439 and 421 mHz. The three KLM antennas listed here fit the requirement and have a long history of rugged operation with ATVers. The gains listed have been proven out at VHF/UHF conference antenna measuring contests, they are not marketing hype.

All KLM antennas listed here take up to the maximum legal power limit. Balun or matching network with female type N connector included. Price includes UPS surface shipping anywhere in the contiguous USA.

NEW MODEL more gain, less cost
440-6X...\$51 delivered
 8.9dBb, 28"boom, H or V rear mount

BANDWIDTH:..... 420-450 MHz	BOOM LENGTH:.....12ft
GAIN:.....14.5 dBd	VSWR:.....1.2:1
BEAMWIDTH:......36	FEED IMP:.....50 ohm unbal
WT.(LBS):......75	BALUN:.....1.1.2KW
MOUNT MAST DIA.: .Center 1/2"	INCLUDED

AEA 450 ISOPOLE OMNI 4 dBd GAIN ANTENNA. 50 ohm type N female feedpoint. DC grounded...\$65del
 High efficiency, decoupling cones puts all the RF on the horizon where it counts. Mounts on 1 1/4" dia masts.
 Works great for local ATV or FM simplex roundtables, portable/ public service/ Kreepie Peepie system, & repeaters.

del=delivered via UPS surface shipping in cont. USA.

June 88.

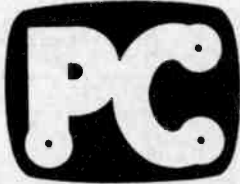

BUILD YOUR OWN 10 WATT ATV STATION

The Basic 10 watt system 3 Transmitting modules (buy all 3 save \$8).....\$199

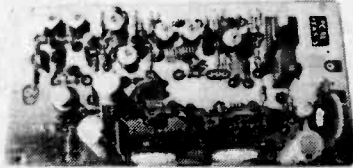

TXA5-5 5.4"x2.8"

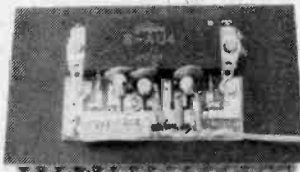

PA5 4.5"x2.8"



FMA5 4"x1.5"

1. TXA5-5 ATV EXCITER/MODULATOR.....\$89

Wired and tested module provides 50-80 mw to drive the PA5 10 watt power amp. High/low power switch for normal 10 watts with PA5, or 100 watts with the addition of a Mirage D1010N-ATV. Accepts standard 1 volt composite video from color camera, VCR, computer, etc. Wideband modulator gives excellent color and high resolution. Built-in sync expander. Draws 70 mA at 13.8 Vdc. One crystal included, but provision for 2. Extra crystal \$15. We stock 439.25, 434.0, & 426.25 MHz, other 70 cm freq. may take 3 weeks to special order xtal. See chapter 20 in ARRL Handbook.

2. PA5 10 WATT P.E.P. ATV POWER MODULE.....\$89

NEW. An all mode Toshiba S-AU4 is mounted on a heatsink with a stripline PC board to output over 10 watts p.e.p. when driven by 80mW from the TXA5. 50 ohms in & out. Broadband, 420-450 MHz, linear, no tuning. 250mW max input. req. 13.8Vdc reg. @ 3 amps.

3. FMA5 AUDIO SUBCARRIER GENERATOR.....\$29

Transmits broadcast standard sound with your picture. Accepts a Low Z mic (100-600 ohms), also line level audio from VCRs, camera mics, computers, etc. Up to 1 v pk-pk drive to the TXA5 & TTXV exciter modulators. Works with any transmitter having 5 MHz modulation bandwidth. Draws 20 ma from 13.8 Vdc supply.

NEW FMA5-E temperature stable version with adj. deviation..\$39

See chapters 20 & 7 in the *ARRL Handbook* and pg 2 of our catalog for more info and system diagram. Mount the boards & parts for the 10 watt basic module transceiver in an aluminum chassis for shielding and heat sinking. Use the DMTR module to switch 50Ω 70cm antenna between PA5 amp & downconverter. Schematic & layout comes with each module.

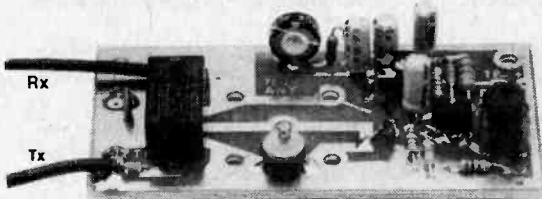

DMTR

DMTR T/R RELAY, DETECTOR & MONITOR.....\$35

T/R switching up to 15 watt 70cm ATV systems. Negligible insertion loss, 60dB isolation. Mounts on flange type N or SO-239 chassis jack. Peak detector relative RF meter output. Video monitor output same as older DM-1 but has sound trap. 3.5x2". 13.8Vdc @ 80 ma.

TR-10 70cm or TR-23 - 23 & 33cm T/R RELAY.....\$29

T/R switching up to 15 watt 70cm xmtrs with TR-10. Specify TR-23 for up to 10 watt 23 or 33cm transmitters. 50 ohm relay plus relay for 13VDC to xmtr & rec. Mounts on flange N conn. RF out V test point.

D1010N-ATV MIRAGE 100 WATT P.E.P. AMP.....\$309

420-450 MHz all mode: FM, SSB, CW, & ATV. Special ATV version for good color and sound from our transmitters. Sync power (p.e.p.) over 100 watts with blanking set for 60-70 watts from PA5 (3-5 watt blanking set up), over 50 watts sync from TC70 or KPA5. ATV duty cycle 15 min on /5 off, other modes 5 on/5 off. RF sense T/R switching. 12x3x5.5". Req. 13.8 Vdc @ 20A.

NEW D100ATVN version >70 Watts p.e.p. when driven with 1.5 Watts from TC70-1, TX70-1 or KPA5.

D1010NR-ATV MIRAGE 70CM REPEATER AMP.....\$459

Continuous duty version of D1010. D100ATVNR version gets 90 watts p.e.p. for 1.5 drive from KPA5. 8.75" H 19" rack panel. No T/R switch. Rugged large heat sink for repeater or long key down time.

ATV RF MODULATORS AND TEST GENERATORS

Connect camera video or audio gen for demos, receiver tests, etc.

TVG-1 tunes 420-450 MHz, AM, 5mW, 9 to 12 Vdc.....\$15

TVG-12A tunes 1240-1300 MHz, AM & FM, 80mW, 12Vdc....\$25



TVG-1



TVG-12A

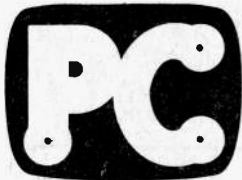

P.C. ELECTRONICS 2522 S. PAXSON LN. ARCADIA CA 91006 (818) 447-4565
 TOM W6ORG MARYANN WB6YSS

ELECTRONICS

ORDERING INFORMATION

P.C. ELECTRONICS manufactures and supplies amateur television equipment for TECHNICIAN class or higher licensed radio amateurs and assumes a level of technical knowledge and resourcefulness to successfully put together a working ATV station by the purchaser. Prices, methods of sale, and information supplied are also geared for direct mail or telephone sale to the licensed amateur. We have no store or showroom, our address is for mail order only. Non amateurs may purchase all but transmitting equipment from us. All orders for transmitting equipment must be purchased by a licensed amateur for lawful amateur purposes only (see CFR 47 part 97), and may be refused by us if we believe the equipment will be used unlawfully, or the purchaser does not check out in this years Callbook. New licensees may send a copy of their ticket if not listed in the Callbook.

RETURN POLICY. All sales are final once shipped by us. Any returns of unused equipment are subject to a 15% shipping, handling, retesting & restocking charge if the purchaser calls us for authorization within 15 days of our shipping date. Unused in this case means never connected up in anyway, no physical damage, or in our opinion completely resaleable as new.

SERVICE POLICY: In case of difficulty, call for technical advice or return authorization for repair. Over 80% of the time the problem is with the customers unfamiliarity with UHF techniques or lack of test equipment. Call so we can give you some trouble shooting hints. Our policy on our manufactured equipment is the customer ships to us at their cost after return authorization. If we deem that the problem is due to our workmanship and materials within a reasonable time period (different parts have different expected lifetimes — we feel this is fairer and more realistic than the usual 90 days by most equipment manufacturers), it will be fixed and returned at no further cost to you asap. If we believe the problem is due to the customers misuse, abnormal wear, natural causes or physical damage then modules will be repaired for \$15 plus parts cost, and packaged units (TC-1, TC70, TVX) repaired for \$30 plus parts cost. Items will be returned via UPS COD unless otherwise authorized. No other warranty is expressed or implied than that noted here. Any equipment not manufactured by us is limited to the warranty made by the manufacturer, your recourse is with the manufacturer and their repair and warranty policy. No exchanges except those authorized by the manufacturer.

METHODS OF PAYMENT WITH ORDER:

VISA or MASTERCARD, purchasers card only, no third party using someone else's card with permission accepted. \$25 minimum charge card order (keeps bank cost down and your prices). We do not accept American Express or Discovery Cards.

COD. Cash only COD via UPS, cash means currency, no checks. Add \$3 for COD charge. Include a daytime telephone number.

CHECK. U.S. Postal Money Orders are treated same as cash and do not delay shipment. ALL other checks may take up to 3 weeks to clear before shipment. All checks must be in U.S. dollars drawn on a U.S. bank.

METHOD OF SHIPMENT. All our prices noted as "ppd" (postage paid) include insured UPS surface (brown) shipment anywhere in the contiguous 48 states, and require a street address or known UPS location for delivery (no PO box). Add \$2 shipping only if the total order is under \$25. Allow up to 6 working days shipping time across country. Next day UPS air (red) and Second day air (blue) are shipped at cost on a priority basis. Other shippers can be used at customer request at cost plus a special handling fee depending on complexity.

Canada, APOs, and outside contiguous USA states and possessions are shipped via Air Parcel Post for 4% of the total order with a \$5 minimum charge. Foreign shipments are made via Air Parcel post at cost. Call or write for amount. We cannot assure foreign delivery, and suggest foreign customers have us ship to their freight forwarder or agent in the USA. We do not have any other agents or dealers.

PURCHASING AGENTS: We do not accept Purchase Orders, or order forms with any terms, conditions, etc., other than those listed here. We do no billing. Payment must accompany the order. A paid invoice is sent in one of the equipment boxes for your records, we will list your order number if requested for your accounting but in no way should be implied that we accept any terms and conditions connected with your order number. We are not into paperwork and won't pass its cost on to other hams in the price of our products.

TELEPHONE ORDERS: (818) 447-4565. This is your fastest way to get on ATV. We can usually ship within 2 days for most items. Have charge card info ready, model numbers and frequency. Telephone times are 8 a.m.-5:30 p.m. Pacific time Monday thru Friday. Tom, Maryann, or Rick can take your order and answer any questions.

MAIL ORDERS: Fill out the form below. Don't forget to list desired frequency on transmitters. Californians only add sales tax. Only add shipping or handling if under \$25, outside contiguous USA, or foreign. Our prices may change later than those in this catalog. Order will be sent back with check or card info if there is a price change or the total is incorrect. On charge card orders double check the numbers and expiration date you list. Mastercard only include the 4 digit interbank number which is usually below and left of the card number. Name must be exactly as printed on the card, please print. Put in the address you receive your charge card bills at even if it might be different from the ship to address if you are paying by charge card. Ship to or charge card address must agree with callbook address or include copy of amateur license if transmitting equipment is ordered.

ORDER FORM

QTY	MODEL #	DESCRIPTION	FREQ.	PRICE EA	TOTAL

Name _____ Ham Call _____
 Ship to Street Add. _____
 City _____ State _____ Zip _____
 Charge Card Billing Address if different:
 Address _____
 City _____ State _____ Zip _____
 Visa or Mastercard # _____
 Expiration Date _____ MC Bank # _____
 COD Orders, Daytime Phone () _____

Equipment Total _____
 (Calif. only) add sales tax 6/6.5% _____
 if total under \$25 add \$2 _____
 CAN., AK, HI, PR, APO shipping add 4%, \$5 min. _____
 If COD add \$3 _____
 Total _____

Charge card \$25 min order.
MAIL TO: P.C. ELECTRONICS, ATTN: MARYANN,
2522 PAXSON LN., ARCADIA CA91006-8537 5/88

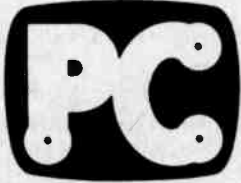

P.C. ELECTRONICS 2522 PAXSON LANE ARCADIA CA 91006-8537 USA
 TOM (W6ORG) & MARYANN (WB6YSS) O'HARA (818) 447-4565

SPECIALS - NEW - OLD - MISC. 10/88

ELECTRONICS

NOVICES:

NOW YOU CAN TRANSMIT VIDEO WITH OUR NEW TX23-1



The TX23-1 is a one watt p.e.p. all in one box, ready to go, television transmitter crystalized for 1289.25, \$299. See page 4. For receiving, connect up the new TVC12G (\$109) downconverter to the built in RF T/R relay. Add your TV set tuned to ch 7 or 8, 23cm antenna and you are on! Run full duplex ATV with 70cm.

BASIC 70CM ATV REPEATER SYSTEM

Put together your own 80+ watt inband repeater system using the modules listed in the block diagram below or go crossband by substituting the RTX-33 or 23 xmtr modules and antennas. Crossband saves one 70cm channel for simplex and enables seeing your own video coming back. The receiver boards are mounted in a Hammond 1590D diecast aluminum box, another for the 1 watt transmitter and VOR board. An excellent vestigial sideband filter/duplexer with only 1.6 db insertion loss is available from TX/RX Systems [call Jon: (716)-5494700] - run one good antenna.

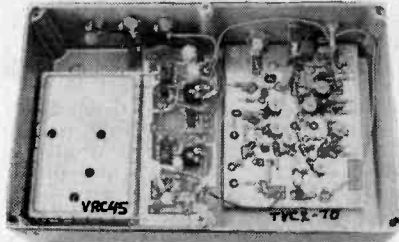

RECEIVER

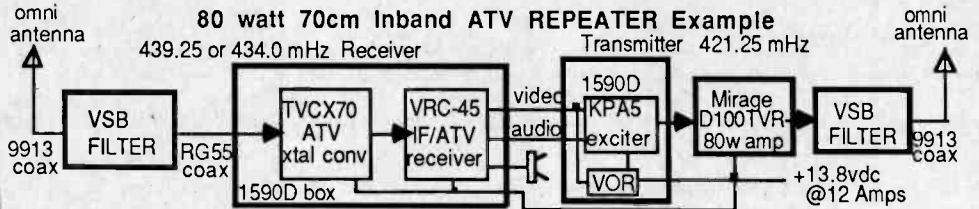

RTX-23



VOR

TVCX-70 CRYSTAL CONTROLLED ATV DOWNCONVERTER.....\$99
 Sensitive GaAsfet preamp & mixer. Specify input frequency & 45.75 MHz output.

VRC45 45.75 MHz IF/ATV RECEIVER MODULE.....\$99
 Outputs: 2 videos, line & speaker audio, S-meter. Squelched audio. 12Vdc. Mount in Hammond 1590D (\$17) with TVCX-70 or TVCX-33 for complete repeater receiver.

VOR VIDEO OPERATED RELAY. Detects horizontal sync to key repeater.....\$25
 Mount in Hammond 1590D box (\$17) with KPA5 on 421.25 MHz for repeater exciter.

NEW ELKTRONICS VDG-1 VIDEO IDENTIFIER AND COLOR BAR GENERATOR BOARD.....\$89
 Used on the WB8ELK ATV balloon with our KPA5. Your call and graphics programmed in ROM. For more info and to order, call Bill Brown at (419) 422-8206 or write to him at 12536 T.77, Findlay OH, 45840.

NEW ATV QUARTERLY MAGAZINE is in the works by Henry Ruh KB9FO and Bill Brown WB8ELK. They promise to have good technical articles by reputable ATVs with factual and usable information with virtually none of the political or editorial content except for FCC and operating news. 48 pages, \$15/yr starting in January. If interested in subscribing, commenting, or submitting articles write to ATVQ, 1545 Lee St. Suite 73, Des Plaines Il 60018, or call (312) 298-2269.



TVX-1 10 WATT COMMUNITY TV TRANSMITTER (Export only)

Rack panel (3.5x19") 10 watt p.e.p. TV transmitter intended for community TV outside the USA & Canada. Continuous duty. Accepts composite video & line level audio from a home satellite receiver, VCR, or camera. NTSC or PAL compatible. Requires 120 Vac 60 Hz or 13.8 Vdc @ 3 amps. 50 ohm N connector antenna output. 100 watt p.e.p. amplifiers (\$550) and transmit 50Ω omni antennas (\$350 ch 3-13) also available. Typical application: subscribers receive 426.25 MHz on ch 3 with our TVC-4G downconverter (\$89) & KLM 440-6X (\$51) antenna. Not licensable in USA & Canada. All orders require a written statement that "The TVX-1 will not be used in the USA, but will be used in (give city and country)". Also give name and address of responsible party in foreign country. Prices are delivered UPS surface to your freight forwarder or agent in cont. USA.

(All TVX transmitters take 2 to 6 weeks delivery after receiving paid order and statement. None are off the shelf as each is made special to your specified channel). UHF ch 14 thru 20 or 380 to 512 MHz\$650, VHF ch3 thru 13\$750

NOTES:

GaAs FET CONVERTER FOR 24 CM AMATEUR TELEVISION

by G. Wehrhahn DD9DUK

This article first appeared in *Elektor Electronics*, July/August 1988. It was reprinted in *BATC's CQ-TV* # 144 and is reprinted here with permission from *CQ-TV/BATC*.

This 24 cm downconverter is the perfect introduction to 24 cm ATV because it is a relatively inexpensive and simple design. It has only one preamplifier stage an active mixer and a free running single transistor local oscillator. Construction is also fairly straightforward thanks to the use of a small printed circuit board with printed inductor (micro-striplines).

All prototypes of the GasFET converter were found to give better results than a formerly used combination of a two stage stripline preamplifier using very expensive bipolar transistors type NE64535 from NEC and a Schottky diode mixer designed by DJ5XA described in *VHF Communications* 1975 #2. Interestingly the cost of the GasFET converter is much lower than the now technically outdated combination.

CIRCUIT DESCRIPTION

The GasFET has enabled receiver noise figures to fall below values that are virtually impossible to achieve with a bipolar device. The GasFET used in the present converter is inexpensive, dual gate type 3SK97. Types S3030 (TI) and CF300 (Siemens) were also tried with excellent results.

Contrary to popular belief there is nothing mysterious about GasFETs. In fact their outlook, static and dynamic operation is very similar to that of well known VHF and UHF dual gate MOSFET in the 3Nxxx and BF9xx series. The main advantage of the GasFET used here is that it can offer an in-circuit noise figure that remains low for frequencies up to 1.5 Ghz. Furthermore, gain is high but stable and matching to tuned circuits is fairly simple thanks to an extremely low internal capacitance that results in a small reactive component.

The circuit diagram of the converter is shown in Fig. 1. The incoming signal from the antenna reaches gate 1 of the preamp T1 via a micro stripline inductor L2. Matching of the input stage to the cable impedance of 50 ohms is optimized by adjusting C2. Preset P1 allows the drain current of the FET to be adjusted to optimize gain/noise figure of the device. In most cases a com-

promise between these two will have to be found.

The amplified 24 CM signals is passed to mixer T2 via a three element top coupled micro stripline filter which is tuned by means of trimmers. It should be noted that C10 and C12 increase the total bandwidth of the filter to a value suitable for reception of 27 Mhz wide FM ATV signals. For FM ATV these capacitors may be omitted to achieve pure inductive coupling resulting in narrower bandwidth.

The local oscillator signal reaches gate 1 of T2 via R16 and a low impedance tap on L5. The intermediate output frequency of the converter can be chosen freely between 40 and 200 Mhz. In prototypes the drain circuit of T2 was tuned to 48 Mhz by C16, L6 and C17 to enable the converter to be used for AM ATV reception with a portable color TV tuned to (UK) channel 2. This frequency is no longer used for broadcast in the UK. Provided C16, L6, C17 and L10 are dimensioned accordingly the IF is simple to move up to say 180 Mhz (channel 6 in band 3 in the UK). Obviously the higher frequency the better the image rejection of the mixer. A domestic TV set of course is not suitable for receiving FM ATV (except by slope detection which can be used at a sacrifice in results) so FM ATV users may choose their own IF to match their other equipment. The most commonly used IF for FM ATV is 70 Mhz but feel free to use your own frequency.

The single transistor varicap tuned LO is a slightly modified version of that discussed in Ref. 1. Properly constructed its stability is so good that an AFC circuit is not required. Presets P2 and P3 enable defining the tuning range of the converter. Capacitor C29 is a coarse frequency adjustment and also serves to stabilize the power output of the oscillator. This trimmer which may not be needed in all cases is simply 10 mm or so of straight wire positioned above the PCB surface. Although not apparent from the circuit diagram the actual length of the anode lead of D1 and the construction of L9a also determine the frequency of operation. The oscillator can be set to operate roughly between 1 Ghz & 1.5 Ghz. Finally the dashed lines in the circuit diagram denote screen around the LO to

"Devoted to Amateur Television"

prevent stray radiation.

CONSTRUCTION

Figure 2 shows the printed circuit board designed for the converter, however the BATC is by arrangement with Elektor Electronics making boards available to constructors. Details may be found in the Members Services section of the #145 CQ-TV. In the description below the upper drawing is called the component side and the lower drawing is called the reverse side. Soldering side would be incorrect as a number of components are also soldered at the component side.

Construction is fairly simple for those accustomed to the use of leadless ceramic capacitors. The actual value of these is uncritical: anything between 470pF and 1.5nF will work; 1nF being the most common value. There are seven of these capacitors in the converter each fitted vertically in a slot which is carefully jig-sawed or drilled and filed in the PCB. The length of the slots is such that the shoulders of the leadless capacitors rest on the PCB surface. The holes for the two GasFETs are drilled to 3.5mm. T3 is not fitted in a hole.

The cross-sectional view of the PCB in fig 3. show the connections of the gate-2 and source terminals of T1 to decouple capacitances C6 and C5 respectively. Micro-stripline L4 is connected to ground by a small piece of copper foil. All 1nF capacitors and C21 not marked with a black triangle in the circuit diagram are miniature ceramic types with a lead space of 2.5mm.

Input inductor L1 is one turn of .5mm diameter silver plated wire. Choke L8 is wound 6 turns of .2mm dia enamelled copper wire through a ferrite bead or small balun. Inductors L9a and L9b are formed by the wire terminals of R15. R9a is 2 turns with an inside diameter of about 3mm and a turn spacing of 1mm. The other inductor L9b is the straight wire terminal soldered to ground as shown on the component overlay. A 2mm hole is made in the screen surrounding the LO so that R16 can be soldered to a tap on L9b about 10 mm from where this is bent down and connected to ground. It is important that R15 runs horizontally at about 4mm above the PCB surface. Also make sure it does not cause excessive strain on the emitter lead of T3.

When required, coupling capacitors C10 and C12 are fitted direct onto the

micro-striplines keeping the leads shorter than 1mm. The GasFETs are the last parts to be mounted on the PCB. As they are very small and static sensitive soldering must be done fast with utmost care and using a low power iron with a grounded tip.

The complete PCB is mounted in a tin-plate box with feed through capacitors for direct voltages and homes for BNC connectors K1 and K2. These are positioned such that the center pin can be soldered direct to the copper area provided. The PCB edges at the reverse side of the board are soldered direct to the inside of the box panels. When a ready made box is not available an alternate enclosure can be made from cut to size pieces of PCB. Note: In the original component layout as reproduced in Elektor Electronics ICI was shown reversed. This has been corrected in the layout here.

SETTING UP

The simplest way of aligning the converter is to ask for assistance of a ham on 24CM ATV. Alternately you may be in the service area of a 24CM ATV RPT. The following description is based upon the availability of an off-air signal and the unit is used with a low IF frequency to a standard TV receiver. NOTE: Due to the difficulty of obtaining 78L09 regulators an alternate method would be to use a readily available 78L05 with a 3.9 volt zener diode between reference leg and ground.

Set all presets and trimmers to center of their travel. Adjust P1 for a drop of 1.3 volts across R2. Check that the LO is working by measuring the drop across R7. Short circuit the emitter of T3 to ground to stop oscillation. This should cause a voltage drop of about .2 volts across R7. Remove the short and peak L6 for maximum noise output of the converter then tune the ATV signal and peak trimmers for optimum reception. This is fairly easy when the signal strength is strong. Reduce the signal strength by rotating your antenna and carefully turning the receiver and redoing the adjustments to reoptimize reception on a weak signal. Continue until no further improvement is noted. It may be necessary to bend C29 closer to the PCB or space the turns of L9a wider to stabilize the LO output across the tuning range. Note, however, that the repositioning of C29 changes the LO frequency so that the tuning control P4 must be adjusted to

"ATVQ"

2 Note: only T1, T2 and C1 are mounted at this side of the board

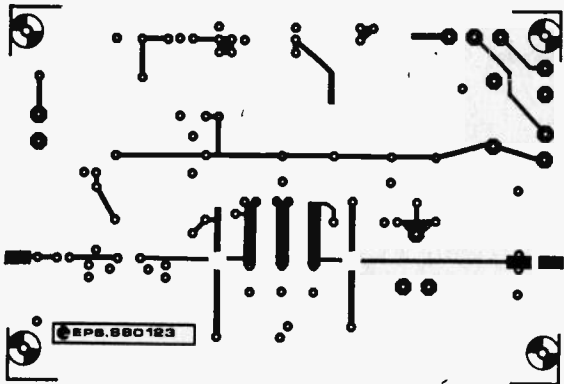

(less than actual size)

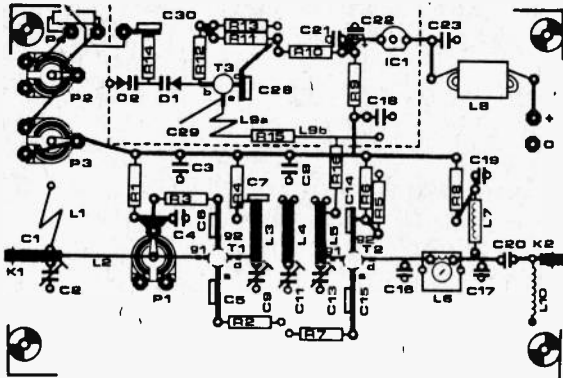
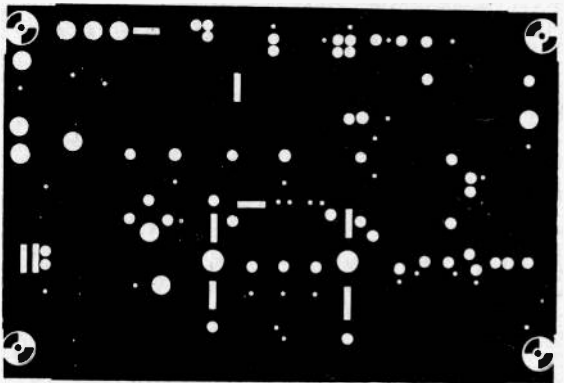

Fig. 2. Double-sided printed circuit board for the converter.

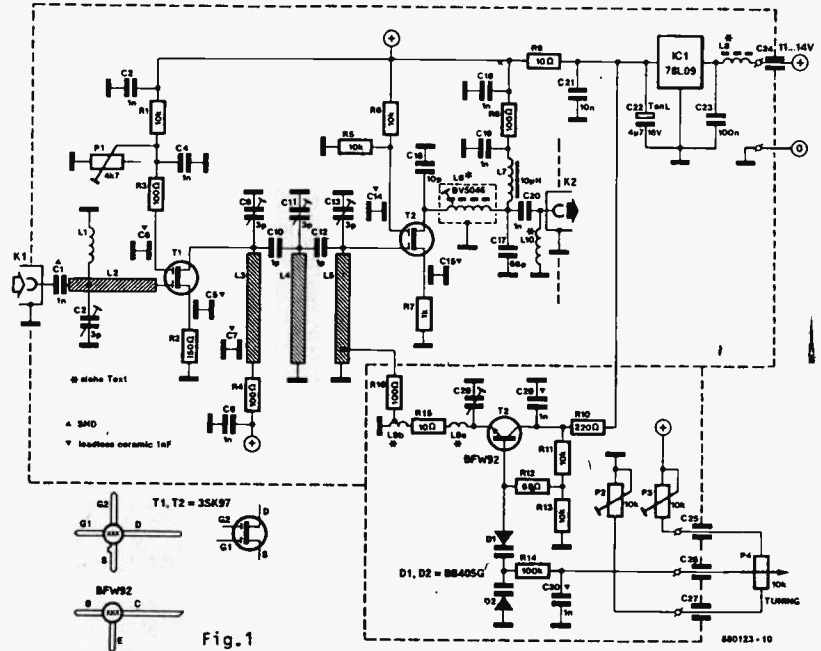

Fig. 1

Parts list

Resistors (0.25 W carbon film; $\pm 5\%$):

R1;R5;R6;R11;R13 = 10K
 R2 = 150R
 R3;R4;R8;R16 = 100R
 R7 = 1K0
 R9;R15 = 10R
 R10 = 220R
 R12 = 68R
 R14 = 100K
 P1 = 4K7 or 5K0 preset H
 P2;P3 = 10K preset H
 P4 = 10K linear potentiometer

Miscellaneous:

K1;K2 = BNC socket (flange type).
 PCB Type 880123 (not available ready-made through the Readers Services).
 Tin-plate box with top and bottom lids. Size: 111 x 74 x 50 mm.

Capacitors:

C1 = 1n0 chip or SMD (Bonex; VeroSpeed; Cirkitt)
 C2;C9;C11;C13 = 3p subminiature trimmer (manufacturer: Sky) (C-I Electronics)
 C3;C4;C8;C18;C19;C20 = 1n0 ceramic
 C5;C6;C7;C14;C15;C28;C30 = 1n0 leadless ceramic (Cirkitt; Bonex)
 C10;C12 = 1p0 (see text)
 C16 = 10p
 C17 = 68p
 C21 = 10n ceramic
 C22 = 4 μ 7; 16 V; tantekum
 C23 = 100n
 C24...C27 incl. = 1n0 feedthrough (solder type) (Cirkitt; Bonex)
 C28 = see text.

Inductors:

L1 = see text.
 L2;L3;L4;L5 = micro-stripline on printed circuit board.
 L6 = Neosid BV5046 (yellow-blue); 0.9 μ H; 5...50 MHz (C-I Electronics).
 L7 = 10 μ H axial choke.
 L8 = see text.
 L10 = see text.

Semiconductors:

D1;D2 = 88405G (Bonex; C-I Electronics)
 IC1 = 7BL09
 T1;T2 = 3SK97 (C-I Electronics)
 T3 = BFW92 (Cirkitt)

3

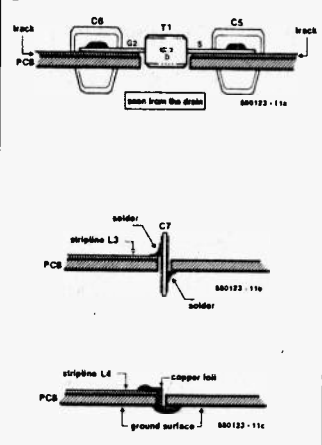

Fig. 3. Showing the use of leadless ceramic capacitors on the PCB (3a; 3b), and the connection to ground of micro-stripline L4 with the aid of a small piece of copper foil (3c).

restore reception. Also P2 and P3 may have to be readjusted to obtain the correct tuning range.

SPECIAL COMPONENTS

Special parts used in this unit are available from several sources found in many ham magazines. Vendors specializing in RF components should have most on hand. If you need to write to the UK for items the following vendors were used in the original project: Bonex Ltd. 12 Elder Way, Langley Business Park, Slough, Bucks, SL3 6EP England.; Piper Communications, 4 Severn Road, Chilton, Didcot, Oxon OX11 0PW England. 73 BATC.

"Devoted to Amateur Television"

THE ELKTRONICS VDG-1 VIDEO ID
by WB8ELK, Bill Brown

The Elktronics Video ID board is a self-contained module that will produce a quick source of computer video upon applying power. The board is powered by applying 12 V. DC to the input marked (+) and draws about 160 mA. Four computer generated color graphic screens are stored into a 27C128 EPROM. There are 2 Hi-RES screens and 2 Colorbar Patterns available. These are located in different areas in the EPROM and are selected by controlling several address lines by means of 4 SPDT switches wired to Switch positions SW1-SW4 on the circuit board. Different sets of graphics can be displayed simply by changing the EPROM. For example you can have EPROMS for Mobile ATV, Space Shuttle Video retransmissions, Mountaintopping, special activities and of course for your home station's ID. If you plan to change the graphics frequently a Quick-Release Socket is recommended to provide for a fast changeover. Output is 1 V p-p of video which can be connected directly to your ATV transmitter, Video monitor, or VCR video input. There is also a video relay on-board which will allow live camera video to be routed through the board when power is turned off. To identify your transmission or for use as a test pattern just turn on the I.D. board and the relay will switch from the live camera to the computer I.D. Finally an automatic sequencer/timer circuit on-board allows you to sequence through all four screens or several combinations of two screens varying from 0.2 seconds per screen up to a maximum of 1 minute per screen.

CIRCUIT DESCRIPTION

The clock frequency to drive the 6847 Video Display Generator I.C. is derived from a 3.579545 Mhz Crystal using part of the MCL372P I.C. as an oscillator. The 6847 VDG I.C. then generates all of the signals necessary to produce a video waveform. The computer graphics information stored in the 27C128 is accessed by the 6847 to produce the desired graphics screen. In combination with the control signals from the 6847 the MCL372P functions as a Color/Video mixer which adds in the colorburst signal. This signal then is fed to a two transistor video amplifier to produce the final 1 volt p-p video output. The 27C128 EPROM contains four graphics screens stored in different

areas of memory. These screens are designed on a Radio Shack Color Computer and are down loaded into the EPROM. The two Hi-RES screens each occupy 6144 bytes of memory and the two Colorbar patterns are 512 bytes long. (See Fig. 1 for EPROM memory map)

Hi-RES screen #1 and Colorbar #1 are located in the lower 8k of the EPROM. Hi-RES screen #2 and Colorbar #2 are in the upper 8k. To switch between the lower and upper memory areas address line A13 (pin 26) is raised high on the 27C128 by switch SW3 or by the timer / sequencer circuit depending on the SW4 position. To select the colorbar patterns the 4066 analog switch I.C. is used to disconnect address lines A11 and A12 from control by the 6847 and raise them high on the 27C128 EPROM. Also the Alphanumeric/Graphics mode select is switched low on the 6847 to produce the colorbar block graphics. In the Colorbar mode the colorburst signal is generated by the 6847 VDG in conjunction with the MCL372P. However, the 6847 was originally designed to produce only a black and white pattern in the Hi-RES screen mode. To produce a color output in the Hi-RES mode a 555 timer I.C. is used to send the proper signal to the MCL372P to allow it to generate the colorburst signal. While producing a color video output this method does have two anomalies. First, when looking at the Hi-RES screens on an oscilloscope you will observe the colorburst extending throughout the horizontal sync as well as it's normal position. This has no effect on the video quality but will be observable on the scope. Second, due to the fact that the 6847 may start on either the rising edge or the falling edge of the clock signal there is a chance of getting reverse colors on the two hi-res screens (i.e. Blues will be Red and Reds will be blue). To correct this just simply turn the board off and on again till you get the correct colors. This has no effect on the two Colorbar patterns as they will always display the correct colors. Proper video waveforms are displayed in figure 2 and show the sync/video ratios you should expect with this board. The white level generated by the 6847 is actually a light shade of gray, therefore you should see 40 units of sync to 62 units of video. This ratio can be adjusted by the setting of the Sync level potentiometer.

"ATVQ"

There is a timer/sequencer circuit on-board which will allow automatic display of the graphics screens. A 2240 timer is used to generate two timer outputs to control the Hi-RES Colorbar control lines as well as low-memory/hi-memory selection on the EPROM. There are four switch positions on the circuit board where SPDT switches can be installed to manually select the four screens as well as select different timer sequences. The SPDT switches should be wired as shown in Fig. 3 so that the center pin on the switch is connected to the center pad of the switch circuit board location. SW1 and SW4 are jumpered for automatic sequencing through all 4 screens and these jumpers should be removed before installing the switches. Position each switch so that when in the UP position, you are connecting the top two pads together on the circuit board for each switch position. We'll call the UP position "ON" and the down position of the switch "OFF" so that you can use the following table (Table 1) to show all of the possible combinations. Switches SW1 and SW4 control the timer functions and SW2 and SW3 control manual selection of the screens when SW1 and SW4 are turned OFF.

NOTE* For repeater applications where computer control of the graphics screen selection is desired move jumpers from top two pads to the bottom two pads of SW1 and SW4. Apply a TTL level signal (+5V) from a repeater controller circuit to the center pads of positions SW2 and SW3 on the I.D. board to control the graphic screen selection. If the automatic sequence through all 4 screens is the only mode needed then no SPDT switches are required, just leave the jumpers on the circuit board at positions SW1 and SW4.

FINAL ADJUSTMENT

The VDG-1 can be mounted into a cabinet such as the TEN-TEC model JW-5. Live camera input as well as video output will usually be either a RCA phono jack or BNC connector. You may also want to install a 10-pin video camera connector and feed the camera video into the I.D. board and just route the audio through the cabinet. This will provide you with a video and audio output to be fed into your ATV transmitter. Adjust your ATV transmitter to the optimum setting with your live camera video and then turn on the VDG-1 I.D. board. Adjust the 20k Video

Gain pot until the transmitter output looks optimal. For external control of the timer circuit remove the 500k timer pot and install a chassis mount 500k pot on the front panel (If longer delay times are desired, then install a larger value potentiometer).

ADDITIONAL INFO

Remember when changing EPROMS to turn off power to the board. Also the 27C128 is a CMOS static sensitive device so take care to store it in an antistatic plastic rail or on static-resistant foam.

For those who would like to experiment with the colorburst circuitry you can replace the 5.6k resistor near the 555 timer with a 10k pot to vary the number of cycles of colorburst in the Hi-RES mode. Also you can replace the 10 ohm resistor near the MCL372P with a 1k pot to vary the amplitude of the colorburst signal. Horizontal sync can be found on pin 38 in the 6847 I.C. and vertical sync is on pin 37. Also the 3.579545 clock signal is present on pin 33 of the 6847 and on pin 1 of the MCL372P. (See AD on back page.)

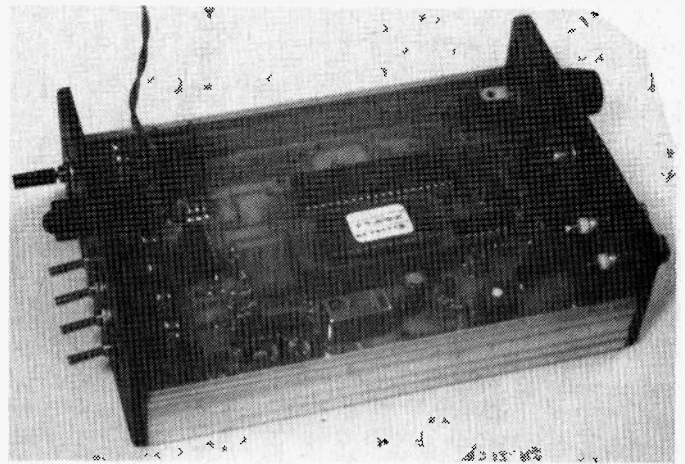

VDG-1 Mounted in Cabinet

SW1	SW2	SW3	SW4	
ON	X	X	ON	Sequences through all screens
OFF	ON	X	ON	Sequences through 2 Hi-RES screens
OFF	OFF	X	ON	Sequences through 2 Colorbar screens
ON	X	ON	OFF	Sequences through Hi-RES#2 & Colorbar2
ON	X	OFF	OFF	Sequences through Hi-RES#1 & Colorbar1
OFF	ON	ON	OFF	Manually selects Hi-RES#2
OFF	ON	OFF	OFF	Manually selects Hi-RES#1
OFF	OFF	ON	OFF	Manually selects Colorbar#2
OFF	OFF	OFF	OFF	Manually selects Colorbar#1

X = Position doesn't matter

"Devoted to Amateur Television"

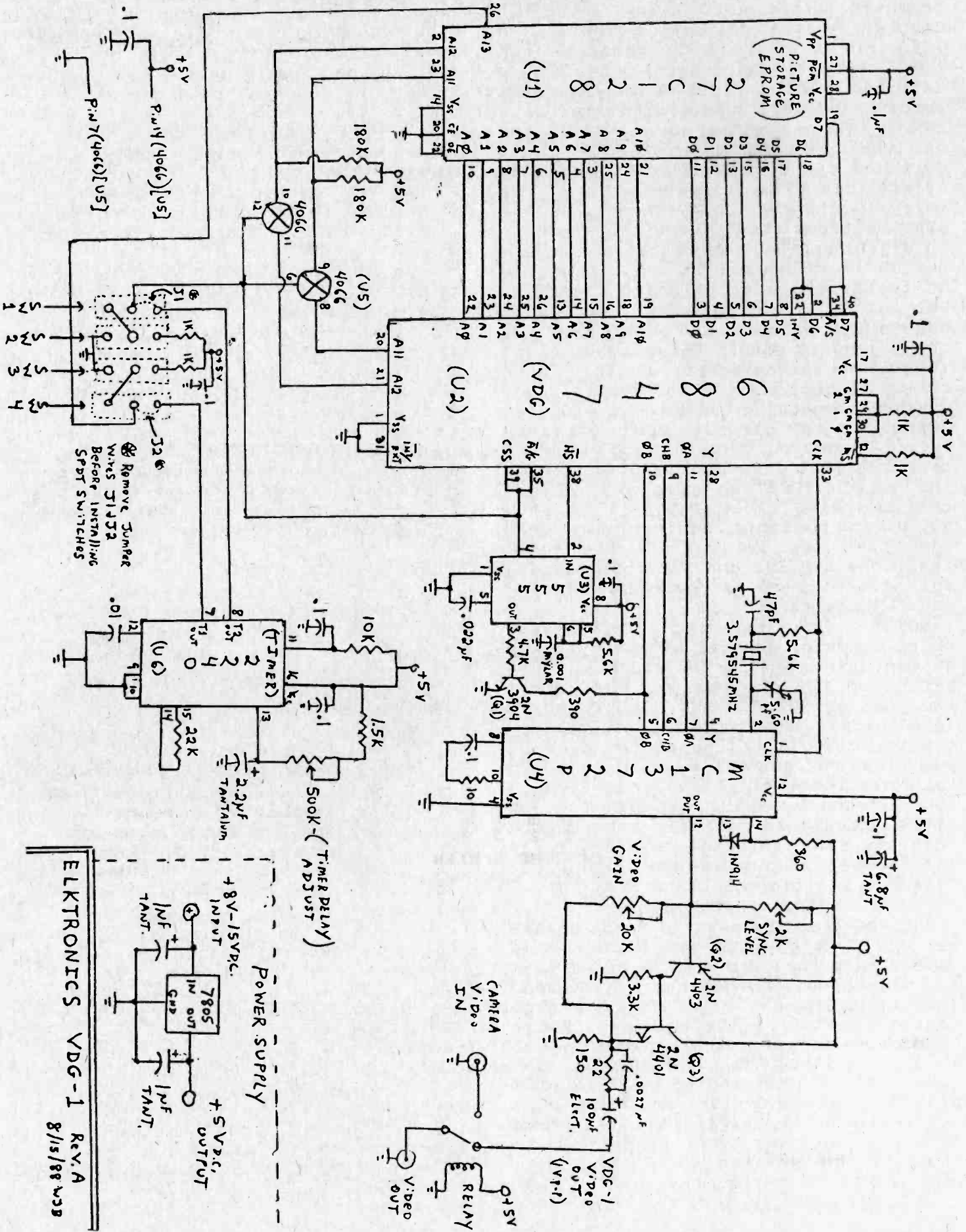

ELEKTRONICS VDG-1 Rev. A
8/15/88 wsb

"ATVQ"

3.75" W x 5" L

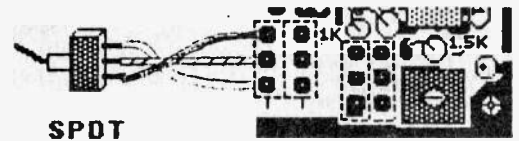

SPDT

Fig. 3 Switch Wiring
(4 switches total)

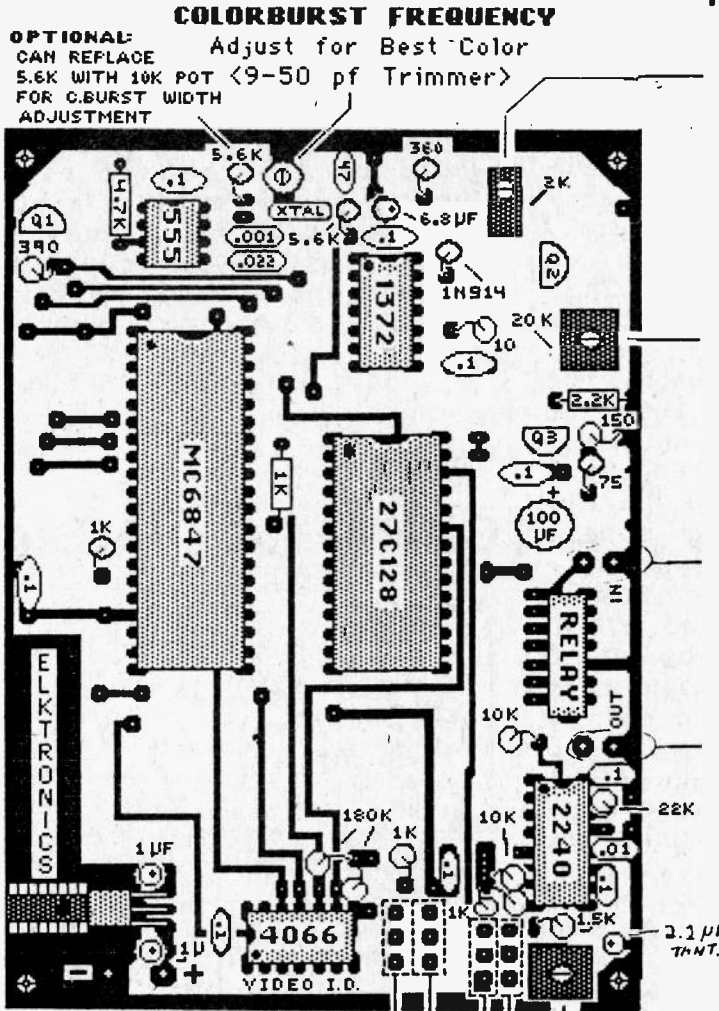

OPERATING VOLTAGE RANGE 8-15 V. DC
160 MA

SYNC LEVEL
PRESET before shipping
Should not need adjustment
Clockwise whites out video
Counter-clockwise clips sync
Best adjusted just below white clipping of Yellow Colorbar
≠≠ Use scope for best results

VIDEO GAIN
[0 - 1.2 V p-p Video output]

CAMERA VIDEO INPUT
When VDG-1 is turned off the Relay will connect the Input to the output providing switching from I.D. to live camera

VIDEO OUTPUT
VDG-1 Board ON = Graphics I.D.
VDG-1 Board OFF = Live Camera

TIMER ADJUST <500k POT.>
Controls amount of time each Graphics screen remains on during automatic sequencing.
Counter-clockwise - .2 sec/screen
Clockwise - 60sec/screen

GRAPHIC SCREEN SELECT SWITCHES

(INSTALL 4-SPDT SWITCHES)
SW1 & SW4 jumpered for automatic sequence through all 4 screens - Remove jumpers before installing switches.
SW1 & SW4 are timer control switches. When SW1 & SW4 are off then SW2 & SW3 allow manual selection of graphic screens. Consult Table 1 on previous page for listing of possible combinations.

Memory Map 27C128

Colorbar*2	← 14848
Hi-RES*2	← 14336
Colorbar*1	← 8192
Hi-RES*1	← 6656
	← 6144
	← 0000

Fig. 1 PICTURE EPROM

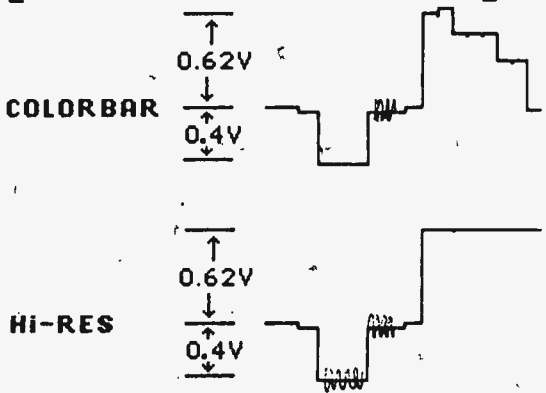

Fig. 2 VIDEO WAVEFORMS

"Devoted to Amateur Television"

RADIO SHACK SPECIAL EFFECTS SWITCHER
MOD FOR DUAL VIDEO SUPERIMPOSITION
by John Spaeth, KD0LO

The Archer Special Effects Switcher (CAT# 15-1274) is an inexpensive and versatile piece of video equipment which can serve as the nucleus for video switching and special effects for ATV. The unit is capable of providing horizontal, vertical, diamond shaped, corner wipes, and variable speed auto-wipe and fade to black. The unit is microprocessor controlled and has few mechanical parts. This makes the wiping and fading functions smoother and noise free.

Although the unit has inputs for two video sources it is not intended for use with synchronous video sources. For this reason the unit fades to black and then switches to the second source. Also the wipe patterns are black superimposed over the current video source. With a simple modification, the effects switcher will fade between two video sources eliminating the fade to black and the normal black wipe patterns will contain a second video source creating split screen, corner inserts and other effects.

It should be noted that nonsynchronous video sources will not work with the unit after modification, although the unit will genlock itself to whatever video source is on Channel A. The switching, wiping and fading functions are gated though CMOS analog switches (MC14053BCP). IC3 uses one of its gates to set the black level for the wipe patterns. This is done by creating a reference voltage on the emitter of Q27 by varying the base voltage the black level is varied. This modification defeats the effect of Q27 by changing it into a buffer stage for the second synchronous video input identical to Q17 and instead of a reference black voltage on the base of Q27 the second video source appears passing the video through the switch normally used to gate the black patterns.

The modifications are as follows:

(See partial schematic Fig. 2)

1. Lift the cathode end of D22 off the board and solder in its place one end of a 5" insulated jumper (J1).
2. Solder the free end of the jumper wire (J1) to pin 1 of IC5.
3. Remove C43 (.1 mF) and insert in its place a 82 pf capacitor and solder.
4. Remove R131

Because video input B has been routed directly to the effects gate, the A-B switching function is not needed and should be left in the A position; putting it in the B position will eliminate video source A.

This unit may also be keyed externally for the purpose of chroma keying etc., by adding an external jack for a negative going key pulse input which would be inserted at pin 11 of IC3. The key source must be synchronous. An additional buffer stage may be needed between the keying current and IC3 if the current sinking ability of the key current is not great enough.

SCHEMATIC DIAGRAM

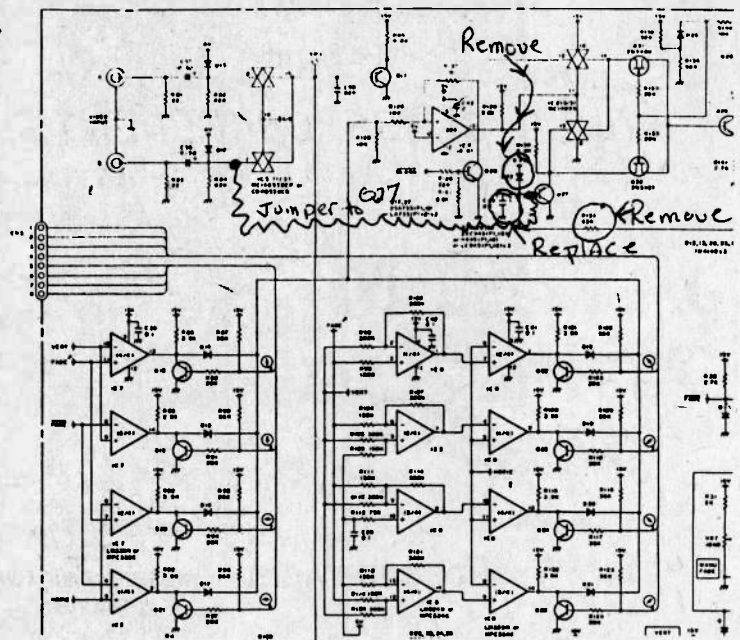

MICROWAVE MODULES EQUIPMENT

Use your existing HF or 2M rig on other VHF or UHF bands.

RECEIVE CONVERTERS

MMK 1891-137	333.00
MMK 1296-144G	235.00
MMc 439-ATV	98.00
MMc 432-28(S)	89.00
MMc 144-28(HP)	95.00
MMc 144-28	75.00

LINEAR TRANSVERTERS

MMI 1296-144G	499.00
MMx 1268-144	395.00
MMc 432-28(S)	370.00
MMI 144-28(R)	499.00
MMI 144-28	265.00
MMI 435-28(S)	390.00

"ATVQ"

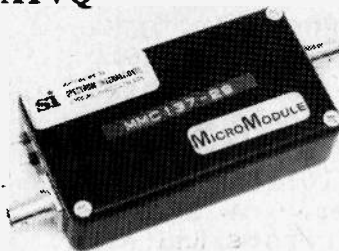

PRE-SELECTOR FILTERS

Spectrum International's low loss, fixed tuned, band-pass filters are a 3 pole, 7/16 bandwidth Interdigital design. The 0.1 dB ripple Tchebycheff characteristic has a 30 dB shape factor of 4:1. They are intended for receiver pre-selector and transmitter applications. The very low loss is realised by using an air dielectric transmission line design.

Technical Data

General:	Ripple	0.1 dB
	Impedance	50 Ohms
	VSWR, typ	1.25
	Power, nom	100 W (BNC)
		250 W (Type N)
Size:	Width	4.0 ins approx
	Thickness	1 inch
Material:	Brass	Plates, Rods & Bars
	Hardware	Stainless Steel

VHF/UHF BANDPASS FILTERS

KNOCK OUT INTERFERING QRM OR SELF-DESENSE!

3 and 5 pole models available

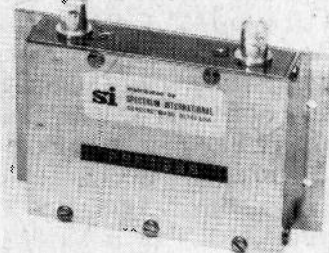

BNC Standard
TNC or Type 'N' optional
(slightly higher prices)

MMF-200-7	145 Mhz.
PSF 137-3	132-142
PSF 144-3	140-150
PSF 220-3	216-228
PSF 432-3	420-450
PSF 421-5	ATV Channel
PSF 426-5	ATV Channel
PSF 434-5	ATV Channel
PSF 439-5	ATV Channel
PSF 900-3	890-940
PSF 923-5	ATV Channel
PSF 1280-3	1230-1320
PSF 1280-5	ATV Channel
PSF 1296-3	1250-1340
PSF 1691-3	1650-1750

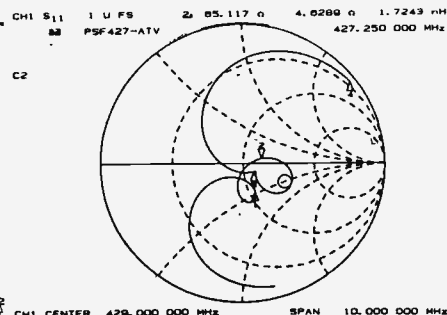
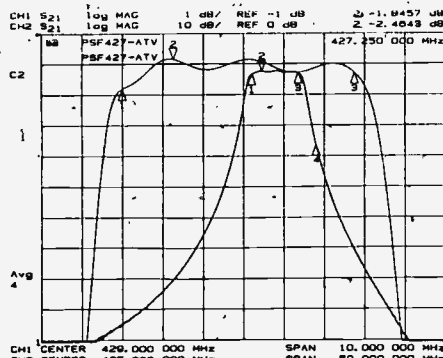

U.H.F. Filters		U.H.F. Filters	
MMI 200-7	\$ 55	PSI 923-ATV	\$155
PSI 137	175	PSI 1280	95
PSI 144	175	PSI 1280-ATV	155
PSI 220	145	PSI 1296	95
PSI432	95	PSI 1691	95
PSI 421-ATV	145	Connector Options for Filters	
PSI 426-ATV	145	for MMI200-7 U.H.F.	\$ 45
PSI 434-ATV	145	Type "N"	15
PSI 439-ATV	145	Type "N"	20
PSI 900	95		

General Information: All prices are NET, FOB Concord, Mass. USA. Our terms are "Payment with Order" or C.O.D. Your personal cheque is welcome; Master Card and VISA are available for your convenience. On foreign orders, U.S. Dollar cheques drawn on a New York bank and Irrevocable Letters of Credit are acceptable. From Canada only, Postal Money Orders in U.S. Funds are convenient. Prices subject to change without notice.

Delivery Information: Domestic U.S.A. delivery is by U.P.S. or the Postal Service. Small parcels are sent U.P.S. Blue Label (air) where the service is available. Overnight express delivery via Federal Express or U.P.S. is available, on request, at increased charge.

Foreign delivery is by Registers (or Insured) Air Mail for small items. Large items and high value shipments are sent Air Freight, from Boston Int'l Airport, to your local airport for Customs clearance and collection. Air freight charges, etc. are payable in your local currency at time of collection of goods. Pro-forma invoices are available (if required) prior to placing your order. All facilities for Export Documentation are available.

Returns: All crystals are "non-returnable". Please request authorization before returning any item for check-out, repair or other reason. A re-stocking/re-testing charge of up to 15% of item list price will be levied on returns, plus a cancellation charge on cancelled orders.

Massachusetts residents add 5% SALES TAX to item cost.

Spectrum International, Inc. qualifies as a SMALL BUSINESS under Federal Procurement Regulation 1-1.702 and other gov. regulations.

WORLD CLASS COMPONENTS AND ANTENNAS...

FOR THOSE WHO ARE SERIOUS ABOUT GETTING THE MOST OUT OF THE VHF, UHF MICROWAVE BANDS ON FM, SSB, FAX OR AMATEUR TV - WE HAVE WHAT YOU NEED!

JAYBEAM 70 cm MULTIBEAMS

WIDEBAND
IDEAL FOR ATV!

"THE DX'ER!"

"Our Most Popular Model!"

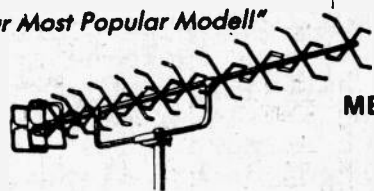

MBM48/70cm

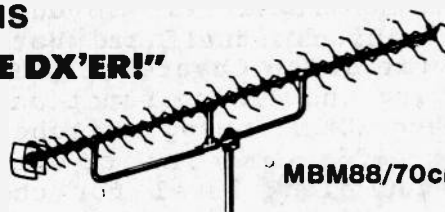

MBM88/70cm

2 way & 4 way Mounting Frames Available (Vertical slightly higher)
MF4H MBM48 HOR \$69.00
MF4V MBM88 HOR \$87.00

2 Mtrs. CROSSED YAGIS

"WE STOCK 2 AND 4 WAY POWER COMBINERS FOR 1268, 1296 and 1691 Mhz.!"
NEW 900 Mhz. BEAM IN STOCK!

Four-way harness



10XY/2M 5XY12M or 137 Mhz. Models
Ideal for OSCAR or WEFAX Satellites!

SPECIFICATION	MBM28	MBM48	MBM88	10XY	5XY-137	DY-20-900
FREQUENCY (MHz)	430-440	430-440	430-440	144-146	134-138	900-930
GAIN (dbd)	11.5	14.0	16.3	10.8	7.8	17 dbi
FRONT TO BACK RATIO	18 db	20 db	22 db	16 db		20 db
3db BEAMWIDTH.	H45° E40°	H35° E28°	H28° E23°	E40°	H 58°	H 32° E 22°
DESIGN IMPEDANCE	50 OHMS	50 OHMS	50 OHMS	50 Ohms	50 Ohms	50 Ohms

PHASING HARNESES

STACKING FRAMES AND MOUNTING KITS	
PMH2/2M	2 way phasing harness for two 2m aeriels
PMH4/2M	4 way phasing harness for four 2m aeriels
PMH2/70cm	2 way phasing harness for two 70cm aeriels
PMH4/70cm	4 way phasing harness for four 70cm aeriels
PMH/2C	2 way phasing harness for circular polarisation for two 2m aeriels
PMH137-C	Circular harness for 5x4/137

MF2-48	48 element stacking frame \$18.00
MF2-88	88 element stacking frame \$22.00
SVMK-48	Vertical Pol Mounting Kit \$22.00

All phasing harnesses and power combiners include Type 'N' (female) connector.
"Write for Prices"

Antennas	
5XY-137 (137 Mhz Weather)	\$ 90
10XY-2M	83
MBM28 - 70cm	65
MBM48 - 70cm	90
MBM88 - 70cm	135
DY20 - 900 (900/930 Mhz)	89
1268-LY	65
1268-LY-XTN (add 21 elements)	89
1268-LY	65
1268-LY-XTN (add 21 elements)	89
1691-LY	75
1691-LY-XTN (add 26 elements)	70

Note: 1. All antennas include 50 ohms build-in BALUN.
2. Order Loop-Yagi connector from accessory list below.

Harness Kits	
PMH-137C 137 circ Pol	\$ 20
PMH- 2C 2M circ Pol	20
PMH2-2M 2M 2-way	23
PMH4-2M 2M 4-way	55
PMH2-70 70cm 2-way	20
PMH4-70 70cm 4-way	37
900-2way (combiner)	ask
900-4way (combiner)	ask
1268-2way (combiner)	65
1268-4way (combiner)	95
1296-2way (combiner)	65
1296-4way (combiner)	95
1691-2way (combiner)	65
1691-4way (combiner)	95

Stacking Frames	
2-way	
MF2-48 MBM48 HV	\$ 20
MF2-88 MBM88 HV	24
4-way	
MF4H-48 MBM48 Hor	\$ 69
MF4V-48 MBM48 Vert	79
MF4H-88 MBM88 Hor	89
MF4V-88 MBM88 Vert	99

PRICES SUBJECT TO CHANGE WITHOUT PRIOR NOTICE

SPECTRUM INTERNATIONAL, INC.

Post Office Box 1084
Concord, Massachusetts-01742
508-263-2145



"Devoted to Amateur Television"

ATCO ATV FOXHUNT

TEST AND MEASUREMENT

On Sept. 17, 1988 the ATCO (Amateur Television in Central Ohio) group staged an ATV Foxhunt. Tom, KA8ZNY and Bill, WB8URI hid out at 10:30am and put on a 2 watt transmitter. A 20 watt signal was used for the first minute to help provide an initial bearing. Soon six vehicles were roaming all over Columbus and surrounding towns in search of the elusive signal. All kinds of mobile and portable antennas were used. KB8UU had a 12 element beam mounted in the back of his pickup truck resembling a machine gun turret! His method of rotating the antenna was to find a very large parking lot and zoom around in circles (He was somewhat dizzy when he arrived). Dick, W8RVH would hop out of his car periodically and raise his beam up on a 15 foot mast (quite a sight to see him do this on the edge of a freeway!). Bill, W8DMR used a 5 element loop antenna suction-cupped to the side of his car and was the first to find it after a 60 minute chase. KB8UU came in second followed by Bill, WB8ELK. Others chasing the fox were KB2ARL, W8AER, W8EHW, KE8SV and WA8EOY. The fox was finally found at a cablevision receive site southeast of the city where WB8MMR worked. After all had arrived it was determined why the signal was so hard to find...The wily fox had used Vertical Polarization and everyone was Horizontal!

KA8ZNY



KB2ARL Finds the Fox.

Just because this is "amateur" television doesn't mean it is less important to be able to test and measure our signals with any less accuracy than the broadcaster. The increase in stations experimenting with video as well as those stations who want a good AM video signal should appreciate the value of proper signal levels. But how good is your measuring technique and equipment? ARRL sponsors frequency measuring contests where stations often are able to determine the carrier frequency to .01 hz. But what about your video voltage? In FM video and to a somewhat lesser degree AM video the signal level determines the receive signal to noise ratio, overly high contrast signal will cause reception problems. Most hams in video are familiar with the waveform scope. If not let ATVQ know and we will run an article on that next. The scope either general purpose or a specialized display such as a waveform monitor has certain measurement abilities. Some of these abilities or limitations are in the manufacturers specifications. Typically frequency response and calibration accuracy is listed. But what about your scope and you the user? How accurate and reliable are the measurements that you make? Typical topics that spring to mind are the graticule marks of the scope. The size of the tube face will also limit our resolving power. Beam width the ambiguity introduced by the width of the little green line can easily cause two or more units error. Just interpretation of the display can



The Fox!

by Jed Hayes

PART ONE

FIVE STEPS TO PRECISION AND ACCURACY

introduce error. Do you split the trace with a graticule line or do you just meet the line or do you set the trace just above the graticule line for measurement? If you have a waveform monitor scope and have single line trace as well as recurrent field or line rate trace do you make use of the single line display to get better resolution in your readings? What about parallax? Do you move your head to observe your scope? Do you have a graticule overlay or an etched faceplate graticule? These are some of the items which can affect how accurate you measure your video signal. Others include calibration signals, age, line power fluctuations, etc. How do you take all these into account to get accurate measurement? This article will take you thru the murky world of test and measurement accuracy and provide you with a simple means of determining your own ability to measure your own signals on your own equipment. How is this possible since we all have different equipment? Easy! A few simple examples and easy-to-follow instructions make you a statistical measurement whiz without having to know fancy math! Don't be scared by the math aspect. If you can add and subtract you can follow the procedures. What's more you can apply these same principles to measure anything. Antenna gain, preamp performance, video tape, audio levels or widget dimensions are all subject to the same measurement analysis. You can just as easily apply them to any measurement you make including the ARRL frequency measuring contests. Here is your opportunity to become an expert in statistical analysis.

What hath statistics to do with audio visual? "Nothing", says one engineer. End of article! But no, the engineer was mistaken for statistics and probability have as much to do with audio and video as they do in medicine, government surveys and quality control. Wherever things are measured, counted or estimated that's where probability and statistics become useful tools. In this issue of ATVQ, Part One will focus on one application of statistics: estimating the accuracy and precision of measurements. (Part Two, in the next issue of ATVQ will address maintaining statistical control of the measurement process.)

According to John Mandel of the National Bureau of Standards the greatest contribution of statistics to the science of measurement is the characterization of any measurement as a random drawing from some universe of similar measurements. This concept allows us to evaluate and control a measurement by evaluating the properties of the statistical population or universe of which this measurement is a member. We may use the properties of location (overall average) and dispersion (standard deviation) to determine accuracy and precision.

"Now wait just a cotton picking minute! If you calibrate your measuring device according to manufacturers directions isn't that all there is to it?" No! And don't get me going on calibration which itself could be the grist of numerous of articles and books not to mention numerous standards (MIL-STD-45662, ANSI D 2865, ISO, NBS, ASQC, etc.). Calibration is extremely important and is in fact part of any good measurement control program. It is important that your device be in calibration and that you use your calibration standard to obtain the measurements described in this article.

Each time you hook up a scope and measure audio levels, luminance, chrominance, RF or distortion you ought to be able to state how precise accurate and reliable your reading of say 95 IRE units is. It's not "close enough for



Henry and Sylvia at Bruce Brown's as seen on Metrovision Net in D.C.

"Devoted to Amateur Television"

government work" unless you know how close it is to reality. And just how do we evaluate this closeness, accuracy, and precision? The only way to properly assess the worth of any measurement is to gather data repeatedly from the measurement process and to statistically analyze it. The end result should be a statement such as, "The scope reads 95 IRE therefore we can be 90 % confident that the true video level lies between 92 and 98 IRE based on a sample of 30 normally distributed measurements taken at 50% Relative Humidity and 23 degrees Celsius." Further, after arriving at the foregoing statement we would also wish to detect any future drifts or changes in the measurement process itself long before any real harm is done. This is amplified in part 2.

This article presents five steps which can be taken to ensure that our stated goals are met. They are:

1. Agree on the measurement method;
2. Gather data in subgroups over time;
3. Establish distribution type;
4. Determine accuracy;
5. Determine precision.

1. AGREE ON MEASUREMENT METHODS AND CONVENTIONS

Before gathering data for analysis we must set some ground rules for identifying the level of an observed measurement on a standard waveform monitor. We know that common scopes are graduated in 10 IRE increments--the scale marks are 10 IRE apart. But surely any person familiar with their own equipment knows that we can resolve better than 10 IRE with our own eyeball. After careful repeat measurements the author was able to resolve about 2 IRE increments between the marked 10 IRE graduations on the scope. We agree then to visually divide the graduations first in half and then in half again as in Figure one.

FIGURE 1 SCALE RESOLUTION

For convenience 107.5 becomes 108 and 102.5 becomes 102. This avoids falsely implying that we were able to measure with 0.5 resolution which would probably require a digital meter at this end of the measurement scale.

2. GATHER DATA IN SUBGROUPS OVER TIME

In this example assume a standard VHS video cassette is to be measured repeatedly using the same equipment by the same technician. We will assume that this tape contains among other things, a video signal of 100 IRE amplitude. By this method operator factors such as parallax and equipment variations are eliminated from the study so that only measurement repeatability is being recorded. In more sophisticated experiments one may wish to include different equipment and operators to examine their effects on measurement repeatability is being recorded. In more sophisticated experiments one may wish to include different equipment and operators to examine their effect on some measurement repeatability but for our purposes the same operator and equipment will be assumed. Table 1 shows repeated measurements of video levels taken in groups of 5 each over a 6 day period. (More on this later.)

test #	GROUPS 1-6 (IRE)					
1	98	95	98	102	95	98
2	100	100	102	102	95	102
3	98	98	98	102	98	95
4	95	102	95	100	98	102
5	100	100	92	98	98	105

TABLE 1 VIDEO LEVELS - IRE

3. ESTABLISH DISTRIBUTION TYPE (IE: NORMAL ?)

Fortunately because they fulfill requirements of independence and randomness under many conditions most measurements are distributed "Normally" around some average target value in a bell shaped curve like Figure 2. (next page) Therefore common normal statistics can be applied to the data. Note: the term "Normal" here is not synonymous with regular. Here the term normal

-----110-----	graduation
- - - - - 108- - - - -	visual
-----105-----	graduation
- - - - - 102- - - - -	visual
-----100-----	graduation
- - - - - 98- - - - -	visual
----- 95-----	graduation
- - - - - 92- - - - -	visual
----- 90-----	graduation

Typical scale of scope

"ATVQ"

refers to the Normal probability density function also called the Gaussian distribution by statisticians.

A DISTRIBUTION is nothing more than a tally of how many measurements are at each level. For instance out of 1000 audio measurements all taken under the same conditions 1 measurement may be at -10db, 20 at -5db, 100 at -4db, 800 at 0db, 60 at +2db and so on relative to some standard amplitude level.

A PROBABILITY DISTRIBUTION allows us to determine the expected level of any measurement or the chance (probability) of obtaining a given measurement based on prior or assumed data. For instance: Based on the 1000 measurements referred to above what is the chance of obtaining 2 measurements at -8 db under the same conditions? Or if we do obtain 2 measurements at -8db, how likely is it that the measurement process has actually changed? If it has changed we need to know. If it likely hasn't changed then we avoid unnecessary tweaking and trouble-shooting.

The area under the curve in Figure 2 defines probability. We can see that a value of 83 or 113 is highly unlikely whereas 103 is much more likely because the area under the curve between 103 and the right tail is relatively large. To compute this exact area requires sophisticated calculus. Fortunately statisticians have developed helpful tables and formulas which enable us to estimate this area without resorting to advanced integrations. In order for the tables and formulas to be valid our data must at least approach normal. Departures of data from the normal bell shaped curve must be detected prior to applying them. This is especially true when we wish to assess the precision of any individual measurement. It is less crucial when assessing accuracy since accuracy deals with averages and averages tend to be normally distributed anyhow for sample sizes of 5 or more. Figure 3 demonstrates an easy graphical method of assessing normality. The graph paper called normal probability paper is available from the same sources who supply log paper for engineering plots. Of course computer software can also be used to create plots like Figure 3. The idea is simple. The more the plotted points follow a straight line the more normal or Gaussian the distribution of measurements are. Figure 3 demonstrates well behaved normally

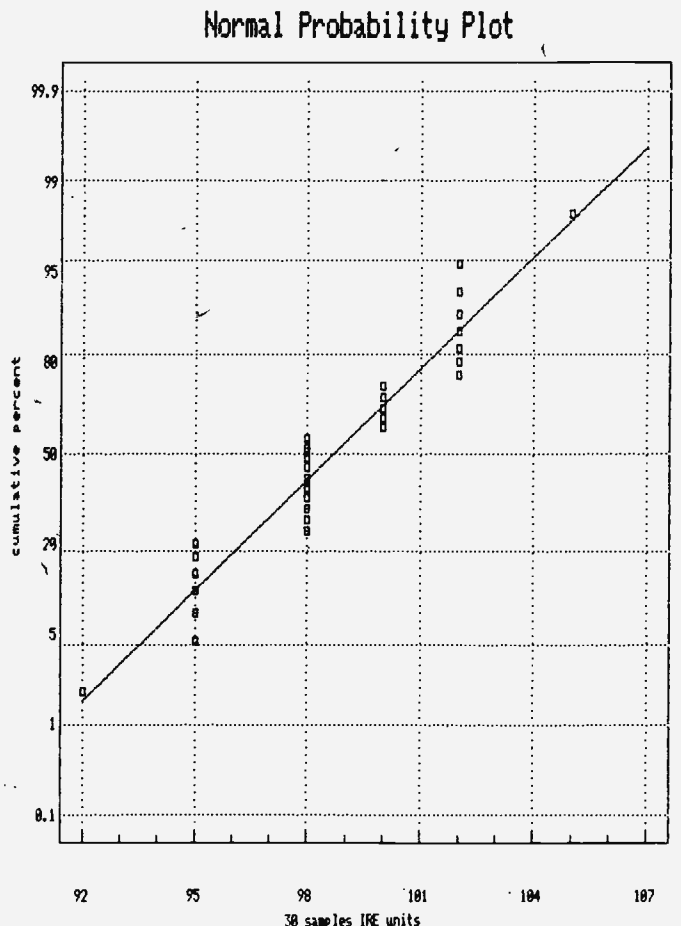
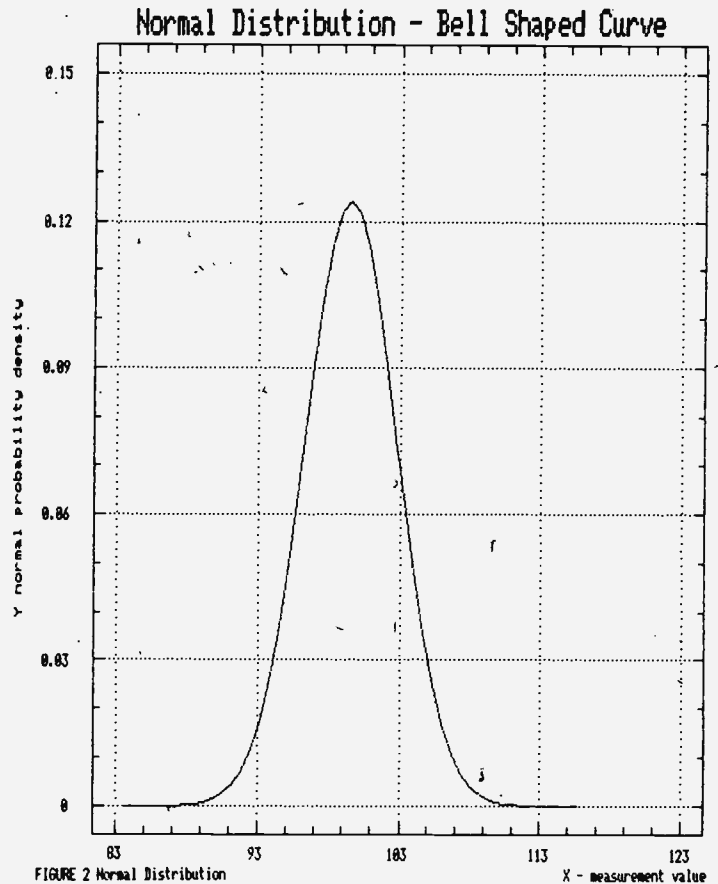

"Devoted to Amateur Television"

distributed data taken from Table 1. The keen observer will detect that the data are bunched into discrete groups rather than being scattered randomly about the fitted line. This behavior is the result of our prior agreements about level resolution using the scope.

To create a normal probability plot scale the x axis in units of measure such as IRE. Then re-order the measurements according to rank from lowest to highest. For example Table 2 below is a re-ordering of the 30 measurements from Table 12. Note that the order of each point depends only on it's magnitude not when it was read.

TABLE 2 RANKED DATA

1	92	n	n
2	95	n	n
3	95	n	n
4	95	n	n
6	95	28	102
7	95	29	102
8	98	30	105

To complete the plot determine the y probability location corresponding to each x point using the formula:

$$y = \{(i-.5)/n\} \times 100$$

where i is the order of the point to be plotted. and n is the total number of points, see Table 3.

ORDER	LEVEL	Y POSITION
1	92	1.66=[(1-.5)/30]100
2	95	5.00=[(2-.5)/30]100
3	95	8.33=[(3-.5)/30]100
4	95	---
5	95	---
6	95	---
AND SO ON.....		
28	102	91.67=[(28-.5)/30]100
29	102	95.00=[(29-.5)/30]100
30	105	98.33=[(30-.5)/30]100

TABLE 3 RANKED DATA AND Y POSITIONS

Finally plot the ordered points according to the x,y coordinates as in Figure 3. First point at x=92, y=1.66. Second at x = 105, y = 98.33.
(refer to figure 3 previous page)

4. DETERMINE ACCURACY

Having satisfied ourselves that our data are reasonably normal we may now determine accuracy and later precision based on normal statistics. To begin

with let's formally define terms:

ACCURACY - the degree to which the arithmetic average of a group of measurements conforms to the standard reference value.

PRECISION - the amount of spread of the distribution of individual measurements around some average value or the closeness of agreement between randomly selected individual measurements. Figure 4 portrays these ideas.

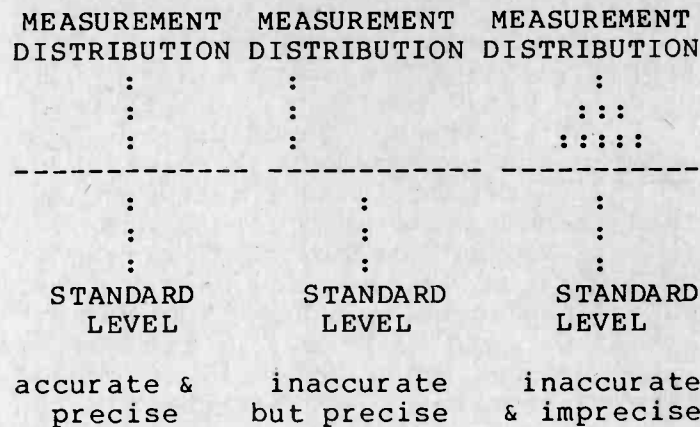

FIGURE FOUR

Recall our original data set from table 1. Notice that instead of just taking 30 consecutive measurements at one time we broke them up into 6 groups (days) of 5 measurements each. Remember also that we defined accuracy in terms of AVERAGES. This is why we broke the measurements up to achieve not only within group averages but also between group averages to account for natural variation in the measurement process. We do this by combining several averages and combining (pooling) several standard deviations (a measure of spread or dispersion). First we com

pute the average \bar{x} , for each subgroup of 5 recordings as shown in Table 4. Next we calculate the standard deviation: S, of each subgroup of 5 by the formula:

$$S = \sqrt{\text{sum } (x - \bar{x})^2 / N - 1}$$

continued.....

“ATVQ”

TABLE FOUR
STATISTICAL CALCULATIONS

TEST #	GROUPS 1-6 (IRE)					
1	98	95	98	102	95	98
2	100	100	102	102	95	102
3	98	98	98	102	98	95
4	95	102	95	100	98	102
5	100	100	92	98	98	105
Average	98.2	99	97	100.8	96.8	100.4
\bar{x}						

STANDARD DEVIATION						
S	2.05	2.65	3.74	1.79	1.64	3.91

Now combine all six averages to obtain the grand mean \bar{x} , by:

$$\bar{x} = \text{sum } (\bar{x}) / k = 592.2 / 6 = 98.7$$

where k = the number of subgroups means combined.

Calculate average ACCURACY:

$$\begin{aligned} \text{ACCURACY} &= \bar{x} - \text{Reference Level} \\ &= 98.7 - 100 \\ &= -1.3 \end{aligned}$$

where x is the computed grand mean, and 100 is the actual reference level of our test videocassette. We now create a reasonable interval around the reference standard value to test the statistical significance of computed Accuracy. Such an interval is generated statistically from our data and is called a CONFIDENCE INTERVAL. The test concept is simple. If confident that this value could have been obtained from the measurement process unchanged. If on the other hand Accuracy lies outside the limits, we can be confident that some "assignable" cause has more than likely affected our results.

From the formula for the confidence interval we note that two quantities need to be determined: a 't' value and Sp, the pooled standard deviation from all measurements. The quantity n is 30 the total number of measurements used.

$$\text{CONFIDENCE INTERVAL} = \text{STANDARD} \pm t_{Sp} \sqrt{\frac{\text{STANDARD}^2}{n}}$$

Because the formula for confidence intervals uses "t-values" this exercise requires t-tables which give values for

a given confidence level and degrees of freedom. Published t-tables are readily available (see Appendix 1.) Figure 5 below illustrates the use of a t-table. To begin with degrees of freedom df, equals the total number of measurements 30 minus the number of sub-groups k=6.

$$\text{Therefore } df = 30 - 6 = 24.$$

Now we must choose a confidence level for the test. In this example we choose a common level of 99% confidence and 24df is t=2.80.

Pool standard deviations to obtain Sp by:

$$Sp = \sqrt{\frac{S1^2(n1-1) + S2^2(n2-1) + S3^2(n3-1) + S4^2(n4-1) + S5^2(n5-1) + S6^2(n6-1)}{n1-1 + n2-1 + n3-1 + n4-1 + n5-1 + n6-1}}$$

$$\sqrt{\frac{S5^2(n5-1) + S6^2(n6-1)}{\text{(part of above)}}}$$

We may now construct the confidence interval by:

$$Sp = \sqrt{\frac{2.05^2(5-1) + 2.65^2(5-1) + 3.74^2(5-1) + 1.79^2(5-1) + 1.64^2(5-1) + 3.91^2(5-1)}{4+4+4+4+4+4}}$$

$$\sqrt{\frac{(5-1) + 1.79^2(5-1) + 1.64^2(5-1) + 3.91^2(5-1)}{\text{(cont.) (5-1)}}}$$

(as above)

(note, this is one equation broken to fit the column space)

$$Sp = \sqrt{\frac{185.58}{24}}$$

$$Sp = 2.78$$

We may now construct the confidence level by:

$$CI = \text{Standard} - \frac{t_{Sp}}{\sqrt{N}} \text{ TO } + \frac{t_{Sp}}{\sqrt{N}}$$

$$= 100 - 2.08(2.78) \quad 100 + 2.80(2.78)$$

$$= 100 - 1.42 \text{ to } 100 + 1.42 = 98.58 \text{ to } 101.42$$

"Devoted to Amateur Television"

Since our overall measured accuracy, grand mean $x = 98.7$ falls between these interval limits the scope accuracy is within 2.84 (ie; the width of the interval is 1.42 on either side of the standard. Any time in the future when the grand mean falls outside this interval the instrument should be carefully checked for calibration problems and requalified before being relied upon. Note that if we had chosen a confidence level of less than 99% for the confidence interval we are more likely to reject any computed accuracy as the interval would be smaller and therefore more sensitive to changes.

DETERMINE PRECISION

$$\begin{aligned} \text{PRECISION} &= 6 \text{ (Sp)} \\ &= 6 (2.78) \\ &= 16.68 \end{aligned}$$

The precision of any individual measurement is less than or equal to 1.7 IRE. At first glance, readers may be surprised at the computed levels of accuracy and precision arrived at here in. However your individual scope may be less variable than the example used here which would place narrower intervals on both accuracy and precision. If you obtain values which are unacceptable then continue to test and find the cause of any unusually high or low individual values such as the lowest (92) and highest (105) obtained in this study. Perhaps the environment changed, or there was an error in reading. Keep in mind that computed accuracy (of overall average) and precision (of individual readings) is based on 30 read

ings from an almost infinite universe of possible readings and are used to place statistical bounds on expected levels of measurements from this universe of possible readings. In part two of this series the reader will be introduced to graphical techniques for maintaining statistical control of measurements and for discovering when outside causes have affected the measurement process.

REFERENCES

- Kimber, R. J. Accuracy and Precision; Quality Feb. 1983
- Mandel, J. Measurement and Statistics. Quality Progress, Aug. 1981 pp34-36
- Filliben, J. J. Testing Basic Assumptions in the Measurement Process. ACS Symposium Series # 63 pp 56-65
- Burchett, G. L. Testing Test Equipment. Quality Progress, Apr. 1984 pp34-36

THE AUTHOR

Gerald B. Hayes is a senior member of the American Society for Quality Control, a Certified Quality Engineer and a member of the American Chemical Society. After several years in the Chemical, aerospace and electronics industry he is Senior Quality Assurance Engineer for the world's largest video duplicator. He has published numerous articles dealing with the use of statistics in industry and research and has taught statistical process control for three years. "Jed" earned his BA (honors) in Biology from Blackburn College in Carlinville, Il.

PART TWO WILL BE IN THE NEXT ISSUE
OF ATVQ.

FIGURE FIVE

Level of significance for two-tailed test*						
	.30	.10	.05	.02	.01 ↓	.001
1	3.078	6.314	12.706	31.821	63.657	636.619
2	1.886	2.920	4.303	6.965	9.925	31.898
3	1.638	2.353	3.182	6.841	12.941	12.941
4	1.533	2.132	2.776	7.147	4.604	6.859
5	1.476	2.015	2.571	7.385	4.032	6.859
6	1.440	1.943	2.447	7.143	3.707	6.909
7	1.415	1.896	2.365	7.298	3.499	6.909
8	1.397	1.860	2.306	7.457	3.355	6.941
9	1.383	1.833	2.262	7.621	3.250	6.781
10	1.372	1.812	2.228	7.784	3.169	6.887
11	1.363	1.794	2.201	7.918	3.106	4.437
12	1.356	1.782	2.179	8.061	3.055	4.318
13	1.350	1.771	2.160	8.200	3.012	4.221
14	1.346	1.761	2.145	8.324	2.977	4.140
15	1.341	1.753	2.131	8.452	2.947	4.073
16	1.337	1.746	2.120	8.583	2.921	4.015
17	1.333	1.740	2.110	8.717	2.896	3.965
18	1.330	1.734	2.101	8.852	2.873	3.923
19	1.328	1.729	2.092	8.989	2.851	3.882
20	1.325	1.725	2.086	9.128	2.844	3.850
21	1.323	1.721	2.080	9.269	2.831	3.819
22	1.321	1.717	2.074	9.412	2.819	3.789
23	1.319	1.714	2.069	9.557	2.807	3.760
24	1.318	1.711	2.064	9.704	2.797	3.732
25	1.316	1.708	2.060	9.852	2.787	3.704
26	1.315	1.706	2.056	9.999	2.778	3.676
27	1.314	1.703	2.052	10.148	2.770	3.648
28	1.313	1.701	2.048	10.298	2.762	3.620
29	1.311	1.699	2.045	10.449	2.754	3.592
30	1.310	1.697	2.042	10.601	2.747	3.564

APPENDIX ONE

CRITICAL VALUES OF t						
Level of significance for one-tailed test						
	.10	.05	.025	.01	.005	.001
1	3.078	6.314	12.706	31.821	63.657	636.619
2	1.886	2.920	4.303	6.965	9.925	31.898
3	1.638	2.353	3.182	6.841	12.941	12.941
4	1.533	2.132	2.776	7.147	4.604	6.859
5	1.476	2.015	2.571	7.385	4.032	6.859
6	1.440	1.943	2.447	7.143	3.707	6.909
7	1.415	1.896	2.365	7.298	3.499	6.909
8	1.397	1.860	2.306	7.457	3.355	6.941
9	1.383	1.833	2.262	7.621	3.250	6.781
10	1.372	1.812	2.228	7.784	3.169	6.887
11	1.363	1.794	2.201	7.918	3.106	4.437
12	1.356	1.782	2.179	8.061	3.055	4.318
13	1.350	1.771	2.160	8.200	3.012	4.221
14	1.346	1.761	2.145	8.324	2.977	4.140
15	1.341	1.753	2.131	8.452	2.947	4.073
16	1.337	1.746	2.120	8.583	2.921	4.015
17	1.333	1.740	2.110	8.717	2.896	3.965
18	1.330	1.734	2.101	8.852	2.873	3.923
19	1.328	1.729	2.092	8.989	2.851	3.882
20	1.325	1.725	2.086	9.128	2.831	3.850
21	1.323	1.721	2.080	9.269	2.819	3.819
22	1.321	1.717	2.074	9.412	2.807	3.789
23	1.319	1.714	2.069	9.557	2.797	3.760
24	1.318	1.711	2.064	9.704	2.787	3.732
25	1.316	1.708	2.060	9.852	2.778	3.704
26	1.315	1.706	2.056	9.999	2.770	3.676
27	1.314	1.703	2.052	10.148	2.762	3.648
28	1.313	1.701	2.048	10.298	2.754	3.620
29	1.311	1.699	2.045	10.449	2.747	3.592
30	1.310	1.697	2.042	10.601	2.740	3.564
40	1.303	1.694	2.039	10.857	2.733	3.536
50	1.299	1.692	2.037	11.114	2.726	3.508
60	1.296	1.690	2.035	11.371	2.719	3.480
70	1.294	1.688	2.033	11.629	2.712	3.452
80	1.292	1.686	2.031	11.887	2.705	3.424
90	1.290	1.684	2.029	12.146	2.698	3.396
∞	1.289	1.683	2.028	12.406	2.691	3.368

"ATVQ"



The Radio Amateur's Journal



ON THE COVER: It looks like Santa will be visiting CQ staffers soon. It's a good time to leave some milk, cookies, and a QSL card for him. Photo by Larry Mulvehill, WB2ZPI.

DECEMBER 1988

VOL. 44, NO. 12

FEATURES

A SIMPLE, EFFECTIVE, INEXPENSIVE APPROACH TO RECEIVE AND/OR TRANSMIT AUDIO EQUALIZATION John J. Schultz, W4FA/SVØ DX	13
RESULTS OF THE 1988 CQ 160 METER CW AND PHONE DX CONTESTS..... Donald McClenon, N4IN	20
ANNOUNCING: A NEW DEFINITION OF PREFIX FOR THE CQ WPX AWARD..... Alan M. Dorhoffer, K2EEK	32
CQ REVIEWS: THE ICOM IC-781 HF SUPER TRANSCEIVER, PART II..... Dave Ingram, K4TWJ	34
HUNTING THE RARE ONE..... Henry Hill, WA3CUC	40
UNUSUAL CALL SIGNS..... Brian D. Smith, KA9OIH	44
CPR FOR DEAD HT BATTERIES..... Neil Lewbell, KA1PJQ.....	48
CQ SHOWCASE: NEW AMATEUR PRODUCTS.....	54
ANNOUNCING: THE 1989 CQ WORLD-WIDE 160 METER DX CONTEST.....	56
WASHINGTON READOUT: REGULATORY HAPPENINGS FROM THE WORLD OF AMATEUR RADIO... Frederick O. Maia, W5YI	58
TOTE 'N TALK, HOW TO BUILD A PORTABLE OPERATING SETUP FOR QRPERS..... Adrian Weiss, WØRSP	60
ANTENNAS AND ACCESSORIES: THE QUAD REVISITED Karl T. Thurber, Jr., W8FX	78
PACKET USER'S NOTEBOOK: PACKET RADIO'S "ALPHABET SOUP"..... Buck Rogers, K4ABT	84
BILL'S BASICS: AMATEUR RADIO STAMPS, PART II Bill Welsh, W6DDB	88
WORLD OF IDEAS: HOLIDAY GIFTS FOR AMATEURS Dave Ingram, K4TWJ	92

DEPARTMENTS

CONTEST CALENDAR: CONTESTS FOR DEC. AND EARLY JAN., RESULTS OF THE 1987 OK-DX CONTEST Frank Anzalone, W1WY	68
AWARDS: STORY OF THE MONTH—STU CASPER, W2PDM Dorothy Johnson, WB9RCY	74
DX: THE WORLD OF DX, NEWS, VIEWS, AND HAPPENINGS FROM AROUND THE WORLD..... Hugh Cassidy, WA6AUD	96
PROPAGATION: CONTEST BULLETIN, DX CHARTS FOR DEC. 15, 1988 TO JAN. 15, 1989..... George Jacobs, W3ASK	104
ZERO BIAS..... 4	OUR READERS SAY..... 10
ANNOUNCEMENTS..... 6	HAM SHOP..... 110

Tune in with



The Ham's Magazine

All year long CQ brings you the best writers... the best reading in Amateur Radio. Written and edited to be enjoyed as much as you enjoy Ham Radio itself. Not just good. It's the best!

Subscribe and SAVE!

SAVE 36% OR MORE ON YOUR COPIES OF CQ

Subscribe now and save \$10 a year or more over the cost of buying your issues on the newsstand.

Yes! I want every issue of CQ delivered to my door, so sign me up.

- 1 year - 12 issues **\$19.95**
(Save \$10.05)
- 2 years - 24 issues **\$38.00**
(Save \$22.00)
- 3 years - 36 issues **\$57.00**
(Save \$33.00)

Canada/Mexico—One year \$22.00, two years \$42.00, three years \$63.00; Foreign—one year \$24.00, two years \$46.00, three years \$69.00. Foreign Air Mail—one year \$77.00, two years \$152.00, three years \$228.00.

(Please print clearly)

Name _____
 Street _____
 City _____
 State _____ Zip _____

Check or Money Order enclosed
 Bill to Mastercard Visa
 My account number is:

--	--	--	--

Expiration date: _____

Note: Allow 6-8 weeks for delivery of first issue.

IMPORTANT: BE SURE TO ENCLOSE YOUR CHECK OR MONEY ORDER

"Devoted to Amateur Television"

TENKAI CONVERSION FOR ATV RECEIVE

Over the past few years several makes of Korean made B/W TV sets have been showing up in discount electronics stores with sensitive varactor tuner. They have many brand names but all seem to have a similar Korean manufacturer. Some names used are TENKAI, MULTITECH and the 5" Radio Shack TV are very similar in design. With only a couple of minor modifications these TV's will operate as a very sensitive ATV receiver (equivalent of a MRF901 down converter) and in some cases will tune down to below 421.25 Mhz. In the case of the Tenkai Model CT-205 or CT-105 it's possible to tweak it to receive part of the 900 Mhz band, usually to about 915 Mhz, although the sensitivity is on the order of 2 microvolts at this end of the band (pre-amp recommended). The following are the conversion steps to tune a TENKAI model CT-205 or CT-105 5" B/W TV to the ATV bands. Although part numbers won't be the same, similar brand names can be modified in the same manner.

CONVERSION

- 1) Remove all screws from the chassis.
- 2) Bend the top of the Front Panel slowly forward until you can lift the cover off.
- 3) You should see a resistor near the tuner usually marked R702. This resistor is used to keep the varactor tuning voltage from going below 0.5 volts. By shorting this resistor the tuner can be tuned to 0 volts and cover 439.25 Mhz, 434 Mhz and in some all the way down below 421.25 Mhz. (NOTE: In many new TV's with varactor tuners the tuning voltage is limited to 0.5 - 1.0 volts by a similar resistor or potentiometer. Find the front panel tuning pot and measure the tuning voltage as you go below channel 14. If it doesn't go to 0 volts then find the limiting resistor or pot and short it.)
- 4) If you have difficulty getting a soldering iron between the tuner and wires to short R702 from the top of the circuit board then remove two screws on the support bracket that attaches the front panel to the chassis. In the case of the Multitech just bend the front panel forward until you hear a loud crack since the front panel snaps into the chassis.
- 5) Remove three screws supporting the circuit board to the chassis and carefully slide the board out and away from

the chassis. You will have to tip the CRT and circuit board on its side to get to the bottom of the circuit board. Near the tuner you will see R702 marked on the board. Short out the resistor.

6) If you want to obtain a video output from the TV set you can tap into the video signal at the junction of R201 and R202 located just below the metal RF shield. Use mini RG-174 or 75 ohm mini coax and solder the center conductor to the R201/R202 junction and the shield to the other side of R201. (NOTE: DO NOT use this directly as a video source as it's not isolated from the TV SET and is very low level video. It should be fed into a video amp i.e. P.C. Electronics VA2 to achieve 1v p-p video. Even though this is a B/W TV set you can now receive color video when hooked to a color monitor!)

- 7) Slide the board back into place and screw it and the Front Panel back onto the chassis. To improve sensitivity remove the antenna input coax leading to the tuner from the small circuit board on the chassis where the antenna inputs are normally connected. Next to the 300 ohm antenna input terminals you will notice a small metal plate covers two unused holes in the back. Peel off this plate with a small knife and widen the top hole to allow mounting a BNC connector. Attach the coax from the tuner directly to the BNC connector and you now have a very sensitive ATV receiver! (The external antenna connections and the whip antenna are now bypassed)
- 8) For those who want to tune the 900 Mhz band adjust pot SVR704 fully counterclockwise which should allow you to tune 915 Mhz. Doing this will make the 439.25 Mhz tuning sharper. Replacing the front panel tuning pot with a ten turn pot will make tuning very smooth.

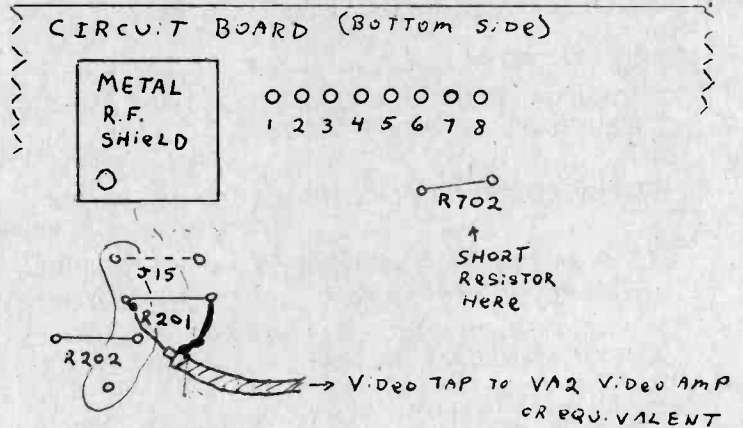

WB8ELK
 FINDLAY
 OHIO
 144.34



ELKTRONICS

12536 T.R. 77
 Findlay, OH 45840
 (419) 422-8206



W H I T E
 Y E L L O W
 C Y A N
 G R E E N
 M A G E N T A
 R E D
 B L U E

WB8ELK

INTRODUCING THE

VDG-1

VIDEO I.O.

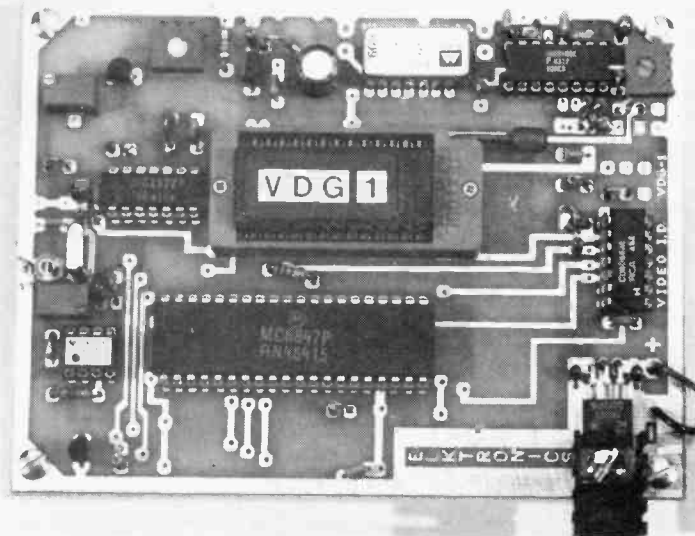

Custom Graphics!



WB8ELK

KA0JAW

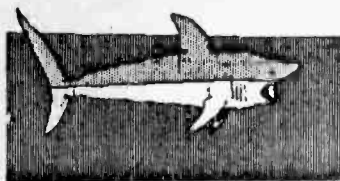

KA8EE

Jim
 Marion Ohio

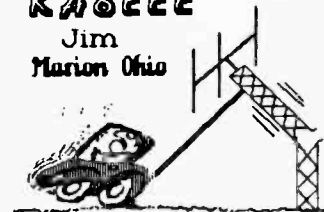

N9CAI /r



KA8ZNY

GROVEPORT

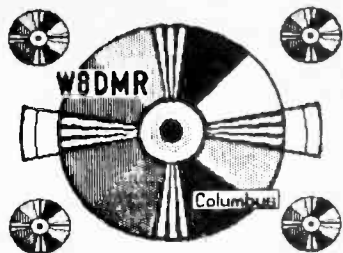

- Instant Video Source
- 4 Graphics Screens
 (2 Hi-RES / 2 Colorbar)
- 12 V D.C. Operation
- Video Relay for switching in
 live camera video
- Built-in Sequencer/Timer
 (Steps through all 4 screens)



WB8RSK
 ROB
 FINDLAY
 OHIO

VDG-1 with Pre-Programmed
 Custom Callsign Logo

— \$89 ppd.

(Quick-release socket option)

— \$10

**Call or Write for CATALOG
 of available Graphics**

Additional Programmed EPROMS
 — \$15

We can transfer CoCo or C-64
 graphics from your Disk or Tape

KA8LWR



IN BUCYRUS, OHIO

KA8WLW

WHERE NO ATV'ER
 HAS GONE BEFORE





FSTV-430

Fast Scan Television Transceiver



In the last ten years AEA has become one of the best known names in amateur radio digital communications. With our multi-mode data controllers you can send and receive data in several digital modes from Morse Code to Packet.

Now AEA joins another growing segment of Amateur Radio....Amateur Television.

The new FSTV 430 fast scan television transceiver from AEA makes getting on ATV easy and inexpensive. Almost any video camera (including most camcorders) can be used. Plug the camera into the FSTV 430, and connect to your 70cm antenna. Use a standard television for display of received signals, and you're on the air. Of course, using an amplifier will add range to your signal.

The AEA engineering standards of high performance are evident in this new transceiver. The FSTV 430 has a sensitive UHF GaAsfet preamp with a crystal controlled downconverter and IF filter (channel 3 or

4) for signal reception. The transmitter in the FSTV 430 uses a VSB (Vestigial Side Band) design to minimize adjacent channel interference. Two frequencies can be selected for transmission, one crystal is included.

Signal output is one watt p.e.p..

Any amateur with a technician class (or higher) license can join the fun of ATV. The FSTV 430 can transmit in either black and white or color. The portable, lightweight FSTV 430 transceiver can be used for in station or on the go operation. You can even connect your VCR for transmission of video tapes.

If you own a video camera, you should be on amateur television. Why not use your amateur radio and video skills together. The FSTV 430 makes putting two hobbies together easy and fun. Contact your local AEA dealer today for more information about the FSTV 430 from AEA.

Amateur Net Price \$369.95

ADVANCED ELECTRONIC APPLICATIONS, INC.

P.O. Box 2160

Lynnwood, Washington 98036 USA