

AUGUST 2002
ISSUE #501
USA \$3.95
CANADA \$4.95

73 Amateur Radio Today

Antennas:

- Plumber's Delight
2m/70cm Circle Quad
- 2m Twin Loop
- More VLF to HF Loop

Hamfest from Hell

Twisted Tale of Dials

Wire-Wrap Primer

Tube Truths: Dimming the Glow?

Åland Islands OHØ

.....

***** 3-DIGIT 231

#00000109389WR6# JUL76

JACK SPEER

BUCKMASTER PUBLISHING

6196 JEFFERSON HIGHWAY
MINERAL VA 23117-3425

219
45
3

P

08

0 74851 08725 1

Meet Our New Family of Mobile/Base Transceivers

Fantastic Features • Rugged • Good Looking • Superior Alinco Value!

Each member of our new "family" includes:

- 100 memory channels
- Large alphanumeric display
- CTCSS and DCS encode+decode, DTMF encode and European Tone Bursts
- Large, comfortable backlit mic
- Ten autodial memories
- Accepts optional EJ-41U internal 1200/9600 TNC
- Rear panel DSUB9 serial connector for packet operation
- Front panel input for GPS/APRS® operations
- Ignition key on/off feature
- Theft alarm feature
- Multiple scan modes including CTCSS and DCS
- Available with classic black(T) or pewter(TG) colored chassis
- Narrow FM operation feature
- 1200/9600 bps capability with internal or external TNC
- Wire clone feature



DR-135T/TP/TG/TPG 2 Meter FM Transceiver

Additional features include:

- 144 ~ 148 MHz TX/RX
- AM Airband RX (118 ~ 136 MHz)
- Extended Receive 136 ~ 174 MHz (FM)
- MARS capability
- 50/10/5 watt power output settings
- Available with or without internal 1200/9600 TNC
- TP and TPG include factory-installed TNC

By Popular Demand!

DR-235T/TG 222 MHz FM Transceiver

Additional features include:

- Amazing low price for 222 MHz
- 222 ~ 225 MHz TX/RX
- Extended receive 216 ~ 280 MHz (FM)
- 219 ~ 220 MHz TX/RX capability (see FCC rules)
- MARS capability
- 25/10/5 watt power output settings
- Accepts optional EJ-41U 1200/9600 internal TNC

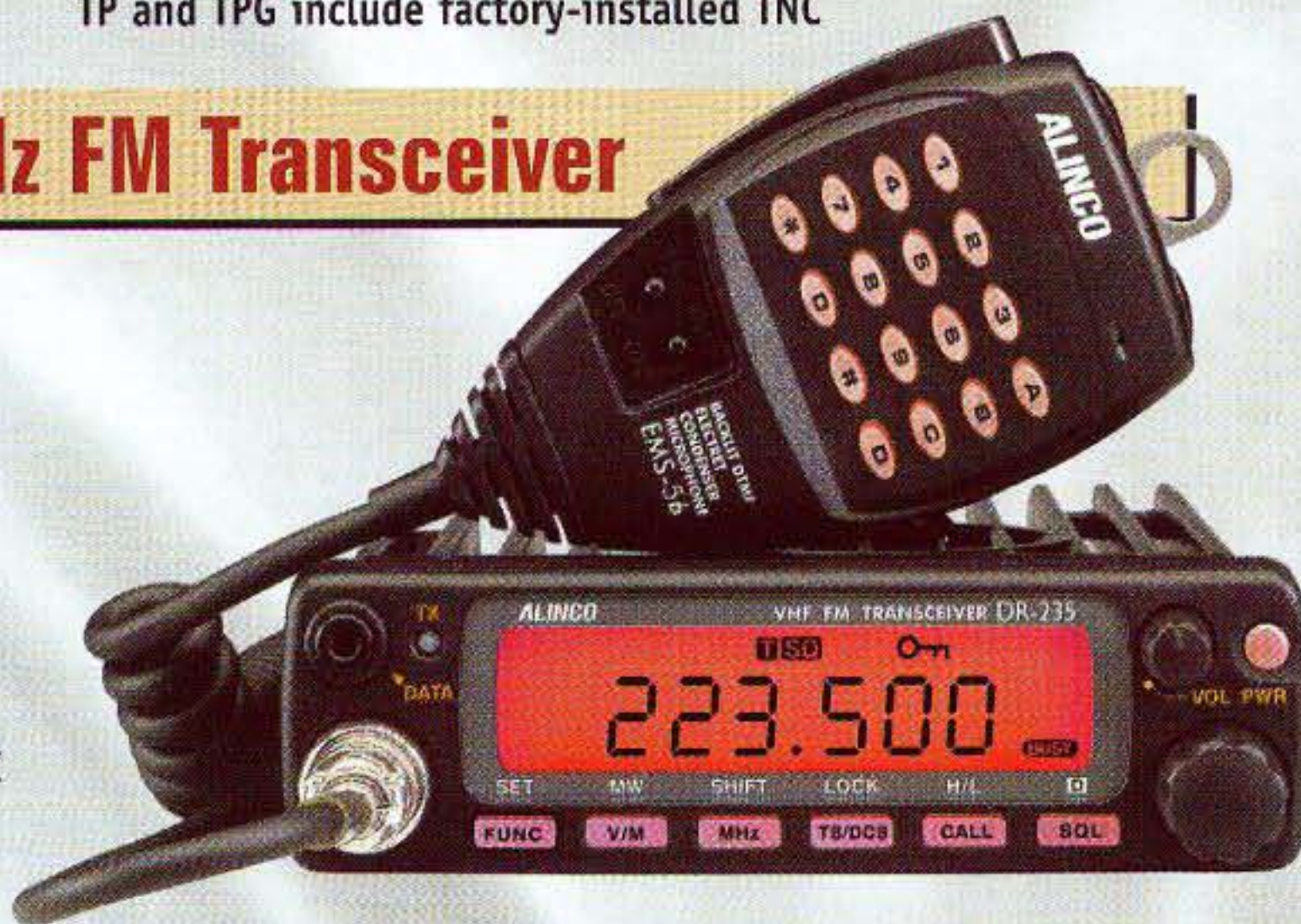

DR-435T/TG 440 MHz FM Transceiver

NEW!

Additional features include:

- 430 ~ 450 MHz TX/RX
- Extended receive 350 ~ 511 MHz (FM)
- All memories capable of odd splits
- 35/10/5 watt power output settings
- Accepts optional EJ-41U 1200/9600 internal TNC



www.**ALINCO**.com

El Supremo & Founder
Wayne Green W2NSD/1

Associate Publisher
F. I. Marion

Executive Editor
Jack Burnett

Managing Editor
Joyce Sawtelle

Technical Editor
Larry Antonuk WB9RRT

Contributing Culprits
Mike Bryce WB8VGE
Jim Gray II
Jack Heller KB7NO
Chuck Houghton WB6IGP
Andy MacAllister W5ACM
Joe Moell KØOV
Steve Nowak KE8YN/Ø
Dr. Rick Olsen N6NR

Advertising Sales
Evelyn Garrison WS7A
21704 S.E. 35th St.
Issaquah WA 98029
425-557-9611
Fax: 425-557-9612

Circulation
Frances Hyvarinen

Data Entry & Other Stuff
Norman Marion

Business Office
Editorial - Advertising - Circulation
Feedback - Product Reviews
73 Amateur Radio Today Magazine
70 Hancock Rd.
Peterborough NH 03458-1107
603-924-0058
Fax: 603-924-8613

Reprints: \$3 per article
Back issues: \$5 each

Printed in the USA

73 Amateur Radio Today

TABLE OF CONTENTS

FEATURES

- 10 **YOU Can Build This VLF to HF Loop Receiving Antenna — K8ZOA**
Part 2 of 3.
- 16 **Vacuum Tubes: Romance and Reality — W8QYR**
A (mostly) glowing tale.
- 19 **2 m/70 cm Quad Revisited — Part 1 — K8IHQ**
Try out this new, improved update to a CQ article.
- 23 **Twisted Tale: The Dial File — W6WTU**
Ever wonder how dials evolved? Well, read this anyway.
- 30 **Twin for Two — AC6XJ**
Give this home-made twin loop for 2m a try — and be surprised
- 32 **This Thing Called Wire-Wrap — K8IHQ**
Whether you refer to it as a technique, a technology, or just plain old-fashioned, wire-wrapping is still valuable to know.
- 36 **Travels with Henryk — Part 7 — SMØJHF**
Hams in the Åland Islands OHØ.
- 39 **Read All About It! — K8JWR**
Part 11 of good stuff from The Hertzian Herald.
- 40 **The Hamfest From Hell — Anonymous**
Are you in this story?
- 41 **The Write Stuff — AA2JZ**
Here's a work-at-home scheme that is no scam.

DEPARTMENTS

- 49 Ad Index
44 Above & Beyond — WB6IGP
64 Barter 'n' Buy
42 Calendar Events
53 The Digital Port — KB7NO
50 Hamsats — W5ACM
55 Homing In — KØOV
4 Never Say Die — W2NSD/1
47 On the Go — KE8YN/Ø
60 Propagation — Gray
1 QRX
63 Radio Bookshop

E-Mail

design73@aol.com

Web Page

www.waynegreen.com

QRX . . .

The Return of "The Doctor is Destinated": Questions & Answers for the New Ham

Q. I've been reading through old QSTs to try to find

out exactly what an antenna tuner does, and I keep running into words like "impedance" that I just don't understand. Please explain!

A. The people who write for QST seem to want to make everything more complicated than it is. But don't

Continued on page 6

Manuscripts: Contributions for possible publication are most welcome. We'll do the best we can to return anything you request, but we assume no responsibility for loss or damage. Payment for submitted articles will be made after publication. Please submit both a disk and a hard copy of your article [IBM (ok) or Mac (preferred) formats], carefully checked drawings and schematics, and the clearest, best focused and lighted photos you can manage. "How to write for 73" guidelines are available on request. US citizens, please include your Social Security number with submitted manuscripts so we can submit it to you know who.

73 Amateur Radio Today (ISSN 1052-2522) is published monthly by 73 Magazine, 70 Hancock Rd., Peterborough NH 03458-1107. The entire contents ©2002 by 73 Magazine. No part of this publication may be reproduced without written permission of the publisher, which is not all that difficult to get. The subscription rate is: one year \$24.97, two years \$44.97; Canada: one year \$34.21, two years \$57.75, including postage and 7% GST. Foreign postage: \$19 surface, \$42 airmail additional per year, payable in US funds on a US bank. Second class postage is paid at Peterborough, NH, and at additional mailing offices. Canadian second class mail registration #178101. Canadian GST registration #125393314. Microfilm edition: University Microfilm, Ann Arbor MI 48106. POSTMASTER: Send address changes to 73 Amateur Radio Today, 70 Hancock Rd., Peterborough NH 03458-1107. 73 Amateur Radio Today is owned by Shabromat Way Ltd. of Hancock NH.



...POWER ON WITH ASTRON

SWITCHING POWER SUPPLIES...



MODEL SS-10TK



MODEL SS-12IF

SPECIAL FEATURES:

- HIGH EFFICIENCY SWITCHING TECHNOLOGY SPECIFICALLY FILTERED FOR USE WITH COMMUNICATIONS EQUIPMENT, FOR ALL FREQUENCIES INCLUDING HF
- HEAVY DUTY DESIGN
- LOW PROFILE, LIGHT WEIGHT PACKAGE
- EMI FILTER
- MEETS FCC CLASS B

PROTECTION FEATURES:

- CURRENT LIMITING
- OVERVOLTAGE PROTECTION
- FUSE PROTECTION.
- OVER TEMPERATURE SHUTDOWN

SPECIFICATIONS:

INPUT VOLTAGE: 115 VAC 50/60HZ
OR 220 VAC 50/60HZ
SWITCH SELECTABLE
OUTPUT VOLTAGE: 13.8VDC

AVAILABLE WITH THE FOLLOWING APPROVALS: UL, CUL, CE, TUV.



MODEL SS-18

DESKTOP SWITCHING POWER SUPPLIES

MODEL	CONT. (Amps)	ICS	SIZE (inches)	Wt.(lbs.)
SS-10	7	10	1 1/2 x 6 x 9	3.2
SS-12	10	12	1 1/2 x 6 x 9	3.4
SS-18	15	18	1 1/2 x 6 x 9	3.6
SS-25	20	25	2 1/4 x 7 x 9 1/2	4.2
SS-30	25	30	3 1/4 x 7 x 9 1/2	5.0



MODEL SS-25M

DESKTOP SWITCHING POWER SUPPLIES WITH VOLT AND AMP METERS

MODEL	CONT. (Amps)	ICS	SIZE (inches)	Wt.(lbs.)
SS-25M*	20	25	2 1/4 x 7 x 9 1/2	4.2
SS-30M*	25	30	3 1/4 x 7 x 9 1/2	5.0



MODEL SRM-30

RACKMOUNT SWITCHING POWER SUPPLIES

MODEL	CONT. (Amps)	ICS	SIZE (inches)	Wt.(lbs.)
SRM-25	20	25	3 1/2 x 19 x 9 1/2	6.5
SRM-30	25	30	3 1/2 x 19 x 9 1/2	7.0

WITH SEPARATE VOLT & AMP METERS

MODEL	CONT. (Amps)	ICS	SIZE (inches)	Wt.(lbs.)
SRM-25M	20	25	3 1/2 x 19 x 9 1/2	6.5
SRM-30M	25	30	3 1/2 x 19 x 9 1/2	7.0

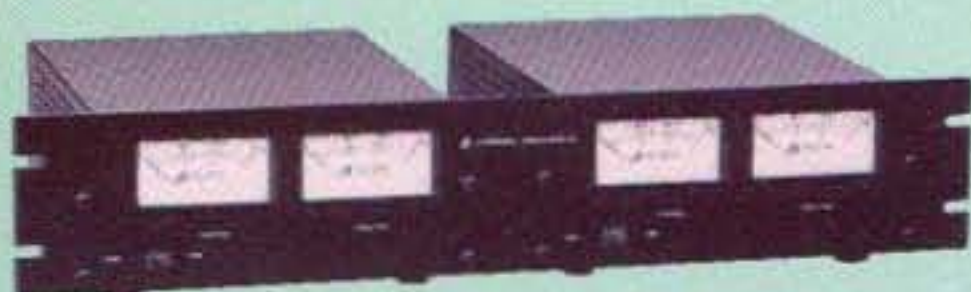

MODEL SRM-30M-2

2 ea SWITCHING POWER SUPPLIES ON ONE RACK PANEL

MODEL	CONT. (Amps)	ICS	SIZE (inches)	Wt.(lbs.)
SRM-25-2	20	25	3 1/2 x 19 x 9 1/2	10.5
SRM-30-2	25	30	3 1/2 x 19 x 9 1/2	11.0

WITH SEPARATE VOLT & AMP METERS

MODEL	CONT. (Amps)	ICS	SIZE (inches)	Wt.(lbs.)
SRM-25M-2	20	25	3 1/2 x 19 x 9 1/2	10.5
SRM-30M-2	25	30	3 1/2 x 19 x 9 1/2	11.0



MODEL SS-12SM/GTX



MODEL SS-10EFJ-98

CUSTOM POWER SUPPLIES FOR RADIOS BELOW

- EF JOHNSON AVENGER GX-MC41
- EF JOHNSON AVENGER GX-MC42
- EF JOHNSON GT-ML81
- EF JOHNSON GT-ML83
- EF JOHNSON 9800 SERIES
- GE MARC SERIES
- GE MONOGRAM SERIES & MAXON SM-4000 SERIES
- ICOM IC-F11020 & IC-F2020
- KENWOOD TK760, 762, 840, 860, 940, 941
- KENWOOD TK760H, 762H
- MOTOROLA LOW POWER SM50, SM120, & GTX
- MOTOROLA HIGH POWER SM50, SM120, & GTX
- MOTOROLA RADIUS & GM 300
- MOTOROLA RADIUS & GM 300
- MOTOROLA RADIUS & GM 300
- UNIDEN SMH1525, SMU4525
- VERTEX — FTL-1011, FT-1011, FT-2011, FT-7011

NEW SWITCHING MODELS

- SS-10GX, SS-12GX
- SS-18GX
- SS-12EFJ
- SS-18EFJ
- SS-10-EFJ-98, SS-12-EFJ-98, SS-18-EFJ-98
- SS-12MC
- SS-10MG, SS-12MG
- SS-101F, SS-121F
- SS-10TK
- SS-12TK OR SS-18TK
- SS-10SM/GTX
- SS-10SM/GTX, SS-12SM/GTX, SS-18SM/GTX
- SS-10RA
- SS-12RA
- SS-18RA
- SS-10SMU, SS-12SMU, SS-18SMU
- SS-10V, SS-12V, SS-18V



GET THE NEW CATALOG TODAY!

New Kits, New LPFM, New Cameras

www.ramseykits.com



WORK THE WORLD WITH A WATT...FOR ONLY \$99!

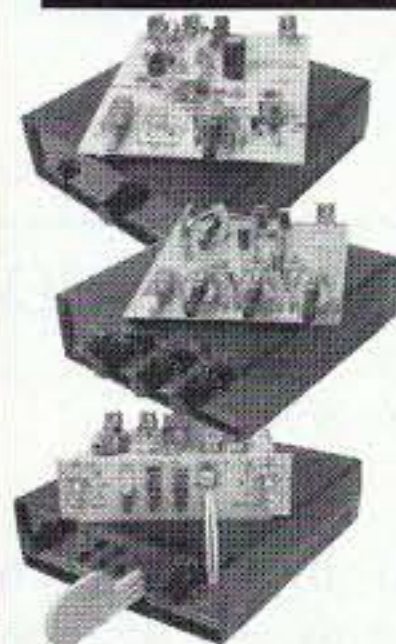

QRP TRANSMITTER

Available in 20, 30, or 40 Meters, these neat little transmitters put out 1 Watt!

HR RECEIVER

Available in 20, 30, or 40 Meters, 1.0 uV sensitivity rivals the big rigs...at a fraction of the price!

CW700 KEYER

With adjustable pitch & speed from 3-60 wpm, features true iambic keying and EPROM memory!

\$99 COMPLETE!

\$155 Sold Separately
Visit www.ramseykits.com/qrp to order this special deal!

\$99 price includes QRP Transmitter kit, HR Receiver kit, and CW700 Micro-Memory Keyer kit, all the matching case & knob sets shown. Visit www.ramseykits.com/qrp to order this special deal!

35 WATT LPFM STEREO TRANSMITTER



- ✓ 35W RF output, VSWR protected
- ✓ Automatic audio & power controls
- ✓ Digital synthesized PLL
- ✓ Full front panel control
- ✓ 110/220VAC, 12VDC operation

Whether your application is export or LPFM, the PX1 has you covered. From the over-rated continuous duty power supply & power amplifier to the 2 line vacuum fluorescent display, your station will be the easiest to setup and the most reliable for continuous operation. Full microprocessor controls provide a "virtual engineer". Check out www.highpowerfm for full details.

PX1 35W Professional FM Stereo Transmitter \$1,795.95

TOUCH-TONE TONE GRABBER



- ✓ New-built-in RJ11 phone jack
 - ✓ Large memory holds over 500 numbers
 - ✓ Big bold 8 digit display, auto insertion of dashes
 - ✓ New-output latch jack
- Dialed phone numbers on the radio, repeater codes, control codes, anywhere touch-tones are used, you can read and store them! All new design for 2002. Capture those tones with the TG2!

TG2 Tone Grabber Tone Reader Kit \$59.95
 CTG2 Matching Case & Knob Set \$14.95
 AC125 110 VAC Power Adapter \$9.95

ELECTROCARDIOGRAM HEART MONITOR



- ✓ Visible and audible display of your heart rhythm
 - ✓ Re-usable sensors included; just like visiting the hospital!
 - ✓ Bright LED "beat" indicator
 - ✓ Monitor output for oscilloscope display
- Enjoy learning about the inner workings of the heart while covering the stage by stage electronic circuit theory of ECG/EKG systems. Be heart smart and learn at the same time!

ECG1 Electrocardiogram Heart Monitor Kit \$34.95
 CECG Matching Case & Knob Set \$14.95
 AC125 110 VAC Power Adapter \$9.95
 ECGP10 Replacement Reusable Probe Patches (10-Pack) \$7.95

XLR TO RCA AUDIO CONVERTER



- ✓ Connect consumer outputs to XLR inputs
 - ✓ Left & right audio gain adjustments
- So you're trying to connect consumer audio outputs with RCA connectors (unbalanced) to XLR (balanced) inputs. Always a problem...Not anymore with the R2XL1!

R2XL1 Unbalanced to Balanced Audio Converter Kit \$49.95
 CR2XL Matching Case & Knob Set \$14.95
 PWR25 12VAC Power Adapter \$9.95

GIVEAWAYS & SPECIALS EVERY MONTH!

Register to receive our E-Mail specials and you will automatically be entered in our monthly drawing! New deals, new specials, new giveaways every month!

Register TODAY

www.ramseykits.com/specials

PROFESSIONAL FM STEREO RADIO STATION



- ✓ Synthesized 88 to 108 MHz with no drift!
- ✓ Built-in mixer - 2 line inputs and one microphone input!
- ✓ High power module available for export use
- ✓ Low pass filter for great audio response

Our FM100 is used all over the world by serious hobbyists as well as churches, drive-in theaters, and schools. Frequency synthesized PLL assures drift-free operation with simple front panel frequency selection. Built-in audio mixer features LED bargraph meters to make setting audio a breeze. The kit includes metal case, whip antenna and built-in 110 volt AC power supply.

FM100 Super-Pro FM Stereo Radio Station Kit \$249.95
 FM100WT 1 Watt, Wired Export Version \$399.95

SYNTHESIZED FM STEREO TRANSMITTER



- ✓ All new design & features for 2002!
 - ✓ Fully adjustable RF output
- Our #1 kit for years has just gotten better for 2002! Totally redesigned, the FM25B has all the features you've asked for. From variable RF output, F connector RF output jack, line input, loop output, and more.

Includes case, power supply, whip antenna, audio cables.
 FM25B Synthesized FM Stereo Transmitter Kit \$129.95

AUTOMATIC COLOR/BW IR CAMERA



- ✓ Color during the day, IR B&W at night!
 - ✓ Automatically turns on IR Illumination!
 - ✓ Waterproof to IP57 standards!
 - ✓ Black anodized housing with universal mount
- Best of both worlds! This video camera is a waterproof COLOR camera during the day. When the light level drops, it automatically changes to B&W and turns on its built-in IR illumination, with 10 IR LEDs. Powered by 12VDC and terminated with a professional BNC connector. B&W only model also available if color is not needed.

Both in heavy anodized black housing.
 CCD309 Color/B&W IR Waterproof Bullet Camera \$169.95
 CCD308 B&W IR Waterproof Bullet Camera \$109.95
 AC125 110 VAC Power Adapter \$9.95

MINI B&W CAMERA WITH IR ILLUMINATION



- ✓ Built in IR illumination!
 - ✓ Sees in total darkness!
- What a deal! This miniature B&W video camera has 6 high power IR LEDs built into it to provide illumination in total darkness! No need for external IR illuminators. Attractive black aluminum housing easily mounts at any angle with the built-in swivel bracket. Runs on 12VDC, and includes professional BNC output plug-in harness.

CCD303 Mini B&W IR Illuminated Camera \$59.95
 AC125 110 VAC Power Adapter \$9.95

Check out all our other new cameras at www.ramseykits.com



RAMSEY ELECTRONICS, INC.
 793 Canning Parkway
 Victor, NY 14564
 716-924-4560
 sales@ramseykits.com



Order Today! 800-446-2295

www.ramseykits.com

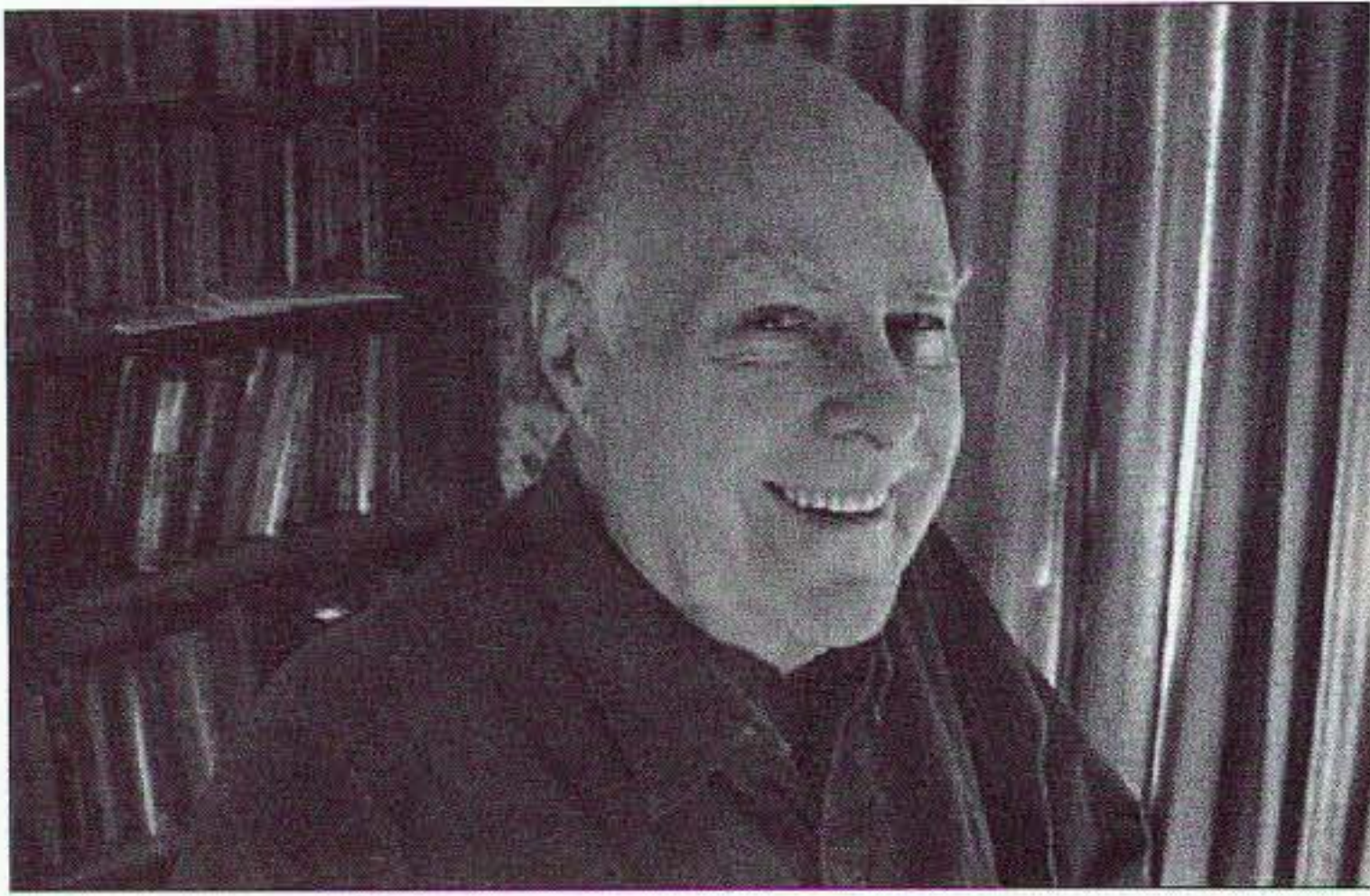

Wise Up & Beat the Odds

NEUER SAY DIE

Wayne Green W2NSD/1

w2nsd@aol.com

www.waynegreen.com

Birthday

My 80th birthday is September 3rd. What would I like for my birthday? To help more people to enjoy life. Oh, how I wish you could be with me as I walk through my north pasture, counting the different kinds of wildflowers growing there. Billions of flowers. And next week it'll be all different! Our language is inadequate to express the feelings of joy these flowers inspire.

All my life I've been driven to share the things I enjoy the most with as many people as possible. The tremendous fun of ham teletype got me to start my first publication, back in 1951. The years of fun I had at the workbench building equipment got me to start this magazine. I wanted as many others as possible to experience the excitement and thrill of building things.

My editorial essays are my way of sharing my excitement in discovering new books and ideas with you. And sharing my frustration with things which we could make better.

My biggest frustration is in my not being able to share my joys with more readers. The fun and excitement that I've had with amateur radio — a 64-year love affair. The joy of music, which I was able to share through a magazine and my recording studio. The joy of new ideas. My excitement when I discovered that *all* illnesses are caused by our mistreating our bodies, and thus could be reversed just

by stopping the mistreatment. My excitement when I discovered the super scam of jobs and a college education.

Many readers have suggested that I do an autobiography. Sure, in ten volumes. But what for? I'm much more interested in the future than the past. I want to help us have a new generation of kids with average IQs of 150, who can speak with no accent and think in a dozen or more languages, who can read at over 10,000 words per minute with 100% comprehension, who will have visited dozens of countries, who will get rid of those crooks in Congress, and so on. All this is doable with what we already know — it's just a matter of getting the word out.

I'm excited over the potential for replacing our fossil fuel culture with one of cold fusion. And for being able to provide the finest education in the world to kids anywhere at a tiny fraction of our current school costs.

My main projects this last year have been the starting of *NH ToDo* magazine ... aimed at getting more people to visit New Hampshire and enjoy the fantastic things we have to do. Joy sharing again. And getting the word out to stop people from making themselves sick. The joy of good health.

I love skiing like the wind down our mountains. I love our incredible fall colors. I love scuba diving the world's reefs. I love Joplin's ragtime music. And, most of all, I love hearing from people who have shared my loves and joys with me.

A Birthday Present

The best present you can give me for my birthday would be more readers. Do you know anyone with even a partially open mind who might enjoy reading 73? Anyone tired enough of being sick so they're open to something other than a doctor's treatment? Maybe a fellow ham who might like to get more fun from the hobby than endless formula contacts.

The regular subscription price is \$25 ... so tell you what, if you'll send me a gift subscription for someone as a present to me for my 80th birthday, just send me \$20 and their name, call and address. And do it before the end of September 2002, okay?

Crackpot

Yes, I admit I'm a crackpot. I don't believe in global warming. And neither would you if you read much beyond the newspaper headlines. I don't believe in treatments for sickness, I believe in prevention. I don't believe it's fair to future generations to leave them a world denuded of oil, coal, and natural gas when cold fusion offers unlimited energy at around a tenth of today's cost (and with no pollution). I don't believe NASA ever sent anyone to the Moon. And neither would you if you took even a day or two to look into the matter. I do believe that UFOs are real, as are the thousands of contactee reports, and that ETs have been here for millennia. And so on.

As I said above, I do believe we can raise a new generation with average IQs of 150, who can speak a dozen languages without any accent (and think in them), and who can read with comprehension at over 10,000 words per minute. A generation who will be better educated by the time they are twelve than 99% of today's college graduates. We can, but we won't.

The intellectually incurious consider me a crackpot for such beliefs.

Almost lost among the mountains of trivia and crapola are books written by the most brilliant of the world's minds. Few of these giants waste their time as professors trying to reach the almost totally sealed minds that end up in today's college classrooms. Their wisdom is available to anyone interested at a fraction of our school system's cost.

Will this new generation put up with a few trillionaire bankers and megabuck businesses controlling the government? Will they be driven by TV attack ads like sheep to the voting booths? Will they be interested in what passes today as entertainment? In listening to dysfunctional families screaming at each other on the TV court shows? In laugh-track-enhanced sitcoms? In screaming audience interview shows? Jeeze, I sure hope not.

Will our high-IQ, super-healthy, wised-up kids be satisfied to work from nine to five for 40 years so they can

Continued on page 7

Big Savings on Radio Scanners

Uniden® NEW!



Bearcat® 780XLT Trunk Tracker III

Mfg. suggested list price \$529.95

Less -\$190 Instant Rebate / Special \$339.95

500 Channels • 10 banks • CTCSS/DCS • S Meter

Size: 7^{5/8}" Wide x 6^{15/16}" Deep x 2^{13/16}" High

Frequency Coverage: 25.0000-512.0000 MHz., 806.000-

823.9875MHz., 849.0125-868.9875 MHz., 894.0125-1300.000 MHz.

The Bearcat 780XLT has 500 channels and the widest frequency coverage of any Bearcat scanner ever. Packed with features such as Trunktracker III to cover EDACS, Motorola and EF Johnson systems, control channel only mode to allow you to automatically trunk certain systems by simply programming the control channel, S.A.M.E. weather alert, full-frequency display & backlit controls, built-in CTCSS/DCS to assign analog and digital subaudible tone codes to a specific frequency in memory, PC Control with RS232 port, Beep Alert, Record function, VFO control, menu-driven design, total channel control and much more. Our CEI package deal includes telescopic antenna, AC adapter, cigarette lighter cord, DC cord, mobile mounting bracket with screws, owner's manual, trunking frequency guide and one-year limited Uniden factory warranty. For maximum scanning enjoyment, order magnetic mount antenna part number ANTMMBNC for \$29.95; The BC780XLT comes with AC adapter, telescopic antenna, owner's manual and one year limited Uniden warranty. Not compatible with AGEIS, ASTRO or ESAS systems. For fastest delivery, order on-line at www.usascan.com.

Bearcat® 895XLT Trunk Tracker

Mfg. suggested list price \$499.95

Less -\$320 Instant Rebate / Special \$179.95

300 Channels • 10 banks • Built-in CTCSS • S Meter

Size: 10^{1/2}" Wide x 7^{1/2}" Deep x 3^{3/8}" High

Frequency Coverage: 29.000-54.000 MHz., 108.000-174

MHz., 216.000-512.000 MHz., 806.000-823.995 MHz., 849.0125-

868.995 MHz., 894.0125-956.000 MHz.

The Bearcat 895XLT is superb for intercepting trunked communications transmissions with features like TurboScan™ to search VHF channels at 100 steps per second. This base and mobile scanner is also ideal for intelligence professionals because it has a Signal Strength Meter, RS232C Port to allow computer-control of your scanner via optional hardware and 30 trunking channel indicator annunciators to show you real-time trunking activity for an entire trunking system. Other features include Auto Store - Automatically stores all active frequencies within the specified bank(s). Auto Recording - Lets you record channel activity from the scanner onto a tape recorder. CTCSS Tone Board (Continuous Tone Control Squelch System) allows the squelch to be broken during scanning only when a correct CTCSS tone is received. For maximum scanning enjoyment, order the following optional accessories: PS001 Cigarette lighter power cord for temporary operation from your vehicle's cigarette lighter \$14.95; PS002 DC power cord - enables permanent operation from your vehicle's fuse box \$14.95; MB001 Mobile mounting bracket \$14.95; EX711 External speaker with mounting bracket & 10 feet of cable with plug attached \$19.95. The BC895XLT comes with AC adapter, telescopic antenna, owner's manual and one year limited Uniden warranty. Not compatible with AGEIS, ASTRO, EDACS, ESAS or LTR systems.



SCANNERS

Bearcat® 245XLT Trunk Tracker II

Mfg. suggested list price \$429.95/CEI price \$189.95

300 Channels • 10 banks • Trunk Scan and Scan Lists

Trunk Lockout • Trunk Delay • Cloning Capability

10 Priority Channels • Programmed Service Search

Size: 2^{1/2}" Wide x 1^{3/4}" Deep x 6" High

Frequency Coverage:

29.000-54.000 MHz., 108-174 MHz., 406-512 MHz., 806-823.995

MHz., 849.0125-868.995 MHz., 894.0125-956.000 MHz.

Our Bearcat TrunkTracker BC245XLT, is the world's first scanner designed to track Motorola Type I, Type II, Hybrid, SMARTNET, PRIVACY PLUS and EDACS® analog trunking systems on any band. Now, follow UHF High Band, UHF 800/900 MHz trunked public safety and public service systems just as if conventional two-way communications were used. Our scanner offers many new benefits such as Multi-Track - Track more than one trunking system at a time and scan conventional and trunked systems at the same time. 300 Channels - Program one frequency into each channel. 12 Bands, 10 Banks - Includes 12 bands, with Aircraft and 800 MHz. 10 banks with 30 channels each are useful for storing similar frequencies to maintain faster scanning cycles or for storing all the frequencies of a trunked system. Smart Scanner - Automatically program your BC245XLT with all the frequencies and trunking talk groups for your local area by accessing the Bearcat national database with your PC. If you do not have a PC simply use an external modem. Turbo Search - Increases the search speed to 300 steps per second when monitoring frequency bands with 5 KHz. steps. 10 Priority Channels - You can assign one priority channel in each bank. Assigning a priority channel allows you to keep track of activity on your most important channels while monitoring other channels for transmissions. Preprogrammed Service (SVC) Search - Allows you to toggle through preprogrammed police, fire/emergency, railroad, aircraft, marine, and weather frequencies. Unique Data Skip - Allows your scanner to skip unwanted data transmissions and reduces unwanted birds.

ies. Memory Backup - If the battery completely discharges or if power is disconnected, the frequencies programmed in your scanner are retained in memory. Manual Channel Access - Go directly to any channel. LCD Back Light - An LCD light remains on for 15 seconds when the back light key is pressed. Autolight - Automatically turns the backlight on when your scanner stops on a transmission. Battery Save - In manual mode, the BC245XLT automatically reduces its power requirements to extend the battery's charge. Attenuator - Reduces the signal strength to help prevent signal overload. The BC245XLT also works as a conventional scanner. Now it's easy to continuously monitor many radio conversations even though the message is switching frequencies. The BC245XLT comes

with AC adapter, one rechargeable long life ni-cad battery pack, belt clip, flexible rubber antenna, earphone, RS232C cable, Trunk Tracker frequency guide, owner's manual and one year limited Uniden warranty. Not compatible with AGEIS, ASTRO, ESAS or LTR systems. Hear more action on your radio scanner today. Order on-line at www.usascan.com for quick delivery.

More Radio Products

Save even more on radio scanners when purchased directly from CEI. Your CEI price after instant rebate is listed below:

Bearcat 895XLT 300 ch. Trunktracker I base/mobile scanner.....	\$179.95
Bearcat 780XLT 500 ch. Trunktracker III base/mobile.....	\$339.95
Bearcat 278CLT 100 ch. AM/FM/SAME WX alert scanner.....	\$159.95
Bearcat 245XLT 300 ch. Trunktracker II handheld scanner.....	\$189.95
Bearcat 248CLT 50 ch. base AM/FM/weather alert scanner.....	\$89.95
Bearcat Sportcat 200 alpha handheld sports scanner.....	\$169.95
Bearcat Sportcat 180B handheld sports scanner.....	\$149.95
Bearcat 80XLT 50 channel handheld scanner.....	\$99.95
Bearcat 60XLT 30 channel handheld scanner.....	\$74.95
Bearcat BCT7 information mobile scanner.....	\$139.95
AOR AR8200 Mark II Wide Band handheld scanner.....	\$539.95
AOR AR16BQ Wide Band scanner with quick charger.....	\$209.95
ICOM ICR8500 wideband communications receiver.....	\$1,469.95
ICOM PCR1000 computer communications receiver.....	\$379.95
ICOM R10 handheld wideband communications receiver.....	\$279.95
Uniden WX100 Weather Alert with S.A.M.E. feature.....	\$49.95

AOR

AOR® AR8200 Mark IIB Radio Scanner

AOR8200 Mark IIB-A wideband handheld scanner/SPECIAL \$539.95

1,000 Channels • 20 banks • 50 Select Scan Channels

PASS channels: 50 per search bank + 50 for VFO search

Frequency step programmable in multiples of 50 Hz.

Size: 2^{1/2}" Wide x 1^{3/8}" Deep x 6^{1/8}" High

Frequency Coverage:

500 KHz to 823.995 MHz., 849.0125-868.995 MHz., 894.0125-2,040.000 MHz.

(Full coverage receivers available for export and FCC approved users.)

The AOR AR8200 Mark IIB is the ideal handheld radio scanner for communications professionals. It features all mode receive:

WFM, NFM, SFM (Super Narrow FM), WAM, AM, NAM (wide, standard, narrow AM), USB, LSB & CW. Super narrow FM plus Wide and Narrow AM in addition to the standard modes. The AR8200 also has a versatile multi-function band scope with save trace facility, twin frequency readout with bar signal meter, battery save feature with battery low legend, separate controls for volume and squelch, arrow four way side rocker with separate main tuning dial, configurable keypad beep/illumination and LCD contrast, write protect and keypad lock, programmable scan and search including LINK, FREE, DELAY, AUDIO, LEVEL, MODE, computer socket fitted for control, clone and record, Flash-ROM no battery required memory, true carrier re-insertion in SSB modes, RF preselection of mid VHF bands, Detachable MW bar aerial. Tuning steps are programmable in multiples of 50 Hz in all modes, 8.33 KHz airband step correctly supported, Step-adjust, frequency offset, AFC, Noise limited & attenuator, Wide and Narrow AM in addition to the standard modes. For maximum scanning pleasure, you can add one of the following optional slot cards to this scanner: CT8200 CTCSS squelch & search decoder \$89.95; EM8200 External 4,000 channel backup memory, 160 search banks. \$69.95; RU8200 about 20 seconds chip based recording and playback \$69.95; TE8200 256 step tone eliminator \$59.95. In addition, two leads are available for use with the option socket. CC8200 PC control lead with CD Rom programming software \$109.95; CR8200 tape recording lead \$59.95. Includes 4 1,000 mAh AA ni-cad batteries, charger, cigar lead, whip aerial, MW bar antenna, belt hook, strap and one year limited AOR warranty. Enter your order now at <http://www.usascan.com>.

Order on-line and get big savings

Buy with Confidence

Order on-line and get big savings

For over 32 years, millions of communications specialists and enthusiasts worldwide have trusted Communications Electronics for their mission critical communications needs. It's easy to order. For fastest delivery, order on-line at www.usascan.com. Mail orders to: Communications Electronics Inc., P.O. Box 1045, Ann Arbor, Michigan 48106 USA. Add \$20.00 per radio transceiver for UPS ground shipping, handling and insurance to the continental USA. Add \$13.00 shipping for all accessories and publications. For Canada, Puerto Rico, Hawaii, Alaska, Guam, P.O. Box or APO/FPO delivery, shipping charges are two times continental US rates. Michigan residents add sales tax. No COD's. Your satisfaction is guaranteed or return item in unused condition in original packaging within 61 days for refund, less shipping, handling and insurance charges. 10% surcharge for net 10 billing to qualified accounts. All sales are subject to availability, acceptance and verification. Prices, terms and specifications are subject to change without notice. We welcome your Discover, Visa, American Express, MasterCard, IMPAC or Eurocard. Call anytime 1-800-USA-SCAN or 800-872-7226 to order toll-free. Call 734-996-8888 if outside Canada or the USA. FAX anytime, dial 734-663-8888. Dealer and international inquiries invited. Order your radio scanners from Communications Electronics Inc. today at www.usascan.com.

For credit card orders call 1-800-USA-SCAN

e-mail: cei@usascan.com

www.usascan.com

PO Box 1045, Ann Arbor, Michigan 48106-1045 USA

For information call 734-996-8888 or FAX 734-663-8888

Price schedule effective March 2, 2001 AD #03020173 © 2001 Communications Electronics Inc.

**COMMUNICATIONS
ELECTRONICS INC.**
Emergency Operations Center

Visit WWW.USASCAN.COM • 1-800-USA-SCAN

continued from page 1

worry — just like the government, we're here to help you. Your radio station is just like a car, and what we need to describe here is the "drive train." Your transmitter is, of course, the engine. Power is generated by the transmitter (engine) and goes through the transmission (gearbox, or antenna tuner) to the drive shaft (feedline) to the wheels (antenna). Now think of impedance as "torque" and you have the whole picture. That was easy, wasn't it?

And just as with a car, you must have a license to "drive" your radio. You need to know about as much about radio to get a radio license as you do about driving to get a driver's license. So anyhow, whenever there is something about radio that you don't understand, just try to picture it as a car.

Q. At a recent hamfest, I purchased an oil-filled dummy load. How often do I need to change the oil, and what kind of oil should I be using?

A. Assuming that you are a QRP operator, peanut oil will do just fine. If you run QRO, though, we'd suggest filling your dummy load with gasoline. You should change the oil every 3,000 miles or three months, whichever comes first. Unless you do fill it with gasoline, in which case you will only need to do it once.

Q. I have an old Vibroplex, and two things perplex me. Why is there a picture of a cockroach on it? Also, I watch it constantly, but have never seen the little red LED on top light up.

A. The LED is to warn you when you start sending too fast. Usually you will see smoke rising up from the dot contacts at about the same time. So if you see the LED light up, you had better shut down instantly or you will risk permanent damage. The cockroach has long been a symbol of New York City, where your Vibroplex was made. Nowadays they are made in Atlanta GA, and the Dr. has heard that the logo will be changed to a Coke bottle soon.

Q. I have heard that old electronic components are very collectible, and I would like to start a collection. What should I start with?

A. Now is certainly a great time to start a collection of components, because lots and lots of them are available at reasonable prices, and one day they'll be worth serious dollars. For example, when the Dr. was a kid you could buy a Coke for a nickel, and now they cost a LOT more. The Dr. sure wishes he had stashed a few away. A good way to start a collection of electronic components is to go into your local Radio Hovel Store and buy a resistor. Buy the best one you can afford, and be careful to treat it well. DON'T clean it, and be sure to save the original packaging materials.

Later, you can go back to the Hovel and buy a bag of assorted resistors or other components. These are called "mixtures" and are specially designed to give collectors something to do. You will find many different varieties, and often very rare ones that nobody knows of a use for. Sort them by their colors, sizes, and shapes, and if you wish to display them be sure to use rosin core solder. You will also find a lot of interesting items (technically called gizmos) in your HT, and you can remove most of them for your collection without much impact on how useful your HT is.

Q. Everybody talks very respectfully about old-timers, so I was wondering: How can I get to be one?

A. Be patient.

Q. I'm left-handed. When I send Morse code, all the dits and dahs come out backwards. What should I do?

A. In the old days, your Elmer would have tied your left hand behind your back and made you send "I will send with my right hand" one hundred times. But this is the 21st century, and it is a very simple procedure to have your doctor surgically remove your left hand.

Q. The other night I wanted to make a DX Q-socket. I fired up my leenyar and shouted my callsign a couple times, but somebody told me I was splattering. Is that a good thing or a bad thing?

A. It's a bad thing. But it's simple to fix: Never eat soup when you are operating DX.

Q. Is it possible to impeach the president of an amateur radio club?

A. Only if the club is located in Santa Monica and has an intern program.

Is something bothering you? The doctor will wrack his brain in trying to help you guys. Just write to him in care of this publication, and don't forget your "free will offering."

Thanks to Marshall Emm N1FN, who sends along the doc's answers via Low Down, newsletter of the Colorado QRP Club.

It's An Enigma No More

Germany's World War II top-secret Enigma spy machine was the message encoding device that gave Germany the ability to keep its military movements secret during much of the conflict. Now, it appears as if a British woman actually cracked a major component of the Enigma before World War II began, but her supervisors dismissed her theory as too simple.

British newspapers have printed excerpts from

the new publication titled *Action This Day*. The book claims that discoveries made by a female codebreaker known only as "Mrs. BB" that could have opened the secrets of the encoding machine much earlier and shortened the war.

In the late 1930s, the Enigma was dubbed the key to Germany's military communications system. Codebreakers including Alan Turing, the father of the modern computer, were trying in the late 1930s to break the Enigma cipher, but they could not work out how the keys of the Enigma machine were wired.

The book's editors, Michael Smith and Ralph Erskine, say that "Mrs. BB" suggested the Germans wired the A key to the A rotor, B to B and so on through the alphabet. This theory dismissed as too simplistic, was later proven to be correct.

The full Enigma code was finally cracked by a team of thousands of men and women, including chess masters, civil servants, and mathematics geniuses [and 73's long-time International Editor, the late Richard Phenix — ed.].

Thanks to Bruce Tennant K6PZW, via Newsline, Bill Pasternak WA6ITF, editor.

The Ten Commandments of Electrical Safety

I Beware of the lightning that lurketh in an undischarged capacitor, lest it cause thee to bounce upon thy buttocks in a most embarrassing manner.

II Cause thou the switch that supplieth large quantities of juice to be opened and thusly tagged, that thy days may be long in this earthly vale of tears.

III Prove to thyself that all circuits that radiateth and upon which thou worketh are grounded and thusly tagged, lest they lift thee to a radio frequency potential and causeth thee to make like a radiator also.

IV Tarry thee not amongst those fools that engage in intentional shocks, for they are not long for this world and are surely unbelievers.

V Take care thou useth the proper method when thou takest the measures of high voltage circuits so that thou dost not incinerate both thee and thy test meter, for verily, though thou hast no stock number and can be easily surveyed, the test meter has one and as a consequence will bringeth much woe unto the supply officer.

VI Take care thou tamperest not with interlocks and safety devices, lest this incurreth the wrath of thy supervisor and bring the fury of the safety officer upon his head.

VII Work thou not on energized equipment for if thou doest so thy shipmates will surely be buying beers for thy widow and consoling her in certain ways not generally acceptable to thee.

VIII Verily, verily I say unto thee never service equipment alone, for electrical cooking is a

slow process and thou might sizzle in thine own fat upon a hot circuit for hours on end before thy Maker sees fit to end thy misery and drag thee into His fold.

IX Trifle thee not with radioactive tubes and like substances, lest thou commence to glow in the dark like a lightning bug and thy spouse be frustrated and have no further use for thee except for thy wages.

X Thou shalt not make unauthorized modifications to equipment, but causeth instead to be recorded all technical directives and authorized modifications made by thee, lest thy successor tear his hair and go slowly mad in his attempt to decide what manner of creature hath made a nest in the wiring of such equipment.

Thanks to Squelch Tale, newsletter of the Chicago FM Club, June 2000. 75

NEVER SAY DIE

continued from page 4

play golf? Or tour the country in an RV?

At a Rotary Club meeting recently I asked for a show of hands of how many had been to Paris. Six hands went up out of the 52 there. How about Berlin? Four hands. Afghanistan? None. India? One. Japan? Two. China? None. That's pathetic! And typical.

Sure, it takes money to be able to travel — though not as much as you probably think. Read my travel diaries and see. Herbert Hoover said, "If a man has not made a million dollars by the time he's 40, he hasn't worked much." Herb should have added, "worked *smart*."

How can the curious find the books which explain what's really going on? My *Secret Guide to Wisdom* reviews the key books and will help you find them, recruiting you into the crackpot ranks with me.

Hey, What's Going On?

Okay, so you missed taping Steven Quayle on The Art Bell Show explaining about 19 of the world's top microbiologists being murdered in the last few months. These have all been scientists who had been working on biological warfare projects. None of their killers have been found.

You can get the gory details at [www.stevequayle.com].

Will the next war be fought with troops landing, with nuclear armed missiles, or with what we have been calling terrorism? Smuggling in small nukes to wipe out our major cities and spreading aerosolized ebola-smallpox via light planes to kill even more millions is an infinitely cheaper approach. And, unlike WWI, WWII, Korea, and Viet Nam, this

war would be waged right here in America. And, unless they brag about it, how'll we know which country we're fighting? Who can we nuke in return?

Which country would benefit by the elimination of the top microbiologists? Any country with a stockpile of stuff ready to dump on us. Like Iraq. Like Libya. Or Osama. And we know Saddam has several thousand Iraqi sleepers living around America. Like Saudi Arabia, which has been fanning the flames of religious hatred against us, and has

enough billions to get people to do anything it wants. Or China, with tens of thousands of Chinese living in every town in America.

So here we are with wide open borders, protected by fast asleep immigration border guards. We have an FBI that doesn't talk to itself, much less any other services. We're sitting ducks for this new kind of war — 250 million sitting ducks.

Continued on page 8

RIGrunner

Intelligent DC power panel

- Conveniently power your station with Anderson PowerPole® connectors.
- 40 Amps total, outlets to run all of your transceivers and accessories.
- Each and every outlet individually ATC fused with LED open fuse indicators.
- Precision LED and audio alert of safe, over or undervoltage, 4012 & 4008.
- No messy binding posts, frayed wires, black tape or short circuits.
- Safe, secure, hot connect, polarized, color keyed, unisex, connector system.
- Conforms to the ARES, RACES, RSGB recommended standard.
- Perfect for home, mobile, rover, portable, emergency and contest stations.

3 Models from \$49.95!



RIGblaster

Have more fun with your radio

The only no compromise sound card interfaces.

The easiest to set up, high quality, complete solution.

The best support too!
Read our user comments!

Get on WSJT JT44, the extreme weak signal mode!

RIGblasters: M8, M4, RJ, Plus or Nomic

<http://www.westmountainradio.com>

West Mountain Radio de N1ZZ and K1UHF

18 Sheehan Avenue, Norwalk, CT 06854 (203) 853 8080



NEVER SAY DIE

continued from page 7

So, why kill the top scientists? That could go a long way toward stopping the development of biological countermeasures. That's what I'd do if I was planning a major biological attack.

Tarfu

Tarfu? For you youngsters, that's snafu[®]. Alas, it also describes our beloved government. An eight-page article in the June 3, 2002, issue of *The New Yorker* does their usual well-researched job of throwing light into dark corners. It almost exhausted my Magic Marker.

I've read about how the FBI not only doesn't like to share information with the CIA, NSA, INS, and other government agencies, but they don't even have a workable system for internally handling information.

Like? Well, we've read about Muslims taking flying lessons, right? And this raising some questions. Like the idiot who insisted on learning how to fly a 747, but didn't want to bother learning how to do take-offs and landings. Talk about waving a red flag!

Sure, an Algerian terrorist group hijacked an Air France airliner and threatened to crash it into the Eiffel Tower in 1994. A wake-up call for our ever-alert agencies? Zzzzzzz. But then, if many Muslims started taking flying lessons, that would wake 'em up, right?

One of the 9/11 hijackers, Saeed Alghamdi, took his flying lessons at a Florida flight school. The school's records show that four men with that name were trained there. Worse, the school had trained more than 1,600 students with the first name Saeed and more than 200 with the surname Alghamdi.

Considering how few private aircraft there are these days and thus a huge undemand for flying lessons, was anyone even remotely awake at the school?

According to a former INS district director, the agency has issued thousands of visas for young Middle Easterners to enroll in flight-instruction programs. And where are these guys now? Anyone's guess.

Did they come here to learn to fly planes in Afghanistan, Saudi Arabia, and so on? Har-de-har. What planes? Are they now sleepers in America, awaiting the call to swoop down on private airports, grab some planes and douse us with anthrax, smallpox, or worse? Or dump poisons in our reservoirs?

As one expert was quoted, "More than half a dozen federal agencies are involved in airline travel, and their inability to

work with each other is notorious. Protecting their own turf is what matters."

So, are the FBI, NSA, CIA, INS and so on solving their problems? Will giving them bigger budgets to hire more people help? It never has before. There seems to be no real rush because "The American people are going back to sleep."

So, are we sitting ducks while Inspector Clouseau hires more assistants to help him shuffle papers? Meanwhile these alert agents are keeping themselves busy hassling grandmothers at airline gates and making me take off my shoes to check for explosives. Yep, me! And giving me a tiny bag of pretzels to eat instead of a meal during the flight.

I wonder how many men would be needed to take control of the Silver Ranch airport in Jaffrey NH, fuel up a couple private planes and dump a few hundred pounds of anthrax upwind of nearby Boston?

Presuming that the feds are no more organized to provide emergency communications when the fan gets hit than they are at keeping track of what apparently are thousands of infiltrated terrorists, I suggest that every ham club get busy and organize their members to be ready to step in and provide communications for the police, fire, hospitals, and all those federal bureaus. Or you can wait until something happens and try to wing it.

Fighting Terrorism

Ya want peace? Well, you aren't going to get it by walking around waving PEACE placards. And you aren't going to get it with peace talks, either. If peace talks worked, the Middle East would by now be a world model for peace.

We Yankees won the Revolutionary war by outsmarting the British. Their generals were furious with us Yankees when we darted around, hiding cowardly behind trees, mowing down their rows of well-armed men.

I'm all for outsmarting our current enemies instead of trying to fight by their rules. An A-bomb on Mecca in retaliation for the next major terrorist outrage in America might make us feel good, but it would sure make a few hundred million Muslims even angrier at us.

So, what's my solution to the misery our government has gotten us into? How can we outsmart the enemy? Piece a cake. Let's use our mightiest weapon against them. No, not those lousy A- and H-bombs. We don't need to encourage nuclear retaliation. Our mightiest weapon — the one which won WWI and WWII for us, as well as the Cold War — is our ability to innovate and produce stuff in huge quantities. Democracy didn't win those wars, capitalism did.

Learning From History

When I visited New Caledonia and talked with the local hams, I learned that when the French arrived they found that the local tribes had been at war with each other for hundreds of years. So they set up TV stations and started broadcasting. The natives had to stop fighting long enough to get jobs to make enough money to buy TV sets for their families. Then, they had to keep on working so they could buy the products being advertised on TV. And that was the end of tribal wars.

Say, whatever happened to Voice of America broadcasting? Is that still going, or did it fade away with the Cold War? Have we set up radio and TV stations in Afghanistan yet? Commercial stations? Are we broadcasting in the local languages? How about in India, Pakistan, and anywhere else where Muslim kids' almost only source of education is memorizing the Koran?

When I talked with the hams in Yugoslavia back in the '50s, I learned that the people there wanted cars so badly that they would spend a year or two's wages to get an old used one. Aha! Another incentive to get people to stop fighting and start working.

So, let's start designing the cheapest possible car we can — something like an advanced go-kart — and start setting up factories in underdeveloped countries to make 'em. That'll get 'em off their camels and donkeys, just as \$600 Volkswagens and Deux Cheveaux got the Germans and French off their bicycles fifty years ago.

But what about jobs? Millions of jobs for the people who want to buy a TV set or a cheap car?

No problem? When I first visited Singapore in 1959 the country had just pulled itself out of terrible poverty. When the British got out of Malaysia, Singapore was an awful mess. It was so bad that Malaysia wanted nothing to do with it, so Singapore was isolated and left on its own.

The new government called in a U.N. team to help. Since Singapore was essentially a 50 square mile island with no resources except a big bunch of very poor Chinese, the team did a survey of the raw materials within easy shipping distance, and then another of the potential nearby markets. They then went to Europe and got the money to build factories to fill the market needs. Up went high-rise apartment complexes to replace the tin hovels. Up went factories and out went the products. The result in record time was a miracle — an Asian Tiger.

Continued on page 62

LOW NOISE PREAMPS

LNY-() ECONOMY PREAMP ONLY \$29/w&t

- Miniature MOSFET Preamp.
- Low noise figure.
- Available for various bands from 28 to 450 MHz.



LNK-() PREAMP ONLY \$59/w&t

Low noise LNY-type preamp in alum case w/ BNC jacks.

LNP-() PRESELECTOR ONLY \$39/w&t

- Eliminate intermod!
- Sharp 3-section filter
- Low noise preamp
- Available for bands from 137 to 170 MHz.



R121 AVIATION RECEIVER



- Exciting new AM receiver for the 118-137 MHz aircraft band.
- Ideal for monitoring at airports.
- Allows pilot control of runway lighting.
- ELT monitor to detect and locate downed aircraft.

- Dip switch frequency selection.
- Superior sensitivity and selectivity.

R121 Receiver module wired/tested \$209
R121 Receiver in cabinet (see website)..... \$299

WEATHER FAX RECEIVER

Join the fun. Get striking images directly from the weather satellites!

A very sensitive wideband fm receiver optimized for NOAA APT & Russian Meteor weather fax on the 137MHz band.

Covers all 5 satellite channels. Scanner circuit & recorder control allow you to automatically capture signals as satellites pass overhead, even while away from home.

- R139 Receiver Kit less case \$159
- R139 Receiver Kit with case and ac power adapter. \$189
- R139 Receiver w/t in case with ac power adapter... \$239
- Internal PC demodulator board & imaging software.. \$289
- Turnstile Antenna \$135



WEATHER ALERT RECEIVER



A sensitive and selective professional grade receiver to monitor critical NOAA weather broadcasts. Good reception even at distances of 70 miles or more with suitable antenna. No comparison with ordinary consumer radios!

Automatic mode provides storm watch, alerting you by unmuting receiver and providing an output to trip remote equipment when an alert tone is broadcast. Crystal controlled for accuracy; all 7 channels (162.40 to 162.55).

RWX Rcvr kit, PCB only \$79
RWX Rcvr kit with cabinet, speaker, & AC adapter \$99
RWX Rcvr wired/tested in cabinet with speaker & adapter \$139

WWV RECEIVER

Get time & frequency checks without buying multiband hf rcvr. Hear solar activity reports affecting radio propagation.

Very sensitive and selective crystal controlled superhet, dedicated to listening to WWV on 10 MHz. Performance rivals the most expensive rcvrs.

- RWWV Rcvr kit, PCB only \$59
- RWWV Rcvr kit with cabt, spkr, & 12Vdc adapter \$89
- RWWV Rcvr w/t in cabt with spkr & adapter \$129



HIGH QUALITY VHF & UHF EXCITER & RECEIVER MODULES

FM EXCITERS:

Rated for continuous duty, 2W continuous duty output.

T301 Synthesized VHF Exciter: for various bands 139-174MHz, 216-226 MHz. Dip switch freq. setting.

- Kit (ham bands only) (TCXO option \$40)..... \$109
- Wired/tested, incl TCXO \$189

T304 Synthesized UHF Exciter: for various bands 400-470 MHz.

- Kit (440-450 ham band only) incl TCXO \$149
- Wired/tested \$189

CRYSTAL CONTROLLED:

- TA51: for 6M, 2M, 220 MHz kit \$99, w/t \$169
- TA451: for 420-475 MHz. kit \$99, w/t \$169
- TA901: for 902-928 MHz, (0.5W out) w/t \$169

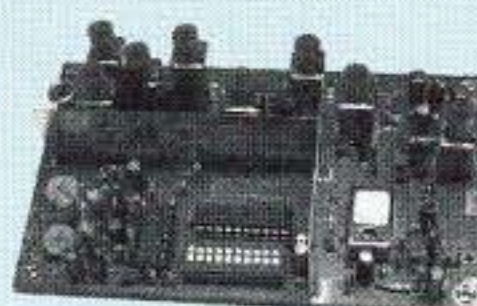

VHF & UHF POWER AMPLIFIERS:

Output levels from 10W to 100W Starting at \$99

FM RECEIVERS:

Very sensitive - 0.2µV.
Superb selectivity, >100 dB down at ±12 kHz, best available anywhere, flutter-proof squelch.

R301 Synthesized VHF Receiver: various bands 139-174MHz, 216-226 MHz.

- Kit (ham bands only) (TCXO option \$40) only \$139
- Wired/tested (incl TCXO) \$209

R304 Synthesized UHF Receiver: various bands 400-470MHz.

- Kit (440-450 ham band only) (incl TCXO) \$179
- Wired/tested \$209

CRYSTAL CONTROLLED:

- R100 for 46-54, 72-76, 140-175, or 216-225 MHz. kit \$129, w/t \$189
- R144 Like R100, for 2M, with helical resonator in front end kit \$159, w/t \$219
- R451 for 420-475 MHz. kit \$129, w/t \$189
- R901 for 902-928MHz kit \$159, w/t \$219

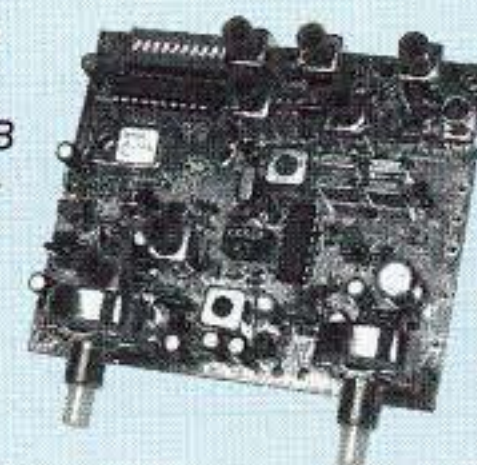

CTCSS TONE ENCODER/DECODER

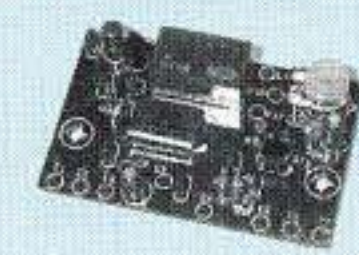

Access all your favorite closed repeaters!

- Encodes all standard sub-audible tones with crystal accuracy and convenient DIP switch selection.

• Decoder can be used to mute receive audio and is optimized for installation in repeaters to provide closed access. High pass filter gets rid of annoying rcvr buzz.

- TD-5 CTCSS Encoder/Decoder Kit \$39
- TD-5 CTCSS Encoder/Decoder Wired/tested \$59

TRANSMITTING & RECEIVING CONVERTERS

No need to spend thousands on new transceivers for each band!

- Convert vhf and uhf signals to & from 10M.
- Even if you don't have a 10M rig, you can pick up very good used xmtrs & rcvrs for next to nothing.
- Receiving converters (shown above) available for various segments of 6M, 2M, 220, and 432 MHz.
- Rcvg Conv Kits from \$49, wired/tested units only \$99.



- Transmitting converters for 2M
- Kits only \$89
- Power amplifiers up to 50W.

Get more features for your dollar with our REP-200 REPEATER

A microprocessor-controlled repeater with full autopatch and many versatile dtmf remote control features at less than you might pay for a bare bones repeater or controller alone!



- kit still only \$1095
- factory assembled still only \$1295

50-54, 143-174, 213-233, 420-475 MHz.
(FCC type accepted for commercial service in 150 & 450 MHz bands.)

Digital Voice Recorder Option. Allows message up to 20 sec. to be remotely recorded off the air. Play back at user request by DTMF command, or as a periodic voice id, or both. Great for making club announcements! only \$100

REP-200C Economy Repeater. Real-voice ID, no dtmf or autopatch. Kit only \$795, w&t \$1195

REP-200N Repeater. Without controller so you can use your own. Kit only \$695, w&t \$995

You'll KICK Yourself If You Build a Repeater

Without Checking Out Our Website First!

Hamtronics has the most complete line of modules for making repeaters. In addition to exciters, pa's, and receivers, we offer the following controllers.



COR-3. Inexpensive, flexible COR module with timers, courtesy beep, audio mixer. only \$49/kit, \$79 w/t

CWID-2. Eprom-controlled ID'er. only \$54/kit, \$79 w/t

DVR-1. Record your own voice up to 20 sec. For voice id or playing club announcements. \$59/kit, \$99 w/t

COR-4. Complete COR and CWID all on one board. ID in eeprom. Low power CMOS only \$99/kit, \$149 w/t

COR-6. COR with real-voice id. Low power CMOS, non-volatile memory. kit only \$99, w/t only \$149

COR-5. µP controller with autopatch, reverse ap, phone remote control, lots of DTMF control functions, all on one board, as used in REP-200 Repeater. \$379 w/t

AP-3. Repeater autopatch, reverse autopatch, phone line remote control. Use with TD-2. kit \$89

TD-2. Four-digit DTMF decoder/controller. Five latching on-off functions, toll call restrictor. kit \$79, w/t \$129

TD-4. DTMF controller as above except one on-off function and no toll call restrictor..... w/t \$89

HANDY FREQUENCY COUNTERS

Pocket sized, but lab quality! 3GHz bandwidth, 1ppm accuracy, very affordable. NiCd battery, ac adapter/charger, rugged black anodized aluminum case. Telescoping whip antenna and great sensitivity allow measurements even from a distance.

Three models with prices from \$99 to \$219. All go up to 3 GHz. Some go as low as 10 Hz with noise filters and other advanced features.

See our website for details.



Hamtronics, Inc.

65 Moul Rd; Hilton NY 14468-9535

Ph: 585-392-9430; Email: sales@hamtronics.com

See special offers and view or download complete catalog on our web site

hamtronics.com

YOU Can Build This VLF to HF Loop Receiving Antenna

Part 2 of 3.

Constructing the air core loops: The air core loops described violate one of the cardinal rules of good loop construction — the wire turns are bunched together, not separated by a quarter inch or more of air.

This is the product of an intentional trade-off; I wanted a mechanically simple loop that could be constructed from inexpensive plumbing fixtures and that used standard enameled magnet wire. There are two main drawbacks to my construction technique, both of which are related to bunching the turns:

- The loops have a lot of distributed capacitance, which reduces the maximum frequency.
- The standard inductance formulas produce inaccurate results, so some cut-and-try will be necessary if you deviate from how I built my loops.

Feel free to experiment with different approaches. For example, I built a three-turn loop using the center conductor

from scrap RG-58A coaxial cable. The polyethylene insulation provides some turn-to-turn spacing and reduced distributed capacitance. An even better approach might be to use magnet wire inside plastic tubing. If you want to try a shielded loop, try copper plumbing pipe instead of PVC. Attach the shield to the sleeve, and remember to break the shield at the top center.

I built three air core loops covering 135 kHz through 7.2 MHz, as outlined in **Table 2**.

The air core loops are built from standard 3/4-inch PVC pipe and plumbing fixtures using the dimensions shown. If I were doing it over again, I would consider using 1/2-inch PVC pipe to reduce the weight.

If you wish to design for a different frequency range, you can use the formula for the inductance of a square loop provided in *The ARRL Antenna Book* as a starting point:

$$L(\mu\text{H}) = 0.008N^2s \{ \ln [1.4142sN/(N + 1)] + 0.37942 + [0.3333 (N + 1)/sN] \} \quad [2]$$

where:

- L is the inductance in microhenries
- N is the number of turns.
- s is the length of side in cm
- ℓ is the coil length in cm

Determining ℓ (coil length) when the wire is scrabble-wound is difficult. Even with a good estimate of ℓ, my experience is that equation [2] overestimates the inductance of a scrabble-wound loop by 25% to 30%.

The loop tuner has maximum and

Turns/Induct./C _{DIST}	Range Setting	Min. Frequency	Max. Frequency	Comments
3T/9.3 μH/26 pF	High	1.95 MHz	7.2 MHz	10-in. leg; center cond. RG-58A wire
	Low	1.120 MHz	4.8 MHz	
10T/93 μH/50 pF	High	600 kHz	1800 kHz	11-in. leg; no. 20 AWG magnet wire
	Low	330 kHz	1300 kHz	
24T/536 μH/102 pF	High	240 kHz	580 kHz	11-in. leg; no. 20 AWG magnet wire
	Low	135 kHz	475 kHz	

Table 2. Air core loops.

Range Mode	Min. Capacitance	Max. Capacitance
High	33 pF	705 pF
Low	104 pF	2362 pF

Table 3. Loop tuner maximum and minimum capacitance values.

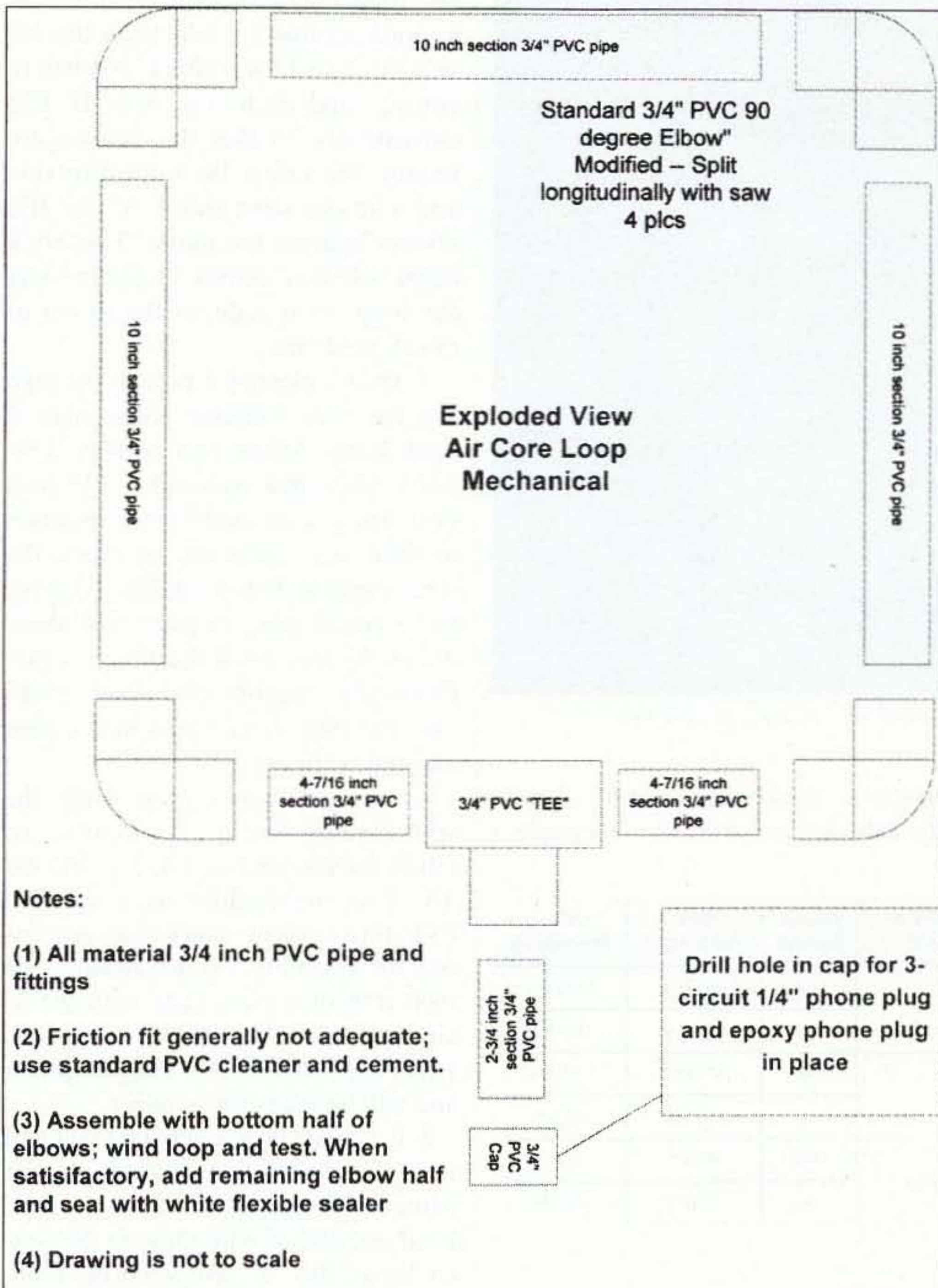

Fig. 8. Air core loop.

minimum capacitance values as shown in Table 3.

You can then use the calculated inductance and the appropriate capacitance to determine the tuning range using the familiar tuned circuit formula in Equation 3. Multiply dimensions in inches by 2.54 to convert to centimeters. Don't forget to add the estimated distributed capacitance of your loop to the values in the above table. I found distributed capacitance values ranging from 20 pF (3 turns) to 102 pF (24 turns).

$$f_{\text{MHz}} = \frac{159.16}{\sqrt{LC}} \quad [3]$$

where:

f is the frequency in MHz

L is the inductance in microhenries

C is the capacitance in picofarads

Once you have selected the number of turns, you can use the following steps to build your loop:

1. Secure the material, and cut the PVC pipe sections to length. (The first two air core loops I built were about 1 inch longer per side than the dimensions shown. I found those to be too top-heavy.)

2. Cut the four 90-degree elbows longitudinally. I used a scroll saw, but a hacksaw should work. If you use a

ALL ELECTRONICS CORPORATION

SHOP OUR ONLINE STORE
www.allelectronics.com

Jumbo Pushbuttons

Durable plastic S.P.D.T. momentary pushbutton switch frequently found in arcade games. Useful in any application requiring a large, rugged pushbutton switch. Button operates a 10 Amp snap-action switch. Plunger is 0.86" diameter. Bezel is 1.33" diameter. Threaded bushing is 1.1" diameter and will mount in panels up to 0.75" thick. Includes large plastic mounting nut. Available in two colors:



RED SWITCH
CAT# PB-211 **\$3⁷⁵** each

BLACK SWITCH
CAT# PB-216 **\$3⁷⁵** each

3.6 Volt 1200 mA Lithium-Ion Cell

Sony # 18650. Rechargeable lithium-ion cell with solder-tabs. Ideal for high energy battery packs. 0.72" dia. x 2.56" long.

CAT # BTE-1200

50 for \$3.00 each



\$3⁵⁰ each

12 Volt 35 Watt Halogen Lamp

General Electric Q35MR11/ NSP(FTE) MR-11 quartz halogen lamp. 12 Volt, 35 Watt. 1.38" diameter Multi-Mirror™ lamp. 0.15" pin spacing.

CAT # HLP-350

10 for \$30.00

\$3⁵⁰ each



Flashing LED

SPECIAL - RED T-1 3/4 water clear

CAT# LED-84

3 for **\$1⁰⁰** each

100 for 25c each
1000 for 18c each



ORDER TOLL FREE
1-800-826-5432

CHARGE ORDERS to Visa, Mastercard, American Express or Discover

TERMS: NO MINIMUM ORDER. Shipping and handling for the 48 continental U.S.A. \$6.00 per order. All orders including AK, HI, PR or Canada must pay full shipping. All orders delivered in CALIFORNIA must include local state sales tax. Quantities Limited. NO COD. Prices subject to change without notice.

CALL, WRITE FAX or E-MAIL for our **FREE** 96 Page CATALOG Outside the U.S.A. send \$3.00 postage.

MAIL ORDERS TO:
ALL ELECTRONICS CORPORATION
P.O. Box 567
Van Nuys, CA 91408
FAX (818)781-2653

e-mail allcorp@allcorp.com

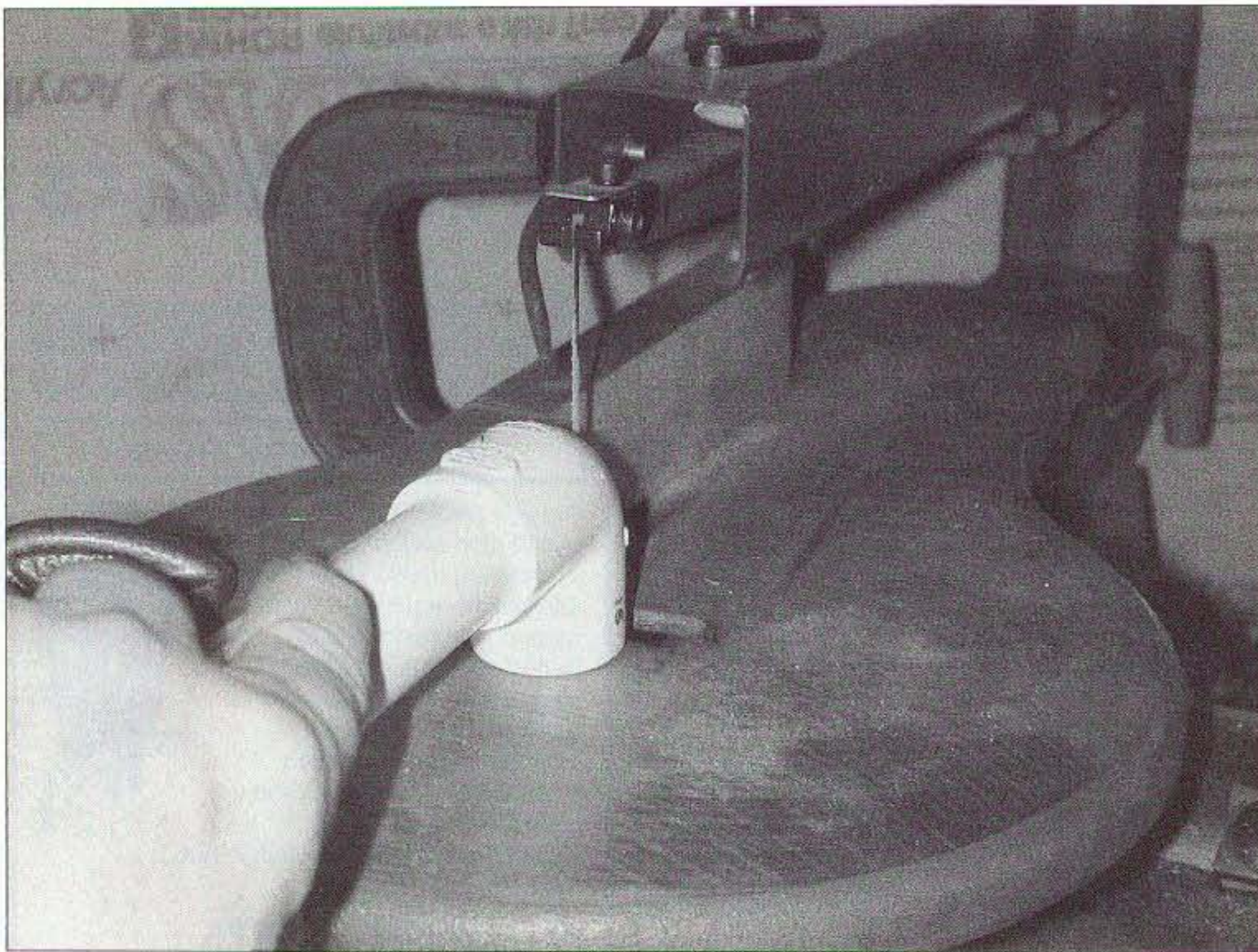

Photo G. Cutting the 90-degree elbows with a scroll saw, using a pusher tube.

power saw, observe proper safety precautions. I used a scrap piece of PVC pipe as a “pusher” to keep my fingers at a safe distance from the saw blade. I

also used a piece of scrap aluminum as a guide so that I could keep the cut straight. Label each elbow 1–4 before cutting, and each side A or B. Cut consistently so that the elbows are fed into the saw in the same direction and with the same side (“A” or “B”) always against the guide. This trick helps when it comes to assembling the loop, as it reduces the effect of misaligned cuts.

3. Drill a clearance hole in the pipe cap for your 3-circuit phone plug. I used Radio Shack part number 274-139A plugs that required a 7/16-inch drill. There seems to be some variation in shell size, however, so check the size required before drilling. Epoxy the 3-circuit plug in place and allow the epoxy to cure. Since the plug mechanically supports the loop, make sure the plug is centered in the pipe cap and is straight.

4. Assemble your loop using the split elbows. Use a consistent set of elbow halves, such as 1A, 2A, 3A, and 4A. I’ve successfully used standard PVC pipe cement, super glue, and epoxy for assembly. Do *not* attach 2-3/4 inch stub or the pipe cap with the 3-circuit plug at this time. At this point, your loop should look like the photo and will be ready for winding.

5. Calculate how much wire you will need, figuring 4 feet per turn plus an extra two feet, and cut it from the reel. Feed one end of wire through the center leg of the “T” and wind the loop. The photo shows how each corner will look. (The illustration shows the 3-turn loop that I wound with RG-58A center conductor.) I found winding the 10- and 24-turn loops easier when I worked outside and stretched the wire out along my driveway. Wind the desired number of turns plus an extra two or three turns.

6. When finished winding, you should have the two wire ends sticking out the center leg of the TEE. Cut off any excess wire, strip and tin the ends, and solder to the *tip* and *ring* pins of the 3-circuit plug. (Polarity isn’t important.) Leave the sleeve (ground) pin unconnected. Temporarily assemble (without glue) the 2-3/4-inch stub and the cap. Install the loop on the tuner and check the tuning range. Since you

No. Turns	Inductance & Rod Type	Wire Size	Turns per Inch	Range Setting	Min. Frequency	Max. Frequency
60	183 μ H; Type 61 mat'l	#24 AWG	10	High	490 kHz	1650 kHz
				Low	240 kHz	1120 kHz
372 μ H; surplus broadcast-band loopstick				High	375 kHz	1250 kHz
				Low	170 kHz	830 kHz
537	20.2 mH; Type 33 mat'l	#34 AWG	82.6	High	46 kHz	150 kHz
				Low	21 kHz	100 kHz

Table 4. Ferrite core loops.

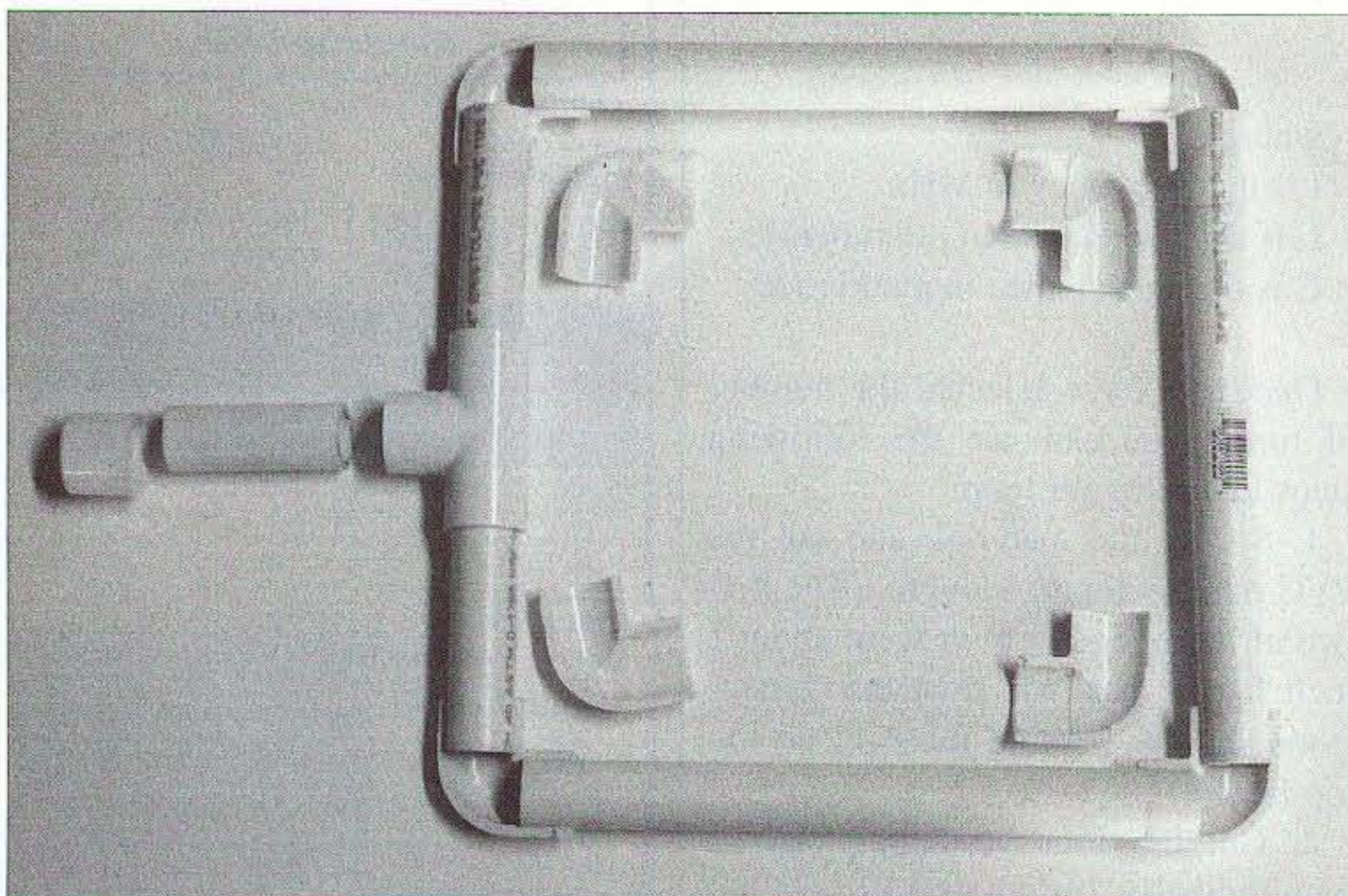

Photo H. Assembled air core loop, ready for winding.

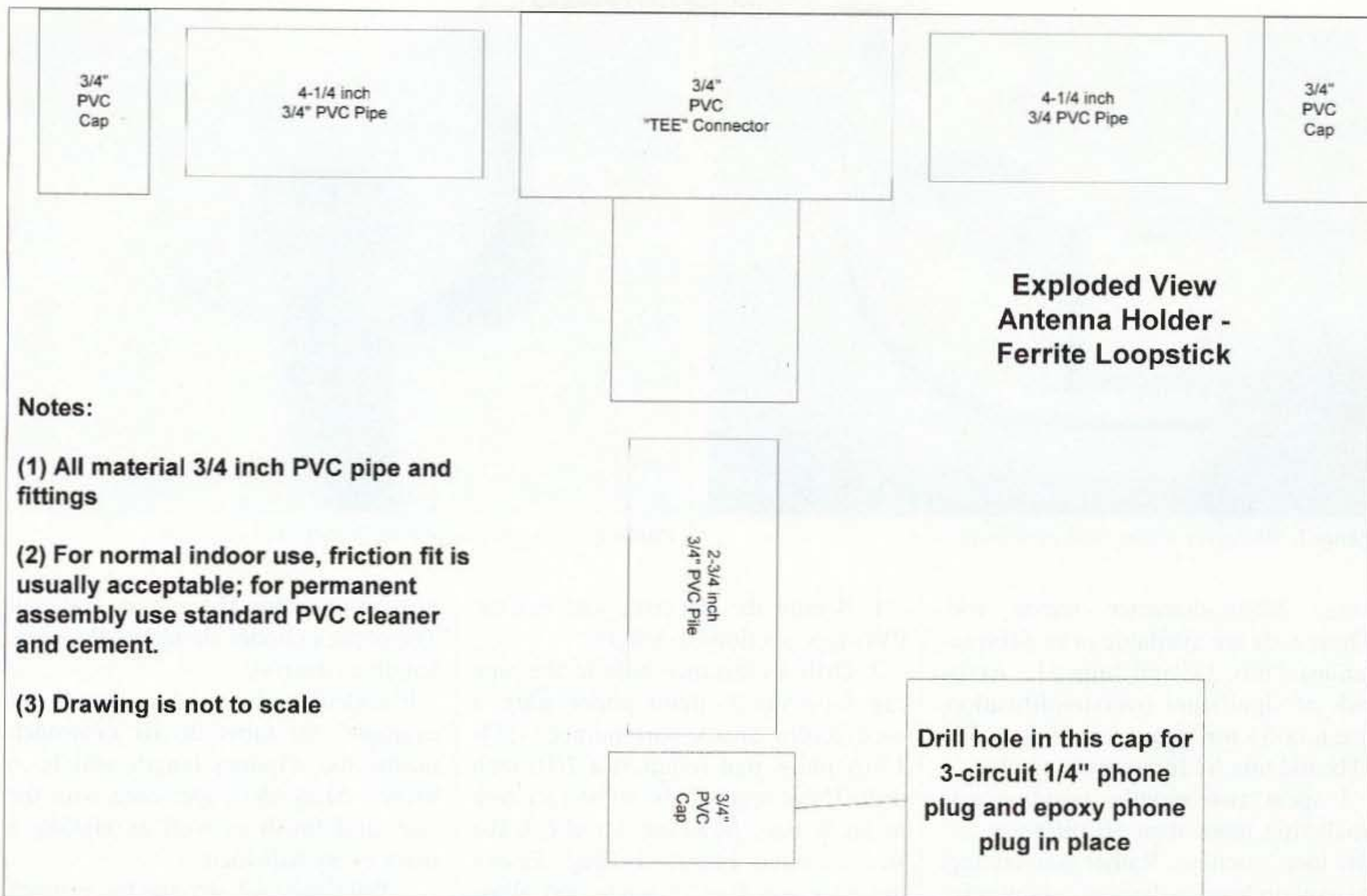

Fig. 9. Ferrite loop.

have extra turns, the tuning range should be below the target range. Remove a turn at a time until you hit the desired tuning range. Of course, it may not be possible for you to precisely hit a target range, since you can only have an integral number of turns.

7. When you are satisfied with the tuning range, glue the 2-3/4-inch stub in place as well as the cap with the 3-circuit plug. Match up the four elbow halves and glue 1B to 1A, etc. Clamp the halves together with spring clamps or heavy weights while the glue sets. If you have cut the elbows with a thin saw blade, you may decide the kerfs are unobjectionable. If the gap is large, you can fill it in with white flexible caulk. You should not use caulk that gives off acidic vapor when curing, as it may corrode the loop windings. If you object to the blue pipe labels printed on PVC pipe, spray paint the completed loop with white paint when completed, masking, of course, the 3-circuit plug. If you have constructed more than one loop, label each loop with its frequency range.

Constructing ferrite core loops

As outlined in **Table 4**, I built three ferrite core loops covering 21 kHz through 1650 kHz. Above this range, I prefer an air core loop.

Since you are unlikely to find a surplus loopstick that matches mine, I'll concentrate on making a custom loopstick antenna using either mix 61 or 33 cores.

My designs are based on a 7-1/2-in.-

MAXX-COM
Automatic Antenna Tuners
Instant Tuning — Fully Automatic
 VSWR is less than 1.5:1 on all frequencies

Since 1983 with over 15,000 Satisfied Owners
Used by the U.S. Military in Operation Desert Storm

150 – 2000 Watts 1.5 – 250 MHz
Prices begin at \$185.00
 Visit us at www.maxx-com.com

MAXX-COM Automatic Antenna Tuners
 3255 SW 11th Avenue - Fort Lauderdale - FL 33315
 954-524-5120 X219 - info@maxx-com.com

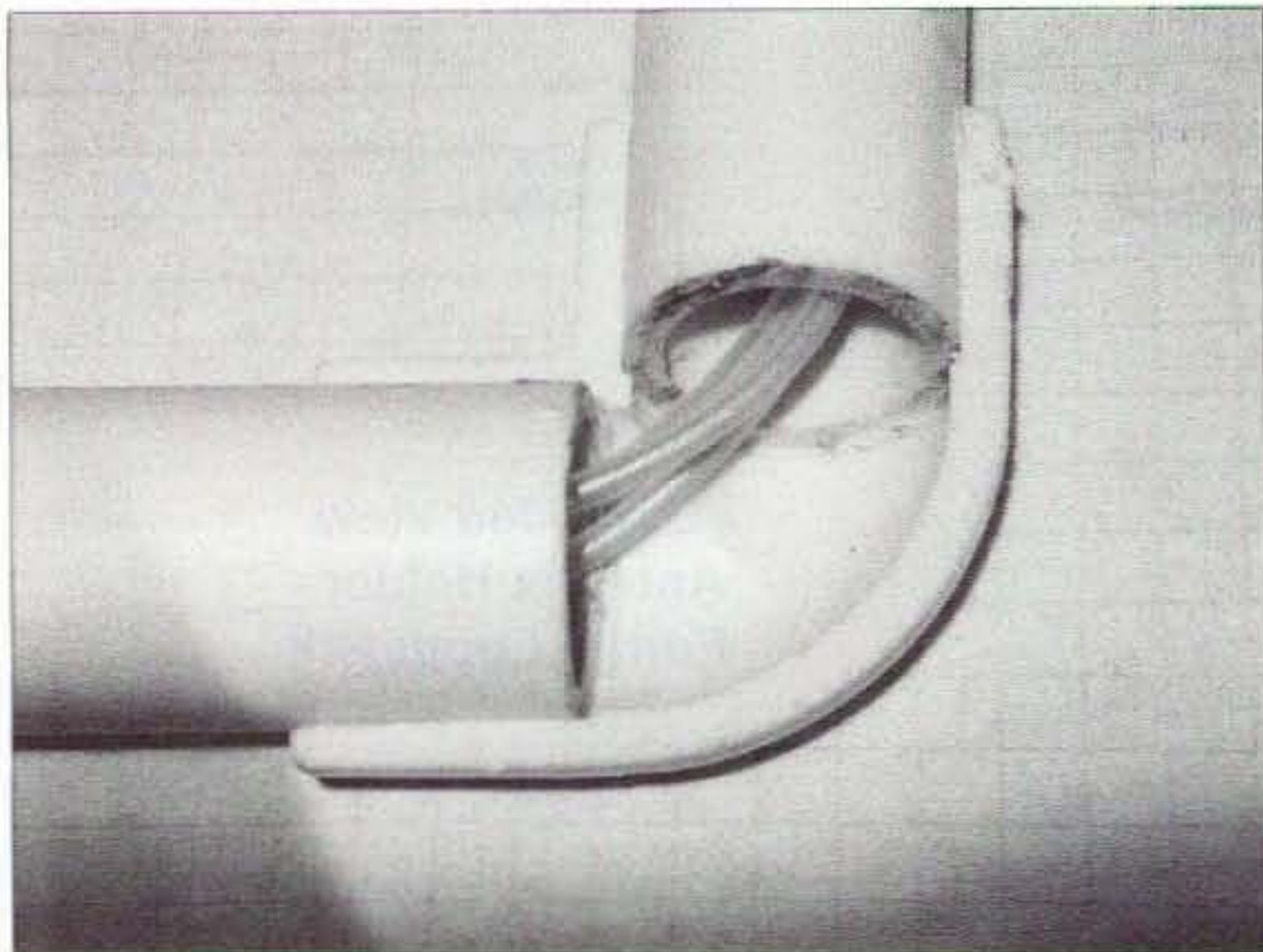

Photo I. 90-degree elbow with turn loop.



Photo J. 3-circuit phone plug mounted in pipe cap.

long, 1/2-in.-diameter ferrite rod. These rods are available in two formulations: "mix 33" and "mix 61." At the risk of significant oversimplification, use mix 33 for frequencies below 500 kHz and mix 61 for everything else.

I spent two months building and analyzing more than 50 different ferrite loop antennas. Rather than attempt to explain how to design and optimize a ferrite loop, I'll instead concentrate on explaining how to duplicate the ones I built. If you wish to depart from these precooked designs, the best readily available reference is Chapter 5 of *The ARRL Antenna Book* (1994). However, in building test antennas I found that the information published in the amateur literature greatly oversimplifies many factors and that differences of 50% between theoretical and measured parameters were common — so be prepared to do some experimenting!

1. Secure the material, and cut the PVC pipe sections to length.

2. Drill a clearance hole in the pipe cap for your 3-circuit phone plug. I used Radio Shack part number 274-139A plugs that required a 7/16-inch drill. There seems to be some variation in shell size, however, so check the size required before drilling. Epoxy the 3-circuit plug in place and allow the epoxy to cure. Since the plug mechanically supports the loop, make sure the plug is centered in the pipe cap and is straight.

3. Wind the coil following a few pointers:

a. Don't wind directly onto the ferrite rod. Instead make a paper core. Wind two layers of typing paper around the rod and glue the paper into a cylinder using glue suitable for paper. The rod should be a snug fit into the paper cylinder, but it should be

possible to slide the rod in and out. The paper cylinder should be the same length as the rod.

b. Calculate the winding length; for example, 60 turns at 10 turns/inch means the winding length will be 6 inches. Mark the paper core with the start and finish as well as making a mark every half-inch.

c. Wind the coil, striving for as much uniformity as possible. Leave a foot or so of wire at the start and end of the windings. To avoid collapsing the paper core, insert the ferrite rod. Please treat the ferrite rod with care, as it is brittle and will fracture if stressed. (I used a mandrel made from a steel rod and wound my coils on a lathe, inserting the ferrite only when the coil was ready for testing.)

d. It is necessary to apply tension to the wire while winding, and while finished, it is necessary to restrain the

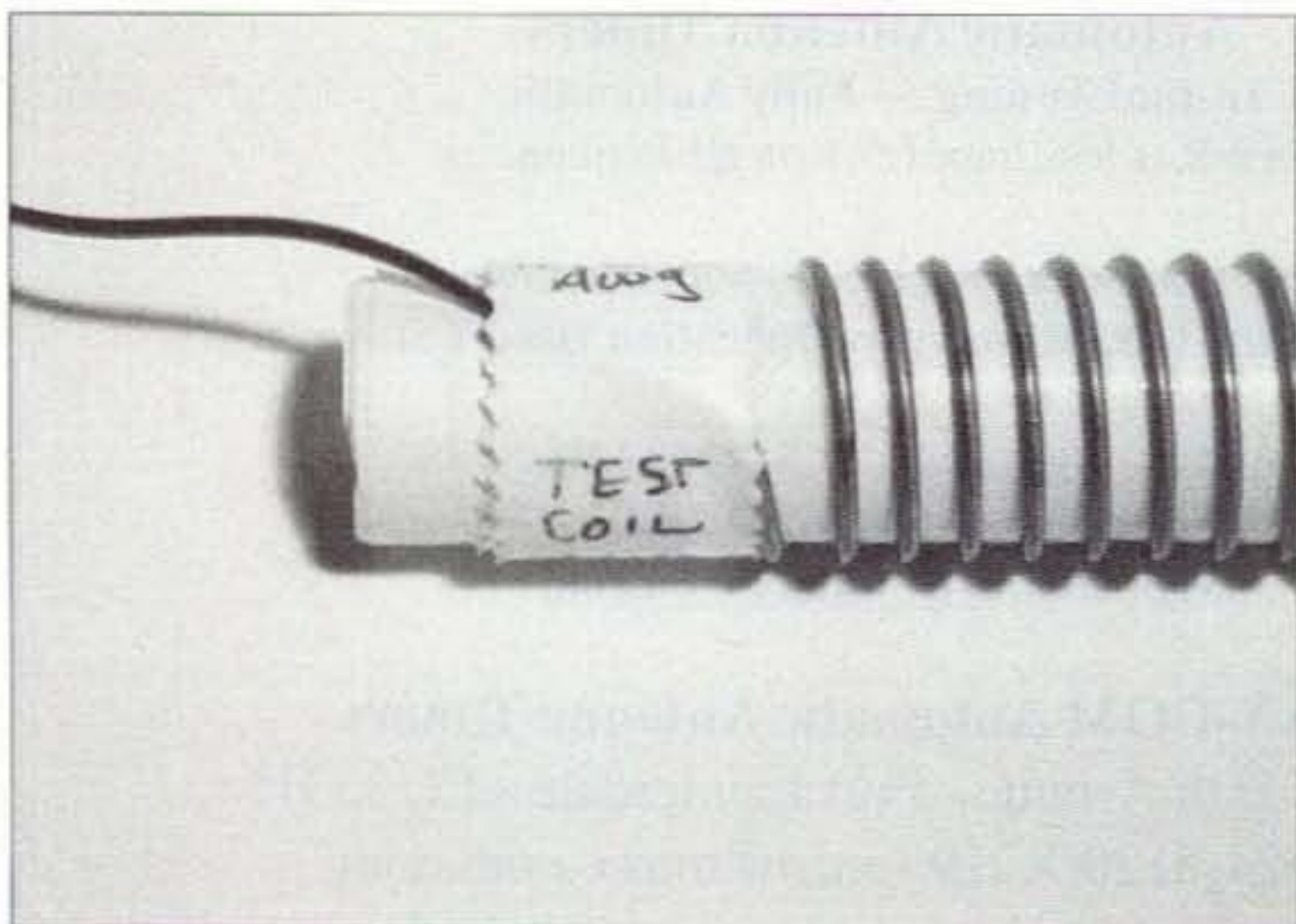

Photo K. Coil for ferrite rod showing paper core and ends anchored with adhesive tape.

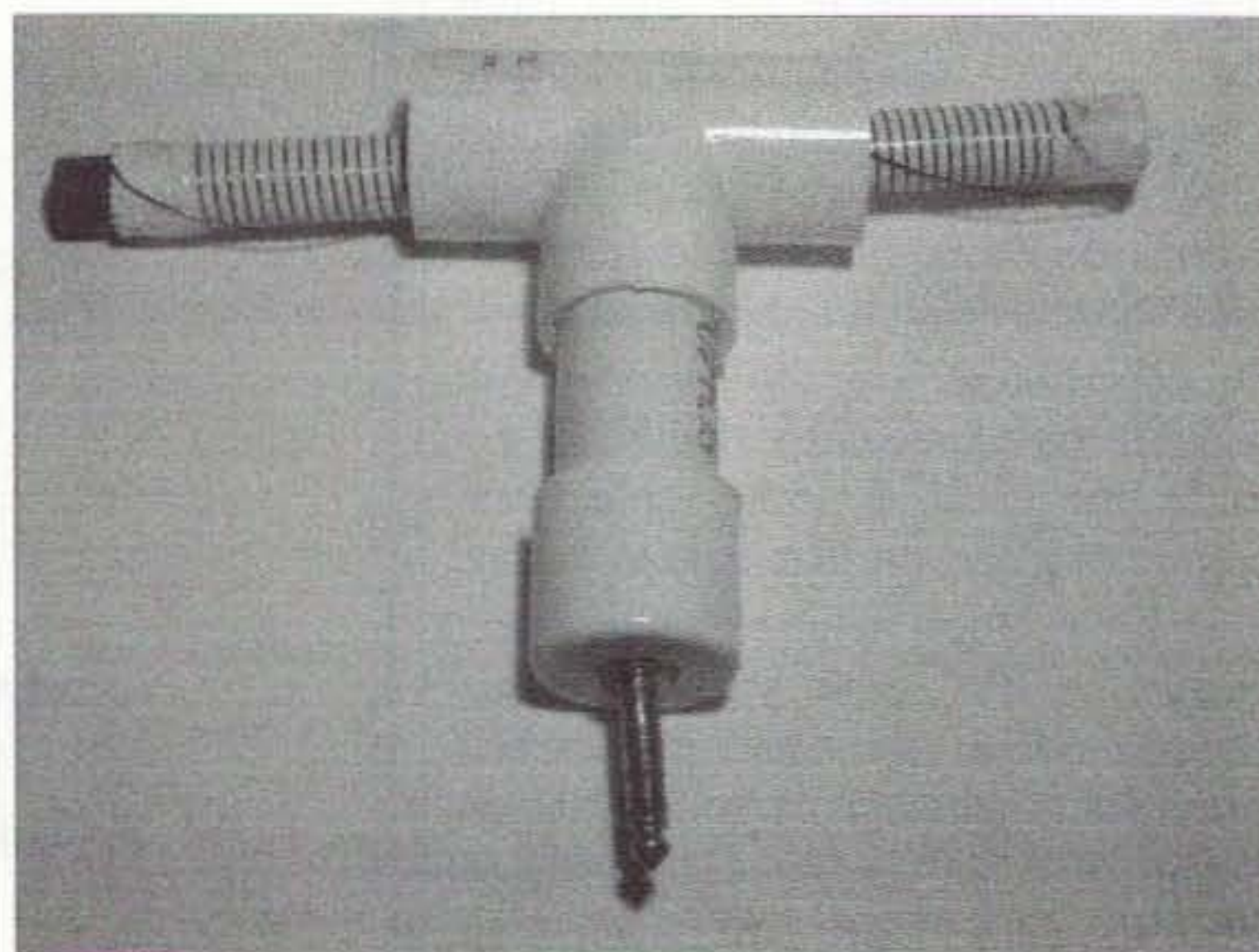

Photo L. Ferrite coil antenna with ends removed.



Arkansas's Communication Store

1710 East Parkway
Russellville, AR 72801
Phone 479-967-8315
Fax 479-967-8317
1-888-315-7388

Kenwood, Icom, Alinco, ADI,
Police & Fire Communications Equipment,
Surveillance Electronics (Installed).
We sell amateur & commercial band radios.

www.rlselectronics.com

winding. I taped the start and finish windings to the core with 1/2-inch adhesive tape.

4. Press-fit the 2-3/4-inch stub into the center of the TEE. Insert the coil into the TEE section, routing both free wire ends through 2-3/4-inch stub. Cut off any excess wire, strip and tin the ends, and solder to the *tip* and *ring* pins of the 3-circuit plug. (Polarity isn't important.) Leave the sleeve (ground) pin unconnected. Temporarily assemble (*without glue*) the 2-3/4-inch stub and the cap. Install the loop on the tuner and check the tuning range.

5. If the tuning range doesn't match expectations, adjust the loop:

a. Squeeze the turns together or stretch the turns farther apart. Squeezing the turns together increases inductance (lowers frequency) while stretching reduces inductance (increases frequency).

b. Slide the ferrite rod away from center position. This will reduce the inductance.

If you can't achieve your desired tuning range, then rewind the loop.

6. When you have achieved your target tuning range, unsolder the loop and remove it from the TEE. Cement the winding to the paper core with Q-Dope® glue. If you don't have Q-Dope, household cement may work. When the glue is dry, reassemble the loop, including the PVC legs, and resolder to the 3-circuit plug. To prevent the loop from rattling inside the pipe, fill the TEE with packing. I've used plastic "peanuts" and scraps of foam rubber successfully. Fill the legs and then slip the caps over the end. I've found that friction fit holds the assembly together without the need for cement. If you wish additional mechanical strength, cement the assembly together, but

Continued on page 58

A GREAT gift idea for yourself, your ham friend(s), or your child's school library

is a subscription to 73 Magazine ... only \$24.97!
Call 800-274-7373 or write to 70 Hancock Rd., Peterborough NH 03458

Two Step Tuning

Step One: Pick up microphone.

Step Two: Transmit.

(Please note: HF Tuning doesn't get much easier than this.)

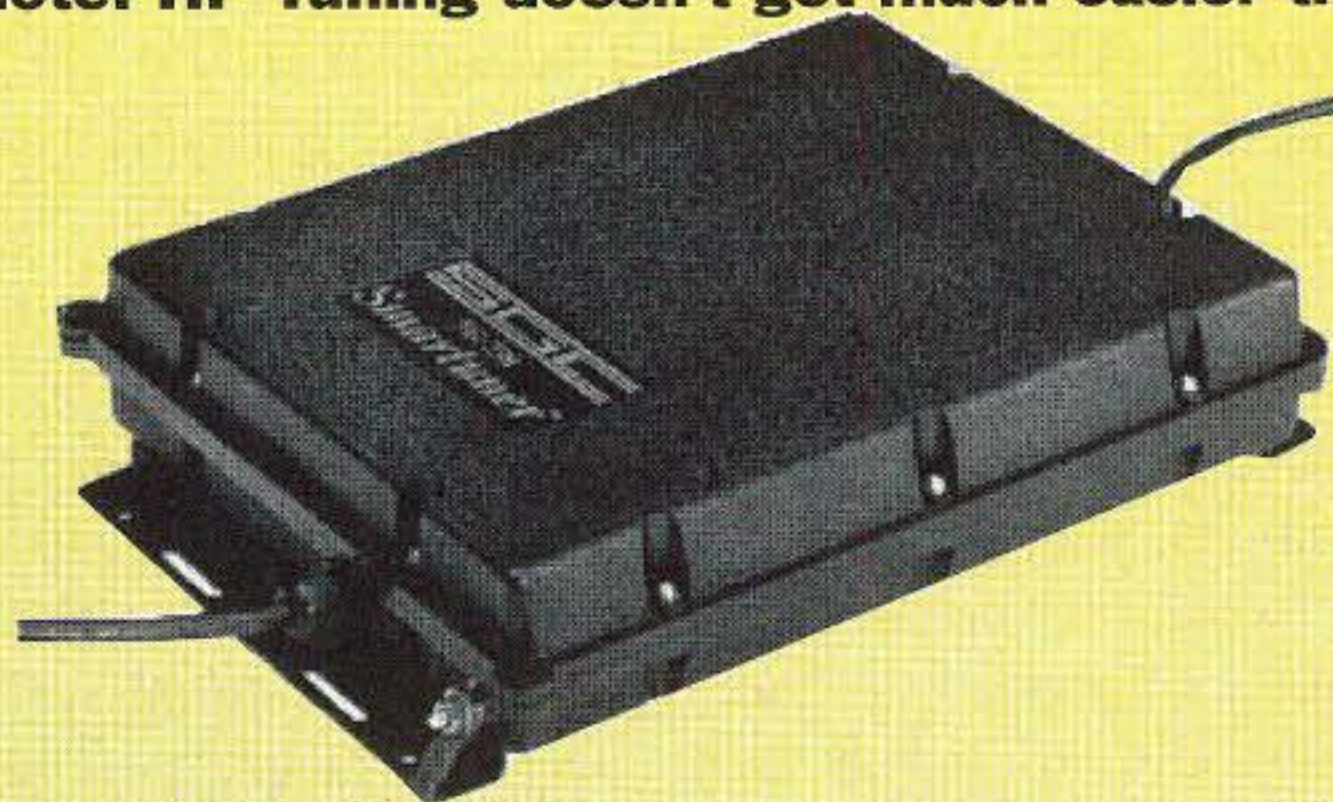

SGC Smartuner™

HF Automatic Antenna Couplers

"For me and my radio dollar, there isn't a better coupler made!"

Jack Huebschen N9XRO

Power Input: From 1.5W - Up to 500W*
HF Frequency Range: From 1MHz - Up to 60MHz*
Up to 4,000,000 element combinations*

Five Sensor Devices

*Specs differ per model

"Undoubtedly the best piece of hamgear I have ever owned."

Ronnie Kane K9MNI

**Marine, Commercial, Amateur Radio,
Aviation, Special Applications**

Starting at \$249



www.sgcworld.com

Toll Free (800) 259-7331 • Tel (425) 746-6310 • Fax (425) 746-6384 • Email: sgc@sgcworld.com

Mailing: PO Box 3526, Bellevue, WA 98009 • Shipping: 13737 SE 26th St. Bellevue, WA 98005 USA

Copyright 2001 SGC, Inc.

Vacuum Tubes: Romance and Reality

A (mostly) glowing tale.

Hams of all ages have long had a love affair with vacuum tubes. Arguably, the 1950s were the golden years for amateur use of vacuum tubes. However, hams who remember those years probably have only a vague understanding of the vacuum tube's origin and history. Also, the demanding nature of vacuum tubes has long been forgotten, while the memory of their beautiful glow lingers on.

The early 1900s marked the first "solid state" era for radio communications, with the emphasis on the word "solid." It was an age of spark transmitters, crystal detectors, and other physically solid devices. It was an unlikely setting for the birth of the fragile, glass bottle vacuum tube.

In those early years, radio communications utilized sparks. To understand a spark transmitter, think about the small spark you create when you walk across a carpet on a dry, cold, winter day and touch a doorknob. If you were carrying a portable AM radio, you would hear the static generated by that spark. That's how spark transmitters worked, only they used much larger sparks, requiring a significant amount of electricity.

An important need in the 1900s was for a better detector (receiver) of spark signals. To try to meet this need, John Ambrose Fleming, an English scientist, began experimenting with the "Edison effect" that had been noted in electric, glass light bulbs.

The Edison effect was named for Thomas A. Edison, the American inventor of the electric light bulb. In the late 1800s, Edison was troubled by the fact that the glass in his light bulbs

would eventually become darkened. This was caused by particles of the carbon from the light bulb filament being transferred to the glass. In investigating this problem, Edison placed another element (a plate) inside the bulb and discovered that a very small electrical current flowed from the filament through the vacuum to the plate. This action came to be called the "Edison effect" and seemed to be of no practical value.

To investigate the Edison effect, Fleming built his own two-element vacuum tube. In the course of his research work, he discovered that his tube could be used as a detector (receiver) of radio waves. Fleming called his two-element vacuum tube a valve.

Lee De Forest

At about the same time, Lee De Forest, an American inventor, was also trying to develop a better detector of spark signals. He invented a flame detector that had two platinum electrodes held close together in the flame of a Bunsen burner. As strange as it sounds, it actually worked.

De Forest knew that, for practical reasons, the flame needed to be inside

a glass mantel. He also realized that the flame could be replaced with a burning filament. He ultimately created a vacuum tube that he called an audion. It was similar to Fleming's valve, but De Forest got there via a different intellectual path, or so he said. Actually, De Forest was quite familiar with Fleming's work with vacuum tubes. However, it was De Forest's decision to add a third element — called a grid — to his audion that produced the start of the vacuum tube revolution.

Nevertheless, for the first few years after its creation, the three-element audion vacuum tube languished. Even its creator was unclear about how it worked and could be best utilized. Then, in the 1910s, engineers like Howard Armstrong and corporations like AT&T began to turn the vacuum tube into a truly useful device.

Through their efforts, the vacuum tube became more than a mere detector of radio waves. It also became an amplifier, and even more importantly, it became an oscillator that could generate continuous waves, which would eventually replace spark transmissions. The development of new electrical circuits had turned the vacuum tube into an all-purpose electronic device.

During the 1910s, there was some limited use of vacuum tubes by hams. It was limited because at that point in time vacuum tubes were very expensive, their quality was poor, and their life was short. However, hams could clearly see their potential.

During the 1920s, vacuum tubes continued to be refined and developed. More grids were added to increase their performance capabilities. The power handling of transmitting tubes continued to increase. It was clear that vacuum tubes were here to stay.

The creation of radio broadcasting, in the 1920s, greatly expanded the demand for vacuum tubes. This meant that the volume production of tubes could create economies of scale and reduce the cost of tubes.

During the 1920s, ham use of vacuum tubes greatly expanded because of their lower cost and greater availability. Vacuum tube receivers and continuous wave tube transmitters were increasingly common; spark was no longer king.

During the 1930s, vacuum tube development continued. However, the great depression of the 1930s impacted ham use of vacuum tubes. In that era, it was not unheard of for a ham to have a one-tube receiver and a one-tube transmitter but have only one vacuum tube. This required physically moving the tube between the receiver and transmitter. Hams learned to make the best of what they could afford.

During World War II, hams went off the air, but vacuum tube development continued at an accelerated pace. New tubes were invented to work on the very high frequencies (VHF), miniature tubes for military applications were created, and tubes with a much lower current drain were developed. All of these vacuum tubes would greatly benefit the civilian market after the war had ended.

The golden years

For most hams, the 1950s brought the return of relative economic prosperity. They could now afford more complex, multiple-tube transmitters and receivers, and they wanted them.

In that era, many hams were able to

Ham Mall

The world's largest internet store dedicated to Ham Radio!

www.HamMall.com

This is the internet store that has it all! Open 7 days per week - 24 hours per day. Browse through our catalog viewing pictures, descriptions, accessories, and our low prices. If you are looking for a hard to find item, Email us at Bill@HamMall.com, and we will try to locate it for you.

Check out all we offer!

Call Wall QSL Manager Listing News, Announcements and Specials
Ham-to-Ham Discussion Groups Ham Shack Photos

Visa/MasterCard accepted on line. Free shipping in continental US on all orders over \$100.

When in Seattle visit us at:

Radio Depot, Suite 176, 5963 Corson Ave., So. Seattle, WA 98108

Phone (206) 763-2936 Fax (206) 763-4172

HI PRO REPEATERS



Starting at
\$639 VHF/\$699 UHF

**Two Year
Warranty**



Starting at
\$1450 VHF/\$1525 UHF

Specializing in repeaters, links, crossband repeaters, receivers and transmitters (separately or in housings)

**Maggiore Electronic Lab, 600 Westtown Rd., West Chester, PA 19382
PH (610) 436-6051 FAX (610) 436-6268 <http://www.hiprorepeater.com>**

- DIP switch programmable
- Miniature in size
- 37 EIA tones, 27 non-standard tones from 33.0 to 254.1 Hz included
- Reverse Burst built-in
- Easy 3 wire hookup

SS-64 CTCSS Encoder
.66" x 1.08" x .21"

SS-64 DIP Switch Programmable CTCSS Encoder \$28.95



- Fully enclosed CTCSS encoder
- All 32 EIA tones from 67.0 to 203.5 Hz included
- Perfect for mobile / base applications

TE-32
5.25" x 3.3" x 1.7"

TE-32 Multi-Tone CTCSS Encoder \$49.95



- 51 CTCSS Tones
- 106 DCS Codes
- Supports 157 Repeater Subscribers
- On-Line Computer Help
- Repeater CW ID
- Air Time Loading & Analysis Graphs
- Signalling Formats: CTCSS DCS & DTMF

TP-3200 Shared Repeater Tone Panel

TP-3200D Table Top Version \$269.95 each
TP-3200RM-A Single Rack Mount version \$279.95 each
***TP-3200RM-B Triple Rack Mount version \$279.95 each**
*Holds up to three TP-3200s

Call or write to receive our full Product Catalog or visit our Web site for complete information at:
<http://www.com-spec.com>



ID-8 Automatic Morse Code Identifier \$69.95
1.85" x 1.12" x .35"

ID-8 Automatic Morse Station Identifier \$69.95

COMMUNICATIONS SPECIALISTS, INC.
426 WEST TAFT AVENUE • ORANGE, CA 92865-4296
(714) 998-3021 • FAX (714) 974-3420
Entire U.S.A. (800) 854-0547 • FAX (800) 850-0547
<http://www.com-spec.com>

afford commercially built multiple-tube receivers. However, building your own transmitter was still very popular. Some hams would even construct their homebuilt transmitter with a glass window that allowed viewing the final amplifier tube or tubes. Those glowing transmitting tubes were indeed a beautiful sight, and they could also warm up a ham shack on a cold winter's night.

In addition, a high-power, high-frequency transmitter would usually have mercury vapor rectifier tubes in the power supply. Those tubes gave off a beautiful blue glow that changed in intensity when you talked into the microphone during amplitude modulation (AM) phone operations. Also,

the audio quality from a glass tube modulator was fantastic; even today, audiophiles still prefer glass tube audio equipment.

Unfortunately, there was a downside to all those beautiful, glowing vacuum tubes.

A typical 300-watt, AM, high-frequency transmitter would need a power supply capable of supplying approximately 1,500 volts. That power supply would require a large expensive power transformer, the associated filter choke, and rectifier tubes.

In addition, that transmitter would require a 150-watt class B plate modulator for AM phone operations. That modulator needed a large, expensive, 150-watt modulation transformer. It also required its own power supply, which would have a large, expensive power transformer, filter choke, and rectifier tubes. Finally, there were the filament transformers to light all those vacuum tubes in the modulator and transmitter.

Many hams of that era also built lower-power transmitters for mobile operations. However, even a 50-watt vacuum tube mobile transmitter presented some interesting challenges, because of the unique demands of vacuum tubes.

Eisenhower era

The 1950s was an era of six-volt automobile batteries and generators — not today's alternators. Building a mobile transmitter that used vacuum tubes with six-volt filaments solved the problem of lighting the tubes. However, supplying the typical 450 volts needed for the tubes' plates was a challenge.

Hams used a dynamotor or vibrator to supply the plate voltage. A dynamotor was a motor generator that used the six volts to make it rotate and generate the 450 volts for the vacuum tubes' plates. A vibrator "chopped up" the six volts into a square-wave AC that a transformer could step up to a higher voltage. Both devices placed a tremendous strain on an automobile's electrical system. It was not unusual to see a car's headlights dim when you turned the transmitter on.

Even though a typical transmitter might have a number of vacuum tubes, they often became a rather minor part of the project. However, there was some concern over the cost of vacuum tubes. Fortunately, in the 1950s, vacuum tubes were being produced in large quantities for television sets. This resulted in economies of scale that helped to reduce the cost of these tubes, many of which were suitable for use by hams. In addition, military surplus tubes were widely available at a greatly reduced price.

Military surplus tubes could be obtained via mail order ads in magazines like *QST*. They could also be purchased at the surplus parts stores located in major cities like Chicago and New York. While the supply lasted, those tubes were a real bargain.

Even the famous Heathkit Company was not above using military surplus tubes in its kits. You knew the tubes were military surplus because of the markings on them and the box they came in. However, no one cared; they were new and unused, and the price was right.

In the 1950s, most drug stores had a tube checker. They were used by individuals to check tubes from home television sets. Hams also used them to check tubes used in their receivers and some of the tubes used in their transmitters. Obviously, tube checkers would not check high-power transmitter tubes, mercury vapor rectifier tubes, etc.

The most common problem with vacuum tubes was that — just like light bulbs — the filament would eventually burn out. However, tubes could also become "gassy" and fail to perform up to standard. Tubes were mounted in sockets, because they often had to be replaced.

The creation of the transistor spelled the end of the vacuum tube era. Today's solid state era has given us very electrically efficient ham equipment. Yet, the popularity of the old vacuum tube equipment still lives on. Even though we know solid state devices are more efficient, the romance of vacuum tubes tugs at the strings of our hearts. 73

Smart Battery Charger

New & Improved



FOR GEL-CELLS or LEAD ACID BATTERIES.

Features: Precision temperature tracking voltage reference & three mode charging sequence. Standard kit is for 12V @ 1/2 or 1 Amp, user selectable. Can be connected to the battery indefinitely, will not overcharge. Weighs 2 pounds and measures 4"Wx5 1/2"Dx2 1/2"H. Finished enclosure included in kit.

Complete Kit Only	\$59.95
Assembled & Tested	\$79.95

CA Residents add 7.50% sales tax; S&H: \$6.50 (insured). Foreign orders add 20%.

For more info or price list go to a-a-engineering.com



A&A Engineering



2521 W. La Palma #K • Anaheim, CA 92801
(714) 952-2114 • FAX: (714) 952-3280

HamCall™ CD-ROM

U.S. & International - Over 1.63 million listings



We make a new HamCall every month! Clearly, the most current and complete CD-ROM available.

Latest Features

- Choose font and color of data display.
- Displays flag and map for each country.
- Shows CQ, ITU zone, and continent.
- History list shows each callsign entered.
- Print labels in a variety of formats.
- View & search interests of 39,000 hams.
- Search for club, military, vanity, silent keys, name, address, and more.

Over 1,631,000 U.S. and International listings, 128,000 e-mail addresses, 4,000 photos and QSL cards, 37,000 vanity calls, and 20,000 references to QSL managers.

Shows path distance & bearing.
Precise latitude/longitude for over 90% of addresses.
HamCall is \$50.00, included is 6 months free access to our HamCall Internet Service - request when ordering.

HamCall Mousepad, with morse code reference, 7.5" x 8", blue with yellow letters. \$5.00 + \$3 shipping.
\$5.00 shipping (\$8 Int'l) per order. Your satisfaction guaranteed!



BUCKMASTER



6196 Jefferson Highway • Mineral, VA 23117 USA
e-mail: info@buck.com
540-894-5777 • 800-282-5628 • 540-894-9141 (fax)

2 m/70 cm Quad Revisited — Part 1

Try out this new, improved update to a CQ article.

The July 1999 issue of CQ Magazine covered my original 2 m/70 cm quad project. This was my first attempt to build a dual-band quad antenna. Some shortcomings were present, including a bit of overconstruction, but who knew what the wind, cold, ice, and other elements were going to do to it. I know a lot more today!

This new design using 3/4-inch PVC water pipe shows a little bit better performance and is much lighter in weight. In this version, I used AWG-12 bare copper wire fed through 1/4-inch agricultural PVA tubing. This looks better and the performance is better on 440 MHz. My use of a ferrite choke also enhanced the

performance considerably: about 13 dBd over a dipole for under \$20 (U.S.). The boom length is about 4 to 5 ft., and an old TV rotor does the rotating.

Part 2 of this article will explain the TV rotor part of the project.

Take a look at **Fig. 1** for the basic dimensions and layout of this PVC wonder. This modern-day “Plumber’s

Delight” is perfect for the 2 m/70 cm bands and in particular for satellite work. The system radiates both two-meter and 70-centimeter frequencies on the same elements with a boom length of under four feet (114 cm). The measured gain figures are about 11 dB over a dipole on two meters and 13 dB over a dipole on 70 cm. The additional

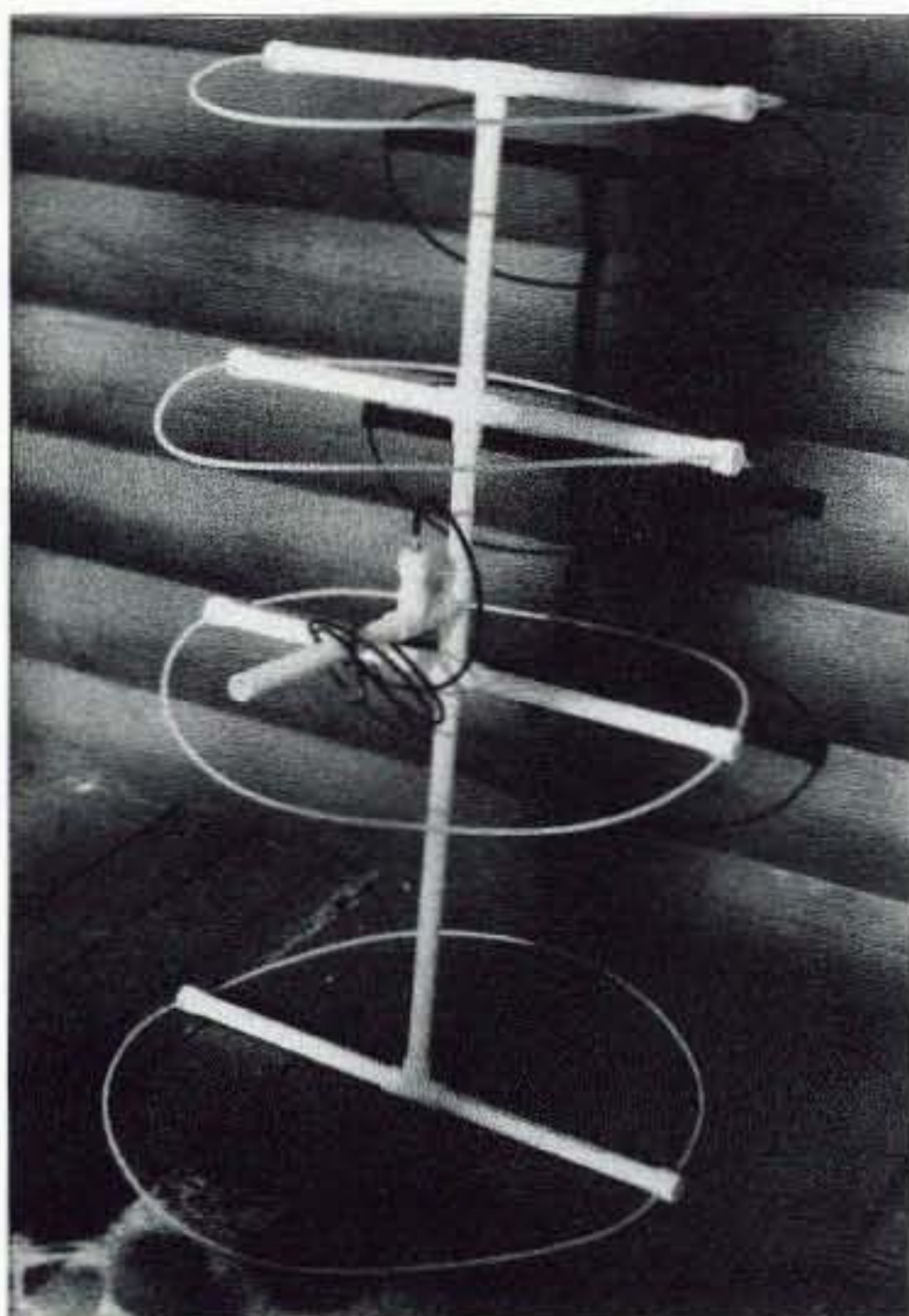

Photo A. Quad antenna without wood dowel stiffeners.

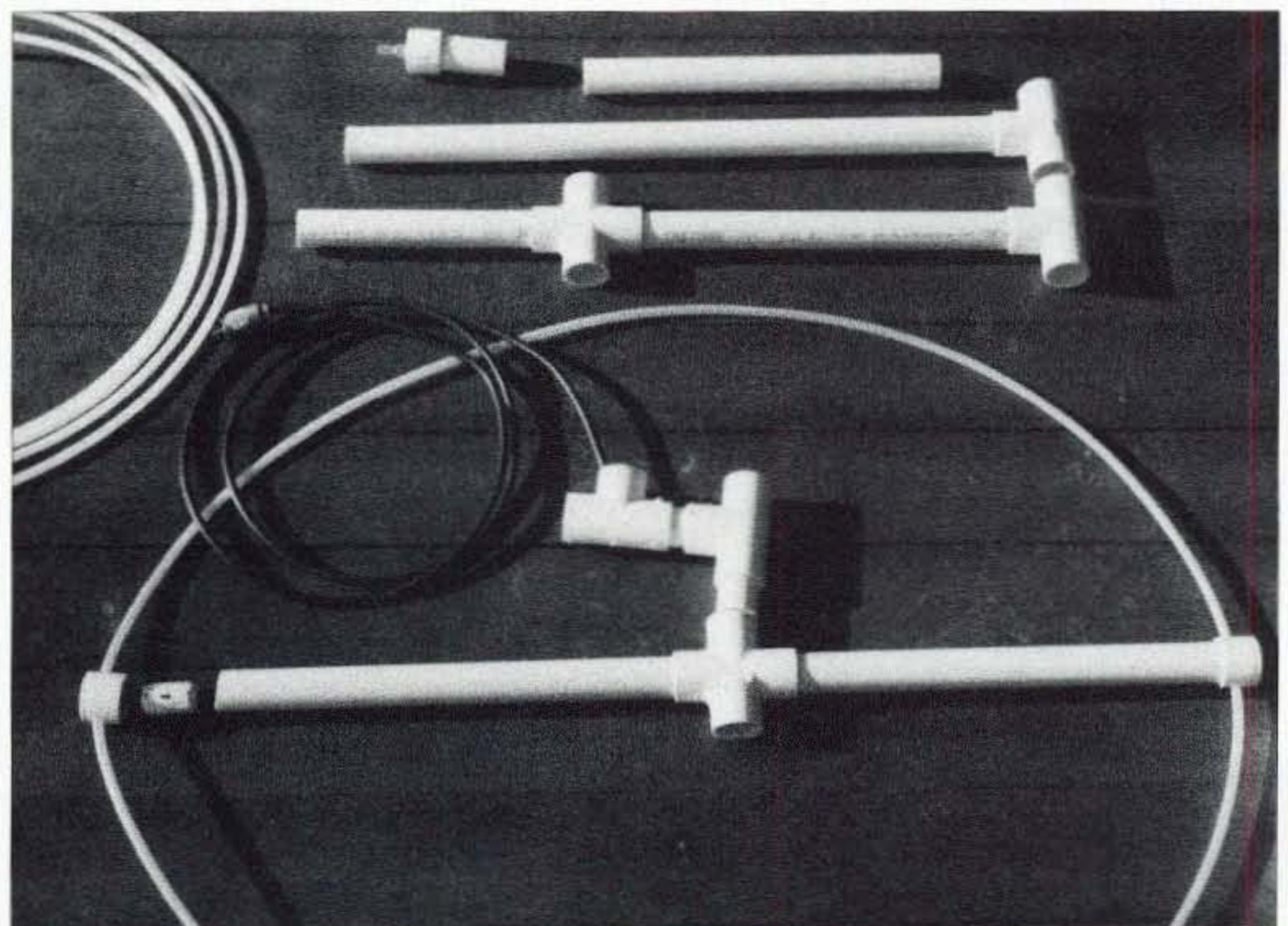

Photo B. Element parts and pieces.

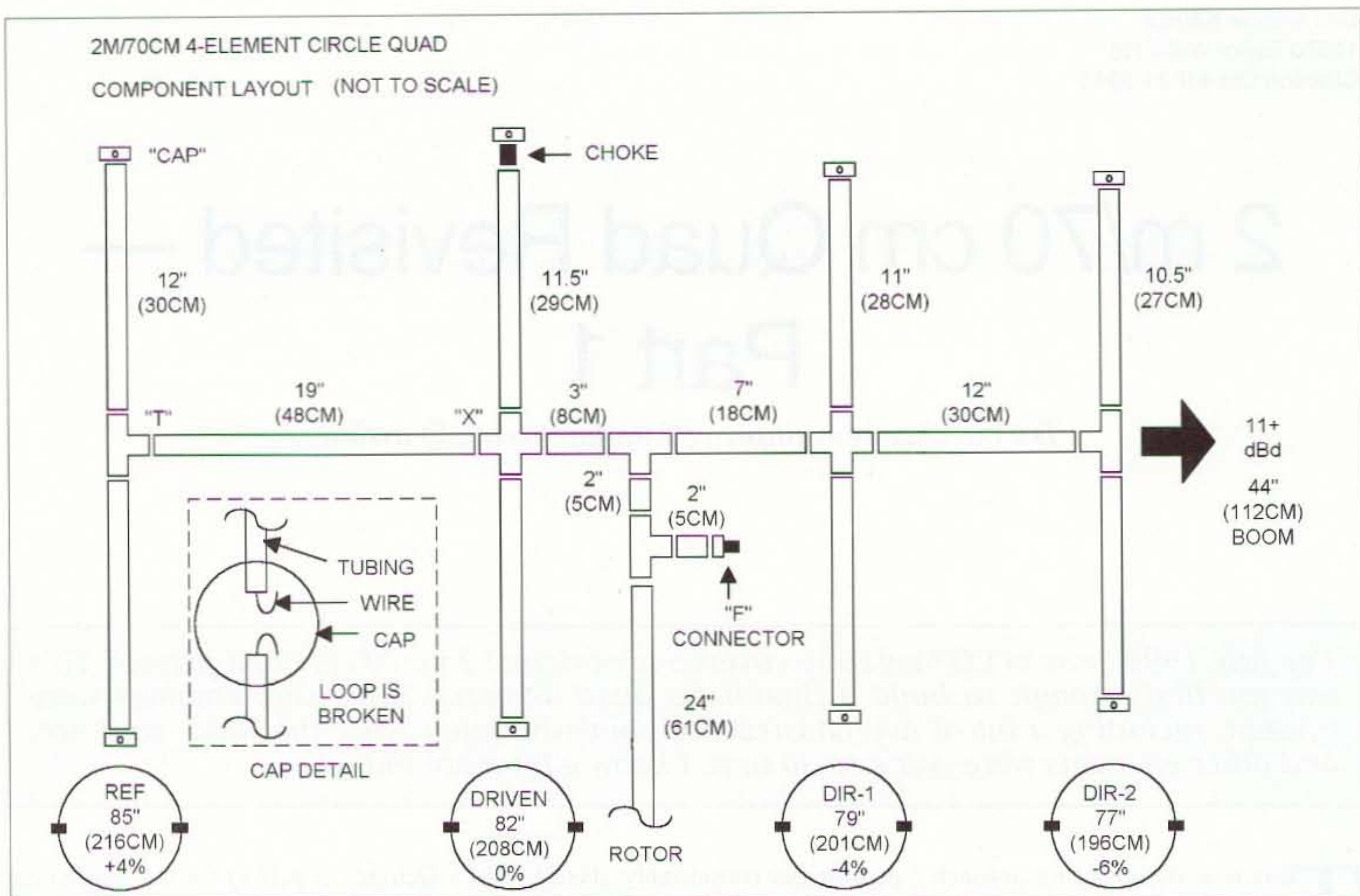

Fig. 1. Component layout for the 2 m/70 cm 4-element circle quad.

gain on 70 cm is due to the three wavelength elements. This is known as an "XL" element — that is, two or more wavelengths of the frequency being radiated. The noise figure, some times referred to as noise floor, is measured at about 3 dB below that of a four-element yagi. Some might consider that as gain also. The feedpoint is about 70 ohms, so a high-grade 75-ohm coax such as RG-6 can be used up to about 200 watts. The low-cost "F" connectors were also attractive at twenty-five cents each. There is no soldering involved since the center solid conductor makes the connection and the braid and foil shields are aluminum and cannot be soldered. After the connections are made, use black plastic PVC tape to weatherproof the connectors.

In regard to the gain figures, you will find Fig. 2 is a circular plot of measured gains under actual conditions. The gain figure and pattern was obtained from a Kenwood TS-780S transceiver's "S"-meter and a magnetic compass. The repeater used was at 145 MHz and located about 50 miles away.

The repeater is a 10-watt unit with an antenna system located on top of a 275-ft. tower.

Well, now let us look at how to put the thing together. The actual construction is very easy. The PVC water pipe can be cut with nearly any sharp object. A table saw is excellent, although a standard wood cutting saw or hack saw will also do the job. Round off the sharp edges prior to assembly to maximize the joint strength.

The end caps are drilled with a 0.125" drill bit to start pilot holes. Then follow up with a sharp 0.25" drill bit to finish the job. The PVA agriculture tubing is really a metric size, approximately 0.25" in diameter, and provides a very tight fit into a 0.25" hole. I use a little of the clear 100% silicone caulk on the outside just to be sure there is a good seal.

Just to make sure you understand: We are feeding on the side — that is, at the 90-degree point of the circle — so that the array is vertically polarized. Some testing has shown that a horizontal feedpoint at 180 degrees is acceptable

also without any apparent difference in repeater work.

The circle element does some things very different from the square or triangle loops. The gamma and balun transformer matching devices were tried without success. When applying twenty watts of RF using these matching devices, the loop could be tuned to a 1:1 SWR without a problem. But, when receiving was tried, the signal strength was affected very negatively. The direct connection of the coax to the driven element proved to give the best results on both receive and transmit situations. If you make any of the parasitic loops, reflector, and directors a closed continuous loop you can expect to see degradation of the antenna system performance. The open loop results in a higher Q element than the low-Q continuous loop, which translates to more gain. The noise figure does not increase, since the small break provides a little bit of coupling capacitance and therefore aids in getting a high-Q circuit. This principle was used in the 1950s on the 6- and 2-

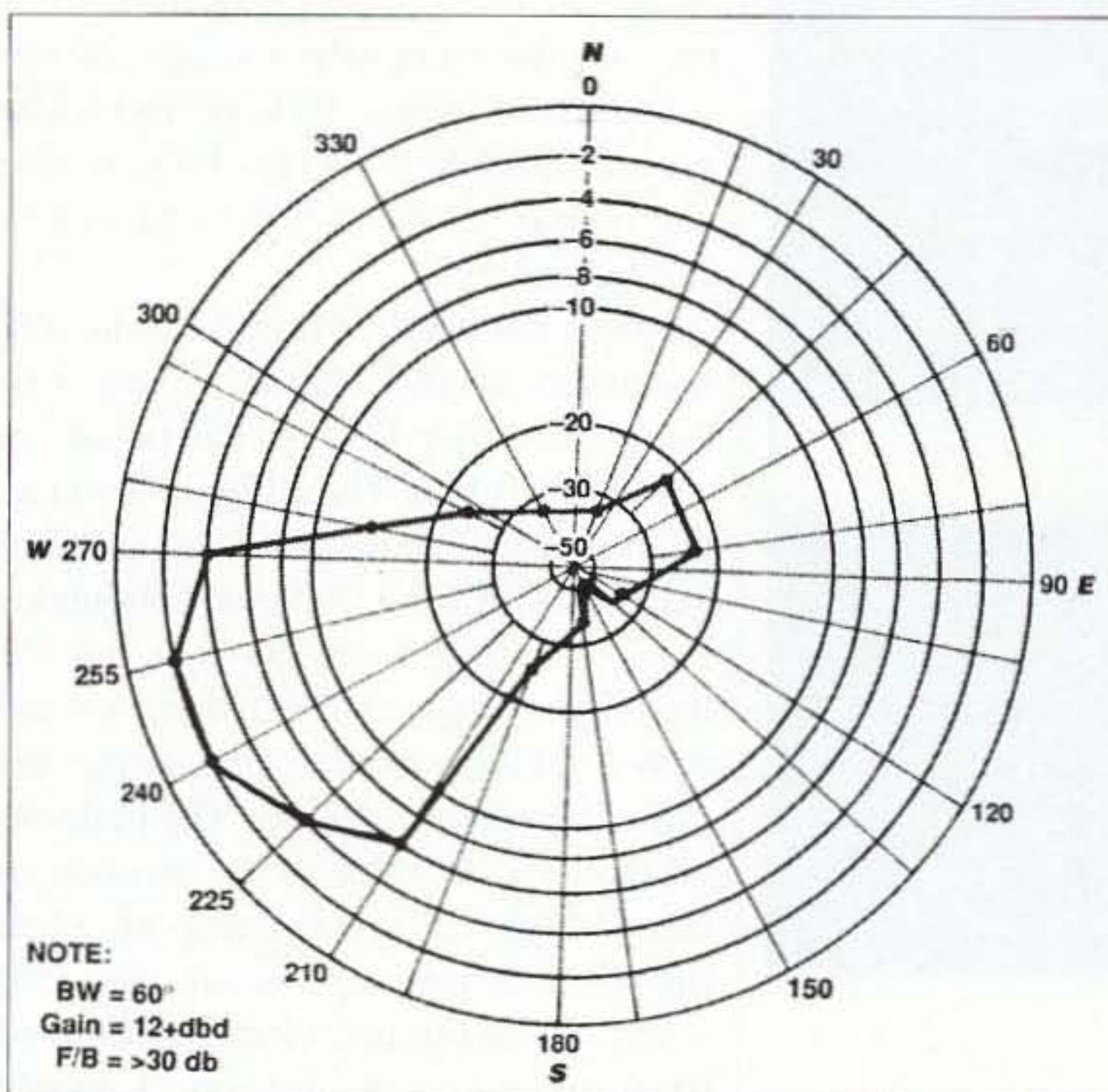

Fig. 2(a). The RF plot for the 4-element circular quad.

meter "Halo" loop mobile antennas. These were horizontal-mounted driven-element-only types which did very well for mobile installations.

No special tools or large efforts are needed to get this quality system. The element dimensions are not critical for good performance. The cost of materials amounts to about \$15.00 (U.S.). The stainless steel #4 sheet metal screws can be used to lock the PVC joints together, or you may use PVC glue. Either method has proven to be reliable. The PVC pipe and fittings are so tight that air and water leakage just does not seem to happen. The bandwidth is about what HF quads display and is in the area of $\pm 2\%$. This is without tuning the antenna to the rig. At 145 MHz, this is about ± 3 MHz, and at 435 MHz, ± 9 MHz. Because there is always a

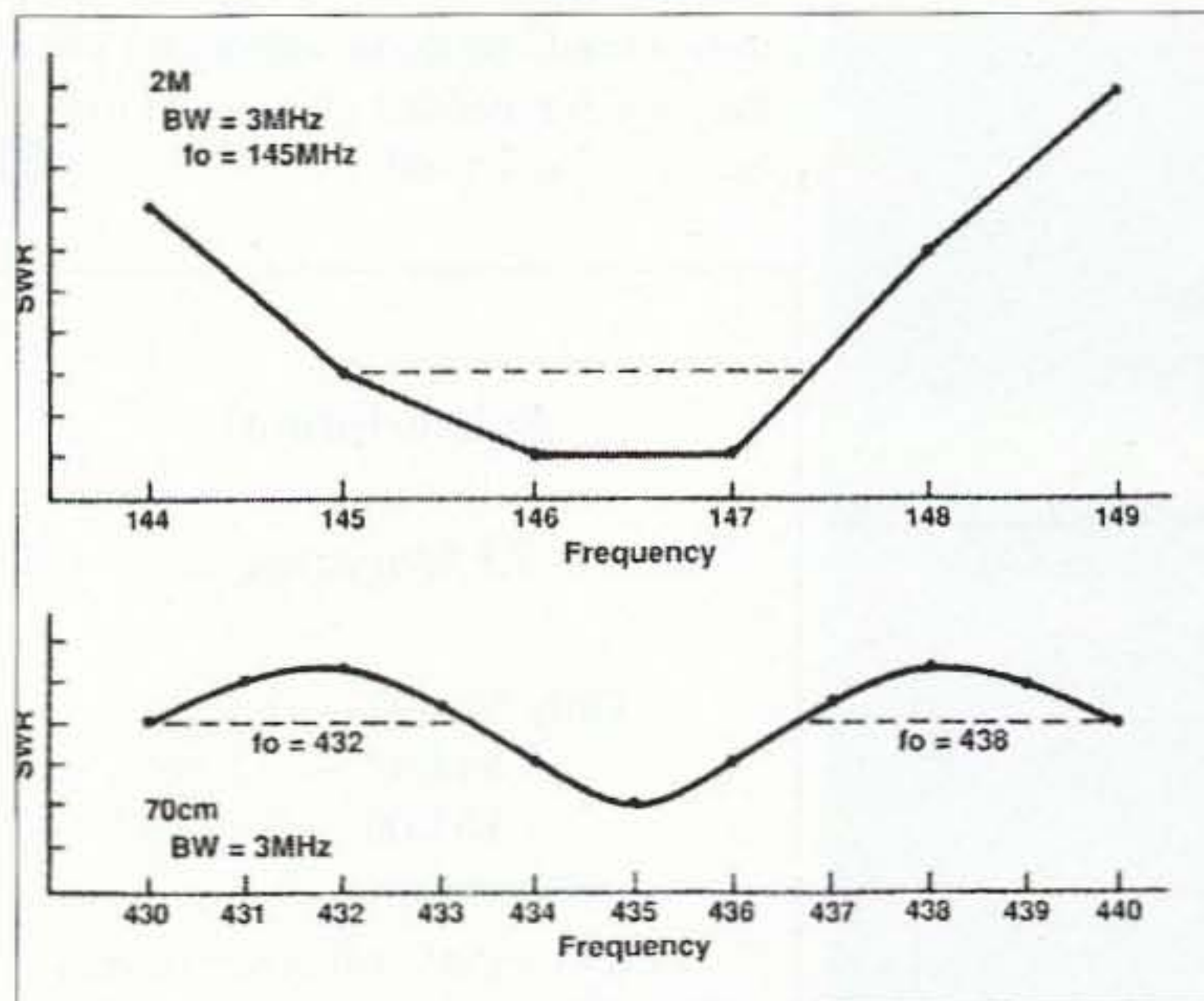
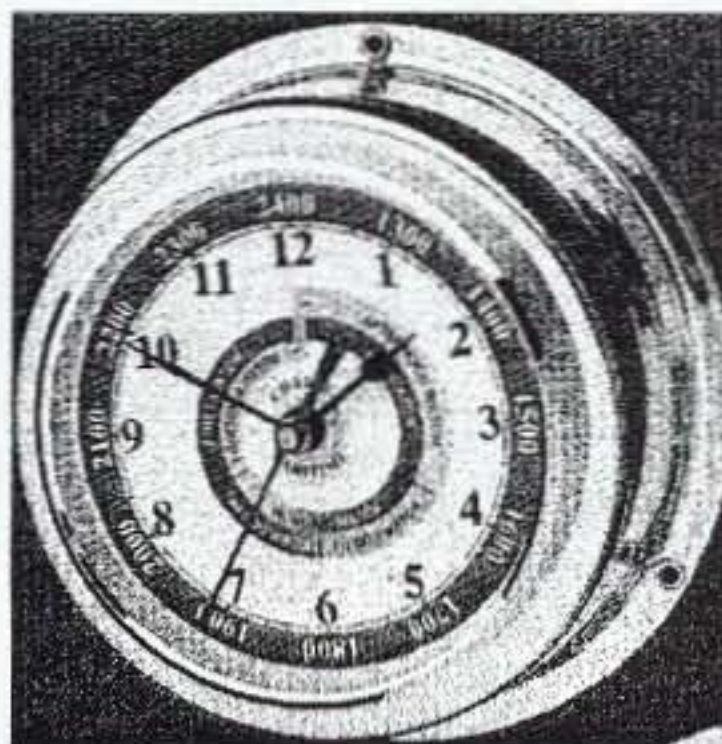

Fig. 2(b). The plot for SWR versus frequency, showing the usable bandwidth.



Chelsea Clock

Clockmakers since 1897
The choice of The Coast
Guard Foundation.

Quartz Clock
4" Dial

Beautifully hand-polished.
Stamped brass case and
bezel.
Curved glass crystal.
Wall or bulkhead mounting.
Made so well they last from
generation to generation!
Order this month and save
\$20!

Your price \$75

Omega Sales

P.O. Box 376

Jaffrey NH 03452

1-800-467-7237

If you're a No-Code Tech, and you're having fun operating, tell us about it! Other No-Code Techs will enjoy reading about your adventures in ham radio—and we'll pay you for your articles. Yes, lots of nice clear photos, please. Call Joyce Sawtelle at 800-274-7373 to get a copy of "How to Write for 73 Magazine."

TRANSMITTER LOCATION

New fixed site direction finders provide 2 degree accuracy, and include software for triangulation from a central control site. Mobile versions also available covering 50MHz to 1 GHz

Doppler Systems Inc.

PO Box 2780 Carefree, AZ 85377
Tel: (480) 488-9755 Fax: (480) 488-1295
www.dopsys.com

European Marketing Director Denis Egan
PO Box 2, Seaton, Devon EX12 2YS England
Tel & Fax: 44 1297 62 56 90



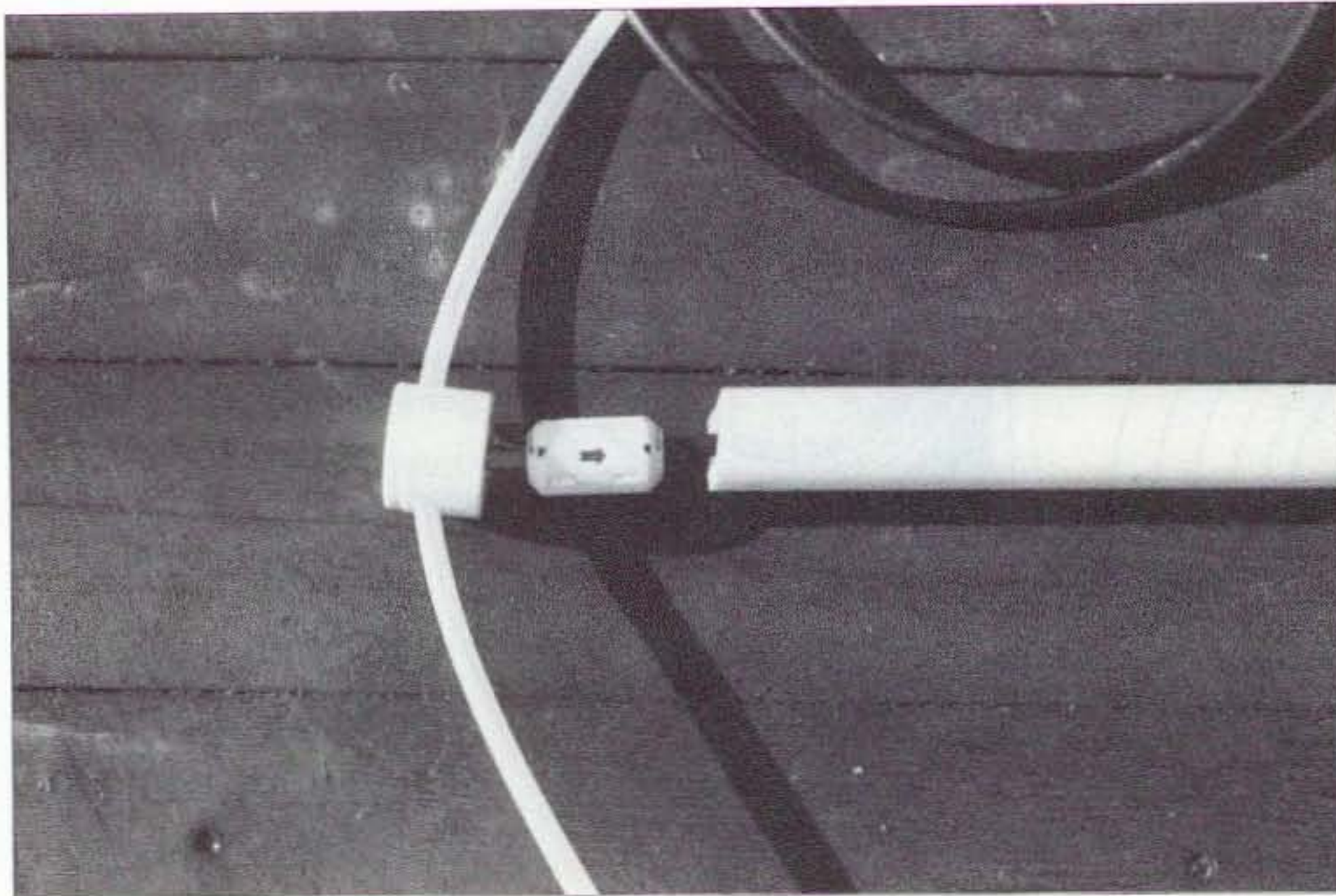

Photo C. Close-up of ferrite RF choke assembly.

mismatch between the antenna and rig in the VHF/UHF spectrum, primarily due to transmission line length, etc., an antenna tuner is very helpful. It is a good idea to cut the feedline to about 7-ft. multiples, which is any odd number of electrical one-half wavelengths. It just makes matching much easier.

Just a helpful note to those who are interested: A dual-band 2 m/70 cm antenna tuner, RF switch, SWR/PWR, DC power filter project will be coming out soon as a "Weekend Project." Most VHF/UHF satellite-capable rigs have separate outputs for the two bands. So

a tuner for each output for antenna matching is almost always necessary. If 52-ohm feedline is used, make sure you use a one-quarter wavelength 2 m-75 Ω matching section of coax to change 52-ohm coax to 75 ohms, which the antenna-driven element is looking for. Remember that the name of the game at 2 m/70 cm is efficiency. You must get the RF power to the antenna!

Now let us get back to the antenna system. The antenna has been through 60+ MPH winds without any problem. Because it is so light and strong, even an occasional icing does not seem to

bother it. The UV and heat buildup of the sun does not degrade any of my schedule-40 (white) PVC projects. The use of schedule-80 (gray) PVC is also acceptable if you prefer to pay extra for the materials.

I keep the length of the feedline to a minimum at my station. Every one knows the line loss of RF power at 430 MHz is bad. The RG-6 is about as good a coax as any, but keep in mind that the SWR = 1:1 200-watt continuous RF is the limit. If the SWR is not 1:1 then RF voltage will build up on the coax feed line thus again limiting the power handling capability. The trade-off on this type of cable is the breakdown due to high voltage building up when the SWR is up or power is over 200 watts. If additional elements beyond the four are contemplated, I would suggest that no real advantage was seen. If yagi one-half wavelength elements are placed as additional directors the noise would come up higher than the yagi director gains. Not a good idea! The advantage of a good quad antenna system is LOW NOISE with large bandwidth! This really comes into play on VHF/UHF bands.

In regard to the spreaders, I found that only two were needed to provide the loop support. If you are not happy with that or you live in an extreme weather area, you might want to consider extra top and bottom loop supports. I am including a very simple and inexpensive solution for that. I am including them in the article to show how it could be done, although I know they are not needed unless you expect heavy ice and wind. 73

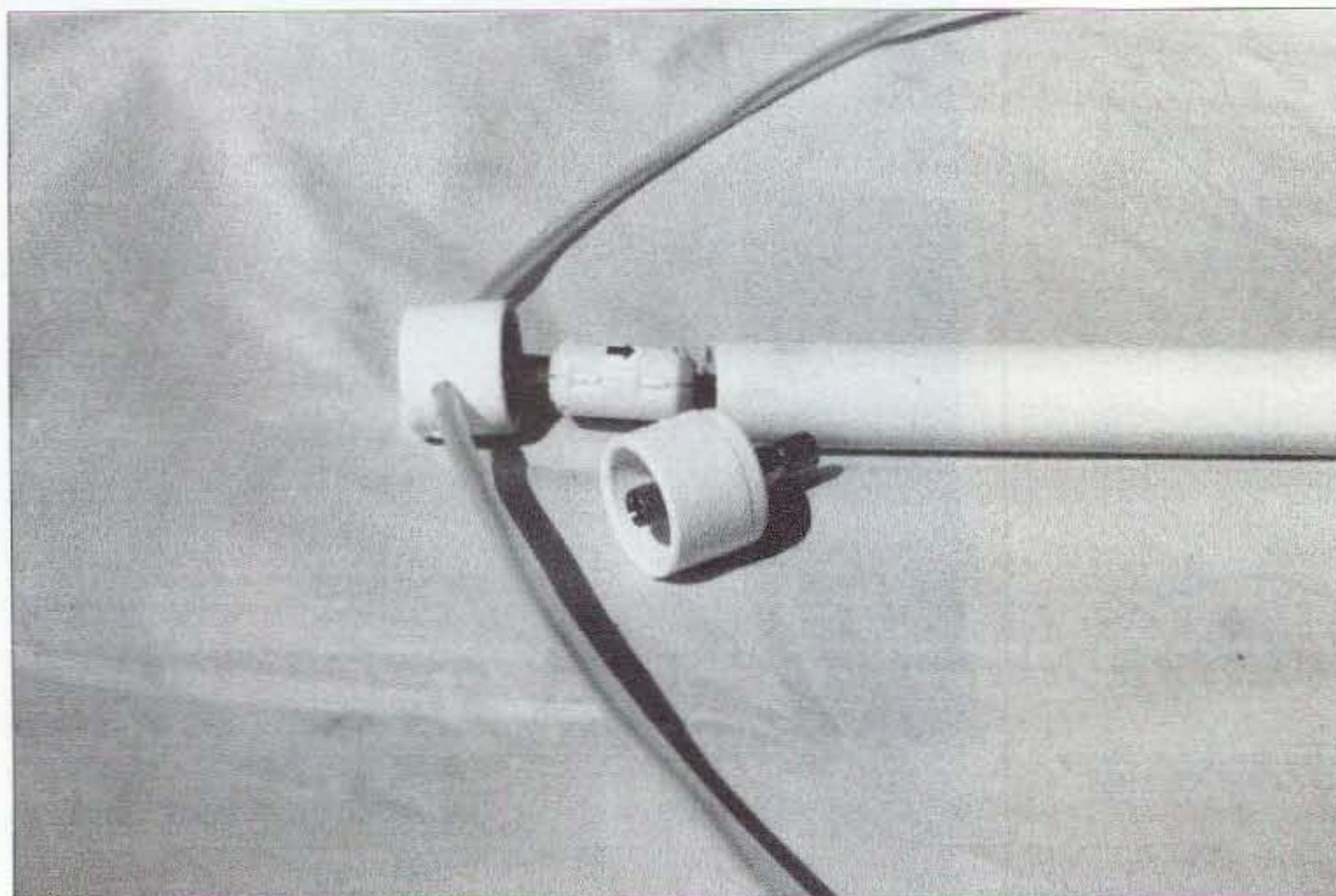

Photo D. Driven element RF choke assembly and "F" connector coax fittings.

Subscriptions to 73 Magazine

Only \$24.97 — 1 year
\$44.97 — 2 years
\$65.00 — 3 years*

*best buy (54% off cover price!)

Call 800-274-7373

Twisted Tale: The Dial File

Ever wonder how dials evolved? Well, read this anyway.

Being scientifically oriented, hams have always needed a way to measure the way things are adjusted. Dials have evolved as a result.

Have you considered the use, application, and design of “dials” as used on radio equipment from the very early days? When you stop to think about it, dials are the communication interface between humans and electronic devices. Dial markings and numbered reference points provide feedback to the operator of how the equipment is set up and/or adjusted.

Because of the importance of dials to ham radio and many other forms of electronic equipment, I’d like to take you on a journey of “dials” as they’ve

been used over the many generations of radio as we know it today. I’ve managed to collect a few pictures of dials dating back to 1918. Because of the numerous dial designs and iterations, I’ve collected only a few that are representative of the many types that have been developed.

The first dials used were really step switches that allowed the equipment operator to have control over the selection of circuit parameters. **Photo A** is a drawing of an early step switch RF transformer. As shown, the switch changes the transformation ratio between the

primary and secondary windings. Since variable capacitors and resonance were still in the stage of infancy, step switches were used to change taps on RF coils used as transformers to meet the desired received signal peak.

Another variation of the step switch transformer arrangement is shown in **Photo B**. In addition to allowing control of the transformation ratio, coupling between the primary and secondary windings could be changed by sliding taps on the top of the coil assembly. The slider was placed on a coil allowing manual selection of the

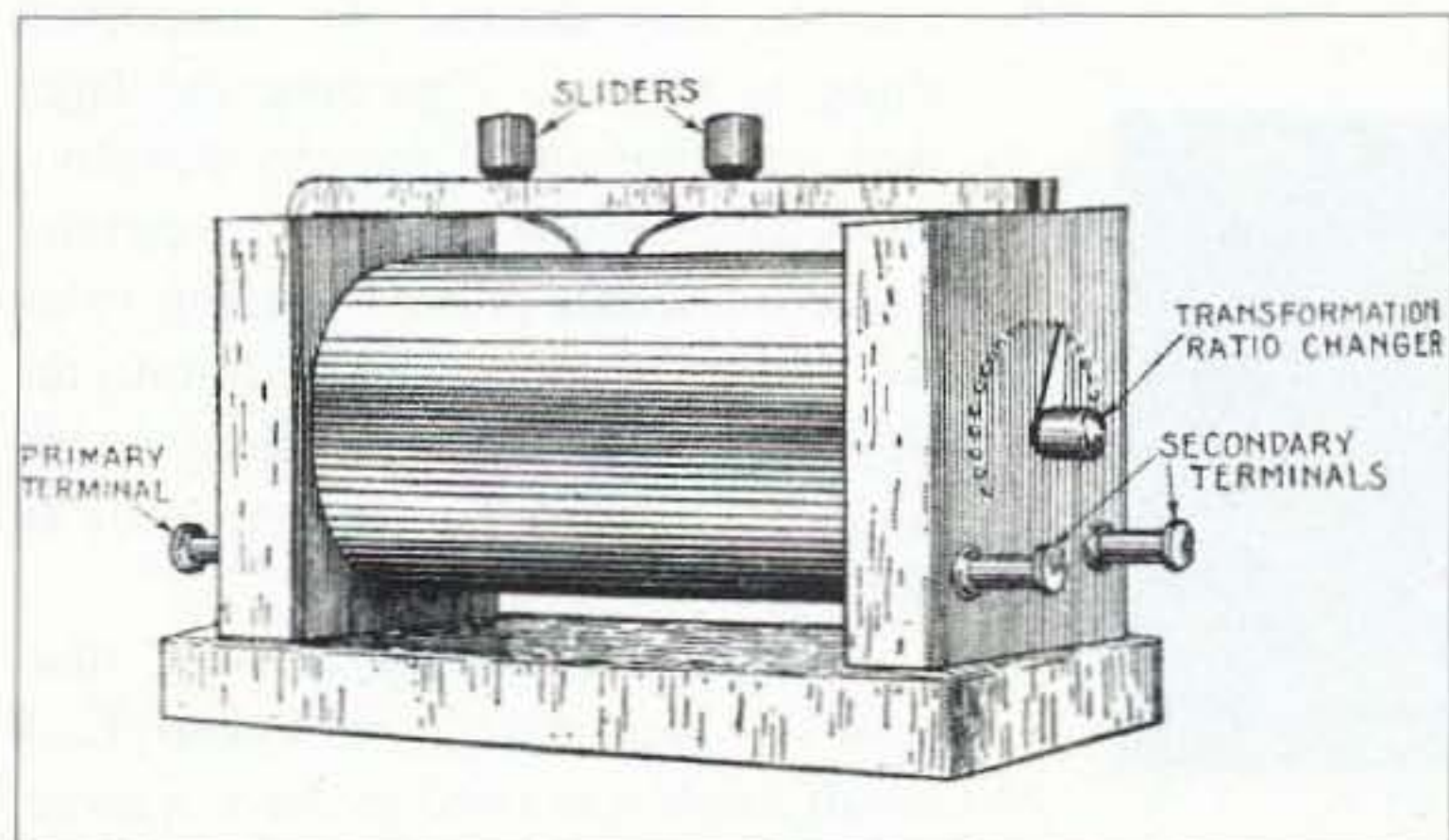

Photo A. Drawing of an RF transformer. A tap switch and sliders are used to select a desired turns ratio between primary and secondary windings. (Photo ref. 1, pg. 2322)

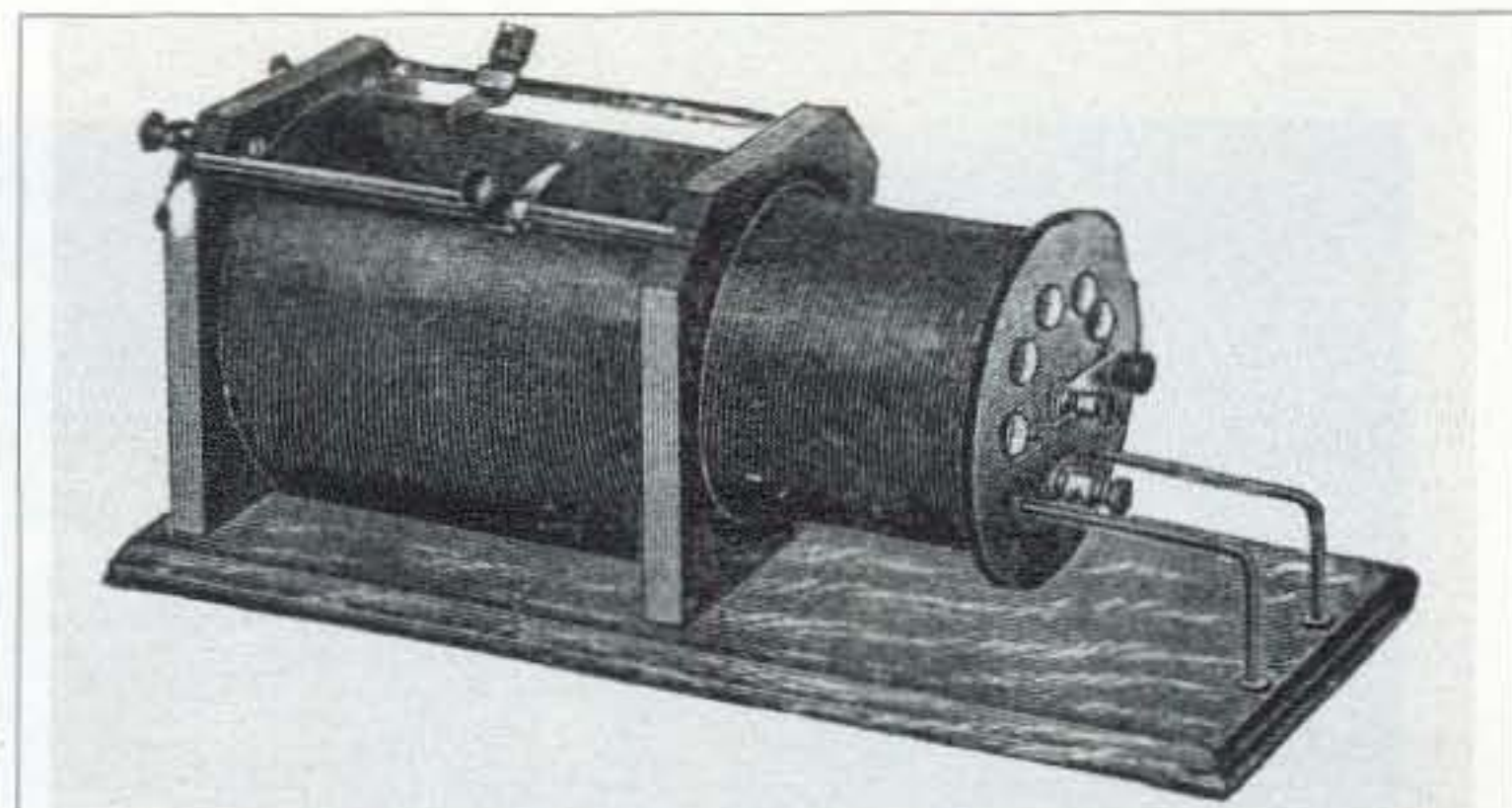

Photo B. This is an RF transformer exhibiting the typical tap switch and slider adjustments. In addition, one winding is capable of sliding along a set of rails providing control over the coupling factor. (Photo ref. 1, pg. 2310)

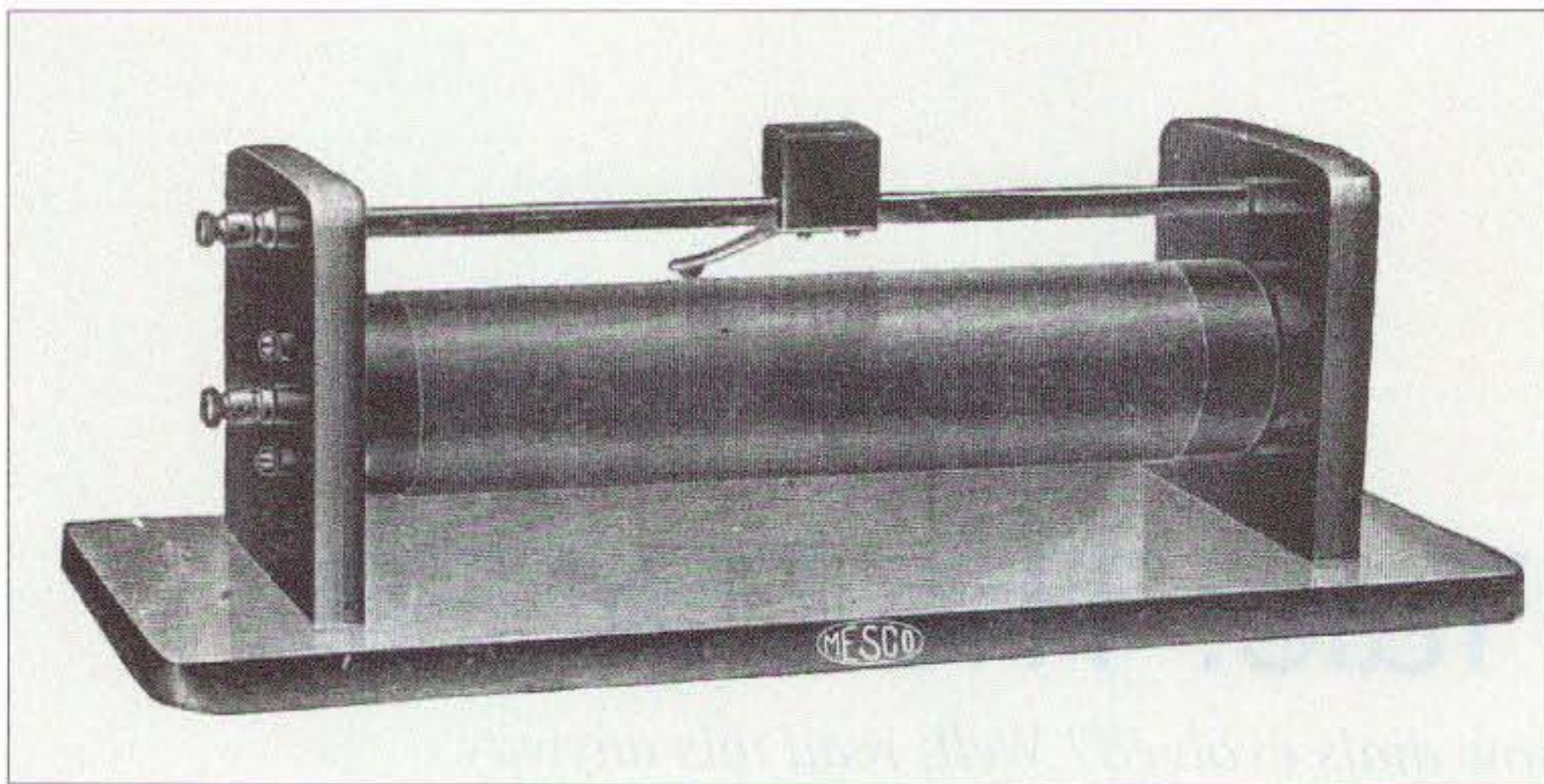

Photo C. This is a single RF inductor having a single slider. (Photo ref. 1, pg. 2308)

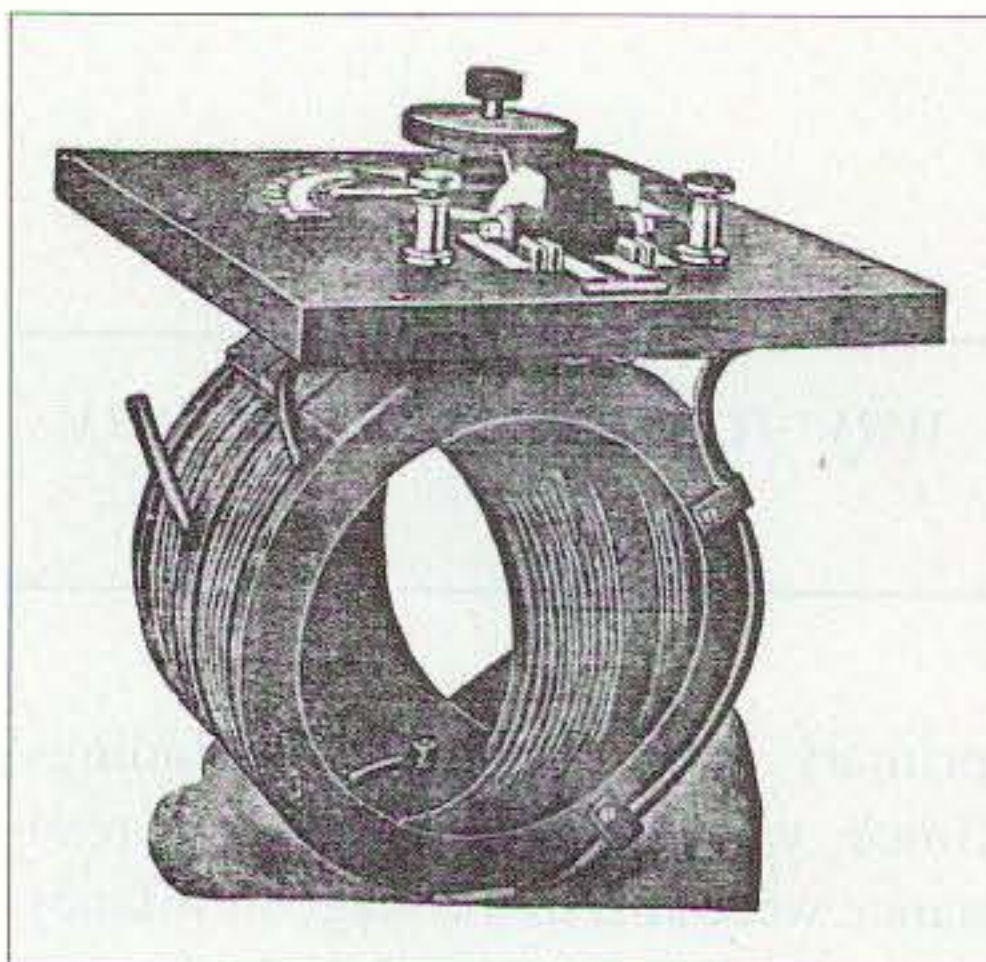

Photo D. This is a variometer. One winding is allowed to rotate within another. A tap switch is provided to change/control the turns ratio. (Photo ref. 2, pg. 80)

turns ratio, which was an advantage over the tap switch design. When this arrangement was used, the coil was placed in front of the operator so that he could “see” how the selections were physically placed for future reference.

In later models, the position of the adjustment was marked with numbers representing the number of turns for each selection. In some applications a linear scale was placed alongside of the slider to indicate the percentage of variability.

When I was a kid, I had a coil with a slider very similar to the one shown in **Photo C**. I used the coil along with a galena crystal and a longwire antenna to create a crystal set. What a pleasure it was to listen to local radio broadcast stations with my simple receiver. As for being able to change stations with the circuit, well, that was a different matter for a long time. Eventually I learned more about impedance matching, and that did enable the simple crystal set to become more frequency selective. Again, the coil assembly was mounted directly in front of me so that the slider position/selection was obvious by inspection.

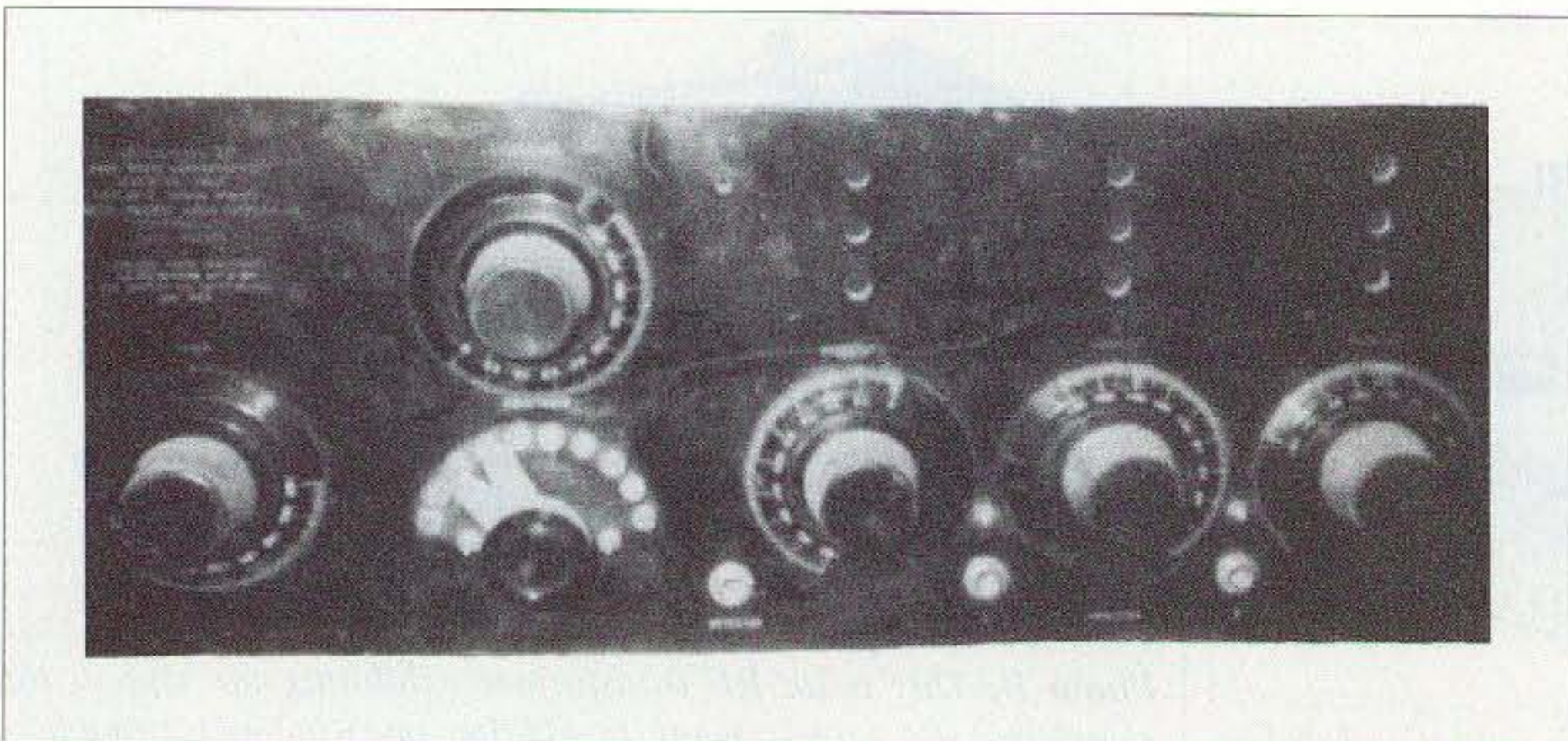

Photo E. Note the use of the large round Bakelite dials. Use of this dial-type remained prominent from about 1935 through 1950.

One of my favorite devices was the variometer as shown in **Photo D**. In a variometer, one coil was mounted internal to another and allowed to rotate around an axis. Rotating the coil changed the amount of coupling between windings. If the windings were connected in series, then the amount of inductance could be varied as desired. A reference dial was mounted on the top of the variometer shown in the photo to indicate the angle of rotation.

During the 1917–1918 era, “dials” began to emerge as the means for logging control settings. Of course, the addition of a control panel in front of the coils increased the “need” to have circuit selections made visible to the operator via a dial. Some of the early dial markings were related to the number of turns selected on the RF transformers. Then as resonance of RF circuits advanced, variable capacitors moved from a “Vernier” adjustment to a device requiring a selectable setting. With that advent, the dial markings became increments of 100 to coincide with 0–100%. An example is shown in **Photo E**, where a combination of dials was used on the equipment.

Take note of the shape of the knobs/dials as shown in the photo and compare it to the shape of the knobs and dials that became very popular with hams during the 1930–1940 era. The knob and dial were integrated into one unit. The knobs came in various sizes and were made of Bakelite. Dial markings were customized per the user’s request; however, the common marking was 0–100. Yes, the numbering was reversed on some dials when a reverse rotation was desired. The important thing to observe regarding the large dial was that small incremental divisions allowed the equipment operator to have a rather precise logging value for an adjustment. In addition, the physically large knob profile gave the operator finer (Vernier) control of an adjustment.

Another one of my favorite dials was the type shown in **Photo F**. A small knob was used to drive a larger calibrated wheel providing a Vernier adjustment for “fine tuning” of a circuit. I built quite a number of VHF and

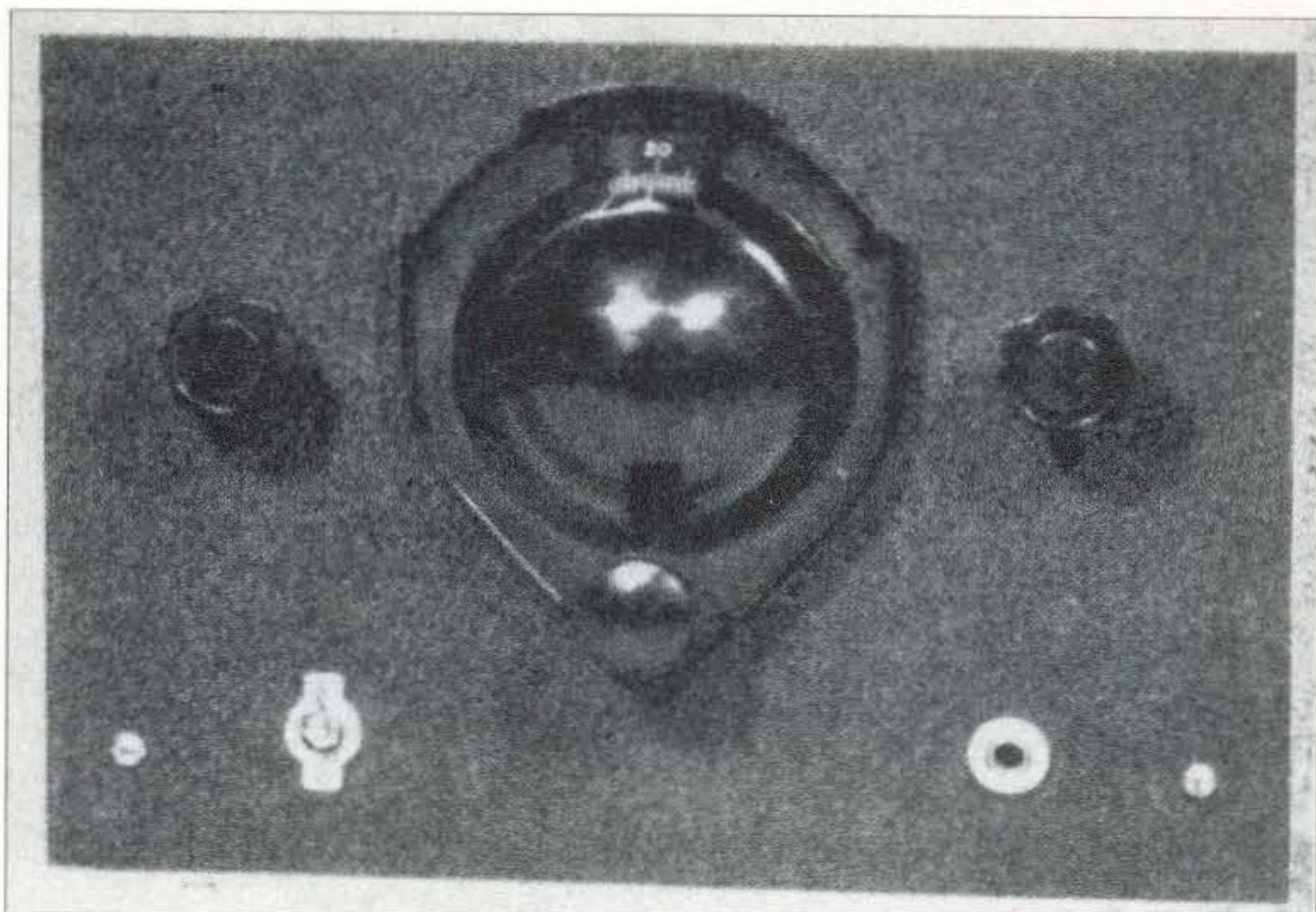

Photo F. This dial was one of the first Vernier adjustment-type dials. It was very popular with hams because of its professional appearance. (Photo ref. 3, pg. 132)

UHF receiver projects using this type of dial arrangement. I don't recall the name of the manufacturer of this dial, but wish that I did so that I could indicate that information here.

Another dial that was built on the same order is shown in **Photo G**. One of the advantages of this dial assembly was that it was easier to use/mount. The large dial had a nut that was used to tighten a collar around the mating

shaft. In this version, the tension nut was on the front of the dial where it was accessible, as compared to the previous dial that had to be mounted to the shaft before the cover and Vernier knob could be mounted.

Dial markings for both Vernier assemblies came with various options. Some markings were simply 0-100 allowing rotation in one direction. Later dials were modified to allow rotation

in either direction. The markings were 100-0-100, with the "0" and "100" markings placed 180 degrees apart.

As dial design evolved, dial cord became a popular method of connecting the knob shaft to the dial assembly. An alternate method was the use of a rubber drive belt. An early dial cord design is shown in **Photo H**, where a large round dial is driven by a small knob. In this design, a large drive wheel constructed like a pulley had a pointer attached to show the dial position. A dial cord was wrapped around the large wheel and the small knob shaft creating a large adjustment ratio between the two shafts. By changing the knob shaft diameter to pulley diameter ratio, the degree of Vernier adjustment could be controlled.

With the use of dial cord increasing during this period, the shape of dials began to vary. One example appeared on the National NC-45 receiver as shown in **Photo I**. One of the user appealing dials of the period was the "slide-rule dial." The use of the slide-rule dial allowed the manufacturer to display many frequency bands and to provide a fine-tuning adjustment as a function of the pulley size ratio.

While looking at the National dials, I'd like to call your attention to the

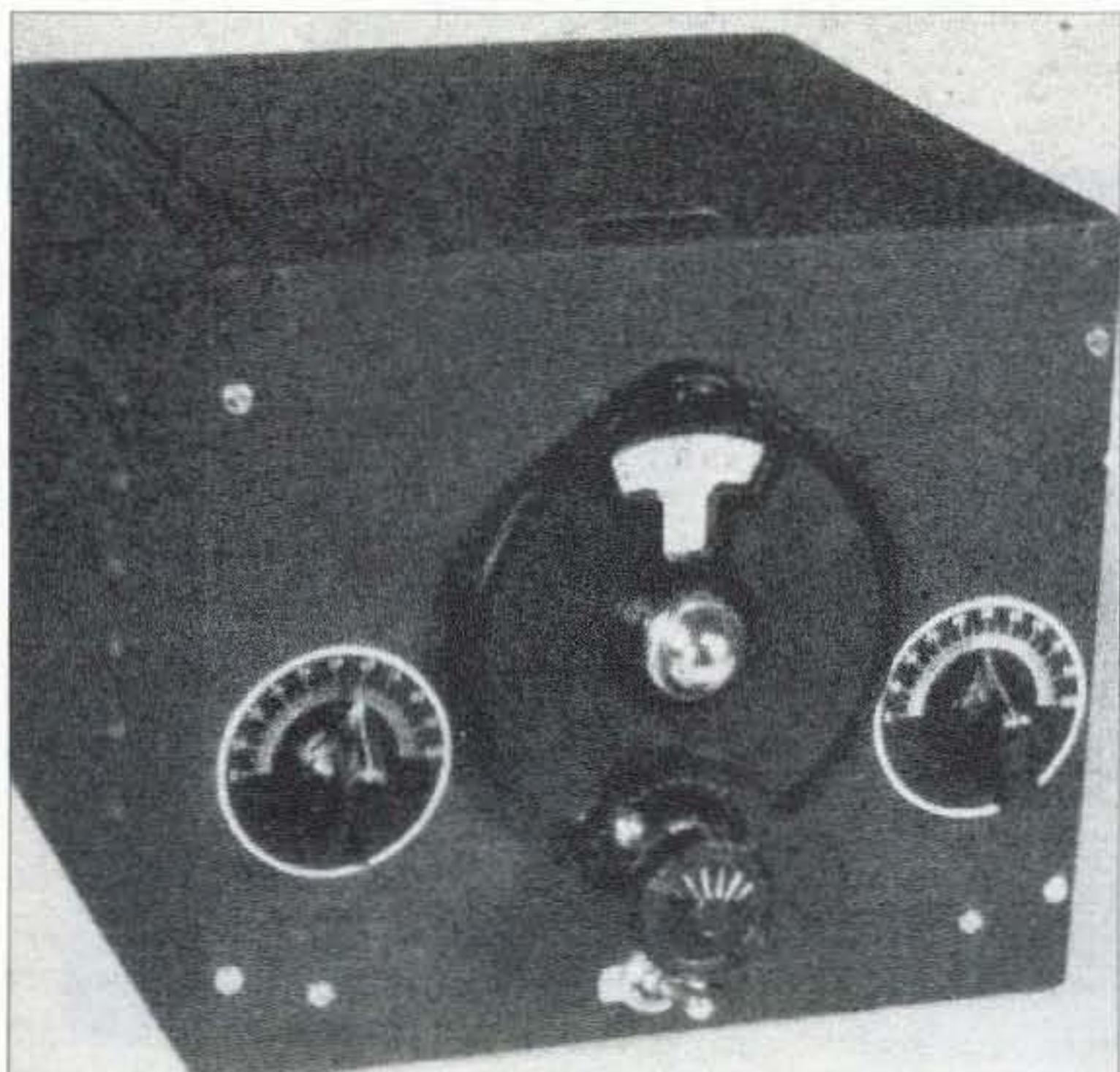

Photo G. Another design of a Vernier dial. The silver cap in the center of the dial covered the tension nut used to lock the main dial to a shaft. (Photo ref. 3, pg. 141)



Photo H. This picture shows one of the early uses of a dial cord-driven dial. Some commercial radios of this era used a flat rubber drive belt instead of dial cord. (Photo ref. 3, pg. 150)

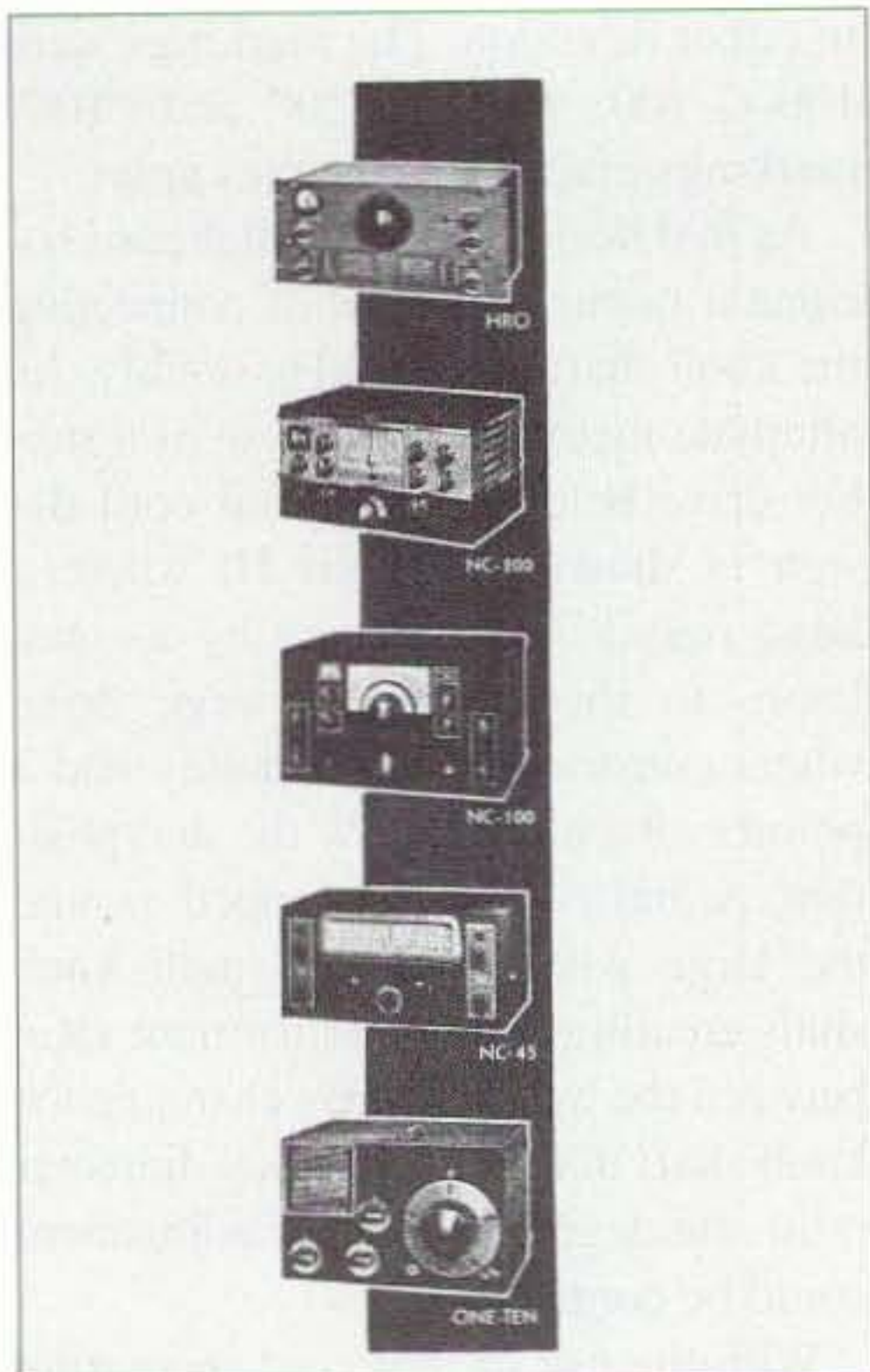

Photo I. National receivers had great appeal to hams because of the dials provided. Each had a professional appearance and function. One of the most popular was the dial shown on the lower receiver.

HRO dial assembly developed by National. It appears on the panel of the lower receiver. A set of planetary gears/wheels driving an inner dial was mounted behind the main dial face allowing dial numbers to change in the small exposed top window as the main dial was rotated. The small incremental

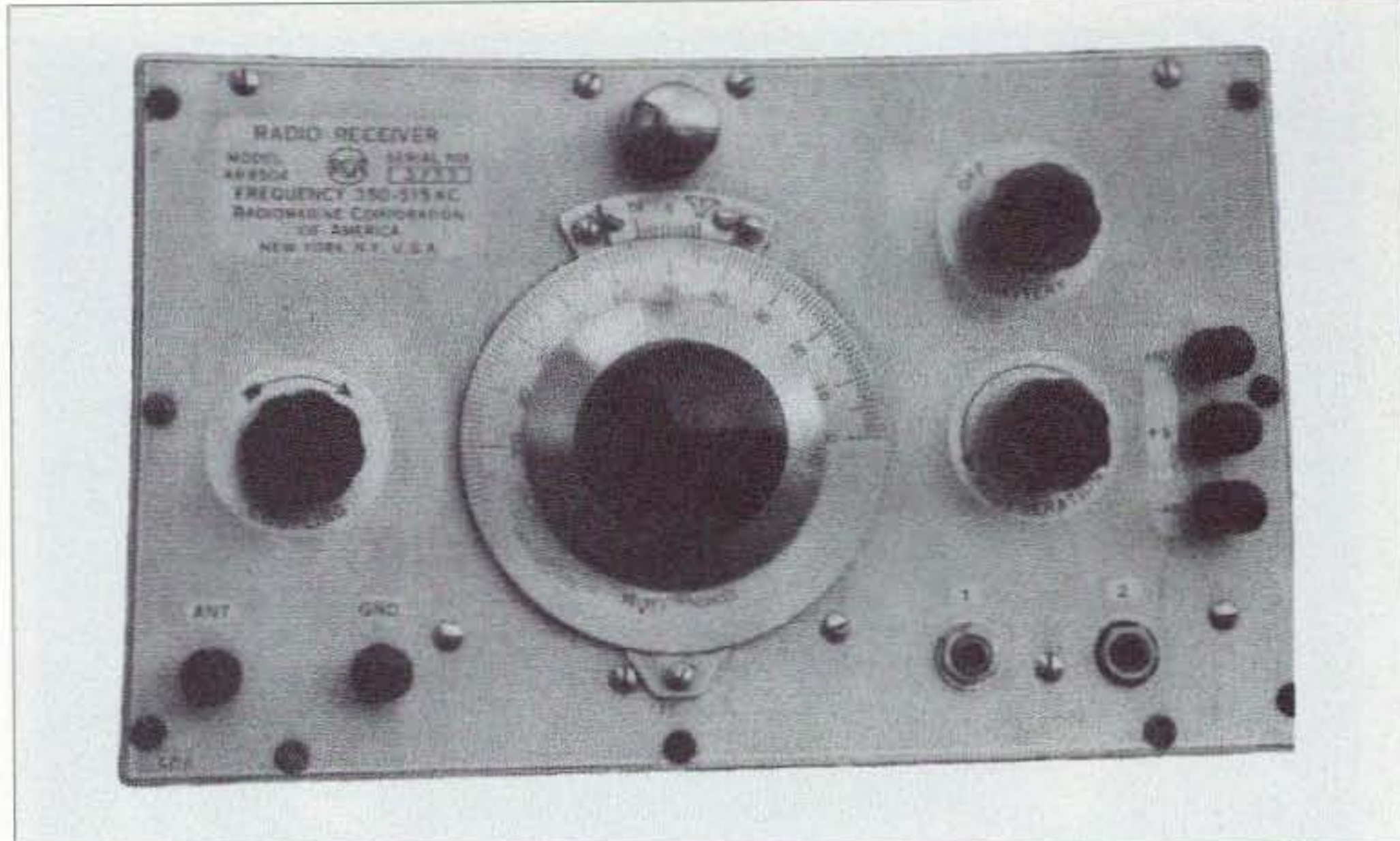

Photo J. This is a National Velvet Vernier dial. The planetary drive and incremental dial division accuracy made this a very sought after prize.

changes gave the user the feeling of extreme band spread control over the receiver's tuning.

World War II brought to our attention many new dial designs. Each, of course, was tailored to meet a rather specific function. A National Velvet dial was used on the receiver shown in **Photo J**. Take note how tuning accuracy and setting repeatability has increased over dials used on equipment prior to the war. The Velvet Vernier dial was divided into 100 linear increments and used a small scale immediately above the main dial allowing each major dial

increment to be further divided into ten parts.

Following the war, hams searched the surplus market for Velvet Vernier dial assemblies. These assemblies were prized items for use on VFOs and the like. Because of the all-metal design, the dial was very rugged and was designed to last for a very long period of time.

Another dial design that came out of the War effort was one like that shown in **Photo K**. The major application was for use on frequency meters such as the Navy's LM series and the Army/AF BC-221. Because of the frequency measurement application, dial setting



Photo K. Frequency meter dials provided the greatest accuracy and setting repeatability of any dial during the 1940-1950 era.

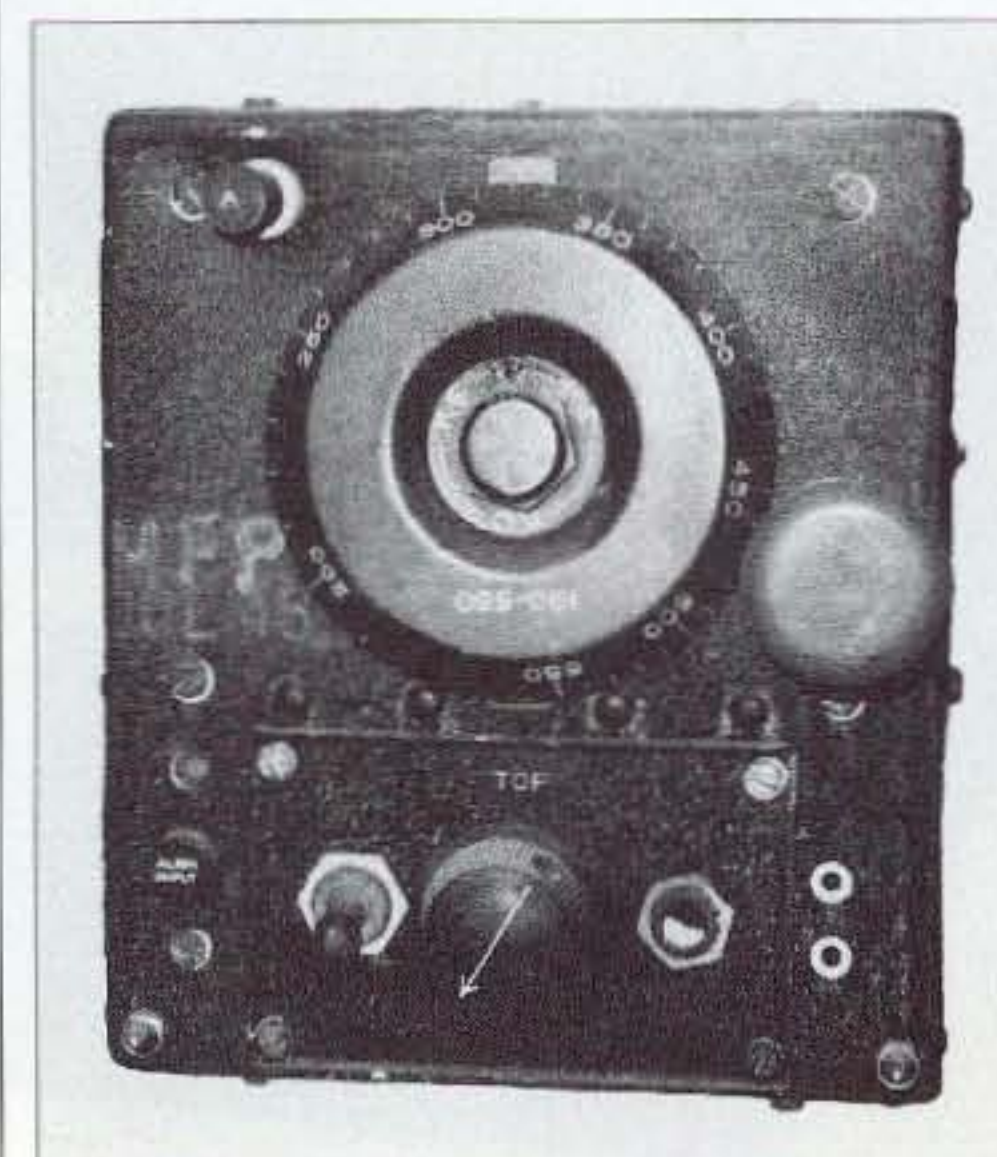

Photo L. This is a typical dial type used on the ARC-5 series of receivers. Note the wide spacing between calibration marks.

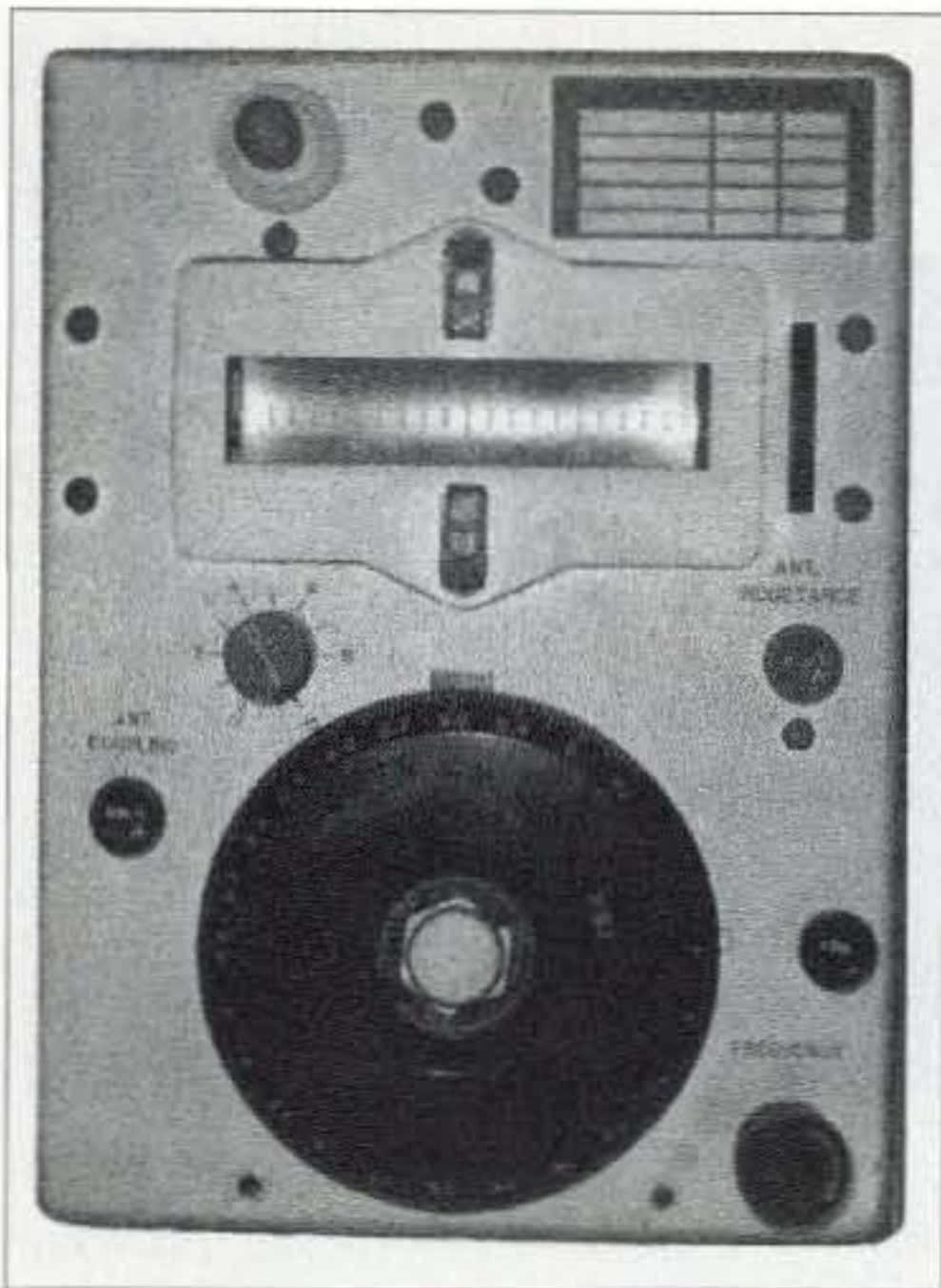

Photo M. An ARC-5 transmitter dial. Note the finer calibration increments as compared to the companion receiver dial.

accuracy was extremely important both for a specific setting and for setting repeatability. This dial used a spiral gear driving a split anti-backlash gear attached to a variable capacitor. Although there was very little backlash in the dial assembly, the entire dial drive train exhibited a small amount that required compensation during use. To compensate after calibration, the user would always rotate the dial in one direction as the desired frequency was approached.

Because the military frequency meters provided frequency stability and tuning accuracy, many hams converted the units for VFO applications. Even

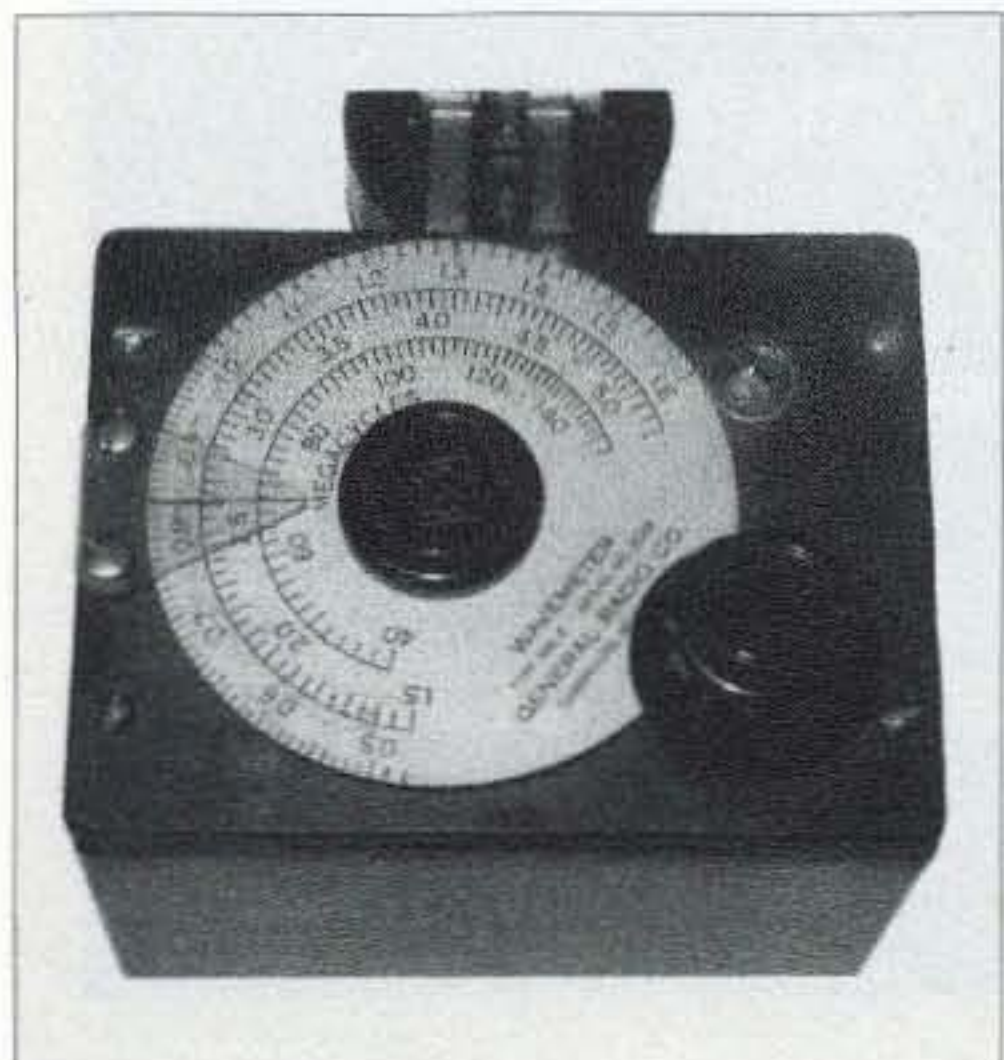

Photo O. A flat friction-driven dial as was used on a General Radio wavemeter.

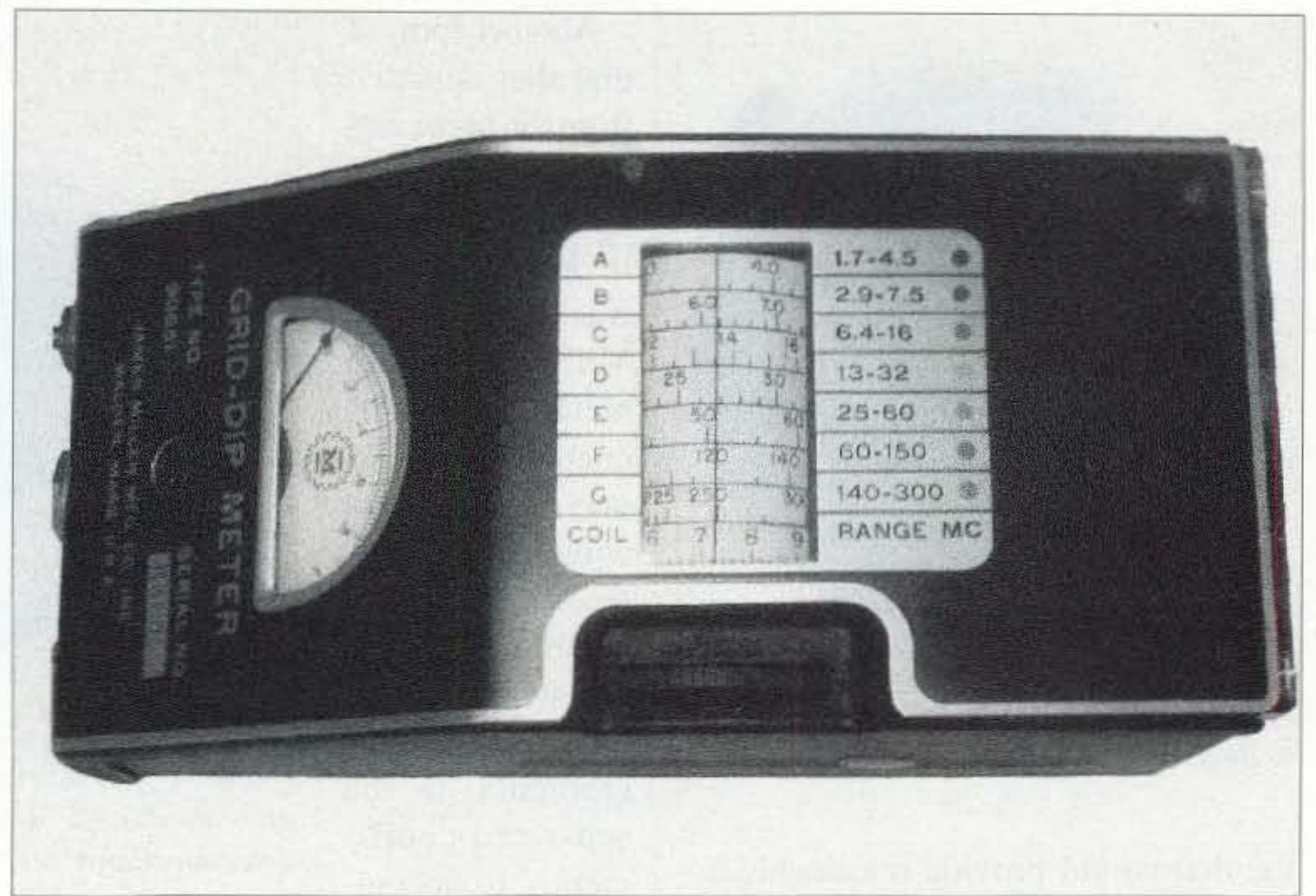

Photo N. A drum-style dial used on a Millen grid-dip meter. Markings on the dial wrap around nearly 360 degrees of the drum.

though digital signal sources being developed today may surpass the capability of the older frequency meter, the older frequency meter continues to have a place in the ham shack as a signal source and for verifying a signal frequency. Because of their usefulness, frequency meters continue to show up at ham swap meets.

Most hams have had the opportunity of working with the ARC-5 series receivers and transmitters that were used primarily in World War II aircraft. **Photo L** shows the typical receiver dial for the series. Note the rather wide spacing of the increments on the receiver. The receiver was normally placed in a remote location away from the user and the dial was not readily visible during use/tuning. The user dial was mounted on a remote control head many feet away from the receiver. In use, the receiver dial was used during equipment setup and remote dial alignment where incremental accuracy

at the receiver was not really needed.

However, the transmitter dial was a different story. As shown in **Photo M**, the dial increments are better defined and divided to provide a more accurate frequency setting. In use, the transmitter was typically set to a desired frequency prior to a mission even though it could be reset while in flight. Part of the reason for the more accurate dial increment was to translate the internal calibration crystal to a specific dial setting. One of the interesting features of the transmitter was the green "magic eye" that would wink when the transmitter's oscillator came into zero-beat with the internal crystal. Once the oscillator was adjusted to a zero-beat,

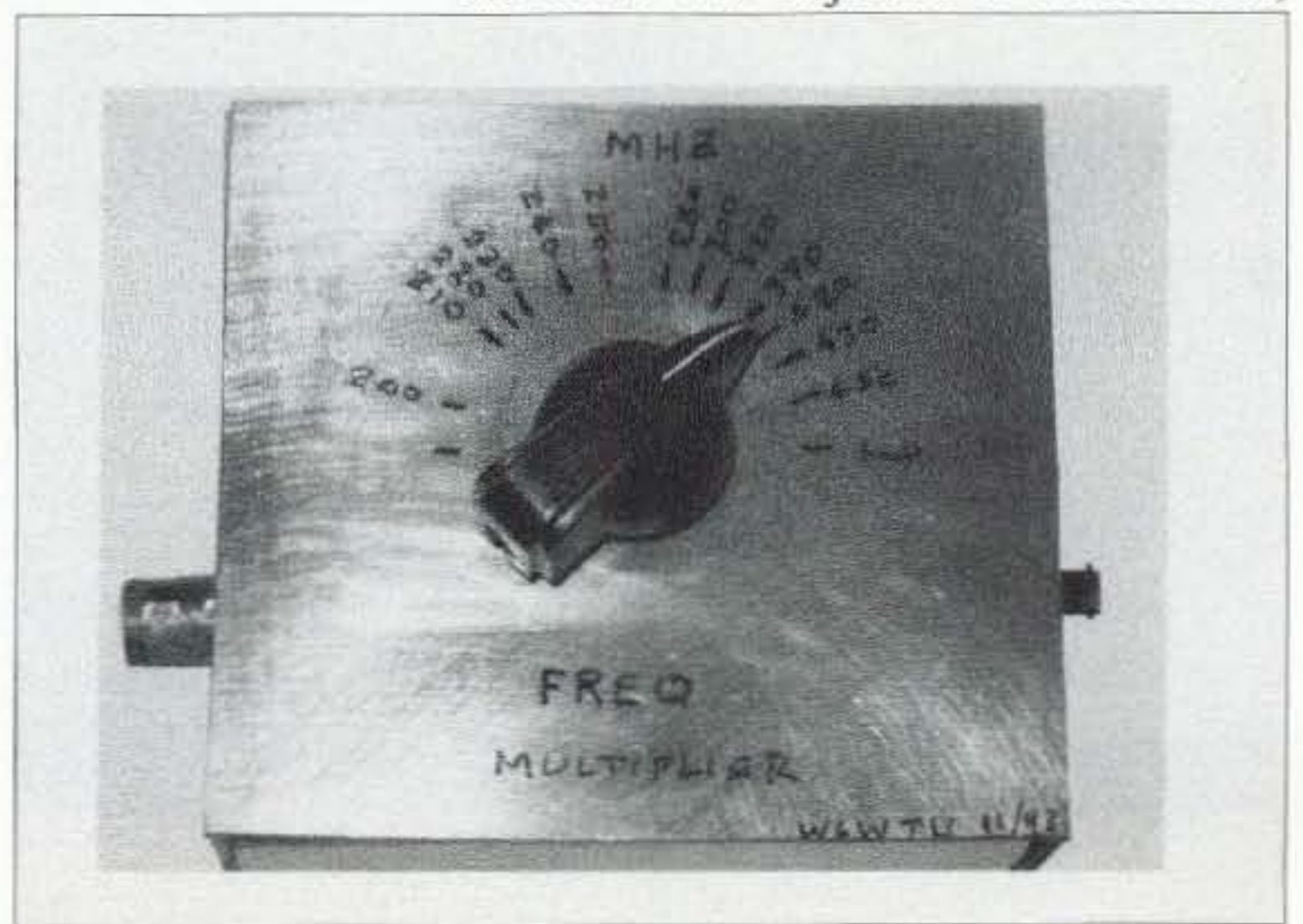

Photo P. A dial hand-drawn onto a panel face. The pointer knob is attached directly to a capacitor's shaft.



Photo Q. This is a multiturn dial designed to be used with a 10-turn potentiometer.

the dial would provide reasonable accuracy in setting a frequency within the tuning range.

Numerous ham projects evolved from the ARC-5 series. Receivers were modified for both mobile and portable operations. The higher-frequency series of the ARC-5 receiver were converted to operate on the 10- and 6-meter bands. The lowest-frequency receivers were used to "listen" to the IF signals of other ham receivers. This process provided multiple conversion capability that narrowed the received signal bandwidth. Because of the oscillator stability exhibited by the transmitter, hams utilized them in both VFO and stand-alone transmitter applications.

Another form of dial that deviated from the norm was the drum dial. An example is shown in **Photo N** that was used on the Millen grid-dip meter. Drum dials enabled the use of one dial to accommodate multiple frequency bands. Driving the dial with gears allowed the dial increments to be separated sufficiently to accommodate a band spread around 360 degrees of drum rotation.

Drum dials were used on some ham radio equipment as well as on test equipment. Because of the multiple bands drawn on the dial, keeping one's eye on a dial track, or finding the correct track at a glance, became a user issue. Some equipment suppliers added a small moving pointer to the assembly that moved with the track selection, allowing one's eye to quickly identify the selected band.

Simple externally mounted dials were and are still quite popular for some applications of equipment. **Photo O** shows a dial assembly used on a

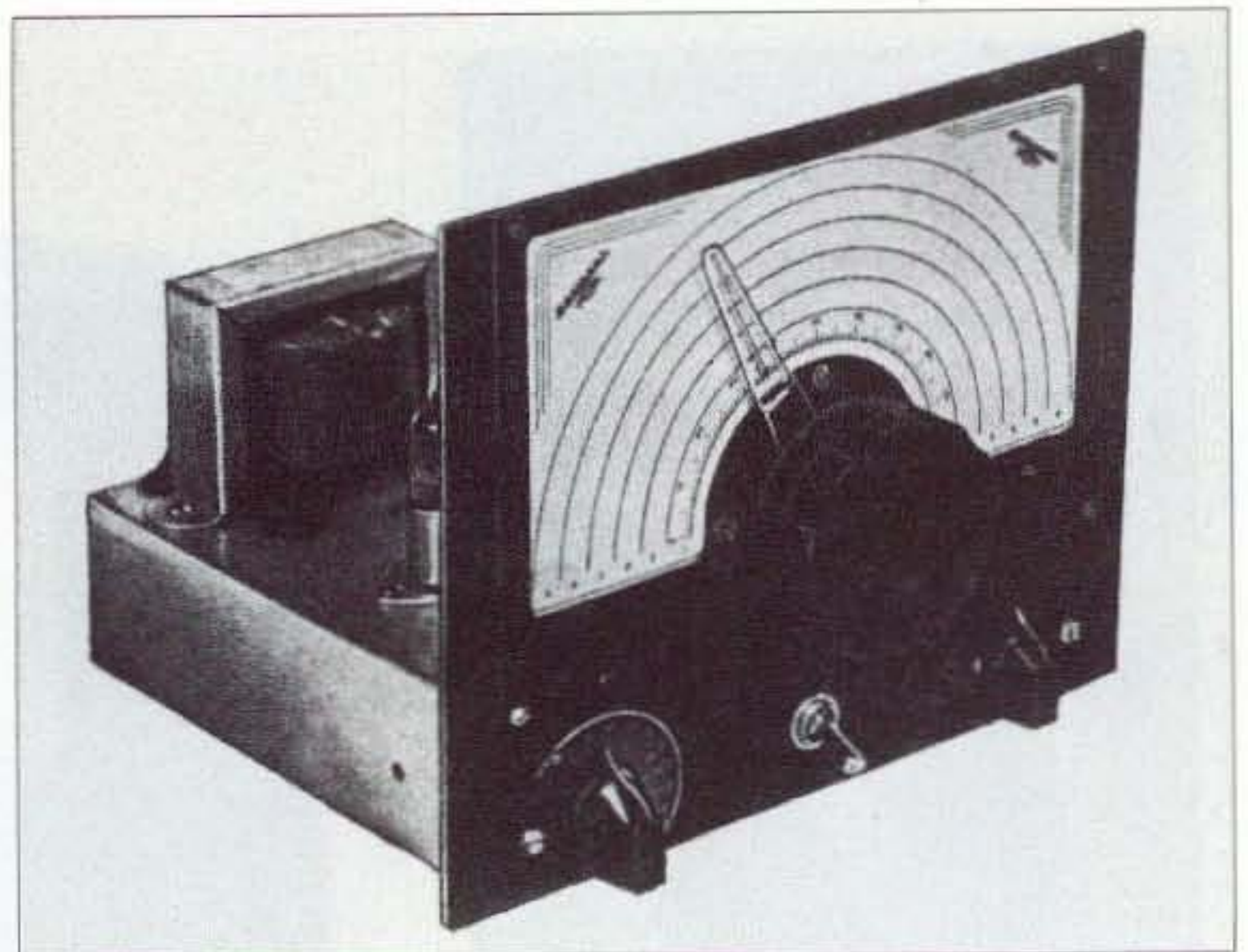

Photo R. A National ACN dial. A smaller version, MCN was also produced. This dial utilized a Velvet Vernier planetary drive mechanism. (Photo ref. 4, pg. 42)

wavemeter made by General Radio Co. The large dial is connected directly to the tuning capacitor and is controlled by a small knob located against the edge of the large dial, creating a friction drive. The small knob "feel" is equivalent to a "band spread," making the control of the dial very easy.

In this case, the large dial has been divided into three bands. Attaching the appropriate coil determines the band that is to be used. Accuracy of the dial indications is only relative in this situation because the application is that of an absorption wavemeter. Coupling between the signal source and the wavemeter can affect the resonant

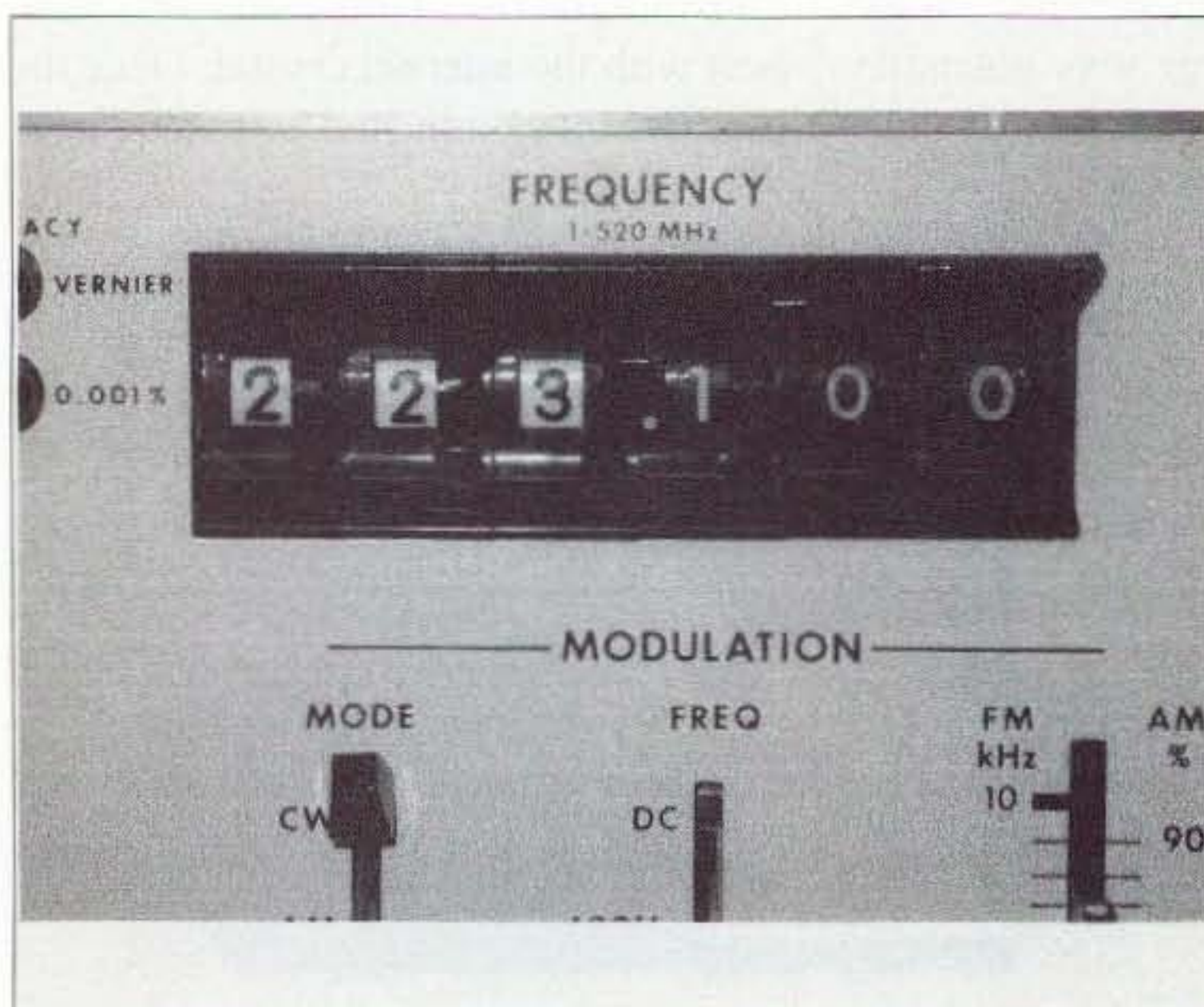

Photo S. Shown is a thumbwheel digital dial. Dialing ambiguity was eliminated with the advent of digital technology.

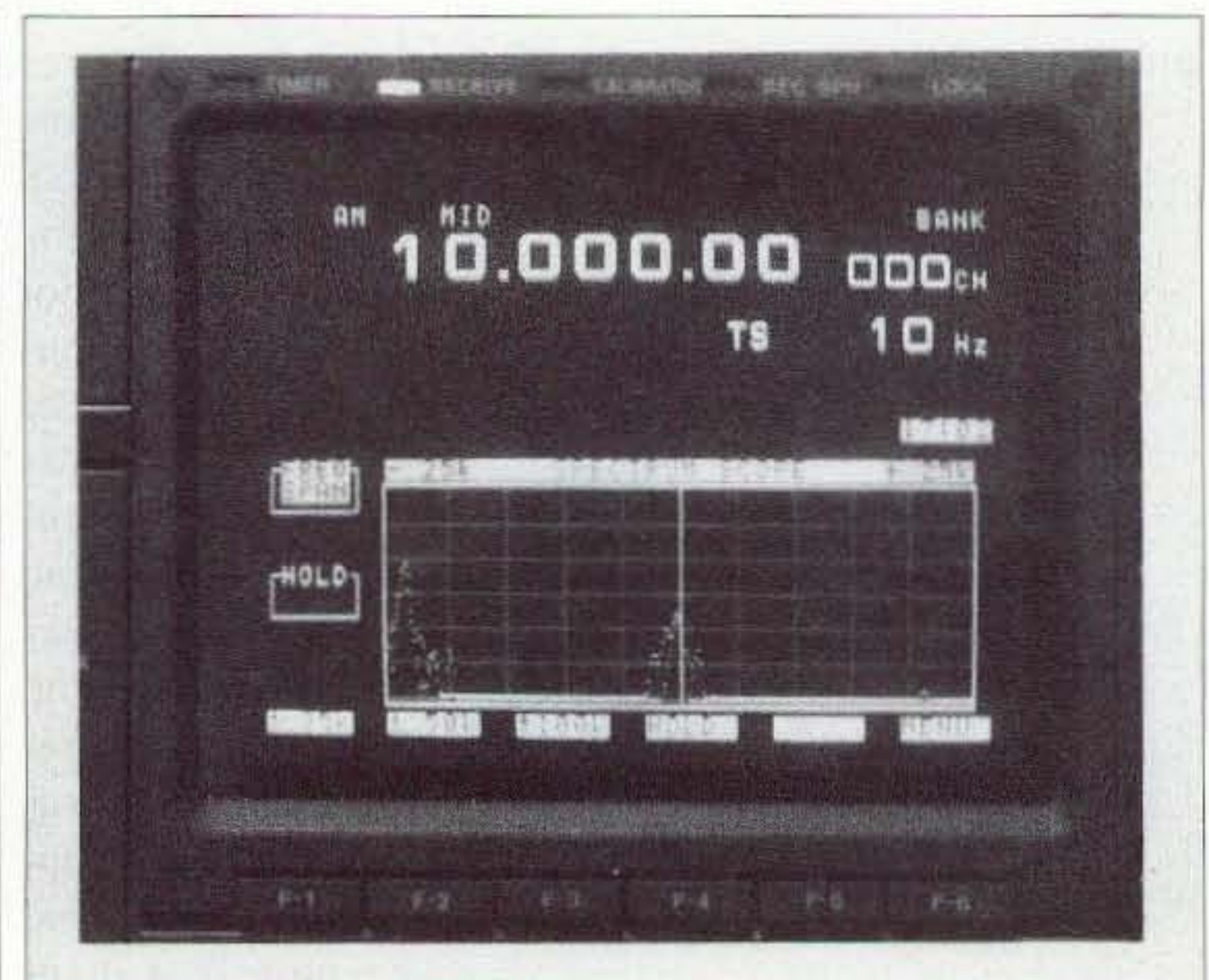

Photo T. This is an oscilloscopic display providing simultaneous feedback of both digital and analog functions.

point indication on the dial. As a result, knowing the relative frequency is sufficient for most uses.

An even simpler dial is the home-made one shown in **Photo P**. Dial markings are placed directly on the panel face using a black marking pen. A pointer knob is attached directly to the shaft of a tuning capacitor. Again, accuracy of the markings is relative to the function of the device. In this case, the markings show a band of frequencies where signal output peaking is expected to occur as a function of the harmonic frequency being selected.

Of course, dials are indicators of settings and hams always want to know where things are set. With the advent of 10-turn potentiometers, special dials were developed to accommodate multiturn devices. **Photo Q** shows one of the many types of multiturn dials that have been developed. This dial divides the 10 rotational turns into 1,000 repeatable setting increments. Multiturn devices have ham applications beyond one's imagination, but to name a few: varactor-controlled VFO, adjusting element in a bridge circuit, TV/VCR tuning control, and precision voltage calibrator.

Perhaps one of the most popular ham dials, which followed the design of the Velvet Vernier, was developed by the National Co.: the ACN and MCN dials. A large paper dial was attached to the planetary drive mechanism, creating a series of professional dials for hams as shown in **Photo R**. The ACN and MCN dial series gave hams a choice in dial size to fit their project. Five bands could be marked on the paper to customize a dial to meet the project's requirements. In addition, a 0-100 divider scale was included for calibration and logging purposes.

As technology advanced, it wasn't long before digital dials came into play. One of the early "digital dials" was of the rotating number counter type, as was used on the Collins R-390 receiver. Even though the early use of rotating digit dials was popular, calibration accuracy remained an issue due to the analog interface. In other words, the circuits had to be adjusted to track with the rotating digits. Later, when

digital took on a stronger emphasis in electronics, counting dials became specific as shown in **Photo S**. The dial shown is a thumbwheel-type dial where small levers are actuated to rotate the numbers and also the appropriate attached switch. With the equipment being digital, the user could count on the dial indicating exactly, in this case, what frequency was being generated. With digital designs, the accuracy of setting a frequency was shifted from a dial reading interpretation to the accuracy of the master clock.

So far, all of the dials shown have been in the physical realm. And of course, for a ham project builder, mechanical dials provide the greatest flexibility at the lowest cost and will continue to be used. But with technology advancing so rapidly, LCD and oscilloscopic dial displays are here now.

Photo T shows a receiver dial having an oscilloscopic display. The advantages of the scope tube and LCD display are the multiple menus and functions that can be displayed pretty much simultaneously with other functions. Both digital and analog functions may be displayed at the same time, providing increased information to the user. The "dial" is no longer just a numerical positioning device, but now communicates a wide variety of things appropriate to the application.

Conclusion

Dials have come a long way in their development progress as a result of input from ham radio tinkerers and designers.

Hams have created a strong influence into equipment design and particularly the human interface with radio equipment. The dial has been the human interface with equipment right from the beginning, and that function has only become more complex with time. What will be the next contribution to dial development that hams will have in the future?

Photo references

1. *Hawkins Electricity*. Dated approximately 1920.
2. Gernsback, S.; Lescarbourea, A.; & Secor, H.W. *Wireless Course in Twenty Lessons*. New York: Experimenter Publishing Co., Inc. 12th ed., 1923.
3. Editors and Engineers. *The "Radio" Handbook*. Los Angeles: Editors and Engineers. 9th ed., 1942.
4. Stern, Lothar. *Electronics Made Easy*. Chicago: Popular Mechanics Co., 1956. **73**

Scrambling News

915 NW First Ave., Suite 2902, Miami FL, 33136
305-372-9427
www.scramblingnews.com

Pay TV and Satellite Descrambling 2002 - NEW! - satellite and cable. Includes latest information. \$19.95 plus \$1.75 shipping.
Hacking Digital Satellite Systems Video 2002 - New! - \$29.95 plus \$3.50 shipping.
Scrambling News Online - Online service for those interested in satellite television news. \$59.95/year. \$59.95/yr.
Pay TV and Satellite Descrambling Series CD-Rom - all 13 volumes over 300 pages, \$59.95 plus \$3.50 shipping.
Best Deal - Everything listed above for only \$99.95 plus \$3.50 shipping.

Ad Sales

Call Frances at 800-677-8838

Quality communications
equipment since 1942.

WWW.RFFUN.COM



Universal Radio

6830 Americana Pkwy.
Reynoldsburg, OH 43068

◆ Orders: 800 431-3939
◆ Info: 614 866-4267
◆ Fax: 614 866-2339

Twin for Two

Give this home-made twin loop for 2m a try — and be surprised!

The full-wave loop antenna, with its large capture area, good signal/noise ratio, and excellent low-angle transmitting characteristics, is about as good as an antenna can get.

That's what I thought, until I realized that doubling the capture area with two full-wave loops fed simultaneously is even better. Several years ago, I replaced my 2-meter J-pole with a 2-element quad, and I was very pleased with the performance of this antenna upgrade. Now that I have replaced the 2-element quad with the twin loop antenna, I am even more pleased. Scratchy signals from outlying areas are now registering 3/4 scale on the S-meter. Now I

can hear everybody on the local 2-meter simplex net and get a good signal back to them with 5 watts. I chose to make this antenna from 1/2-inch copper tubing because of its good conductivity and large surface area.

Here is a 2m antenna I constructed from info that I got from W7YP of western Wyoming. Of course, I changed it all around to suit my purposes, but the idea is the same.

W7YP had a 17m double delta. It was described to me as a W with a

horizontal line across the top, but the center apex of the W did not connect to the horizontal line. It is fed with 50-ohm coax. The outer braid connects to the center apex of the W, and the center conductor feeds to the center of the horizontal line, directly above the apex. In this way, two full-wave loops are fed simultaneously, one to the left and one to the right, radiating a great signal, and being outstanding on receive. The impedance is near 50 ohms.

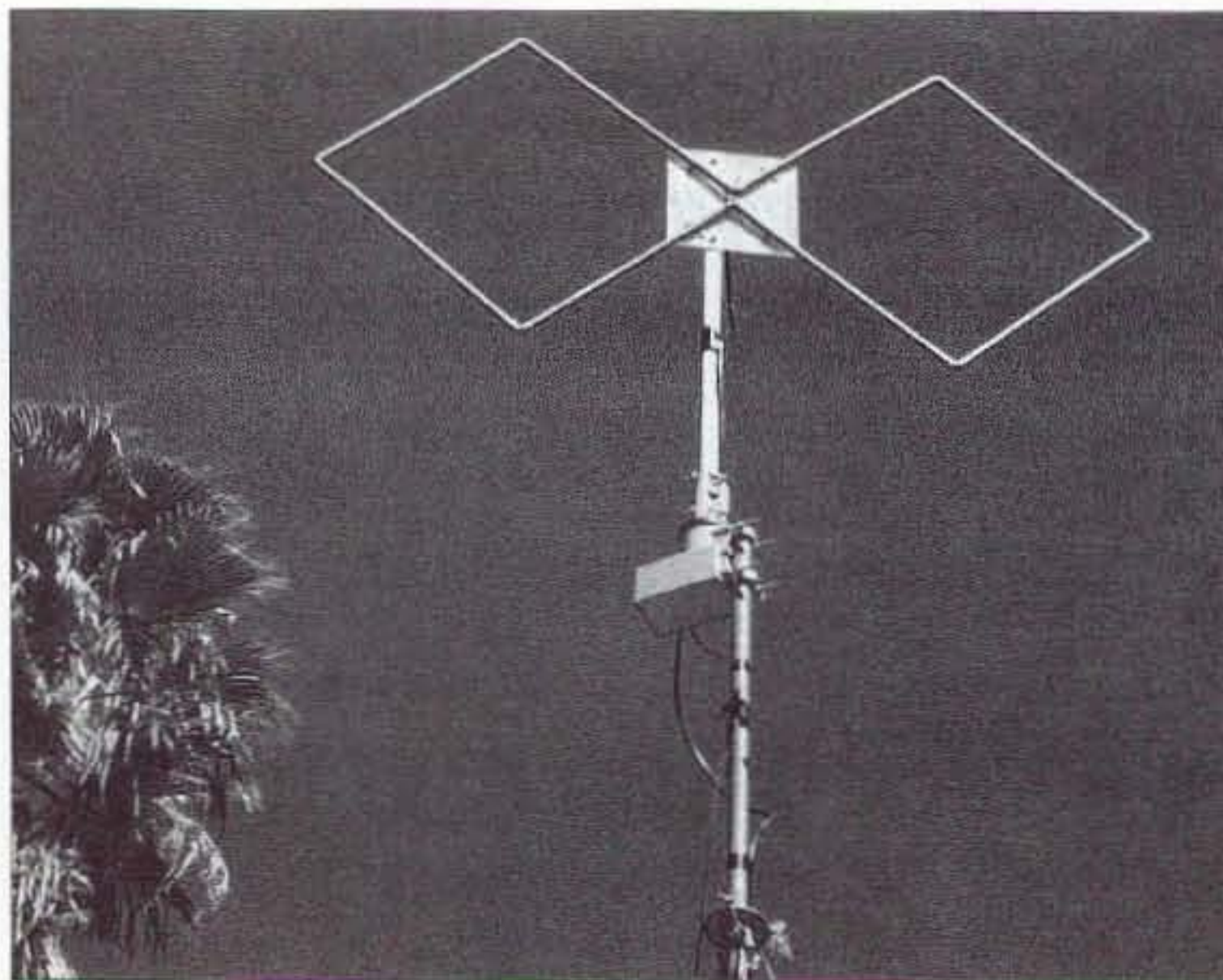

Photo A. 2m twin loop antenna.



Photo B. Copper straps.

The double delta idea can be constructed in various ways. I decided to design and build a 2m version, which I will share with you, but you can use your own imagination on band, materials, and design.

My 2m twin loop antenna has two square loops made from 1/2-inch copper plumbing tubing (type M) and eight elbows. After sweat-soldering the eight elbows and eight straight pieces (20-1/4 inches long) together on a flat surface, it will resemble a figure 8 (**Photo A**). Use the armstrong method to spread it apart in the middle so that there is a 1-inch gap. Cut a piece of 1/4-inch plastic to 9-1/4 inches by 10-1/2 inches and put a 5/8-inch hole in the center for the SO-239 connector. The antenna is secured to the plastic using four copper straps, and 10-32 screws and nuts. Position the copper straps so that there is room to mount the 1-1/4-inch

dowel mast to the plastic (**Photo B**). The dowel is 3 feet long, and has a flat area where it mounts to the plastic using two 10-32 screws and nuts as shown in **Photo C**.

Tuning

The SO-239 is connected to the antenna feedpoints with #14 stranded antenna wire. One wire is kept as short as possible, but in connecting the center conductor, use a piece of wire 4-1/2 inches long. Shape this wire like a U (**Photo D**). It can be lengthened or shortened to fine-tune the antenna to 146 MHz. This tuning loop also lowers the SWR, although I don't know why. My twin loop antenna has under 1.2-to-1 SWR across the 2m band. It is bi-directional, favoring the directions broadside to the loops, but reception and transmission to the sides is still good.

The Gordon West Study Guides

Examination Test Questions & Answers for General Class and Extra Class with explanations of the answers



General Class
\$12.95
Plus \$3.50 S&H



Extra Class
\$14.95
Plus \$3.50 S&H

Omega Sales

P.O. Box 376

Jaffrey, NH 03452

800-467-7237



Say You Saw it In 73!

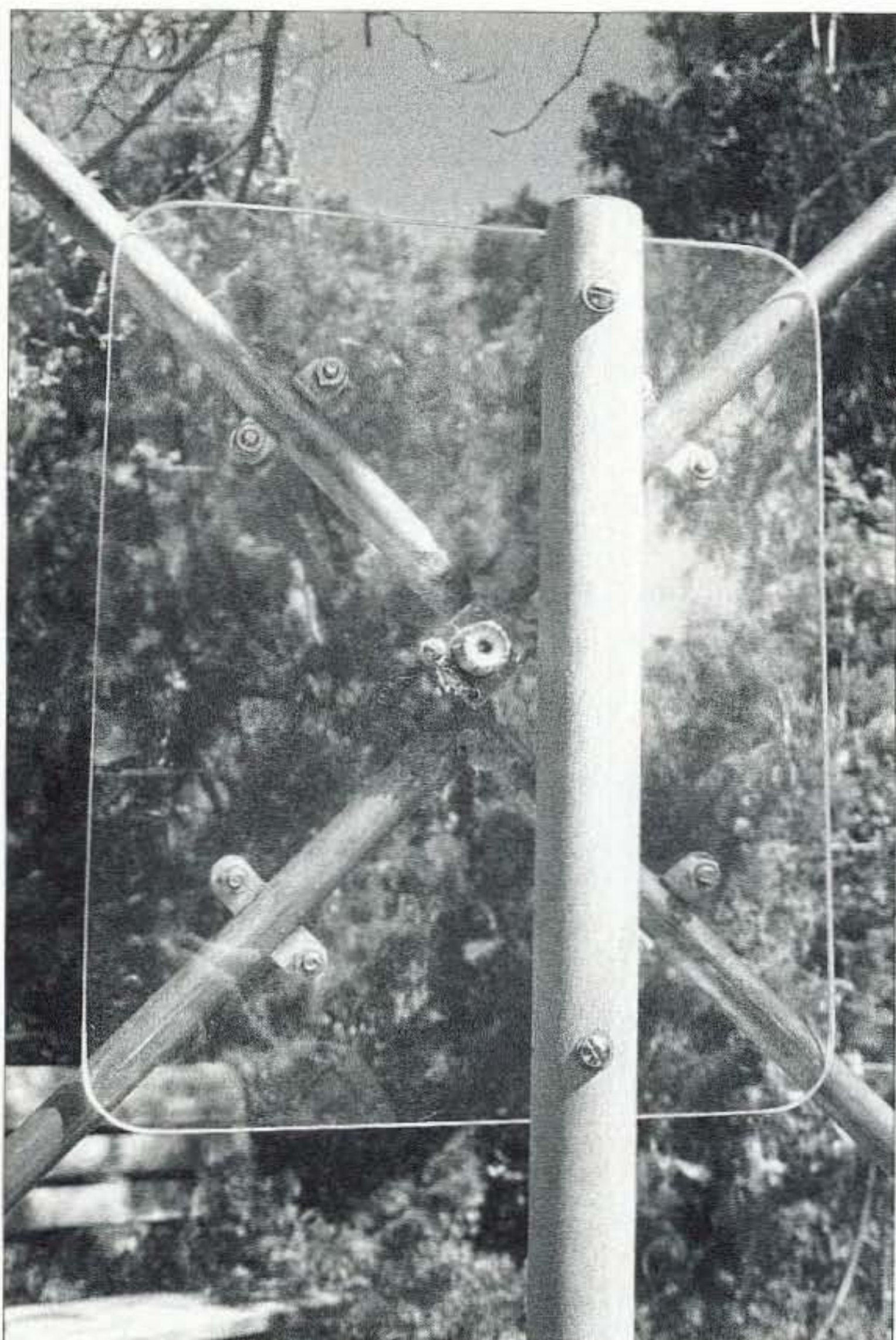

Photo C. The dowel is mounted to the plastic by two 10-32 screws and nuts.

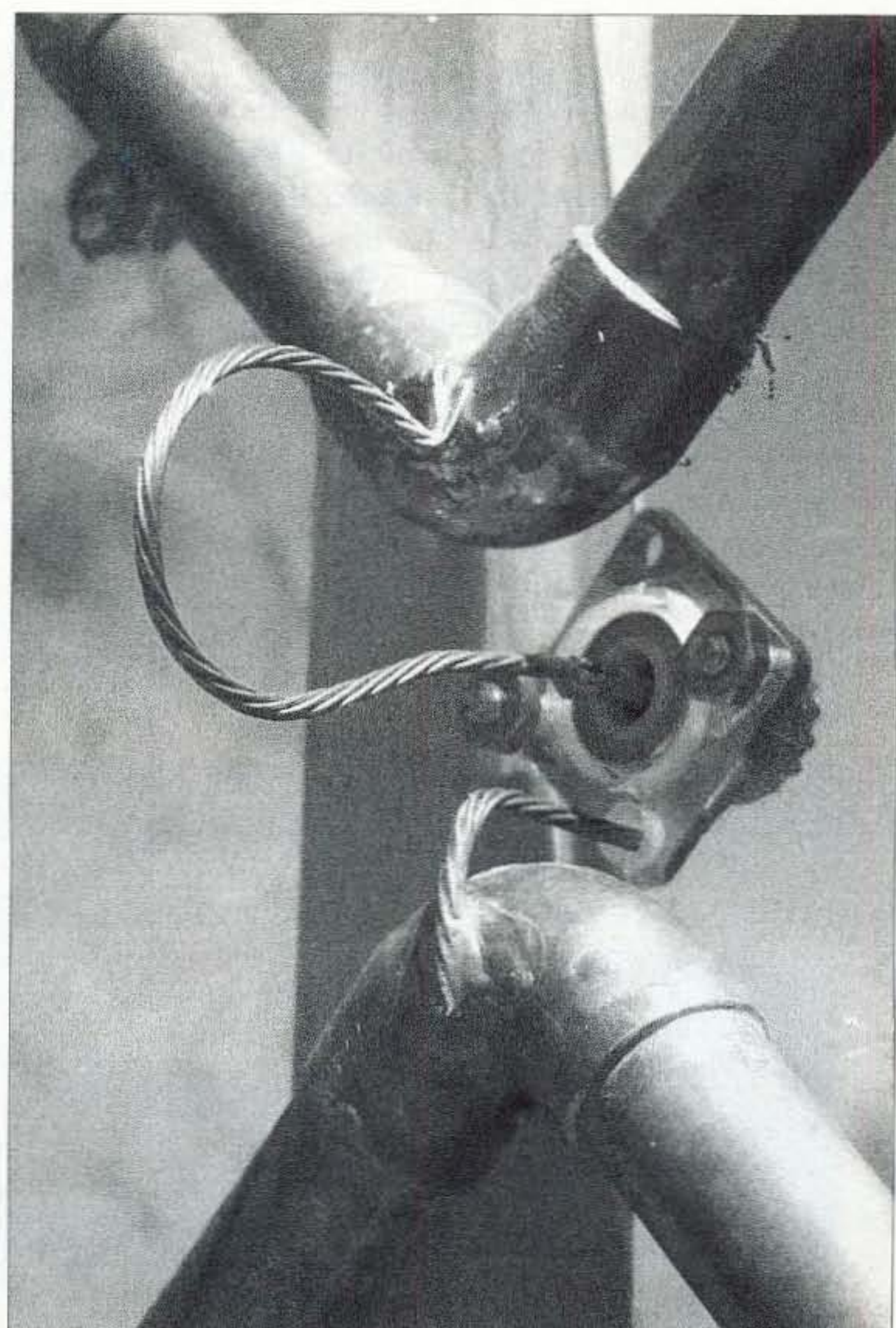

Photo D. A 4-1/2-inch-long piece of number 14 stranded antenna wire is shaped like a "U" to form a tuning loop for the antenna.

This Thing Called Wire-Wrap

Whether you refer to it as a technique, a technology, or just plain old-fashioned, wire-wrapping is still valuable to know.

What are the pros and cons of using wire-wrap technology? Well, let's check into it a little bit.

Right from the start, you must breadboard a prototype of the "want to be" new circuit to check the function and the expected performance. We folks with an engineering background know that a computer simulation is not less expensive, easier to use, and so on. Using the "freehand" design utilizing multisourced components requires a bread board to check the function. Expensive software packages, etc., just do not lend themselves to the ham radio community very well.

I have found over the years that a

good breadboard system such as shown in **Photo B** is very helpful. Pushing components into the grid system performs some of the interconnects. The rest of the connections are made with #22 solid wire jumpers. This is an inexpensive and effective system of breadboarding. The system is reusable many times over. You breadboard only small parts of the overall design just to verify the circuit function.

Now that you have a good-looking schematic of the item you are designing you can move on to the "wire-wrap"

portion of the circuit board that will go into the enclosure. If it is anticipated that 50 or more boards are to be made, such as a ham radio club project, then the finished schematic can be used to have an actual printed circuit board created. It will take about twice the board area if this is done, unless expensive multilayer boards are used. Remember, the computer software will require a computer-captured schematic which is costly and time-consuming. The schematic will provide a point-to-point grid for all of the interconnect routes. This is usually called a net list. If everything works out OK, a PC board foil pattern will be made. This will be used to make a PC board, etched, holes drilled, tin plate over the copper foil, and finally the silk screen with component markings. The etched PC board is expensive and a lot of work. It is not justified unless many boards are required!

Now, the alternative is "wire-wrap" technology. It uses point-to-point wiring using sockets and AWG-30 wire-wraps. If a mistake is made, a little "unwrapper" tool will remove the wire-wrap. Your local Radio Shack store has a wrapper/unwrapper tool,

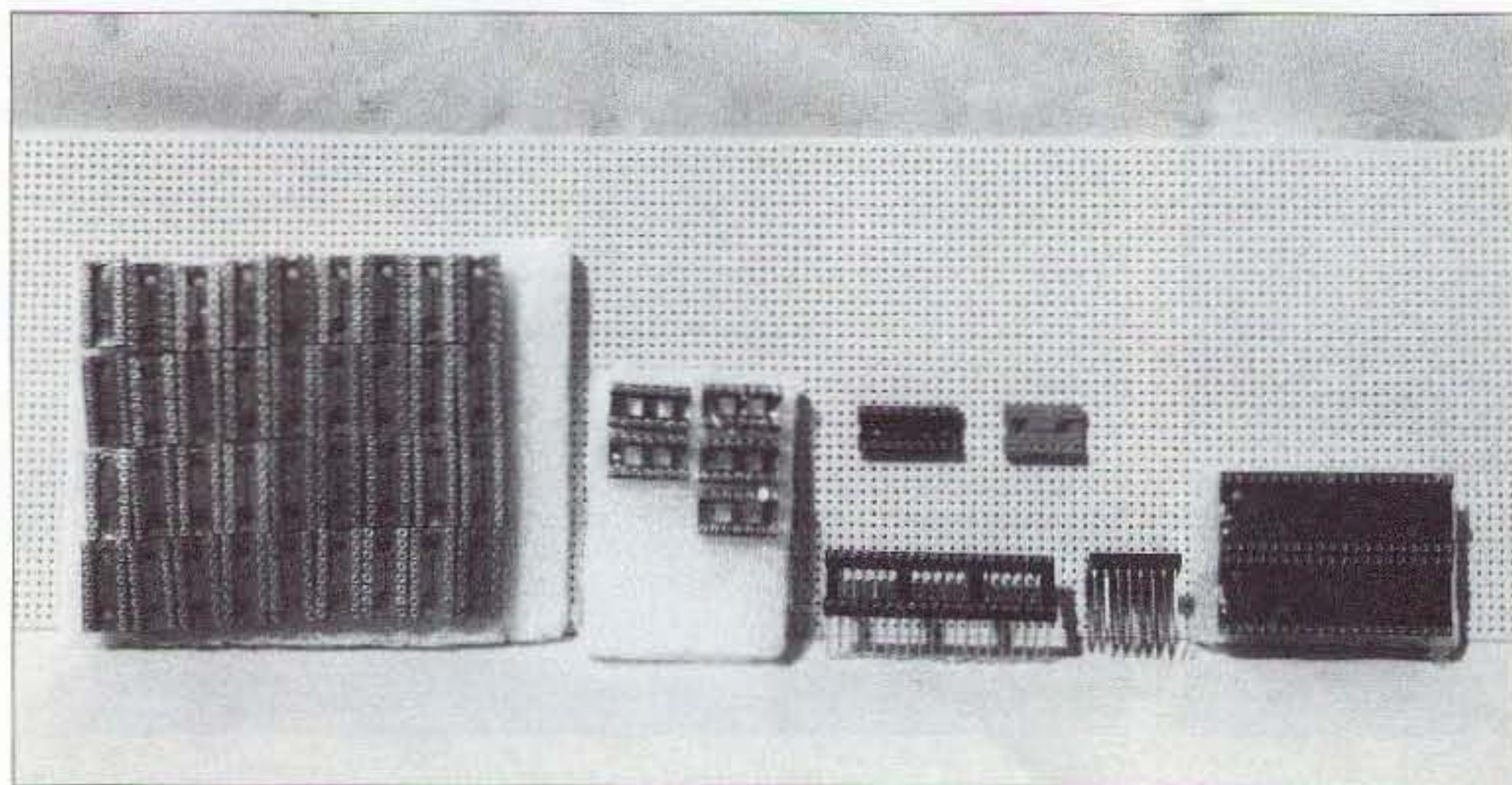

Photo A. CEM-1 perforated PC board and machined pin wire-wrap sockets.

#RS-276-1570A, which sells for about \$8. The tool also has a wire stripper stored in the handle. A very nice tool for the price.

You might now ask, "Where do I get the IC sockets, perforated boards, and AWG-30 Kynar wire?"

There are several companies that supply these items, such as Jameco Electronics, Mouser Electronics, and Hosfelt Electronics. Make sure that the IC sockets are the machined-pin-type round pins so that the round wire leads of components can be accommodated. (Normally, a square pin is used for wire-wrapping sockets. The objective of the square pins is to create a gas-tight joint. Wire is pulled tight against the four corners of the pin to produce a reliable and permanent joint. The machined-pin wire-wrap pins on the DIP sockets are like ALL wire-wrap pins, square with four corners. The point the author is making is that a normal socket, not machine-pinned, will not accommodate a round wire such as is on passive components like resistors, capacitors, and diodes. Therefore, a DIP IC socket must have a machined pin. All DIP IC sockets used in wire-wrap have square lower pin construction. Key word: machine pins. — ed.)

Either the two- or three-level gold or nickel pins are suitable. When wiring a board full of sockets, it is recommended that the ground and supply wire leads be put into place first using black and red wires respectively. The interconnects can then be green or white wire. Several colors are available, so use the colors you prefer. The spools of wire are usually available in 100- and 1000-ft. spools. The cost is typically less than 3 cents per foot.

After a few projects are done, your confidence and expertise will improve to the point where any project will not be too hard. You will then want to move up to the high performance end of things to make everything easier and faster.

This of course requires some tools which are more expensive. The investment can generally be recouped in one good-sized project which would normally require an etched PC board. See **Photo C** for a look at some of the tools

which are used. Notice the 120 VAC wire-wrap gun and professional strippers. These are the high performance tools I mentioned. The gun shown is one that I picked up at a hamfest flea market for \$15. It came in its original package with a bit and sleeve. Ready to go! The same model's new cost is about \$200, plus the \$20 for a sleeve and bit. Still not bad, considering! The new tools are available from Mouser Electronics and others should you need to purchase new items. I purchased 1000-ft. spools of Kynar wire from Jameco Electronics at under \$30 per spool. The sockets usually cost between 35 cents and \$1.25 each for DIP-14, 16, 24. Either gold- or silver-plated sockets work equally well. The gold shows up a little better against the grid PC board for us old folks with bifocals. Bargains can be found, such as with Hosfelt Electronics, where DIP WW sockets can be had at 35 to 50 cents each.

I purchased over 100 DIP-14 and

good deals on what you want

- Keeping the FUN in Ham Radio is what we're all about! Since 1980!
- Great prices & customer care on today's major brands, including:

MFJ QRZ GORDON WEST PROCOMM CALLBOOK IRON HORSE LDG ELECT.	DIAMOND BATTERY TECH ARRL TRANSEL W4RT ELECT. AND MORE!	MAHA Heil PATCOMM RAMSEY POWERPORT MIRACLE ANTENNA
--	--	--

Call Today

217-352-1725

"Our name says it all!"



**Amateur
Accessories**

P.O. Box 7333, Champaign, IL 61826

www.amateuraccessories.com

kr4s@msn.com

WANTED

Fun, easy to build projects for publication in 73.

For more info, write to:

Joyce Sawtelle,
73 Amateur Radio Today,
70 Hancock Road
Peterborough NH 03458.

Amplifiers, ATU Down Converters & Hard to Find Parts

LINEAR AMPLIFIERS

HF Amplifiers
PC board and complete parts list for HF amplifiers described in the Motorola Application Notes and Engineering Bulletins:

AN779H (20W)	AN 758 (300W)
AN779L (20W)	AR313 (300W)
AN 762 (140W)	EB27A (300W)
EB63 (140W)	EB104 (600W)
AR305 (300W)	AR347 (1000W)

2 Meter Amplifiers
(144-148 MHz)
(Kit or Wired and Tested)

35W - Model 335A,	\$79.95/\$109.95
75W - Model 875A,	\$119.95/\$159.95

HARD TO FIND PARTS

- RF Power Transistors
- Broadband HF Transformers
- Chip Caps - Kemet/ATC
- Metalclad Mica Caps - Unelco/Semco
- ARCO/SPRAGUE Trimmer Capacitors

We can get you virtually any RF transistor!
Call us for "strange" hard to find parts!

DIGITAL FREQUENCY READOUT
For older analog transceivers
TK-1 (Wired and Tested) \$149.95

ATU Down Converters

(Kit or Wired and Tested)
Model ATV-3 (420-450)
(Ga AS - FET) \$49.95/\$69.95
Model ATV-4 (902-926)
(GaAS - FET) \$59.95/\$79.95

For detailed information and prices, call or write for our free catalog!

Phone
(937) 426-8600
FAX
(937) 429-3811

CCI Communication Concepts Inc.

508 Millstone Drive • Beaver Creek, Ohio 45434-5840
e-mail: cci.dayton@pobox.com
www.communication-concepts.com

ADDITIONAL ITEMS

Heat Sink Material
Model 99 Heat Sink (6.5" x 12" x 1.6"), \$24
CHS-8 Copper Spreader (8" x 6" x 3/8"), \$24
Low Pass Filters (up to 300W)
for harmonics \$12.95
Specify 10M, 15M, 20M, 40M, 80M or 160M
HF Splitters and Combiners up to 2KW

LED FLASHLIGHTS (and more!)



Colors: white, blue, red, and green
D & L Antenna Supply Co.

Secure Ordering On Line at
www.wavehunter.com

1-800-965-8880

Prices from \$4.95 to \$59.95

- Lasts 4 times longer than regular flashlights
- Lifetime warranty including LED lights
- Shockproof
- Features 4 high intensity LED lights
- Powered by 3 AA alkaline batteries

After continuously being turned on for 14 days (336 hours), it was possible to read a newspaper using only the output from this amazing system. This item sold out at Dayton!

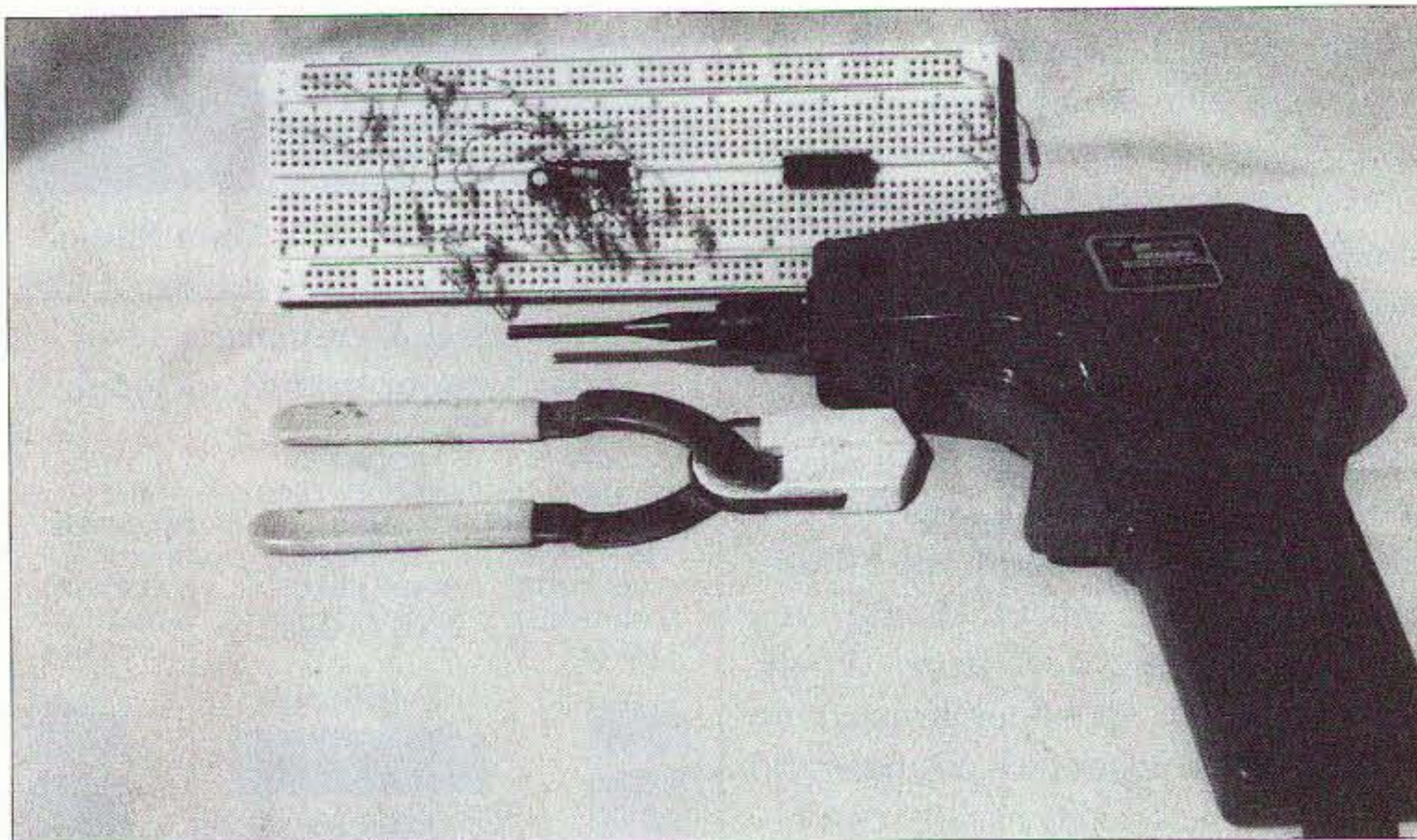

Photo B. Breadboard prototype system with wire-wrap strippers and 120 VAC wire-wrap gun.

DIP-16 WW sockets, gold type, at a recent hamfest flea market at 8 cents each. A real bargain! I prefer brands such as Augat or similar types because they are solid plastic, which provides good mechanical strength. They also use specific colors for the various sockets so that easy identification is possible.

Now let us take a look at the PC board (perforated) to see what is available for our specific use. Never purchase phenolic boards. There are too many reasons to go into about that material! Use either CEM-1 or FR-4 materials. These board materials are available from Jameco, Mouser, Digi-Key, and others in the price range of from \$10 to \$20 each. I tend to use CEM-1 boards, 4.5- x 17-inch size, with the mandatory 0.1- x 0.1-inch hole space.

The price on these is about \$11 each. Take a look at the catalogs to see what you like for size and price.

The alternative to the CEM-1 is the more expensive FR-4 (green) board material. It is only necessary with RF or high frequency circuits where high impedance is of concern. I used CEM-1 type on a 400 MHz counter with no ill effects, so I am not at all sure that the extra 50% price increase is justified. I like the CEM-1 (white) board the best for these home-brew projects.

After doing a paper location drawing, you can insert the WW IC sockets into a board. If you prefer, and are sure of yourself, you can put a dab of 100% clear silicone caulk on the bottom of the socket and leave it overnight for a permanent fix to the PC board. I prefer to just wire-wrap the red wire for VDD

(+) and black wire for VSS (g) power connections. I use white wire for the VEE (-) power when working with linear ICs. This procedure keeps the sockets in place and provides the "housekeeping" interconnects of power to the sockets. You can build the power supply section of the project first, and then check each socket with a voltmeter to make sure that there are no mistakes. After all of that, you can start the interconnect wiring using green wire.

When cutting the board to your particular need, use either tin snips or a good sharp set of scissors. The material will cut very easily. Upon completion of cutting, use a double-cut file or sandpaper to smooth the edges of the board. You can then put several 0.75- to 1.00-inch standoffs on the board so that it will stand off the surface of a table and allow the wire-wrap sockets to clear that surface. This makes it easier to wire-wrap, also.

Sometimes a wire-wrap termination point is required to accommodate wires leaving the PC board to connect to switches, pots, other boards, etc. The best way to handle this, I found, is to use a SIP-40 header. (By the way, DIP means dual in-line, and SIP means single in-line.) When using an SIP, you can weave the wires in and out of holes before wrapping to the post. This allows a strain to be placed on the wire without causing the wire to unwrap itself when leaving the PC board.

Now we have to consider all of those wires and where they are going. The best method I found to keep track of things is to make a copy of your schematic as a working spreadsheet. Next, get a new yellow felt marker, sometimes called a "Hi-Liter." After each wire connection and conformation using a continuity checker to verify the connection, you can mark the schematic to show that the wire connection is complete. This method works well! Upon the completion of the board and verification of the circuit's performance, we are on to an enclosure.

Now that we have a good working project that needs an enclosure, we can take a look at a few types. I tend to move to Ten-Tec's JW series for my projects. Other choices are also available in the \$10 to \$25 range.



Photo C. A wire-wrap/unwrap tool, with spools of AWG-30 "Kynar" WW wire in the background.

I lay out a front and rear panel scale drawing to make sure everything fits OK. When happy, I mark and drill the holes. The Ten-Tec enclosures are aluminum except for the plastic side panels. Woodworking tools work well on these aluminum enclosures. A little scratching occurs when drilling, saber sawing, and filing, so you will want to spray paint after all of that stuff. I found a spray enamel paint at my local "ACE" hardware store called "almond" color (#1003979). It dries to an eggshell white color and looks pretty good.

I then use the black "rub-on" decals which Radio Shack and others make available for about \$3 a package. A package can do several projects. When everything looks good, spray the complete aluminum enclosure with a couple of coats of polyurethane spray. I like Min-Wax's "Varathene" gloss type, but any type will work. Now, in the area of component procurement you have to always check out the hamfest flea market items. Inspect carefully! Other sources are given at the end of this article. Use their free 800 telephone numbers for a catalog request.

The next question is, "Where do I get power for these projects?" In the old days, we had a 120 VAC power line and a transformer to deal with. That is dangerous and costly and besides, vacuum tubes are a thing of the past except for those HF linears. Nowadays we can use the wall-pluggable power converters. These are UL-, CSA-, VDE-approved devices that bring in the low-voltage, class II, AC power, and better yet the DC power. Some even come with built-in DC voltage regulators. The prices range from \$2 to about \$10, depending on the VA (watts) rating of the transformer device. Make note that sometimes AC types have a center tap also, so now you can have those POS and NEG supplies for linear projects. Do not forget that two AC types can be made to do the job also.

Next comes the technical information. Many sources are available from catalogs, magazines, *ARRL Handbook*, *WIFB notebook*, and loads of flea market boxes of old semiconductor databooks. New databooks are available

for about \$20 each if you get desperate. Most technical databooks are on CD (compact disk) and require a computer with Windows, etc., to use them, or an Internet connection and patience to get your information. Component suppliers are really helpful if you want only one datasheet along with your purchased component. Customer service is great!

Home-brewing can never be dead if we just get with it. Wire-wrap makes it easy and enjoyable. With proper photographs and a little manuscript writing, the magazines will give you \$100 for an article and your name in print besides. The magazine readers will certainly appreciate your efforts and will send you letters telling you so. Some will be good and some not so good, but you will have made them finally get moving. Home-brewing is an old and honorable part of this hobby. It is what got this thing going in the first place. Appliance operating is something new which came about with the flood of rice boxes and CB appliance operators. Let's get some good home-brew stuff going like the Japanese and English hams still enjoy. 73, Carl K8IHQ.

Resources

Jameco Electronics, 1-800-831-4242.
Mouser Electronics, 1-800-346-6873.
Digi-Key Electronics, 1-800-344-4539.
Hosfelt Electronics, 1-800-524-6464.

HOUSTON AMATEUR RADIO SUPPLY

267 Cypresswood Drive • Spring, TX 77388
800-471-7373
Local: 281-355-7373
email: houstonamateurradio@prodigy.net
COMPLETE SALES & SERVICE
Yaesu, Icom, ALinco, ADI, Hustler, Cushcraft

WANTED

Fun, easy to build projects
for publication in 73.

For more info, write to:

Joyce Sawtelle,
73 *Amateur Radio Today*,
70 Hancock Road
Peterborough NH 03458.

GORDON WEST HAM TEST PREP TAPES BOOKS SOFTWARE VIDEOS

Prepare for your ham test with "Gordo"
WB6NOA as your personal instructor.

- **THE NEW THEORY** on audio cassettes
No-Code Technician (4 tapes)\$19.95
General Class (4 tapes) \$19.95
Amateur Extra Class (4 tapes)\$19.95
- **THE CODE** on audio cassettes
Learning CW (0-7wpm 6 tapes)\$29.95
Speed Builder (5-16wpm 6 tapes) .. \$29.95
Speed Builder (10-28wpm 6 tapes). \$29.95
- **NEW STUDY MANUALS** by "Gordo"
No-Code Technician (Element 2) .. \$11.95
General Class (Element 3) \$12.95
Extra Class (Element 4) \$14.95
- **PC SOFTWARE** with study manuals
No Code Technician (Element 2)\$34.95
Tech/Tech+/Gen. (+ Code, Windows)\$49.95
General Class (3+Code, Windows). \$34.95
Extra Class (4 + Code, Windows).. \$34.95
Ham Operator (Tech.-Extra + Code) \$59.95
Morse Software Only\$12.95
- **VIDEO** VHS with study manual
No-Code Tech Video Course..... \$31.95

Add \$5.00 shipping 1st item, .50 each additional
Priority Mail 2-3 day service available

VISA, Mastercard, Discover, & AMEX Accepted

W5YI Group

P.O. Box 565101 • Dallas TX 75356

1-800-669-9594

www.w5yi.org

EVERY ISSUE OF 73 Amateur Radio Today on Microfiche!

The entire run of 73 from October 1960 through last year is now available. Over 800 fiche!

You can have access to the treasures of 73 without several hundred pounds of bulky back issues. Our 24x fiche have 98 pages each and will fit in a card file on your desk.

We offer a battery operated hand held viewer for \$150, and a desk model for \$260. Libraries have these readers.

The collection of microfiche, is available as an entire set, (no partial sets) for \$325, plus \$10 shipping (USA). Annual updates available for \$10, plus \$3 shipping/handling. Satisfaction guaranteed or money back!

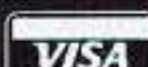

BUCKMASTER



6196 Jefferson Highway
Mineral, Virginia 23117 USA
540:894-5777•800:282-5628
Fax 540:894-9141
e-mail: info@buck.com

Henryk Kotowski SMØJHF
Sibeliusgängen 28 XI
SE-164 77 Kista
Sweden

Travels with Henryk — Part 7

Hams in the Åland Islands OHØ.

Each and every one of these islands is small, and you won't see them on the world map. But there are 6,500 of them, so someone must have counted.

Most of the 25,000 people who live here are to be found on the main island. There is the capital city, Mariehamn, where the local radio club, OHØAA, has a nice clubhouse. The club was founded in 1959 and is "still going strong." Almost 50 members, a contest station on one of the hills, FM and digital repeaters — just to mention a few pieces of evidence of their well-being.

When approaching Mariehamn by car from the west, the way I usually take, you can hardly avoid seeing the impressive 100-ft. antenna tower of

Roland OHØAZX. The CNN T-shirt he wears in the picture (**Photo A**) indicates that he is in the TV business. To be exact, in cable TV. 50 MHz and up are his favorite bands; the high antenna tower is advantageous on these frequencies.

Melcher OHØQF (**Photo B**) has a simple wire outside of his house, almost invisible. He is the oldest ham in the islands, a retired medical doctor. Every morning, he talks to his friends in Finland and Sweden on 80 or 40 meters. In spite of being well over 80 years old, Melcher is no enemy of modern computers.

Marcus OHØHEH (**Photo C**) is into computers. He works for a media company and helps the club with software problems. His very neat station is accomplished with an impressive array of VHF-UHF antennas outside.

His neighbor, Guy OHØNH, is mainly interested in lower frequencies and has an HF yagi on the backside of his house. In the basement (**Photo D**), he has a lot of gear, tools, and instruments. He still believes in home-brewing radio equipment.

But Harry OHØAZZ is a full-time experimenter. His home is filled with



Photo A. Roland OHØAZX in his radio shack.

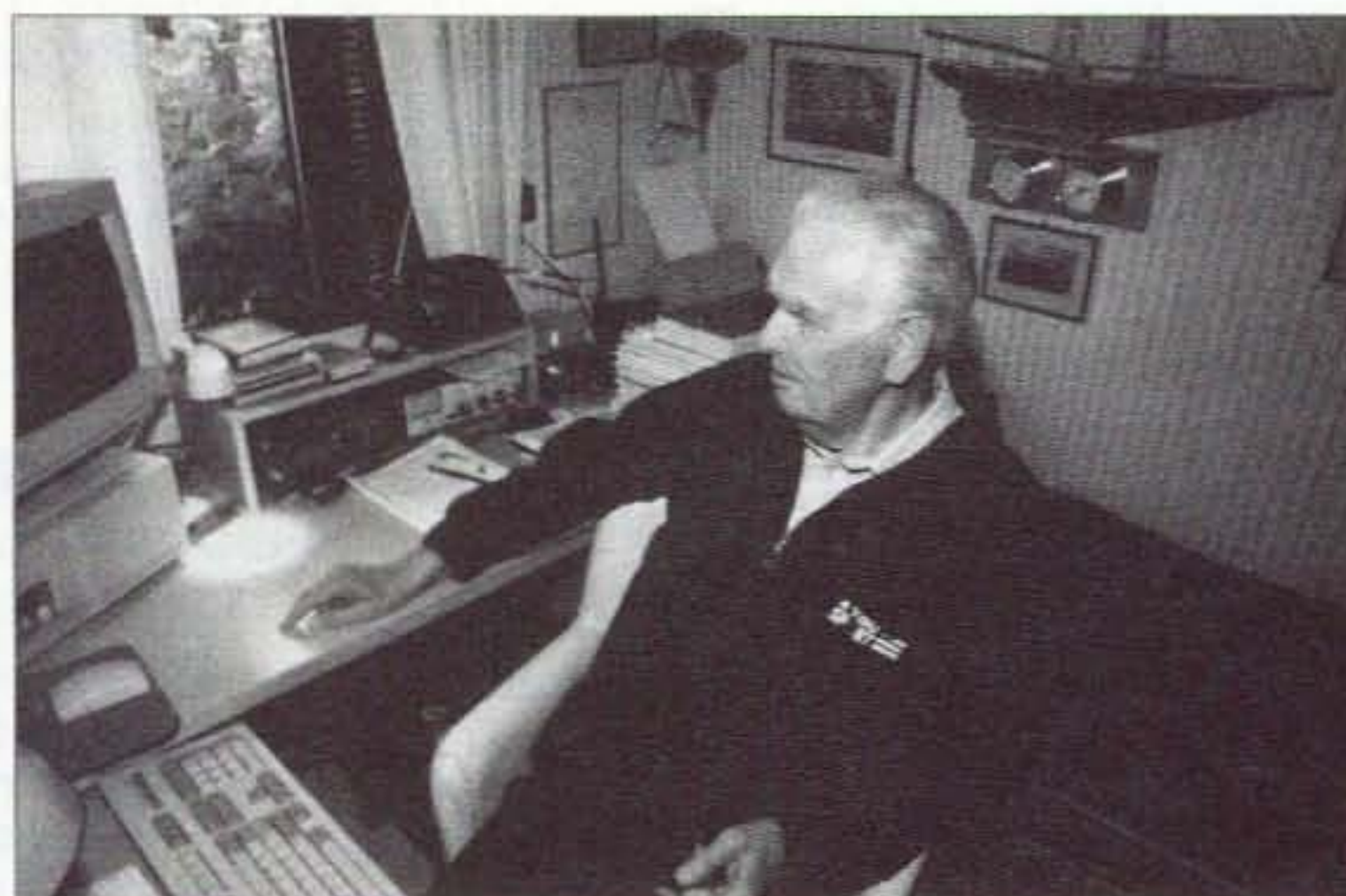

Photo B. Melcher OHØQF at home.

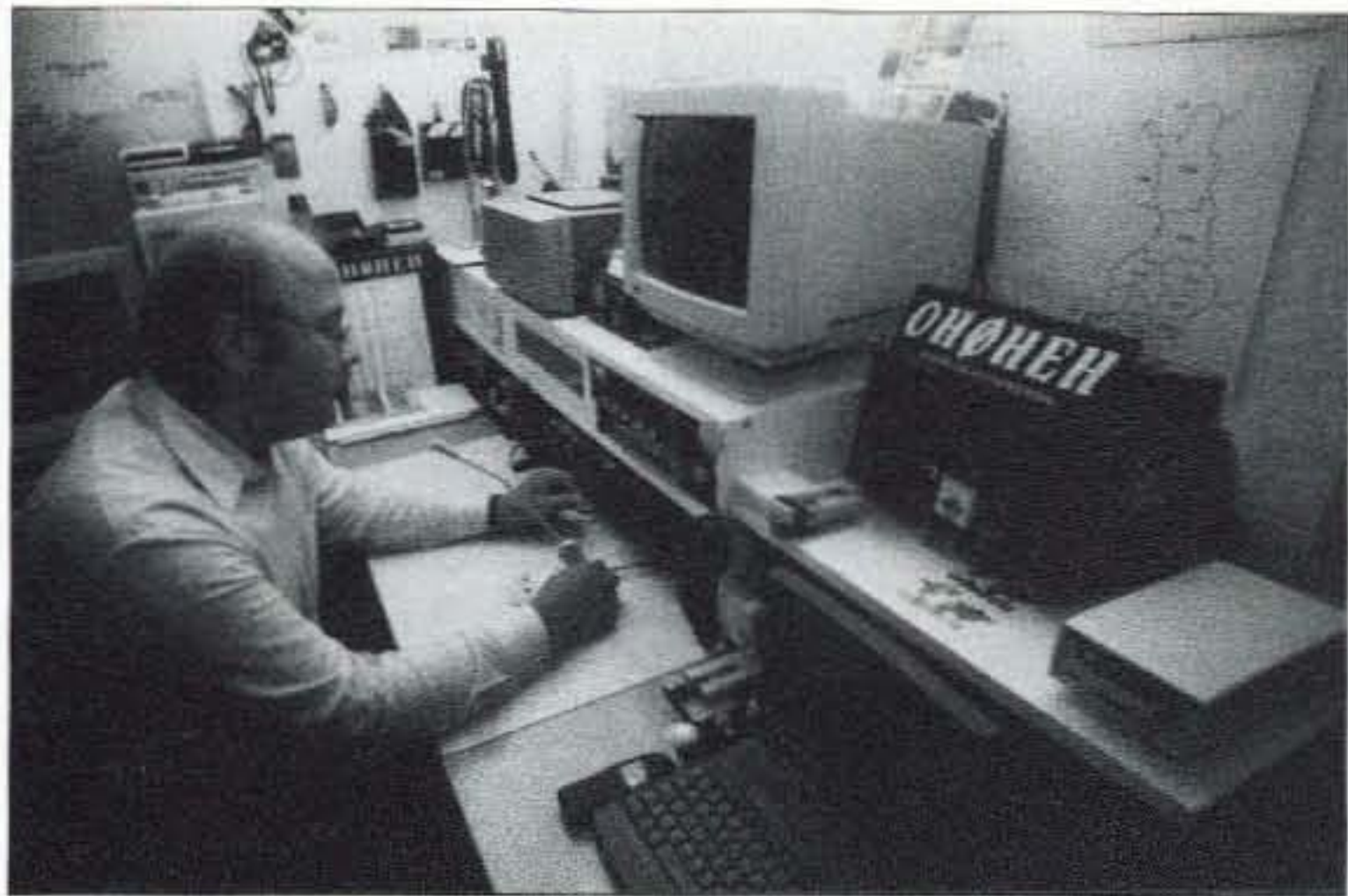

Photo C. Marcus OHØHEH — a very neat and modern station.



Photo D. Guy OHØNH in the basement shack-shop.

so much radio and electronic items of different vintages that he has no space for on-the-air operating. He helped a few younger hams build a VHF-UHF contesting site, where they use the callsign OHØAB. In the picture he sits in front of 50-144-432-MHz stacked rigs (**Photo E**) at this station.

The one who is more interested in HF and DXing is Lars OHØRJ. Living very close to the sea gives him the advantage on long-haul communication (**Photo F**). Lars is often on the air and logs 10k QSOs a year.

Sture OHØJFP (**Photo G**) is a very ambitious person. During the past year or so, he built a complete VHF-UHF station out of town, with large arrays

for each band from 6m to 23cm. He wins the local activity contests with ease — after all, the Åland Islands lie between Finland and Sweden, two countries with large ham populations. The picture was taken at Nyhamn lighthouse during the Lighthouse Weekend Activity.

The person who has access to every lighthouse in the archipelago is a retired lighthouse keeper, a skipper, and a nautical pilot — Karl Erik OHØNA. Karl Erik, nicknamed Kee, is the only one of all the above mentioned people who lives outside of Mariehamn. His home is in Saltvik, a few miles north of the capital. Kee is the president of the OHØAA radio club, but is sometimes

active from his home as well. Apart from a high tower in the forest, he has a multiband vertical in front of the house (**Photo H**). Kee was introduced to amateur radio in a spectacular way — in 1969, he served as lighthouse keeper on Market Reef and the first DXpedition landed there. He got interested in this wonderful hobby then. He obtained the callsign OHØMA and has made countless contacts since then. One day, I plan to convince Kee to go back to Market Reef for a radio expedition. It might be this summer — you never know.

Visitors are always welcome in the Åland Islands. Should you be in this vicinity in late August, come along and



Photo E. Harry OHØAZZ in the OHØAB contesting station.

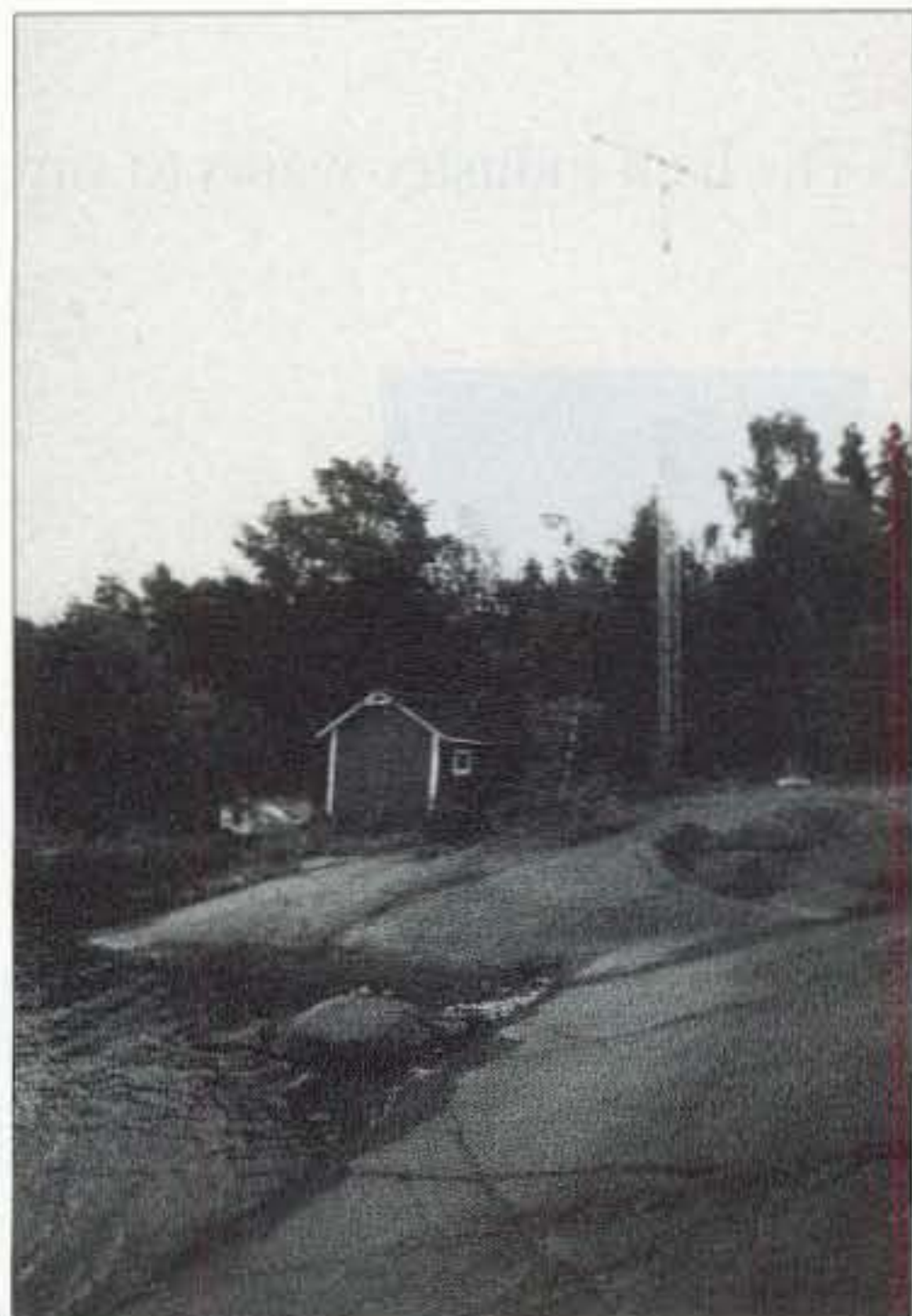

Photo F. The radio shack and antenna of Lars OHØRJ.



Photo G. Sture OHØJFP in Nyhamn, a small island south of Mariehamn.

join the local hams in some lighthouse activity. The Mother Nature part alone is worth it, even if propagation that far north can be poor.

The islands have a high degree of autonomy. The League of Nations ruled

for it in 1918, when Sweden and Finland argued about this territory. Almost all people here speak Swedish, but officially it is a part of Finland. Today it is a peaceful place, appreciated by thousands of visitors every summer. 73



Photo H. Karl Erik OHØNA checks the coax cable to his multiband vertical at home.

ELMERS • VE's • INSTRUCTORS • CLUB GREETERS

Become A

HAM AMBASSADOR

The ham industry wants to support your efforts for ham radio growth with free instructor materials.

- Wall Maps • Log Books • Band Plan Charts
- Frequency Charts • Grid Square Guides
- Discounts on Licensing Materials
- Equipment Discount Program
- Gift Certificates



To start off the flow of materials, include \$5.95 for up to 2 pounds of training materials, and send your request to:

Ham Ambassadors, Gordon West Radio School, 2414 College Drive, Costa Mesa CA 92626.

Please note: **All requests** must be accompanied by a class flyer for your upcoming course, including class dates and location.

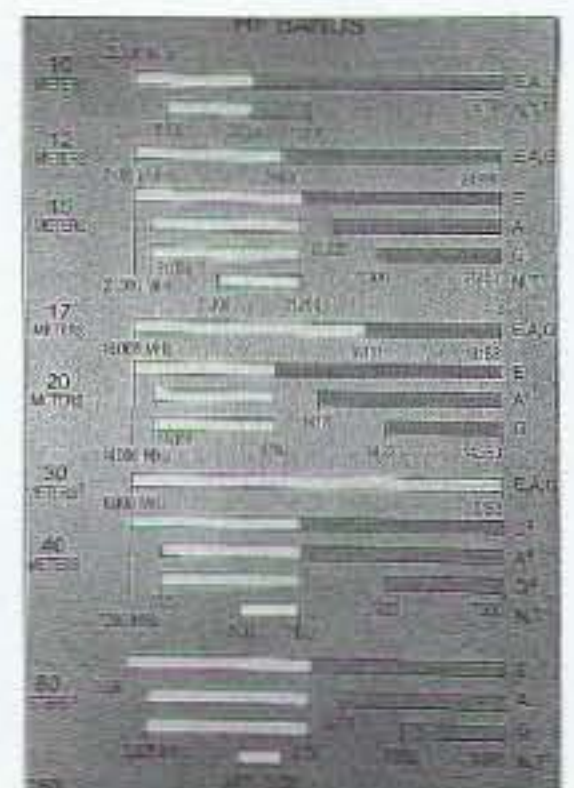

Read All About It!

Part II of good stuff from The Hertzian Herald.

The Antenna Raising

Ah, to have reached my fifty-third year, the age of maturity and wisdom! The kids were grown up and moved out of the house. I had survived my midlife crisis by buying a boat, realizing what a poor cost/benefit ratio it represented, and selling it after five years. Now it was time to get back to the passion of my youth — amateur radio.

A morning at my local hamfest got me a low-band transceiver (everybody called it a “rice box”) for what seemed to me a very reasonable price. The antenna, however, was a more difficult problem. Antenna supports had not been on the list of desirables we had presented to the Realtor when we bought our present home. The front yard sported only a few ornamental trees, the back yard was a ravine sloping down to a creek 40 feet below street level, and there were deed restrictions against antennas in the whole ’hood.

Well, the main roof gable was 45 feet long, so I put a couple of two-foot poles at either end, halfway down the back slope and tucked a 20-meter dipole neatly out of sight on the back side of the roof. That was fine, but my first love had always been 40 meters, and that takes 66 feet; 45 won’t do.

A few measurements on the gable, and some trigonometry showed that a ten-foot pole at the center of the ridge would support four “guy wires” of 34 feet to each corner of the roof. I bought a length of 3/4-inch conduit, painted it black, and put up a parallel dipole for 40 and 20, and the devil take the deed restrictions.

All quite satisfactory, until I got hooked on antique radios and CW rag chewing; all that activity is on 80 meters, and no way could I find space to stretch out a 132-foot dipole. Then I remembered the 99-foot long-wire I had used at my last QTH: three quarter-waves on 40 (a purely resistive load), and 3/8 wave on 80 (an inductive load, easily tuned out with a simple series variable capacitor). So I snaked the wire up the side of the house, across the roof to the chimney, up to the ridge, down the front slope,

and over to the front of the garage gable. I connected a ground wire to the city water pipe, which happened to be right next to the operating position in the basement, and fired up the rig.

As I was tuning up I heard water start to run in that pipe. Going upstairs to investigate, I found that the sprinkler system had been triggered, all five zones spraying away like mad. And the garage door was gaping wide; the opener had been triggered. And the burglar alarm was going off; the cops were on their way. I asked the XYL to phone the company that it was a false alarm, but she had already tried, and the phone wasn’t working; so apparently I was getting into that, too. Then the front doorbell rang.

It was my neighbor — with his dog. Close up, the dog looked a lot bigger and more menacing than he had seemed from a distance. The neighbor had just installed one of those invisible fences, with the electronic collar that zaps the dog if he wanders out of bounds. He said the dog had been sleeping comfortably when he suddenly woke up yelping and jumping,

(Name and address submitted;
withheld by 73 for the
purpose of possibly
preserving this friendship)

The Hamfest from Hell

Are you in this story?

A few years ago, I wanted to travel to a hamfest three hours from where I live, but my usual hamfest buddies were not available because the date was so close to a big holiday. I did not want to drive that far alone in the dark. But this hamfest was quite big and has many commercial dealers, and I did not want to miss it.

So, a week before, I checked into the Wednesday Night Trader's Net on 2 meters and announced that I was looking for a travel partner and that I would pay for the gasoline. A few days later I received a call from "Fred," who said that he would take me up on my offer. (Actually his real name is not Fred. I think it is best if I do not reveal his true identity.) This was great! I was all set.

During the next few days, however, I received many warnings that if I went with Fred, he would drive me crazy. "Don't go to a hamfest with Fred." But I've gone to hamfests in pouring rain and still had a good time. I've gone in snowstorms. I was even at the hamfest the year a tornado tore off part of the roof of the Hara Arena in Dayton. I still had fun. I have gone to hamfests with many different guys over the years, with no problems. And I have known Fred for a very long time, so how bad could it be?

Or so I thought.

Fred and I agreed to leave 2:30 a.m. so that with one stop for breakfast we would arrive at the hamfest around 6 a.m. He would drive his truck and I would pay for the gasoline.

Here is what happened.

I find hamfests so exciting that I rarely get much sleep the night before. So I set my alarm and awoke at 12:30 a.m., two hours early, in order to be certain that I would be ready on time. But at 2:30, our agreed-upon time, Fred was not there. At 3:30, still no Fred. I called his house. His wife said that she would "try" to wake him, and that he would call me back. At 5:00 a.m. he finally arrived. Now we were 2-1/2 hours behind schedule. He said that he had gone to a party the night before and was too "tired" to drive, so I would have to drive his truck. It was the big old truck with no power steering. Candy wrappers, soda cans, and other debris littered the dashboard, seats, and floor, but I figured that maybe it would be nice to have such a large truck in the event that I wanted to buy something big at the hamfest.

As we drove off, the first thing Fred told me was that he had forgotten to fill the tank with gas. This set us back another 15 minutes. He said that his truck only takes the very expensive, super-high-octane gasoline, and only gets about 6 miles to the gallon. Our round trip would be 300 miles. That

would be 50 gallons. This would be a very expensive hamfest.

Driving his truck proved to be very tiring, as it pulled to the right and the steering wheel wiggled and vibrated in my hands. The accelerator pedal had a very tight spring that made my foot ache. I arrived at the hamfest exhausted. By this time, I had been awake for eight hours, with very little sleep the night before.

The hamfest had that "picked over" look. We arrived late, so all of the best bargains were already sold. There was, however, one large item that I wanted to buy, but it turned out that Fred could not open the truck's back gate because he had forgotten the key. I had to pass it up.

Finally, it was time to go home. I was tired and anxious to go. As we reached the interstate, Fred said that his grandmother lived in the next city over, and that he would like to stop by for a few minutes and say hello. So we got back off the interstate and began to travel around the streets of this city. We drove around and around, until Fred admitted that he was not exactly

Continued on page 59

The Write Stuff

Here's a work-at-home scheme that is no scam.

Say now, that's a really nice project you've just finished! I bet that you're proud enough to "pop the buttons" off your shirt, or will at least "brag" a little about it at the next ham club meeting. Maybe you'll even take it along to "show off" just a little.

And you're allowed to do that! Really!! The other club members are going to gawk and mumble things like, "nice job, couldn't have done better" ... or you shoulda coulda woulda done it this or that way. (Envy rears its ugly head, and these comments I find come from those whose last project was a "Tinker Toy" windmill during the Truman administration.)

All you have to do is stand there and take the praise. You know that you did a fantastic job, and the end product shows it.

"It's only a kit," is your feeble excuse, or maybe the project didn't require a lot of technical "know-how," or it's not even a radio, but a project related to our hobby. Maybe you helped teach a license class, or worked with the Boy Scouts to help them earn their radio merit badges.

"I wasn't the 'main speaker' and all I did was —" and I will never know what you did, unless you tell me.

So, why are you keeping it a secret from the rest of us? I don't live next door to you, but I would really like to see and hear about your latest effort. We like to admire the work of fellow

amateurs, see what the other guy is doing, and maybe gain some inspiration for a project of our own. Not all of us build projects that require a degree in advanced electronics — simple ones are just fine for me! They allow me to begin building slowly, gaining knowledge and confidence as I go. Later, I'll tackle the more advanced ones, but for now I'll stick with the ones I think I can handle without too much trouble. And not just building things either — community and club events interest me, too.

"My writing skills 'stink.' The teacher failed me X years ago because I couldn't tell a sentence from a baseball," you lament.

Well, you've sort of got me there. I know how it is to think that your skills aren't the greatest in this area, but guess what?! I'll bet there's somebody near you who can handle the writing chores, if you can provide the technical part! You should try writing the article yourself first. It may not be the greatest literary work you've ever done, but you won't know until you've tried it! Besides, your ghost writer can use it as a starting point to put your article in better form.

The same is true if your article should have pictures. You know who the camera "nuts" are in your area. They're just waiting to be asked to help you with your project. Their world has a language of its own, like "F" stops and bus stops and whatever other "stops" they gloat over. Of course, you'll have to share the "by-line" with them if the piece gets published, but this is a price that may have to be paid if you want to see your name in print.

"I don't know what to write about," seems to be the next comment.

That's an easy one: Write about what you know best! You're the one who's familiar with the project and made it through to the finish. Use those old adages from school; remember Who, What, When, Where, and Why? If your article can address these questions, you're well on your way to success. Tell me honestly and truthfully about the project. Adding "fiction" to glorify the piece may be impressive to you, but can be embarrassing when "Joe Engineer" comes back with "that can't be done" responses. So don't do

Continued on page 59

CALENDAR EVENTS

Listings are free of charge as space permits. Please send us your Calendar Event two months in advance of the issue you want it to appear in. For example, if you want it to appear in the November issue, we should receive it by August 31. Provide a clear, concise summary of the essential details about your Calendar Event.

AUG 3

COLUMBUS, OH The 12th Annual Columbus Hamfest, sponsored by the Voice of Aladdin ARC, will be held Saturday, August 3rd, at the air conditioned Aladdin Shrine Complex at 3850 Stelzer Rd. Talk-in on 147.24(600 MHz). Directions: Exit I-270 at the Easton exit. Proceed west to the first light, then turn north (right). The Aladdin Complex is located about 1/10 of a mile up the road on the right. Entrance to the hamfest is near the rear of the building. Commercial exhibits, flea market, free seminars, refreshments, VE exams. Exams being conducted at 9:30 a.m. Please be on site to register no later than 9 a.m. if you are planning to take an exam. Admission tickets are \$4 in advance, \$5 at the door. Children under 10-years-old admitted free. Indoor display tables (6 ft.) are \$6 in advance, \$8 each at the door. Outdoor flea market is \$5 per marked parking space the day of the hamfest. Deadline for advance tickets and tables is July 20th. Advance sales available at Universal Radio and Hall Electronics in Columbus OH; the Aladdin Shrine Complex, or with an SASE sent to: Jim Morton KB8KPJ, 6070 Northgap Dr., Columbus OH 43229-1945. Phone 614-846-7790 evenings for further info. Visit the club Web site at [<http://www.qsl.net/w8fez>].

AUG 10

LONGVIEW, WA The Lower Columbia ARA, W7DG, will sponsor its 11th Annual Ham Radio, Computer, & Electronic Equipment Swap Meet from 9 a.m. to 1 p.m. at the Cowlitz County Expo Center in Longview. There is 14,000 sq. feet of indoor sales area, with tailgate sales outside. Admission is \$5, tables are \$12, tailgate spaces are \$6, with free space and admission for commercial dealers. Also, northwest radio clubs can contact the ARA for a free club table; table attendants will pay only for admission. Food concessions; free parking; overnight RV parking on the fairgrounds for \$12, electrical hookup available. Sorry, no VE exams. Vendor setup on Friday 5 p.m. to 8 p.m., Saturday 7:30 a.m. to 8:45 a.m. Talk-in on 147.26(+), PL 114.8. Take Exit 36 or 39 off Interstate 5 and follow the signs west for the Expo Center (fairgrounds). Mt. St. Helens and the Oregon coast are nearby. For more info, write to LCARA Swap Meet, P.O. Box 906, Longview WA 98632; or call Bob KB7ADO at 360-425-6076 in the evening. E-mail to

[KB7ADO@aol.com]. An Internet link to the flyer is at [www.qsl.net/nc7p/].

AUG 11

BAYVILLE NJ The Jersey Shore ARS will host their Hamfest "Shorefest 2002" August 11th at the Bayville Fire House, Route 9, Bayville NJ. Talk-in on 146.910 MHz PL 127.3, and 443.350 MHz PL 141.3. Setup starts at 6 a.m. and the doors open to the general public at 8 a.m. Admission is \$5. Tables, reserved in advance only, are \$15 each, first come basis, includes one admission. Contact Bob W2CE at 732-657-9339 or [hamfest@jsars.org]. VE exams registration is at 11:30 a.m.; testing starts at 12 noon.

GREENTOWN, IN The 5th Annual Greentown Hamfest will be held 7:30 a.m. to 1 p.m. at the Greentown Lions Club Fairgrounds. Talk-in on 147.24 and 146.79. Handicapped parking available. VE exams — anyone who obtains a license or upgrade at this testing session will be admitted free. Tickets are \$4 each in advance, \$5 at the door. 17 and under admitted free. Vendor setup Saturday 6 p.m. to 8 p.m., Sunday 5:30 a.m. to 7:30 a.m. Inside tables \$8 plus ticket; tailgate setup \$3 plus ticket. Vendors pre-register by sending form or E-mail to [k9nqw@arrl.net]. Web site [www.grantarc.com/greentown.html]. For more info contact Greentown Hamfest, c/o L.B. Nickerson K9NQW, 517 N. Hendricks Ave., Marion IN 46952, or phone 765-668-4814. This event is being co-sponsored by Kokomo and Grant County Amateur Radio Clubs and the ARRL.

ST JOSEPH, MN The 55th St. Cloud Amateur Radio Club Hamfest invites all radio hams and those interested to the Middle of the State Flea Market and Fun Time. It is being held August 11th at the Del-Win Ballroom, located on Hwy. 75 and 88th Ave. near St. Joseph MN. Talk-in is on 147.015 MHz, gabbing on 146.940 MHz. VE exams at 1 p.m. For current info, see the Web site at [www.w0sv.org].

AUG 16, 17, 18

ESCONDIDO, CA The ARRL Southwestern Division Convention for this year will be held at the California Center for the Performing Arts, August 16, 17, and 18. Exhibits will be set up in the ballroom. Free parking for both exhibitors and attendees. Secured hotel rooms at excellent rates at hotels within a three-mile

radius of the convention site. Drawings all day Saturday August 17th, each hour 9 a.m. to 5 p.m. To request information, please contact Nancy Paine KD6WUL, Exhibits Chairwoman, at 619-466-4216; or John Hudson III WB6HYQ, Convention Chairman, at 619-525-4291. E-mail [npaine@earthlink.net].

AUG 17

OAKLAND, NJ The Ramapo Mountain ARC will hold its 26th Annual Ham Radio and Computer Flea Market on Saturday, August 17th, at the American Legion Hall, 65 Oak St., Oakland NJ 07436. Talk-in on 147.49/146.49 and 146.52 simplex. Vendors' setup starts at 6 a.m. The event is open to buyers 8 a.m. until Noon. The kitchen opens at 7 a.m. Donations \$4. Spouse and kids admitted free. Inside tables \$10 each. Tailgate space \$8 per space. Please contact Steve Oliphant N2KBD, 10 Glen Rd., Ringwood NJ 07456-2331. Phone 973-962-4584, fax 973-962-6210, Club E-mail [rmarc@qsl.net]. Visit the Web site at [www.qsl.net/rmarc].

AUG 17, 18

HUNTSVILLE, AL The Huntsville Hamfest will be held Saturday and Sunday, August 17th and 18th, at the Von Braun Center, 700 Monroe St., Huntsville AL. "America's Friendliest Hamfest" is a sanctioned ARRL Alabama Section Convention. Admission is \$6, under 12 free. Doors open both days at 9 a.m. All activities are indoors. VE exams will be held both days at 10 a.m. The big event will be the National Young Ham of the Year (YHOTY) award presentation. Forums include ARRL, MARS, Skywarn, QRP, APRS, AMSAT, WARC 2003, and more! Convenient parking, giant dealer/manufacturer show. Huge flea market. E-Z drive-in vendor unloading. DX banquet. Friday and Saturday night there will be Hospitality rooms at the nearby Huntsville Hilton. Talk-in on 146.94 K4BFT. Call the Huntsville Hilton for special Hamfest Rates, 256-533-1400. Contacts: General info, 256-880-8004; dealer show, 256-536-3904, [DonTunstill@hamfest.org]; flea market, 256-883-2760; forums, 256-539-8950; DX Banquet, 256-721-5996. Visit the Web site at [www.hamfest.org].

AUG 23, 24

ALBUQUERQUE, NM The 2002 Duke City

Hamfest will be held Friday and Saturday, August 23rd and 24th, at the University of New Mexico Continuing Education and Conference Center, 1634 University Blvd. NE, in Albuquerque. The building is one-half mile south of I-40 on University Blvd., just north of the intersection of Indian School Rd. and University Blvd. Hours are Friday, 5 p.m. to 9 p.m.; Saturday, 7 a.m. to 3 p.m. Flea market, free outdoor tailgates, VE exams, forums. Free admission. Talk-in on 145.33(-) 100 Hz and 444.00(+) 100 Hz. RV parking (dry camping only, no hookups). Indoor tables \$12 (no power) and \$18 (with power). Contact Richie Allen KC5NZR, 1624 Columbia Dr. SE, Albuquerque NM 87106; phone 505-242-0208; E-mail [kc5nzs@arrl.net]. Get the latest info from the Web site at [www.qsl.net/dchf].

AUG 24

LAPORTE, IN The LaPorte ARC will hold their LPARC Summer Hamfest August 24th at the LaPorte County Fairgrounds, State Rd. 2 West of LaPorte, 7 a.m. to 1 p.m. Admission \$5, Table \$10, outdoor tailgating \$2. One admission included with table reservation. Talk-in on 146.52 and 146.61(-) PL 131.8. For info contact Neil Straub WZ9N, P.O. Box 30, LaPorte IN 46352. Phone 219-324-7525. For table reservations E-mail to [tables@k9jsi.org]. The Club Web site is at [www.k9jsi.org].

AUG 25

DANVILLE, IL The Vermilion County ARC will hold their 2002 Hamfest August 25th at the Vermilion County ARC clubhouse, Woodbury Hill Rd., Danville IL. For more info contact Terry Powell KB9REE, Vice President, V.C.A.R.A., P.O. Box 80, Catlin IL 61817-1007. Phone 217-446-1379, or E-mail [KB9REE@YAHOO.COM].

AUG 31

ALAMOGORDO, NM The Alamogordo ARC will host their 18th Annual Hamfest August 31st, 7 a.m. to 3 p.m. at the Otero County Fairgrounds in Alamogordo. Admission is free. Talk-in will be on 146.800 with 100 Hz tone. Pre-registration for door prizes is \$5, \$6 at the door. Pick up pre-paid tickets at the event. Registrations received by August 29th are eligible for the special pre-registration door prize, a dual-band mobile. Main door prize is an HF transceiver; 2nd prize, a dual-band mobile; 3rd prize, a 2M mobile. Food available at the fairgrounds, and it's close to White Sands Mall. A No-Host Banquet will be held Saturday at 7 p.m. All facilities are air conditioned. Ample parking space. VE exams, ARRL forum, traffic net forum, MARS forum, hourly prizes. Reserve swap meet tables, \$5. For additional info please contact Richard R. Norton KB7SQF, 505-443-6190; Larry Moore WA5UNO, 505-437-0145. Pre-registration contact is June Richmond K5BHE, 505-437-

0298. E-mail inquiries to [k5lrw@zianet.com]. To pre-register by mail, send payment with your name, callsign and address to Alamogordo Amateur Radio Club, ATTN: June Richmond K5BHE, P.O. Box 1191, Alamogordo NM 88310.

SEP 7

BALLSTON SPA, NY The Saratoga County R.A.C.E.S. Assn. Inc. will hold its 17th Annual Hamfest Saturday, September 7th, at the Saratoga County Fairgrounds in Ballston Spa. This will be held all under cover, rain or shine. Gates open at 7 a.m., with the hamfest running until 3 p.m. Admission is \$5 (includes 1 tailgate spot and free parking). There will be door prizes, a fox hunt, VE exams, and plenty of food. Talk-in on 146.40/147.00 and 147.84/.24. Reserved tables \$5 each, first come, first served. Reservations and pre-pay are encouraged. Early setup for all vendors. For further info or reservations contact Darlene Lake N2XQG, 314 Loudon Rd. #84, Saratoga Springs NY 12866; phone 518-587-2385. E-mail [lake@capital.net].

SEP 8

SOUTH DARTMOUTH, MA The Southeastern Massachusetts ARA, Inc. will hold its annual flea market on the club's grounds at 54 Donald St., South Dartmouth MA. The event will run from 9 a.m. to 1 p.m. Talk-in on 147.00/.60. Admission \$2 (spouse and children free). Food, door prizes, and more. Free space for vendors! For further info contact Tim Smith N1TI at 508-758-3680, or by E-mail at [rt_smith@yahoo.com].

SEP 21

NEW PORT RICHEY, FL The Suncoast Amateur Radio Club will host the 12th Pasco County Hamfest at New Port Richey Rec. Center, 6630 Van Buren Rd., New Port Richey FL, 9 a.m. to 4 p.m. Talk-in on 145.35(-) rptr. Admission \$5, XYLs and under 12 admitted free. 8 ft. inside tables \$15 each; electric \$5. Tailgate spaces \$3 each. You must have admission to enter tailgate or exhibit hall. For info contact Tim WD8MVU, 727-848-0353. E-mail [TRobin@homeemail.com].

ROLLING MEADOWS, IL The Northern Illinois DX Assn. will sponsor the 50th Annual W9DXCC Midwest DX Convention and Banquet, Saturday, September 21st, at the Holiday Inn in Rolling Meadows IL. Details and registration form are at [www.w9dxcc.com]. Friday, September 20th, there will be a Welcome Reception hosted by Carl Smith N4AA and DX Publications. Late Friday, a Hospitality Suite will be hosted by the Northern Illinois DX Assn. Stay late Saturday night for the Hospitality Suite being hosted by the Greater Milwaukee DX Assn. An ARRL Forum and presentations by major DXpeditions will be happening on Saturday at the main event.

SEP 22

NEWTOWN, CT The Western CT Hamfest will be held 9 a.m. to 1 p.m. at Edmond Town Hall, Rt. 6. Exit 10 off I-84. Follow signs. Setup at 7 a.m. Talk-in on 146.67/.17. New equipment dealers, flea market, tailgating, electronics, computers, refreshments. Tables \$10, tailgating \$6 (each includes one admission). Admission \$4, under 12-years-old free. For reservations and info, contact John M. Ahle W1JMA, 120 Fire Hill Rd., Ridgefield CT 06877. Phone 203-438-6782; E-mail [W1JMA@aol.com]. This event is being sponsored by the Western CT Hamfest. Thanks to the Candlewood ARA of Danbury CT for this announcement.

SEP 28

LAWRENCEVILLE, NJ The Delaware Valley Radio Assn., W2ZQ Hamfest, will be held rain or shine, September 28th, at the NJ National Guard Armory, Eggerts Crossing Rd., Lawrenceville NJ. Talk-in on 146.67(-) 131.8. Vendor setup at 0600-0800; general admission 0800-1400. Admission \$6 per person, under 12-years-old free. Tailgate vendor \$10, includes one admission. Indoor vendor \$15, includes one admission. Indoor vendor wall space with electricity \$20, includes one admission. Extra tables \$10 each. For more info contact Glenn Costello N2RPM, [abbott0903@aol.com], phone 609-882-2240. Visit the Web site at [http://www.w2zq.com].

OCT 5

WARSAW, MO The Twin Lakes ARC will sponsor the Warsaw MO Hamfest Saturday, October 5th from 9 a.m. to 4 p.m., at the Warsaw Community Bldg., one block west of the square. Talk-in on 147.300 on the Warsaw rptr. Setup is at 5:30 a.m. Admission \$2 at the gate. 8 ft. tables \$10 each (hurry, only 30 available). Breakfast and lunch will be served on site. For more info call Gene at 660-438-8650, or E-mail to [gpo@advertisenet.com].

SPECIAL EVENTS, ETC.

AUG 10, 11

MARYLAND-DC QSO PARTY On the air 1600-0400 UTC August 10th to 11th, and 1600-2359 August 11th. Suggested frequencies: 3.643, 3.92, 7.07, 7.23, 14.055, 14.268, 21.115, 21.37, 28.055, 28.38, 50.15, 52.525, 146.55, 146.58 and 446.00 MHz. Try CW on the odd half hours. Scoring: Add up your QSO points and multiply by the sum of the multipliers. Multipliers may be claimed once each and they do not repeat from band to band. QSO Points: 10 points per club station, 5 points per mobile station, 4 points per QRP station, 4 points per Technician

Continued on page 59

Converting Surplus: A 1296 MHz 5 Watt Amplifier — Part 2

This month is a continuation of last month's column that concerned a 1 watt power amplifier PC board that we obtained in surplus for the 1296 MHz amateur band operation.

This time, the focus is on converting a higher power module that is capable of a minimum of 5 watts output and can be pushed to higher output power levels. There is some similarity between the surplus modules and commercial modules that are available for this same frequency band that do not require modification. Existing modules are the older Mitsubishi M57762, see **Photo C**, and the newer Mitsubishi M67715 1296 MHz power amplifier 5 watt class modules. The Mitsubishi modules are constructed in black epoxy and cannot be modified as they are completely sealed, unlike the Fujitsu surplus module. They run from 12 volts directly and do not require minus bias supplies.

Comparing the Mitsubishi modules and the Fujitsu module, they are quite similar except that the Fujitsu module has a removable metal cover. It can be gently lifted off to expose the circuitry of the amplifier PC board, allowing modification to the internal circuitry to make it useful at 1296 MHz. Modification details are shown in **Photo A**. The Mitsubishi modules are sealed in a black plastic epoxy case with two heat sink fins on either side and five connection leads protruding from the module case. No hint of circuitry is apparent in the black modules. The cost of the Mitsubishi modules is a little expensive, slightly over \$60 last time I checked. A fine module but costly.

Power output is rated for +39 dBm using both the +7 and +9 volt power supplies. That's 1 dB under 10 watts power output when the final device is run from a +9 volt power supply.

The circuit board is obtained from cutting the power amp module and its bypass capacitors out of the larger main circuit board. Originally, the amp is set up to run from a single +7 volts power supply. This produces originally about +36 to +37 dBm power output (5 watts is +37 dBm) at 1616 MHz. Power falls off quite rapidly as frequency is lowered out of its normal frequency range of operation. That's where changing circuit elements comes into place to increase performance at 1296 MHz. Fortunately the module is not sealed and the cover can be pried open and the required simple changes made to allow operation at 1296 MHz.

The plan was to see what could be done to modify the Fujitsu modules to 1296 MHz operation. My partner Kerry N6IZW figured out the values needed to convert the Fujitsu 1616 power module. The changes are easy. What is required is to increase four chip capacitor values to increase performance in the 1296 MHz band. The values selected are nearly correct (not optimized) and were selected because they were obtainable from our junk box. Other values varying 10 percent or so should work just as well as the values we selected. One 1.5 pF chip cap and two each 3 pF chips caps and a single 6.8 pF chip cap did the trick. **Fig. 1** shows the location where to place the additional chip caps on top of the existing chip caps on the power amplifier board.

As shown in the drawing, there are three amplifier devices surrounded with a couple of chip caps marked "C". The four capacitors to be increased in value are shown with

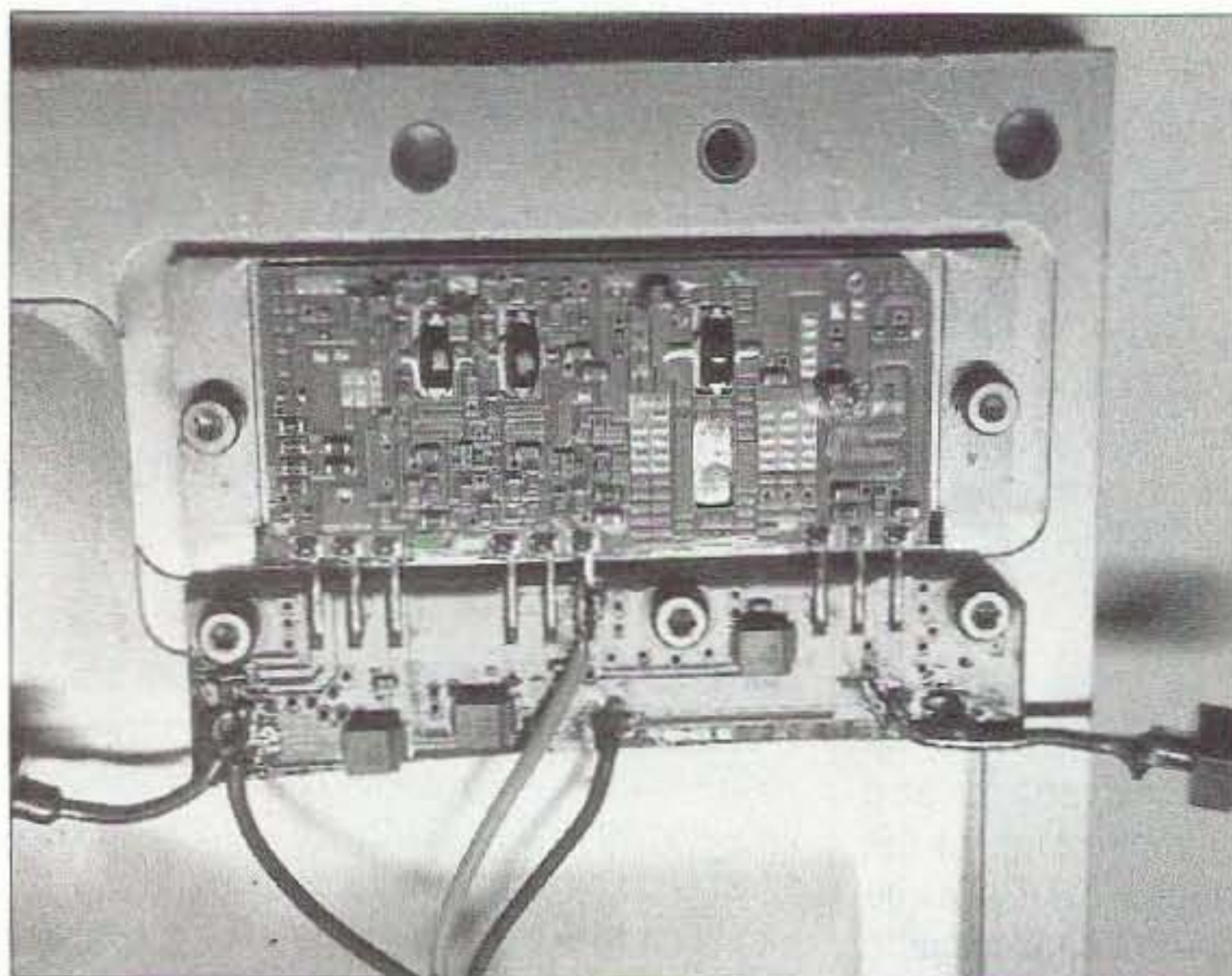

Photo A. A picture of the internal workings of a Fujitsu FMC1616L1015 power amplifier for the 1600 MHz satellite telephone service. Like most power modules that are sealed, this device has a cover that can be pried open and modified. Please note that there are four chip capacitors. This is where additional 0.05-inch chip capacitors will be mounted piggyback on top of the existing chip capacitor on the PC board amplifier to lower frequency of operation.

When the Fujitsu modules were located in surplus and the details on their performance capabilities were realized, we knew a conversion to 1296 MHz was going to be attempted. Looking at the Fujitsu FMC 1616L1015 specification will show you the interest we had when its ratings were obtained. Its main frequency of operation is centered on about 1616 MHz and was intended for use in the Globalstar fixed telephone system. The PA requires +9 volts @ 2.5 amps, +7 volts @ 1 amp and -4 volts bias.



Photo B. Test bench devices used for testing the amplifier include RF sweeper (not shown) for RF drive. For measurements I use both a Bird 43 power meter for coarse work and a HP432 power meter for more exact results. I like to use the Bird 43 RF power measurements and the HP432 and suitable attenuators to do the final exacting measurements.

a circle drawn around them individually. Other nearby chip caps are shown to provide a layout perspective of the board's component parts. Resistors and other circuitry were not shown — just the major chip capacitors to reduce confusion and give a perspective of the board layout as to which chip capacitors to increase in value. We used a small, miniature, 0.05-inch chip cap to

modify the amplifier. If larger capacitors are used, the necessary amplifier cover might short them out to the cover, which is ground when cover is reattached. We will supply the necessary chip caps with the amplifier PC board obtainable from the author.

Instructions

Installing the chip caps can be dangerous,

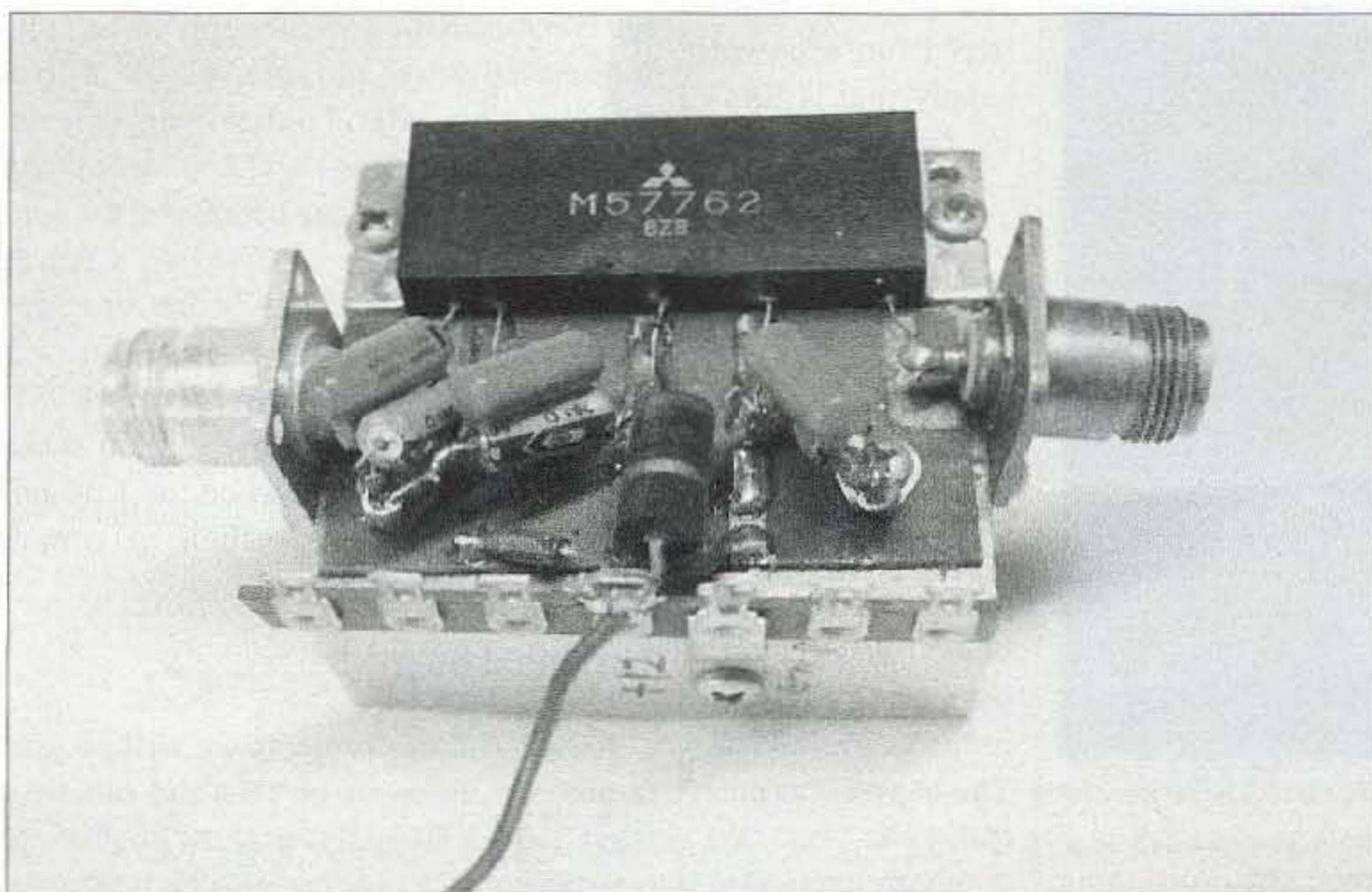

Photo C. Mitsubishi M57762 5-watt commercial 1296 MHz amateur band amplifier. Note the large-style components used in this older amplifier. This unit is sealed in black epoxy unlike the Fujitsu Module. A rebuild using chip electrolytic and bypass capacitors is in order. After some 8 years, this workhorse module still functions.

especially if you drop the chip caps on the floor or in a rug. A familiar problem comes when you grab them with a pair of tweezers; if you pinch them too greatly, twang, the chip cap flies off to never-never land. Best to work with good lighting on a sheet of paper or something to give you contrast to the white chip cap, and work with only one at a time. Locate the first capacitor to receive a piggyback chip cap. Add a small dot of solder to one end of this chip cap on the PC board. This is to facilitate receiving the new capacitor on top of the target chip cap. The solder dot added to the cap will be enough to tack solder in place one end of the modification capacitor.

I use a small surgical tweezers to hold and position the chip cap in proper place and then just touch solder the chip cap's one end to the bottom chip cap. Examine position, and if all is OK, solder the other end of the chip caps together. Resolder the first end over again to make it a good connection and do not leave any solder spikes to short out when the cover is placed back on. Additionally, the new chip cap should lie as flat on top of the existing chip cap as is possible for cover clearance. Repeat the procedure for the remaining three chip capacitors to be so modified.

DC power leads need be nothing more than standard stranded hookup wire. I found a short section of stranded 20-gauge wire that must have had 50 different color conductors. Striping the insulation cover produced several different colored wires: black, red, green, blue, yellow, to mention a few. I purchased a 5- to 10-foot section of the cable and cut it up into 1- and 2-foot sections for a wire junk box. It's proven to be quite handy. When I need bias I pull yellow, ground black and +DC red, or whatever color needed to run simple wiring needs. It's worked out well over the years. I'm still working on the 5- or 10-foot section I stripped down to the wire box.

For coax connections, look for small diameter microwave-rated shielded coax with a connector you normally use, like an SMA male or female connector, attached to one end. It's good material to add to your junk wire box, be it hard coax line like .141 solid copper jacket or its smaller brothers the .085 and .041 hard line. It all has its uses and will be used on a project sooner or later. The .141 solid jacket coax is a little hard to form to my needs but the smaller variety (.085 and especially the .041) bend and form to fit quite well for circuit modifications, especially in tight soldering spots.

Don't use RG-174 miniature coax, as it tends to be too lossy and the soft insulation

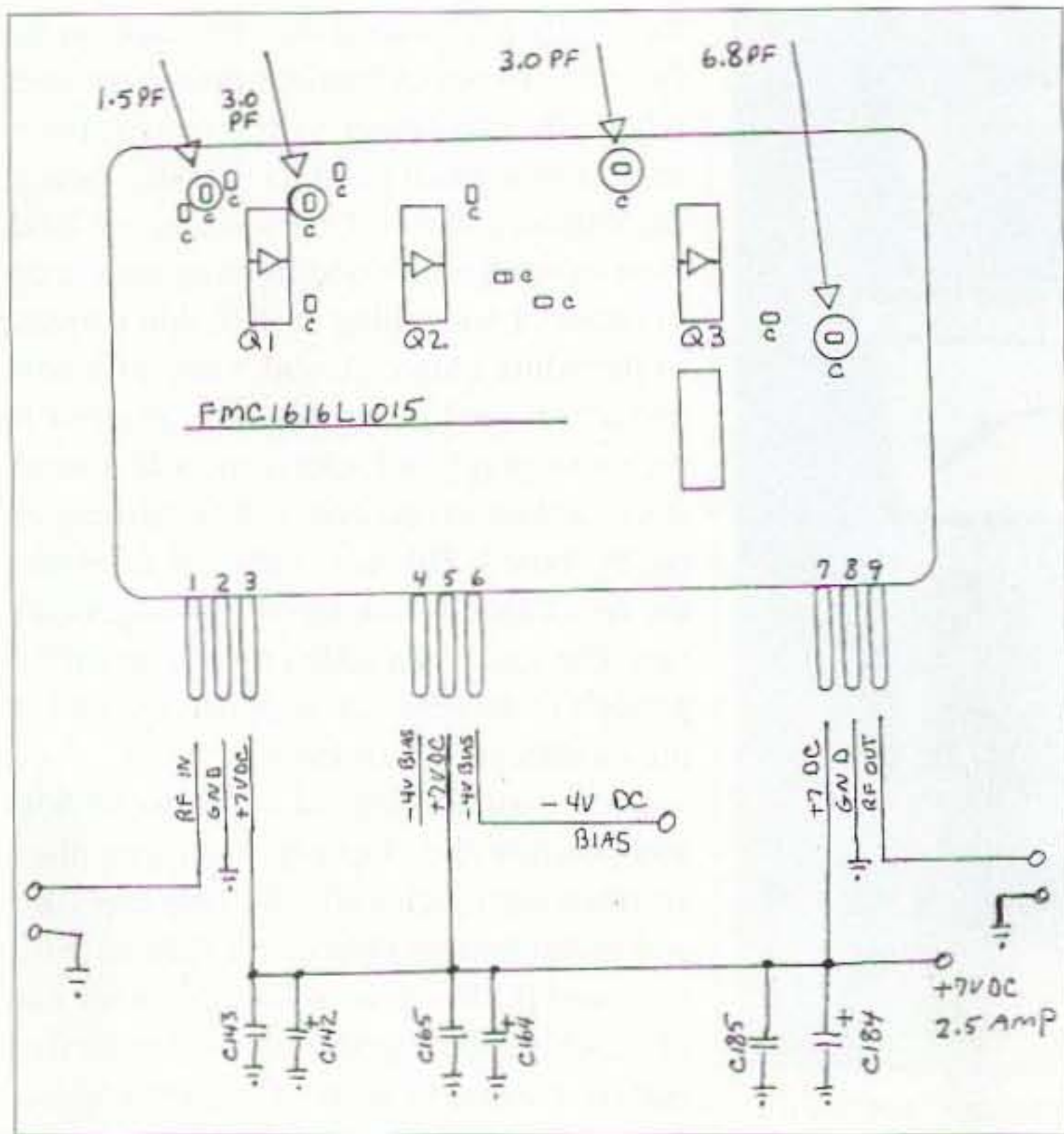

Fig. 1. The internal circuitry of the Fujitsu power amp's three-amplifier stages. Shown in detail on the drawing are the chip capacitors noted as "C" and the three power amplifier devices. The four chip capacitors with circles around them are the chip capacitors that need additional capacitance to lower the frequency of operation into the 1296 MHz amateur band. I used 0.05-inch-size chip caps in this conversion. The more common surface mount chips caps are too large to mount on top of the existing circuit's capacitors.

is apt to burn while you are soldering. Teflon coax of nearly the same dimensions as RG-174 works out well and stands up to soldering

conversion is not difficult. Main power supply requirements at a minimum of about 3 amps at 7 volts is necessary to give some

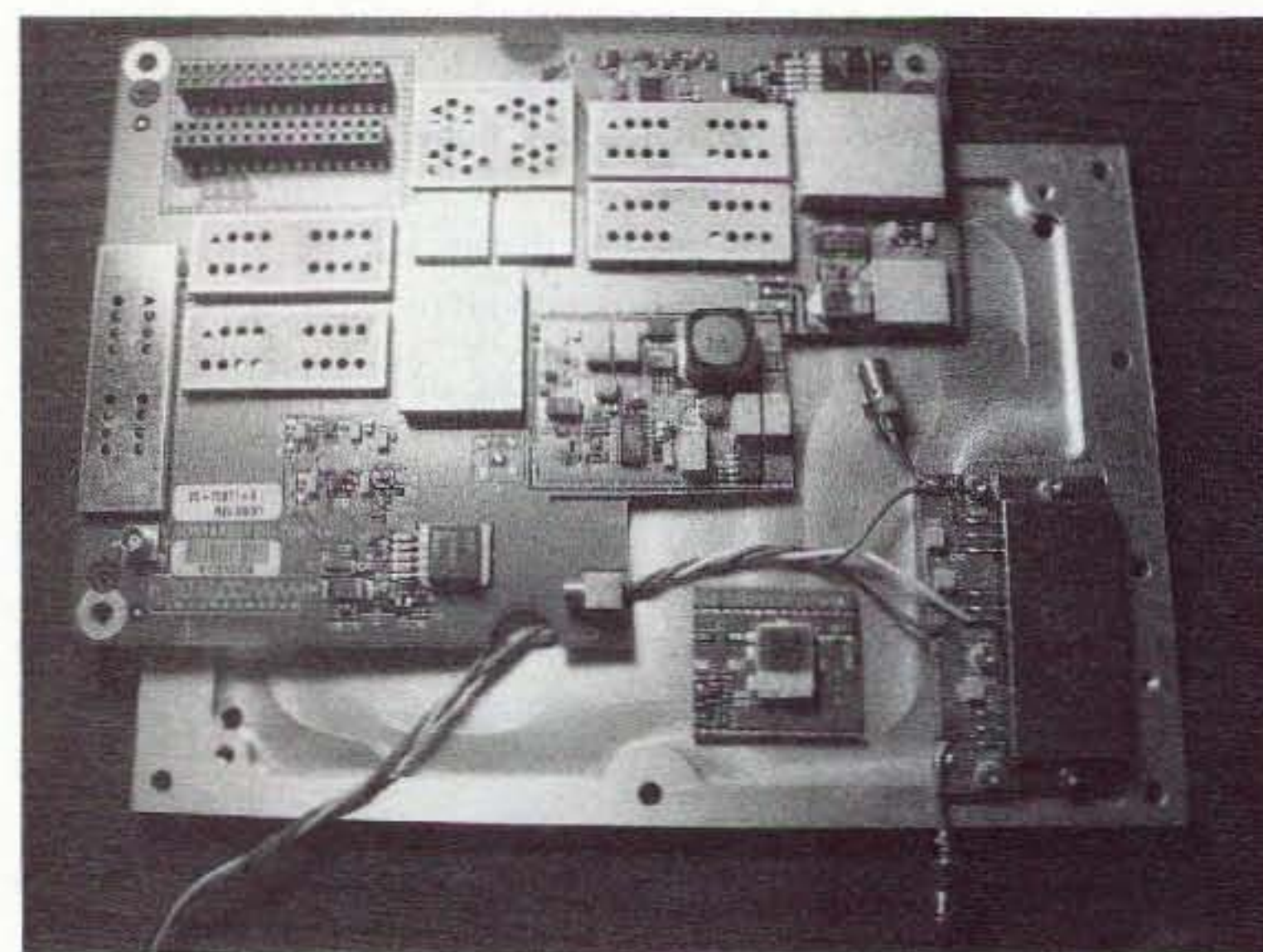

Photo D. This is the original PC board from which the high power amplifier is cut. The smaller PC postage stamp board shown is a 1600 MHz filter that can be converted to a 1296 MHz filter. For details look on the Web at [<http://www.ham-radio.com/sbms/sd>]. Look under technical papers from the SDMG 1296 MHz transceiver for expanded details on this 1296 MHz system and filter details.

abuses. It's kind of hard to melt Teflon or short out a miniature coax connection when Teflon insulation is used. Keep an eye out at swap meets for short sections of Teflon miniature cable with an SMA connector on one end. I will bet the material can be picked up for very little cost. Then cut it to the length required, and you do not need to go through the time-consuming processes of attaching an SMA connector to a short section of coax. It's already done. A great junk box item that not only saves time but money as well.

Testing the converted power module

The test and evaluation of your conversion is not difficult. Main power supply requirements at a minimum of about 3 amps at 7 volts is necessary to give some comfort level lest you get false readings from a power supply that is folding back in voltage as it cannot deliver 3 amps of current for the positive supply. Power connection for the single +7 volt supply can be made to any of the electrolytic capacitor positive trace on the PC board, as all + DC pins are tied common on the board. The -4 volt bias pins (pin 4 and 6) are tied common internal to the amp chip and only one pin need be wired out for -4 volt bias control. I made

my connection to pin #6 for -4 volts bias. The metal heat sink is cut out slightly larger than the amplifier, allowing bolting the metal frame to a larger surface heat sink such as the metal plate of a cabinet.

I suggest keeping the top section of the original heat sink just above the cover plate of the amplifier, where there are three holes in the original heat sink plate. These holes can be used to firmly attach to a bottom metal plate for good heat sink transfer of heat. Use some heat sink grease to maximize heat transfer. A little bit will do the trick.

Testing

For workbench test connections, apply -4 volts bias first, then apply the +7 volts DC. Watch current readings on the +7 volt supply — it can be an amp or more. Then, if all is still well, apply RF at 1296 MHz. RF drive from my HP-8620 Sweeper will provide about +17 dBm, which is overdrive. Reducing drive to something in the +5 to +10 dBm range is more normal for actual simulated drive conditions. With +10 drive idle current of the amplifier was in the 1.5 amp region and with RF drive applied RF output power went to +36.5 dBm, just about 5 watts of power. Current increased from 1.5 amps to just over 2.5 amps at full RF output of 5 watts.

I had to try the mod to provide +9 volts to just the final stage #3 amplifier with +7 volts going to the first two stages, bias remains at -4 volts. I was in a hurry so I just tried to kick the tail of the dragon and see what happens. I disconnected the +DC voltage and raised the power supply to +8 volts and applied power and received +38.2 dBm output at 1296 MHz. I did not want to leave overvoltage on stages 1 and 2 so I shut down the power supply before I damaged the unit. Maybe next time I will build up a power supply from +9 volts and +7 volts for stages 1 and 2. And give it a go. But for now 5 watts is plenty for my 1296 MHz FM/SSB station that is all home-brew. I am satisfied with its basic operation, as I do not want to stress things to their maximum limits.

Technical help

As with all our projects we will be glad to answer questions on this and other related items. Our goal is to show you how to interface and change circuits, be it this amplifier or some other device you have. This is just a concept on how to use material for

Emergency HF Operations

With every challenge there is, by definition, an opportunity. With recent events, what are the opportunities that present themselves to the amateur radio community?

Although this column focuses on three different areas, mobile — portable, and emergency communications — to a great degree they tend to intertwine. The ability to provide communications to support a community effort, whether it is a routine event like a parade or “fun run,” or a disaster, requires that we set up communications in a manner that supports the event. In some cases, this means that some or all of the radio operators will be at the scene, and if so, the ability to set up a station in an unexpected location on short notice will be critical. We tend to assume that the focus will be on short range communications, and this can often be quickly and easily done by use of UHF and VHF equipment.

However, amateur radio may no longer be the primary method to provide short range communications during a disaster. Public service radios are becoming more flexible and even the cell system has made major advances. It is safe to assume that eventually these systems will increase in

reliability to the point where they will continue to operate to full expectation even under the worst of conditions. What will amateur radio’s role be when that happens? If we are going to continue to be an important asset, we need to be able to provide other appropriate services.

Let’s create a generic emergency, add a couple of assumptions and see what opportunities exist. First, let’s assume that regular power is not reliably available. Second, assume short range communications are being adequately addressed. There may even be some local telephone service. What services might be required that we can offer?

This scenario is within the realm of possibility. There are various traditional scenarios that involve the loss of a major switching point for the long distance lines, such as an earthquake along the New Madrid fault in Missouri. Of course, a terrorist attack could accomplish the same thing, and would be a significant event. Even worse, this could be accomplished not only

by a physical attack on the facilities, but potentially by hacking into the control computers while the terrorists sit safely in some far off land. This type of incident could equally affect the Internet either by direct attack or by the Net being impacted as millions of people try to access it (as occurred during the attacks on September 11, 2001). If so, we might be called upon to provide long range communications. In case we are called upon, we must be thinking of ways in which we could provide for the accurate and rapid handling of a significant amount of message traffic.

If we are going to meet this need, we will need to think through how we would do so. Perhaps the biggest challenge is the need to assemble the equipment. While it may be easy to grab the handie-talkie and head out on a moment’s notice, it will be a little more difficult to rapidly assemble a station to work effectively on HF. In most cases, the equipment that is used for regular ham operations will have to be disconnected and transported to the emergency support location. In some respects this parallels what happens on Field Day or for a special event station, but in those cases there is time to plan and discuss how everything is going to be handled. For Field Day, we may know that Bob will bring his all-mode HF rig this year because Bill will be out of town. Unfortunately, when a disaster strikes there is precious little time to begin the planning process. Instead, we should plan now for what might be needed. I’d recommend that your club or group develop a plan with who brings what, and then reviews that plan at least once a year — perhaps as a regular meeting topic. Here are some of the things that need to be discussed now so that there can be a rapid response in the future.

1. HF rig — While there are some great QRP rigs available, in disaster support you will want to have a full-featured rig with a

Wire Lug

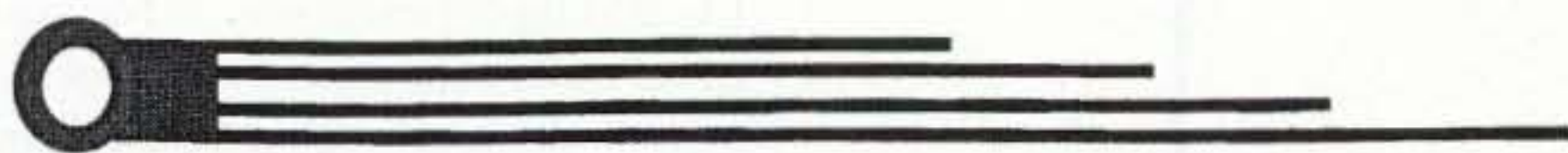

Multi-Conductor Rotor Wire

Use shrink tubing at end of wire

Suggested lengths: (Calculated as $234/\text{frequency in MHz}$)

80 Meter Radial: for 3.93 MHz 59' 6"

40 Meter Radial: for 7.26 MHz 32' 3"

20 Meter Radial: for 14.29 MHz 16' 5"

10 Meter Radial: for 29.1 MHz 8' 5"

Fig. 1. If you plan on using a vertical for portable HF operations, you should plan on using radials. These can be made in advance from multiconductor rotor cable with each wire cut to a different band. Plan on three or four radials that can be coiled up until needed.

**LOW PROFILE HF ANTENNAS
THAT REALLY WORK!**
"Work the World Without Working Up the Neighborhood"

ISOTRON
BILAL COMPANY
Call for a FREE Catalog:
719/687-0650
137 Manchester Dr.
Florissant, CO 80816
www.rayfield.net/isotron



Say You Saw It In 73!

reasonable amount of power. In most cases, this will mean about 100 watts — enough power to be heard while able to be used with most easily assembled antennas. It should at least offer both upper and lower sideband, and be capable of running digital modes at a high duty cycle. Dual VFOs would be good as would expanded coverage for Military Affiliate Radio Service (MARS) and Civil Air Patrol (CAP) frequencies. If the rig can tune 10, 15, 20, 40, and 80 meters for the ham bands you will have good coverage for most propagation conditions.

2. Required ancillary equipment — I recommend two microphones and headsets and an extra power cord as well as extra fuses. You will also need a power supply for operating from AC line power when available,

as well as an alternative power source such as a deep cycle battery. If you use a battery, it will need some means for recharging. This could be a sophisticated power source such as a solar panel, or something as simple as jumper cables, to allow you to periodically refresh the battery by connecting it to an automobile.

3. Antenna — Something versatile and quick to assemble. Possibilities include a random-length long wire. Used with an antenna tuner this can be very flexible. Two insulators, a spool of insulated wire and some rope and you can at least get on the air. The only coax required is enough to connect the transceiver to the antenna tuner. You'll need some type of ground and a way to connect to the ground. You may prefer a dipole of some type, and they can also be easy to erect. If you have any type of wire antenna, the antenna can be coiled and stored in a large plastic bucket with a snap-on lid. Usually there will be room for the antenna and any auxiliary items. For any type of wire antenna, you'll need some method for getting the antenna up above ground level. A large ball of string and a weight that can be thrown or launched by a slingshot will be essential if there are suitable supports in the area.

I've seen verticals used effectively in a rapid deployment situation. Generally it is best to have a vertical that is designated to be used for emergency situations rather than

trying to disassemble your home antenna. If you plan on using a vertical, here are a few hints:

(a) Long before you expect to need it, set the vertical up and tune it, then break it down into three or four foot lengths. When you disassemble it, mark where one tube fits into the other with magic marker so you can slide the pieces back together to the correct lengths. Tape the disassembled sections together along with the correct-size wrenches and screwdrivers needed to reassemble the antenna.

(b) Make radials that can be quickly and easily deployed. I use multiconductor wire such as the type used for antenna rotors. You can trim one conductor for your preferred segment of the 80-meter band, the next for the 40-meter band and so on. By having the radials available, you can set this antenna up at ground level or on a roof top. (See Fig. 1.)

(c) Some means of erecting the antenna. For ground mounting into soil you'll need a length of the appropriate-diameter pipe and a sledge hammer. For any other location, a sturdy base and rope for guy wires. Plastic tent pegs are good for securing guys into soil. On a rooftop or parking lot, sandbags or buckets filled with water or dirt can do the trick. (See Fig. 2.)

(d) I would recommend bringing an antenna tuner along if possible. An antenna perfectly tuned back home will not necessarily exhibit the same characteristics when installed somewhere else. The antenna tuner may help you avoid damaging your rig.

(e) And finally, don't forget to bring along plenty of coax.

4. Recommended accessories — I would strongly recommend a TNC and a laptop with software to run PACTOR. This would provide compatibility with MARS as well as a way of sending text messages that would not be copied by the casual listener. An old laptop can be used as a terminal, but I would figure some way to bypass the internal battery and run it from gel cells. Those of us who travel with a laptop know how unreliable the internal battery is.

I'd strongly suggest some redundancy. I'd much rather have one rig up and running and two others locked in trunks in the parking lot than have only one rig that might fail. And all of these ideas are in addition to the usual grab-and-go materials, including pens, paper, clipboards, extra clothing, snacks, small tool kit, etc.

Next time, I'll be discussing operating options at the scene. In the meantime, let me know what you think is essential for emergency HF operations.

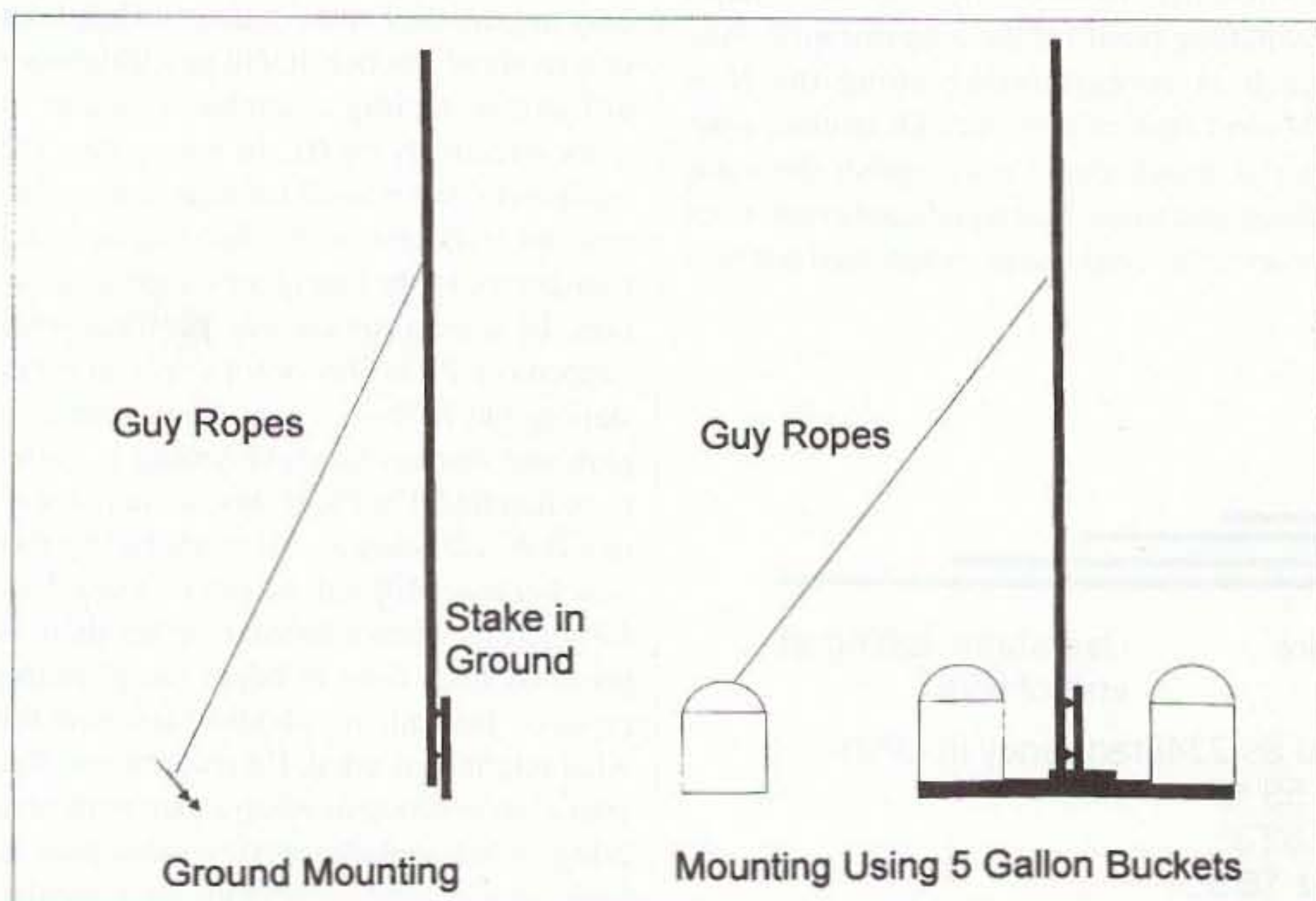

Fig. 2. A vertical antenna can be readily mounted in several ways. On the left, the radial is mounted to a post driven into the ground and guyed with ropes attached to plastic tent pegs. On the right, the antenna is mounted to a post attached to a flange on a sheet of heavy plywood. Five gallon buckets filled with water or sand are placed on the plywood and anchor the ends of the guy ropes. Empty buckets are easier to transport and the weight can be added at the site.

ADVERTISERS' INDEX

R.S.#	page	R.S.#	page	R.S.#	page	R.S.#	page
• A & A Engineering	18	• Communications	42	• Isotron	48	• Radio Book Shop	22
• Alinco	CV2	• Electronics, Inc.	5	• M ²	58	• Radio Book Shop	31
• Alinco	CV3	10 • Communications		• Maggiore		• Radio Book Shop	33
• All Electronics Corp.	11	• Specialists, Inc.	17	• Electronics Lab	17	• Radio Book Shop	35
• Amateur Accessories	33	• D & L Antenna		• Maxx-Com	13	• Radio Book Shop	48
16 Astron Corporation	2	• Supply Co.	33	• Michigan Radio	49	• Radio Book Shop	63
• ATOC Amateur		13 Doppler Systems	21	160 Micro Computer		34 Ramsey Electronics	3
• Distributing LLC	CV2	• Fair Radio Sales	52	• Concepts	52	• RLS	15
• ATOC Amateur		193 GGTE	58	193 Morse Tutor Gold	58	• Scrambling News	29
• Distributing LLC	CV3	• Ham Ambassadors	38	• Omega Sales	21	• SGC	15
42 Bilal Company	48	• Ham Mall	17	• Omega Sales	31	• Universal Radio	29
168 Buckmaster Publishing	18	• Hamtronics, Inc.	9	• Omega Sales	52	• W5YI Group	35
56 Buckmaster Publishing	35	• Houston Amateur		• Radio Book Shop	15	• West Mountain Radio	7
99 Communication Concepts	33	• Radio Supply	35	• Radio Book Shop	21	• Yaesu	CV4

When you buy products from these advertisers, please tell them that you saw their ads in 73.
 Subscribe to 73 right now...call 800-274-7373 (9-5 Monday-Friday EST).

WE SHIP WORLDWIDE
Michigan Radio
 SALES SERVICE

Local & Tech 1-810-771-4711, Service 1-810-771-4712, Fax Service 1-810-771-6546

OPEN
 TUES, WED, THUR 10-6
 FRI 11-8
 SAT 10-3
 CLOSED SUN & MON



Terms do not include shipping. Price and availability subject to change without notice. Most orders shipped same day. COD's welcome (\$5.50 & shipping).

26014 Groesbeck, Warren, MI 48089
1-800-TRU-HAMM (orders only)
 (800-878-4266)

Now on the World Wide Web

<http://michiganradio.com>

E-mail mirad@mich.com

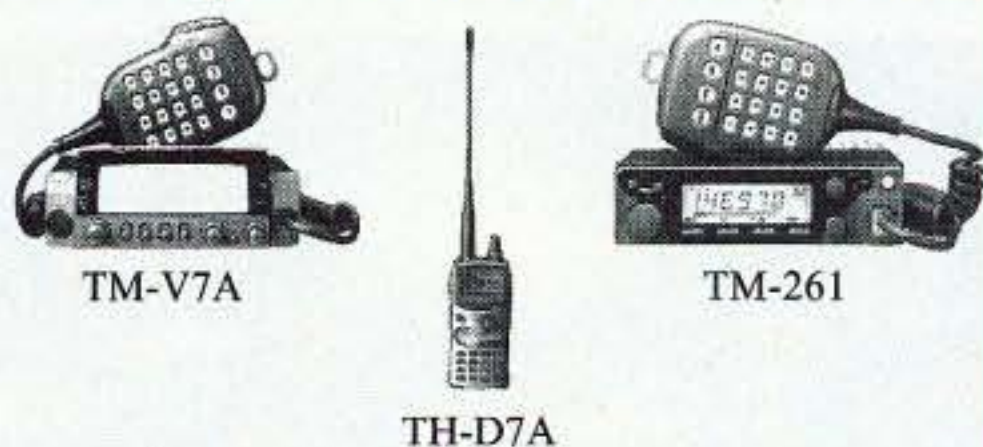

KENWOOD



ICOM

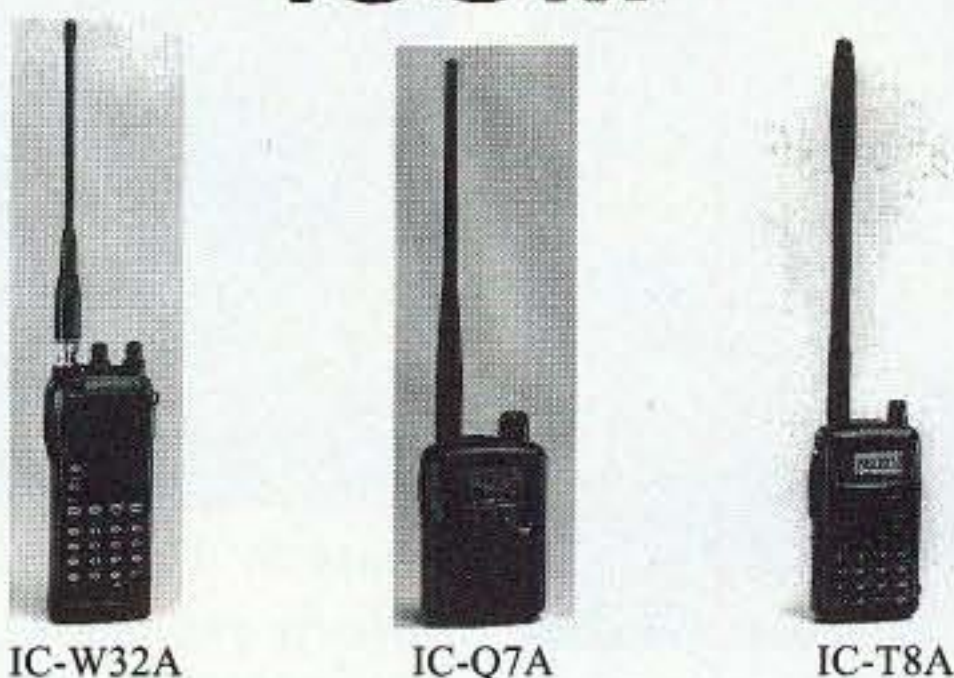

YAESU



Convert Excess Equipment to CASH • We buy good, clean, used equipment • Estate Sales

ECHO and EAGLE

AMSAT-NA, The Radio Amateur Satellite Corporation of North America, has two major near- and long-term projects mapped out for the future; AMSAT-OSCAR-ECHO and EAGLE. Both are ambitious, but neither will be of the magnitude of the AMSAT-OSCAR-40 program.

In mid-January, the AMSAT Board of Directors held a teleconference to discuss an opportunity to build a new low-earth-orbit microsat. Subsequent meetings and discussions in February and April have gelled into a plan for a complex microsat to be ready for launch late next year.

Why ECHO? On March 5, 1978, AMSAT-OSCAR-8 achieved orbit riding a two-stage Delta 2910 launcher from the NASA Western Test Range in Lompoc, California. Prior to launch, this hamsat was known as AMSAT-OSCAR-D, or just AO-D. It was the fourth AMSAT satellite project. AMSAT has been involved with a number of satellites since then. AMSAT president Robin Haighton VE3FRH has announced a return to the original sequential project designators for the new AMSAT project; thus AMSAT-OSCAR-ECHO, AO-E, or just ECHO.

The original microsats, AMSAT-OSCAR-16, Dove-OSCAR-17, WeberSat-OSCAR-18, and LUSAT-OSCAR-19, were launched together on January 22, 1990, as secondary payloads on an Ariane rocket. These small satellites are cubes about 10 inches on a side and weigh about 18 pounds each. The basic design was excellent, and other satellites like ITAMSAT-OSCAR-26, AMRAD-OSCAR-17, Mexico-OSCAR-30 and SAUDISAT-OSCAR-41 are variations and improvements on the originals.

SpaceQuest, of Fairfax, Virginia, has been using the microsat format for a number of years, and has been a participant in a number of microsat-based programs like AO-27. SpaceQuest is to provide the basic satellite bus for ECHO and some of the subsystems. Thanks to advances in electronics, more functionality can be built into ECHO, while still keeping it small. Solar cell efficiency

and battery capacity are also up in the last decade, so more power will be available for the experiments and radio gear.

ECHO is to have five internal trays and weigh about 22 pounds. The size should be like that of the original microsats, about 10 inches on a side. Receivers include four VHF units, a multiband, multimode system, a low-frequency receiver, and an L-band digital receiver. Transmitters include two UHF units with a true circular-polarization antenna and an S-band digital system. The digital capability is to include ADCARS (Advanced Data Communications for Amateur Radio Service). Other onboard systems are to include full telemetry, GPS (Global Positioning System) receivers, APRS (Automatic Packet Reporting System) capability, and an active magnetic orientation system.

The cost of ECHO to AMSAT has been

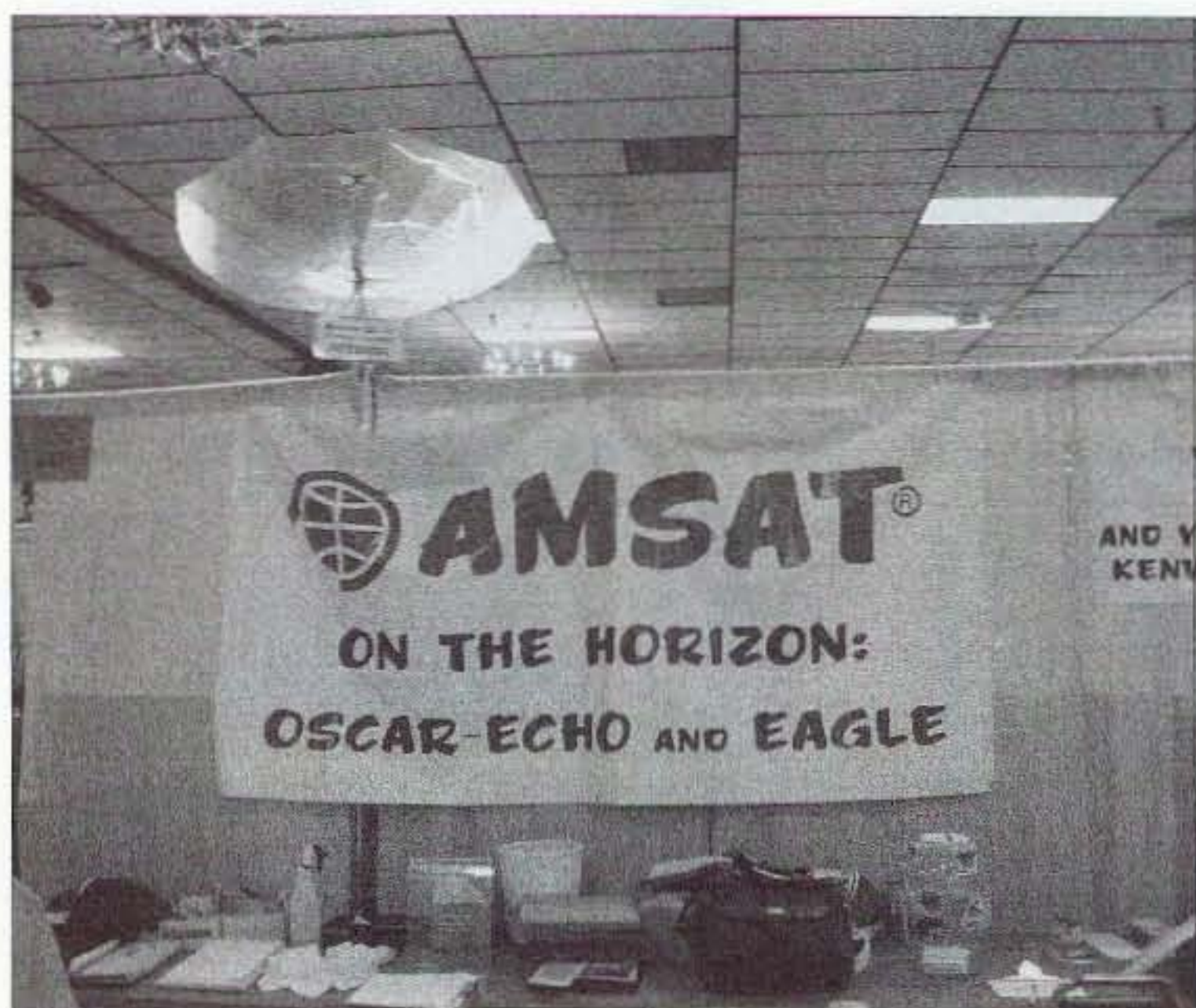

Photo A. The AMSAT booth at the Dayton 2002 Hamvention. (N5EM photo)



Photo B. Another view of the AMSAT booth at Dayton. Note the full-size engineering model of ECHO in the lower left just in front of Frank Bauer KA3HDO. A model of PCSat (N-O-44) is also on display. (N5EM photo)

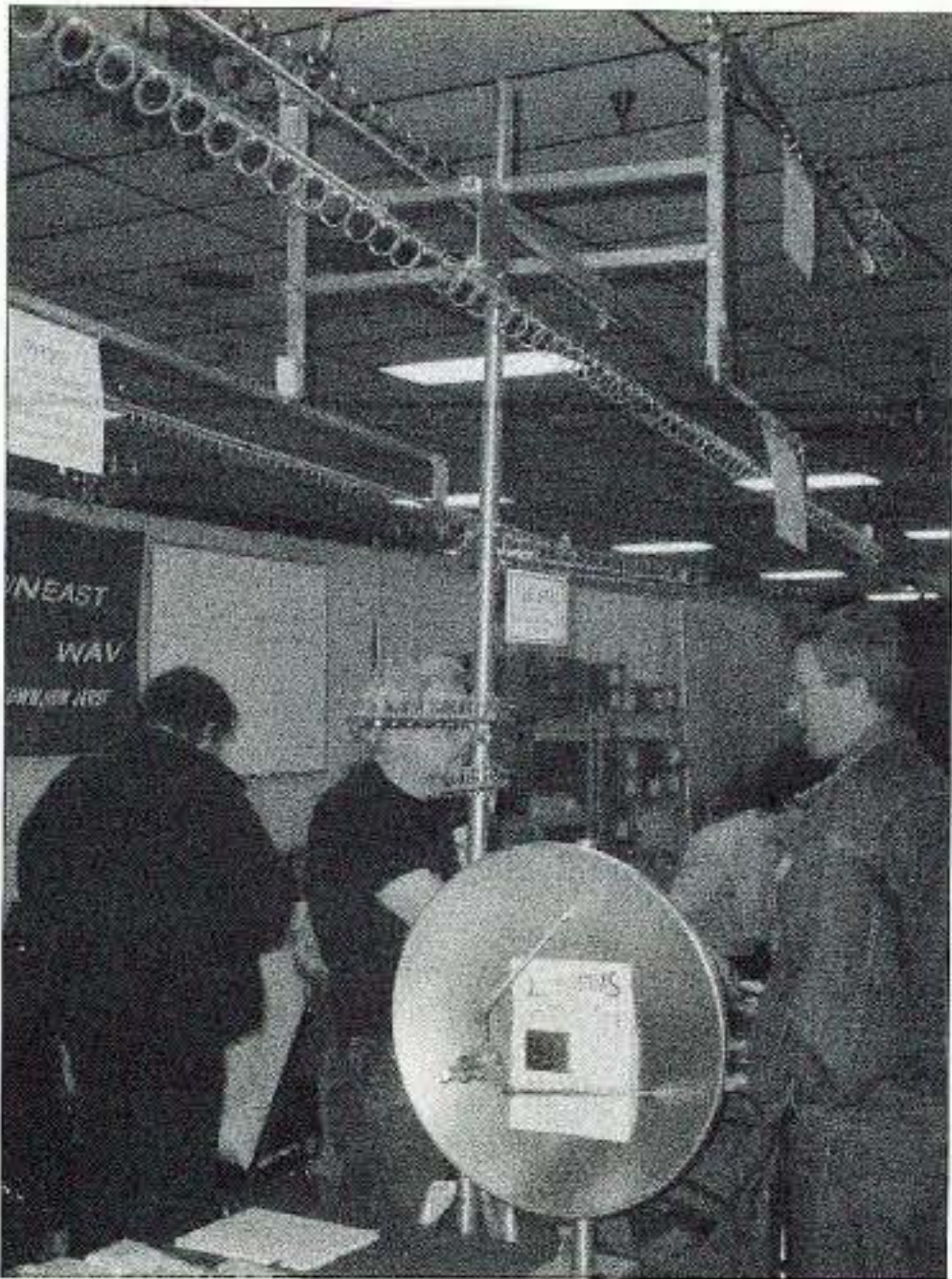

Photo C. Downeast Microwave had plenty of antennas and microwave gear at the Dayton event. (N5EM photo)



Photo D. Many hams are quite familiar with the satellite antennas manufactured by M-Squared. (N5EM photo)

estimated at \$200,000. Although this is small compared to the cost of AO-40, it is still significant, and will require support from the amateur community and AMSAT membership. Full technical details about ECHO are available in an article by Rick Hambly W2GPS in the May-June issue of *The AMSAT Journal*. The *Journal* is included in AMSAT membership. To join AMSAT, call toll free 1-888-322-6728 or write to: AMSAT, 850 Sligo Ave., Silver Spring MD 20910.

EAGLE

AMSAT's longer-term and even more

ambitious project is called EAGLE. Originally this satellite was expected to weigh in at over 200 pounds and cost about \$600,000, not including launch. The cost has not changed, but once again, due to advances in technology, the designers feel that the mass can be reduced. The weight is now expected to be just over 100 pounds. The orbit is expected to be elliptical and similar to that of AO-40, but with a lower apogee (orbital high point).

Digital voice and computer experiments on ECHO are expected to provide valuable experience for the design of EAGLE. The design phase of EAGLE should be complete

in late 2003, with full integration done in 2005. AMSAT is currently searching for a launch opportunity in 2006. The new size and weight parameters for the spacecraft may allow AMSAT to look beyond the usual Ariane launcher to get EAGLE into orbit.

While not all of the experiments and systems for EAGLE have been decided, some basic



Photo E. Roger Ley WA9PZL and Doug Howard KG5OA discuss satellites at the AMSAT booth during the Arlington, Texas, Ham-Com 2002.

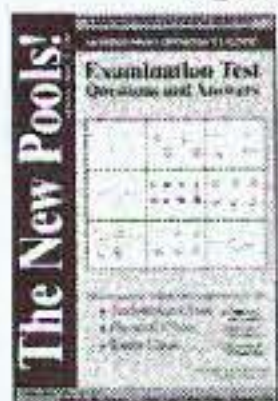

Photo F. A better view of the complete, fully functional AO-40 ground-station antenna system on display and used at Ham-Com 2002 for demonstrations. The system has a linear yagi for the 70-cm uplink and a BBQ-grill semidish with modified commercial downconverter for 13-cm receive.

The New Pools!

Examination Test
Questions & Answers

The exact questions, multiple choices
and answers for the Technician Class,
General Class, and Extra Class
operator's license.



Only
\$9.95
Plus \$3.50 S&H

Omega Sales

P.O. Box 376
Jaffrey, NH 03452
800-467-7237



Repeaters

6 & 2 m & 440 On your frequency
\$399.95 & \$499.95

Repeater Controllers

RC-1000V \$259.95 / RC-100 \$129.95

Micro Computer Concepts

8849 Gum Tree Ave

New Port Richey, FL 34653

727-376-6575 10 AM-10 PM

e-mail n9ee@akos.net

<http://mcc.stormfan.com>

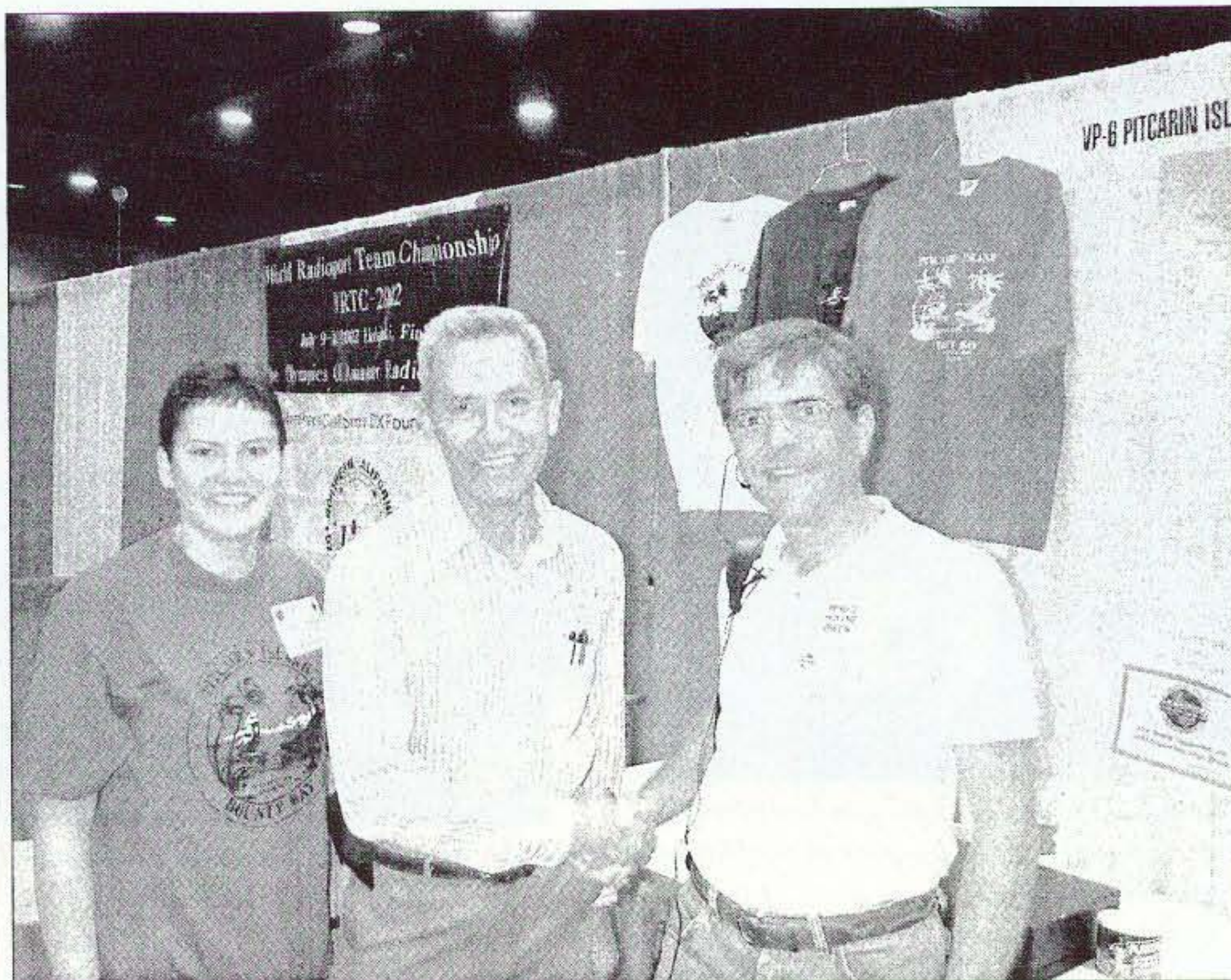

Photo G. My first satellite contact with Pitcairn Island was in 1992, but I had worked Tom Christian VR6TC on 20 meters 21 years earlier. It was great to meet Tom and Sheri Christian in person at the Arlington, Texas, Ham-Com 2002.

parts include transponders using two meters, 70 cm, 23 cm, and 13 cm. A simple kick motor will also be needed to boost the perigee (orbital low point) after release from the launcher, and to allow ground controllers to actively deorbit the satellite when it is near its end of life. EAGLE promises to be an exciting follow-on to AO-40 as a high-altitude DX satellite.

AMSAT at the shows

AMSAT has been working hard to promote the ECHO and EAGLE projects for the future of amateur radio in space, and also to demonstrate how easy it is to use AO-40 today. The complexity of a fully functional AO-40 station is barely more than that of a station used for AO-10. In fact, due to the much smaller size of the required antennas, demonstrations have been much easier for AMSAT Area Coordinators and other volunteers. AMSAT had small systems on display at their booth at the Dayton, Ohio, Hamvention, and just a month later at the Arlington, Texas, Ham-Com 2002.

A complete antenna system for AO-40 can be easily mounted on a tripod. For 70 cm, a 10-element linear yagi will do the job with a short run of quality coax back to a 50-watt, all-mode transmitter. On the 2.4 GHz (13 cm) downlink, a BBQ-grill-style semidish with a converted commercial MMDS downconverter, coupled

through some reasonable-quality RG-59 to a two-meter, all-mode receiver is all that is needed for quality reception. Bob K5GNA sold hundreds of plug-and-play antenna/converter packages at Dayton and Arlington.

Don't let microwave phobias keep you off AO-40. It's never been easier. ICOM even markets a 2.4 GHz downconverter to work with their radios that are capable of all-mode VHF reception. For the experimenter, there are plenty of things that can be done to optimize an already-functional system. Improvements include circular polarization on the uplink and downlink, a preamp, screening the BBQ-grill antenna, better cable, and more on-the-air practice.

AMSAT on-line

While the AMSAT Web site [<http://www.amsat.org>] has always been a great source of information, it has not been able to provide an on-line store for books, software, hardware, CDs, and trinkets. That's changed. In addition to the "1-800" number for orders and memberships (1-888-322-6728), AMSAT now has on-line ordering capability. You can securely use your MasterCard or VISA to place an order for just one or several items that AMSAT has available. You can get there via the usual AMSAT site noted above, or go directly to [<http://www.amsat-na.org/s-cart/>].

FAIR RADIO SALES

ELECTRONIC MILITARY SURPLUS

40 Foot Mast Kit

AB-155 Mast Kit, includes eight self-stacking 66" long x 1.6" diameter aluminum MS-44 mast sections to make 40 foot mast. Also 4 each guy ropes MX-381 (40'), MX-382 (31'), MX-383 (50'), one MX-516 rope, 5 each MX-378 guy rings, AB-154 swivel base, six GP-101 15" stakes, and HM-1 hammer; 70 lbs sh. Used, \$225.00 plus shipping.

Electron Tubes, unused originalboxed.

4D32 Raytheon,	\$28.00	5998A Sylvania,	\$16.00
6AJ5 Tung-sol,	\$3.50	6336B Cetron,	\$45.00
24A or 27,	\$9.50	6922 ECG,	\$6.95
30,	\$16.50	7308 Amperex,	\$14.00
955 Hytron,	\$3.50	7360 ECG,	\$29.95

Allow money for shipping on merchandise.

WEBSITE: fairradio.com

E-MAIL: fairradio@wcoil.com

PHONE: 419-227-6573 - FAX: 419-227-1313
2395 St Johns RD - Box 1105 Lima, OH 45802
VISA, MASTERCARD, DISCOVER accepted
Write for latest Catalog - Address Dept. 73

Capacitors - Motors - Relays - Power Supplies - Test Equipment

Radios - Antennas - Roller Inductors - Transformers - Wire - Tubes

More Macros for You

A few months back, I wrote about using macros for rig control with the MixW 2 program. There is a growing interest in controlling rigs from the keyboard these days. To the casual observer/ham, it appeared, for a time, that the rigs such as the Ten-Tec Pegasus had a lock on this sort of control and that would be the rig of choice for remote control.

Other manufacturers have been making rig control available for quite a few years. Even my old IC-735, now obsolete, had a fair amount of control available if you had the correct software and a little patience to get it to perform. Don't let me leave out Kenwood, Yaesu, and a little surprise package — the Elecraft K2 can also sit up and do its own bag of tricks. I don't own or have access to any of these latter rigs, but hams are controlling them quite well.

The important part of controlling the rig from the keyboard is having the control work in conjunction with the other software you are using at the same time. A number of rig control programs have been written which do nothing other than take over the control of the rig, but what most of us appreciate is recording of frequency and mode for logging purposes. A real plus is when the rig control is implemented within a communications program, then we can peak the signal copy by whatever means is available in the rig while continuing the QSO.

Zakanaka-Logger macros

I have had the idea for a while to see what was possible using the Zakanaka and Logger combo for rig control and, as I read the Zakanaka Help file, I realized why there is a group of really devoted users of this software. It does just about everything if you set it up for your personal preferences.

Most of us have personal preferences and you will find the macro commands in the various software packages are dictated first by the desires of the program author. Each of us is an individual.

After working with various programs over the air, I have found a number of macros that are very helpful. Other than the most necessary "CQ" and "Answer CQ" along

with other QSO shortcuts, I like to be able to change frequency, mode, band, and filter without fussing with the knobs on the rig.

My first request on the list for automated frequency selection looked as though it could get difficult until I read the Macro Help File in Zakanaka. I realized, after a few minutes' consideration, there are relatively few frequencies that I regularly switch to when working digital modes.

This made it a little easier, so I experimented a bit and found that if I wished to check the PSK activity on 10, 15, and 20 meters quickly, I could simply program a macro button for individual frequencies and the rig (Icom 756PRO) would go directly to the frequency. So I wrote QSY macros for the three bands — such as \$qsy28120.0\$ for 10 meters — and named that one 10M PSK. Switch between these macros in moments, check the waterfall for activity, and take appropriate steps to make contact.

This might seem that you would set aside a lot of macros, but again, the popular frequencies can be covered easily, especially when you consider there are 36 macros available for PSK and another 36 for RTTY.

My next item in the wish box was the filter selections. This was only slightly more problematic. One Filter command already existed on a button labeled "HEXCOM" (I think). I edited it for the rig at hand and gave it a try, and something was amiss — the program locked up. I had to go into thinking mode. It didn't look as though I had done anything incorrectly.

The problem surprised me. Somehow, whoever had written that macro inserted a colon between the macro command \$hexcommand\$ and the hexadecimal string that followed. I changed it to \$hexcommand fe fe 5c e0 06 01 01 fd\$ and the macro took

off and selected the filter designated as "filter 1" in the PRO.

From there, I was able to quickly write two additional macros to select the remaining defined filters in the PRO. These hexadecimal strings are applicable to the Icom and make it possible for you to select not only filters, but USB and LSB and any of the other controls selectable according to the commands for your particular rig.

I found the information supplied with the rig was a little hard to follow, but there is a great Web site for Icom rig control at [<http://www.plicht.de/ekki/civ/>]. This is an excellent site to scan for other commands for your rig, and it explains the order of those strings. Yes, there is a rhyme and a reason to it all. One of these days, I will happen on similar information for other brands. I know it is out there somewhere.

As I mentioned, I had written some similar macros for the MixW 2 software, so naturally I wanted to have the same result from these macros. This did prove a small challenge, but if I can do it, it cannot be too hard.

One of the macros that comes with Zakanaka uses the "align" command. The off-the-shelf macro when you load the program has \$align\$ written in it three times. I am not sure of the necessity of the repetition, but I decided if that was what the program author found worked best, there would be no argument here, so where you see that in the macros I have written, that is the reason.

Speaking of aligning the signal within the center of the filters, I found that originally the filter was not centered as I had them defined. The simple fix for that in the case of the PRO is simply to adjust the passband filter skirts to fit. They stay at that setting

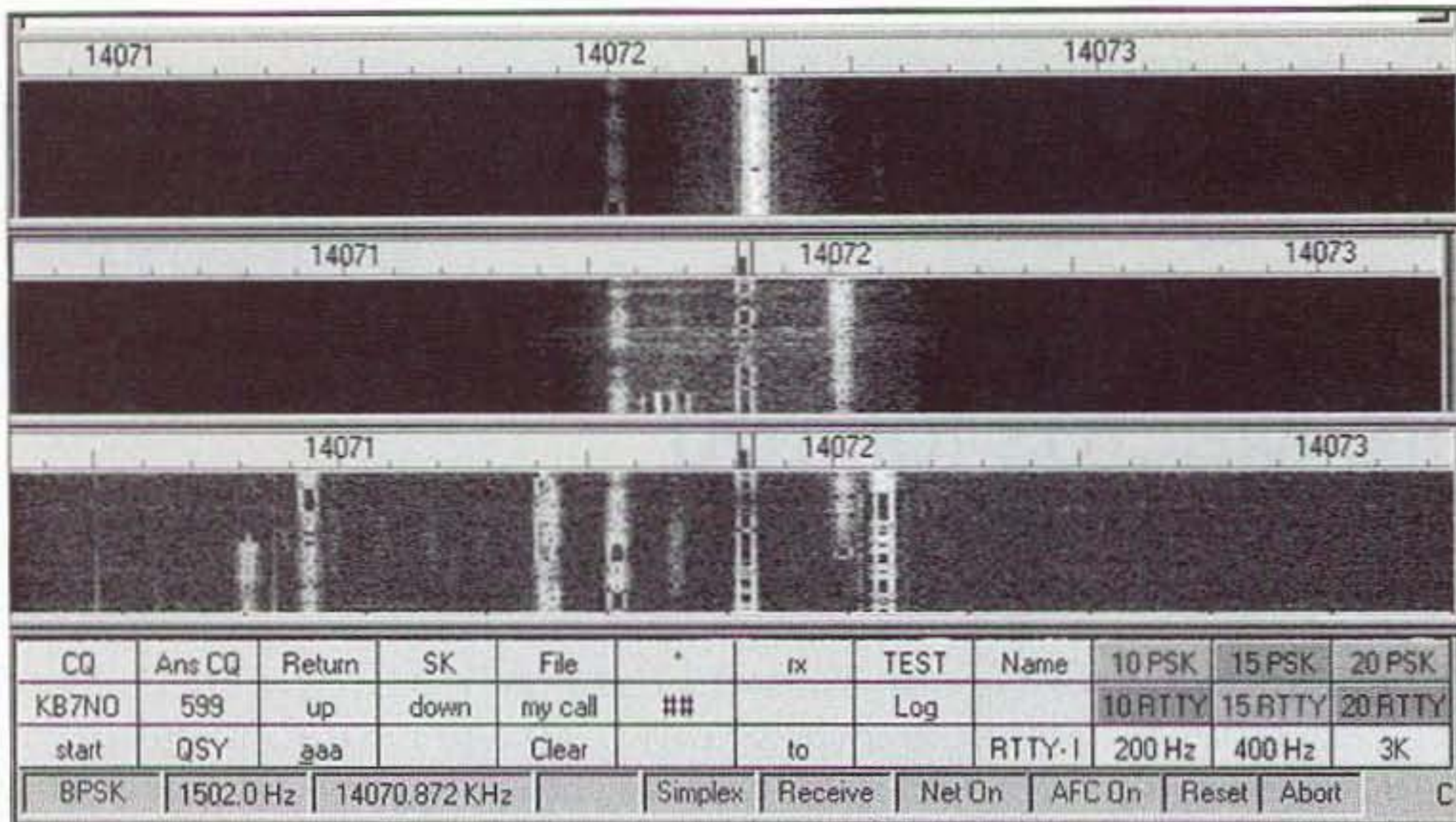

Fig. 1. Screenshot. This is a composite demonstrating the effects of the 3 filters as they progress from wide at the bottom to narrow in the top waterfall. At the bottom are the 36 macro keys. The right group of 9 have been given colors. They are the new macros written as described in the text. The Zakanaka-Logger programs are an excellent vehicle to pass along rig control. There are 36 macro buttons showing, plus another 36 display when in the RTTY mode. The new macros make it possible to switch modes and frequencies with one click or Hot-key. The filter macros enable you to choose the filter and center it on your signal with a single click also. Good filters that are easily activated can save the day on a QSO during marginal conditions. Most modern rigs can be controlled from programs such as these and the operating chore becomes an operating pleasure.

when you turn the rig off and on again, so that was simpler than hunting for a way to adjust the align frequency.

Just as a little aside about using filters with these soundcard modes that already have a DSP built into them; there are times when the band is crowded, or when there is just one really strong signal nearby that ruins your copy. A filter can save the day for you, especially if it is easily activated.

But you still have to be the operator and remember to do it. A few weeks ago I was working a ham on PSK who was running two watts and he was pretty good copy except when the other signals started to crowd him, then the print would deteriorate badly. This was one of my less alert days and it took me a few go-arounds to "get the picture" and recall what I had those filters in there for. I activated the filter and we probably communicated almost flawlessly for another fifteen minutes. It works.

The macros

As you look at the screenshot, you will see there are three rows of macros totaling 36 macros in all. This is only the PSK group of macros. There are another 36 programmable buttons displayed when you switch to RTTY.

I wrote nine macros for this exercise, as follows:

10 PSK (button label)

```
$qsy28120.0$
$bpsk$
$hexcommand fe fe 5c e0 06 01 01 fd$
```

The first line changes the frequency. The second line, the mode. The third line selects the wide filter. It is best to go with the wide filter command in case you were using a narrow filter previously. It saves another click. You are ready to see what is there.

15 PSK (button label)

```
$qsy21069.5$
$bpsk$
$hexcommand fe fe 5c e0 06 01 01 fd$
```

Same reasoning as for the 10-meter macro, except for the frequency.

20 PSK

```
$qsy14069.5$
$bpsk$
$hexcommand fe fe 5c e0 06 01 01 fd$
```

Again, only the frequency change.

10 RTTY

```
$qsy28080.0$
```

```
$rtty-i$
```

```
$hexcommand fe fe 5c e0 06 01 01 fd$
```

In addition to the frequency change, the mode change is to RTTY inverted so you can leave the rig in USB for both modes as you go back and forth.

15 RTTY

```
$qsy21080.0$
```

```
$rtty-i$
```

```
$hexcommand fe fe 5c e0 06 01 01 fd$
```

Just the frequency difference here.

20 RTTY

```
$qsy14080.0$
```

```
$rtty-i$
```

```
$hexcommand fe fe 5c e0 06 01 01 fd$
```

Again, only the frequency change.

200 Hz

```
$align$$align$$align$
```

```
$hexcommand fe fe 5c E0 06 01 03 FDS
```

The first line brings the selected trace to the center of the waterfall. The second line selects the narrow filter which on the PRO is designated 100 Hz, but it is not really that narrow. With a little tweaking I can get good copy on a RTTY signal with this filter setting, but recommend the 400 Hz for RTTY. Incidentally, the filter command is the last command in the string before "FD."

400Hz

```
$align$$align$$align$
```

```
$hexcommand fe fe 5c e0 06 01 02 fd$
```

The only difference here is the "02" filter selection.

3K

```
$hexcommand fe fe 5c e0 06 01 01 fd$
```

Life gets a little easier when we are not aligning anything. This is the wide filter, set at your preference on the rig, and gives the full view of the waterfall.

There is a moment of panic you may experience when you first click a RTTY macro and your nice shiny new PSK macro buttons disappear from view because only the

Continued on page 61

USA ARDF Championships in Georgia — Part 2

Q: What's better than southern hospitality? A: Southern ham radio hospitality! When you get together with hidden transmitter hunters and orienteers in the Peachtree State, get ready for a great time and a serious challenge.

Pine Mountain, a community of about a thousand souls, is an hour's drive south of Atlanta. When it was chartered in 1882 as a railroad stop, the founders named it Chipley. Then in 1952, Cason Callaway opened his gardens to the public. Slowly they grew to today's 14,000-acre resort with nature trails, butterfly center, birds of prey show, and much more. Four years later, the city fathers renamed the town Pine Mountain. Now it's a magnet for tourists from around the country who come for the gardens plus golf, fishing, hiking, biking and now — radio-orienteering.

There's no McDonald's or Burger King

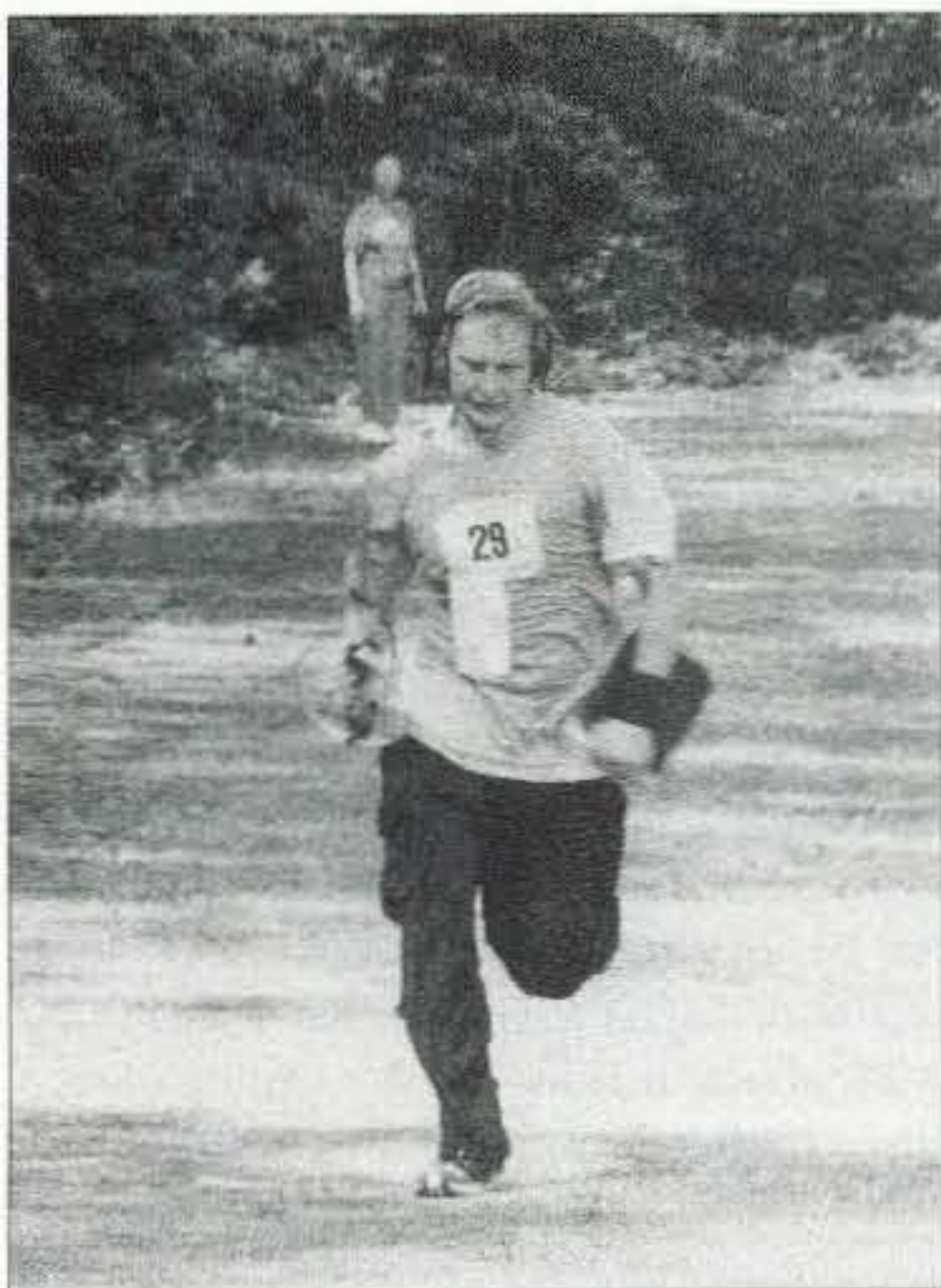

Photo A. Sergei Storkov KD5RNL sprinted through the M21 80m course at just over 15-minutes-per-fox pace to be second overall. In the distant background is April Moell WA6OPS, who spotted bib numbers for the finish line crew as runners emerged from the woods. (K0OV photo)

in Pine Mountain. The locals prefer to live high off the hog, so to speak, if the names of three of the most popular restaurants are any clue: Three Lil' Pigs, Moore's Whistling Pig Cafe, and the Hog Wild Bar-B-Q. Lodging choices range from camping and cabins in the woods to beautiful chalets that are part-time homes for some well-known celebrities.

Last month's "Homing In" introduced the folks in the Georgia Orienteering Club that organized and hosted the Second USA ARDF Championships near Pine Mountain, April 19–21, 2002. Hams came from 14 states to test their on-foot radio direction finding (RDF) skills. Check that article to see how the competition was staged, how the competitors were divided into age/gender categories, and who got the gold medals. This month, I have more on the courses and the competitors, plus news of next year's championships.

Medals and mouse pads

For many years, foreigners have participated in the national ARDF Championships of Europe and Asia. They offer separate awards in two divisions — country-only and overall. At the First USAARDF championships in Albuquerque last year, there were 17 overseas competitors from Australia, China, and Ukraine.^{1,2}

European and Asian foxhunters have shown eagerness to come to ARDF events in the USA, but they prefer to travel during their vacation months of July and August. That would have been too late to hold the USA Championships this year because of the need for early selection of Team USA to the ARDF World Championships in September. So we didn't expect many European visitors in Pine Mountain. Three from

Continued on page 56



Photo B. KD5RNL brought several Altai 80m ARDF sets, made in Russia. (K0OV photo)



Photo C. Here comes Hiroshi "Yoh" Izuta JF1RPZ/KG6CEH to capture second place overall in M40 category on 80 meters. (KØOV photo)

HAMSATS

continued from page 55

Ukraine sent advance registrations, but they could not obtain USA visas in time to make the trip.

Nevertheless, there were several competitors who could be called "visitors" because they were not citizens and they weren't eligible for membership on ARDF Team USA. Best performing of them was Sergei Storkov KD5RNL, who competed in the most-difficult M21 category, with five required foxes (**Photo A**). He found them all in 167 minutes on two meters to take third overall, then the next day he blazed to the finish in under 76 minutes, just half a minute behind winner Gyuri Nagi KF6YKN.

Sergei, who is originally from Russia, now works for a company in Arkansas and hopes to have his green card soon. Back in his native country, he trained for about eight years under Nikolai Semenov, winner of silver and bronze medals at the World Championships in 2000. Hams like Sergei have been very helpful to ARDF development in the USA. Many competitors got training tips from him and he arranged for a supply of 80-meter ARDF sets (**Photo B**).

Another award-winning visitor was Hiroshi "Yoh" Izuta JF1RPZ/KG6CEH, who was second overall in M40 category on



Photo D. Gold, silver, and bronze medals awaited finishers in the USA-only division. Overall winners, most of whom captured medals as USA competitors, received individualized mouse pads. (KØOV photo)

both bands (**Photo C**). He won national ARDF Championships for 1987 and 1993 in his native Japan and now resides in Sunnyvale, California.

Despite the small number of visitors, there were still two complete sets of awards at Pine Mountain. US citizens and aliens with resident status are potential members of Team USA. As such, they competed for gold, silver, and bronze medals in the USA-Only Division. All competitors were eligible for awards in the Overall Division. Instead of medals, the Overall Division winners received cleverly designed mouse pads (**Photo D**). The pads had event category and placing printed on them, so no two were alike.

Climb complicates courses

Last month, I compared the courses in Pine Mountain with the 2001 championship courses in Albuquerque. That led to questions about the meaning of the official descriptions, such as "6.2 kilometers long with 275 meters of climb" for the 2-meter course. Pine Mountain course-setter Sam Smith N4MAP is a long-time orienteer, so he used international standards for orienteering courses. They state: "Course lengths shall be given as the length of the straight line from the start via the controls to the finish deviating for, and only for, physically impassable obstructions (high fences, lakes, impassable cliffs), prohibited areas, and marked routes. ... The total climb shall be given as the climb in meters along the shortest sensible route."

OK, but exactly what is climb? Does that mean that the courses were all uphill? Not necessarily. In fact, the finish line for the 80m course in Albuquerque last year was 185 meters lower in elevation than the starting line, but the official course climb was 20 meters. That's because climb is computed by plotting the shortest route on a topographical map, counting the number of times that an elevation contour is crossed in the uphill direction, and multiplying by the increment of each contour (usually 5 meters). Downhill contour crossings are ignored.

Everyone knows that it takes much more effort to run uphill than on level terrain. However, the relative ease of running downhill isn't nearly as great as the relative difficulty of running uphill, so climb is the only important measure of altitude change as it affects course severity. According to N4MAP, "A rule of thumb used by the orienteers is to multiply the climb by 10 and add it to the distance. For example, a 6 km course with 250m of climb might feel more like 8.5 km. Of course the actual route chosen by a competitor may have less climb and more distance. That's what orienteering is all about, making the best route choice based on the information that you have."

N4MAP's courses were on par with those of other world-class competitions. For instance, the 80m course at the 2000 World Championships in China was 5.5 km with 420 meters climb. Sam's 80m course at Pine Mountain was 5.7 km with 165 meters climb.

You will find lots more photos of the Pine Mountain ARDF action at the "Homing In"



Photo E. Brian DeYoung K4BRI of Kentucky had never attended a championship ARDF event before Pine Mountain. He took home a silver medal in the M40 category from his first 80m hunt. (KØOV photo)

Web site. There is also a link to GAOC's event site, with even more pictures, articles by the organizers, and comments from participants. For instance, one attendee wrote: "Radio-orienteers are getting serious about training; competition was tough. While I was sitting back admiring my medal from last year, the guys from Albuquerque and North Carolina were out running to get in shape for this year's event. They left me behind as they raced for the finish line."

As soon as the 2002 USA Championships ended, it was time for final selection of ARDF Team USA members for the 2002 World Championships in Slovakia, September 2-7.³ In age/gender categories such as M40, where there were more applications than slots available, first offers went to those who performed best in the 2001 and 2002 USA Championships. Some of them agreed to run in M21 category, making room for others to join the team. As of this writing, there are 12 on the roster, including two YLs. Check the "Homing In" Web site for latest news of Team USA. A full report on the World Championships will be in "Homing In" at the end of this year.

Cincinnati in 2003

Next year, with no World Championships



Photo F. Bob Frey WA6EZV (left) and Dick Arnett WB4SUV have been named co-chairs of the 2003 USA ARDF Championships to be held near Cincinnati. Here they are in split-screen at the 80m finish in Pine Mountain. (KØOV photo)

to prepare for, the USA ARDF Championships will be back to a midsummer weekend. Hosts and organizers will be members of the OH-KY-IN Amateur Radio Society. Events will take place from July 30 to August 2, 2003, near Cincinnati, Ohio. Yes, that's about a year away, but this early announcement will help ARDF enthusiasts from all over the world to make advance plans.

Event venues are being mapped, the official jury is being selected, and the registration period will begin soon. The championships are open to anyone, at any ARDF skill level, from any country with an IARU Amateur Radio society. Even if you've never been to a big formal ARDF event before, you could come home a winner (**Photo E**). Mark your calendar now.

The OH-KY-IN ARS Co-Chairs overseeing the events are Bob Frey WA6EZV of Cincinnati and Dick Arnett WB4SUV of Erlanger, KY (**Photo F**). Both have a wealth of experience in the sport, having competed at the first two USA national Championships, the 1999 IARU Region 2 Championships, and the 2000 World Championships. Other officials on the event committee are Joe Haltermann KI4QI (Awards), Carol

Hugentober WA8YL (Registration/Lodging), Rick Haltermann KI4QJ (Start/Finish), and Brian DeYoung K4BRI (Transportation). Additional support will be provided by the Cincinnati Orienteering Group (OCIN).

To simplify logistics for all competitors, especially the anticipated visitors from Europe and Asia, group housing and local transportation will be available. OH-KY-IN has arranged for a block of double-occupancy rooms at Havighurst Hall, a co-ed dormitory at Miami University in Oxford, Ohio, close to five buffet dining halls on the campus.

The 2003 USA ARDF Championships Web site is already in operation with more details about the events. Registration will soon be available at that site. Get there by link from the "Homing In" site. You can also subscribe to a group E-mail list for latest updates on these events.

Try foxoring next time

One reason for the recent growth in ARDF is that it appeals to both health-conscious hams and technically-minded athletes. Fans of classic (non-radio) orienteering are discovering the fun of radio-orienteering, but have

WANT TO LEARN CODE?

Morse Tutor Gold from G.G.T.E. is the answer for beginners and experts alike.

*Get the software the ARRL sells and uses to create practice and test tapes; and Morse Tutor Gold is approved for VE exams at all levels.

*Since 1987, GGTE has guided nearly 25,000 hams and prospective hams around the world through proven structured lessons and a variety of character, word and conversational drills. Straight forward menus make the process simple and fun.

*This program features easy and speedy self-installation; random character drills with the characters you select; and you can create your own drills or import text files. You can type what you hear or copy by hand and see the results one line at a time. Pick the Farnsworth or the standard method; select the tone frequency most comfortable for you or select your code speed in tenths of a word per minute. For all DOS computers. You are always in command.

Certified by



Morse Tutor Gold uses your internal speaker or sound board. And, if you use a sound board Morse Tutor Gold supports volume control.

Sound Blaster and the Sound Blaster Compatibility Logo are trademarks of Creative Technology Ltd.



Available thru dealers, the ARRL, or send \$29.95 + \$5.00 S&H (CA residents add \$2.62 tax) to:
GGTE, 23801 Cassandra Bay,
Dana Point, CA 92629

SAVE 47%!

on 12 months of **73**

Only \$24.97

Call 800-274-7373

M²

EXTRA, EXTRA! M2 BUILDS TRIBANDER

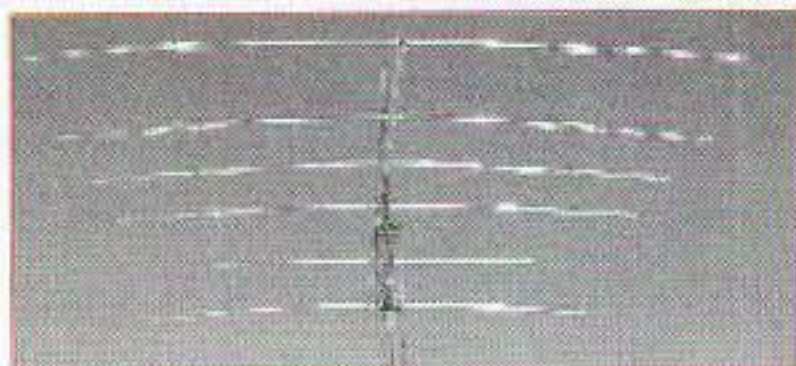

The tried and true KT34 series antennas have been made better using the latest computer modeling and mechanical design techniques to provide you with the best tribander performer available today. Just take a look!

**INCREASED FRONT TO BACK
INCREASED GAIN
MECHANICALLY SUPERIOR
ELECTRICALLY SUPERIOR
LOWER WIND LOAD THAN COMPETITORS
LESS WEIGHT THAN COMPETITORS
RATED AT 100 MPH WIND SURVIVAL
AND OF COURSE, NO POP RIVETS**

Contact us for our new catalog of ALL the goodies!!
Can't wait? Visit our Website
@m2inc.com



4402 N. Selland, Fresno, CA 93722
559-432-8873 Fax 559-432-3059
E-Mail: wyatt@m2inc.com
Website: www.m2inc.com



difficulty getting used to course maps with no controls marked on them, just start and finish. To help your local orienteers ease the transition into radio-O, consider an in-between sport that has gained popularity in Europe, especially the Netherlands. It's called "foxoring," and as the name implies, it's an amalgam of foxtailing and classic-O. Competitors get a map pre-marked with start and finish, plus 12 to 16 small circles. On a normal O-course, the circles would represent controls to be found and punched, but in foxoring they are areas where very weak fox transmitters are on the air.

Because of their low power, these foxes can all be on the same frequency and operate continuously. That will be appreciated by orienteers who haven't gotten used to the one minute on, four minutes off cycle of IARU-rules ARDF events. As a competitor, your mission is to use orienteering techniques to get to the circles in the most efficient order, then use RDF to pinpoint the transmitters, mark your card and get to the finish in minimum time.

Dutch hams use very simple 80m foxes, consisting of little more than a crystal, a CMOS logic gate IC, and an RF transformer to match the output to an antenna that's just six feet long, or less. They call them "spoetnik" foxes because their beeping signals are reminiscent of transmissions from the first Russian Sputnik satellites. Typically, the signals can be picked up 100 to 200 yards away on hand-held receivers.

How about making up some low-power fox transmitters and putting on a foxoring course at the next event of your local orienteering club? Just three or four foxes would be fine to start. You might convince some orienteers to get into ham radio! For more details on foxoring, see the Web site by Alex Buulage. There is a link to it at the "Homing In" site.

Don't forget to include hidden transmitter hunts at your club's hamfests and other outdoor activities this summer. Make sure there is plenty of extra RDF equipment so the kids and grandkids can get in on the fun. Send your stories and photos of local transmitter hunts to me via electronic or postal mail, to the address at the beginning of this article.

Footnotes

1. Moell, Joe, "Homing In: ARDF Championships Part 1 — Triumph in the Land of Enchantment," *73 Magazine*, December 2001.
2. Moell, Joe, "Homing In: ARDF Championships Part 2 — The World Comes to Duke City," *73 Magazine*, January 2002.
3. Moell, Joe, "Homing In: USA's Fox-hunters Take On The World," *73 Magazine*, April 2002.

YOU Can Build This VLF to HF Loop Receiving Antenna

continued from page 15

don't expect to easily disassemble it for later experimentation!

Next time: linearizing a nonlinear world; parts availability; and references. 73

Read All About It!

continued from page 39

and having seen me stringing wires on the roof, he wondered if I might have had something to do with it. Not being a very good liar, I confessed, and we patched things up at the cost of two beers and a whole can of kitty treats.

I waited for a weekend when Neighbor and his dog were gone, and tried a ten-foot ground rod, and then a few gallons of salt water around the rod. Finally, I buried three 60-foot radials. All to no avail. Our soil was pure beach sand, and with the water table 45 feet down there was no way I was going to get a good ground connection.

Then I remembered the 160-meter mobile antenna I had in 1961. If I could resonate an eight-foot antenna on 160 with a loading coil, I could surely resonate a much longer dipole on 80; it would just take two loading coils. For a bonus, I placed the loading coils each at 12 ft., 10 in., from the center insulator. They would isolate the ends of the antenna at high frequencies, giving me a 17-meter (18 MHz) dipole.

After some experimenting, the final form of the 80/17 meter dipole was as follows:

- RG-59U coax feed to center insulator.
 - Run two no. 18 wires, 12 ft. 10 in., to loading coils.
 - Coils consist of 59 turns of no. 18 enamel wire close-wound on 7/8-in. diameter form.
 - Run two no. 18 wires 26 feet from coils to end supports. These end lengths may be bent if necessary. Mine run 10 feet to the edge of the roof, then 16 feet down the edge to the eaves.
- Of course, you can customize the antenna to your needs: shorter end wires, more turns on the loading coil. But very short ends make for poor efficiency.

Does it work? You bet! I've worked California on 80 with five watts. Typically, if I give a 100 W station with a full-size dipole 60 feet up a 589, I'll get back a 579 with my 100 watts; and my antenna is 78 feet long and two feet off the roof. Am I happy? Well, yes. But recently I've developed a yen to work 160 meters ... 73

The Hamfest from Hell

continued from page 40

sure where his grandmother lived, but that she was in a white house on a street that starts with the letter "B". We searched for two hours, driving around on expensive gasoline that I was paying for, at 6 miles per gallon! Fred called home on his cell phone and asked members of his family if they knew where Grandma lived or what her telephone number was. They didn't seem to know what he was talking about. It was as if Grandma were not real. I was so tired that I wasn't sure if I were real. And we still had almost three hours of driving ahead of us.

It was like a bad, expensive dream. We never did locate his elusive grandmother. Finally he gave up and we drove home. What an experience.

I had been warned that Fred would drive me crazy. If Fred reads this article, I know that he will recognize himself, so all I can say is, "Fred, I am pleased to have you as a friend, but you sure can drive people crazy. So next time we go to a hamfest, let us each drive our own car and I'll meet you there. And one more thing: After my experience of us being together for only one day, I would like to suggest that you thank your poor wife for putting up with you. Buy her some pretty flowers." 73

The Write Stuff

continued from page 41

it. Just tell me how the project really went.

Don't forget to tell me about your mistakes, too! Honestly, I've been known to "let the smoke" out of a few

transistors, put a polarized "cap" in reversed, and all the other "duhhh" factors of building. Your comment just may keep me from making a mistake, but I doubt it!

Wouldn't it be great to see your name in print in an international magazine? Believe me, it really is a boost to your ego to have an article make it to publication. The editors at 73 will be glad to send you their "how to" piece on submitting an article for consideration. If (big word with lots of meaning) they select your work for publication and make you a monetary offer for it, **DON'T QUIT YOUR DAY JOB!**

This is a "hobby venture," and the dollar amount received is pleasant enough, but not enough to put your kids through college.

So, while you're sitting there gloating over that latest venture, turn your computer on and try writing a piece telling me how much you accomplished. I will never know about your accomplishment unless you tell me, and you won't know if you can write an article if you haven't tried.

Who knows, you may have one more talent hidden away that even you aren't aware of! And 73 pays cash! 73

CALENDAR EVENTS

continued from page 43

station, 3 points for a CW QSO, 1 point all other QSOs. Remember, only the highest single point value may be applied per QSO. Multipliers: For stations outside MDC: 1 per MD county + DC + Baltimore City (25 possible). For MDC Stations Only: The basic 25 above + each of the other 49 US states + each DX country. Note: An optional scoring/summary sheet that makes scoring easy is available for an SASE. This is available from Antietam Radio Association and at the Web site. Certificates are awarded to all stations with 50 or more QSO points in their entry. Please visit the Maryland-DC QSO Party Web site at [www.w3cwc.org]. Send logs and scoring summary with an SASE by September 20th to the contest primary sponsor, Antietam Radio Association, P.O. Box 52, Hagerstown MD 21741-0052. Logs can also be E-mailed in plain text format to [wa3eop@arrl.net]. A Special Award — The Worked All Maryland Multipliers Award — has yet to be claimed. Last year W3LRC almost did it with 24 of 25 worked. WA3HAE accomplished that the year before! Who will be the first person to do this? The

only stipulations are: 1) all contacts must be from a single QTH, 2) all contacts must be made during a single year's QSO party. Donations towards the continued operation of this activity are always welcome and may be sent along with hard copy entries to the primary sponsor. See you in the pileups. Page WA3EOP.

AUG 17, 18, 19

NEW JERSEY QSO PARTY The Englewood Amateur Radio Association, Inc. invites all amateurs the world over to take part in the 43rd Annual New Jersey QSO Party. Rules: (1) The time of the contest is from 2000 UTC Saturday, August 17th to 0700 UTC Sunday August 18th, and from 1300 UTC Sunday August 18th to 0200 UTC Monday August 19th. (2) Phone and CW are considered the same contest. A station may be contacted once on each band — phone and CW are considered separate bands — CW contacts may not be made in phone band segments. New Jersey stations may work other New Jersey stations. (3) General call is "CQ New Jersey" or "CQ NJ". New Jersey stations are requested to identify themselves by signing "De NJ" on CW and "New Jersey calling" on phone. Suggested frequencies are 1810, 3535, 3950, 7035, 7235, 14035, 14285, 21100, 21355, 28100, 28400, 50-50.5, and 144-146. Suggest phone activity on the even hours; 15/10 meters on the odd hours (1500 to 2100 UTC); 160 meters at 0500 UTC. (4) Exchange consists of QSO number and QTH state/province or country. New Jersey stations will send county for their QTH. (5) Scoring: Out-of-state stations multiply number of complete contacts with NJ stations times 3 points per QSO times the number of New Jersey counties worked (maximum of 21). New Jersey stations multiply the number of complete contacts times 3 points per QSO times the multiplier. The multiplier is the sum of the number of states (other than NJ), Canadian provinces, and NJ counties worked. Maximum is 49 + 13 + 21 = 83. (6) Certificates will be awarded to the first place station in each New Jersey county, state, province, and country. In addition, a second place certificate will be awarded when four or more logs are received. A total of two plaques have been donated by the ARRL Section Managers for NNJ and SNJ to the highest scoring single operator station residing in each of their sections. (7) Logs must also show the UTC date and time, QSO exchange, band, and emission, and be received not later than September 14, 2002. The first contact for each claimed multiplier must be indicated and numbered and a check list of contacts and multipliers should be included. Multi-operator stations should be noted and calls of participating operators listed. Logs and comments should be sent to: Englewood Amateur Radio Association, Inc., P.O. Box 528, Englewood NJ 07631-0528. A #10 size SASE

Continued on page 61

Coronal Holes

The "summer doldrums" aren't quite over, but a seasonal improvement in conditions should become apparent toward the end of August. The range between the Maximum Usable Frequency (MUF) and Lowest Usable Frequency (LUF) will begin to expand as autumn approaches, providing longer and more frequent openings on more bands.

Solar activity is also likely to decrease during the latter half of the month, improving the propagation outlook even further. However, there are five trouble spots to watch out for, as indicated by the "Fair-to-Poor" (F-P) and "Poor" (P) days marked on the calendar. The 19th-21st looks particularly troublesome with moderate to strong flares or other events likely.

You may have noticed a lack of clearly "Good" (G) days in my forecasts over the last year. One reason for this has been the high incidence of another solar phenomenon — coronal holes. Coronal holes are large regions — much larger than sunspots — that are cooler and less dense than the surrounding atmosphere, or corona. They are usually located over the polar regions of the sun, but during solar maximum they may appear anywhere on the solar disc. When this happens we often see a marked increase in the solar flux and more frequent geomagnetic disturbances.

Unlike the rest of the sun, where looping magnetic fields reconnect to the surface and help contain the solar "plasma," the magnetic field lines associated with coronal holes are open ended and extend far out into the solar system. As a consequence, huge amounts of ionized particles (plasma) escape into interplanetary space, traveling along these field lines up to three times faster than the ordinary solar wind. These energetic particles stream out at speeds up to 900 km/s and, if directed toward us, slam into our magnetosphere causing distortions in earth's magnetic field. If the distortions are large enough, we have a geomagnetic storm and much degraded HF communications. When the distortions are small we experience spotty conditions, particularly across or near the auroral ovals.

Coronal holes often last for months, and some have been observed to last for years. Unfortunately for us, they reappear

August 2002						
SUN	MON	TUE	WED	THU	FRI	SAT
				1 F	2 F-G	3 F
4 F	5 F-G	6 F	7 F-P	8 F-G	9 F-G	10 F
11 F-P	12 F	13 F	14 F-P	15 F	16 G	17 VG
18 F-G	19 F-P	20 F-P	21 F-P	22 F-G	23 G	24 G
25 VG	26 F-G	27 F-G	28 F	29 F	30 P	31 F-P

EASTERN UNITED STATES TO:												
GMT	00	02	04	06	08	10	12	14	16	18	20	22
Central America	15-20	(15) 30	20 (40)	(20-40)	x	(20)	20	(20)	(15)	(15)	15 (20)	(10) 17
South America	15 (20)	(15) 20	20 (40)	(20-40)	(20)	x	(15)	(15)	x	(10)	(10-20)	(10) 20
Western Europe	20	20	(20-40)	(40)	x	(20)	x	x	x	x	(20)	20
South Africa	x	(40)	x	(20)	x	x	x	x	(15)	(15)	x	x
Eastern Europe	20	20 (40)	(20)	x	x	x	(20)	x	x	(15)	(15)	(20)
Middle East	20	20 (40)	(20)	x	x	x	x	x	x	x	(20)	(15)
India/Pakistan	(15-20)	(20)	x	x	(20)	x	x	x	x	x	x	x
Far East/ Japan	(15)	x	x	x	x	x	(20)	(15-20)	(15)	x	x	(15)
Southeast Asia	(15-20)	x	x	(20)	x	x	(20)	x	x	(15)	x	x
Australia	(15)	(15)	x	x	(20-30)	(20-30)	(20)	(20)	x	x	x	x
Alaska	(15-20)	(15-20)	(15-20)	20	20 (40)	(20-40)	(20)	(20)	x	x	(15)	(15-20)
Hawaii	(15-20)	(15-20)	(15-20)	20	20 (40)	(20-40)	(20)	(20)	x	x	x	(15)
Western USA	(10) 30	(10) 30	(10) 40	(15) 40	(20) 40	(20-40)	(15) 20	(10) 20	(10-20)	(10-20)	(10-20)	(10) 20
CENTRAL UNITED STATES TO:												
Central America	(10) 20	(15) 30	20 (40)	20 (40)	(20-40)	(20)	(20)	(15) 20	(15-20)	(10-20)	(10-20)	(10) 17
South America	10 (20)	(10) 20	(15) 30	(15) 30	(20-40)	(20)	(20)	(15)	(15)	(10)	(10-15)	(10-20)
Western Europe	(15) 20	20	(20-40)	(20-40)	x	(20)	(20)	x	x	x	x	(15-20)
South Africa	x	x	(40)	(20-40)	(20)	x	x	x	(10-15)	(10-20)	(20)	x
Eastern Europe	(20)	(20)	(20)	(20)	x	x	(20)	(20)	x	(15)	(15-20)	(15-20)
Middle East	(15-20)	(20)	(20)	(20)	x	x	x	x	x	x	(20)	(20)
India/Pakistan	(15-20)	(15-20)	(20)	x	x	x	(20)	x	x	x	x	x
Far East/ Japan	x	(15)	(15)	x	x	(20-40)	(20)	20	(20)	x	x	x
Southeast Asia	(15)	(15)	(15-20)	(20)	x	x	(20)	(20)	(15-20)	(15)	(15)	x
Australia	(15)	(15)	(15)	(20)	20 (40)	(20-40)	(20-40)	20	(20)	x	(15)	x
Alaska	(10) 30	(10) 30	(10) 40	(15) 40	(20) 40	(20) 40	(20-40)	(15) 40	(10) 30	(10-20)	(10-20)	(10) 20
Hawaii	(15-20)	15 (20)	(15-20)	20	20	(20)	20	(20)	x	x	x	(15)
Western USA	(10) 17	(15) 20	(15) 20	20	(20)	(20)	(20)	(20)	(20)	(10-20)	(10-15)	(15-20)
Central America	(10-20)	(10) 17	15-20	(15) 20	(20)	(20)	(20)	(15)	(15)	x	(15)	(10-15)
South America	(15-20)	(20)	20	(20)	x	x	x	(20)	(15)	(15)	(20)	(15-20)
Western Europe	x	x	x	(20)	(20)	x	x	(20)	(20)	(15)	x	x
South Africa	(15-20)	(20)	(20)	(20)	x	x	x	(20)	x	x	x	(15-20)
Eastern Europe	(20)	(15-20)	(15-20)	(20)	x	x	x	x	x	x	x	(20)
Middle East	x	x	(15)	x	x	x	x	(20)	x	(15)	x	x
India/Pakistan	(15)	(15)	(20)	(20)	(20)	(20-40)	(20-40)	(20)	(20)	(15-20)	x	(15)
Far East/ Japan	x	x	(15)	(15)	x	(20)	(20)	(20)	(15-20)	(15-20)	(15)	x
Southeast Asia	(10-15)	(10-15)	15	(15-20)	20	20	20	(20)	20	(20)	x	(15)
Australia	(10) 40	(10) 40	(10) 40	(15) 40	(20) 40	(20) 40	(20-40)	20-40	(15) 40	(10) 40	(10) 40	(10) 40
Alaska	(10-15)	(10-20)	(10-20)	(15-20)	20	20	(20-40)	20 (40)	(20-40)	x	x	(10-15)
Hawaii	(10) 30	(10) 30	(10) 40	(15) 40	(20) 40	(20) 40	(20-40)	(15) 20	(10) 20	(10-20)	(10-20)	(10) 20

Table 1. Band, time, country chart. Plain numerals indicate bands which should be workable on Fair to Good (F-G) and Good (G) days. Numbers in parentheses indicate bands usually workable on Good (G) days only. Dual numbers indicate that the intervening bands should also be usable. When one number appears in parentheses, that end of the range will probably be open on Good (G) days only.

every 27 days with the sun's rotation, causing recurring problems for DXers. On the other hand, their effects are somewhat more predictable than other solar phenomena. Coronal holes have also been observed to occur more frequently after the peak of a sunspot cycle (where we are now) and also seem to indicate the intensity of the next cycle. If we see lots of coronal holes over the next several years it is a good bet that Cycle 24 will be a doozy!

For those interested in looking at x-ray spectrum photographs and learning more about coronal holes, go to the Yukoh X-Ray Observatory Web site at [<http://solar.physics.montana.edu/YPOP>]. Until next time, 73!

Band-by-band summary

10 and 12 meters

Signals will be weak due to daytime absorption, but some openings can still be found, especially from the southeast through southwest. Peaks will occur in the morning or late afternoon, with evenings remaining weak but open until 9 or 10 p.m. Skip should fall between 1,000 and 2,000 miles.

15 and 17 meters

DX should be slightly improved over last month with stronger signals heard early in the morning or late in the afternoon. These bands should hold up well into the evening, especially later in the month. Skip should extend out to 2,300 miles.

20 meters

Expect strong signals in the morning, late afternoon, and evening hours. Some days the band should hold up past midnight, especially west or northwest of your location. Short-skip can vary between 500 and 200 miles during the day and from 1,000 to 2,300 miles at night.

30 and 40 meters

Atmospheric noise will continue to plague these bands, but some improvement should be seen late in the month. Try the gray-line technique for your best chance at very long distances. Skip can vary between 500 to 2,000 miles at night and about 750 miles during the day.

80 and 160 meters

High static will mask signals on these bands most of the time, but late August may provide some relief for this situation. Peaks

will occur around midnight and in the hour or so before sunrise. Short-skip will be between 1,000 and 2,000 miles. 73

CALENDAR EVENTS

continued from page 43

should be included for results. (8) Stations planning active participation in New Jersey are requested to advise EARA by August 1st of your intentions so that we may plan for full coverage from all counties. Portable and mobile operation is encouraged. 73

ABOVE & BEYOND

continued from page 46

amateur-related projects. My thanks go to Kerry N6IZW, who worked out the conversion on this amplifier and so many other things too numerous to mention.

If you have any questions, drop me an E-mail to [WB6IGP@ham-radio.com]. For general information on this and other related 1296 MHz conversion project items, and amateur microwave radio in general, look on the San Bernardino Microwave Society Web page at [<http://www.ham-radio.com/sbms/sd/>]. Look under technical papers from the San Diego Microwave Group. This Web page has a lot of information, not just on 1296 MHz, but on all frequencies of operation up to 24 GHz and beyond. A great Web site to visit!

For those who are interested in obtaining a 5 watt amplifier module and PC board for conversion to 1296 MHz, I will make them available with a set of four chip capacitors for \$25 postpaid, US destinations (Calif. residents only, add sales tax). 73

THE DIGITAL PORT

continued from page 54

RTTY macro buttons appear in that mode. You really do not have to revert to knobs on the rig just to escape. There is a default BPSK macro included with Zakanaka that will bring you back to where the new PSK macros are visible.

It will become obvious that you will need to at least write copies of the filter macros in the set of RTTY macro buttons. Otherwise, it is clumsy to switch back and forth.

An easy chore

It may have taken you a bit of time to get the first set of macros set up and working,

but I found it is very quick and easy to copy the contents of a macro from one macro to another using the copy (Ctrl+C) and paste (Ctrl+V) commands in Windows. Have to highlight the text first, but once you get the hang of it, moving those hard-to-write sequences is a snap.

So pick your favorite spot in the RTTY macros and go for it. By the way, that is how I brought the contents of the macros into the article, and it is the method I use, whenever possible, to insert Web site addresses into my browser. Makes the work much less intimidating.

For those who are not familiar, Zakanaka and Logger are freeware programs. They are free for the download. A lot of work has gone into their development.

The upcoming surprise is there is a new version of Logger on the way. I have no idea of a release date. It could be many months down the road. I am sure it will be much improved over what I consider a very fine product now. So we will just have to wait and see what is hiding in the wings.

A mighty piece of software has reawakened

I mentioned a while back that it appeared the XPWin program from XPWare was no longer available. I got word in the last month there is a new Web site at [www.glaswerks.com/xpware/].

I went there and sure enough, the software is alive and kicking and I was able to download and install an update that looks like a user friendly package. This is shareware to control the PK232 in my case, and there are versions available for other popular TNCs. Glad to see it is back.

Limiting Web ads

If you are like me, you get annoyed with some of the pop-up ads on the Internet. There are several in my case. One was some sort of surveillance camera, another was a phone company to beat all rates and then there was a life insurance ad, just to name a few. You notice I said "was."

Got rid of them. There is piece of software at [<http://www.analogx.com/contents/download/network/pow.htm>] that simply puts all that baloney behind you. It is called "POW" and all I did was download the program, install it, and that was the end of those pesky little ads, hopefully, forever.

Shack repairs and updates

A few weeks ago, I had a project force itself on me. My antenna had stood its last wind. I was getting so much noise in the

receiver it was nearly impossible to copy anyone. I pulled it down and had three broken traps. Did some repairs and do not have it back up at this writing. The wind has to be calm for that operation.

However, I had the tiltover in such a place the antenna was sitting on the ground directed straight up. This made an antenna effectively consisting of a trap dipole eight feet off the ground broadside toward Europe. I plugged it in and, not only is the noise to a minimum, but the first few stations heard were from Europe!

What is good is I was without any way to display a signal trace so I could observe the filtering described in this article until the repair. Plus it made the screenshot possible.

Speaking of making things possible, this new computer has only one 9-pin serial port. Several USB ports, but they seem to think nothing hooks up to those old-timey ports. Well, I decided I needed at least two more, so I found a board and got it here.

Another minor learning experience. I spent a little time reading the documentation for the board. It looks to be an excellent bit of circuitry, but the supplied literature is in two sections. The first is a little booklet that leaves something to be desired in the translation. The second is several pages including a title, "How to understand the documentation." Just about enough material to get the full meaning of "Rolling on the Floor Laughing." I think I understand, made some notes and underlined several important seeming phrases. Will know all about these things by next month.

Where's The Chart?

For the last five years 73 has been kind enough to publish my listing of software and Internet Web sites where software and other information could be found and downloaded. This becomes a momentous task to keep such a thing in order. Last winter, Bob WA2HNG very kindly placed The Chart on his informative ham radio site at [http://www.qsl.net/wa2hng/ham_radio.htm].

That has been a real help to a lot of hams because it is so easy to go to Bob's Web site and click on an URL and not have to type in the address. I received a number of favorable comments along those lines and said to myself, "That is a good idea. I should have done that long ago." But it stopped there until recently.

73 was beginning to bog down with all the changes I kept sending them, so we agreed it was time to get official and establish a site and put as much useful ham info on it as I could and include

the information from the used-to-be-published Chart.

So this is the address: [<http://kb7no.home.att.net/>]. Short and to the point. Easy to type in the first time, then store it for later in the browser. It works. I just went there and clicked a link and downloaded a piece of software I had forgotten to install in this computer.

That is the news from here for this month. I appreciate the E-mails you folks send. I try to answer whatever questions you may have. So give me a shout at [KB7NO@worldnet.att.net]. 73 for now, Jack KB7NO. 73

NEVER SAY DIE

continued from page 8

So let's get teams into the Middle Eastern and Asian countries that need economic development and light the flame.

Products? Take a look at what I'm wearing these days. My shoes come from China, my socks from Bangladesh, my pants from United Arab Emirates, my jacket from Guatemala, and my shirt from Mongolia. No, I'm not exaggerating — Mongolia! Just take a good look at your clothing labels.

Using modern technology (Jim Patterson's patented root feeders), we can help the Arab countries make their deserts bloom, producing some of the best-tasting and healthiest food in the world, while using a minimum of water. How'd you like to be able to buy a five-pound tomato that tastes like you grew it in your own hot house and picked it fully ripe?

Like America, more and more developed countries are moving their low-pay jobs to developing countries. Here in America, the prospects for unskilled, uneducated workers is bleak. Not even the strongest unions can protect low-skilled jobs from moving out of the country. Shipping and communications are just too cheap in these days of container ships and satellites. Sure, we still have old farts like Senator Hollings trying to get Congress to set up trade barriers to protect southern clothing makers, thus helping keep his constituents making low wages instead of getting into higher-wage businesses.

Education

By setting up radio and TV stations, we can help trigger a whole new era in education in Muslim and other developing countries. Remember, there are very few well educated poor people and very few

poorly educated wealthy people. Education is the key, and that key can unlock the minds of billions of people, freeing them from poverty, ignorance, and oppression. Low cost, high quality education delivered by radio, TV, and DVDs. No, I'm certainly not talking about teaching the pitiful crap our public school system and colleges are foisting on our kids. We need to close down that whole government-controlled nightmare.

One of the basic reasons we're so hated by Third World people is our obvious ability to outperform them. So, let's give them a way to start catching up. We have everything to gain, and little to lose. Sure, it's going to take a year or two to get this all going, but it'll eventually defuse the hate and blow away our worry about terrorism or being nuked or anthraxed by Saddam.

You know, if we start teaching the world's kids to speak English when they are two years old, they'll take to it and we won't have to translate our educational stuff into 200 languages.

Conspiracies

Conspiracy buffs (a/k/a crackpots, nuts, fans) are having a ball with the WTC mess. I'm building up quite a file and would appreciate more candidates. Well, there's obviously some fishy things going on which are feeding the frenzy. Like the strong suspicion that the fourth plane, which crashed in Pennsylvania, was shot down by the Air Force instead of being crashed by the passengers fighting with the terrorists.

Like the reason the Russians attacked Afghanistan was so that they could lay a 1,000-mile pipeline from the Caspian Sea, where there are said to be some \$6 trillion in oil and gas reserves (larger than under Saudi Arabia), to the Arabian Sea. Like the U.S., wanting to own that pipeline, supporting Bin Laden and the Taliban in their fight against the Russians with billions of dollars of arms. Like as late as 1998 the U.S. paying the salary of every Taliban official in Afghanistan. Like Unocal, the giant American oil conglomerate spending over a billion dollars on geological surveys (with Taliban support) for the pipeline. Like all of the leading Taliban officials visiting Texas in 1998 to negotiate with Unocal.

Like in 1999 when the Taliban threw Unocal out of Afghanistan and awarded the pipeline project to a company in Argentina. Like John Maresca, Unocal VP, testifying to Congress that there would be no pipeline until the Taliban was gone so a more friendly government could be established. Like the Taliban suddenly

Continued on page 64

Wise Up!

Here are some of my books which can change your life (if you'll let 'em). If the idea of being healthy, wealthy and wise interests you, start reading. Yes, you can be all that, but only when you know the secrets which I've spent a lifetime uncovering.

.....Wayne

The Secret Guide to Health: Yes, there really is a secret to regaining your health and adding 30 to 60 years of healthy living to your life. The answer is simple, but it means making some serious lifestyle changes. Will you be skiing the slopes of Aspen with me when you're 90 or doddering around a nursing home? Or pushing up daisies? No, I'm not selling any health products, but I can help you cure yourself of cancer, heart trouble, or any other illness. Get this new, 2001 expanded edition (156p). \$10 (#05)

The Secret Guide to Wealth: Just as with health, you'll find that you have been brainwashed by "the system" into a pattern of life that will keep you from ever making much money and having the freedom to travel and do what you want. I explain how anyone can get a dream job with no college, no résumé, and even without any experience. I explain how you can get someone to happily pay you to learn what you need to know to start your own business. \$5 (#03)

The Secret Guide to Wisdom: This is a review of around a hundred books that will boggle your mind and help you change your life. No, I don't sell these books. They're on a wide range of subjects and will help to make you a very interesting person. Wait'll you see some of the gems you've missed reading. You'll have plenty of fascinating stuff to talk about on the air. \$5 (#02)

The Blood Purifier Handbook: This explains how to build or buy (\$155) a little electrical gadget that can help clean your blood of any virus, microbe, parasite, fungus or yeast. The process was discovered by scientists at the Albert Einstein College of Medicine, quickly patented, and hushed up. It's curing AIDS, hepatitis C, and a bunch of other serious illnesses. It's working miracles! \$10 (#01)

Plant Growth Stimulator: This has the same circuit as the above, all ready to use. Postpaid: \$155 (#PGS).

My WWII Submarine Adventures: Yes, I spent from 1943-1945 on a submarine, right in the middle of the war with Japan. We almost got sunk several times, and twice I was in the right place at the right time to save the boat. What's it really like to be depth charged? And what's the daily life

aboard a submarine like? How about the Amelia Earhart inside story? If you're near Mobile, please visit the *Drum*. \$5 (#10)

Travel Diaries: You can travel amazingly inexpensively - once you know the ropes. Enjoy Sherry and my budget visits to Europe, Russia, and a bunch of other interesting places. How about a first class flight to Munich, a rented Audi, driving to visit Vienna, Krakow in Poland (and the famous salt mines), Prague, back to Munich, and the first class flight home for two, all for under \$1,000. Yes, when you know how you can travel inexpensively, and still stay in first class hotels. \$5 (#11)

73 Writer's Guide: It's easy, fun, can pad your résumé, and impress the hell out of your friends. Yes, of course we pay for your articles! \$0 (#78)

Wayne's Caribbean Adventures: My super budget travel stories - where I visit the hams and scuba dive most of the islands of the Caribbean. You'll love the special Liat fare which let me visit 11 countries in 21 days, diving all but one of the islands, Guadeloupe, where the hams kept me too busy with parties. \$5 (#12)

Cold Fusion Overview: This is both a brief history of cold fusion, which I predict will be one of the largest industries in the world in the 21st century, plus a simple explanation of how and why it works. This new field is going to generate a whole new bunch of billionaires, just as the personal computer industry did. \$5 (#20)

Improving State Government: Here are 24 ways that state governments can cut expenses enormously, while providing far better service. I explain how any government bureau or department can be gotten to cut its expenses by at least 50% in three years and do it cooperatively and enthusiastically. I explain how, by applying a new technology, the state can make it possible to provide all needed services without having to levy any taxes at all! Read the book, run for your legislature, and let's get busy making this country work like its founders wanted it to. Don't leave this for "someone else" to do. \$5 (#30)

Mankind's Extinction Predictions: If any one of the experts who have written books predicting a soon-to-come catastrophe which will virtually wipe most of us out are right, we're in trouble. In this book I explain about the various disaster scenarios, like Nostradamus, who says the poles will soon shift (as they have several times in the past), wiping out 97% of mankind. Okay, so he's made a long string of past lucky guesses. The worst part of these predictions is the accuracy record of some of the experts. Will it be a pole shift, a new ice age, a massive solar flare, a comet or asteroid, a bioterrorist attack? I'm getting ready, how about you? \$5 (#31)

Moondoggle: After reading René's book, *NASA Mooned America*, I read everything I could find on our Moon landings. I watched the NASA videos, looked carefully at the photos, read the astronaut's biographies, and talked with some readers who worked for NASA. This book cites 45 good reasons I believe the whole Apollo program had to have been faked. \$5 (#32)

No, I'm not a nut case.
Classical Music Guide: A list of 100 CDs which will provide you with an outstanding collection of the finest classical music ever written. This is what you need to help you reduce stress. Classical music also raises youngsters' IQs, helps plants grow faster, and will make you healthier. Just wait'll you hear some of Gottschalk's fabulous music! \$5 (#33)

The Radar Coverup: Is police radar dangerous? Ross Adey K6UI, a world authority, confirms the dangers of radio and magnetic fields, including our HTs and cell phones. \$3 (#34)

Three Gatto Talks: A prize-winning teacher explains what's wrong with American schools and why our kids are not being educated. Why are Swedish youngsters, who start school at 7 years of age, leaving our kids in the dust? Our kids are intentionally being dumbed down by our school system - the least effective and most expensive in the world. \$5 (#35)

Aspartame: a.k.a. NutraSweet, the stuff in diet drinks, etc., can cause all kinds of serious health problems. Multiple sclerosis, for one. Read all about it, two pamphlets for a buck. (#38)

\$1 Million Sales Video: The secret of how you can generate an extra million dollars in sales just by using PR. This will be one of the best investments you or your business will ever make. \$40 (#52)

Reprints of My Editorials from 73. Very few things in this world are as we've been taught, and as they appear. As an iconoclast I blow the whistle on the scams around us, such as the health care, our school system, our money, the drug war, a college education, sugar, the food giants, our unhealthy food, fluorides, EMFs, NutraSweet, etc.

1996 100 Editorial Essays: \$5 (#72)
1997 157 Editorial Essays: \$8 (#74)
1998 192 Editorial Essays: \$10 (#75)
1999 165 Editorial Essays: \$8 (#76)
2000 101 Editorial Essays: \$5 (#77)
2001 104 Editorial Essays: \$5 (#78)
Silver Wire: With two 5-in. pieces of heavy pure silver wire + three 9V batteries you can make a thousand dollars worth of silver colloid. What do you do with it? It does what the antibiotics do, but germs can't adapt to it. Use it to get rid of germs on food, for skin fungus, warts, and even to drink. Read some books on the uses of silver colloid, it's like magic. \$15 (#80)

Colloid Reprint. April 97 article on a silver colloid maker, history, and how to use the stuff. \$5 (#98).

Colloid Clips. Three 9V battery clips, 2 alligator clips & instructions. \$5 (#99)

Silver Colloid Kit: \$25 (#80-98-99)

Four Small Booklets Combined: Dowsing: why and how it works; Super Organic Food: a trillion dollar new industry; Schools in 2020: another \$ trillion industry; Anthrax, a simple cure. \$3 (#86)

Stuff I didn't write, but you need:
NASA Mooned America: René makes an air-tight case that NASA faked the Moon landings. This book will convince even you. \$30 (#90)

Last Skeptic of Science: This is René's book where he debunks a bunch of accepted scientific beliefs - such as the ice ages, the Earth being a magnet, the Moon causing the tides, etc. \$30 (#91)

Dark Moon: 568 pages of carefully researched proof that the Apollo Moon landings were a hoax—a capping blow for René's skeptics. \$25 (#92)

Dark Moon Video: 222-minute exposé nailing NASA with their own photos. If you've watched the NASA films of the astronauts walking on the Moon and wondered at their weird gait. Wait'll you see it speeded up. It looks exactly like they're running on Earth! They catch NASA in dozens of give aways that the photos and films had to have been faked. With our gov't it seems to be just one cover-up after another. \$40 (#93)

Radio Bookshop

Box 416, Hancock NH 03449

Name _____ Call _____

Address _____

City-State-Zip _____

Use the numbers in the brackets or copy page and mark the books you want. Add \$3 s/h per total order in US (\$6 priority mail), \$6 Can, \$10 foreign. _____

Order total: US\$ _____ Phone (for CC orders) _____

MC/Visa # _____ Expire _____

www.waynegr.com • phone orders: 603-588-0107 • fax: 603-588-3205 • w2nsd@aol.com

Yes! Put me down for a year of 73 for only \$25 (a steal). Canada US\$32.

Foreign US\$44 by sea.

Allow 4 weeks for delivery except foreign, though we try to get most orders shipped in a day or two. Your e-mail address: _____

Barter 'n' Buy

Turn your old ham and computer gear into cash now. Sure, you can wait for a hamfest to try and dump it, but you know you'll get a far more realistic price if you have it out where 100,000 active ham potential buyers can see it, rather than the few hundred local hams who come by a flea market table. Check your attic, garage, cellar and closet shelves and get cash for your ham and computer gear before it's too old to sell. You know you're not going to use it again, so why leave it for your widow to throw out? That stuff isn't getting any younger!

The 73 Flea Market, Barter 'n' Buy, costs you peanuts (almost) — comes to 35 cents a word for individual (noncommercial!) ads and \$1.00 a word for commercial ads. Don't plan on telling a long story. Use abbreviations, cram it in. But be honest. There are plenty of hams who love to fix things, so if it doesn't work, say so.

Make your list, count the words, including your call, address and phone number. Include a check or your credit card number and expiration. If you're placing a commercial ad, include an additional phone number, separate from your ad.

This is a monthly magazine, not a daily newspaper, so figure a couple months before the action starts; then be prepared. If you get too many calls, you priced it low. If you don't get many calls, too high.

So get busy. Blow the dust off, check everything out, make sure it still works right and maybe you can help make a ham newcomer or retired old timer happy with that rig you're not using now. Or you might get busy on your computer and put together a list of small gear/parts to send to those interested?

Send your ads and payment to: 73 Magazine, Barter 'n' Buy, 70 Hancock Rd., Peterborough NH 03458 and get set for the phone calls. The deadline for the October 2002 classified ad section is August 10, 2002.

220 MHz Award; see W9CYT on WWW.QRZ.COM for information. BNB645

K8CX HAM GALLERY [<http://hamgallery.com>]. BNB620

TELEGRAPH COLLECTOR'S PRICE GUIDE: 250 pictures/prices. \$12 postpaid. **ARTIFAX BOOKS**, Box 88, Maynard MA 01754. Telegraph Museum: [<http://wftp.com>]. BNB113

New miniature oscillator modules are now available ... all under \$20 ... plus our great reference book is still for sale. Write to **RMT Engineering**, 6863 Buffham Road, Seville OH 44273 or see our Web site at [www.ohio.net/~rtormet/index.html]. BNB640

RF TRANSISTORS TUBES 2SC2879, 2SC1971, 2SC1972, MRF247, MRF455, MB8719, 2SC1307, 2SC2029, MRF454, 2SC3133, 4CX250B, 12DQ6, 6KG6A, etc. **WESTGATE**, 1-800-213-4563. BNB6000

METHOD TO LEARN MORSE CODE FAST AND WITHOUT HANGUPS Johan N3RF. Send \$1.00 & SASE. **SVANHOLM RESEARCH LABORATORIES**, P.O. Box 81, Washington DC 20044 USA. BNB421

Cash for Collins: Buy any Collins Equipment. **Leo KJ6HI**. Tel./FAX (310) 670-6969. [radioleo@earthlink.net]. BNB425

Browse our Web site and check out the "Monthly Special." TDL Technology, Inc. [www.zianet.com/tdl]. BNB500

MAHLON LOOMIS, INVENTOR OF RADIO, by Thomas Appleby (copyright 1967). Second printing available from **JOHAN K.V. SVANHOLM N3RF**, SVANHOLM RESEARCH LABORATORIES, P.O. Box 81, Washington DC 20044. Please send \$25.00 donation with \$5.00 for S&H. BNB420

Ham Radio Repair, Quality workmanship. All Brands, Fast Service. **Affordable Electronics**, 7110 E. Thomas Rd., Scottsdale, AZ 85251. Call 480-970-0963, or E-mail [HAM_SERVICE@AOL.COM]. BNB427

SATELLITE TV — Large selection of items at reasonable prices. We specialize in Big Dish TVRO C & Ku Band equipment. Check us out at [www.daveswebshop.com]. BNB646

HEATHKIT COMPANY is selling photocopies of most Heathkit manuals. Only authorized source for copyright manuals. **Phone:** (616) 925-5899, 8-4 ET. BNB964

"MORSE CODE DECIPHERED" Simple, elegant, inexpensive, comprehensive, logical, easy! E-mail [judlind@earthlink.net]. BNB428

Electricity, Magnetism, Gravity, The Big Bang. New explanation of basic forces of nature in this 91-page book covering early scientific theories and exploring latest controversial conclusions on their relationship to a unified field theory. To order, send check or money order for \$16.95 to: American Science Innovations, P.O. Box 155, Clarington OH 43915. Web site for other products [http://www.asi_2000.com]. BNB100

COLLOIDAL SILVER GENERATOR! Why buy a "box of batteries" for hundreds of dollars? Current regulated, AC powered, fully assembled with #12 AWG silver electrodes, \$74.50. Same, but DC powered, \$54.50. Add \$2.50 shipping. **Thomas Miller**, 216 East 10th St., Ashland OH 44805. Web address [www.bioelectrifier.com]. BNB342

COLD FUSION! - FUEL CELL! - ELECTRIC BICYCLE! Each educational kit: (Basic - \$99.95, Deluxe - \$199.95, Information - \$9.95.) CATALOG - \$5.00. **ELECTRIC AUTOMOBILE BOOK** - \$19.95. **KAYLOR-KIT**, POB 1550ST, Boulder Creek CA 95006-1550. (831) 338-2300. BNB128

ANTENNA SCIENCE: Why do antennas radiate electromagnetic waves? Learn for yourself from this enlightening paper by **MAX RESEARCH**. Gain an understanding of the radiation mechanism of antennas! Written in a clear style for radio hobbyists, inquisitive amateurs and experimenters. \$4.95 ... ppd. Order from **MAX RESEARCH**, P.O. Box 1306, East Northport NY 11731. BNB426

DWM COMMUNICATIONS - Neat stuff! SASE brings catalog! POB 87-BB, Hanover MI 49241. BNB641

FOR SALE — **DRAKE TR-7/R-7** 13 Extender Boards and Digital Jumper Card for servicing. See <http://users.atnet.net/~rsrollne>. \$63.50 includes postage. **Bob W7AVK**, 2327 Malaga Road NE, Moses Lake, WA 98837, email: w7avk@arrl.net. BNB647

SMART BATTERY CHARGERS and more, [www.a-engineering.com] BNB653

Wanted: Information and References on PRC-6 Walkie-Talkie. **Louis L. D'Antuono**, 8802 Ridge Blvd., Brooklyn, NY 11209. Tel: 718-748-9612. After 6:00PM. BNB654

NEUER SAYS DIE

continued from page 8

became evil in the American media. Like Pakistani Foreign Secretary Naik being told by senior American officials in July 2001 that military action against Afghanistan would start in October. Like even though none of the 9/11 hijackers were from there, Bush declaring war against Afghanistan. Like there's now a new government in Afghanistan whose leader formerly worked for Unocal. Like the U.S. special envoy to deal with the new government was the "chief consultant to Unocal." Like the Bush family is up to here in the oil business. Like President Bush made his fortune in the oil business. Like Bush Sr. works with the Carlyle Group, which specializes in oil investments. Like the U.S. government quietly announcing in January 2002 that it would support construction of the Trans-Afghanistan pipeline. Like President Musharref of Pakistan and Afghanistan-Unocal's announcement of an agreement in February 2002 to build a pipeline from Central Asia to Pakistan via Afghanistan. 73

Are You Prepared?

Every radio enthusiast should own at least one scanning receiver.
Alinco offers four great choices!

No matter what your role, if you're an emergency responder, part of the government, media, business or just an involved citizen, a multi-mode scanning receiver can keep you informed and up with current events. There's a world of communications happening all day, every day. Stay on top of developments with an Alinco scanning receiver.

Here are some of the activities you can monitor: Shortwave, commercial AM & FM broadcasts, Ham radio, police, auto racing communications, fire, security, medical, FRS, GMRS, CB, maritime, weather, news media, railways, military, aircraft control, service industries, search & rescue operations and much more!



DJ-X2000

Alinco's top of the line "Intelligent Receiver" tunes from 100 KHz ~ 2.15 GHz with excellent sensitivity and a triple conversion front end. Receives WFM, NFM, AM, USB, LSB, CW and FM stereo*, 2000 memory channels with alpha-numeric labeling, download free computer control software from the Alinco web site. Flash Tune™ locks onto and monitors strong local signals! On board "Help" feature, digital recorder, frequency counter, CTCSS search & decode, Channel Scope™ spectrum activity display, Ni-Cd battery & quick charger included. BNC antenna port with new, wide-range "ducky" antenna included.

DJ-X3

Amazing performance in a small, easily carried package! Coverage range from 100 KHz ~ 1.3 GHz with 700 memory channels. Receives WFM, FM stereo*, NFM and AM modes. Includes SMA "ducky" antenna, earphone, and internal ferrite-bar antennas for AM & shortwave. Ultra sensitive triple-conversion front end. Large illuminated display. Free downloadable control software from the Alinco web site.



DJ-X10

This high-performance receiver covers 100 KHz ~ 2 GHz, has 1200 alpha-numeric memory channels, internal "help" feature, Channel Scope™ spectrum display, receives, AM, NFM, WFM, USB, LSB and CW, triple conversion front end, superb sensitivity, BNC antenna port with wide-range "ducky" antenna and an amazing array of optional accessories. Check Alinco's web site for computer control software.



DJ-X2

Is this the world's smallest scanning receiver? "Credit Card" size is easily carried in a shirt or jacket pocket, yet it opens a world of reception, covering 522 KHz ~ 1 GHz. 700 memory channels; AM, FM, WFM modes. Internal Lithium-ion battery PLUS snap-on dry-cell power pack. Effective RF "sniffer" feature detects hidden transmitters (patent pending). Three different antenna modes including internal ferrite bar. Easy and Expert user operating profiles. Preset, memory and VFO operating modes. Illuminated display. Free computer control software available at the Alinco web site.



IHMM3 Magnetic Scanner Antenna

BNC connector, just 13.5 inches high. Powerful rare-earth magnet, 9 feet of RG-174 cable. Receives 100 ~ 1200 MHz, can transmit on 2m, 440~ 450 MHz and 824~ 896 cellular frequencies. Also available with Motorola style antenna connector.



www.ALINCO.com



Distributed in North America by ATOC Amateur Distributing LLC • 23 S. High St., Covington, OH 45318 • (937) 473-2840

Cellular reception blocked on USA models. Unblocked versions available for qualifying agencies, documentation required.

*Optional stereo headphones required to receive FM stereo transmissions.

Specification subject to change without notice or obligation. Check local regulations before using a scanning receiver in mobile operation.

ULTRA-RUGGED, SUBMERSIBLE TRI-BAND MAGNESIUM HANDIE

Own the brightest star in the Ham Radio Galaxy! The exciting new YAESU VX-7R sets new standards in ruggedness, water resistance, and versatility, and its memory capacity is unparalleled. Own the VX-7R, and you'll own the best.

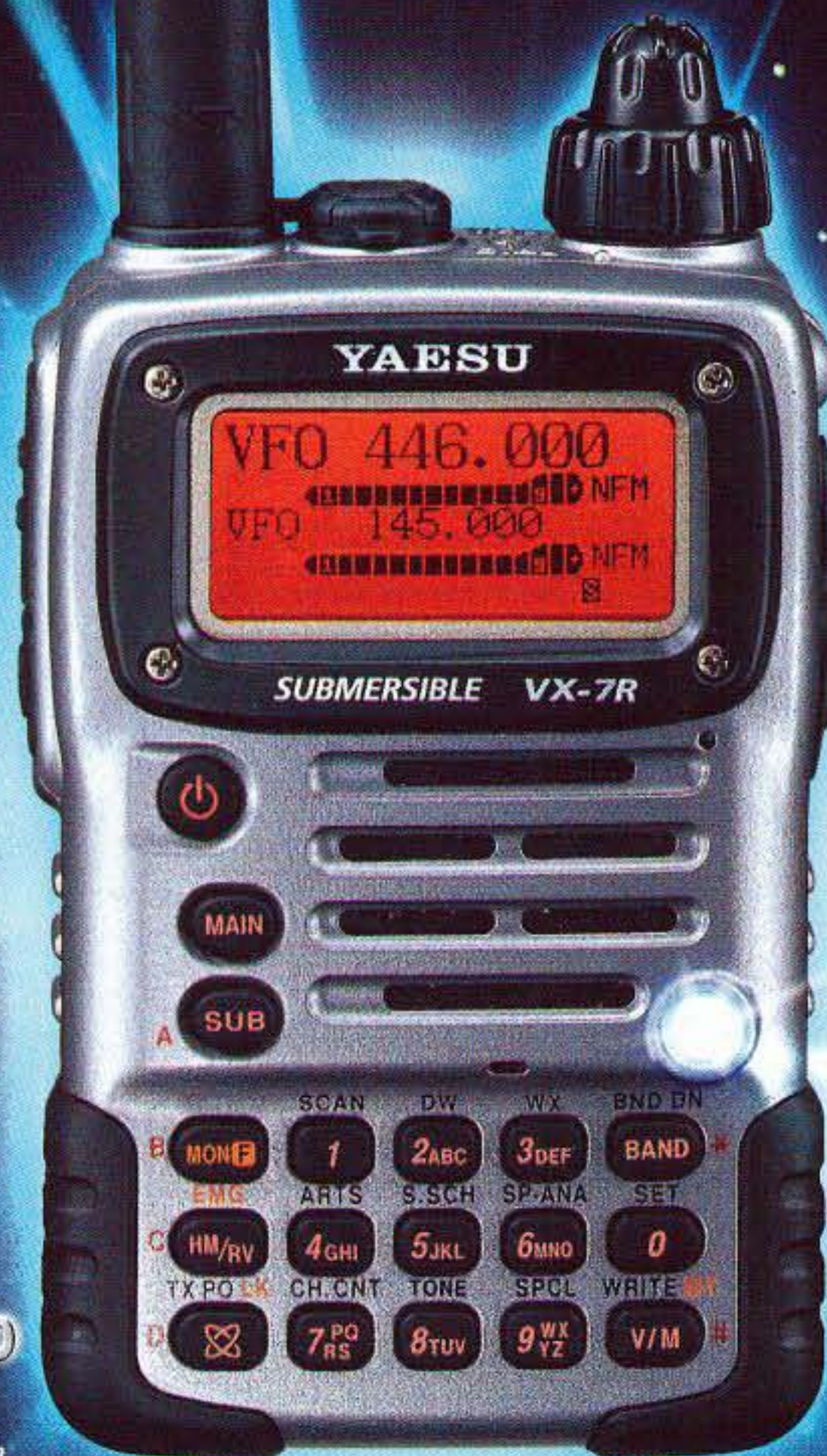

**TRUE DUAL RECEIVE
(V+V/U+U/V+U/HAM+GEN)**

WIDE-RANGE RECEIVER

MAGNESIUM CASE

**SUBMERSIBLE
(3 feet for 30 minutes)**

**OVER 500 MEMORY
CHANNELS**

**MIXED TONE (CTCSS/DCS)
CAPABILITY**

INTERNET KEY FOR ACCESS TO

WIRES

Wide-Coverage Internet Repeater Enhancement System

**SHORTWAVE BROADCAST
MEMORY BANK**

**WEATHER BROADCAST MEMORY
BANK WITH "SEVERE WEATHER"
ALERT**

MARINE BAND MEMORY BANK

MULTI-COLOR STROBE LED

**LOW-POWER 222 MHz TX
(U.S. version)**

RUBBER CASE PROTECTOR

VX-7R

50/144/430 MHz 5W FM Transceiver

Actual Size

For the latest Yaesu news, visit us on the Internet:
<http://www.vxstdusa.com>

Specifications subject to change without notice. Some accessories and/or options may be standard in certain areas. Frequency coverage may differ in some countries. Check with your local Yaesu Dealer for specific details.

YAESU
Choice of the World's top DX'ers™

Vertex Standard
US Headquarters
10900 Walker Street
Cypress, CA 90630 (714)827-7600